

NASA TECHNICAL NOTE

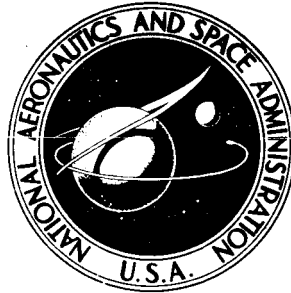

NASA TN D-8227

NASA TN D-8227

CASE FILE
COPY

APOLLO EXPERIENCE REPORT -
GUIDANCE AND CONTROL SYSTEMS:
PRIMARY GUIDANCE, NAVIGATION,
AND CONTROL SYSTEM DEVELOPMENT

*M. D. Holley, W. L. Swingle, S. L. Bachman,
C. J. LeBlanc, H. T. Howard, and H. M. Biggs*

*Lyndon B. Johnson Space Center
Houston, Texas 77058*



1. Report No. NASA TN D-8227	2. Government Accession No.	3. Recipient's Catalog No.	
4. Title and Subtitle APOLLO EXPERIENCE REPORT GUIDANCE AND CONTROL SYSTEMS: PRIMARY GUIDANCE, NAVIGATION, AND CONTROL SYSTEM DEVELOPMENT		5. Report Date May 1976	6. Performing Organization Code JSC-08583
		8. Performing Organization Report No. S-453	
7. Author(s) M. D. Holley, W. L. Swingle, S. L. Bachman, C. J. LeBlanc, H. T. Howard, and H. M. Biggs		10. Work Unit No. 961-21-31-89-72	11. Contract or Grant No.
9. Performing Organization Name and Address Lyndon B. Johnson Space Center Houston, Texas 77058		13. Type of Report and Period Covered Technical Note	
		14. Sponsoring Agency Code	
12. Sponsoring Agency Name and Address National Aeronautics and Space Administration Washington, D. C. 20546			
15. Supplementary Notes			
16. Abstract The primary guidance, navigation, and control systems for both the lunar module and the command module are described. Development of the Apollo primary guidance systems is traced from adaptation of the Polaris Mark II system through evolution from Block I to Block II configurations; the discussion includes design concepts used, test and qualification programs performed, and major problems encountered. The major subsystems (inertial, computer, and optical) are covered in individual sections of this report. In addition, separate sections on the inertial components (gyroscopes and accelerometers) are presented because these components represent a major contribution to the success of the primary guidance, navigation, and control system.			
17. Key Words (Suggested by Author(s)) Computer Guidance Gyro Electronics Accelerometer Inertial subsystem Navigation Optical subsystem		18. Distribution Statement STAR Subject Category: 12 (Astronautics, General)	
19. Security Classif. (of this report) Unclassified	20. Security Classif. (of this page) Unclassified	21. No. of Pages 71	22. Price* \$4.50

* For sale by the National Technical Information Service, Springfield, Virginia 22161

CONTENTS

Section	Page
<u>SUMMARY</u>	1
<u>INTRODUCTION</u>	1
<u>INERTIAL SUBSYSTEM</u>	2
SYSTEM DESCRIPTION	2
MAJOR SYSTEM FUNCTIONS	4
BLOCK I DESIGN HISTORY	4
Instrument Selection	4
Three-Gimbal-Platform Selection	5
Displays and Controls	6
Packaging	6
Thermal Control	7
BLOCK I PROBLEMS	8
Angular Differentiating Accelerometer	8
Thermal Interface	8
Design Changes	9
In-Flight Maintenance	9
IMU Mechanical Resonance	9
Lexan Case	10
Humidity-Proof Modules	10
Cold-Flow Teflon	11
Coupling Data Unit Gears	11
BLOCK II CHANGES	11
IMU Size Change	11

Section	Page
PEA/PTA Package	12
Gyro Drift	12
Power and Servo Assembly Repackaging	13
Block II Coupling Data Unit	13
BLOCK II AND LM PROBLEMS	14
Structural Problems	14
Function Problems	14
Component Problems	15
MAJOR TESTS	17
<u>COMPUTER SUBSYSTEM</u>	17
DESIGN	18
SYSTEM DESCRIPTION	24
Electrical	24
Power Distribution	29
Mechanical	30
Display and Keyboard	30
Software Requirements	32
DEVELOPMENT PROBLEMS	32
Timing	32
Noise	32
Sneak Paths (Blue Nose Gates)	33
Flatpack Corrosion	33
Diode Channeling	34
Relay Contamination	34
Transistor Bonds	34

Section	Page
Flatpack Lifted (Gold Rich) Bonds	35
Diode Switching Characteristics	35
<u>OPTICAL SUBSYSTEM</u>	36
DESCRIPTION	36
DESIGN AND DEVELOPMENT	37
Major Test Programs	38
Major Hardware Changes	40
FLIGHT HARDWARE PERFORMANCE	43
In-flight Problems	43
Flight Failures	44
<u>INERTIAL REFERENCE INTEGRATING GYRO</u>	45
CONTRACT HISTORY	46
DESIGN DESCRIPTION	47
Apollo I IRIG	47
Apollo II IRIG	48
FAILURE HISTORY AND FAILURE SUMMARY	48
PROGRAM PROBLEMS	50
Float Freedom	51
Bearings	52
Normalization Circuit Board	55
Gravity Transient	55
Hot Storage Sensitivity	55
Tolerance Problems	55
Field Sensitivity	56
Workmanship Problems	56

Section	Page
<u>PULSED INTEGRATING PENDULOUS ACCELEROMETER</u>	56
DEVELOPMENT HISTORY	57
Conceptual Phase	57
Block I Definition	57
Block II Definition	58
Repair Program	58
Data Analysis	59
RESOLVED PROBLEMS	59
<u>CONCLUDING REMARKS</u>	60
INERTIAL SUBSYSTEM	60
COMPUTER SUBSYSTEM	60
OPTICAL SUBSYSTEM	61
INERTIAL REFERENCE INTEGRATING GYRO	62
PULSED INTEGRATING PENDULOUS ACCELEROMETER	62

TABLE

Table	Page
I COMPUTER CHARACTERISTICS	26

FIGURES

Figure	Page
1 Location of the primary guidance and navigation system in the CM	3
2 Location of the primary guidance and navigation system in the LM	3
3 Capacitor-coupled transistor switch circuit diagram	15
4 Error amplifier circuit diagram	15
5 Block I (100) Apollo guidance computer	23
6 Block I (0) Apollo guidance computer	23
7 Block II Apollo guidance computer (spacecraft interface side)	24
8 Block II Apollo guidance computer (spacecraft cabin side)	24
9 Apollo guidance computer block diagram	25
10 Display and keyboard	31
11 Command module optical unit assembly	36
12 Lunar module alinement optical telescope	37
13 Mobile Optical System Evaluation Simulator	40
14 Inertial reference integrating gyro operating hours as a function of months	46
15 Generalized pictorial schematic of Apollo II IRIG	49
16 Apollo IRIG mission performance requirements	50

Figure		Page
17	Gyro bearing failure rate as a function of wheel time from assembly	
	(a) Apollo I	50
	(b) Apollo II	50
18	Gyro test sequence	
	(a) Block I	52
	(b) Block II	52
19	Gyro test sequence, Block II repair and replacement	
	(a) Original	54
	(b) Current	54
20	Model D, size 16, pulsed integrating pendulum	59

APOLLO EXPERIENCE REPORT
GUIDANCE AND CONTROL SYSTEMS:
PRIMARY GUIDANCE, NAVIGATION, AND CONTROL SYSTEM DEVELOPMENT

By M. D. Holley, W. L. Swingle, S. L. Bachman,
C. J. LeBlanc, H. T. Howard, and H. M. Biggs
Lyndon B. Johnson Space Center

SUMMARY

The primary guidance, navigation, and control system development progressed in three increments: Block I (0), Block I (100), and Block II. The Block I (0) phase was devoted primarily to research and development and provided the design baseline. In the Block I (100) development, flight-qualified systems were produced. The Block II phase resulted in the final design and development of the flight systems for both the command module and the lunar module.

The technological advances in the art of producing materials and components as a result of the program have been a benefit to space and military programs and have resulted in commercial applications. The integrity of the primary guidance, navigation, and control system has been proved by its successful performance during the Apollo Block I and lunar missions.

INTRODUCTION

For convenience, this report is divided into five sections in which the basic elements of the primary guidance, navigation, and control system (PGNCS) are discussed individually. These sections and the authors of each are as follows: "Inertial Subsystem," M. D. Holley and S. L. Bachman; "Computer Subsystem," H. T. Howard; "Optical Subsystem," C. J. LeBlanc; "Inertial Reference Integrating Gyro," M. D. Holley and W. L. Swingle; and "Pulsed Integrating Pendulous Accelerometer," H. M. Biggs.

As an aid to the reader, where necessary the original units of measurement have been converted to the equivalent value in the Système International d'Unités (SI). The SI units are written first, and the original units are written parenthetically thereafter.

INERTIAL SUBSYSTEM

The Apollo inertial subsystem performed successfully on 10 lunar module (LM) flights, on 3 command module (CM) flights in the Block I configuration, and on 11 CM flights in the Block II configuration. This complex subsystem supported both unmanned and manned Apollo flights without an in-flight failure.

The primary inertial subsystems used in both the LM and the CM were common with minor differences in packaging, scaling, and interfaces. These subsystems consisted basically of the electronics to drive and control, and a mechanical system to hold and position, a set of three orthogonally mounted accelerometers. The gyro and accelerometer histories are discussed in separate sections of this report. The inertial subsystem is divided into five major groupings: (1) the inertial measurement unit (IMU) containing three gimbals, gimbal-mounted electronic packages, resolvers, slip-rings, torque motors, and six inertial instruments; (2) the power and servo assembly (PSA) containing the power supplies, switching circuits, and servocontrol electronics; (3) the coupling data units containing the digital-to-analog and analog-to-digital conversion equipment; (4) the pulse electronics assembly containing the circuits required to generate the calibrated torquing pulses for the accelerometers; and (5) the guidance and navigation (G&N) interconnect control group, which includes the interconnecting harnesses and control panels.

The design of the inertial subsystem required for the navigation and guidance of the Apollo spacecraft was a responsibility separate from spacecraft vehicle design. Early mission-error analysis indicated that accelerometers and gyros of the Polaris Mark II system had performance characteristics adequate for the Apollo lunar mission. The Apollo inertial system thus evolved from basic Polaris Mark II designs. This decision was heavily based on the initial requirement for an Earth-orbital flight in late 1963.

SYSTEM DESCRIPTION

The Block II and LM inertial subsystems consisted of the IMU, the electronic coupling data unit (ECDU), the PSA, a navigation base, the pulsed integrating pendulous accelerometer (PIPA) electronics assembly (PEA) in the CM, and the pulse-torquing assembly (PTA) in the LM.

The inertial subsystem equipment installed in the CM and its location relative to the other subsystems of the PGNCS are shown in figure 1. The navigation base is mounted to the spacecraft sidewall and is used as a holding fixture for the IMU and the optical assembly. The IMU and the optical assembly are attached and precisely aligned to the navigation base. The lower display and control (D&C) panel comprises the front of the PGNCS structure and contains several individual panels. The panels with displays and controls are located so the astronaut can view and manually operate the controls from a standing position. The PSA, which contains power supplies, amplifiers, and miscellaneous electronics, is mounted on a coldplate below the navigation base

and the indicator control panel. All PSA modules are plugged into a single flat interconnect-harness assembly, which is attached to the coldplate. Immediately below the PSA is the CM computer (CMC), and mounted at the left of the CMC is the coupling data unit (CDU). The PEA is mounted at the left of the IMU to reduce cable lengths for critical switching signals. The signal conditioners and one display and keyboard (DSKY) are mounted at the right of the optical assembly and the indicator control panel. The various hardware elements are interconnected by a cabling harness.

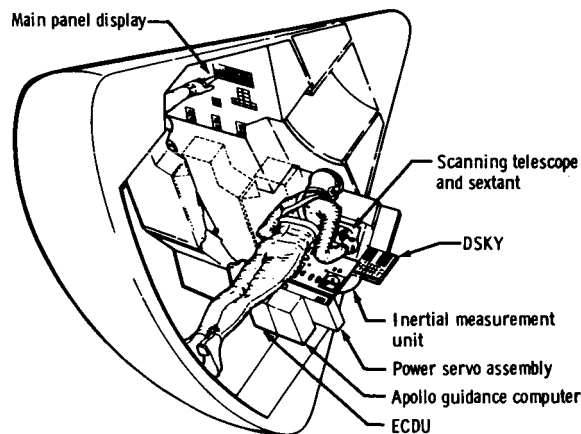

Figure 1. - Location of the primary guidance and navigation system in the CM.

The inertial subsystem equipment installed in the LM and its location relative to the other PGNCS subsystems are shown in figure 2. The navigation base is mounted to the upper structure at the front of the LM cabin and is used as a holding fixture for the IMU and the optical sensor. The IMU and the optical sensor are attached and precisely aligned to the navigation base. The LM guidance computer (LGC) and the ECDU are mounted on coldplates located on the upper portion of the rear compartment wall. The PSA and the signal conditioner also are mounted on a coldplate and are located below the LGC and the ECDU. The PTA is mounted to the rear wall of the IMU compartment. The LGC DSKY, together with the other controls and displays, is located on the front wall of the LM cabin such that the astronaut can operate it while confined in his harness.

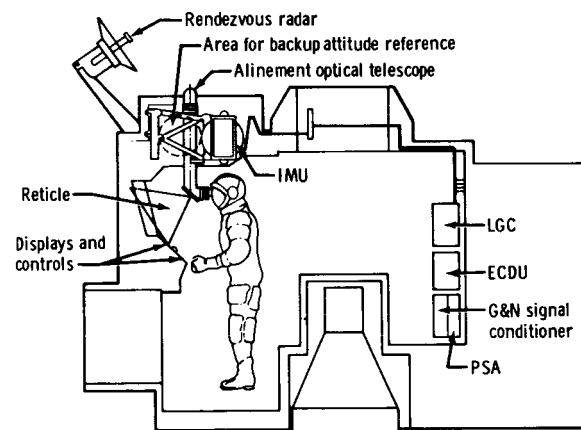

Figure 2. - Location of the primary guidance and navigation system in the LM.

The primary area of design departure from the Polaris Mark II guidance system was the need for functional crew interfaces such as displays and those interfaces required for mode switching and realignment of the IMU. The conceptual design to define these interfaces was accomplished in 1962. A complete systems review in 1965 led to an integration of the guidance, navigation, and control (GN&C) functions to ensure that alternate functional modes would be available in case of a failure in either the PGNCS or the stabilization and control system.

MAJOR SYSTEM FUNCTIONS

The inertial subsystem performs three major functions: (1) measures changes in spacecraft attitude, (2) assists in generating steering commands, and (3) measures spacecraft velocity changes caused by thrust or atmospheric drag. To accomplish these functions, the IMU provides an inertial reference consisting of a stable member having three degrees of freedom that is stabilized by three integrating gyros. When the inertial system is operated before launch, the stable member is alined through a gyrocompassing routine; during flight, the stable member is alined by sighting the optical instruments on stars. If the inertial subsystem is operated for several hours, realinement may be necessary because the gyros that maintain the space-referenced stable member may drift and cause an error in flight calculations.

Acceleration of the spacecraft is sensed by three pendulous accelerometers mounted on the stable member with their input axes orthogonal. The output signals from the accelerometers are used by the computer to update the spacecraft state vector.

BLOCK I DESIGN HISTORY

The design decisions concerning the inertial subsystems were heavily influenced by the plan (late 1961) to fly in 2 to 3 years. That period of time would not permit a complete new inertial system development. Thus, the design of the Block I inertial system was based on the Polaris Mark II system. Both the gyro and accelerometer used basic Polaris designs with minor mechanical and electrical changes. The early programmatic decisions also committed the Apollo inertial program to the competence and experience of the Polaris Mark II institutional and industrial team. The new areas of development were for the Apollo manned-mission design requirements of (1) in-flight optical alinement interface, (2) pilot moding interface, (3) general-purpose digital-computer gimbal-angle interface, (4) in-flight repair, and (5) packaging and interconnect wiring.

Instrument Selection

Detailed analytical work involving the relationship between inertial component performance and position and velocity dispersions could not begin until mission and trajectory profiles had been selected. However, as early as July 1961, preliminary estimates based primarily on the entry maneuver as the most demanding on the inertial subsystem indicated that Polaris Mark II instruments would meet the requirements.

In November 1961, preliminary gyro performance specifications were established. Actual gyro error studies began early in 1962 with the entry maneuver because entry parameters were relatively well defined and the maneuver had critical operational requirements. Results for this mission phase were published in June 1962, followed by a study of lunar-orbit-insertion performance, the results of which were published in July. By early 1963, the Apollo mission definition was in a state that permitted

analysis of other mission phases, such as translunar injection, lunar landing, and lunar lift-off. The results of these studies were made available in March of the same year. At the same time, the errors involved in the process of fine-aligning the IMU in space by means of the optical star sightings had been determined. An error budget applicable to the alinement process, including both IMU and optical errors, was published in February 1963.

A specification for the PIPA performance requirements was issued in November 1961. The adoption of the Polaris 25 inertial reference integrating gyro (IRIG) design for the Apollo spacecraft enabled the beginning of specification work on the pulse-torquing requirements, which were crucial in the mission because of the multiple in-flight alinements. Specifications were firm for the pulse-torquing electronics by May 1962.

The performance requirements for the inertial subsystem or indeed for the G&N system were never clearly specified during early program phases. The error analysis of the trajectories and early mission studies were done by the Massachusetts Institute of Technology (MIT), and reasonable design specifications were formulated using the analysis results. From an inertial performance standpoint, an IMU error analysis revealed that moderate performance capability would suffice for manned missions. Because the most critical parameter was the gyro bias drift, which was the result of the long time between alinement and thrust termination, it was decided to conform to the Polaris inertial performance specification because of two factors: (1) the early flights were to be unmanned, thus not permitting the alinement, and (2) tighter performance would be indicative of higher reliability.

Three-Gimbal-Platform Selection

With an in-flight realinement concept and the recognition that all maneuvers for which the IMU was required would be in-plane maneuvers with little or no out-of-plane steering, it was reasoned that a three-gimbal system could be used. This configuration had several advantages over a four-gimbal IMU in terms of system complexity, weight, power, reliability, and cost.

The function of the gimbal system is to support the gyros and the accelerometers on a structure that can be kept nonrotating in space despite rotations of the spacecraft. The motivation for having a four-degree-of-freedom gimbal system would be that such a configuration can be made and operated so that all attitudes of the spacecraft can be accommodated without the problem of gimbal lock, which can occur with a three-degree-of-freedom system. The questions posed in 1961 and 1962 were whether the simpler three-degree-of-freedom IMU would meet all the Apollo spacecraft attitude maneuvering requirements and whether the danger of gimbal lock would be high enough that a four-gimbal platform would be necessary. The answer in brief was that all normal Apollo attitude maneuvers would be such that gimbal lock could be avoided by properly instituted operational procedures. The operation near gimbal lock in non-emergency maneuvers could be simply avoided. Direct means were available to warn of approaching difficulty so that corrective action could be taken. Finally, the procedures for recovery from loss of alinement in emergency situations seemed straightforward.

Although a strapdown or body-mounted inertial subsystem configuration was briefly examined at the start of the program, no serious consideration was given to this technique. The brief development time permitted by the schedule and the fact that no such body-mounted system was out of the laboratory experimental stage at that time precluded its use. Moreover, it was evident that schedules could be met by the development team only by using its experience with the design of the gimballed IMU of the Polaris Mark II guidance system.

Displays and Controls

The conceptual development of the displays and controls for the astronauts was completed during 1962. This effort defined the useful system modes and the displays to be used. The onboard navigation techniques required a general-purpose digital computer having an attitude interface with the IMU. The analog-to-digital and digital-to-analog conversion technique initially selected was electromechanical. This electromechanized CDU became a basic element in displaying IMU gimbal angles to the crewmen and in commanding gimbal angles in a coarse-aline mode. Five coupling data units, one for each of the three IMU gimbals and one for each of two optical axes, were used. Each CDU, a servomotor, a resolver set, a digital encoder, three display dials, and a thumbwheel were all interconnected by a gear train. The gimbal and optics axis positions then could be repeated, displayed, and controlled by the crewmen or by the computer.

Considerable effort was spent in making available to the crewmen as many backup D&C modes as possible. Usage of segments of the system with other segments currently operating was a ground rule. The use of the IMU as an attitude reference independent of the computer was also incorporated. An early attempt was made to incorporate the capability for manual differential velocity (ΔV) steering by a visual monitoring of the Y- and Z-axis PIPA outputs. The astronaut would manually aline the IMU with the X-axis PIPA along the direction of thrust, then manually start and stop the engine, steer to maintain zero ΔV along the Y-axis and the Z-axis, and time the burn for the net ΔV gained. However, operational problems were encountered with the design and with production. Subsequently, in the middle of Block I production, the requirement for manual ΔV steering was dropped and the design was changed to reflect the deletion. Other backup modes were maintained but in ensuing flights were not used. All Block I flights were unmanned, and no capability to use backup modes was available.

Packaging

The driving factor in the design of packaging for the changed and new components from Polaris Mark II was the adoption of an in-flight maintenance capability where possible. All five coupling data units were interchangeable and easily removable. The power supplies for the inertial subsystem, the servo loop, the components, and the electronic modules for each of the 6 inertial elements were packaged on 10 removable trays. Each tray contained removable modules, which were made as common as

possible and repeated for each gimbal loop or instrument. The IMU was not considered as a candidate for in-flight repair because its complexity, form factor, and alignment requirements were prohibitive for such an effort.

Thermal Control

Proper thermal control of the inertial instruments is of prime importance in achieving satisfactory performance. The Block I IMU temperature-control design was hampered from the start by an inadequate definition of the environment in which the IMU was expected to perform. In particular, the spacecraft thermal environment, primary-coolant-loop characteristics, and prime-power voltage excursions were unknown. For these reasons, an attempt was made to include much flexibility in the design to establish the capability to adjust to the actual environments as they became better defined.

The use of thermal-heat-of-fusion materials to serve as a heat reservoir was considered early in the design. This approach was taken to conserve electrical power. A thermal study, one of the first to define system operation for a lunar landing mission, showed that, although this concept was sound, the use of these materials was unworkable based on IMU time-line usage. This approach was abandoned, and an electronic temperature-control system was designed.

The temperature-control scheme incorporated resistance-wire temperature-sensing elements located in the IRIG end mounts. Connected in series, these sensors measure the average temperature of the three gyros and form one arm of a four-arm resistance bridge. The remainder of the bridge is located in the PSA. The bridge error signal, proportional to the temperature difference between the actual average gyro temperature and the desired temperature, controls the operation of magnetic amplifiers in the PSA. In turn, these amplifiers provide power in proportion to temperature deviation. The power is in the form of a 20-volt, 3200-hertz, pulse-width-modulated square-wave voltage to the stable-member heaters.

An additional set of heaters, controlled by a thermostat on the stable member and powered directly from spacecraft primary power to the G&N system, comprises a redundant temperature-control system. This system does not provide the precise control of the primary system but is adequate to satisfy the crew-safety and mission-success requirements.

Temperature-sensing thermistors within the gyros are used to monitor the gyro temperature. The thermistors are connected in series and form one arm of a four-arm space resistance bridge; the other elements of the bridge are located in the PSA. The error-signal output of this bridge controls a magnetic amplifier, which illuminates an alarm light if the gyro temperature exceeds specified limits. The amplifier also provides an output for telemetry of IRIG temperature and an output to the front of the PSA tray for use by the in-flight-failure monitor. The temperature-sensor resistance elements of the accelerometers are used to monitor pulsed integrating pendulum (PIP) temperature in a manner similar to that of the gyro temperature-monitoring scheme.

Two blowers on the middle gimbal are used to vary the thermal resistance between the inner gimbal and the case. Saturable reactors on the outer gimbal vary the blower speed as a function of stable-member heater power.

The Block I PSA design consists of removable modules mounted on a vertical member of a removable tray. The requirement for in-flight maintenance together with the requirement for handling the modules and trays precluded the use of thermally conductive grease between the PSA trays and the coldplate. Consequently, the CM prime contractor developed a thermal interface material consisting of a rubberlike tubing (0.32 centimeter (0.125 inch) outside diameter) with a copper foil helically wound on the outside. This material was laid side by side to form a mat and was placed between the coldplate and the PSA. Late in the Block I program, the in-flight maintenance requirement was abandoned and a thermally conductive grease (Dow-Corning DC-340) was used in conjunction with the thermal interface material to effect a better heat transfer.

BLOCK I PROBLEMS

In all parts of the inertial subsystem designed for in-flight repair, problems were encountered in meeting vehicle humidity requirements. In fact, the problems were solved only by changes that invalidated any in-flight maintenance capability. The electromechanical coupling data units were a prime example. To meet the humidity specifications, these mechanically precise rotating devices, matched for interchangeability, were placed in an environmentally sealed box and read through a window. A gasket seal could not be maintained for the large connector header into which the 10 PSA trays were mated, and a water-resistant grease was added.

Angular Differentiating Accelerometer

A problem arose during the acceleration test phase of the IMU qualification program. The IMU was mounted rigidly to the arm of a centrifuge. During the centrifuge testing, the gimbals oscillated at the rotational frequency of the centrifuge. It became apparent that the angular differentiating accelerometer (ADA) mounted to the gimbal was nonrotating and, as such, was under the influence of a rotating acceleration. The ADA is a damped torsional mass that senses inertial angular acceleration. The device has a low pendulosity, preferably zero. With the low pendulosity, the response was as if the ADA were in inertial rotation with attendant stable-member misalignments. A review of operational requirements, however, revealed no rotating accelerations for any missions that would cause any problem. The decision to use the ADA was based on a Polaris servo design that was removed early in the Polaris development program. Subsequently, a new servo design that did not include an ADA was incorporated into the Block II system.

Thermal Interface

A major mechanical difficulty in the Block I PSA was achieving an adequate thermal interface between the PSA trays and the spacecraft coldplate. Tests of the thermal

interface material showed that thermal conductance varied in direct proportion to the depth of its compression. Other tests indicated that the contact pressures required for deflecting the material to achieve the desired conductance ($568 \text{ W/m}^2 \text{ K}$ ($100 \text{ Btu/hr/}^\circ\text{F/ft}^2$)) were much higher than originally anticipated. These forces caused bowing at the trays and plate; this condition reduced conductivity across local areas on the interface. Establishing appropriate tolerances for the tray locating tongues, stiffening of the trays, and changing the toeplate material from aluminum to beryllium produced an adequate but marginal design. However, not until the in-flight maintenance concept was dropped, thus permitting the use of conductive grease on the thermal interface material, was the problem adequately solved.

Design Changes

The PSA module designs were plagued by numerous modifications required by circuit and component changes. Scheduling constraints dictated a release to production concurrent with engineering evaluation testing. Nearly all the required modifications resulted from circuit changes dictated by this testing. Component changes were made to optimize circuit design parameters or to obtain higher reliability. Wiring and component placement were altered to minimize electromagnetic coupling between circuits. Circuit changes were also made when the original design was found to be marginal under adverse operating conditions. In some instances, high-power-dissipation components were relocated to remove local hotspots. When possible, the changes were made as a "repair fix" by depotting or by rework of manufactured modules with the necessary changes being incorporated into forward production. Where changes were too extensive, modules were scrapped and replaced with new designs. The change from ternary to binary torquing of the PIPA units also required new module design.

In-Flight Maintenance

The Block I in-flight module replacement feature required that the modules be removed using only a number 10 Allen wrench. The modules were fastened to the trays with number 10 captive Allen-head bolts, which were reduced in thickness, or "necked down," near the bolthead to provide clearance through a threaded portion of the module. Numerous bolt failures in the early systems were caused by shearing of the boltheads. Necking-down the bolts left an insufficient wall thickness in the region between the bolt shank and the Allen-head recess. A bolt configuration change to increase the material thickness in that region and a change to a stronger bolt material solved this problem.

IMU Mechanical Resonance

The IMU models were vibrated at one-g, 2g, and 3g (rms) sinusoidal input with a logarithmic frequency sweep from 20 to 2000 to 20 hertz in 16 minutes along each axis. Each IMU was also vibrated with a 5g (rms) random-noise input along each axis. The results of these tests indicated resonant frequencies in the range of 110 to 170 hertz having transmissibilities of 7 to 22.

As a result of high magnification seen at the resonant frequency on the Block I IMU, fatigue cracks developed in the middle- and outer-axis stub shafts. The stub shafts were redesigned, and vibration dampers were added to each axis in the torque-motor intergimbal assemblies.

Strain-gage test results indicated a reduction in the stub-shaft stresses by a factor of 3. This stress reduction, together with the reduction of the transmissibility by the addition of dampers, resulted in a reduction of the stresses in the stub shafts to a level well below the fatigue limit of the material. A friction damper was added at the floated bearings.

Lexan Case

When the IMU gimbal-mounted electronic packages were designed, it was thought that an added measure of quality control could be achieved if the modules were encapsulated in transparent potting material. It was reasoned that if one could see inside the module, greater care would be taken in the assembly of the module and that fact would add to the reliability of the assembly. The cordwood assembly was packaged inside a transparent Lexan case and then potted with a transparent potting material. The Lexan cases exhibited a high incidence of cracking and crazing, and numerous attempts to solve the crazing problem proved futile. Finally, a drawn aluminum case was designed for the gimbal-mounted electronics, and the visual inspection feature was abandoned.

Humidity-Proof Modules

Block I PSA modules were packaged using a black-anodized aluminum housing and two types of encapsulation materials. The bottom end of the module was encapsulated with solid polyurethane, and the remainder of the module was encapsulated with polyurethane foam. After encapsulation, the bottom of the module was machined to obtain the required dimension from the bottom of the module to the bottom of the connector. An examination of several modules that failed during humidity qualification testing disclosed that the solid polyurethane had separated from the housing and allowed moisture to penetrate the module. An engineering investigation determined that the adhesion of solid polyurethane to black-anodized aluminum was at best marginal because contaminating agents were present in sufficient quantities to prevent adhesion. The forces imparted by the milling cutter during the machining operations were found to cause separation where low peel strength existed. Satisfactory adhesion was obtained by first priming the aluminum housing with a thin coating of C7 epoxy adhesive. This change was incorporated in all subsequent production modules. In addition, greater emphasis was placed on cleaning and handling operations to ensure that module components were free of contamination. The module machining technique was revised to prevent the imparting of abnormal peel forces to the assembly during the milling operation.

Cold-Flow Teflon

Block I hardware short circuits were experienced in the PSA tray header wire resulting from cold flow of the wire insulation. This phenomenon occurs when a Teflon-insulated wire is subjected to small but constant pressure against a sharp corner, such as a wire-wrap pin, a mounting boss, or a thermal island. This continuous pressure does not result in immediate cutting of the insulation but rather in gradual regression of the insulation. Proper selection of new wire-insulation materials, such as polyimides, that were more resistant to cold flow and still compatible with the encapsulant material in the wire-wrap plane alleviated the problem.

Coupling Data Unit Gears

The problems associated with the Block I CDU were mechanical. The gear trains used with the CDU exhibited excessive wear, and a few units "froze" in operation. To correct this failure mode, a carefully selected lubricant was added to the gears. Another gearbox-associated failure occurred in the motor-tachometer supplied by one of the two vendors of this component. Because of mechanical tolerances, the motor-tachometer froze at elevated temperatures. The corrective action for this failure was to select the motor-tachometer from the vendor whose product did not exhibit this failure mode.

BLOCK II CHANGES

As the Apollo spacecraft development became more advanced, a number of factors made a block change of design desirable. From the beginning, a block-change concept was visualized as being inevitable because the Block I design was created in the absence of many necessary guidelines and specifications. In July 1962, the lunar landing concept was changed from the Earth-orbital-rendezvous to the lunar-orbital-rendezvous technique. In the fall of 1963, it was decided that a common system would be used to provide navigation, guidance, and control for both the LM and the CM. Thus, the LM concept made an obvious block-change point for the inertial subsystem of the CM also.

In June 1964, the development contractor was directed to proceed with a Block II PGNCs design for the CM as well as for the LM. For both vehicles, the system was given direct interfaces with the gimbaleed primary propulsion systems and with the reaction control jet clusters. Major Block II inertial subsystem changes are described in the following paragraphs.

IMU Size Change

The common inertial subsystem made weight an even more important consideration. After studying the possibilities, it was recommended that, while keeping the same stable member, the IMU weight could be reduced by approximately two-thirds

with a corresponding reduction in diameter from 35.5 to 31 centimeters (14 to 12 inches). The resolver-chain simplification that accompanied the CDU changes permitted a reduced number of resolvers. The combining of 1- and 16-speed resolvers onto the same rim reduced the number of resolvers by three, leaving only one resolution unit and three angle-measuring units in the IMU. The removal of three torque motors and the angular differentiating accelerometers and ADA amplifiers made possible the shrinkage of the intergimbal assemblies to reduce the overall IMU weight and size. The temperature-control system was simplified and, thereby, the quantity of gimbal-mounted electronic components was reduced. The IRIG was designed to have more compact realignment hardware by incorporating the preamplifier into the end-cap hardware. The PIP suspension module was redesigned as an integral assembly having a connector that would allow easy assembly of the PIP into the IMU.

PEA/PTA Package

The LM accelerometer package installation presented significant problems in view of the 5.2 meters (17 feet) of cable between the IMU and the PSA or the proposed PIPA electronics location. A location near the IMU and in a coldplate with better temperature control was desired. Discussions with the LM prime contractor revealed that it was possible to put the accelerometer electronics in an assembly in the vicinity of the IMU and also to have its coldplate in series following the IMU and, thus, to achieve a lower coldplate temperature and a lower temperature deviation of the heat sink. This revelation suggested the possibility of modifying the CM in the same manner. Approval of the ECDU for incorporation left the old CDU coldplate, which was in series right after the IMU in the coolant loop, available. Use of this coldplate provided a colder, better controlled heat sink. Because the Block II design was to be humidity proof, the concept of a sealed assembly was introduced. This step necessitated several changes in philosophy with respect to the accelerometers. Module interchangeability was no longer required. Finally, because of the sealed accelerometer electronics package, larger average values of bias and scale factor were permitted and the computer compensation range was changed accordingly.

Gyro Drift

The most sensitive performance parameter for the gyro in the Apollo mission was the bias drift. To optimize gyro performance, several changes in the gyro electromagnetic characteristics were made. First, a stiffer radial suspension could be incorporated as well as additional axial suspension. This modification would reduce the geometrical changes of the float with respect to the case. Second, the Block I gyro, when pulse-torqued, required two reset pulses to restore the magnetic state of the rim and the resulting torque to its original value. Redesign of the torque generator to include a reset winding made the application of reset pulses unnecessary. Third, a bias-compensation winding was added to correct for the total gyro bias drift and to provide compensation for tracking changes in electromagnetic reaction torque caused by suspension and changes in signal current and voltage. A more efficient signal generator was also added. The gyro wheel package was not changed, but the prealignment hardware was redesigned because the torque changes necessitated adding the IRIG preamplifier and other components.

Power and Servo Assembly Repackaging

The PSA required repackaging because of the form factor changes in the CM and the addition of the LM concept. These were essentially two different PSA units, although they carried many common modules. The LM design was straightforward, but the CM location and size determinations presented more difficulty. Whereas the GN&C development contractor desired integral cooling, the CM prime contractor remained opposed to the concept. Finally, a compromise configuration was accepted that consisted of a flat PSA with the coldplate on top and attached through flexible hoses to permit installation. The size of the Block II PSA was ultimately reduced by the removal of the pulse torque electronics and the CDU electronics.

Block II Coupling Data Unit

Repeated difficulties in manufacturing and operational failures of the electromechanical CDU initiated an effort in 1963 to replace the unit with an all-electronic CDU. A resolver reading system breadboard was fabricated and demonstrated. The weight saving of 8.2 kilograms (18 pounds) and a potential reliability improvement were the major factors in the decision to incorporate the ECDU. Subsequently, the incorporation of a digital autopilot and other components into both the CM and the LM increased the weight.

The new ECDU and Apollo guidance computer (AGC) made numerous moding changes necessary and desirable. Except for IMU turn-on and coarse alignment, IMU cage was to be the only manual mode; everything else was to be moded by the AGC. The PIPA units were to be activated only when both the IMU and the AGC were in operation; in this manner, the problem of PIPA gaussing (change in magnetic characteristics) as a result of incorrect power turn-ons would be avoided.

A design effort was undertaken to develop a smaller, lighter, simpler, more reliable temperature-control system for the Block II IMU. Advantage was taken of the knowledge and experience gained from the Block I design. The Block II spacecraft was thermally similar to the Block I vehicle; therefore, the IMU environment was well known. A good thermal model of the IMU was developed from the Block I experience. The uncontrolled IMU heat sources (e.g., inertial components, torquers, resolvers, and gimbal-mounted electronics) were well defined.

The Block II system incorporated a mercury-thermometer thermostat that was used for Block I emergency temperature control. This thermostat, which had a very small deadband, proved to be accurate, stable, and extremely reliable. The Block II IMU temperature-control system performed the same functions as the Block I system except that it did not provide monitoring signals of IRIG temperature for telemetry.

In the Block II system, temperature is controlled by using a mercury thermostat as the temperature-sensing element in a bistable temperature-control system. Additional mercury thermostats are used for providing an out-of-limits temperature alarm indication and for controlling the two blowers. Each blower, which extends the dynamic

range of operation, is limit-cycled by a thermostat. Two separate sensors that detect out-of-limits temperature are used to caution the astronaut should this condition occur. In addition, high-temperature-limit mechanical thermostats are used in every heater powerline to prevent overheating. These thermostats are set to open the heater power at a temperature approximately 5 K (5° C) above the normal control temperature. These thermostats have rarely been used; however, when necessary, they have prevented damage to valuable equipment.

BLOCK II AND LM PROBLEMS

The major problems of the Block II and LM inertial subsystem appeared in the newly designed and changed items. As would be expected, the only electronic assembly entirely new to the inertial subsystem, the ECDU, had the major difficulties.

Structural Problems

A structural problem appeared during the environmental design evaluation of the Block II ECDU. The response of the modules within the headers to vibration or shock inputs from the spacecraft structure was higher than anticipated. A corrugated metal damper plate was placed between the two arrays of modules to help restrain the modular response. Installation of this damper plate decreased the module resonance peaks to reasonable levels with a sufficient margin of safety.

The mechanical interface chosen for the IMU mount in the LM led to a complex mounting solution. A tubular aluminum navigation base was used to ensure alinement control between the alinement optical telescope (AOT) and the IMU. These three units, designed by the GN&C development contractor, were then mounted to the basic vehicle structure by an angular aluminum navigation base designed by the LM contractor. The basic softness of the combination design mount together with the large moment arms of the masses mounted led to structural failure during qualification testing. Two redesigns were necessary. The last redesign, accomplished after a system-resonance study by the PGNCS manufacturing contractor, included a tubular sleeve construction in place of welded connections.

Function Problems

The operation of the Block II ECDU, in a system configuration, disclosed two problems that required design changes. The coarse-fine crossover for the ECDU was originally designed to take place at a maximum coarse error of 9°. System tests showed that, under certain conditions, an oscillatory limit-cycle condition developed between the coarse and fine systems. A design change made to reduce the crossover point to 7.5° from null corrected the problem.

The ECDU contained capacitor-coupled transistor switches as shown in figure 3. Immediately following power application or after long periods of inactivity, the direct

current (dc) charge that would normally accumulate on the capacitor would not be present or would have "leaked off." When switching action was initiated, the charging action of the coupling capacitor in conjunction with the frequency response of the operational amplifier would create a low-frequency "bounce" on the output of the switch. The cumulative effect of several switches being activated during coarse alinement of the IMU would cause the input-limiting diodes of the error amplifier to be driven into the active region and effectively short circuit the alternating current (ac) error signal to the amplifier as shown in figure 4.

With loss of this error signal, the read counter would not increment and the feedback pulses to the digital-to-analog converter (DAC) error counter would not exist. The AGC would "load" the DAC error counter to perform the coarse alinement and, in the absence of the feedback pulses, to subtract the "loaded" angle; when the gimbals moved, the error counter would overflow on subsequent computer commands and thus result in a loss of information to the ECDU and a failure to achieve the commanded ECDU angle.

The diodes were removed and the error amplifier modified to improve its saturation characteristics. In this manner, a larger linear operational region was produced.

Component Problems

Several component-associated problems were encountered in the Block II ECDU during the manufacturing period. The part types that exhibited failure modes were (1) micrologic circuits, (2) transistors, (3) transformers, (4) capacitors, (5) relays, and (6) resistors.

The micrologic NOR gates used in the digital modules of the ECDU exhibited both "open" gate failures and "shorted" gate failures during subassembly testing at the inertial subsystem contractor's plant. The majority of the failures occurred during vibration tests. The failures induced by the vibration of the modules were attributed to contaminants within the micrologic flatpack. A "screening" vibration test was conducted at the module manufacturing facility to remove this mode of failure. The vibration "screening" consisted of vibrating the micrologic flatpacks along three perpendicular axes to eliminate those modules containing contaminants.

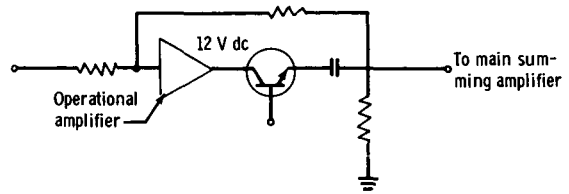

Figure 3.- Capacitor-coupled transistor switch circuit diagram.

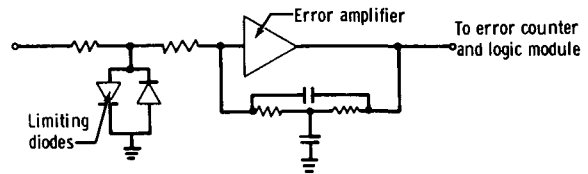

Figure 4.- Error amplifier circuit diagram.

The transistor used in the ECDU ac switches was a 2N2351 device. During the program, this transistor exhibited failure modes that were attributed to the deterioration of gold-aluminum internal bonds (called "purple plague") and to internal contamination. The corrective action was to institute a centrifuge and X-ray inspection for incoming transistors at the inertial subsystem contractor's plant and to improve cleaning procedures at the manufacturer's facility. A second source of supply was also obtained for parts procurement.

Transformer failures occurred through two different modes. The transformer used in the main summing amplifier exhibited inductance shifts after the module was potted. The inductance shift was caused by lamination shifts within the transformer and was corrected by an improved method of sealing the laminations. The other mode of transformer failure was associated with wire breakage inside the transformer. The wire used to wind these transformers was # 50 AWG. The internal stresses placed on the wire terminations and on the fine wire used to wind the transformer were believed to be caused by the hard potting compound used in the transformer. The corrective action was to replace the transformer with a compatible unit wound with larger wire.

Failure modes of the capacitors used in the ECDU were associated with two types of capacitors. One capacitor exhibited high-leakage characteristics after being potted in a module and after being subjected to vibration testing. Because this failure mode was found to be predominantly associated with one manufacturer's capacitor, the corrective action consisted of not using this product in the construction of the ECDU. The other capacitor was a polystyrene film unit, which exhibited film rupture resulting in shorted units and poor connections to the film for external leads. The corrective action consisted of replacing the polystyrene unit with a polyamide capacitor.

The relays used in the ECDU for DAC output transfers were the electromagnetic-sensitive type. Contamination of the relay by solder balls produced failures of these units in the initial stages of ECDU manufacturing. Subsequent improvements in processing, cleaning, and inspection procedures by the manufacturer reduced this failure mode as a problem.

Failures associated with resistors were confined to the high-resistance-value metal films and to the carbon resistors used in the main summing amplifiers. The metal film resistors were found to have changing values under module rework. It was concluded that the abrasive material used during depotting was establishing a high electrostatic voltage on the resistors and in turn was punching through and/or changing the metal film characteristics of the resistor. The corrective action was changing the type of abrasive material used during the depotting process. When potted, the carbon resistors, only two of which are located in each ECDU axis, exhibited a drift characteristic that forced their resistance values outside the specified limits. The corrective action for this phenomenon consisted of changing the specification to accommodate the drift. These resistors occupied a noncritical position in the ECDU function; hence, the specification variance could be tolerated.

MAJOR TESTS

The design environment within which the G&N system was required to operate was defined in interface control documents negotiated among PGNCS development contractors, the two spacecraft contractors, and the NASA. The design environments included such parameters as acceleration, vibration, shock, temperature, humidity, pure oxygen atmosphere, electrical input power, and pressure. Because these documents were negotiated early in the program when the anticipated environments were largely unknown, the interface control document design limits were generally conservative.

Design evaluation testing was performed early in the design phase on mockups, prototypes, and first-article development hardware to ensure that the equipment as designed did indeed have the integrity and the capability to meet and exceed performance requirements and to determine and define margins and limitations of the design in excess of requirements. The design of each element was rigorously examined with regard to thermal evaluation, mechanical integrity, marginal voltages, vacuum, functional and operating characteristics, stability, alignment, system integration, and interface requirements. Other peculiar characteristics or environments to which a particular element was sensitive, such as humidity, salt, contaminants, and electromagnetic interference, were also examined.

A formal qualification test program was established to provide maximum assurance that the G&N equipment would perform its required functions under the environmental conditions for the Apollo mission. The Apollo Airborne Guidance and Navigation Qualification Specification identified the elements of the G&N system and the block configuration to be qualified to each type of environmental stress level. In general, the total G&N system was qualified to nominal mission levels and the subsystems and subassemblies were qualified to design levels with overstress in critical environments. Parts were qualified to a design level with emphasis on ability to determine part quality. The qualification criteria for parts were established by (1) the expected maximum stress level anticipated in the worst-case system application, (2) an adequate margin of safety, and (3) the degree to which a measure of quality in the manufacturing techniques was desired.

Separate testing programs were performed for the IRIG and the PIPA. These testing programs are discussed in the sections of this report entitled "Inertial Reference Integrating Gyro" and "Pulsed Integrating Pendulous Accelerometer," respectively.

COMPUTER SUBSYSTEM

The computer subsystems used for the Apollo CM and LM are described in this section. The Block II CM computer subsystem consists of one AGC and two DSKY assemblies; the LM computer subsystem consists of one AGC and one DSKY. In both cases, the AGC and the DSKY assemblies are identical except that the LM DSKY has two additional status displays.

In the operational configuration, which was used for the lunar landing mission, the computer subsystem included the AGC, the DSKY, and six fixed-memory modules designated "ropes." During the mission phases in which acceleration maneuvers are performed, the AGC accepts inputs from the IMU, which provides attitude data and measures velocity change. This information is processed by the AGC and is used to steer the vehicle and to compute position and velocity. During nonthrusting phases of the mission, the system is concerned with navigational computations (i. e., determination of position and velocity) from which required trajectory changes can be determined and made.

The PGNCS consists of elements to provide sensing, display, manual controls, and spacecraft steering control modes. In all modes, the computer provides the functions of mode control, display of information, and computation. Manual control commands are entered by means of the DSKY, an optics mark button, and hand controllers for manual engine control inputs.

Each spacecraft (LM and CM) has a guidance system, and each contains one of these computers. Although the guidance systems of the two vehicles are similar, different functions are performed in each vehicle; however, the computers are identical. The interconnection between the equipment and the different programs stored in the computer provides for the different functions required. The CM has two DSKY assemblies, one on the main spacecraft display panel and one in the lower equipment bay where the PGNCS is located. In the LM, the single DSKY is mounted on the spacecraft display panel.

DESIGN

The AGC is the descendant of a series of computer designs intended for a proposed space vehicle designed to photograph Mars and return by means of a self-contained G&N capability. The Mars machine, although never actually built, was designed to use magnetic-core and transistor logic. The instruction repertoire, word length, and number of erasable-memory cells were all small. Provisions were made, however, for a moderately large amount of fixed memory for instructions and constants. A high-density memory of the read-only type, called a rope memory (because of the ropelike wire weaving through the magnetic cones), was developed especially for this purpose. Rope memories were used in the AGC because of their high density and information-retention advantages, although this usage placed a burden on software delivery schedules because of the time required for their manufacture and on system integration and testing because of their inflexibility.

Other important aspects of the Mars computer of evolutionary significance were the incorporation of a method of accommodating real-time inputs and outputs that were unusual at that time and the use of an interpretive program. Real-time inputs and outputs were accomplished by the program-interrupt method. The use of interruptions in various forms was an important addition to the aerospace computer field and was a major attribute of the AGC. The interpretive program is a means of trading off execution time with instruction repertoire. This technique allows use of a restrictive basic set of instructions, with the more powerful instructions actually being executed by sub-routines.

The first AGC, designated AGC3, consisted of 1024 words of erasable memory and 12 288 words of rope memory and was capable of executing 11 basic instructions. Normal instruction-execution time was 40 microseconds, of which approximately 20 microseconds were consumed by the two memory-access cycles required to fetch (or store) instructions and data. The remaining time was occupied in manipulation and transfer of numbers among the central and special registers, which included the adder and various buffering and editing registers.

The editing and input/output operations, which are commonly handled by special instructions, were handled by special memory cells. For example, to shift a word in this family of machines, the word is stored in a special register dedicated to this purpose and is read out again. The shifting is accomplished between storing and reading. This technique sacrifices memory for hardware and is essential for cases in which the instruction list is severely limited.

During the evolutionary period of these computers from 1958 to 1962, the hardware technology available to the aerospace computer designer was rapidly evolving. A three-dimensional magnetic-core array had been designed and adapted to meet the Apollo vibration environment.

Another important line of evolution was semiconductor technology, in which silicon transistors progressed first to planar and then to epitaxial form and monolithic integrated circuits were developed. Still another area of development was packaging, in which the introduction of welding and matrix-interconnection techniques allowed significant reductions in volume and weight over previous circuit-board techniques while enhancing reliability. The welding techniques and some of the silicon transistor technology mentioned were used by the GN&C development contractor in the development of earlier computers. These techniques were applied more or less directly to the Apollo computer design.

Integrated circuits were in development by the semiconductor industry during the late 1950's under U. S. Air Force sponsorship. In late 1961, a number of integrated circuits were procured for evaluation as candidates for the AGC. An integrated circuit was constructed to reveal any problems the units might present when used in large numbers. Reliability, power consumption, noise generation, and noise susceptibility were the primary subjects of concern. The performance of the units under evaluation was sufficiently good to justify their exclusive use in place of core-transistor logic, except for a portion of the erasable-memory addressing circuitry in which metal tape cores were retained as a medium for current switch selection. Accordingly, the AGC Block I computer was designed to use integrated-circuit logic.

The first rack-mounted AGC emerged in late 1962 with integrated-circuit logic, rope fixed memory, coincident-current-core erasable memory, and discrete-component circuits for oscillators, power supplies, selected alarms, interface and memory driving, and sensing. The rope memory contained 12 288 words, but this figure was shortly raised to 24 576 words, a revision made possible by designing the rope modules with the eventual expansion in mind. No particular mission need for this expansion had been identified other than an uneasiness about the possible insufficiency of

the 12 000-word memory. Within a year, when the first mission program requirements had been conceived, documented, and collected, concern about the possible insufficiency of the 24 000-word memory prompted a further expansion in the Block II computer to 36 000 words.

The erasable memory contained 1024 words, of which the first 16 were central and special registers contained as flip-flops in the logic of the computer rather than in the core memory unit. Both fixed and erasable memories were operated at a cycle time of approximately 12 microseconds. This cycle was quite leisurely for the erasable memory and permitted time between reading and writing for content modification such as incrementing and shifting needed for memory-cycle-stealing operations. The rope memory is inherently slow and was operating much less leisurely. No hierarchical distinction was made between the fixed and erasable memories; both were accessible by any instruction. The instructions written into memory would of course fail to alter the contents of fixed memory.

The integrated-circuit logic section for Block I was composed solely of three-input NOR gates, with one gate in each TO-47-style transistor package (can). These gates were relatively simple in form, consisting of the equivalent of three n-p-n bipolar transistors and four resistors connected as a modified direct-coupled transistor logic (DCTL) NOR gate also referred to less precisely as a resistor-transistor logic NOR gate. A total of 60 gates could be interconnected with each other and with a module plug containing 70 pins by a welded nickel-ribbon matrix. Two such assemblies fit into each of 36 logic modules, for a total of more than 4300 NOR gates. The computer would have required fewer integrated-circuit packages if a variety of logic types (e. g., gated flip-flop) had been used. It was estimated, however, that the problem of producing and qualifying even a second circuit type would outweigh the advantages of using a variety of logic types. In retrospect, this approach is believed to be correct. Use of the single logic type simplified packaging, manufacturing, and testing and gave higher confidence to the reliability predictions because of the large quantity used.

One other integrated circuit was used in the Block I AGC, a differential amplifier for sensing memory outputs. This device was developed especially for the AGC and contained the equivalent of six n-p-n bipolar transistors and eight resistors. These units were preferred over discrete-component sense amplifiers not only for their small size but also for the close match of characteristics and tracking desired between components of the differential state.

As an adjunct to the AGC, a DSKY unit was required as an information interface with the crew. The original design was made during the latter stages of the breadboard computer development, when neon numeric indicator (Nixie) tubes were used to generate three four-digit displays for information and three two-digit displays for identification. These six displays were considered to be the minimum necessary for providing the capability to display three space vectors with sufficient precision for crew operations. The two-digit indicators were used to display numeric codes for verbs, nouns, and program numbers. The verb-noun format permitted communication in a language having a syntax similar to that of a spoken language. Examples of verbs were "display," "monitor," "load," and "proceed"; examples of nouns were "time," "gimbal angles," "error indications," and "star number." A keyboard was incorporated

together with the display for entering numbers and codes and for identifying each. In the Block I system, two different physical outlines were generated, one for the navigation station in the vicinity of the G&N system (lower equipment bay) and one for the main control panel located above the crew couches.

The Block II CM and LM DSKY design evolved to incorporate electroluminescent (EL) segmented numeric displays instead of neon, and a five-digit display instead of four to accommodate a base eight (octal) display of a 15-bit computer word. The displays are switched by miniature latching and nonlatching relays. Solid-state switching circuits, although preferred for this function, were ruled out because of the high voltage required for EL operation. High-voltage solid-state switching circuits were available at the time of the DSKY design, but their reliability had not been proved.

In 1964, when the Apollo G&N system underwent redesign for both the Block II CM and the LM, the final version of the AGC was conceived. This machine was known by the various designations AGC, Block II AGC, LGC, and CMC. As stated previously, the need was evident for increased memory over that of the Block I AGC, both fixed and erasable. There were two major reasons for this need. One was the experience gained with mission-related programs for Block I; the other was the identification of new functions for the Block II system, including the autopilot function. Both memory expansions were accommodated with a moderate effect on existing designs. The braid memory, a new form of fixed memory with some similarities to the rope but with several potential advantages, was under development for possible inclusion in the Block II AGC in place of the rope memory. However, because the braid-memory development was not sufficiently advanced for the Block II schedule, the rope memory was retained, with an increase in capacity from 24 576 to 36 864 words, a factor of 1.5 greater than Block I, made possible by increasing the number of sense lines in each module. The mechanical design of the rope modules was changed to allow their removal and insertion without removing the computer from the spacecraft or breaking any connections other than those of the rope modules themselves.

The erasable-memory capacity was doubled to 2048 words, of which the first 8 were central registers outside the core unit. This increase was made with a small increase in driving circuitry, double the number of cores, and an overall volume reduction owing to more efficient space usage and the use of smaller driving transistors.

In the logical design area, the number of input/output operations in the Block II AGC was greater than that in Block I and the overall speed requirement was also greater, both largely as a result of the autopilot requirements. The input/output requirement was met by a number of special circuits for such interfaces as the radar and the hand controller and a larger number of standard circuits, such as counter (memory-cycle stealing) inputs and discrete inputs and outputs. The speed requirement was met by speeding up all circuitry. Indeed, the circuitry was made slightly slower in Block II because of a change from high-power micrologic to low-power micrologic. The number of instructions was increased from 11 to 34 to include more flexible branching and data handling, some double-precision capability, and special input/output instructions. Some instructions, including multiply and divide, were made faster through the use of extra logic, particularly in the adder circuitry where the time to propagate carriers was reduced to approximately one-third its duration in the Block I circuitry. The number of gates rose by approximately 1400, from approximately 4300 to approximately 5700.

Improvements in integrated-circuit technology led to the adoption of a new NOR gate for Block II. Although still a modified DCTL three-input gate, this circuit dissipated less than half the power of a Block I gate. Additionally, mounting two of these gates on a single silicon chip in a 10-lead "flatpack" container resulted in doubling the Block I packaging density. Power usage was reduced in these logic units by increasing the output impedance and thereby increasing rise-time sensitivity to stray wiring capacitances. Two steps were taken to permit the use of the new device and effect a saving in power: multilayer etched boards were adopted as the means of interconnection within modules in place of the ribbon matrices to minimize the stray capacitance, and the clock timing circuit was improved to accommodate greater uncertainties in sign signal-propagation delays. This gate was designed to have a fan-out capability of approximately 5 and an average propagation delay of approximately 20 nanoseconds while dissipating approximately 5 milliwatts of power. These gates are designed to operate over the temperature range of 273 to 343 K (0° to 70° C).

The importance of using a single circuit should not be underestimated. Thousands of logic gates are used in each computer. High reliability is essential for every gate. This reliability can best be attained by standardization and can only be demonstrated by the evaluation of large samples. Had a second type of logic microcircuit been used in the AGC, the number of logic elements could have been reduced by approximately 20 percent, but neither of the two circuits would have accumulated the high mean time to failure and high confidence level achieved by the single NOR circuit.

The Block II AGC design that resulted from the change in technology achieved approximately double the speed, between 1.5 and 2 times the memory capacity, an increase in input/output capability, and decreases in size and power consumption. The Block II DSKY also was redesigned, but the functional characteristics were essentially unchanged. The new DSKY design consisted of a smaller mechanical envelope that was the same for the three locations, two in the CM and one in the LM. In addition, the Block II design of both AGC and DSKY was constrained by new mechanical requirements, such as the environmental seal on all connectors or modules that could be subjected to and damaged by the high moisture content of the spacecraft.

The mechanical design evolved from the experience of welded cordwood construction and other construction techniques that were applied very successfully to the packaging of the Polaris guidance system and guidance computer. From this background and the changing constraints, the mechanical configuration evolved through a series of designs. The major requirements that significantly affected the early configurations were the requirements for in-flight repair, for mounting on the spacecraft coldplate structure, and for the spacecraft cabling interface. These requirements resulted in a configuration having modular construction and removable trays. The housing also contained a tray with spare modules.

Various mechanical and thermal interface problems dictated a change in configuration to what became the Block I (0) computer. The early production computers were of this configuration. The mechanical design was not stabilized, however, until the requirement for in-flight repair was replaced by the requirement for moisture-proofing, which led to a significant change in mechanical configuration using the same module designs that were used in Block I (0). Figure 5 is a photograph of the moisture-proofed design, which was the final Block I mechanical configuration for the computer and the DSKY units.

Before the requirement for in-flight repair was deleted, a series of mechanical designs was coupled with studies to determine the feasibility of fault isolation in flight or the feasibility of dual-computer operation using manual switchover. The Block I (0) AGC (fig. 6) was the only version of this general configuration that was built; this configuration was built with room for two spare trays to be mounted beside the two active trays. This configuration shows the result of the various constraints: (1) room for spares to accomplish in-flight repair, (2) the right-hand tray containing cabling to interconnect the computer with the rest of the G&N system through the top connectors and through the front connector to the spacecraft cabling, and (3) the thermal interface material that was to provide heat transfer to the spacecraft coldplate. The change to the Block I (100) design was accomplished after the requirements for spares and thermal interface were eliminated.

The increased functional requirements that resulted in the Block II design discussed earlier also resulted in a completely new mechanical design. The main problem of mechanical design in guidance computer logic is the creation of signal interconnections; indeed, approximately three-fourths of the AGC volume is used for this purpose. Interconnections are primarily of two types: wrapped wire between modules and multilayer boards within modules.

In the AGC, one of the basic goals has been to make the electronic circuits in small pieces that are easily installed and removed, for the sake of producibility, testing, easy diagnosis, and economical maintenance. This goal can only be realized insofar as it does not excessively degrade the overall packaging density of the computer, because volume is, of course, critically limited in the spacecraft.

The Block II redesign resulted in an end product that was not only smaller and lighter than the Block I AGC but that provided better environmental sealing, easy access to fixed memory for replacement in the spacecraft, and commonality between the LM and CM mounting. Internally, the same type modular construction was used in the Block II AGC as in the Block I version.

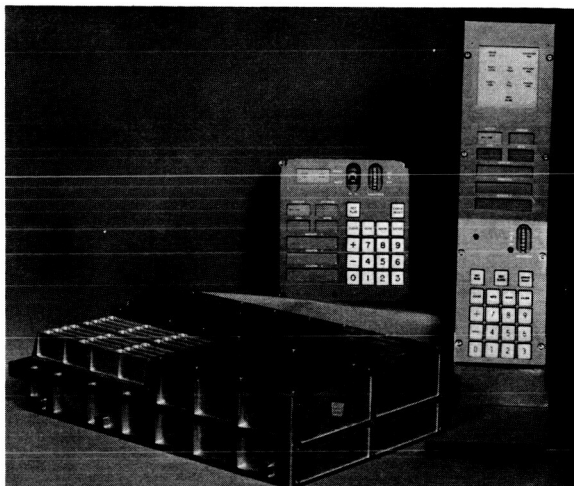

Figure 5. - Block I (100) Apollo guidance computer.

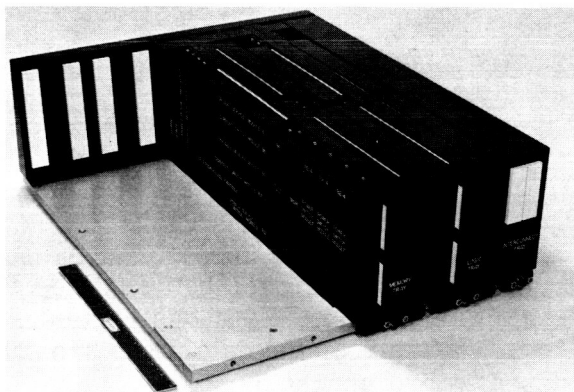

Figure 6. - Block I (0) Apollo guidance computer.

SYSTEM DESCRIPTION

The Block II computer (figs. 7 and 8) evolved from a series of technological developments. Because this design was the only one used for manned operational flights, the following description concentrates on the Block II AGC. The computer characteristics are listed in table I.

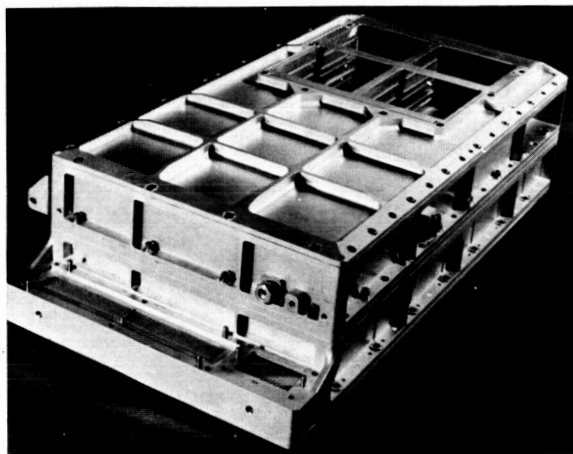

Figure 7.- Block II Apollo guidance computer (spacecraft interface side).

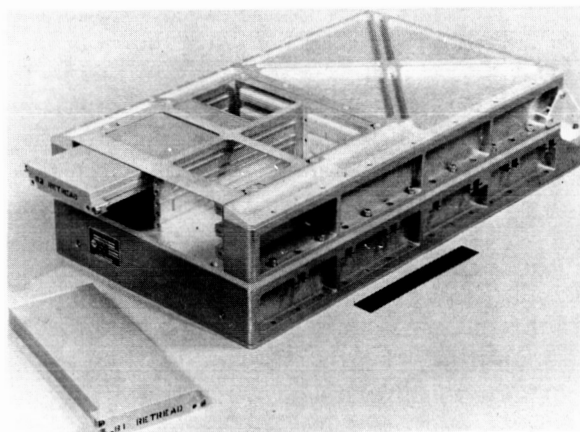

Figure 8.- Block II Apollo guidance computer (spacecraft cabin side).

The backbone of the AGC is the set of 16 write buses; these are the means for transferring information between the various registers shown in figure 9. The arrowheads to and from the various registers show the possible directions of information flow. In figure 9, the data paths are shown as solid lines and the control paths are shown as broken lines.

The AGC is a "common storage" machine; that is, instructions may be executed from erasable memory as well as from fixed memory and data (obviously constants, in the case of fixed memory) may be stored in either memory. The word sizes of both types of memory must be compatible in some sense; the easiest solution was to have equal word lengths.

Electrical

The AGC has three principal sections as shown in figure 9. The first is a memory, the fixed (read only) portion of which has 36 864 words and the erasable portion of which has 2048 words. The next section may be called the central section; it includes an adder, an instruction decoder (SQ), a memory address register (S), and a number of addressable registers having either special features or special use. The

third section is the sequence generator, which includes a portion for generating various microprograms and a portion for processing interrupting requests. All logical operations in the computer were accomplished using an integrated-circuit NOR gate with simple interfaces; the other circuits (i. e., oscillator, power supply, memory circuits, alarms, and external interfaces) could not be designed using integrated circuits.

Memory. - The AGC fixed memory is of the transformer type. It is designated a "core rope" memory because of the physical resemblance of early models to lengths of rope. Incorporated into its wiring structure is an address decoding property, because of which its cycle time is not as short as that of some other transformer memories having external address decoding. The resulting bit density is extremely high: approximately 100 bits/cm^3 (1500 bits/in^3), including all driving and sensing electronics, interconnections, and packaging hardware. This high density of storage is achieved by "storing" a large number of bits in each magnetic core. A stored bit is a "1" when a sense wire threads a core and is a "0" when a sense wire fails to thread a core. The total number of bits is the number of cores multiplied by the number of sense lines capable of threading the cores. The AGC memory is composed of six

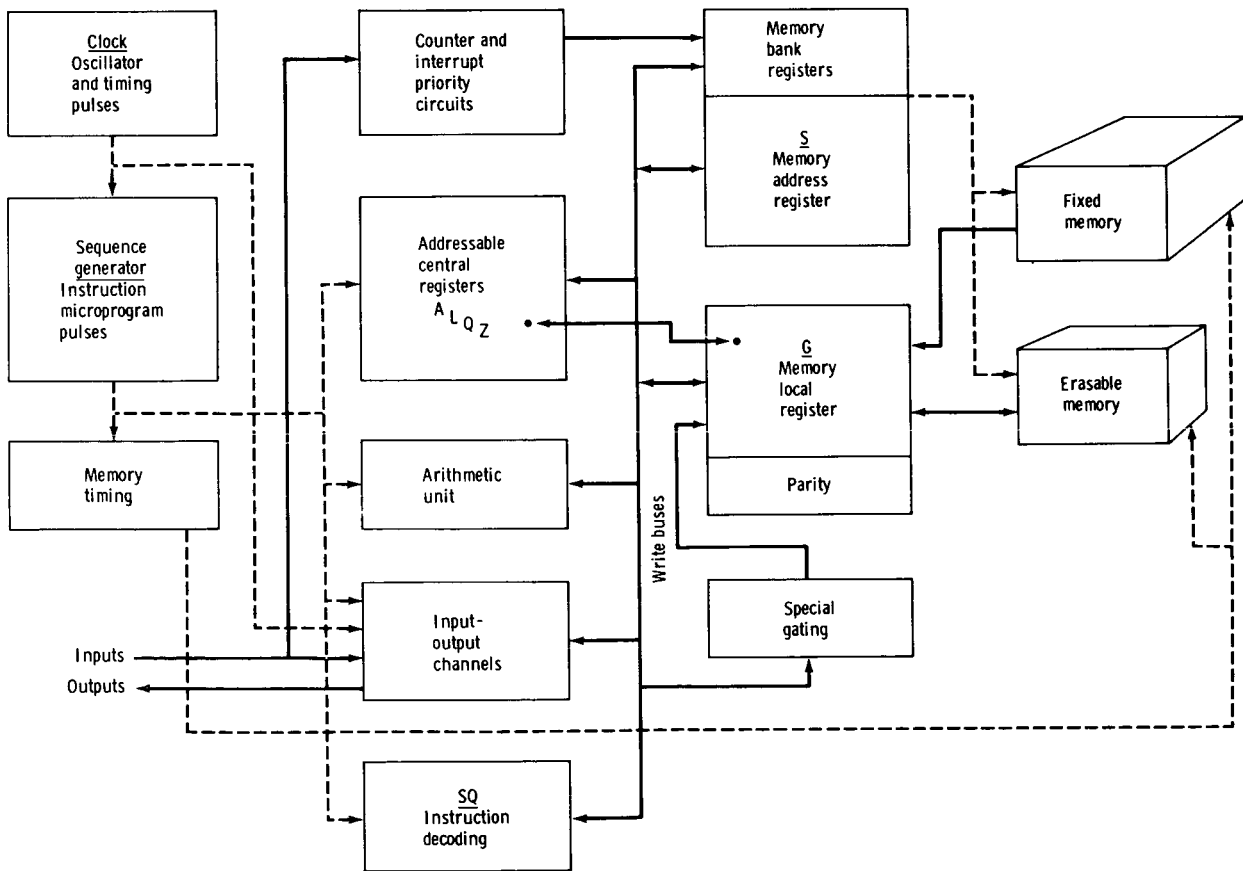

Figure 9. - Apollo guidance computer block diagram.

TABLE I. - COMPUTER CHARACTERISTICS

Performance characteristic	Value	
	Block I	Block II
Word length, bits	15 plus parity	15 plus parity
Number system	1's complement	1's complement
Fixed-memory registers, words	24 576	36 864
Erasable-memory registers, words	1024	2048
Number of normal instructions	11	34
Number of involuntary instructions (interrupt, increment, etc.)	8	10
Number of interrupt options	5	10
Number of counters	20	29
Number of interface circuits	143	227
Memory-cycle time, μsec	11.7	11.7
Counter increment time, μsec	11.7	11.7
Addition time, μsec	23.4	23.4
Multiplication time, μsec	117	46.8
Double precision addition time, μsec	^a 1650	35.1
Number of logic gates (microcircuits)	4100	^b 5600
Volume, cm^3 (ft^3)	34 300 (1.21)	27 400 (0.97)
Weight, kg (lb)	39.4 (87)	31.7 (70)
Power consumption, W	100	70

^aSubroutine.

^b2800 packages.

modules. Each module contains 512 cores and 192 sense lines and hence contains $192 \times 512 = 98\,304$ bits of information. This information is permanently wired; once the module has been manufactured, not a single bit can be changed, either intentionally or unintentionally, except by physical destruction or by failure of one or more semiconductor diodes.

The erasable memory of the AGC was inherited from its core-transistor logic ancestor. It is a conventional coincident-current, ferrite-core array, the ferrite compound of which yields a combination of high squareness and comparatively low sensitivity to temperature. Moreover, the silicon transistor circuits that drive this memory vary their outputs with temperature to match the requirements of the cores over a wide range, from 273 to 343 K (0° to 70° C). Compared to linear (word) selection, coincident-current selection affords an economy in selection circuitry at the expense of speed. This is advantageous to the AGC, in which the memory cycle time is already long, largely because of the fixed memory. The 2048-word array is wired in 32 by 64 planes with no splices in the wires for highest reliability.

The erasable memory is a coincident-current ferrite-core system having the same cycle time as the fixed memory. Instructions can address registers in either memory and can be stored in either memory. The only logical difference between the two memories is the inability to change the contents of the fixed part by program steps.

Central section. - The central section is shown in block form in the middle part of figure 9. It contains the address register (S), the memory bank registers mentioned previously, a block of addressable registers called "central and special registers" (to be discussed subsequently), an arithmetic unit, and an instruction decoder register (SQ). The arithmetic unit is an adder with shifting gates and control logic. The SQ register bears the same relationship to instructions as the S register bears to memory locations; neither S nor SQ is explicitly addressable. The central and special registers are A, L, Q, Z, and a set of input and output channels.

The special and central registers include six addressable and five unaddressable flip-flop registers. These include the upper and lower accumulators, memory address and bank registers, program counter, adder, memory buffer, and auxiliary registers. Only two of these registers (program counter Z and return address auxiliary register Q) can be considered nonspecial; that is, having no function other than temporary 15-bit storage. The auxiliary register B has an inverted output (denoted C) as well as a direct output. The upper and lower accumulators, A and L, perform shifting and overflow storage functions. The memory buffer register G performs shifting and cycling functions and controls inhibit digit drivers in the erasable memory. The memory address register S controls memory selection circuits. The bank registers EB and FB likewise control memory selection, and both are accessible by way of a common address denoted BB as well as individually. The adder uses two operand registers, X and Y, and generates their sum, which is accessed by way of a gate set denoted U.

Parallel information transfer is effected among these registers by a bus system as well as by a certain amount of dedicated transfer circuitry. The read bus and write bus have identical information; the former drives the latter through amplifying logic. One notable exception, the X register of the adder, is connected to neither bus. This register is loaded directly from the upper accumulator A and feeds the adder circuitry. Other exceptions are the Y, S, and B registers.

Other than the flip-flop registers, a number of the erasable registers in the core memory are classified as special, owing to special actions connected with their use or to their dedication to limited use. The nine registers following the seven central register addresses are dedicated in various ways. The eighth register is vacant and can be considered a source of zeros. The 9th to 16th registers are used for temporary storage of central register contents during program interrupts, and two of these are automatically read and written by the interrupting and resuming instructions. The 17th to 20th register addresses are reserved for shifting and cycling, making use of special write gate logic built into the memory buffer register G. Finally, the next 28 registers (counters) are involved in cycle-steal operations and are either incremented, decremented, or shifted as the result of input, output, or timing actions of the computer.

The AGC arithmetic is based on a single adder, which is used for addition, subtraction, multiplication, and division. Information transfer between the AGC and its environment occupies a substantial fraction of the computer hardware and time budget.

Essentially, the Block II AGC has four types of interfaces (neglecting the test equipment interface): an input and output circuit that is transformer coupled and an input and output circuit that is dc coupled. The nature of information handled through the interfaces is varied. In some cases, computer words are transferred directly into and out of the computer. Prelaunch and in-flight radio links are maintained between the computer and ground controllers. Because of the great difference in data rates between up and down directions, the mechanizations differ considerably. The downlink operates at a relatively high rate (100 AGC words/sec or 1600 bits/sec) and is designed to occupy a minimum of the computer time budget. The downlink serializes two words stored in parallel in flip-flop registers and, on command, sends the bits in a burst to the spacecraft central timing system. The uplink for serial-to-parallel conversion is used for whole-word transfers out of the computer to digital spacecraft display units. The uplink is also used to accept data from the radar measurement subsystem and can be used if desired to communicate between the CM AGC and the LM AGC. This interface was called crosslink, and the capability has not been used.

Incremental information transfer is similar to serial information transfer in that a sequence of pulses is transmitted over a single channel. It differs in that each incremental transfer pulse represents the same value, or weight, as opposed to serial transfer, in which two adjacent pulses differ in weight by a factor of 2, and in which the concept of positional notation is used. An incremental receiver counts pulses to form a word, whereas a serial receiver shifts pulses to form a word. The Apollo accelerometers are incremental by nature, producing a pulse output to the computer for each unit change in velocity. Incremental transfer is also used for angle commands from the computer to the gyros and to the coupling data units, and for thrust control and certain display functions in the spacecraft. Pulses are sent in groups or "bursts" at a fixed rate.

Discrete signals are individual or small groups of binary digits that issue commands or provide feedback for discrete actions, such as switch closures, mission phase changes, jet firings, display initiations, and many other similar controlled events. The display portion of the computer communicates with the computer proper by discrete signals in groups that carry encoded information. All these discrete signals have relatively slow reaction-time requirements; therefore, these interfaces use the dc interface circuits.

The computer is the primary source of timing signals for the spacecraft central timing system. Within the G&N system, the AGC furnishes approximately 20 time-pulsed signals to various subsystems.

Sequence generator. - The sequence generator provides the basic memory timing and the sequences of control pulses (microprograms) that constitute instructions. The sequence generator also contains the priority-interrupt circuitry and a scaling network that provides various pulse frequencies used by the computer and by the remainder of the navigation system. It is a logic equivalent to wired memory that, for a given time pulse of a given memory cycle of a given instruction, stores, shapes, and amplifies the appropriate control pulses.

The instructions are arranged so as to last an integral number of memory cycles. In addition to these instructions, there is a number of "involuntary" sequences, not under normal program control, that may break into the normal sequence of instructions. These are triggered either by external events or by certain overflows within the AGC and may be divided into two categories: counter incrementing and program interruption.

Counter incrementing may take place between any two instructions. External requests for incrementing a counter are stored in a counter-priority circuit. At the end of every instruction, a test is made to determine whether any incrementing requests exist. If not, the next instruction is executed directly. If a request is present, an incrementing memory cycle is executed directly. All outstanding counter incrementing requests are processed before proceeding to the next instruction. This type of interrupt provides asynchronous incremental or serial entry of information into the working erasable memory.

Program interruption also occurs between program steps. An interruption consists of storing the contents of the program counter and transferring control to a fixed location. Each interrupt option has a different location associated with it. Interrupting programs may not be interrupted, but interrupt requests are not lost and are processed as soon as the earlier interrupted program is resumed.

The clock section of the AGC consists of a ring counter, a scaler, a time-pulse generator, and circuits to generate subphases of the time pulses using the 2.048-megapulse oscillator as the primary source of timing pulses. The spacecraft reference signal of 1.024 megapulses/sec is obtained by dividing the 2.048-megapulse oscillator output in a single-stage scaler. This reference signal is also used together with the oscillator output to generate four phases of the 1.024-megapulse signal for use in sequencing activity within time pulses. A divide-by-12 circuit generates the 12 separate pulses of 0.977-microsecond duration that occur sequentially within a memory-cycle time of 11.7 microseconds.

Power Distribution

Power distribution is a special problem in the AGC. The current drawn by the gates is approximately 6 amperes at 4 volts dc. For the sake of efficiency, these currents must be distributed from the power supply to the logic modules with very little

dc-voltage drop. Moreover, the current return, or zero-volt distribution, must not sustain any ac voltages of a frequency or amplitude sufficient to activate or deactivate a gate inadvertently. This controlled power distribution is accomplished by building an interlaced gridwork of heavy conductors on the terminal posts of the tray. Each group of 60 gates shares, in a module, a ground plane that is brought out at three equally spaced places to connect to this gridwork, which provides multiple paths for return current in much the same manner as a ground plane. The other power source, the positive voltage, is distributed by a gridwork circuit to two points on the power bus shared in a module by each 60-gate group.

Mechanical

The mechanical carrier into which all modules are inserted is called a "tray." The AGC consists of two trays: one for logic, power supply, and interface modules and the other for memory and ancillary circuit modules. The 15 000 jacks on the tray into which signal pins are inserted pass through the tray and extend out the other side in the form of posts having square cross sections. Interconnections between pins are made by wires the ends of which are tightly wrapped around the posts without the use of any further contact mechanism such as solder or welds. This method has several advantages: it is executed by a machine, which requires only a few seconds per wire; it is controlled by a punched-card input; it can easily be altered if a change is desired; wires can be run point to point if desired; and the reliability of the connection is extremely high because there is no signal point at which bending stress is applied. Moreover, this interconnection method is compatible with hand wiring, which is required wherever wires are twisted together to protect low-level signals or where heavy-gauge wire is needed for accommodating high currents.

The main tray structure of the AGC is a magnesium frame into which the modules are affixed by jacking screws, providing a good thermal path between modules and tray. The tray in turn is screwed to a coldplate, where heat is removed. The frame also provides moisture seals for all internal wiring and connectors.

Display and Keyboard

The display and keyboard unit (fig. 10) is in some respects like an integral computer part, yet it is operated using the same interface circuits used for connection to other subsystems and systems. Because the DSKY serves as the channel for human communication with the computer, it needs a rather high peak-data rate without being very large or having too many wires between the DSKY and the computer, located a few feet distant along a cable.

The principal part of the display is the set of three light registers, each containing five decimal digits composed of electroluminescent segmented numerical lights. Five digits are used so that an AGC word of 15 bits can be displayed in one light register by five octal digits. In addition, there are three two-digit numerical codes for the verb, noun, and major program. In addition to the numerical lights, a computer activity segment and a sign position are included in each light register. Electroluminescent

lights are small and easy to read and require relatively little power. The EL lights are driven by an 800-hertz, 250-volt ac power supply, switched by miniature latching relays. Both latching and nonlatching relays are used for external interfaces with other subsystems and systems and are located in the DSKY, where they share driving circuits with the light-register relays. A double-ended selection matrix, organized so that one of 14 groups of 11 relays is set at a time, is used for actuating the relays; 11 signals are required from the computer to govern the configuration of the 11 relays in a group, and 4 more bits are used to select one group out of 14, making 15 bits. The fact that this is the size of the AGC word is not entirely coincidental. This arrangement allows one word in the DSKY output channel to control enough relays to light two numbers in a light register and one stroke of a sign.

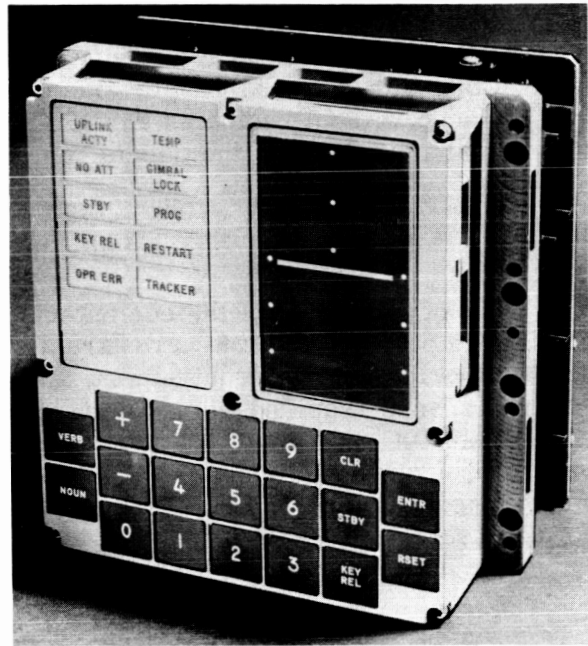

Figure 10. - Display and keyboard.

The keyboard has 19 keys, which are used to enable concise yet flexible communication between man and computer. Commands and requests are made in the form of sentences each having an object and an action, such as "display velocity" or "load desired angle." The first is typical of a command from man to machine; the second is typical of a request from machine to man. The DSKY is designed to transmit such simple commands and requests made up of a limited vocabulary of "verbs" and "nouns." Because these verbs and nouns are displayed by number rather than by written word, it is necessary to either learn them or have a reference document at hand.

The interface between the computer and DSKY uses the standard dc interfaces. The key depressions are coded in the DSKY into a 5-bit word as inputs to input channel 15, bits 1 to 5, of the computer; and the computer outputs are derived from output channel 10, bits 1 to 15, with additional bits for nonlatching relay drivers in channel 11. The output from channel 10 is decoded in the DSKY by way of a matrix to drive the various light segments.

The principal parts of the DSKY are the frame, six indicator-driver modules, the 800-hertz power supply, two pluggable display panels, and a keyboard. The power supply provides high-voltage ac power for lighting the EL display panel. The panel lighting is controlled by way of the latching relay, which provides coding and storage for the commanded display data. The status and caution panel is lighted with filamentary bulbs also switched by means of either latching or nonlatching relays. In the case of nonlatching relays, the information is stored in the AGC output register driving a detailed display light. The keyboard is a special design to permit lighted keys, the

required actuating force, and small size. All these elements are interconnected and environmentally sealed by the frame and covers. The mechanical design of the DSKY is such that either the EL display panel or the status and caution panel can be removed and replaced without removing the DSKY from the spacecraft or breaking any connections other than those of the panels removed.

Software Requirements

The development of the computer software started early in the program and progressed in parallel with the hardware development. Software capable of testing the hardware was the first requirement; and, to accomplish this end, many of the utility programs were required also. The test software initially released was in a very preliminary state but was capable of accomplishing the functional test of the hardware. Expanded programs with capability for operation of a system followed as techniques for software preparation and rope manufacturing were developed. The flight software is not discussed in the PGNCs report.

DEVELOPMENT PROBLEMS

Computer development problems in the areas of excessive delay times, noise susceptibility, presence of diode sneak paths, flatpack corrosion, diode channeling effect, relay contamination, transistor bonds, flatpack lifted bonds, and diode switching characteristics are discussed in the following paragraphs.

Timing

The logic section of the computer consists of 24 modules containing 120 dual flatpacks. The original concept was to interconnect these gates with several layers of matrices stamped out of nickel ribbon. During testing of the prototype computer, it was determined that the capacitance between these layers prevented the computer from operating properly because of long delay times. Before this, the use of multilayer boards was being investigated as the interconnect but, because of the state of the art, they had not been selected. After looking at all the alternates to correct this timing problem, it was determined that the multilayer board would best accomplish this end. A program was implemented to use the multilayer board in all production computers.

Noise

Originally, the computer was highly susceptible to noise. This problem was corrected as follows: (1) by tying the power ground to the chassis ground inside the computer and (2) by installing a module on the test connector that loads the test-point outputs when the test connector was not being used. This procedure prevented noise feedback into the computer circuits.

Sneak Paths (Blue Nose Gates)

Originally, the logic section of the computer used only one component, a dual three-input NOR gate per package using a common B+ connection, to perform all functions. As a result of the inherent design of the dual flatpack integrated circuit, diode sneak paths exist between the two circuits within the same package. The problem occurred when the outputs of two or more circuits were tied together to increase the fan-in capability. When the B+ connection was not made to the circuit (blue nose gate), as is the case when the circuit is used as a fan-in interface, the diodes became forward biased and caused cross coupling between the two circuits within the same package.

A change of flatpack components for those circuits being used as blue nose gates was required. This approach involved the development of a modified dual-integrated circuit in which the collector resistors are not connected to the collector. However, because the resistors and extraneous diodes would still exist within the package, it was necessary to connect the B+ lead to back bias the diodes.

Flatpack Corrosion

Early in the program, a time-dependent failure mode caused by corrosion of the chip element was detected. During the subsequent failure analysis and investigation, it was determined that the corrosion was caused by leakers not detected during the gross leak tests. Because the hermetic integrity of integrated circuits is essential for maximum reliability and because the assurance of this integrity is dependent on the effectiveness of the leak tests, it was incumbent on the G&N contractor to develop an effective yet nondestructive screening test. After investigations of various methods of detecting leakers, the following gross leak test was found to be the most effective and reliable method for detecting the leakers. The test is accomplished by weighing each device and recording the weight, immersing in a Freon solution under pressure, and reweighing the device. A device that gains more than 0.00050 gram (0.0000175 ounce) during this procedure is a leak reject. This method of conditioning of flatpacks affords the following advantages.

1. Corrosive liquids are eliminated.
2. Very few good devices are rejected; therefore, a higher yield in production is realized.
3. The criterion for failure is a change in specimen weight, and a decision by the test observer is not necessary.
4. Specimen weights are recorded and can be easily rechecked.
5. Although backfilling fluid can become trapped within a specimen, leak detection can still be accomplished.

6. The method contains a weighing fail-safe feature by requiring unit rejection on either increasing or decreasing weight indications.

7. The method allows storage of specimens in Freon for as long as 4 hours before the final weighing.

The military specification controlling the leak test methods has been changed to include this procedure as an acceptable method.

Diode Channeling

During the design of the computer, the number of different types of the same component was held to a minimum. A diode of "mesa" construction was originally used extensively throughout the computer subsystem. During qualification testing, it was determined that this diode was not suitable in all applications because of channeling and surface instabilities that resulted in unacceptably high leakage currents. Replacement of this component with a diode having planar construction decreased the channeling effect.

Relay Contamination

The early computer subsystems (e. g., DSKY) were continually plagued with an inherent relay contamination problem. Although the relay vendors implemented extensive cleaning, handling, processing, and tooling changes to lessen contaminants, particles were still present in the relays. Along with the suppliers' improvements, additional efforts to separate acceptable relays produced a relay vibration screening test. This test was designed to eliminate contaminated relays through the detection of contact short and open circuits during relay operation. Resultant data analysis indicated that these vibration tests provided an overall effective screen but were not cost-effective.

Transistor Bonds

The main transistor trouble areas were bonds and leads. For the gold (Au) and aluminum (Al) system, "purple plague" was a problem for those manufacturers having difficulty controlling their bonding pressures and temperatures. Bonds made with an all-aluminum system contributed a rash of other problems. Making a strong bond was one problem, shorting to the chip edge was another, and the most dramatic of all was the moving (fatigued) aluminum wire. The bond-strength and chip-shortening problems diminished as transistor manufacturers gained experience. The moving lead and fatigue problem was associated primarily with wedge bonds and 25.4-micrometer (1 mil) diameter aluminum wire. The cooling and heating of the wire during computer operation caused the lead to move (wiggle); consequently, the lead would break because of fatigue. The problem was minimized or eliminated when the material of the wire was changed to gold, when the diameter of the wire was increased to 38.1 micrometers (1.5 mils), or when a different bonding (ultrasonic) technique was used. A mixture of these corrections was implemented by various manufacturers.

Flatpack Lifted (Gold Rich) Bonds

Early in the Block II AGC history, the flatpacks exhibited bond failures that had not previously been observed in the Apollo integrated circuit. Through failure analysis, it was determined that the failed (lifted) bonds had separated through an intermetallic region of the ball.

At temperatures above 473 K (200° C), it is known that intermetallic formation occurs at a significant rate. Also, failure of the bond usually occurred from mechanical fracture through the brittle Au_5Al_2 intermetallic layer. This excessive intermetallic formation most probably resulted from exposure to the lead bonding temperature (593 K (320° C)) for an extended period. It has been concluded that the random failures throughout the AGC program were the result of random and relatively remote workmanship (operator) errors, in that the operator left the devices on the heated bonding stage for several minutes. Normal bonding time is less than 1 minute. Although the vendor was made aware of and attempted to minimize this failure mode, occasional failures still occurred in the AGC.

The larger share of these AGC failures have been detected at system turn-on; as a probable explanation, studies have determined that potentials as low as 2 volts could "heal" bond failures by electrostatic attraction. The overall failure rate (0.2765 failure per 10 million operating hours through 1972) of the part remains low because of the large number of components used in the system compared to the small number of system failures.

Diode Switching Characteristics

The problem of diode switching characteristics was detected in several fixed-memory modules (ropes) having flight programs, when operating in computers. All these ropes had passed the tests required by the procurement specifications and had been accepted by the Government. The results of an investigation are summarized as follows. The failure caused the computer to read out an erroneous word from the rope memory. The failure was intermittent and dependent on the rate at which the computer addressed the defective area. The cause of this failure was eventually proven to be one diode of a matched pair of fast-switching diodes that was slow to activate when operating in the memory circuits. In the circuit application, the very slow turn-on time (≥ 1.0 microsecond) of the defective diode in the matched pair was causing transients that resulted in erroneous outputs; as a component, however, the slow diode of the matched pair was only on the order of 0.1 microsecond slower turning on than was the mate. It was determined that, if one diode activates much faster than the other, the diode that turns on quickly will clamp the voltage across the slow diode to a value roughly equal to the dc forward-voltage drop and thereby cause it to switch much more slowly and offset the output. This proved to be an applications problem, not a component problem. This problem was corrected for the application by matching the diodes under both dynamic and static conditions.

OPTICAL SUBSYSTEM

In this section, the design criteria, development, hardware changes, major test programs, and equipment performance of the Apollo optical subsystem are presented. The Apollo optical subsystem is divided into two major parts — CM and LM systems — the design considerations for which included experience gained from Project Mercury, the Gemini Program, and unmanned programs. The Apollo CM optical subsystem consists of a scanning telescope (SCT) and a sextant (SXT) mounted in a single beryllium block. The SCT is used for gross star acquisition and the SXT for accurate navigation and alinement sightings.

The LM optical subsystem is a single-power AOT developed from a basic concept of providing the capability for star sightings from the lunar surface for inertial alinement purposes.

The successful performance of both optical instruments during 10 manned Apollo missions is indicative of the quality of this equipment.

DESCRIPTION

The CM optical unit assembly (OUA) consists of two optical instruments (SXT and SCT) mounted within a common base (fig. 11). The SCT is a single-line-of-sight (LOS), refracting-type, low-power instrument with an instantaneous field of view of approximately 60° . The SCT wide field of view is used for general celestial observations and recognition of target bodies. The instrument is also used for initial coarse orientation of the IMU. An additional use is for landmark tracking during Earth and lunar orbits.

The SXT is an extremely accurate, dual-LOS, electro-optical instrument having 28-power magnification and a 1.8° field of view. This instrument is capable of sighting two celestial targets simultaneously and measuring the subtended angle between these bodies to an accuracy of $10''$ of arc. The SXT is used for IMU-orientation purposes by celestial body sightings. Celestial navigation is accomplished by star-horizon or star-landmark measurements. The SXT also contains the capability for landmark tracking during Earth or lunar orbits.

The AOT (fig. 12) is a periscopic-type telescope having an external field of view of approximately 60° . Optical sightings on lunar surface objects or celestial bodies are accomplished by manual rotation of the AOT to one of six available detent positions. The AOT sighting information is used to orient the IMU in lunar orbit or on the lunar surface.

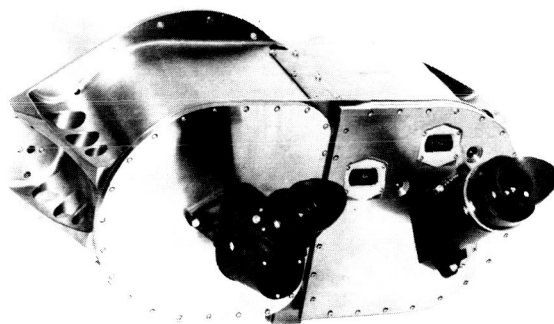

Figure 11. - Command module optical unit assembly.

The PGNCS development contractor was responsible for the design concept of both Apollo optical instruments. The detailed design was approved by the NASA Lyndon B. Johnson Space Center (JSC) (formerly the Manned Spacecraft Center (MSC)) and provided to the optics subcontractor. The optics subcontractor provided resident personnel at the development contractor's facility during the initial design phase to assist with the design details. The development contractor provided the optics contractor and subcontractor with technical direction during the design and development phases.

DESIGN AND DEVELOPMENT

The OUA and AOT evolved from a combined effort of the development contractor and the optical subcontractor. The design concept was the prime responsibility of the development contractor with subcontractor personnel in residence to assist with the formulation of the concept. The subcontractor was responsible for initiating detailed layout, assembly, and specification control drawings.

Throughout the design concept and drawing generation phases, extensive effort was expended in choosing materials that would withstand space environmental requirements. The equipment design and development phase required approximately 3.5 years to complete.

The three basic configurations during the course of the OUA development were Block I (0), Block I (100), and Block II. The following is a brief outline of each system configuration.

1. Block I (0) - Initial design concepts fabricated into working hardware
2. Block I (100)
 - a. Addition of an antibacklash gear for increased accuracy
 - b. Application of high-efficiency optical coating to improve light transmissibility

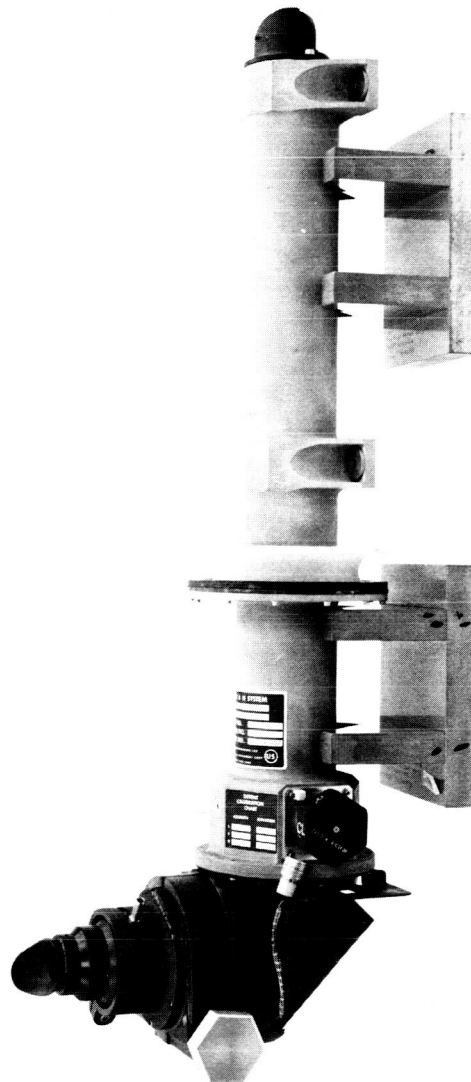

Figure 12. - Lunar module alignment optical telescope.

c. Implementation of large-diameter optical base to ensure an overall error of less than 10 arc-seconds

d. Addition of tracker/photometer electronics to provide astronauts with an automatic star-tracking capability and with assistance in horizon seeking

3. Block II

a. Incorporation of Block I (100) changes except for the tracker/photometer capability¹

b. Incorporation of new motor-tachometers to provide additional power for increased mechanical load

c. Inclusion of quick-disconnect eyepieces having electrical heaters to provide antifogging and quick-change capabilities

The design philosophy of the AOT emphasized simplicity and reliability. No major configuration changes were required. Minor modifications were made late in the program to accommodate operational interface changes and to minimize visibility problems such as solar light impingement, stray light reflections, and structural obstructions to vision.

Major Test Programs

The major test programs performed during the design, development, and manufacturing of the OUA and the AOT can be categorized as design verification, qualification, acceptance level testing, and field testing.

Design verification. - The design verification tests consisted of mechanical integrity and thermal-vacuum tests. Because the OUA and the AOT were designed to be exposed to cabin and space environments at the same time, special facilities were required to test these units. A dual-compartment chamber simulating both internal spacecraft and external space environments was used. Portholes with windows were required to have an accuracy of 10 arc-seconds for the OUA. Testing of the AOT was performed at the development contractor's facility, whereas OUA testing was accomplished at the optics subcontractor facility. Test programs at both facilities were performed on the AOT and on the Block I and Block II optical unit assemblies in the following manner.

1. If any abnormal condition occurred, the test was terminated and the results were reviewed by representatives of the development contractor, NASA, and the subcontractor to determine the cause of the problem (i. e., design test procedures and/or test equipment).

¹The tracker/photometer electronics proved impossible to make operational within the allotted timespan; hence, this capability was deleted from the Block II configuration.

2. If a design change were required, the instrument was modified and retested to the environment at which the failure occurred.

3. Upon successful completion of the retest, the test program was continued.

An additional OUA mechanical integrity unit was tested to destruction, which occurred at approximately 600 percent of the qualification of vibration levels.

Qualification program. - Qualification tests were performed at the part, subassembly, and subsystem levels. Only critical parts, such as motors and resolvers, and subassemblies were tested. The subcontractor performed full-scale qualification test programs on both the AOT and the OUA in accordance with the Apollo Airborne Guidance and Navigation Qualification Specifications. The same test facilities used during the design verification tests were used for the qualification program. The design verification program was excellent and precluded any major qualification failures except for the OUA motor-tachometers. Failure analysis indicated insufficient bearing lubrication and contamination as the causes of this failure. These deficiencies were corrected and the OUA was retested with no problems. Design changes incorporated to facilitate operational requirements required delta-qualification programs to ensure hardware integrity. Additional testing was performed on the spacecraft level to support mission requirements. No major failures occurred in flight, thus indicating the adequacy of the qualification test program.

Acceptance level testing. - Operational thermal-vacuum and random vibration acceptance tests were run on each production unit and each unit after major repairs. The significant thing that was found to be unique to optical systems was that, after initial assembly, an optical alinement shift occurred during the first exposure to vibration. This shift stabilized after one vibration exposure. The acceptance test was thus preceded by a pretest vibration and alinement to ensure that no shift would occur upon acceptance vibration.

Field testing. - Computer analysis and engineering studies indicated a severe visibility problem with the OUA and AOT because of sunlight reflection from the spacecraft structure. To understand these problems and to determine whether design changes could be implemented, a field test program was developed using flight-equivalent hardware and full-scale models of the respective spacecraft involved. This program became known as Project MOSES, referring to the Mobile Optical System Evaluation Simulator that is shown in figure 13.

All field tests had a common goal of evaluating the visual performance and capability of the CM and LM optical subsystems. Previous Gemini Program and Project Mercury experience had demonstrated the difficulty in seeing stars under daylight conditions in space. To achieve the best test conditions with minimal atmospheric disturbance and contamination, these tests were performed at the following field sites: McDonald Observatory, Kitt Peak National Observatory, Climax Solar Observatory, and U. S. Army Fort Huachuca.

As a result of the field tests, the AOT was provided with a sunshade to preclude visibility problems during its operation. There were no practical means of providing a design change to prevent all types of visibility problems from occurring with the OUA during CM/LM docked configurations because of the proximity of the CM in the AOT field of view during sunlight. However, the tests did verify the results of previous

analyses and studies and made possible the definition of sighting constraints for Apollo missions. During the early flights, the fulfillment of detailed test objectives verified the visibility performance of the OUA.

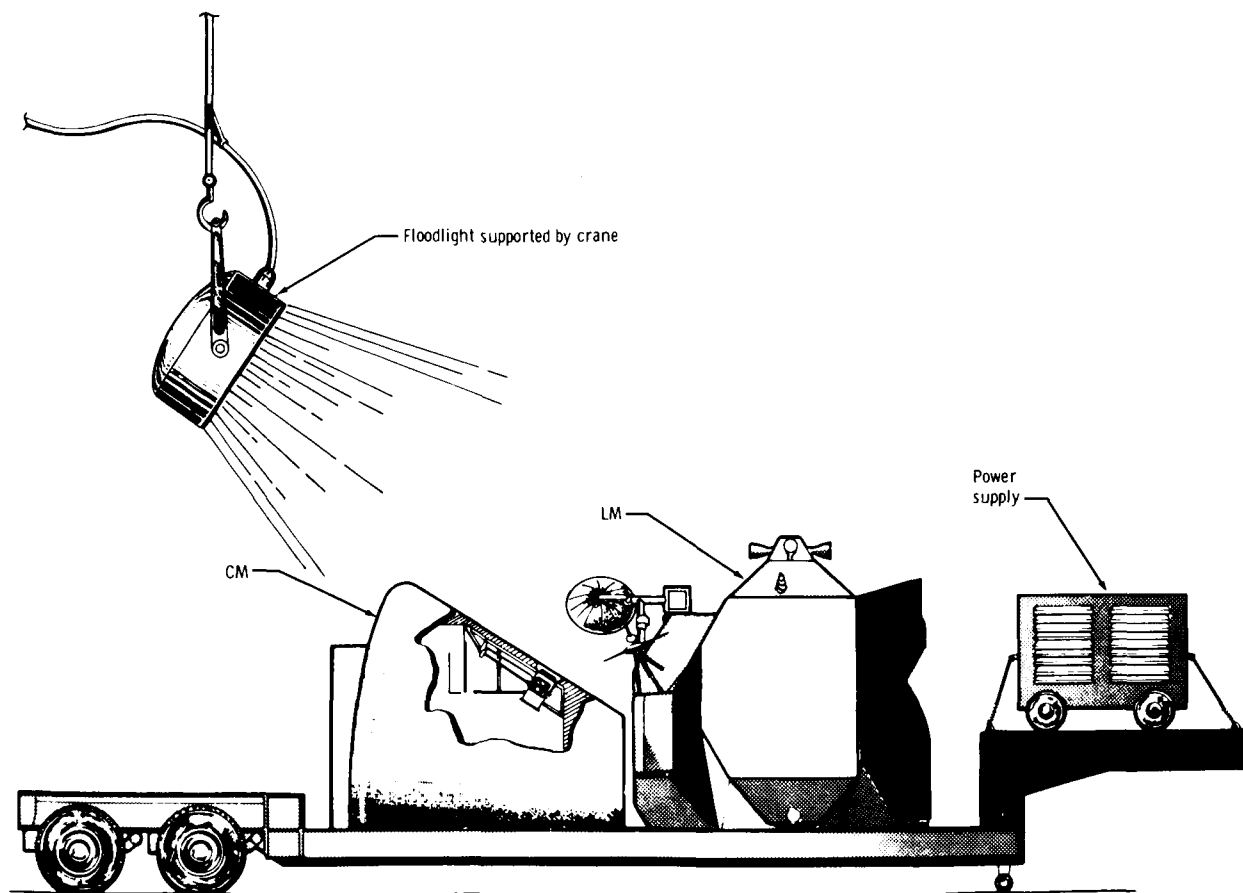

Figure 13.- Mobile Optical System Evaluation Simulator.

Major Hardware Changes

Major hardware changes required in the development of the optical subsystem are described in the following paragraphs.

Eyepiece development. - The OUA eyepieces required several major configuration changes because of complex interfaces with the space suits and because of operational difficulties. These changes included quick-disconnect features, focusable capabilities, and the development of long eye relief for suit operations. Humidity in the CM caused eyepiece fogging and necessitated electrical heaters to keep the temperature of the eyepieces above the dewpoint level. Operational difficulties within a limited amount of space created the necessity to design a storage compartment for the eyepieces in an area near the OUA. The OUA eyepieces are turret mounted by means of a detent mechanism for quick installation or removal.

The original eyepiece incorporated a heater and a foam rubber blanket insulator configuration. The 1967 fire hazard investigation resulted in the replacement of the foam rubber blankets with metallic guards. An additional problem with eyepiece fogging occurred during the Apollo 15 flight in July 1971. The SCT eyepiece visibility was impaired by moisture formation on the optical elements. Subsequent investigation revealed that no visual sightings through the SCT or SXT were performed during the initial humidity test cycle. An engineering evaluation of visual sightings during humidity environment exposure was performed during the latter part of 1971. The results of this evaluation proved that the SXT heater arrangement was adequate but revealed the SCT needed a larger and more strategically located heater. A program to incorporate this SCT heater change in all Apollo flight units was accomplished before the Apollo 16 flight. The satisfactory results of the Apollo 16 optical sightings proved the value of this late design change.

The AOT sunshade. - Tests performed by NASA on the amount of stray light reflected by the LM spacecraft skin, rendezvous radar, and so forth revealed that such reflections would "wash out" any star sighting attempted through the AOT. A sunshade was designed to reduce the reflected light to a level that would permit AOT star sightings. Maximum allowable weight of the sunshade was not to exceed 284 grams (10 ounces).

Design go-ahead was authorized November 21, 1967, and the final design consisted of a truncated cone containing internal baffles and two mounting clamps. The entire assembly was machined from aluminum; the internal baffles were black anodized, and the cone exterior was painted white. The entire assembly was mounted to the inner tube of the AOT and rotated with the AOT. Testing performed by NASA with the sunshade, using a LM mockup, showed a drastic reduction in the amount of reflected stray light. Satisfactory performance was demonstrated during the Apollo 11 mission.

A side effect from the introduction of the sunshade was the immediate availability of three more detent positions for star sightings. Through a mathematical technique, these three "rear" detent positions were calibrated from alinement data obtained on the three existing detents (i. e., the front, right, and left detents). Use of the rear detents during Apollo 11 lunar surface alinements proved their acceptability.

The OUA refurbishment. - Two major problems that appeared during the Apollo Program were evaluated and considered limited-life constraints to the OUA. The problems were beryllium corrosion and silicone lubricant migration from motor-tachometer bearings. A major refurbishment program, implemented in late 1969, made provisions for passivation of the beryllium cavity and development of a longer life motor-tachometer lubricant. These changes increased the estimated operational lifetime of the OUA from 3 years to 10 years. Previous attempts to correct these problems had been unsuccessful.

Apollo tracker/photometer. - The star tracker and the photometer were initially designed and developed as part of the Apollo G&N system to be implemented in Block II production.

The star tracker was an electro-optical device used to maintain closed-loop tracking after manual acquisition of a navigation star. Measurement of the angle

between the landmark and the star in the Block I OUA SXT required the astronaut to manipulate the optics hand controller and the CM rotation hand controller simultaneously to obtain coincidence. When the tracker was added to the SXT star LOS, the astronaut needed only to maintain landmark lock-on; the tracker would maintain star lock-on and coincidence of both images.

The photometer was introduced along with the landmark LOS feature to relieve the astronaut of the responsibility of determining when the optics instruments were aimed at the actual edge of the Earth disk. The photometer is an electro-optical device used to determine the Earth horizon by locating and marking the half-power point as the SXT scanned the Earth disk. The Earth edge, which under visual observation is distorted by atmospheric and sunlight variations, could then be used as a navigational reference.

The Block II design concept incorporated the new optics and electro-optical elements in the OUA SXT head; the downstream signal processing electronics, in the PSA. The OUA redesign was completed in time for implementation in the Block I (100) configuration in the spring of 1965. However, development problems with system integration electronics led to program difficulties. Rather than allow the problems to affect overall Apollo schedules, NASA in December 1965 decided to forego the conveniences of the new tracker/photometer features and to delete the unit from Block II equipment. This decision was predicated on the following reasons.

1. The software was to include the capability for automatic positioning of the optics. This capability would alleviate control problems and reduce the need for a tracker that was only semiautomatic; that is, the star tracker required manual positioning of the OUA to the star before lock-on.
2. The entry corridor angle was decreased, and studies indicated that visual observation of the horizon was adequate; thus, the need for a photometer was eliminated.
3. The Manned Space Flight Network became the primary mode of updating the vehicle state vectors. The OUA was secondary for navigation.

Apollo rangefinder. - The Apollo 7 flightcrew pointed out the need for a rangefinder to aid in the rendezvous operation as a substitute for very-high-frequency ranging, which was not available until the Apollo 10 mission. The MSC generated the specification for an optical ranging device using the KS-205 diastimeter (a space sextant developed by the NASA Ames Research Center) principle. In November 1968, the optics contractor undertook a program to design, fabricate, qualify, and deliver flight hardware and to train the astronauts in the use of the Apollo rangefinder in time for the February 28, 1969, Apollo 9 launch.

To convert the KS-205 diastimeter for use as an Apollo rangefinder, it was necessary to rescale the basic parameters to a particular LM target size and to associate it integrally with a telescope sight to provide a compact, lightweight, handheld or bracket-mounted system with convenient range readout.

The flightcrew of Apollo 9 reported that the rangefinder was used with good results during the docking maneuvers with the LM. The crewmen also used the rangefinder as an 8-power telescope to view a Pegasus satellite that passed in close orbit. At the mission debriefing, the flightcrew stated that the performance of the instrument was adequate.

Astro sextant passive thermal protection system development. - In May 1966, the Apollo Program Manager made a decision that resulted in removal of the OUA spacecraft doors. This decision was made to eliminate the in-flight safety problem of a possible catastrophic failure of the CM OUA protective doors during flight; such a failure would completely block the OUA line of sight and render the instrument useless.

It was decided that a passive ablative thermal protection system would be used to enclose the OUA. The MSC was given the responsibility for developing the design requirement, and the CM prime contractor was to manufacture the necessary hardware. The astro sextant passive thermal protection system consisted of covers and crowns attached to the SXT and the SCT to provide thermal protection of the CM structure. Ejectable dust covers were provided to prevent contamination during launch and orbit insertion. Special qualification tests were performed to ensure the thermal integrity of the hardware under simulated entry conditions. The installation of this system reduced the instantaneous field of view of the OUA from 60° to approximately 45°.

FLIGHT HARDWARE PERFORMANCE

The OUA and the AOT underwent a series of preinstallation, installation, and postinstallation checks at both subassembly and system levels. These checks were performed at facilities of the prime G&N contractor, the LM contractor, the NASA John F. Kennedy Space Center, and the CM contractor. Preflight testing included but was not limited to OUA and AOT functional accuracy tests at the subsystem level, LM IMU functional accuracy tests at the spacecraft level, CM spacecraft systems tests and spacecraft integrated tests, and CM IMU functional accuracy checks at the launch site.

All OUA and AOT units successfully passed all preflight requirements and no major failures were encountered. Of major importance was the confirmation that all ground-support test equipment, expressly designed and fabricated for preflight testing, proved adequate for its task. As a consequence of the failure-free performance of the OUA and the AOT in preflight testing, no unresolved anomalies of the flight equipment existed before any of the Apollo missions.

In-flight Problems

The in-flight performance of the optical subsystem was excellent. Only a few "human factor" type hardware problems were observed throughout the Apollo Program. These problems, which were corrected with a minimum of effort, are summarized in the following paragraphs.

Sextant reticle. - The refraction of the glass-air interface in ground tests changes slightly in space where glass-vacuum is encountered. Thus, two reticles were required, one for ground tests in the glass-air focal plane and one for space in the glass-vacuum focal plane. The dual-reticle pattern was singled out as a possible source of measurement error. Proper training of flightcrew personnel to recognize which reticle was which resolved this problem.

Reticle halos. - The extraneous light in the form of peripheral glow or "halo" resulting from the lighting arrangement used to illuminate the reticle was distracting and caused some offcenter stars to be washed out. This problem was corrected by adding a field stop in the eyepiece.

Eyepiece mounting. - The panel mount for the eyepieces, although affording a quick-disconnect capability, was not sturdy enough to prevent wobble. This problem was corrected by the addition of a shim on the OUA faceplate.

Solar impingement and stray light reflections. - Limited SCT and SXT use while the CM and the LM were joined suggested the need for a Sun shield or for other corrective measures. The final correction for this problem was procedural and resulted in reorientation of the spacecraft stack before performance of optical sightings.

Eyepiece fogging. - The CM cabin relative humidity during late Apollo missions was very high and resulted in SCT eyepiece fogging despite the previously added heater. Use of a larger and more strategically located heater corrected this problem.

Foreign particles in AOT. - Crewmen of one Apollo mission reported foreign particles on the AOT index head. This particular problem was traced to AOT installation procedures and was subsequently corrected by covering all openings during installation processes that generated particles.

Flight Failures

Two problems, both in the OUA, were considered actual hardware flight failures.

Counter failure. - During the Apollo 9 mission, a counter failed because a pin lodged in the OUA gear-train mechanism. In this mechanism, a geneva gear pin in an interference fit application was found to have been used when dimension variance allowed a no-interference in a number of instances. Although this failure did not render the optical subsystem inoperable, because the free pin lodged between a split gear mechanism, all pin applications were checked and replaced if they were found to have an inadequate interference.

Internal harness connector. - During the Apollo 16 flight, an erratic or jerky SCT reticle motion was observed. Postflight analysis indicated a female socket spring contact of an internal OUA harness connector was broken and thus provided an intermittent connection. Further analysis indicated the breakage was caused by a fracture during assembly which slowly had propagated during the years of storage by stress corrosion due to exposure of the unsealed connector. All similar connectors in Apollo-Skylab vehicles were replaced before the Apollo 17 mission.

INERTIAL REFERENCE INTEGRATING GYRO

The history of the Apollo inertial reference integrating gyro is discussed in terms of its initial selection, procurement history, design description, failure history, and problems. The Apollo IRIG design is based on the reasonably successful Polaris Mark II model 25 IRIG. Unfortunately, no data were available on Polaris instruments relative to bearing life. As a result of bearing and contamination problems, four vendors supplied IRIG units during the Apollo Program.

The two major problem areas were contamination of the float cavity and wheel-bearing failures. Contamination was primarily a low-yield (high rejection rate) problem involving state-of-the-art cleaning procedures and practices. Wheel-bearing failures resulted in several actions that were taken over a period of years to increase the life and improve manufacturing yields.

Selection of MIT as the prime G&N contractor made the selection of an MIT-designed gyro probable. Because early mission-error analyses indicated performance compatibility, the MIT system proposal was based on the use of the Polaris system; and, because the Polaris procurement had been reasonably successful, the Polaris Mark II model 25 IRIG was selected as the Apollo gyro.

Certain changes were made in adapting the Polaris instrument for the Apollo application. The torque generator was changed from a two-winding, current-product torquer to a single-winding, current-squared torquer to provide a more efficient computer torquing interface. Torque generator and signal generator excitation frequencies were changed from 4800 and 800 hertz, respectively, to 3200 hertz to match the computer timing-pulse frequency.

Of all the manufacturing and technological problems that were encountered in the 8-year span of the development and manufacture of the Apollo PGNCs, the IRIG ball bearing problem was the most persistent and was the last to yield to solutions. To understand the origin of the problem, a review of the early decisions in the Apollo Program is necessary. The inertial instruments, of course, are the heart of any inertial system design. In early Apollo G&N concepts, the Polaris missile IRIG was considered to have adequate performance to be the base design for the Apollo system. Thus, with minor changes (all outside the floated wheel assembly), the Polaris model 25 IRIG became the Apollo IRIG. Because the philosophy of the Apollo Program was to build on existing technology if it were adequate, no reason to suspect a problem in adapting the Polaris wheel package was apparent. In fact, the Apollo Block I gyroscopes used the same wheel-assembly line as the Polaris line, with mixed parts. The wheel time expected to accrue before launch was 2000 hours for the early flights and 1200 hours for later flights. These estimates proved to be approximately 40 percent low. No data were available on Polaris instruments relative to useful life. Although the basic failure rate with time for the Polaris wheel seemed adequate for the Apollo application, the basic difference in operating time was not appreciated. This dramatic difference is illustrated in figure 14.

The flight operational techniques of the Apollo Program have required constant IRIG wheel operation, which amounts to more than 200 hours on the design-reference

lunar landing missions. Little engineering effort or management concern was spent on the IRIG bearing during the first years of the Apollo Program because the inadequacy of the design for the application simply was not recognized. In fact, experience was thought to have demonstrated the adequacy of the design for in-flight reliability. The effect of the low average wheel life on the ground prelaunch-checkout logistics was not appreciated.

At the G&N program management level, the cost of bearing hardware has never been a significant limitation. Unfortunately, cost probably has been a limitation for the vendors. Of course, cost alone cannot yield better bearings when the desirable elements of the product are uncertain. During the Apollo Program, vendor cost per bearing set has ranged from a few hundred dollars to almost \$1000. That figure, with a typical 20-percent yield, results in a cost of as much as \$5000 per delivered gyro. Those involved in vendor process efforts were aware of these facts and made efforts to "improve" bearing specifications in both geometrical tolerances and visual criteria. From 1962 until the time of publication of this report, more than \$20 million has been spent on the Apollo IRIG, and the high failure rate of the bearing assembly has been the leading gyro problem.

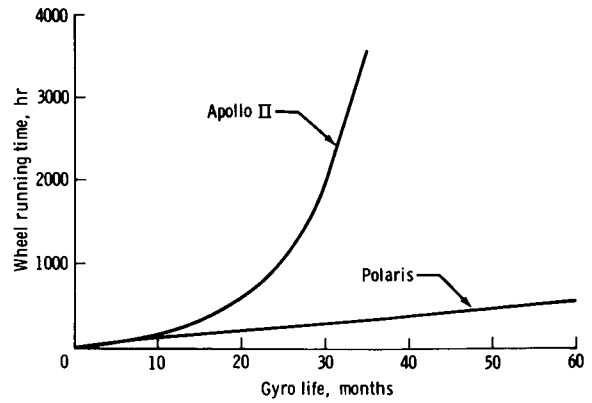

Figure 14. - Inertial reference integrating gyro operating hours as a function of months.

CONTRACT HISTORY

A significant contributing element to the expense and difficulty in solving the gyro problems was related to the method of contracting and defining contractors' responsibilities. The PGNCS development contractor was given the design responsibility while as many as four different organizations, including the development contractor, were attempting to manufacture the gyro to the designer's specifications at one time in the Apollo Program.

The initial Block I Apollo gyro procurement was a single-source, competitive procurement for 70 instruments and was awarded to contractor A on a cost-plus-fixed-fee basis. Follow-on procurement for groups of 30 and 24 instruments was contracted on a sole-source basis by modification of the existing contract.

During the Block I procurement, it became evident that a dual competitive source would have been desirable. Considerable discussion was held at MSC regarding establishing a dual competitive source for the Block II procurement. Primarily because of the cost consideration, contractor A was selected to manufacture a total of 300 Block II instruments on a cost-plus-incentive-fee contract. The delivery and performance incentives were poorly balanced; thus, it always was in the contractor's interest to seek waivers on "out of specification" instruments rather than correct them. Later, the

end-item total was reduced from 300 units to 235 units. In the spring of 1967, the high failure rate on Block II gyros made the need for a repair program or for additional procurement evident. In June 1967, a fixed-fee supplement to the basic Apollo contract was issued for the repair of failed units that did not require disassembly below the float level. In February 1968, another supplement was made on a sole-source basis to contractor A to include the repair of all failures as required to support the contract plus 10 units.

By late 1967, the production yields were at zero at contractor A facilities and issues were developing with the development contractor regarding whether the design were buildable or the manufacturer were controlling his progress. The development contractor offered to prove they were buildable by manufacturing some in-house.

A contract was awarded to the development contractor for 40 instruments. A competitive subcontract was eventually awarded to contractor B for 32 of the 40 instruments on a cost-plus-incentive-fee basis by the development contractor.

By 1969, the bearing yields at contractors A and B and the development contractor were almost zero. A competitive fixed-price contract was issued to contractor C for the procurement of 25 IRIG units and included a design and qualification responsibility for the bearing package. In March 1972, an option was exercised for an additional 15 IRIG units. The last unit was delivered in February 1973.

DESIGN DESCRIPTION

The Apollo gyro was procured in two basic configurations: the Apollo I IRIG, which was used in the Block I G&N system, and the Apollo II IRIG, which was used in the Block II CM and LM lunar mission configurations.

Apollo I IRIG

The Apollo I IRIG is a single-degree-of-freedom, floated, integrating gyro. The wheel assembly is supported by a pair of preloaded, angular-contact (R-2 size) ball bearings, adjusted to achieve an isoelastic structure having equal compliance along the spin and output axes. The wheel assembly is driven by a two-phase, synchronous, hysteresis motor of 28 volts at 800 hertz. The wheel is enclosed in a sealed, spherical beryllium float. The float pressure is internally maintained at $50\,663\text{ N/m}^2$ (0.5 atmosphere) of helium, which provides good heat transfer and reduces wheel windage torques. The Polaris Mark II and Apollo I float assemblies are identical.

The float is suspended in a brominated fluorocarbon fluid, which provides flotation and damping. The fluid is fractionally distilled to yield a narrow-cut blend of approximately equal viscosities to minimize fluid stratification.

A ducosyn at each end performs the tasks of magnetic suspension and torque and signal generation. The ducosyn is composed of a separate magnetic suspension and

transducer microsyn mounted as a single coaxial, coplanar assembly. The potted stator assembly is mounted to the case, and two separate rotors are mounted to a single ring at each end of the float assembly. The signal generator is an eight-pole, E-connected (centertap, single phase) microsyn at 2-volt, 3200-hertz excitation. The torque generator is an eight-pole torquer. Only radial magnetic suspension was provided. A normalization package was added to the signal generator end to normalize gyro gain and the temperature-sensor output. The package also contained an end-mount ring and heater having a slot alined with the input axis of the gyro. The implementation of a prealined, normalized instrument greatly simplified IMU assembly and enhanced instrument-to-IMU data correlation.

Apollo II IRIG

The major changes reflected in the Apollo II instrument were in the ducosyn and the normalization assemblies. The Apollo I float assembly was unchanged. The signal generator and torque generator microsyns were changed from 8 to 12 poles to reduce residual magnetism caused by pulse torquing. The residuals have an adverse effect on bias drift. At the same time, the radial suspension stiffness was increased by a factor of 3 and axial suspension was added, both to improve bias stability. A bias-compensation winding was also added. The change to the 12-pole torquer introduced a scale-factor sensitivity to external magnetic fields. The sensitivity was large enough to require Mu Metal shielding of the torque generator. Signal generator excitation was increased to 4 volts. The printed circuit bond was redesigned, suspension capacitors were repackaged, bias compensation was added, and a preamplifier was added to the gyro prealined assembly. Figure 15 is a cutaway illustration showing the main features of the shrouded gyro.

FAILURE HISTORY AND FAILURE SUMMARY

Although specifications were written for all levels of testing, failures were not measured solely by specifications. All significant parameter data on units from component incoming and acceptance tests through all system- and spacecraft-level testing were collected through a reporting system and converted to punchcards and magnetic tape in formats suitable for data processing and printing. Monthly inventory listings and data summaries were distributed to cognizant persons. Determining failures was usually a process of data review by responsible parties, and failure was assessed whenever data indicated one or more of the following.

1. Performance unacceptable for the mission
2. Significant wheel-bearing degradation
3. Unexplainable behavior that could not be demonstrated to result from a known and acceptable cause
4. Indication of float restriction or hangup

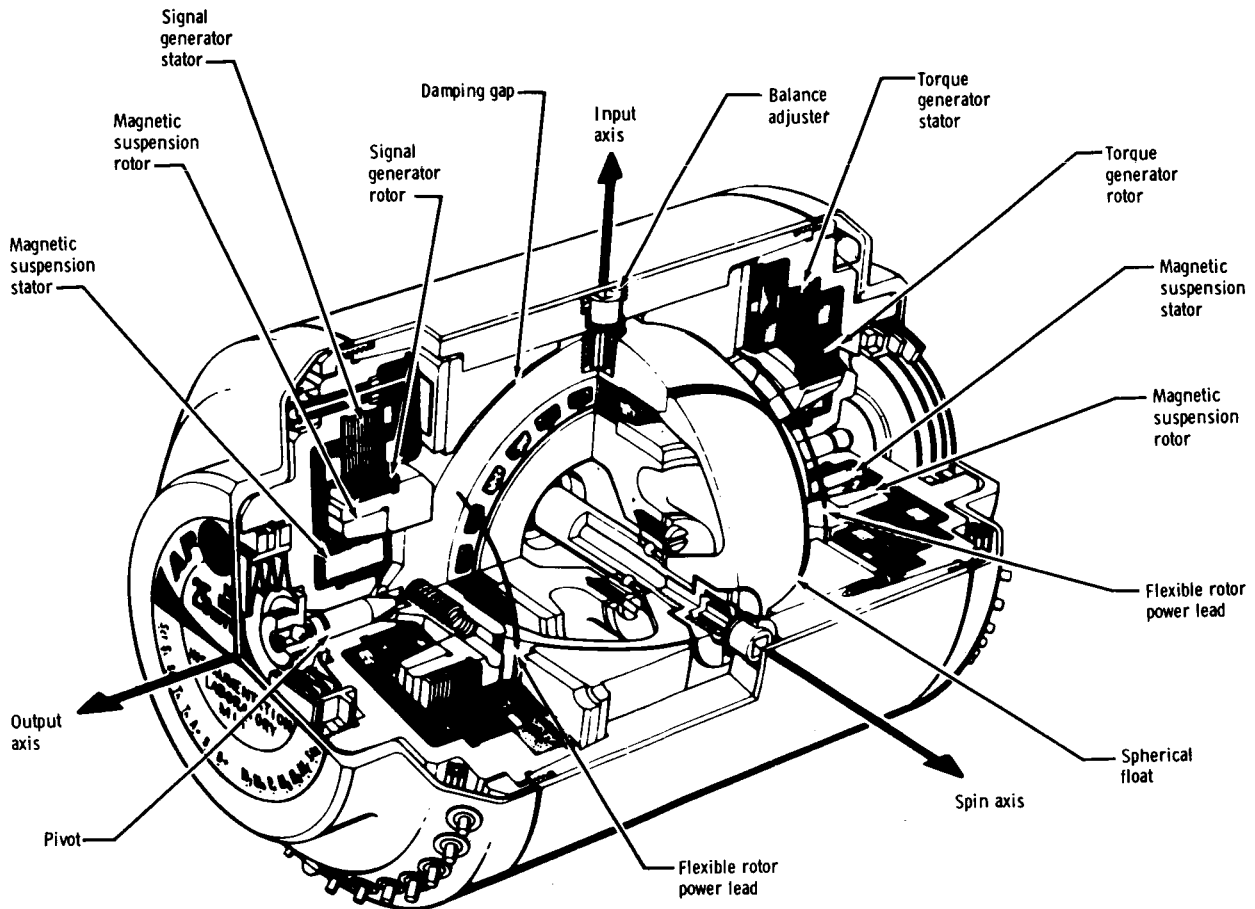

Figure 15. - Generalized pictorial schematic of Apollo II IRIG.

In figure 16, the probability boundaries for a successful mission are shown as a function of gyro performance. It should be noted that a 20-meru null bias drift (NBD) and a 200-meru acceleration drift along input axis (ADIA) are the outer bounds for a successful mission. These performance levels are far outside the operating characteristics of a properly functioning instrument.

At the factory, failure judgment was based on drift performance parameters and substantiated by other data intrinsic to the type of failure. Bearing failures, for example, would require rundown time, differential wheel power, and perhaps retainer beat-frequency data to substantiate failure as indicated by ADIA stability. All indications of float restriction were verified by special tests specifically designed to detect such restriction. In the field, evaluations were based primarily and more subjectively on drift performance data. Other failure criteria, such as the Delta 25 criterion by which a wheel failure was assessed whenever a level shift in ADIA greater than 25 meru was experienced, were also used.

Figure 17 is a failure summary for the Apollo I and II gyros. The Apollo I data are for bearing failures only, because such failures comprise the bulk of the failed units. Approximately 45 of the first failures (102 total failures) were due to float restriction. This mode of failure tended to be predominant and detectable relatively early in the IRIG life. In addition to the high incidence of float-freedom failure in the Apollo II instruments, the bearing failure rate was 25 times that of the Apollo I units. Although many possibilities could be offered to explain the differences, the following are considered most significant.

1. For the Apollo I gyro, no specific sensitive float-freedom testing was performed at the gyro or system level after gyro delivery.

2. For the Apollo II gyros, no visual inspection of the bearing was made after run-in because run-in was performed in the float rather than in a dynamometer.

Finally, wheel performance of the Apollo II gyros was categorically worse than that of the Apollo I gyros, although both were within specification. (See the subsequent section entitled "Bearings.")

PROGRAM PROBLEMS

The two major problems of the program were float-cavity contamination and wheel-bearing failure. These failure modes had the most significant production effect on gyros and systems and were the primary reasons for removal of inertial measurement units from spacecraft and for initiation of an extensive repair program.

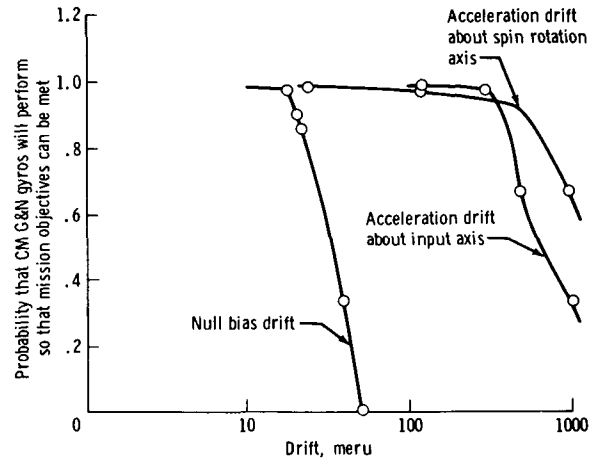
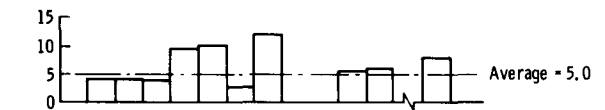
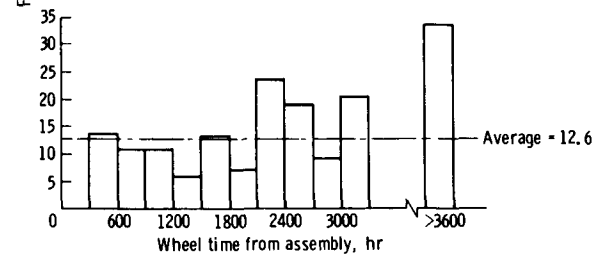

Figure 16. - Apollo IRIG mission performance requirements.



(a) Apollo I.



(b) Apollo II.

Figure 17. - Gyro bearing failure rate as a function of wheel time from assembly.

Float Freedom

Float-freedom failure was the second most common failure mode of the Apollo PGNCS. Approximately 60 out of 235 delivered Apollo II gyros failed because of float restriction. After concerted effort, float-freedom failures or evidences of contamination were largely eliminated during the last year (December 1968 to December 1969) of the repair program. Progress was made slowly and in stages. When the repair program started in early 1967, the contractor attempted to defend the contamination level and the incurred failure rates as representing the state of the art. By comparing the production float-freedom-test failure rates of manufacturers involved in the Polaris Mark II IRIG, it was shown that an order of magnitude improvement was achievable.

To maintain progress on the problem during the repair program, the following actions were taken.

1. All defective units, regardless of cause of failure, were carefully scrutinized for particle contamination. The quantity and size of particles found were noted.
2. A weighted contamination counting system was developed. The model was based on the weighted volumes of the four damping-gap sizes characteristic of the model 25 IRIG and the number of particles with major dimensions exceeding the respective gap sizes.
3. Tabular summaries of contamination findings, grades, and related details were kept, and correlation was attempted. The distribution of contamination grades was also examined.

The results of these efforts were that no distribution pattern was evident and no correlation with event, time, personnel, or other detail could be established. It was concluded that contamination resulted from uncontrolled process events.

In late 1968, contractor A implemented the following six-point program.

1. Improved inspection microscopy was incorporated. This step involved the use of better microscopes having good depth of field and dark background lighting or shading to enhance the perception of light-colored or relatively transparent particles.
2. The final assembly process was minimized. The number of assemblies or piece parts that went to final assembly was minimized by doing as much as possible at lower levels and even by redundant final assembly operations, where necessary.
3. A flush-and-filter-until-clean operation was incorporated on all items going to final assembly. Cleanliness was determined by filter analysis of the flushing medium and by microscopic inspection.
4. Blue filtering of the flushing medium was added to the existing white filtering because it had been shown that, as a result of insufficient contrast, the white filters would not show light-colored contamination.

5. The gyro-fill overflow was analyzed for contamination. The presence of any particles larger than 75 micrometers was cause for assembly rejection.

6. Intensive personnel training programs designed to teach processes and techniques and to instill an extreme contamination consciousness were incorporated.

After full incorporation of these points, production and system float-freedom failures were practically eliminated.

Contractor C implemented the same basic contamination control procedures. The MSC engineering and quality control personnel established a priority for this area and finally approved the contamination control efforts. Experience has shown the extensive efforts to be extremely successful.

Bearings

The Apollo Program was started with the same bearing metal used in the Polaris gyro, and torque was monitored by dynamometer for a 50-hour run-in period followed by float assembly and a brief 1- to 2-hour milliwatt evaluation (fig. 18). The Apollo Block I basic wheel package, incorporating minor changes outside the float, was used for the Apollo Block II IRIG build program. However, the 50-hour dynamometer screen was replaced by a direct build of the wheel into a float, and the milliwatt power trace for a 50-hour screen was used (fig. 18). This procedure was followed to reduce the possibility of contamination of the screened wheel in the float assembly and to ensure that the screening was done in the final running environment.

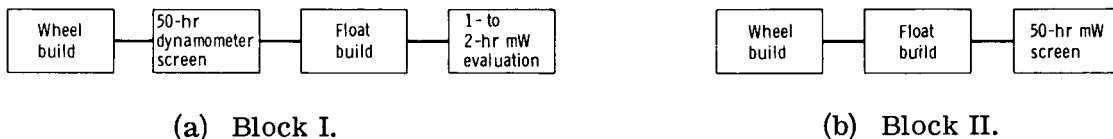

Figure 18. - Gyro test sequence.

Soon after the Block II gyroscope production was completed, it became evident that wheel failure rates would require an extensive repair program. An experience of 8000 to 9000 hours calculated mean time between failures on the Block I gyros decreased to 3000 to 4000 hours for the Block II gyros. A multifold bearing-improvement program was initiated in late 1967 with the beginning of the repair program. This effort included four areas: (1) a smoother (double honed) metal finish on the bearings; (2) a sintered nylon (Nylasint) retainer that was impregnated to the upper limit of the specification and that would yield a larger quantity of oil; (3) a more complex cleaning process to aid oil-film retention by the metal; and (4) a longer, more intensive run-in screen evaluation. It was hoped that the smoother metal and the better cleaning process would improve assembly yields; however, the added oil-handling capability and the more rigorous screening procedure were aimed at attaining longer life.

Of course, all deviations from the Block I configuration were suspect. The first potential problem area eliminated was that of the retainer; however, trial builds with the Block I Synthane retainers also resulted in failures in the first hours of dynamometer monitoring. Next, the surface film developed with the new cleaning technique became suspect. Although the impossibility of measuring a surface film or inspecting for the absence of a surface film delayed and clouded test results, no improvements from zero yields were demonstrated by using any of the cleaning methods on available metals. Cleaning agents used included caustic solutions, detergents, and all common solvents that were well-mixed, vacuum dried, and stirred by ultrasonic means.

On a longer duration time scale, the condition of the surface finish of the races was investigated. The goal of this task was to return to Polaris/Apollo Block I surface-finish characteristics. Scanning electron microscope and replication studies were made of the double-honed metal.

As in all phases of the Apollo Program, documentation on the gyroscope bearing was thorough. However, none of the finishing processes used on the bearing were shown on Apollo drawings. The critical processes were identified, and the vendors kept these documents in bonded files. A review of the bonded files of both major vendors did not allow a duplication of the finishes found in the Apollo Block I IRIG program. The major delay in studies of raceway-finishing techniques was the lack of any evaluation (other than successful bearing assembly run experience) or inspection tools that could be used to determine quickly the presence of asperities and lapping compounds of several micrometers. The use of a scanning electron microscope and an interference microscope by a bearing vendor provided these necessary tools. With these tools, processes can be better controlled to ensure that metal cutting has been effected on each successive stage, that lapping material has been removed, and that the surface effect of the previous process has been eliminated. The timing of the Apollo Program was such, however, that the resulting metal could not be obtained expeditiously.

While the long-term bearing metal studies were proceeding, program commitment required support within a shorter timespan. Because only hardware giving zero or very low yields was available, two approaches were taken to use the metal available. One approach was to change the bearing design so that less stress would be placed on the metal as it existed, and a second approach was to refinish the metal by a metal-removing process to improve the surface characteristics.

An alternative method, capable of improving yields and of extending bearing life and performable within the time available to support the Apollo production effort, was to increase the oil-film thickness. It has been demonstrated repeatedly that bearing life is affected by the relationship of film thickness to the sum of rolling-surface finishes. Because previous efforts had been made to improve the surface finish, it seemed reasonable to consider increasing the oil-film thickness.

The most viscous commercial basic-bright-stock lubricant was selected, to which was added 1 percent oxidation inhibitor to ensure long life and 3 percent tricresyl phosphate as a mild extreme-pressure additive. This oil was termed N-3. Tests on four bearings showed a running life of 200 to 300 hours before visually detectable tracks were developed on the raceway. The same hardware lubricated with standard V-78 oil had been limited to a running time of less than 16 hours before burn tracks appeared.

Although time was too limited to develop life-test data before making commitments, this quick burn-track evaluation did give a valuable indication that a definite operational margin improvement would be obtained by lubricant change alone. Nevertheless, whether this evaluation was sufficient for the program was a matter of concern.

Because the quantity of oil in the contact area would always be marginal without significant bearing design changes, more effective ways of developing films were considered with such changes. In discussions with A. Cameron and D. Dawson of Leeds University, London, England, the significance of the inlet-throat meniscus dimensions was emphasized. Then, it followed that, if the meniscus dimension could not be increased, the Hertzian area could be decreased in an attempt to reduce the starvation. After much analysis and discussion, 0.36 to 0.45 kilogram (0.8 to 1 pound) was selected as a nominal static preload instead of the 1.36-kilogram (3 pound) preload that was used previously. This hypothesis has been demonstrated by film thickness measurements made in a running bearing.

In mid-1969, the most promising of the changes were combined and incorporated as a group. Because bearing manufacturers had not been able to produce metal that was equivalent to that used in the Block I program, improved polishing and refinishing techniques were used on existing metal. This metal was combined with an inner-race-riding Nylasint retainer that had a slightly higher percentage of a three-times-more viscous oil and was assembled with a 0.36- to 0.45-kilogram (0.8 to 1 pound) nominal preload. To increase the effectiveness of the run-in screen, off-nominal running conditions were introduced. A low-temperature run at 325 K (125° F) and a high-temperature run at 344 K (160° F) were incorporated before the 200-hour dynamometer screen at 331 K (137° F). The low-temperature run was designed to increase the viscous drag of the oil and to determine whether the retainer was stable marginally. The high-temperature run, which also was incorporated to determine the retainer stability, reduced the potential oil-film thickness to near that of V-78 oil. In all evaluations of metal process changes, the 1.36-kilogram (3 pound) preload, V-78 oil configuration was used to provide quick evaluation of the effectiveness of the change.

The total resulting screening test is summarized in figure 19. Metal yields of zero at the beginning were increased to a working 10 to 15 percent when only the metal reworking was incorporated and to more than 50 percent when heavy-oil/low-preload changes were added.

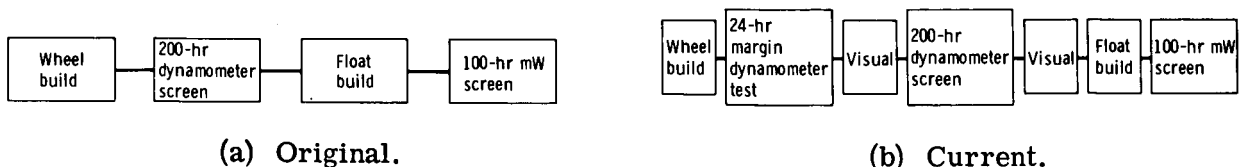

Figure 19.- Gyro test sequence, Block II repair and replacement.

Normalization Circuit Board

Numerous problems were encountered with the printed circuit board and harness used in the gyro normalization assembly, including the following.

1. Improper harness layout causing insulation cold flow over pins and sharp edges
2. Cracked and cold solder joints
3. Connector-pin solder failures caused by rigidly soldering floated connector pins to the circuit board

The problems caused numerous removals of gyros from inertial measurement units for inspection, rework, and retrofit. Good product-design review might have averted many of these problems.

Gravity Transient

The occurrence of gravity transients was due to entrapment of damping fluid in a nonvented annulus around the gyro output axis. The annulus resulted from a machining relief on the rotor holder. When the rotor was assembled and cemented to the holder, cement would partially fill the annulus in random geometric patterns. These cement blockages prevented the annulus from being properly filled with fluid during gyro fill. Later, seepage under operating pressures would either fill small cavities in the annulus to cause mass shifts or would partially fill a cavity to cause an unstable mass distribution. This seepage caused a g-sensitive drift for a relatively short time when the gyro was repositioned during testing. The problem was avoided by careful development and application of the cement.

Hot Storage Sensitivity

Hot storage sensitivity is believed to have resulted from seepage of damping fluid into the small cement voids in the rotors. This seepage creates a g-sensitive drift similar to the gravity-transient condition, but for a much longer time. A significant problem existed in the contractor B IRIG units. Polaris IRIG units still have this problem to some degree. Contractor C incorporated a high-pressure impregnation on the rotors in an effort to preclude hot storage sensitivity; this procedure apparently succeeded because hot storage sensitivity has not occurred in contractor C IRIG units.

Tolerance Problems

Other problems were encountered because of inadequate design review of worst-case tolerance combinations. Problems caused by this deficiency included the following.

1. Suspension hangup: Excessive end shake along the gyro output axis allowed float corner positions that were unstable and from which the magnetic suspension would not recenter.

2. Alinement problems: Worst-case tolerance combinations between end housings and end-cover trunnions prevented adequate grip to maintain alinement. The same type of situation existed between the end-cover trunnion and the end-mount heater.

Field Sensitivity

The initial Apollo II gyros showed an extreme torquer-scale-factor sensitivity to external magnetic fields. This sensitivity was cured by changing the torque generator end-cover material to Mu Metal.

Workmanship Problems

The forward production and early repair program included a constant stream of workmanship and production-error problems. An improvement program with the following features was implemented.

1. Organizational merging of all engineering functions to eliminate diverse responsibilities
2. Generation of new gyro-build documentation to a usable format (Previous documentation involved so much descriptive material and so much cross-referencing that it was impractical to use.)
3. Gross improvement in the quality of build documentation and process controls
4. Enforcement of the control and use of build documents (Previous practices allowed many different persons to make redline changes to build documents with no central control authority. Quality control also required that build documentation be kept current.)
5. Implementation of a tight failure-analysis/corrective-action loop
6. Gross improvement in the management and discipline of failure-analysis functions
7. Motivation and discipline of technicians to ensure consistency and control

After implementation of these improvements, a well-controlled program evolved and workmanship problems were virtually eliminated.

PULSED INTEGRATING PENDULOUS ACCELEROMETER

Three pulsed integrating pendulous accelerometers are used in the Apollo IMU in an orthogonal set to sense acceleration in any direction. The PIPA consists of an unbalanced float with attached ferrite rotors, high-viscosity damping fluid, a signal generator, a torque generator, a main housing, and a suspension module together with associated electronics and calibration modules.

With zero acceleration, the float is constantly torqued three pulses in one direction and then three pulses in the other direction. This process is called "3:3 moding." Accelerations of the IMU resulting from forces or applied thrusts create torques on the unbalanced float. These torques are summed by the float with those caused by the 3:3 moding. A signal is sent to the electronics module, which determines the direction of rotation and generates equal but opposite torque signals. These signals are sent to the torque generator, which drives the float back within the limit-cycle threshold. The computer receives the difference in plus and minus torque commands proportional to a change in spacecraft velocity and uses the signals as data to compute spacecraft trajectory information.

DEVELOPMENT HISTORY

This discussion of the PIPA development history includes the results of a repair program and of a comprehensive performance data analysis.

Conceptual Phase

The Polaris Mark II inertial system design was selected for the Apollo spacecraft. The selection of the accelerometer was limited to a device that would be compatible with the Polaris system design and also meet the Apollo requirements. Because no existing accelerometer completely met both requirements, the Polaris model D, size 16, PIP was selected on the basis of compatibility, simplicity, reliability, and ease of modification.

Two initial modifications were made to the accelerometer. Reduction of the pendulous mass from 1 gram-centimeter to 0.25 gram-centimeter increased the acceleration range from 4g to 16g, and tapering of the ducosyn rotors to provide magnetic suspension axially as well as radially improved the scale-factor stability from 1000 parts per million (ppm) to within 100 ppm.

A contract was awarded in June 1962 to produce the initial 72 PIPA units. To minimize the delivery time for the first few units, the contractor modified some available Polaris subassemblies and the PGNCSS development contractor supplied some major hardware items. The first six Block I (0) units were delivered in October 1962. Acceptance testing was performed at the PGNCSS development contractor because the contractor did not have operational Apollo acceptance test equipment at that time.

Block I Definition

The first 19 Block I units, which incorporated a torquer reset coil, were delivered in February 1963. Acceptance testing was performed at the contractor facility starting with unit 1A21. The design of the torquing loop was changed from ternary to binary in March 1963 because the testing of Block I (0) PIPA units revealed that residual magnetic effects caused large bias variations. These variations were determined to be dependent on the polarity and frequency of the ternary pulses, and the design change to continuous

alternate binary torquing neutralized or averaged these effects. A reliability test program initiated in May 1963 consisted of a bellows evaluation, a PIP performance evaluation, and a suspension module qualification. The bellows evaluation was completed in July 1965; the results showed that both the nickel bellows and the silver antimony bellows exhibited cycle life, spring rate, and volume compensation adequate for normal PIP operation. Subsequent experience has indicated a requirement to place emphasis on quality control in bellows manufacture and on inspection by X-ray examination of the assembled instrument. The performance evaluation and suspension qualification test programs were terminated in November 1965 with a technical decision that all useful data had been extracted.

Block II Definition

In September 1963, the PIP assembly design was changed to include an end heater, a suspension module, and a plug-in cable. A major cause of bias changes was eliminated by moving the torque generator from the inboard end, which contained the mounting arrangement, to the outboard end. This relocation eliminated a major source of bias changes by removing the nonsymmetrical stresses on the torquer caused by clamping pressures during the alinement of the unit to the stable member.

A contract was awarded in June 1964 for the manufacture of 200 Block II PIP units. Process changes to the alinement-ring machining operations were initiated to ensure limited dimensional variations at each step for achieving an alinement capability of 10" of arc. A failure-analysis/corrective-action program was initiated in December 1965 by teardown and analysis of the first group of 14 PIPA units. This program revealed many defects (contamination sources, voids in cement, and wiring discrepancies) that were significant to unexplained failure modes and that contributed to follow-on design changes.

An additional 49 Block II PIP units were added to the contract in early 1966. These units incorporated the latest assembly processes, float sealing techniques, X-ray inspection of bellows, and packaging of the suspension module as shown in figure 20.

Repair Program

In the early part of 1967, the failure rates together with the program length required an additional 50 instruments. An analysis of failure modes dictated that improvements in the float sealing operation, the bellows quality control, and the final instrument seal were necessary to decrease the amount of air entering the damping fluid. Sample instruments were built and tested using new techniques and processes.

A PIP repair contract was awarded in December 1967 for 50 units. The contract called for harness and suspension module repair on 10 units and a complete teardown and rebuilding of 40 units, using the new manufacturing techniques in bellows, float, and housing seals.

In the final configuration released in June 1968, the redesigned housing and assembly procedures provided the final instrument seal. Basically, the instrument

formerly had been assembled within a container of damping fluid with an O-ring providing the final seal and with no method of checking this seal. In the new design, the instrument was assembled dry with a cement-band seal taking the place of the O-ring, leak-checked to 1×10^{-9} cm³/sec, and then filled with damping fluid through portholes in the end. Delivery of the repaired units was completed in May 1969; 44 internally repaired units and 7 externally repaired units were delivered for a total of 51.

Data Analysis

A comprehensive analysis of PIPA data obtained from the Apollo Block II instrument population was completed in September 1968 with the following results.

1. At least 94 percent of all scale-factor and bias measurements were within Apollo system specification.
2. Turn-on, turn-off, and random "gaussing" represent data points outside the system specification and are uncorrelated with the main body of data. System performance data analysis should, therefore, not consider these data points.
3. IMU axis assignment does not affect performance.
4. The vibration environment does not affect scale-factor or bias stabilities.

RESOLVED PROBLEMS

The following problems were investigated and solved.

1. Several heater/sensor circuit failures occurred in Block I units. As a result, strain loops on the sensor wire and pull tests on the harness were introduced for the Block II units.
2. Impurities were found in the damping fluid in Block I units. Reduction in the use of Tygon plastic tubing and changes in the filtering processes eliminated this problem.
3. Many of the thin-wall connectors located on the suspension module were found to be cracked or chipped. The connectors were encased in potting material to prevent cracking and chipping.

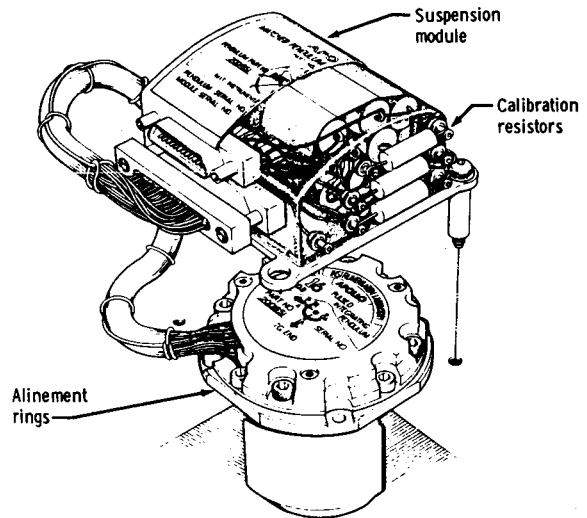

Figure 20.- Model D, size 16, pulsed integrating pendulum.

4. Several early Block II units were found to have fluid within the hollow float that caused variations in the float pendulosity and resulted in large and unstable changes in scale factor. The cause was traced to voids in the cement used to seal the float. Changes were made in the cementing processes, and a more viscous cement was introduced.

5. A small shift in input-axis alignment was observed in early Block II units. The cause was determined to be small voids behind the rotors that were partly filled with damping fluid. The damping fluid moved as a function of the instrument position and caused small pendulosity changes. The cementing technique was changed to alleviate this effect.

6. Many Block I and Block II units were found to have gas bubbles in the damping fluid, a condition that caused unstable bias. Three areas of gas leakage were suspect: (1) the gas-filled bellows, (2) the float assembly, and (3) the O-ring external seal. Improved bellows and float assembly leak checks were incorporated in the manufacturing process. When the repair program was initiated, a cemented bond was used instead of the O-ring. The outside seal as well as the bellows and float seals then were leak-checked. The instrument was then filled through small portholes in the end housing, after which the portholes were sealed with metallic compression seals.

CONCLUDING REMARKS

Conclusions and recommendations are presented by subsystem and component to reflect the individual coverage given the basic elements of the primary guidance, navigation, and control system in this report.

INERTIAL SUBSYSTEM

It appears that the schedule push early in the Apollo Program (i. e., fly by late 1963) may very well have led to inadequate systems review before designs were frozen. Within the inertial subsystem, however, the conservative design decisions in most cases were very close to optimum. Use of the Polaris technology certainly reduced the risk and effort required for most elements of the inertial subsystem design. Unrealistic workloads required of the crewmen in maintenance, fault isolation, mode selections, and operational techniques were the primary mistakes corrected in the change from Block I to Block II configurations.

COMPUTER SUBSYSTEM

The Apollo guidance computer has proven its capabilities, and spacecraft for future deep-space flights will probably use similar or larger onboard general-purpose

digital computers. In the development of future designs requiring additional sophistication, consideration should be focused on modernization of displays, the use of solid-state switching devices, and the use of higher levels of integration in logic circuitry. Further recommendations for future programs are as follows.

1. The specification control drawings for parts should include application information.
2. Computer design should include an isolated power supply to prevent noise susceptibility.
3. The number of components should be kept to a minimum; that is, one logic circuit type should be used to perform all logic operations.
4. Maximum use should be made of wire wrap for module interconnections. This connection has proved to be highly reliable.

OPTICAL SUBSYSTEM

A review of the Apollo missions shows that both the optical unit assembly and the alignment optical telescope performed the intended functions in a most satisfactory manner. The design, testing, and fabrication were well planned and adequate for the mission use of the two optical subsystems. This was further indicated by the use of the Apollo hardware long past the intended time frame.

The later equipment modifications were largely the result of a natural evolutionary process as requirements were better defined by actual mission applications. The overall performance of the optical subsystem can be considered more than adequate in function and outstanding in reliability.

Any recommendations for improvement would have to include better coordinated design functions and additional worst-case testing to ensure detection of equipment anomalies during extreme environmental conditions. More attention should be given to items that are considered to have limited lifetimes. Examples of problems that could have been corrected by early design changes or identified as limited-life areas are as follows.

1. Eyepiece fogging of the scanning telescope: Visual observations during environmental testing would have shown the need for a larger heater to prevent fogging of the scanning telescope eyepiece.
2. Refurbishment of the optical unit assembly: The beryllium corrosion passivation process and the motor-tachometer lubrication changes were successful only after the mistakes made during the first program to correct the same initial design deficiencies had been corrected. Refurbishment of the optical unit base assembly is an excellent example of the criticality of limited-life items.

3. Internal harness connector springs of the optical unit assembly: The optical unit assembly internal harness connector was an area in which a little design effort to prevent breakage of spring contacts would have precluded the need for a major retrofit. This problem is an ideal example of both design deficiencies and limited life.

INERTIAL REFERENCE INTEGRATING GYRO

The high-viscosity-oil changes made in 1969 produced higher bearing metal yields and more reliable gyro wheel assemblies than any previously produced in the Apollo Program. Other programs such as Polaris and some of the ball bearing manufacturers are incorporating this Apollo-originated basic configuration when operating conditions permit.

At the end of the Apollo gyro production effort, an advancement that is near accomplishment is bringing metal finishes of high integrity together in a configuration that develops an oil film several times thicker than the asperities and inclusions on the bearing surface. This achievement has been substantiated by direct film measurements.

Apollo experience has shown the importance of constantly improving processes in which the yields are low. Constant attention to fundamental elements of the design is necessary to provide basic design margins when possible. This method is preferred over attempts to optimize marginal processes.

Ball bearing designs for future instruments should be directed toward establishing large design margins and demonstrating them. The tools that can be used to accomplish this goal are advanced measurement techniques, qualification of bearing hardware, and the understanding of basic elastohydrodynamic theory. The extensive contamination control efforts together with the incorporation of an assembly-rejection filter criterion have practically eliminated the once major problem of float restriction.

The NASA Lyndon B. Johnson Space Center (formerly the Manned Spacecraft Center) was involved in a much closer and detailed control of the production program of the final contractor (contractor C) of the inertial reference integrating gyro. Even small Class II changes required Manned Spacecraft Center concurrence. Very close control is extremely important for obtaining consistently good gyros.

PULSED INTEGRATING PENDULOUS ACCELEROMETER

The performance of the pulsed integrating pendulous accelerometer has actually exceeded that required for the Apollo Program. In retrospect, consideration given to alternate simpler accelerometers early in the program could have saved money and system test time. The large number of magnetic suspension problems that occurred might have been smaller if the pendulous mass had been reduced by a factor of 2 rather

than 4. This reduction would have provided an acceleration range of 8g, which would have been adequate for the Apollo mission requirements. The bubble problems and contamination of the fluid could have been reduced earlier by initial X-ray screening and by exercising more care in cleanliness control.

It should be emphasized, however, that the pulsed integrating pendulous accelerometer proved satisfactory for performing the Apollo mission as is evidenced in the analysis of both flight and test data.

Lyndon B. Johnson Space Center
National Aeronautics and Space Administration
Houston, Texas, February 12, 1976
961-21-31-89-72