

N76-31159

STUDY OF AN ACT DEMONSTRATOR
WITH SUBSTANTIAL PERFORMANCE IMPROVEMENTS
USING A REDESIGNED JETSTAR

Roy H. Lange
Lockheed-Georgia Company

and

Dwain A. Deets ✓
NASA Flight Research Center

SUMMARY

A study has been made of the feasibility of modifying a JetStar airplane into a demonstrator of benefits to be achieved from incorporating active control concepts in the preliminary design of transport type aircraft. Substantial benefits are shown in terms of fuel economy and community noise by virtue of reduction in induced drag through use of a high aspect ratio wing which is made possible by a gust alleviation system. An intermediate configuration was defined which helps to isolate the benefits produced by active controls technology from those due to other configuration variables.

INTRODUCTION

Active controls is a developing technology which could offer substantial payoffs for the air transport industry. Three aspects must be developed before active controls is ready for application. These are: highly reliable fly-by-wire systems, implementation of active control functions, and integration of the active control system into the airframe preliminary design process. The first of these, fly-by-wire, is being adequately addressed in several programs such as the F-8 Digital Fly-By-Wire (DFBW) (refs. 1 and 2). The second aspect, implementation of active control functions, is progressing rapidly in programs such as the B-52-CCV flight tests (ref. 3). Although for single design points, the flight tests have validated the procedures and modeling techniques used in the designs. Active control functions are also being introduced into operational aircraft in order to expand aircraft capabilities. For example, the C-5A Lift Distribution Control System (ref. 4) reduces wing fatigue.

Limited uses of active controls are also finding their way into initial designs to improve performance. For example, a relaxed static stability system is part of the basic YF-16 augmentation system (ref. 5).

The third aspect, integration of active control systems into the preliminary design, has not progressed as rapidly. It is only through the leverage of resizing the airframe that maximum performance benefits are possible. The ATT system studies (ref. 6) included active controls in their integrated preliminary designs, but the designs were never implemented and flight tested, thus verification of the predicted benefits was not possible.

Active controls, then, is clearly emerging as a viable technology for certain airplane applications. Whether or not it will provide realizable benefits for civil transport aircraft is unclear. There is a serious lack of flight verification that promised performance benefits are actually achievable for transports. Recognizing this situation, the NASA is considering various approaches for demonstrating the benefits possible from ACT in a way that would develop confidence within the air transport community. One approach being considered is to redesign, modify, and flight test an existing jet transport to determine the ACT benefits.

This paper presents the results from a feasibility study into the reconfiguration of a Lockheed JetStar, making full use of active controls in the redesign, in order to minimize fuel requirements. The emphasis was on the integration of active controls into the preliminary design in order to maximize performance benefits. In order to more effectively integrate the various aspects of active control, a digital fly-by-wire system was assumed to be available for system implementation.

SYMBOLS

AR	aspect ratio
C	wing chord
$C_{L_{CR}}$	cruise lift coefficient
$C_{L_{\alpha}}$	lift curve slope, per radian
L/D	lift-to-drag ratio
n_z	normal acceleration, g
S	wing area, feet ²
W	weight, pounds
A	wing sweep angle, degrees

STUDY FORMULATION

Study Objectives

The feasibility study summarized in this paper had as its primary objectives to determine whether substantial performance benefits could be shown from a synergistic redesign of the JetStar airplane utilizing Active Controls Technology (ACT) concepts, to quantify these benefits, and to direct the configuration development toward the most substantial benefits possible in the reduction of fuel consumption. The utilization of other advanced technologies was encouraged if the interaction would enhance active control system benefits. This latter objective was directed primarily at supercritical wing technology, since it was considered an important aspect in order to make the study results applicable to future transports. An assessment was then to be made of the applicability of these benefits to transport class aircraft in general.

Ground Rules

The most important consideration was to minimize fuel consumption. The Model 1329-6A JetStar was to be used as the baseline aircraft to which modifications would be made. The design was to adhere to the following ground rules:

- (1) Maintain current design cruise Mach number (0.82).
- (2) Maintain or improve long range cruise speed, ride qualities, handling qualities, range, and payload.
- (3) Limit redesign to the wing and empennage. Avoid major redesign to the fuselage and related subsystems.
- (4) Assume the availability of a full-time digital fly-by-wire system with a reliability equivalent to that of the basic aircraft structure.
- (5) Restrict new technologies considered to those that will be ready for production application by 1980.

REDESIGN STRATEGY

The approach used in the JetStar redesign was to increase the lift-to-drag ratios in all flight regimes by exploiting the use of active controls technology. Increased L/D in takeoff, climb, cruise, approach, and landing produced a direct reduction in fuel required. Summarized in figure 1 are the major elements of the redesign strategy. Beginning with the reference JetStar aircraft, the first step was the application of supercritical wing technology in the redesign of the wing. The higher wing thickness ratios at a given cruise Mach number obtainable for supercritical airfoil sections offer the possibility of achieving adequate mission fuel volume inside

the wing. The redesign then followed two separate paths, one leading to an Intermediate Configuration without ACT and the other leading to an ACT Configuration which made maximum use of an active control system in addition to supercritical wing technology. The reason for defining these two configurations was to isolate the contribution to improved performance due to ACT alone. The rationale utilized in the ACT Configuration evaluation followed the sequence given on the right side of figure 1:

With the supercritical wings, reduce the wing sweep angle and increase the aspect ratio to reduce the induced drag.

Maximize the increase in aspect ratio and minimize any resultant weight penalty by the use of ACT to control acceleration response and wing bending moments.

Resize the empennage by the use of ACT relaxed static stability.

Wing Optimization

Some of the effects of the wing redesign process which were anticipated are illustrated in figure 2 for no ACT and ACT. The general trends in L/D, wing root bending moment, and fuel consumption are shown for variations in aspect ratio. Other parameters such as wing thickness, sweep, and area affect the performance as well, but were expected to have a lesser effect than aspect ratio. It is seen that L/D would be improved at the same aspect ratio as that for the JetStar by the deletion of the external tanks. Increase in aspect ratio should then provide major improvements in wing efficiency. However, as seen in the second graph, an increase in wing root bending moment at the same aspect ratio as the JetStar would accompany the higher lift curve slope of the supercritical wing section. Further increases in aspect ratio would incur substantial increases in bending moment and would be reflected in increased wing weight. An ACT system which reduces bending moment offers the potential for sizable reductions in wing weight, which would be reflected in reduced fuel consumption. This simplified description suggests that optimized wings would have aspect ratios of approximately 7 for no ACT and approximately 9 for ACT. A more detailed examination including all of the wing parameters, the various practical constraints, and the ACT system burden was necessary to see if the initial estimates of aspect ratio and fuel consumption were attainable.

Wing/Fuselage Mating Constraints

If a JetStar were to be used as an ACT demonstrator, several geometrical constraints would be necessary in order to minimize modification costs relative to the fuselage and major subsystems. Major constraints would be the preservation of spar attach points, the main landing gear attachment structure, and stowage provisions for the gear indicated in figure 3 by the heavy lines. An indication of the impact of these constraints on two candidate wing sweeps (0° and 20°) can be seen in the figure. At 20° sweep the gear support structure occupies the area of the inboard flap panel and there is insufficient depth to house the gear. At 0° sweep the gear is

accommodated, but there is a severe angle in the rear spar. From these two candidate wings, the impact of the wing/fuselage mating constraints is seen to be strongly dependent on the specific wing configuration being considered. The design would require an iterative process in which a candidate wing geometry is selected on the basis of performance considerations. It would then be examined from the standpoint of geometrical constraints. If it did not meet these constraints, a different configuration would be considered.

INTERMEDIATE CONFIGURATION

Selection of the Intermediate Configuration without benefit of ACT was heavily dependent upon matching the ride quality of the basic JetStar. Analysis showed that the worst case for the JetStar was in high speed descent. The criterion used in this study was a ride comfort index which was based on acceleration response and was proportional to wing lift curve slope divided by wing loading. To satisfy ride quality requirements, therefore, the Intermediate Configuration had to have a relatively low aspect ratio wing with moderate sweep to reduce the lift curve slope and gust sensitivity. Trade studies showed that a wing sweep of 30° provided satisfactory lift curve slope and fuel volume capability. The matrix of candidate wing geometries for the Intermediate Configuration is shown in figure 4 plotted against the ride comfort index normalized with respect to the JetStar. The configurations shown have a wing sweep of 30° , aspect ratios from 4 to 6, and wing loading represented by cruise lift coefficients from 0.30 to 0.40. For ride qualities equal to or better than those of the JetStar, the range of possible configurations varies from aspect ratio = 4, $C_{L_{CR}} = 0.34$ to aspect ratio = 6 where wing loading must be increased to an equivalent $C_{L_{CR}}$ of approximately 0.40.

The selection of the Intermediate Configuration is summarized in figure 5. The carpet plot shows fuel consumption in pounds per nautical mile plotted as a function of aspect ratio and cruise lift coefficient for the required 1850 nautical mile range. The data are provided for a constant wing sweep of 30° . Boundary curves superimposed on the carpet are for fuel volume, ride comfort, and rear spar location. Those boundaries result in a small range of feasible configurations which satisfies all requirements. The selected configuration has an aspect ratio of 5 and will cruise at a lift coefficient of 0.38. The fuel consumption is approximately 8 percent lower than that of the JetStar based on fuel used to accomplish the mission.

A plan view of the Intermediate Configuration is given in figure 6. The wing has an aspect ratio of 5.0, a sweep of 30° at the quarter chord, a wing area of 490 square feet, and a thickness-to-chord ratio of 16 percent at the mean aerodynamic chord. No change in the basic JetStar empennage is required for this configuration. These characteristics compare to those of the basic JetStar which has an aspect ratio of 5.27, a sweep of 30° , a wing area of 542 square feet, and a thickness-to-chord ratio of 11.2 percent.

ACT CONFIGURATION

Results from parametric studies to determine a candidate ACT Configuration are given in figure 7. The carpet plot of fuel consumption for candidate configurations for a sweep angle of 5.5° is based on a match of the cruise segment range requirement of 1850 nautical miles. Wing/fuselage mating constraints were satisfied at this wing sweep. Cruise altitude is assumed to be constant at 40,000 feet. All candidate configurations shown on the carpet plot satisfy the ride comfort criterion. Selection of the ACT Configuration is obtained from the intercept of a line representing adequate fuel volume and a value of minimum fuel consumption which is achieved with an aspect ratio of 9 and a cruise lift coefficient of 0.38. This gives a fuel consumption figure of 5.5 pounds per nautical mile. The start-of-cruise wing loading is 60.4 pounds per square foot for the ACT Configuration compared to 65.5 pounds per square foot for the JetStar. The ride comfort index of the ACT Configuration is 69 percent of the value of the JetStar and the Intermediate Configuration, which is a substantial improvement in acceleration response to turbulence.

Loads Analysis

The limited scope of this feasibility study necessitated restricting the loads investigations wherever possible; accordingly, a single flight condition was selected as being typical of the likely design condition. The condition selected was the cruise speed case (350 knots) at 20,000 feet altitude which represents a suitable datum; the effects of the major increase in wing lift curve slope of the supercritical wing also peak at about this cruise Mach number of 0.78.

The decision was then made to base the gust analyses on the discrete gust case. The short duration of the study did not permit comprehensive spectral density analyses of the several configurations envisaged, and the nonlinearities due to control system limitations (hinge moment, authority, and rate) were likely to be more significant at the larger gust velocities. Hence, the FAR 25 gust of 50 feet per second with a (1 - cosine) profile over a length of 25 chords was selected as the study basis. The overall lift-curve-slope value was 10.2 per radian for the ACT Configuration.

Some results of the loads analyses given in figure 8 show wing root bending moments for both maneuver and gust load conditions. Values for the JetStar airplane are noted by the symbols. The results show that gust loads are more critical for the aspect ratio 9 wing than those due to maneuver conditions. Studies of aircraft response to gusts with various gust alleviation system characteristics resulted in the selection of full-span trailing-edge flaps with a flap actuation rate of 60 degrees per second as the most effective system. The results of dynamic load response at a flap control rate of 60 degrees per second show a reduction in flexible wing root bending moment from 13.2×10^6 in-lb to 9.4×10^6 in-lb, which is of the same magnitude as the rigid wing with no ACT but is over twice the value for the JetStar. The impact of a wing with higher root bending moment than the JetStar is the need for a sizable wing carry through structure. A doubling of the bending moment is near the practical limit for increasing the strength of this carry through structure.

The results further indicate that maneuver loads are relatively insignificant, and no appreciable benefit would result from the incorporation of a maneuver load control system for this particular configuration. The amount of load alleviation obtainable for the flexible aircraft is much less than that for the rigid aircraft; therefore, the dynamic structural response must be included in any control system analysis. Preliminary flutter analyses, conducted to establish the torsional stiffness required for flutter and divergence prevention, revealed no apparent problems.

The time history of the root bending moment response given in figure 9 shows the substantial reduction of the initial gust load peak as a result of the ACT system. There is little effect on the second (negative) load peak. The gust-induced peak load occurs at about 0.2 second after entering the gust, which is long before any overall pitch response can occur. The basic objective of the active control system, therefore, is to destroy this lift, rather than to change the angle of attack. In an up gust, an upward flap deflection is required together with a proportional downward elevator deflection to counteract the pitching moment. The rapidity of the gust velocity buildup requires the high flap rates discussed previously.

ACT System Burden

The design to this point has assumed the availability of an ACT system; however, the penalty for providing such a system must also be assessed to determine practicality. Ideally, a relationship between system burden and system capability could be established for incorporation into the wing definition process. Unfortunately, this relationship is not easily defined, as illustrated in figure 10. Complexity and weight, indications of the system burden, are shown as a function of control system capability. This relationship is difficult to quantify; thus, only a subjective indication of increasing system penalty with increasing capability is shown.

Lacking a well-defined relationship, an ACT system configuration was assumed which would meet the needs of the design. Figure 11 itemizes the major features for this system and indicates where it might be placed on the penalty versus capability plot, specifically for weight as the penalty and reduction in bending moment as the capability. The gust alleviation portion of the ACT system involves five trailing-edge surfaces and actuators on each half of the wing. These surfaces serve as high-lift devices in addition to the active control function. The surfaces are pivoted at the 75-percent chord. The angular displacement limits for active control are $\pm 20^\circ$ in all segments. Each surface segment is supported on three hinges, and the segments are operated by dual-tandem hydraulic actuators. For a 29-percent reduction in root bending moment corresponding to an actuator rate limit of 60 degrees per second, the system would weigh approximately 370 pounds and would require approximately 6 gallons per minute hydraulic flow capacity. This burden was judged to be reasonable from practical considerations.

ACT General Arrangement

A plan view of the ACT Configuration selected is shown in figure 12. The characteristics of the ACT wing necessary to satisfy the objectives of this study consist of

an aspect ratio of 9.0, a wing sweep of 5.5°, a wing area of 560 square feet, and a wing thickness-to-chord ratio at the mean aerodynamic chord of 12.7 percent.

The horizontal tail has been reduced in size by 40 percent as compared to the tail of the basic JetStar. Of this reduction, 75 percent is made possible by a smaller tail size requirement for the ACT Configuration wing to achieve the same stability level as that of the basic JetStar. The remaining reduction is made possible by a relaxed static stability system.

Plan views of the Intermediate Configuration and the ACT Configuration are compared in figure 13. Large differences are apparent in aspect ratio, wing sweep, and horizontal tail size. Both aircraft have supercritical wing sections. The Intermediate Configuration has no active control technology applied. As stated earlier in the section on REDESIGN STRATEGY, in order to isolate the benefits attributable to ACT, all comparisons of performance were made between the Intermediate Configuration and the ACT Configuration.

COMPARISONS

Comparison of Weights

A comparison of weight buildup for the JetStar, Intermediate Configuration, and ACT Configuration is presented in figure 14. The major differences occur in the wing weight and mission fuel components. The Intermediate Configuration wing is about 700 pounds heavier than the JetStar wing, primarily because of higher root bending moments resulting from use of the supercritical wing. The wing weight of the ACT Configuration is almost identical to that of the Intermediate Configuration, but it should be noted that for an aspect ratio of 9.0, a considerable penalty would have been incurred without the benefits of active controls in reducing root bending moments. The mission fuel requirement is shown to progressively decrease from the JetStar to the ACT Configuration as a result of the improved lift-to-drag ratios of the Intermediate Configuration and the ACT Configuration. Finally, small changes in systems weight are reflected in the "miscellaneous" block, and the ACT Configuration benefits from a 266-pound reduction in horizontal tail weight because of its smaller size. The takeoff gross weight is 38,378 pounds, 37,821 pounds, and 35,470 pounds for the JetStar, Intermediate Configuration, and ACT Configuration, respectively. Although the takeoff gross weight has been reduced a small amount, this is a side effect of the most important consideration of the study—minimization of fuel consumption.

Comparison of Fuel Usage Benefits

The benefits in fuel consumption were derived from the difference between the Intermediate Configuration and the ACT Configuration. The fuel required to accomplish the mission (less reserves) was used to calculate these benefits. Thus the reduction in fuel consumption of the Intermediate Configuration over that of the

JetStar is 8 percent, and the ACT Configuration reduction over the JetStar is 27 percent. The direct benefit of active control technology, i.e., the ACT Configuration over the Intermediate Configuration, is 20 percent.

Comparison of Fallout Benefits

An analysis of performance characteristics under FAR 36 rules indicated that the use of an active control system would reduce approach noise by 6 EPNdB and takeoff flyover noise, under cutback power, by 8 EPNdB. The benefits in terms of community noise would result directly from the increase in lift-to-drag ratio in the high-lift configuration. The application of active controls technology would improve the ride comfort by 31 percent.

CONCLUSIONS

A study has been made of the feasibility of modifying a JetStar aircraft to demonstrate benefits which may be achieved through active controls. The specific conclusions of the study are:

(1) A 20-percent reduction in fuel consumption was attributable to active controls.

(2) No penalty was incurred in any other performance parameter in order to achieve a fuel consumption benefit.

(3) Additional benefits in the reduction in community noise and improved passenger ride qualities were indicated.

(4) The general relationship between control system burden and capability was not readily attainable. For the specific gust loads alleviation and relaxed static stability system studied, the burden was judged to be reasonable from practical considerations.

PROJECTIONS FOR NEW DESIGNS

The applicability of the results of a feasibility study of this type to transport class aircraft in general is difficult to assess, but it is felt that some generalizations are in order. The results of this study are consistent with those of other similar studies, such as the ATT system studies, in that we can expect benefits in transport aircraft performance from incorporating ACT in the design. It should be noted, however, that the performance increment for a new design transport is uncertain. It would be erroneous to assume that the magnitude of the benefits obtained in this study would be realized in all new transport designs. ATT studies showed the ACT benefits to be highly configuration sensitive. In general, the design strategy employed for a new ACT transport would be essentially the same as that used in

this study, which includes wing optimization to satisfy system requirements of fuel volume, ride quality, and stability and control. There is a need for a more realistic definition of a ride quality criterion, since this is an important design parameter for ACT aircraft.

REFERENCES

1. Szalai, Kenneth J.: Flight Test Experience With the F-8 Digital Fly-By-Wire System—A Forecast for ACT. NASA Symposium on Advanced Control Technology and Its Potential for Future Transport Aircraft, July 9-11, 1974.
2. Jarvis, Calvin R.: An Overview of NASA's Digital Fly-By-Wire Technology Development Program. NASA Symposium on Advanced Control Technology and Its Potential for Future Transport Aircraft, July 9-11, 1974.
3. Arnold, James I.; and Murphy, Frank B.: B-52 Control Configured Vehicles Flight Test Results. NASA Symposium on Advanced Control Technology and Its Potential for Future Transport Aircraft, July 9-11, 1974.
4. Hargrove, W. J.: The C-5A Active Lift Distribution Control System. NASA Symposium on Advanced Control Technology and Its Potential for Future Transport Aircraft, July 9-11, 1974.
5. Anderson, Charles A.: Development of an Active Fly-By-Wire Flight Control System. NASA Symposium on Advanced Control Technology and Its Potential for Future Transport Aircraft, July 9-11, 1974.
6. Hood, R. V.: A Summary of the Application of Active Controls Technology in the ATT System Studies. NASA Symposium on Advanced Control Technology and Its Potential for Future Transport Aircraft, July 9-11, 1974.

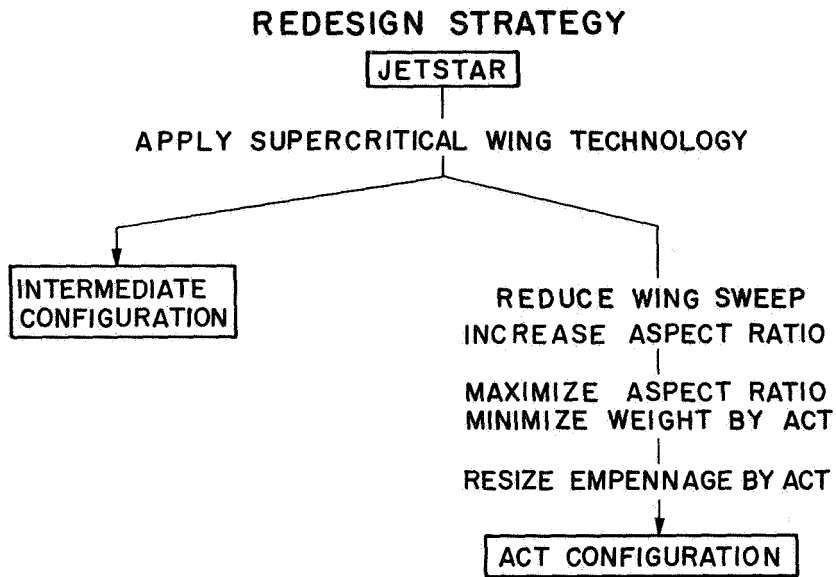

Figure 1

WING OPTIMIZATION

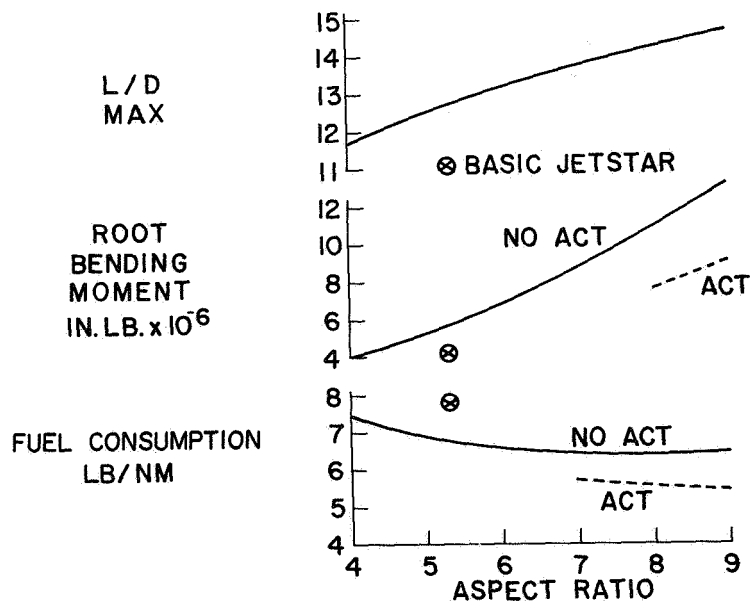

Figure 2

WING - FUSELAGE GEOMETRY CONSTRAINTS

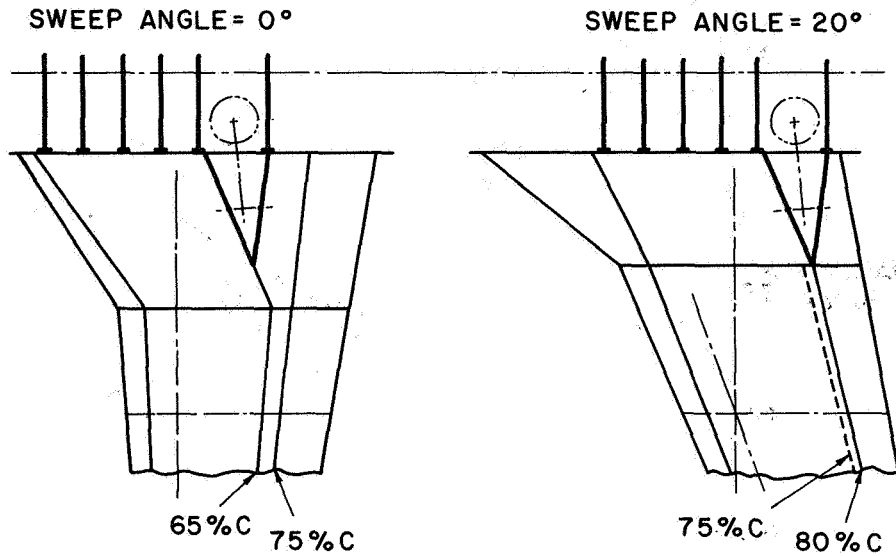

Figure 3

RIDE COMFORT FOR COMBINATIONS OF ASPECT RATIO AND CRUISE LIFT COEFFICIENT

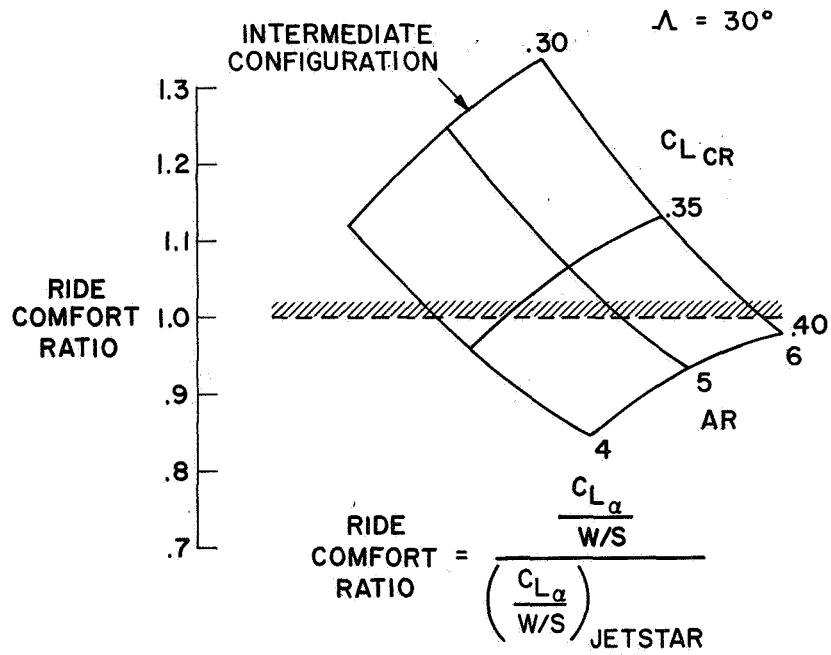

Figure 4

INTERMEDIATE CONFIGURATION SELECTION

$\Lambda = 30^\circ$

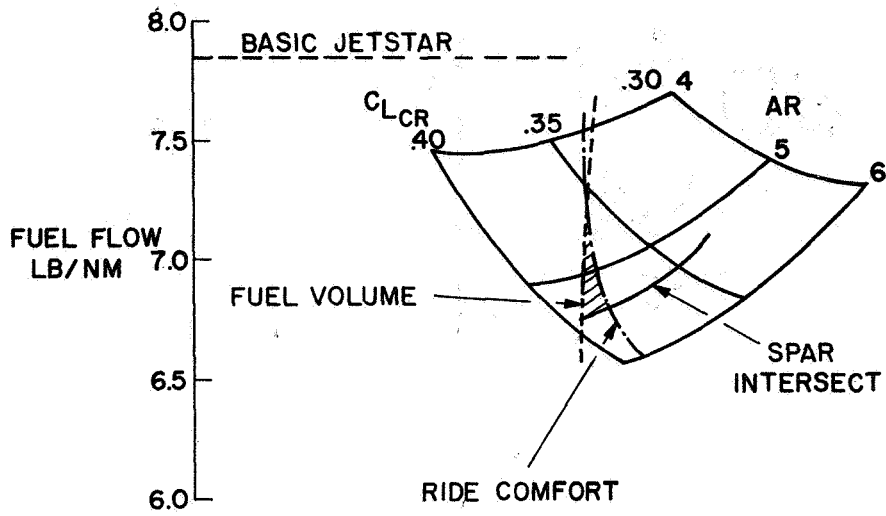

Figure 5

INTERMEDIATE CONFIGURATION

AR = 5.0
 $\Lambda = 30^\circ$
 S = 490 SQ.FT.

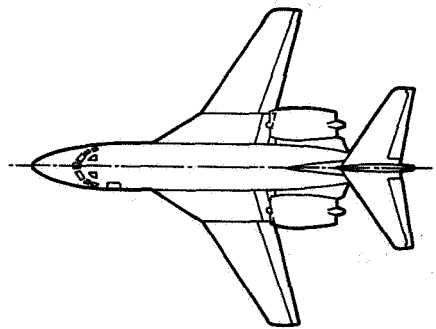

Figure 6

ACT CONFIGURATION SELECTION

$\Lambda = 5.5^\circ$

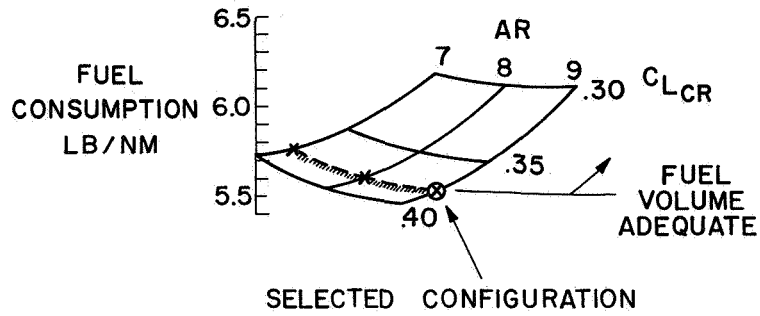

Figure 7

EFFECT OF ACT ON WING BENDING MOMENT

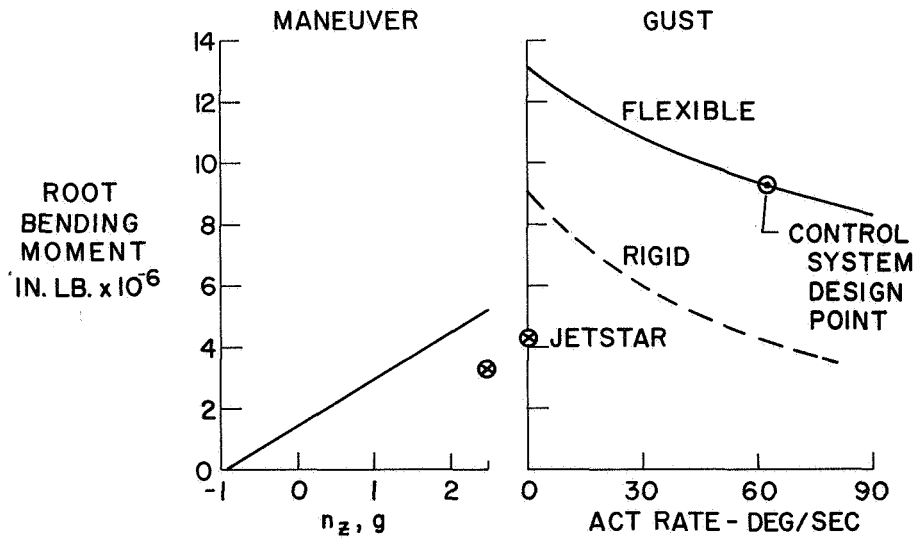

Figure 8

BENDING MOMENT DUE TO DISCRETE GUST

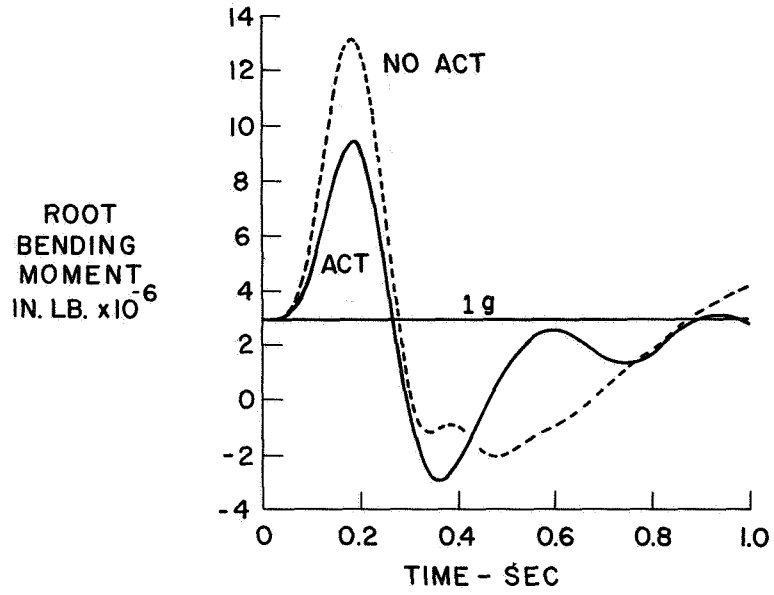

Figure 9

ACT SYSTEM BURDEN

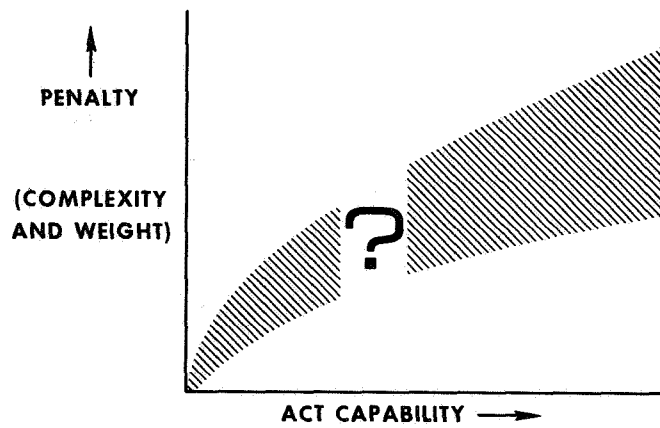

Figure 10

EXAMPLE FOR GUST ALLEVIATION

CANDIDATE SYSTEM

10 DUAL-TANDEM ACTUATORS

60 DEG/SEC RATE LIMIT

CAPABILITY

29 PERCENT LESS ROOT BENDING MOMENT

PENALTY

370-POUND SYSTEM WEIGHT

Figure 11

ACT CONFIGURATION

AR = 9.0
 $\Lambda = 5.5^\circ$
S = 560 SQ. FT.

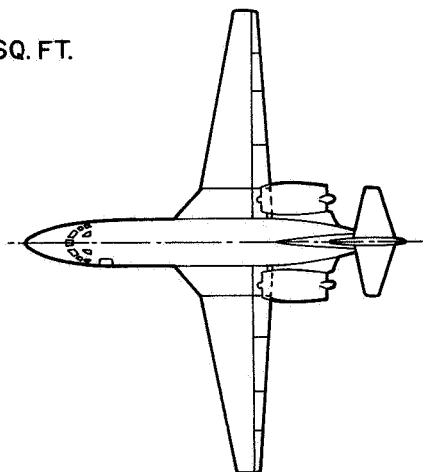

Figure 12

AIRPLANE CONFIGURATIONS

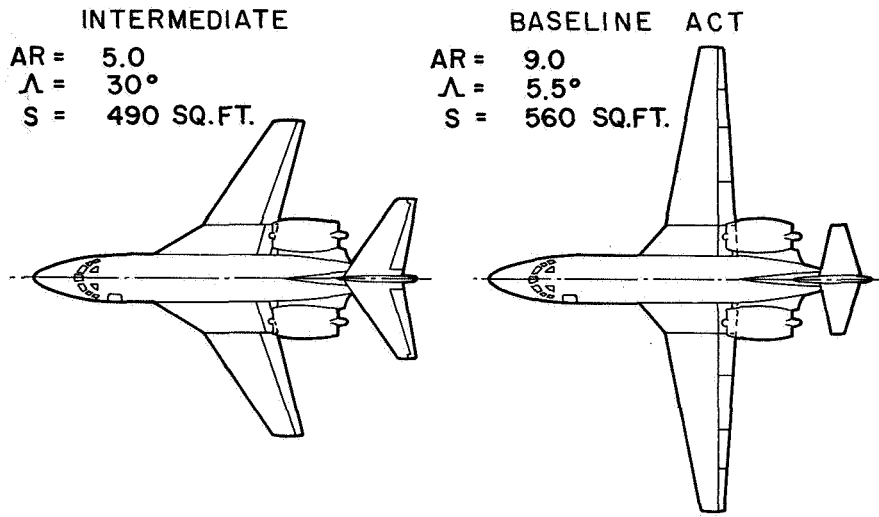

Figure 13

COMPARISON OF WEIGHTS

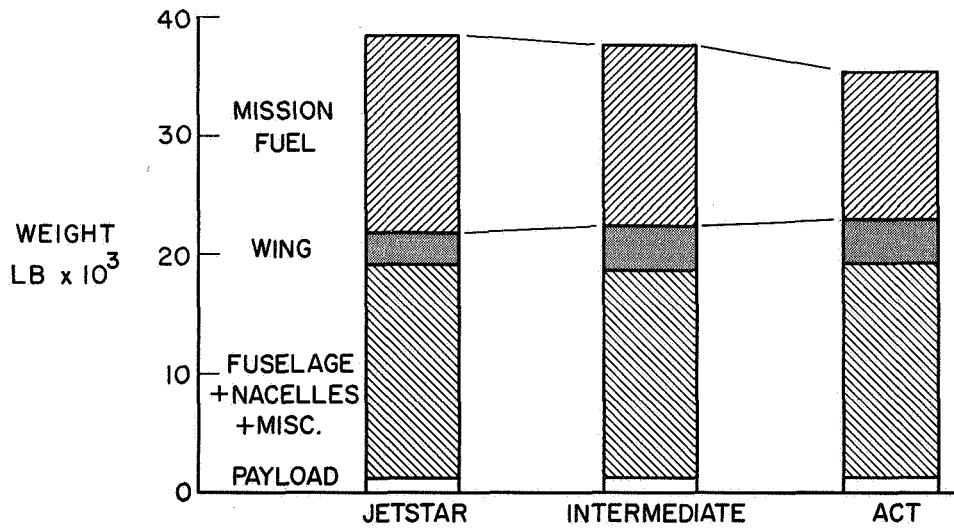

Figure 14