

NASA TECHNICAL NOTE

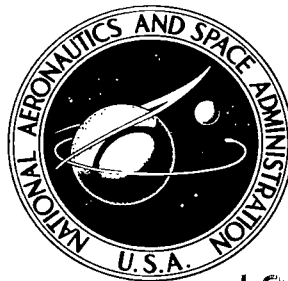

NASA TN D-8313 *e.l*

NASA TN D-8313

LOAN COPY: RI  
AFWL TECHNICAL  
KIRTLAND AFB

0134017



TECH LIBRARY KAFB, NM

# FLEXURAL FATIGUE OF HOLLOW ROLLING ELEMENTS

*Eric N. Bamberger, Richard J. Parker,  
and Marshall W. Dietrich*

*Lewis Research Center  
Cleveland, Ohio 44135*

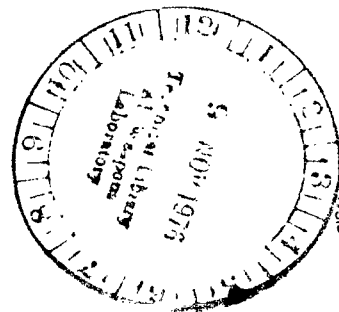



0134017

1. Report No. NASA TN D-8313	2. Government Accession No.	3. Recipient's Catalog No.
4. Title and Subtitle FLEXURAL FATIGUE OF HOLLOW ROLLING ELEMENTS	5. Report Date October 1976	6. Performing Organization Code
7. Author(s) Eric N. Bamberger, General Electric Co., Cincinnati, Ohio; Richard J. Parker and Marshall W. Dietrich, Lewis Research Center	8. Performing Organization Report No. E-8621	10. Work Unit No. 505-04
9. Performing Organization Name and Address Lewis Research Center National Aeronautics and Space Administration Cleveland, Ohio 44135	11. Contract or Grant No.	13. Type of Report and Period Covered Technical Note
12. Sponsoring Agency Name and Address National Aeronautics and Space Administration Washington, D.C. 20546	14. Sponsoring Agency Code	
15. Supplementary Notes		
16. Abstract Hollow cylindrical bars were tested in the rolling-contact fatigue tester to determine the effects of material and outside diameter to inside diameter (OD/ID) ratios of 2.0, 1.6, 1.4, and 1.2 on fatigue failure mode and subsequent failure propagation. The range of applied loads with these OD/ID ratios resulted in maximum tangential tensile stresses ranging from 165 to 655 megapascals (24 000 to 95 000 psi) at the bore surface. Flexural failures of the hollow test bars occurred when this bore stress was 490 megapascals (71 000 psi) or greater with AISI 52100 hollow bars and 338 megapascals (49 000 psi) or greater with AISI M-50 hollow bars. Good correlation was obtained in relating the failures of these hollow bars with flexural failures of drilled balls from previously published full-scale bearing tests.		
17. Key Words (Suggested by Author(s)) Bearings; Ball bearings; Roller bearings; Fatigue; Bending fatigue	18. Distribution Statement Unclassified - unlimited STAR Category 37	
19. Security Classif. (of this report) Unclassified	20. Security Classif. (of this page) Unclassified	21. No. of Pages 23
		22. Price* \$3.50

## FLEXURAL FATIGUE OF HOLLOW ROLLING ELEMENTS

by Eric N. Bamberger,\* Richard J. Parker, and Marshall W. Dietrich

Lewis Research Center

### SUMMARY

Hollow test bars with outside diameter to inside diameter (OD/ID) ratios of 2.0, 1.6, 1.4, and 1.2 were tested in the rolling-contact fatigue tester to determine the effects of material and tensile stress at the bore on fatigue failure mode and subsequent failure propagation. Applied loads ranged from 680 to 3820 newtons (153 to 860 lbf). The cycling rate was 25 000 stress cycles per minute. Hollow test bars of two commonly used rolling-element-bearing steels, AISI 52100 and AISI M-50, were evaluated. The bars were run until either flexural failure or spalling fatigue failure of the bar surface was encountered or until a predetermined number of stress cycles were accumulated without failure. The results were analyzed with respect to the maximum tangential tensile stress at the bore of the hollow test bar. These stresses ranged from 165 to 655 megapascals (24 000 to 95 000 psi) for the various test conditions.

Flexural fatigue failures occurred with the AISI 52100 hollow test bars when the maximum tangential tensile stress at the bore was 490 megapascals (71 000 psi) or greater. With the AISI M-50 hollow test bars, flexural fatigue failures occurred when this bore stress was 338 megapascals (49 000 psi) or greater. The fatigue cracks always began in the bore of the hollow bar. Those that propagated to the bar surface resulted in surface cracks and spalling, which terminated the test, or in extreme cases caused complete fracture of the test bar.

Good correlation was obtained between the results of these hollow-bar tests and previously published results of tests with drilled balls in full-scale bearings. Flexural fatigue failures of the AISI M-50 hollow test bars and drilled balls of the same material occurred at similar maximum tangential (tensile) bore stresses. Further, the visual appearances of the failures were nearly identical.

---

\* General Electric Company, Cincinnati, Ohio.

## INTRODUCTION

Analysis has shown that high Hertz stresses at the outer-race contacts caused by centrifugal force can seriously shorten the predicted bearing fatigue life (ref. 1). Reducing the mass of the balls by 50 percent can reduce the calculated detrimental effect of centrifugal forces produced by the balls (ref. 2). To determine how to effectively reduce the mass of rolling elements for very high-speed ball and roller bearings, hollow balls and rollers, solid balls and rollers of low-density ceramic material, and composite (or duplex structure) balls have been investigated.

Hollow balls fabricated by joining two hemispherical shells (refs. 3 and 4) have met with problems such as stress concentrations in the weld area and nonuniform wall thickness and the resultant ball unbalance. In other studies (ref. 5) where these difficulties were largely overcome, unexplained short lives were obtained in single-ball tests, and short-time destructive ball fractures were experienced in full-scale bearing tests. Bending stresses at the bore of hollow balls have been determined (ref. 6) and have aided in understanding the experimental results.

Lightweight ceramic materials such as hot-pressed silicon nitride have shown encouraging rolling-element fatigue life results (refs. 7 and 8). However, the high elastic modulus of the ceramics yields significantly higher Hertz stresses in the steel races. Thus, the potential improvement in high-speed bearing life with silicon nitride balls and steel races is limited (ref. 8). The concept of a composite (or duplex structure) low-mass ball consisting of a solid, lightweight core material and a hardened, plated iron surface (ref. 9) avoids weld joint and elastic modulus problems. However, this concept has not yet been proven or reduced to practice.

Drilled (or cylindrically hollow) balls, which are made by machining an accurate concentric hole through a ball, have shown promise at approximately 50 percent mass reduction (refs. 10 to 14). However, some drilled balls fractured in the more heavily loaded bearings (refs. 11 to 13). Metallographic examination of failed balls disclosed that cracks were initiated at the bore of the drilled ball and propagated through the wall, resulting in ball fracture.

The bending stresses at the bore of drilled balls subjected to loads similar to those in high-speed ball bearings are analyzed in references 15 and 16. The finite-element stress analysis of reference 15 and the empirical method of stress calculation of reference 16 both suggest that high tangential (tensile) stresses at the bore of the order of 480 to 550 megapascals (70 000 to 80 000 psi) were present in tests where ball fracture occurred. Further, in bearing tests where no ball fracture occurred (ref. 10), maximum tangential bending stresses were of the order of 280 to 340 megapascals (40 000 to 50 000 psi) (ref. 16).

The surface condition or topography of the bore of drilled balls, relative to surface finish as well as to a layer of material adversely affected by the electric discharge

machining (EDM) of the hole (ref. 12), may have had significant effects on the fracture failures observed.

For drilled (or cylindrically hollow) balls to become a viable replacement for solid balls in high-speed bearings, it must be assured that conditions leading to ball fracture will be avoided. Ball fracture would undoubtedly lead to destructive bearing failure. Thus, conditions where drilled-ball fracture can occur must be absolutely defined. The variables involved in defining these conditions include OD/ID ratio, applied load, ball material, and the surface condition of the bore.

The objectives of this investigation were (1) to experimentally evaluate the flexural fatigue characteristics of rolling-element specimens of several OD/ID ratios at various applied loads and (2) to determine the relative performance of two commonly used bearing steels, AISI 52100 and AISI M-50, under known flexural fatigue conditions.

To accomplish these objectives, hollow test bars with OD/ID ratios of 2.0, 1.6, 1.4, and 1.2 and with an outside diameter of 0.952 centimeter (0.375 in.) were tested in the rolling-contact fatigue tester at applied loads of 680 to 3820 newtons (153 to 860 lbf) at a speed of 12 500 rpm (25 000 cycles per minute). The tests were run at ambient temperature conditions with a superrefined naphthenic mineral oil. Testing was continued until either flexural fatigue failure of the hollow test bar or rolling-element fatigue spall occurred or until a preset number of stress cycles had been accumulated without failure.

## APPARATUS AND PROCEDURE

### Rolling-Contact Fatigue Tester

The test apparatus used in this investigation was the rolling-contact fatigue tester shown in figure 1. This apparatus is ideally suited for the type of flexural fatigue testing desired with hollow test specimens. The hollow, cylindrical test bar is mounted in a precision chuck. A drive motor is attached to the chuck. It drives the bar, which in turn drives two large idler rollers. The rollers are 19.1 centimeters (7.50 in.) in diameter and have a crown radius of 0.64 centimeter (0.25 in.). The rollers are mounted on double-row ball bearings and are supported by massive pendulum yokes. Load is applied by closing the rollers against the test bar with a micrometer-threaded turnbuckle and a calibrated load cell. The concentrated Hertzian contact between the rollers and the test bar is lubricated by drip feeding with a needle valve to control the flow rate. The test bar is rotated at 12 500 rpm, thus receiving 25 000 stress cycles per minute from the pair of rollers. A velocity type of vibration pickup is mounted on one of the support yokes. This pickup acts as a failure sensor and terminates the test upon occurrence of a failure. The lubricant used in these tests was a superrefined naphthenic

mineral oil with a viscosity at 311 K (100° F) of  $72.8 \times 10^{-6}$  square meter per second (72.8 cS).

### Test Bars

The cylindrically hollow test bars used in this investigation were 0.952 centimeter (0.375 in.) in diameter and 7.62 centimeters (3.00 in.) long, as shown in figure 2. The test bars of AISI 52100 and AISI M-50 were each made from single heats of consumable-electrode vacuum-melted material. Fabrication of the hollow test bars included the following operations. Bar stock was cut to length and rough machined and ground between centers to approximately 0.025 centimeter (0.01 in.) oversize on the diameter. The bars were axially drilled to the desired depth and reamed, maintaining the original center chamfers to provide an index for final grinding. The bars were fully heat treated according to the specifications in table I to a Rockwell C hardness of  $63 \pm 1$  at room temperature. The holes were again reamed to remove oxides, and the outside diameter was ground to final dimensions.

Subsequent inspection assured that all bars met the roundness, concentricity, and surface finish specifications shown in figure 2(a). Typical finished hollow test bars are shown in figure 2(b). The OD/ID ratios were 2.0, 1.6, 1.4, and 1.2, which correspond to hollow-roller weight reductions of 25, 40, 50, and 69 percent, respectively.

### Test Procedure

All hollow bars were tested in the rolling-contact fatigue tester. The test bar was mounted in the drive chuck so that the rollers contacted the bar within 0.952 to 1.27 centimeters (0.375 to 0.500 in.) from the end of the bar. Adjustments were made to minimize runout to less than 0.0025 centimeter (0.001 in.). The rollers were brought against the bar by using the mechanical turnbuckle. A load was applied that was sufficient to permit the test bar to drive the contacting rollers without slip. The test bar was then run up to the full speed of 12 500 rpm, whereupon the full test load was applied. The test was run until either a flexural failure or a rolling-element fatigue failure of the test bar occurred or until a preset number of stress cycles had been accumulated without failure. When a failure occurred, the apparatus and related instrumentation were automatically shut down. Unless a complete fracture of the test bar occurred, the opposite end was used for a subsequent test.

A series of exploratory tests were run with both the AISI 52100 and AISI M-50 materials. For each OD/ID ratio, a test was run at a load of 60 newtons (13.5 lbf) for 1 million stress cycles. If a test survived this load/life combination, another test was run at

an increased load for 1 million stress cycles. This procedure was repeated for each OD/ID ratio until a load was reached where flexural failure occurred or until the maximum load of 3820 newtons (860 lbf) was reached. The significant portion of these exploratory test conditions is shown in table II. The value of these exploratory tests was to determine the approximate threshold conditions where flexural fatigue failures could be expected to occur.

Based on the results of the exploratory tests, life tests were planned wherein groups of from 10 to 21 tests with each material were run at a given load to fatigue failure or to a preset cutoff time of approximately 40 million stress cycles. The applied loads for these life tests were below the threshold load at which flexural failure had occurred within 1 million cycles in the exploratory tests. These test conditions are summarized in table III. The life data were analyzed by using the Weibull analysis of reference 17. Comprehensive metallographic examinations were performed on all of the test bars to determine the point of origin of failures as well as to explore the presence of incipient failures.

#### Bending Stress Calculation

The load condition of the rollers on a hollow test bar is shown in figure 3. A constant symmetrical load  $P$  is applied for each test. This load condition is only an approximation of the load condition on drilled balls or hollow rollers in high-speed bearings since centrifugal forces result in higher loads at the outer-race contact than at the inner-race contact. Further, the angle of the contact load on drilled balls for thrust-loaded, high-speed ball bearings usually is not perpendicular to the axis of the hole, as described in reference 15.

According to observations in reference 18, the critical stress for destruction due to bending fatigue for the load condition of figure 3 is the tangential stress at the bore of the hollow bar at points C beneath the point of load application. The stresses at points C and at points D,  $90^\circ$  from points C, due to load  $P$  can be estimated by the methods of reference 19. These stresses, tensile at points C and compressive at points D, are plotted in figure 4 as a function of load for each OD/ID ratio used in this investigation. For each load and OD/ID ratio, the tensile stress at points C is slightly greater in magnitude than the compressive stress at points D. An element of material at the bore of the hollow test bar experiences two identical cycles of stress in one revolution of the bar. For the drilled-ball-bearing tests described in reference 15, the stress-time pattern repeats on alternate cycles since the ball is subjected to differing inner and outer contact loads.

## RESULTS AND DISCUSSION

Hollow test bars with OD/ID ratios of 2.0, 1.6, 1.4, and 1.2 and an outside diameter of 0.952 centimeter (0.375 in.) were tested in the rolling-contact fatigue tester to determine the effects of applied load, OD/ID ratio, and material on fatigue failure mode and subsequent failure propagation. Applied loads ranged from 680 to 3820 newtons (153 to 860 lbf). The cycling rate was 25 000 cycles per minute (shaft speed of 12 500 rpm). The tests were run at ambient temperature (no external heat source) with a superrefined naphthenic mineral oil lubricating the concentrated contact of the load rollers and the test bars. Hollow test bars of two common rolling-element-bearing steels, AISI 52100 and AISI M-50, were evaluated.

### Exploratory Tests

The initial series of tests were exploratory in nature and designed to determine the approximate test conditions under which flexural fatigue failures could be expected to occur in a given number of stress cycles. The results of these tests, run for a maximum of 1 million stress cycles, at the various OD/ID ratios and applied loads are shown in table II for both materials. The calculated maximum (tensile) tangential stress at the bore of the hollow bar beneath the point of load application is also shown for each condition.

For the AISI 52100 material (table II(a)), flexural fatigue failure occurred in less than 1 million stress cycles when the tangential (tensile) stress was 579 megapascals (84 000 psi) or greater. For the AISI M-50 test bars, flexural fatigue failure occurred at 469 megapascals (68 000 psi) and greater. Tests were repeated at each condition where a flexural failure occurred and, in each case, the second test confirmed the initial result.

Figure 5 shows the appearance of typical flexural fatigue failures of the hollow test bars. If a slight delay occurred in stopping the test or if the rate of crack propagation was sufficiently rapid, severe and total fracture occurred, as is shown in figure 5(a). With the parts reassembled, the fractured bar appears as in figure 5(b). If the vibration sensor on the test apparatus was adjusted to maximum sensitivity, the failure could be contained, as shown in figure 5(c).

The photomicrograph in figure 5(d) is of a section through the failure in figure 5(c). The cracks extend from the bore surface to the outside surface. In sections of other bars, several cracks were observed that were suspended before they reached the outside surface. The appearance of these cracks is evidence that the failure began at the bore surface.



At OD/ID ratios of 2.0 and 1.6, neither the 52100 nor the M-50 test bars failed by flexural fatigue within 1 million stress cycles up to the maximum contact load of 3820 newtons (860 lbf). This load was not exceeded because of the magnitude of the maximum Hertz stress (5520 MPa (800 000 psi) in the concentrated contact of the rollers and the test bar. At a contact stress greater than this level, it was expected that rolling-element fatigue spalling of the test-bar outer surface would be the predominant mode of failure and that the fatigue life would be less than the desired 1 million stress cycles. An example of a spalling type of fatigue failure is shown in figure 6(a); it markedly differs in appearance from the flexural fatigue failure. A section through this fatigue spall (fig. 6(b)) shows that cracking did not originate at the bore.

### Life Tests

Life tests were run on test bars of each material for each OD/ID ratio at loads below that where flexural failure had occurred within 1 million cycles in the exploratory tests. At least 10 test bars were run at each of seven combinations of load and OD/ID ratio with the AISI 52100 bars and at each of five combinations with the AISI M-50 bars. The maximum tensile tangential stress at the bore of the bars ranged from 200 to 490 megapascals (29 000 to 71 000 psi). The results of the life tests are shown on Weibull coordinates in figures 7 and 8 and are summarized in table III. With the AISI 52100 hollow test bars, no flexural failures occurred when the bore stress was 379 megapascals (55 000 psi) or less. In the tests where the bore stress was 490 megapascals (71 000 psi), 10 of the 14 test bars failed by flexural fatigue, with a life distribution from 0.7 to 40.1 million cycles. Tests on the other four bars were suspended without failure at approximately 40 million cycles. The appearances of the flexural failures, regardless of life, were similar to those shown in figure 5. In the tests where no flexural failures occurred, rolling-element fatigue spalling of the bar outside surface (fig. 6) was the mode of failure.

For the AISI M-50 hollow test bars, flexural failures occurred at tensile tangential bore stresses as low as 338 megapascals (49 000 psi), but only two flexural failures occurred out of 26 tests at this bore stress. Rolling-element fatigue spalling was predominant at this stress and less. At 359 megapascals (52 000 psi) all 10 AISI M-50 hollow test bars failed by flexural fatigue in less than 6 million cycles.

For both materials, flexural fatigue failures occurred at lower bore stresses than they did in the exploratory tests, primarily because of the greater number of bars tested and the greater number of cycles accumulated before suspending the test.

## Comparison with Drilled-Ball-Bearing Testing

Drilled balls or cylindrically hollow balls that have been run in ball bearings (refs. 11 to 14) have experienced some flexural failures at the more heavily loaded conditions. The balls in these tests were through-hardened AISI M-50. Figure 9 (from ref. 14) shows typical flexural fatigue failures in drilled balls. They show a very close resemblance to the flexural failures of the test bars shown in figure 5. These hollow-bar failures are also very similar to hollow-ball failures from full-scale, 140-millimeter-bore ball bearings reported in reference 5. Based on these comparisons, the hollow-bar tests simulate the flexural failure mechanism of hollow or drilled balls in full-scale bearing tests.

The maximum tangential tensile stress at the bore of the drilled balls tested in reference 11 was of the order of 483 to 552 megapascals (70 000 to 80 000 psi), as calculated in references 15 and 16. The maximum bore stress for the drilled balls tested in reference 12 was calculated in reference 16 and ranged from 276 to 345 megapascals (40 000 to 50 000 psi). The few ball failures reported in references 12 and 13 were apparently related to an undesirable metallurgical structure at the bore surface that was caused by the EDM operation. More exact stress values where ball fracture occurred or, more importantly, where flexural fatigue damage was initiated are not attainable since the bearings in each of these test programs (refs. 11 to 13) were run under a variety of speed and load conditions. These various conditions change the angle of load application relative to the axis of the cylindrical hole as well as changing the ball loading.

Since the AISI M-50 hollow test bars experienced some flexural failures at a maximum bore stress of 338 megapascals (49 000 psi) and experienced all flexural failures at 360 megapascals (52 000 psi), there appears to be good correlation between the bearing test results and the hollow-bar test results.

## Bore Surface Finish Effects

The effect of bore surface finish on the flexural fatigue of hollow bars, hollow rollers, or drilled balls is expected to be significant. Data in reference 20 show that smooth rotating-beam specimens of vacuum-melted AISI 52100 and M-50 with a Rockwell C hardness of 62 had endurance limits at room temperature of approximately 620 and 760 megapascals (90 000 and 110 000 psi), respectively. These endurance limits at  $10^8$  cycles represent the magnitude of the maximum allowable fiber stress at the surface of the rotating-beam specimen. These smooth specimens typically have surface finishes of 0.15 to 0.20 micrometer (6 to 8  $\mu\text{in.}$ ) root mean square (rms).

The specification of the surface finish on the bore of the hollow test bars in this program was 0.61 micrometer (24  $\mu\text{in.}$ ) rms or better. Measurements of the bore surface

finish of selected bars indicate an average of 0.33 micrometer (13  $\mu$ in.) rms for the AISI 52100 bars and 0.56 micrometer (22  $\mu$ in.) rms for the AISI M-50 bars. Surface finish measurements were made on the bores of drilled balls from bearings used in tests reported in reference 11, where flexural failures were experienced. These finishes, not reported in reference 11, ranged from 0.28 to 0.64 micrometer (11 to 25  $\mu$ in.) rms.

The flexural fatigue failures of the hollow bars and the drilled balls at tensile stresses considerably below the endurance limit suggested in reference 20 are possibly due to the rougher bore surface and the stress-raising effect of the minute surface irregularities. Also, the failure of the AISI M-50 bars at lower stresses than the AISI 52100 bars is possibly related to the rougher surface finish on the bore of the AISI M-50 bars. In general, the importance of the bore surface finish for drilled balls or hollow rollers is indicated by these data.

For surface finish on the bore that may be as high as 0.64 micrometer (25  $\mu$ in.), it is apparent that the tangential tensile stress at the bore must be well below 345 megapascals (50 000 psi) for AISI M-50 drilled balls to reduce the possibility of the flexural fatigue mode of failure occurring. Improved surface finishes may allow an increase in this limiting stress. However, even with optimized surface finishes, flexural failures are still expected to occur in thin-wall, hollow components when they are exposed to high loads. Since the flexural fatigue mode of failure is totally unacceptable in aircraft applications, it appears that the probability of using hollow rolling elements in turbine engine bearings remains small.

## SUMMARY OF RESULTS

Hollow test bars with outside diameter to inside diameter (OD/ID) ratios of 2.0, 1.6, 1.4, and 1.2 were tested in the rolling-contact fatigue tester to determine the effect of material and tensile stress at the bore on fatigue failure mode and subsequent failure propagation. Applied loads ranged from 680 to 3820 newtons (153 to 860 lbf). The cycling rate was 25 000 cycles per minute. Hollow test bars of two common rolling-element-bearing steels, AISI 52100 and AISI M-50, were evaluated. The bars were run until either flexural failure or spalling fatigue failure of the bar surface occurred or until a predetermined number of cycles were accumulated without failure. The results were analyzed with respect to the maximum tangential tensile stress at the bore of the hollow test bar, which ranged from 165 to 655 megapascals (24 000 to 95 000 psi) for the various test conditions. The following results were obtained:

1. Flexural fatigue failures in AISI 52100 hollow test bars occurred when the maximum tangential tensile stress at the bore was 490 megapascals (71 000 psi) or greater. For the AISI M-50 hollow test bars, flexural fatigue failures occurred when this bore stress was 338 megapascals (49 000 psi) or greater. The fact that the surface finish of

the bore of the AISI 52100 bars was better than that of the AISI M-50 bars may have influenced these results.

2. Correlation between the results of these hollow-bar tests and previously published results of tests with drilled balls in full-scale bearings was good. Flexural fatigue failures of the AISI M-50 hollow test bars and drilled balls of the same material occurred at similar maximum tangential bore stresses. Further, the visual appearances of the failures were nearly identical.

Lewis Research Center,  
National Aeronautics and Space Administration,  
Cleveland, Ohio, June 3, 1976,  
505-04.

#### REFERENCES

1. Jones, A. B. : The Life of High-Speed Ball Bearings. Trans. ASME, vol. 74, no. 5, July 1952, pp. 695-703.
2. Harris, T. A. : On the Effectiveness of Hollow Balls in High-Speed Thrust Bearings. ASLE Trans., vol. 11, no. 4, Oct. 1968, pp. 290-294.
3. Coe, Harold H. ; Parker, Richard J. ; and Scibbe, Herbert W. : Evaluation of Electron-Beam-Welded Hollow Balls for High-Speed Ball Bearings. J. Lub. Tech., vol. 93, no. 1, Jan. 1971, pp. 47-59.
4. Coe, Harold H. ; Parker, Richard J. ; and Scibbe, Herbert W. : Performance of 75-Millimeter-Bore Bearings Using Electron-Beam-Welded Hollow Balls with a Diameter Ratio of 1.26. NASA TN D-7869, 1975.
5. Potts, J. R. : Manufacturing Methods for Production of Hollow-Ball Bearings for Use in Gas Turbine Engines. PWA-4519, Pratt & Whitney Aircraft Div. (AFML-TR-72-170; AD-904689L), 1972.
6. Nypan, L. J. ; Coe, H. H. ; and Parker, R. J. : Bending Stresses in Spherically Hollow Ball Bearing and Fatigue Experiments. ASME Paper 75-Lub-8, Oct. 1975.
7. Baumgartner, H. R. : Evaluation of Roller Bearings Containing Hot Pressed Silicon Nitride Rolling Elements. Ceramics for High Performance Applications. John J. Burke, Alvin E. Gorum, and R. Nathan Katz, eds., Brook Hill Publ. Co., 1974, pp. 713-727.
8. Parker, R. J. ; and Zaretsky, E. V. : Fatigue Life of High-Speed Ball Bearings with Silicon Nitride Balls. J. Lub. Tech., vol. 97, no. 3, July 1975, pp. 350-357.

9. Parker, Richard J.: Low Mass Rolling Element for Bearings. U.S. Patent 3,751,123, Aug. 1973.
10. Coe, Harold H. ; Scibbe, Herbert W. ; and Anderson, William J.: Evaluation of Cylindrically Hollow (Drilled) Balls in Ball Bearings at DN Values to 2.1 Million. NASA TN D-7007, 1971.
11. Holmes, P. W. : Evaluation of Drilled-Ball Bearings at DN Values to Three Million. II - Experimental Skid Study and Endurance Tests. NASA CR-2005, 1972.
12. Scibbe, H. W. ; and Munson, H. E. : Experimental Evaluation of 150-Millimeter - Bore Ball Bearings to 3 Million DN Using Either Solid or Drilled Balls. J. Lub. Tech., vol. 96, no. 2, April 1974, pp. 230-236.
13. Scibbe, Herbert W. ; and Munson, Harold H. : Comparison of Experimental and Predicted Performance of 150-Millimeter-Bore Solid and Drilled Ball Bearings to 3 Million DN. NASA TN D-7737, 1974.
14. Munson, H. E. : Effect of Ball Geometry on the Endurance Limit in Bending of Drilled Balls. (TRW, Inc. ; NAS3-17351) NASA CR-134930, 1975.
15. Coe, Harold H. ; and Lynch, John E. : Analysis of Stresses at the Bore of a Drilled Ball Operating in a High-Speed Bearing. NASA TN D-7501, 1973.
16. Nypan, L. J. ; Coe, H. H. ; and Scibbe, H. W. : An Experimental Evaluation of the Stresses in Drilled Balls. J. Lub. Tech., vol. 97, no. 3, July 1975, pp. 533-538.
17. Johnson, Leonard G. : The Statistical Treatment of Fatigue Experiments. Elsevier Publ. Co., 1964.
18. Pikovskii, V. A. ; et al. : Study of the Working Capacity of High-Velocity Radial Bearings with Hollow Rollers. Strength of Materials, vol. 3, no. 10, June 1972, pp. 1178-1185.
19. Roark, Raymond J. : Formulas for Stress and Strain. McGraw-Hill Book Co., Inc., 1965, p. 333.
20. Sachs, G. ; Sell, R. ; and Weiss, V. : Tension, Compression, and Fatigue Properties of Several SAE 52100 and Tool Steels Used for Ball Bearings. NASA TN D-239, 1960.

TABLE I. - HEAT TREATMENT OF TEST MATERIALS

Heat treatment	Material	
	AISI 52100	AISI M-50
Preheating	None	1116 K (1550 <sup>o</sup> F)
Austenitizing	1116 K (1550 <sup>o</sup> F)	1380 K (2025 <sup>o</sup> F)
Quenching	In 327 K (130 <sup>o</sup> F) oil; air cool to room temperature	In 394 K (250 <sup>o</sup> F) oil to 811 K (1000 <sup>o</sup> F); air cool to room temperature
First tempering	450 K (350 <sup>o</sup> F) for 6 hr; air cool; 200 K (-100 <sup>o</sup> F) for 3 hr	825 K (1025 <sup>o</sup> F) for 2 hr; air cool; 189 K (-120 <sup>o</sup> F) for 2 hr
Second tempering	450 K (350 <sup>o</sup> F) for 2 hr; air cool	825 K (1025 <sup>o</sup> F) for 2 hr; air cool; 189 K (-120 <sup>o</sup> F) for 2 hr
Third tempering	450 K (350 <sup>o</sup> F) for 2 hr; air cool	825 K (1025 <sup>o</sup> F) for 2 hr; air cool

TABLE II. - SUMMARY OF EXPLORATORY TESTS WITH HOLLOW BARS  
IN ROLLING-CONTACT FATIGUE TESTER

(a) Material, AISI 52100

Ratio of outside diameter to inside diameter, OD/ID	Contact load, P		Maximum (tensile) tangential stress at bore		Result
	N	lbf	MPa	ksi	
	2.0	3150	708	16	
2.0	3820	860	200	29	
1.6	2050	461	200	29	
1.6	2560	576	248	36	
1.6	3820	860	372	54	
1.4	1820	409	338	49	
↓	2050	461	379	55	
↓	2560	576	469	68	
↓	3150	708	579	84	
1.2	680	153	359	52	
1.2	934	210	490	71	
1.2	1240	279	65	95	

(b) Material, AISI M-50

2.0	3150	708	165	24	Suspend at $1 \times 10^6$ cycles; no failure ↓ Flexural failure, two tests, 396 000 and 825 000 cycles Suspend at $1 \times 10^6$ cycles; no failure Flexural failure, two tests, 283 000 and 560 000 cycles
2.0	3820	860	200	29	
1.6	2050	461	200	29	
1.6	2560	576	248	36	
1.6	3820	860	372	54	
1.4	1820	409	338	49	
1.4	2050	461	379	55	
1.4	2560	576	469	68	
1.2	680	153	359	52	
1.2	934	210	490	71	

TABLE III. - SUMMARY OF LIFE TESTS WITH HOLLOW BARS IN ROLLING-CONTACT FATIGUE APPARATUS

(a) Material, AISI 52100

Ratio of outside diameter to inside diameter, OD/ID	Contact load, P		Maximum (tensile) tangential stress at bore		Maximum Hertz contact stress		Results			Fatigue life, millions of stress cycles			
	N	lbf	MPa	ksi	MPa	ksi	Number of flexural failures	Number of spalls	Number of tests suspended <sup>a</sup>	10-Percent life	50-Percent life	Weibull slope	
2.0	3820	860	200	29	5520	800	0	10	0	4.8	10.6	2.38	
1.6	2850	641	276	40	5000	725	↓	10	0	6.1	16.6	1.96	
1.6	3820	860	372	54	5520	800		10	0	2.0	10.7	1.14	
1.4	1820	409	338	49	4310	625		4	10	27.4	73.1	1.92	
1.4	2050	461	379	55	4480	650		15	6	13.9	39.4	1.81	
1.2	680	153	359	52	3100	450		9	3	23.2	47.0	2.75	
1.2	934	210	490	71	3450	500		10	0	4	.5	12.3	.58

(b) Material, AISI M-50

2.0	3820	860	200	29	5520	800	0	10	0	2.3	6.6	1.81
1.6	2850	641	276	40	5000	725	0	10	0	13.8	25.8	2.98
1.6	3480	783	338	49	5340	775	0	10	1	8.5	24.0	1.81
1.4	1820	409	338	49	4310	625	2	13	0	2.8	8.0	1.77
1.2	680	153	359	52	3100	450	10	0	0	1.0	2.6	1.99

<sup>a</sup>Tests suspended at approximately  $40 \times 10^6$  stress cycles without failure



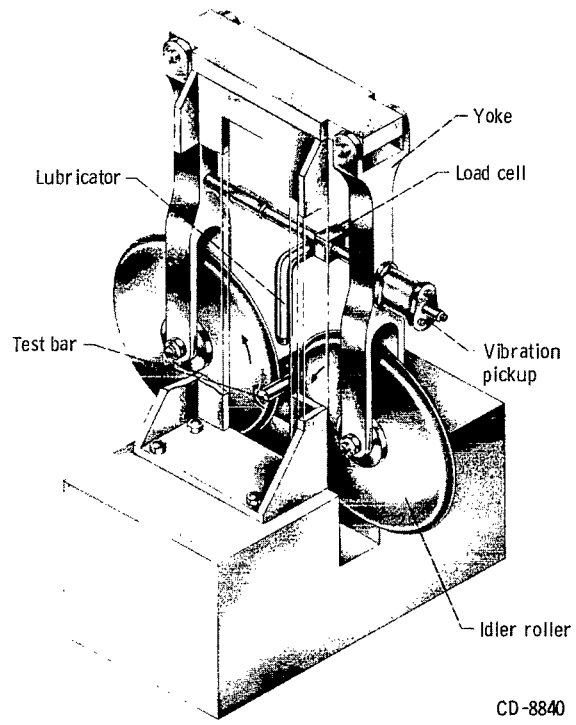
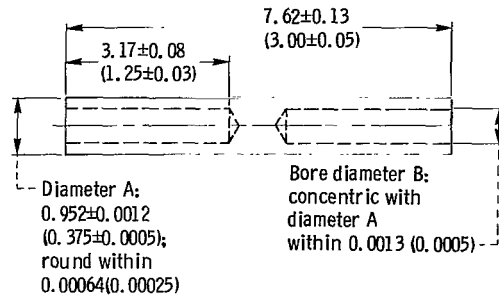

Figure 1. - Rolling-contact fatigue tester.



OD/ID ratio	Bore diameter B	
	cm	in.
1.2	$0.795 \pm 0.008$	$0.313 \pm 0.003$
1.4	$.681 \pm 0.008$	$.268 \pm 0.003$
1.6	$.594 \pm 0.008$	$.234 \pm 0.003$
2.0	$.475 \pm 0.008$	$.187 \pm 0.003$

(a) Specifications and dimensions (in cm (in.)).

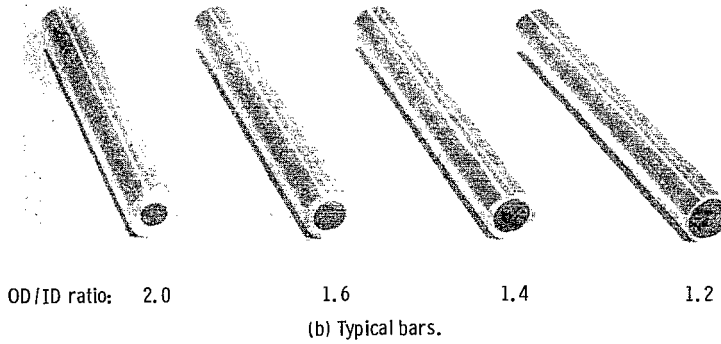

Figure 2. - Hollow test bars used in rolling-contact fatigue tester. Surface finish,  $\mu\text{m}$  ( $\mu\text{in.}$ ) rms: diameter A, 0.2 (8) or better; bore B, 0.6 (24) or better.

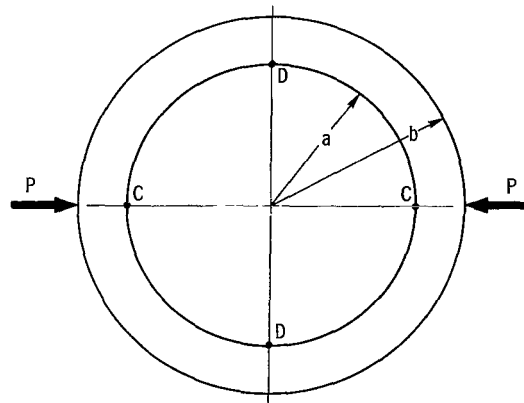

Figure 3. - Load condition on hollow test bars in rolling-contact fatigue tester. OD/ID ratio,  $b/a$ .

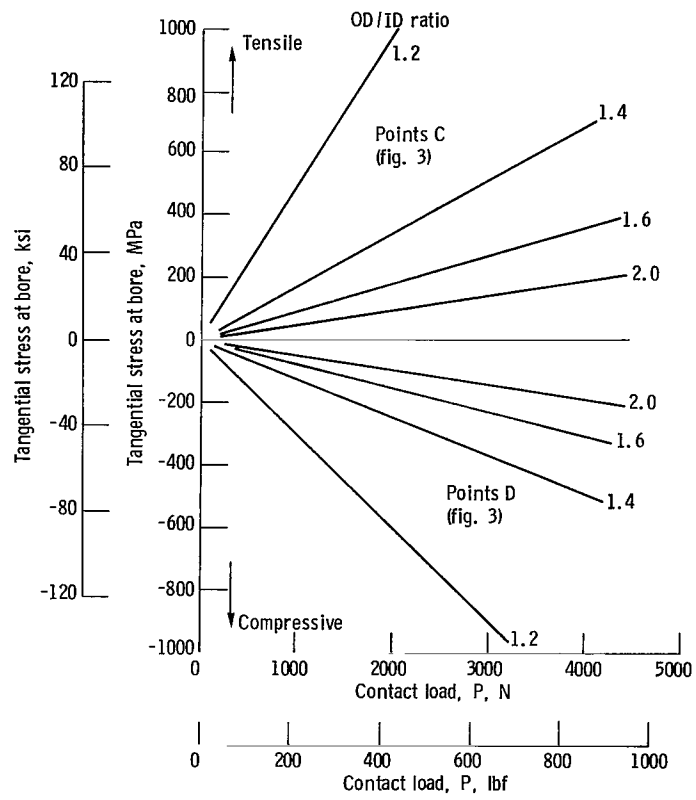
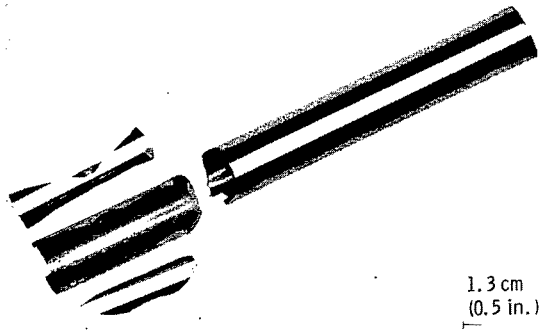
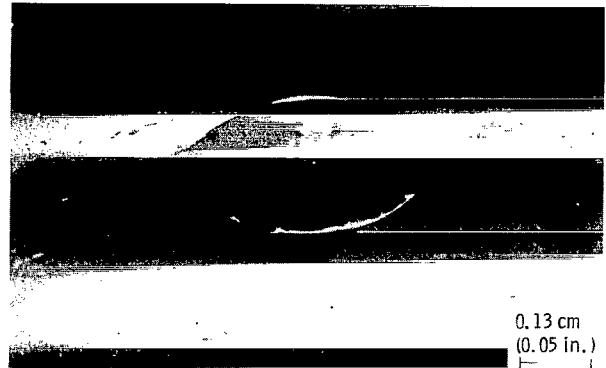

Figure 4. - Calculated tangential stresses at bore of hollow test bar as function of contact load.



(a) Fracture of hollow test bar due to flexural fatigue.



(b) Fracture appearance with parts of (a) reassembled.

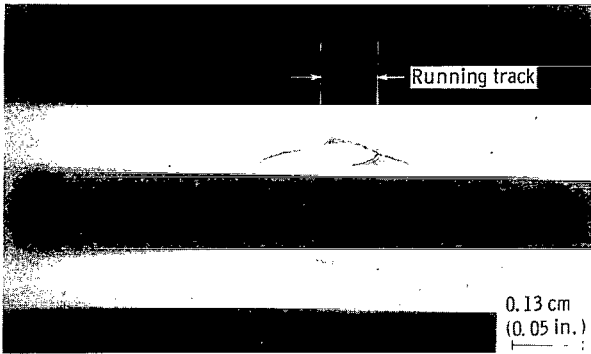

(c) Failure appearance on bar surface, sensed early and test terminated before total fracture.

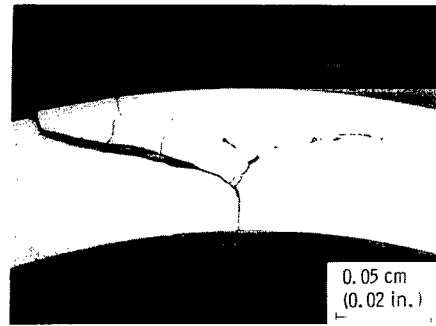

(d) Section through failure in (c).

Figure 5. - Flexural fatigue failures of hollow test bars. Material, AISI 52100; OD/ID ratio, 1.2.



(b) Section through spall in (a).

Figure 6. - Typical rolling-element fatigue spall on hollow test bar surface.  
Material, AISI M-50; OD/ID ratio, 2.0.

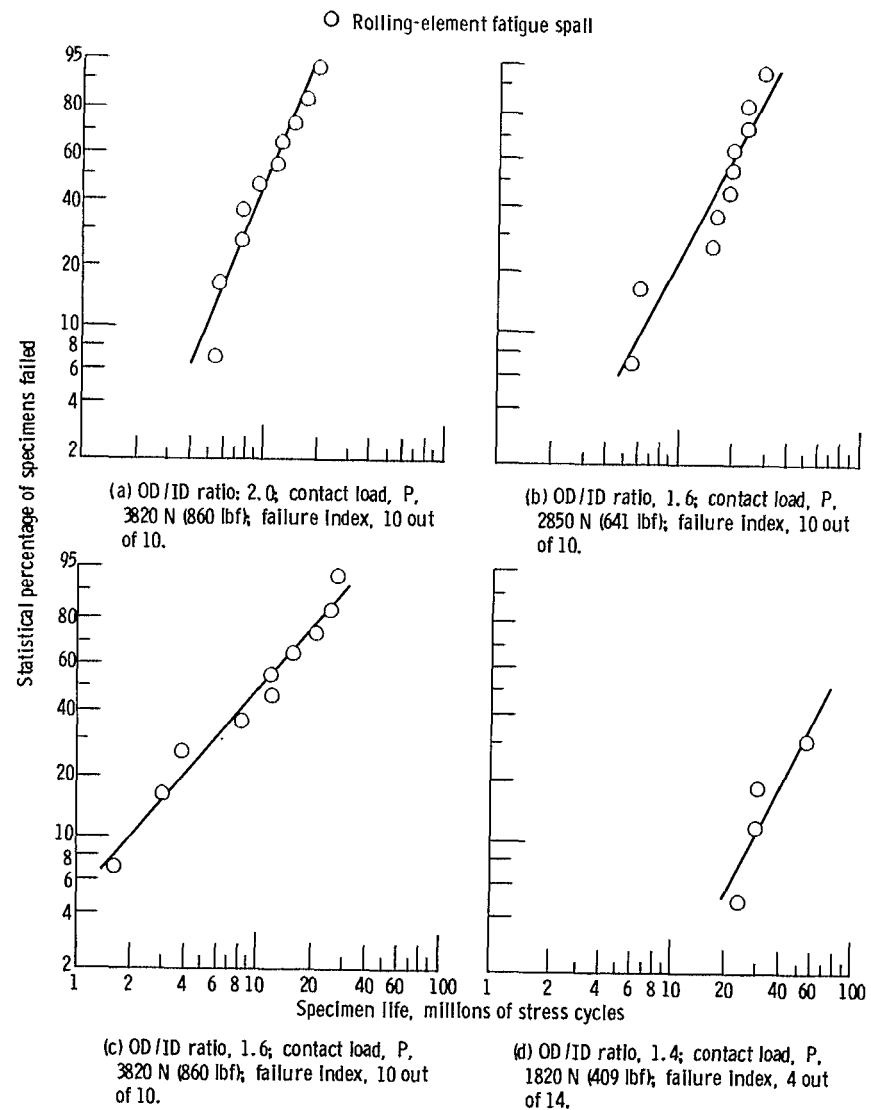
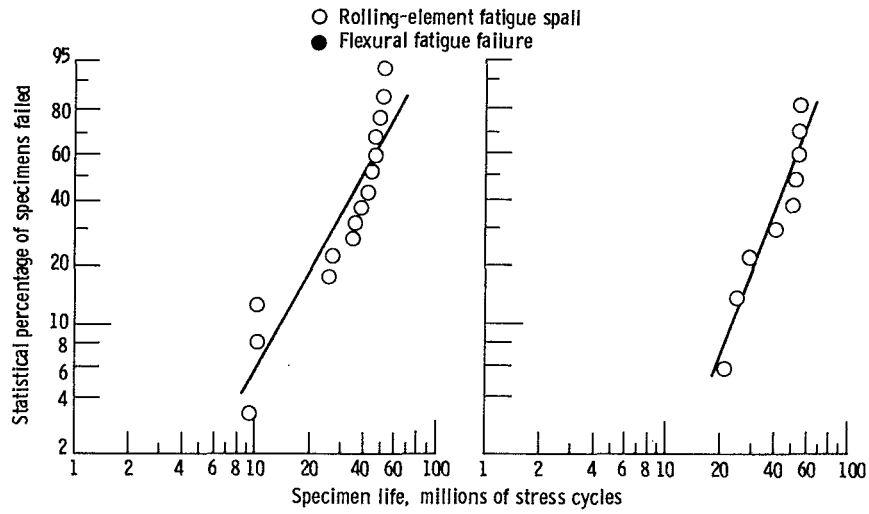
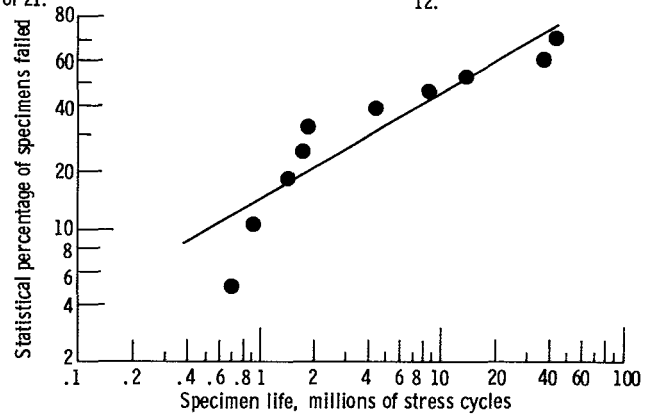

Figure 7. - Fatigue life of AISI 52100 hollow test bars in rolling-contact fatigue tester.



(e) OD/ID ratio, 1.4; contact load, P, 2050 N (461 lbf); failure index, 15 out of 21.

(f) OD/ID ratio, 1.2; contact load, P, 680 N (153 lbf); failure index, 9 out of 12.



(g) OD/ID ratio, 1.2; contact load, P, 934 N (210 lbf); failure index, 10 out of 14.

Figure 7. - Concluded.

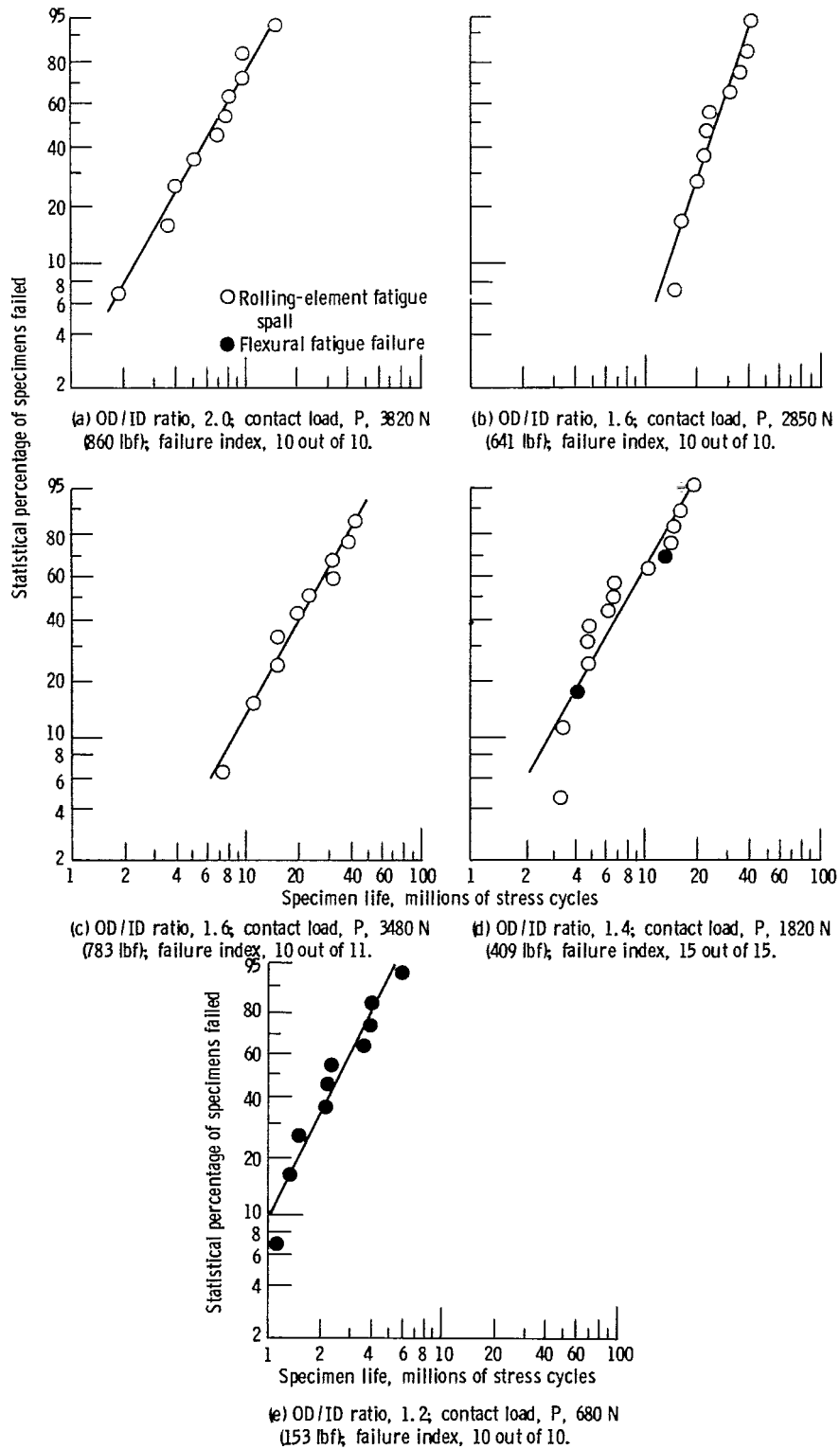

Figure 8. - Fatigue life of AISI M-50 hollow test bars in rolling-contact fatigue tester.



(a) Single crack in drilled ball.



(b) Advanced stage of flexural failure of drilled ball.

Figure 9. - Flexural fatigue failures of drilled balls. (From ref. 14.)





786 001 C1 U D 760916 S00903DS  
DEPT OF THE AIR FORCE  
AF WEAPONS LABORATORY  
ATTN: TECHNICAL LIBRARY (SUL)  
KIRTLAND AFB NM 87117

POSTMASTER: If Undeliverable (Section 158  
Postal Manual) Do Not Return

*"The aeronautical and space activities of the United States shall be conducted so as to contribute . . . to the expansion of human knowledge of phenomena in the atmosphere and space. The Administration shall provide for the widest practicable and appropriate dissemination of information concerning its activities and the results thereof."*

—NATIONAL AERONAUTICS AND SPACE ACT OF 1958

## NASA SCIENTIFIC AND TECHNICAL PUBLICATIONS

**TECHNICAL REPORTS:** Scientific and technical information considered important, complete, and a lasting contribution to existing knowledge.

**TECHNICAL NOTES:** Information less broad in scope but nevertheless of importance as a contribution to existing knowledge.

**TECHNICAL MEMORANDUMS:** Information receiving limited distribution because of preliminary data, security classification, or other reasons. Also includes conference proceedings with either limited or unlimited distribution.

**CONTRACTOR REPORTS:** Scientific and technical information generated under a NASA contract or grant and considered an important contribution to existing knowledge.

**TECHNICAL TRANSLATIONS:** Information published in a foreign language considered to merit NASA distribution in English.

**SPECIAL PUBLICATIONS:** Information derived from or of value to NASA activities. Publications include final reports of major projects, monographs, data compilations, handbooks, sourcebooks, and special bibliographies.

**TECHNOLOGY UTILIZATION PUBLICATIONS:** Information on technology used by NASA that may be of particular interest in commercial and other non-aerospace applications. Publications include Tech Briefs, Technology Utilization Reports and Technology Surveys.

*Details on the availability of these publications may be obtained from:*

**SCIENTIFIC AND TECHNICAL INFORMATION OFFICE**

**NATIONAL AERONAUTICS AND SPACE ADMINISTRATION**

**Washington, D.C. 20546**