

NASA TECHNICAL NOTE

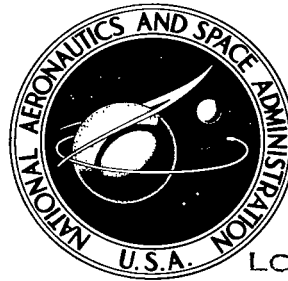

NASA TN D-8284 *c.1*

NASA TN D-8284

LOAN COPY: REF.
AFWL TECHNICAL
KIRTLAND AFB,



**A FLIGHT INVESTIGATION
OF PILOTING TECHNIQUES
AND CROSSWIND LIMITATIONS
DURING VISUAL STOL-TYPE
LANDING OPERATIONS**

*Bruce D. Fisher, Robert A. Champine,
Perry L. Deal, James M. Patton, Jr.,
and Albert W. Hall*

*Langley Research Center
Hampton, Va. 23665*

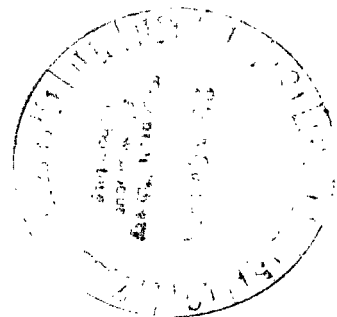

NATIONAL AERONAUTICS AND SPACE ADMINISTRATION • WASHINGTON, D. C. • OCTOBER 1976



0134083

1. Report No. NASA TN D-8284		2. Government Accession No.		3. Recipient's Catalog No.	
4. Title and Subtitle A FLIGHT INVESTIGATION OF PILOTING TECHNIQUES AND CROSSWIND LIMITATIONS DURING VISUAL STOL-TYPE LANDING OPERATIONS				5. Report Date October 1976	
				6. Performing Organization Code	
7. Author(s) Bruce D. Fisher, Robert A. Champine, Perry L. Deal, James M. Patton, Jr., and Albert W. Hall				8. Performing Organization Report No. L-10923	
				10. Work Unit No. 505-08-30-01	
9. Performing Organization Name and Address NASA Langley Research Center Hampton, VA 23665				11. Contract or Grant No.	
				13. Type of Report and Period Covered Technical Note	
12. Sponsoring Agency Name and Address National Aeronautics and Space Administration Washington, DC 20546				14. Sponsoring Agency Code	
				15. Supplementary Notes	
16. Abstract A flight-research program was undertaken to investigate problems concerned with landing a STOL airplane in crosswind conditions. The program included a study of piloting techniques and crosswind limitations during visual STOL-type landing operations. The results indicated that the crosswind was more limiting during the ground roll-out than during the airborne phases. The pilots estimated that the crosswind limit for commercial STOL-type operations with the test aircraft would be approximately 15 to 20 knots. The pilots thought that the crosswind limits for ground operation might be extended by incorporating wing-lift spoilers, improved nose-gear steering, and improved engine response. The pilots agreed that a crosswind landing gear would also be beneficial.					
17. Key Words (Suggested by Author(s)) Crosswinds Aircraft operations			18. Distribution Statement Unclassified - Unlimited Subject Category 02		
19. Security Classif. (of this report) Unclassified		20. Security Classif. (of this page) Unclassified		21. No. of Pages 55	22. Price* \$4.25

A FLIGHT INVESTIGATION OF PILOTING TECHNIQUES
AND CROSSWIND LIMITATIONS DURING VISUAL
STOL-TYPE LANDING OPERATIONS

Bruce D. Fisher, Robert A. Champine,
Perry L. Deal, James M. Patton, Jr.,
and Albert W. Hall
Langley Research Center

SUMMARY

A flight-research program was undertaken to investigate problems concerned with landing a STOL airplane in crosswind conditions. The program included a study of piloting techniques and crosswind limitations during visual STOL-type landing operations. The results indicated that the crosswind was more limiting during the ground roll-out than during the airborne phases. The pilots estimated that the crosswind limit for commercial STOL-type operations with the test aircraft would be approximately 15 to 20 knots. The pilots thought that the crosswind limits for ground operation might be extended by incorporating wing-lift spoilers, improved nose-gear steering, and improved engine response. The pilots agreed that a crosswind gear would also be beneficial.

INTRODUCTION

STOL airports of the future are envisioned as single-strip runways within or near large cities, and sometimes within the boundaries of existing major airports. The use of single-strip runways will result in a large percentage of crosswind operations. In addition, because STOL aircraft use low approach speeds, the

crosswinds will affect the STOL aircraft more than they affect conventional transport aircraft. As the forward speed of the aircraft decreases, the correction required to compensate for the crosswind becomes progressively larger.

The National Aeronautics and Space Administration (NASA) has undertaken a flight-research program to investigate problems concerned with landing a STOL airplane in crosswind conditions. This paper describes the results of a study of piloting techniques and crosswind limitations during VFR STOL-type landing operations. Several airplane modifications which could increase the crosswind limits are also discussed.

SYMBOLS AND ABBREVIATIONS

Except for airspeed and windspeed, which are given in knots (1 knot = 0.5144 m/sec), data are presented here in the International System of Units (SI) with the equivalent values given parenthetically in U.S. Customary Units. Factors relating the two systems of units in this paper may be found in reference 1.

STOL	short take-off and landing
VFR	visual flight rules
V_i	indicated airspeed, knots
V_{SO}	full flap, approach-configuration stall speed, knots
V_{TD}	indicated airspeed at touchdown, knots
v	direct crosswind component of wind, positive for right crosswind, knots
β	angle of sideslip, deg

γ	approach angle, deg
δ_a	total aileron deflection, positive for left roll, deg
δ_r	rudder deflection, positive trailing edge left, deg
ΔU	difference between wind velocity measured at given site and wind velocity measured at touchdown site, knots
$\Delta \psi_{TD}$	difference between aircraft relative heading at touchdown and average relative heading in approach, deg
$\Delta \Omega$	difference at touchdown between wind direction measured at given site and wind direction measured at touchdown site, deg
θ_{TD}	pitch attitude at touchdown, deg
ϕ	roll attitude, deg
ϕ_{TD}	roll attitude at touchdown, deg

EQUIPMENT AND PROCEDURES

Test Airplane

The test airplane was a twin-engine, high-wing, light STOL-type transport with fixed, tricycle gear (fig. 1). The maximum design gross weight was 48 928 N (11 000 lb) and the aircraft weight ranged between 38 253 and 45 370 N (8600 and 10 200 lb), during these tests. The STOL capability of this aircraft was derived from the high-lift wing which incorporated full-span, double-slotted Fowler flaps. Flap retraction from full down to full up took 35 sec. The outboard flap panels were differentially

deflected as ailerons for roll control. Full aileron travel was $\pm 41.25^\circ$, and full rudder travel was $+17^\circ$ to -19° .

The free turbine engines powered three-bladed Beta control propellers. The propeller pitch was interconnected with the throttle system so that the propeller blades went into reverse pitch only as the throttles were pulled through the idle setting and into the reverse-thrust quadrant. Approximately 6 sec were required for the engines to reach full thrust from idle, which meant that full reverse thrust was obtained only near the end of the ground roll-out. Reverse thrust was used only during ground maneuvers.

The nose-gear steering system was designed to be used only during low-speed taxiing of the aircraft. The nose-gear control was a tiller bar mounted on the control column behind the pilot's control wheel. To operate the tiller bar, the pilot had to take his hand off either the throttles or the control wheel. Therefore, nose-gear steering was used rarely in these tests.

The steady sideslip characteristics of the test airplane are presented in figure 2. The rudder deflection, aileron deflection, and roll attitude are shown as a function of sideslip angle for steady sideslips in the full-flap approach configuration at $V_i = 70$ knots. Throughout this paper, the term "aileron deflection" will apply to total deflection of left and right ailerons with the positive and negative signs given for aileron deflections producing left and right bank, respectively.

There was sufficient rudder authority to develop sideslip angles greater than $\pm 20^\circ$ with corresponding $+8^\circ$ and -11° roll attitude. Less than one-third of the full aileron travel was used during the slips.

Data Acquisition

Thirty-two parameters were recorded aboard the aircraft by a magnetic tape data system. These parameters included angle of attack and sideslip; control surface deflections; altitude; air-

speed; pitch, roll, and heading angles; linear accelerations; angular velocities about the three aircraft axes; throttle position; and engine torque and speed for both engines. All data were correlated by a time code. An automatic ground-based data system was used to produce time-history plots of the desired data.

The airspeed was measured by a standard NASA pitot-static head mounted approximately 1.5 maximum body diameters (2.7 m (9 ft)) ahead of the nose of the aircraft on a nose boom. The position error for the nose-boom installation has not been removed from the data. The error ranged between 1 to 2.5 knots. The side-slip and angle-of-attack vanes were mounted on the nose boom behind the airspeed head. The touchdown position, ground-roll distance, and wind-data measurements are described in the following section.

Test Facility

The VFR STOL-type crosswind landings were made at the airport shown in figure 3. The test site had a field elevation of 12.5 m (41 ft). During the test program, landings were made on all runways to get the desired crosswind conditions. Runway 10-28 is 61 m (200 ft) wide, and the other two runways are 45.7 m (150 ft) wide.

A touchdown target was painted on each of the three runways. The target was the desired touchdown point for approaches from either direction to a given runway. The targets were 30.5 m (100 ft) squares formed by 0.305 m (1 ft) wide white lines.

The visual guidance system, shown in figure 4, was used to indicate 3° and 6° approach angles. The three spheres of the system were portable and were placed beside the runway far enough ahead of the target so that the pilot did not have to "duck under" the glide path to flare into the target. The system worked as follows: when the center ball appeared lower than the flanking balls, the pilot knew he was below the intended glide path; when the center ball appeared high, he was above the glide path.

Markers were placed near the runway edge at 30.5 m (100 ft) intervals to aid the ground observers in estimating the longitudinal touchdown point and stopping distance of the aircraft. The lateral distance of the touchdown from the runway center line was estimated by an observer in the airplane cockpit.

Wind direction and magnitude were measured at three sites on the field. The ground observers near the touchdown site used a hand-held wind sensor. An observer in the control tower recorded the wind at touchdown as sensed by a wind sensor mounted at a height of 3.05 m (10 ft) at the site shown in figure 3. In addition, continuous wind records were taken from sensors mounted at four elevations on the erectable tower shown in figure 5. The elevations were 4.57, 8.23, 11.89, and 15.85 m (15, 27, 39, and 52 ft). The wind-sensor tower was located at the central position shown in figure 3.

Crosswind Approach and Landing Techniques

Three types of crosswind landing techniques were studied: slip, crab, and cross runway.

In the slip, or wingdown, technique (fig. 6(a)), the aircraft track and heading are aligned with the runway. The upwind wing is lowered and the pilot uses "cross control" of ailerons and rudder to maintain a straight flight track to the landing area. The pilot may level the wing during the flare and may land before appreciable drift has developed, or he may land the aircraft on the upwind gear.

In the crab technique (fig. 6(b)), the aircraft heading is adjusted into the wind so that a straight track along the runway center line is maintained. Since there is essentially no sideslip, the wings are nearly level and the rudder and aileron deflections are small. During the flare, the rudder is used to align the aircraft with the runway, and the ailerons are used to keep the wings level. As in the slip technique, the landing is completed before any significant drift angle can be developed.

In the cross-runway technique, the pilot approaches parallel to the runway on the downwind side using the crab approach and turns toward the landing area so that the crosswind component is reduced (fig. 6(c)). The touchdown is made near the downwind edge of the runway, after which the aircraft arcs out to a stop along the upwind edge.

Test and Procedures

A total of 432 VFR STOL-type crosswind landings were made during this program. Table I contains a matrix of the test conditions grouped according to a nominal crosswind, approach angle, and crosswind landing technique. These landings were made by three research pilots.

Typically, the glide slope was intercepted at an altitude of 183 m (600 ft) for a 3° approach, and at 366 m (1200 ft) for a 6° approach. The aircraft was then stabilized on the approach path at an indicated speed of 65 to 70 knots with full flaps. To acquire sufficient statistical data, one technique was used during the final 30 to 60 sec of the approach down to the flare. The aircraft was flared at about a 4.6-m (15-ft) altitude for a touchdown as close as possible to the center of the touchdown target. All landings were made in daylight, with VFR conditions, on a dry runway. Most landings were made to complete stop. After touchdown, the throttles were placed in the reverse-thrust position, but the engine response was too slow to produce appreciable reverse thrust during the ground roll-out.

RESULTS AND DISCUSSION

Notes on Data Presentation

A substantial portion of the data in this paper is presented in the form of histograms. The data given for each interval include values equal to the lower limit, but exclude those equal to

the upper limit. The data were sorted into the number of samples per interval, or, in the case of control usage, into the lengths of time during which the control deflections were within an interval. In most instances, the data were normalized either by dividing by the total number of samples or by dividing by the total length of time to produce relative frequency or relative time, respectively.

Considerable wind data were recorded during this program. These data are analyzed and discussed in the appendix of this paper to show that wind can vary with time and differ in magnitude between various locations on the airfield. These data illustrate that a single value of crosswind from one location, such as that reported to the pilot by the control-tower operator, may not represent the wind that influences the airplane at a critical time during the initial phase of the ground roll, for example. Although no single value of wind reading represents the winds during an approach and landing completely, to have a consistent reference, the single value measured at the 4.6-m (15-ft) elevation on the wind tower at the time of touchdown was used to compute the crosswind for classifying the data for each run. (Throughout this paper, the term "crosswind" means direct crosswind component.)

Touchdown Conditions

Touchdown dispersion.- The longitudinal touchdown dispersion data showed no appreciable difference because of pilot, approach angle, or crab or slip approach. The longitudinal dispersion data for those runs for which the crosswind was 5 knots or greater are shown in figure 7, where the results for the crab and slip landings are combined; those for the cross-runway landings are shown separately. The combined data for touchdown dispersion for the crab and slip techniques ranged from 76.2 m (250 ft) short of the center of the target to 152.4 m (500 ft) long. The mean value was 17.4 m (57 ft) beyond the target center. The cross-runway landings were radically different in technique, and the data reflect this difference. The data for the cross-runway landings show much less

longitudinal touchdown dispersion (only 106.7 m (350 ft)) with the mean value only 1.3 m (4 ft) beyond the target center. The reduced dispersion shown for the cross-runway technique is probably forced upon the pilots, since they attempt to land across the runway and are constrained by the runway edges. On the other hand, when landing straight down the runway, the pilots had no longitudinal pavement constraints for these tests.

The critical runway dimension was found to be the runway width. One runway was 61 m (200 ft) wide and the other two runways were 45.7 m (150 ft) wide. The lateral-touchdown dispersion data combined for the three pilots and two approach angles for each of the three techniques are shown in figure 8. The crab and slip data were very similar, about 80 percent of the landings for each technique falling within ± 1.5 m (± 5 ft) of the center line. There were no landings any further than 10.7 m (35 ft) from the center line. The cross-runway data showed a considerable downwind shift, as would be expected, since the pilot was deliberately landing the aircraft near the downwind edge of the runway.

Although the data from such a small number of runs are not sufficient to define runway width, the data do show that a width of 25.3 m (83 ft) (maximum dispersion plus landing gear width) is needed just to cover the lateral touchdown dispersion of the landings from crab and slip approaches. The opinion of all pilots was that any decrease in width below the minimum in these tests (45.7 m (150 ft)) would reduce the crosswind limits appreciably. An increase in runway width would be beneficial because it would allow the pilot to angle across the runway after touchdown, and thereby reduce the effective crosswind.

Figure 9 is a histogram of ground-roll distance for those runs with crosswinds of 5 knots or greater. Ground-roll distance is the longitudinal runway distance from the point of touchdown to the point where the aircraft stops. Data were deleted for roll-outs where the pilot was obviously not attempting to stop, but was only slowing down and rolling into take-off position for the next run. There was no consistent attempt to stop the aircraft in the short-

est distance possible. As there was no consistent effect due to pilot, approach angle, crab or slip technique, the data were combined in figure 9. Although there was a difference in the ground-roll technique, the ground-roll distances were essentially the same for the cross-runway technique as those for the crab and slip techniques. The aircraft was stopped in as short a distance as 30.5 m (150 ft) and as long a distance as 305 m (1000 ft). The pilots stated that they could always stop the aircraft in less than 305 m (1000 ft).

Touchdown speed ratio and pitch attitude at touchdown.- Figure 10 shows the touchdown speed ratio V_{TD}/V_{SO} for all techniques as a function of crosswind for each pilot and approach angle; V_{SO} is the full-flap, approach-configuration stall speed for the aircraft, based on a maximum lift coefficient of 2.6 and the weight at each landing, where the weight was based on the fuel weight gage readings in the cockpit. For reference, the average approach speed was $1.3V_{SO}$. The touchdown speed data were grouped into 5-knot increments of crosswind. The grouped touchdown speed values were then averaged within each increment and were plotted at the midpoints of the crosswind intervals. Pilots A and C landed faster from approaches made at $\gamma = -6^\circ$ than at $\gamma = -3^\circ$ (an increase in V_{TD}/V_{SO} of about 0.04), but pilot B did not show this trend.

A difference in landing technique was observed in these tests. Pilots A and B touched down firmly at speeds averaging about $1.06V_{SO}$ and rapidly decelerated to a full stop. Pilot C tended to touch down more smoothly at higher speeds (overall mean of $1.14V_{SO}$) and made less effort to stop abruptly.

The touchdown speed ratios are presented in figure 11 as a histogram showing the relative frequency of occurrence combined for all crosswinds, pilots, techniques, and approach angles. Less than 10 percent of the touchdowns were made at speeds lower than V_{SO} .

The differences in pilot landing technique also may be seen in the pitch attitudes at touchdown. Figure 12 presents the pitch

attitude at touchdown as a function of crosswind for each pilot and approach angle. Figure 12 was constructed by using the same averaging technique as was used in figure 10. There were no consistent crosswind or approach angle effects. The variation between pilots, however, is evident. The mean touchdown attitude was 3.1° , 5.7° , and 0.4° for pilots A, B, and C, respectively. In a steady-state condition, speed ratios and pitch attitudes should roughly correspond. It should be noted that the mean value of θ_{TD} for pilot B is twice as large as that for pilot A, whereas the corresponding mean values of V_{TD}/V_{SO} are nearly equal. This apparent discrepancy is caused by the nature of the landing flare maneuver. The flare was a dynamic maneuver in which there was a rapid pitch-up with relatively little loss in forward speed. This dynamic maneuver was more pronounced for pilot B than for pilot A.

In figure 13, the pitch-attitude data are combined for all crosswinds, pilots, techniques, and both approach angles, and are presented as a histogram showing relative frequency of occurrence. About 90 percent of the touchdown attitudes were greater than 0° , with about 80 percent falling between 0° and 8° . Pilots A and B made a few landings where the tail skid hit the runway ($\theta_{TD} \geq 10.5^\circ$). Pilot C contributed virtually all the negative values and none of the high positive values. The aircraft had a tendency to "wheelbarrow" on the nose wheel following touchdown at negative attitudes. The aircraft was also exposed to the crosswinds for a longer period of time with only a small vertical load on the wheels when the fast and shallow flared landing technique was used. Pilot C believed, however, that his landing technique was more representative of passenger-carrying operations and also that the higher speed allowed him more precision for control of the touchdown and initial transition to ground roll. On the other hand, the firm, near-stall landings used by pilots A and B may be more uncomfortable to typical passengers, but they minimized the exposure time of the aircraft to crosswinds in the ground roll-out.

All the pilots stated that it would be desirable to reduce wing lift quickly after touchdown, which in turn would allow increased braking force and would also allow the wheels to develop a side force to resist the crosswind effects. They felt that wing-lift spoilers would be very useful for this purpose during the ground roll-out.

Roll attitude at touchdown.- Regardless of crosswind landing technique, the pilots expressed a desire to land level on both main gears. The pilots found that the wings-level landings were smoother and allowed for better braking control during roll-out than did the one wheel landings. Pilots A and B frequently commented about a rocking oscillation (roll direction) during the initial roll-out following a firm landing on one main wheel. Pilot C stated that he did not experience this oscillation following his relatively fast and shallow landings. This rocking caused a variable vertical force which made it difficult for the pilot to control braking force as required for directional control during ground roll-out.

The roll attitude at touchdown for all crosswinds, all pilots, and both approach angles is presented in figure 14 for each crosswind technique as a histogram, showing relative frequency of occurrence. The roll attitude has been multiplied by the sign of the crosswind so that a landing with the wing down into the wind is a positive value, and a landing with the wing up into the wind is a negative value. The crab approaches had a fairly large number of wings-level landings (37 percent), while the lowest percentage of wings-level landings were made with the slip technique (15.5 percent). The highest percentage of wings-level landings (45 percent) was made with the cross-runway approach technique. This is not surprising, since the aircraft is more nearly aligned with the wind when the pilot lands across the runway.

Few landings were made with the wing up into the wind. These runs were probably caused either by overcorrection by the pilot or, in the case of the lowest crosswinds, by the wind shifting from one side of the runway to the other at the last minute.

Decrab at touchdown.- The airplane heading was recorded relative to the heading at the time the data switch was turned on. Therefore, the crab angle relative to the runway heading is indicated only in a general manner in figures 15 and 16. Figure 15 shows a typical time history of relative heading and illustrates how the average heading was faired during an approach, and the incremental change between this value and the value at the time of touchdown was taken as the amount of decrab for that landing maneuver. Again, as for roll attitude, the algebraic sign of the decrab angle was normalized by the crosswind direction so that a turn away from the wind (normal procedure) has a negative sign. The decrab prior to touchdown for all crab approaches, all pilots, all crosswinds, and both approach angles is shown in figure 16 as a histogram showing relative frequency of occurrence. Ninety-four percent of the "decrab" maneuvers were turns away from the wind. The mean heading change was -7.9° with maximum values up to -22° .

Normal load factor just prior to touchdown.- When an airplane is airborne with wings level, the indicated normal acceleration at the center of gravity in g units is essentially equivalent to the ratio of airplane lift force to airplane weight and is referred to in this paper as normal load factor. The normal load factor is 1.0 for steady-level flight where lift is equal to weight. The normal load factor just prior to touchdown for each of 429 landings made by all pilots for all techniques and crosswinds, and for both 3° and 6° approach paths are presented in figure 17. These data have been grouped in 11 equally spaced intervals having center values ranging from 0.70 to 1.20 normal load factor (0.05 interval). A normal distribution curve was fitted to the observed distribution, and both distributions were integrated to determine the probability that the normal load factor would be less than a given value. These data show that probability of the lift at touchdown being less than 0.78 of the airplane weight is 10^{-3} (one in a thousand landings). Extending the fitted normal curve beyond the range shown in fig-

ure 17 indicates about a 10^{-6} probability that the lift at touch-down will be less than two-thirds the airplane weight.

Control Use

General comments.- The aileron and rudder control problems related to crosswind approaches and landings are illustrated in figure 18. This figure presents time histories of sideslip angle, roll attitude, aileron deflection, rudder deflection, and indicated airspeed during the approach, flare, touchdown, and landing roll-out for two 15-knot crosswind tests. The slip technique is shown in figure 18(a), and the crab technique is shown in figure 18(b). The control use analysis which follows was not carried out for the cross-runway approaches, since they presented no unique situations not covered by the slip or crab approaches.

Approach.- The characteristic features of a slip approach are evident in figure 18(a). To cancel the effects of a right crosswind, the pilot held the aircraft in a right sideslip with right aileron deflection and left rudder deflection. Because of the turbulence and variability of the winds, large control deflections were required in addition to the steady deflections to hold the slip. A significant amount of the total control deflection for rudder was required, and somewhat less was required for aileron. The aileron and rudder deflection data for the approaches of all slip test runs with crosswinds of 15 to 20 knots are presented in figure 19 as histograms showing the relative time the controls were deflected between given values. The most distinctive feature of the data is the "cross control" of aileron and rudder required during a slip approach. There is adequate aileron control margin, with few deflections greater than $\pm 30^\circ$. In right crosswinds, the rudder was against the left stops 1 percent of the time. (Each data interval included the lower limit, but excluded the upper limit; therefore, whenever the rudder was against the left stop 17° , the data were grouped in the 17° to 19° interval.) For the left crosswinds, the rudder was never closer than 2° to the stop.

The aileron and rudder data, shown in figure 19, are presented as cumulative frequencies in figures 20 and 21. These data are similar to probability curves and show the relative time during a slip approach that the control deflection will exceed in magnitude a given positive or negative deflection. These two figures also include data for crosswinds between 5 to 10 knots and 10 to 15 knots. Data in this form can be used to predict the effects of greater winds and to extrapolate given wind data to larger deflections.

Figure 20 shows that the aileron deflection exceeds about two-thirds of full travel only 1 percent of the time (relative time of 0.01), and would reach full travel between 0.1 and 0.01 percent of the time (extrapolating negative δ_a for 15- to 20-knot crosswinds from the right).

Since none of the pilots reported that control travel was a limitation during approaches with crosswinds up to 20 knots, it would appear that being on the rudder stops only 1.0 percent of the time, as shown in figures 19 and 21, does not affect the pilot's capability to control the aircraft. By extrapolating data of figure 21, it would appear that 20- to 25-knot crosswinds from the right would cause the rudder to be against the left stop about 10 percent of the time during a slip approach. The opinion of the pilots about these conditions would probably be that rudder control would not be adequate for slip approaches.

In figure 18(b), it can be seen that the control deflections were relatively small during the crab approach, as expected since the aircraft was headed into the relative wind. Figures 22 and 23 compare aileron and rudder, respectively, for those crab and slip runs with 15- to 20-knot crosswinds. As in figures 20 and 21, the data are presented as cumulative frequencies. Since the crab approach is conducted with essentially zero crosswind relative to the airplane, the control activity shown is probably caused by the variable and gusty conditions usually associated with crosswinds of the 15- to 20-knot intensity. The increment in aileron deflection shown in figure 22, for example, represents the additional

requirements for a slip approach. A comparison of figures 22 and 23 shows that even though the 15- to 20-knot crosswinds cause appreciable aileron activity in the crabbed approach, there is very little rudder activity.

In the entire program, there was only one aborted approach. Several time histories from this approach are shown in figure 24. The wind was extremely gusty, and the pilot had great difficulty in handling the aircraft. When the pilot broke off the approach, with the wheels 1.5 to 3.0 m (5 to 10 ft) above the runway, the reference wind sensor on the wind-sensor tower measured a right crosswind of 12.1 knots and the handheld wind sensor near the intended touchdown site measured a right crosswind of 22 knots. Significantly, although the pilot hit both aileron and rudder stops during the approach, he was far more concerned with airspeed and the longitudinal touchdown position of the aircraft.

Generally, the data show that there was adequate control authority for making full flap, VFR, STOL-type crosswind approaches for research purposes in steady crosswinds of up to 20 knots. Based on a reasonable extrapolation of statistical data, the rudder control probably would limit the slip capability during approaches where the crosswinds are between 20 and 25 knots from the right.

Flare.- The aileron and rudder deflections used in flaring the aircraft during those slip runs with 15- to 20-knot crosswinds are given in histogram form in figure 25. The corresponding data for the crab runs are given in figure 26. The flare portion of an approach was very brief, only lasting from 3 to 8 sec. In addition, there were relatively few slip or crab runs where there were 15- to 20-knot crosswinds. Therefore, figures 25 and 26 are based on a relatively small amount of data. The meagerness of the data limits the discussion of these figures to general statements although several valid comparisons can be made.

The data for the slip crosswind technique showed essentially the same characteristics for the flare as for the approach (figs. 19 and 25). This similarity is to be expected since the flare maneuver

from a slip approach involves essentially a continuation of the slip approach, with the pitch attitude steadily increasing, and a relatively abrupt maneuver to level the wings just prior to touchdown. The data for the flare portions of the crab approaches (fig. 26) are also similar to the data from the slip approaches (fig. 19), although the rudder data in figure 26 show a less orderly distribution, probably because of the small amount of data. This meager amount of data suggests that there is adequate control authority to flare the airplane from slip and crab approaches in crosswinds up to 20 knots.

Roll-out.- The pilot used three principal controls for handling the aircraft during the ground roll-out: ailerons, rudder, and main gear braking. As can be seen in the time histories of figure 18, the ground roll-out was characterized by extremely heavy use of the ailerons and rudder. Both the ailerons and the rudder went to the stops within seconds of landing while the aircraft was still at a fairly high forward speed (50 knots). Once against the stops, the controls tended to stay there. Frequently, full-aileron deflection was required to keep the upwind wing from lifting immediately after touchdown, while full-rudder deflection was used to help keep the aircraft from heading into the relative wind. Occasionally, full-rudder deflection was not adequate to keep the aircraft from weathercocking in high crosswinds, and the pilot used differential main-gear braking to keep the aircraft on the runway. Directional control was complicated when the aircraft landed on one main gear, because braking effectiveness was lowered since the aircraft tended to rock from gear to gear during the roll-out.

The auxiliary aircraft controls (flaps, engines, and nose-wheel steering) were of little or no use during the ground roll-out. The flap-retraction cycle was too slow (35 sec) to destroy any appreciable lift on the wing. The engine-thrust response was too slow for the engines to be used for directional control, although some wing lift was destroyed when the propellers went to reverse pitch. The nose-wheel steering system was not designed

for high-speed ground maneuvers, and was not used during the ground roll-out.

The control usage of aileron and rudder during ground roll-out is shown in figure 27, which presents the data as histograms showing the relative time that the control deflections were within given intervals during ground roll-outs, following both slip and crab approaches with crosswinds from 15 to 20 knots. The ground roll-out data for the two techniques were combined, since there was no appreciable difference between the roll-out following either a slip or a crab approach. As can be seen in figure 27, both controls were severely limited during the ground roll-out. Although the ailerons rarely exceeded 30° in the approach and flare (figs. 19, 25, and 26), they were at or near the stops a large part of the time during the roll-out. The rudder was also at or near the stops a much greater percentage of time during the roll-out than during the approach.

The pilots firmly believed that the ground roll-out was the limiting crosswind operation of the VFR, STOL-type crosswind landings made in this program. They found that there was great difficulty in keeping the aircraft on the runway with the wings level, even with full deflection of ailerons and rudder, and with heavy use of asymmetric main gear braking. To provide a reasonable level of safety and reliability for commercial, STOL-type operations, two pilots estimated that a crosswind limit of 15 knots would be required. One pilot felt that crosswinds of up to 20 knots would be acceptable. It is interesting to note that the crosswind limit used for the simulated STOL tests of references 2 and 3 was also 15 knots.

The pilots thought that the following aircraft modifications would be helpful in extending the crosswind limits: wing-lift spoilers, improved nose-wheel steering, and faster engine response. The pilots agreed that a crosswind landing gear would also be beneficial.

Choice of Technique

In these tests, one technique was used during the entire approach down to flare. Although this is an impractical and undesirable operational procedure, several valid general comments on approach technique can be made. The pilots agreed that they could fly the aircraft more precisely to the touchdown point using the slip technique. However, the touchdown quite often resulted in a landing on one main wheel. One wheel landings led to a rocking oscillation and degraded braking control. In the crab technique, if the decrab maneuver was accomplished precisely, the touchdown was symmetrical and braking could be accomplished quickly. The pilots found it difficult to decrab precisely; the decrab was occasionally too early and the pilots had to go to a slip late in the flare to arrest the lateral drift. Finally, the utility of the cross-runway technique was limited by the narrow width of the runways and by the extreme touchdown accuracy required. The pilots agreed that a combination technique would be best, starting with a crab over the downwind edge of the runway. Then a slight cross-runway technique during the transition from the crab to a pseudo-slip should be used for touchdown.

CONCLUDING REMARKS

NASA has undertaken a flight-research program to investigate problems concerned with landing a STOL-type airplane in crosswind conditions. The program included a study of piloting techniques, airplane response, and crosswind limitations, during visual, STOL-type landing operations. The results of this study indicated:

1. The crosswind was more limiting during ground roll-out than during the airborne phases. It was quite difficult to keep the aircraft on the runway with the wings level, even with full deflection of ailerons and rudder and with heavy use of asymmetric main gear braking. Based on this limitation, the pilots estimated

that the crosswind limit for commercial, STOL-type operations with this aircraft would be approximately 15 to 20 knots.

2. The pilots thought that the crosswind limits for ground operation might be extended by incorporating wing-lift spoilers, improved nose-wheel steering, faster engine response, and a crosswind landing gear. Based on extrapolation of the statistical control use data, however, the rudder control then may limit the slip capability during approaches where the crosswinds are between 20 and 25 knots.

3. For typical crosswind operations, the pilots stated that a combination method of the slip, crab, and cross-runway techniques would be best.

4. The longitudinal touchdown dispersion data for the landings from slip and crab approaches ranged from 76.2 m (250 ft) short of the intended touchdown point to 152.4 m (500 ft) long.

5. Stopping the aircraft within a 305-m (1000-ft) ground roll after touchdown presented no problems.

6. The pilots thought that any decrease in runway width below 45.7 m (150 ft) would reduce the crosswind limits, and that an increase in runway width would be beneficial.

7. A single value of crosswind from one location at an airfield may not represent the wind that influences the aircraft at a critical time during a landing.

Langley Research Center
National Aeronautics and Space Administration
Hampton, VA 23665
July 21, 1976

APPENDIX

WIND DATA

Two samples of wind data from the 4.6-m (15-ft) elevation on the wind-sensor tower are given in figure 28. These data were recorded on one of the most turbulent days in the research program. Figure 28(a) is a record of the wind during the only wave-off (aborted run) of the entire program. After the approach, the pilot commented on the extreme turbulence and variability of the winds. While the aircraft was repositioning for the next approach, the large wind shift shown in figure 28(b) occurred. The wind increased about 10 knots in magnitude and changed heading nearly 70° in less than 15 sec. In such winds, a pilot could suddenly and unexpectedly find himself in an extreme crosswind at a critical time. When low approach speeds are used, the effects of such adverse winds become critical.

Figure 29 contains a summary of the wind conditions for the 432 runs. As can be seen in table I and figure 29, most of the runs were made with a crosswind of 5 to 10 knots or 10 to 15 knots. There were relatively few occasions during the test program when it was possible to schedule flight tests to obtain a crosswind in the 15- to 20-knot range. Figure 29 also shows that a significant number of landings had a tailwind component which resulted from the variability of winds which were nearly direct crosswinds.

To show the variation of winds at a given time for several locations at the airfield, a comparison was made using the wind magnitude and direction measured (by the handheld wind sensor) at the touchdown site as a reference. These differences in magnitude and direction for the various wind sensors relative to the touchdown site values are given in table II. The comparisons in table II are limited to those runs in which winds at the touchdown site were greater than 10 knots. This was done to avoid the possibility of having winds at some station too low to give a reliable indication

APPENDIX

of direction. (The wind sensors on the wind tower are not reliable below about 4 knots.)

On the average, these differences in magnitude and direction are small; there are a substantial number of times, however, when the wind measured at one site on the airfield is appreciably different from the wind measured at the touchdown site. For example, winds indicated at the 4.6-m (15-ft) elevation on the wind tower (the reference wind sensor for computing crosswinds) were found to be as much as 12.6 knots greater and 112.5° different in heading from those measured at the touchdown site. The winds read in the control tower were found to be as much as 10 knots greater and 122.5° different in heading.

These data show that a single value of crosswind from one location at an airfield may not represent the crosswind that influences the airplane at a critical time during a run.

REFERENCES

1. Mechtly, E. A.: The International System of Units - Physical Constants and Conversion Factors (Second Revision). NASA SP-7012, 1973.
2. Spangler, Roman M., Jr.: Simulated Ground-Level STOL Runway/Aircraft Evaluation. FAA-RD-73-110, Federal Aviation Administration, Sept. 1973.
3. Spangler, Roman M., Jr.: Simulated Ground-Level STOL Runway/Aircraft Evaluation. Phase III Tests. Rep. No. FAA-RD-74-96, Federal Aviation Administration, Aug. 1974. (Available from DDC as AD 783 749.)

TABLE I.- MATRIX OF TEST CONDITIONS RECORDED

[432 STOL-type landings (full flap)]

Approach angle, deg	Number of landings for each 5-knot crosswind interval				Technique
	0 to 5	5 to 10	10 to 15	15 to 20	
-3	12	51	32	5	Crab
-3	10	44	30	9	Slip
-3	9	30	14	2	Cross-runway
-6	4	27	31	3	Crab
-6	5	18	39	6	Slip
-6	2	16	27	6	Cross-runway

TABLE II.- COMPARISON OF WIND DATA FOR VARIOUS WIND-SENSOR SITES
AT TOUCHDOWN REFERENCED TO HAND-HELD WIND-SENSOR READINGS

[Those runs in which the hand reading was less than
10 knots have been deleted]

Wind velocity			
Wind-sensor site	Mean ΔU , knots	Standard deviation of ΔU , knots	Number of runs
Control tower	0.2	3.5	264
Wind tower:			
4.6 m (15 ft)	.9	3.4	262
8.2 m (27 ft)	1.6	3.5	254
11.9 m (39 ft)	2.8	3.7	261
15.8 m (52 ft)	2.9	3.7	262
Wind direction			
Wind-sensor site	Mean $\Delta \Omega$, deg	Standard deviation of $\Delta \Omega$, deg	Number of runs
Control tower	1.7	19.3	264
Wind tower:			
4.6 m (15 ft)	-.7	19.6	262
8.2 m (27 ft)	4.4	18.1	254
11.9 m (39 ft)	-5.4	19.3	261
15.8 m (52 ft)	2.4	17.7	261

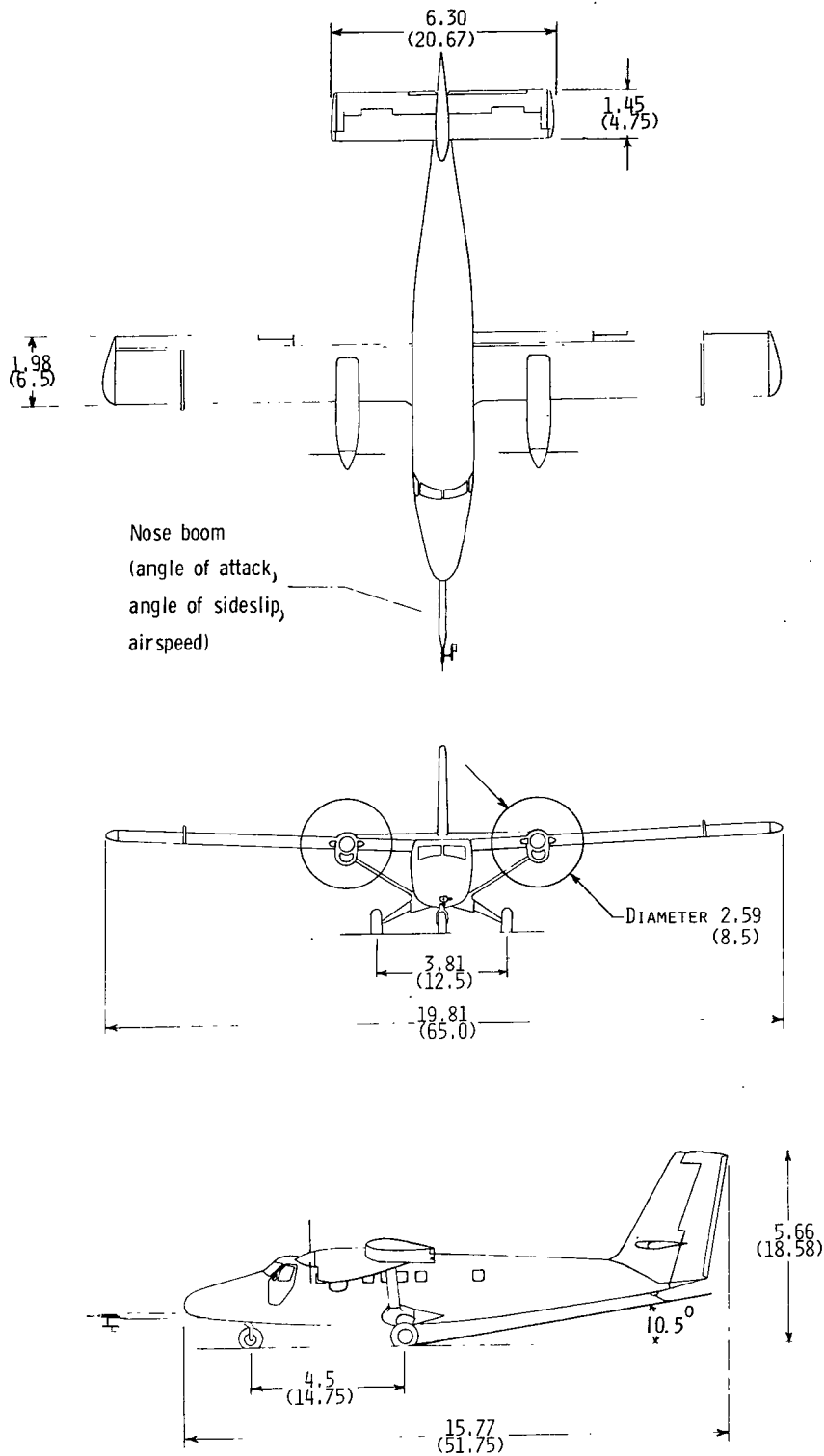

Figure 1.- Three-view of test aircraft. All dimensions in meters (feet).

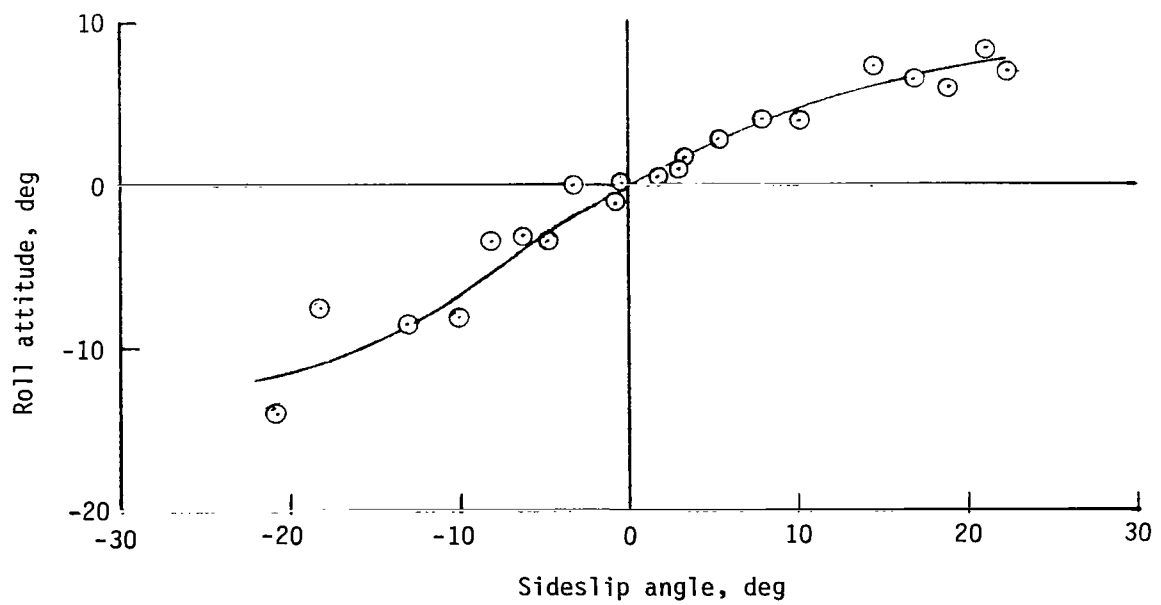
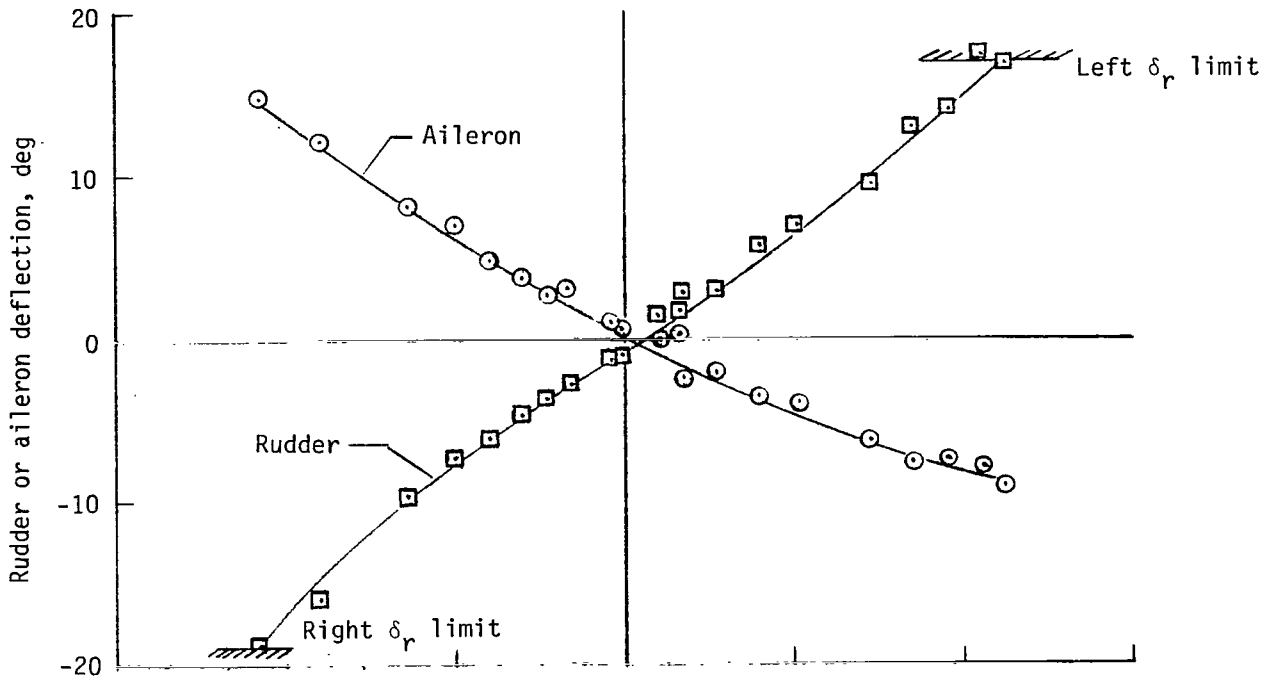

Figure 2. Steady sideslips in full-flap, approach configuration. $V_i = 70$ knots.

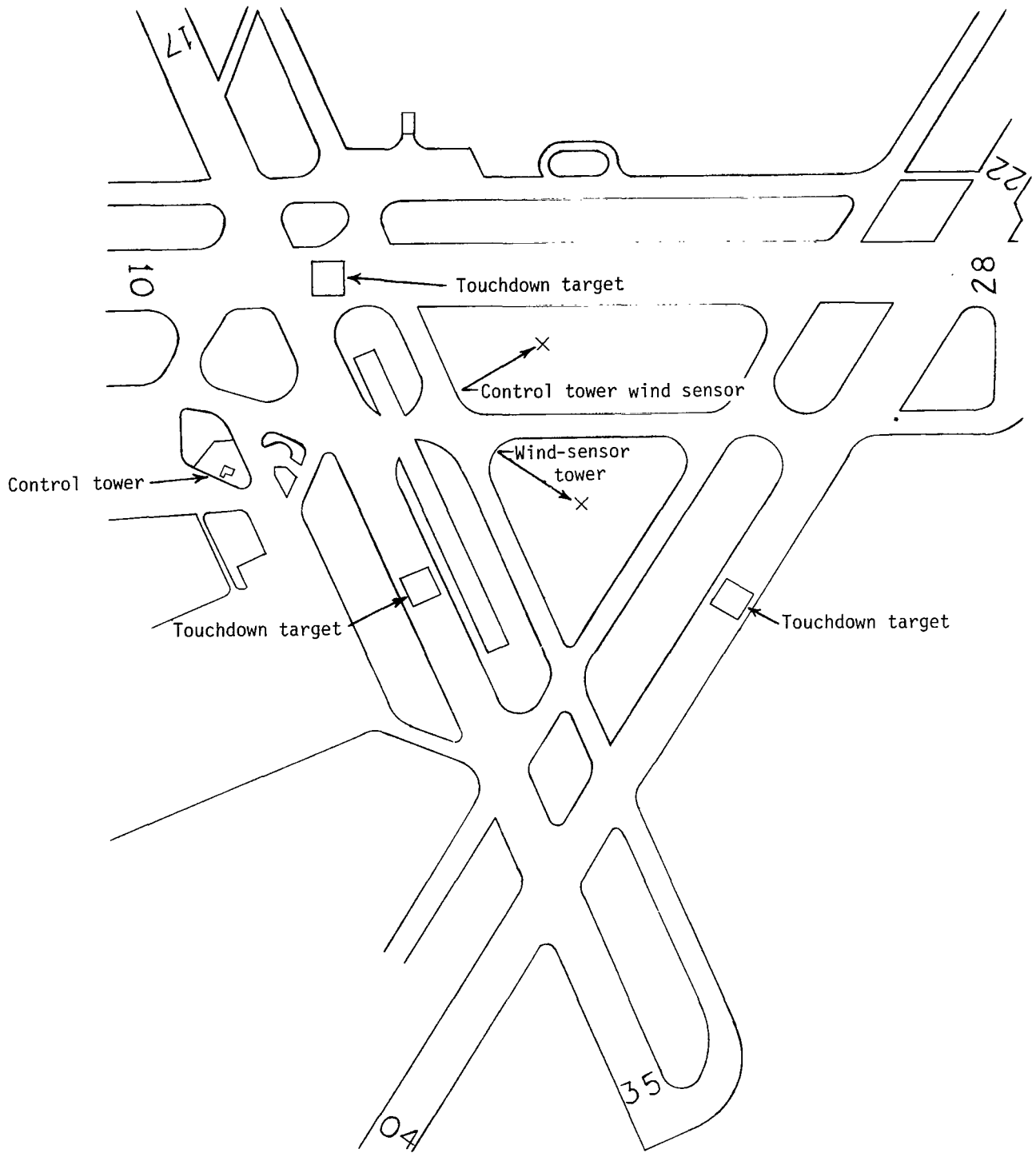

Figure 3.- Test site.

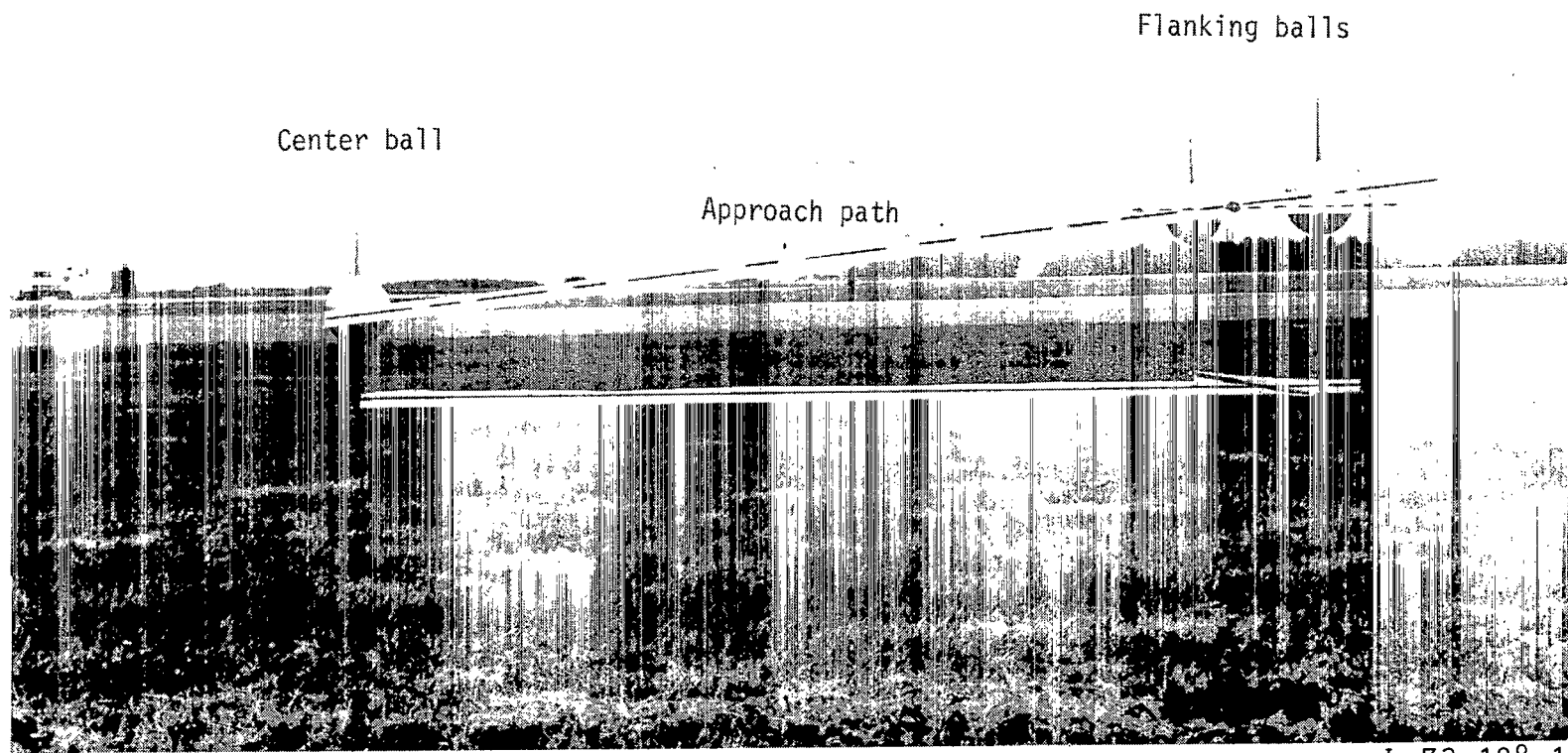
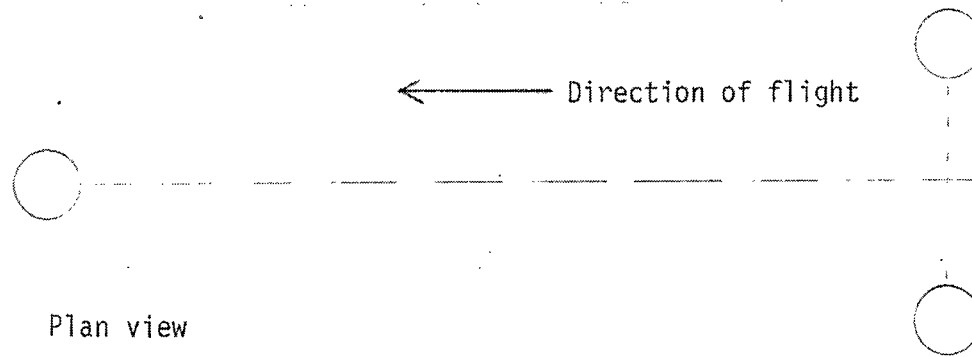
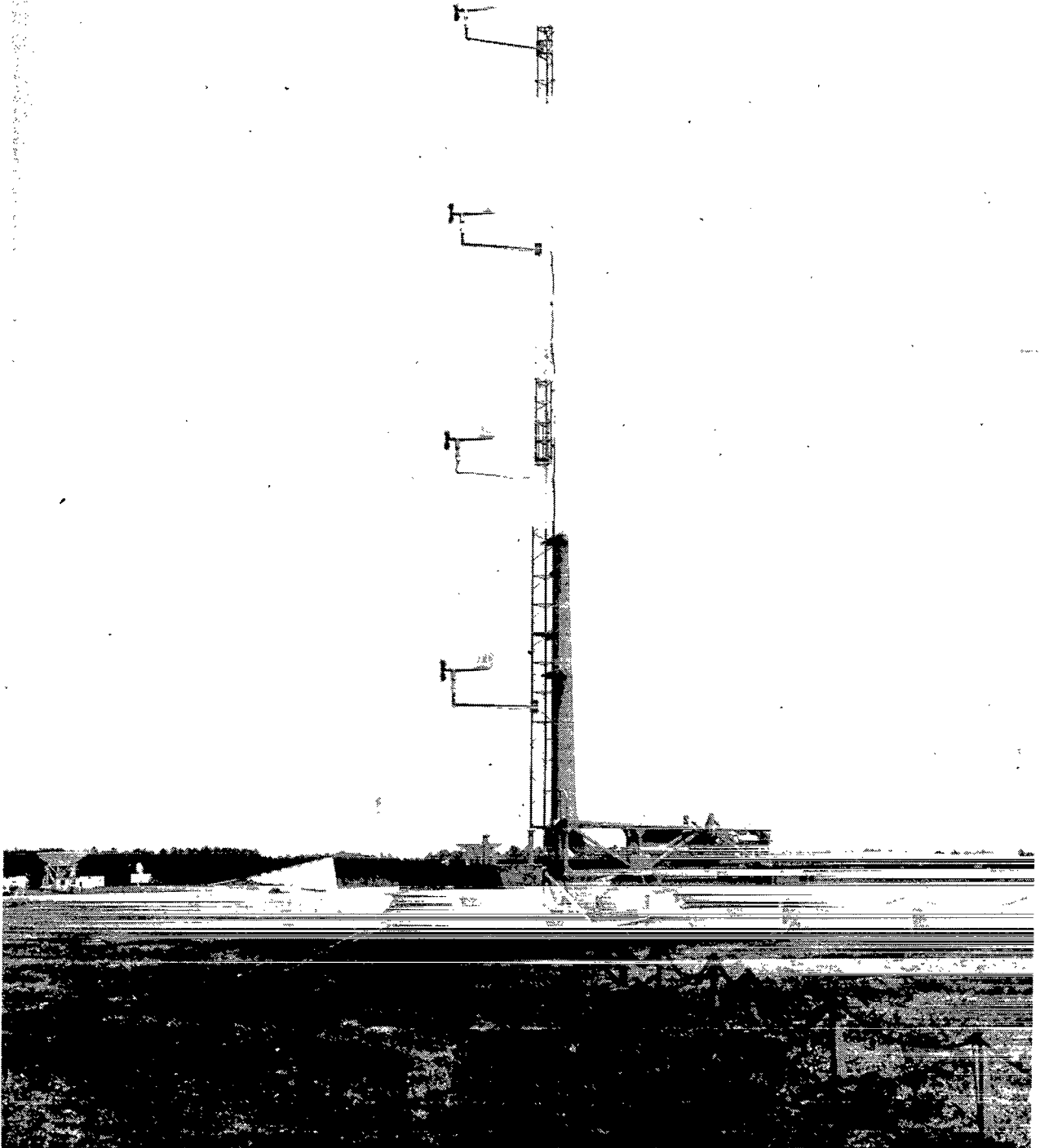
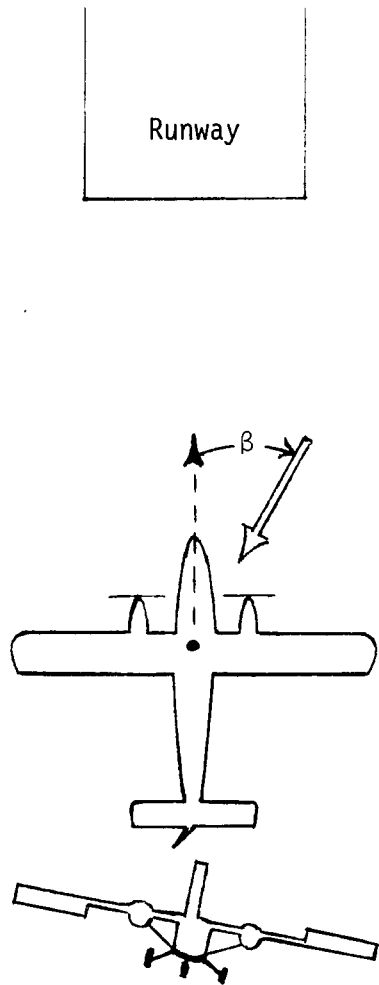

Figure 4.- Visual guidance system.



L-73-112

Figure 5.- Wind-sensor tower.



(a) Slip.

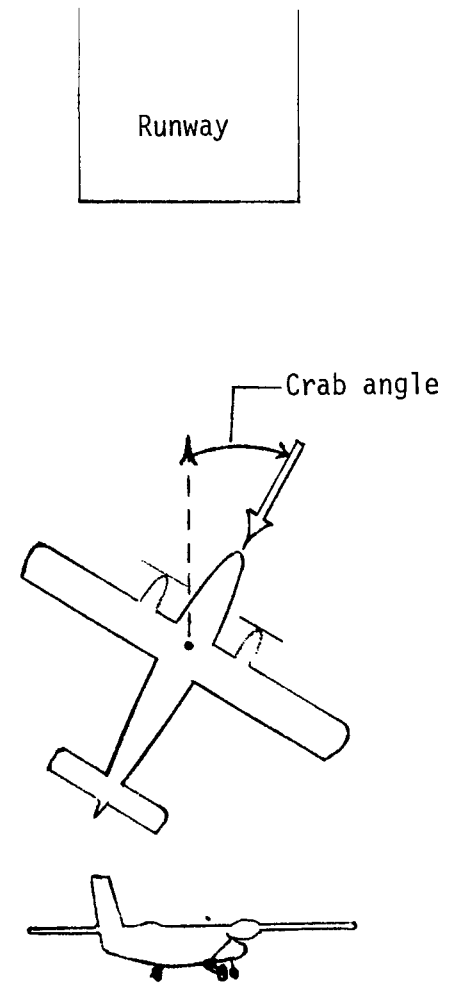
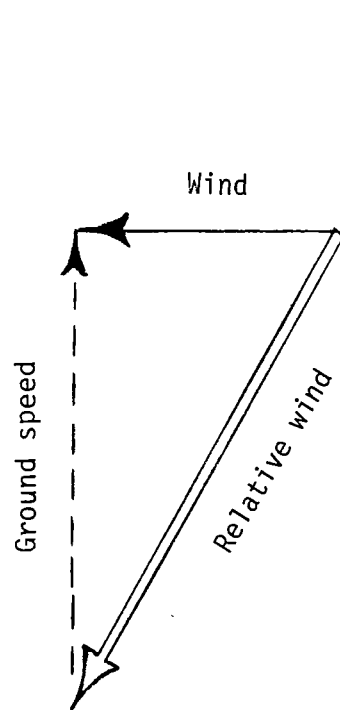

(b) Crab.

Figure 6.- Crosswind landing techniques.

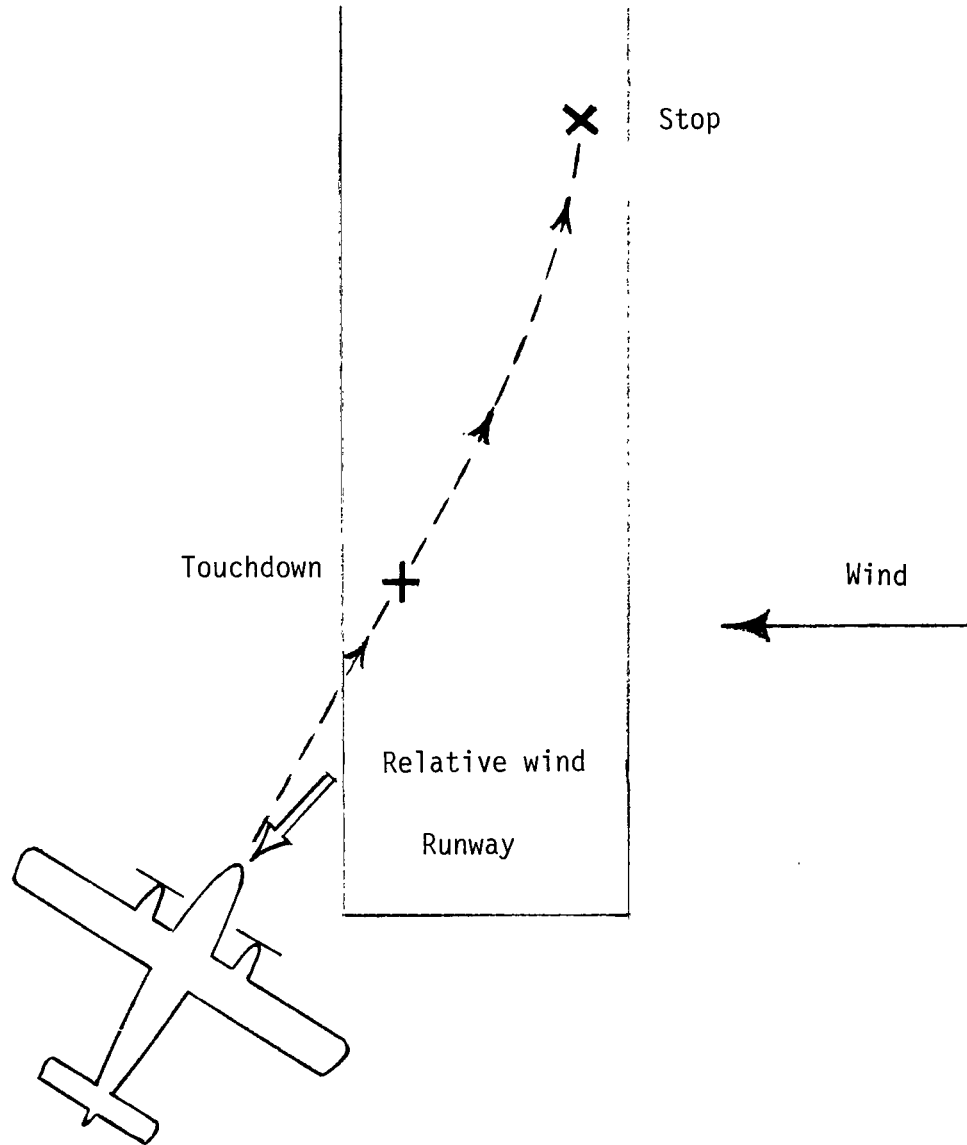

(c) Cross runway.
Figure 6.- Concluded.

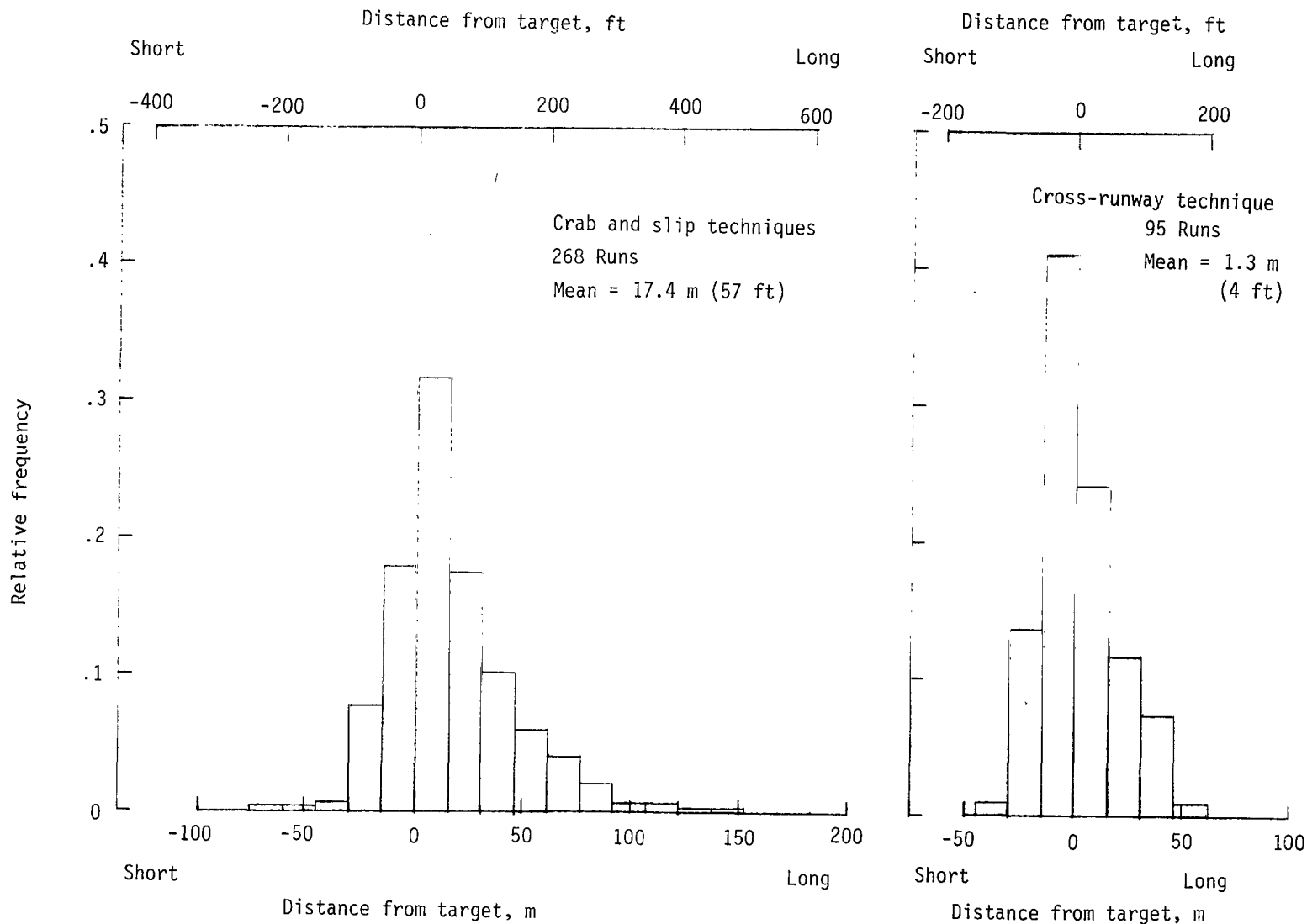

Figure 7.- Longitudinal touchdown dispersion for those runs with crosswinds greater than 5 knots. Data combined for all pilots and both approach angles.

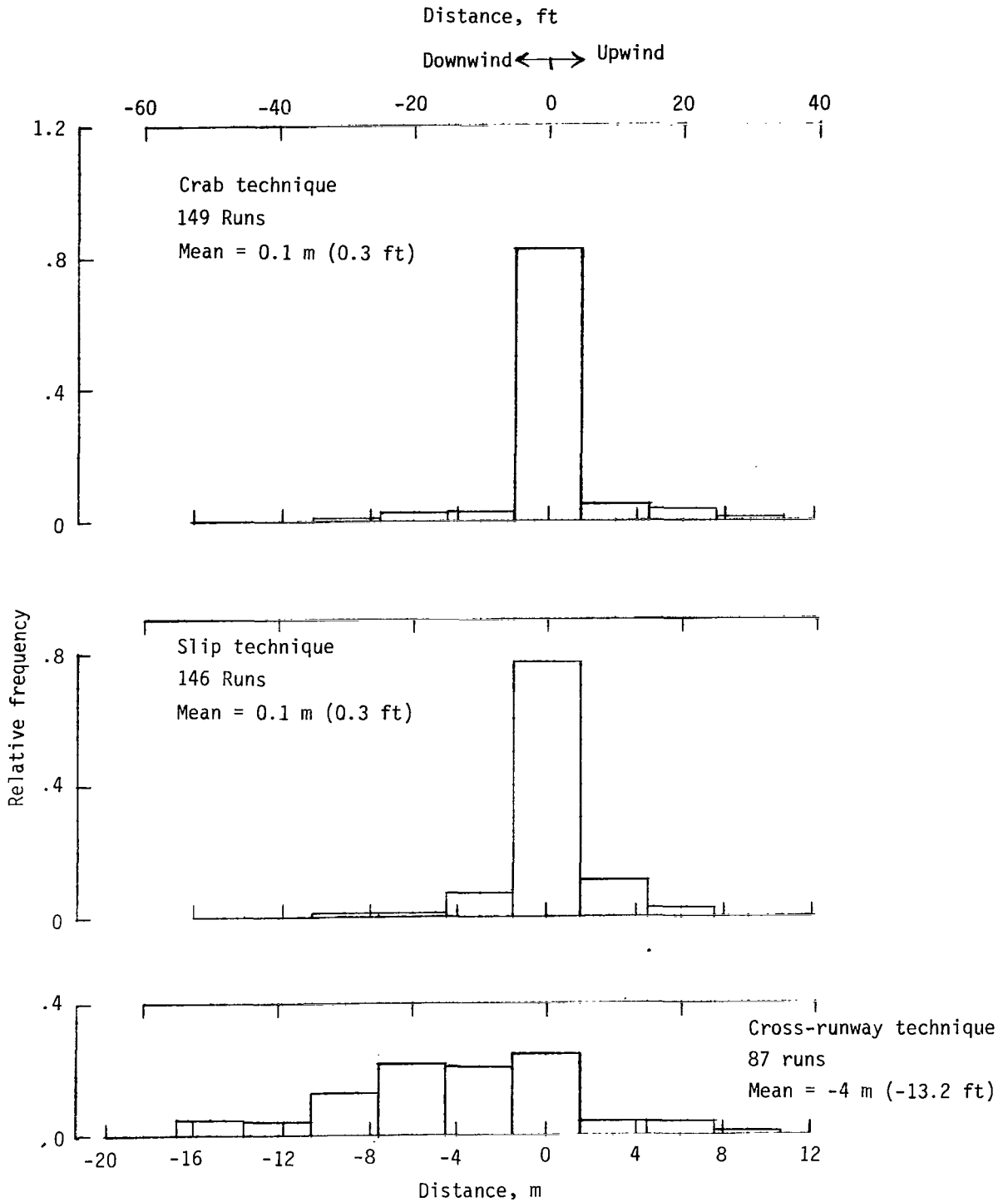

Figure 8.- Lateral-touchdown dispersion for those runs with crosswinds greater than 5 knots. Data combined for all pilots and both approach angles.

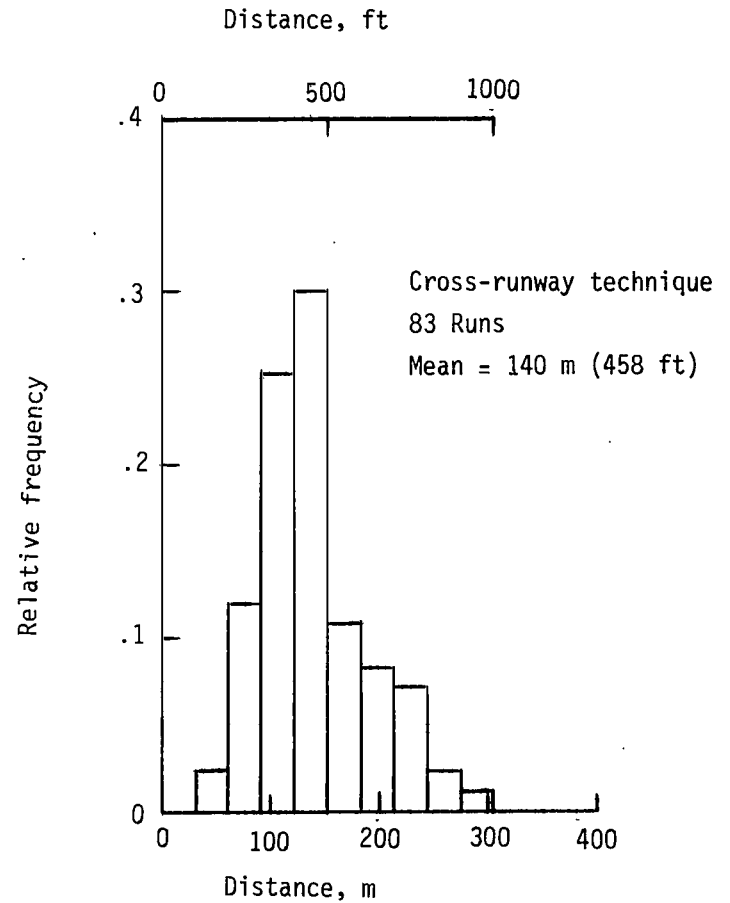
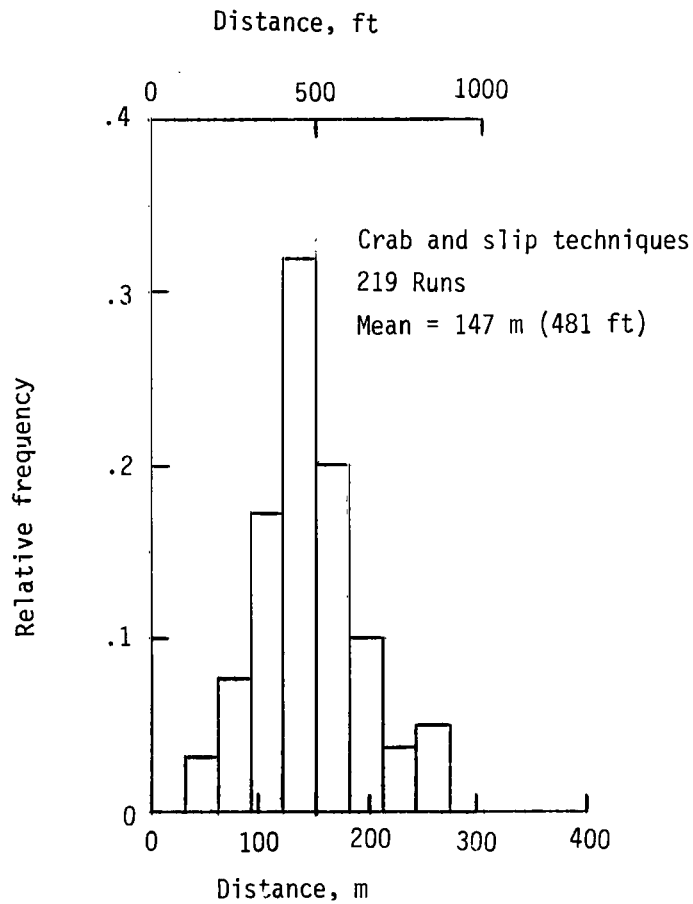

Figure 9.- Ground-roll distance for those runs with crosswind of 5 knots or greater. Data combined for all pilots and both approach angles.

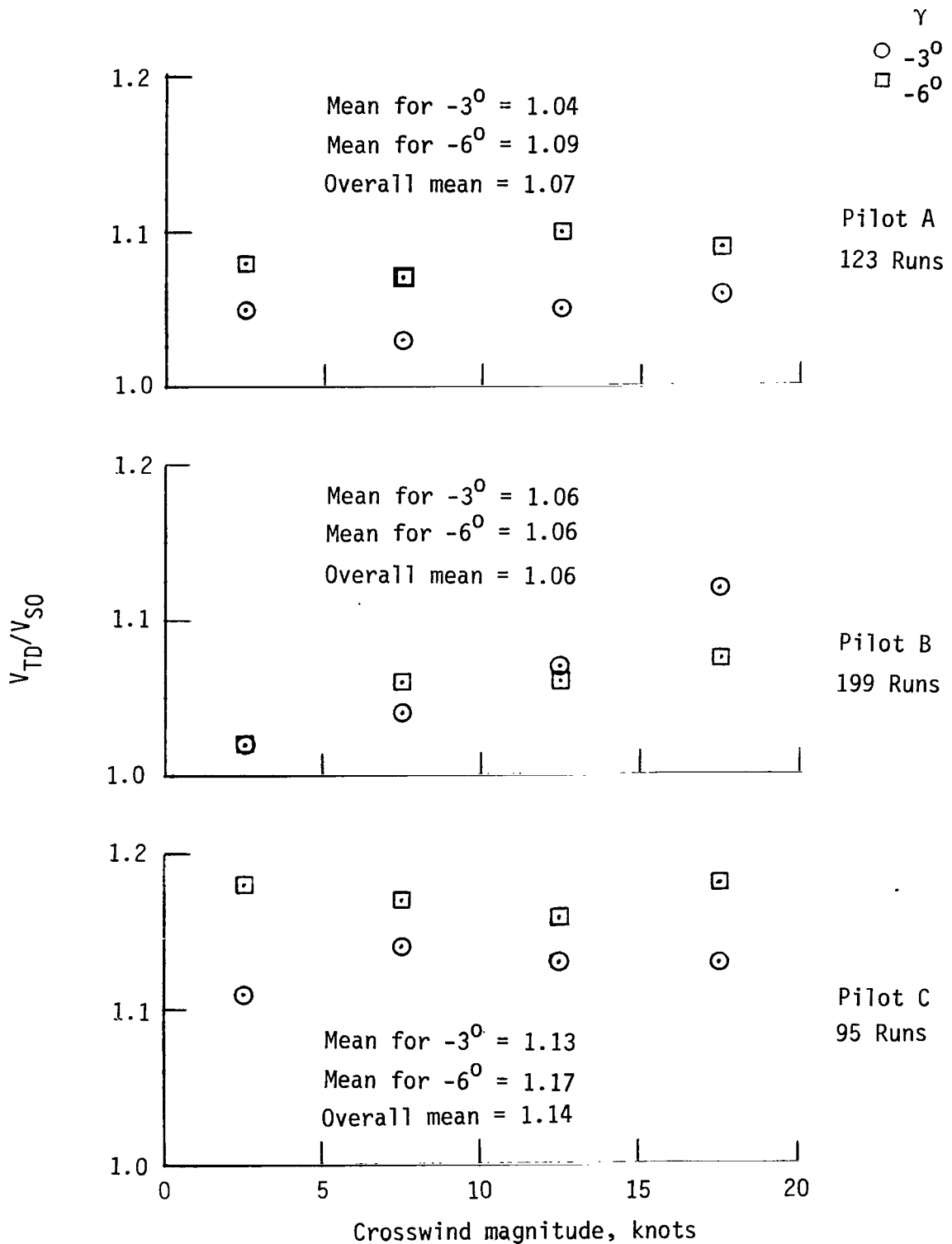

Figure 10.- Touchdown speed ratio as function of crosswind, pilot, and approach angle. Data combined for all techniques.

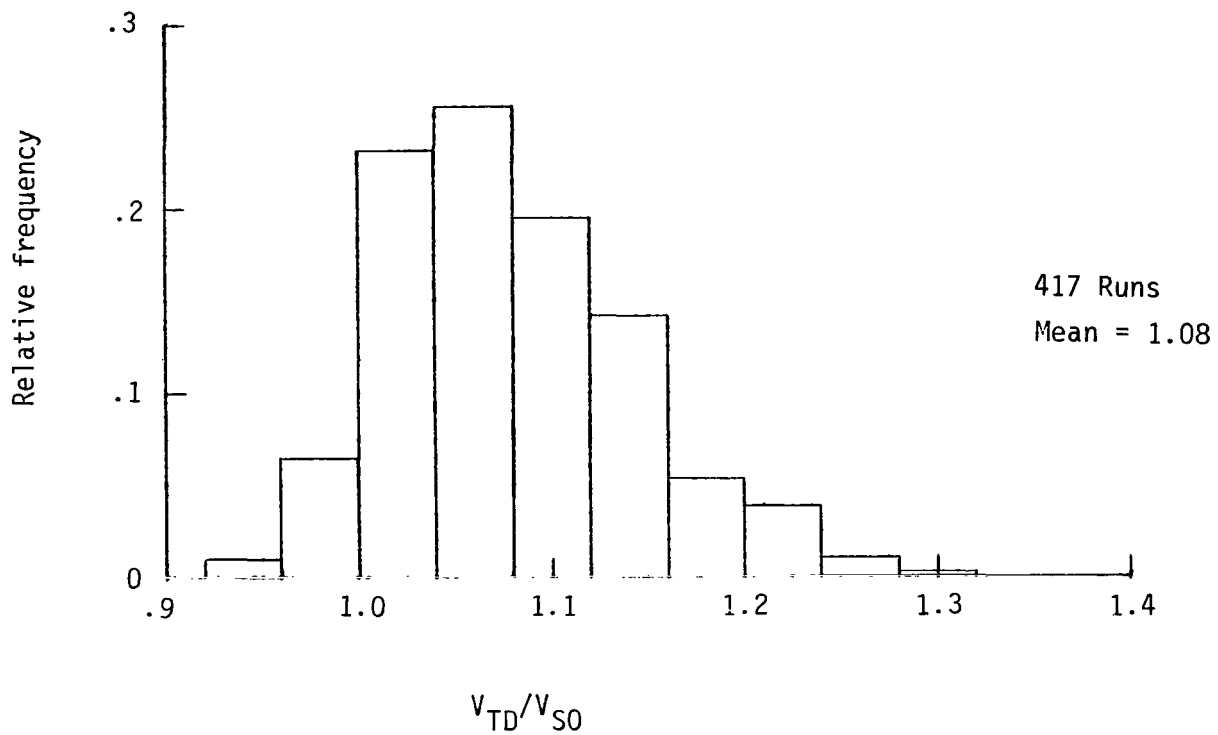

Figure 11.- Touchdown speed ratios combined for all crosswinds, pilots, techniques, and both approach angles.

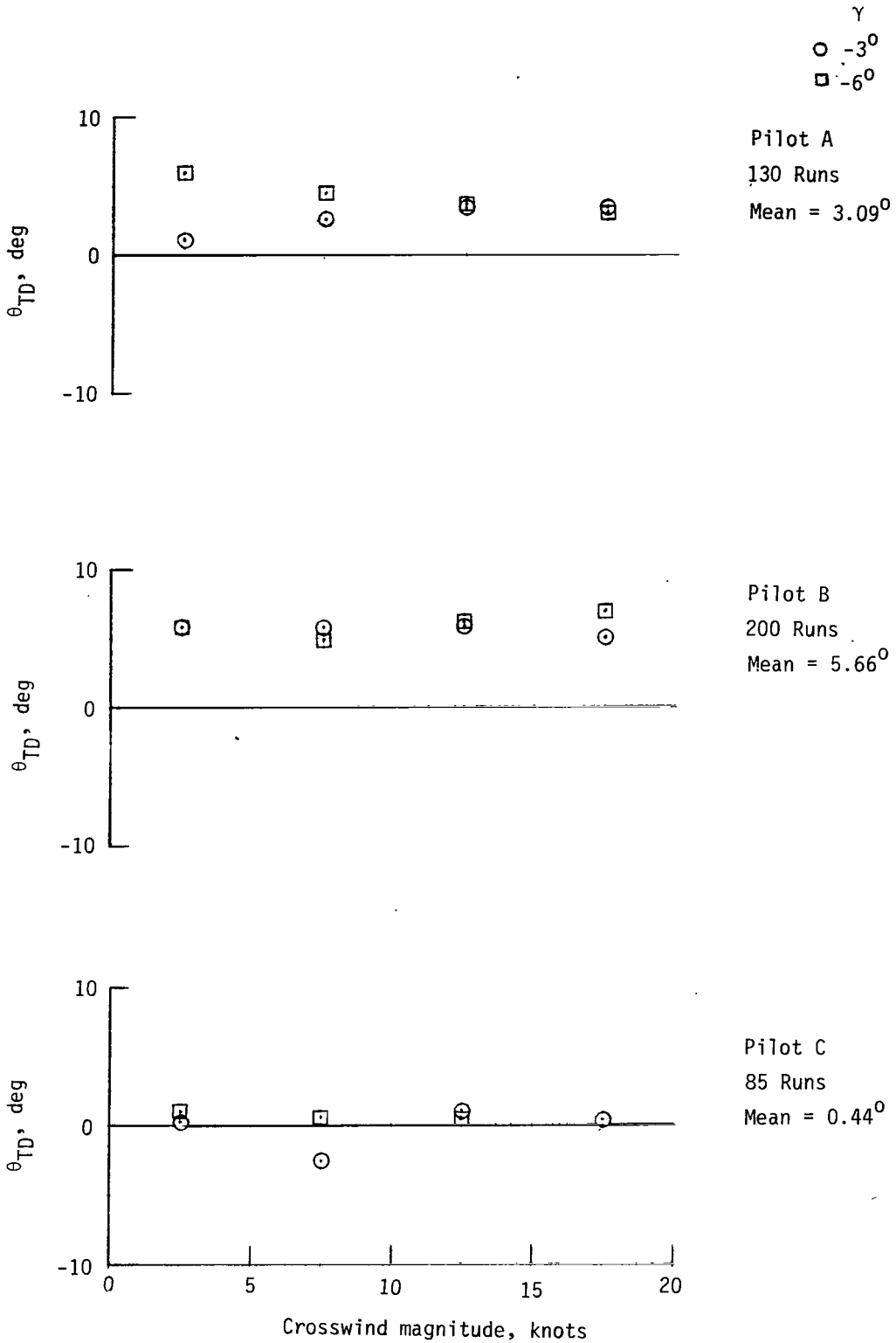

Figure 12.- Pitch attitude at touchdown as function of crosswind, pilot, and approach angle. Data combined for all techniques.

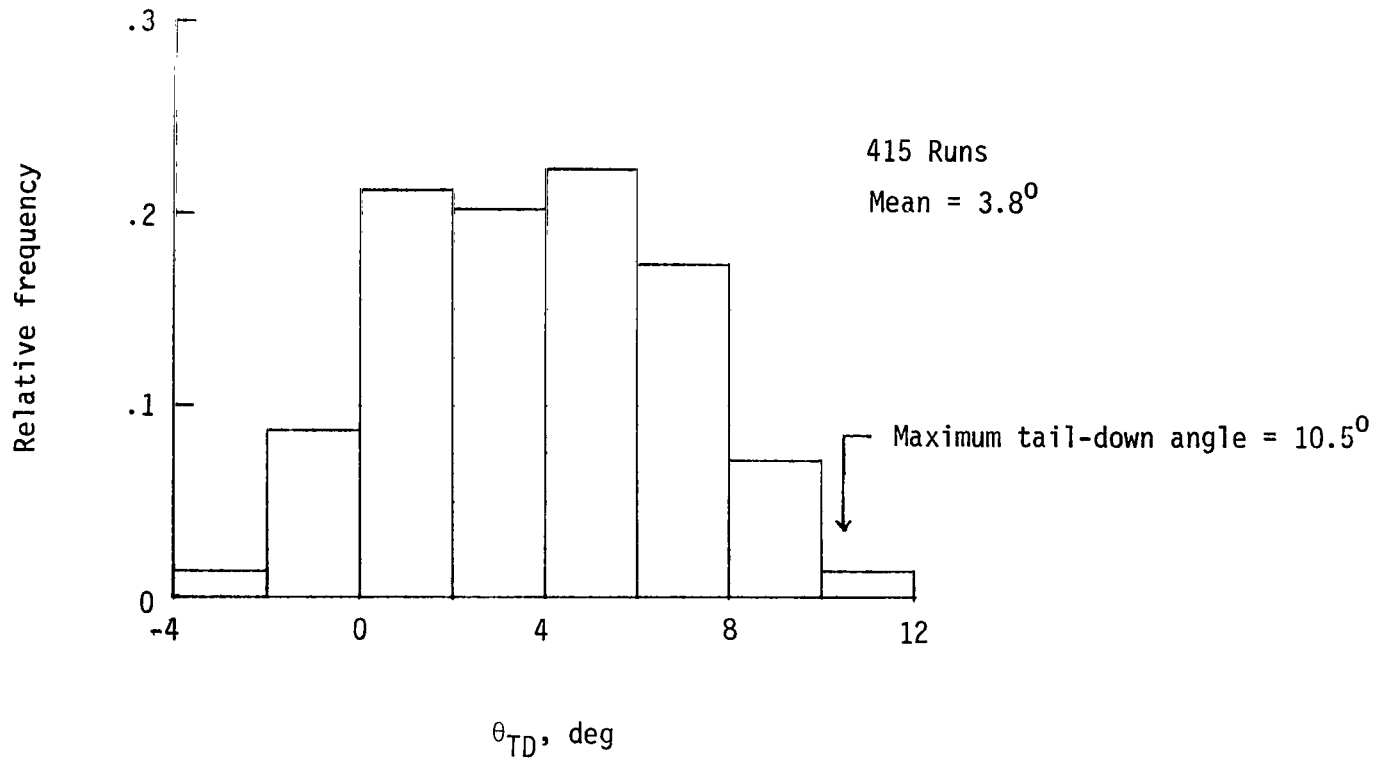

Figure 13.- Pitch attitude at touchdown combined for all crosswinds, pilots, techniques, and both approach angles.

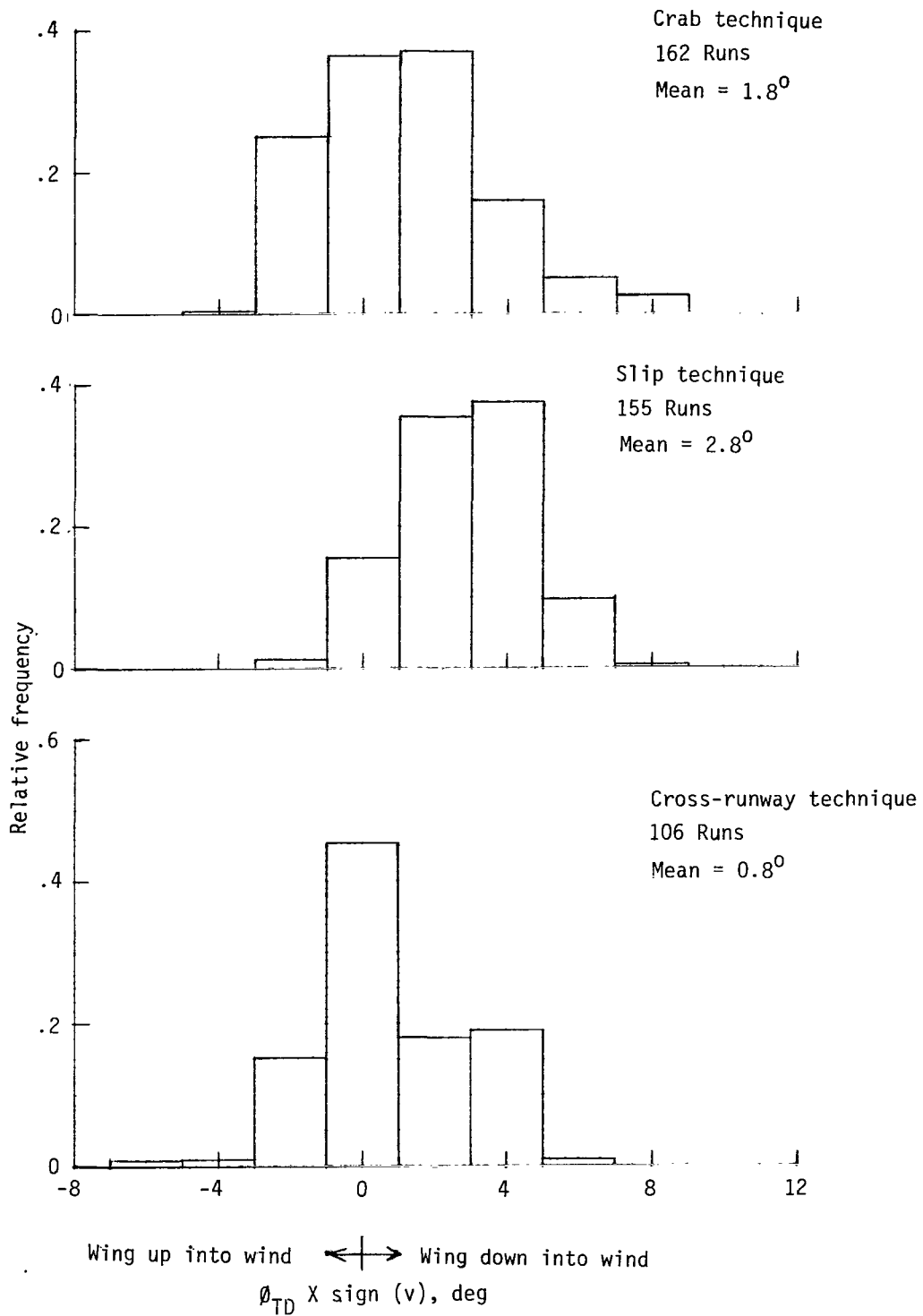

Figure 14.- Roll attitude at touchdown combined for all cross-winds, all pilots, and both approach angles.

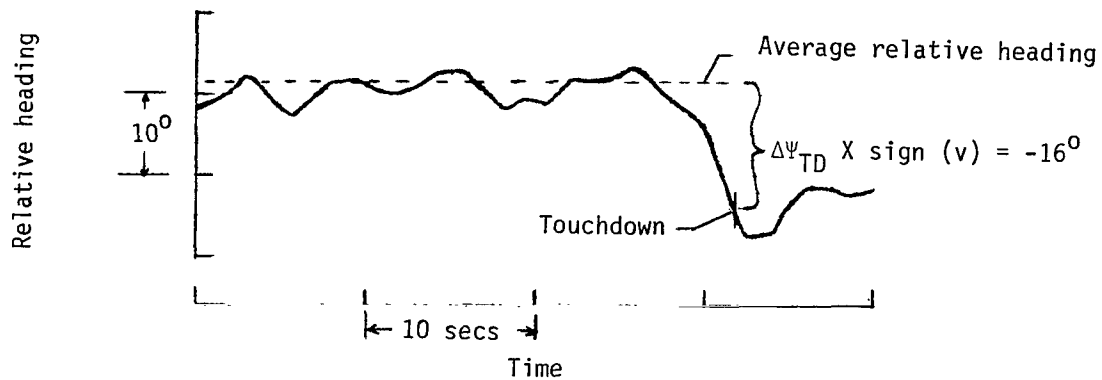

Figure 15.- Typical time history of relative heading showing decrab prior to touchdown. $v = 15.7$ knots.

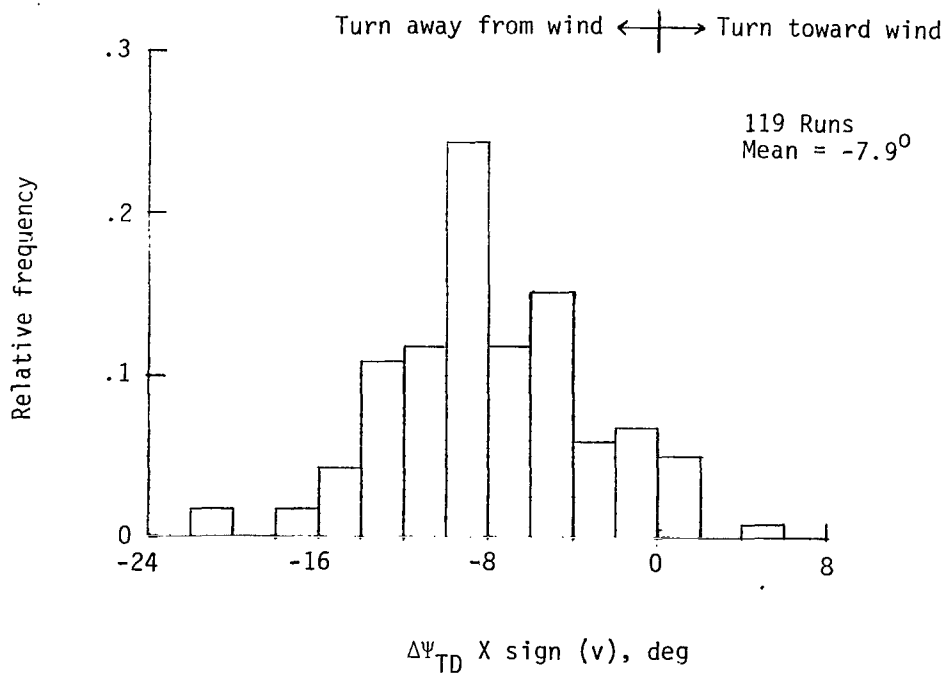

Figure 16.- Decrab prior to touchdown combined for all crosswinds, all pilots, and both approach angles.

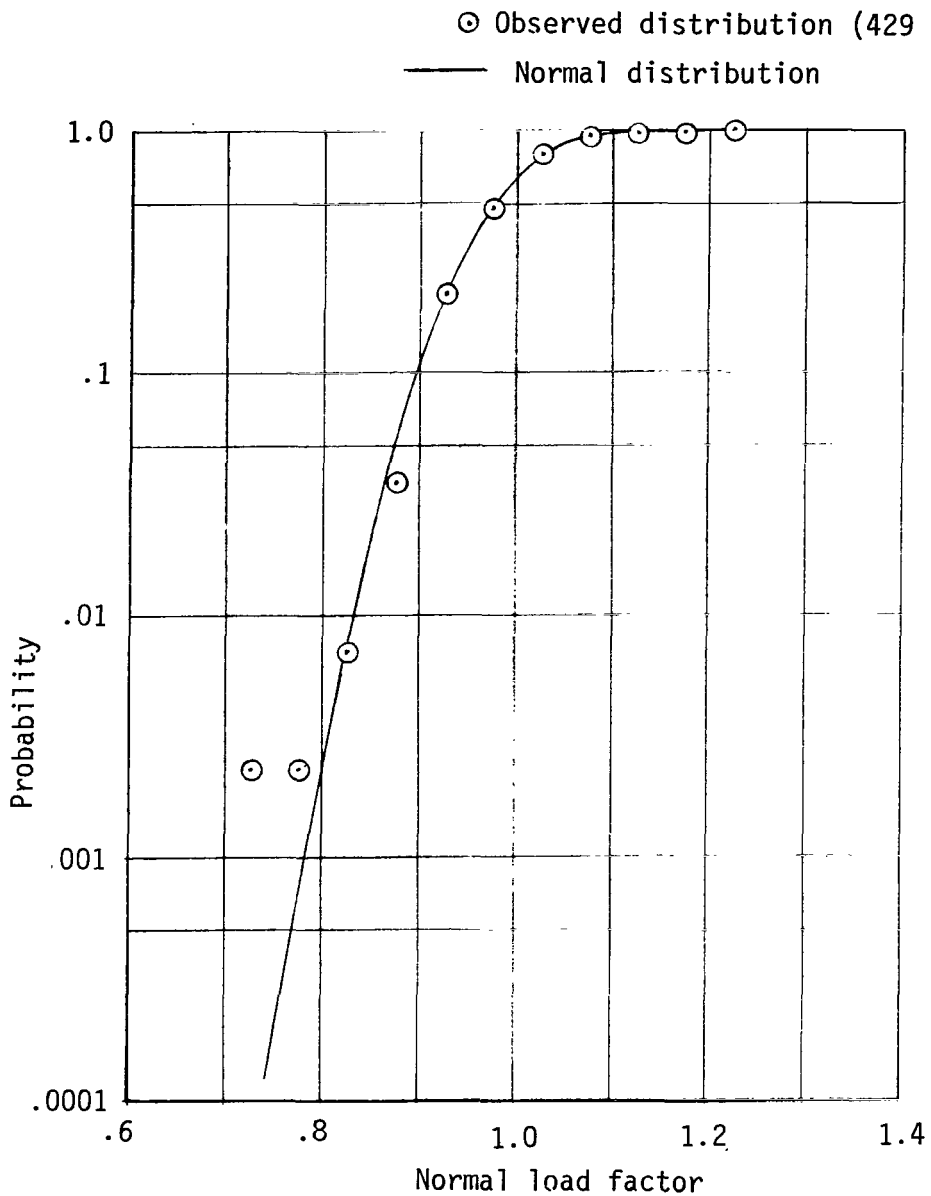
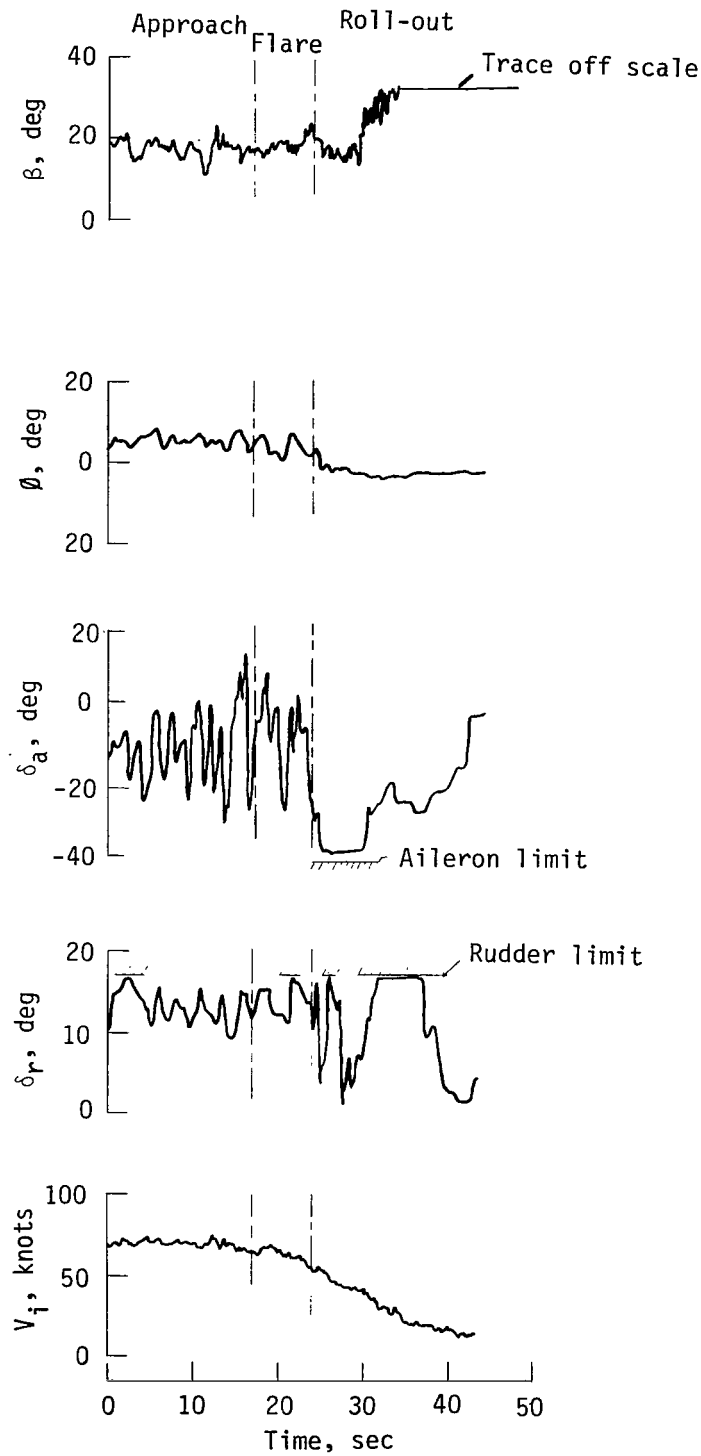
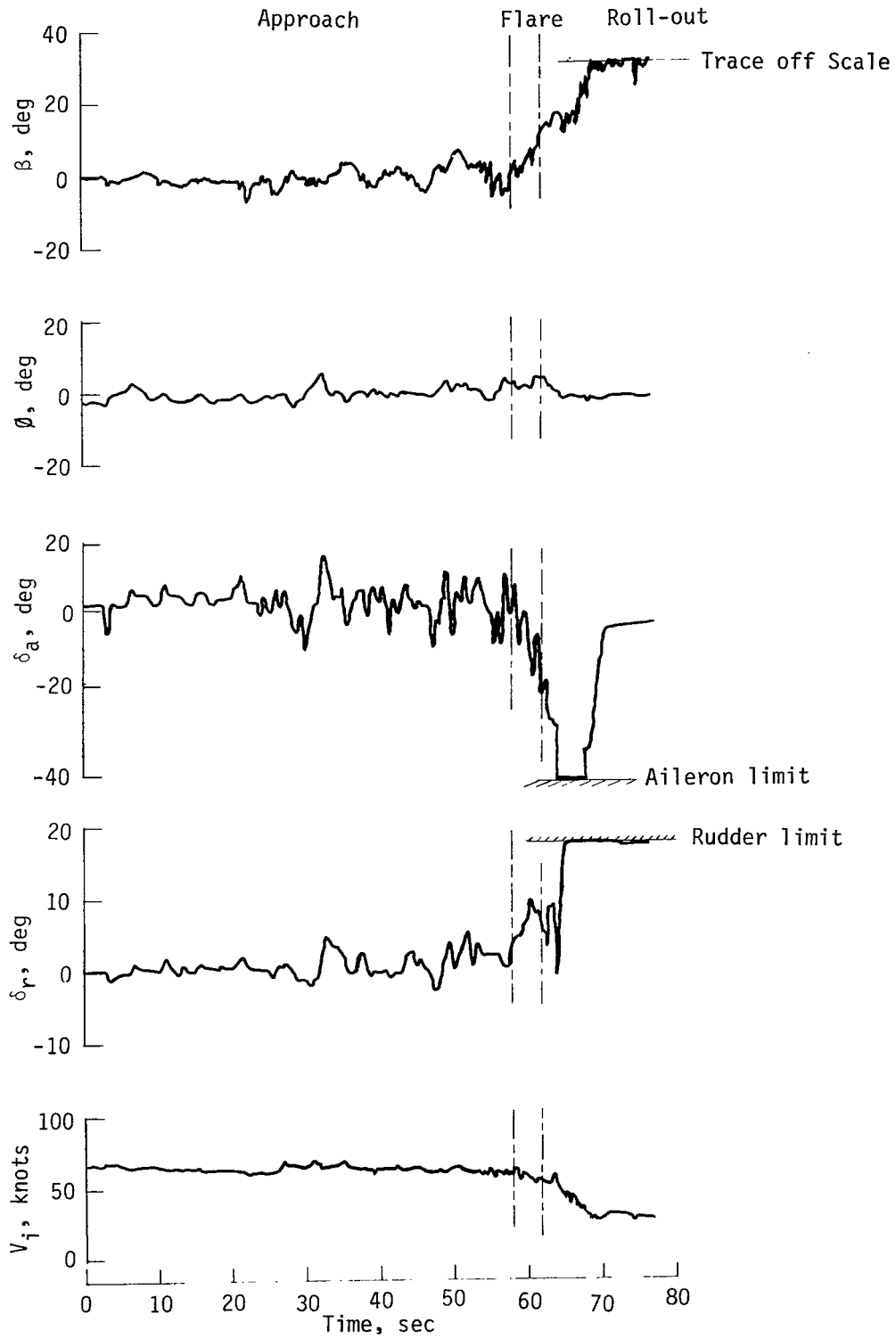

Figure 17.- Probability that normal load factor just prior to touchdown is less than indicated value. Data combined for all crosswinds, pilots, techniques, and both approach angles.



(a) Slip approach. $v = 15.2$ knots, $\gamma = -6^\circ$.

Figure 18.- Time histories of two typical crosswind approaches.



(b) Crab approach. $v = 15.7$ knots, $\gamma = -3^\circ$.

Figure 18.- Concluded.

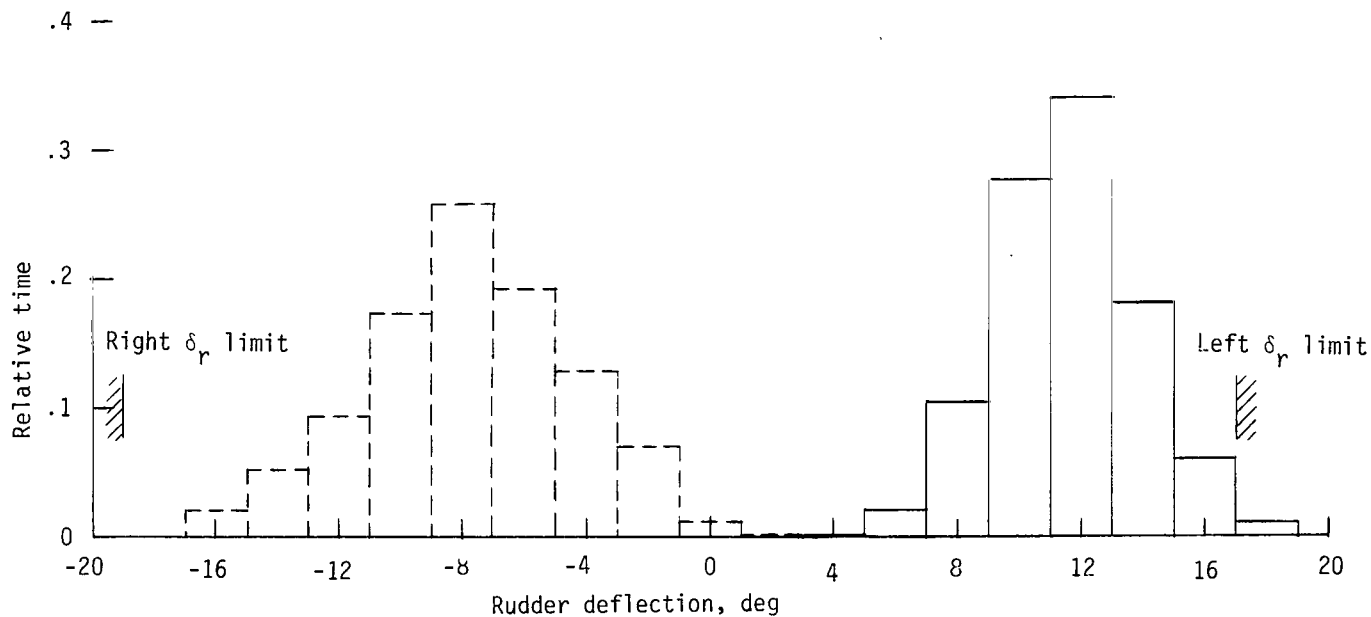
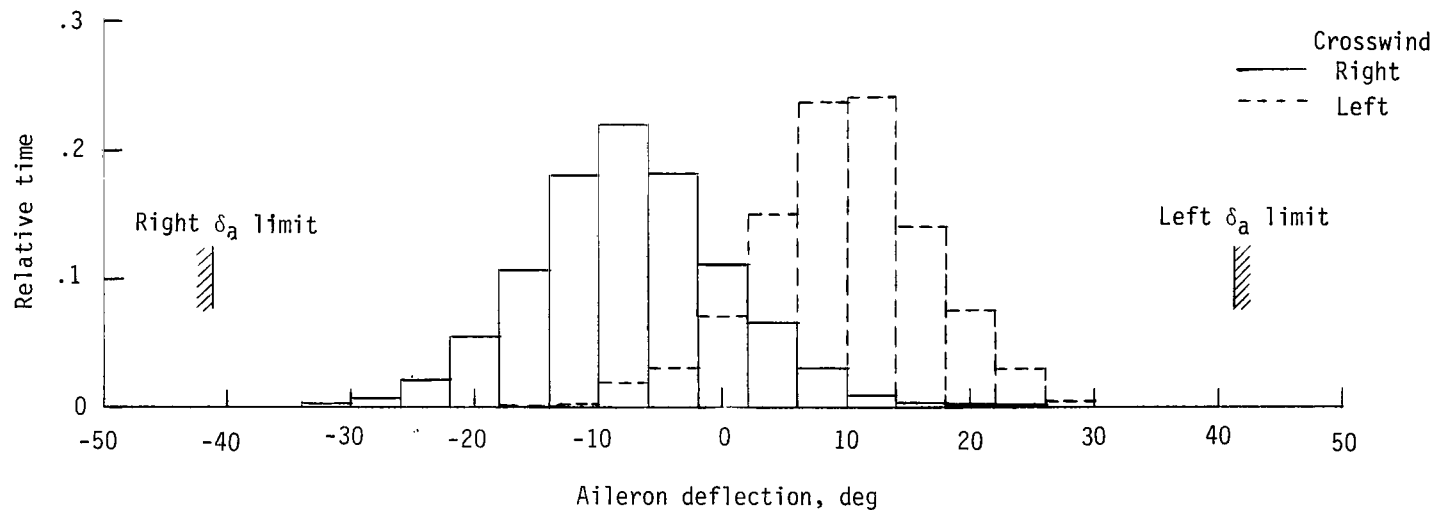

Figure 19.- Histogram showing relative time controls were deflected between given values during slip approaches with crosswinds from 15 to 20 knots. Data combined for all pilots and both approach angles.

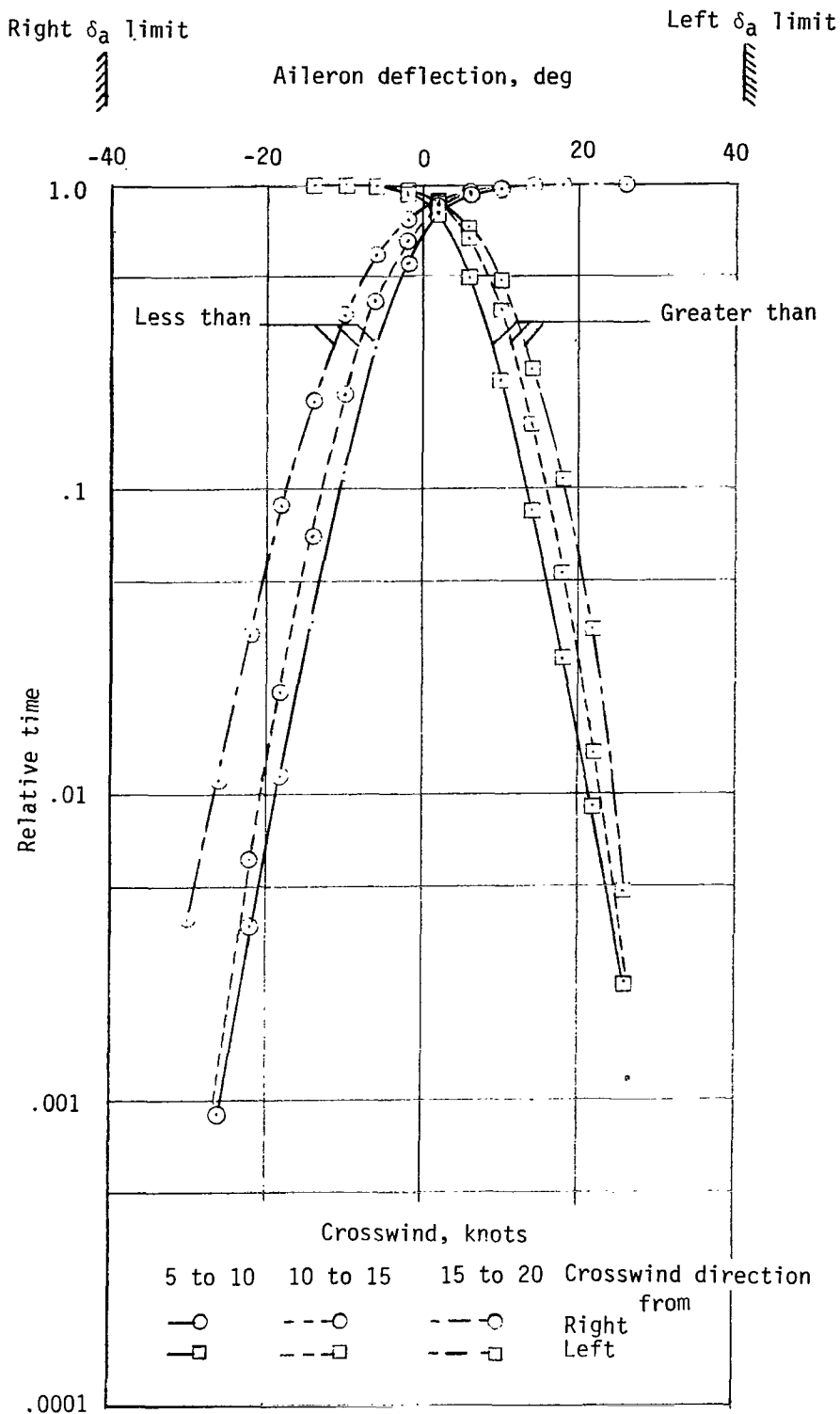

Figure 20.- Relative time ailerons are greater or less than given value during slip approaches with crosswinds greater than 5 knots. Data combined for all pilots and both approach angles.

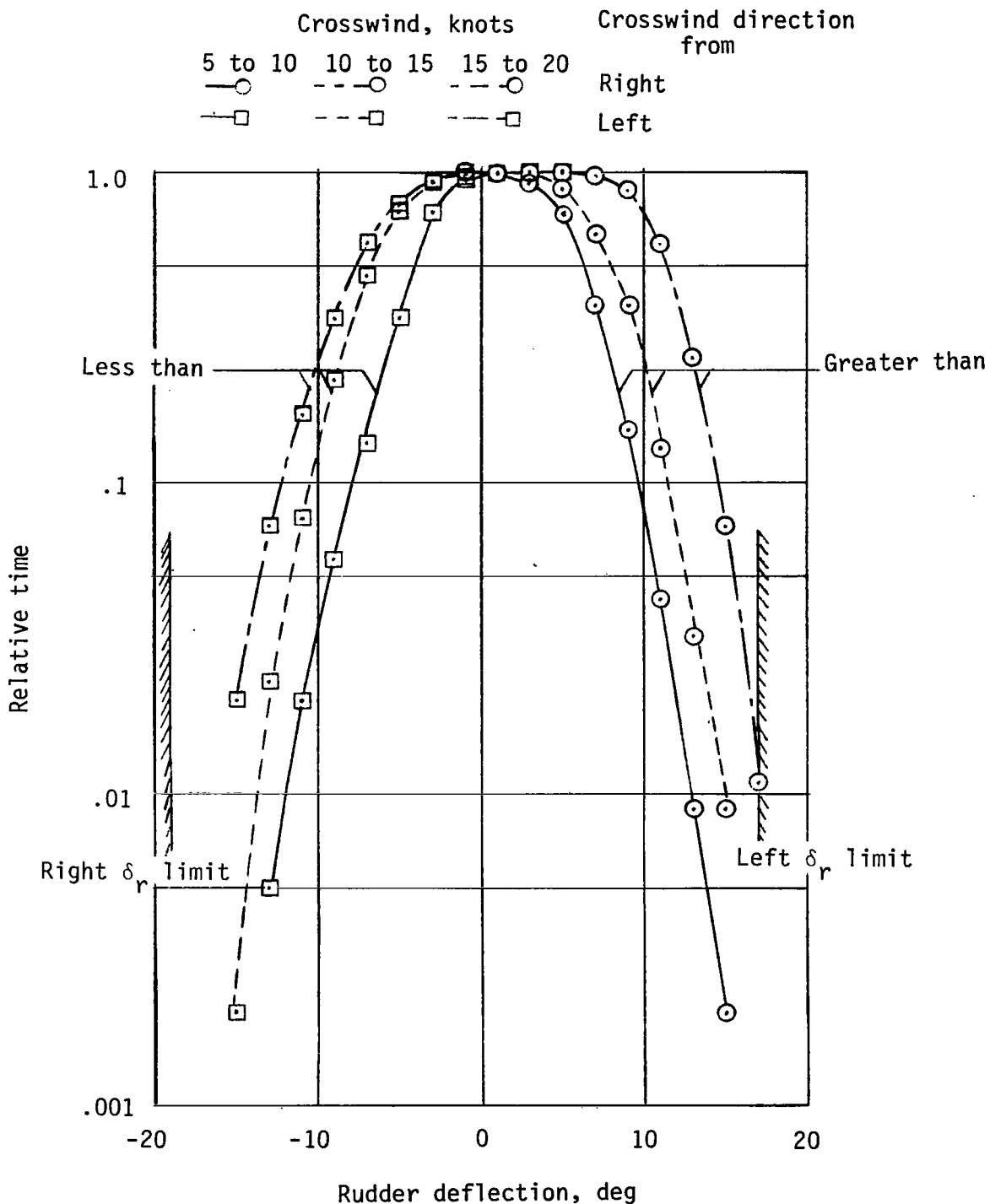

Figure 21.- Relative time rudder is greater or less than given value during slip approaches with crosswinds greater than 5 knots. Data combined for all pilots and both approach angles.

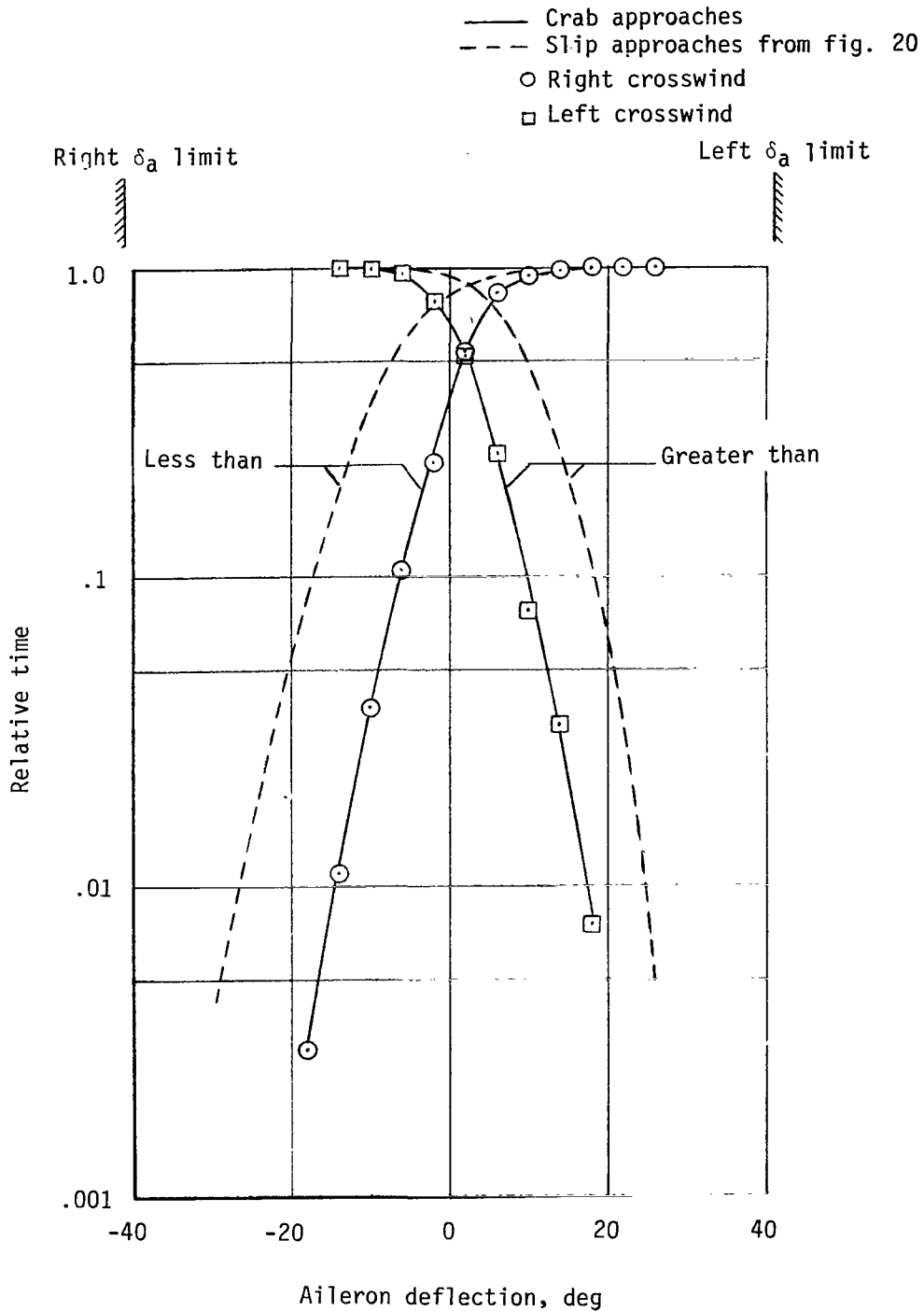

Figure 22.- Relative time ailerons are greater or less than given value for crab and slip approaches with 15- to 20-knot crosswinds. Data combined for all pilots and both approach angles.

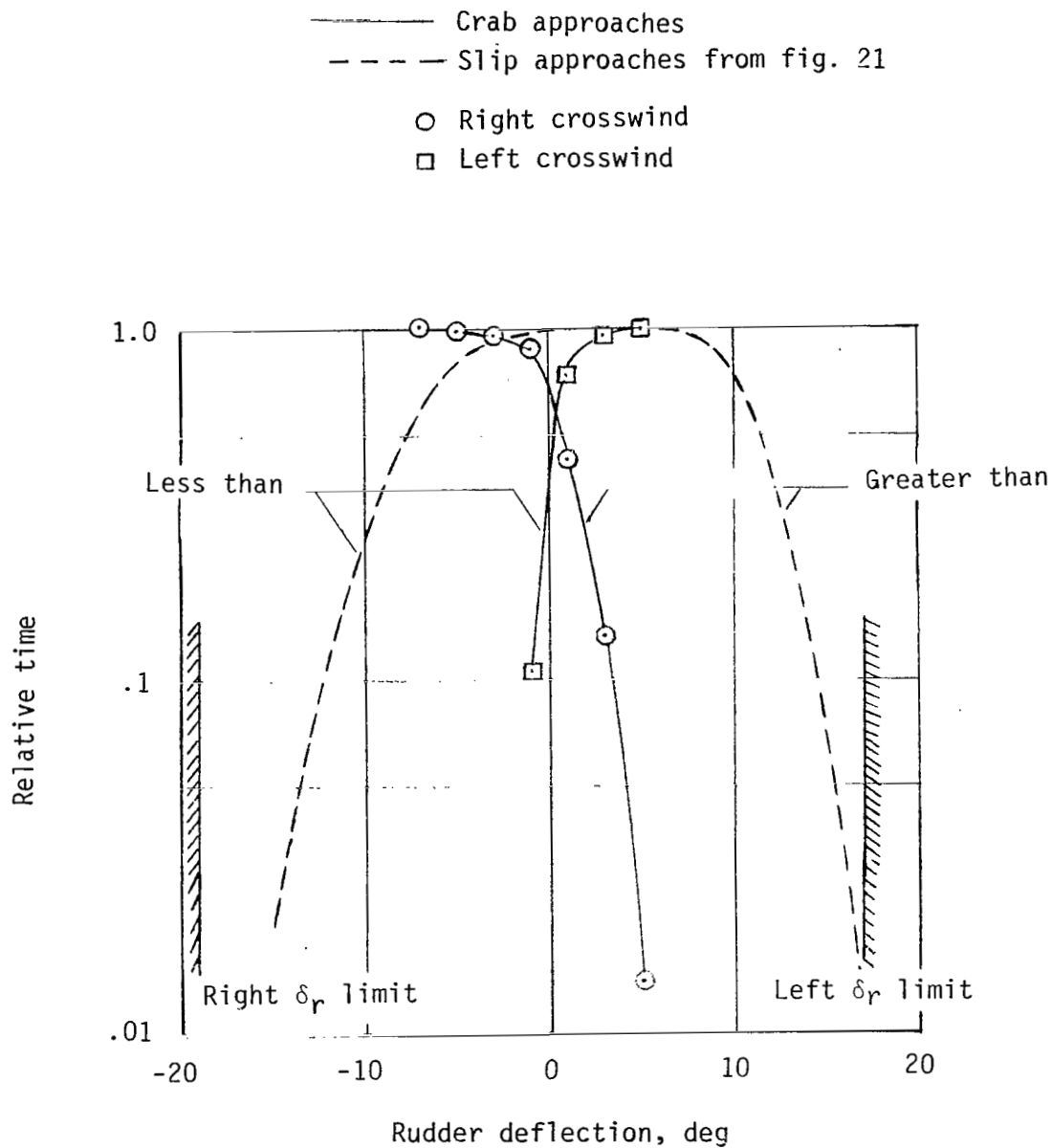

Figure 23.- Relative time rudder is greater or less than given value for crab and slip approaches with 15- to 20-knot crosswinds. Data combined for all pilots and both approach angles.

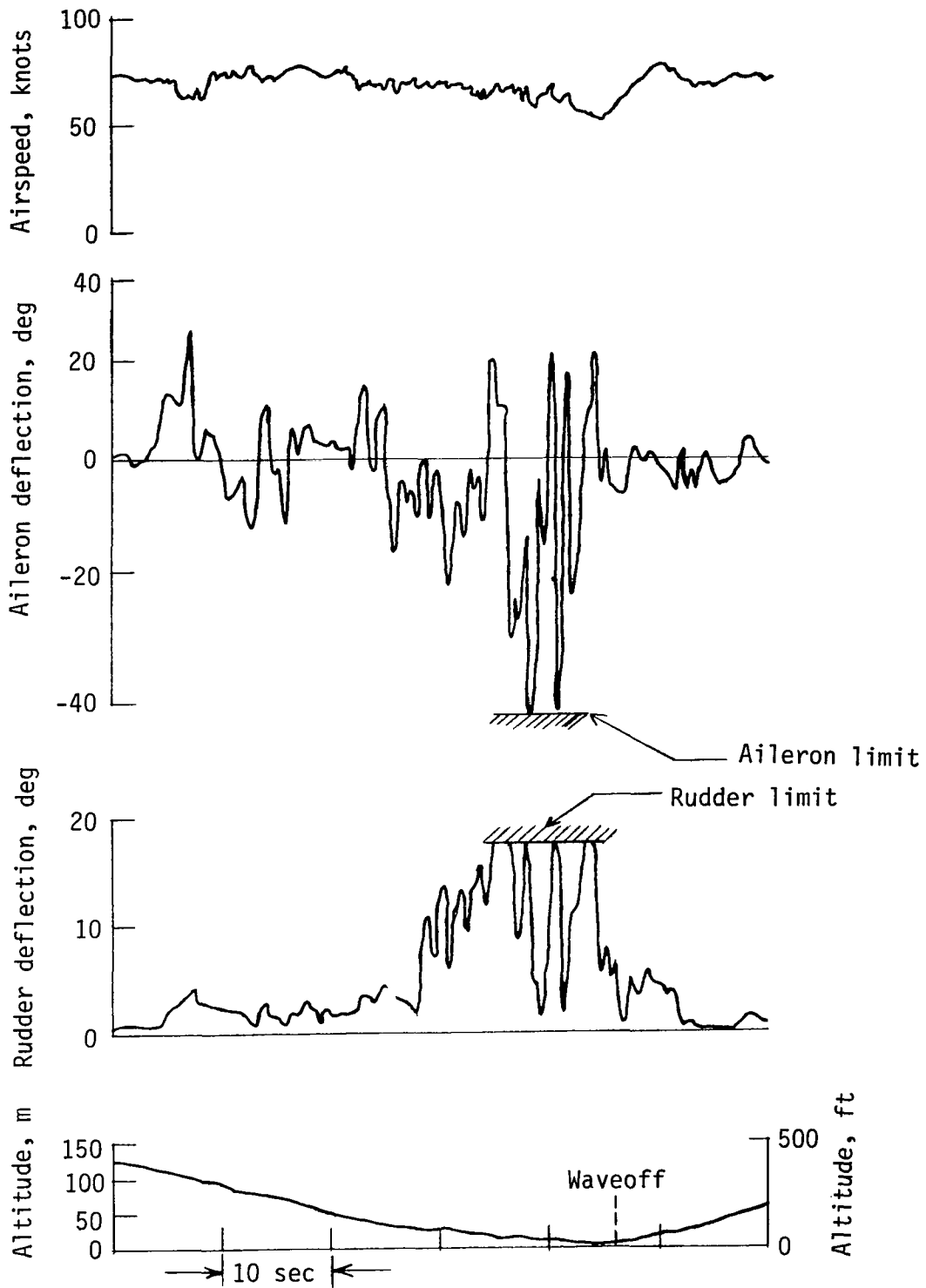

Figure 24.- Time histories of waveoff from combined crab and slip technique approach with $\gamma = -6^\circ$ and $v = 12.1$ knots (22 knots from hand held sensor).

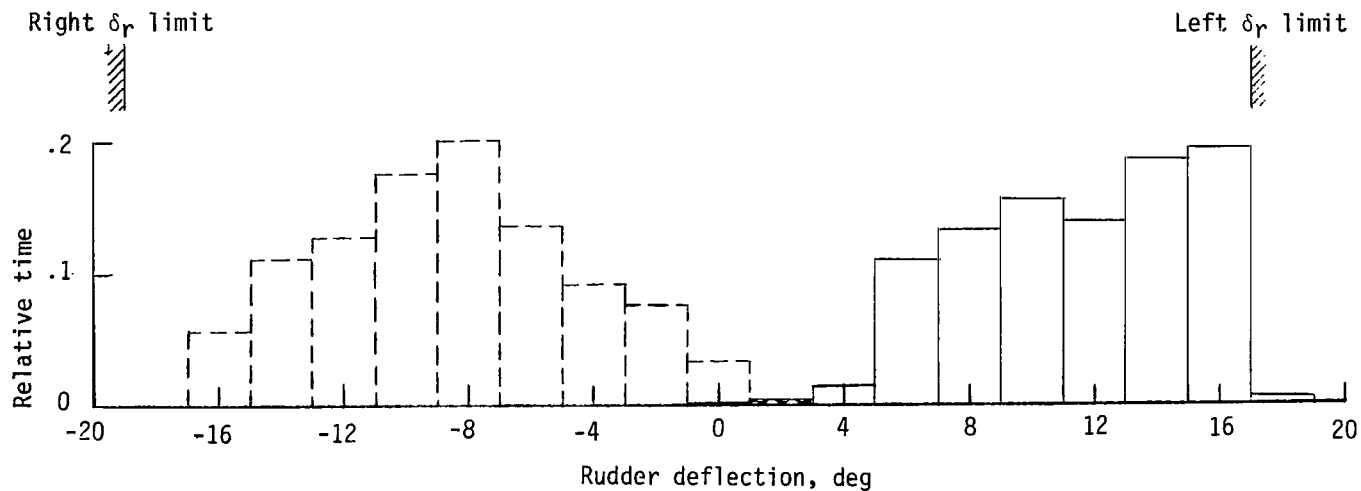
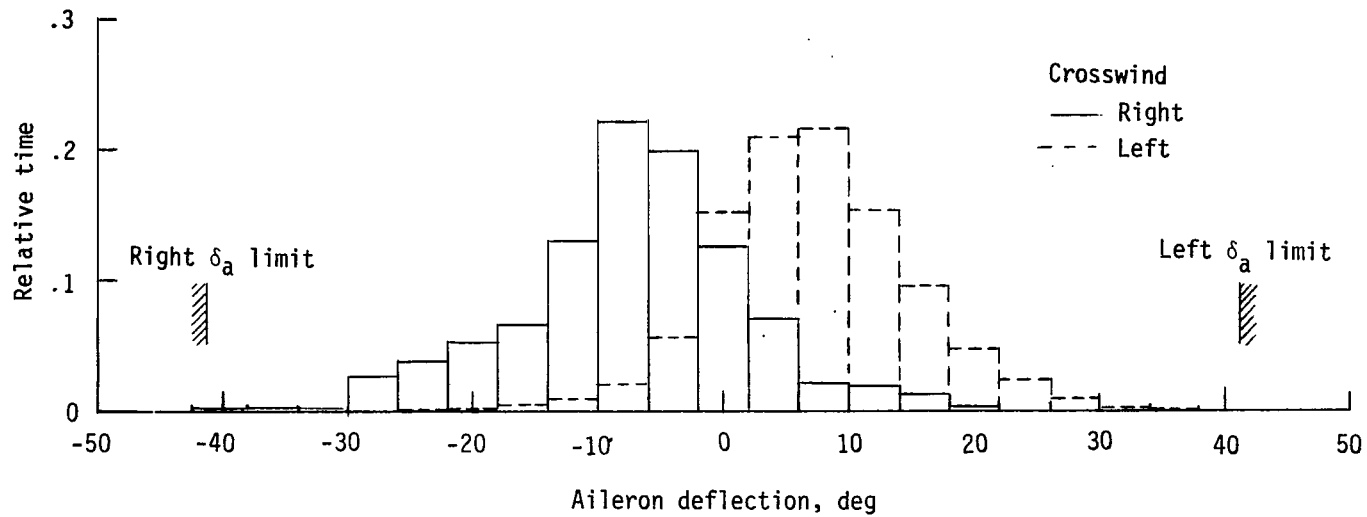

Figure 25.- Histogram showing relative time controls were deflected between given values during flare from slip approaches with 15- to 20-knot crosswinds. Data combined for all pilots and both approach angles.

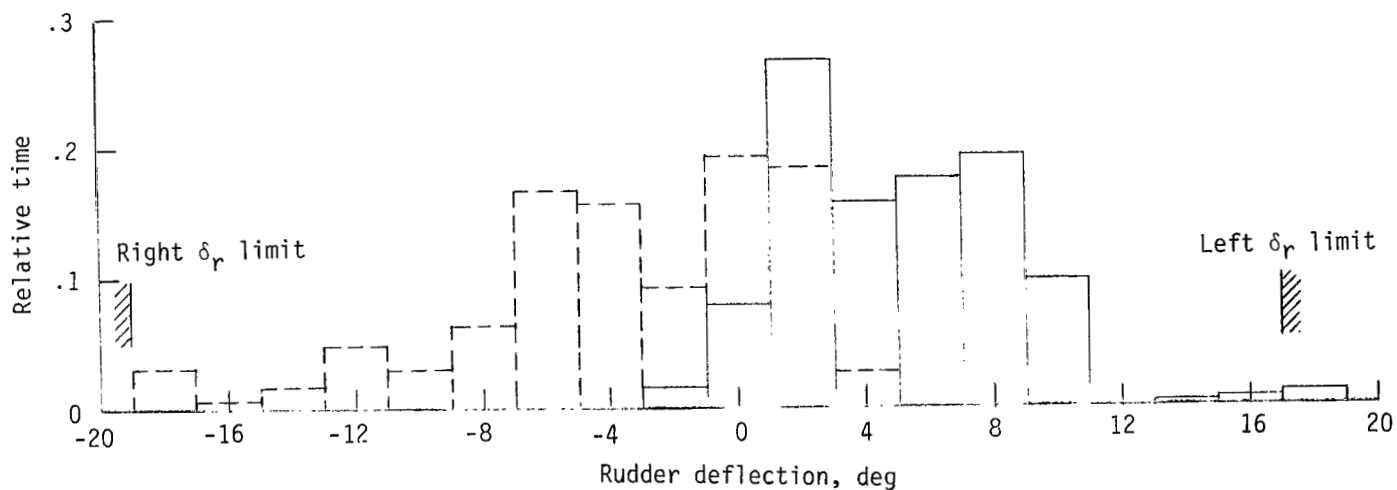
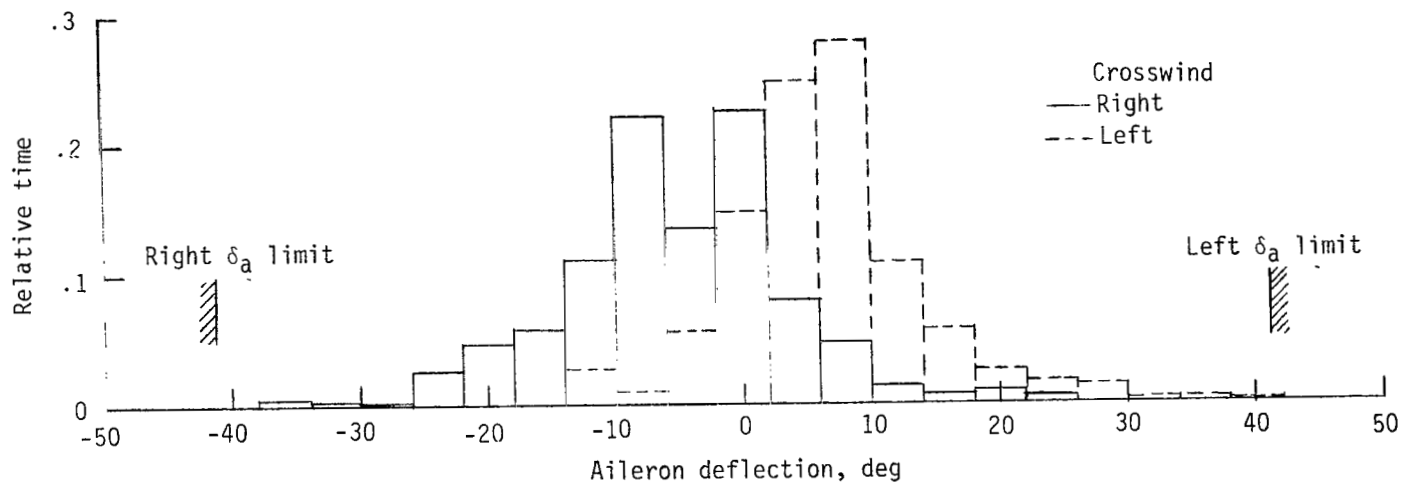

Figure 26.- Histogram showing relative time controls were deflected between given values during flare from crabbed approaches with 15- to 20-knot crosswinds. Data combined for all pilots and both approach angles.

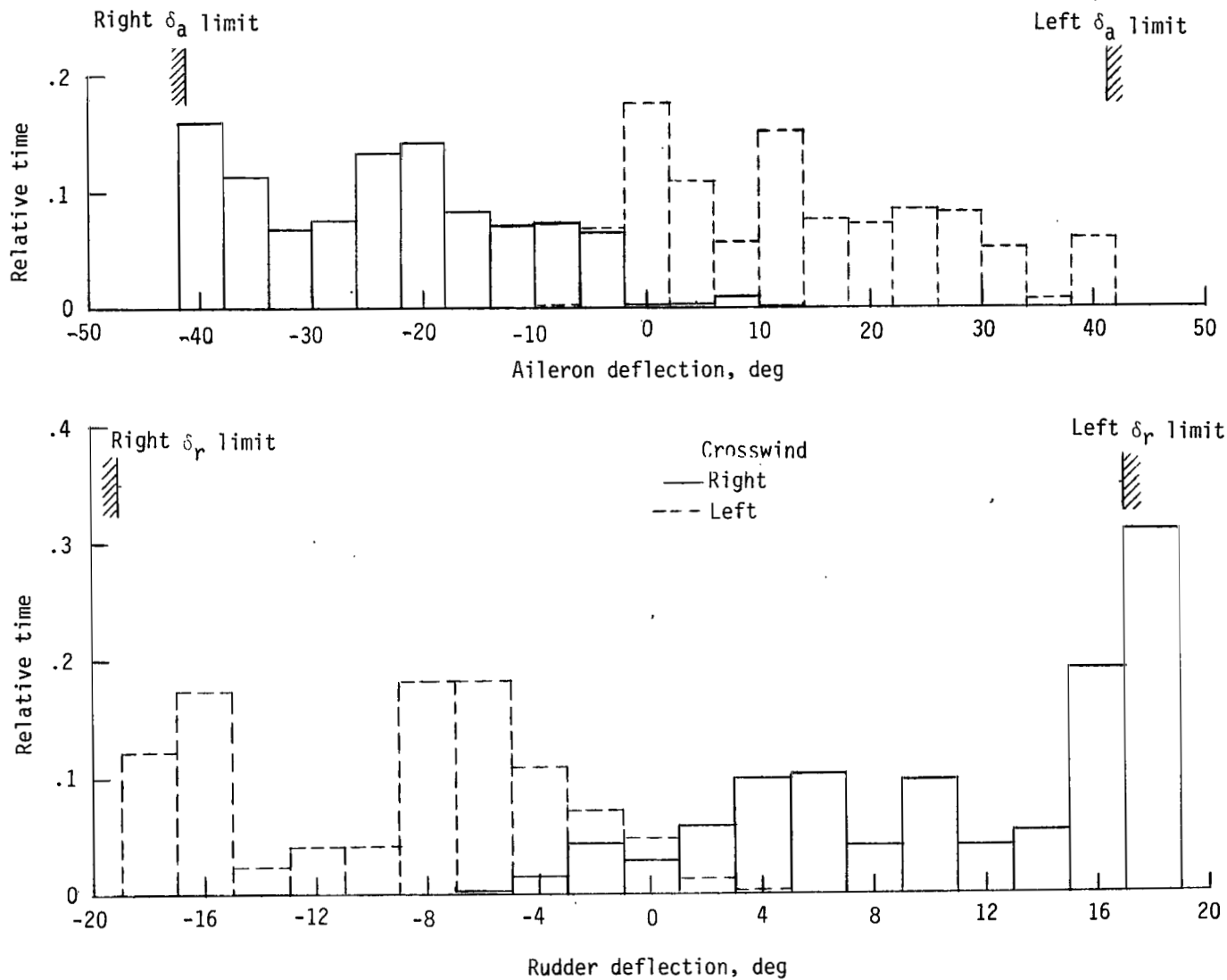
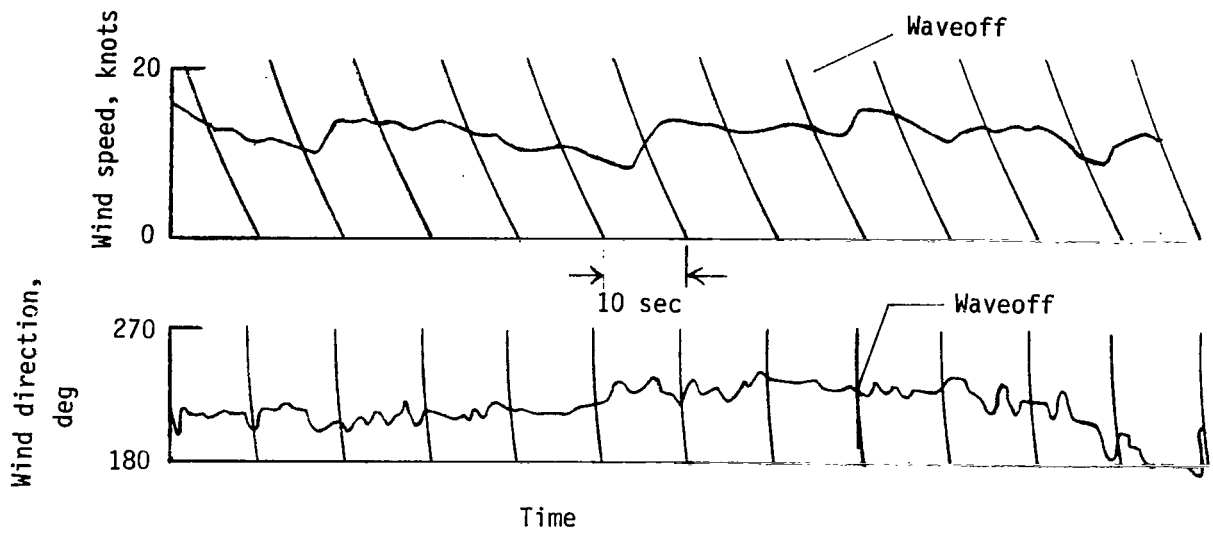
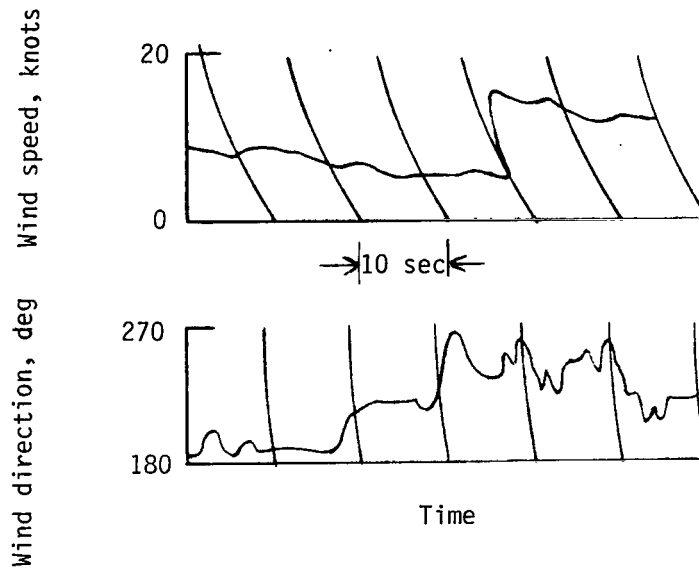

Figure 27.- Histogram showing relative time controls were deflected between given values during ground roll-out following both slip and crab approaches with crosswinds from 15 to 20 knots. Data combined for all pilots and both approach angles.



(a) Waveoff wind sample.



(b) Example of extreme wind shift.

Figure 28.- Samples of wind data from 4.6-m (15-ft) elevation on wind-sensor tower.

Pilots A, B, C

$\gamma = -3^{\circ}, -6^{\circ}$

Full flaps

VFR

Airplane weight: 38 253 N to 45 370 N (8 600 lb to 10 200 lb)

432 Runs

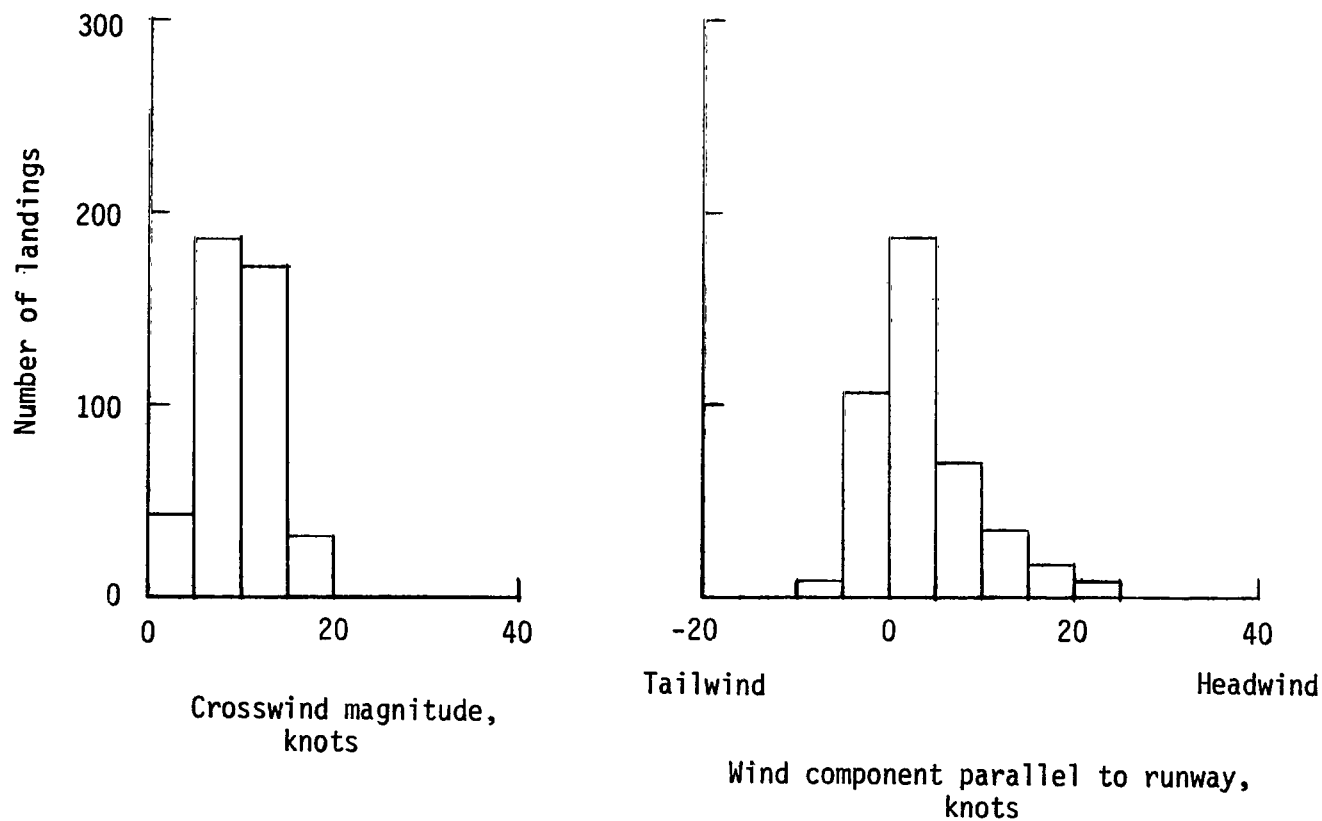

Figure 29.- Summary of wind conditions for all tests. (Based on readings from wind sensor at 4.6 m (15 ft) on wind-sensor tower.)



828 001 C1 U A 761008 S00903DS
DEPT OF THE AIR FORCE
AF WEAPONS LABORATORY
ATTN: TECHNICAL LIBRARY (SUL)
KIRTLAND AFB NM 87117

ASTER : If Undeliverable (Section 158
Postal Manual) Do Not Return

"The aeronautical and space activities of the United States shall be conducted so as to contribute . . . to the expansion of human knowledge of phenomena in the atmosphere and space. The Administration shall provide for the widest practicable and appropriate dissemination of information concerning its activities and the results thereof."

—NATIONAL AERONAUTICS AND SPACE ACT OF 1958

NASA SCIENTIFIC AND TECHNICAL PUBLICATIONS

TECHNICAL REPORTS: Scientific and technical information considered important, complete, and a lasting contribution to existing knowledge.

TECHNICAL NOTES: Information less broad in scope but nevertheless of importance as a contribution to existing knowledge.

TECHNICAL MEMORANDUMS: Information receiving limited distribution because of preliminary data, security classification, or other reasons. Also includes conference proceedings with either limited or unlimited distribution.

CONTRACTOR REPORTS: Scientific and technical information generated under a NASA contract or grant and considered an important contribution to existing knowledge.

TECHNICAL TRANSLATIONS: Information published in a foreign language considered to merit NASA distribution in English.

SPECIAL PUBLICATIONS: Information derived from or of value to NASA activities. Publications include final reports of major projects, monographs, data compilations, handbooks, sourcebooks, and special bibliographies.

TECHNOLOGY UTILIZATION PUBLICATIONS: Information on technology used by NASA that may be of particular interest in commercial and other non-aerospace applications. Publications include Tech Briefs, Technology Utilization Reports and Technology Surveys.

Details on the availability of these publications may be obtained from:

SCIENTIFIC AND TECHNICAL INFORMATION OFFICE

NATIONAL AERONAUTICS AND SPACE ADMINISTRATION

Washington, D.C. 20546