

NASA TECHNICAL
MEMORANDUM



NASA TM X-3456

NASA TM X-3456

PURGING OF A MULTILAYER INSULATION
WITH DACRON TUFT SPACER
BY GAS DIFFUSION

Irving E. Sumner and William J. Fisk

*Lewis Research Center
Cleveland, Ohio 44135*



1. Report No. NASA TM X-3456		2. Government Accession No.		3. Recipient's Catalog No.	
4. Title and Subtitle PURGING OF A MULTILAYER INSULATION WITH DACRON TUFT SPACER BY GAS DIFFUSION				5. Report Date December 1976	
				6. Performing Organization Code	
7. Author(s) Irving E. Sumner and William J. Fisk				8. Performing Organization Report No. E-8833	
9. Performing Organization Name and Address Lewis Research Center National Aeronautics and Space Administration Cleveland, Ohio 44135				10. Work Unit No. 506-21	
				11. Contract or Grant No.	
12. Sponsoring Agency Name and Address National Aeronautics and Space Administration Washington, D.C. 20546				13. Type of Report and Period Covered Technical Memorandum	
				14. Sponsoring Agency Code	
15. Supplementary Notes					
16. Abstract <p>An experimental investigation was conducted to determine the time and purge gas usage required to purge a multilayer insulation (MLI) panel with gaseous helium by means of gas diffusion to obtain a condensable gas (nitrogen) concentration of less than 1 percent within the panel. Two different, flat, rectangular MLI panels, one incorporating a butt joint, were constructed of 11 double-aluminized Mylar (DAM) radiation shields separated by Dacron tuft spacers. The DAM/Dacron tuft concept is known commercially as Superfloc. The test results for the MLI panels indicated that the nitrogen gas concentration as a function of time within the MLI panel could be adequately predicted by using a simple, one-dimensional gas diffusion model in which the boundary conditions at the edge of the MLI panel were time dependent. The test results for the MLI panel with the butt joint indicated that the time and purge gas usage required to achieve 1 percent nitrogen gas concentration within the MLI panel varied from 208 to 86 minutes and 34.1 to 56.5 MLI panel purge volumes, respectively, for gaseous helium purge rates from 10 to 40 MLI panel volumes per hour.</p>					
17. Key Words (Suggested by Author(s)) Multilayer insulation; Insulation purge; Cryogenic propellant storage; Spacecraft; Cryogenes				18. Distribution Statement Unclassified - unlimited STAR Category 15	
19. Security Classif. (of this report) Unclassified		20. Security Classif. (of this page) Unclassified		21. No. of Pages 28	22. Price* \$4.00

PURGING OF A MULTILAYER INSULATION WITH DACRON

TUFT SPACER BY GAS DIFFUSION

by Irving E. Sumner and William J. Fisk

Lewis Research Center

SUMMARY

An experimental investigation was conducted to determine the time and purge gas usage required to purge a multilayer insulation (MLI) panel with gaseous helium by means of gas diffusion to obtain a condensable gas (nitrogen) concentration of less than 1 percent within the panel. Two different, flat, rectangular MLI panels, both constructed of 11 double-aluminized Mylar (DAM) radiation shields separated by Dacron tuft spacers, were each mounted in a purge box and tested. The DAM/Dacron tuft concept is known commercially as Superfloc. The first (or basic) MLI panel configuration was purged by exposing the panel edges on two sides to helium purge gas. The second MLI panel configuration incorporated a butt joint through which all of the helium purge gas was forced to flow.

The purge technique relied on the flow of helium purge gas to reduce the condensable gas concentration at the edge or butt joint of the MLI panel and then on the diffusion of the helium purge gas into the panel to displace the condensable gas therein.

The test results for the basic MLI panel indicated that the nitrogen gas concentration as a function of time within the MLI panel could be adequately predicted by using a simple, one-dimensional gas diffusion model in which the boundary conditions at the edge of the MLI panel were time dependent. The analytically calculated value of the diffusion coefficient ($4.12 \times 10^{-3} \text{ m}^2/\text{min}$ ($4.43 \times 10^{-2} \text{ ft}^2/\text{min}$)) was used for this basic MLI panel. The same value had been used previously for a DAM/silk net MLI panel with equally good results.

The test results for the MLI panel with the butt joint indicated that the rate at which the nitrogen gas concentration at the butt joint was reduced was a significant factor in the total time required to reduce the condensable gas concentration within the panel. The time and purge gas usage required to achieve 1 percent nitrogen gas concentration within the MLI panel varied from 208 to 86 minutes and 34.1 to 56.5 MLI panel purge volumes, respectively, for gaseous helium purge rates from 10 to 40 MLI panel volumes per hour. Values of the corrected diffusion coefficient from 4.65×10^{-3} to 9.80×10^{-3} square meter per minute (5.00×10^{-2} to $1.05 \times 10^{-1} \text{ ft}^2/\text{min}$) were used to obtain good agreement between experimental and predicted nitrogen gas concentration within the MLI panel.

INTRODUCTION

Multilayer insulation (MLI) systems continue to be used extensively for the thermal protection of cryogenic propellants in space vehicles. The space-hold thermal performance of MLI systems depends, to a large extent, on the ability to purge the insulation of condensable gases on the ground prior to filling the cryogenic propellant tanks. Any freezing of condensable gases within the MLI system degrades its thermal performance by increasing the time required to achieve the low interstitial pressure between the radiation shields necessary for good space-hold thermal performance. Also, the presence of condensed gases may reduce the emissivity of the highly reflective surfaces of the radiation shields. The capability of suitably purging the insulation to remove condensable gases is even more critical for a reusable insulation system which may be exposed to many cycles of atmospheric and space-vacuum thermal conditions.

Some of the recent investigations concerning the purging of multilayer insulation are reported in references 1 to 3. Reference 1 presents the results of gaseous helium purge tests conducted with a double aluminized mylar (DAM) silk net insulation system. In these tests, the condensable gas (nitrogen) contained within flat, rectangular insulation panels was displaced by the helium purge gas by means of gas diffusion. The test program of reference 1 was conducted in a similar manner using the same experiment test apparatus and technique as the program described herein.

References 2 and 3 describe a more rapid purge process in which the helium purge gas was injected directly into the insulation panel between each radiation shield by means of purge pins penetrating the insulation. The insulation system investigated was DAM/Dacron tufts (more commonly known as Superfloc) which is a proprietary insulation system manufactured by the Convair Aerospace Division of General Dynamics Corporation. This purge technique has the advantage of being able to purge the condensable gases from within the insulation panel very quickly (approximately 5 min to reach a 1 percent condensable gas concentration). The disadvantage is the requirement of having purge pins penetrating the insulation which would degrade the thermal performance of the insulation.

It was, therefore, of interest to determine the purge characteristics of the DAM/Dacron tuft insulation system using the gas diffusion process. The gas diffusion process was again chosen for this investigation because (1) no maximum time requirement for purging the insulation on a reusable space vehicle has yet been specified, and (2) no penetrations (purge pins) through the insulation panel were required to distribute the purge gas. In addition, the gas diffusion process could be compared directly for MLI systems having relatively closely spaced radiation shields (such as DAM/silk net MLI of ref. 1) as opposed to those having relatively open spaced radiation shields (such as DAM/Dacron tuft MLI). In this investigation, two different MLI panels, one basic panel and one panel incorporating a butt joint, were tested to determine the time and purge

gas usage required to achieve less than 1 percent condensable gas (nitrogen) concentration within an MLI panel. Various gaseous helium purge flow rates were used. The experimental data obtained were compared with analytical predictions based on standard equations for one-dimensional gas diffusion. The analytical model is described in the appendix of reference 1.

Although many test measurements were made using U.S. Customary Units, the International System of Units (SI) is used as the primary system for reporting purposes.

EXPERIMENTAL APPARATUS

Multilayer Insulation Panels

Two multilayer insulation panels, shown in figures 1 and 2, were fabricated for purge testing. Each MLI panel consisted of 11 double-aluminized Mylar (DAM) radiation shields with Dacron tufts adhesively bonded to one side of each shield. A laminated aluminized Mylar/Dacron scrim cover sheet was applied to each side of the panel. The Dacron tuft spacers contacted only one of the cover sheets. The other cover sheet was in direct contact with the surface of one of the radiation shields. The assembly of cover sheets and radiation shields was held together by nylon button-pin studs in rows spaced approximately 20.3 centimeters (8.0 in.) apart. Also incorporated into each panel were six nylon grommets, which were used in conjunction with nylon positioning pins to position and hold each MLI panel in the purge box during testing.

The first (or basic) MLI panel fabricated and tested for this investigation is shown in figure 1(a). The dimensions of the flat, rectangular panel were 81.3 by 239 by 0.95 centimeter (32.0 by 94.0 by 3/8 in.) thick. The edges of the basic insulation panel in the lengthwise direction were left open so that the helium purge gas could diffuse between the individual radiation shields. The edges of the insulation panel at each end were sealed by placing a 2.5-centimeter- (1-in.-) wide strip of double-backed tape, 0.076 centimeter (0.030 in.) thick, between adjacent aluminized Mylar radiation shields and cover sheets. After final trimming, the sealed edges of the completed MLI panel assembly were covered with aluminized Mylar tape. The fabrication technique provided an insulation panel that was to be purged from the edges along each side of the panel with a no-flow boundary existing along the centerline of the panel lengthwise. The nominal purge volume of this MLI panel was calculated to be 1.85×10^{-2} cubic meter (0.653 ft³).

The second MLI panel incorporated a butt joint as shown in figures 1(b) and 2. The dimensions of this panel were 82.5 by 239 by 0.95 centimeter (32.5 by 94.0 by 3/8 in.) thick. All four outside edges of the panel were sealed with double-backed tape between adjacent radiation shields and cover sheets and were covered with aluminized Mylar tape. The panel was then cut lengthwise to create a butt joint 62.9 centimeters (24.8 in.)

from one edge. The butt joint was overlapped with the aluminized Mylar/Dacron scrim cover sheet on both sides of the MLI panel; the overlapping cover sheets were secured with a hook and pile (Velcro) fastener as shown in figures 2 and 3. The nominal purge volume of this MLI panel was calculated to be 1.88×10^{-2} cubic meter (0.663 ft^3).

Purge Gas System

Each of the two MLI panels was installed and tested in a purge box, which is shown in figure 4. The inside of the purge box was 2.39 meters (7.83 ft) long, 0.826 meter (2.71 ft) wide, and 3.89 centimeters (1.53 in.) deep. The total volume of the purge box was 7.66×10^{-2} cubic meter (2.71 ft^3).

The basic MLI panel was simply laid in the horizontally oriented purge box and held in place with the six nylon positioning pins which were adhesively bonded to the bottom of the purge box. The sealed ends of the MLI panel fitted snugly against the ends of the purge box. A gap of approximately 0.6 centimeter ($1/4$ in.) was left between each side of the purge box and the edges of the MLI panel.

The MLI panel with the butt joint was laid in the purge box, and the joint between the sealed edges of the panel and the inside of the purge box was bridged (and sealed) with aluminized Mylar tape. This ensured that all the purge gas introduced underneath the insulation panel would flow through the butt joint before being vented out of the purge box. The nylon grommet MLI penetrations were also sealed to prevent the flow of purge gas through these openings.

The purge gas system employed in the test program is shown in figure 5. Helium purge gas was introduced underneath the insulation panel through two 0.63-centimeter- (0.25-in.-) diameter purge tubes located 60 centimeters (24 in.) from each inside end of the purge box. Each purge tube contained 12 holes 0.033 centimeter (0.013 in.) in diameter to distribute the purge gas underneath the insulation panel. The free volume between the MLI panel and the cover of the purge box could also be purged separately with a single 0.63-centimeter- (0.25-in.-) diameter purge tube. The purge gas flow rate underneath the MLI panel (MLI panel purge) and the rate into the free volume of the purge box (purge-box purge) were measured separately by means of two rotameters. A separate nitrogen purge gas supply was provided to purge the insulation panel and purge box prior to each gaseous helium purge test. All purge gases were vented from the purge box at both ends.

For the purge test with the basic MLI panel, a helium purge gas was introduced into the purge box through both the MLI panel purge tubes as well as the purge-box purge tube as shown in figure 6. The helium purge gas introduced underneath the insulation panel had to flow past the open edges of the panel from where the helium could diffuse between the radiation shields.

For the purge tests with the MLI panel incorporating the butt joint, the helium purge gas was introduced into the purge box underneath the insulation panel only through the two MLI panel purge tubes as shown in figure 7. All of the helium purge gas then had to flow through the butt joint into the free volume of the purge box before being vented. The helium could therefore diffuse into the insulation panel between the radiation shields from the butt joint.

Gas Sampling System

Six gas sampling tubes were provided to withdraw samples of purge gas as shown in figures 6 to 8. One tube was used to obtain samples of purge gas at the edge of an MLI panel to determine the time-dependent boundary conditions needed as an input in order to obtain a solution of the analytical model. These purge gas samples were obtained exactly at the edge of the basic MLI panel and exactly at the butt joint of the second MLI panel. The other five gas sampling tubes were used to obtain samples of purge gas from within the MLI panel (between the radiation shields) at various locations. The portion of the sampling tubes located within an MLI panel was fabricated of 0.102-centimeter- (0.040-in. -) diameter stainless steel tubing to minimize any disturbance to the MLI panel.

The gaseous helium-nitrogen concentration from each individual gas sampling tube was sensed by a commercial thermal conductivity cell normally used for chromatography and process gas analysis. The thermal conductivity cell used in this program utilized two glass bead thermistors to sense the difference in thermal conductivity of the sample gas flow as compared to a reference helium gas flow. The thermal conductivity cell was immersed in an ice-water bath to provide a relatively constant temperature environment. The thermal conductivity cell was connected to the six MLI gas sampling tubes as shown in the flow schematic shown in figure 8. Figure 9 is a photograph of the flow-control panel. The gas sample from each sampling tube was drawn through the sample side of the thermal conductivity cell by manipulating the hand toggle valves. Small diameter tubing (0.069-cm (0.027-in.) inside diameter) and valves having a small internal volume were utilized throughout the gas sampling system up to the needle valves to minimize the time response of the flow system. This made it possible to withdraw only a small volume of purge gas from within the MLI panel so that the experimentally measured gas concentration within the panel would not be significantly affected by previous samples of gas withdrawn. Also, small diameter tubing of approximately equal lengths was used for the gas sampling tubes to provide for equal gas flow rates through all six tubes for a given gas concentration. The gaseous helium for the reference side of the thermal conductivity cell, as well as known mixtures of gaseous helium/nitrogen for calibration purposes, were supplied from standard "K" bottles shown as a part of the gas calibration system

(fig. 8). These gases were supplied to the gas sampling system at pressures just slightly greater than 1.01×10^5 newtons per square meter (1 atm) to duplicate the pressure in the purge box during a purge test. The low cracking-pressure check valves acted as pressure-relief valves to vent gas flow from the "K" bottles that was in excess of the flow through the thermal conductivity cell. The flow through the cell was initially set at the desired value by adjusting the downstream needle valve. The check valves had a nominal cracking pressure of 0.1 newton per square centimeter (0.15 lb/in^2) and provided a relatively constant upstream pressure of 0.09 ± 0.01 newton per square centimeter ($0.13 \pm 0.015 \text{ lb/in}^2$) gage. The 3.66-meter- (12.0-ft-) long small-diameter tubing provided a pressure drop in the gas calibration flow system that was approximately the same as that provided by the tubing in the MLI gas sampling system.

The electrical output signal from the thermal conductivity cell was visually read on a digital voltmeter and was also recorded on a strip chart.

Instrumentation

The thermal conductivity cell was the primary instrumentation for this investigation. Periodic calibrations of the cell were made throughout the test program utilizing known mixtures of gaseous helium and nitrogen as determined by an analytical mass spectrometer. The calibration curve for the instrument reading is shown in figure 7 of reference 1. The instrument provided relatively poor sensitivity to variations in gaseous nitrogen concentration above 40 percent. But it did provide good sensitivity as well as a nearly linear calibration for gaseous nitrogen concentrations below 20 percent, which was the range of primary interest.

The maximum errors in determining the gaseous nitrogen concentration under steady-state conditions are noted in figure 8 of reference 1. The data points shown indicate the errors resulting from the maximum deviation from the nominal calibration curve noted during several steady-state calibrations. Although some drift of the zero and full-scale outputs of the instrument was noted during the steady-state calibrations and transient data taking, this effect was minimized by zeroing and spanning the output frequently while flowing helium and nitrogen, respectively, through the sample side of the thermal conductivity cell. In general, the anticipated error due to drift while conducting the purge tests was less than 3 percent while measuring gaseous nitrogen concentration near 100 percent; it was approximately 0.3 percent or less while measuring concentrations near 0 percent.

The overall time response of the thermal conductivity cell under transient gas concentration conditions necessarily includes the time response of the flow system. The overall time response for a step change in gas concentration was investigated during the "in-place" calibration of the instrument. It was noted that the overall time response in-

cluded an initial dead time t_d of approximately 0.23 minute, which represented the time required to purge the volume of the flow system upstream of the thermal conductivity cell. This was followed by a change in the instrument reading θ to a new value in a manner typical of a critically damped second-order system. The response of the instrument reading for two different initial and final gaseous nitrogen concentrations is compared with the theoretical response in figure 9 of reference 1. The experimental calibration data compare favorably with the theoretical curve for the assumed time constant τ of 0.0855 minute.

The total lag time t_l of the response of the instrument to a linear change in the gas concentration, such as would be present in the insulation panel during a purge test, would be $t_l = t_d + 2\tau$, or approximately 0.40 minute for the assumed time constant of 0.0855 minute. The dynamic error $Kt_d + 2K\tau$ occurring during a linear change K in the gaseous nitrogen concentration of 0.05 percent per minute, for example, would be approximately 0.02 percent. The change in gaseous nitrogen concentration of 0.05 percent per minute is of interest as this was the approximate rate of change within the MLI panel as the concentration was approaching 1 percent gaseous nitrogen. Since the gas flow through the thermal conductivity cell was continued for at least 1 minute for each gas sampling tube while taking experimental data, and since the dynamic error was small compared to the anticipated error due to drift, no corrections for instrument error due to dynamic response were applied to the experimental data.

Other instrumentation included pressure and temperature transducers which were used in conjunction with four rotameters (figs. 5 and 8) to determine gaseous helium flow rates through both the sample and reference sides of the thermal conductivity cell as well as through the purge system for the MLI panel and purge box.

TEST PROCEDURE

Prior to the start of each gaseous helium purge test, the MLI panel and purge box were oriented in a vertical position and thoroughly purged with gaseous nitrogen for several hours. The MLI panel and purge box were then reoriented to a horizontal position for the purge test.

The gaseous helium flow rate through both the sample and reference sides of the thermal conductivity cell were set at 13.8 ± 0.2 standard cubic centimeters per minute (0.842 ± 0.012 standard in³/min). Gas samples were then taken from within the MLI panel to confirm the presence of nearly 100 percent nitrogen. The helium purge rates for the MLI panel and purge box were set at the desired value at the start of each purge test and monitored intermittently thereafter. Purge gas samples were withdrawn for 1 minute through each of the six gas sampling tubes at regular intervals during the purge test. For the five tubes located within the MLI panels, the sample intervals were generally

1/2 hour. However, the intervals were extended to 1 hour in some cases to determine if the volume of purge gas withdrawn from the insulation panel affected subsequent data. Samples from the tube at the edge or at the butt joint of the MLI panels (which represented the boundary condition) were obtained more frequently. The purge test was continued until it was determined that the nitrogen concentration within the MLI panel had been reduced to less than 1 percent. Because of the time involved and limited quantities of gaseous helium available, no attempt was made to experimentally determine the minimum nitrogen concentration that might be obtained within the MLI panel. The specific conditions for each test are listed in table I.

RESULTS AND DISCUSSION

Basic Multilayer Insulation Panel

The purpose of the two (essentially identical) helium purge tests conducted with the basic MLI panel was to experimentally determine the purge characteristics of a simple, one-dimensional, gas-diffusion purge technique for direct comparison with the analytical model noted in reference 1. A helium purge rate of 20 MLI panel and purge-box free volumes per hour (as noted in table I) was selected for these two tests to duplicate the test conditions for the DAM/silk net basic MLI panel tested previously (ref. 1). Depending on the test, MLI panel gas sampling intervals of every 30 or 60 minutes were used.

The results of the two purge tests for this investigation are shown in figure 10. The gaseous nitrogen concentration at the edge of the MLI panel (the boundary condition) decreased to 1 percent 78 minutes after the start of the test. Approximately 119 minutes were required for the purge gas concentration within the MLI panel to reach a nitrogen concentration of 1 percent. These times for the DAM/silk net MLI panel (ref. 1) were 77 and 115 minutes, respectively, which compare very closely with the results obtained for the DAM/Dacron tuft MLI panel in this investigation. At no time during the purge tests did there appear to be a significant dependency of the purge gas concentration on (1) the distance from the edge of the MLI panel for the two distances examined, or (2) the gas sampling interval at which gas samples were withdrawn from the MLI panel.

The dashed curve for the boundary condition shown in figure 10 represents the curve fit of the experimentally measured boundary conditions (i. e., data from sample tube 1). The equation of the curve fit is given in table II. Using this equation and the one-dimensional gas diffusion model (ref. 1) enabled the analytical prediction of the gas concentration within the MLI panel along the centerline (the no-flow boundary). The solid curve in figure 10 is the resulting analytical prediction. The diffusion coefficient ($D_{AB} = 4.12 \times 10^{-3} \text{ m}^2/\text{min}$ ($4.43 \times 10^{-2} \text{ ft}^2/\text{min}$)) was the value obtained from the recommended standard equation (noted in ref. 1) for the binary diffusion of two gases (in this

case, helium and nitrogen). The analytical model, using this value of the diffusion coefficient, provided a very good correlation with the experimental data, just as it had for the DAM/silk net basic MLI panel (ref. 1). The analytical model itself, therefore, appears to be adequate in predicting purge gas concentrations in MLI panels over a range of layer densities of at least 12 to 17 layers per centimeter (30 to 43 layers/in.) where the basic gas diffusion process can be assumed to occur because of the low purge gas flow velocity past the open edge of the insulation panel.

Multilayer Insulation Panel with Butt Joint

A second series of helium purge tests was conducted to experimentally determine (1) how rapidly a DAM/Dacron tuft MLI panel incorporating a butt joint could be purged to less than 1 percent gaseous nitrogen concentration and (2) the effect of purge gas flow rate on the resulting purge time and gaseous helium required such that the results could be compared with the previously tested DAM/silk net MLI panel of reference 1. The helium purge gas was introduced only underneath the MLI panel since previous tests with the DAM/silk net panel (ref. 1) had indicated that the MLI panel was not purged any more rapidly by simultaneously purging the free volume of the purge box. All of the helium gas introduced underneath the MLI panel had to flow through the butt joint (located 62.9 cm (24.8 in.) from the farthest sealed edge of the panel, fig. 1(b) before flowing into the free volume in the purge box and then venting from the purge box entirely. The helium purge rates for this series of tests (tests 3 to 6) varied from 10 to 40 MLI panel volumes per hour as noted in table I. Gas sampling intervals of 30 and 60 minutes were used for gas samples withdrawn from within the MLI panel.

The results for tests 3 to 6 are shown in figures 11(a), (b), and (c). Increasing the purge rate reduced the times required to reach 1 percent gaseous nitrogen concentration at both the butt joint (the boundary condition) and within the MLI panel itself; these times are summarized in table III. The data for four of the five gas sampling tubes withdrawing gas samples from within the MLI panel appeared to be consistent with no significant dependency on the tube location noted. The fifth sampling tube (tube 2) gave lower nitrogen gas concentrations than the others, particularly as the purge rate was increased. It was noted during several preliminary checkout purge tests, that the nitrogen gas concentration within the MLI panel could vary from place to place depending on the evenness and uniformity of gap in the butt joint. The butt joint was subsequently retrimmed to improve the evenness and uniformity which resulted in more consistent data (except for that from tube 2).

Again, the dashed curve for the tests in each of figures 11(a), (b), and (c) represents the curve fit of the experimentally measured boundary conditions used to predict the nitrogen gas concentration within the MLI panel. The equations for these curve fits

are given in table II. The predicted gaseous nitrogen concentrations at the farthest location (i. e., the no-flow boundary) within the MLI panel from the butt joint (a distance of 59.7 cm (23.5 in.)) is shown as the solid curve. It was found that the analytical value of the diffusion coefficient D_{AB} had to be multiplied by a correction factor f_c for each test condition to provide good agreement with the experimental test results. These values of the corrected diffusion coefficient $f_c D_{AB}$ ranging from 4.65×10^{-3} to 9.80×10^{-3} square meter per minute (5.00×10^{-2} to 1.05×10^{-1} ft²/min), are noted on each of the figures and are summarized in table IV.

The total volume of helium purge gas required to achieve 1 percent gaseous nitrogen concentration within the MLI panel ranged from 34.1 to 56.5 MLI panel volumes are noted in table III. The time required varied from 208 to 86 minutes.

Comparison of Results with Previous Tests

A comparison of the values of the diffusion coefficient D_{AB} used in this investigation and reference 1 to provide good agreement between the measured and predicted gaseous nitrogen concentrations within the MLI panels is shown in figure 12. The calculated value for a binary mixture of helium and nitrogen of 4.12×10^{-3} square meter per minute (4.43×10^{-2} ft²/min) was used for the basic MLI panel configuration for both the silk net and Dacron tuft spacers. In both of these cases, the purge gas flow velocity past the open edges of the panel was relatively low, and a pure gas diffusion process could be assumed.

A slightly higher value of the corrected diffusion coefficient (5.30×10^{-3} m²/min (5.70×10^{-2} ft²/min)), which provided a good correlation between analytically predicted and experimentally measured gaseous nitrogen concentrations within the MLI panel, was used for the DAM/silk net MLI panel with the butt joint (ref. 1). For this MLI panel, a constant value that was not a function of the purge gas flow rate appeared to be adequate in all cases. In the present investigation with the DAM/Dacron tuft MLI panel, it appeared that the value of the corrected diffusion coefficient which provided a good correlation between predicted and experimental results was a function of the purge gas flow rate. This relation may be due to the increased purge gas flow from test to test providing some sort of a pumping action or perhaps deflecting (or fluttering) individual radiation shields at the butt joint which influenced the basic gas diffusion process and increased the corrected diffusion coefficient from the calculated value.

A comparison of the time required to achieve a 1 percent gaseous nitrogen concentration within the MLI panels with the butt joint is shown in figure 13. The required time is presented as a function of both a dimensionalized and normalized form of the gaseous helium purge rate. The MLI panel with the Dacron tuft spacer required less time than the panel with the silk net spacer in all cases, particularly at the higher purge rates.

This was due partly to the shorter period of time required for the gaseous nitrogen concentration at the butt joint to reach 1 percent as shown in figure 14. The reason for the faster rate of reduction of the gaseous nitrogen concentration at the butt joint of the DAM/Dacron tuft MLI panel is not known at the present time.

A comparison of the resulting volume of helium purge gas required to achieve a gaseous nitrogen concentration of 1 percent within the MLI panels with the butt joint for both the silk net and Dacron tuft spacers is shown in figure 15. The data are again presented in both a dimensionalized and a normalized form. The MLI panels with the Dacron tuft spacer required a smaller volume of helium purge gas in all cases, particularly at the higher purge rates.

SUMMARY OF RESULTS

Two double-aluminized Mylar/Dacron tuft (Superfloc) multilayer insulation panels were tested to determine the time and purge gas usage required to achieve less than 1 percent condensable gas (nitrogen) concentration within the panels which were purged with helium by means of gas diffusion. Two different MLI panels were tested. The first (or basic) MLI panel was purged by exposing the edges of the panel to gaseous helium. The second MLI panel incorporated a butt joint through which all of the helium purge gas introduced underneath the insulation panel was forced to flow. The experimental data obtained were compared with analytical predictions based on standard equations for one-dimensional gas diffusion.

The results of this investigation may be summarized as follows:

1. For the basic MLI panel tested, the analytical prediction agreed very well with the experimentally measured reductions of nitrogen concentration within the MLI panel as a function of time. The diffusion coefficient used was calculated from standard equations for a binary mixture of helium and nitrogen. The calculated value of the diffusion coefficient D_{AB} was 4.12×10^{-3} square meter per minute (4.43×10^{-2} ft²/min). This value had also been shown previously to be applicable to a MLI panel using silk netting as the spacer material (ref. 1). Therefore, the analytical model itself appeared to be adequate in predicting purge gas concentration in MLI panels over a range of layer densities of at least 12 to 17 layers per centimeter (30 to 43 layers/in.) where the basic gas diffusion process can be assumed to occur.

2. For the MLI panel with the butt joint, the analytical predictions agreed very well with the experimentally measured reduction in nitrogen concentration as a function of time for a range of the corrected diffusion coefficient $f_c D_{AB}$ from 4.65×10^{-3} to 9.80×10^{-3} square meter per minute (5.00×10^{-2} to 1.05×10^{-1} ft²/min). The value of the corrected diffusion coefficient used increased as the purge rate was increased from 10 to

40 MLI panel volumes per hour. This range of values noted previously is compared to a constant value of 5.30×10^{-3} square meter per minute (5.70×10^{-2} ft²/min) used previously for the DAM/silk net panel which also incorporated a butt joint.

3. The time and purge gas usage required to achieve 1 percent nitrogen concentration within the MLI panel with the butt joint varied from 208 to 86 minutes and 34.1 to 56.5 MLI panel volumes, respectively, for helium purge rates from 10 to 40 MLI panel volumes per hour. These values were less than those measured for the DAM/silk net MLI panel.

Lewis Research Center,
National Aeronautics and Space Administration,
Cleveland, Ohio, August 19, 1976,
506-21.

REFERENCES

1. Sumner, Irving E.; and Spuckler, Charles M.: Purging of Multilayer Insulation by Gas Diffusion. NASA TN D-8122, 1975.
2. Leonhard, K. E.: Cryogenic Insulation Development. (GDCA-DDB72-004, General Dynamics/Convair; NAS8-26129), NASA CR-123938, 1972.
3. Walburn, A. B.: Development of a Reusable Flightweight Cryogenic Storage System. AIAA Paper 74-726, July 1974.

TABLE I. - SUMMARY OF GASEOUS HELIUM
PURGE TEST CONDITIONS

Test	Panel type	Gaseous helium purge rates			Sample interval, min (a)
		Multilayer insulation panel, vol/hr	Purge box, vol/hr	Total standard, m ³ /hr	
1	Basic	20	20	1.53	30
2	Basic	20	20	1.53	60
3	Butt joint	10	0	.185	30
4	↓	20	↓	.370	30
5	↓	20	↓	.370	60
6	↓	40	↓	.740	30

^aTime interval between withdrawal of gas samples from within multilayer insulation panels.

TABLE II. - EQUATIONS FOR PURGE TEST BOUNDARY CONDITIONS

Test	Equation
1 and 2	$\%GN_2 = (0.01750 e^{-0.00845 t} + 0.42196 e^{-0.07688 t} + 0.57380 e^{-0.20482 t}) 100$
3	$\%GN_2 = (0.02563 e^{-0.00859 t} + 0.49568 e^{-0.04327 t} + 0.46536 e^{-0.17254 t}) 100$
4 and 5	$\%GN_2 = (0.00954 e^{-0.00541 t} + 0.32649 e^{-0.06948 t} + 0.66886 e^{-0.33632 t}) 100$
6	$\%GN_2 = (0.00657 e^{-0.00561 t} + 0.20766 e^{-0.12712 t} + 0.84039 e^{-0.31536 t}) 100$

TABLE III. - SUMMARY OF GASEOUS HELIUM
PURGE TEST RESULTS

Test	Time required to reach 1 percent gaseous nitrogen concentration, min		Total gaseous helium purge gas required to reach 1 percent gaseous nitrogen concentration within multilayer insulation	
	At boundary	Within multilayer insulation	Standard m ³	Multilayer panel volumes
^a 1 and 2	78	119	3.03	164
3	131	208	.641	34.1
^a 4 and 5	66	150	.925	49.2
6	31	86	1.06	56.5

^aData from indicated tests combined to yield single curve.

TABLE IV. - CORRECTED DIFFUSION
COEFFICIENTS

Test	Corrected diffusion coefficient necessary to fit experimental data, $f_c D_{AB}$, m ² /min
1 and 2	4.12×10^{-3} (analytical value, ref. 1)
3	4.65
4 and 5	5.75
6	9.80

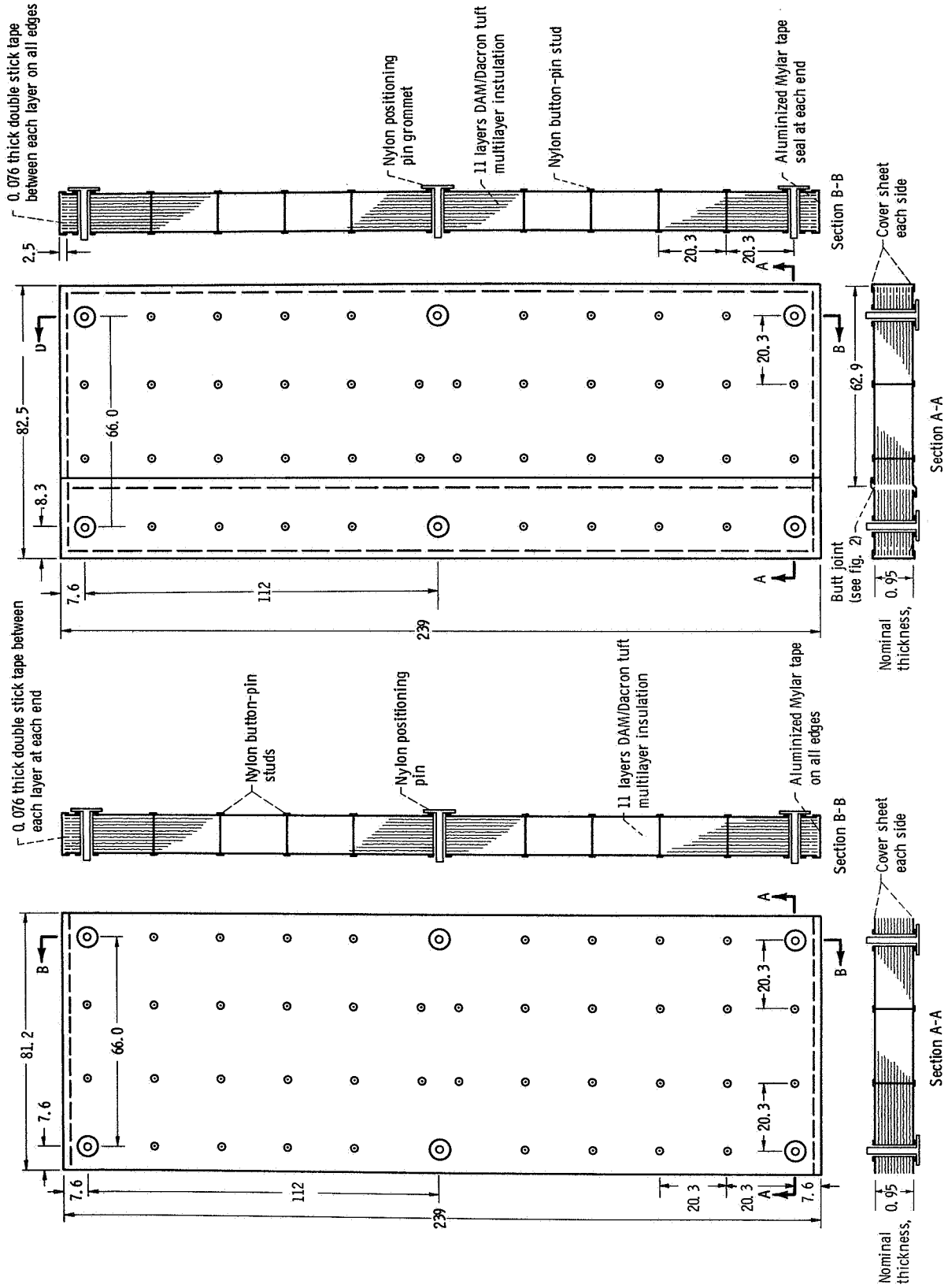

(b) MLI panel with butt joint.

(a) Basic MLI panel.

Figure 1. - Multilayer insulation panels. All dimensions in centimeters.

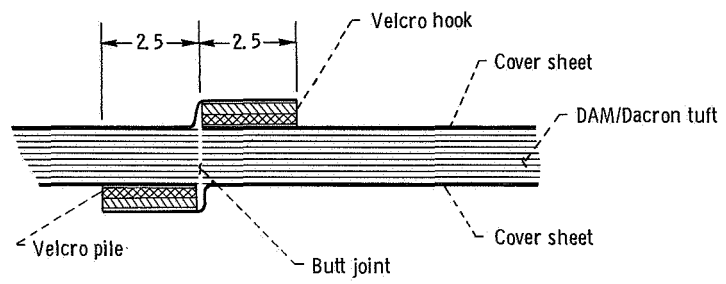
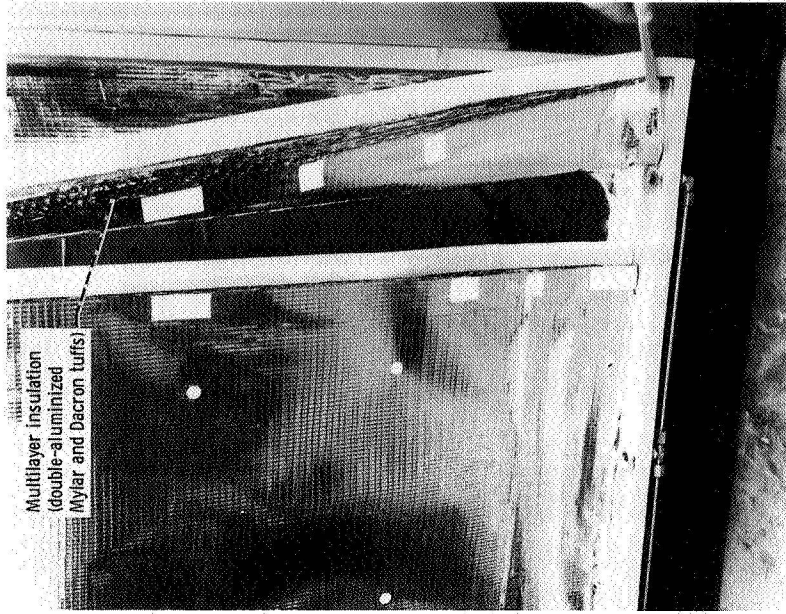
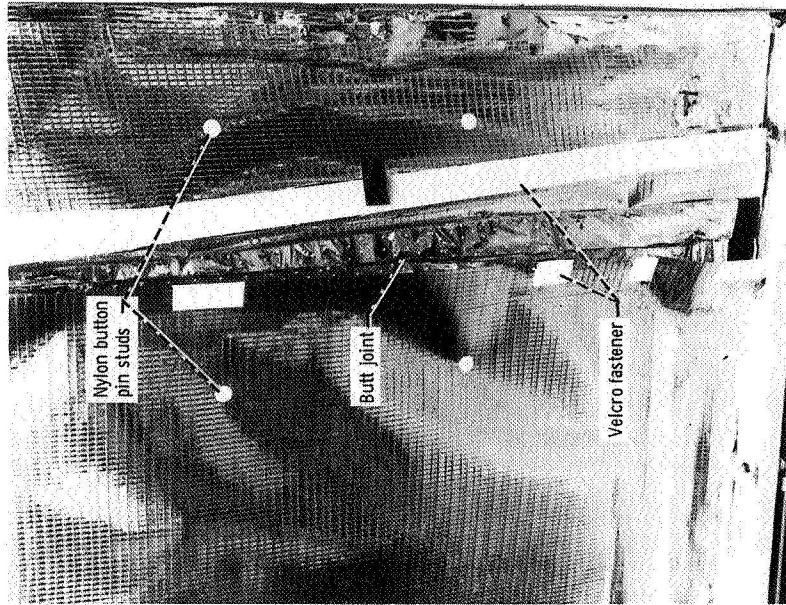

Figure 2 - Detail of butt joint. All dimensions in centimeters.



(a) Cover sheet pulled back.



(b) Portion of multilayer insulation panel pulled back.

Figure 3 - Butt joint configuration.

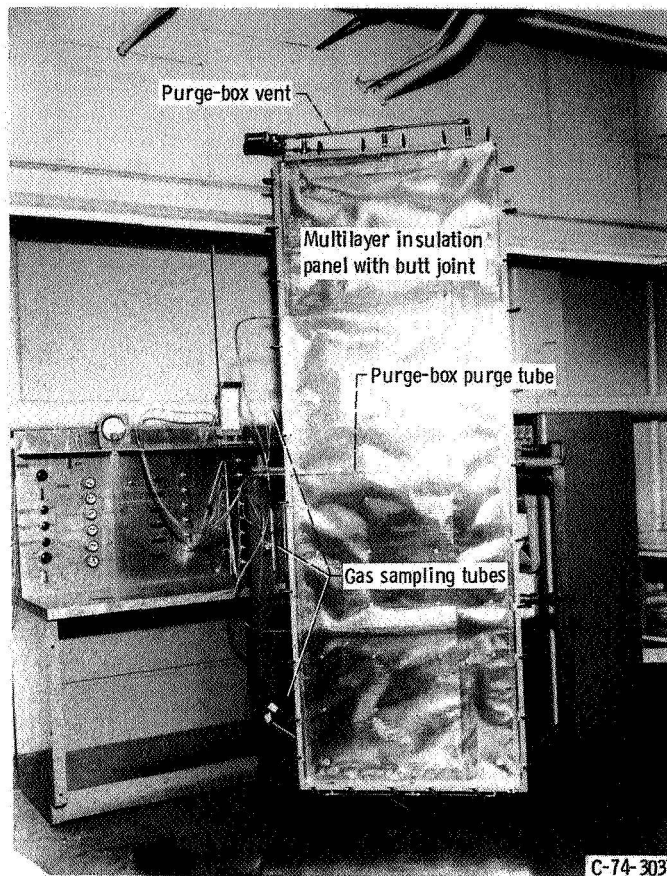

Figure 4. - Purge box (vertical orientation).

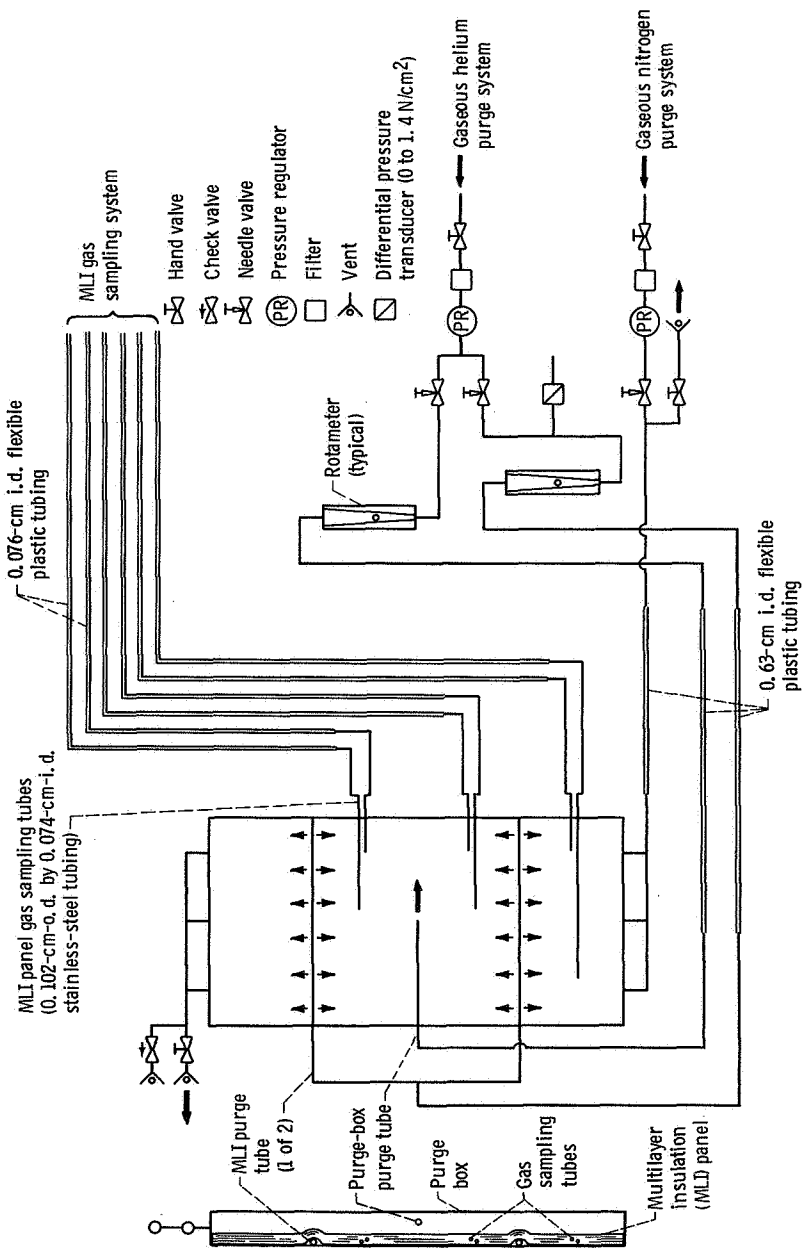

Figure 5. - Flow schematic for purge and gas sampling systems.

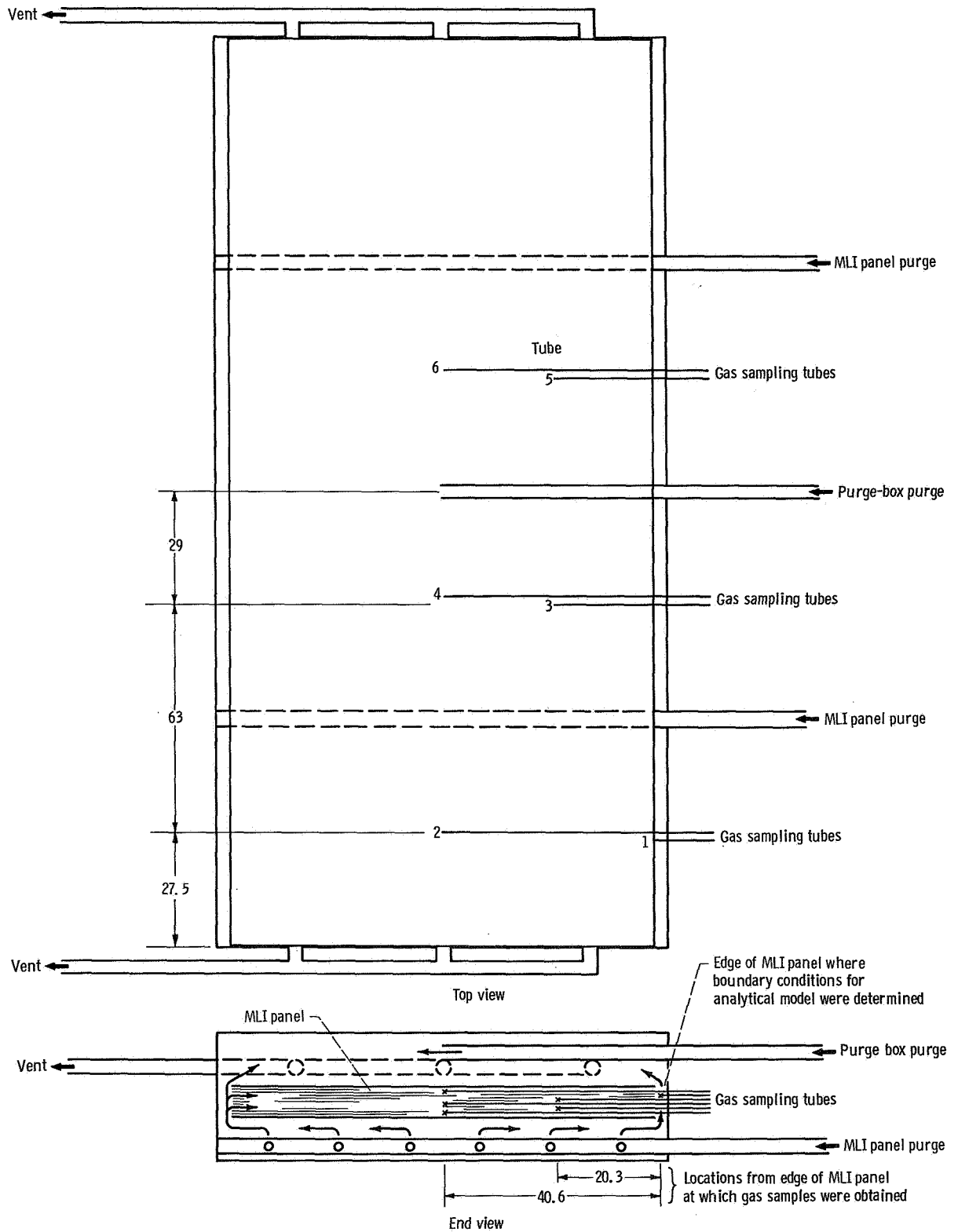

Figure 6. - Schematic of gaseous helium purge flow path and gas sampling locations for basic multilayer insulation (MLI) panel. All dimensions in centimeters.

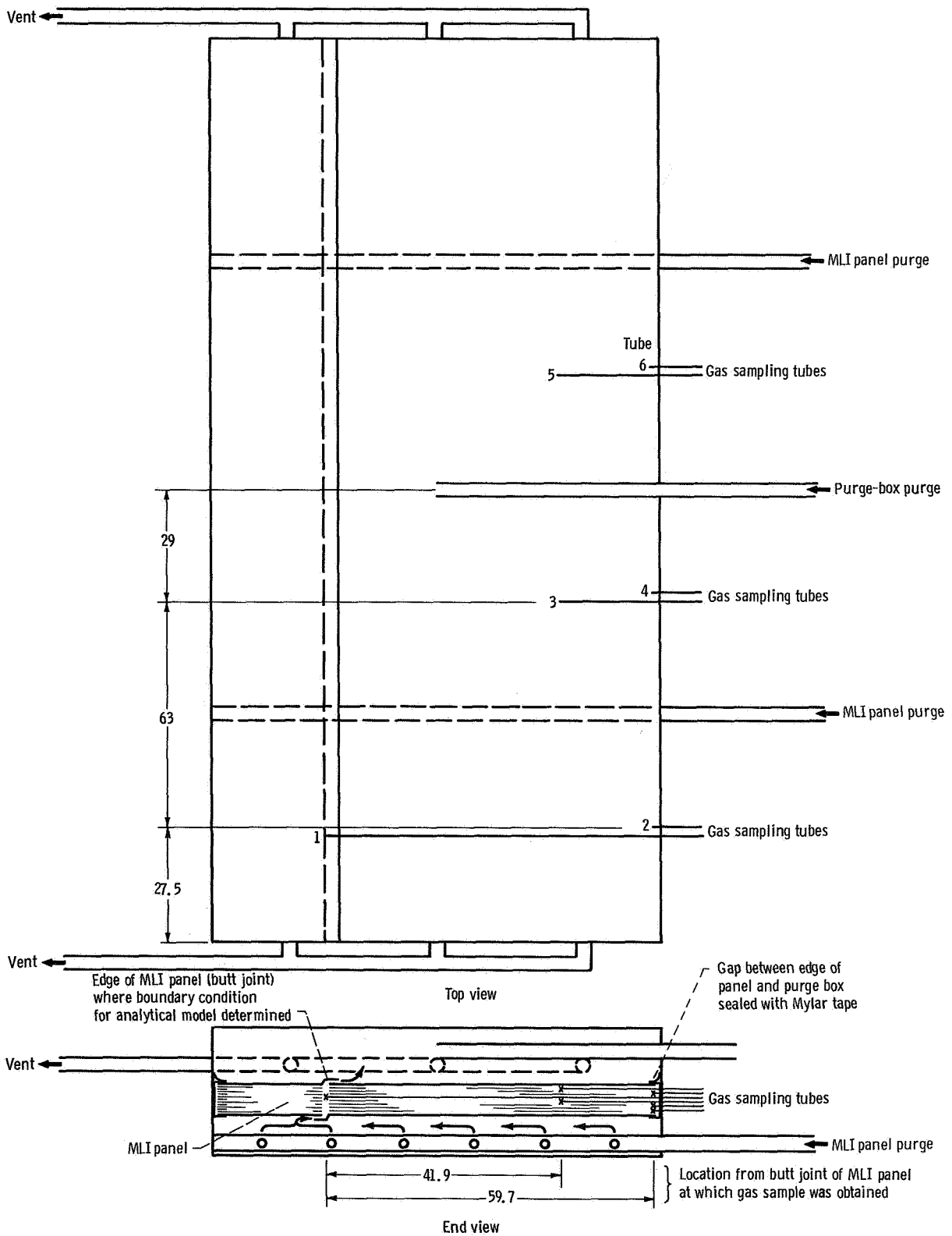

Figure 7. - Schematic of gaseous helium purge flow path and gas sampling locations for multilayer insulation (MLI) panel with butt joint. All dimensions in centimeters.

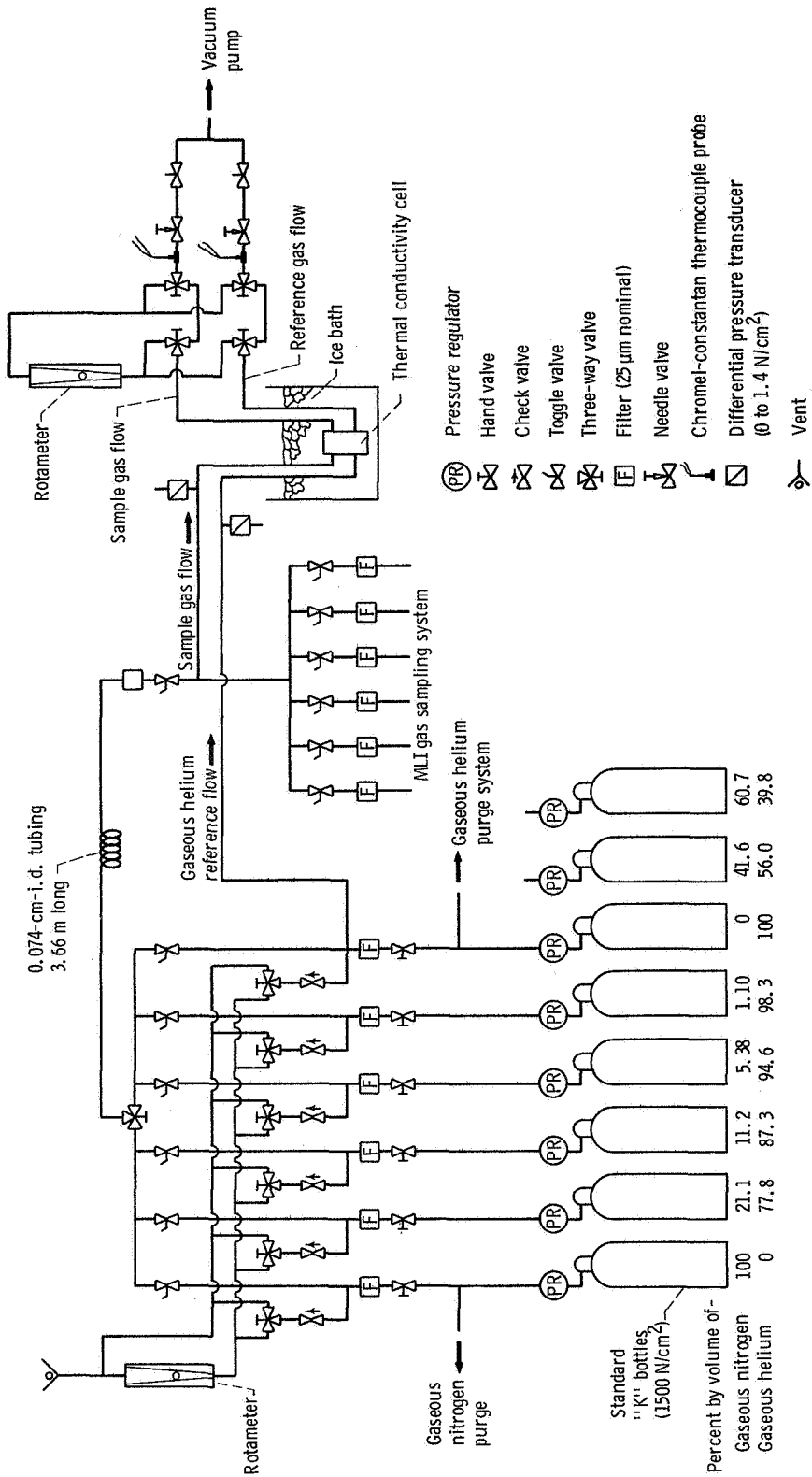

Figure 8. - Flow schematic of gas concentration measurement system.

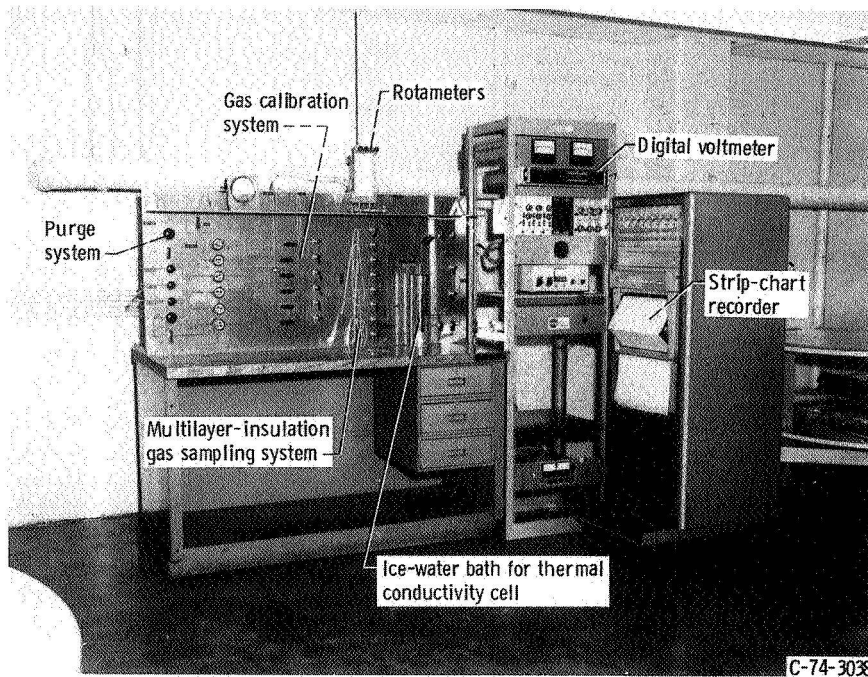

Figure 9. - Flow panel for gas concentration measurement.

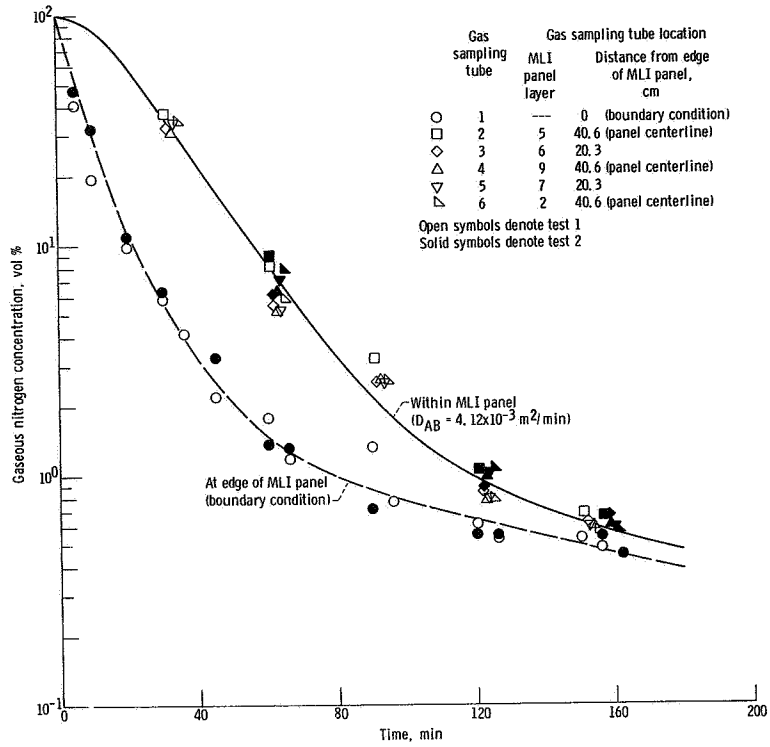
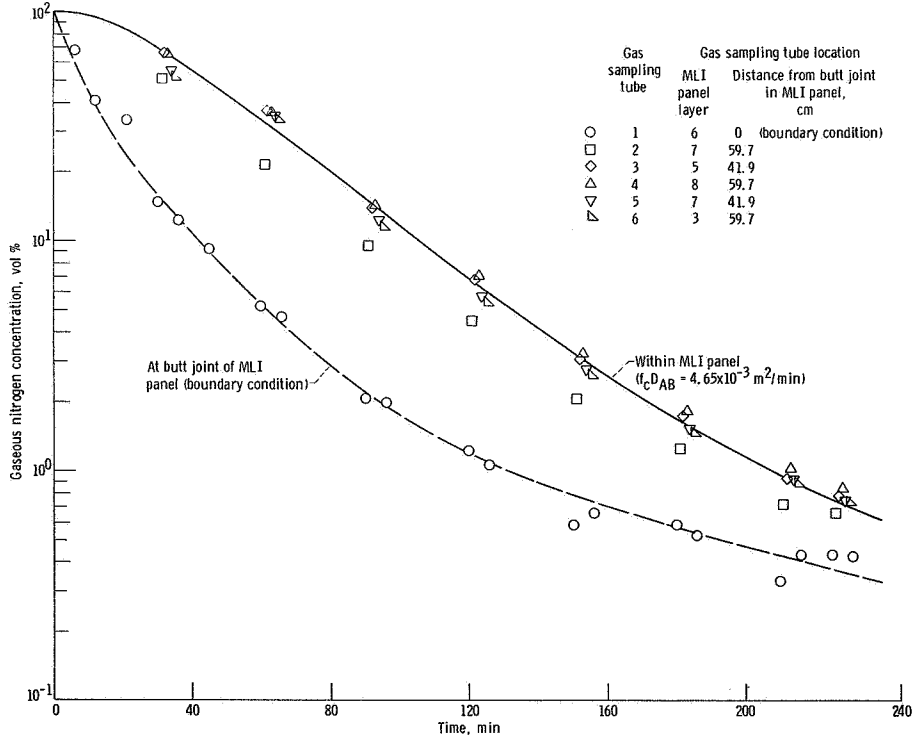

Figure 10. - Comparison of analytically and experimentally determined gaseous nitrogen concentration for basic MLI panel. Gaseous helium purge rate, 20 volumes per hour.



(a) Test 3; gaseous helium purge rate, 10 MLI volumes per hour.

Figure 11. - Comparison of analytically and experimentally determined gaseous nitrogen concentration for multilayer insulation (MLI) panel with butt joint.

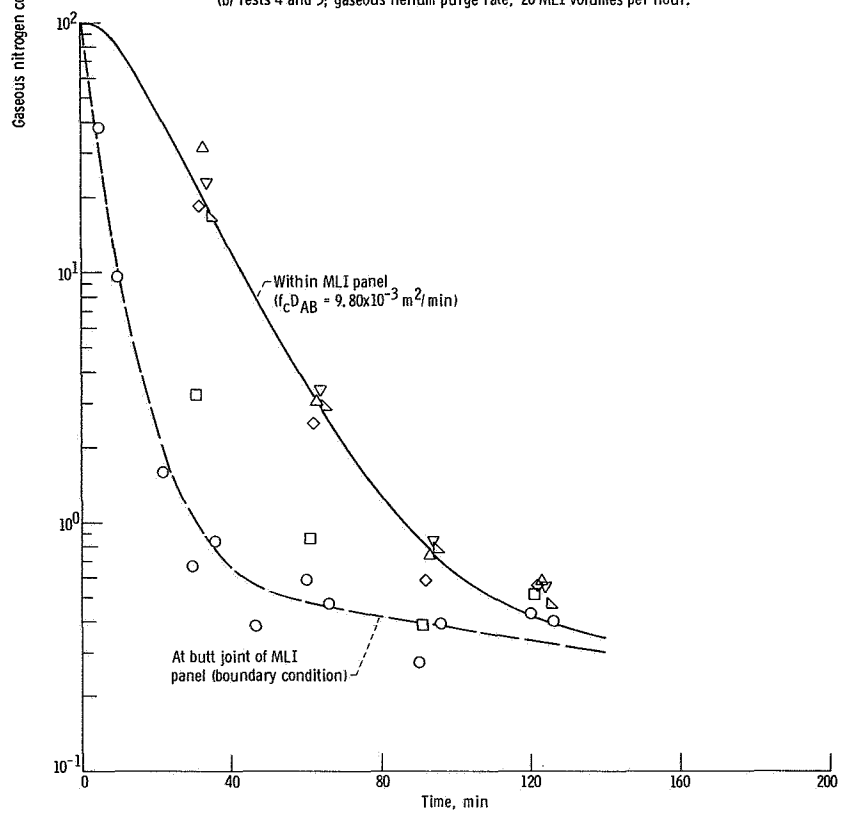
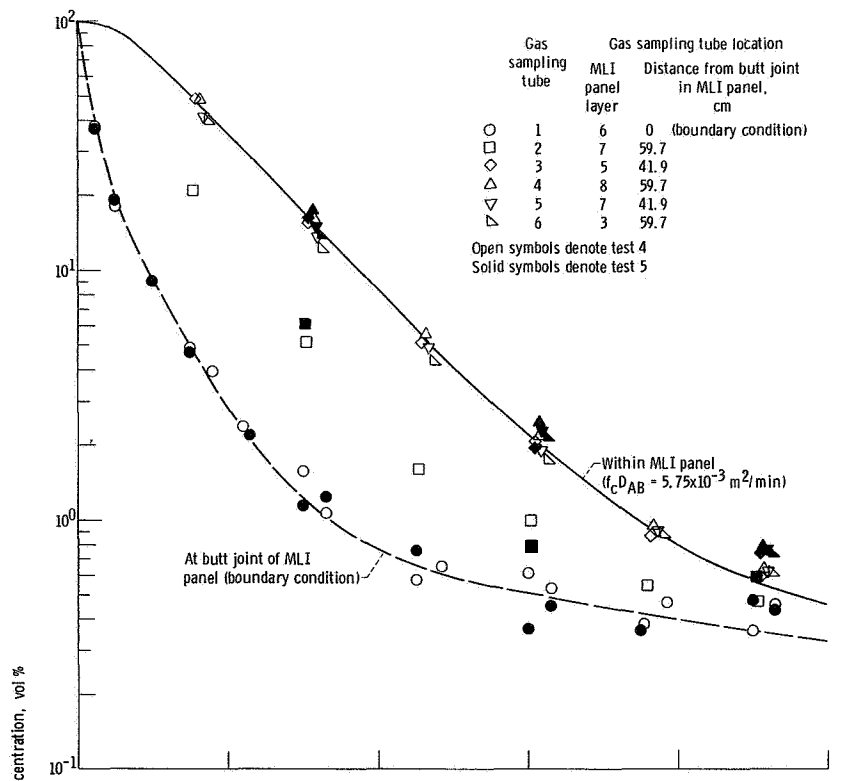

Figure 11. - Concluded.

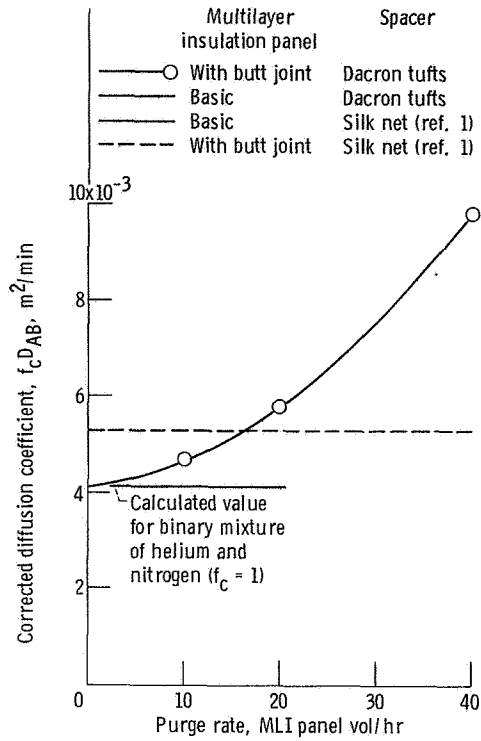

Figure 12. - Comparison of values of corrected diffusion coefficient ($f_c D_{AB}$) used in analytical predictions.

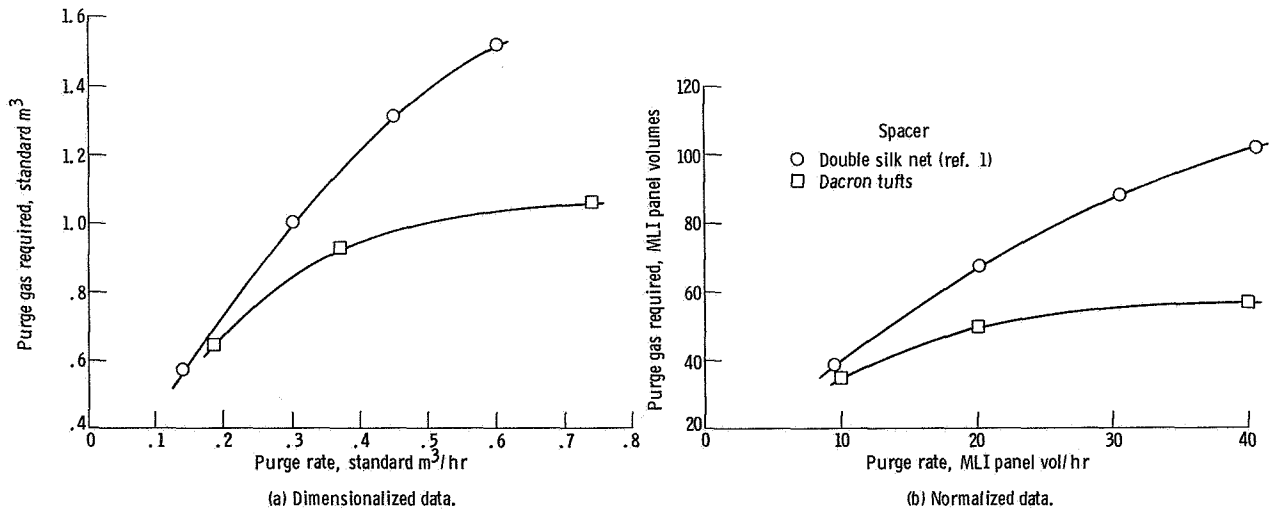

Figure 15. - Comparison of volume of purge gas required to achieve gaseous nitrogen concentration of 1 percent within multilayer insulation panel with butt joint.

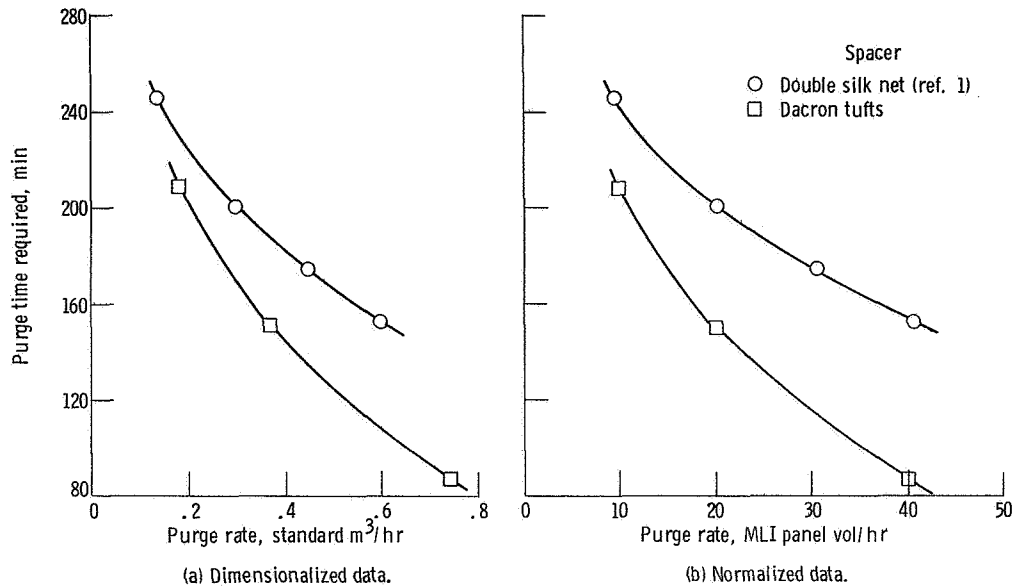

Figure 13. - Comparison of time required to achieve gaseous nitrogen concentration of 1 percent within multilayer insulation panel with butt joint.

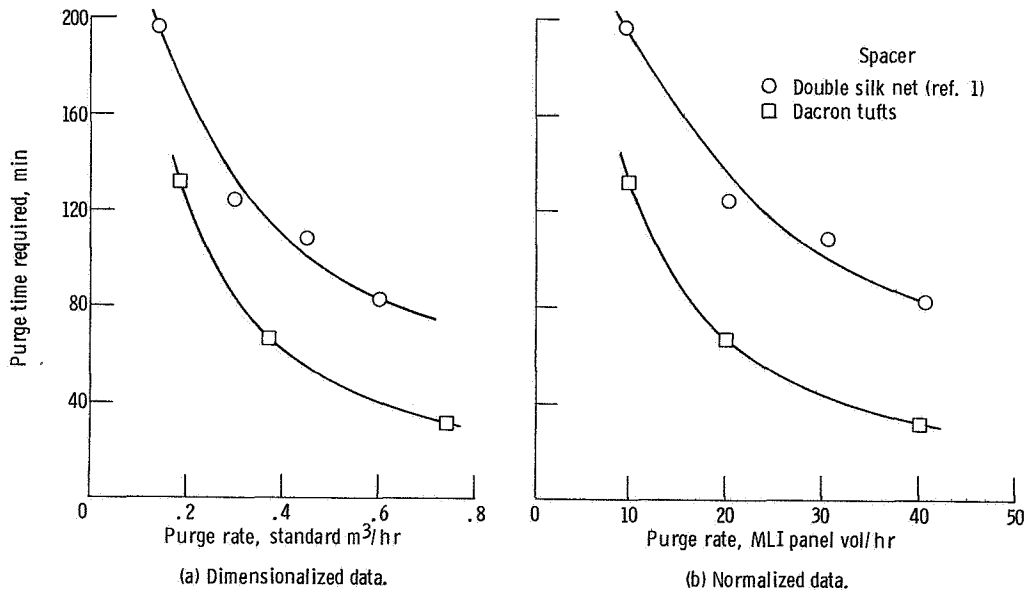

Figure 14. - Comparison of time required to achieve gaseous nitrogen of 1 percent at butt joint (boundary condition).



POSTMASTER: If Undeliverable (Section 168
Postal Manual) Do Not Return

"The aeronautical and space activities of the United States shall be conducted so as to contribute . . . to the expansion of human knowledge of phenomena in the atmosphere and space. The Administration shall provide for the widest practicable and appropriate dissemination of information concerning its activities and the results thereof."

—NATIONAL AERONAUTICS AND SPACE ACT OF 1958

NASA SCIENTIFIC AND TECHNICAL PUBLICATIONS

TECHNICAL REPORTS: Scientific and technical information considered important, complete, and a lasting contribution to existing knowledge.

TECHNICAL NOTES: Information less broad in scope but nevertheless of importance as a contribution to existing knowledge.

TECHNICAL MEMORANDUMS: Information receiving limited distribution because of preliminary data, security classification, or other reasons. Also includes conference proceedings with either limited or unlimited distribution.

CONTRACTOR REPORTS: Scientific and technical information generated under a NASA contract or grant and considered an important contribution to existing knowledge.

TECHNICAL TRANSLATIONS: Information published in a foreign language considered to merit NASA distribution in English.

SPECIAL PUBLICATIONS: Information derived from or of value to NASA activities. Publications include final reports of major projects, monographs, data compilations, handbooks, sourcebooks, and special bibliographies.

TECHNOLOGY UTILIZATION PUBLICATIONS: Information on technology used by NASA that may be of particular interest in commercial and other non-aerospace applications. Publications include Tech Briefs, Technology Utilization Reports and Technology Surveys.

Details on the availability of these publications may be obtained from:

**SCIENTIFIC AND TECHNICAL INFORMATION OFFICE
NATIONAL AERONAUTICS AND SPACE ADMINISTRATION
Washington, D.C. 20546**