

NASA TECHNICAL NOTE

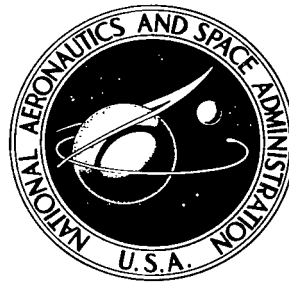

NASA TN D-8352 c.1

NASA TN D-8352

LOAN COPY: RE
AIRWL TECHNICAL
KIRTLAND AFB



MEASUREMENT TECHNIQUES INVESTIGATED FOR DETECTION OF HYDROGEN CHLORIDE GAS IN AMBIENT AIR

Gerald L. Gregory
Langley Research Center
Hampton, Va. 23665

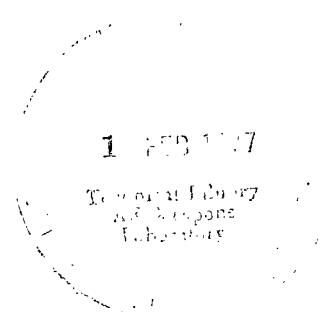



0134066

1. Report No. NASA TN D-8352		2. Government Accession No.		3. Recipient's Catalog No.	
4. Title and Subtitle MEASUREMENT TECHNIQUES INVESTIGATED FOR DETECTION OF HYDROGEN CHLORIDE GAS IN AMBIENT AIR		5. Report Date December 1976		6. Performing Organization Code	
		7. Author(s) Gerald L. Gregory		8. Performing Organization Report No. L-11073	
9. Performing Organization Name and Address NASA Langley Research Center Hampton, VA 23665		10. Work Unit No. 989-15-20-01		11. Contract or Grant No.	
		12. Sponsoring Agency Name and Address National Aeronautics and Space Administration Washington, DC 20546		13. Type of Report and Period Covered Technical Note	
15. Supplementary Notes		14. Sponsoring Agency Code			
16. Abstract <p>As part of NASA's tropospheric research program on the effects of solid rocket motor and launch vehicle effluents on ground-level air quality, the Langley Research Center initiated in 1972 a program to develop an in situ technique to monitor low concentrations of hydrogen chloride gas in ambient air. The program required instrumentation capable of measuring concentrations of hydrogen chloride gas in parts per million or less with response times from a few seconds to less than a minute. This paper summarizes the results of the instrument development program, presents the status of each technique considered, and summarizes the available laboratory data for each technique. This paper is not an all-inclusive summary of hydrogen chloride detection techniques. Nine basic techniques are discussed, ranging from concentration (parts per million) to dosage only (parts per million-seconds) measurement techniques. Data for each technique include lower detection limit, response time, instrument status, and in some cases, specificity. Several techniques discussed can detect ambient hydrogen chloride concentrations below 1 part per million with a response time of seconds.</p>					
17. Key Words (Suggested by Author(s)) Hydrogen chloride detection Instrumentation - hydrogen chloride Ambient effluent sampling - hydrogen chloride			18. Distribution Statement Unclassified - Unlimited Subject Category 35		
19. Security Classif. (of this report) Unclassified	20. Security Classif. (of this page) Unclassified	21. No. of Pages 36	22. Price* \$3.75		

MEASUREMENT TECHNIQUES INVESTIGATED FOR DETECTION OF
HYDROGEN CHLORIDE GAS IN AMBIENT AIR

Gerald L. Gregory
Langley Research Center

SUMMARY

As part of the tropospheric research program of the National Aeronautics and Space Administration on the effects of solid rocket motor and launch vehicle effluents on ground-level air quality, the Langley Research Center initiated in 1972 a program to develop an in situ technique to monitor low concentrations of hydrogen chloride gas in ambient air. The program required instrumentation capable of measuring concentrations of hydrogen chloride gas in parts per million or less with response times from a few seconds to less than a minute. Methods described in the literature as well as newly conceived techniques were evaluated in the laboratory and, in some cases, in the field. This paper summarizes the results of the instrument development program, presents the status of each technique considered, and includes the available laboratory data for each technique. This report is not intended to be an all-inclusive summary of hydrogen chloride detection techniques but rather a summary of the efforts and experience at Langley Research Center in the instrument development program. The data are presented so that the reader can judge the best technique for individual application. For each technique discussed, an operating and laboratory tested instrument exists.

This report discusses nine basic techniques for monitoring low parts-per-million concentrations of hydrogen chloride gas in moist ambient environments. The nine techniques are: (1) bubbler, (2) pH, (3) indicator tube, (4) microcoulometer, (5) modified condensation nuclei counter, (6) dual isotope infrared, (7) gas filter correlation, (8) chemiluminescent nitric oxide detection, and (9) chemiluminescent luminol oxidation. The first three techniques are predominantly dosage (parts per million-seconds) measurement techniques. Data presented for each measurement technique include lower detection limit, response time and, in some cases, specificity. Techniques (4), (6), and (9) have the capability to detect ambient hydrogen chloride concentrations below 1 part per million. Only techniques (1), (4), and (9) are considered operational techniques requiring minimal additional laboratory investigation. The other six techniques are classified as laboratory techniques, requiring extensive additional laboratory investigation, or as research and development techniques, requiring either major hardware or conceptual design changes.

INTRODUCTION

The National Aeronautics and Space Administration (NASA) is actively pursuing tropospheric and stratospheric environmental studies in conjunction

with the launch and operation of rocket vehicles. One major portion of the tropospheric program is directed toward measuring and predicting the impact of rocket exhaust clouds produced at launch on the surface level air quality. Since 1972, the Langley Research Center has been conducting a launch vehicle effluent (LVE) monitoring program (refs. 1 to 5) at the John F. Kennedy Space Center, using regularly scheduled launch vehicles (primarily Titan III) as targets of opportunity. The goal of the LVE program is to assess the applicability and accuracy of diffusion models for predicting the dispersion of exhaust effluents from current and future launch vehicles used by NASA. The approach employed to meet these objectives is the measurement of rocket exhaust products produced by the launch of large solid rocket motor launch vehicles. Measurements are made both at surface level and within the "stabilized ground cloud" formed in the troposphere as the result of the launch. These measurements are then compared with various analytical schemes (refs. 6, 7, and 8) for predicting the exhaust effluent concentrations.

Early in the LVE program, it was determined that detection techniques for hydrogen chloride (HCl) gas, a major exhaust product from combustion in most solid rocket motors, were inadequate. Several techniques were available for detection of hydrogen chloride in a dry environment and at concentrations of about 50 parts per million by volume (ppm) or higher. However, initial field and laboratory studies demonstrated that these techniques showed the following deficiencies: (1) could not detect HCl in realistic ambient environment because of the high reactivity of HCl in the presence of moisture; (2) did not have satisfactory response time; and (3) did not have detection limits of 1 ppm or lower. Therefore, as a result of this need for a high performance HCl detector to monitor ambient air concentrations, Langley Research Center began to develop a suitable detector in-house and by contract. The purpose of this report is to summarize the various techniques which have been evaluated or developed. This report is not intended to be an all-inclusive summary of HCl detection techniques, but rather a summary of the experience in search of a suitable detector at Langley Research Center. This paper focuses on the more general problem of the detection of HCl gas in ambient air rather than specifically on the LVE problem. It is hoped that this document together with the survey in reference 9 represent the current state of the art in HCl (gas) ambient air monitors.

More specifically, this paper describes the operational principles of various HCl detectors. Laboratory and field data are cited as needed to present the capabilities of each of the instruments. In some cases, the instruments described are commercially available and are currently being used; in other cases, only the breadboard instrument exists, and further investigation of the technique is not anticipated.

MEASUREMENT TECHNIQUES

Before discussing the various instruments, it is necessary to discuss briefly the measurement environment and the gaseous species, HCl. HCl gas is hygroscopic in nature, showing a strong affinity for moisture and moist surfaces. Analysis of HCl in dry environments (i.e., HCl in dry nitrogen (N₂)) is considerably easier than in moist ambient environments. The major problem

encountered in ambient analysis of HCl is the transport of the sample to the detection region of the particular instrument without serious depletion (reaction) of HCl. Once this is accomplished, detection is generally not a major problem. In ambient air, HCl is generally found in two states: as a gas and as a liquid acid aerosol. Although some of the instruments show capabilities of detecting both HCl states, this report focuses on the detection of gaseous HCl existing in the moist ambient environment.

Historical Hydrogen Chloride Detection Techniques

A quick search of the literature for established methods of detecting acids or HCl in gas mixtures shows that bubblers, pH measurements, and indicator tubes are among the most frequently employed techniques. Therefore, it is appropriate to discuss these techniques first.

Bubbler method.- The bubbler has been for some time a standard laboratory and field sampling device for many gas species. In its simplest form, the bubbler is a device in which a trapping solution is stored and through which an air sample is drawn. The trapping solution captures and retains some ion or chemical complex associated with the gas species being detected. The trapping solution is analyzed in the laboratory. The trapped ion concentration is then related to the ambient air concentration of the gas species through the air sampling rate, sampling time, trapping solution volume, chemical formulation of the gas species, and capture coefficient of the trapping solution. Typically, the bubbler configuration, air sampling rate, and trapping solution composition and volume are chosen to produce a capture coefficient of unity. The bubbler technique provides a time integrated measurement giving the average concentration for the time period sampled. However, the bubbler method gives no information about maximum concentration or concentration as a function of time. This method does permit various trapping solutions and analysis techniques, depending upon the gas being detected.

The bubbler system of interest in this investigation is shown in figure 1. Table I gives the operational parameters for this system. Although many bubbler configurations, trapping solutions, and analysis techniques can be selected for the detection of HCl, the system described in figure 1 and table I is representative of the capabilities of the bubbler technique for detection of HCl. This bubbler system has a capture coefficient of at least 0.99, provided the ratio of air sample rate to trapping solution volume is 200 min^{-1} or less. Since the analysis technique is chloride ion detection, the background chloride ion concentration of the trapping solution (water) must be known or be negligible when compared with the sample. Laboratory analysis has shown that background chloride ion concentrations of approximately $0.2 \text{ ng}/\mu\text{l}$ (0.2 ppm in solution) can be readily obtained in deionized-distilled water.

The coulometric (ref. 10) detection of chloride ions is based on automatic titration of chloride ion with silver ion producing silver chloride (AgCl) precipitate. The heart of the instrument is the titration cell, which contains acetic acid electrolyte and two pairs of electrodes: a sensing pair (silver versus silver acetate) and a generating pair (silver versus platinum).

The concentration of silver ions in the cell is maintained at 10^{-7} M by a 250 mV potential bias across the sensing electrodes. Any change in silver ion concentration as the result of the introduction of chloride ions into the cell is detected by the sensing electrodes as a potential difference. This difference results, through the coulometer electronics, in a generation of silver titrant at the generator electrode. The total quantity of current (in coulombs) required to return the cell to its initial silver ion concentration is related to the quantity of silver ion generated and, consequently, to the quantity of chloride ion introduced into the cell. To analyze the chloride ion concentration of the bubbler trapping solution, precise quantities of the solution are injected into the coulometer cell. The detection limit of the coulometer for a given chloride ion sample is approximately 3 ng. Laboratory studies show that a maximum of 30 μ l of sample can be injected into the cell for analysis before dilution effects become serious. Thus, concentrations of 0.1 ng/ μ l of chloride ion can be detected. The detection capability of the bubbler system shown in figure 1 and table I is approximately 50 ppm-sec and is limited by the background chloride concentration of the trapping solution.

Table II summarizes the measured performance of the bubbler system of figure 1. The data of table II were obtained by preparing HCl-air mixtures ranging from 0.05 to 10 ppm and by sampling these mixtures with the bubbler over periods ranging from 2 minutes up to 1 hour. The theoretical dosages (input to bubbler) are accurate to approximately ± 10 percent. The shown confidence intervals are based on a sample size of 5 bubblers at each concentration. Table II shows that at all dosage levels investigated, the average (5 bubblers) measured dosage is accurate to within the expected ± 10 percent accuracy of the input dosages. However, with a single bubbler measurement, an accuracy of ± 20 percent or better can only be attained above 200 ppm-sec because only above 200 ppm-sec is the confidence interval (hence, the standard deviation of the measurement) of reasonable magnitude as compared with the input dosage.

pH measurement method.— Since HCl is hygroscopic and readily forms an acid with water, pH measurements are obviously a detection method for HCl. Several types of pH measurement techniques have been tried. First, a technique similar to the bubbler technique can be used in which the pH of the trapping solution (rather than chloride concentration) is measured in the laboratory. This technique has limited application because of pH variations in the trapping solution as a result of dissolved carbon dioxide (CO_2). Secondly, an instrument can be built (ref. 11) similar to the standard pH meter except that the pH electrodes are immersed in a single water droplet instead of in a liquid bath. In this case, the incoming airstream impinges on the water droplet formed on the tip of the pH electrodes. The water droplet absorbs the HCl from the airstream, and a pH change is observed. Periodically (typically every 20 sec), the pH electrodes are flushed with clean water, forming a new droplet; and the measurement cycle is reinitiated. The final pH of each water droplet is related to the total HCl sampled during that time. (See ref. 11.)

A third pH measurement technique for gaseous HCl is the pH-sensitive paper method. Certain natural and synthetic substances (for example; methyl

orange, methyl red, etc.) have the property of changing color when the hydrogen ion concentration in the solution attains a definite value. In determining the hydrogen ion concentration of a solution, a number of indicators can be used and, by a process of elimination, the hydrogen ion concentration can be fixed within rather narrow limits. Commercial pH papers (similar to litmus paper) are available which have discrete color changes for 1/2 pH increments from 1 to 14 pH. In the presence of ambient moisture, the HCl disassociates to produce hydrogen ions; these ions produce the color change in the pH paper. These color changes are related to HCl dosage (concentration by time) by laboratory calibration. Concentrations of 1-ppm HCl for a duration of 1 minute have been detected in laboratory chamber tests. The pH papers are available as strips and as sheets. This pH-sensitive technique has had limited success because of problems with nonpermanent color changes and paper sensitivity to ambient humidity.

Indicator tube.- Generally, indicator tubes for HCl detection contain a granular material, typically silica gel, impregnated with a substance which changes color upon exposure to HCl. Two such substances currently used are pH-sensitive dyes and silver nitrate (AgNO_3) emulsions. The impregnated matrix is sealed in a glass tube. When ready for use, the tips of the tube are broken off, and the air sample is drawn over the impregnated matrix. After pulling a fixed volume of sample air through the tube, a stain is developed whose length is compared to laboratory calibration to determine the average HCl concentration. Detection limit is approximately 1 ppm over a 2- to 5-minute sampling period. Sampling flow rate is limited to a few hundred cubic centimeters per minute. The tubes are available commercially; however, because of the limited accuracy of the technique, this method is most suited for initial assessment.

Other types of indicator tube techniques can be devised; for example, the tubes can be coated with various chemical compounds designed to trap the HCl. The tubes are then returned to the laboratory where, through proper processing, the HCl or chloride ion is released by the coating and then quantified. Such a technique has been evaluated (Contract NAS 1-13175-1, Virginia Polytechnic Institute and State University), and the results are representative of this type of approach. In the particular application discussed here, glass capillary tubes (1 mm in internal diameter and 1 m in length) coated with a dried solution of sodium nitrate (10^{-2} M NaNO_3) sample the HCl gas stream at a rate of about $100 \text{ cm}^3/\text{min}$. The NaNO_3 coating traps the HCl in the gas stream, and the tubes are returned to the laboratory for analysis. In the laboratory, the interior walls of the tubes are washed with 20 μl to 30 μl of distilled water, and a 10- μl sample of the wash water is analyzed for chloride using the coulometer technique (see bubbler discussion). The wash water is introduced into the coated tube through capillary action of the tube.

Figure 2 shows the results obtained in the laboratory using the HCl-moist air mixture at 4.2-ppm HCl. The theoretical line in figure 2 indicates the calculated results expected from the technique. As shown, the technique gives a time integrated measurement (ppm-sec) rather than a concentration measurement. The lower detection limit of the technique is about 10 ppm-sec (25-ng chloride) and is limited by the chloride content of both the wash

water and the coating. The upper detection limit is a function of the tube length and diameter. As shown in figure 2, the 1-mm-diameter by 1-m-long tubes are not efficient trappers above about 170 ppm-sec. Additional laboratory work would be required to determine the upper limit of the coated tubes as a function of tube dimensions. In addition, more detailed laboratory work is needed to evaluate the lifetime of the coating, the repeatability of the tube measurement, and the accuracy of the technique. Initial laboratory studies suggest that these areas present only minor problems and should not place major limitations on the applicability of this technique.

Recently Developed Hydrogen Chloride Techniques

This section discusses some of the newly developed techniques for the detection of gaseous HCl in the ambient environment. In some cases, the techniques are highly successful; in other cases, applications appear to be limited. All techniques discussed are in situ sampling methods requiring no laboratory analysis to obtain the HCl concentration or dosage data. In addition, for each technique discussed, an instrument employing the method has been constructed and tested.

Microcoulometer method.- The microcoulometer method of detecting HCl is described in detail in reference 12, and most of the following discussion is from that reference. The instrument is the same unit used in the chloride ion analysis of the bubbler trapping solution discussed earlier, except that an inlet system is added to the titration cell, and a sample pump draws the gaseous HCl sample mixture directly into the titration cell. The coulometer is operated in the continuous mode, and the incoming HCl gas bubbles through the electrolyte in the titration cell. The silver ions in the electrolyte react with the HCl, form the AgCl precipitate, and this reaction changes the silver ion concentration of the electrolyte. The silver ion imbalance is detected by the sensing electrodes, and the detection results in subsequent generation of silver ion at the generating electrodes. As discussed earlier, the amount of silver generated can be related to the quantity of HCl introduced into the titration cell. The titration cell in the continuous mode has a detection limit of approximately 0.08-ppm HCl at a flow rate of 200 cm³/min. Once the HCl reaches the titration cell, its detection is simple and presents no problem; however, design and construction of a suitable inlet system has been more troublesome. A suitable inlet must allow the HCl to reach the titration cell without serious loss of HCl and with a response time characteristic of the phenomena being sampled. Much of the research described in reference 12 deals with the inlet system problem where the desired response time is approximately 1 minute.

A brief summary of reference 12 shows that the authors found that glass made the most suitable inlet tube and that inlet tube length should be minimized for any given sampling requirement. In addition, to alleviate loss of HCl in the inlet tube, it is necessary both to passivate the inlet tube (typically 30-min exposure to 5-ppm HCl-dry N₂ mixture), and to maintain the tube at 50° C during the sampling operation. Under these conditions, the coulometer response to a constant HCl concentration is similar to the response shown in figure 3. The area under the coulometer trace and the plateau (equi-

librium) output value has been shown both analytically and experimentally to equal, respectively, the total quantity of the HCl sampled and the concentration of the HCl mixture. The detection limit of the system is approximately 0.08-ppm HCl for a sample flow of 200 cm³/min (maximum permissible flow due to titration cell construction is 400 cm³/min).

As shown in figure 3, a steady-state response is not obtained until approximately 1 min after the sample has been introduced into the inlet tube. This delay suggests that considerations must be given to the time frequency of the variation of the HCl being sampled. This delay is best illustrated in figure 4. Figure 4 shows the coulometer trace for 6-min, 1-min, and 30-sec samplings of 5 ppm of HCl in N₂. As previously noted, the mass of HCl sampled or the HCl concentration can readily be determined for the 6-min data. However, this is not the case for the 1-min and 30-sec samples. As shown in figure 4, a plateau response is never obtained for these two cases, and the concentration of the incoming HCl mixture cannot be directly determined. Techniques for estimating the HCl concentration when a plateau response is not obtained are discussed in reference 12, but these estimation techniques require an assumption about the time dependence of the concentration of the incoming HCl stream. However, for all three cases shown in figure 4, the area under the data trace is equivalent to the mass of HCl sampled. Figure 5 shows a typical data trace obtained in the field during launch vehicle monitoring at the John F. Kennedy Space Center. As indicated in the figure, a plateau response was not obtained. The plateau sensitivity of the instrument for the measurements shown in figure 5 is 0.6 mV/ppm.

To summarize, the microcoulometer method is one of the more reliable methods for monitoring ambient HCl dosages and, in many cases, concentrations. For many applications, the limitation of the technique for determining HCl concentrations is not serious. The microcoulometer instrument is available commercially, but the inlet system is not.

Modified condensation nuclei counter method.- The modified condensation nuclei counter method is shown schematically in figure 6. This method works on the principle of converting HCl to ammonium chloride (NH₄Cl) by passing the air sample over a solution of ammonium hydroxide (NH₄OH). The NH₄Cl particles are detected by a conventional condensation nuclei counter using light scattering principles. The particle count is then related by laboratory calibration to the HCl concentration of the incoming sample stream. The method exists as a breadboard unit which has been evaluated in the laboratory for HCl-dry N₂ mixtures from about 1- to 10-ppm HCl. Figure 7 shows a diagram of the HCl converter. Because of the sensitivity of the condensation nuclei counter, only a portion of the incoming HCl stream is reacted with the ammonia. The primary problem with the technique is a steadily increasing particle (background) count with increased instrument usage. This particle count is attributed to the reactivity of both HCl and ammonia in the presence of water and the resulting internal corrosion of the instrument. Replacement of the HCl converter components with more inert (Teflon) components has failed to alleviate the problem. Much of the corrosion occurs in the condensation nuclei counter, and the only recognized solution is to rebuild the counter using inert materials. Initial laboratory results indicated that the instrument has some potential to detect 1- to 2-ppm HCl with a response

time of a few seconds. However, the problem of corrosion negates any meaningful conclusions. As previously noted, primary changes in the breadboard unit would be required for additional studies to be conducted. In addition, the preliminary laboratory results indicate that the inlet filter, the inlet tubulation, and the silicone rubber membrane (see fig. 7) would result in significant HCl scavenging when moist HCl environments are sampled. Removal of the inlet filter would cause additional problems with the particulate loading in the ambient environment. Only the breadboard instrument exists, and additional development is not anticipated.

Dual isotope infrared absorption method.- The dual isotope method belongs to the nondispersive infrared class of analyzers. In the present application for HCl detection, two cells each containing a stable isotopic species of hydrogen chloride, HCl^{35} or HCl^{37} , are mounted in a chopper wheel assembly and rotated to alternately filter radiation from an infrared source. The two alternating infrared beams, one missing HCl^{35} radiation and one missing HCl^{37} radiation, are passed through the sample cell (ambient HCl is approximately 75-percent HCl^{35} and 25-percent HCl^{37}) where the beam missing HCl^{35} is only slightly reduced in energy, and the beam missing HCl^{37} is strongly reduced. After passing through the sample cell, the alternating radiation pulses are converted to electrical signals by a solid-state detector. Ratio comparisons of the two alternating signals and proper signal conditioning yield a voltage proportional to the HCl concentration in the sample cell. Theoretically, the instrument responds only to gaseous HCl. Changes in optical and transmission properties due to contamination or presence of other known pollutants affect both pulses equally but do not affect the ratio measurement. Figure 8 shows a diagram of the operation of the instrument. The energy spectra of the radiation at various points within the unit are also shown in figure 8.

Currently, the instrument exists as a breadboard unit which has been evaluated in the laboratory. This laboratory evaluation is discussed in detail in reference 13 and thus is only summarized in this report. Figure 9 shows a typical data trace from the instrument. For this particular trace, a mixture of 9-ppm HCl in dry N_2 was introduced into the instrument at a flow rate of approximately 1 l/min. Studies of this type showed the detector to have a lower detection limit of about 0.3 ppm and a response time to 90 percent of reading at approximately 8 sec. Additional studies at flow rates of 1 l/sec showed that a response time of approximately 2.2 sec could be obtained (electronic time constant of instrument is 2.2 sec) without significant increases in noise-to-signal ratio. Interference studies for such species as CO , CO_2 , H_2O , CH_4 , and $n\text{-C}_6\text{H}_{14}$ are summarized in table III. For these interference studies, as well as others reported in this paper, the interference species was introduced to the instrument in the absence of any HCl. A major problem with the instrument has been the detection of HCl in moist airstreams when both HCl and water vapor condense on the walls of the sample cell. The result of this condensation has been unacceptable zero stability. Redesign of the sample cell or incorporation of an "open" cell into the instrument should minimize or eliminate this problem. In the present configuration, the instrument is not acceptable for monitoring HCl in moist ambient environments at ppm concentrations.

Gas filter correlation method.- The gas filter correlation spectrophotometer (ref. 14) is a modification of the nondispersive infrared analyzer. Radiation from a source, at a wavelength of 3 to 4 μm , passes through the sample cell where it is spectrally absorbed by HCl and is also absorbed by interfering gases. The radiation, having traversed the sample cell, is alternately passed through a reference cell (typically N_2) or through a specifying cell (HCl). When the radiation traverses the reference cell, it is unattenuated (unabsorbed); but when the radiation traverses the specifying cell, it is further attenuated at the absorption lines of HCl. The result is an alternating signal generated at the detector, and the magnitude of the signal is related to the concentration of the gaseous HCl in the sample cell. Figure 10 shows a diagram of the instrument. The lower detection limit of an instrument of this type is about 1 ppm with a response of a few seconds to 90-percent reading. Lower detection limits are possible by trade-offs with specificity; this trade-off is usually a problem area, however, since both methane (CH_4) and water vapor have interference lines in the 3.5- μm range, and both are common ambient constituents. At the 1-ppm lower detection limit, these interferents cause no difficulty; however, a primary problem can be sorptive losses of HCl in the sample cell. For application in moist ambient environments, the basic technique can be extended to an "open" cell sampling approach which eliminates the sorptive loss problem.

An open cell gas filter correlation instrument has been constructed to make HCl concentration measurements in the ambient environment. The instrument developed is a dual channel model which senses both CO and HCl. This instrument is designed to operate while located in the cabin of an aircraft, and a retroreflector is located externally. The open cell is that area between the instrument and the retroreflector. Figure 11 shows a diagram of the instrument. The 5-m distance between the instrument and the retroreflector results in a total optical path for the measurement of 10 m. The open cell correlation instrument is similar in principle to the closed cell instrument already described and is summarized below. (See fig. 11.)

As previously mentioned, the infrared source, chopper, split cell, optics, and detectors are packaged in a unit and are located at a cabin window within the aircraft. The retroreflector is located on the wing tip of the aircraft, 5 m from the cabin window. The infrared source radiance is passed through a chopper wheel and then is modulated by a rotating split gas cell. One section of the split cell contains HCl diluted with dry N_2 , whereas the other contains CO diluted with dry N_2 . Since the spectral bands of HCl and CO do not overlap, the alternate cell is used as a reference cell for each of the gases. (The CO-N_2 cell is the reference cell for the HCl measurement.) The chopped light is then collimated by a lens onto a beam splitter which directs the light through the window, and onto the retroreflector to monitor the HCl and CO outside the aircraft. The reflector bends the beam back through the window, then through the beam splitter, and the light is focused by a second lens and beam splitter onto two solid-state detectors. Narrow band-pass filters are located in front of each detector so that only the absorption of a selected HCl band (3.4 μm) is observed by one detector, and another selected CO band (4.6 μm) is observed by the other detector. These signals are separated electronically by using the modulating and chopper frequency as references. The signals between the corresponding reference cell

and specifying cell are subtracted and related to the pollutant average concentration in the 10-m optical path. Output variations as the result of infrared source variations, transmission changes of the optical path, and temperature changes are adjusted by comparison of a reference signal with the signal difference between the two cells.

Figure 12 shows the results of HCl laboratory calibration of the instrument. The calibration technique consists of placing a 15-cm diameter by 1-m-long glass cell with sapphire end windows between the instrument package and the retroreflector, and HCl-dry N₂ mixtures flow through the calibration cell. Since there are no sorptive losses associated with the operation of the instrument (that is, there is no sample cell), this calibration technique is acceptable for evaluation of the instrument for measurements in moist ambient environments. As shown in figure 12, the gas concentration is expressed indirectly in terms of column density or concentration by path-length product. Because of noise limitations of the detector, the lowest concentration measured in the laboratory was 50 ppm-m. This 50 ppm-m is equivalent to a 5-ppm concentration over a 10-m path. As shown, the instrument is slightly nonlinear at the higher concentrations, and the laboratory results and the calibration of the manufacturer agree reasonably well. In addition to the calibration studies, interference studies were also performed using the same calibration setup. As stated earlier, methane and water vapor are expected interferences. For HCl detection and this particular instrument, interference studies were limited to these expected interferences and CO (the second channel pollutant). No channel pollutant interference was observed for CO or water vapor, even for conditions simulating 100-percent relative humidity in the calibration cell. For methane, a 100 ppm-m column density is equivalent to 1 ppm-m HCl signal.

To summarize, the existing instrument has a gaseous HCl detection limit of about 5 ppm for a 10-m path (50 ppm-m) and a response of about 10 sec to 90 percent of reading. Modifications to the time constant can result in a response of about 1 sec without serious increase in the lower detection limit. The standard gas filter correlation instrument (single channel) is available commercially; dual channel units are obtainable by request and may require some research and development work by the manufacturer.

Chemiluminescent method - nitric oxide detection.- The principle of operation of this method (Grant NGR 23-005-599, University of Michigan) is the reaction of HCl gas with ammonia, and the conversion of the remaining ammonia to nitric oxide (NO). The NO is then detected by using a conventional chemiluminescent NO detector. Figure 13 shows a diagram of the operational principles. The incoming HCl reacts with a known (excess) concentration of ammonia (permeation tube) to produce NH₄Cl particles which are filtered from the airstream. The excess ammonia remaining in the airstream is converted to NO when it passes a heated platinum bed. The resulting NO is measured with a commercial chemiluminescent detector. As the HCl concentration in the sample stream increases, more ammonia is used in the conversion process, and less NO is generated by the heated platinum bed. Thus, the decrease in NO at the detector is related to the increased concentration of HCl in the sample stream. Theoretically, the detection limit of the technique is 0.05 ppm, but this has not been demonstrated in the breadboard unit. Typically, 1- to

2-ppm HCl can be detected in the laboratory if some care is used. Response time is typically a few seconds to 90 percent of reading; however, decay to zero baseline is slower, approximately 30 sec at 2 ppm. Laboratory evaluation of the breadboard unit has been limited, and only the breadboard instrument exists.

Chemiluminescent method - luminol oxidation.- This chemiluminescent method (ref. 15) is based on a chemiluminescent reaction in which visible light is generated in an alkaline solution of luminol during oxidation by hydrogen peroxide. Figure 14 shows a diagram of the operating principle. The instrument contains a reaction cell from which the visible light is monitored by a photomultiplier tube. The output light from the cell is proportional to the HCl concentration of the incoming sample stream. Prior to reaching the reaction cell, the incoming gas stream is passed through an alumina tube coated with sodium bromate and sodium bromide. This coating reacts with the HCl to produce a series of bromine-chlorine compounds which catalyze the luminol oxidation (chemiluminescent process). The unique feature of this chemiluminescent detector is the coated alumina tube (instrument inlet system) which makes use of the reactivity of HCl at the low ppm concentrations. This coated alumina tube eliminates the HCl-inlet reaction problem encountered with most other instruments when sampling moist ambient environments. Reference 15 describes in some detail the detection capabilities of the instrument.

A brief summary of reference 15 gives the data of figure 15. Figure 15 shows the results of laboratory calibration of the instrument from 0.05-ppm to 50-ppm HCl. All calibrations were performed with mixtures of moist air (60 to 70 percent relative humidity) and HCl and were accurate to about ± 10 percent. The broken lines in the figure indicate the ± 10 -percent accuracy of the HCl mixtures. From this calibration data, the lower detection limit of the instrument is at least 0.05 ppm (lowest HCl concentration that could be repeatably prepared in the laboratory). However, based on signal-noise ratios, some laboratory data, and some field monitoring experience, the instrument is believed to have a lower detection limit of about 5 parts per billion by volume (ppb). Studies are currently being conducted to verify this detection limit. Figure 16 illustrates the response time of the instrument to moist-air-HCl mixtures. For figure 16(a), the incoming HCl sample stream was varied every 10 sec by approximately 1 ppm from 0- to 10-ppm HCl; whereas, in figure 16(b), the variation was 0.1 ppm every 10 sec from 0 to 1 ppm. As can be seen in figure 16, the response of the instrument is a few seconds at these levels. Table IV summarizes the response time of the instrument, and some results from interference studies conducted to date are given in table V. Figure 17 is a typical data trace obtained during LVE monitoring at the John F. Kennedy Space Center.

In summary, this detector is commercially available and is currently being used by a number of organizations to make ground-level and airborne ambient HCl measurements. In addition, laboratory studies are being continued to further define the operational characteristics of the instrument.

Comparison of Techniques

Table VI contains a brief summary of the techniques discussed in this report. Where both performance data for a general technique and a specific instrument using that technique were discussed in this report, table VI data are for the specific instrument. The lower detection limit and response time of the measurement in comparison with the physical phenomena being measured must be considered when selecting a technique for a given application. It must be recognized that complete interference (specificity) studies have not been performed for most of the techniques discussed. The existing interference data are an outgrowth of specificity studies conducted for particular sampling applications, and the data have not necessarily defined all interference species. It is recommended that for a given application of a technique, detailed interference studies be considered. The current status of a technique should also be considered. Some of the techniques are operational and require little additional laboratory work prior to use for a given application; others are still in the research and development stages and require considerably more effort and occasionally require concept changes or hardware redesign. In table VI (column 2), the status of each method is shown. The three status categories are discussed subsequently and are helpful in determining the status of each method. In addition, the categories indicate confidence in the data available for each method.

Operational category.- The methods listed in this category have been evaluated in some detail for HCl measurements in moist ambient environments. There can be reasonable confidence in the available data on the capabilities of the technique. If suited for a given application, implementation of the technique should require only limited additional laboratory studies. The primary shortcoming in the available data base is the effect of pollutant interferences. Instruments representative of these methods of detection are available commercially.

Laboratory category.- The methods in this category have been evaluated in some detail for the monitoring of HCl in dry environments (typically N_2); in some cases, cursory studies have been performed with moist mixtures. The confidence in the dry mixture data is reasonable. Generally, the moist mixture data have just enough depth to ascertain the current capability of the method for detecting moist HCl mixtures. Comprehensive laboratory studies are yet to be conducted for the detection of moist mixtures; in some cases, hardware modifications in the existing breadboard concept are required prior to these comprehensive studies. Generally, this instrument is not available off the shelf, but can be obtained in conjunction with some research and development costs.

Research and Development category.- These methods exist as conceptual designs and prototype hardware. The existing body of data is limited to dry HCl mixtures and studies to verify detection principles. In general, available data are limited, and primary design or hardware changes are required before additional evaluation can be considered.

CONCLUDING REMARKS

The focus of this report is the summation of approximately 4 years of research and development work in search of a suitable in situ hydrogen chloride detector to meet the needs of the launch vehicle effluent monitoring program of the National Aeronautics and Space Administration. This report is not intended to determine or select the best measurement technique for monitoring hydrogen chloride in the ambient environment, nor to be an all-inclusive dissertation on hydrogen chloride detection methods. The detection techniques discussed are in various stages of development. Some techniques, those suitable for the launch vehicle effluent program, are well developed, have been comprehensively evaluated in the laboratory, and are operational. For other techniques, only the concept and breadboard instrument have been tested. In most of these cases, lack of further development does not signify an unacceptable detection method, but does indicate that the particular technique is not as attractive a method as others for the launch vehicle effluent program. For all detection methods presented, an instrument (breadboard only, in many cases) has been built and tested. The information in the report should allow the reader to judge which of those techniques discussed is most suitable for his individual application, and to assess the current status of that technique.

This report discusses nine basic techniques for monitoring low parts-per-million concentrations of hydrogen chloride gas in moist ambient environments. Techniques discussed include both concentration (parts per million) measuring instruments and dosage only (parts per million-seconds) measurement techniques. The nine techniques discussed are: (1) bubbler, (2) pH, (3) indicator tube, (4) microcoulometer, (5) modified condensation nuclei counter, (6) dual isotope infrared, (7) gas filter correlation, (8) chemiluminescent nitric oxide detection, and (9) chemiluminescent luminol oxidation. Data presented for each measurement technique include lower detection limit, response time, and, in some cases, specificity. It is pointed out that the primary shortcoming in the available data for each technique is in the specificity or interference area. Several of the techniques discussed have the capability to detect ambient HCl concentrations below 1 part per million with a response time of seconds.

Langley Research Center
National Aeronautics and Space Administration
Hampton, VA 23665
November 12, 1976

REFERENCES

1. Gregory, Gerald L.; Hulten, William C.; and Wornom, Dewey E.: Apollo Saturn 511 Effluent Measurements From the Apollo 16 Launch Operations - An Experiment. NASA TM X-2910, 1974.
2. Hulten, William C.; Storey, Richard W.; Gregory, Gerald L.; Woods, David C.; and Harris, Franklin S., Jr.: Effluent Sampling of Scout "D" and Delta Launch Vehicle Exhausts. NASA TM X-2987, 1974.
3. Gregory, Gerald L.; and Storey, Richard W., Jr.: Effluent Sampling of Titan III C Vehicle Exhaust. NASA TM X-3228, 1975.
4. Stewart, Roger B.; Sentell, Ronald J.; and Gregory, Gerald L.: Experimental Measurements of the Ground Cloud Effluents and Cloud Growth During the February 11, 1974 Titan-Centaur Launch at Kennedy Space Center. NASA TM X-72820, 1976.
5. Gregory, Gerald L.; Wornom, Dewey E.; Bendura, Richard J.; and Wagner, H. Scott: Hydrogen Chloride Measurements From Titan III Launches at the Air Force Eastern Test Range, FL 1973 Through 1975. NASA TM X-72832, 1976.
6. Dumbauld, R. K.; Bjorklund, J. R.; and Bowers, J. F.: NASA/MSFC Multilayer Diffusion Models and Computer Program for Operational Prediction of Toxic Fuel Hazards. NASA CR-129006, 1973.
7. Dumbauld, R. K.; and Bjorklund, J. R.: NASA/MSFC Multilayer Diffusion Models and Computer Programs - Version 5. NASA CR-2631, 1975.
8. Stewart, Roger B.; and Grose, William L.: Parametric Studies With an Atmospheric Diffusion Model That Assesses Toxic Fuel Hazards Due to the Ground Clouds Generated by Rocket Launches. NASA TN D-7852, 1975.
9. Gaarder, D. S.; and Jensen, A. V., eds.: Hydrogen Chloride Detection, Measurement and Monitoring. CPIA Publ. No. 272 (Contract N00017-72-C-4401), Appl. Phys. Lab., Johns Hopkins Univ., Dec. 1975.
10. Dennison, J. E.; and Menichelli, R. P.: A Method for Monitoring Organic Chlorides, Hydrochloric Acid and Chlorine in Air. AIAA Paper No. 71-1063, Nov. 1971.
11. Hendel, Frank J.: pH Monitor of Air Pollutants - Research and Development of a New pH Recording Method and Instruments for the Recording of Acid and/or Gaseous Components Resulting From Launches of Rockets. SAMTEC-TR-75-190, U.S. Air Force, May 1975.
12. Reyes, Robert J.; Miller, Richard L.; and Beatty, David C.: Monitoring of HCl From Solid Propellant Launch Vehicles. 1974 JANNAF Propulsion Meeting, Vol. I, Pt. II, CPIA Publ. No. 260, The Johns Hopkins Univ., Oct. 1974, pp. 705-722. (Available from DDC as AD-B002590.)

13. Williams, Kevin G.: The Continuous Measurement of Hydrogen Chloride in the Ambient Atmosphere Using the Dual Isotope Infrared Absorption Technique. ARFR-66 (Contract NAS 1-12404), Andros Inc., Feb. 1974. (Available as NASA CR-132520.)
14. Bartle, E. R.; Kaye, S.; and Meckstroth, E. A.: An In-Situ Monitor for HCl and HF. AIAA Paper No. 71-1049, Nov. 1971.
15. Gregory, Gerald L.; Hudgins, Charles H.; and Emerson, Burt R., Jr.: Evaluation of a Chemiluminescent Hydrogen Chloride and a NDIR Carbon Monoxide Detector for Environmental Monitoring. 1974 JANNAF Propulsion Meeting, Vol. I, Pt. II, CPIA Publ. No. 260, The Johns Hopkins Univ., Oct. 1974, pp. 681-704.

TABLE I.- BUBBLER SYSTEM OPERATIONAL PARAMETERS

Trapping solution	Deionized distilled water
Trapping solution volume, ml	20
Air sample rate, cm ³ /min	3000
HCl capture coefficient	>0.99
Analysis technique	Chloride detection by coulometric technique
Range of application, ppm-sec	Above 50

TABLE II.- BUBBLER SYSTEM DATA - HYDROGEN CHLORIDE/AIR MIXTURES

Theoretical input dosage, ppm-sec	Average ^a measured dosage, ppm-sec	95-percent confidence interval ^a for measured dosage, ppm-sec
60	66.5	±33
90	88.2	±25
120	105.8	±27
200	199.0	±40
1200	1260.0	±57
2500	2444.0	±250
5000	4914.0	±309

^aBased on sample size of five bubblers, standard confidence interval calculation using students "t" test statistic.

TABLE III.- INTERFERENCE DATA FOR DUAL ISOTOPE ABSORPTION INSTRUMENT

Species	Equivalent species concentration to produce 0.1-ppm HCl signal, ppm
CO	1 000
CO ₂	1 000
H ₂ O	25 000
CH ₄	100
n-C ₆ H ₁₄	10

TABLE IV.- RESPONSE TIME RESULTS FOR CHEMILUMINESCENT
(LUMINOL OXIDATION) INSTRUMENT

HCl ^a concentration, ppm	Response time to 90 percent of final reading, sec
0.05	20.0
.25	15.0
.50	15.0
1.00	10.0
5.00	5.0
10.00	3.0
20.00	1.5
50.00	0.5

^aHCl/moist air (60- to 70-percent relative humidity) mixtures.

TABLE V.- INTERFERENCE DATA FOR CHEMILUMINESCENT
(LUMINOL OXIDATION) INSTRUMENT

Species	Equivalent species concentration to produce 1-ppm HCl signal
CO	No interference ^a
H ₂ O	No interference ^b
CO ₂	No interference ^a
O ₃	2 to 3 ppm
^c SO ₂	1 ppm
^c NO ₂	50 ppm

^aNo interference observed for mixtures of low ppm to pure species.

^bNo interference observed at relative humidities from 20 to 95 percent at room temperatures.

^cFunction of humidity of sample stream; data are for relative humidity of approximately 60 to 70 percent.

TABLE VI.- SUMMARY OF MEASUREMENT METHODS

Method	Instrument status ^a	HCl concentration measurement	Lower detection limit	Response to 90 percent of reading	Laboratory analysis required
Bubbler	Operational	No	50 ppm-sec	NA ^b	Yes
pH	Laboratory	No	60 ppm-sec	NA	No
Indicator tube	Laboratory	No	10 ppm-sec	NA	Yes
Microcoulometer	Operational	Yes	0.08 ppm	1 to 2 min	No
Aerosol - condensation nuclei	R/D ^c	Yes	1 to 2 ppm	Few sec	No
Dual isotope infrared	R/D	Yes	0.3 ppm	8 sec	No
Gas filter correlation	Laboratory	Yes	5 ppm	Few sec	No
Chemiluminescent (NO)	R/D	Yes	1 to 2 ppm	Few sec	No
Chemiluminescent (luminol)	Operational	Yes	Less than 0.05 ppm	1 to 20 sec	No

^aSee text for definition of status.

^bNot appropriate.

^cResearch and development.

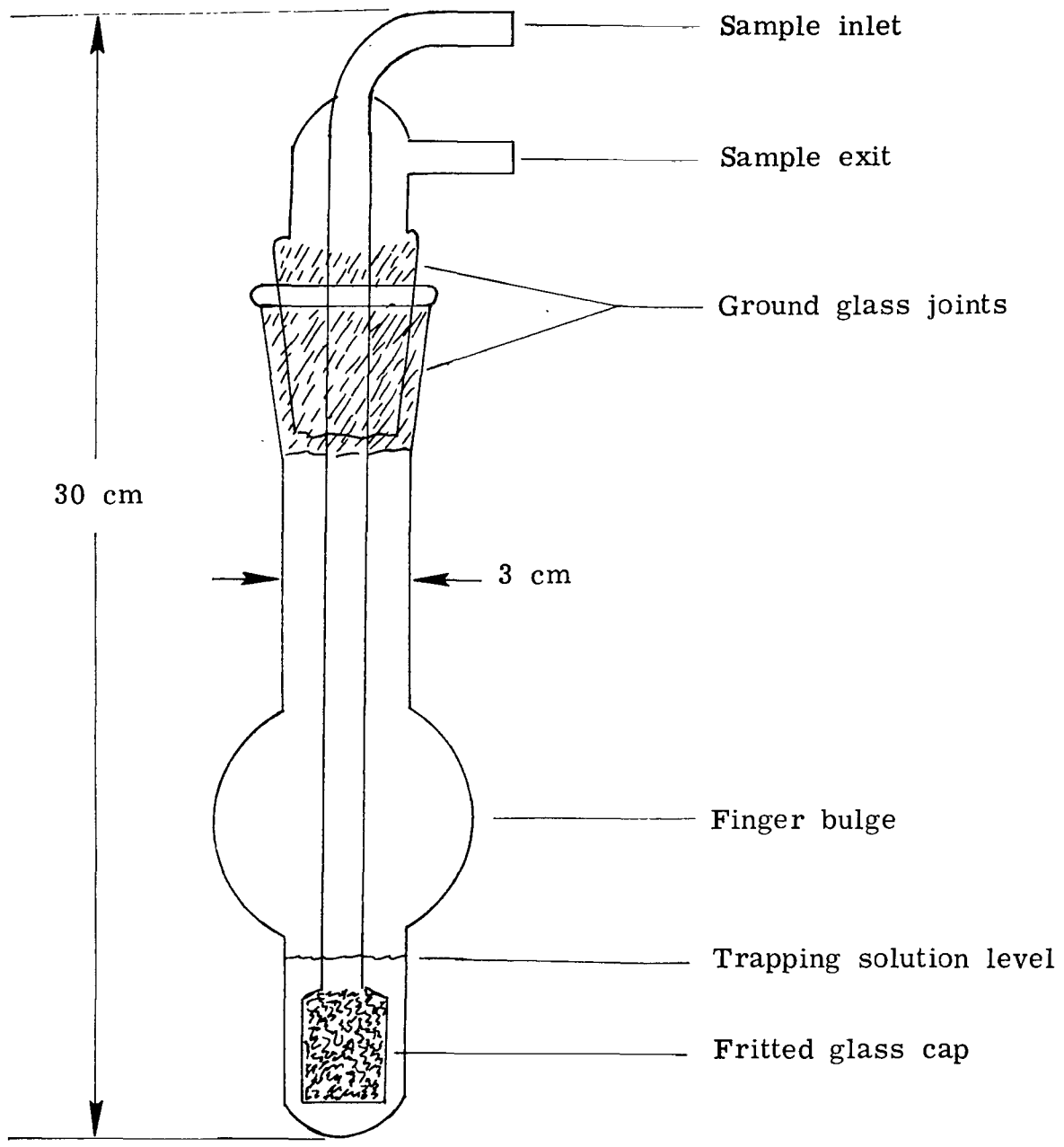

Figure 1.- Bubbler system.

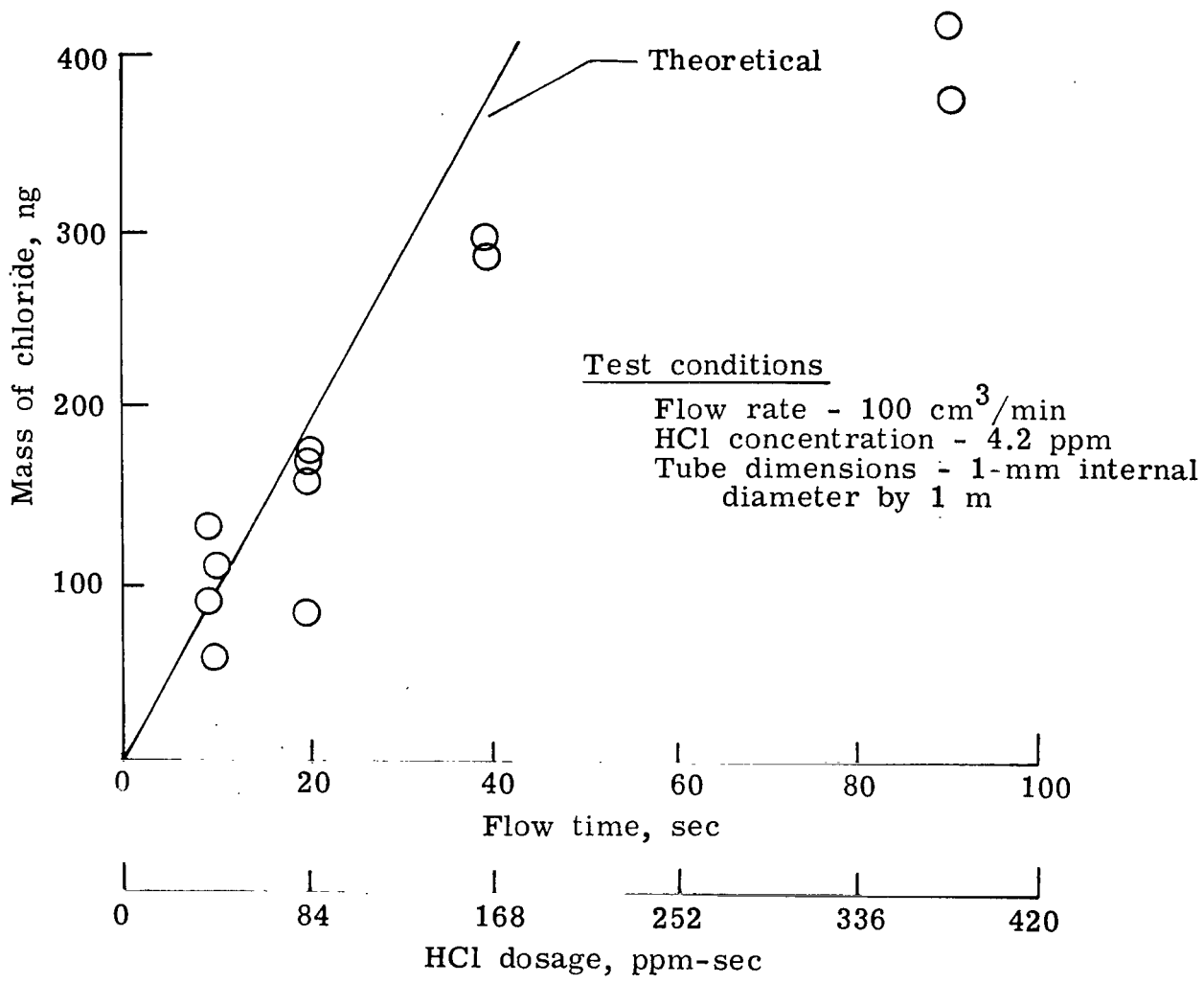

Figure 2.- NaNO₃ tube calibration.

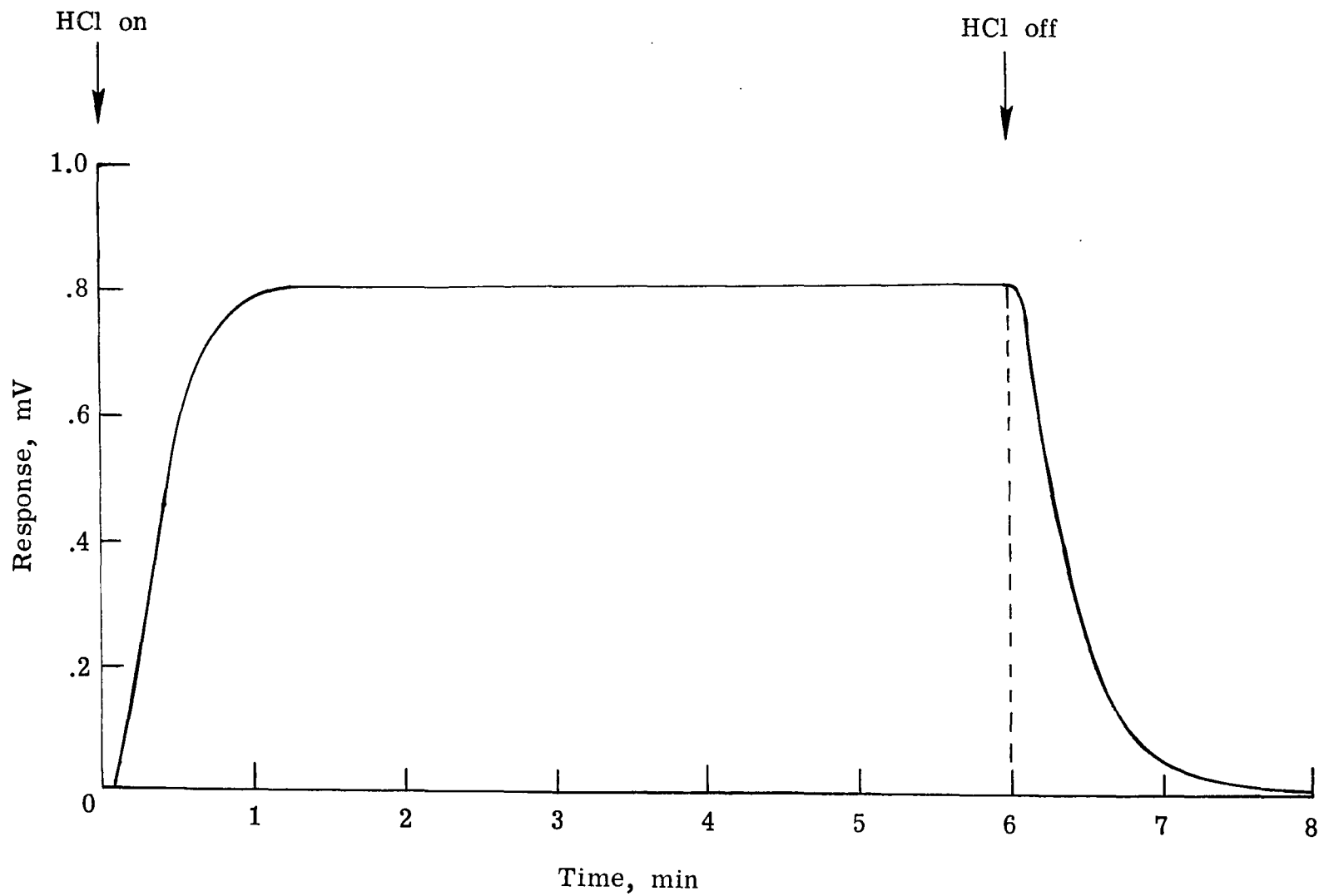

Figure 3.- Microcoulometer response to 5-ppm HCl; flow rate 100 cm³/min.

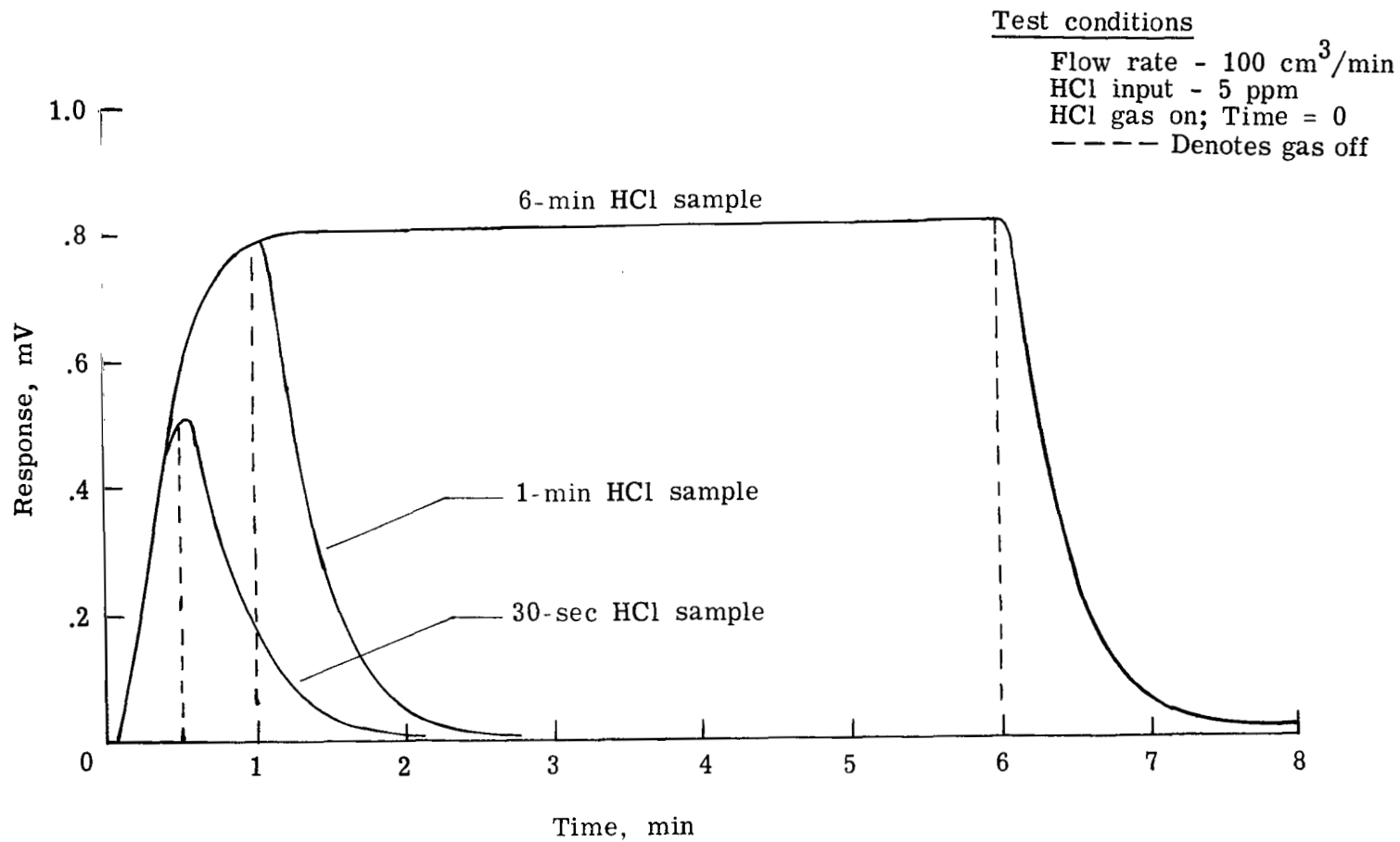

Figure 4.- Microcoulometer response as function of sample time.

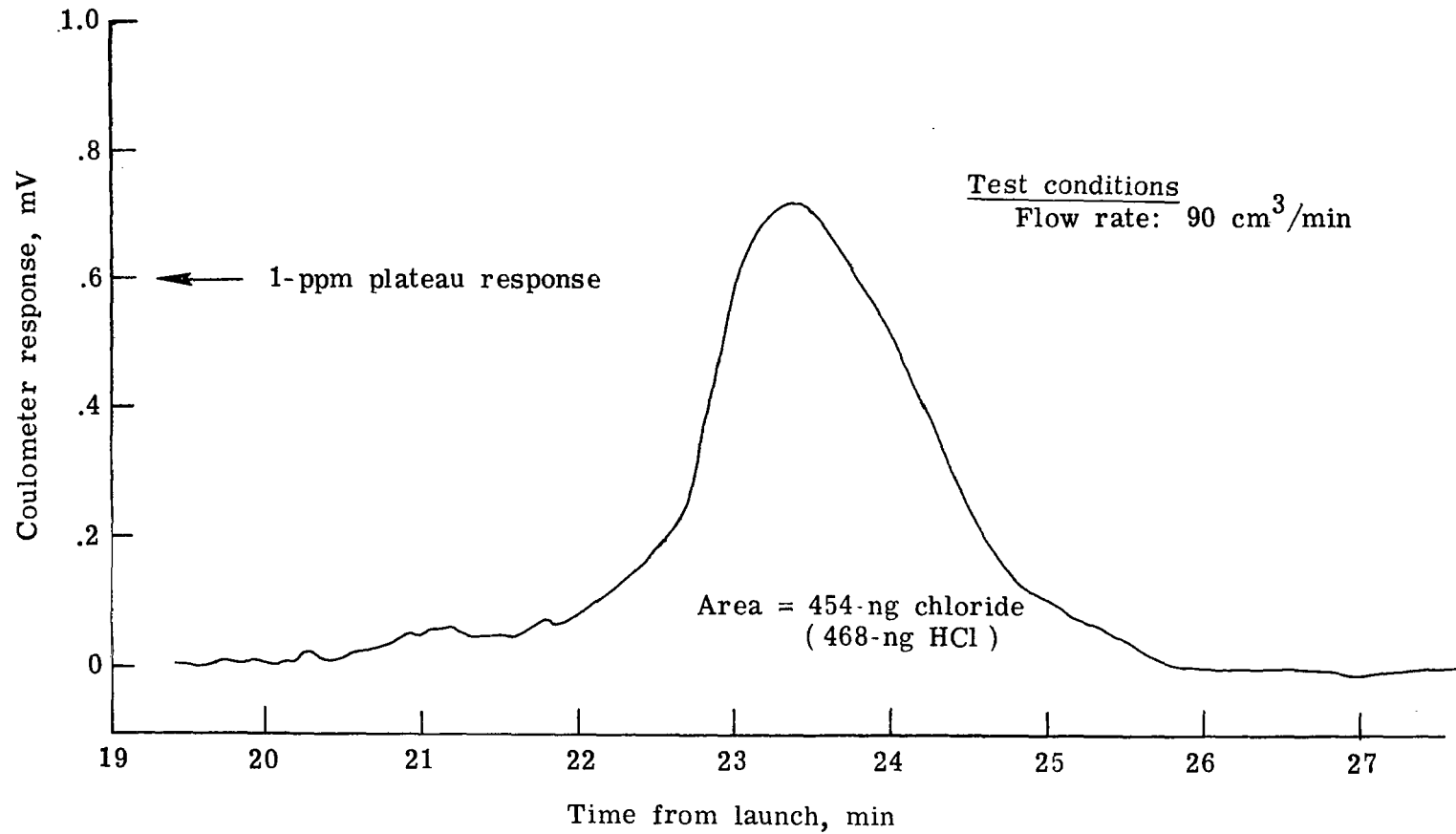

Figure 5.- Typical microcoulometer data trace from launch vehicle effluent monitoring program.

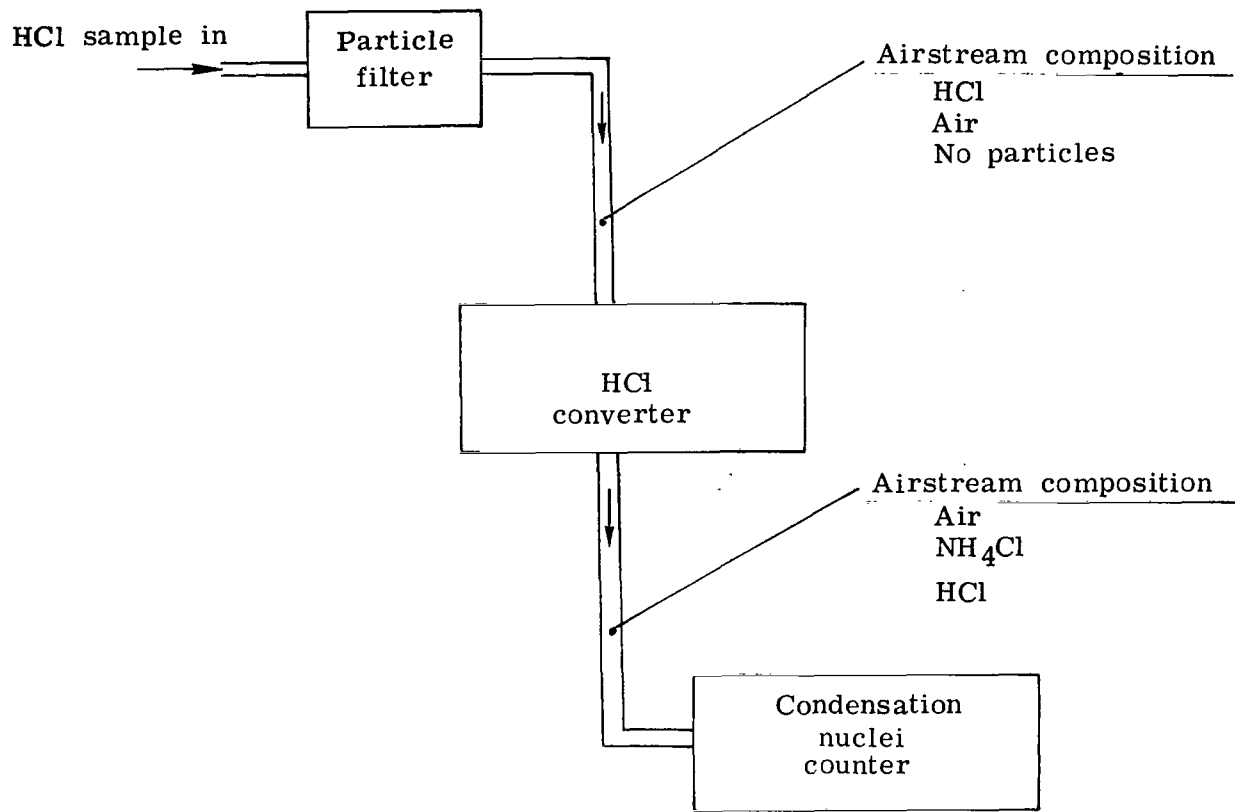
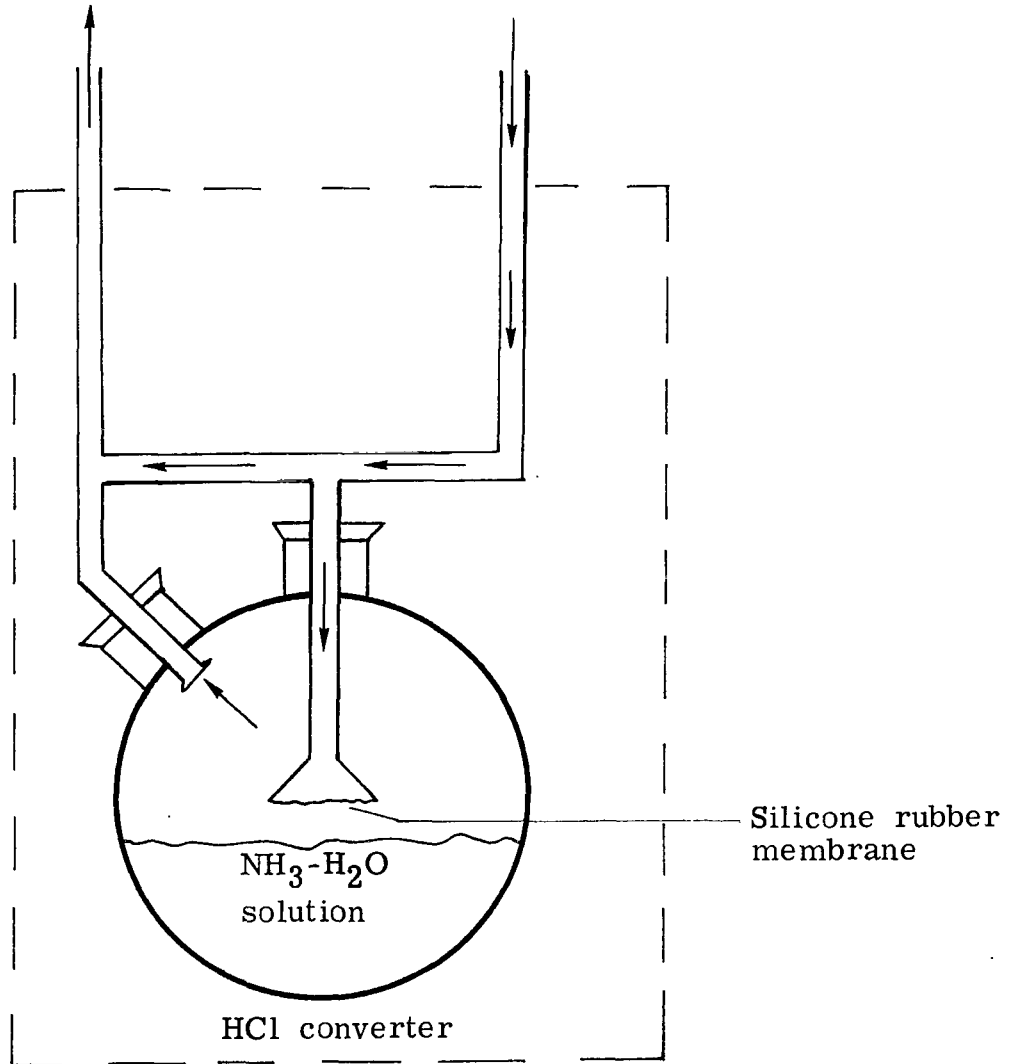

Figure 6.- Diagram of condensation nuclei method.

To nuclei counter

From filter



Silicone rubber membrane

HCl converter

← Denotes sample flow

Figure 7.- HCl converter.

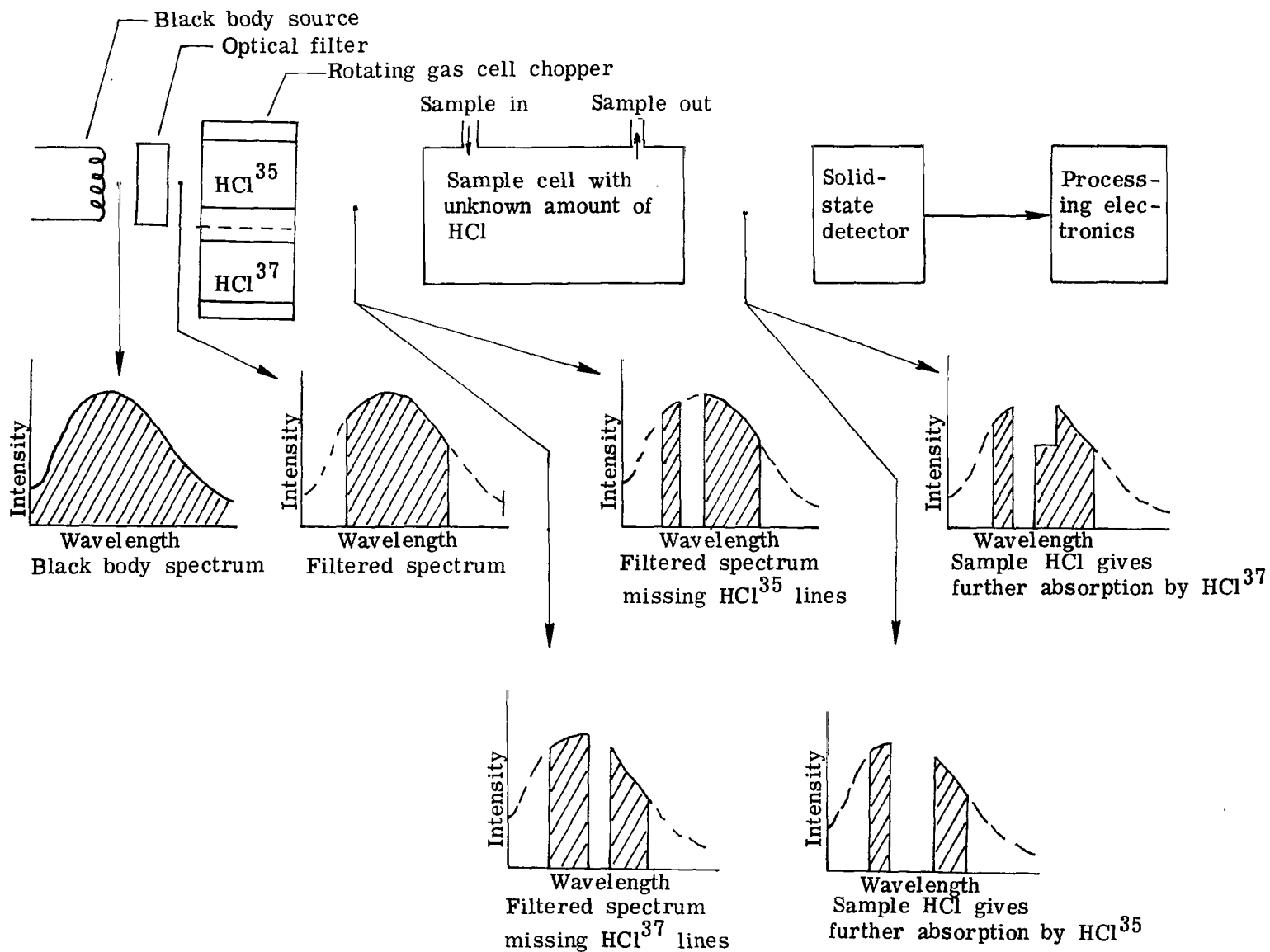

Figure 8.- Diagram of dual isotope absorption method.

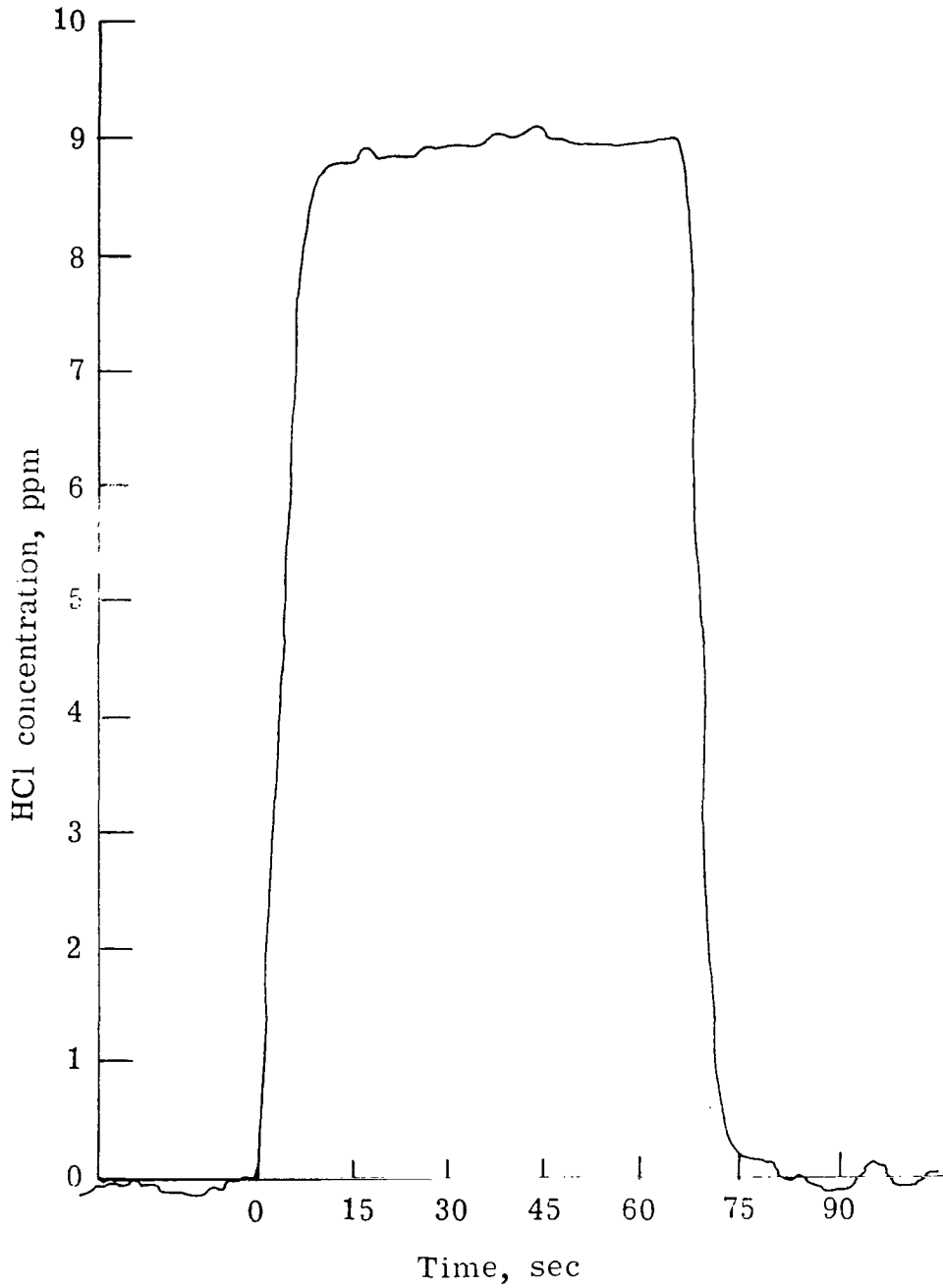

Figure 9.- Response of dual isotope absorption instrument to 9-ppm HCl; dry N₂ mixture.

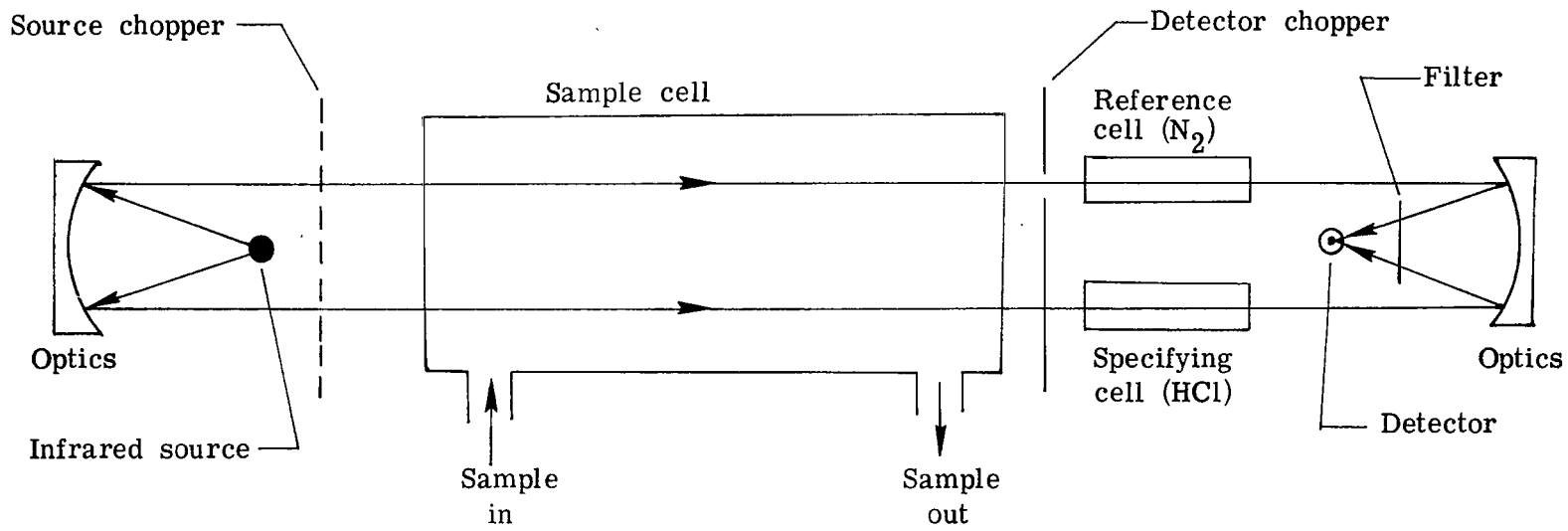

Figure 10.- Diagram of gas filter correlation method.

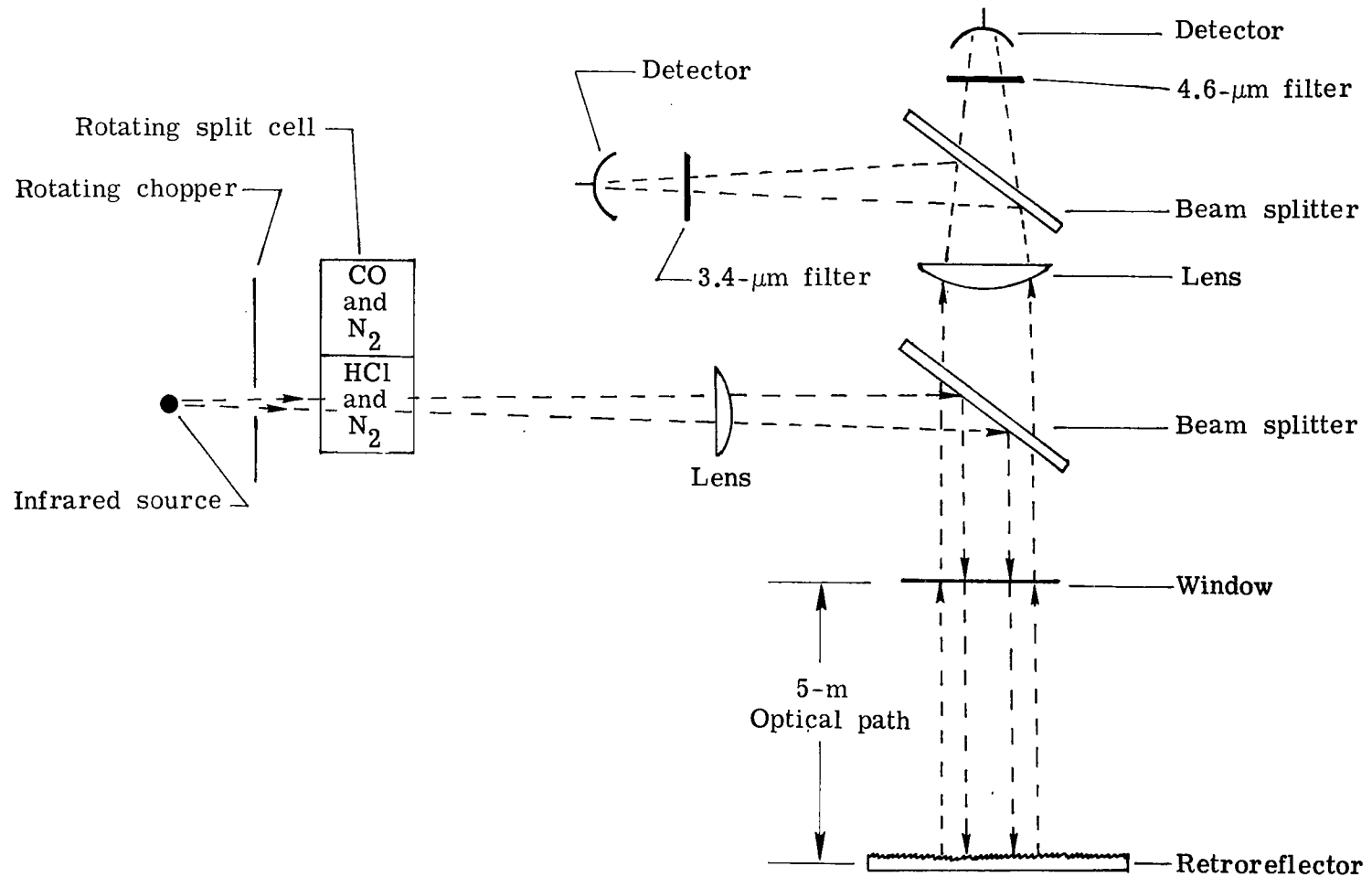

Figure 11.- Diagram of dual channel HCl-CO gas filter correlation instrument.

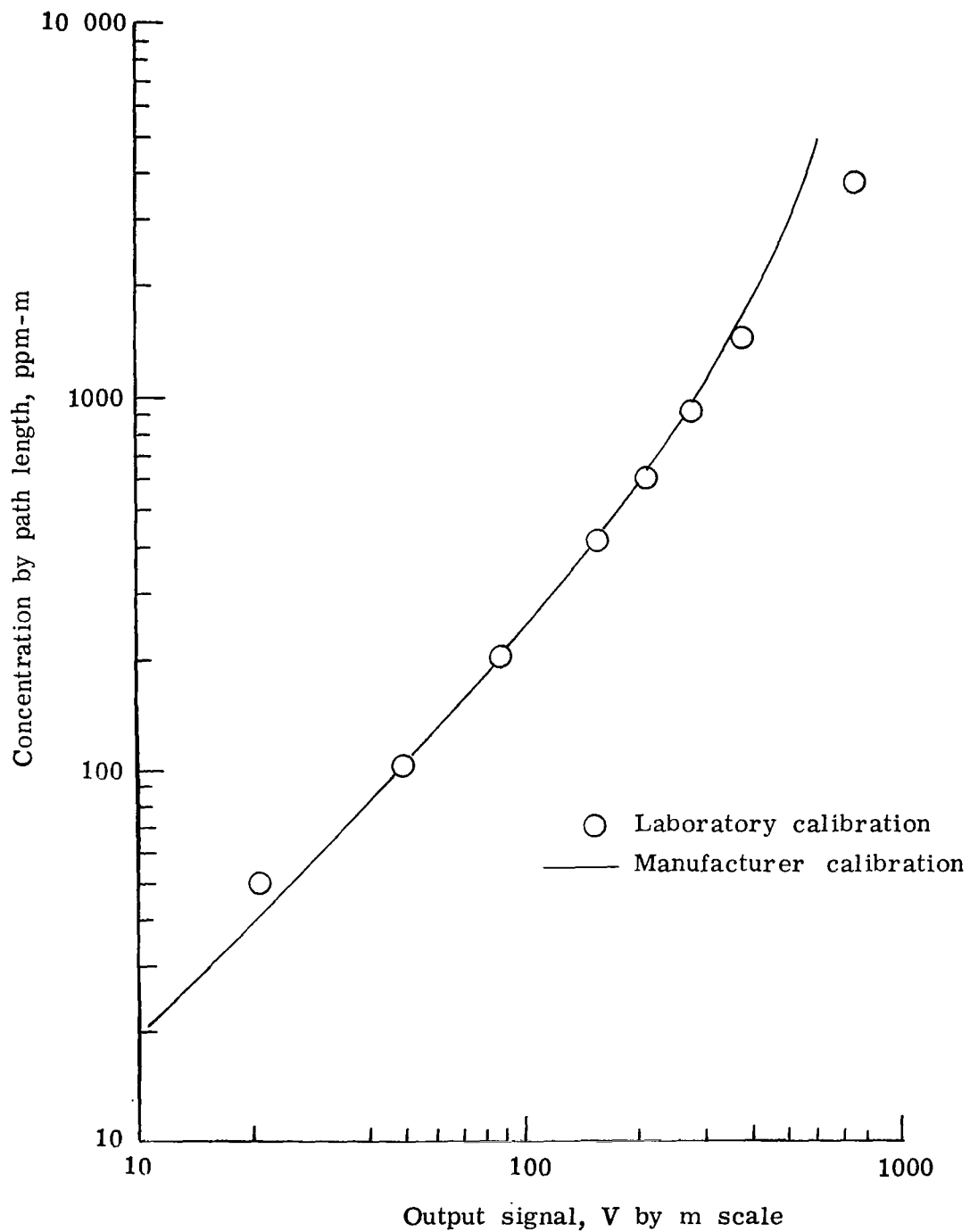

Figure 12.- Calibration results for dual channel gas filter correlation instrument.

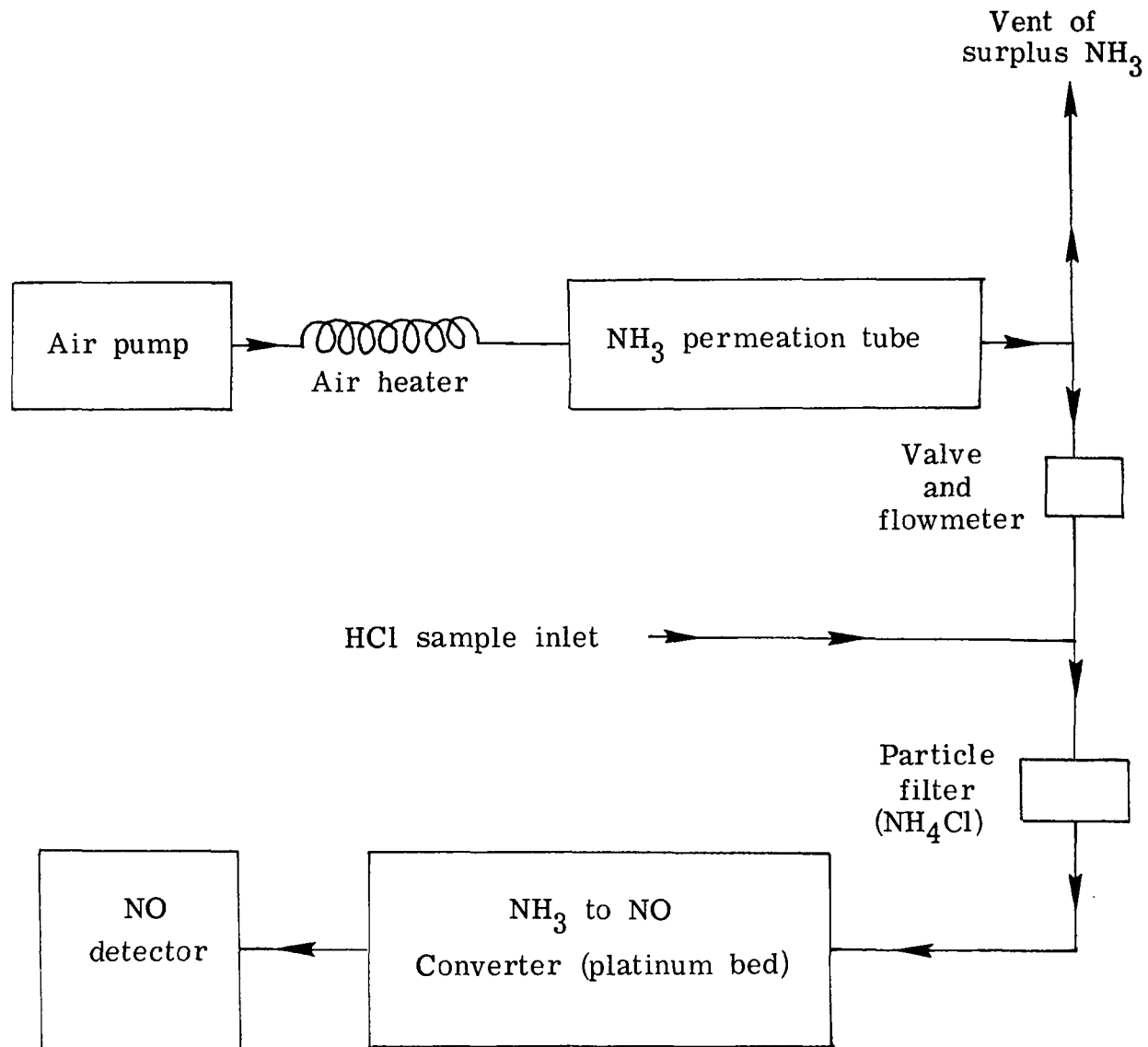

Figure 13.- Diagram of chemiluminescent method using nitric oxide detection.

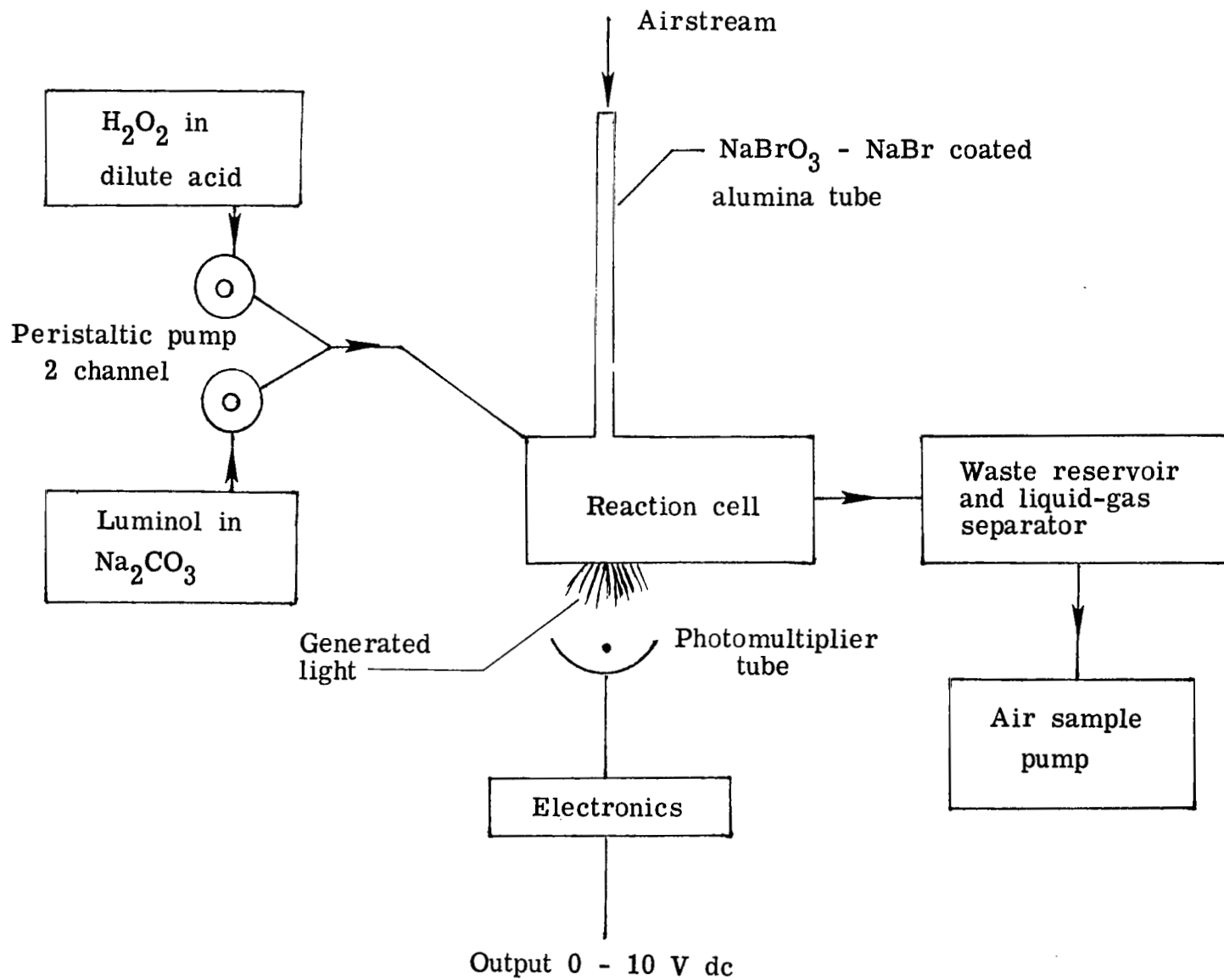

Figure 14.- Diagram of HCl detector.

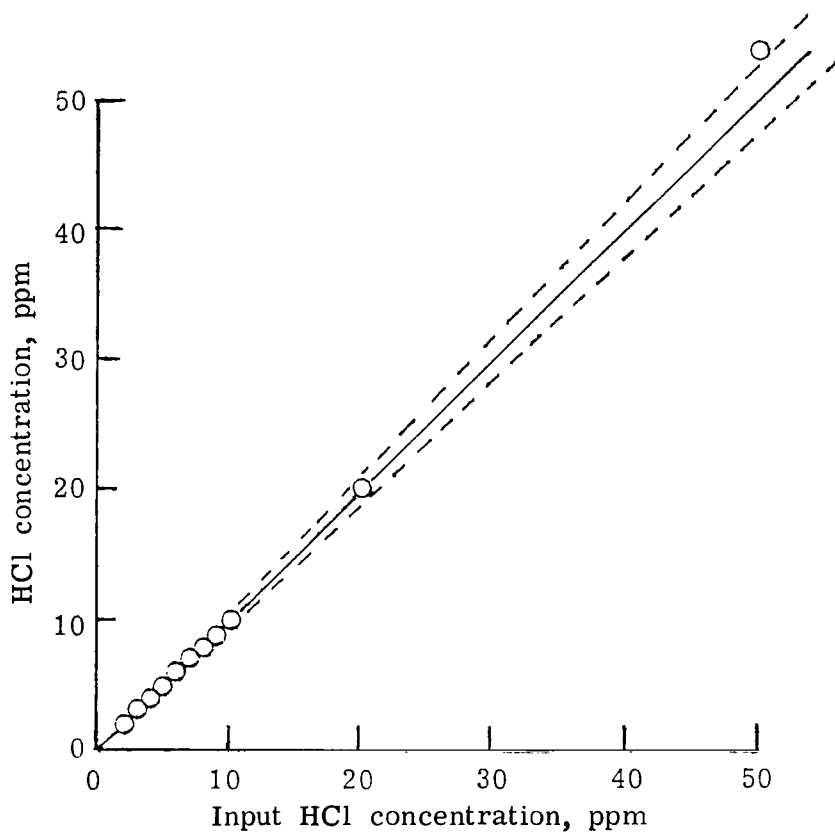
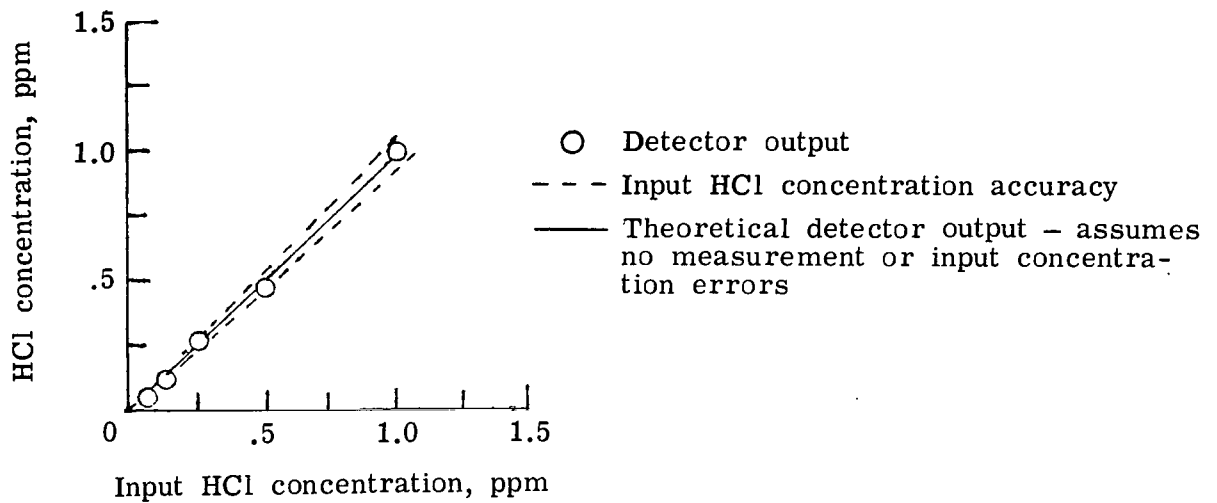
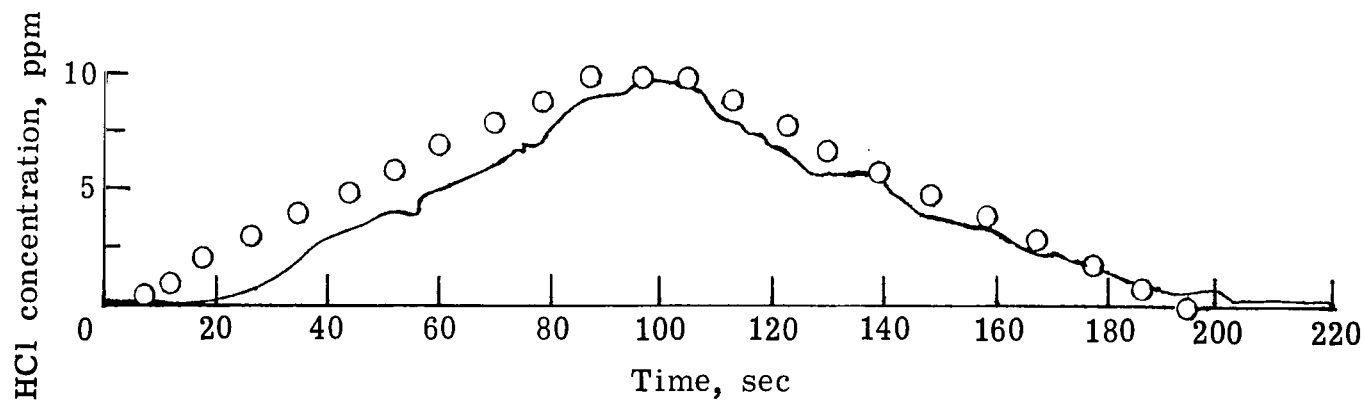
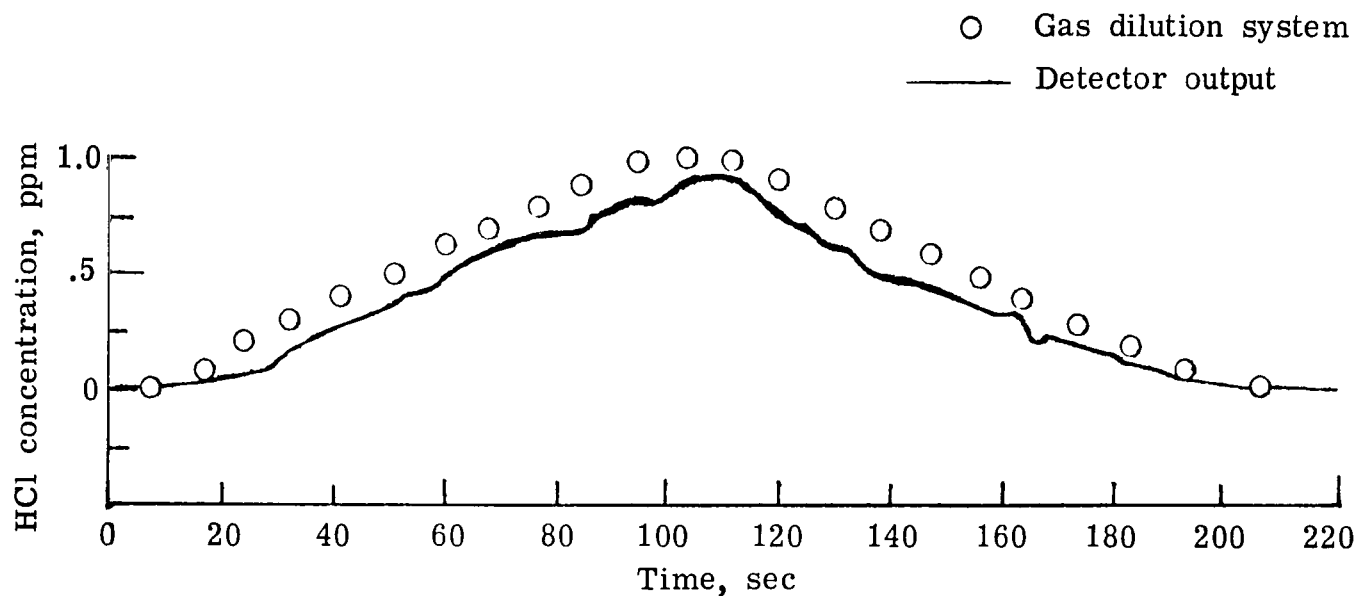

Figure 15.- HCl calibration data for chemiluminescent instrument; luminol oxidation method.



(a) 0 to 10 ppm.



(b) 0 to 1 ppm.

Figure 16.- Response of HCl detector to step change in HCl concentration.

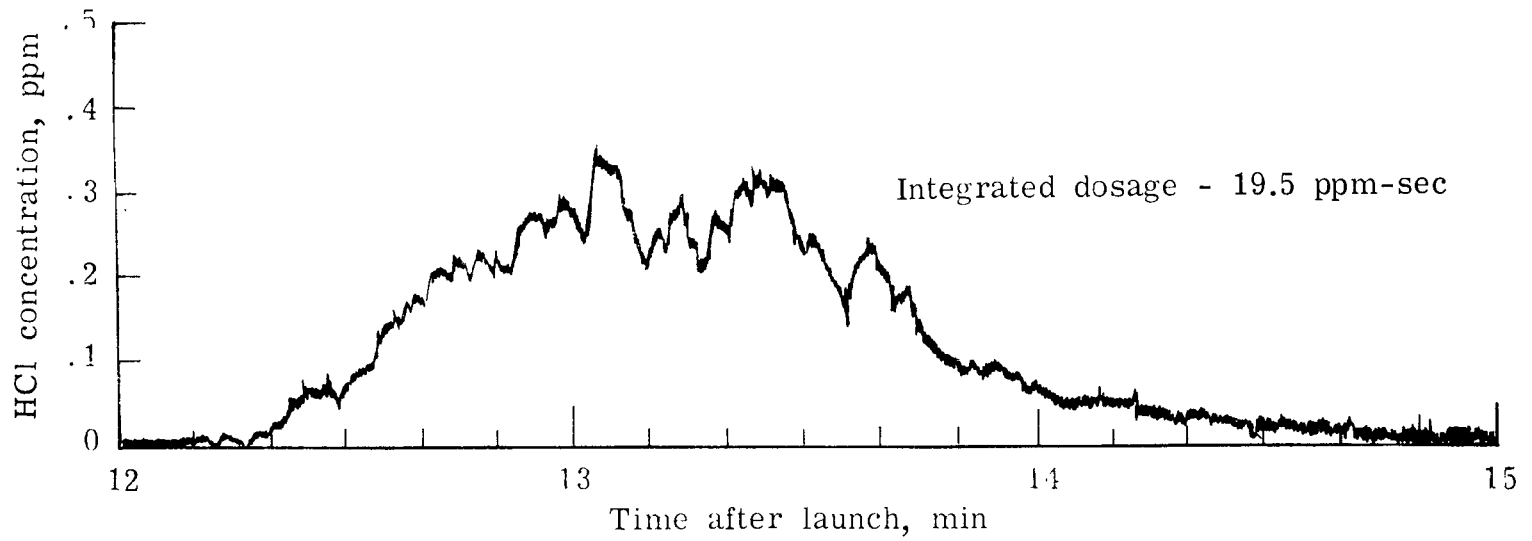

Figure 17.- Typical measurement data during launch vehicle monitoring.



011 001 C1 U D 770107 S00903DS
DEPT OF THE AIR FORCE
AF WEAPONS LABORATORY
ATTN: TECHNICAL LIBRARY (SUL)
KIRTLAND AFB NM 87117

Undeliverable (Section 158
Postal Manual) Do Not Return

"The aeronautical and space activities of the United States shall be conducted so as to contribute . . . to the expansion of human knowledge of phenomena in the atmosphere and space. The Administration shall provide for the widest practicable and appropriate dissemination of information concerning its activities and the results thereof."

—NATIONAL AERONAUTICS AND SPACE ACT OF 1958

NASA SCIENTIFIC AND TECHNICAL PUBLICATIONS

TECHNICAL REPORTS: Scientific and technical information considered important, complete, and a lasting contribution to existing knowledge.

TECHNICAL NOTES: Information less broad in scope but nevertheless of importance as a contribution to existing knowledge.

TECHNICAL MEMORANDUMS: Information receiving limited distribution because of preliminary data, security classification, or other reasons. Also includes conference proceedings with either limited or unlimited distribution.

CONTRACTOR REPORTS: Scientific and technical information generated under a NASA contract or grant and considered an important contribution to existing knowledge.

TECHNICAL TRANSLATIONS: Information published in a foreign language considered to merit NASA distribution in English.

SPECIAL PUBLICATIONS: Information derived from or of value to NASA activities. Publications include final reports of major projects, monographs, data compilations, handbooks, sourcebooks, and special bibliographies.

TECHNOLOGY UTILIZATION PUBLICATIONS: Information on technology used by NASA that may be of particular interest in commercial and other non-aerospace applications. Publications include Tech Briefs, Technology Utilization Reports and Technology Surveys.

Details on the availability of these publications may be obtained from:

SCIENTIFIC AND TECHNICAL INFORMATION OFFICE

NATIONAL AERONAUTICS AND SPACE ADMINISTRATION

Washington, D.C. 20546

