

NASA TECHNICAL NOTE

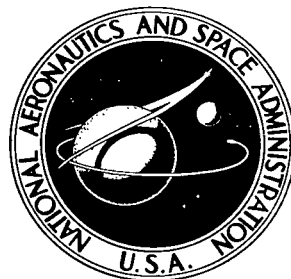

NASA TN D-8359 C.I.

NASA TN D-8359

LOAN COPY: RE  
AFWL TECHNICAL  
KIRTLAND AFB

0134115



TECH LIBRARY KAFB, NM

SUBJECTIVE ASSESSMENT  
OF SIMULATED HELICOPTER  
BLADE-SLAP NOISE

*Ben William Lawton*

*Langley Research Center*

*Hampton, Va. 23665*





0134115

1. Report No. NASA TN D-8359		2. Government Accession No.		3. Recipient's Catalog No.	
4. Title and Subtitle SUBJECTIVE ASSESSMENT OF SIMULATED HELICOPTER BLADE-SLAP NOISE				5. Report Date December 1976	
				6. Performing Organization Code	
7. Author(s) Ben William Lawton				8. Performing Organization Report No. L-11137	
				10. Work Unit No. 505-09-11-01	
9. Performing Organization Name and Address NASA Langley Research Center Hampton, VA 23665				11. Contract or Grant No.	
				13. Type of Report and Period Covered Technical Note	
12. Sponsoring Agency Name and Address National Aeronautics and Space Administration Washington, DC 20546				14. Sponsoring Agency Code	
				15. Supplementary Notes	
16. Abstract <p>A study was conducted to examine the effects of several characteristics of helicopter blade slap upon human annoyance. Blade-slap noise was simulated by using continuous and impulsive noises characterized by five parameters: The number of sine waves in a single impulse; the frequency of the sine waves; the impulse repetition frequency; the sound pressure level (SPL) of the continuous noise; and the idealized crest factor of the impulses. Ten-second samples of noise were synthesized with each of the five parameters at representative levels. The annoyance of each noise was judged by 40 human subjects.</p> <p>Analysis of the subjective data indicated that each of the five parameters had a statistically significant effect upon the annoyance judgments. The impulse crest factor and SPL of the continuous noise had very strong positive relationships with annoyance. The other parameters had smaller, but still significant, effects upon the annoyance judgments.</p>					
17. Key Words (Suggested by Author(s)) Human response to noise Helicopter noise Psychoacoustics			18. Distribution Statement Unclassified - Unlimited  Subject Category 71		
19. Security Classif. (of this report) Unclassified	20. Security Classif. (of this page) Unclassified	21. No. of Pages 54	22. Price* \$4.25		



## CONTENTS

SUMMARY . . . . .	1
INTRODUCTION . . . . .	1
EXPERIMENTAL DESIGN . . . . .	3
EXPERIMENTAL EQUIPMENT AND PROCEDURES . . . . .	4
Stimuli . . . . .	4
Experimental Facility . . . . .	5
Subjects . . . . .	5
Testing Procedure . . . . .	5
DATA ANALYSIS AND RESULTS . . . . .	6
Analysis of Variance . . . . .	6
Test-Retest Repeatability . . . . .	7
DISCUSSION . . . . .	8
Significance of Impulse Parameters . . . . .	8
Subjective and Objective Measures . . . . .	8
CONCLUDING REMARKS . . . . .	10
REFERENCES . . . . .	11
TABLES . . . . .	12
FIGURES . . . . .	19
APPENDIX A - NOISE DESCRIPTION . . . . .	27
APPENDIX B - NOISE EXPERIMENT MATERIAL . . . . .	50

# SUBJECTIVE ASSESSMENT OF SIMULATED HELICOPTER BLADE-SLAP NOISE

Ben William Lawton  
Langley Research Center

## SUMMARY

A study was conducted to examine the effects of several characteristics of helicopter blade slap upon human annoyance. Blade-slap noise was simulated by using continuous and impulsive noises characterized by five parameters: The number of sine waves in a single impulse; the frequency of the sine waves; the impulse repetition frequency; the sound pressure level (SPL) of the continuous noise; and the idealized crest factor of the impulses. Ten-second samples of noise were synthesized with each of the five parameters at representative levels. The annoyance of each noise was judged by 40 human subjects.

Analysis of the subjective data indicated that each of the five parameters had a statistically significant effect upon the annoyance judgments. The impulse crest factor and SPL of the continuous noise had very strong positive relationships with annoyance. The other parameters had smaller, but still significant, effects upon the annoyance judgments.

## INTRODUCTION

Human reaction to conventional take-off and landing aircraft may be quantified or predicted fairly well by using a variety of noise-rating scales. These rating schemes are commonly based upon A-weighted sound pressure level or perceived noise level. However, these scales do not predict or quantify so well the human response to helicopter noise. Such noises, which can range from pulsing to impulsive, are different in character from the continuous noise of conventional aircraft.

Subjectively, helicopter noise is easily recognized as such because of its impulsive nature. This impulsiveness varies between aircraft and flight condition, ranging from marginally perceptible modulation to severe repetitive bangs, called blade slap. When blade slap occurs, the helicopter noise is markedly different from conventional aircraft; blade slap is the most easily detectable and most annoying noise that a helicopter can make (refs. 1 to 3).

The common aircraft noise-rating scales generally underestimate human reaction to impulsive helicopter noise, particularly blade slap; that is, such noises are subjectively louder or more annoying than the noise scales indicate (refs. 2 to 8). This underestimation discrepancy has been well documented, and it is generally agreed that the discrepancy is caused by some factor that has to do with the impulsiveness of helicopter noise. As a solution to this problem, some researchers have suggested modifying the accepted noise-rating scales or using an impulse noise correction to account for the added subjective reaction to helicopter blade slap.

When a helicopter exhibits blade slap, a pressure-time trace of the acoustic signal shows a series of relatively short duration acoustic events with high amplitude. Each of these acoustic events, which stands out from the helicopter continuous noise, is repeated at a very low frequency, usually between 8 and 20 Hz. Certain characteristics of blade slaps and other impulsive noises have attracted the interest of noise researchers, namely:

- (1) Impulse rise time
- (2) Peak amplitude and crest factor
- (3) Duration of impulse
- (4) Harmonic or narrow-band spectral analysis of the impulses
- (5) Impulse repetition frequency

Generally, these factors are known to influence human reaction to helicopter blade slap. However, information relating these individual factors to annoyance or disturbance is sketchy or scarce. In most cases, only one variable has been examined, holding any other variables at typical or arbitrary values.

In sonic-boom research (ref. 9), rise time of the impulse was examined. The reference states that for single sonic booms, as the rise time, or time for the impulse to reach its maximum value, increases, the loudness and annoyance decrease. For repeated impulses simulating helicopter blade slap, this finding was duplicated in another study (ref. 3). In reference 3, decreasing rise time made repeating impulse noise more annoying when compared to a one-third octave band of noise centered at 1 kHz.

Sonic-boom research has also dealt with the duration of impulses and annoyance effects (ref. 9). For impulse durations on the order of hundreds of milliseconds (much longer than for helicopter blade slap), duration of the single impulse had no effect on loudness or annoyance. For impulses within the range of normal blade-slap impulses (ref. 7), it was found that, when the duration exceeded 3 msec, loudness was independent of duration for repeated impulses.

Perhaps the most striking attribute of helicopter noise is the strength of the impulse in relation to the broadband helicopter noise. This relationship is quantified by crest factor, expressed in terms of dB. In a relatively early experiment to establish some measure of the disturbance value of rhythmic, amplitude modulated noise as might be generated by helicopter rotors (ref. 10), it was found that the subjective assessment of such noise depends upon its peak, rather than root mean square, sound pressure level. More recent experiments (refs. 6 and 11) have resulted in the classification of blade-slap severity in terms of crest factor. The references suggest that a blade-slap penalty should be added to the measurement of helicopter noise and should be applied when the blade-slap crest factor exceeds some threshold value. The proposals for blade-slap penalty specify that once the crest-factor threshold has been exceeded, the penalty shall be directly proportional to the increasing blade-slap crest factor. For severe blade slap, with crest factor approximately 20 dB, references 6 and 11, respectively, propose impulse corrections or penalties of 12 and 6 dB, A-weighted.

Such a wide discrepancy may indicate that, although an objective measure of impulsiveness is useful in distinguishing between helicopter noises, any blade-slap penalty may have to include interactions between blade-slap characteristics (ref. 11).

Most investigations of the subjective effects of blade slap, either real or simulated, have been confined to testing only one out of the many possible characteristics.

The study described in this paper was conducted to examine the subjective effects of several repeated impulse noise characteristics. Five variables were chosen to characterize helicopter blade slap, and these characteristics or parameters were varied simultaneously. In this manner, it was possible to determine which of the five impulsive noise parameters made significant contributions to the subjective annoyance of each noise. Human subjects listened to short bursts of simulated helicopter blade-slap noise and rated the annoyance or disturbance of each noise. It was also possible to compare the subjective ratings and the objective rating scale measurements of each noise so as to assess how well the various noise-rating scales quantify human response to impulsive noise.

#### EXPERIMENTAL DESIGN

The purpose of this study was to determine which components of impulsive noise contribute significantly to the noise annoyance or disturbance. This determination was done by synthesizing impulsive noises, incorporating helicopter blade-slap characteristics, and having human subjects rate the annoyance caused by each noise.

Five parameters were chosen to characterize helicopter blade slap and other repetitive impulsive noises. In order that these characteristics be tested in a systematic manner, all other possible sources of variation were held constant. The following parameters were chosen to characterize impulsive noises consisting of a series of repeated impulses superimposed upon a continuous noise:

- (1) The number of pressure excursions making one complete impulse, ideally the number of sine waves in a single impulse
- (2) The frequency of the sine waves used to synthesize the individual impulses
- (3) The repetition frequency of the impulses
- (4) The sound pressure level of the continuous noise used to simulate helicopter broadband noise
- (5) The ratio of impulse peak to broadband noise sound pressure levels

A factorial experimental design was chosen to test the effects of the five parameters listed. This experimental method requires that a low and high numerical value be assigned to each parameter. These values, presented in table I, were chosen to bracket the parameter ranges found in helicopter blade slap.

Thus, a  $2^5$  factorial design was made that requires 32 noises to be judged or rated. Four samples of the nonimpulsive, broadband noise were added to the experimental design at various sound pressure levels.

The 32 impulsive and 4 nonimpulsive noises made a total of 36 to be randomly ordered for presentation to the subjects. The order of noises was planned to be in four groups of nine, with the restriction that one nonimpulsive test condition should occur within each of the four noise groups. Table II presents the ordering of the 36 test conditions or noises into the four groups, which were used to randomize further the noise presentation order.

It was planned that human subjects listen to and give ratings for each of the test conditions or noises. So that the order of presentation should have minimum systematic bias on the subjective data, the four noise groups were specially ordered or counterbalanced. This counterbalance was done by constructing a simple  $4 \times 4$  Latin square for the various noise groups to make four presentation orders, as shown in table III. The conditions of presentation with replication imposed other restrictions; table IV shows the arrangement of subjects, sex, and tape order for each subject.

## EXPERIMENTAL EQUIPMENT AND PROCEDURES

### Stimuli

Human subjects were to judge short bursts of repetitive impulsive noise. In order to have suitable control of the stimuli to be judged, the impulsive and continuous portions of the stimuli were synthesized and recorded simultaneously on separate channels of a stereo tape recorder. Thus, each portion of the noise stimuli could be controlled so as to produce the desired waveforms as specified in table II. Owing to the frequency response and transient signal characteristics of the loudspeakers to be used and the reflection characteristics of the test room, each input signal had to be specially tailored to produce the desired waveform at a position to be occupied by the subject's head.

The tape-recorded noise stimuli were synthesized and reproduced by means of the electronic systems shown diagrammatically in figure 1. Special care was taken to reproduce the impulsive noises. For this portion of the stimuli, a large, low-frequency cone woofer was used. The speaker box was packed with fiberglass so as to provide maximum acoustic damping. By using this specially modified loudspeaker, it was possible to reproduce reasonably the waveforms called for in the experimental design.

The stimuli heard by the subjects were a constant level burst of noise lasting 10 sec. In order to avoid pedestal or startle effects, each noise stimulus had a 0.5-sec onramp and offramp. Each stimulus was followed by a 9-sec period of silence, during which the subject was to record the rating for the stimulus before hearing the next noise. This presentation method is illustrated in figure 2, which is a sketch of the pressure-time history of several noise stimuli.



The noises to be heard by the subjects were monitored by using a microphone at a position to be occupied by the subject's head. The acoustic signal was examined in several ways, all of which are contained in appendix A. For each of the 36 test noises, a pressure-time-history sample is given along with the one-third octave-band analysis. The test noises were also subjected to narrow-band analysis to determine the harmonic structure of each. Representative narrow-band analyses are also presented in appendix A.

### Experimental Facility

The test noises were presented to the subjects in a large auditorium-like room, having a volume of approximately 340 m<sup>3</sup>. This chamber is a relatively reverberant room, with a reverberation time of approximately 0.5 sec at 1 kHz. Owing to the reflection and reverberation characteristics of the test chamber, it was necessary to take special precautions that the subjects receive the desired stimulus waveforms. The impulse and continuous noise speakers were placed against the front wall of the room, as shown in the photograph of figure 3. The subject's chair was positioned as shown in the photograph, with the subject's head approximately 1 m from and on the axis of the impulse woofer. In order to shield the subject from undesirable room reflections, the chair was surrounded by an arrangement of free-standing sound-absorbing panels, which can be seen in the photograph.

### Subjects

Forty human subjects were hired to listen to and rate the test noises. Before participating in the experiment, each subject was screened to meet minimum audiological standards, 20-dB hearing level. The numbers of test subjects were equally divided between the two sexes. The 20 male subjects, ranging in age from 19 to 47 yr with median 27.5 yr, were students, professionals, and businessmen. The 20 female subjects, ranging in age from 19 to 63 yr with median 34.5 yr, were housewives, students, and businesswomen.

### Testing Procedure

Before reporting to the laboratory to participate in this study, all subjects were screened for medical and audiological contraindications and questioned to obtain minimal demographic data. Two subjects participated in each testing session, which lasted approximately 2 hr. Upon arriving for testing, both subjects were asked to read the instructions (see appendix B) so that they could give their informed consent to participate in the experiment. Each subject was then given the voluntary consent form (see appendix B) to read, date, and sign. Following these preliminaries, the instructions were read aloud to the subjects as they read along to themselves silently; also the subjects were introduced to the rating sheet (see appendix B), which they would use to record their annoyance ratings for each noise.

The subjects were tested individually; one subject listened to and rated the 36 test noises, while the other remained in the briefing lounge. The first

subject was taken into the test chamber and seated in the subject's chair. At this time, the safety equipment and procedures were explained to the subject, after which the experimenter left the test room and the test was begun.

The first subject then heard a sample of three test noises so that the noises and rating procedure would be familiar. If the subject had no questions after listening to the familiarization sample, the main body of the experiment was begun. The four counterbalanced noise groups were played for the subject, who had four rating sheets for this first turn at testing.

When the first subject had heard and rated the annoyance of the 36 test noises, he returned to the briefing room while the second subject went into the test chamber and followed a similar procedure. For each subject's second turn of rating the noises, the familiarization sample noises were not presented. In all, the two subjects for a particular session would each listen to and judge the test noises twice, and each have two periods in the lounge, taking turns as appropriate.

An entire test session would last approximately 2 hr. This period included pretest briefing and instructions, taking turns judging the noises, and a brief rest break after each subject had taken his first turn. When the subjects had completed their assigned portion of the experimental design, they were dismissed and given post-test audiograms.

In all, 40 subjects participated in the experiment. Testing sessions were held in the morning and afternoon, with two subjects for each of 20 sessions, with sex, tape orders, and so forth being counterbalanced as shown in table IV.

## DATA ANALYSIS AND RESULTS

Forty subjects participated in this study, each listening to and judging the annoyance of 36 noises. Thus, including repeat judgments, there were 80 judgments for each of the 36 noises, both impulsive and continuous. In all, there were 2560 judgments for the impulsive noises, with an additional 320 for the nonimpulsive continuous noises.

### Analysis of Variance

The 2560 annoyance judgments made on the impulsive noises were analyzed by using an analysis-of-variance procedure. This analysis was done to determine which parameters of the experiment had any significant effect upon the annoyance judgments made by the subjects.

The parameters, or sources of variation in the judgments, examined fall into two general classes. First, the conditions were examined which specify the test noises, that is, the five parameters used in synthesizing the impulsive noise. Also included are all combinations or interactions of noise parameters, which might produce systematic changes in the annoyance responses. The second main class of parameters or sources are concerned with the subjects. Here, the analysis examined changes in annoyance response due to the individual subjects and

their repeatability. The results of the analysis of variance are presented in table V. In this table, the sources of variation are listed and the two hypotheses for each source are tested. The null hypothesis, that any particular source produced no change in the annoyance responses, is intended to be rejected if possible. Rejection of this null hypothesis leaves the alternate hypothesis remaining, that the net effect for a source was not equal to zero. Of the variables listed in the table, rejection of the null hypothesis at the 0.01 significance level is indicated by an asterisk (\*); that is, the sources of possible variation were shown to produce changes in the annoyance responses given by the subjects. All other variables were shown to produce no effects statistically distinguishable from chance response variations (failure to reject the null hypothesis).

Reference to the analysis of variance in table V indicates that each of the main sources of variation (the five parameters used in synthesizing the test noises) shows F-values which greatly exceed the critical F-value of 6.63. Thus, each of the synthesizing parameters had a statistically very strong effect upon the annoyance responses to the noises. A more severe test of only the five main sources is presented in table VI. This simple five-way classification minimizes the possibility of rejection of each null hypothesis, that each source had no effect upon the annoyance judgments. As in the more detailed analysis of variance, each source was found to be significant at the 0.01 level.

Since each of the sources or parameters is found to be significant, it is now necessary to determine in which direction the parameters influence the annoyance responses. Figure 4 illustrates the effect of each of the five parameters. In the figure, the vertical axis is mean annoyance rating over all subjects, and on the horizontal axis is shown the value chosen to quantify the parameter. The bars of each part of the figure represent half of the impulsive noises, that is, noises characterized by the high and low values assigned to the parameter. For each of the five parameters, the high value (for example, 20-Hz impulse repetition frequency in contrast to 8 Hz) produced higher mean annoyance response. A comparison between the parts of the figure shows that level of the continuous noise and idealized crest factor have a very strong positive relation with mean annoyance. In contrast, the other variables, number of sine waves, frequency of sine waves, and impulse repetition frequency, have a considerably smaller positive relation with mean annoyance, though still statistically significant.

#### Test-Retest Repeatability

As explained in previous sections, each subject judged each noise twice. This procedure was done to assess how well the subjects were able to perform their annoyance judgment task. If each subject was able to act as an ideal annoyance meter, there should be no variable in judgment between the two times each noise was judged. In the analysis of variance (table V), this idea was tested under the source repeats. At the 0.01 level, the analysis of variance failed to reject the null hypothesis that repeated judgments had no effect upon the annoyance responses given.

This concept of repeatability of judgment is also illustrated in figure 5. In this figure, the horizontal and vertical axes are, respectively, first and second annoyance judgments (over repeats) for the same noise. Ideal subjects,

with perfect repeatability, could be represented as the dashed line  $y = x$ . The 40 subjects who participated in the study are represented as the solid line, with equation and Pearson product-moment correlation coefficient given. Qualitatively, the nearness of the theoretical and actual lines in the figure indicates that the subjects were able to perform their judgment task with good repeatability, thereby supporting the repeats result of the analysis of variance.

## DISCUSSION

### Significance of Impulse Parameters

The analysis of variance (table V) indicates the statistical results used to determine which parameters significantly contributed to the annoyance response. In this analysis scheme, only the five main parameters and their interactions were of major interest. The main conclusion of this analysis scheme was that, of the five parameters used to synthesize the test noises, each proved to have a significant effect upon the annoyance responses. An even more severe test of these parameters is presented in table VI. Here, an analysis-of-variance procedure was used to examine only the five main parameters; all other sources were combined into the random-error term. This five-way classification maximizes the random error against which the source effects are tested, thus making this a most severe test of each source effect. This five-way classification scheme generalizes to the population rather than the specific subject sample used for this experiment. Even with this most severe test, the five main parameters of the test noise still show significant effects upon the annoyance responses to the test noises.

A comparison of the F-ratio values in table VI gives an indication of the strength of the effects of each of the various noise parameters. The level of the continuous broadband noise determines the general level of all the test noises and thus is the strongest of the parameters. The idealized crest factor specifies the level of the impulses superimposed on the broadband noise level. These two variables show very strong effects on annoyance, as indicated by the very large F-values and as illustrated in figure 4. The other three parameters, number of sine waves, frequency of sine waves, and impulse repetition frequency, have comparatively much smaller F-ratios, thereby indicating much smaller effects on annoyance response. These effects are relatively subtle when heard in the test noises as compared to the striking effects of changing both overall and impulse level.

### Subjective and Objective Measures

This study has shown that each of the five parameters had a significant effect upon the noises' annoyance and in which direction the parameters affected the annoyance responses. Each of the five parameters also had an effect upon the objective measures of noise level. The test noises judged were constant level, 10-sec bursts, approximating short samples of helicopter hover noise with varying degrees of blade slap. These noise samples were measured and quantified by using noise-rating scales in common use for aircraft noise measurements.

Table VII presents these objective measures, as well as the subjective judgments, for both impulsive and continuous noises.

Part of the data from table VII is plotted in figures 6 to 9. For each figure, the vertical axis is median annoyance rating over all subjects, whereas for the horizontal axis, different noise-rating scales are used. Median annoyance rating was chosen instead of the mean as a better representation of central tendency. This choice was made to account for skewness and truncation near the ends of the annoyance scale.

In each figure, the nonimpulsive, continuous noises (numbers 9, 12, 23, and 32) are represented as the solid symbols. The impulsive noises are represented by the open symbols. The trend of the impulsive noise is represented by the S-shaped dashed line in each figure. These curves were constructed by transforming the median annoyance judgments to unit normal deviates and performing a least-squares linear regression upon the deviate scores (dependent variable) and the various rating-scale units (independent variables). The resulting linear regression line was then transformed back into the medium annoyance scale. This procedure takes into account the truncation of the judgment distributions at the ends of the annoyance scale, thus giving a good representation of the overall trend in the data.

In examining the figures, several interesting observations may be made. When the noises are quantified in terms of sound pressure level, both linear and A-weighted, and perceived noise level (all of which are scales commonly used to quantify aircraft noise), the impulsive-noise-trend line falls to the left of the nonimpulsive, continuous noise points on the dB scale (as shown in figs. 6 to 8), thereby indicating a bias or discrepancy between objective and subjective measures. Ideally, the two noise conditions, impulsive and continuous, should be indistinguishable when measured or plotted. For the two noise conditions, impulsive and nonimpulsive, when judged equal in annoyance, the objective measurement of the impulsive noise underestimated the subjective reaction by approximately 2 dB. However, when the noises were quantified in terms of A-weighted sound pressure level impulse, the nonimpulsive data points fall close to the trend line, thereby suggesting possible random error instead of systematic bias. These rather limited data imply that the A-weighted impulse gives a more accurate quantification of repeated impulse noise than the commonly used slow noise-rating scales.

The results of the analysis of variance may be compared with the figures showing median annoyance rating as a function of noise level. Table VI shows that two of the sources of variation, level of continuous noise and idealized crest factor, are quite strong in relation to the other three sources. This relation between sources of variation may be seen in figures 6 to 9. The data points in these figures generally fall into four groups, determined by the low and high values for the two sources. These four groups of impulse noises generally determine the trend line of the impulse-noise-data points. However, within one group of impulse points, high level of continuous noise and low idealized crest factor, for example, there is some variation among the points. This variation, along both the dB and median annoyance scales, is due to the subjective and objective influence of the first three sources of variation in table VI. These sources, number of sine waves in an impulse, frequency of the

sine waves, and impulse repetition frequency, had relatively small but significant effects upon the annoyance responses. These sources may be considered "fine tuning" variables in predicting human response to repeated impulsive noise simulating helicopter blade slap.

#### CONCLUDING REMARKS

This study was conducted to examine the subjective effects of several helicopter blade-slap characteristics. Five parameters were chosen to synthesize blade-slap noise: The number of sine waves in a single impulse; the frequency of the sine waves; the impulse repetition frequency; the sound pressure level (SPL) of the continuous, broadband continuous noise; and the SPL of the impulses superimposed upon the continuous noise. Short bursts of noise were synthesized, with the parameters at representative levels, and the annoyance of each noise was judged by 40 human subjects.

The analysis of the annoyance data for the test noises indicated that each of the five parameters had a significant effect upon the annoyance judgments at the 0.01 level. The SPL of the continuous noise and the crest factor (derived by using SPL of the impulses) were shown to have very strong positive relations with annoyance. The other three parameters had smaller, but still significant, effects upon annoyance judgments.

Annoyance judgments were also correlated with several noise measurement scales. This subjective-objective comparison showed that the noise scales commonly used to quantify aircraft noise, linear SPL, A-weighted SPL, and perceived noise level, underestimate by approximately 2 dB the annoyance caused by the impulsive noises. One noise measurement scale, A-weighted impulse SPL, did give a more accurate representation of the annoyance of the noises simulating helicopter hover with blade slap.

Langley Research Center  
National Aeronautics and Space Administration  
Hampton, VA 23665  
November 5, 1976

## REFERENCES

1. Boxwell, D. A.; Schmitz, F. H.; and Hanks, M. L.: In-Flight Far Field Measurement of Helicopter Impulsive Noise. Paper presented at the First European Rotorcraft and Powered Lift Aircraft Forum (Southampton, England), Sept. 22-24, 1975.
2. Munch, Charles L.: A Study of Noise Guidelines for Community Acceptance of Civil Helicopter Operations. J. American Helicopter Soc., vol. 20, no. 1, Jan. 1975, pp. 11-19.
3. Stave, A.; and King, R.: The Annoyance of V/STOL Noise - Phase I, Impulse Noise. Rep. No. SER 50678, Sikorsky Aircraft Div., United Aircraft Corp., Oct. 1970.
4. Leverton, John W.: Helicopter Noise: Can It Be Adequately Rated? J. Sound & Vib., vol. 43, no. 2, Nov. 22, 1975, pp. 351-361.
5. Hinterkeuser, Ernest G.; and Sternfeld, Harry, Jr.: Civil Helicopter Noise Assessment Study - Boeing Vertol Model 347. NASA CR-132420, 1974.
6. Munch, Charles L.; and King, Robert J.: Community Acceptance of Helicopter Noise: Criteria and Application. NASA CR-132430, [1974].
7. Leverton, John W.: Helicopter Noise - Blade Slap. Part 2: Experimental Results. NASA CR-1983, 1972.
8. Sternfeld, Harry, Jr.; Hinterkeuser, Ernest G.; Hackman, Roy B.; and Davis, Jerry: Acceptability of VTOL Aircraft Noise Determined by Absolute Subjective Testing. NASA CR-2043, 1972.
9. Shepherd, L. J.; and Sutherland, W. W.: Relative Annoyance and Loudness Judgments of Various Simulated Sonic Boom Waveforms. NASA CR-1192, 1968.
10. Crosse, G. W.; Davidson, I. M.; Hargest, T. J.; and Porter, M. J.: A Controlled Experiment on the Perception of Helicopter Rotor Noise. J. Roy. Aeronaut. Soc., vol. 64, no. 598, Oct. 1960, pp. 629-632.
11. Southwood, B. J.; and Pike, A. C. (appendix 1 by B. F. Berry, A. J. Rennie, and H. C. Fuller): The Rating and Subjective Assessment of Helicopter Blade Slap. AA Note 1147, Westland Helicopters Ltd. (Yeovil, England), May 1976.

TABLE I.- VALUES ASSIGNED TO FIVE PARAMETERS CHOSEN TO  
SIMULATE HELICOPTER BLADE SLAP

Parameter	Value of parameter	
	Low	High
Number of sine waves in impulse . . . . .	1	3
Sine-wave frequency, Hz . . . . .	200	400
Repetition frequency of impulses, Hz . . . . .	8	20
Level of continuous noise, dB <sup>a</sup> . . . . .	65	80
Idealized crest factor <sup>b</sup> of impulsive noise, dB . . . . .	15	25

<sup>a</sup>SPL dB referenced to 20 μPa.

<sup>b</sup>Crest factor is defined as ratio of peak to root-mean-square pressure for an acoustic signal

$$\text{Crest factor} = \frac{\text{Peak pressure}}{\text{rms pressure}}$$

When converted to dB scale, crest factor is peak SPL minus rms SPL. For purposes of defining noises used in this study, an idealized crest factor was specified, peak SPL of impulses minus rms SPL of continuous noise.



TABLE II.- RANDOMIZATION OF 36 TEST NOISES

Noise	No. of sine waves	Frequency of sine waves, Hz	Impulse repetition frequency, Hz	SPL of continuous noise, dB	Idealized crest factor, dB
Noise group I					
1	3	200	20	65	25
2	3	400	20	65	15
3	1	400	8	65	25
4	1	400	8	80	25
5	1	200	8	65	15
6	3	400	8	65	15
7	1	200	8	80	15
8	3	400	8	80	25
9	---	---	---	80	---
Noise group II					
10	1	400	8	80	15
11	1	400	20	65	25
12	---	---	---	73	---
13	1	200	8	80	25
14	3	400	20	80	25
15	3	400	8	65	25
16	3	200	20	80	25
17	3	200	20	80	15
18	1	200	8	65	25

TABLE II.- Concluded

Noise	No. of sine waves	Frequency of sine waves, Hz	Impulse repetition frequency, Hz	SPL of continuous noise, dB	Idealized crest factor, dB
Noise group III					
19	1	400	8	65	15
20	1	400	20	80	25
21	1	200	20	80	15
22	3	400	20	65	25
23	---	---	---	65	---
24	1	200	20	65	15
25	3	400	8	80	15
26	1	400	20	65	15
27	1	200	20	80	25
Noise group IV					
28	3	200	8	65	15
29	3	200	8	80	25
30	3	200	8	80	15
31	1	400	20	80	15
32	---	---	---	73	---
33	3	200	20	65	15
34	3	200	8	65	25
35	1	200	20	65	25
36	3	400	20	80	15

TABLE III.- COUNTERBALANCED NOISE GROUPS  
WITH FOUR NOISE TAPE RECORDINGS

Noise group tape recording			
I	II	IV	III
II	III	I	IV
III	IV	II	I
IV	I	III	II

TABLE IV.- ASSIGNMENTS OF SUBJECTS AND SEXES TO  
VARIOUS TAPE PRESENTATION ORDERS

Sex	Subject	Tape presentation	
		First	Repeat
Male	1,5,9,13,17	I II IV III	III IV II I
	2,6,10,14,18	III IV II I	I II IV III
Female	3,7,11,15,19	III IV II I	I II IV III
	4,8,12,16,20	I II IV III	III IV II I
Female	21,25,29,33,37	II III I IV	IV I III II
	22,26,30,34,38	IV I III II	II III I IV
Male	23,27,31,35,39	IV I III II	II III I IV
	24,28,32,36,40	II III I IV	IV I III II

TABLE V.- RESULTS OF ANALYSIS OF VARIANCE

Source	Degrees of freedom	Sum of squares	Mean square	F-ratio
Number of sine waves (A)	1	77.006	77.006	*63.068
Frequency of sine waves (B)	1	104.248	104.248	*85.379
Impulse repetition frequency (C)	1	55.460	55.460	*45.422
Level of continuous noise (D)	1	9 307.838	9307.838	*7623.127
Idealized crest factor (E)	1	1 460.170	1460.170	*1195.880
A × B	1	43.943	43.943	*35.989
A × C	1	3.969	3.969	*3.251
A × D	1	33.810	33.810	*27.690
A × E	1	.200	.200	.164
B × C	1	.252	.252	.206
B × D	1	5.738	5.738	4.699
B × E	1	1.106	1.106	.906
C × D	1	.356	.356	.292
C × E	1	4.709	4.709	3.857
D × E	1	69.169	69.169	*56.649
A × B × C	1	8.719	8.719	*7.141
A × B × D	1	28.392	28.392	*23.253
A × B × E	1	12.100	12.100	*9.910
A × C × D	1	20.129	20.129	*16.486
A × C × E	1	.166	.166	.136
A × D × E	1	2.704	2.704	2.215
B × C × D	1	10.201	10.201	*8.355
B × C × E	1	1.278	1.278	1.047
B × D × E	1	2.717	2.717	2.225
C × D × E	1	1.661	1.661	1.360
A × B × C × D	1	12.155	12.155	*9.955
A × B × C × E	1	67.600	67.600	*55.364
A × B × D × E	1	14.732	14.732	*12.066
A × C × D × E	1	.008	.008	.007
B × C × D × E	1	21.061	21.061	*17.249
A × B × C × D × E	1	14.131	14.131	*11.573
Repeats	1	4.048	4.048	3.315
Subjects	39	5 315.159	136.286	*111.618
Error	2488	3 037.076	1.221	-----
Total	2559	19 742.011		

\*These F-ratio values are significant at 0.01 level. For one and infinite degrees of freedom at this level, critical F-value equals 6.63. For 40 and infinite degrees of freedom at 0.01 level, critical F-value equals 1.59.

TABLE VI.- RESULTS OF ABBREVIATED ANALYSIS OF VARIANCE

Source	Degrees of freedom	Sum of squares	Mean square	F-ratio
Number of sine waves	1	77.006	77.006	*22.510
Frequency of sine waves	1	104.248	104.248	*30.473
Impulse repetition frequency	1	55.460	55.460	*16.212
Level of continuous noise	1	9 307.838	9307.838	*2720.795
Idealized crest factor	1	1 460.170	1460.170	*426.825
Error	2554	8 737.289	3.421	-----
Total	2559	19 742.011		

\*These F-ratio values are significant at 0.01 level. For one and infinite degrees of freedom at this level, critical F-value equals 6.63.

TABLE VII.- VARIOUS SUBJECTIVE AND OBJECTIVE MEASUREMENTS FOR 36 TEST NOISES

[Peak and impulse noise-level measurements were made by eye-averaging many meter readings from sound-level meter having peak- and impulse-hold functions; other noise levels were obtained by appropriate computations performed on one-third octave-band levels for each noise found in appendix A]

Noise	Annoyance rating		Noise level, dB					
	Mean	Median	Linear (rms)	Linear (peak)	A-weighted (rms)	A-weighted (peak)	A-weighted (impulse)	PNL
1	1.92	1.90	80.0	90	68.3	80	70	80.5
2	1.59	1.45	70.4	85	63.9	78	67	75.1
3	2.70	2.55	74.0	91	66.2	86	69	76.4
4	6.59	7.30	87.7	105	81.2	100	85	91.8
5	1.02	.90	68.5	82	59.1	72	59	71.0
6	1.84	1.70	68.9	83	61.5	77	65	73.2
7	4.85	5.15	82.8	97	73.4	87	75	86.2
8	7.02	7.85	89.9	106	84.3	99	89	95.2
9	3.79	4.10	81.2	93	72.4	83	73	84.9
10	4.23	4.65	82.1	97	74.2	91	78	85.9
11	2.80	2.70	74.5	91	68.4	85	70	78.4
12	2.00	1.60	73.5	86	65.2	77	66	76.7
13	6.04	7.00	88.7	105	78.5	95	81	90.9
14	7.35	8.35	93.2	106	87.8	100	89	98.1
15	2.48	2.25	75.1	91	69.5	85	74	79.9
16	7.18	8.05	94.5	105	83.9	95	87	96.3
17	4.85	5.40	85.8	97	75.8	88	78	89.1
18	1.76	1.80	73.5	89	63.4	80	67	75.2
19	1.27	1.10	68.1	82	59.7	77	62	71.0
20	6.43	7.05	89.6	105	83.5	99	86	93.8
21	4.64	5.15	84.3	97	74.6	88	77	87.1
22	3.48	3.65	78.8	90	73.4	86	76	83.4
23	.77	.70	67.2	78	58.0	68	59	69.8
24	1.31	1.20	69.8	82	60.3	72	61	72.1
25	5.74	6.20	83.4	98	76.0	91	78	88.1
26	1.93	1.75	68.7	82	61.2	77	63	72.0
27	6.94	7.70	91.3	105	81.1	95	83	93.4
28	1.07	.95	69.5	83	59.7	72	61	72.1
29	6.42	7.30	91.1	105	80.8	94	85	93.6
30	4.44	4.80	84.8	97	75.2	87	77	88.2
31	4.58	4.95	83.5	98	76.0	90	78	87.2
32	1.80	1.45	74.1	85	65.2	77	66	77.3
33	1.32	1.15	71.1	82	61.0	72	62	73.7
34	2.86	2.70	76.2	89	65.7	79	68	78.5
35	2.82	3.00	76.4	89	66.2	79	69	77.9
36	5.91	6.60	85.2	98	78.9	92	80	90.3

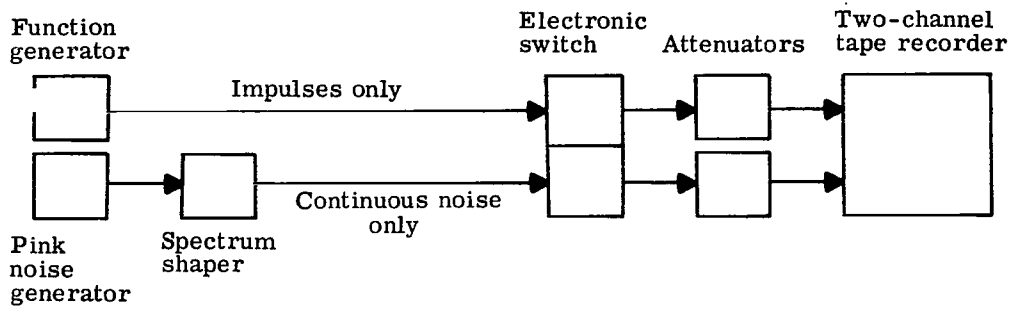

(a) Test-noise synthesis.

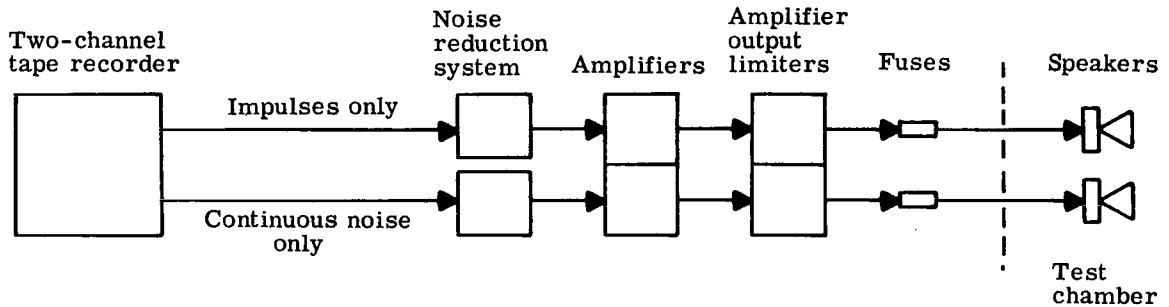

(b) Test-noise reproduction.

Figure 1.- Diagram of electronic systems used to synthesize and reproduce test noises.

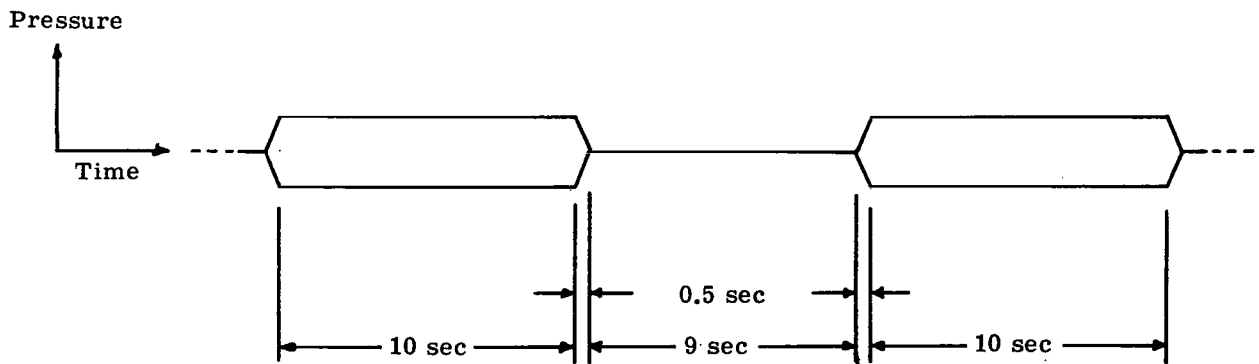
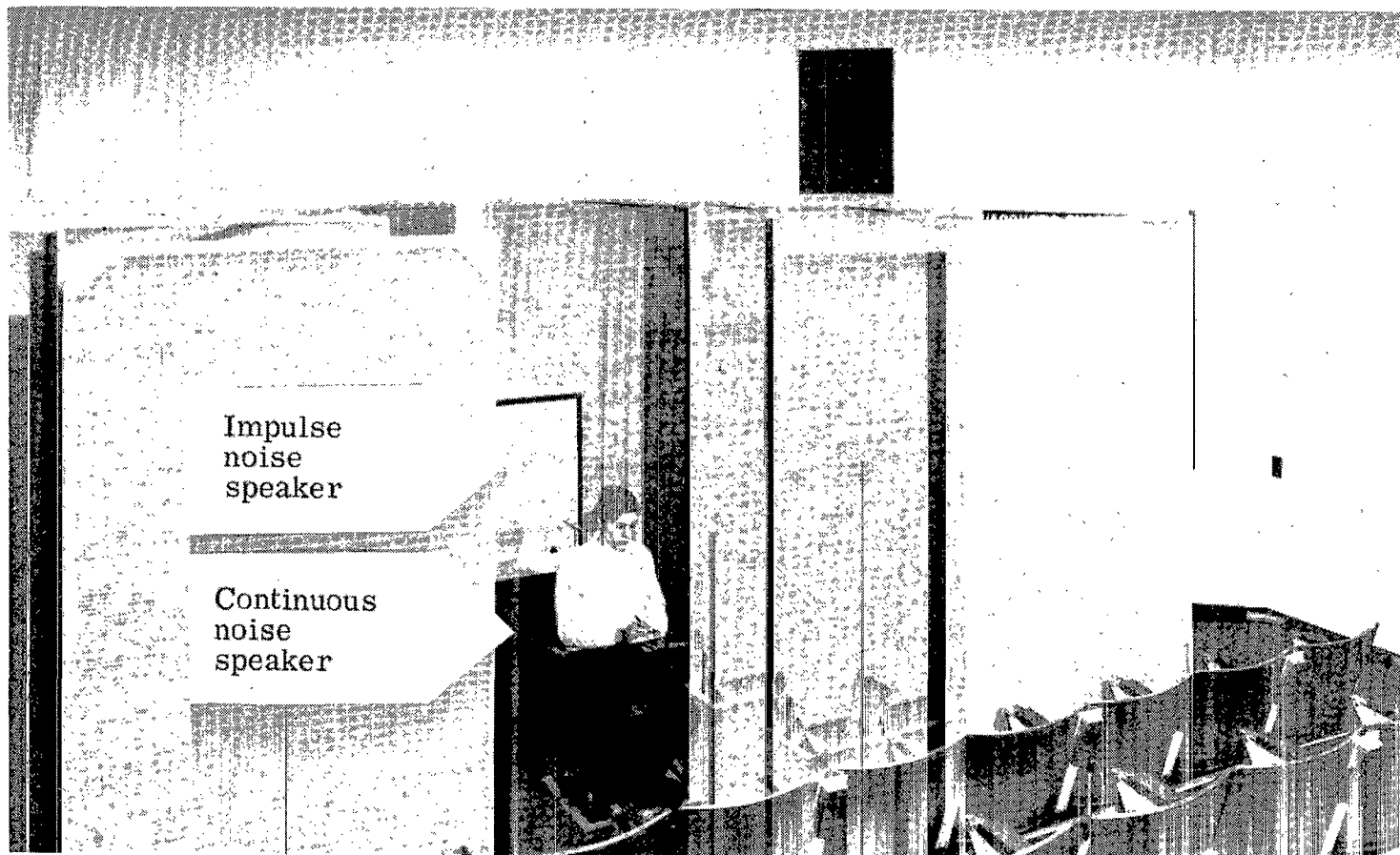

Figure 2.- Sketch of pressure-envelope time history for two test noises to illustrate method used to present test noises to subjects.



L-76-3083.1

Figure 3.- Photograph of test chamber showing orientation of subject and loudspeakers.



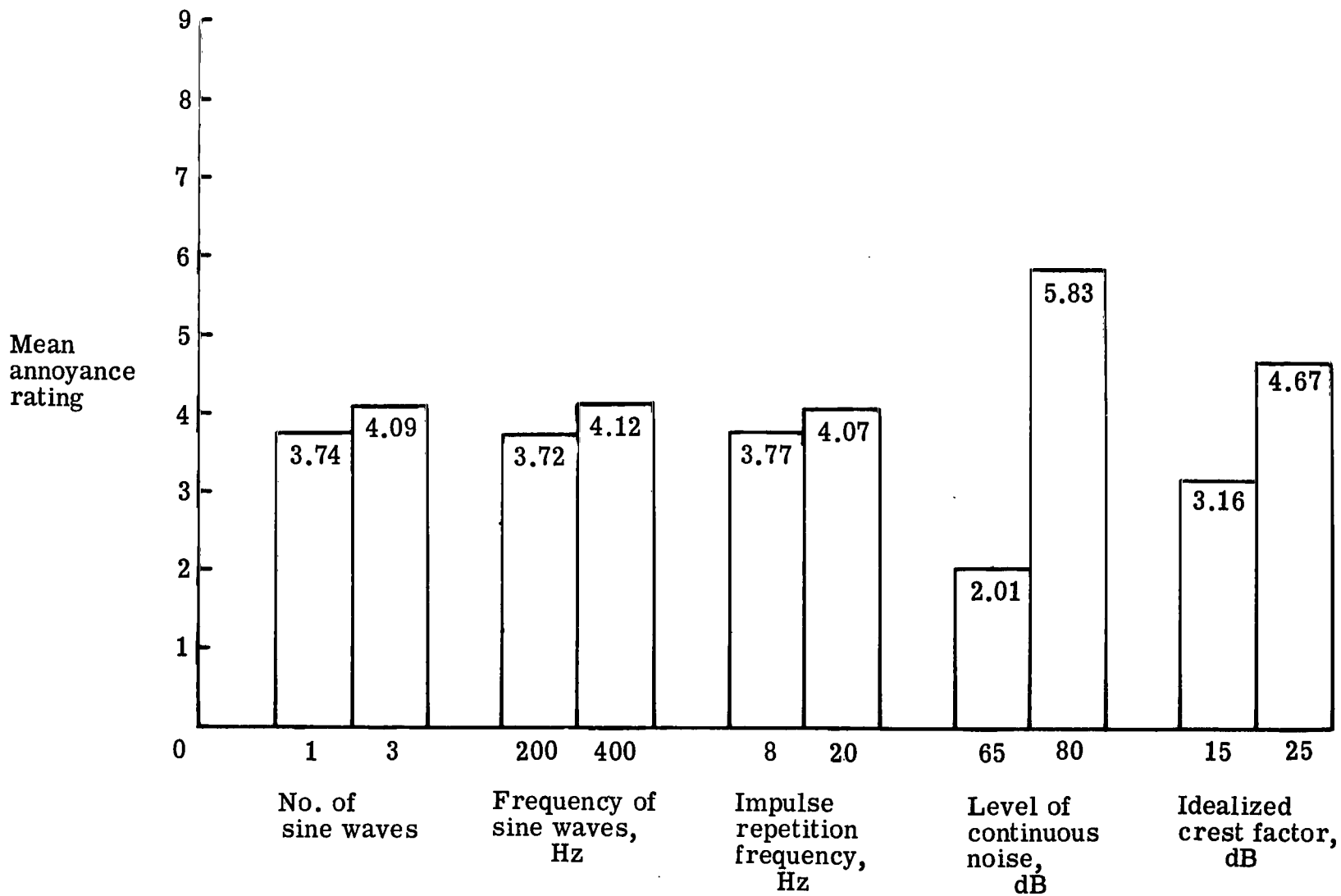

Figure 4.- Bar graph showing annoyance effect of five factors used to synthesize impulsive test noises.

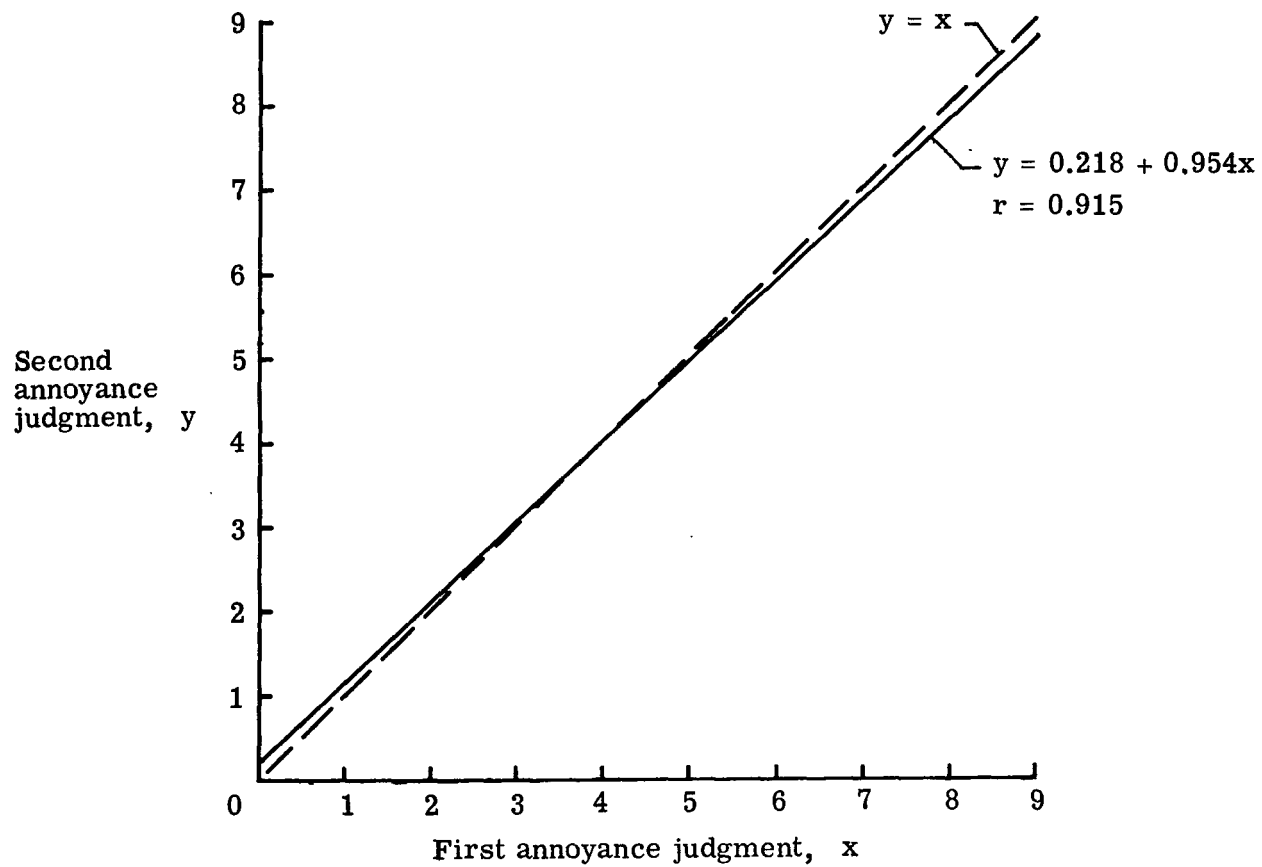

Figure 5.- Subject repeatability over all noises.

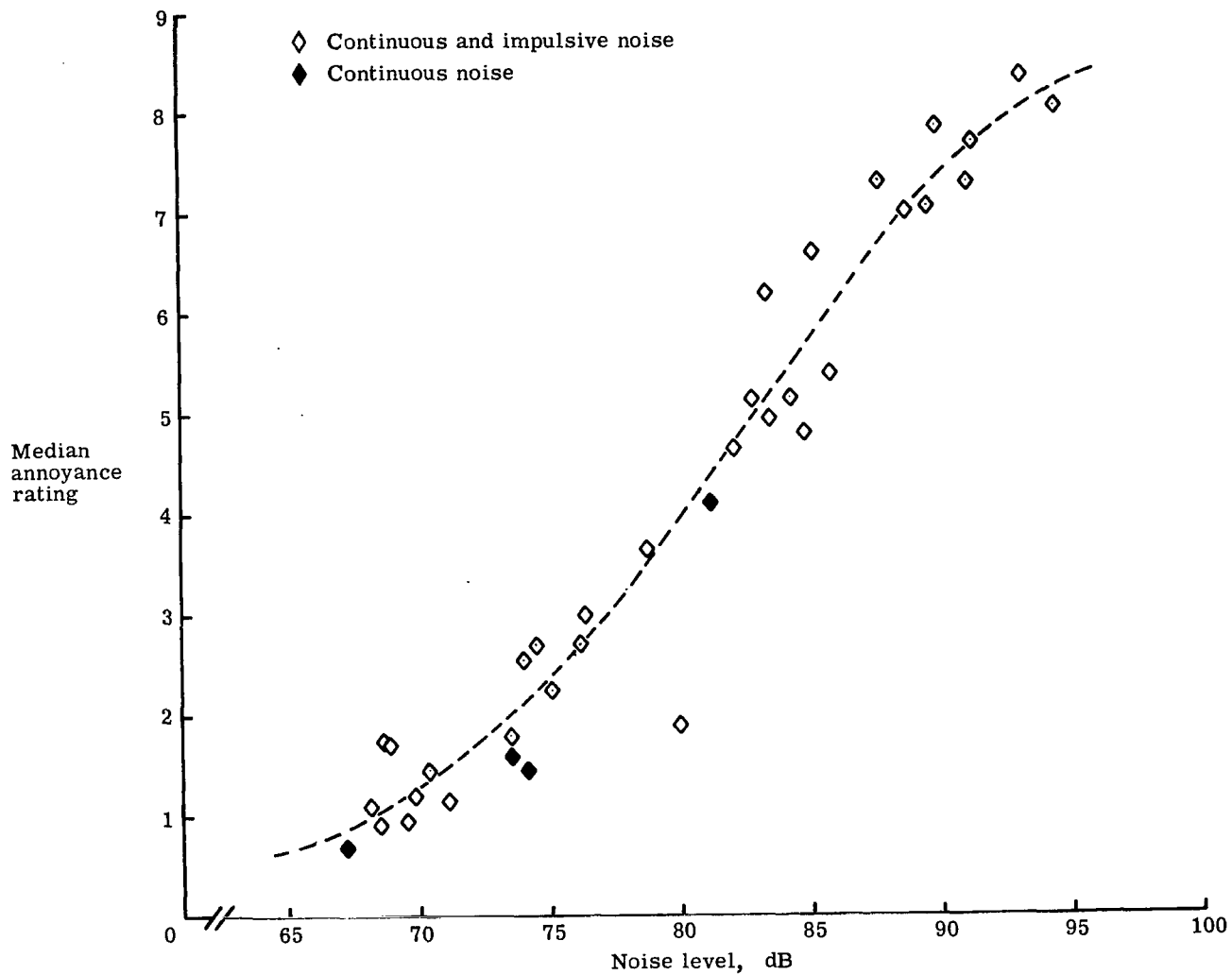

Figure 6.- Annoyance rating as function of linear sound pressure level.

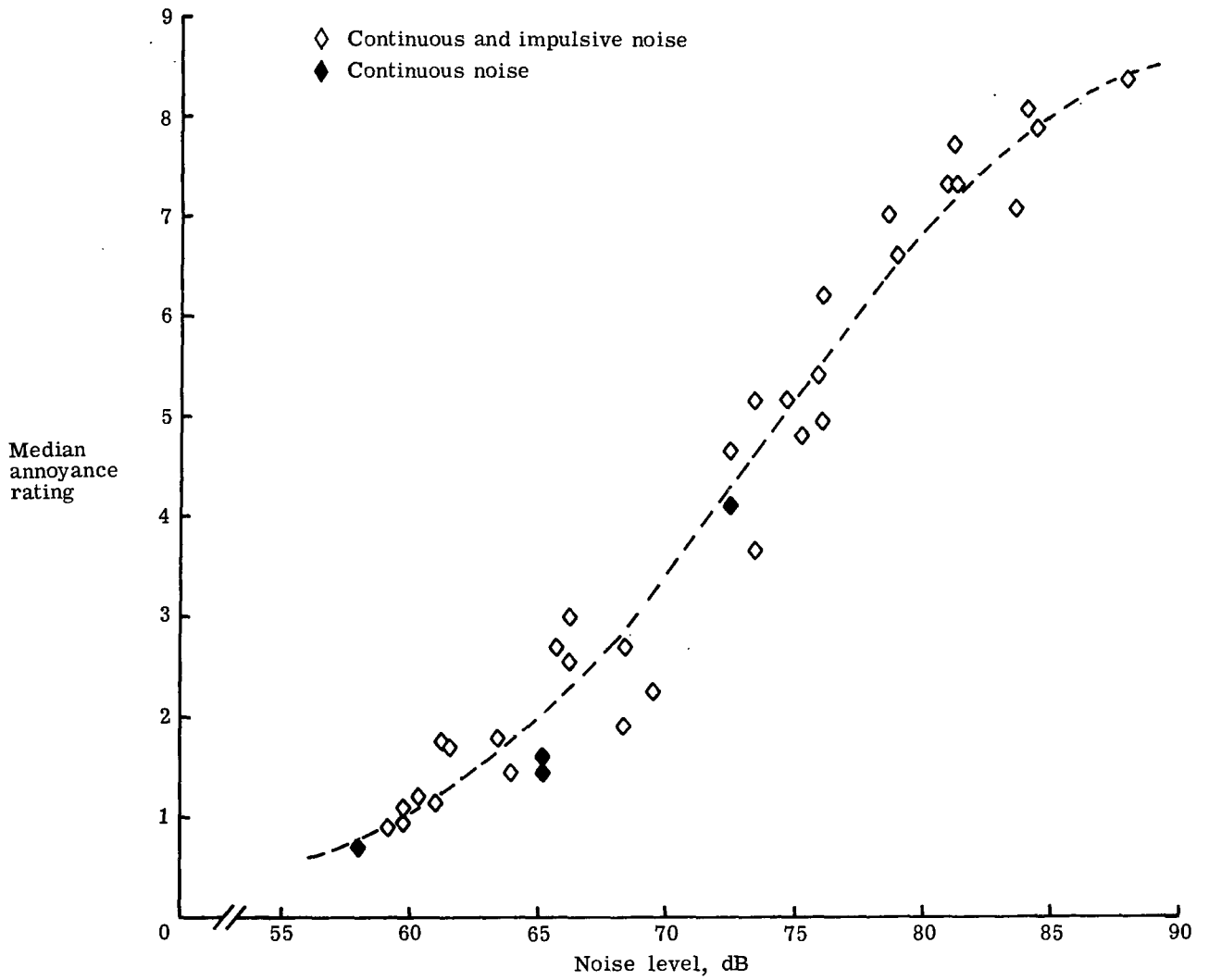

Figure 7.- Annoyance rating as function of A-weighted sound pressure level.

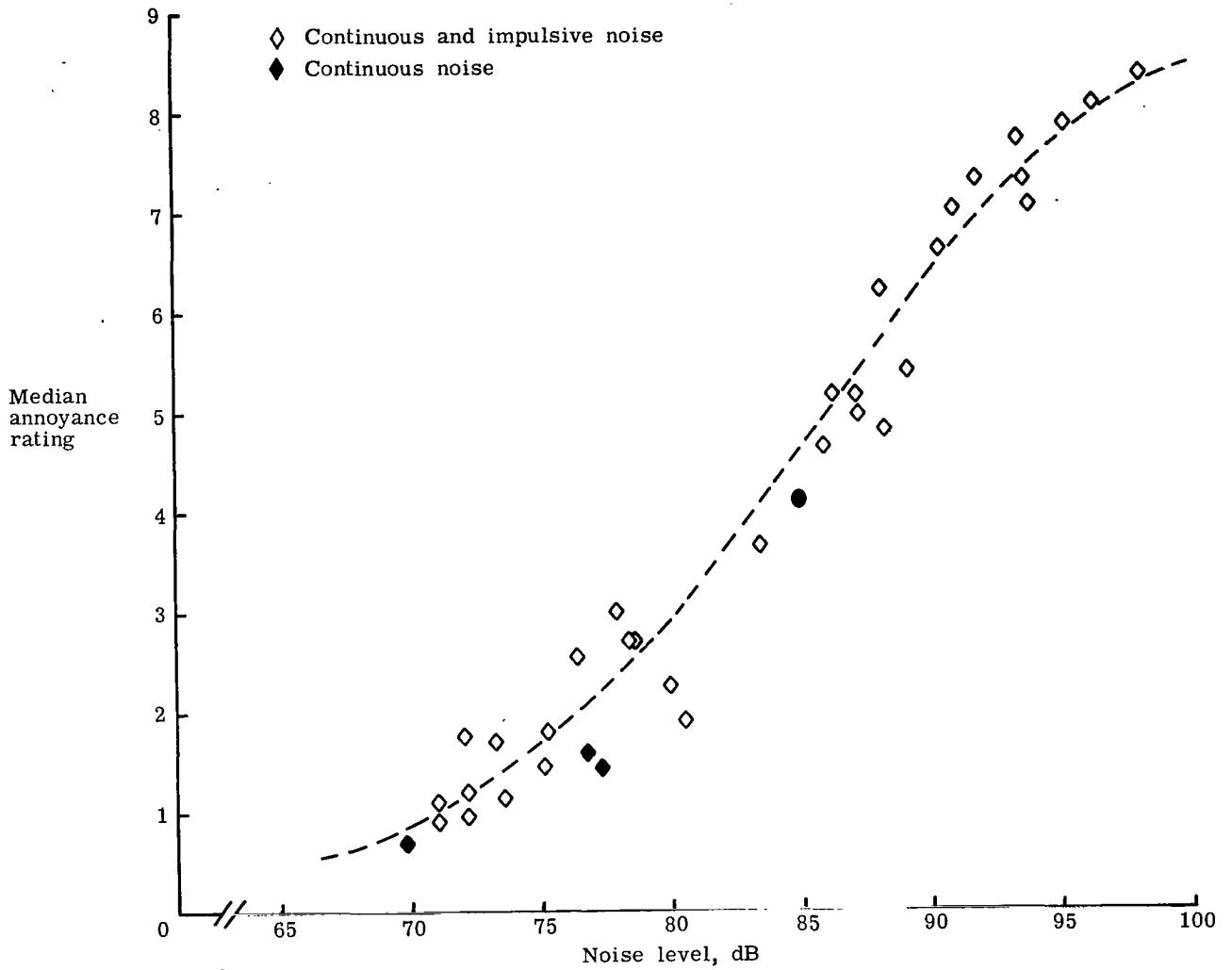

Figure 8.- Annoyance rating as function of perceived noise level.

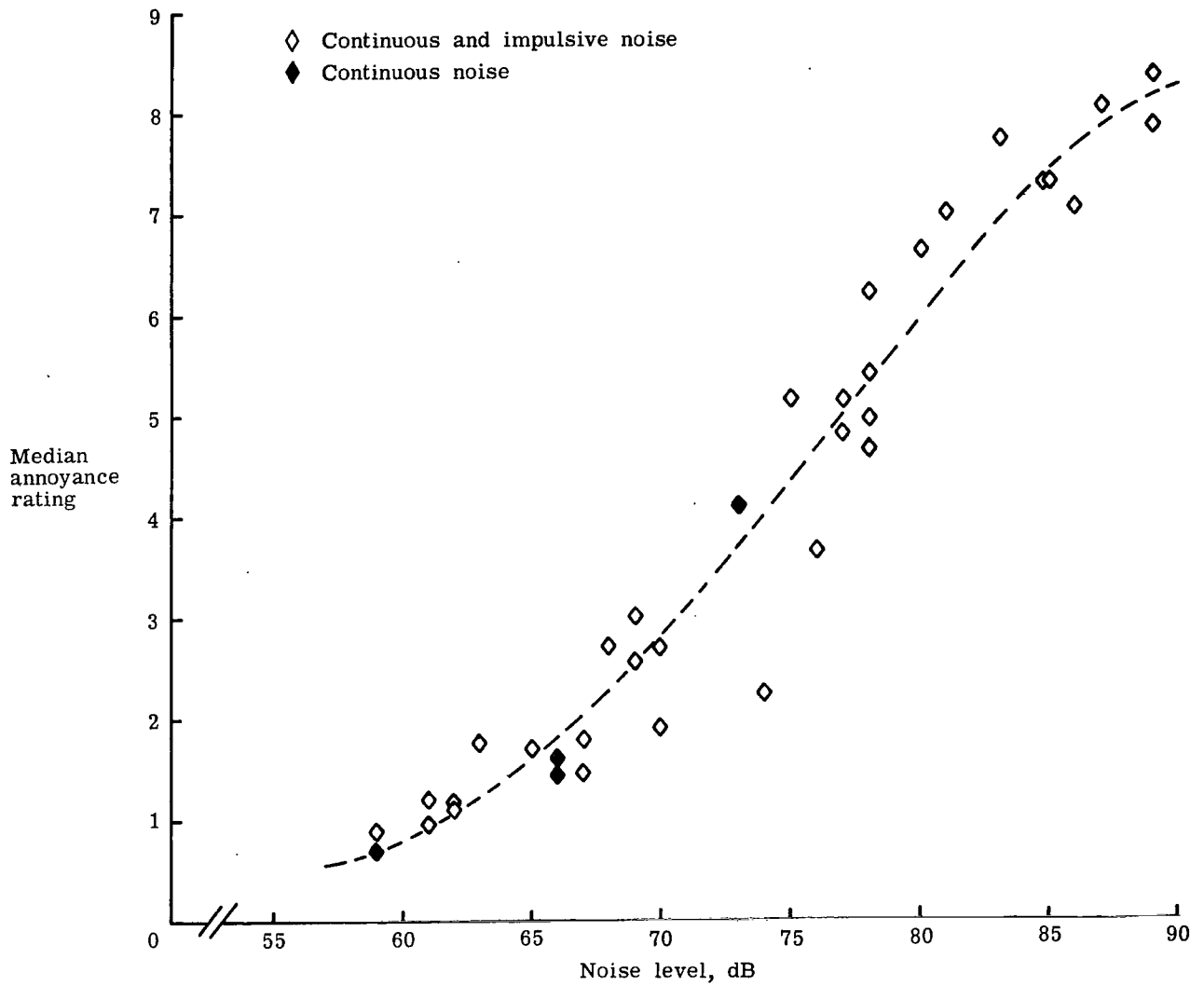

Figure 9.- Annoyance rating as function of A-weighted impulse sound pressure level.

## APPENDIX A

### NOISE DESCRIPTION

The noises to be heard by the subjects were monitored by using a microphone at a position to be occupied by the subject's head. For each noise, the acoustic signal in this head volume was subjected to one-third octave-band and narrow-band analysis. Oscillograph traces were also made of each test noise.

Figures A1 to A36 present a portion of the acoustic analysis for each of the 36 test noises. The top part of each figure shows a 0.3-sec sample of the oscillograph traces. Each pressure time history is presented with the same arbitrary vertical or pressure scale. The bottom part of each figure shows the results of real time, one-third octave-band analysis. These spectra are the result of averaging over 8 sec of the total noise length of 10 sec.

The test noises were also subjected to narrow-band analysis to determine the harmonic structure of each. Representative narrow-band analyses, averaged over 4 to 8 sec, are presented in figures A37 to A40. In these figures, the effects on harmonic structure of several experimental variables may be seen. The impulse repetition frequency determines the frequency spacing of the individual harmonic components, which are located along the frequency scale at integer multiples of the repetition frequency. The number of sine waves or complete cycles in an individual impulse determines the shape of the envelope of the harmonic components; as the number of cycles in an impulse increases, the envelope of level and frequency harmonic spikes shows more lobes in a specific pattern. The frequency of the sine waves used to synthesize the test noise shows up as the maximum SPL harmonic component or near the maximum SPL spike in the major envelope lobe.

APPENDIX A

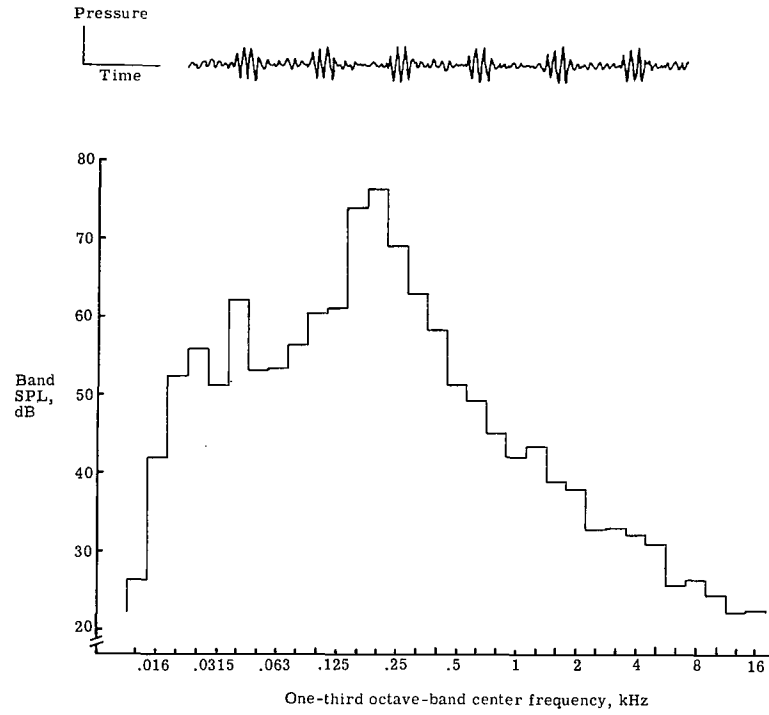

Figure A1.- Noise 1.

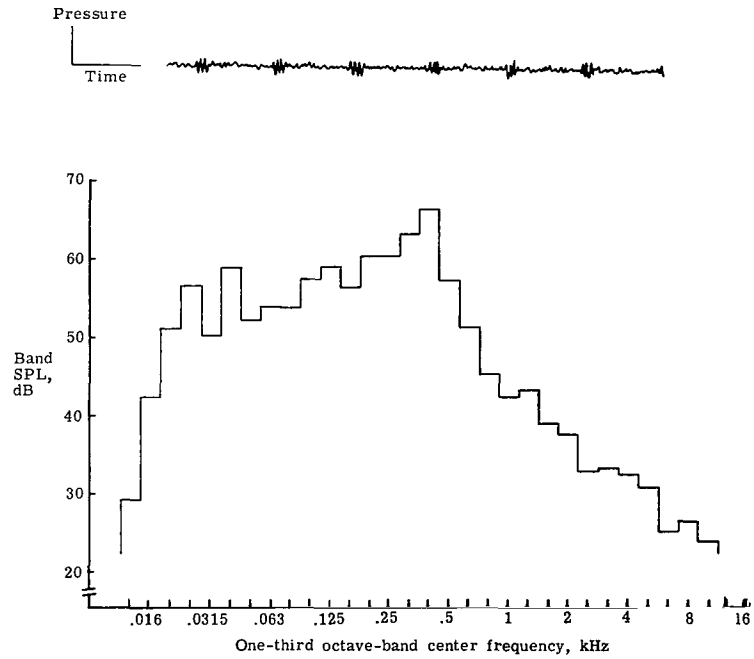

Figure A2.- Noise 2.



APPENDIX A

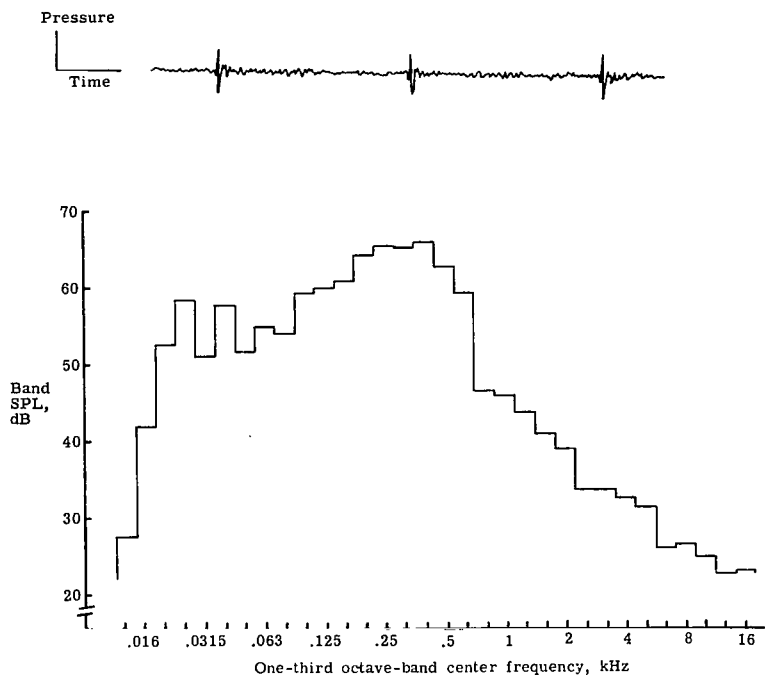

Figure A3.- Noise 3.

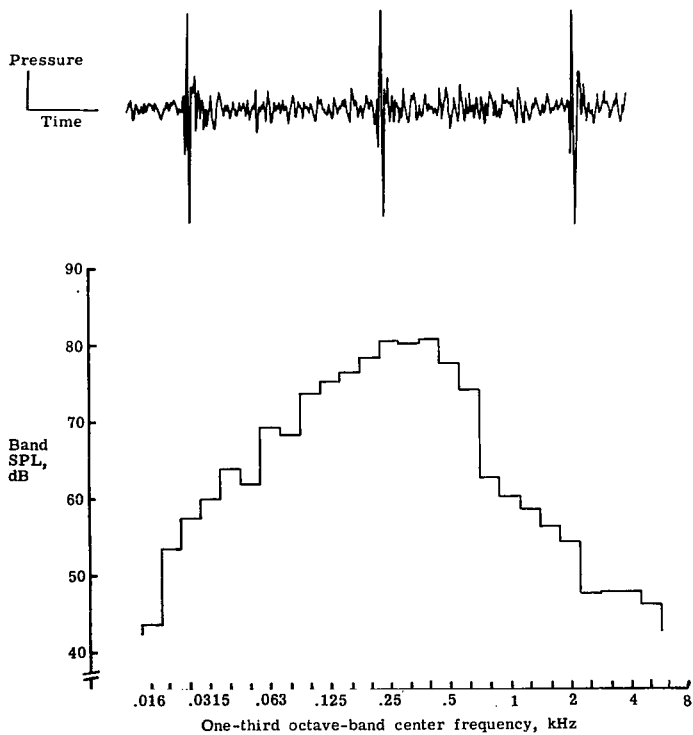

Figure A4.- Noise 4.

APPENDIX A

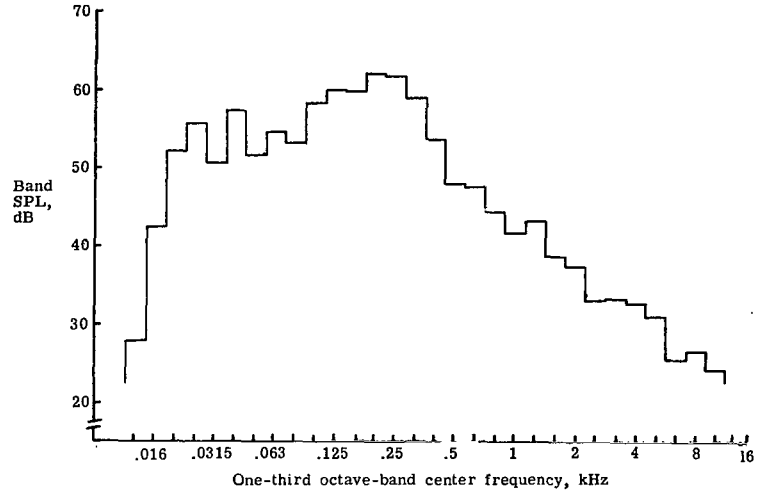
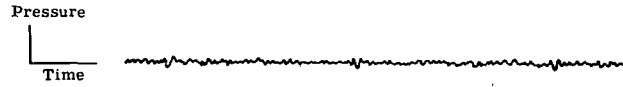

Figure A5.- Noise 5.

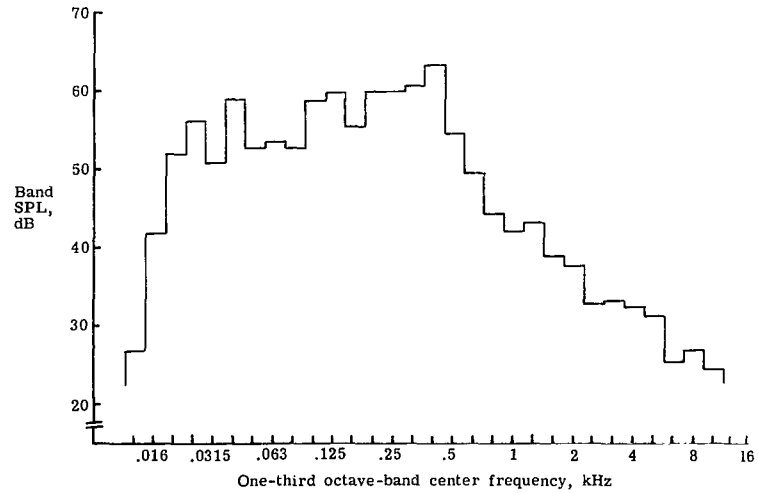
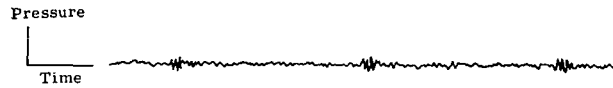

Figure A6.- Noise 6.

APPENDIX A

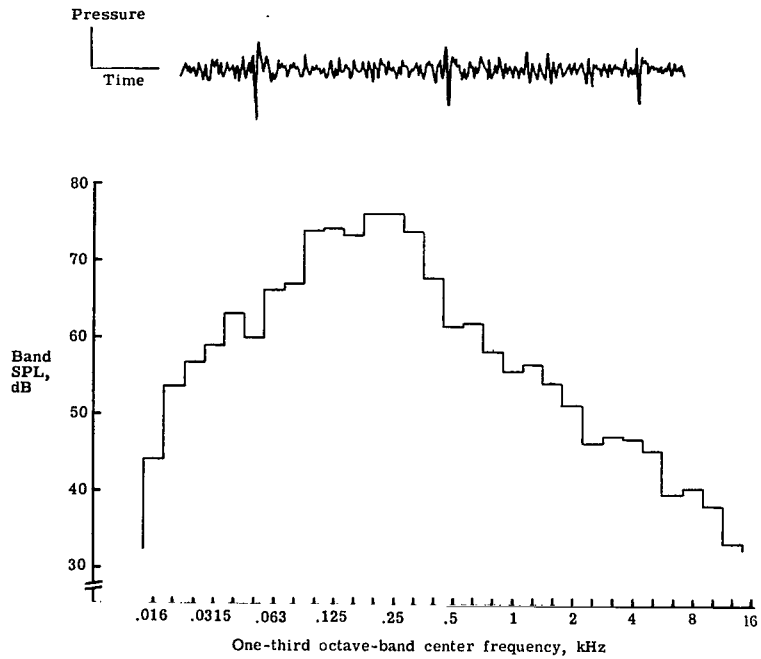

Figure A7.- Noise 7.

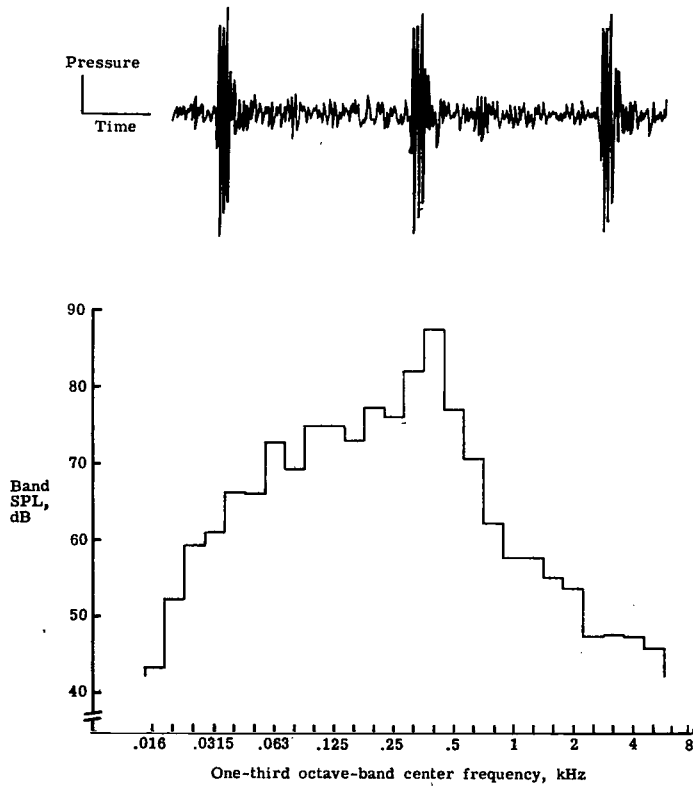

Figure A8.- Noise 8.

APPENDIX A

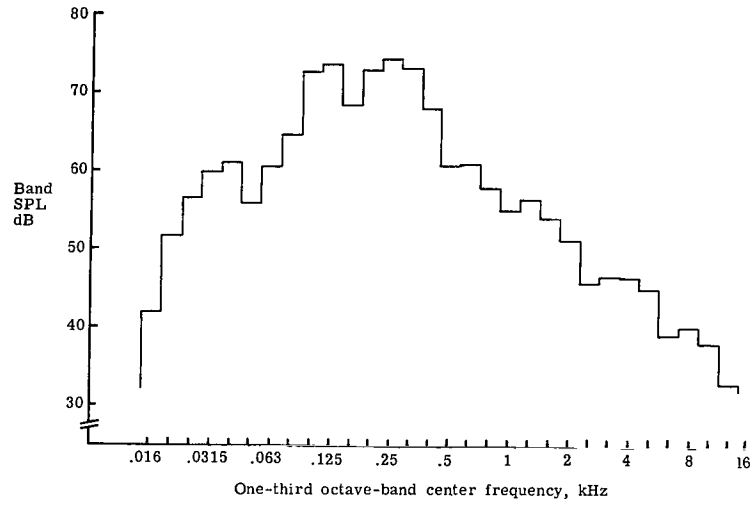

Figure A9.- Noise 9.

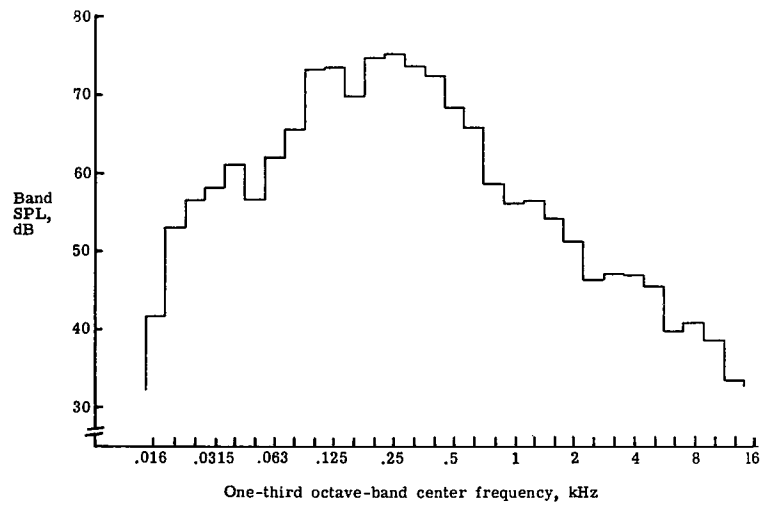

Figure A10.- Noise 10.

APPENDIX A

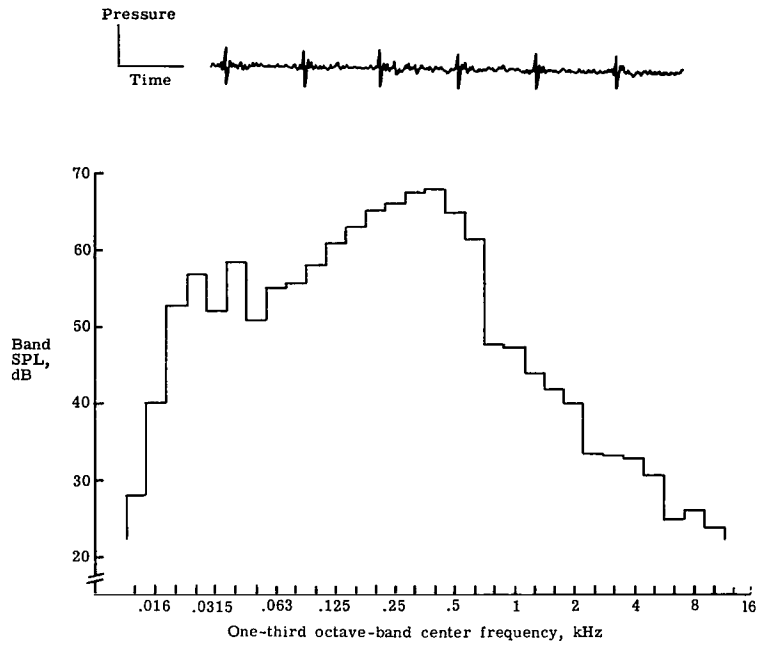

Figure A11.- Noise 11.

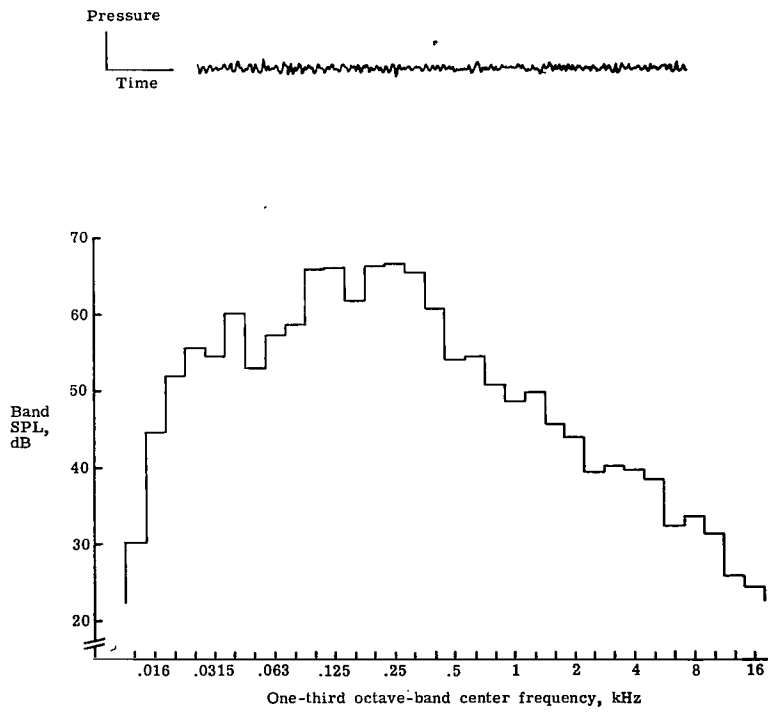

Figure A12.- Noise 12.

APPENDIX A

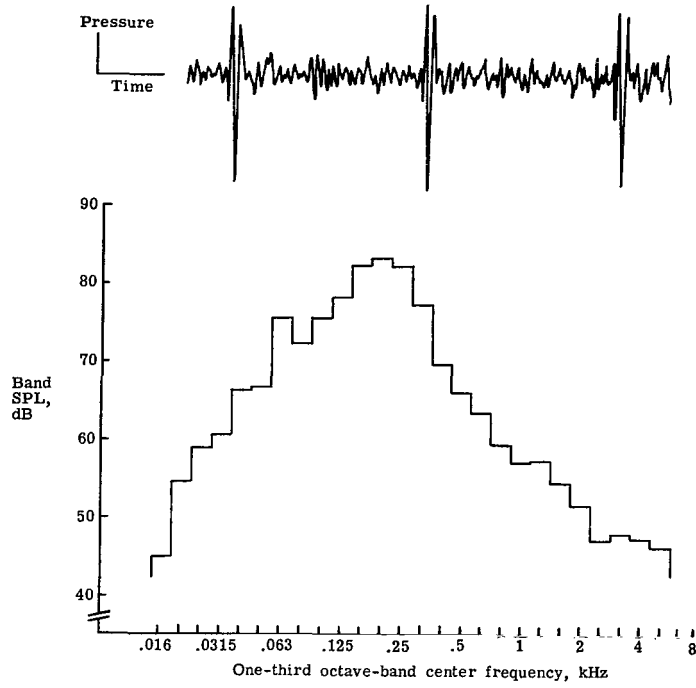

Figure A13.- Noise 13.

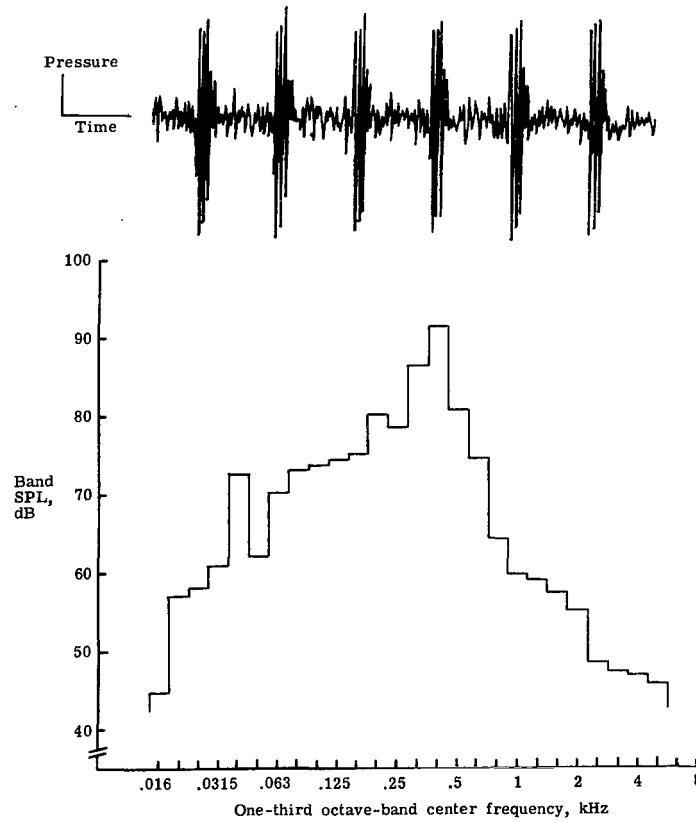

Figure A14.- Noise 14.

# APPENDIX A

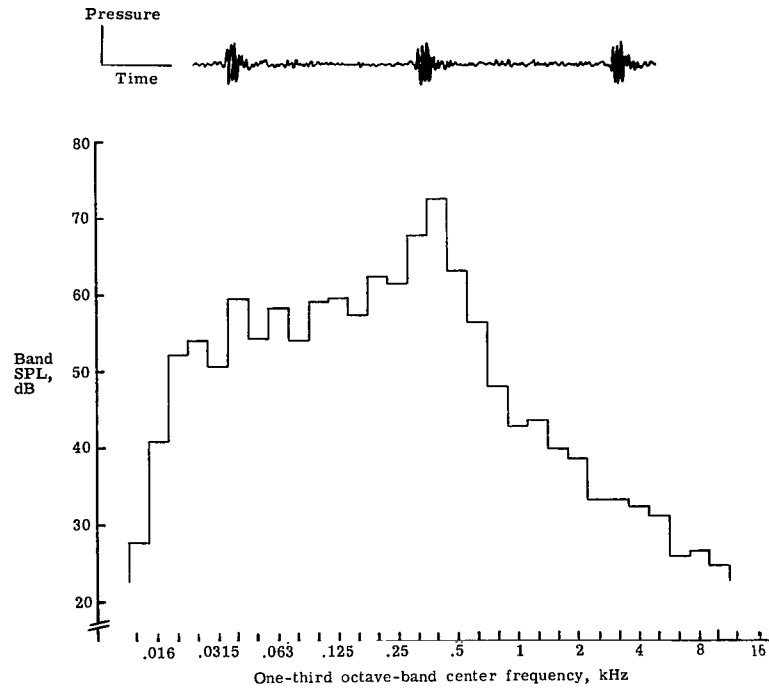

Figure A15.- Noise 15.

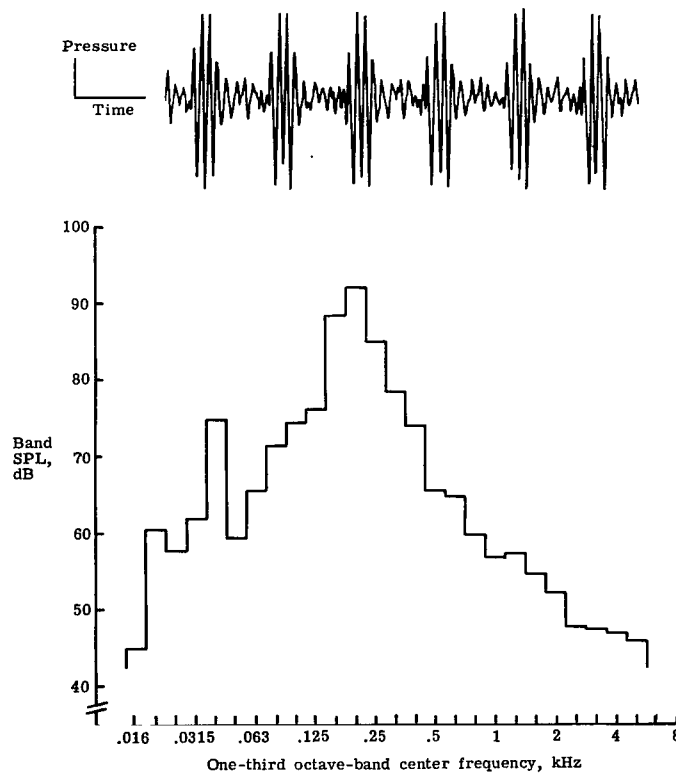

Figure A16.- Noise 16.

APPENDIX A

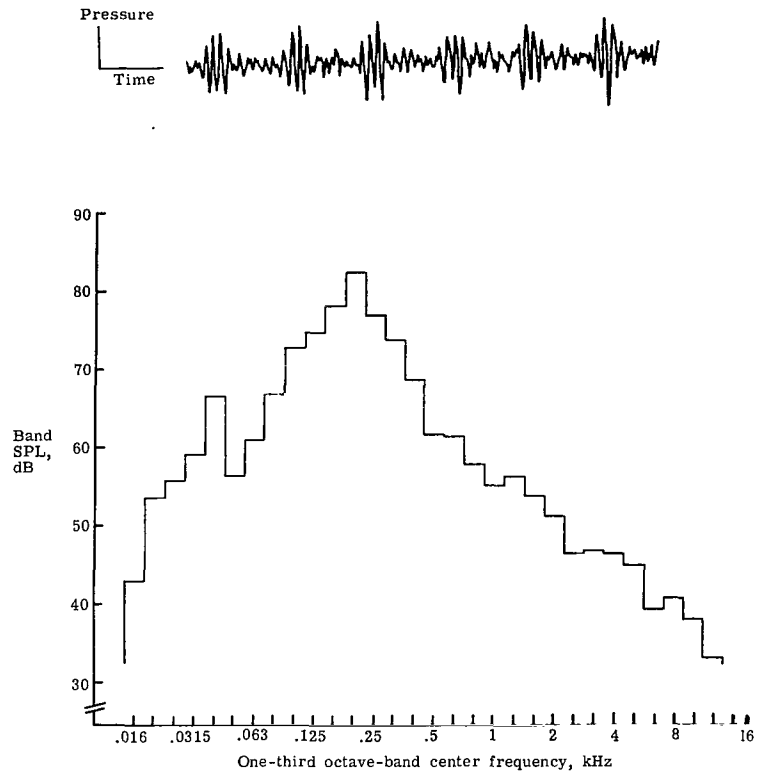

Figure A17.- Noise 17.

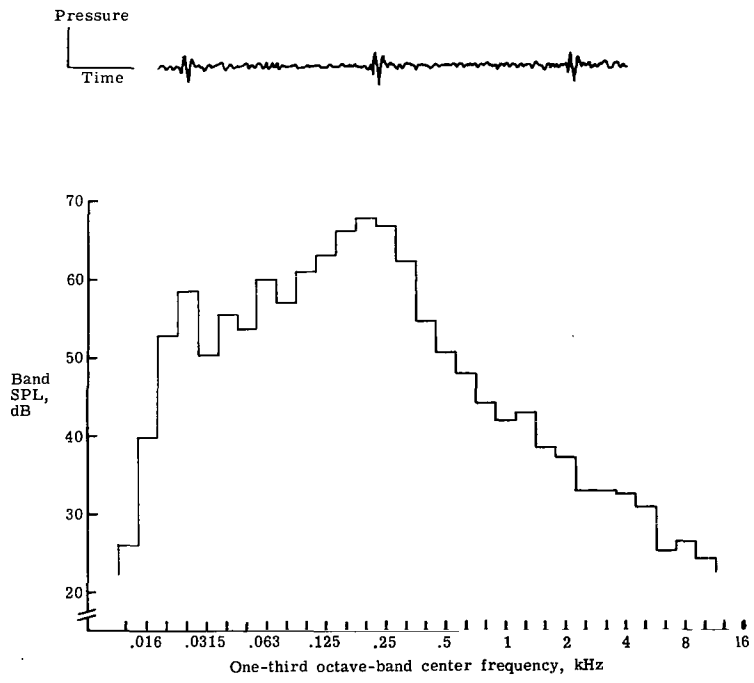

Figure A18.- Noise 18.



APPENDIX A

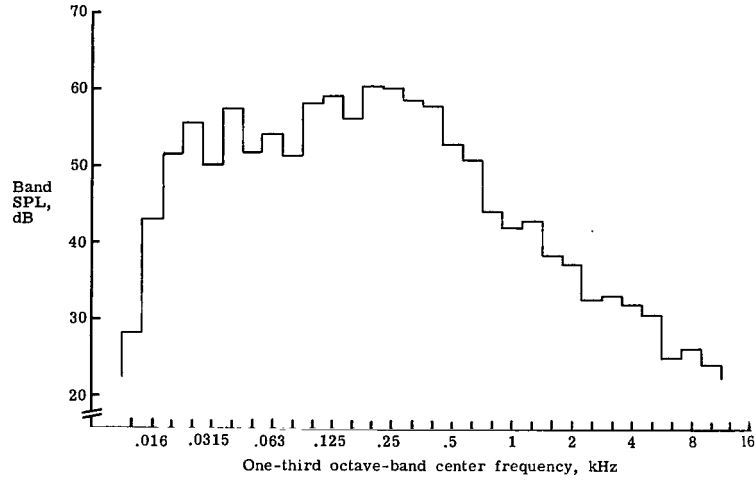
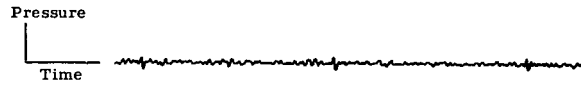

Figure A19.- Noise 19.

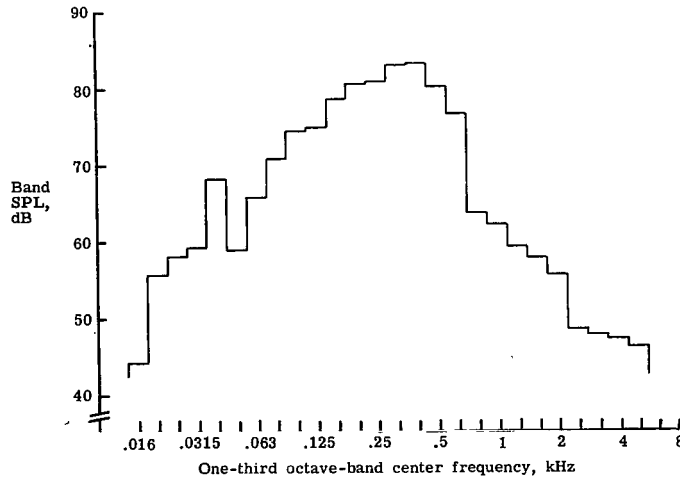
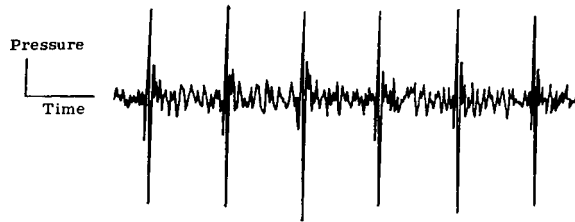

Figure A20.- Noise 20.

APPENDIX A

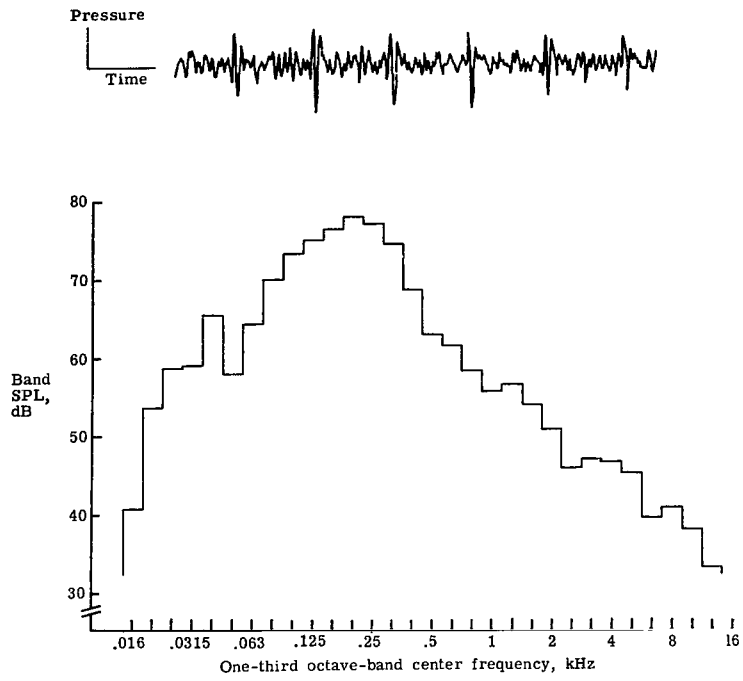

Figure A21.- Noise 21.

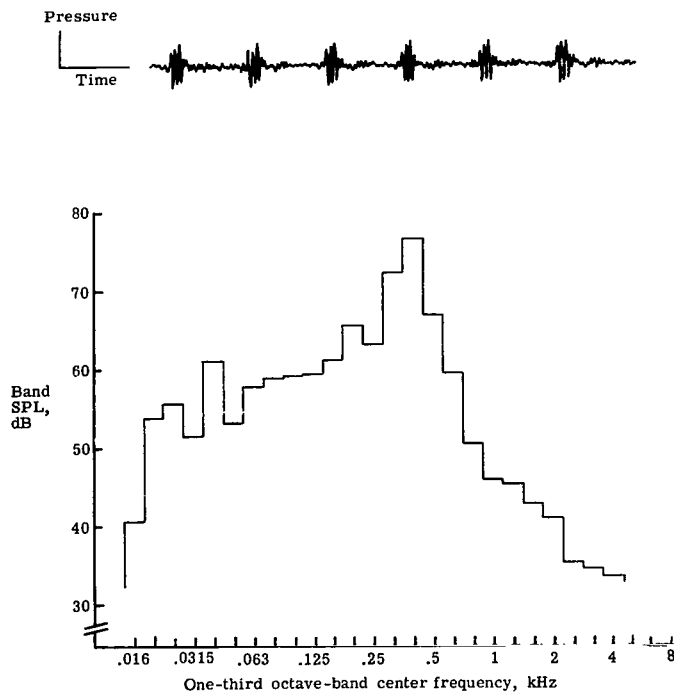

Figure A22.- Noise 22.

APPENDIX A

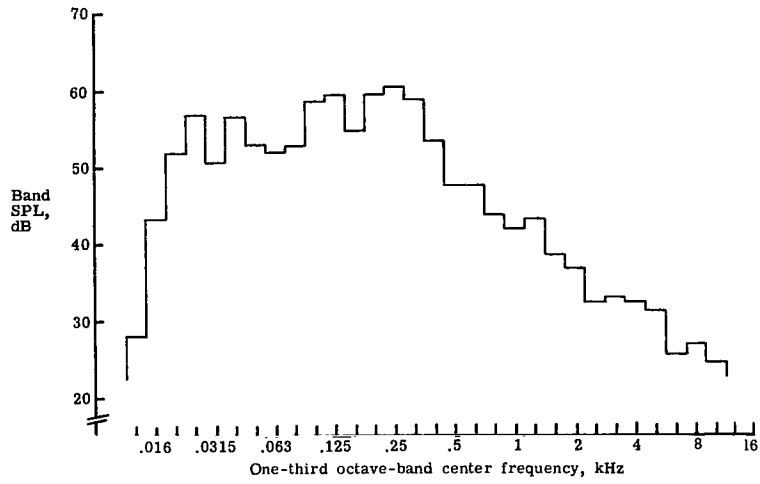
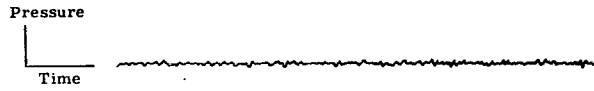

Figure A23.- Noise 23.

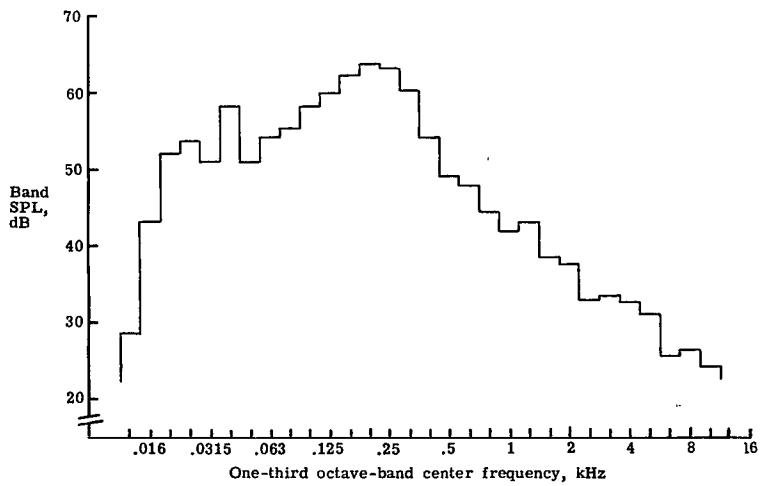
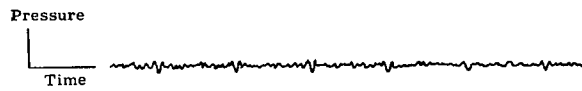

Figure A24.- Noise 24.

APPENDIX A

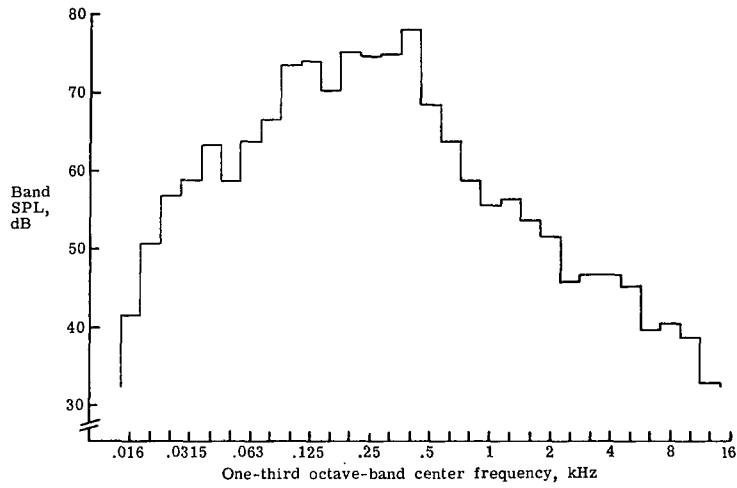

Figure A25.- Noise 25.

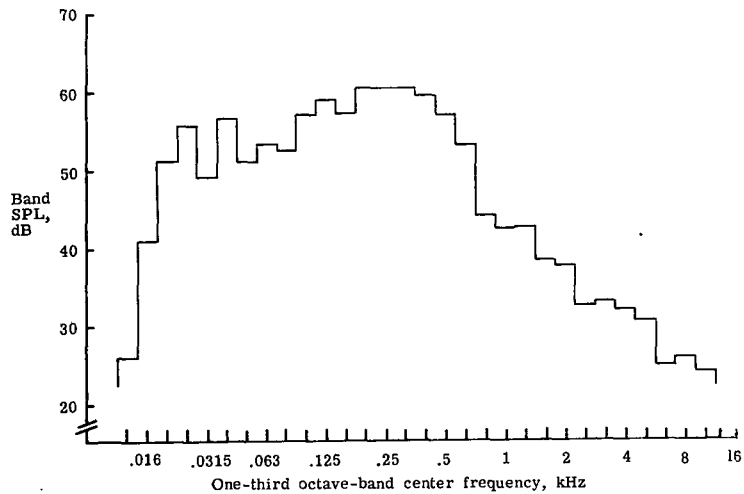
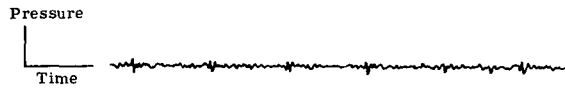

Figure A26.- Noise 26.

APPENDIX A

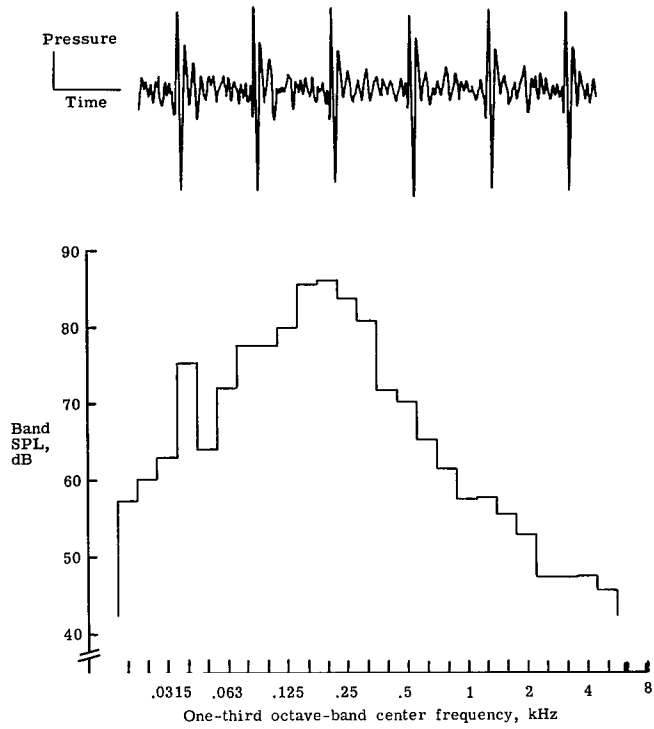

Figure A27.- Noise 27.

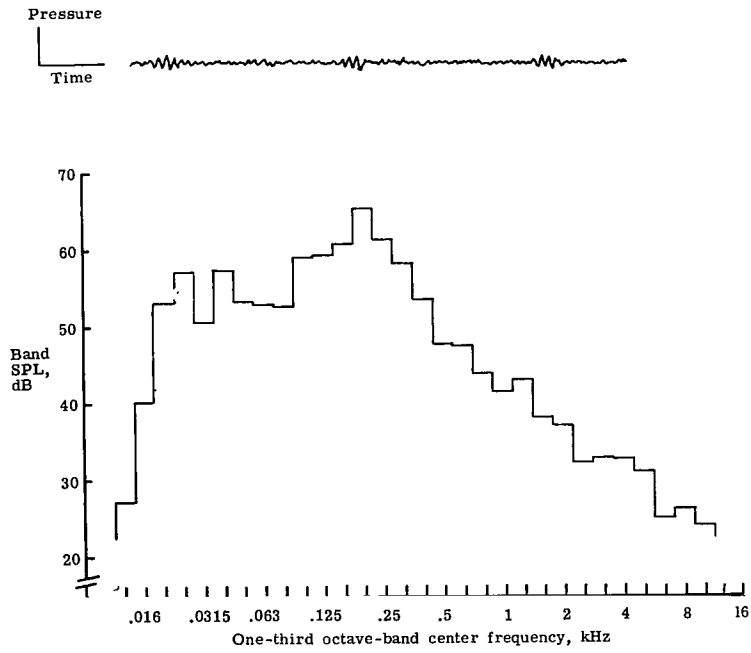

Figure A28.- Noise 28.

APPENDIX A

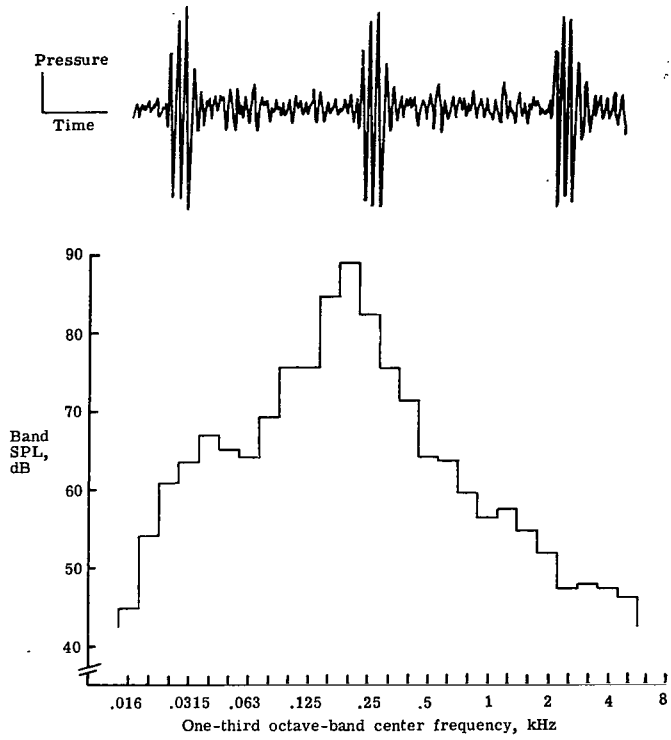

Figure A29.- Noise 29.

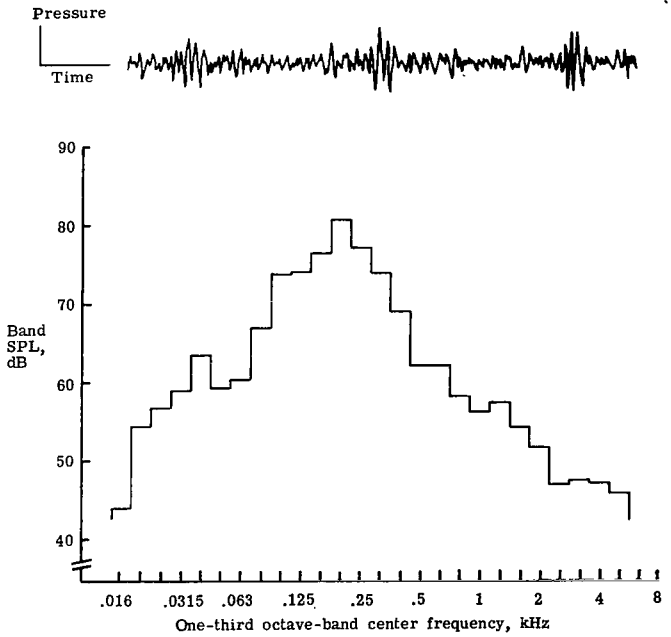

Figure A30.- Noise 30.

APPENDIX A

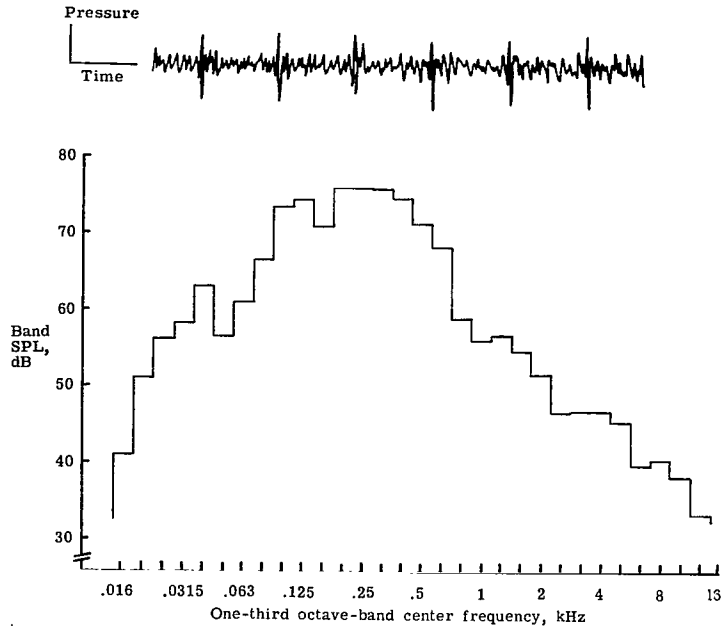

Figure A31.- Noise 31.

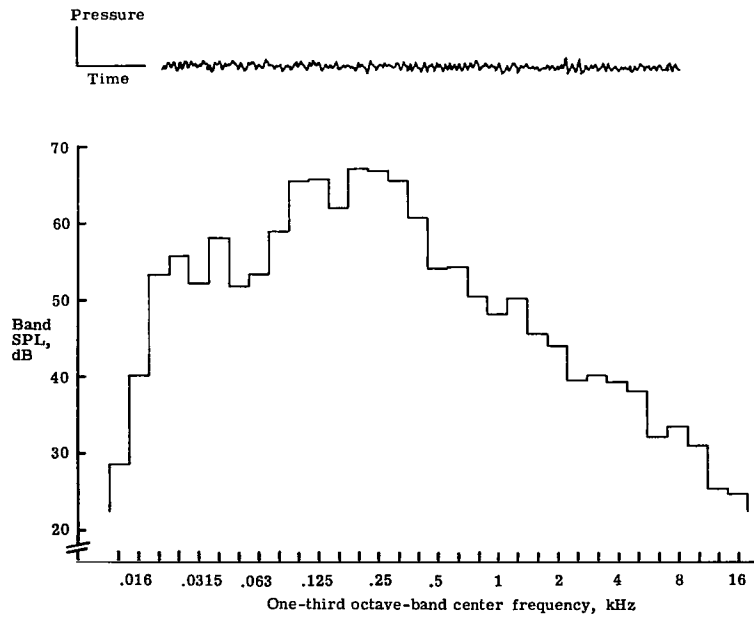

Figure A32.- Noise 32.

APPENDIX A

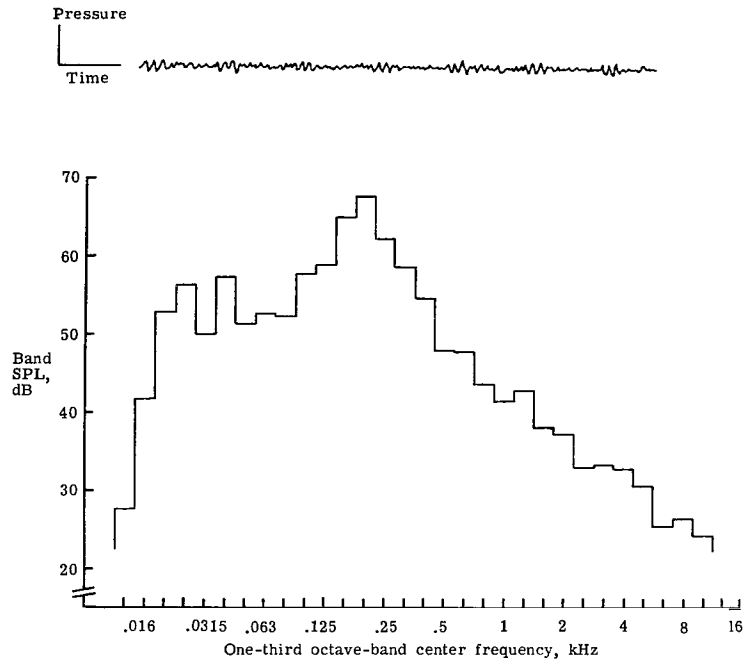

Figure A33.- Noise 33.

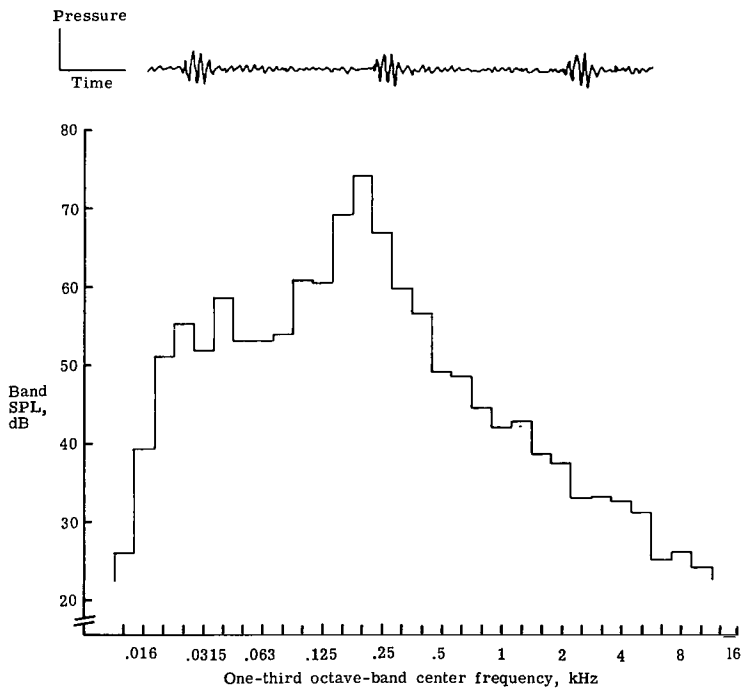

Figure A34.- Noise 34.



APPENDIX A

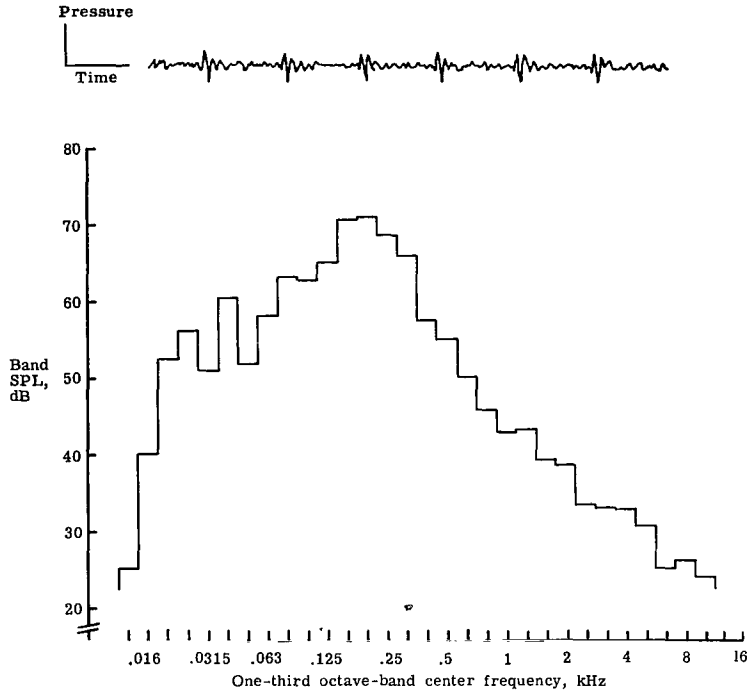

Figure A35.- Noise 35.

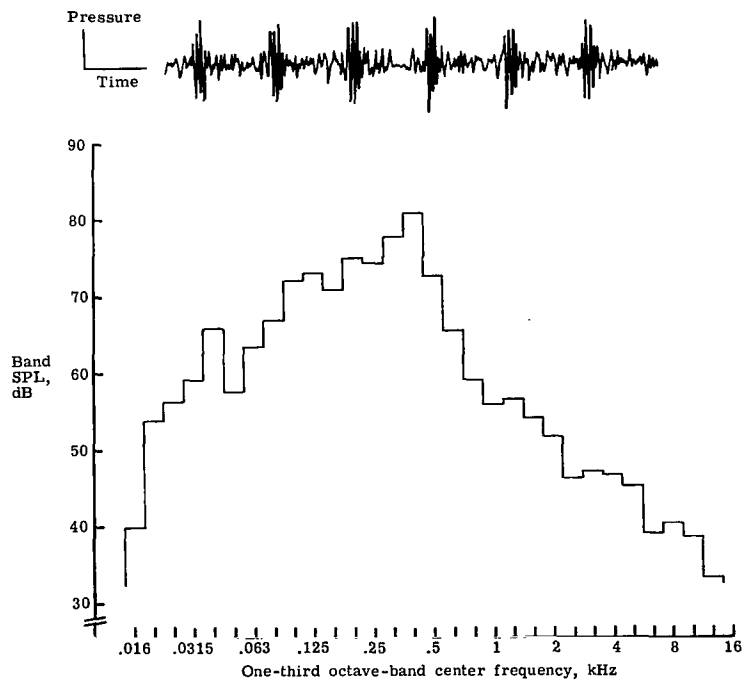

Figure A36.- Noise 35.

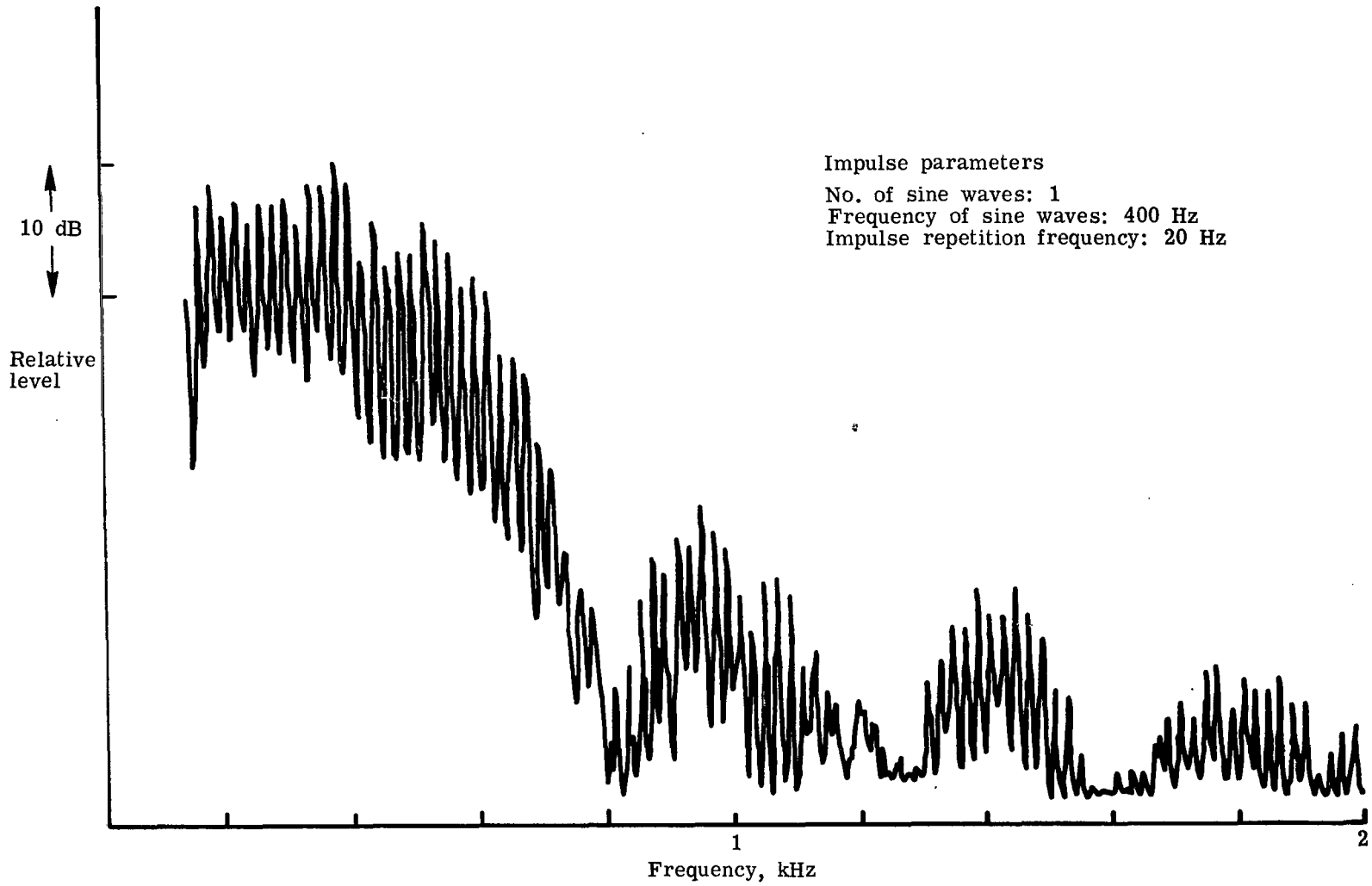

Figure A37.- Narrow-band analysis of test noise 20; bandwidth equals 4 Hz.

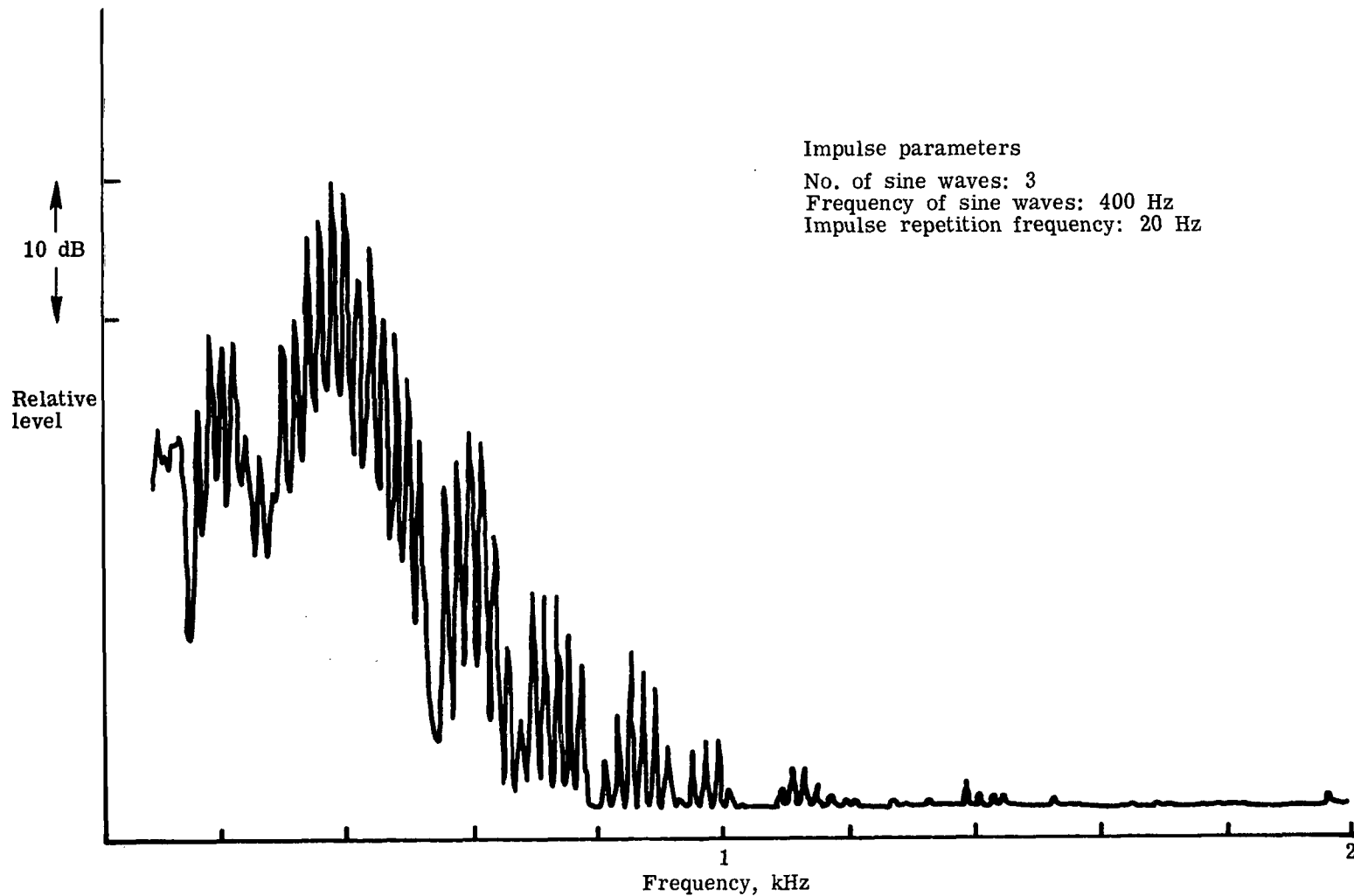

Figure A38.- Narrow-band analysis of test noise 14; bandwidth equals 4 Hz.

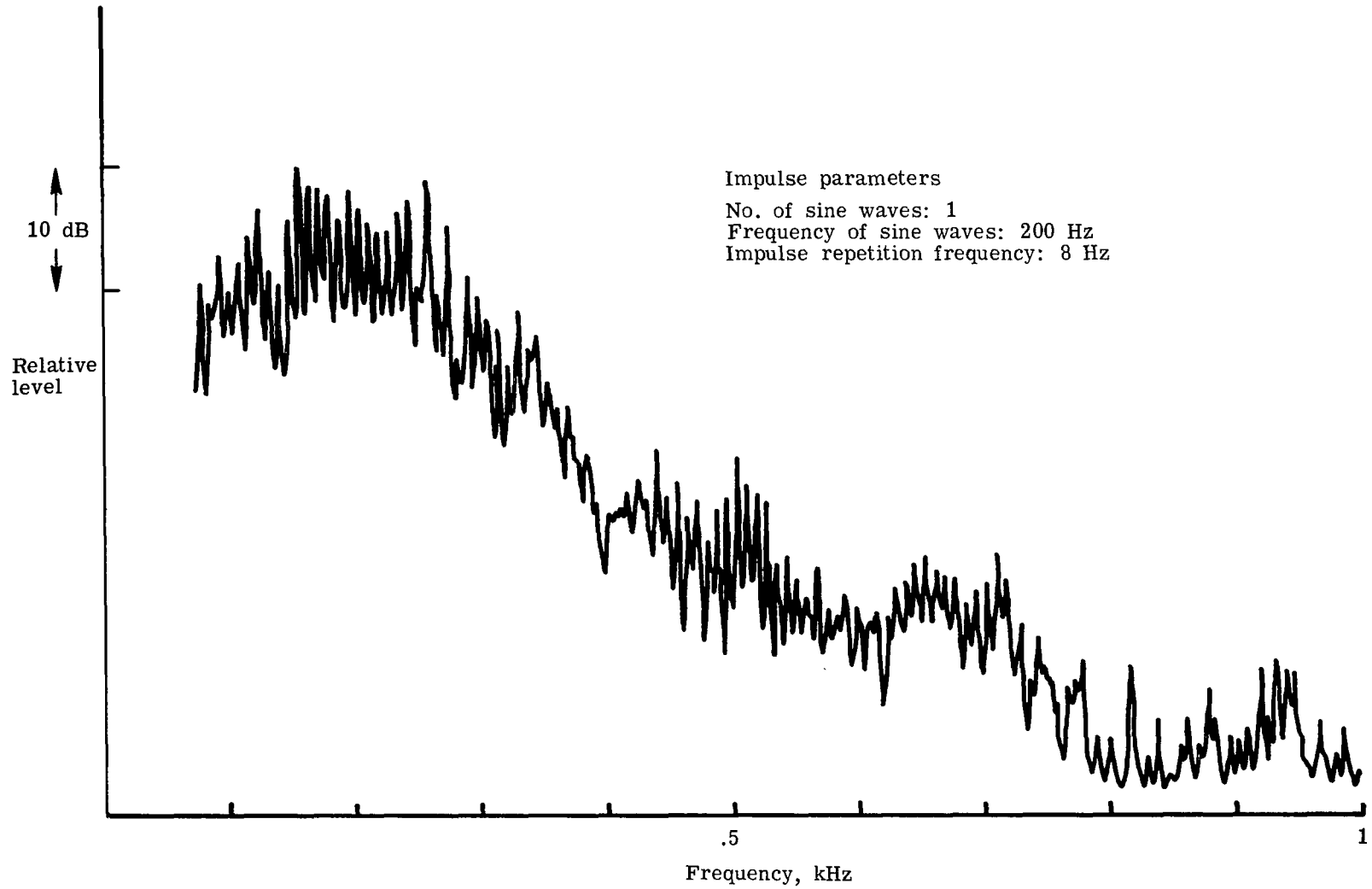
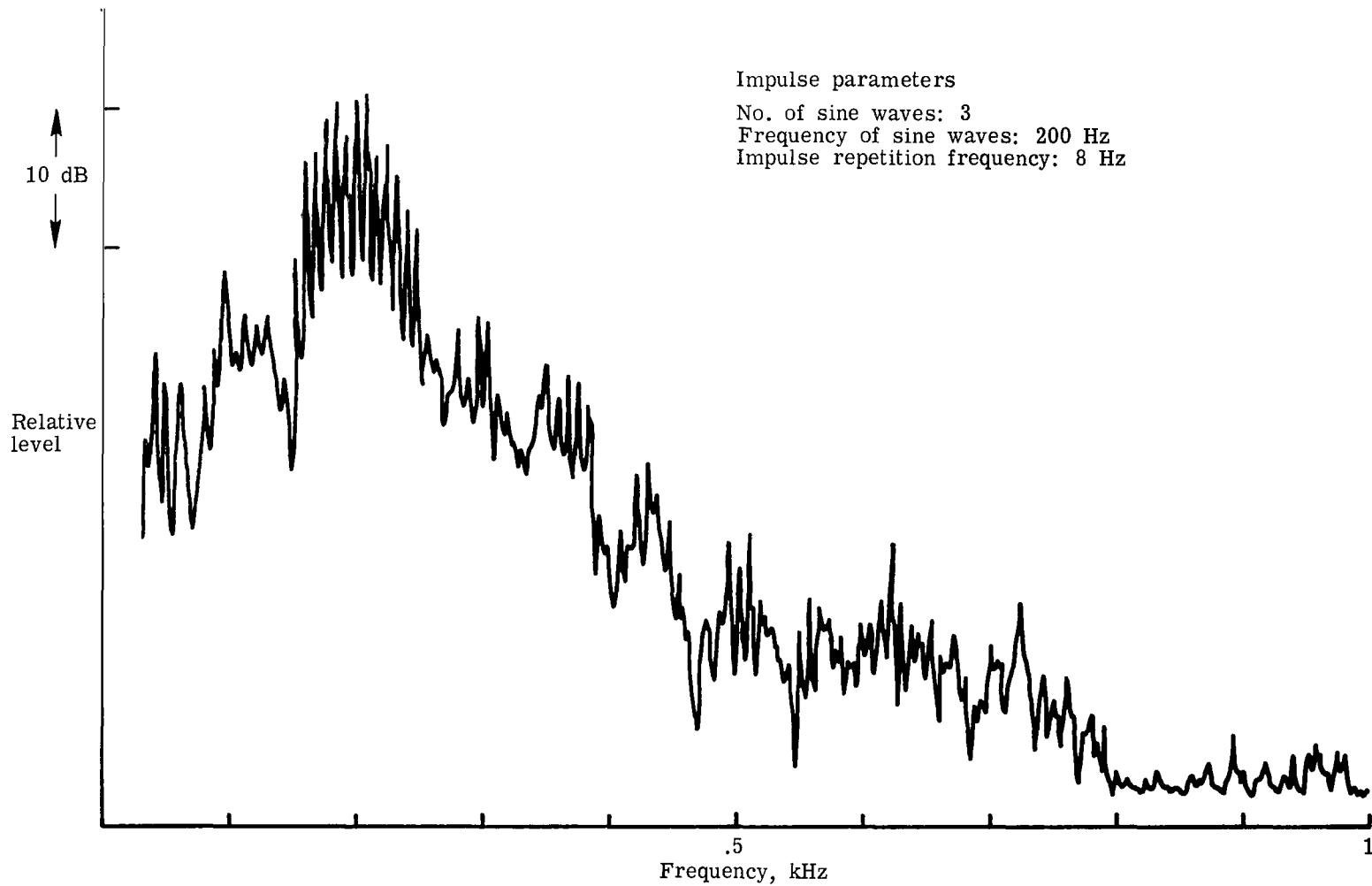

Figure A39.- Narrow-band analysis of test noise 13; bandwidth equals 2 Hz.



APPENDIX A

Figure A40.- Narrow-band analysis of test noise 29; bandwidth equals 2 Hz.

## APPENDIX B

### NOISE EXPERIMENT MATERIAL

In this appendix are presented copies of the instructions given to the subjects, the voluntary consent form the subjects were required to sign, and the rating sheet which the subjects used to record their annoyance ratings for each noise.

#### INSTRUCTIONS

The experiment you are participating in today is to help us understand people's reaction to helicopter noise. You will listen to a series of noises and give a rating for each of the noises - how annoying, noisy, or objectionable is each noise.

You will be listening to two noise sessions. Each will last approximately 20 min, during which you will hear a series of short bursts of noise, separated by a longer period of silence. During the silent periods between each noise, please record your judgment of the preceding noise, using a scale like the one illustrated here.

You see that the scale works like a thermometer. A noise that is not annoying, noisy, or objectionable would go at the bottom of the thermometer. The maximum of these qualities is at the top. In between these extremes, there are equal intervals for noises that you judge to be between zero and maximum. After you have heard a noise, please make a mark on the thermometer to show how noisy, annoying, or objectionable you thought the noise was. There are no right or wrong answers; we want a measure of your personal reaction to each of the noises.

Your participation in this experiment is voluntary, so you are free to withdraw at any time. If you wish to stop the noises for any reason, you may do so by pressing the red abort button on the side of the subjects's chair.

Thank you for helping us in this investigation.

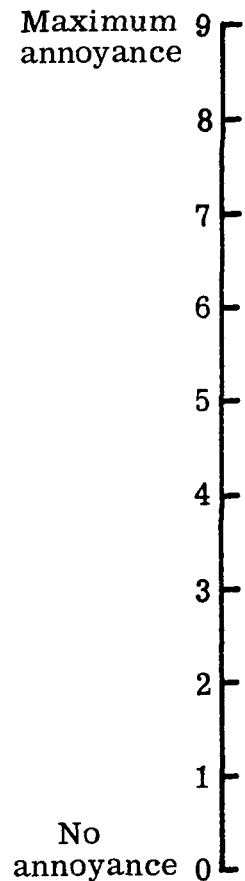

APPENDIX B

VOLUNTARY CONSENT FORM FOR SUBJECTS FOR HUMAN RESPONSE TO

AIRCRAFT NOISE AND VIBRATION

I understand the purpose of the research and the technique to be used, including my participation in the research, as explained to me by the Principal Investigator (or qualified designee).

I do voluntarily consent to participate as a subject in the human response to aircraft noise experiment to be conducted at NASA Langley Research Center on \_\_\_\_\_ date.

I understand that I may at any time withdraw from the experiment and that I am under no obligation to give reasons for withdrawal or to attend again for experimentation.

I undertake to obey the regulations of the laboratory and instructions of the Principal Investigator regarding safety, subject only to my right to withdraw declared above.

I affirm that, to my knowledge, my state of health has not changed since the time at which I completed and signed the medical report form required for my participation as a test subject.

\_\_\_\_\_  
Signature of Subject

### RATING SHEET

Name \_\_\_\_\_  
 Date \_\_\_\_\_ a.m./p.m.  
 Sheet no. \_\_\_\_\_

I II IV III II III I IV  
 III IV II I IV I III II

	a	b	c	d	e	f	g	h	i	j	k	l
Maximum annoyance	9	9	9	9	9	9	9	9	9	9	9	9
	8	8	8	8	8	8	8	8	8	8	8	8
	7	7	7	7	7	7	7	7	7	7	7	7
	6	6	6	6	6	6	6	6	6	6	6	6
	5	5	5	5	5	5	5	5	5	5	5	5
	4	4	4	4	4	4	4	4	4	4	4	4
	3	3	3	3	3	3	3	3	3	3	3	3
	2	2	2	2	2	2	2	2	2	2	2	2
	1	1	1	1	1	1	1	1	1	1	1	1
No annoyance	0	0	0	0	0	0	0	0	0	0	0	0

APPENDIX B





014 001 C1 U H 770107 S00903DS  
DEPT OF THE AIR FORCE  
AF WEAPONS LABORATORY  
ATTN: TECHNICAL LIBRARY (SUL)  
KIRTLAND AFB NM 87117

POSTMASTER: If Undeliverable (Section 158  
Postal Manual) Do Not Return

*"The aeronautical and space activities of the United States shall be conducted so as to contribute . . . to the expansion of human knowledge of phenomena in the atmosphere and space. The Administration shall provide for the widest practicable and appropriate dissemination of information concerning its activities and the results thereof."*

—NATIONAL AERONAUTICS AND SPACE ACT OF 1958

## NASA SCIENTIFIC AND TECHNICAL PUBLICATIONS

**TECHNICAL REPORTS:** Scientific and technical information considered important, complete, and a lasting contribution to existing knowledge.

**TECHNICAL NOTES:** Information less broad in scope but nevertheless of importance as a contribution to existing knowledge.

**TECHNICAL MEMORANDUMS:** Information receiving limited distribution because of preliminary data, security classification, or other reasons. Also includes conference proceedings with either limited or unlimited distribution.

**CONTRACTOR REPORTS:** Scientific and technical information generated under a NASA contract or grant and considered an important contribution to existing knowledge.

**TECHNICAL TRANSLATIONS:** Information published in a foreign language considered to merit NASA distribution in English.

**SPECIAL PUBLICATIONS:** Information derived from or of value to NASA activities. Publications include final reports of major projects, monographs, data compilations, handbooks, sourcebooks, and special bibliographies.

**TECHNOLOGY UTILIZATION PUBLICATIONS:** Information on technology used by NASA that may be of particular interest in commercial and other non-aerospace applications. Publications include Tech Briefs, Technology Utilization Reports and Technology Surveys.

*Details on the availability of these publications may be obtained from:*

**SCIENTIFIC AND TECHNICAL INFORMATION OFFICE**

**NATIONAL AERONAUTICS AND SPACE ADMINISTRATION**

**Washington, D.C. 20546**