

# THERMAL AND STRUCTURAL ANALYSIS OF HELICOPTER TRANSMISSION HOUSINGS USING NASTRAN\*

R. W. Howells and J. J. Sciarra  
Boeing Vertol Company

G. Shek Ng  
USAAMRDL, Eustis Directorate

## SUMMARY

The application of NASTRAN to improve the design of helicopter transmission housings is described. A finite element model of the complete forward rotor transmission housing for the Boeing Vertol CH-47C helicopter has been used to study thermal distortion and stress, stress and deflection due to static and dynamic loads, load paths, and design optimization by the control of structural energy distribution. The analytical results are being correlated with test data and used to reduce weight and to improve strength, service life, failsafety, and reliability. The techniques presented, although applied herein to helicopter transmissions, are sufficiently general to be applicable to any power transmission system.

## INTRODUCTION

Improved power-to-weight ratio capability, extended service life, improved reliability/maintainability, better survivability/vulnerability, reduced vibration/noise, and lower cost are among the continually escalating design requirements imposed upon helicopter transmissions. To meet this array of goals substantial research has been devoted to investigating and improving individual transmission components such as gears, bearings, and lubrication systems. In contrast, housings have not received the attention necessary to fully define and optimize their functional requirements and a gap in transmission technology has existed in this area.

\*This work has been performed under U. S. Army contracts DAAJ02-75-C-0053 and DAAJ02-74-C-0040, U. S. Army Air Mobility Research and Development Laboratory, Eustis Directorate, Fort Eustis, Virginia.

The functions of a helicopter transmission housing are to transmit rotor loads to the airframe, to support the gears and bearings, and to contain the lubricant. These housings are generally designed to have high strength margins and hence seldom exhibit gross structural failures. However, since the housing provides structural support to the internal components, its characteristics significantly affect overall transmission performance and life in terms of internal bearing capacity, gear capacity, fretting, misalignments, and load maldistributions. Housing deflections under load have been identified as a cause of accelerated wear and surface deterioration of gears, bearings, splines, retention hardware, and interface connections and joints. Reduction in the magnitude of these housing deflections by structural optimization and the use of advanced materials will prolong the life and improve the performance of transmission components.

During the past few years a variety of computer studies have been conducted at Boeing Vertol to evaluate the feasibility of applying finite element methods to the design of transmission systems. NASTRAN has been found to be extremely versatile and has been used to study many facets of transmission design and operation. The thrust of the current effort at Boeing Vertol is concentrated in two areas - dynamic analysis aimed at vibration/noise reduction, which was covered in reference 1, and thermal/static structural analyses of the housing which are discussed herein.

## FINITE ELEMENT MODEL

### Housing Model

The finite element model of the transmission housing used for this work is shown in figure 1. The geometric grid points for the model were defined from design drawings and by cross-checking on an actual housing. CQUAD2 (Quadrilateral) and CTRIA2 (Triangular) homogeneous plate (membrane and bending) elements were used to connect the grid points and build the NASTRAN structural model. A Boeing Vertol preprocessor program (SAIL II - Structural Analyses Input Language) for the automatic generation of grid point coordinates and structural element connections was used. This preprocessor allows the user to take advantage of any pattern which occurs in the data by providing techniques for describing algorithms to generate blocks of data. The extensive computer generated plotting capability of NASTRAN was used to debug the structural model.

For ease of identification the housing was subdivided into several regions and the grid points in each region were labeled with a specific, but arbitrary, series of numbers. Although these grid point numbers act only as labels, they effect the bandwidth of the stiffness and mass matrices. In order to minimize the matrix bandwidth for most efficient running of NASTRAN, the BANDIT computer program (reference 2) was used to automatically renumber and assign internal sequence numbers to the grid points. The output from BANDIT is a set of SEQGP cards which is then included in the NASTRAN bulk data deck and which relates the original external grid numbers to the new internal numbers. A summary of the important model parameters is provided in figure 2. A more thorough description of the model was presented in reference 1.

### Internal Components

For the dynamic analysis of the housing (reference 1) the internal components were included only in the sense that the dynamic forces generated by them were applied to excite the housing. The additional structural constraints imposed upon the housing when subjected to static load conditions must also be considered. Since only the gross effect on the housing was desired, these components were represented by simple beam models.

For the thermal analysis the internal components were not included. The bearing outer races, which are the housing/internal component interface, are press-fit into the housing. Elevated temperatures cause the magnesium case to expand away from the steel outer races and may result in a "floating" fit at operating temperatures. This has happened during testing and it was necessary to key the outer races to prevent rotation permitted by increased clearances caused by thermal expansion. This condition, plus bearing internal tolerances, precludes the transmittal into the housing of thermally induced radially outward loads. Furthermore, the bearing races cannot impose radial restraint upon the housing expansion. Thus, no representation of the internal components in the radial direction is necessary. Since axial thermal growth of the internal components is absorbed by reduction of gear backlash, no axial loads are induced unless the temperature exceeds that necessary to reduce the backlash to zero. In such a situation the housing loads would be of little interest since the gears would distress and fail.

For the static stress analysis, only the resistance of the outer races to radially inward forces on the housing is significant. The races do not resist outward forces on the housing. NASTRAN has no capability for a beam which acts only in compression. Thus, a beam model of a bearing race will also act to impose unwanted restraint on the housing directed radially inward. This could be circumvented by first analyzing only the housing model and thereby

defining the housing/bearing interfaces with inward deflections. A beam model could then be inserted at these points to resist the radially inward forces and the analysis could be re-run.

## TRANSMISSION HOUSING DESIGN REQUIREMENTS

To provide an understanding of the configuration, functional requirements, and design criteria for a helicopter transmission, a brief description is included. A contemporary helicopter main transmission housing is generally composed of three main parts with essentially separate functions: the upper cover, ring gear and case. This configuration is demonstrated by the CH-47C forward rotor transmission in figure 1.

The upper cover supports the rotor shaft and provides lugs for mounting the transmission to the airframe. The rotor system loads are transmitted through the upper cover into the airframe. The upper cover design criteria include ultimate, fatigue, and crash load conditions. The case contains and supports the main bevel gears and may also include a tail rotor or sync shaft drive, lube pump, or accessory drives. The transmission may also have a separate sump for containment of the lubricant, as does the CH-47C, or it may use an integrally closed lower portion of the case for this purpose. The gear case design criteria include strength and stiffness for gear mounting and fatigue loads in certain areas. The stationary ring gear, which connects the upper cover and case, contains the planetary gear system. The ring gear must provide adequate strength to react the planetary gear loads and support the case and must also provide sufficient stiffness to maintain planet/ring gear tooth alignment. The entire housing also performs the functions of sealing in the lubricant, providing passages for lubricant delivery, protecting critical transmission components and dissipating heat. Figure 3 shows the transmission case in detail since much of the work herein is concentrated upon analysis of the case.

A critical requirement of a helicopter transmission is proper alignment of each gear-mesh and bearing, which requires dimensional stability of the housing at bearing mounting locations. Predicted improvement in load capacity due to advances in gear and bearing technology may be offset in practice by poor load distribution resulting from misalignment caused by the deflection of mounting surfaces within the housing.

Analytical evaluation of the load capacity of gears involves assumptions regarding the nature of the tooth contact for the specific gear mountings under load. A uniform stress distribution across the tooth and rigid mounting are typically assumed. Unless

these assumptions are relatively accurate, actual stresses may vary considerably from the calculated values (figure 4) resulting in a service life reduction. The detrimental effect of misalignment on gear teeth has been documented by the American Gear Manufacturers Association (reference 3). Gear tooth bending and surface contact stresses are proportional to factors which evaluate the effects of non-uniform load distribution. These load distribution factors are in turn dependent upon items including gear mesh misalignment due to housing distortion caused by loads and thermal variations. Cases of gear failure can be attributed to uneven load distribution caused by misalignment, which can result in tooth pitting and scuffing. Gear mesh misalignment is also important from the aspect of vibration/noise generation (figure 5).

Present bearing life equations also assume that the bearing is rigidly supported, operates under no misalignment, and operates under a constant and uniform load. In helicopter applications, both the above assumptions are not true and therefore calculated lives are not precise. Experience to date has been associated with reduced bearing lives due to indeterminable system stiffness and early bearing failures have resulted from shaft misalignment (edge loading) and non-uniform housing support (local hard spots).

Although present methods of transmission analysis include complex computer programs, the capability to evaluate the effect on life of structural shape and flexibility is very limited. Since the full benefits of advancements achieved in component technology cannot be realized until the housing is optimized, analytical methods must be developed to permit evaluation of design parameters, allow trade-studies, and provide guidance to designers. Special consideration must be given to the uniform rigid support of critical components, since reduced shaft and housing deflection will result in better performance and life of gears, bearings, and other components.

To continue to improve transmission analysis capability and to design for improved performance, a detailed understanding of the structural and thermal aspects of the transmission housing must be developed. Because of the many functions performed by a transmission housing and its complex geometry, analysis is difficult and previously the designer had little guidance for selection of the design with best structural efficiency. The objective of the work being conducted at Boeing Vertol is to develop and demonstrate a comprehensive finite element technique with the capability for analyzing and designing transmission housings. NASTRAN fulfills this need by providing a multi-purpose standardized source for static, thermal, and dynamic analysis as well as possessing the capability and flexibility for analyzing conventional cast metal housings, advanced composites, or fabricated structures. The work encompasses the study of thermal distortion and stress, stress and deflection due to static and dynamic loads, load path definition, dynamic response, and the

control of structural energy distribution. The results are being used to optimize strength and weight, and to assess operational housing life, failsafety, and reliability. The investigation of the housing structural characteristics has been categorized under two broad headings - thermal analyses and stress analyses. Each of these is discussed below.

## THERMAL ANALYSES

When two bevel gears are properly mounted, their cone centers are coincident (at room temperature). The gears, shafts, and bearings are made of steel, but the housing and bearing cartridges are generally made of a lighter material such as magnesium. Due to the different thermal coefficients and the varying temperatures existing within the transmission, differential thermal expansion causes the relative positions of mating bevel gears to change. The cone centers therefore may no longer be coincident at operating temperature and the contact pattern and stress distribution across the gear teeth will change. This is one example of the importance of temperature effects in regard to transmission design. Figure 6 indicates the overall scheme of the thermal analysis which will enable the design team to define the thermally induced distortions and stresses in a transmission housing.

### Uniform Temperature Study

As part of a thermal investigation, uniform temperature distributions were applied analytically to the housing model to represent current operating ( $71^{\circ}\text{C}$ ), projected operating ( $177^{\circ}\text{C}$ ), and loss-of-lubricant emergency operating ( $371^{\circ}\text{C}$ ), temperatures. The thermally induced deformations and growth are indicated in the computer generated plots of figure 7. For validation of the NASTRAN thermal model, the housing was experimentally heated to several temperatures in the range of  $71$ - $204^{\circ}\text{C}$ , and selected dimensions of the housing were measured before and after heating. Figure 8 shows the housing in the oven and a typical measuring instrument used. This dimensional data at normal and elevated temperatures experimentally determined the thermal distortion and growth of the transmission case.

The experimental data obtained is plotted in figure 9 as the change in linear dimensions versus temperature. Also shown in the figure are the theoretical changes in the dimensions predicted both by the NASTRAN thermal analysis and by a simple linear thermal expansion calculation. The agreement of the data and both analyses

confirms the validity of the model and provides confidence in the model for predicting deformations of the housing.

### Thermal Mapping Study

A complete thermal map of an operating CH-47C forward rotor transmission at various torque loads and inlet oil temperatures was determined in a previous experimental program conducted by Boeing Vertol (reference 4). This program provided considerable insight into the thermodynamics of an operating transmission. Figure 10 is a cut-away diagram of the specimen transmission showing typical temperature measurements. Measurements between selected points on the transmission housing were made at room temperature and also at various operating temperatures. The results indicated that significant thermal growth had occurred.

To further investigate the effects of temperature upon a transmission housing, thermal map data similar to figure 10 for oil-out temperatures of 85°C, 141°C, and 204°C at 100% torque were applied to the housing model, and NASTRAN Rigid Format 1 static analysis was used to calculate the thermal distortions and stresses. For each case clearances, dimensional stability of critical housing points, and misalignment effects were evaluated.

The computer generated plot in figure 11 shows the regions of the housing where it interfaces with the bearings. The vectors plotted indicate the displacements at each grid point due to the applied temperature distribution from reference 4 for 85°C oil-out temperature. First consider the pinion shaft. By evaluating the distortion of the bearing interface at each end of the shaft individually and then evaluating the relative distortion between the shaft ends, the thermally induced misalignment of the pinion shaft was calculated. By comparing the relative misalignment between the pinion and gear shafts, the overall effect of temperature upon the gear mesh alignment was assessed.

A NASTRAN post-processor computer program was written which uses the grid point displacement and geometry data to calculate these induced misalignments. This program indicates that the induced slopes of the pinion and bevel/sun shaft are .0003 and .0004, respectively. Also, the displacements at the pinion and bevel gear pitch diameter are .015cm and .018cm, respectively. These displacements are shown schematically in figure 12.

At the 204°C condition, the pinion and sun/bevel gear shaft slopes are .0007 and .0009, respectively; the displacements at the pitch diameter are .033cm and .038cm, respectively. Depending upon the type of shaft support bearings, shaft slopes of these magnitudes can be detrimental to bearing performance. Similarly, the displacements at the gear mesh point must be further evaluated

to determine the effect on gear performance. A summary of the housing thermal distortions and also thermal stresses is included in table I.

Although thermal mapping tests determine the thermal conditions of an existing transmission, the design of a new transmission requires this information prior to manufacture. In order to determine thermal distortions/stresses for a new or conceptual transmission housing, it is necessary to calculate the heat generated by the gear meshes and bearings which are the forcing functions for the thermal model. The analysis of gear/bearing heat generation is a goal of the work being conducted currently. It is necessary input to a realistic conceptual modeling procedure. Approximate methods may be used rather than completely rigorous analyses.

### STRESS ANALYSES

Using the finite element housing model, a variety of static and dynamic analyses have been conducted to predict structural deformation and stress distributions. By applying loads representative of the operating transmission to the model, stress distributions throughout the housing have been calculated. The static and dynamic stresses thus calculated, when superimposed upon the thermal stress distribution, provide an accurate overall picture of both the steady-state and time dependent (fatigue producing) stresses occurring in the housing of an operating transmission. From this combined stress distribution, the structural load paths can be identified, and the structural portions of the housing segregated from the non-structural portions. Furthermore, methods for structural optimization using strain energy have been used to define wall thickness and geometry changes. Figure 13 depicts the stress analysis scheme.

Various maneuver conditions, such as symmetric dive and pull-out (nose-up pitching), yawing, and recovery from rolling pull-out, have been analyzed. Resulting forces imposed upon the housing due to rotor loads, steady-state gear loads, and inertia loads have been considered. Rotor hub loads and gear loads were converted to forces acting at the shaft support bearings and applied to the housing at the bearing support locations. The inertia loads were applied uniformly throughout the housing. After running a NASTRAN Rigid Format 1 analysis, the post-processor mentioned in the previous section was used to calculate the deflections. In order to establish a baseline for comparison of the rigidity of magnesium and advanced material housings, the deflections were also calculated for a steel housing. The deflections due to the ultimate load condition for both the magnesium and steel housings are shown schematically in figure 14 and are summarized for comparison in



table II. Also shown in table II are some typical maximum stresses calculated by NASTRAN for various load conditions.

#### CONCLUDING REMARKS

A transmission is a complex system wherein all components interact and influence each other; hence, a unified analysis is necessary to optimize the components for the unique operating environment of a specified transmission system. The housing structural analysis using NASTRAN described herein represents a significant step toward this goal. Based on the Thermal/Static/Dynamic analyses accomplished to date, it is apparent that NASTRAN can be applied to transmission design. In fact, there is no other comprehensive analytical tool. Application of these methods during the design phase may return substantial benefits over the life of a transmission.

The ability of NASTRAN to accurately predict thermal distortions of a transmission housing has been verified by correlation of test data. The heat transfer/thermal stress capability of NASTRAN has been utilized for a lubrication/cooling analysis.

When analyzing the housing structure, the effect of the internal components (i.e. gears, bearings, shafts) must be considered. Hence, it may be necessary to model these components either in detail or in a simplified manner. Furthermore, in some instances such as a thermal growth analysis it may be possible to ignore the internal components because of different coefficients of thermal expansion.

More significant application of a structural load path analysis can probably be made to advanced transmission concepts employing fabricated housings, composite materials and other advanced concepts which will permit greater design flexibility. For example, major load paths could be selectively reinforced while the thickness of non-load carrying regions of the housing wall could be reduced to the minimum necessary for containment of the lubricant. NASTRAN can handle composite materials by using a 6 x 6 material property matrix along with an orienting angle for each element to define the direction of the input properties.

By evaluating the displacements of the housing model grid points at the bearing/housing interfaces, the shaft slopes and displacements at the gear mesh have been determined. Although the magnitude of these displacements is appreciable, further evaluation is needed to establish the effect on life and performance.

## REFERENCES

1. Howells, R. W., and Sciarra, J. J., FINITE ELEMENT ANALYSIS USING NASTRAN APPLIED TO TRANSMISSION VIBRATION/NOISE REDUCTION, NASA TMX-3278, September 1975.
2. Everstine, G., BANDIT - A COMPUTER PROGRAM TO RENUMBER NASTRAN GRID POINTS FOR REDUCED BANDWIDTH, Naval Ship Research and Development Center Technical Note AML-6-70, February 1970.
3. American Gear Manufacturers Association Standard 210.02.
4. Tocci, R. C., Lemanski, A. J., and Ayoub, N. J., TRANSMISSION THERMAL MAPPING, USAAMRDL TR 73-24, May 1973.

TABLE I. THERMAL DISTORTION AND THERMAL STRESS SUMMARY

THERMAL LOAD CONDITION	SHAFT SLOPE		MESH DISPLACEMENT - cm (in)	
	PINION	GEAR	PINION	GEAR
85°C (185°F) Thermal Map	.0003	.0004	.015 (.006)	.018 (.007)
204°C (400°F) Thermal Map	.0007	.0009	.033 (.013)	.038 (.015)

THERMAL LOAD CONDITION	HOUSING THERMAL STRESSES - kPa (PSI)	
	MAXIMUM	NOMINAL RANGE
85°C (185°F) Thermal Map	22060 (3200)	1380 - 17240 (200 - 2500)
Uniform Temperature 71°C (160°F)	13790 (2000)	690 - 4140 (100 - 600)

TABLE II. DEFLECTION AND STRESS SUMMARY

LOAD CONDITION	SHAFT SLOPE		MESH DISPLACEMENT - cm (in)	
	PINION	GEAR	PINION	GEAR
ULTIMATE				
Magnesium	.0017	.0005	.0429 (.0169)	.0091 (.0036)
Steel	.0004	.0001	.0094 (.0037)	.0018 (.0007)
STEADY FLIGHT (1-g)				
Magnesium	.0006	.0002	.0147 (.0058)	.0030 (.0012)
Steel	.0001	.0000	.0033 (.0013)	.0005 (.0002)

LOAD CONDITION	TYPICAL MAGNESIUM HOUSING STRESS - kPa (PSI)
ULTIMATE	<u>+103425</u> to <u>+172375</u> ( <u>+15000</u> to <u>+25000</u> )
STEADY FLIGHT (1-g)	<u>+20685</u> ( <u>+3000</u> )
YAWING MANEUVER	<u>+137900</u> ( <u>+20000</u> )
RECOVERY FROM ROLLING PULLOUT	<u>+34475</u> ( <u>+5000</u> )

# CH-47 FORWARD TRANSMISSION

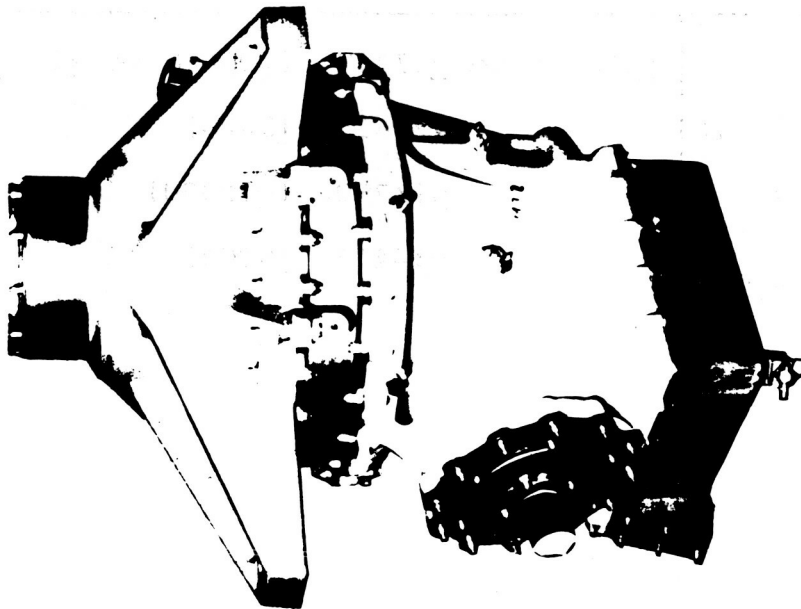

2684 kW (3600 HP) Rating

# TRANSMISSION HOUSING MODEL

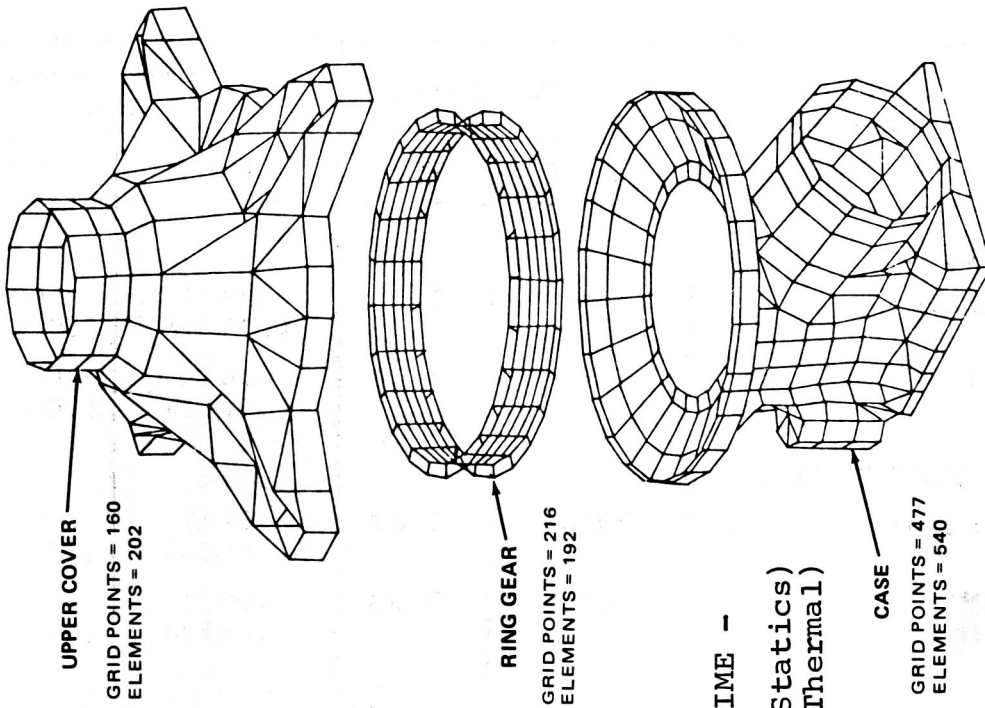

CPU TIME -

.66 HR (Statics)  
.05 HR (Thermal)

Figure 1. Boeing Vertol CH-47 Helicopter Forward Rotor Transmission Housing and Computer Generated Plot of NASTRAN Model.

## MODEL PARAMETERS

	NUMBER	NUMBER	NUMBER	DEGREES OF FREEDOM	BANDWIDTH	CPU TIME (HOURS)*			
	GRID POINTS	ELEMENTS	DEGREES OF FREEDOM						
	TOTAL SPC OMIT RETAINED			FULL REDUCED COLUMNS		ACTIVE			
Upper Cover	160	202	960	184	614	162	34	162	0
Ring Gear	216	192	1296	216	828	252	-	252	0
Case	477	540	2862	529	2024	309	61	309	0
TOTAL	853	934							

.66 Statics  
.05 Thermal

\*RIGID FORMAT 1 ON IBM 370

## COMPARISON OF CALCULATED AND ACTUAL WEIGHTS\*

	MODEL	HARDWARE	DIFFERENCE
Sump	3.7 kg ( 8.2 lb)	5.5 kg ( 12.2 lb)	**
Case	25.1 kg ( 55.4 lb)	24.6 kg ( 54.2 lb)	+ 2.2%
Ring Gear	34.9 kg ( 77.0 lb)	34.9 kg ( 77.0 lb)	0% (Lumped Masses for Teeth)
Upper Cover	62.8 kg (138.5 lb)	64.1 kg (141.4 lb)	- 2.0%

\*(Case weight based on AZ91C cast magnesium alloy, density 1.799g/cc (.065 lb/in<sup>3</sup>); upper cover weight based on 2014-T6 forged aluminum, density 2.796g/cc (.101 lb/in<sup>3</sup>), both per MIL-HDBK-5B 1 September 71.)

\*\*Model excludes internal passageways.

Figure 2. Summary of CH-47 Forward Transmission Housing NASTRAN Model.

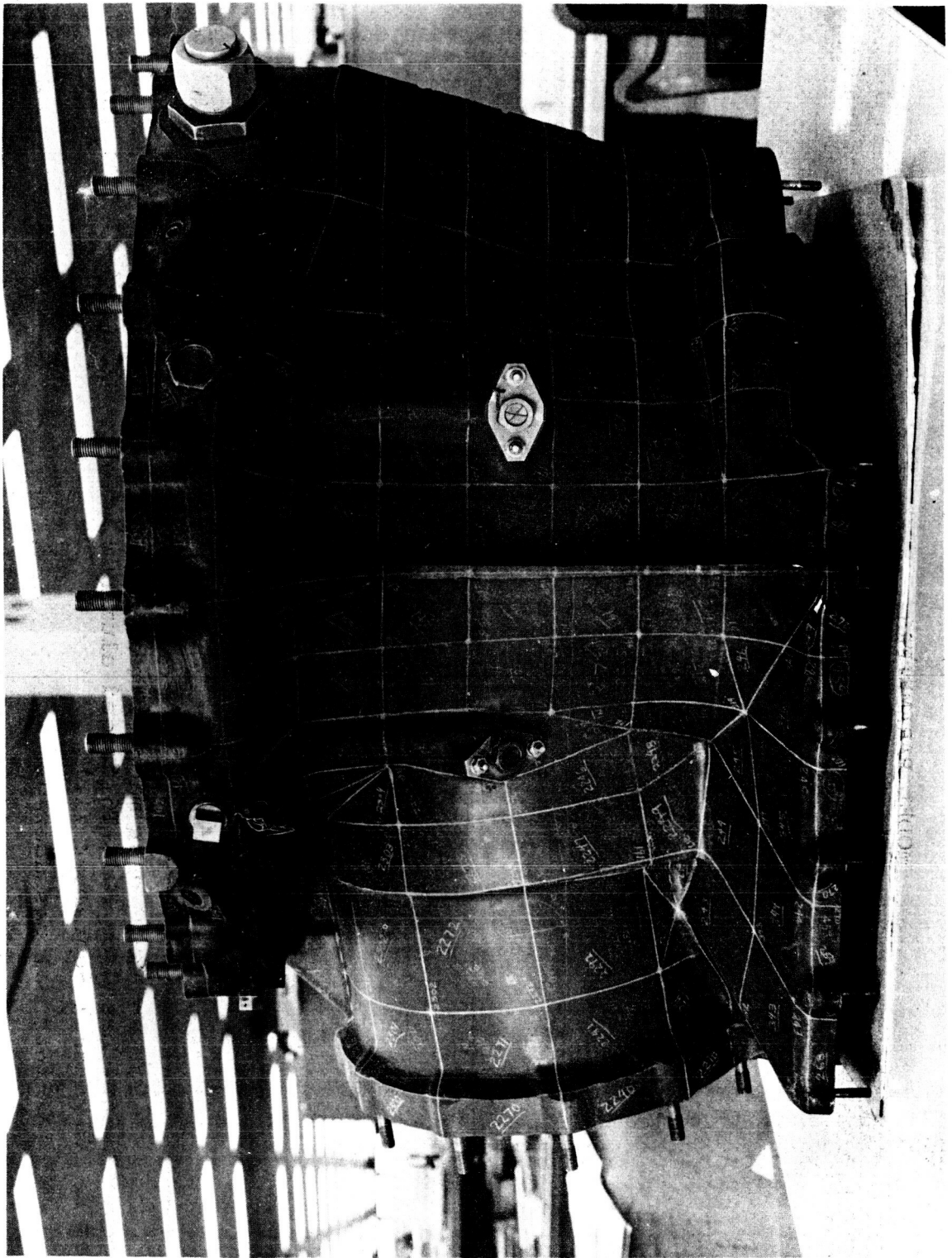

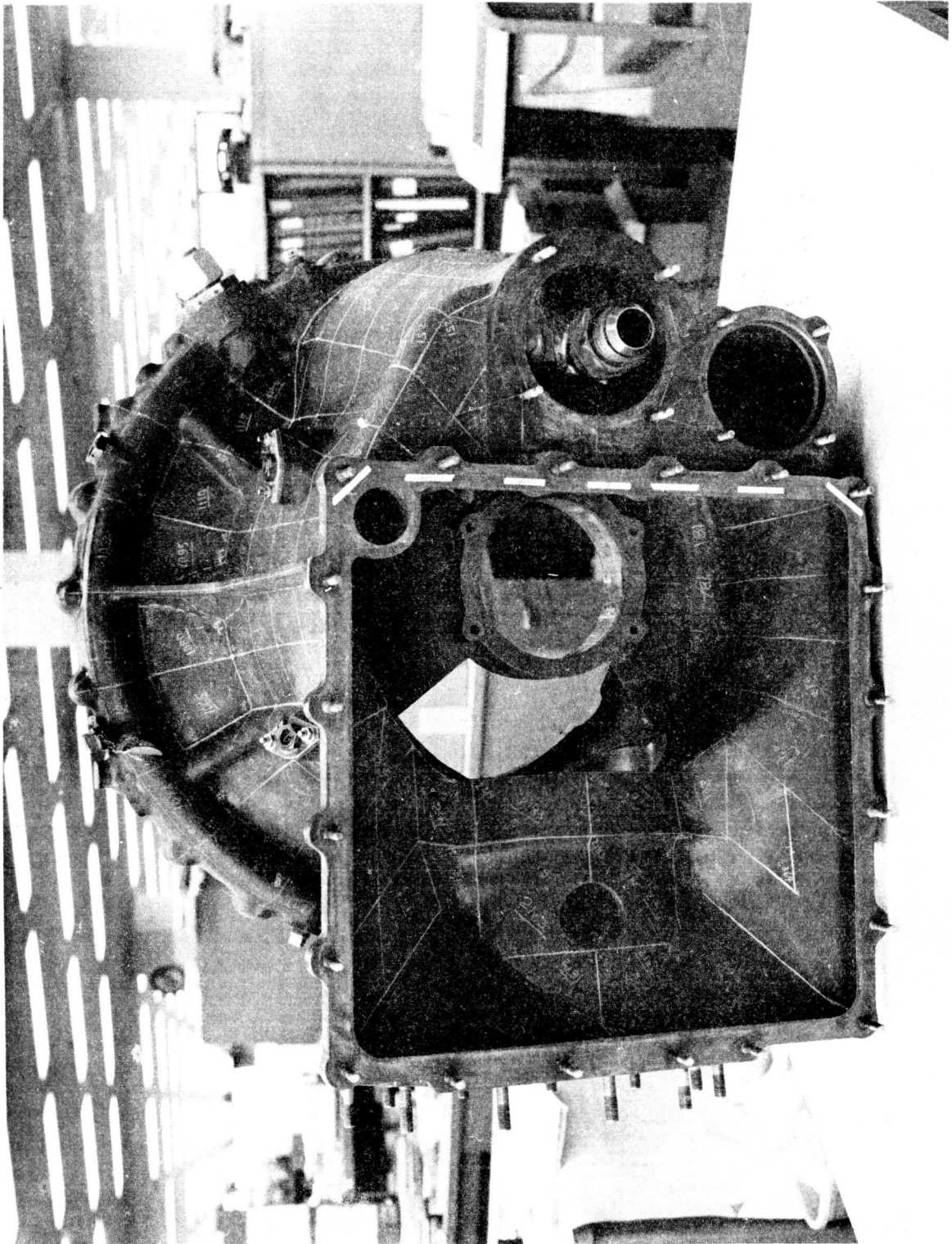

Figure 3b. CH-47C Forward Transmission Lower Housing (Bevel Gear Case).



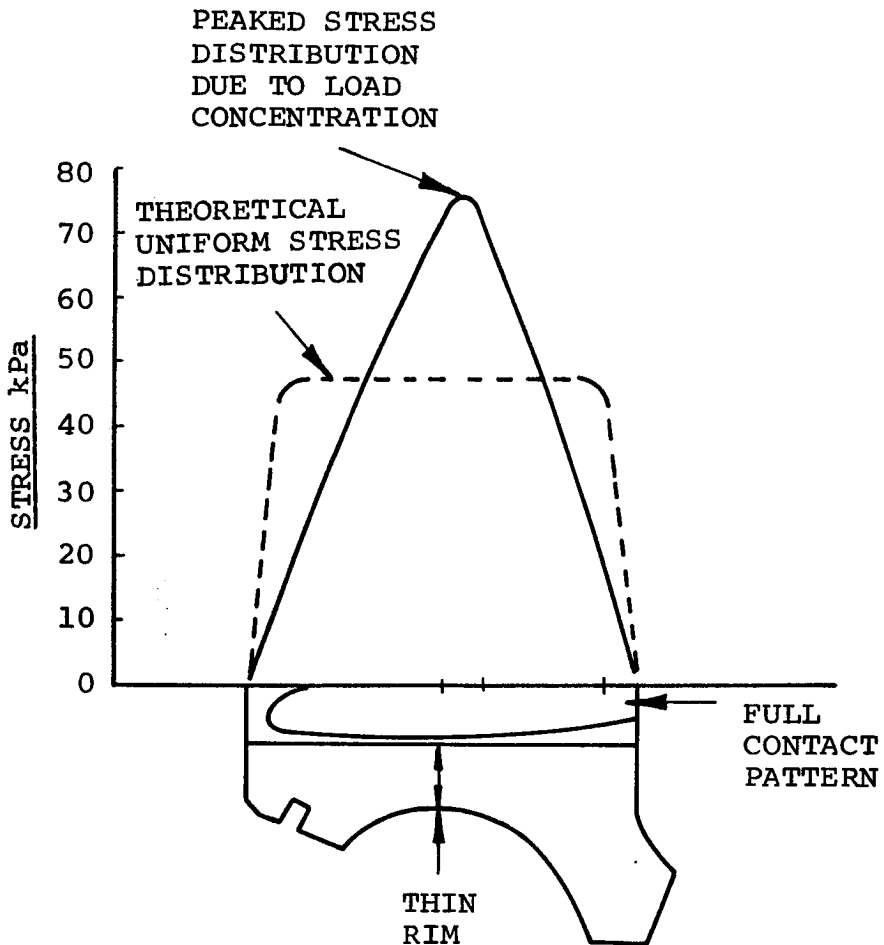

Figure 4. Typical Measured and Theoretical Stresses in Bevel Gears.

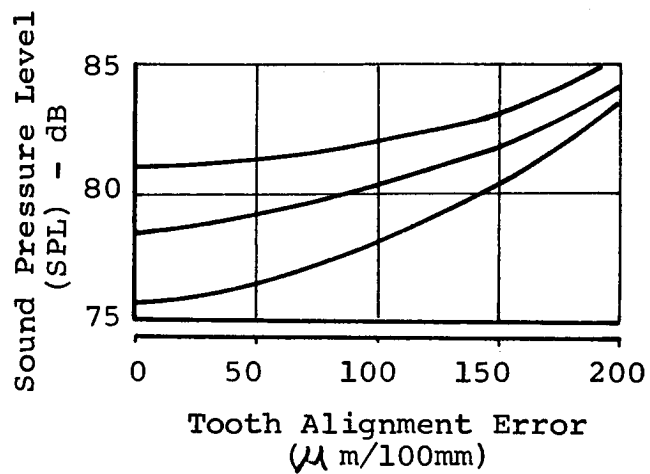

Figure 5. Typical Influence of Tooth Alignment Error on Gear Noise.

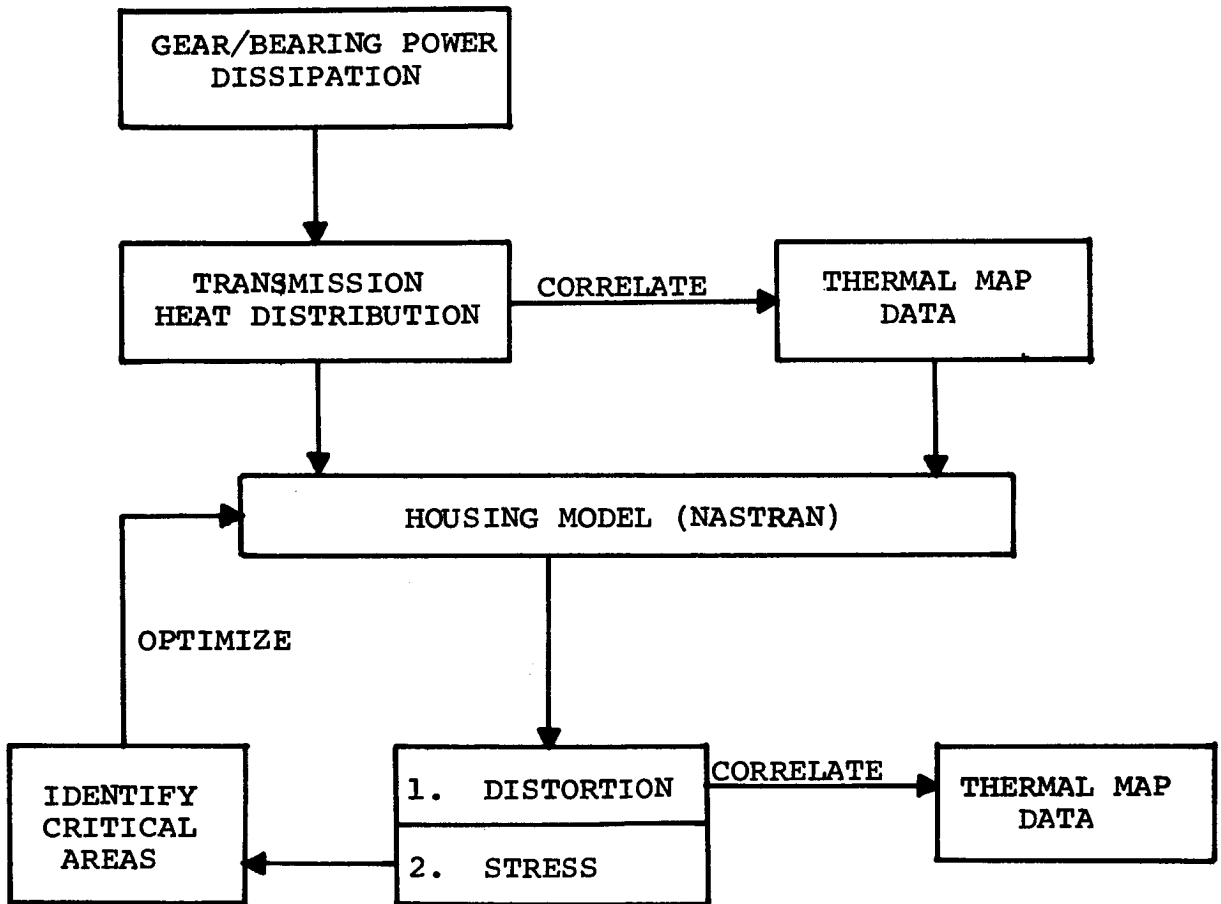
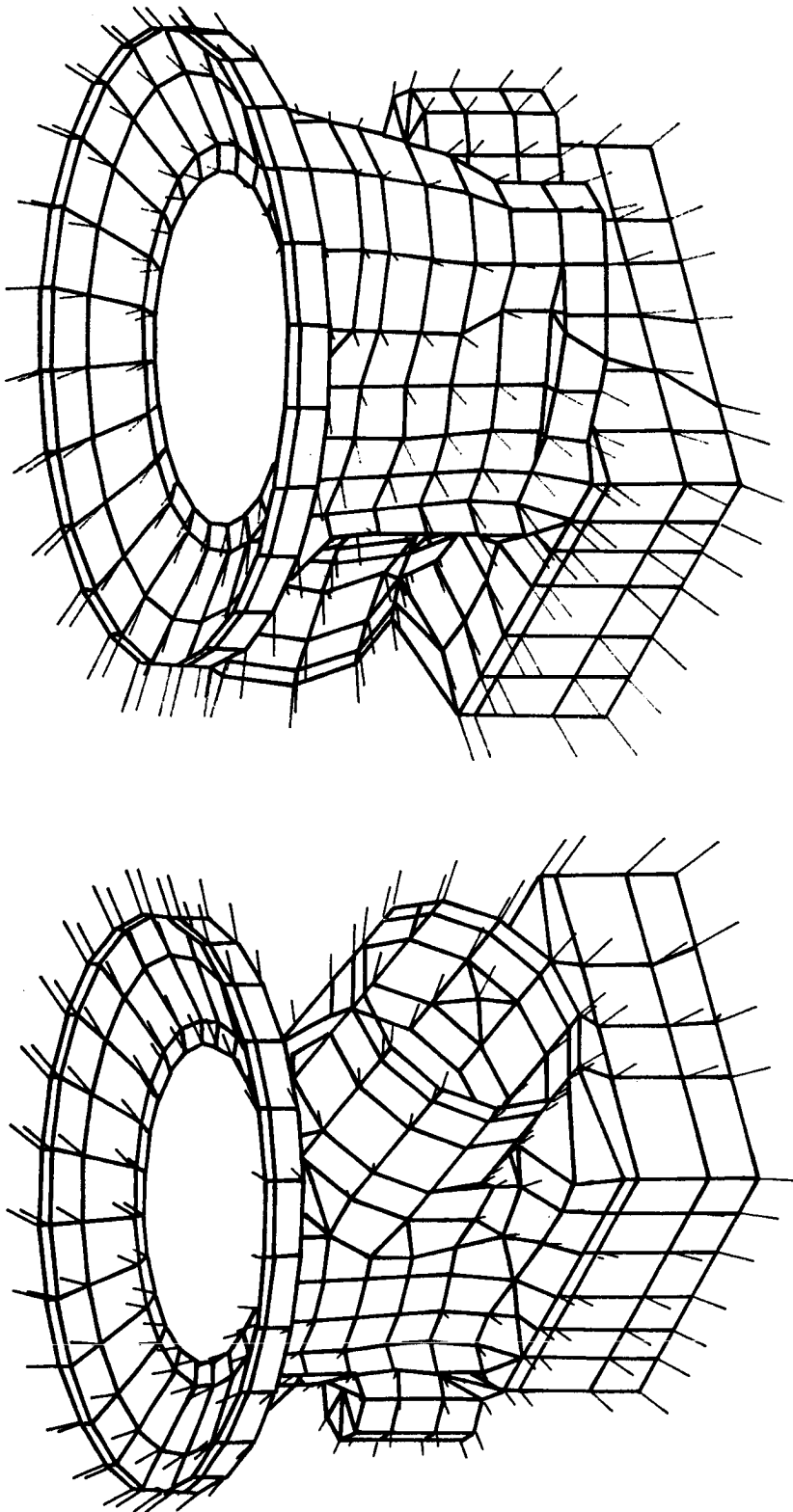

Figure 6. Flow Diagram of NASTRAN Thermal Analysis.



NOTE: VECTORS INDICATE DIS-PLACEMENTS.

<u>SUBCASE</u>	<u>TEMPERATURE</u>	<u>MAXIMUM DEFORMATION</u>
1	71°C (160°F)	0.0612 cm (0.0241 in)
2	177°C (350°F)	0.1839 cm (0.0724 in)
3	371°C (700°F)	0.4100 cm (0.1614 in)

Figure 7. CH-47 Forward Transmission Case Uniform Temperature Analysis, Static Deformation Due to Elevated Temperatures.

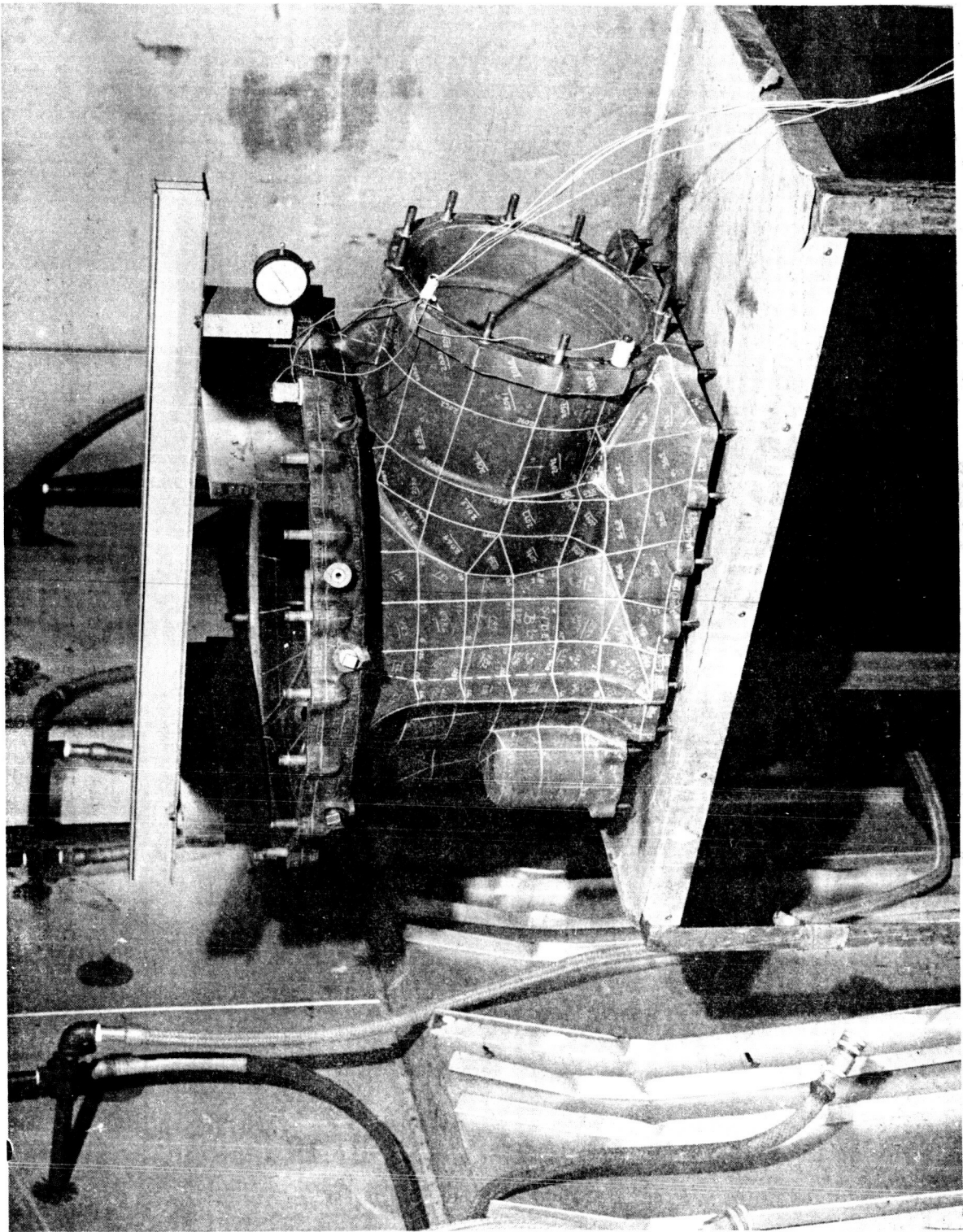

Figure 8. Measurement Procedure — Bar Type Dial Indicator Gage.

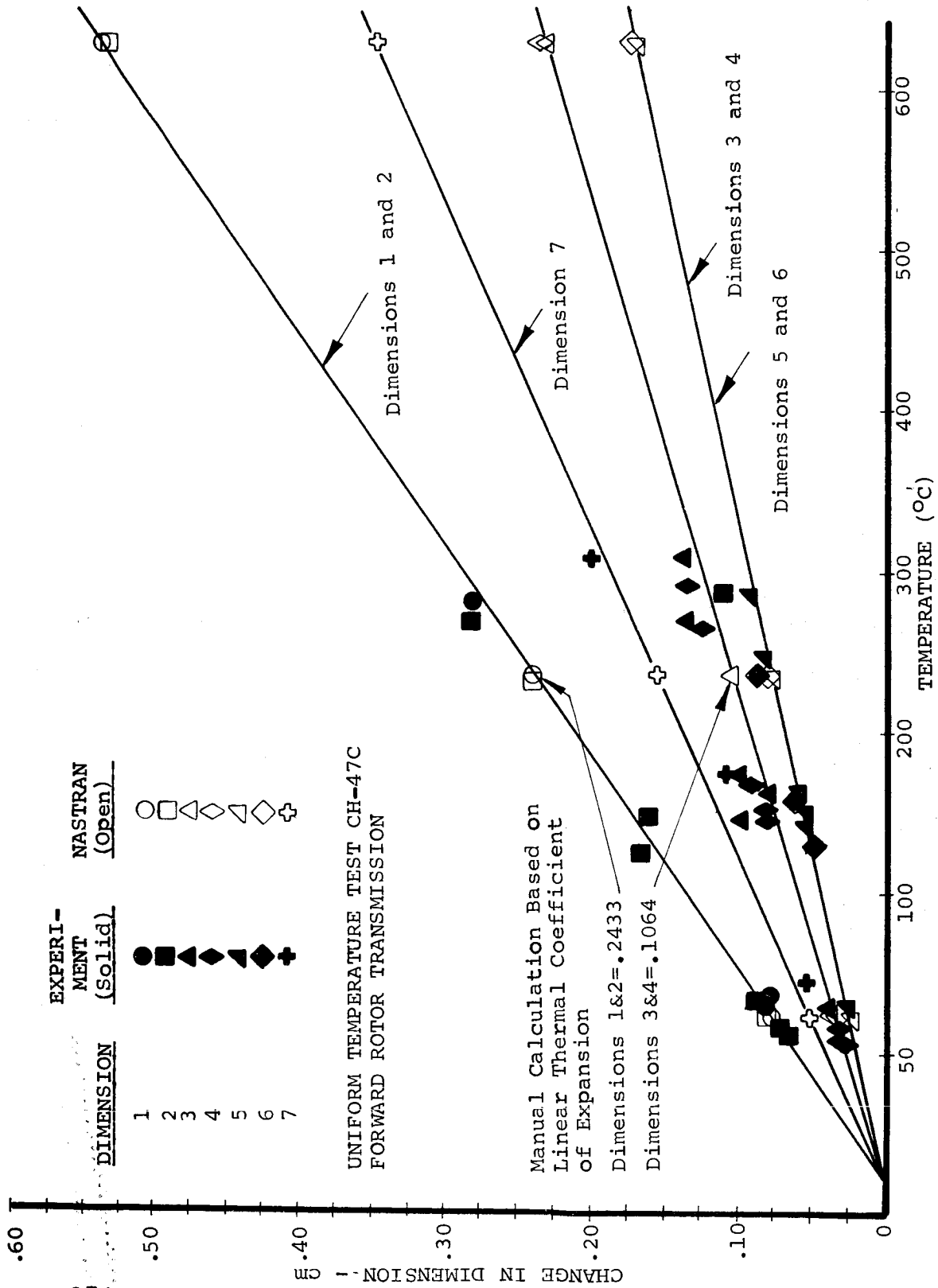

Figure 9. Transmission Housing Dimensional Changes as a Function of Temperature.

NOTE: All numbers shown are temperatures in degrees Centigrade (at shutdown).

Test Stand (Heat Sink) =  
36, 37, 48

Test Cell Air =  
32, 35, 37

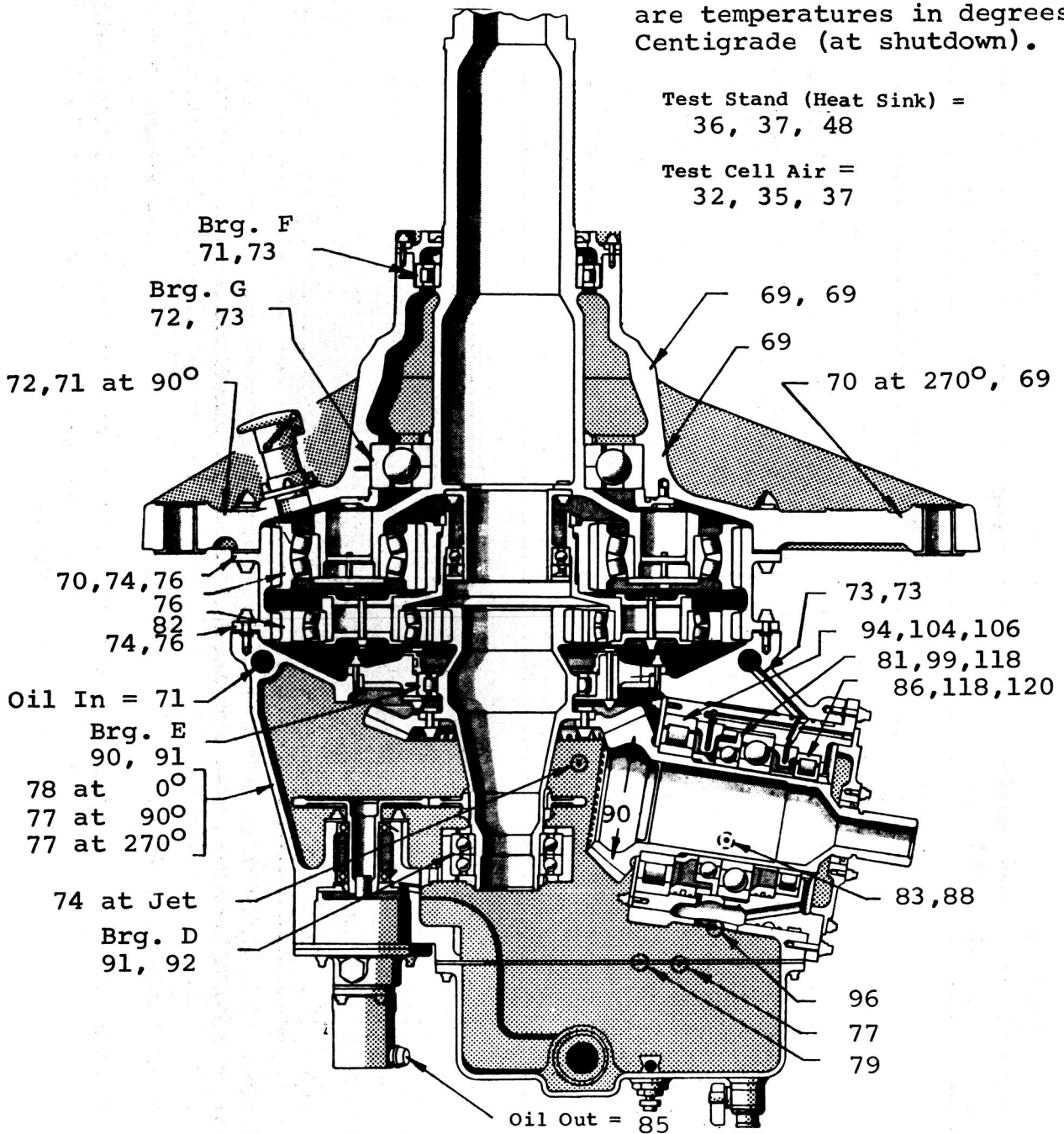

Figure 10. Typical Thermal Map of CH-47C Forward Transmission - 85°C (185°F) Oil-Out Temperature.

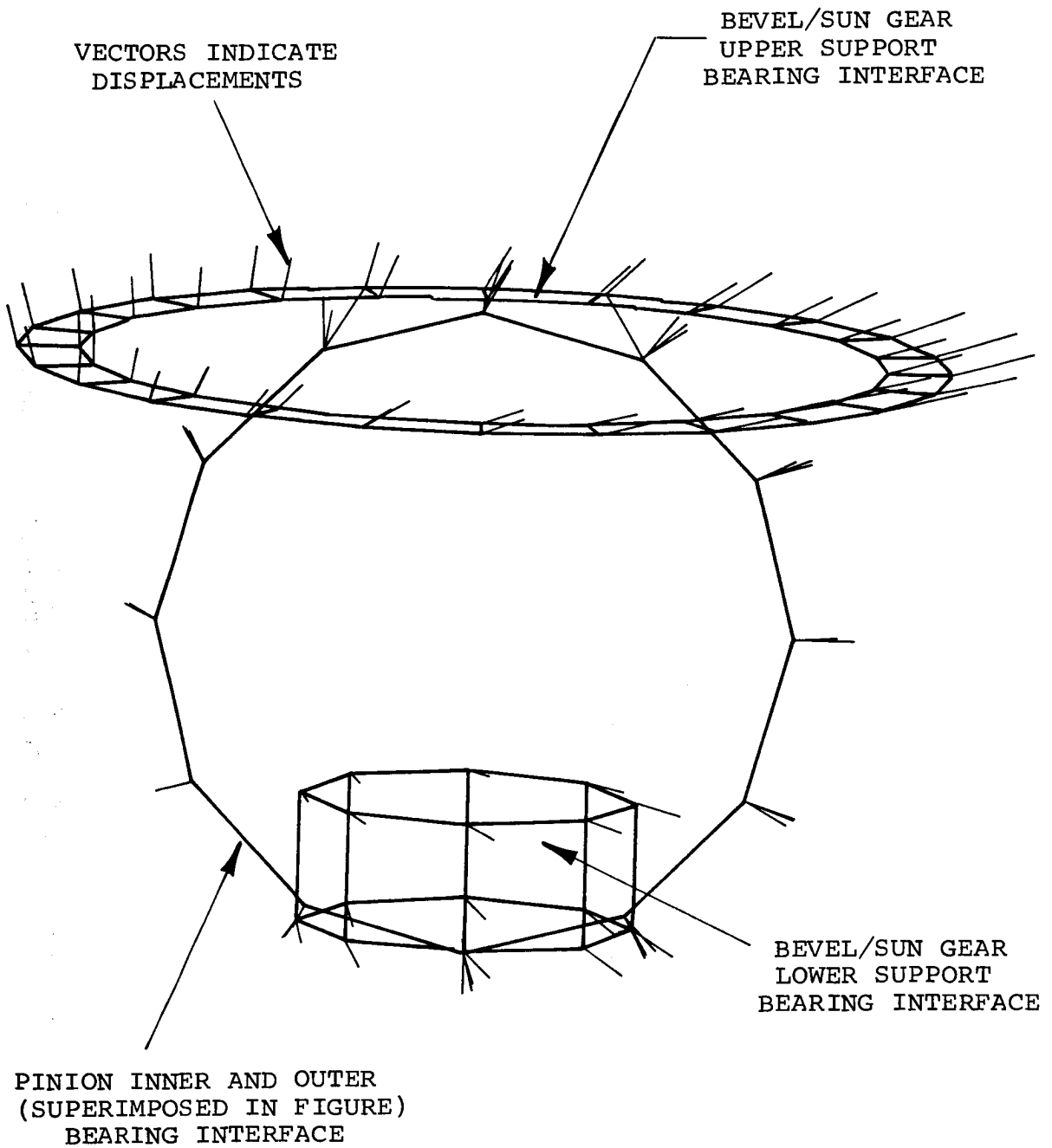

Figure 11. Induced Displacements at Housing/Bearing Interfaces Due to Temperature - Thermal Map Data for 85°C (185°F) Oil-Out.



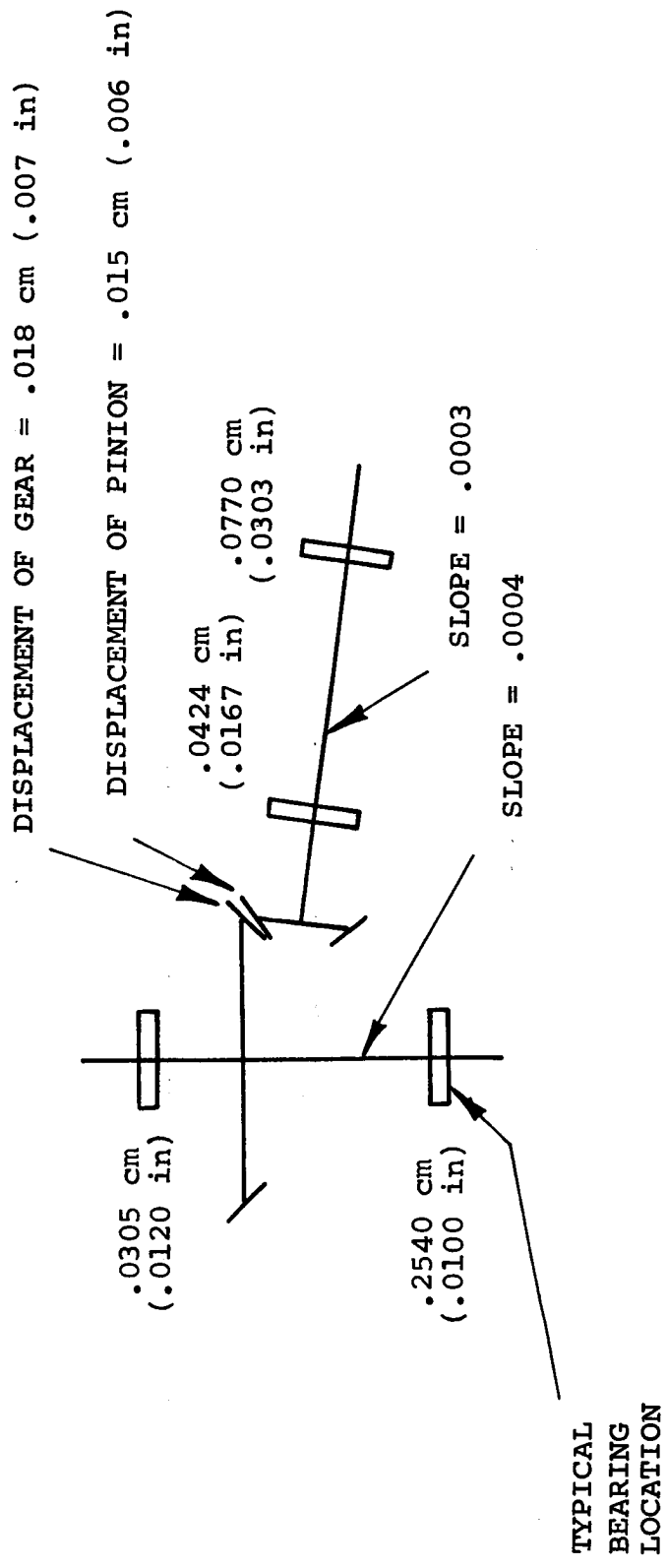

Figure 12. Displacement of Internal Components Due to Thermal Loads - Thermal Map Data 85°C (185°F).

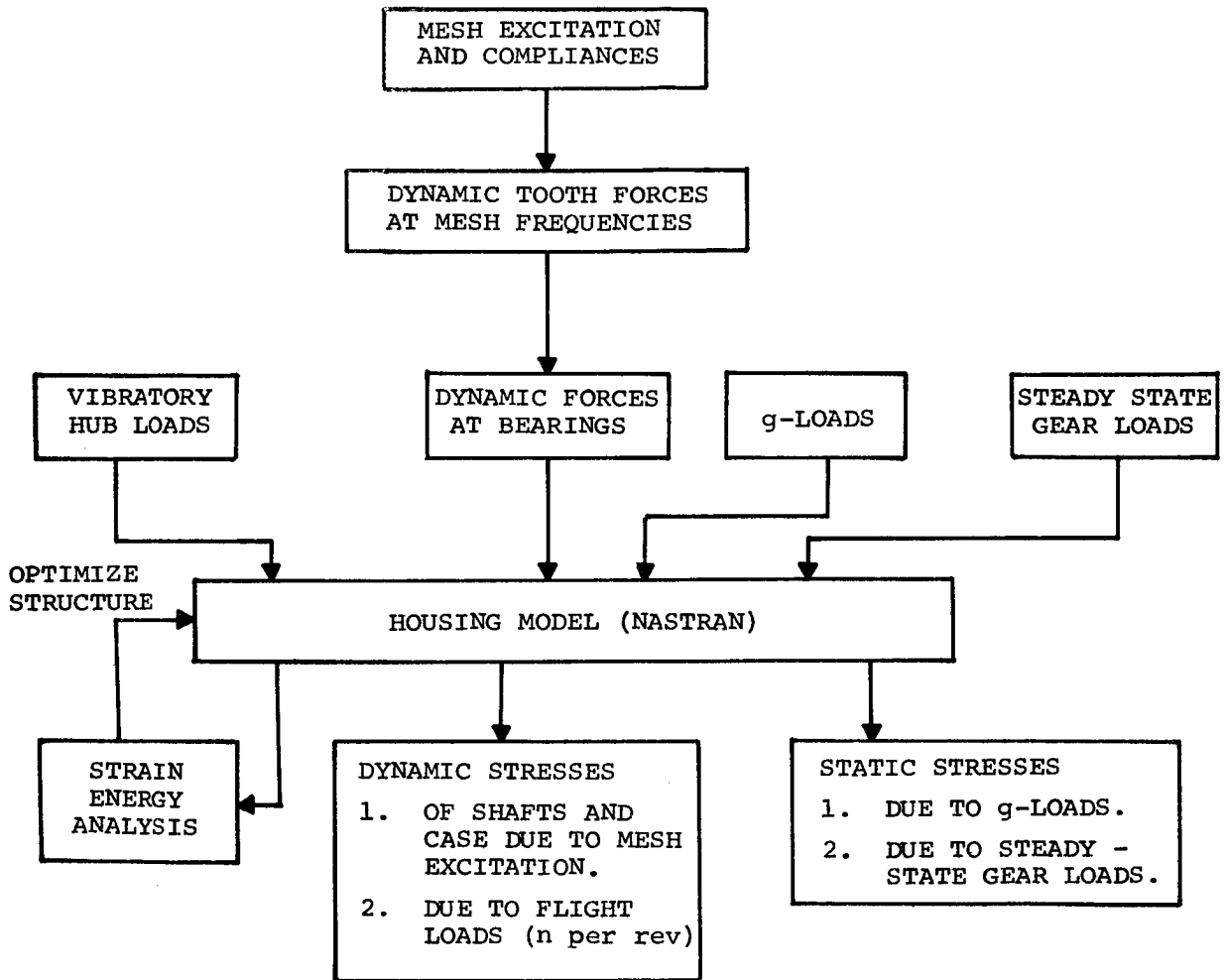
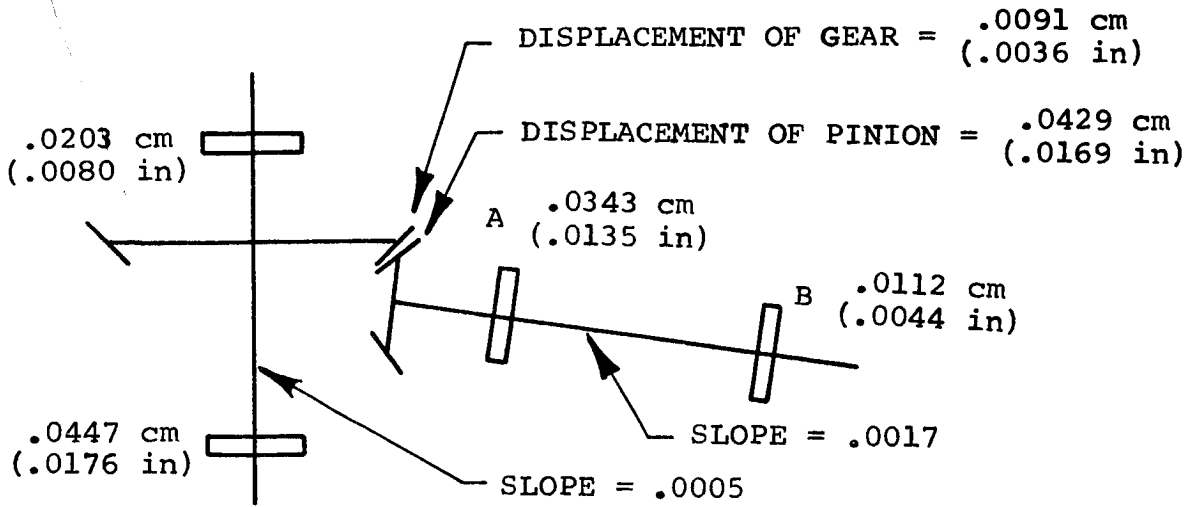

Figure 13. Flow Diagram of NASTRAN Stress Analysis.

MAGNESIUM CASE (Figure 14a)



STEEL CASE (Figure 14b)

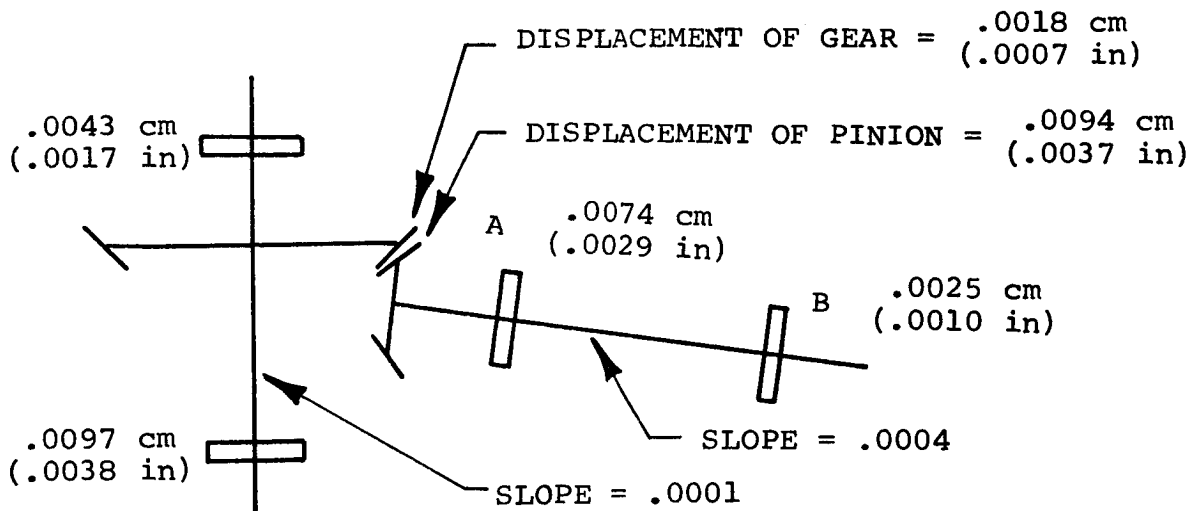

Figure 14. Displacement of Internal Components Due to Ultimate Load Condition.