

NASA Contractor Report 2922

NASA
CR
2922
pt. 2
c. 1

LOAN COPY: RETURN
AFWL TECHNICAL LIBRARY
KIRTLAND AFB, NM



TECH LIBRARY KAFB, NM

Feasibility Study
of Modern Airships,
Phase II - Executive Summary

CONTRACT NAS2-8643
NOVEMBER 1977

NASA



NASA Contractor Report 2922

Feasibility Study of Modern Airships, Phase II - Executive Summary

Goodyear Aerospace Corporation
Akron, Ohio

Prepared for
Ames Research Center
under Contract NAS2-8643

NASA

National Aeronautics
and Space Administration

**Scientific and Technical
Information Office**

1977



FOREWORD

Goodyear Aerospace Corporation (GAC) under a jointly sponsored NASA/Navy Contract (NAS2-8643) has conducted a two-phase Feasibility Study of Modern Airships. References 1 through 6 summarize the details of the contractual effort. This document is an overview of the entire study with emphasis upon the Phase II Study results.

Ralph Huston was the GAC Program Manager of the Feasibility Study. Gerald Faurote was the Project Engineer for the Phase II Heavy Lift Airship investigation and Jon Lancaster was the Project Engineer for the Airport Feeder and Navy application studies.

Dr. Mark Ardema, the NASA Project Monitor, provided valuable technical guidance and direction to the entire study effort, as did the LTA Project Office of the Naval Air Development Center.

The contractor wishes to acknowledge that NASA Ames Research Center (ARC) provided the use of the ARC 7 x 10-foot Wind Tunnel Facility for the purpose of an exploratory evaluation of the Phase II Heavy Lift Airship.

Subcontractors and other industry contributors supporting the Goodyear Study included:

Neilsen Engineering and Research, Inc.
Battelle Columbus Laboratories
Piasecki Aircraft Corporation
Sikorsky Aircraft Corporation
General Electric Company
Radio Corporation of America
Summit Research Corporation
Northrop Research & Technology Center



TABLE OF CONTENTS

	<u>PAGE</u>
FOREWORD.	i
LIST OF FIGURES	v
LIST OF TABLES.	vi
LIST OF ACRONYMS.	vii
<hr/>	
SUMMARY	1
INTRODUCTION.	1
PHASE I OVERVIEW.	3
HEAVY LIFT AIRSHIP STUDY RESULTS.	7
Summary	7
Description of HLA and Related Performance.	13
Design Analysis	14
Aerodynamics	14
Flight Dynamics.	16
Flight Control System.	18
Structural Analysis and Materials.	20
Economic Analysis	22
Operational Analysis.	24
Technology Assessment Analysis.	25
Conclusions and Recommendations	27
AIRPORT FEEDER STUDY RESULTS.	28
Summary	28
Vehicle Design Definition	30
Operational Procedures Analysis	35
Cost Analysis and Comparison with Alternative Modes	36
Mission/Vehicle Feasibility and Technology Assessment	39
NAVY MISSION STUDY RESULTS.	41
Mission Description	41
Generalized Parametric Analysis Results	42
Mission Specific Results.	48
Trail Mission.	48
SOSUS Augmentation Mission.	48
ASW Barrier Mission.	51
Convoy Escort Mission.	51

TABLE OF CONTENTS

	<u>PAGE</u>
Overall Mission/Vehicle Conclusions.	52
Operational Considerations	53
Ground Handling	53
Weather	53
Wind.	54
Vulnerability	55
Conclusions.	56
REFERENCES	57

LIST OF FIGURES

FIGURE NO.	TITLE	PAGE
1.	Feasibility Study of Modern Airships.	2
2.	Phase I: General Approach and Overview.	4
3.	Structural Efficiency of Modern and Historical Neutrally-Buoyant Rigid Airships.	4
4.	Basic Methods of Analysis (GASP Computer Program)	6
5.	Specific Productivity of Fully Buoyant Airships .	6
6.	Phase II Heavy Lift Airship Concept	9
7.	Military Payloads Beyond Helicopter Lift Capability.	10
8.	Phase II General Arrangement and Selected Performance Characteristics ¹	13
9.	Powered Model in ARC 7 x 10-Foot Wind Tunnel Facility in Presence of Ground Plane.	15
10.	Phase II HLA Response to Lateral Gust	17
11.	HLA Fly-By-Wire Control System Block Diagram. . .	19
12.	Major Structural Components of HLA.	20
13.	Frame Analysis Procedure.	21
14.	Comparison of S64F and HLA Total Operating Cost Per Payload Ton Mile at Design Range of HLA	23
15.	Final Phase II Baseline Airport Feeder Configuration	29
16.	Airport Feeder Concept of Operations.	30
17.	Two-Segmented Payload Module Cabin Layout (6 Abreast Seating)	32
18.	Buoyancy Ratio Trends for Maximum Productivity Phase I and Phase II Study.	34
19.	Comparison of Representative Vehicle Concepts . .	44
20.	Structural Efficiency Comparison.	45
21.	11 MCF Rigid Design Characteristics	46
22.	Hover Capable Non-Rigid Airship	47

LIST OF FIGURES

(Continued)

<u>FIGURE NO.</u>	<u>TITLE</u>	<u>PAGE</u>
23.	Trail Mission Parametric Performance Results (Neutrally Buoyant Rigid).	49
24.	Trail Mission Parametric Performance Results (Construction Concepts).	49
25.	TOS Versus ROA for 11 MCF Rigid Airship.	50

LIST OF TABLES

<u>TABLE NO.</u>	<u>TITLE</u>	<u>PAGE</u>
I	BASELINE CONFIGURATION WEIGHT SUMMARY.	33
II	BASELINE DOC/ASSM COST BREAKDOWN	37
III	SUMMARY OF DOC SENSITIVITY ANALYSIS RESULTS.	38
IV	REQUIRED R&D AREAS	40

LIST OF ACRONYMS

A/F	Airport Feeder
AFCS	Automatic Flight Control System
APU	Auxilliary Power Unit
ARC	Ames Research Center
ASL	Average Stage Length
ASSM	Available Seat Statute Mile
ASW	Anti Submarine Warfare
	Static Lift/Gross Weight
CER	Cost Estimating Relationship
CTOL	Conventional Take Off and Landing
DOC	Direct Operating Cost
DOF	Degree of Freedom
EW	Empty Weight
FAA	Federal Aviation Administration
FBW	Fly By Wire
FRV	Flight Research Vehicle
GAC	Goodyear Aerospace Corporation
GASP	Goodyear Airship Synthesis Program
GW	Gross Weight
HLA	Heavy Lift Airship
LERTA	Lake Erie Regional Transportation Authority
MCF	Million Cubic Feet
MCM	Million Cubic Meter
NADC	Naval Air Development Center
nm	Nautical Mile
PAX	Passenger
PHS	Precision Hover Sensor
pNdB	Perceived Noise Decibels
PV/E	Specific Productivity, Payload Times Velocity over Empty Weight
R	Range
RABH	Revenue Aircraft Block Hours
RDT&E	Research, Development, Test and Evaluation

LIST OF ACRONYMS (Continued)

ROA	Radius of Action
RPV	Remotely Piloted Vehicle
SOSUS	Sound Surveillance System
STU	Steward(ess)
SURTASS	Surveillance TASS
TAA	Technology Assessment Analysis
TASS	Towed Array Sonar System
TOC	Total Operating Cost
TOS	Time on Station
UL	Useful Load
V_c	Cruise Velocity
VTOL	Vertical Takeoff and Landing
WER	Weight Estimating Relationship

SUMMARY

A feasibility study of modern airships has been completed. In the second half of this study, summarized herein, three promising modern airship system concepts and their associated missions were studied: (1) a heavy-lift airship, employing a non-rigid hull and a significant amount of rotor lift, used for short-range transport and positioning of heavy military and civil payloads; (2) a VTOL (vertical take-off and landing), metalclad, partially buoyant airship used as a short-haul commercial transport; and (3) a class of fully-buoyant airships used for long-endurance Navy missions. The heavy-lift airship concept offers a substantial increase in vertical lift capability over existing systems and is projected to have lower total operating costs per ton-mile. The VTOL airship transport concept appears to be economically competitive with other VTOL aircraft concepts but can attain significantly lower noise levels. The fully-buoyant airship concept can provide an airborne platform with long endurance that satisfies many Navy mission requirements.

INTRODUCTION

In the fall of 1974, Goodyear Aerospace Corporation (GAC) was awarded one of two identical contracts by NASA Ames Research Center to study the feasibility of modern airships under certain ground rules. Figure 1 summarizes the tasks that were to be accomplished in this two-phase study. At the end of the four-month Phase I, promising concepts were identified on the basis of competitive mission value (The Goodyear Phase I results are detailed in Reference 1).

Phase II, performed solely by Goodyear, focused on the design features of the selected concepts, with lesser attention paid to cost and operational factors. This summary report concentrates on the results of Phase II

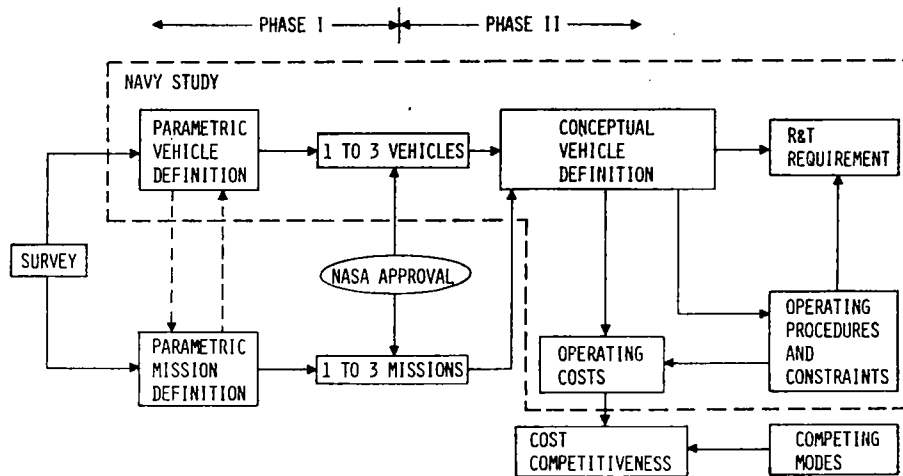

Figure 1. Feasibility Study of Modern Airships

of the study as reported in References 2, 3, 4, 5, and 6. An abbreviated summary was given in Reference 7. Of necessity, only the highlights of the study are given herein, and the reader is referred to the above references for details.

Whereas Phase I was limited to civil applications, the Phase II effort was broadened to include missions of potential military worth for the Navy.

For the NASA portion of Phase II, two concepts were selected and analyzed: (1) a 75-ton-payload, heavy-lift vehicle consisting of an aerostat and four CH-54 helicopters, and (2) an 80-passenger/cargo VTOL transport approximately the same length as a Goodyear advertising airship but with double the envelope volume.

The Navy portion of the study focused on the application of fully-buoyant airships to long-endurance Navy missions. As contrasted with the NASA portion of Phase II, the Navy study included parametric analysis and excluded cost competitive analysis.

PHASE I OVERVIEW

Before discussing the Phase II results, Phase I will be briefly summarized. As mentioned previously, Phase I results are detailed in Reference 1; a more complete summary, including both Phase I studies, may be found in Reference 8. Figure 2 depicts the evolution of Phase I of the Feasibility Study and the interactions among the four major tasks.

The first task was to conduct a brief historical overview of the airship vehicles and operations. Included were summaries of major missions, markets, vehicle performance and technical features, acquisition and operating costs, operating procedures, other system elements, and key subsystem characteristics. The goal was not to obtain a comprehensive catalog of data on past airships but to concentrate on data relevant for modern airship designs. Also, part of this task was a comparison between the technical and economic states of the art in 1930 and 1974 for the purpose of assessing the impact of modern technology. An example of the information developed in Task 1 is shown in Figure 3, which depicts the type of improvement on structural efficiencies that new materials and propulsion technology can provide.

In Task 2, a survey was conducted to identify potential missions for airship applications. Emphasis was on civil transportation missions although other types of missions were also considered. Included were unique LTA applications as well as conventional missions currently performed by other transportation modes. Because the operating characteristics and economics of most of the potential modern airship concepts had not been established and because of the broad scope of the study, the mission analysis was necessarily of a primarily qualitative nature.

The vehicle parametric analysis was regarded as the most important task in Phase I of the Feasibility Study. In this third task, the entire spectrum of airship concepts, encompassing both conventional airships and hybrids, was examined. Emphasis was placed on conventional, ellipsoidal-shaped concepts and a modified delta planform lifting-body hybrid. Vehicles

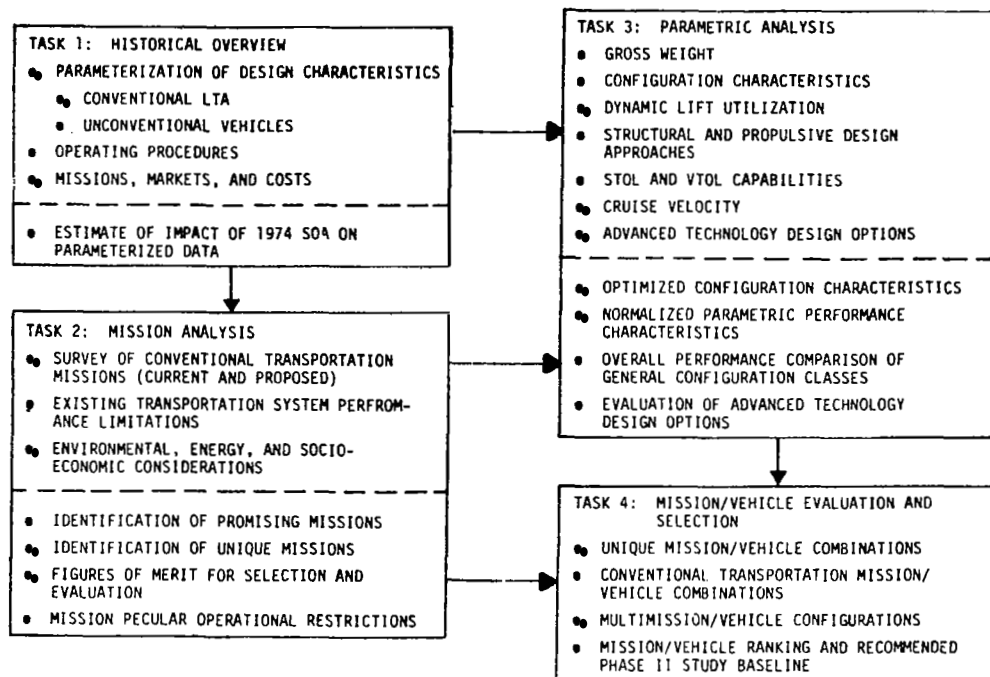

Figure 2. Phase I: General Approach and Overview

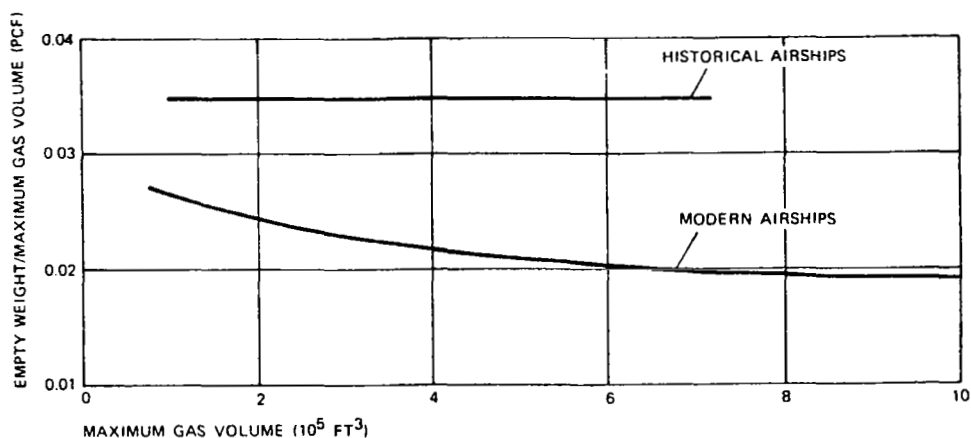

Figure 3. Structural Efficiency of Modern and Historical Neutrally-Buoyant Rigid Airships

with gross lifting capabilities ranging from 3000 lbs to 6,000,000 lbs were investigated. The parametric studies included the effects of important design factors such as vehicle geometry, ratio of buoyant lift-to-total lift, and cruise speed. Since the emphasis of Phase I was on transportation missions, the principal figures of merit were productivity, defined as either payload or useful load times cruise speed, and specific productivity, defined as productivity divided by empty weight. (Since the heavy-lift airship concept is not meant for productivity missions, it was treated separately.)

A key part of Task 3 was the development and use of a vehicle synthesis (integrated conceptual design) computer program. The program is called the Goodyear Airship Synthesis Program (GASP) and Figure 4 shows its functional capability. This program computes mission performance for a specified vehicle concept, shape, and mission definition and can be used to conduct parametric studies of a wide variety of both conventional and hybrid airships. Although many of the subprograms in GASP were derived from airship analysis capability which has evolved over many years, a significant amount of effort was required to develop weight estimating relationships for hybrid airships since these represent a new class of vehicle.

As an example of the parametric results which were obtained for conventional airships, effects of type of construction and size are shown in Figure 5. The dashed lines for the non-rigid concepts at the higher gross weights indicate a requirement for improved seaming technology in this region. This figure shows that non-rigids tend to be favored for small sizes, metalclads for mid-sizes, and rigids for large sizes but that there is generally not a great deal of difference between the concepts. In fact, all concepts had a structural weight-to-gross-weight ratio of about 0.4 over a wide range of gross weights. Figure 5 also shows that if Kevlar is developed as an envelope material for a non-rigid, then the non-rigid is the superior concept for almost all sizes.

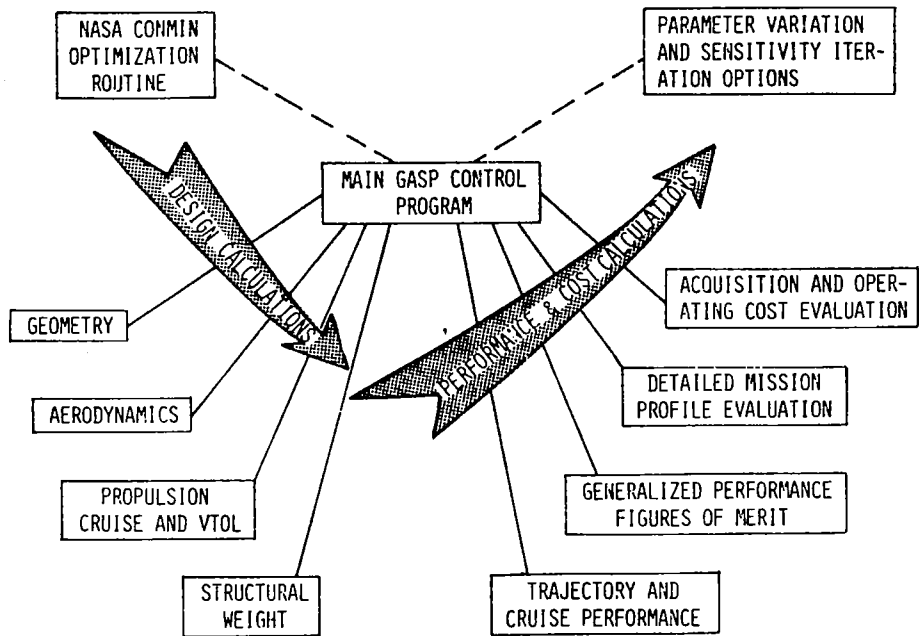

Figure 4. Basic Methods of Analysis (GASP Computer Program)

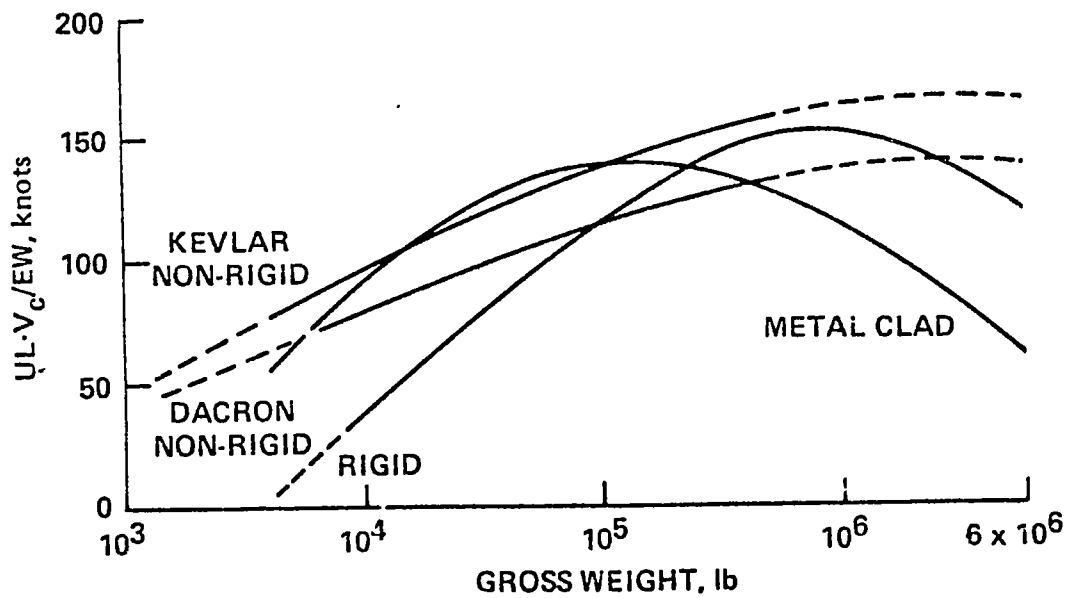

Figure 5. Specific Productivity of Fully Buoyant Airships

After a preliminary screening, one hybrid concept was selected for parametric evaluation for productivity missions. This was a lifting body shape which had a parabolic planform with elliptical cross sections; it was chosen because of structural weight considerations and the proximity of the centers of buoyancy and pressure. The parametric analysis focused on determining the values of aspect ratio, thickness-to-chord ratio, and cruise speed which maximized productivity at various values of gross weight (GW), buoyant-to-total lift ratio (β), and range (R). The results showed that at almost all values of GW and R, the best productivity was obtained as β tended to zero, i.e., a vehicle with no buoyant lift (an airplane) is optimum. The lifting body hybrid concept was compared with the conventional rigid airship at various values of GW, β , and R. Except for very large values of GW, the conventional rigid consistently had a higher productivity than the hybrid.

The final task in Phase I was to select promising vehicle/mission combinations for further study in Phase II. Based on results from the other tasks, the heavy-lift and VTOL transport concepts appeared to be the most promising and were selected, with NASA approval, for more detailed study in Phase II.

HEAVY LIFT AIRSHIP STUDY RESULTS¹

Summary

A major deficiency in current air transportation systems is the short haul of heavy and very heavy outsized cargo and this was identified during Goodyear's Phase I Study as a mission uniquely suited to modern airship vehicles. The military need for a heavy vertical lift capability is well documented² and the civil need, while equally apparent, is in the process of being more completely characterized and documented in a forthcoming NASA Study. The primary military requirement is the off-loading of cargo³

¹ References 2, 3, and 4 provide comprehensive results relative to the Phase II Heavy Lift Airship Study

² Navy Operational Requirement Number W1019-SL

³ Primarily Containerized Cargo

from ships in areas lacking deep water port facilities while the civil needs are centered in the power generating, petroleum, construction, logging, and heavy equipment industries. There also appears to be a considerable foreign civil market in the off-loading of cargo from ships in developing nations lacking deep water ports. Currently, military air-borne heavy lift scenarios consider aggregate loads requiring payload capacities up to 140 tons while potential civil applications could involve several hundred tons. Range requirements vary from a few hundred yards in some construction industry applications with a range capability of several hundred miles of interest in the movement of mining equipment to remote sites.

Various heavy lift concepts combining buoyant and rotor lift have been proposed in recent years for performing the emerging heavy lift short haul missions. The Heavy Lift Airship (HLA) evaluated during Phase II is a concept first proposed by Piasecki Aircraft Corporation (Reference 9) which combines buoyant lift derived from a conventional helium-filled airship hull with propulsive lift derived from conventional helicopter rotors. The buoyant lift essentially offsets the empty weight of the vehicle; thus the rotor thrust is available for lifting the useful load and to maneuver and control the vehicle. The ability to offset the entire empty weight of the vehicle with buoyancy permits a quantum increase in current and projected helicopter lifting capabilities plus potentially a substantial reduction in current vertical lift costs.

The concept also eliminates the significant historical airship deficiency of interchanging ballast and payload. In addition, the concept promises to significantly improve the low speed control and hovering qualities of prior airships while also leading to improved ground handling characteristics. The classical helicopter problems of high fuel consumption and airframe weight are implicitly minimized in the concept. Further, significantly improved maintainability and reliability characteristics appear to be available if dedicated propulsion systems (rotor/turbine/transmission modules) are developed, making the use of existing helicopters unnecessary. The HLA concept is relatively immune to scale effects and

prior analyses (References 1 and 10) have shown that payloads up to several hundred tons can be transported several hundred miles.

The specific HLA configuration studied in Phase II combines four CH-54B helicopters, by means of an interconnecting structure, to a two and one-half million cubic foot non-rigid airship hull fabricated of present-day proven airship materials (Figure 6). This HLA has a payload capacity of

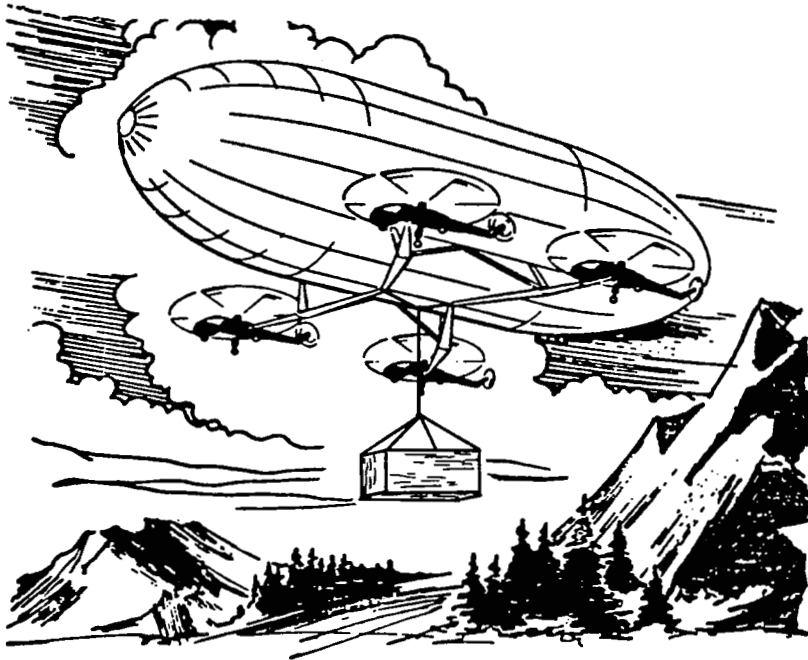

Figure 6. Phase II Heavy Lift Airship Concept¹

68,040 Kg (75 tons) and a non-refueled range of 1.852×10^5 m (100 nautical miles). Without the buoyancy, the collective payload capability of the four helicopters at the same range would be on the order of 50% of that of the HLA. Figure 7 illustrates the many military payloads which can be lifted by the HLA but which cannot be lifted by existing helicopters.

The HLA is controlled from the aft left helicopter by a command pilot using Fly-By-Wire (FBW) techniques. Automatic flight control and

¹ The range capability of an operational HLA configuration using dedicated propulsion systems reflective of current technology will be substantially greater than the Phase II configuration (Reference 10).

Figure 7. Military Payloads Beyond Helicopter Lift Capability

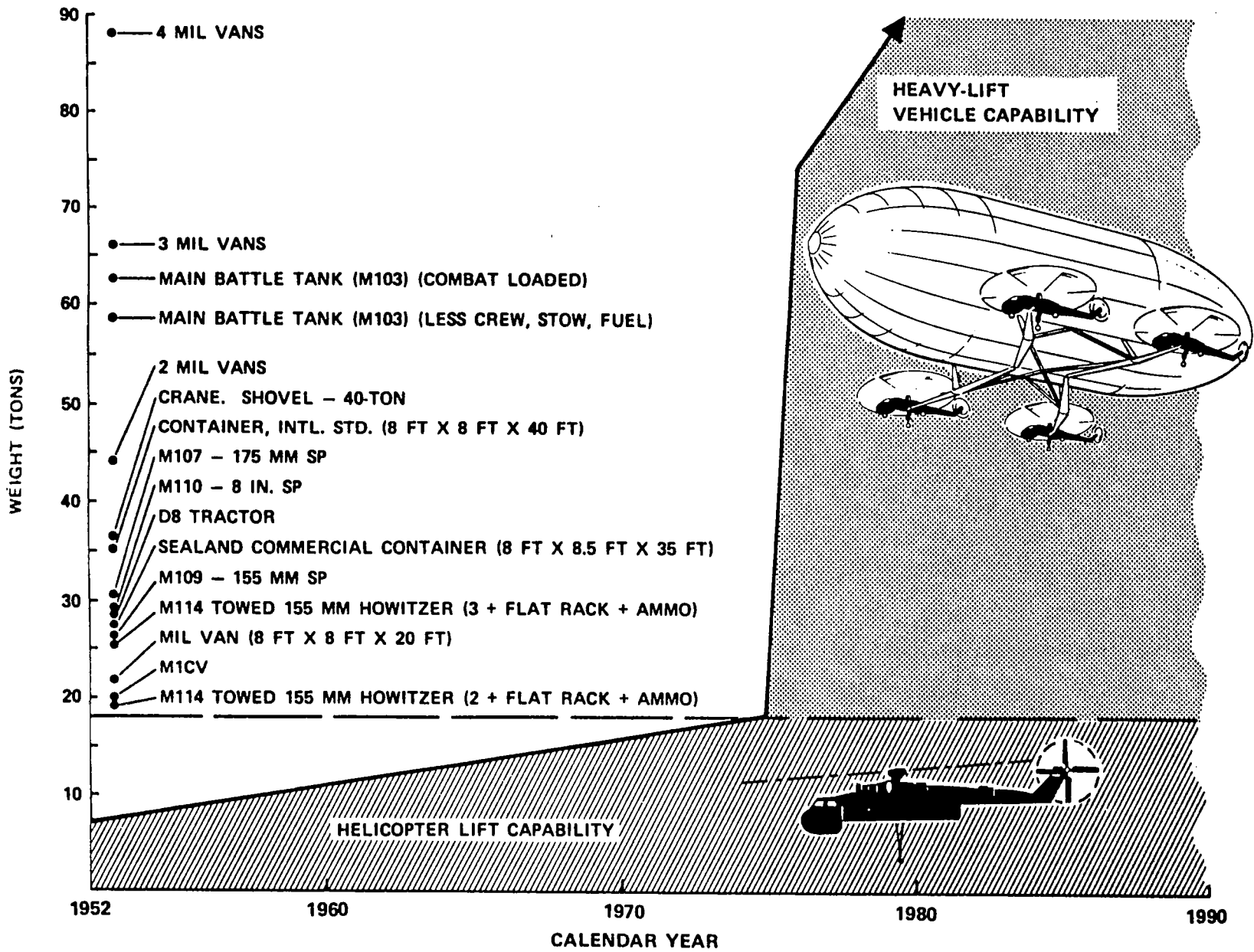

NOTE: 1.0 ton = 907.2 kg

hover modes, with the hover capability enhanced by a Precision Hover Sensor (PHS), would be provided in addition to the manual flight modes. The Automatic Flight Control System (AFCS), PHS and FBW electronics required for the HLA involve principles, techniques, and hardware developed and demonstrated during the U. S. Army Heavy Lift Helicopter Program and a NASA-Langley Program during which Sikorsky Aircraft modified a CH-54B helicopter to obtain a FBW capability.

The configuration investigated during Phase II retains the entire helicopter with a minimum of modification because of the economy involved in using existing hardware assets for an initial flight research vehicle. A significant benefit of the coming NASA Study of the civil heavy lift market will be a market size definition such that a determination can be made as to whether a sufficient quantity of heavy lift vehicles is needed over which the development costs of a dedicated propulsion system can be cost effectively amortized. This dedicated propulsion system would be used on the operational version of the HLA along with a central control car for the flight crew.

The major areas of investigation during the Phase II HLA Study included: (1) a point design analysis (aerodynamics, flight dynamics, controls, structures, and weights); (2) an economic analysis; (3) an operational analysis; and (4) a technology assessment analysis.

A corporately funded powered wind tunnel model of the HLA was evaluated during Phase II in the NASA Ames 7 x 10-foot wind tunnel facility. The results of these tests indicate the aerodynamic feasibility of combining large rotors in close proximity to a large hull. These tests have also shown that the cross-wind station keeping capability of the vehicle can be improved by modifications, such as changing rotor locations, to the current HLA configuration.

As an additional area of corporate support, a Six Degree-of-Freedom (6 DOF) hybrid computer flight dynamics simulation was developed to assess the flight dynamics and precision hover mode accuracy of the HLA

and to assist in the synthesis of the fly-by-wire control laws and auto-pilot system. Based upon the wind tunnel and flight dynamics simulation efforts it appears that the HLA has sufficient controllability to perform the military and civil missions for which it is being considered over an acceptable range of atmospheric conditions.

During Phase II, various structural arrangements and material trade studies were performed in order to minimize structural weight, while maintaining acceptable acquisition costs. A reasonably detailed point design analysis was performed on the arrangement finally selected and as a result the empty weight estimates for the vehicle are believed to be reasonably accurate.

The Phase II economic analysis indicates the Total Operating Costs (TOC) of the HLA on a payload ton-mile basis to be substantially reduced over current large helicopter vertical lift costs basically due to the economic leverage afforded by the buoyant lift. Given proper technology programs in the areas of low maintenance rotor concepts and the inclusion of current turbine technology, the TOC for the HLA should be more favorable than estimated herein.

The technology assessment of the HLA indicates that there appears to be no major unresolvable technology problems and thus the concept is basically feasible. However, additional data and analysis capability is needed in several technical areas before an operational HLA could be designed with low risk and high efficiency. As part of Phase II, a technology development program to supply this information has been outlined.

A logical step towards development of an operational vehicle is a flight research vehicle (FRV) program. This would give research capabilities not obtainable in ground based facilities and would serve to verify feasibility of the concept. The FRV would make maximum use of existing components to minimize program costs.

Description of HLA and Related Performance

Figure 8 presents the Phase II HLA general arrangement and selected performance characteristics of interest. The design gross weight¹ is 147,365 kg (324,950 lbs) of which 65,375 kg (144,150 lbs) is buoyant lift and 81,993 kg (180,800 lbs) is rotor lift. The four helicopters are capable of providing this amount of lift with one engine out and adequate reserve for a 30.48 m/min (100 ft/min) climb. There are on the order of fifteen airship hangars remaining in this country that can accommodate two such vehicles.

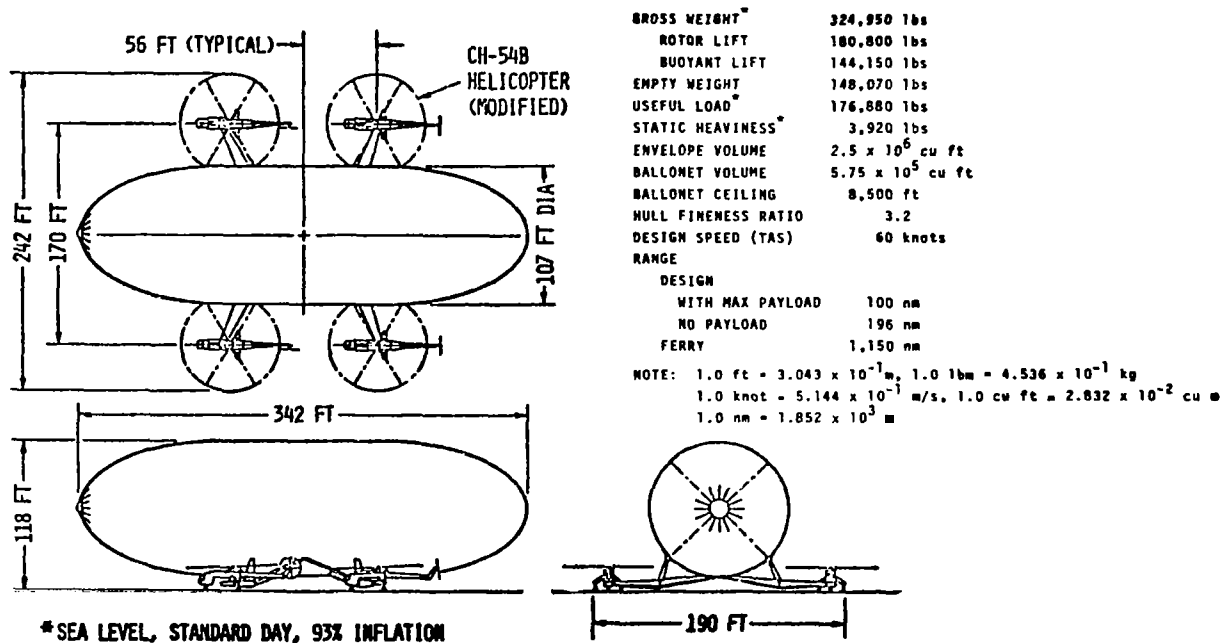

Figure 8. Phase II General Arrangement and Selected Performance Characteristics²

¹ At sea level, standard day, 93% inflation.

² The range capability of an operational HLA configuration using dedicated propulsion systems reflective of current technology will be substantially greater than the Phase II configuration (Reference 10).

The buoyant portion of the lift is obtained from a two and one-half million cubic foot non-rigid hull fabricated from present day proven airship fabrics. Basic fabric and seam strengths required are only slightly greater than the maximum of the largest non-rigid ever built, the ZPG-3W built by Goodyear for the U. S. Navy in the late 1950's. The lifting gas is helium.

The twin-engine helicopters are attached to the buoyant hull by means of the interconnecting structure much of which is "submerged" within the envelope to reduce aerodynamic drag and overall vehicle height. The four Sikorsky CH-54B helicopters have been adapted to the interconnecting structure by means of a gimbal device. The tail rotors of the aft helicopters are replaced with propellers and reoriented to provide sufficient propulsive force for forward flight and directional control at or near minimum gross weight. The tail rotors of the forward helicopters are unaltered and used to provide side force for increasing the cross-wind station keeping ability.

The FBW control system combines the normal pilot control modes with the needed automatic flight control and hover modes. The control system technology is similar to that demonstrated in the Heavy Lift Helicopter Program during which a prototype FBW control system was successfully flown on the tandem rotor CH-47 helicopter with over 300 hours of flight time accumulated.

The Phase II configuration permits center point mooring to be considered which minimizes mooring area and mooring mast requirements. Additional wind tunnel data are required to permit a final assessment as to whether the concept can accommodate all mooring requirements of operational interest.

Design Analysis

Aerodynamics

One factor leading to Goodyear's Phase I recommendation of this HLA concept was the judgment that it possessed far fewer aerodynamic uncertainties

than the other heavy lift concepts combining buoyant and rotor lift. One uncertainty that existed was the extent of aerodynamic interference between the large rotors and the large hull. As a result of this uncertainty, a joint Goodyear/NASA sponsored exploratory wind tunnel investigation of the concept was undertaken in the NASA Ames 7 x 10-foot wind tunnel facility.

The model, shown in Figure 9, is 1.22 m (4 ft) long and 0.41 m (16 inches) in diameter. Rotor location, thrust magnitude and inclination (in roll) along with the model angle of sideslip and height above the ground plane can be varied. The model employs six component balances in each outrigger and a six-component main balance in the model hull.

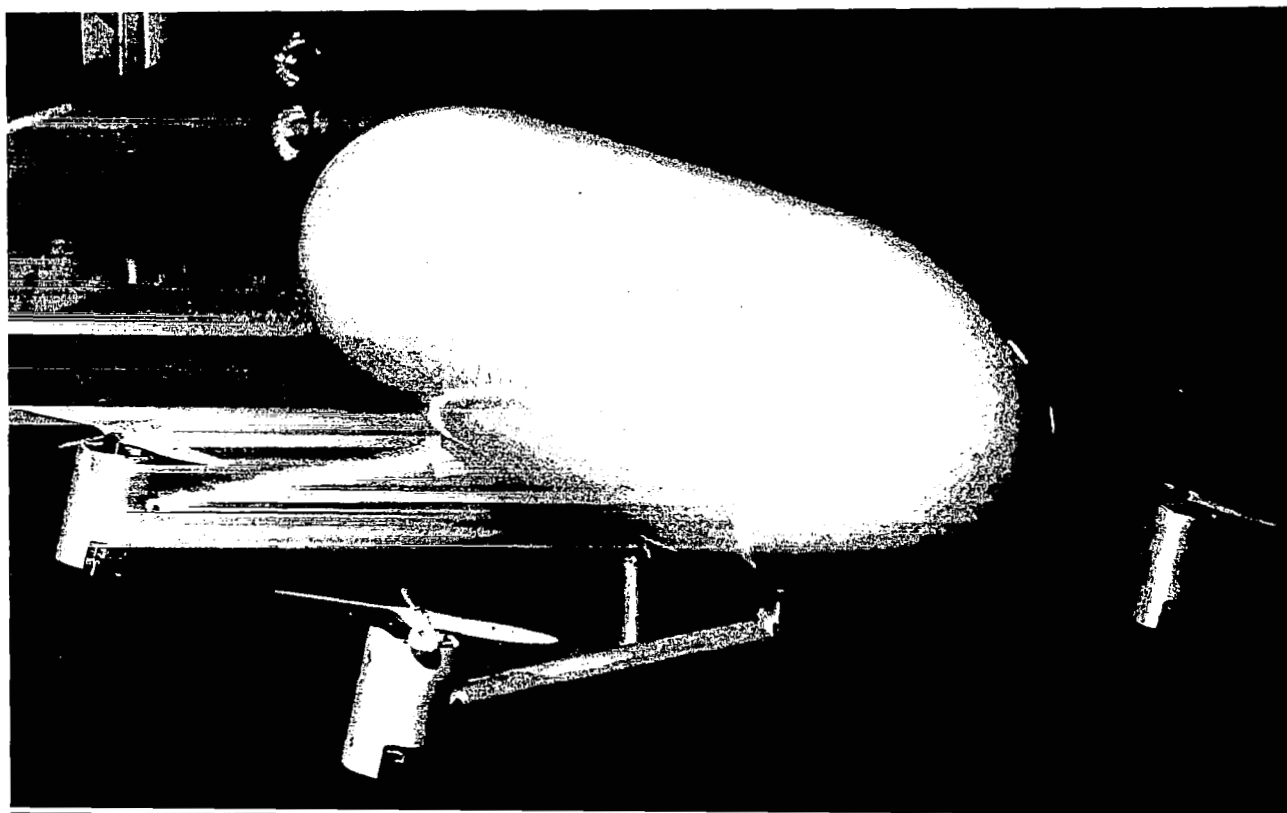

Figure 9. Powered Model in ARC 7 x 10-Foot Wind Tunnel Facility in Presence of Ground Plane

The following represent the most significant conclusions from the wind tunnel testing: (1) no appreciable interference effects in forward flight were observed; (2) no appreciable interference effects were observed for angles of sideslip less than 60 degrees (at zero degrees angle of attack); (3) rotor-rotor interference was negligible and the effect of the hull on the rotors was small; and (4) a considerable increase in crossflow drag of the hull occurs as a result of the operation of all four motors. This last adverse interference effect is a strong function of rotor placement with the effect decreasing as the rotors are moved outboard. Fore and aft displacement of the rotors resulted in no appreciable change in the observed interference effects. The test results also indicate that in a crossflow the modification of the flow field around the hull by the operation of the rotors may be a usable phenomenon in controlling the vehicle. More testing, however, is necessary to confirm this.

Reference 5 provides a comprehensive summary of the model and instrumentation characteristics and test program results.

Flight Dynamics

A preliminary 6 DOF simulation has been developed using the Goodyear hybrid computer facility to assess the flight dynamics characteristics of the HLA. Specific uses of the simulation include: (1) synthesis of overall control system requirements; (2) synthesis of the fly-by-wire control laws and autopilot characteristics; and (3) verification that the control laws developed for interface with the AFCS and PHS modes are compatible with manual modes.

The elements involved in the simulation and their respective location in the hybrid setup are as follows. The HLA gust model, control laws and autopilots are programmed on the EAI 7800 analog computer. The analog computer is linked, through an EAI 8831 hybrid interface system to a Xerox Sigma 9 digital computer which contains the equations of motion, airship and helicopter non-linear aerodynamics, and the cross wind hover interference model developed from the wind tunnel test results. Although the simulation has proved useful in its present form, many of its elements will have to be improved and expanded for use in more detailed design studies.

In Phase II the HLA simulation was "flown" with autopilot control in the cruise and hover modes. In addition, the HLA simulation can be flown manually by stick inputs to the analog computer. The simulation operates in real time to provide realistic flight responses for flight inputs. All results are displayed as an output of the analog computer on an oscillograph or on a cathode ray tube.

A preliminary assessment of the precision hover and directional stability characteristics of the HLA were obtained using the flight dynamics simulation. Figure 10 presents typical simulation results indicating the vehicle response to a lateral gust.

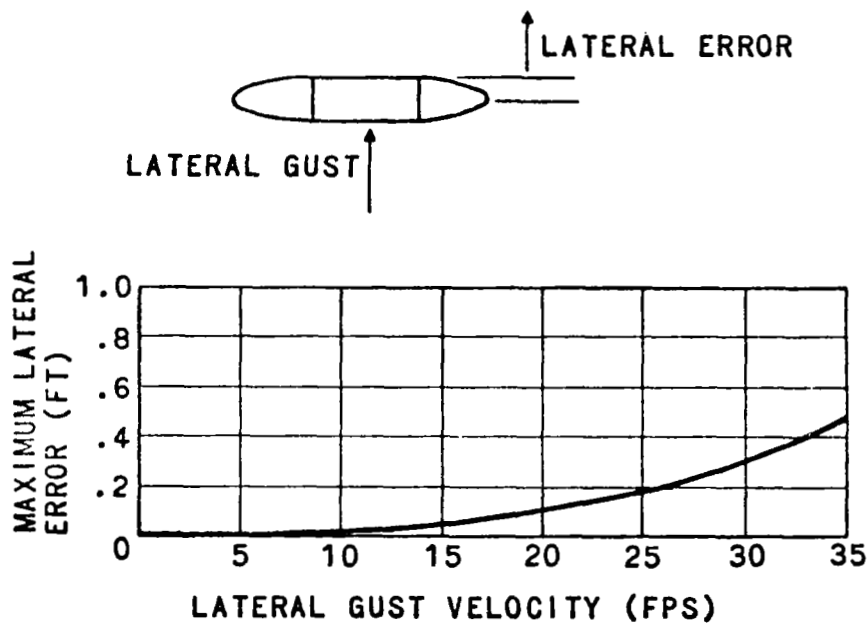

Figure 10. Phase II HLA Response to Lateral Gust

The simulation studies to-date indicate that the hover and directional stability characteristics of the HLA are adequate for operations over a significant range of expected atmospheric conditions.

Flight Control System

The preliminary flight dynamics simulation studies have shown that the available rotor forces can be appropriately combined to control the vehicle in both flight and hover modes. This active control system approach eliminates a severe deficiency of past airships (i.e., lack of low speed control) since airspeed is not required for the HLA to develop maximum control forces. As stated earlier, the HLA control system would use FBW control system techniques and hardware similar to those developed and flight tested on a tandem rotor CH-47 helicopter program during the HLH program. Automatic modes are provided including automatic hover employing a precision hover sensor.

The HLA is flown using standard helicopter controls. The aft left helicopter serves as the command station in which a command and safety pilot are located. The command pilot's conventional mechanical controls are replaced with electric cyclic and collective sticks as well as electric pedals which generate the commands to the analog FBW flight control system. The remaining helicopters are slaved to the command helicopter through the FBW commands as indicated in the simplified block diagram of Figure 11. Safety pilots could be used in the slave helicopters with the conventional mechanical helicopter controls available if needed.

The HLA fly-by-wire primary flight control system is a dual redundant system from the command pilot's commands to the input commands to each helicopter autopilot. The helicopter autopilot, also a dual redundant electronic system, flies the helicopter on the gimbal through the electro-mechanical AFCS servo.

Implementation of the control laws in dual paths for redundancy is consistent with the CH-54B AFCS concept which has a redundant electrical channel such that either or both can be used. The HLA therefore has three modes of operation for safety-of-flight: (1) active path fly-by-wire; (2) redundant path fly-by-wire; and (3) a safety pilot using a manual flight control system.*

* It is envisioned that an operational configuration would use a central control car much like prior airships thus safety pilots would not be required and a triple redundant system similar to the HLH would be implemented.

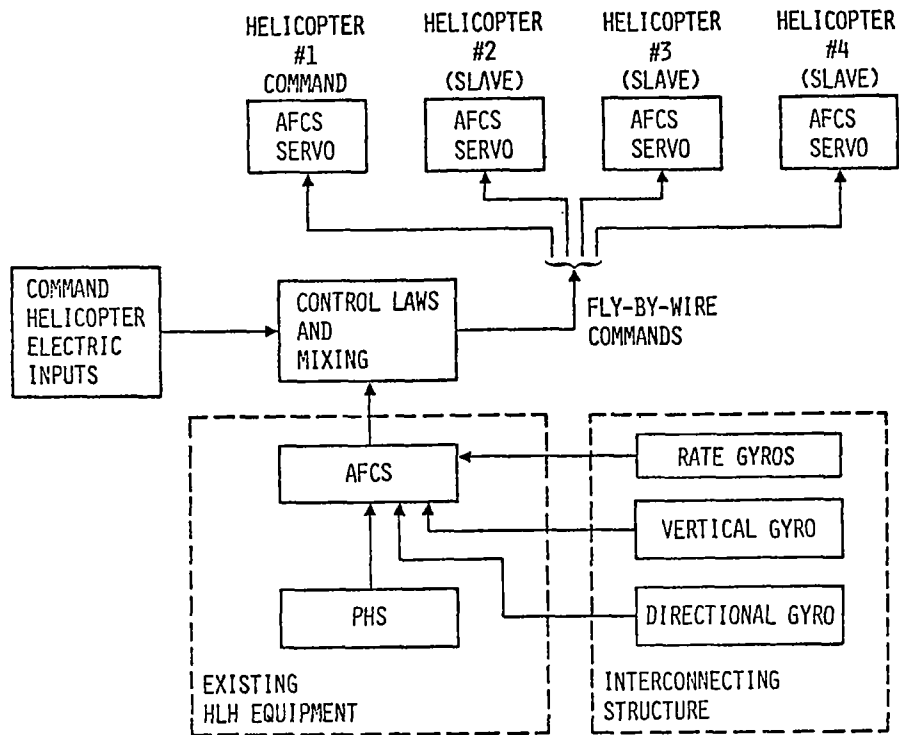

Figure 11. HLA Fly-By-Wire Control System Block Diagram

The CH-54B helicopter is ideally suited to conversion to fly-by-wire control with safety pilot override because of the AFCS servo. In fact, a similar conversion has been achieved by Sikorsky for NASA Langley for variable stability test purposes. In that conversion the test pilot's cyclic stick was disconnected mechanically from the co-pilot stick and electrical transducers with a stick feel system were added. The co-pilot (safety pilot) had the ability to override the test pilot at any time with mechanical stick positions taking command of the helicopter if required.

An autopilot is required on the HLA for the precision hover mode and pitch attitude hold. The precision hover mode uses a position sensor that commands the autopilot which provides load spotting accuracy beyond the capabilities of a pilot manually flying the HLA via primary

flight control system in a hover mode. The static trim capability afforded by the fore and aft ballonets could be integrated into the pitch attitude hold autopilot function. As noted previously the flight dynamics simulation was used in the synthesis of the autopilot system and also to experimentally define the autopilot gains.

Structural Analysis and Materials

During the preliminary studies of Phase I it became obvious that the HLA concept introduces structural design conditions never before encountered in airship design. The basic reason for this is the fact that the maximum rotor forces available are in excess of the empty weight of the vehicle and are therefore capable of creating accelerations far in excess of previous airship experience. Furthermore, the very nature of the vehicle results in rotor locations which provide large moment arms and create the possibility of very large moments about all three axes being transmitted to the envelope (Figure 12). These considerations indicate a requirement for a broad based suspension system with an arrangement facilitating large rigging tensions in the cables so that no cables go slack in the most severe loadings.

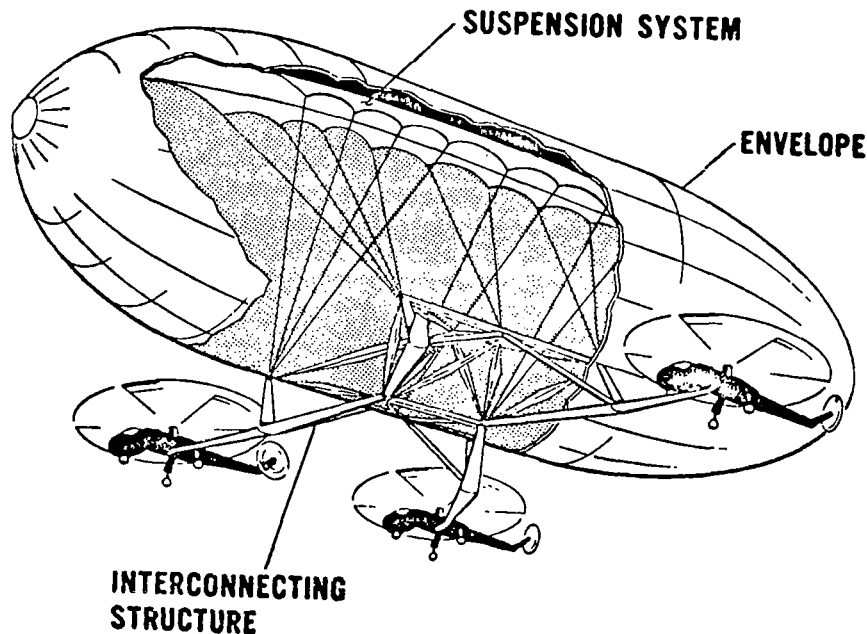

Figure 12. Major Structural Components of HLA

It was also apparent that a large structure, sufficient to preclude physical and aerodynamic interference between the rotors and the envelope and between adjacent rotors, becomes an important consideration from the standpoint of structural integrity and inert weight. It was clear that considerable effort was justified toward defining a structurally sound, lightweight, interconnecting structure. Toward this end numerous design approaches were investigated. The selected interconnecting structural concept consisted of an internal "star frame" which is submerged within the envelope as shown in Figure 12. The star frame is fabricated of three-boomed, welded high performance steel girders employing pin ended joints. The outriggers and lift struts which are external to the envelope are of an aluminum honeycomb sandwich construction.

The large number of helicopter and landing loading conditions experienced by the interconnecting structure led to the development of a series of computer programs combined as indicated in Figure 13 to facilitate the structural analysis effort.

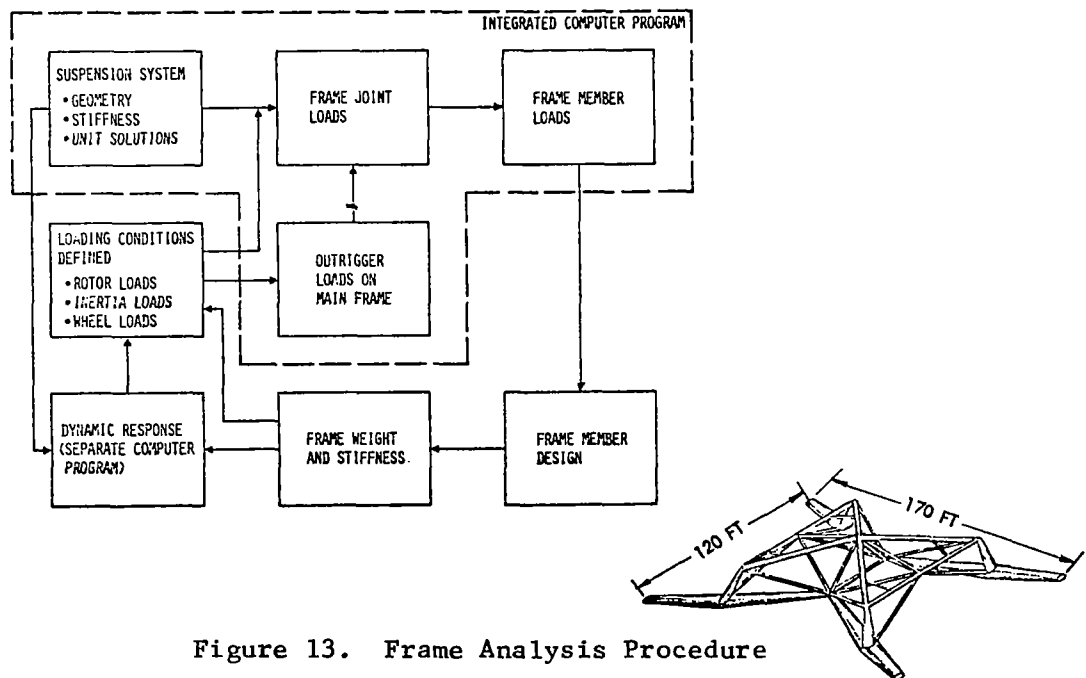

Figure 13. Frame Analysis Procedure

The fabric strength required for the various design conditions is dependent upon the frequency of occurrence of these conditions and the length of time the fabric is under stress in these conditions. Since in the design of an envelope the creep rupture strength is usually critical rather than the quick break strength of the fabric, the quick break strength is reduced by a factor which will guarantee adequate life of the structure. This factor provides not only for creep rupture effects, but also nominal stress concentrations, wear and a scatter factor. Proven fabrics are available for this application and were assumed in the Phase II design. Advanced materials would give significant component weight reductions but a verification program would be required.

A two-dimensional envelope shape analysis computer program was developed to define the cross-sectional deformations occurring for both the unsymmetrical air loads when masted out and symmetrical rigging loads.

The envelope pressure was selected so that wrinkling and excessive deformation will not occur under limit loads.

The envelope analysis has indicated that the critical loads which define the envelope fabric strength requirements are those associated with the airship being masted out. This indicates that alternatives to center-point mooring should be investigated. Additional wind tunnel data are needed to confirm that the new center point mooring concept can be used over a suitable range of operational conditions. If not, a more conventional mooring concept will have to be adopted.

Economic Analysis¹

A preliminary estimate of the Total Operating Cost (TOC) per available payload ton-mile (statute) was made as part of Phase II. The TOC analysis considered an operational configuration that differs from the Phase II HLA in that only the helicopter rotor/turbine/transmission

¹ All dollars are constant 1976 dollars

module is retained on each outrigger and a central car is provided for the flight crew. It is estimated that this approach would result in approximately a 20% reduction in the acquisition cost as compared to the Phase II configuration which retains the entire helicopter on the outriggers. Flight crew requirements and costs are also based on the operational configuration (i.e., safety pilots not required).

The model used in calculating the direct portion of the total operating cost is the standard Air Transport Association approach. The indirect elements are derived from costs needed to support large helicopters in commercial operations.

Comparison of the HLA TOC with the largest commercial U. S. Helicopter, the Sikorsky S64F, is made in Figure 14. Both vehicles are considered to be performing a mission that the helicopter is capable of performing in terms of payload weight. The figure indicates the

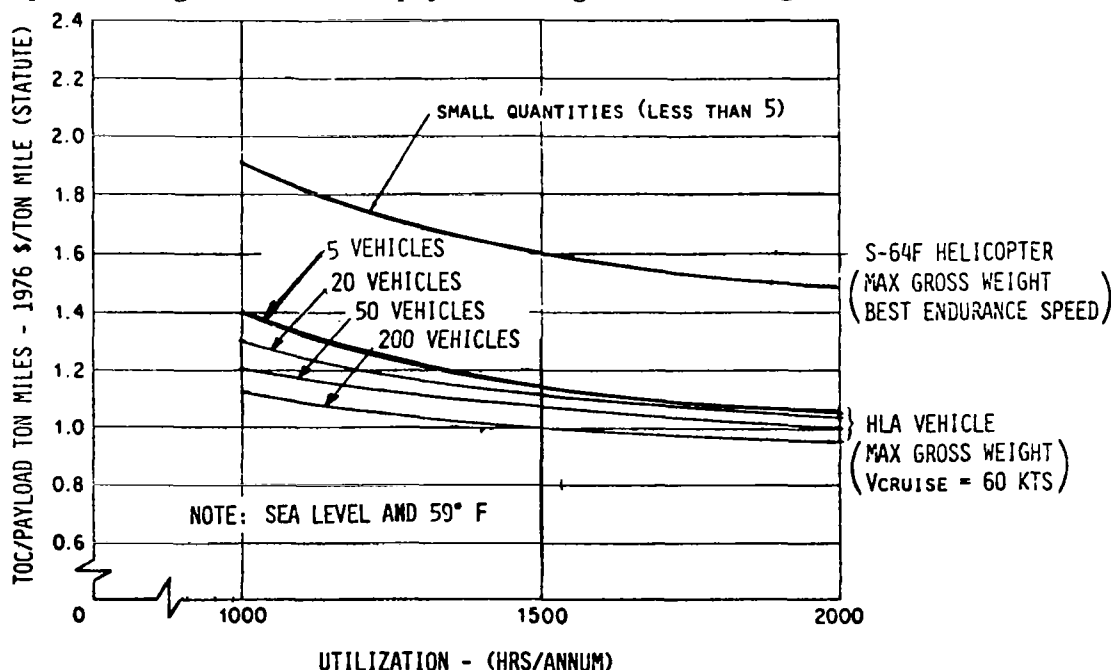

Figure 14. Comparison of S64F and HLA Total Operating Cost Per Payload Ton Mile at Design Range of HLA

general economic benefits to be derived from combining rotor and buoyant lift. The reduced maintenance and improved fuel consumption characteristics of a dedicated current technology propulsion system will serve to further improve the economics of the HLA. The additional economic benefits that a vehicle capable of lifting large outsized loads can provide in terms of factory versus remote site assembly, special highway or roadways receiving only limited use, etc., must also be included in any detailed market and economic analysis.

For purposes of the economic analysis, the HLA RDT&E costs have been estimated at $\$50 \times 10^6$. The HLA fuel consumption for the design speed of 60 kts is estimated to be 0.36 gal/ton-mile. As a matter of interest, without the benefits of buoyancy the fuel requirements would be on the order of 0.52 gal/ton-mile.

Operational Analysis

The HLA concept eliminates or minimizes the significant historical airship deficiencies. The most important of these is the need to interchange payload and ballast which is eliminated by the use of sufficient rotor lift to give a vehicle which is always in a heavier-than-air condition. The severe (in terms of currently postulated uses) historical limitation of lack of low speed control is significantly minimized in the HLA concept, again due to the large rotor forces being available for control. Prior airships have had no appreciable hovering capabilities except into a steady headwind. However, the flight dynamics simulation studies, discussed previously, show that the HLA has good potential in this regard.

Ground handling of the HLA in comparison to prior airships will be much improved for two reasons. First, the rotor control forces can be used on the ground as in flight to control the vehicle when the vehicle is not moored. Secondly, the HLA has a wide based landing gear arrangement whereas prior airships in some cases were limited to a single wheel gear. The wide based landing gear arrangement provides a

significant improvement in vehicle roll stability on the ground which will minimize vehicle response to ground turbulence. The wide based landing gear arrangement will also decrease the historical problem that snow and ice accumulation have represented to past airships when moored. Prior airships, which after used only a single wheel landing gear, were very susceptible to overturning due to snow and ice accumulation.

A new "center point" mooring concept for the HLA, which reduces prior mooring data requirements, has evolved during the Phase II Study. The concept takes advantage of the wide based landing gear arrangement as well as the "rugged" nature of the suspension system. It appears that with this mooring concept the HLA can be moored out, and operated from unprepared fields involving a wide range of soil conditions. The center point mooring system utilizes a "stub" mast which interfaces with structure at the center of the interconnecting structure. Thus, the vehicle stabilizes, when masted out, broadside to the wind thereby reducing the mooring area in comparison to that required in the conventional bow mooring arrangement.

Transport or "ferry" of the HLA to the area of operational need will be accomplished much the same as in the past airships. The operational HLA configuration will likely use an auxiliary turboprop propulsion system for the ferry mission; thus the high fuel efficiency inherent in past airship operations will be achieved.

Technology Assessment Analysis

The final task of the HLA Phase II Study was a Technology Assessment Analysis (TAA). This included three major subtasks:

- (1) Identification of areas where advanced technology could contribute toward improved safety, performance, or economics of the vehicle.
- (2) Identification of the need for flight research vehicles.
- (3) Identification of costs and schedules for technology development and flight research vehicle programs.

Only the first two items will be summarized herein.

Although no technical barriers to development of the vehicle concept were discovered in the course of the HLA Phase II investigation, there are several areas in which further analysis and data are needed. In aerodynamics, the immediate requirement is for further small-scale testing. An obvious choice for this work is the 12-foot pressure tunnel at NASA Ames Research Center since the variable density feature of this tunnel will allow testing significantly above the critical Reynolds number. Test results will provide aerodynamic data for: (1) flight dynamics simulation, (2) verification of the theoretical techniques for predicting aerodynamic interference effects which are currently being developed, (3) definition of a final configuration (e.g., selection of rotor location, hull fineness ratio, and tail surface configuration, if any), (4) envelope analysis, and (5) mooring system analysis.

Final aerodynamic data from testing in a large tunnel such as the 40 x 80 foot wind tunnel facility at Ames will be needed. This facility allows a model of sufficient size such that articulated rotors can be used. Articulated rotors are necessary to assess unsteady aerodynamic effects.

A key technical requirement is continued development and refinement of flight dynamics simulation. The following is needed in terms of upgrading existing simulation capabilities: (1) complete, experimentally verified 6 DOF aerodynamics; (2) improved representation of the rotor dynamics; (3) improved turbulence spectra; (4) improved representation of the interaction of the turbulence with the vehicle; and (5) inclusion of aeroelastic effects. The main uses of the flight dynamics simulation will be to support (1) control system design and analysis, (2) ground-based simulator experiments, (3) development of design criteria, and (4) structural design and analysis.

There are several areas in structures and materials which need technology development. One need is for development of structural design criteria. A detailed structural dynamics analysis will be required to assure a vehicle structure free of instabilities. A comprehensive analysis of the envelope and suspension system will also be necessary. The large

deformations (as compared to prior airships) of the HLA will require new envelope analysis techniques. A program to experimentally validate advanced materials, particularly fabrics and films, would lead to substantially improved vehicle performance.

A technology program which would lead to economic benefit is the development of a low maintenance propulsion system. The projected maintenance costs of the Phase II HLA are dominated by the maintenance requirements of the helicopters. The availability of buoyant lift to offset the weight of the rotor system components can permit greater margins on the dynamic components and this could be exploited in the design of a propulsion system for low maintenance.

The TAA has indicated the desirability of a Flight Research Vehicle (FRV). The primary purpose of an FRV would be to obtain research capabilities that cannot be duplicated in ground-based facilities or in ground-based component and sub-system testing. If the FRV is patterned after the Phase II HLA, it would also be capable of providing concept verification and operating cost data under actual mission conditions. Use of existing helicopters and other off-the-shelf components would result in a low cost FRV program.

One approach to an HLA FRV program is to develop the FRV concurrently with the technology development program and this approach was adopted in Reference 2. The FRV initially would be constructed using existing, proven technology insofar as possible so that flight testing could begin at a relatively early date. The results from the technology program would then be integrated into the FRV as they became available.

Conclusions and Recommendations

Significant conclusions resulting from the investigation of the heavy lift airship concept are:

- (1) The concept appears to be technically feasible and has the potential for meeting the need for the heavy and very heavy vertical lift of large outsized cargo.
- (2) The buoyancy, in addition to permitting a substantial increase

in single vehicle vertical lift capability, should provide a significant reduction in current vertical lift costs. Additionally, the buoyancy reduces the fuel requirements for lifting and transporting cargo in comparison to current helicopter systems.

(3) The concept minimizes or eliminates significant operational deficiencies of past airship designs.

(4) The technology assessment analysis has indicated that significant technology efforts (e.g. wind tunnel testing, flight dynamics simulation, structural dynamics analysis) are needed to assure the successful development of the concept. Other technology programs (e.g. in materials and propulsion systems) would substantially improve the performance and economics.

(5) The technology assessment analysis also has indicated the great utility of a flight research vehicle for research and proof-of-concept purposes.

Significant recommendations resulting from the investigation of the HLA concept are:

(1) A market study is required to better define the commercial market size and the optimum vehicle and mission parameters.

(2) A series of technology programs are needed to acquire sufficient analytical tools and empirical data to successfully develop the concept. Other programs to improve the vehicle performance and economics should also be pursued.

(3) A flight research vehicle would be highly desirable and should be developed in a timely manner.

AIRPORT FEEDER STUDY RESULTS

Summary

The Airport Feeder Vehicle is a VTOL semi-buoyant airship capable of transporting passengers or cargo to major CTOL hub terminals from suburban and downtown depots. The baseline Phase II configuration is

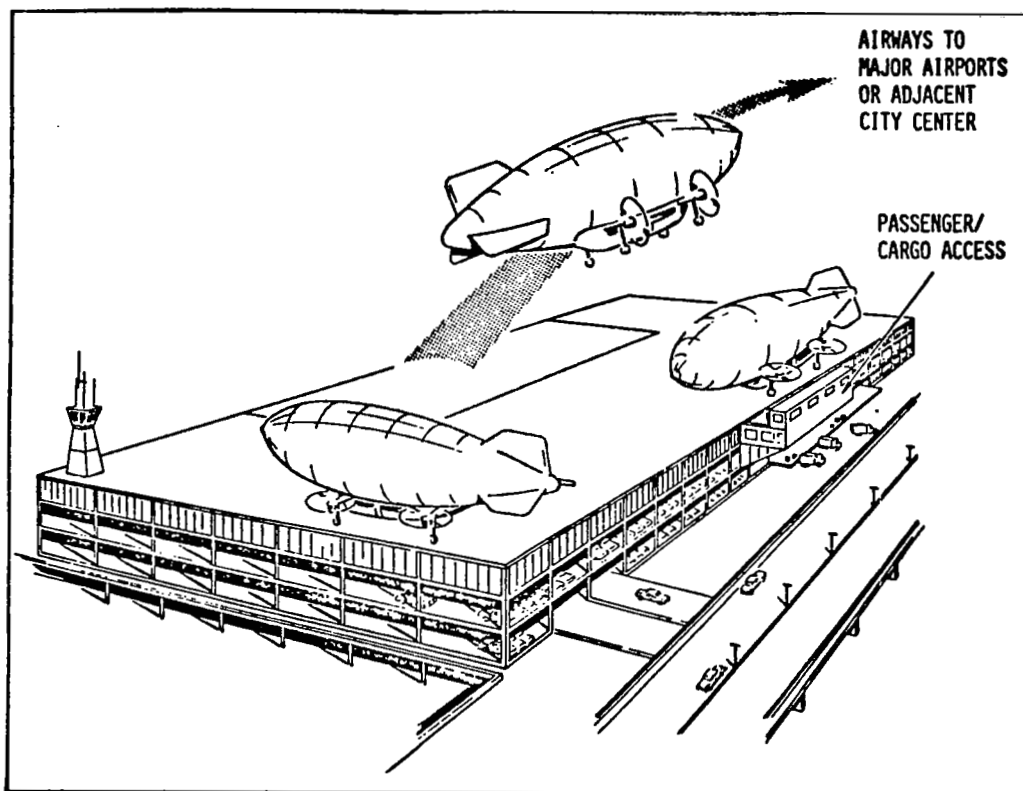

Figure 16. Airport Feeder Concept of Operations

The Phase II study effort was organized into four tasks: 1) Vehicle Design Definition, 2) Operational Procedures Analysis, 3) Cost Analysis and Modes, and 4) Mission/Vehicle Feasibility and Technology Assessment. The following sections describe the work done in these tasks.

Vehicle Design Definition

The vehicle design definition was a combination of point design analysis and parametric vehicle sizing and performance optimization. The objective was to define the vehicle characteristics of an 80 passenger airport feeder for maximum specific productivity. The propulsion system design and performance characteristics required for one-engine-out VTOL received special emphasis. The major parameter of interest was the ratio of buoyant-to-total lift (β).

Several alternate passenger seating arrangements and car configuration concepts were evaluated. The selected concept is a modular configuration with two-forty passenger modules and six abreast seating as shown in Figure 17. Either all passenger, all cargo, or combined operations are possible.

Propulsion systems evaluated included four engine fully cross-shafted propeller, four engine fully cross-shafted ducted fan, and six engine uncross-shafted configurations. The four engine fully cross-shafted configuration was selected as the baseline configuration based on minimum weight, VTOL and cruise power requirements, and VTOL sideline noise levels.

The final configuration definition study was performed by incorporating the results of point design analyses into the Goodyear Airship Synthesis Program (GASP). The optimization criteria for the study was maximum specific productivity, i.e. payload times velocity divided by empty weight, PV/E, evaluated at the design range, which was 740 kilometers (400 n mi) plus a 74 kilometer diversion (40 n mi) plus a 20-minute hold at a speed for maximum endurance. The independent variables considered in the optimization study included cruise altitude, cruise velocity, β , gross weight and fineness ratio for two types of construction: pressurized metalclad and pressurized Kevlar non-rigid.

The Phase II results, consistent with the Phase I trends, indicated that the pressurized metalclad type of construction was slightly superior to the pressurized non-rigid for maximum PV/E. A weight statement of the selected design is given in Table I. The pressurized Kevlar non-rigid could potentially offer a lower cost, more operationally flexible airport feeder vehicle and should be retained as a potential candidate in future studies.

The Phase II results are shown in Figure 18 along with a comparison of the Phase I Study trend. An optimum β of 0.35 was found for the Phase II vehicle, although the sensitivity of PV/E between β 's of from about 0.3 to 0.5 is small. The difference between the Phase I and Phase II trends

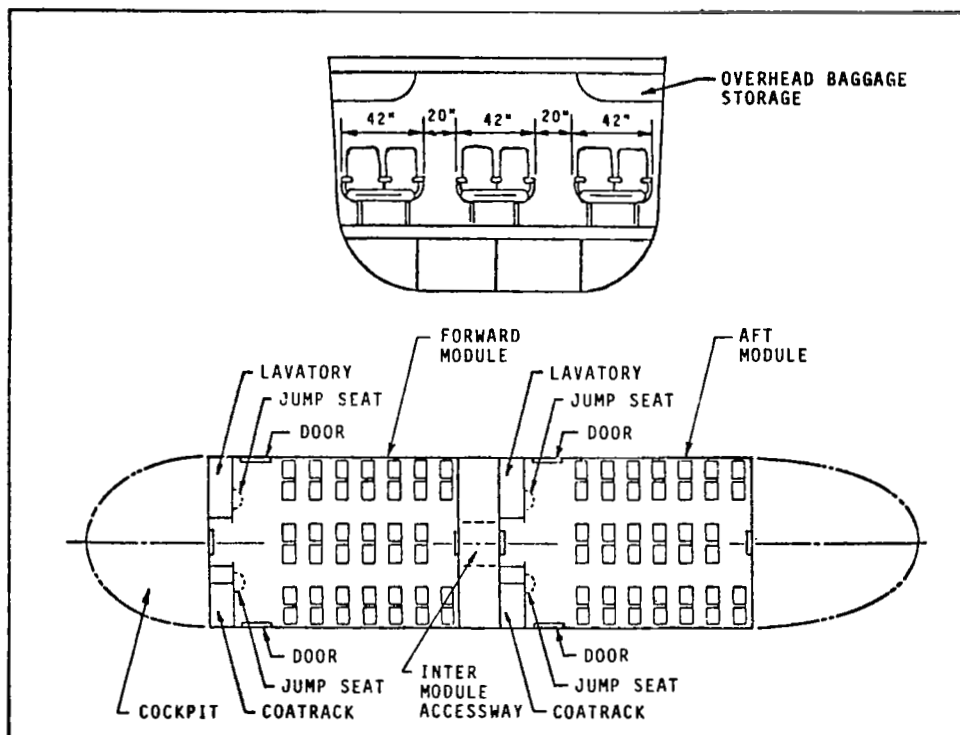

Figure 17. Two-Segmented Payload Module Cabin Layout (6 Abreast Seating)

Table I - BASELINE CONFIGURATION WEIGHT SUMMARY

Hull Structure	11,150 Lb
Car Structure	4,600
Modular PAX Compartment (2)	7,000
Empennage and Controls	3,100
Landing Gear	1,120
Propulsion System	15,050
Fuel and Fuel System	7,400
Flight Instruments and APU	1,200*
Furnishings/Seats and Belts	1,820*
Crew (2) STU's (2) and Gear	660*
80 PAX @ 160 Lb/PAX + 20 Lb/PAX Baggage	<u>14,400*</u>
TAKEOFF GROSS WEIGHT	67,500 Lb

* Based on NASA "Study Guidelines for Conceptual 1985 V/STOL Aircraft"

NOTE: 1 Lb = 0.453 kg

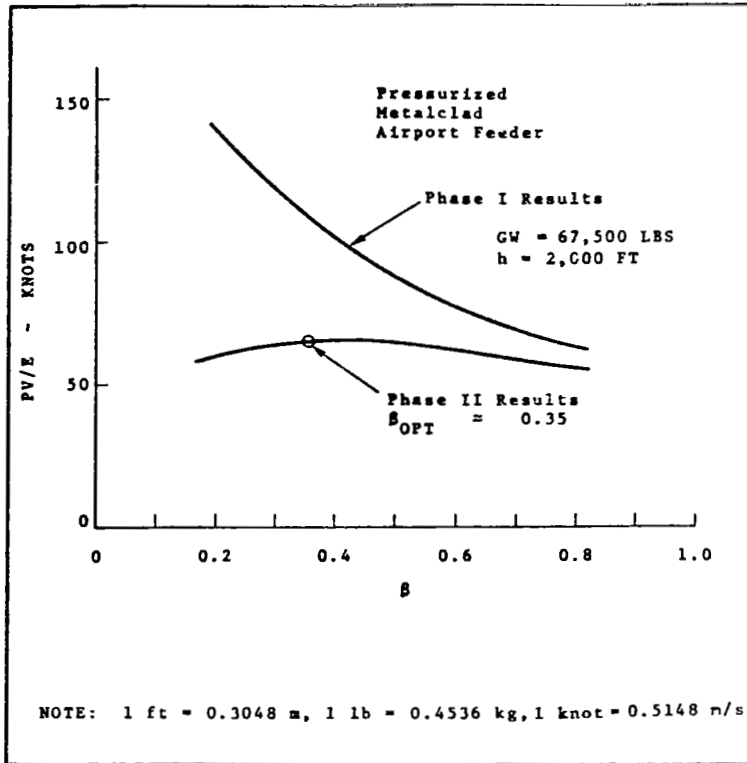

Figure 18. Buoyancy Ratio Trends for Maximum Productivity:
Phase I and Phase II Study

can be traced to the car structure/passenger accommodations design and weight requirement and the propulsion system requirements for one-engine-out VTOL capability. The cruise velocity for maximum PV/E was 67 m/s (130 knots) at an altitude of 610 meters (2000 ft). All NASA specified design and performance criteria defined for the mission can be met or exceeded. The noise at takeoff is 86.5 pNdB, 8.5 pNdB under the specified constraint. Fuel Consumption is about 0.25 gallons/ton mile.

The major areas of technical uncertainty were identified to be the hover/transition phase stability and the control characteristics and flying/ride qualities in turbulent air.

Operational Procedure Analysis

A generalized analysis of operational characteristics of a "most probable" airport feeder system operating within the existing transportation infra-structure was performed. Both a non-locale oriented effort and a site specific analysis were investigated. Important institutional considerations and the implied operational requirements are summarized below.

The system will likely serve business travelers. Therefore, the user must perceive convenience and/or time advantage over alternatives. From the user's point of view, the system should provide adequate trip frequencies, scheduled departures, CTOL flight safety in virtually all weather, and reasonable ride quality and comfort.

From the non-user/community acceptance point of view, noise, air pollution and ground congestion should be minimized, as well as any adverse impact on property value and hazard due to accidents. These considerations dictate quiet operations and careful terminal and land access planning. An extensive public program may be needed to define the benefits of the system to the public.

Airport operations represent the first level of contract with user/non-user group. The major areas of concern include the income potential of the airport feeder (A/F) system and the compatibility with existing operations. Ideally, the system should reduce congestion and terminal delays resulting from airport access. This indicates that the feeder must be integrated into or be compatible with existing airport operations. A preliminary evaluation of the market size for the A/F system indicated that only the largest 7 - 10 metropolitan areas may have passenger demand sufficient to support an A/F service. The market potential for an Airport Feeder type of service is an important factor which unfortunately is not well-defined at present.

The Lake Erie Regional Transportation Authority (LERTA) service region was selected for a site-specific evaluation. The physical

restrictions associated with airport access to the proposed lakeport site may result in a unique requirement for and benefit from a short haul airport feeder system. The results of the LERTA analysis confirmed many of the operational requirements derived in the generalized analysis and provided the guidelines for developing the A/F operational procedures.

Several approaches to the loading and unloading of passengers and cargo were examined. The selected concept is a modular passenger/payload module which can be transferred from the basic Airport Feeder with all passengers aboard or can use CTOL type ramp facilities for passenger access. This operational concept offers substantial improvements in the landing/on-ground operations of the A/F vehicle as compared with past airships. The low value of β also should facilitate ground handling.

Cost Analysis and Comparison with Alternative Modes

The objective of the cost analysis was to estimate the operating cost of the Airport Feeder final baseline vehicle defined previously, operating in the short haul passenger transportation market. Extensive use was made of several NASA developed cost estimating relationships (CER's). Cost data is in 1975 dollars unless otherwise noted. Major areas of uncertainty in RDT&E include Government support of RDT&E, FAA Certification Requirements, RDT&E required for the "Second Ever" Metalclad and the cost of developing the terminal facilities.

The approach used was to investigate the RDT&E costs parametrically and to determine the variations of the operating costs as a function of the RDT&E costs. The baseline RDT&E cost estimate for the A/F System was \$80,000,000. The upper and lower bounds considered in the sensitivity analysis were \$160,000,000 and \$40,000,000, respectively.

The acquisition cost estimates for the Airport Feeder vehicle concept were calculated for production quantities of 1, 25, and 125 vehicle production runs. Established aircraft cost estimating relationships (CER's) were used for learning factors, aircraft systems, passenger provisions and furnishings, propulsion group, and the car structure and

passenger accommodations. GAC reference data was used to develop modifications to the basic CER's for the car structure, the hull structure and the empennage.

Operating cost estimating relationships developed for short haul passenger turboprop aircraft operations (Reference 11) were utilized to estimate IOC and DOC. Baseline assumptions for the analysis were 125 unit fleet size, 3000 revenue aircraft block hours per year, fuel cost of 30 cents/gallon, block speed based on 13 m/s (25 knot) wind speed (half head wind, half tail wind), and an average stage length of 74 km (40 n mi). The resulting baseline DOC breakdown is shown in Table II. The DOC sensitivity to alternate assumptions is shown in Table III.

TABLE II. BASELINE DOC/ASSM COST BREAKDOWN

Item	DOC (Cents/ASSM)	% of DOC
Depreciation	1.37	25
Flight Crew Expense	0.75	13.7
Fuel Oil and Taxes	1.25	22.8
Insurance	0.26	4.7
Maintenance		
Air Frame	0.41	8.5
Engine	0.42	7.6
Maintenance Burden	0.95	17.3
Helium Replenishment	0.11	0.3
DOC (Cents/Available Seat Stat Mi) =	5.52 Cents/ASSM	99.9%

NOTE: 1 Statute Mile = 1.609 km

TABLE III. SUMMARY OF DOC SENSITIVITY ANALYSIS RESULTS

Parameter		Parameter Values			DOC/ASSM CENTS/ASSM		
		- Δ	Baseline	+ Δ	- Δ	Baseline	+ Δ
RDT&E	\$10 ⁶	40	80	160	5.45	5.52	5.71
RABH	HRS	2000	3000	4000	6.37	5.52	5.10
ASL	N.MI.	15	40	100	6.80	5.52	5.07
Fuel	¢/GAL	15	30	60	4.92	5.52	6.62

NOTE: 1 n.mi. = 1.853 km

The DOC per available seat statute mile (ASSM) ranges from about 5¢/ASSM to about 7¢/ASSM over a wide range of average stage lengths, (ASL) yearly utilization, (Revenue Aircraft Block Hours, RABH per year) fleet size and fuel costs. DOC sensitivity to fuel costs suggest that optimum operating and design characteristics of the Airport Feeder vehicle should vary with fuel cost.

In comparison with recent results of studies of conceptual short-haul airplanes, the A/F appears to be economically competitive. In comparison with actual helicopter airline experience, the A/F is estimated to be superior by a factor of two based on direct operating cost per available seat statute mile. Fuel consumption per available set statute mile is estimated to be approximately 30% better than current technology helicopters. As mentioned earlier, the A/F noise level at takeoff is considerably below the study objective of 95 pNdB and therefore below most if not all heavier-than-air designs.

Mission/Vehicle Feasibility and Technology Assessment

The greatest area of uncertainty associated with the Airport Feeder concept is the market for the service provided. Several key questions have been identified which should be investigated in more detail. These include market size, vehicle performance/design requirements for maximum economic viability, user acceptance, non-user reaction, and a more detailed investigation of cargo operations.

Detail market studies need to be performed to further define the demand and potential utilization for the Airport Feeder system concept. This analysis should be integrated with further vehicle design, performance and operational trade studies. Promising study areas would include vehicle DOC minimization as a function of design passenger capacity, fuel costs, and buoyancy ratio.

No unknowns have been defined which present technological barriers to the successful development of the vehicle concept. Many areas have been identified which require additional research and development; primary among these are hover performance/stability and control, aerodynamics, vehicle response to turbulence associated with CTOL airport and suburban/downtown operations, flying/ride qualities, and development and integration of cyclic propeller/prop-rotor technology for hover control. Table IV summarizes key areas requiring further RDT&E. Overall, the specified design and performance requirements appear to be achievable based on the results to date. The results indicate that in terms of operating economics, fuel consumption, and noise performance, the Airport Feeder vehicle concept is at least as promising as competing aircraft.

TABLE IV. REQUIRED R&D AREAS

Aerodynamics/Stability and Control/Flight
Dynamics R&D Areas

Hull/Rotor Interference Effects (Hover and Cruise)
Gust Environment/Vehicle Response in Airport and City Center
Regions
Ride Quality During Cruise at Low Altitudes
Stability and Control in Transition and Hover Flight
Application of Active Controls Technology
Aerodynamic Configuration Modifications for Improved Lift/Drag

Mission/Market Analysis R&D Areas

Market Analysis vs Vehicle Design and Performance Capability
Passenger Acceptance of Low Altitude Ride Quality
Design Optimization based on Return on Investment
Design Optimization at High Fuel Cost

General R&D Areas

Operational Development/Verification of Tether/Winch Landing
System
Propeller Interference during Transition
Low Cost Materials Handling/Manufacturing Approaches
Passenger Compartment Noise Level Reduction
Environmental and Operational Limitations of Minimum Gauge
Metalclad Hull Structure
Design Implications of High Ground-Air-Ground Cycle Operations
Applications of Advanced Materials

NAVY MISSION STUDY RESULTS

Mission Description

The primary purpose of the Navy portion of Phase II was to assess the technical feasibility of utilizing LTA vehicles or LTA vehicular systems to perform pertinent Navy missions. The analysis accounted for the tradeoffs and interactions among aerodynamic, structural, and propulsive efficiencies dictated by the mission requirements. Vehicle concepts with buoyant-to-total lift ratios, (β) down to 0.8 were considered. Four missions were identified for these fully buoyant airships: (1) submarine trail, (2) SOSUS (sound surveillance system)/ocean surveillance, (3) ASW Barrier, and (4) convoy escort.

In the submarine trail mission, the airship is self-sufficient and capable of independent operations from land bases for periods requiring multiple crews and crew facilities. The mission objective is to maintain close contact with submarines subsequent to localization by other means. The primary sensor is an advanced nonacoustic system currently under investigation by the Naval Air Development Center. A reacquisition capability is necessary, and a limited self-defense capability is desirable. In addition to the overt mode, a covert mode using towed arrays was also considered.

The SOSUS/Ocean Surveillance mission objective is to detect, classify and maintain surveillance of submarine targets in ocean areas where the land-based SOSUS performance is poor or temporarily out of operation. The primary sensor is a SURTASS (Surveillance TASS) equivalent thin line towed array. A hybrid processing system is included onboard the airship which permits the data to be displayed and processed onboard the airship and/or data linked to shore for use in the land-based main evaluation centers. ASW support forces from land-based or sea-based operations could be vectored to support the airship system in conducting localization, classification, and negation portions of the ASW missions. Secondary operations

such as air and surface surveillance could be performed in some approaches to the SOSUS/Ocean Surveillance Mission.

The ASW barrier mission will require an LTA vehicle which is self-sufficient and capable of independent operations from land bases for periods requiring multiple crews and crew facilities. It will be supplementary to both surface and aircraft resources, thus relieving the burden on these forces in situations where economics or threat levels make the long endurance LTA attractive. In simplistic terms, it is intended to fill the gap between relatively slow-speed, long endurance, large payload surface ships and high-speed, short endurance, small payload aircraft. It will be able to use dipped, towed or retrievable sensors because of its onstation hover capability. The mission objective is to maintain a counting or detection only barrier across submarine transit routes. Barrier lengths of 1300 km (700 n mi) and onstation endurance of 20 to 30 days were general mission objectives.

In the baseline convoy escort mission the mission objective is to provide detection, classification, and early warning of air, surface, and subsurface threats. An endurance of 7 to 10 days without replenishment will provide unrefueled trans-Atlantic escort mission capability. In-flight refueling and replenishment from surface ships is also possible for extended missions. The LTA vehicle has a limited onboard capability for self-defense, and will rely primarily on other air and surface units for protection against air/surface threats. Similarly, a limited onboard capability is available to localize and attack close-in ASW targets; however, it will rely primarily on other air ASW vehicles for prosecution of its surface and subsurface detections. The primary acoustic sensor is an advanced, thin line, tactical array. Sprint-and-drift tactics that exploit the LTA vehicle's speed capability permit a high percentage of search time while maintaining the convoy speed of advance.

Generalized Parametric Analysis Results

Vehicle concepts ranging from approximately 42,500 cubic meters (1.5 million cubic feet, MCF) to over 1.133 million cubic meters, MCM

(40 MCF) were evaluated in the parametric study. Figure 19 illustrates concepts over this study range as compared with the Akron size airship (0.21 MCM, 7.4 MCF) and the most recent Navy non-rigid airship the ZPG-3W (41,300 cu m, 1.5 MCF).

A technology assessment and design option evaluation was conducted for generalized endurance mission applications. This included consideration of propulsion system cycle, stern propulsion, active controls technology, vectored thrust/low speed dynamics and control, towing performance and control, structures and materials, and aerodynamically augmented flight. Two significant design options are the optimum fineness ratio for the four different construction concepts and the optimum value of β .

The optimum length to diameter ratio was found to depend on vehicle structural concept. The sandwich monocoque optimized at the lowest value allowed during the study of 3.5, the non-rigid airship at 4.75, the pressurized metalclad airship at 5.2, and the rigid airship at 7.0. The optimum fineness ratios resulted from the interaction between aerodynamic drag and structural weight fraction. These values are valid for vehicles in the 0.283 to 0.425 MCM (10 to 15 MCF) volume range. NASA Phase I results (Reference 1) indicate a fineness ratio dependency on gross weight. For expediency, these values were used during this study. The comparison of the structural weight fractions of the four different construction concepts at the optimum fineness ratio is shown in Figure 20.

Aerodynamically augmented flight (vertical takeoff capable) can increase the performance (time on station) of a constant volume vehicle. The optimum β is mission dependent and depends upon the maximum design mission velocity, the radius of action, the minimum allowable loiter speed, the speed profile associated with the on-station time, and the transit velocity. In general, β which will maximize on station endurance is in the range of 0.85 to 0.9 for the vehicle configurations and missions investigated during this study.



7.40 MCF RIGID
USS AKRON



1.46 MCF NON-RIGID
ZPG-3W

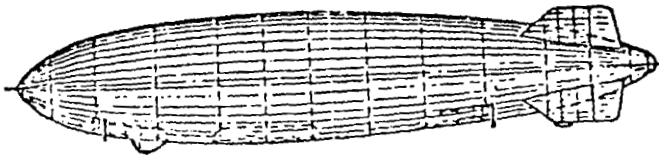

11.20 MCF RIGID

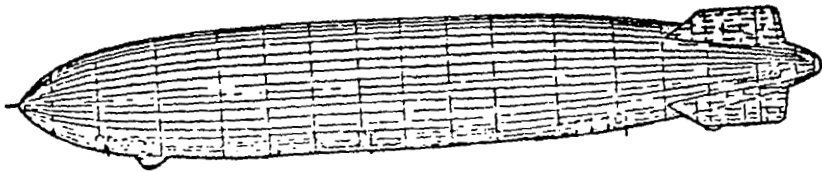

15.40 MCF RIGID

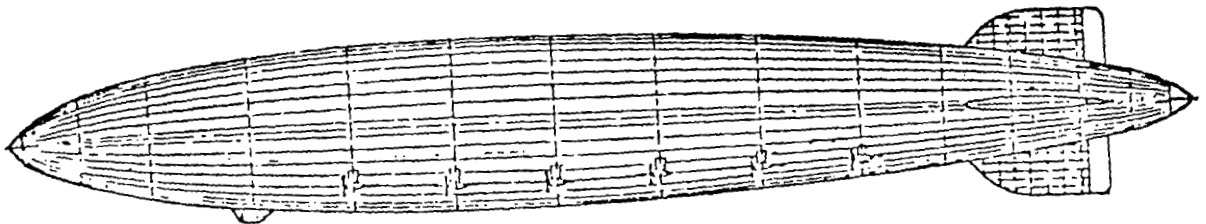

38.10 MCF RIGID

Figure 19. Comparison of Representative Vehicle Concepts

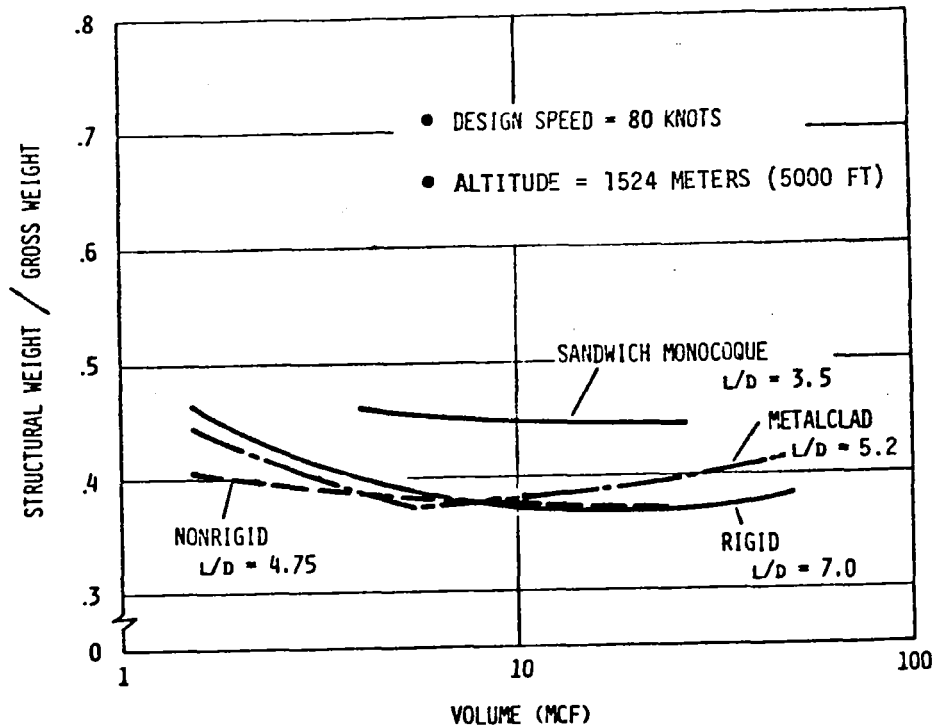
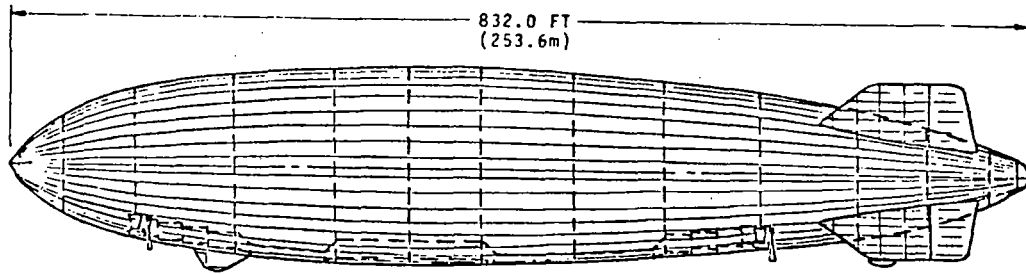

Figure 20. Structural Efficiency Comparison

As a result of the combined mission/technology analysis, two point design configurations were selected for further analysis: The first is a 311,500 cubic meter, (11 MCF) rigid airship (Figure 21) using modern design techniques and subsystems. This design can perform the entire spectrum of specified missions independent from other than home base support. The second is a 42,480 cu m (1.5 MCF), hover-capable, non-rigid airship (Figure 22) capable of performing some less demanding missions (such as coastal surveillance and defense) independently and the convoy escort mission if supported by surface vessels.



DESIGN CHARACTERISTICS

HULL VOLUME	11.2 MCF (0.317 MCM)
HELIUM VOLUME	10.53 MCF (0.298 MCM)
DESIGN SPEED	80 KNOTS (41 M/S)
PROPULSION:	
CRUISE - VECTORABLE TURBOSHAFT	
4 @ 1340 HP/ENGINE	
LOITER - FIXED PROPELLER DEISELS	
2 @ 325 HP/ENGINE	

<u>WEIGHT</u>	<u>WT-LBS (KG)</u>
GROSS WEIGHT (5000' DESIGN ALT)	562,500 (255150)
EMPTY WEIGHT (VEHICLE)	253,400 (114942)
MISSION/CREW SYSTEMS WEIGHTS	24,900 (11295)
AIRPLANE COMPARTMENT	5,860 (2658)
CREW QUARTERS (36 MAN)	12,190 (5529)
ASW COMPARTMENT & EQUIPMENT	4,180 (1896)
REPAIR FACILITIES	
OPERATING WEIGHT EMPTY	278,300 (126237)
USEFUL LOAD	284,100 (128868)
PAYLOAD (SOSUS)	72,500 (32886)
FUEL, OIL AND CONSUMABLES	211,600 (95982)

PERFORMANCE

<u>AIRSPEED</u>	<u>FUEL RATE</u>
75	1680 LBS/HR (762 KG/HR)
30	128 LBS/HR (58 KG/HR)

Figure 21. Conceptual 11.2 MCF Rigid Design and Performance Characteristics

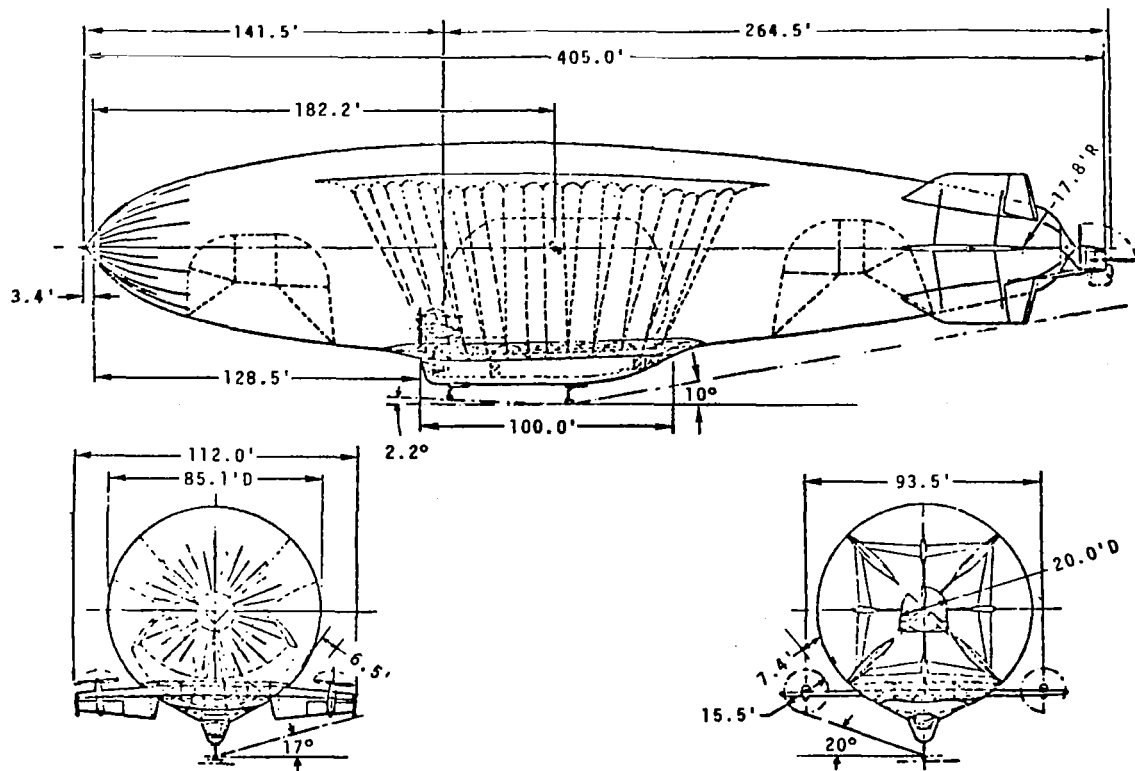

DESIGN CHARACTERISTICS

HULL VOLUME 1.49 MCF (42197M³)
 DESIGN SPEED 90 KNOTS (46 M/S)
 PROPULSION

MAIN PROPULSION 2 AVCO LTC1K TURBOPROPS
 CROSS SHAFTED ON TILT WING
 STERN PROPULSION
 2 ALLISON C250-20B TURBOSHAFTS
 "V" RUDDER DEFLECTED SLIPSTREAM

<u>WEIGHTS</u>	<u>LBS (KG)</u>
GROSS WEIGHT ($\beta = 0.86$)	96500 (43772)
OPERATING WEIGHT EMPTY	51100 (23178)
PAYLOAD + CREW	24340 (11040)
FUEL & OIL	21060 (9553)

PERFORMANCE

ENDURANCE @ V \geq 30 KTS 88 HOURS

Figure 22. Hover Capable Non-Rigid Airship

Mission Specific Results

Trail Mission

Ninety-five percent of the time on station of the trail mission profile is at low altitude and loiter speed. Five percent of the time on station is spent at the maximum (dash) speed at 1524 m (5000 feet) altitude. The performance range of interest includes TOS from 10 to 30 days, radii of action (ROA) from 1853 to 4632 km (1000 to 2500 nautical miles) and dash speeds from 38.6 to 64.35 m/s (75 knots to 125 knots). The trail mission payload is 20,400 kg (45,000 lbs) which includes a 20 man crew.

Representative performance capabilities of neutrally buoyant rigid airships are shown in Figure 23 in terms of TOS as a function of ROA, cruise speed and vehicle volume. Time on station is relatively insensitive to radius of action for large volume vehicles (greater than 0.2 MCM, 7.0 MCF) but is highly sensitive to the design dash speed even though only 5% of the mission time is spent in dash.

Figure 24 compares the performance of the four different construction concepts in terms of time on station versus hull volume. In the 0.142 MCM to 0.283 MCM (5 to 10 MCF) range, the rigid, non-rigid and metalclad concepts are approximately competitive. The figure indicates that the minimum size vehicle for a 30-day on station capability will be achieved by the rigid type of construction. Conventional rigid airships in this volume range are a near term, low risk extension of the conventional rigid airship state-of-the-art.

SOSUS Augmentation Mission

Three operational concepts were considered for this mission: 1) the airship deploys an off-board array and monitors via a data link, 2) the airship tows an advanced thin line array at low speed, and 3) the airship deploys a powered sea sled which provides the array tension force.

Array drag is significant (approximately 20 times the airship drag for low speed tow). Figure 25 summarizes TOS vs ROA for the conceptual

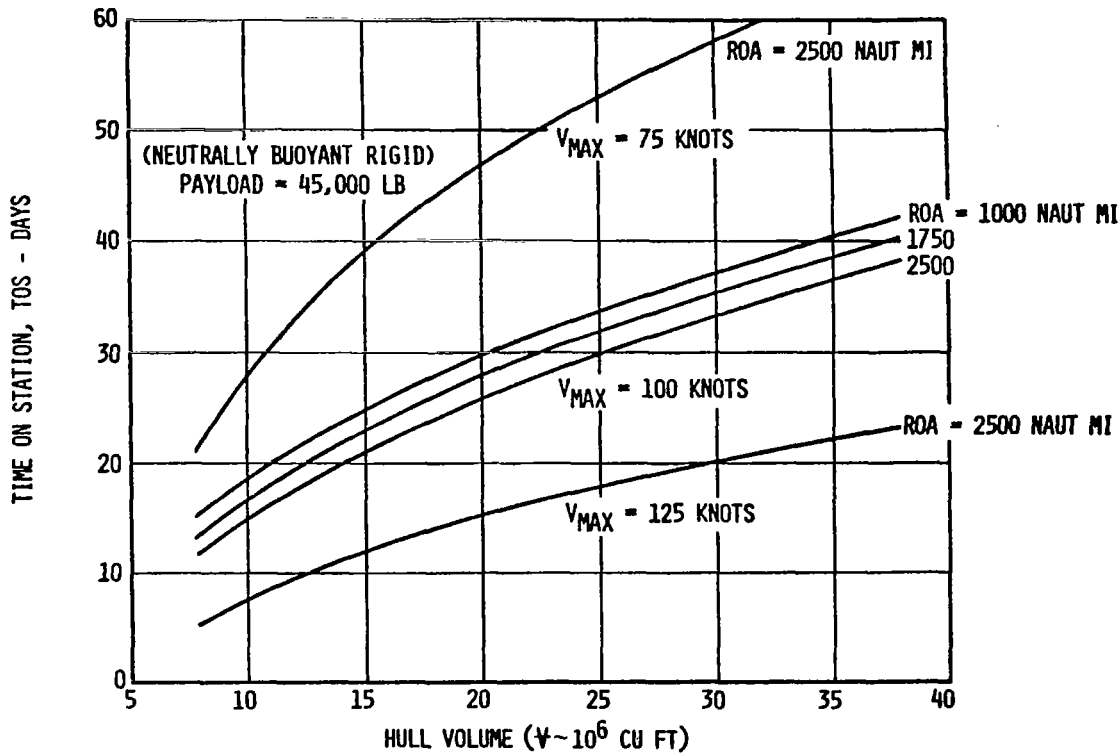

Figure 23. Trail Mission Parametric Performance Results (Neutrally Buoyant Rigid)

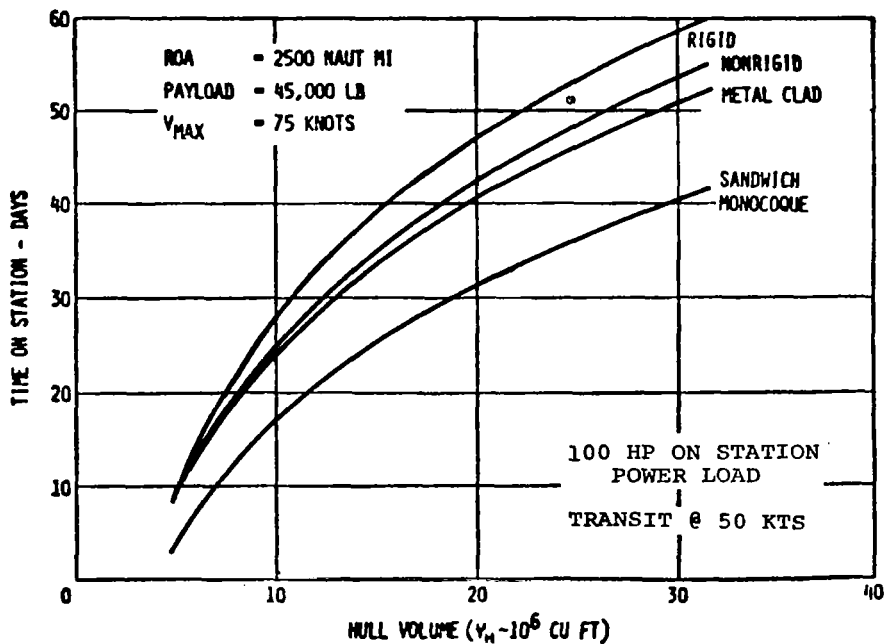
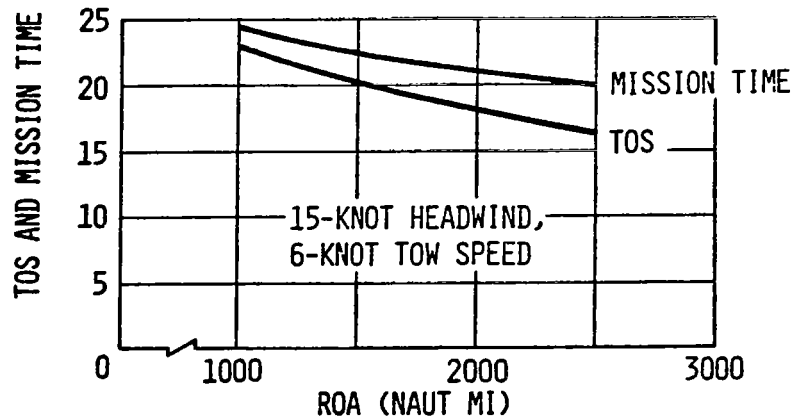

Figure 24. Trail Mission Parametric Performance Results (Construction Concepts)

large rigid vehicle in the tow and off-board modes. In the tow mode of operation, TOS capabilities of from 15 to 22 days, depending on ROA, can be achieved. In the off-board mode of operations TOS of 20 to 30 days can be achieved depending on ROA.

11.2 MCF RIGID TOWING THIN-LINE SURVEILLANCE ARRAY



11.2 MCF RIGID MONITORING OFF-BOARD ARRAY

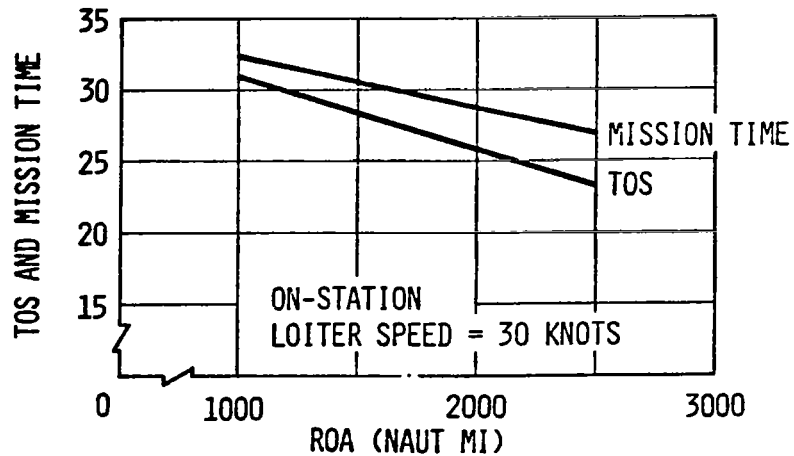

Figure 25. TOS Versus ROA for 11 MCF Rigid Airship

The SOSUS augmentation or open ocean surveillance mission concept is a promising airship mission. Vehicles on the order of 200,000 to 317,000 cu m (7 to 11 MCF) which are near term, low risk airship concepts can provide 2 to 3 weeks on-station capability in a tow mode. The TOS can be increased or vehicle size reduced via the use of off-board array operational concepts. The trades between the tow mode, off-board array and sled operational approaches needs further examination, including an assessment of security from jamming, array linearity, and array performance in both the off-board and tow modes. Operational concepts which use multiple arrays to enhance localization and classification operations warrant further investigation.

ASW Barrier Mission

Results obtained from an abbreviated analysis of a towed array ASW barrier operation indicate that for vehicles in the 0.283 to 0.425 MCM (10 to 15 MCF) size range, the "backup" factor (number of airships required to maintain one station continuously) for a 2500 nautical mile radius of action is below 2 in all cases. If towed array detection ranges on the order of 463 Km (250 n mi) can be achieved, the number of airship stations required to mount a 1300 Km (700 n mi) ASW detection barrier will be less than 2.

Convoy Escort

Any vehicle sized for the trail mission, the SOSUS augmentation mission or the ASW barrier mission will be sufficient to conduct the independent convoy escort operations. Substantial excess payload or performance capability would be available from the vehicle sizes on the order of 0.317 MCM (11 MCF) which are required for the trail and SOSUS missions.

An alternate operational approach to the convoy escort mission utilizing at sea replenishment can substantially reduce the vehicle size required. Vehicles the size of the last Navy non-rigid airship, the ZPG-3W can perform the convoy escort mission utilizing advanced

thin line towed arrays in a sprint/drift operational mode. Refuel and replenishment from surface vessels on a one to two day cycle is sufficient depending on mission specifics. An additional operational capability could be realized by utilizing the same vehicle, reconfigured for airborne early warning and/or surface surveillance to perform AEW/SS operations as well as over the horizon command, control and communications and targeting. Several operational/tactical approaches appear promising for either small vehicles or large vehicles in convoy escort missions.

Overall Mission/Vehicle Conclusions

The overall parametric analysis conclusions indicate that vehicle sizes of approximately 0.317 MCM cu m (11 MCF) can satisfy the mission requirements for all four missions as defined for this study. Twenty to thirty day times-on-station are achievable with current technology rigid airships which are near term, low risk vehicles. Airship applications utilizing towed array sensors represent a unique accommodation of sensor requirements and platform capabilities.

The metalclad, rigid and non-rigid construction concepts are all competitive in the range from 0.141 to 0.317 MCM (5 to 11 MCF) for the long endurance missions investigated. In general, the rigid concept results in the minimum volume required to achieve a specified time-on-station. A design speed of 38.6 m/s (75 knots) and an altitude of 1524 m (5000 feet) can satisfy all mission requirements specified for the four missions. Higher speeds up to 51.9 m/s (100 knots) can be achieved with modest penalties in vehicle empty weight and propulsion system requirements. The penalty in on-station performance associated with the higher speed capability results primarily from the duration of the mission time spent at the high speed as opposed to the actual design capability. Improvements in vehicle empty weight due to modern materials and propulsion technology allow higher payloads or altitudes to be achieved for a given volume.

The ratio of on-station time to mission time for the airships operating in the conceptual missions is high; 70% to 90% depending on the radius of action. Thus, a high percentage of the total yearly utilization will be spent on station. An important characteristic of long endurance LTA vehicles is the low (less than 2) backup factor required to maintain a station.

Operational Considerations

Prior airships were operationally inferior to the capabilities of potential modern LTA vehicles. Two areas of operational deficiency were dash speed and low speed control. Current technology provides the capability to largely overcome these deficiencies. Lightweight gas turbines allow higher dash and cruise speed capability at lower installed propulsion system weight fractions. Modern V/STOL technology, including advanced automatic flight control systems, provide the capability for fully hover capable, low speed controllable, VTOL capable LTA vehicles. Precise low speed and hover control results in improved ground handling operations and expands the mission applicability of modern Naval LTA vehicles.

Ground Handling

During the late 1950's, the U. S. Navy developed mechanized ground handling equipment and mooring techniques for the ZPG-3W airships. Landing and mooring of the ZPG-3W required only 10 to 18 personnel in the ground crew. Docking and undocking were performed with 11 to 12 men; takeoff required approximately the same number. The mooring and ground handling equipment techniques developed for the 3W airship are applicable to the larger airships considered for future naval missions.

Weather

No vehicle is truly an all-weather vehicle in that it can effectively perform its assigned mission in any weather condition (except possibly a submarine). However, many vehicles can survive severe weather conditions

and resume operations after the weather has passed; modern airships would be such vehicles.

In 1954, the Office of Naval Research assigned to the Naval Air Development Unit at South Weymouth, Mass., conducted a project to demonstrate the all-weather capability of the airship. Technical guidance and instrumentation were furnished by the National Advisory Committee for Aeronautics. The conclusions of the official Navy report (Reference 12) on the project included the following:

"Airship ground handling evolutions can be accomplished in virtually all weather conditions."

"Routine ground maintenance can be accomplished under extremely adverse weather conditions."

"Rime ice accretion at normal airship operating altitudes is not considered a deterrent to proper station keeping for protracted periods of time."

"Maintaining a continuous barrier station over the Atlantic Ocean appears to be feasible under all weather conditions."

Wind

Wind is an important weather element in airship operations. However, while high winds in themselves are no threat to the structural safety of an airship in flight, historically the low airspeed necessitated that high head winds be avoided by flying the pressure patterns. Higher speed capability of modern Naval LTA vehicles will allow them to remain operational at higher wind speeds.

Significant progress in forecasting general and local meteorological conditions has been realized since the last rigid airships were flown. The advent of weather satellites, onboard radar, improved navigation, and improved communications will result in safety benefits and improved operational capability.

Vulnerability

Any discussion of the use of airships in military operations must address the question of the vulnerability of these large vehicles. This has always been a foremost argument against the military use of airships, both rigid and non-rigid. Although the military rigid airship evolved during World War I as a bombing platform designed to operate against formidable opposition, it did not prove to be effective in this role and has never since been considered seriously as a combat vehicle. Current technology has not reversed this decision but has contributed to the improvement in expected survivability when the airship is used in military roles such as the sea control missions.

From a technical aspect the large rigid airship could probably sustain hits, from a number of air-to-air missiles or surface-to-air missiles without serious consequences. In this respect it is much more survivable than a C-5A, for example, where a single missile hit would normally be catastrophic. Furthermore, the airship can be equipped with a very credible self-defense capability. This could consist of early warning and fire control radar, anti-air and anti-missile missiles or other advanced weapon systems, ESM equipment and a variety of electronic countermeasures suitable to the threat.

In spite of this capability to sustain damage, to conduct inflight repair and to provide for its own self-defense, prudent military operation would not permit the airship to be used in situations that were beyond its limited combat capabilities. In short, the answer to achieving acceptable levels of survivability lies in employing the airship in missions for which it is particularly suited, and in tactical environments for which it has been designed. A preliminary examination (classified) of the self-defense capability of LTA's using an advanced weapon system was performed by the Northrop Research and Technology Center. The results are encouraging and could expand the potential tactical environments for modern Naval airships.

Conclusions

The Navy Mission Feasibility Study concluded that: (1) LTA vehicle sizes of approximately 311,500 million cu meters (11 MCF) can satisfy all specified mission requirements; (2) 20 to 30 days time-on-station is achievable; (3) three construction concepts -- rigid, non-rigid, and metalclad -- are generally competitive; (4) design speeds of 39 m/s (75 knots) and altitudes of 1524 m (5000 feet) can satisfy all specified mission requirements; and (5) higher speeds and altitudes to 4572 m (15,000 feet) are feasible but would require larger vehicles. Rigid airships in the required volume range are low risk extensions of previous LTA vehicles. Small (non-rigid) airships may also satisfy less demanding missions such as ship supported convoy escort.

The primary sensors for all missions tend to be items either towed or deployed, expended or retrieved by the LTA platform. One significant advantage of using an airship as a tow platform is virtual elimination of propagation of tow platform noise into the medium. The airship also appears to be an ideal platform for the carriage, deployment, monitoring, and recovery of off-board arrays and for RPV launch and recovery operations.

REFERENCES

1. "Feasibility Study of Modern Airships," Phase I, Volumes I, II, III, & IV; Goodyear Aerospace Corporation; NASA CR-137692, July 1975.
2. "Feasibility Study of Modern Airships," Phase II, Volume I, Book I; Goodyear Aerospace Corporation; NASA CR-151917; September 1976.
3. "Feasibility Study of Modern Airships," Phase II, Volume I, Book II; Goodyear Aerospace Corporation; NASA CR-151918, September 1976.
4. "Feasibility Study of Modern Airships," Phase II, Volume I, Book III; Goodyear Aerospace Corporation; NASA CR-151919, September 1976.
5. "Feasibility Study of Modern Airships," Phase II, Volume II; Goodyear Aerospace Corporation; NASA CR-151920, September 1976.
6. "Feasibility Study of Modern Airships," Phase II, Volume III; Goodyear Aerospace Corporation; NASA CR-151989, July 1977.
7. Huston, R. F. and Ardema, M. D.: "Feasibility of Modern Airships - Design Definition and Performance of Selected Concepts;" AIAA Paper 77-331, January 1977.
8. Ardema, M. D.: "Feasibility of Modern Airships - Preliminary Assessment;" Journal of Aircraft, vol. 14, no. 11, November 1977.
9. Piasecki, F. N.: "Ultra-Heavy Vertical Lift System - The 'Heli-Stat'," Proceedings of the Interagency Workshop on Lighter Than Air Vehicles, FTL Report R75-2, January 1975.
10. "Development of Weight Estimating Relationships for Rigid and Non-Rigid Heavy Lift Airships," Goodyear Aerospace Corporation; NASA CR-151976, March 1977.
11. "Study of Short-Haul Aircraft Operating Economics," Final Report; Douglas Aircraft Company; NASA CR-137685, September 1975.
12. "Summary of Airship All Weather Capabilities," USN, Bureau of Aeronautics, Navy Department, Washington, DC, Memorandum AER-AC-721, April 6, 1956.

1. Report No. NASA CR-2922	2. Government Accession No.	3. Recipient's Catalog No.	
4. Title and Subtitle "Feasibility Study of Modern Airships, Phase II Executive Summary"		5. Report Date November 1977	
		6. Performing Organization Code	
7. Author(s)		8. Performing Organization Report No.	
		10. Work Unit No.	
9. Performing Organization Name and Address Goodyear Aerospace Corporation 1210 Massillon Road Akron, Ohio 44315		11. Contract or Grant No. NAS 2-8643	
		13. Type of Report and Period Covered Contractor Report	
12. Sponsoring Agency Name and Address National Aeronautics & Space Administration Washington, D.C. 20546		14. Sponsoring Agency Code	
		15. Supplementary Notes	
16. Abstract A feasibility study of modern airships has been completed. In the second half of this study, summarized herein, three promising modern airship system concepts and their associated missions were studied: (1) a heavy-lift airship, employing a non-rigid hull and a significant amount of rotor lift, used for short-range transport and positioning of heavy military and civil payloads; (2) a VTOL (vertical take-off and landing), metalclad, partially buoyant airship used as a short-haul commercial transport; and (3) a class of fully-buoyant airships used for long-endurance Navy missions. The heavy-lift airship concept offers a substantial increase in vertical lift capability over existing systems and is projected to have lower total operating costs per ton-mile. The VTOL airship transport concept appears to be economically competitive with other VTOL aircraft concepts but can attain significantly lower noise levels. The fully-buoyant airship concept can provide an airborne platform with long endurance that satisfies many Navy mission requirements.			
17. Key Words (Suggested by Author(s)) Airships Lighter Than Air Technology		18. Distribution Statement UNCLASSIFIED-UNLIMITED STAR Category 01	
19. Security Classif. (of this report) UNCLASSIFIED	20. Security Classif. (of this page) UNCLASSIFIED	21. No. of Pages 64	22. Price* \$3.75