

NASA Technical Paper 1089

LOAN COPY
AFWL TECHNICAL LIBRARY
KIRTLAND AFB, N.M.



Laboratory Measurements of Radiance and Reflectance Spectra of Dilute Secondary-Treated Sewage Sludge

William G. Witte, J. W. Usry,
Charles H. Whitlock, and E. A. Gurganus

DECEMBER 1977

NASA



NASA Technical Paper 1089

Laboratory Measurements of Radiance and Reflectance Spectra of Dilute Secondary-Treated Sewage Sludge

William G. Witte, J. W. Usry,
Charles H. Whitlock, and E. A. Gurganus
Langley Research Center
Hampton, Virginia

NASA

National Aeronautics
and Space Administration

**Scientific and Technical
Information Office**

1977



NASA Technical Paper 1089

Laboratory Measurements of Radiance and Reflectance Spectra of Dilute Secondary-Treated Sewage Sludge

William G. Witte, J. W. Usry,
Charles H. Whitlock, and E. A. Gurganus
Langley Research Center
Hampton, Virginia



National Aeronautics
and Space Administration

**Scientific and Technical
Information Office**

1977

SUMMARY

The National Aeronautics and Space Administration (NASA), in cooperation with the Environmental Protection Agency (EPA) and the National Oceanic and Atmospheric Administration (NOAA), is conducting a research program to evaluate the feasibility of remotely monitoring ocean dumping of waste products such as acid and sewage sludge. One aspect of the research program involves the measurements of upwelled spectral signatures for sewage-sludge mixtures of different concentrations in an 11600-liter tank. This paper describes the laboratory arrangement and presents radiance and reflectance spectra in the visible and near-infrared ranges for concentrations ranging from 9.7 to 180 ppm of secondary-treated sewage sludge mixed with two types of base water. Results indicate that upwelled radiance varies in a near-linear manner with concentration and that the sludge has a practically flat signal response between 420 and 970 nm. Reflectance spectra were obtained for the sewage-sludge mixtures at all wavelengths and concentrations. No significant variations (peaks and valleys) were observed in the reflectance spectra for any of the concentrations. The reflectance may be considered to increase linearly with concentration at all wavelengths without introducing large errors. The spectral reflectance values appear to be influenced by the type of base water.

INTRODUCTION

The National Aeronautics and Space Administration (NASA), in cooperation with the Environmental Protection Agency (EPA) and the National Oceanic and Atmospheric Administration (NOAA), is conducting a research program to evaluate the feasibility of remotely monitoring ocean dumping of waste products such as acid and sewage sludge. Pollution of the marine environment from these and other products and its effects on the social and economic health of the public have become problems of national significance (refs. 1 and 2). For this reason, NASA devotes part of its resources to the research and development of remote sensing systems and to the application of these systems to the investigation of problems related to water quality (ref. 3). More specifically, one research program at the Langley Research Center (LaRC) involves conducting fundamental spectral signature studies and analytical studies related to pollutants in the marine environment. Some of these studies are directed toward evaluating the feasibility of remotely monitoring ocean dumping of wastes such as acid and sewage sludge (refs. 4 to 8).

Sewage sludge is routinely dumped into coastal zone waters in areas specifically designated for that purpose. Generally, these areas cover several square kilometers. The environmental factors which determine the ultimate fate of these materials, such as water and atmospheric dynamics, are not completely understood. Also, for various reasons, the dumping operations do not always occur in the designated zones, and the sewage may drift and contaminate beaches or areas rich in marine life. Because of the uncertainties in the ultimate fate of these materials, it is desirable to monitor these designated dump areas remotely and to be able to identify coastal zone waters which contain various concentrations of sewage sludge. To accomplish this remotely, the reflectance spectra of the material in the water at various concentrations are required.

Several airplane flights with multispectral scanners were made by NASA over sewage-sludge dump sites in the New York Bight (refs. 6 and 8) and the Atlantic Ocean off Cape Henlopen, Delaware. Also, small-scale laboratory investigations are being conducted to determine the composition and optical characteristics of the sewage sludge that produce the spectral signature of the material. In addition, reflectance spectra of sewage-sludge mixtures of different concentrations were measured in a spectral signature laboratory. Results obtained with primary-treated sewage sludge in this facility are presented in reference 9. Results obtained with secondary-treated sewage sludge, in two experiments conducted in this laboratory during March and April 1977, are presented in this paper. The upwelled spectral signature laboratory, as well as some of the components in the laboratory setup, is described in this paper. The objectives of these experiments were:

- (1) To determine upwelled spectral radiance and reflectance of diluted sewage sludge
- (2) To measure these spectra at various concentration levels and to investigate the functional relationship of the upwelled spectral radiance with concentration
- (3) To assess the effects of base water

To accomplish these objectives, secondary-treated sewage sludge was mixed with two types of base water. Conditioned tap water was used for the first experiment (March 31, 1977), and water from Back River was used for the second experiment (April 7, 1977). (Back River is located in Hampton, Virginia, on the western side of the Chesapeake Bay and about 16 km from its mouth.) The sewage sludge was mixed with these two water types to obtain sludge concentrations of 9.7, 38.8, 77.6, 155, and 180 ppm (samples 1, 2, 3, 4, and 5, respectively) in the conditioned tap water and in the natural water. Upwelled radiance spectra were measured for these mixtures. Reflectance spectra were calculated from these data and approximations of the linearity of reflectance

with concentration were made. Comparisons of the reflectance values from the experiment conducted with conditioned tap water were made with values from the experiment conducted with natural water.

SYMBOLS

A	area of spectrometer entrance slit, cm^2
D	vertical displacement of oscilloscope measurement, cm
$E(\lambda)$	spectral irradiance, $\text{W}/\text{m}^2\text{-nm}$
K	ratio of instrument throughput to vertical-scale sensitivity factor, $13.7 \times 10^3 \frac{\text{cm}^2\text{-sr}}{\text{mW}/\text{nm-cm}}$
$L_u(\lambda)$	upwelled spectral radiance, $\frac{\text{mW}/\text{nm}}{\text{cm}^2\text{-sr}}$
$P(\lambda)$	spectral power, mW/nm
S	vertical-scale sensitivity factor, $\text{mW}/\text{cm-nm}$
λ	wavelength, nm
$\rho_u(\lambda)$	spectral reflectance, percent of input (relative to a 100-percent diffuse reflector)
Ω	acceptance solid angle of spectrometer, sr

LABORATORY AND EQUIPMENT

Figure 1 is a sketch of the laboratory arrangement. Major parts of the setup include a water tank, circulation system, filtration and deionization system, solar simulator, first-surface mirror, and rapid scan spectrometer. A black canvas tent covers the water tank to block out background radiation during testing and to minimize the amount of contaminants, such as dust, entering the water tank.

The cylindrical steel water tank has a diameter of 2.5 m and a depth of 3 m. The bottom is concave as illustrated in figure 1. The tank interior is coated with a black

phenolic paint that absorbs 97 percent of incident radiation over the spectral range used. For these experiments, the tank was filled to within 0.3 m of the top with about 11 600 liters of water.

The circulation system was designed to maintain a vertical and horizontal homogeneous mixture in the tank and to maintain in suspension sediment particles up to about 100 μm in diameter (Specific gravity = 2.6). Particles of this size can be categorized as fine sand. To accomplish these design goals, water is pumped from the drain at the bottom of the tank into a system of pipes which returns the water to the tank through two vertical pipes on opposite sides of the interior of the tank; the water is emptied just above the concave bottom of the tank. Water entering the tank through these pipes washes over the concave bottom, meets at a location away from the drain, and wells upward. Tests using tracer techniques and transmission measurements have confirmed that this circulation system provides a uniform homogeneous mixture throughout the tank and keeps particles larger than fine sand in suspension. For pollutants such as sewage sludge with specific gravities of less than 2.6, the present laboratory setup will suspend particles that are much larger than 100 μm in diameter.

The filtration and deionization system includes a commercial fiber swimming-pool filter, an activated carbon filter, and a charged resin deionizer. These units are aligned with water lines parallel to the main circulation system water lines and can be used separately or in any combination by the use of valves. The two filters remove suspended materials and dissolved organic materials from the water before it reaches the deionizer, where dissolved ionic substances are removed. Generally, after tap water is conditioned through this system, it contains less than 0.5 ppm of suspended solids less than 20 μm in diameter and less than 2 ppm of dissolved ionic substances.

The light source is a solar radiation simulator designed to approximate the spectral content of the Sun's rays. The radiation spectrum is produced by a 2.5-kW xenon short-arc lamp and transmitted to the target plane through an optical arrangement inside the simulator and a collimating lens accessory. Without the collimating lens accessory, the simulator projects a beam of light, uniform in intensity and spectral content, on a 0.3-m-diameter plane surface located 0.61 m from the instrument which is uniform in intensity and spectral content. With the collimating lens accessory, the projected beam is collimated to a 0.15-m diameter 0.3 m from the instrument and has a $\pm 2.5^\circ$ collimation angle. For these experiments, the simulator was located approximately 15.2 m from the water tank as illustrated in figure 1. At this distance from the simulator, the beam is about 1.2 m in diameter. A mirror positioned 1.52 m above the water tank reflects the center of the beam to the water surface. The incidence angle with the water surface is 13° . This angle was chosen to avoid specular reflectance. The mirror is a first-surface mirror coated with aluminum and protected by an overcoat of silicon monoxide.

It has a 0.3-m diameter and reflects an elliptical spot on the surface of the water which has a maximum diameter of 0.35 m. The simulator spectrum input to the water surface is similar to, but not a precise duplicate of, sea-level standard solar-radiation curves often used in engineering calculations (ref. 10). Figure 2(a) shows that the standard sea-level curves are variable depending on the solar elevation angle. Figure 2(b) is the simulator spectrum normalized to the 30° solar spectrum at 600 nm. These curves suggest that, when laboratory measurements are made at a 32-nm spectral resolution, the input spectrum and possibly the output measurements are similar to those that would be expected in the field if the solar elevation angle was greater than about 30°. The total intensity of the light hitting the water surface is on the order of 8 percent of that in the field.

The rapid-scanning spectrometer system consists of a spectrometer unit with a telephoto lens attachment and a plug-in unit with an oscilloscope and Polaroid camera attachment. The spectrometer unit with telephoto lens attachment is mounted 2.43 m above the surface of the water as illustrated in figure 1. The spectrometer uses a Czerny-Turner grating monochromator with no exit slit. The spectral output of the monochromator is focused on the target of a vidicon tube where the spectrum is stored as an electrical charge image. An electron beam periodically scans across the vidicon target, thereby converting the charge image into an electronic signal. This signal is processed by the plug-in unit which functions as an electronic signal processor and controller between the spectrometer and the oscilloscope. The signal is displayed on the oscilloscope and is photographically recorded by the camera. The spectrometer is designed to measure power per nanometer of spectral bandwidth. The oscilloscope screen is used to show displacement. The spectral power $P(\lambda)$ is proportional to displacement D as shown in the following equation:

$$P(\lambda) = DS \tag{1}$$

The vertical-scale sensitivity factor S is calibrated internally by the manufacturer and is displayed on the oscilloscope screen. The upwelled radiance per nanometer of spectral bandwidth $L_u(\lambda)$ is defined as

$$L_u(\lambda) = \frac{P(\lambda)}{A\Omega} \tag{2}$$

where A is the area of spectrometer entrance slit and Ω is the acceptance solid angle of the instrument. The quantity $A\Omega$ is defined as the instrument throughput and is a measure of the capacity of a system to collect light. Combining equations (1) and (2) gives

$$L_u(\lambda) = \frac{DS}{A\Omega} \quad (3)$$

or

$$L_u(\lambda) = \frac{D}{K} \quad (4)$$

where

$$K = \frac{A\Omega}{S}$$

Thus, upwelled spectral radiance per nanometer is proportional to displacement, and the proportionality constant is a function of instrument calibration. For the tests described herein, the actual measured upwelled spectra are presented in terms of radiance or $L_u(\lambda)$.

EXPERIMENTAL METHOD

Two experiments were conducted to obtain upwelled radiance spectra for various concentrations of secondary-treated sewage sludge in two types of base water. Samples of the sewage sludge were collected in thirty-two 1-gal containers from the Northeast Philadelphia Waste Treatment Facility on March 24, 1977. (1 gal = 0.004 m³.) Usually, this material is carried by barge about 65 km offshore of the entrance to Delaware Bay and dumped into the Atlantic Ocean. These samples were transported on ice in coolers to LaRC and kept under refrigeration at 4^o C until the experiments were conducted.

Prior to the first experiment the 32 sludge samples were combined in a large vat and stirred with an electric outboard trolling motor. This procedure was used because the consistency of the 32 sludge samples varied from almost clear water to a thick black paste. After stirring, a sample was withdrawn from the vat and was used in a laboratory analysis, as described subsequently, to measure the total suspended solids in the sewage sludge.

To prepare for an experiment, the water tank was filled to within 0.3 m of the top with 11 600 liters of water. Conditioned tap water (filtered and deionized) was used in the tank for the first of these experiments. Water from Back River was pumped directly into the tank without conditioning for the second experiment. Sewage sludge was mixed with the water in each case to obtain the various sludge concentrations shown in table I. The conditioned tap water contained 0.1 ppm suspended solids and less than 2 ppm

dissolved substances. Water from Back River, however, contained 14.1 ppm suspended solids and 11 500 ppm dissolved substances. Table II presents the results of the base water analyses.

For the first sample in the water tank, a volume of sludge was withdrawn from the vat into a graduated cylinder. This sludge was gradually added to the tank until the signal displacement from the baseline, with the chosen instrument settings, was of a magnitude that was found from previous experience to be convenient to work with. The volume used was noted. Four additional samples were similarly withdrawn and added to the tank to produce roughly the same incremental increase in upwelled radiance.

The laboratory analysis for total suspended solids was conducted by injecting a 1-ml sample into a preweighed crucible containing a glass-fiber filter. The liquid was pulled through the filter by suction. The crucible was heated to 82^o C for 1 hour. After cooling, the crucible was reweighed and total suspended solids were calculated. Based on three determinations using this method, the sludge contained an average of 45 300 ppm of total suspended solids. By using this value for total suspended solids, a water tank capacity of 11 600 liters, and the volume of the sample used for mixing with the water in the tank, the concentration was calculated for each of the five samples added to the water tank. These values are listed in table I. After each of the five samples was added to the water in the tank and the spectral signal measured, a sample was extracted from the tank. From each of these samples (six in all, because a base-water sample was also taken) three 1-ml samples were extracted and a laboratory analysis similar to that discussed previously was performed. The results of these three analyses were averaged to obtain total suspended solids for the water-tank mixtures. These values are listed in table III.

After the first experiment, the sludge remaining in the vat was rebottled in the original 1-gal bottles and returned to the refrigerator until the second experiment was conducted. At that time the sludge was again combined in the vat and stirred as before. Again five samples were withdrawn to mix with the Back River water and to provide the concentrations shown in table I. The sampling and analysis process described was repeated to obtain the results listed in table III for Back River water.

After the tank was filled, the circulation system was activated and the water was allowed to circulate with no filtration until a steady-state condition existed in the tank. During this period, a reflectance spectrum of a standard neutral test card was measured with the gray side (18 percent reflectance) placed near the surface of the water. Additional test-card measurements, the same as these, were made halfway through the experiment and at the end of the experiment to check for instrument drift. No significant drift occurred. These test-card data were averaged and the average was used to normalize the sewage-sludge radiance spectra so that spectral differences were more

easily recognized. The test card had a flat spectral response of 18 percent between 360 and 690 nm, but the reflectance gradually increased to about 25 percent from 690 to 970 nm. A correction was applied to account for this increase before the normalization procedure was carried out.

Following the test-card measurements, an upwelled radiance spectrum for the base water was obtained. Then the first sample of sewage sludge was mixed with the water in the tank to achieve the first mixture concentration. This mixture was allowed to circulate for a period of time (approximately 15 minutes) until the sewage sludge was evenly distributed throughout the tank. An upwelled spectrum was measured as before and the procedure was repeated to obtain upwelled spectra for the other concentrations. Generally, after the water tank was filled, 2.5 to 3.0 hours were required to complete an experiment. Differences in the experimental procedures were minimized so that cursory effects of background water could be evaluated.

RESULTS AND DISCUSSION

The values for total suspended solids listed in table III indicate differences between the three determinations for a given sample. Also, when the values for total suspended solids of the base waters shown in table II are added to the sewage-sludge concentrations shown in table I, the resulting values of total suspended solids differ from the experimental values shown in table III. Generally, these differences are large because it is difficult to obtain accurate measurements of total suspended solids for nonhomogeneous materials such as sewage sludge. The calculated values of sludge concentration shown in table I have been selected for use in the discussion which follows.

Upwelled radiance distributions with wavelength for the two experiments are shown in figure 3 for the base waters and for sludge concentrations of 9.7, 38.8, 77.6, 155, and 180 ppm. Conditioned tap water was used as the base water for the experiment conducted on March 31 (fig. 3(a)), whereas Back River water was used as the base water for the experiment conducted on April 7 (fig. 3(b)). It should be noted that the spectrometer system spectral resolution for these experiments was 32 nm. According to instrument specifications, absolute accuracy of the measurements is believed to be ± 20 percent in the 400- to 600-nm range and ± 12 percent in the 600- to 900-nm range. Included in the absolute error is a repeatability uncertainty of ± 13 percent in the 400- to 600-nm range and ± 3.5 percent in the 600- to 900-nm range. Discussions with a representative of the manufacturer indicate that these values represent 3-sigma error bands. The abrupt spectral variations in these curves above 700 nm were caused by the light source and other factors not related to the spectral response of the sewage sludge.

Figure 4 shows the reflectance spectra for the two experiments. Reflectance is presented as a percentage of the radiance incident on the water. Data for the sewage sludge in conditioned tap water are presented in figure 4(a) and in Back River water in figure 4(b). Notice that the abrupt spectral variations seen in figure 3 above 700 nm are not seen in these figures. The results of figure 4 show only slight variations in the reflectance with wavelength for a particular concentration. Reflectance increased with increasing concentration at all wavelengths. Generally, for all concentrations the reflectance decreased with increasing wavelength and leveled out at about 700 nm. In some cases a minimum value occurred near 750 nm. There were no prominent features (peaks or valleys) at any wavelength for any of the concentrations. However, reflectance values were measured for all wavelengths and concentrations considered. The level (magnitude) of the curve for each concentration was different from the curves for other concentrations.

A comparison of figures 4(a) and 4(b) shows that the reflectance spectra for the natural base water was greater than for the conditioned tap water. This initial enhancement of reflectance in the natural water was due to suspended materials other than sludge. With additions of equal increments of sludge to the two water types, however, the increases in reflectance were less for the natural-water mixtures than for the conditioned-tap-water mixtures. At the highest concentrations the reflectance for the natural-water mixture was only about 75 percent of that for the conditioned-tap-water mixture. Additional comparisons of these data are made in figures 5 and 6.

Figure 5 shows reflectance for several wavelengths plotted against concentration for the two tests. These data were obtained from figure 4. Linear regression curves have been drawn through the data since modeling techniques often assume a linear increase in reflectance with concentration. Correlation coefficients for these linear regressions were calculated and were greater than 0.98 for all cases, which indicates that the assumption of linearity is valid. Figure 5 shows that at each wavelength the slope of the linear curve for conditioned tap water is greater than that for natural water. Also, the slopes for both cases decrease with increasing wavelength.

An overall view of these same data (plus the values for the base waters) is given in figure 6, which presents $\rho_u(\lambda)$ for conditioned tap water plotted against $\rho_u(\lambda)$ for Back River water at the indicated wavelengths. Also, groups of points in the figure are identified with the concentration for that set of points and alternate concentrations are shaded to help distinguish sets. For perfect agreement, all points would fall on the 45° line. Scatter of the points in a set indicates the variation of reflectance values with wavelength for that concentration, whereas displacement from the 45° line shows how the reflectance measurements agree in magnitude for the two experiments. The water

from Back River contained 14.1 ppm suspended solids, whereas the conditioned tap water contained 0.1 ppm. The reflectance values for the Back River base water data are higher, as expected. This increment of reflectance, attributable to the presence of suspended solids and other naturally occurring material in the Back River water, might also have been expected to appear in the other mixture concentrations. Instead, at higher concentrations the reflectance values are lower for the Back River data. These results suggest that the reflectance measurements made using Back River water were different because of a physical (coagulation, for example) or chemical process that became obvious for the higher concentrations in the natural water but not in the conditioned water. Additional experimental tests would be required, however, to clarify these points.

CONCLUSIONS

Radiance and reflectance spectra for secondary-treated sewage sludge were obtained for sewage-sludge concentrations from 9.7 to 180 ppm and wavelengths from 420 to 970 nm. Based on the results of these laboratory experiments, the following conclusions were drawn:

1. Reflectance increased with increasing concentration at all wavelengths. At each concentration reflectance decreased as wavelength increased and generally leveled out at about 700 nm, with a minimum sometimes occurring at about 750 nm.
2. No significant variations (peaks or valleys) were observed in the reflectance spectra at any wavelength for any of the concentrations.
3. The reflectance may be considered to increase linearly with concentration at all wavelengths without introducing large errors.
4. The spectral reflectance values appear to be influenced by the type of base water.

Langley Research Center
National Aeronautics and Space Administration
Hampton, VA 23665
November 9, 1977

REFERENCES

1. Hanna, William J.; Marshall, Harold G.; and Slowey, James F., eds.: A Survey of the Problems and Research Needs in the Coastal Zone. NASA CR-111780, 1970.
2. Adams, D. A.; Fry, J.; Gurk, H.; Hudgens, J.; Newell, R.; Singleton, J.; and Smith, C. R.: Advance Study of Coastal Zone Oceanographic Requirements for ERTS E & F. NASA CR-111823, 1971.
3. Usry, J. W.; and Hall, John B., Jr.: National Aeronautics and Space Administration Operations – Remote Sensing Experiments in the New York Bight, April 7-17, 1975. NASA TM X-72802, 1975.
4. Hypes, Warren D.; and Ohlhorst, Craig W.: A Summary of the Test Procedures and Operational Details of a Delaware River and an Ocean Dumping Pollution Monitoring Experiment Conducted August 28, 1975. NASA TM X-74005, 1977.
5. Lewis, Beverley W.; and Collins, Vernon G.: Remotely Sensed and Laboratory Spectral Signatures of an Ocean Dumped Acid Waste. NASA TN D-8467, 1977.
6. Johnson, Robert W.: Multispectral Analysis of Ocean Dumped Materials. NASA paper presented at the Eleventh International Symposium on Remote Sensing of Environment (Ann Arbor, Michigan), Apr. 25-29, 1977.
7. Grew, Gary W.: Characteristic Vector Analysis as a Technique for Signature Extraction of Remote Ocean Color Data. NASA paper presented at the Sixth Annual Remote Sensing of Earth Resources Conference (Tullahoma, Tennessee), Mar. 29-31, 1977.
8. Johnson, Robert W.; and Hall, John B., Jr.: Remote Sensing Operations (Multispectral Scanner and Photographic) in the New York Bight September 22, 1975. NASA TM X-73993, 1977.
9. Usry, J. W.; Witte, William G.; Whitlock, Charles H.; and Gurganus, E. A.: Laboratory Measurements of Radiance and Reflectance Spectra of Dilute Primary-Treated Sewage Sludge. NASA TP-1038, 1977.
10. Moon, Parry: Proposed Standard Solar-Radiation Curves for Engineering Use. J. Franklin Inst., vol. 230, no. 5, Nov. 1940, pp. 583-617.

**TABLE I.- SECONDARY-TREATED SEWAGE-SLUDGE
SAMPLE CONCENTRATIONS**

Sample	Calculated ^a total sludge concentration, ppm
Base water	0.0
1	9.7
2	38.8
3	77.6
4	155
5	180

^aBased on sludge measured to be 45 300 ppm and a tank volume of 11 600 liters.

TABLE II.- CHARACTERISTICS OF BASE WATER

	Conditioned tap water	Back River water
Total suspended solids, ppm	0.1	14.1
Chlorophyll <u>a</u> , µg/liter	0	1.0
Dissolved ionic substances, ppm . .	^a <2	11 500

^aCondition, in general, after passing through filters and charged resin deionizer.

TABLE III.- TOTAL SUSPENDED SOLIDS

Sample	Concentration of total suspended solids, ppm, in -				
	Conditioned tap water (March 31, 1977)		Back River water (April 7, 1977)		
	1-ml sample	Average	1-ml sample	Average	
Base water	0.08 .06 .16	0.1	16.2 12.7 13.4	14.1	
1	8.9 10.9 8.9		20.8 23.1 20.6		
2	26.0 24.0 30.1		-----		-----
3	52.6 53.4 58.5	54.8	61.6 87.2 86.2	78.3	
4	105 113 123		191 211 209		204
5	157 132 154		216 208 227		

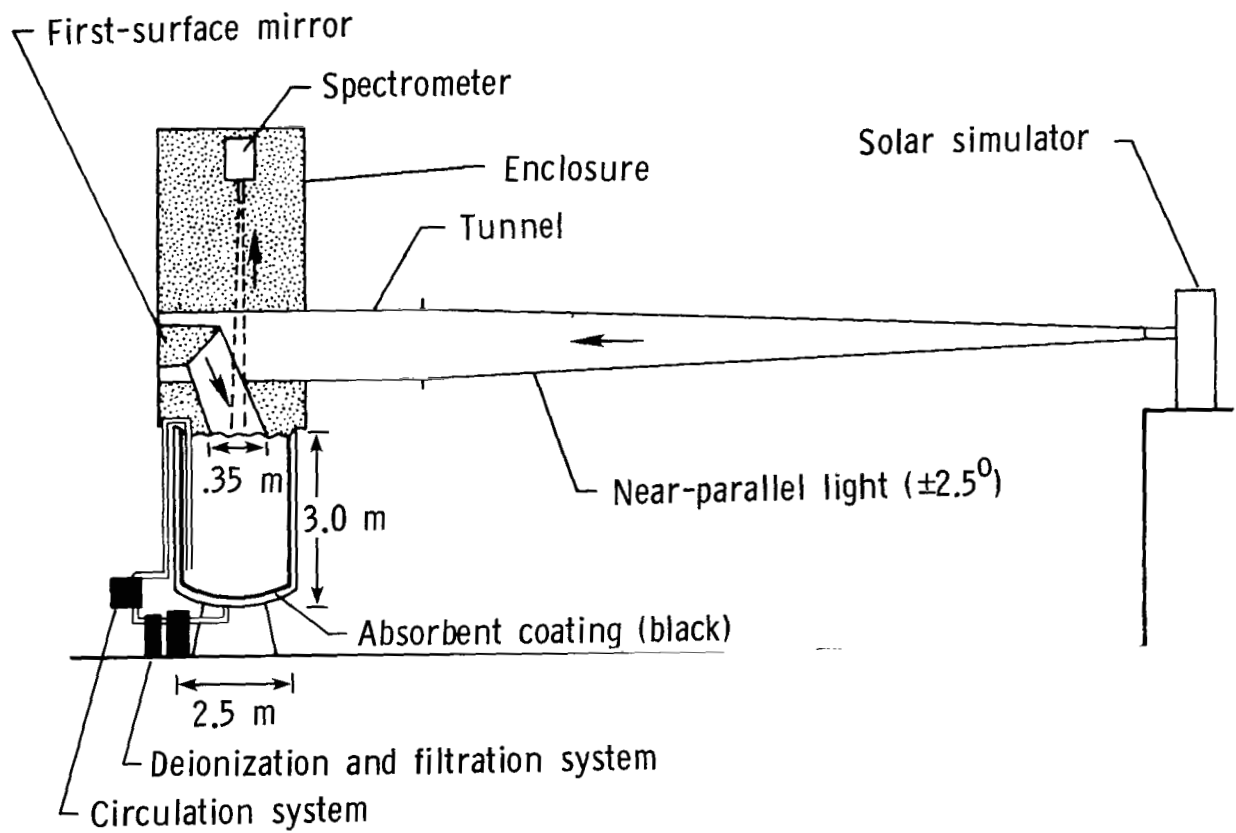
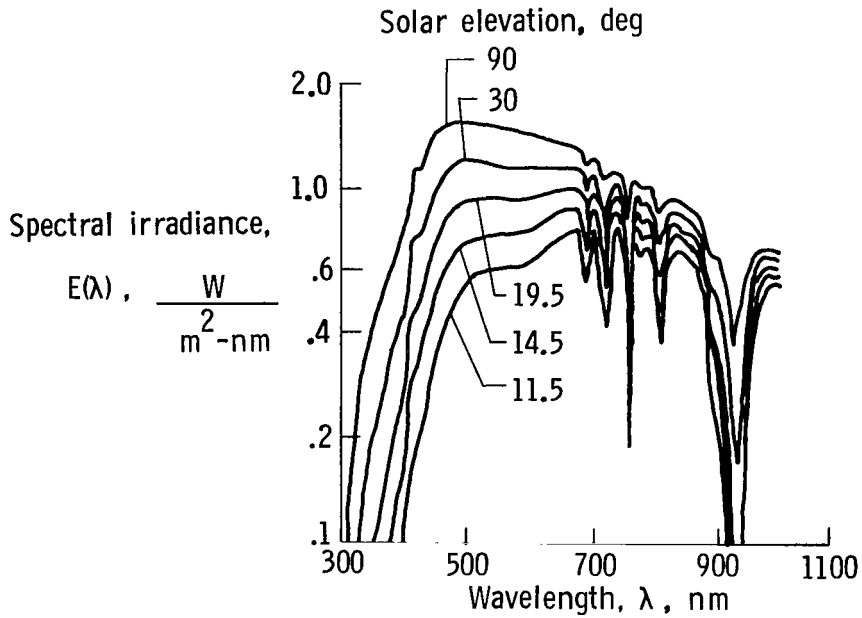
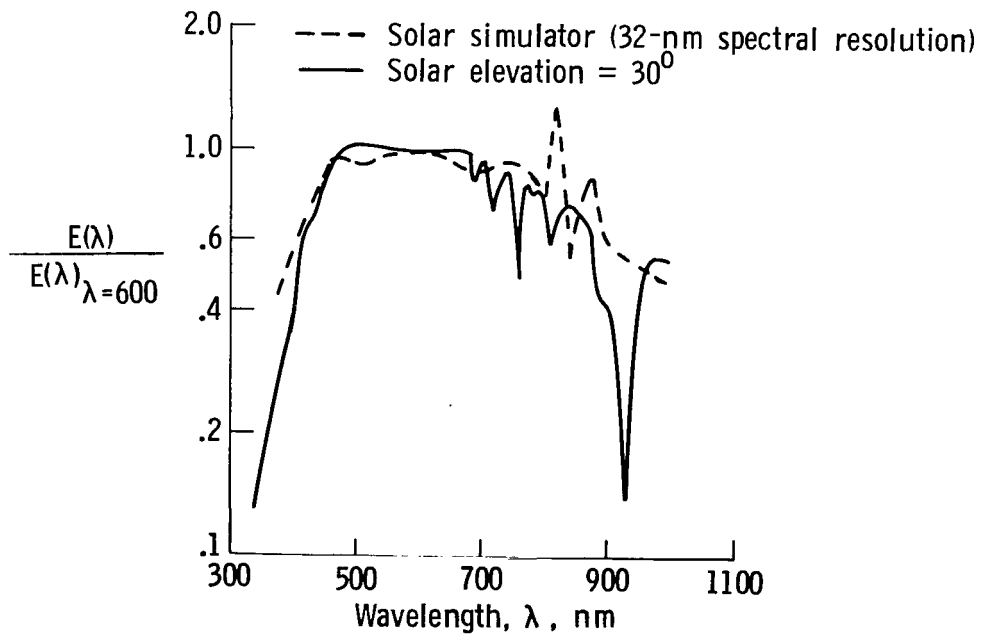

Figure 1. - Sketch of laboratory setup.



(a) Standard sea-level solar irradiance spectra (ref. 10).



(b) Solar simulator and standard sea-level spectra.

Figure 2.- Standard sea-level solar irradiance spectra and comparison with solar simulator data.

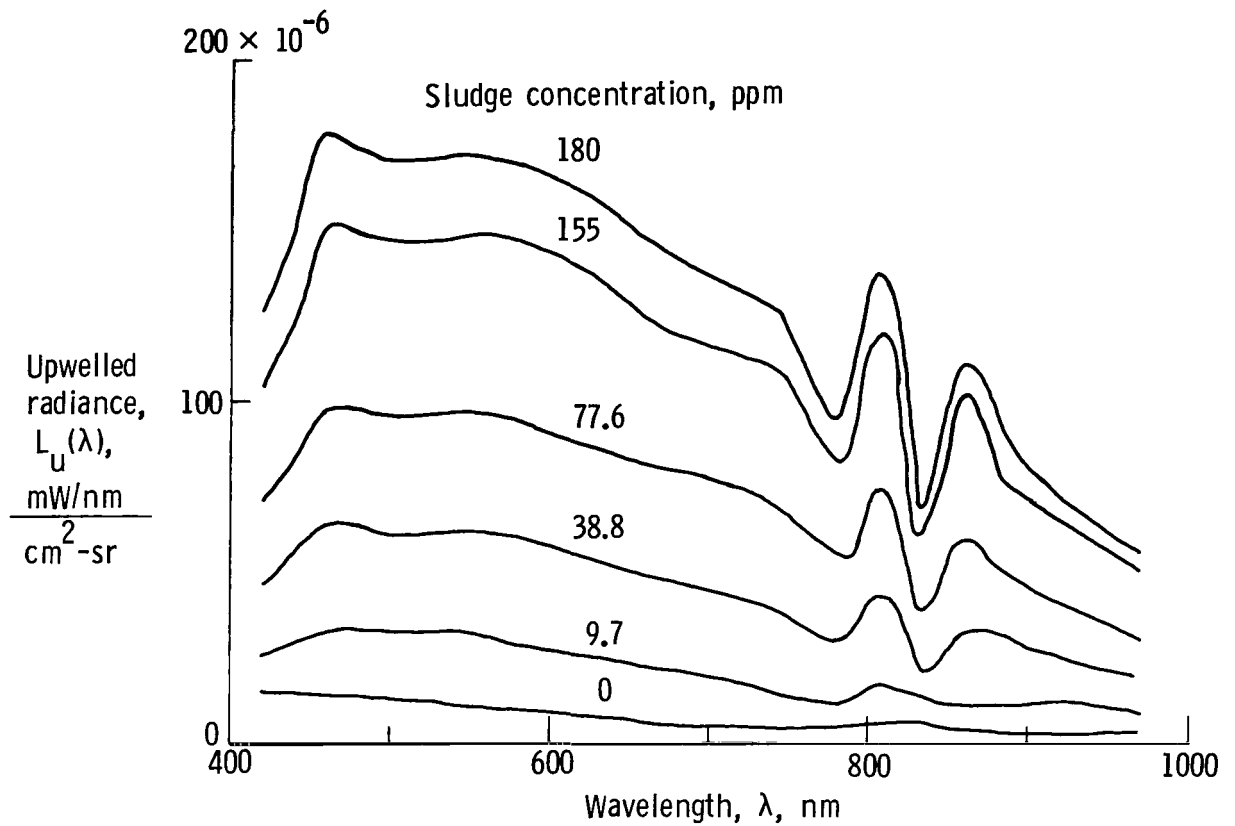

(a) Conditioned tap water as base water; March 31, 1977.

Figure 3.- Upwelled radiance plotted against wavelength. Spectral resolution, 32 nm.

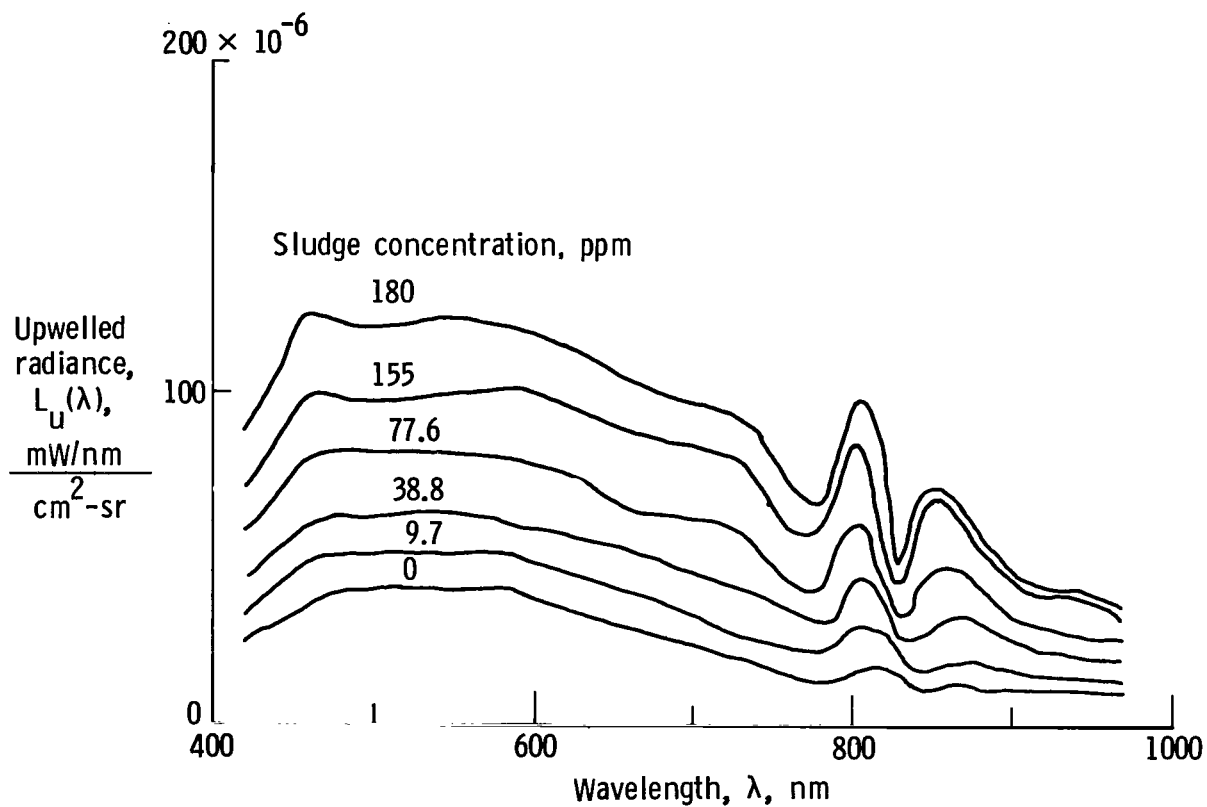

(b) Back River water as base water; April 7, 1977.

Figure 3. - Concluded.

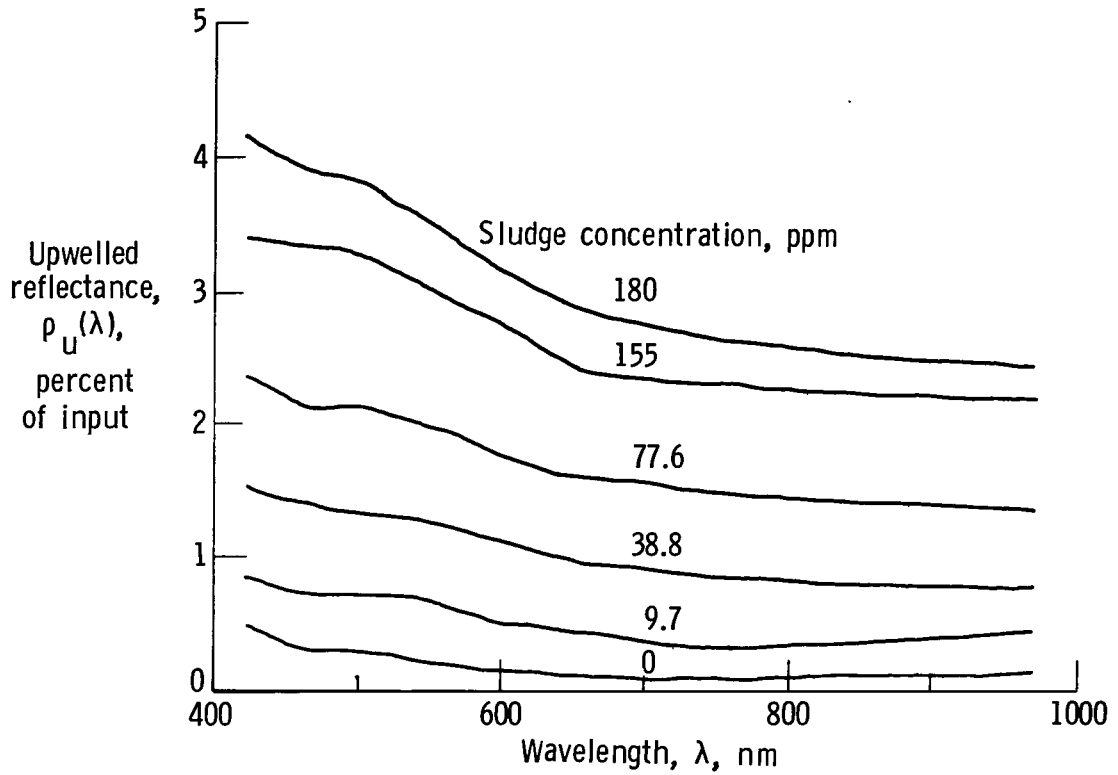

(a) Conditioned tap water as base water; March 31, 1977.

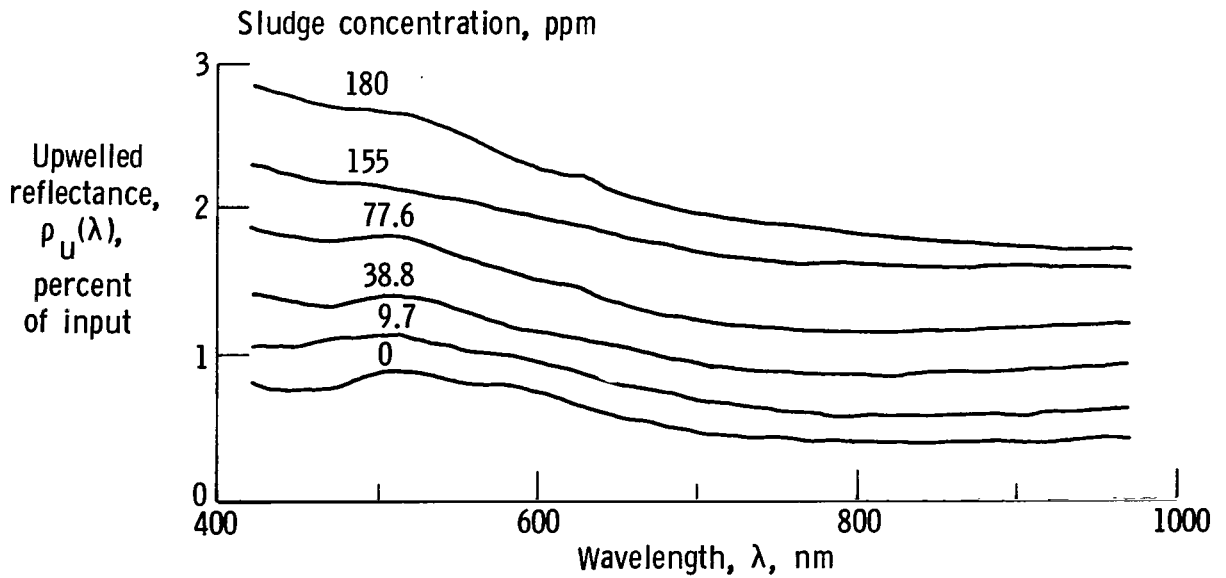

(b) Back River Water as base water; April 7, 1977.

Figure 4. - Upwelled reflectance plotted against wavelength.
Spectral resolution, 32 nm.

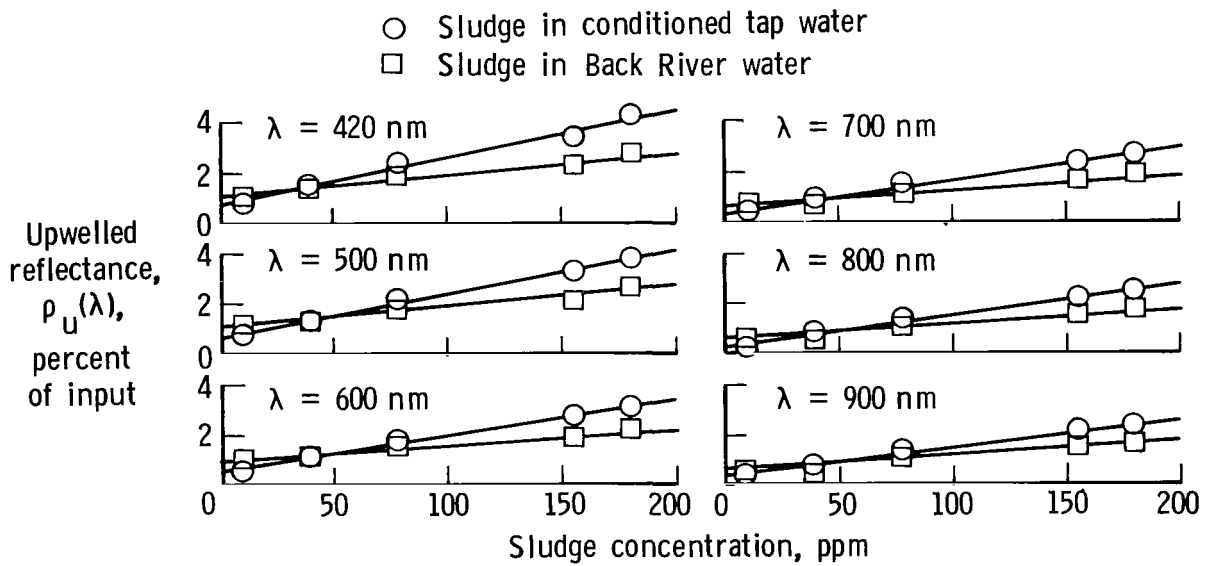

Figure 5.- Linearity of reflectance with concentration for various wavelengths.

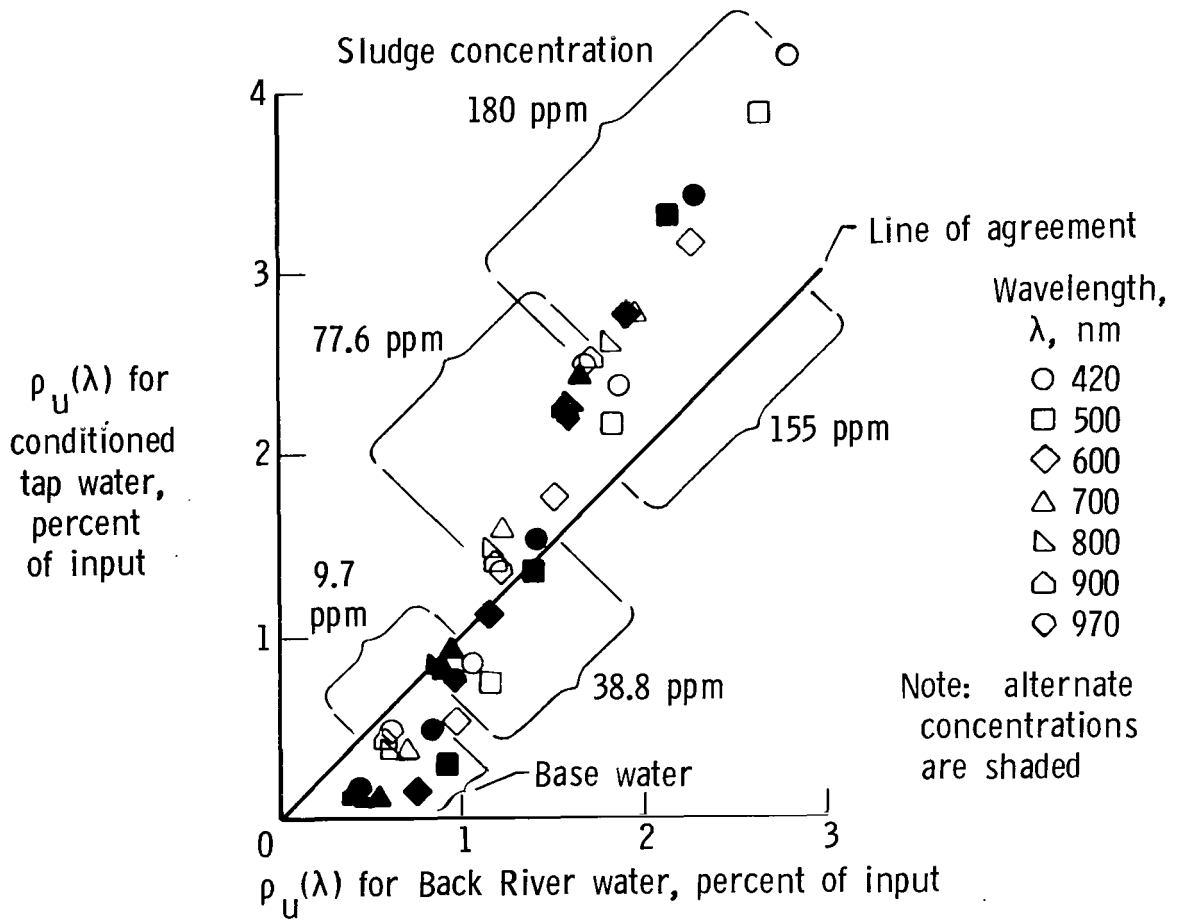

Figure 6.- Comparison of reflectance data for conditioned tap water and Back River water.

1. Report No. NASA TP-1089		2. Government Accession No.		3. Recipient's Catalog No.	
4. Title and Subtitle LABORATORY MEASUREMENTS OF RADIANCE AND REFLECTANCE SPECTRA OF DILUTE SECONDARY-TREATED SEWAGE SLUDGE				5. Report Date December 1977	
7. Author(s) William G. Witte, J. W. Usry, Charles H. Whitlock, and E. A. Gurganus				6. Performing Organization Code	
9. Performing Organization Name and Address NASA Langley Research Center Hampton, VA 23665				8. Performing Organization Report No. L-11870	
12. Sponsoring Agency Name and Address National Aeronautics and Space Administration Washington, DC 20546				10. Work Unit No. 176-30-31-11	
15. Supplementary Notes				11. Contract or Grant No.	
16. Abstract <p>The National Aeronautics and Space Administration (NASA), in cooperation with the Environmental Protection Agency (EPA) and the National Oceanic and Atmospheric Administration (NOAA), is conducting a research program to evaluate the feasibility of remotely monitoring ocean dumping of waste products such as acid and sewage sludge. One aspect of the research program involves the measurements of upwelled spectral signatures for sewage-sludge mixtures of different concentrations in an 11600-liter tank. This paper describes the laboratory arrangement and presents radiance and reflectance spectra in the visible and near-infrared ranges for concentrations ranging from 9.7 to 180 ppm of secondary-treated sewage sludge mixed with two types of base water. Results indicate that upwelled radiance varies in a near-linear manner with concentration and that the sludge has a practically flat signal response between 420 and 970 nm. Reflectance spectra were obtained for the sewage-sludge mixtures at all wavelengths and concentrations.</p>				13. Type of Report and Period Covered Technical Paper	
17. Key Words (Suggested by Author(s)) Remote sensing Spectral signature Laboratory measurements Sewage sludge Ocean dumping				14. Sponsoring Agency Code	
18. Distribution Statement Unclassified - Unlimited Subject Category 45					
19. Security Classif. (of this report) Unclassified	20. Security Classif. (of this page) Unclassified	21. No. of Pages 20	22. Price* \$4.00		

National Aeronautics and
Space Administration

Washington, D.C.
20546

Official Business

Penalty for Private Use, \$300

THIRD-CLASS BULK RATE

Postage and Fees Paid
National Aeronautics and
Space Administration
NASA-451



7 1 1U,E, 113077 S00903DS
DEPT OF THE AIR FORCE
AF WEAPONS LABORATORY
ATTN: TECHNICAL LIBRARY (SUL)
KIRTLAND AFB NM 87117

NASA

POSTMASTER: If Undeliverable (Section 158
Postal Manual) Do Not Return
