

General Disclaimer

One or more of the Following Statements may affect this Document

- This document has been reproduced from the best copy furnished by the organizational source. It is being released in the interest of making available as much information as possible.
- This document may contain data, which exceeds the sheet parameters. It was furnished in this condition by the organizational source and is the best copy available.
- This document may contain tone-on-tone or color graphs, charts and/or pictures, which have been reproduced in black and white.
- This document is paginated as submitted by the original source.
- Portions of this document are not fully legible due to the historical nature of some of the material. However, it is the best reproduction available from the original submission.

**NASA TECHNICAL
MEMORANDUM**

NASA TM-73742

NASA TM -73742

(NASA-TM-73742) MECHANICAL PROPERTIES OF
ION-BEAM-TEXTURED SURGICAL IMPLANT ALLOYS
(NASA) 24 p HC A02, MF A01 CSCL 11F

N78-13181

G3/26 Unclas
55200

**MECHANICAL PROPERTIES OF ION-BEAM-
TEXTURED SURGICAL IMPLANT ALLOYS**

by A. J. Weigand
Lewis Research Center
Cleveland, Ohio 44135

TECHNICAL PAPER to be presented at the
Twenty-fourth National Symposium
sponsored by the American Vacuum Society
Boston, Massachusetts, November 8-11, 1977

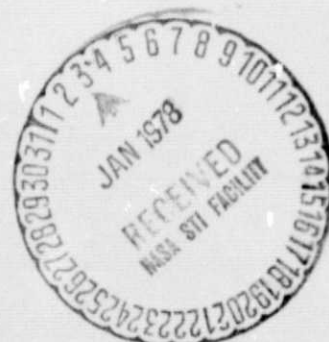

MECHANICAL PROPERTIES OF ION-BEAM-TEXTURED
SURGICAL IMPLANT ALLOYS

by A. J. Weigand
National Aeronautics and Space Administration
Lewis Research Center
Cleveland, Ohio 44135

ABSTRACT

An electron-bombardment Hg ion thruster was used as an ion source to texture surfaces of materials used to make orthopedic and/or dental prostheses or implants. The materials textured include 316 stainless steel, titanium-6% aluminum, 4% vanadium, and cobalt-20% chromium, 15% tungsten. To determine the effect of ion texturing on the ultimate strength and yield strength, stainless steel and Co-Cr-W alloy samples were tensile tested to failure. Three types of samples of both materials were tested. One type was ion-textured (the process also heats each sample to 300^o C), another type was simply heated to 300^o C in an oven, and the third type was untreated. Stress-strain diagrams, 0.2% offset yield strength data, total elongation data, and area reduction data will be presented. Fatigue specimens of ion textured and untextured 316 stainless steel and Ti-6% Al-4% V were tested. Included as an ion textured sample is a Ti-6% Al-4% V sample which was ion milled by means of a Ni screen sputter mask so as to produce an array of 140 μm×140 μm ×60 μm deep pits. A table is presented that compares the fatigue characteristics of ion textured and untextured samples. Scanning electron microscopy was used to characterize the ion textured surfaces. An electron beam microprobe was used to analyze the cross sections of the ion textured samples.

E-9056-1

INTRODUCTION

Ion thrusters used as an industrial tool can modify the surface structure of biological implants for tissue response studies (refs. 1 and 2). Using this tool, microscopic surface textures can be produced on biocompatible materials (metals, alloys, and polymers) in a controlled and precise manner. Ion-textured materials are being evaluated at the Case Western Reserve University in animal implant studies (refs. 3 and 4) to determine hard and soft tissue response to surface texture properties for optimum compatibility.

While tissue response studies of ion-textured surfaces implanted in animals are being conducted, there is also a need to determine if mechanical properties (ultimate strength, yield strength, and fatigue strength) of materials are effected by the ion-texturing process. This paper discusses an experimental effort to ascertain the effects on mechanical properties due to ion texturing. In this study, samples of three materials used for biological implants (ref. 5) were ion-textured and then tensile and/or fatigue tested to determine the resulting mechanical properties. The representative implant materials that were tested included 316 stainless steel (17% chromium, 14% nickel), a titanium alloy (6% aluminum, 4% vanadium), and a cobalt alloy (20% chromium, 15% tungsten). The cobalt alloy and stainless steel samples were machined into standard tensile test specimens. Fatigue test samples were prepared out of the titanium alloy and stainless steel.

Three different sample preparations were used for tensile testing. The first group were untextured samples used as controls for comparison with handbook values of mechanical properties. The second were ion-textured samples. Because of the heating effect of ion-texturing, a third set of samples were heated in an oven to 300^o C (the temperature reached during texturing) and tensile tested. It was then possible to differentiate the effects of heating and ion-texturing on the tensile properties. The fatigue samples had

been annealed to 800^o C prior to ion-texturing, and it was not necessary to test samples that were heated only.

SPUTTERING APPARATUS AND TECHNIQUE

Ion Thruster

A 5-centimeter-diameter electron bombardment mercury ion thruster was used as the ion-beam source for the results reported herein. Figure 1 shows the schematic of the ion source, which is similar to the thruster reported in reference 6, except a double-strand, titanium-wire loop coated with an emissive mix is used for a neutralizer instead of a plasma bridge hollow cathode (ref. 7). Either type of neutralizer provides the electrons needed to produce a high velocity neutral beam. All the samples were textured at a 10-centimeter ion-source-to-sample distance. The ion source operating conditions were maintained at a constant level of a 30 mA ion-beam current and a 2000 eV ion-beam energy. The current density at these operating conditions was $190 \mu\text{A}/\text{cm}^2$ at the sample location.

During all testing the facility operating pressure was between 1.3×10^{-3} to 4.0×10^{-3} pascal (1×10^{-5} to 3×10^{-5} torr).

Ion sources using inert gases have been used to ion-texture surfaces (refs. 1 and 2). The resulting surface microstructures are not significantly different from these data reported herein using a mercury ion beam. Therefore, if any materials that react with, absorb, or are effected by mercury are to be textured, argon may be used as the fuel source.

Alloys

All three alloys that were investigated are used to make various types of biological implants. Ti-6% Al, 4% V is used for orthopedic prostheses and is manufactured according to ASTM standard specification designation, F136-70. Co-20% Cr, 15% W, which is used for heart pacemaker enclosures and dental implants, has the ASTM designation of F90-68. The stainless steel used for

surgical implants is made according to ASTM specification designation F55-71. Orthopedic implants such as bone pins, screws, and hip prostheses are made from this material.

Ion-Texturing

The type of cylindrical tensile specimen (ASTM E-8) that was tested is shown in figure 2. All samples were made from the same stock of cobalt alloy and stainless steel. Each 0.29-centimeter-diameter sample, polished to a $0.1 \mu\text{m}$ - ($4 \mu\text{in.}$ -) rms-roughness, lapped finish was placed in the beam so that its axis was perpendicular to the thruster axis. The sample was attached to an apparatus to rotate it without turning off the ion beam. The sample was ion-textured for a given length of time and then rotated to expose another portion of the sample to the ion beam. The sample was rotated four times so that almost the entire surface was covered with an ion-beam-produced microstructure. Table I gives the duration of ion-beam texturing for each specimen tested. The surface temperature resulting from ion-texturing for all tensile samples was approximately 300°C .

Two different standard types of fatigue samples were tested (ref. 8). Figure 3(a) shows a Ti-6Al, 4V sample, and figure 3(b) shows a 316 stainless steel sample. Each sample had a surface finish of $0.2 \mu\text{m}$ - ($8 \mu\text{in.}$ -) rms-roughness. All pertinent dimensions for each sample are given in the figure. It was assumed that the different sample dimensions would not effect the final fatigue results. All fatigue samples of the same material were taken from the same heat.

Because of their greater mass (larger samples) the fatigue samples reached a temperature of only 200°C during ion-texturing. Therefore, it was necessary to vary the ion-texturing technique to produce the desired surface microstructure (ref. 9). The surfaces of the fatigue samples were textured by simultaneous ion-beam-sputtering of the implant material and a sputter-resistant, "seed" material while redepositing the seed material onto the implant surface.

For this study tantalum was used as the sputter resistant material. The tantalum, called the seed material (ref. 10), was located in proximity to the implant material and at a 45° angle with respect to the thruster axis. Sputtered Ta atoms were deposited on the implant target by this technique. Sputter resistant sites of Ta are thought to be formed. These sites foster the generation of a rough, sputtered surface (ref. 11). The seed material atoms can be removed from the implant surface by removal of the Ta from the ion beam and subsequent sputtering of the implant for 1 to 5 minutes. Analysis of the surface using a scanning electron microscope in conjunction with X-ray energy dispersive spectroscopy indicated that almost all of the Ta seed material was removed after 5 minutes.

To determine the effect of large variations in surface roughness on the fatigue strength, a sample of Ti-6Al, 4V was ion-machined (ref. 12) with a $158\ \mu\text{m} \times 158\ \mu\text{m}$ pore nickel mesh superimposed. The mesh ($75\ \mu\text{m}$ thick) was spot welded to the sample to insure that it was touching or not farther away than $20\ \mu\text{m}$ from the surface. Only one area of this sample was exposed to the ion beam for a duration of 12 hours. This time corresponded to the complete erosion of the nickel mesh. The resulting surface structure, shown in figure 4, has $140\ \mu\text{m} \times 140\ \mu\text{m}$ pores which are $60\ \mu\text{m}$ deep in the surface.

TENSILE TESTS

Three different sample treatments were examined to determine the effect of ion-texturing on the tensile properties. First, untextured samples of both 316 stainless steel and Co-20Cr, 15W were tensile tested to obtain control data for comparison with handbook data. The second set of test samples was heated to 300°C in a furnace (in air) for 16 hours, which corresponded to the maximum ion-beam exposure duration for any one sample, to determine the effect of high temperature on the tensile properties. The third set tested was the ion-textured samples.

Scanning electron photomicrographs were taken of the surface of each sample, and the cross-sectional area of each sample was determined by using a shadowgraph before the tensile tests were performed. A stress-strain diagram was obtained by using a Wiedemann Baldwin tensile testing machine. A load rate of 0.1 centimeter per minute (0.04 in./min) was used. The ultimate strength and yield strength (0.2% offset) were determined from the diagrams. After a sample was fractured, the diameter at the fracture site and the total elongation were measured to determine any changes that might occur because of ion-texturing. The surface hardness of each ion-textured sample was measured using the Rockwell hardness technique.

FATIGUE TESTS

SEM photomicrographs (to be discussed and shown later) were taken of untextured and ion-textured samples of 316 stainless steel and Ti-6Al, 4V before they were fatigue tested. Each sample was tested until failure or until a significant number of cycles were performed (700 000 to 800 000) using the low-cycle fatigue testing facility at Lewis Research Center (ref. 10). Negligible plastic strain hysteresis was observed during the fatigue tests of Ti-6Al, 4V. However, because of the considerable amount of plastic strain hysteresis involved in the fatigue tests of 316 stainless steel, strain control rather than load control was used. Two different cyclic strain levels were imposed. These loading conditions, together with all other fatigue loading values, are given in Table II.

RESULTS AND DISCUSSION

Ion-Textured Surfaces of Cobalt - 20-Percent-Chromium - 15-Percent-Tungsten Alloy and 316 Stainless Steel and Their Effects on Tensile Properties

Figure 5 shows scanning electron photomicrographs of the Co-20Cr-15W tensile test sample surface before and after ion-beam texturing. The striations

on the control sample followed the circumference of the rod. However, the cones produced by ion-texturing formed rows that were parallel to the rod axis. This result was contrary to the theory of A. N. Broers of the University of Cambridge, Cambridge, England. His unpublished results showed cone formation following surface scratches. One difference between Broers' theory and the Co-20-Cr-15W results was that he used a seed material to develop the microstructure while no seed was used with Co-20Cr-15W. Energy dispersion spectrometry results (fig. 6) indicated very little change in the surface composition of Co-20Cr-15W as a result of ion-beam texturing.

The ion-textured surface of surgical stainless steel is shown in figure 7. The microstructure (made without any seed material) was less pronounced than that of Co-20Cr-15W. However, if the microstructure affected the structural properties of the material, these effects should have been observed whether the topographical features were dense or sparse. Figure 8 shows that traces of Hg (present in the vacuum facility) and/or Mo (ion source grid material) may have been present on the surface, but the minor amounts indicated for either should not have affected the tensile results.

Figures 9 and 10 show typical stress-strain diagrams for Co-20Cr-15W and surgical stainless steel, respectively, for a control sample, a sample that was only heated, and an ion-textured sample. Table III lists all the parameters that were measured or calculated from the tensile tests. ASTM mechanical property values are footnoted in Table III for comparison with control sample results.

For both materials the ultimate strength was essentially unaltered after heating and ion texturing. The ultimate strength of treated (ion-textured and heated) surgical stainless steel was within 4 percent of the control sample value, and the ultimate strength of treated Co-20Cr-15W was within 5 percent of the control sample values. The ion-texturing duration (Table I) had no effect on the ultimate strength of the Co-20Cr-15W samples.

The measured yield strengths (at 0.2 percent offset) of the heat-treated surgical stainless steel samples were not significantly different from the control sample values. The average yield strength of the heat-treated samples was 11 percent higher than the average yield strength of the control samples. However, the average yield strength of the ion-textured samples was 20 percent greater than the average control sample value. Because of the statistically insignificant number of samples tested, it can be concluded that the yield strength did not change. To verify that ion-texturing did not affect the composition of the stainless steel, metallographic examination of the cross sections of ion-textured and control samples by an electron microprobe were taken. The analysis indicated that there was no significant compositional difference between the ion-textured and control samples. Also, there was no change in surface hardness (Rockwell hardness of approximately C-40) associated with the ion-texturing process.

The average yield strength of the ion-textured Co-20-Cr-15W sample was nearly identical to the average yield strength of the control and heat-treated samples. And, like the stainless steel, Co-20Cr-15W showed no change in surface hardness (Rockwell hardness of approximately C-25) as a result of ion texturing.

The total elongations of the treated samples of Co-20Cr-15W and stainless steel did not change significantly from the control sample values which indicates that ion-texturing did not change the ductility of these materials.

These results indicate that ion-texturing does not alter the mechanical properties of materials which are not affected by the heating which occurs.

The Effects of Ion-Textured Surfaces of 316 Stainless Steel and
Titanium - 6-Percent-Aluminum - 4-Percent-Vanadium
Alloy on Fatigue Properties

Figure 11 shows scanning electron photomicrographs of the surfaces of Ti-6Al, 4V fatigue samples before and after ion-beam texturing with a Ta seed. The ridge structure is characteristic of this alloy when textured under the given conditions (ref. 13).

The results of the fatigue tests of Ti-6Al, 4V and 316 stainless steel are shown in figure 12. The data are shown in terms of stress levels that developed to allow direct comparison between the two alloys. Ion-texturing with a Ta seed did not degrade the fatigue strengths of either metal. For the severe case in which a Ni mesh was superimposed over the Ti-6Al, 4V sample during ion-texturing the fatigue strength only degraded 30%. From these preliminary data points it seems that microscopic ion-texturing does not significantly degrade the fatigue strength.

CONCLUDING REMARKS

Examination of the effects of an ion-textured surface on the mechanical properties (ultimate strength, yield strength, and fatigue strength) of representative biological implant materials revealed very little degradation of the properties. The average ultimate strength and average yield strength of Co-20Cr-15W was the same (within 5%) for ion-textured and untextured samples. The 316 stainless steel samples that were tensile tested revealed that the average ultimate strength was unchanged (within 4%) after ion-texturing. The average yield strength increased 20% after ion-texturing but this increase may be due to the lack of a statistically significant number of samples rather than a change in the yield strength.

Fatigue specimens of Ti-6Al, 4V and 316 stainless steel that were ion-textured showed no change in fatigue strength when compared to untextured

samples. The fatigue strength of a Ti-6Al, 4V sample that was ion-textured with a $158\ \mu\text{m} \times 158\ \mu\text{m}$ pore Ni mesh covering its surface was 30 percent lower than the untextured fatigue strength.

REFERENCES

1. A. J. Weigand and B. A. Banks, *J. Vac. Sci. Technol.* 14, 326 (1977).
2. B. A. Banks, et al., Paper No. 76-1018, AIAA (1976).
3. D. F. Gibbons, "The Evaluation of Surface Texturing by Ion Beam Sputtering on the Mechanical Fixation and Biological Compatibility of Orthopedic Alloys in Bone," NASA Grant NSG 3151 (1977).
4. D. F. Gibbons, "Effect of Surface Texture by Ion Beam Sputtering on Implant Biocompatibility and Soft Tissue Attachment," NASA Grant NSG 3126 (1976).
5. A. C. Fraker and A. W. Rugg, *J. Met.* 29, 22 (1977).
6. S. Nakanishi, Paper No. 72-1151, AIAA (1972).
7. A. J. Weigand and S. Nakanishi, "A Survey of Kaufman Taruster Cathodes," NASA TM X-68386 (1971).
8. M. H. Hirschberg, Manual on Low Cycle Fatigue Testing, ASTM STP-465, (Am. Soc. Testing Mater., Philadelphia, Pa., 1969), p. 67.
9. A. J. Weigand, M. L. Meyer, and J. S. Ling, "Scanning-Electron-Microscopy Observations and Mechanical Characteristics of Ion-Beam-Sputtered Surgical Implant Alloys," NASA proposed Technical Memorandum.
10. G. K. Wehner and D. J. Hajicek, *J. Appl. Phys.* 42, 1145 (1971).
11. P. G. Gloersen, *J. Vac. Sci. Tech.* 12, 28 (1975).
12. W. R. Hudson, Paper No. 76-1015, AIAA (1976).
13. W. R. Hudson, A. J. Weigand, and M. J. Mirtich, "Optical Properties of Ion Beam Textured Metals," presented at 6th Annual Symposium on Applied Vacuum Science and Technology, American Vacuum Society, Tampa, Florida, Feb. 14-16, 1977.

14. S. S. Manson and M. H. Hirschberg, Fatigue-Interdisciplinary Approach Proceedings of 10th Sagamore Army Materials Research Conference, J. J. Burke, ed. (Syracuse Univ. Press, N. Y., 1963), p. 133

TABLE I. - ION-BEAM EXPOSURE DURATIONS FOR
 Co-20Cr-15W ALLOY AND 316 STAINLESS STEEL
 TENSILE SAMPLES AND 316 STAINLESS STEEL
 AND Ti-6Al, 4V FATIGUE SAMPLES

Sample material	Ion-beam texturing time per side rotation, hr	Number of areas exposed to ion beam
Tensile Co-20Cr-W15 alloy	7	5
	4	3
	2½	2
	4	5
Tensile 316 stainless steel	4	5
Fatigue Ti-6Al, 4V	2½	5
Fatigue 316 stainless steel	2½	5

TABLE II. - LOADING CONDITIONS
FOR 316 STAINLESS STEEL AND
Ti-6Al, 4V FATIGUE SAMPLES

Sample	Load	
	N/m^2 $\times 10^8$	psi $\times 10^3$
Untextured 316 stainless steel	± 2.8	± 41.5
	± 3.5	± 51
Ion-textured stainless steel	± 2.9	± 42.2
	± 3.3	± 48
Untextured Ti-5Al, 4V	± 4.4	± 64.8
Ion-textured Ti-6Al, 4V	± 4.4	± 64.8
Ion-textured Ti-6Al, 4V with 158 μ pore Ni mesh	± 4.5	± 66.2

TABLE III. - RESULTS OF TENSILE TESTS OF Co-20Cr-15W ALLOY AND SURGICAL STAINLESS STEEL

Sample material	Sample number	Ultimate strength		0.2% offset yield strength		Elongation, percent	Average initial diameter		Reduction in area at fracture site, percent
		N/m ²	psi	N/m ²	psi		cm	in.	
Stainless steel Control ^a Heated (300 ^o C) Ion-textured	1	1.23×10 ⁹	177 400	1.02×10 ⁹	147 000	9	0.29	0.114	65
	2	1.25	180 300	1.11	160 600	8	.23	.092	62
	3	1.24	179 200	1.14	164 000	4	.29	.114	31
	4	1.26	181 000	1.17	165 800	----	.29	.114	----
	5	1.37	197 400	1.25	180 400	7	.28	.110	60
	6	1.30	187 700	1.23	185 000	8	.27	.110	64
	7	1.24	178 900	1.28	176 900	7	.27	.107	72
	8	1.36	186 400	1.28	184 000	5	.19	.075	55
	9	1.28	185 000	1.31	188 000	7	.22	.086	45
Co-20Cr-15W alloy Control ^b Heated (300 ^o C) Ion-textured	10	9.40×10 ⁸	135 600	4.62×10 ⁸	66 700	----	0.29	0.114	35
	11	9.35	134 800	4.56	65 800	57	.29	.114	32
	12	8.82	127 100	4.30	62 000	49	.29	.113	35
	13	8.93	128 600	4.53	65 400	53	.29	.114	45
	14	9.35	134 400	4.29	61 700	79	.29	.114	48
	15	9.30	134 000	4.74	68 300	53	.24	.096	38
	16	8.75	126 100	4.42	63 800	57	.27	.108	48
	17	9.05	130 400	4.70	67 800	49	.25	.100	38
	18	9.50	136 900	4.64	66 600	52	.25	.100	62
19	9.64	138 700	4.72	68 000	53	.25	.097	53	

^aASTM designation F55-71, surgical stainless steel; ultimate strength, 7.65×10⁸ to 9.73×10⁸ N/m² (110 000 to 140 000 psi).

^bASTM designation F66-68, Co-20Cr-15W alloy; ultimate strength, 8.69×10⁸ N/m² (125 000 psi); yield strength, 3.12×10⁸ N/m² (45 000 psi).

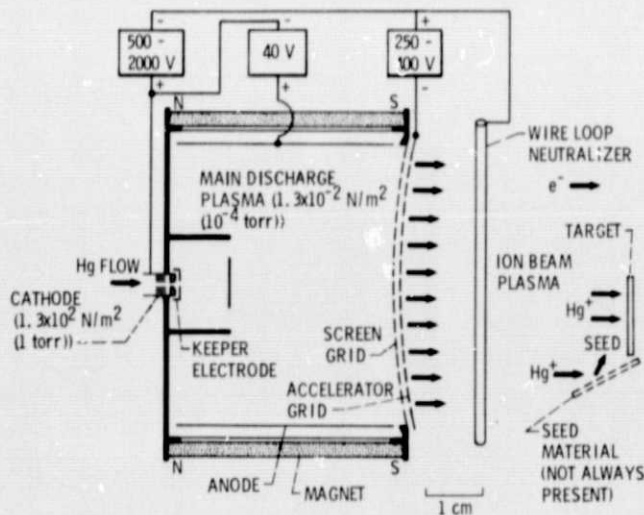

Figure 1. - Ion source.

E-3056

14

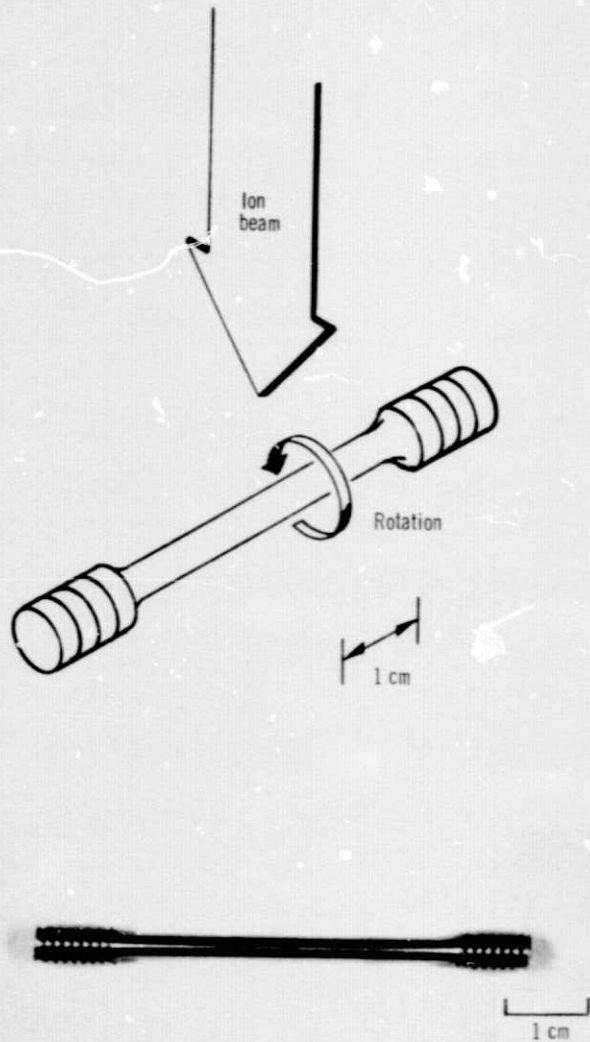
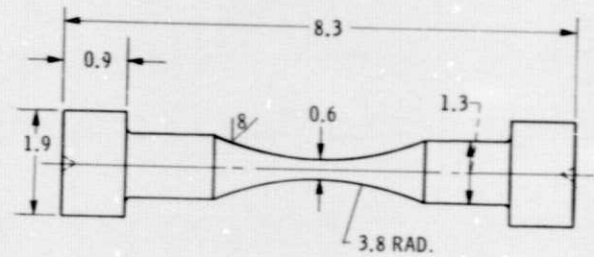
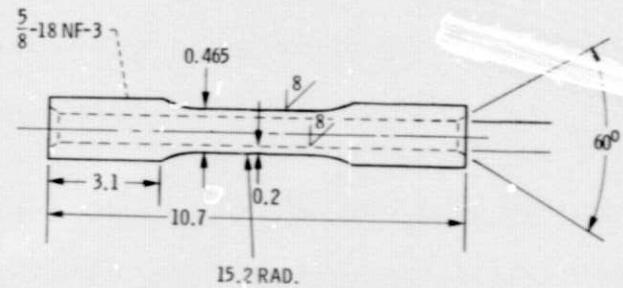

Figure 2. - Tensile test specimen and its relation to ion beam.



(a) SOLID HOUR-GLASS BUTTON-HEAD Ti-5%Al, 4%V SAMPLE.



(b) TUBULAR HOUR-GLASS THREADED 316 STAINLESS STEEL SAMPLE.

Figure 3. - Fatigue samples. (All dimensions in cm.)

ORIGINAL PAGE IS
OF POOR QUALITY

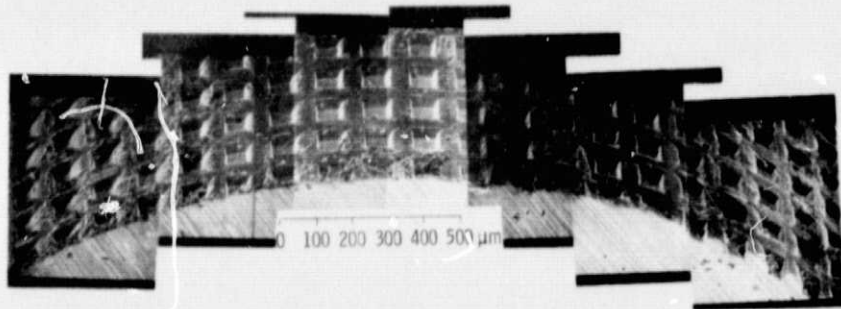
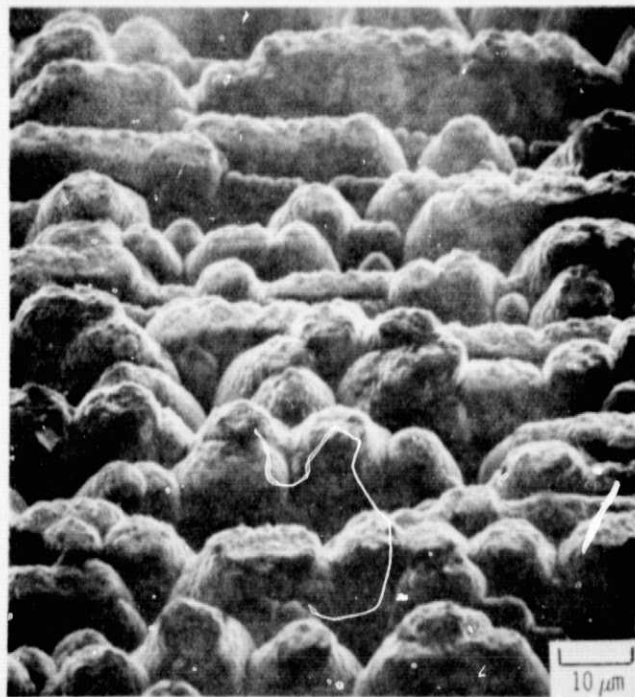

Figure 4. -Ti-6Al, 4V ion textured with 158 μx 158 μ pore Ni mesh superimposed.

E-9056



(a) Before.



(b) After; 30° tilt.

Figures 5. - Scanning electron photomicrographs of Co-20Cr-15W before and after ion-beam texturing.

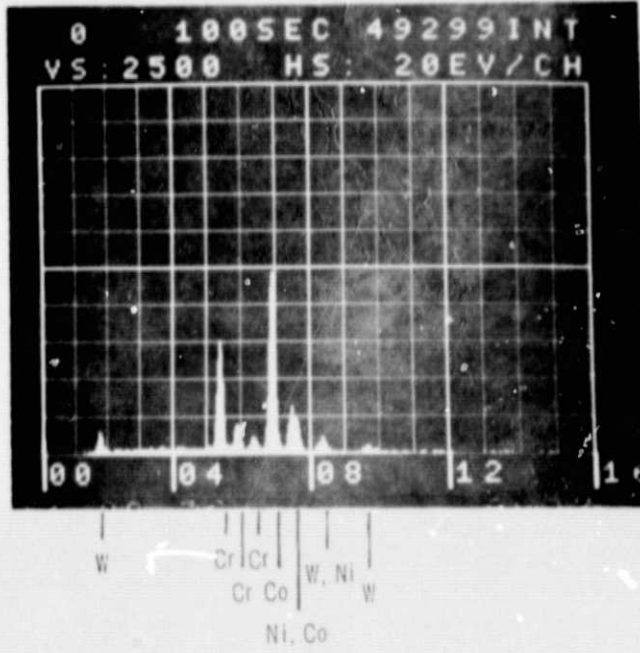

(a) Before.

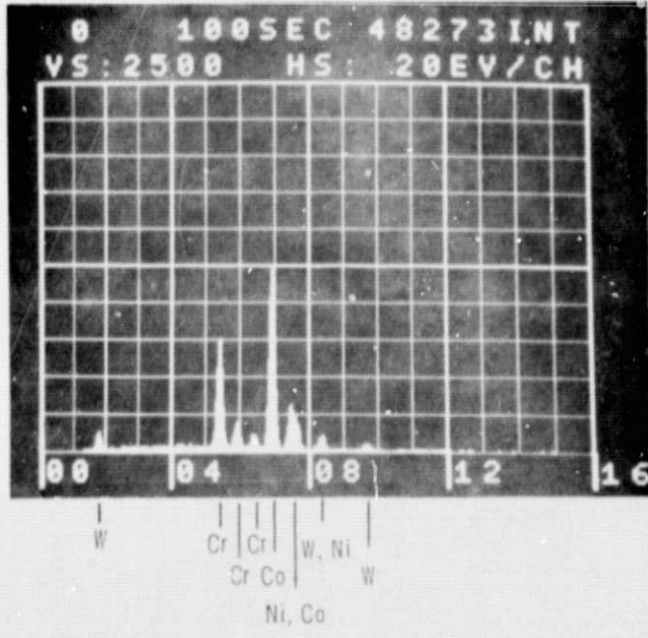

(b) After.

Figure 6. - Energy dispersion analysis of Co-20Cr-15W before and after ion texturing.



(a) Before.

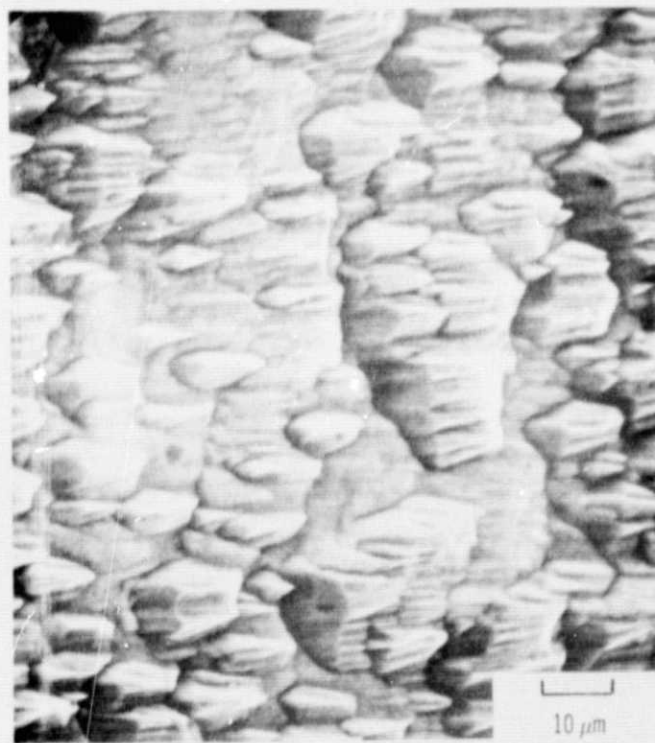

(b) After.

Figure 7. - Scanning electron photomicrographs of stainless steel before and after ion texturing.

E-9056

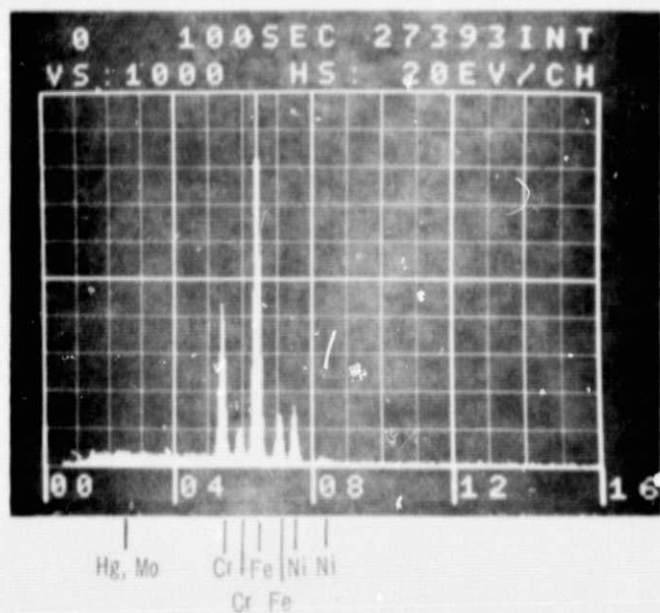

(a) Before.

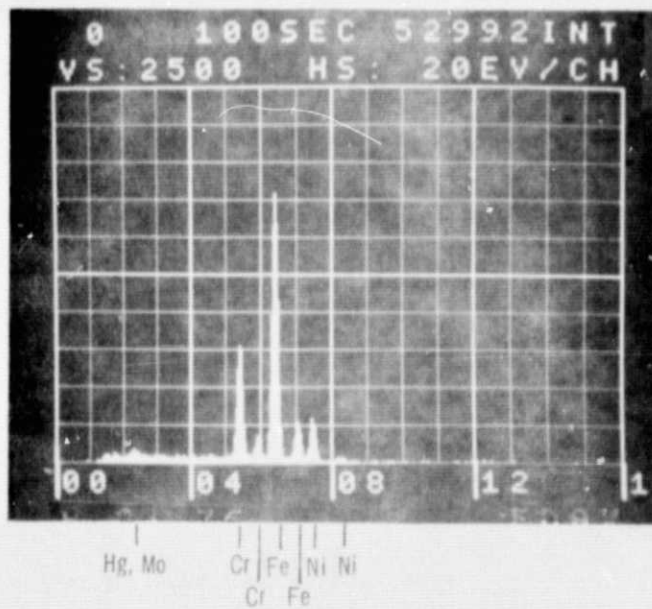

(b) After.

Figure 8. - Energy dispersion analysis of stainless steel before and after ion texturing.

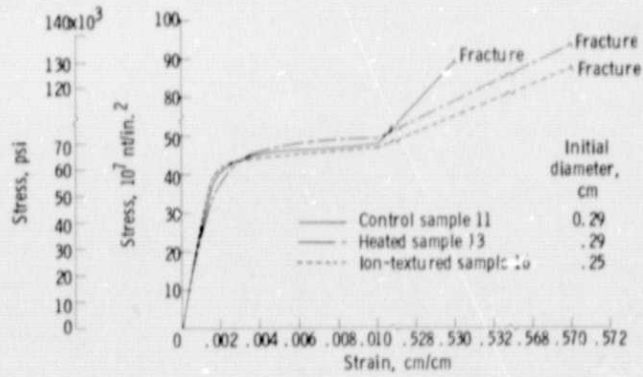

Figure 9. - Ion-texturing effects on stress-strain diagram for Co-20Cr-15W.

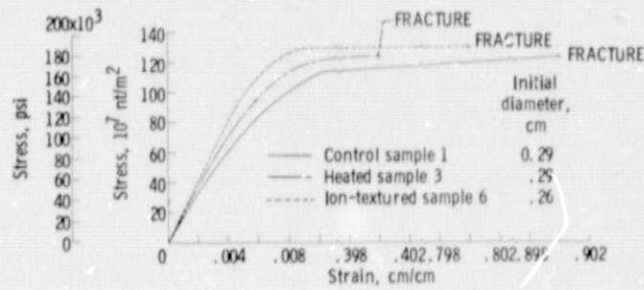
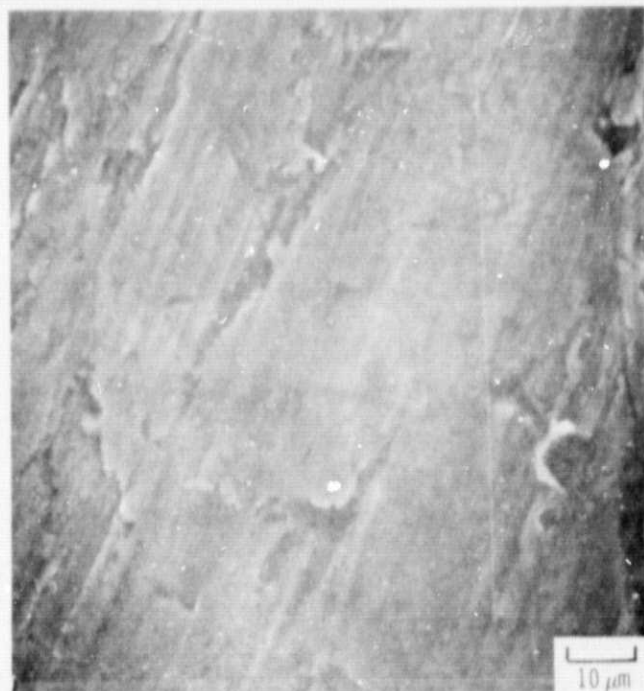
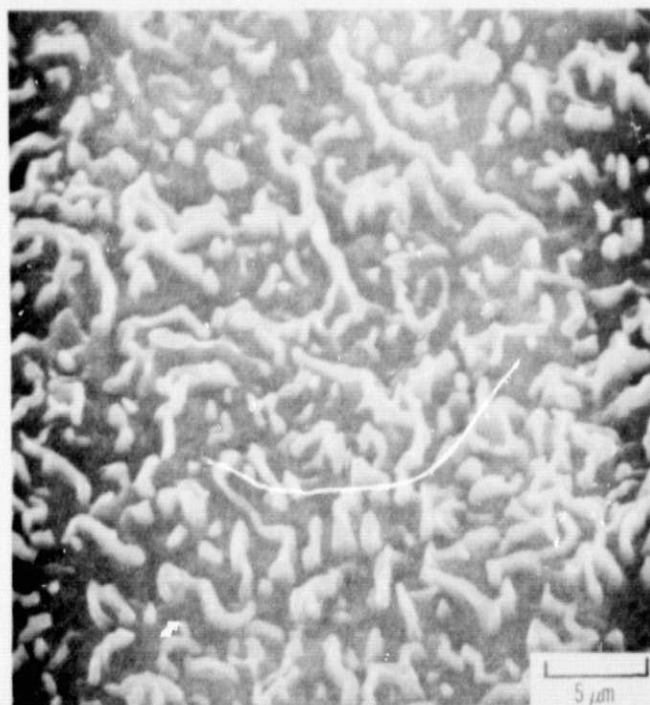

Figure 10. - Ion-texturing effects on stress-strain diagram for surgical stainless steel.



(a) Before.



(b) After; 30° tilt.

Figure 11. - Scanning electron photomicrographs of Ti-6Al-4V before and after ion texturing.

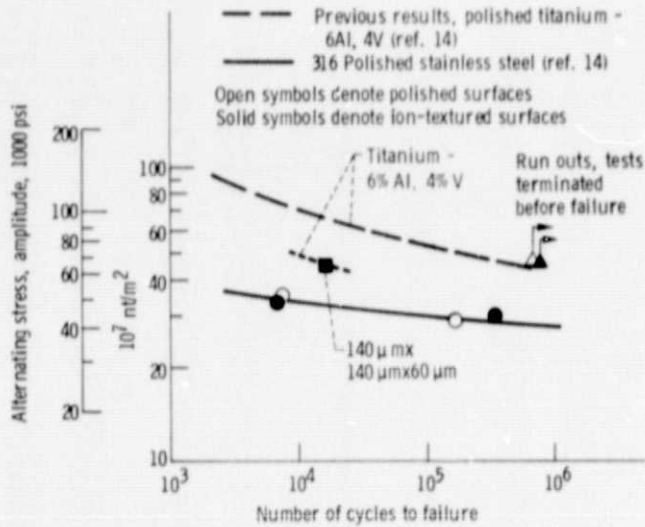

Figure 12. - Fatigue strengths of untextured and ion textured Ti-6Al, 4 V and 316 stainless steel.