

Space Shuttle Orbiter Approach and Landing Test

MH
LD
ERS

Final Evaluation Report

February 1978



National Aeronautics and
Space Administration

Lyndon B. Johnson Space Center
Houston, Texas

SPACE SHUTTLE ORBITER
APPROACH AND LANDING TEST
FINAL EVALUATION REPORT

PREPARED BY

Approach and Landing Test Evaluation Team

APPROVED BY

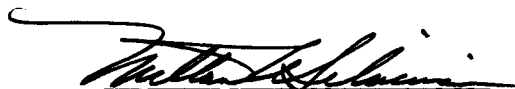

Aaron Cohen
Manager, Orbiter Project

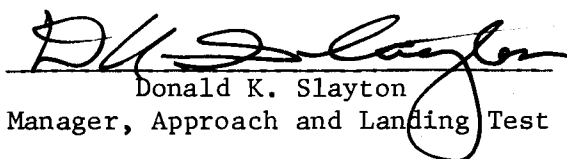

Donald K. Slayton
Manager, Approach and Landing Test

NATIONAL AERONAUTICS AND SPACE ADMINISTRATION
LYNDON B. JOHNSON SPACE CENTER
HOUSTON, TEXAS
February 1978



CONTENTS

Section	Page
1.0 <u>INTRODUCTION</u>	1-1
2.0 <u>CAPTIVE-INERT TEST PHASE</u>	2-1
2.1 TAXI TESTS	2-1
2.2 FLIGHT TEST PROGRAM	2-1
2.3 PERFORMANCE ASSESSMENT	2-1
3.0 <u>CAPTIVE-ACTIVE TEST PHASE</u>	3-1
3.1 FLIGHT TEST PROGRAM	3-1
3.2 PERFORMANCE ASSESSMENT	3-1
4.0 <u>FREE FLIGHT TEST PHASE</u>	4-1
4.1 FLIGHT TEST PROGRAM	4-1
4.1.1 <u>Free Flight 1</u>	4-3
4.1.2 <u>Free Flight 2</u>	4-5
4.1.3 <u>Free Flight 3</u>	4-7
4.1.4 <u>Free Flight 4</u>	4-9
4.1.5 <u>Free Flight 5</u>	4-11
4.2 ORBITER PERFORMANCE ASSESSMENT	4-13
4.2.1 <u>Structures</u>	4-13
4.2.2 <u>Mechanical Systems</u>	4-16
4.2.3 <u>Power</u>	4-26
4.2.4 <u>Pyrotechnics</u>	4-29
4.2.5 <u>Avionics</u>	4-29
4.2.6 <u>Environmental Control and Life Support System</u>	4-37
4.2.7 <u>Aerodynamics</u>	4-37
4.2.8 <u>Government-Furnished Equipment</u>	4-47

Section	Page
4.3 PILOT'S REPORTS	4-59
4.3.1 <u>Free Flight 1</u>	4-59
4.3.2 <u>Free Flight 2</u>	4-64
4.3.3 <u>Free Flight 3</u>	4-70
4.3.4 <u>Free Flight 4</u>	4-74
4.3.5 <u>Free Flight 5</u>	4-79
4.4 FLIGHT 5 APPROACH AND LANDING ASSESSMENT	4-89
4.5 FLIGHT TEST REQUIREMENTS ASSESSMENT	4-91
5.0 <u>FLIGHT OPERATIONS ASSESSMENT</u>	5-1
5.1 TRAINING AND SIMULATIONS	5-1
5.2 ONBOARD SYSTEMS	5-1
5.2.1 <u>Software Flexibility</u>	5-1
5.2.2 <u>Ground Monitoring Concept</u>	5-1
5.2.3 <u>Redundancy Management</u>	5-1
5.2.4 <u>Redundancy Management Switches</u>	5-2
5.3 GROUND SYSTEMS	6-1
7.0 <u>ANOMALY SUMMARY</u>	7-1
7.1 CAPTIVE-ACTIVE FLIGHTS	7-1
7.1.1 <u>Hydraulic System 1 Water Boiler Steam</u> <u>Vent Line Temperature Reading Was Low.</u>	7-1
7.1.2 <u>Inertial Measurement Unit 1 Would Not Go</u> <u>To Operate</u>	7-1
7.1.3 <u>Nose Landing Gear Door Thruster Triggering</u> <u>Pawl Did Not Function</u>	7-2
7.1.4 <u>Auxiliary Power Unit 1 Exhaust Duct</u> <u>Temperature Measurement Failed</u>	7-2

7.2	<u>FREE FLIGHTS</u>	7-5
7.2.1	<u>General Purpose Computer 2 Lost Synchronization at Separation</u>	7-5
7.2.2	<u>Equivalent Airspeed "Off" Flag Was Reported On Commander's Alpha/Mach Indicator During Free Flight 1</u>	7-7
7.2.3	<u>Main Landing Gear Door Hinge Pin Assembly Was Missing</u>	7-7
7.2.4	<u>Orbiter UHF Communications Were Marginal and Noisy on Channel 259.7 Megahertz</u>	7-8
7.2.5	<u>OPS 203, OPS ITEM 13 and OPS 201 Error Messages</u>	7-8
7.2.6	<u>Orbiter Pilot's Intercommunications Were Intermittent</u>	7-12
7.2.7	<u>Fuel Cell 1 Condenser Exit Temperature Was Low</u>	7-12
7.2.8	<u>Orbiter Landing Gear "Chattered" During Hard Braking</u>	7-15
7.2.9	<u>Centerline Camera Activated Prematurely</u>	7-16
7.2.10	<u>Maintenance Recorder Tracks 8 Through 14 and "Bulk Erase" Were Inoperative</u>	7-16
7.2.11	<u>Left Main Landing Gear Brake Lining and Heat Sink Were Damaged</u>	7-17
7.2.12	<u>Inertial Measurement Unit 1 Y-Axis Accelerometer Calibration Was Out of Tolerance</u>	7-17
7.2.13	<u>TACAN Failures To Lock</u>	7-17
7.2.14	<u>Auxiliary Power Unit 3 Exhaust Duct Temperature Measurement Failed</u>	7-18
7.2.15	<u>Main Landing Gear Camera 1 Film Had Torn Sprocket Holes</u>	7-18
7.2.16	<u>Carrier Aircraft Aft Camera Failed To Transport Film</u>	7-18
7.2.17	<u>Hydraulic System 3 Pressure Was Low During Postlanding Load Test</u>	7-20

Section	Page
8.0 <u>CONCLUSIONS AND RECOMMENDATIONS</u>	8-1
9.0 <u>REFERENCES</u>	9-1
APPENDIX A - <u>VEHICLE DESCRIPTION</u>	A-1
APPENDIX B - <u>VEHICLE HISTORICAL DATA</u>	B-1
APPENDIX C - <u>CAPTIVE-INERT AND CAPTIVE-ACTIVE FLIGHT DESCRIPTIONS</u> . .	C-1
APPENDIX D - <u>VEHICLE MASS PROPERTIES</u>	D-1
APPENDIX E - <u>FLIGHT TEST REQUIREMENTS SUMMARY</u>	E-1
APPENDIX F - <u>METEOROLOGICAL DATA</u>	F-1
APPENDIX G - <u>PROBLEM SUMMARY</u>	G-1

1.0 INTRODUCTION

The Approach and Landing Test Program consisted of a series of steps leading to the demonstration of the capability of the Space Shuttle orbiter to safely approach and land under conditions similar to those planned for the final phases of an orbital flight. The tests were conducted with the orbiter mounted on top of a specially modified carrier aircraft (fig. 1-1).

The first step, completed January 10, 1977, provided airworthiness and performance verification of the carrier aircraft after modification. The second step, completed on March 2, 1977, consisted of three taxi tests and five flight tests with an inert unmanned orbiter. The third step, completed on July 26, 1977, consisted of three mated tests with an active manned orbiter. The fourth step, completed October 26, 1977, consisted of five flights in which the orbiter was separated from the carrier aircraft. For the final two flights, the orbiter tail cone, which had been used to reduce buffeting effects, was replaced by dummy main engines to simulate the actual orbital configuration. Landing gear braking and steering tests were accomplished during rollouts following the free flight landings. Ferry testing was integrated into the Approach and Landing Test Program to the extent possible. In addition, four ferry test flights were conducted with the orbiter mated to the carrier aircraft in the ferry configuration after the free-flight tests were completed.

The primary objectives of the program were as follows.

- a. Verify orbiter subsonic airworthiness, integrated systems operations and selected subsystems operation for First Orbital Flight.
- b. Verify an orbiter pilot-guided approach and landing capability.
- c. Verify an orbiter subsonic automatic terminal area energy management/automatic landing capability.
- d. Verify an orbiter capability to safely approach and land in selected gross weight/center of gravity configurations within the operational envelope.

These objectives were accomplished by flying well within the flight envelope and extrapolating the results to the limits of the flight envelope.

References 1 and 2 contain the results of the postflight evaluations of the captive-inert and captive-active flights. Reference 3 contains the results of the ferry flight testing. In general, this report contains only the results of the postflight evaluation of the free flights. However, summaries of information contained in references 1 and 2 have been included. Descriptions of the test vehicle, Enterprise (Orbiter 101), and the Shuttle carrier aircraft are given in appendix A. Vehicle historical information is given in appendix B.

Greenwich mean time (G.m.t.) is used in this report and elapsed flight time is referenced to carrier aircraft brake release. Unless otherwise noted, altitudes have been determined from C-band radar data and are referenced to mean sea level (MSL). All tests were conducted at Edwards Air Force Base, California.



Figure 1-1.- Mated Shuttle Carrier Aircraft/Orbiter.

2.0 CAPTIVE-INERT TEST PHASE

2.1 TAXI TESTS

Test plans called for three taxi runs to be made at progressively higher speeds to evaluate handling qualities of the mated carrier aircraft/orbiter and obtain engineering data prior to the first captive flight. Specific objectives were to evaluate the technique of setting thrust for takeoff, directional stability and control, elevator effectiveness, pitch response, thrust reverser effectiveness, and airframe buffet. The three runs were successfully accomplished on February 15, 1977, at maximum speeds of 78, 122 and 137 knots. No areas of concern were identified that prevented proceeding with the first flight of the mated carrier aircraft/orbiter. Details of the test conditions and results are given in reference 1.

2.2 FLIGHT TEST PROGRAM

Areas requiring flight data prior to the initiation of the captive-inert flight testing included (1) the definition of the flight envelope boundary based on adequate flutter margin, empennage loads (vertical tail, horizontal tail, and tip fins) during maneuvering flight, mated configuration buffet, and the effects of a carrier aircraft/orbiter longitudinal trim modification; (2) verification of the interface loads and corresponding flight conditions to ensure a positive launch separation; and (3) verification that a launch abort maneuver could be performed within the orbiter 75-percent wing load design criteria boundary.

Five captive flights were conducted with an inert unmanned orbiter to satisfy these requirements. The first four flights were conducted to evaluate the airworthiness of the mated configuration and to establish the operational flight envelope for the captive-active and launch phases of the Approach and Landing Test Program. The purpose of the fifth flight was to evaluate mated performance and operational procedures while flying two simulated launch profiles. Table I and appendix C contain general information concerning the five captive-inert flights. Appendix D contains vehicle mass properties data.

2.3 PERFORMANCE ASSESSMENT

The five mated inert flights showed that the carrier aircraft had the necessary performance to successfully climb to the desired altitude, accomplish the launch maneuver, and attain the desired separation parameters. The flights also showed that a recovery could be safely effected if launch was not performed. Specific flight test requirements satisfied by the captive-inert flights are listed in appendix E. A detailed assessment of the test vehicle performance is given in reference 1.

TABLE I.- CAPTIVE-INERT FLIGHT GENERAL INFORMATION

Description	Flight 1	Flight 2	Flight 3	Flight 4	Flight 5
Flight crew					
Captain	Fulton	Fulton	Fulton	Fulton	Fulton
Copilot	McMurtry	McMurtry	McMurtry	McMurtry	Roy
Flight Engineers	Horton Guidry	Horton Guidry	Horton Guidry	Horton Guidry	Horton Guidry
Flight date	Feb. 18, 1977	Feb. 22, 1977	Feb. 25, 1977	Feb. 28, 1977	Mar. 2, 1977
Time of brake release, G.m.t.	15:30	15:32	14:55	15:00	15:00
Elapsed flight time, Hr:min	2:10	3:15	2:30	2:15	1:40

3.0 CAPTIVE-ACTIVE TEST PHASE

3.1 FLIGHT TEST PROGRAM

In the captive-active test phase, the orbiter was active and manned while mated to the carrier aircraft. Separation of the orbiter from the carrier aircraft was neither planned nor executed, although provisions were made for separation to be performed in an emergency situation. The original plan for this phase was to conduct five flights; however, the program was restructured upon completion of the captive-inert flights. Flight 2 was deleted by adding the test requirements to those of flight 1. A flight was added to precede flight 1 with test conditions below the hardware structural limit speed envelope because of concern that a hardover orbiter control surface was possible. This flight was designated flight 1A. Flights 4 and 5 were to be flown only if there were problems on prior flights that warranted additional flights. The captive-active flights were conducted to verify the separation profile; verify the integrated structure, aerodynamics, and flight control system; verify orbiter integrated system operations; and refine and finalize procedures in preparation for free flight tests.

Table II and appendix C contain general information concerning the captive-active flights. Appendix D contains vehicle mass properties data and appendix F contains meteorological data.

3.2 PERFORMANCE ASSESSMENT

The first flight verified the performance of selected orbiter subsystems, integrated subsystems, and ground operations in a reduced-speed/altitude environment, especially with those operations affecting orbiter control surface deflections. The flight also verified the orbiter stability and performance in the mated configuration with combined operation of the primary flight control system (in the control stick steering and manual direct modes), the auxiliary power units, hydraulics, and structure. Vertical tail buffet data obtained during speed brake and rudder operation at 180 knots showed that there were no significant longitudinal oscillations.

Results of flutter clearance tests performed on the second flight with orbiter control surfaces active (restricted to low amplitude limits) at approximately 230 and 270 knots indicated that there were no sustained vibrations. Dynamic response of the orbiter to rapid control inputs from both the orbiter and carrier aircraft was highly damped and was considered satisfactory. Buffet tests conducted at 230 knots with the orbiter speed brakes set at several increments up to 100 percent and the orbiter rudder deflected produced only light buffet. Similar tests at 270 knots produced a slight increase in buffet at the 40 percent speed brake setting and a slight decrease above 70 percent. The structural responses were well within limits. A separation data run performed on the second flight verified that the separation conditions planned for free flight 1 were satisfactory. Additionally, an autoland fly-through allowed the orbiter crew to monitor the attitude director indicator and horizontal situation indicator for proper onboard indications.

The third flight primarily demonstrated that the operational separation profile and procedures were satisfactory. The results of the separation profile analysis were in agreement with the results from the second flight.

In addition to showing that the separation conditions and procedures were satisfactory for free flight, the captive-active flight tests showed that the orbiter hardware and software performance was satisfactory for the Approach and Landing Test requirements, and that the support operations, including turnaround, mission control, and mission evaluation were satisfactory. Specific flight test requirements satisfied by the captive-active flights are listed in appendix E. Anomalies encountered during the captive-active flights are listed in appendix G. A detailed assessment of the orbiter performance is given in reference 2.

TABLE II.- CAPTIVE-ACTIVE FLIGHT GENERAL INFORMATION

Description	Flight 1A	Flight 1	Flight 3
Flight crews			
Orbiter			
Commander	Haise	Engle	Haise
Pilot	Fullerton	Truly	Fullerton
Carrier aircraft			
Captain	Fulton	Fulton	Fulton
Copilot	McMurtry	McMurtry	McMurtry
Flight Engineers	Horton Guidry	Guidry Young	Horton Alvarez
Flight date	June 18, 1977	June 28, 1977	July 26, 1977
Time of brake release, G.m.t.	15:06	14:50	14:47
Elapsed flight time, hr:min	0:56	1:03	1:00

4.0 FREE FLIGHT TEST PHASE

4.1 FLIGHT TEST PROGRAM

Five flights were conducted in which the orbiter was separated from the carrier aircraft to demonstrate the capability of the orbiter to safely approach and land in selected center-of-gravity configurations within the operational envelope, progressing from the most benign to the most critical flight regime. For all flights, the orbiter was ballasted to be a lightweight orbiter of approximately 150 000 pounds. The orbiter was configured with the tail cone on for the first three flights and with the tail cone off and dummy main engines installed for the final two flights. On the first flight, two left turns of approximately 90° were made after separation from the carrier aircraft opposite the touchdown point. On the second flight, a left turn of approximately 135° and one of 45° were made. On the third flight, the pattern was similar to that of the second except that the first turn was approximately 140° and the second, 40°. On the fourth flight, two left turns of approximately 10° were made to align with the runway. On the final flight, a straight-in approach to the runway was made.

Two centers of gravity were used with the tail-cone-on configuration. These were based on the pitch static margin equivalency for the tail-cone-off configuration and a flight control system test requirement to have a center of gravity spread of 2 percent of the reference body length. The forward center of gravity provided the more stable static margin. Therefore, free flights 1 and 2 were conducted with the center of gravity at 63.8 percent of the reference body length, which simulated a tail-cone-off forward center of gravity of 65 percent. Free flight 3 was conducted with the center of gravity at 65.8 percent, which simulated a tail-cone-off aft center of gravity of 67 percent. The two tail-cone-off flights were conducted with the center of gravity at 66.25 percent, which is the same as that planned for the approach and landing phase of the first orbital flight test.

Braking and steering were evaluated during rollout after each flight. Lakebed runways were used on all flights except the final one. A paved runway was used on flight 5 to obtain data on the orbiter tire/paved runway interface to support qualification of the deceleration system.

Table III and appendix C contain general information on the five free flights. Appendix D contains vehicle mass properties data and appendix G contains meteorological data. Velocities given in the following flight descriptions are in knots equivalent airspeed (KEAS). Altitudes were determined from ground radar data.

TABLE III.- FREE FLIGHT GENERAL INFORMATION

Description	Tail cone on			Tail cone off	
	Flight 1	Flight 2	Flight 3	Flight 4	Flight 5
Flight crews					
Orbiter					
Commander	Haise	Engle	Haise	Engle	Haise
Pilot	Fullerton	Truly	Fullerton	Truly	Fullerton
Carrier aircraft					
Captain	Fulton	Fulton	Fulton	Fulton	Fulton
Copilot	McMurtry	McMurtry	McMurtry	McMurtry	McMurtry
Flight Engineers	Horton Guidry	Horton Guidry	Horton Guidry	Horton Guidry	Horton Guidry
Flight date	Aug. 12, 1977	Sep. 13, 1977	Sep. 23, 1977	Oct. 12, 1977	Oct. 26, 1977
Time of brake release, G.m.t.	15:00	15:00	15:00	14:45	15:00
Free flight time, min:sec	5:22	5:31	5:35	2:35	2:06
Total flight time, hr:min	0:54	0:55	0:51	1:08	0:55

4.1.1 Free Flight 1

Takeoff was from runway 22 and the turn to intersect the racetrack flight pattern was made 15 minutes into the flight. Flight control system checks were initiated about 22 minutes after takeoff. The checks were completed after 5 minutes and a TACAN long-range test was performed. After reaching a maximum altitude of approximately 30 250 feet, pushover for the orbiter separation maneuver was performed at 15:47:40. Separation was initiated by the orbiter crew 49 seconds later. Computer 2 stopped executing at separation. The remaining three computers in the redundant set continued operating properly and the crew took the necessary actions to continue the flight as planned. The orbiter was landed on lakebed runway 17 with touchdown at 15:53:51. Touchdown was approximately 1 mile past the predicted landing point. Free-flight time was 5 minutes and 22 seconds. Steering, braking, and coasting tests were performed during rollout which was approximately 11 000 feet. The altitude profile for free flight 1 is shown in figure 4-1.

7-7

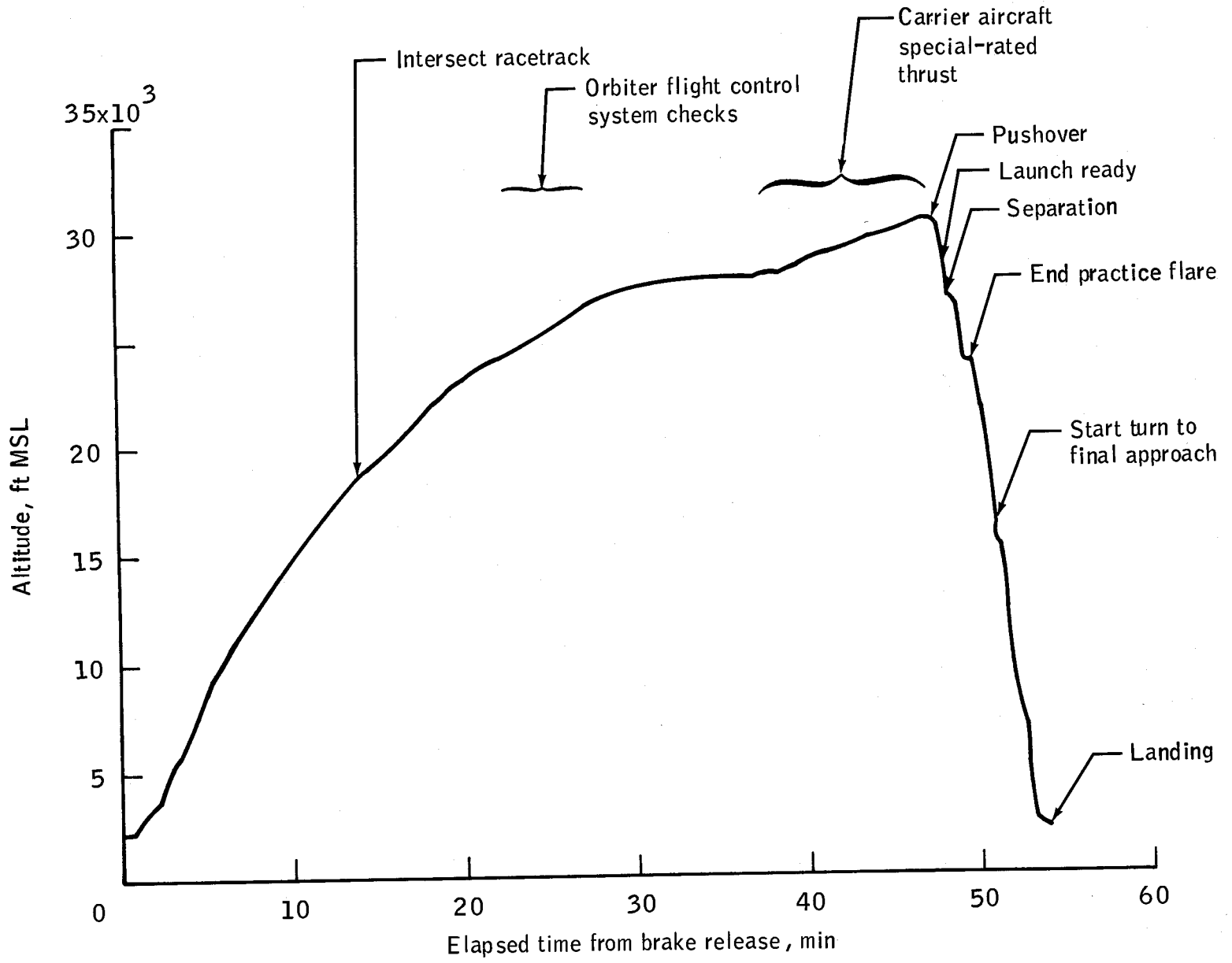

Figure 4-1.- Free Flight 1 altitude profile.

4.1.2 Free Flight 2

After takeoff from runway 22, a turn to intersect the racetrack flight pattern was made about 17 minutes into the flight. Flight control system checks were completed about 21 minutes into the flight and special rated thrust was initiated about 16 minutes later to achieve the desired altitude for pushover. At 28 minutes into the flight, a Dryden Flight Research Center power surge resulted in the loss of all radar data which, if not corrected, would have caused the flight to be terminated. The prime radar data were restored and the flight continued as planned. Preseparation checks were made and pushover was performed at 15:48:34 after reaching an altitude of 30 600 feet. Separation was accomplished 50 seconds later at an airspeed of 269 knots. The subsequent free flight of the orbiter was performed as planned accomplishing a 1.8-g windup turn, programmed test inputs, and aerodynamic stick inputs for aerodynamic, flight control system, and structural evaluation. The orbiter was landed on runway 15 with touchdown at 15:54:55. Braking and steering tests were performed during rollout. Upon brake application, almost no feeling of braking action was felt until a hard "chattering" sensation was experienced. This chattering occurred during heavy, moderate, and differential brake pedal deflection. The landing point was 680 feet beyond the preflight predicted point and rollout was 10 037 feet. The altitude profile for free flight 2 is shown in figure 4-2.

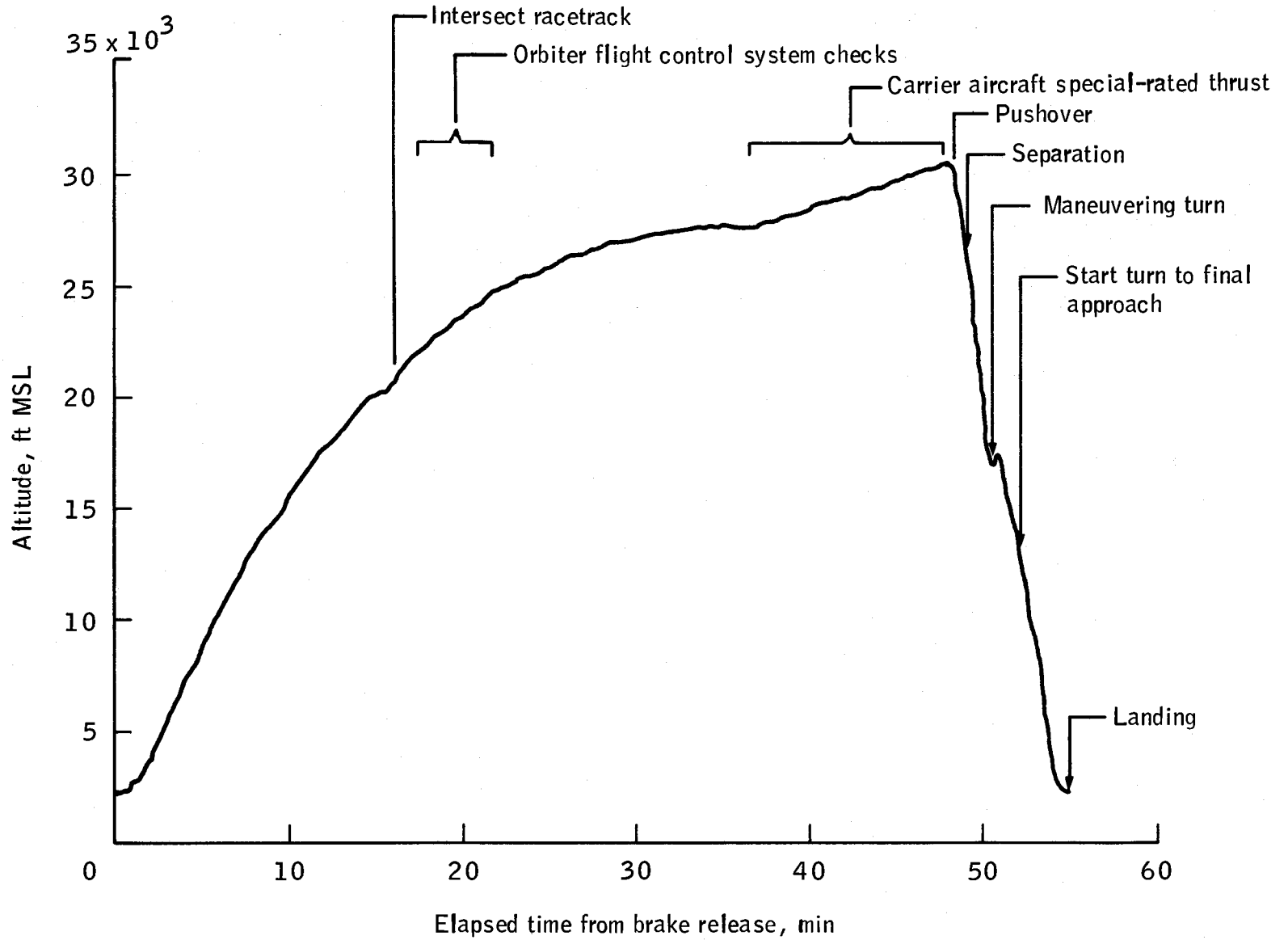

Figure 4-2. - Free Flight 2 altitude profile.

4.1.3 Free Flight 3

Takeoff for the third flight was again from runway 22. The captive flight phase was normal and the sequence of events was similar to that of free flight 2 except that a mass damping system in the carrier aircraft was checked out. Pushover was performed at 15:44:58 after reaching an altitude of 29 500 feet. Prior to this flight, the orbiter center of gravity location had been moved aft from 63.8 to 65.8 percent of the reference body length to simulate the tail-cone-off pitch stability characteristics at 67 percent. The center of gravity change necessitated a lower separation velocity to decrease the probability of high g loads. Separation was accomplished 40 seconds after pushover at an airspeed of about 250 knots.

The free flight phase was essentially the same as that of free flight 2 (i.e., a 1.8-g windup turn and application of both programmed test inputs and aerodynamic stick inputs for aerodynamic, flight control, and structural evaluation) except that closed-loop automatic guidance was employed after the final turn for approximately 50 seconds starting at 49 minutes and 21 seconds into the flight. The orbiter was landed on runway 17 with touchdown at 15:51:12. After 23 seconds of coasting following touchdown, gentle to moderate differential braking was performed commencing at speeds of approximately 150 knots. Moderate to hard braking was performed at low speeds (approximately 115 to 20 knots). "Chattering" was again experienced during hard braking commencing at about 110 knots. Nosewheel steering was engaged at a speed of 12 knots. The touchdown point was 786 feet beyond the preflight predicted point. Nosewheel touchdown occurred 3489 feet after main landing gear touchdown. Total rollout distance, including excursions, was 9184 feet. Total runway rollout distance was 9147 feet. The altitude profile for free flight 3 is shown in figure 4-3.

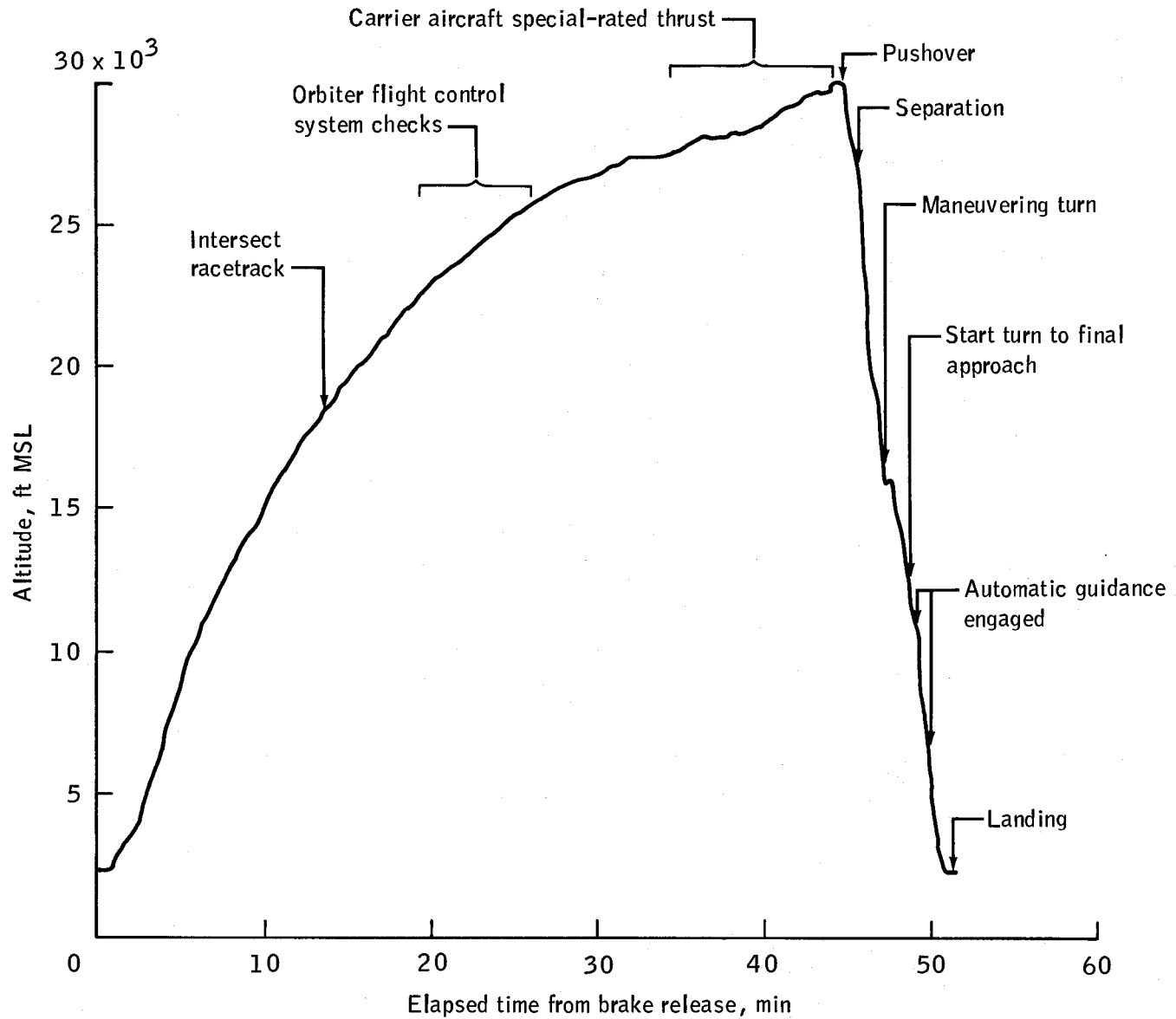

Figure 4-3.- Free Flight 3 altitude profile.

4.1.4 Free Flight 4

Takeoff for free flight 4, the first with the orbiter in the tail-cone-off configuration, was from runway 04. Two circuits of a racetrack pattern were flown, the first extending about 70 nautical miles and the second about 75 nautical miles northeast of Rogers Lake. The flightworthiness and safe buffet levels of the mated carrier aircraft and orbiter in the tail-cone-off configuration as well as the separation performance were demonstrated on the first circuit. Special-rated thrust was initiated at 26 minutes into the flight to gain additional altitude prior to the separation data run. The separation data run was initiated at an altitude of 20 200 feet with pushover at 15:16:12. The data run was terminated 156 seconds later at an altitude of about 16 000 feet.

Orbiter flight control system checks were performed after completing the first circuit. A turn was then made back to the southwest, special rated thrust was initiated, pre-separation checks were made, and pushover was performed. The time of pushover was 15:49:35 and the altitude was 25 200 feet. Separation was accomplished within the planned envelope 38 seconds later at an airspeed of 248 knots. The subsequent 2 minute and 35 second free flight of the orbiter was performed as planned with application of an angle-of-attack sweep and aerodynamic stick inputs for performance as well as stability and control flight test data. Flight handling qualities were also evaluated.

The orbiter was landed on runway 17 with touchdown at 15:52:48. Braking tests were performed and nose wheel steering was engaged during rollout. The touchdown point was approximately 510 feet beyond the preflight-planned point. Total runway rollout distance was about 5725 feet. The altitude profile for free flight 4 is shown in figure 4-4.

4-10

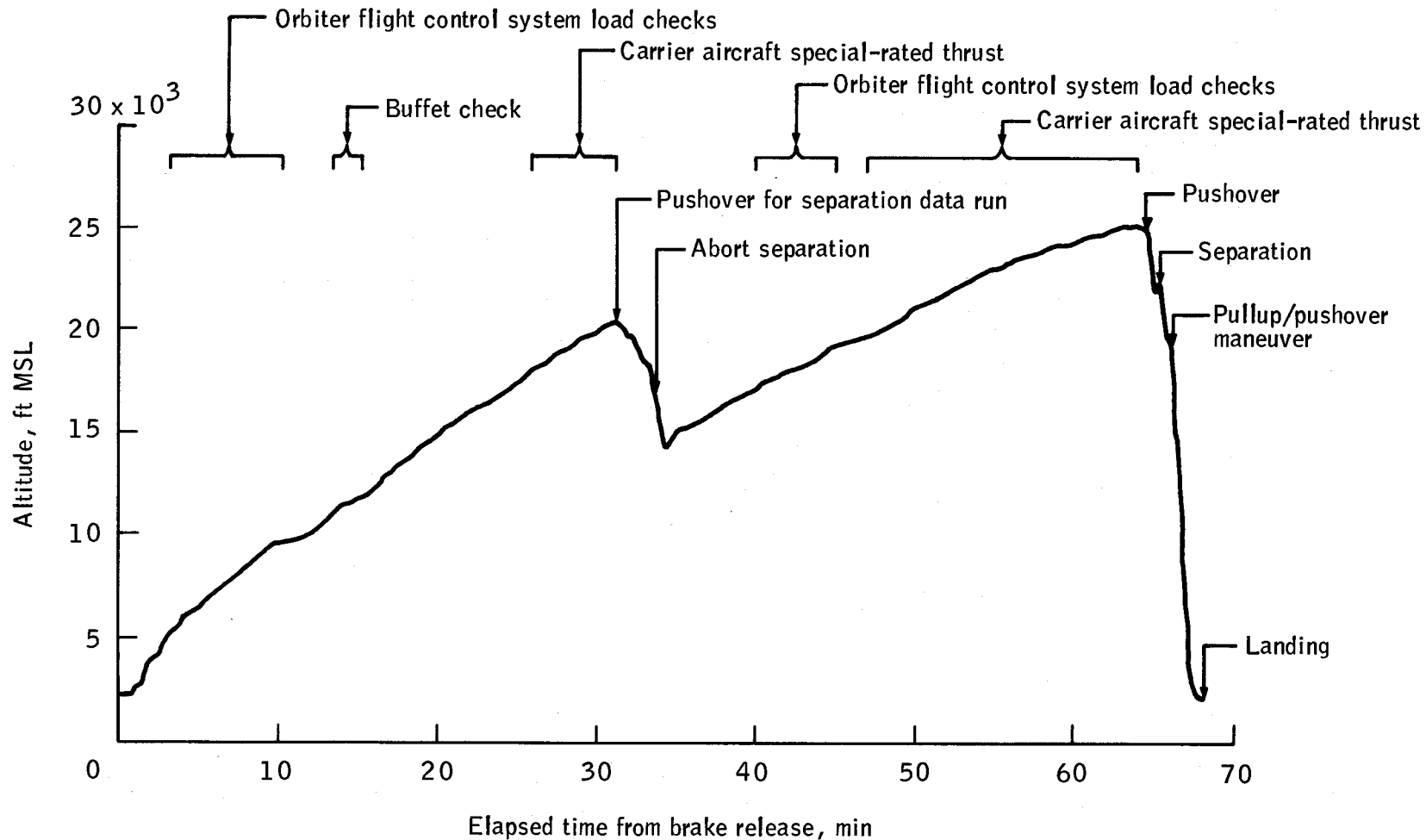

Figure 4-4.- Free Flight 4 altitude profile.

4.1.5 Free Flight 5

Following takeoff from runway 04, a turn to the north was made to intersect a 25- by 10-nautical-mile racetrack pattern. TACAN checks were made and auxiliary power unit 1 was activated while flying a single circuit of the racetrack. A left turn was then made at the north end of the racetrack and the mated vehicles were flown approximately 60 nautical miles on a heading of 204°. Flight control system checks were made during this period beginning 26 minutes after takeoff. Another left turn was then made to a heading of 40° to get into position for the orbiter approach and landing on concrete runway 04. Special rated thrust on engines 2 and 3 was initiated prior to the final turn at approximately 42 minutes into the flight to achieve pushover altitude. Pushover was performed at 15:51:56 with the mated vehicles on a heading of 42°. Separation was accomplished 40 seconds later at an airspeed of 245 knots.

The orbiter approach and landing were controlled manually in the control stick steering flight control mode through the entire free flight until touchdown. For the last 8 seconds prior to touchdown, there was a pitch oscillation caused by control stick inputs to control sink rate. The inputs kept the elevons rate limited and the flight control system did not respond to some roll inputs. This appears to have triggered very large roll commands just at touchdown. The vehicle touched down softly with wings level, but skipped back into the air rolling right. A pilot-induced oscillation in roll then occurred for 4 seconds. The pilot ceased roll input momentarily and the motion damped quickly just prior to second touchdown which occurred 6 seconds after the first. The left wheel lifted off slightly on the rebound but the vehicle stayed on the ground and completed a normal rollout.

After nosewheel touchdown, the braking sequence was as follows: light braking from nosewheel touchdown to 100 knots, heavy braking from 100 knots to 50 knots, and light braking from 50 knots until stopping. The point of first main landing gear touchdown was approximately 1000 feet past the preflight planned point and the final touchdown point was approximately 2900 feet past the preflight planned point. Total runway rollout distance from the first touchdown point was about 7930 feet. The altitude profile for free flight 5 is shown in figure 4-5.

4-12

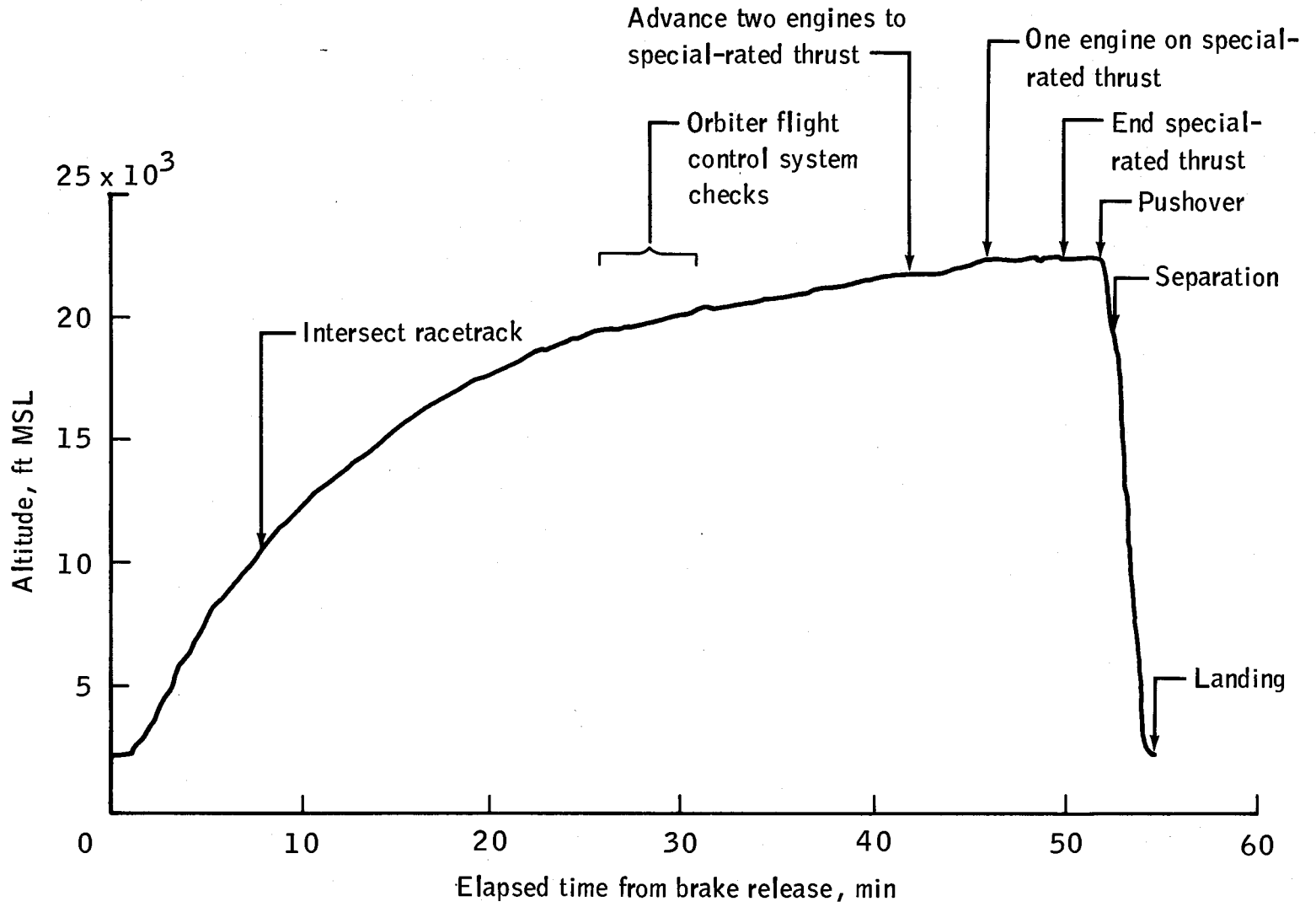

Figure 4-5.- Free Flight 5 altitude profile.

4.2 ORBITER PERFORMANCE ASSESSMENT

This section provides an assessment of the performance of the orbiter and discussions of problems encountered. In some cases, additional discussions of problems are given in section 7.0 that include details and action taken for resolution.

4.2.1 Structures

General strength integrity: Mid and aft fuselage flight strain measurements and fuselage bending moments derived from these measurements indicate that all loads were well within design limits. Maximum fuselage bending moments occurred during landing. Vertical stabilizer measured strains were low and well within specified limits. Crew module to forward fuselage attach link maximum loads were approximately 50 percent of levels allowable for the Approach and Landing Test Program.

Compartment internal pressure: Comparison of compartment pressures derived from flight data with predicted pressures shows good agreement for compartments forward of the 1307 bulkhead. The aft compartment, however, experienced a pressure that was approximately 1/2 lb/in² lower than expected. The reason for this difference is not apparent at this time and is being investigated. When resolved, the venting mathematical model will be updated as necessary. All compartment pressures were well within structure design limits.

Landing loads: The orbiter landing loads were computed using the landing gear load calibrated strain gages. The nose landing gear and both main landing gear strut assemblies were instrumented with load calibrated "wideband" strain gages. These strain gages were used to compute drag brace and ground reaction (tire) loads.

Presented in table IV are comparisons of the measured and predicted main landing gear tire maximum vertical loads for the five free flights. The horizontal velocities and elevon deflections which correspond to these loads also are presented in the table. The maximum difference between measured and predicted values for tire loads is less than 14 percent. The main gear tire maximum loads occurred within 1 second after nose landing gear impact. During this period, the orbiter is at a negative angle of attack and the elevons are in a trailing-edge-up position. This configuration results in a downward net aerodynamic load that is reacted by the landing gear. The tire loads for free flight 4 were the highest of the free flight landing tests.

The main landing gear lower drag brace loads and corresponding ground reaction loads during braking are presented in table V. The drag brace loads for all flights are well within design limit even though significant vibrations occurred on flights 2 and 3 due to dynamic coupling of the anti-skid system with the landing gear/structure.

TABLE IV.- MAIN LANDING GEAR TIRE MAXIMUM VERTICAL LOADS ^{a,b}

Flight	Loads, lb				Horizontal velocity, knots	Elevon deflection, deg
	Right main landing gear		Left main landing gear			
	Measured	Predicted	Measured	Predicted		
Tail cone on:						
1	70 100	72 300	75 900	72 300	148.0	-33
2	67 400	67 000	(c)	67 000	136.8	-33
3	66 900	73 200	76 000	73 200	149.7	-33
Tail cone off:						
4	74 300	83 500	82 400	83 500	162.8	-16
5	54 900	62 500	57 000	62 500	131.1	-12

^a Loads occurred within 1 second after nose landing gear impact.

^b Maximum allowable main landing gear tire load is 100 000 pounds.

^c Data not available.

TABLE V.- MAIN LANDING GEAR DRAG BRACE AND GROUND REACTION MAXIMUM LOADS DURING BRAKING

Flight	Loads, lb					
	Right main landing gear			Left main landing gear		
	^a Drag brace (PDB)	^b Ground reaction, vertical (FG)	Ground reaction, horizontal (FX)	^a Drag brace (PDB)	^b Ground reaction, vertical (FG)	Ground reaction, horizontal (FX)
Tail cone on:						
1	49 100	88 200	19 300	(c)	(c)	(c)
2	78 500	71 000	30 900	79 700	82 600	31 300
3	54 000	118 000	21 200	55 800	106 800	21 900
Tail cone off:						
4	49 600	117 100	19 500	65 600	135 800	25 800
5	63 500	105 300	25 000	48 900	92 300	19 200

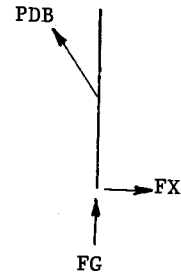

^aMaximum allowable lower drag brace tension load is 237 000 pounds.
^bMaximum allowable ground reaction for two tires is 200 000 pounds.
^cData not available.

4-15

The nose landing gear drag brace and ground reaction maximum loads for each flight are presented in table VI. The drag brace maximum load occurred on flight 2 when the nose landing gear impact velocity was approximately 6.8 feet per second. These loads are well below design values both for structure and tires.

Preliminary evaluation of ALT landing loads indicates that the main landing gear tire loads reached 82.4 percent of the "one-time use" design limit (97 percent of multi-use design limit) while other landing gear loads were well below limit. Correlation between measured and predicted tire loads was good.

Flutter/buffet: Orbiter structural response to control surface programmed test inputs was satisfactory. No indications of flutter were observed and flight data indicated that the wing modes significant to flutter were well damped. In the frequency range of structural interest (4 to 8 hertz) flight data indicated vertical fin responses that agreed satisfactorily with predictions. Also flight data indicated substantially lower speed brake response in the 30-hertz range than predicted by worst-case analyses.

Vibration: The maximum vibration response noted during the free flights occurred during landing-rollout where significant responses were noted throughout the vehicle as a result of landing gear/anti-skid chatter. Accelerometer traces indicate that elevon transients of up to 18 g (Z axis) in the 16- to 25-hertz range occurred during landing-rollout. In general, the dynamic responses of the elevons resulted from transient loading conditions and were satisfactorily damped. Sustained oscillations were low-level and no evidence of instabilities was noted.

Wing loads: Wing root loads and moments derived from strain data have been calculated for the highest wing loading cases during the free flight tests. Calculated wing root shears and bending moments agree with predicted values within 15 percent while torsional moments agree within 22 percent. All wing loads, with the exception of those encountered during the aerodynamic stick input checks on free flight 5 when the vertical load factor flight limit of 2.0 g was exceeded, were within mission structural placards. On free flight 5, a maximum vertical load factor (referenced to the orbiter c.g.) of approximately 2.5 g was produced. However, a review of wing loads and stresses determined from flight data indicates that no structural design limits were exceeded during any of the flights.

Main landing gear door hinge pin assembly: A main landing gear door hinge pin assembly was found missing after free flight 1. This anomaly is discussed in paragraph 7.2.3.

4.2.2 Mechanical Systems

Mechanical systems evaluated during the free flight phase of the Approach and Landing Test Program were the landing gear, nose wheel steering, and brakes. The landing gear performed well throughout the test program. Nose wheel steering was used on flights 1, 3 and 4 and performed well with no reported difficulties. Utilization of the braking system progressed from light braking on flight 1 to hard braking on flights 4 and 5. Landing performance data for the five free flights are given in table VII. Tire and brakes usage is summarized in table VIII.

TABLE VI.- NOSE LANDING GEAR DRAG BRACE AND
GROUND REACTION MAXIMUM LOADS^a

Flight	Loads, lb		
	Drag brace ^b (PDB)	Ground reaction, vertical (FG)	Ground reaction, horizontal (FX)
Tail cone on:			
1	64 500	28 200	17 900
2	90 600	50 700	27 400
3	72 800	(c)	(c)
Tail cone off:			
4	53 300	23 000	15 000
5	58 800	37 300	17 800

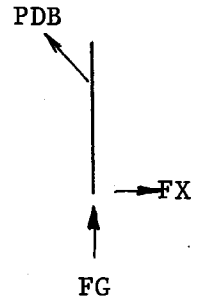

^aLoads occurred during nose landing gear impact.

^bMaximum allowable lower drag brace tension load is 211 000 pounds.

^cData not available.

TABLE VII.- LANDING GEAR PERFORMANCE SUMMARY

Condition	FF-1	FF-2	FF-3	FF-4	FF-5
^a Runway relative velocity, knots					
Landing gear armed	311	274	297	295	306
Landing gear deployed	278	260	291	294	293
Main landing gear touchdown	192	186	192	199	^b 187,160
Nose landing gear touchdown	148	137	150	163	131
^b Distances, feet					
Touchdown beyond aim point	5 444	679	786	510	994
Main landing gear touchdown to nose landing gear touchdown	3 869	4 676	3 499	1 730	4 098
Main landing gear touchdown to stop	11 845	10 037	9 184	5 725	7 930
^c Times, seconds					
Landing gear deployment					
Nose	7.2	8.1	7.4	8.4	7.2
Right	6.4	7.3	6.6	7.6	7.4
Left	5.4	6.3	5.4	6.6	6.2
Main landing gear touchdown to nose landing gear touchdown	12.8	14.3	10.5	5.3	15.7
Main landing gear touchdown to stop	136.8	74.2	86.0	45.4	62.6
Rates					
Approximate sink rate at main landing gear touchdown, ft/sec	1	1	1	3	^b 1,5
Pitch rate at nose landing gear touchdown, deg/sec	3.6	5.9	3.7	2.8	5.5
Nose wheel steering utilization	X		X	X	
Braking utilization					
Light	X		X		X
Moderate		X	X	X	
Hard				X	X

^aRunway relative velocities from phototherodolite data.

^bVelocities and approximate sink rates are given for the first and second main landing gear touchdowns. The second touchdown occurred approximately 1754 feet from the first.

^cDistances and times were measured from first main landing gear touchdown.

TABLE VIII.- TIRE AND BRAKES USE HISTORY

Flight	Tires		Brakes
	Nose	Main	
1	^a New	^a New	New
2	New	New	Used on flight 1
3	Used on flight 2	New	Used on flights 1 and 2
4	Used on flights 2 and 3	Used on flight 3	Used on flights 1, 2 and 3
5	New	New	New

^aTires subjected to non-destructive postflight inspection (infrared holography) and no damage found.

On flight 1, light braking was applied at approximately 80 knots and was held until the velocity decreased to 55 knots. Nose wheel steering was engaged at 50 knots and was used until the velocity reached 25 knots. Nose wheel steering was once again engaged at 10 knots and was used until the vehicle came to rest. A time history of the flight 1 landing-rollout is shown in figure 4-6. The crew reported that nose wheel steering was effective and smooth with no overshoot. The measured ground track exhibited a lateral displacement of as much as 80 feet.

Following flights 2 and 3, the crews reported "chattering" (a low-frequency vibration) during heavy application of the brakes (ref. par. 7.2.8). In application of hard braking on flights 4 and 5, deceleration was improved and no "chatter" was detected.

Aileron steering was used following nose landing gear touchdown on flight 2. The steering was not as effective as expected because of rudder compensation while in the control stick steering mode. A lateral displacement of 40 feet was achieved in 14 seconds and a linear distance of 2100 feet. On subsequent flights, the crew proceeded to the manual direct mode in roll and yaw to preclude the nulling effect of the rudder. The flight 2 crew also reported that differential braking was not an effective steering procedure; however, effective steering was achieved by means of differential braking on flight 3 where the crew had been alerted to probable "chatter" during hard braking. On flight 2, a lateral displacement of 25 feet was achieved in 41 seconds and a linear distance of 2900 feet using differential braking. On flight 3, a lateral displacement of 140 feet was achieved in 19 seconds and a linear distance of 2100 feet. Time histories of landing-rollout for flights 2 and 3 are shown in figures 4-7 and 4-8, respectively.

Landing and rollout on flight 4 were normal in all respects. As shown in figure 4-9, nose wheel steering was engaged at 115 knots for 4 seconds, thus demonstrating its use at high speed. Postflight inspection of the brakes revealed that one carbon lining segment was loose. This anomaly is discussed in paragraph 7.2.11.

Flight 5 was conducted using all new brakes. Hard braking was applied following nose landing gear touchdown (fig. 4-10) and was reported to be smooth and effective. Postflight viewing of orbiter camera film revealed apparent smoke coming from the left outboard tire; this would be a normal result of a tire producing hard braking on a dry surface. The anti-skid system performed normally during partial skids in that it dumped pressure to the brakes and allowed the tire to spin up. On the basis of the pressures applied and wheel speed data, all tires were slipping partially as commanded by the skid control system to provide optimum braking with the left-hand outboard tire exhibiting the highest momentary slip ratios. Postflight inspection of the tires showed scuffing of all main landing gear tires with that of the left outboard tire being the most severe. The tire wear was determined to be commensurate with the hard braking applied. Postflight inspection of the brakes has been accomplished and a minor amount of chipping was found on four of the 160 carbon lining segments of the left-hand inboard brake (ref. par. 7.2.11).

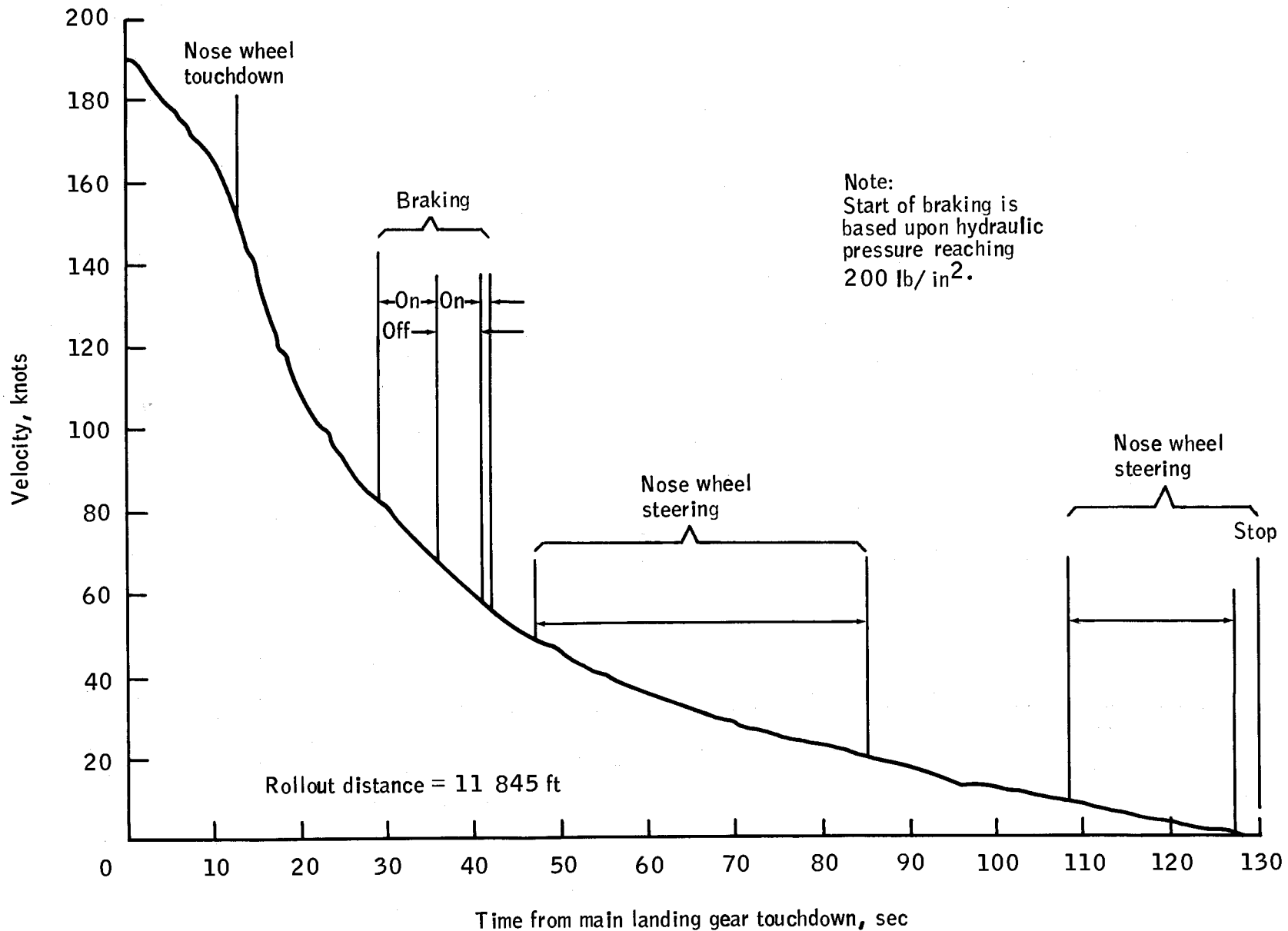

Figure 4-6.- Flight 1 landing-rollback time history.

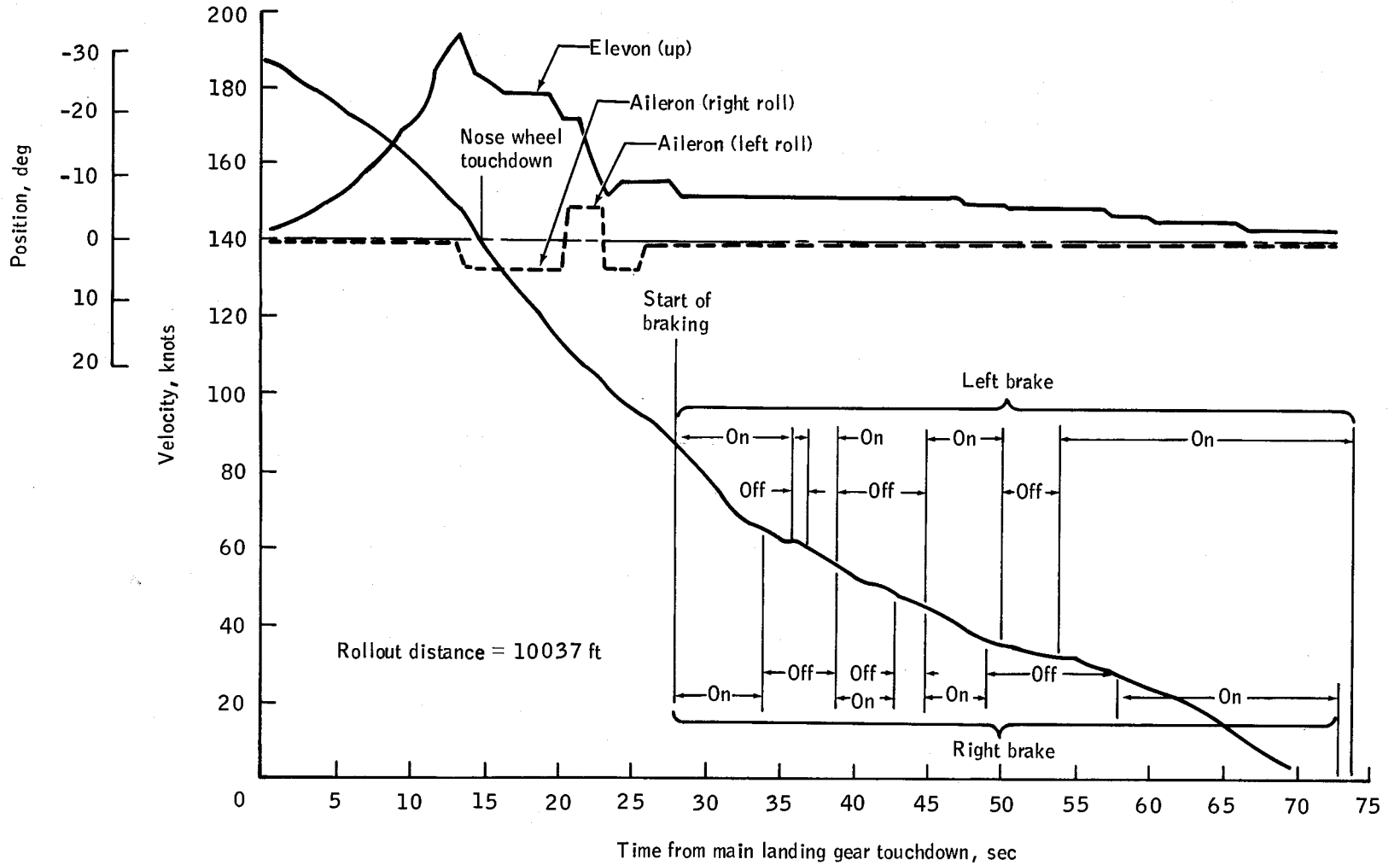

Figure 4-7.- Flight 2 landing-rollback time history.

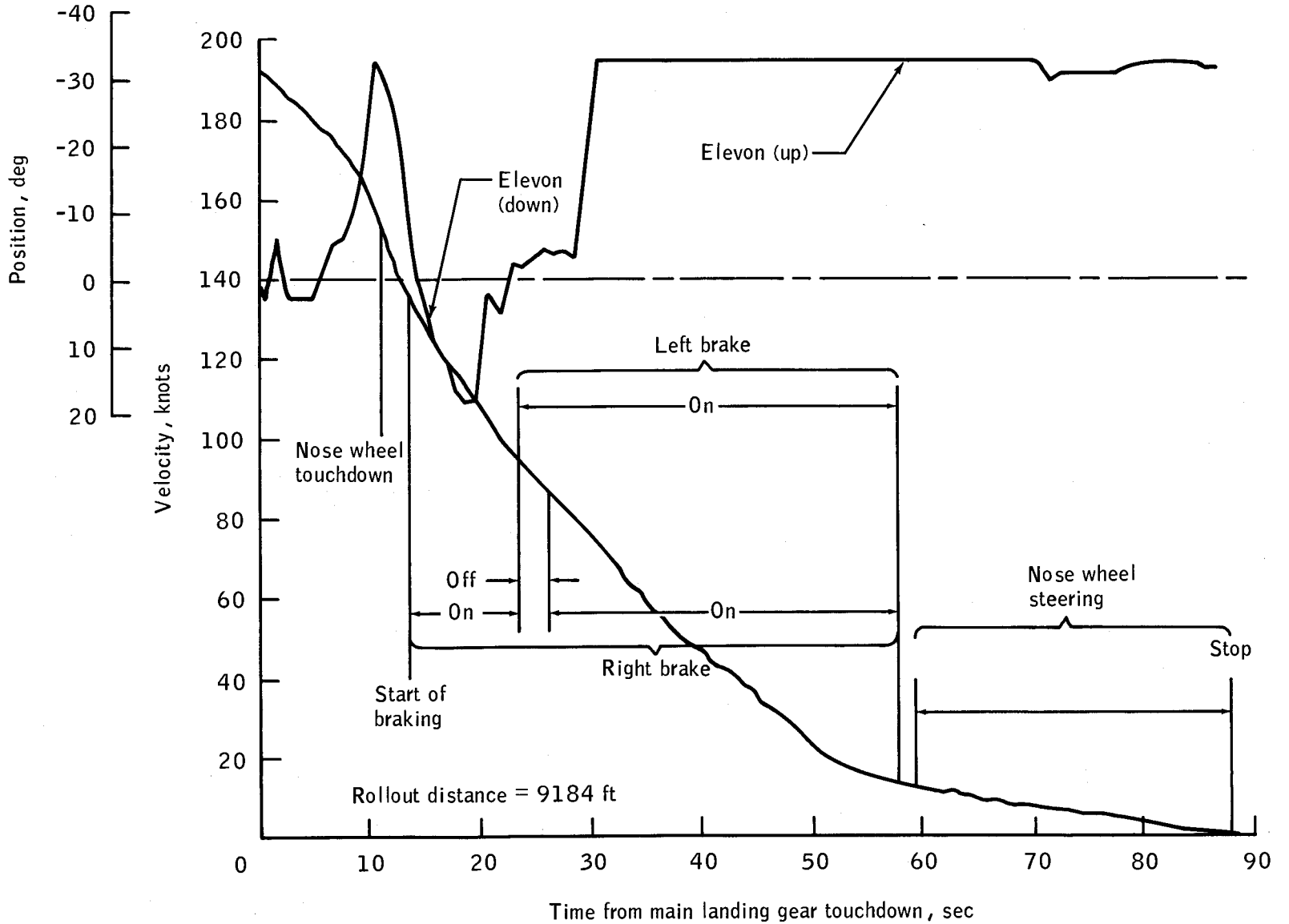

Figure 4-8.- Flight 3 landing-rollout time history.

4-24

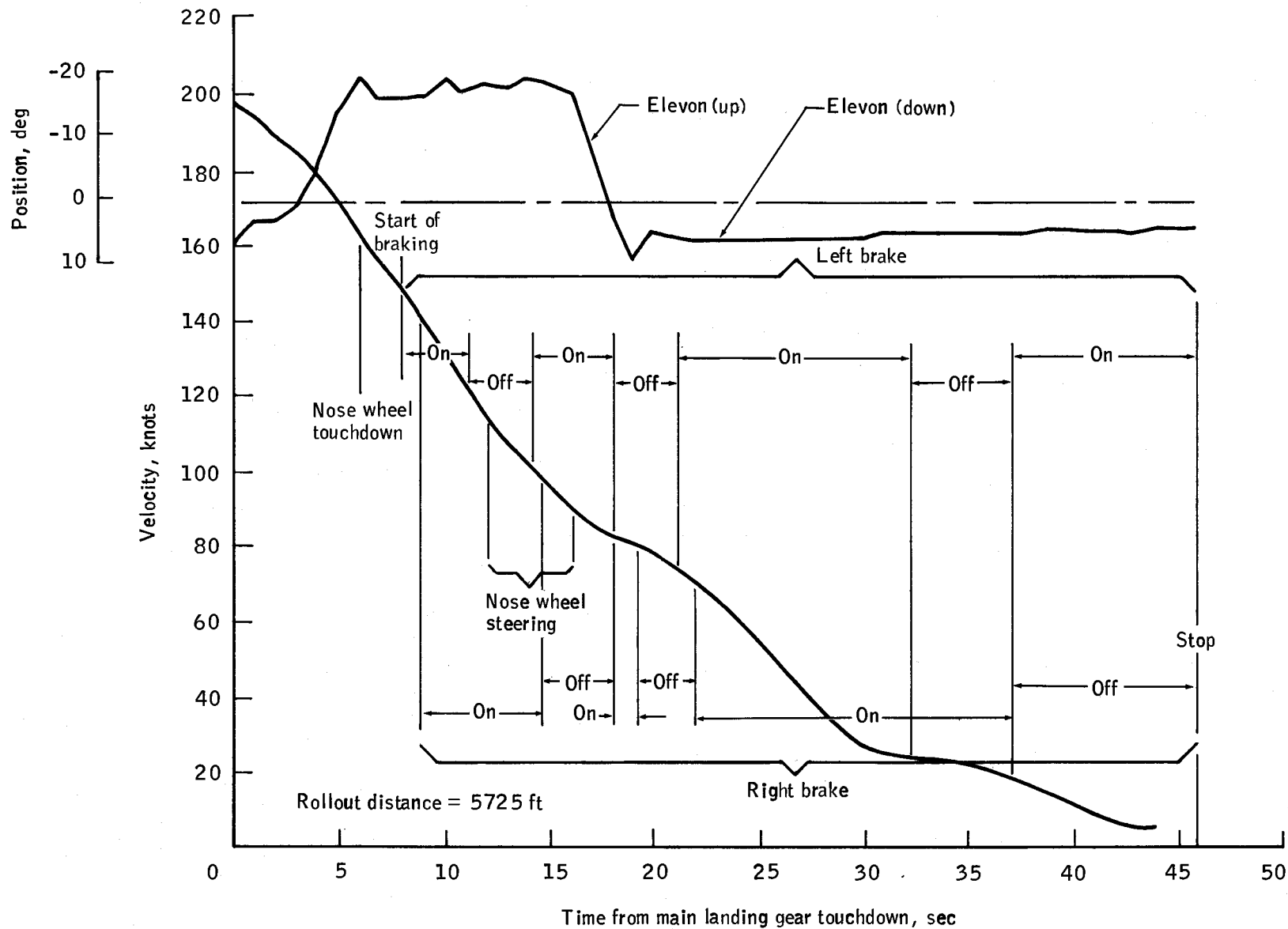

Figure 4-9.- Flight 4 landing-rollback time history.

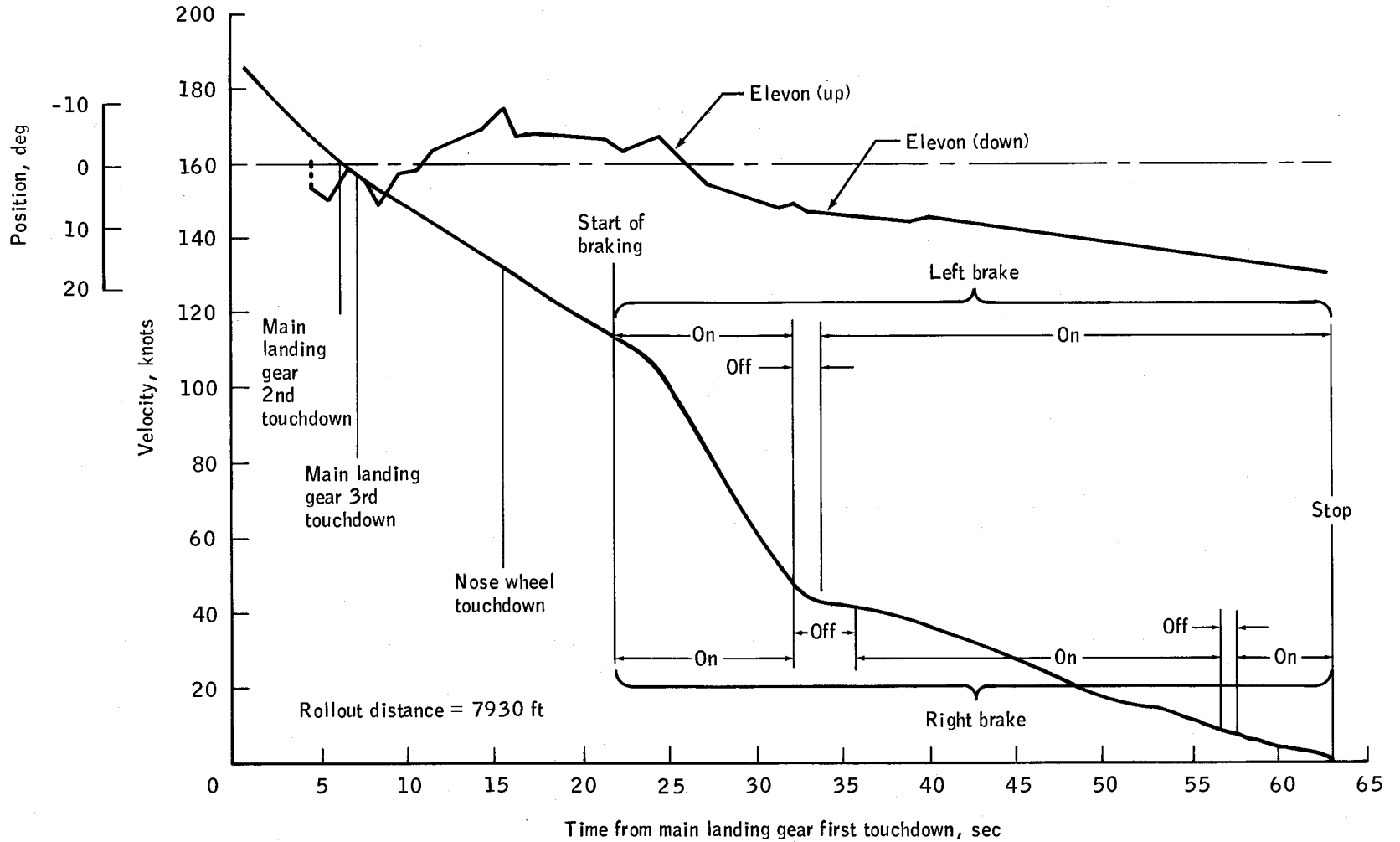

Figure 4-10.- Flight 5 landing-rollback time history.

4.2.3 Power

4.2.3.1 Auxiliary Power Units

The inflight performance of the auxiliary power units during the free-flight phase of the Approach and Landing Test Program was normal except for the following discrepancies.

Indications of occasional extraneous pulses were seen in gas generator chamber pressure data from two of the auxiliary power units. Four out of 80 000 pulses occurred out of their expected sequence during 18.5 hours of running time. Review of the captive-active data indicated that one pulse was from auxiliary power unit 1 and occurred on captive-active flight 1A. One pulse was from auxiliary power unit 2 and occurred on free flight 2. The other two pulses were also from unit 2 but occurred on free flight 3. Examination of data from free flights 4 and 5 showed no extraneous pulses. The pulses do not cause loss of speed control and cannot propagate to an overspeed condition. An investigation of possible causes indicated that a transient voltage was probably induced in the auxiliary power unit controller 15-volt reference power supply by electromagnetic interference.

After free flight 4, carbon particles were found in the fuel pump seal leakage collection bottle of auxiliary power unit 2. Postflight examination and ground testing of the unit showed no significant damage or deterioration. The carbon was most likely a random accumulation from normal operational wear and drain line contamination. Consideration is being given to possible improvements in techniques and processes to purge drain lines and seal cavities for Orbiter 102.

Approximately 200 cubic centimeters of lubrication oil leaked from the auxiliary power unit 1 gear box during the free flights. The leakage was probably caused by the turbine shaft bellows seal. Corrective action was not required for the Approach and Landing Test Program. Corrective action being considered for Orbiter 102 and subsequent vehicles consists of using a double damper turbine shaft bellows seal and a gear box repressurization system that utilizes gaseous nitrogen.

On several occasions, flaming of the auxiliary power unit exhaust plumes on the left side of the vehicle was observed by the ground crews after rollout and prior to shutdown. This phenomenon was associated with auxiliary power units 1 and 2, but was not seen on unit 3. There was no evidence of any adverse effect on the vehicle.

Instrumentation problems associated with the auxiliary power units are discussed in section 4.2.5.2.

Approximate fuel usage, flight operating time, and cumulative operating time for the auxiliary power units were as shown in table IX.

TABLE IX.- AUXILIARY POWER UNIT RUN TIME

Auxiliary power unit	Serial number	Fuel usage, lb	Flight run time, min	^a Cumulative run time, min
Free Flight 1				
1	107	92	41.0	389
2	109	177	70.5	591
3	108	210	72.3	537
Free Flight 2				
1	107	84	40.7	430
2	109	164	70.7	662
3	108	204	71.4	608
Free Flight 3				
1	107	79	37.8	468
2	109	147	64.0	726
3	108	191	66.5	675
Free Flight 4				
1	107	98	47.5	515
2	109	(b)	80.3	806
3	108	238	80.8	756
Free Flight 5				
1	107	88	41.8	557
2	103	143	66.4	788
3	108	206	69.1	825

^aIncludes operating time during captive-active flights and ground operations.

^bData not available.

4.2.3.2 Hydraulics

The inflight performance of the hydraulics system was normal. Operating temperatures and pressures remained within expected limits except during the full-load tests following flights 3 and 5. On flight 5, the caution and warning system indicated an under-pressure condition on hydraulic system 3. Details of this anomaly are given in paragraph 7.2.17. The bootstrap pressurization system of hydraulic system 3 exhibited slow leakage between flights; however, this did not affect auxiliary power unit/hydraulic system start-up.

4.2.3.3 Fuel Cells

The fuel cell subsystem met all of the electrical power requirements of the flights. The average power level for all flights was approximately 14 to 15 kilowatts. The three fuel cells supplied currents ranging from 300 amperes before ground disconnect to 504 amperes during the flights. The current levels of each flight compared very closely with each other. Fan tests performed during flight 2 caused the fuel cell currents to increase to approximately 520 amperes.

The fuel cell 1 exit temperature was lower than expected after switchover to internal power prior to flight 3. However, the temperature remained within specification limits and stabilized at approximately 133° F for the last two flights. The associated control valve anomaly is discussed in paragraph 7.2.7. The anomaly had no adverse effects on fuel cell performance.

4.2.3.4 High Pressure Gas Storage System

The high pressure gas storage system operated satisfactorily and pressures remained well within redline limits for all flights. A summary of fluid usage is shown in the table that follows. Actual usage was less than planned because the auxiliary power unit heater power requirements were less than anticipated.

Reactant	Expected usage, lb	Actual usage, lb				
		Flight 1	Flight 2	Flight 3	Flight 4	Flight 5
Oxygen						
Primary	31.63	25.98	25.98	26.11	29.17	26.29
Secondary	0	0	0	0	0	0
Hydrogen						
Primary	3.99	3.50	3.33	3.40	3.82	3.54
Secondary	0	0	0	0	0	0

4.2.4 Pyrotechnics

Pyrotechnic functions that were required to operate did so normally. These consisted of (1) actuation of the strut that assisted the hydraulics in deploying the nose landing gear and (2) carrier aircraft/orbiter separation. Shock from the separation system explosive bolts caused the electrical connector to be damaged during separation. On orbital flights, the orbiter/external tank separation system electrical connector will be replaced after each flight.

A potential problem identified prior to flight 1 was that, with a single-point failure, a pyrotechnic initiator controller at the forward or aft attach points could fire when armed without the "fire 1" or "fire 2" command being present. To preclude this possibility, modifications were made on the pyrotechnic initiator controller separation circuits so that, even with a failure, a controller would not operate prematurely.

4.2.5 Avionics

4.2.5.1 Electrical Power Distribution and Control

The electrical power distribution and control systems operated normally throughout the free-flight test phase except that the system B aft separation pyrotechnic initiator circuit voltages did not indicate proper levels when the pyrotechnic initiator circuit was safed after touchdown on flight 1. This condition was attributed to the loss of the data path in string 2 due to the failure of computer 2 (ref. par. 4.2.5.4).

4.2.5.2 Instrumentation

Operational instrumentation: The operational[®] instrumentation subsystem provided 1026 measurements, the associated signal conditioning, timing, and pulse code modulation (PCM) downlink formatting via the PCM master unit. The system adequately supported all the mission requirements. The major anomalous conditions observed were broken and/or intermittent wiring connections. These failure modes were responsible for six of the eight measurement failures listed in table X. The remaining two failures (freon coolant loop 1 and 2 inlet pressure measurements) were the result of a generic contamination problem within the pressure transducer. The final item listed in table X is discussed in detail in paragraph 7.2.14. Additional information concerning the operational instrumentation problems is given in appendix G.

Development flight instrumentation: The development flight instrumentation subsystem provided 650 measurements with associated signal conditioning and timing via the PCM master unit. The overall system performed satisfactorily and supported all mission requirements although nose boom oscillations on free flight 2 nullified angle of sideslip data for that flight. The development flight instrumentation measurements that failed are identified in appendix G. The major causes of anomalies were broken and/or intermittent wiring and loose connections. To prevent problems of this type from occurring in Orbiter 102, the following • corrective action is being implemented: procedures for better quality control of soldering and crimping are being developed, a positive lock wire installation method is being developed, devices to protect sensors and sensor connections in high-traffic work areas are being installed, and the use of precaution signs is being increased.

TABLE X.- OPERATIONAL INSTRUMENTATION FAILURES

<p>Flight 1:</p> <p>Freon coolant loop 2 accumulator quantity</p> <p>Freon coolant loop 1 inlet pressure</p> <p>Freon coolant loop 2 inlet pressure</p> <p>Left inboard elevon actuator channel 2 position</p>
<p>Flight 3:</p> <p>Auxiliary power unit 1 X-axis accelerometer</p> <p>Auxiliary power unit 1 Z-axis accelerometer</p> <p>Auxiliary power unit 3 X-axis accelerometer</p>
<p>Flight 5:</p> <p>Auxiliary power unit 3 exhaust gas temperature</p>

A number of measurements were installed in inaccessible locations. In these cases, fault isolation was not pursued because of cost and scheduling impacts. In general, these problems were attributed to sensor or wiring deficiencies and loose connectors.

There were several other causes of anomalous performance of development flight instrumentation. For example, main and nose landing gear accelerometers displayed a bias shift at landing gear deployment lasting approximately 6 seconds. The bias shift was attributed to transient charge currents entering the amplifiers. The source of these transients has not been determined. Since these accelerometers will not be used on Orbiter 102, no further troubleshooting is planned. A number of vibration measurements also displayed interference from transients during transmitter keying when transmitting through the top antennas. These antennas will not be installed in this location on Orbiter 102; however, a method of grounding RF signals at the amplifier signal input is being developed to eliminate interference in the event that transients are still present with the Orbiter 102 configuration.

The wideband tape recorder speed was erratic during landing-rollout on flight 2. The condition was caused by excessive vehicle vibration at a frequency of approximately 16 hertz. The vibration was reduced on flight 3 and subsequent flights by the action taken to correct the brake "chattering" discussed in section 4.2.2. The 16-hertz oscillation occurred at the resonant frequency of the landing gear structure and resulted in the recorder being exposed to low-frequency vibration in excess of design specifications.

4.2.5.3 Communications and Tracking System

The communications and tracking equipment performance was good. The problems encountered are discussed below.

Flight 1:

- a. Two general purpose computer errors were experienced while switching between microwave landing systems 1, 2 and 3 during preflight checkout. The switching sequences were preplanned to eliminate the possibility of redundancy management alarms before entering the microwave landing system cone of coverage. The possibility of the computer errors was known since the microwave landing system has internal checks to verify channel switch parity. The transition time for the switch change was longer than expected; thus, the output data parity was set incorrectly, thereby signifying a problem. To prevent nuisance error messages during flight, the flight procedure was changed so that the proper channel was selected for all three units, then two units were deselected from redundancy management.
- b. One TACAN failed to acquire lock on the Mission Bay TACAN station. A second station was selected and lock-on was achieved. Other failures of the TACAN system to lock onto ground stations are discussed in paragraph 7.2.13.

- c. Problems were experienced with the voice uplink from the ground. The condition was cleared prior to the pushover maneuver. This problem is discussed further in paragraph 7.2.4.

Flights 2 and 3:

Radar altimeter 1 exhibited intermittent tracking at an altitude of approximately 100 feet. Both units indicated a rapid decrease in the altitude reading of approximately 30 feet in 1 second when the rate was actually less than 10 feet per second. Data analysis by the vendor is in progress.

Flight 3:

Three communications problems were encountered on flight 3. The first was determined to be an intermittently keyed microphone in the carrier aircraft. The second was an intermittent in the Pilot's intercommunication system. The third was noisy communications on the air-to-ground 259.7 megahertz link. The carrier aircraft keying problem occurred prior to flight and for about 3 seconds during mated flight. The Pilot's intercommunications problems did not occur after takeoff. The noisy communications problem was resolved during flight by disabling the 259.7 megahertz ground receiver. The two orbiter communications problems are discussed further in paragraphs 7.2.4 and 7.2.6.

Flight 4:

Two problems were encountered. First, a redundancy management message on the TACAN system occurred. The crew reported intermittent or total loss of data. After switching to another station, the problem cleared and there were no further redundancy management messages. The second problem was that the fundamental frequency of the S-band transmitter drifted. The transmitter was replaced for flight 5 and no further drift problems occurred. The faulty transmitter was returned to the vendor where failure analysis is in progress. Two transmitters exhibited frequency drift during preflight checkout for flight 1. The vendor determined that the condition was due to aging of electronic components used for thermal compensation.

Flight 5:

TACAN unit 3 experienced a redundancy management alarm and failed to lock onto a ground station during malfunction procedure investigation sequences. The unit was deselected from redundancy management for the remainder of the flight, although it did lock on and operate normally later in the flight. Failures of the TACAN system to lock onto ground stations are discussed further in section 7.2.13.

4.2.5.4 Data Processing Systems

The overall performance of the data processing system during the free-flight test phase was satisfactory except for the problems discussed.

Flight 1:

During preflight checkout activities, computer 3 failed to synchronize while in operational sequence 1. The computer was replaced prior to flight and the replacement computer performed normally. Subsequently, a memory dump performed on the failed computer disclosed that a machine check error had occurred. The error was attributed to a central processing unit parity error. Extensive testing was performed on the failed computer but the problem could not be duplicated. A memory interface page was replaced since this was the most probable cause of the problem. The computer was retested and installed in the computer 3 location prior to free flight 2. The computer performed satisfactorily in that location for the remainder of the Approach and Landing Test Program. Failure analysis of the removed memory interface page has not been completed.

A second problem occurred at the time of separation when computer 2 stopped processing and the redundant computers voted computer 2 out of the redundant set. During subsequent testing at the vendor, the anomaly was reproduced while the computer was undergoing low-level vibration testing. The anomaly was traced to a faulty solder joint. Redesigned pages were installed; the computer was retested and replaced in the orbiter in the computer 1 location. The computer performed satisfactorily on all subsequent flights. Additional details of this anomaly are given in paragraph 7.2.1.

Flights 2 through 5:

Several error messages were displayed on the cathode ray tube scratch pad line. Subsequent entry of the original key strokes cleared the error messages and the system continued normal operation. Postflight memory dumps of the display electronics units were performed and indicated that each error message was caused by an illegal key code. The illegal key codes were attributed to electromagnetic interference entering the system between the keyboard and the display electronics unit. Since the problem was understood and the error messages could be cleared, no corrective action was taken for Orbiter 101. The specific error messages and display electronic units involved are discussed in paragraph 7.2.5.

Free Flight 5:

While running operational sequence 800 during preflight checkout, an "initial program load incomplete" was displayed on the left cathode ray tube. The display was due to a "check sum invalid" being generated. The initial program load was reloaded and it processed satisfactorily. Possible causes are incorrect switch configurations or data bits being dropped during bus transmission; however, the cause cannot be definitely determined due to unavailability of data.

4.2.5.5 Flight Control System

All flight control system preflight checks and inflight preseparation checks were performed as planned with no anomalies. Performance of the flight control system during each of the free flights is discussed in the following paragraphs.

Flight 1:

The flight control accelerometers were powered down immediately after separation following loss of general purpose computer 2 in accordance with the planned computer malfunction procedures. Loss of these accelerometers tends to degrade turn coordination; however, the handling qualities were still considered very good (Cooper-Harper rating = 2, fig. 4-11) and the free flight was executed as planned. The landing maneuver appeared to be well controlled with no noticeable ballooning or oscillation due to ground effects. The pitch control was reported as being like the simulators and the roll control was crisper, but not too sensitive. A "lateral lurch" was noticed during roll maneuvers and was the same as experienced during moving base simulations.

Flight 2:

All planned programmed test input and aerodynamic stick input test sequences were completed plus some additional aerodynamic stick input test points. The first turn was controlled at a steady 1.8 g and a bank angle of approximately 60° was reached. The descent rate at touchdown was less than 1 foot per second. The pitch axis control at landing was rated 1.5 on the Cooper-Harper scale.

Flight 3:

All planned programmed test input and aerodynamic stick input test sequences were completed plus some additional aerodynamic stick input test points. The first turn was controlled at a steady 1.8 g and a bank angle of approximately 59° was reached.

The autoland closed-loop performance was nominal. The steep slope acquisition was smooth and the guidance loops were very stable. No significant vehicle oscillations in pitch or roll were evident. Steady-state speed control was near the nominal 270 knots. Approximately 50 seconds of closed-loop operation was obtained.

Pitch rate at nose wheel touchdown was 3.6° per second. The manual direct control mode was selected in the roll/yaw axis during rollout and it appeared that the differential brake steering profile was as planned. The pitch axis control at landing was rated 2 on the Cooper-Harper scale.

Flight 4:

No problems were apparent in the tailcone-off configuration either on the ground or during flight. Carrier aircraft buffeting did not adversely affect the control stick steering mode pre-separation checks. Handling qualities during the free-flight portion were not noticeably different than on previous flights. Control was very positive and longitudinal control was judged to be equivalent to 2 on the Cooper-Harper scale. Lateral maneuvers were not sufficient to provide a rating.

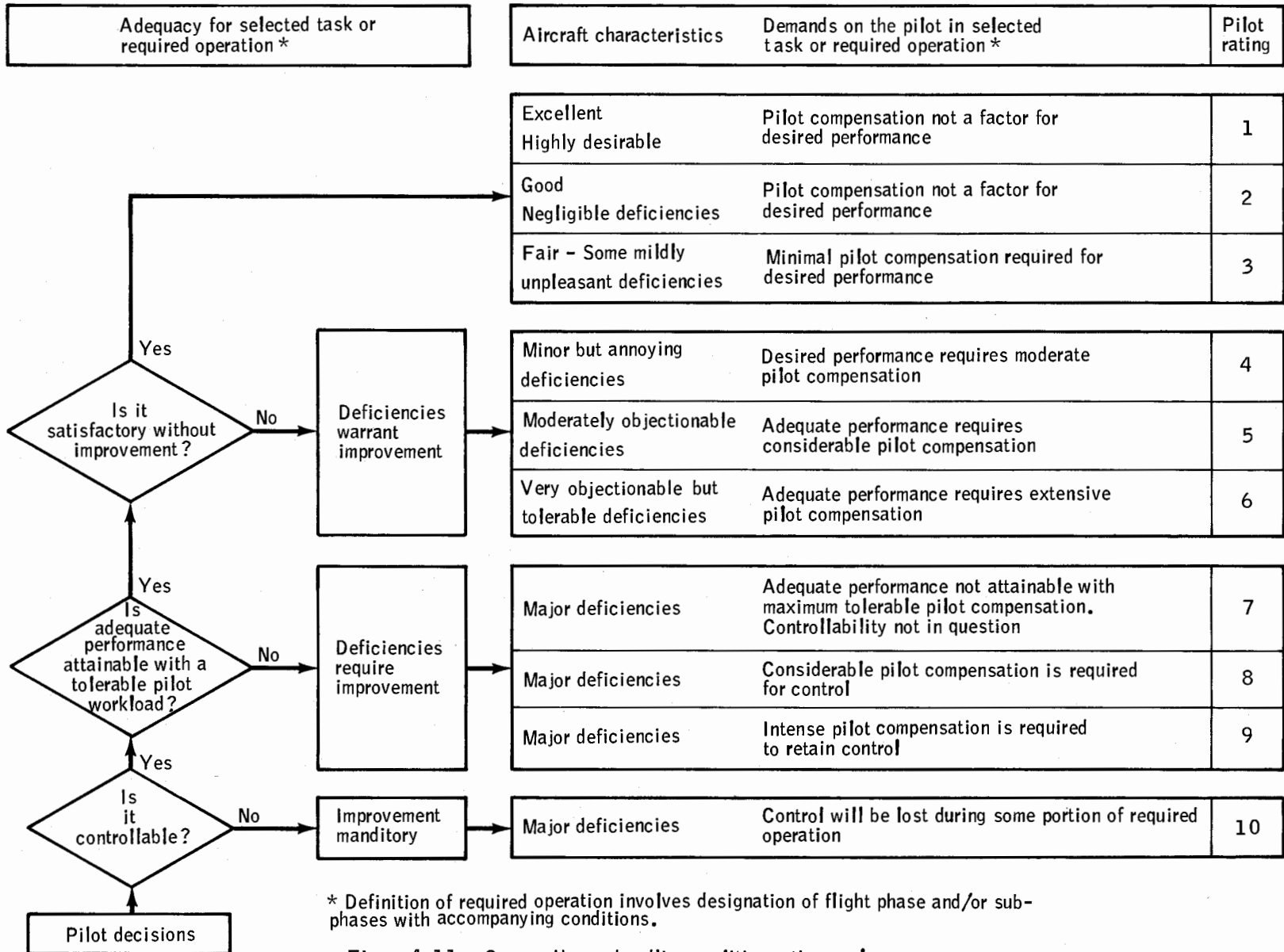

Figure 4-11.- Cooper-Harper handling qualities rating scale.

Flight 5:

Separation was normal as was subsequent flight control up to a point just prior to touchdown. At this time, there was a pitch oscillation for the last 8 seconds prior to touchdown. Subsequent analysis and simulation have not shown any anomalous operations of the flight control system; however, changes will be required to accommodate this condition. Changes being considered and currently under investigation include revised elevon rate-limiting logic, increased hand controller forces, and reduced system gains. A detailed description of the flight events is given in section 4.3.5 and an assessment is given in section 4.4.

4.2.5.6 Guidance, Navigation and Control Hardware

All equipment in the guidance, navigation and control systems performed well throughout the flights; however, several problems were noted during preflight checkout as described in the following paragraphs.

Flight 1:

Results of the preflight inertial measurement unit calibration indicated all parameters were less than 1 sigma except for one parameter of the second unit which was slightly over 1 sigma. At the completion of gyrocompassing, the gyrocompass goodness test indicated a miscompare between units 1 and 2. Miscompares have been experienced during ground tests and are usually due to the azimuth gyro. Worst-case drift results indicated that navigation accuracies would be acceptable for flight and would be within the redundancy management limits.

Flight 2:

Two inertial measurement unit built-in test equipment (BITE) errors were observed during preflight operations. The errors were caused by an echo check performed during operational sequence 1. The errors do not occur in flight (operational sequence 2) because different software module priorities are assigned.

Flight 5:

During preflight calibration, the Y-axis accelerometer bias term for inertial measurement unit 1 exceeded specification limits. A recalibration indicated that the bias term was stable within specification limits at the new value. Gyrocompass testing indicated normal operation during preflight checkout and navigation parameters were normal during the flight test. This anomaly is discussed further in paragraph 7.2.12.

4.2.5.7 Displays and Controls

All displays and controls appeared to operate properly except that, on flight 1, the crew observed an erroneous equivalent airspeed "off" flag on the left alpha/Mach indicator. The instrument functioned normally except for the "off" flag. Details are given in paragraph 7.2.2.

4.2.5.8 Flight Software

All flight software performed satisfactorily. As in the captive-active flights, on several occasions the computers indicated attempts to take the square root of a negative number. The cause was attributed to noisy TACAN data or TACAN's failing to lock onto ground stations (par. 4.2.5.3).

An additional discrepancy was noted by the crew prior to takeoff on free flight 2. After keying ITEM 18 EXEC (execute) on SPEC 041, the asterisk did not jump to the 18 position after DISP (display) was keyed, indicating that data had not been updated on the cathode ray tube display when the EXEC key was depressed. This is a software phasing condition which occurs occasionally. A program note has been issued, and the crews have been trained to recognize the incorrect sequence and take corrective action by depressing the DISP key.

4.2.6 Environmental Control and Life Support System

Performance of the environmental and life support system was normal for all five free flights except for an instrumentation problem and a performance peculiarity which initially occurred during the captive-active flights and continued to occur on the free flights. The instrumentation problem was due to contamination within the transducers used in the freon coolant loop 1 and 2 pump inlet pressure measurements. (Also see par. 4.2.5.2.) The performance peculiarity involved the freon coolant loop heat sink outlet temperature measurements. Immediately following the pushover maneuver, the temperature would go unstable for approximately 1 minute. The freon coolant loop damped out any thermal effect of the instability so that no interfacing systems were affected. The cause of the instability is unknown; however, this problem is not expected to occur on Orbiter 102 because of configuration differences.

An apparent abnormal condition noted during postflight analysis of captive-active flight data was that the heat transferred to the freon coolant loop by the fuel cell heat exchanger was approximately 50 percent of that expected. Prior to free flight 3, the temperature sensors at the fuel cell heat exchanger outlet were insulated by application of thermal grease. Postflight analysis of the free flight 3 data indicated that the sensors had been cold-biased prior to application of the thermal grease and that the expected level of fuel cell heat was being transferred to the freon coolant loop as predicted.

A test was conducted during free flight 2 to determine the effect of simultaneous operation of both cabin fans and all six avionics bay fans. Results indicate that cooling was not increased. Therefore, simultaneous operation of backup and primary fans will not be considered as an option for future flights.

4.2.7 Aerodynamics

4.2.7.1 Orbiter Air Data System Calibration

The air data calibrations for corrected static pressure, total pressure and angle of attack were analyzed by examining the static pressure decrement, total pressure decrement and the RAX parameter. Flight-calculated data were compared to the latest wind tunnel calibration and the differences noted. Data from all flights showed good agreement.

Static pressure decrement presented in figure 4-12 shows that the flight data do not have the "hump" at an angle of attack of 10° as predicted by the wind tunnel data. The general trend of the flight data shows a positive bias of approximately 0.04. The flight data confirms that the magnitude of the difference caused by the deployment of the nose landing gear is correct.

The total pressure decrement shown in figure 4-13 indicates very good agreement with the wind tunnel data. No significant effect of nose landing gear deployment is evident in the flight data, confirming wind tunnel results.

The RAX parameter, used to calibrate angle of attack, is shown in figure 4-14. Note that there is a negative bias of approximately 0.02 at the higher angles (this equates to approximately 1° in angle of attack). No significant effect of nose landing gear deployment is seen. No difference was seen between the tail-cone-on versus the tail-cone-off configuration.

The angle of attack used for all aerodynamic data correlations is the result of a statistical analysis of all data sources. Data from the flight test boom (corrected for misalignment, acceleration load, and pitch rate), theodolite, radar and the baseline side probes showed the theodolite data to be the most consistent. Figure 4-15 shows these data correlated with the side probe data, which has been shifted, to form the best estimated flight-measured angle of attack.

4.2.7.2 Separation Performance

The primary separation parameters achieved on all free flights were in excellent agreement with predicted values. The results from the flights are shown in table XI.

These values are within the separation windows as shown in figure 4-16. In conjunction with these results, other pertinent parameters at separation are given in table XII.

Postflight analysis showed excellent agreement between flight and predicted separation trajectories, where the predicted trajectories were based on flight initial conditions at separation and pilot steering commands during separation. Example trajectories with tail cone on and off are shown in figure 4-17.

4.2.7.3 Aerodynamic Performance Verification

The approach and landing flight test data verifies preflight aerodynamic predictions for the basic vehicle, both with and without the tail cone. Since the tail-cone-off configuration of flights 4 and 5 represents a more meaningful vehicle for analysis, the test data shown in figures 4-18 through 4-21 represents flights 4 and 5. (Note: These figures are based on angle of attack data in fig. 4-15. The data are being reevaluated using nose boom angle of attack.) Figure 4-18 confirms the basic aerodynamic performance with a comparison of the flight and predicted normal force coefficient (C_N) against the axial force coefficient (C_A). Such a comparison is independent of any unknowns in the flight angle of attack. The flight angle of attack (α_F) uncertainties

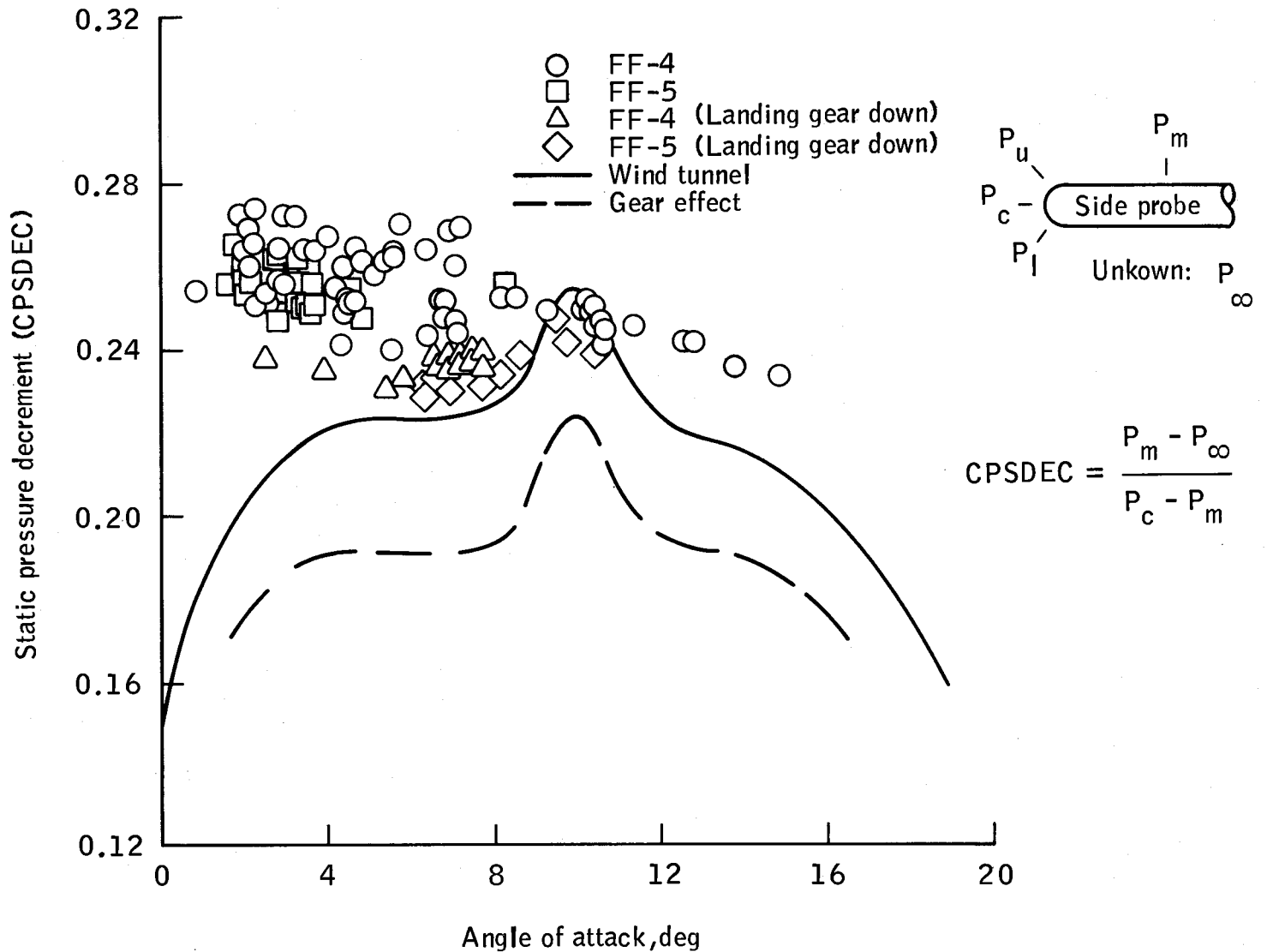

Figure 4-12.- Comparison of flight and wind tunnel static pressure decrement.

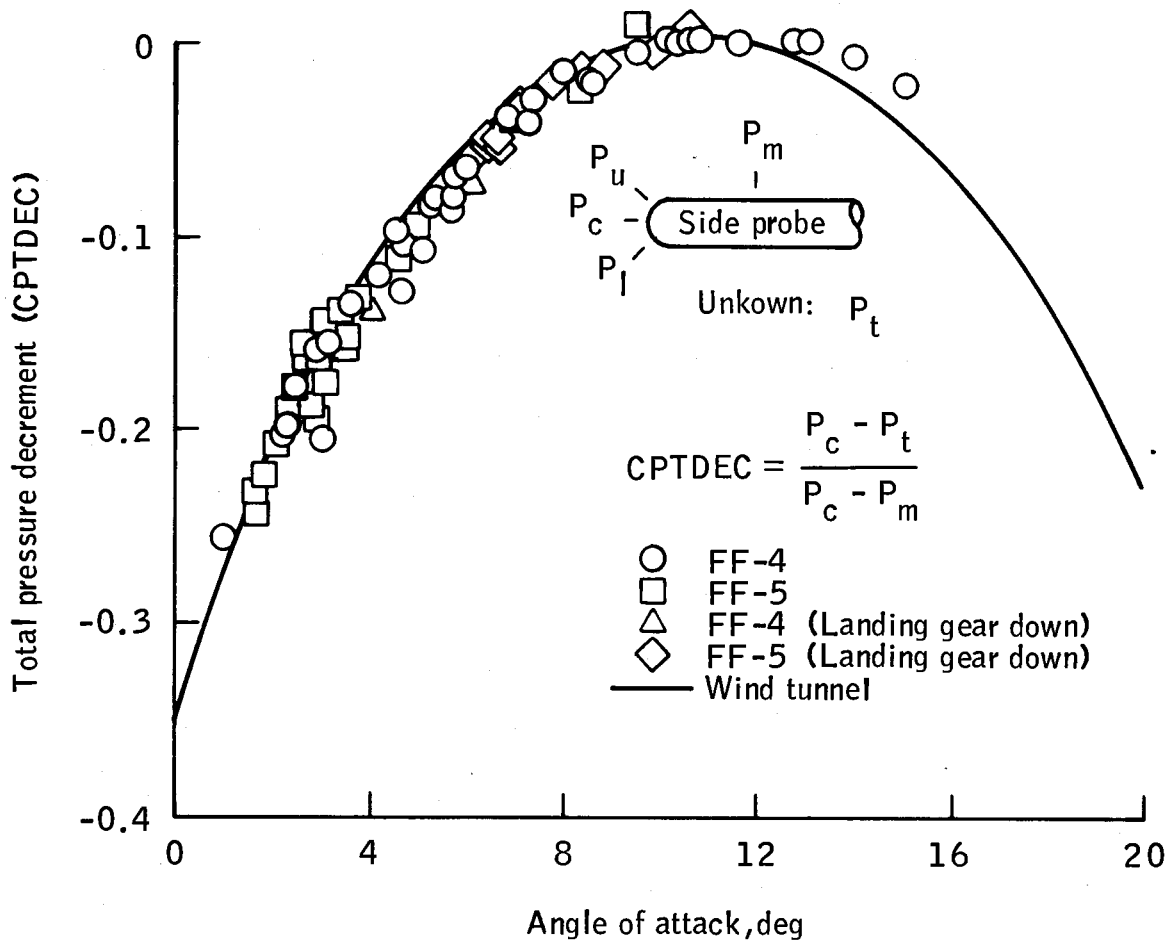

Figure 4-13.- Comparison of flight and wind tunnel total pressure decrement.

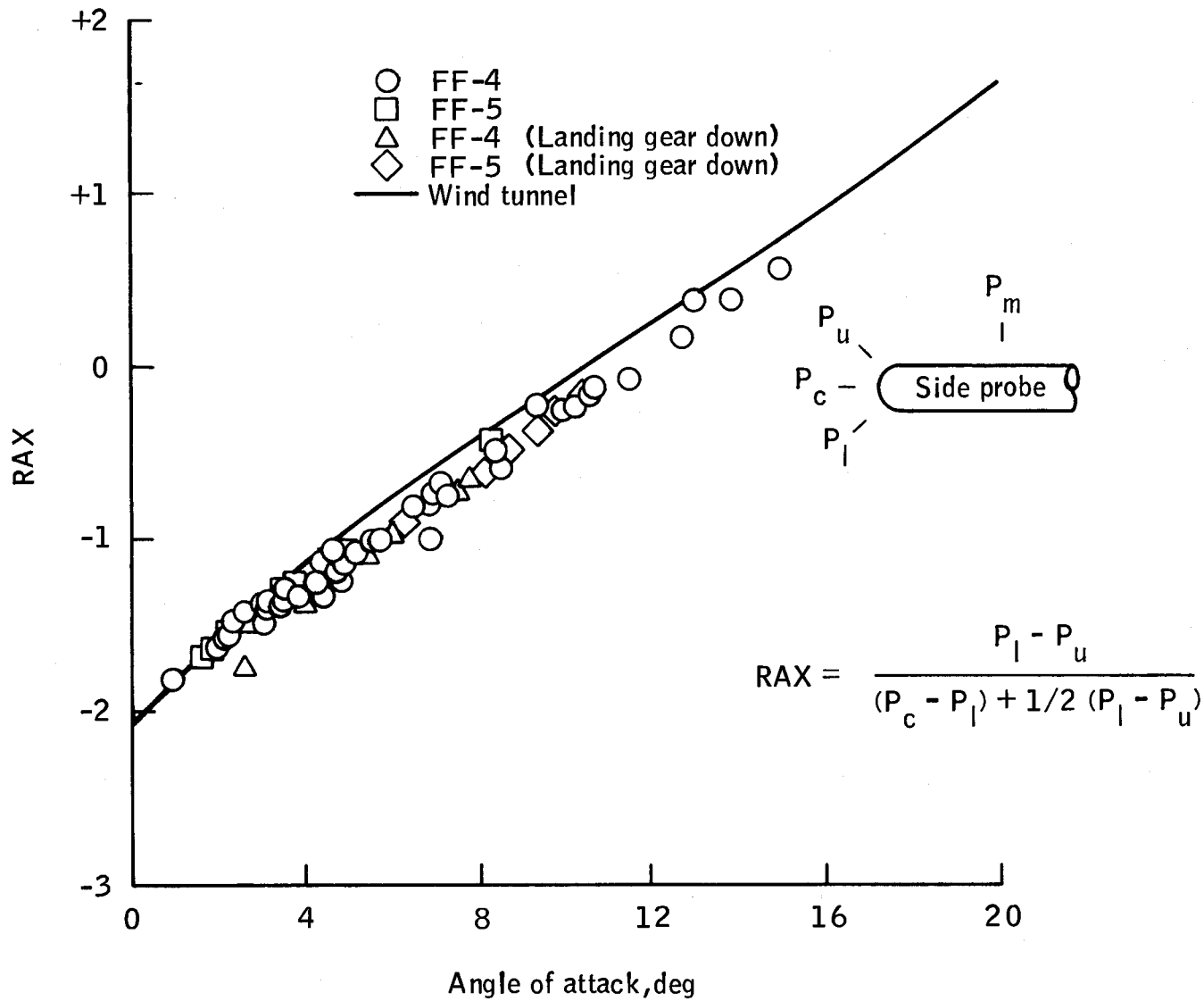

Figure 4-14.- Comparison of flight and wind tunnel RAX parameter

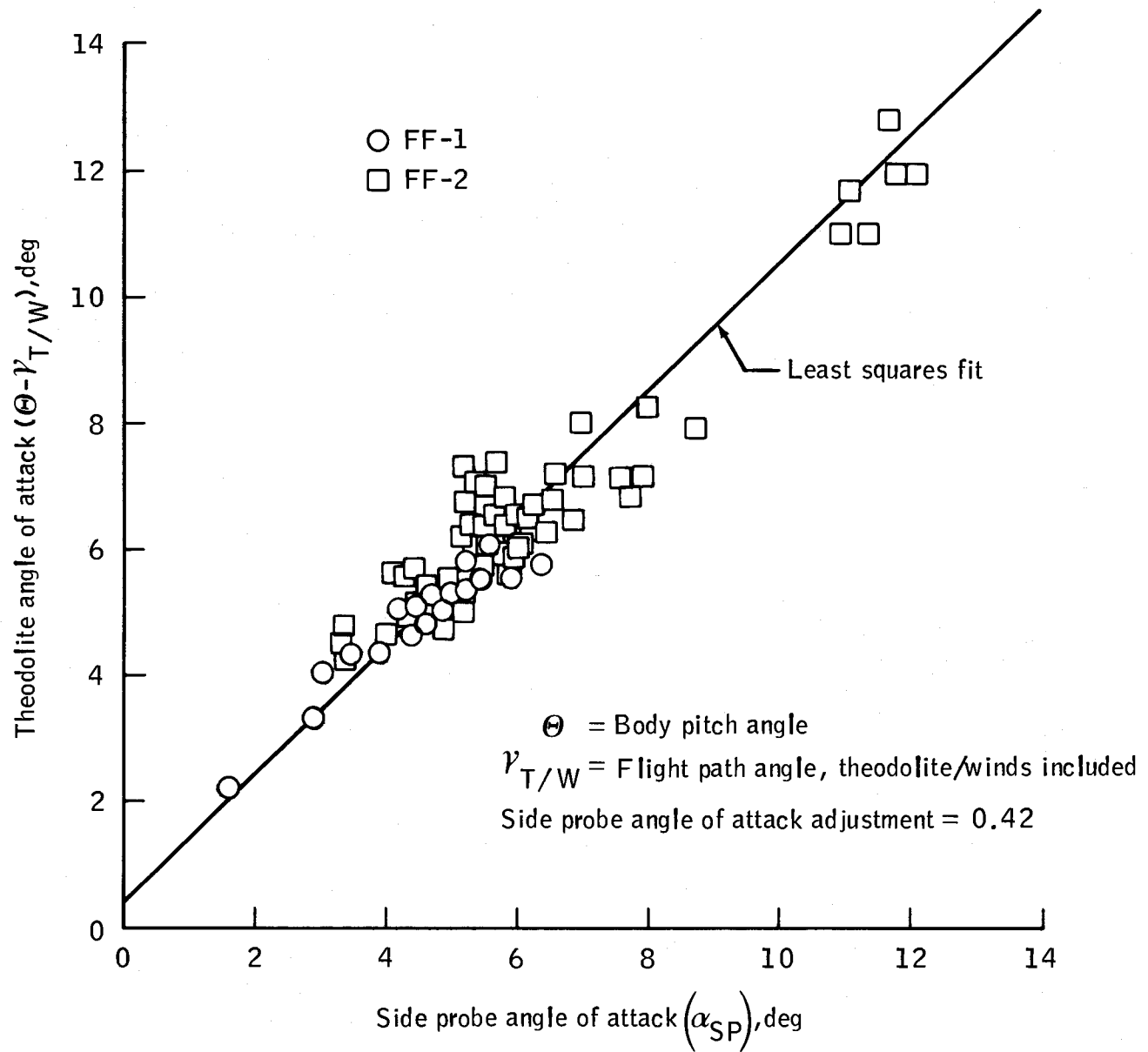

Figure 4-15.- Comparison of theodolite angle of attack with adjusted side probe data.

TABLE XI.- SEPARATION PERFORMANCE^a

Flight	Relative normal load factor, g	Relative axial load factor, g	Pitch acceleration, deg/sec ²
1	0.991 (0.9)	-	3.1 (2.5)
2	0.956 (0.9)	-	2.4 (2.5)
3	0.917 (0.88)	-	1.0 (0.6)
4	1.037 (1.0)	0.17 (0.2)	0 (0.6)
5	1.0 (1.0)	0.17 (0.2)	-1.0 (0.6)

^aTarget values are in parenthesis.

TABLE XII.- PARAMETERS AT SEPARATION

Flight	Orbiter c.g., percent	Orbiter elevon angle, percent	Carrier aircraft airspeed, KEAS	Carrier aircraft pitch attitude, deg	Altitude, ft (a)	Position, n. mi. (b)	
						Downrange	Crossrange
Tail cone on:							
1	63.8	0	268.3	-6.38	25 080	+0.5	0.2L
2	63.8	0	269.2	-5.91	25 320	+0.4	0.4L
3	65.9	2.5	252.7	-2.95	26 040	+0.4	0.2R
Tail cone off:							
4	66.25	7	247.7	-5.25	21 460	+0.5	0.1R
5	66.25	7	250.7	-6.07	19 000	-0.1	0.1L

^aCarrier aircraft pressure altitude referenced to mean sea level.

^bPosition relative to planned separation point. Plus in downrange column indicates closer to aim point than planned.

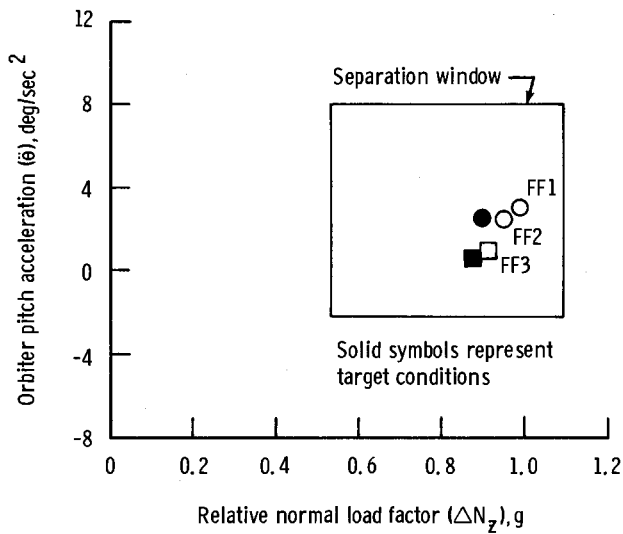

Note:
Target differences between Free Flights 1 and 2 and Free Flight 3 are due to c. g. change.

(a) Relative normal load factor versus pitch acceleration, tail cone on

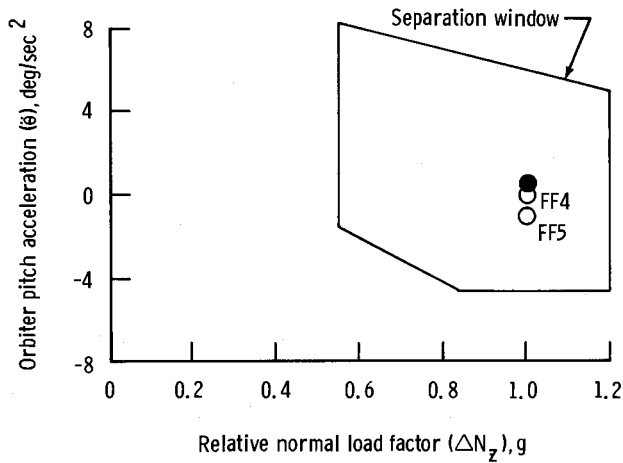

(b) Relative normal load factor versus pitch acceleration, tail cone off

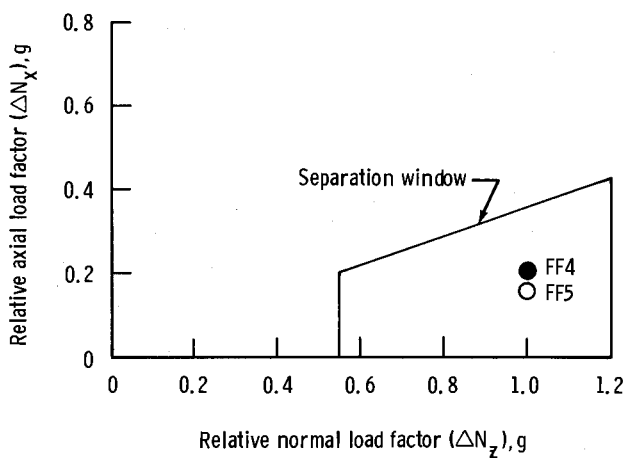

(c) Relative normal load factor versus relative axial load factor

Figure 4-16. - Separation initial conditions.

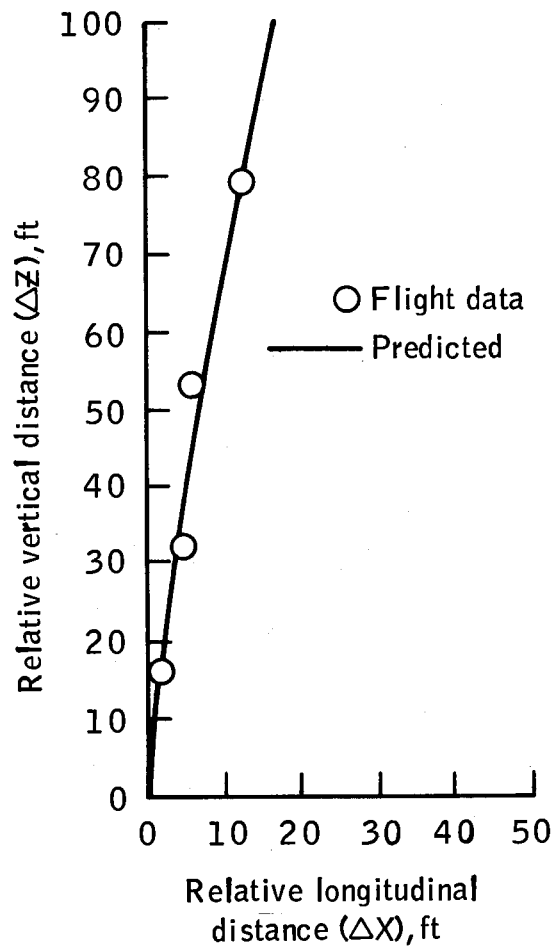

(a) Free flight 3, tail cone on

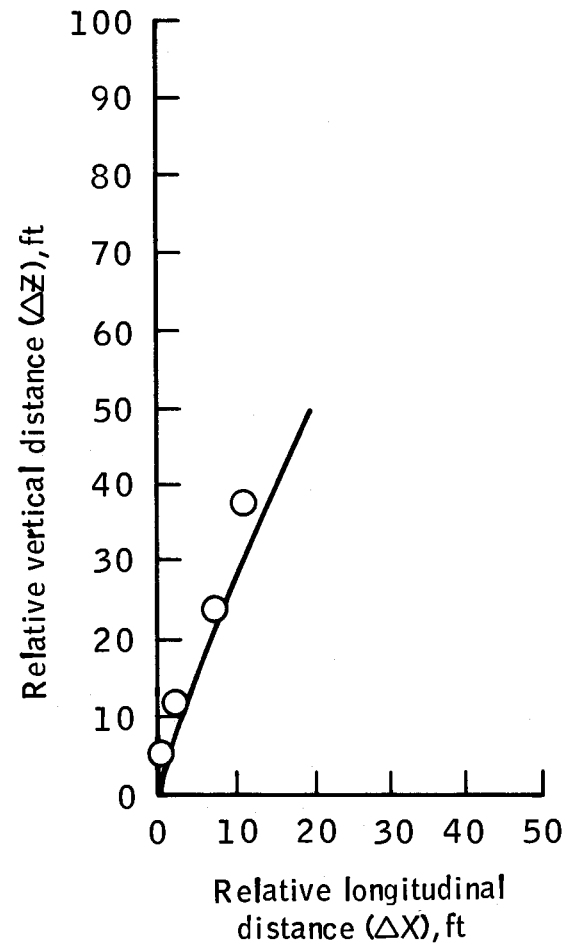

(b) Free flight 4, tail cone off

Figure 4-17.- Separation trajectory.

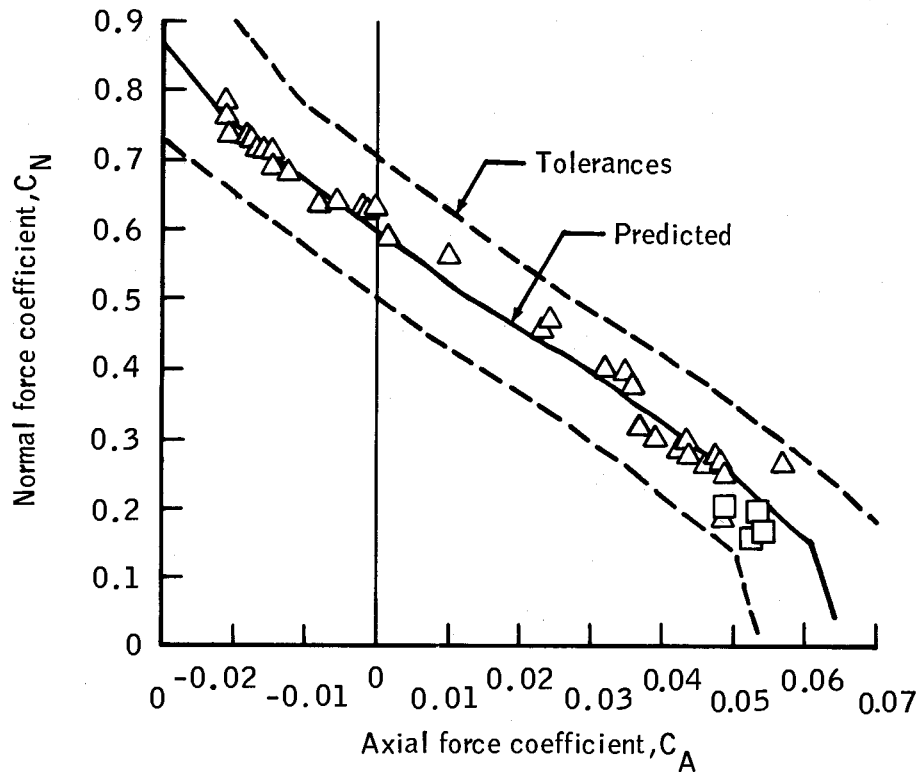

Orbiter conditions:

Mach number (M) = 0.4

Angle of attack (α), deg = 4.6 \rightarrow 15.4

Elevon deflection (δ_e), deg = 4.5

Speed brake deflection (δ_{SB}), deg = 3.7

Body flap deflection (δ_{BF}), deg = 0

Flight data:

\triangle FF-4 (pull up/pushover)

\square FF-5

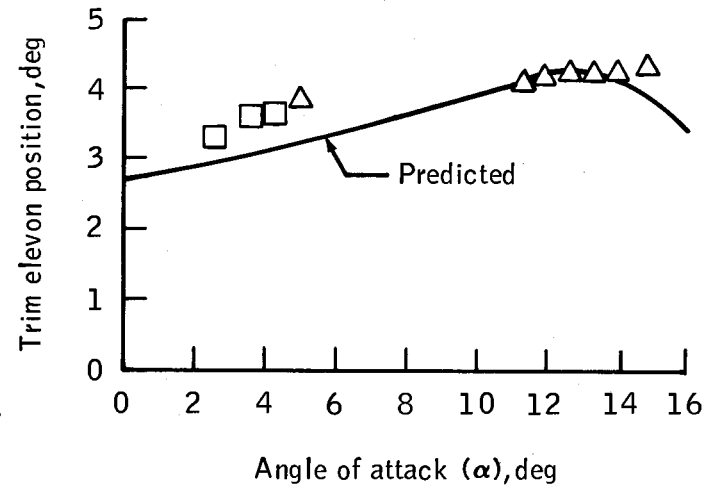

Figure 4-18.- Comparison of flight and predicted basic aerodynamic performance.

become apparent in figures 4-19 and 4-20 in that the angle of attack is required for predicted data look-up and further affects the stability axis data through the transformation process from body axis to stability axis. However, the majority of the stability axis data, lift force coefficient (C_L) and drag force coefficient (C_D), even with α_F unknowns, is within the predicted tolerances.

Within the flight data uncertainties, both flights 4 and 5 confirm predicted speed brake effectiveness (fig. 4-21) and ground effects for C_L and C_D (fig. 4-22). The ground effects on pitching moment appear to be less than predicted; however, pitching moment is well within predicted tolerances. Preliminary estimates of flight landing gear axial force indicate a 27-percent overprediction which is attributed to incorrect Reynolds number correction. The wind tunnel test results applicable to Orbiter 102 are shown in figure 4-23. The test utilized a large (5 percent) high-fidelity scale model at a high Reynolds number and results agree well with the axial force due to landing gear as derived from free flights 1, 2, 4, and 5.

Elevon hinge moments have been correlated with predictions for tail-cone-on only. As shown in figure 4-24, the flight data agree with predictions except for the right inboard panel. The high right inboard data are possibly due to incorrect actuator pressure calibrations.

4.2.7.4 Dynamics

Maneuvers were performed that provided data for aerodynamic derivative extraction. The maneuvers were performed with both the tail-cone-on and tail-cone-off configuration and in all three axes. Several problems occurred during flight and in data handling that caused the extraction of derivatives to be difficult for some of the maneuvers. The two major problems are time skews, which are evident in all of the data, and angle of attack accuracy. Recalibration of the data sources has been performed and the analysis is continuing. The stability and control results presented should be considered preliminary. Final analysis is awaiting completion of the development of the previously mentioned calibration data. Primarily based on flight 2, stability and control derivatives extracted from flight generally agree with the predicted values within the predicted aerodynamic tolerances.

The predicted data are based on reference 4. Aeroelastic corrections have been applied and the data have been transferred to the flight center of gravity. The flight uncertainties shown in figures 4-25, 4-26 and 4-27 are as determined by the extraction program and do not account for uncertainties in vehicle attitude, control surface positions, dynamic pressure, velocity, or inertias, which may be as large as 20 percent.

4.2.8 Government-Furnished Equipment

The crew-related government-furnished equipment performed satisfactorily with the exception of camera malfunctions on flights 1, 3, 4 and 5.

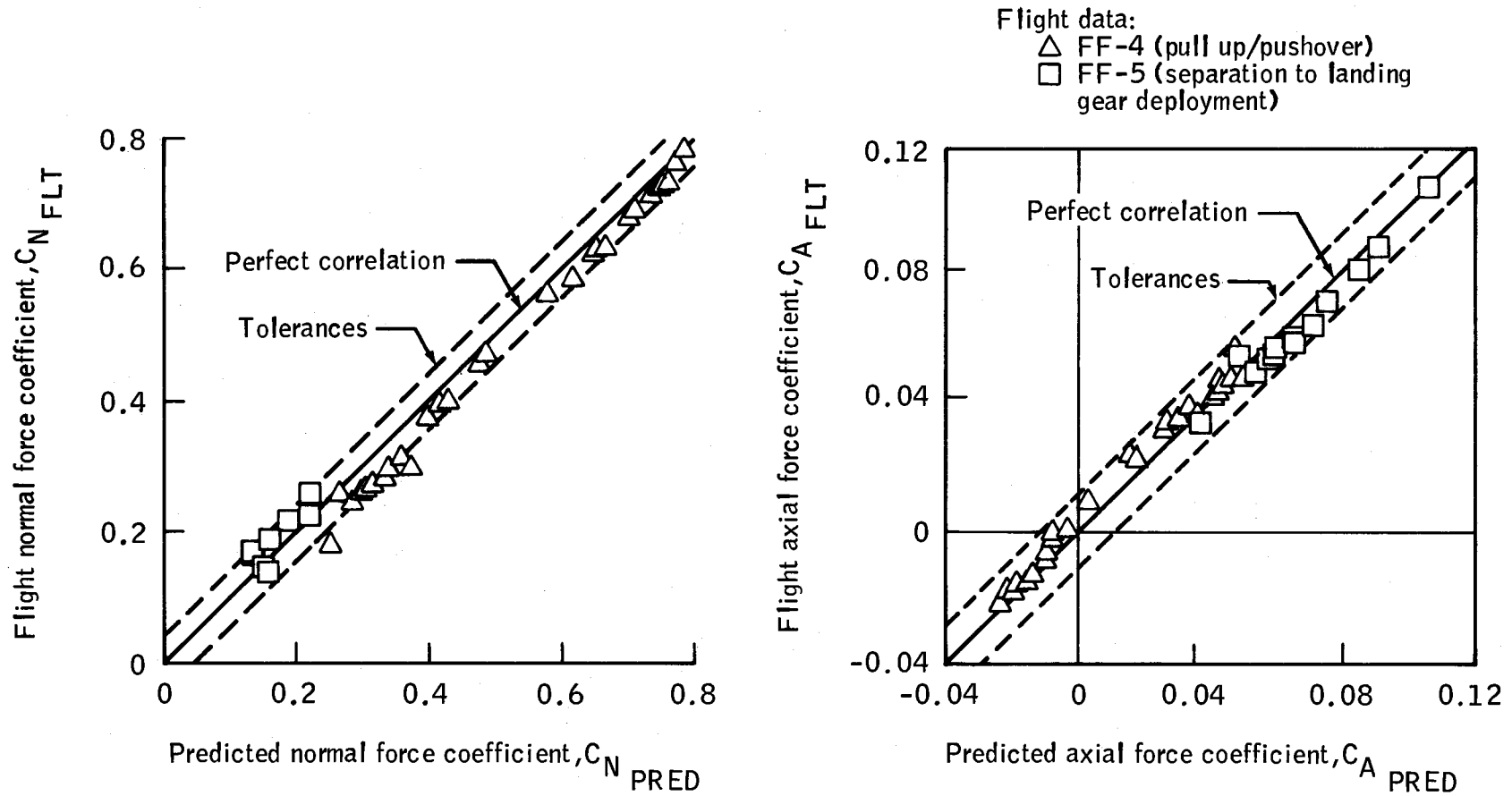

Figure 4-19.- Flight versus predicted normal and axial force coefficients.

67-7

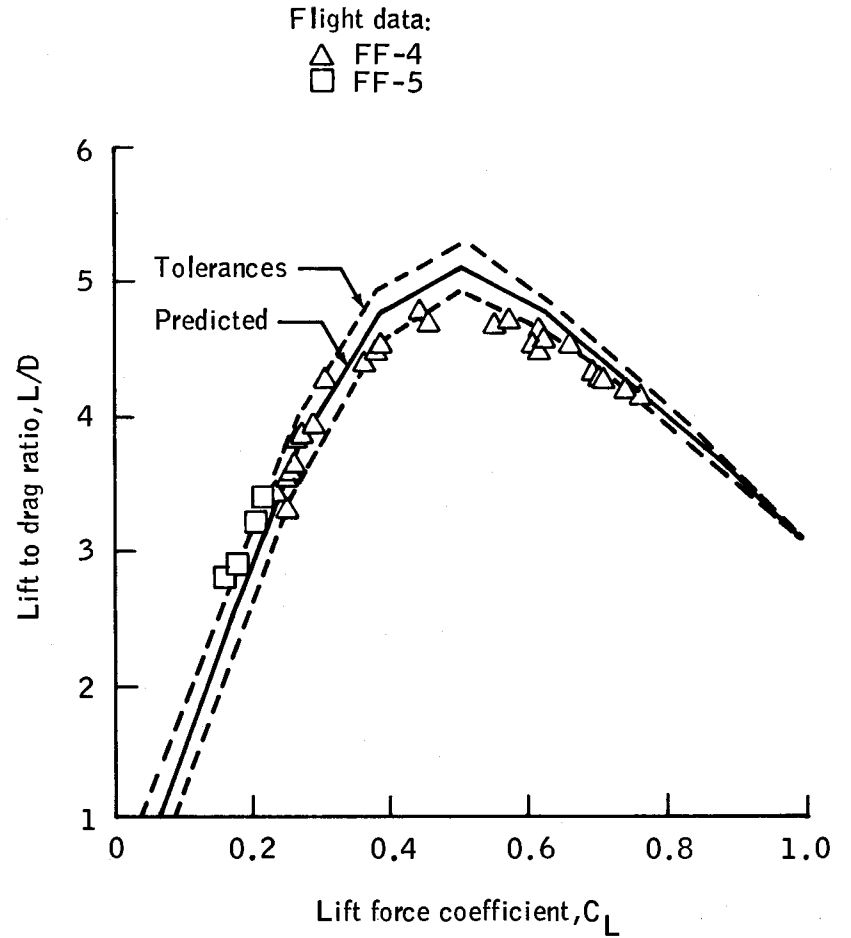
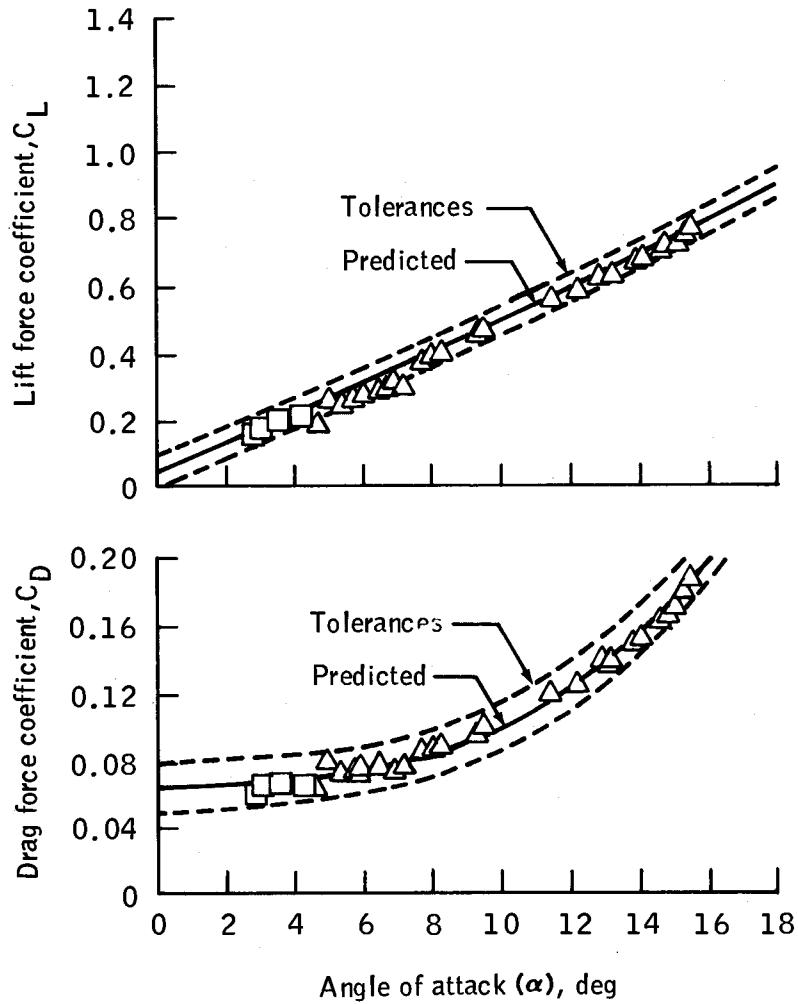

Figure 4-20.- Stability axis data.

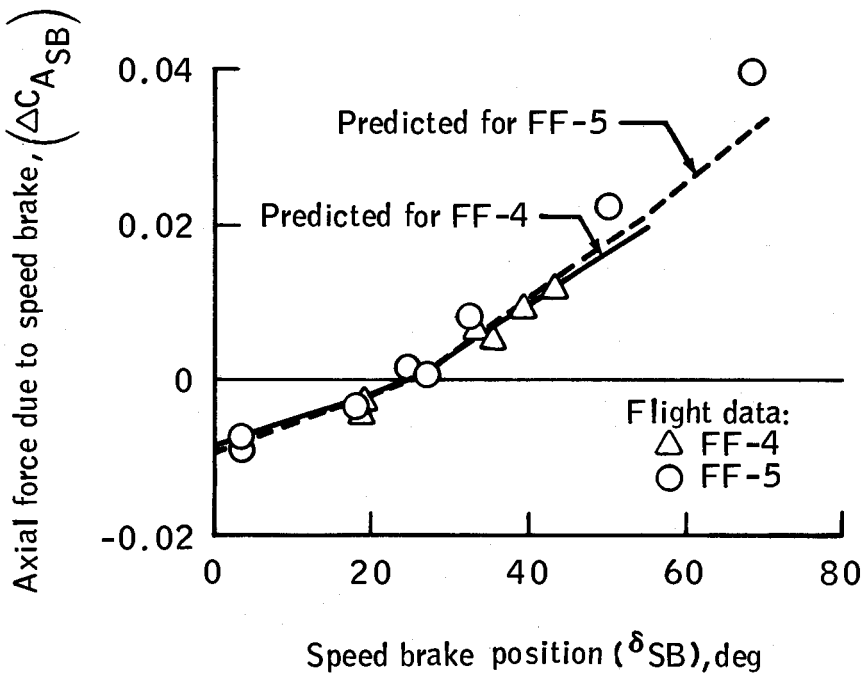
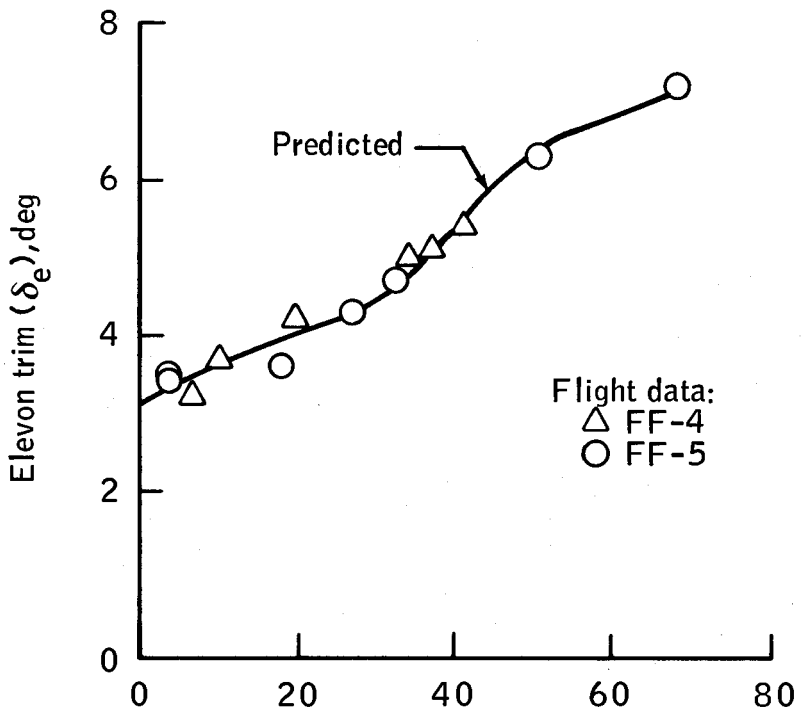

Figure 4-21.- Speed brake effectiveness.

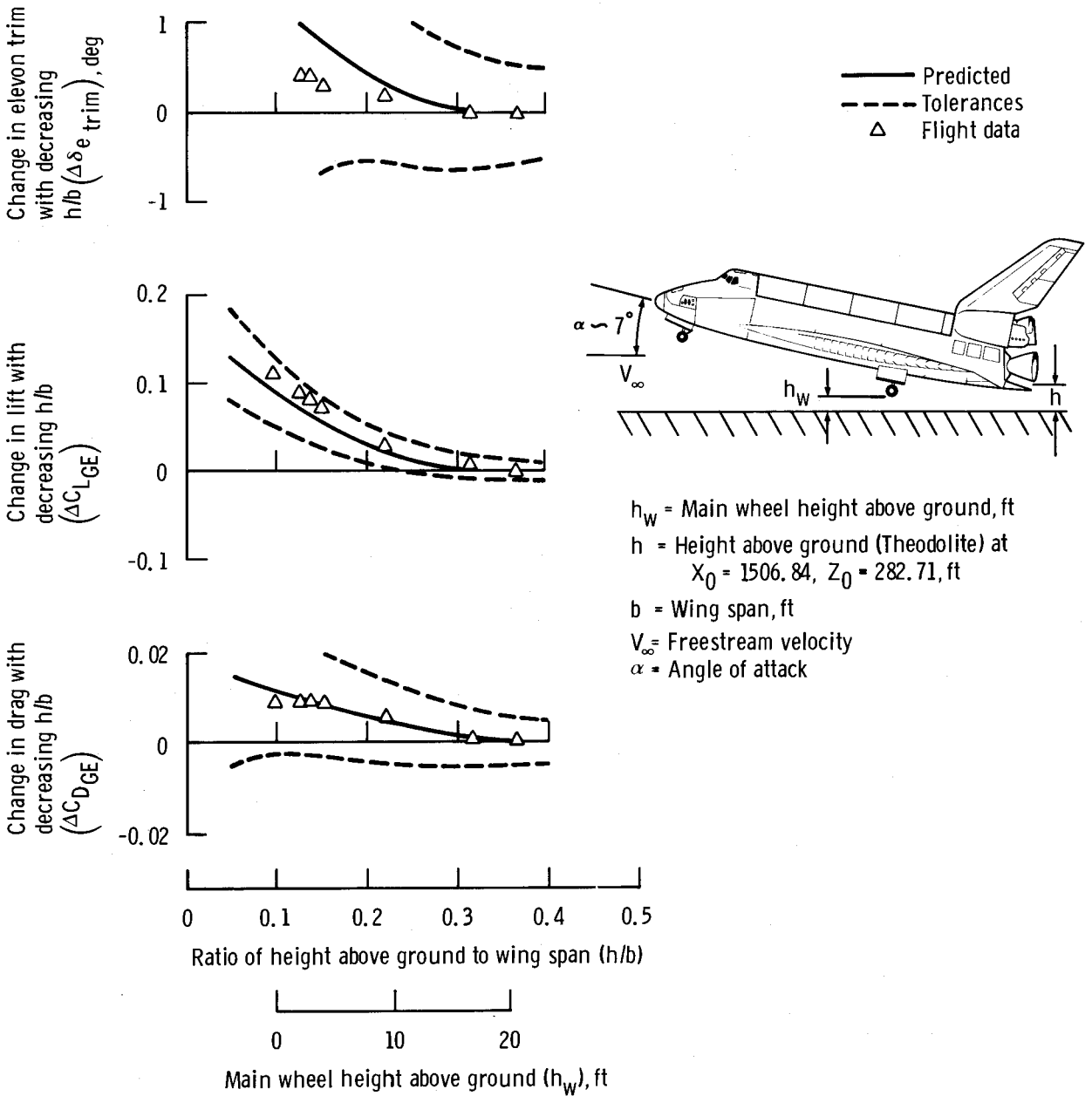

Figure 4-22. - Free flight 4 ground effects.

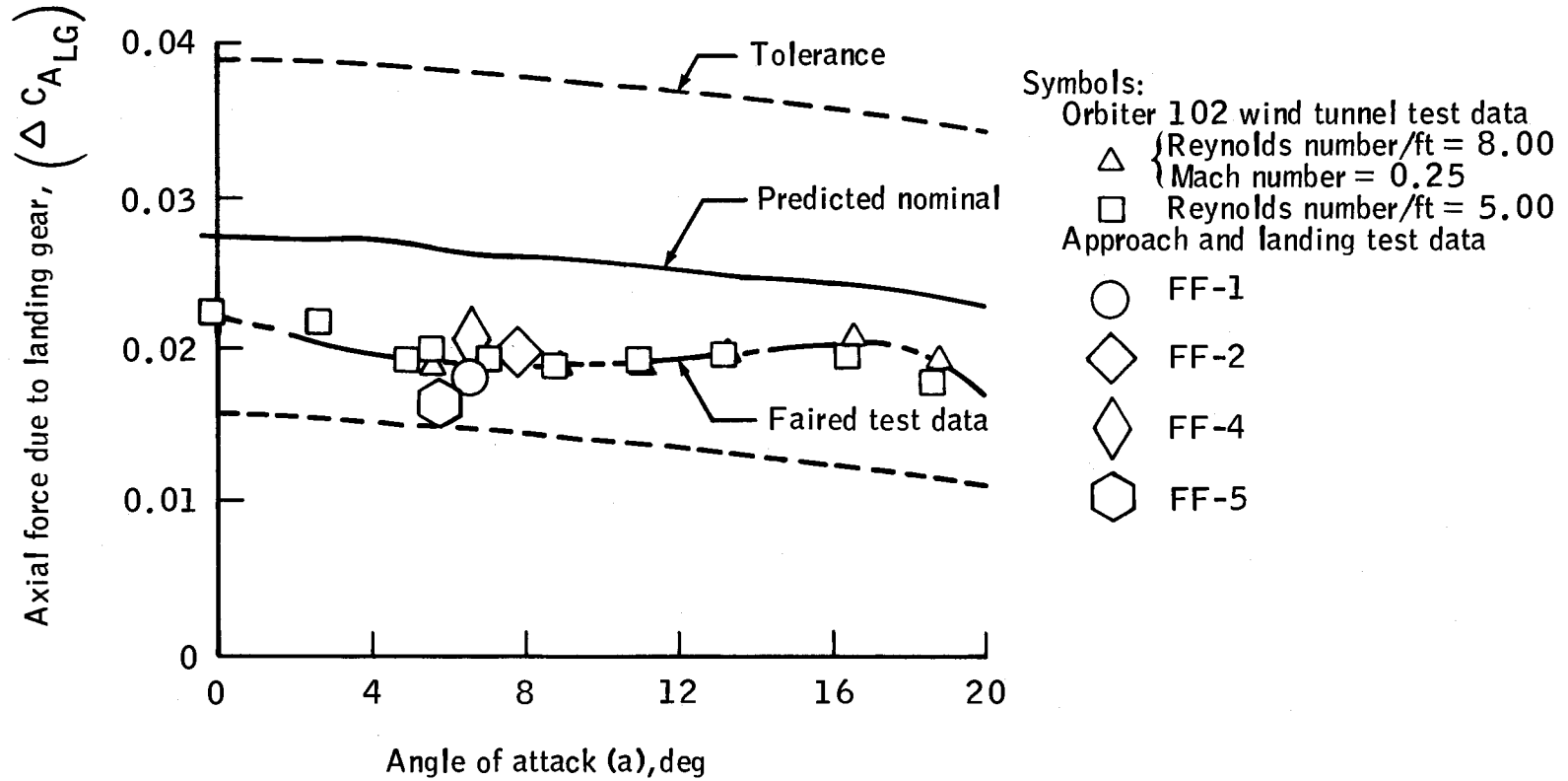

Figure 4-23.- Axial force due to landing gear.

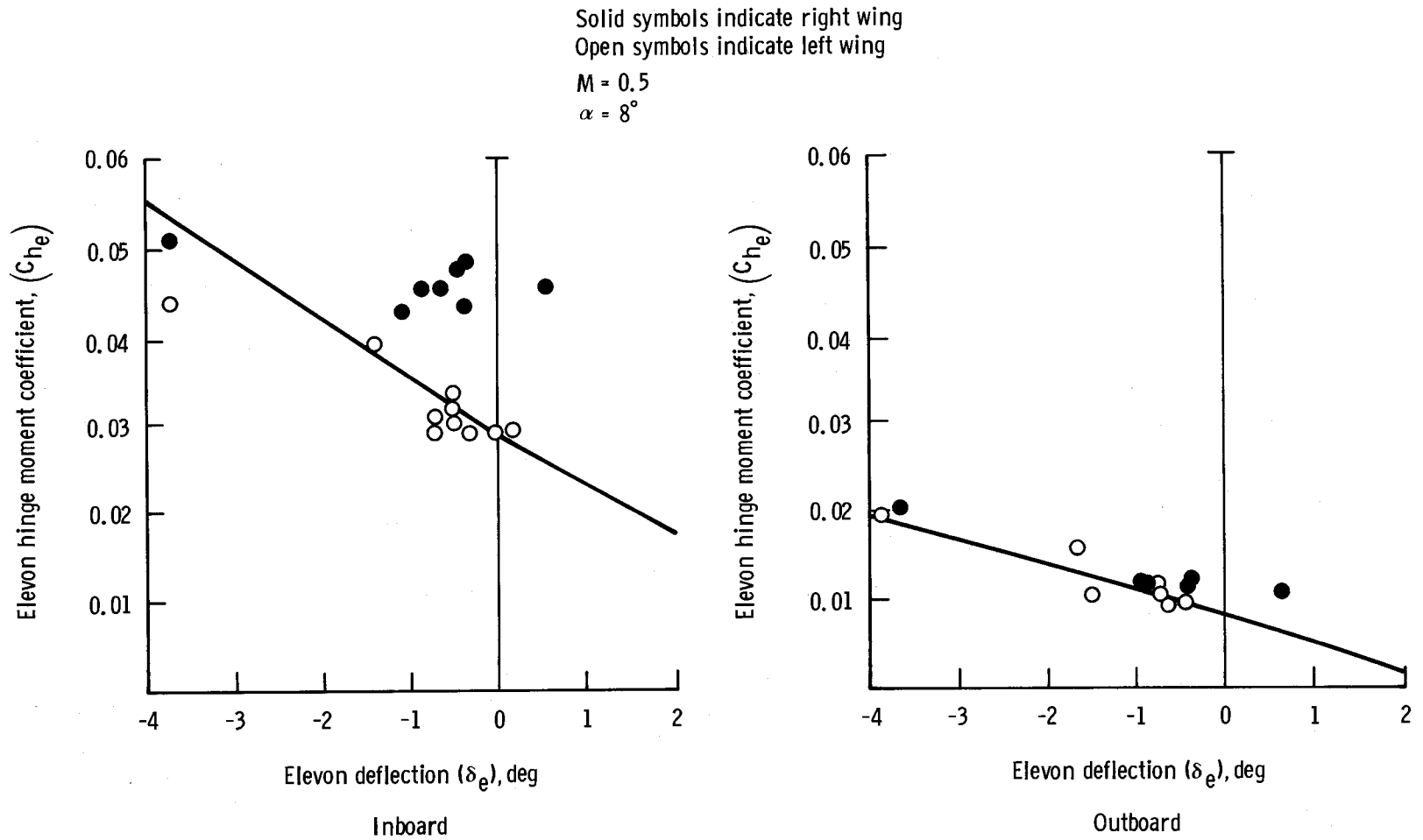
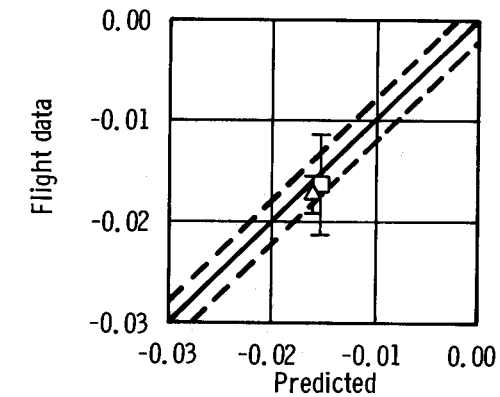

Figure 4-24. - Elevon hinge moments - tail cone on.



Symbols:

- \triangle Extraction program estimate for first set of flight conditions
- \square Extraction program estimate for second set of flight conditions
- Predicted value
- - - Predicted tolerance

Side force derivative due to sideslip, $(C_{Y_{\beta}})$

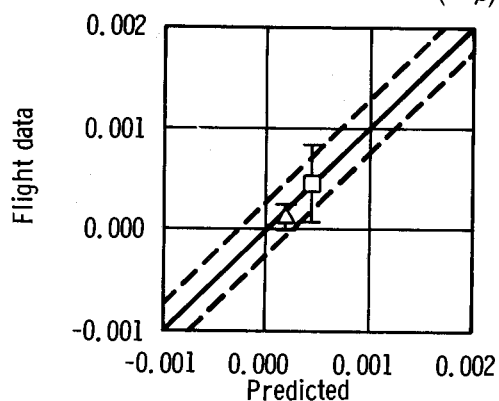

Flight conditions:

	First set	Second set
Mach number	0.39	0.45
Dynamic pressure, lb/ft ²	122.5	244.6
Angle of attack, deg	9.4	5.1
Speed brake deflection, deg	3.7	3.7
C. g. , percent of ref. body length	63.9	63.9

Yawing moment derivative due to sideslip, $(C_{n_{\beta}})$

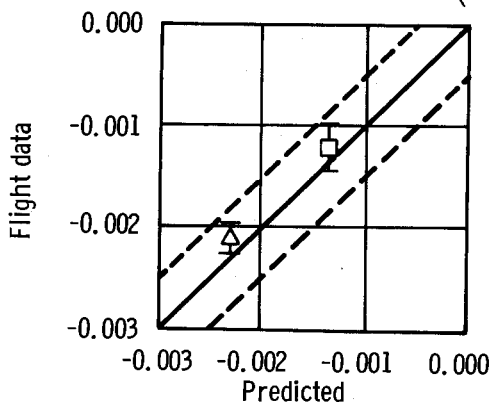

Rolling moment derivative due to sideslip, $(C_{l_{\beta}})$

Figure 4-25. - Sideslip derivatives, Free Flight 2.

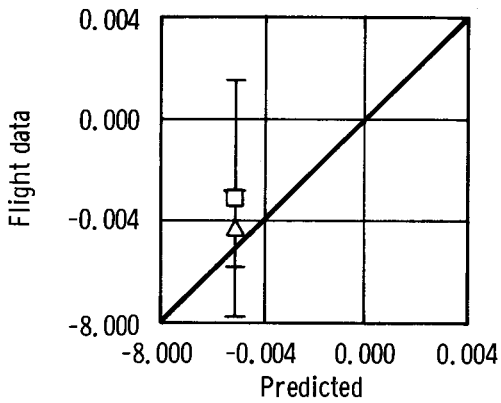

Symbols:

- \triangle Extraction program estimate for first set of flight conditions
- \square Extraction program estimate for second set of flight conditions
- Predicted value
- - - Predicted tolerance

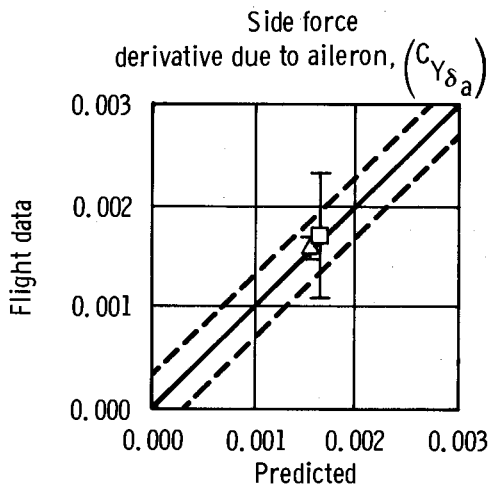

Flight conditions:

First set Second set

Mach number	0.39	0.45
Dynamic pressure, lb/ft ²	122.5	244.6
Angle of attack, deg	9.4	5.1
Speed brake deflection, deg	3.7	3.7
C. g. , percent of ref. body length	63.9	63.9

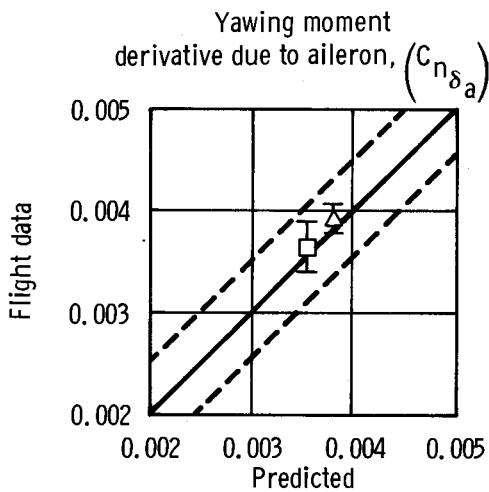

Rolling moment derivative due to aileron, ($C_{l\delta_a}$)

Figure 4-26. - Aileron derivatives, Free Flight 2.

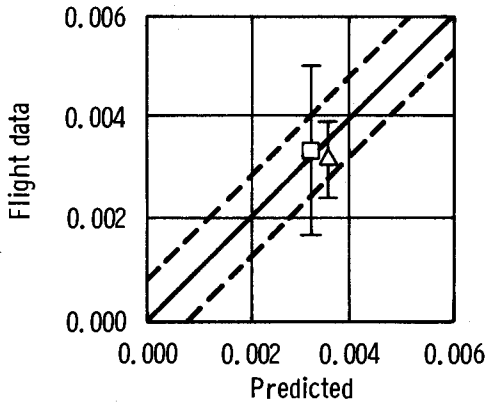

Symbols:

- \triangle Extraction program estimate for first set of flight conditions
- \square Extraction program estimate for second set of flight conditions
- Predicted value
- - - Predicted tolerance

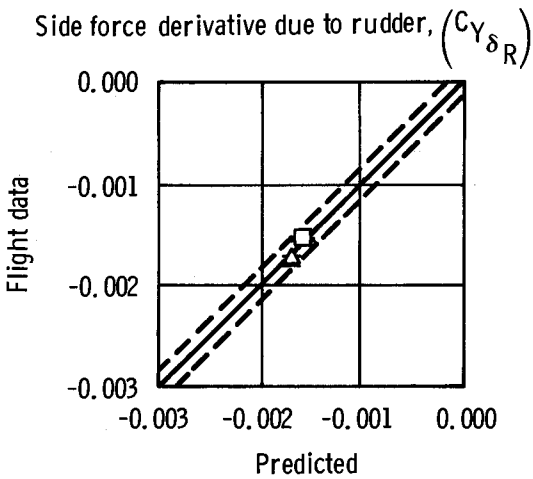

Flight conditions:

First set Second set

Mach number	0.39	0.45
Dynamic pressure, lb/ft ²	122.5	244.6
Angle of attack, deg	9.4	5.1
Speed brake deflection, deg	3.7	3.7
C. g., percent of ref. body length	63.9	63.9

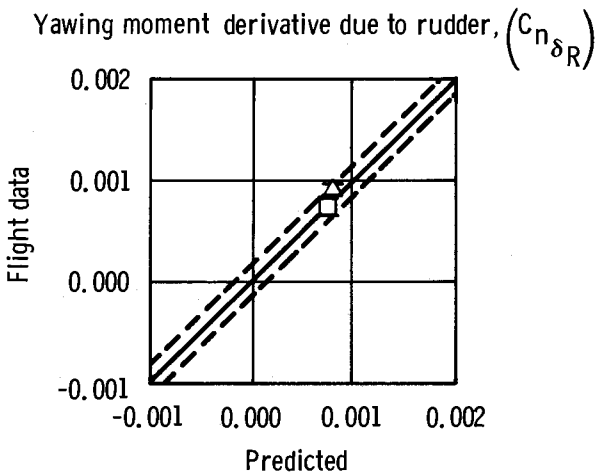

Rolling moment derivative due to rudder, $(C_{l\delta_R})$

Figure 4-27. - Rudder derivatives, Free Flight 2.

On flight 1, the film jammed in main landing gear camera 1 and nose landing gear camera 1. The failure mode was duplicated in postflight testing and the conclusion was that the "soft" coating of the black-and-white film was degraded prior to flight 1 as a result of being subjected to high temperatures. Color film, which has a harder coating, was used in the wheel well cameras on subsequent flights.

On flights 3 and 4, the orbiter centerline camera was actuated early. This anomaly is discussed in section 7.2.9.

On flight 5, the film was not properly transported in orbiter main landing gear camera 1 and carrier aircraft camera 2. These problems are discussed in sections 7.2.15 and 7.2.16, respectively.



Approach and Landing Test Flight Crews

Left to right: Thomas C. McMurtry, carrier aircraft Copilot; Victor W. Horton, carrier aircraft flight engineer; Fitzhugh L. Fulton, carrier aircraft Captain; Joe H. Engle, Orbiter Commander (free flights 2 and 4); Richard H. Truly, Orbiter Pilot (free flights 2 and 4); Charles G. Fullerton, Orbiter Pilot (free flights 1, 3 and 5); and Fred W. Haise, Jr., Orbiter Commander (free flights 1, 3 and 5). Missing from photograph: Louis E. Guidry, William R. Young, and Vincent A. Alvarez, carrier aircraft flight engineers.

4.3 PILOT'S REPORTS

The following are the orbiter crew reports of the five free flights. Crew reports of the captive-inert and captive-active flights are contained in references 1 and 2. The orbiter and carrier aircraft crewmembers are listed in tables I, II and III. The events are described chronologically with general comments and recommendations at the end. Underlined titles (e.g., FLIGHT CONTROL SYSTEM MODE SWITCH CHECK) refer to blocks of procedures contained in the integrated flight checklist. Acronyms and abbreviations that are used for cathode ray tube displays and switch positions are defined at the end of this section. Altitudes are altimeter altitudes above ground level.

4.3.1 Free Flight 1

4.3.1.1 Crew Ingress to Backout From Mate/Demate Device

The Commander ingressed at 13:00 as planned. The Pilot's ingress was delayed until 13:46 because of a question on the results of the inertial measurement unit gyrocompassing test (ref. par. 4.2.5.6). The backup Pilot remained until resolution was reached on the requirement to repeat inertial measurement unit alignment and other onboard procedures. The Pilot's ingress was accomplished in about 10 minutes and backout from the mate/demate device was started only 5 minutes late. The only difference from the planned configuration was a change in the microwave landing system configuration to prime select 1 because of a suspected problem with the microwave landing system channel select thumbwheels.

4.3.1.2 Backout From Mate/Demate Device to Takeoff

During taxi, horizontal situation indicator heading card momentary deviations like those reported on captive-active flight 3 (ref. 2) were noted and verified to occur simultaneously on both horizontal situation indicators when near a heading of 165°. Several bearing pointer "glitches" were also observed. They were separate from the heading card deviations and occurred at times when TACAN's broke lock.

During the FLIGHT CONTROL SYSTEM MODE SWITCH CHECK, the expected master alarm tone generated with the body flap switch check was noted to be at a lower volume than during captive-active flight 3. The tone could be heard but was not immediately obvious over the normal background noise.

The ejection seat pin had two red streamer flags attached, whereas only one was attached on earlier flights. This resulted in a bundle that was too bulky for the flight suit pocket, creating concern that rotational hand controller or rudder pedal inputs might be affected.

When arriving at the end of the runway, both crewmen observed the cabin to be noticeably warmer than on previous flights, although it was not uncomfortably hot.

4.3.1.3 Takeoff to Separation

Carrier aircraft brake release occurred exactly at the planned time, 15:00. Rotation was begun at 140 knots and lift-off occurred at approximately 150 knots after 5000 feet of ground roll.

Approximately 5 minutes after takeoff, both crewmembers noticed loud intermittent static which sounded as though the squelch had been defeated on one of the UHF receivers. The noise persisted for several seconds and then disappeared. Pushing in the UHF-2 control knob on either audio panel would stop the noise to the corresponding crewmember. Therefore, the source of the static was believed to be the UHF-2 receiver, which was tuned to 259.7 megahertz. The noise was loud enough to be bothersome so the UHF-2 knob was left in. After approximately 10 minutes, the source of the static seemed to disappear and the UHF-2 audio was enabled for the remainder of the flight. This problem is discussed further in paragraph 7.2.4.

During the climb, the crew noticed that the Commander's alpha/Mach indicator equivalent airspeed "off" flag was in view (ref. par. 7.2.2). It was present regardless of the positions of the air data select switch and the data bus select switch. Tapping on the face of the instrument would cause the flag to retract briefly, but it would reappear a short time later. Even when the flag was in view, the airspeed indications on the tape were proper and compared well with the corresponding data on the Pilot's instrument.

A "go" from Houston for activation of auxiliary power unit 1 was anticipated at 16 minutes after takeoff but the call was not received. Upon being queried after a 1- to 2-minute delay, Mission Control reported that two separate calls had been made authorizing auxiliary power unit 1 activation. Neither call was received by the orbiter. Both the carrier aircraft and a chase aircraft verified that neither call had been received. (Note: The problem was attributed to the ground transmitter configuration.)

The FLIGHT CONTROL SYSTEM INFLIGHT CHECKOUT procedure was completed with nominal indications throughout. After the Commander had completed his portion of the procedure, he began the TACAN LONG RANGE TEST. None of the three sets would lock up satisfactorily on Mission Bay. The TACAN antenna were switched to automatic in an attempt to receive Mission Bay, but without success (ref. par. 7.2.13).

A zero state vector update was accomplished at 15:42:50. The PRESEPARATION CHECK and PUSHOVER MINUS ONE procedures were accomplished without being rushed, and all circuit breakers on panels L4 and R4 were verified to be in the proper configuration. The Commander's equivalent airspeed "off" flag was noticed once again to be in view, but his indications cross-checked properly with those of the Pilot's alpha/Mach indicator and the noseboom. As noticed on previous flights, after pushover, the ambient noise level due to external aerodynamic noise gradually increased as airspeed increased. The orbiter/carrier separation circuits were armed as the airspeed increased through 240 knots. It seemed to take 2 or 3 seconds for the SEP PYRO A and B lights to illuminate rather than the expected 1 second. The Commander initiated separation immediately after the "launch ready" call from the carrier aircraft.

4.3.1.4 Separation Through Touchdown

The separation event was marked by a sharp, but not loud, explosive sound and a brief, sharp, upward lurch. Neither the noise nor the jolt were particularly distracting and did not affect the accomplishment of the planned procedures. A right roll after separation had been predicted from the load cell data but was not noticed.

Immediately after the separation event, a master alarm occurred and a computer caution and warning light, a computer annunciation matrix column on general purpose computer 2, and a big "X" on cathode ray tube 2 were noticed (ref. par. 7.2.1). At this time, the crew also sensed that the pitch rate had decreased almost to zero. The attitude, as indicated by the attitude indicator, was observed at 2° to 3°, and the pitch rate was 1° per second. Additional pitch-up command was made with the rotational hand controller to increase pitch rate to 2° per second and to attain the desired pitch attitude. After a 10° pitch attitude was established, a 20° right bank was established. Both chase aircraft calls came sooner than expected with the Chase-2 "clear" coming just as 20° bank was achieved. The call to Mission Control on general purpose computer 2 "fail to sync" and pushover were accomplished together. It was obvious from the combined pitch/roll task after separation that the orbiter was handling well on three primary computers.

The general purpose computer 2 mode switch was placed to STANDBY for approximately 2 seconds and then to HALT. After receiving a "go" for terminal area energy management from Mission Control, major mode 203 was selected with the inputs made to CRT 3. The data processing system malfunction procedures were then completed which involved turning off aerosurface servo amplifier 2, pulling the three accelerometer assembly circuit breakers, and pulling the air data transducer assembly 3 circuit breaker.

After completing the planned post-separation maneuvering and accelerating to 250 knots, the Commander accomplished a practice flare, leveling at 20 000 feet above ground level instead of the planned 19 000 feet. Approximately 1.4 to 1.5 g was maintained easily until reaching level flight. Pitch control was very precise which allowed very small inputs to be made as the airspeed decreased. There were no apparent handling characteristic changes with decreasing airspeed. During the deceleration, roll inputs were made in both directions up to 15° of bank. It was apparent that roll control was more sensitive than had been observed in the Shuttle training aircraft. Roll acceleration appeared greater for a given stick input. The "sideways lurch" characteristic (cockpit lateral movement with roll inputs) was present at a magnitude predicted by simulation, but at a quicker onset because of the greater roll acceleration. Attitude control of both roll and pitch was very tight whenever the rotational hand controller was in detent. There were no visible overshoots in either the pitch or roll axis after making an attitude change and no dutch roll oscillations were noticed.

After reaching an indicated noseboom alpha indication of 11° at approximately 185 knots, the nose was lowered, acceleration started, and control was transferred to the Pilot. The Pilot immediately started a left turn but was advised by the Commander to roll wings level and wait a short time before starting the turn to base. The turn to base was accomplished at approximately 30° of bank and, again, it was found that there was no problem in precise attitude control in either axis. The airspeed was allowed to increase to 250 knots and an attempt was made to stabilize at that speed. It was found to be a very easy task. Airspeed was held within 1 knot of that desired. Mission Control had advised after the practice flare that the lift-to-drag ratio might possibly be 10 percent low, but it was apparent upon observation of runway 17 while on the base leg that the energy was high.

The speed brakes were deployed at a setting of 30 percent during the turn to final approach at 255 knots. Shortly thereafter, they were increased to 40 percent and then to 50 percent as airspeed increased gradually through 270 knots on final. No trim change was apparent with speed brake deployment. As the airspeed increased to a maximum value of 287 knots, a definite yaw and sideslip was noticed. No rudder or yaw trim inputs were being made. The crew suspected that an unintentional rudder deflection might be the cause. The surface position indicator was checked and it showed the rudder to be exactly at trail. The onset of the sideslip was fairly abrupt, but it appeared to gradually reduce as the airspeed decreased below 280 knots as the vehicle proceeded on final approach. It became apparent that it would be impossible to maintain a velocity vector toward the planned aim point, so a touchdown beyond the planned position was expected at this time. Speed brakes were not increased beyond the preflight planned maximum of 50 percent. They were retracted passing 2000 feet above ground level, again with no apparent trim change.

Preflare was begun at 900 feet. Precise trajectory control was easily accomplished and visual perception of altitude and sink rate appeared exactly as experienced in the Shuttle training aircraft. The landing gear was armed and lights were observed in both arm pushbutton indicators. The GEAR DOWN pushbutton was depressed as the airspeed passed through approximately 265 knots and a muffled "thump" was heard. About 3 seconds after Chase-1 called "gear down," indications were observed approximately simultaneously on both main gear indicators followed shortly thereafter by the nose gear down indication. There was no audible indication of the gear locking down. All three gear were down and locked just prior to decelerating through 240 knots.

There seemed to be no roll task throughout the flare-landing maneuver. Without appreciable winds or turbulence, the vehicle held the desired wings-level attitude without crew input required. No ground effects were noted until a slight cushioning or floating effect was detected less than 10 feet off the ground. There was no pitch-up or ballooning tendency. The vehicle was gradually flown to a couple of feet off the ground and was easily controlled in a level attitude by reference to sink rate out the window and chase calls for altitude. The Pilot called airspeed and when 195 knots was heard, the Commander simply relaxed controlling pitch. The vehicle touched down at about 185 knots. Wheel contact was noticeable but felt very gentle.

4.3.1.5 Touchdown Through Rollout

Pitch attitude remained steady at touchdown without the instant feeling of deceleration and pitch-down felt in the orbiter aeroflight simulator. Slight nose-down rotational hand controller inputs were required to start the nose slowly down. The speed brakes were deployed to 100 percent within a couple of seconds after touchdown when the Commander was sure the vehicle was going to stay on the ground without skipping.

A slow derotation was maintained as commanded until a nose wheel height of about 4 feet was called by Chase-1. The pitch rate started to increase and full-back stick was commanded by the time of nose wheel touchdown. By horizon reference, the nose wheel touchdown rate was judged to be 3° per second, but touchdown impact felt lighter than expected.

Rudder control was investigated from about 130 knots to 110 knots. The first input was left rudder. There was no response from this input so more was commanded. The nose finally swung left and the rudder was then displaced right to stop the yaw rate. The response seemed sluggish compared to simulations.

The Commander commenced braking following the Pilot's call at 155 knots; however, he did not feel the onset of braking until the orbiter had decelerated approximately 20 knots because of the slow application of brakes. Although light braking was achieved without a differential braking problem, the Commander felt the left brake first. Braking was increased toward a moderate deceleration level smoothly for a brief interval and released at about 60 knots. The brakes exhibited no chatter, vibration or asymmetry. The Pilot did not detect starting or stopping of braking, which is contrary to the orbiter aeroflight simulator where lurches are induced, even with slow inputs.

Nose wheel steering was engaged and evaluated by both crewmen. Heading changes could be effected without overshoot and the wheel tracked well. The steering was excellent, contrary to that seen in the orbiter aeroflight simulator where control is loose and overshoots are common. The steering was turned off at 30 knots and briefly turned back on just before rolling to a stop to orient the vehicle straight down the runway.

When the vehicle was allowed to coast beginning at 60 knots, it was apparent that the rollout was considerably longer than seen in simulations. With the latest lakebed coefficients in the orbiter aeroflight simulator, the total rollout distance was barely more than a mile for the free flight 1 procedures. Just after steering was disengaged the "soft spot snake" was noted when right upon it. A slight vibration was felt when the vehicle rolled through the discolored zone.

During postflight procedures, prior to de-arming the orbiter-carrier pyro switch, the crew noticed that the "A" arm light was off but the "B" arm light was on. (Editor's note: Normally, both arm lights should have been extinguished following firing of the separation pyrotechnics. Loss of computer 2 after separation resulted in the loss of control of the "B" arm light.) The auxiliary power unit hydraulic load test and deactivation procedure had just begun when the convoy commander notified Mission Control that an auxiliary power unit exhaust plume

had been observed. Auxiliary power unit 2 had been shut down, and the load test on auxiliary power units 1 and 3 was accomplished just prior to the decision by Mission Control to shut down all the auxiliary power units. All shutdown indications were normal. The remainder of the postflight procedures were accomplished exactly as planned. The convoy commander advised that the protective breathing system would not be required. After sniff checks were complete, the hatch was opened and both crewmen egressed via a portable stairway which was positioned at the hatch entrance.

4.3.2 Free Flight 2

4.3.2.1 Crew Ingress to Takeoff

Crew ingress by both the Commander and the Pilot went smoothly and without incident. Prior to carrier aircraft engine start, several TACAN azimuth "glitches" were noted on the horizontal situation indicator bearing pointers and on SPEC 201. Since this had occurred on several earlier flights, there was no concern, although the Mission Control Center was advised. During the body flap valve reconfiguration, the crew noted that the level of the system management alert tone (which had been adjusted after free flight 1) balanced well with the intercommunication and UHF volumes. Brake release was on schedule at 15:00.

4.3.2.2 Mated Flight

One bearing pointer "glitch" was noted on TACAN 1 while tuned to the Edwards station. The carrier aircraft crew established special rated thrust at 15:37. The PRESEPARATION CHECK, PUSHOVER MINUS ONE, MAJOR MODE CHANGE and PUSHOVER procedures were accomplished with no anomalies.

4.3.2.3 Free Flight

Separation: Separation conditions were 279 knots equivalent airspeed and 24 000 feet above ground level (onboard air data source). The "g" onset was solid and abrupt. The crew noted the explosive sound of the separation pyrotechnics and a brief, sharp, upward lurch. The "chase clear" calls were quick and articulate. Separation dynamics gave a slight sensation of an oscillatory motion which damped quickly. To avoid inadvertent inputs during separation, the Commander's right leg was pressed against the rotational hand controller box to provide a more solid wrist support. No attempt was made to alter the vehicle motions until after the initial separation dynamics were damped. The maximum load factor during the separation maneuver was 1.78 g. Control during the clearing maneuver was positive in both pitch and roll.

Immediately following separation, OPS 203 was entered and verified on the scratch pad line of CRT 2. When the PRO (proceed) key was hit, no major mode transition occurred and, to the best of the Pilot's recollection, the scratch pad line reflected OPS 203 ERR (error). The Pilot decided to repeat the OPS 203 PRO and the second attempt worked (ref. par. 7.2.5). During the clearing maneuver, a right heading correction was received from Mission Control and the correction was made during the acceleration to 290 knots. Vehicle response to attitude corrections was positive, precise, and there was no apparent overshoot.

Programmed Test Inputs: Programmed test inputs consisted of a series of three single-axis unidirectional rate-command pulses generated by the general purpose computer software and initiated by crew command. The desired spread in dynamic pressure for two test conditions (approximately 90 knots equivalent airspeed) determined that the aim airspeeds for the two conditions be ≥ 290 knots and ≤ 200 knots. The specific inputs were:

- Pitch: 4° per second, 0.4 second duration
- Yaw: 3° per second, 0.96 second duration
- Roll: 5° per second, 0.96 second duration

High-Speed Programmed Test Input Set: While the vehicle was being stabilized at 294 knots, the Pilot accomplished ITEM 2 EXEC (execute), arming the programmed test inputs, and entered ITEM 3 on the scratch pad line. When all vehicle rates were damped, the EXEC key was pushed to activate the pitch programmed test input. The same procedure was used to activate the roll and yaw programmed test inputs. ITEM 4 EXEC was used to terminate the programmed test inputs.

Aerodynamic Inputs: In order to obtain aerodynamic stability and control derivatives from flight data and reduce uncertainties, a set of aerodynamic stick inputs was used. The vehicle motions resulting from the inputs were compared to estimated time histories, and iterations of coefficients were made to cause a match in time histories. Sharp inputs with proper timing were important to excite proper vehicle motion, whereas the magnitude of controller deflections was less critical. Aerodynamic stick inputs were made at approach speed angles of attack (approximately 4°) and best lift-to-drag ratio angles of attack (approximately 9°).

Low-Angle-of-Attack Aerodynamic Inputs: An attitude adjustment was made following the roll programmed test input; however, a 2° heading correction received from the Mission Control Center was not made because of concern that there might not be adequate time for the aerodynamic stick input set. To assure the desired low angle-of-attack conditions, the desired airspeed was ≥ 290 knots. The aerodynamic stick inputs were initiated at 294 knots. The control inputs were intended to be mechanical, but the second rudder input during this set was influenced by vehicle dynamics.

There had been concern that the sideslip angle developed during the lateral/directional aerodynamic stick inputs might be large enough to cause the air data transducer assembly redundancy management software to declare a left/right probe dilemma. Since fixed gains would have been set, the accelerated turn would have been limited to 1.5 g instead of the desired 1.8 g. To save reconfiguration time, SPEC 301 was called up on CRT 2 and ITEM 37 placed on the scratch pad line, awaiting only the EXEC to reset the dilemma. This configuration was maintained until after the low-speed lateral/directional aerodynamic stick input.

Maneuvering Turn: Simulations showed that energy management during the maneuvering turn was essential to assure adequate time on the dogleg for the high angle-of-attack aerodynamic stick input and low-speed programmed test input sets. Numerous flights were made in T-38's and Shuttle training aircraft to

develop techniques to control airspeed bleed-off rate and assure arrival at the desired angle of attack, airspeed, and heading, allowing immediate transition into the high-angle-of-attack aerodynamic stick input set.

The turn was actually started at 300 knots. The 1.8 g load factor was applied at a bank angle of approximately 45° to initiate a faster airspeed bleed-off rate. A slightly higher than normal roll rate was held until the "250 knots" call by the Pilot which came just as Bear Mountain passed the nose. At this point, the roll rate was reduced slightly and the remaining airspeed bleed-off schedule occurred as planned. The desired "15° angle of attack" call came exactly as the edge of Rosamond Lake came into view. There was no noticeable lag, overshoot or tendency toward pilot-induced oscillations in applying or controlling g's during the turn. Load factor was maintained at 1.78 ± 0.04 g throughout the decelerating turn. The pilot task in flying the maneuver was easier than in either the orbiter aeroflight simulator or the Shuttle training aircraft. Environmental cues provided the advantage over the orbiter aeroflight simulator, and the positive immediate pitch response made the task easier than in the Shuttle training aircraft. The low force gradient of the rotational hand controller required considerable attention to preclude a "g" overshoot and maintain constant "g" with an increasing pitch rate. Roll control seemed natural. Control harmony was not a factor in this maneuver.

High Angle-of-Attack Aerodynamic Stick Inputs: When airspeed had increased to approximately 195 knots, pitch attitude was established and the low-speed aerodynamic stick input set was begun. Control input techniques were identical to the previous aerodynamic stick input sequence. Although vehicle response at this speed was more sluggish and not as well damped as at the 290 knot condition, damping was still good and the vehicle had a feeling of solid, positive control.

Low-speed Programmed-Test Inputs: The Pilot began flying the orbiter after vehicle oscillations damped from the last aerodynamic stick input. Keystroking and crew monitoring techniques for the low-speed programmed test inputs were identical to the previous programmed test input sequence. When the vehicle oscillations damped out, an ITEM 4 EXEC de-armed the programmed test inputs. An unscheduled pitch aerodynamic stick input at a 9° angle of attack was accomplished just prior to Mission Control's call to start the turn to final.

Immediately prior to the small turn from the low-speed dogleg to final approach, the crew noticed that the nose boom was oscillating left and right (Chase 1 reported in the debriefing that vertical oscillations were also observed). The out-the-window motion pictures taken by camera 3 clearly show the start of this oscillation, which continued essentially undamped for the remainder of the flight. Postflight review of this film showed that the oscillations started immediately prior to the pitch aerodynamic stick input which preceded the turn to final. The oscillations compromised the sideslip data during subsequent aerodynamic stick inputs; however, the data were usable.

Outer Glide Slope Capture: The turn to final approach appeared to roll the vehicle out exactly on centerline and the first energy call from Mission Control was "500 feet above the glide slope." Glide slope capture and acceleration to 270 knots were accomplished. The velocity increase was slow, but the

succeeding energy calls from Mission Control and the familiar out-the-window view of the aim point (1000 feet short of the lakebed shore) made the situation comfortable. Another pitch aerodynamic stick input was initiated at approximately 240 knots (6° angle of attack).

Speed-Brake-Open Aerodynamic Stick Inputs: As 270 knots was approached, speed brakes were opened to maintain a constant airspeed during the aerodynamic stick inputs. Although crew attention was primarily on energy management and aerodynamic stick input test conditions, no significant increase in buffet level was noticed as the speed brakes were deployed to 50 percent. No pitch trim changes were noticed during speed brake deployment or subsequent speed brake setting changes. Minor glide path and speed brake adjustments were made after each aerodynamic stick input had damped. Time permitted one pitch aerodynamic stick input and two lateral/directional aerodynamic stick inputs. At 2000 feet above ground level, the landing gear were armed and vehicle control was relinquished by the Pilot.

Preflare to Landing: Speed brakes were closed at 200 feet above ground level. An attempt was made to get an aileron and rudder doublet at this condition, but the feeling of required inputs for attitude control increased with ground proximity and vehicle residual motion to these doublets was affected by control inputs. The attempted yaw/roll inputs left the orbiter misaligned with the runway but the control task for the lateral/directional realignment was easy and natural with no oscillation or overshoot. Precise attitude and low pitch rate control were possible with minimum attention. The landing gear deployed at 260 knots with no noticeable trim change. The cushioning or floating apparently due to ground effects was noted as the airplane was flown below 10 feet, but there was no nose-up pitch tendency. Attitude and height control was solid and precise. Wheel height calls from the chase aircraft were extremely helpful in controlling the touchdown sink rate to less than 1 foot per second. Touchdown occurred about 680 feet past the planned point and 20 feet left of the runway centerline.

4.3.2.4 Rollout

At touchdown, it was apparent that, with normal derotation, nose wheel touchdown would occur in the proximity of a removed and leveled railroad bed. On previous landings with T-38 aircraft, crossing this railroad bed had given a noticeable bump. Therefore, the Commander delayed nose wheel touchdown until after the railroad bed had been crossed. The attention given to this apparently interrupted the post-touchdown procedural pattern and the Commander deviated from two planned procedures. First, the speed brakes were not deployed at main landing gear touchdown; second, the elevons were not returned to approximately 0° after nose wheel touchdown. Regarding the second deviation, pitch attitude control during nose lowering was positive and precise until the "3 feet" call from the chase aircraft. At 3 feet, the rotational hand controller was returned to detent and it was intended for the flight control system to complete the derotation. However, as the nose continued well beyond the anticipated attitude, the rotational hand controller was deflected aft in an attempt to control pitch rate. No effect from the rotational hand controller input was apparent as the elevons reached the full-up position just prior to nose wheel touchdown at 140 knots. The sharp contact and the unexpected low attitude of

the nose gave the impression that the nose landing gear or tires had been unintentionally altered. The combination of the hard nose wheel touchdown and the unexpected nose attitude influenced the Commander to keep minimum weight on the nose until he was convinced that the nose landing gear was still intact.

While the elevons were still in the full-up position, the first aileron input was made to assess directional steering. A full-left rotational hand controller input was made for approximately 6 seconds with no noticeable steering effect. Elevons were then moved to the minus 15° (up) position and brief right and left rotational hand controller inputs of approximately 3 to 4 seconds were made. Aileron steering was not as effective as expected. This impression was probably influenced by (1) the relatively long period of time in which aileron steering was attempted with elevons full-up, (2) the extremely low nose attitude and the attention on the nose landing gear status (looking at the immediate area of the nose boom rather than the horizon to see yaw effects), and (3) the short period of time in which aileron was commanded with elevons at an intermediate (approximately minus 15°) setting. Data show that a yaw rate was generated when the elevons were less than full-up.

Braking characteristics were poor (ref. par. 7.2.8). After the aileron deflections, brakes were applied with almost no feeling of braking action until a hard "chattering" sensation was experienced. This chattering occurred during high-speed differential braking and moderate-speed braking phases when sufficient brake pedal deflection was applied. With the light pedal forces and low deceleration cues prior to the chattering (presumed to be anti-skid cycling) combined with no feel or feedback, precise brake control required more than normal pilot attention. Differential braking was not as effective as expected at the higher speeds. However, at a low ground speed (15 to 20 knots), a small but positive change in heading was made with differential braking. There was no tendency to excite an X-axis or directional pilot-induced oscillation using the brakes.

(Editor's note: The use of the control stick steering flight control mode resulted in the rudder counteracting steering by ailerons and differential braking. On free flight 3 and subsequent flights, this situation was corrected by using the manual direct mode.)

4.3.2.5 Postflight Procedures

Following vehicle stop, postflight procedures were accomplished as planned.

4.3.2.6 General

Orbiter Handling Characteristics: All comments regarding handling qualities apply only to the orbiter in the tail-cone-on configuration and using the primary flight control system in the control stick steering mode with scheduled gains. No other flight control system modes were evaluated on this flight.

The orbiter flight characteristics were generally solid, well damped and particularly responsive for a vehicle with large size and inertias. Initial response in pitch and roll was positive with good damping, minimal overshoot and

no tendencies toward pilot-induced oscillations. Precise rudder control was difficult because of the response delay and lack of feel or feedback. Although response was not as crisp and damping not as high at low (195 knot) airspeeds as at high (greater than 290 knot) airspeeds, pitch and roll oscillations were essentially deadbeat, and yaw oscillations well damped at all airspeeds investigated.

In the control stick steering mode, no trim change was noticed with landing gear or speed brake configuration changes. Neither was a trim change noticed because of airspeed changes or ground effect.

Generally, the orbiter flying characteristics were better than the Shuttle training aircraft. The response delay characteristic of the Shuttle training aircraft was not evident in the orbiter. Additionally, precise control of vehicle rates, attitude, and load factor was more positive in the orbiter.

Keyboard Operation During Free Flight: The keyboard entries necessary to accomplish this free flight required 47 keystrokes between separation and the completion of the low speed programmed test inputs. Almost total concentration was needed by the Pilot during this time. The worst offender was the programmed test input crew interface design (15 keystrokes to accomplish one set). Compared to simulations, the inherent vehicle motion in flight caused an additional potential for keystroke errors.

Rotational Hand Controller Characteristics: The rotational hand controller was generally satisfactory but did exhibit some minor deficiencies. The breakout force, low force gradient and high signal gradient at small deflections resulted in some compensation for precise control of small pitch rates. These rotational hand controller characteristics were most noticeable in the float to touchdown where control inputs reverted to a step or duty cycle technique.

Stabilized displacement positioning did require moderate attention and support of the wrist or hand.

Pivot points were different for pitch (palm) and roll (4 inches below hand) but did not affect the feeling of control harmony.

Energy Management: Because test data points were being obtained throughout the flight, thorough knowledge and recognition of progressive energy conditions was desirable. The separation and initial northbound leg were controlled by and corrections directed by Mission Control (FIDO) via radar data. Initiation of the maneuvering turn was critical and was made at a predetermined altitude. Cues for this altitude were a "1000 feet" lead call from Chase 1, a "10 seconds to turn" call from Mission Control, and monitoring the onboard-indicated altitude.

Correction to an off nominal energy condition at completion of the maneuvering turn was provided by adjusting the rollout and dogleg heading (provided by Mission Control) to either cut the corner or to extend the groundtrack.

In addition to the perspective and aim point familiarity described in section 4.3.2.3, seven altitude/ground reference check points had been identified on final approach to assure adequate energy management.

4.3.3 Free Flight 3

4.3.3.1 Preflight

Crew ingress began at 13:00 and proceeded smoothly without delay. During the period prior to backout from the mate/demate device, there were several occurrences of unintentionally keyed UHF transmissions from the carrier aircraft. Numerous communications system configuration changes were made on both the carrier aircraft and the orbiter in attempting to isolate the cause of the problem. The attempts were unsuccessful, however, and the condition continued to occur intermittently both during taxi and after takeoff during mated flight. Because of the extensive checks made in troubleshooting the problem, the pre-takeoff communications check was deleted.

During the period between backout from the mate/demate device and carrier aircraft engine start, the Pilot experienced an intermittent loss of intercommunication side-tone (ref. par. 7.2.6). The problem affected only his ability to hear his own voice when talking with "hot mike" enabled and did not affect his ability to either hear or talk to the Commander or to receive or transmit on UHF. The Pilot's intercommunication side-tone gradually faded out completely and then returned to normal two or three times prior to carrier aircraft engine start. Subsequently, the Pilot's intercommunications functioned normally.

The following additional discrepancies were noted prior to takeoff.

- a. After keying ITEM 18 EXEC (execute) on SPEC 041, the asterisk did not jump to the 18 position until after DISP (display) was keyed. This had not been observed on previous flights (ref. par. 4.2.5.8).
- b. The red and green tape used to designate normal and limit readings was loose or missing on several of the systems meters.

The body flap valve redundancy management messages that normally occur during the flight control system checkout provided an opportunity to verify that the master alarm tone volumes had been readjusted to satisfactory levels since free flight 1.

4.3.3.2 Mated Flight

The audio panel mid-deck main C circuit breaker was in the "in" position at takeoff and it became apparent during two brief periods that the carrier aircraft was experiencing the inadvertent UHF keying condition noted earlier. Mission Control directed that the circuit breaker be pulled. This was done and the circuit breaker was left in this position until a revised communications configuration was directed for separation. The revised configuration consisted of selection of UHF channel A on the carrier aircraft, closing the mid-deck

main C circuit breaker on the orbiter, and selecting the 279.0 megahertz frequency on the Chase 3 aircraft UHF. This configuration did not allow Chase aircraft 1, 2, and 4 to monitor carrier aircraft transmissions, so the "pushover" and "power" calls from the carrier aircraft were repeated by Mission Control for the chase pilots' benefit.

Turbulence encountered on this flight was heavier than noticed on any of the previous flights. Light turbulence was encountered just prior to initiation of special-rated thrust by the carrier aircraft, which caused the primary airspeed to vary from 203 to 207 knots equivalent airspeed. At approximately 15:40, prior to pushover, light to moderate turbulence was encountered with airspeed varying from 200 to 208 knots. Approaching pushover, the turbulence reached its highest level with airspeed variations of 190 to 200 knots and noticeable roll oscillations. After pushover, the turbulence condition decreased markedly, and separation occurred in smooth air.

During microwave landing system selection at 15:40, ITEM 13 EXEC was keyed when attempting to select MLS 1. MLS 1 was not selected, however, and ITEM 13 ERR appeared on the scratch pad line. The proper keystrokes were repeated with normal results (ref. par. 7.2.5).

4.3.3.3 Free Flight

The jolt at separation seemed more abrupt than on free flight 1. The Commander braced his arm and hand firmly at a 2° per second pitch rate command setting of the rotational hand controller, and the post-separation pitch maneuver was smooth with no noticeable deviations in pitch rate. The "separation" calls from Chase 1 and 2 were very clear, and the pushover was accomplished to the acceleration attitude. At this time, the crew felt a small but very definite 2- to 4-hertz longitudinal oscillation which lasted on the order of 5 seconds. The oscillation did not have the random nature of turbulence and the surface position indicator was checked for an indication of control system cycling. The only movements were a very slight oscillation of the elevon needles, but it could not be determined whether the movement was the cause of the oscillation or that the oscillation was causing a slight movement of the needles. The oscillation abruptly stopped and was not felt during the remainder of the flight. (Editor's note: Data review indicated that low-level oscillations [pitch rate of $1/4^\circ$ per second peak-to-peak at a frequency of 1 hertz] occurred for 4 seconds.)

A practice pitch aerodynamic stick input was performed prior to stabilizing the orbiter at 290 knots. The input was larger than desired with 1.6 g noted on the precision accelerometer. The planned programmed test input sequence was then accomplished and was followed by a pitch aerodynamic stick input, and two lateral/directional aerodynamic stick input sequences. Vehicle motion resulting from all inputs was well damped.

Particular attention was paid to the ambient noise level in the cabin during this free flight, and it was observed that there is no marked change in noise level at separation and the aerodynamic noise seems to be proportional to equivalent airspeed and is approximately the same level as noted while mated.

The very tight longitudinal control allowed the 1.8 g maneuvering turn to be accomplished smoothly. Equivalent airspeed and angle of attack were cross checked during the turn with the following readings called out as the turn progressed:

<u>Angle of attack, deg</u>	<u>Velocity, knots equivalent airspeed</u>
7	270
8-1/2	250
9-1/2	240
11	220
13	200
14	Maximum reached

At the completion of the turn, the vehicle had gone past the planned rollout heading so an abrupt right turn was made back to the 210° heading recommended by Mission Control to intercept final approach. During this turn, the resulting sideslip caused the left probe airspeed to indicate 180 knots while the right probe airspeed indicated 170 knots. The Pilot assumed control at this time and began the low-speed aerodynamic stick input sequence. The pitch-down pulse was somewhat larger than intended. On the first attempt at the lateral/directional aerodynamic stick input sequence, the sideslip resulting from the right rudder input did not feel as large as desired, so the yaw aerodynamic stick input was repeated.

Mission Control suggested starting the turn to final approach. As this was accomplished, the airspeed increased to approximately 220 knots. Airspeed was bled off to 210 knots and the low-speed programmed test input sequence was accomplished. Again, all vehicle motions were well damped.

The microwave landing system was selected on the Pilot's and Commander's horizontal situation indicators. The indications were that the vehicle was just slightly above the 11° glideslope and very close to the runway 17 centerline. The ROLL/YAW AUTO pushbutton was depressed with approximately 10-percent roll steering pointer deviation. The ensuing sharp roll input and corresponding lateral "lurch" caused the rotational hand controller to be inadvertently deflected enough to disengage automatic control and revert to control stick steering for the roll/yaw axes. The pitch needle was then centered and PITCH AUTO was engaged, followed successfully by ROLL/YAW AUTO engagement. All axes were engaged at an equivalent airspeed of approximately 230 knots and an altitude of 6500 feet above ground level.

Automatic guidance was very smooth with the vehicle tracking precisely down the glideslope and centerline as indicated by the horizontal situation indicator and with visual tracking toward the planned steep glideslope intercept point as determined by the tail-cone-off aim point runway marking. Airspeed increased very slowly to 270 knots. Automatic guidance had begun to deploy the speed brakes, which had reached 30 percent when manual control was resumed.

At 3000 feet, the Commander resumed control of the aircraft by downmoding roll/yaw to control stick steering with a lateral stick input, increasing the speed brake deflection to 50 percent, and then accomplishing a yaw aerodynamic stick input. At 2000 feet above ground level, the pitch axis was downmoded to control stick steering with a rotational hand controller input and a pitch aerodynamic stick input was accomplished as the speed brakes were retracted. The noseboom was noticed to be oscillating at this time, but neither crewman knew precisely when the oscillation had begun.

Preflare was begun immediately following the pitch aerodynamic stick input, the landing gear were lowered at 270 knots, and three "down and locked" indications were noticed as the airspeed decreased through 250 knots. Touchdown occurred just beyond the planned touchdown point at approximately 185 knots. Longitudinal control, as on free flight 1, was very precise with only small pitch-up rotational hand controller inputs required to rotate the aircraft as the airspeed decreased during the final flare and float. Lateral control was very tight and very few inputs were required during the final phase prior to touchdown.

No difference was noticed in vehicle response or damping in either the longitudinal or lateral/directional axes during any of the airborne maneuvers or at landing as a result of the aft center of gravity on this flight.

Derotation was begun immediately and nosegear touchdown occurred at approximately 155 knots. The nose wheel touchdown impact seemed more severe than on free flight 1.

4.3.3.4 Rollout

Immediately following nose landing gear touchdown, the Pilot lowered the elevons to approximately the trail position and began to call airspeed to the Commander. The Commander selected ROLL/YAW DIRECT to preclude opposing rudder motion. Upon glancing back at the surface position indicator, the Commander found that the elevons had drifted to almost full-down and he raised them back to trail. After the orbiter had decelerated to a velocity below 100 knots, the Commander raised the elevons to the full-up position and held them there for the remainder of the ground roll.

The planned task after reaching the three-point attitude was for the Commander to use differential braking to steer the orbiter from the centerline of the runway over to the right side and remain adjacent and parallel to the right side runway marking. This was accomplished smoothly as planned. Next, the Commander applied brakes equally in an attempt to increase braking to a moderate level. Severe vehicle vibrations resulted when the brakes were applied an amount required to accomplish moderate (estimated 0.2 g) deceleration. The level of the vibrations caused concern for structural integrity and the installed equipment. Therefore, the brake pedal pressure was eased. The oscillations decreased proportionately, but it was impossible to obtain a moderate deceleration level without inducing severe vibrations. The vibration amplitude seemed to reduce as speed decreased.

At approximately 20 knots, the moderate braking was discontinued, nosewheel steering was engaged, and the orbiter was steered back toward the runway centerline. Nosewheel steering was smooth and positive and the vehicle rolled to a complete stop just prior to being straightened out on the runway centerline.

4.3.3.5 Postflight Procedure

Just after auxiliary power unit 2 was shut down, the convoy commander reported observing an auxiliary power unit exhaust plume. The hydraulic load test was accomplished and the remainder of the postflight procedures were completed as planned.

4.3.4 Free Flight 4

4.3.4.1 Crew Ingress Through Takeoff

During the COMMUNICATIONS CHECK, both the Commander and Pilot noticed that the relative volume of the transmissions from the carrier aircraft was lower than those of all other stations. This situation was improved considerably at both audio stations by pulling up the carrier aircraft receiver button, allowing the crew to monitor the carrier aircraft onboard receiver output. This was done at crew option for the remainder of the flight. After arrival at the runway 04 benchmark, a BENCHMARK UPDATE was accomplished. This resulted in an automatic update to that benchmark at the time of the later OPS 201 PRO (proceed), which allowed a slightly earlier "go for taxi off the benchmark" from the orbiter. AIR DATA DEACTIVATION was not accomplished because the outside air temperature was 53° F. (Editor's note: A redundancy management alarm did not occur because of the low outside temperature.)

Because of concern for the unknown buffet and vibration characteristics of the mated vehicles on this first tail-cone-off flight and after the customary "go for takeoff" calls from the carrier aircraft, Orbiter 101 and the Houston Mission Control Center, the air-to-ground voice loops were held open during the takeoff sequence for direct communication between the carrier aircraft and the Dryden Flight Research Center control room, which was monitoring carrier aircraft buffet and vibration levels in real time. Further, the takeoff was planned for runway 04 to allow a straight-ahead landing immediately after lift-off if deemed necessary by the carrier aircraft pilot.

Brake release was on schedule at 14:45. The crew noticed that at high speed on the runway prior to nose rotation, and immediately following takeoff, the lateral motions felt in the orbiter cockpit were more pronounced than on the tail-cone-on flights, but not objectionable.

4.3.4.2 Mated Flight

The crew noticed no difference in levels of buffet as the elevons were positioned during the MANUAL DIRECT/CONTROL STICK STEERING/LOAD CHECK at 180 knots.

During the BUFFET CHECK at 210 knots, the crew noticed no difference in buffet level as a function of the various elevon positions, but did notice that the vehicle motion was worse at 210 knots calibrated airspeed.

The carrier aircraft crew activated the onboard damper system. Although the orbiter crew could notice no difference in the onboard indications of lateral acceleration magnitude, the acceleration onset rate seemed less and the "ride" became more comfortable with the carrier aircraft damper on.

The separation data run was commenced following the climb to pushover altitude. Other than trimming the elevons to 7.0° down during the PRESEPARATION CHECK, the orbiter crew had no active role in this test. Airspeed was first stabilized after pushover at 225 knots calibrated airspeed at which time the orbiter crew noticed no particular increased level of vehicle motion. Further acceleration to 250 knots calibrated airspeed was accomplished, and the carrier aircraft crew established the launch configuration (idle power, spoilers up). At the launch configuration and airspeed, the crew noticed a slightly decreased buffet. Following the ABORT SEPARATION, the elevons were trimmed to 1.0° down.

In preparation for the free-flight speed-brake-open test point, the speed brake thrust controller on the right side was preset to the 30-percent commanded position using the RM-CONTROLLERS SPEC. To account for the possibility of a high energy state at that point in the flight, the 50-percent commanded position was also marked using gray tape next to the speed brake thrust controller quadrant. Speed brake control remained on the left side.

During mated flight, SPEC 201 displayed random "M's" and large delta azimuth and delta range values primarily on TACAN's 1 and 2. Forty-three minutes after takeoff, a TACAN RM message was displayed. SPEC 201 showed that TACAN 1 had been automatically deselected by redundancy management due to delta azimuth; however, the delta azimuth had since returned within limits. TACAN 1 was re-selected and no further TACAN RM messages were received.

The PRESEPARATION CHECK, MAJOR MODE CHANGE, PUSHOVER MINUS 1, and PUSHOVER procedures were accomplished with no anomalies.

4.3.4.3 Free Flight

Separation: Separation conditions were 245 knots equivalent airspeed and 20 300 feet above ground level. The "g" onset, explosive noise, and the brief, sharp upward lurch felt similar to the sensations of the tail-cone-on separation of free flight 2. The separation resulted in a slight oscillatory motion (similar to that of free flight 2) and no attempt to alter vehicle motion was made until these dynamics had damped. The maximum load factor during the separation maneuver was 1.66 g.

Initial Performance Pullup Maneuver: After the separation dynamics had damped, a pitch rate of 2° per second was established to begin the performance data acquisition. This pitch rate was held to the predetermined conditions of 210 knots and plus 15° pitch attitude. The vehicle was then pitched over to plus 3° for the subsequent set of stability and control data points. The angle of attack sweep during this pullup maneuver was from 9° to 11° .

High-Angle-of-Attack Aerodynamic Stick Inputs: At approximately 180 knots equivalent airspeed, the angle of attack was stabilized at 10° . Aerodynamic stick inputs were made in all three axes. Vehicle response and damping were good, and no difference between tail-cone-on and tail-cone-off vehicle dynamics was noted.

Performance Pullup/Pushover Maneuver: After vehicle motions had damped from the high-angle-of-attack roll aerodynamic stick input, a pushover was made to set conditions for the performance maneuver. The nose was pushed over to minus 10° , and as airspeed increased to 190 knots, a plus 2° per second pitch rate was begun. The pitch rate was increased to 3° per second so that, at the conditions of plus 10° pitch attitude and approximately 180 knots, the angle of attack had reached the desired maximum of 15° . Vehicle control was transferred to the Pilot and a minus 3° per second pitch rate was begun to drive angle of attack to the low range of values. A minimum value of 3° was observed on the left alpha/Mach indicator which completed the desired angle of attack envelope for performance derivative extraction. At the completion of this maneuver, the flight conditions were minus 28° pitch with airspeed at approximately 200 knots and increasing.

Mid-Angle-of-Attack Aerodynamic Stick Inputs: At the end of the pullup/pushover maneuver and after allowing the vehicle to accelerate to 210 knots, the Pilot initiated a gentle pull-up, using a 7° angle of attack as the primary control parameter. After the Pilot had stabilized the angle of attack, the Commander initiated the lateral/directional aerodynamic stick input.

Low-Angle-of-Attack Aerodynamic Stick Inputs: After allowing the vehicle motions to damp following the mid-angle-of-attack aerodynamic stick input set, the pullup at a 7° angle of attack was terminated, and only a minor adjustment was required to attain the proper attitude for the low (4°) angle of attack aerodynamic stick input set. Both a longitudinal and a lateral/direction aerodynamic stick input were initiated.

Speed-Brake-Open Aerodynamic Stick Inputs: Vehicle control was transferred back to the Commander at this time. The desired speed brake position to obtain speed brake effects was ≥ 30 percent. The right speed brake thrust controller had been set to 30 percent prior to separation, requiring only activation of the Pilot's takeover button. In anticipation of a possible high-energy condition, the 50 percent command position had also been marked. Since the high-energy condition had been identified onboard early in the flight, the Pilot repositioned his speed brake thrust controller to 50 percent as the takeover button was depressed. Adequate time was available to perform both a lateral/directional and longitudinal aerodynamic stick input maneuver.

Preflare to Landing: At the completion of the speed-brake-open aerodynamic stick input maneuvers, the profile energy was still high (the Mission Control Center call was "1500 feet above glideslope"), and the desire was to leave the speed brakes out as long as possible. Because of the influence of training and the crew's reluctance to deviate from preplanned procedures on this first tail-cone-off flight, the speed brakes were retracted. A slow pitch rate was begun at a higher than normal preflare altitude because of the concern that

available pitch rate might be reduced during speed brake retraction. When the flare was assured and a feel for airspeed bleed-off rate was acquired, the speed brakes were repositioned to approximately 50 percent and left there through touchdown. The landing gear were deployed at approximately 275 knots.

Although the energy was higher than desired and a touchdown beyond the double stripe was imminent, all the planned energy dissipation techniques had been used, so attention was concentrated on landing the vehicle. The desire to spike the vehicle on the double stripe was resisted, but no final flare to attempt a roll-on landing was made. Touchdown conditions were: 510 feet long, 189 knots, and approximately 3.5 ft/sec sink rate (theodolite data). After the vehicle was stabilized on the main landing gear, the nose derotation maneuver was made.

4.3.4.4 Rollout

Heavy braking was begun immediately after nose wheel contact. Although feedback through the brake pedals was still absent, positive and smooth vehicle deceleration was felt. Braking was solid, effective, and there was no chattering or vibration which had been experienced on the previous two flights. Only a slight cycling was noticed by the Commander during maximum braking at approximately 120 knots and during the differential braking. At 115 knots, the nose wheel steering was engaged and a right turn initiated. At 100 knots, the nose wheel steering was disengaged and left differential braking used to realign the vehicle with the centerline. At approximately 70 knots, heavy braking was applied by the Pilot and, again, was smooth and effective. At 10 to 20 knots, heavy braking was terminated and the vehicle was stopped using the Commander's left brake and the Pilot's right brake.

4.3.4.5 Postflight Procedures

Following vehicle stop, postflight procedures were accomplished as planned except for the AUXILIARY POWER UNIT/HYDRAULICS LOAD TEST. Because the Pilot was dissatisfied with the first load test procedure (the rudder portion of the test was done incorrectly), the load test was repeated and the auxiliary power units deactivated.

Telemetry data indicated that shutdown of auxiliary power units 2 and 3 was due to fuel starvation rather than being a controlled shutdown. No voice call was made to the crew, and the post-egress cockpit inspection showed that the APU CONTROL switch (which is an unguarded three-position switch) for auxiliary power unit 1 was in OFF (the proper position), but the switches for auxiliary power units 2 and 3 were in START/ORIDE. All three FUEL TANK VALVE switches were in CLOSE.

Apparently the Pilot inadvertently moved the APU CONTROL switches for auxiliary power units 2 and 3 through the OFF position to the START/ORIDE position, and the auxiliary power units shut down when he subsequently closed the fuel tank valves. No damage to the auxiliary power units resulted from this procedural deviation.

4.3.4.6 General

Orbiter Handling Qualities: All comments regarding handling qualities apply only to the orbiter in the tail-cone-off configuration and using the primary flight control system in the control stick steering mode with scheduled gains. No other flight control system modes were evaluated on this flight.

The tail-cone-off configuration showed no noticeable differences in handling qualities from the tail-cone-on configuration. Any increase in airframe vibration due to buffet at the aft fuselage was not noticed by the crew. The difference in tail-cone-off performance, however, was spectacular. Lift/drag modulation using both airspeed and speed brakes was much more apparent in the tail-cone-off configuration.

The orbiter flight characteristics were generally solid, well damped, and particularly responsive for a vehicle with large size and inertias. Initial response in pitch and roll was positive with good damping and minimal overshoot. No tendencies toward pilot-induced oscillations were noted. Precise rudder control was difficult due to the response delay and lack of feel or feedback. Although response was not as crisp and damping not as high at low (180-knot) airspeeds as at high (greater than 290-knot) airspeeds, pitch and roll oscillations were essentially deadbeat, and yaw oscillations well damped at all airspeeds investigated.

In the control stick steering mode, no trim change was noticed with landing gear or speed brake configuration changes. No trim change was noticed due to airspeed changes or in ground effect.

Generally, flying characteristics were better in the orbiter than in the Shuttle Training Aircraft. The response delay characteristic of the Shuttle Training Aircraft was not evident. Precise control of vehicle rates, attitude, and load factor was more positive in the orbiter.

Energy Management: During preflight profile development simulations in both the Shuttle Training Aircraft and the Orbiter Aeroflight Simulator, techniques were developed for both high and low energy conditions at separation.

For the low-energy case: (a) the flight time at near-maximum lift/drag conditions was extended as long as possible, (b) airspeed for the low-angle-of-attack stability and control data points was reduced by approximately 10 knots (increasing lift/drag but not significantly affecting angle of attack), and (c) the duration of the 30 percent speed brake data time was minimized, or in the extreme-low-energy case, deleted entirely.

For the high-energy case: (a) flight time at near-maximum lift/drag conditions was minimized, (b) airspeed for the low-angle-of attack stability and control data points was increased by approximately 10 knots (decreasing lift/drag but not significantly affecting angle of attack), and (c) the speed brake deflection was increased to 50 percent and the time of flight with speed brakes open was extended as much as possible.

The actual pushover altitude was higher than planned, which caused the Mission Control Center to adjust the pushover point. The time from "pushover" to "launch ready" was several seconds longer than expected, however, and this resulted in a separation that was approximately 3500 feet further downrange, creating the high-energy case in flight.

Immediately after pushover, to set conditions for the high-angle-of-attack stability and control data points, the Pilot acquired a visual on the runway and identified the high-energy condition which was confirmed 18 seconds later by a call from the Mission Control Center. The high-energy techniques were used effectively, and at an altitude of 5000 feet, the call from the Mission Control Center was "1500 feet above glideslope." Energy was further reduced to effect a landing 510 feet long at 189 knots.

4.3.5 Free Flight 5

4.3.5.1 Preflight

Crew ingress was on schedule and both crewmen were strapped in at 13:25. Because sunrise had not occurred at the time of backout from the mate/demate device, the floodlights were still on. The crew noticed that the strong point sources of light from these floodlights viewed through the thick panes of the windshield glass appeared as a double image with the false image displaced upward approximately one fifth of the windshield vertical dimension and toward the vehicle centerline. This effect is mentioned because of possible similar effects in later operations when viewing star fields or runway lights at night. The false image was nearly as bright as the primary image.

On about three occasions during the pre-takeoff period and once about 20 minutes after takeoff, the Pilot's intercommunications sidetone gradually faded away and then gradually returned to normal. As on free flight 3, the problem affected only the ability of the Pilot to hear his own voice when talking with hot mike enabled and did not affect his ability to either hear or talk to the Commander or to receive or transmit on UHF.

4.3.5.2 Mated Flight

Immediately after takeoff, the effect of buffet from the tail-cone-off configuration was apparent as a sporadic moderate-level oscillation with the primary motion being side-to-side. The altitude director indicator rate needles oscillated +10 percent with occasional excursions to +20 percent, and the error needles oscillated +20 percent. The altitude director indicator rate switches were in the MEDIUM position and the error switches were in the HIGH position at this time. The intensity of the buffet made writing legibly impossible but did not cause undue discomfort.

At 15:08:33, TACAN 3 broke lock as indicated by M's on SPEC 201 for both azimuth and range and a TACAN RM message. It remained unlocked until 15:22:20, about 3 minutes after it had been returned to George, when it regained lock and operated normally for the remainder of the flight.

The carrier aircraft mass damper was turned off briefly but no difference in the buffet effect was discernible in the orbiter.

4.3.5.3 Free Flight

The period from carrier aircraft pushover through orbiter rollout on the runway is discussed in three segments because of the distinction in techniques and tasks. In addition to the assigned flight test requirements, the operational scheme was designed to achieve the desired 22° flight path angle outer glideslope as soon as possible after separation and to touchdown on runway 04 at 185 ± 5 knots equivalent airspeed and 5000 feet past the runway threshold.

Pushover Through Outer Glideslope Intercept: Planning and execution were directed toward achieving separation at an exact geometric location in space. This assumed the use of standardized techniques by the carrier aircraft up to separation, by the orbiter after separation, and factoring of upper winds at altitudes from 20 000 to 10 000 feet above ground level. The planned procedure was as follows.

Rather than continue climbing as high as possible using special-rated thrust, the carrier aircraft was to level off at 20 000 feet above ground level before pushover. The actual pushover was to be called by the Houston Mission Control Center. The carrier aircraft crew was to execute the pushover, reduce power, and establish the launch configuration to arrive at a "launch ready" condition in 37 seconds after pushover at 17 000 feet. The orbiter was to perform the separation 40 seconds after pushover followed by the standard post-separation maneuver. This was a pitch-up at 2° per second for 3 seconds and a roll-right to a bank angle of 20°. After the "clear" call by the Chase 2 aircraft, a pushover at 0.5 g was to be executed to a nose-down pitch attitude of 25°. As speed accelerated to 290 knots, the speed brakes were to be extended to approximately 50 percent while the nose was raised to track the 22° glideslope. Mission Control, with the preceding planned techniques and the upper wind data factored, was to bias the pushover call to assure that the outer glideslope intercept would occur near the time the orbiter achieved 290 knots.

Approximately 120 runs were made in the Orbiter Aeroflight Simulator with wind and lift/drag variations to verify the plan. In addition, 14 runs were made in the Shuttle Training Aircraft while integrated with the Houston Mission Control Center. From these runs, several mission rule changes were made that bound trajectory energy. First, the wind biasing allowance could not exceed +5000 feet so that biasing short would not exceed the distance from the nominal touchdown point to the runway threshold. One run with the Orbiter Aeroflight Simulator involved a separation just after carrier aircraft pushover. By maintaining maximum lift/drag, the orbiter was comfortably stabilized on the outer glideslope at 290 knots before preflare. To preclude tail wind cases of getting steep attitudes at preflare, a tail wind limit was chosen that would insure a speed brake setting of <80 percent to maintain the 22° glideslope. This limit was about 45 knots at 10 000 feet above ground level. The minimum energy separation condition was defined by either a time after pushover of 55 seconds or an altitude of 14 000 feet above ground level.

The actual flight conditions were as follows:

The pushover call was made 4 seconds earlier than the nominal time for no wind at 20 600 feet above ground level. The carrier aircraft "launch ready" call was made at 34 seconds after pushover and orbiter separation was executed at 40 seconds after pushover within 100 feet of the planned position in space. Normal acceleration at separation (1.83 g) felt similar to that experienced previously on free flights 1 and 3. The nose-up pitch rate was normal and no lateral asymmetry was noted. The pitch-up command was held for 2.5 seconds and the roll-right commenced 3 seconds after separation. Orbiter pitchover was performed following the Chase 2 "clear" call (8 seconds after separation) holding 0.5 g indicated on the glareshield-mounted accelerometer. Because the call occurred sooner than in preflight simulation, the pushover was executed 1200 feet further from the runway than the nominal distance. While passing through about 20° nose-down attitude during pitchover, a call from the Mission Control Center indicated that the position was low. As a result, the pitchover was stopped prior to the planned 25°. A pitch doublet was executed with the initial pitch-up input noticeably too large. A peak reading of 1.8 g was observed on the glareshield g-meter. Subsequently, the doublet was repeated with a nose-down input initially.

The Pilot assumed control of the vehicle and adjusted attitude to track the visual ground aim point. Speed slowly increased to the desired 290 knots. Single left rudder and left roll inputs were overlain by the Commander prior to speed brake deployment to complete an aerodynamic stick input set. The resulting peak sideslip was just over 1°. As planned, the Commander positioned the AIR DATA SELECT switch briefly from LEFT to CMPTR and then back to LEFT.

Outer Glideslope Tracking: The outer glideslope was intercepted at 9600 feet above ground level. The predominant task was to visually keep the velocity vector pointed toward Lancaster Boulevard, the surface aim point, while manually positioning the speed brakes to hold 290 knots. The attitude director indicator guidance needles and horizontal situation indicator glideslope were cross checked several times during this phase and then correlated correctly. To preclude a transient on takeover, the Commander positioned the left speed brake thrust controller to approximately 50 percent to match the Pilot's command. The Commander assumed control of the speed brake just below 7000 feet and shortly thereafter took over with his rotational hand controller. Visual reference as well as the horizontal situation indicator glideslope needle showed that the trajectory had drifted above the glideslope. The maximum distance measured was about 400 feet at 4000 feet above ground level. To reacquire the aim point and prevent overspeed, the Commander pitched the nose over and deployed the speed brakes to about 80 percent. The Commander noted a momentary decrease in airspeed to 280 knots, requiring speed brake reduction. At the same time, the Pilot reported a decrease in airspeed to 275 knots followed by a rapid increase back to 290 knots. At preflare, the trajectory was slightly steep but directed toward the aim point with 294 knots shown on the alpha-Mach indicator. Radar data indicated that the trajectory at preflare (2000 feet above ground level) was 600 feet closer to the runway threshold than planned.

Preflare Through Rollout: The no-wind nominal trajectory is depicted by the dashed line in figure 4-28. (This trajectory assumes retraction of the speed brakes at 2500 feet and start of flare at 1700 feet above ground level.) The landing gear deployment is at 270 knots as the runway overrun threshold passes under the nose. A simple scheme of cross checks leading to the touchdown point was to:

- a. Look for 250 knots and 50 feet altitude at the approach end of the runway.
- b. Thereafter, verify a reduction of 10 knots and 10 feet altitude as each runway marker was approached; i.e., 240 knots and 40 feet at the 14 000-foot-to-go marker.
- c. At the 12 000-foot-to-go marker, attempt to reduce altitude to 5 feet or less within the next 1500 feet. This would preclude an early touchdown but yet be low enough to achieve the desired touchdown point without requiring a large sink rate.

This nominal scheme did not require the use of speed brakes.

Wind was another variable to be factored, both steady-state surface wind and the wind shear from 3000 feet to the ground. The shear was to be handled by either deploying the landing gear early for a tailwind shear case or late for a headwind shear case. For example, with the worst-case 15-knot tailwind shear case used in training, the landing gear were lowered at 280 to 285 knots coming up on a prominent "bullseye" landmark. This was 2000 feet and 10 to 15 knots earlier than with no wind.

Orbiter Aeroflight Simulator training runs included both upper wind as well as shear wind variables. Utilizing the techniques described, the velocity variation at the planned touchdown point on 78 runs varied from 164 to 208 knots with an average velocity of 185 knots. Shuttle Training Aircraft results were considered only for the last four training flights which included the automatic throttle and initialization-load update (flight path angle of 20° to 22°). This airspeed was consistently 10 to 15 knots slower than that with the Orbiter Aeroflight Simulator at the intended touchdown point. In 29 runs, the velocity at the 10 000-foot-to-go touchdown point varied from 155 to 180 knots with an average speed of 168 knots.

The actual flight sequence of events and pilot impressions are as follows:

As the preflare point was approached, the velocity was 294 knots, 4 knots higher than planned, and the velocity vector was directed toward Lancaster Boulevard, the desired aim point. (The actual flare point is masked somewhat in the data by pitch adjustment with speed brake reduction to hold airspeed and the aim point.) Following the Chase aircraft call at 2500 feet, the flare was started after the primary air data and radar altitude indications were that the orbiter was passing through 2000 feet above ground level. Speed brake retraction was delayed to compensate for the excess speed. The actual low-altitude winds were a 7-knot tailwind shear (half the training worst case). This required dropping

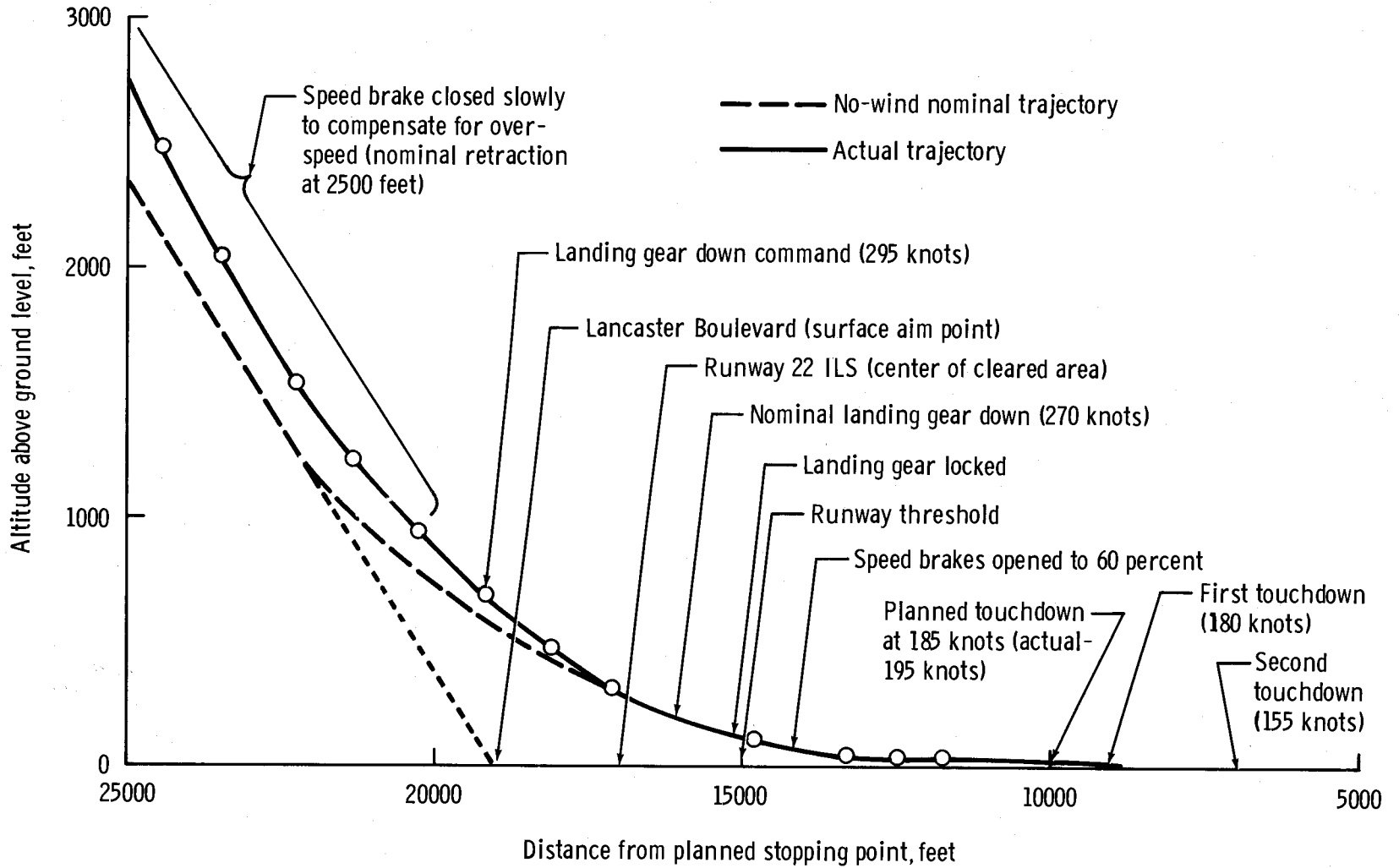

Figure 4-28. - Final approach and landing events.

the landing gear at the edge of the bullseye landmark closest to the runway at an expected 275 to 280 knots. When coming up on the outer edge of the bullseye with 290 knots, it was apparent that the vehicle was not slowing as expected and the gear were lowered at 290 knots. Approaching the runway threshold, the altitude was correct but airspeed was 20 knots faster than planned. Another call that airspeed was 20 knots too fast at the 14 000-foot-to-go marker warranted further action. Therefore, the speed brakes were opened to approximately 50 percent. Based on free flight 4 results where a similar speed brake setting was used after flare, the expected result was that the vehicle would be slow at the planned touchdown point. In actuality, the velocity checks continued to be high with 200 knots being called out within 500 feet of the touchdown line across the runway. At this point, the vehicle seemed to "hang up" at an altitude of 4 feet. Attempts to push the vehicle on with forward rotational hand controller commands seemed to have no effect in overcoming the floating tendency.

After almost touching down, the vehicle ballooned slightly, then touched down smoothly 1000 feet beyond the planned point. The vehicle then skipped gradually back into the air and touched more firmly 6 seconds later, rebounding slightly. Figure 4-29 shows the actual altitude versus runway position during the touchdown sequence. Pitch inputs were made between the touchdowns to keep the vehicle airborne until roll oscillations could be damped. During this entire period, pitch control of altitude and sink rate seemed normal. However, a review of flight data indicates that pitch rate oscillations of $\pm 3^\circ$ per second occurred during this interval which caused elevon rate saturation. It is significant that these pitch oscillations were not apparent to either crewman at the time from visual or physiological cues. The crew impression was that the pitch rotational hand controller commands were small in amplitude which is contrary to the up-to-half deflection shown in the postflight data. This impression is possibly due to the light stick force gradient, whereby deflection is related to the response noted as compared to actual stick movement. There was an additional 10 percent speed-brake-open command to approximately 60 percent at 15:54:24.5, just before the near-touchdown. This cannot be accounted for except by an inadvertent movement of the speed brake controller.

Impressions of the lateral-axis control are best separated into the period before the first touchdown and thereafter. As on previous flights, there was virtually no roll task from preflare up to just short of the near-touchdown at 15:54:29.5. At this point, one wing dropped slightly. A manual input larger than that required for the small bank angle correction was made which resulted in an overshoot of bank past wings-level. Vehicle response appeared to be normal in picking the wing up and achieving the desired near-wings-level attitude prior to touchdown. The first touchdown at 180 knots felt very light, comparable to previous landings. This was followed shortly by the realization that the vehicle had skipped back into the air with a roll off to the right. In attempting to level the wings, a lateral pilot-induced oscillation developed and was sustained for several oscillations. It was perceived in real time that the rotational hand controller commands in roll were abnormally large and the response was lagging the inputs. On previous flights, no delay had been noted in bank angle response to the controller. With a cue from the Pilot, the large input commands were discontinued and the roll rate damped to a near-wings-level attitude. The bank-angle excursions were judged to be about $\pm 5^\circ$ which was of

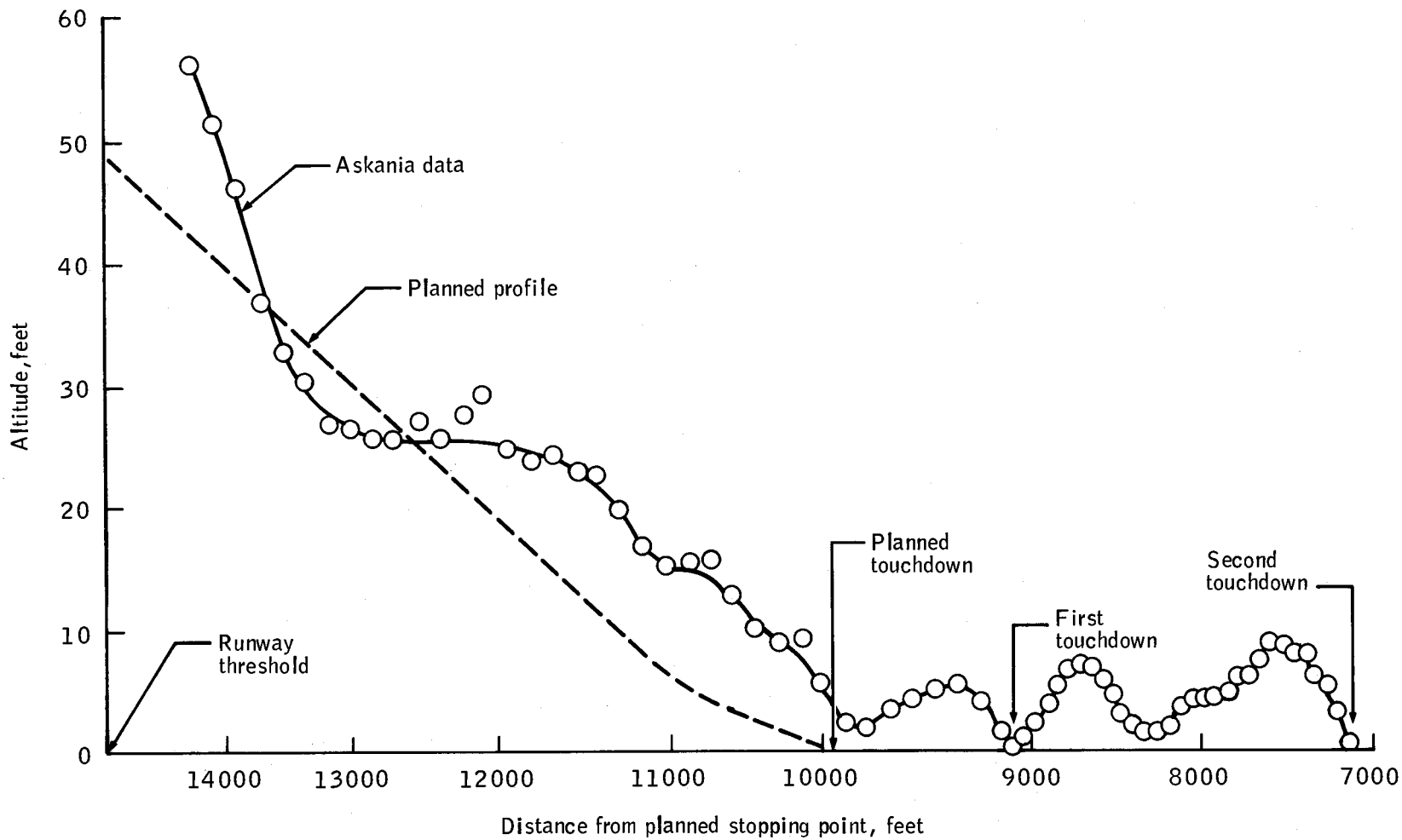

Figure 4-29.- Altitude versus runway position during landing.

sufficient concern to warrant holding off at 5 to 6 feet altitude before reattempting a landing. A noticeably higher-than-normal sink rate was accepted because of concern about airspeed bleedoff for the second touchdown at 155 knots. The sink rate was judged to be about 5 to 6 ft/sec qualitatively (actually 4.0 ft/sec). The vehicle seemed to lift up slightly with a landing gear oleo rebound; however, the actual data indicated that the left main landing gear became airborne again for about 2 seconds. During all the preceding activity, the vehicle tracked down the centerline and there were no directional concerns at any time.

Following the second touchdown, the speed brake was commanded to full-open from 60 percent and a normal derotation was accomplished. Nosewheel contact was at 125 knots at a pitch rate of 3.5 deg/sec, which qualitatively felt as soft as the contact on two previous derotations. The elevons were initially commanded up but subsequently were allowed to slowly drift down.

Only light braking was used until 100 knots, when maximum braking was applied and held until decelerating to 50 knots. Thereafter, light braking decreasing to no braking was utilized as the vehicle rolled to a stop. The brakes were solid, responsive and very effective at maximum braking. There was no "chatter" nor even a sense of cycling when into the anti-skid range. Directional control was not a factor at any time so nosewheel steering was not activated. It was apparent that, even with the 1000-foot-long touchdown and the approximately 2000 feet traversed in handling the bounce, there would be no problem stopping on the remaining runway.

4.3.5.4 Postflight

All postflight procedures were accomplished per the checklist. The crew completed powerdown and remained onboard until the vehicle was towed clear of the runway when a normal egress was made.

ACRONYMS, ABBREVIATIONS AND TERMINOLOGY USED IN ALT PILOT'S REPORTS

APU	Auxiliary power unit
AUTO	Automatic
CMPTR	Computer
CRT	Cathode ray tube
ERR	Error
EXEC	Execute
FIDO	Flight Dynamics Officer (Mission Control Center)
MLS	Microwave landing system
MLS	Mean sea level
MM	Major Mode
NAV	Navigation
OPS	Operational sequence
ORIDE	Override
PRO	Proceed
PYRO	Pyrotechnic
RM	Redundancy management
SEP	Separation
SPEC	Specialist (function)
TACAN	Tactical air navigation
TAEM	Terminal area energy management
UHF	Ultrahigh frequency

SOFTWARE TERMINOLOGY

Operational Sequences

OPS 1 - Preflight

MM 101 - Preflight preparation

OPS 2 - Flight

MM 201 - Mated flight

MM 202 - Separation

MM 203 - TAEM

MM 204 - Autoland

MM 205 - Rollout

Specialist Functions

Guidance, navigation and control functions are divided into principal and specialist functions. Principal functions are those that can be initiated only by software. Specialist functions are those that can be initiated only by the crew, and include the following used in this report.

SPEC 041 - MEMORY READ/WRITE

SPEC 201 - RM-NAV

SPEC 301 - RM-SENSORS

4.4 FLIGHT 5 APPROACH AND LANDING ASSESSMENT

Separation occurred at an airspeed of 245 knots and at an altitude of 19 900 feet MSL. The orbiter approach and landing were controlled manually in the control stick steering mode through the entire flight until touchdown. During the initial part of the free flight, the orbiter was below the glideslope because of an earlier-than-planned "Chase-2 clear" call. This was corrected and the vehicle was on the proper glideslope at an altitude of 12 000 feet MSL.

Preflight planning indicated that a speed brake setting of approximately 50 percent would maintain the proper airspeed on the outer glideslope. The initial speed brake setting was 30 percent and the vehicle drifted high on the glideslope. The crew then nosed the vehicle over to acquire the outer glideslope aim point and the speed brakes were deployed to 80 percent. At the preflare point (4300 feet MSL), the orbiter velocity was approximately 5 knots high, the position was about 700 feet long, and the flight path angle was 25.3° instead of the nominal 22° . In accordance with the flight plan, the crew slowly retracted the speed brakes at the preflare point. To compensate for the recognized high energy state, the airspeed at which the landing gear were lowered was 20 knots faster than the planned 270 knots. As the orbiter approached the runway, the energy state was higher than desired and the crew then opened the speed brakes to 50 percent - a procedure not required for a nominal energy state.

After speed brake deployment, there was a pitch oscillation caused by control stick inputs for the last 8 seconds prior to touchdown. These pilot inputs to control sink rate near landing resulted in large elevon motion (12° peak-to-peak) at 0.6 hertz and kept the elevons rate limited during most of this period. The vehicle pitch rate was $\pm 3^\circ$ per second and the attitude change was within $\pm 1^\circ$. The pilot was unaware of any problem other than that he was landing long and trying to get the vehicle on the ground near the desired touchdown spot. Since the center of pitch motion was near the cockpit, there was a lack of normal acceleration cues during a small pitch oscillation. Also, the steeply sloping nose of the vehicle is not visible from the cockpit, so small changes in pitch attitude are not readily apparent. The result was that the oscillation that caused elevon rate limiting was not detected by either crew member. The vehicle touched down very softly with wings level but skipped back into the air, rolling to the right. As a result of the rate-saturated pitch channel, the priority rate limiting design did not allow response to some roll inputs. This triggered very large roll commands just at touchdown, and a pilot induced oscillation in roll occurred for 4 seconds with a peak roll rate of 15° per second and $\pm 5^\circ$ of bank angle at a rate of 0.6 hertz. The pilot released the controller momentarily and the motion damped quickly just prior to the second touchdown which occurred 6 seconds after the first at 4 ft/sec. The right wheel touched first and the left wheel lifted off slightly on the rebound, but the vehicle stayed on the ground and a normal rollout was accomplished.

To improve the chances of coping with deviations at landing (i.e., turbulence and crosswinds), the following recommendations are made and should be incorporated in training and flight control system design as applicable.

- a. The energy state should be maintained at the preplanned nominal level throughout the flight trajectory utilizing standardized pilot techniques or autoland. The trajectory from preflare to touchdown should be optimized for manual control.
- b. Limits of trajectory, velocity, altitude, etc., and limitations of the flight control system should be determined and verified by simulation to determine the crew and vehicle capabilities and limitations to perform a safe landing.
- c. The flight control system must be modified to always provide at least some combination of pitch and roll capability to allow manual and automatic control for landing.
- d. The flight control system sensitivity to pilot-induced oscillations should be reduced.
- e. Nominal trajectory planning should not require the use of speed brakes after flare.
- f. The existence of rate limiting of the aerodynamic surfaces should be annunciated to the crew.

4.5 FLIGHT TEST REQUIREMENTS ASSESSMENT

All assigned objectives and flight test requirements were satisfactorily accomplished. Specific objectives accomplished for each flight are listed below. Flight test requirements accomplished are listed in appendix E.

Flight 1:

- a. The handling qualities of the orbiter vehicle through the Approach and Landing Test free-flight regime were verified.
- b. Carrier aircraft/orbiter separation was verified.
- c. Landing gear deployment in free flight was demonstrated.
- d. Braking, steering and coasting during rollout were verified.
- e. The performance of selected orbiter subsystems during the Approach and Landing Test free-flight regime was verified.

Flight 2:

- a. Using programmed test inputs and the control stick steering mode of the primary flight control system, longitudinal and lateral/directional control and response of the orbiter were verified at high and low speeds and with two speed brake positions. Also, high-rate pitch response was evaluated as part of a constant-g windup turn.
- b. Aerodynamic derivative extraction data were obtained during dynamic flight conditions using prescribed aerodynamic stick inputs to verify lift/drag characteristics as well as to verify longitudinal and lateral aerodynamic derivatives in the approach and landing operational ranges for velocities, angle of attack, and speed brake positions.
- c. The landing gear subsystem was verified during rollout. Moderate braking was accomplished at high and low speeds and hard braking was attempted. Steering by differential braking was accomplished. In addition, landing gear/attach structure interface stability, landing gear loads, and strut energy absorption were determined and steering by ailerons was evaluated.
- d. Using programmed test inputs, the orbiter was verified to be flutter free during the approach and landing phase.

Flight 3:

- a. Both open-loop and closed-loop operation of the autoland system were verified during the approach phase including the switching characteristics of enabling and disabling the autoland system.

- b. Manual landing control was verified with an aft c.g. from main landing gear touchdown to stopping, including effects from aerodynamics, flight control structures and runway.
- c. With an aft c.g. and using programmed test inputs and the control stick steering mode of the primary flight control system, longitudinal and lateral/directional control and response were verified at high and low speeds. Also, high-rate pitch response was evaluated as part of a constant-g windup turn.
- d. Hard braking was attempted at high speeds and steering by differential braking was verified at moderate speeds.
- e. Data were obtained for verification of aerodynamic derivatives.
- f. The carrier aircraft mass damper system was verified for use during the tail-cone-off flight tests.

Flight 4:

- a. The performance of the anti-skid system as modified after free flight 3 was verified.
- b. Data were obtained on the general handling qualities of the orbiter in the control stick steering flight control mode, tail-cone-off configuration, and with the c.g. near that planned for the first orbital flight test.
- c. Data were obtained on the lift/drag and the longitudinal and lateral/directional performance characteristics of the tail-cone-off configuration during the approach and landing phase. This was accomplished by performing an angle-of-attack sweep, employing aerodynamic stick inputs at high and low angles of attack, and employing a rudder stick input with deflected speed brake.
- d. Data were obtained on the autoland system in the open-loop configuration.
- e. The buffet loads of the mated orbiter with tail cone off and carrier aircraft were verified to be acceptable at separation speeds and the mated vehicles were verified to be flutter free.
- f. Separation conditions and operations were determined to be satisfactory during a practice separation run.
- g. Data were obtained during moderate to hard braking at high speed including engagement of nose wheel steering.

Flight 5:

- a. Performance of the landing gear and landing gear/airframe systems was verified using a paved runway.
- b. An approach, landing, and rollout on a paved runway with a simulated 10 000-foot length were verified.
- c. Data were obtained for open-loop autoland operation.

5.0 FLIGHT OPERATIONS ASSESSMENT

Summaries of problem areas addressed by Flight Operations during the Approach and Landing Test real-time operations and during operations planning that are applicable to the Orbital Flight Test Program are included in this section. Where applicable, recommendations are given for Orbital Flight Test.

5.1 TRAINING AND SIMULATIONS

Considered mandatory for the Orbital Flight Test Program is a programmed capability to verify that all training and verification facilities use the same modeling so that the same results will be produced with a given set of inputs. Change control should be instituted such that one facility is not changed without formal notification to the other facilities.

5.2 ONBOARD SYSTEMS

5.2.1 Software Flexibility

Operational procedures for software workarounds should be prepared and submitted to the community. Simulations using these procedures should not be conducted until they have been certified. New procedures should not be used for the initial flights. Variable-parameter word loading, as a mechanism to increase ground monitoring flexibility, should be avoided as it will be easier to add the new parameter to the ground equipment than to make an onboard change.

5.2.2 Ground Monitoring Concept

Ground monitoring should not be dependent on redundancy management annunciation for critical flight phases. Visibility should be provided on the ground for understanding which unit has failed and why.

5.2.3 Redundancy Management

Four observations were made on redundancy management. First, in several cases, the out-of-tolerance limits were too tight and resulted in failure annunciation for acceptable conditions. Second, there were several items of equipment such as TACAN's and radar altimeters where redundancy management had to be disabled on one or more units to prevent nuisance master alarms from equipment operating within specification. Third, in several flight-critical areas, redundancy management continued to process data from a unit that was functionally off. For the Approach and Landing Test Program, this could occur for the rate gyro assemblies after the second failure, and resulted in downmoding to the backup flight control system merely to allow flying to be continued safely with a single rate gyro assembly. Pitching moments induced on the second failure during critical portions of a flight could have resulted in loss of the vehicle and, possibly, the crew. Fourth, multilevel redundancy management, with its inherent complexity, was used in areas where a single level would have been adequate.

5.2.4 Redundancy Management Switches

Single-contact-switch redundancy management caused alarms because of the timing of status sampling routines during switch operation. The latching nature of the resulting redundancy management message masked the system status.

5.3 GROUND SYSTEMS

Orbital Flight Test ground systems design should have the capability to permit addition, deletion, and rescaling of parameters within a short turnaround period.

6.0 GROUND OPERATIONS

Actions taken for correction of preflight and flight anomalies are described in the discussions of those anomalies in other sections of this report. Ground operations not already described are included here.

The orbiter was left mated with the carrier aircraft upon completion of the captive-active flights.

Subsequent to free flight 1, during performance of a test checkout procedure on Orbiter 101, a "Terminate B" line transient caused the four primary computers to drop aft data busses over a 6 minute period. The cause of the transient was operation of a switch on overhead panel 07 under the following conditions: Computers 1, 2, 3 and 4 operating while in the OPS-1 operational sequence; computer 5 removed; backup controller off; and terminate switches normal. In order to prevent "Terminate B" line susceptibility in the event of a backup controller power failure, relay circuits were added to panel 07.

Another modification made after free flight 1 was the addition of circuit components to the separation pyrotechnic initiator controller circuits to prevent inadvertent firing that could have resulted from a single-point failure when a "fire" command was not present.

The following modifications were performed after free flight 2.

- a. The aerodynamic coefficient instrumentation package was moved from the development flight instrumentation pallet to a more stable location on the lower mid fuselage.
- b. Additional development flight instrumentation strain gages were added to the wings for structural analysis.
- c. Ballast was moved and added to obtain the desired aft center of gravity.
- d. The pyrotechnic connectors for the separation system were safety-wired because of an apparently loose fitting after mate. The connectors and harnesses were replaced after free flight 3.
- e. Air data transducer assembly 4 and display electronics unit 2 were replaced because of test anomalies.

Ground operations after free flight 3 were as follows.

- a. A thermal blanket was installed over the body flap power drive unit to maintain higher temperatures on hydraulic components during periods of low usage.
- b. Strain gages were installed for structural evaluation of the wings.

- c. Ballast was moved and deleted to obtain the desired center of gravity for tail-cone-off flights.
- d. The tail cone was removed and weight and balance measurements were made.
- e. The auxiliary power unit tankage was checked while loading the systems to determine fill accuracy. The system 3 load was increased to allow for additional run time of auxiliary power unit 3 if required.

Following free flight 5, a final calibration was performed on the aerosurfaces and a final test was performed on the air data system, calibrating the nose boom alpha vane measurements with the side probes. After deservicing, the final powerdown was performed on November 4, 1977.

7.0 ANOMALY SUMMARY

This section contains discussions of orbiter flight anomalies. Discussions of captive-active flight anomalies that were open or were closed only for the Approach and Landing Test Program as of the time of publication of reference 2 are updated here if closed. Anomalies that are still open as of the time of publication of this report will be updated at the time of closure in supplemental reports or will be closed through the Space Shuttle problem tracking system.

7.1 CAPTIVE-ACTIVE FLIGHTS

7.1.1 Hydraulic System 1 Water Boiler Steam Vent Line Temperature Reading Was Low

The hydraulic system 1 water boiler steam vent temperature reading was lower than expected during captive-active flight 1A.

The steam vent heater circuit included an 89-watt and a 33-watt heater group connected in parallel. Each group was controlled by two thermostats in series and set for temperatures to prevent freezing in the 2-inch duct.

Postflight testing confirmed that the 33-watt heater group was inoperable. The 89-watt heater group was operating normally and was determined to be adequate for the remainder of the Approach and Landing Test Program.

Heater checkout procedures used prior to the first captive-active flight were such that only an increase in vent temperature was required for the heater to pass checkout. Since this increase in temperature would have resulted from either heater group functioning, a failed heater could have gone undetected.

Redesign of the water boiler system for Orbiter 102 includes the elimination or parallel redundant heater circuits. Checkout will include current measurements to verify operation of each heater along with subcooling using ground support equipment to verify thermostat and heater operation where thermostats are set below ambient. All functional paths will be verified.

This anomaly is closed.

7.1.2 Inertial Measurement Unit 1 Would Not Go To Operate

During preflight checks for the first captive-active flight, inertial measurement unit 1 would not go to "operate." The first flight was conducted the following day with the failed unit and the unit was replaced for the second flight. The replacement unit performed normally in flight.

Bench testing of the failed unit isolated the problem to a failure of the DC-1 internal power supply of the inertial measurement unit. Internal inspection revealed that the solder did not properly adhere to a power supply Q-11 transistor lead due to improper metallurgical bonding. The power transistor lead

had an uneven gold coating that was insufficient in some areas to protect it from oxidation (fig. 7-1). Heavy oxidation on some areas of the power transistor leads resulted in dewetting of the solder coating.

Failure of an inertial measurement unit was not a constraint to free flight and no change was required for Orbiter 101. For Orbiter 102 and subsequent vehicles, new parts will be screened by a 10-power microscope inspection prior to soldering to insure that the leads are not oxidized. Transistors in all inertial measurement units are being replaced with transistors with good lead solder wetting.

This anomaly is closed.

7.1.3 Nose Landing Gear Door Thruster Triggering Pawl Did Not Function

The nose landing gear door thruster actuator trigger was pulled by firing of the backup pyrotechnic system during landing rollout on captive-active flight 3. However, the pawl movement did not rotate the arm that releases the bungee spring.

The door thruster is required to provide an initial push to overcome high aerodynamic pressure, high sideslip angle, high seal stiction, and higher differential pressure. Several ground tests using a pneumatic bottle all resulted in normal operation; however, ground tests using pyrotechnic devices and a pawl retention spring of higher force resulted in failure to release the bungee spring, repeating the inflight failure mode.

Operation of the spring bungee was not required for proper nose landing gear operation for the Approach and Landing Test Program.

The system was redesigned for Orbital Flight Test eliminating the triggering pawl. The modification concept is shown in figure 7-2. Pulling out a spring-loaded retention pin on the telescoping actuator arm allows the bungee spring to be cocked. Nose landing gear retraction resets the actuator arm and the retention pin snaps into place locking the telescoping section.

This anomaly is closed.

7.1.4 Auxiliary Power Unit 1 Exhaust Duct Temperature Measurement Failed

During operation of auxiliary power unit 1 on captive-active flight 3, the exhaust duct temperature reading went off-scale high and triggered the caution and warning signal. The redundant measurement, not displayed in the cabin, showed normal temperature readings which indicated that the off-scale high reading was probably the result of an open circuit. Postflight examination confirmed that the sensor lead had broken at the flex stress joint adjacent to the brazed joint support clamps.

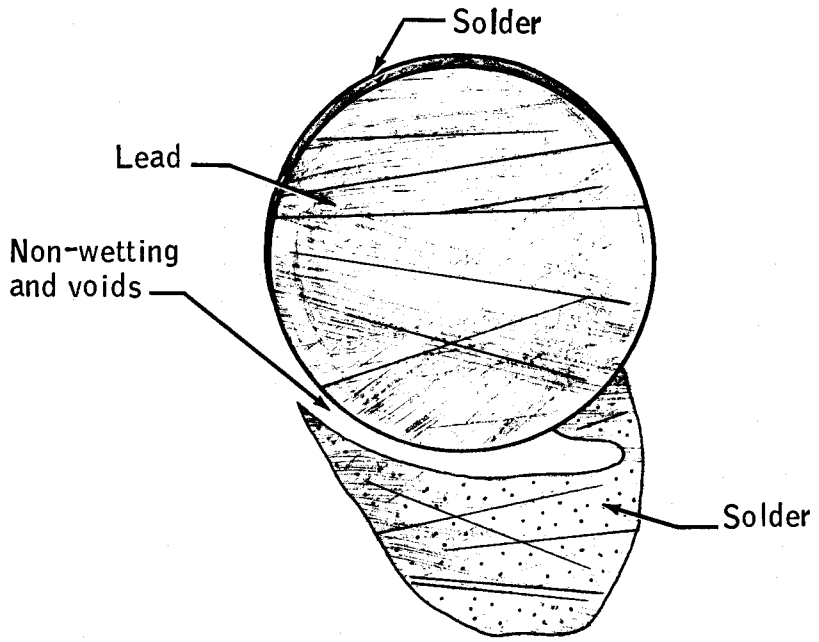

(a) Solder joint

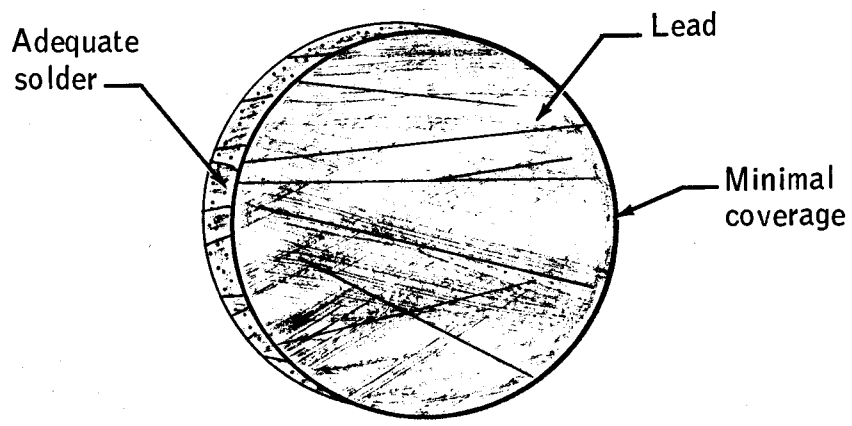

(b) Pretinned section

Figure 7-1. - Sections of solder joint and pretinned lead (magnified 100 times).

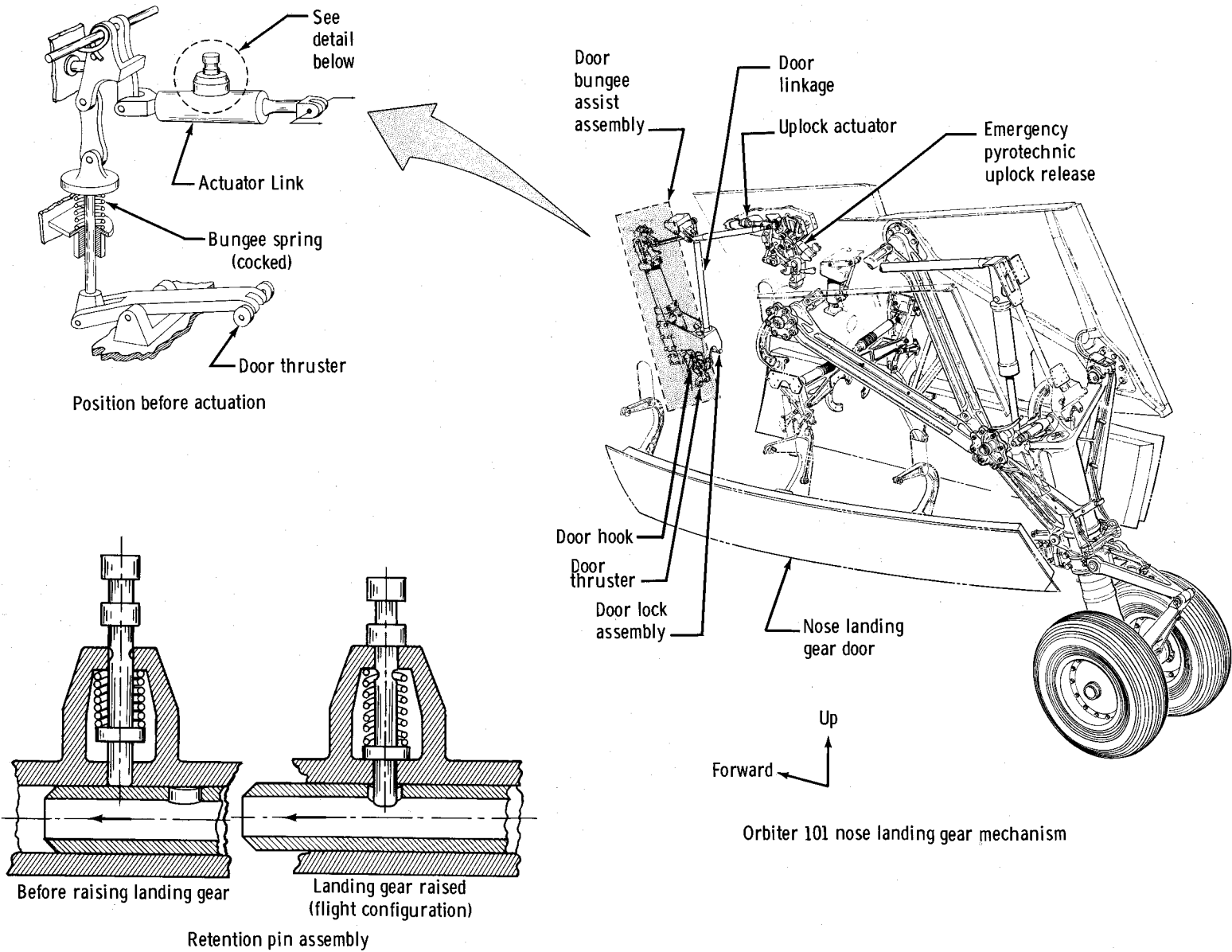

Figure 7-2. - Redesign concept for actuation of nose landing gear door thruster.

Corrective action taken for the remainder of the Approach and Landing Test flights included (1) the addition of fill insulation to better protect the copper lead from the high temperature of the boss and provide support to dampen lead movement and minimize flex stress by the hold-down clamp and (2) provide readout of the redundant temperature measurement in the cabin for crew monitoring.

A more durable probe-type sensor will be installed in the boss for Orbiter 102 and subsequent vehicles (see par. 7.2.14).

This anomaly is closed.

7.2 FREE FLIGHTS

7.2.1 General Purpose Computer 2 Lost Synchronization at Separation

Computer 2 (system F8) lost synchronization at separation on free flight 1. (Dump data showed that the first failure indication occurred within approximately 20 milliseconds after separation.) Fourteen of fifteen input-output errors logged by computer 2 after separation were on busses commanded by computer 2. The input-output processor/central processing unit interface was executed in an unusual manner with missing or unsolicited interrupts and receipt of an unknown level B input-output error. In addition, several unexplained or unexpected computer 2 memory locations were altered, including changes in input-output processor code, an abnormally large input-output processor program data variable and unexpected modification of input-output control blocks.

Computers 1, 3 and 4 logged eight input-output errors after separation. All but one were on busses commanded by computer 2. Computers 1, 3 and 4 saw separation A discrete only, while computer 2 saw separation B discrete. Computer 2 did open flight control limits and initiate separation guidance, navigation and control processing.

Postflight testing on the vehicle (including pyrotechnic shock and electromagnetic interference tests) did not reproduce the problem. Also, the grounding paths in the vehicle were measured and verified to be proper. However, the problem was reproduced at the vendor's facility when the flight unit (input-output processor, serial number 7) was subjected to low-level vibration testing at $0.01 \text{ g}^2/\text{Hz}$. Subsequent inspection revealed a solder crack at a prom lead on the queue page (fig. 7-3). The solder had failed to wick in a plated-through hole. The unit had been acceptance tested at $0.04 \text{ g}^2/\text{Hz}$ after 1848 hours of field run time. The failure occurred after only 150 additional hours. The failure was probably caused by fatigue due to vibration and thermal cycling. Acceptance testing is unable to screen out potential fatigue failures.

In-line changes had been implemented to circumvent this kind of problem, but not in time to be applied to system F8. Using the old verification procedure, the crowded page configuration made even oblique X-ray examination of some solder joints unsatisfactory for verification of the complete page. To correct this situation, the procedure was modified so that component X-ray inspection of solder wetting is accomplished before back-plate installation. Other changes

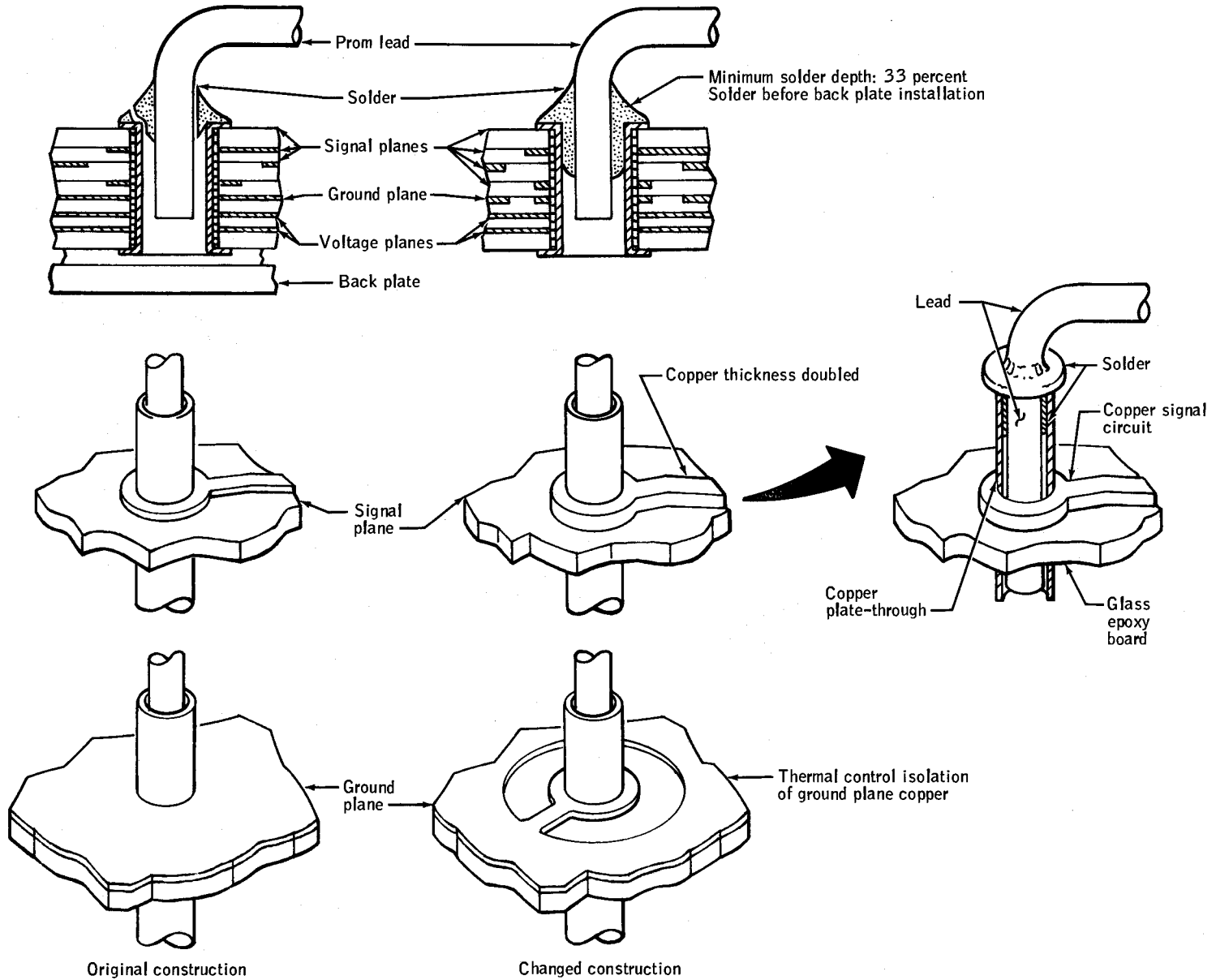

Figure 7-3.- Change in computer page lead connections to improve solder wicking.

consisted of doubling the copper thickness of the signal planes to increase physical strength during solder heating and providing thermal relief around the ground plane junction, reducing thermal conductivity away from the solder connection (fig. 7-3). The thermal relief modification provides a smaller, controlled heat path between the solder connection and the rest of the ground plane, slowing the heat sink rate and allowing flow, filling, and bonding of solder to at least 33 percent of full depth.

The changed procedure is applicable to the local store page, the queue page and the two prom pages in the input-output processor, and the two prom pages in the central processing unit. All flight computers were retrofitted with the improved pages prior to free flight 2 and the computers performed satisfactorily.

This anomaly is closed.

7.2.2 Equivalent Airspeed "Off" Flag Was Reported On Commander's Alpha/Mach Indicator During Free Flight 1

The equivalent airspeed indicator "off" flag is a spring-loaded dropout flag normally hidden from sight. The flag appears over the indicator tape when the associated data channel fails to update within 100 milliseconds, the tape position error exceeds 0.38 inch but not less than 0.19 inch for 2.5 seconds, or the 28-volt dc power drops below 20 volts. The failure may be caused by a computer data lapse, the indicator electronics unit, the indicator unit, or the interconnecting cable.

The problem was not isolated during ground test. The indicator unit was replaced. The "off" flag of the replacement indicator unit was intentionally made inoperative. The electronics unit may not be removed without disturbing numerous cable harnesses and other equipment. Therefore, the electronics unit was left in place for the subsequent flights.

The electronics unit and interconnecting cable will not be removed prior to April 1978 because removal would impact scheduled testing.

This anomaly is open.

7.2.3 Main Landing Gear Door Hinge Pin Assembly was Missing

The following anomalies were reported after the free flight 1 postflight inspection:

- a. Left main landing gear door: The forward hinge pin assembly was missing and the aft hinge pin assembly had moved approximately 1/4 inch.
- b. Right main landing gear door: The forward and aft hinge pin assemblies had moved approximately 1/4 inch.

Examination showed that undersized washers were specified in the drawings (fig. 7-4). As a result of a drawing search conducted on all joint fittings, undersized washers were also found in the clevis joint at the wing rib truss tube and the wing aft spar.

Larger retainer washers were installed on the hinge pins of the landing gear door hinges and the clevis pins of the wing truss tube and the wing aft spar.

This anomaly is closed.

7.2.4 Orbiter UHF Communications Were Marginal and Noisy on Channel 259.7 Megahertz

During free flight 1, orbiter UHF communications on the 259.7 megahertz frequency were marginal and noisy. Postflight, the problem was isolated to an intermittent connection in the antenna (fig. 7-5) and the antenna was replaced. However, the problem re-occurred during free flight 3. Postflight troubleshooting determined that the cable leads connecting to the antenna feed network were shorted due to improper soldering (fig. 7-6). In addition, inspection of the antenna installation showed that a flange gasket, which should not have been installed, and overtightening of the mounting bolts had caused distortion of the antenna flange. The antenna was replaced for free flight 4 and UHF communications on the 259.7 megahertz frequency were satisfactory for the remainder of the Approach and Landing Test Program. The antenna will be flush mounted for the Orbital Flight Test Program.

This anomaly is closed.

7.2.5 OPS 203, OPS ITEM 13 and OPS 201 Error Messages

After separation on free flight 2, at the start of the programmed test input routines, an OPS 203 error message occurred when the Pilot entered "OPS 203" on the keyboard followed by "PRO" (proceed). A display electronics unit memory dump performed after the flight showed three illegal key codes on display electronics unit 2. Two were logged during ground checkout and one after separation. The display electronics unit was replaced for flight 3.

On free flight 3, an OPS ITEM 13 error message occurred prior to separation during microwave landing system selection by the Commander. A display electronics unit memory dump performed postflight showed the illegal key code on display electronics unit 1. No other illegal key codes were logged for the flight.

On free flight 4, an OPS 201 error message occurred during preflight checkout. A postflight display electronics unit memory dump showed three error messages on unit 2 and one on unit 3, all of which had been logged during preflight checkout.

7-9

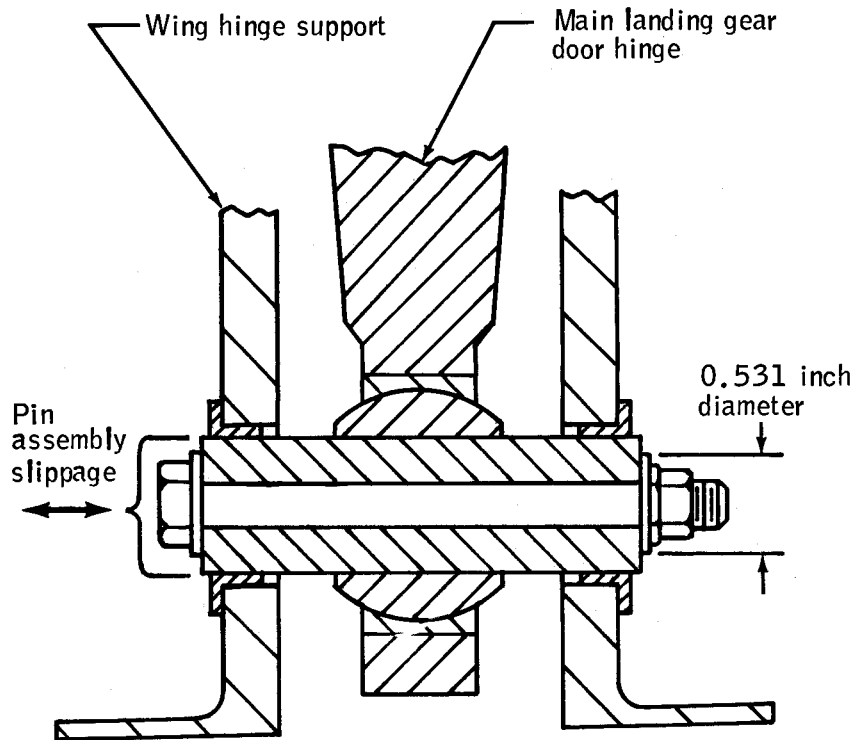

Washer too small to retain pin on forward and aft hinges

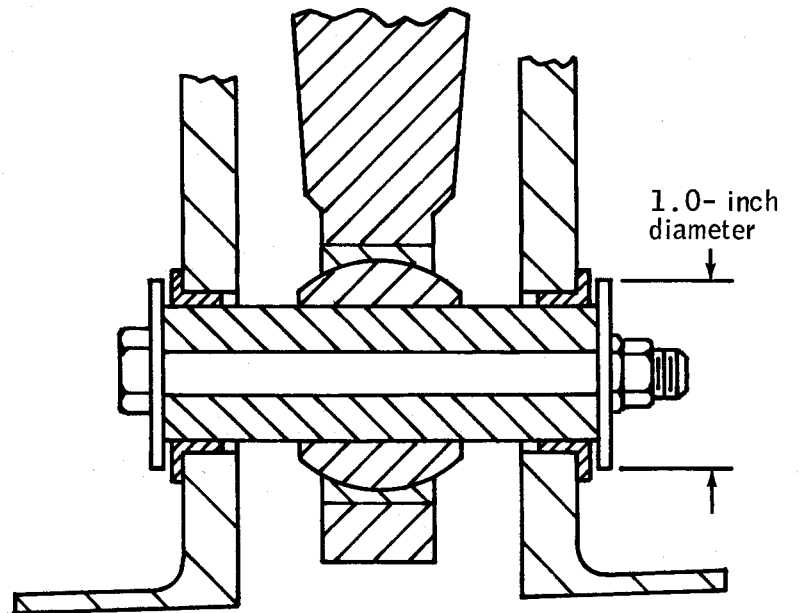

Washer diameter increased

Figure 7-4.- Main landing gear door hinge assembly.

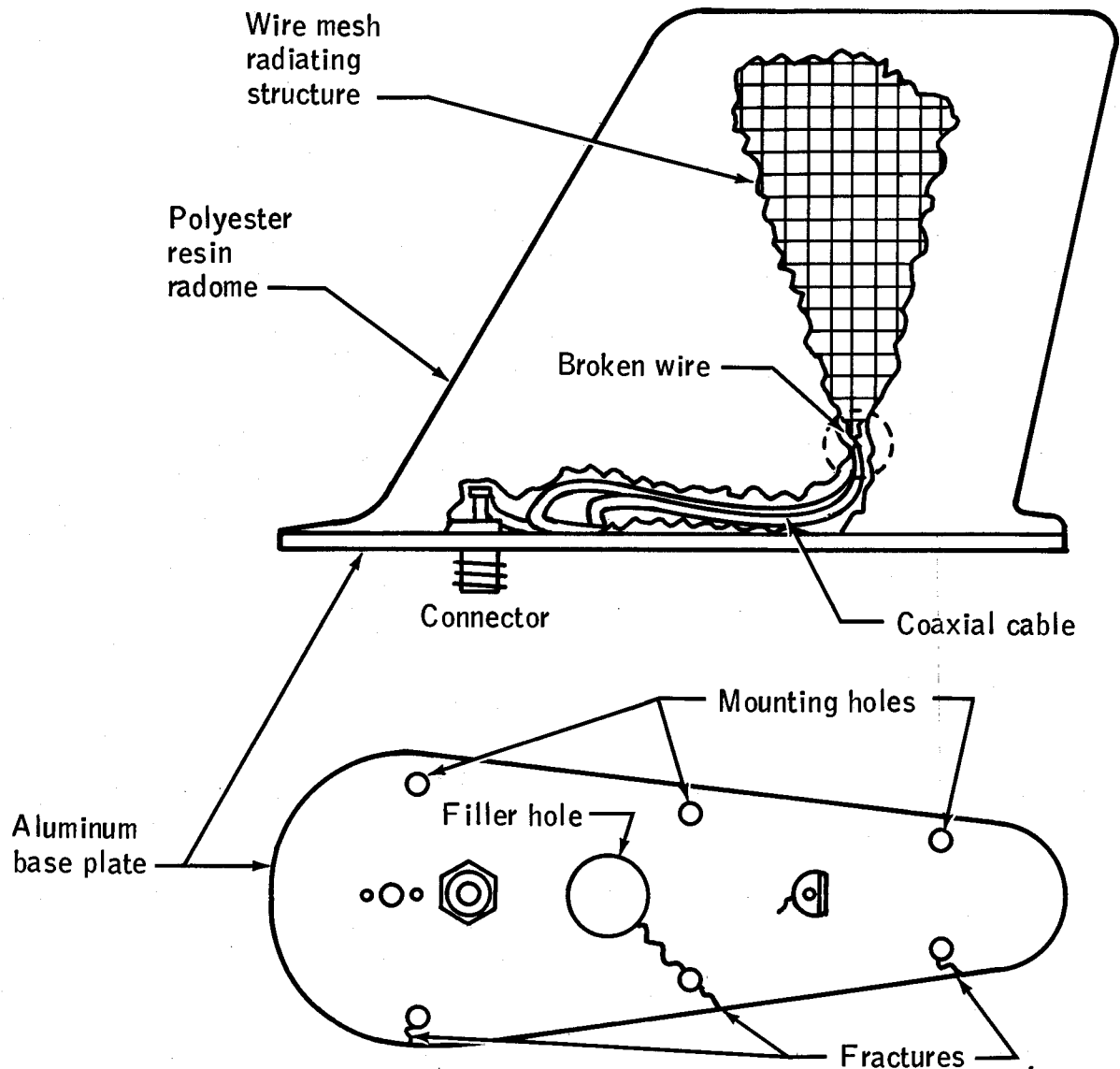

Figure 7-5.- UHF blade antenna failure on Free Flight 1.

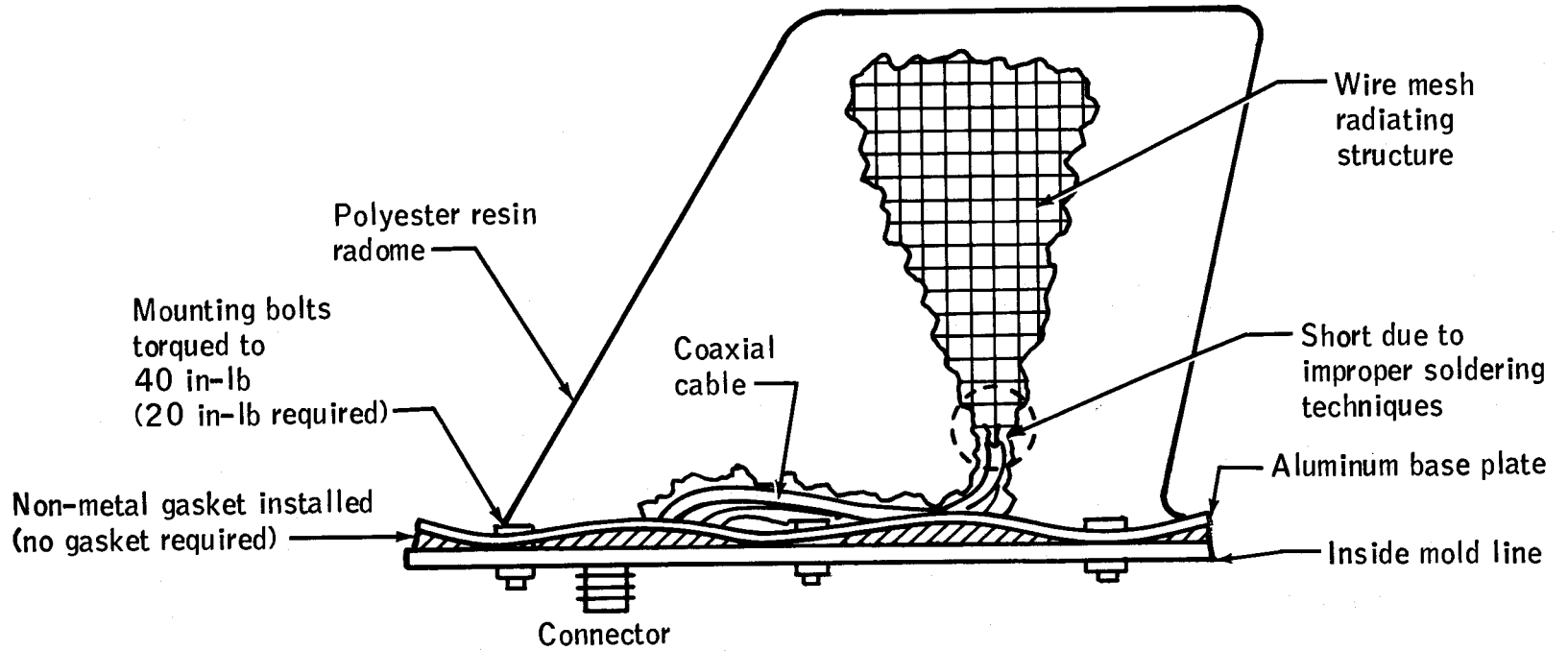

Figure 7-6.- UHF blade antenna failure on Free Flight 3.

There was also an error message on the display electronics unit 2 scratch pad line during preflight checkout for free flight 5. This occurrence was attributed to operator error. A postflight memory dump revealed an illegal key code on display electronics unit 1 that was not reported at the time of occurrence.

Electromagnetic interference most probably caused the display electronics unit to reject and log valid crew keyboard entries as illegal key codes. An in-line change has been approved which will provide for shielding of display electronics unit input and output signals for Orbiter 102 and subsequent vehicles.

This anomaly is closed.

7.2.6 Orbiter Pilot's Intercommunications Were Intermittent

The orbiter Pilot's intercommunications side tone slowly faded out two or three times over a 30-second interval before carrier aircraft engine start on free flight 3. Postflight troubleshooting isolated the problem to a Pilot's intercommunication station line-replacable unit. The communications panel on the Pilot's side was replaced for free flight 4 but a similar problem was reported by the Pilot on free flight 5.

An interim Air Force intercommunications system was used for the Approach and Landing Test Program. A newly developed communications system will be installed on Orbiter-102 and subsequent vehicles.

This anomaly is closed.

7.2.7 Fuel Cell 1 Condenser Exit Temperature Was Low

After switchover from ground support equipment to internal power and the fuel cell purge during preflight operations for free flight 3, the condenser exit hydrogen temperature reached a low of about 136° F, compared to a normal reading of 142° to 148° F. Prior to this time, the temperature central point had been in the normal range. The 136° F temperature corresponds to an electrolyte concentration of about 46 percent potassium hydroxide. The flight limit is 48 percent potassium hydroxide, which corresponds to a condenser exit hydrogen temperature of 125° F for the observed operating conditions. Operation at temperatures lower than 125° F can cause localized drying out and potential loss of the fuel cell.

The condenser exit temperature is controlled by selective mixing of hot and cold coolant by the condenser exit temperature control valve. The mix position of the valve (fig. 7-7) is directly controlled by the plunger and the sensor medium (expanding/contracting wax) assembly, which is mounted in the flow stream of the condenser exit line (fig. 7-8). The temperatures at the hot and cold inlets to the valve are controlled by the hot premixing valve and the cold premixing valve. An off-nominal condition in either of these three valves could result in abnormal condenser exit temperatures.

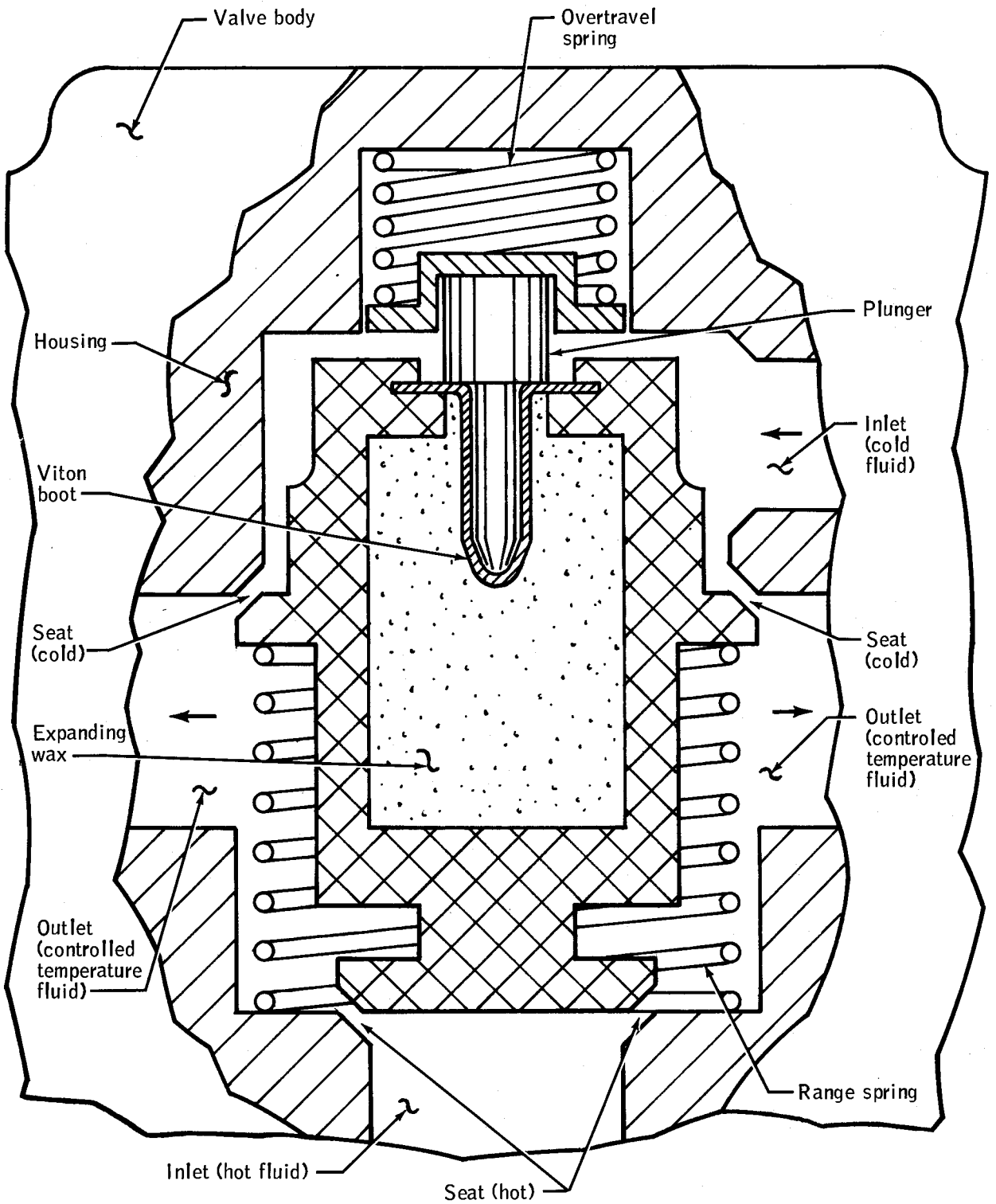

Figure 7-7.- Typical fuel cell thermal control valve (simplified).

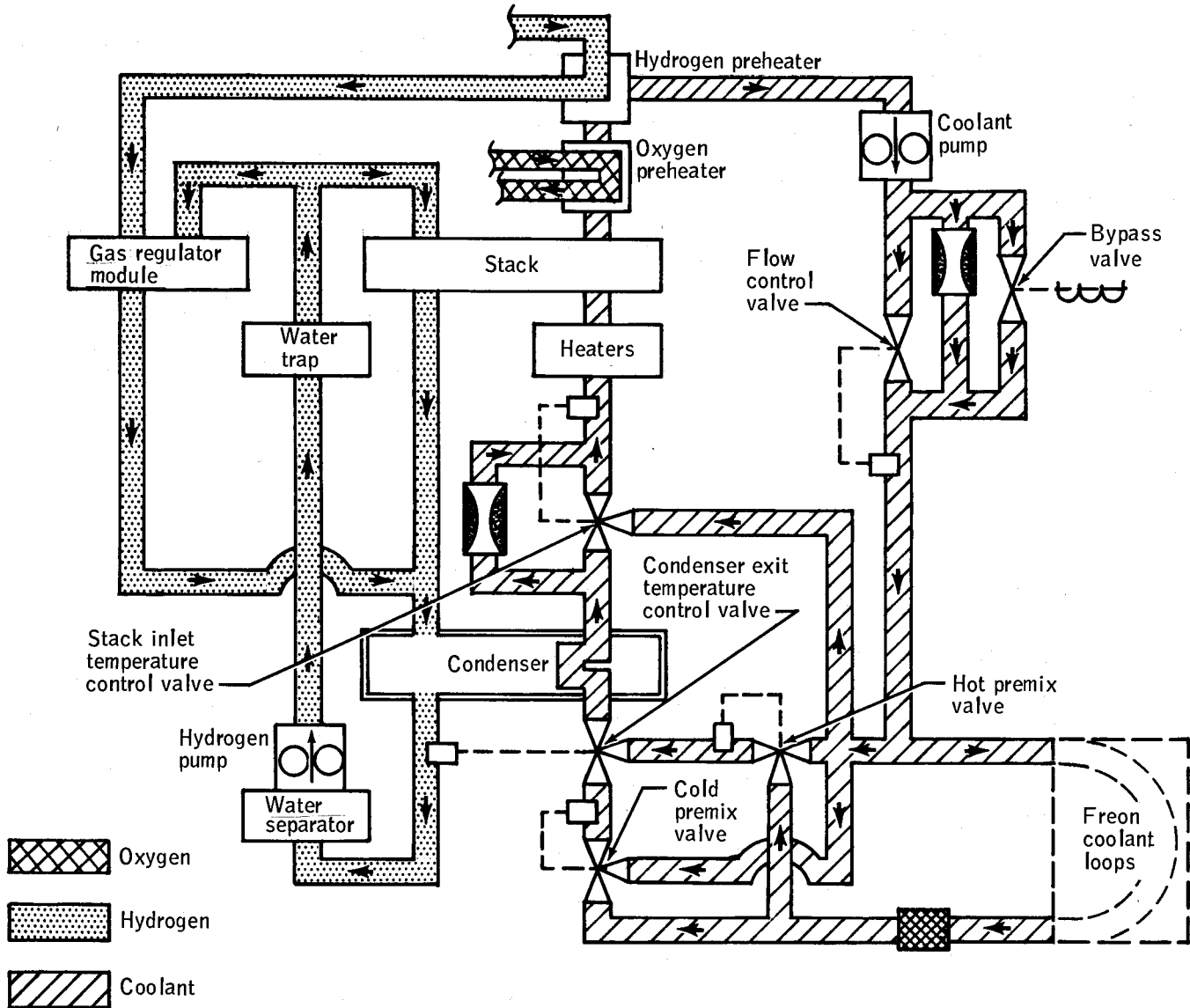

Figure 7-8.- Fuel cell thermal control system.

Figure 7-7 is typical of both the hot and cold premixing valves, and similar to the condenser exit temperature control valve. The wax expands as it heats, forcing the plunger out of the housing, gradually closing off the hot fluid inlet, and gradually opening the cold fluid inlet. Swelling of the Viton boot by fuel cell coolant absorption would tend to shift the valve setting so as to admit more cold and less hot fluid. A similar 8° to 10° F shift occurred during fuel cell development because of swelling of the Viton boot.

The Viton boots in the fuel cell condenser exit temperature control valves were not presoaked and could have swollen, causing a change in valve position, resulting in the temperature shift observed. The low temperature observed on free flight 3 and small shifts observed on free flights 4 and 5 were within the range that analyses and ground test data have shown could provide satisfactory fuel cell operation. The conclusion was reached that the swelling of the boot or boots was essentially complete and stabilized.

Viton boots for the higher temperature coolant valves are now presoaked to ensure dimensional stability and to avoid swelling.

This anomaly is closed.

7.2.8 Orbiter Landing Gear "Chattered" During Hard Braking

Following free flights 2 and 3, the crews reported "chatter" during heavy application of the brakes. On flight 2, the chatter occurred during high-speed differential braking and moderate-speed braking.

After nose wheel touchdown on free flight 3, light braking was applied followed by increased braking until the chatter was encountered. At 110 knots, moderate to hard left braking was reapplied for left differential braking and severe chatter was again encountered. As the speed was reduced from 80 to 20 knots, the crew maintained constant braking and the chatter was less severe, diminishing as velocity decreased.

Postflight ground tests on Orbiter 101 verified that the hydraulic portion of the brake skid control system had an excessive amount of hydraulic phase lag (slow hydraulic response to an electronic brake command) which resulted in poor landing gear strut damping producing the "anti-skid chatter." This problem was attributed to incorrect values of strut frequency and hydraulic phase lag being given to the vendor for design and test use in the brake/skid control simulator.

The brake skid control electronics were modified to provide more phase lead, thus compensating for the excessive hydraulic lag. Anti-skid performance on the subsequent flights was effective and smooth with no "chatter."

This anomaly is closed.

7.2.9 Centerline Camera Activated Prematurely

The forward-pointing centerline camera beneath the orbiter was armed, started, and stopped prior to separation on free flight 3. The actuator employs a baro-switch for arming at an altitude of about 12 000 feet on climbout and for starting at an altitude of about 12 000 feet on descent. A 6-minute timer controls run time. When the camera was armed during climbout, it started and ran for 5 minutes.

Troubleshooting of the actuator at the vendor's indicated that the timer could be actuated during ground assembly prior to installation and would continue cycling until the camera was armed. After arming, the camera would start immediately and time-out on the current timer cycle. Ground assembly procedures were modified to ensure that the actuator timer was manually reset prior to installation in the vehicle.

On free flight 4, the centerline camera activated prematurely but ran for the normal 6 minutes. The pictures showed that the camera started on climbout. Postflight testing demonstrated that the barostat would activate at $9.05 \pm 0.05 \text{ lb/in}^2$, corresponding to $13\,550 \pm 650$ feet on free flight 4. The actuator logic waits for 1-1/2 minutes after arming by the barostat before looking for the barostat start signal. This corresponded to 900 feet delta altitude at 13 500 feet on free flight 4 compared to 1950 feet on free flight 3 due to the decreased rate of climb between the tail-cone-on and the tail-cone-off configurations. The variance in baroswitch trigger points and in local atmospheric conditions in conjunction with the lower rate of climb probably resulted in premature camera activation.

The delay logic was increased to 5 minutes after the arm signal and the actuator timer was replaced. The camera operated properly on free flight 5.

This anomaly is closed.

7.2.10 Maintenance Recorder Tracks 8 Through 14 and "Bulk Erase" Were Inoperative

Tracks 8 through 14 and "bulk erase" were inoperative on the maintenance recorder after free flight 3. Tracks 1 through 7 provided sufficient coverage for free flight and the "erase-before-record" function was adequate for erasing.

Troubleshooting will be performed at a later date.

This anomaly is open.

7.2.11 Left Main Landing Gear Brake Lining and Heat Sink Were Damaged

Postflight inspection after free flight 4 revealed that the left main inboard and outboard landing gear brake carbon lining segments and a heat sink had been damaged. On the left inboard brake, one carbon lining segment was removable, eight segments had chipped edges, several surfaces were scored or scratched, and one beryllium heat sink was chipped on a corner. Several carbon lining segments had chipped edges on the left-hand outboard brake also. The brakes on the right main landing gear were not damaged.

All four brake assemblies were replaced, and the brakes operated normally on free flight 5; however, postflight inspection revealed that four carbon lining segments on the left inboard brake had chipped edges on the unloaded side of the stators.

This anomaly is open.

7.2.12 Inertial Measurement Unit 1 Y-Axis Accelerometer Calibration Was Out of Tolerance

Inertial measurement unit 1 Y-axis accelerometer calibration during the free flight 5 countdown was out of tolerance. A 105-sigma shift was indicated in one term. Recalibration showed that the bias shift was stable within 0.3 sigma. Troubleshooting on inertial measurement unit 1, serial number 7, is to be performed.

This anomaly is open.

7.2.13 TACAN Failures to Lock

TACAN 3 failed to track properly on captive-active flight 3. A solder bridge was found in a transistor in the AGC loop. This is a workmanship problem with off-the-shelf hardware and is dependent on thermal cycling and vibration. Experience with existing units indicates that this is not a generic problem. The unit was repaired, reinstalled, and retested.

On free flight 5, TACAN 3 failed to lock for about 8 minutes on both the China Lake and Edwards TACAN's while the race track pattern was being flown. TACAN 3 was deselected. Subsequently, TACAN 3 locked on George and then China Lake, operating satisfactorily for the rest of the flight. TACAN 3 was left deselected.

Postflight onboard testing indicated low sensitivity. Additional testing is to be performed.

This anomaly is open.

7.2.14 Auxiliary Power Unit 3 Exhaust Duct Temperature Measurement Failed

Prior to pushover on free flight 5, the auxiliary power unit 3 exhaust gas temperature measurement began to intermittently read zero. The redundant measurement verified instrumentation failure and the failure mode indicated an open power return lead wire to the sensor.

Postflight examination confirmed that a break existed on the copper wire side of the platinum-to-copper-wire brazed joint of the power return from the sensor. The inspection also revealed that the fiberglass support pad between the brazed joint and the exhaust duct wall was degraded, charred, and crystallized (fig. 7-9).

The function of the pad was to support the brazed joint for vibration conditions and to protect the brazed joint from direct exhaust duct temperatures which could rise to levels for which the joint was not qualified.

This design was recognized as being deficient prior to the Approach and Landing Test Program. A similar failure also occurred on captive active flight 3. As a result, a more durable thermocouple probe-type sensor has been procured for Orbiter 102. The sensor will be mounted in the probe boss, which is integral with the exhaust duct.

This anomaly is closed.

7.2.15 Main Landing Gear Camera 1 Film Had Torn Sprocket Holes

Only 10 percent of the film was advanced from the film magazine in main landing gear camera 1. Examination of the film showed torn sprocket holes.

Troubleshooting revealed that a misaligned drive coupling caused the film to jam.

A decal will be installed on the camera giving a warning to check for proper alignment of the drive coupling during magazine installation.

This anomaly is closed.

7.2.16 Carrier Aircraft Aft Camera Failed To Transport Film

Carrier aircraft camera 2 transported only 20 percent of the film. Supply reel startup acceleration during high inflight vibration caused the film to disengage from the sprocket drive teeth.

The same type of camera is planned to be used during the Orbital Flight Test Program to monitor external tank separation. For this application, a keeper has been built around the feed sprocket, the film speed has been reduced to 240 frames per second, and a new electronic speed control will lengthen the film acceleration ramp.

This anomaly is closed.

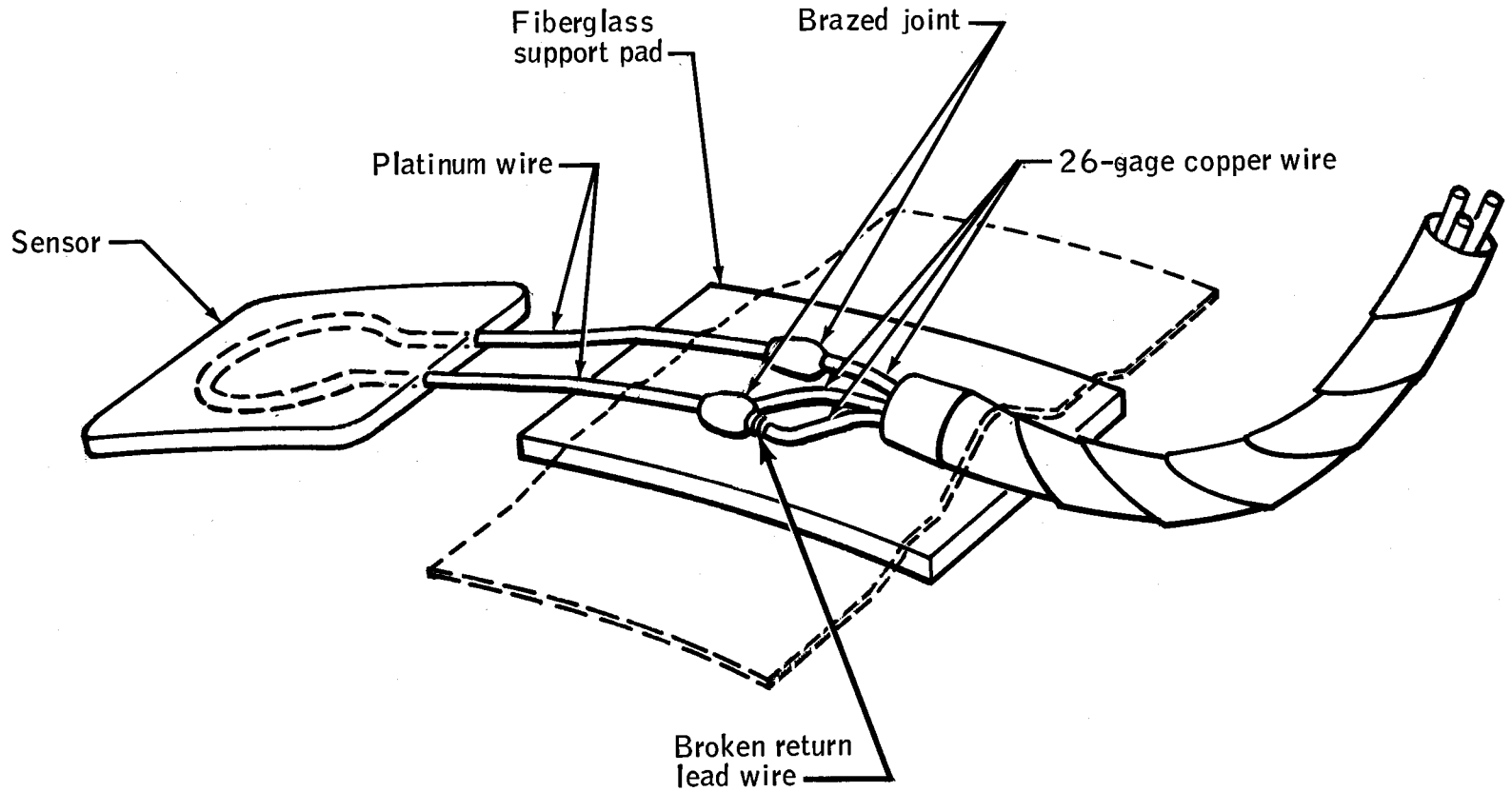

Figure 7-9.- Auxiliary power unit temperature measurement.

7.2.17 Hydraulic System 3 Pressure Was Low During Postlanding Load Test

The hydraulic system performed normally during flight. However, caution and warning response during the postlanding load test indicated an under-pressure condition on hydraulic system 3. Examination of the data revealed that the pressure had decreased from the normal minimum of about 2900 to about 2500 lb/in² for 1 second and then recovered.

The following are possible causes of the excursion.

- a. The priority-rate-limiting software was not functioning properly, possibly allowing momentary demand for a flow rate in excess of pump capability.
- b. An increase in internal system leakage resulted in a demand in excess of pump capability.
- c. A pump problem may have existed which could have resulted in a below-normal flow.

The pump from system 3 has been removed, and is to be tested in the laboratory.

Preflight verification testing of the system for Orbiter 102 is to include independent verification of the new modified priority-rate-limiting system software.

This anomaly is open.

8.0 CONCLUSIONS AND RECOMMENDATIONS

Based on the flight data and crew evaluation:

1. All objectives of the Approach and Landing Test Program were accomplished.
2. The orbiter aerodynamic performance and loads were as predicted.
3. The control authority of the flight control system was less than expected by the crew during touchdown on free flight 5. To improve the chances of coping with deviations at landing (i.e., turbulence and crosswinds), the following recommendations are made and should be incorporated in training and flight control system design as applicable.
 - a. The energy state should be maintained at the preplanned nominal level throughout the flight trajectory utilizing standardized pilot techniques or autoland. The trajectory from preflare to touchdown should be optimized for manual control.
 - b. Operational and flight control system limits should be determined and verified by simulation to determine the crew and vehicle capabilities and limitations to perform a safe landing.
 - c. The flight control system must be modified to always provide at least some combination of pitch and roll capability to allow manual and automatic control for landing.
 - d. The flight control system sensitivity to pilot-induced oscillations should be reduced.
 - e. Nominal trajectory planning should not require the use of speed brakes after flare.
4. Additional significant problems which were encountered during the Approach and Landing Test Program requiring design changes are:
 - a. Landing gear "chattering" during hard braking.
 - b. A "Terminate B" line transient that caused four primary computers to drop aft data busses.
 - c. TACAN's failing to track properly.
 - d. Redundancy management out-of-tolerance limits that were too tight for navigation aids and the air data display system.
 - e. Ingestion of hydrazine into the aft bay.
 - f. Failure of general purpose computer 2 at separation.
5. With modifications appropriate to correct the above problems, the orbiter performance is satisfactory for the approach and landing phase within the Orbital Flight Test operational envelope.

9.0 REFERENCES

1. Shuttle Carrier Aircraft Test Team: Space Shuttle Orbiter Approach and Landing Test - Captive-Inert Flight Test Program Summary. DFRC SOD 40.1, June 1977.
2. Approach and Landing Test Evaluation Team: Space Shuttle Orbiter Approach and Landing Test Evaluation Report - Captive-Active Flight Test Summary. JSC-13045, September 1977.
3. Shuttle Carrier Aircraft Test Team: Summary of the Ferry Qualification Flights. DFRC SOD 40.2, January 1978.
4. Rockwell International, Space Division: Aerodynamic Design Data Book, Vol. IV, Orbiter Vehicle 101. RI-SD72-SH-0060-4J, October 1976.

APPENDIX A - VEHICLE DESCRIPTION

Figure A-1 shows the configuration of the mated Shuttle carrier aircraft and Orbiter 101. Figure A-2 shows the arrangement of Orbiter 101 for the Approach and Landing Test Program. The configuration was, in many respects, unique for the Approach and Landing Test flights. These unique features are listed in table A-I.

A.1 ORBITER 101

A.1.1 Structures

A.1.1.1 Forward Fuselage

The forward fuselage was a semimonocoque structure comprised of skin, stringers, longerons, bulkheads, and frames. It consisted of four major assemblies: upper, lower, wheel well, and boilerplate reaction control subsystem module. The upper assembly contained windshield panels, windows, ejection hatches, star tracker access panels, and antenna support provisions. The lower assembly contained the crew side hatch, an emergency ejection access door, hoisting and jacking provisions, crew module support, and antenna support provisions. The wheel well structure supported all the mechanism for the nose landing gear. The reaction control subsystem module served only as an aerodynamic fairing and to maintain structural continuity.

A.1.1.2 Crew Module

The crew module was a pressure-tight vessel supported within the forward fuselage. The module was constructed of aluminum alloy plate with integral stiffening stringers and internal framing welded together. Equipment support was provided for the environmental control and life support subsystem, avionics, displays and controls, crew accommodations and emergency escape.

A.1.1.3 Mid Fuselage

The mid fuselage consisted of primary structure between the forward and aft fuselage and wing carry-through structure. The forward and aft ends were open, with reinforced skin and longerons interfacing with the bulkheads of the adjacent structure. This section, which was constructed mostly of aluminum, provided support for equipment tie-down fittings, payload bay door hinges, subsystem components and had mounting provisions for the wing glove. Frame trusses and stabilizing members were boron/aluminum composite tubes.

A.1.1.4 Aft Fuselage

The main elements of the aft fuselage were the forward bulkhead with web front face, internal thrust structure, outer shell and floor structure, base heat shield, and secondary structure for systems support. It interfaced with the wing, vertical fin, mid fuselage, body flap, orbital maneuvering subsystem/reaction control subsystem pods, and external tank. Support was provided for avionics, electrical, hydraulic, environmental control and auxiliary power subsystem components.

A-2

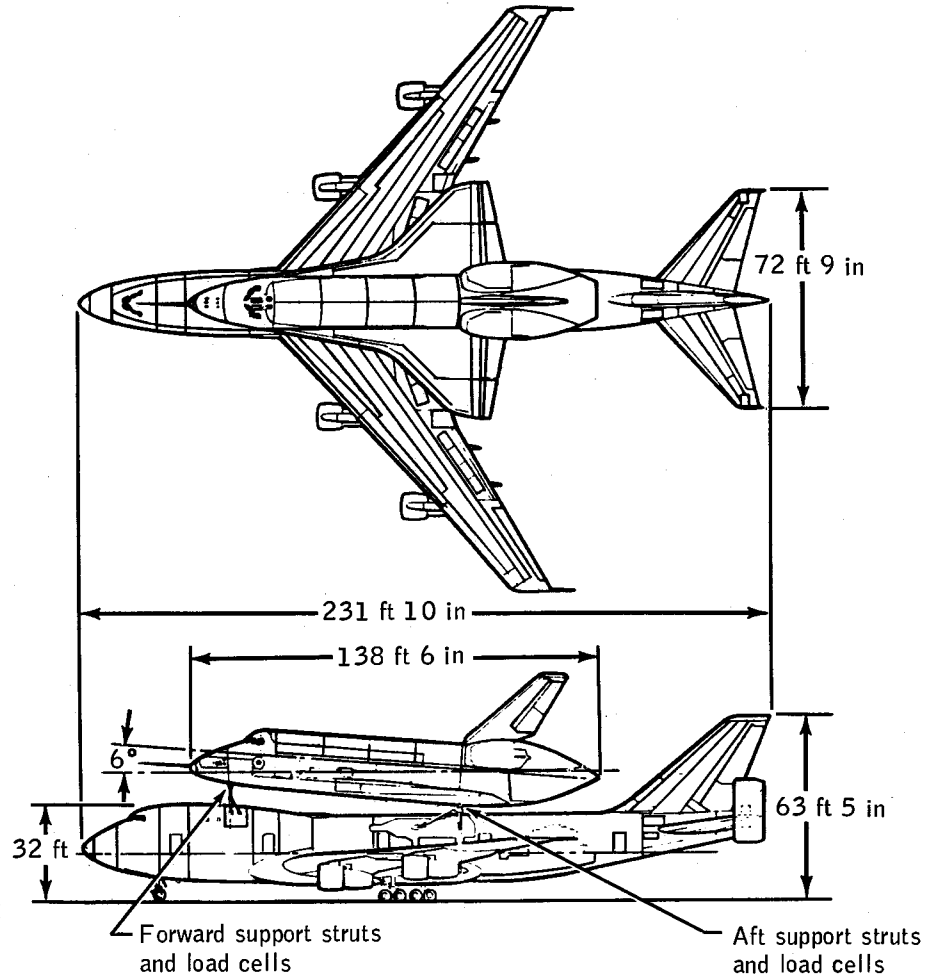
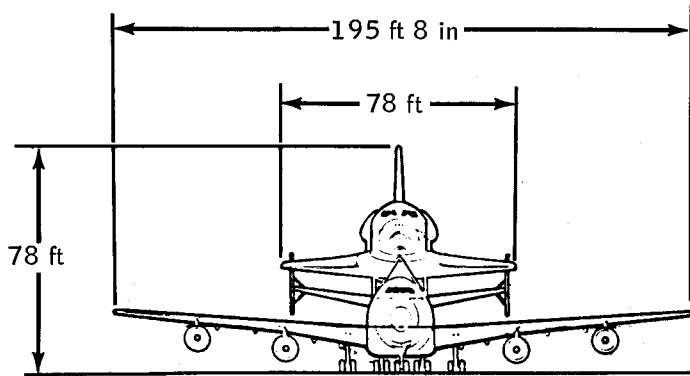

Figure A-1.- Orbiter 101/carrier aircraft configuration.

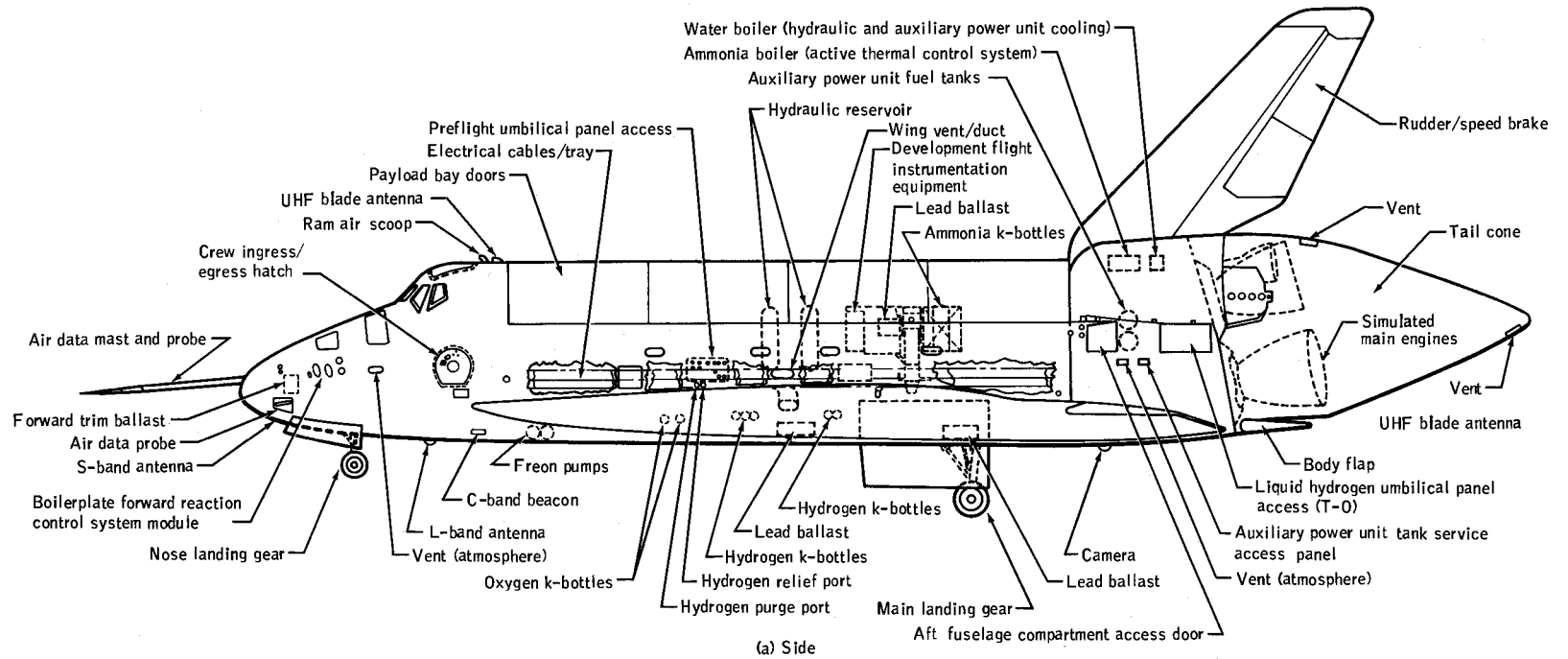

Figure A-2.- Orbiter 101 configuration for approach and landing test.

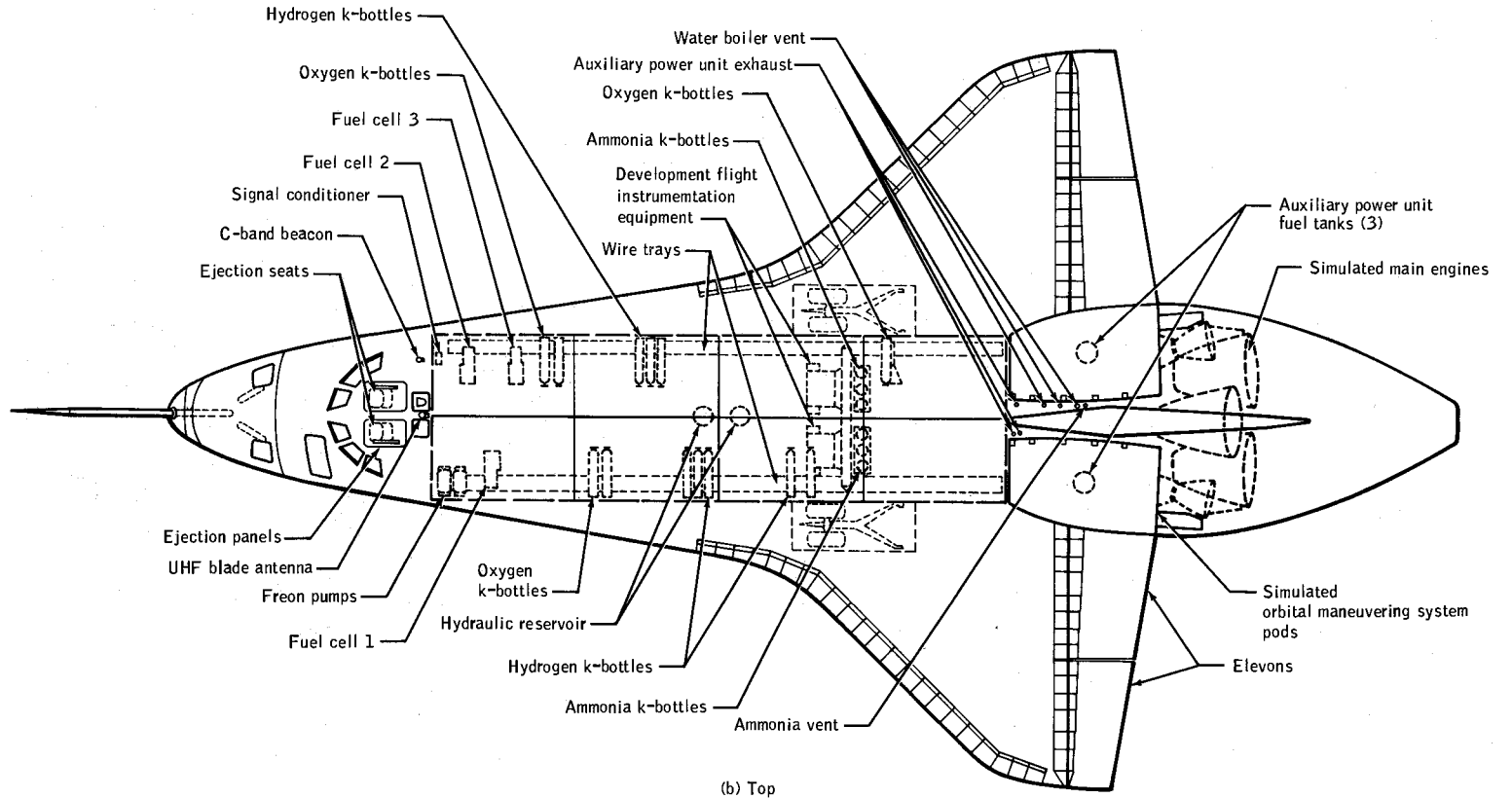

Figure A-2.- Orbiter 101 configuration for Approach and Landing Test.

A.1.1.5 Payload Bay Doors

The payload bay door was 60 feet long with a surface area of over 1600 square feet. It consisted of two panels that opened at the center line. The doors were latched at the upper center line, forward fuselage, and aft fuselage. The door primary structure was of honeycomb panels and frame construction employing composite materials. The door frames were made of multiple graphite/epoxy tape and fabric layups. The face sheets consisted of graphite/epoxy tapes and graphite/epoxy fabric.

A.1.1.6 Wings

The wing subsystem provided conventional aerodynamic lift and control. The forward wing box aerodynamically blended the wing leading edge into the fuselage. The main wing box structure transferred loads to the fuselage, provided for stowage of main landing gear, and reacted a portion of the main landing gear loads. Elevons provided flight control and were hinged to the rear spar that extended the full span of the wing.

A.1.1.7 Vertical Tail

The vertical tail provided aerodynamic stability. It consisted of a structural fin surface and the rudder/speed brake control surface together with actuation subsystems. The structural fin consisted of stiffened skins with mechanically attached ribs and stringers which provided a torque box for primary loads. The rudder/speed brake control surface was attached through rotating hinge points.

A.1.1.8 Tail Cone

The tail cone structure was of conventional aluminum skin/stringer construction. The body flap fairing and trailing edge closeout were constructed of fiberglass.

A.1.1.9 Body Flap

The body flap was basically of aluminum honeycomb construction. It was a two-spar configuration incorporating four actuator ribs and eight aluminum honeycomb stability ribs. Upper and lower honeycomb panels joined a full-depth honeycomb trailing edge assembly at the rear spar.

A.1.2 Thermal Protection

The thermal protection system is a passive system that maintains acceptable outer skin temperatures on the operational Orbiter. Since Orbiter 101 did not experience entry environments during the Approach and Landing Test Program, the actual thermal protection system was not required. Simulated reusable surface insulation was used in areas where maintenance of the outer mold line was required for aerodynamic reasons.

A.1.3 Passive Thermal Control

The thermal control system consisted of passive equipment, fibrous bulk insulation blankets, multilayer insulation blankets, and fasteners to maintain thermal control of all compartments. The thermal control system was installed on Orbiter 101 only where it is functionally required; however, the complete forward-fuselage thermal control system was installed to minimize changes in converting to an operational vehicle. The thermal control system was designed to maintain the crew compartment to acceptable thermal limits, to maintain the hydraulic subsystem water boilers above the freezing point, and to maintain the auxiliary power unit servicing panel above the freezing point of hydrazine.

A.1.4 Purge, Vent and Drain

Orbiter 101 was equipped with a purge system to maintain the thermal environments of the forward reaction control subsystem, mid fuselage, and aft fuselage compartments at levels consistent with the equipment located within those compartments.

The vent system consisted of 16 open holes through the orbiter outer mold line. During ascent or descent, vent/repressurization air freely exited or entered through the vent ports to maintain control of internal compartment pressure. Each vent was fitted with a debris screen. One vent port also served as a disconnect for the purge system and was designed to accommodate the ground support equipment onboard ducting interface.

The drain system included a passive system and an active system. The passive system consisted of holes drilled in selected structural elements to permit free water drainage. The active drain system consisted of three elements, each designed to remove water from inaccessible portions of the fuselage while the vehicle was on jacks.

Orbiter 101 was equipped with a window cavity conditioning system to maintain the window cavities free of fog or frost during ground and flight phases. The system consisted of six distinct subsystems. They serviced the left-hand inner window cavities, right-hand inner window cavities, left-hand outer cavities, right-hand outer cavities, and side hatch inner and outer cavities. Each subsystem has both a purge and vent circuit.

A.1.5 Mechanical

A.1.5.1 Separation

The separation system provided the capability to release the orbiter from the carrier aircraft. This was accomplished by pyrotechnic frangible bolts at three structural attachments, one forward and two aft. Load sensors at each of the structural attachment interfaces provided measurement of the loads between the orbiter and carrier. Separation of electrical umbilicals was accomplished by pull-apart connectors subsequent to structural attachment separation using relative separation motion.

A.1.5.2 Landing and Deceleration

The landing and deceleration system employed a fully retractable tricycle landing gear designed to provide safe landing at speeds up to 221 knots. Dual wheels and tires were used. The shock struts were of conventional aircraft design. Braking was accomplished using brakes with antiskid protection.

A.1.5.3 Surface Control

Aerodynamic control surface movement was accomplished by hydraulically powered actuators that positioned the elevons and by hydraulically powered drive units that positioned the body flap and combination rudder/speed brake through geared rotary actuators. Three redundant systems supplied the necessary hydraulic power.

A.1.5.4 Payload Bay Door Latching

The payload bay doors were manually latched closed for the Approach and Landing Test Program. In this configuration, the payload bay doors acted as part of the orbiter structure.

A.1.5.5 Yaw and Brake Control

The Commander and Pilot were each provided with a set of control pedals. The pedal sets were interconnected to operate in unison with rudder inputs, but operated independently for brake control. Foot pressure applied to the left pedal resulted in left rudder control inputs. Foot pressure applied to the right pedal resulted in right rudder control inputs. Toe pressure applied to either pedal caused the pedal to rotate about the pedal shaft and initiated braking action. Both the rudder and brake systems incorporated an artificial feel system to manage crew input forces. Both systems, through mechanical linkages, transferred the crew-initiated displacements to position transducers which, in turn, converted these displacements to electrical signals that were relayed to flight control avionics.

A.1.5.6 Actuation Mechanisms

Actuation mechanisms were included on Orbiter 101 for the ingress/egress hatch, ejection access door and air data probes.

The ingress/egress hatch provided access to the interior of the crew module. The hatch was hinged to open outward and was attenuated to prevent damage to the vehicle when the hatch was allowed to free fall on opening. The hatch was held in the closed/sealed position by a series of overcenter latches. The latches were driven by a hatch latch actuator.

The ejection access door was a manually operated external door that could have been opened by ground personnel during an emergency, if required, to gain access to the ejection panel jettison handle.

Air data probes and actuators were located one on either side of the orbiter forward fuselage. The probe sensed local pressures and total temperature. For the Approach and Landing Test Program, the probes were normally held in the deployed position.

The air data nose boom was mounted on a mast that extended forward from the orbiter nose. The boom consisted of a Pitot-static tube, total temperature sensor, and pivoted vanes for sensing angle of attack and sideslip. This boom served as a backup to the air data probes and to calibrate the orbiter production air data system.

A.1.6 Hydraulic Power

The hydraulic system provided hydraulic power to the main and nose landing gear, brakes, nose wheel steering, rudder/speed brake, body flap actuators, and elevator actuators. Hydraulic power was provided by three independent systems that were each powered by hydraulic pumps driven by separate auxiliary power units.

A.1.7 Pyrotechnics

Pyrotechnic devices were provided for the following functions.

- a. Emergency ejection (seats and overhead panels)
- b. Backup uplock release of nose landing gear strut and door opening
- c. Orbiter/carrier aircraft separation
- d. Fire extinguisher activation

A.1.8 Power

A.1.8.1 Auxiliary Power Units

The auxiliary power unit subsystem consisted of three independent systems that provided mechanical shaft power to hydraulic pumps (one pump per auxiliary power unit). The pumps transmitted hydraulic power to aerodynamic surfaces (elevons, rudder/speed brakes, body flap), landing gear, brakes and steering controls.

A.1.8.2 Electrical Power Generation

Three fuel cells provided dc power to the electrical power distribution and control subsystem.

A.1.8.3 High-Pressure Gas Storage

The high-pressure gas storage subsystem provided hydrogen and oxygen reactants to the fuel cells for generation of vehicle electrical power. The reactants were stored as high pressure gases at ambient temperatures. The system was used only on Orbiter 101. It will be replaced with a cryogenic reactant storage system having significantly greater capacity for space flight missions.

A.1.9 Propulsion

A.1.9.1 Main Propulsion Subsystem

The main propulsion subsystem was not installed for the Approach and Landing Test Program. Dummy main engines simulating the mass and envelope of the actual engines were installed for the tail-cone-off flights.

A.1.9.2 Orbital Maneuvering Subsystem/Aft Reaction Control Subsystem

No subsystem hardware, actual or simulated, was installed.

A.1.9.3 Forward Reaction Control Subsystem

No subsystem hardware, actual or simulated, was installed.

A.1.10 Avionics

A.1.10.1 Guidance, Navigation and Control

The guidance, navigation and control subsystem included the equipment required for automatic and manual control capability, provision of guidance commands that drove control loops and provided displays to the crew, and inertial navigation updated by RF navigation aids for approach and landing.

A.1.10.2 Communications and Tracking

The communication subsystem consisted of the RF processing and distribution equipment necessary for reception, transmission, and distribution of orbiter and ground-originated voice; transmission of PCM data; and carrier aircraft relay of PCM data. The subsystem also included TACAN navigational aids, radar altimeter, and microwave scan beam landing system. Off-the shelf aircraft-type UHF transmitter/receivers and aircraft-type intercom stations and controls were used. An S-band FM transmitter was used for data transmission.

A.1.10.3 Displays and Controls

The displays and controls subsystem consisted of those equipments and devices required by the crew to supervise, monitor, and control the various orbiter operational subsystems.

A.1.10.4 Instrumentation

The instrumentation subsystem was made up of operational instrumentation and development flight instrumentation. The development flight instrumentation will not be used after the development phase of the program has been completed.

The Orbiter 101 tape recorders were designed to store and reproduce digital and analog flight data both singularly and in combination as programmed prior to flight. A maintenance recorder recorded digital data. A wideband recorder recorded the outputs of 12 frequency division multiplexers.

A.1.10.5 Data Processing

The data processing system provided onboard data processing, data transfer, data entry, and data display associated with operations of the orbiter avionics.

A.1.10.6 Electrical Power Distribution and Control

The electrical power distribution and control subsystem distributed dc vehicle power and generated ac power for use of the various subsystems throughout all of the Shuttle missions and mission phases. Also included as part of the subsystem were the events control and pyrotechnic sequencing functions.

A.1.10.7 Flight Software

The Orbiter 101 software subsystem provided data processing capabilities for guidance, navigation, and control; communication and tracking; displays and controls; system performance monitoring; subsystem sequencing; and selected ground functions.

A.1.11 Environmental Control and Life Support

The environmental control and life support system included the atmospheric revitalization subsystem, life support functions, and the active thermal control system.

A.1.11.1 Atmospheric Revitalization

The following functions were provided for the Approach and Landing Test Program: passive cabin pressure control, emergency smoke removal, humidity and temperature control, and avionics equipment temperature control. The atmospheric revitalization system was operated continuously during all phases of a flight.

A.1.11.2 Life Support

The life support functions included water storage and fire detection and suppression. The water condensate resulting from humidity control collected from the cabin heat exchanger and the water produced from the fuel cell reaction was collected and stored. The fire detection and suppression subsystem could detect smoke in the avionic bays and the crew compartment. Portable fire extinguishers were provided for the crew compartment. Fixed fire extinguishers for each avionics bay could have been actuated from the flight deck.

A.1.11.3 Active Thermal Control

The active thermal control provided for the rejection of vehicle waste heat and active thermal control of selected equipment. This system consisted of fluid transport loops, an ammonia boiler system, and coldplate networks in the aft fuselage, mid body and on the development flight instrumentation pallet.

A.1.12 Crew Escape System

The crew escape system provided emergency escape capability for the flight crew under stationary conditions on the ground, or in flight. The system included: two ejection seats, ejection panels above each seat, ejection guide rails and support structure, and a redundant energy transfer system consisting of pyrotechnic devices.

A.1.13 Crew Equipment

The crew equipment consisted of items such as clothing, survival kits, cameras, voice recorders, flight data file, et cetera. The following equipment was provided for the Approach and Landing Test Program.

A.1.13.1 Crew Support Equipment

The crew support equipment for each crewman consisted of clothing, helmet, shroud line cutter, integrated harness, water container, urine container, and spur assemblies for foot retention in case of emergency ejection. The integrated harness interfaced with the ejection seat and also interfaced with the descent device for emergency escape from a stationary Orbiter.

A.1.13.2 Ejection Seat and Parachute Survival Kits

The survival kits contained items that would have been used for crew survival in water or on land in the event that emergency ejection from the orbiter had been necessary.

A.1.13.3 Carry-On Oxygen System

The carry-on oxygen system provided breathing capability to the crew through the entire profile of the Approach and Landing Test Program. This included cabin air for breathing under sea-level conditions, supplemental oxygen during flight, and 100-percent oxygen for a contaminated cabin atmosphere, or during ejection. A communication microphone was also provided with the oxygen mask.

A.1.13.4 Sixteen-Millimeter Camera Systems

The following camera systems were provided.

- a. Three cameras were located in the cabin: camera 1 recorded the panel F5 clock and panel F6 instruments, camera 2 recorded the Commander's activity, and camera 3 viewed the approach and landing from the forward right-hand window.
- b. Two cameras were located in the right main landing gear wheel well: camera 1 viewed the door release mechanism and camera 2 viewed the landing gear deployment and motion of the strut, wheel and tires during touchdown and rollout.

- c. Two cameras were located in the nose landing gear wheel well: camera 1 viewed the door release mechanism and camera 2 viewed the landing gear deployment and motion of the strut, wheel and tires during touch-down and rollout.
- d. A centerline track camera located on the underside of the aft fuselage viewed deployment of the nose landing gear, left main landing gear, and motion of the landing gear and struts, wheels and tires during rollout.
- e. Orbiter/carrier aircraft separation cameras were located on the top of the carrier aircraft: camera 1 viewed the two aft attach points and camera 2 viewed the forward attach point.

A.1.13.5 Crew Intercom Recorder

Two recorders were provided on the mid deck to record crew voice transmissions.

A.1.13.6 Crew Ancillary Equipment

This equipment included such items as sunglasses, chronographs, and writing materials.

A.1.13.7 Flight Data File

The flight data file consisted of onboard documentation and related crew aids. It included checklists, schematics, charts, and cue cards.

A.1.13.8 Crew Removal Radio System

This system consisted of two VHF/FM handheld radios which were used for communications between the ground crew and Orbiter crew during post-landing operations after power-down.

A.1.13.9 Protective Breathing System

This system consisted of two portable breathing systems which provided compressed air through breathing masks to allow egress on the ground in a hazardous atmosphere.

A.2 SHUTTLE CARRIER AIRCRAFT

The Shuttle carrier aircraft, designated NASA 905, is a Boeing 747 that has been modified to serve as a transporter vehicle for the Orbiter. Permanent modifications were made to the basic structure and subsystems that remain with the aircraft. Other modifications are removable as kit hardware.

Government-furnished equipment installed in the carrier aircraft consists of a crew bailout system, L-band telemetry equipment, a C-band system, a UHF transceiver, and two separation cameras. The crew bailout system consists of (1) an escape tunnel from the flight deck to the cargo bay, (2) a pyrotechnic system for bursting windows to provide depressurization through the passenger compartment and for cutting an egress port in the fuselage structure, and (3) an aerodynamic spoiler that extends through the egress port.

Permanent and removable modifications are shown in figures A-3 and A-4, respectively.

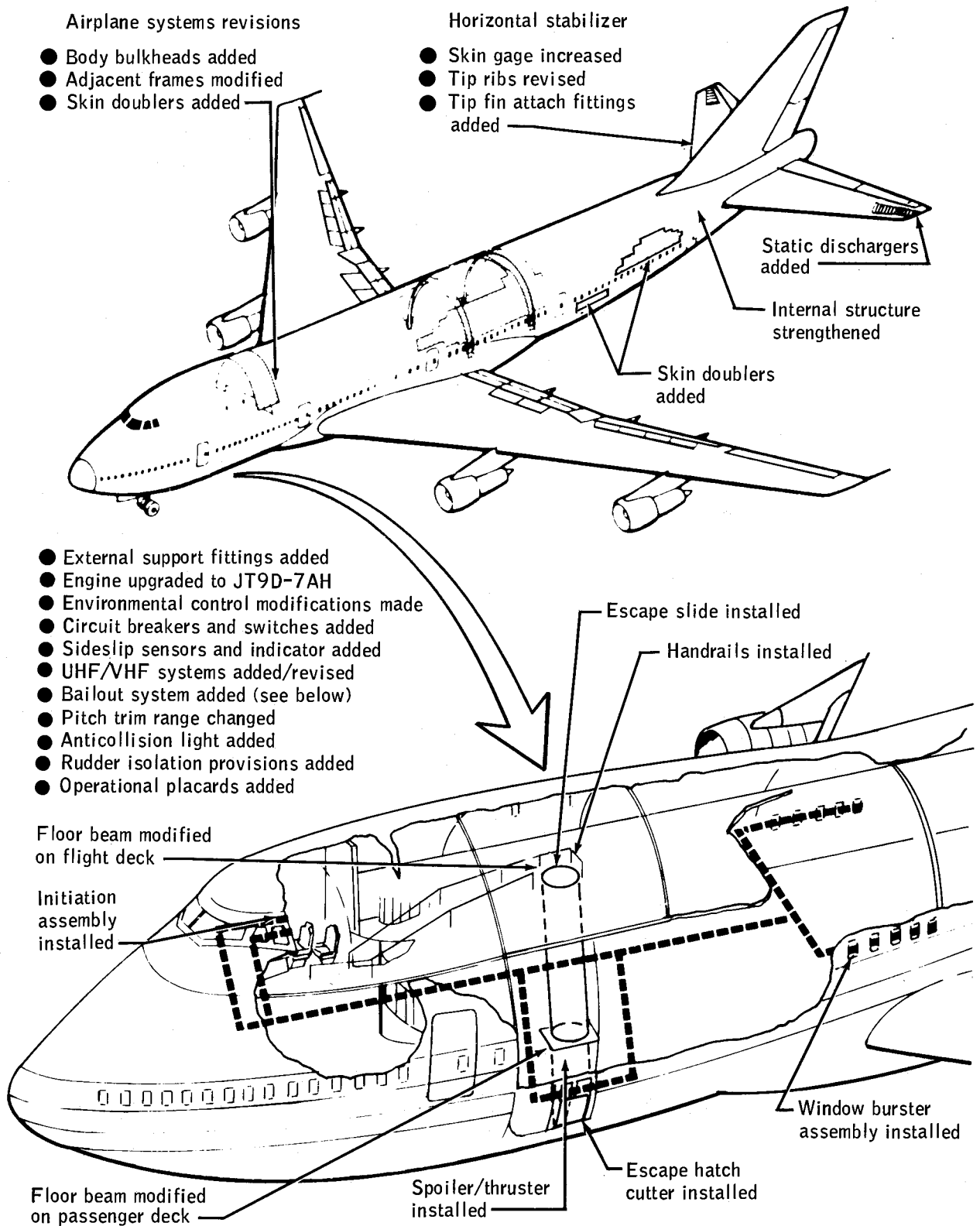

Figure A-3.- Carrier aircraft permanent modifications.

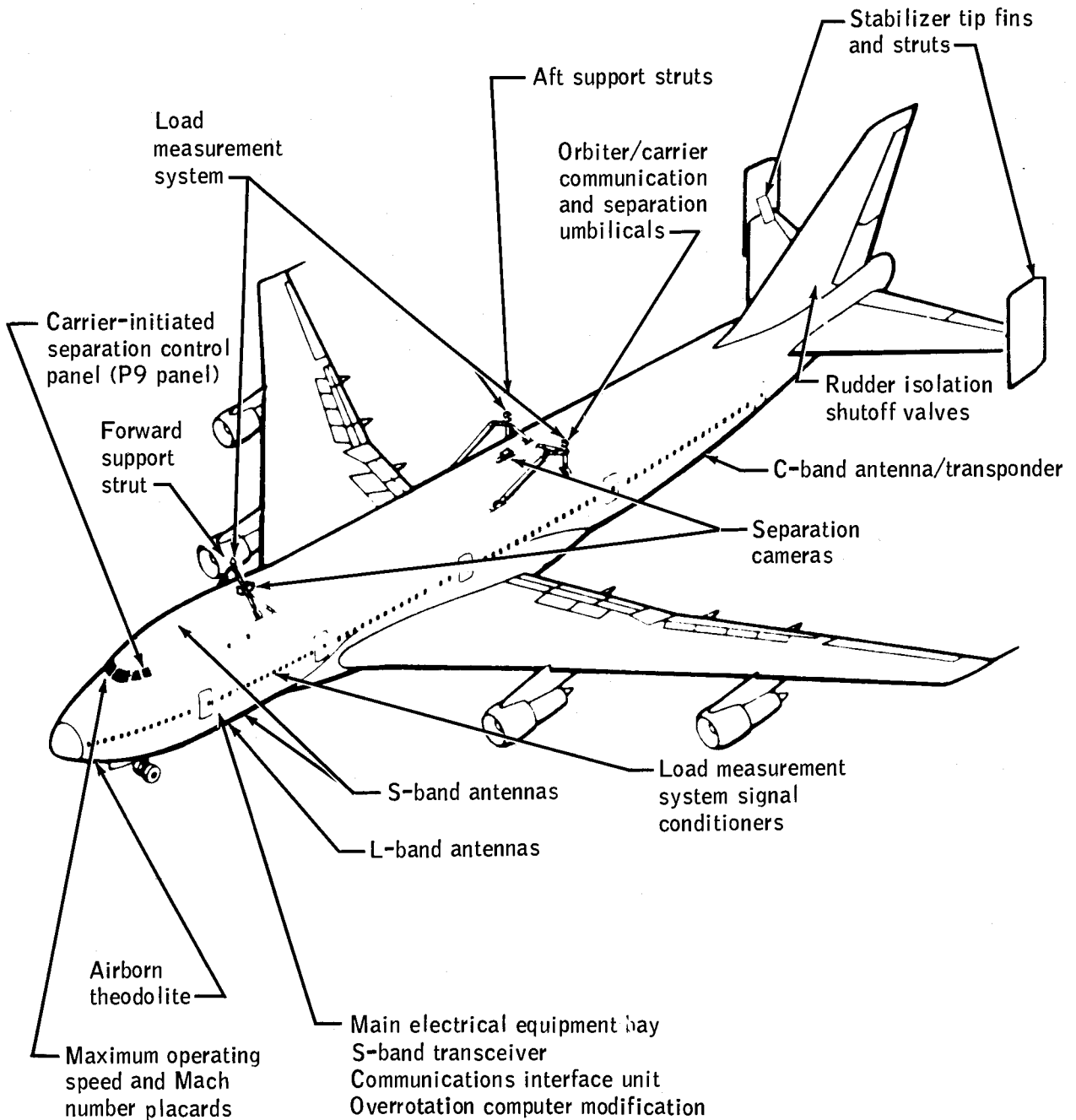

Figure A-4.- Carrier aircraft removable modifications.

TABLE A-I.- ORBITER 101 UNIQUE FEATURES
FOR THE APPROACH AND LANDING TEST PROGRAM

Subsystem/Component	Description
STRUCTURES	
<u>Forward Fuselage</u>	<p>The right upper observation window was replaced by a ram air ventilation scoop.</p> <p>The aft viewing and left overhead windows were replaced by aluminum plates.</p> <p>A boilerplate forward reaction control subsystem module was installed - ballast support provisions were included.</p> <p>An air data mast was installed.</p> <p>A fiberglass nose cap was installed in place of a carbon-carbon nose cap.</p>
<u>Aft Fuselage</u>	<p>A boilerplate base heat shield was installed.</p> <p>Boilerplate T-0 umbilical panels/closeout doors and external tank umbilical door were installed.</p> <p>Simulated orbital maneuvering subsystem/aft reaction control subsystem pods were installed.</p>
<u>Wings</u>	<p>Fiberglass leading edge structure was substituted for carbon-carbon except for two panels on the right wing.</p> <p>Aerosurface interface seals did not have thermal protection provisions.</p>
<u>Vertical Tail</u>	<p>Aerosurface interface seals did not have thermal protection provisions.</p>
<u>Tail Cone</u>	<p>A tail cone was installed for captive-inert and captive-active flights. The tail cone was also used for the initial free flights and will be used for ferry flights following the Approach and Landing Test Program.</p>
<u>Body Flap</u>	<p>A special aerodynamic seal was used which does not have thermal protection provisions.</p>
THERMAL PROTECTION	
	<p>Simulated reusable surface insulation (polyurethane foam) was generally substituted for the operational thermal protection subsystem. Materials to be used for orbital flight were installed in selected areas for installation experience and evaluation. Fused silica was installed on areas of the vertical tail and aft body to protect against local heating from the auxiliary power unit exhaust plumes.</p>

TABLE A-I.- ORBITER 101 UNIQUE FEATURES
FOR THE APPROACH AND LANDING TEST PROGRAM - Continued

Subsystem/Component	Description
PASSIVE THERMAL CONTROL	
	Fibrous bulk insulation and multilayer insulation were installed only where functionally required with the exception of the forward fuselage where the installation was complete to minimize later changes.
PURGE, VENT AND DRAIN	
	The purge, vent and drain subsystem was specially configured for Approach and Landing Test requirements.
MECHANICAL	
	<p>An Orbiter/carrier aircraft separation subsystem was installed instead of the Orbiter/external tank separation subsystem.</p> <p>Rigid arms were installed in place of thrust vector control actuators.</p> <p>Manually actuated mechanisms were installed for latching the payload bay doors.</p> <p>Air data probes were fixed in the deployed position.</p> <p>The following were not installed:</p> <ul style="list-style-type: none"> Payload retention and deployment subsystem Payload bay access hatch Docking module and hatches Airlock hatch Space radiator hinges, and radiator latch and drive mechanism Star tracker and active vent door operating mechanisms T-0 umbilical panels/closeout doors External tank closeout door
REMOTE MANIPULATOR	
	The subsystem was not installed.

TABLE A-I.- ORBITER 101 UNIQUE FEATURES
FOR THE APPROACH AND LANDING TEST PROGRAM - Continued

Subsystem/Component	Description
HYDRAULICS	
	<p>The electric motor-driven on-orbit circulation pumps were replaced by pump simulators.</p> <p>A wick-type water boiler was used instead of a spray-type water boiler.</p> <p>Backup hydraulic fluid reservoirs were installed.</p> <p>Main engine gimbal/control and warmant flow units were not installed.</p>
PYROTECHNICS	
	<p>Pyrotechnic devices were provided for:</p> <p style="padding-left: 40px;">Orbiter/carrier aircraft separation</p> <p>Pyrotechnic devices were not provided for:</p> <p style="padding-left: 40px;">Remote manipulator system emergency jettison</p> <p style="padding-left: 40px;">Rendezvous radar antenna emergency jettison</p> <p style="padding-left: 40px;">Ku-band antenna jettison</p> <p style="padding-left: 40px;">Docking tunnel jettison</p> <p style="padding-left: 40px;">Space radiator emergency jettison</p> <p style="padding-left: 40px;">Orbital/external tank separation and umbilical disconnect</p>
POWER	
<p><u>Auxiliary Power Units</u></p> <p><u>Electrical Power Generation</u></p>	<p>The fuel quantity gaging system was not provided for the Approach and Landing Test Program.</p> <p>Fuel cell power plant performance characteristics were unique.</p> <p>The operational cryogenic reactant storage system was replaced by a high pressure gas storage system for the Approach and Landing Test Program. Special tanks were provided for storage of fuel-cell-generated water.</p>
PROPULSION	
<p><u>Main Engines</u></p>	<p>The main engines were not installed. Dummy main engines simulating the mass and envelope of the actual engines were installed after Free Flight 3.</p>

TABLE A-I.- ORBITER 101 UNIQUE FEATURES
FOR THE APPROACH AND LANDING TEST PROGRAM - Continued

Subsystem/Component	Description
PROPULSION (Concluded)	
<u>Orbital Maneuvering and Reaction Control</u>	The orbital maneuvering subsystem, forward reaction control subsystem and aft reaction control subsystem were not installed.
AVIONICS	
<u>Guidance, Navigation and Control</u>	<p>The rate gyro assembly contained three rate gyros instead of four.</p> <p>The navigation base was built to support inertial measurements units only. There was no star tracker boom.</p> <p>The inertial measurement unit installation was unique for the Approach and Landing Test Program.</p> <p>There were three accelerometer assemblies instead of four.</p> <p>A nose boom probe assembly and a dedicated air data computer were provided for calibration of the operational system.</p> <p>A backup flight control subsystem was provided. The subsystem was functionally independent, single-string, and pilot-commanded. It used both dedicated hardware and hardware shared with the primary flight control system. General purpose computer no. 5 was dedicated to backup flight control subsystem use.</p> <p>The following were not installed:</p> <ul style="list-style-type: none"> Star trackers Crew optical alignment sight Mission specialist station rotation hand controller Translation hand controller Ascent thrust vector control drivers and actuators Orbital maneuvering subsystem drivers and thrust vector control actuators Reaction jet drivers Aft reaction control subsystem valves Forward reaction control subsystem valves

TABLE A-I.- ORBITER 101 UNIQUE FEATURES
FOR THE APPROACH AND LANDING TEST PROGRAM - Continued

Subsystem/Component	Description
AVIONICS (Continued)	
<u>Communications and Tracking</u>	<p>The communications and tracking subsystem installation was unique for the Approach and Landing Test Program.</p> <p>A C-band transponder was provided for precision tracking.</p> <p>The following capabilities were not provided for the Approach and Landing Test flights.</p> <ul style="list-style-type: none"> Uplink commands Orbital navigation Rendezvous radar Television
<u>Displays and Controls</u>	<p>The configuration of the following was unique for the Approach and Landing Test Program.</p> <ul style="list-style-type: none"> Forward flight control station panel Overhead panels Alpha/Mach indicator Altitude/vertical velocity indicator Annunciators Event indicator Toggle switches Thumbwheel switches Variable transformer Interior lights Caution and warning system <p>The following displays and controls were not installed.</p> <ul style="list-style-type: none"> Aft flight deck panels Mid deck panels Airlock panels Range/range rate indicator Propellant quantity indicator Timers Three-phase circuit breakers Translation controller Exterior lights

TABLE A-I.- ORBITER 101 UNIQUE FEATURES
FOR THE APPROACH AND LANDING TEST PROGRAM - Continued

Subsystem/Component	Description
AVIONICS (Concluded)	
<u>Instrumentation</u>	<p>The operational instrumentation and development flight instrumentation were integrated for the Approach and Landing Test Program, whereas the two subsystems will be separate for Orbital Flight Tests. Additional differences for Orbital Flight Tests are as follows.</p> <p>Operational Instrumentation:</p> <ul style="list-style-type: none"> A payload data interleaver is to be added. New types of sensors will be used. Functional usage of pulse code modulation (PCM) and master timing units will be increased. Subsystem interfaces will be increased. Capability will be provided for inflight playback of recorders. The number of measurements will be increased. <p>Development flight instrumentation:</p> <p>The Orbital Flight Test configuration will contain a separate PCM master unit and PCM recorder, an additional wideband recorder for ascent data, and additional measurements.</p>
<u>Data Processing</u>	<p>The engine interface unit was not installed.</p>
<u>Electrical Power Distribution and Control</u>	<p>The dc and ac distribution systems were unique. Changes for Orbital Flight Test will include additional utility outlets, added payload power provisions, and additional distribution and control assemblies. Inverter on-off controls have been redesigned for Orbital Flight Test use.</p> <p>Events control equipment configurations unique for the Approach and Landing Test Program include the master events controller, component drivers, and relays. The range safety system was not installed.</p>
<u>Flight Software</u>	<p>The flight software was designed to meet the specific requirements of the Approach and Landing Test Program.</p>

TABLE A-I.- ORBITER 101 UNIQUE FEATURES
FOR THE APPROACH AND LANDING TEST PROGRAM - Continued

Subsystem/Component	Description
ENVIRONMENTAL CONTROL AND LIFE SUPPORT	
<u>Atmospheric Revitalization</u>	<p>The atmospheric revitalization subsystem design was unique for the Approach and Landing Test Program. A ram air vent system was installed for emergency smoke removal.</p> <p>Numerous items necessary for orbital flight were not installed, including:</p> <ul style="list-style-type: none"> Two-gas (oxygen and nitrogen) system for cabin gas makeup. Lithium hydroxide cartridges for the carbon dioxide absorber assembly. Water chiller. Liquid cooled garment heat exchanger and accumulator. Pressure control valves and regulators.
<u>Life Support</u>	<p>The water management subsystem was not included except for two Apollo-type waste water tanks to store water generated by the fuel cells and an Apollo-type glycol reservoir to collect water condensed in the cabin heat exchanger.</p> <p>The waste management subsystem was not installed.</p>
<u>Active Thermal</u>	<p>Elements of the subsystem which were unique for the Approach and Landing Test Program included the ammonia boiler and ammonia storage facilities.</p> <p>The following items were not installed:</p> <ul style="list-style-type: none"> Redundant freon pump (only 1 in each coolant loop) Payload heat exchanger Hydraulics heat exchanger Proportioning valve Baseline ammonia storage tanks Flash evaporator system Space radiator panels
<u>Airlock Support</u>	<p>The subsystem was not installed.</p>

TABLE A-I.- ORBITER 101 UNIQUE FEATURES
FOR THE APPROACH AND LANDING TEST PROGRAM - Concluded

Subsystem/Component	Description
CREW EQUIPMENT	
	<p>The following items were unique for the Approach and Landing Test flights.</p> <ul style="list-style-type: none"> Hand-held radios Crew intercom recorders Carry-on oxygen system Protective breathing systems Camera systems Descent devices for emergency egress Biomedical monitoring system Urine and water bottles <p>Equipment not provided for the Approach and Landing Test includes:</p> <p>Life Support Assemblies:</p> <ul style="list-style-type: none"> Personal oxygen system Personal rescue enclosure Extravehicular mobility unit Manned maneuvering unit Trace gas analyzer Anti-G suit Bioinstrumentation system Cameras, film and accessories Radiation monitors Food management system Shuttle Orbiter medical system

APPENDIX B - VEHICLE HISTORICAL DATA

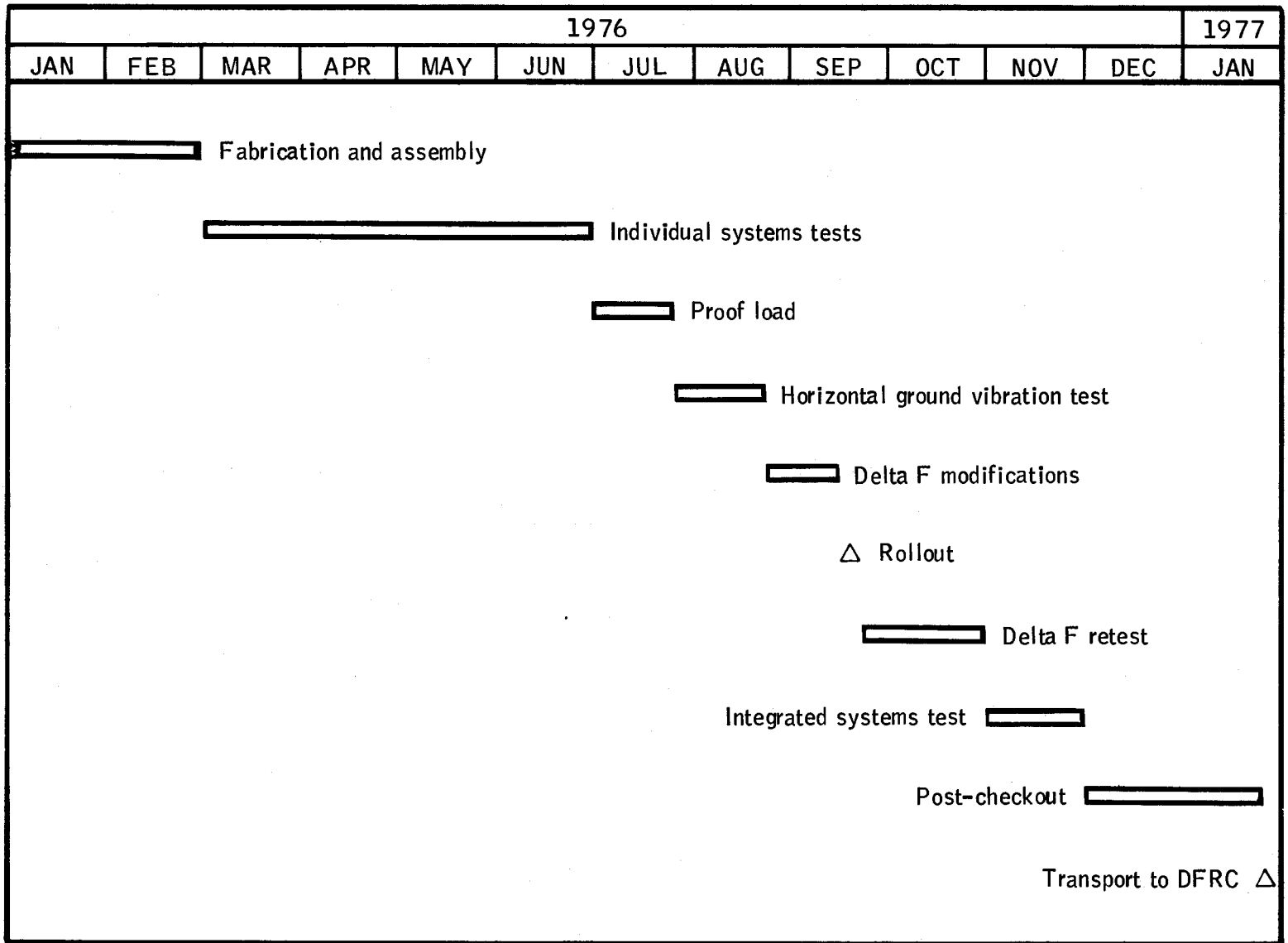

B-2

Figure B-1.- Orbiter 101 history at contractor's manufacturing facility.

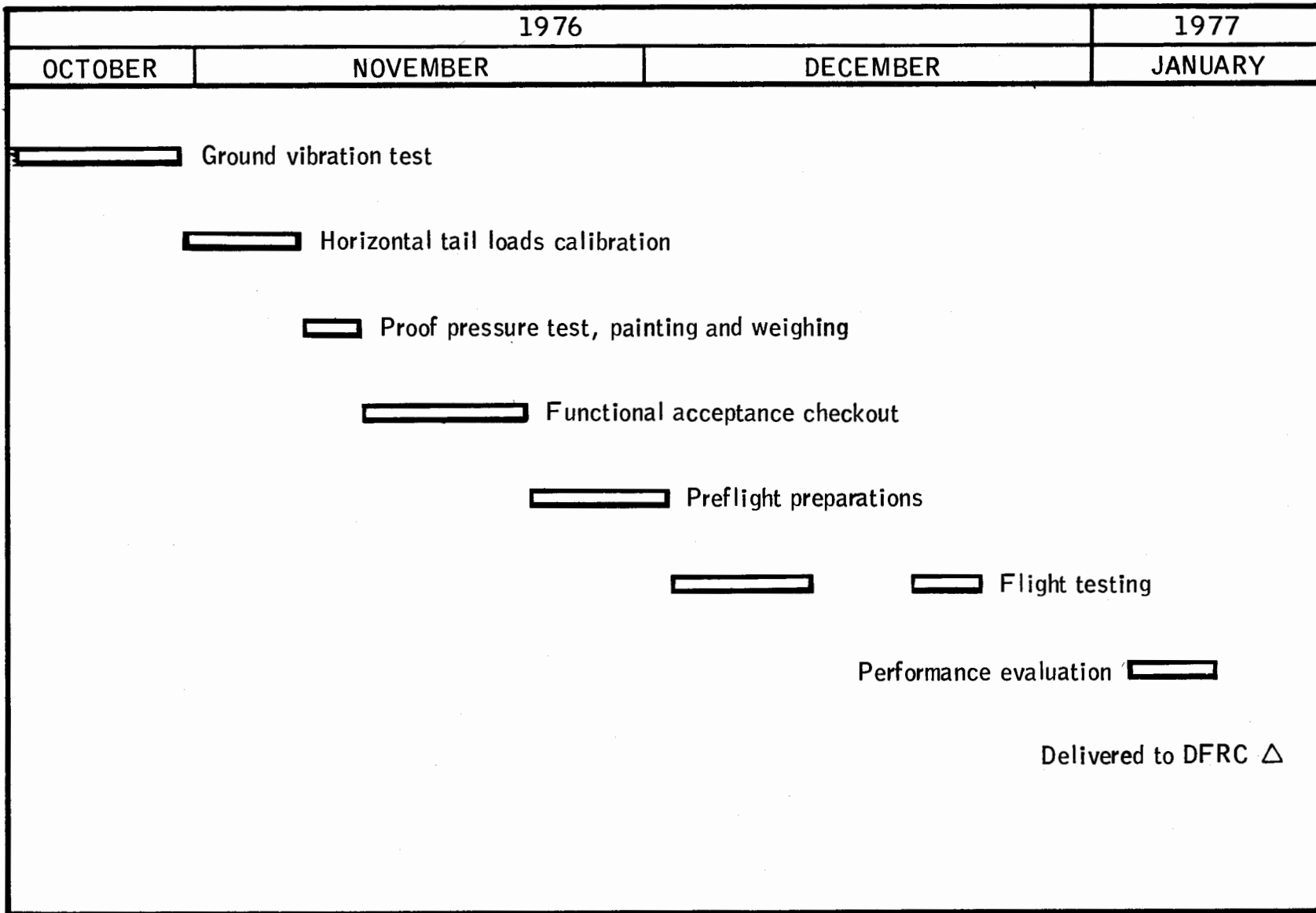

B-3

Figure B-2.- Carrier aircraft acceptance testing history.

1977

JAN	FEB	MAR	APR	MAY	JUN	JUL	AUG	SEP	OCT	NOV
-----	-----	-----	-----	-----	-----	-----	-----	-----	-----	-----

△ Carrier aircraft received at DFRC (Jan 14)

△ Orbiter 101 received at DFRC (Jan 31)

△ Carrier aircraft/orbiter mate

▢ Mated ground vibration test

△ Taxi test (3 taxi runs)

▢ Captive-inert flight tests (5 flights)

▢ Modification and combined systems tests

▢ Delta integrated checkout

▢ Hot-fire ground tests

Captive-active flight tests (3 flights) ▢

Preparations for free-flight tests ▢

Free-flight tests, tail cone on (3 flights) ▢

Preparations for tail-cone-off flights ▢

Free-flight tests, tail cone off (2 flights) ▢

Preparations for ferry test flights ▢

Ferry test flights (4 flights) ▢

B-4

Figure B-3.- Test history at Dryden Flight Research Center.

APPENDIX C - CAPTIVE-INERT AND CAPTIVE-ACTIVE FLIGHT DESCRIPTIONS

C.1 CAPTIVE-INERT FLIGHTS

The velocities in the following flight descriptions are given in knots calibrated airspeed (KCAS) and altitudes are carrier aircraft pressure altitudes.

C.1.1 Captive-Inert Flight 1

Following takeoff from runway 04, a climb was initiated to an altitude of 16 000 feet with the landing gear and flaps retracted at approximately 7300 feet. An airspeed of 250 knots was established at 16 000 feet and a series of rapid aileron, elevator, and rudder control inputs was made to evaluate structural responses (flutter) for various combinations of autopilot gain and mode settings. At the completion of this test sequence, an airspeed system calibration was performed with a pacer aircraft at airspeeds of 225, 200, and 175 knots. All speeds were checked with the carrier aircraft landing gear retracted. The effects of 10° and 20° flaps were evaluated at 200 and 175 knots. A series of stability and control maneuvers was then performed at an airspeed of 210 knots. After a descent to 10 000 feet, airspeed calibration was completed at 155 knots with the landing gear both retracted and extended and flap settings of 20°. In addition, stability and control maneuvers were performed, first at an airspeed of 155 knots with the landing gear up and flaps set at 20°, then at an airspeed of 145 knots with the landing gear down and flaps set at 30°. The flight testing was completed with an evaluation of the landing configuration (landing gear down, 30° flaps) stick-shaker speed with engine 4 retarded to idle. This test was initiated at approximately 7300 feet and at an airspeed of 145 knots. The flight was terminated with a landing on runway 04. The altitude profile for captive-inert flight 1 is shown in figure C-1.

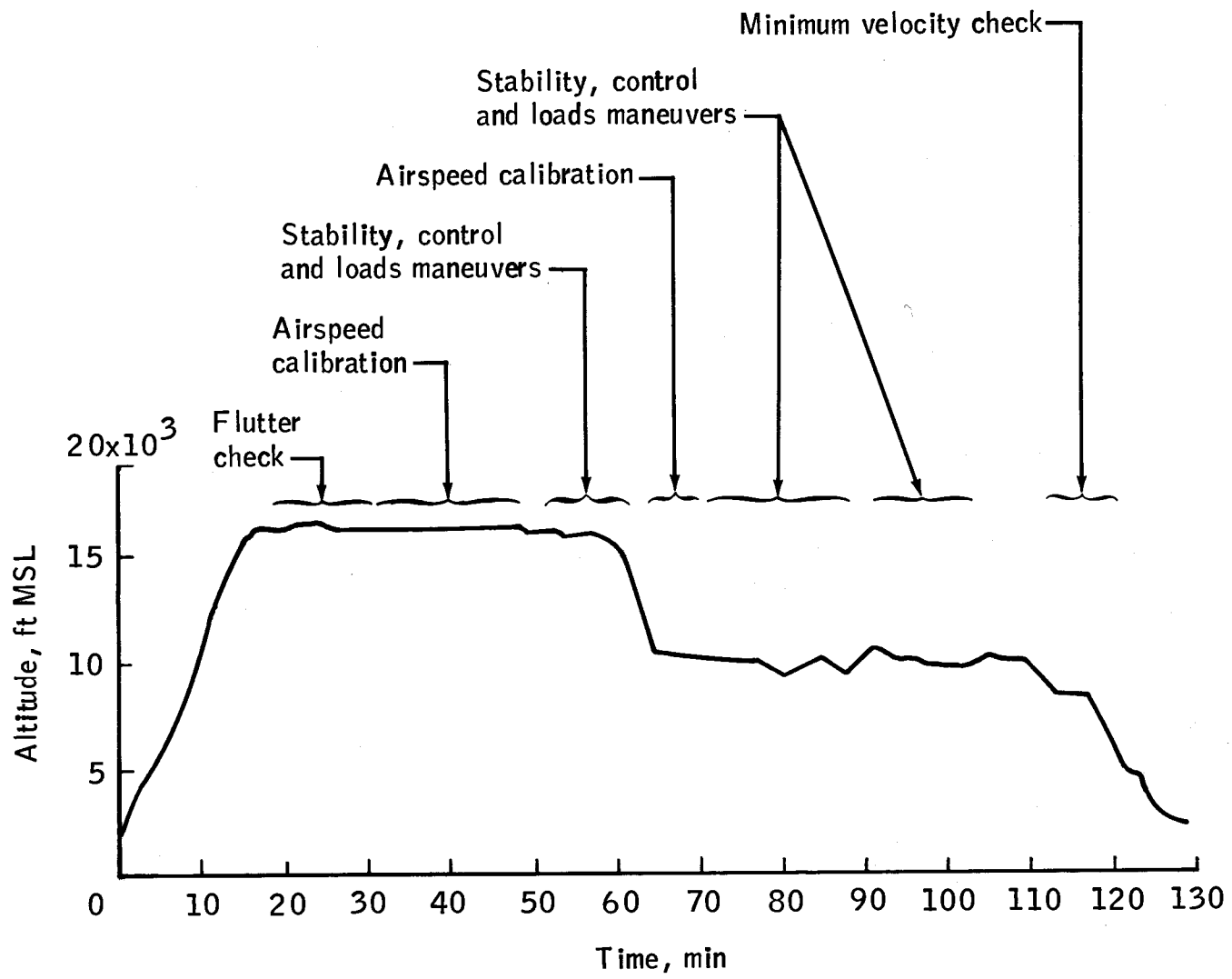

Figure C-1.- Captive-Inert Flight 1 altitude profile.

C.1.2 Captive-Inert Flight 2

Takeoff for the second flight was from runway 22. At an altitude of 10 000 feet, stick-shaker speeds were evaluated from decelerations initiated at 220, 180, and 160 knots. The first two decelerations were performed with the landing gear up and the flaps set at 0° and 20°, respectively. The third deceleration was performed with the landing gear down and the flaps set at 30°. Upon completion of this test sequence, the climb was continued to 16 000 feet where flutter tests were conducted at airspeeds of 250 and 267 knots. The aircraft was then decelerated to 250 knots at which velocity a complete set of stability and control maneuvers was performed. A climb was then initiated to 22 000 feet where the stability and control testing was continued at 210 knots followed by flutter tests and airspeed system checks at 245 and 265 knots. The aircraft was decelerated to 250 knots for the completion of the stability and control tests. Upon completion of these maneuvers, the altitude was reduced to 16 000 feet where the flutter testing was completed at airspeeds of 277 and 288 knots. The flight was terminated with a landing on runway 22. The altitude profile for captive-inert flight 2 is shown in figure C-2.

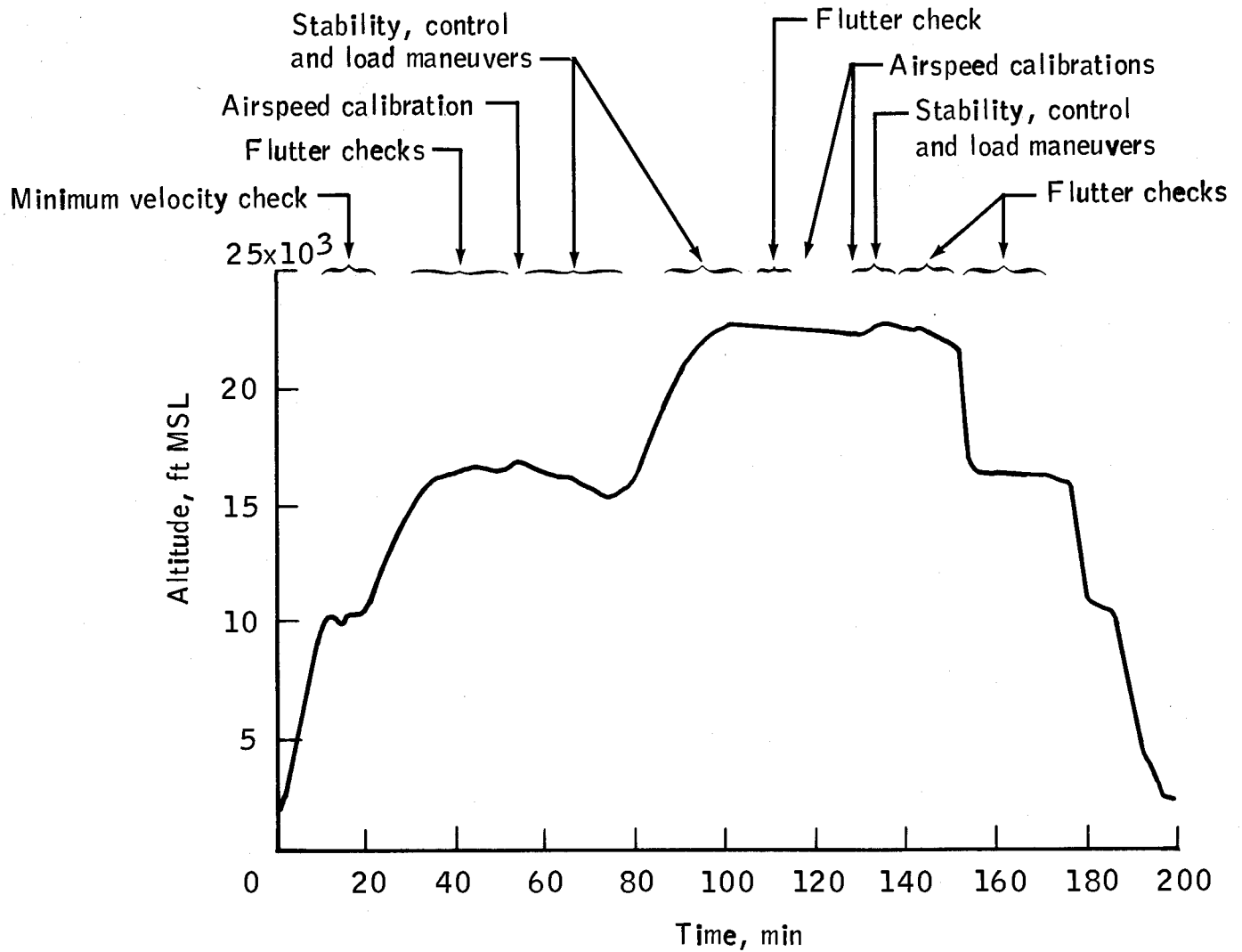

Figure C-2.- Captive-Inert Flight 2 altitude profile.

C.1.3 Captive-Inert Flight 3

Following takeoff from runway 04, engine 4 power was reduced to idle at approximately 500 feet and the climb continued to 5000 feet. This was accomplished with the landing gear up and 20° flaps. At 5000 feet, engine 4 power was advanced to maximum-continuous-thrust and the climb continued to 7300 feet. At this altitude, stick-shaker speeds were again evaluated from initial speeds of 220, 170, and 160 knots. The first two runs of this series were conducted with the landing gear up and with 0° and 20° flaps, respectively. The 160-knot condition was evaluated with the landing gear down and 30° flaps. This test sequence was followed by an evaluation of the directional control required to handle the critical engine failure. After this phase, a climb was initiated to 16 000 feet where stability and control maneuvers were performed at an airspeed of 280 knots. These maneuvers were followed by a climb to approximately 26 000 feet. A pushover was then made to attain an airspeed of 282 knots for a flutter check at 22 000 feet. This procedure was followed by a climb to 24 000 feet, pushover to attain an airspeed of 270 knots, and stability and control tests at 22 000 feet. A climb to 26 000 feet and pushover were then performed to establish conditions for flutter tests and an airspeed system check at 288 knots.

Prior to the landing, the minimum control speed with engine 4 in the idle power setting was evaluated at an altitude of 5000 feet and an initial airspeed of 160 knots. The aircraft was landed on runway 04 completing flight testing to evaluate the operational envelope relative to flutter. The altitude profile for captive-inert flight 3 is shown in figure C-3.

C-7

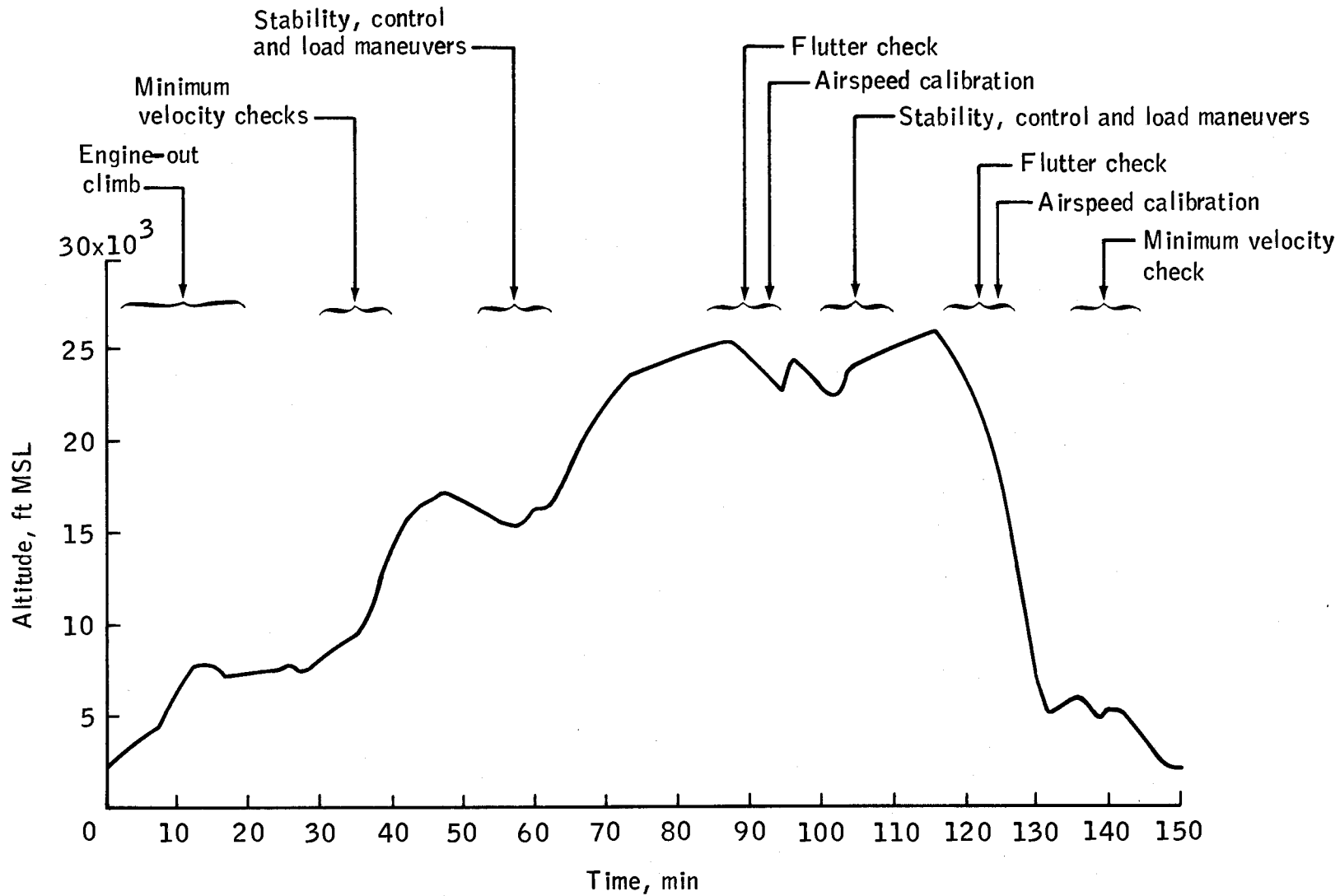

Figure C-3.- Captive-Inert Flight 3 altitude profile.

C.1.4 Captive-Inert Flight 4

The test conditions specified for this flight were to evaluate the stability and control and the buffet loads associated with the Approach and Landing Test launch configuration.

Following the takeoff from runway 04, a four-engine climb was performed to an altitude of 25 000 feet. Pushover was then performed to accelerate to 225 knots at 22 000 feet where the inflight speed brakes (spoilers) were extended and a series of stability and control maneuvers was performed. The same test technique was employed on three additional runs to conduct similar evaluations at 250, 270, and 283 knots. Special rated thrust was applied during the climb to obtain the 283-knot condition. Lateral directional stability was evaluated at the peak of the climb (approximately 28 000 feet). After the 283-knot test was completed, the descent was continued from 22 000 to 16 000 feet with the landing gear and spoilers extended to evaluate the emergency descent potential at 250 knots. The flight was concluded with a missed approach executed prior to landing on runway 04. The altitude profile for captive-inert flight 4 is shown in figure C-4.

6-0

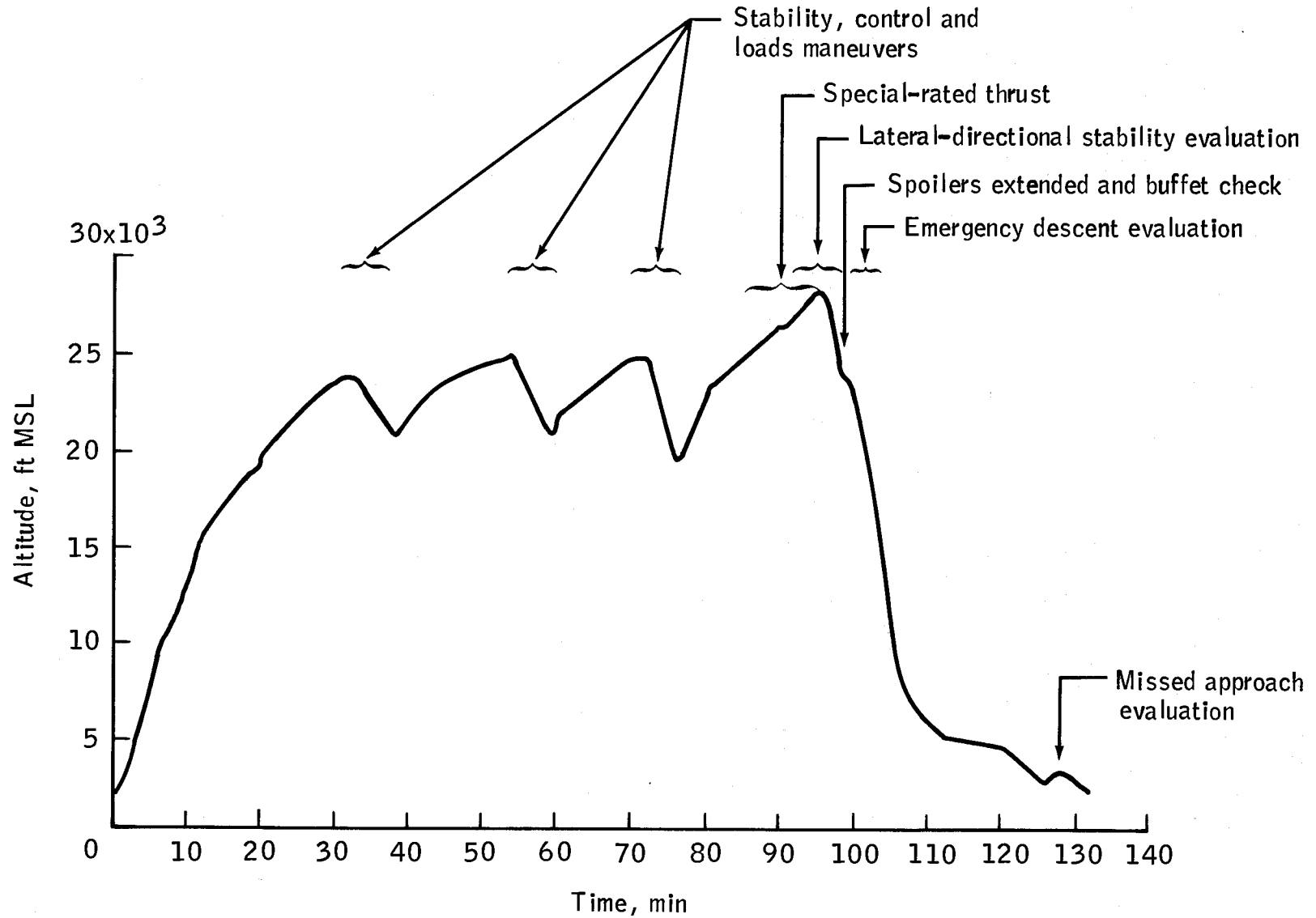

Figure C-4.- Captive-Inert Flight 4 altitude profile.

C.1.5 Captive-Inert Flight 5

The primary purpose of the final flight in this series was to fly the ground track and altitude profile of a two-launch-attempt test flight to evaluate the mated performance and operational procedures.

The takeoff was performed using runway 22 followed by a climb to 25 000 feet at an airspeed of 225 knots. The engine power setting was adjusted to special rated thrust at approximately 26 500 feet when the rate of climb approached 200 feet per minute. The climb for the first simulated launch attempt was continued to an altitude of 29 000 feet. At this altitude, pushover was performed and a "launch ready" condition was established at an airspeed of 278 knots and an altitude of 24 000 feet. The simulated launch abort was completed at approximately 21 000 feet with the normal load factor reaching a value of about 1.15 g. After the recovery, a climb was performed for the second simulated launch attempt. On this run, special rated thrust was initiated at about 27 700 feet and a climb rate of 200 feet per minute was attained at an altitude of about 30 100 feet. The pushover was performed at this altitude. "Launch ready" was established at 278 knots and an altitude of 25 700 feet. The descent was continued to an altitude of approximately 15 000 feet where a performance speed power point was obtained at an airspeed of 191 knots. The flight was completed with a landing on runway 22. The altitude profile for captive-inert flight 5 is shown in figure C-5.

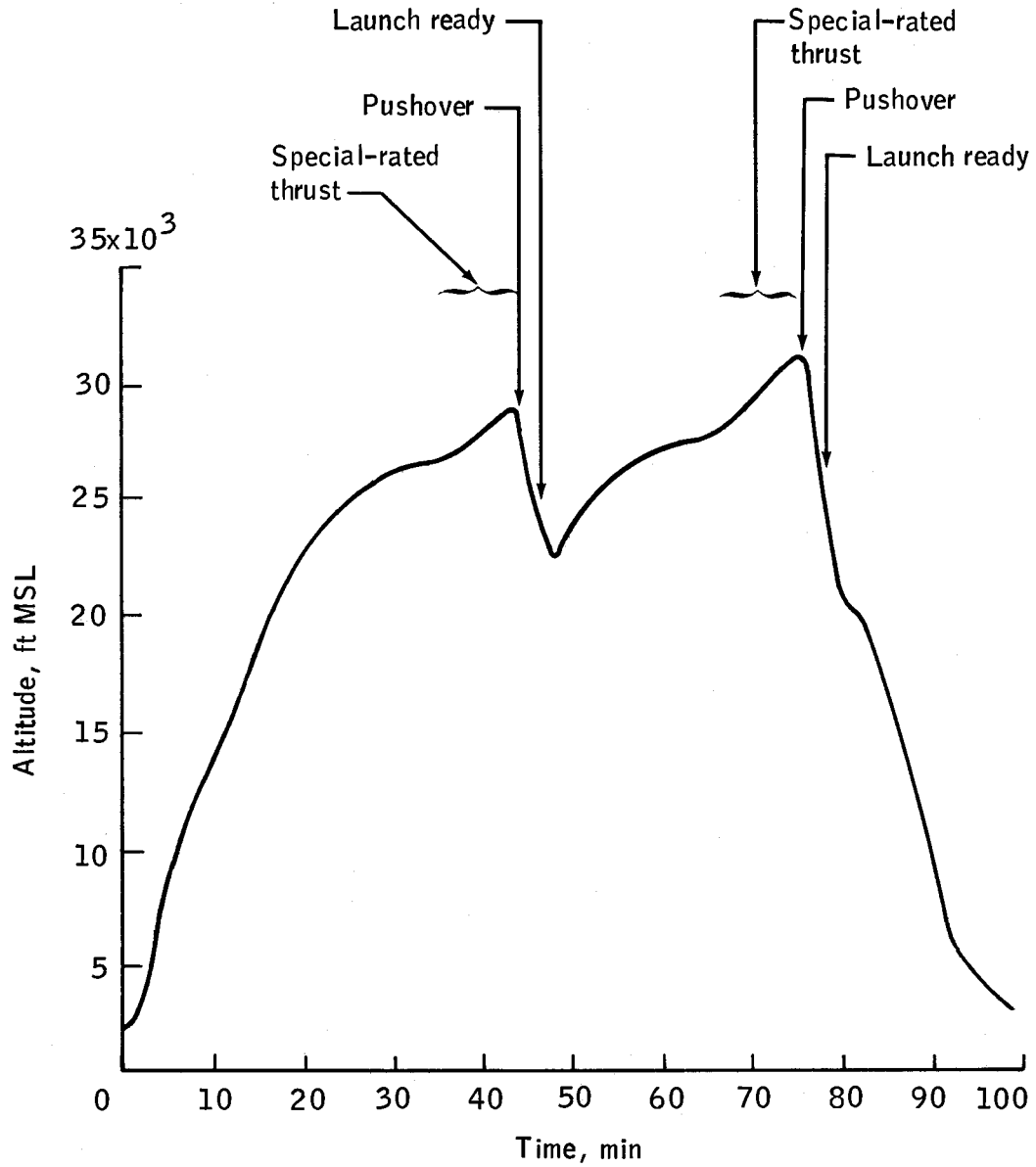

Figure C-5.- Captive-Inert Flight 5 altitude profile.

C.2 CAPTIVE-ACTIVE FLIGHTS

Velocities given in the following flight descriptions are in knots equivalent airspeed (KEAS). Altitudes were determined from ground radar data. Runway 22 was used for takeoff and landing for all three flights.

C.2.1 Captive-Active Flight 1A

A single circuit of a generally oval 10- by 60-nautical mile ground track pattern was flown at a maximum altitude of about 15 600 feet and a maximum airspeed of 180 knots (orbiter hard-over control surface structural limit). An orbiter flight control system direct mode check was performed 12 minutes after takeoff with application of control surface pulses from the rotational hand controller and the rudder pedals. A flutter test was performed at 19 minutes elapsed time at a velocity of approximately 180 knots. This test involved three orbiter control surface inputs, with a 10-second period between each input. Four minutes later, the orbiter speed brakes were deployed to 60, 80 and 100 percent with a pause between each setting for rudder deflection tests and flight assessment. A control stick steering stability and polarity check was initiated at 38 minutes elapsed time. This test included orbiter control surface inputs (low amplitude inputs and limited) from the rotational hand controller and rudder pedals while operating in the pitch, roll, and yaw control stick steering modes. The flight was terminated about 10 minutes after completion of the test. Total flight time was about 56 minutes. The altitude profile for captive-active flight 1A is shown in figure C-6.

G-13

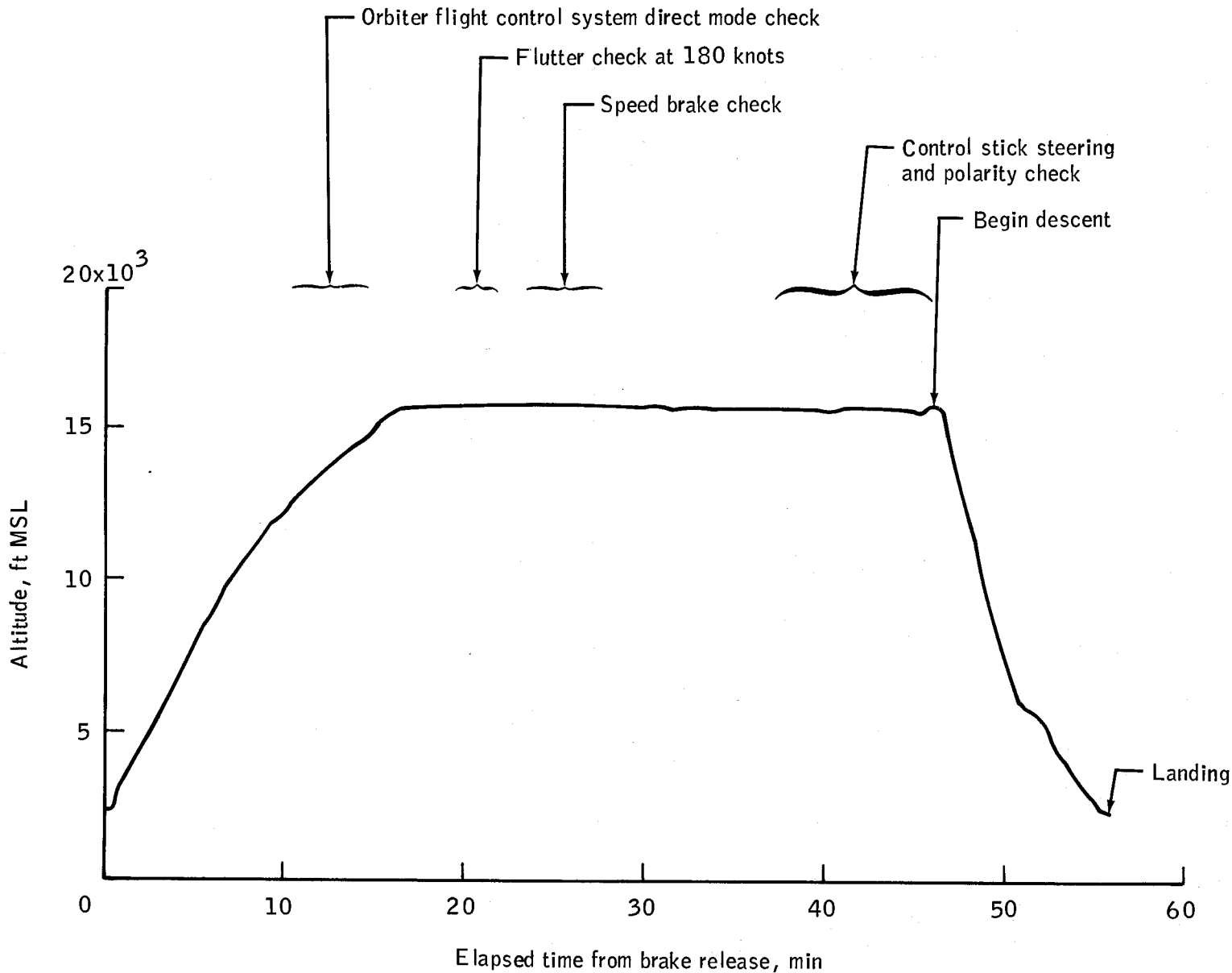

Figure C-6.- Captive-Active Flight 1a altitude profile.

C.2.2 Captive-Active Flight 1

A flutter test was performed beginning about 3 minutes after takeoff at an air-speed of about 230 knots, first with orbiter control surface movements, then with carrier aircraft control surface movements. The orbiter speed brakes were then deployed to the 60, 80 and 100 percent positions with a pause between each setting for rudder deflection tests and flight assessment.

Approximately 18 minutes into the flight, auxiliary power unit 1 was activated as planned. There was an increase in the rate of fuel usage for the unit about 25 minutes after activation. It was determined postflight that failure of the auxiliary power unit 1 fuel pump bellows seal had caused significant hydrazine leakage.

Upon reaching an altitude of approximately 23 000 feet and a speed of 270 knots, a high-speed flutter test was performed. This sequence was followed by a speed brake buffet test conducted between 23 000 and 18 700 feet at a speed of 270 knots. These tests were performed in the same sequence as the tests at 230 knots except that the speed brake settings were reduced to 10-percent increments from 60 to 100 percent deflection because of nearly saturated instrumentation. These tests were completed about 34 minutes into the flight and the carrier aircraft climbed to 24 200 feet in preparation for a separation data run. Pushover occurred at about 43 minutes. During the run at 270 knots, the orbiter elevons were deflected 1.5° in both directions from the trim setting and the ailerons were deflected 1° . The data run was terminated by "abort separation" at about 17 700 feet. The carrier aircraft then regained an altitude of 20 500 feet for an autoland fly-through test. Pushover for this test occurred about 54 minutes into the flight with the vehicle in a 9° glide slope and flying at a speed of about 225 knots. Total flight time was about 63 minutes. The altitude profile for captive-active flight 1 is shown in figure C-7.

C-15

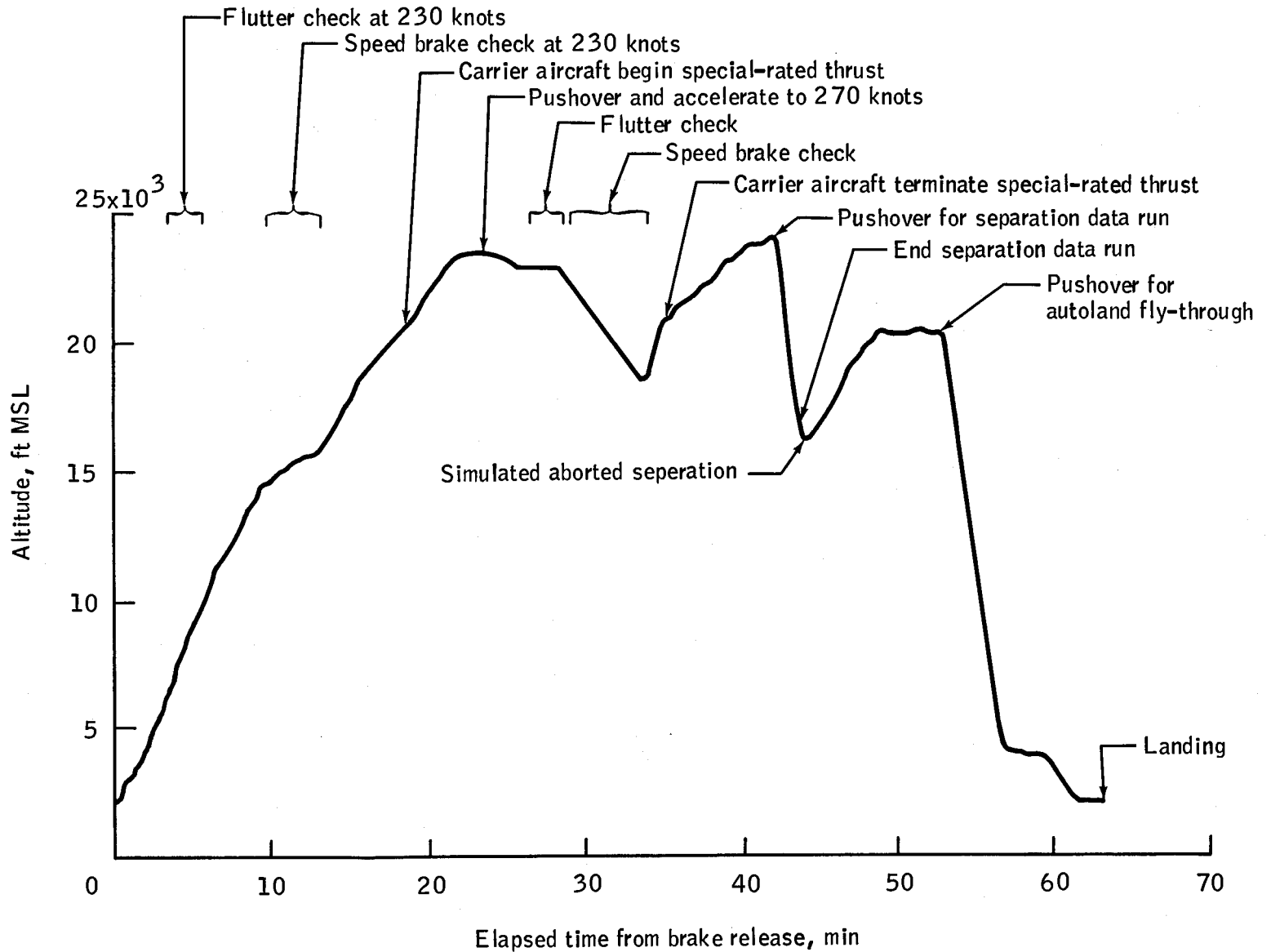

Figure C-7.- Captive-Active Flight 1 altitude profile.

C.2.3 Captive-Active Flight 3

The third flight proceeded as planned until auxiliary power unit 1 was activated about 16 minutes after takeoff. Four minutes after activation, the caution and warning system indicated an over-temperature condition of the exhaust gas duct and the orbiter crew immediately shut down the unit. An orbiter flight control system check was performed beginning 26 minutes into the flight. This check was followed by a TACAN long-range test about 2 minutes later. Special-rated thrust was initiated upon reaching an altitude of about 28 000 feet. As the vehicle reached a maximum altitude of 30 300 feet, a state vector update and a pre-separation check were made. Pushover was initiated approximately 48 minutes into the flight. The practice separation run was normal and "abort separation" was called about 1 minute after pushover at an altitude of about 25 600 feet. The free-flight approach and landing profile then was simulated. The right and left air data probes were stowed and redeployed just prior to landing. During carrier aircraft rollout, at approximately 124 knots, the orbiter landing gear were deployed by the backup systems because of the auxiliary power unit 1 shutdown. The altitude profile for captive-active flight 3 is shown in figure C-8.

C-17

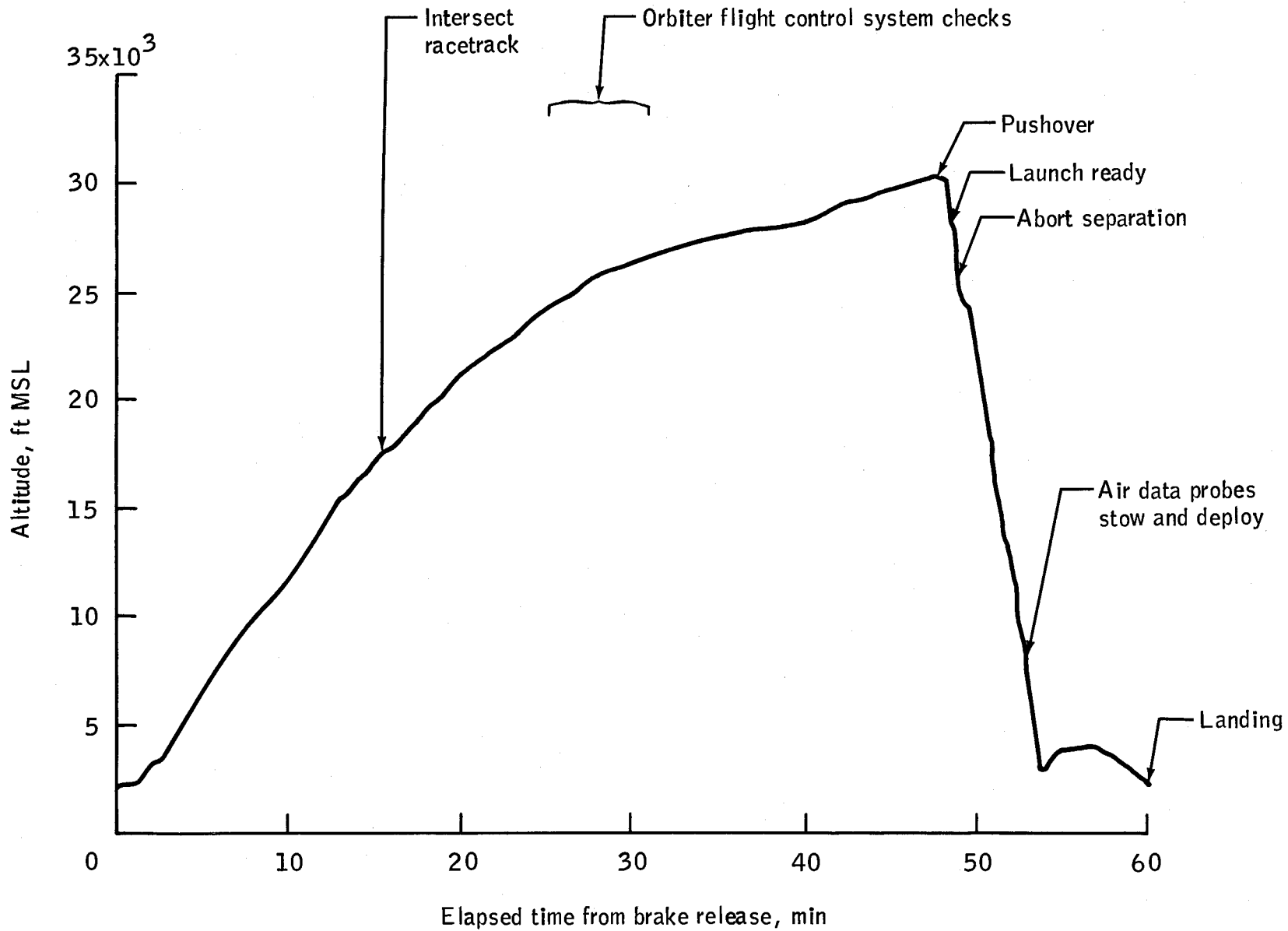

Figure C-8.- Captive-Active Flight 3 altitude profile.

APPENDIX D - VEHICLE MASS PROPERTIES

TABLE D-I.- CARRIER AIRCRAFT/ORBITER APPROXIMATE GROSS WEIGHTS

Test	Weight x 1000, lb	
	Takeoff	Landing
Taxi runs		
1	583	-
2	581	-
3	575	-
Captive-inert flights		
1	585	508
2	626	503
3	602	506
4	591	514
5	552	499
Captive-active flights		
1A	576	541
1	558	514
3	557	515
Free flights		
1	551	513
2	549	498
3	555	515
4	567	513
5	570	516

TABLE D-II.- ORBITER 101 WEIGHT SUMMARY

Description	Weight, lb							
	Captive-Active Flights			Free Flights				
	1A	1	3	1	2	3	4	5
Orbiter inert	127 590	127 590	127 590	127 144	127 144	127 144	127 459	127 459
Personnel	564	564	564	446	436	446	449	446
Ballast	14 650	14 650	14 650	14 598	14 598	14 985	8 575	8 575
Tail cone	5 927	5 927	5 927	5 927	5 927	5 927	N/A	N/A
Simulated main engines	N/A	N/A	N/A	N/A	N/A	N/A	12 897	12 897
Orbiter less consumables	148 731	148 731	148 731	148 115	148 105	148 502	149 380	149 377
Non-propulsive consumables	2 355	2 356	2 296	2 345	2 355	2 355	2 382	2 355
Orbiter total	151 086	151 087	151 027	150 460	150 460	150 857	151 762	151 732
Consumed to takeoff	-	-	-	-303	-303	-303	-303	-303
Orbiter at takeoff	-	-	-	150 157	150 157	150 554	151 459	151 429
Consumed-takeoff to separation	-	-	-	-510	-510	-510	-510	-510
Orbiter at separation	-	-	-	149 647	149 647	150 044	150 949	150 919
Consumed-separation to landing	-	-	-	-073	-073	-073	-073	-073
Orbiter at landing	150 036	150 152	150 231	149 574	149 574	149 971	150 876	150 846

TABLE D-III.- ORBITER 101 CENTER OF GRAVITY AT TAKEOFF

Axis	Captive-Active Flights			Free Flights				
	1A	1	3	1	2	3	4	5
X_o , percent of reference body length	63.9	63.9	63.9	63.8	63.8	65.8	66.3	66.3
X_o , inches	1062.2	1062.2	1062.2	1061.0	1061.1	1086.9	1093.0	1092.9
Y_o , inches	0.0	0.0	0.0	0.0	0.0	0.0	0.0	0.0
Z_o , inches	372.4	372.4	372.4	372.3	372.3	373.8	371.5	371.5

TABLE D-IV.- CARRIER AIRCRAFT WEIGHT SUMMARY

Description	Weight, lb							
	Captive-Active Flights			Free Flights				
	1A	1	3	1	2	3	4	5
Carrier aircraft inert	342 533	342 533	342 533	342 500	340 500	344 000	344 000	344 000
Fuel loaded	88 250	68 470	67 300	62 500	63 200	63 700	78 600	80 300
Carrier aircraft loaded	430 783	411 003	409 833	405 000	403 700	407 700	422 600	424 300
Fuel consumed to brake release	-5 873	-4 200	-4 195	-4 600	-5 000	-3 700	-6 900	-5 900
Carrier aircraft at brake release	424 910	406 803	405 638	400 400	398 700	404 000	415 700	418 400
Fuel consumed to touchdown	-33 900	-42 700	-41 200	-37 100	-50 700	-39 300	-53 500	-53 400
Carrier aircraft at touchdown	391 010	364 103	364 438	363 300	348 000	364 700	362 200	365 000

D-5

TABLE D-V.- ORBITER 101 CONSUMABLES - CAPTIVE-ACTIVE FLIGHTS

System/Consumables	Quantity, lb					
	CA-1A		CA-1		CA-3	
	Loaded	Landing	Loaded	Landing	Loaded	Landing
Fuel cells						
Oxygen	125	96	130	105	130	105
Hydrogen	11	7	11	8	11	8
Hydraulic subsystem						
Water	483	440	483	423	483	423
Active thermal control						
Ammonia	834	374	830	450	770	450
Auxiliary power units						
Hydrazine	873	328	873	375	873	454
Pressurant gas	4	4	4	4	4	4
By-product water	2	2	2	2	2	2
Waste water	23	54	23	54	23	54

TABLE D-VI.- ORBITER 101 CONSUMABLES - FREE FLIGHTS

System/Consumable	Weight, lb									
	FF-1		FF-2		FF-3		FF-4		FF-5	
	Loaded	Landing	Loaded	Landing	Loaded	Landing	Loaded	Landing	Loaded	Landing
Fuel cells										
Oxygen	129	97	125	93	125	93	125	93	125	93
Hydrogen	11	7	11	7	11	7	11	7	11	7
Hydraulic subsystem										
Water	483	373	483	373	483	373	483	373	473	373
Active thermal control										
Ammonia	820	465	834	479	834	479	834	479	834	479
Auxiliary power units										
Hydrazine	873	456	873	456	873	456	900	483	873	456
Pressurant gas	4	4	4	4	4	4	4	4	4	4
By-product water	2	2	2	2	2	2	2	2	2	2
Waste water	23	54	23	54	23	54	23	54	23	54

APPENDIX E - FLIGHT TEST REQUIREMENTS SUMMARY

TABLE E-I.- FLIGHT TEST REQUIREMENT SUMMARY FOR CAPTIVE-INERT FLIGHTS

Requirement		Accomplished				
Number	Title	CI-1	CI-2	CI-3	CI-4	CI-5
Structures						
S-1	Taxi loads	-	-	Yes	Yes	-
S-2	Empennage Strain and Vibration	Yes	Yes	Yes	Yes	-
S-3	Buffet Boundary	Yes	Yes	Yes	Yes	-
S-4	Orbiter Attach Loads	Yes	Yes	Yes	-	Yes
S-5	Flutter Clearance	Yes	Yes	Yes	-	-
Performance						
P-1	Four-Engine Takeoff	Yes	Yes	Yes	Yes	Yes
P-3	Low Speed Drag	Yes	-	Yes	-	-
P-4	Climb	Yes	Yes	Yes	-	-
P-5	Cruise Performance	-	Yes	Yes	-	-
P-6	Air Data System Calibration	Yes	Yes	Yes	-	-
P-8	Minimum Safe Operation Speeds	Yes	Yes	Yes	-	-
P-9	Minimum Control Speed	-	-	Yes	-	-
Stability/Handling Qualities						
H-1	Longitudinal Stability and Handling Qualities	Yes	Yes	Yes	Yes	-
H-2	Lateral-Directional Stability and Handling Qualities	Yes	Yes	Yes	Yes	-
H-3	Flight Control Systems	Yes	Yes	Yes	Yes	-
H-4	Verification of Aerodynamic Data Base	Yes	Yes	Yes	-	-
H-5	Separation Profile Boundary	-	-	-	Yes	Yes
Mechanical Systems						
M-1	Engine Stability	-	-	-	Yes	Yes
Electronics						
E-1	VOR/LOC, UHF, VHF	Yes	Yes	Yes	Yes	Yes
Operational Systems						
O-1	Functional Check Flight	Yes	Yes	-	-	-

TABLE E-II.- FLIGHT TEST REQUIREMENT SUMMARY FOR CAPTIVE-ACTIVE FLIGHTS

Requirement		Accomplished		
Number	Title	CA-1A	CA-1	CA-3
Primary Flight Test Requirements				
08HV001e	Flutter/Acoustics/Vibrations 225 and 270 Knots flutter Acoustic/Vibration	- Yes	Yes Yes	- -
08HV001f	Vertical Tail Buffet 180 knots 225 and 260 knots	Yes -	- Yes	- -
79HV013b	Small Signal Verification Flight Control System Control Stick Steering/Manual Direct Tests Autoland Fly Through	Yes -	- Yes	- -
90HV001	Simulated Separation Flight Verification Demonstration	- -	Yes -	Yes Yes
90HV003	Aborted Launch Recovery	-	Yes	-
91HV004	Reduced Speed Checks Free Flight Profile Simulation	Yes -	- -	- Yes
Data Gathering Flight Test Requirements				
08HV001g	747 Horizontal Tail Loads	-	Yes	-
45HV001	Fuel Cell Performance	Yes	Yes	-
38HV002	Window Conditioning	-	Yes	-
71HV003	Inertial Measurement Unit Performance	Yes	Yes	-
71HV004a	Air Data Probe Deploy	-	-	Yes
72HV001	Computer Performance	Yes	Yes	-
90HV005	UHF Voice Communications Link	Yes	-	-
61HV001	ALT Atmospheric Revitalization Subsystem Performance	Yes	Yes	-
63HV001	ALT Active Thermal Control Subsystem Performance	Yes	Yes	-
73HV001	Displays/Controls	Yes	-	-
74HV002	Microwave Scan Beam Landing Performance	-	Yes	-
74HV003	Operational Telemetry Downlink	Yes	-	-
74HV004	TACAN	-	Yes	-
75HV001	Flight Recorders	Yes	-	-
76HV001	Electrical Power Distribution	Yes	Yes	-
91HV002	Auxiliary Power Unit Hydraulics/Flight Control	Yes	Yes	-
91HV003	Mated Gear Deployment	-	-	Yes

TABLE E-III.- FLIGHT TEST REQUIREMENT SUMMARY FOR FREE FLIGHTS

Requirement		Accomplished				
Number	Title	FF-1	FF-2	FF-3	FF-4	FF-5
Primary Flight Test Requirements						
07HV001a	Orbiter Aerodynamics Performance Characteristics					
	L/D Determination	Yes	Yes	Yes	-	-
	Landing Performance	Yes	Yes	Yes	-	-
	Tail-Cone-Off Configuration	-	-	-	Yes	-
07HV001 b/c	Longitudinal and Lateral Inputs With: Two Speed Brake Positions	-	Yes	Yes	-	-
	Tail Cone Off, Angle of Attack Sweep, Aerodynamic Stick Inputs, Rudder Kick and Speed Brake De- flection	-	-	-	Yes	-
08HV001b	Flutter, Vibration and Acoustics Free Flight (Programmed Test Inputs) Tail-Cone-Off, Captive Flight	-	Yes	Yes	-	-
		-	-	-	Yes	-
51HV001a	Landing Rollout Tests					
	Coasting Periods					
	Low Speed	Yes	-	-	-	-
	High Speed	Yes	-	Yes	-	-
	Braking Hard					
	Low Speed	-	Yes	-	Yes	-
	High Speed	-	Yes	Yes	Yes	-
	Nose Wheel Steering					
	Low Speed	Yes	-	-	-	-
	High Speed	-	-	-	Yes	-
	Aerodynamic Steering					
	Rudder	Yes	-	-	-	-
	Aileron	-	Yes	-	-	-
	Paved Runway Landing	-	-	-	-	Yes
51HV001b	Differential Braking (Steering)	-	Yes	Yes	Yes	-
51HV003	Landing Rollout Dynamic Stability					
	Lakebed	Yes	Yes	Yes	-	-
	Paved Runway	-	-	-	-	Yes
71HV001	Autoland					
	Closed Loop (Minimum 20 sec)	-	-	Yes	-	-
	Tail-Cone-Off, Open Loop	-	-	-	Yes	Yes
79HV007a	Control Stick Steering Longitudinal Control and Response/Programmed Test Inputs (High and Low Speed, Two Speed Brake Positions)					
	Forward c.g.	-	Yes	-	-	-
	Aft c.g.	-	-	Yes	-	-
	Tail-Cone-Off, c.g. near OFT-1	-	-	-	Yes	-

TABLE E-III.- FLIGHT TEST REQUIREMENT SUMMARY FOR FREE FLIGHTS - Continued

Requirement		Accomplished				
Number	Title	FF-1	FF-2	FF-3	FF-4	FF-5
Primary Flight Test Requirements						
79HV007b	High-Rate Pitch Response Forward c.g. Aft c.g.	- -	Yes -	- Yes	- -	- -
79HV007c	Control Stick Steering Lateral- Directional Programmed Test Inputs (High and Low Speed, Two Speed Brake Positions and Windup Turn) Forward c.g. Aft c.g. Tail-Cone-Off, c.g. near OFI-1	- - -	Yes - -	- Yes -	- - Yes	- - -
79HV007c	Initial Flare Capability Anti-Skid Performance After Adjust- ment	Yes -	- -	- -	Yes Yes	- -
79HV013a	In and Out of Autoland Switching Transient	-	-	Yes	-	-
90HV001	Practice Separation, Tail-Cone-Off, Captive Flight	-	-	-	Yes	-
91HV001	Manual Landing Rollout Control Forward c.g. Aft c.g.	Yes -	- -	- Yes	- -	- -
DFRC (SCA)	Mass Damper System Checkout	-	-	Yes	-	-
Data Gathering Flight Test Requirements						
08HV001a	Compartment Venting and Aerodynamic Pressure	Yes	Yes	-	-	-
08HV001c	Primary Structural Response	Yes	Yes	-	-	-
38HV002	Window Conditioning System	Yes	Yes	-	-	-
45HV001	Fuel Cell Performance	Yes	Yes	-	-	-
46HV001	Auxiliary Power Unit and Hydraulics Performance Control Stick Steering Mode Automatic Mode	Yes -	- -	- Yes	- -	- -
51HV004	Landing Gear Deployment	Yes	Yes	-	-	-
51HV005	Landing Loads/Strut Performance	Yes	Yes	Yes	-	-

TABLE E-III.- FLIGHT TEST REQUIREMENT SUMMARY FOR FREE FLIGHTS - Concluded

Requirement		Accomplished				
Number	Title	FF-1	FF-2	FF-3	FF-4	FF-5
Data Gathering Flight Test Requirements						
61HV001	ALT Atmospheric Revitalization Subsystem Performance	Yes	-	-	-	-
	Dual Fan Cooling Performance (Cabin and Avionics Bay)	-	Yes	-	-	-
63HV001	ALT Active Thermal Control Subsystem Performance	Yes	-	-	-	-
71HV003a	Inertial Measurement Unit Performance	Yes	Yes	-	-	-
71HV003b	Orbiter Navigation	Yes	Yes	Yes	-	-
71HV004a	Air Data Subsonic Performance	Yes	Yes	Yes	-	-
71HV004b	Development Flight Instrumentation Air Data Calibration	Yes	Yes	Yes	-	-
72HV001	Computer Performance	Yes	Yes	Yes	-	-
73HV001	Displays/Control Subsystem	Yes	-	-	-	-
74HV002	Microwave Scan Beam Landing System Performance	Yes	-	Yes	-	-
74HV003	Operational Telemetry Downlink Performance	Yes	-	-	-	-
74HV004	TACAN	Yes	Yes	-	-	-
74HV005	Radar Altimeter Performance	Yes	Yes	-	-	-
75HV001	Flight Recorders	Yes	-	-	-	-
76HV001	Electrical Power Distribution and Control	Yes	Yes	-	-	-
79HV017	Control Sensor Performance/Location	Yes	Yes	-	-	-
90HV004	Orbiter/747 Separation	Yes	-	-	-	-
90HV005	UHF Voice Communications Link	Yes	-	-	-	-
91HV002	Auxiliary Power Unit Hydraulics/ Flight Control	Yes	-	Yes	-	-

APPENDIX F - METEOROLOGICAL DATA

TABLE F-I.- METEOROLOGICAL DATA

Flight	Visibility, mi.		Ceiling, ft		Barometric pressure, in. Hg		Surface temperature, °F		Wind direction, deg		Wind velocity, knots		Turbulence		
	Takeoff	Landing	Takeoff	Landing	Takeoff	Landing	Takeoff	Landing	Takeoff	Landing	Takeoff	Landing	Takeoff	Landing	
Captive-Active:															
1A	45	45	25 000, scat.	25 000, scat.	29.96	29.96	68	75	220	210	8	8	None	None	
1	25	45	25 000, broken	25 000, broken	30.02	30.02	78	81	210	180	6	4	Light	None	
3	50	60	Clear	Clear	30.07	30.07	70	75	170	200	3	4	None	None	
Free Flight:															
1	45	45	15 000, scat.	15 000, scat.	29.97	29.96	76	85	220	180	0-1	1	Light	Light	
2	40	40	25 000, broken	25 000, broken	30.02	30.01	58	66	180	250	2	2	Trace light	None	
3	50	50	25 000, broken	25 000, broken	29.92	29.93	55	59	30	50	4	2	Light chop at sep.	Light	
4	Unlim.	Unlim.	Unlim.	Unlim.	30.10	30.17	52	60	360	-	2	Calm	None	None	
5	15	15	Unlim.	Unlim.	29.96	29.96	47	54	-	-	Calm	Calm	None	None	

APPENDIX G - PROBLEM SUMMARY

TABLE G-I.- APPROACH AND LANDING TEST FLIGHT PROBLEM SUMMARY

Tracking number	Statement	Cause	Corrective action	Status	Reference
Captive-Active Flight 1A					
1	Inertial measurement unit 1 would not go to "operate" during pre-flight checks (June 17, 1977).	Solder did not adhere to power supply transistor lead because of improper metallurgical bonding.	New parts will be screened prior to soldering to ensure that leads are not oxidized. Transistors in all IMU's are being replaced by transistors with good lead solder wetting for OV-102 and subsequent.	Closed	JSC-13864, par. 7.1.2
2	General purpose computer 3 failed during pre-flight checks (June 17, 1977).	Troubleshooting could not isolate the problem and analysis could not determine the cause.	Failed unit was replaced by a spare and sent to vendor for troubleshooting. Unit was acceptance tested and sent back to Palmdale as a spare.	Closed	JSC-13045, par. 6.6
3	No commands were seen on backup flight control system in response to Pilot's speed brake hand controller.	Indication was normal for this flight control system configuration.	The Backup Flight Control System Flight Program Requirements Document was corrected to reflect the flight program coding.	Closed	JSC-13045, par. 3.5.7
4	Cabin vent valve was inoperable.	A GSE cover used for the cabin leak check had not been removed prior to flight.	The ram air valve was used to control cabin pressure during flight. A test variance was added to the cabin leak check procedure.	Closed	JSC-13045, par. 3.6
5.	Hydraulic system 1 water boiler steam vent line temperature reading was low.	The 33-watt heater group was inoperable.	The 33-watt heater group was not required for ALT. Parallel redundant heater circuits to be eliminated in redesign for OV-102. Current measurements to verify operation of each heater and all functional paths to be verified.	Closed	JSC-13864, par. 7.1.1
6	Film in cabin data acquisition camera 1 broke.	"Softness" of black-and-white film coating resulted in debris build-up in critical clearance areas of film transporter.	Color film, which has a harder coating, was used on next flight. Acceptance testing procedures were changed and black-and white film was used for subsequent flights.	Closed	JSC-13045, par. 3.8
7	Exhaust plume from auxiliary power unit systems 1 and/or 2 ignited after landing.	Proximity of exhaust ports for auxiliary power units 1 and 2 and simultaneous operation of units 1 and 2 may contribute to the cause of postlanding plume ignition.	Criteria were established limiting ground operations that include simultaneous operation of auxiliary power units 1 and 2 after a plume has been observed.	Closed	JSC-13045, par. 3.3.1
8	No data on pitch channel of aerodynamic coefficient instrumentation package.	Pitch channel was inoperable.	Unit was removed and replaced for CA-3. Unit was supplied by DFRC as GFE.	Closed	ALT Problem Report 7/18/77

TABLE G-I.- APPROACH AND LANDING TEST FLIGHT PROBLEM SUMMARY - Continued

Tracking number	Statement	Cause	Corrective action	Status	Reference
Captive-Active Flight 1					
9	Alert message "HSI TRANS SW R" was displayed to the crew.	The system performed as designed. Fourteen switches may cause computer to generate momentary nuisance alerts.	Crews were informed of potential nuisance alert messages.	Closed	JSC-13045, par. 6.2
10	A built-in test equipment (BITE) fail indication was observed for inertial measurement unit 2.	The indication was due to a difference in priorities allocated to two of the software modules during ground check-out and a miscompare resulted.	Tests verified that flight software priorities prevent this condition from occurring in flight.	Closed	JSC-13045, par. 3.5.6
11	Orbiter intercom volume was extremely low when other communications channels were set to proper listening levels.	Improper audio balance resulted in low intercom volume.	Audio system was rebalanced by reducing the carrier aircraft UHF gain and adjusting the Orbiter receiver levels internally. CA-3 communications were improved but the problem still existed. The levels were readjusted for free flight and performance was verified during free flight 1.	Closed	JSC-13045, par 3.5.3
12	Commander's attitude director indicator roll display failed.	Roll axis servo motor bearings were damaged prior to installation in the attitude director indicator.	Indicator was replaced by a spare.	Closed	JSC-13045, par. 6.3
13	Auxiliary power unit 1 fuel pump bellows seal failed and fuel was ingested into aft bay causing wiring damage.	Bellows seal failure resulted in excessive hydrazine leakage to the drain system.	An alternate design using an elastomeric seal in place of the bellows design was used in all auxiliary power units for subsequent flights. Damaged wiring was repaired. Seals were added to aft fuselage doors and panels. Vent screen frame was inverted to direct flow around vent.	Closed	JSC-13045, par. 6.4
14	Right-hand outboard elevon accelerometer measurement (V08D9737A) failed.	Undetermined.	None. Measurement was not mandatory for subsequent flights.	Closed	JSC-13045, par. 3.5.2
15	Left-hand outboard elevon primary delta pressure measurement (V58P0868A) was intermittent.	Undetermined	None for ALT. Measurement was not mandatory for subsequent flights. The system is fail-safe with the remaining channels.	Open	JSC-13045, par. 6.7
16	Microwave landing system 3 error message occurred.	Hardware and software operated normally.	Crew procedures were developed to detune the MLS's should the error messages re-occur. Beginning with FF-2, redundancy management delta azimuth limits were opened to 0.35°.	Closed	JSC-13045, par. 3.5.3

TABLE G-I.- APPROACH AND LANDING TEST FLIGHT PROBLEM SUMMARY - Continued

Tracking number	Statement	Cause	Corrective action	Status	Reference
Captive-Active Flight 3					
17	Auxiliary power unit 1 exhaust duct temperature measurement. (V46T0142A) went off-scale high and triggered the caution and warning signal.	Sensor lead opened.	Fill insulation was added to protect the copper lead from the high temperature of the boss on the exhaust duct and provide support. Readout of redundant temperature measurements was provided in cabin. A more durable thermocouple probe sensor will be installed on OV-102. (See item 57.)	Closed	JSC-13864, par. 7.1.4
18	TACAN 3 receiver failed to track properly.	A defective solder bridge was found in a transistor in the AGC loop. Experience with existing units indicates that this was not a generic problem.	Unit was repaired, reinstalled and retested.	Closed	JSC-13045, par. 3.5.3
19	Flight heading and bearing were erratic on both horizontal situation indicators.	Bearing problem was isolated to TACAN "glitches" Heading transient was caused by a software computation problem.	TACAN data will be filtered for navigation on OFT. The heading card problem has been corrected in the OFT software.	Closed	JSC-13045, par. 3.5.7
20	Altitude rate meters were erratic when using air data transducer assembly (ADTA) data.	Current hardware and/or software implementation provides unacceptable altitude rate data for 1 FR flight.	A smoothing algorithm will filter noise in ADTA's pressure data on OFT.	Closed	JSC-13045, par. 3.5.7
21	Hydraulic system 3 had an excessive pressure drop after shutdown.	Manual dump valve was left in wrong position.	Caution note was added to procedure to verify that valve is in proper orientation.	Closed	JSC-13045, par. 3.3.2
22	Instrumentation problems:				
a.	Aft fuselage sidewall strain gage (V35G96) went off-scale high.	Failed signal conditioner.	Signal conditioner was removed and replaced.	Closed	JSC-13045, par. 3.5.2
b.	Ammonia evaporator discharge temperature (V63T9152A) failed off-scale low.	Defective splice.	Splice was repaired.	Closed	JSC-13045, par. 3.5.2
c.	Bulkhead 1307 X-axis (V08D9507A) and Y-axis (V08D9508A) accelerometers were erratic during 4-minute APU-1 operation.	Two loose connectors.	Connectors were tightened and secured.	Closed	JSC-13045, par. 3.5.2
d.	Auxiliary power unit 1 X-axis accelerometer (V46D0180A) was erratic.	Loose cable connector, recessed center pin, and loose transducer.	Transducer, charge amplifier, and coaxial cable were replaced.	Closed	JSC-13045, par. 3.5.2
e.	Auxiliary power unit 1 Z-axis accelerometer (V46D0181A) was erratic.	Undetermined.	New lead was installed.	Closed	JSC-13045, par. 3.5.2
23	Nose landing gear door thruster triggering pawl did not function.	Pawl movement resulting from pyrotechnic actuation did not rotate the arm that releases the bungee spring.	Operation of the spring bungee was not required for ALT. The system is being redesigned for OFT to eliminate the triggering pawl.	Closed	JSC-13864, par. 7.1.3

TABLE G-I.- APPROACH AND LANDING TEST FLIGHT PROBLEM SUMMARY - Continued

Tracking number	Statement	Cause	Corrective action	Status	Reference
Captive-Active Flight 3 - Continued					
24	Cabin data acquisition camera 1 light was not visible.	Light had been blanked out for use on Skylab and was not changed for ALT.	Usable light provided for subsequent flights.	Closed	ALT Problem Report 8/25/77
25	Auxiliary power unit 1 leaked 22 cc of fuel in about 4 minutes of operation.	High leak rate probably occurred during dynamic seating of seal components. Subsequent ground test resulted in leakage of 8 cc during 30 minutes of operation.	Leakage was within limits. No corrective action was required.	Closed	JSC-13045, par. 3.3.1
26	Auxiliary power unit 1 accelerometer data were indicative of random impact.	Instrumentation problem. (See items 22c, 22d and 22e.)	See items 22c, 22d and 22e.	Closed	ALT Problem Report 8/25/77
Free Flight 1					
27	General purpose computer 3 (F9) failed to synchronize during countdown.	Problem was not duplicated in postflight testing but was isolated to the memory interface page.	Memory interface page was replaced; computer was retested and reinstalled in vehicle.	Closed	JSC-13864, par. 4.2.5.4
28	Microwave landing system errors were indicated during channel select operation in countdown.	Errors were caused by bus initialization after PCM switchover and channel select switching.	Flight procedures were revised to reduce potential of nuisance alarms.	Closed	JSC-13864, par. 4.2.5.3
29	General purpose computer 2 (F8) lost synchronization at separation.	Problem was caused by a solder crack in a deficient solder joint on the queue page.	The manufacturing process was changed to ensure good solder wicking and the inspection procedure was improved. All flight computers were retrofitted with pages that were manufactured using the new process.	Closed	JSC-13864, par. 7.2.1
30	Equivalent air speed "off" flag was reported on Commander's alpha/Mach indicator during free flight 1.	Problem was not isolated during ground test. Electronics unit could not be removed without disturbing other equipment.	Electronics unit to be removed for testing in April 1978.	Open	JSC-13864, par. 7.2.2
31	Main landing gear camera 1 and nose landing gear camera 1 jammed.	"Soft" coating on black-and-white film was degraded by high temperature.	Color film used in wheel well cameras on subsequent flights.	Closed	JSC-13864, par. 4.2.8
32	Main landing gear door hinge pin assembly was missing.	Undersize retainer washers were specified on drawings.	Larger washers were installed on hinge pins of landing gear door hinges and clevis pins of the wing truss tube and aft spar. Drawings were corrected.	Closed	JSC-13864, par. 7.2.3
33	Inertial measurement unit 1 gyrocompass test indicated an excessive gyro drift rate during pre-flight checks.	Initial postflight tests were within specification. Laboratory verification tests indicated excessive gyro drift rate.	Unit was replaced for subsequent flights and returned to the vendor for further evaluation.	Open	JSC-13864 par. 4.2.5.6

TABLE G-I.- APPROACH AND LANDING TEST FLIGHT PROBLEM SUMMARY - Continued

Tracking number	Statement	Cause	Corrective action	Status	Reference
Free Flight 1 - Continued					
34	Instrumentation problems:				
a.	Freon coolant loop 2 accumulator quantity measurement was intermittent (operational inst. V63Q1330A).	Intermittent wiring in MDM channel in PCM.	Measurement output was reloaded on new MDM channel.	Closed	JSC-13864, par. 4.2.5.2
b.	Freon coolant loop 2 inlet pressure was intermittent (operational inst. V63P1308A).	Generic contamination within pressure transducer.	None. System performance was determined from flow and temperature data.	Closed	JSC-13864, par. 4.2.5.2
c.	Freon coolant loop 1 inlet pressure was inoperative (operational inst. V63P1108A).	Generic contamination within pressure transducer.	Replaced for FF-4.	Closed	JSC-13864, par. 4.2.5.2
d.	Main landing gear right-hand strut stroke indicator was inoperative (dev. flt. inst. V51H9231A).	Bent pin in connector.	Connector was repaired.	Closed	ALT Problem Report 8/25/77
e.	Left inboard elevon actuator channel 2 position indicator was inoperative (operational inst. V58H0803C).	Open splice.	Splice was repaired.	Closed	ALT Problem Report 8/25/77
f.	Nose landing gear steering actuator pressure transducer port 2 was inoperative (dev. flt. inst. V51P9128A).	Return wire was not installed.	Wire was installed.	Closed	ALT Problem Report 9/12/77
g.	Fuel cell 1 external coolant delta pressure was intermittent (dev. flt. inst. V45P9138A).	Faulty transducer believed to be the cause.	Schedule commitment for further fault isolation has not been established.	Open	ALT Problem Report 12/12/77
h.	Right wingtip, aft, Z-axis accelerometer failed (dev. flt. inst. V08D9764A).	Inaccessible. Attributed to sensor and/or wiring problem or loose connector. Fault isolation not pursued because of cost/schedule considerations.	Procedures to be implemented for better quality control, installation and protection.	Closed	ALT Problem Report 10/7/77
i.	Right outboard elevon, outboard, Z-axis accelerometer failed (dev. flt. inst. V08D9737A).	Loose connection.	Connection was tightened and safety wired.	Closed	ALT Problem Report 10/7/77
j.	Body flap, aft left, Z-axis accelerometer was noisy (dev. flt. inst. V08D9063A).	Loose connection.	Connection was tightened and safety wired.	Closed	ALT Problem Report 10/7/77
k.	Vertical stabilizer, right rear spar, Y-axis accelerometer failed (dev. flt. inst. V08D9791A).	Inaccessible. Attributed to sensor and/or wiring problem or loose connector. Fault isolation not pursued because of cost/schedule considerations.	Procedures to be implemented for better quality control, installation and protection.	Closed	ALT Problem Report 12/12/77
l.	Acoustic measurement, mid fuselage surface, sta. 1300, microphone was erratic after separation (dev. flt. inst. V08Y9404A).	Undetermined. Most probable cause was loose connector.	More positive connector locking technique to be used for OFT.	Closed	ALT Problem Report 9/12/77

TABLE G-I.- APPROACH AND LANDING TEST FLIGHT PROBLEM SUMMARY - Continued

Tracking number	Statement	Cause	Corrective action	Status	Reference
Free Flight 1 - Continued					
34	Instrumentation problems continued:				
m.	Acoustic measurement, inside cargo bay, sta. 640, microphone was erratic after separation (dev. flt. inst. V08Y9405A).	Undetermined. Most probable cause was loose connector.	More positive connector locking technique to be used for OFT.	Closed	ALT Problem Report 12/12/77
n.	Right rudder actuator, hinge moment strain gage was noisy (dev. flt. inst. V23G9022A).	Inaccessible. Attributed to sensor and/or wiring problem or loose connector. Fault isolation not pursued because of cost/schedule considerations.	Procedures to be implemented for better quality control, installation, and inspection.	Closed	ALT Problem Report 12/12/77
o.	Left outboard elevon accelerometer failed (dev. flt. inst. V08D9729A).	Inaccessible. Attributed to sensor and/or wiring problem or loose connector. Fault isolation not pursued because of cost/schedule considerations.	Procedures to be implemented for better quality control, installation, and inspection.	Closed	JSC-13864 par. 4.2.5.2
p.	Main and nose landing gear accelerometers (18 measurements) had bias shift at gear deployment.	Bias shift was attributed to transient charge currents entering amplifiers. Source of transient undetermined.	Accelerometers will not be used on OV-102.	Closed	ALT Problem Report 12/12/77
q.	Hydraulic system 2 water boiler inlet temperature measurement was erratic (dev. flt. inst. V58T9225A).	Water percolated into vent.	None Required.	Closed	ALT Problem Report 9/12/77
r.	Right main landing gear trunnion strain gage data reversed (V51G9238A and V51G9240A).	Measurements were reversed.	None. Data good.	Closed	ALT Problem Report 12/12/77
s.	Nose landing gear trunnion strain gages read high by a factor of 2 (dev. flt. inst. V51G9140 and V51G9141).	Undetermined.	Measurements were calibrated for FF-4.	Closed	ALT Problem Report 12/12/77
t.	Freon coolant loop 1 and 2 heat exchanger outlet temperature reading was low (dev. flt. inst. V63T9071A and V63T9073A).	Temperature sensor bias was influenced by heat exchanger mass.	Temperature bias will be adjusted analytically for OV-102.	Closed	ALT Problem Report 12/12/77
u.	Aerodynamic coefficient instrumentation package accelerometers were noisy.	Eight-hertz noise due to location of package.	Package was relocated for FF-3. Flight data good.	Closed	ALT Problem Report 10/7/77
35	Orbiter UHF communications were marginal on channel 259.7 megahertz.	Intermittent connection in antenna.	Antenna was replaced.	Closed	JSC-13864, par. 7.2.4

TABLE G-I.- APPROACH AND LANDING TEST FLIGHT PROBLEM SUMMARY - Continued

Tracking number	Statement	Cause	Corrective action	Status	Reference
Free Flight 2					
36	OPS 203 error message after separation.	Most probably, electromagnetic interference.	Display electronics unit was replaced for FF-3. Display electronics unit cabling to be shielded on OV-102 and subsequent vehicles.	Closed	JSC-13864, par. 7.2.5
37	Wideband tape recorder speed was erratic during landing rollout.	Tape fluttered during braking due to 16-hertz vibration.	Vibration was reduced when brake "chattering" was corrected for FF-3.	Closed	JSC-13864, par. 4.2.5.2
Free Flight 3					
38	Orbiter UHF communications were marginal and noisy on channel 259.7 megahertz.	Short in connection to antenna feed network.	Antenna was replaced and operated satisfactorily for FF-4 and FF-5. Antenna to be flush mounted for OFT.	Closed	JSC-13864, par. 7.2.4
39	Carrier aircraft UHF communications were erratic.	Intermittently keyed hot microphone. Source of keying was undetermined.	Clearance improved between UHF select switch and panel. Alternate communications plan was developed.	Closed	ALT Problem Report 12/12/77
40	OPS item 13 error message occurred during MSBLS selection	Electromagnetic interference probably caused the display electronics unit to reject and log a crew keyboard entry as an illegal key code.	Display electronics unit cabling to be shielded on OV-102 and subsequent vehicles.	Closed	JSC-13864, par. 7.2.5
41	Orbiter Pilot's communications were intermittent prior to carrier aircraft engine start.	Source of problem was not identified.	Communications's panel on Pilot's side was replaced. A newly developed communications system will be installed in OV-102 and subsequent vehicles.	Closed	JSC-13864, par. 7.2.6
42	Fuel cell 1 condenser exit temperature was low after switchover to internal power.	Viton boots in the fuel cell condenser exit temperature control valves most likely swelled, causing a change in valve position and resulting in temperature shift.	Viton boots for higher temperature valves are now presoaked to avoid swelling. Operation was within temperature control specification limits.	Closed	JSC-13864, par. 7.2.7
43	Orbiter landing gear "chattered" during hard braking.	"Chattering" was caused by improper phase compensation in the anti-skid controller.	Controller was modified to provide more phase lead and the gain was changed.	Closed	JSC-13864, par. 7.2.8
44	Centerline camera actuated prematurely.	Actuator timer was inadvertently started during ground assembly causing camera to start immediately after arming.	Ground assembly procedures were modified.	Closed	JSC-13864, par. 7.2.9
45	Maintenance recorder tracks 8-14 and "bulk erase" were inoperative.	Undetermined. Troubleshooting to be performed.	None required for ALT. Recorder was returned to vendor for troubleshooting.	Open	JSC-13864, par. 7.2.10
46	Auxiliary power unit gas generator chamber pressure indicated extraneous partial pulses.	Transient voltage probably induced in APU controller 15-volt reference power supply by electromagnetic interference.	None. Pulses do not cause loss of speed control and cannot propagate to an overspeed condition.	Closed	JSC-13864, par. 4.2.3.1

TABLE G-I.- APPROACH AND LANDING TEST FLIGHT PROBLEM SUMMARY - Continued

Tracking number	Statement	Cause	Corrective action	Status	Reference
Free Flight 3 - Continued					
47	Instrumentation problems:				
a.	Nose landing gear strut stroke torsional load. No measurement trace (dev. flt. inst. V51G9137A).	Amplifier was over-ranged.	Measurement deleted and replaced by V51G9136A.	Closed	ALT Problem Report 12/12/77
b.	Right inboard elevon differential pressure. Measurement drifted and failed off-scale high (dev. flt. inst. V08P9779A).	Inaccessible. Attributed to sensor problem. Fault isolation not pursued because of cost/schedule considerations.	Measurement will not be used on OV-102 and type of transducer will be changed.	Closed	ALT Problem Report 12/12/77
c.	Right outboard elevon differential pressure. Measurement failed off-scale high at separation (dev. flt. inst. V08P9776A).	Inaccessible. Attributed to sensor problem. Fault isolation not pursued because of cost/schedule considerations.	Measurement will not be used on OV-102 and type of transducer will be changed.	Closed	ALT Problem Report 12/12/77
d.	Auxiliary power unit 1 X-axis accelerometer was intermittent (operational inst. V46D0180A).	Wiring connection was intermittent and opened on FF-4.	Unknown.	Open	
e.	Auxiliary power unit 1 Z-axis accelerometer was intermittent (operational inst. V46D0181A).	Wiring connection was intermittent.	Unknown.	Open	
f.	Auxiliary power unit 3 X-axis accelerometer failed at separation (operational inst. V46D0380A).	Wiring connection was intermittent. Operated on FF-4 with some drop-outs.	Unknown.	Open	
Free Flight 4					
48	OPS 201 error message on display electronics unit 2 during countdown.	Electromagnetic interference probably caused the display electronics unit to reject and log crew keyboard entries as illegal key codes.	Display electronics unit cabling to be shielded on OV-102 and subsequent vehicles.	Closed	JSC-13864, par. 7.2.5
49	Frequency shifts occurred on downlink.	Shift was probably due to sensitivity of S-band transmitter to low temperature.	S-band transmitter was replaced. New test selection of components will reduce sensitivity to low temperature.	Closed for ALT only	JSC-13864, par. 4.2.5.3
50	Centerline camera actuated prematurely.	Variance in baroswitch trigger points and in local atmospheric conditions in conjunction with lower rate of climb probably caused premature actuation.	Delay logic was increased to 5 minutes after arm signal and actuator timer was replaced.	Closed	JSC-13864, par. 7.2.9
51	Left main landing gear brake lining and heat sink were damaged.	Undetermined.	Brake linings replaced. Brakes operated properly on FF-5; however, four carbon lining segments on left inboard brake had chipped edges on unloaded side.	Open	JSC-13864, par. 7.2.11

TABLE G-I.- APPROACH AND LANDING TEST FLIGHT PROBLEM SUMMARY - Continued

Tracking number	Statement	Cause	Corrective action	Status	Reference
Free Flight 4 - Continued					
52	Instrumentation problems:				
a.	Freon coolant loop 1 pump inlet pressure transducer was erratic (operational inst. V63P1108A).	Contamination within transducer.		Open	JSC-13864, par. 4.2.5.2
b.	Left main landing gear accelerometer spikes noted during braking (dev. flt. inst. V08D9745).	Connector was loose.	Accelerometer was re-bonded.	Closed	ALT Problem Report 12/12/77
c.	Five wing strain gages were inoperative (dev. inst. V12G9340A, V12G9341A, V12G9342A, V12G9343A, and V12G9344A).	Gages were improperly wired.	Gages rewired for FF-5.	Closed	ALT Problem Report 10/25/77
53	Auxiliary power unit 1 gear box leak.	Most probable cause was dynamic gas leak through turbine shaft bellows seal.	Corrective action not required for ALT. Corrective action being considered for OV-102 consists of using a double-damper turbine shaft bellows seal and gaseous nitrogen gear box repressurization system.	Open	JSC-13864, par. 4.2.3.1
54	Carbon particles found in auxiliary power unit 2 accumulator bottle.	Not significant. Most likely was random accumulation from normal operational wear and drain line contamination.	Consideration is being given to improvements in processes to purge drain lines and seal cavities for OV-102.	Closed	JSC-13864, par. 4.2.3.1
Free Flight 5					
55	Inertial measurement unit 1 Y-axis accelerometer calibration was out of tolerance.	Undetermined.	IMU has been returned to vendor for evaluation.	Open	JSC-13864, par. 7.2.12
56	TACAN 3 failed to lock.	Postflight onboard testing showed low sensitivity.	Additional troubleshooting to be performed.	Open	JSC-13864, par. 7.2.13
57	Auxiliary power unit 3 exhaust duct temperature intermittently read zero.	Instrumentation failure. Open in return lead at sensor junction (V46T0340A).	A more durable thermocouple probe sensor has been procured for OV-102.	Closed	JSC-13864, par. 7.2.14
58	Main landing gear camera 1 film had torn sprocket holes.	Misaligned drive coupling caused film to jam.	Decal will be added to camera warning to check for proper alignment of drive coupling during magazine installation.	Closed	JSC-13864, par. 7.2.15
59	Carrier aircraft aft camera 2 failed to transport film.	Supply reel startup acceleration during high inflight vibration caused film to disengage from sprocket teeth.	Keeper was built around film sprocket, film speed was reduced, film thickness was increased, and film acceleration ramp was lengthened.	Closed	JSC-13864, par. 7.2.16

TABLE G-I.- APPROACH AND LANDING TEST FLIGHT PROBLEM SUMMARY - Concluded

Tracking number	Statement	Cause	Corrective action	Status	Reference
Free Flight 5 - Continued					
60	Hydraulic system 3 pressure was low during postlanding load test.	Undetermined. Leak test could not be performed. Pump to be tested in laboratory after removal from OV-101.	Unknown.	Open	JSC-13864, par. 7.2.17
61	Landing control problem.	Pilot inputs to control sink rate near landing resulted in large elevon motion and kept elevons rate-limited.	Modifications being considered include revising priority rate limiting to always provide some combination of pitch and roll capability, lower gains, increase stick forces and reduce transport times.	Open	JSC-13864, sec. 4.4