

**U.S. Department of Commerce
National Technical Information Service**



N79-10021

**WIND TUNNEL TESTS OF THE GA (W)-2
AIRFOIL WITH 20% AILERON, 25% SLOTTED
FLAP, 30% FOWLER FLAP, AND 10% SLOT-LIP
SPOILER**

**WICHITA STATE UNIVERSITY
WICHITA, KS**

AUG 76



Wind Tunnel Tests of the GA(W)-2
Airfoil with 20% Aileron, 25% Slotted Flap,
30% Fowler Flap, and 10% Slot-Lip Spoiler

by

W. H. Wentz, Jr.

(NASA-CR-145139)	WIND TUNNEL TESTS OF THE	N79-10021
GA(W)-2 AIRFOIL WITH 20% AILERON, 25%		
SLOTTED FLAP, 30% FOWLER FLAP AND 10%		
SLOT-LIP SPOILER (Wichita State Univ.)	75 p	Unclas
HC A04/MF A01	CSCL 01A G3/02	35694

Report of Research Conducted Under NASA Grant NSG 1165

Prepared by

Wichita State University

Wichita, Kansas

for

NASA Langley Research Center

August 1976

REPRODUCED BY
NATIONAL TECHNICAL
INFORMATION SERVICE
U.S. DEPARTMENT OF COMMERCE
SPRINGFIELD, VA. 22161

1. Report No. NASA CR-145139	2. Government Accession No.	3. Recipient's Catalog No.
4. Title and Subtitle WIND TUNNEL TESTS OF THE GA(W)-2 AIRFOIL WITH 20% AILERON, 25% Slotted Flap, 30% Fowler Flap and 10% Slot-Lip Spoiler	5. Report Date January 1977	6. Performing Organization Code
	8. Performing Organization Report No. AR 76-2	10. Work Unit No. 505-06-33-10
7. Author(s) W. H. Wentz, Jr.	11. Contract or Grant No. NSG-1165	13. Type of Report and Period Covered Contractor Report
9. Performing Organization Name and Address Wichita State University Wichita, KS 67208	14. Sponsoring Agency Code	
	12. Sponsoring Agency Name and Address National Aeronautics & Space Administration Washington, DC 20546	
15. Supplementary Notes Langley Monitor: Robert J. McGhee		
16. Abstract Two-dimensional wind tunnel tests have been conducted for the GA(W)-2 airfoil section with: 20% aileron, 25% slotted flap; 30% Fowler flap and 10% slot-lip spoiler. All tests were conducted at a Reynolds number of 2.2×10^6 and a Mach Number of 0.13. In addition to force measurements, tuft studies were conducted for the slotted and Fowler flap configurations. Aileron and Spoiler hinge moments were obtained by integration of surface pressure measurements. Tests results show that a $c_{l_{max}}$ value of 3.82 was obtained with 30% Fowler flap. Aileron control effectiveness and hinge moments are similar to other airfoils. The slot-lip spoiler provides powerful, positive roll control at all flap settings.		
17. Key Words (Suggested by Author(s)) Airfoil, aileron, flap, spoiler Two-dimensional force measurements Flow visualization Optimized slot geometry		
19. Security Classif. (of this report) Unclassified	20. Security Classif. (of this page) Unclassified	

INTRODUCTION

As part of NASA's recent program for developing new airfoil sections for general aviation applications (Ref. 1), Wichita State University is conducting flap and control surface research for the new airfoils. This report documents two-dimensional wind tunnel tests of the GA(W)-2 airfoil section with: (a) 20% chord aileron; (b) 25% chord slotted flap, (c) 30% chord Fowler flap; and (d) 10% chord slot-lip spoiler.

All experimental tests reported herein were conducted in the Walter Beech Memorial Wind Tunnel at Wichita State University. High Reynolds number tests of the GA(W)-2 airfoil have been reported in reference 2.

SYMBOLS

The force and moment data have been referred to the .25c location on the flap-nested airfoil. Dimensional quantities are given in both International (SI) Units and U.S. Customary Units. Measurements were made in U.S. Customary Units. Conversion factors between the various units may be found in reference 3. The symbols used in the present report are defined as follows:

- c Airfoil reference chord (flap-nested)
- c_a Airfoil forward section chord
- c_d Airfoil section drag coefficient, section drag/
(dynamic pressure x chord)
- c_f Flap chord
- c_h Control surface moment coefficient about hingeline,
section moment/(dynamic pressure x reference chord²)
- c_ℓ Airfoil section lift coefficient, section lift/
(dynamic pressure x chord)

- c_{l}^* Lift coefficient based upon airfoil plus flap chord,
 $c_{l} / ((c_{a} + c_{f}) / c)$
- c_{m} Airfoil section pitching moment coefficient with re-
 spect to the .25c location, section moment/(dynamic
 pressure x chord²)
- c_{p} Coefficient of pressure, $(p-p_{\infty})$ /dynamic pressure
- h Spoiler projection height normal to local contour
- p Pressure
- x Coordinate parallel to airfoil chord
- z Coordinate normal to airfoil chord
- α Angle of attack, degrees
- Δ Increment
- δ Rotation of surface from nested position, degrees.

Subscripts:

- a Aileron
- f Flap
- max Maximum
- n Nose
- p Pivot
- s Spoiler
- ∞ Free stream condition

APPARATUS AND TEST METHODS

Model Description

The GA(W)-2 airfoil section is a 13% maximum thickness section derived from the 17% thick GA(W)-1 section (Ref. 4). For tests in the WSU two-dimensional facility, the models are sized with 91.4 cm (36 inch) span and 61.0 cm (24 inch) chord.

The forward 70% of the airfoil was fabricated from laminated mahogany bonded to a 2.5 cm x 34.8 cm (1 inch x 13.7 inch) aluminum spar. Trailing edge sections were fabricated from solid aluminum for each trailing edge device. Configuration geometric details are given in figure 1.

The 20% chord aileron is designed with a 0.5% leading-edge clearance gap. Earlier tests (Ref. 5) have shown that a gap this size has little effect on aileron performance. The 25% slotted flap design is used with an airfoil forward section terminating at 87.5% chord. The 30% Fowler flap is fitted with an airfoil forward section which extends to the full 100% chord location. The 10% spoiler is arranged in a slot-lip configuration with the 25% slotted flap.

All models are equipped with 1.07 mm (.042 inch) diameter pressure taps for pressure distribution surveys. Flap and aileron positioning is provided through a set of guide rails mounted on the outside of the end plate disks (external to the test section).

Test models are attached to the tunnel main balance system through a set of 1.07 m (42 inch) diameter aluminum end plate disks. Model pivot location is the airfoil 50% chord station. The end plates are fitted with foam seals around the circumference. The seals are carefully adjusted during static calibration to avoid interference friction forces.

Instrumentation

The tunnel is equipped with an automated data system which converts analog force and pressure transducer output signals to digital form, and records the data on punched cards. Force measurements are made using a pyramidal balance. Computation work is done through the University Digital Computing Center.

Test Procedure

Lift, drag and pitching moment data are obtained from direct force measurements. For each airfoil section to be tested, a wake survey is conducted with a traversing 5-tube probe (Ref. 6) to obtain section total drag coefficient as a function of lift coefficient. The difference between the wake survey drag and the balance force measured drag is end plate tare including interference. The drag measurement is complicated by the fact that the wake survey method cannot be used with flaps or ailerons because of rotational losses in the wake. Therefore the flap-nested end plate tare is subtracted from all measured drag force data obtained with flaps or ailerons deployed. By extrapolating the end plate tare curve in a conservative fashion, it is possible to obtain satisfactory drag information for any flap or aileron setting. The measurement accuracy is aided by the fact that end plate tare is a small proportion of total drag when high lift devices are employed. All force measurements have been corrected for wind tunnel wall effects using the linear correction techniques given in reference 7. At the high lift coefficient conditions associated with high flap deflections, these corrections are significant. All tests were conducted at a Reynolds number of 2.2×10^6 and Mach number of 0.13.

Wind Tunnel

The WSU Walter Beech Tunnel is a closed return tunnel with atmospheric test section static pressure. The test section with two-dimensional inserts is 0.91 m x 2.13 m (3 ft x 7 ft). Complete description of the insert and calibration details are given in reference 8.

TEST RESULTS

Flap Nested

For the WSU GA(W)-1 research, transition strips were located at 5% chord on upper and lower surfaces. However, pressure studies with the GA(W)-1 airfoil indicated that for large flap deflections the lower surface stagnation point was located as far aft as 7% or 8% chord. In order to provide more positive lower surface transition fixing for the present tests, the strips were located at 5% on the upper surface and 10% on the lower surface.

Comparisons of WSU data with NASA data for the flap-nested configuration are shown in figure 2. The lift and pitching moment data agree extremely well, even including stalling effects. It is noted that at low lift coefficients the WSU tests indicate slightly higher drag values, and at moderate lift coefficients somewhat lower drag values than the NASA tests. Overall agreement is considered quite good, however.

20% Aileron

Effects of a 20% aileron applied to the GA(W)-2 airfoil are shown in figure 3. Control effectiveness is very similar to data obtained for a similar aileron applied to the GA(W)-1 section (Ref. 5).

For the zero aileron deflection case, lift coefficient data are presented for aileron gap sealed as well as 0.5% aileron gap. These data show that the gap causes a progressive loss in lift as angle of attack is increased from 0° to 12°. For higher angles the unsealed gap provides an increase in lift. Evidently the slot flow provides boundary layer control which delays the separation.

Effects of the 0.5% gap on drag are shown in figure 3(b). These data show that at low lift coefficients ($c_l < 1.5$) a gap leak penalty of $\Delta c_d = .0020$ (approximately) is present. At higher lift coefficients a slight drag reduction is observed, since the gap delays stalling. The data also show that the gap leak drag penalty at cruise could be offset by 5° up-rigging of the aileron. A substantial loss in c_{lmax} ($\Delta c_{lmax} = -.17$) would be the penalty for this arrangement.

25% Slotted Flap

This flap is called a "slotted flap" because it has less than full flap chord overlap in the nested position. It was designed to provide a portion of the high-lift capabilities of the 30% Fowler flap with considerably shorter flap tracks and consequently simpler structure, and as a candidate for a slot-lip spoiler design of reasonable thickness. Flap settings and lift, drag and pitching moment performance are shown in figure 4. For both 35° and 40° flap deflections, a c_{lmax} of 3.35 is obtained. For 30°, 35°, and 40° flap, the results show a peculiar non-linearity in the c_l vs. alpha curve with an increasing slope just prior to stall. This effect has been observed in other research (Ref. 9), but the reasons for the behavior are not clear. Contour plots of c_{lmax} for various gap and overlap settings (figure 5) show trends very similar to GA(W)-1 flap optimization contours (Ref. 10) and to earlier NACA slotted flap research (Refs. 11 and 12). For highest c_{lmax} values, overlap is near zero and gap opening ranges from 1% to 3% chord.

For practical flap track design, some compromises to optimum aerodynamic performance are necessary. For the present case the following design guides were invoked:

(1) For 10° deflection, no attempt was made to optimize overlap. An intermediate overlap position was selected and tests were conducted to determine optimum gap opening. These

tests showed that $c_{\ell\max}$ was very insensitive to gap opening. Therefore an intermediate gap opening was selected.

(2) For 20° deflection, the highest $c_{\ell\max}$ measured occurred at a position more aft than optimum 30° and 35° settings (fig. 5). The gradients are mild, however, and locating the flap in a more practical position results in only 0.02 loss in $c_{\ell\max}$. Therefore the more practical (forward) position was used.

(3) For 30°, 35° and 40° flap deflections the gradients are substantial, and the flap is located at the optimum position for each deflection.

In order to facilitate sealing the flap slot at zero deflection to minimize cruise drag, the slot for this flap was designed with a sharp entry lip. Earlier research (ref. 12) indicates that entry lip shape has little effect on $c_{\ell\max}$, but does influence optimum gap and overlap settings. A moderately rounded lip was tested on the present model, after optimization had been conducted with the sharp lip. Results show a loss in $c_{\ell\max}$ of 0.21 for the rounded lip without re-optimizing gap and overlap (fig. 6).

30% Fowler Flap

A 30% Fowler flap was designed for the GA(W)-2 airfoil, similar to a flap developed for the GA(W)-1 airfoil. Results of optimum flap-extended tests are shown in figure 7. These data show that a $c_{\ell\max}$ of 3.82 is obtained with 40° flap deflection. This is almost exactly the same value of $c_{\ell\max}$ that was obtained with the GA(W)-1 airfoil with the Fowler flap. Since the unflapped section $c_{\ell\max}$ for the GA(W)-2 airfoil is greater than for the GA(W)-1, the increment in $c_{\ell\max}$ due to flap deflection is reduced.

Experimental studies were conducted to determine optimum gap and overlap for 40° and 50° flap deflections. Results of these tests are shown in the contour plots of figure 8. These

data are useful in determining penalties associated with non-optimum flap settings. For any flap deflection, the highest $c_{l,max}$ will occur with nearly zero overlap since this configuration maximizes effective chord. Optimum gaps are 2 to 3%. For practical flap track design, however, it is of interest to know an optimum gap for intermediate flap positions. For this reason a series of runs were made with 10° and 20° deflections with intermediate overlap settings and various gaps. The recommended settings for 10° and 20° flap deflections (fig. 7) are based upon the results of these runs.

Comparative Flap Effectiveness

Flap effectiveness for the 20% aileron, 25% slotted flap and 30% Fowler flap are compared in figure 9. This graph illustrates the increasing lift effectiveness available as flap system complexity increases from plain flap to slotted flap to Fowler flap.

It is interesting to compare the relative merits of the present flap designs to earlier designs. A common baseline for comparison is provided by referring lift coefficients to flap-extended chord. For simplicity in this analysis, extended reference chord is taken as the sum of c_a and c_f (i.e., without accounting for flap deflection). Calhoun (ref. 13) has suggested comparing flapped airfoil data from earlier NACA research (ref. 12) with results of recent GA(W) airfoil research as shown in figure 10. These data show that the recent designs provide substantially higher maximum lift coefficients than the earlier designs. It is an interesting coincidence that the c_f/c_a ratio for the present 25% chord flap and 30% chord flaps are nearly identical. It is an experimental fact that the maximum lift coefficients based upon extended chord are nearly identical. It would be interesting to evaluate flap designs of different c_f/c_a ratio applied to the GA(W) airfoil family to determine

whether the expected trend applies for other flap chord ratios. The new flaps are generally more cambered than earlier designs. From the standpoint of retrofitting existing airplanes or making low cost changes to airplanes in current production, it would be interesting to know what performance could be obtained from a highly cambered trailing edge and flap applied to an "old" generation airfoil, and conversely what performance could be obtained from a "new" (GA-) airfoil leading edge applied to an old airfoil with moderately cambered trailing edge and flap.

Tuft Patterns

Tuft studies showing flow separation patterns for the basic GA(W)-2 section are shown in figure 11. These data show that the airfoil separates from the trailing edge forward.

For flaps-down configurations with optimum flap settings (figs. 12 and 13), first separation occurs at the trailing edge of the main airfoil section, and moves progressively forward as angle of attack is increased. The flap flow appears to have nearly incipient separation at low angles of attack, but shows improvement as angle of attack is increased. Flap flow remains attached through stall.

10% Slot-Lip Spoiler

Prior research with a spoiler applied to the GA(W)-1 airfoil (refs. 14 and 15) revealed that locating a spoiler at some distance ahead of a large Fowler flap tended to result in regions of near-zero or reversed control effectiveness for small deflections, and high drag penalties at cruise due to clearance gap leaks. Limited tests of a slot-lip spoiler applied to the GA(W)-1 (ref. 14) indicated that a slot-lip arrangement would provide more satisfactory control

response. Therefore a slot-lip spoiler was designed for evaluation with the GA(W)-2 airfoil, in conjunction with the 25% slotted flap. The configuration selected for testing is shown in figure 1(e).

The spoiler was designed with a hingeline on the airfoil upper surface to facilitate sealing, and with a lower surface contour designed to promote flow attachment to the lower surface when the spoiler is deployed. The brackets for spoiler attachment and setting were attached to the tunnel sidewall endplates to minimize interference. The spoiler was fitted with pressure taps for evaluation of hinge-moments.

Effects of spoiler deflection on lift are shown in figure 14 for various flap deflections. Incremental effects of spoiler deflection are shown in figure 15. These data show positive control response (loss of lift) for even the smallest control deflection (2.5°) at all flap settings. The results are especially encouraging in light of the earlier research, and clearly indicate the advantages of the slot-lip arrangement as opposed to a more forward spoiler location.

The control response for small spoiler deflections with 30° , 35° , and 40° flap deflections is so large that one questions whether over-controlling might arise with this configuration.

Flight research using a variable stability aircraft has been conducted by Ellis and Tilak (ref. 16) to explore the effects of various non-linear control characteristic curves, including cases with steep initial gradients. This research indicates that a steep initial gradient is less satisfactory than a linear characteristic, but more satisfactory than an initially shallow gradient or dead band.

In any case, potential problems related to too much control are probably easier to solve than too little control. For example, with the present configuration the problem might be minimized by limiting flap deflection to about 30° and utilizing a somewhat shorter spoiler chord. The penalty in $c_{l,max}$ for limiting

flap deflection to 30° is quite modest, amounting to only 0.07 increment.

Spoiler hinge moment data reflect trends very similar to those exhibited by spoilers applied to the GA(W)-1 airfoil. For zero spoiler deflection, relatively large opening moments are present, due to the aft camber of the GA(W) airfoils. For 10° flap a peculiar non-linear hinge moment characteristic is observed at 20° spoiler. Reasons for this behavior are not clear, but it is speculated that the large overlap associated with the 10° flap setting might lead to an unstable slot flow, with the flow attaching alternately to the flap and to the spoiler. The non-linearity was not observed in the spoiler control effectiveness tests.

CONCLUSIONS

1. The present wind tunnel tests provide a data base for designers for a 20% aileron, 25% and 30% flaps and a 10% spoiler applied to the GA(W)-2 airfoil.
2. Aileron performance with the GA(W)-2 section is quite consistent with ailerons applied to other airfoils.
3. The GA(W)-2 airfoil provides significantly higher $c_{l,max}$ performance than NACA airfoils, both with and without flaps. Performance with flaps is nearly identical to the GA(W)-1 section.
4. A slot-lip spoiler applied to the GA(W)-2 airfoil section in combination with a slotted flap provides powerful, positive control at all flap settings.

Aeronautical Engineering Department
Wichita State University
Wichita, Kansas 67208
August, 1976

REFEPENCES

1. Pierpont, P.K.: Bringing Wings of Change. *Astronautics and Aeronautics Magazine*, October 1975.
2. McGhee, R.J. and Beasley, W.D.: Effects of Thickness on the Aerodynamic Characteristics of an Initial Low-Speed Family of Airfoils for General Aviation Applications. NASA TMX-72843, date for general release, December 1978.
3. Mechtly, E.A.: The International System of Units--Physical Constants and Conversion Factors (Revised). NASA SP-7012, 1969.
4. McGhee, R.J. and Beasley, W.D.: Low-Speed Aerodynamic Characteristics of a 17-Percent Thick Airfoil Section Designed for General Aviation Applications. NASA TND-7428, 1973.
5. Wentz, W.H., Jr.; Seetharam, H.C.; and Fisco, K.A.: Force and Pressure Tests of the GA(W)-1 Airfoil with a 20% Aileron and Pressure Tests with a 30% Fowler Flap. AR 76-1, Wichita State University, 1976.
6. Seetharam, H.C.; Wentz, W.H., Jr.; and Walker, J.K.: Measurement of Post-Separated Flow Fields on Airfoils. AIAA Paper no. 75-1426, 1975.
7. Pope, A. and Harper, J.J.: *Low-Speed Wind Tunnel Testing*. John Wiley and Sons, 1966.
8. Siew, R.J.: Calibration of a Two-Dimensional Insert for the WSU 7' x 10' Wind Tunnel. AR 73-2, Wichita State University, 1973.
9. Bingham, G.J. and Noonan, K.W.: Low-Speed Aerodynamic Characteristics of NACA 6716 and NACA 4416 Airfoils with 35-Percent-Chord Single-Slotted Flaps. NASA TMX-2623, 1974.
10. Wentz, W.H. and Seetharam, H.C.: Development of a Fowler Flap System for a High Performance General Aviation Airfoil. NASA CR-2443, 1974.
11. Wenzinger, C.J. and Harris, T.A.: Wing Tunnel Investigation of an NACA 23012 Airfoil with Various Arrangements of Slotted Flaps. NACA Rept. 664, 1939.
12. Cahill, J.F.: Summary of Section Data on Trailing-Edge High-Lift Devices. NACA Rept. 938, 1949.

13. Calhoun, J.T. (Senior V.P. Engineering, Robertson Aircraft: Private communication with the author).
14. Wentz, W.H., Jr.: Effectiveness of Spoilers on the GA(W)-1 Airfoil with a High Performance Fowler Flap. NASA CR-2538, 1975.
15. Wentz, W.H. Jr.; and Volk, C.G. Jr.: Reflection-Plane Tests of Spoilers on an Advanced Technology Wing with a Large Fowler Flap. NASA CR-2696, 1976.
16. Ellis, D.L.; and Tilak, N.W.: An In-Flight Investigation of Non-Linear Roll Control. SAE Paper 750528, 1975.

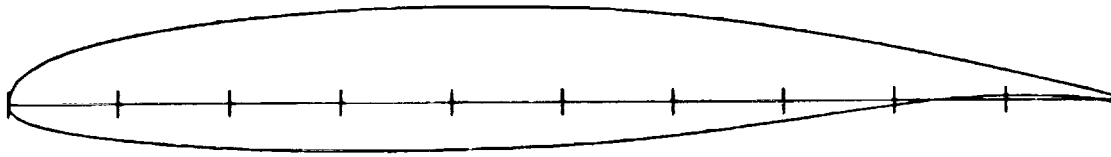

UPPER SURFACE		LOWER SURFACE	
x/c	z/c	x/c	z/c
0.0000	0.0000	0.0000	0.0000
.0020	.0103	.0020	-.0066
.0050	.0163	.0050	-.0097
.0125	.0246	.0125	-.0144
.0250	.0336	.0250	-.0188
.0375	.0400	.0375	-.0223
.0500	.0451	.0500	-.0250
.0750	.0528	.0750	-.0294
.1000	.0588	.1000	-.0328
.1250	.0637	.1250	-.0357
.1500	.0677	.1500	-.0380
.1750	.0712	.1750	-.0398
.2000	.0742	.2000	-.0415
.2500	.0788	.2500	-.0438
.3000	.0820	.3000	-.0449
.3500	.0840	.3500	-.0452
.4000	.0849	.4000	-.0449
.4500	.0846	.4500	-.0437
.5000	.0833	.5000	-.0417
.5500	.0807	.5500	-.0386
.5750	.0789	.5750	-.0362
.6000	.0767	.6000	-.0337
.6250	.0739	.6250	-.0307
.6500	.0708	.6500	-.0276
.6750	.0672	.6750	-.0243
.7000	.0633	.7000	-.0210
.7250	.0591	.7250	-.0175
.7500	.0545	.7500	-.0143
.7750	.0497	.7750	-.0110
.8000	.0447	.8000	-.0078
.8250	.0395	.8250	-.0051
.8500	.0341	.8500	-.0028
.8750	.0285	.8750	-.0012
.9000	.0228	.9000	.0000
.9250	.0170	.9250	.0001
.9500	.0110	.9500	-.0007
.9750	.0049	.9750	-.0028
1.0000	-.0015	1.0000	-.0071

(a) Basic GA(W)-2 Airfoil.

Figure 1 - Geometry.

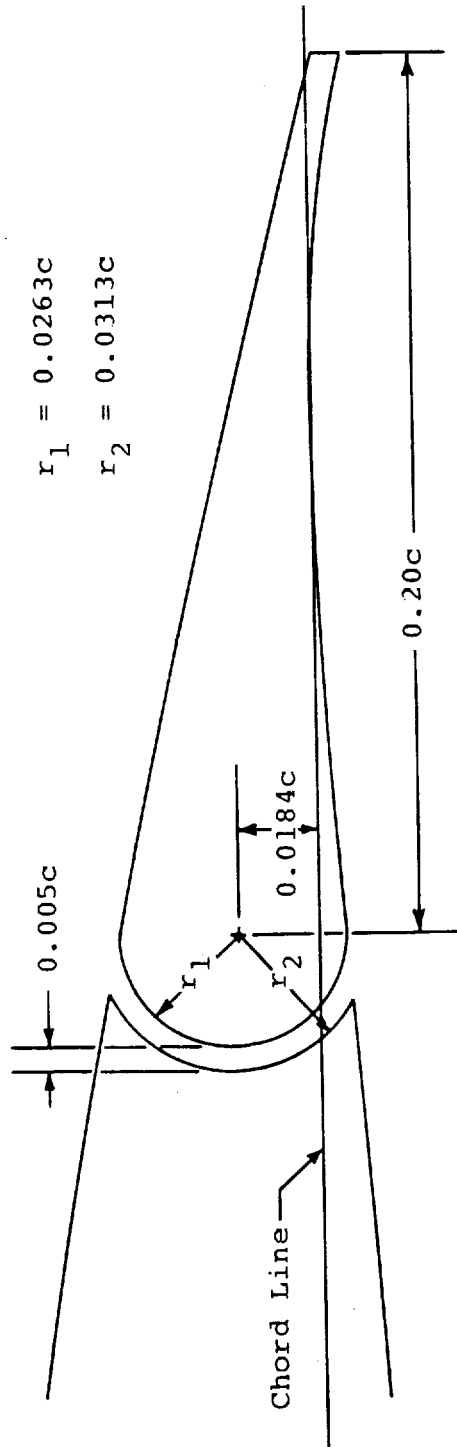

(b) 20% Aileron.
Figure 1 - Continued.

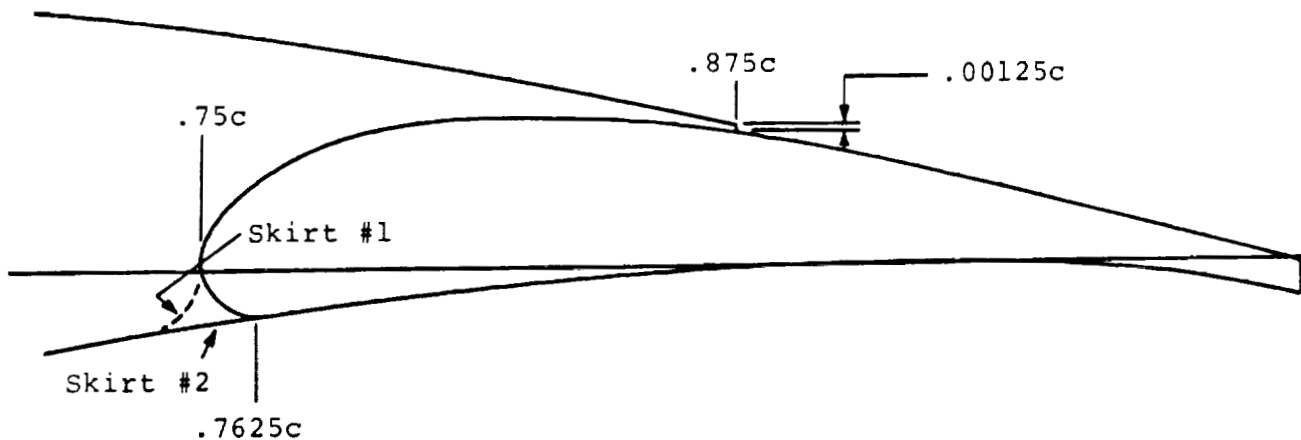

Flap Upper Surface

x/c	z/c
0.7500	-0.0010
.7531	0.0072
.7562	.0109
.7593	.0138
.7625	.0164
.7750	.0234
.7875	.0276
.8000	.0298
.8125	.0307
.8250	.0308
.8375	.0306
.8500	.0302
.8625	.0288
.8742	.0271
.8875	.0250
.8992	.0229

Nose Radius = 0.012c

Nose Radius Location

(x/c,z/c) = (0.762c,-0.00087c)

Note: Remainder of flap contour matches basic airfoil.

Skirt #1

Radius = 0.012c

Location (x/c,z/c) = (0.738c,-0.00087c)

(c) 25% Slotted Flap.

Figure 1 - Continued.

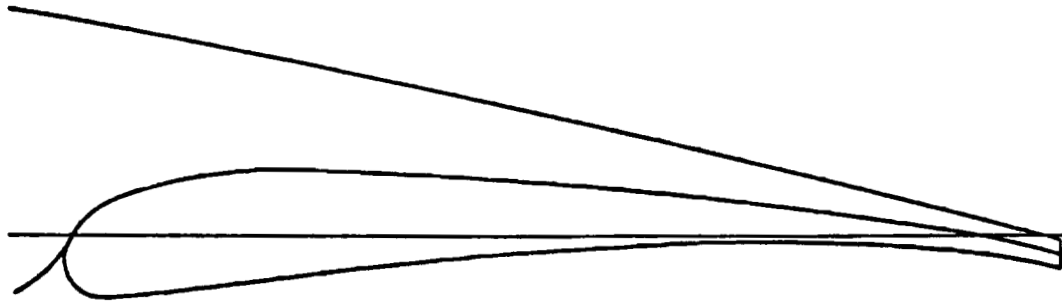

Skirt		Flap Upper Surface	
x/c	z/c	x/c	z/c
.675	-.0231	.700	-.0069
.680	-.0215	.705	.0030
.685	-.0204	.710	.0075
.690	-.0158	.720	.0119
.700	-.0105	.740	.0171
.705	.0030	.760	.0194
		.775	.0190
		.800	.0184
		.825	.0172
		.850	.0156
		.875	.0137
		.900	.0114
		.925	.0086
		.950	.0051
		.975	.0014
		1.000	-.0044

Nose Radius = 0.0117c

Nose Radius Location (x/c,z/c) = (0.7119c,-0.0071c)

Note: Remainder of Flap contour matches basic airfoil.

(d) 30% Fowler Flap.
Figure 1 - Continued.

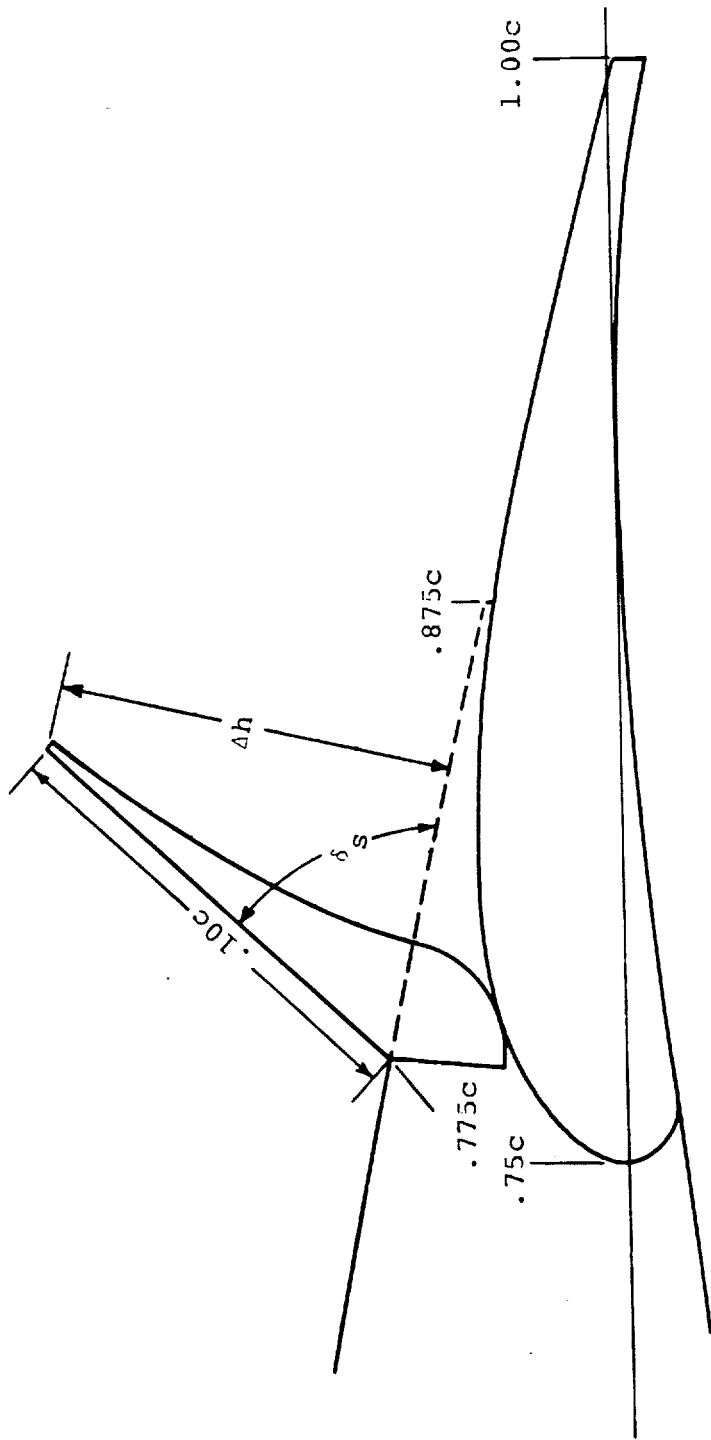

(e) 10% Slot-lip Spoiler.

Figure 1 - Concluded.

46 1513

W. X. 10 TO THE ENGINEER
REUFF, L. & ESSIGER CO. MARION, VA

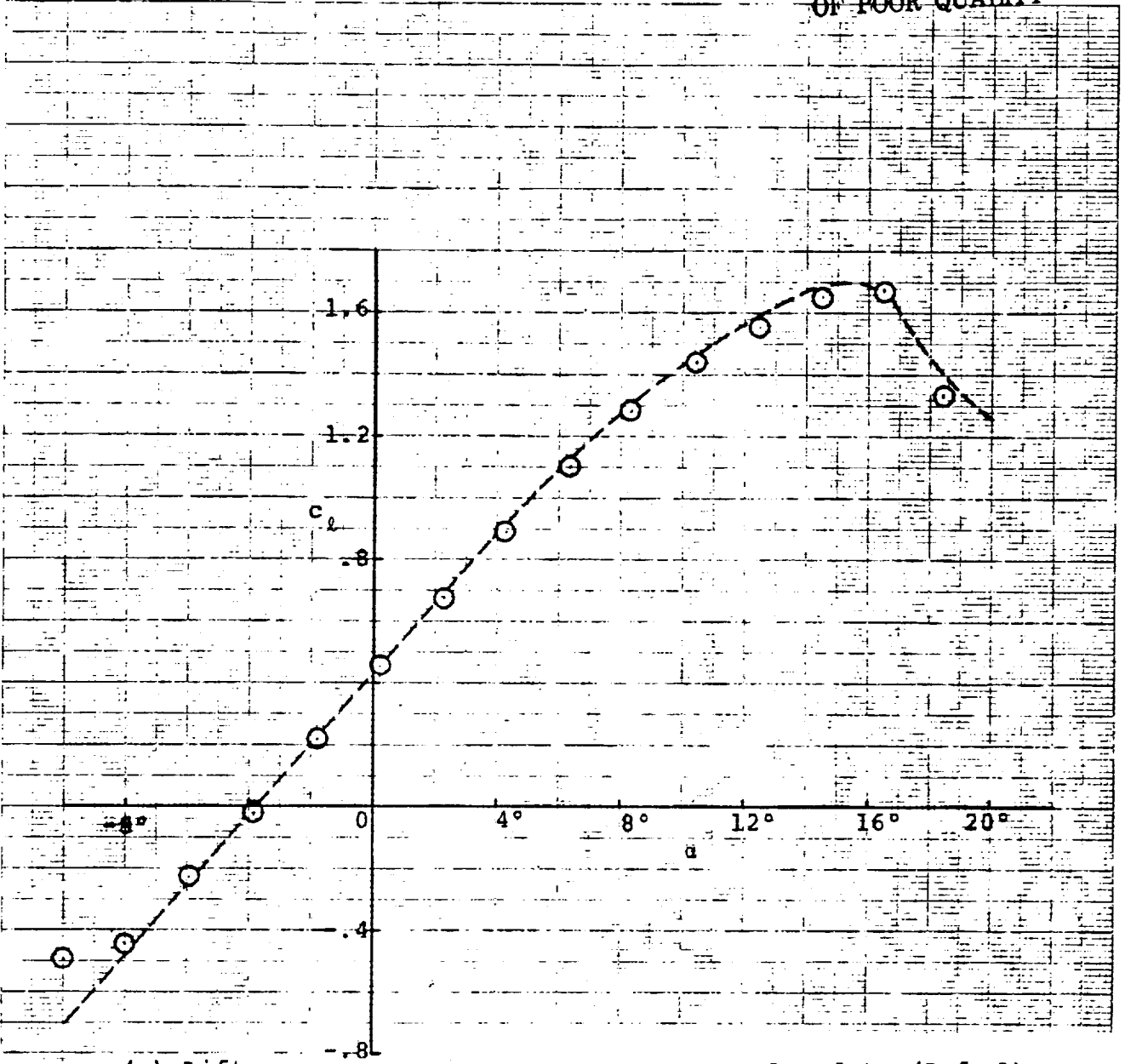

(a) Lift.

----- NASA Langley data (Ref. 2)

○ WSU data

Note: With transition strips.

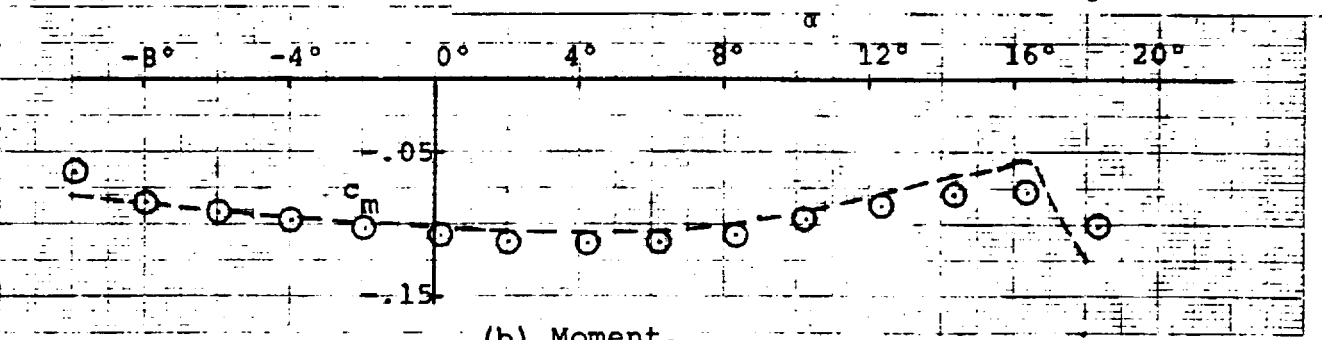

(b) Moment.

Figure 2 - Basic Airfoil Data - Comparisons with NASA Data.

REPRODUCIBILITY OF THE
ORIGINAL PAGE IS POOR

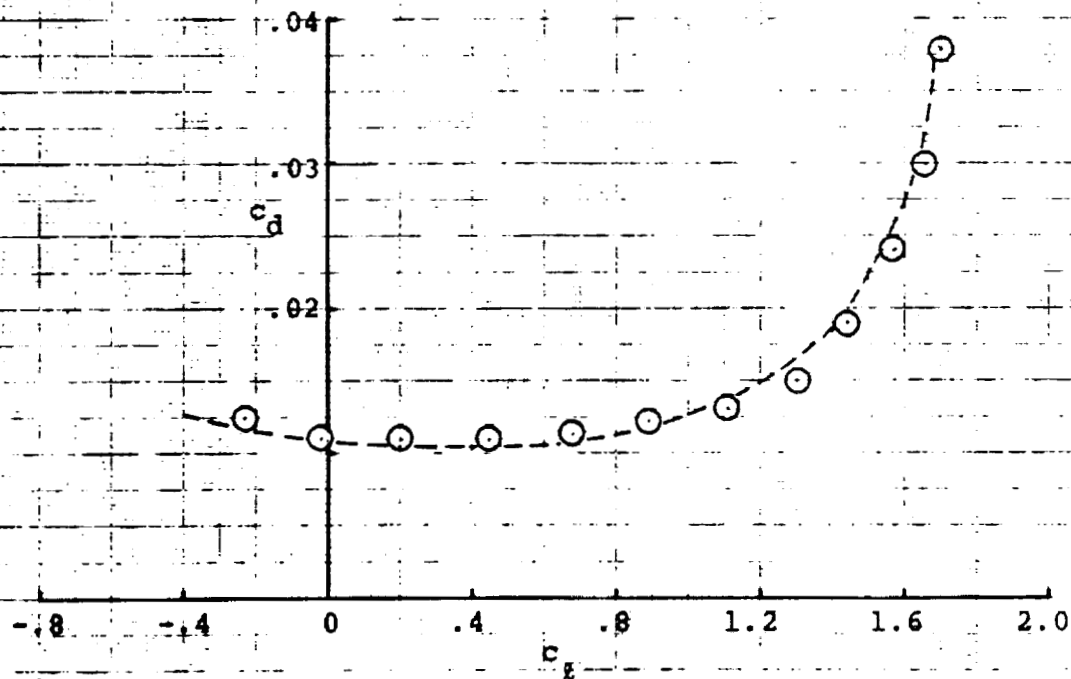

----- NASA Langley data (Ref. 2)

○ WSU data

Note: With transition strips.

(c) Drag.

Figure 2 - Concluded.

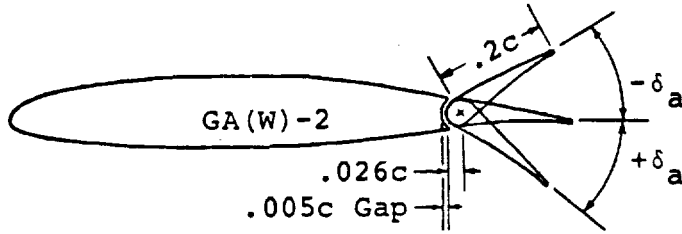

Symbol	δ_a
	0° (Gap Sealed)
	0°
	5°
	10°
	20°
	40°
	60°

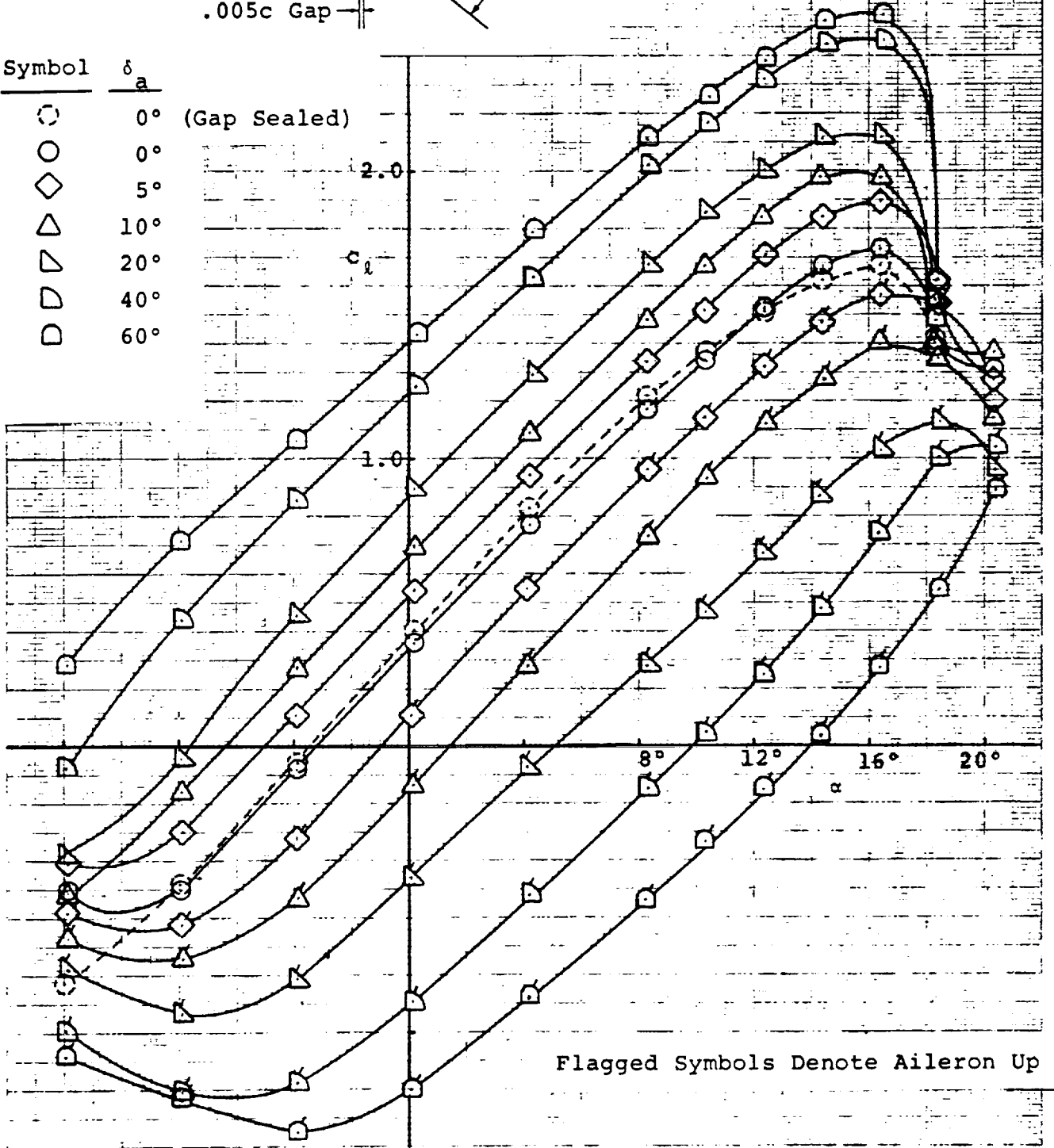

(a) Lift.

Figure 3 - 20% Aileron Performance.

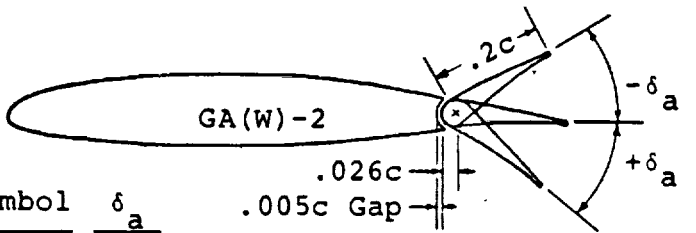
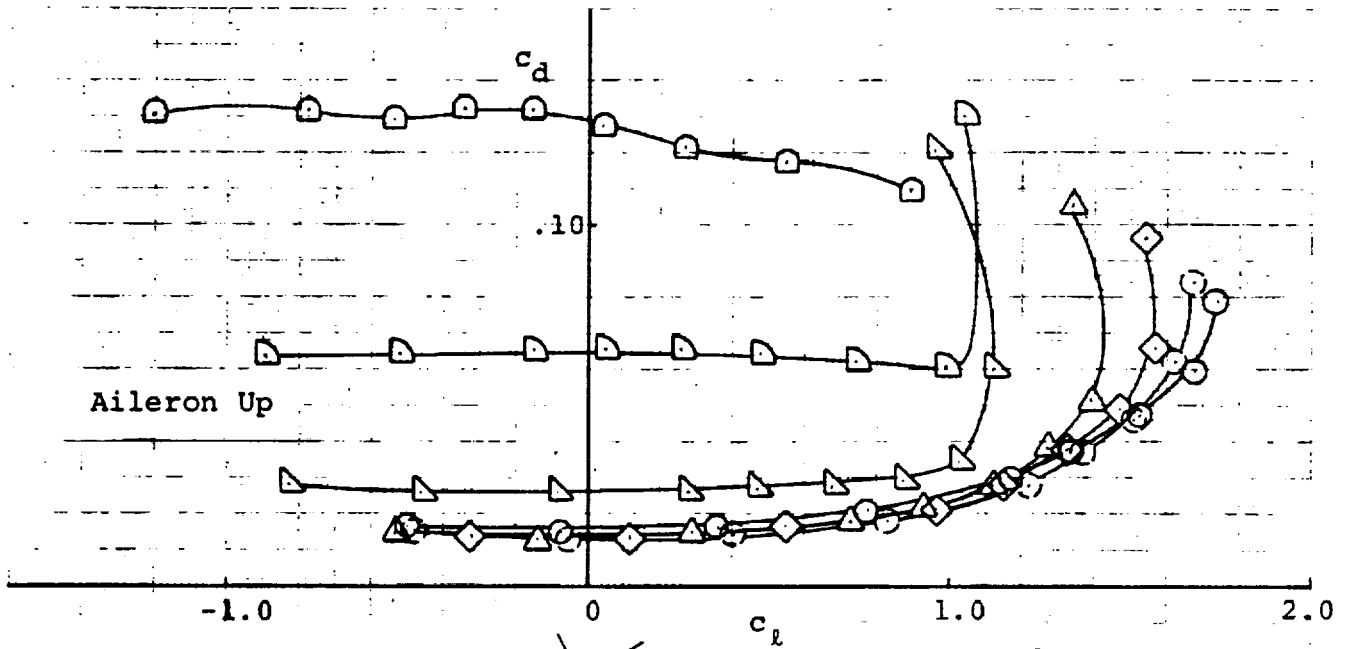

Symbol	δ_a
○	0° (Gap Sealed)
○	0°
◇	5°
△	10°
▽	20°
◐	40°
◑	60°

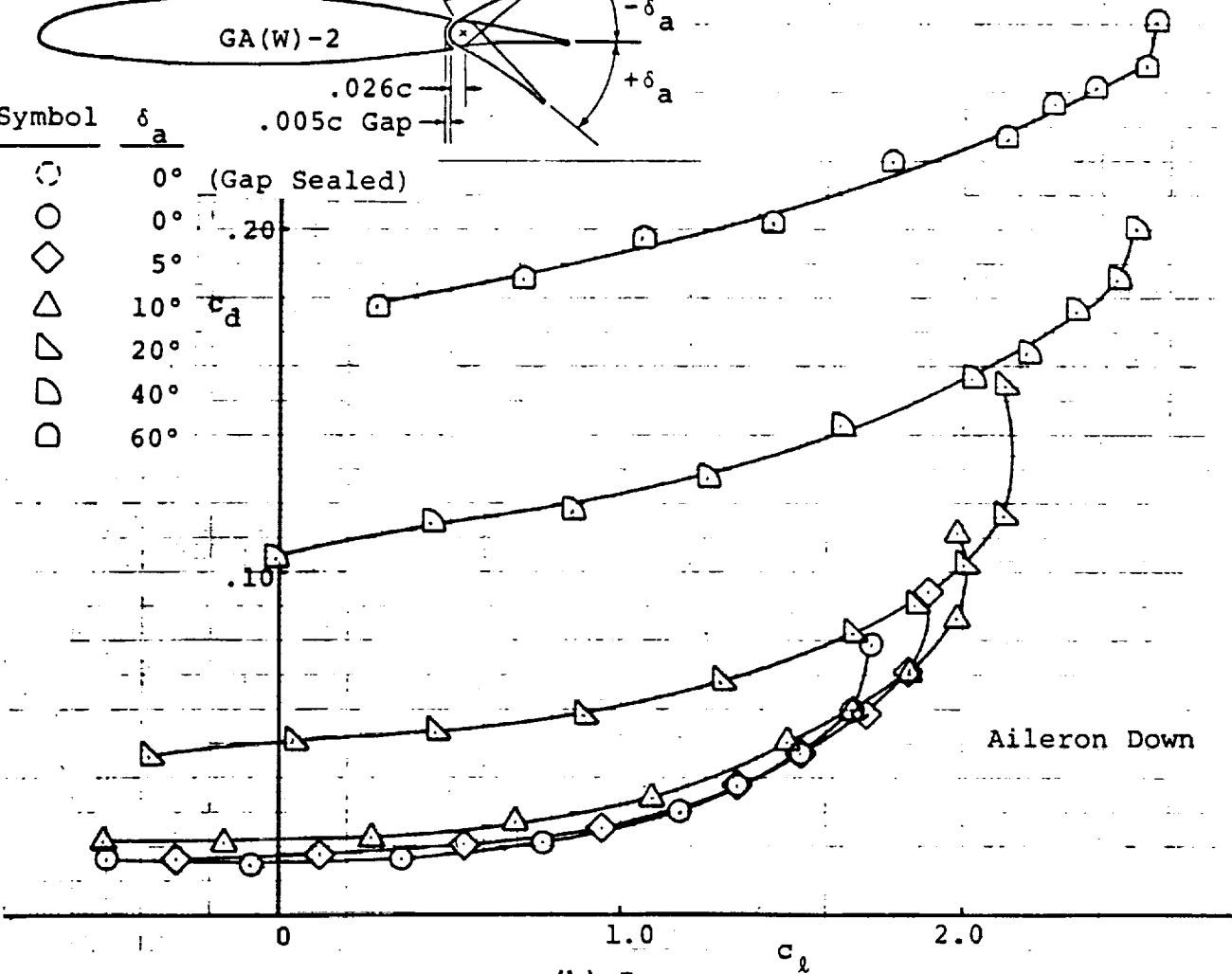

(b) Drag.

Figure 3 - Continued.

ORIGINAL PAGE IS
 OF POOR QUALITY

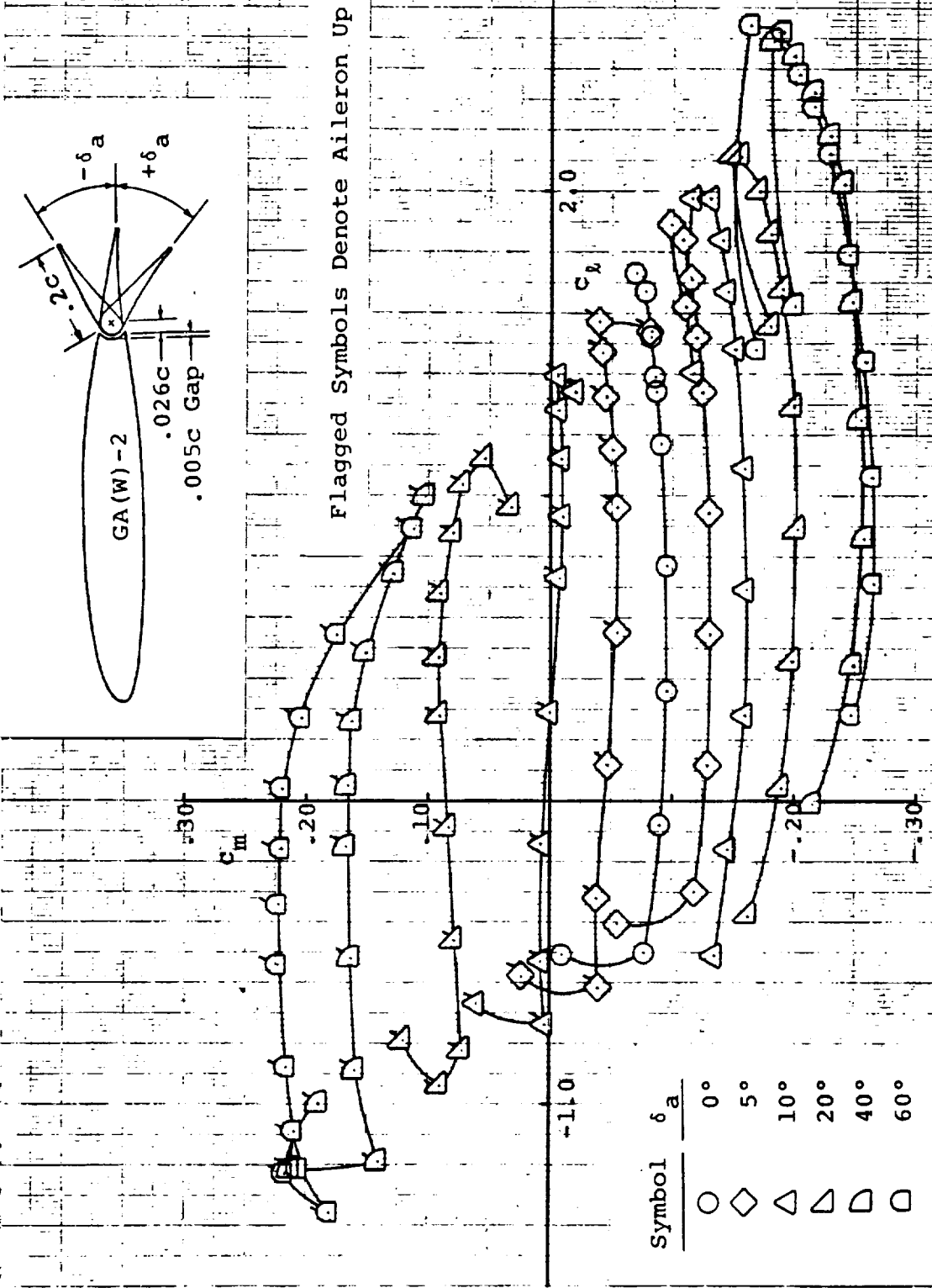

Flagged Symbols Denote Aileron Up

(c) Moment.

Figure 3 - Continued.

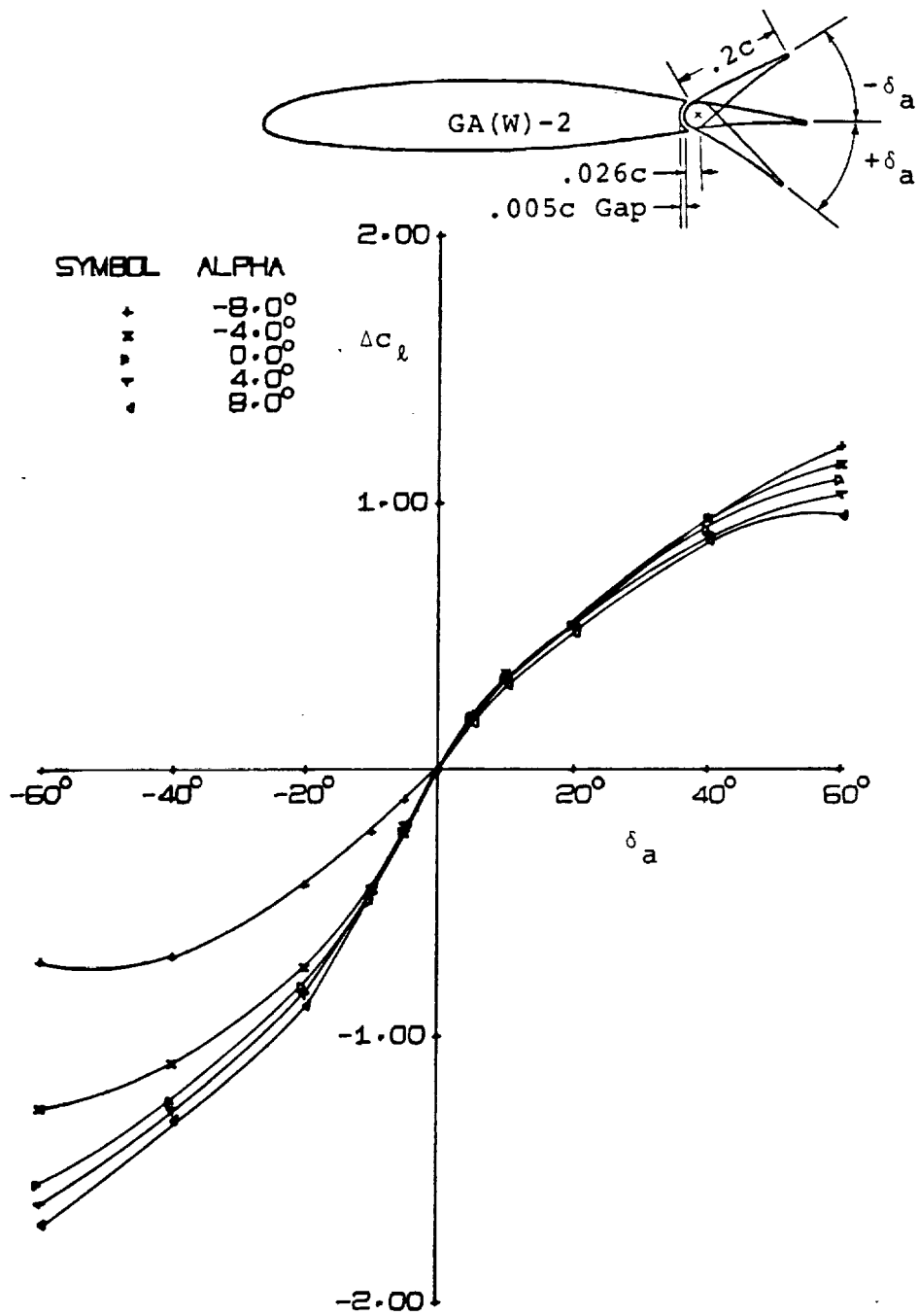

(d) Incremental Lift.

Figure 3 - Continued.

ORIGINAL PAGE IS
OF POOR QUALITY

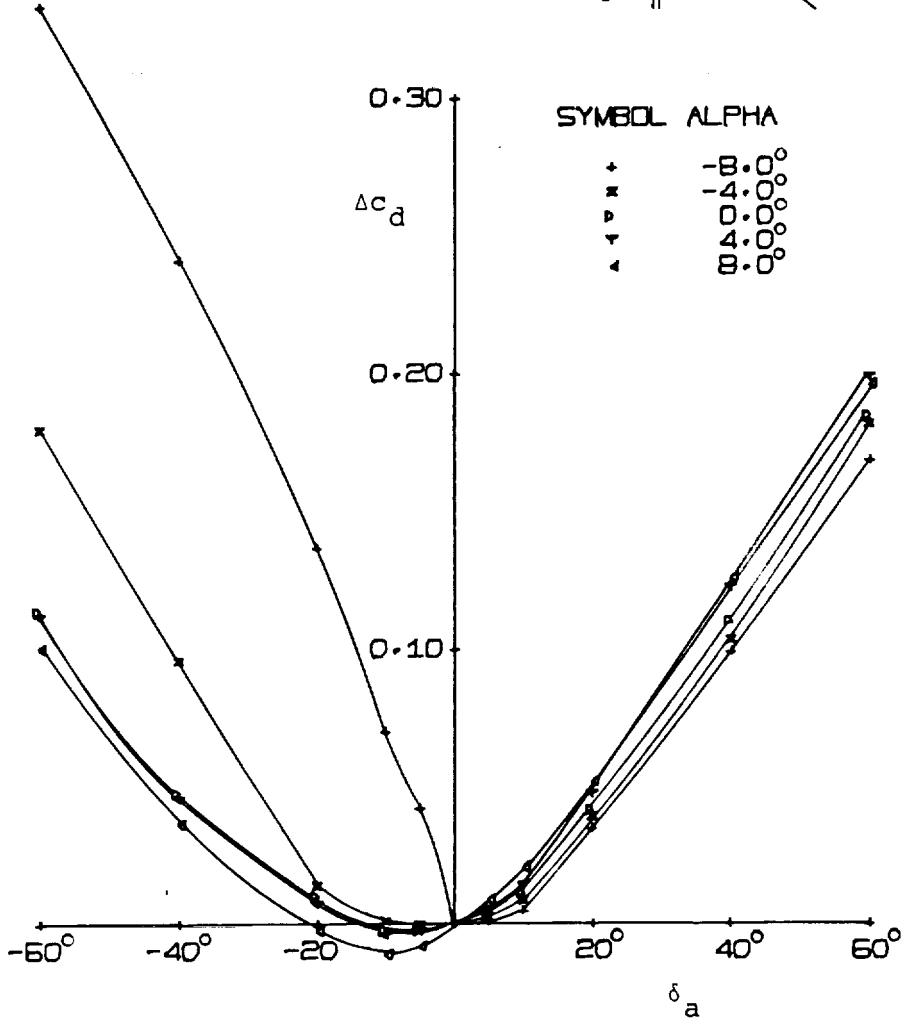
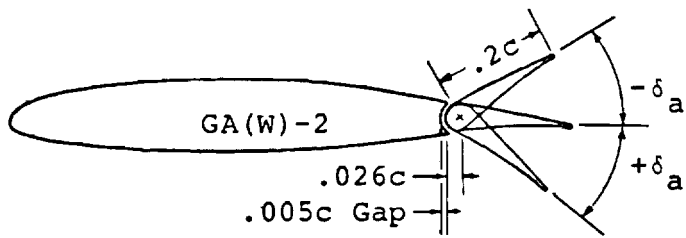

(e) Incremental Drag.
 Figure 3 - Continued.

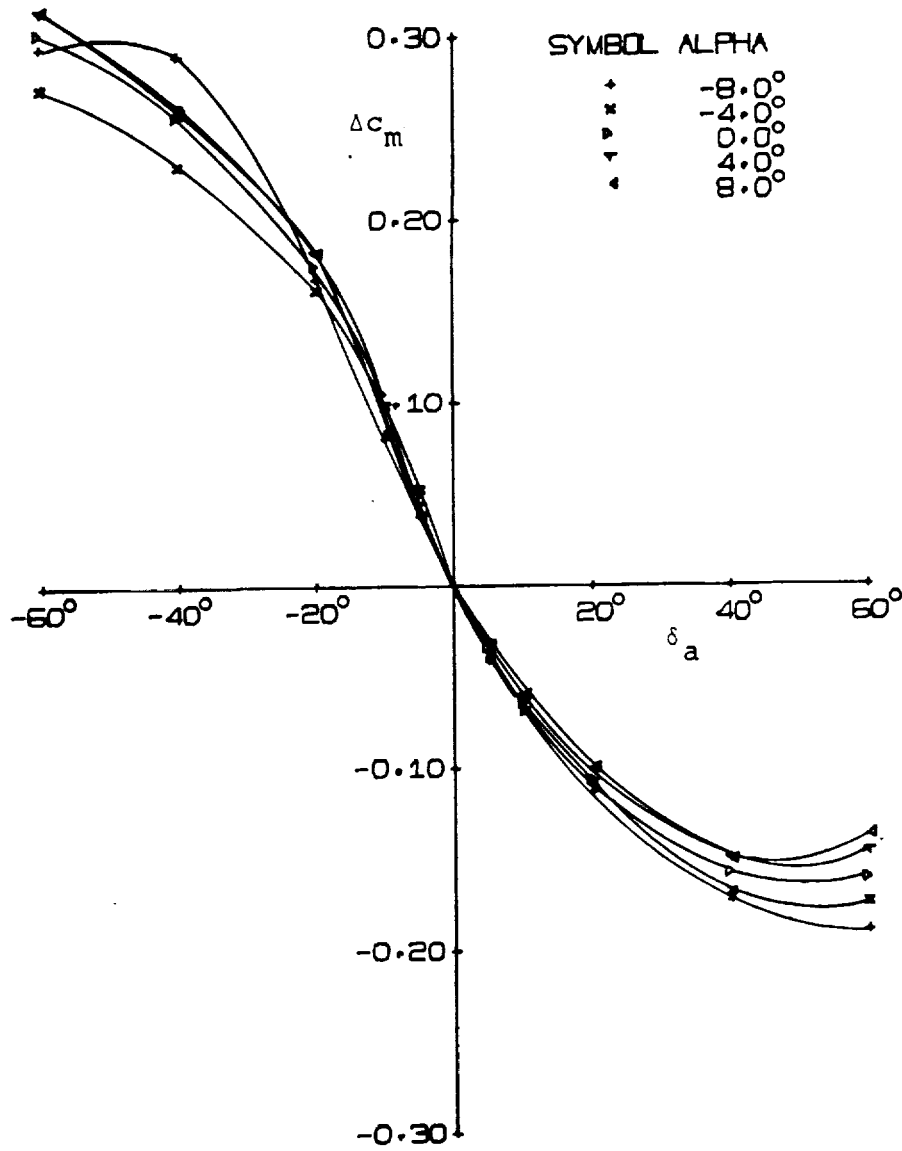
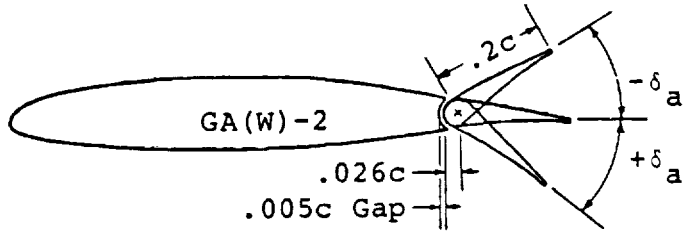

(f) Incremental Moment.
Figure 3 - Continued.

46 1513

10 X 10 TO THE CENTIMETER KEUFFEL & ESSER CO. BALTIMORE

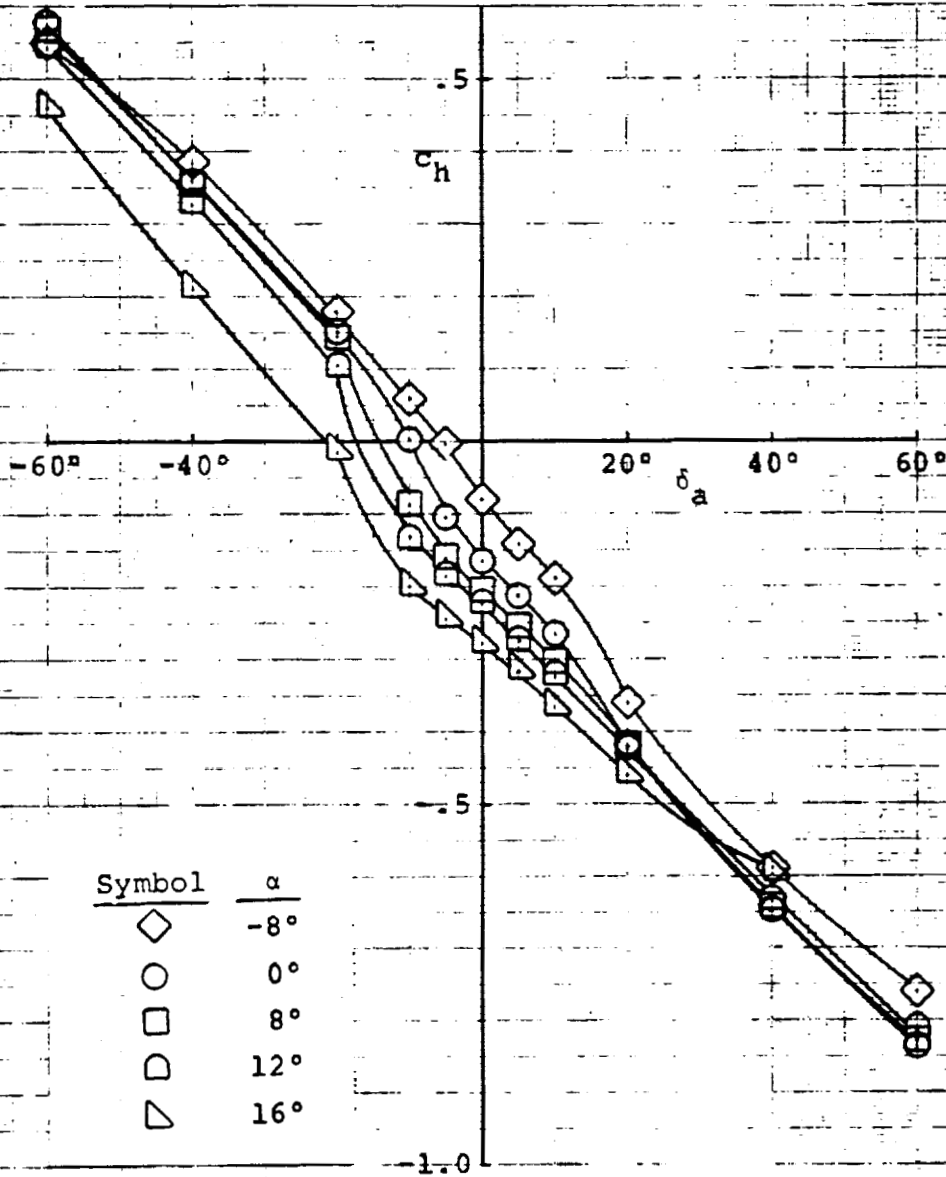
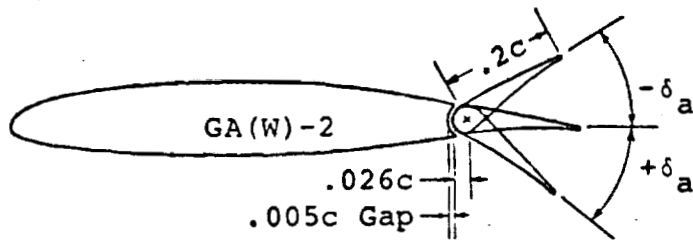

(g) Hinge Moment.

Figure 3 - Concluded.

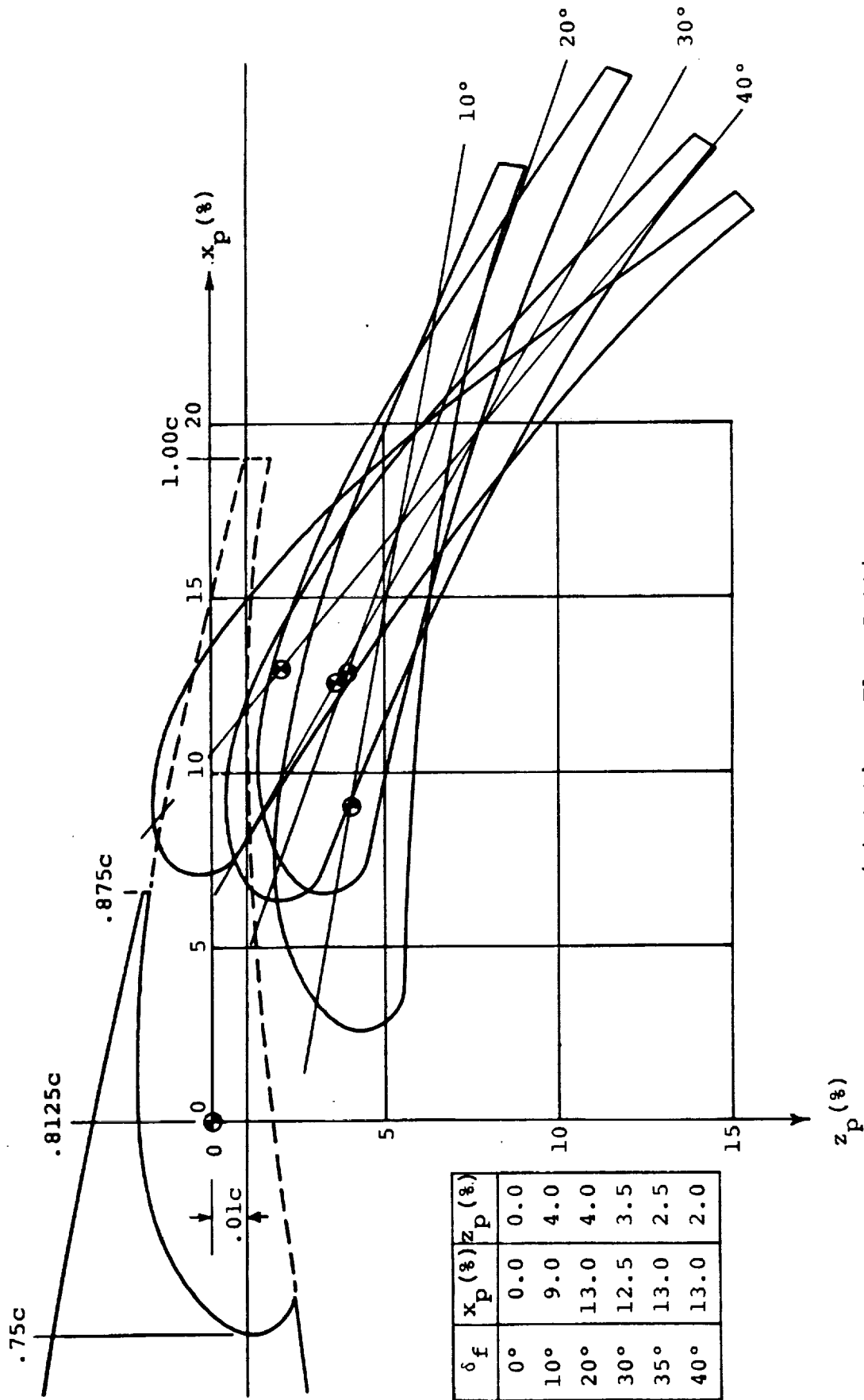

(a) Optimum Flap Settings.
 Figure 4 - 25% Slotted Flap Performance.

ORIGINAL PAGE IS
OF POOR QUALITY

Symbol	δ_f	x_p (%)	z_p (%)
○	0°	0	0
△	10°	9.0	4.0
▽	20°	13.0	4.0
◇	30°	12.5	3.5
◊	35°	13.0	2.5
◻	40°	13.0	2.0

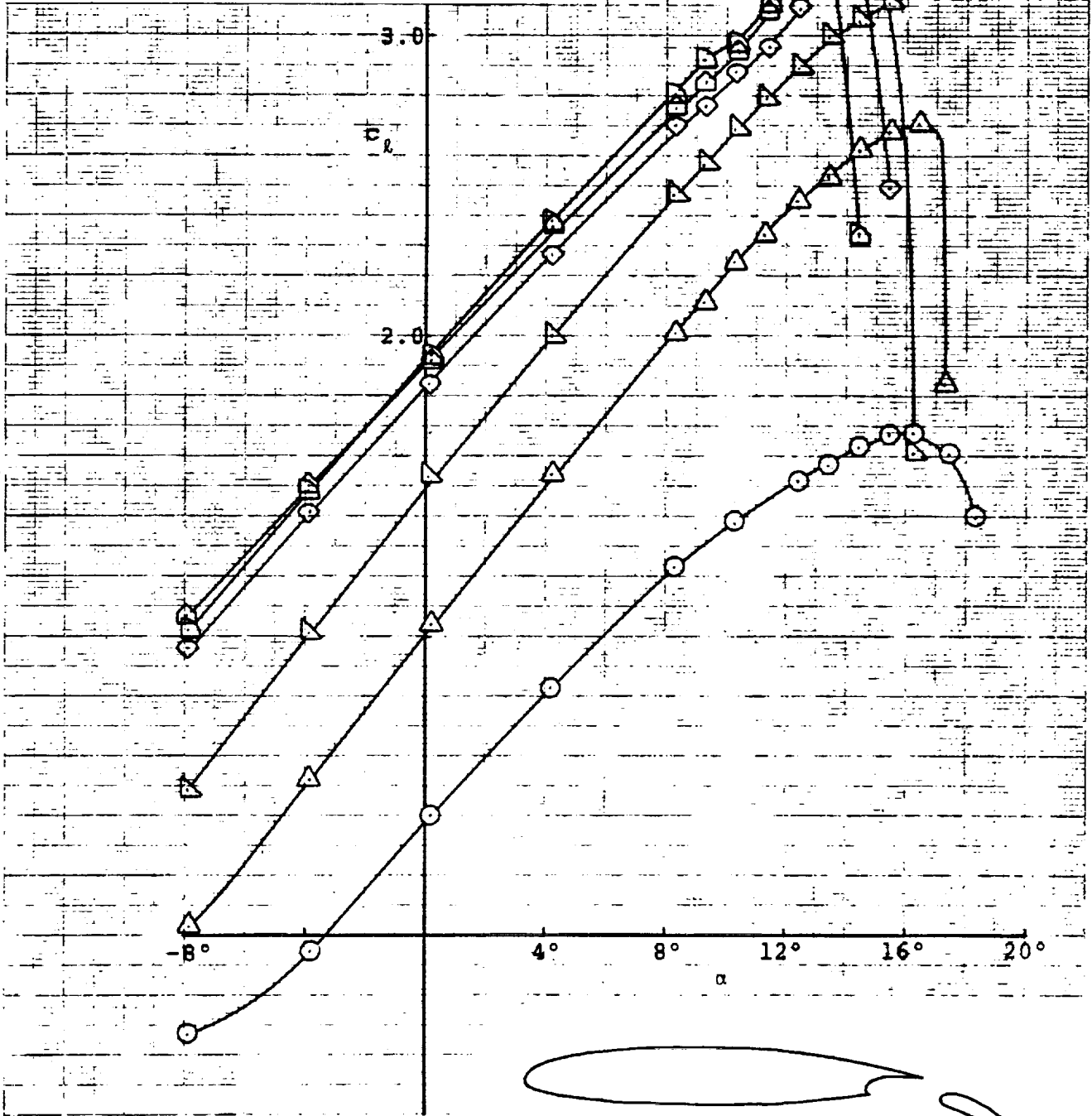

(b) Lift.

Figure 4 - Continued.

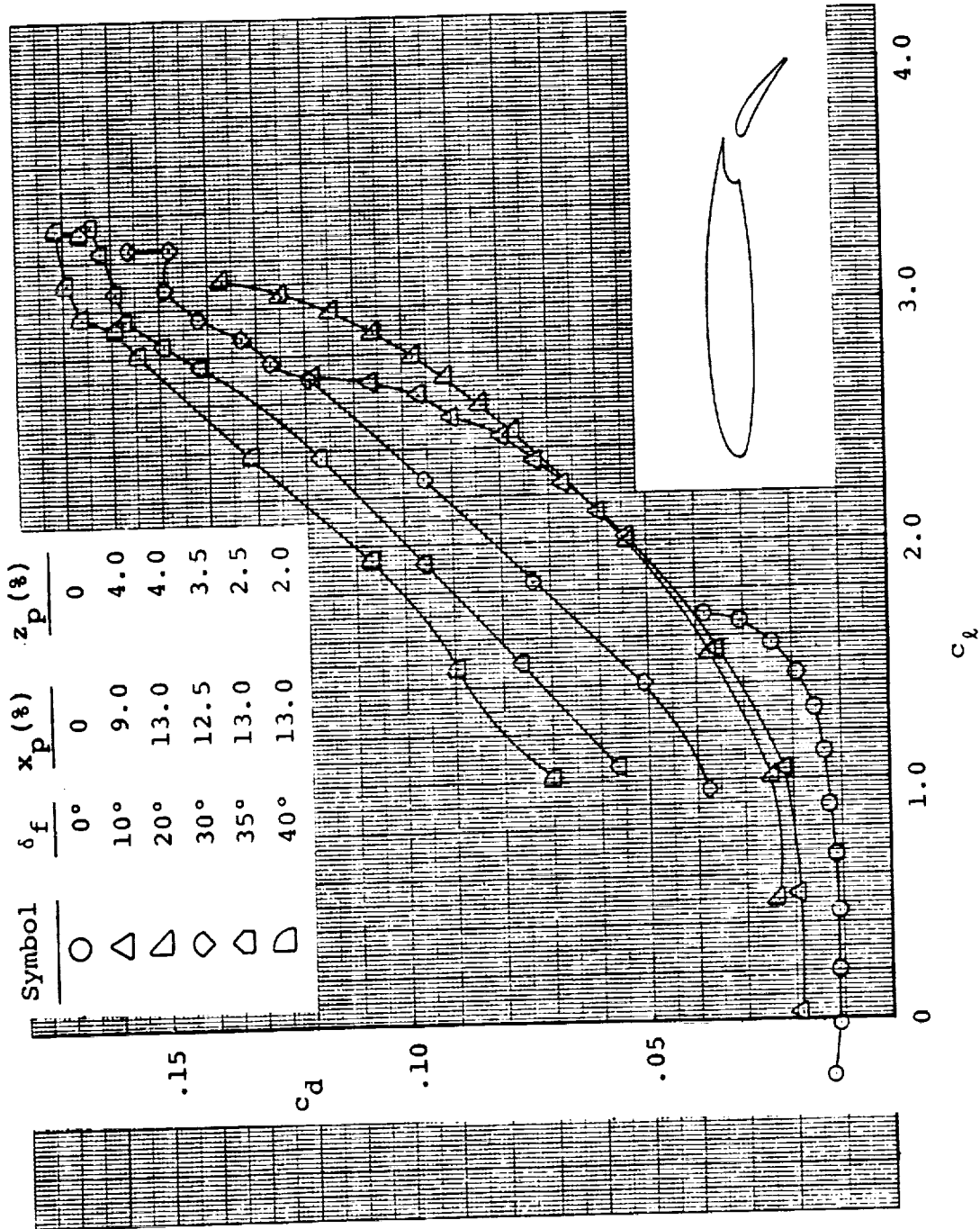

(c) Drag.

Figure 4 - Continued.

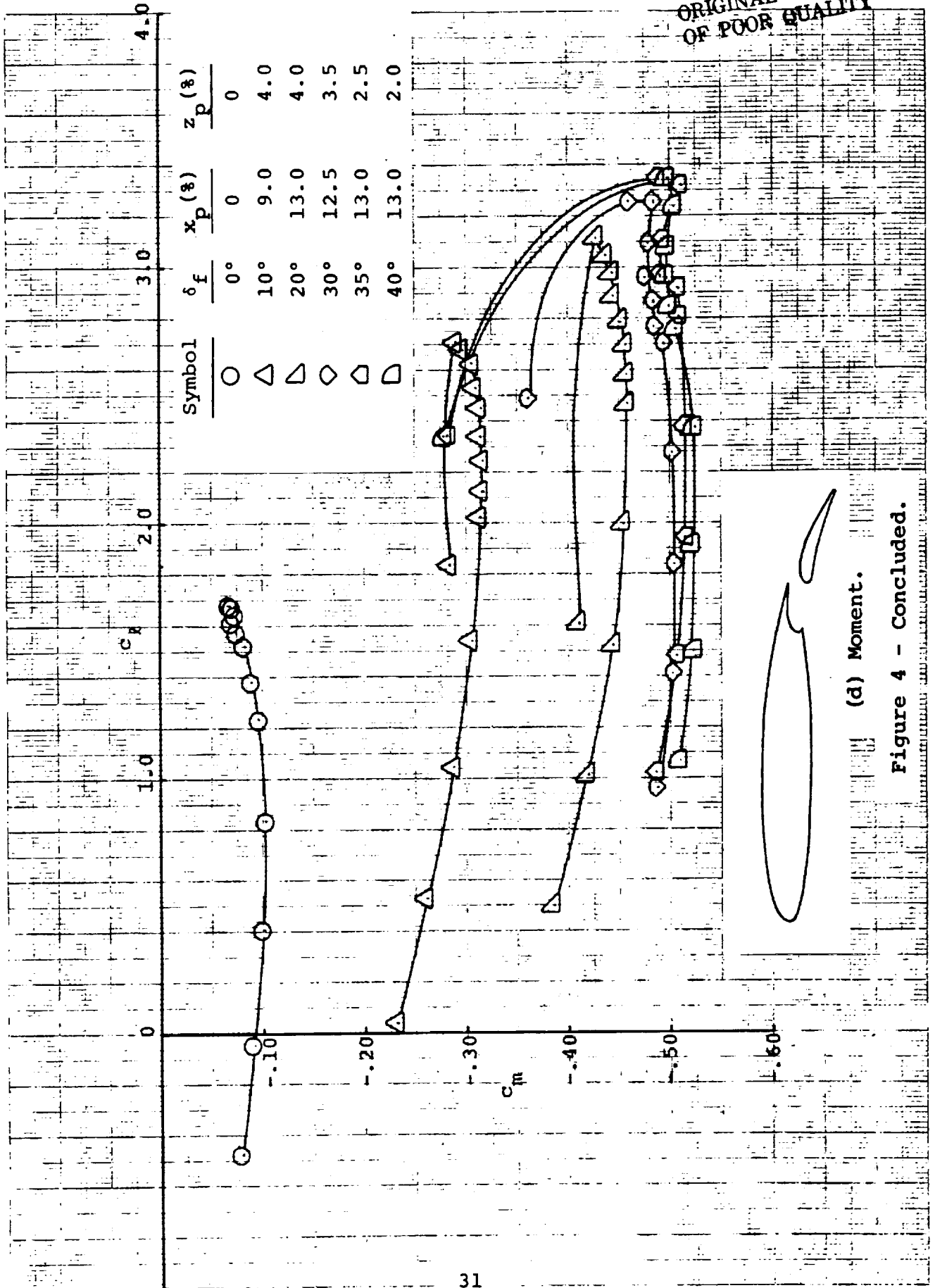

ORIGINAL PAGE IS OF POOR QUALITY

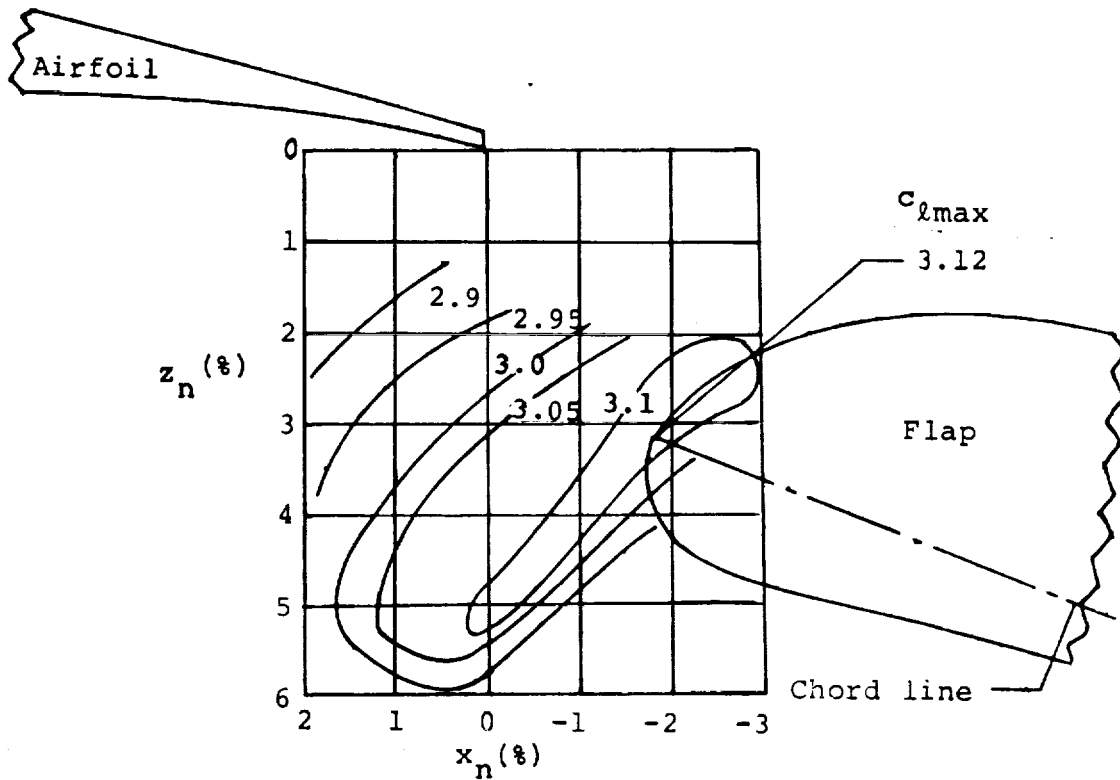

(a) 20° Flap Deflection.

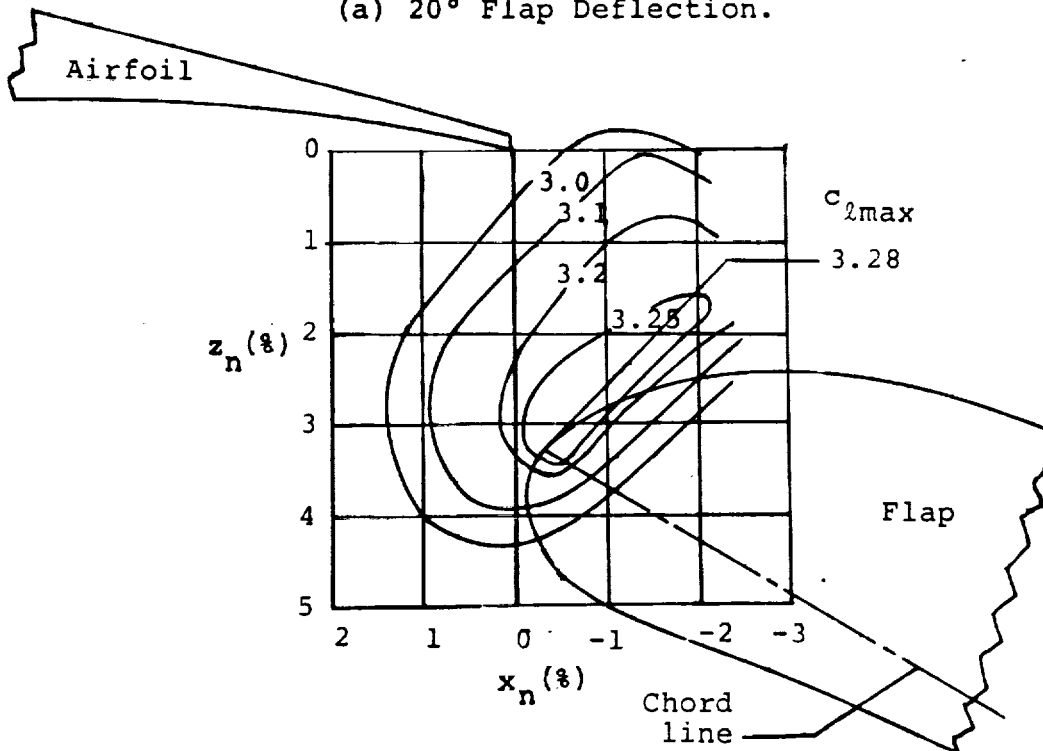

(b) 30° Flap Deflection.

Figure 5 - Optimization of 25% Flap.

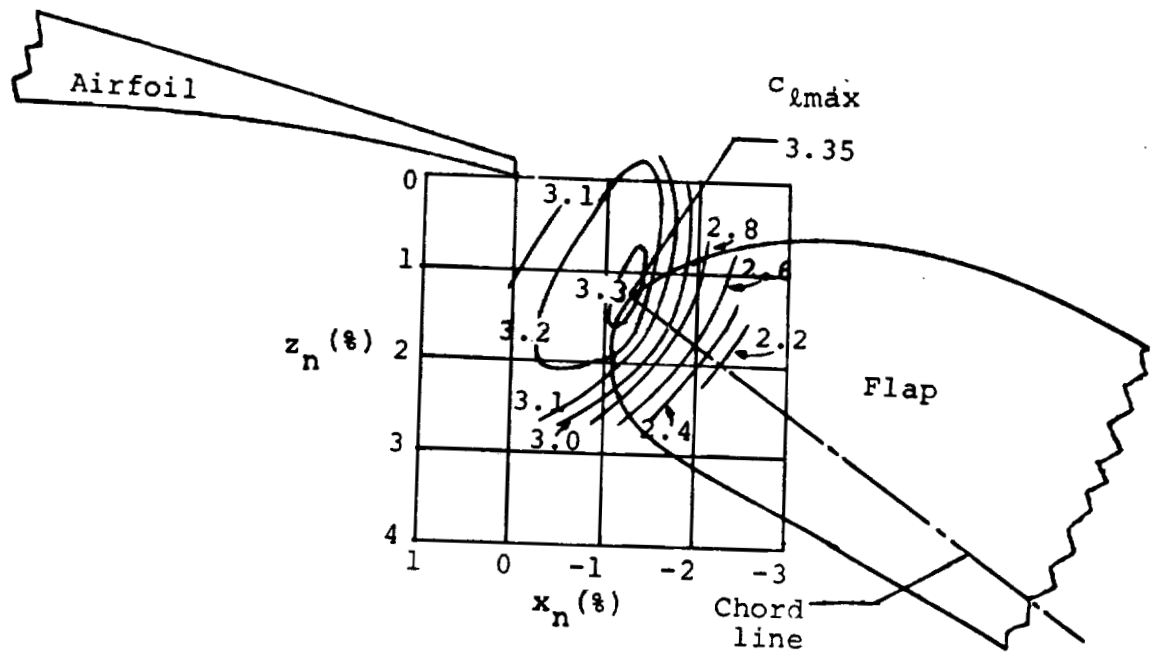

(c) 35° Flap Deflection.

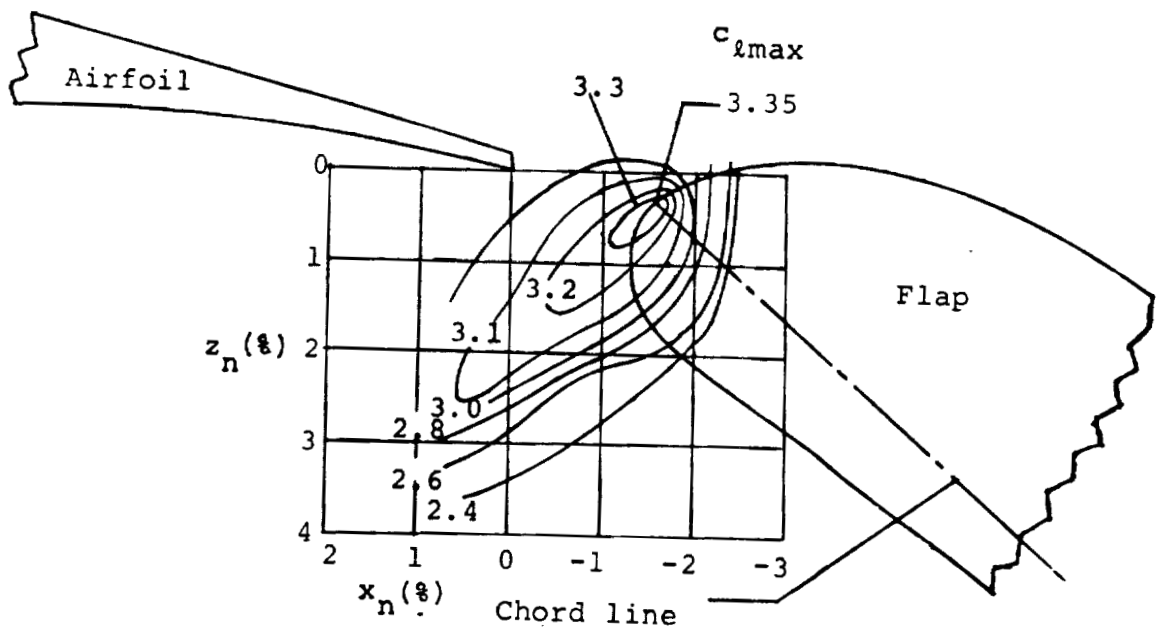

(d) 40° Flap Deflection.

Figure 5 - Concluded.

Rounded Slot Entry

Sharp Slot Entry

167

167

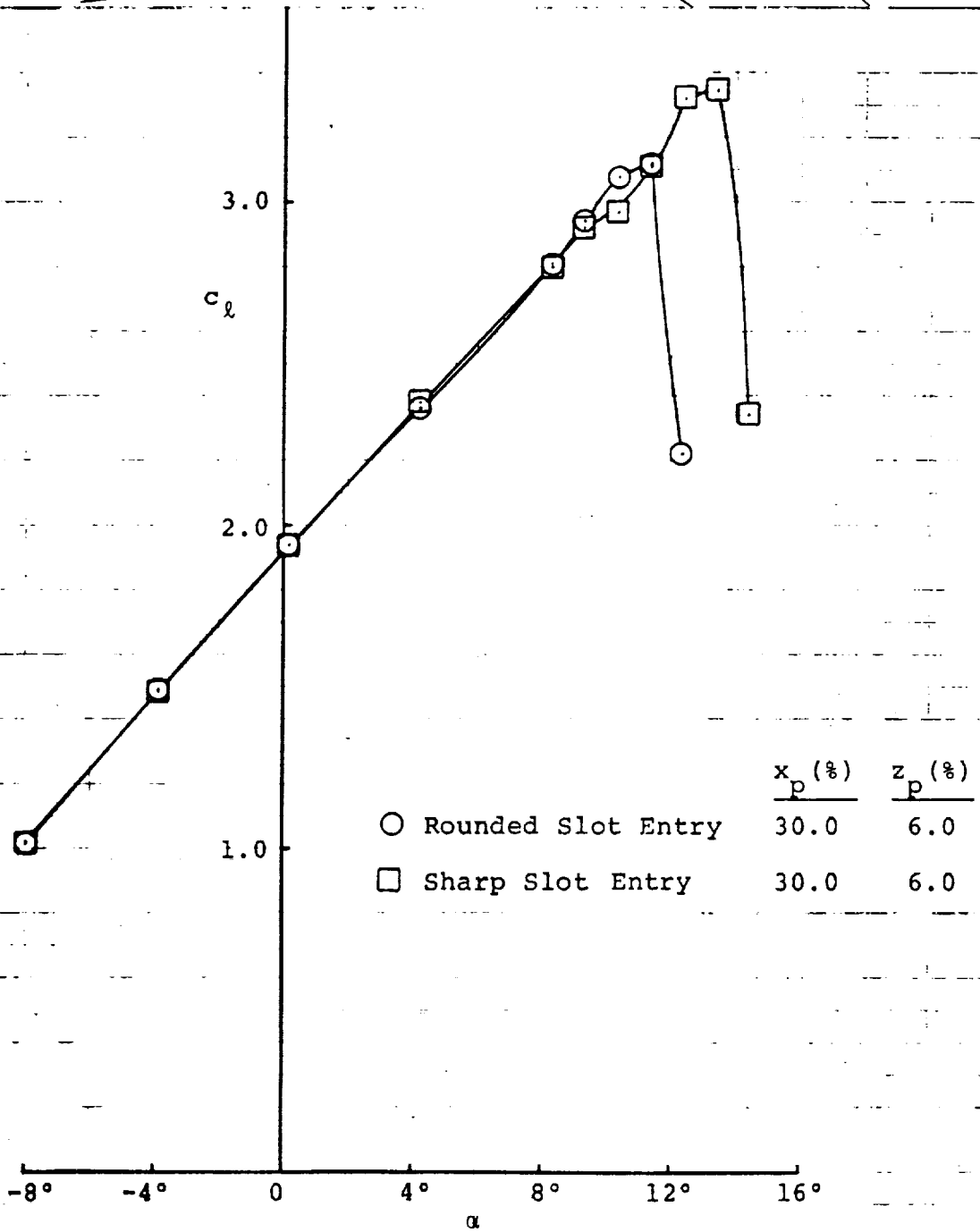
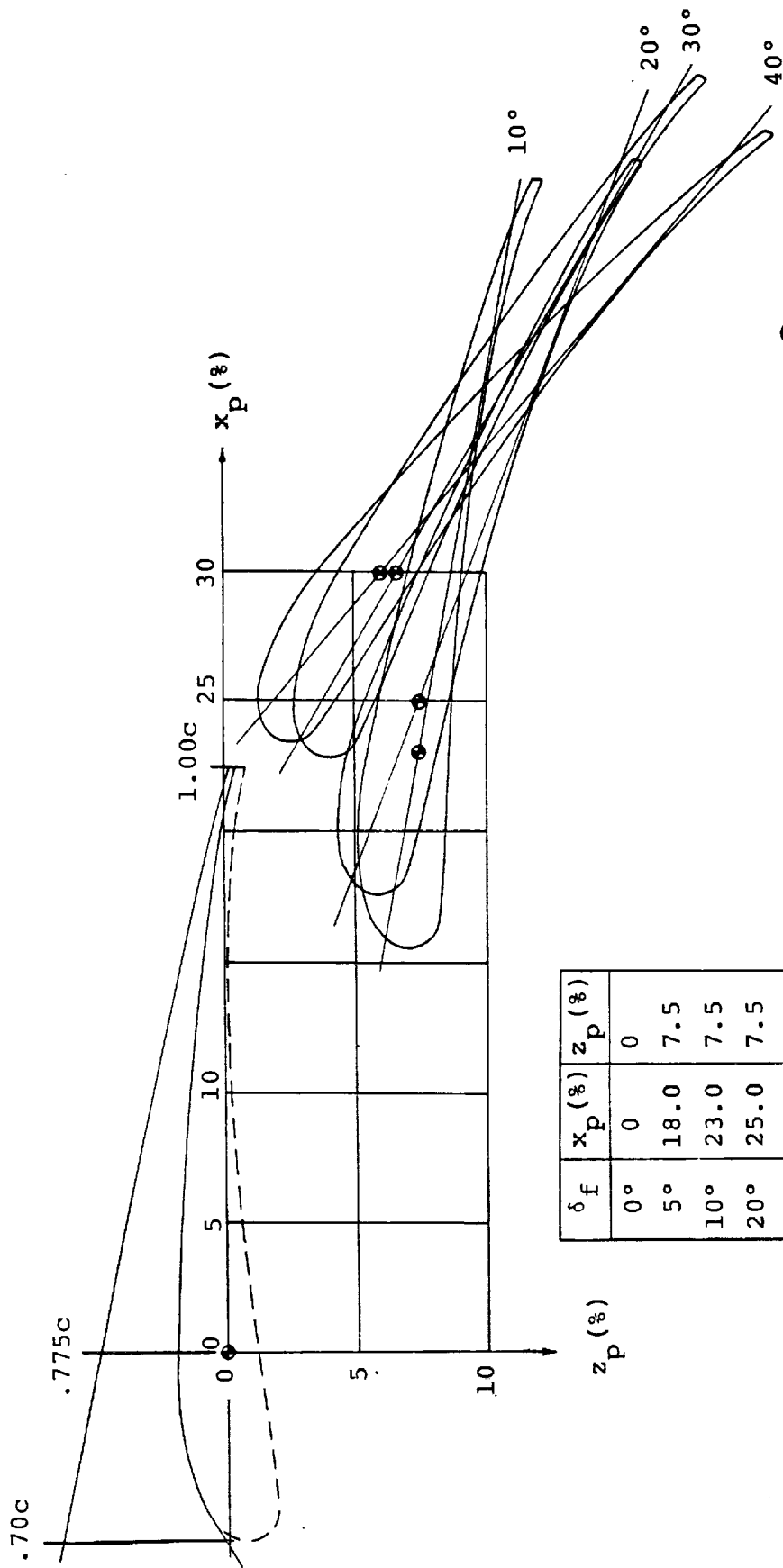

Figure 6 - Effects of Cove Shape on c_{lmax} , $\delta_f = 40^\circ$.



ORIGINAL PAGE IS
OF POOR QUALITY

δ_f	x_p (%)	z_p (%)
0°	0	0
5°	18.0	7.5
10°	23.0	7.5
20°	25.0	7.5
30°	30.0	6.75
35°	30.0	6.75
40°	30.0	6.0

(a) Optimum Flap Settings.
Figure 7 - 30% Fowler Flap Performance.

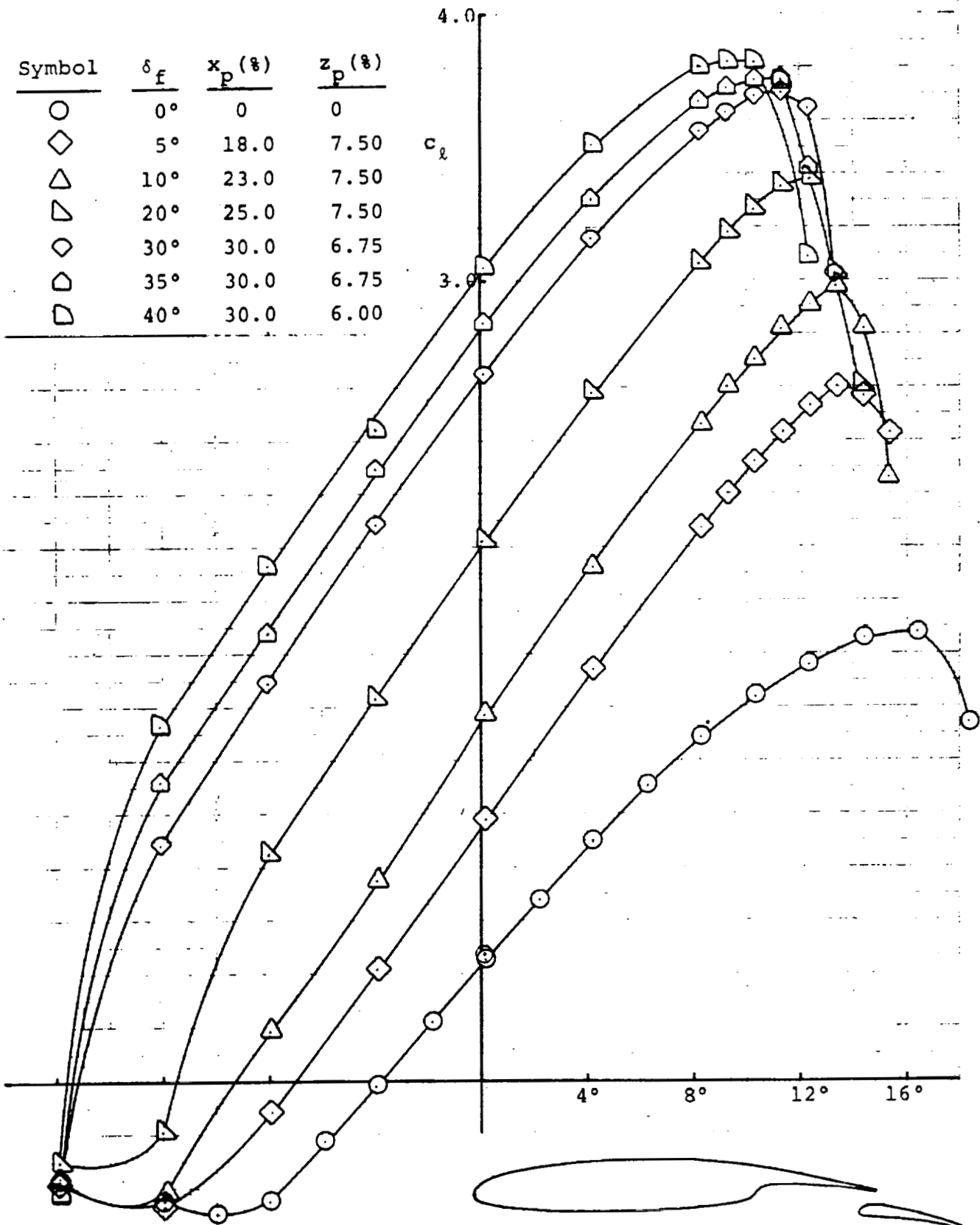

(b) Lift.

Figure 7 - Continued.

45 1513

NO. 10, X-1, 12, THE CASE MEASUREMENTS
RESEARCH LABORATORY

Symbol	δ_f	x_p (%)	z_p (%)
∇	40°	30.0	6.00
\diamond	50°	27.0	8.00
\square	60°	28.0	8.75

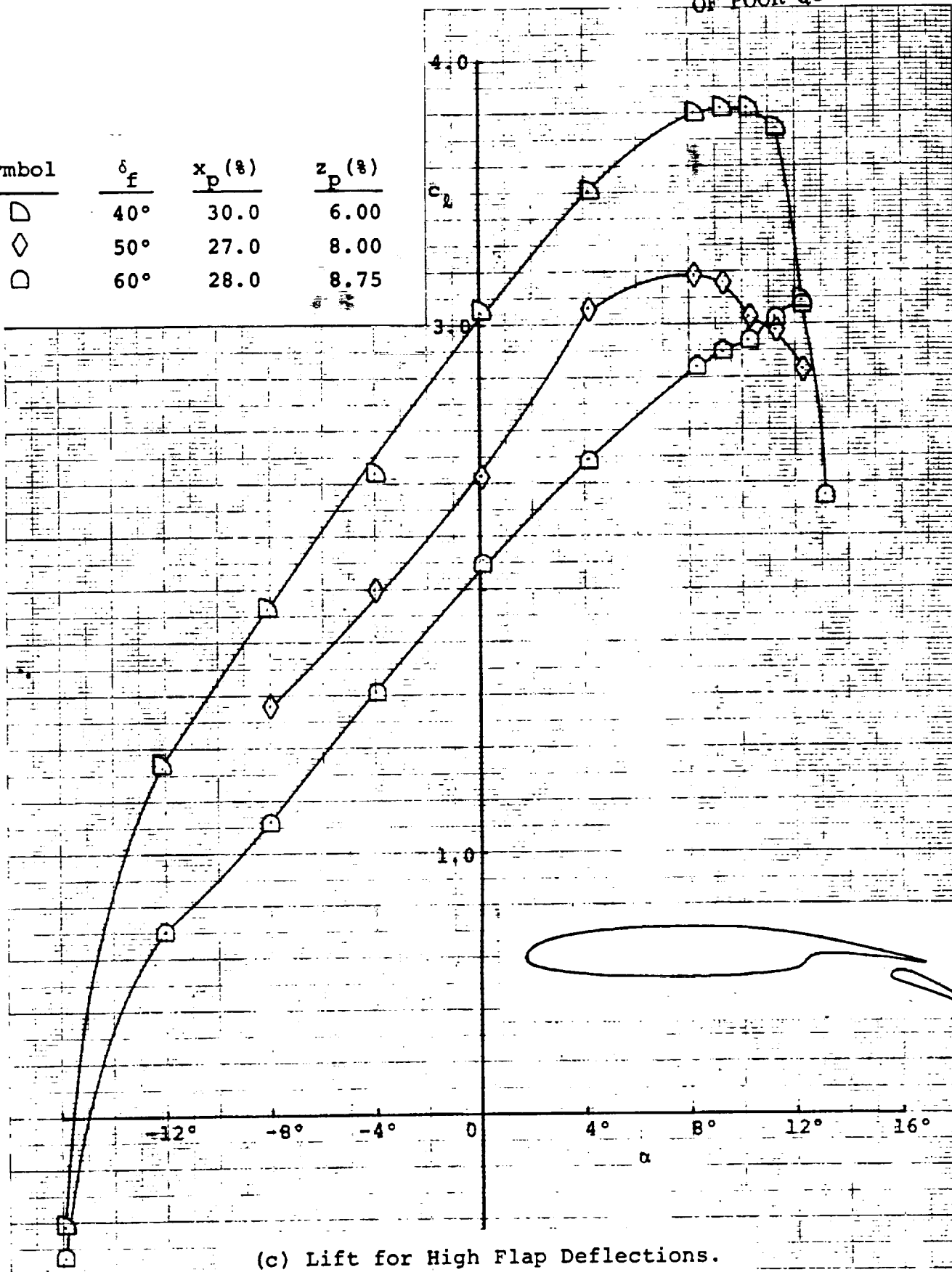

(c) Lift for High Flap Deflections.

Figure 7 - Continued.

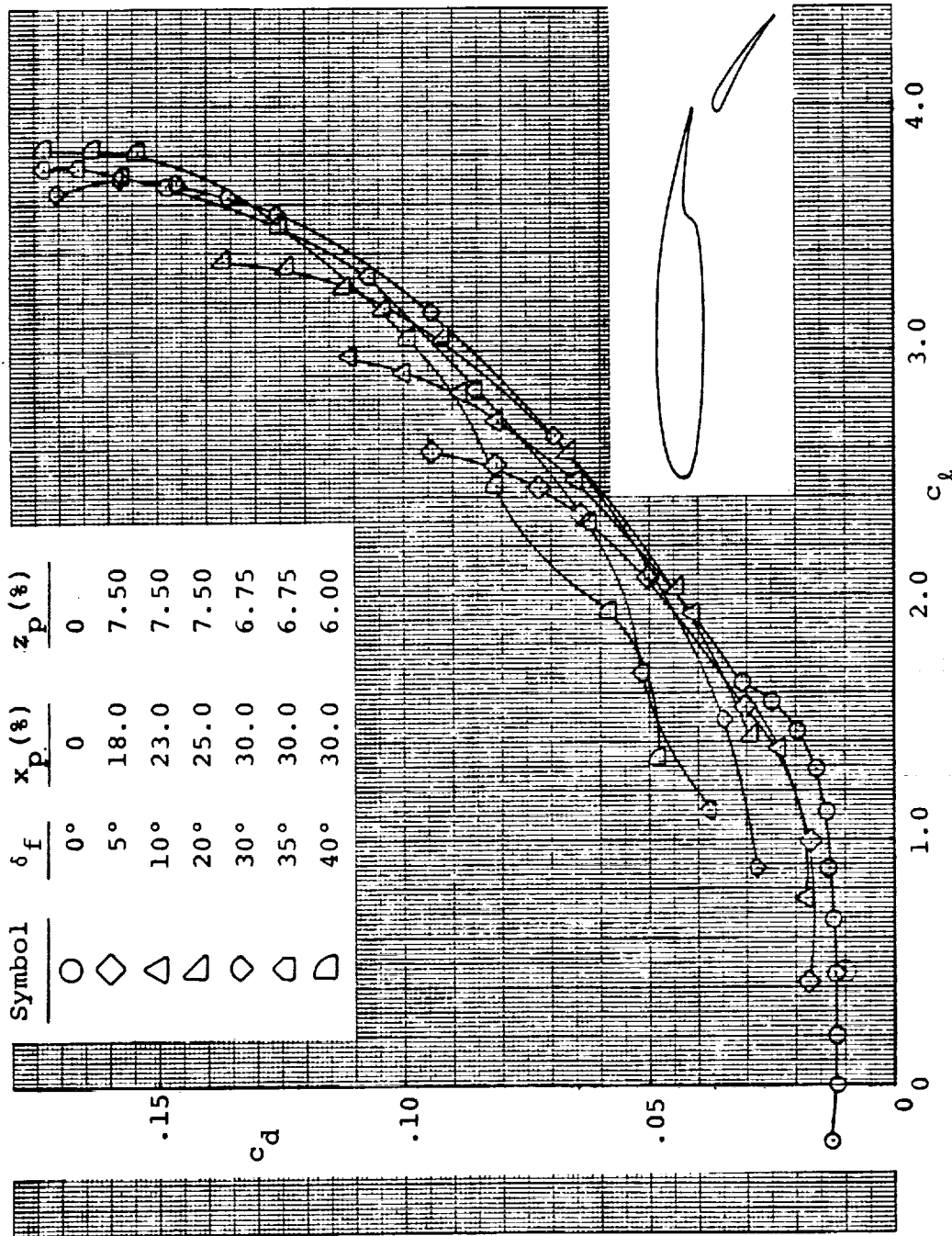

(d) Drag.

Figure 7 - Continued.

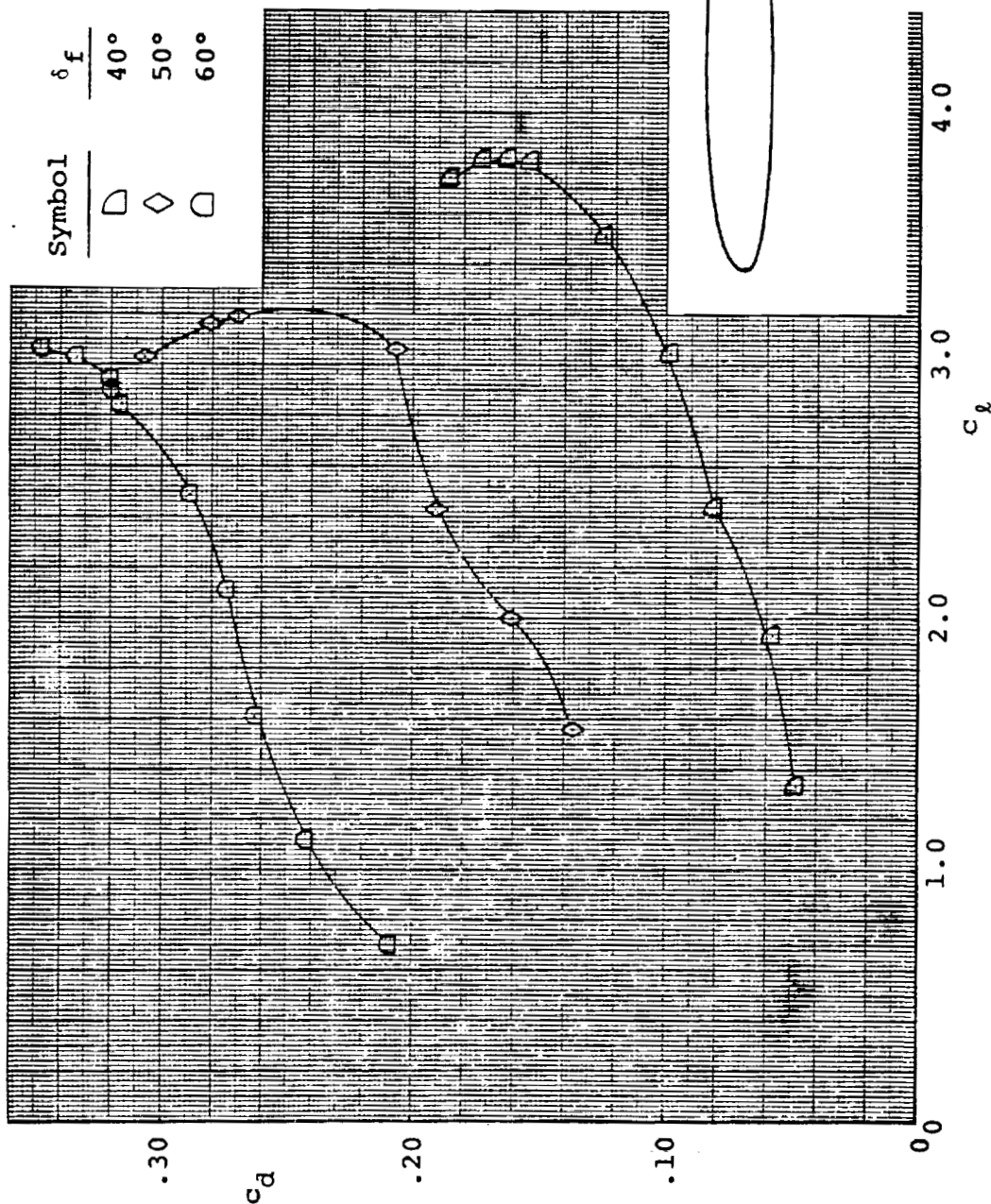

ORIGINAL PAGE IS
OF POOR QUALITY

(e) Drag for High Flap Deflections.
Figure 7 - Continued.

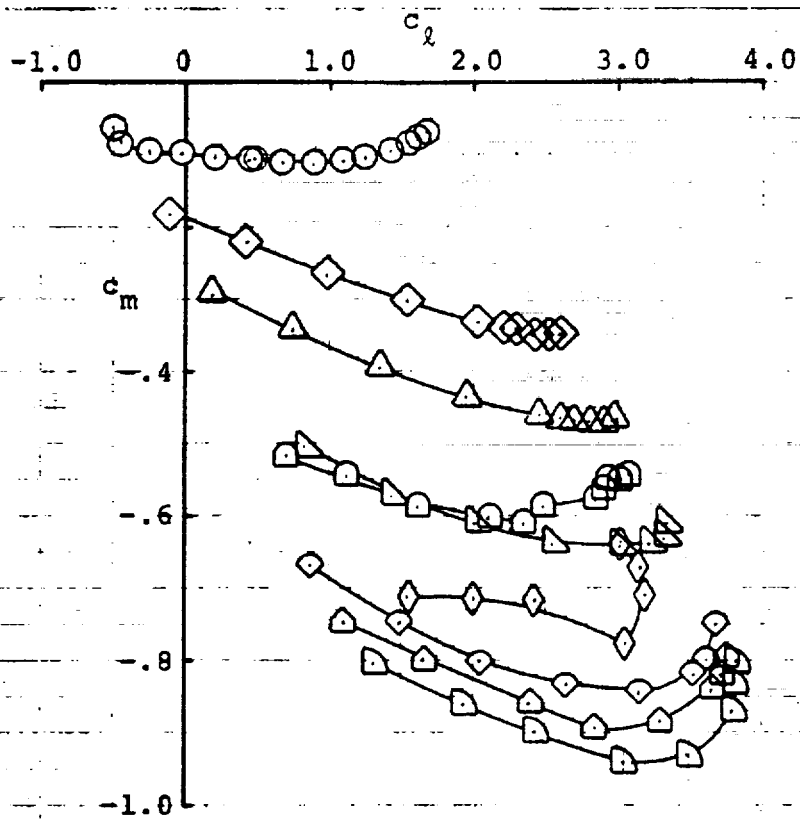

Symbol	δ_f	x_p (%)	z_p (%)
○	0°	0	0
◇	5°	18.0	7.50
△	10°	23.0	7.50
▽	20°	25.0	7.50
◊	30°	30.0	6.75
◓	35°	30.0	6.75
◔	40°	30.0	6.00
◕	50°	27.0	8.00
◖	60°	28.0	8.75

ORIGINAL PAGE IS
OF POOR QUALITY

(f) Moment.
Figure 7 - Concluded.
40

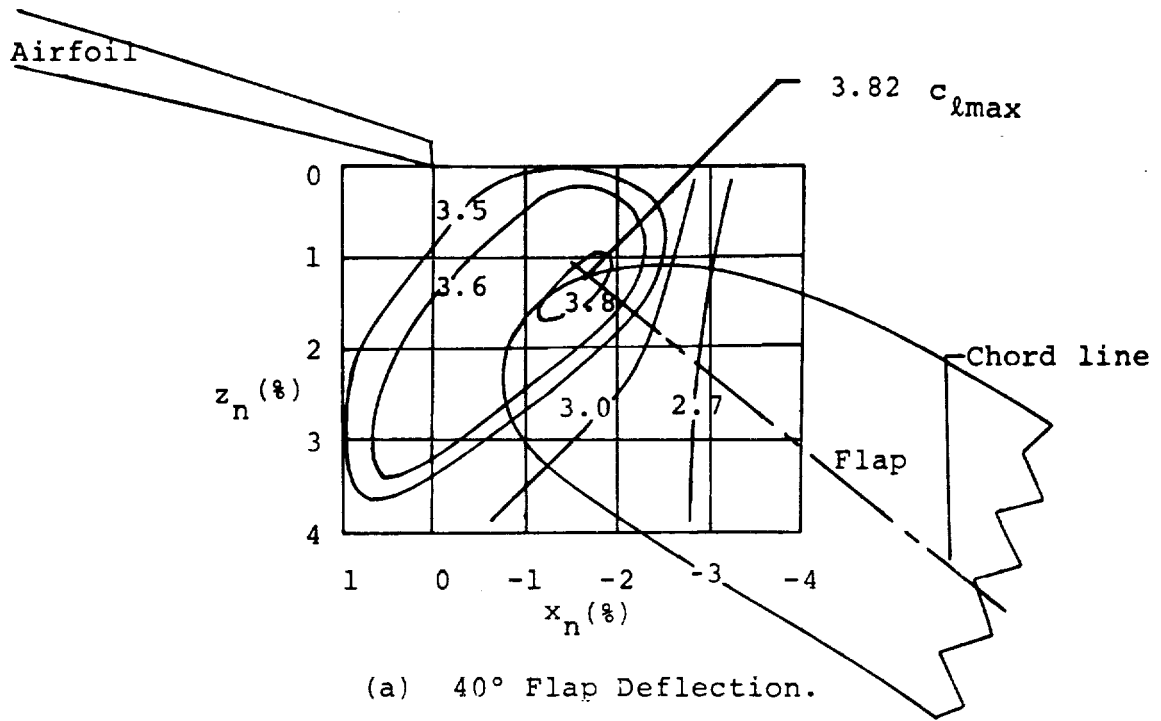

(a) 40° Flap Deflection.

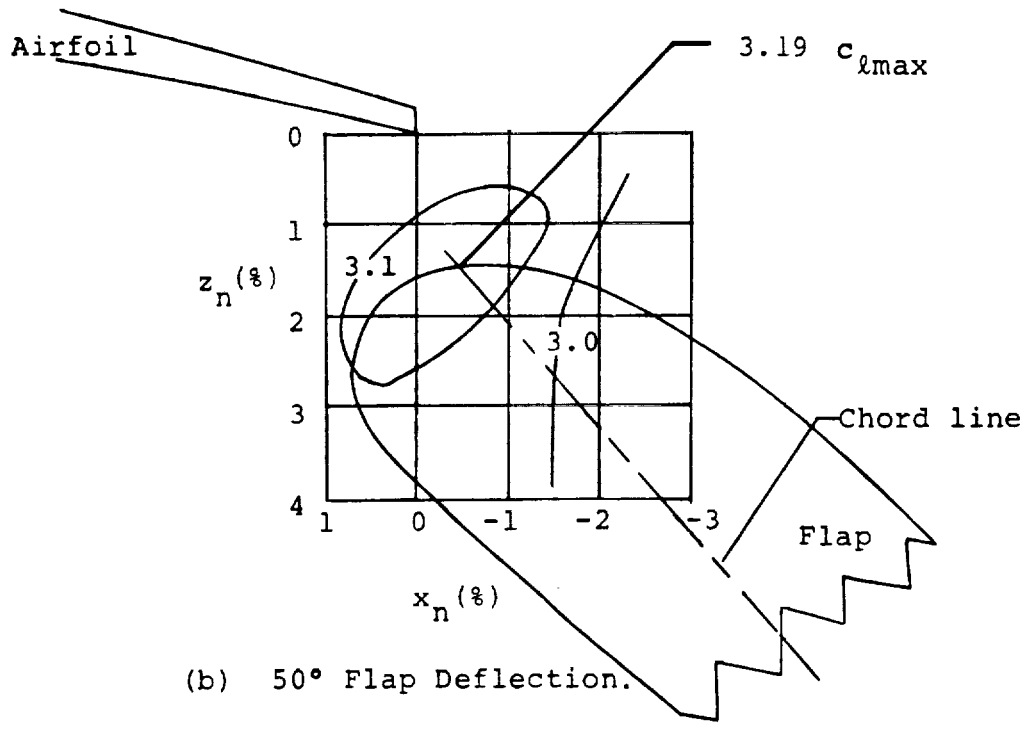

(b) 50° Flap Deflection.

Figure 8 - Optimization of 30% Flap.

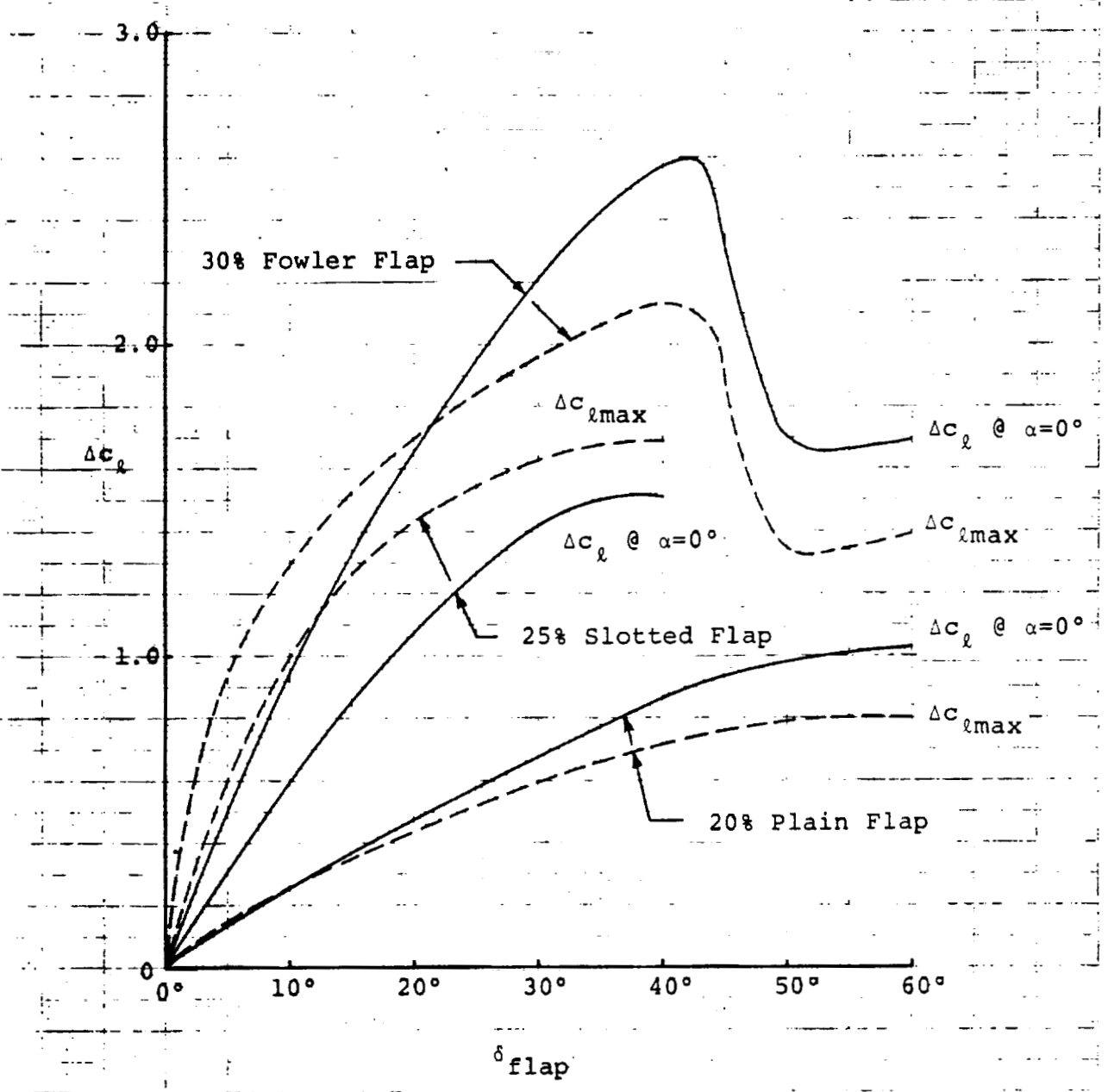

ORIGINAL PAGE IS
OF POOR QUALITY

Figure 9 - Flap Effectiveness.

○ NACA 23012 Airfoil, (Ref. 12)

	<u>Airfoil</u>	<u>Flap</u>	<u>Source</u>
1.	GA(W)-2	25%	Fig. 4
2.	GA(W)-2	30%	Fig. 7
3.	GA(W)-1	30%	Ref.10
4.	GA(W)-1	29%	Ref.10

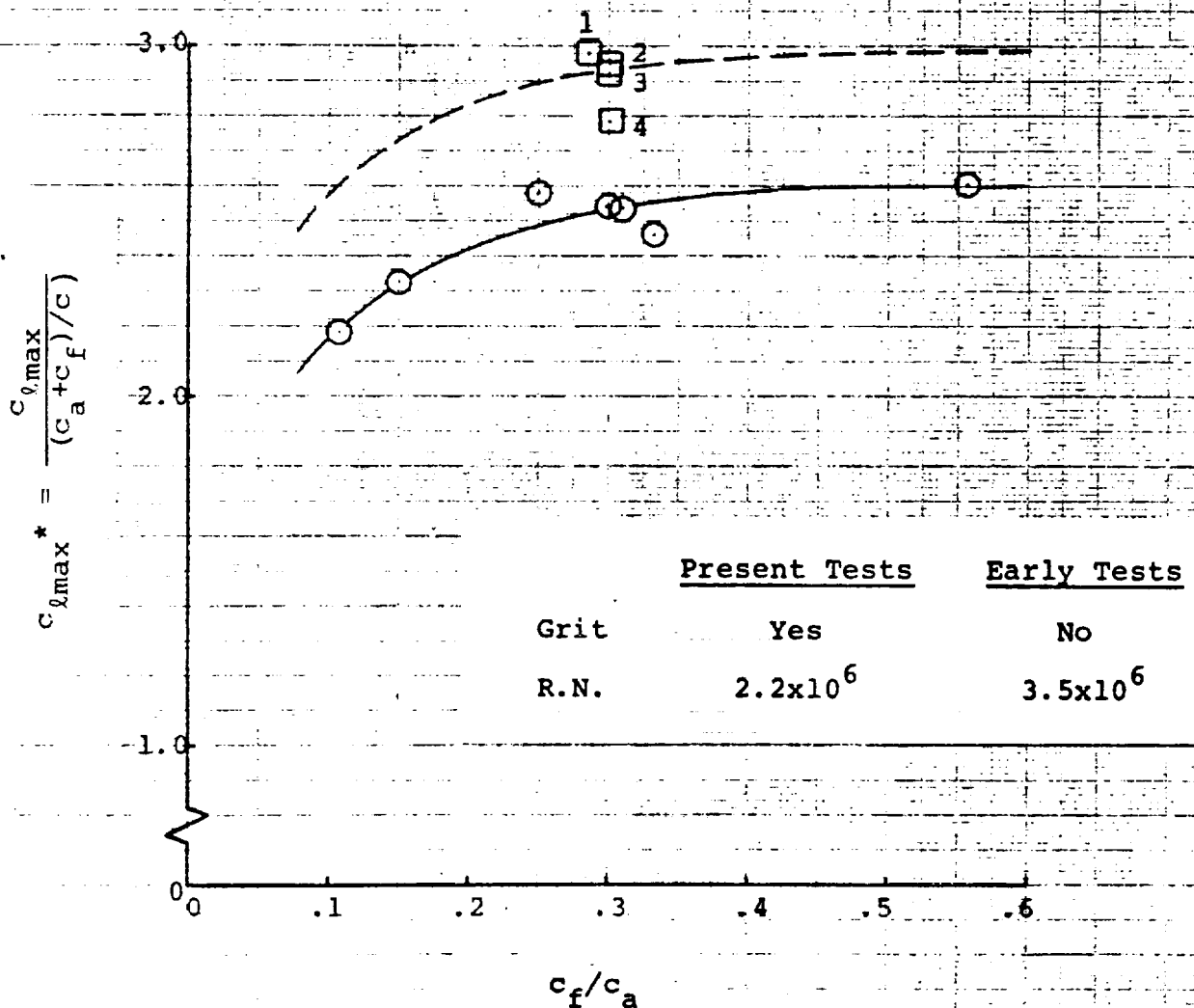
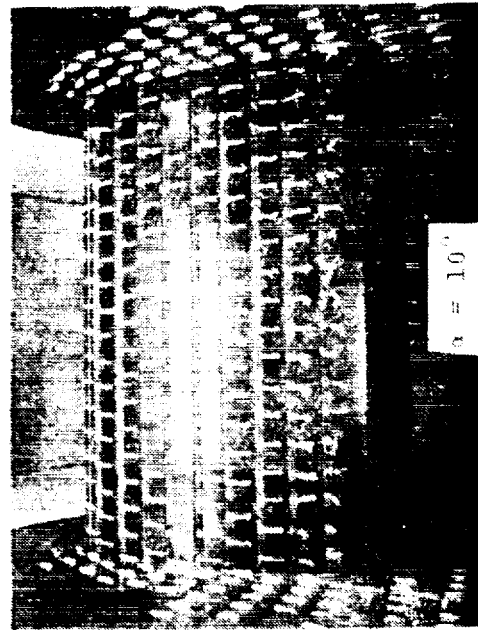
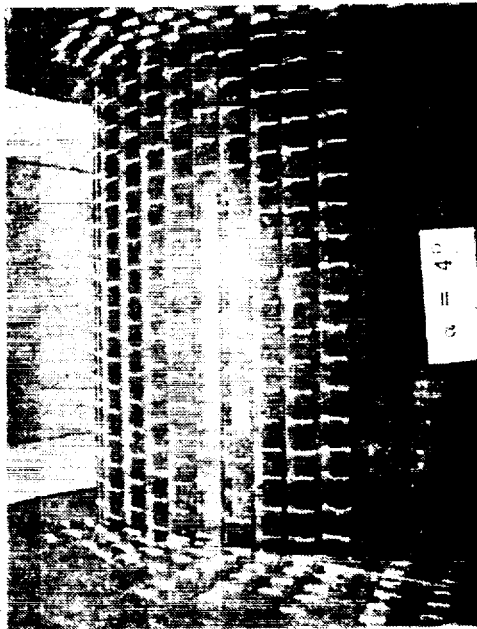
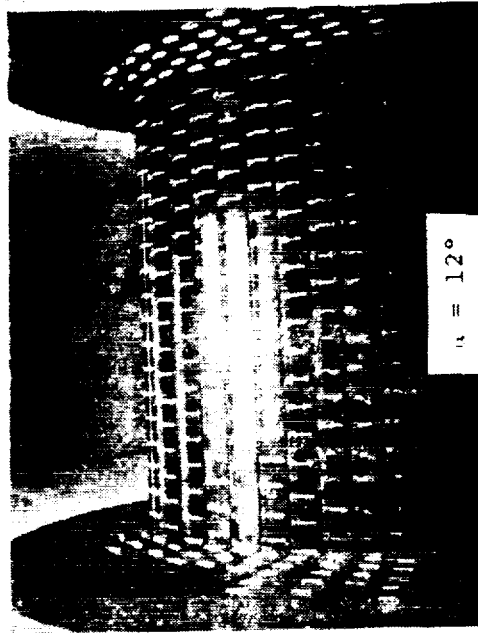
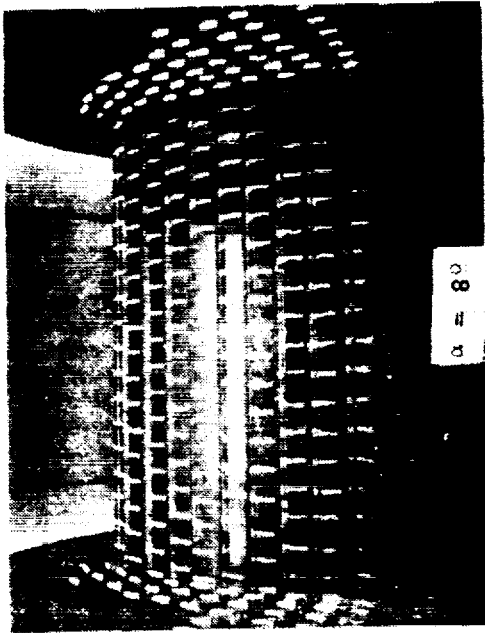

Figure 10 - c_{lmax} Performance with Single-slotted Flaps
NASA and NACA Airfoils.



REPRODUCIBILITY OF THE ORIGINAL PAGE IS POOR

ORIGINAL PAGE IS
OF POOR QUALITY

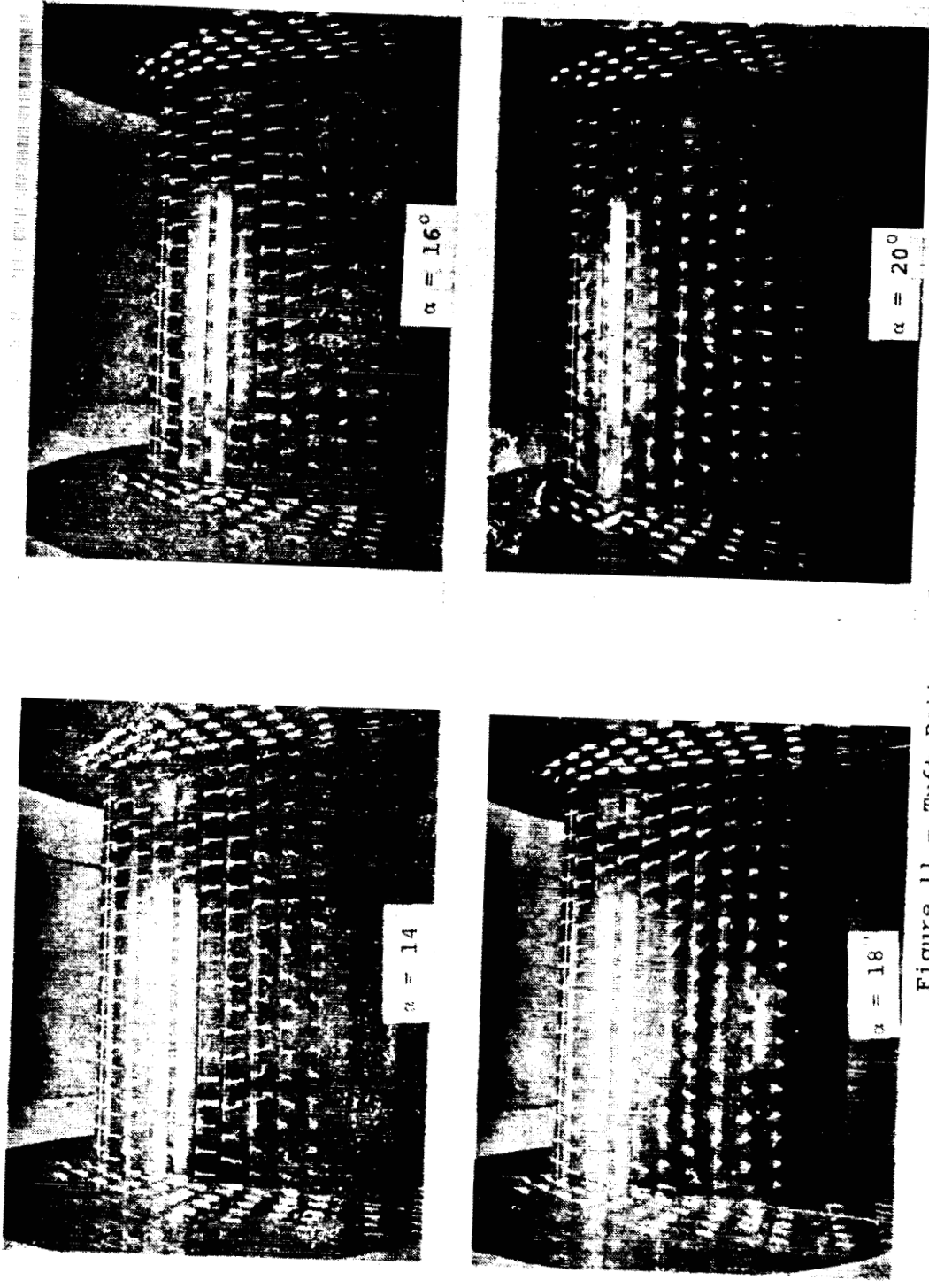
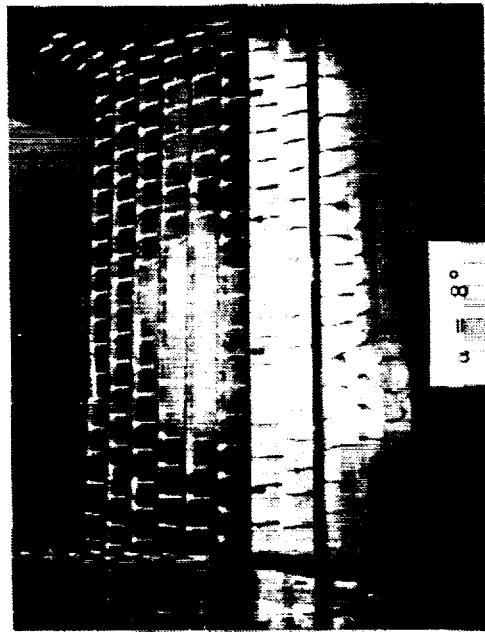
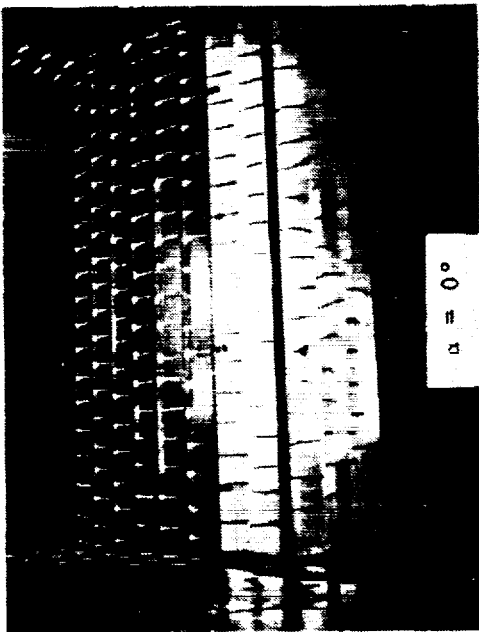
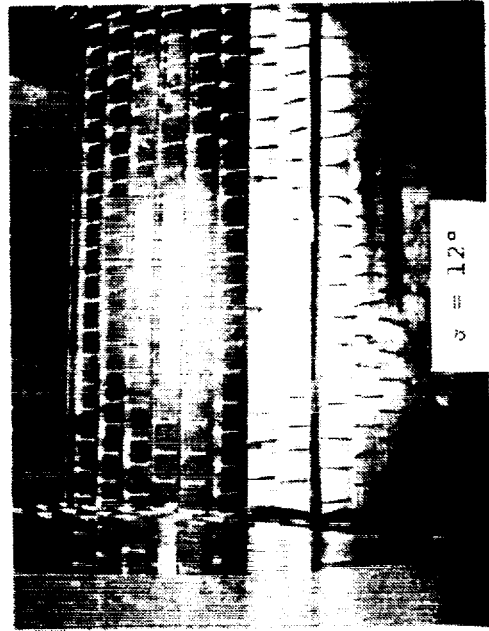
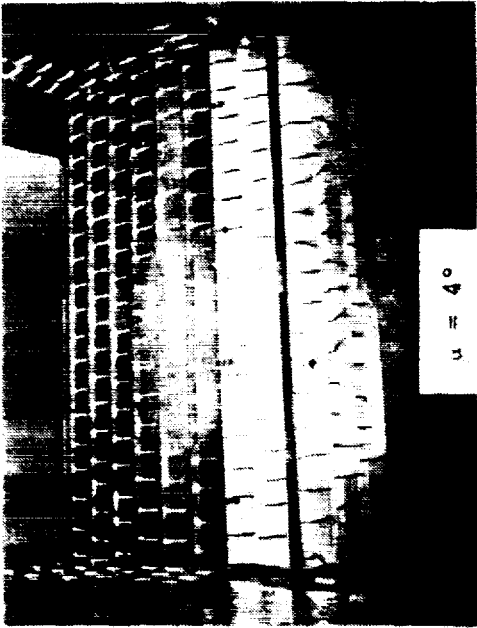

Figure 11 - Tuft Patterns for Basic Airfoil.



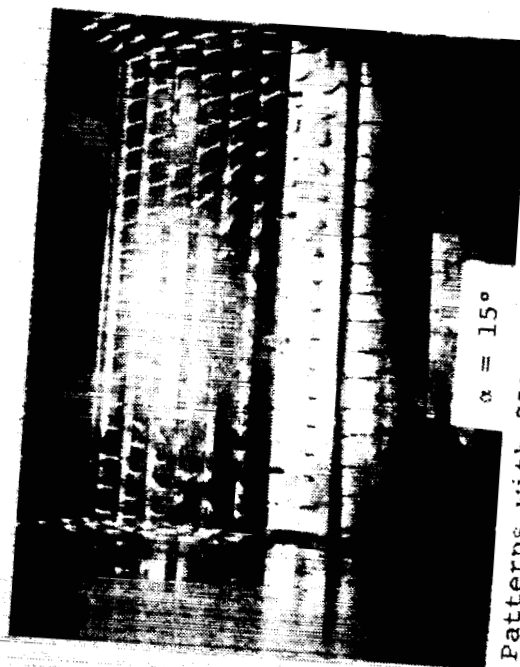
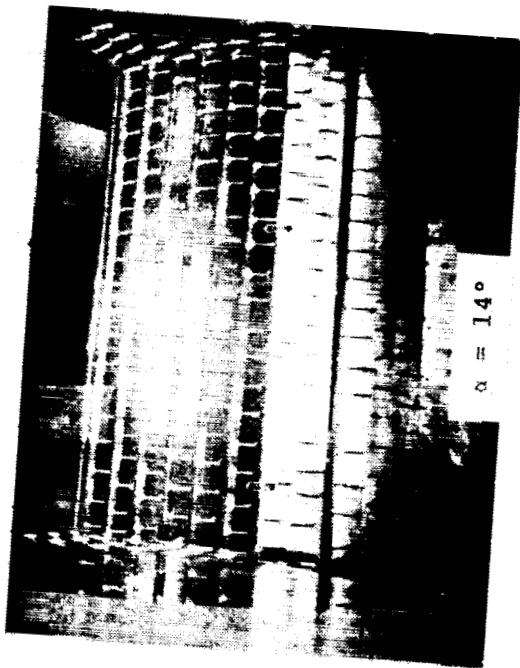
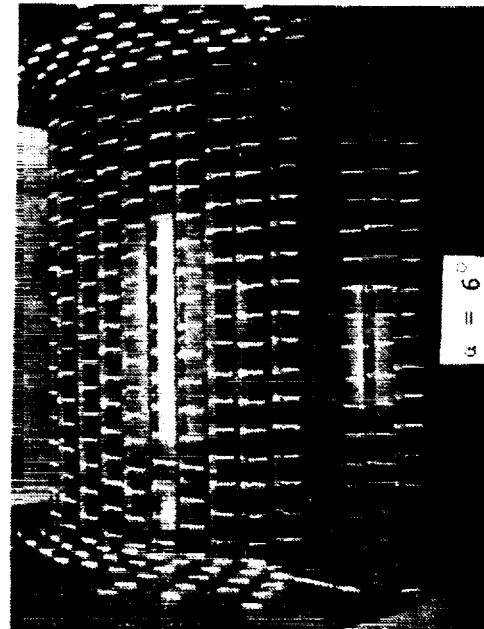
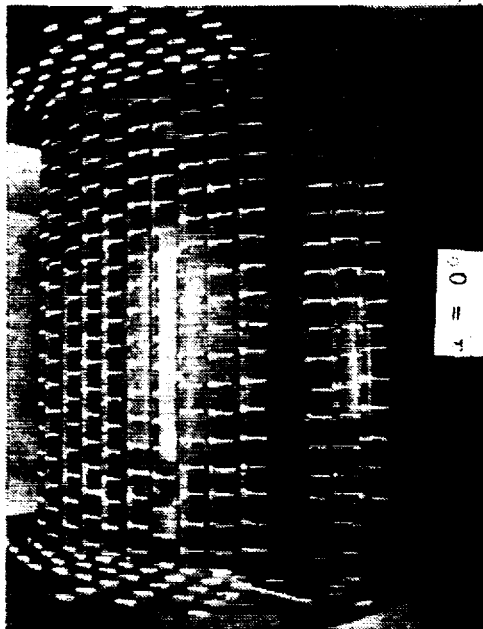
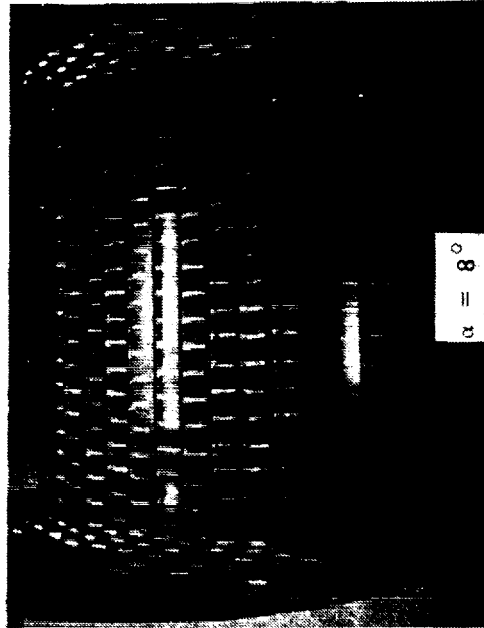
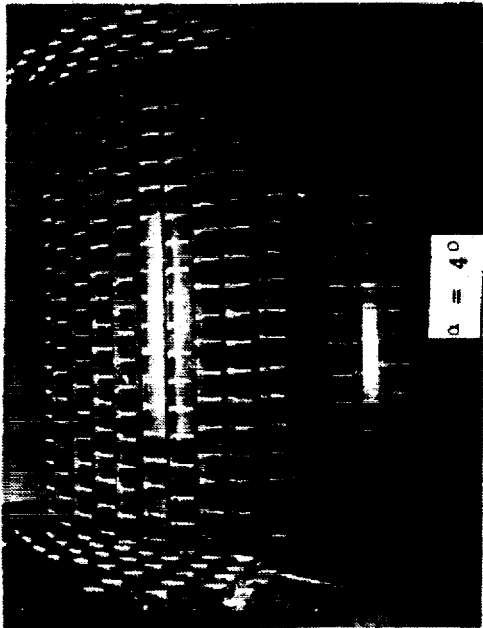
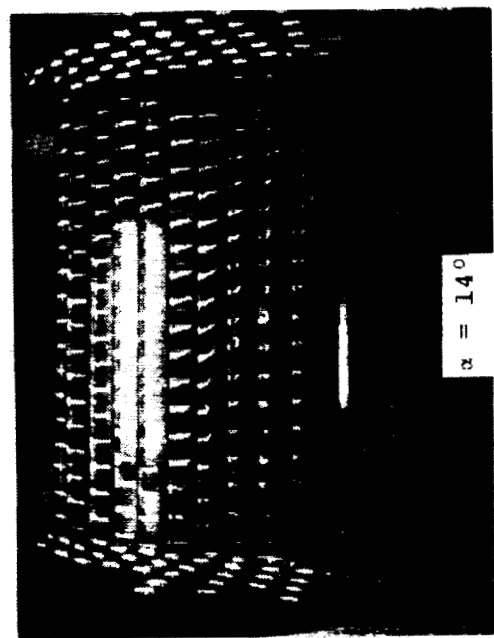
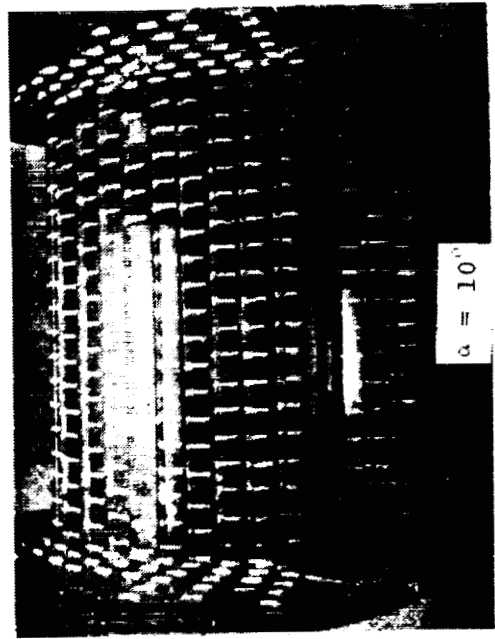
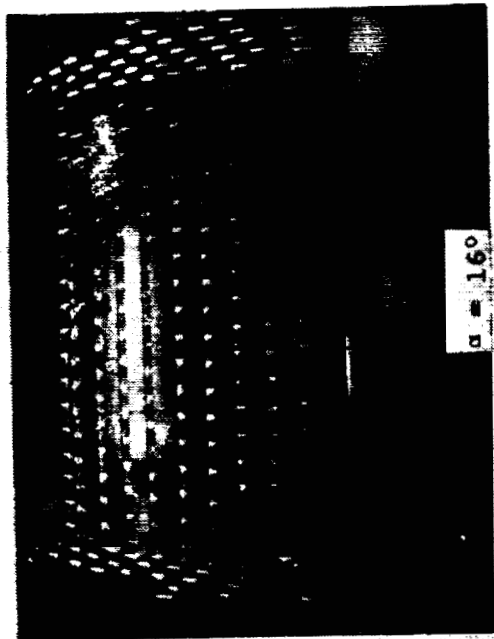
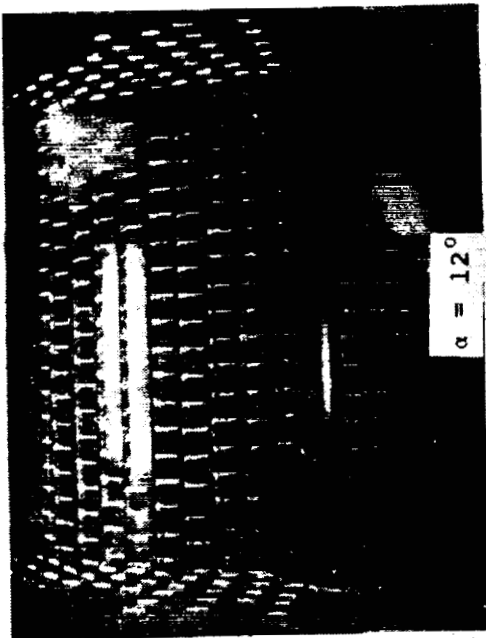

Figure 12 - Tuft Patterns with 25% Slotted Flap, 30' Flap Deflection.



REPRODUCIBILITY OF THE ORIGINAL PAGE IS 100%



(a) 10° Flap Deflection.
Figure 13 - Tuft Patterns with 30% Fowler Flap.

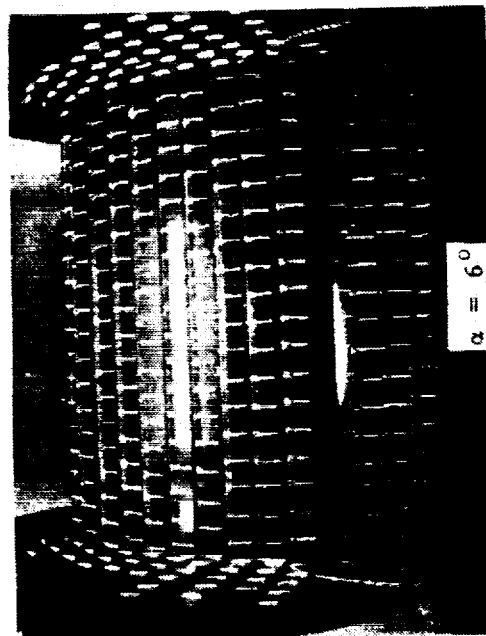
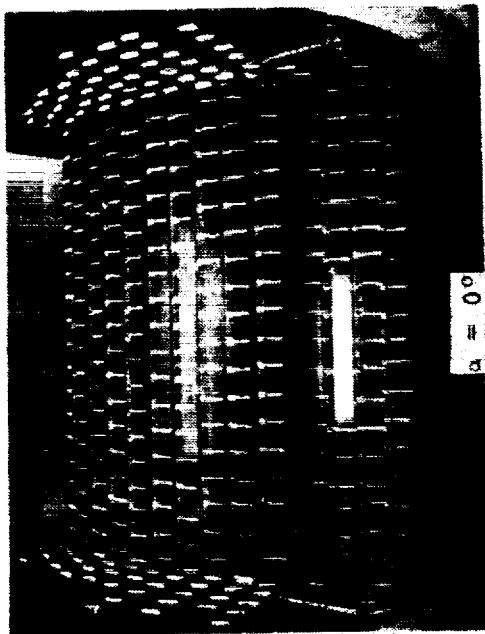
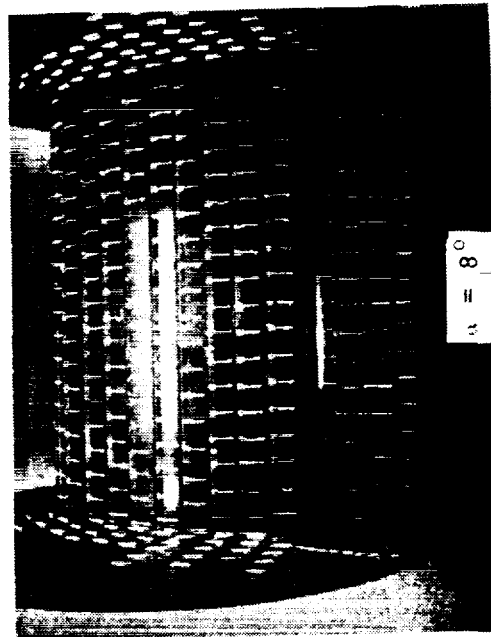
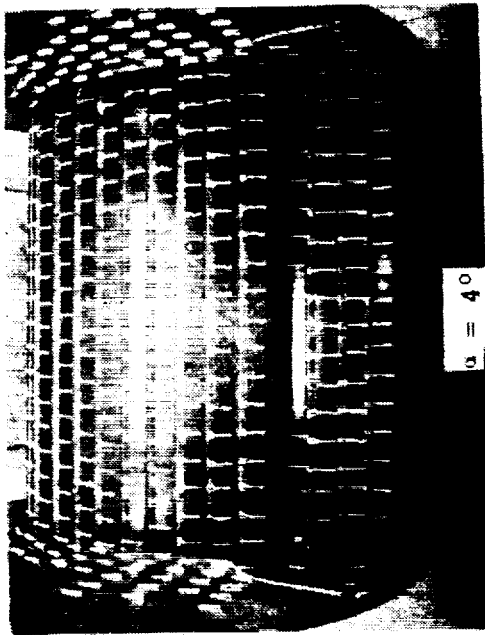

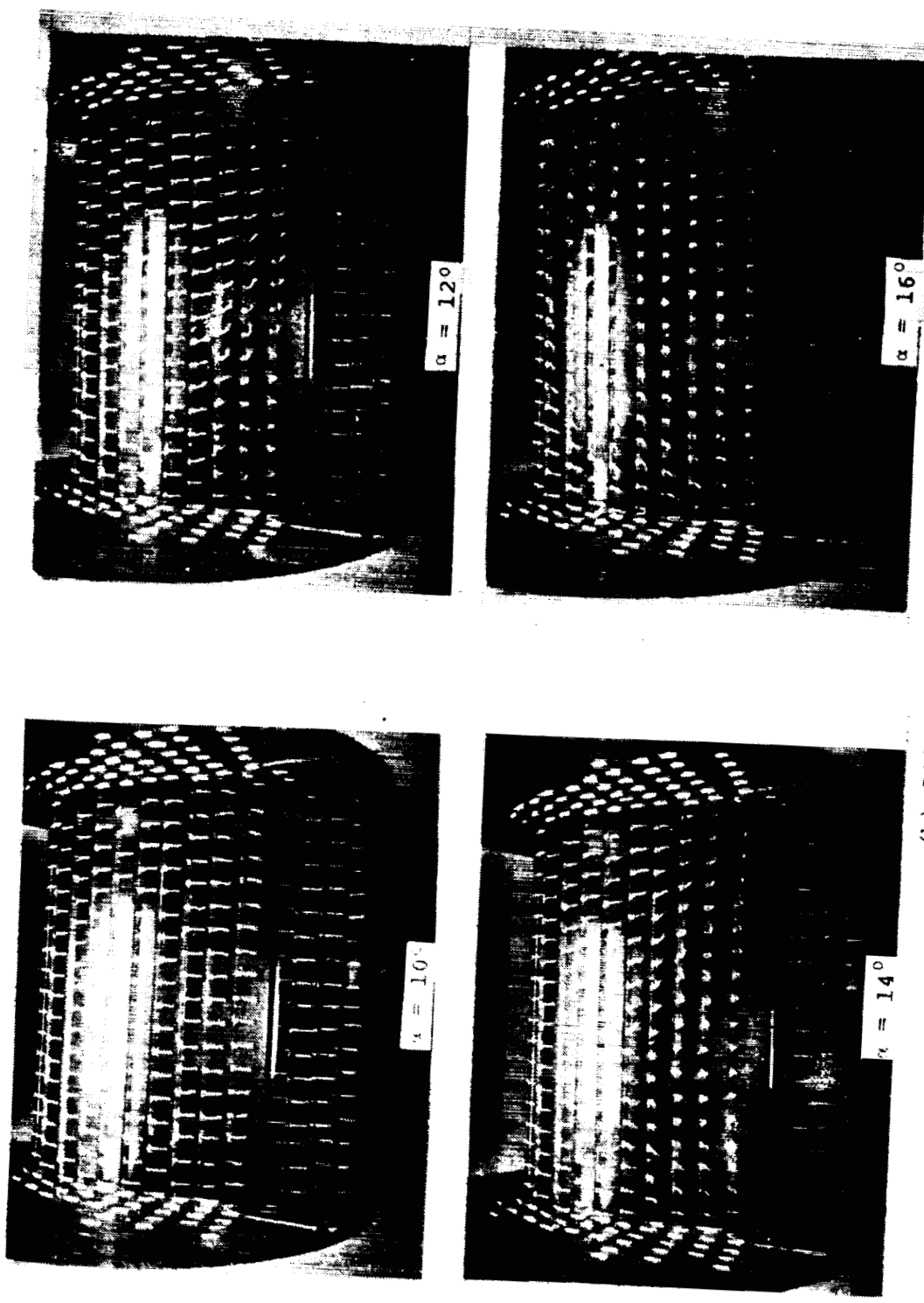

(b) 20° Flap Deflection.
Figure 13 - Continued.

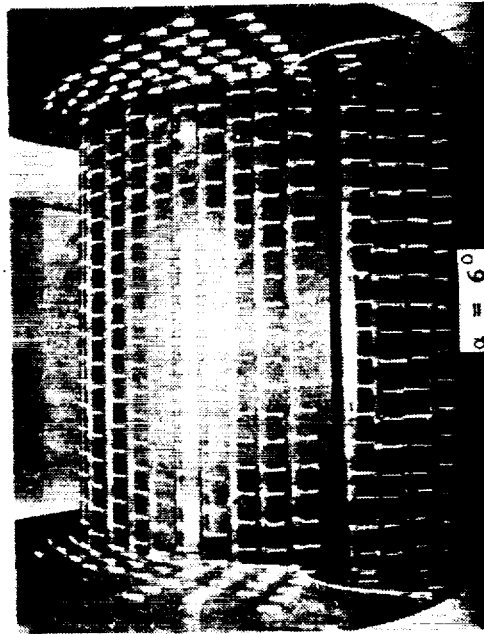
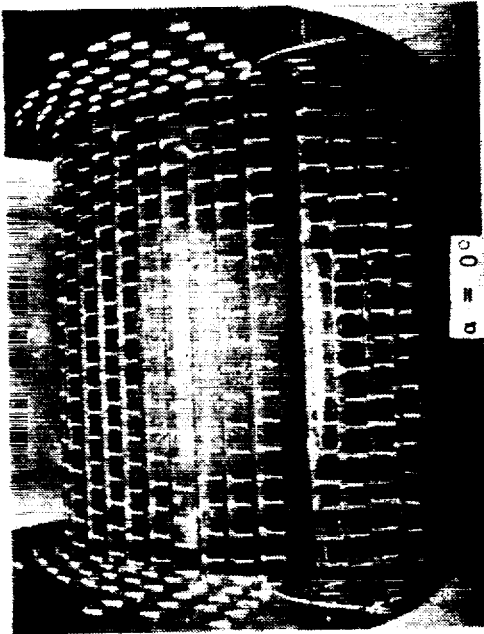
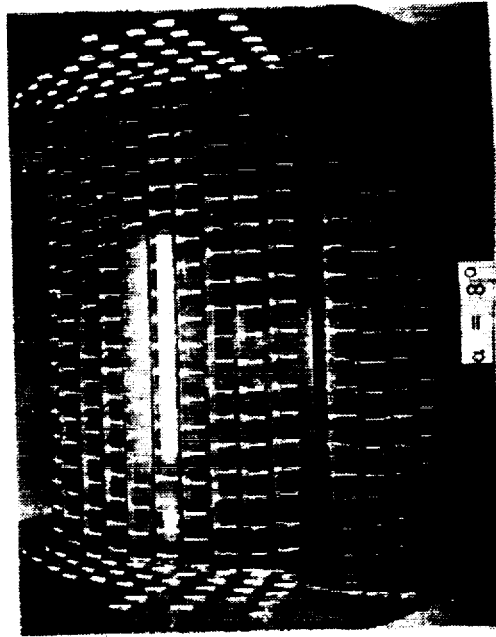
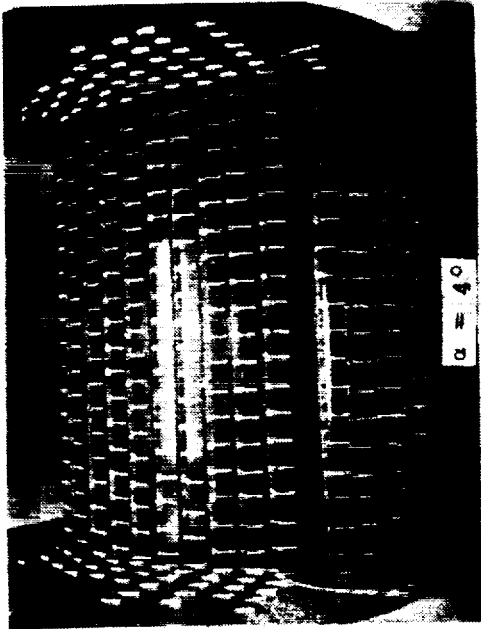

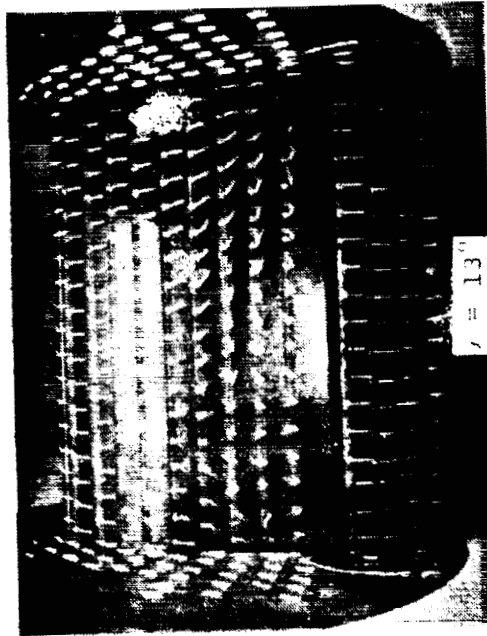
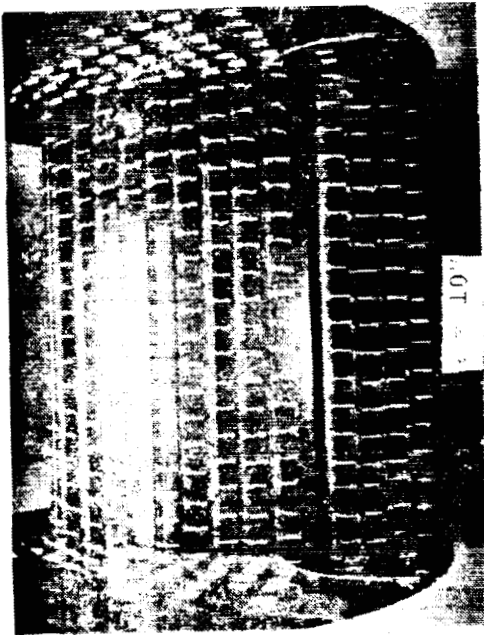
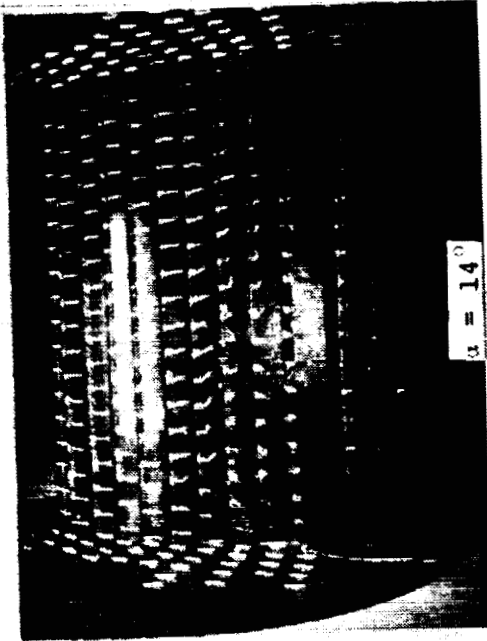
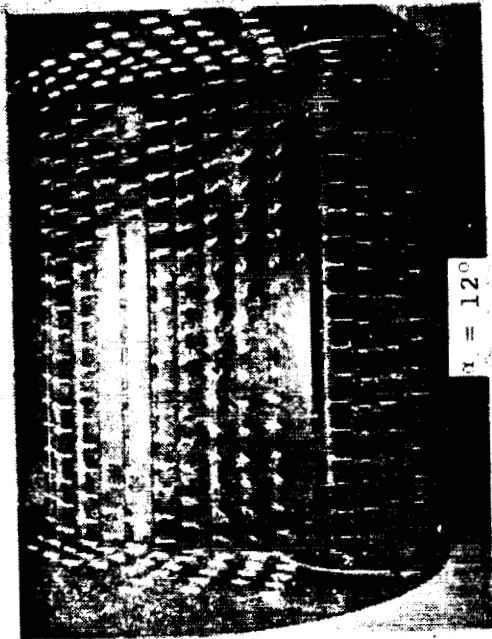

(c) 30° Flap Deflection.
Figure 13 - Continued.

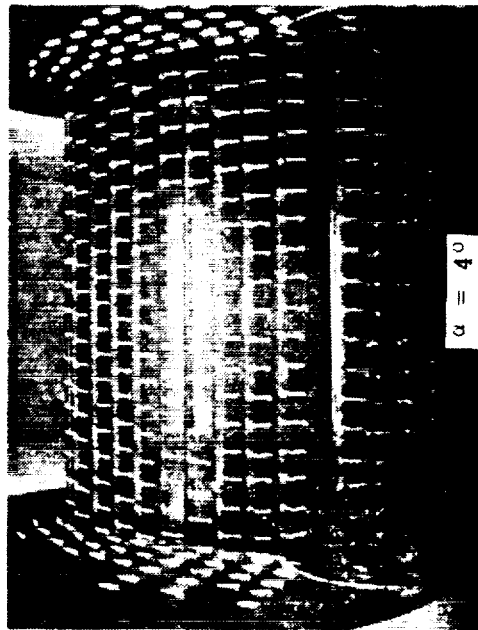
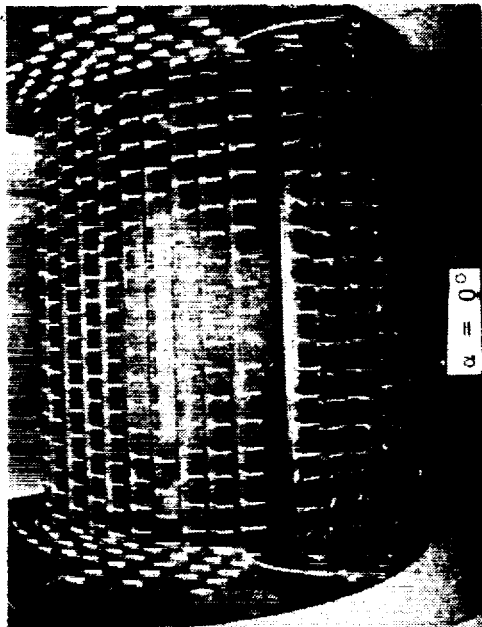
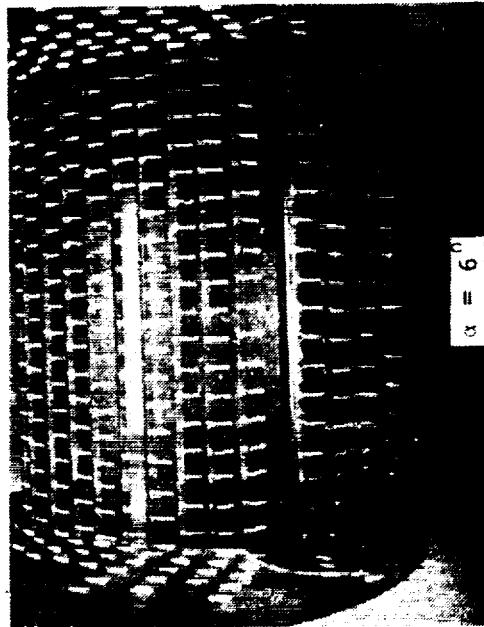
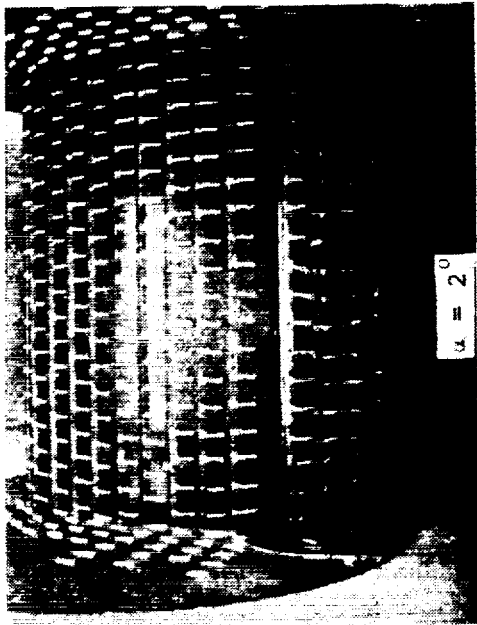

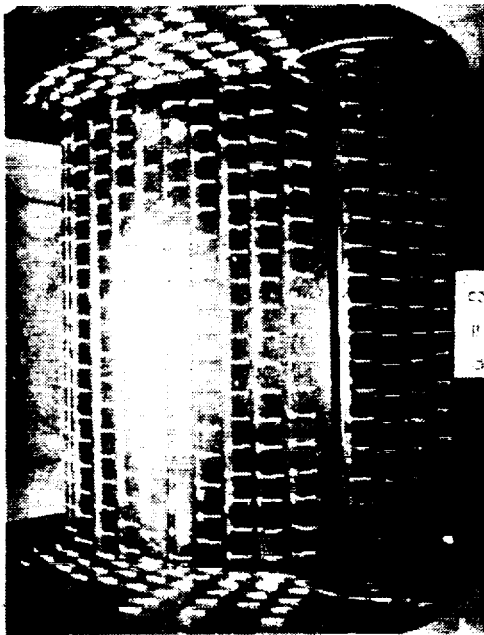
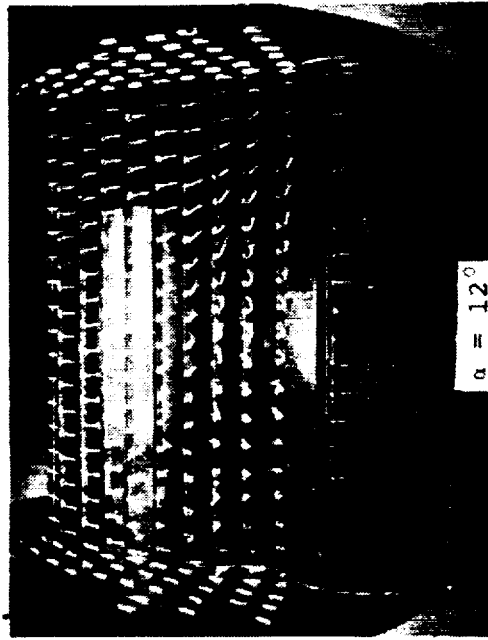
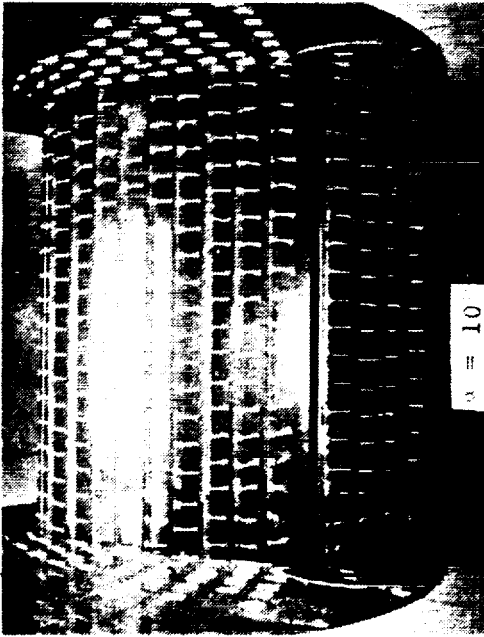

(d) 40° Flap Deflection.
Figure 13 - Concluded.

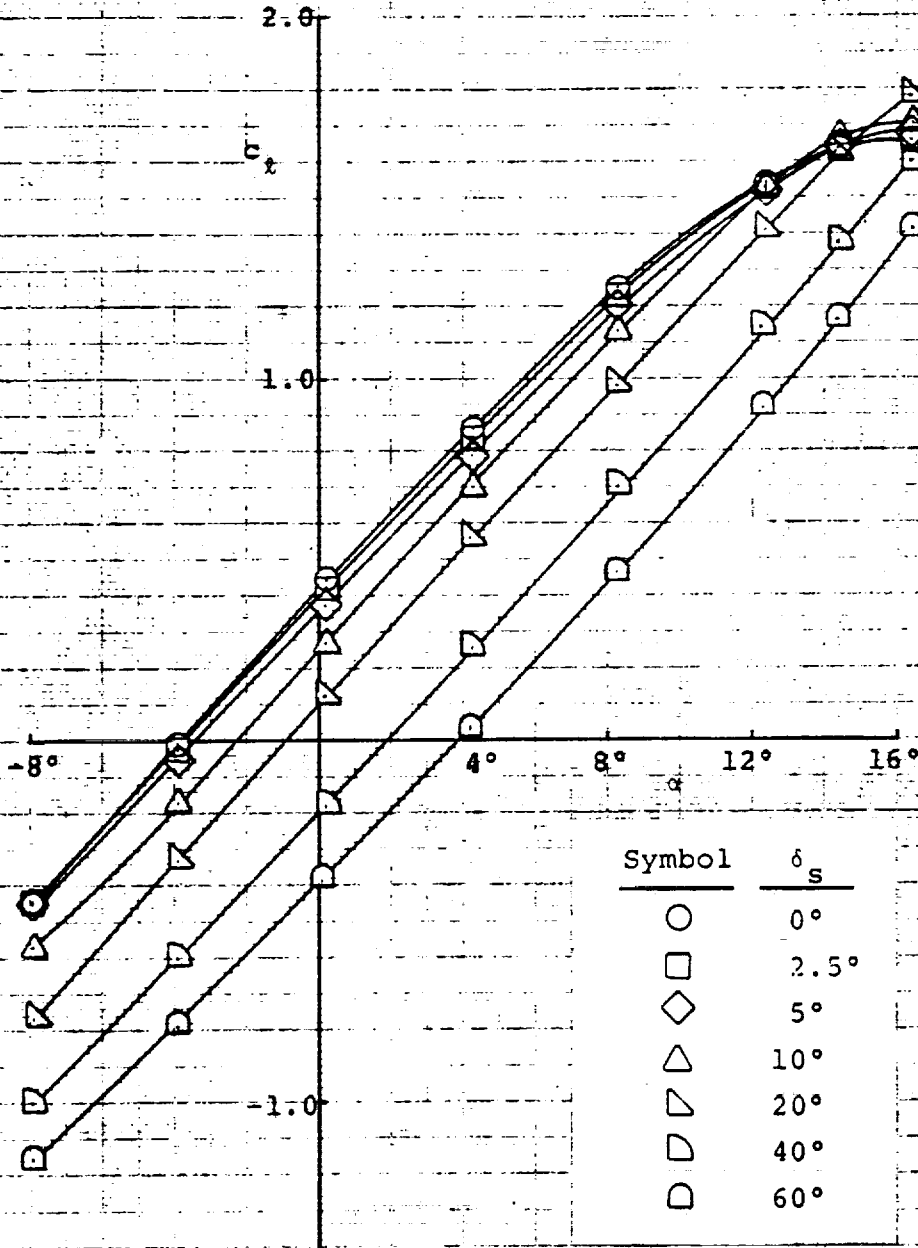
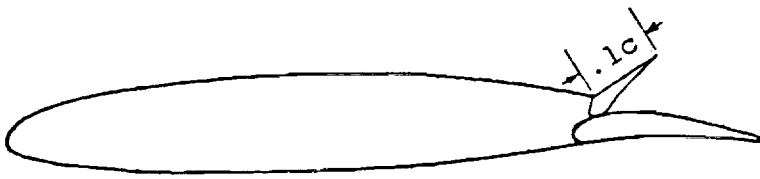

(a) Flap Nested.

Figure 14 - Effects of Spoiler Deflection on Lift for 25% Flap.

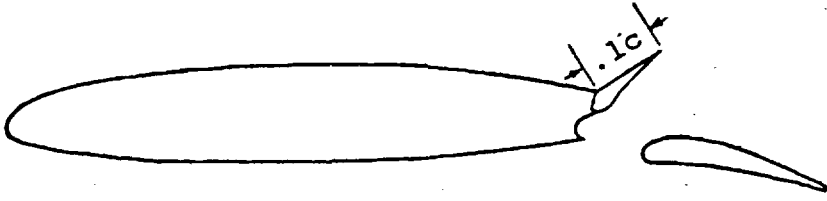

46 1513

K-E 10 X 10 TO THE CENTIMETER 18 X 20 CM
KEUFFEL & ESSER CO. MADE IN U.S.A.

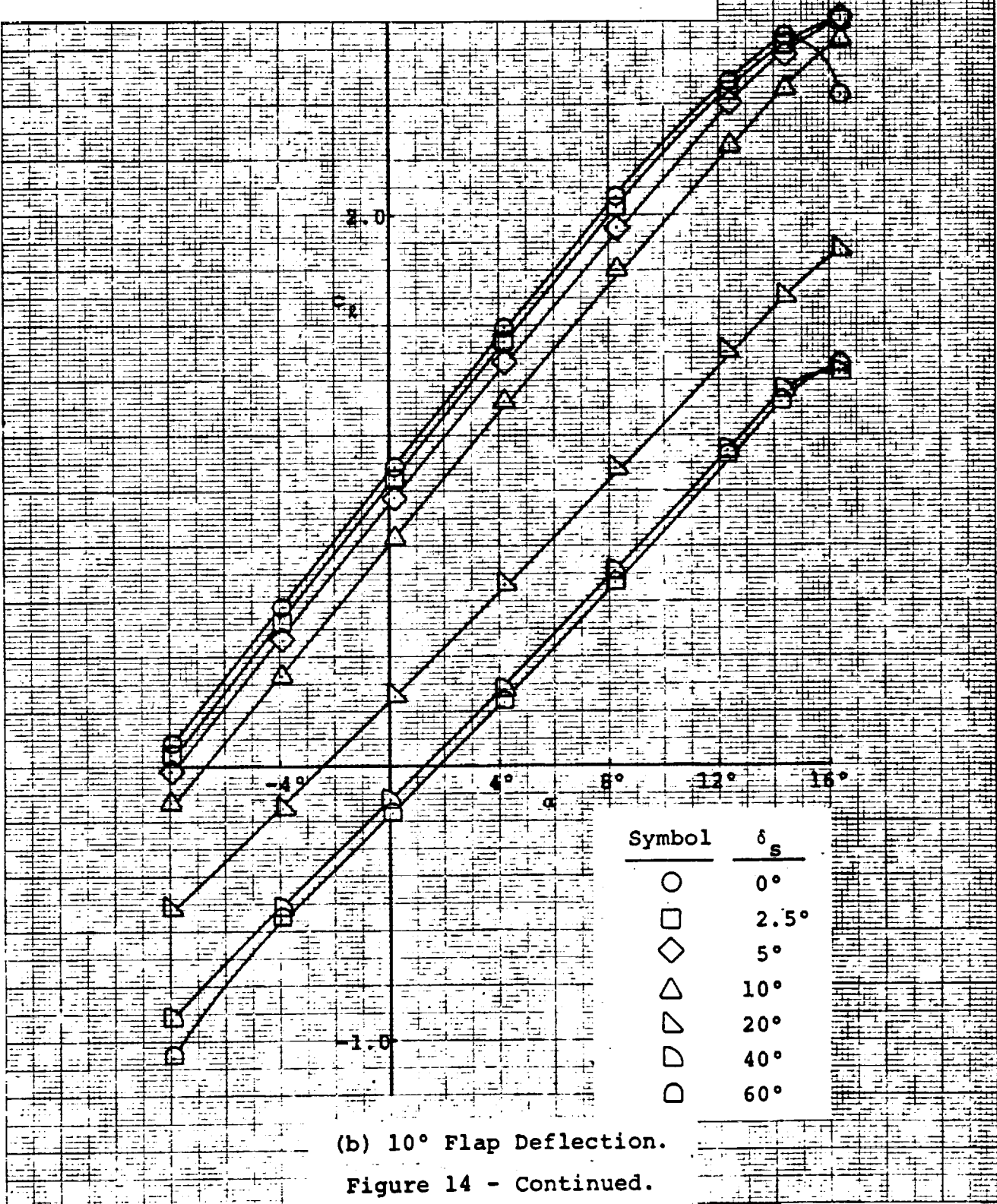

(b) 10° Flap Deflection.
Figure 14 - Continued.

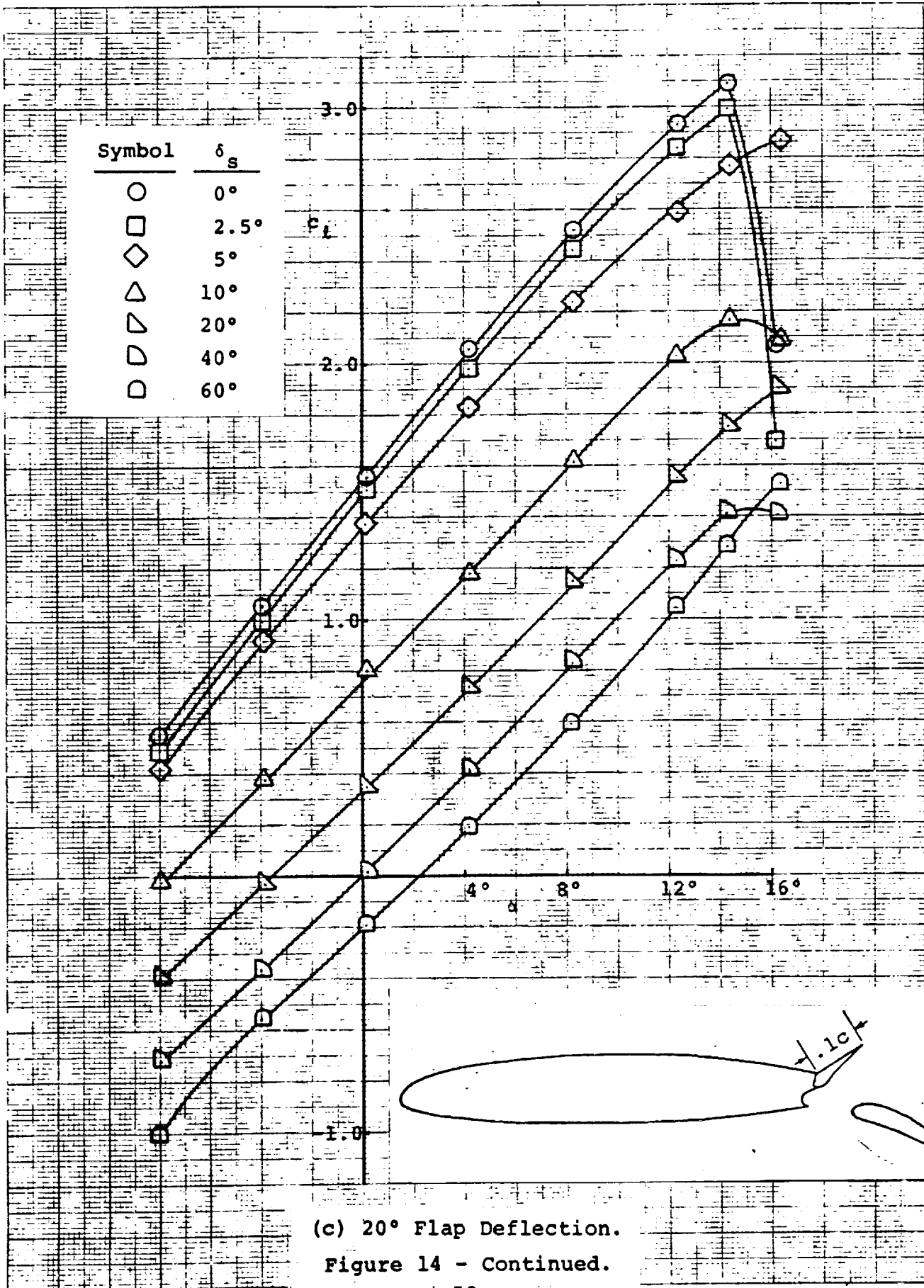

(c) 20° Flap Deflection.
 Figure 14 - Continued.

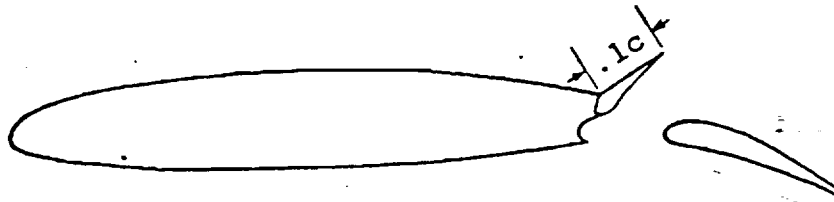

46 1513

K&E 10 X 10 TO THE CENTIMETER 18 X 18 CM
LEUFFEL & ESSER CO. MADE IN U.S.A.

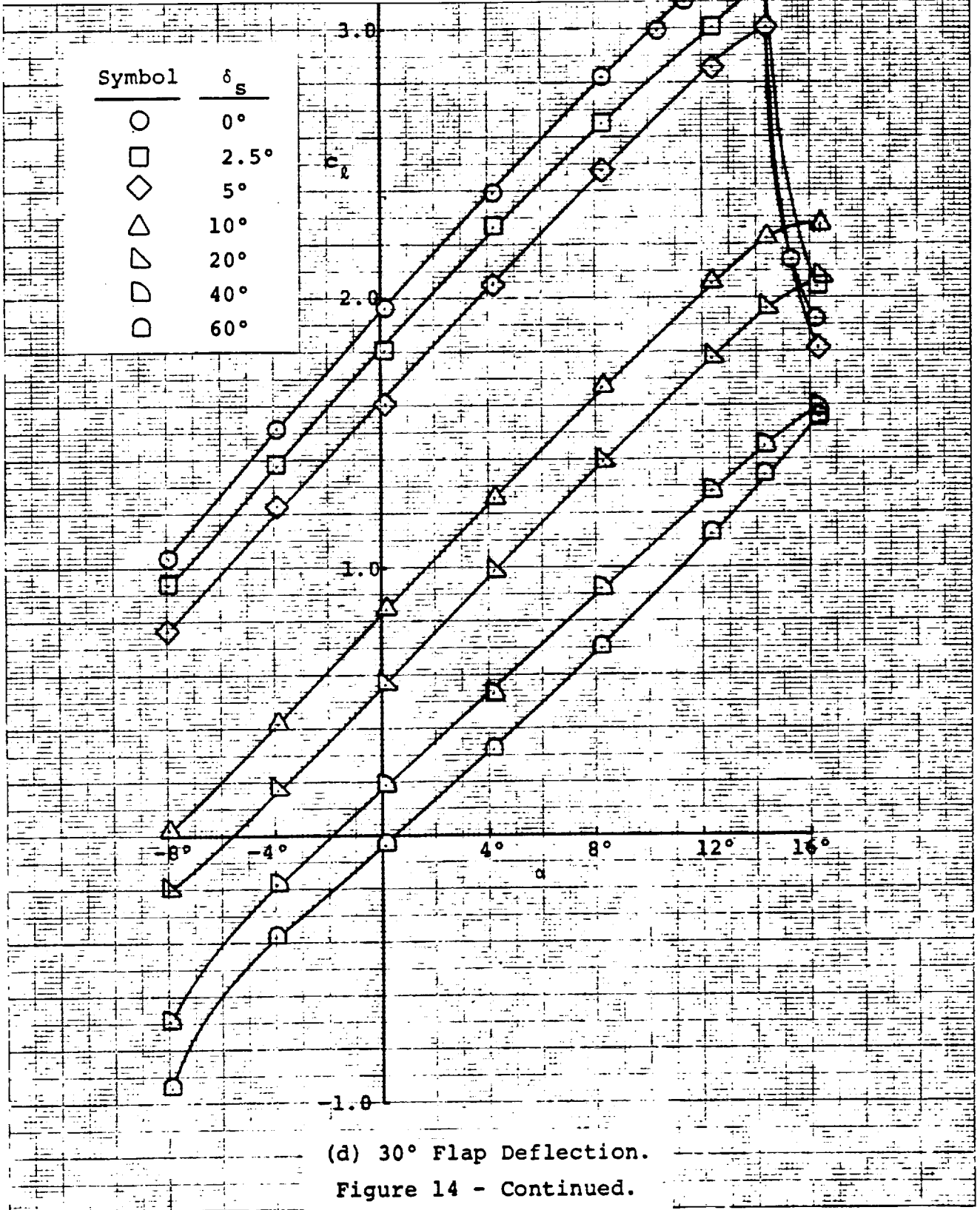

(d) 30° Flap Deflection.
Figure 14 - Continued.

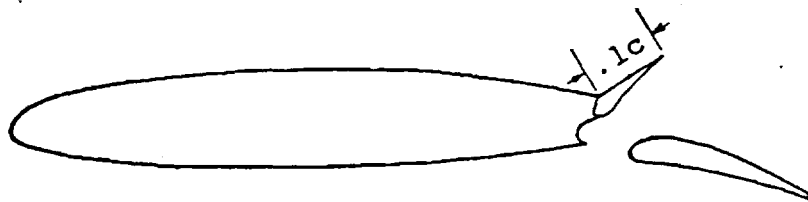

Symbol	δ_s
○	0°
□	2.5°
◇	5°
△	10°
▽	20°
◐	40°
◑	60°

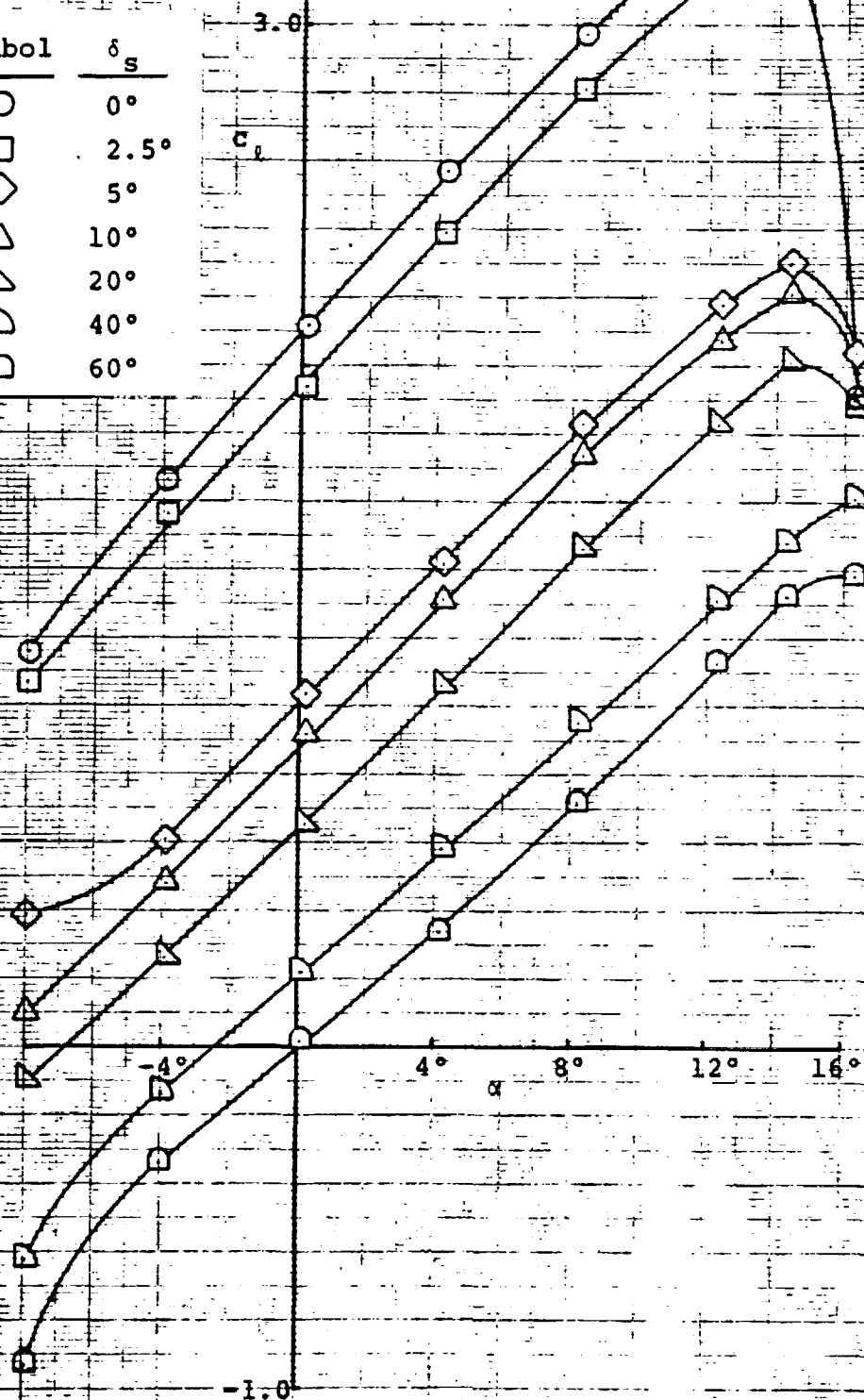

(e) 35° Flap Deflection.
Figure 14 - Continued.

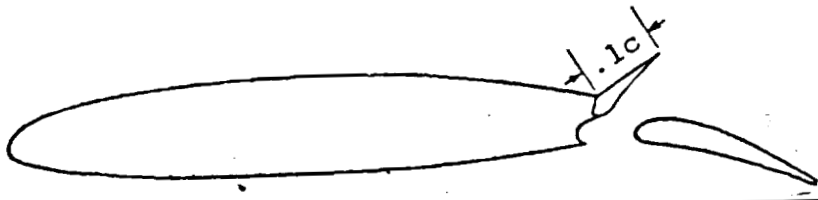

Symbol	δ_s
○	0°
□	2.5°
◇	5°
△	10°
▽	20°
◐	40°
◑	60°

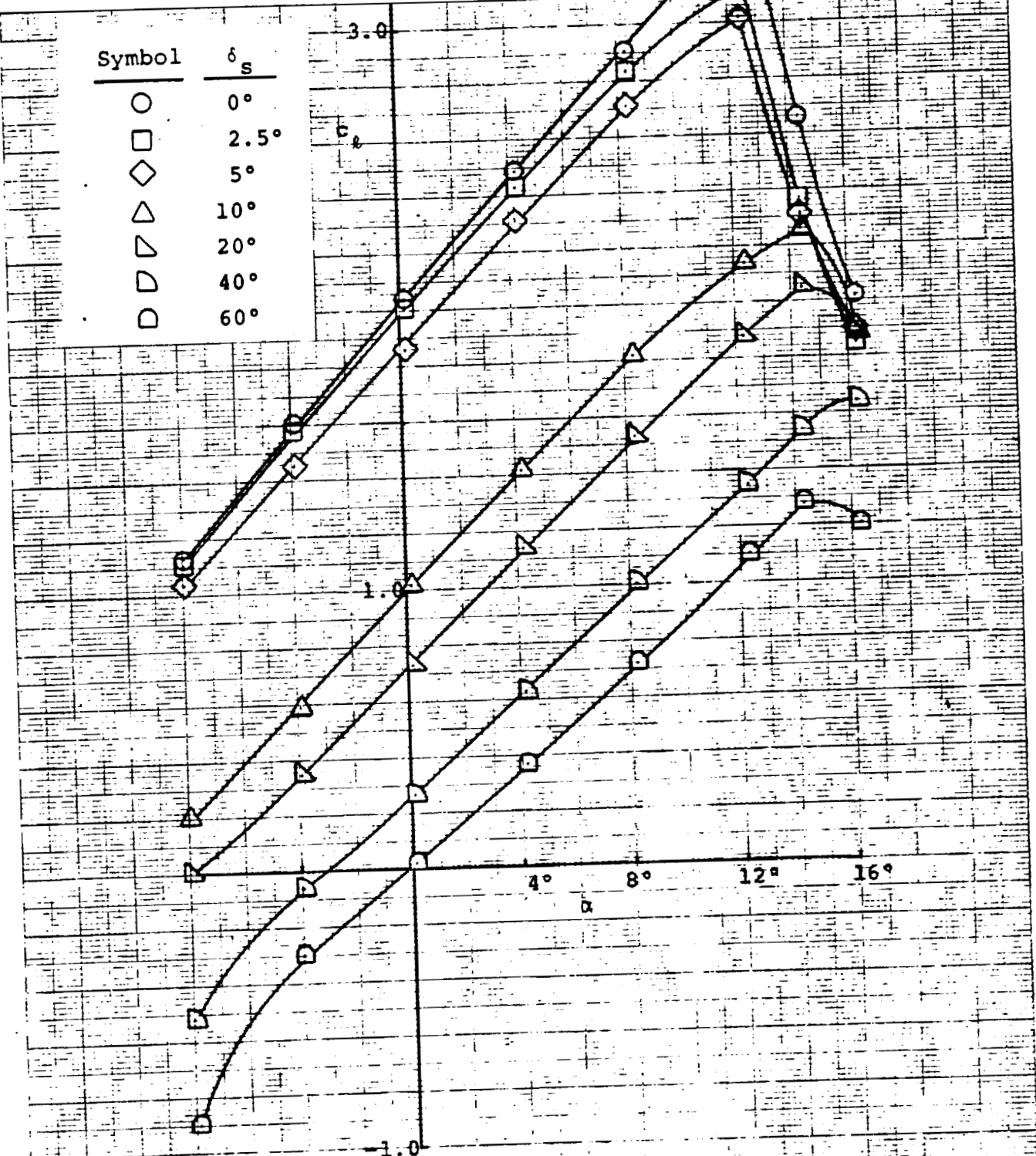

(f) 40° Flap Deflection.

Figure 14 - Concluded.

46 1513

10" X 10" TO THE CENTIMETER 14 X 25 CM
K. & E. KLÜPFEL & ESSER G. M. B. H. MADE IN GERMANY

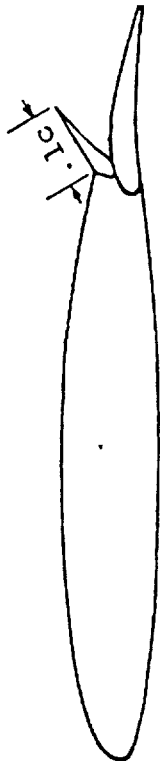

Gap 0%
 Hingeline 77.5%
 Flap 25%

Symbol α
 -8° \diamond
 -4° \triangleleft
 0° \circ
 4° \triangle
 8° \square

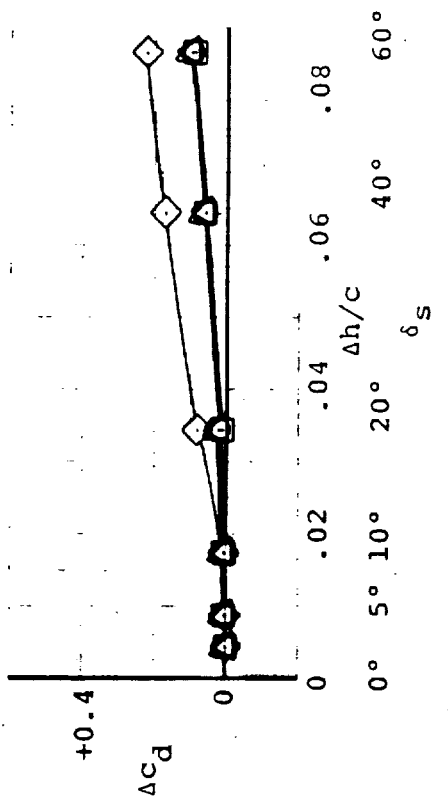
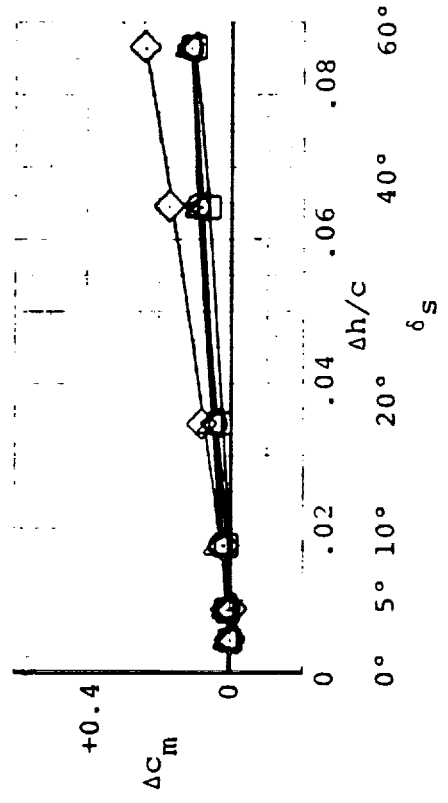

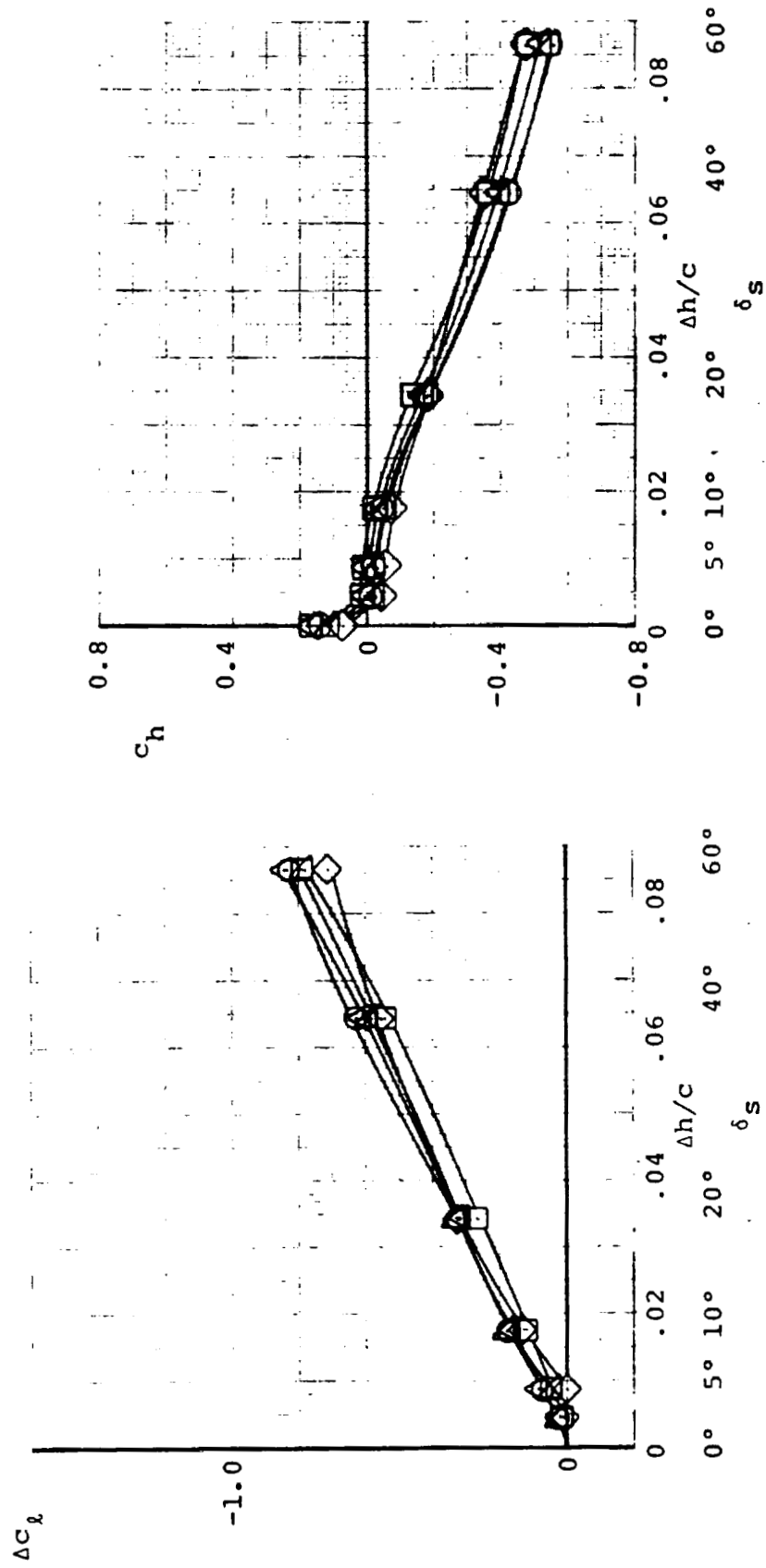

(a) Flap Nested.

Figure 15 - Incremental Effects of Spoiler Deflection.

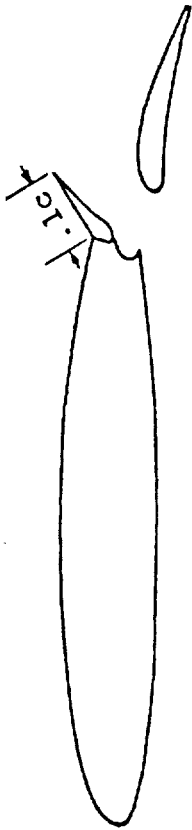

Symbol α

\diamond	-8°
\triangleleft	-4°
\circ	0°
\triangle	4°
\square	8°

Gap 0%
 Hingeline 77.5%
 Flap 25%

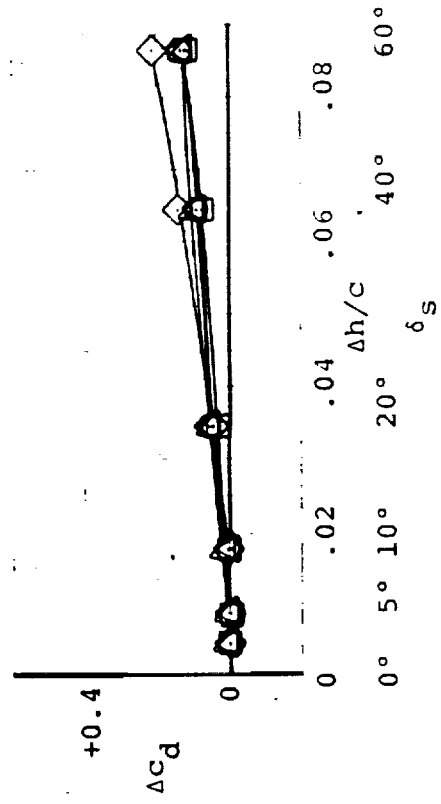
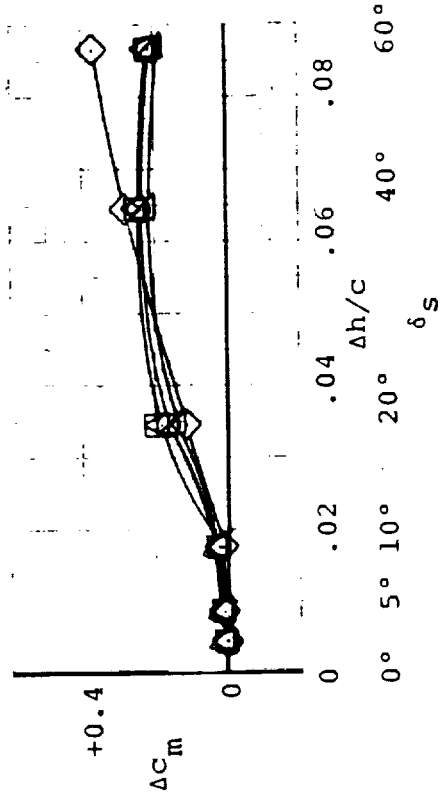

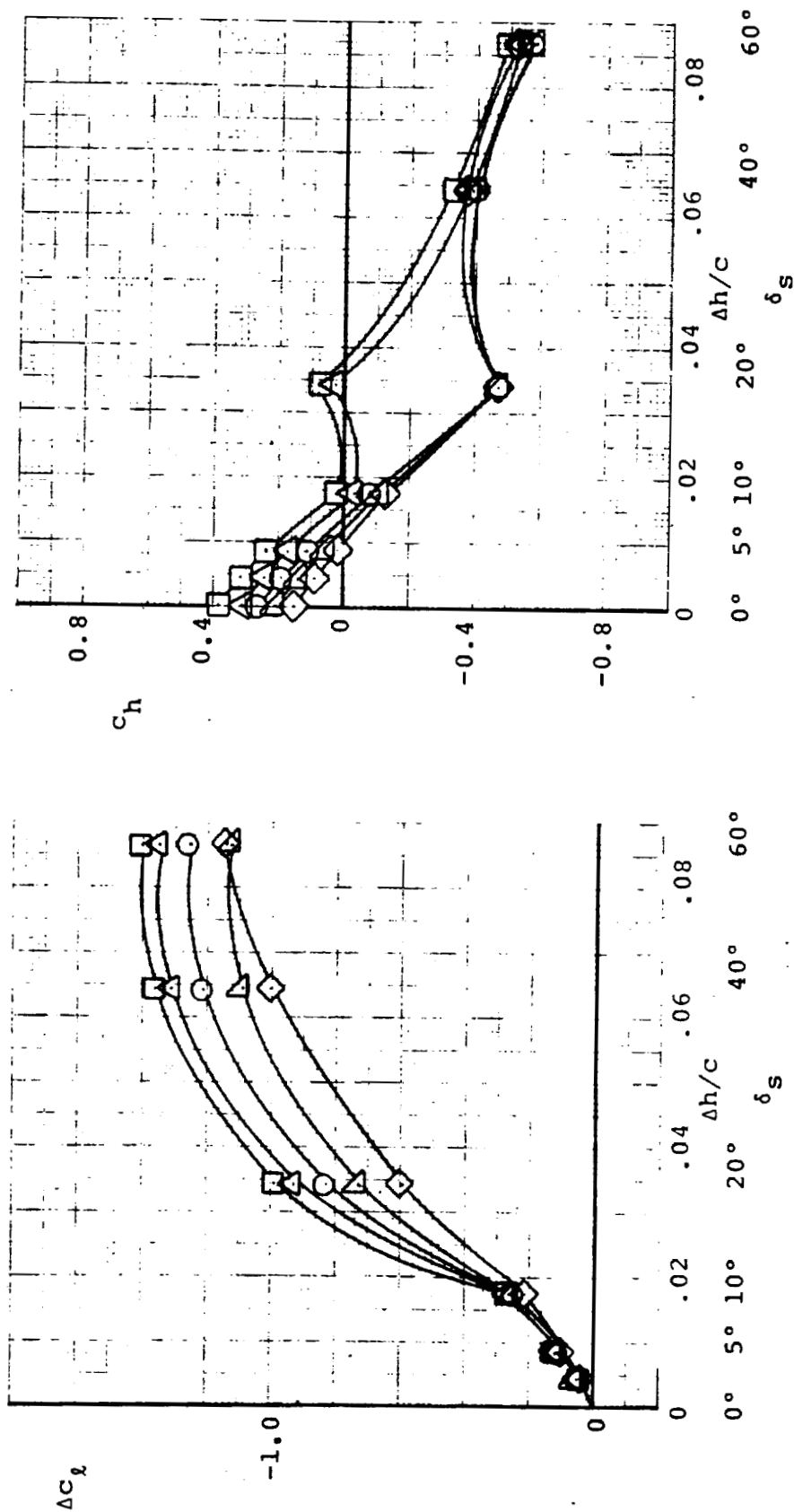

(b) 10° Flap Deflection.

Figure 15 - Continued.

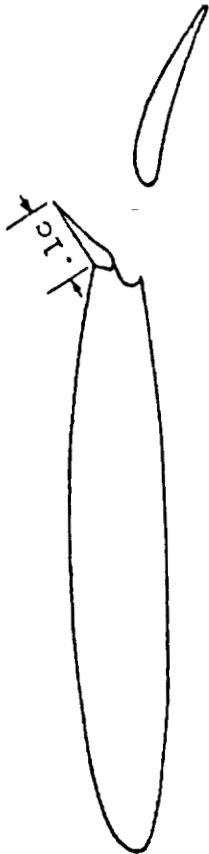

Gap 0%
 Hingeline 77.5%
 Flap 25%

Symbol α
 -8° \diamond
 -4° \triangle
 0° \square
 4° \circ
 8° \square

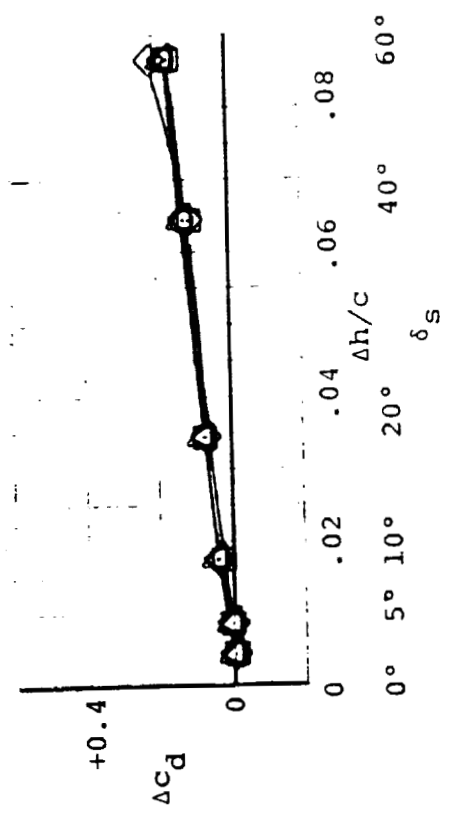
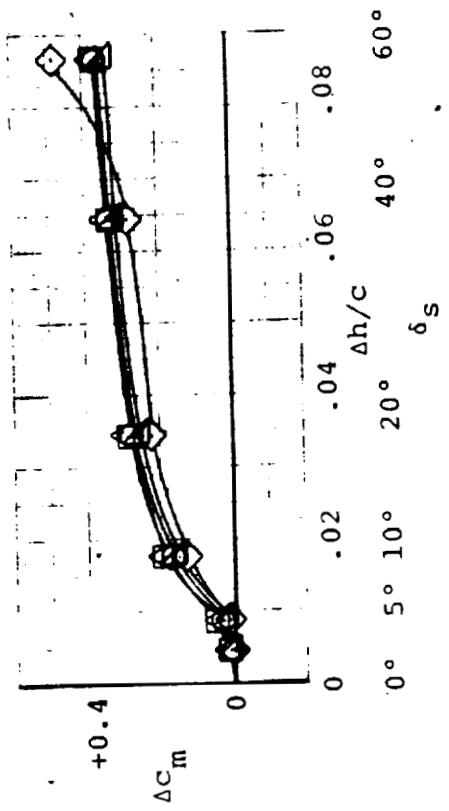

REPRODUCIBILITY OF THE ORIGINAL PAGE IS POOR

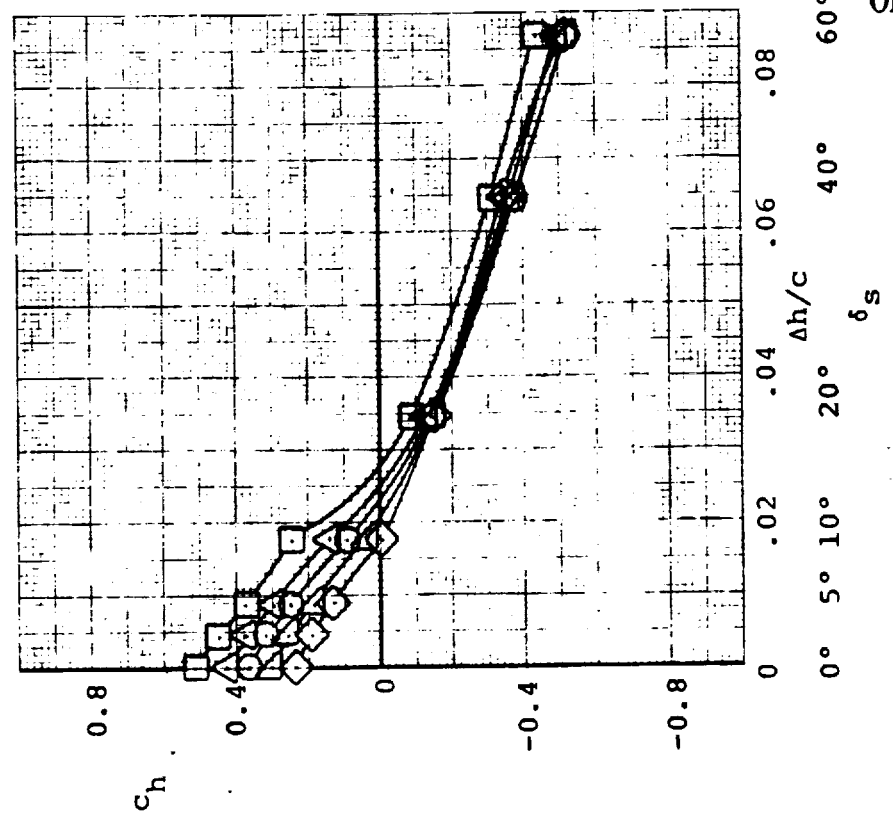
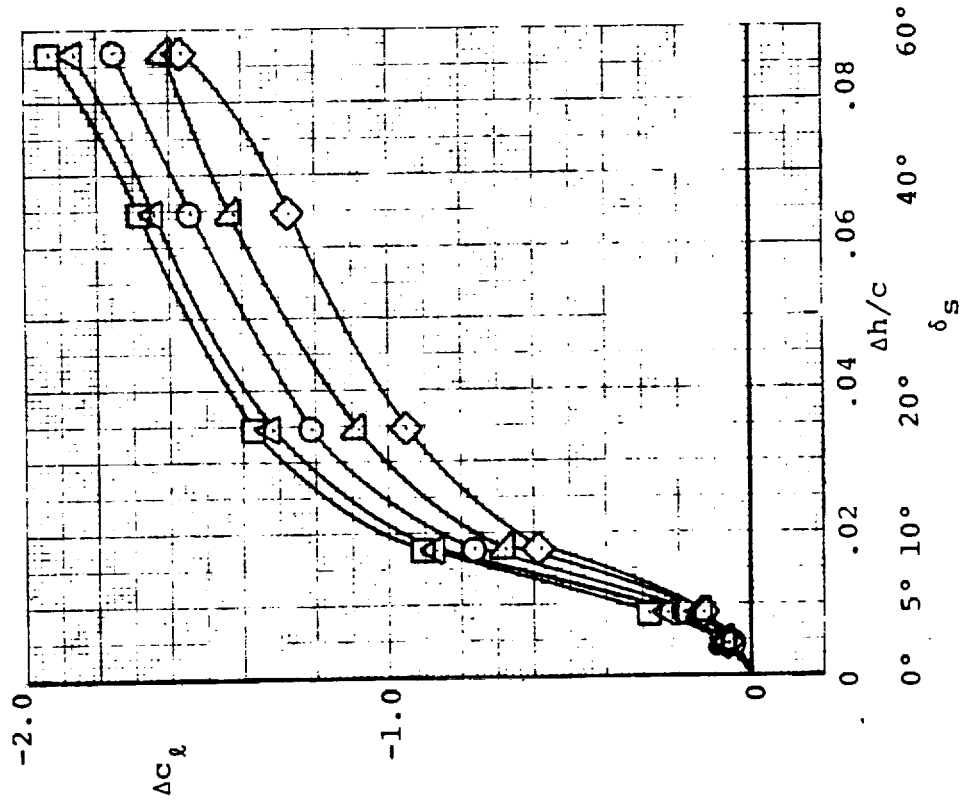

(c) 20° Flap Deflection.

Figure 15 - Continued.

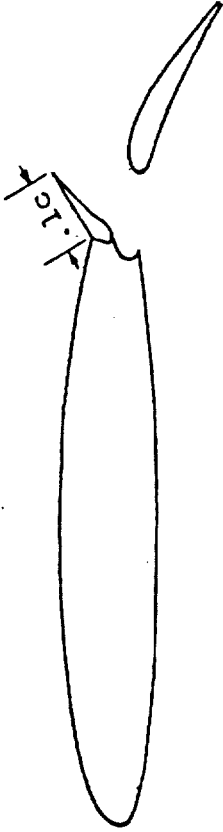

Gap 0%
 Hingeline 77.5%
 Flap 25%

Symbol α
 \diamond \triangle \circ \triangleleft \square
 -8°
 -4°
 0°
 4°
 8°

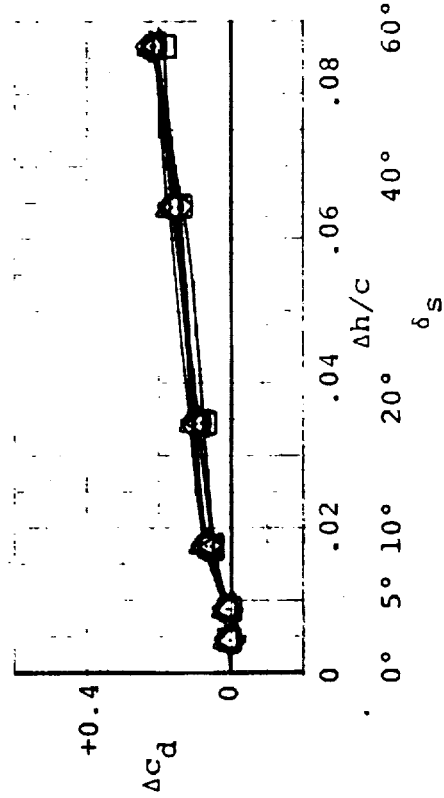
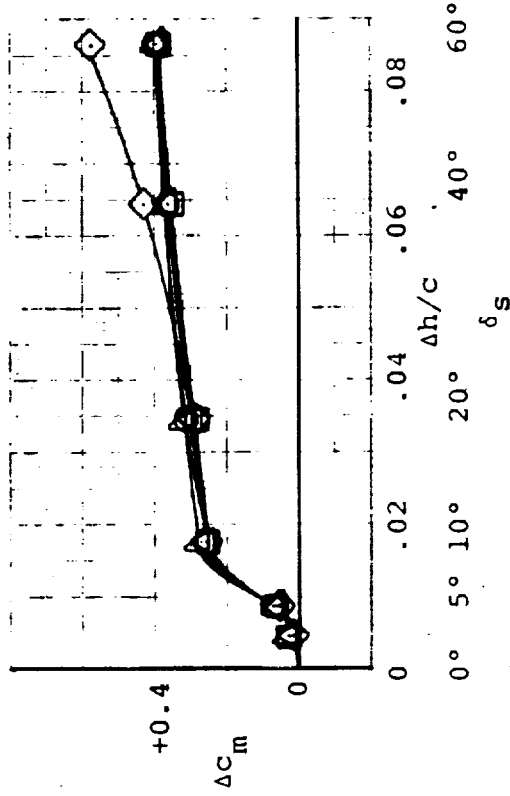

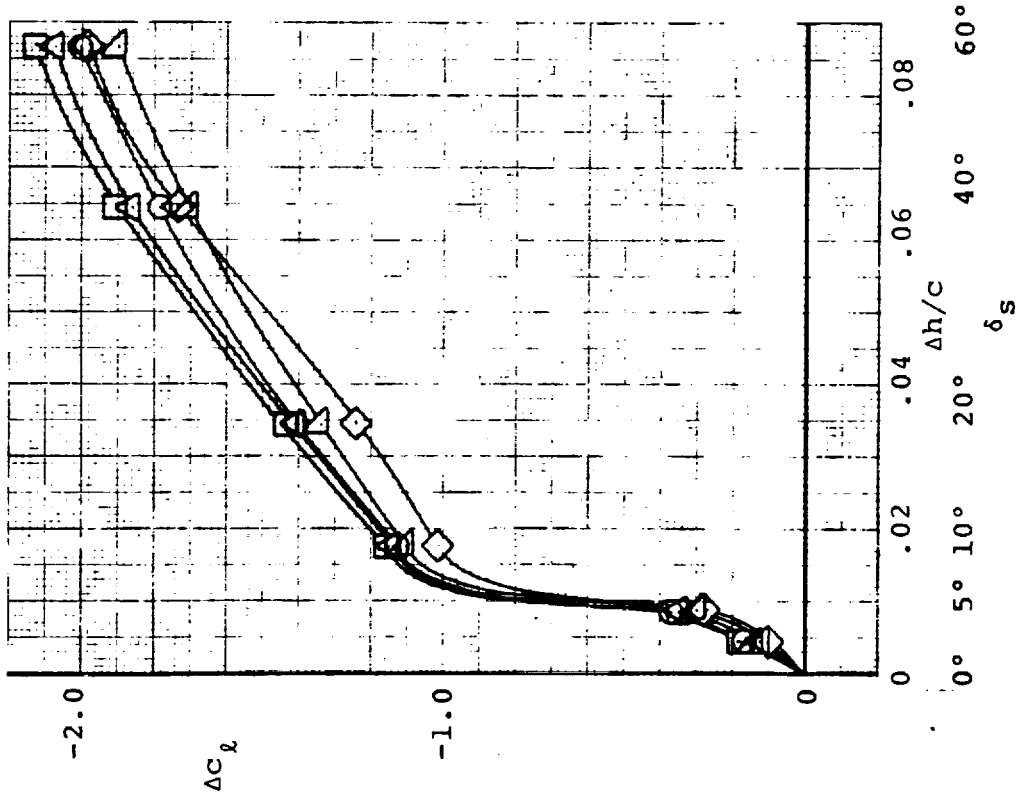
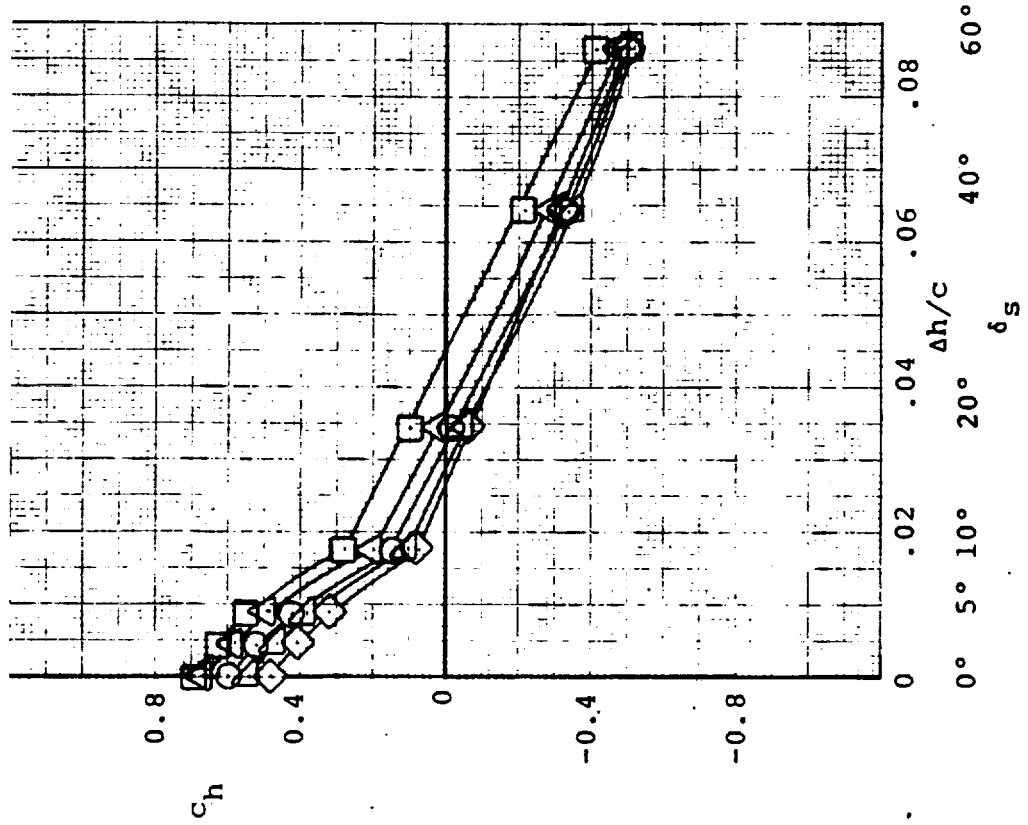

(d) 30° Flap Deflection.
Figure 15 - Continued.

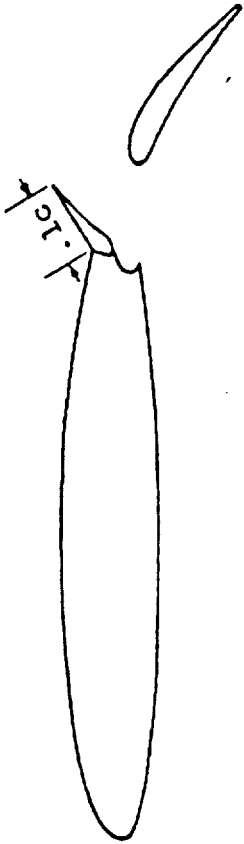

Gap 0%
 Hingeline 77.5%
 Flap 25%

Symbol α
 -8° \diamond
 -4° \triangle
 0° \circ
 4° \blacktriangle
 8° \square

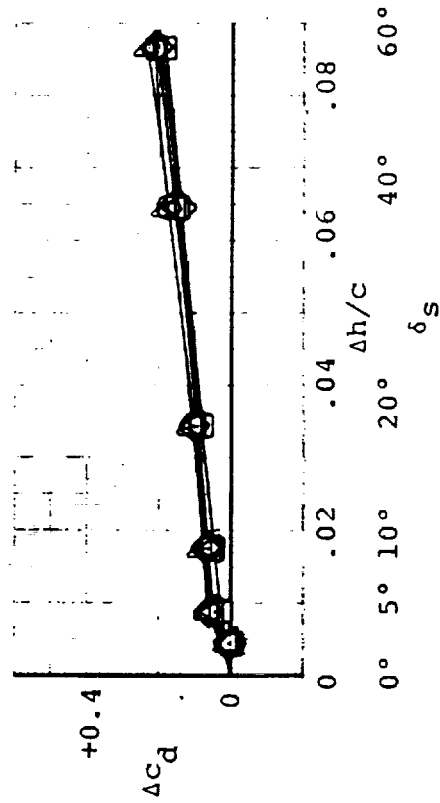
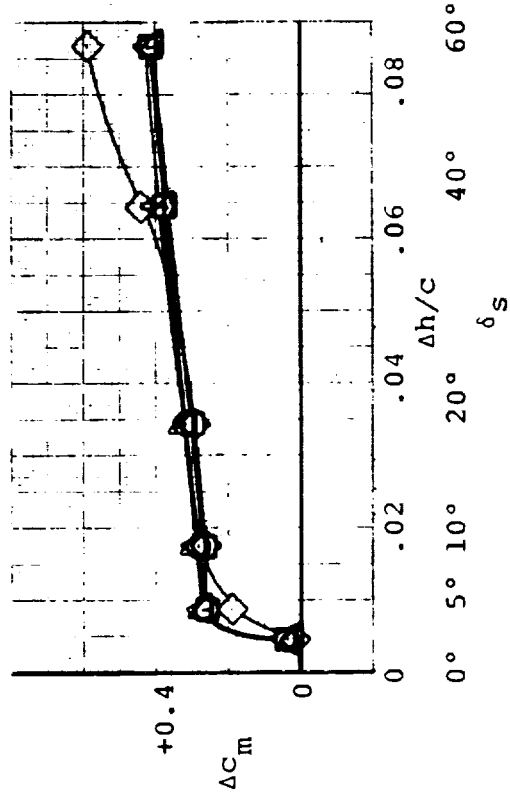

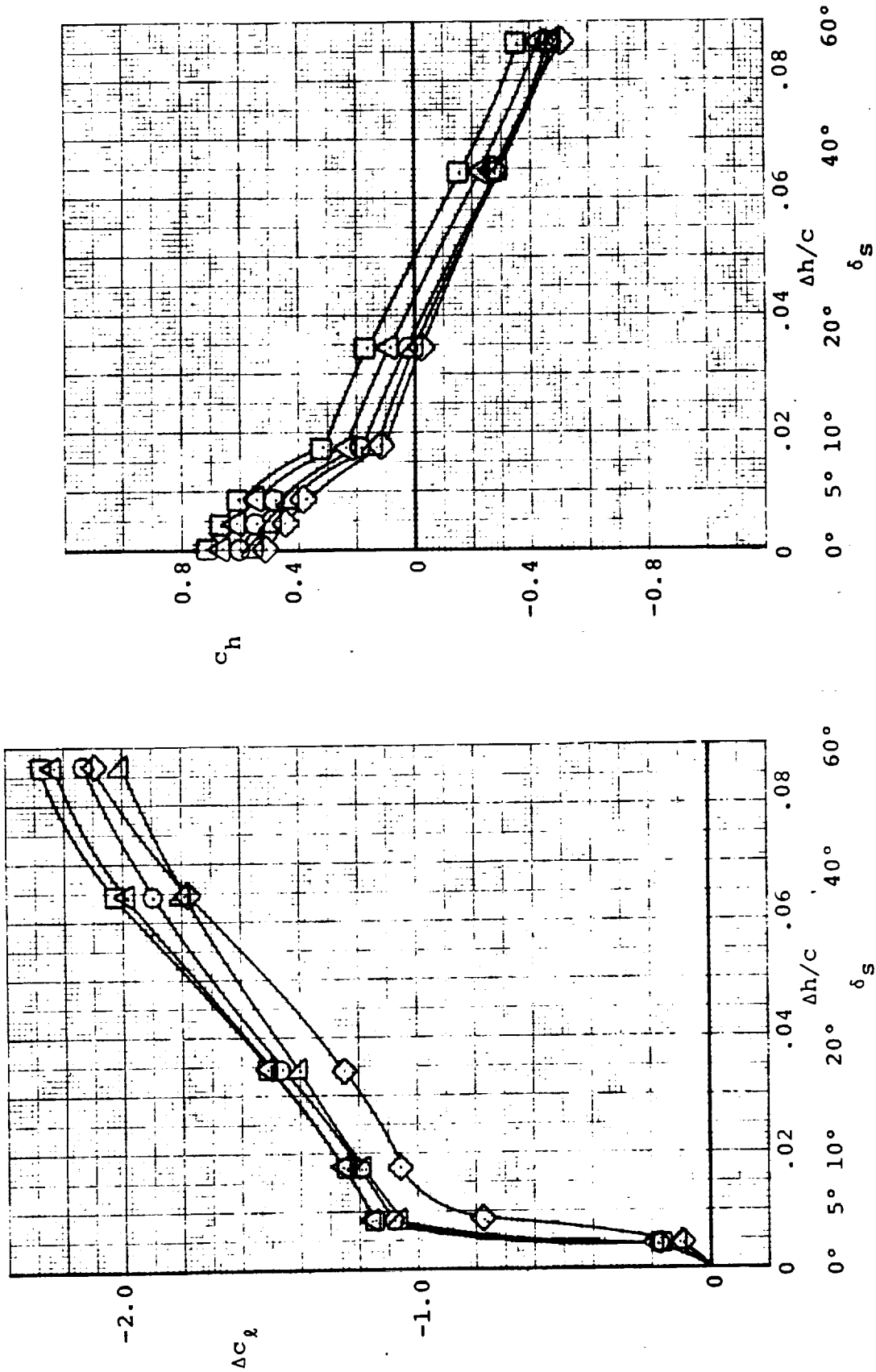

(e) 35° Flap Deflection.

Figure 15 - Continued.

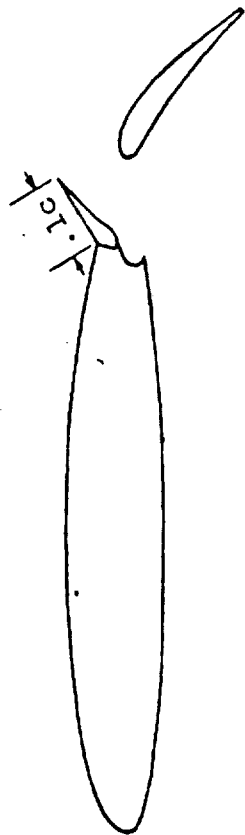

Gap 0%
 Hingeline 77.5%
 Flap 25%

Symbol α
 -8° \diamond
 -4° \triangle
 0° \circ
 4° ∇
 8° \square

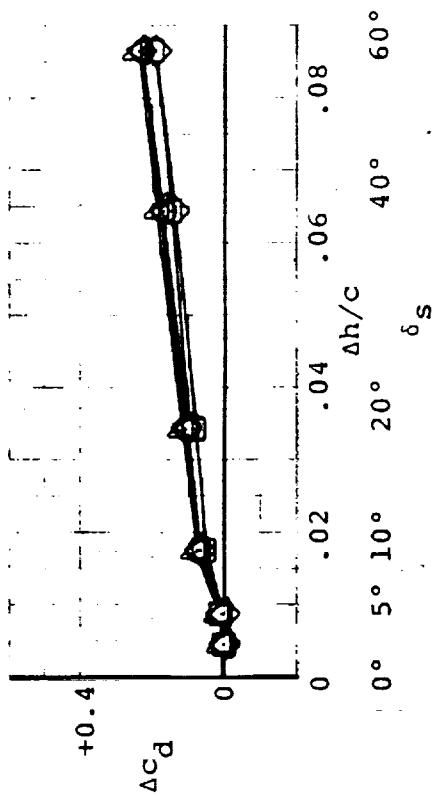
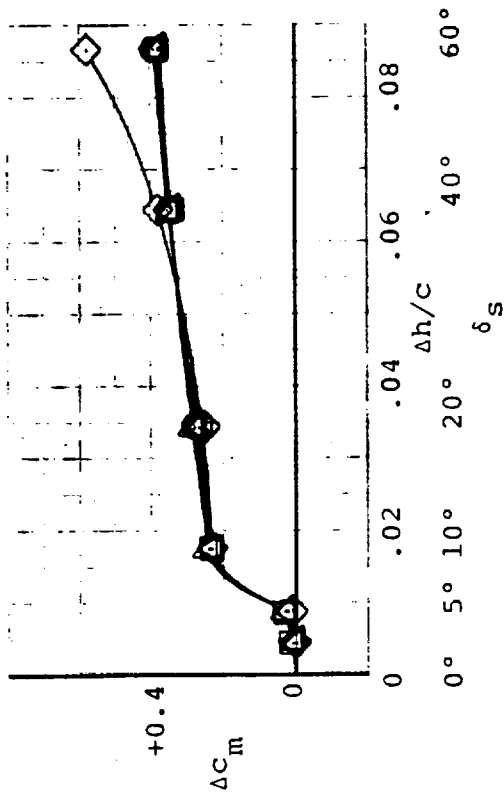

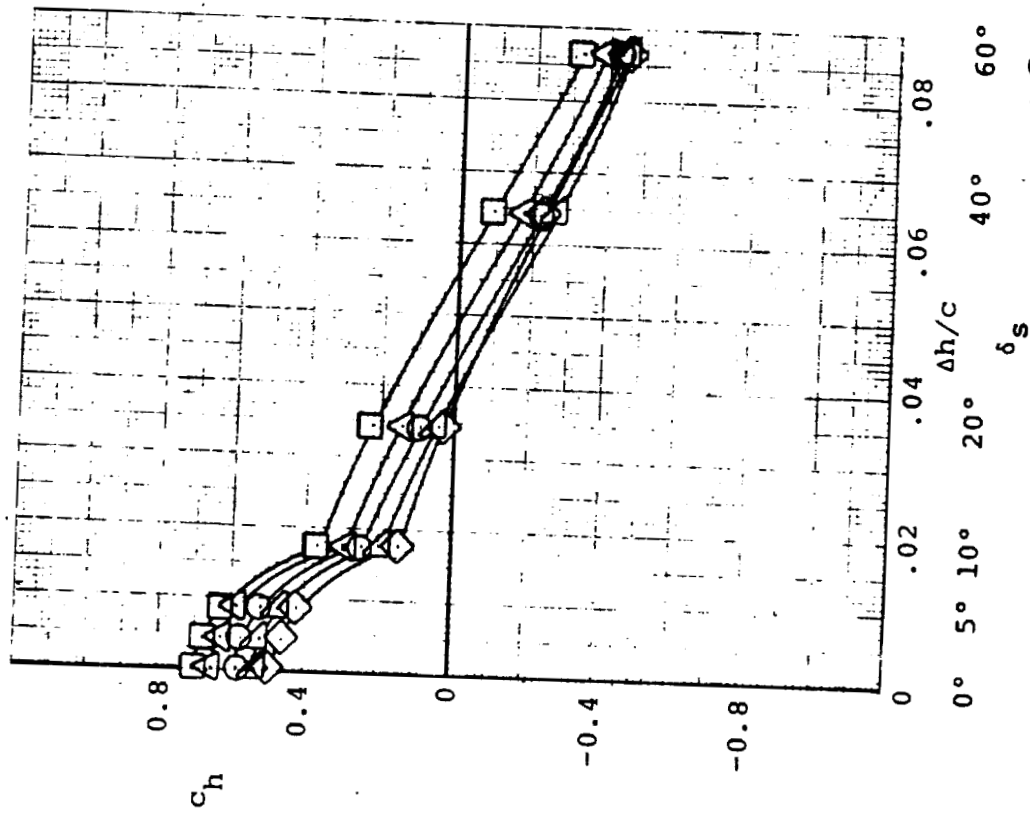
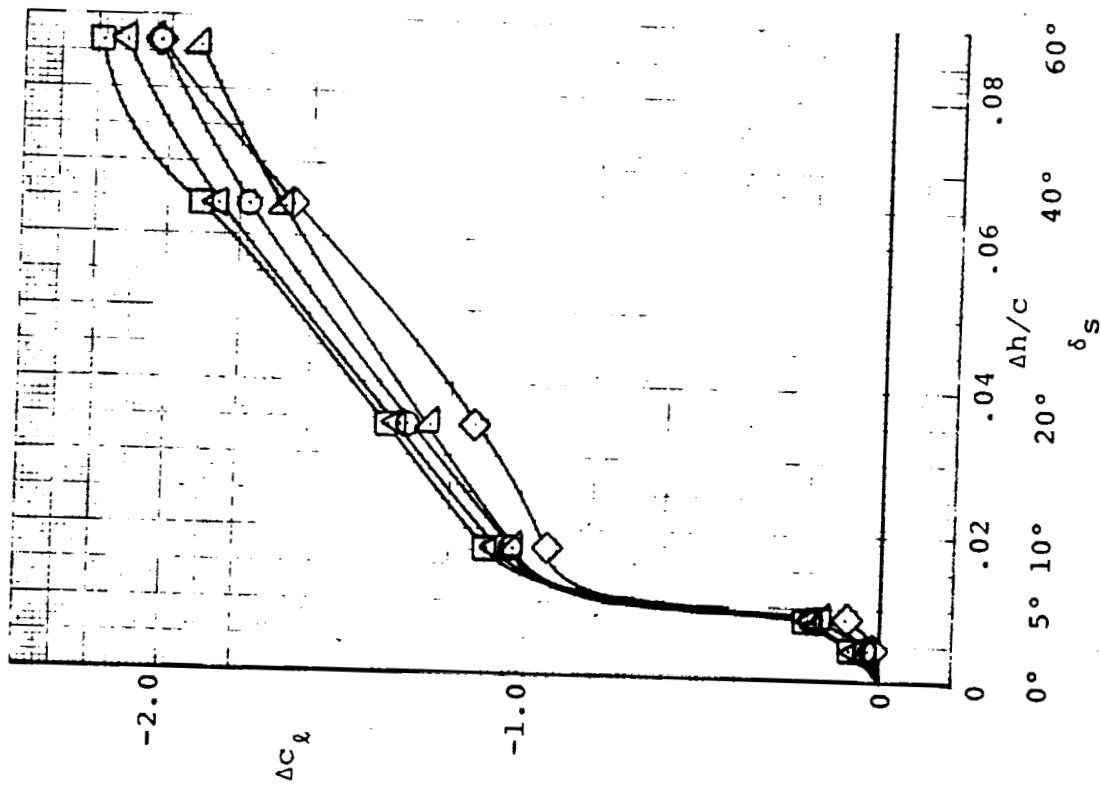

ORIGINAL PAGE IS
OF POOR QUALITY

(f) 40° Flap Deflection.
Figure 15 - Concluded.



NTIS does not permit return of items for credit or refund. A replacement will be provided if an error is made in filling your order, if the item was received in damaged condition, or if the item is defective.

Reproduced by NTIS
National Technical Information Service
U.S. Department of Commerce
Springfield, VA 22161

This report was printed specifically for your order from our collection of more than 2 million technical reports.

For economy and efficiency, NTIS does not maintain stock of its vast collection of technical reports. Rather, most documents are printed for each order. Your copy is the best possible reproduction available from our master archive. If you have any questions concerning this document or any order you placed with NTIS, please call our Customer Services Department at (703)487-4660.

Always think of NTIS when you want:

- Access to the technical, scientific, and engineering results generated by the ongoing multibillion dollar R&D program of the U.S. Government.
- R&D results from Japan, West Germany, Great Britain, and some 20 other countries, most of it reported in English.

NTIS also operates two centers that can provide you with valuable information:

- The Federal Computer Products Center - offers software and datafiles produced by Federal agencies.
- The Center for the Utilization of Federal Technology - gives you access to the best of Federal technologies and laboratory resources.

For more information about NTIS, send for our FREE *NTIS Products and Services Catalog* which describes how you can access this U.S. and foreign Government technology. Call (703)487-4650 or send this sheet to NTIS, U.S. Department of Commerce, Springfield, VA 22161. Ask for catalog, PR-827.

Name _____
Address _____

Telephone _____

**- Your Source to U.S. and Foreign Government
Research and Technology.**

