

NASA Technical Paper 1299

28

Aerodynamic Performance
of a 1.35-Pressure-Ratio
Axial-Flow Fan Stage

Walter M. Osborn, Royce D. Moore,
and Ronald J. Steinke

OCTOBER 1978

NASA

NASA Technical Paper 1299

Aerodynamic Performance
of a 1.35-Pressure-Ratio
Axial-Flow Fan Stage

Walter M. Osborn, Royce D. Moore,
and Ronald J. Steinke
*Lewis Research Center
Cleveland, Ohio*



National Aeronautics
and Space Administration

**Scientific and Technical
Information Office**

1978

CONTENTS

	Page
SUMMARY	1
INTRODUCTION	1
AERODYNAMIC DESIGN	2
APPARATUS AND PROCEDURE	3
Compressor Test Facility	3
Test Stage	3
Instrumentation	4
Test Procedure	5
Calculation Procedure	5
RESULTS AND DISCUSSION	6
Overall Performance	6
Radial Distributions	7
Variations with Incidence Angle	7
SUMMARY OF RESULTS	8
APPENDIXES	
A - SYMBOLS	10
B - EQUATIONS	12
C - DEFINITIONS AND UNITS USED IN TABLES	15
REFERENCES	17
TABLES	18
FIGURES	83

Preceding Page Blank

AERODYNAMIC PERFORMANCE OF A 1.35-PRESSURE-RATIO

AXIAL-FLOW FAN STAGE

by Walter M. Osborn, Royce D. Moore, and Ronald J. Steinke

Lewis Research Center

SUMMARY

The overall and the blade-element performances and the aerodynamic design parameters are presented for a 1.35-pressure-ratio fan stage. This fan was designed for a weight flow of 32.7 kilograms per second and a tip speed of 302.8 meters per second. Detailed radial surveys of the flow conditions were made over the stable operating flow range at rotative speeds from 70 to 120 percent of design speed.

At design speed the stage peak efficiency of 0.879 occurred at a pressure ratio of 1.329 and design flow. Stall margin was approximately 14 percent based on conditions at stall and peak efficiency. At design speed and flow the rotor efficiency was 0.94 and the pressure ratio was 1.360.

INTRODUCTION

The Lewis research program on axial-flow fans and compressors for advanced air-breathing engines is directed primarily toward reducing the size and weight of the fans and compressors while maintaining a high level of performance.

To that end a series of fans has been designed and built to obtain definitive information for the selection of fans for propulsion systems for short-haul aircraft using the externally blown flap as the powered-lift system. The externally blown flap needs a large flow of low-velocity air for effective lift with low noise during takeoff and landing (ref. 1). Fans with high air-bypass ratios, low pressure ratios, and low tip speeds should meet this criterion. However, the choice of fan pressure ratio and other parameters may depend on tradeoffs between fan aerodynamic performance and the low-noise goals. Performance data must be obtained on suitable fans over a range of pressure ratios and speeds to optimize propulsion systems for the externally blown-flap short-haul aircraft. The pressure ratios being investigated in this series were between 1.15 and 1.40. Fans with both adjustable and fixed rotor blades are included in the investigation.

The experimental performances of three of the adjustable-rotor-blade fans in the series are given in references 2 to 11 and of two of the fixed-rotor-blade fans in references 12 and 13. The design pressure ratios for these studies were from 1.15 to 1.25. All of the fans were tested at speeds as high as 120 percent of design speed.

This report presents the experimental performance of fan stage 53, another of the fixed-rotor-blade fans in the series. The 30-bladed, 50.8-centimeter-diameter fan was designed for a tip-speed of 302.8 meters per second. The design pressure ratio of 1.35 near the high end of the range for the series and occurs at a flow rate of 32.7 kilograms per second. Overall performances of both the rotor and the stage, along with the blade-element performances of both rotor and stator, are presented. The data are presented over the stable operating flow range of the stage at rotative speeds from 70 to 120 percent of design speed. Blade-element survey data were obtained at nine radial positions. The data are presented in machine tabulated and plotted form. The symbols and equations are defined in appendixes A and B. The abbreviations and units used in the tables are defined in appendix C.

AERODYNAMIC DESIGN

A compressor design computer program (refs. 14 to 16), which consists of a streamline analysis subprogram, a blade-geometry subprogram, and a blade-coordinate subprogram, was used in the design of fan stage 53.

The streamline analysis subprogram (ref. 14) calculates the velocity vector diagrams at several axial locations, including planes approximating the blade leading and trailing edges. This program accounts for streamline curvatures and entropy gradients. Weight flow, rotor speed, flow path geometry, boundary-layer blockages and radial distributions of rotor total pressure and stator outlet tangential velocity are inputs to this program.

The results from the streamline analysis subprogram are then used in the blade-geometry subprogram (ref. 14). This program calculates the blade geometry that will satisfy the vector diagrams.

After the blade geometry is defined for both the rotor and stator, the blade coordinate subprogram (ref. 16) is used to compute the blade elements on conical surfaces approximating the stream surfaces passing through the blade. The program then stacks these blade elements on a radial line about their centers of gravity and computes the Cartesian blade coordinates for fabrication.

Because fan stage 53 was designed for low noise, the design procedure consisted of an iteration of the aerodynamic, acoustic, and mechanical parameters. Thus, compromises were made to the aerodynamic parameters. The design procedure was similar to that used for fan stage 51A (ref. 2).

The overall design parameters for stage 53 are listed in table I, and the flow path geometry is shown in figure 1. The stage was designed for an overall pressure ratio of 1.35 at a weight flow of 32.7 kilograms per second ($194.8 \text{ (kg/sec)/m}^2$ of annulus area). The design tip speed was 302.8 meters per second. The tip speed, rotor aerodynamic loading, and stator incidence angles were selected for low noise. The total pressure at the rotor outlet decreases quadratically from tip to hub. The rotor hub loading decreases further locally where the rotor relative fluid turning is limited to 42.7° for low noise. The rotor and stator have double circular arc blade sections. Rotor thickness to chord ratio varies cubically from 0.03 at the tip to 0.08 at the hub. This variation reduces rotor vibration with no increase in rotor hub camber. Stator thickness to chord ratio is 0.08 and is radially constant. There are 30 rotor blades and 38 stator blades. The rotor tip solidity is 1.00, and the stator tip solidity is 1.27. Rotor aspect ratio is 2.86, and stator aspect ratio is 2.62 based on the chord length at the mean blade height. For low noise the spacing between the rotor trailing edge and the stator leading edge was made equal to four times the axial projection of the rotor blade chord at the hub.

The blade-element design parameters for rotor 53 and stator 53 are presented in tables II and III, and the rotor and stator blade geometries are presented in tables IV and V.

APPARATUS AND PROCEDURE

Compressor Test Facility

The compressor stage was tested in the Lewis single-stage compressor test facility which is described in detail in reference 14. Atmospheric air enters the test facility (fig. 2) through an inlet on the roof of the building and flows through the flow measuring orifice and into the plenum chamber upstream of the test stage. The air then passes through the experimental compressor stage into the collector from which it is exhausted to the atmosphere.

Test Stage

Photographs of the rotor and stator are shown in figures 3 and 4. The nonrotating radial tip clearance of the rotor was a nominal 0.050 centimeter at ambient conditions. The axial spacing between the rotor-hub trailing edge and the stator-hub leading edge was four times the rotor hub chord.

Instrumentation

The compressor weight flow was determined from measurements on a calibrated thin-plate orifice. The temperature at the orifice was measured with two Chromel-constantan thermocouples. Pressures at the orifice were measured by calibrated transducers.

Radial surveys of the flow were made upstream of the rotor, between the rotor and stator, and downstream of the stator (fig. 1). Photographs of the survey probes are shown in figure 5. Total pressure, total temperature, and flow angle were measured with a combination probe (fig. 5(a)). The thermocouple material for the combination probe is Chromel-constantan. The static pressure was measured with an 8° C-shaped wedge probe (fig. 5(b)). Each probe was positioned with a null-balancing, stream-direction-sensitive control system that automatically alined the probe to the direction of flow. The probes were angularly alined in an air tunnel. Two combination probes and two wedge static probes were used at each of the three measuring stations.

Inner and outer wall static-pressure taps were located at the same axial stations as the survey probes. The circumferential locations of both types of survey probes along with inner- and outer-wall-static pressure taps are shown in figure 6. The combination probe downstream of the stator (station 3) was circumferentially traversed one stator blade passage (9.5°) counterclockwise from the nominal value shown. An electronic speed counter, in conjunction with a magnetic pickup, was used to measure rotative speed (rpm). The estimated errors of the data based on inherent accuracies of the instrumentation and recording system are as follows:

Weight flow, kg/sec	±0.3
Rotative speed, rpm	±30
Flow angle, deg	±1
Temperature, K	±0.6
Rotor-inlet total pressure, N/cm ²	±0.01
Rotor-outlet total pressure, N/cm ²	±0.10
Stator-outlet total pressure, N/cm ²	±0.10
Rotor-inlet static pressure, N/cm ²	±0.04
Rotor-outlet static pressure, N/cm ²	±0.07
Stator-outlet static pressure, N/cm ²	±0.07

An indication of the consistency of the data can be observed by comparing the integrated weight flow at each measuring station to the orifice weight flow.

Test Procedure

The stage survey data were taken over a range of weight flows from maximum flow to the near-stall at speeds of 70, 80, 90, 100, and 120 percent of design. Data were recorded at nine radial positions for each speed and weight flow. At each radial position the two combination probes behind the stator were circumferentially traversed to nine different locations across the stator gap. The two wedge probes were set at mid-gap because previous studies showed that the static pressure across the stator gap was constant. Values of pressure, temperature, and flow angle were recorded at each circumferential position. At the last circumferential position values of pressure, temperature, and flow angle were also recorded at stations 1 and 2. All probes were then traversed to the next radial position, and the circumferential traverse procedure repeated.

The weight flow at stall was obtained in the following manner: during operation at the near-stall condition, the downstream control valve was slowly closed in small decrements. After each decrement the weight flow was obtained. The weight flow obtained just before stall occurred is called the stall weight flow.

Orifice weight flows, total pressures, static pressures, and temperatures were all corrected to standard-day conditions based on the rotor-inlet conditions.

Calculation Procedure

Measured total temperatures and total pressures were corrected for Mach number and streamline slope. These corrections were based on instrument probe calibrations given in reference 17. The stream static pressure was corrected for Mach number and streamline slope based on an average calibration for the type of probe used.

Because of the size of the C-shaped, static-pressure wedges, it was not possible to obtain static-pressure measurements at 5, 10, and 95 percent of span. The static pressure at 95 percent span was obtained by assuming a linear variation in static pressure between the values at the inner wall and the probe measurement at 90 percent span. A similar variation was assumed between measurements at the outer wall and the 15 percent span to obtain the static pressure at 5 and 10 percent span.

At each radial position averaged values of the nine circumferential measurements of pressure, temperature, and flow angle downstream of the stator (station 3) were obtained. The nine total temperatures were mass averaged to obtain the stator-outlet total temperature. The nine total pressures were energy averaged. The measured values of pressure, temperature, and flow angle were used to calculate axial and tangential velocities at each circumferential position. The flow angles presented for each radial position are calculated based on these mass-averaged axial and tangential velocities. To

obtain the overall performance, the radial values of total temperature were mass averaged, and the values of total pressure were energy averaged. At each measuring station the integrated weight flow was computed based on the radial survey data.

The data, measured at the three measuring stations, were translated to the rotor and stator blade leading and trailing edges by the method presented in reference 14. Orifice weight flow, total pressures, static pressures, and temperatures were all corrected to sea-level conditions based on the rotor-inlet conditions.

RESULTS AND DISCUSSION

The overall performances for the rotor and the stage are presented first. Radial distributions of several performance parameters are then presented for both the rotor and the stator, followed by blade-element data. Finally, a brief discussion of the data is given.

All the plotted data, together with some additional performance parameters, are also tabulated: The overall performance data are presented in table VI; and the blade-element data are given first for the rotor and then for the stator in tables VII and VIII. The abbreviations and units for the tabular data are defined in appendix C.

Overall Performance

The overall performance for rotor 53 is presented in figure 7 and for stage 53 in figure 8. For both figures data are presented for speeds from 70 to 120 percent of design speed. The design point values are shown by the solid symbols.

The measured performance of rotor 53 at design flow (32.7 kg/sec) agrees closely with the design values. The measured pressure ratio was 1.360; the design value was 1.373. The efficiency of 0.940 is only 1 percentage point less than design. At design speed the efficiency was essentially constant over a flow range from 32.7 to 34.8 kilograms per second.

The stage peak efficiency of 0.879 occurred at design weight flow (32.7 kg/sec). The measured pressure ratio was 1.329; the design value was 1.351. The difference between the measured rotor and stage efficiencies was 0.061; the design difference was 0.050.

Stall margin for this stage at design speed is approximately 14 percent, based on weight flow and pressure ratio at peak efficiency and stall conditions.

Radial Distributions

The radial distributions of several parameters for 100 percent of design speed are presented in figure 9 for rotor 53 and in figure 10 for stator 53. In each figure data are presented for three weight flows: near choke, stage peak efficiency, and near stall. The design values are shown by the solid symbols. A line is faired through the data at the peak efficiency condition. Temperature-rise efficiency, temperature ratio, pressure ratio, suction-surface incidence angle, meridional velocity ratio, deviation angle, total-loss parameter, total-loss coefficient, and diffusion factor are presented as functions of percent span from the blade tip.

Rotor. - At the design weight flow of 32.7 kilograms per second, the total-pressure ratio is equal to design from the tip to 30 percent span and is slightly less than design from 30 percent span to the hub (fig. 9). The losses are higher than design and thus the efficiency is lower at 5, 10, 90, and 95 percent span locations. The deviation angles are essentially equal to design from the tip to midspan; however, they are significantly greater than design from midspan to the hub. The distribution of inlet meridional velocity is different from design (see table VII(c)). The velocity is higher than design in the tip region and lower than design in the hub region. This together with the radial distribution of velocity ratio (fig. 9) indicate that the flow has moved radially inward through the rotor at the design condition.

Stator. - At the peak efficiency weight flow of 32.7 kilograms per second, the measured deviation angles were greater than design values (fig. 10). Their radial distribution was also different from the design distribution. The losses in the tip and hub regions are greater than design. The diffusion factor is less than design over the entire blade span. Examination of the circumferential distribution of total pressure indicated the same lack of a well-defined wake in the stator hub region as that described in reference 18. This type of wake pattern is indicative of flow separation on the blade surface and of a radial shift of flow through the stators. Thus flow separation probably occurred in the hub of stator 53; this is illustrated by the rapid rise in deviation angle and losses there.

Variations with Incidence Angle

The variations of selected blade-element parameters with suction-surface incidence angle are presented for the rotor and the stator in figures 11 and 12. The data are presented for 80, 100, and 120 percent of design speed for blade-element locations of 5, 10, 30, 50, 70, 90, and 95 percent of span from the blade tip. Design values are shown by solid symbols. In addition to the parameters shown in the radial distribution plots, the inlet relative Mach number is also presented in these figures.

Rotor. - The rotor was designed for a suction-surface incidence angle of zero at all blade elements. At design speed the 5 percent blade element produced the desired pressure ratio and deviation angle at the design incidence angle; however, the energy addition (temperature ratio) was slightly greater than design. The losses were greater than design and thus the efficiency was lower. At 10 percent span both pressure ratio and temperature ratio were higher than design. The losses were greater than design and the efficiency lower. At 30 percent span the measured values were approximately equal to design. At 50, 70, 90, and 95 percent spans the pressure ratios and temperature ratios were slightly less than design. At 50 and 70 percent spans efficiency and losses were approximately equal to design. At 90 and 95 percent spans the deviation angles and losses were significantly greater than design.

The minimum measured loss occurred at suction-surface incidence angles less than the design values at all elements except 90 and 95 percent spans, where losses changed very little with changes in incidence angle. At 50 and 70 percent span, total-pressure ratio showed essentially no variation with incidence angle.

Stator. - The stator was designed for a suction-surface incidence angle, which varied from 2.2° at the 5 percent element to -2.5° at the 95 percent element. At all span locations, the measured deviation angles were significantly greater than design values. At the 30, 50, 70, and 90 percent span locations, minimum loss is about equal to or less than the design value and generally occurs at less than design incidence angle. At 5, 10, and 95 percent spans minimum losses are significantly greater than design. At the 5, 50, and 70 percent span locations there was little variation in losses with incidence angle. The 95 percent span blade element has high losses at all incidence angles, probably as a result of flow separation at the stator hub.

The data indicate that the 90 and 95 percent elements have a narrow incidence angle range. At the low incidence angle these elements are probably choked. At the high incidence angle, they probably stall (indicated by the sharp rise in loss with increasing incidence angle). It is difficult to determine from the data presented herein whether the flow conditions in the stator hub region or those in the rotor tip region were the limiting factor for minimum stable flow for the stage.

SUMMARY OF RESULTS

This report presents both the aerodynamic design parameters and the overall and blade-element performances of a 1.35-pressure-ratio fan stage. The stage was designed for a weight flow of 32.7 kilograms per second and a tip speed of 302.8 meters per second. Detailed radial surveys of the flow conditions were made over the stable operating flow range at rotative speeds from 70 to 120 percent of design speed. The following principal results were obtained from this investigation:

1. At design speed and design weight flow the rotor pressure ratio was 1.360 and efficiency was 0.940. The design-speed efficiency was essentially constant over a flow range of 32.7 to 34.8 kilograms per second.

2. The stage peak efficiency at design speed was 0.879, and it occurred at design weight flow. The corresponding pressure ratio was 1.329.

3. Stall margin for this stage at design speed is approximately 14 percent based on weight flow and pressure ratio at peak efficiency and stall conditions.

Lewis Research Center,
National Aeronautics and Space Administration,
Cleveland, Ohio, May 18, 1978,
505-04.

APPENDIX A

SYMBOLS

A_{an}	annulus area at rotor leading edge, m^2
A_f	frontal area at rotor leading edge, m^2
C_p	specific heat at constant pressure, 1004 J/kg/K
c	aerodynamic chord, cm
D	diffusion factor
i_{mc}	mean incidence angle, angle between inlet air direction and line tangent to blade mean camber line at leading edge, deg
i_{ss}	suction-surface incidence angle, angle between inlet air direction and line tangent to blade suction surface at leading edge, deg
N	rotative speed, rpm
P	total pressure, N/cm^2
p	static pressure, N/cm^2
r	radius, cm
SM	stall margin
T	total temperature, K
U	wheel speed, m/sec
V	air velocity, m/sec
W	weight flow, kg/sec
Z	axial distance referenced from rotor blade hub leading edge, cm
α_c	cone angle, deg
α_s	slope of streamline, deg
β	air angle, angle between air velocity and axial direction, deg
β'_c	relative meridional air angle based on cone angle, $\arctan(\tan \beta'_m \cos \alpha_c / \cos \alpha_s)$, deg
γ	ratio of specific heats (1.40)
δ	ratio of rotor-inlet total pressure to standard pressure of 10.13 N/cm^2

δ°	deviation angle, angle between exit air direction and tangent to blade mean camber line at trailing edge, deg
η	efficiency
θ	ratio of rotor-inlet total temperature to standard temperature of 288.2 K
κ_{mc}	angle between blade mean camber line and meridional plane, deg
κ_{ss}	angle between blade suction-surface camber line at leading edge and meridional plane, deg
σ	solidity, ratio of chord to spacing
$\bar{\omega}$	total-loss coefficient
$\bar{\omega}_p$	profile-loss coefficient
$\bar{\omega}_s$	shock-loss coefficient

Subscripts:

ad	adiabatic (temperature rise)
id	ideal
LE	blade leading edge
m	meridional direction
mom	momentum-rise
p	polytropic
ref	reference
TE	blade trailing edge
t	tip
z	axial direction
θ	tangential direction
1	instrumentation plane upstream of rotor
2	instrumentation plane between rotor and stator
3	instrumentation plane downstream of stator

Superscript:

'	relative to blade
---	-------------------

APPENDIX B

EQUATIONS

Suction-surface incidence angle:

$$i_{ss} = (\beta'_c)_{LE} - \kappa_{ss} \quad (B1)$$

Mean incidence angle:

$$i_{mc} = (\beta'_c)_{LE} - (\kappa_{mc})_{LE} \quad (B2)$$

Deviation angle:

$$\delta^0 = (\beta'_c)_{TE} - (\kappa_{mc})_{TE} \quad (B3)$$

Diffusion factor:

$$D = 1 - \frac{V'_{TE}}{V'_{LE}} + \left| \frac{(rV_\theta)_{TE} - (rV_\theta)_{LE}}{(r_{TE} + r_{LE})^\sigma (V'_{LE})} \right| \quad (B4)$$

Total loss coefficient:

$$\bar{\omega} = \frac{(P'_{id})_{TE} - P'_{TE}}{P'_{LE} - P_{LE}} \quad (B5)$$

Profile loss coefficient:

$$\bar{\omega}_p = \bar{\omega} - \bar{\omega}_s \quad (B6)$$

Total loss parameter:

$$\frac{\bar{\omega} \cos (\beta'_m)_{TE}}{2\sigma} \quad (B7)$$

Profile-loss parameter:

$$\frac{\bar{\omega}_p \cos(\beta'_m)_{TE}}{2\sigma} \quad (B8)$$

Adiabatic (temperature rise) efficiency:

$$\eta_{ad} = \frac{\left(\frac{P_{TE}}{P_{LE}}\right)^{(\gamma-1)/\gamma} - 1}{\frac{T_{TE}}{T_{LE}} - 1} \quad (B9)$$

Momentum-rise efficiency:

$$\eta_{mom} = \frac{\left(\frac{P_{TE}}{P_{LE}}\right)^{(\gamma-1)/\gamma} - 1}{\frac{(UV_\theta)_{TE} - (UV_\theta)_{LE}}{T_{LE} g J C_p}} \quad (B10)$$

Equivalent weight flow:

$$\frac{W\sqrt{\theta}}{\delta} \quad (B11)$$

Equivalent rotative speed:

$$\frac{N}{\sqrt{\theta}} \quad (B12)$$

Mass flow per unit annulus area:

$$\frac{W\sqrt{\theta}}{\delta A_{an}} \quad (B13)$$

Mass flow per unit frontal area:

$$\frac{\frac{W\sqrt{\theta}}{\delta}}{A_f} \quad (\text{B14})$$

Head-rise coefficient:

$$\frac{gJ C_p T_{LE}}{U_{tip}^2} \left[\left(\frac{P_{TE}}{P_{LE}} \right)^{(\gamma-1)/\gamma} - 1 \right] \quad (\text{B15})$$

Flow coefficient:

$$\left(\frac{V_z}{U_{tip/LE}} \right) \quad (\text{B16})$$

Stall margin:

$$SM = \left[\frac{\left(\frac{P_{TE}}{P_{LE/stall}} \right) \times \left(\frac{W\sqrt{\theta}}{\delta} \right)_{ref}}{\left(\frac{P_{TE}}{P_{LE/ref}} \right) \times \left(\frac{W\sqrt{\theta}}{\delta} \right)_{stall}} - 1 \right] \times 100 \quad (\text{B17})$$

Polytropic efficiency:

$$\eta_p = \frac{\ln \left(\frac{P_{TE}}{P_{LE}} \right)^{(\gamma-1)/\gamma}}{\ln \left(\frac{T_{TE}}{T_{LE}} \right)} \quad (\text{B18})$$

APPENDIX C

DEFINITIONS AND UNITS USED IN TABLES

ABS	absolute
AERO CHORD	aerodynamic chord, cm
BETAM	meridional air angle, deg
CHOKE MARGIN	ratio of actual flow area minus critical area to critical area (where local Mach number is 1)
CONE ANGLE	angle between axial direction and conical surface representing blade element, deg
DELTA INC	difference between mean camber blade angle and suction surface blade angle at leading edge, deg
DEV	deviation angle (defined by eq. (B3)), deg
D-FACT	diffusion factor (defined by eq. (B4))
EFF	adiabatic efficiency (defined by eq. (B9))
IN	inlet (leading edge of blade)
INCIDENCE	incidence angle (suction surface defined by eq. (B1) and mean surface by eq. (B2))
KIC	angle between blade mean camber line at leading edge and meridional plane, deg
KOC	angle between blade mean camber line at trailing edge and meridional plane, deg
KTC	angle between blade mean camber line at transition point and meridional plane, deg
LOSS COEFF	loss coefficient (total defined by eq. (B5) and profile by eq. (B6))
LOSS PARAM	loss parameter (total defined by eq. (B7) and profile by eq. (B8))
MERID	meridional
MERID VEL R	meridional velocity ratio
OUT	outlet (trailing edge of blade)
PERCENT SPAN	percent of blade span from tip at rotor outlet
PHISS	suction-surface camber ahead of assumed shock location, deg

PRESS	pressure, N/cm^2
PROF	profile
RADII	radius, cm
REL	relative to blade
RI	inlet radius (leading edge of blade), cm
RO	outlet radius (trailing edge of blade), cm
RP	radial position
RPM	equivalent rotative speed, rpm
SETTING ANGLE	angle between aerodynamic chord and meridional plane, deg
SOLIDITY	ratio of aerodynamic chord to blade spacing
SPEED	speed, m/sec
SS	suction surface
STREAMLINE SLOPE	slope of streamline, deg
TANG	tangential
TEMP	temperature, K
TI	thickness of blade at leading edge, cm
TM	thickness of blade at maximum thickness, cm
TO	thickness of blade at trailing edge, cm
TOT	total
TOTAL CAMBER	difference between inlet and outlet blade mean camber lines, deg
TURN RATE	ratio of change in blade angle per unit path distance for front blade segment to the change in blade angle per unit path distance for aft blade segment
VEL	velocity, m/sec
WT FLOW	equivalent weight flow, kg/sec
ZI	axial distance from inlet hub to blade leading edge, cm
ZMC	axial distance from inlet hub to blade maximum thickness point, cm
ZO	axial distance from inlet hub to blade trailing edge, cm
ZTC	axial distance from inlet hub to transition point, cm

REFERENCES

1. Rosen, George: An Engine for Quiet STOL Propulsion. *Astronaut. Aeronaut.*, vol. 9, no. 12, Dec. 1971, pp. 50-55.
2. Osborn, Walter M.; and Steinke, Ronald J.: Performance of a 1.15 Pressure Ratio Axial-Flow Fan Stage With a Blade Tip Solidity of 0.5. NASA TM X-3052, 1974.
3. Kovich, George; and Steinke, Ronald J.: Performance of a Low-Pressure-Ratio, Low-Tip-Speed Fan Stage With Blade Tip Solidity of 0.65. NASA TM X-3341, 1976.
4. Kovich, George; Tysl, Edward R.; and Moore, Royce D.: Performance of a Low-Pressure-Ratio Fan Stage at Two Off-Design Blade Setting Angles. NASA TM X-3447, 1977.
5. Kovich, George; and Moore, Royce D.: Performance of 1.15-Pressure-Ratio Fan Stage at Several Rotor Blade Setting Angles with Reverse Flow. NASA TM X-3451, 1976.
6. Lewis, George W., Jr.; Moore, Royce D.; and Kovich, George: Performance of a 1.20-Pressure-Ratio STOL Fan Stage at Three Rotor Blade Setting Angles. NASA TM X-2837, 1973.
7. Lewis, George W., Jr.; and Tysl, Edward R.: Overall and Blade-Element Performance of a 1.20-Pressure-Ratio Fan Stage at Design Blade Setting Angle. NASA TM X-3101, 1974.
8. Lewis, George W., Jr.; Osborn, Walter M.; and Moore, Royce D.: Overall and Blade-Element Performance of a 1.20-Pressure-Ratio Fan Stage with Rotor Blades Reset Minus 5° . NASA TM X-3338, 1976.
9. Lewis, George W., Jr.; and Kovich, George: Overall and Blade-Element Performance of a 1.20-Pressure-Ratio Fan Stage with Rotor Blades Reset Minus 7° . NASA TM X-3342, 1976.
10. Moore, Royce D.; Lewis, George W., Jr.; and Tysl, Edward R.: Performance of a Low-Pressure Fan Stage with Reverse Flow. NASA TM X-3349, 1976.
11. Moore, Royce D.; and Kovich, George: Aerodynamic Performance of Two Variable-Pitch Fan Stages. NASA TM X-73416, 1976.
12. Moore, Royce D.; and Steinke, Ronald J.: Aerodynamic Performance of a 1.25-Pressure-Ratio Axial-Flow Fan Stage. NASA TM X-3083, 1974.
13. Lewis, George W., Jr.; and Moore, Royce D.: Aerodynamic Performance of a 1.20-Pressure-Ratio Fan Stage Designed for Low Noise. NASA TM X-3430, 1976.

14. Urasek, Donald C.; and Janetzke, David C.: Performance of Tandem-Bladed Transonic Compressor Rotor with Tip Speed of 1375 Feet Per Second. NASA TM X-2484, 1972.
15. Ball, Calvin L.; Janetzke, David C.; and Reid, Lonnie: Performance of 1380-Foot-Per-Second-Tip-Speed Axial-Flow Compressor Rotor with Blade Tip Solidity of 1.5. NASA TM X-2379, 1972.
16. Crouse, James E.; Janetzke, David C.; and Schwirian, Richard E.: A Computer Program for Composing Compressor Blading from Simulated Circular-Arc Elements on Conical Surfaces. NASA TN D-5437, 1969.
17. Glawe, George E.; Krause, Lloyd N.; and Dudzinski, Thomas J.: A Small Combination Sensing Probe for Measurement of Temperature, Pressure, and Flow Direction. NASA TN D-4816, 1968.
18. Lewis, George W.; Urasek, Donald C.; and Reid, Lonnie: Effects of Reset Stators and a Rotating, Grooved Hub on Performance of a 1.92-Pressure Ratio Compressor Stage. NASA TM X-3472, 1977.

TABLE I. - DESIGN OVERALL
PARAMETERS FOR
STAGE 53-53

ROTOR TOTAL PRESSURE RATIO	1.373
STAGE TOTAL PRESSURE RATIO	1.351
ROTOR TOTAL TEMPERATURE RATIO	1.100
STAGE TOTAL TEMPERATURE RATIO	1.100
ROTOR ADIABATIC EFFICIENCY952
STAGE ADIABATIC EFFICIENCY902
ROTOR POLYTROPIC EFFICIENCY954
STAGE POLYTROPIC EFFICIENCY906
ROTOR HEAD RISE COEFFICIENT299
STAGE HEAD RISE COEFFICIENT284
FLOW COEFFICIENT633
WT FLOW PER UNIT FRONTAL AREA	163.247
WT FLOW PER UNIT ANNULUS AREA	194.829
WT FLOW	32.659
RPM	11459.200
TIP SPEED.	302.820

TABLE II. - DESIGN BLADE-ELEMENT PARAMETERS

FOR ROTOR 53

RP	RADII		ABS BETAM		REL BETAM		TOTAL TEMP		TOTAL PRESS	
	IN	OUT	IN	OUT	IN	OUT	IN	RATIO	IN	RATIO
TIP	25.235	24.498	.0	30.5	61.5	44.0	288.2	1.113	10.14	1.419
1	24.422	23.781	.0	31.8	59.2	43.1	288.2	1.112	10.14	1.419
2	23.568	23.064	.0	32.8	57.3	41.6	288.2	1.111	10.14	1.418
3	22.737	22.348	.0	33.4	55.9	39.7	288.2	1.110	10.14	1.415
4	20.285	20.197	.0	35.7	51.6	33.4	288.2	1.106	10.14	1.403
5	17.170	17.329	.0	39.0	46.1	22.7	288.2	1.099	10.14	1.372
6	14.231	14.461	.0	41.7	40.5	9.5	288.2	1.088	10.14	1.325
7	12.144	12.311	.0	43.4	36.0	-1.8	288.2	1.078	10.14	1.280
8	11.473	11.594	.0	43.7	34.5	-5.5	288.2	1.074	10.14	1.263
9	10.814	10.877	.0	43.9	32.9	-8.9	288.2	1.070	10.14	1.245
HUB	10.160	10.160	.0	44.1	31.3	-12.3	288.2	1.066	10.14	1.227

RP	ABS VEL		REL VEL		MERID VEL		TANG VEL		WHEEL SPEED	
	IN	OUT	IN	OUT	IN	OUT	IN	OUT	IN	OUT
TIP	164.4	219.3	344.5	262.8	164.4	188.9	.0	111.3	302.8	294.0
1	174.5	216.0	341.1	251.1	174.5	183.5	.0	113.9	293.1	285.4
2	181.5	214.8	336.0	241.4	181.5	180.5	.0	116.5	282.8	276.8
3	184.5	215.8	329.4	234.0	184.5	180.2	.0	118.8	272.8	268.2
4	192.6	216.7	310.4	210.9	192.6	176.1	.0	126.3	243.4	242.4
5	198.1	218.0	285.8	183.6	198.1	169.4	.0	137.2	206.0	208.0
6	200.1	219.8	263.1	166.3	200.1	164.0	.0	146.2	170.8	173.5
7	200.5	222.4	247.9	161.6	200.5	161.5	.0	152.9	145.7	147.7
8	200.6	223.5	243.3	162.2	200.6	161.5	.0	154.5	137.7	139.1
9	200.6	224.8	238.9	163.9	200.6	162.0	.0	155.9	129.8	130.5
HUB	200.6	226.1	234.7	166.3	200.6	162.5	.0	157.2	121.9	121.9

RP	ABS MACH NO		REL MACH NO		MERID MACH NO		STREAMLINE SLOPE		MERID PEAK SS	MACH NO
	IN	OUT	IN	OUT	IN	OUT	IN	OUT		
TIP	.495	.635	1.037	.761	.495	.547	-9.35	-10.88	1.149	1.626
1	.527	.625	1.030	.726	.527	.531	-8.11	-8.97	1.051	1.567
2	.549	.622	1.017	.698	.542	.522	-6.87	-7.35	.995	1.527
3	.559	.625	.998	.678	.559	.522	-5.74	-6.07	.977	1.506
4	.585	.629	.943	.612	.585	.511	-3.04	-3.02	.914	1.367
5	.603	.635	.870	.535	.603	.494	-.82	-.63	.855	1.188
6	.609	.644	.801	.488	.609	.481	.20	.41	.820	1.015
7	.611	.656	.755	.476	.611	.476	.40	.54	.805	.893
8	.611	.661	.741	.480	.611	.477	.38	.48	.805	.852
9	.611	.666	.728	.486	.611	.480	.32	.36	.807	.810
HUB	.611	.672	.715	.494	.611	.483	.26	.24	.810	.763

RP	PERCENT SPAN	INCIDENCE		DEV	D-FACT	EFF	LOSS COEFF		LOSS PARAM	
		MEAN	SS				TOT	PROF	TOT	PROF
TIP	.00	3.6	-.1	4.1	.398	.932	.047	-.006	.017	-.002
1	5.00	3.6	-.1	4.4	.425	.937	.044	.002	.016	.001
2	10.00	3.8	-.0	4.7	.444	.943	.041	.007	.014	.003
3	15.00	3.9	-.0	4.9	.454	.949	.037	.009	.013	.003
4	30.00	4.7	.1	5.5	.488	.961	.030	.022	.010	.007
5	50.00	5.8	.1	5.9	.527	.960	.032	.032	.011	.011
6	70.00	6.8	.1	5.9	.532	.957	.036	.036	.010	.010
7	85.00	7.1	.1	5.8	.503	.937	.051	.051	.013	.013
8	90.00	7.2	.1	5.8	.483	.928	.057	.057	.013	.013
9	95.00	7.1	.0	5.7	.459	.918	.063	.063	.014	.014
HUB	100.00	7.1	-.1	5.8	.430	.907	.070	.070	.014	.014

TABLE III. - DESIGN BLADE-ELEMENT PARAMETERS

FOR STATOR 53

RP	RADII		ABS BETAM		REL BETAM		TOTAL TEMP		TOTAL	PRESS
	IN	OUT	IN	OUT	IN	OUT	IN	RATIO	IN	RATIO
TIP	24.168	24.168	29.9	.0	29.9	.0	320.8	1.000	14.39	.986
1	23.395	23.422	30.5	.0	30.5	.0	320.5	1.000	14.38	.986
2	22.718	22.772	31.1	.0	31.1	.0	320.3	1.000	14.37	.987
3	22.044	22.126	31.6	.0	31.6	.0	319.9	1.000	14.35	.987
4	20.014	20.197	33.5	.0	33.5	.0	318.7	1.000	14.22	.987
5	17.316	17.672	36.8	.0	36.8	.0	316.6	1.000	13.90	.984
6	14.599	15.176	40.1	.0	40.1	.0	313.4	1.000	13.43	.981
7	12.510	13.263	43.2	.0	43.2	.0	310.7	1.000	12.97	.976
8	11.785	12.604	44.7	.0	44.7	.0	309.6	1.000	12.80	.974
9	11.048	11.935	46.4	.0	46.4	.0	308.4	1.000	12.62	.972
HUB	10.160	11.153	48.5	.0	48.5	.0	307.1	1.000	12.39	.970

RP	ABS VEL		REL VEL		MERID VEL		TANG VEL		WHEEL	SPEED
	IN	OUT	IN	OUT	IN	OUT	IN	OUT	IN	OUT
TIP	226.6	194.7	226.6	194.7	196.4	194.7	112.9	.0	.0	.0
1	228.1	194.8	228.1	194.8	196.5	194.8	115.8	.0	.0	.0
2	229.2	194.6	229.2	194.6	196.4	194.6	118.2	.0	.0	.0
3	230.1	194.1	230.1	194.1	196.0	194.1	120.5	.0	.0	.0
4	231.1	190.9	231.1	190.9	192.8	190.9	127.5	.0	.0	.0
5	229.5	182.4	229.5	182.4	183.9	182.4	137.4	.0	.0	.0
6	224.9	168.1	224.9	168.1	172.0	168.1	144.9	.0	.0	.0
7	219.8	152.4	219.8	152.4	160.2	152.4	150.5	.0	.0	.0
8	216.4	148.0	216.4	148.0	153.9	148.0	152.1	.0	.0	.0
9	212.1	143.8	212.1	143.8	146.3	143.8	153.5	.0	.0	.0
HUB	207.2	139.0	207.2	139.0	137.2	139.0	155.2	.0	.0	.0

RP	ABS MACH NO		REL MACH NO		MERID MACH NO		STREAMLINE SLOPE		MERID PEAK	SS
	IN	OUT	IN	OUT	IN	OUT	IN	OUT	VEL R	MACH NO
TIP	.658	.559	.658	.559	.570	.559	-.02	-.01	.991	.862
1	.663	.559	.663	.559	.571	.559	.29	.25	.991	.858
2	.667	.559	.667	.559	.571	.559	.57	.50	.991	.853
3	.670	.558	.670	.558	.571	.558	.86	.75	.990	.847
4	.675	.549	.675	.549	.563	.549	1.82	1.62	.990	.837
5	.672	.525	.672	.525	.538	.525	3.30	3.06	.992	.817
6	.661	.485	.661	.485	.505	.485	4.90	4.92	.977	.770
7	.648	.440	.648	.440	.472	.440	5.85	6.59	.952	.726
8	.638	.427	.638	.427	.454	.427	5.07	7.09	.962	.706
9	.626	.415	.626	.415	.432	.415	5.73	7.58	.983	.685
HUB	.611	.402	.611	.402	.405	.402	5.57	8.15	1.013	.663

RP	PERCENT	INCIDENCE		DEV	D-FACT	EFF	LOSS COEFF		LOSS PARAM	
	SPAN	MEAN	SS				TOT	PROF	TOT	PROF
TIP	.00	9.9	2.6	5.0	.337	.000	.056	.056	.022	.022
1	5.00	9.5	2.2	5.2	.340	.000	.053	.053	.020	.020
2	10.00	9.1	1.8	5.4	.342	.000	.051	.051	.019	.019
3	15.00	8.7	1.5	5.5	.345	.000	.051	.051	.018	.018
4	30.00	7.9	.7	5.9	.354	.000	.050	.050	.016	.016
5	50.00	6.9	-.2	6.3	.374	.000	.060	.060	.017	.017
6	70.00	5.9	-1.2	6.7	.405	.000	.075	.075	.018	.018
7	85.00	5.1	-2.0	6.9	.445	.000	.098	.098	.020	.020
8	90.00	4.8	-2.2	7.0	.450	.000	.108	.108	.021	.021
9	95.00	4.5	-2.5	7.1	.451	.000	.122	.122	.022	.022
HUB	106.00	4.2	-2.7	7.3	.451	.000	.136	.136	.023	.023

TABLE IV. - BLADE GEOMETRY FOR ROTOR 53

RP	PERCENT RADII			BLADE ANGLES			DELTA INC	CONE ANGLE
	SPAN	RI	RO	KIC	KTC	KOC		
TIP	0.	25.235	24.498	57.67	48.68	39.79	3.67	-12.422
1	5.	24.422	23.781	55.43	46.98	38.52	3.70	-10.420
2	10.	23.568	23.064	53.48	45.16	36.85	3.79	-7.939
3	15.	22.737	22.348	52.00	43.36	34.72	3.93	-5.957
4	30.	20.285	20.197	47.02	37.48	27.95	4.60	-1.242
5	50.	17.170	17.329	40.30	28.51	16.72	5.70	2.014
6	70.	14.231	14.461	33.67	18.58	3.50	6.64	2.712
7	85.	12.144	12.311	28.86	10.59	-7.69	7.04	1.891
8	90.	11.473	11.594	27.30	8.05	-11.21	7.09	1.364
9	95.	10.814	10.877	25.75	5.55	-14.65	7.12	.710
HUB	100.	10.160	10.160	24.22	3.08	-18.08	7.14	.057

RP	BLADE THICKNESSES			AXIAL DIMENSIONS			
	TI	TM	TO	ZI	ZMC	ZTC	ZO
TIP	.041	.207	.041	.899	2.426	2.426	4.243
1	.041	.209	.041	.828	2.433	2.433	4.310
2	.041	.214	.041	.762	2.438	2.438	4.375
3	.042	.222	.041	.705	2.440	2.440	4.439
4	.051	.258	.052	.537	2.449	2.449	4.620
5	.065	.319	.063	.327	2.460	2.460	4.843
6	.073	.375	.074	.155	2.480	2.480	5.020
7	.083	.406	.083	.061	2.509	2.509	5.107
8	.084	.410	.084	.038	2.519	2.519	5.122
9	.083	.411	.083	.019	2.530	2.530	5.129
HUB	.082	.412	.082	.000	2.540	2.540	5.135

RP	AERO SETTING			TOTAL		TURNING		CHOKE MARGIN
	CHORD	ANGLE	CAMBER	SOLIDITY	RATIO	PHISS		
TIP	5.163	48.67	17.87	.991	1.000	15.40	.156	
1	5.165	46.94	16.91	1.023	1.000	13.75	.125	
2	5.154	45.13	16.64	1.055	1.000	12.64	.110	
3	5.145	43.33	17.28	1.090	1.000	12.21	.113	
4	5.133	37.48	19.07	1.211	1.000	10.36	.107	
5	5.134	28.51	23.58	1.421	1.000	7.90	.105	
6	5.135	18.63	30.17	1.709	1.000	5.12	.100	
7	5.136	10.63	36.55	2.005	1.000	3.03	.088	
8	5.135	8.08	38.51	2.126	1.000	2.30	.077	
9	5.134	5.57	40.40	2.260	1.000	1.56	.063	
HUB	5.142	3.07	42.30	2.416	1.000	.83	.049	

TABLE V. - BLADE GEOMETRY FOR STATOR 53

RP	PERCENT RADII		BLADE ANGLES			DELTA INC	CONE ANGLE
	SPAN	R1 RO	KIC	KTC	KOC		
TIP	0.	24.168 24.168	19.95	7.46	-5.04	7.30	.057
1	5.	23.395 23.422	21.03	7.90	-5.23	7.29	.310
2	10.	22.718 22.772	21.95	8.29	-5.37	7.28	.612
3	15.	22.044 22.126	22.85	8.67	-5.51	7.27	.935
4	30.	20.014 20.197	25.54	9.84	-5.86	7.23	2.092
5	50.	17.316 17.672	29.79	11.73	-6.33	7.17	4.108
6	70.	14.599 15.176	34.17	13.76	-6.67	7.10	6.694
7	85.	12.510 13.263	37.95	15.56	-6.87	7.04	8.796
8	90.	11.785 12.604	39.64	16.35	-6.98	7.02	9.589
9	95.	11.048 11.935	41.55	17.25	-7.12	6.99	10.428
HUB	100.	10.160 11.153	43.84	18.32	-7.27	6.96	11.715

RP	BLADE THICKNESSES			AXIAL DIMENSIONS			
	T1	TH	TO	ZI	ZHC	ZTC	ZO
TIP	.081	.405	.081	25.459	27.935	27.935	30.482
1	.081	.405	.081	25.466	27.935	27.935	30.483
2	.081	.405	.081	25.471	27.935	27.935	30.484
3	.081	.405	.081	25.477	27.935	27.935	30.486
4	.081	.406	.081	25.492	27.930	27.930	30.485
5	.081	.406	.081	25.522	27.921	27.921	30.481
6	.082	.408	.082	25.562	27.913	27.913	30.479
7	.082	.409	.082	25.600	27.901	27.901	30.469
8	.082	.410	.082	25.620	27.896	27.896	30.466
9	.082	.411	.082	25.643	27.892	27.892	30.463
HUB	.082	.412	.082	25.671	27.886	27.886	30.460

RP	AERD SETTING			TURNING		PHISS	CHOKE MARGIN
	CHORD	ANGLE	TOTAL CAMBER	SOLIDITY	RATIO		
TIP	5.065	7.45	24.99	1.267	1.000	3.81	.131
1	5.064	7.90	26.26	1.308	1.000	3.81	.128
2	5.065	8.29	27.33	1.347	1.000	3.80	.126
3	5.067	8.68	28.35	1.388	1.000	3.76	.123
4	5.070	9.86	31.40	1.525	1.000	3.87	.119
5	5.077	11.79	36.12	1.755	1.000	4.19	.126
6	5.097	13.88	40.84	2.071	1.000	3.99	.137
7	5.116	15.76	44.83	2.401	1.000	3.72	.145
8	5.125	16.59	46.63	2.542	1.000	3.71	.155
9	5.136	17.53	48.66	2.703	1.000	3.74	.168
HUB	5.159	18.69	51.12	2.928	1.000	3.78	.183

TABLE VI. - OVERALL PERFORMANCE FOR STAGE 53

(a) 70 Percent of design speed

READING NUMBER	3027	3028	3029	3030	3031
ROTOR TOTAL PRESSURE RATIO	1.110	1.130	1.145	1.157	1.157
STAGE TOTAL PRESSURE RATIO	1.077	1.114	1.131	1.145	1.143
ROTOR TOTAL TEMPERATURE RATIO	1.039	1.055	1.058	1.043	1.048
STAGE TOTAL TEMPERATURE RATIO	1.033	1.055	1.039	1.044	1.048
ROTOR TEMP. RISE EFFICIENCY	1.010	1.026	1.017	0.977	0.882
STAGE TEMP. RISE EFFICIENCY	0.656	0.895	0.920	0.899	0.806
ROTOR MOMENTUM RISE EFFICIENCY	0.945	0.980	0.986	0.967	0.871
ROTOR HEAD RISE COEFFICIENT	0.196	0.231	0.254	0.275	0.275
STAGE HEAD RISE COEFFICIENT	0.137	0.204	0.233	0.255	0.251
FLOW COEFFICIENT	0.798	0.719	0.645	0.565	0.476
WT FLOW PER UNIT FRONTAL AREA	151.74	139.71	127.93	114.67	98.42
WT FLOW PER UNIT ANNULUS AREA	181.10	166.74	152.68	136.86	117.46
WT FLOW AT ORIFICE	30.36	27.95	25.59	22.94	19.69
WT FLOW AT ROTOR INLET	30.33	27.92	25.54	22.88	19.63
WT FLOW AT ROTOR OUTLET	30.32	27.98	25.72	23.22	20.08
WT FLOW AT STATOR OUTLET	31.01	27.98	25.71	23.29	20.51
ROTATIVE SPEED	8024.7	7986.3	7985.1	8009.5	8009.3
PERCENT OF DESIGN SPEED	70.0	69.7	69.7	69.9	69.9

(b) 80 Percent of design speed

READING NUMBER	3011	3012	3014	3015	3007	3006
ROTOR TOTAL PRESSURE RATIO	1.171	1.188	1.201	1.211	1.212	1.207
STAGE TOTAL PRESSURE RATIO	1.137	1.169	1.186	1.196	1.196	1.189
ROTOR TOTAL TEMPERATURE RATIO	1.046	1.050	1.054	1.058	1.061	1.064
STAGE TOTAL TEMPERATURE RATIO	1.047	1.051	1.055	1.059	1.061	1.063
ROTOR TEMP. RISE EFFICIENCY	0.991	1.002	0.991	0.966	0.929	0.866
STAGE TEMP. RISE EFFICIENCY	0.794	0.897	0.916	0.896	0.867	0.805
ROTOR MOMENTUM RISE EFFICIENCY	0.955	0.972	0.970	0.957	0.924	0.857
ROTOR HEAD RISE COEFFICIENT	0.227	0.247	0.264	0.275	0.278	0.272
STAGE HEAD RISE COEFFICIENT	0.164	0.223	0.246	0.257	0.259	0.250
FLOW COEFFICIENT	0.749	0.689	0.632	0.581	0.537	0.489
WT FLOW PER UNIT FRONTAL AREA	159.89	150.63	140.95	132.00	123.12	113.54
WT FLOW PER UNIT ANNULUS AREA	190.83	179.77	168.23	157.54	146.95	135.50
WT FLOW AT ORIFICE	31.99	30.13	28.20	26.41	24.63	22.71
WT FLOW AT ROTOR INLET	31.94	30.11	28.17	26.35	24.62	22.68
WT FLOW AT ROTOR OUTLET	32.06	30.27	28.36	26.56	25.01	23.05
WT FLOW AT STATOR OUTLET	32.73	30.45	28.68	26.93	25.39	23.69
ROTATIVE SPEED	9180.9	9197.4	9188.3	9201.0	9173.5	9166.5
PERCENT OF DESIGN SPEED	80.1	80.3	80.2	80.3	80.1	80.0

(c) 90 Percent of design speed

READING NUMBER	3016	2997	2998	2999	3000	3001
ROTOR TOTAL PRESSURE RATIO	1.242	1.261	1.275	1.281	1.276	1.267
STAGE TOTAL PRESSURE RATIO	1.209	1.259	1.254	1.259	1.255	1.244
ROTOR TOTAL TEMPERATURE RATIO	1.065	1.070	1.074	1.076	1.079	1.082
STAGE TOTAL TEMPERATURE RATIO	1.065	1.070	1.073	1.076	1.078	1.080
ROTOR TEMP. RISE EFFICIENCY	0.985	0.977	0.970	0.958	0.917	0.857
STAGE TEMP. RISE EFFICIENCY	0.862	0.906	0.910	0.891	0.858	0.804
ROTOR MOMENTUM RISE EFFICIENCY	0.955	0.963	0.961	0.942	0.907	0.849
ROTOR HEAD RISE COEFFICIENT	0.249	0.267	0.279	0.284	0.280	0.272
STAGE HEAD RISE COEFFICIENT	0.218	0.246	0.259	0.264	0.260	0.249
FLOW COEFFICIENT	0.715	0.655	0.626	0.585	0.545	0.505
WT FLOW PER UNIT FRONTAL AREA	167.66	159.66	153.13	145.53	137.77	128.93
WT FLOW PER UNIT ANNULUS AREA	200.12	199.55	182.75	173.69	164.42	153.87
WT FLOW AT ORIFICE	33.55	31.94	30.63	29.11	27.56	25.79
WT FLOW AT ROTOR INLET	33.48	31.89	30.57	29.07	27.48	25.80
WT FLOW AT ROTOR OUTLET	33.72	32.18	30.84	29.29	27.75	26.17
WT FLOW AT STATOR OUTLET	34.24	32.59	31.36	29.87	28.44	27.01
ROTATIVE SPEED	10311.1	10312.4	10331.5	10336.0	10331.1	10334.1
PERCENT OF DESIGN SPEED	90.0	90.0	90.2	90.2	90.2	90.2

TABLE VI. - Concluded.

(d) 100 Percent of design speed

READING NUMBER	3017	2996	2995	2994	2995	3026
ROTOR TOTAL PRESSURE RATIO	1.314	1.359	1.360	1.366	1.356	1.354
STAGE TOTAL PRESSURE RATIO	1.275	1.308	1.329	1.334	1.322	1.317
ROTOR TOTAL TEMPERATURE RATIO	1.086	1.092	1.098	1.101	1.102	1.104
STAGE TOTAL TEMPERATURE RATIO	1.085	1.091	1.096	1.099	1.099	1.101
ROTOR TEMP. RISE EFFICIENCY	0.941	0.945	0.940	0.925	0.950	0.872
STAGE TEMP. RISE EFFICIENCY	0.845	0.878	0.879	0.870	0.855	0.808
ROTOR MOMENTUM RISE EFFICIENCY	0.913	0.926	0.929	0.921	0.823	0.859
ROTOR HEAD RISE COEFFICIENT	0.256	0.274	0.289	0.294	0.265	0.265
STAGE HEAD RISE COEFFICIENT	0.227	0.252	0.267	0.271	0.262	0.258
FLOW COEFFICIENT	0.683	0.661	0.620	0.584	0.548	0.519
WT FLOW PER UNIT FRONTAL AREA	173.98	170.57	165.50	156.85	149.87	143.57
WT FLOW PER UNIT ANNULUS AREA	207.65	203.57	195.14	187.20	178.06	171.35
WT FLOW AT ORIFICE	34.81	34.12	32.71	31.58	29.98	28.72
WT FLOW AT ROTOR INLET	34.73	34.09	32.67	31.56	29.95	28.74
WT FLOW AT ROTOR OUTLET	35.10	34.36	32.93	31.74	30.34	29.31
WT FLOW AT STATOR OUTLET	35.57	35.04	33.73	32.60	31.20	30.29
ROTATIVE SPEED	11465.1	11468.0	11466.9	11467.0	11469.0	11470.3
PERCENT OF DESIGN SPEED	100.0	100.1	100.1	100.1	100.1	100.1

(e) 110 Percent of design speed

READING NUMBER	3025	3024
ROTOR TOTAL PRESSURE RATIO	1.455	1.450
STAGE TOTAL PRESSURE RATIO	1.410	1.401
ROTOR TOTAL TEMPERATURE RATIO	1.125	1.128
STAGE TOTAL TEMPERATURE RATIO	1.121	1.124
ROTOR TEMP. RISE EFFICIENCY	0.908	0.876
STAGE TEMP. RISE EFFICIENCY	0.855	0.813
ROTOR MOMENTUM RISE EFFICIENCY	0.834	0.823
ROTOR HEAD RISE COEFFICIENT	0.296	0.294
STAGE HEAD RISE COEFFICIENT	0.270	0.265
FLOW COEFFICIENT	0.592	0.559
WT FLOW PER UNIT FRONTAL AREA	168.48	157.75
WT FLOW PER UNIT ANNULUS AREA	201.08	188.28
WT FLOW AT ORIFICE	33.71	31.56
WT FLOW AT ROTOR INLET	33.67	31.59
WT FLOW AT ROTOR OUTLET	34.24	32.26
WT FLOW AT STATOR OUTLET	35.41	35.82
ROTATIVE SPEED	12578.0	12555.0
PERCENT OF DESIGN SPEED	109.8	109.6

(f) 120 Percent of design speed

READING NUMBER	3038	3039	3040	3042
ROTOR TOTAL PRESSURE RATIO	1.439	1.492	1.518	1.526
STAGE TOTAL PRESSURE RATIO	1.385	1.438	1.462	1.459
ROTOR TOTAL TEMPERATURE RATIO	1.130	1.142	1.150	1.154
STAGE TOTAL TEMPERATURE RATIO	1.127	1.135	1.145	1.150
ROTOR TEMP. RISE EFFICIENCY	0.844	0.855	0.847	0.832
STAGE TEMP. RISE EFFICIENCY	0.770	0.807	0.794	0.761
ROTOR MOMENTUM RISE EFFICIENCY	0.810	0.835	0.851	0.820
ROTOR HEAD RISE COEFFICIENT	0.240	0.266	0.277	0.280
STAGE HEAD RISE COEFFICIENT	0.214	0.240	0.251	0.249
FLOW COEFFICIENT	0.627	0.611	0.585	0.551
WT FLOW PER UNIT FRONTAL AREA	185.98	181.10	176.51	169.85
WT FLOW PER UNIT ANNULUS AREA	219.58	216.14	210.66	202.71
WT FLOW AT ORIFICE	36.81	36.23	35.31	33.98
WT FLOW AT ROTOR INLET	36.67	36.17	35.28	34.04
WT FLOW AT ROTOR OUTLET	37.67	37.08	35.88	34.55
WT FLOW AT STATOR OUTLET	38.05	37.98	37.53	36.56
ROTATIVE SPEED	13752.9	13745.4	13758.5	13769.4
PERCENT OF DESIGN SPEED	120.0	120.0	120.1	120.2

TABLE VII. - BLADE-ELEMENT DATA AT BLADE EDGES FOR ROTOR 53

(a) 70 Percent of design speed; reading 3027

RP	RADII		ABS BETAM		REL BETAM		TOTAL TEMP		TOTAL PRESS	
	IN	OUT	IN	OUT	IN	OUT	IN	RATIO	IN	RATIO
1	24.422	23.762	0.0	10.3	52.4	44.4	288.8	1.023	10.09	1.074
2	25.569	25.063	0.0	11.2	50.0	42.5	288.8	1.024	10.13	1.085
3	22.738	22.347	0.0	12.6	48.9	40.5	288.6	1.025	10.14	1.091
4	20.284	20.196	0.0	16.3	44.5	33.2	288.1	1.029	10.14	1.109
5	17.170	17.328	0.0	22.5	39.0	21.5	287.8	1.034	10.14	1.125
6	14.232	14.460	0.	26.6	33.9	9.4	287.7	1.035	10.14	1.131
7	12.144	12.311	-0.0	29.4	29.9	-0.0	287.8	1.034	10.14	1.127
8	11.473	11.593	-0.0	30.2	28.6	-3.0	287.8	1.033	10.14	1.123
9	10.813	10.876	-0.0	30.6	27.5	-4.5	287.7	1.030	10.10	1.099

RP	ABS VEL		REL VEL		MERID VEL		TANG VEL		WHEEL SPEED	
	IN	OUT	IN	OUT	IN	OUT	IN	OUT	IN	OUT
1	158.3	175.0	258.7	240.9	158.0	172.2	0.1	31.2	204.9	199.6
2	165.9	177.2	258.1	235.8	165.9	173.9	0.1	34.3	197.8	193.5
3	167.1	178.9	253.9	229.5	167.1	174.6	0.1	39.1	191.3	188.0
4	174.9	187.1	244.3	214.5	174.9	179.6	0.1	52.6	170.6	169.9
5	178.5	195.6	229.8	194.3	178.5	180.8	0.0	74.8	144.7	146.0
6	178.5	204.5	215.1	185.3	178.5	182.8	0.	91.6	119.9	121.9
7	177.5	211.0	204.8	183.8	177.5	183.8	-0.0	103.7	102.2	103.6
8	176.6	212.2	201.1	183.6	176.6	183.4	-0.1	106.8	96.1	97.1
9	173.6	206.3	196.0	178.1	173.8	177.5	-0.1	105.1	90.6	91.1

RP	ABS MACH NO		REL MACH NO		MERID MACH NO		MERID PEAK SS	
	IN	OUT	IN	OUT	IN	OUT	VEL R	PEAK MACH NO
1	0.474	0.522	0.776	0.718	0.474	0.513	1.090	1.027
2	0.499	0.528	0.776	0.703	0.499	0.518	1.048	0.984
3	0.503	0.534	0.764	0.684	0.503	0.521	1.045	0.964
4	0.528	0.559	0.738	0.640	0.528	0.536	1.027	0.870
5	0.540	0.585	0.695	0.581	0.540	0.540	1.013	0.748
6	0.540	0.613	0.651	0.555	0.540	0.548	1.024	0.651
7	0.537	0.634	0.619	0.552	0.537	0.552	1.036	0.619
8	0.534	0.639	0.608	0.552	0.534	0.552	1.038	0.608
9	0.525	0.621	0.592	0.536	0.525	0.534	1.021	0.592

RP	PERCENT SPAN	INCIDENCE		DEV	D-FACT	EFF	LOSS COEFF		LOSS PARAM	
		MEAN	SS				TOT	PROF	TOT	PROF
1	5.00	-3.3	-7.0	5.7	0.127	0.900	0.023	0.023	0.008	0.008
2	10.00	-3.6	-7.3	5.6	0.149	0.983	0.004	0.004	0.001	0.001
3	15.00	-3.2	-7.1	5.7	0.166	1.010	-0.003	-0.003	-0.001	-0.001
4	30.00	-2.7	-7.3	5.2	0.211	1.027	-0.009	-0.009	-0.003	-0.003
5	50.00	-1.3	-7.0	4.8	0.269	1.020	-0.008	-0.008	-0.003	-0.003
6	70.00	0.2	-6.4	5.9	0.264	1.022	-0.010	-0.010	-0.003	-0.003
7	85.00	1.1	-6.0	7.7	0.230	1.011	-0.005	-0.005	-0.001	-0.001
8	90.00	1.3	-5.8	8.2	0.213	1.012	-0.006	-0.006	-0.001	-0.001
9	95.00	1.8	-5.3	10.1	0.211	0.921	0.037	0.037	0.008	0.008

TABLE VII. ¹ - Continued.

(b) 70 Percent of design speed; reading 3028

RP	RADII		ABS BETAM		REL BETAM		TOTAL TEMP		TOTAL PRESS	
	IN	OUT	IN	OUT	IN	OUT	IN	RATIO	IN	RATIO
1	24.422	23.782	-0.0	17.5	55.1	44.0	288.7	1.035	10.09	1.116
2	25.569	23.063	-0.0	17.4	52.8	42.4	289.7	1.035	10.13	1.125
3	22.738	22.347	-0.0	18.0	51.5	40.4	288.5	1.034	10.13	1.130
4	20.284	20.196	-0.0	21.4	47.3	33.5	288.0	1.036	10.13	1.137
5	17.170	17.328	-0.0	26.6	42.0	22.5	287.9	1.036	10.14	1.138
6	14.232	14.460	-0.0	29.6	36.9	11.0	287.9	1.034	10.14	1.132
7	12.144	12.311	-0.0	32.7	33.0	0.6	287.9	1.033	10.14	1.125
8	11.473	11.593	-0.0	33.3	31.6	-2.4	287.9	1.032	10.14	1.119
9	10.813	10.876	-0.0	33.9	30.5	-4.7	287.9	1.029	10.11	1.102

RP	ABS VEL		REL VEL		MERID VEL		TANG VEL		WHEEL SPEED	
	IN	OUT	IN	OUT	IN	OUT	IN	OUT	IN	OUT
1	142.8	162.8	249.4	215.9	142.8	155.2	-0.1	49.0	204.4	199.1
2	153.1	165.2	248.0	213.4	150.1	157.7	-0.1	49.3	197.3	193.1
3	151.2	167.0	242.8	208.6	151.2	158.9	-0.1	51.5	189.9	186.6
4	156.8	172.1	231.1	192.1	156.8	160.2	-0.1	62.9	169.6	168.9
5	159.8	177.3	215.0	171.6	159.8	158.5	-0.1	79.4	143.8	145.1
6	158.7	182.6	196.5	161.7	158.7	158.8	-0.1	90.2	119.1	121.1
7	156.7	187.5	186.7	157.9	156.7	157.9	-0.1	101.2	101.5	102.9
8	156.3	188.8	183.4	158.0	156.3	157.9	-0.1	103.5	96.0	97.0
9	153.5	185.1	178.1	154.1	153.5	153.6	-0.1	103.3	90.2	90.7

RP	ABS MACH NO		REL MACH NO		MERID MACH NO		MERID PEAK SS	
	IN	OUT	IN	OUT	IN	OUT	VEL R	MACH NO
1	0.427	0.481	0.746	0.637	0.427	0.458	1.087	1.058
2	0.450	0.488	0.743	0.630	0.450	0.466	1.050	1.016
3	0.453	0.494	0.728	0.617	0.453	0.470	1.051	0.987
4	0.471	0.510	0.694	0.569	0.471	0.474	1.021	0.899
5	0.481	0.526	0.647	0.509	0.481	0.470	0.992	0.784
6	0.477	0.543	0.597	0.481	0.477	0.472	1.000	0.667
7	0.471	0.559	0.561	0.471	0.471	0.471	1.008	0.570
8	0.470	0.563	0.551	0.472	0.470	0.471	1.010	0.551
9	0.461	0.553	0.535	0.460	0.461	0.459	1.001	0.535

RP	PERCENT	INCIDENCE		DEV	D-FACT	EFF	LOSS COEFF		LOSS PARAM	
	SPAN	MEAN	SS				TOT	PROF	TOT	PROF
1	5.00	-0.5	-4.2	5.4	0.229	0.911	0.033	0.033	0.012	0.012
2	10.00	-0.8	-4.6	5.5	0.233	0.987	0.035	0.005	0.002	0.002
3	15.00	-0.5	-4.5	5.7	0.238	1.028	-0.011	-0.011	-0.004	-0.004
4	30.00	0.5	-4.3	5.6	0.281	1.036	-0.017	-0.017	-0.006	-0.006
5	50.00	1.7	-4.0	5.8	0.333	1.049	-0.024	-0.024	-0.008	-0.008
6	70.00	3.2	-3.4	7.5	0.319	1.051	-0.028	-0.028	-0.008	-0.008
7	85.00	4.1	-2.9	8.3	0.291	1.032	-0.019	-0.019	-0.005	-0.005
8	90.00	4.3	-2.8	8.8	0.272	1.031	-0.018	-0.018	-0.004	-0.004
9	95.00	4.7	-2.4	10.0	0.263	0.962	0.021	0.021	0.005	0.005

TABLE VII. - Continued.

(c) 70 Percent of design speed; reading 3029

RP	RADI I		ABS BETAM		REL BETAM		TOTAL TEMP		TOTAL PRESS	
	IN	OUT	IN	OUT	IN	OUT	IN	RATIO	IN	RATIO
1	24.422	23.782	-0.0	23.0	57.9	43.8	288.6	1.043	10.10	1.150
2	23.569	23.063	-0.0	22.4	55.6	42.5	288.5	1.042	10.13	1.155
3	22.738	22.347	-0.0	22.9	54.6	41.1	288.4	1.041	10.14	1.155
4	20.284	20.196	-0.0	26.2	50.2	34.4	283.0	1.040	10.14	1.151
5	17.170	17.328	-0.0	30.3	45.2	24.2	288.0	1.059	10.14	1.145
6	14.232	14.460	-0.0	33.5	40.1	12.0	283.0	1.055	10.14	1.134
7	12.144	12.311	-0.0	35.8	36.0	1.2	287.9	1.034	10.14	1.124
8	11.473	11.593	-0.0	36.4	34.7	-1.8	287.9	1.032	10.13	1.115
9	10.813	10.876	-0.0	37.3	33.5	-5.3	287.9	1.030	10.11	1.106

RP	ABS VEL		REL VEL		MERID VEL		TANG VEL		WHEEL SPEED	
	IN	OUT	IN	OUT	IN	OUT	IN	OUT	IN	OUT
1	128.6	156.2	241.6	199.3	128.6	143.7	-0.1	61.1	204.5	199.1
2	134.7	157.0	238.6	196.7	134.7	143.1	-0.1	59.9	196.8	192.6
3	135.3	155.6	233.2	191.4	135.3	144.3	-0.1	60.9	189.9	188.6
4	141.1	159.6	220.3	173.6	141.1	143.3	-0.1	70.4	169.2	168.4
5	142.8	162.5	202.6	153.8	142.8	140.4	-0.1	81.9	143.6	144.9
6	141.6	165.4	165.0	142.1	141.6	139.1	-0.1	91.5	119.0	120.9
7	140.0	171.5	173.2	139.1	140.0	139.1	-0.1	100.4	101.6	103.2
8	139.2	171.0	169.2	137.7	139.2	137.6	-0.1	101.6	96.2	97.2
9	136.6	170.8	163.8	136.5	136.6	135.9	-0.1	103.5	90.3	90.8

RP	ABS MACH NO		REL MACH NO		MERID MACH NO		MERID PEAK SS	
	IN	OUT	IN	OUT	IN	OUT	VEL R	MACH NO
1	0.383	0.458	0.720	0.585	0.383	0.422	1.118	1.089
2	0.402	0.461	0.712	0.578	0.402	0.426	1.077	1.044
3	0.404	0.459	0.696	0.562	0.404	0.424	1.067	1.019
4	0.422	0.470	0.659	0.511	0.422	0.422	1.016	0.922
5	0.427	0.486	0.606	0.454	0.427	0.414	0.933	0.808
6	0.424	0.492	0.554	0.421	0.424	0.411	0.932	0.692
7	0.419	0.509	0.518	0.413	0.419	0.413	0.935	0.613
8	0.416	0.508	0.506	0.409	0.416	0.406	0.939	0.586
9	0.408	0.507	0.489	0.405	0.408	0.404	0.995	0.558

RP	PERCENT SPAN	INCIDENCE		DEV	D-FACT	EFF	LOSS COEFF		LOSS PARAM	
		MEAN	SS				TOT	PROF	TOT	PROF
1	5.00	2.3	-1.4	5.2	0.297	0.985	0.022	0.022	0.006	0.008
2	10.00	2.1	-1.7	5.6	0.293	0.995	0.002	0.002	0.001	0.001
3	15.00	2.5	-1.4	6.4	0.298	1.014	-0.007	-0.007	-0.002	-0.002
4	30.00	3.2	-1.4	6.5	0.344	1.035	-0.017	-0.017	-0.006	-0.006
5	50.00	4.9	-0.8	7.4	0.384	1.055	-0.021	-0.021	-0.007	-0.007
6	70.00	6.3	-0.3	8.4	0.378	1.034	-0.022	-0.022	-0.006	-0.006
7	85.00	7.2	0.1	8.9	0.342	1.013	-0.009	-0.009	-0.002	-0.002
8	90.00	7.4	0.3	9.4	0.328	0.992	0.005	0.005	0.001	0.001
9	95.00	7.7	0.6	9.3	0.307	0.962	0.026	0.026	0.006	0.006

TABLE VII. - Continued.

(d) 70 Percent of design speed; reading 3030

RP	RAD II		ABS BETAM		REL BETAM		TOTAL TEMP		TOTAL PRESS	
	IN	OUT	IN	OUT	IN	OUT	IN	RATIO	IN	RATIO
1	24.422	23.782	-0.0	29.9	61.1	44.8	289.8	1.052	10.10	1.170
2	23.569	23.363	-0.0	28.5	59.9	42.9	289.5	1.050	10.13	1.177
3	22.758	22.547	-0.0	26.8	57.9	41.7	289.4	1.046	10.13	1.177
4	20.284	20.196	-0.0	31.9	53.9	38.1	288.1	1.046	10.14	1.170
5	17.179	17.328	-0.0	35.7	49.1	28.2	288.0	1.042	10.14	1.155
6	14.252	14.460	-0.0	37.9	43.9	18.4	287.9	1.039	10.14	1.138
7	12.144	12.511	-0.0	40.1	39.9	11.7	288.0	1.035	10.14	1.126
8	11.473	11.593	-0.0	40.5	38.3	-2.5	287.9	1.035	10.13	1.116
9	10.813	10.876	-0.0	41.4	37.2	-6.8	287.9	1.032	10.11	1.111

RP	ABS VEL		REL VEL		MERID VEL		TANG VEL		WHEEL SPEED	
	IN	OUT	IN	OUT	IN	OUT	IN	OUT	IN	OUT
1	112.6	146.2	235.1	178.6	112.6	126.7	-0.1	72.9	204.0	198.7
2	118.7	149.7	239.0	178.5	118.7	130.7	-0.1	71.1	196.9	192.7
3	119.5	148.3	235.1	174.0	119.5	129.9	-0.1	71.5	190.7	187.4
4	124.1	150.4	218.7	156.1	124.1	127.6	-0.1	79.5	170.1	169.4
5	125.3	151.0	191.2	135.6	125.3	122.7	-0.1	88.0	144.3	145.7
6	124.1	155.9	172.2	124.3	124.1	121.8	-0.1	94.6	119.3	121.2
7	122.5	158.6	159.6	121.6	122.5	121.5	-0.1	102.2	102.2	103.6
8	122.0	157.9	155.6	120.1	122.0	120.0	-0.1	102.6	96.4	97.4
9	119.7	159.8	150.3	120.7	119.7	119.8	-0.1	105.7	90.8	91.3

RP	ABS MACH NO		REL MACH NO		MERID MACH NO		MERID PEAK SS	
	IN	OUT	IN	OUT	IN	OUT	VEL R	MACH NO
1	0.354	0.426	0.692	0.520	0.354	0.369	1.125	1.124
2	0.353	0.434	0.684	0.521	0.353	0.382	1.100	1.079
3	0.356	0.433	0.670	0.509	0.356	0.380	1.087	1.056
4	0.370	0.440	0.628	0.457	0.370	0.374	1.028	0.958
5	0.375	0.443	0.570	0.398	0.373	0.360	0.979	0.836
6	0.370	0.453	0.513	0.366	0.370	0.358	0.979	0.713
7	0.365	0.469	0.475	0.359	0.365	0.359	0.992	0.632
8	0.363	0.467	0.463	0.355	0.363	0.355	0.984	0.604
9	0.356	0.473	0.447	0.357	0.356	0.354	1.001	0.577

RP	PERCENT SPAN		INCIDENCE		DEV	D-FACT	EFF	LOSS COEFF		LOSS PARAM	
	SPAN	MEAN	SS	TOT				PROF	TOT	PROF	
1	5.00	5.5	1.8	6.1	0.385	0.881	0.074	0.074	0.026	0.026	
2	10.00	5.4	1.6	6.0	0.369	0.958	0.026	0.026	0.009	0.009	
3	15.00	5.9	2.0	7.0	0.371	0.982	0.011	0.011	0.004	0.004	
4	30.00	6.9	2.3	7.2	0.415	0.995	0.003	0.003	0.001	0.001	
5	50.00	8.7	3.0	8.4	0.454	0.997	0.002	0.002	0.001	0.001	
6	70.00	10.2	3.6	8.9	0.440	0.996	0.003	0.003	0.001	0.001	
7	85.00	11.0	3.9	8.4	0.399	0.990	0.008	0.008	0.002	0.002	
8	90.00	11.0	3.9	8.8	0.384	0.967	0.027	0.027	0.006	0.006	
9	95.00	11.4	4.3	7.8	0.353	0.970	0.025	0.025	0.006	0.006	

TABLE VII. - Continued.

(e) 70 Percent of design speed; reading 3031

RP	RADII		ABS BETAM		REL BETAM		TOTAL TEMP		TOTAL PRESS	
	IN	OUT	IN	OUT	IN	OUT	IN	RATIO	IN	RATIO
1	24.422	23.782	-0.0	46.9	65.5	47.6	288.5	1.066	10.11	1.168
2	23.569	23.063	-0.0	38.6	63.5	45.2	288.4	1.060	10.13	1.173
3	22.738	22.347	-0.0	36.8	62.5	42.9	288.3	1.056	10.13	1.178
4	20.284	20.196	-0.0	38.5	58.6	36.0	288.1	1.052	10.13	1.173
5	17.170	17.328	-0.0	41.7	53.7	25.8	288.0	1.045	10.13	1.155
6	14.232	14.460	-0.0	42.5	48.5	12.2	288.0	1.040	10.14	1.140
7	12.144	12.311	-0.0	43.1	44.0	0.5	288.0	1.035	10.13	1.126
8	11.473	11.593	-0.0	43.4	42.5	-3.0	288.0	1.033	10.13	1.118
9	10.813	10.876	-0.0	44.2	41.3	-7.5	288.0	1.032	10.12	1.112

RP	ABS VEL		REL VEL		MERID VEL		TANG VEL		WHEEL SPEED	
	IN	OUT	IN	OUT	IN	OUT	IN	OUT	IN	OUT
1	93.4	135.1	225.3	136.7	93.4	92.2	-0.0	98.7	205.0	199.6
2	98.5	137.1	221.1	152.2	98.5	107.2	-0.1	85.5	197.8	193.6
3	99.4	139.9	215.5	152.9	99.4	112.1	-0.0	85.8	191.1	187.8
4	103.9	142.5	199.7	137.9	103.9	111.5	-0.1	88.7	170.5	169.8
5	105.9	141.9	178.9	117.7	105.9	106.0	-0.1	94.3	144.1	145.5
6	105.9	145.5	159.7	109.8	105.9	107.3	-0.1	93.2	119.5	121.4
7	105.1	149.3	148.2	109.0	105.1	109.0	-0.1	102.1	101.6	103.0
8	104.8	149.4	142.1	108.7	104.8	108.6	-0.1	102.7	96.0	97.0
9	103.0	150.8	137.1	109.0	103.0	108.1	-0.1	105.2	90.5	91.0

RP	ABS MACH NO		REL MACH NO		MERID MACH NO		MERID PEAK SS	
	IN	OUT	IN	OUT	IN	OUT	VEL R	MACH NO
1	0.276	0.390	0.667	0.395	0.276	0.266	0.988	1.183
2	0.292	0.397	0.655	0.441	0.292	0.311	1.088	1.136
3	0.294	0.407	0.638	0.444	0.294	0.326	1.128	1.107
4	0.308	0.415	0.593	0.402	0.308	0.325	1.073	0.999
5	0.315	0.415	0.531	0.344	0.315	0.310	1.000	0.863
6	0.314	0.427	0.474	0.322	0.314	0.315	1.014	0.733
7	0.312	0.440	0.434	0.321	0.312	0.321	1.037	0.640
8	0.311	0.441	0.422	0.321	0.311	0.320	1.037	0.611
9	0.306	0.445	0.407	0.322	0.306	0.319	1.050	0.584

RP	PERCENT		INCIDENCE		DEV	D-FACT	EFF	LOSS COEFF		LOSS PARAM	
	SPAN	MEAN	SS	SS				TOT	PROF	TOT	PROF
1	5.00	9.9	6.2	8.9	0.604	0.685	0.256	0.256	0.084	0.084	
2	10.00	10.0	6.2	8.3	0.493	0.783	0.167	0.167	0.056	0.056	
3	15.00	10.5	6.6	8.2	0.467	0.859	0.107	0.107	0.036	0.036	
4	30.00	11.7	7.1	8.1	0.493	0.903	0.079	0.079	0.026	0.026	
5	50.00	13.4	7.7	9.0	0.529	0.931	0.060	0.060	0.019	0.019	
6	70.00	14.8	8.1	8.7	0.494	0.946	0.052	0.052	0.015	0.015	
7	85.00	15.2	8.1	8.2	0.430	0.978	0.022	0.022	0.005	0.005	
8	90.00	15.2	8.1	8.2	0.406	0.973	0.026	0.026	0.006	0.006	
9	95.00	15.6	8.4	7.2	0.375	0.970	0.030	0.030	0.007	0.007	

TABLE VII. - Continued.

(f) 80 Percent of design speed; reading 3011

RP	RADII		ABS BETAM		REL BETAM		TOTAL TEMP		TOTAL PRESS	
	IN	OUT	IN	OUT	IN	OUT	IN	RATIO	IN	RATIO
1	24.422	23.782	0.0	16.5	53.9	43.8	288.9	1.043	10.09	1.148
2	23.569	23.063	0.0	16.9	51.6	42.1	288.8	1.045	10.13	1.160
3	22.738	22.347	0.0	17.9	50.4	40.0	288.7	1.045	10.14	1.168
4	20.284	20.196	0.0	21.4	45.9	32.7	288.1	1.048	10.14	1.180
5	17.170	17.328	0.0	26.5	40.7	21.3	287.8	1.050	10.14	1.187
6	14.232	14.460	0.0	29.3	35.6	10.3	287.7	1.047	10.14	1.173
7	12.144	12.311	0.0	32.2	31.7	0.3	287.7	1.045	10.14	1.162
8	11.473	11.593	0.0	32.9	30.3	-2.7	287.7	1.044	10.14	1.153
9	10.813	10.876	0.0	33.5	29.2	-4.5	287.7	1.040	10.10	1.126

RP	ABS VEL		REL VEL		MERID VEL		TANG VEL		WHEEL SPEED	
	IN	OUT	IN	OUT	IN	OUT	IN	OUT	IN	OUT
1	171.2	190.2	290.7	252.8	171.2	182.4	0.1	53.9	235.0	228.9
2	179.5	191.8	288.8	247.2	179.5	183.5	0.1	55.8	226.3	221.5
3	180.6	194.2	283.5	241.4	180.6	184.8	0.1	59.6	218.6	214.9
4	188.6	201.4	271.3	222.9	188.6	187.5	0.1	73.6	195.0	194.2
5	191.8	209.4	253.0	201.3	191.8	187.5	0.1	93.4	165.1	166.6
6	190.8	214.6	234.6	190.2	190.8	187.2	0.1	104.9	136.7	138.9
7	189.0	220.5	222.0	186.6	189.0	186.6	0.1	117.4	116.6	118.2
8	188.7	221.7	218.6	186.4	188.7	186.2	0.1	120.4	110.5	111.6
9	185.6	215.7	212.7	180.6	185.6	180.0	0.2	118.9	104.0	104.6

RP	ABS MACH NO		REL MACH NO		MERID MACH NO		MERID PEAK SS	
	IN	OUT	IN	OUT	IN	OUT	VEL R	MACH NO
1	0.516	0.564	0.875	0.749	0.516	0.541	1.066	1.207
2	0.542	0.568	0.872	0.733	0.542	0.544	1.022	1.156
3	0.546	0.576	0.857	0.716	0.546	0.548	1.023	1.130
4	0.572	0.599	0.823	0.662	0.572	0.557	0.994	1.025
5	0.583	0.624	0.769	0.600	0.583	0.559	0.977	0.891
6	0.580	0.642	0.713	0.569	0.580	0.560	0.981	0.743
7	0.574	0.661	0.674	0.560	0.574	0.560	0.988	0.674
8	0.573	0.666	0.664	0.560	0.573	0.559	0.986	0.664
9	0.563	0.648	0.645	0.542	0.563	0.540	0.970	0.645

RP	PERCENT		INCIDENCE		DEV	D-FACT	EFF	LOSS COEFF		LOSS PARAM	
	SPAN	MEAN	SS	SS				TOT	PROF	TOT	PROF
1	5.00	-1.7	-5.4	5.2	0.220	0.930	0.025	0.025	0.009	0.009	
2	10.00	-2.0	-5.8	5.2	0.234	0.969	0.012	0.012	0.004	0.004	
3	15.00	-1.6	-5.5	5.3	0.244	1.005	-0.002	-0.002	-0.001	-0.001	
4	30.00	-1.0	-5.6	4.8	0.290	1.009	-0.004	-0.004	-0.001	-0.001	
5	50.00	0.4	-5.3	4.6	0.335	1.012	-0.006	-0.006	-0.002	-0.002	
6	70.00	1.9	-4.7	6.8	0.321	0.994	0.003	0.003	0.001	0.001	
7	85.00	2.8	-4.3	8.0	0.292	0.971	0.017	0.017	0.004	0.004	
8	90.00	3.0	-4.1	8.5	0.277	0.951	0.028	0.028	0.007	0.007	
9	95.00	3.5	-3.7	10.1	0.275	0.860	0.077	0.077	0.017	0.017	

TABLE VII. - Continued.

(g) 80 Percent of design speed; reading 3012

RP	RADII		ABS BETAM		REL BETAM		TOTAL TEMP		TOTAL PRESS	
	IN	OUT	IN	OUT	IN	OUT	IN	RATIO	IN	RATIO
1	24.422	23.782	0.1	21.7	56.1	43.7	288.9	1.054	10.09	1.187
2	23.569	23.063	0.0	21.4	53.8	42.0	288.8	1.053	10.13	1.200
3	22.738	22.347	0.1	21.9	52.6	40.4	288.6	1.053	10.13	1.199
4	20.284	20.196	0.1	24.8	48.2	33.7	288.0	1.053	10.14	1.200
5	17.170	17.328	0.1	29.4	45.2	23.0	287.8	1.051	10.14	1.192
6	14.232	14.460	0.1	32.1	38.1	11.2	287.8	1.048	10.14	1.180
7	12.144	12.311	0.1	34.8	34.1	0.6	287.2	1.045	10.14	1.165
8	11.473	11.593	0.1	35.5	32.8	-2.4	287.8	1.043	10.13	1.153
9	10.813	10.876	0.1	36.3	31.9	-4.9	287.9	1.040	10.10	1.135

RP	ABS VEL		REL VEL		MERID VEL		TANG VEL		WHEEL SPEED	
	IN	OUT	IN	OUT	IN	OUT	IN	OUT	IN	OUT
1	157.6	182.1	282.9	233.9	157.6	169.2	0.1	67.5	235.1	228.9
2	165.6	184.4	280.4	230.8	165.6	171.6	0.1	67.3	226.4	221.6
3	167.1	184.8	275.0	225.2	167.1	171.5	0.2	68.9	218.5	214.7
4	174.4	189.9	261.7	207.1	174.4	172.4	0.2	79.6	195.3	194.4
5	176.3	193.8	241.7	185.4	176.3	168.0	0.2	95.2	165.5	167.0
6	174.6	199.4	222.0	172.1	174.6	168.8	0.2	106.1	137.2	139.4
7	172.8	204.6	208.7	167.9	172.8	167.9	0.2	116.9	117.1	118.8
8	171.3	204.0	203.8	166.2	171.3	166.0	0.2	118.5	110.6	111.7
9	167.6	200.8	197.4	162.5	167.6	161.9	0.2	118.7	104.4	105.0

RP	ABS MACH NO		REL MACH NO		MERID MACH NO		MERID PEAK SS	
	IN	OUT	IN	OUT	IN	OUT	VEL R-MACH NO	SS
1	0.473	0.536	0.849	0.688	0.473	0.497	1.073	1.235
2	0.498	0.543	0.843	0.679	0.498	0.505	1.037	1.184
3	0.503	0.544	0.828	0.663	0.503	0.505	1.026	1.154
4	0.527	0.561	0.790	0.612	0.527	0.509	0.988	1.051
5	0.533	0.574	0.731	0.543	0.533	0.500	0.957	0.919
6	0.528	0.593	0.671	0.512	0.528	0.502	0.967	0.787
7	0.522	0.610	0.630	0.501	0.522	0.501	0.972	0.689
8	0.517	0.609	0.615	0.496	0.517	0.495	0.969	0.654
9	0.505	0.599	0.595	0.485	0.505	0.483	0.966	0.627

RP	PERCENT SPAN	INCIDENCE		DEV	D-FACT	EFF	LOSS COEFF		LOSS PARAM	
		MEAN	SS				TOT	PROF	TOT	PROF
1	5.00	0.5	-3.2	5.0	0.288	0.938	0.029	-0.029	0.010	0.010
2	10.00	0.3	-3.5	5.1	0.289	1.065	-0.002	-0.002	-0.001	-0.001
3	15.00	0.6	-3.4	5.7	0.295	1.009	-0.004	-0.004	-0.002	-0.002
4	30.00	1.2	-3.4	5.7	0.334	1.010	-0.005	-0.005	-0.002	-0.002
5	50.00	2.8	-2.9	6.3	0.380	1.015	-0.008	-0.008	-0.003	-0.003
6	70.00	4.4	-2.2	7.7	0.365	1.021	-0.013	-0.013	-0.004	-0.004
7	85.00	5.2	-1.8	8.3	0.336	0.989	0.007	0.007	0.002	0.002
8	90.00	5.5	-1.6	8.9	0.322	0.972	0.017	0.017	0.004	0.004
9	95.00	6.1	-1.0	9.8	0.310	0.910	0.057	0.057	0.013	0.013

TABLE VII. - Continued.

(h) 80 Percent of design speed; reading 3014

RP	RADII		ABS BETAM		REL BETAM		TOTAL TEMP		TOTAL PRESS	
	IN	OUT	IN	OUT	IN	OUT	IN	RATIO	IN	RATIO
1	24.422	23.702	0.1	26.6	58.2	43.6	298.8	1.063	10.10	1.218
2	23.539	23.063	0.1	25.7	56.1	42.4	298.7	1.061	10.13	1.224
3	22.758	22.347	0.1	25.9	55.0	41.0	298.6	1.060	10.13	1.223
4	20.284	20.196	0.1	28.7	50.7	34.4	287.9	1.057	10.14	1.217
5	17.170	17.328	0.1	32.9	45.6	25.9	287.9	1.053	10.14	1.199
6	14.232	14.460	0.1	35.2	40.6	11.8	287.9	1.049	10.14	1.182
7	12.144	12.311	0.1	37.3	36.6	0.8	287.9	1.045	10.14	1.167
8	11.473	11.593	0.1	38.2	35.1	-2.5	287.8	1.042	10.14	1.153
9	10.813	10.876	0.1	38.9	34.0	-5.5	287.9	1.040	10.11	1.137

RP	ABS VEL		REL VEL		MERID VEL		TANG VEL		WHEEL SPEED	
	IN	OUT	IN	OUT	IN	OUT	IN	OUT	IN	OUT
1	145.3	176.0	276.0	217.3	145.3	157.4	0.2	78.9	234.8	228.7
2	152.4	176.9	273.2	215.8	152.4	159.5	0.2	76.6	226.9	222.0
3	153.0	176.5	266.8	210.2	153.0	158.8	0.2	77.2	218.7	215.0
4	159.5	179.7	252.0	191.2	159.5	157.7	0.2	86.2	195.2	194.3
5	161.6	182.1	230.9	167.1	161.6	152.8	0.2	98.9	165.1	166.6
6	159.3	186.2	210.0	155.5	159.3	152.2	0.2	107.3	137.0	139.2
7	157.3	192.0	195.9	152.7	157.3	152.7	0.2	116.3	116.9	118.6
8	156.9	190.9	191.7	150.2	156.9	150.1	0.2	118.0	110.3	111.5
9	154.1	189.2	185.9	147.9	154.1	147.3	0.2	118.8	104.1	104.7

RP	ABS MACH NO		REL MACH NO		MERID MACH NO		MERID PEAK SS	
	IN	OUT	IN	OUT	IN	OUT	VEL R	MACH NO
1	0.435	0.514	0.825	0.635	0.435	0.460	1.083	1.260
2	0.457	0.518	0.819	0.631	0.457	0.467	1.046	1.214
3	0.459	0.517	0.800	0.616	0.459	0.465	1.038	1.183
4	0.480	0.528	0.758	0.562	0.480	0.463	0.989	1.074
5	0.486	0.536	0.695	0.493	0.486	0.450	0.946	0.936
6	0.479	0.551	0.631	0.460	0.479	0.450	0.955	0.804
7	0.473	0.570	0.589	0.453	0.473	0.453	0.971	0.710
8	0.471	0.567	0.576	0.446	0.471	0.446	0.957	0.678
9	0.463	0.562	0.558	0.440	0.463	0.438	0.956	0.650

RP	PERCENT SPAN		INCIDENCE		DEV	D-FACT	EFF	LOSS COEFF		LOSS PARAM	
	SPAN	MEAN	SS	TOT				PROF	TOT	PROF	
1	5.00	2.6	-1.1	4.9	0.350	0.922	0.044	0.044	0.016	0.015	
2	10.00	2.5	-1.3	5.5	0.341	0.973	0.015	0.015	0.005	0.005	
3	15.00	3.0	-0.9	6.2	0.343	0.994	0.003	0.003	0.001	0.001	
4	30.00	3.7	-0.9	6.5	0.382	1.008	-0.005	-0.005	-0.002	-0.002	
5	50.00	5.3	-0.4	7.1	0.427	1.010	-0.006	-0.006	-0.002	-0.002	
6	70.00	6.9	0.3	8.3	0.410	1.002	-0.002	-0.002	-0.000	-0.000	
7	85.00	7.7	0.7	8.5	0.369	0.999	0.001	0.001	0.000	0.000	
8	90.00	7.8	0.7	8.7	0.362	0.976	0.017	0.017	0.004	0.004	
9	95.00	8.3	1.1	9.2	0.346	0.930	0.049	0.049	0.011	0.011	

TABLE VII. - Continued.

(i) 80 Percent of design speed; reading 3015

RP	RADII		ABS BETAM		REL BETAM		TOTAL TEMP		TOTAL PRESS	
	IN	OUT	IN	OUT	IN	OUT	IN	RATIO	IN	RATIO
1	24.422	23.782	0.1	30.8	60.3	44.5	288.7	1.071	10.10	1.235
2	23.569	23.063	0.1	29.1	58.3	42.8	288.6	1.068	10.13	1.244
3	22.738	22.347	0.1	29.5	57.2	41.7	288.4	1.065	10.13	1.239
4	20.284	20.196	0.1	32.5	53.0	35.1	288.0	1.061	10.14	1.228
5	17.170	17.328	0.1	36.3	48.2	24.8	287.9	1.055	10.14	1.206
6	14.232	14.460	0.1	38.2	43.1	12.1	287.9	1.051	10.14	1.185
7	12.144	12.311	0.1	40.1	38.9	0.8	287.9	1.046	10.14	1.164
8	11.473	11.593	0.1	40.7	37.5	-2.5	287.9	1.043	10.13	1.151
9	10.813	10.876	0.1	41.2	36.5	-6.3	287.9	1.042	10.10	1.144

RP	ABS VEL		REL VEL		MERID VEL		TANG VEL		WHEEL SPEED	
	IN	OUT	IN	OUT	IN	OUT	IN	OUT	IN	OUT
1	134.2	169.2	270.9	203.8	134.2	145.4	0.1	86.6	235.5	229.3
2	140.2	171.4	266.7	204.1	140.2	149.7	0.1	83.4	227.0	222.2
3	141.2	170.0	260.4	198.0	141.2	148.0	0.2	83.6	219.0	215.2
4	147.0	172.2	244.4	177.4	147.0	145.2	0.2	92.6	195.4	194.6
5	148.0	173.2	221.9	153.8	148.0	139.7	0.1	102.5	165.4	166.9
6	146.4	177.1	200.6	142.3	146.4	139.1	0.2	109.5	137.3	139.5
7	144.6	181.2	185.8	138.7	144.6	138.7	0.2	116.6	116.9	118.5
8	143.7	180.5	181.2	137.1	143.7	136.9	0.2	117.6	110.5	111.7
9	140.7	182.2	174.9	138.0	140.7	137.1	0.1	120.0	104.2	104.8

RP	ABS MACH NO		REL MACH NO		MERID MACH NO		MERID PEAK SS	
	IN	OUT	IN	OUT	IN	OUT	VEL R	MACH NO
1	0.400	0.492	0.808	0.592	0.400	0.422	1.084	1.290
2	0.419	0.499	0.797	0.594	0.419	0.436	1.067	1.241
3	0.422	0.495	0.779	0.577	0.422	0.431	1.048	1.208
4	0.440	0.504	0.732	0.519	0.440	0.425	0.988	1.096
5	0.444	0.508	0.665	0.451	0.444	0.410	0.944	0.955
6	0.439	0.522	0.601	0.419	0.439	0.410	0.951	0.819
7	0.433	0.536	0.556	0.410	0.433	0.410	0.959	0.721
8	0.430	0.534	0.542	0.406	0.430	0.405	0.953	0.690
9	0.421	0.540	0.523	0.409	0.421	0.406	0.975	0.661

RP	PERCENT		INCIDENCE		DEV	D-FACT	EFF	LOSS COEFF		LOSS PARAM	
	SPAN	MEAN	SS	SS				TOT	PROF	TOT	PROF
1	5.00	4.7	1.0	5.8	0.402	0.876	0.060	0.079	0.028	0.028	
2	10.00	4.7	0.9	5.9	0.381	0.952	0.031	0.031	0.011	0.011	
3	15.00	5.2	1.2	6.9	0.385	0.968	0.020	0.020	0.007	0.007	
4	30.00	6.0	1.4	7.2	0.430	0.985	0.010	0.010	0.003	0.003	
5	50.00	7.8	2.1	8.0	0.470	0.993	0.005	0.005	0.002	0.002	
6	70.00	9.4	2.8	8.6	0.451	0.981	0.015	0.015	0.004	0.004	
7	85.00	10.0	3.0	8.5	0.411	0.971	0.023	0.023	0.006	0.006	
8	90.00	10.2	3.1	8.7	0.397	0.950	0.040	0.040	0.009	0.009	
9	95.00	10.7	3.6	8.3	0.363	0.935	0.054	0.054	0.012	0.012	

TABLE VII. - Continued.

(j) 80 Percent of design speed; reading 3007

RP	RADII		ABS BETAM		REL BETAM		TOTAL TEMP		TOTAL PRESS	
	IN	OUT	IN	OUT	IN	OUT	IN	RATIO	IN	RATIO
1	24.422	23.782	-0.0	36.1	62.4	45.9	289.7	1.076	10.10	1.229
2	23.569	23.063	-0.0	32.5	69.4	43.8	288.6	1.071	10.14	1.241
3	22.738	22.347	-0.0	32.7	59.3	42.1	288.4	1.069	10.14	1.242
4	20.284	20.196	-0.0	35.4	55.3	35.5	289.0	1.065	10.13	1.231
5	17.170	17.328	-0.0	38.8	50.3	24.6	289.0	1.059	10.13	1.211
6	14.232	14.460	-0.0	40.2	45.2	12.0	287.9	1.052	10.14	1.187
7	12.144	12.311	-0.0	42.1	41.0	0.6	287.9	1.046	10.13	1.163
8	11.473	11.593	-0.0	42.4	39.7	-2.3	287.9	1.044	10.13	1.151
9	10.813	10.876	-0.0	43.1	38.5	-7.2	287.9	1.042	10.11	1.145

RP	ABS VEL		REL VEL		MERID VEL		TANG VEL		WHEEL SPEED	
	IN	OUT	IN	OUT	IN	OUT	IN	OUT	IN	OUT
1	122.8	160.6	265.0	186.7	122.8	129.9	-0.0	94.6	234.8	228.6
2	128.6	164.5	260.4	192.4	126.6	138.8	-0.0	88.3	226.4	221.5
3	129.9	165.1	254.3	187.3	129.9	138.9	-0.0	89.3	218.7	214.9
4	135.1	167.2	237.2	167.5	135.1	136.3	-0.0	96.9	195.0	194.1
5	138.6	169.1	214.0	144.9	136.6	131.8	-0.0	106.0	164.7	166.2
6	135.7	172.1	192.7	134.4	135.7	131.5	-0.0	111.0	138.8	139.0
7	134.2	174.8	177.9	129.8	134.2	129.8	-0.0	117.1	116.8	118.4
8	132.9	174.6	172.7	129.2	132.9	129.0	-0.0	117.7	110.2	111.3
9	130.3	176.5	166.5	129.9	130.3	128.9	-0.0	120.6	103.6	104.2

RP	ABS MACH NO		REL MACH NO		MERID MACH NO		MERID PEAK SS	
	IN	OUT	IN	OUT	IN	OUT	VEL R	MACH NO
1	0.365	0.464	0.788	0.540	0.365	0.375	1.658	1.315
2	0.383	0.477	0.776	0.558	0.383	0.403	1.060	1.264
3	0.387	0.480	0.758	0.544	0.387	0.404	1.069	1.231
4	0.403	0.488	0.709	0.488	0.403	0.397	1.009	1.115
5	0.408	0.495	0.640	0.424	0.408	0.386	0.965	0.966
6	0.405	0.506	0.576	0.395	0.405	0.386	0.969	0.827
7	0.401	0.516	0.531	0.383	0.401	0.383	0.967	0.728
8	0.397	0.516	0.516	0.382	0.397	0.381	0.971	0.696
9	0.389	0.522	0.497	0.384	0.389	0.381	0.989	0.664

RP	PERCENT SPAN		INCIDENCE		DEV	D-FACT	EFF	LOSS COEFF		LOSS PARAM	
	MEAN	SS	MEAN	SS				TOT	PROF	TOT	PROF
1	5.00	6.8	3.1	7.3	0.468	0.798	0.143	0.143	0.049	0.049	
2	10.00	6.9	3.1	6.9	0.420	0.895	0.073	0.073	0.025	0.025	
3	15.00	7.3	3.4	7.4	0.423	0.930	0.049	0.049	0.017	0.017	
4	30.00	8.3	3.7	7.6	0.462	0.944	0.042	0.042	0.014	0.014	
5	50.00	10.0	4.3	7.8	0.498	0.959	0.033	0.033	0.011	0.011	
6	70.00	11.5	4.9	8.5	0.473	0.969	0.026	0.026	0.008	0.008	
7	85.00	12.1	5.1	8.3	0.436	0.959	0.036	0.036	0.009	0.009	
8	90.00	12.4	5.3	8.4	0.413	0.943	0.051	0.051	0.012	0.012	
9	95.00	12.7	5.6	7.4	0.380	0.937	0.057	0.057	0.013	0.013	

TABLE VII. - Continued.

(k) 80 Percent of design speed; reading 3006

RP	RADII		ABS BETAM		REL BETAM		TOTAL TEMP		TOTAL PRESS	
	IN	OUT	IN	OUT	IN	OUT	IN	RATIO	IN	RATIO
1	24.422	23.782	-0.0	48.1	65.0	47.8	288.7	1.087	10.11	1.217
2	23.569	23.063	0.0	39.9	63.0	45.2	288.5	1.079	10.14	1.224
3	22.758	22.347	0.0	37.2	62.0	42.6	288.4	1.074	10.13	1.254
4	20.284	20.196	-0.0	38.4	57.9	36.0	288.0	1.068	10.14	1.227
5	17.170	17.328	-0.0	41.5	52.8	24.6	288.0	1.061	10.14	1.210
6	14.232	14.460	0.0	41.8	47.5	12.5	287.9	1.052	10.13	1.183
7	12.144	12.311	0.	43.3	43.3	0.6	287.9	1.047	10.13	1.163
8	11.473	11.593	0.	43.8	41.8	-3.1	287.9	1.044	10.13	1.152
9	10.813	10.876	-0.0	44.0	40.5	-7.4	287.9	1.043	10.12	1.146

RP	ABS VEL		REL VEL		MERID VEL		TANG VEL		WHEEL SPEED	
	IN	OUT	IN	OUT	IN	OUT	IN	OUT	IN	OUT
1	109.1	154.1	258.2	152.9	109.1	102.8	-0.0	114.7	234.1	227.9
2	115.2	156.5	253.8	170.5	115.2	120.2	0.0	100.3	226.1	221.3
3	116.4	160.6	247.7	173.8	116.4	127.8	0.0	97.2	218.6	214.9
4	122.2	162.8	230.0	157.9	122.2	127.7	-0.0	101.1	194.8	194.0
5	125.1	165.3	206.7	136.2	125.1	123.9	-0.0	109.4	164.6	166.1
6	125.2	166.8	185.3	127.2	125.2	124.2	0.0	111.2	136.6	138.8
7	125.8	170.6	170.1	124.2	123.8	124.2	0.	117.0	116.6	118.2
8	123.2	170.6	165.4	123.3	123.2	123.2	0.	118.1	110.3	111.5
9	121.4	173.4	159.7	125.7	121.4	124.7	-0.0	120.5	103.7	104.4

RP	ABS MACH NO		REL MACH NO		MERID MACH NO		MERID PEAK SS	
	IN	OUT	IN	OUT	IN	OUT	VEL R	MACH NO
1	0.324	0.442	0.766	0.439	0.324	0.295	0.942	1.346
2	0.342	0.452	0.754	0.492	0.342	0.347	1.043	1.295
3	0.346	0.465	0.736	0.503	0.346	0.370	1.098	1.262
4	0.364	0.473	0.685	0.459	0.364	0.371	1.045	1.138
5	0.373	0.483	0.616	0.398	0.373	0.362	0.990	0.981
6	0.373	0.489	0.552	0.373	0.373	0.365	0.992	0.855
7	0.369	0.503	0.507	0.366	0.369	0.366	1.003	0.734
8	0.367	0.503	0.493	0.364	0.367	0.363	1.000	0.703
9	0.362	0.512	0.476	0.371	0.362	0.368	1.027	0.669

RP	PERCENT	INCIDENCE		DEV	D-FACT	EFF	LOSS COEFF		LOSS PARAM	
	SPAN	MEAN	SS				TOT	PROF	TOT	PROF
1	5.00	9.4	5.7	9.1	0.622	0.659	0.233	0.285	0.093	0.093
2	10.00	9.5	5.7	8.3	0.514	0.757	0.191	0.191	0.064	0.064
3	15.00	10.0	6.0	7.9	0.477	0.856	0.127	0.127	0.043	0.043
4	30.00	10.9	6.3	8.1	0.465	0.805	0.095	0.095	0.032	0.032
5	50.00	12.5	6.8	7.8	0.528	0.924	0.067	0.067	0.022	0.022
6	70.00	13.8	7.1	9.0	0.490	0.954	0.042	0.042	0.012	0.012
7	85.00	14.4	7.4	8.3	0.443	0.946	0.055	0.055	0.013	0.013
8	90.00	14.5	7.4	8.1	0.425	0.939	0.059	0.059	0.014	0.014
9	95.00	14.8	7.6	7.3	0.386	0.932	0.067	0.067	0.015	0.015

TABLE VII. - Continued.

(L) 90 Percent of design speed; reading 3016

RP	RADII		ABS BETAM		REL BETAM		TOTAL TEMP		TOTAL PRESS	
	IN	OUT	IN	OUT	IN	OUT	IN	RATIO	IN	RATIO
1	24.422	25.782	0.1	22.3	55.1	43.2	289.0	1.069	10.08	1.244
2	23.569	23.663	0.1	22.0	52.8	41.8	288.8	1.069	10.13	1.257
3	22.758	22.347	0.1	22.4	51.6	40.1	288.6	1.068	10.14	1.259
4	20.204	20.196	0.1	25.6	47.0	52.9	288.1	1.068	10.14	1.260
5	17.170	17.328	0.1	29.9	41.9	21.9	287.8	1.065	10.14	1.249
6	14.232	14.460	0.1	52.2	36.9	10.9	287.7	1.061	10.14	1.223
7	12.144	12.311	0.1	34.3	52.9	0.7	287.7	1.057	10.14	1.208
8	11.473	11.593	0.1	35.0	31.6	-2.4	287.6	1.055	10.14	1.194
9	10.813	10.876	0.1	35.9	30.7	-5.0	287.7	1.052	10.10	1.167

RP	ABS VEL		REL VEL		MERID VEL		TANG VEL		WHEEL SPEED	
	IN	OUT	IN	OUT	IN	OUT	IN	OUT	IN	OUT
1	183.5	205.4	321.1	260.9	183.5	190.0	0.2	78.1	263.7	256.8
2	193.3	207.2	319.6	257.7	193.3	192.1	0.2	77.5	254.7	249.2
3	194.2	207.7	312.7	251.2	194.2	192.0	0.2	79.1	245.3	241.1
4	203.7	214.7	298.7	230.5	203.7	193.7	0.2	92.7	218.7	217.8
5	236.6	226.8	277.4	266.4	206.6	191.5	0.2	109.9	185.3	187.0
6	204.3	224.8	255.6	195.7	204.3	190.3	0.2	119.7	153.8	156.3
7	202.1	231.7	240.8	191.4	202.1	191.4	0.2	130.6	131.1	132.9
8	200.9	232.2	235.9	190.5	200.9	190.3	0.2	133.0	123.9	125.1
9	196.9	227.6	228.9	185.0	196.9	184.3	0.2	133.5	116.9	117.6

RP	ABS MACH NO		REL MACH NO		MERID MACH NO		MERID PEAK SS	
	IN	OUT	IN	OUT	IN	OUT	VEL R	MACH NO
1	0.555	0.604	0.971	0.767	0.555	0.559	1.036	1.379
2	0.587	0.610	0.970	0.758	0.587	0.565	0.994	1.327
3	0.590	0.612	0.950	0.740	0.590	0.566	0.989	1.293
4	0.621	0.635	0.911	0.682	0.621	0.573	0.951	1.172
5	0.631	0.655	0.848	0.613	0.631	0.568	0.927	1.024
6	0.624	0.670	0.780	0.577	0.624	0.567	0.931	0.873
7	0.617	0.694	0.735	0.573	0.617	0.573	0.947	0.743
8	0.613	0.696	0.720	0.571	0.613	0.571	0.947	0.720
9	0.600	0.682	0.697	0.555	0.600	0.553	0.936	0.697

RP	PERCENT	INCIDENCE		DEV	D-FACT	EFF	LOSS COEFF		LOSS PARAM	
	SPAN	MEAN	SS				TOT	PROF	TOT	PROF
1	5.00	-0.5	-4.2	4.6	0.305	0.927	0.036	0.024	0.013	0.009
2	10.00	-0.8	-4.6	4.9	0.307	0.932	0.009	0.002	0.003	0.001
3	15.00	-0.4	-4.3	5.4	0.311	0.995	0.002	-0.002	0.001	-0.001
4	30.00	0.0	-4.6	4.9	0.356	1.005	-0.003	-0.003	-0.001	-0.001
5	50.00	1.5	-4.2	5.2	0.396	1.003	-0.002	-0.002	-0.001	-0.001
6	70.00	3.2	-3.4	7.4	0.380	0.970	0.019	0.019	0.005	0.005
7	85.00	4.1	-3.0	8.4	0.341	0.966	0.021	0.021	0.005	0.005
8	90.00	4.3	-2.8	8.8	0.326	0.946	0.034	0.034	0.008	0.008
9	95.00	4.9	-2.2	9.7	0.321	0.870	0.080	0.080	0.018	0.018

TABLE VII. - Continued.

(m) 90 Percent of design speed; reading 2997

RP	RADII		ABS BETAM		REL BETAM		TOTAL TEMP		TOTAL PRESS	
	IN	OUT	IN	OUT	IN	OUT	IN	RATIO	IN	RATIO
1	24.422	23.782	0.0	27.0	57.1	43.0	289.0	1.080	10.08	1.286
2	23.569	23.063	0.0	26.0	54.7	41.8	288.8	1.078	10.13	1.293
3	22.738	22.347	0.0	26.1	53.6	40.2	288.6	1.077	10.14	1.296
4	20.284	20.196	0.0	29.0	49.1	33.3	288.0	1.074	10.14	1.283
5	17.170	17.328	0.0	32.6	44.0	23.1	287.8	1.069	10.14	1.258
6	14.232	14.460	0.0	34.8	39.0	11.1	287.8	1.063	10.14	1.233
7	12.144	12.311	0.0	36.7	35.1	0.8	287.8	1.059	10.14	1.208
8	11.473	11.593	0.0	37.6	33.7	-2.5	287.7	1.056	10.13	1.191
9	10.813	10.876	0.0	38.4	32.6	-5.7	287.8	1.053	10.10	1.175

RP	ABS VEL		REL VEL		MERID VEL		TANG VEL		WHEEL SPEED	
	IN	OUT	IN	OUT	IN	OUT	IN	OUT	IN	OUT
1	170.4	199.8	313.7	243.4	170.4	176.1	0.1	90.6	263.5	256.6
2	180.0	200.7	311.8	241.9	180.0	180.3	0.1	88.1	254.7	249.3
3	181.0	201.4	305.1	236.7	181.0	180.8	0.1	88.7	245.7	241.4
4	189.1	205.5	289.1	215.2	189.1	179.8	0.1	99.5	218.7	217.8
5	191.9	208.6	266.8	191.0	191.9	175.7	0.1	112.4	185.5	187.2
6	189.4	213.4	243.7	178.6	189.4	175.3	0.1	121.7	155.5	155.9
7	186.7	218.3	228.1	175.1	186.7	175.1	0.1	130.4	131.1	133.0
8	185.9	217.8	223.4	172.7	185.9	172.5	0.1	132.9	124.0	125.3
9	182.3	216.6	216.5	170.7	182.3	169.8	0.1	134.4	116.9	117.6

RP	ABS MACH NO		REL MACH NO		MERID MACH NO		MERID PEAK SS	
	IN	OUT	IN	OUT	IN	OUT	VEL R	MACH NO
1	0.513	0.583	0.944	0.710	0.513	0.520	1.045	1.405
2	0.544	0.587	0.942	0.707	0.544	0.527	1.002	1.353
3	0.547	0.589	0.922	0.693	0.547	0.529	0.999	1.319
4	0.574	0.604	0.877	0.652	0.574	0.528	0.951	1.195
5	0.583	0.615	0.811	0.563	0.583	0.518	0.916	1.046
6	0.575	0.633	0.740	0.529	0.575	0.520	0.926	0.895
7	0.566	0.650	0.692	0.521	0.566	0.521	0.938	0.790
8	0.564	0.649	0.678	0.515	0.564	0.514	0.928	0.754
9	0.552	0.646	0.656	0.509	0.552	0.507	0.932	0.721

RP	PERCENT		INCIDENCE		DEV	D-FACT	EFF	LOSS COEFF		LOSS PARAM	
	SPAN		MEAN	SS				TOT	PROF	TOT	PROF
1	5.00		1.5	-2.2	4.3	0.363	0.932	0.039	0.028	0.014	0.010
2	10.00		1.2	-2.6	4.9	0.356	0.976	0.014	0.007	0.005	0.002
3	15.00		1.6	-2.3	5.5	0.356	1.002	-0.001	-0.005	-0.000	-0.002
4	30.00		2.2	-2.4	5.4	0.397	0.996	0.002	0.002	0.001	0.001
5	50.00		3.7	-2.0	6.3	0.433	0.979	0.014	0.014	0.004	0.004
6	70.00		5.3	-1.3	7.6	0.414	0.982	0.012	0.012	0.004	0.004
7	85.00		6.2	-0.9	8.5	0.376	0.945	0.039	0.039	0.010	0.010
8	90.00		6.4	-0.7	8.7	0.368	0.915	0.039	0.039	0.014	0.014
9	95.00		6.9	-0.2	9.0	0.349	0.883	0.082	0.082	0.018	0.018

TABLE VII. - Continued.

(n) 90 Percent of design speed; reading 2998

RP	RADII		ABS BETAM		REL BETAM		TOTAL TEMP		TOTAL PRESS	
	IN	OUT	IN	OUT	IN	OUT	IN	RATIO	IN	RATIO
1	24.422	23.782	0.0	29.7	58.6	45.8	289.0	1.087	10.09	1.306
2	23.569	23.063	0.0	29.0	56.3	41.6	288.8	1.065	10.13	1.323
3	22.738	22.347	0.0	29.5	55.2	40.3	288.5	1.085	10.14	1.316
4	20.284	20.196	0.0	32.0	51.0	35.5	287.9	1.079	10.14	1.363
5	17.170	17.328	0.0	35.0	45.9	25.9	287.8	1.072	10.14	1.267
6	14.232	14.460	0.0	37.0	40.8	11.5	287.8	1.064	10.13	1.257
7	12.144	12.311	0.0	39.0	36.8	0.6	287.8	1.059	10.14	1.209
8	11.473	11.593	0.0	39.8	35.4	-2.5	287.8	1.055	10.13	1.168
9	10.813	10.876	0.0	40.5	34.3	-6.1	287.8	1.055	10.10	1.175

RP	ABS VEL		REL VEL		MERID VEL		TANG VEL		WHEEL SPEED	
	IN	OUT	IN	OUT	IN	OUT	IN	OUT	IN	OUT
1	161.3	193.7	309.3	233.0	161.3	169.3	0.1	95.9	265.9	257.0
2	169.7	197.7	305.9	231.1	169.7	172.9	0.1	95.8	254.6	249.1
3	170.9	196.3	299.3	224.2	170.9	170.9	0.1	96.5	245.8	241.6
4	177.8	200.1	282.2	203.6	177.8	169.8	0.1	95.9	219.3	218.3
5	180.0	200.6	258.6	179.5	180.0	164.2	0.1	95.2	185.8	187.5
6	178.1	204.9	235.5	166.9	178.1	163.6	0.1	95.4	154.1	156.6
7	175.7	209.0	219.4	162.3	175.7	162.3	0.1	93.6	131.5	133.3
8	175.0	207.2	214.6	159.4	175.0	159.3	0.1	95.6	124.3	125.6
9	171.7	207.4	207.8	158.7	171.7	157.8	0.1	94.6	117.1	117.8

RP	ABS MACH NO		REL MACH NO		MERID MACH NO		LOSS	MERID PEAK SS	
	IN	OUT	IN	OUT	IN	OUT		VEL R	MACH NO
1	0.484	0.562	0.929	0.676	0.484	0.488	0.058	1.045	1.428
2	0.511	0.575	0.921	0.672	0.511	0.563	0.014	1.018	1.372
3	0.515	0.572	0.902	0.653	0.515	0.498	0.013	1.000	1.339
4	0.537	0.585	0.853	0.596	0.537	0.497	0.003	0.955	1.216
5	0.545	0.589	0.783	0.527	0.545	0.482	0.017	0.912	1.063
6	0.539	0.605	0.712	0.493	0.539	0.483	0.015	0.918	0.912
7	0.531	0.620	0.663	0.481	0.531	0.481	0.040	0.924	0.805
8	0.529	0.615	0.648	0.473	0.529	0.475	0.058	0.910	0.770
9	0.518	0.617	0.627	0.472	0.518	0.469	0.078	0.919	0.737

RP	PERCENT		INCIDENCE		DEV	D-FACT	EFF	LOSS COEFF		LOSS PARAM	
	SPAN	MEAN	SS	SS				TOT	PROF	TOT	PROF
1	5.00	3.0	-0.7	5.1	0.396	0.909	0.058	0.046	0.020	0.016	
2	10.00	2.8	-1.0	4.7	0.391	0.978	0.014	0.007	0.005	0.002	
3	15.00	3.2	-0.8	5.6	0.397	0.980	0.013	0.009	0.005	0.003	
4	30.00	4.0	-0.6	5.6	0.433	0.996	0.003	0.002	0.001	0.001	
5	50.00	5.6	-0.1	7.0	0.463	0.975	0.017	0.017	0.006	0.006	
6	70.00	7.1	0.5	8.0	0.446	0.980	0.015	0.015	0.004	0.004	
7	85.00	7.9	0.9	8.3	0.411	0.948	0.040	0.040	0.010	0.010	
8	90.00	8.1	1.0	8.7	0.403	0.922	0.058	0.058	0.014	0.014	
9	95.00	8.5	1.4	8.6	0.380	0.896	0.078	0.078	0.017	0.017	

TABLE VII. - Continued.

(o) 90 Percent of design speed; reading 2999

RP	RADII		ABS BETAM		REL BETAM		TOTAL TEMP		TOTAL PRESS	
	IN	OUT	IN	OUT	IN	OUT	IN	RATIO	IN	RATIO
1	24.422	23.782	0.0	33.5	60.2	43.9	288.9	1.094	10.10	1.322
2	23.569	23.063	0.0	31.7	58.1	41.9	288.7	1.091	10.13	1.336
3	22.738	22.347	0.0	31.8	57.0	40.3	288.4	1.088	10.13	1.333
4	20.284	20.196	0.0	34.4	52.8	34.3	288.0	1.081	10.14	1.308
5	17.170	17.328	0.0	37.8	47.8	24.8	287.9	1.072	10.14	1.264
6	14.232	14.460	0.0	39.9	43.0	12.0	287.9	1.064	10.14	1.235
7	12.144	12.311	0.0	40.7	38.7	0.7	287.9	1.058	10.14	1.209
8	11.473	11.593	0.0	41.3	37.2	-2.6	287.9	1.055	10.13	1.190
9	10.813	10.876	0.0	42.5	36.2	-7.1	287.9	1.053	10.10	1.180

RP	ABS VEL		REL VEL		MERID VEL		TANG VEL		WHEEL SPEED	
	IN	OUT	IN	OUT	IN	OUT	IN	OUT	IN	OUT
1	151.6	190.4	305.0	220.4	151.6	158.6	0.1	105.0	264.8	257.8
2	158.7	193.6	309.4	221.3	158.7	164.7	0.1	101.7	255.1	249.6
3	159.6	193.4	292.8	215.4	159.6	164.3	0.1	102.0	245.5	241.3
4	166.4	193.5	275.3	193.3	166.4	159.6	0.1	109.4	219.3	218.4
5	167.7	191.2	249.9	166.4	167.7	151.0	0.1	117.2	185.3	187.0
6	166.2	195.6	227.0	153.4	166.2	150.1	0.1	125.4	154.8	157.3
7	164.1	201.5	210.2	152.7	164.1	152.7	0.1	131.5	131.4	133.3
8	163.2	200.0	205.0	150.3	163.2	150.1	0.1	132.1	124.1	125.4
9	160.0	201.5	198.3	149.6	160.0	148.5	0.1	136.3	117.1	117.8

RP	ABS MACH NO		REL MACH NO		MERID MACH NO		MERID PEAK SS	
	IN	OUT	IN	OUT	IN	OUT	VEL R	MACH NO
1	0.454	0.550	0.913	0.637	0.454	0.459	1.048	1.455
2	0.477	0.561	0.902	0.641	0.477	0.477	1.037	1.398
3	0.479	0.561	0.880	0.625	0.479	0.477	1.030	1.359
4	0.501	0.564	0.829	0.564	0.501	0.466	0.959	1.235
5	0.506	0.560	0.753	0.487	0.506	0.442	0.900	1.074
6	0.501	0.576	0.684	0.451	0.501	0.442	0.903	0.928
7	0.494	0.596	0.633	0.452	0.494	0.452	0.931	0.814
8	0.491	0.592	0.617	0.445	0.491	0.445	0.920	0.778
9	0.481	0.598	0.596	0.444	0.481	0.440	0.928	0.747

RP	PERCENT		INCIDENCE		DEV	D-FACT	EFF	LOSS COEFF		LOSS PARAM	
	SPAN	MEAN	MEAN	SS				TOT	PROF	TOT	PROF
1	5.00	4.6	0.9	5.2	0.443	0.281	0.033	0.070	0.029	0.024	
2	10.00	4.6	0.8	5.0	0.422	0.944	0.040	0.031	0.014	0.011	
3	15.00	5.0	1.0	5.6	0.423	0.968	0.025	0.018	0.008	0.006	
4	30.00	5.8	1.2	6.4	0.461	0.985	0.011	0.011	0.004	0.004	
5	50.00	7.5	1.8	8.1	0.500	0.969	0.024	0.024	0.008	0.008	
6	70.00	9.3	2.6	8.5	0.487	0.972	0.022	0.022	0.006	0.006	
7	85.00	9.8	2.8	8.3	0.450	0.957	0.035	0.035	0.009	0.009	
8	90.00	9.9	2.8	8.7	0.419	0.929	0.057	0.057	0.013	0.013	
9	95.00	10.4	3.3	7.6	0.398	0.907	0.077	0.077	0.017	0.017	

TABLE VII. - Continued.

(p) 90 Percent of design speed; reading 3000

RP	RADII		ABS BETAM		REL BETAM		TOTAL TEMP		TOTAL PRESS	
	IN	OUT	IN	OUT	IN	OUT	IN	RATIO	IN	RATIO
1	24.422	25.782	0.0	35.6	61.9	44.7	288.9	1.098	10.10	1.314
2	23.589	23.063	0.0	34.0	59.9	42.9	288.6	1.094	10.13	1.327
3	22.738	22.347	0.0	34.0	58.8	41.7	288.5	1.090	10.13	1.320
4	20.284	20.196	0.0	37.1	54.6	35.6	289.0	1.084	10.14	1.296
5	17.170	17.328	0.0	40.4	50.0	24.7	287.9	1.075	10.14	1.269
6	14.232	14.460	0.0	41.2	44.9	12.1	287.9	1.065	10.14	1.236
7	12.144	12.311	0.0	42.4	40.6	0.9	287.9	1.058	10.14	1.204
8	11.473	11.593	0.0	42.9	39.3	-2.8	287.9	1.055	10.13	1.192
9	10.813	10.876	0.0	43.6	38.1	-7.2	287.9	1.055	10.11	1.185

RP	ABS VEL		REL VEL		MERID VEL		TANG VEL		WHEEL SPEED	
	IN	OUT	IN	OUT	IN	OUT	IN	OUT	IN	OUT
1	140.7	185.1	298.9	211.9	140.7	150.5	0.0	107.8	253.8	256.9
2	147.9	188.0	294.9	212.7	147.9	155.9	0.0	105.0	255.2	249.7
3	149.0	186.3	287.8	206.9	149.0	154.4	0.0	104.3	246.2	242.0
4	154.6	186.0	268.5	182.5	154.6	148.4	0.0	112.2	219.5	218.5
5	155.7	187.6	242.1	157.3	155.7	142.9	0.0	121.5	185.4	187.1
6	154.6	191.0	218.3	147.0	154.6	143.7	0.1	125.8	154.1	156.6
7	152.9	194.0	201.5	143.4	152.9	143.4	0.0	130.7	131.3	133.1
8	151.8	194.7	196.1	142.8	151.8	142.7	0.0	132.5	124.2	125.4
9	149.2	197.2	189.6	144.0	149.2	142.8	0.1	135.9	117.1	117.8

RP	ABS MACH NO		REL MACH NO		MERID MACH NO		MERID PEAK SS	
	IN	OUT	IN	OUT	IN	OUT	VEL R	MACH NO
1	0.420	0.533	0.893	0.610	0.420	0.434	1.070	1.475
2	0.443	0.543	0.883	0.615	0.443	0.451	1.054	1.423
3	0.446	0.539	0.862	0.599	0.446	0.447	1.037	1.386
4	0.464	0.540	0.806	0.530	0.464	0.431	0.959	1.255
5	0.468	0.548	0.727	0.459	0.468	0.417	0.918	1.089
6	0.464	0.561	0.655	0.432	0.464	0.422	0.930	0.933
7	0.459	0.572	0.605	0.423	0.459	0.423	0.938	0.820
8	0.455	0.575	0.588	0.422	0.455	0.422	0.940	0.786
9	0.447	0.583	0.569	0.426	0.447	0.423	0.958	0.752

RP	PERCENT	INCIDENCE		DEV	D-FACT	EFF	LOSS COEFF		LOSS PARAM	
	SPAN	MEAN	SS				TOT	PROF	TOT	PROF
1	5.00	6.3	2.6	6.1	0.465	0.829	0.127	0.113	0.044	0.039
2	10.00	6.4	2.6	6.0	0.446	0.898	0.075	0.066	0.026	0.023
3	15.00	6.8	2.9	7.0	0.446	0.914	0.063	0.058	0.022	0.020
4	30.00	7.8	3.2	7.7	0.492	0.918	0.063	0.063	0.021	0.021
5	50.00	9.6	3.9	7.9	0.528	0.944	0.046	0.046	0.015	0.015
6	70.00	11.2	4.6	8.6	0.496	0.962	0.032	0.032	0.009	0.009
7	85.00	11.8	4.7	8.6	0.451	0.939	0.054	0.054	0.013	0.013
8	90.00	12.0	4.9	8.4	0.431	0.927	0.064	0.064	0.015	0.015
9	95.00	12.4	5.3	7.4	0.400	0.901	0.090	0.090	0.020	0.020

TABLE VII. - Continued.

(q) 90 Percent of design speed; reading 3001

RP	RADII		ABS BETAM		REL BETAM		TOTAL TEMP		TOTAL PRESS	
	IN	OUT	IN	OUT	IN	OUT	IN	RATIO	IN	RATIO
1	24.422	23.782	0.0	45.3	64.3	47.0	288.7	1.108	10.10	1.284
2	23.569	23.063	0.0	39.0	62.3	44.6	288.5	1.100	10.13	1.295
3	22.738	22.347	0.0	37.5	61.1	42.5	288.3	1.095	10.14	1.299
4	20.284	20.196	0.0	39.5	57.0	35.8	288.0	1.087	10.13	1.289
5	17.170	17.328	0.0	41.7	51.9	24.3	288.0	1.077	10.14	1.271
6	14.232	14.460	-0.0	41.9	46.6	11.7	288.0	1.067	10.14	1.241
7	12.144	12.311	0.	43.3	42.4	0.1	287.9	1.060	10.14	1.211
8	11.473	11.593	-0.0	43.7	41.0	-3.3	287.9	1.056	10.13	1.195
9	10.813	10.876	0.	43.9	39.8	-7.4	287.9	1.055	10.11	1.187

RP	ABS VEL		REL VEL		MERID VEL		TANG VEL		WHEEL SPEED	
	IN	OUT	IN	OUT	IN	OUT	IN	OUT	IN	OUT
1	127.6	176.0	293.7	181.5	127.6	123.9	0.0	125.1	264.6	257.7
2	134.1	178.9	288.1	195.3	134.1	139.1	0.0	112.5	255.1	249.6
3	135.8	180.8	280.9	194.7	135.8	143.5	0.0	110.0	245.9	241.7
4	142.2	183.0	261.1	174.1	142.2	141.2	0.0	116.4	219.0	218.1
5	145.3	186.6	235.6	152.9	145.3	139.3	0.0	124.2	185.5	187.2
6	145.7	190.8	212.3	145.1	145.7	142.1	-0.0	127.3	154.3	156.8
7	144.0	194.0	195.0	141.2	144.0	141.2	0.	132.9	131.4	133.2
8	142.8	193.4	189.2	140.1	142.8	139.9	-0.0	133.5	124.2	125.4
9	140.4	196.3	182.9	142.5	140.4	141.3	0.	136.2	117.2	117.8

RP	ABS MACH NO		REL MACH NO		MERID MACH NO		MERID PEAK SS	
	IN	OUT	IN	OUT	IN	OUT	VEL R	MACH NO
1	0.380	0.503	0.875	0.519	0.380	0.354	0.971	1.515
2	0.400	0.514	0.860	0.561	0.400	0.400	1.037	1.455
3	0.406	0.521	0.839	0.561	0.406	0.413	1.056	1.413
4	0.425	0.530	0.781	0.504	0.425	0.409	0.993	1.275
5	0.435	0.544	0.706	0.446	0.435	0.406	0.959	1.104
6	0.436	0.560	0.636	0.426	0.436	0.417	0.975	0.943
7	0.431	0.572	0.584	0.416	0.431	0.416	0.981	0.828
8	0.428	0.571	0.566	0.414	0.428	0.413	0.979	0.792
9	0.420	0.580	0.547	0.421	0.420	0.418	1.006	0.757

RP	PERCENT		INCIDENCE		DEV	D-FACT	EFF	LOSS COEFF		LOSS PARAM	
	SPAN	MEAN	SS	TOT				PROF	TOT	PROF	
1	5.00	8.7	5.0	8.3	0.587	0.683	0.261	0.244	0.087	0.081	
2	10.00	8.7	4.9	7.7	0.505	0.764	0.189	0.179	0.064	0.060	
3	15.00	9.1	5.1	7.8	0.485	0.814	0.148	0.143	0.050	0.048	
4	30.00	10.0	5.4	7.8	0.517	0.866	0.111	0.111	0.037	0.037	
5	50.00	11.6	5.9	7.6	0.537	0.917	0.073	0.073	0.023	0.023	
6	70.00	12.9	6.3	8.2	0.493	0.944	0.052	0.052	0.015	0.015	
7	85.00	13.5	6.5	7.8	0.447	0.940	0.058	0.058	0.014	0.014	
8	90.00	13.7	6.6	7.9	0.427	0.927	0.070	0.070	0.016	0.016	
9	95.00	14.1	7.0	7.3	0.366	0.911	0.088	0.088	0.019	0.019	

TABLE VII. - Continued.

(r) 100 Percent of design speed; reading 3017

RP	RADII		ABS BETAM		REL BETAM		TOTAL TEMP		TOTAL PRESS	
	IN	OUT	IN	OUT	IN	OUT	IN	RATIO	IN	RATIO
1	24.422	23.782	0.1	27.4	56.7	44.4	289.0	1.097	10.06	1.321
2	23.589	23.063	0.1	26.1	54.1	42.7	286.7	1.096	10.13	1.332
3	22.758	22.347	0.1	27.2	52.9	40.7	288.5	1.094	10.14	1.341
4	20.284	20.196	0.1	29.9	48.4	33.0	288.1	1.092	10.14	1.341
5	17.170	17.328	0.1	32.7	43.1	22.1	287.9	1.084	10.14	1.324
6	14.232	14.460	0.1	34.5	38.0	10.5	287.8	1.078	10.14	1.294
7	12.144	12.311	0.1	36.4	33.9	0.7	287.7	1.071	10.14	1.252
8	11.473	11.593	0.1	36.9	32.6	-1.8	287.7	1.067	10.14	1.227
9	10.813	10.876	0.1	37.7	31.6	-4.4	287.7	1.063	10.10	1.199

RP	ABS VEL		REL VEL		MERID VEL		TANG VEL		WHEEL SPEED	
	IN	OUT	IN	OUT	IN	OUT	IN	OUT	IN	OUT
1	192.5	214.6	350.5	266.8	192.5	190.5	0.2	99.7	293.1	285.4
2	204.4	217.9	348.8	266.4	204.4	195.6	0.2	96.0	282.8	276.8
3	206.2	219.7	342.1	257.7	206.2	195.4	0.2	100.5	273.1	268.4
4	216.1	228.4	325.5	236.1	216.1	197.9	0.2	113.9	245.7	242.6
5	220.1	235.6	301.3	214.0	220.1	198.3	0.2	127.2	205.9	207.8
6	216.6	241.6	277.4	202.5	216.6	199.1	0.2	136.8	171.0	173.7
7	216.3	244.6	260.6	196.9	216.3	196.9	0.2	145.2	145.7	147.7
8	215.2	242.0	255.4	193.7	215.2	193.6	0.2	145.2	137.7	139.1
9	210.8	237.5	247.5	188.5	210.8	187.9	0.2	145.3	129.9	130.7

RP	ABS MACH NO		REL MACH NO		MERID MACH NO		MERID PEAK SS	
	IN	OUT	IN	OUT	IN	OUT	VEL R	MACH NO
1	0.584	0.624	1.063	0.776	0.584	0.554	0.990	1.497
2	0.623	0.635	1.063	0.777	0.623	0.570	0.957	1.439
3	0.629	0.642	1.044	0.753	0.629	0.571	0.948	1.421
4	0.662	0.670	0.998	0.693	0.662	0.581	0.916	1.334
5	0.676	0.697	0.925	0.633	0.676	0.586	0.901	1.160
6	0.671	0.719	0.852	0.603	0.671	0.592	0.911	0.994
7	0.664	0.732	0.800	0.589	0.664	0.589	0.910	0.866
8	0.660	0.724	0.783	0.580	0.660	0.580	0.900	0.821
9	0.645	0.711	0.758	0.564	0.645	0.563	0.891	0.784

RP	PERCENT SPAN		INCIDENCE		DEV	D-FACT	EFF	LOSS COEFF		LOSS PARAM	
			MEAN	SS				TOT	PROF	TOT	PROF
1	5.00	1.1	-2.6	5.8	0.374	0.850	0.088	0.054	0.031	0.019	
2	10.00	0.6	-3.2	5.8	0.365	0.891	0.065	0.038	0.022	0.013	
3	15.00	0.9	-3.0	6.0	0.380	0.932	0.040	0.019	0.014	0.007	
4	30.00	1.4	-3.2	5.1	0.419	0.947	0.033	0.024	0.012	0.008	
5	50.00	2.7	-3.0	5.4	0.439	0.992	0.005	0.005	0.002	0.002	
6	70.00	4.3	-2.3	7.0	0.415	0.978	0.014	0.014	0.004	0.004	
7	85.00	5.0	-2.0	8.4	0.384	0.936	0.043	0.043	0.011	0.011	
8	90.00	5.3	-1.8	9.4	0.376	0.898	0.067	0.067	0.016	0.016	
9	95.00	5.8	-1.3	10.2	0.369	0.848	0.098	0.098	0.022	0.022	

TABLE VII. - Continued.

(s) 100 Percent of design speed; reading 2996

RP	RADII		ABS BETAM		REL BETAM		TOTAL TEMP		TOTAL PRESS	
	IN	OUT	IN	OUT	IN	OUT	IN	RATIO	IN	RATIO
1	24.422	23.782	0.0	30.3	57.3	43.3	289.1	1.109	10.08	1.373
2	25.569	23.063	0.0	30.0	54.9	41.8	288.8	1.106	10.13	1.381
3	22.738	22.347	0.0	30.1	53.7	40.3	288.6	1.104	10.14	1.378
4	20.284	20.196	0.0	32.5	49.3	32.6	288.0	1.098	10.14	1.374
5	17.170	17.328	0.0	35.1	44.1	21.8	287.8	1.090	10.14	1.345
6	14.232	14.460	0.0	36.1	39.0	11.0	287.7	1.080	10.14	1.295
7	12.144	12.311	0.0	38.1	35.1	0.7	287.6	1.072	10.14	1.256
8	11.473	11.593	0.0	38.6	33.6	-2.1	287.5	1.069	10.14	1.228
9	10.813	10.876	0.0	39.8	32.7	-5.6	287.6	1.065	10.09	1.209

RP	ABS VEL		REL VEL		MERID VEL		TANG VEL		WHEEL SPEED	
	IN	OUT	IN	OUT	IN	OUT	IN	OUT	IN	OUT
1	188.5	216.9	348.7	257.4	188.5	187.3	0.1	109.3	293.5	285.8
2	198.8	217.2	345.7	252.6	198.8	188.2	0.1	108.5	283.0	276.9
3	200.5	217.4	338.7	246.7	200.5	188.2	0.1	108.9	273.2	268.5
4	239.2	224.9	320.6	225.2	209.2	189.8	0.1	120.7	245.1	242.1
5	213.1	230.9	296.5	203.6	213.1	189.0	0.2	132.6	206.4	208.3
6	211.1	235.0	271.7	191.8	211.1	188.3	0.2	137.3	171.2	173.9
7	207.3	235.8	253.4	185.5	207.3	185.5	0.1	145.5	145.9	147.9
8	206.5	233.2	247.9	182.3	206.5	182.2	0.2	145.6	137.4	138.8
9	201.9	231.5	240.0	178.7	201.9	177.9	0.2	148.1	150.0	150.8

RP	ABS MACH NO		REL MACH NO		MERID MACH NO		MERID PEAK SS	
	IN	OUT	IN	OUT	IN	OUT	VEL R	MACH NO
1	0.571	0.626	1.056	0.745	0.571	0.542	0.994	1.513
2	0.604	0.630	1.051	0.732	0.604	0.546	0.947	1.459
3	0.610	0.631	1.031	0.716	0.610	0.546	0.939	1.442
4	0.639	0.658	0.980	0.659	0.639	0.555	0.907	1.340
5	0.653	0.680	0.908	0.600	0.653	0.557	0.887	1.174
6	0.646	0.690	0.832	0.568	0.646	0.558	0.892	1.006
7	0.634	0.702	0.775	0.552	0.634	0.552	0.895	0.886
8	0.631	0.695	0.758	0.543	0.631	0.543	0.882	0.841
9	0.616	0.690	0.732	0.535	0.616	0.531	0.881	0.809

RP	PERCENT SPAN	INCIDENCE		DEV	D-FACT	EFF	LOSS COEFF		LOSS PARAM	
		MEAN	SS				TOT	PROF	TOT	PROF
1	5.00	1.7	-2.0	4.7	0.413	0.871	0.084	0.048	0.030	0.017
2	10.00	1.4	-2.4	4.9	0.416	0.910	0.059	0.051	0.021	0.011
3	15.00	1.7	-2.2	5.6	0.418	0.922	0.051	0.028	0.018	0.010
4	30.00	2.3	-2.3	4.7	0.452	0.969	0.021	0.012	0.007	0.004
5	50.00	3.8	-1.9	5.1	0.471	0.936	0.009	0.009	0.003	0.003
6	70.00	5.3	-1.3	7.5	0.443	0.957	0.030	0.030	0.009	0.009
7	85.00	6.2	-0.8	8.4	0.412	0.927	0.052	0.052	0.013	0.013
8	90.00	6.3	-0.8	9.1	0.403	0.891	0.024	0.034	0.020	0.020
9	95.00	7.0	-0.1	9.1	0.392	0.853	0.104	0.104	0.023	0.023

TABLE VII. - Continued.

(t) 100 Percent of design speed; reading 2993

RP	RADII		ABS BETAM		REL BETAM		TOTAL TEMP		TOTAL PRESS	
	IN	OUT	IN	OUT	IN	OUT	IN	RATIO	IN	RATIO
1	24.422	23.782	0.0	34.9	59.9	43.0	289.3	1.118	10.08	1.414
2	25.569	23.063	0.0	33.3	56.6	41.6	288.9	1.116	10.13	1.424
3	22.738	22.347	0.0	33.1	55.4	39.8	288.6	1.114	10.13	1.424
4	20.284	20.196	0.0	35.1	51.1	32.7	288.0	1.105	10.14	1.403
5	17.170	17.328	0.0	37.9	46.1	22.7	287.7	1.093	10.14	1.351
6	14.232	14.460	0.0	38.7	41.0	12.1	287.7	1.079	10.14	1.288
7	12.144	12.311	0.0	40.4	37.0	0.5	287.6	1.074	10.14	1.259
8	11.473	11.593	0.0	41.1	35.6	-2.6	287.6	1.069	10.14	1.232
9	10.813	10.876	0.0	42.1	34.4	-6.8	287.6	1.067	10.10	1.216

RP	ABS VEL		REL VEL		MERID VEL		TANG VEL		WHEEL SPEED	
	IN	OUT	IN	OUT	IN	OUT	IN	OUT	IN	OUT
1	177.2	213.6	342.7	239.6	177.2	175.1	0.1	122.3	293.5	285.8
2	187.0	215.1	339.9	240.6	187.0	179.9	0.1	118.0	283.9	277.9
3	188.3	215.8	331.6	235.2	188.3	180.8	0.1	117.9	273.1	268.4
4	196.3	220.5	312.8	214.2	196.3	180.3	0.1	126.9	243.6	242.6
5	198.3	220.5	285.9	188.5	198.3	173.9	0.1	135.5	206.2	208.0
6	196.1	218.9	259.9	174.8	196.1	170.9	0.1	136.8	170.7	173.4
7	193.0	225.8	241.8	171.9	193.0	171.9	0.1	146.4	145.8	147.8
8	192.3	223.6	236.5	168.7	192.3	168.6	0.1	146.9	137.8	139.2
9	188.7	223.9	228.7	167.3	188.7	166.2	0.1	150.1	129.5	130.2

RP	ABS MACH NO		REL MACH NO		MERID MACH NO		MERID PEAK SS	
	IN	OUT	IN	OUT	IN	OUT	VEL R	MACH NO
1	0.534	0.614	1.033	0.689	0.534	0.504	0.989	1.557
2	0.566	0.620	1.029	0.694	0.566	0.519	0.962	1.508
3	0.571	0.623	1.005	0.679	0.571	0.522	0.960	1.493
4	0.597	0.641	0.952	0.623	0.597	0.525	0.918	1.362
5	0.604	0.646	0.871	0.552	0.604	0.509	0.877	1.189
6	0.597	0.645	0.791	0.515	0.597	0.504	0.871	1.018
7	0.587	0.663	0.735	0.509	0.587	0.509	0.891	0.900
8	0.585	0.663	0.719	0.501	0.585	0.500	0.877	0.861
9	0.573	0.665	0.695	0.497	0.573	0.494	0.881	0.821

RP	PERCENT SPAN	INCIDENCE		DEV	D-FACT	EFF	LOSS COEFF		LOSS PARAM	
		MEAN	SS				TOT	PROF	TOT	PROF
1	5.00	5.3	-0.4	4.4	0.473	0.880	0.087	0.047	0.031	0.017
2	10.00	3.1	-0.7	4.7	0.455	0.916	0.061	0.029	0.021	0.010
3	15.00	3.4	-0.5	5.1	0.452	0.934	0.049	0.022	0.017	0.008
4	30.00	4.1	-0.5	4.8	0.482	0.970	0.023	0.014	0.008	0.005
5	50.00	5.8	0.1	5.9	0.508	0.970	0.023	0.023	0.007	0.007
6	70.00	7.3	0.7	8.6	0.482	0.943	0.043	0.043	0.012	0.012
7	85.00	8.2	1.1	8.2	0.441	0.918	0.065	0.065	0.016	0.016
8	90.00	8.3	1.2	8.6	0.433	0.885	0.089	0.089	0.021	0.021
9	95.00	8.7	1.6	7.8	0.414	0.859	0.112	0.112	0.025	0.025

TABLE VII. - Continued.

(u) 100 Percent of design speed; reading 2994

RP	RADII		ABS BETAM		REL BETAM		TOTAL TEMP		TOTAL PRESS	
	IN	OUT	IN	OUT	IN	OUT	IN	RATIO	IN	RATIO
1	24.422	23.782	0.0	37.2	60.4	43.8	289.5	1.125	10.09	1.418
2	23.569	23.063	0.0	35.1	58.2	41.3	288.8	1.122	10.14	1.442
3	22.738	22.347	0.0	35.1	57.0	39.8	288.5	1.119	10.13	1.440
4	20.284	20.196	0.0	36.8	52.7	33.2	288.0	1.108	10.14	1.407
5	17.170	17.328	0.0	39.9	47.8	23.7	287.7	1.093	10.14	1.347
6	14.232	14.460	0.0	40.9	42.9	11.6	287.8	1.083	10.14	1.296
7	12.144	12.311	0.0	42.2	38.7	-0.0	287.7	1.075	10.14	1.263
8	11.473	11.593	0.0	43.1	37.4	-3.7	287.7	1.071	10.14	1.239
9	10.813	10.876	0.0	43.6	36.3	-7.7	287.8	1.068	10.10	1.229

RP	ABS VEL		REL VEL		MERID VEL		TANG VEL		WHEEL SPEED	
	IN	OUT	IN	OUT	IN	OUT	IN	OUT	IN	OUT
1	166.5	208.8	337.2	230.4	166.5	166.3	0.1	126.3	293.4	285.7
2	175.6	213.8	332.8	232.8	175.6	174.8	0.1	123.1	282.8	276.7
3	177.6	213.9	325.8	227.7	177.6	175.0	0.1	123.0	273.3	268.6
4	185.2	215.9	305.9	206.7	185.2	172.9	0.1	129.3	243.6	242.5
5	187.1	212.8	278.4	178.3	187.1	163.3	0.1	136.4	206.2	208.1
6	183.8	213.9	250.7	165.0	183.8	161.6	0.1	140.1	170.7	173.4
7	181.7	220.4	232.9	163.3	181.7	163.3	0.1	148.0	145.9	147.9
8	180.2	218.7	226.7	160.0	180.2	159.7	0.1	149.5	137.7	139.1
9	176.4	220.8	219.0	161.4	176.4	159.9	0.1	152.2	129.9	130.7

RP	ABS MACH NO		REL MACH NO		MERID MACH NO		MERID PEAK SS	
	IN	OUT	IN	OUT	IN	OUT	VEL R	MACH NO
1	0.500	0.598	1.013	0.659	0.500	0.476	0.999	1.603
2	0.530	0.615	1.004	0.669	0.530	0.502	0.996	1.553
3	0.536	0.616	0.984	0.656	0.536	0.504	0.986	1.521
4	0.561	0.626	0.927	0.600	0.561	0.502	0.933	1.378
5	0.568	0.621	0.845	0.521	0.568	0.477	0.873	1.232
6	0.557	0.628	0.760	0.484	0.557	0.474	0.879	1.028
7	0.550	0.651	0.706	0.483	0.550	0.483	0.899	0.909
8	0.545	0.647	0.686	0.473	0.545	0.472	0.886	0.869
9	0.533	0.654	0.662	0.478	0.533	0.474	0.907	0.833

RP	PERCENT		INCIDENCE		DEV	D-FACT	EFF	LOSS COEFF.		LOSS PARAM	
	SPAN	MEAN	SS	TOT				PROF	TOT	PROF	
1	5.00	4.8	1.1	5.1	0.497	0.858	0.125	0.080	0.044	0.028	
2	10.00	4.6	0.8	4.4	0.474	0.907	0.072	0.036	0.026	0.013	
3	15.00	5.0	1.0	5.1	0.473	0.922	0.062	0.033	0.022	0.012	
4	30.00	5.7	1.1	5.3	0.498	0.953	0.037	0.029	0.013	0.010	
5	50.00	7.4	1.7	7.0	0.532	0.956	0.035	0.035	0.011	0.011	
6	70.00	9.2	2.5	8.1	0.506	0.928	0.060	0.060	0.017	0.017	
7	85.00	9.9	2.8	7.6	0.458	0.925	0.064	0.064	0.016	0.016	
8	90.00	10.1	3.0	7.5	0.450	0.894	0.090	0.090	0.021	0.021	
9	95.00	10.6	3.5	7.0	0.417	0.890	0.096	0.096	0.021	0.021	

TABLE VII. - Continued.

(v) 100 Percent of design speed; reading 2995

RP	RADIO		ABS BETAM		REL BETAM		TOTAL TEMP		TOTAL PRESS	
	IN	OUT	IN	OUT	IN	OUT	IN	RATIO	IN	RATIO
1	24.422	23.782	0.0	59.0	61.9	44.2	299.2	1.128	10.10	1.406
2	23.569	23.063	0.0	36.3	59.8	42.1	289.8	1.124	10.13	1.427
3	22.738	22.547	0.0	36.3	58.6	40.5	288.4	1.119	10.14	1.421
4	20.284	20.196	0.0	38.6	54.6	34.4	287.9	1.108	10.13	1.389
5	17.170	17.328	0.0	42.2	49.7	24.5	287.9	1.095	10.14	1.355
6	14.232	14.460	0.0	42.6	44.7	11.1	287.8	1.084	10.13	1.300
7	12.144	12.311	0.0	43.5	40.4	-0.7	287.8	1.076	10.13	1.266
8	11.473	11.593	0.0	43.7	39.1	-4.1	287.8	1.072	10.13	1.250
9	10.813	10.876	0.0	44.2	37.9	-7.8	287.9	1.068	10.11	1.231

RP	ABS VEL		REL VEL		MERID VEL		TANG VEL		WHEEL SPEED	
	IN	OUT	IN	OUT	IN	OUT	IN	OUT	IN	OUT
1	156.4	205.9	332.0	223.4	156.4	160.1	0.1	129.5	292.9	285.3
2	164.9	209.8	327.6	228.0	164.9	169.1	0.1	124.3	285.2	277.2
3	166.5	209.2	319.4	221.9	166.5	168.7	0.1	123.8	272.6	267.9
4	173.5	209.6	299.3	198.4	173.5	163.7	0.1	130.8	244.0	242.9
5	174.8	206.5	270.3	188.0	174.8	152.9	0.1	158.7	206.4	208.3
6	172.9	211.7	243.2	158.8	172.9	155.8	0.1	145.3	171.2	174.0
7	171.1	217.4	224.7	157.7	171.1	157.7	0.1	149.7	145.7	147.7
8	169.5	217.9	218.4	157.9	169.5	157.5	0.1	150.5	137.9	139.2
9	166.7	217.9	211.2	157.7	166.7	156.2	0.1	151.9	129.8	130.5

RP	ABS MACH NO		REL MACH NO		MERID MACH NO		MERID PEAK SS	
	IN	OUT	IN	OUT	IN	OUT	VEL R	MACH NO
1	0.469	0.588	0.995	0.638	0.469	0.457	1.024	1.643
2	0.496	0.602	0.985	0.654	0.496	0.485	1.025	1.584
3	0.501	0.602	0.961	0.638	0.501	0.485	1.013	1.538
4	0.524	0.606	0.904	0.574	0.524	0.474	0.943	1.399
5	0.528	0.601	0.817	0.489	0.528	0.445	0.875	1.217
6	0.522	0.620	0.735	0.465	0.522	0.457	0.901	1.041
7	0.516	0.641	0.678	0.465	0.516	0.465	0.922	0.914
8	0.511	0.644	0.659	0.467	0.511	0.466	0.929	0.876
9	0.502	0.645	0.636	0.467	0.502	0.463	0.937	0.836

RP	PERCENT		INCIDENCE		DEV	D-FACT	EFF	LOSS COEFF		LOSS PARAM	
	SPAN		MEAN	SS				TOT	PROF	TOT	PROF
1	5.00		6.3	2.6	5.6	0.515	0.796	0.164	0.113	0.057	0.040
2	10.00		6.2	2.5	5.2	0.482	0.866	0.108	0.069	0.038	0.024
3	15.00		6.6	2.6	5.8	0.481	0.884	0.094	0.065	0.033	0.023
4	30.00		7.6	3.0	6.5	0.517	0.911	0.072	0.064	0.025	0.022
5	50.00		9.4	3.7	7.7	0.560	0.905	0.081	0.081	0.026	0.026
6	70.00		11.0	4.4	7.6	0.521	0.922	0.071	0.071	0.020	0.020
7	85.00		11.5	4.5	7.0	0.465	0.919	0.075	0.075	0.019	0.019
8	90.00		11.8	4.7	7.1	0.440	0.918	0.075	0.075	0.018	0.018
9	95.00		12.1	5.0	6.9	0.413	0.896	0.097	0.097	0.021	0.021

TABLE VII. - Continued.

(w) 100 Percent of design speed; reading 3026

RP	RADII		ABS BETAM		REL BETAM		TOTAL TEMP		TOTAL PRESS	
	IN	OUT	IN	OUT	IN	OUT	IN	RATIO	IN	RATIO
1	24.422	23.782	0.0	44.1	63.3	44.8	289.1	1.137	10.10	1.400
2	23.569	23.063	0.0	39.1	61.2	42.3	288.7	1.129	10.14	1.423
3	22.738	22.347	0.0	38.8	60.1	40.6	288.3	1.124	10.14	1.420
4	20.284	20.196	0.0	40.0	56.0	34.3	289.0	1.110	10.14	1.392
5	17.170	17.328	0.0	43.1	51.2	24.8	287.9	1.095	10.14	1.333
6	14.232	14.460	0.0	43.8	46.2	11.3	287.9	1.083	10.14	1.294
7	12.144	12.311	0.0	44.1	42.1	-0.8	237.8	1.076	10.14	1.271
8	11.473	11.593	0.0	44.1	40.4	-4.3	287.8	1.072	10.14	1.253
9	10.813	10.876	0.0	44.4	39.1	-7.9	287.8	1.068	10.11	1.233

RP	ABS VEL		REL VEL		MERID VEL		TANG VEL		WHEEL SPEED	
	IN	OUT	IN	OUT	IN	OUT	IN	OUT	IN	OUT
1	147.2	202.6	328.0	205.0	147.2	145.4	0.1	141.1	293.2	285.5
2	155.5	207.6	323.1	217.6	155.5	161.0	0.1	131.0	283.4	277.3
3	157.8	208.2	316.2	213.6	157.8	162.2	0.1	150.5	274.2	269.5
4	164.7	209.0	294.6	193.7	164.7	160.1	0.1	154.4	244.4	243.4
5	165.4	203.7	264.1	163.8	165.4	148.7	0.1	159.2	206.0	207.9
6	163.3	207.1	236.0	152.3	163.3	149.4	0.1	143.4	170.4	173.1
7	162.0	216.3	218.3	155.4	162.0	155.4	0.1	150.5	146.4	148.4
8	161.4	216.8	212.1	156.0	161.4	155.6	0.1	150.9	137.7	139.1
9	158.7	216.2	204.5	155.9	158.7	154.4	0.1	151.4	129.2	129.9

RP	ABS MACH NO		REL MACH NO		MERID MACH NO		MERID PEAK SS	
	IN	OUT	IN	OUT	IN	OUT	VEL R	MACH NO
1	0.440	0.576	0.981	0.582	0.440	0.413	0.983	1.667
2	0.466	0.594	0.969	0.622	0.466	0.461	1.036	1.606
3	0.474	0.597	0.950	0.613	0.474	0.465	1.028	1.567
4	0.496	0.604	0.837	0.560	0.496	0.463	0.972	1.417
5	0.498	0.592	0.796	0.476	0.498	0.432	0.899	1.226
6	0.492	0.606	0.710	0.446	0.492	0.457	0.915	1.043
7	0.488	0.638	0.657	0.458	0.488	0.458	0.959	0.925
8	0.486	0.640	0.638	0.461	0.486	0.460	0.964	0.879
9	0.477	0.640	0.615	0.462	0.477	0.457	0.973	0.836

RP	PERCENT		INCIDENCE		DEV	D-FACT	EFF	LOSS COEFF		LOSS PARAM	
	SPAN	MEAN	SS	TOT				PROF	TOT	PROF	
1	5.00	7.8	4.1	6.2	0.582	0.739	0.224	0.170	0.078	0.059	
2	10.00	7.7	3.9	5.4	0.517	0.825	0.148	0.107	0.052	0.037	
3	15.00	8.1	4.1	5.9	0.512	0.851	0.126	0.094	0.044	0.033	
4	30.00	9.0	4.4	6.3	0.530	0.899	0.086	0.078	0.029	0.026	
5	50.00	10.9	5.2	8.1	0.566	0.960	0.089	0.089	0.028	0.028	
6	70.00	12.5	5.8	7.8	0.535	0.918	0.077	0.077	0.022	0.022	
7	85.00	13.2	6.2	6.9	0.461	0.928	0.071	0.071	0.018	0.018	
8	90.00	13.1	6.0	6.9	0.453	0.929	0.069	0.069	0.016	0.016	
9	95.00	13.4	6.3	6.7	0.402	0.914	0.084	0.084	0.018	0.018	

TABLE VII. - Continued.

(x) 110 Percent of design speed; reading 3023

RP	RADII		ABS BETAM		REL BETAM		TOTAL TEMP		TOTAL PRESS	
	IN	OUT	IN	OUT	IN	OUT	IN	RATIO	IN	RATIO
1	24.422	23.782	0.1	40.5	60.3	44.8	289.1	1.157	10.07	1.510
2	23.569	23.063	0.1	38.1	58.0	41.7	288.8	1.153	10.11	1.544
3	22.738	22.347	0.1	38.4	56.8	39.6	288.4	1.150	10.13	1.542
4	20.284	20.196	0.1	39.3	52.4	32.4	288.1	1.135	10.15	1.509
5	17.170	17.328	0.1	40.8	47.1	22.1	287.9	1.116	10.14	1.446
6	14.232	14.460	0.1	41.0	42.1	10.3	287.7	1.099	10.14	1.380
7	12.144	12.311	0.1	42.5	38.1	0.4	287.7	1.086	10.14	1.312
8	11.473	11.593	0.1	43.2	36.6	-3.3	287.7	1.085	10.14	1.286
9	10.813	10.876	0.1	44.0	35.6	-7.5	287.7	1.080	10.10	1.271

RP	ABS VEL		REL VEL		MERID VEL		TANG VEL		WHEEL SPEED	
	IN	OUT	IN	OUT	IN	OUT	IN	OUT	IN	OUT
1	183.8	223.3	370.8	239.4	185.8	169.8	0.2	145.1	322.2	313.8
2	193.8	230.7	366.0	243.3	193.8	181.7	0.2	142.2	310.7	304.0
3	195.8	231.8	357.6	235.9	195.8	181.8	0.2	143.9	299.4	294.3
4	205.5	236.2	336.5	216.5	205.5	182.8	0.2	149.6	266.7	265.6
5	209.6	237.6	308.2	194.1	209.6	179.8	0.2	155.3	226.2	228.2
6	207.2	240.0	279.2	184.1	207.2	181.1	0.2	157.5	187.4	190.4
7	203.7	238.5	258.9	176.0	203.7	176.0	0.2	161.0	160.0	162.2
8	203.0	238.0	253.0	173.9	203.0	173.6	0.2	162.8	151.2	152.8
9	198.7	238.7	244.3	173.2	198.7	171.7	0.2	165.8	142.3	143.1

RP	ABS MACH NO		REL MACH NO		MERID MACH NO		MERID PEAK SS	
	IN	OUT	IN	OUT	IN	OUT	VEL R	MACH NO
1	0.556	0.633	1.121	0.678	0.556	0.481	0.924	1.655
2	0.588	0.658	1.111	0.693	0.588	0.518	0.938	1.601
3	0.595	0.662	1.087	0.674	0.595	0.519	0.928	1.576
4	0.627	0.681	1.027	0.624	0.627	0.527	0.890	1.481
5	0.641	0.692	0.943	0.565	0.641	0.524	0.858	1.321
6	0.633	0.706	0.854	0.542	0.633	0.533	0.874	1.132
7	0.622	0.706	0.790	0.521	0.622	0.521	0.864	1.000
8	0.619	0.705	0.772	0.515	0.619	0.515	0.855	0.957
9	0.606	0.709	0.744	0.514	0.606	0.510	0.864	0.914

RP	PERCENT		INCIDENCE		DEV	D-FACT	EFF	LOSS COEFF		LOSS PARAM	
	SPAN		MEAN	SS				TOT	PROF	TOT	PROF
1	5.00		4.7	1.0	6.2	0.543	0.794	0.170	0.098	0.059	0.034
2	10.00		4.5	0.7	4.8	0.517	0.864	0.112	0.053	0.040	0.019
3	15.00		4.8	0.9	4.9	0.523	0.878	0.103	0.052	0.036	0.018
4	30.00		5.4	0.8	4.5	0.540	0.922	0.066	0.038	0.023	0.013
5	50.00		6.8	1.1	5.3	0.548	0.957	0.036	0.031	0.012	0.010
6	70.00		8.4	1.8	6.8	0.507	0.972	0.024	0.024	0.007	0.007
7	85.00		9.2	2.2	8.1	0.476	0.932	0.056	0.056	0.014	0.014
8	90.00		9.3	2.2	7.9	0.465	0.902	0.080	0.080	0.019	0.019
9	95.00		9.8	2.7	7.1	0.441	0.885	0.096	0.096	0.021	0.021

TABLE VII. - Continued.

(y) 110 Percent of design speed; reading 3024

RP	RADII		ABS BETAM		REL BETAM		TOTAL TEMP		TOTAL PRESS	
	IN	OUT	IN	OUT	IN	OUT	IN	RATIO	IN	RATIO
1	24.422	23.782	0.1	46.5	62.8	45.5	289.3	1.169	10.07	1.508
2	23.569	23.063	0.1	41.1	60.5	41.9	288.9	1.160	10.12	1.547
3	22.738	22.347	0.1	40.5	59.2	39.9	288.5	1.155	10.14	1.542
4	20.284	20.196	0.1	41.2	55.0	33.0	288.0	1.139	10.14	1.510
5	17.170	17.328	0.0	42.6	49.8	23.0	287.8	1.117	10.14	1.435
6	14.232	14.460	0.1	44.0	44.8	11.2	287.7	1.099	10.14	1.353
7	12.144	12.311	0.1	44.6	40.8	-0.6	287.7	1.087	10.14	1.309
8	11.473	11.593	0.0	45.0	39.5	-4.1	287.7	1.085	10.14	1.293
9	10.813	10.876	0.0	45.3	38.4	-8.3	287.7	1.082	10.11	1.282

RP	ABS VEL		REL VEL		MERID VEL		TANG VEL		WHEEL SPEED	
	IN	OUT	IN	OUT	IN	OUT	IN	OUT	IN	OUT
1	165.9	220.1	362.4	216.3	165.9	151.6	0.2	159.5	322.3	313.9
2	176.1	228.3	357.2	230.8	176.1	171.9	0.2	150.2	310.9	304.2
3	178.5	229.0	348.5	227.0	178.5	174.2	0.2	148.7	299.5	294.3
4	187.5	232.5	326.8	208.4	187.5	174.8	0.2	153.2	267.8	266.7
5	190.3	229.8	294.7	185.8	190.3	169.2	0.2	155.5	225.2	227.2
6	187.2	225.5	263.7	165.3	187.2	162.2	0.2	156.7	185.9	188.8
7	183.3	230.5	242.0	164.0	183.3	164.0	0.2	162.0	158.1	160.3
8	183.1	233.1	237.4	165.4	183.1	165.0	0.2	164.7	151.3	152.8
9	180.0	235.7	229.5	167.5	180.0	165.7	0.2	167.6	142.6	143.4

RP	ABS MACH NO		REL MACH NO		MERID MACH NO		MERID PEAK SS	
	IN	OUT	IN	OUT	IN	OUT	VEL R	MACH NO
1	0.498	0.619	1.089	0.609	0.498	0.427	0.914	1.718
2	0.531	0.648	1.077	0.655	0.531	0.488	0.976	1.662
3	0.539	0.652	1.053	0.646	0.539	0.496	0.976	1.638
4	0.569	0.668	0.991	0.599	0.569	0.503	0.933	1.549
5	0.578	0.668	0.895	0.534	0.578	0.491	0.889	1.335
6	0.568	0.660	0.800	0.484	0.568	0.474	0.866	1.156
7	0.555	0.680	0.733	0.484	0.555	0.484	0.895	0.993
8	0.555	0.689	0.719	0.489	0.555	0.487	0.901	0.968
9	0.545	0.698	0.695	0.496	0.545	0.491	0.921	0.925

RP	PERCENT	INCIDENCE		DEV	D-FACT	EFF	LOSS COEFF		LOSS PARAM	
	SPAN	MEAN	SS				TOT	PROF	TOT	PROF
1	5.00	7.2	3.5	6.9	0.615	0.736	0.236	0.154	0.081	0.053
2	10.00	6.9	3.1	5.0	0.551	0.828	0.152	0.085	0.054	0.030
3	15.00	7.2	3.2	5.2	0.542	0.851	0.133	0.075	0.047	0.026
4	30.00	8.0	3.4	5.1	0.555	0.901	0.089	0.055	0.031	0.019
5	50.00	9.5	3.8	6.2	0.563	0.933	0.060	0.056	0.019	0.018
6	70.00	11.1	4.4	7.7	0.548	0.914	0.078	0.078	0.022	0.022
7	85.00	11.9	4.8	7.1	0.490	0.916	0.078	0.078	0.019	0.019
8	90.00	12.2	5.1	7.1	0.467	0.901	0.095	0.093	0.022	0.022
9	95.00	12.6	5.5	6.3	0.432	0.896	0.100	0.100	0.022	0.022

TABLE VII. - Continued.

(z) 120 Percent of design speed; reading 3038

RP	RADII		ABS BETAM		REL BETAM		TOTAL TEMP		TOTAL PRESS	
	IN	OUT	IN	OUT	IN	OUT	IN	RATIO	IN	RATIO
1	24.422	23.782	0.0	31.7	58.4	45.9	289.0	1.149	10.07	1.457
2	23.569	23.063	0.0	31.2	56.0	44.0	288.7	1.146	10.14	1.480
3	22.738	22.347	0.0	31.7	55.0	42.2	288.5	1.143	10.13	1.480
4	20.284	20.196	0.0	35.8	50.5	34.9	288.1	1.138	10.14	1.466
5	17.170	17.328	0.0	38.4	45.6	23.2	287.8	1.128	10.14	1.432
6	14.232	14.460	0.0	37.6	40.5	10.4	287.8	1.116	10.14	1.424
7	12.144	12.311	0.0	39.6	36.4	-1.3	287.7	1.107	10.14	1.390
8	11.473	11.593	0.0	40.5	34.9	-3.9	287.7	1.098	10.14	1.335
9	10.813	10.876	0.0	41.0	33.6	-5.4	287.8	1.088	10.09	1.276

RP	ABS VEL		REL VEL		MERID VEL		TANG VEL		WHEEL SPEED	
	IN	OUT	IN	OUT	IN	OUT	IN	OUT	IN	OUT
1	216.0	243.9	412.7	298.2	216.0	207.5	0.0	128.3	351.7	342.5
2	228.5	247.1	408.9	293.7	228.5	211.4	0.0	127.9	339.1	331.8
3	229.5	248.0	399.7	284.8	229.5	210.9	0.0	130.4	327.3	321.7
4	243.5	256.0	378.2	259.2	240.5	212.7	0.1	142.4	291.9	290.7
5	242.5	260.6	346.3	222.1	242.5	204.1	0.1	162.0	247.3	249.6
6	243.0	275.3	315.6	221.7	240.0	218.0	0.1	168.2	204.9	208.2
7	237.7	285.9	295.2	220.2	237.7	220.1	0.1	182.4	175.1	177.5
8	236.9	279.0	288.9	212.5	236.9	212.0	0.1	181.4	165.4	167.1
9	234.4	268.1	281.4	203.3	234.4	202.5	0.1	175.7	155.8	156.7

RP	ABS MACH NO		REL MACH NO		MERID MACH NO		MERID PEAK SS	
	IN	OUT	IN	OUT	IN	OUT	VEL R	MACH NO
1	0.661	0.700	1.263	0.855	0.661	0.595	0.961	1.709
2	0.703	0.711	1.258	0.845	0.703	0.608	0.925	1.651
3	0.707	0.715	1.231	0.821	0.707	0.608	0.919	1.624
4	0.745	0.743	1.172	0.753	0.745	0.617	0.884	1.509
5	0.752	0.762	1.074	0.650	0.752	0.597	0.842	1.376
6	0.744	0.816	0.978	0.657	0.744	0.646	0.908	1.238
7	0.736	0.856	0.914	0.659	0.736	0.659	0.926	1.094
8	0.733	0.836	0.894	0.637	0.733	0.635	0.895	1.045
9	0.725	0.803	0.870	0.609	0.725	0.606	0.864	0.997

RP	PERCENT		INCIDENCE		DEV	D-FACT	EFF	LOSS COEFF		LOSS PARAM	
	SPAN	MEAN	SS	TOT				PROF	TOT	PROF	
1	5.00	2.8	-0.9	7.3	0.427	0.760	0.164	0.058	0.056	0.020	
2	10.00	2.5	-1.3	7.1	0.428	0.813	0.127	0.036	0.043	0.012	
3	15.00	3.0	-1.0	7.5	0.436	0.828	0.119	0.038	0.040	0.013	
4	30.00	3.5	-1.1	7.0	0.470	0.835	0.119	0.070	0.040	0.024	
5	50.00	5.2	-0.5	6.5	0.524	0.842	0.119	0.100	0.039	0.032	
6	70.00	6.8	0.1	6.9	0.455	0.919	0.064	0.061	0.018	0.018	
7	85.00	7.5	0.4	6.4	0.409	0.926	0.060	0.060	0.015	0.015	
8	90.00	7.6	0.5	7.4	0.413	0.879	0.093	0.093	0.022	0.022	
9	95.00	7.9	0.7	9.3	0.416	0.817	0.131	0.131	0.029	0.029	

TABLE VII. - Continued.

(aa) 120 Percent of design speed; reading 3039

RP	RADII		ABS BETAM		REL BETAM		TOTAL TEMP		TOTAL PRESS	
	IN	OUT	IN	OUT	IN	OUT	IN	RATIO	IN	RATIO
1	24.422	23.782	0.0	37.0	59.2	46.1	288.9	1.172	10.09	1.519
2	23.569	23.063	0.0	35.9	57.1	43.1	288.6	1.168	10.13	1.567
3	22.738	22.347	0.0	36.0	56.0	41.3	288.4	1.166	10.14	1.561
4	20.284	20.196	0.0	38.3	51.4	34.0	288.1	1.151	10.14	1.531
5	17.170	17.328	0.0	40.1	46.2	21.8	287.9	1.137	10.14	1.499
6	14.232	14.460	0.0	39.4	40.9	10.2	287.8	1.117	10.14	1.431
7	12.144	12.311	0.0	40.7	36.8	-1.4	287.7	1.107	10.14	1.398
8	11.473	11.593	0.0	41.8	35.5	-4.0	287.6	1.099	10.14	1.344
9	10.813	10.876	0.0	42.6	34.3	-6.1	287.7	1.092	10.10	1.295

RP	ABS VEL		REL VEL		MERID VEL		TANG VEL		WHEEL SPEED	
	IN	OUT	IN	OUT	IN	OUT	IN	OUT	IN	OUT
1	209.2	238.9	409.0	275.5	209.2	199.9	0.1	143.6	351.5	342.3
2	219.7	246.7	404.1	273.7	219.7	199.8	0.1	144.7	359.2	331.9
3	221.0	247.6	394.8	266.9	221.0	200.4	0.1	145.4	327.2	321.6
4	252.8	253.1	373.3	239.7	252.8	198.8	0.1	156.7	292.0	290.7
5	236.8	262.3	342.2	216.0	236.8	200.6	0.1	169.1	247.0	249.3
6	236.2	268.6	312.5	210.8	236.2	207.4	0.1	170.6	204.8	208.0
7	233.7	279.8	291.9	212.0	233.7	212.0	0.1	182.6	174.9	177.3
8	231.2	271.4	284.1	202.8	231.2	202.3	0.1	181.0	165.1	166.8
9	228.5	262.1	276.5	194.1	228.5	193.0	0.1	177.4	155.8	156.7

RP	ABS MACH NO		REL MACH NO		MERID MACH NO		MERID PEAK SS	
	IN	OUT	IN	OUT	IN	OUT	VEL R	MACH NO
1	0.639	0.677	1.249	0.780	0.639	0.541	0.912	1.723
2	0.674	0.702	1.239	0.779	0.674	0.569	0.909	1.670
3	0.678	0.707	1.212	0.761	0.678	0.572	0.907	1.641
4	0.719	0.729	1.153	0.691	0.719	0.573	0.854	1.525
5	0.733	0.764	1.059	0.630	0.733	0.585	0.847	1.390
6	0.731	0.793	0.967	0.622	0.731	0.612	0.878	1.240
7	0.722	0.835	0.902	0.633	0.722	0.632	0.907	1.095
8	0.714	0.810	0.877	0.605	0.714	0.604	0.875	1.048
9	0.705	0.782	0.853	0.579	0.705	0.575	0.844	1.002

RP	PERCENT	INCIDENCE		DEV	D-FACT	EFF	LOSS COEFF		LOSS PARAM	
	SPAN	MEAN	SS				TOT	PROF	TOT	PROF
1	5.00	3.6	-0.1	7.5	0.496	0.737	0.204	0.096	0.069	0.033
2	10.00	3.5	-0.3	6.2	0.490	0.813	0.147	0.054	0.051	0.019
3	15.00	3.9	0.0	6.6	0.491	0.820	0.144	0.062	0.049	0.021
4	30.00	4.4	-0.2	6.1	0.531	0.857	0.113	0.064	0.039	0.022
5	50.00	5.9	0.2	5.1	0.543	0.895	0.085	0.067	0.028	0.022
6	70.00	7.2	0.6	6.7	0.466	0.920	0.065	0.062	0.019	0.018
7	85.00	7.9	0.9	6.3	0.430	0.935	0.053	0.053	0.013	0.013
8	90.00	8.2	1.1	7.2	0.437	0.887	0.090	0.090	0.021	0.021
9	95.00	8.5	1.4	8.5	0.441	0.836	0.126	0.126	0.028	0.028

TABLE VII. - Continued.

(bb) 120 Percent of design speed; reading 3040

RP	RADII		ABS BETAM		REL BETAM		TOTAL TEMP		TOTAL PRESS	
	IN	OUT	IN	OUT	IN	OUT	IN	RATIO	IN	RATIO
1	24.422	23.782	0.0	43.2	60.8	47.2	289.0	1.188	10.07	1.542
2	23.569	23.063	0.0	39.1	58.5	43.4	288.7	1.181	10.13	1.597
3	22.730	22.347	0.0	39.2	57.4	41.1	288.4	1.178	10.13	1.602
4	20.284	20.196	0.0	41.1	52.8	33.2	288.1	1.162	10.14	1.575
5	17.170	17.328	0.0	42.5	47.3	21.6	287.9	1.143	10.15	1.520
6	14.252	14.460	0.0	41.1	41.9	9.5	287.7	1.122	10.15	1.453
7	12.144	12.311	0.0	42.4	37.8	-1.5	287.8	1.107	10.15	1.395
8	11.473	11.593	0.0	43.1	36.7	-4.0	287.8	1.100	10.15	1.347
9	10.813	10.876	0.0	44.3	35.5	-7.7	287.8	1.095	10.10	1.318

RP	ABS VEL		REL VEL		MERID VEL		TANG VEL		WHEEL SPEED	
	IN	OUT	IN	OUT	IN	OUT	IN	OUT	IN	OUT
1	196.6	233.1	403.2	250.1	196.6	170.0	0.1	159.5	352.1	342.9
2	207.6	243.6	397.8	259.9	207.6	189.0	0.1	153.6	339.4	332.1
3	209.1	246.3	388.7	253.4	209.1	191.0	0.1	155.5	327.7	322.0
4	221.6	252.6	366.5	227.4	221.6	190.3	0.1	166.1	291.9	290.7
5	228.0	258.2	336.4	204.6	228.0	190.3	0.1	174.5	247.4	249.7
6	228.2	265.9	336.7	203.3	228.2	200.5	0.1	174.6	204.9	208.2
7	225.4	271.3	285.4	200.5	225.4	200.4	0.1	182.8	175.0	177.5
8	221.7	264.0	276.4	193.3	221.7	192.8	0.1	180.3	165.3	167.0
9	218.9	260.6	268.7	188.1	218.9	186.4	0.1	182.2	156.0	156.9

RP	ABS MACH NO		REL MACH NO		MERID MACH NO		MERID PEAK SS	
	IN	OUT	IN	OUT	IN	OUT	VEL R	MACH NO
1	0.597	0.654	1.225	0.702	0.597	0.477	0.865	1.756
2	0.634	0.688	1.214	0.735	0.634	0.534	0.910	1.698
3	0.639	0.698	1.187	0.719	0.639	0.542	0.913	1.671
4	0.681	0.724	1.126	0.652	0.681	0.545	0.859	1.552
5	0.703	0.749	1.037	0.593	0.703	0.552	0.835	1.419
6	0.704	0.782	0.945	0.598	0.704	0.590	0.878	1.247
7	0.694	0.806	0.879	0.596	0.694	0.595	0.889	1.102
8	0.681	0.784	0.850	0.574	0.681	0.573	0.870	1.055
9	0.672	0.775	0.825	0.559	0.672	0.554	0.851	1.010

RP	PERCENT		INCIDENCE		DEV	D-FACT	EFF	LOSS COEFF		LOSS PARAM	
	SPAN		MEAN	SS				TOT	PROF	TOT	PROF
1	5.00		5.2	1.5	8.5	0.570	0.702	0.250	0.139	0.083	0.046
2	10.00		5.0	1.2	6.5	0.528	0.790	0.177	0.082	0.061	0.028
3	15.00		5.4	1.5	6.4	0.530	0.810	0.164	0.079	0.057	0.027
4	30.00		5.8	1.2	5.3	0.566	0.857	0.124	0.073	0.043	0.025
5	50.00		7.0	1.3	4.8	0.575	0.888	0.098	0.078	0.032	0.025
6	70.00		8.2	1.6	6.0	0.505	0.927	0.063	0.061	0.018	0.017
7	85.00		8.9	1.9	6.2	0.458	0.932	0.058	0.058	0.015	0.015
8	90.00		9.4	2.3	7.3	0.455	0.884	0.098	0.098	0.023	0.023
9	95.00		9.7	2.6	6.9	0.450	0.863	0.114	0.114	0.025	0.025

TABLE VII. - Concluded.

(cc) 120 Percent of design speed; reading 3042

RP	RADII		ABS BETAM		REL BETAM		TOTAL TEMP		TOTAL PRESS	
	IN	OUT	IN	OUT	IN	OUT	IN	RATIO	IN	RATIO
1	24.422	23.782	0.0	50.8	62.4	48.7	289.1	1.205	10.07	1.538
2	23.569	23.063	0.0	42.9	60.3	44.0	288.6	1.192	10.12	1.592
3	22.738	22.347	0.0	41.5	59.3	41.2	288.4	1.185	10.12	1.611
4	20.284	20.196	0.0	42.5	54.6	33.6	288.2	1.167	10.14	1.581
5	17.170	17.328	0.0	43.4	48.8	21.4	287.9	1.146	10.14	1.538
6	14.232	14.460	0.0	42.6	43.6	9.3	287.7	1.124	10.15	1.466
7	12.144	12.311	0.0	43.6	39.6	-0.8	287.5	1.108	10.14	1.389
8	11.473	11.593	0.0	44.6	38.5	-4.4	287.5	1.103	10.14	1.355
9	10.813	10.876	0.0	44.6	37.2	-7.6	287.6	1.099	10.11	1.335

RP	ABS VEL		REL VEL		MERID VEL		TANG VEL		WHEEL SPEED	
	IN	OUT	IN	OUT	IN	OUT	IN	OUT	IN	OUT
1	183.9	229.6	397.1	219.7	183.9	145.1	0.1	177.9	352.1	342.9
2	193.6	239.8	391.3	244.3	193.6	175.7	0.1	163.2	340.1	332.8
3	195.0	244.7	381.5	243.5	195.0	183.3	0.1	162.1	328.0	322.3
4	208.0	249.7	358.7	220.9	208.0	184.0	0.1	168.8	292.3	291.0
5	216.4	256.6	328.5	200.2	216.4	186.4	0.1	176.4	247.3	249.6
6	215.7	261.5	297.7	195.1	215.7	192.5	0.1	176.9	205.3	208.6
7	211.5	261.4	274.5	189.5	211.5	189.5	0.1	180.1	175.1	177.5
8	207.9	258.8	265.6	185.0	207.9	184.4	0.1	181.6	165.5	167.2
9	205.3	258.8	257.7	186.1	205.3	184.4	0.1	181.6	155.9	156.8

RP	ABS MACH NO		REL MACH NO		MERID MACH NO		MERID PEAK SS	
	IN	OUT	IN	OUT	IN	OUT	VEL R	MACH NO
1	0.556	0.638	1.201	0.611	0.556	0.403	0.789	1.791
2	0.588	0.674	1.188	0.686	0.588	0.494	0.908	1.738
3	0.593	0.691	1.159	0.688	0.593	0.518	0.940	1.710
4	0.636	0.713	1.096	0.631	0.636	0.525	0.884	1.591
5	0.664	0.742	1.008	0.579	0.664	0.539	0.861	1.459
6	0.662	0.767	0.913	0.572	0.662	0.565	0.892	1.257
7	0.648	0.773	0.841	0.560	0.648	0.550	0.896	1.110
8	0.636	0.766	0.812	0.548	0.636	0.546	0.887	1.063
9	0.627	0.768	0.787	0.552	0.627	0.547	0.898	1.015

RP	PERCENT SPAN	INCIDENCE		DEV	D-FACT	EFF	LOSS COEFF		LOSS PARAM	
		MEAN	SS				TOT	PROF	TOT	PROF
1	5.00	6.8	3.1	10.0	0.663	0.639	0.327	0.210	0.106	0.068
2	10.00	6.8	3.0	7.1	0.571	0.741	0.232	0.131	0.079	0.045
3	15.00	7.2	3.3	6.4	0.555	0.791	0.190	0.100	0.066	0.035
4	30.00	7.6	3.0	5.7	0.578	0.836	0.151	0.096	0.052	0.033
5	50.00	8.5	2.8	4.7	0.580	0.894	0.098	0.076	0.032	0.025
6	70.00	9.9	3.2	5.8	0.520	0.933	0.061	0.060	0.018	0.017
7	85.00	10.7	3.7	6.9	0.474	0.912	0.080	0.080	0.020	0.020
8	90.00	11.2	4.1	6.8	0.465	0.881	0.109	0.109	0.026	0.026
9	95.00	11.4	4.3	7.0	0.434	0.869	0.122	0.122	0.027	0.027

TABLE VIII. - BLADE-ELEMENT DATA AT BLADE EDGES FOR STATOR 53

(a) 70 Percent of design speed; reading 3027

RP	RADII		ABS BETAM		REL BETAM		TOTAL TEMP		TOTAL PRESS	
	IN	OUT	IN	OUT	IN	OUT	IN	RATIO	IN	RATIO
1	23.396	23.421	9.8	0.2	9.8	0.2	295.4	1.000	10.85	0.966
2	22.718	22.771	10.5	-0.5	10.5	-0.5	295.7	1.000	10.99	0.974
3	22.045	22.126	11.8	-0.9	11.8	-0.9	295.9	1.001	11.06	0.979
4	20.015	20.196	15.1	-0.9	15.1	-0.9	296.6	1.001	11.25	0.975
5	17.315	17.673	20.8	0.2	20.8	0.2	297.4	1.005	11.41	0.975
6	14.600	15.176	25.2	1.0	25.2	1.0	297.9	1.005	11.47	0.969
7	12.509	13.264	29.2	0.6	29.2	0.6	297.7	1.005	11.45	0.965
8	11.786	12.603	31.1	1.5	31.1	1.5	297.5	1.003	11.38	0.950
9	11.049	11.935	32.9	5.0	32.9	5.0	296.2	1.006	11.10	0.897

RP	ABS VEL		REL VEL		MERID VEL		TANG VEL		WHEEL SPEED	
	IN	OUT	IN	OUT	IN	OUT	IN	OUT	IN	OUT
1	185.9	199.1	185.9	199.1	183.1	199.1	31.7	0.7	0.	0.
2	191.4	207.1	191.4	207.1	188.2	207.1	34.8	-1.9	0.	0.
3	193.4	210.5	193.4	210.5	189.3	210.4	39.6	-3.4	0.	0.
4	204.1	216.1	204.1	216.1	197.1	216.1	55.0	-3.6	0.	0.
5	211.3	222.2	211.3	222.2	197.6	222.2	74.9	0.9	0.	0.
6	213.3	225.4	213.3	225.4	193.0	225.3	90.8	3.7	0.	0.
7	209.2	229.0	209.2	229.0	182.6	229.0	102.0	2.2	0.	0.
8	203.4	231.2	203.4	231.2	174.2	231.2	105.1	6.0	0.	0.
9	190.2	211.1	190.2	211.1	159.6	210.3	103.4	18.5	0.	0.

RP	ABS MACH NO		REL MACH NO		MERID MACH NO		MERID PEAK SS	
	IN	OUT	IN	OUT	IN	OUT	VEL R	MACH NO
1	0.556	0.598	0.556	0.598	0.548	0.538	1.087	0.556
2	0.573	0.624	0.573	0.624	0.564	0.624	1.100	0.573
3	0.579	0.634	0.579	0.634	0.567	0.634	1.112	0.579
4	0.613	0.652	0.613	0.652	0.592	0.652	1.096	0.613
5	0.635	0.670	0.635	0.670	0.594	0.670	1.125	0.635
6	0.641	0.679	0.641	0.679	0.589	0.679	1.167	0.641
7	0.628	0.692	0.628	0.692	0.548	0.692	1.254	0.628
8	0.610	0.700	0.610	0.700	0.522	0.700	1.327	0.610
9	0.569	0.634	0.569	0.634	0.477	0.632	1.317	0.569

RP	PERCENT SPAN	INCIDENCE		DEV	D-FACT	EFF	LOSS COEFF		LOSS PARAM	
		MEAN	SS				TOT	PROF	TOT	PROF
1	5.00	-11.2	-18.5	5.4	-0.008	0.	0.131	0.181	0.069	0.069
2	10.00	-11.5	-18.7	4.9	-0.011	0.	0.131	0.131	0.049	0.049
3	15.00	-11.0	-18.3	4.6	-0.008	0.	0.103	0.105	0.037	0.037
4	30.00	-10.5	-17.7	4.9	0.032	0.	0.112	0.112	0.037	0.037
5	50.00	-9.0	-16.2	6.6	0.047	0.	0.105	0.105	0.030	0.030
6	70.00	-9.1	-16.2	7.6	0.040	0.	0.128	0.128	0.031	0.031
7	85.00	-8.9	-16.0	7.4	0.002	0.	0.159	0.159	0.033	0.033
8	90.00	-8.8	-15.8	8.4	-0.044	0.	0.223	0.223	0.044	0.044
9	95.00	-8.9	-15.9	12.1	-0.032	0.	0.520	0.520	0.096	0.096

TABLE VIII. - Continued.

(b) 70 Percent of design speed; reading 3028

RP	RADII		ABS BETAM		REL BETAM		TOTAL TEMP		TOTAL PRESS	
	IN	OUT	IN	OUT	IN	OUT	IN	RATIO	IN	RATIO
1	23.396	23.421	16.9	1.6	16.9	1.6	298.8	0.999	11.26	0.979
2	22.718	22.771	16.4	0.7	16.4	0.7	298.7	1.000	11.40	0.987
3	22.045	22.126	17.0	0.1	17.0	0.1	298.4	1.000	11.45	0.989
4	20.015	20.196	20.0	-0.3	20.0	-0.3	298.4	1.000	11.53	0.987
5	17.315	17.673	24.9	-0.4	24.9	-0.4	298.2	1.002	11.54	0.993
6	14.600	15.176	28.2	-0.8	28.2	-0.8	297.8	1.000	11.48	0.988
7	12.509	13.264	32.4	-0.1	32.4	-0.1	297.4	1.000	11.41	0.981
8	11.785	12.603	34.0	1.2	34.0	1.2	297.1	1.001	11.35	0.969
9	11.049	11.935	36.1	3.3	36.1	3.3	296.3	1.006	11.14	0.955

RP	ABS VEL		REL VEL		MERID VEL		TANG VEL		WHEEL SPEED	
	IN	OUT	IN	OUT	IN	OUT	IN	OUT	IN	OUT
1	171.8	164.1	171.8	164.1	164.4	164.0	49.9	4.7	0.	0.
2	176.9	172.8	176.9	172.8	169.7	172.8	50.1	2.1	0.	0.
3	179.0	175.4	179.0	175.4	171.2	175.4	52.2	0.2	0.	0.
4	185.5	178.1	185.5	178.1	174.3	178.1	63.5	-0.9	0.	0.
5	189.1	182.1	189.1	182.1	171.6	182.1	79.5	-1.4	0.	0.
6	189.1	179.2	189.1	179.2	166.6	179.1	89.3	-2.6	0.	0.
7	185.9	177.3	185.9	177.3	157.0	177.3	99.6	-0.2	0.	0.
8	181.9	175.4	181.9	175.4	150.7	175.5	101.8	3.6	0.	0.
9	172.5	166.4	172.5	166.4	139.3	166.2	101.7	9.5	0.	0.

RP	ABS MACH NO		REL MACH NO		MERID MACH NO		MERID PEAK SS	
	IN	OUT	IN	OUT	IN	OUT	VEL R	MACH NO
1	0.538	0.485	0.538	0.485	0.486	0.485	0.998	0.538
2	0.525	0.512	0.525	0.512	0.503	0.512	1.018	0.525
3	0.531	0.520	0.531	0.520	0.508	0.520	1.024	0.531
4	0.552	0.528	0.552	0.528	0.518	0.528	1.022	0.552
5	0.563	0.541	0.563	0.541	0.511	0.541	1.061	0.563
6	0.564	0.532	0.564	0.532	0.497	0.532	1.075	0.564
7	0.554	0.527	0.554	0.527	0.468	0.527	1.130	0.554
8	0.542	0.521	0.542	0.521	0.449	0.521	1.163	0.542
9	0.513	0.492	0.513	0.492	0.414	0.492	1.192	0.513

RP	PERCENT SPAN	INCIDENCE		DEV	D-FACT	EFF	LOSS COEFF		LOSS PARAM	
		MEAN	SS				TOT	PROF	TOT	PROF
1	5.00	-4.2	-11.4	6.9	0.145	0.	0.129	0.129	0.049	0.049
2	10.00	-5.5	-12.8	6.1	0.124	0.	0.074	0.074	0.027	0.027
3	15.00	-5.9	-13.2	5.6	0.125	0.	0.061	0.061	0.022	0.022
4	30.00	-5.5	-12.8	5.6	0.153	0.	0.068	0.068	0.022	0.022
5	50.00	-5.0	-12.1	5.9	0.158	0.	0.034	0.034	0.010	0.010
6	70.00	-6.1	-13.2	5.8	0.168	0.	0.064	0.064	0.015	0.015
7	85.00	-5.7	-12.8	6.8	0.155	0.	0.100	0.100	0.021	0.021
8	90.00	-5.8	-12.9	8.1	0.152	0.	0.169	0.169	0.033	0.033
9	95.00	-5.7	-12.7	10.4	0.130	0.	0.274	0.274	0.051	0.051

TABLE VIII. - Continued.

(c) 70 Percent of design speed; reading 3029

RP	RADII		ABS BETAM		REL BETAM		TOTAL TEMP		TOTAL PRESS	
	IN	OUT	IN	OUT	IN	OUT	IN	RATIO	IN	RATIO
1	23.396	23.421	22.2	2.9	22.2	2.9	300.9	1.000	11.62	0.976
2	22.718	22.771	21.3	2.2	21.3	2.2	300.7	1.000	11.71	0.985
3	22.045	22.126	21.7	1.6	21.7	1.6	300.4	1.000	11.70	0.990
4	20.015	20.196	24.6	1.1	24.6	1.1	299.4	1.001	11.67	0.993
5	17.315	17.673	28.5	-0.2	28.5	-0.2	293.9	1.000	11.60	0.996
6	14.600	15.176	31.9	-0.0	31.9	-0.0	298.1	1.001	11.49	0.995
7	12.509	13.264	35.5	0.7	35.5	0.7	297.6	1.000	11.40	0.983
8	11.786	12.603	37.2	2.9	37.2	2.9	297.1	1.002	11.30	0.983
9	11.049	11.935	39.4	5.2	39.4	5.2	296.6	1.005	11.18	0.967

RP	ABS VEL		REL VEL		MERID VEL		TANG VEL		WHEEL SPEED	
	IN	OUT	IN	OUT	IN	OUT	IN	OUT	IN	OUT
1	164.1	148.5	164.1	148.5	151.8	148.3	62.1	7.6	0.	0.
2	167.1	156.5	167.1	156.5	155.6	156.4	60.8	6.0	0.	0.
3	166.7	157.6	166.7	157.6	154.8	157.6	61.7	4.5	0.	0.
4	170.5	159.2	170.5	159.2	155.0	159.2	71.0	3.1	0.	0.
5	172.0	159.5	172.0	159.5	151.1	159.5	82.0	-0.6	0.	0.
6	171.4	156.1	171.4	156.1	145.5	156.1	90.6	-0.1	0.	0.
7	170.0	149.7	170.0	149.7	138.4	149.6	98.8	1.9	0.	0.
8	165.4	149.3	165.4	149.3	131.8	149.1	99.9	7.5	0.	0.
9	160.4	138.7	160.4	138.7	123.9	138.1	101.9	12.5	0.	0.

RP	ABS MACH NO		REL MACH NO		MERID MACH NO		MERID PEAK SS	
	IN	OUT	IN	OUT	IN	OUT	VEL R	MACH NO
1	0.483	0.435	0.483	0.435	0.447	0.435	0.977	0.483
2	0.492	0.460	0.492	0.460	0.458	0.459	1.005	0.492
3	0.491	0.463	0.491	0.463	0.456	0.463	1.018	0.491
4	0.504	0.469	0.504	0.469	0.458	0.469	1.027	0.504
5	0.509	0.470	0.509	0.470	0.447	0.470	1.055	0.509
6	0.508	0.460	0.508	0.460	0.431	0.460	1.073	0.508
7	0.504	0.441	0.504	0.441	0.410	0.441	1.081	0.504
8	0.490	0.440	0.490	0.440	0.390	0.439	1.131	0.490
9	0.475	0.407	0.475	0.407	0.357	0.406	1.115	0.475

RP	PERCENT SPAN		INCIDENCE		DEV	D-FACT	EFF	LOSS COEFF		LOSS PARAM	
	SPAN	MEAN	SS	TOT				PROF	TOT	PROF	
1	5.00	1.2	-6.1	8.2	0.222	0.	0.162	0.162	0.062	0.062	
2	10.00	-0.6	-7.9	7.6	0.185	0.	0.098	0.098	0.036	0.036	
3	15.00	-1.1	-8.4	7.2	0.178	0.	0.068	0.068	0.025	0.025	
4	30.00	-0.9	-8.2	7.0	0.196	0.	0.045	0.045	0.015	0.015	
5	50.00	-1.3	-8.5	6.1	0.208	0.	0.025	0.025	0.007	0.007	
6	70.00	-2.3	-9.4	6.6	0.215	0.	0.029	0.029	0.007	0.007	
7	85.00	-2.6	-9.7	7.6	0.235	0.	0.109	0.109	0.023	0.023	
8	90.00	-2.7	-9.7	9.9	0.203	0.	0.111	0.111	0.022	0.022	
9	95.00	-2.4	-9.4	12.3	0.233	0.	0.232	0.232	0.043	0.043	

TABLE VIII. - Continued.

(d) 70 Percent of design speed; reading 3030

RP	RADII		ABS BETAM		REL BETAM		TOTAL TEMP		TOTAL PRESS	
	IN	OUT	IN	OUT	IN	OUT	IN	RATIO	IN	RATIO
1	23.396	23.421	29.0	3.5	29.0	3.5	303.7	1.000	11.82	0.981
2	22.718	22.771	27.3	3.3	27.3	3.3	302.9	1.001	11.93	0.984
3	22.045	22.126	27.6	2.6	27.6	2.6	302.4	1.000	11.92	0.989
4	20.015	20.196	30.2	2.0	30.2	2.0	301.3	1.000	11.86	0.993
5	17.315	17.673	33.8	1.6	33.8	1.6	300.1	0.999	11.70	0.993
6	14.600	15.176	36.5	0.9	36.5	0.9	298.8	1.000	11.54	0.991
7	12.509	13.264	39.7	3.7	39.7	3.7	298.0	1.001	11.42	0.990
8	11.786	12.603	41.2	7.3	41.2	7.3	297.4	1.003	11.30	0.989
9	11.049	11.935	43.5	7.4	43.5	7.4	297.0	1.005	11.24	0.973

RP	ABS VEL		REL VEL		MERID VEL		TANG VEL		WHEEL SPEED	
	IN	OUT	IN	OUT	IN	OUT	IN	OUT	IN	OUT
1	152.7	135.2	152.7	135.2	133.5	135.0	74.1	8.4	0.	0.
2	157.3	142.3	157.3	142.3	139.7	142.1	72.2	8.2	0.	0.
3	156.8	143.8	156.8	143.8	139.0	143.7	72.5	6.4	0.	0.
4	159.3	143.6	159.3	143.6	137.6	143.6	80.2	5.1	0.	0.
5	158.3	138.1	158.3	138.1	131.6	138.0	88.1	3.9	0.	0.
6	157.6	131.3	157.6	131.3	126.8	131.3	93.7	2.0	0.	0.
7	157.3	128.4	157.3	128.4	120.9	128.1	100.6	8.3	0.	0.
8	153.1	124.2	153.1	124.2	115.1	123.2	100.9	15.8	0.	0.
9	151.1	112.5	151.1	112.5	109.6	111.5	104.0	14.5	0.	0.

RP	ABS MACH NO		REL MACH NO		MERID MACH NO		MERID PEAK SS	
	IN	OUT	IN	OUT	IN	OUT	VEL R	MACH NO
1	0.446	0.393	0.446	0.393	0.390	0.392	1.011	0.552
2	0.460	0.415	0.460	0.415	0.409	0.414	1.017	0.519
3	0.459	0.420	0.459	0.420	0.407	0.419	1.054	0.502
4	0.468	0.420	0.468	0.420	0.404	0.420	1.043	0.515
5	0.466	0.404	0.466	0.404	0.387	0.404	1.049	0.504
6	0.465	0.384	0.465	0.384	0.374	0.384	1.036	0.465
7	0.464	0.376	0.464	0.376	0.357	0.375	1.059	0.464
8	0.452	0.364	0.452	0.364	0.340	0.361	1.070	0.452
9	0.446	0.328	0.446	0.328	0.323	0.325	1.018	0.446

RP	PERCENT	INCIDENCE		DEV	D-FACT	EFF	LOSS COEFF		LOSS PARAM	
	SPAN	MEAN	SS				TOT	PROF	TOT	PROF
1	5.00	8.0	0.7	8.8	0.279	0.	0.151	0.151	0.058	0.058
2	10.00	5.4	-1.9	8.7	0.246	0.	0.115	0.115	0.043	0.043
3	15.00	4.7	-2.6	8.1	0.234	0.	0.082	0.082	0.030	0.030
4	30.00	4.7	-2.5	7.9	0.252	0.	0.047	0.047	0.015	0.015
5	50.00	4.0	-3.2	7.9	0.278	0.	0.049	0.049	0.014	0.014
6	70.00	2.2	-4.9	7.5	0.304	0.	0.066	0.066	0.016	0.016
7	85.00	1.6	-5.4	10.6	0.302	0.	0.071	0.071	0.015	0.015
8	90.00	1.3	-5.7	14.3	0.293	0.	0.086	0.086	0.017	0.017
9	95.00	1.6	-5.4	14.5	0.360	0.	0.209	0.209	0.038	0.038

TABLE VIII. - Continued.

(e) 70 Percent of design speed; reading 3031

RP	RADII		ABS BETAM		REL BETAM		TOTAL TEMP		TOTAL PRESS	
	IN	OUT	IN	OUT	IN	OUT	IN	RATIO	IN	RATIO
1	23.396	25.421	46.0	5.1	46.0	5.1	307.6	0.995	11.80	0.982
2	22.718	22.771	37.2	4.6	37.2	4.6	305.6	0.999	11.89	0.980
3	22.045	22.126	35.4	4.3	35.4	4.5	304.4	1.001	11.94	0.981
4	20.015	20.196	36.7	3.2	36.7	3.2	303.0	0.999	11.89	0.989
5	17.315	17.673	39.8	2.4	39.8	2.4	301.0	1.000	11.71	0.993
6	14.600	15.176	41.0	3.1	41.0	3.1	299.6	1.000	11.55	0.991
7	12.509	13.264	42.8	5.8	42.8	5.8	298.1	1.001	11.41	0.985
8	11.786	12.603	44.1	7.2	44.1	7.2	297.5	1.003	11.32	0.979
9	11.049	11.935	46.3	4.6	46.3	4.6	297.1	1.005	11.25	0.972

RP	ABS VEL		REL VEL		MERID VEL		TANG VEL		WHEEL SPEED	
	IN	OUT	IN	OUT	IN	OUT	IN	OUT	IN	OUT
1	139.5	118.8	139.5	118.8	96.9	118.3	100.3	10.6	0.	0.
2	143.5	122.0	143.5	122.0	114.2	121.6	96.8	9.9	0.	0.
3	146.7	125.5	146.7	125.5	119.6	125.2	84.9	9.4	0.	0.
4	149.6	128.6	149.6	128.6	119.9	123.4	89.5	7.2	0.	0.
5	147.5	122.7	147.5	122.7	113.4	122.5	94.4	5.2	0.	0.
6	149.2	114.8	148.2	114.8	111.8	114.7	97.2	6.3	0.	0.
7	147.8	105.6	147.8	105.6	108.5	105.1	100.5	10.6	0.	0.
8	145.2	96.9	145.2	96.9	104.3	96.1	101.0	12.2	0.	0.
9	143.3	86.3	143.3	86.3	99.1	86.1	103.5	7.0	0.	0.

RP	ABS MACH NO		REL MACH NO		MERID MACH NO		MERID PEAK SS	
	IN	OUT	IN	OUT	IN	OUT	VEL R	MACH NO
1	0.403	0.343	0.403	0.343	0.280	0.341	1.221	0.736
2	0.416	0.353	0.416	0.353	0.332	0.351	1.065	0.623
3	0.427	0.363	0.427	0.363	0.348	0.362	1.047	0.598
4	0.437	0.374	0.437	0.374	0.350	0.373	1.071	0.594
5	0.432	0.357	0.432	0.357	0.332	0.357	1.031	0.574
6	0.435	0.335	0.435	0.335	0.328	0.334	1.025	0.524
7	0.435	0.308	0.435	0.308	0.319	0.306	0.969	0.479
8	0.428	0.282	0.428	0.282	0.307	0.280	0.921	0.459
9	0.422	0.251	0.422	0.251	0.292	0.250	0.869	0.460

RP	PERCENT SPAN	INCIDENCE		DEV	D-FACT	EFF	LOSS COEFF		LOSS PARAM	
		MEAN	SS				TOT	PROF	TOT	PROF
1	5.00	25.0	17.7	10.4	0.394	0.	0.173	0.173	0.066	0.066
2	10.00	15.3	8.0	10.0	0.348	0.	0.182	0.182	0.067	0.067
3	15.00	12.5	5.3	9.8	0.329	0.	0.160	0.160	0.058	0.058
4	30.00	11.2	4.0	9.1	0.320	0.	0.091	0.091	0.030	0.030
5	50.00	10.0	2.8	8.7	0.339	0.	0.057	0.057	0.016	0.016
6	70.00	6.7	-0.4	9.8	0.370	0.	0.076	0.076	0.018	0.018
7	85.00	4.7	-2.4	12.6	0.407	0.	0.120	0.120	0.025	0.025
8	90.00	4.2	-2.8	14.2	0.448	0.	0.178	0.178	0.035	0.035
9	95.00	4.4	-2.6	11.7	0.517	0.	0.246	0.246	0.045	0.045

TABLE VIII. - Continued.

(f) 80 Percent of design speed; reading 3011

RP	RADII		ABS BETAM		REL BETAM		TOTAL TEMP		TOTAL PRESS	
	IN	OUT	IN	OUT	IN	OUT	IN	RATIO	IN	RATIO
1	23.396	23.421	15.7	1.5	15.7	1.5	301.4	0.999	11.58	0.963
2	22.718	22.771	15.8	0.5	15.8	0.5	301.7	0.999	11.76	0.978
3	22.045	22.126	16.7	-0.0	16.7	-0.0	301.7	0.999	11.84	0.980
4	20.015	20.196	19.8	-0.1	19.8	-0.1	301.9	1.000	11.96	0.980
5	17.315	17.673	24.4	1.0	24.4	1.0	302.1	1.002	12.04	0.980
6	14.600	15.176	27.7	1.0	27.7	1.0	301.2	1.001	11.89	0.964
7	12.509	13.264	31.9	0.5	31.9	0.5	300.7	1.002	11.78	0.970
8	11.786	12.603	35.8	2.0	35.8	2.0	300.3	1.001	11.69	0.943
9	11.049	11.935	35.9	5.1	35.9	5.1	299.2	1.005	11.38	0.891

RP	ABS VEL		REL VEL		MERID VEL		TANG VEL		WHEEL SPEED	
	IN	OUT	IN	OUT	IN	OUT	IN	OUT	IN	OUT
1	202.2	206.4	202.2	206.4	194.6	206.3	54.8	5.3	0.	0.
2	207.3	215.1	207.3	215.1	199.4	215.1	56.6	2.0	0.	0.
3	210.1	219.5	210.1	219.5	201.3	219.5	60.4	-0.0	0.	0.
4	219.6	223.2	219.6	223.2	206.6	223.2	74.3	-0.5	0.	0.
5	225.8	227.1	225.8	227.1	205.5	227.0	93.4	3.8	0.	0.
6	223.4	224.0	223.4	224.0	197.8	223.9	103.9	4.1	0.	0.
7	218.4	228.8	218.4	228.8	185.3	228.6	115.5	1.8	0.	0.
8	212.7	225.1	212.7	225.1	176.7	224.9	118.4	7.7	0.	0.
9	199.6	202.7	199.6	202.7	161.6	201.8	117.1	18.1	0.	0.

RP	ABS MACH NO		REL MACH NO		MERID MACH NO		MERID PEAK SS	
	IN	OUT	IN	OUT	IN	OUT	VEL R	MACH NO
1	0.602	0.615	0.602	0.615	0.579	0.615	1.060	0.602
2	0.618	0.643	0.618	0.643	0.594	0.643	1.079	0.618
3	0.627	0.657	0.627	0.657	0.600	0.657	1.090	0.627
4	0.657	0.669	0.657	0.669	0.618	0.669	1.080	0.657
5	0.677	0.680	0.677	0.680	0.616	0.680	1.104	0.677
6	0.671	0.672	0.671	0.672	0.594	0.672	1.132	0.671
7	0.655	0.688	0.655	0.688	0.555	0.688	1.235	0.655
8	0.637	0.676	0.637	0.676	0.529	0.676	1.273	0.637
9	0.596	0.604	0.596	0.604	0.482	0.601	1.249	0.596

RP	PERCENT SPAN	INCIDENCE		DEV	D-FACT	EFF	LOSS COEFF		LOSS PARAM	
		MEAN	SS				TOT	PROF	TOT	PROF
1	5.00	-5.3	-12.6	6.7	0.075	0.	0.169	0.169	0.065	0.065
2	10.00	-6.1	-13.4	5.9	0.060	0.	0.095	0.095	0.035	0.035
3	15.00	-6.1	-13.4	5.5	0.059	0.	0.084	0.084	0.030	0.030
4	30.00	-5.8	-13.0	5.7	0.095	0.	0.078	0.078	0.025	0.025
5	50.00	-5.4	-12.5	7.3	0.106	0.	0.076	0.076	0.022	0.022
6	70.00	-6.5	-13.6	7.7	0.103	0.	0.140	0.140	0.034	0.034
7	85.00	-6.2	-13.2	7.3	0.057	0.	0.121	0.121	0.025	0.025
8	90.00	-6.9	-13.1	8.9	0.040	0.	0.239	0.239	0.047	0.047
9	95.00	-6.0	-12.9	12.2	0.071	0.	0.509	0.509	0.094	0.094

TABLE VIII. - Continued.

(g) 80 Percent of design speed; reading 3012

RP	RADII		ABS BETAM		REL BETAM		TOTAL TEMP		TOTAL PRESS	
	IN	OUT	IN	OUT	IN	OUT	IN	RATIO	IN	RATIO
1	23.395	25.421	20.9	3.0	20.9	3.0	304.4	0.998	11.97	0.971
2	22.718	22.771	20.2	2.1	20.2	2.1	304.1	1.000	12.15	0.981
3	22.045	22.126	20.6	1.3	20.6	1.3	303.8	1.000	12.15	0.988
4	20.015	20.196	23.1	0.8	23.1	0.8	303.2	1.001	12.17	0.991
5	17.315	17.673	27.5	-0.5	27.5	-0.5	302.4	1.002	12.08	0.994
6	14.600	15.176	30.6	-0.2	30.6	-0.2	301.5	1.000	11.97	0.965
7	12.509	13.284	34.6	0.5	34.6	0.5	300.7	1.000	11.81	0.974
8	11.786	12.603	36.4	1.9	36.4	1.9	300.1	1.002	11.68	0.966
9	11.049	11.935	38.6	4.3	38.6	4.3	299.5	1.005	11.47	0.941

RP	ABS VEL		REL VEL		MERID VEL		TANG VEL		WHEEL SPEED	
	IN	OUT	IN	OUT	IN	OUT	IN	OUT	IN	OUT
1	192.4	179.1	192.4	179.1	179.8	178.8	68.6	9.4	0.	0.
2	197.8	188.6	197.8	188.6	185.6	188.4	68.5	6.8	0.	0.
3	198.4	191.3	198.4	191.3	185.7	191.3	69.6	4.2	0.	0.
4	204.9	194.1	204.9	194.1	188.4	194.1	80.3	2.6	0.	0.
5	206.7	195.2	206.7	195.2	183.4	195.2	95.5	-1.5	0.	0.
6	206.3	189.9	206.3	189.9	177.5	189.9	105.0	-0.6	0.	0.
7	202.6	185.3	202.6	185.3	166.8	185.3	115.0	1.8	0.	0.
8	196.5	182.2	196.5	182.2	158.2	182.1	116.6	5.9	0.	0.
9	187.3	167.9	187.3	167.9	146.4	167.5	116.9	12.5	0.	0.

RP	ABS MACH NO		REL MACH NO		MERID MACH NO		MERID PEAK SS	
	IN	OUT	IN	OUT	IN	OUT	VEL R	MACH NO
1	0.568	0.527	0.568	0.527	0.530	0.526	0.995	0.568
2	0.585	0.556	0.585	0.556	0.549	0.555	1.015	0.585
3	0.587	0.565	0.587	0.565	0.549	0.565	1.030	0.587
4	0.608	0.574	0.608	0.574	0.560	0.574	1.030	0.608
5	0.615	0.578	0.615	0.578	0.546	0.578	1.064	0.615
6	0.615	0.563	0.615	0.563	0.529	0.563	1.070	0.615
7	0.604	0.549	0.604	0.549	0.497	0.549	1.111	0.604
8	0.585	0.539	0.585	0.539	0.471	0.539	1.151	0.585
9	0.557	0.494	0.557	0.494	0.435	0.493	1.144	0.557

RP	PERCENT		INCIDENCE		DEV	D-FACT	EFF	LOSS COEFF		LOSS PARAM	
	SPAN		MEAN	SS				TOT	PROF	TOT	PROF
1	5.00		-0.1	-7.4	8.2	0.187	0.	0.149	0.149	0.057	0.057
2	10.00		-1.7	-9.0	7.4	0.162	0.	0.090	0.090	0.033	0.033
3	15.00		-2.2	-9.5	6.8	0.154	0.	0.059	0.059	0.021	0.021
4	30.00		-2.5	-9.7	6.6	0.176	0.	0.042	0.042	0.014	0.014
5	50.00		-2.4	-9.5	5.9	0.188	0.	0.026	0.026	0.007	0.007
6	70.00		-3.6	-10.7	6.5	0.200	0.	0.066	0.066	0.016	0.016
7	85.00		-3.5	-10.6	7.4	0.199	0.	0.120	0.120	0.025	0.025
8	90.00		-3.5	-10.5	8.8	0.179	0.	0.166	0.166	0.033	0.033
9	95.00		-3.3	-10.3	11.4	0.202	0.	0.311	0.311	0.057	0.057

TABLE VIII. - Continued.

(h) 80 Percent of design speed; reading 3014

RP	RADII		ABS BETAM		REL BETAM		TOTAL TEMP		TOTAL PRESS	
	IN	OUT	IN	OUT	IN	OUT	IN	RATIO	IN	RATIO
1	23.396	23.421	25.7	3.3	25.7	3.3	307.0	0.999	12.30	0.973
2	22.718	22.771	24.4	3.0	24.4	3.0	306.3	1.000	12.40	0.984
3	22.045	22.126	24.6	2.5	24.6	2.5	305.8	1.000	12.40	0.988
4	20.015	20.196	26.9	2.0	26.9	2.0	304.4	1.002	12.34	0.995
5	17.315	17.673	30.9	0.2	30.9	0.2	303.1	0.999	12.16	0.995
6	14.600	15.176	33.7	0.3	33.7	0.5	301.9	1.000	11.98	0.994
7	12.509	13.264	37.0	1.9	37.0	1.9	300.8	1.001	11.82	0.981
8	11.786	12.603	39.0	4.7	39.0	4.7	300.0	1.005	11.68	0.979
9	11.049	11.935	41.2	7.0	41.2	7.0	299.5	1.007	11.49	0.963

RP	ABS VEL		REL VEL		MERID VEL		TANG VEL		WHEEL SPEED	
	IN	OUT	IN	OUT	IN	OUT	IN	OUT	IN	OUT
1	185.0	167.2	185.0	167.2	166.8	166.9	80.2	9.7	0.	0.
2	188.6	175.7	188.6	175.7	171.8	175.4	77.8	9.1	0.	0.
3	188.1	176.4	188.1	176.4	171.1	176.2	78.2	7.6	0.	0.
4	192.2	177.4	192.2	177.4	171.4	177.5	87.0	6.0	0.	0.
5	192.5	173.6	192.5	173.6	165.1	173.6	99.0	0.7	0.	0.
6	191.6	170.7	191.6	170.7	159.4	170.6	106.3	0.9	0.	0.
7	190.1	162.9	190.1	162.9	151.8	162.9	114.5	5.5	0.	0.
8	184.5	161.3	184.5	161.3	143.4	160.7	116.0	13.2	0.	0.
9	177.7	150.0	177.7	150.0	133.8	148.9	117.0	18.4	0.	0.

RP	ABS MACH NO		REL MACH NO		MERID MACH NO		MERID PEAK SS	
	IN	OUT	IN	OUT	IN	OUT	VEL R	MACH NO
1	0.542	0.487	0.542	0.487	0.489	0.487	1.001	0.592
2	0.554	0.514	0.554	0.514	0.504	0.513	1.021	0.554
3	0.553	0.517	0.553	0.517	0.503	0.516	1.030	0.553
4	0.567	0.520	0.567	0.520	0.506	0.520	1.034	0.557
5	0.569	0.510	0.569	0.510	0.488	0.510	1.051	0.569
6	0.568	0.502	0.568	0.502	0.472	0.502	1.070	0.568
7	0.564	0.479	0.564	0.479	0.450	0.479	1.075	0.564
8	0.547	0.474	0.547	0.474	0.425	0.472	1.121	0.547
9	0.526	0.439	0.526	0.439	0.396	0.436	1.113	0.526

RP	PERCENT		INCIDENCE		DEV	D-FACT	EFF	LOSS COEFF		LOSS PARAM	
	SPAN	MEAN	SS	TOT				PROF	TOT	PROF	
1	5.00	4.7	-2.6	8.6	0.242	0.	0.147	0.147	0.056	0.056	
2	10.00	2.4	-4.9	8.4	0.205	0.	0.088	0.088	0.032	0.032	
3	15.00	1.7	-5.6	8.0	0.197	0.	0.062	0.062	0.022	0.022	
4	30.00	1.4	-5.9	7.8	0.215	0.	0.036	0.036	0.012	0.012	
5	50.00	1.1	-6.0	6.6	0.242	0.	0.037	0.037	0.011	0.011	
6	70.00	-0.6	-7.7	7.0	0.240	0.	0.052	0.052	0.008	0.008	
7	85.00	-1.1	-8.2	8.8	0.258	0.	0.097	0.097	0.020	0.020	
8	90.00	-0.9	-7.9	11.6	0.231	0.	0.116	0.116	0.023	0.023	
9	95.00	-0.7	-7.7	14.1	0.255	0.	0.215	0.215	0.040	0.040	

TABLE VIII. - Continued.

(i) 80 Percent of design speed; reading 3015

RP	RADII		ABS BETAM		REL BETAM		TOTAL TEMP		TOTAL PRESS	
	IN	OUT	IN	OUT	IN	OUT	IN	RATIO	IN	RATIO
1	23.596	23.421	29.8	3.6	29.8	3.6	509.2	1.000	12.47	0.976
2	22.718	22.771	27.8	3.3	27.8	3.3	508.1	1.001	12.61	0.981
3	22.045	22.126	28.1	2.9	28.1	2.9	507.2	1.001	12.55	0.990
4	20.015	20.196	30.7	2.3	30.7	2.3	505.7	1.000	12.45	0.992
5	17.315	17.673	34.3	1.8	34.3	1.8	505.9	1.000	12.22	0.991
6	14.600	15.176	36.7	1.0	36.7	1.0	502.5	1.000	12.01	0.988
7	12.509	13.264	39.8	4.1	39.8	4.1	501.1	1.001	11.80	0.990
8	11.786	12.603	41.4	7.4	41.4	7.4	500.5	1.005	11.66	0.966
9	11.049	11.935	43.4	7.7	43.4	7.7	500.0	1.005	11.56	0.966

RP	ABS VEL		REL VEL		MERID VEL		TANG VEL		WHEEL SPEED	
	IN	OUT	IN	OUT	IN	OUT	IN	OUT	IN	OUT
1	177.1	158.1	177.1	158.1	153.7	157.8	88.0	9.9	0.	0.
2	181.7	165.3	181.7	165.3	160.8	165.0	84.7	9.5	0.	0.
3	180.2	166.3	180.2	166.3	159.0	166.0	84.8	8.4	0.	0.
4	182.9	164.9	182.9	164.9	157.2	164.7	93.4	6.5	0.	0.
5	182.0	158.0	182.0	158.0	150.4	157.9	102.5	5.0	0.	0.
6	181.5	150.7	181.5	150.7	145.5	150.7	108.5	2.7	0.	0.
7	179.4	147.9	179.4	147.9	137.9	147.5	114.8	10.6	0.	0.
8	174.8	142.6	174.8	142.6	131.1	141.4	115.7	18.5	0.	0.
9	171.9	129.0	171.9	129.0	124.9	127.9	118.2	17.3	0.	0.

RP	ABS MACH NO		REL MACH NO		MERID MACH NO		MERID PEAK SS	
	IN	OUT	IN	OUT	IN	OUT	VEL R	MACH NO
1	0.516	0.458	0.516	0.458	0.448	0.457	1.027	0.653
2	0.531	0.480	0.531	0.480	0.470	0.480	1.026	0.610
3	0.527	0.484	0.527	0.484	0.465	0.483	1.044	0.589
4	0.537	0.481	0.537	0.481	0.461	0.481	1.043	0.603
5	0.536	0.462	0.536	0.462	0.442	0.462	1.050	0.594
6	0.535	0.441	0.535	0.441	0.429	0.440	1.036	0.555
7	0.530	0.435	0.530	0.435	0.407	0.432	1.070	0.530
8	0.516	0.417	0.516	0.417	0.387	0.413	1.079	0.516
9	0.508	0.376	0.508	0.376	0.369	0.372	1.024	0.508

RP	PERCENT SPAN	INCIDENCE		DEV	D-FACT	EFF	LOSS COEFF		LOSS PARAM	
		MEAN	SS				TOT	PROF	TOT	PROF
1	5.00	8.8	1.5	8.8	0.276	0.	0.143	0.143	0.055	0.055
2	10.00	5.8	-1.4	8.7	0.244	0.	0.109	0.109	0.041	0.041
3	15.00	5.2	-2.1	8.4	0.230	0.	0.060	0.060	0.022	0.022
4	30.00	5.2	-2.1	8.1	0.254	0.	0.044	0.044	0.014	0.014
5	50.00	4.5	-2.7	8.2	0.283	0.	0.049	0.049	0.014	0.014
6	70.00	2.5	-4.6	7.7	0.308	0.	0.066	0.066	0.016	0.016
7	85.00	1.6	-5.4	11.0	0.292	0.	0.057	0.057	0.012	0.012
8	90.00	1.5	-5.5	14.4	0.289	0.	0.083	0.083	0.016	0.016
9	95.00	1.5	-5.5	14.8	0.353	0.	0.208	0.208	0.038	0.038

TABLE VIII. - Continued.

(j) 80 Percent of design speed; reading 3007

RP	RADII		ABS BETAM		REL BETAM		TOTAL TEMP		TOTAL PRESS	
	IN	OUT	IN	OUT	IN	OUT	IN	RATIO	IN	RATIO
1	23.396	23.421	35.1	4.6	35.1	4.6	310.7	0.999	12.42	0.979
2	22.718	22.771	31.1	3.8	31.1	3.8	309.1	1.001	12.58	0.978
3	22.045	22.126	31.3	3.3	31.3	3.3	308.2	1.001	12.59	0.984
4	20.015	20.196	33.6	2.7	33.6	2.7	306.7	0.999	12.47	0.990
5	17.315	17.673	36.8	2.4	36.8	2.4	304.8	0.998	12.27	0.992
6	14.600	15.176	38.7	2.1	38.7	2.1	302.8	1.000	12.05	0.987
7	12.509	13.264	41.8	5.8	41.8	5.8	301.1	1.001	11.78	0.990
8	11.786	12.603	43.1	8.0	43.1	8.0	300.4	1.003	11.67	0.984
9	11.049	11.935	45.3	6.4	45.3	6.4	300.0	1.004	11.57	0.966

RP	ABS VEL		REL VEL		MERID VEL		TANG VEL		WHEEL SPEED	
	IN	OUT	IN	OUT	IN	OUT	IN	OUT	IN	OUT
1	167.3	147.0	167.3	147.0	136.9	146.5	96.1	11.9	0.	0.
2	173.7	153.3	173.7	153.3	148.7	153.0	89.7	10.2	0.	0.
3	174.2	156.1	174.2	156.1	148.9	155.8	90.5	9.0	0.	0.
4	176.8	155.2	176.8	155.2	147.3	155.1	97.8	7.3	0.	0.
5	176.9	150.0	176.9	150.0	141.6	149.8	106.1	6.3	0.	0.
6	175.9	139.7	175.9	139.7	137.3	139.7	110.0	5.1	0.	0.
7	173.0	134.4	173.0	134.4	129.1	133.7	115.2	13.7	0.	0.
8	169.3	127.2	169.3	127.2	123.6	126.0	115.7	17.7	0.	0.
9	167.1	111.9	167.1	111.9	117.6	111.2	118.7	12.4	0.	0.

RP	ABS MACH NO		REL MACH NO		MERID MACH NO		MERID PEAK SS	
	IN	OUT	IN	OUT	IN	OUT	VEL R	MACH NO
1	0.485	0.424	0.485	0.424	0.397	0.422	1.070	0.704
2	0.505	0.443	0.505	0.443	0.433	0.442	1.029	0.647
3	0.508	0.452	0.508	0.452	0.434	0.451	1.046	0.637
4	0.517	0.451	0.517	0.451	0.431	0.451	1.053	0.643
5	0.519	0.437	0.519	0.437	0.415	0.437	1.058	0.633
6	0.518	0.407	0.518	0.407	0.404	0.407	1.017	0.569
7	0.510	0.392	0.510	0.392	0.381	0.390	1.036	0.529
8	0.499	0.371	0.499	0.371	0.365	0.367	1.019	0.499
9	0.493	0.325	0.493	0.325	0.347	0.323	0.945	0.502

RP	PERCENT		INCIDENCE		DEV	D-FACT	EFF	LOSS COEFF		LOSS PARAM	
	SPAN	MEAN	SS	TOT				PROF	TOT	PROF	
1	5.00	14.0	6.7	9.9	0.314	0.	0.143	0.143	0.054	0.054	
2	10.00	9.1	1.9	9.2	0.287	0.	0.136	0.136	0.050	0.050	
3	15.00	8.4	1.2	8.8	0.272	0.	0.099	0.099	0.036	0.036	
4	30.00	8.0	0.8	8.6	0.289	0.	0.060	0.060	0.020	0.020	
5	50.00	7.0	-0.1	8.7	0.311	0.	0.047	0.047	0.013	0.013	
6	70.00	4.4	-2.7	8.8	0.346	0.	0.078	0.078	0.019	0.019	
7	85.00	3.6	-3.4	12.7	0.341	0.	0.064	0.064	0.013	0.013	
8	90.00	3.2	-5.8	14.9	0.357	0.	0.102	0.102	0.020	0.020	
9	95.00	3.4	-3.6	13.4	0.443	0.	0.220	0.220	0.041	0.041	

TABLE VIII. - Continued.

(k) 80 Percent of design speed; reading 3006

RP	RADII		ABS BETAM		REL BETAM		TOTAL TEMP		TOTAL PRESS	
	IN	OUT	IN	OUT	IN	OUT	IN	RATIO	IN	RATIO
1	23.396	23.421	47.2	4.8	47.2	4.8	314.0	0.993	12.29	0.977
2	22.718	22.771	38.4	4.6	38.4	4.6	311.2	0.998	12.41	0.975
3	22.045	22.126	35.8	4.3	35.8	4.3	309.7	1.001	12.50	0.975
4	20.015	20.196	36.5	3.5	36.5	3.5	307.6	0.998	12.44	0.988
5	17.315	17.673	39.5	2.7	39.5	2.7	305.4	0.998	12.27	0.989
6	14.600	15.176	40.4	3.4	40.4	3.4	302.8	1.000	11.99	0.991
7	12.509	13.264	43.0	6.3	43.0	6.3	301.3	1.001	11.78	0.985
8	11.786	12.603	44.5	7.6	44.5	7.6	300.6	1.003	11.67	0.977
9	11.049	11.935	46.2	5.1	46.2	5.1	300.2	1.004	11.59	0.964

RP	ABS VEL		REL VEL		MERID VEL		TANG VEL		WHEEL SPEED	
	IN	OUT	IN	OUT	IN	OUT	IN	OUT	IN	OUT
1	159.0	134.6	159.0	134.6	108.1	134.1	116.6	11.2	0.	0.
2	163.8	138.5	163.8	138.5	128.3	138.0	101.9	11.1	0.	0.
3	168.5	142.7	168.5	142.7	136.8	142.3	98.5	10.7	0.	0.
4	171.3	147.5	171.3	147.5	137.7	147.2	102.0	8.9	0.	0.
5	172.2	141.9	172.2	141.9	132.9	141.7	109.5	6.8	0.	0.
6	170.1	132.3	170.1	132.3	129.6	132.0	110.2	7.8	0.	0.
7	168.8	121.7	168.8	121.7	123.5	121.0	115.1	13.3	0.	0.
8	165.7	111.8	165.7	111.8	118.1	110.8	116.2	14.7	0.	0.
9	164.4	98.8	164.4	98.8	113.9	98.4	118.6	8.9	0.	0.

RP	ABS MACH NO		REL MACH NO		MERID MACH NO		MERID PEAK SS	
	IN	OUT	IN	OUT	IN	OUT	VEL R	MACH NO
1	0.457	0.386	0.457	0.386	0.311	0.385	1.240	0.853
2	0.474	0.398	0.474	0.398	0.371	0.397	1.076	0.728
3	0.489	0.411	0.489	0.411	0.397	0.410	1.041	0.692
4	0.499	0.427	0.499	0.427	0.401	0.427	1.069	0.675
5	0.504	0.412	0.504	0.412	0.389	0.412	1.067	0.665
6	0.500	0.385	0.500	0.385	0.381	0.384	1.018	0.588
7	0.497	0.354	0.497	0.354	0.364	0.352	0.980	0.552
8	0.488	0.325	0.488	0.325	0.348	0.322	0.939	0.537
9	0.484	0.286	0.484	0.286	0.336	0.285	0.864	0.525

RP	PERCENT		INCIDENCE		DEV	D-FACT	EFF	LOSS COEFF		LOSS PARAM	
	SPAN	MEAN	SS	TOT				PROF	TOT	PROF	
1	5.00	26.1	18.8	10.0	0.407	0.	0.171	0.171	0.065	0.065	
2	10.00	16.5	9.2	10.0	0.360	0.	0.177	0.177	0.065	0.065	
3	15.00	12.9	5.6	9.8	0.340	0.	0.163	0.163	0.059	0.059	
4	30.00	11.0	3.8	9.3	0.316	0.	0.077	0.077	0.025	0.025	
5	50.00	9.7	2.5	9.1	0.344	0.	0.066	0.066	0.019	0.019	
6	70.00	6.1	-1.0	10.0	0.365	0.	0.058	0.058	0.014	0.014	
7	85.00	4.9	-2.2	13.1	0.400	0.	0.095	0.095	0.020	0.020	
8	90.00	4.6	-2.4	14.5	0.440	0.	0.152	0.152	0.030	0.030	
9	95.00	4.3	-2.7	12.2	0.517	0.	0.244	0.244	0.045	0.045	

TABLE VIII. - Continued.

(l) 90 Percent of design speed; reading 3016

RP	RADII		ABS BETAM		REL BETAM		TOTAL TEMP		TOTAL PRESS	
	IN	OUT	IN	OUT	IN	OUT	IN	RATIO	IN	RATIO
1	23.396	23.421	21.3	3.0	21.3	3.0	309.0	0.998	12.54	0.959
2	22.718	22.771	20.6	1.9	20.6	1.9	308.7	0.999	12.73	0.973
3	22.045	22.126	20.9	1.4	20.9	1.4	308.3	0.999	12.76	0.982
4	20.015	20.196	23.6	0.8	23.6	0.8	307.7	1.001	12.77	0.986
5	17.315	17.673	27.6	0.4	27.6	0.4	306.6	1.002	12.67	0.988
6	14.600	15.176	30.5	0.0	30.5	0.0	305.3	0.999	12.40	0.974
7	12.509	13.264	34.1	0.8	34.1	0.8	304.2	1.000	12.25	0.959
8	11.786	12.603	36.0	2.3	36.0	2.3	303.4	1.001	12.11	0.932
9	11.049	11.935	38.5	4.9	38.5	4.9	302.6	1.004	11.79	0.880

RP	ABS VEL		REL VEL		MERID VEL		TANG VEL		WHEEL SPEED	
	IN	OUT	IN	OUT	IN	OUT	IN	OUT	IN	OUT
1	218.3	206.5	218.3	206.5	203.3	206.2	79.4	10.9	0.	0.
2	224.0	218.3	224.0	218.3	209.7	218.1	78.7	7.2	0.	0.
3	224.7	220.7	224.7	220.7	209.8	220.6	80.2	5.5	0.	0.
4	253.8	224.7	253.8	224.7	214.2	224.7	93.5	3.3	0.	0.
5	237.4	228.2	237.4	228.2	210.3	228.2	110.0	1.6	0.	0.
6	233.5	221.4	233.5	221.4	201.1	221.4	118.5	0.1	0.	0.
7	229.2	221.5	229.2	221.5	189.8	221.5	128.5	3.0	0.	0.
8	222.8	213.4	222.8	213.4	180.3	213.2	130.8	8.5	0.	0.
9	211.0	187.2	211.0	187.2	165.1	186.6	131.5	15.9	0.	0.

RP	ABS MACH NO		REL MACH NO		MERID MACH NO		MERID PEAK SS	
	IN	OUT	IN	OUT	IN	OUT	VEL R	MACH NO
1	0.645	0.608	0.645	0.608	0.600	0.607	1.014	0.645
2	0.663	0.646	0.663	0.646	0.621	0.645	1.040	0.663
3	0.666	0.653	0.666	0.653	0.622	0.653	1.051	0.666
4	0.696	0.667	0.696	0.667	0.638	0.667	1.049	0.696
5	0.709	0.679	0.709	0.679	0.629	0.679	1.085	0.709
6	0.698	0.660	0.698	0.660	0.602	0.660	1.101	0.698
7	0.686	0.661	0.686	0.661	0.568	0.661	1.167	0.686
8	0.666	0.635	0.666	0.635	0.539	0.635	1.183	0.666
9	0.629	0.552	0.629	0.552	0.492	0.550	1.130	0.629

RP	PERCENT	INCIDENCE		DEV	D-FACT	EFF	LOSS COEFF		LOSS PARAM	
	SPAN	MEAN	SS				TOT	PROF	TOT	PROF
1	5.00	0.3	-7.0	8.3	0.174	0.	0.170	0.170	0.065	0.065
2	10.00	-1.4	-8.7	7.3	0.144	0.	0.104	0.104	0.039	0.039
3	15.00	-1.9	-9.2	6.9	0.137	0.	0.068	0.068	0.025	0.025
4	30.00	-2.0	-9.2	6.7	0.165	0.	0.050	0.050	0.016	0.016
5	50.00	-2.2	-9.4	6.7	0.167	0.	0.042	0.042	0.012	0.012
6	70.00	-3.7	-10.8	6.7	0.172	0.	0.095	0.095	0.023	0.023
7	85.00	-4.0	-11.1	7.6	0.144	0.	0.151	0.151	0.032	0.032
8	90.00	-3.9	-10.9	9.2	0.146	0.	0.266	0.266	0.052	0.052
9	95.00	-3.3	-10.3	11.9	0.209	0.	0.513	0.513	0.095	0.095

TABLE VIII. - Continued.

(m) 90 Percent of design speed; reading 2997

RP	RADII		ABS BETAM		REL BETAM		TOTAL TEMP		TOTAL PRESS	
	IN	OUT	IN	OUT	IN	OUT	IN	RATIO	IN	RATIO
1	23.396	23.421	25.9	3.5	25.9	3.5	312.1	0.999	12.97	0.967
2	22.718	22.771	24.6	3.2	24.6	3.2	311.4	1.000	13.10	0.980
3	22.045	22.126	24.6	2.7	24.6	2.7	310.8	0.999	13.13	0.984
4	20.015	20.196	27.0	1.9	27.0	1.9	309.3	1.001	13.00	0.991
5	17.315	17.673	30.4	0.1	30.4	0.1	307.7	0.998	12.76	0.990
6	14.600	15.176	33.2	0.2	33.2	0.2	305.9	0.999	12.50	0.988
7	12.509	13.264	36.4	1.9	36.4	1.9	304.7	0.999	12.25	0.970
8	11.786	12.603	38.5	4.0	38.5	4.0	303.8	1.001	12.07	0.961
9	11.049	11.935	40.8	6.2	40.8	6.2	303.1	1.004	11.86	0.926

RP	ABS VEL		REL VEL		MERID VEL		TANG VEL		WHEEL SPEED	
	IN	OUT	IN	OUT	IN	OUT	IN	OUT	IN	OUT
1	210.9	191.4	210.9	191.4	189.7	191.0	92.1	11.8	0.	0.
2	215.2	200.7	215.2	200.7	195.7	200.3	89.4	11.3	0.	0.
3	216.0	202.0	216.0	202.0	196.4	201.8	89.9	9.6	0.	0.
4	221.3	203.4	221.3	203.4	197.3	203.3	100.4	6.7	0.	0.
5	222.0	199.7	222.0	199.7	191.4	199.7	112.5	0.3	0.	0.
6	220.3	196.7	220.3	196.7	184.5	196.7	120.5	0.8	0.	0.
7	216.0	188.8	216.0	188.8	173.8	188.7	128.3	6.1	0.	0.
8	209.8	184.6	209.8	184.6	164.1	184.2	130.7	12.8	0.	0.
9	202.3	166.3	202.3	166.3	153.1	165.3	132.3	18.0	0.	0.

RP	ABS MACH NO		REL MACH NO		MERID MACH NO		MERID PEAK SS	
	IN	OUT	IN	OUT	IN	OUT	VEL R	MACH NO
1	0.618	0.557	0.618	0.557	0.556	0.556	1.007	0.681
2	0.632	0.587	0.632	0.587	0.575	0.536	1.024	0.632
3	0.636	0.591	0.636	0.591	0.578	0.591	1.027	0.636
4	0.654	0.597	0.654	0.597	0.583	0.597	1.031	0.654
5	0.658	0.588	0.658	0.588	0.568	0.588	1.043	0.658
6	0.655	0.580	0.655	0.580	0.548	0.580	1.066	0.655
7	0.642	0.556	0.642	0.556	0.517	0.556	1.086	0.642
8	0.623	0.544	0.623	0.544	0.488	0.542	1.122	0.623
9	0.600	0.487	0.600	0.487	0.454	0.484	1.080	0.600

RP	PERCENT		INCIDENCE		DEV	D-FACT	EFF	LOSS COEFF		LOSS PARAM	
	SPAN	MEAN	SS	TOT				PROF	TOT	PROF	
1	5.00	4.9	-2.4	8.8	0.238	0.	0.143	0.143	0.055	0.055	
2	10.00	2.6	-4.7	8.6	0.202	0.	0.085	0.083	0.031	0.031	
3	15.00	1.7	-5.5	8.2	0.199	0.	0.069	0.069	0.025	0.025	
4	30.00	1.4	-5.8	7.8	0.219	0.	0.034	0.034	0.011	0.011	
5	50.00	0.6	-6.5	6.4	0.243	0.	0.039	0.039	0.011	0.011	
6	70.00	-1.1	-8.2	6.9	0.236	0.	0.047	0.047	0.011	0.011	
7	85.00	-1.7	-8.7	8.7	0.240	0.	0.123	0.123	0.026	0.026	
8	90.00	-1.3	-8.4	10.9	0.226	0.	0.169	0.169	0.033	0.033	
9	95.00	-1.0	-8.0	13.3	0.277	0.	0.341	0.341	0.063	0.063	

TABLE VIII. - Continued.

(n) 90 Percent of design speed; reading 2998

RP	RADII		ABS BETAM		REL BETAM		TOTAL TEMP		TOTAL PRESS	
	IN	OUT	IN	OUT	IN	OUT	IN	RATIO	IN	RATIO
1	23.396	23.421	28.6	3.5	28.6	3.5	314.2	1.000	13.17	0.974
2	22.718	22.771	27.5	3.5	27.5	3.5	313.4	1.000	13.41	0.978
3	22.045	22.126	27.9	3.2	27.9	3.2	312.6	1.000	13.34	0.988
4	20.015	20.196	30.0	2.4	30.0	2.4	310.7	1.000	13.22	0.986
5	17.315	17.673	32.9	1.3	32.9	1.3	308.5	0.997	12.84	0.986
6	14.600	15.176	35.4	0.8	35.4	0.8	306.3	0.999	12.54	0.987
7	12.509	13.264	38.8	3.2	38.8	3.2	304.7	1.000	12.25	0.983
8	11.786	12.603	40.7	6.5	40.7	6.5	303.6	1.003	12.04	0.977
9	11.049	11.935	42.8	7.7	42.8	7.7	303.0	1.005	11.88	0.954

RP	ABS VEL		REL VEL		MERID VEL		TANG VEL		WHEEL SPEED	
	IN	OUT	IN	OUT	IN	OUT	IN	OUT	IN	OUT
1	203.7	184.7	203.7	184.7	178.8	184.3	97.5	11.5	0.	0.
2	210.8	192.9	210.8	192.9	187.1	192.5	97.3	11.8	0.	0.
3	209.2	193.8	209.2	193.8	185.0	193.5	97.8	10.9	0.	0.
4	214.0	191.0	214.0	191.0	185.4	190.8	106.9	8.2	0.	0.
5	212.1	185.5	212.1	185.5	178.0	183.4	115.3	4.3	0.	0.
6	210.7	178.5	210.7	178.5	171.7	178.5	122.2	2.5	0.	0.
7	206.8	174.0	206.8	174.0	161.2	173.8	129.5	9.6	0.	0.
8	200.2	168.6	200.2	168.6	151.9	167.5	139.4	19.0	0.	0.
9	194.8	155.5	194.8	155.5	142.8	154.1	132.5	20.7	0.	0.

RP	ABS MACH NO		REL MACH NO		MERID MACH NO		MERID PEAK SS	
	IN	OUT	IN	OUT	IN	OUT	VEL R	MACH NO
1	0.593	0.534	0.593	0.534	0.521	0.533	1.031	0.724
2	0.616	0.560	0.616	0.560	0.547	0.559	1.029	0.699
3	0.612	0.564	0.612	0.564	0.541	0.563	1.046	0.679
4	0.629	0.557	0.629	0.557	0.545	0.557	1.029	0.683
5	0.626	0.537	0.626	0.537	0.525	0.537	1.030	0.638
6	0.624	0.523	0.624	0.523	0.508	0.525	1.040	0.624
7	0.613	0.510	0.613	0.510	0.478	0.509	1.078	0.613
8	0.593	0.494	0.593	0.494	0.450	0.490	1.103	0.593
9	0.577	0.454	0.577	0.454	0.425	0.449	1.079	0.577

RP	PERCENT SPAN		INCIDENCE		DEV	D-FACT	EFF	LOSS COEFF		LOSS PARAM	
	SPAN	MEAN	SS	TOT				PROF	TOT	PROF	
1	5.00	7.6	0.3	8.7	0.255	0.	0.121	0.121	0.046	0.046	
2	10.00	5.5	-1.8	8.9	0.235	0.	0.097	0.097	0.036	0.036	
3	15.00	5.0	-2.2	8.7	0.223	0.	0.055	0.053	0.019	0.019	
4	30.00	4.4	-2.8	8.3	0.258	0.	0.060	0.060	0.020	0.020	
5	50.00	3.1	-4.1	7.7	0.282	0.	0.058	0.058	0.017	0.017	
6	70.00	1.2	-5.9	7.5	0.297	0.	0.057	0.057	0.014	0.014	
7	85.00	0.6	-6.4	10.0	0.275	0.	0.075	0.075	0.016	0.016	
8	90.00	0.8	-6.3	13.4	0.263	0.	0.107	0.107	0.021	0.021	
9	95.00	1.0	-6.0	14.7	0.302	0.	0.226	0.226	0.041	0.041	

TABLE VIII. - Continued.

(o) 90 Percent of design speed; reading 2999

RP	RADII		ABS BETAM		REL BETAM		TOTAL TEMP		TOTAL PRESS	
	IN	OUT	IN	OUT	IN	OUT	IN	RATIO	IN	RATIO
1	25.396	25.421	32.4	4.2	32.4	4.2	316.1	1.000	13.34	0.972
2	22.718	22.771	30.2	3.7	30.2	3.7	315.1	1.000	13.54	0.974
3	22.045	22.126	30.2	3.5	30.2	3.5	315.9	1.000	13.51	0.981
4	20.015	20.196	32.4	2.5	32.4	2.5	311.3	0.999	13.25	0.984
5	17.315	17.673	35.7	2.2	35.7	2.2	308.5	0.999	12.82	0.992
6	14.600	15.176	38.3	1.6	38.3	1.6	306.3	1.000	12.53	0.985
7	12.509	13.264	40.5	5.0	40.5	5.0	304.7	1.001	12.26	0.985
8	11.786	12.603	42.2	7.9	42.2	7.9	303.7	1.003	12.06	0.983
9	11.049	11.935	44.9	7.3	44.9	7.3	303.3	1.005	11.92	0.959

RP	ABS VEL		REL VEL		MERID VEL		TANG VEL		WHEEL SPEED	
	IN	OUT	IN	OUT	IN	OUT	IN	OUT	IN	OUT
1	199.4	177.5	199.4	177.5	168.4	177.0	106.8	12.9	0.	0.
2	205.5	184.3	205.5	184.3	177.7	183.9	103.3	11.9	0.	0.
3	205.4	185.1	205.4	185.1	177.4	184.7	103.4	11.3	0.	0.
4	205.8	179.9	205.8	179.9	173.7	179.8	110.4	7.9	0.	0.
5	200.9	171.9	200.9	171.9	165.1	171.8	117.3	6.5	0.	0.
6	200.3	162.2	200.3	162.2	157.1	162.1	124.2	4.5	0.	0.
7	199.4	158.7	199.4	158.7	151.7	158.1	129.4	13.7	0.	0.
8	193.5	152.3	193.5	152.3	143.4	150.9	129.9	20.9	0.	0.
9	190.1	136.3	190.1	136.3	134.8	135.2	134.1	17.3	0.	0.

RP	ABS MACH NO		REL MACH NO		MERID MACH NO		MERID PEAK SS	
	IN	OUT	IN	OUT	IN	OUT	VEL R	MACH NO
1	0.578	0.511	0.578	0.511	0.488	0.509	1.051	0.786
2	0.598	0.532	0.598	0.532	0.517	0.531	1.035	0.745
3	0.599	0.536	0.599	0.536	0.517	0.535	1.041	0.726
4	0.603	0.523	0.603	0.523	0.509	0.522	1.035	0.723
5	0.590	0.501	0.590	0.501	0.479	0.500	1.054	0.693
6	0.590	0.472	0.590	0.472	0.463	0.472	1.032	0.637
7	0.589	0.463	0.589	0.463	0.448	0.461	1.042	0.589
8	0.572	0.444	0.572	0.444	0.424	0.440	1.053	0.572
9	0.562	0.396	0.562	0.396	0.398	0.392	1.003	0.562

RP	PERCENT		INCIDENCE		DEV	D-FACT	EFF	LOSS COEFF		LOSS PARAM	
	SPAN	MEAN	SS	SS				TOT	PROF	TOT	PROF
1	5.00	11.3	4.0	9.4	0.290	0.	0.138	0.138	0.053	0.053	
2	10.00	8.2	0.9	9.1	0.268	0.	0.121	0.121	0.045	0.045	
3	15.00	7.4	0.1	9.0	0.260	0.	0.090	0.090	0.033	0.033	
4	30.00	6.9	-0.3	8.4	0.288	0.	0.071	0.071	0.023	0.023	
5	50.00	5.9	-1.3	8.5	0.299	0.	0.036	0.036	0.010	0.010	
6	70.00	4.1	-3.0	8.3	0.332	0.	0.071	0.071	0.017	0.017	
7	85.00	2.3	-4.7	11.8	0.321	0.	0.074	0.074	0.015	0.015	
8	90.00	2.3	-4.7	14.8	0.318	0.	0.088	0.088	0.017	0.017	
9	95.00	3.0	-4.0	14.4	0.391	0.	0.212	0.212	0.039	0.039	

TABLE VIII. - Continued.

(p) 90 Percent of design speed; reading 3000

RP	RADII		ABS BETAM		REL BETAM		TOTAL TEMP		TOTAL PRESS	
	IN	OUT	IN	OUT	IN	OUT	IN	RATIO	IN	RATIO
1	23.396	23.421	34.5	5.0	34.5	5.0	317.1	0.999	13.27	0.976
2	22.718	22.771	32.4	4.4	32.4	4.4	315.7	1.000	13.45	0.969
3	22.045	22.126	32.4	3.9	32.4	3.9	314.3	1.001	13.37	0.978
4	20.015	20.196	35.2	2.7	35.2	2.7	312.1	0.998	13.14	0.988
5	17.315	17.673	38.3	2.4	38.3	2.4	308.4	0.998	12.86	0.991
6	14.600	15.176	39.7	2.5	39.7	2.5	306.6	1.000	12.53	0.987
7	12.509	13.264	42.1	6.1	42.1	6.1	304.6	1.002	12.21	0.988
8	11.786	12.603	43.7	8.0	43.7	8.0	303.9	1.005	12.07	0.980
9	11.049	11.935	45.9	6.0	45.9	6.0	303.6	1.003	11.96	0.958

RP	ABS VEL		REL VEL		MERID VEL		TANG VEL		WHEEL SPEED	
	IN	OUT	IN	OUT	IN	OUT	IN	OUT	IN	OUT
1	193.4	167.9	193.4	167.9	159.4	167.3	109.6	14.6	0.	0.
2	198.8	173.3	198.8	173.3	167.8	172.8	106.6	13.4	0.	0.
3	197.0	174.1	197.0	174.1	166.2	173.7	105.7	11.8	0.	0.
4	196.7	171.4	196.7	171.4	160.8	171.2	113.2	8.0	0.	0.
5	196.2	165.1	196.2	165.1	154.0	164.9	121.5	6.9	0.	0.
6	195.3	153.7	195.3	153.7	150.3	155.6	124.6	6.7	0.	0.
7	191.9	146.2	191.9	146.2	142.4	145.4	128.7	15.6	0.	0.
8	188.6	137.9	188.6	137.9	136.4	136.6	130.3	19.1	0.	0.
9	186.4	121.1	186.4	121.1	129.8	120.5	133.8	12.7	0.	0.

RP	ABS MACH NO		REL MACH NO		MERID MACH NO		MERID PEAK SS	
	IN	OUT	IN	OUT	IN	OUT	VEL R	MACH NO
1	0.558	0.481	0.558	0.481	0.460	0.480	1.030	0.801
2	0.576	0.499	0.576	0.499	0.487	0.497	1.030	0.767
3	0.572	0.502	0.572	0.502	0.483	0.501	1.045	0.742
4	0.573	0.496	0.573	0.496	0.469	0.496	1.054	0.747
5	0.574	0.479	0.574	0.479	0.451	0.479	1.071	0.732
6	0.574	0.447	0.574	0.447	0.442	0.446	1.022	0.658
7	0.566	0.425	0.566	0.425	0.420	0.423	1.021	0.600
8	0.556	0.400	0.556	0.400	0.402	0.396	1.001	0.534
9	0.550	0.350	0.550	0.350	0.383	0.348	0.928	0.586

RP	PERCENT SPAN		INCIDENCE		DEV	D-FACT	EFF	LOSS COEFF		LOSS PARAM	
	SPAN	MEAN	SS	TOT				PROF	TOT	PROF	
1	5.00	13.5	6.2	10.2	0.319	0.	0.157	0.157	0.060	0.060	
2	10.00	10.5	3.2	9.8	0.302	0.	0.154	0.154	0.057	0.057	
3	15.00	9.6	2.3	9.4	0.287	0.	0.111	0.111	0.040	0.040	
4	30.00	9.6	2.4	8.5	0.303	0.	0.059	0.059	0.019	0.019	
5	50.00	8.5	1.3	8.7	0.323	0.	0.043	0.043	0.012	0.012	
6	70.00	5.4	-1.7	9.2	0.355	0.	0.065	0.065	0.016	0.016	
7	85.00	4.0	-3.1	13.0	0.356	0.	0.061	0.061	0.015	0.015	
8	90.00	3.8	-3.2	14.9	0.380	0.	0.106	0.106	0.021	0.021	
9	95.00	4.0	-3.0	13.1	0.465	0.	0.225	0.225	0.041	0.041	

TABLE VIII. - Continued.

(r) 100 Percent of design speed; reading 3017

RP	RADII		ABS BETAM		REL BETAM		TOTAL TEMP		TOTAL PRESS	
	IN	OUT	IN	OUT	IN	OUT	IN	RATIO	IN	RATIO
1	23.396	23.421	26.2	3.8	26.2	3.8	317.1	0.999	13.28	0.968
2	22.718	22.771	24.5	3.6	24.5	3.6	316.4	0.999	13.50	0.973
3	22.045	22.126	25.5	3.1	25.5	3.1	315.5	1.000	13.60	0.973
4	20.015	20.196	27.6	2.4	27.6	2.4	314.7	0.998	13.61	0.972
5	17.315	17.673	30.2	0.4	30.2	0.4	312.2	1.001	13.43	0.989
6	14.600	15.176	32.7	0.1	32.7	0.1	310.2	0.998	13.12	0.975
7	12.509	13.264	36.2	1.7	36.2	1.7	308.1	0.999	12.70	0.953
8	11.786	12.603	37.9	3.7	37.9	3.7	306.9	1.001	12.44	0.929
9	11.049	11.935	40.4	5.7	40.4	5.7	305.7	1.003	12.11	0.873

RP	ABS VEL		REL VEL		MERID VEL		TANG VEL		WHEEL SPEED	
	IN	OUT	IN	OUT	IN	OUT	IN	OUT	IN	OUT
1	227.2	210.8	227.2	210.8	203.9	210.3	100.3	13.8	0.	0.
2	235.0	219.4	235.0	219.4	213.9	219.0	97.4	13.8	0.	0.
3	236.9	222.1	236.9	222.1	213.9	221.8	101.9	12.0	0.	0.
4	247.8	223.1	247.8	223.1	219.5	222.9	114.9	9.3	0.	0.
5	253.0	232.3	253.0	232.3	218.6	232.3	127.3	1.8	0.	0.
6	253.7	225.8	250.7	225.8	211.0	225.8	135.4	0.3	0.	0.
7	241.9	216.9	241.9	216.9	195.1	216.8	142.9	6.5	0.	0.
8	232.3	205.5	232.3	205.5	183.2	205.1	142.8	13.1	0.	0.
9	220.6	174.0	220.6	174.0	168.0	173.1	143.0	17.3	0.	0.

RP	ABS MACH NO		REL MACH NO		MERID MACH NO		MERID PEAK SS	
	IN	OUT	IN	OUT	IN	OUT	VEL R	MACH NO
1	0.664	0.613	0.664	0.613	0.596	0.611	1.032	0.742
2	0.690	0.640	0.690	0.640	0.628	0.639	1.024	0.690
3	0.697	0.650	0.697	0.650	0.629	0.649	1.037	0.697
4	0.733	0.654	0.733	0.654	0.650	0.654	1.015	0.733
5	0.754	0.686	0.754	0.686	0.651	0.686	1.063	0.754
6	0.749	0.668	0.749	0.668	0.630	0.668	1.070	0.749
7	0.722	0.642	0.722	0.642	0.583	0.641	1.111	0.722
8	0.692	0.606	0.692	0.606	0.546	0.605	1.120	0.692
9	0.656	0.508	0.656	0.508	0.500	0.506	1.030	0.656

RP	PERCENT INCIDENCE		DEV	D-FACT	EFF	LOSS COEFF		LOSS PARAM		
	SPAN	MEAN SS				TOT	PROF	TOT	PROF	
1	5.00	5.2	-2.1	9.0	0.218	0.	0.126	0.126	0.048	0.048
2	10.00	2.5	-4.7	9.0	0.198	0.	0.099	0.099	0.037	0.037
3	15.00	2.6	-4.6	8.6	0.199	0.	0.099	0.099	0.036	0.036
4	30.00	2.1	-5.1	8.3	0.239	0.	0.094	0.094	0.031	0.031
5	50.00	0.4	-6.8	6.8	0.222	0.	0.035	0.035	0.010	0.010
6	70.00	-1.6	-8.7	6.8	0.227	0.	0.080	0.080	0.019	0.019
7	85.00	-1.9	-9.0	8.6	0.217	0.	0.160	0.160	0.035	0.033
8	90.00	-1.9	-9.0	10.6	0.221	0.	0.259	0.259	0.051	0.051
9	95.00	-1.5	-8.5	12.8	0.312	0.	0.505	0.505	0.093	0.093

TABLE VIII. - Continued.

(q) 90 Percent of design speed; reading 3001

RP	RADII		ABS. BETAM		REL. BETAM		TOTAL TEMP		TOTAL PRESS	
	IN	OUT	IN	OUT	IN	OUT	IN	RATIO	IN	RATIO
1	23.396	23.421	44.2	5.1	44.2	5.1	320.0	0.995	12.97	0.970
2	22.718	22.771	37.5	4.8	37.5	4.8	317.4	0.998	15.13	0.967
3	22.045	22.126	35.9	4.5	35.9	4.5	315.8	0.999	15.17	0.972
4	20.015	20.196	37.5	3.5	37.5	3.5	313.0	0.998	13.06	0.987
5	17.315	17.673	39.7	2.7	39.7	2.7	310.5	0.997	12.88	0.988
6	14.600	15.176	40.3	3.4	40.3	3.4	307.4	0.999	12.58	0.985
7	12.509	13.264	43.0	6.3	43.0	6.3	305.1	1.001	12.28	0.981
8	11.786	12.603	44.5	7.9	44.5	7.9	304.1	1.002	12.11	0.975
9	11.049	11.935	46.2	5.3	46.2	5.3	303.8	1.003	12.00	0.955

RP	ABS VEL		REL VEL		MERID VEL		TANG VEL		WHEEL SPEED	
	IN	OUT	IN	OUT	IN	OUT	IN	OUT	IN	OUT
1	182.3	152.9	182.3	152.9	130.6	152.3	127.1	15.5	0.	0.
2	187.8	157.1	187.8	157.1	149.1	156.5	114.2	13.1	0.	0.
3	190.2	161.2	190.2	161.2	154.0	160.7	111.5	12.6	0.	0.
4	192.7	165.4	192.7	165.4	152.8	165.1	117.4	10.0	0.	0.
5	194.7	160.2	194.7	160.2	149.9	160.1	124.3	7.5	0.	0.
6	194.9	149.6	194.9	149.6	148.6	149.3	126.1	8.8	0.	0.
7	191.9	138.5	191.9	138.5	140.3	137.7	130.8	15.1	0.	0.
8	187.4	128.3	187.4	128.3	135.8	127.1	131.3	17.6	0.	0.
9	185.7	112.6	185.7	112.6	128.5	112.2	134.0	10.4	0.	0.

RP	ABS MACH NO		REL MACH NO		MERID MACH NO		MERID PEAK SS	
	IN	OUT	IN	OUT	IN	OUT	VEL R	MACH NO
1	0.522	0.436	0.522	0.436	0.374	0.434	1.166	0.921
2	0.541	0.449	0.541	0.449	0.430	0.448	1.050	0.814
3	0.550	0.462	0.550	0.462	0.445	0.461	1.043	0.780
4	0.560	0.477	0.560	0.477	0.444	0.477	1.080	0.777
5	0.569	0.464	0.569	0.464	0.438	0.464	1.068	0.754
6	0.572	0.434	0.572	0.434	0.436	0.433	1.005	0.673
7	0.565	0.402	0.565	0.402	0.413	0.399	0.981	0.627
8	0.552	0.372	0.552	0.372	0.394	0.368	0.950	0.606
9	0.547	0.325	0.547	0.325	0.379	0.324	0.873	0.594

RP	PERCENT		INCIDENCE		DEV	D-FACT	EFF	LOSS COEFF		LOSS PARAM	
	SPAN		MEAN	SS				TOT	PROF	TOT	PROF
1	5.00		23.2	15.9	10.3	0.399	0.	0.179	0.179	0.068	0.068
2	10.00		15.5	8.2	10.2	0.363	0.	0.185	0.185	0.068	0.068
3	15.00		13.1	5.8	10.0	0.359	0.	0.152	0.152	0.055	0.055
4	30.00		12.0	4.8	9.3	0.323	0.	0.068	0.068	0.022	0.022
5	50.00		9.8	2.7	9.0	0.346	0.	0.060	0.060	0.017	0.017
6	70.00		6.1	-1.0	10.0	0.375	0.	0.074	0.074	0.018	0.018
7	85.00		4.9	-2.2	13.1	0.399	0.	0.098	0.098	0.020	0.020
8	90.00		4.6	-2.4	14.8	0.430	0.	0.142	0.142	0.028	0.028
9	95.00		4.3	-2.7	12.4	0.511	0.	0.243	0.243	0.045	0.045

TABLE VIII. - Continued.

(s) 100 Percent of design speed; reading 2996

RP	RADII		ABS BETAM		REL BETAM		TOTAL TEMP		TOTAL PRESS	
	IN	OUT	IN	OUT	IN	OUT	IN	RATIO	IN	RATIO
1	23.396	23.421	29.0	3.7	29.0	3.7	320.6	0.993	13.84	0.960
2	22.716	22.771	28.2	3.8	28.2	3.8	319.5	0.999	13.98	0.973
3	22.045	22.126	28.3	3.7	28.3	3.7	318.7	0.999	13.97	0.982
4	20.015	20.196	30.2	2.8	30.2	2.8	316.3	1.001	13.94	0.987
5	17.315	17.675	32.6	1.1	32.6	1.1	313.6	0.997	13.63	0.985
6	14.600	15.176	34.4	0.7	34.4	0.7	310.8	0.997	13.13	0.982
7	12.509	13.264	37.9	2.9	37.9	2.9	308.4	0.999	12.73	0.963
8	11.786	12.603	39.6	5.4	39.6	5.4	307.2	1.002	12.45	0.953
9	11.049	11.935	42.4	6.9	42.4	6.9	306.4	1.004	12.20	0.919

RP	ABS VEL		REL VEL		MERID VEL		TANG VEL		WHEEL SPEED	
	IN	OUT	IN	OUT	IN	OUT	IN	OUT	IN	OUT
1	229.0	203.7	229.0	203.7	200.2	205.2	111.1	13.2	0.	0.
2	232.7	212.4	232.7	212.4	205.0	212.0	110.1	14.1	0.	0.
3	233.0	214.3	233.0	214.3	205.1	213.8	110.4	13.7	0.	0.
4	242.2	216.7	242.2	216.7	209.3	216.4	121.8	10.7	0.	0.
5	246.1	213.7	246.1	213.7	207.2	213.7	132.7	4.2	0.	0.
6	240.8	205.6	240.8	205.6	198.7	205.6	136.0	2.6	0.	0.
7	233.1	194.2	233.1	194.2	183.9	194.0	143.2	9.9	0.	0.
8	224.4	188.1	224.4	188.1	172.8	187.2	143.2	17.9	0.	0.
9	216.2	169.8	216.2	169.8	159.7	168.6	145.8	20.4	0.	0.

RP	ABS MACH NO		REL MACH NO		MERID MACH NO		MERID PEAK SS	
	IN	OUT	IN	OUT	IN	OUT	VEL R	MACH NO
1	0.666	0.587	0.666	0.587	0.582	0.586	1.015	0.824
2	0.679	0.615	0.679	0.615	0.598	0.614	1.034	0.793
3	0.680	0.622	0.680	0.622	0.599	0.620	1.042	0.768
4	0.713	0.631	0.713	0.631	0.616	0.631	1.034	0.783
5	0.729	0.626	0.729	0.626	0.614	0.626	1.031	0.729
6	0.715	0.603	0.715	0.603	0.590	0.603	1.035	0.715
7	0.693	0.570	0.693	0.570	0.547	0.569	1.055	0.693
8	0.667	0.551	0.667	0.551	0.513	0.548	1.083	0.667
9	0.641	0.495	0.641	0.495	0.474	0.491	1.055	0.641

RP	PERCENT	INCIDENCE		DEV	D-FACT	EFF	LOSS COEFF		LOSS PARAM	
	SPAN	MEAN	SS				TOT	PROF	TOT	PROF
1	5.00	8.0	0.7	9.0	0.274	0.	0.155	0.155	0.059	0.059
2	10.00	6.3	-1.0	9.2	0.240	0.	0.102	0.102	0.038	0.038
3	15.00	5.4	-1.8	9.2	0.229	0.	0.068	0.068	0.025	0.025
4	30.00	4.7	-2.6	8.7	0.255	0.	0.046	0.046	0.015	0.015
5	50.00	2.8	-4.3	7.5	0.279	0.	0.051	0.051	0.015	0.015
6	70.00	0.1	-7.0	7.4	0.277	0.	0.064	0.064	0.015	0.015
7	85.00	-0.2	-7.3	9.8	0.282	0.	0.134	0.134	0.028	0.028
8	90.00	-0.2	-7.3	12.4	0.267	0.	0.182	0.182	0.036	0.036
9	95.00	0.5	-6.5	14.0	0.316	0.	0.336	0.336	0.062	0.062

TABLE VIII. - Continued.

(t) 100 Percent of design speed; reading 2993

RP	RADII		ABS BETAM		REL BETAM		TOTAL TEMP		TOTAL PRESS	
	IN	OUT	IN	OUT	IN	OUT	IN	RATIO	IN	RATIO
1	23.396	23.421	33.7	4.3	33.7	4.3	323.5	1.000	14.26	0.960
2	22.718	22.771	31.5	4.0	31.5	4.0	322.4	1.000	14.42	0.971
3	22.045	22.126	31.3	3.5	31.3	3.5	321.5	0.999	14.43	0.977
4	20.015	20.196	32.9	2.9	32.9	2.9	318.2	0.998	14.23	0.982
5	17.315	17.673	35.6	2.3	35.6	2.3	314.3	0.996	13.70	0.981
6	14.600	15.176	37.0	1.4	37.0	1.4	310.5	0.999	13.06	0.982
7	12.509	13.264	40.2	4.8	40.2	4.8	308.9	0.999	12.76	0.976
8	11.786	12.603	42.0	7.8	42.0	7.8	307.6	1.003	12.48	0.973
9	11.049	11.935	44.6	7.5	44.6	7.5	306.9	1.004	12.29	0.946

RP	ABS VEL		REL VEL		MERID VEL		TANG VEL		WHEEL SPEED	
	IN	OUT	IN	OUT	IN	OUT	IN	OUT	IN	OUT
1	224.2	197.6	224.2	197.6	186.6	197.0	124.4	14.9	0.	0.
2	229.0	205.9	229.0	205.9	195.2	205.4	119.8	14.2	0.	0.
3	229.9	207.5	229.9	207.5	196.4	207.1	119.5	12.8	0.	0.
4	235.6	205.8	235.6	205.8	197.8	205.5	128.0	10.3	0.	0.
5	232.8	194.7	232.8	194.7	189.2	194.5	135.6	7.8	0.	0.
6	224.9	180.8	224.9	180.8	179.6	180.8	135.5	4.5	0.	0.
7	223.3	175.7	223.3	175.7	170.6	175.1	144.0	14.6	0.	0.
8	215.8	168.8	215.8	168.8	163.4	167.2	144.5	22.8	0.	0.
9	210.4	151.7	210.4	151.7	149.9	150.4	147.7	19.9	0.	0.

RP	ABS MACH NO		REL MACH NO		MERID MACH NO		MERID PEAK SS	
	IN	OUT	IN	OUT	IN	OUT	VEL R	MACH NO
1	0.647	0.565	0.647	0.565	0.539	0.563	1.056	0.911
2	0.664	0.592	0.664	0.592	0.566	0.590	1.052	0.861
3	0.668	0.598	0.668	0.598	0.570	0.597	1.054	0.838
4	0.690	0.596	0.690	0.596	0.579	0.595	1.039	0.840
5	0.685	0.566	0.685	0.566	0.557	0.566	1.028	0.801
6	0.664	0.526	0.664	0.526	0.530	0.526	1.037	0.664
7	0.661	0.512	0.661	0.512	0.505	0.510	1.027	0.661
8	0.639	0.491	0.639	0.491	0.474	0.486	1.043	0.639
9	0.622	0.439	0.622	0.439	0.443	0.435	1.003	0.622

RP	PERCENT	INCIDENCE		DEV	D-FACT	VEFF	LOSS COEFF		LOSS PARAM	
	SPAN	MEAN	SS				TOT	PROF	TOT	PROF
1	5.00	12.7	5.4	9.5	0.305	0.	0.181	0.181	0.061	0.061
2	10.00	9.6	2.3	9.3	0.272	0.	0.115	0.115	0.043	0.043
3	15.00	8.5	1.2	9.0	0.264	0.	0.083	0.083	0.032	0.032
4	30.00	7.4	0.1	8.7	0.290	0.	0.064	0.064	0.021	0.021
5	50.00	5.8	-1.4	8.6	0.318	0.	0.069	0.069	0.020	0.020
6	70.00	2.8	-4.3	8.1	0.334	0.	0.071	0.071	0.017	0.017
7	85.00	2.0	-5.0	11.6	0.329	0.	0.095	0.095	0.020	0.020
8	90.00	2.1	-4.9	14.7	0.324	0.	0.113	0.113	0.022	0.022
9	95.00	2.7	-4.3	14.6	0.386	0.	0.235	0.235	0.043	0.043

TABLE VIII. - Continued.

(u) 100 Percent of design speed; reading 2994

RP	RADII		ABS BETAM		REL BETAM		TOTAL TEMP		TOTAL PRESS	
	IN	OUT	IN	OUT	IN	OUT	IN	RATIO	IN	RATIO
1	23.596	23.421	36.0	4.8	36.0	4.8	325.7	0.998	14.30	0.970
2	22.718	22.771	33.4	4.2	33.4	4.2	324.0	0.999	14.62	0.966
3	22.045	22.126	33.3	3.8	33.5	3.8	322.8	0.998	14.59	0.972
4	20.015	20.198	34.6	3.1	34.6	3.1	319.0	0.997	14.27	0.979
5	17.315	17.673	37.7	2.1	37.7	2.1	314.4	0.997	13.66	0.984
6	14.600	15.176	39.3	2.2	39.3	2.2	311.6	0.997	13.14	0.978
7	12.589	13.264	42.0	1.1	42.0	1.1	309.2	1.000	12.81	0.973
8	11.786	12.693	44.0	1.0	44.0	1.0	308.1	1.002	12.56	0.970
9	11.049	11.935	46.0	1.0	46.0	1.0	307.5	1.003	12.41	0.944

RP	ABS VEL		REL VEL		MERID VEL		TANG VEL		WHEEL SPEED	
	IN	OUT	IN	OUT	IN	OUT	IN	OUT	IN	OUT
1	218.5	194.7	218.5	194.7	176.8	194.0	128.4	16.1	0.	0.
2	226.9	201.4	226.9	201.4	189.3	200.9	124.9	14.7	0.	0.
3	227.0	202.2	227.0	202.2	189.7	201.8	124.7	13.4	0.	0.
4	229.7	197.1	229.7	197.1	189.1	196.8	130.6	10.7	0.	0.
5	223.5	184.3	223.5	184.3	176.9	184.1	133.5	6.9	0.	0.
6	219.0	168.8	219.0	168.8	169.5	168.6	138.2	6.6	0.	0.
7	217.9	161.6	217.9	161.6	162.0	160.6	145.7	17.3	0.	0.
8	211.6	152.5	211.6	152.5	152.2	151.0	147.0	21.2	0.	0.
9	208.2	133.7	208.2	133.7	144.5	133.0	149.8	13.8	0.	0.

RP	ABS MACH NO		REL MACH NO		MERID MACH NO		MERID PEAK SS	
	IN	OUT	IN	OUT	IN	OUT	VEL R	MACH NO
1	0.627	0.555	0.627	0.555	0.508	0.555	1.097	0.932
2	0.655	0.577	0.655	0.577	0.547	0.575	1.061	0.894
3	0.657	0.581	0.657	0.581	0.549	0.580	1.064	0.873
4	0.670	0.569	0.670	0.569	0.551	0.568	1.041	0.860
5	0.655	0.534	0.655	0.534	0.519	0.533	1.041	0.820
6	0.644	0.489	0.644	0.489	0.498	0.489	0.995	0.728
7	0.643	0.468	0.643	0.468	0.478	0.466	0.991	0.676
8	0.624	0.441	0.624	0.441	0.449	0.437	0.992	0.659
9	0.614	0.385	0.614	0.385	0.426	0.333	0.920	0.661

RP	PERCENT		INCIDENCE		DEV	D-FACT	EFF	LOSS COEFF		LOSS PARAM	
	SPAN		MEAN	SS				TOT	PROF	TOT	PROF
1	5.00		15.0	7.7	10.0	0.305	0.	0.130	0.130	0.050	0.050
2	10.00		11.5	4.2	9.6	0.292	0.	0.135	0.135	0.050	0.050
3	15.00		10.5	3.2	9.3	0.266	0.	0.112	0.112	0.040	0.040
4	30.00		9.1	1.8	9.0	0.312	0.	0.080	0.080	0.026	0.026
5	50.00		7.8	0.7	8.5	0.339	0.	0.065	0.063	0.018	0.018
6	70.00		5.0	-2.1	8.9	0.372	0.	0.091	0.091	0.022	0.022
7	85.00		3.8	-3.2	13.0	0.377	0.	0.112	0.112	0.023	0.023
8	90.00		4.1	-2.9	14.9	0.391	0.	0.130	0.130	0.025	0.025
9	95.00		4.1	-2.8	13.0	0.473	0.	0.248	0.248	0.046	0.046

TABLE VIII. - Continued.

(v) 100 Percent of design speed; reading 2995

RP	RADIUS		ABS BETAM		REL BETAM		TOTAL TEMP		TOTAL PRESS	
	IN	OUT	IN	OUT	IN	OUT	IN	RATIO	IN	RATIO
1	23.596	23.421	37.8	5.3	37.8	5.3	325.3	0.997	14.19	0.964
2	22.718	22.771	34.6	5.0	34.6	5.0	324.4	0.998	14.46	0.960
3	22.045	22.126	34.5	4.4	34.5	4.4	322.6	0.998	14.40	0.967
4	20.015	20.196	36.5	3.0	36.5	3.0	319.0	0.996	14.08	0.978
5	17.315	17.673	40.0	2.4	40.0	2.4	315.3	0.996	13.54	0.987
6	14.600	15.176	41.0	3.1	41.0	3.1	312.1	0.997	13.18	0.978
7	12.509	13.264	43.3	6.2	43.3	6.2	309.7	0.999	12.83	0.972
8	11.786	12.603	44.6	7.6	44.6	7.6	308.4	1.000	12.66	0.960
9	11.049	11.935	46.6	5.0	46.6	5.0	307.5	1.003	12.45	0.944

RP	ABS VEL		REL VEL		MERID VEL		TANG VEL		WHEEL SPEED	
	IN	OUT	IN	OUT	IN	OUT	IN	OUT	IN	OUT
1	214.9	186.4	214.9	186.4	169.9	185.6	131.6	17.5	0.	0.
2	222.1	191.9	222.1	191.9	182.8	191.2	126.2	16.7	0.	0.
3	221.4	192.4	221.4	192.4	182.4	191.6	125.5	14.9	0.	0.
4	221.9	188.0	221.9	188.0	178.4	187.7	132.0	9.9	0.	0.
5	215.8	176.4	215.8	176.4	165.2	176.2	138.8	7.4	0.	0.
6	216.3	163.0	216.3	163.0	163.1	162.7	142.0	8.9	0.	0.
7	214.9	153.0	214.9	153.0	156.5	152.1	147.3	16.5	0.	0.
8	210.9	141.6	210.9	141.6	150.1	140.6	146.0	18.7	0.	0.
9	205.8	124.9	205.8	124.9	141.4	124.4	149.5	10.8	0.	0.

RP	ABS MACH NO		REL MACH NO		MERID MACH NO		MERID PEAK SS	
	IN	OUT	IN	OUT	IN	OUT	VEL R	MACH NO
1	0.616	0.530	0.616	0.530	0.487	0.528	1.092	0.952
2	0.640	0.548	0.640	0.548	0.526	0.546	1.046	0.960
3	0.639	0.551	0.639	0.551	0.527	0.549	1.051	0.877
4	0.645	0.541	0.645	0.541	0.519	0.540	1.052	0.872
5	0.630	0.509	0.630	0.509	0.482	0.509	1.067	0.843
6	0.635	0.471	0.635	0.471	0.479	0.470	0.997	0.764
7	0.635	0.442	0.635	0.442	0.461	0.440	0.972	0.712
8	0.622	0.409	0.622	0.409	0.443	0.406	0.936	0.686
9	0.607	0.359	0.607	0.359	0.417	0.358	0.886	0.671

RP	PERCENT		INCIDENCE		DEV	D-FACT	EFF	LOSS COEFF		LOSS PARAM	
	SPAN	MEAN	SS	TOT				PROF	TOT	PROF	
1	5.00	16.7	9.4	10.6	0.336	0.	0.163	0.168	0.060	0.060	
2	10.00	12.7	5.4	10.4	0.319	0.	0.185	0.165	0.061	0.061	
3	15.00	11.7	4.4	9.9	0.311	0.	0.137	0.137	0.049	0.049	
4	30.00	11.0	3.7	8.9	0.332	0.	0.089	0.089	0.029	0.029	
5	50.00	10.2	3.1	8.7	0.354	0.	0.055	0.055	0.016	0.016	
6	70.00	6.8	-0.3	9.8	0.392	0.	0.033	0.033	0.022	0.022	
7	85.00	5.1	-1.9	13.0	0.410	0.	0.120	0.120	0.025	0.025	
8	90.00	4.7	-2.3	14.5	0.443	0.	0.176	0.176	0.034	0.034	
9	95.00	4.7	-2.3	12.0	0.512	0.	0.255	0.255	0.047	0.047	

TABLE VIII. - Continued.

(w) 100 Percent of design speed; reading 3026

RP	RADI		ABS BETAM		REL BETAM		TOTAL TEMP		TOTAL PRESS	
	IN	OUT	IN	OUT	IN	OUT	IN	RATIO	IN	RATIO
1	23.396	23.421	45.0	4.9	43.0	4.9	323.6	0.993	14.13	0.931
2	22.718	22.771	37.4	4.5	37.4	4.5	325.2	0.997	14.42	0.952
3	22.045	22.126	37.1	4.0	37.1	4.0	324.0	0.998	14.40	0.959
4	20.015	20.196	37.9	3.1	37.9	3.1	319.7	0.997	14.11	0.975
5	17.315	17.673	41.0	2.2	41.0	2.2	315.3	0.996	13.52	0.985
6	14.600	15.176	42.3	3.4	42.3	3.4	311.8	0.998	13.11	0.981
7	12.509	13.264	43.9	6.3	43.9	6.3	309.2	0.997	12.88	0.963
8	11.786	12.605	45.0	7.3	45.0	7.3	308.5	0.999	12.70	0.951
9	11.049	11.935	46.8	5.0	46.8	5.0	307.3	1.003	12.47	0.944

RP	ABS VEL		REL VEL		MERID VEL		TANG VEL		WHEEL SPEED	
	IN	OUT	IN	OUT	IN	OUT	IN	OUT	IN	OUT
1	210.4	180.0	210.4	180.0	153.9	179.4	143.4	15.2	0.	0.
2	218.7	184.3	218.7	184.3	173.7	183.8	133.0	14.3	0.	0.
3	219.5	186.7	219.5	186.7	175.2	186.2	132.3	13.1	0.	0.
4	223.7	185.1	220.7	185.1	174.2	184.8	135.6	10.1	0.	0.
5	212.4	171.1	212.4	171.1	160.4	171.0	139.3	6.6	0.	0.
6	211.2	157.8	211.2	157.8	156.3	157.5	142.0	9.5	0.	0.
7	213.8	144.8	213.8	144.8	154.2	143.9	148.1	16.0	0.	0.
8	209.9	132.5	209.9	132.5	148.3	131.4	149.5	16.9	0.	0.
9	204.3	118.5	204.3	118.5	139.8	118.0	149.0	10.3	0.	0.

RP	ABS MACH NO		REL MACH NO		MERID MACH NO		MERID PEAK SS	
	IN	OUT	IN	OUT	IN	OUT	VEL R	MACH NO
1	0.599	0.510	0.599	0.510	0.439	0.508	1.165	1.032
2	0.628	0.524	0.628	0.524	0.499	0.522	1.053	0.944
3	0.632	0.532	0.632	0.532	0.504	0.531	1.063	0.922
4	0.641	0.532	0.641	0.532	0.506	0.531	1.061	0.897
5	0.619	0.493	0.619	0.493	0.467	0.495	1.066	0.849
6	0.619	0.456	0.619	0.456	0.458	0.455	1.008	0.775
7	0.630	0.418	0.630	0.418	0.454	0.416	0.933	0.724
8	0.618	0.382	0.618	0.382	0.437	0.379	0.886	0.695
9	0.602	0.341	0.602	0.341	0.412	0.339	0.844	0.673

RP	PERCENT SPAN	INCIDENCE		DEV	D-FACT	EFF	LOSS COEFF		LOSS PARAM	
		MEAN	SS				TOT	PROF	TOT	PROF
1	5.00	21.9	14.7	10.1	0.377	0.	0.182	0.182	0.069	0.069
2	10.00	15.5	8.2	9.8	0.358	0.	0.208	0.208	0.077	0.077
3	15.00	14.2	6.9	9.5	0.345	0.	0.172	0.172	0.062	0.062
4	30.00	12.3	5.1	9.0	0.347	0.	0.103	0.103	0.034	0.034
5	50.00	11.2	4.0	8.5	0.370	0.	0.068	0.068	0.019	0.019
6	70.00	8.0	0.9	10.1	0.401	0.	0.085	0.085	0.020	0.020
7	85.00	5.7	-1.3	13.2	0.447	0.	0.156	0.156	0.032	0.032
8	90.00	5.1	-1.9	14.3	0.487	0.	0.216	0.216	0.042	0.042
9	95.00	4.9	-2.1	12.1	0.540	0.	0.260	0.260	0.048	0.048

TABLE VIII. - Continued.

(x) 110 Percent of design speed; reading 3023

RP	RADI I		ABS BETAM		REL BETAM		TOTAL TEMP		TOTAL PRESS	
	IN	OUT	IN	OUT	IN	OUT	IN	RATIO	IN	RATIO
1	23.396	23.421	39.2	5.0	39.2	5.0	334.6	0.995	15.20	0.959
2	22.718	22.771	36.2	4.7	36.2	4.7	333.0	0.997	15.62	0.948
3	22.045	22.126	36.4	4.4	36.4	4.4	331.7	0.996	15.62	0.958
4	20.015	20.196	36.9	3.3	36.9	3.3	327.0	0.994	15.31	0.972
5	17.315	17.673	39.4	2.1	38.4	2.1	321.4	0.993	14.67	0.981
6	14.600	15.176	39.3	2.7	39.3	2.7	316.2	0.996	14.00	0.967
7	12.509	13.264	42.3	6.5	42.3	6.5	312.6	1.000	13.31	0.966
8	11.786	12.603	44.2	7.9	44.2	7.9	311.5	1.001	13.04	0.956
9	11.049	11.935	46.6	5.5	46.6	5.5	310.7	1.003	12.84	0.933

RP	ABS VEL		REL VEL		MERID VEL		TANG VEL		WHEEL SPEED	
	IN	OUT	IN	OUT	IN	OUT	IN	OUT	IN	OUT
1	233.2	204.2	233.2	204.2	180.7	203.4	147.4	17.7	0.	0.
2	244.6	210.7	244.6	210.7	197.4	210.0	144.4	17.2	0.	0.
3	245.6	214.1	245.6	214.1	197.6	213.5	145.9	16.5	0.	0.
4	251.2	212.6	251.2	212.6	200.8	212.3	150.9	12.2	0.	0.
5	250.2	202.8	250.2	202.8	196.1	202.6	155.4	7.5	0.	0.
6	246.2	182.8	246.2	182.8	190.6	182.6	155.9	8.6	0.	0.
7	235.7	166.3	235.7	166.3	174.4	165.3	158.5	18.7	0.	0.
8	229.9	154.3	229.9	154.3	164.9	152.8	160.2	21.1	0.	0.
9	224.7	134.2	224.7	134.2	154.5	133.5	163.2	12.9	0.	0.

RP	ABS MACH NO		REL MACH NO		MERID MACH NO		MERID PEAK SS	
	IN	OUT	IN	OUT	IN	OUT	VEL R	MACH NO
1	0.663	0.576	0.663	0.576	0.514	0.574	1.126	1.058
2	0.701	0.597	0.701	0.597	0.565	0.595	1.064	1.024
3	0.706	0.609	0.706	0.609	0.568	0.607	1.080	1.014
4	0.729	0.610	0.729	0.610	0.583	0.609	1.057	0.996
5	0.733	0.585	0.733	0.585	0.574	0.585	1.033	0.937
6	0.726	0.528	0.726	0.528	0.562	0.527	0.958	0.620
7	0.696	0.480	0.696	0.480	0.515	0.477	0.948	0.745
8	0.679	0.444	0.679	0.444	0.487	0.440	0.927	0.733
9	0.663	0.385	0.663	0.385	0.456	0.383	0.864	0.733

RP	PERCENT	INCIDENCE	DEV	D-FACT	EFF	LOSS COEFF		LOSS PARAM		
	SPAN	MEAN				SS	TOT	PROF	TOT	PROF
1	5.00	18.2	10.9	10.2	0.337	0.	0.162	0.162	0.062	0.062
2	10.00	14.2	7.0	10.1	0.331	0.	0.186	0.186	0.069	0.069
3	15.00	13.6	6.3	9.9	0.318	0.	0.149	0.149	0.053	0.053
4	30.00	11.4	4.2	9.2	0.334	0.	0.096	0.096	0.031	0.031
5	50.00	8.6	1.4	8.5	0.356	0.	0.062	0.062	0.018	0.018
6	70.00	5.0	-2.1	9.4	0.399	0.	0.113	0.113	0.027	0.027
7	85.00	4.1	-2.9	13.3	0.413	0.	0.123	0.123	0.025	0.025
8	90.00	4.3	-2.7	14.8	0.443	0.	0.165	0.165	0.032	0.032
9	95.00	4.7	-2.3	12.6	0.521	0.	0.264	0.264	0.049	0.049

TABLE VIII. - Continued.

(y) 110 Percent of design speed; reading 3024

RP	RADII		ABS BETAM		REL BETAM		TOTAL TEMP		TOTAL PRESS	
	IN	OUT	IN	OUT	IN	OUT	IN	RATIO	IN	RATIO
1	23.396	23.421	45.2	4.9	45.2	4.9	338.2	0.992	15.18	0.958
2	22.718	22.771	39.5	4.5	39.3	4.5	335.2	0.996	15.65	0.959
3	22.045	22.126	38.6	4.3	38.6	4.3	335.1	0.997	15.63	0.943
4	20.015	20.196	38.9	3.6	38.9	3.6	328.0	0.995	15.31	0.968
5	17.315	17.673	40.3	2.1	40.3	2.1	321.3	0.994	14.56	0.972
6	14.600	15.176	42.4	3.7	42.4	3.7	316.0	0.998	13.72	0.983
7	12.509	13.264	44.4	7.4	44.4	7.4	312.8	0.999	13.28	0.962
8	11.786	12.603	45.9	7.5	45.9	7.5	312.1	0.999	13.12	0.945
9	11.049	11.935	47.8	4.9	47.8	4.9	311.4	1.002	12.96	0.950

RP	ABS VEL		REL VEL		MERID VEL		TANG VEL		WHEEL SPEED	
	IN	OUT	IN	OUT	IN	OUT	IN	OUT	IN	OUT
1	228.4	200.3	228.4	200.3	160.8	199.6	162.2	17.0	0.	0.
2	240.6	203.9	240.6	203.9	186.1	203.3	152.5	16.1	0.	0.
3	241.6	206.4	241.6	206.4	188.8	205.8	150.8	15.4	0.	0.
4	246.0	206.8	246.0	206.8	191.3	206.4	154.6	12.9	0.	0.
5	240.7	189.4	240.7	189.4	183.7	189.3	155.6	7.1	0.	0.
6	230.1	172.0	230.1	172.0	169.9	171.7	155.2	11.1	0.	0.
7	227.7	150.5	227.7	150.5	162.6	149.2	159.4	19.3	0.	0.
8	225.5	136.3	225.5	136.3	156.9	135.1	162.0	17.8	0.	0.
9	222.6	121.7	222.6	121.7	149.4	121.2	165.0	10.5	0.	0.

RP	ABS MACH NO		REL MACH NO		MERID MACH NO		MERID PEAK SS	
	IN	OUT	IN	OUT	IN	OUT	VEL R	MACH NO
1	0.645	0.562	0.645	0.562	0.454	0.560	1.241	1.161
2	0.686	0.575	0.686	0.575	0.530	0.573	1.092	1.075
3	0.691	0.584	0.691	0.584	0.540	0.582	1.090	1.045
4	0.711	0.591	0.711	0.591	0.553	0.590	1.079	1.021
5	0.702	0.544	0.702	0.544	0.536	0.544	1.031	0.946
6	0.675	0.495	0.675	0.495	0.498	0.494	1.010	0.848
7	0.671	0.433	0.671	0.433	0.479	0.429	0.918	0.788
8	0.664	0.391	0.664	0.391	0.462	0.387	0.861	0.774
9	0.656	0.348	0.656	0.348	0.440	0.347	0.811	0.764

RP	PERCENT	INCIDENCE		DEV	D-FACT	EFF	LOSS COEFF		LOSS PARAM	
	SPAN	MEAN	SS				TOT	PROF	TOT	PROF
1	5.00	24.2	16.9	10.1	0.366	0.	0.172	0.172	0.066	0.066
2	10.00	17.4	10.1	9.9	0.363	0.	0.227	0.227	0.084	0.084
3	15.00	15.8	8.5	9.8	0.347	0.	0.191	0.191	0.068	0.068
4	30.00	13.4	6.2	9.4	0.347	0.	0.113	0.113	0.037	0.037
5	50.00	10.5	3.3	8.5	0.387	0.	0.101	0.101	0.029	0.029
6	70.00	8.1	1.0	10.4	0.400	0.	0.064	0.064	0.015	0.015
7	85.00	6.3	-0.8	14.2	0.463	0.	0.147	0.147	0.030	0.030
8	90.00	6.0	-1.0	14.5	0.516	0.	0.215	0.215	0.042	0.042
9	95.00	6.0	-1.0	12.0	0.576	0.	0.280	0.280	0.052	0.052

TABLE VIII. - Continued.

(z) 120 Percent of design speed; reading 3038

RP	RADII		ABS BETAM		REL BETAM		TOTAL TEMP		TOTAL PRESS	
	IN	OUT	IN	OUT	IN	OUT	IN	RATIO	IN	RATIO
1	23.396	23.421	30.2	3.9	30.2	3.9	332.1	0.999	14.67	0.943
2	22.718	22.771	29.1	3.6	29.1	3.6	330.7	1.001	15.00	0.947
3	22.045	22.126	29.6	3.4	29.6	3.4	329.9	1.000	15.00	0.962
4	20.015	20.196	31.1	2.4	31.1	2.4	327.9	0.996	14.87	0.969
5	17.315	17.673	35.7	2.0	35.7	2.0	324.7	0.994	14.52	0.975
6	14.600	15.176	35.6	1.3	35.6	1.3	321.1	0.997	14.44	0.976
7	12.509	13.264	39.6	5.8	39.6	5.8	318.4	0.997	14.10	0.945
8	11.786	12.603	41.9	7.4	41.9	7.4	315.6	1.000	13.53	0.931
9	11.049	11.935	44.0	6.5	44.0	6.5	313.2	1.004	12.88	0.909

RP	ABS VEL		REL VEL		MERID VEL		TANG VEL		WHEEL SPEED	
	IN	OUT	IN	OUT	IN	OUT	IN	OUT	IN	OUT
1	258.9	217.0	258.9	217.0	223.7	216.5	130.4	14.9	0.	0.
2	267.0	226.5	267.0	226.5	233.3	226.0	129.9	14.4	0.	0.
3	268.0	231.2	268.0	231.2	233.1	230.8	132.2	13.5	0.	0.
4	278.4	232.0	278.4	232.0	238.5	231.8	143.7	9.7	0.	0.
5	277.8	231.3	277.8	230.3	225.6	230.2	162.1	8.0	0.	0.
6	266.0	234.4	266.0	234.4	232.5	234.4	166.5	5.4	0.	0.
7	261.8	223.5	261.8	223.5	217.2	222.4	179.5	22.4	0.	0.
8	267.2	206.5	267.2	206.5	199.0	204.7	178.4	26.6	0.	0.
9	249.2	180.9	249.2	180.9	179.4	179.7	173.0	20.5	0.	0.

RP	ABS MACH NO		REL MACH NO		MERID MACH NO		MERID PEAK SS	
	IN	OUT	IN	OUT	IN	OUT	VEL R	MACH NO
1	0.747	0.616	0.747	0.616	0.646	0.615	0.968	0.960
2	0.775	0.646	0.775	0.646	0.677	0.645	0.969	0.954
3	0.779	0.662	0.779	0.662	0.678	0.661	0.990	0.924
4	0.817	0.668	0.817	0.668	0.699	0.668	0.972	0.931
5	0.819	0.667	0.819	0.667	0.665	0.667	1.020	0.961
6	0.852	0.683	0.852	0.683	0.693	0.683	1.008	0.852
7	0.842	0.652	0.842	0.652	0.649	0.649	1.024	0.842
8	0.796	0.600	0.796	0.600	0.593	0.595	1.029	0.796
9	0.740	0.523	0.740	0.523	0.533	0.519	1.002	0.740

RP	PERCENT	INCIDENCE		DEV	D-FACT	EFF	LOSS COEFF		LOSS PARAM	
	SPAN	MEAN	SS				TOT	PRCF	TOT	PRCF
1	5.00	9.2	1.9	9.2	0.332	0.	0.185	0.185	0.071	0.071
2	10.00	7.1	-0.1	9.0	0.312	0.	0.161	0.161	0.060	0.060
3	15.00	6.7	-0.6	8.9	0.296	0.	0.115	0.115	0.041	0.041
4	30.00	5.5	-1.7	8.2	0.324	0.	0.087	0.087	0.028	0.028
5	50.00	5.9	-1.3	8.3	0.327	0.	0.070	0.070	0.020	0.020
6	70.00	1.4	-5.7	8.0	0.313	0.	0.064	0.064	0.016	0.016
7	85.00	1.4	-5.6	12.6	0.319	0.	0.148	0.148	0.031	0.031
8	90.00	2.0	-5.0	14.3	0.334	0.	0.203	0.203	0.040	0.040
9	95.00	2.1	-4.9	13.6	0.382	0.	0.297	0.297	0.055	0.055

TABLE VIII. - Continued.

(aa) 120 Percent of design speed; reading 3039

RP	RADII		ABS BETAM		REL BETAM		TOTAL TEMP		TOTAL PRESS	
	IN	OUT	IN	OUT	IN	OUT	IN	RATIO	IN	RATIO
1	23.396	23.421	35.5	4.8	35.5	4.8	338.6	0.995	15.33	0.953
2	22.718	22.771	33.9	4.4	33.9	4.4	357.2	0.997	15.87	0.959
3	22.045	22.126	33.8	4.1	33.8	4.1	356.2	0.996	15.83	0.955
4	20.015	20.196	35.7	2.3	35.7	2.3	351.8	0.994	15.52	0.967
5	17.315	17.673	37.4	2.0	37.4	2.0	327.3	0.994	15.20	0.975
6	14.600	15.176	37.5	2.3	37.5	2.3	321.5	0.991	14.51	0.981
7	12.509	13.264	40.6	7.1	40.6	7.1	318.6	0.997	14.17	0.950
8	11.786	12.603	43.1	7.9	43.1	7.9	316.2	1.000	13.64	0.942
9	11.049	11.935	45.5	5.3	45.5	5.3	314.0	1.004	13.08	0.923

RP	ABS VEL		REL VEL		MERID VEL		TANG VEL		WHEEL SPEED	
	IN	OUT	IN	OUT	IN	OUT	IN	OUT	IN	OUT
1	251.2	210.6	251.2	210.6	204.4	209.8	146.0	17.5	0.	0.
2	263.6	218.8	263.6	218.8	218.8	218.2	146.9	16.8	0.	0.
3	264.7	223.3	264.7	223.3	219.9	222.7	147.4	15.8	0.	0.
4	271.2	223.0	271.2	223.0	220.3	222.9	158.1	9.1	0.	0.
5	278.4	223.0	278.4	223.0	221.1	222.9	169.2	7.8	0.	0.
6	277.4	216.0	277.4	216.0	220.0	215.9	169.0	8.6	0.	0.
7	275.9	204.2	275.9	204.2	209.3	202.7	179.7	25.3	0.	0.
8	260.7	182.7	260.7	182.7	190.5	180.9	178.0	25.2	0.	0.
9	245.0	154.3	245.0	154.3	171.9	153.6	174.7	14.4	0.	0.

RP	ABS MACH NO		REL MACH NO		MERID MACH NO		MERID PEAK SS	
	IN	OUT	IN	OUT	IN	OUT	VEL R	MACH NO
1	0.715	0.592	0.715	0.592	0.582	0.590	1.027	1.051
2	0.756	0.618	0.756	0.618	0.628	0.616	0.997	1.044
3	0.761	0.632	0.761	0.632	0.632	0.631	1.013	1.025
4	0.788	0.637	0.788	0.637	0.640	0.637	1.011	1.041
5	0.817	0.642	0.817	0.642	0.649	0.642	1.008	1.015
6	0.822	0.627	0.822	0.627	0.652	0.627	0.981	0.841
7	0.821	0.591	0.821	0.591	0.623	0.587	0.968	0.821
8	0.774	0.527	0.774	0.527	0.566	0.522	0.950	0.774
9	0.725	0.442	0.725	0.442	0.509	0.440	0.894	0.753

RP	PERCENT	INCIDENCE		DEV	D-FACT	EFF	LOSS COEFF		LOSS PARAM	
	SPAN	MEAN	SS				TOT	PROF	TOT	PROF
1	5.00	14.5	7.2	10.0	0.357	0.	0.163	0.163	0.062	0.062
2	10.00	11.9	4.6	9.8	0.353	0.	0.193	0.193	0.071	0.071
3	15.00	11.0	3.7	9.6	0.335	0.	0.142	0.142	0.051	0.051
4	30.00	10.1	2.9	8.2	0.357	0.	0.096	0.098	0.032	0.032
5	50.00	7.6	0.4	8.3	0.362	0.	0.070	0.070	0.020	0.020
6	70.00	3.3	-3.8	8.9	0.358	0.	0.053	0.053	0.013	0.013
7	85.00	2.5	-4.5	13.9	0.372	0.	0.139	0.139	0.029	0.029
8	90.00	3.2	-3.9	14.9	0.410	0.	0.178	0.178	0.035	0.035
9	95.00	3.6	-3.4	12.4	0.486	0.	0.261	0.261	0.048	0.048

TABLE VIII. - Continued.

(bb) 120 Percent of design speed; reading 3040

RP	RADII		ABS BETAM		REL BETAM		TOTAL TEMP		TOTAL PRESS	
	IN	OUT	IN	OUT	IN	OUT	IN	RATIO	IN	RATIO
1	23.396	23.421	41.9	4.8	41.9	4.8	345.2	0.993	15.53	0.962
2	22.718	22.771	37.1	4.5	37.1	4.5	341.0	0.996	16.18	0.937
3	22.045	22.126	37.1	4.4	37.1	4.4	339.7	0.996	16.22	0.945
4	20.015	20.196	38.6	3.3	38.6	3.3	334.6	0.994	15.96	0.962
5	17.315	17.673	39.9	1.8	39.9	1.8	329.1	0.992	15.42	0.980
6	14.600	15.176	39.2	3.3	39.2	3.3	322.7	0.996	14.74	0.973
7	12.509	13.264	42.3	7.5	42.3	7.5	318.7	0.998	14.16	0.952
8	11.786	12.603	44.2	7.7	44.2	7.7	316.7	0.999	13.66	0.941
9	11.049	11.935	47.1	5.2	47.1	5.2	315.2	1.003	13.32	0.922

RP	ABS VEL		REL VEL		MERID VEL		TANG VEL		WHEEL SPEED	
	IN	OUT	IN	OUT	IN	OUT	IN	OUT	IN	OUT
1	243.0	209.5	243.0	209.5	181.0	208.7	162.1	17.7	0.	0.
2	258.3	214.7	258.3	214.7	205.9	214.1	156.0	16.8	0.	0.
3	261.4	218.7	261.4	218.7	208.5	218.0	157.6	16.7	0.	0.
4	268.5	220.5	268.5	220.5	209.8	220.1	167.6	12.5	0.	0.
5	271.9	218.0	271.9	218.0	208.5	217.9	174.6	6.7	0.	0.
6	273.6	204.9	273.6	204.9	212.0	204.6	172.9	11.8	0.	0.
7	267.6	186.0	267.6	186.0	198.1	184.4	179.9	24.4	0.	0.
8	254.2	162.9	254.2	162.9	182.1	161.5	177.3	21.7	0.	0.
9	244.7	140.6	244.7	140.6	166.5	140.0	179.3	12.6	0.	0.

RP	ABS MACH NO		REL MACH NO		MERID MACH NO		MERID PEAK SS	
	IN	OUT	IN	OUT	IN	OUT	VEL R	MACH NO
1	0.684	0.585	0.684	0.585	0.510	0.585	1.153	1.152
2	0.734	0.602	0.734	0.602	0.585	0.600	1.040	1.097
3	0.746	0.615	0.746	0.615	0.595	0.613	1.046	1.089
4	0.775	0.626	0.775	0.626	0.606	0.625	1.049	1.105
5	0.793	0.625	0.793	0.625	0.608	0.624	1.045	1.060
6	0.808	0.590	0.808	0.590	0.626	0.589	0.965	0.909
7	0.794	0.535	0.794	0.535	0.587	0.530	0.931	0.849
8	0.752	0.467	0.752	0.467	0.539	0.463	0.887	0.815
9	0.723	0.401	0.723	0.401	0.492	0.399	0.841	0.818

RP	PERCENT	INCIDENCE		DEV	D-FACT	EFF	LOSS COEFF		LOSS PARAM	
	SPAN	MEAN	SS				TOT	PROF	TOT	PROF
1	5.00	20.8	13.5	10.1	0.365	0.	0.141	0.141	0.054	0.054
2	10.00	15.2	7.9	9.9	0.368	0.	0.209	0.209	0.077	0.077
3	15.00	14.2	7.0	9.9	0.357	0.	0.178	0.178	0.064	0.064
4	30.00	13.1	5.8	9.1	0.367	0.	0.117	0.117	0.038	0.038
5	50.00	10.1	3.0	8.1	0.372	0.	0.059	0.059	0.017	0.017
6	70.00	4.9	-2.2	9.9	0.390	0.	0.079	0.079	0.019	0.019
7	85.00	4.1	-2.9	14.4	0.421	0.	0.142	0.142	0.029	0.029
8	90.00	4.3	-2.7	14.6	0.474	0.	0.188	0.188	0.037	0.037
9	95.00	5.2	-1.7	12.2	0.546	0.	0.264	0.264	0.049	0.049

TABLE VIII. - Concluded.

(cc) 120 Percent of design speed; reading 3042

RP	RADII		ABS BETAM		REL BETAM		TOTAL TEMP		TOTAL PRESS	
	IN	OUT	IN	OUT	IN	OUT	IN	RATIO	IN	RATIO
1	23.396	23.421	49.6	3.8	49.6	3.8	348.3	0.987	15.49	0.957
2	22.718	22.771	41.0	3.7	41.0	3.7	343.9	0.995	16.12	0.926
3	22.045	22.126	39.5	3.8	39.5	3.8	341.7	0.996	16.30	0.927
4	20.015	20.196	40.1	3.7	40.1	3.7	336.4	0.995	16.04	0.956
5	17.315	17.673	40.9	2.2	40.9	2.2	330.1	0.992	15.60	0.969
6	14.600	15.176	40.8	4.5	40.8	4.5	323.3	0.997	14.87	0.968
7	12.509	13.264	43.4	7.4	43.4	7.4	318.6	0.998	14.09	0.955
8	11.786	12.603	45.7	7.9	45.7	7.9	317.1	0.999	13.74	0.942
9	11.049	11.935	47.3	6.1	47.3	6.1	316.1	1.001	13.49	0.924

RP	ABS VEL		REL VEL		MERID VEL		TANG VEL		WHEEL SPEED	
	IN	OUT	IN	OUT	IN	OUT	IN	OUT	IN	OUT
1	237.4	203.9	237.4	203.9	153.8	203.4	180.9	13.4	0.	0.
2	252.5	206.5	252.5	206.5	190.5	206.1	165.7	13.3	0.	0.
3	258.4	211.1	258.4	211.1	199.4	210.6	164.3	13.9	0.	0.
4	264.3	217.2	264.3	217.2	202.2	216.8	170.3	14.0	0.	0.
5	269.5	212.8	269.5	212.8	203.7	212.6	176.5	8.3	0.	0.
6	268.2	198.0	268.2	198.0	203.1	197.3	175.2	15.7	0.	0.
7	258.0	173.3	258.0	173.3	187.4	171.9	177.3	22.2	0.	0.
8	249.7	156.2	249.7	156.2	174.5	154.7	178.6	21.5	0.	0.
9	243.2	139.7	243.2	139.7	164.9	138.9	178.8	14.8	0.	0.

RP	ABS MACH NO		REL MACH NO		MERID MACH NO		MERID PEAK SS	
	IN	OUT	IN	OUT	IN	OUT	VEL R	MACH NO
1	0.662	0.566	0.662	0.566	0.429	0.565	1.323	1.294
2	0.713	0.575	0.713	0.575	0.538	0.574	1.082	1.158
3	0.734	0.590	0.734	0.590	0.566	0.589	1.056	1.131
4	0.759	0.615	0.759	0.615	0.581	0.613	1.072	1.121
5	0.784	0.608	0.784	0.608	0.593	0.607	1.044	1.074
6	0.789	0.567	0.789	0.567	0.597	0.566	0.972	0.943
7	0.762	0.497	0.762	0.497	0.557	0.492	0.917	0.861
8	0.736	0.447	0.736	0.447	0.515	0.442	0.887	0.849
9	0.717	0.398	0.717	0.398	0.486	0.396	0.842	0.817

RP	PERCENT		INCIDENCE		DEV	D-FACT	EFF	LOSS COEFF		LOSS PARAM	
	SPAN	MEAN	SS	TOT				PROF	TOT	PROF	
1	5.00	28.6	21.3	9.0	0.411	0.	0.171	0.171	0.065	0.065	
2	10.00	19.1	11.8	9.1	0.406	0.	0.257	0.257	0.095	0.095	
3	15.00	16.6	9.4	9.3	0.392	0.	0.242	0.242	0.087	0.087	
4	30.00	14.6	7.3	9.5	0.371	0.	0.138	0.138	0.045	0.045	
5	50.00	11.1	3.9	8.6	0.386	0.	0.092	0.092	0.026	0.026	
6	70.00	6.5	-0.6	11.2	0.402	0.	0.094	0.094	0.023	0.023	
7	85.00	5.3	-1.8	14.2	0.449	0.	0.140	0.140	0.029	0.029	
8	90.00	5.8	-1.3	14.8	0.493	0.	0.193	0.193	0.038	0.038	
9	95.00	5.4	-1.6	13.2	0.545	0.	0.261	0.261	0.048	0.048	

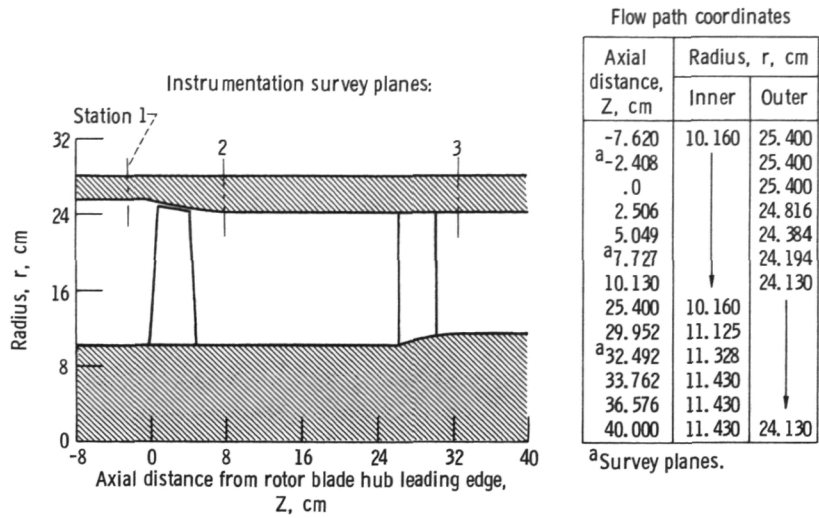

Figure 1. - Flow path and instrumentation locations for stage 53.

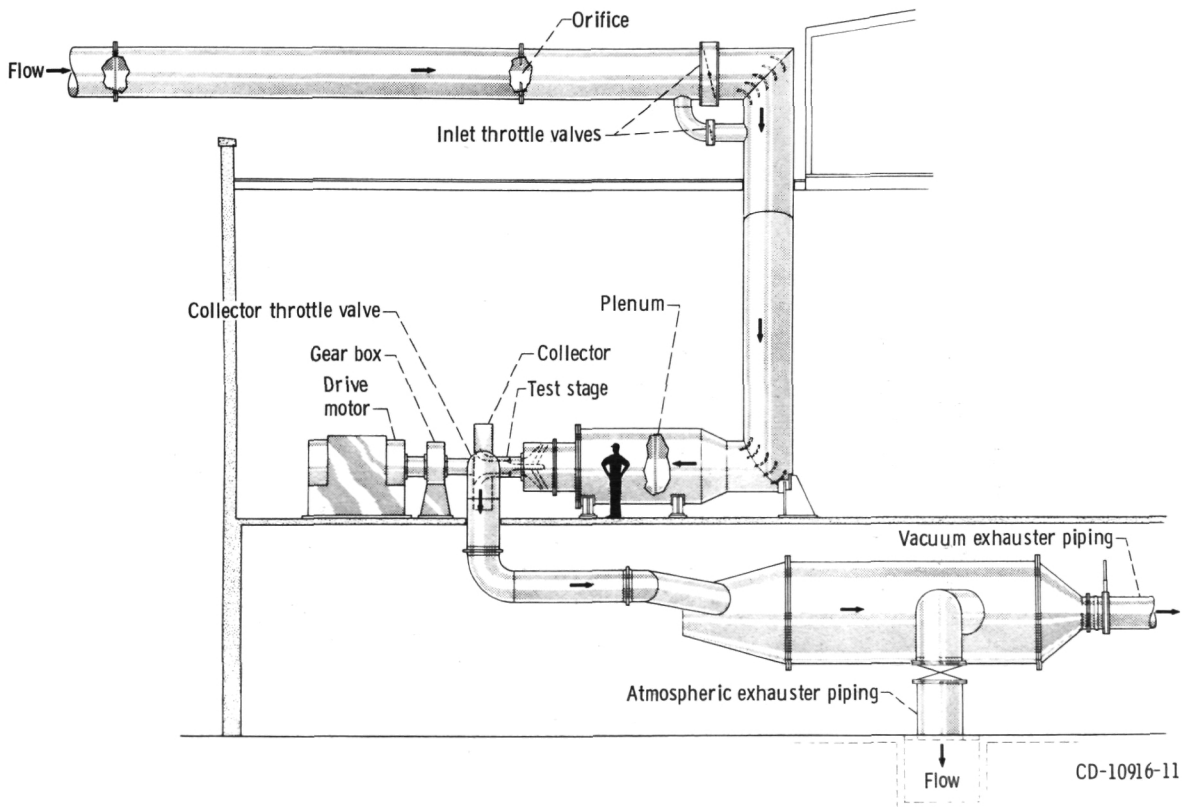

Figure 2. - Single-stage compressor facility.

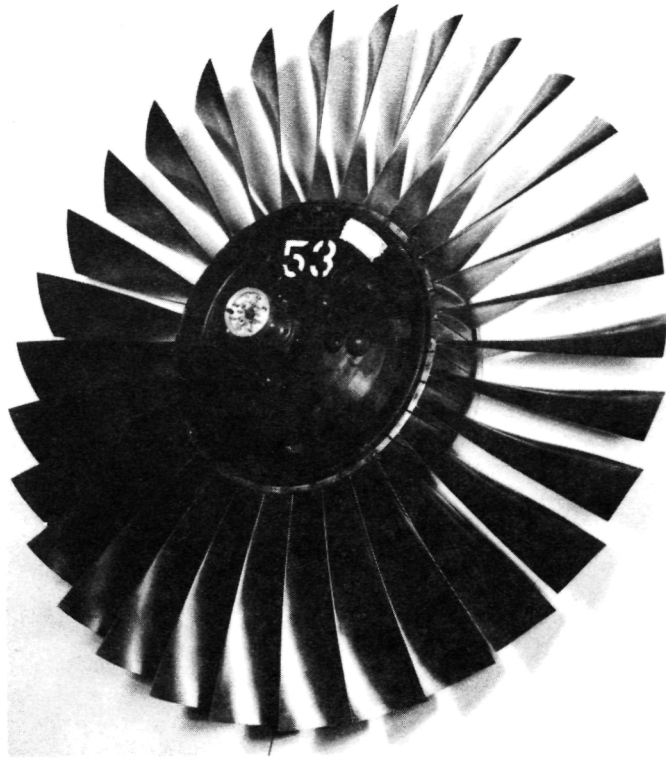

Figure 3. - Rotor 53.

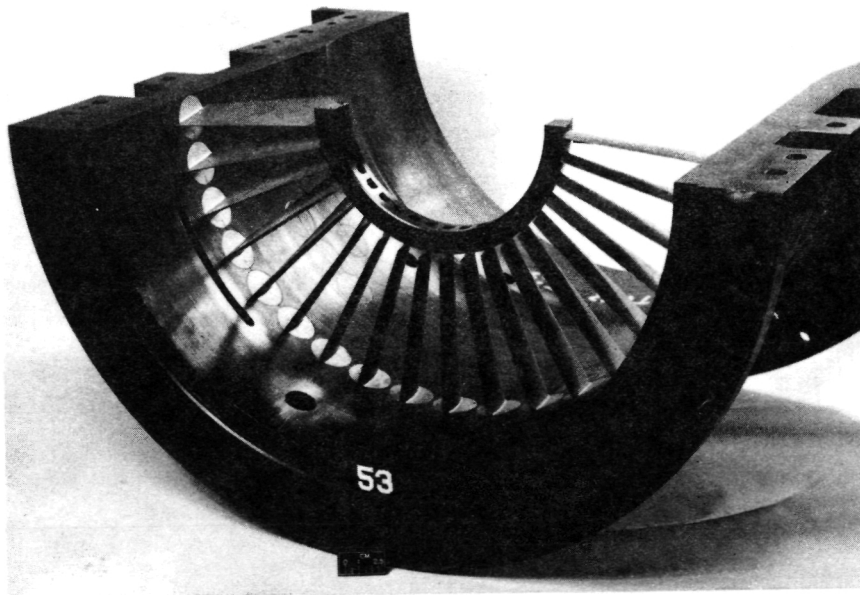
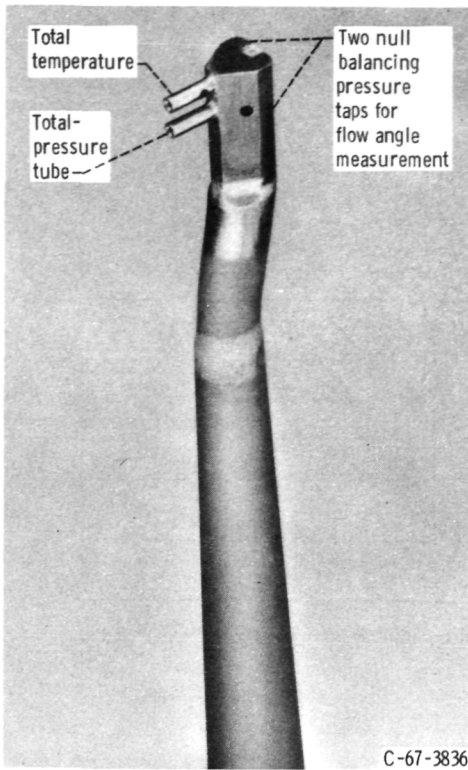

Figure 4. - Stator 53.





(a) Combination total pressure, total temperature, and flow angle probe (double barrel probe).



(b) Static pressure probe (8° wedge).

Figure 5. - Sensing probes.

-  Combination probe
-  Wedge probe
-  Wall static pressure taps

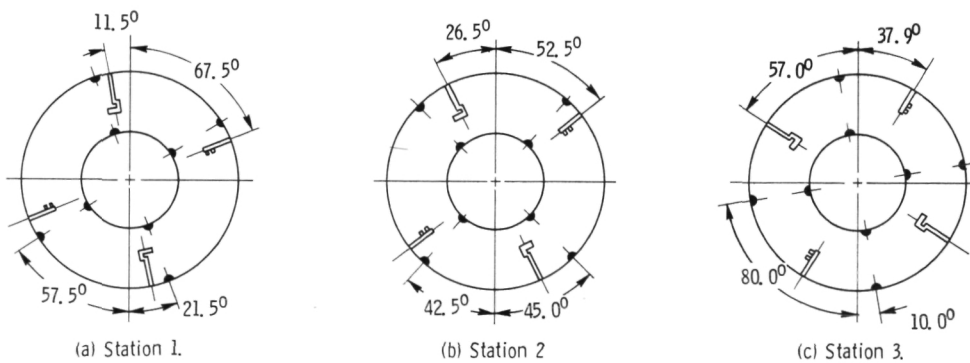

Figure 6. - Circumferential location of instrumentation at measuring stations (looking downstream).

E-9025

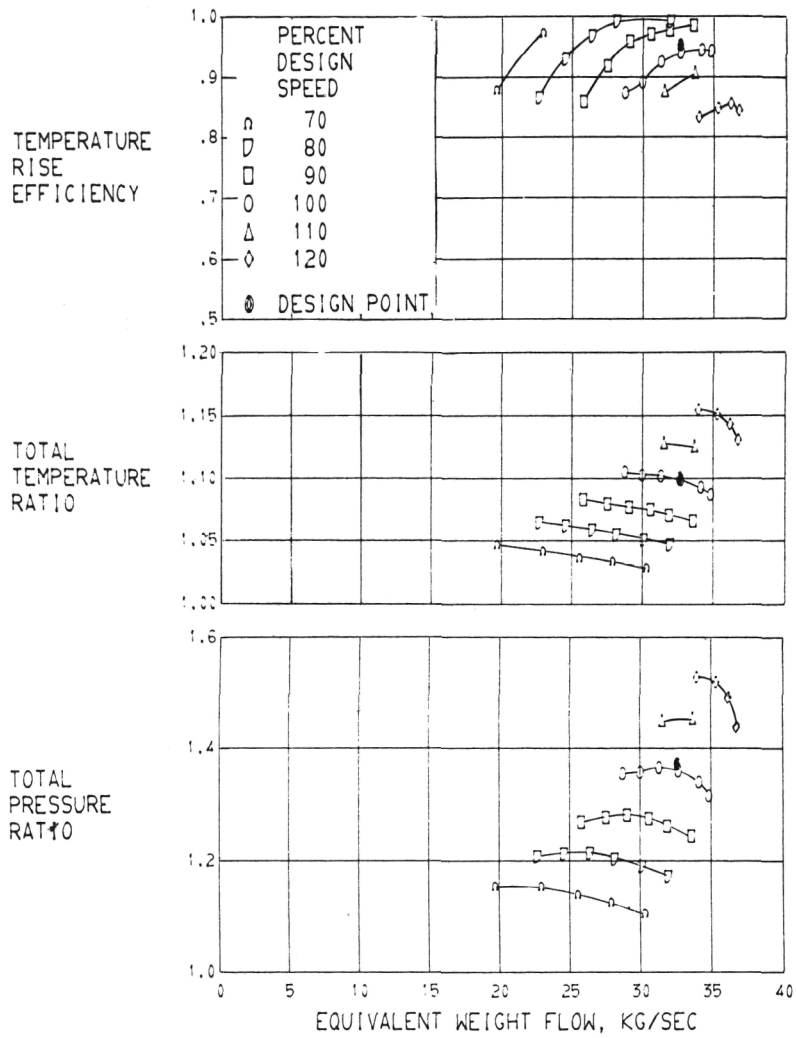

FIGURE 7. - OVERALL PERFORMANCE FOR ROTOR 53.

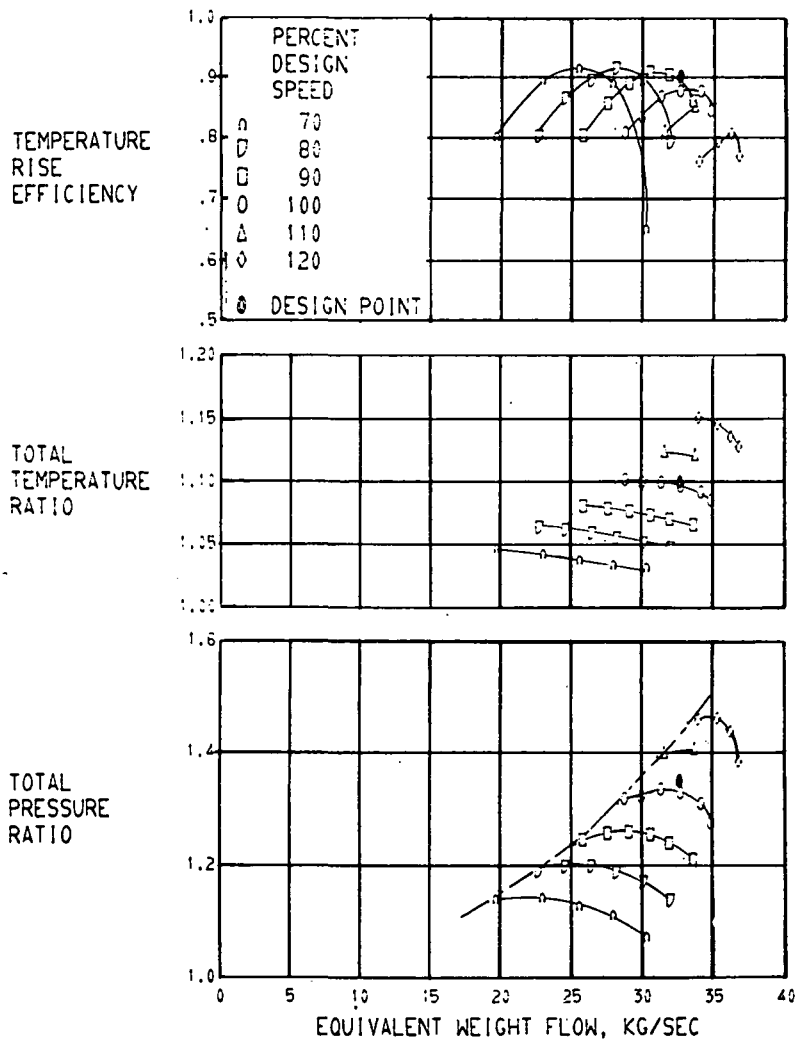

FIGURE 8. - OVERALL PERFORMANCE FOR STAGE 53-53.

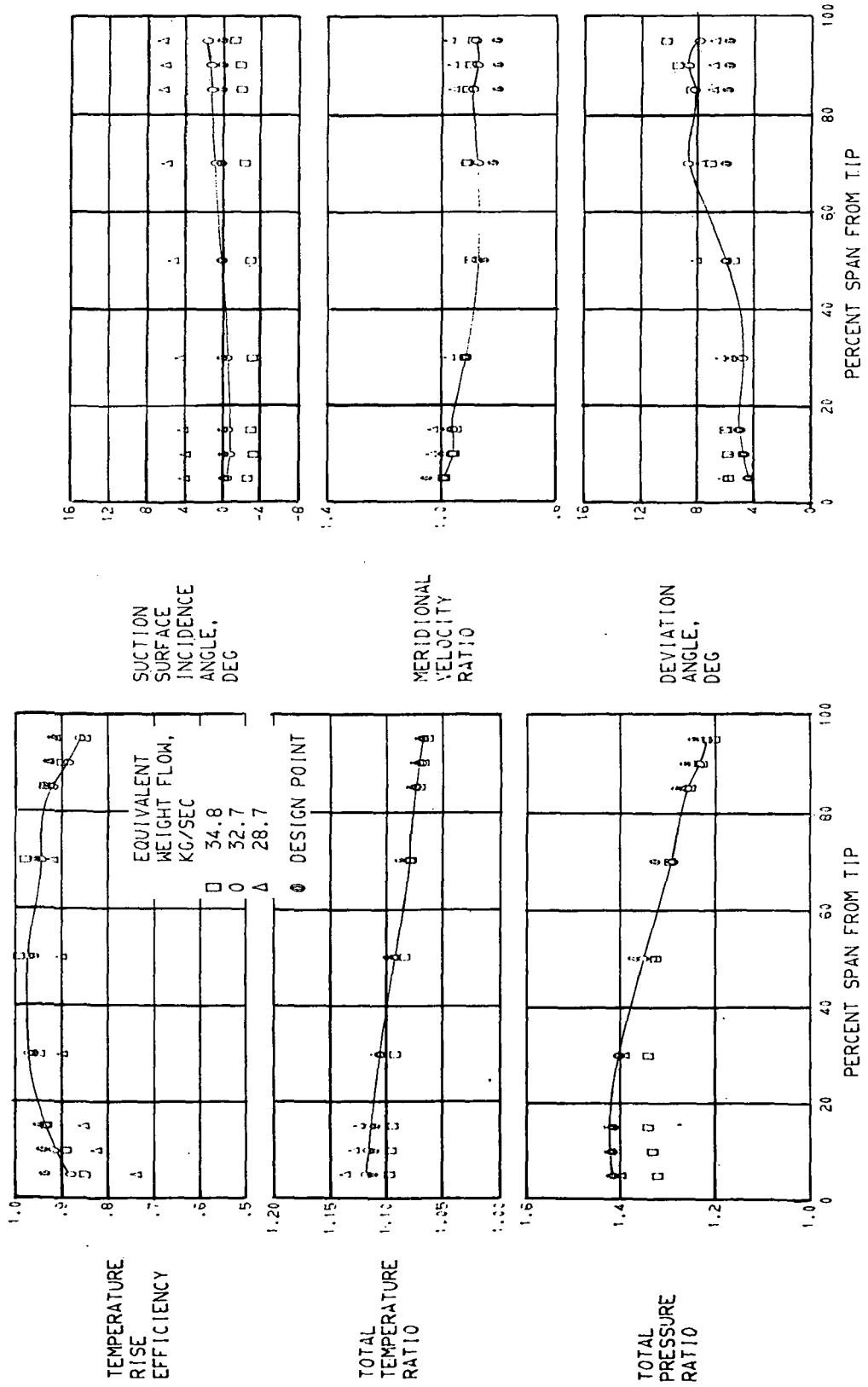

FIGURE 9. - RADIAL DISTRIBUTION OF PERFORMANCE FOR ROTOR 53 AT 100 PERCENT OF DESIGN SPEED.

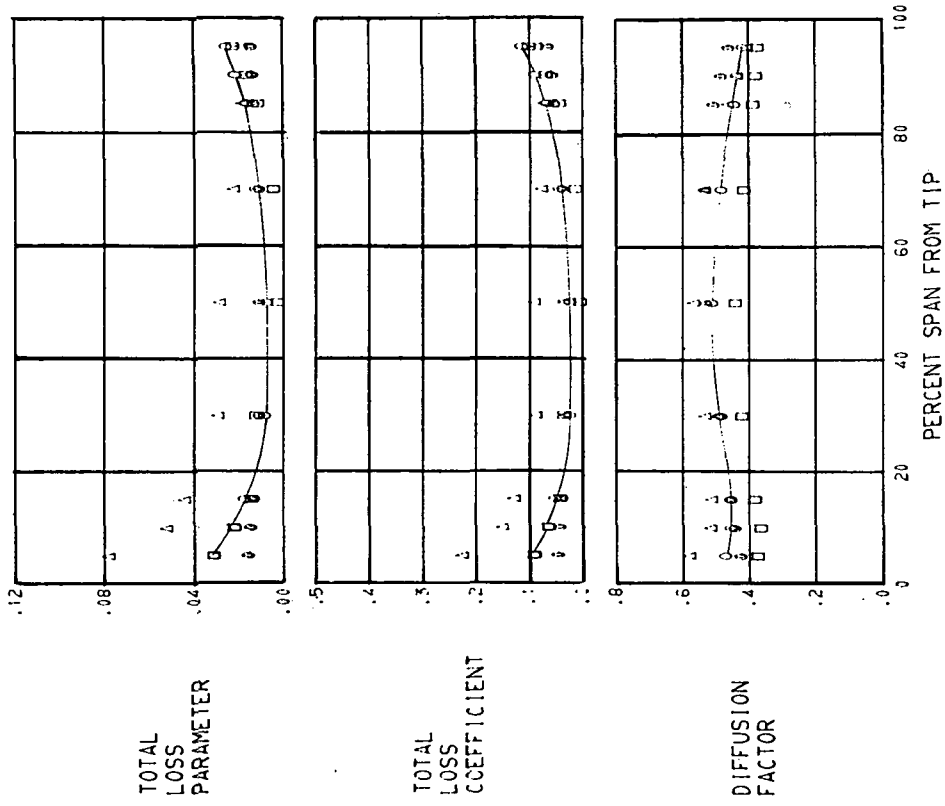

FIGURE 9. - CONCLUDED.

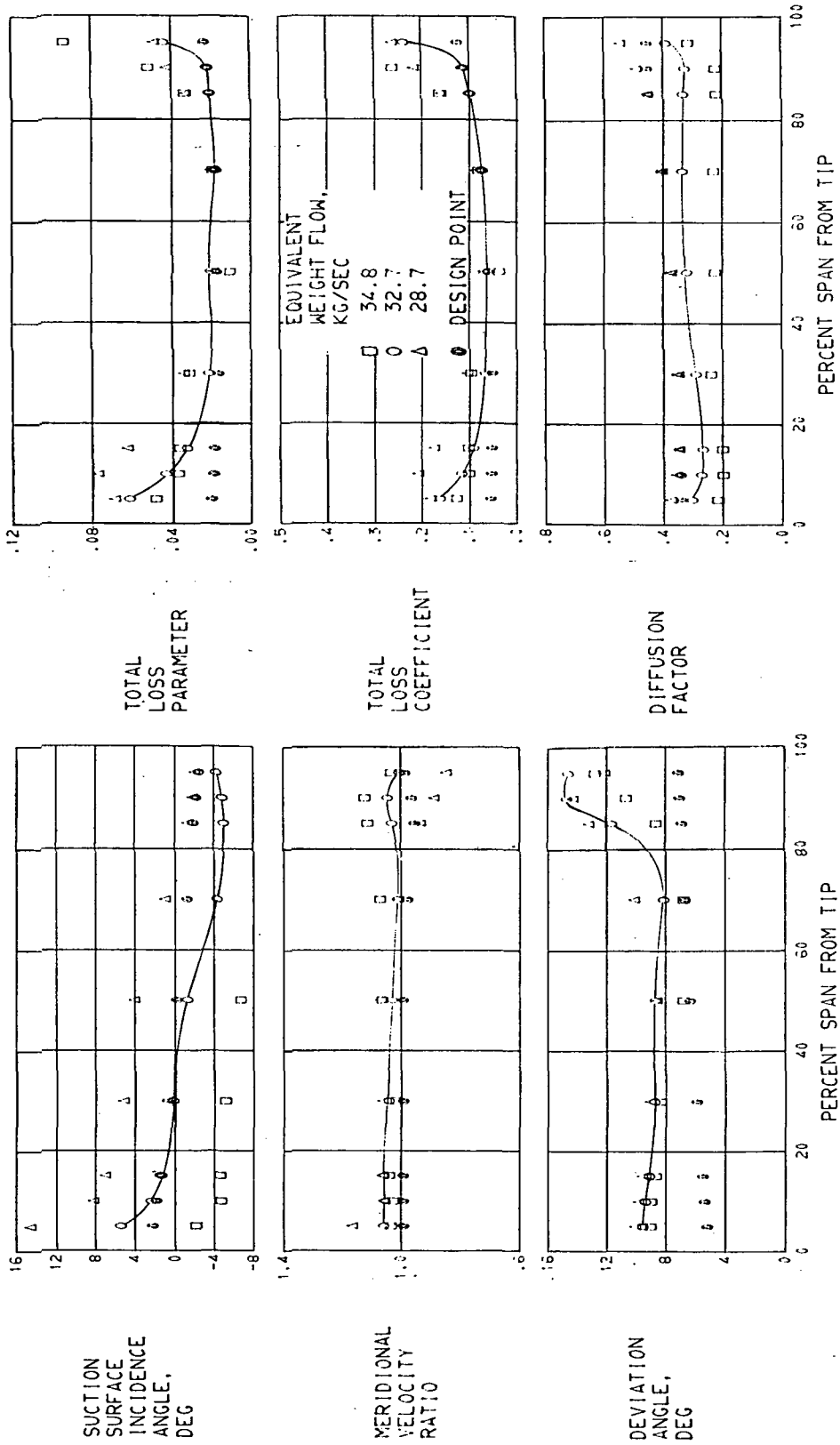
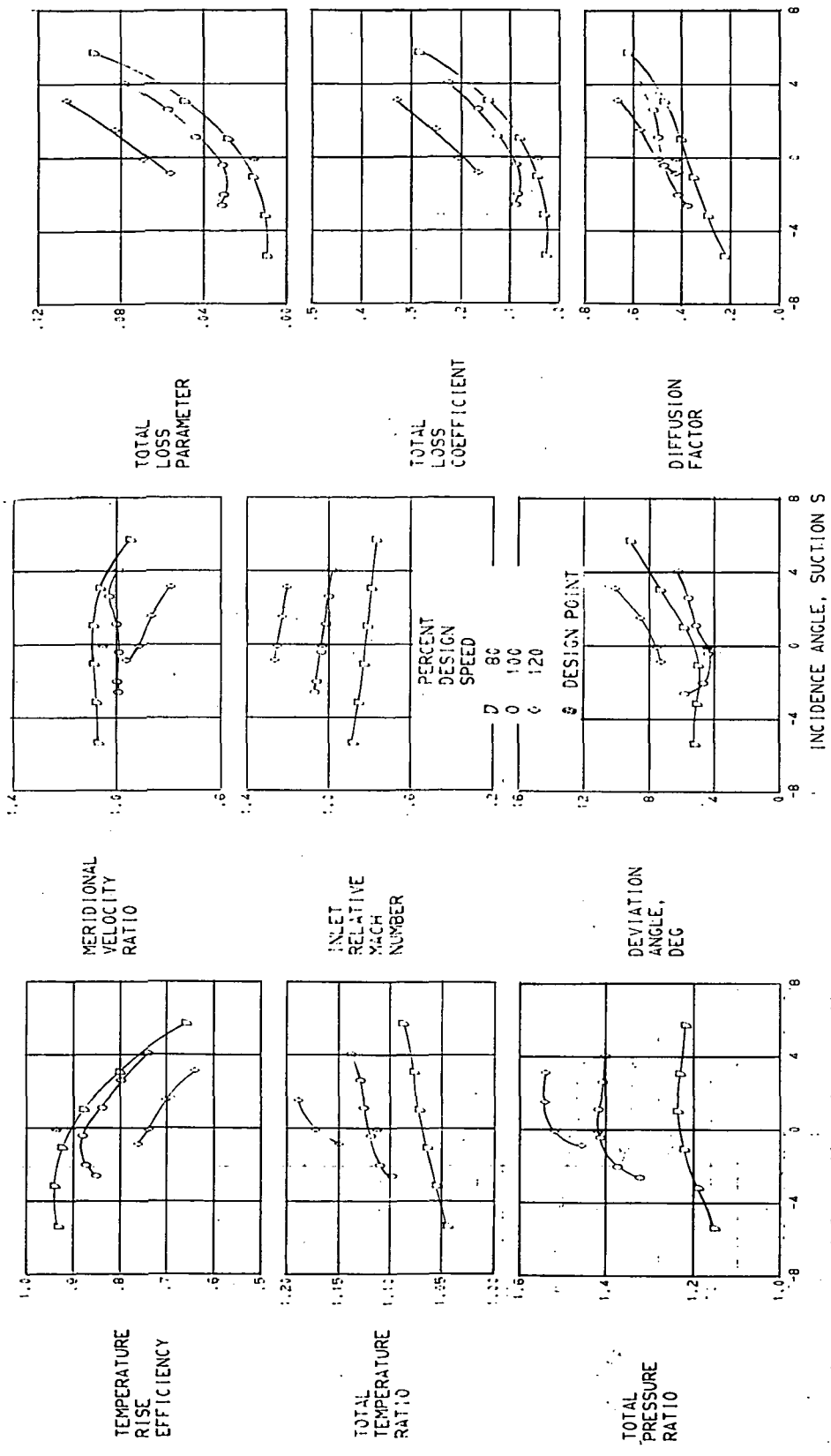
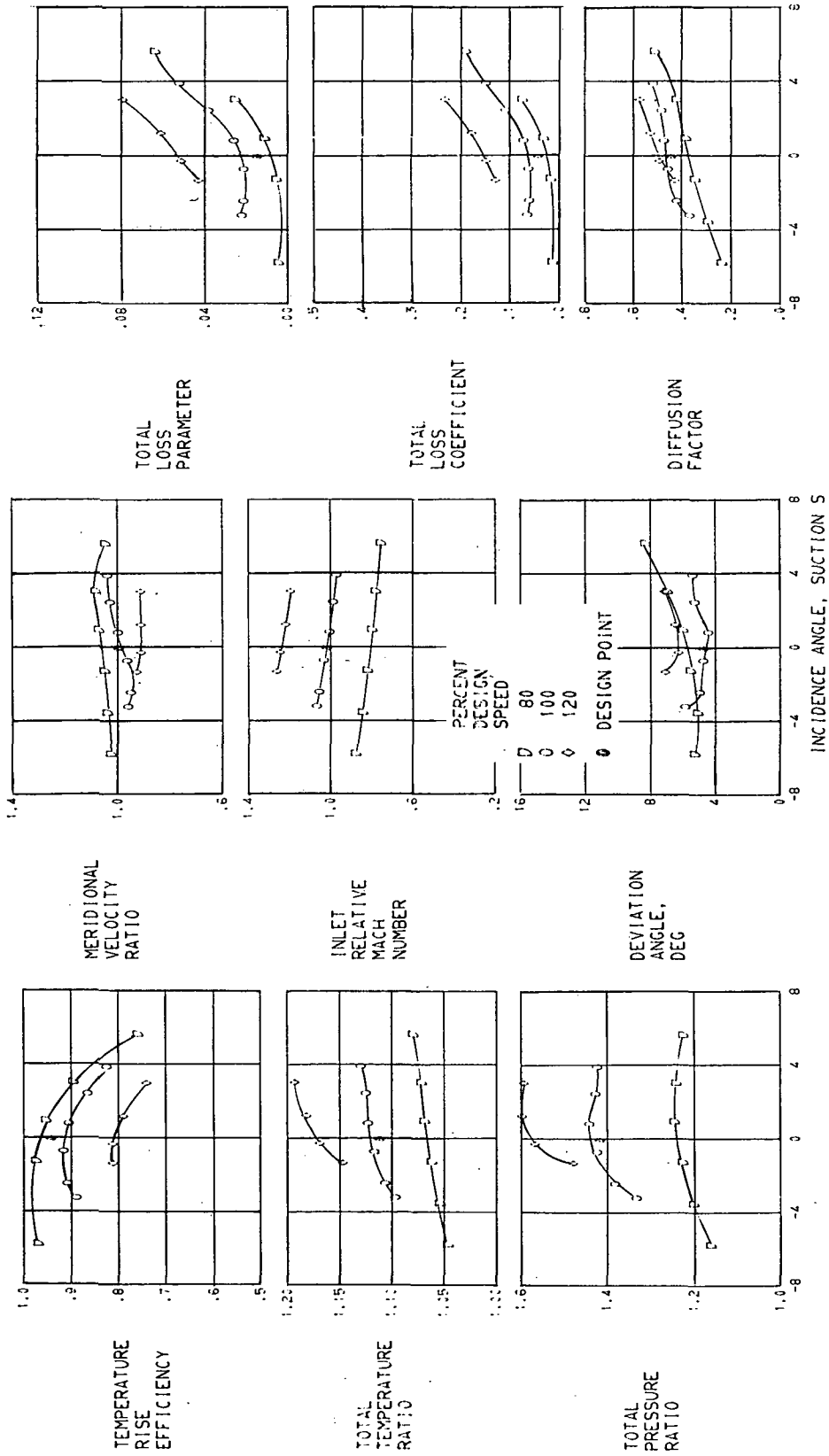

FIGURE 10. - RADIAL DISTRIBUTION OF PERFORMANCE FOR STATOR 53 AT 100 PERCENT OF DESIGN SPEED.



(A) 5 PERCENT OF SPAN.
 FIGURE 11. - BLADE-ELEMENT PERFORMANCE FOR ROTOR 53.



(B) 10 PERCENT OF SPAN.

FIGURE 11. - CONTINUED.

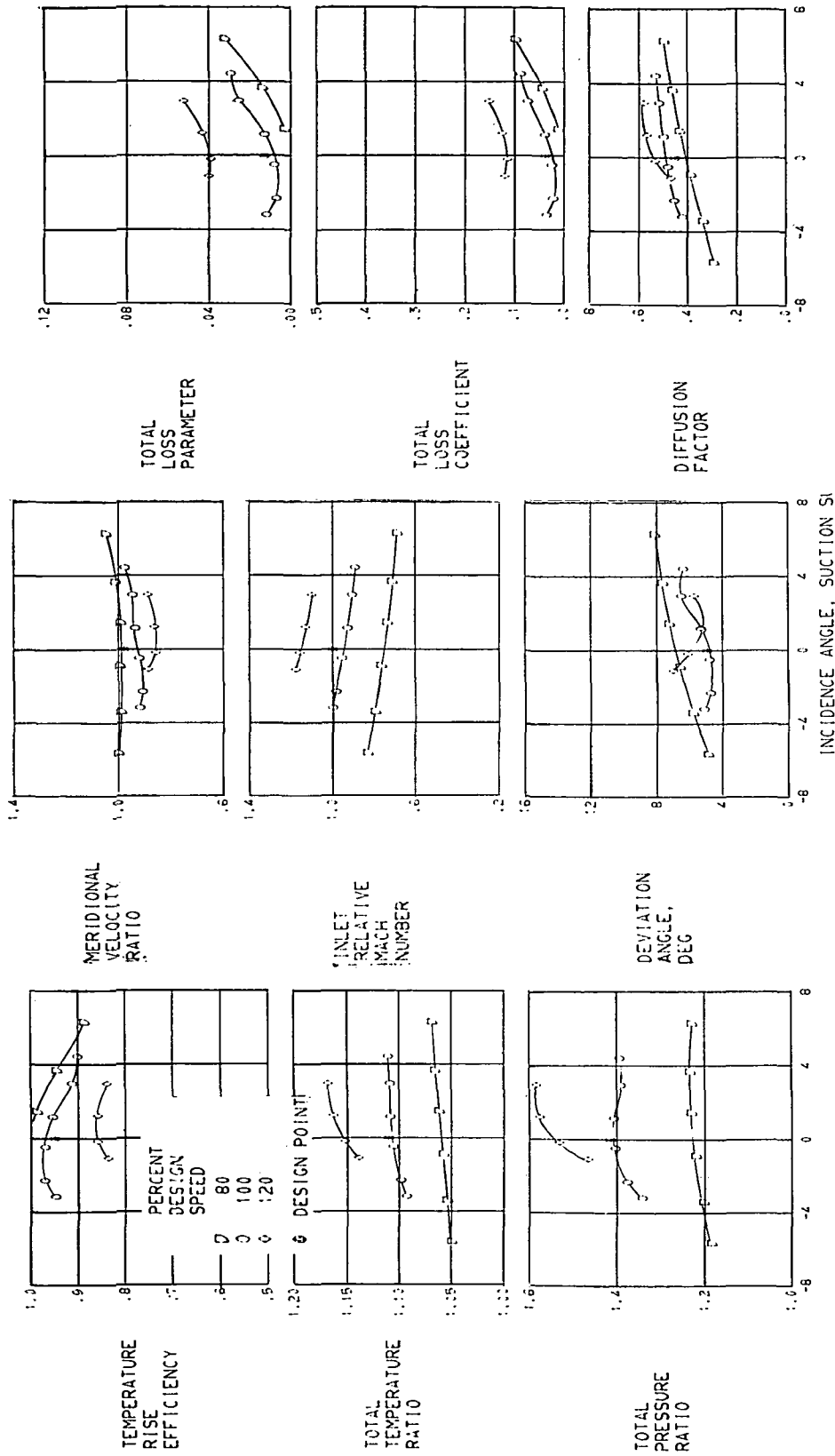

(C) 30 PERCENT OF SPAN.
 FIGURE 11. - CONTINUED.

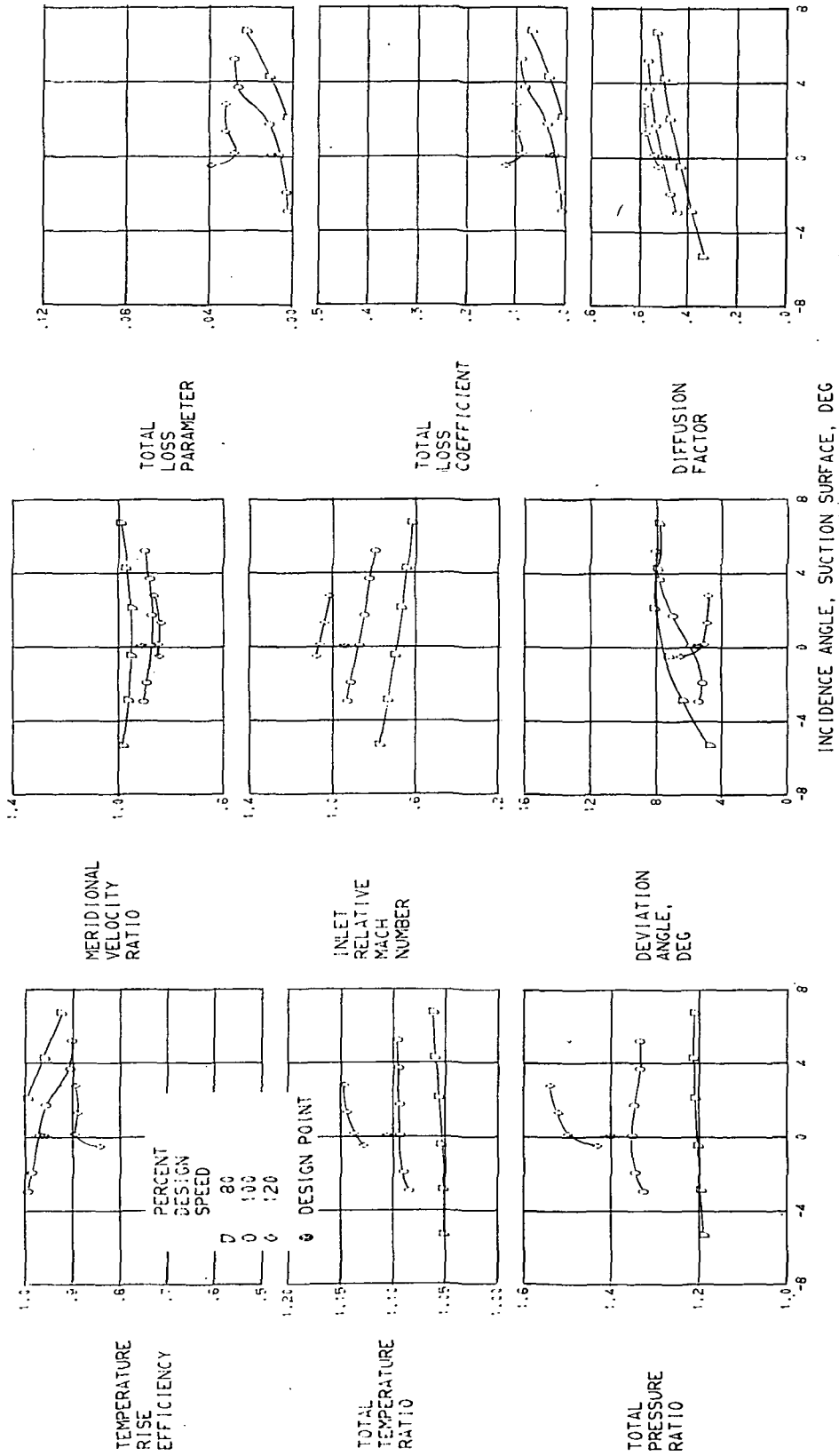

(D) 50 PERCENT OF SPAN.

FIGURE 11. - CONTINUED.

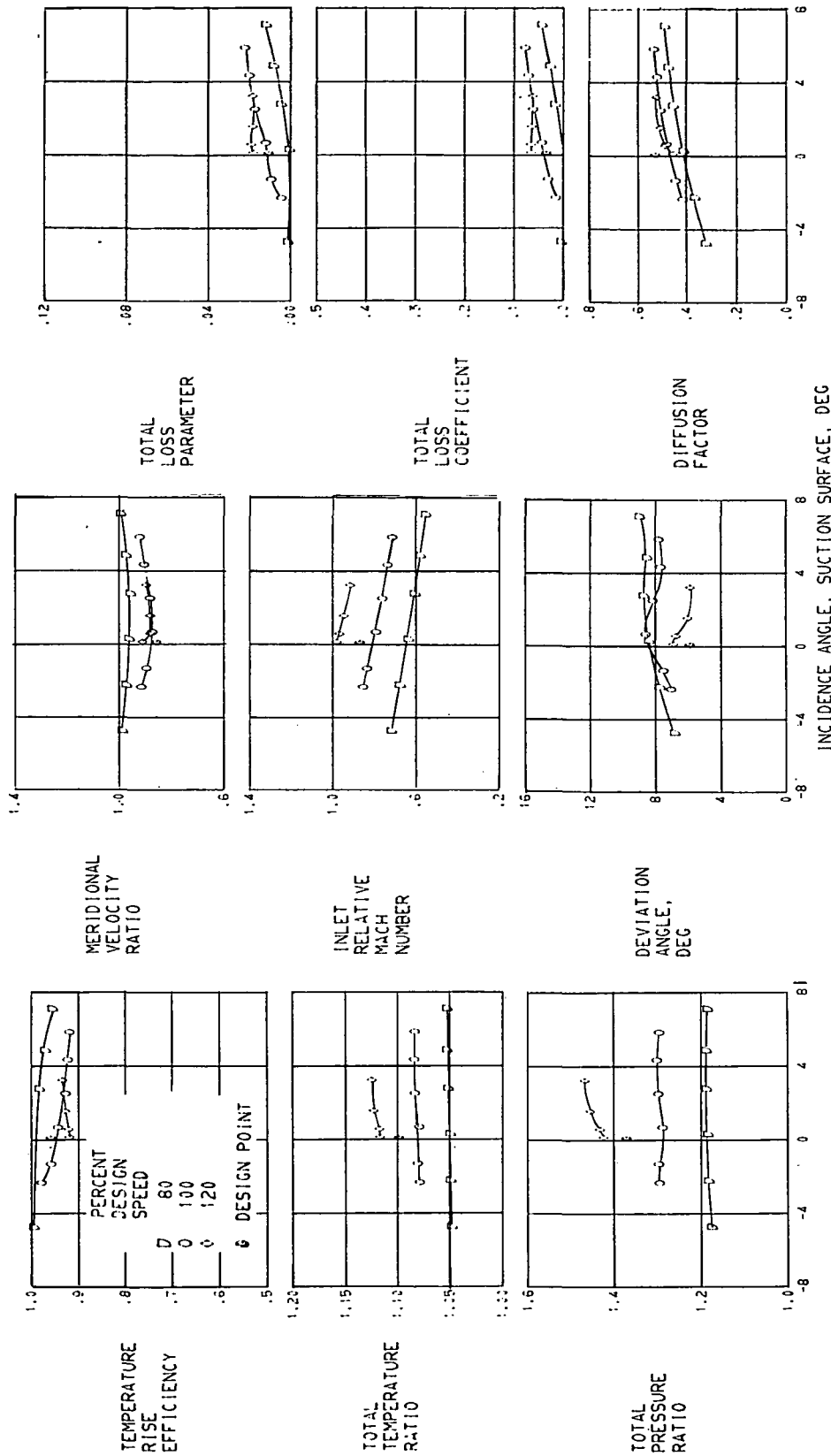

(E) 70 PERCENT OF SPAN.
 FIGURE 11. - CONTINUED.

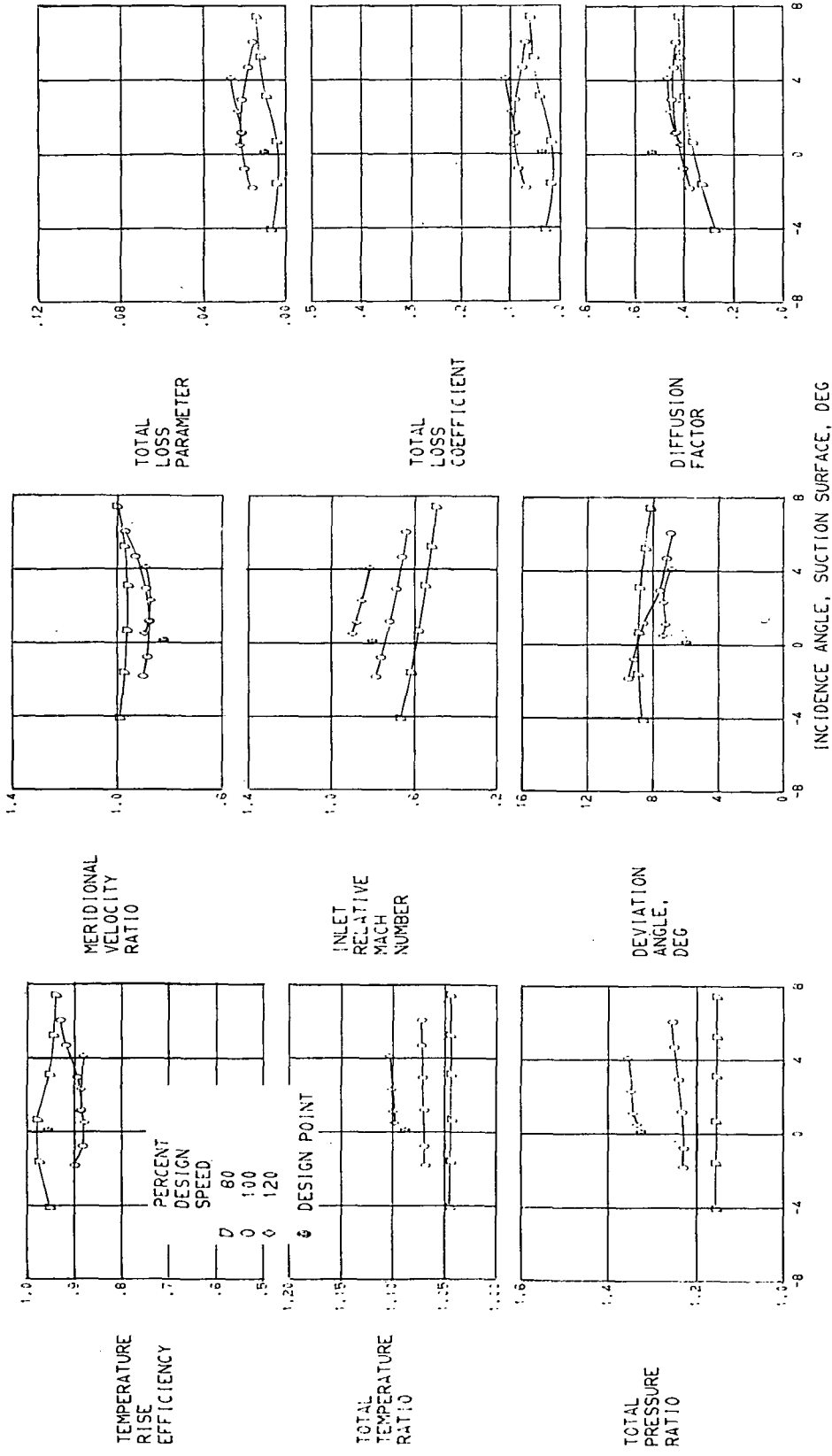

(F) 90 PERCENT OF SPAN.

FIGURE 11. - CONTINUED.

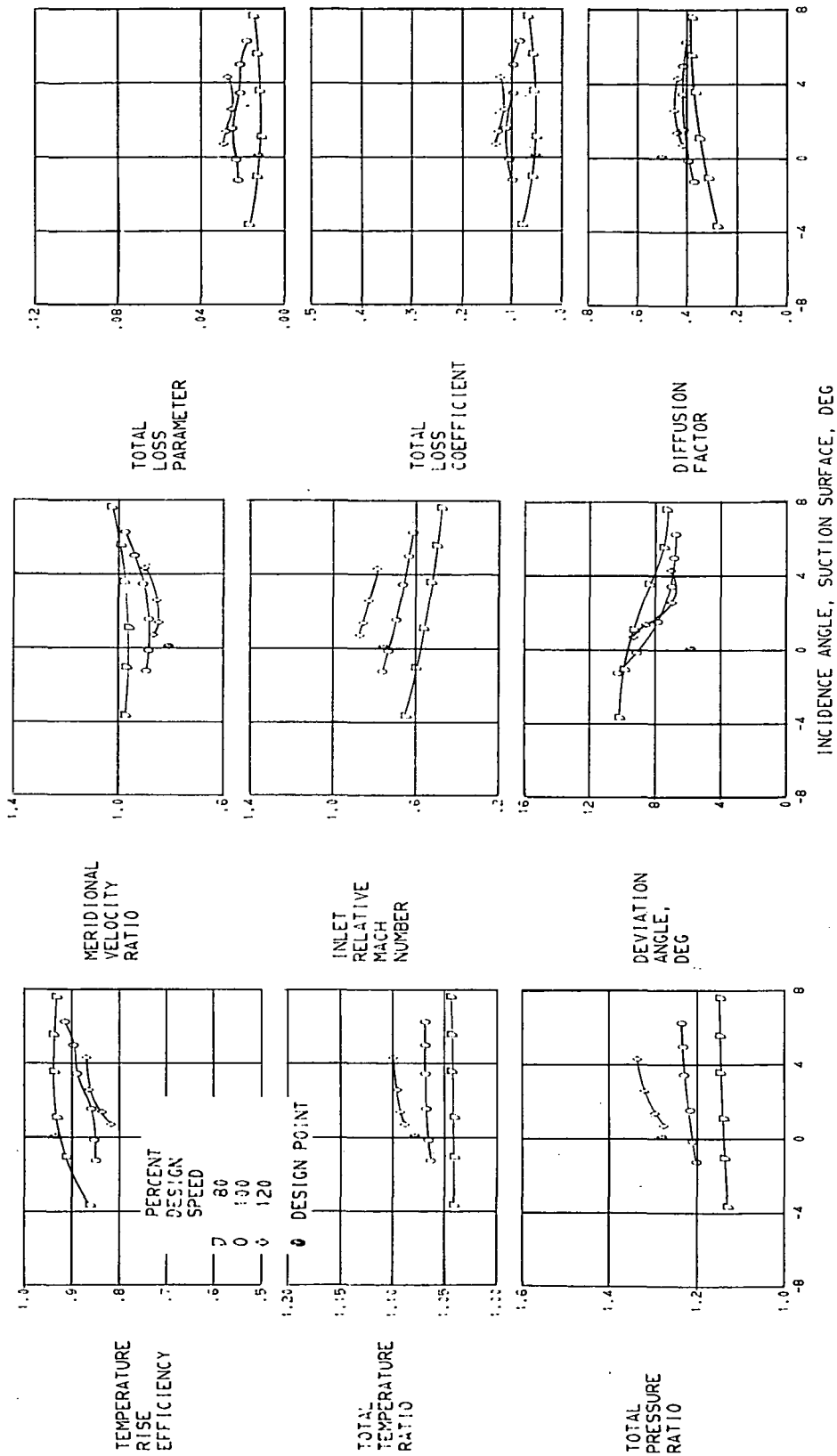

(G) 95 PERCENT OF SPAN.

FIGURE 11. - CONCLUDED.

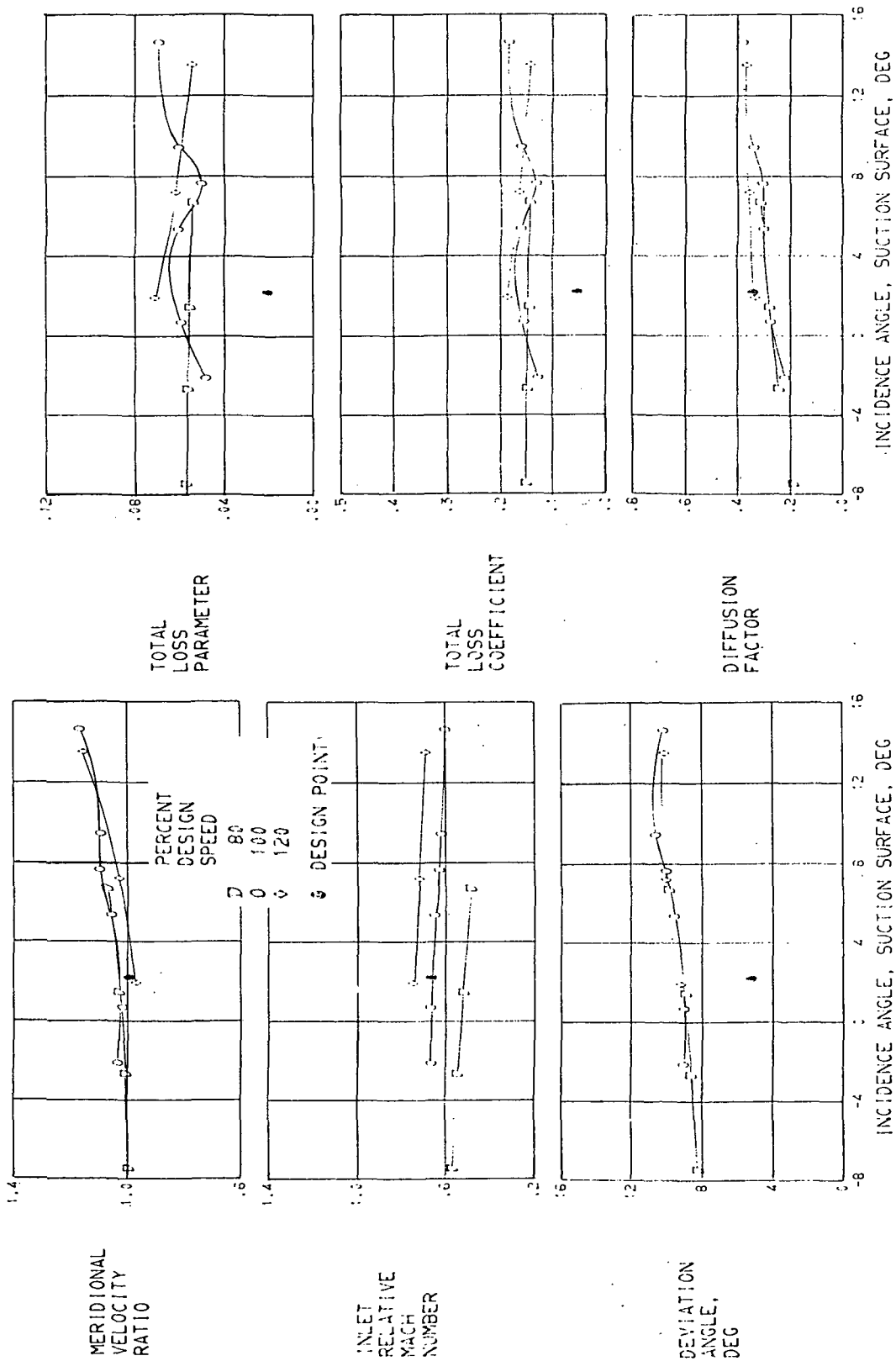

(A) 5 PERCENT SPAN.

FIGURE 12. - BLADE-ELEMENT PERFORMANCE FOR STATOR 53.

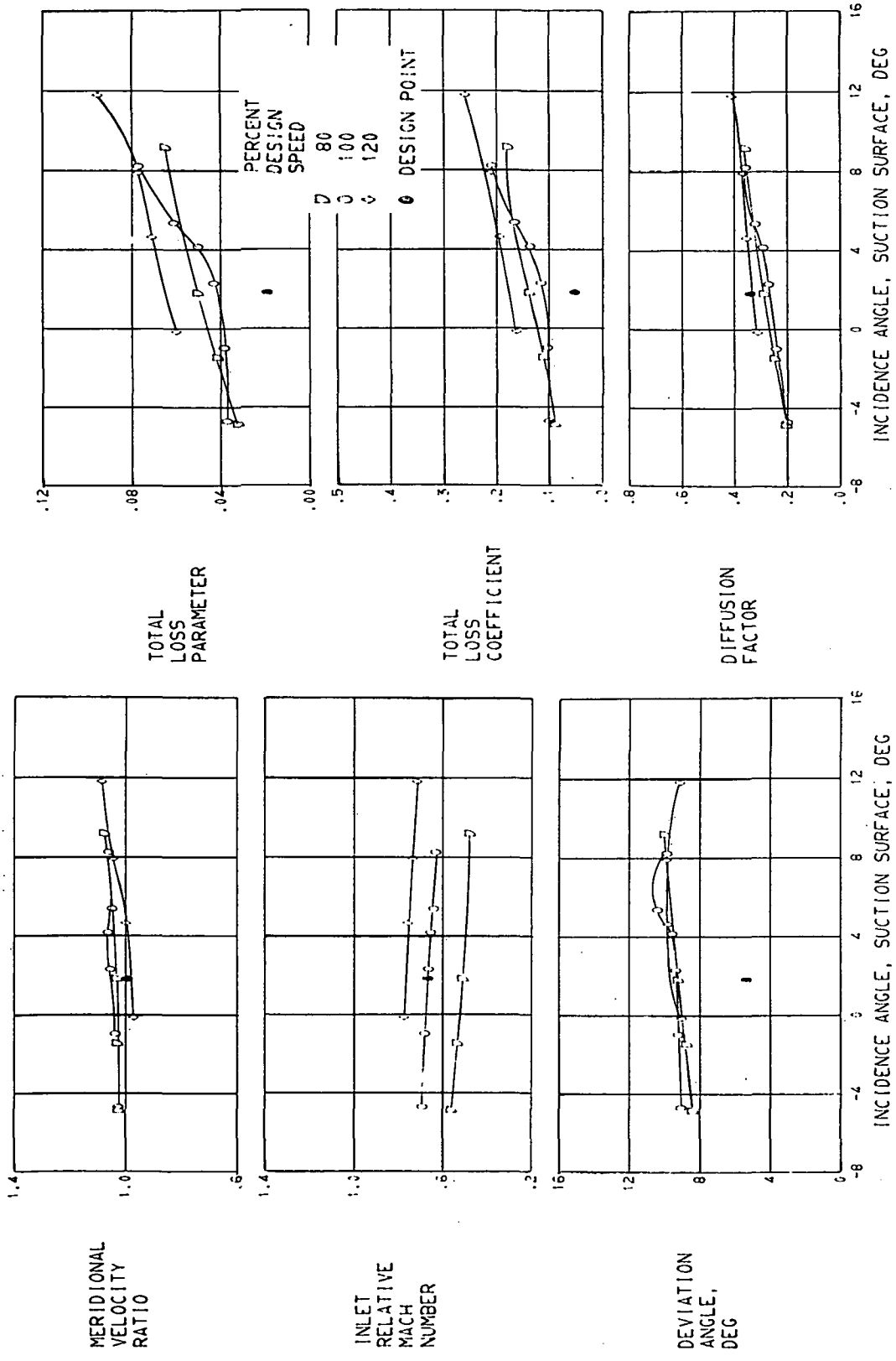

(B) 10 PERCENT OF SPAN.
 FIGURE 12. - CONTINUED.

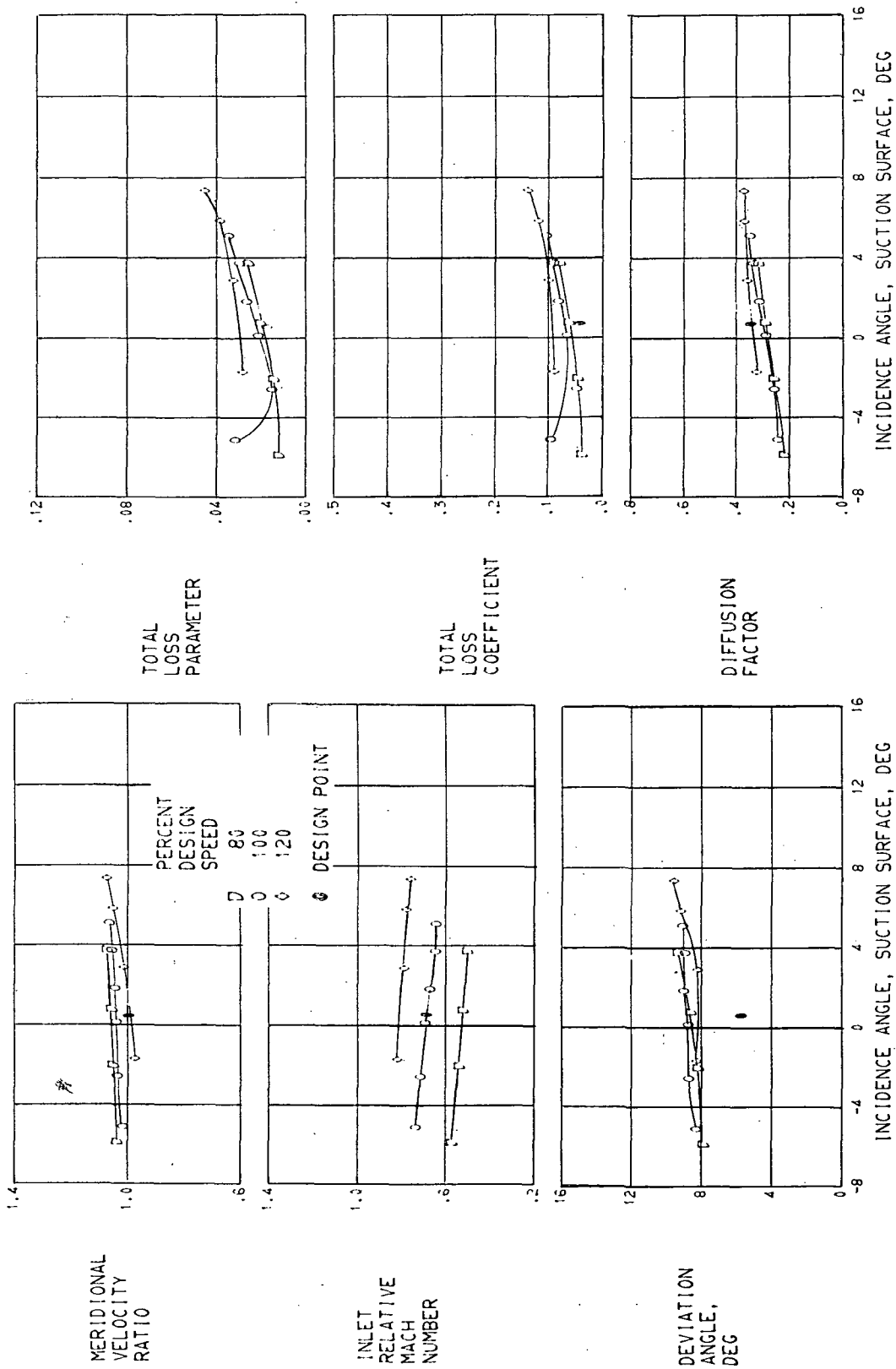

(C) 30 PERCENT OF SPAN.
 FIGURE 12. - CONTINUED.

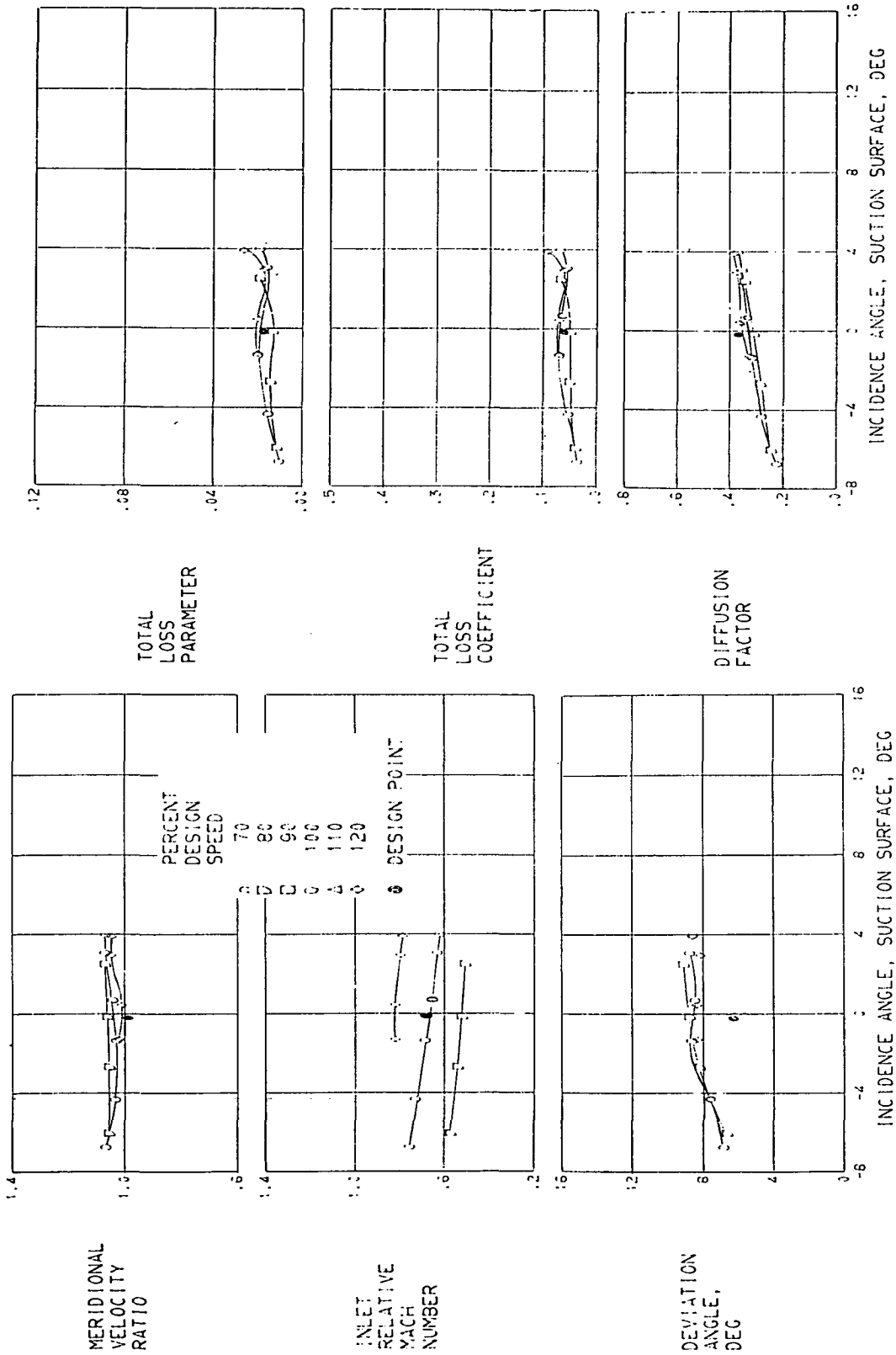

(D) 50 PERCENT OF SPAN,
 FIGURE 12. - CONTINUED.

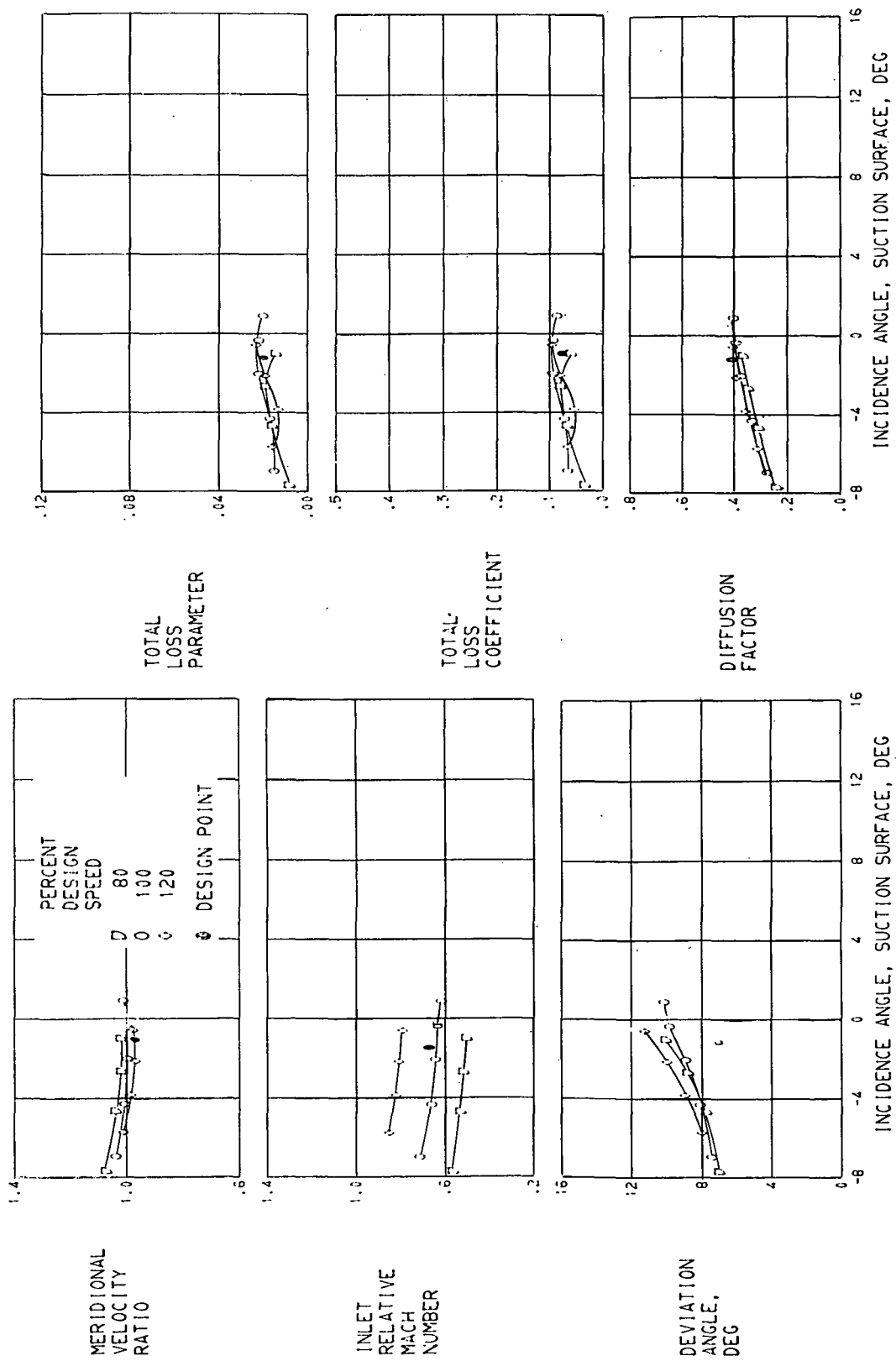

(E) 70 PERCENT OF SPAN.
 FIGURE 12. - CONTINUED.

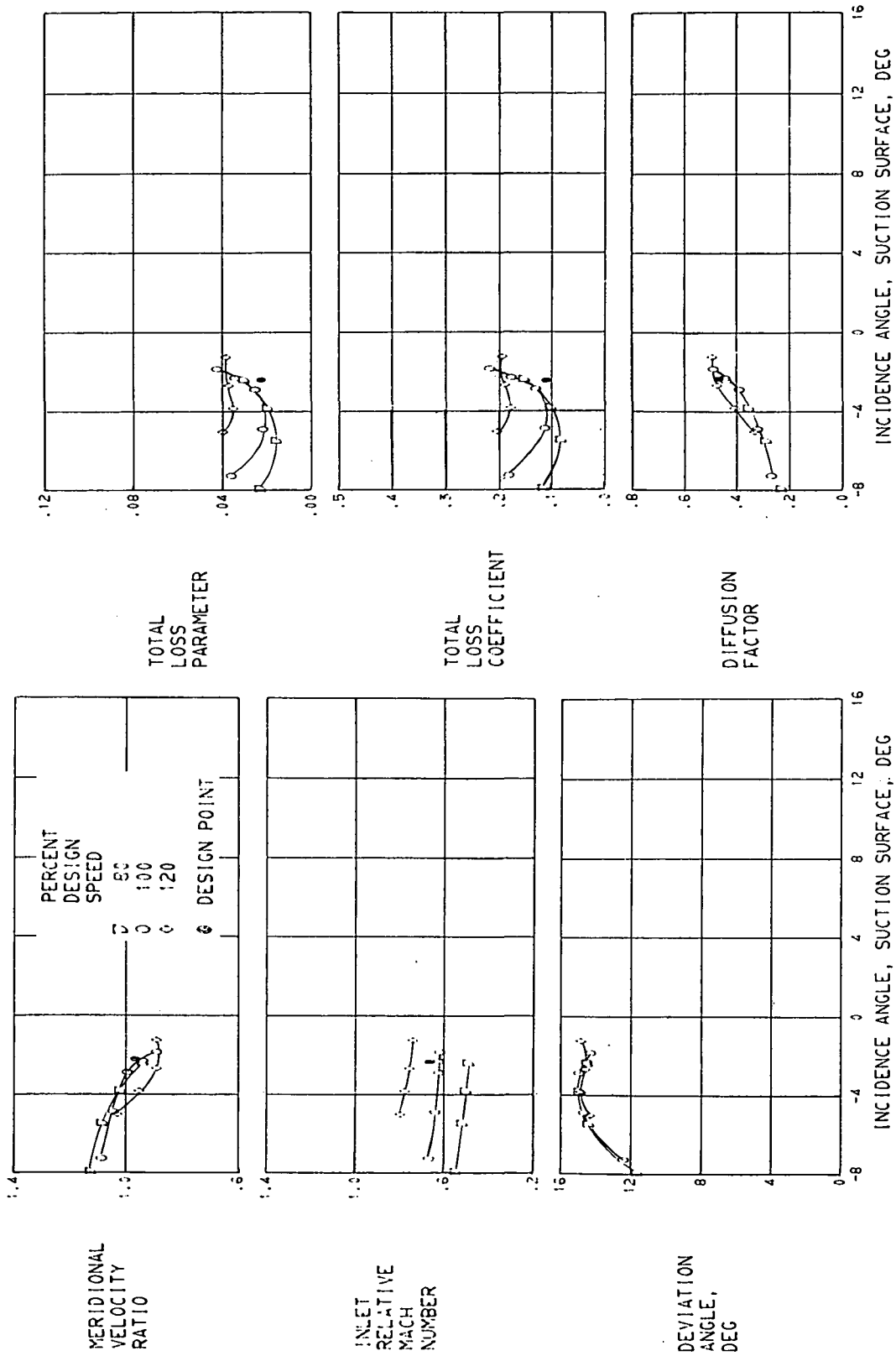

(F) 90 PERCENT OF SPAN.

FIGURE 12. - CONTINUED.

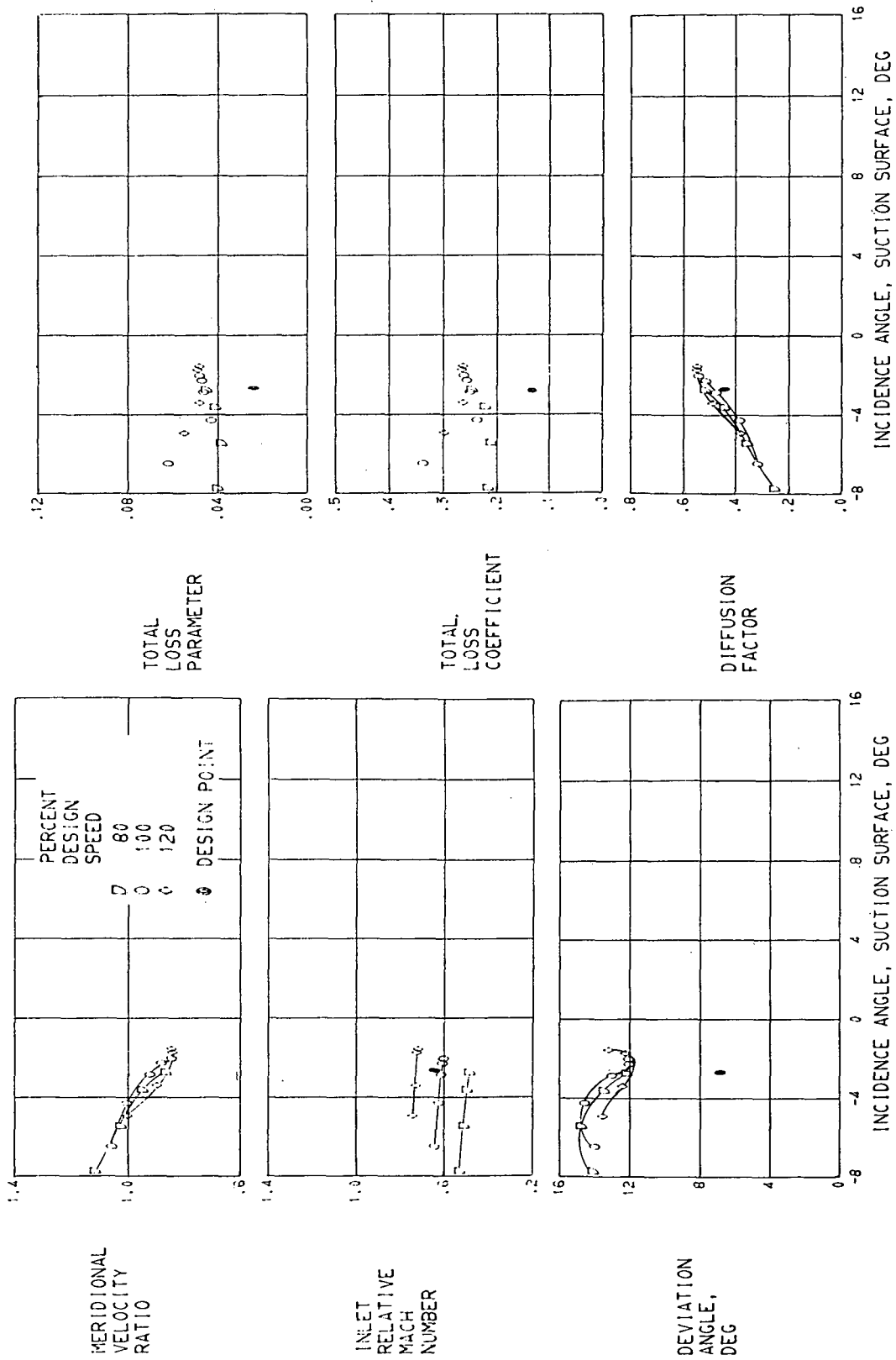

(G) 95 PERCENT OF SPAN.
 FIGURE 12. - CONCLUDED.

1. Report No. NASA TP-1299		2. Government Accession No.		3. Recipient's Catalog No.	
4. Title and Subtitle AERODYNAMIC PERFORMANCE OF A 1.35-PRESSURE-RATIO AXIAL-FLOW FAN STAGE				5. Report Date October 1978	
				6. Performing Organization Code	
7. Author(s) Walter M. Osborn, Royce D. Moore, and Ronald J. Steinke				8. Performing Organization Report No. E-9025	
9. Performing Organization Name and Address National Aeronautics and Space Administration Lewis Research Center Cleveland, Ohio 44135				10. Work Unit No. 505-04	
				11. Contract or Grant No.	
12. Sponsoring Agency Name and Address National Aeronautics and Space Administration Washington, D. C. 20546				13. Type of Report and Period Covered Technical Paper	
				14. Sponsoring Agency Code	
15. Supplementary Notes					
16. Abstract The overall and the blade-element performances and the aerodynamic design parameters are presented for a 1.35-pressure-ratio fan stage. The fan stage was designed for a weight flow of 32.7 kilograms per second and a tip speed of 302.8 meters per second. At design speed the stage peak efficiency of 0.879 occurred at a pressure ratio of 1.329 and design flow. Stage stall margin was approximately 14 percent. At design flow rotor efficiency was 0.94 and the pressure ratio was 1.360.					
17. Key Words (Suggested by Author(s)) Turbomachinery			18. Distribution Statement Unclassified - unlimited STAR Category 02		
19. Security Classif. (of this report) Unclassified		20. Security Classif. (of this page) Unclassified		21. No. of Pages 107	22. Price* A06

National Aeronautics and
Space Administration

Washington, D.C.
20546

Official Business

Penalty for Private Use, \$300

THIRD-CLASS BULK RATE

Postage and Fees Paid
National Aeronautics and
Space Administration
NASA-451



NASA

POSTMASTER: *If Undeliverable (Section 158
Postal Manual) Do Not Return*
