

THE COST OF APPLYING CURRENT HELICOPTER EXTERNAL NOISE REDUCTION
METHODS WHILE MAINTAINING REALISTIC VEHICLE PERFORMANCE*

MICHAEL A. BOWES
KAMAN AEROSPACE CORPORATION

SUMMARY

Analytical methods were developed and/or adopted for calculating helicopter component noise, and these methods were incorporated into a unified total vehicle noise calculation model. Analytical methods were also developed for calculating the effects of noise reduction methodology on helicopter design, performance and cost.

These methods were used to calculate changes in noise, design, performance and cost due to the incorporation of engine and main rotor noise reduction methods. All noise reduction techniques were evaluated in the context of an established mission performance criterion which included consideration of hover ceiling, forward flight range/speed/payload and rotor stall margin.

INTRODUCTION

The helicopter, which has long been considered an essential military tool, is now enjoying rapidly expanding use in civilian applications. The size of the civil helicopter fleet, which numbered less than 1000 vehicles in 1960, has now grown to over 5000, and continued expansion is anticipated (figure 1). This growth in fleet size, coupled with a corresponding increase in the type and number of civil missions being performed, has caused a heightened awareness of and reaction to helicopter noise in the community. As a consequence of this, the Federal Aviation Administration (FAA) has taken steps to formulate a helicopter noise certification rule, which will limit the allowable noise of future design helicopters in much the same way that the existing Federal Air Regulation (FAR) Part 36 limits jet transport noise.

In establishing such a rule, consideration must be given to the needs of the helicopter operator as well as the desires of the community. Consequently, definition of a reasonable specification requires knowledge of both the communities' subjective acceptance of helicopter noise, and the technological and economic aspects of helicopter noise reduction. The study which forms the basis for this paper (reference 1) was directed towards the technological and economic aspects of the problem. Specifically, the objective of this study was to determine the degree of noise reduction obtainable with current helicopter noise reduction technology, and the cost of applying this technology.

* This study was sponsored by the U. S. Department of Transportation, Federal Aviation Administration, under Contract DOT-FA76WA-3791.

The technical effort included the development of a unified method for predicting helicopter vehicle noise including the noise contributions of the rotors, engines and drive system. Analytical methods were also formulated for determining the impact of noise reduction on vehicle design, performance and cost. These tools were then used to estimate and compare the benefits and costs of alternative noise reduction methods, within the context of established vehicle performance criteria.

STUDY APPROACH

The noise signature of a helicopter is composed of contributions from the rotors, engines and drive train. Well developed technologies exist for reducing the noise generated by each of these components. However, because these contributions combine in a complex, spatially and frequency dependent manner it is not possible to evaluate these noise reduction methods on an isolated component basis. Component noise reduction methods, therefore, must be evaluated within the context of the total helicopter noise signature. This requires the use of a noise calculation method which, although capable of estimating the combined noise contributions of all components, still retains a high degree of detail for estimating the noise output of each individual component. This "systems" approach to helicopter noise modeling was applied in the present study.

The noise calculation approach discussed above provided the means for evaluating the potential for helicopter noise reduction. To apply these approaches realistically, however, it was necessary to determine the nature and extent of changes in vehicle design and performance characteristics which must be made to incorporate noise reduction methodology. This information was also required to assess the economic cost of helicopter noise reduction.

The intent of the overall study effort was to determine how much noise reduction can be achieved in future design civil helicopters using existing noise reduction technology, and what changes in total life cycle cost will result from the achievement of this noise reduction. Since the study concerned itself only with future design civil helicopters, it was necessary to make certain assumptions as to the nature of these vehicles and what their noise and cost characteristics would be if noise reduction was not considered in their design. The effects of noise reduction could then be determined relative to these baseline characteristics. In the study program it was assumed that future design civil helicopters will be required to perform similar missions to those presently being performed. Since vehicle design is principally a function of required mission performance, it was further assumed that future civil helicopters will be similar in design to existing vehicles. These assumptions lead directly to the use of existing civil helicopter characteristics (table 1) as the baseline for determining changes due to the incorporation of noise reduction methodology.

The basic premise of the study was that noise reduction of future civil

helicopters will be achieved in addition to, rather than at the expense of, required mission performance. Noise-reduced vehicles will fly as fast, as high, as far and with the same payload, although they may be heavier and more costly to own and operate. This concept of a constant mission performance requirement provided a realistic context within which the effects of helicopter noise reduction could be determined and assessed.

To apply this approach, the following mission performance criteria were established:

1. Constant payload.
2. Constant out-of-ground effect hover ceiling.
3. Constant range (at the best cruise speed of the baseline vehicle).
4. Adequate (equal or greater) stall margin.

In general terms, these criteria were applied in the following manner, as illustrated in figure 2, beginning with a baseline reference vehicle configuration having known performance characteristics. First, the direct effect of the introduction of a noise reduction method was determined in terms of a change in vehicle gross weight at constant payload. This new gross weight was then used to establish a new installed power requirement, and the consequent changes in engine weight and rated fuel consumption rate which result from this change in installed power. Installed power, as well as engine weight and rated fuel consumption, were also changed to reflect any direct effects of noise reduction such as engine silencer losses. Weight and installed power changes were then iterated until a combination was arrived at which satisfied the baseline vehicle out-of-ground effect hover ceiling capability.

The above procedure resulted in a vehicle configuration which could operate at the same altitude with the same payload as the reference configuration. Forward flight performance was then considered in order to satisfy the established range and speed capability criteria. Given the new vehicle gross weight determined by hover performance requirements, rotor stall margin was calculated and compared to that of the baseline vehicle. If insufficient stall margin was indicated, changes in rotor design were effected, which increased stall margin to that of the baseline configuration. Any changes in weight which resulted from these rotor design changes were calculated and accounted for, iteratively, through reconsideration of the hover performance requirement. Once stall margin and hover performance were determined to be consistent with the established criteria, forward flight power required for the new vehicle configuration was calculated.

Forward flight power required was determined for flight at the best cruise speed of the baseline vehicle. This power was then used to determine the need for any change in fuel load required to maintain a maximum range equal to that of the baseline vehicle. If fuel load

was changed, vehicle gross weight was adjusted accordingly and, again, compensated for through consideration of hover performance and stall margin criteria.

The new vehicle configurations resulting from the above procedure were often substantially different in design from the baseline vehicles. In general, these new configurations showed changes in gross weight, airframe weight, installed power, engine weight and fuel load. These changes in vehicle design were in addition to, and were the direct result of, one or more changes in vehicle design associated with the introduction of some noise reduction methodology. Since all of these changes had the potential for affecting the net noise reduction achieved with a given noise reduction methodology all were considered in the subsequent calculation of vehicle noise reduction. These design changes were also used to assess noise reduction cost.

ANALYTICAL METHODS

The analytical methods developed and/or adapted for use in the present program fall into three general categories. These are:

1. Noise calculation.
2. Vehicle design and performance calculation.
3. Cost calculation.

With respect to noise, analytical models were either derived or adapted from existing methods. These enabled calculation of the rotor system, engine (turbine and reciprocating) and transmission noise components. These component models were incorporated in a unified vehicle noise calculation method, which had the capability of generating 1/3 octave sound pressure level spectra as a function of time, at any observer location, for any steady state translational flight condition. This method is illustrated in figure 3. These calculated 1/3 octave spectra are automatically converted to effective perceived noise level (EPNL) and instantaneous A-weighted sound pressure level (dBA), overall sound pressure level (OASPL), perceived noise level (PNdB) and tone corrected perceived noise level (PNLT) units.

A separate analytical method was developed to enable calculation of the changes in helicopter design and performance characteristics which result from the application of noise reduction technology to the various noise producing vehicle components. This method reflects the approach discussed in the preceding section and illustrated in figure 2.

The cost calculation method was developed from historical helicopter cost data, which relate the three elements of life cycle cost to the various vehicle design parameters (table 2). This model considers initial investment cost to be related to vehicle airframe weight and installed engine weight. Indirect operating cost is related to vehicle total empty weight. Direct operating cost is assumed to be a function of both empty weight and installed engine power. The cost calculation

method permits determination of both absolute vehicle dollar costs and percentage changes in costs relative to an established baseline helicopter design. Life cycle costs are calculated as a function of both annual usage rate and total useful life.

The preceding analytical methods were used to calculate baseline noise, performance and cost characteristics for several existing helicopter models, with gross weights ranging from 8 kN to 80 kN. Calculated EPNL's for these vehicles are shown in figure 4. Investigation of the results of these calculations revealed that the main rotor and engines contributed most to the vehicle EPNL and, consequently, subsequent noise reduction evaluations were directed at these sources.

TURBINE ENGINE NOISE REDUCTION

Helicopter turboshaft engine noise was found to be dominated by exhaust radiated components. Since these noise components may be effectively reduced through exhaust duct treatment, a study was performed to evaluate the effect of such treatment on the total vehicle noise signature.

Three representative present generation helicopters were chosen for this study (table 1). A generalized exhaust silencer configuration, illustrated in figure 5, was established, and the normalized acoustic and aerodynamic performance characteristics of this duct treatment were derived (figures 6 and 7). Various levels of duct treatment were simulated, for each study vehicle, and estimates of the total vehicle noise reduction were made.

The average of fly-over and fly-by vehicle EPNL reductions achieved with engine silencing is shown in figure 8 as a function of silencer weight, for each study vehicle. To provide a meaningful comparison, silencer weight is expressed as a percentage of vehicle gross weight. On this basis, achieved noise reductions are roughly comparable, for comparable weight penalties, for the three vehicles.

The additions to vehicle gross weight and reductions in engine performance indicated in figures 7 and 8 do not reflect the total impact of engine silencing, and these changes alone do not represent an adequate basis for estimating changes in vehicle cost due to silencer use. To provide this basis, the changes in vehicle design necessary to accommodate these direct penalties were determined.

Incorporation of an engine silencer increases vehicle gross weight by an amount equal to the silencer weight. Vehicle airframe weight, however, must also increase, to carry the added silencer weight. This change in airframe weight further increases gross weight, requiring additional engine power and, consequently, increased engine weight. These three weight changes increase the fuel load required to maintain constant range capability. Additions to fuel load and engine weight further increase airframe weight, gross weight and power required. The ultimate gross weight, airframe weight, engine power and weight and fuel load can be calculated

through an iterative solution of the individual weight and power relationships involved in the analytical method. Additional effects of engine silencing are decreased available power and increased specific fuel consumption. These direct penalties result in the need for increased installed power and added fuel load, and these factors were also taken into account in redesigning the vehicle.

The net effects of incorporating exhaust duct treatment are illustrated in figure 5, which compares induced vehicle design changes to vehicle EPNL reductions. Significant changes are shown in all the design parameters considered, with the magnitude of change increasing sharply with noise reduction. As might be expected, installed engine power is most greatly affected, with a 6% to 10% engine power growth shown for a 3-3.5 EPNdB reduction in EPNL.

The changes in vehicle design shown in figure 9 have been interpreted in terms of changes in vehicle costs. Cost changes have been calculated in terms of percentage changes in the basic cost elements of initial investment cost, indirect operating cost and direct operating cost, as well as total life cycle cost. These calculations have been made using the parametric helicopter cost model discussed previously, with the direct silencer cost added to initial investment cost.

Change in investment and indirect operating costs due to engine exhaust silencing are given in figure 10, with direct operating cost and life cycle cost changes shown in figure 11. The life cycle cost data shown refer to a useful life of 15 years, with an annual usage of 1500 hours.

The magnitudes of the cost increases shown are best illustrated by considering these changes in absolute terms. Considering an S-61 vehicle, for example, a 3 EPNdB noise reduction obtained through engine silencing would raise initial investment cost from \$1.779 million per aircraft to \$1.846 million per aircraft, an increase of \$67,000. Indirect costs, on a yearly basis, would rise by over \$5000 per year, from \$147,000/year to \$152,000/year. Direct operating cost, initially at \$272 per hour would go up to \$281 per hour, an increase of over \$8 per hour. Taken together, and assuming a useful life of 15 years with a usage rate of 1500 hours/year, total cost to own and operate this aircraft would increase by \$293,000, from a baseline of \$10.111 million to \$10.404 million. This represents an annual cost increase of nearly \$20,000.

MAIN ROTOR NOISE REDUCTION

Evaluation of the significance of the various helicopter noise components indicated that the main rotor contributes substantially to the total vehicle noise signature. Consequently, analyses were performed to determine the extent of vehicle noise reduction obtainable through the application of rotor noise reduction methodology. Methods considered in these analyses consisted of changes in gross rotor design parameters only, including increased rotor radius, blade chord and blade number and reduced

rotor speed. The effects of these changes were evaluated in terms of the net vehicle noise reduction obtainable, considering potentially offsetting induced changes in vehicle design, for constant performance. These induced design changes were also interpreted in terms of changes in vehicle cost, which were then compared to anticipated vehicle noise reductions. The baseline vehicles used for the preceding engine noise reduction study, the Hughes 500, Bell 205 and Sikorsky S-61, were also used in the performance of the main rotor noise reduction study.

Performance of the main rotor noise reduction evaluation was predicated on the same performance criteria used in evaluating turbine engine noise reduction. In this regard the geometric rotor design parameters, including rotor radius, blade chord and number of blades, were treated as independent variables, and the effects of increasing each of these relative to baseline vehicle values was evaluated separately. This could be done because changes in these parameters could be compensated for by iterating the vehicle design without violating the basic performance criteria. The remaining rotor design parameter, rotor tip speed, was not evaluated independently since a reduction in rotor speed leads directly to a reduced rotor stall margin, and this cannot be compensated for through the type of vehicle reconfiguration considered in the design analyses. Reduced speed can, however, be achieved without sacrificing stall margin, if a compensating increase in blade or disk area is affected, since these area changes tend to increase stall margin. Consequently, in the present study, rotor speed variation has been considered only in conjunction with appropriate blade or disk area changes.

The design implications of changes in rotor radius, blade chord and number of blades are illustrated in figures 12 and 13. These curves show the changes in gross weight and installed power which result from increasing rotor radius, blade chord and number of blades. Data are included for both constant and reduced rotor speed, with rotor speed changes in accordance with the constant stall margin curve of figure 14. While the data of figures 12 and 13 pertain to the S-61 baseline vehicle only, similar results were obtained for the other study vehicles.

In figure 12, gross weight is seen to increase with rotor radius, blade chord and blade number, with identical trends shown for chord and blade number. Rotor radius increases gross weight most quickly and the trend indicated is nonlinear, with increasing slope. This is due to the fact that rotor radius growth necessitates an increased fuselage size, in addition to increased structural weight due to load requirements. The maximum 25% increase in S-61 rotor radius results in a 6.6% increase in vehicle gross weight.

The trend of gross weight with either chord or blade number is linear and less steep than the trend with rotor radius. In this case, airframe weight only increases due to the added rotor system weight and the added structural weight needed to support the heavier rotor. Only a 4.1% gross weight increase is indicated for a 25% blade area change,

whether due to chord or blade number increase. Doubling the chord or number of blades causes a 16.4% increase in gross weight.

The trends of installed power with chord, blade number, and rotor radius are given in figure 13. Installed power is shown to increase linearly with both chord and blade number, but to decrease nonlinearly with rotor radius, in this case with decreasing (absolute) slope. A 9.1% installed power reduction is indicated for the maximum 25% rotor radius increase. Installed power increases 6.3% for a 25% increase in blade area, whether due to blade chord or blade number. Doubling chord or number of blades increases installed power by 24%.

The data of figures 12 and 13 show only an insignificant difference in the effects of rotor geometry changes evaluated alone and evaluated in conjunction with rotor speed reduction. The magnitude of rotor speed reduction considered in these data is, however, relatively small, as indicated in figure 14. This figure relates rotor tip speed to change in blade area, and the curves shown represent lines of constant stall margin. As shown, only a 3.1% reduction in rotor tip speed can be accommodated by a 25% radius increase. A 3.7% reduction in rotor speed is indicated for a similar 25% blade area increase, accomplished by increasing chord or blade number. A 12% tip speed reduction can be obtained by doubling either blade chord or blade number.

The magnitude of vehicle gross weight increase associated with the various rotor system changes strongly suggested that noise reductions anticipated to result from the rotor system changes would tend to be offset by increases in noise due to rotor thrust growth. Based on this indication, it was decided to use a simplified rotor noise calculation method to determine the approximate magnitude of achievable net rotor noise reduction and, based on the results of these calculations, decide whether to proceed with the more involved rotor and total vehicle noise calculations. This approach was arrived at based on the premise that unless significant rotor noise reductions were shown through the simple analysis, no worthwhile reductions would be calculated for the total vehicle using the detailed analysis.

The simplified rotor noise calculation method chosen for use was obtained from reference 2. This method relates the magnitude of the high frequency random component of rotor noise to rotor speed squared, thrust squared and blade area.

This method was used to estimate the maximum possible rotor system noise reduction obtainable with the various rotor system parameter changes considered. The results of these calculations are summarized in table 3 for the three study vehicles. Also given are the changes in cost associated with each of the rotor system variations.

Comparison of the cost and approximate rotor noise reduction data of

Table 3 reveals that the cost of reducing helicopter rotor noise levels is very high. Considering the S-61 study vehicle, for example, increasing rotor size by 25%, raises life cycle cost by over 5.7%, for a 1500 hour per year use rate, and the cost differential is greater for lower annual use rates. In absolute terms, the 25% greater rotor radius increases life cycle cost by almost \$.6 million dollars, or more than \$38,000/year. This rotor design change reduces rotor noise by less than .5dB which, in all probability, would produce no measurable change in total vehicle noise.

The most beneficial rotor design change, doubling the number of blades and reducing rotor speed by approximately 12%, raises life cycle cost by almost 30%. This translates into a \$3.03 million dollar life cycle cost increase, or in yearly terms, over \$200,000 added annual cost. In terms of total vehicle noise, as discussed previously, the 2.8dB rotor noise reduction associated with this design change, would probably only result in a 1.6dB reduction in vehicle noise.

Because of the high cost to benefit ratios determined for the selected rotor noise reduction methods, it was concluded that these methods are not practical means for reducing helicopter noise, and that further analyses of these methods was not warranted. Consequently, these methods were not evaluated with the more involved noise calculation techniques originally intended for use. However, a small number of rotor noise reduction design changes were subjected to further evaluation in order to verify the appropriateness of the approximate noise calculation method. In all cases studied, the involved noise calculation technique indicated noise reductions similar in magnitude to those obtained with the approximate method.

CONCLUSIONS

The results of the present study indicate that small, but meaningful, reductions in helicopter noise can be obtained by treating the turbine engine exhaust duct. Furthermore, these reductions do not result in excessive life cycle cost penalties. Currently available main rotor noise reduction methodology, however, was shown to be inadequate and excessively costly. This result strongly suggests the need for additional helicopter rotor noise research, which should be directed at developing more efficient methods for reducing rotor noise.

As with any study of this nature, the results of the present effort should be interpreted only within the context of the study groundrules. In this regard, two such groundrules are particularly important. First, the vehicle design analysis used in this study considered only current helicopter design and fabrication technology. Improvements in these technologies, particularly those which result in better structural efficiency, rotor performance and engine efficiency, could improve the effectiveness of current noise reduction methods, by minimizing the extent of offsetting vehicle design changes.

The second study groundrule which must be considered in evaluating the study results relates to the use of the constant performance concept. While this approach provides a realistic framework for evaluating the cost of noise reduction, other approaches might also be equally valid. One such alternative approach would be the specification of minimum induced design change, with variable performance capability. In this context, the major impact of noise reduction would be interpreted in terms of performance penalties, which would then be related to cost differentials. This approach is equally valid, although it is somewhat more difficult to apply and interpret than the constant performance method.

REFERENCES

1. Bowes, M. A.: Helicopter Noise Reduction Design Trade-off Study. DOT/FAA Report FAA-AEQ-77-4, January 1977.
2. King, R. J. and R. G. Schlegel: Prediction Methods and Trends for Helicopter Rotor Noise. CAC/AVLABS Symposium Proceedings, June 1969.

TABLE 1. STUDY VEHICLE CHARACTERISTICS

Study Vehicle	Manufacturer	Gross Weight (kN)	Installed Power (kW)	Fly-Away Cost (\$)
S-61	Sikorsky	86.3	2237	1.8m
B-205	Bell	42.2	1043	.6m
H-500	Hughes	10.7	236	.12m

TABLE 2. COST MODEL

- | | |
|---|---|
| <ul style="list-style-type: none"> ● <u>INITIAL INVESTMENT COST - C_I</u> ○ Airframe = f (Airframe Weight) ○ Engine = f (Installed Power) ○ Initial Spares = f (Empty Weight) ○ Avionics = f (Empty Weight) | <ul style="list-style-type: none"> ● <u>DIRECT OPERATING COST - DOC</u> ○ Maintenance and spares = f (Empty Weight) ○ Fuel and Oil = f (Installed Power) ○ Crew = f (Empty Weight) |
| <ul style="list-style-type: none"> ● <u>INDIRECT OPERATING COST - IOC</u> ○ Insurance = f (Empty Weight) | <ul style="list-style-type: none"> ● <u>LIFE CYCLE COST - LCC</u> $LCC = C_I + DOC(N_A L_U) + IOC(L_U)$ <ul style="list-style-type: none"> ○ N_A = Annual Usage ○ L_U = Useful Life |

TABLE 3. VEHICLE COST AND NOISE CHANGES FOR
MAXIMUM NOISE REDUCTION CONFIGURATIONS -
S-61

Parameter Varied	Δ Investment Cost (%)	Δ IOC-%	Δ DOC-%	Δ LCC - % (15 Yr Life)		Δ EPNL (EPNdB)
				300 Hr/Yr	1500 Hr/Yr	
+25% Radius	13.66	13.65	.58	10.58	5.73	- .4
+50% Chord	25.0	23.66	9.0	20.44	14.86	-1.08
+5 Blades	51.83	49.82	18.15	43.06	30.99	-1.67
+25% Radius -3% Ω R	14.02	13.98	.73	10.88	5.96	- .68
+50% Chord -7.2% Ω R	24.04	23.30	8.81	20.15	14.65	-1.74
+5 Blades -11.9% Ω R	50.05	48.12	17.61	41.6	29.98	-2.82

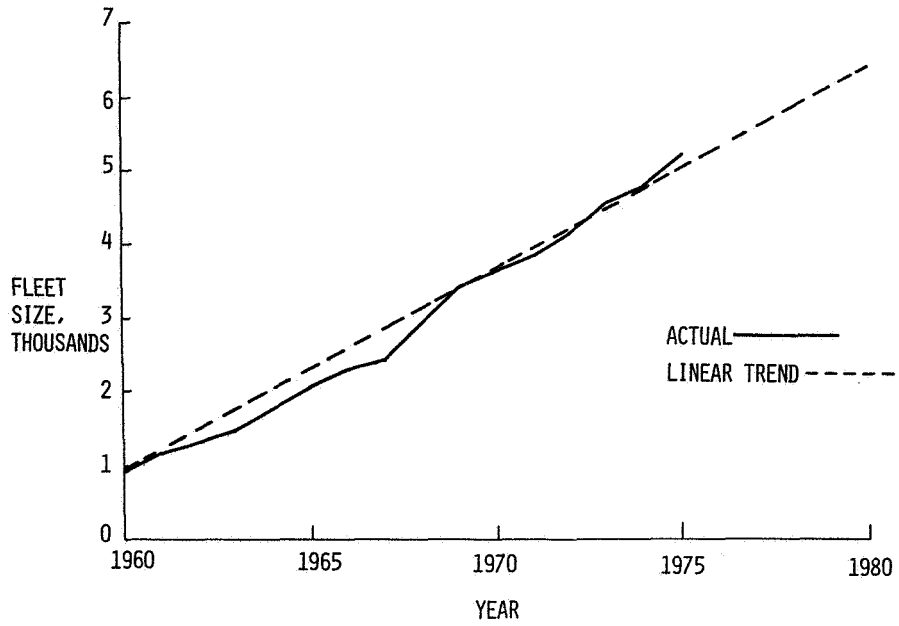

Figure 1.- Domestic civil helicopter fleet growth.

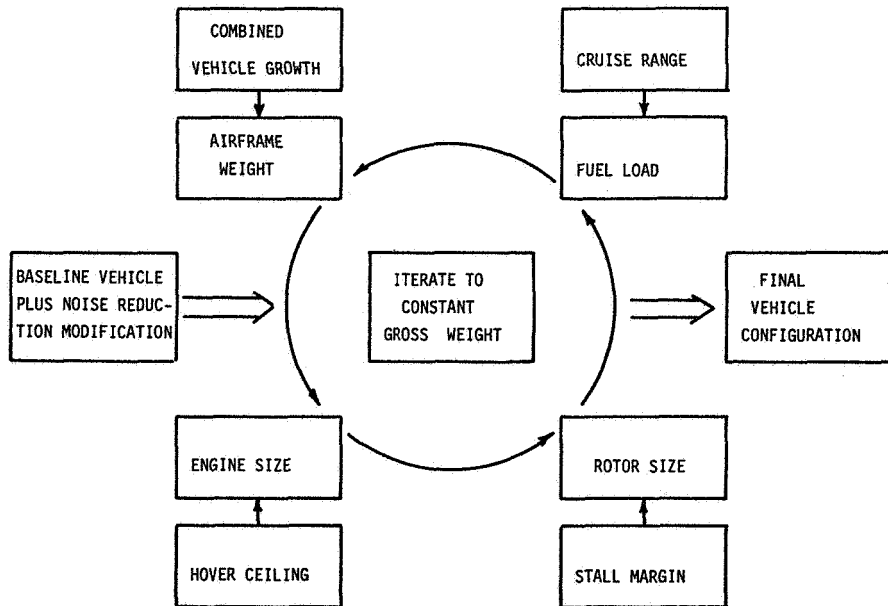

Figure 2.- Vehicle design methodology.

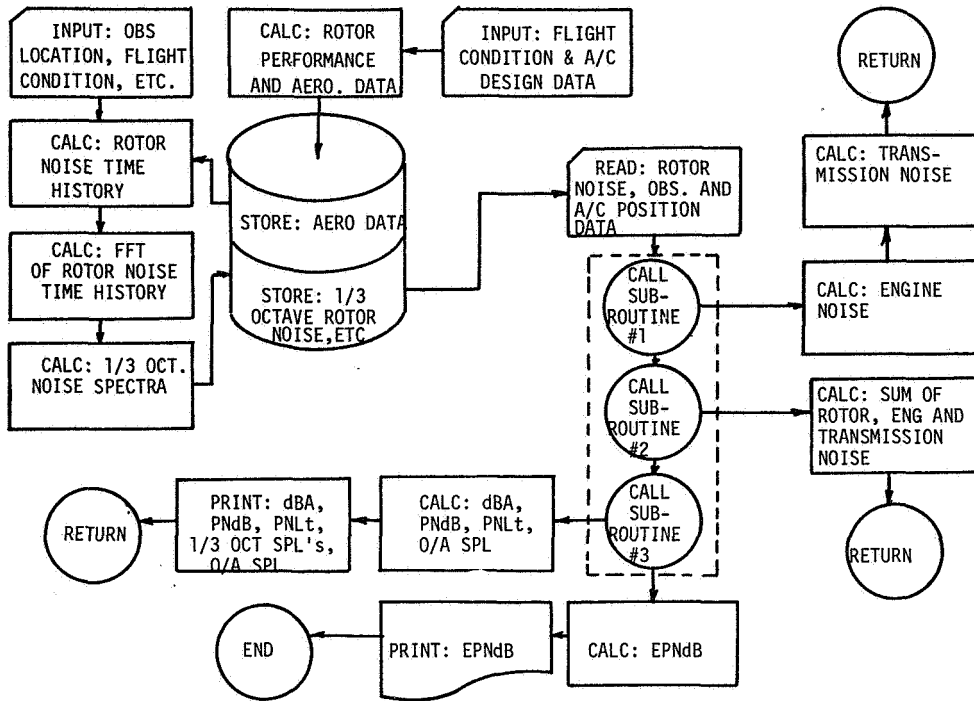

Figure 3.- Noise calculation methodology.

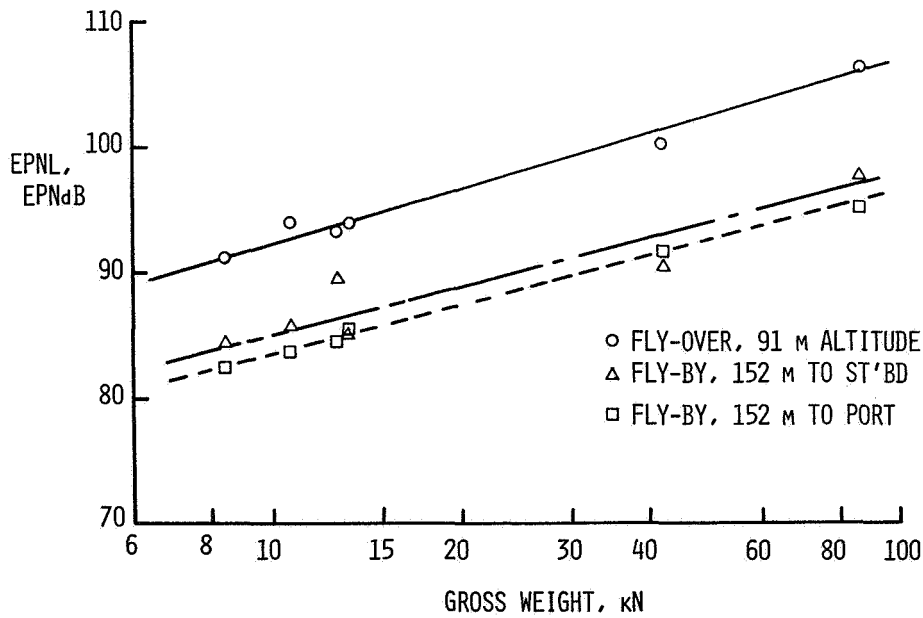

Figure 4.- Calculated vehicle noise.

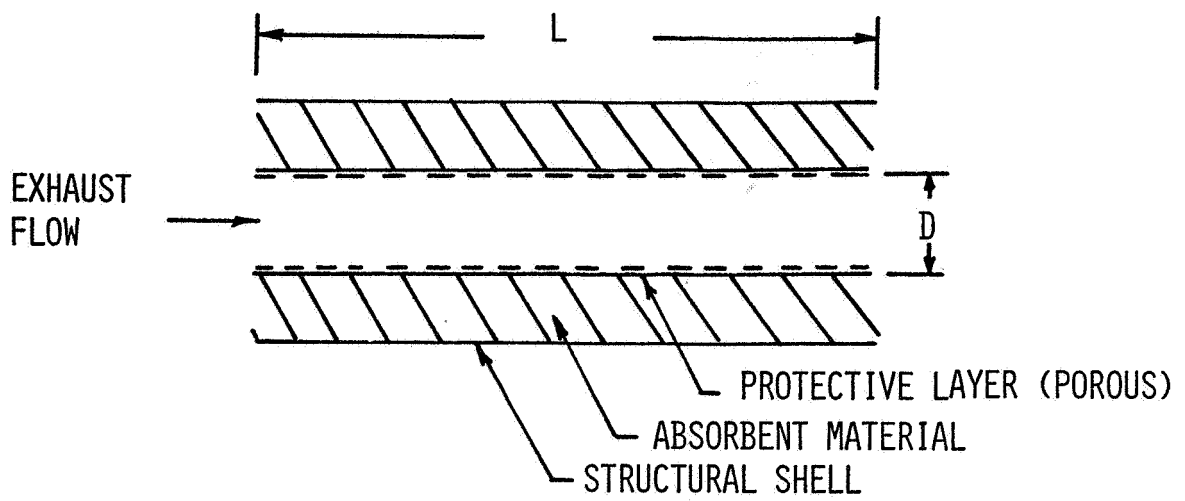

Figure 5.- Exhaust silencer configuration.

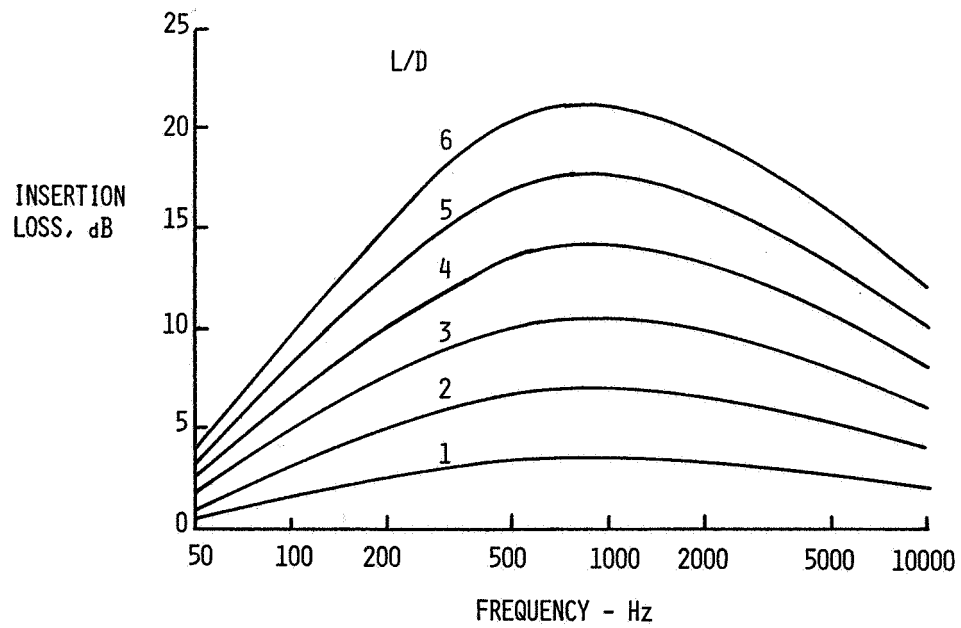

Figure 6.- Exhaust silencer acoustic performance.

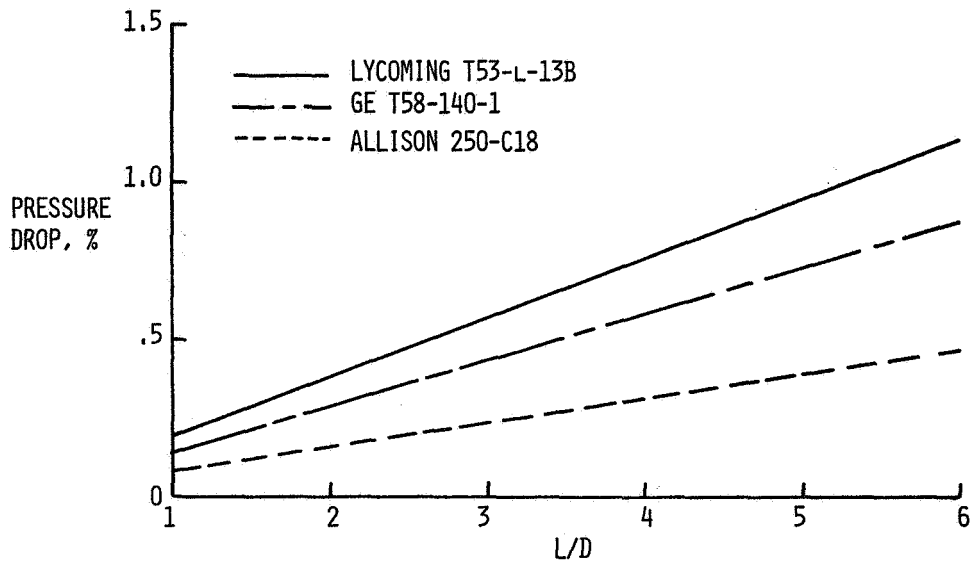

Figure 7.- Exhaust silencer aerodynamic performance.

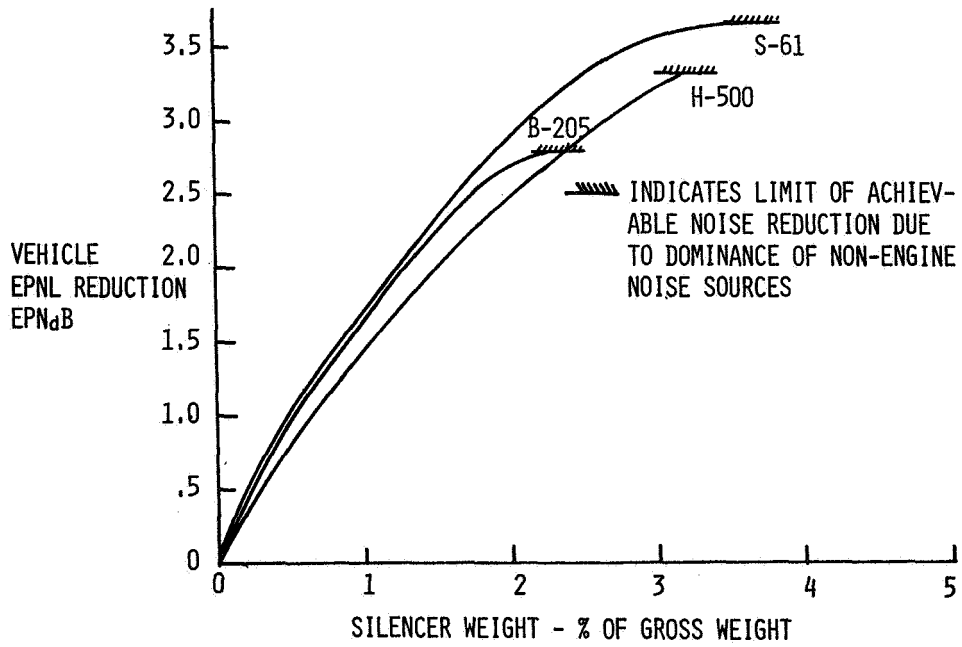

Figure 8.- Exhaust silencer weight.

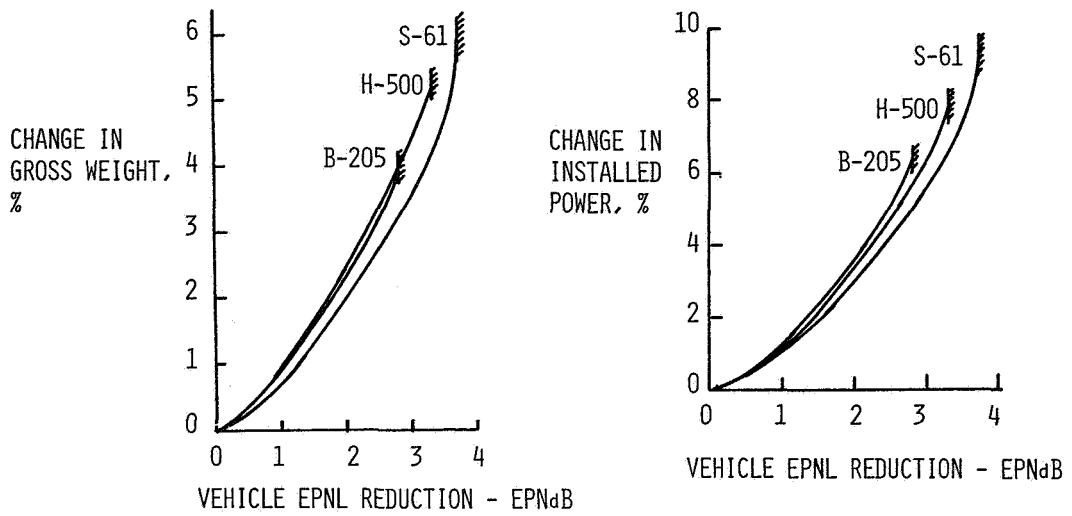

Figure 9.- Design changes due to exhaust silencing.

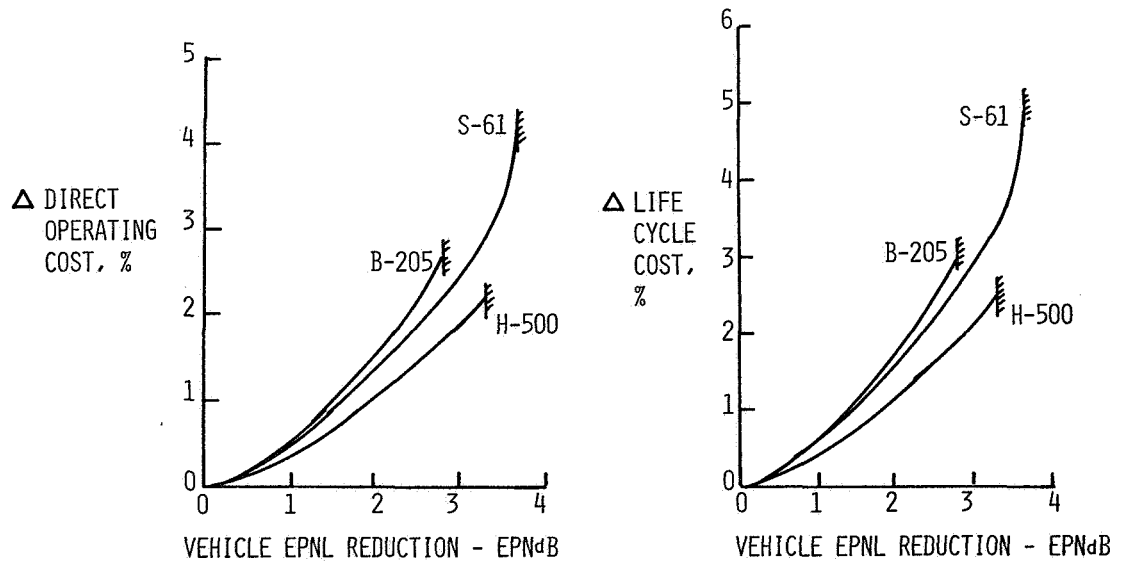

Figure 10.- Direct operating cost and life cycle cost of exhaust silencing.

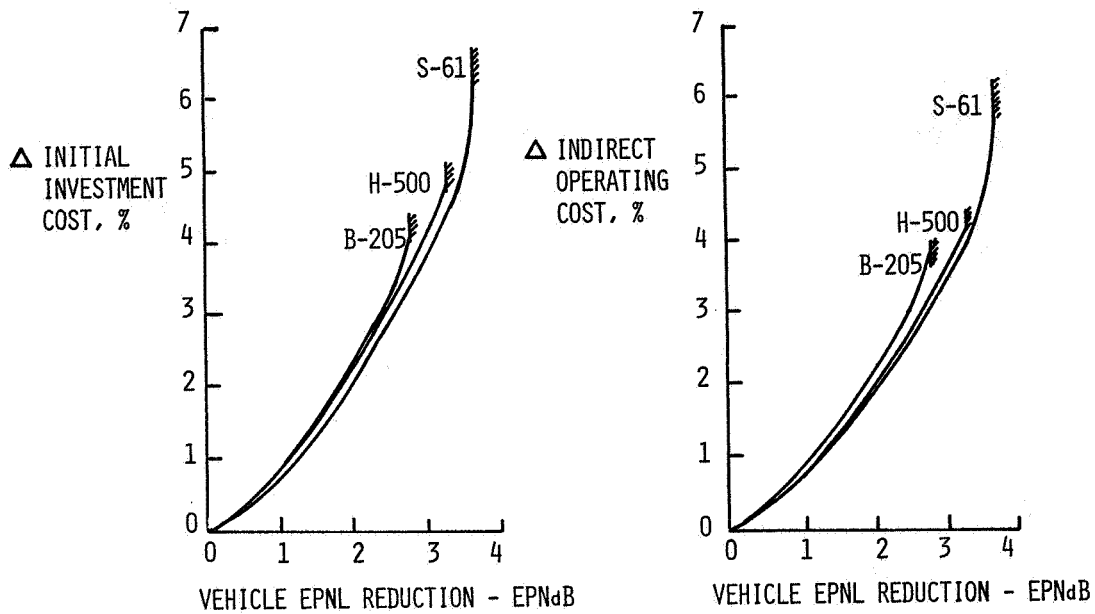

Figure 11.- Initial investment cost and indirect operating cost of exhaust silencing.

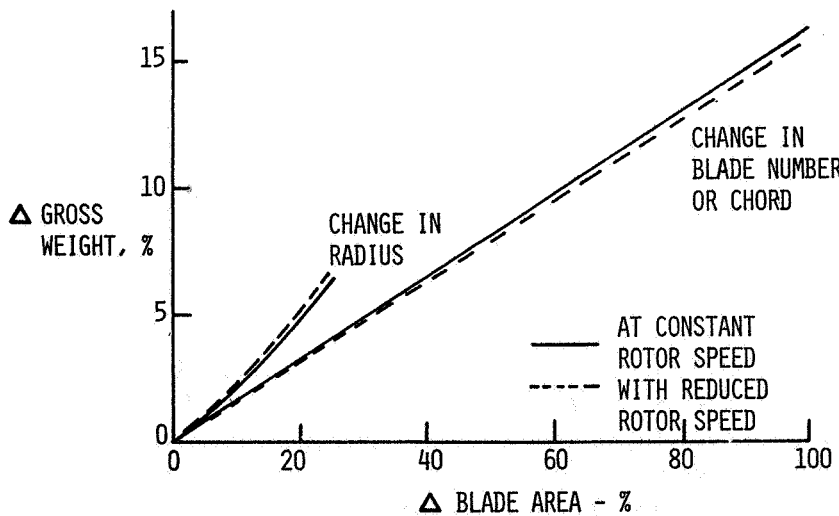

Figure 12.- Gross weight with blade area.

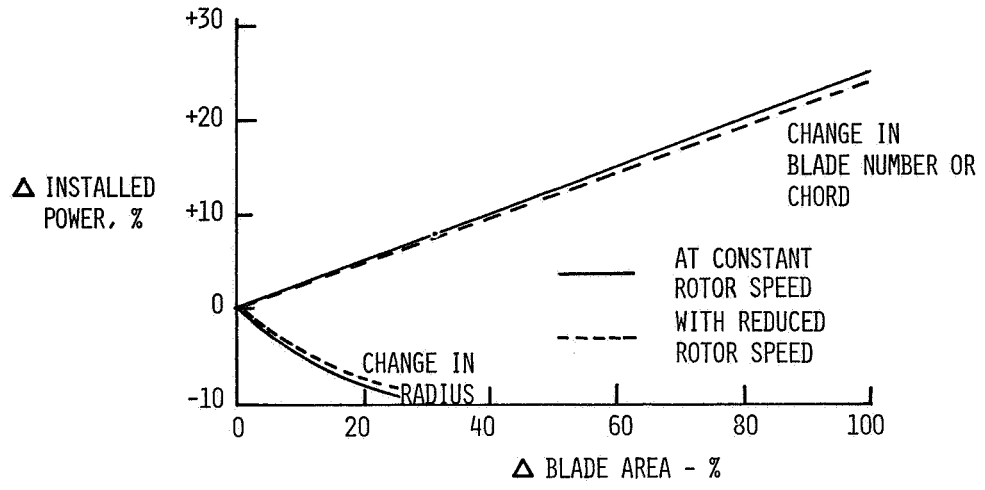

Figure 13.- Installed power with blade area.

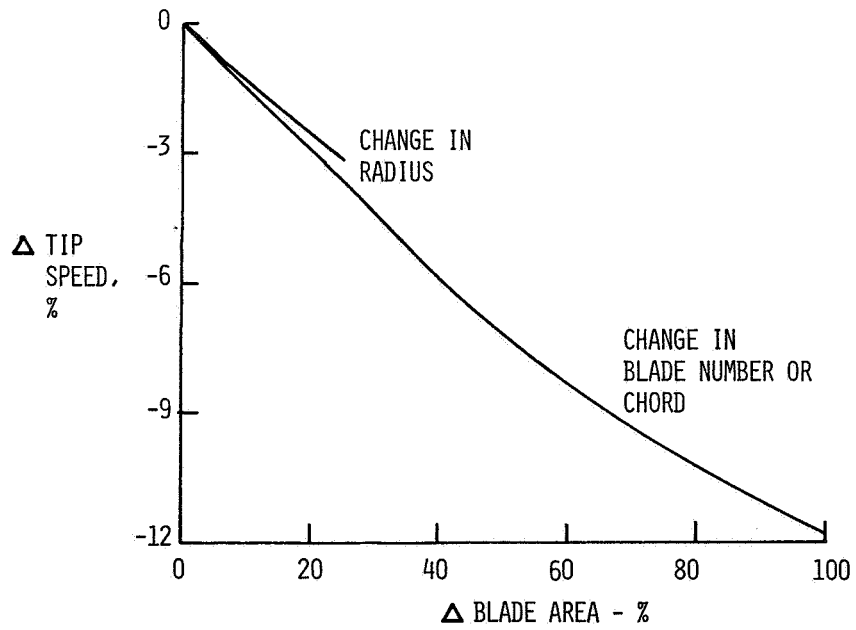

Figure 14.- Constant stall margin.