

43

N79-15591

AN EXTENSION OF THE QUICKENED DISPLAY FOR MANUAL CONTROL

By Masayoshi Tomizuka and Wai Ming Tam

Department of Mechanical Engineering
University of California, Berkeley

SUMMARY

It is very difficult (or even impossible) for a human to control plants of third order or more with little or no damping by just knowing the instantaneous error. It has been shown that adding first and/or higher order derivatives to the error signal and displaying the combined signal are effective in facilitating human control over such plants---signal quickening by Birmingham and Taylor. Their technique is further extended to incorporate the future trajectory variation into the displayed signal so as to minimize the tracking error. A method for tuning free parameters in ordinary and extended quickening is established by applying discrete-time optimal control. Experimental results for a triple integrator plant indicate the effectiveness of the proposed method to achieve high quality tracking.

INTRODUCTION

It is known to be very difficult for a human to control higher order plants with little or no damping with conventional compensatory or pursuit display (reference 1). To facilitate human control over such plants, Birmingham and Taylor (reference 2) proposed to incorporate the derivatives of the plant output into the displayed signal. The technique is called "signal quickening," and its effectiveness has been demonstrated. This can sometimes be done as shown in figure 1 for a triple integrator plant. When the reference trajectory, $r(t)$, is constant, the quickened display makes it possible to achieve high quality regulation. However, if $r(t)$ is time varying, it can not be expected that high quality tracking be achieved with the quickened display. This is because the human operator and plant introduce phase shifts between the reference trajectory and the plant output. To improve the tracking performance, more information on the reference trajectory, such as derivatives, future values, etc., is needed.

In many manual control situations, the reference trajectory is predetermined, or a portion of future reference trajectory can be detected in advance if not all future information is available. In such cases, the preview display in figure 2 has been shown to improve the tracking performance when the plant is relatively easy to control (references 3, 4 and 5). If the plant is higher order and weakly damped, preview information alone is not sufficient to achieve high quality tracking or even to stabilize the plant.

After noticing the limitations of quickened display and preview display, one may propose to combine those two and use a display as illustrated in figure 3. However, this scheme is not good for tracking since with such a dis-

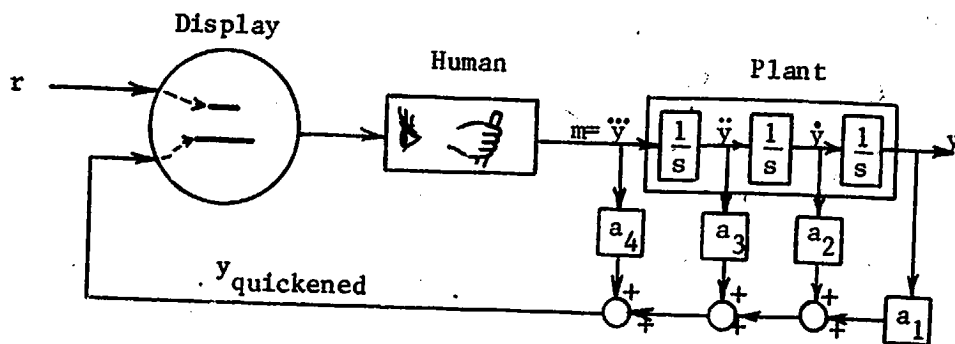

Fig. 1 Signal Quickening (Pursuit Type)

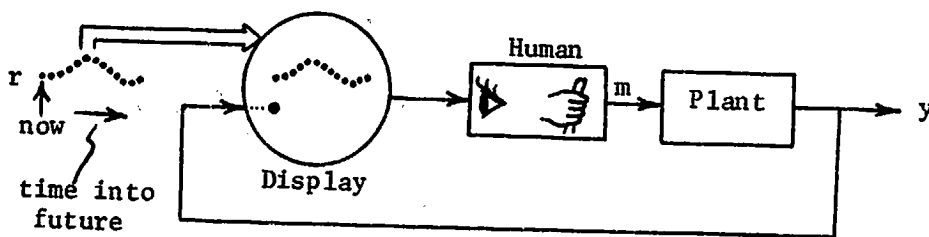

Fig. 2 Preview Tracking

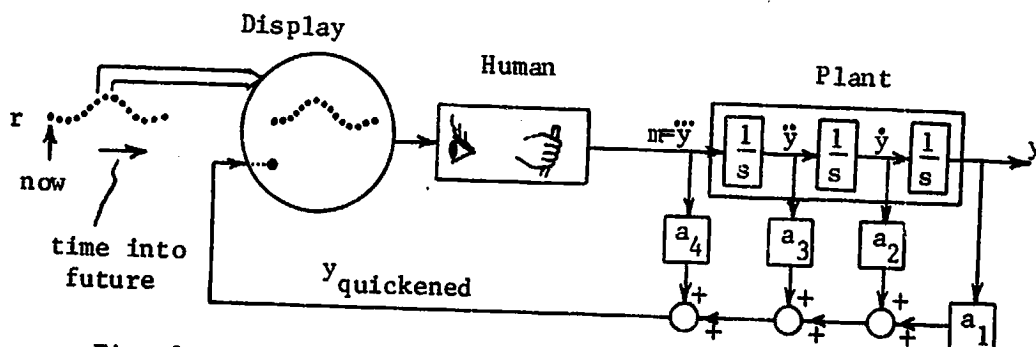

Fig. 3 Naive Combination of Quickened and Preview Displays

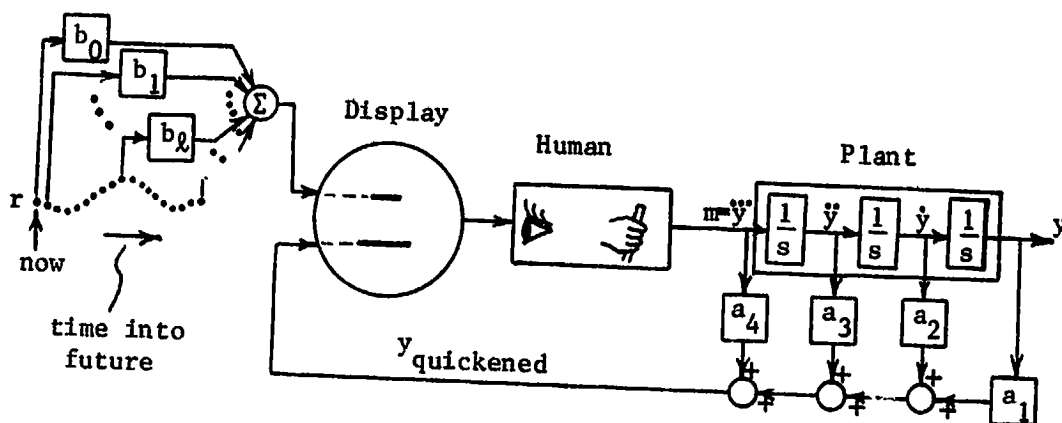

Fig. 4 Extended Quickening

play the human operator tries to match the distorted plant output with the reference trajectory. A better approach is to process future trajectory information by computer to generate a distorted reference signal which is compatible to the distorted plant output. This scheme is illustrated in figure 4 and is named "extended quickening". Due to innovations in microcomputer technology, this kind of digital data processing is not difficult nor expensive. The design of extended quickened displays involves the determination of the feedback (quickening) gains, a_i 's, and feedforward or preview gains, b_i 's, such that high quality tracking is assured. A design method based on discrete-time optimal control is presented in the next section.

DESIGN OF EXTENDED QUICKENED DISPLAY

To simplify treatment, the design method is described for a triple integrator plant. However, the method applies equally to other kinds of plants.

Controlled Plant

A triple integrator plant can be represented by the following state and output equations.

$$\frac{dx_p}{dt} = A_p x_p + B_p m \quad (1)$$

$$y = x_{p1} \quad (2)$$

where

$$\underline{x}_p = \begin{bmatrix} x_{p1} \\ x_{p2} \\ x_{p3} \end{bmatrix} = \begin{bmatrix} y \\ \dot{y} \\ \ddot{y} \end{bmatrix}, \quad A_p = \begin{bmatrix} 0 & 1 & 0 \\ 0 & 0 & 1 \\ 0 & 0 & 0 \end{bmatrix}, \quad B_p = \begin{bmatrix} 0 \\ 0 \\ 1 \end{bmatrix},$$

$\dot{}$ denotes the time derivative, m is the controlling input adjusted by the human operator and y is the plant output. Since extended quickening assumes the use of digital computers, equation (1) is approximated by the discrete state equation,

$$\underline{x}_p(k+1) = A'_p \underline{x}_p(k) + B'_p m(k) \quad (3)$$

where

$$A'_p = e^{A_p \Delta t} = \begin{bmatrix} 1 & \Delta t & (\Delta t)^2/2 \\ 0 & 1 & \Delta t \\ 0 & 0 & 1 \end{bmatrix}, \quad B'_p = \int_0^{\Delta t} e^{A_p \sigma} B_p d\sigma = \begin{bmatrix} (\Delta t)^3/6 \\ (\Delta t)^2/2 \\ \Delta t \end{bmatrix},$$

Δt is the sampling period and the index k denotes k -th sampling instance or time $k \cdot \Delta t$. The sampling period is selected to be 0.025 sec which is short enough to maintain small approximation error and yet is long enough for most microcomputers to implement extended quickening.

Human Operator

For design purposes, the human operator is first approximated by a simple time delay, e^{-sL} , where the delay time, L , is typically 0.1~0.2 sec. With a sampling period of Δt , the discrete-time model is a simple delay chain, z^{-d} , where d can be determined from $(0.1\sim 0.2)/\Delta t$. In the following development, d is selected to be 6 which corresponds to 0.15 sec time delay with the selected Δt of 0.025 sec. The input to the human, $u(k)$, is the displayed signal and the output of the human is the plant input, $m(k)$. A state space model for the human operator is

$$\underline{x}_h(k+1) = \underline{A}_h \underline{x}_h(k) + \underline{B}_h u(k) \quad (4)$$

$$m(k) = x_{h1}(k) \quad (5)$$

where

$$\underline{x}_h = \begin{bmatrix} x_{h1} \\ x_{h2} \\ x_{h3} \\ x_{h4} \\ x_{h5} \\ x_{h6} \end{bmatrix}, \quad \underline{A}_h = \begin{bmatrix} 0 & 1 & 0 & 0 & 0 & 0 \\ 0 & 0 & 1 & 0 & 0 & 0 \\ 0 & 0 & 0 & 1 & 0 & 0 \\ 0 & 0 & 0 & 0 & 1 & 0 \\ 0 & 0 & 0 & 0 & 0 & 1 \\ 0 & 0 & 0 & 0 & 0 & 0 \end{bmatrix} \quad \text{and} \quad \underline{B}_h = \begin{bmatrix} 0 \\ 0 \\ 0 \\ 0 \\ 0 \\ 1 \end{bmatrix}.$$

Equations (3), (4) and (5) characterize the open loop human-plant dynamics.

Optimal Control Problem

The parameters, a_i 's and b_i 's, in extended quickening can be found from the solution of an optimal control problem in which $u(k)$ must be determined so as to minimize the cost functional given by

$$J = \sum_{i=k}^{\infty} \{ (y(i) - r(i))^2 + w \cdot (\Delta u(i)/\Delta t)^2 \} \quad (6)$$

where $\Delta u(i) = u(i) - u(i-1)$ ($=\Delta m(i+6)$), $\Delta u(i)/\Delta t \sim du/dt$, r is the reference trajectory and w is a positive constant. The first term in the cost functional penalizes the tracking error and the second term penalizes the jerky motion of the displayed signal.

The reference trajectory, r , is assumed to be previewable (by computer) in the sense that future information which includes the sampled values $\{r(k), r(k+1), \dots, r(k+N_{\ell_a})\}$ is available at time k where N_{ℓ_a} is the preview (or look ahead) time. N_{ℓ_a} is zero for conventional quickening. Preview information is not sufficient for finding the optimal control, $u(k)$, since the cost functional includes $r(i)$'s from $i=k$ to $i=\infty$. Therefore, it is further assumed that the reference trajectory does not change from the time $i=k+N_{\ell_a}$: i.e.

$$r(k+N_{\ell_a}+i+1) = r(k+N_{\ell_a}+i) \quad \text{for all } i > 0 \quad (7)$$

Equation (7) applies for the determination of $u(k)$ only. For determining $u(k+1)$, updated preview information at time $k+1$ which includes the sampled value $r(k+1+N_{\ell a})$ is used, and the lower limit of the summation in the cost functional becomes $k+1$. If the statistical properties of the reference trajectory are known, they can be used in place of equation (7) (references 6,7). Figure 5 shows the assumptions made about the reference trajectory.

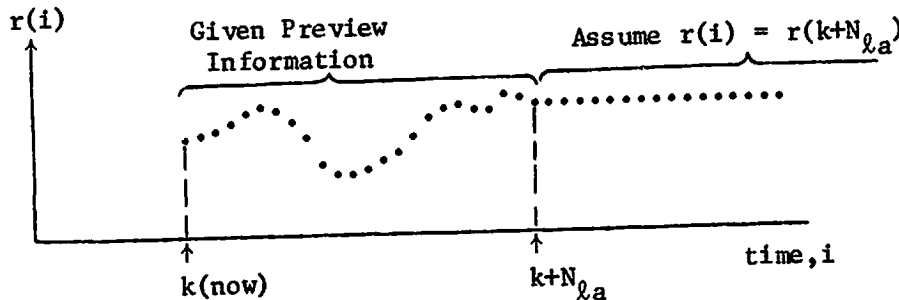

Fig. 5 Information on Future Reference Trajectory (at time k)

Equations (2)-(7) define an optimal control problem or more specifically a discrete time optimal preview control problem. This problem can be solved by dynamic programming or applying the results of linear quadratic (LQ) optimal control (reference 8).

Solution of the Optimal Control Problem

The optimal control, $u^{opt}(k)$, is

$$u^{opt}(k) = - \sum_{i=1}^3 g_{pi} x_{pi}(k) - \sum_{i=1}^6 g_{hi} x_{hi}(k) + \sum_{\ell=0}^{N_{\ell a}} g_{r\ell} r(k+\ell) \quad (8)$$

where g_{pi} 's, g_{hi} 's and $g_{r\ell}$'s are all constant gains.

The feedback gains, g_{pi} 's and g_{hi} 's, are given by

$$\begin{bmatrix} g_{p1} & g_{p2} & g_{p3} & g_{h1} & \dots & g_{h6} \end{bmatrix} = \left[R + \underline{B}^T \underline{K} \underline{B} \right]^{-1} \left[\underline{B}^T \underline{K} \underline{A} + \underline{P} \right] \quad (9)$$

where

$$\underline{A} = \begin{bmatrix} \underline{A}' & \underline{B}' & \underline{0} \\ \underline{0} & \underline{A}_h \end{bmatrix}, \quad \underline{B} = \begin{bmatrix} \underline{0} \\ \underline{B}_h \end{bmatrix}, \quad R = w/(\Delta t)^2, \quad \underline{P} = \begin{bmatrix} 0 & 0 & 0 & 0 & 0 & 0 & 0 & 0 & -R \end{bmatrix},$$

\underline{K} is the steady state solution of the matrix Riccati equation,

$$\underline{K}(i) = \underline{A}^T \underline{K}(i+1) \underline{A} + \underline{Q} - \left[\underline{B}^T \underline{K}(i+1) \underline{A} + \underline{P} \right]^T \left[R + \underline{B}^T \underline{K}(i+1) \underline{B} \right]^{-1} \left[\underline{B}^T \underline{K}(i+1) \underline{A} + \underline{P} \right] \quad (10)$$

$$(\underline{K}(\infty) = \underline{Q})$$

and \underline{Q} is a 9x9 matrix whose 1-1 element is 1, 9-9 element is R and all other elements are 0. Since \underline{A} , \underline{B} , \underline{Q} and \underline{P} are sparse, the Riccati equation can be efficiently solved by simple recursions. For example, it can be easily seen that $\underline{B}^T \underline{K} = [k_{91} \ k_{92} \ k_{93} \ \dots \ k_{99}]$ and $\underline{B}^T \underline{K} \underline{B} = k_{99}$.

The feedforward or preview gains, $g_{r\ell}$'s, are given as follows:
 For $N_{\ell a} = 0$ (no preview),

$$g_{r0} = g_{p1} \quad (11)$$

For $N_{\ell a} > 0$,

$$\left. \begin{aligned} g_{r0} &= 0, & g_{r\ell} &= -[R + \underline{B}^T \underline{K} \underline{B}]^{-1} \alpha_{\ell-1}, & 1 \leq \ell \leq N_{\ell a} - 1 \\ g_{rN_{\ell a}} &= g_{p1} - \sum_{\ell=0}^{N_{\ell a}-1} g_{r\ell} \end{aligned} \right\} \quad (12)$$

where α_{ℓ} is the 1-9 element of the matrix

$$(\underline{A}_{\text{closed}})^{\ell} = (\underline{A} - \underline{B}[g_{p1} \ g_{p2} \ g_{p3} \ g_{h1} \ \dots \ g_{h6}])^{\ell}. \quad (13)$$

Notice that the matrix $\underline{A}_{\text{closed}}$ characterizes the closed loop dynamics of the human-plant model plus feedback control law, and is normally asymptotically stable. Equations (12) and (13) indicate that the future values of the reference trajectory must be used in a way compatible to the closed loop dynamics and that $g_{r\ell}$'s with increasing ℓ are closely related to the unit pulse response of the closed loop system. The second expression in (12) implies that the summation of $g_{r\ell}$'s with respect to ℓ must be equal to g_{p1} , which assures zero steady state error for the step reference trajectory. For asymptotically stable $\underline{A}_{\text{closed}}$, α_{ℓ} approaches zero as ℓ increases, which implies that the future is less important to determine $u^{\text{opt}}(k)$ as it becomes further apart from the present time. This point has also been found in preview tracking (references 3, 4, 5)

Structure of Extended Quickening

The structure of extended quickening based on the optimal control result is depicted in figure 6.

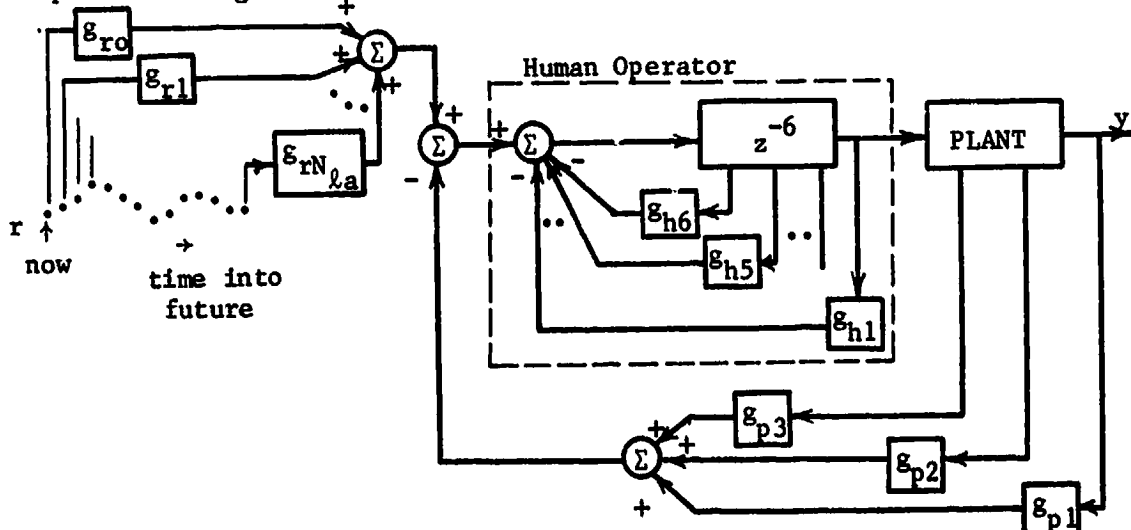

Fig. 6 Structure of Extended Quickening based on Optimal Control

The portion of the structure inside the dashed lines can be viewed as human operator. The reason for this will soon be explained.

For selected values of w over a wide range (w is defined in the cost functional (6)), the steady state solution of the Riccati equation (10) was computed and the feedback gains, g_{pi} 's and g_{hi} 's, were found. Results are summarized in the following table.

w	g_{p1}	g_{p2}	g_{p3}	g_{h1}	g_{h2}	g_{h3}	g_{h4}	g_{h5}	g_{h6}
1.0	0.0242	0.0669	0.0924	0.0023	0.0022	0.0022	0.0022	0.0021	-0.9347
0.1	0.0757	0.160	0.168	0.0042	0.0041	0.0040	0.0039	0.0038	-0.9129
0.01	0.236	0.382	0.309	0.0076	0.0074	0.0072	0.0069	0.0067	-0.884
0.001	0.730	0.914	0.573	0.014	0.013	0.013	0.012	0.012	-0.845
0.0001	2.255	2.20	1.076	0.026	0.025	0.024	0.022	0.021	-0.7935

Table 1 g_{pi} 's and g_{hi} 's for selected values of w

From Table 1, it is found that $g_{h1} \dots g_{h5}$ are orders of magnitudes smaller than other feedback gains and that the values of g_{h6} is around $-(0.8 \sim 0.9)$ regardless of the value of w . Hence it is possible to approximate the portion inside the dashed lines in figure 6 by

$$\frac{z^{-6}}{1 - (0.8 \sim 0.9)z^{-1}} \quad (14)$$

With our selection of $\Delta t = 0.025$ sec, the discrete transfer function (14) corresponds to

$$\frac{K e^{-0.15s}}{\tau_N s + 1}, \quad \tau_N = (0.125 \sim 0.25) \text{ sec} \quad (15)$$

where the time constant, τ_N , was computed by $\tau_N \sim \Delta t / (1 + g_{h6})$. τ_N has a reasonable value as the human neuromuscular lag constant (reference 1), which implies that the feedback effect via g_{h6} can be interpreted as a part of human dynamics. Therefore, the portion inside the dashed lines in figure 6 can be viewed as human operator, and the feedback gains to be externally furnished become g_{p1} , g_{p2} and g_{p3} . The feedforward and preview gains, g_{rl} 's, must also be externally furnished.

Determination of Parameters in Extended Quickening

In (extended) quickening (or more generally in manual tracking), the gain constants of the display and joystick are rather arbitrarily defined since their inputs and outputs are in different physical domains. It is also known that the human operator adjusts his gain so that the closed loop dynamics have reasonable response speed and adequate stability (reference 1). Therefore, for implementation of (extended) quickening the ratios among the feedback and feedforward gains (g_{pi} 's and g_{rl} 's) are more important than their values themselves. Based on this observation, we normalize the control gains with respect to g_{p1} . The normalized gains are the extended quickening parameters, a_i 's and b_l 's, in figure 4, and they are

$$a_1 = 1, a_2 = g_{p2}/g_{p1}, a_3 = g_{p3}/g_{p1}, a_4 = 0 \text{ and } b_l = g_{rl}/g_{p1} \quad (16)$$

Using a_i 's and b_ℓ 's in (16), the signals to be displayed in extended quickening are, for pursuit type displays

$$s_p(k) = \sum_{i=1}^3 a_i x_{pi}(k) \quad \text{and} \quad s_r(k) = \sum_{\ell=0}^{N_{\ell a}} b_\ell r(k+\ell) \quad (17)$$

and for compensatory type displays

$$s(k) = s_r(k) - s_p(k) \quad (18)$$

where s is the quickened plant output and s_r is the quickened reference trajectory. Final tuning of the parameters, a_i 's and b_ℓ 's, must be done by experiment.

EXPERIMENT

An experiment was conducted to examine the effect of different sets of feedback gains in Table 1 and to verify performance improvement that can be achieved by extended quickening. In the experiment, a triple integrator plant was implemented on an analog computer. An LSI-11 microcomputer was used for generating the reference trajectory, computing the extended quickening signals (s_p and s_r) and on-line data acquisition of experimental data. The display was of the pursuit type, and the two signals, s_p and s_r , were displayed by dots each with different intensity. Human subjects were asked to control the plant so that the quickened plant output, s_p , follow the quickened reference signal, s_r . Two kinds of reference trajectories were used in the experiment. One was a sequence of step changes with a 20 sec duration for each. The other was a Gauss-Markov random signal which was generated by a second order digital filter excited by a Gaussian white signal. The digital filter was an approximation of the continuous second order filter with the transfer function

$$G(s) = \frac{1}{s^2 + 2\zeta\omega_n s + \omega_n^2} \quad (19)$$

where ω_n and ζ were selected to be 1.5 rad/sec and 0.7. Selectable preview settings were provided which could be varied from $N_{\ell a} = 0$ (0 sec) to $N_{\ell a} = 200$ (5 sec). Evaluation of $s_r(k)$ with $N_{\ell a} = 200$ was not feasible in a 0.025 sec sampling period (cyclic time of computation). However, it was noted that the reference trajectory was smooth relative to a 0.025 sec sampling period (the approximate bandwidth of the filter (19) is 1.5 rad/sec ~ 0.25 Hz) and that a good approximation to $s_r(k)$ in (17) was

$$s_r(k) \approx \sum_{\rho=0}^{N_{\ell a}/4} b'_\rho r(k+\rho) \quad (20)$$

where $b'_\rho = b_{4\rho} + b_{4\rho+1} + b_{4\rho+2} + b_{4\rho+3}$. b'_ρ 's were all precomputed, and (20) was used for on-line computation of $s_r(k)$.

Effect of Feedback Gains

The first set of experiment was conducted to examine the closed loop behavior with different combinations of feedback gains, g_{pi} 's (i.e. a_i 's) in Table 1. In the experiment, the reference trajectory was a series of step changes and N_{la} was zero, i.e. conventional signal quickening. Time histories of the plant output (y 's) for different values of w are shown in figure 7. It can be seen in the figure that the feedback gains obtained with the larger w make the closed loop relatively slow to respond while those obtained with the smaller w make the closed loop oscillatory and require more controlling effort of the human operator. It was concluded that the feedback gains obtained with $w=0.01-0.1$ were most suited for human control of the triple integrator plant.

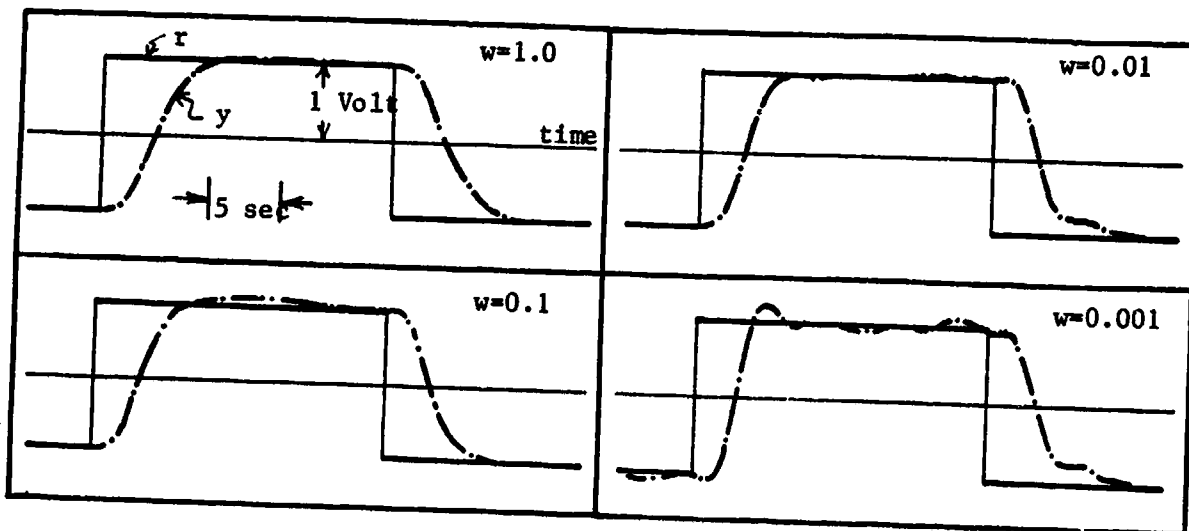

Fig. 7 Effect of Feedback Gains on Closed Loop Behavior

Extended Quickening

The extended quickening experiment was first conducted with the step reference trajectory. The parameters, a_i 's and b_l 's, were selected to be those computed with $w=0.1$. This choice was based on the result of the first set of experiment, effect of feedback gains, described above. Time histories of the plant output for different values of preview time (or N_{la}) are shown in figure 8.

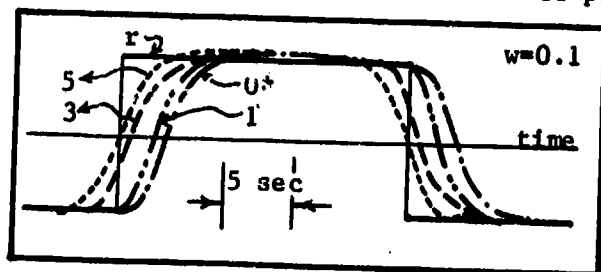

Fig. 8 Effect of Preview Time (* numbers indicate preview times in sec)

The inclusion of future values of the reference trajectory in the displayed signal, s_r , causes the plant output to respond prior to the step reference change. The maximum and RMS values of the tracking error were both improved by previewing the reference trajectory. A 4-5 second preview time ($N_{la}=160-200$) was found to be sufficient to attain almost all the possible performance improvement relative

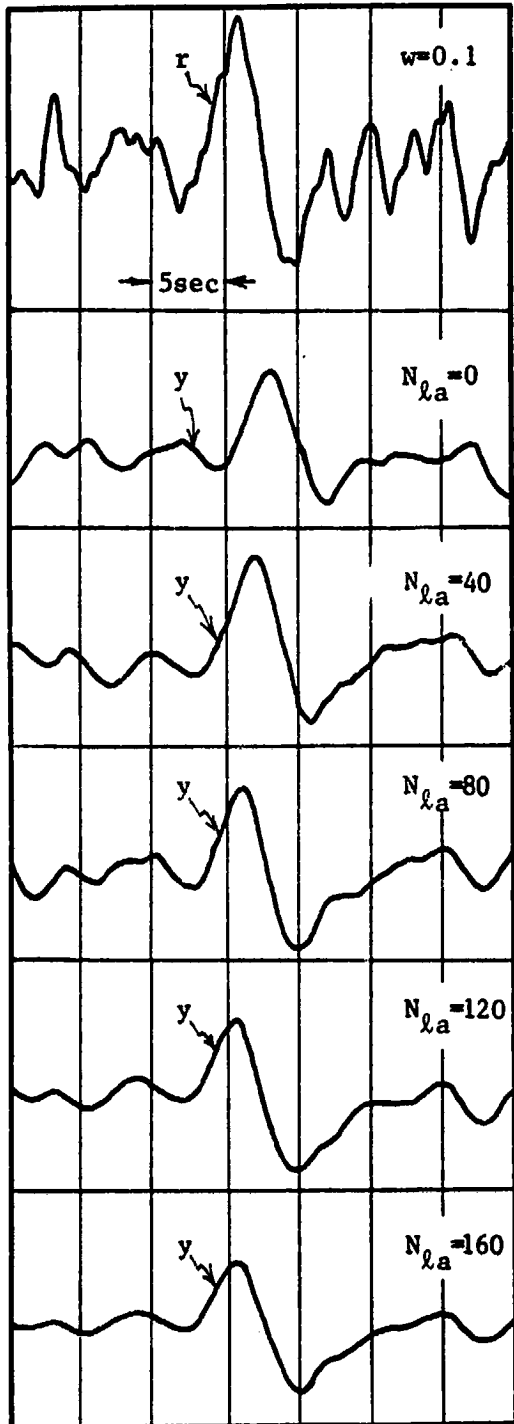

Fig. 9 Effect of Preview Time
(random reference trajectory,
Preview Time = $0.025 \times N_{\ell a}$ sec)

to the zero preview case which was about 50 % reduction of the maximum error (observed at the time of step reference change) and about 70 % reduction of the RMS error computed over 60 sec (i.e. 3 step changes of the reference trajectory). A similar improvement was also observed in the controlling input. Therefore, the difference among the four response curves in figure 8 is not simply a matter of translation.

The extended quickening experiment was also conducted with the random reference trajectory. Figure 9 shows the plant output for different values of $N_{\ell a}$. It can be seen in the figure that the phase shifts between the reference trajectory and the plant output gradually reduce as $N_{\ell a}$ increases. It was found that approximately a 2 second preview time ($N_{\ell a} \sim 80$) was sufficient to achieve almost all the improvement in terms of the RMS tracking error, approximately 50 % reduction relative to the zero preview case. Further performance improvement beyond $N_{\ell a} \sim 80$ was observed primarily in the controlling signal whose peak and RMS values were both continuously decreasing as $N_{\ell a}$ was increased from 80 to 200.

CONCLUSIONS

The signal quickening technique was extended to incorporate the future reference trajectory variation into the displayed signal so as to achieve high quality tracking in manual control of higher order plants with little or no damping. A design method for extended quickening systems was established based on the discrete time optimal control theory. The experiment for a triple integrator plant indicated that a drastic improvement of the closed loop performance can be obtained by extended quickening.

The extended quickening technique should be useful for various man-vehicle systems including airplane landing, maneuver, submarine control, etc. The main

motivation of (extended) quickening was to facilitate human control over high order plants with little or no damping. However, for the cases that plants are relatively easy to control, the technique should be still useful in various respects, e.g. for reducing the human work load.

The work reported in this paper is being continued to investigate the extended quickening technique in more realistic situations. Emphasis is placed on the following two points:

1. State Estimation: It was assumed that the derivatives of the plant output are directly measurable. Although the assumption holds in ideal situations such as the triple integrator plant on an analog computer in this paper, it is usually not possible to measure all derivatives directly. In such cases, one possibility is to include a Kalman filter or state observer in computer software.
2. Effect of Disturbance: In this paper, external disturbance inputs and/or noise were not considered. In practical situations, disturbance and noise can not be ignored, and their effect must be investigated.

REFERENCES

1. Sheridan, T. B. and Ferrell, W. R., Man-Machine Systems: Information, Control, and Decision Models of Human Performance, MIT Press, 1974.
2. Birmingham, H. P. and Taylor, F. V., "A Human Engineering Approach to the Design of Man-Operated Continuous Control Systems," Naval Res. Lab. Rep. 4333, April 1954.
3. Sheridan, T. B. et al., "Control Models of Creatures which Look Ahead," Proceedings of the 5th National Symposium on Human Factors in Electronics, 1964, pp. 229-240.
4. Reid, L. D. and Drewell, N. H., "A Pilot Model for Tracking with Preview," Proceedings of the 8th Annual Conference on Manual Control, AFFDL-TR-72-92, May 1972.
5. Tomizuka, M. and Whitney, D. E., "The Human Operator in Manual Preview Tracking (an Experiment and Its Modeling via Optimal Control)," Trans. of ASME, Journal of Dynamic Systems, Measurement, and Control, Vol. 98, No. 4, December 1976, pp. 407-413.
6. Tomizuka, M. and Whitney, D. E., "Optimal Discrete Finite Preview Problems (Why and How is Future Information Important?)," Trans. of ASME, Journal of Dynamic Systems, Measurement, and Control, Vol. 97, No. 4, Dec. 1975.
7. Tomizuka, M., "Optimum Linear Preview Control with Application to Vehicle-Suspension---Revisited," Trans. of ASME, Journal of Dynamic Systems, Measurement, and Control, Vol. 98, No. 3, September 1976.
8. Dorato, P. and Levis, A. H., "Optimal Linear Regulators: The Discrete-Time Case," IEEE Trans. on Automatic Control, Vol. AC-16, No. 6, Dec. 1971.