

Contractor Report 3068

Acoustic Scattering by Circular Cylinders of Various Aspect Ratios

Algirdas Maciulaitis

CONTRACT NAS1-14766
JANUARY 1979

NASA

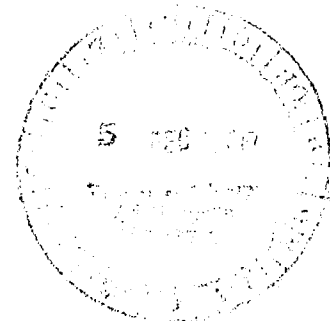

LOAN COPY: RETU
AFWL TECHNICAL L
KIRTLAND AFB, N. M.

0062769
MI.



NASA Contractor Report 3068

Acoustic Scattering
by Circular Cylinders
of Various Aspect Ratios

Algirdas Maciulaitis
Grumman Aerospace Corporation
Bethpage, New York

Prepared for
Langley Research Center
under Contract NAS1-14766

NASA

National Aeronautics
and Space Administration

**Scientific and Technical
Information Office**

1979

TABLE OF CONTENTS

<u>Item</u>	<u>Page</u>
Summary	1
Introduction.	2
Experimental Apparatus.	4
Initial Experiments Using Piezoelectric Transducers	4
Final Experimental Arrangement.	4
Circular Cylinder Models.	5
Instrumentation	8
Microphone Calibration.	8
Discussion of Results	12
Surface Pressure Augmentation	12
Phase Angle Variations.	18
Scattering Parameter.	19
Conclusions	31
References	32
Appendices.	33

LIST OF ILLUSTRATIONS

<u>Figure</u>		<u>Page</u>
1	Cylindrical Model and Loudspeaker inside the Anechoic Room. . .	6
2	Scattering Model.	6
3	Interior of the Cylindrical Model	7
4	Loudspeaker Adaptor Bracket for Alignment with the Laser Gun. .	7
5	Microphone and Preamplifier Installation Inside the Cylindrical Model	9
6	Data Acquisition Circuit Schematic.	10
7	Computer and Some of the Instrumentation Used in the Scattering Experiments.	11
8	Schematic Plan View of the Scattering Experiment Geometry . . .	14
9	Surface Pressure Augmentation on an L/D = 0.5 Cylinder Body at $ka = 0.407$	15
10	Surface Pressure Augmentation on an L/D = 0.5 Cylinder Body at $ka = 2.288$	16
11	Surface Pressure Augmentation on an L/D = 0.5 Cylinder Body at $ka = 4.232$	17
12	Surface Pressure Augmentation on an L/D = 0.25 Cylinder Body at $ka = 0.407$	21
13	Surface Pressure Augmentation on an L/D = 0.25 Cylinder Body at $ka = 2.288$	22
14	Surface Pressure Augmentation on an L/D = 0.25 Cylinder Body at $ka = 4.232$	23
15	Pressure Phase Variations on an L/D = 0.5 Cylinder Body at $ka = 0.407$	24
16	Pressure Phase Variations on an L/D = 0.5 Cylinder Body at $ka = 2.288$	25
17	Pressure Phase Variations on an L/D = 0.5 Cylinder Body at $ka = 4.232$	26

<u>Figure</u>	<u>Page</u>
18 Pressure Phase Variations on an L/D = 0.25 Cylinder Body at $ka = 0.407$	27
19 Pressure Phase Variations on an L/D = 0.25 Cylinder Body at $ka = 2.288$	28
20 Pressure Phase Variations on an L/D = 0.25 Cylinder Body at $ka = 4.232$	29
21 Variation of the Scattering Parameter as a Function of ka for Circular Cylinders Having L/D of 0.5 and 0.25	30

SUMMARY

A frequently used configuration for pressure gradient (PG) microphones, designed to measure the spatial acoustic pressure variation (gradient) at a point in space, is a short circular cylinder having either two pressure transducers flush-mounted into the ends of the cylinder body, or a single differential transducer measuring pressure difference between cylinder ends.

Acoustic scattering on a microphone body can severely limit the useful frequency range of pressure gradient microphones. These scattering effects were investigated experimentally between ka values of 0.407 and 4.232 using two circular cylindrical models ($L/D = 0.5$ and 0.25) having a 25 cm outside diameter. Small condenser microphones, attached to preamplifiers by flexible connectors, were installed from inside the cylindrical bodies. A 38 cm diameter woofer in a large speaker enclosure was used as the sound source. The experiment was done in the new anechoic chamber at the NASA Langley Research Center. Sound waves were not assumed to be plane.

Surface pressure augmentation and phase differences were computed from measured data for various sound wave incidence angles. Results are graphically compared with theoretical predictions supplied by NASA for $ka = 0.407$, 2.288, and 4.232. All other results are tabulated in the appendices. With minor exceptions, the experimentally determined pressure augmentations agreed to within 0.75 dB with theoretical predictions. The agreement for relative phase angles was within 5 percent without any exceptions. This is excellent, and approaches the realistic repeatability limits in an acoustic experiment of the type reported here. The fact that such agreement was achieved means that the theoretical procedure is fully validated and can be used in investigating, with confidence, scattering about any axisymmetric shape. It also means that the experimental technique employed possesses the necessary precision to explore acoustic scattering situations where a theoretical analysis might not be feasible at the present time.

Scattering parameter variations with ka and L/D ratio, as computed from experimental data, are also presented. This type of data represents a useful tool in the design of pressure gradient microphones.

INTRODUCTION

As its name implies, the function of a pressure gradient (PG) microphone is to measure the slope in the spatial acoustic pressure variation. In practice, the slope is determined from simultaneous acoustic pressure measurements using either two back-to-back mounted pressure transducers, or a single transducer exposed to the ambient pressure on both sides. A common geometric configuration for a PG microphone is a short circular cylinder. PG microphones are used in conjunction with ordinary pressure (P) microphones to study the acoustic source details by taking measurements in the far field. They can also be used to measure the acoustic intensity vector. In this application, the particle velocity is obtained from the local pressure gradient by means of the momentum equation.

In designing pressure gradient microphones for maximum frequency response, it is mandatory that the effect of the presence of the microphone body on the measurables be fully taken into account. Only then is it possible to design a PG microphone that, depending on the operating frequencies, is either practically distortion free, or if not, can still be utilized successfully if proper corrections are made. Such corrections can be determined from preliminary investigations of the type described in this report. As far as it could be determined, the first systematic theoretical effort to optimize body shapes for reducing the effect of body scattering on pressure gradient microphone frequency response was reported in Ref. 1. The present study was aimed at an experimental verification of the findings of that work.

The main reason for the microphone disturbance of the acoustic pressure field existing in the absence of the microphone body is due to acoustic scattering by the body surface. Until recently, scattering fields could be computed only for simple geometric shapes whose surfaces constitute a coordinate surface in a coordinate system in which the wave equation is separable. The oblate spheroids constitute one such family of body shapes. This was the reason prompting the selection of that particular body shape as the scattering model in Ref. 2. The idea there was to confirm experimentally the scattering pressure distributions generated by a computer program. Having demonstrated very good agreement between experiment and

theory in that instance, it was decided to extend the proven experimental technique to bodies of revolution holding a greater practical interest from a point of view of application in PG microphones; namely circular cylinders of various length-to-diameter ratios. At the time the present work was initiated, no theoretical scattering solutions for this geometric shape were available. The situation has changed in the interim, and the present report contains numerous comparisons between experimental and analytical results.

Our approach in the experiments is to make the scattering models large (25 cm diameter) and hollow, which brings about several advantages. The main advantage of the size is that it affords a reasonable surface spatial resolution with use of conventional transducers that have a high pressure sensitivity. The additional advantage accrued consists in our ability to mount the transducers from inside the body and to run the electrical conduits through the model support pipe. This results in a very clean configuration, which in its "lollypop" shape closely resembles a PG microphone.

To maintain a uniform incident spherical sound field, tests were conducted inside an anechoic chamber. Although during the course of the contract work models of various L/D ratios were designed and fabricated, some having various types of edge roundness, lack of time and funds allowed testing only with two square-edged circular cylinder models having L/D of 0.5 and 0.25. It has been shown recently (in Ref. 1) that L/D = 0.5 is about the optimum aspect ratio for a PG microphone and that the effect of rounding the edges on the usable frequency range is minimal. In view of these findings, the two models tested do not constitute an overly restricted range of variables.

The data acquisition procedure, as finally adopted, was fully automated and was under computer control. This included changes in frequency, incidence angle, multiplexed measurements, and averaging of six different pressure amplitudes and five relative phase angles. John M. Seiner of the NASA Langley Research Center prepared the computer program that controlled the experimental data acquisition.

EXPERIMENTAL APPARATUS

INITIAL EXPERIMENTS USING PIEZOELECTRIC TRANSDUCERS

Our original plan was to conduct all scattering experiments in the anechoic chamber of the Pennsylvania State University. The chamber and the loudspeaker were tested using a standard condenser microphone mounted in a two-dimensional transversing mechanism. These tests helped to decide on proper locations for both the loudspeaker and the scattering models, and which frequencies would be particularly suited for scattering experiments. (Within a desired frequency operating range these frequencies depend on the loudspeaker characteristics and on room acoustics.)

In the original configuration, scattering models were instrumented with piezoelectric type pressure transducers. Unfortunately, after extensive tests, it was realized that these transducers were unsuitable because, owing to the scattering model design and its support within the anechoic chamber, slight mechanical vibrations were induced in the scattering model when the loudspeaker output power was raised to a sufficiently high level to produce reasonable signal levels from the piezoelectric transducers. Under these conditions the transducers began acting as accelerometers and the acoustic signal was no longer recognizable. It was decided to switch to condenser microphones as pressure transducers. This meant added design and machining effort. Unavoidably, this change caused some delays and a certain amount of duplication of effort.

FINAL EXPERIMENTAL ARRANGEMENT

The experiment was ultimately conducted in the new anechoic chamber at the NASA Langley Research Center. The inside dimensions of the chamber are 3 by 4 by 2.5 m (2.5 being the height). Preliminary tests showed the chamber to be anechoic down to below 178 Hz, the lowest frequency used in the experiments.

The tests consisted of measuring the surface pressures and phase angles on two circular cylindrical bodies (L/D of 0.5 and 0.25) exposed to the

harmonic sound field emanating from a 38 cm diameter lead guitar speaker mounted in a 100 Hz enclosure. The distance between the loudspeaker and the center of the cylinder model was 1.35 m. A photograph of the loudspeaker and a cylindrical model mounted inside the anechoic chamber is shown in Fig. 1.

Circular Cylinder Models

A simplified drawing of the scattering model is shown in Fig. 2. Two circular cylinder models were used in the tests. They both had an outside diameter of 25 cm, but different L/D ratios: 0.5 and 0.25. These particular L/D ratios were selected because of the strong indication in Ref. 1 that 0.5 is about the optimum L/D ratio for a PG microphone. The models were machined from aluminum and consisted of six major parts each. Two transducer (microphone) holders were each mounted in an end plate that could be rotated around the cylinder axis. The cylinder body itself was made of two parts to provide access to the interior. One of the microphone holders had provisions to hold five 0.635 cm diameter microphones arranged on a radial line at 2.46 cm centers, starting with one microphone on the cylinder axis. The other microphone holder, which was installed in the end plate at the opposite end of the model, contained only a single microphone on the cylinder axis. Figure 3 shows a photographic view of the inside of the cylindrical model, which also shows the special adaptors for flush mounting the microphone cartridges.

The model was supported in the anechoic room on a model holder machined from a 3.175 cm diameter pipe. Microphone cables were run through the inside of this holder. The holder itself was attached to an in-line small electric stepping motor to provide accurate rotational positioning of the model about a vertical axis.

To ensure proper alignment between the loudspeaker and the model end face, a surface mirror was installed temporarily at the center of the latter, while a laser gun was placed normal to the speaker surface using the special adaptor bracket shown in Fig. 4. The alignment was accomplished by first leveling the top of the speaker enclosure using a carpenter's level, and then

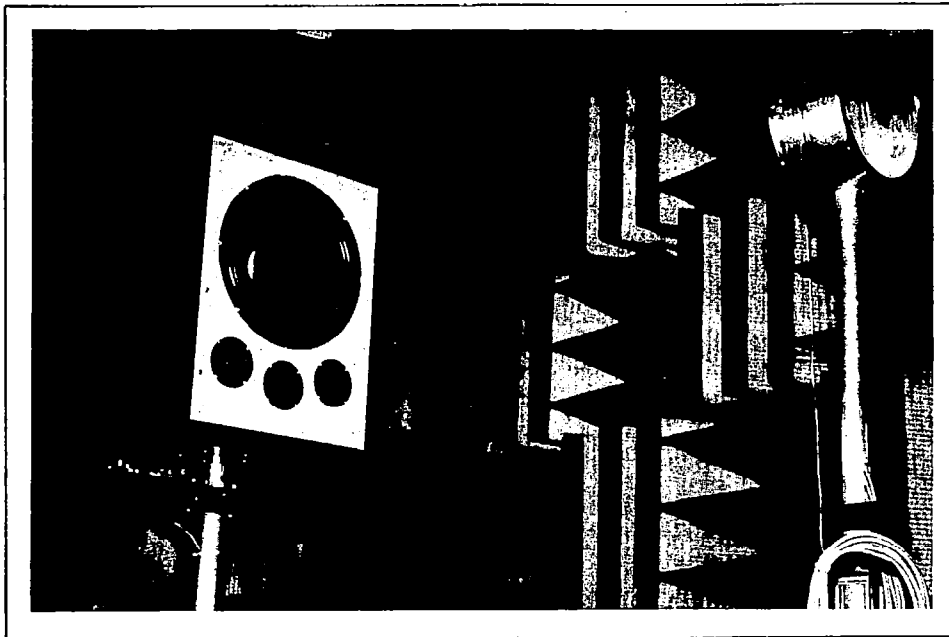
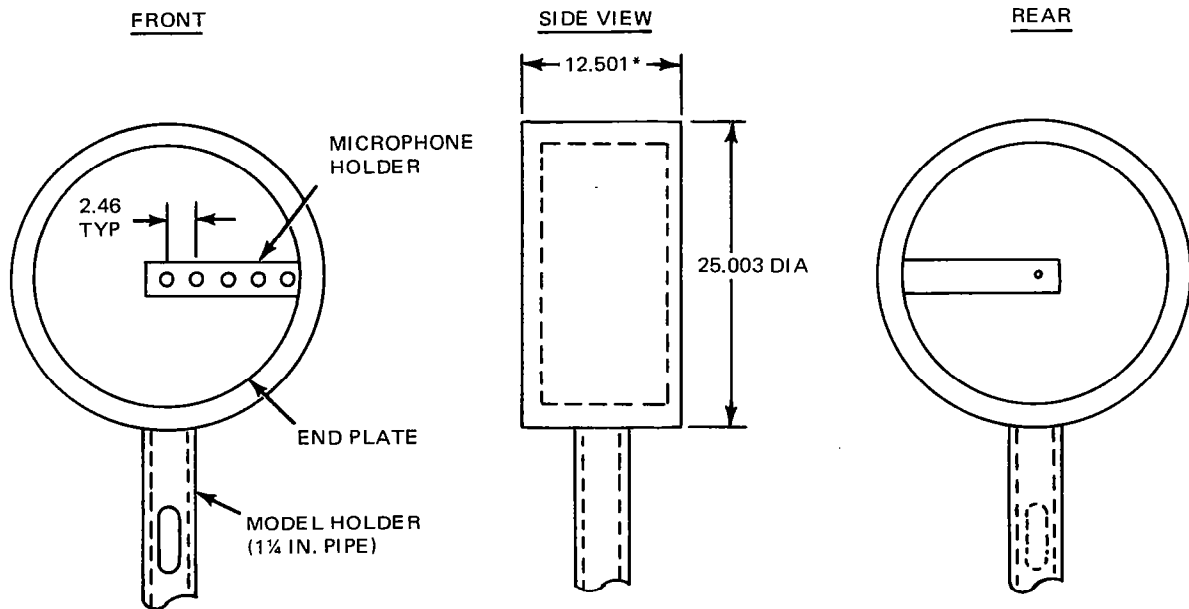

Fig. 1 Cylindrical Model and Loudspeaker Inside the Anechoic Room



* FOR THE L/D = 0.5 MODEL
 FOR THE L/D = 0.25 MODEL: 6.250
 (ALL DIMENSIONS IN cm)

Fig. 2 Scattering Model

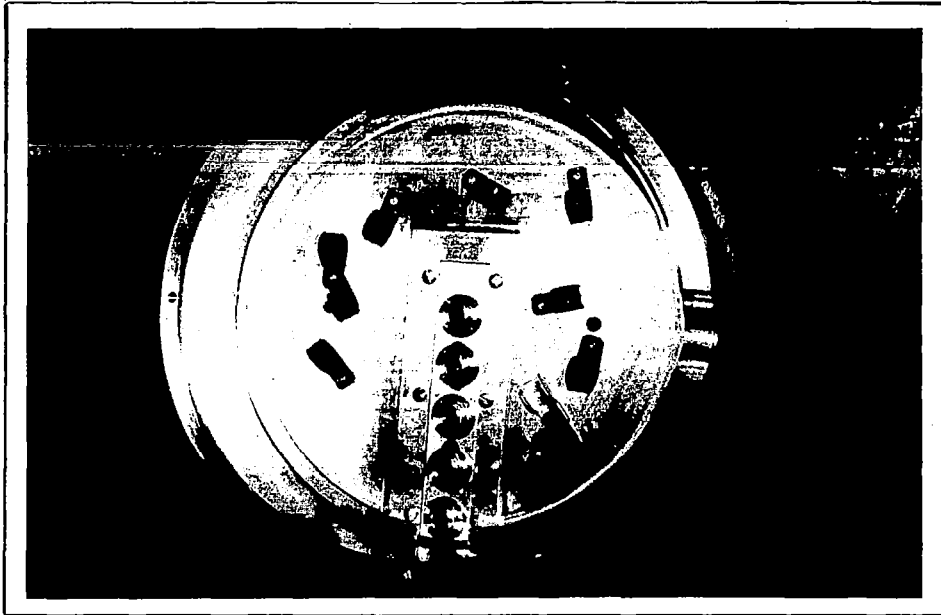

Fig. 3 Interior of Cylindrical Model

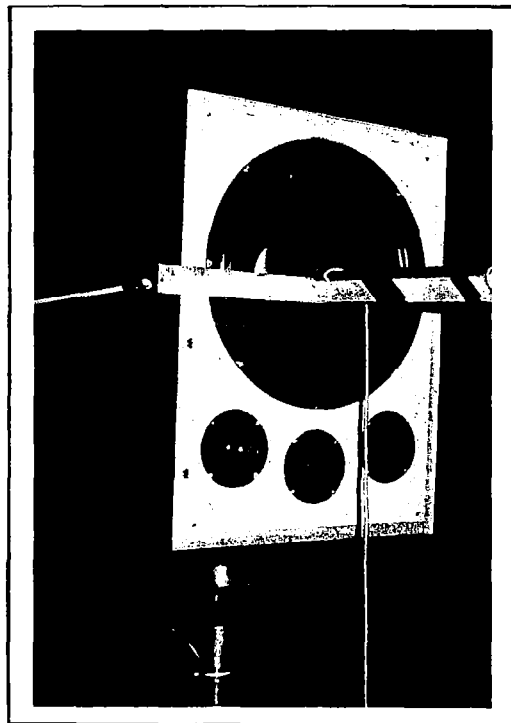

Fig. 4 Loudspeaker Adapter Bracket for Alignment with Laser Gun

turning the loudspeaker about a vertical axis and adjusting relative heights and the position of the model until the reflected laser beam almost coincided with the beam reaching the mirror.

Instrumentation

Acoustic surface pressures and phase angles were measured with six 0.635 cm diameter (pressure response) microphones in conjunction with commercially available right angle flexible connectors. The flexibility of the connectors made the microphone assembly less sensitive to mechanical vibration and made it possible to install five preamplifiers in a rather confined space. The microphone installation from inside the model is shown in Fig. 5. Microphones and their preamplifiers were electrically insulated from the model body, and thus from each other, by plastic preamplifier holders and nylon seals inside the flush mounting adaptors. Holes in the microphone holders were sized to ensure that the cartridges did not touch the microphone holder.

Sound pressure levels in the absence of the cylinder model were measured with a 1.3 cm diameter condenser microphone, which had been calibrated with a piston-phone calibrator.

Equipment used during the experiments to drive the speaker and to measure acoustic pressures, phase angles, and incidence angles is shown schematically in Fig. 6. Also shown is the computer that controlled the experiment. In addition to this instrumentation, anechoic room temperature and barometric pressure were also recorded and stored in the computer. These values were used to compute the speed of sound. The photograph in Fig. 7 shows some of the instrumentation used in this experiment.

Microphone Calibration

Microphones were calibrated for signal amplitude by means of a acoustic calibration piston phone at a SPL of 124 dB at 250 Hz. Phase response for each microphone was determined using an electrostatic actuator.

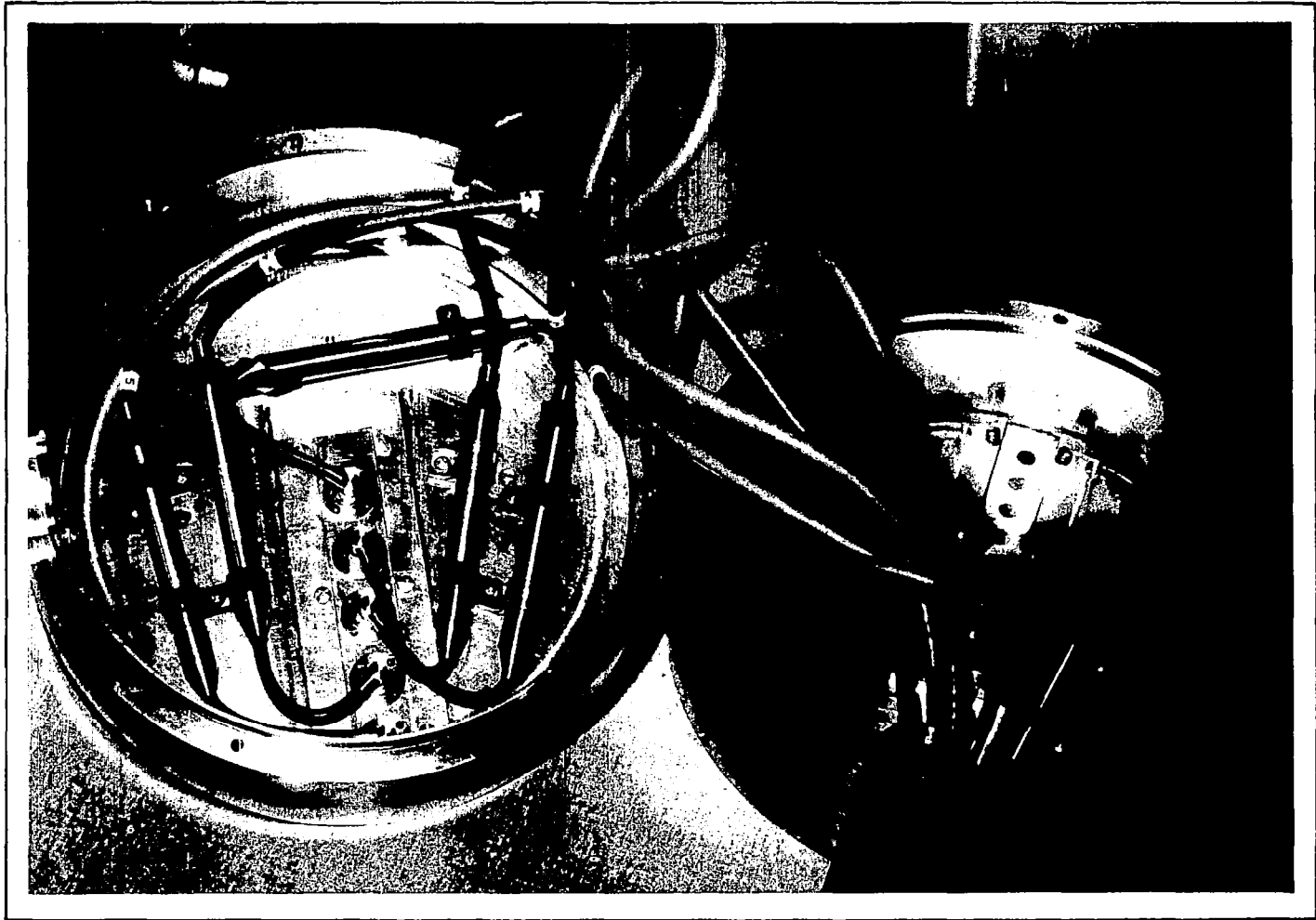

Fig. 5 Microphone and Preamplifier Installation Inside the Cylindrical Model

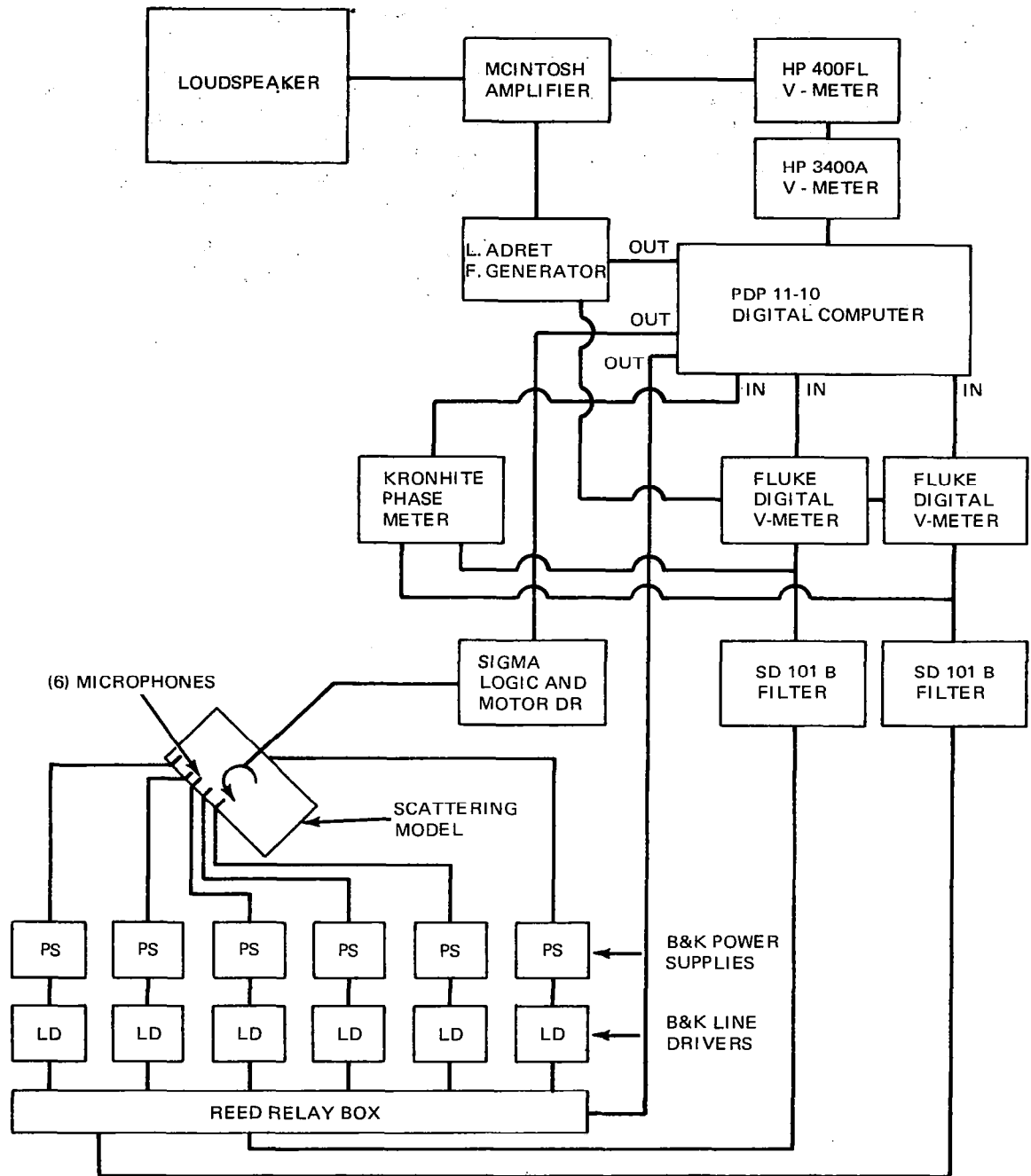

Fig. 6 Data Acquisition Circuit Schematic

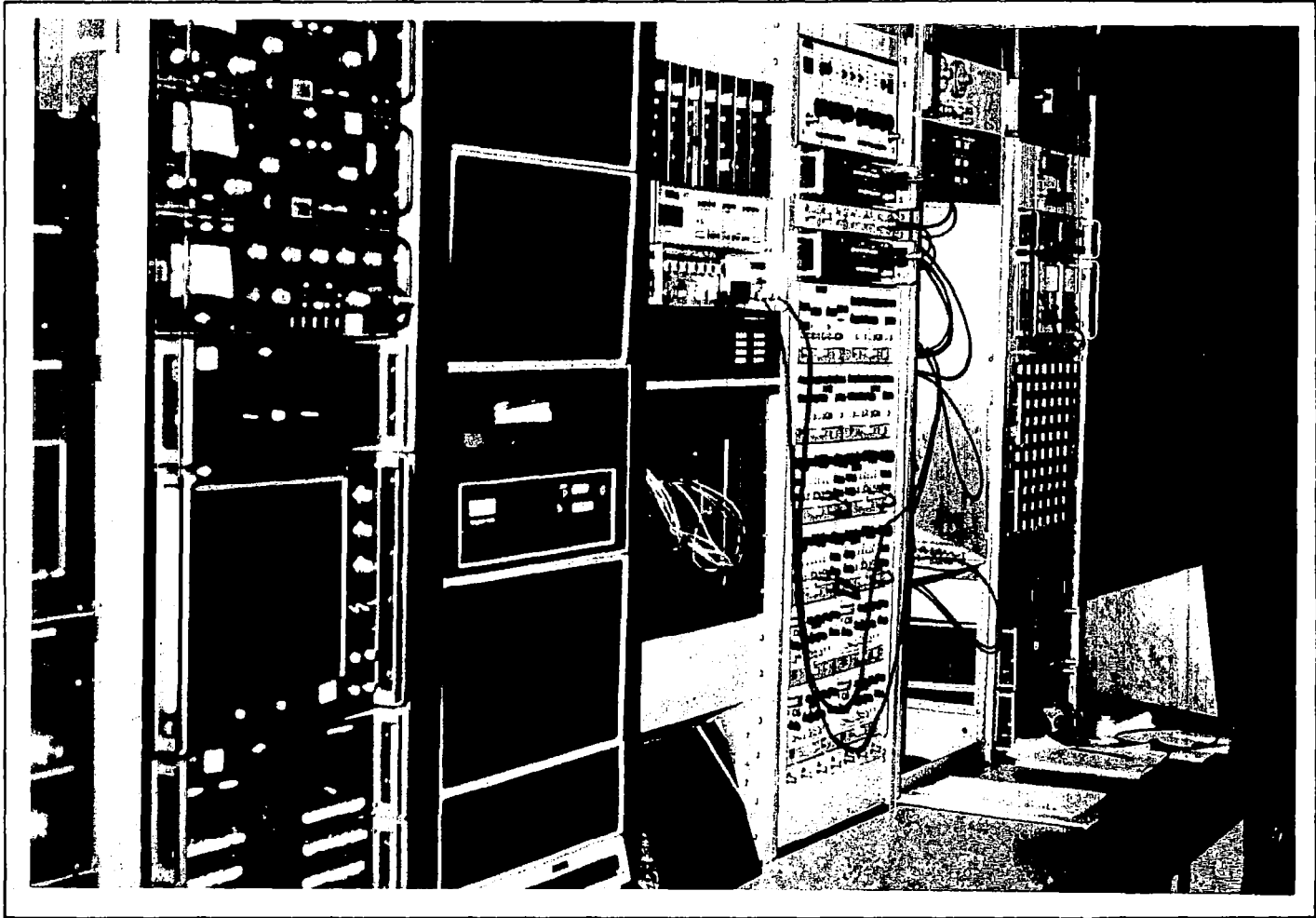

Fig. 7 Computer and Some of the Instrumentation Used in the Scattering Experiments

DISCUSSION OF RESULTS

Experimental results are presented in the form of three parameters: the surface pressure augmentation ratio π , relative phase angle, and the scattering parameter σ . Experimentally determined π and phase angle variations are compared with theoretical values provided by Thomas D. Norum of the Aeroacoustics Branch, NASA Langley Research Center. The methodology employed in the theoretical solution of the scattering problem for the particular problem of circular cylinders of finite length is described in Ref. 1. Numerical results became available after the initiation of the experimental program.

SURFACE PRESSURE AUGMENTATION

The surface pressure augmentation ratio π is defined as the absolute value of the ratio of the surface pressure existing at a given point on the surface of the cylinder body to the acoustic pressure that would exist at the same point in space in the absence of the cylinder body. It is, thus, a measure of the rearrangement in the acoustic field brought about by the introduction of the cylindrical body. The absolute value of the ratio is, of course, equal to the ratio of the rms values, which are the actual measurables. In the experimental procedure followed, each pressure measurement recorded is an averaged value over ten samples taken in quick succession, producing an averaging time of approximately 1.3 seconds. The reference acoustic pressures were obtained from SPL measurements at a position close to the model, with the model removed from the anechoic chamber. In computing π , corrections to the reference pressure were introduced for each model incidence angle to account for the difference in the loudspeaker to microphone distances for the microphones in the model surface.

Surface pressures were measured and π computed for 22 frequencies, ranging from 178 to 1850 Hz; in terms of the ka ratio, this covers a range from 0.407 to 4.232. Since, as mentioned previously, only one horizontal radius on one cylinder end face and the center point of the end plate on the opposite end were instrumented with microphones, the model was turned to eight different incidence positions and the model end face rotated 180° about its axis positions (from $\theta = 180^\circ$ to $\theta = -135^\circ$ in 45° steps) to

provide enough data for the front and back surfaces at three incidence angles: 180° , 135° and 90° . Figure 8 presents geometric definitions of the incidence angle θ and the end face nondimensional position x . Circular cylindrical models having L/D ratios of 0.5 and 0.25 were tested; in the latter case, the end face was not rotated 180° about its axis.

Results are presented for three ka values: 0.407, 2.288, and 4.232 (in terms of frequency: 178, 1000, and 1850 Hz). Results for intermediate ka values are tabulated in Appendix A.

Theoretical results are shown in Fig. 9 as solid lines for the front end face and as dash-dot lines for the back face. Triangles and circles stand for experimental measurements on the front and back end faces, respectively. The figure shows the experimental and theoretical pressure augmentation (π) distributions on the front and back of the L/D = 0.5 model end faces for $ka = 0.407$. As expected from Ref. 1, at this low ka value the effects of the model's presence are quite weak. The agreement between experimental and theoretical values is excellent.

The corresponding π distributions for the same cylindrical model at $ka = 2.288$ are shown in Fig. 10. Scattering effects are very clearly evident. At $\theta = 180^\circ$, the pressure at the center of the front face is about three times its free-field value. On the back face, which also exhibits strong scattering effects, one can see the beginning of the development of a diffraction ring pattern, which is well known in optics. The agreement between experimental and theoretical values is again, very good. Curves of π for the same model at $ka = 4.232$, shown in Fig. 11, attest to a very strongly scattering-dominated situation having a more elaborate fine structure. Diffraction rings on the rear face are fully developed. At $\theta = 135^\circ$, the peak value is located about half way on the radius further removed from the sound source. The agreement between theory and experiments is still quite good, but not as perfect as for the lower frequency cases. Slight disagreements can be noted at those positions where the theory predicts rather steep local peaks or valleys. As to the possible causes of these slight disagreements, it is important to realize that the experimental and theoretical representations of π differ in that each represents a different finite element of surface. The theoretical surface element is that of a cone, whereas the experimental element

LOUDSPEAKER

MODEL

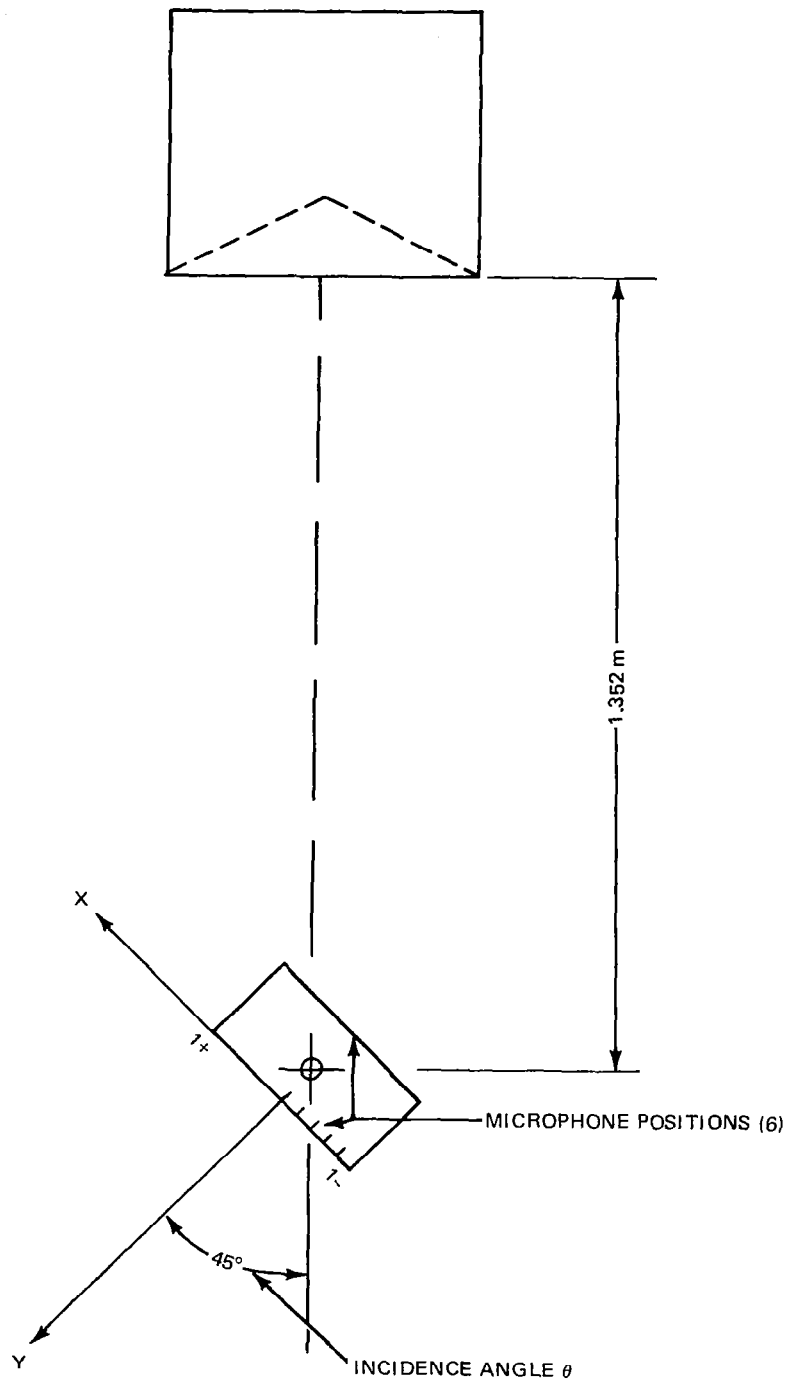

Fig. 8 Schematic Plan View of the Scattering Experiment Geometry

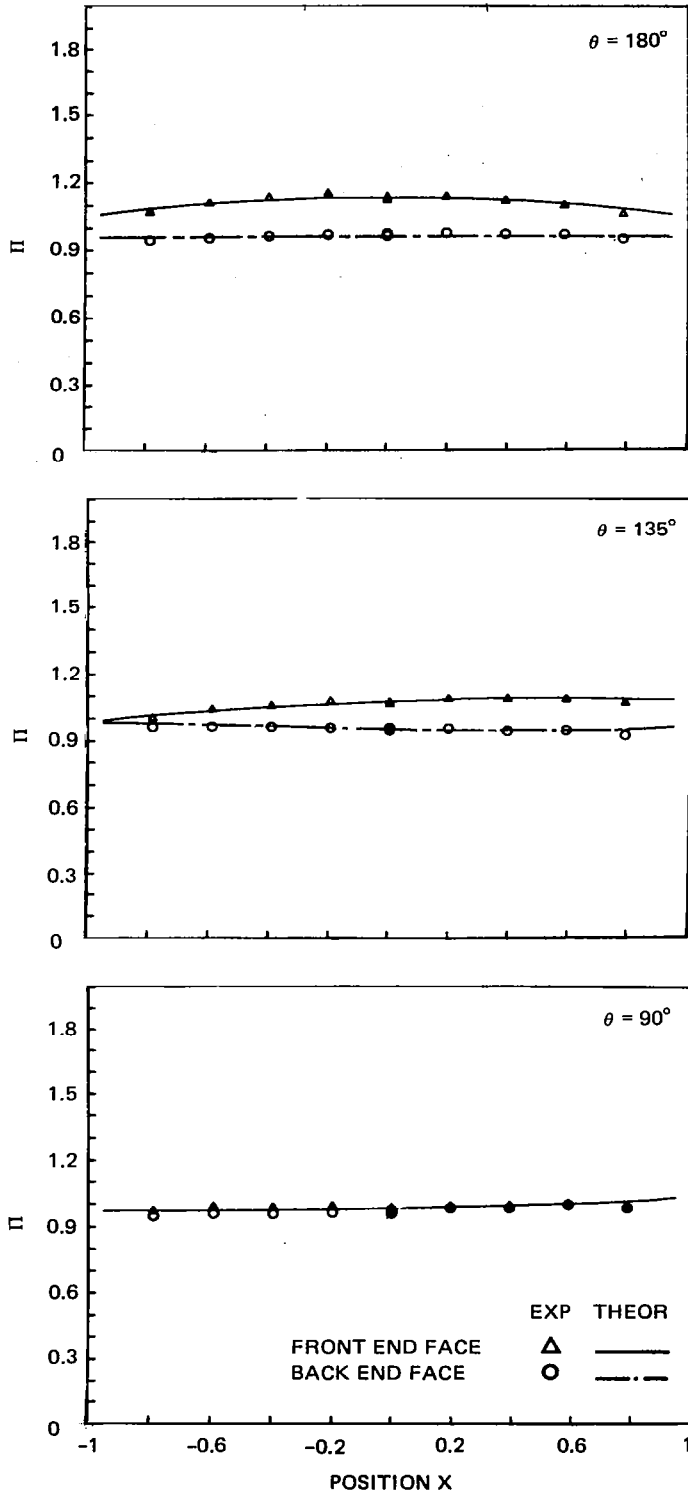

Fig. 9 Surface Pressure Augmentation on an $L/D = 0.5$ Cylinder Body at $ka = 0.407$

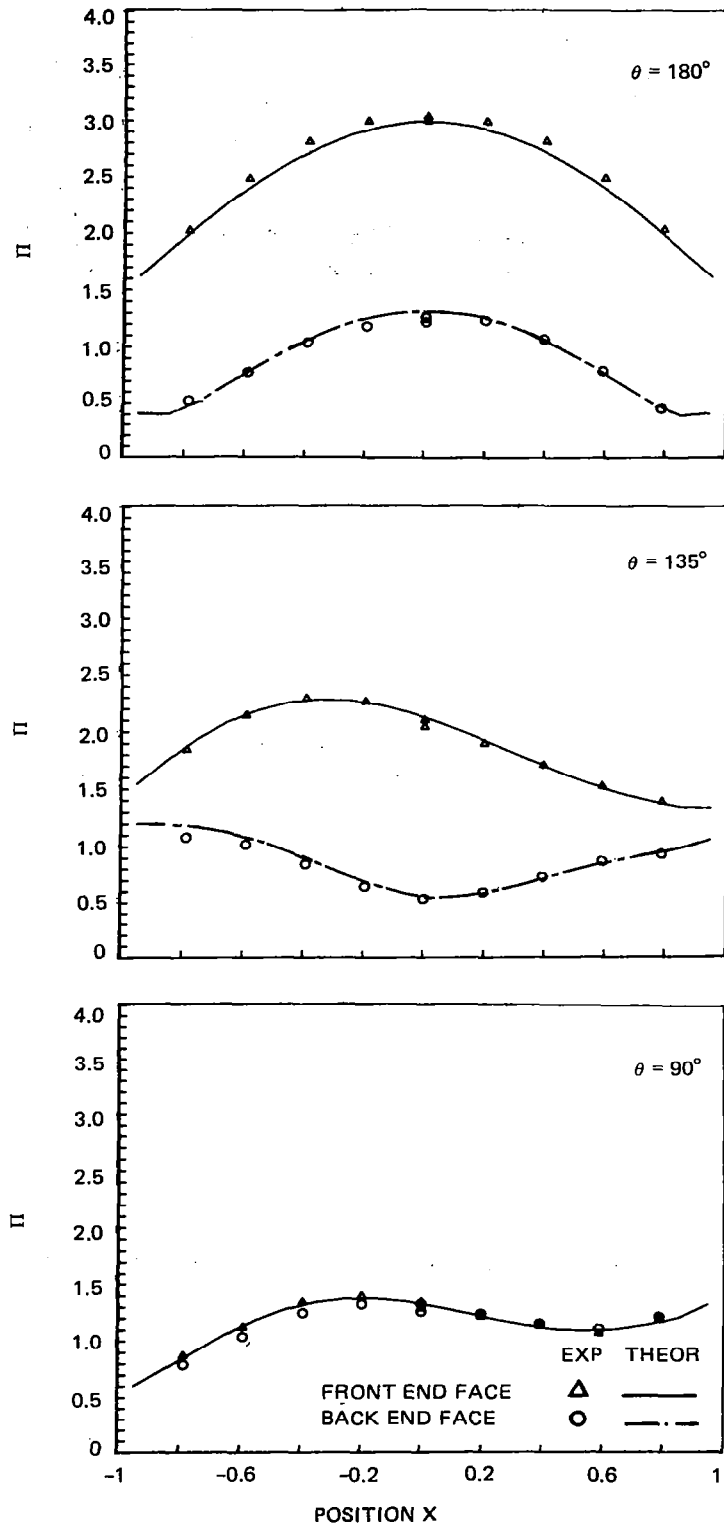

Fig. 10 Surface Pressure Augmentation on an $L/D = 0.5$ Cylinder Body at $ka = 2.288$

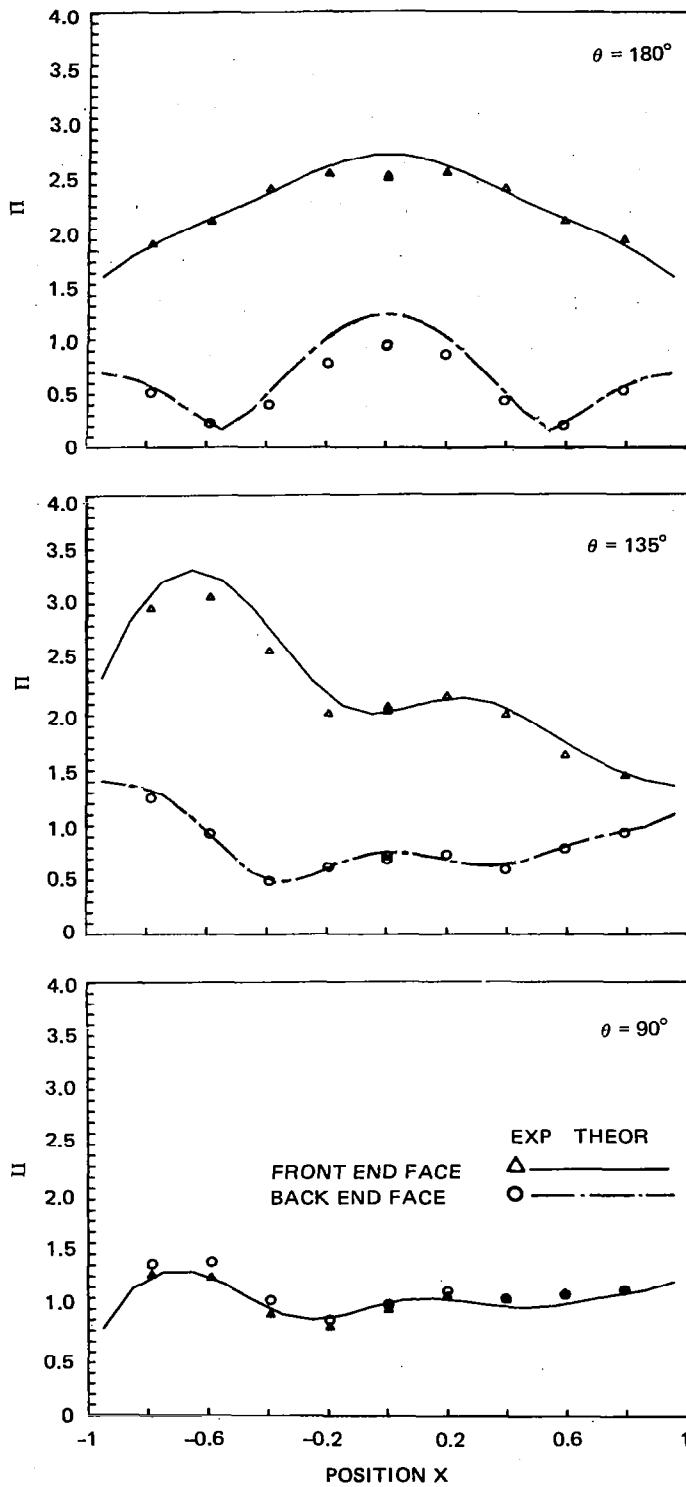

Fig. 11 Surface Pressure Augmentation on an $L/D = 0.5$ Cylinder Body at $ka = 4.232$

is that of a circular microphone. In both cases the elements are not small at high values of ka , and the difference between computed and measured distribution of π at high ka is expected. Furthermore, one should also keep in mind that whereas the theory assumed an ideal point source and a perfectly anechoic environment, in the real world no loudspeaker is a true point source at all frequencies and no room is perfectly anechoic. Sharp peaks or valleys in surface pressure would require near perfect local signal addition or cancellation; these are extremely difficult to duplicate in an experimental environment.

Figures 12-14 show comparisons of experimental pressure augmentation results with theory for a cylinder having half the length ($L/D = 0.25$) of that used to obtain data just presented. Trends are similar to those for the longer cylinder; however, there are noticeable differences in the corresponding π values. Generalizations on the effects on scattering brought about by halving the L/D ratio are hard to make. The effect seems to depend on the sound frequency and on the incidence angle. For instance, one can see by comparing Figs. 11 and 14 that at $ka = 4.232$ the shorter cylinder showed stronger scattering effects at $\theta = 180^\circ$ and 90° , but at $\theta = 135^\circ$ π values for the longer cylinder were larger.

Agreement between theory and experiment for $L/D = 0.25$ is generally very good, except for $\theta = 180^\circ$ at $ka = 4.232$ (Fig. 14). For some unknown reason, experimental data fell about 0.6 dB higher than the theoretical prediction at the center and about 0.8 dB higher towards the cylinder edge. It was not possible to repeat this particular configuration.

PHASE ANGLE VARIATIONS

Pressure phase variations were measured in conjunction with rms pressure measurements on the same two cylindrical models over the same range of test conditions. Phase angles relative to the microphone signal at the center of the model were measured with a phase meter. Results of the pressure phase measurements are presented in Figs. 15 through 21. As before, triangles and circles represent measured data on the model front and rear face, respectively, while the corresponding theoretical results are indicated as solid, or dash-dot lines. All phase angles are relative to

the phase at the center of the model front end face. Note that the plots showing phase variations corresponding to $ka = 0.407$ have an expanded scale to better display the modest phase differences at this low frequency. As expected, phase differences become more pronounced as the ka product increases. Compared to variations of pressure augmentation, curves of relative phase exhibit much less fine structure and have a more monotonic character. A comparison of corresponding phase variations for the $L/D = 0.5$ and 0.25 cylinder bodies leads to the following not surprising conclusions: First, the trends of phase variations are similar in both instances; secondly that at the $\theta = 90^\circ$ incidence angle the variations are practically the same, as one would expect; and, thirdly, that at incidence angles other than 90° , the phase differences between the cylinder front and rear end faces are larger for the longer cylinder. This is also logical since the path the sound waves have to travel between corresponding points is longer for the longer cylinder. An attempt was made to collapse the experimental results into curves valid for both L/D ratios by including simple geometric considerations. This did not lead to a satisfactory result.

The agreement between experimental phase data and theoretical predictions throughout the entire range of experimental variables is excellent. This is very rewarding since it represents a convincing verification both of theory and of the experimental approach, including such things as the suitability of the anechoic chamber, model design, and choice of loudspeaker and instrumentation.

SCATTERING PARAMETER

Whenever an acoustic pressure gradient at a point in space is measured with a pressure-difference sensor of finite dimensions, inaccuracies are introduced into the pressure gradient determination both by the scattering effects owing to the sensor's body and to the need for approximating a gradient from finite difference measurements. To assess the extent of these effects in a particular test configuration, it is expedient to introduce a scattering parameter σ . This parameter was first introduced in Ref. 2 and was used later extensively in Ref. 1. It is rederived here in Appendix B for the

particular case of spherical sound waves. It can be noted from the derivation that in terms of decibels σ would equal zero if the measurement could yield the actual free field values.

Figure 21 shows a plot of σ in decibels vs. the ka product, as computed from experimental data for the $L/D = 0.5$ and 0.25 cylinder models. Incidence at $\theta = 180^\circ$ and measurements from single pairs of microphones (front and back at $x = 0$) were used to prepare this graph. Two sets of experimental data are shown for the $L/D = 0.5$ case; they correspond to the microphones on the model being either between $x = 0$ and $x = 1$, or between $x = 0$ and $x = -1$ (see Fig. 8), respectively. These data are identified by different symbols in order to display the degree of reproducibility. Also shown in the figure are the theoretical predictions for $L/D = 0.5$ and $L/D = 0.25$ from Ref. 1. In spite of the fact that in Ref. 1 plane acoustic waves had been assumed, the agreement with experimental values is satisfactory. It has been shown previously (Ref. 2) that the results are not much different if larger front and back areas are included. It is apparent from Fig. 21 that the $L/D = 0.5$ cylinder is better suited for PG microphone applications since its indicated acceptable upper frequency limit is higher.

The practical usefulness of scattering parameter plots of the type depicted in Fig. 21 becomes evident in microphone size selection, once the allowable σ value and the maximum operating frequency are fixed.

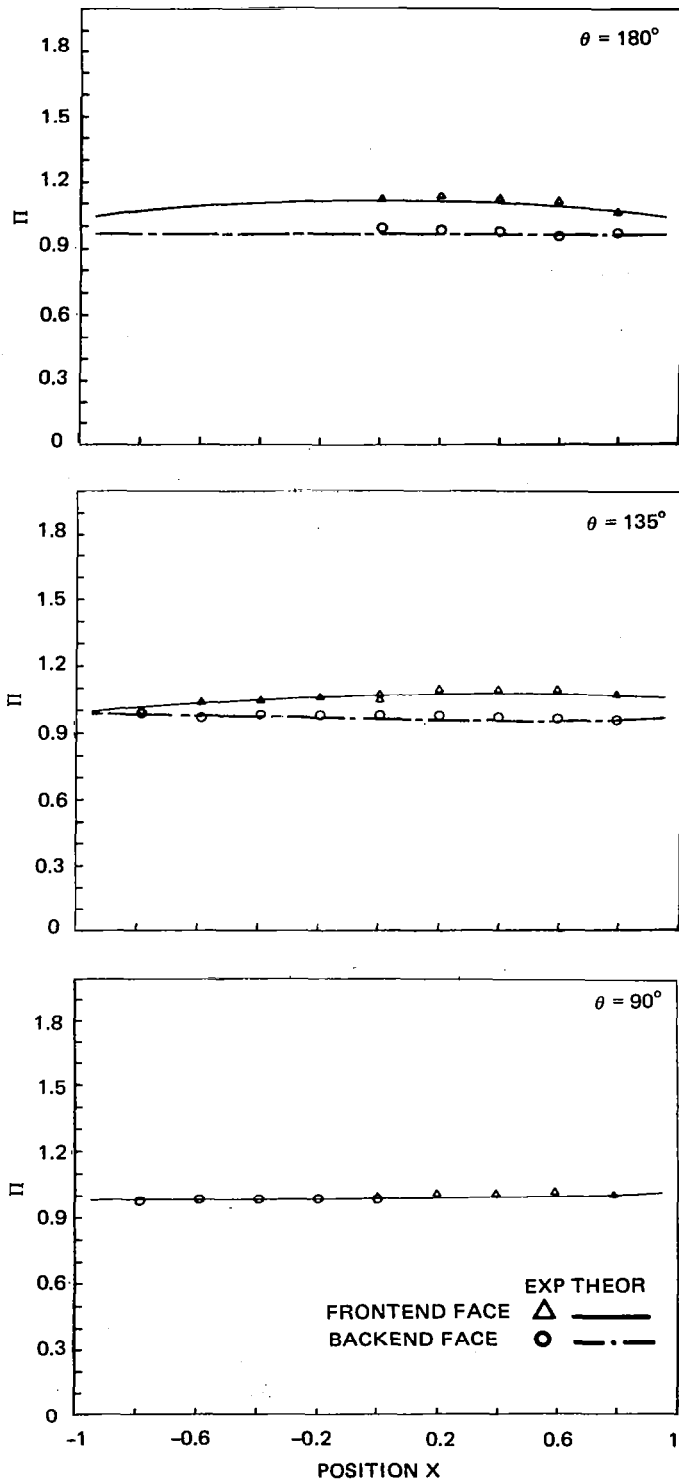

Fig. 12 Surface Pressure Augmentation on an $L/D = 0.25$ Cylinder Body at $ka = 0.407$

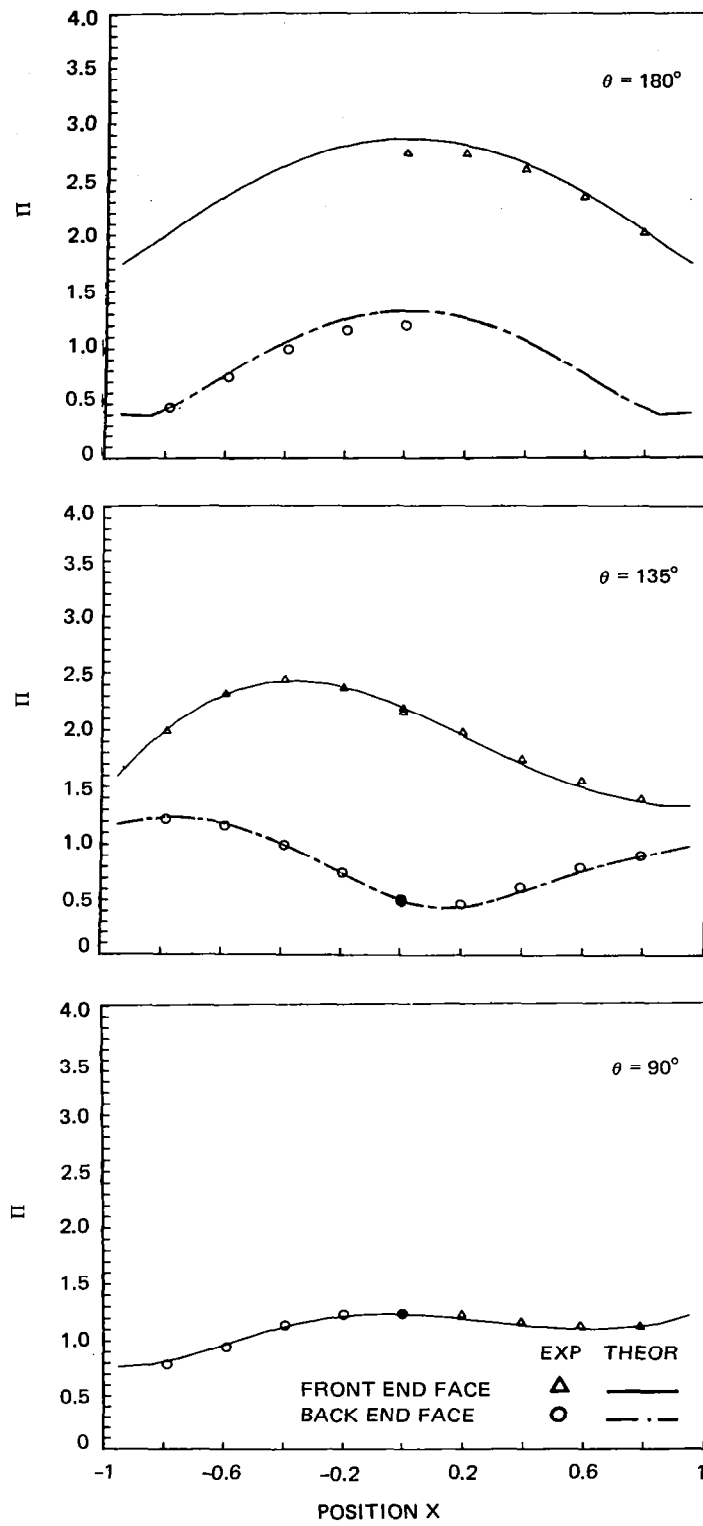

Fig. 13 Surface Pressure Augmentation on an $L/D = 0.25$ Cylinder Body at $ka = 2.288$

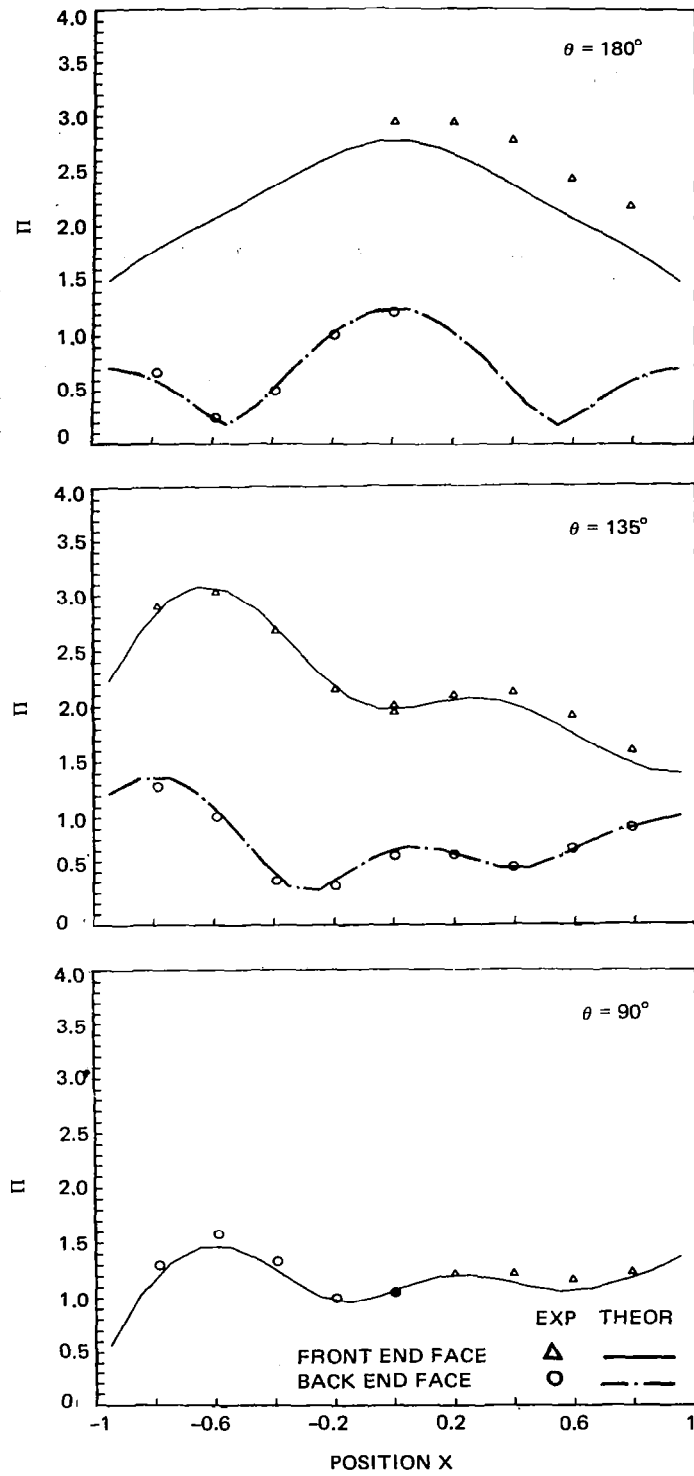

Fig. 14 Surface Pressure Augmentation on an $L/D = 0.25$ Cylinder Body at $ka = 4.232$

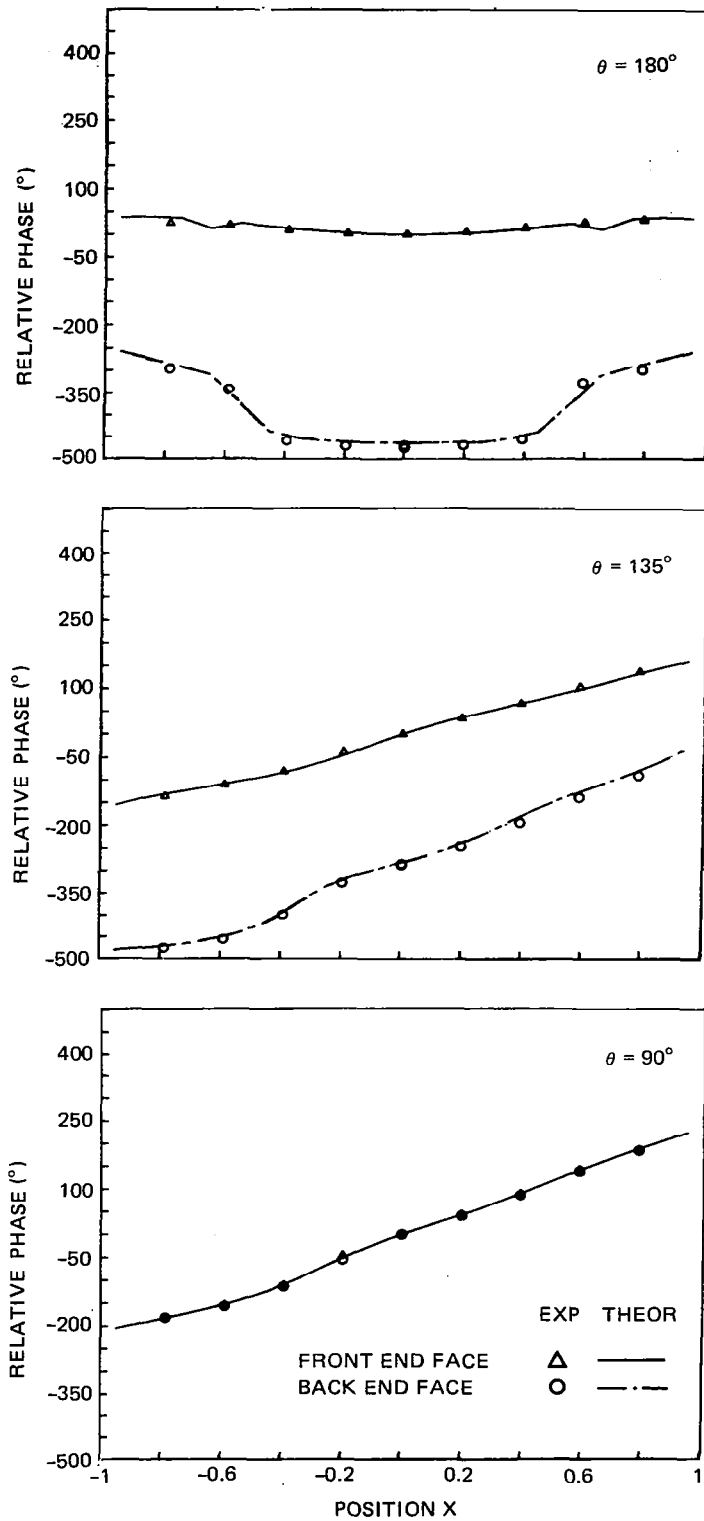

Fig. 17 Pressure Phase Variations on an $L/D = 0.5$ Cylinder Body at $ka = 4.232$

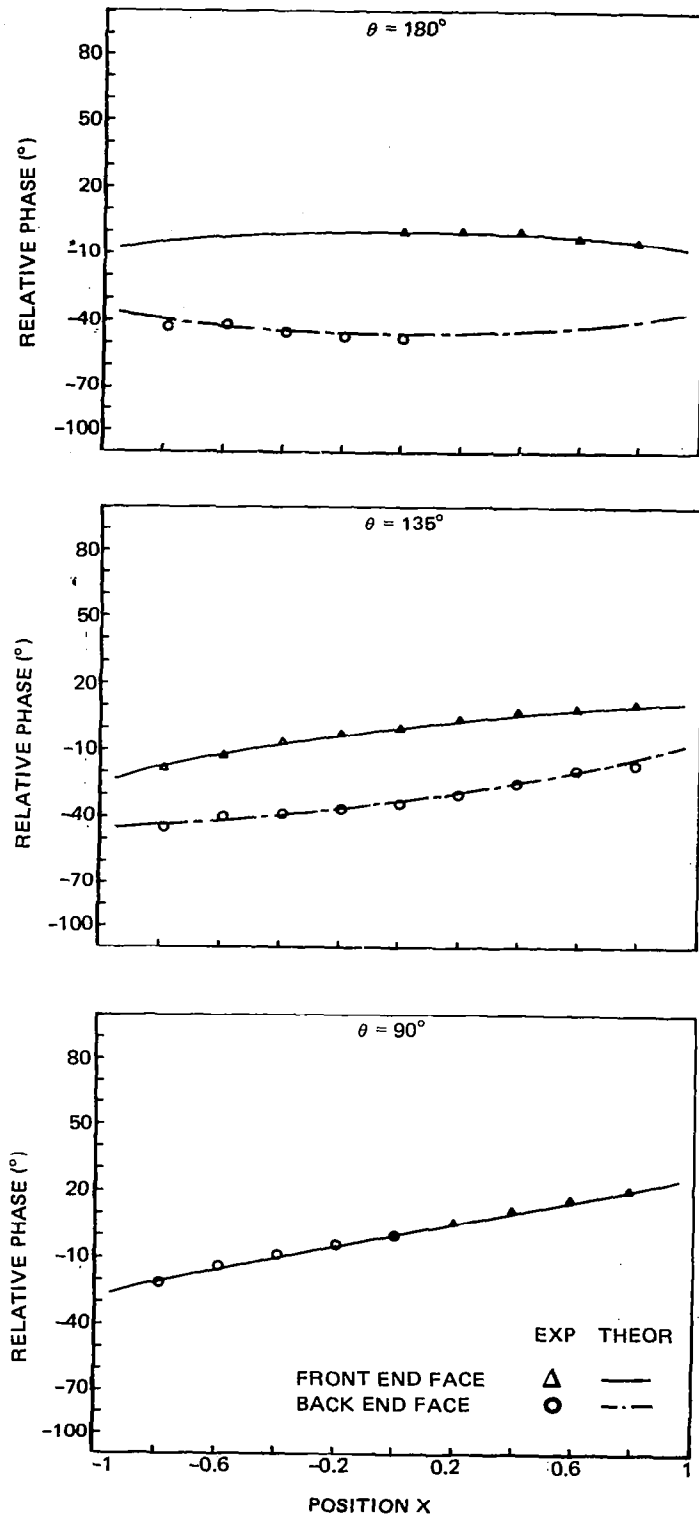

Fig. 18 Pressure Phase Variations on an L/D = 0.25 Cylinder Body at ka = 0.407

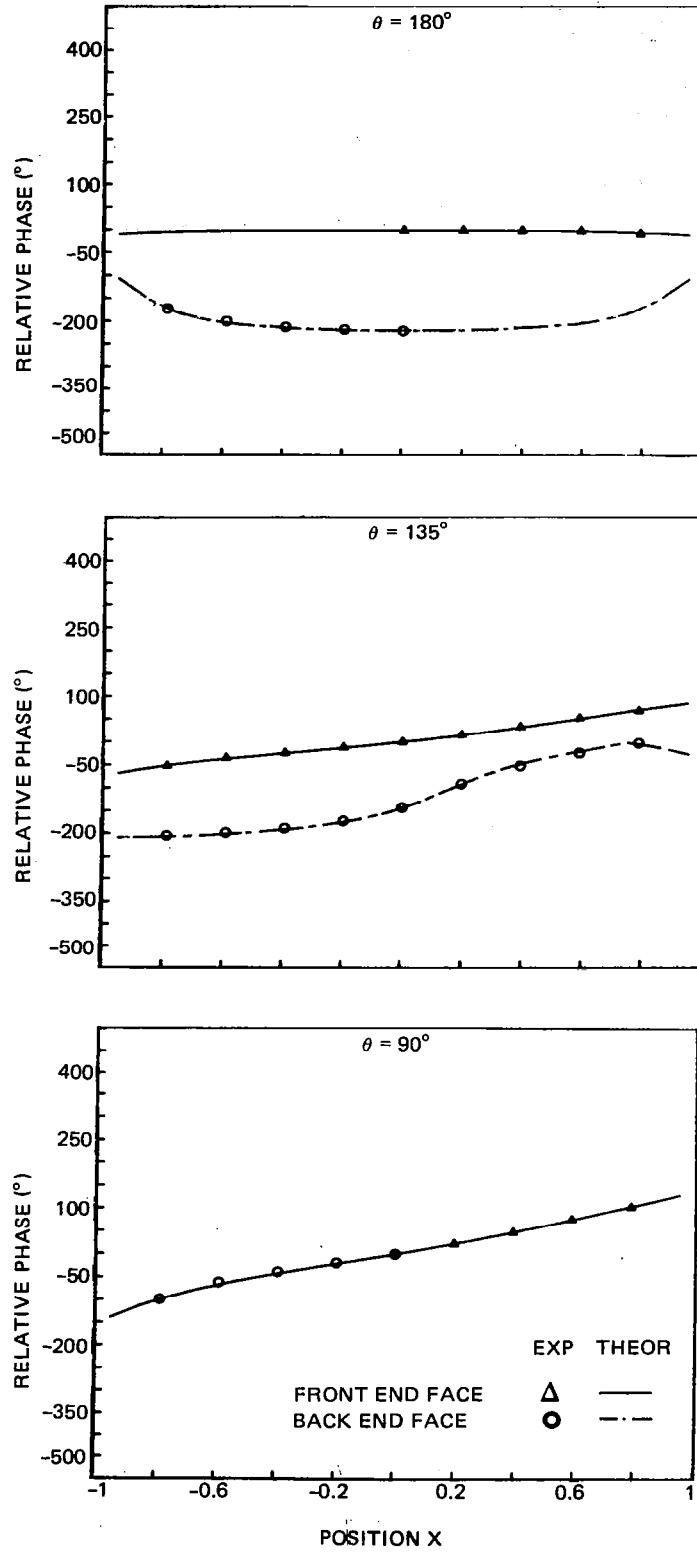

Fig. 19 Pressure Phase Variations on an L/D = 0.25 Cylinder Body at $ka = 2.288$

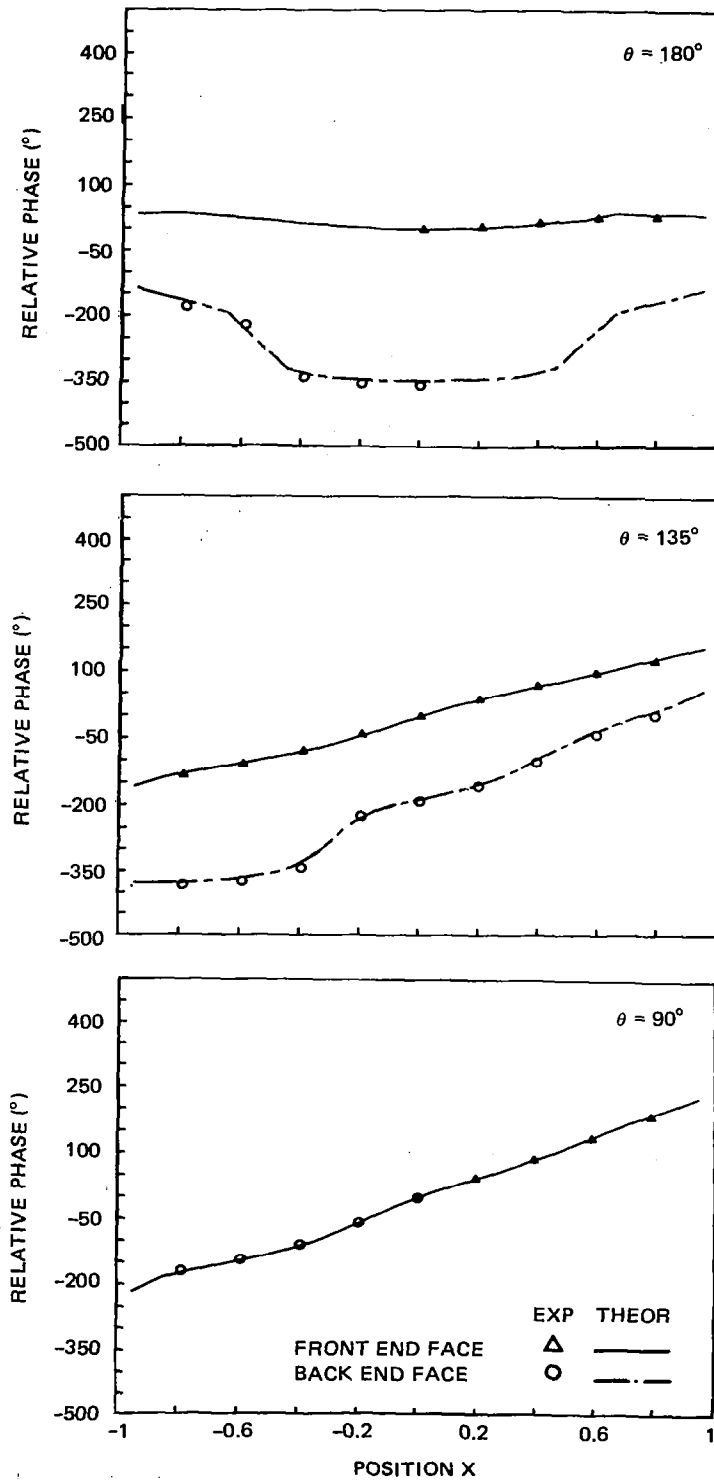

Fig. 20 Pressure Phase Variations on an $L/D = 0.25$ Cylinder Body at $ka = 4.232$

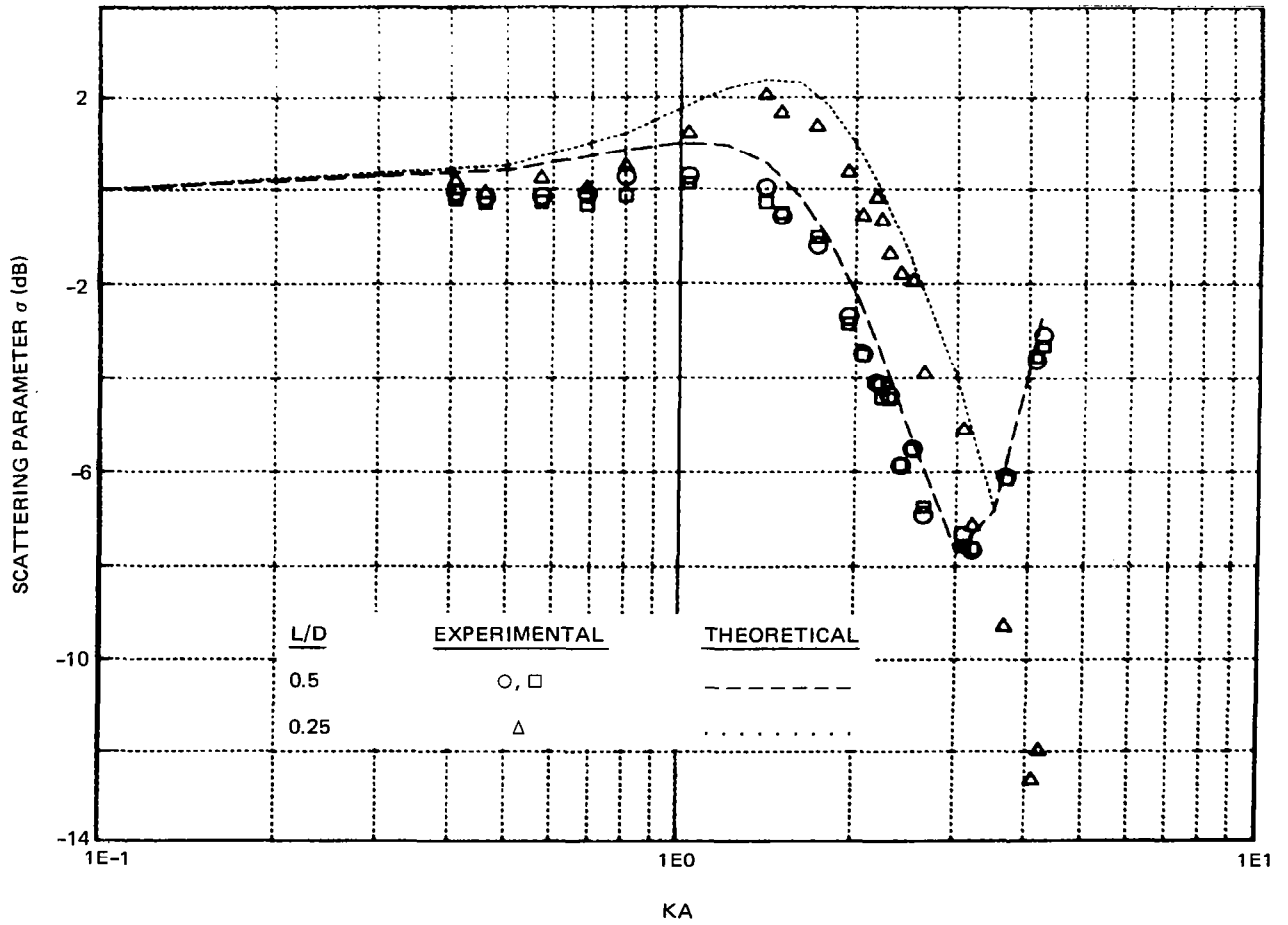

Fig. 21 Variations of the Scattering Parameter as a Function of ka for Circular Cylinders Having L/D of 0.5 and 0.25

CONCLUSIONS

Surface pressure augmentation and pressure phase changes brought about by acoustic scattering in a spherical sound field were experimentally determined for short circular cylinders having L/D ratios of 0.5 and 0.25. As expected, scattering effects were found to become more pronounced as the sound frequency was increased. Pressure augmentations in excess of three were measured.

Very good agreement was achieved between measured pressure augmentations and phase differences with theoretical values supplied by the Aeroacoustics Branch of the NASA Langley Research Center. This attests both to the suitability of the experimental approach and to the reliability of the theoretical model. Based on these results, scattering parameter variations were computed for both cylindrical bodies.

The scattering parameter curves are very useful in the preselection of proper geometries for pressure gradient microphones. It has been found that the longer cylinder model ($L/D = 0.5$) would possess a wider frequency operating range. This validates the findings arrived at theoretically in Ref. 1.

REFERENCES

1. Norum, T.D., and Seiner, J.M., "Shape Optimization of Pressure Gradient Microphones," NASA TM 78632, December 1977.
2. Maciulaitis, A., Seiner, J.M. and Norum, T.D., "Sound Scattering by Rigid Oblate Spheroids, with Implication to Pressure Gradient Microphones," NASA TN D-8140, May 1976.

APPENDIX A

TEST RESULTS

Measured pressure augmentation ratios and relative phase angles for 8 incidence angles and 22 frequencies between 178 to 1850 Hz are fully tabulated in this appendix. The tabulation is divided into three sections. Case 1 contains data for the $L/D = 0.5$ cylinder with the microphones 1-5 at the nondimensional positions $X = 0, -0.1968, -0.3931, -0.5905,$ and -0.7873 . Position 6 is always on the opposite cylinder end face at $X = 0$. Case 2 covers the same cylinder but for microphones rotated 180° about the cylinder axis, i.e., the X values are $0, +0.1968,$ etc. Case 3 contains data for the $L/D = 0.25$ cylinder with the microphone positions as in Case 2. Pressure augmentation ratios are designated by PI, phase angles relative to position by PH.

CASE 1

THETA	FREQ	PI(1)	PI(2)	PI(3)	PI(4)	PI(5)	PI(6)	PH(2)	PH(3)	PH(4)	PH(5)	PH(6)
180.000	178.000	1.136	1.150	1.134	1.110	1.070	.988	-.017	-.245	-2.368	-5.476	-59.607
180.000	200.000	1.129	1.149	1.134	1.105	1.062	1.052	.412	.026	-3.347	-6.072	-65.670
180.000	250.000	1.218	1.244	1.236	1.208	1.166	1.057	.339	-.576	-1.885	-7.270	-79.576
180.000	300.000	1.270	1.287	1.277	1.236	1.172	1.004	.325	-.528	-2.808	-7.735	-99.630
180.000	350.000	1.419	1.423	1.404	1.348	1.272	1.019	.230	-.606	-2.808	-7.571	-112.670
180.000	450.000	1.682	1.717	1.671	1.613	1.492	1.116	.427	-.340	-3.224	-8.650	-142.696
180.000	610.000	2.107	2.096	2.030	1.830	1.720	1.251	2.771	2.002	-1.457	-6.184	-181.000
180.000	650.000	1.988	2.092	2.064	1.996	1.724	1.331	-.396	.623	-1.270	-6.989	-170.437
180.000	750.000	2.305	2.302	2.236	2.051	1.836	1.349	.106	-1.985	-4.994	-11.173	-222.440
180.000	850.000	2.472	2.504	2.310	2.159	1.896	1.338	-.479	-1.061	-4.196	-12.097	-254.136
180.000	900.000	2.501	2.492	2.375	2.147	1.856	1.302	-.388	-.550	-3.907	-11.025	-263.379
180.000	950.000	2.731	2.722	2.534	2.314	2.013	1.341	.125	-.611	-3.124	-10.705	-280.973
180.000	976.000	2.897	2.881	2.727	2.432	2.087	1.371	-.286	-.952	-3.577	-13.047	-287.233
180.000	1000.000	3.039	3.001	2.822	2.490	2.024	1.369	.428	-.094	-2.531	-10.301	-294.231
180.000	1050.000	3.803	2.738	2.605	2.299	1.824	1.159	.506	-.916	-.916	-7.955	-303.512
180.000	1100.000	3.252	3.244	3.046	2.669	2.170	1.272	.419	.533	-1.247	-5.059	-316.506
180.000	1150.000	2.911	2.884	2.682	2.312	1.951	1.085	.490	1.262	.621	-2.891	-323.762
180.000	1150.000	3.175	3.168	2.949	2.528	2.048	1.137	.858	4.108	3.233	-369.119	
180.000	1400.000	2.988	2.865	2.656	2.245	1.913	.988	.747	3.329	5.561	5.609	-379.621
180.000	1600.000	2.731	2.319	2.536	2.268	1.873	1.029	1.704	5.971	11.384	14.520	-420.306
180.000	1300.000	2.547	2.631	2.509	2.197	1.956	1.056	3.897	11.085	16.747	24.427	-463.383
180.000	1350.000	2.473	2.490	2.356	2.068	1.861	1.065	2.257	9.856	20.554	24.701	-474.698
135.000	178.000	1.075	1.080	1.057	1.040	1.001	.973	-3.294	-7.289	-12.524	-18.959	-42.716
135.000	200.000	1.035	1.049	1.031	1.020	.977	1.045	-3.837	-7.886	-15.163	-22.515	-46.686
135.000	250.000	1.126	1.128	1.101	1.053	1.015	1.015	-4.016	-7.414	-15.789	-25.384	-60.285
135.000	300.000	1.144	1.139	1.105	1.049	.995	.923	-5.198	-11.010	-18.509	-29.278	-73.235
135.000	350.000	1.240	1.214	1.168	1.101	1.029	.931	-5.644	-11.972	-20.710	-32.193	-80.455
135.000	450.000	1.448	1.417	1.348	1.256	1.114	.942	-5.488	-13.161	-22.732	-35.545	-106.953
135.000	610.000	1.823	1.757	1.692	1.573	1.319	.976	-9.098	-16.922	-27.672	-41.643	-134.379
135.000	650.000	1.732	1.794	1.723	1.584	1.381	.954	-7.394	-14.275	-23.385	-38.752	-134.941
135.000	750.000	1.901	1.926	1.874	1.715	1.476	.824	-8.814	-13.589	-29.581	-43.973	-151.955
135.000	850.000	1.844	2.036	1.973	1.870	1.632	.877	-10.693	-21.253	-33.327	-49.767	-174.084
135.000	900.000	1.921	2.015	2.014	1.881	1.647	.850	-11.644	-22.936	-36.148	-52.279	-172.660
135.000	950.000	2.022	2.152	2.137	2.008	1.799	.585	-11.849	-23.525	-36.915	-53.776	-181.171
135.000	976.000	2.059	2.210	2.227	2.079	1.895	.564	-12.342	-24.518	-38.026	-56.777	-180.567
135.000	1000.000	2.182	2.264	2.295	2.145	1.844	.577	-12.814	-25.130	-38.683	-59.371	-184.096
135.000	1050.000	1.954	2.145	2.194	2.094	1.778	.486	-13.815	-27.408	-41.360	-61.375	-181.307
135.000	1100.000	2.114	2.364	2.446	2.335	1.968	.525	-14.610	-28.617	-43.874	-61.620	-179.304
135.000	1150.000	1.924	2.162	2.295	2.136	1.889	.528	-17.029	-31.671	-47.493	-66.742	-187.019
135.000	1350.000	2.009	2.445	2.718	2.670	2.295	.601	-23.200	-40.752	-58.739	-78.497	-203.884
135.000	1400.000	1.928	2.295	2.622	2.635	2.311	.631	-26.348	-45.825	-64.046	-84.416	-211.204
135.000	1600.000	1.898	2.293	2.768	2.793	2.669	.695	-37.265	-61.853	-83.475	-105.777	-244.260
135.000	1800.000	2.102	2.179	2.765	2.957	3.132	.765	-41.117	-79.559	-105.514	-130.279	-276.780
135.000	1850.000	2.034	2.013	2.570	3.055	2.955	.743	-38.638	-80.546	-110.151	-136.370	-287.725

CASE 1

THETA	FREQ	PI(1)	PI(2)	PI(3)	PI(4)	PI(5)	PI(6)	PH(2)	PH(3)	PH(4)	PH(5)	PH(6)
90.000	178.000	.984	.993	.986	.988	.970	.999	-4.648	-9.505	-15.171	-22.511	.334
90.000	200.000	.940	.965	.971	.997	.978	1.055	-4.909	-10.556	-18.515	-24.541	2.055
90.000	250.000	.951	.954	.946	.919	.912	1.014	-6.545	-13.900	-22.924	-32.473	-3.718
90.000	300.000	.935	.955	.946	.926	.922	.900	-7.993	-16.417	-26.154	-36.700	-.462
90.000	350.000	.957	.958	.947	.930	.925	.996	-9.864	-19.505	-30.577	-42.923	3.330
90.000	450.000	.970	.958	.912	.900	.872	.954	-10.925	-25.549	-40.565	-57.846	-1.522
90.000	610.000	.947	.999	.947	.833	.794	1.145	-25.128	-39.122	-47.869	-83.827	-7.977
90.000	650.000	1.100	1.040	.968	.887	.786	1.212	-15.965	-31.819	-53.662	-79.740	-.900
90.000	750.000	1.186	1.121	1.022	.856	.720	1.377	-14.998	-31.788	-53.395	-82.654	.155
90.000	850.000	1.262	1.252	1.093	.924	.733	1.255	-16.009	-32.667	-52.626	-84.461	-2.803
90.000	900.000	1.286	1.300	1.210	1.032	.808	1.384	-17.363	-32.935	-53.365	-81.518	.011
90.000	950.000	1.265	1.277	1.195	.939	.734	1.323	-17.291	-34.551	-54.624	-82.595	-3.747
90.000	970.000	1.302	1.325	1.246	1.031	.773	1.367	-17.716	-34.860	-53.995	-80.276	-3.333
90.000	1000.000	1.349	1.404	1.346	1.125	.872	1.434	-17.456	-34.686	-53.747	-80.507	-7.440
90.000	1050.000	1.220	1.328	1.300	1.124	.771	1.149	-19.981	-37.201	-55.968	-89.075	1.490
90.000	1100.000	1.232	1.361	1.358	1.187	.827	1.203	-21.362	-39.981	-59.732	-89.349	.118
90.000	1150.000	1.115	1.290	1.337	1.185	.864	1.108	-23.646	-42.622	-61.492	-85.572	2.212
90.000	1350.000	.996	1.170	1.344	1.330	1.042	1.001	-38.417	-65.275	-88.495	-110.548	-2.750
90.000	1400.000	.925	1.108	1.300	1.305	1.025	.961	-39.429	-67.065	-89.688	-111.550	2.000
90.000	1600.000	.917	.947	1.209	1.434	1.253	.952	-56.199	-95.797	-124.371	-148.833	-2.516
90.000	1800.000	1.005	.843	1.059	1.307	1.305	.999	-52.279	-108.907	-146.599	-173.648	3.903
90.000	1850.000	1.036	.839	.954	1.291	1.313	1.103	-45.688	-110.987	-154.040	-182.916	.948
45.000	178.000	.965	.979	.980	.987	.971	1.097	-3.210	-5.911	-7.866	-12.479	42.907
45.000	200.000	.965	.991	1.006	1.031	1.020	1.138	-2.591	-5.040	-6.366	-11.774	49.666
45.000	250.000	.902	.913	.924	.925	.905	1.147	-4.003	-8.325	-14.401	-18.240	58.025
45.000	300.000	.927	.976	.991	.990	.990	1.128	-4.368	-8.616	-13.652	-18.016	72.771
45.000	350.000	.945	.986	1.008	1.012	1.007	1.303	-5.978	-11.159	-16.551	-21.257	93.395
45.000	450.000	.909	.962	1.019	1.050	1.041	1.423	-7.333	-15.592	-21.390	-28.090	105.947
45.000	610.000	.785	1.013	1.029	.850	1.075	1.837	3.769	-4.268	-16.993	-20.998	152.659
45.000	650.000	.764	.947	1.047	1.158	1.077	1.925	-14.803	-21.298	-28.593	-36.630	144.345
45.000	750.000	.705	.848	.994	1.078	1.119	2.132	-17.367	-30.090	-40.063	-47.894	155.902
45.000	850.000	.614	.769	.909	1.041	1.110	1.937	-24.057	-41.824	-53.376	-63.109	162.279
45.000	900.000	.628	.768	.908	1.029	1.091	2.036	-25.032	-42.959	-56.187	-66.222	166.299
45.000	950.000	.535	.701	.893	1.053	1.148	2.075	-31.276	-50.664	-64.135	-74.938	173.613
45.000	970.000	.520	.671	.868	1.039	1.140	2.135	-34.931	-56.701	-70.818	-83.398	171.375
45.000	1000.000	.543	.664	.856	1.030	1.075	2.196	-36.965	-60.147	-75.897	-90.809	167.747
45.000	1050.000	.509	.636	.846	1.055	1.152	1.939	-39.430	-64.547	-79.792	-88.440	179.363
45.000	1100.000	.541	.620	.844	1.078	1.194	2.107	-45.031	-74.788	-93.257	-104.745	179.833
45.000	1150.000	.550	.600	.790	.996	1.083	1.985	-43.433	-74.467	-94.914	-107.435	186.183
45.000	1350.000	.575	.498	.703	1.024	1.194	2.040	-54.270	-102.452	-128.256	-141.704	203.917
45.000	1400.000	.614	.478	.611	.919	1.108	1.983	-49.849	-103.777	-133.847	-149.536	208.763
45.000	1600.000	.674	.455	.500	.881	1.165	1.976	-44.275	-113.265	-153.205	-171.298	240.772
45.000	1800.000	.775	.596	.442	.851	1.224	2.168	-30.821	-107.606	-163.784	-186.842	278.154
45.000	1850.000	.741	.571	.439	.846	1.231	2.162	-38.672	-111.378	-169.376	-189.367	288.846

CASE 1

THETA	FREQ	PI(1)	PI(2)	PI(3)	PI(4)	PI(5)	PI(6) *	PH(2)	PH(3)	PH(4)	PH(5)	PH(6)
.000	178.000	.978	.980	.975	.972	.953	1.155	.246	1.596	3.894	3.520	60.125
.000	200.000	1.011	1.019	1.021	1.029	1.004	1.181	1.228	2.954	6.421	5.679	67.228
.000	250.000	.912	.905	.904	.894	.846	1.281	1.478	3.157	3.535	7.224	82.361
.000	300.000	.985	1.014	1.003	.980	.952	1.272	1.821	3.112	4.696	7.783	99.250
.000	350.000	1.026	1.040	1.030	.998	.959	1.459	.990	3.191	6.118	10.192	112.905
.000	450.000	1.086	1.092	1.092	1.051	.977	1.695	2.019	4.134	8.273	13.291	144.525
.000	610.000	1.331	1.286	1.160	.815	.982	2.177	12.535	15.325	17.105	30.942	197.569
.000	650.000	1.163	1.230	1.166	1.106	.901	2.382	1.990	9.351	16.229	27.235	200.870
.000	750.000	1.270	1.266	1.203	1.032	.840	2.509	2.399	5.656	13.629	27.713	222.963
.000	850.000	1.257	1.249	1.097	.914	.678	2.531	1.293	6.416	15.058	31.980	253.450
.000	900.000	1.214	1.193	1.077	.870	.651	2.646	2.043	6.984	16.323	36.315	263.166
.000	950.000	1.256	1.226	1.079	.828	.577	2.831	1.931	6.278	15.955	36.811	280.935
.000	970.000	1.279	1.244	1.087	.817	.533	3.038	1.814	6.517	16.505	35.627	286.198
.000	1000.000	1.279	1.246	1.078	.793	.457	3.299	2.332	6.655	17.415	38.978	291.906
.000	1050.000	1.150	1.109	.941	.679	.407	2.959	2.235	7.669	20.761	60.885	302.502
.000	1100.000	1.223	1.178	.979	.662	.399	3.337	2.370	8.639	21.966	65.577	316.239
.000	1150.000	1.091	1.048	.861	.569	.333	3.074	2.151	8.540	23.521	72.862	323.651
.000	1350.000	1.060	.998	.749	.382	.279	3.262	2.562	9.949	32.444	124.638	369.245
.000	1400.000	.976	.907	.662	.312	.291	3.412	2.456	10.666	38.014	134.589	378.306
.000	1600.000	.947	.821	.524	.178	.426	2.871	.622	13.663	77.394	163.339	420.469
.000	1800.000	1.063	.856	.440	.168	.524	2.793	3.897	16.682	124.499	177.295	463.351
.000	1850.000	.959	.872	.441	.211	.537	2.549	6.089	20.595	147.899	177.381	476.030
-45.000	178.000	.963	.959	.947	.950	.928	1.096	3.920	8.783	14.584	18.637	43.254
-45.000	200.000	.997	.995	.990	1.005	.969	1.090	4.922	10.679	16.938	20.516	47.715
-45.000	250.000	.856	.851	.854	.845	.842	1.248	7.588	14.564	20.852	30.045	59.546
-45.000	300.000	.936	.947	.929	.901	.896	1.128	7.084	14.491	22.400	30.913	73.513
-45.000	350.000	.944	.938	.924	.906	.902	1.253	8.398	17.667	27.693	38.636	84.174
-45.000	450.000	.933	.913	.890	.880	.861	1.448	12.040	22.647	36.908	51.605	109.155
-45.000	610.000	.755	.833	.771	.776	.803	1.681	27.481	51.401	68.598	96.786	150.732
-45.000	650.000	.755	.722	.721	.721	.772	1.924	16.805	40.544	61.127	88.015	143.662
-45.000	750.000	.770	.700	.684	.735	.641	2.048	24.150	50.855	80.225	104.521	153.021
-45.000	850.000	.588	.539	.578	.686	.794	1.982	33.181	68.355	96.383	119.568	169.268
-45.000	900.000	.602	.574	.628	.722	.811	1.996	33.176	66.337	94.555	118.164	169.659
-45.000	950.000	.537	.520	.616	.752	.833	2.131	41.235	77.274	125.478	125.936	179.913
-45.000	970.000	.516	.535	.661	.808	.846	2.202	43.666	77.300	104.319	127.576	178.440
-45.000	1000.000	.534	.593	.732	.871	.931	2.364	42.055	74.325	99.975	127.138	177.550
-45.000	1050.000	.516	.572	.710	.842	.918	2.044	44.477	76.388	103.092	128.311	181.743
-45.000	1100.000	.512	.657	.827	.937	.963	2.201	42.203	69.852	94.188	119.577	178.823
-45.000	1150.000	.507	.626	.753	.819	.827	1.998	39.613	69.204	96.370	124.874	187.395
-45.000	1350.000	.557	.787	.871	.809	.779	2.084	32.835	58.940	89.294	130.787	201.051
-45.000	1400.000	.601	.770	.800	.715	.700	1.946	29.974	56.677	93.197	140.083	209.488
-45.000	1600.000	.662	.741	.638	.589	.802	1.971	29.057	65.866	123.479	175.053	242.963
-45.000	1800.000	.747	.637	.570	.787	.947	2.173	36.248	94.981	152.582	193.438	276.527
-45.000	1850.000	.732	.738	.597	.790	.934	2.112	37.174	94.753	157.420	199.471	285.912

CASE 1

THETA	FREQ	PI(1)	PI(2)	PI(3)	PI(4)	PI(5)	PI(6)	PH(2)	PH(3)	PH(4)	PH(5)	PH(6)
-90.000	178.000	.976	.986	.987	1.001	.987	.993	5.772	11.736	17.037	21.639	.725
-90.000	200.000	.998	1.012	1.019	1.039	1.017	.987	6.793	13.208	18.742	24.226	-.482
-90.000	250.000	.882	.918	.950	.962	.987	1.131	8.826	16.623	24.053	29.888	.144
-90.000	300.000	.932	.964	.984	.993	1.014	.900	9.602	18.394	27.093	34.528	1.395
-90.000	350.000	.961	.999	1.033	1.055	1.079	.930	10.688	20.670	30.253	38.516	1.669
-90.000	450.000	.953	1.023	1.045	1.094	1.108	.951	13.679	24.992	35.939	46.609	4.916
-90.000	610.000	1.009	1.113	1.194	1.312	1.193	1.162	7.314	20.760	34.659	49.292	-3.934
-90.000	650.000	1.075	1.150	1.197	1.197	1.206	1.198	15.088	30.475	45.767	61.404	-3.170
-90.000	750.000	1.263	1.319	1.336	1.306	1.279	1.263	16.557	32.088	50.416	68.863	.049
-90.000	850.000	1.200	1.228	1.164	1.127	1.096	1.305	17.387	38.359	59.925	83.089	1.395
-90.000	900.000	1.285	1.249	1.193	1.132	1.137	1.352	19.620	41.930	67.164	93.219	-.930
-90.000	950.000	1.219	1.186	1.127	1.076	1.067	1.335	21.037	45.062	72.519	99.816	2.794
-90.000	970.000	1.262	1.213	1.140	1.084	1.097	1.387	21.055	46.077	74.616	104.653	1.763
-90.000	1000.000	1.334	1.247	1.160	1.115	1.220	1.534	23.025	49.854	80.734	109.771	3.968
-90.000	1050.000	1.214	1.121	1.046	1.039	1.157	1.288	26.204	56.736	90.115	120.320	-3.604
-90.000	1100.000	1.199	1.084	1.015	1.032	1.181	1.290	28.793	62.848	98.229	127.607	-.857
-90.000	1150.000	1.075	.977	.981	1.078	1.192	1.182	33.082	70.625	105.511	132.558	-3.291
-90.000	1350.000	.960	.988	1.121	1.214	1.267	1.019	44.495	82.411	115.222	145.645	1.455
-90.000	1400.000	.892	.964	1.125	1.200	1.219	.943	45.387	82.326	115.785	147.085	-3.455
-90.000	1600.000	.920	1.111	1.168	1.121	1.112	.941	45.375	79.422	118.707	159.398	2.390
-90.000	1800.000	.962	1.039	1.021	1.069	1.106	1.035	40.948	65.952	137.525	179.471	-1.675
-90.000	1850.000	1.053	1.172	1.102	1.141	1.182	1.069	40.735	86.651	139.486	184.634	-1.258
-135.000	178.000	1.066	1.087	1.037	1.035	1.067	.971	3.904	7.432	7.421	11.069	-42.541
-135.000	200.000	1.073	1.102	1.109	1.105	1.081	.999	4.558	8.403	10.283	12.554	-47.672
-135.000	250.000	1.072	1.120	1.144	1.131	1.142	1.059	5.494	9.229	13.161	13.786	-55.732
-135.000	300.000	1.119	1.162	1.182	1.187	1.170	.913	6.146	11.122	15.291	16.807	-72.217
-135.000	350.000	1.232	1.277	1.302	1.297	1.274	.918	6.708	11.922	15.822	18.154	-81.726
-135.000	450.000	1.393	1.465	1.485	1.466	1.416	.913	7.706	13.491	17.930	21.185	-103.829
-135.000	610.000	1.780	1.753	1.711	1.593	1.501	.881	9.147	16.666	22.885	29.753	-129.566
-135.000	650.000	1.704	1.758	1.738	1.677	1.549	.975	9.167	18.926	26.715	34.386	-137.766
-135.000	750.000	1.961	1.914	1.827	1.671	1.524	.763	10.438	19.399	30.002	38.328	-155.826
-135.000	850.000	1.873	1.812	1.640	1.512	1.358	.625	11.698	26.159	38.165	49.300	-159.950
-135.000	900.000	1.877	1.774	1.648	1.488	1.357	.689	13.538	27.929	42.217	55.029	-164.282
-135.000	950.000	1.954	1.824	1.662	1.482	1.349	.580	14.416	29.301	45.809	58.420	-171.103
-135.000	970.000	2.010	1.861	1.686	1.503	1.341	.571	14.938	30.752	47.721	61.396	-170.213
-135.000	1000.000	2.069	1.909	1.722	1.539	1.378	.641	16.161	33.434	51.376	66.309	-167.391
-135.000	1050.000	1.974	1.801	1.605	1.426	1.304	.548	17.132	35.727	55.573	72.089	-184.685
-135.000	1100.000	2.052	1.846	1.652	1.492	1.417	.554	19.498	40.738	62.788	80.056	-181.202
-135.000	1150.000	1.911	1.715	1.535	1.387	1.308	.571	20.250	43.216	66.465	84.307	-183.926
-135.000	1350.000	1.938	1.734	1.686	1.660	1.597	.589	31.170	61.025	86.233	104.261	-204.740
-135.000	1400.000	1.853	1.683	1.673	1.645	1.544	.609	31.833	62.519	88.410	104.976	-207.624
-135.000	1600.000	1.881	1.956	2.015	1.885	1.606	.676	40.896	66.473	90.562	111.161	-239.778
-135.000	1800.000	2.050	2.146	2.025	1.778	1.513	.781	32.226	63.489	101.243	128.231	-276.292
-135.000	1850.000	2.060	2.129	1.982	1.782	1.440	.754	30.249	63.589	99.886	132.316	-280.609

CASE 2

THETA	FREQ	PI(1)	PI(2)	PI(3)	PI(4)	PI(5)	PI(6)	PH(2)	PH(3)	PH(4)	PH(5)	PH(6)
190.000	178.000	1.124	1.138	1.120	1.100	1.061	.979	.396	.345	-1.962	-4.585	-59.203
190.000	200.000	1.121	1.148	1.146	1.122	1.100	1.038	.802	.365	-3.247	-4.980	-65.313
190.000	250.000	1.209	1.218	1.201	1.175	1.122	1.025	-.008	-.324	-1.661	-6.625	-79.897
190.000	300.000	1.258	1.270	1.256	1.215	1.159	.981	.771	-.166	-2.235	-6.760	-97.952
190.000	350.000	1.390	1.413	1.404	1.356	1.285	1.013	.372	-.472	-2.280	-6.577	-112.387
190.000	450.000	1.661	1.671	1.625	1.545	1.459	1.073	-.315	.036	-4.050	-9.004	-141.555
190.000	610.000	2.020	2.071	2.040	1.854	1.712	1.221	1.567	1.577	-.559	-6.236	-181.317
190.000	650.000	2.005	2.023	2.050	1.902	1.774	1.353	-.704	-2.562	-5.066	-8.190	-194.701
190.000	750.000	2.323	2.360	2.273	2.124	1.929	1.400	.452	-1.616	-3.888	-9.628	-221.811
190.000	850.000	2.425	2.380	2.273	2.084	1.824	1.308	-.107	-.305	-3.937	-10.217	-253.618
190.000	900.000	2.517	2.437	2.367	2.123	1.852	1.247	1.175	.583	-1.950	-8.870	-263.522
190.000	950.000	2.671	2.669	2.522	2.250	1.930	1.321	.877	.426	-1.490	-9.674	-278.049
190.000	970.000	2.617	2.619	2.654	2.361	1.985	1.349	.555	.500	-1.738	-9.986	-235.122
190.000	1000.000	3.001	2.927	2.822	2.497	2.040	1.354	.805	.606	-1.129	-8.269	-293.852
190.000	1050.000	2.772	2.764	2.640	2.286	1.860	1.169	.473	.736	-.227	-5.423	-301.732
190.000	1100.000	3.232	3.204	2.997	2.613	2.086	1.295	.564	.794	-.531	-4.248	-315.253
190.000	1150.000	2.961	2.929	2.719	2.316	2.063	1.109	.566	1.762	1.238	-.695	-322.959
190.000	1250.000	3.115	3.106	2.877	2.464	2.061	1.126	1.344	4.199	5.930	5.920	-367.541
190.000	1400.000	2.933	2.875	2.659	2.263	1.939	1.100	1.631	4.497	7.639	8.720	-378.444
190.000	1500.000	2.731	2.746	2.562	2.203	1.830	.971	3.187	8.094	14.331	17.569	-416.700
190.000	1800.000	2.623	2.603	2.413	2.069	1.842	1.061	5.367	13.670	33.414	30.016	-460.425
190.000	1950.000	2.451	2.498	2.358	2.072	1.901	1.055	5.357	15.456	27.735	33.135	-470.779
135.000	178.000	1.066	1.039	1.089	1.088	1.072	.971	3.991	7.582	9.831	11.390	-42.587
135.000	200.000	1.039	1.072	1.036	1.087	1.081	1.032	5.209	9.151	10.281	13.039	-45.772
135.000	250.000	1.124	1.139	1.173	1.179	1.159	.979	4.681	8.945	12.750	13.711	-60.228
135.000	300.000	1.138	1.179	1.179	1.174	1.176	.910	6.101	10.643	14.649	16.599	-71.533
135.000	350.000	1.209	1.267	1.297	1.275	1.279	.931	6.455	11.072	15.426	18.246	-80.490
135.000	450.000	1.422	1.494	1.474	1.442	1.420	.926	5.835	13.194	16.798	19.616	-104.583
135.000	610.000	1.795	1.775	1.748	1.640	1.535	.862	8.328	16.149	22.344	28.354	-129.947
135.000	650.000	1.710	1.723	1.738	1.620	1.559	.914	8.170	15.387	23.817	31.401	-138.825
135.000	750.000	1.900	1.896	1.792	1.673	1.543	.865	10.058	19.345	29.441	38.042	-149.501
135.000	850.000	1.837	1.775	1.647	1.486	1.353	.633	11.886	25.246	38.421	49.607	-170.398
135.000	900.000	1.916	1.808	1.675	1.514	1.372	.627	14.091	28.279	42.986	54.953	-167.342
135.000	950.000	1.953	1.851	1.682	1.496	1.331	.598	14.681	29.645	45.690	59.511	-177.698
135.000	970.000	2.000	1.869	1.638	1.499	1.358	.573	14.826	30.817	47.905	63.098	-178.798
135.000	1000.000	2.043	1.897	1.710	1.523	1.385	.514	15.977	33.350	51.091	64.925	-186.555
135.000	1050.000	1.919	1.770	1.601	1.431	1.307	.515	17.259	35.673	55.567	72.297	-177.496
135.000	1100.000	2.096	1.890	1.680	1.503	1.406	.528	18.392	39.112	60.882	80.214	-177.629
135.000	1150.000	1.909	1.718	1.547	1.376	1.345	.543	20.652	43.867	67.126	85.284	-182.275
135.000	1350.000	1.935	1.734	1.662	1.656	1.604	.602	30.600	61.271	87.554	105.051	-201.004
135.000	1400.000	1.811	1.668	1.634	1.676	1.567	.611	31.386	61.677	86.301	103.506	-210.362
135.000	1600.000	1.908	2.032	2.001	1.670	1.572	.681	36.687	64.520	88.880	109.525	-245.031
135.000	1800.000	2.124	2.199	2.029	1.679	1.487	.743	35.325	66.103	97.654	129.480	-272.192
135.000	1850.000	2.071	2.165	1.977	1.634	1.446	.761	34.905	67.537	104.773	137.417	-283.544

CASE 2

THETA	FREQ	PI(1)	PI(2)	PI(3)	PI(4)	PI(5)	PI(6)	PH(2)	PH(3)	PH(4)	PH(5)	
90.000	178.000	.983	.993	.996	1.004	.989	.987	5.577	11.116	16.483	21.217	-1.177
90.000	200.000	.955	.961	.966	.983	.971	1.040	6.862	13.694	19.339	25.008	1.473
90.000	250.000	.951	.991	1.014	1.027	1.051	.977	7.638	15.123	22.520	28.448	-3.255
90.000	300.000	.949	.979	.998	1.009	1.024	.904	9.451	17.993	26.698	34.065	.872
90.000	350.000	.941	.983	1.018	1.037	1.059	.965	11.104	20.974	30.515	39.435	3.249
90.000	450.000	.959	1.051	1.050	1.083	1.136	.949	12.337	24.986	34.429	45.047	.834
90.000	610.000	1.062	1.133	1.195	1.293	1.248	1.131	7.335	20.204	33.135	47.645	-6.514
90.000	650.000	1.090	1.161	1.208	1.198	1.215	1.162	15.001	28.813	44.358	59.124	1.553
90.000	750.000	1.136	1.259	1.238	1.247	1.229	1.433	16.364	31.988	50.037	68.100	-.051
90.000	850.000	1.224	1.218	1.182	1.121	1.094	1.216	17.763	37.681	59.874	82.711	-1.220
90.000	900.000	1.302	1.265	1.204	1.152	1.151	1.379	20.738	42.580	68.405	93.812	.142
90.000	950.000	1.226	1.211	1.151	1.111	1.074	1.320	22.142	46.415	73.353	99.936	-3.427
90.000	970.000	1.243	1.224	1.159	1.108	1.093	1.352	21.558	46.284	73.822	104.440	-4.759
90.000	1000.000	1.293	1.223	1.142	1.075	1.194	1.226	22.351	48.266	77.707	106.850	-10.666
90.000	1050.000	1.206	1.111	1.034	1.040	1.133	1.199	25.906	56.774	90.836	110.170	2.492
90.000	1100.000	1.213	1.123	1.068	1.096	1.192	1.229	28.453	61.018	95.121	125.385	.100
90.000	1150.000	1.116	.994	.970	1.065	1.212	1.137	31.742	70.481	107.432	135.738	1.425
90.000	1350.000	.938	1.027	1.172	1.250	1.267	1.021	44.382	79.725	111.189	142.008	-2.110
90.000	1400.000	.862	.915	1.001	1.159	1.201	.936	44.538	82.873	116.918	147.810	-2.130
90.000	1600.000	.955	1.179	1.221	1.152	1.124	.938	46.433	78.083	116.469	156.838	-.833
90.000	1800.000	.986	1.068	1.039	1.032	1.146	.978	43.943	89.850	142.535	183.106	6.879
90.000	1850.000	.999	1.127	1.091	1.152	1.186	1.128	42.919	89.645	142.498	185.955	2.775
45.000	178.000	.962	.962	.952	.949	.935	1.080	3.908	8.896	14.519	18.024	42.598
45.000	200.000	.977	.959	.949	.945	.914	1.124	4.419	9.554	16.118	19.998	48.478
45.000	250.000	.894	.914	.919	.912	.929	1.118	6.708	13.709	20.447	28.720	58.381
45.000	300.000	.929	.934	.931	.905	.906	1.128	7.065	14.291	22.384	31.149	71.817
45.000	350.000	.934	.933	.928	.904	.890	1.264	8.408	17.181	27.178	38.128	83.965
45.000	450.000	.905	.906	.852	.853	.850	1.412	12.052	22.667	35.938	52.488	107.221
45.000	610.000	.682	.789	.782	.802	.820	1.806	22.205	43.352	75.477	93.418	143.495
45.000	650.000	.781	.737	.717	.696	.787	1.891	16.718	34.370	60.133	81.953	141.579
45.000	750.000	.710	.634	.602	.656	.759	2.217	24.550	52.763	82.756	107.491	155.118
45.000	850.000	.609	.555	.612	.716	.830	1.924	32.361	65.779	94.174	116.257	163.450
45.000	900.000	.629	.595	.655	.751	.845	2.021	33.754	65.364	93.732	117.012	166.981
45.000	950.000	.552	.531	.625	.764	.881	2.048	41.659	76.451	105.264	125.793	175.639
45.000	970.000	.522	.543	.662	.810	.889	2.100	44.038	77.565	104.510	123.367	174.325
45.000	1000.000	.493	.561	.692	.848	.836	1.935	43.213	76.119	101.722	128.198	170.749
45.000	1050.000	.504	.575	.717	.838	.915	1.987	43.131	74.135	99.433	-119.660	182.563
45.000	1100.000	.515	.649	.816	.920	.964	2.138	43.312	72.196	96.931	122.833	183.118
45.000	1150.000	.514	.660	.805	.880	.880	2.026	38.581	66.949	93.256	120.768	185.282
45.000	1350.000	.514	.753	.817	.788	.761	2.063	33.479	60.436	93.965	137.325	203.395
45.000	1400.000	.601	.769	.805	.732	.717	1.961	26.878	53.851	88.645	134.193	203.071
45.000	1600.000	.680	.722	.630	.582	.787	1.989	28.653	65.770	124.311	175.421	239.750
45.000	1800.000	.777	.711	.620	.746	.983	2.137	36.683	93.876	156.222	193.594	280.609
45.000	1850.000	.758	.729	.639	.794	.913	2.171	38.928	90.633	146.555	194.712	284.519

CASE 2

THETA	FREQ	PI(1)	PI(2)	PI(3)	PI(4)	PI(5)	PI(6)	PH(2)	PH(3)	PH(4)	PH(5)	PH(6)
.000	178.000	.968	.972	.966	.957	.946	1.141	.360	1.621	4.367	4.243	59.863
.000	200.000	1.013	1.004	1.002	.989	.969	1.167	.158	1.520	4.349	2.931	66.191
.000	250.000	.897	.920	.926	.923	.908	1.252	2.244	3.942	4.901	10.211	83.926
.000	300.000	.972	.998	.994	.962	.929	1.268	1.130	2.935	4.971	7.846	98.238
.000	350.000	1.007	1.024	1.024	.995	.955	1.430	1.386	3.398	5.625	9.343	113.462
.000	450.000	1.075	1.093	1.075	1.048	.957	1.685	2.464	2.603	7.028	12.685	145.208
.000	610.000	1.169	1.254	1.205	.938	.863	2.140	10.236	16.035	23.279	30.376	196.360
.000	650.000	1.137	1.173	1.195	1.060	.949	2.246	.703	2.934	8.915	22.112	197.913
.000	750.000	1.284	1.277	1.181	1.006	.801	2.592	.935	3.380	10.198	22.315	220.205
.000	850.000	1.237	1.209	1.091	.893	.671	2.467	1.222	6.331	14.549	31.263	252.608
.000	900.000	1.215	1.182	1.065	.850	.622	2.656	2.204	7.122	16.910	36.912	263.420
.000	950.000	1.238	1.226	1.089	.848	.558	2.790	2.416	7.239	17.359	37.967	279.802
.000	970.000	1.252	1.236	1.091	.834	.509	2.995	1.631	6.253	16.464	40.904	284.630
.000	1000.000	1.238	1.200	1.051	.780	.521	3.069	1.797	6.507	16.826	46.389	288.430
.000	1050.000	1.143	1.116	.962	.696	.404	2.872	1.777	6.556	17.751	48.572	301.784
.000	1100.000	1.227	1.190	1.082	.692	.392	3.318	1.624	6.436	18.363	61.652	314.983
.000	1150.000	1.126	1.083	.892	.568	.343	3.179	1.633	7.909	22.017	71.099	322.909
.000	1350.000	1.035	.970	.723	.365	.293	3.186	3.311	11.065	35.944	125.405	368.410
.000	1400.000	.969	.920	.677	.321	.284	3.171	1.819	10.022	37.386	133.343	366.882
.000	1600.000	.911	.776	.489	.177	.432	2.908	.798	14.861	83.185	162.497	418.329
.000	1800.000	1.065	.950	.546	.173	.508	2.911	2.306	13.846	106.002	172.320	460.803
.000	1850.000	.949	.792	.406	.231	.516	2.547	-1.249	11.062	126.664	173.411	468.694
-45.000	178.000	.952	.963	.964	.964	.962	1.083	-3.300	-5.705	-7.844	-12.616	43.169
-45.000	200.000	.995	1.000	1.012	1.015	1.006	1.077	-3.180	-6.258	-8.245	-13.647	47.097
-45.000	250.000	.837	.871	.890	.897	.898	1.217	-3.682	-7.894	-13.245	-15.099	60.305
-45.000	300.000	.919	.966	.977	.972	.966	1.123	-4.639	-9.070	-13.605	-17.714	72.361
-45.000	350.000	.917	.957	.986	.989	.985	1.236	-5.787	-11.050	-16.464	-21.733	83.340
-45.000	450.000	.922	.995	1.015	1.073	1.042	1.447	-6.415	-16.107	-22.066	-27.623	109.801
-45.000	610.000	.673	.965	1.073	1.000	1.060	1.830	-9.672	-17.005	-22.373	-32.600	139.419
-45.000	650.000	.769	.891	1.037	1.098	1.128	1.895	-16.044	-28.008	-36.751	-41.691	139.683
-45.000	750.000	.792	.925	1.044	1.118	1.149	2.095	-17.126	-31.131	-41.969	-50.517	149.702
-45.000	850.000	.595	.735	.881	1.007	1.074	1.947	-24.259	-39.743	-51.794	-61.466	166.108
-45.000	900.000	.620	.740	.889	1.001	1.056	2.017	-25.210	-43.151	-57.181	-67.858	167.218
-45.000	950.000	.531	.701	.896	1.055	1.121	2.114	-30.512	-49.441	-62.706	-73.690	177.380
-45.000	970.000	.522	.668	.876	1.048	1.093	2.201	-35.121	-56.006	-70.145	-82.041	174.010
-45.000	1000.000	.534	.646	.847	1.021	1.083	2.250	-34.926	-59.267	-74.855	-82.535	172.150
-45.000	1050.000	.528	.644	.840	1.031	1.122	2.020	-37.986	-63.132	-79.128	-90.521	177.381
-45.000	1100.000	.539	.605	.826	1.068	1.188	2.205	-45.156	-75.840	-94.819	-105.891	175.800
-45.000	1150.000	.560	.606	.785	.977	1.088	2.022	-41.652	-72.049	-93.725	-106.501	184.997
-45.000	1350.000	.589	.501	.714	1.034	1.200	2.072	-56.856	-104.876	-129.786	-143.633	198.329
-45.000	1400.000	.625	.483	.627	.928	1.102	1.895	-49.459	-102.231	-131.192	-147.005	210.175
-45.000	1600.000	.674	.412	.504	.914	1.194	1.963	-50.605	-118.857	-153.967	-171.325	239.854
-45.000	1800.000	.707	.587	.399	.827	1.175	2.127	-32.374	-104.870	-170.390	-190.967	271.964
-45.000	1850.000	.692	.624	.494	.932	1.253	2.159	-41.033	-108.780	-169.130	-191.281	282.568

CASE 2

THETA	FREQ	PI(1)	PI(2)	PI(3)	PI(4)	PI(5)	PI(6)	PH(2)	PH(3)	PH(4)	PH(5)	PH(6)
-90.000	178.000	.963	.966	.959	.960	.949	.982	-4.866	-9.714	-15.181	-22.911	.750
-90.000	200.000	.991	.998	1.002	1.014	.991	.978	-4.753	-9.864	-16.467	-24.227	-.712
-90.000	250.000	.860	.873	.862	.841	.846	1.105	-6.842	-14.928	-24.084	-32.385	.299
-90.000	300.000	.923	.940	.940	.919	.910	.882	-8.565	-16.856	-25.882	-36.385	.613
-90.000	350.000	.943	.940	.932	.909	.895	.930	-9.226	-19.247	-30.519	-43.119	.384
-90.000	450.000	.950	.965	.880	.908	.884	.942	-12.211	-26.081	-42.499	-56.644	6.226
-90.000	610.000	1.111	1.002	.945	.907	.811	1.141	-20.014	-36.625	-53.449	-79.530	-3.999
-90.000	650.000	1.078	1.020	.954	.850	.767	1.170	-15.356	-31.679	-53.707	-79.481	-2.905
-90.000	750.000	1.290	1.235	1.127	.959	.826	1.271	-14.996	-32.271	-53.063	-81.606	-1.150
-90.000	850.000	1.186	1.146	1.038	.860	.681	1.273	-16.288	-32.413	-53.601	-84.222	.942
-90.000	900.000	1.307	1.309	1.220	1.019	.795	1.385	-15.613	-31.783	-51.130	-78.582	.148
-90.000	950.000	1.228	1.243	1.164	.964	.745	1.324	-16.937	-34.190	-54.288	-81.772	2.799
-90.000	970.000	1.256	1.290	1.203	.995	.793	1.391	-16.857	-34.547	-54.277	-81.955	2.358
-90.000	1000.000	1.265	1.330	1.250	1.040	.790	1.472	-17.933	-34.604	-52.750	-88.800	-2.293
-90.000	1050.000	1.223	1.324	1.300	1.121	.808	1.267	-19.873	-37.187	-56.232	-84.099	-2.987
-90.000	1100.000	1.230	1.363	1.362	1.179	.841	1.289	-21.135	-39.227	-58.246	-84.704	-1.441
-90.000	1150.000	1.131	1.300	1.354	1.208	.891	1.208	-24.050	-42.630	-61.637	-86.403	-3.140
-90.000	1350.000	.994	1.186	1.364	1.341	1.031	1.004	-38.689	-64.874	-87.290	-109.447	-1.578
-90.000	1400.000	.935	1.095	1.288	1.289	1.013	.925	-38.769	-66.567	-88.980	-111.098	-.614
-90.000	1600.000	.914	.930	1.203	1.373	1.316	.937	-53.223	-92.524	-121.458	-145.224	2.634
-90.000	1800.000	.893	.633	1.014	1.354	1.198	1.025	-53.192	-107.219	-145.395	-172.208	-2.755
-90.000	1850.000	1.047	.910	1.087	1.433	1.413	1.087	-54.233	-113.228	-156.729	-181.924	-3.431
-135.000	178.000	1.049	1.048	1.026	1.008	.973	.958	-3.334	-6.864	-12.587	-19.376	-42.037
-135.000	200.000	1.065	1.074	1.063	1.051	1.014	.989	-3.065	-7.415	-14.626	-20.604	-47.555
-135.000	250.000	1.055	1.049	1.018	.967	.929	1.038	-4.615	-9.800	-16.170	-25.744	-56.548
-135.000	300.000	1.113	1.098	1.069	1.016	.969	.892	-5.102	-11.417	-19.102	-29.417	-72.434
-135.000	350.000	1.218	1.202	1.164	1.093	1.013	.913	-5.168	-11.791	-19.697	-30.659	-82.432
-135.000	450.000	1.385	1.375	1.265	1.183	1.086	.882	-6.982	-13.037	-25.367	-37.570	-103.407
-135.000	610.000	1.765	1.734	1.664	1.495	1.298	.868	-5.911	-13.313	-25.170	-38.479	-129.280
-135.000	650.000	1.691	1.706	1.720	1.547	1.308	.937	-6.943	-17.425	-28.245	-39.675	-140.786
-135.000	750.000	1.998	2.056	2.014	1.844	1.606	.788	-8.520	-18.840	-29.797	-44.232	-157.918
-135.000	850.000	1.861	1.910	1.877	1.737	1.515	.614	-10.637	-20.882	-33.174	-49.005	-162.489
-135.000	900.000	1.915	2.003	2.005	1.864	1.650	.665	-10.561	-21.576	-34.582	-50.841	-161.939
-135.000	950.000	1.946	2.084	2.086	1.934	1.723	.604	-10.653	-22.649	-35.658	-53.712	-171.437
-135.000	970.000	1.986	2.151	2.167	2.022	1.787	.593	-11.742	-23.583	-36.762	-55.887	-170.703
-135.000	1000.000	1.977	2.140	2.180	2.049	1.773	.668	-12.307	-24.881	-38.575	-56.867	-176.909
-135.000	1050.000	1.969	2.153	2.199	2.077	1.756	.536	-13.439	-26.729	-40.826	-60.089	-185.315
-135.000	1100.000	2.085	2.331	2.429	2.323	1.967	.554	-14.997	-28.725	-43.808	-62.194	-183.688
-135.000	1150.000	1.978	2.212	2.313	2.210	1.891	.577	-16.407	-30.975	-47.039	-66.003	-185.742
-135.000	1350.000	1.995	2.391	2.664	2.643	2.284	.591	-24.978	-43.055	-60.942	-81.077	-208.640
-135.000	1400.000	1.930	2.266	2.568	2.578	2.253	.591	-24.652	-44.154	-62.679	-82.947	-205.727
-135.000	1600.000	1.852	2.223	2.696	2.793	2.618	.671	-37.029	-61.854	-83.224	-105.523	-239.522
-135.000	1800.000	1.909	2.123	2.687	2.957	2.935	.765	-41.656	-77.616	-107.606	-128.797	-275.271
-135.000	1850.000	1.973	2.073	2.672	3.055	3.099	.754	-45.386	-85.861	-116.732	-139.302	-287.173

CASE 3

THETA	FREQ	PI(1)	PI(2)	PI(3)	PI(4)	PI(5)	PI(6)	PH(2)	PH(3)	PH(4)	PH(5)	PH(6)
180.000	178.000	1.122	1.138	1.124	1.114	1.065	1.001	.033	-.162	-3.184	-5.010	-47.392
180.000	200.000	1.122	1.147	1.143	1.120	1.105	1.042	.304	-.168	-4.799	-5.883	-51.279
180.000	256.000	1.179	1.187	1.180	1.145	1.114	.977	-.198	-.393	-1.569	-7.171	-67.077
180.000	300.000	1.226	1.237	1.227	1.176	1.122	1.054	-.021	-.847	-3.077	-8.346	-75.654
180.000	350.000	1.354	1.367	1.356	1.307	1.235	1.073	.431	-.614	-2.814	-7.576	-89.647
180.000	450.000	1.649	1.645	1.639	1.516	1.405	1.154	-1.135	-2.960	-4.461	-10.817	-115.141
180.000	610.000	2.239	2.207	2.134	2.057	1.824	1.393	-1.259	-1.499	-4.520	-8.910	-151.767
180.000	850.000	2.288	2.276	2.206	2.023	1.824	1.345	.492	.027	-2.301	-7.158	-159.334
180.000	950.000	2.578	2.592	2.499	2.323	2.111	1.382	.013	-.039	-2.439	-6.069	-173.610
180.000	1000.000	2.632	2.613	2.497	2.275	2.040	1.348	1.353	.753	-.342	-5.598	-193.905
180.000	900.000	2.619	2.522	2.414	2.193	1.967	1.275	.656	.763	-.859	-6.262	-199.468
180.000	950.000	2.653	2.666	2.732	2.462	2.149	1.405	.805	.499	-.681	-7.665	-212.694
180.000	970.000	2.613	2.824	2.634	2.419	2.100	1.334	.270	.028	-.863	-6.789	-217.154
180.000	1000.000	2.720	2.714	2.576	2.334	2.015	1.245	.260	.216	-.446	-6.941	-221.283
180.000	1050.000	2.754	2.735	2.598	2.345	1.921	1.275	1.257	1.417	-.155	-3.071	-228.600
180.000	1100.000	2.579	2.973	2.807	2.483	2.185	1.321	.762	1.040	-.260	-4.016	-240.605
180.000	1150.000	2.533	2.949	2.395	2.093	1.767	1.101	.857	1.749	1.152	-2.624	-246.918
180.000	1200.000	3.117	3.008	2.671	2.436	2.013	1.178	1.139	2.902	3.060	2.526	-281.284
180.000	1400.000	2.631	2.591	2.415	2.062	1.693	.932	.496	3.269	5.417	4.749	-287.218
180.000	1500.000	2.796	2.691	2.803	2.403	1.995	1.137	3.232	6.597	11.677	14.541	-314.833
180.000	1600.000	2.934	2.913	2.320	1.904	1.770	1.029	3.654	11.570	21.821	25.845	-346.338
180.000	1700.000	2.927	2.924	2.769	2.434	2.176	1.249	4.903	13.899	24.990	28.695	-353.491
180.000	1780.000	1.074	1.097	1.095	1.096	1.073	.983	3.787	6.986	8.215	10.597	-33.972
180.000	200.000	1.050	1.031	1.029	1.038	1.034	1.035	4.018	7.853	8.603	11.537	-36.472
180.000	250.000	1.007	1.103	1.101	1.144	1.142	.931	4.363	9.024	12.439	12.568	-49.099
180.000	300.000	1.120	1.152	1.169	1.195	1.157	1.001	5.577	9.868	13.783	15.164	-56.499
180.000	350.000	1.187	1.230	1.235	1.251	1.229	.988	6.110	11.644	15.169	17.293	-65.302
180.000	400.000	1.378	1.430	1.469	1.488	1.364	1.017	5.536	10.909	16.001	18.242	-86.726
180.000	450.000	1.803	1.795	1.762	1.756	1.596	1.025	5.302	13.437	18.728	24.737	-118.881
180.000	500.000	1.855	1.846	1.810	1.678	1.571	.934	8.231	16.458	23.716	29.312	-122.763
180.000	550.000	2.670	2.646	1.942	1.784	1.641	.906	9.036	18.290	27.184	35.827	-128.331
180.000	600.000	2.666	1.749	1.772	1.696	1.402	.677	11.844	23.834	37.369	48.305	-141.193
180.000	650.000	2.631	1.721	1.745	1.633	1.373	.683	12.642	26.464	41.107	54.157	-140.161
180.000	700.000	2.142	1.585	1.750	1.531	1.337	.547	13.783	28.541	46.114	60.217	-149.068
180.000	750.000	2.145	1.972	1.733	1.518	1.344	.503	13.979	30.223	48.581	64.307	-144.658
180.000	800.000	2.193	1.935	1.747	1.556	1.396	.521	15.237	32.642	52.120	68.288	-142.476
180.000	850.000	2.368	1.861	1.658	1.476	1.412	.499	17.796	37.660	58.967	78.181	-146.828
180.000	900.000	2.165	1.828	1.701	1.531	1.437	.428	19.549	41.426	65.052	84.843	-143.833
180.000	950.000	1.963	1.746	1.586	1.495	1.465	.408	21.552	46.516	71.264	88.387	-144.614
180.000	1000.000	1.988	1.818	1.732	1.703	1.658	.439	28.062	56.579	82.029	100.771	-138.916
180.000	1100.000	1.914	1.765	1.755	1.741	1.666	.469	29.590	58.535	83.197	100.920	-143.369
180.000	1200.000	1.931	1.937	1.931	1.844	1.673	.571	35.681	65.179	90.482	111.130	-157.646
180.000	1300.000	2.056	2.155	2.179	1.967	1.634	.704	37.473	67.397	96.759	121.173	-180.418
180.000	1400.000	1.996	2.026	2.108	1.902	1.585	.712	38.027	68.633	98.743	126.376	-186.972

CASE 3

THETA	FREQ	PI(1)	PI(2)	PI(3)	PI(4)	PI(5)	PI(6)	PH(2)	PH(3)	PH(4)	PH(5)	PH(6)
90.000	178.000	.998	1.013	1.013	1.022	1.007	1.007	5.456	10.953	16.134	20.195	- .696
90.000	200.000	.969	.985	.988	1.005	.988	1.041	6.329	12.614	17.755	23.167	1.546
90.000	250.000	.958	.994	1.014	1.018	1.053	.949	7.235	15.032	21.951	28.166	- .567
90.000	300.000	.969	.995	1.008	1.005	1.018	.982	8.623	17.300	25.518	32.204	-1.589
90.000	350.000	.958	.985	1.013	1.024	1.039	.985	10.387	20.012	29.455	38.072	1.664
90.000	450.000	.973	1.018	1.074	1.062	1.089	1.000	10.957	23.310	34.394	44.302	-2.030
90.000	610.000	.990	1.059	1.088	1.209	1.174	1.009	10.795	27.407	40.763	55.788	-6.884
90.000	650.000	1.025	1.067	1.119	1.118	1.145	1.007	15.400	31.564	47.252	62.538	.064
90.000	750.000	1.030	1.150	1.131	1.130	1.179	1.218	17.723	35.183	52.396	69.462	-1.588
90.000	850.000	1.137	1.146	1.136	1.098	1.069	1.128	19.510	39.353	61.022	82.726	- .633
90.000	950.000	1.139	1.157	1.141	1.099	1.074	1.206	20.519	43.071	66.759	90.803	-3.103
90.000	950.000	1.168	1.138	1.132	1.195	1.090	1.176	22.183	44.047	69.906	94.896	- .466
90.000	970.000	1.196	1.208	1.157	1.103	1.086	1.230	21.748	44.390	71.748	98.477	- .129
90.000	1000.000	1.240	1.231	1.155	1.131	1.121	1.285	22.149	47.222	75.888	103.482	-1.498
90.000	1050.000	1.154	1.132	1.091	1.045	1.180	1.228	26.152	54.080	85.169	113.704	- .304
90.000	1100.000	1.236	1.199	1.131	1.110	1.139	1.247	25.900	55.315	88.438	119.029	- .922
90.000	1150.000	1.121	1.091	1.006	1.034	1.132	1.178	26.684	63.126	99.007	129.207	.822
90.000	1350.000	1.194	1.055	1.039	1.132	1.246	1.139	38.004	76.514	113.565	146.619	-5.567
90.000	1400.000	.996	.949	1.044	1.117	1.259	1.043	42.592	84.755	121.476	152.113	-4.015
90.000	1600.000	.996	1.134	1.036	1.254	1.261	1.020	48.596	87.908	125.908	165.183	-1.349
90.000	1800.000	1.138	1.219	1.274	1.229	1.227	1.014	46.980	87.489	134.629	180.961	1.130
90.000	1850.000	1.052	1.224	1.223	1.172	1.239	1.188	44.514	87.421	136.364	186.850	- .589
95.000	178.000	.930	.930	.972	.966	.960	1.086	3.750	6.664	14.554	17.075	32.589
95.000	200.000	.931	.977	.967	.973	.936	1.112	4.582	9.494	16.478	19.407	38.979
95.000	250.000	.925	.934	.935	.933	.957	1.110	5.383	13.066	19.714	28.078	47.957
95.000	300.000	.965	.971	.962	.958	.937	1.142	6.765	13.741	21.411	30.408	54.749
95.000	350.000	.964	.962	.952	.928	.915	1.230	7.405	16.301	25.892	36.137	66.887
95.000	450.000	.957	.958	.929	.934	.836	1.433	9.592	22.553	33.823	48.269	84.740
95.000	610.000	.863	.895	.785	.792	.792	1.798	14.533	31.663	60.957	82.146	113.148
95.000	650.000	.904	.846	.754	.710	.741	1.884	14.246	35.516	58.347	85.750	120.196
95.000	750.000	.787	.644	.537	.576	.639	2.239	20.944	50.696	84.997	112.808	131.221
95.000	850.000	.627	.516	.514	.629	.752	2.131	32.919	72.207	105.698	128.974	136.086
95.000	900.000	.622	.514	.507	.629	.736	2.122	34.045	74.879	107.967	131.460	136.846
95.000	930.000	.522	.429	.546	.713	.858	2.176	45.883	91.109	119.394	142.051	141.743
95.000	970.000	.504	.444	.505	.750	.887	2.295	48.836	89.805	117.308	139.102	-135.833
95.000	1000.000	.491	.459	.625	.798	.905	2.237	51.010	87.171	116.824	138.336	139.738
95.000	1050.000	.453	.439	.610	.736	.869	2.174	55.523	94.489	118.281	145.910	145.209
95.000	1100.000	.417	.329	.710	.670	.971	2.209	56.503	88.199	111.962	133.535	138.510
95.000	1150.000	.393	.521	.729	.650	.833	2.189	54.425	85.172	108.402	131.679	140.339
95.000	1350.000	.430	.705	.825	.798	.722	2.030	32.028	55.930	83.439	123.458	126.606
95.000	1400.000	.508	.725	.801	.709	.629	1.961	31.814	56.505	87.001	134.472	136.865
95.000	1600.000	.580	.738	.839	.505	.692	1.921	25.221	56.424	112.106	172.131	156.066
95.000	1800.000	.726	.734	.553	.663	.915	2.037	28.744	79.983	151.023	193.278	186.887
95.000	1850.000	.650	.657	.535	.709	.896	2.063	32.800	87.172	149.573	193.182	189.612

CASE 3

THETA	FREQ	PI(1)	PI(2)	PI(3)	PI(4)	PI(5)	PI(6)	PH(2)	PH(3)	PH(4)	PH(5)	PH(6)
.000	178.000	.996	.987	.981	.961	.973	1.115	.397	2.280	5.740	4.388	47.780
.000	200.000	1.009	1.014	1.012	1.008	.984	1.160	1.040	2.423	6.240	3.791	54.284
.000	250.000	.925	.938	.940	.944	.927	1.228	1.462	3.476	4.183	10.606	67.854
.000	300.000	1.002	1.025	1.019	.995	.980	1.258	1.668	3.519	5.460	9.108	76.832
.000	350.000	1.027	1.049	1.047	1.018	.984	1.381	1.137	3.276	5.891	10.100	91.088
.000	450.000	1.096	1.140	1.105	1.073	1.001	1.712	1.177	4.620	7.642	13.177	113.250
.000	610.000	1.245	1.323	1.248	1.063	.944	2.267	3.704	6.089	15.753	23.095	150.830
.000	650.000	1.264	1.308	1.224	1.115	.944	2.309	2.124	6.306	12.504	23.503	158.714
.000	750.000	1.322	1.301	1.200	1.017	.823	2.775	.993	4.442	11.265	24.987	174.934
.000	850.000	1.264	1.236	1.111	.906	.694	2.702	3.143	7.754	18.211	35.186	194.013
.000	900.000	1.206	1.183	1.057	.848	.639	2.591	2.327	7.109	17.701	36.130	199.142
.000	950.000	1.313	1.283	1.119	.854	.570	2.934	2.312	7.289	18.421	42.250	212.672
.000	970.000	1.271	1.237	1.073	.810	.534	2.928	2.223	7.294	18.988	45.170	216.084
.000	1000.000	1.199	1.161	.997	.744	.468	2.840	2.428	7.945	19.712	47.346	220.828
.000	1050.000	1.195	1.157	.979	.669	.447	2.841	2.233	7.217	20.554	50.754	230.833
.000	1100.000	1.253	1.199	1.002	.682	.387	3.133	2.349	8.033	21.731	65.993	239.463
.000	1150.000	1.055	1.003	.803	.495	.322	2.678	1.650	8.184	25.059	78.721	247.708
.000	1350.000	1.124	1.036	.769	.385	.344	3.220	3.956	12.164	40.726	123.534	279.888
.000	1400.000	.915	.840	.603	.272	.280	2.714	1.492	8.878	40.118	134.701	284.772
.000	1600.000	1.084	.941	.577	.228	.505	2.940	3.540	15.911	86.661	158.257	314.675
.000	1300.000	.966	.812	.461	.230	.547	2.581	6.880	22.891	121.262	171.509	345.703
.000	1350.000	1.220	1.012	.504	.248	.667	3.035	3.121	17.153	136.909	174.242	353.350
-45.000	178.000	.981	.991	.982	.970	.988	1.030	-2.898	-5.027	-6.256	-11.161	35.490
-45.000	200.000	.997	1.015	1.025	1.036	1.025	1.076	-2.754	-5.387	-6.259	-12.650	39.229
-45.000	250.000	.679	.904	.913	.924	.920	1.155	-4.206	-7.508	-12.879	-13.771	50.280
-45.000	300.000	.955	.997	1.014	1.013	1.006	1.148	-3.730	-7.730	-12.109	-14.969	57.868
-45.000	350.000	.952	.994	1.019	1.018	1.014	1.210	-5.842	-10.408	-15.297	-19.666	67.048
-45.000	450.000	.955	1.045	1.067	1.095	1.077	1.453	-7.957	-13.186	-19.945	-24.888	86.174
-45.000	610.000	.913	1.101	1.155	1.122	1.131	1.828	-9.331	-17.394	-20.281	-27.998	115.746
-45.000	650.000	.893	1.060	1.142	1.199	1.167	1.881	-10.986	-17.666	-24.500	-29.997	122.186
-45.000	750.000	.861	1.020	1.145	1.209	1.211	2.230	-13.549	-23.635	-31.355	-36.457	131.322
-45.000	850.000	.620	.828	1.003	1.114	1.159	2.124	-16.430	-27.757	-35.253	-41.763	143.005
-45.000	900.000	.637	.850	1.024	1.136	1.164	2.110	-19.016	-30.886	-40.112	-47.036	142.922
-45.000	950.000	.524	.789	1.035	1.173	1.220	2.260	-23.551	-36.851	-45.268	-49.487	148.762
-45.000	970.000	.494	.747	.990	1.145	1.211	2.258	-28.243	-42.969	-52.231	-57.883	144.711
-45.000	1000.000	.516	.753	.999	1.164	1.220	2.293	-30.268	-46.456	-56.476	-63.334	144.558
-45.000	1050.000	.471	.721	.986	1.156	1.302	2.183	-33.300	-49.817	-58.776	-67.301	150.490
-45.000	1100.000	.424	.655	.957	1.198	1.228	2.276	-41.765	-62.402	-74.693	-81.757	145.069
-45.000	1150.000	.386	.607	.891	1.085	1.161	2.981	-47.240	-66.903	-78.152	-84.196	148.246
-45.000	1350.000	.437	.448	.812	1.149	1.257	2.125	-75.217	-110.078	-125.751	-133.066	140.220
-45.000	1400.000	.453	.431	.779	1.114	1.231	1.932	-79.179	-110.144	-126.451	-135.148	149.087
-45.000	1600.000	.539	.279	.522	1.066	1.235	1.957	-71.514	-141.425	-160.365	-169.086	159.536
-45.000	1800.000	.662	.373	.448	1.051	1.303	2.102	-34.374	-149.741	-177.400	-187.160	186.765
-45.000	1850.000	.646	.363	.415	1.006	1.281	2.091	-34.475	-153.657	-184.210	-193.274	190.439

CASE 3

THETA	FREQ	PI(1)	PI(2)	PI(3)	PI(4)	PI(5)	PI(6)	PH(2)	PH(3)	PH(4)	PH(5)	PH(6)
-90.000	178.000	.987	.989	.987	.986	.978	.986	-4.482	-9.027	-14.043	-21.412	.725
-90.000	200.000	1.001	1.018	1.024	1.039	1.020	.980	-4.862	-9.814	-15.829	-23.429	.301
-90.000	250.000	.900	.899	.892	.875	.892	1.000	-6.815	-13.756	-22.545	-29.930	1.349
-90.000	300.000	.940	.904	.969	.954	.968	.980	-7.478	-15.041	-23.940	-33.121	1.071
-90.000	350.000	.953	.958	.952	.944	.938	.959	-9.150	-18.484	-29.172	-40.719	-1.403
-90.000	450.000	.951	.952	.951	.941	.937	1.019	-14.200	-25.587	-40.586	-55.295	.119
-90.000	610.000	.987	.972	.929	.927	.874	1.009	-19.914	-35.346	-49.379	-73.573	-2.297
-90.000	650.000	1.000	.959	.928	.891	.874	1.019	-17.710	-35.104	-56.770	-78.629	-1.149
-90.000	750.000	1.147	1.109	1.035	.954	.892	1.137	-17.041	-35.904	-58.157	-84.400	2.365
-90.000	850.000	1.055	1.015	.927	.839	.749	1.141	-17.883	-38.445	-63.776	-95.481	1.136
-90.000	900.000	1.125	1.108	1.040	.907	.808	1.180	-19.085	-39.017	-63.471	-93.254	1.599
-90.000	950.000	1.149	1.114	1.003	.852	.811	1.235	-19.819	-40.952	-66.765	-102.436	1.317
-90.000	970.000	1.193	1.160	1.051	.859	.770	1.264	-19.340	-39.629	-64.695	-101.951	.412
-90.000	1000.000	1.240	1.233	1.139	.945	.788	1.313	-19.309	-39.103	-61.950	-99.610	2.308
-90.000	1050.000	1.172	1.190	1.116	1.002	.766	1.234	-20.414	-41.330	-66.524	-107.362	1.850
-90.000	1100.000	1.205	1.266	1.194	.993	.767	1.287	-21.316	-41.887	-67.239	-100.654	-.217
-90.000	1150.000	1.119	1.133	1.158	.997	.798	1.176	-24.101	-45.506	-69.943	-104.157	-1.384
-90.000	1350.000	1.128	1.272	1.315	1.143	.827	1.182	-30.176	-54.889	-80.152	-112.930	1.504
-90.000	1400.000	1.016	1.213	1.295	1.155	.824	1.052	-32.033	-56.675	-81.347	-113.169	1.189
-90.000	1600.000	.950	1.119	1.304	1.373	1.042	1.007	-51.246	-83.317	-110.425	-139.961	.765
-90.000	1800.000	.969	.960	1.300	1.497	1.161	1.062	-56.714	-103.321	-133.646	-161.330	.219
-90.000	1850.000	1.057	1.007	1.337	1.583	1.301	1.077	-56.639	-108.664	-142.923	-169.899	1.369
-135.000	178.000	1.049	1.060	1.045	1.037	.897	.985	-3.101	-6.780	-12.822	-18.142	-.33.409
-135.000	200.000	1.070	1.080	1.074	1.067	1.039	.995	-3.745	-7.952	-15.192	-20.716	-.38.194
-135.000	250.000	1.053	1.040	1.014	.967	.946	.950	-4.255	-9.089	-15.568	-24.625	-47.359
-135.000	300.000	1.086	1.086	1.065	1.014	.987	.966	-5.123	-11.457	-19.038	-29.037	-53.952
-135.000	350.000	1.184	1.165	1.139	1.075	1.011	.976	-5.112	-12.003	-20.483	-32.056	-66.758
-135.000	450.000	1.364	1.307	1.262	1.135	1.058	1.021	-7.750	-15.436	-26.711	-40.682	-85.194
-135.000	610.000	1.776	1.716	1.641	1.551	1.295	.985	-8.858	-16.627	-27.056	-41.049	-116.719
-135.000	650.000	1.826	1.796	1.711	1.521	1.306	.924	-7.397	-15.771	-27.119	-42.099	-121.953
-135.000	750.000	2.102	2.145	2.074	1.895	1.616	.859	-8.411	-17.435	-28.456	-41.456	-131.400
-135.000	850.000	2.009	2.074	2.061	1.831	1.626	.643	-9.108	-18.822	-29.844	-45.147	-136.842
-135.000	900.000	2.038	2.161	2.163	1.996	1.759	.656	-10.404	-20.971	-33.022	-47.824	-139.878
-135.000	950.000	2.126	2.282	2.300	2.121	1.830	.540	-11.059	-21.964	-33.752	-51.625	-144.277
-135.000	970.000	2.145	2.327	2.367	2.188	1.880	.507	-11.484	-22.417	-34.153	-51.980	-142.389
-135.000	1000.000	2.162	2.373	2.445	2.321	1.990	.487	-12.299	-24.091	-35.270	-52.200	-139.210
-135.000	1050.000	2.085	2.313	2.401	2.310	1.918	.475	-13.295	-25.536	-39.518	-55.859	-142.384
-135.000	1100.000	2.116	2.419	2.567	2.473	2.148	.442	-14.770	-28.279	-42.673	-59.085	-141.190
-135.000	1150.000	1.988	2.276	2.431	2.356	2.072	.441	-17.154	-31.528	-46.141	-63.552	-141.583
-135.000	1350.000	2.017	2.349	2.642	2.668	2.497	.444	-23.900	-42.674	-61.024	-80.351	-133.574
-135.000	1400.000	1.905	2.283	2.606	2.674	2.434	.496	-25.386	-45.625	-64.263	-83.939	-137.519
-135.000	1600.000	1.829	2.111	2.555	2.752	2.578	.585	-37.040	-62.315	-85.698	-109.289	-156.123
-135.000	1800.000	1.966	2.203	2.703	3.002	2.831	.710	-39.607	-74.689	-103.400	-128.787	-183.005
-135.000	1850.000	1.937	2.139	2.670	3.021	2.890	.685	-41.776	-79.114	-108.998	-133.937	-189.284

APPENDIX B

DERIVATION OF THE SCATTERING PARAMETER FOR THE CASE OF SPHERICAL ACOUSTIC WAVES

As long as the microphone itself is of finite size and its pressure-sensing elements are separated by a finite distance, a pressure gradient microphone having any arbitrary shape will be subject to three effects that tend to impede its pressure gradient measurement capability. The most obvious effect arises from the inherent need to approximate a gradient at a point in space by a slope determined by finite differences. The other two effects are related to scattering, and it is primarily for the purposes of clearer analysis that they are considered as two distinct phenomena. One arises from the fact that even at low frequency, pressure phase distortion takes place due to the presence of the body. Finally, the last effect is attributable to pressure amplitude and phase changes due to high frequency scattering.

The derivation of a scattering parameter σ which incorporates all three phenomena for the plane wave case has been previously presented in Refs. 1 and 2. This appendix is devoted to the derivation of an analogous expression for σ for the case where the distance between the sound source and scattering body is not large enough for the plane wave approximation to hold. In the experiments described in this report, the acoustic waves were considered to be spherical.

The complex pressure in a spherical wave field is assumed to be in the form

$$p_i = p_o \frac{e^{ikr}}{kr}$$

Note that the assumed sinusoidal time variation is suppressed. Let the center point of a cylindrical body having a face-to-face separation Δr be located a distance R from the acoustic source. It follows then that across the cylinder

$$\Delta p_i = \frac{p_o e^{ikR}}{k} \left(\frac{e^{ik \frac{\Delta r}{2}}}{R + \frac{\Delta r}{2}} - \frac{e^{-ik \frac{\Delta r}{2}}}{R - \frac{\Delta r}{2}} \right)$$

and

$$\frac{\Delta p_i}{\Delta r} = \left(\frac{\partial p_i}{\partial r} \right)_{r=R} \left[\frac{R^2 \left(\frac{e^{ik \frac{\Delta r}{2}}}{R + \frac{\Delta r}{2}} - \frac{e^{-ik \frac{\Delta r}{2}}}{R - \frac{\Delta r}{2}} \right)}{(ikR-1)\Delta r} \right] \quad (B-1)$$

In analogy with previous work in Refs. 1 and 2, the term in the square brackets can be viewed as the finite difference factor.

The body shape calibration factor K , accounting for low frequency phase distortion, is introduced through the definition

$$K = \lim_{ka \rightarrow 0} \left(\frac{\Delta p_i}{\Delta p} \right) \quad (B-2)$$

where Δp is the measured pressure difference.

The effects of finite difference measurements and of low and high frequency scattering can be investigated by means of a scattering parameter σ , defined as

$$\sigma = \left| \frac{K \frac{\Delta p}{\Delta r} \frac{\Delta r (ikR-1)}{R^2 \left(\frac{e^{ik\Delta r/2}}{R+\Delta r/2} - \frac{e^{-ik\Delta r/2}}{R-\Delta r/2} \right)}}{\left(\frac{\partial p_i}{\partial r} \right)_{r=R}} \right| \quad (B-3)$$

After substitution for $\left(\frac{\partial p_i}{\partial r} \right)_{r=R}$, combining all complex terms, with the exception of Δp into the denominator, and evaluation of the absolute value, Eq. (B-3) assumes the form

$$\sigma = \frac{K k \left[R^2 - \left(\frac{\Delta r}{2} \right)^2 \right] |\Delta p|}{2 p_o \sqrt{R^2 \sin^2 k \frac{\Delta r}{2} + \left(\frac{\Delta r}{2} \right)^2 \cos^2 k \frac{\Delta r}{2}}}$$

Finally, realizing that in terms of measurables

$$p_o = |p_i| k r$$

the expression for the scattering parameter can be written as

$$\sigma = \frac{K \left[R^2 - \left(\frac{\Delta r}{2} \right)^2 \right] |\Delta p|}{2 |p_i| R \sqrt{R^2 \sin^2 k \frac{\Delta r}{2} + \left(\frac{\Delta r}{2} \right)^2 \cos^2 k \frac{\Delta r}{2}}} \quad (\text{B-4})$$

This is the expression which was used to compute scattering parameters from experimental data. It should be noted that since pressures are non-dimensionalized by the incoming pressure, no distinction need be made between maximum pressure amplitudes, or the rms values which are actually measured. The Δp difference, of course, takes into account the pressure phase differences.

In Fig. 21 σ is plotted on a decibel scale, i.e., the ordinate on the plot is $20 \log \sigma$.

1. Report No. NASA CR-3068	2. Government Accession No.	3. Recipient's Catalog No.	
4. Title and Subtitle Acoustic Scattering by Circular Cylinders of Various Aspect Ratios		5. Report Date January 1979	
		6. Performing Organization Code	
7. Author(s) Algirdas Maciulaitis		8. Performing Organization Report No.	
		10. Work Unit No.	
9. Performing Organization Name and Address Research Department Grumman Aerospace Corporation Bethpage, NY 11714		11. Contract or Grant No. NAS1-14766	
		13. Type of Report and Period Covered	
12. Sponsoring Agency Name and Address National Aeronautics and Space Administration Washington, DC 20546		14. Sponsoring Agency Code	
		15. Supplementary Notes Langley Technical Monitor: John M. Seiner Final Report	
16. Abstract Acoustic scattering on a microphone body can severely limit the useful frequency range of pressure gradient microphones. These scattering effects were investigated experimentally between ka values of 0.407 and 4.232 using two circular cylindrical models (L/D = 0.5 and 0.25) having a 25 cm outside diameter. Small condenser microphones, attached to preamplifiers by flexible connectors, were installed from inside the cylindrical bodies, and flush mounted on the exterior surface of the cylinders. A 38 cm diameter woofer in a large speaker enclosure was used as the sound source. Surface pressure augmentation and phase differences were computed from measured data for various sound wave incidence angles. Results are graphically compared with theoretical predictions supplied by NASA for ka = 0.407, 2.288, and 4.232. All other results are tabulated in the appendices. With minor exceptions, the experimentally determined pressure augmentations agreed to within 0.75 dB with theoretical predictions. The agreement for relative phase angles was within 5 percent without any exceptions. This is excellent, and approaches the realistic repeatability limits in an acoustic experiment of the type reported here. Scattering parameter variations with ka and L/D ratio, as computed from experimental data, are also presented. This type of data represents a useful tool in the design of pressure gradient microphones.			
17. Key Words (Suggested by Author(s)) Acoustic Scattering		18. Distribution Statement Unclassified - Unlimited Subject Category 71	
19. Security Classif. (of this report) Unclassified	20. Security Classif. (of this page) Unclassified	21. No. of Pages 52	22. Price* \$5.25