

\* N79-24740

PERFORMANCE OF PREPRODUCTION MODEL CESIUM BEAM  
FREQUENCY STANDARDS FOR SPACECRAFT APPLICATIONS

Martin W. Levine  
Frequency & Time Systems, Inc.  
Danvers, Massachusetts

ABSTRACT

The first of a series of Preproduction Model (PPM) Cesium Beam Frequency Standards for spaceflight application on Navigation Development Satellites has been designed and fabricated and preliminary testing has been completed. The PPM is identical in form, fit and function, to the production cesium standards for the GPS NAVSTAR System.

The PPM evolved from an earlier Prototype Model launched aboard NTS-2 (June, 1977) and the Engineering Development Model (EDM) to be launched aboard NTS satellites during 1979. A number of design innovations, including a hybrid analog/digital integrator and the replacement of analog filters and phase detectors by clocked digital sampling techniques will be discussed.

Thermal and thermal-vacuum PPM testing has been concluded and test data will be presented. Stability data for 10 to  $10^4$  seconds averaging interval, measured under laboratory conditions, will also be shown.

## INTRODUCTION

The Preproduction Model (PPM) Cesium Beam Frequency Standards are the most recent version of a series of atomic frequency standards specifically designed for spacecraft applications in the Global Positioning Satellites (GPS). The first atomic frequency standards to be successfully operated on an orbiting satellite were the rubidium devices flown by the U.S. Naval Research Laboratory aboard NTS-1 in 1974. Two Prototype Model Cesium Standards were launched on NTS-2 in June, 1977.<sup>1</sup> Figure 1 is a photograph of the prototype units. The next stage in the evolution of the GPS cesium standards was the Engineering Development Model (EDM).<sup>2</sup> EDM Number 2 is currently installed and awaiting launch on the U.S. Air Force NDS-4 payload and EDM Number 3 is in test on the NDS-5 satellite. A photograph of the EDM Standard is shown in Figure 2.

The PPM is similar in size, weight and outward appearance to the EDM; internally there are a number of electrical and mechanical refinements. The PPM is intended to be representative, in all physical and performance aspects to the production model phase III cesium standards for GPS satellites. Figure 3 is a photograph of the qualification model PPM in the initial test phase.

## DESCRIPTION

Two fundamental requirements for the GPS frequency standard are that the standard operate in space for at least five years without adjustment and that it be capable of operating in the specified radiation environment. These two requirements strongly influenced the design of the PPM, particularly in the servo loop and integrator.

An overall block diagram of the PPM cesium beam standard is shown in Figure 4. The basic building blocks are common to all cesium standards; a high-quality voltage-controlled crystal oscillator (VCXO), a phase-modulated frequency multiplier and a digital frequency synthesizer to generate the 9.19 GHz cesium hyperfine transition frequency, a cesium beam tube, a low-noise modulation signal amplifier and filter, a phase detector, an integrator, and power supplies and controllers. As indicated in the block diagram, these blocks can be loosely combined into four functional subsystems, servo/integrator, cesium-beam, r.f. and power supply.

#### Servo/Integrator Subsystem

The servo/integrator subsystem is shown in block diagram form in Figure 5. The modulated signal at the output of the beam tube is amplified and filtered by the first stage. The second stage is a commutative filter which samples the amplified beam signal at twice the modulation rate. The sample-and-hold filter is followed by a synchronous detector and the hybrid analog/digital integrator.

The integrator in a cesium beam standard is a problem in any application. Given the five-year life and the radiation hardening requirements of GPS, the problem is particularly severe. The loop gain and loop time constant dictate an integrator time constant, however, is limited by the bias current of the amplifier and the leakage resistance of the integrator capacitor and the circuit board. The hybrid integrator, shown in the block diagram of Figure 5, uses a combination of analog and digital techniques to circumvent these problems. The rate-of-change of the output voltage of an integrator can be increased by increasing the R - C time constant or, more simply, by attenuating the output by means of a resistance divider. The difficulty with the second approach is that the maximum output voltage

that can be obtained is reduced by the attenuation factor. The attenuation can be tolerated if the analog integrator is augmented by a digital-to-analog converter which is incremented (or decremented) by one count whenever the analog integrator reaches its upper (or lower) limit, the digital-to-analog converter is implemented in the PPM cesium standard by using latching relays as the digital switches. The relay contacts have no offset voltages or series resistances as do semiconductor switches, but more importantly, they provide a non-volatile memory which retains the last oscillator control voltage setting in the event of a radiation-induced transient. Each count of the D-to-A converter corresponds to approximately 10 mV, a  $\Delta f/f$  of approximately  $1 \times 10^{-10}$  for the VCXO. Interpolation between discrete converter steps is provided by attenuating the  $\pm 10$  mV output range by 1024, to about  $\pm 10$   $\mu$ V, and adding this voltage to the output of the D-to-A converter.

#### Cesium Beam Tube Subsystem

The cesium beam tube subsystem consists of the cesium beam tube, the C-field regulator, and the cesium oven controller. The beam tube is the FTS-1A; used in the Prototype Model and EDM standards as well as the 4000 series manufactured by Frequency & Time Systems.

The C-field current regulator uses a latching-relay-controlled D-to-A converter similar to that used in the digital integrator. The latching relays provide immunity to radiation induced transients while allowing ground-commanded adjustments to the field current. The resolution of the C-field is one part in 1024 which corresponds to a change in the normalized standard frequency of approximately  $4 \times 10^{-13}$ .

The cesium oven is maintained at a constant temperature by a variable-duty-cycle switching regulator. The cesium oven temperature is sensed by a thermistor on the cesium oven located within the cesium tube;

the thermistor forms one leg of a resistance bridge which is balanced at the oven setpoint temperature.

#### R.F. Subsystem

The 10.23 MHz signal for the satellite GPS systems is generated by doubling the 5.115 output frequency from a modified FTS Model 1000 precision voltage-controlled crystal oscillator.<sup>3</sup> The doubler output is carefully filtered to suppress the 5.115 MHz sub-harmonic by at least 100 dB.

The 36th harmonic of 5.115 MHz, at 184.14 MHz is generated by the low-order frequency multiplier. The input stage of the low-order multiplier is square-wave phase (frequency-impulse) modulated at approximately 450 Hz, the cesium beam tube line-width. The output stage of the multiplier in turn is phase modulated by the 14.36...MHz output of the digital frequency synthesizer. The 184.14 MHz carrier, with its complex phase modulation spectrum, is fed to the X50 high-order multiplier; the first sideband, 9192.631770 MHz phase-modulated at 450 Hz, is selected by an output filter to excite the Ramsey cavity within the cesium beam tube.

#### Power Supply Subsystem

The PPM power supplies provide +15V, -15V, and +5V to operate the servo, and r.f. electronic circuitry. A separate +24V supply is used for the VCXO and two high-voltage supplies to power the cesium tube ion pump and the electron-multiplier.

All of the PPM supplies are preregulated by a high efficiency switching regulator followed by a series-pass regulator. The output of the preregulator feeds two transformer-coupled inverter stages which supply all of the required voltages.

The preregulator switching regulator and both inverters are clocked from a stable oscillator at approximately 37 KHz. The clock frequency is

selected to minimize power supply ripple at the Zeeman frequency and the harmonics of the Zeeman frequency.

The normal power consumption is approximately 24 watts after a one-hour warmup period. The maximum power consumption of the PPM is approximately 44 watts at startup.

#### Mechanical Construction

The mechanical design of the PPM is very similar to that of the EDM. The PPM package is 15 inches (38.1 cm) long, 7.6 inches (19.4 cm) high, and 5.1 inches (13 cm) wide and weighs 25.5 lbs. (11.6 kg).

The PPM packaging concept differs in only relatively minor respects from the EDM; the PPM circuit boards are connectorized, rather than hard-wired, and the cesium tube in the PPM has a soft mount. Although the FTS-1A cesium beam tube used in the PPM survived the 23 g qualification-level vibration test when hard-mounted to the shake table, the chassis structure resonances increase the vibration levels imposed on the installed tube to the point that it seemed prudent to shock mount the tube. The shock mounting consists of relatively thin elastomer strips sandwiched between stainless steel clamping bands.

#### QUALIFICATION REQUIREMENTS

The PPM Cesium Beam Frequency Standard must survive the vigors of the launch environment and then perform within specified limits for a minimum of five years in space.

#### Environmental Requirements

Qualification testing of the PPM, scheduled to begin on 27 November 1978 includes vibration, shock, EMI, thermal vacuum cycling, phase noise, and temperature stability tests. The qualification vibration levels

for the PPM are shown in Figure 6. Three minutes of random vibration in each of three mutually perpendicular axis are required.

The qualification levels for a three-axis simulated and pyrotechnic shock test are shown in Figure 7. The thermal profile for the long-term thermal cycling test is shown in Figure 8. Twenty-four full cycles at atmospheric pressure and eight cycles in vacuum are required for qualification.

#### Performance Requirements

The PPM performance limits with respect to frequency stability, frequency versus temperature spurious signal levels and phase noise must be maintained over a baseplate temperature range of 20 to 45°C.

Figure 9 is a plot of the frequency stability requirements as a function of averaging time, from one second to  $10^5$  seconds.

Figure 10 shows the acceptable spurious signal levels as a function of frequency offset from the carrier.

Figure 11 is a plot of the phase noise requirement as a function of frequency offset from the carrier.

The maximum allowable temperature coefficient of frequency for the PPM is  $5 \times 10^{-14}$  per degree C averaged over any 20 degree interval within the 20 to 45°C operating range.

#### PRELIMINARY PERFORMANCE DATA

The temperature coefficient of frequency of the PPM qualification model has been measured in vacuum with the results shown in Figure 12. The coefficient is approximately  $1.5 \times 10^{-14}/^{\circ}\text{C}$  averaged over the +15 to +45°C temperature range, significantly better than the  $5 \times 10^{-14}$  per degree C contractual requirement. The frequency offset at 25°C, in air at atmospheric pressure, is shown on the figure to indicate the

measured change in frequency from air to vacuum at constant baseplate temperature.

The measured frequency stability, expressed as the Allan variance for averaging intervals of 10 to  $10^4$  seconds is shown in Figure 13. The broken line on the figure represents the contractual requirement; again the PPM performance exceeds the minimum requirements by a substantial margin. The phase noise as a function of offset frequency from the carrier has not been measured for the PPM. However, since the phase noise characteristics at offset frequencies greater than one Hz are determined solely by the crystal oscillator, the EDM data<sup>3</sup> is representative of the phase noise performance expected for the PPM.

The author wishes to acknowledge the support of the Office of Naval Research under contract N00014-74-C-0061, for portions of this work.



### References

1. J. White, F. Danzy, S. Falvey, A. Frank, J. Marshall, "NTS-2 Cesium Beam Frequency Standard for GPS", Proceedings of the Eighth Annual PTTI Applications and Planning Meeting, December, 1976.
2. T. Gregory, "New Cesium Beam Frequency Standards for Flight and Ground Applications", Proceedings of the 31st Annual Symposium on Frequency Control, June, 1977.
3. D. Emmons, "A New Rugged Low-Noise High Precision Oscillator", Proceedings of the Eighth Annual PTTI Applications and Planning Meeting, December 1976.

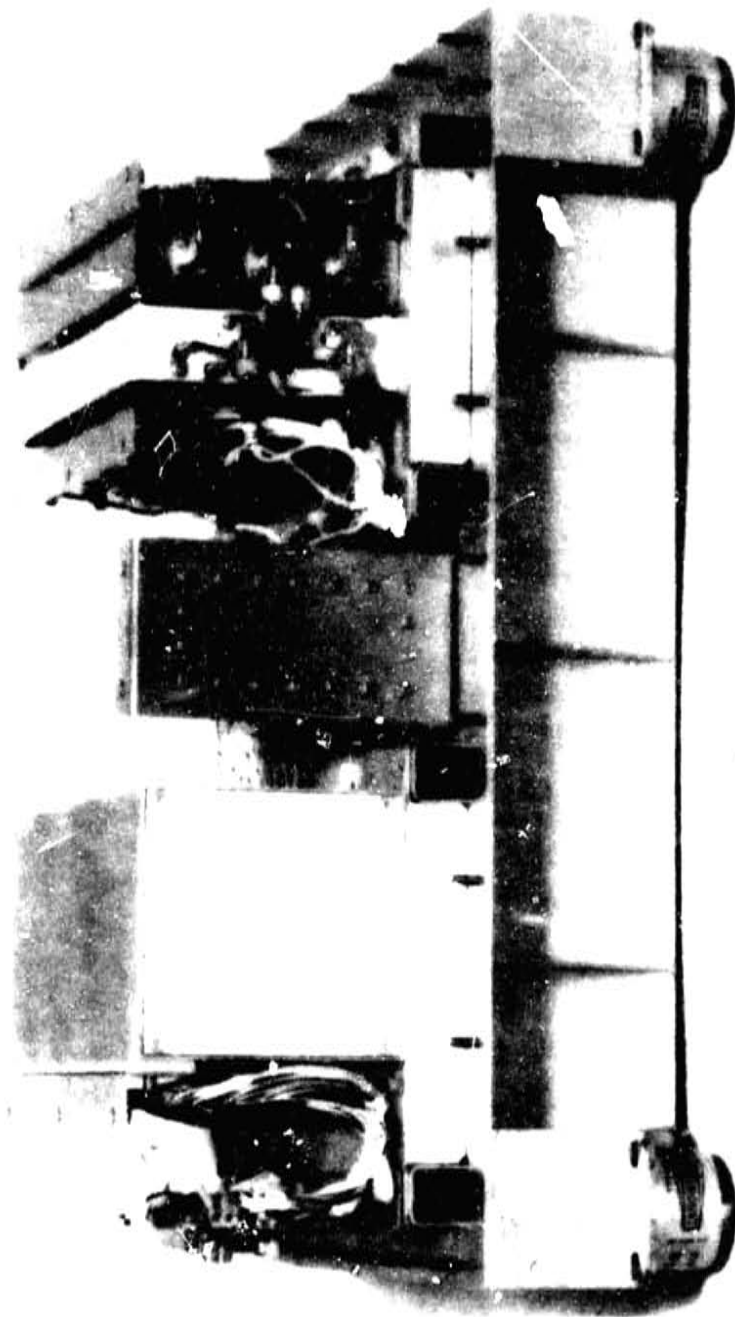

Figure 1  
PHOTOGRAPH OF  
PROTOTYPE MODEL

ORIGINAL FILE IS  
OF POOR QUALITY



ORIGINAL PAGE IS  
OF POOR QUALITY

Figure 2  
PHOTOGRAPH OF  
EDM

Figure 3  
PHOTOGRAPH OF  
PPM

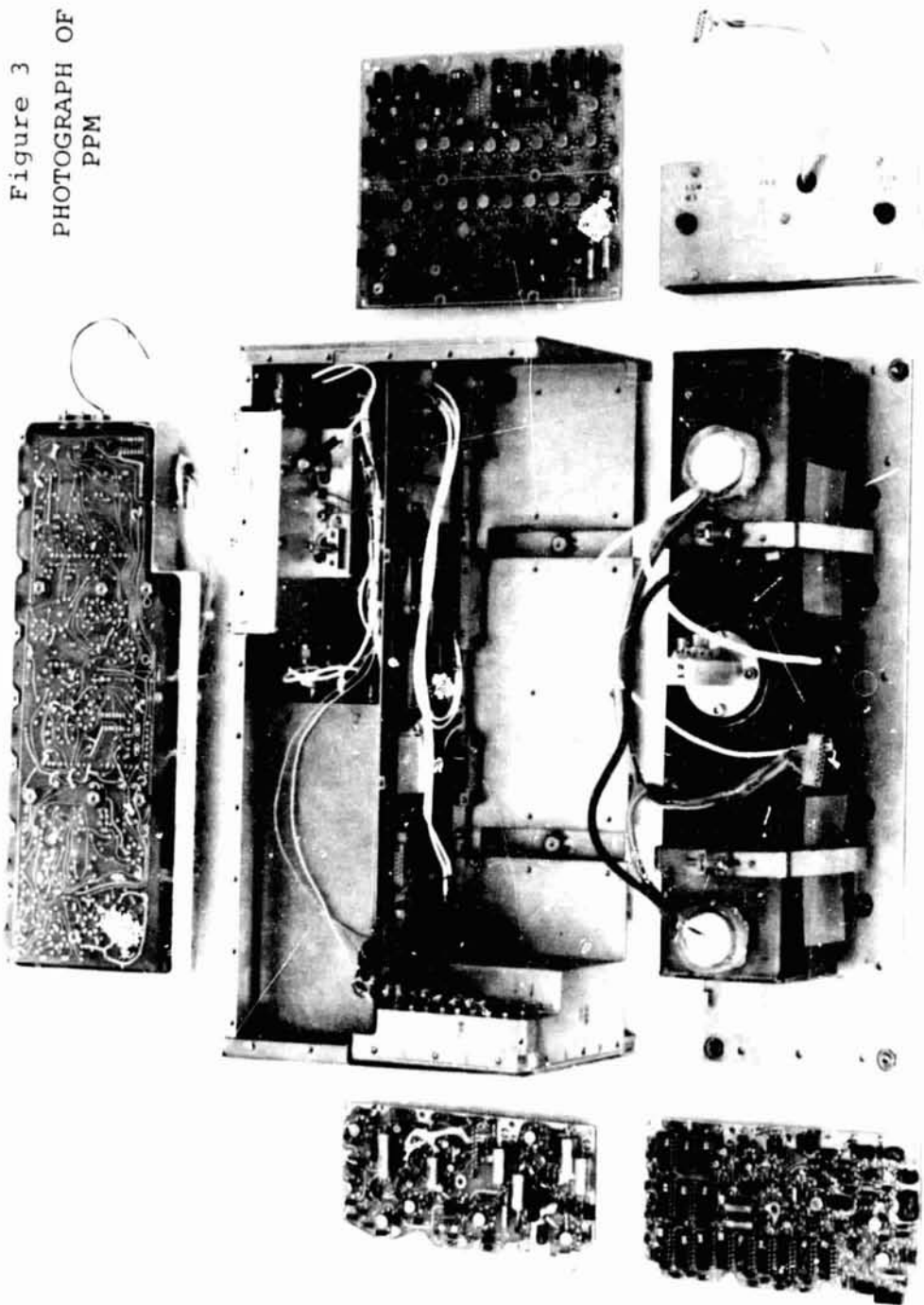

ORIGINAL PAGE IS  
OF POOR QUALITY

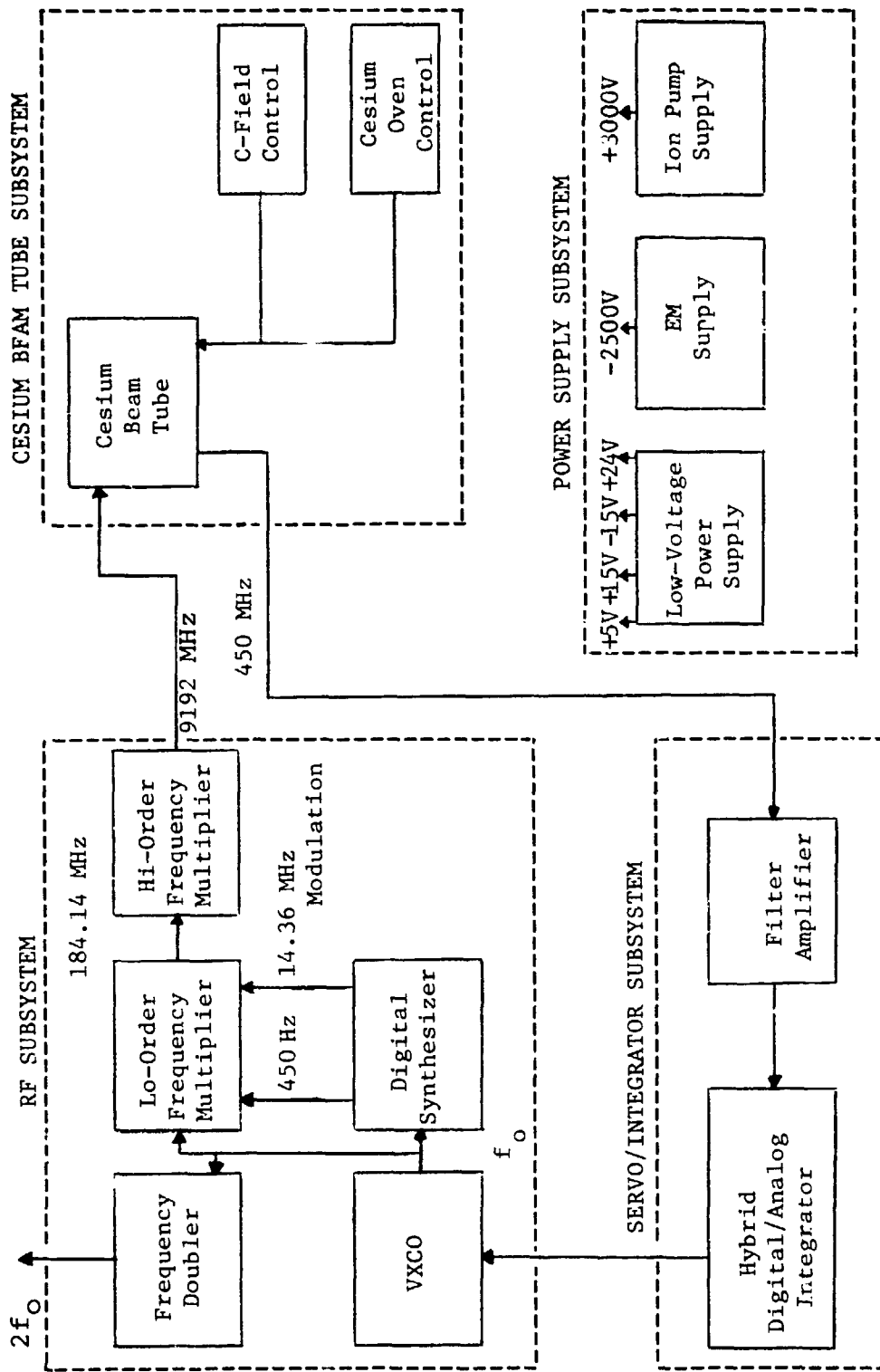

Figure 4  
 PPM CESIUM BEAM FREQUENCY STANDARD  
 SYSTEM BLOCK DIAGRAM

11/14/78 MWL

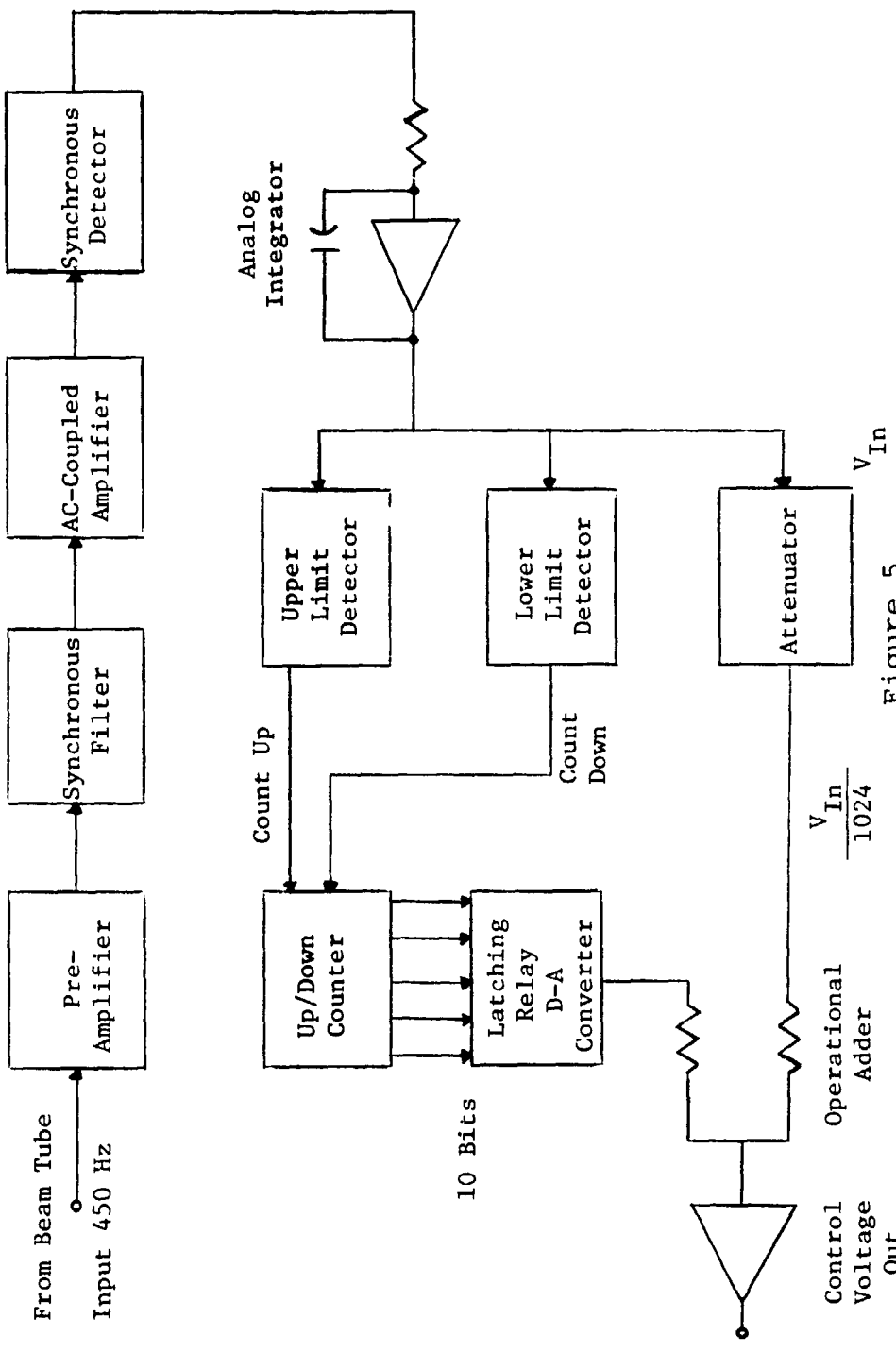

Figure 5  
PPM SERVO/INTEGRATOR SUBSYSTEM  
BLOCK DIAGRAM

11/14/78 MML

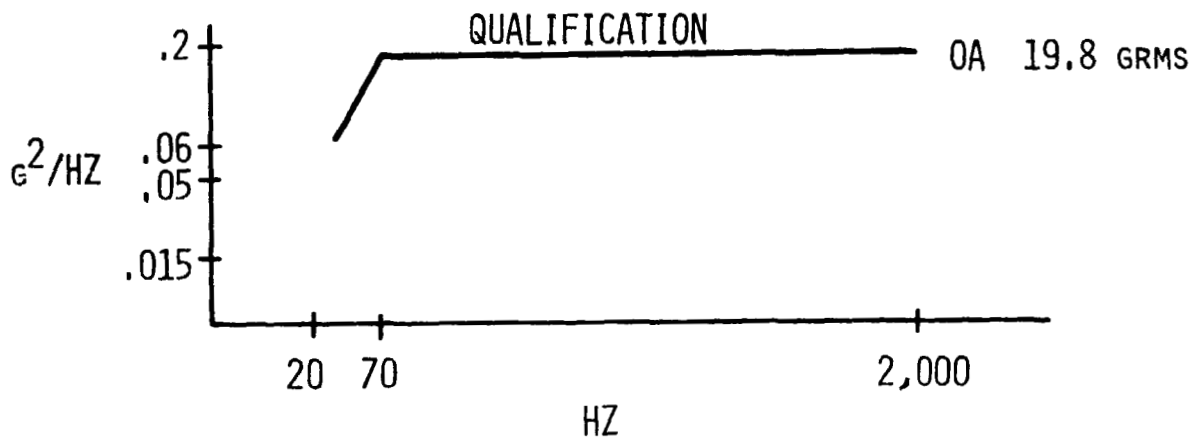

Figure 6. Vibration Level Requirements

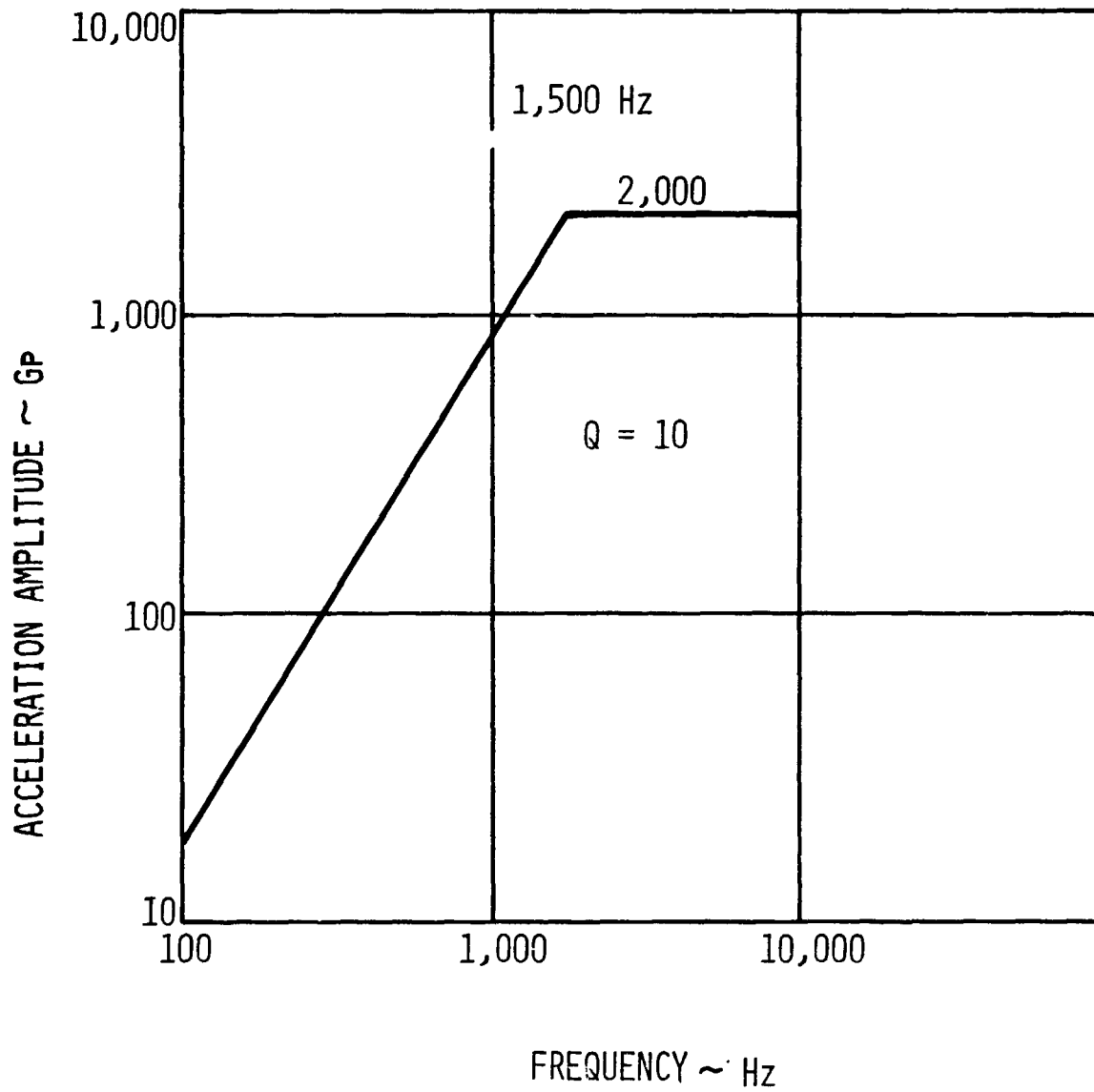
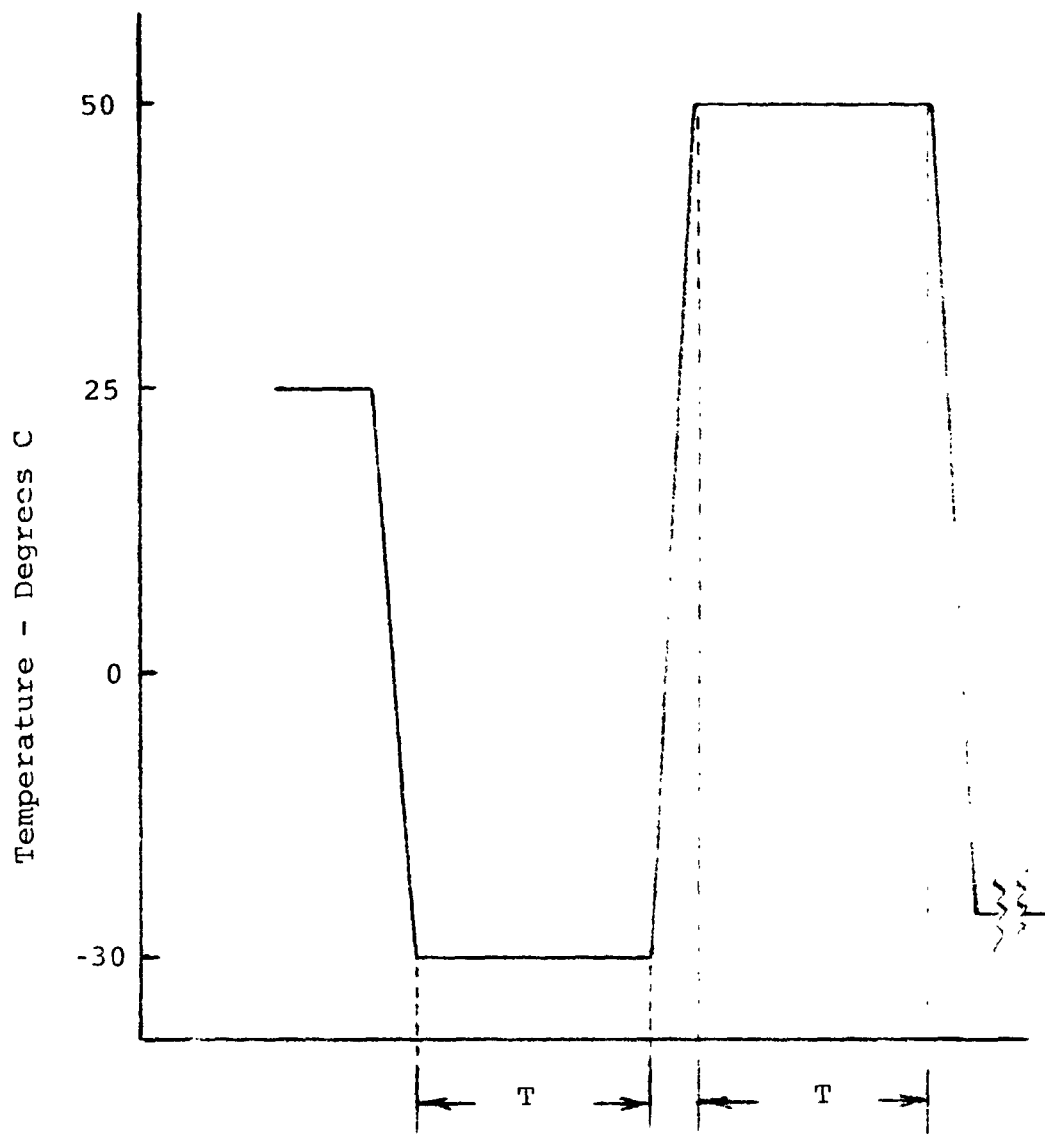

Figure 7. Shock Level Requirements for Qualification





T = 1 hour in air  
 T = 12 hours in vacuum

Figure 8  
 TEMPERATURE CYCLING REQUIREMENT FOR QUALIFICATION

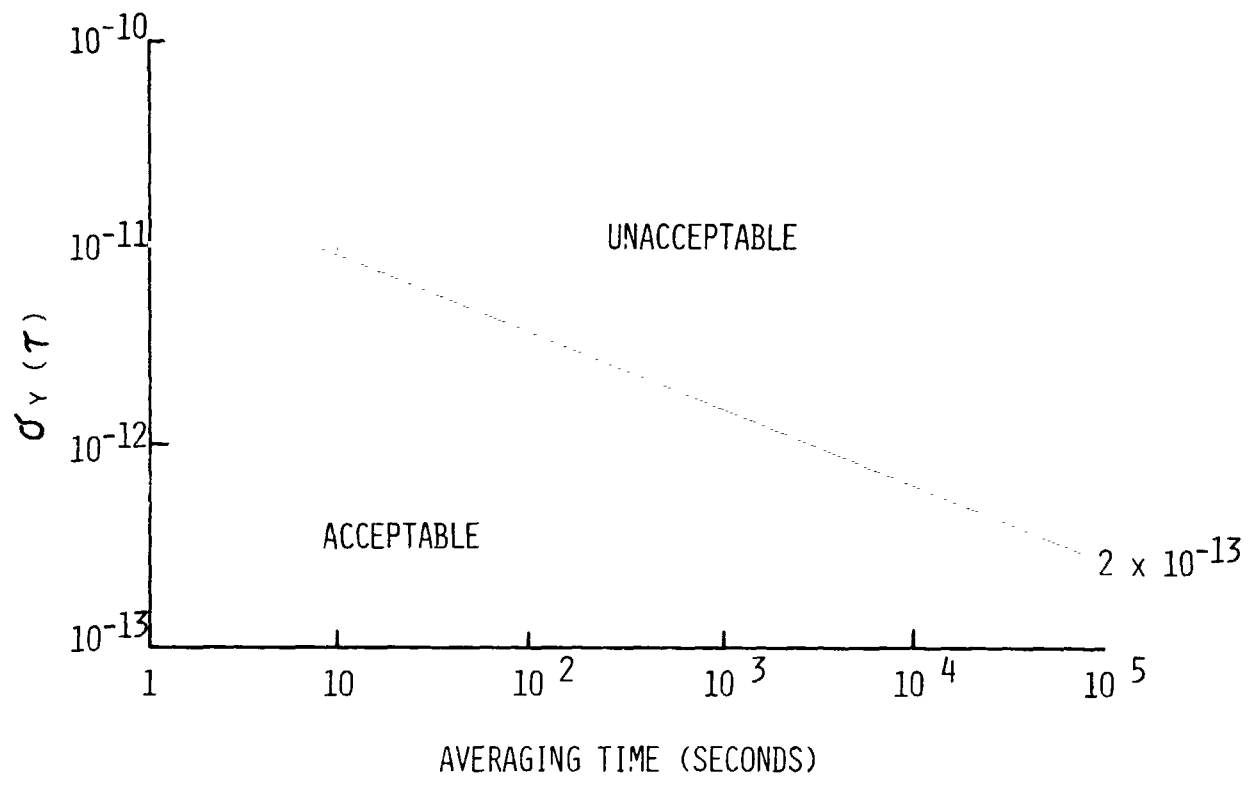

Figure 9. Frequency Stability Requirements

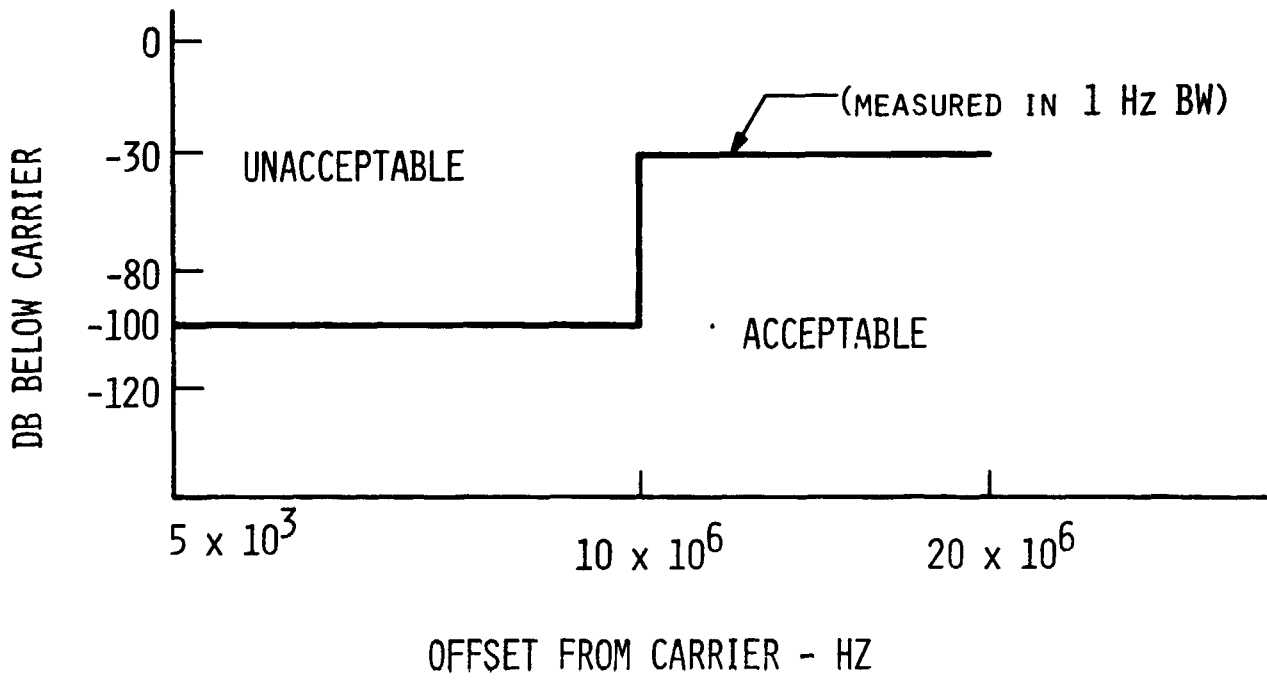

Figure 10. Spurious Signal Levels

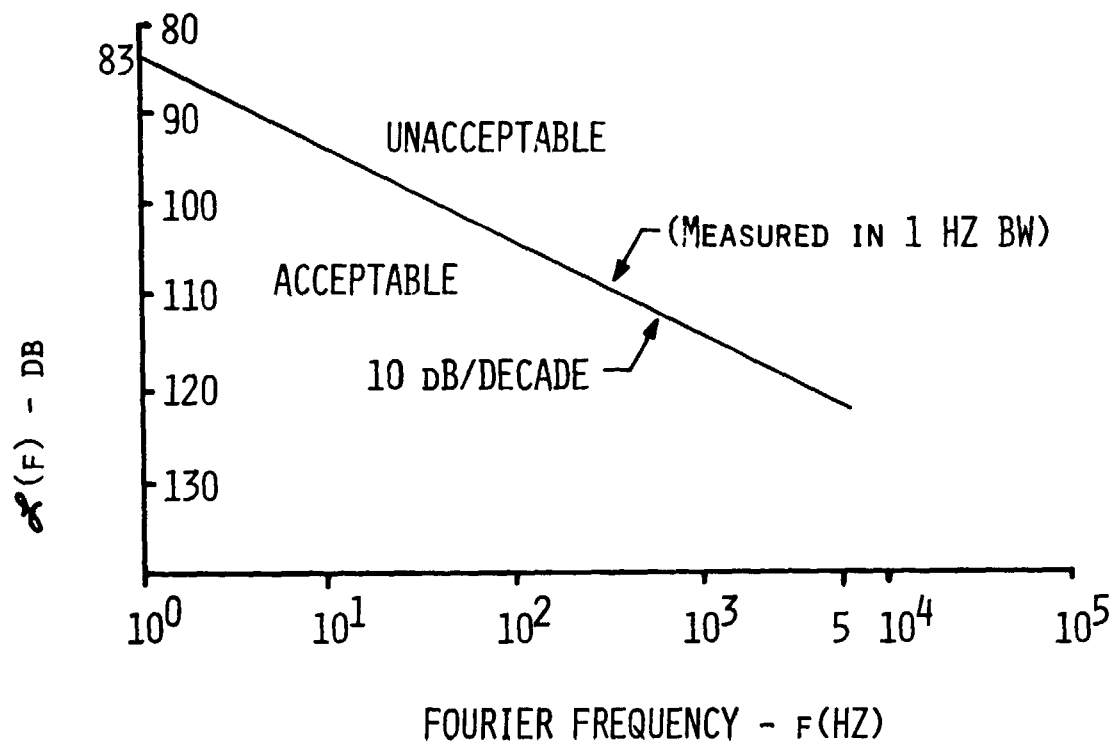

Figure 11  
Phase Noise Versus Frequency Offset

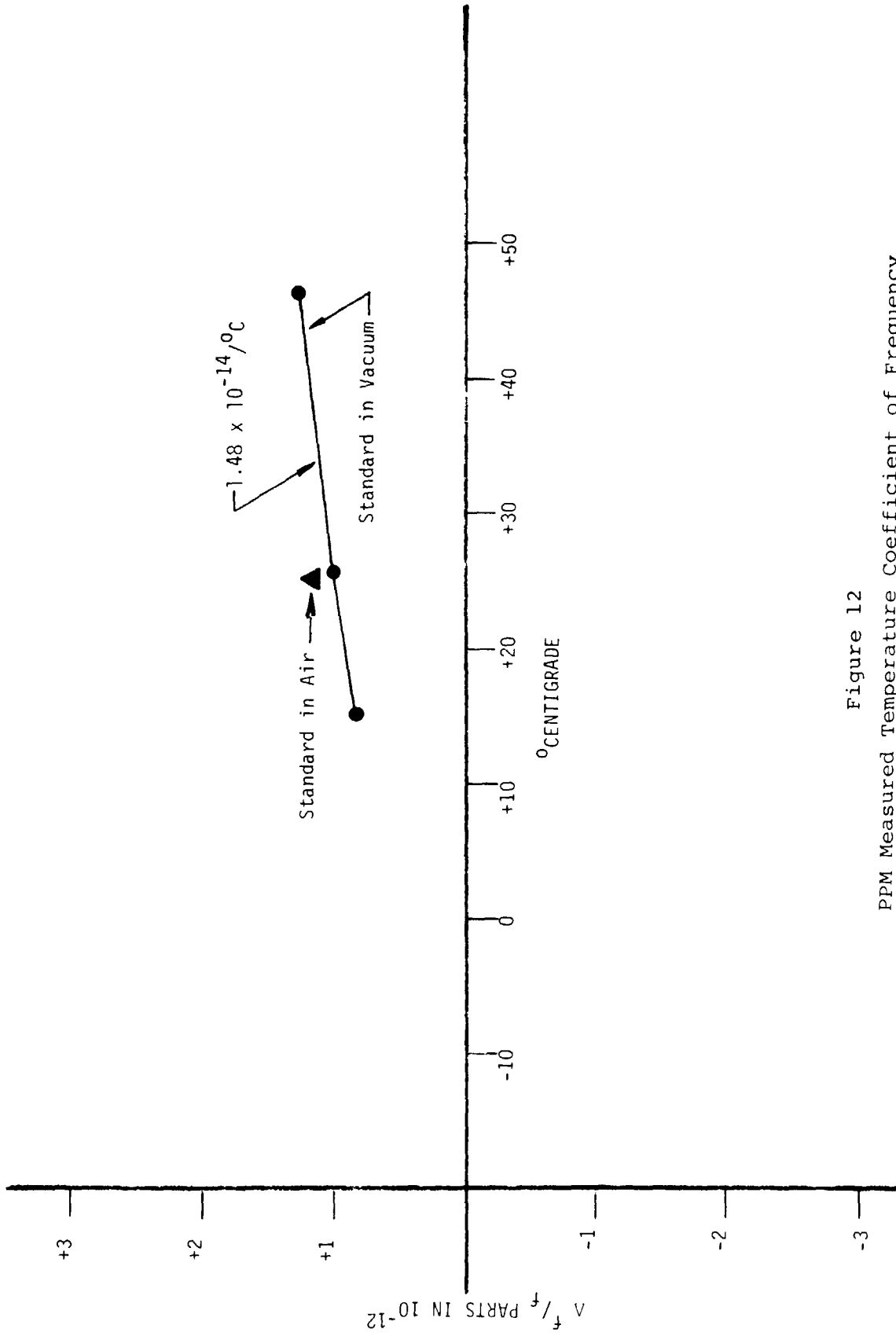

Figure 12  
PPM Measured Temperature Coefficient of Frequency

FREQUENCY & TIME SYSTEMS, INC.

STABILITY PERFORMANCE DATA

UNIT: PPM #001 FILE: PPM1A01

OPERATING - FREQUENCY:

TEMPERATURE 25 DEG(C)

FREQUENCY OFFSET: -8.80E-13

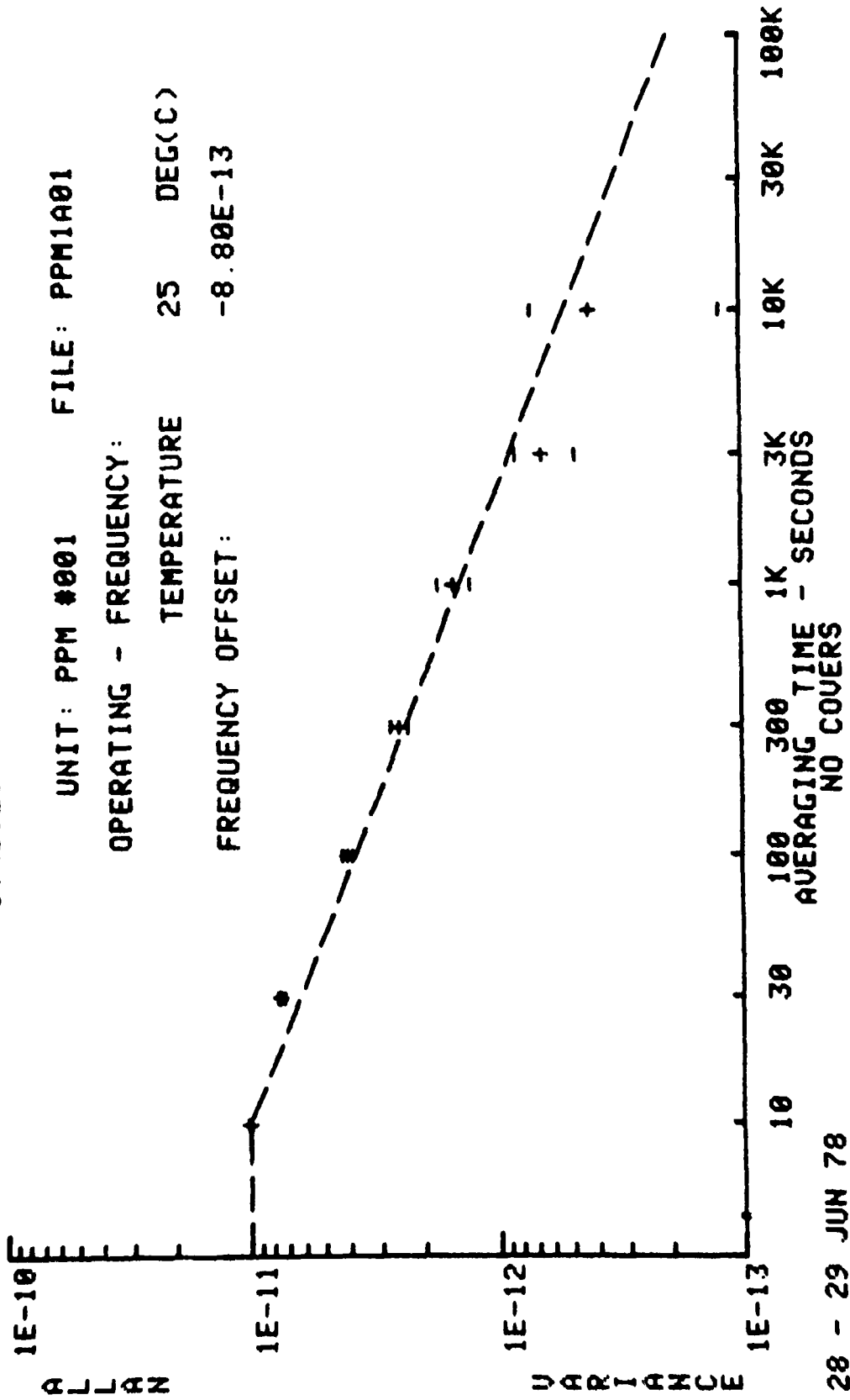

28 - 29 JUN 78

Figure 13

PFM Frequency Measured Stability

## QUESTIONS AND ANSWERS

DR. HELMUT HELLWIG, National Bureau of Standards:

I have a comment. I am glad to see a portable clock finally, because I am getting tired of building my own--a portable clock in the sense of being really independent of power. You said eight hours?

DR. EMMONS:

Six hours. Two hours per pack. There are two battery packs, and, cleverly concealed under those is a last ditch pack spread out.

DR. GERNOT M. R. WINKLER, U.S. Naval Observatory:

Could you carry additional packs with you and plug them in, mid-term, and prolong the clock's life if you see that you are stuck?

DR. EMMONS:

As each pack dies, you plug in another--before it dies.

MR. JECHART:

It would mean the purchase order for a lot of these--I would say we can do this order.

DR. EMMONS:

How many does he have?

DR. HELLWIG:

Efratom wants a purchase order also, if there are enough. A little more on the serious side; if there is a marketable product, I think somehow it will be built. And the technology for that (portable clocks) has existed for quite some time. Maybe we should ask FTS Company, "What do you expect as a market for this kind of device?" Don't answer if you don't want to.

DR. EMMONS:

I had better not. I don't feel up to that one.

DR. HELLWIG:

Maybe Dr. Winkler has a comment. No? No guess at the Market? You know the clock carrying business.

DR. WINKLER:

I think the answer depends entirely upon performance; I mean, performance under practical field conditions. And after we see that, we will say.

DR. EMMONS:

There has been a real snag, and that is in eliminating...well, since the advent of travel restrictions and anti-first class policies, we find a little bit of backlash concerning no more first class necessities.

DR. HELLWIG:

So that may create a market--no more first class travel. You are forced into economy or subeconomy, and then you have to buy little clocks that fit under the seat. Then they will be produced.

DR. WINKLER:

What is the price?

DR. EMMONS:

I would have to check from the floor here. Would someone care to comment on the price?

MR. THOMAS PARELLO, Frequency and Time Systems:

\$26,000, and it is not GSA scheduled.

DR. EMMONS:

There is one back behind the screen if anyone wants to look at it.

MR. DAVID W. ALLAN, National Bureau of Standards:

A couple of questions, Don. On the stability slide, you showed just the white noise. Have you looked long enough to see if it starts to flatten and you get flicker noise or some other problems? And if so.....

DR. EMMONS:

My feeling is that we haven't looked long enough. I don't have any hot off the press data. I'm sorry.

MR. ALLAN:

The stability of  $10^4$  seconds is  $4 \times 10^{-13}$ , I believe you reported, and that seems inconsistent with the nominal 10 second data, as if it doesn't go as white noise. I was just curious whether you get some other strange thing there.



DR. EMMONS:

Well, I am inclined to say that maybe we have enough statistical spread to cover that.

MR. ALLAN:

To cover your tracks.

DR. EMMONS:

I will let you look in detail at it here.

DR. VICTOR REINHARDT, NASA Goddard Space Flight Center:

On the commercial units, since we have a little bit of in- in that, are the data that you got on the temperature coefficient, on the spacecraft unit, expected in the commercial unit? The 1.5 in  $10^{14}$  per degree C?

DR. EMMONS:

I'm sorry. I don't have good numbers with me, but the commercial unit behaves very well over temperature. Do you remember some numbers, Tom?

MR. PARELLO:

Not precisely, but if I had to take a guess, I would say it is perhaps parts in  $10^{12}$  over the full -28 to +61 degree C range.

DR. EMMONS:

Yes, over the full temperature range, parts in  $10^{12}$ .

## DISCUSSION FORUM: ATOMIC FREQUENCY STANDARDS

### CESIUM

C. C. Costain, National Research Council of Canada

I am not sure how this panel was picked, but I expect it was for our objectivity. I will therefore try to be objective on the subject of cesium standards. They are certainly important to us in the standards laboratories because, I think, they will remain as the defined basis for time and frequency for at least the next twenty years.

I am not going to say much about commercial cesium standards. They are widely used and well known. They are normally within specifications, and most of us are annoyed if they do not perform an order of magnitude better than specified. The entry of the Frequency and Time Systems into the field is important, and our measurements, and I think others, show the FTS performance is between the HP and HP high-performance option. My only question with respect to commercial standards would be as to whether too much lifetime is sacrificed in attaining short-term stability.

I am now going to go directly to a discussion of our primary cesium standards at NRC. I have a particular reason for doing so, which will become obvious. CsV has been operating continuously since May 1, 1975, and has undergone six full evaluations in that time. If it is assumed that TAI has been decreasing in frequency by  $8 \times 10^{-14}$ /year, with this one-parameter fit, the standard deviation between TAI and CsV, from the BIH circular D, is less than  $0.4 \mu\text{s}$ . We do not know what the flicker floor of CsV is because we have nothing as good to measure it.

Al Mungall and Herman Daams have completed the three new standards, CsVI, A, B and C. The next two figures show part of the construction. Figure 1 shows the inner C field structure, and the six coils to measure the LF resonances. Figure 2 shows the three standards completed. They have been operating as clocks for a few weeks, but they have not been evaluated. This will take most of a year, but the resonances are beautifully symmetric out to the  $m = -3$  and  $m = +3$ , with a symmetry which would delight any physicist.

But the stability to date has been disappointing. The Allan  $\sigma$  approaches  $1 \times 10^{-14}$ , and then after maybe 24 hours, a frequency change of up to  $1 \times 10^{-13}$  occurs. The culprit is the C field. Al Mungall has found by measuring the low frequency resonances that the change in frequency is the result of a change in the C field. Sometimes one, two or three of the coils show a range. It is the residual magnetism in the shields which is changing. Better degaussing is expected to reduce the effects, and work is proceeding on this feature.

Mungall has suggested that the magnetic shields could well be the limiting factor in the stability of atomic standards. The same effects occur in CsV, where changes of parts in  $10^{15}$  are seen in the biweekly C field measurements. But the field of a dipole is dependent on the cube of the distance, and as CsVI is nearly a factor of 2 smaller diameter, the effects are nearly an order of magnitude larger. It is likely that the residual magnetism will have a much greater effect on the frequency than the distributed phase shift when the beam position is changed.

Perhaps in H-masers, when a dielectric cavity reduces the size by a factor of 3, magnetic effects which are now  $3 \times 10^{-15}$  could become one or two orders of magnitude larger. Certainly at this level of precision one must expect the unexpected, and it becomes increasingly difficult to convert dreams into reality.



Figure 1. The C field structure of the three CSVI standards. The C field current in the four rods produces the transverse C field. The LF coils measure the C field outside each end of the cavity as well as in the drift space.

ORIGINAL PAGE IS  
OF POOR QUALITY

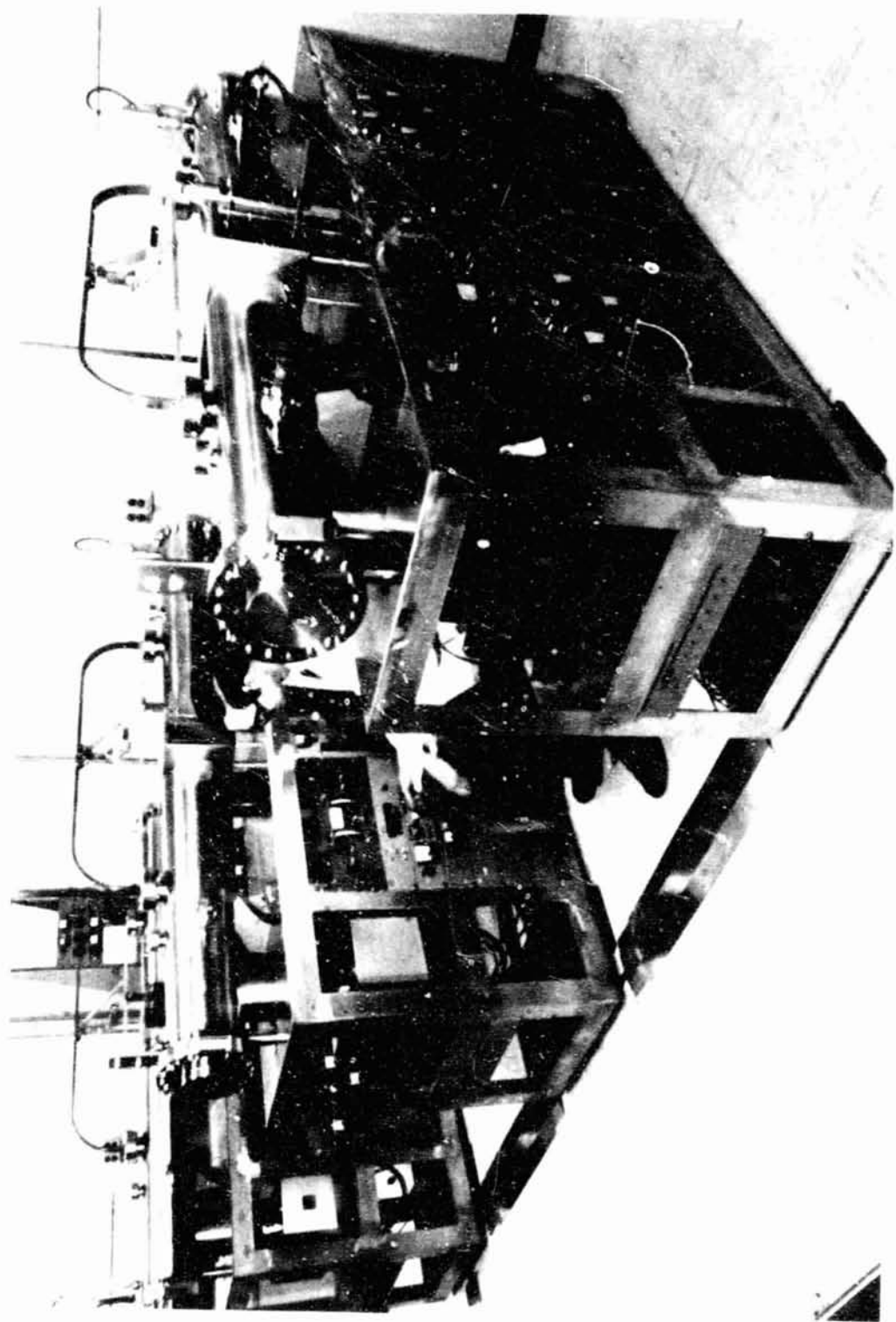

Figure 2. Dr. Mungall with the three CsVI primary clocks.

## DISCUSSION FORUM: ATOMIC FREQUENCY STANDARDS

### RUBIDIUM

Thomas C. English  
Efratom Systems Corporation

#### INTRODUCTION

The purpose of this presentation is to point out the advantages of rubidium gas cell frequency standards relative to both quartz oscillators and other atomic standards. We also consider how these advantages determine the types of applications that are suitable for rubidium devices, and what improvements can be expected in the future.

#### MAJOR ADVANTAGES OF RB RELATIVE TO QUARTZ

We begin this presentation by enumerating the advantages of commercial rubidium frequency standards relative to commercial quartz oscillators. See Table 1. In the first column, the characteristic to be compared is listed. In the second column, values of these characteristics are given for a small commercial rubidium standard. All of the parameter values given in this column are realized simultaneously in a single, commercial device. In the third column, state-of-the-art parameter values are listed for presently available commercial quartz oscillators (developmental devices are not included!). It is important to point out here that these parameter values cannot be simultaneously realized in a single commercial quartz device, and that the values for a typical high quality commercial quartz oscillator are usually about an order of magnitude worse than shown here. For example, a typical, high quality commercial quartz oscillator will have drift rate of about  $1 \times 10^{-10}$ /day. The value of  $< 2 \times 10^{-11}$ /day indicated in Table 1 can be realized in a currently available quartz device, but the price tag is rather high, of the order of \$15k. On the other hand, a long-term drift rate of less than  $1 \times 10^{-11}$ /month is readily available from a rubidium device. This is about a factor of 60 better than the table value of  $2 \times 10^{-11}$ /day for the best commercial quartz.

In summary, Table 1 shows that rubidium is one to two orders of magnitude better in each parameter listed, with the possible exception of short-term stability over periods of minutes to hours. Moreover, all parameter values given here are simultaneously realized in a small

TABLE 1  
 MAJOR ADVANTAGES OF RUBIDIUM RELATIVE TO  
 QUARTZ OSCILLATORS

CHARACTERISTIC	SMALL COMMERCIAL RUBIDIUM	STATE-OF-THE-ART PARAMETERS COMMERCIAL QUARTZ <sup>A</sup>
SHORT-TERM STABILITY (MINUTES TO HOURS)	PARTS IN $10^{13}$	NOT USUALLY SPECIFIED
LONG-TERM DRIFT	$< 1 \times 10^{-11}$ /MONTH	$< 2 \times 10^{-11}$ /DAY
WARMUP TIME (25 °C AMBIENT)	10 MIN TO $< 2 \times 10^{-10}$	30 MIN TO $1 \times 10^{-9}$
RETRACE (ON-OFF 24 HRS-ON)	$< 2 \times 10^{-11}$	$J \times 10^{-9}$
ACCELERATION SENSITIVITY	$< 8 \times 10^{-12}$ /G	$8 \times 10^{-10}$ /G

<sup>A</sup> THESE PARAMETERS ARE NOT SIMULTANEOUSLY AVAILABLE IN A SINGLE DEVICE.

commercial rubidium, whereas this is not the case for commercial quartz.

#### MAJOR ADVANTAGES OF RB RELATIVE TO OTHER ATOMIC STANDARDS

The main advantages of rubidium relative to other atomic standards are listed in Table 2. These advantages include small size, light weight, low power consumption and low cost.

#### PHOTOGRAPH OF SMALL COMMERCIAL RB

Figure 1 shows the size of a small commercial rubidium frequency standard. It is a cube that is 4 inches on a side. The pocket watch serves to give one a gut feel for the small size of this device.

#### PHYSICAL CHARACTERISTICS OF COMMERCIAL RB & CS STDS

The first two lines of Table 3 compare small commercial rubidium and cesium devices. These are the basic, no-frills units. Note that rubidium is 8 times smaller, 7 times lighter, uses  $\frac{1}{2}$  as much power and costs from  $\frac{1}{3}$  to  $\frac{1}{5}$  as much.

The last two lines of Table 3 are for those persons who are interested in a bench or rack mount unit, including an AC power supply and a standby battery pack for uninterrupted operation in the event of a powerline failure. In this case, small size, weight and power consumption are not of major concern, so no effort has been made to minimize these characteristics.

By the way, hydrogen devices have not been included in this comparison because we are concerned here only with commercially available atomic standards; to the best of our knowledge, there are no commercially available hydrogen devices.

#### SIZE COMPARISON OF TWO COMMERCIAL ATOMIC STANDARDS

Figure 2 allows a direct comparison of the relative sizes of a small commercial rubidium and a small commercial cesium. For many years I did physics research in the area of atomic and molecular beams, with big, long, machines that filled up most of a room. For this reason, it is always amazing to me to see that it has been possible to make cesium standards as small as they are today. But, of course, the same is also true for present-day rubidium devices. In any case, it



TABLE 2  
MAJOR ADVANTAGES OF RUBIDIUM RELATIVE TO  
OTHER ATOMIC STANDARDS

- SMALL SIZE
- LIGHTWEIGHT
- LOW POWER CONSUMPTION
- GOOD SHORT-TERM STABILITY
- LOW PHASE NOISE
- POTENTIALLY FASTER WARMUP
- LOW COST

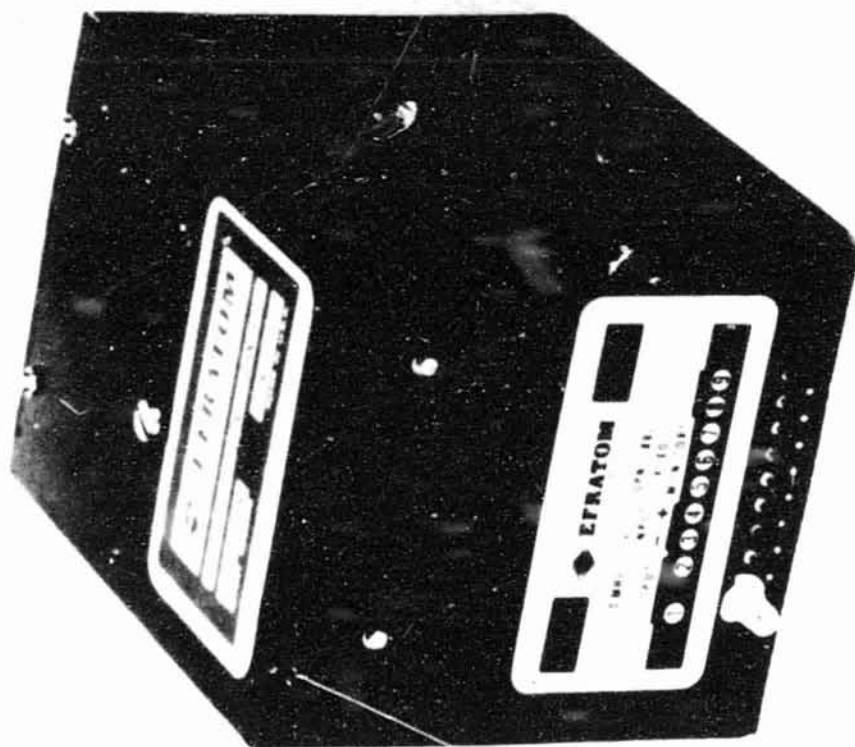

Figure 1. Small commercial rubidium frequency standard.

ORIGINAL FILE IS  
OF POOR QUALITY

TABLE 3  
 PHYSICAL CHARACTERISTICS OF COMMERCIAL RUBIDIUM AND  
 CESIUM FREQUENCY STANDARDS

DEVICE	SIZE (CU IN)	WEIGHT (LBS)	DC POWER (W)	COST <sup>B</sup> (K\$)
SMALL COMMERCIAL RUBIDIUM	67	3	13	4 - 6
SMALL COMMERCIAL CESIUM RUBIDIUM/CESIUM	560 x 1/8	22 x 1/7	24 x 1/2	19 x 1/3 - 1/5
COMMERCIAL RUBIDIUM <sup>A</sup>	900 - 1400	27 - 38	---	7 - 10
COMMERCIAL CESIUM <sup>A</sup>	1600 - 2400	57 - 75	---	20 - 25

<sup>A</sup> INCLUDES AC POWER SUPPLY & STANDBY BATTERY PACK.

<sup>B</sup> SINGLE QUANTITIES.

FIGURE 2. SIZE COMPARISON OF TWO COMMERCIAL ATOMIC STANDARDS

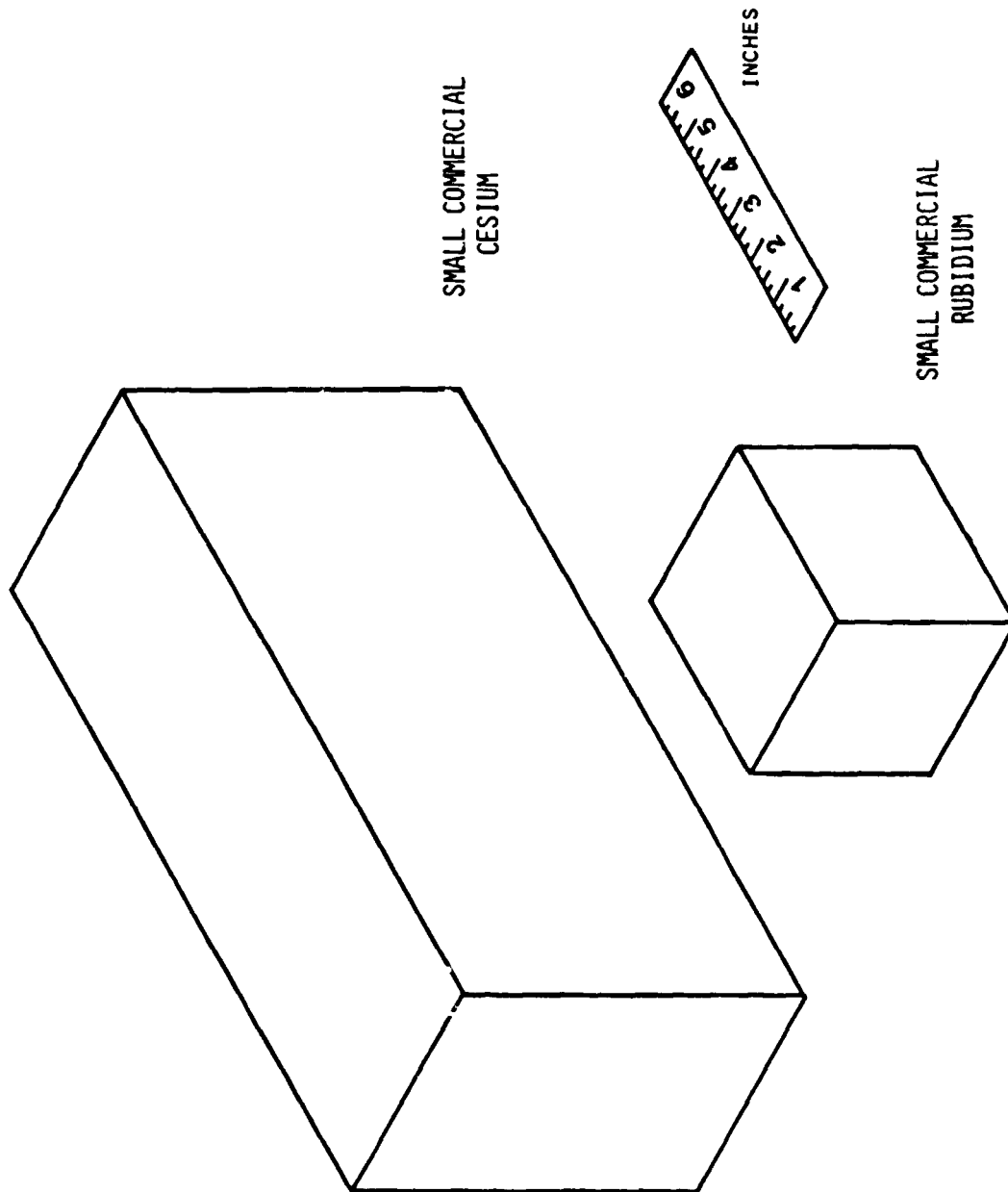

is evident from Figure 2 that the small size of rubidium devices is one of their major advantages.

#### MEASUREMENT TIME REQ'D TO REALIZE A FREQUENCY ACCURACY OF $1 \times 10^{-12}$

Figure 3 shows the time required to make a frequency measurement to 1 part in  $10^{12}$  using commercially available atomic frequency standards. In plotting these curves, we have assumed that the performance of the frequency standard used as the measuring device is the limiting factor. For each curve, the measuring device is specified to the right of the curve; for example, the measuring device for the uppermost curve is a commercial cesium.

In general, it should be obvious that the measurement time will depend on how good the short-term stability of the measuring device is; the better the short-term stability, the shorter the measurement time that is required. Because of the excellent short-term stability of rubidium standards, the measurement time required to attain  $1 \times 10^{-12}$  accuracy with them is very short.

In discussing measurement time, it is important to understand that we are really dealing with frequency fluctuations over a given period of time, and that these fluctuations are statistical in nature. For this reason, it is necessary to make multiple measurements in order to reduce the statistical uncertainty. For example, 19 measurements are required to specify an accuracy of  $1 \times 10^{-12}$  to within  $\pm 20\%$ . For the commercial rubidium having the best available short-term stability, this will require a total measurement time of 8 minutes. For the small commercial rubidium, 32 minutes will be required. When we look at the measurement times for the cesiums, we can see how good the rubidium times really are. One commercial cesium, a very commonly used one, requires a total measurement time of 1 day! A small commercial cesium is available that requires only about half this amount of time, but this is still quite long when compared to the rubidium figures.

Now, you will look at this graph and say, "but hey, wait, you forgot one of the cesiums!--the high performance cesium." Yes, you are right, the high performance cesium has good short-term stability -- it is comparable to that of the rubidiums, but it is obtained at a price. It is obtained by increasing the cesium beam intensity by more than an order of magnitude, and this reduces the life of the beam tube. This reduced lifetime is reflected in the manufacturer's warranty for the beam tube. For most commercial cesiums, the warranty is 3 years, but for the high performance cesium, the warranty is only 14 months. Here again, the cost factor enters: in general,

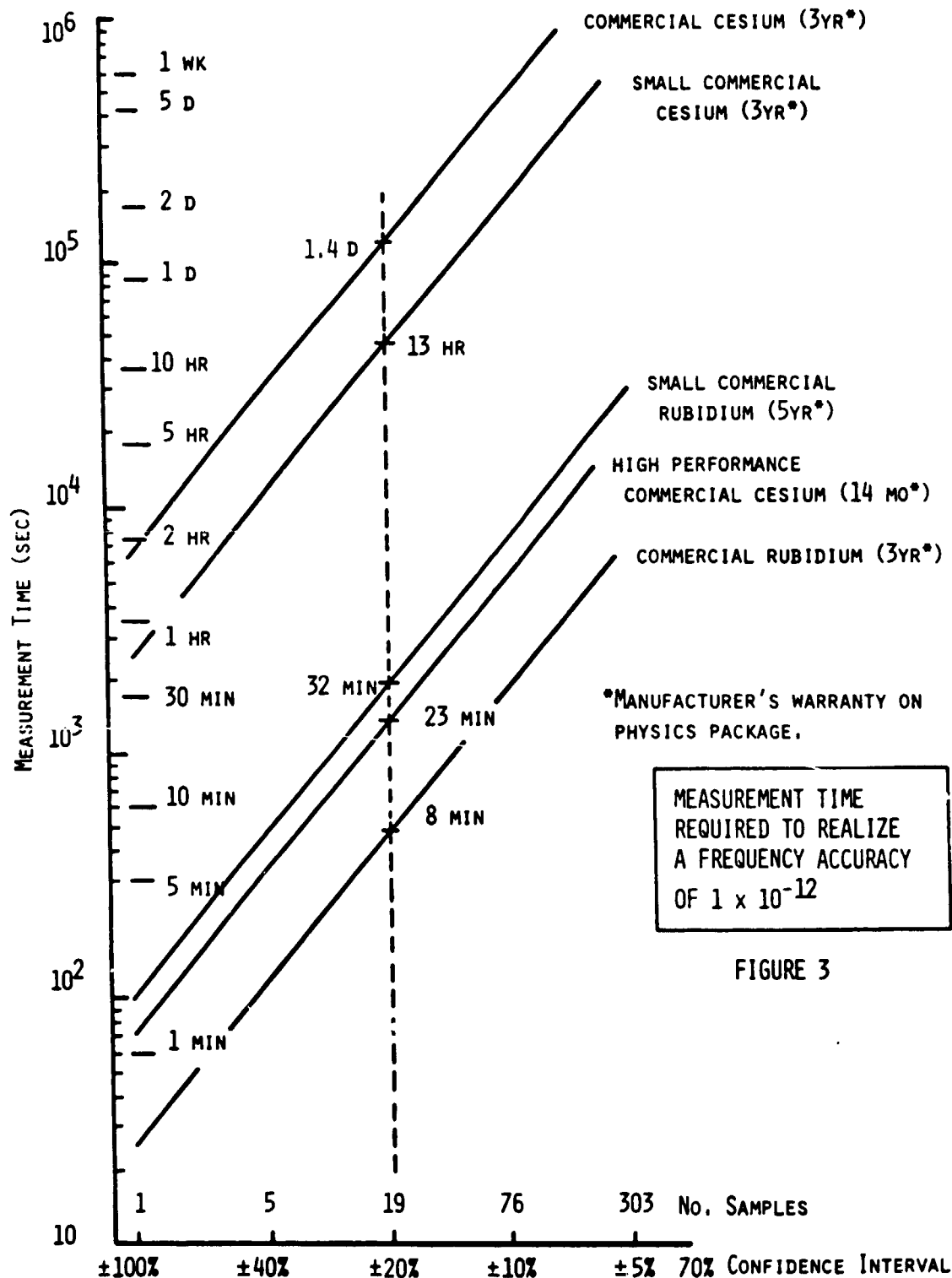

FIGURE 3

the beam tube replacement costs for any cesium are on the order of, or greater than the purchase price of a complete rubidium frequency standard. In the rubidium devices, the component in the physics package that is most likely to fail is the rubidium lamp whose replacement cost is only a few hundred dollars. Moreover, the manufacturers' warranties vary from 3 to 5 years on the physics package, which includes the lamp.

To summarize, conventional cesiums require long measurement times to attain frequency accuracies of 1 part in  $10^{12}$ . It is possible to buy cesiums that allow short measurement times, but they suffer from the disadvantage of reduced beam tube life and high replacement costs. Rubidium standards, on the other hand, do not suffer from these disadvantages.

#### RUBIDIUM PHASE NOISE SPECIFICATION

Figure 4 shows the phase noise specification for a small commercial rubidium. Low phase noise is important when multiplying signals in the MHz region up into the GHz region and beyond because the noise power increases by  $n^2$  for a frequency multiplication by a factor of  $n$ . The specification shows that the single sideband phase noise is down by 92 dB one Hz away from the carrier, and decreases as  $1/f^3$  until the white phase modulation floor of -155 dB is reached at a Fourier frequency of 100 Hz. To the best of my knowledge, the phase noise spec shown here is better than that of any commercial cesium.

#### EFFECT OF NUCLEAR RADIATION ON AN OPERATING RB STD

One topic, about which not much information seems to be available, is the effect of nuclear radiation on atomic frequency standards. Data are now available for the effects of dose rate and total dose on rubidium frequency standards, and we present some of these data here.

Table 4 shows the result of a recently conducted test to determine the effect of dose rate on an operating rubidium frequency standard. The unit tested is one of the Rockwell engineering models for the GPS satellite program. This unit uses an Efratom small rubidium physics package. The unit was exposed to flash x-ray radiation at a dose rate of about  $4 \times 10^8$  rads/sec while operating. This dose rate was the maximum dose rate that could be obtained from the flash x-ray facility. There are two main results from this experiment. First, the radiation had a negligible effect on the physics package. Second, the accumulated phase error due to the radiation was  $< 1$  nsec.

FIGURE 4  
PHASE NOISE  
SMALL COMMERCIAL RUBIDIUM

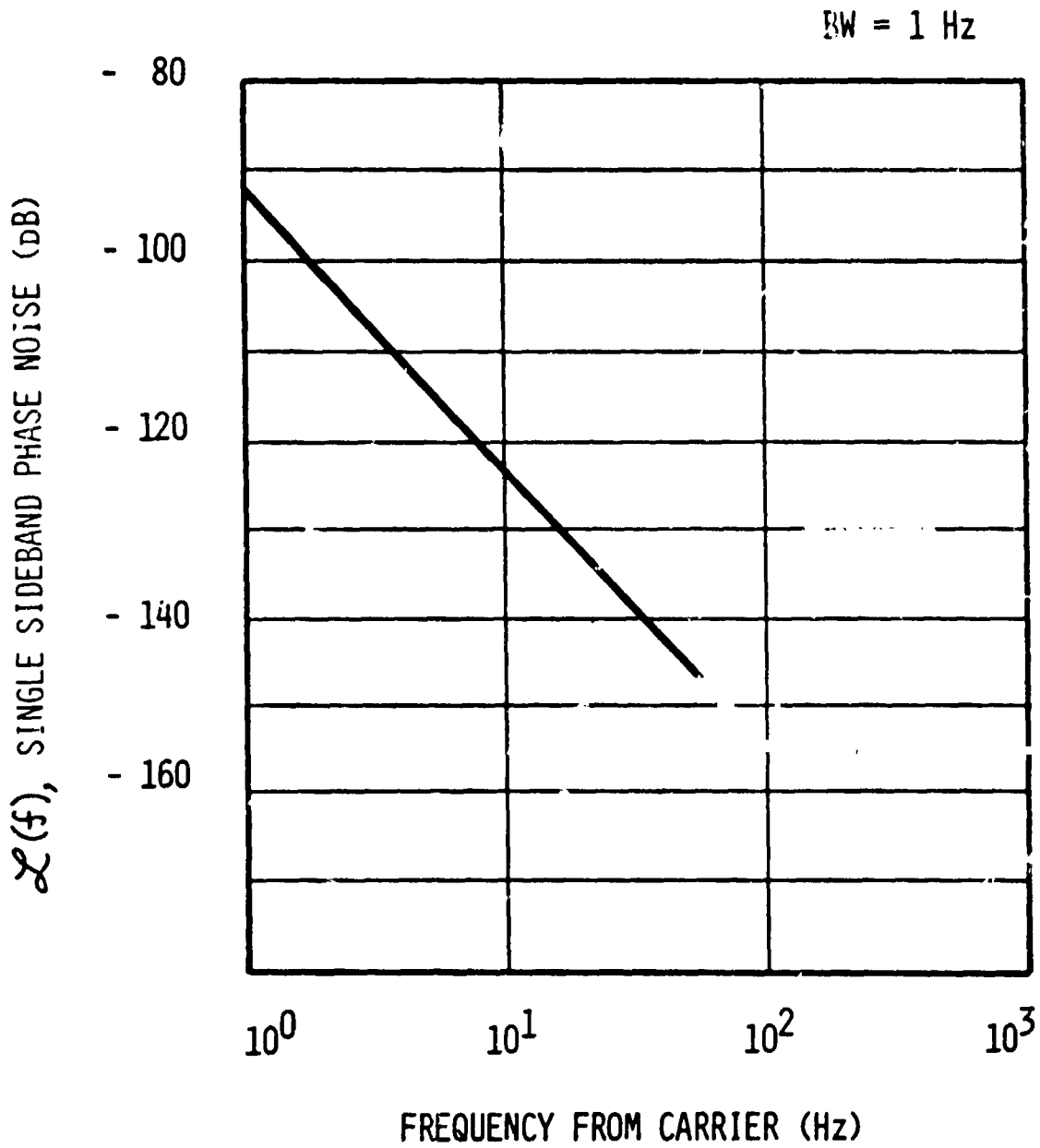



TABLE 4

EFFECT OF NUCLEAR RADIATION (DOSE RATE) ON AN OPERATING  
RUBIDIUM FREQUENCY STANDARD

DEVICE TESTED : UNSHIELDED GPS PHASE I RUBIDIUM SPACE CLOCK (EM3)  
LOCATION OF TEST : ROCKWELL INTERNATIONAL, AUTONETICS DIVISION,  
FLASH X-RAY FACILITY

DOSE RATE :  $> 3.8 \times 10^8$  RAD (SI)/SEC (MAX ATTAINABLE RATE)

RESULTS

- EFFECT OF RADIATION ON PHYSICS PACKAGE: NEGLIGIBLE
- ACCUMULATED PHASE ERROR:  $< 1$  NSEC

#### ACCUMULATED PHASE ERROR FOR MOST SENSITIVE DIRECTION

The engineering model tested contained two radiation-hardened crystal oscillators (VCXO's). The first VCXO was used in the primary loop and was locked to the rubidium resonance with a loop time constant of  $< 0.1$  sec. The second VCXO was used in a secondary 10.23 MHz loop that was locked to the first loop with a time constant of 21 sec. The main effect of the radiation is to alter the properties of the radiation-hardened VCXO's. This results in VCXO frequency changes which are subsequently servoed out by the control loops (each VCXO is locked, in effect, to the rubidium resonance). However, accumulated phase changes will result if the VCXO frequency changes occur in times short compared to the loop time constant; i.e., transient effects are responsible for the accumulated phase errors.

Figure 5 shows the accumulated phase error for the secondary loop. The radiation burst occurred at  $t = 0$  while the unit was operating. After about 1 minute the phase stabilized with an accumulated phase error of about 22 nsec. Under the same conditions, the accumulated phase error for the primary loop was  $< 1$  nsec. This difference may be attributed mostly to the smaller time constant for the primary loop and the fact that the rubidium resonance is essentially unaffected by the radiation. Here the important results are those for the primary loop. Secondary loops are rarely used, and in any event can be considered as a loop that is external to the actual rubidium device, whereas the primary loop is part of the rubidium device.

#### EFFECT OF $10^4$ RADS ON AN OPERATING, UNMODIFIED SMALL COMMERCIAL RUBIDIUM STANDARD.

Figure 6 shows the effect of total radiation dose from a cobalt 60 source on an operating, unmodified, small commercial rubidium standard, essentially an Efratom Model FRK with high reliability electronic components. That is, the device was unmodified in any essential respect as far as its capacity to resist radiation was concerned. The total dose of  $10^4$  rads was accumulated at a steady rate over a 1 hour period.

As a result of the irradiation, the frequency of the unit increased by about 6 parts in  $10^{11}$ . This frequency change resulted from a change in the characteristics of the electronics in the servo loop. The photo cell voltage, here labelled "Rb lamp voltage," changed by less than 1%. This shows that the rubidium lamp and the physics package optics were essentially unaffected by the radiation. On the other hand, the VCXO control voltage changed by 6 volts, indicating that the VCXO characteristics had been altered by the radiation.

FIGURE 5  
ACCUMULATED PHASE ERROR FOR MOST  
SENSITIVE DIRECTION

SECONDARY 10.23 MHZ LOOP,  $\tau = 21$  SEC  
>  $3.8 \times 10^8$  RAD (SI)/SEC

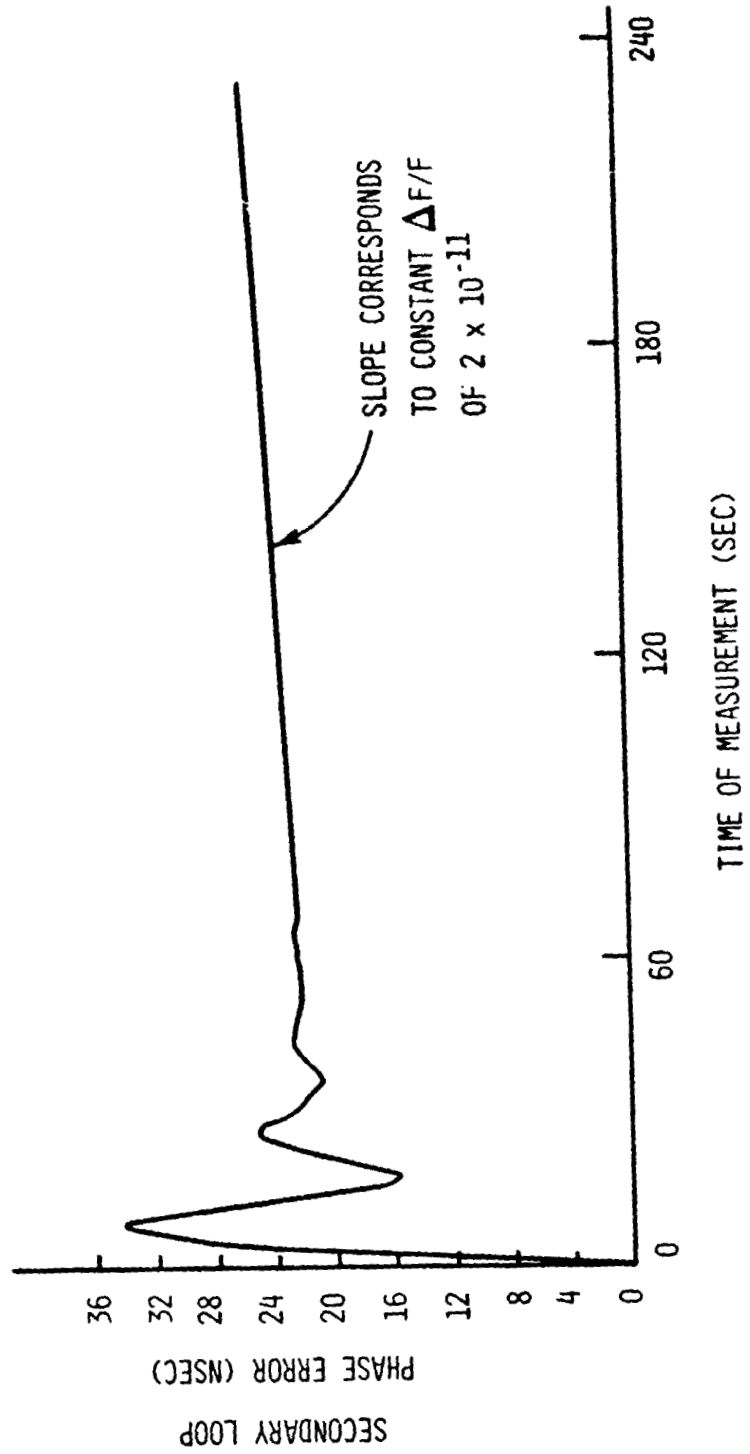
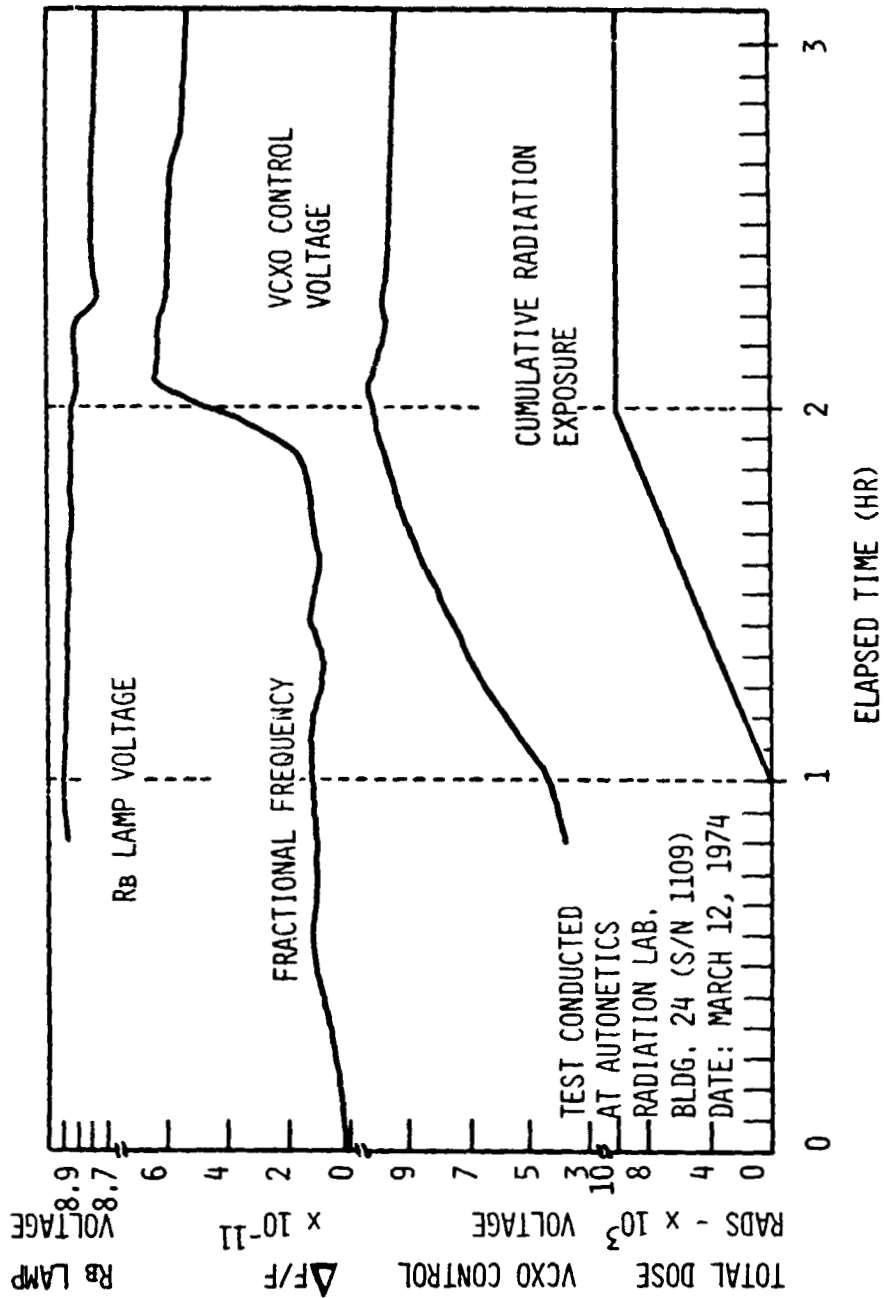

FIGURE 6. EFFECT OF  $10^4$  RADS ( $Co^{60}$ ) ON AN OPERATING,  
UNMODIFIED, SMALL COMMERCIAL RUBIDIUM STANDARD



This was not surprising, however, since the VCXO crystal was not designed or selected to withstand radiation effects.

In summary: The physics package of a small commercial rubidium frequency standard was essentially unaffected by a radiation dose rate of  $4 \times 10^8$  rads/sec, and a total dose of  $10^4$  rads, in independent tests. For the dose rate of  $4 \times 10^8$  rads/sec, the accumulated phase error was  $< 1$  nsec, and this occurred within 60 sec after the radiation burst. For the experiment where the total dose was  $10^4$  rads, there was a frequency shift of about 6 parts in  $10^{11}$  due to the irradiation. However, since this was due to a change in the electronics rather than to any changes in the physics package, and since the electronics in this case were not radiation hardened, this frequency shift could be eliminated in a carefully designed device.

#### APPLICATIONS ESPECIALLY SUITED FOR SMALL, LOW-COST RB STDS

Most of the applications for rubidium frequency standards utilize one or both of the two basic techniques listed in Table 5, namely, time-keeping, usually in the sense of measuring precise time and time intervals over periods up to about 10 hours, and also the generation of spectrally pure and stable microwave frequencies having high signal-to-noise ratios using the method of frequency multiplication from high quality low frequency signals.

Most of the applications peculiar to rubidium, as opposed to cesium, utilize the small size and weight, the low power consumption, and the low cost that rubidium provides. By far the largest application for rubidium at the present time is the use of these standards for navigation purposes in light and medium aircraft. We discuss this in some detail below. A related application is the use of these standards for positioning and geodetic survey purposes. An example of a positioning application would be locating the correct position at which to place an offshore oil and gas drilling platform.

Another class of applications is the use of these devices for secure communications systems; i.e., for military communications systems. This is an application that is just getting started and of which we will see quite a bit in the coming years. The area of secure communications can be divided into two groups: The first is message modulation and synchronous demodulation which uses the timekeeping capability of rubidium devices. The second is the use of spread spectrum techniques such as frequency hopping and pseudo random noise phase modulation that require spectrally pure and stable microwave frequencies with low phase noise, which is the second technique listed above. Again, the small size and weight, low power consump-

TABLE 5  
APPLICATIONS ESPECIALLY SUITED FOR  
SMALL, LOW-COST RUBIDIUM FREQUENCY STANDARDS

BASIC TECHNIQUES:

- TIMEKEEPING (PTTI)
- GENERATION OF SPECTRALLY PURE & STABLE MICROWAVE FREQUENCIES  
(USING FREQUENCY MULTIPLICATION)

APPLICATIONS:

- NAVIGATION (SMALL-MEDIUM AIRCRAFT)
- POSITIONING & GEODETIC SURVEY
- SECURE COMMUNICATIONS  
MESSAGE MODULATION & SYNCHRONOUS DEMODULATION  
SPREAD SPECTRUM (E.G., FREQUENCY HOPPING; PRN PHASE MODULATION)
- DIGITAL NETWORK SYNCHRONIZATION & MULTIPLEXING
- FREQUENCY CONTROL & CALIBRATION
- TIMEKEEPING PER SE (CLOCKS)

tion, and low cost make rubidium more suitable for applications of this type which require portability, such as in moveable field stations and military aircraft.

A somewhat related application is the use of rubidium standards for the synchronization of digital networks. This includes civilian, as well as military uses. An example of this is the Datran commercial communication system which uses rubidium standards for timing purposes (R. L. Mitchell, "Survey of Timing/Synchronization of Operating Wideband Digital Communications Networks," Paper 11, Session IV, this conference (10th PTTI)). The last two applications in Table 5 are not especially suited to rubidium, except inasmuch as cost is a factor. In any case, these two applications are two of the more conventional ones as regards atomic standards.

#### NAVIGATION APPLICATION--RADIO NAVIGATION (VLF - OMEGA)

In Table 6 we are talking about the use of rubidium frequency standards in VLF & Omega navigation systems. The users here are owners and operators of light-medium aircraft. This includes both Lear jets and helicopters. In this application, price is a very important consideration. These types of radio navigation systems are typically priced in the range of \$40,000 to \$50,000. By way of comparison, inertial navigation systems sell for more than \$100,000 and up. It is worth noting that it is obviously impractical to use a cesium standard costing about \$20,000 in a radio navigation system that sells for \$40,000. For this reason, the small commercial rubidium standard is the clear choice for this application.

A conventional VLF-Omega navigation system, which does not use an atomic standard, uses the hyperbolic method of locating position. In this method, a minimum of 3 VLF and/or Omega stations is required. Sometimes, radio conditions are such that it is not possible to receive as many as three stations. In this case, the accuracy of the system is greatly degraded. Even if three stations can be received, it may not be possible to obtain an accurate position determination. This depends on the geometical positions of the stations relative to the aircraft and the signal-to-noise ratios of the received signals.

A VLF-Omega navigation system that uses a rubidium standard does not suffer from these disadvantages. The inclusion of the atomic standard in the plane's navigation system allows the rho-rho navigation method to be used instead of, or in addition to, the hyperbolic system. The main advantages of the rho-rho system are that it is simpler to implement and is more accurate under adverse conditions.

TABLE 6

NAVIGATION APPLICATION

RADIO NAVIGATION (VLF - OMEGA)

USERS: LIGHT - MEDIUM AIRCRAFT, INCLUDING HELICOPTERS

NO RUBIDIUM STANDARD: HYPERBOLIC, MINIMUM OF 3 STATIONS REQ'D

WITH RUBIDIUM STANDARD: RHO - RHO, ONLY 2 STATIONS REQ'D

NAVIGATION ACCURACY

$$\Delta X = C \cdot \Delta T$$

DISTANCE ERROR = 1 FT/NSEC x TIME ERROR

CLOCK OFFSET OF  $4 \times 10^{-10}$  GIVES:

TIME ERROR = 6  $\mu$ SEC  
DISTANCE ERROR = 1 MILE  
} IN 4 HOURS

COMPARE WITH INERTIAL NAVIGATION ERROR OF  $\sim 4$  MILES IN 4 HOURS!



In the rho-rho method, the distance to a radio navigation station having known position is determined by measuring the time  $T$  that it takes for the radio signal to travel from the radio station to the aircraft. The distance  $X$  from the station to the plane is then given by  $X = C \cdot T$ , where  $C$  is the speed of light. The distance of the aircraft from the radio station defines a line of position (or locus) that is a circle of radius  $X$  with its center at the station. If the distances from two such radio stations are known, then we will have two such circles, one centered on each radio station. The aircraft is then located at one of the two points of intersection of the two circles. In this method, the distance error,  $\Delta X$ , is related to the time error,  $\Delta T$ , by the equation shown in Table 6, where  $C$  is the speed of light. In this equation the time error,  $\Delta T$ , is the accumulated time error of the atomic clock since the aircraft left its point of origin (point of clock synchronization).

Even if the atomic clock has a large average frequency offset, the navigational accuracy is still quite good. For example, suppose the average frequency offset of the clock were as large as  $4 \times 10^{-10}$ . Then the accumulated time error over a 4 hour period would amount to approximately 6 microseconds, and this would give a distance error of only about 1 mile. It is interesting to compare this navigational accuracy with that attainable by inertial navigation. For inertial navigation, the error would typically be about 1 mile for every hour of flight time, or about 4 miles in 4 hours! The rho-rho method is therefore capable of greater navigational accuracy at considerably lower cost.

#### FUTURE IMPROVEMENTS IN SMALL RUBIDIUM STANDARDS

Table 7 shows some of the improvements that can be expected in rubidium frequency standards in the future. We can expect the size to decrease by about a factor of two from the present small rubidium size of 1 liter. This will be accompanied by a weight reduction of about 40 % and a power reduction of about a factor of 2. In addition, we can expect warmup times to decrease further, by about a factor of five for a room temperature ambient. At  $-55^\circ\text{C}$  ambient, warmup times of less than 5 minutes should be easily possible.

The temperature sensitivity will be less by at least a factor of 4. At the same time, it should be possible to reduce the sensitivity to changes in barometric pressure by about an order of magnitude. As quantities increase and manufacturing techniques improve, the price will decrease at the same time. It is difficult to predict this with much accuracy, but a price decrease of approximately a factor of 2 is reasonable to expect.

TABLE 7  
 FUTURE IMPROVEMENTS IN SMALL RUBIDIUM STANDARDS

CHARACTERISTIC	PRESENT	FUTURE	IMPROVEMENT
SIZE (CU IN)	67	34	x 2
WEIGHT (LBS)	3	1.8	x 1.7
POWER CONSUMPTION (W)	13	7	x 2
WARMUP TIME (25 °C AMBIENT)	10 MIN TO < 2 x 10 <sup>-10</sup>	< 2 MIN TO 5 x 10 <sup>-10</sup>	~ x 5
TEMPERATURE EFFECT (-55 °C AMB. TO + 71 °C B.P.)	4 x 10 <sup>-10</sup>	~ 1 x 10 <sup>-10</sup>	~ x 4
ATMOSPHERIC PRESSURE EFFECT (SEA LEVEL TO 40,000 FT)	8 x 10 <sup>-11</sup>	~ 1 x 10 <sup>-11</sup>	~ x 8
COST (K\$)	4 - 6	2 - 5	~ x 2

To summarize: The main improvements will be in the areas of size, weight, power consumption, warmup time, and environmental sensitivity. Other characteristics will either also improve, or else remain about the same as they are now. This should result in a wider range of applications and concomitant lower prices.