



NASA CR-159,078

NASA Contractor Report 159078

NASA-CR-159078
19790016974

Study of High Resistance Inorganic Coatings on Graphite Fibers

F.S. Galasso, R.D. Veltri, D.A. Scola

UNITED TECHNOLOGIES RESEARCH CENTER
EAST HARTFORD, CT 06108

Contract NAS1-14346
June 1979

NASA

National Aeronautics and
Space Administration

Langley Research Center
Hampton, Virginia 23665
AC 804 827-3966

LIBRARY COPY

JUL 17 1979

LANGLEY RESEARCH CENTER
LIBRARY, NASA
HAMPTON, VIRGINIA

UNITED TECHNOLOGIES RESEARCH CENTER



East Hartford, Connecticut 06108

Report R79-914212-9

Study of High Resistance Inorganic Coatings on Graphite Fibers

Interim Report
Contract NAS1-14346

REPORTED BY F. S. Galasso

F. S. Galasso
Program Manager

R. D. Veltri

R. D. Veltri

D. A. Scola

D. A. Scola

APPROVED BY E. R. Thompson

E. R. Thompson, Manager
Materials Sciences

DATE June 1979

NO. OF PAGES 120

COPY NO. _____

N79-25145 #

Study of High Resistance Inorganic Coatings
on Graphite Fibers

TABLE OF CONTENTS

SUMMARY	1
INTRODUCTION	2
COATING APPARATUS AND PROCEDURES	3
Static CVD Coating Apparatus	3
Continuous CVD Coating Apparatus	3
Static Organo-Silicone Coating Apparatus and Procedure	4
Organo-Silicone Coating Apparatus for Continuous Processing	5
EXPERIMENTAL TEST PROCEDURES	6
Oxidation-Weight Loss Measurements	6
Electrical Resistance Measurements	6
Arcing Tests	7
Ultimate Tensile Strength Measurements	7
Coating Thickness Measurements	8
X-ray Diffraction Analysis	8
Scanning Electron Microscope Examination	9
Ion Scattered Spectroscopy/Scattered Ion Mass Spectrometry (ISS/SIMS) Analysis	9
Mechanical Testing of Composites	9
DISCUSSION AND RESULTS	11
CVD SiC Coating Approach	11
Organo-Silicone Coating Approach	18
CONCLUSIONS	25

TABLE OF CONTENTS (Cont'd)

RECOMMENDATIONS FOR FURTHER RESEARCH	26
ACKNOWLEDGEMENTS	27
REFERENCES	28
TABLES I - XXVI	31
FIGURES 1 - 43	
APPENDIX A	
APPENDIX B	

Study of High Resistance Inorganic Coatings
on Graphite Fibers

SUMMARY

Several approaches for applying high resistance coatings continuously to HTS graphite yarn were investigated. Two of the most promising approaches involved (1) chemically vapor depositing (CVD) SiC coatings on the surface of the fiber followed by oxidation and (2) drawing the graphite yarn through an organo-silicone solution followed by heat treatments. In both methods, coated fibers were obtained with exhibited increased electrical resistances over untreated fibers and which were not degraded.

The CVD SiC coated and oxidized graphite fibers were found to have high electrical resistances, but variation was measured from run to run. The pyrolyzed organo-silicone coated graphite fiber did not exhibit such a large increase in resistance and yielded lower shear strengths in composites, but the process for coating the fibers offered potential as a rapid coating technique.

"Use of commercial products or names of manufacturers in this report does not constitute official endorsement of such products or manufacturers, either expressed or implied, by the National Aeronautics and Space Administration."

INTRODUCTION

Over the past several years, graphite fibers have been used to produce low density high strength composites for many aerospace structures. The interest in these composites has been growing steadily especially for use in aircraft structures. Because of this growing interest, it became of concern to both composite users and manufacturers when it was announced that the release of carbon fibers from composites due to fire or explosions could have serious effects on electrical and electronic equipment (Refs. 1,2).

In order to solve this problem, NASA looked at several approaches to either prevent the release of fibers or to make the fibers nonconductive so they would not short circuit electrical equipment. A summary of these approaches was discussed at a NASA workshop in Hampton, VA on March 23-24, 1978 (Ref. 3).

The approach taken on this NASA program to solve the fiber conductivity problem was to coat the graphite fibers with a layer which would increase the resistance of the fiber. Hercules HTS graphite fibers were selected for use in the development of electrically resistant coatings because of the wide range of NASA programs for which this fiber was used. A preliminary study was first conducted on drawing graphite fiber through glass, dipping the fibers in colloidal silica, drawing fiber through organo-silicones and chemical vapor depositing (CVD) coatings of SiC and B or B alloys. The results of the preliminary study along with a brief description of each technique are given in Appendix A. This was followed by a more detailed study of the most promising methods which were the CVD SiC coating and organo-silicone approaches.

COATING APPARATUS AND PROCEDURES

Static CVD Coating Apparatus

The initial experiments on the chemical vapor deposition of SiC began with the coating of graphite yarn in a static reactor. A schematic of this reactor is shown in Fig. 1. The graphite yarn to be coated was suspended in the center of a graphite cylinder which was heated with an rf induction coil. The reactant gases were introduced into the reactor after the graphite yarn was brought to the desired temperature. The reactant gas flow rates were 0.015ℓ/min of methyl-dichlorosilane, 0.110ℓ/min of hydrogen and 0.110ℓ/min of methane. These gas flow rates were selected from previous research at UTRC which showed that they yielded the best β SiC. For the static coating studies the deposition temperature and times were varied.

The methyl-dichlorosilane vapor needed for the SiC deposition process was obtained from a liquid evaporator. A schematic of this evaporator is shown in Fig. 2.

The constant temperature of the water jacket together with the pressure within the supply tank was measured so that calculations could be made to determine the amount of methyl-dichlorosilane which was introduced into the reactor during an experiment.

Continuous CVD Coating Apparatus

Vertical Reactor

Continuous deposition was conducted in the vertical reactor apparatus shown in Fig. 3. Argon gas seals on both the top and bottom of the reactor kept the reactant gases within the chamber and minimized the introduction of outside air into the hot zone. An rf induction coil was used to heat a graphite susceptor which was placed within a double walled water cooled silica chamber. The yarn to be coated was taken off the manufacturer's spool, pulled over appropriate pulleys and guides, threaded through the top electrode, passed down through the hot zone and out of the reactor via the lower argon gas seal. Once outside the reactor the coated yarn was then attached to a take-up drum and the rotation of the take-up drum was used to control the through-put speed of the yarn to be coated.

The ability to continuously oxidize the SiC coated yarn was added to the vertical reactor by the installation of a small tubular furnace after the exit port of the CVD SiC reactor and before the take-up spool. This furnace was capable of operation from 773 to 923 K. Numerous experiments were made at various oxidation temperatures and drawing rates. For CVD experiments in which no oxidation was desired the furnace was left in the line but no power was applied.

Horizontal Reactor

A modification to the deposition apparatus was made so that the coating operation could be carried out in a horizontal mode. In Figs. 4 and 5 are shown two views of the horizontal continuous CVD reactor set for operation. The in-line oxidation furnace retained its relative position, that of being between the exit port of the reactor and the take-up spool. For horizontal operation the inner graphite susceptor was separated from the silica water cooled walls by aluminum oxide spacers. The manner of introducing the reactant gases and the argon gas seals were similar to those used in the vertical deposition apparatus.

Static Organo-Silicone Coating Apparatus and Procedure

The static organo-silicone coating tests were conducted simply by dipping the fiber in a 1 liter beaker containing 100 ml of coating solution. These coatings were then treated further in separate operations involving draining, drying, and pyrolysis.

Four types of silicone materials were selected for these experiments. Two of these were monomeric silanes, capable of forming a polymeric gel on the fiber surface, and two others were soluble silicone prepolymers. Another criteria of selection was that each material would be capable of undergoing decomposition to mostly silicon dioxide, containing little or no silicon carbide.

The silanes selected were methyltriethoxysilane (MTS) and vinyltriacetoxysilane (VTS). The prepolymers selected were GE silicone resin SR-355 and a commercial prepolymer of ethyl silicate (ES). The materials selected are listed in Table I. Initial experiments were conducted on one meter lengths of HTS graphite tows. Three and one-half weight percent of the selected silicone materials, except ethyl silicate, were prepared in electronic grade toluene. A three volume percent of ethyl silicate in isopropanol was prepared. The HTS graphite tows were submersed in the liquid solutions for a period of 1 min, removed, allowed to drain in a vertical position for about 2 min, then immersed

in a steam heated 500 ml graduate, containing 50 ml of water at a temperature of ~353 K, for a period of 2 min, and then air dried. A summary of experiments carried out using this static screening approach is listed in Table II. The procedure was repeated for graphite tows undergoing more than one deposition.

The hydrolyzed silicone coated fibers were centered in a 1 meter long x 5 cm diameter glass tube, having a continuous flow of nitrogen (100 ml/min). The ends of each tow were connected to alligator clips. A current was introduced in order to raise the temperature of the tows to 783 K. Electrical resistance heating of the tows was continued for 1 hr at 783 K. The tows were removed and subjected to evaluation, as described below. For multiple coatings, only a single pyrolysis was performed after the last coating. The graphite tow coated with ethyl silicate was heated to 423 K in air for 15 min before pyrolysis to initiate chain extension of the prepolymer.

Organo-Silicone Coating Apparatus for Continuous Processing

A photograph of the continuous fiber coating apparatus is shown in Fig. 6 and a schematic drawing in Fig. 7. The apparatus consists of four basic sections, a multipass coating section (A), a drying section (B), a hydrolysis section (C), another drying section (D), and finally pyrolysis section (E). The yarn is directed into the multipass coater (A) followed by a drying section (B), and then into a steam section (C) of the chamber where hydrolysis occurs. The yarn is then led into another drying tube (D) via pulleys, and back into the coating bath (A). This is repeated five times and then directed into section E, the pyrolysis chamber. The pyrolysis experiments were carried out in a nitrogen atmosphere over a temperature range at a nitrogen flow rate of 5.4 liters/min.

EXPERIMENTAL TEST PROCEDURES

Oxidation-Weight Loss Measurements

Static oxidation of coated and uncoated graphite fibers was conducted in a standard laboratory furnace. Specimens to be oxidized were introduced into the hot furnace after having been first placed in either a high purity aluminum oxide boat or crucible or a porcelain crucible.

A crucible was used to prevent physical loss of remaining fiber samples after oxidation at temperatures of greater than 1073 K. This was found to be necessary, since even when extreme care was taken in transferring the oxidized graphite fiber from the hot furnace to an appropriate analytical balance a significant portion of the sample could become airborne.

Electrical Resistance Measurements

Two techniques were used to measure the resistance of the as-received and CVD SiC coated or oxidized CVD SiC coated fiber. The first method involved the placing of a 10 cm length of fiber on an insulating sheet and applying drops of conducting silver paste over the entire yarn. These drops were spaced about 5 cm apart. Approximately one-half hour was given for the paste to dry. Resistance measurement leads were then pressed into the paste and the reading in ohms on a standard volt-ohm microammeter was recorded. The meters used had nominal input impedances of 100 K per volt DC.

A second more rapid technique for obtaining the relative, but only approximate, resistance of one coated yarn compared to another involved laying out the coated fiber on an insulator. Two copper blocks 2.5 x 7.5 x .6 cm thick were then placed across the tows 2.5 cm apart. Care had to be taken so that about the same area of fiber was contacted each time and the contact pressure of the resistance measurement leads was the same. As above, a volt-ohm microammeter was used to record the resistance.

The resistances of fibers coated using the organo-silicone approach were also measured by the latter technique. However, in the case of those fibers, the measuring leads were clamped to the copper block electrodes. A sketch of the copper blocks in a measurement position is shown in Fig. 8. The values obtained for uncoated HTS fiber by either clamping the leads or pressing them on the copper blocks were approximately the same and were considered to be equivalent. All resistance measurements reported except where noted were obtained with the use of these copper blocks.

Arcing Tests

An open circuit test was used to determine if the CVD SiC coated graphite fiber would arc when placed across electrical leads. In this apparatus, two copper electrodes were placed in the bottom of a Teflon lined Lucite box and the output of a 120 VAC Variac with an in-line voltmeter was connected to these copper electrodes. An experimental setup is shown in Fig. 9. The tube that can be seen between the copper plates in the photograph is a piece of aluminum oxide used to prevent accidental contact between the bare copper electrodes.

To observe the benefit of a CVD SiC coating, an oxidized coating or one that had been in-line oxidized, a 6 cm length of the yarn to be evaluated was placed across the two bare flat copper electrodes. The spacing of the electrodes was maintained at 1.3 cm.

An example of the procedure used with this apparatus is as follows. With the Variac set at 0 voltage a 6 cm length of as-received yarn was placed across the electrodes. As the voltage was increased spot flashing of fibers within the bundle would start at 20 to 25 VAC and at 45 to 50 VAC the entire yarn would arc giving off white light. This catastrophic white arcing was used as an indication of complete breakdown. This behavior was then used as a base line to compare with arcing results obtained on coated yarn.

Ultimate Tensile Strength Measurements

Single Filament Tests

The tensile strength and modulus of individual fibers were measured for the uncoated, CVD SiC coated, and oxidized yarn in a UTRC test apparatus (Ref. 4) which had been developed for fine filament testing. This technique involved the extraction of single filament from a 10,000 filament bundle for attachment to the test apparatus. Careful calibration of the load cell and crosshead movement allowed for the calculation of both ultimate tensile strength from the breaking load and modulus from the elastic portion of the stress-strain curve. A photograph of the apparatus is shown in Fig. 10.

A minimum of ten fibers which broke in the gage length were used to determine the average tensile strength of the fibers. The area of an individual fiber which was used in the calculation of tensile strength was initially obtained from the average of 50 planimeter measurements. These measurements were made from 1000X photomicrographs of mounted cross sections of the yarns being tested. From observing the variation of individual fiber area measurements, it was decided that the use of eight microns as a typical diameter was well within the spread of diameters measured from most all photomicrographs. Hence all tensile and modulus data were based upon individual fiber diameters of eight micrometers.

Yarn Tests

There is no ASTM accepted standard for measuring tensile loads or strengths of high modulus graphite yarns. Tensile measurements of graphite fiber coated using the organo-silicone approach were made using the whole yarn. The specimens were prepared by impregnation of the graphite yarn with a 45 w/o solution of epoxy resin (Epon 828/Sonite 21, 100g/19g) in methylethylketone. The resin impregnated yarn bundle was pulled taut, fixed in this position and allowed to cure at room temperature overnight. The cured resin impregnated yarn was cut into 13.9 cm specimens (or 10.9 cm specimens) and placed on an aluminum plate. Each end was reinforced with 4.2 cm pieces of the same impregnated yarn by bonding it with epoxy resin (described above), at the same time as 2.5 cm square cellulose tabs were bonded to the ends, using Epon 907 adhesive.

Yarn tensile specimens were measured on a 890N Instron using pneumatic air driven grips to hold the specimens, at a crosshead speed of 0.05 cm/cm. A specimen gage length of 2.5 cm or 5 cm was used.

Coating Thickness Measurements

An initial goal of this program was to obtain coating thicknesses on individual fibers of approximately $0.10\mu\text{m}$. The static CVD experiments produced SiC coatings of an order of magnitude greater than this and were observed and measured with conventional optical techniques. When continuous operation began, it was found that the coatings were too thin to measure accurately even at 1000X with conventional metallography.

Preparations of mounted cross sections were then examined in the SEM with both chemical etchant and ion milling used to obtain edge relief. Specimens were also prepared and examined with an electron microscope.

X-ray Diffraction Analysis

The coated HTS fibers were formed into twisted yarn samples approximately 2.5 cm long and mounted in a standard Debye camera having a radius of 117.5 mm. Copper $k\alpha$ radiation was used at 40 kV and 20 ma. settings.

An eight hour exposure was typical for all samples in this series. During the exposure, the yarn sample was rotated to insure all possible planes within the specimen were presented to the X-ray beam.

After the development of the film direct comparisons were made of each film with a standard SiC X-ray diffraction pattern. In the case of the fibers coated by the organo-silicone process, no pattern except that of the HTS graphite fiber was ever observed, so it was assumed that the coating on these fibers was amorphous.

Scanning Electron Microscope Examination

An AMR-900 scanning electron microscope (SEM) was employed to examine the fiber surfaces of fibers coated with organo-silicone material. Small sections (2.5 cm lengths) of each yarn sample were mounted on a 3.75 cm x 3.75 cm stainless steel pedestal. The yarn samples were fixed in a flat-wise position by copper tape. The mounted specimens were placed in the SEM and gold sputtered until approximately 200Å of gold coated the fiber surfaces. The samples were then examined by SEM using a TV scan to examine the surfaces. Photographs of the surfaces were taken at magnifications from 1000X to 10,000X, depending on the particular phenomena being examined.

Ion Scattered Spectroscopy/Scattered Ion Mass Spectrometry (ISS/SIMS) Analysis

The 3M Model 520B ion scattering spectrometer/scattered ion mass spectrometer (ISS/SIMS) was used in performing a chemical analysis of the surface of the fibers coated with organo-silicone material. The surface composition analysis is obtained by monitoring the binary elastic scattering of low-energy noble gas ions from surface atoms. The energy spectrum of a fixed angle of scattering, θ , consists of a number of peaks corresponding to the material or constituents present in the surface under examination. This forms the basis of ion scattering spectroscopy (ISS).

In addition to the scattered noble gas ions, ionized atoms and molecules are sputtered from the surface by the primary ion beam. These "secondary" ions are analyzed in a mass spectrometer forming the basis for SIMS.

In ISS, the number of counts/sec of noble gas ion scattered from the surface with an energy E_1/E_0 , where E_1 is the energy of the scattered noble gas ion and E_0 is the energy of the probe noble gas ion, is a measure of the constituent component on the surface. In SIMS, the probe noble gas primary beam eject ionized atoms or molecules from the surface. The ejected "secondary" ions are analyzed in a mass spectrometer forming the basis for SIMS.

Mechanical Testing of Composites

Preparation of Composites

A resin formulation containing MY720, epoxy Novalac DEN 438, and curing agent 4,4'-diaminodiphenyl sulfone (DDS) in the weight ratios, MY720/DEN 438/DDS of 4.5/1.0/2.25 was developed for use as a resin matrix in HTS graphite/epoxy composites. The epoxy resin system was designated UTRC-89Z. Flexural specimens were prepared and measured according to ASTM procedure D790-71. The specimen dimensions were 10 cm x 1.25 cm x .47 cm.

Fabrication of Graphite/Epoxy Prepreg Tape

Forty-five weight percent solution of the UTRC resin in a 50:50 weight percent of methylethylketone and cellusolve was prepared for impregnation of untreated HTS graphite fiber and silica-like coated HTS graphite fibers. The objective in the initial coating process was to obtain a resin coated graphite yarn containing 33-35 w/o resin, in order to obtain a fiber volume percent of approximately 60% in a finished composite. Using the above solution, a graphite tape containing 43 w/o resin was produced and a composite with a fiber volume of only about 48% was formed. In order to decrease the resin content to 33 w/o in the graphite prepreg, the concentration of the impregnation solution was reduced to 35 w/o.

Resin impregnated tape 8.8 cm wide was prepared by passing the untreated or pyrolyzed organo-silicone treated HTS yarn through the resin solution via pulleys and then winding onto a 45 cm diameter drum. The tape was allowed to stand at room temperature in a hood to remove solvent. It was then cut into the appropriate size for fabrication into a composite, and placed in an oven at 298 K for 1 hr to remove excess solvent.

Fabrication of Graphite/Epoxy Composites

The solvent free precut tapes are stacked one over the other to yield layered composites 3.75 cm x 20 cm x .25 cm or 8.8 cm x 16.3 cm x .5 cm. The uncured lay-up was sealed in a nylon bag for vacuum molding. The bag was evacuated and the temperature was raised to 398 K, and maintained at this temperature for 1 hr. Pressure (690 Pa) was applied after 1 hr at 398 K. The temperature was raised to 423 K, and held at this temperature and pressure (690 Pa) for 1 hr. The composite was cured for an additional hour at 453 K, while at 690 Pa.

Flexural Properties of Composites

The specimens used in determining flexural properties had a nominal size 8.8 cm long x .63 cm wide x .25 cm thickness, and were measured either by a 3-point or 4-point method at a span-to-depth ratio of 32/1 or less, according to ASTM procedure D790-71.

Shear Strengths of Composites

The specimens used in determining the interlaminar shear strength had a nominal size of 1.5 cm long x .63 cm wide x .25 cm thick, and were measured at a span-to-depth ratio of 4/1.

DISCUSSION AND RESULTS

CVD SiC Coating Approach

Static CVD Experiments

In the static CVD experiments the graphite tow was hung vertically along the center line of the 12.5 cm long graphite susceptor in the apparatus that was shown in Fig. 1. Coating thickness varied within the susceptor in agreement with the thermal profile that was present, being thicker in the center than at the ends. Bridging of fibrils did not appear to be a significant problem. A typical cross section of one of the thicker CVD SiC coated graphite tows is shown in Fig. 11. Examination of the entire yarn cross section indicated penetration of the gases into the 10,000 filaments in the yarn was good. X-ray diffraction analysis indicated that the coating was β -SiC. Care was taken when comparing results of runs to assure that sampling of the fibers was taken within the same relative vertical position in the reactor so that the effect of thermal gradients was the same. A thickness versus time curve was generated for various temperatures. A typical result is shown in Fig. 12 for SiC deposited at 1383 K and atmospheric pressure. From extrapolated data, approximate rates were selected for continuous deposition to obtain a coating with a target thickness of about 0.1 μ m.

Continuous CVD Coating Experiments

Continuous deposition was conducted in the vertical apparatus which was shown in Fig. 3. From the information derived in the static experiments, CVD runs were made at rates of 2.84 cm/min to 15.2 cm/min and a deposition temperature of 1373 K. The reactant gas inputs were the same as those described for the static apparatus and are listed in Appendix, Table B-I, along with the rate data. In this manner information was generated to relate the coating thickness to drawing rates.

In these continuous CVD SiC coating experiments, it appeared that the deposition process itself degraded the ultimate tensile strength of the individual filaments approximately 15%. In Table III are listed results of the ultimate tensile tests of individual fibers from the as-received and representative SiC coated graphite fibers produced at two different rates. The difference between the as-received strengths which were taken from different locations of the supply spool are typical of those found in commercial graphite fiber. In both cases the CVD SiC coated fibers were made from material adjacent to the as-received tested sample.

The data shown in Table IV represent the resistances of the total yarn bundle of several representative runs as measured with the copper block technique for CVD SiC coated yarns all made at a drawing rate of 7.6 cm/min. These results (80 to 2500 ohms) for fibers coated under the same deposition conditions indicated that there must be some variation in the coating process or in the graphite fiber.

Static Oxidation Measurement

Because of difficulty of measuring coating thickness of the continuously coated fibers (solution to this problem of measuring these extremely thin coating thicknesses will be discussed later), static oxidation tests were made on coated fibers produced at various rates in an attempt to detect coating thickness differences in these fibers. The weight loss data for fibers exposed at temperatures of 873, 973, and 1075 K for 10, 30 and 60 min oxidation are listed in Table V.

The data in Table V are shown in Fig. 13 for the 10 min exposure, Fig. 14 for the 30 min exposure, and Fig. 15 for the 60 min exposure. As can be seen in these figures, the fibers coated at slower rates are more oxidation resistant than those coated at the faster rates.

The amount of oxidation as evidenced by weight loss measurements increases dramatically for the longer times (60 min exposure) especially for the fibers coated at the higher rates. This can be seen in Fig. 15 for the fibers coated at 15.3 cm/min which lost weight much more rapidly for a particular temperature and to a lesser degree those fibers made at 10.2 cm/min and 5.1 cm/min.

These data indicate that the coating thickness is probably greater for those fibers coated at the slower rates. In addition, observations of the oxidized fibers indicate that the fibers were completely coated. These observations also showed that the most rapid oxidation of these fibers proceeded from the ends where the carbon is exposed. Therefore, the true oxidation protection of the SiC coating was not determined from these tests. However, they did show that the thin SiC could be oxidized; the extreme case being where thin white tubes were formed. These tubes gave no X-ray pattern and were assumed to be amorphous SiO₂.

The formation of some SiO₂ on the surface, of course, would be desirable since SiO₂ should increase the electrical resistance of the fiber. The electrical resistance of a SiC coated fiber was measured after being heated at various temperatures for 30 min. These resistance measurements were made with the silver paste technique and the results are shown in Fig. 16. Although the highest

resistance was observed after 30 min at 1073 K, the quality and handleability of the remaining graphite yarn were poor. These measurements showed that the resistance of the coated fiber could be increased by oxidation to very high values but these values would be limited by the degradation effect of oxidation at high temperatures.

In-Line Oxidation

An in-line continuous oxidation furnace was installed after the exit port of the CVD SiC reactor and before the take-up spool. In this manner the CVD SiC coated yarn could be oxidized in a controlled manner without the necessity of using a two step operation. It was felt that this might make the resistance more uniform and also might increase the resistance of the fibers. Numerous experiments were made at drawing rates of 7.6 cm/min up to 30.5 cm/min at various temperatures. Since the length of this oxidation furnace was fixed, the residency time of the yarn at temperature was obviously dependent on the drawing rate of yarn which had passed through the CVD reactor. Experiments made with this furnace installed are listed in Appendix B, Table II. Reactant gas flows were kept the same as in the other experiments with temperatures of deposition of 1373 K and 1423 K used. The in-line oxidation furnace was either off or set at 773 K, 823 K, 873 K and 923 K. The 923 K temperature level proved to be too high; the control yarn that passed through the in-line furnace at this temperature was too brittle to handle so no further experiments were run at that temperature.

Electrical resistance measurements on yarns were made with the copper block technique and individual fiber tensile tests were made on representative coated fibers from these experiments and these results are listed in Table VI. For those runs made with the in-line oxidation furnace, off tensile strengths of 2400 MPa (348 ksi) were measured. With the in-line furnace at 823 K or 873 K the tensile strength dropped to about 2100 MPa (305 ksi). The lower strength of those fibers oxidized in-line indicated that these oxidation temperatures were too high for these drawing rates. The resistance for these runs listed in the table does show an increase when the in-line oxidation furnace was in operation.

Horizontal Reactor Operation

To ease restringing problems, a horizontal reactor was employed. The experiments made with this reactor configuration are listed in Table B-III of the Appendix. The tensile strength data for the first series of six runs made in this reactor at a deposition temperature of 1423 K are listed in Table VII. The drawing rates were 7.6, 15.2 and 30.5 cm/min with half the runs having the in-line oxidation furnace set at 773 K. The average tensile strength of these

six runs, 2406 MPa (349 ksi) differs very little from the average tensile strength, 2394 MPa (347 ksi) of the as-received HTS yarn which was sampled from the spool prior to the fiber used in run N673 and after run N680 of this series.

A length of coated yarn from each run was placed on an insulator and resistance measurements with the copper block technique were made at each end of this length and in the center section. These three measurements were labeled top, middle, and bottom resistance. In Table VIII are listed the resistance measurements for this same series of runs (N673 to N680). The as-received HTS yarn was found to have a comparative resistance of 4.3 ohms during these measurements. The last column in Table VIII is a resistance factor increase obtained by dividing the average resistance of yarn from a particular experimental run by the 4.3 ohms resistance of the as-received yarn.

Comparing the data for these coated fibers with relatively low resistances (7 to 90 ohms) with the data obtained in other studies (see Table IV), it was noted that the reactor temperature was 25 K higher (1423 K vs 1398 K) than that used in the runs listed in those tables. This indicated that the deposition temperature was an important factor in increasing the resistance of the coated fiber. Therefore, a set of experiments was conducted in which reactor temperatures were selected to bracket the temperature used in all of the CVD SiC studies in an attempt to determine which temperatures would give the highest resistance fibers. These temperatures were 1368, 1398, 1423 and 1473 K. The in-line oxidation furnace was set at 773 K. A sample of each run was used to obtain three resistance measurements for each particular run condition. The resistance data for the 7.6 cm/min drawing rate are given in Table IX where the resistance factor column is again the ratio of the resistance of the coated fiber divided by the 4.3 ohms of the as-received yarn. In Table IX are also listed the resistance data for 15.2 cm/min drawing rate and the resistances of coated yarn drawn at 30.5 cm/min. One run was made at a drawing rate of 46 cm/min and the resistances of this run are also listed in this table.

A comparison of coated yarn resistance made at a reactor temperature of 1398 K with and without the in-line oxidation furnace in operation is given in Table X. At all three drawing rates an increase in resistance was found when the in-line oxidation was conducted.

In Figs. 17, 18 and 19 are shown the resistance of the coated and oxidized yarn as a function of reactor temperature for 7.6, 15.2, and 30.5 cm/min drawing rates. In Fig. 20 these same resistance data are shown as a function of drawing rates.

In these figures, it can be seen that a 1398 K reactor temperature (used in the first runs) yielded the highest resistance yarn and that the CVD SiC coated yarn resistance appears to increase with increasing drawing rates up to 30.5 cm/min (see Fig. 20) when the reactor temperature was held constant at 1398 K.

A reason for resistance variation for the same conditions seen in Figs. 17-19 may be due to differences in fiber characteristics. This has been observed in strength variation in the fiber which does present a problem in evaluating the effects of fiber coatings on strength. Another problem in reproducibility may be in process control which must be improved since examination of the data from these experiments indicate that the higher resistance coated fibers were formed in the first experiments when new susceptors and clean reactors were used.

To investigate the strength variation, tensile strength data were obtained on experiments N673-N680. These data together with previous tested results are listed in Table XI. From this table it can be said that the averages of both tensile strength and modulus of CVD SiC yarn are not too different from the as-received yarn. Although the individual ultimate tensile strength averages can vary from 2759 MPa (400 ksi) down to 2359 MPa (342 ksi) for N674 and from 2223 MPa (323 ksi) up to 2788 MPa (405 ksi) for N677, the coefficient of variation (standard deviation divided by the mean) is large enough to encompass both mean values in the same statistical population. This was borne out by using the student "t" test to compare various sets of data.

The remaining single filament data are listed in Table XII. In general, the values of ultimate tensile strength and modulus obtained from these tests again fall within the as-received graphite yarn range. An occasional low value CVD run such as N688 with a tensile value of 1882 MPa (273 ksi) fails to repeat itself when the same deposition conditions are used in a similar run such as N689, 2242 MPa (325 ksi). This same lack of reproducibility holds true on the high end of tensile strength scale also such as N693, 2671 MPa (388 ksi) and N690, 2311 MPa (335 ksi) both of which were run with reactor temperatures of 1398 K and 773 K in-line oxidation furnace setting.

Arcing Tests

Base line qualitative data were obtained on the short circuit apparatus by setting the open circuit voltage at 0 and placing a 6 cm length of as-received yarn across the electrodes. The voltage was increased slowly and at 20 to 25 VAC spot flashing within the fiber bundle began to occur. At 45 to 50 VAC the entire yarn bundle would arc producing white light and if allowed to continue would cause all circuit fuses to fail. This catastrophic white arc was used as the indication of complete breakdown. A photograph of the as-received yarn arcing, when dropped across the copper electrodes which for this picture had been preset at 120 VAC, is shown in Fig. 21. A sample of CVD SiC coated yarn made at 15.2 cm/min produced spot flashes at 35 to 40 VAC, a glow at 60 to 75

VAC and a white arc at 90 VAC. A specimen of CVD SiC coated yarn again made at 15.2 cm/min but oxidized in line at 873 K showed only slight spot flashing up to 50 VAC, a soft glow up to 80 VAC and a jumping slow burning glow at 120 VAC. A photograph of this last specimen in the arcing apparatus is shown in Fig. 22. These arcing results are summarized in Table XIII.

Coating Thickness Measurements

The static CVD experiments produced SiC coatings that could easily be observed and measured with conventional optical techniques. An example of the coatings obtained on the graphite fibers in the static deposition chamber were shown in Fig. 11. When continuous operation began, it was found that the coatings were too thin to measure accurately even at 1000X. An example of the thinner more difficult to measure coatings is shown in Fig. 23.

Mounted cross sections of the continually coated graphite fibers were then examined with the SEM. Chemical etching did not improve the resolution of the thin coating. Ion milling was then used to attempt to obtain an edge relief. A SEM photograph of an ion milled prepared specimen is shown in Fig. 24. The behavior of the mounting material and coated filament during the ion milling procedure was such that reproducible control could not be obtained from specimen to specimen.

Therefore, although it took more time for specimen preparation, electron microscopy studies of polished cross sections were undertaken. This technique was found to yield relatively good definition of the CVD SiC coating on graphite yarn. In Figs. 25, 26 and 27 are shown representative electron photomicrographs at 10,000, 14,000 and 22,000X magnification of a coated yarn produced at 7.6 cm/min.

Initial thickness measurements of the CVD SiC layer made from these photographs are listed in Table XIV and a plot of thickness versus drawing rate shown in Fig. 28. From this figure it can be seen that for constant reactor temperature and reactant gas flow rates, the thickness of the SiC layer becomes thinner when the carbon yarn moves faster through the reactor.

X-Ray Diffraction Analysis

X-ray diffraction photographs that were taken of uncoated HTS fiber gave a pattern showing (002) and (100-101) broad reflections. The fiber showed a high degree of orientation but not as great as higher modulus fibers. In the patterns of the coated fibers the coating thicknesses were thin enough so that the carbon fiber X-ray pattern also could be seen. In the patterns of coated fibers produced at 7.5 cm/min and 15 cm/min, the β SiC lines could be observed as shown in Fig. 29a. Those fibers coated at 30 cm/min and 45 cm/min did not show the SiC lines (see Fig. 29b), probably because the coating was too thin.

Composite Results

Continuous silicon carbide deposition runs of 130 and 150 min were made. Rates of 7.6 cm/min were used for both experiments yielding 10 and 11.4 meters respectively. Material from the 11.4 meter run was used with PR 288 resin* to make a unidirectional composite 10 cm x 15 cm. Due to the fairly short length of coated yarn (compared to commercial spools of carbon fiber) the tapes that were made for this composite were effectively hand laid up.

The number of tape layers chosen to put into the composite was selected to yield a finished thickness of 1.8 mm. The final thickness was only 1.3 mm. This was felt to be due to the lower density of starting fiber which results from a hand lay-up versus a machine lay-up that is normally used.

Six specimens 0.5 cm x 7.6 cm were cut from this panel and were submitted for testing to measure the flexural strength and modulus. In this first composite, the fiber volume fraction was low due to the hand lay-up procedure used. The strength of the composite was about 413 MPa (60 ksi) and the modulus was 89.6 GPa ($13.3 \cdot 10^6$ psi).

A portion of the silicon carbide coated HTS/epoxy composite and an untreated carbon/epoxy composite as a control was burned using a Bunsen burner and the electrical resistance of the remaining carbon fiber residue was measured using copper block contacts about 1 cm apart. The carbon fiber residue from the untreated HTS/epoxy composite had a resistance of about 30 ohms while carbon fiber residue from the silicon carbide coated HTS/epoxy had an electrical resistance of about 8000 ohms. While the 8000 ohm value is high, it is not clear whether the high resistance of this material is due to oxidation of the SiC coating on the fiber, or to a char residue on the fiber.

In a second attempt to make a composite, CVD coated yarn from run N601 was used to make the resin matrix composite. Three point bend test specimens were cut from this composite for flexural strength testing. An average of 1007 MPa (146 ksi) was obtained for these specimens. Examination of the fracture surfaces indicated that these specimens were resin rich. A volume fraction measurement was then made via resin digestion and it was determined that these composites contained only 38% by volume graphite reinforcement again due to the hand lay-up procedure. Normalizing the original data to the accepted 60% volume graphite fiber content yielded a flexure strength for this composite of 1586 MPa (230 ksi). This value is within the range of flexural strengths obtained for unidirectional graphite epoxy composites made with the as-received graphite yarn.

*3M Company PR-288 resin; manufacturer specified 250^oF cure cycle used.

Organo-Silicone Coating Approach

Static Coating Experiments

In the organo-silicone coating experiments, the objective was to determine if the graphite filaments could be coated with an organo-silicone precursor, and through pyrolysis convert the organo-silicone to a continuous coating of amorphous silica. The procedure used to coat HTS graphite yarn by the static method was described in a previous section. The results of these static experiments are described below.

Scanning Electron Microscopy (SEM) Analysis

The coated fibers were subjected to scanning electron microscopic examination. The observations are given in Table XV. As can be seen, the thicker coating can sometimes be rough before pyrolysis and after pyrolysis the coating is smoother and contains less bridging, i.e. S23 vs S22, S10 vs S9.

The appearance of an "as received" fiber is shown in Fig. 30. A coating can be identified when it is nonuniform as in Figs. 31 and 32 for fiber samples S28 and S32 respectively, when there is bridging as in Fig. 31, and when the coating is fractured as in Fig. 33 for sample S30.

When the coating is smooth and uniform as in Fig. 34 for sample S36 it is difficult to tell if a coating is really present. However, higher electrical resistance and oxidation resistances are evidence for the presence of a coating.

Ion Scattering Spectroscopy/Scattered Ion Mass Spectrometry (ISS/SIMS) Analysis

The ISS/SIMS spectra for "as received" untreated HTS fibers are shown in Fig. 35 at various depths of penetration into the surface. The bottom curve of each figure is the ISS spectrum while the top curve of each figure represents the SIMS spectrum. The ISS spectrum of the "as received" HTS surface is nearly identical to the ISS spectrum of A-1100 silane coated glass, shown in Fig. 36. This indicates that "as received" HTS graphite fibers may contain a uniform coating of A-1100 silane coupling agent, not revealed in the SEM photomicrograph (Fig. 30).

The ISS/SIMS spectra for pyrolyzed ethyl silicate coated HTS are shown in Figs. 37a through 37d at various depths of penetration into the surface. Although the initial spectra at a depth up to 1.2\AA of the "as received" and ethyl silicate coated HTS are similar, since they are both silane-like materials, the spectra of these two fiber surfaces at a depth of 48\AA are clearly different. The "as received" fiber shows the presence of Na, Mg, Al, Si and Cl between the E/E_0 ratios 0.60 to 0.74, while the ethyl silicate pyrolyzed coated fibers show two major peaks, indicating a predominance of Na, and Si at E/E_0 ratios of 0.63 and 0.67 respectively, and a broad band peaking at 0.17 similar to the silane coated S-glass (Fig. 36); this latter band is absent in the untreated fibers. Clearly the "as received" and pyrolyzed ethyl silicate coated fibers appear to be different according to ISS/SIMS analysis.

The percent relative intensity of peaks due to carbon, oxygen, and silicon for the "as received" and surface treated fibers (S1 through S18) are listed in Table XVI. Comparison of the silicon contents of the "as received" and pyrolyzed ethyl silicate coated fibers reveals that the latter fibers contain more silicon than the "as received".

Oxidation Results

The "as received" and surface treated HTS were subjected to a temperature of 783 K in air for 8 hrs to determine the oxidation behavior of the fibers. The results expressed as a weight loss are shown in Table XVII. The weight losses exhibited by the fibers coated five times with 2.3% silicone resin SR 355 or five times with 2.3% ethyl silicate were only 15 and 10% respectively. The "as received" HTS fiber exhibited a weight loss of 99%. Clearly, these two coated fiber systems show promise as protective oxidation coatings, and possibly electrically resistant coated fibers. Note that these coatings were produced with the highest concentrations and several dips. It may be a higher number of dips produced coatings which were too thick to remain intact.

Electrical Resistance Measurements

The coated fibers were subjected to electrical resistivity measurements. One 2.5 cm section of each fiber system was measured using copper plates as electrodes. The results, shown in Table XVII, reveal that the four pyrolyzed systems exhibit higher resistances than the "as received" HTS fibers. These resistances are probably lower than the true values because heavy copper blocks were placed on the fibers and may have broken through the coatings. However, they do indicate that the fibers which are the most oxidation resistant (S32 and S40) have the highest electrical resistances.

The coatings produced in the first studies were too thick and they were better insulators than the HTS fiber, but the fibers were not flexible. The coated fibers produced in the later studies are all flexible, but it appears that thicker coatings might be needed to get higher resistances. Therefore, obtaining a balance between flexibility and high electrical resistance will be the objective of the future studies. It may also be possible to increase the resistance of the pyrolyzed organo-silicone coating by oxidation treatments. This will also be investigated in future studies.

Tensile Strength Measurements

A few of the HTS yarns, surface coated by the static method, were encapsulated in an epoxy matrix to prepare tensile specimens of each yarn bundle. These were cured at room temperature and subjected to tensile tests. These preliminary results are shown in Table XVIII. The strength values are reported in terms of P_{max} for each yarn sample tested. It becomes obvious from the data that there is a discrepancy between untreated and coated yarns, and that the untreated yarns should not have load values which are much lower than the load values for coated yarns. The second obvious point is that samples S42 and S43 exhibited very poor load values, suggesting that the coating is causing embrittlement and weakening of the fibers. These coatings were probably too thick.

Continuous Coating Experiments

A study of the results from the static coating screening studies showed that two organo-silicone materials warranted further studies in a continuous process to coat HTS graphite fibers. A summary of the conclusions for the oxidation resistance, electrical resistance, SEM observations and tensile results is listed in Table XIX. The two systems, silicone resin SR 355 and ethyl silicate (ES) prepolymer on HTS graphite tows yielded silica-like coated fibers with the highest resistance to oxidation at 783 K in an 8 hr period. The SEM photographs of the ethyl silicate coated HTS, however, revealed that coating on the HTS yarn was more coherent than the SR 355 coating. In addition, the oxidation resistance and tensile properties of the ES coated HTS are superior to the SR 355 coated HTS. Based on these results, ethyl silicate prepolymer was selected for additional studies to coat HTS fiber on a continuous basis.

The equipment used in conducting the continuing coating experiments was shown in Fig. 6 (photograph) and described schematically in Fig. 7. The continuous coating procedure was described in a previous section. The series of experiments carried out in the continuous coating apparatus are listed in Table XX. The results of these studies are delineated by a discussion of the properties of the pyrolyzed organo-silicone coated HTS yarn in yarn form, and as a reinforcement in graphite/epoxy composites.

The results of the resistance measurements on the fibers coated in the continuous process are listed in Table XXI. The results show that except for run SC10, each coating condition produced pyrolyzed organo-silicone coated HTS with at least a fivefold increase in electrical resistance relative to "as received" HTS graphite yarn.

Oxidation Measurements

The pyrolyzed organo-silicone coated HTS graphite yarns were exposed to an oxidation environment at 783 K for 8 hrs in static air. The results of these tests are listed in Table XXI. Relative to the loss experienced by the "as received" HTS (99.2 w/o loss), all fiber treatment conditions produced coated yarn with superior oxidation resistance than "as received" HTS graphite yarn.

From the electrical resistance and weight loss data, it is difficult to select a condition which should be optimized. All conditions produced fiber with good oxidation resistance. The electrical resistances between coated fibers are not sufficiently different to warrant the selection of a condition for optimization. This property must be improved considerably before selection of optimum processing conditions can be made.

Tensile Strength Measurements

The experimental procedure used in preparing tensile specimens was described in a previous section. The tensile strengths of untreated "as received" HTS and pyrolyzed organo-silicone coated HTS graphite yarn are listed in Table B-IV, Appendix B, and summarized in Table XXII.

By comparing the failure loads for 5.1 cm gage length tests (Table XXII) of coated fibers with those of as-received HTS graphite fibers, the following conclusion can be drawn. The conditions used to produce coatings in runs SC1, SC2 and SC3 do not appear to degrade the fibers.

In the next set of testing data in Table XXII, measured using a 2.5 cm gage length, the failure loads for the coated fibers, on the average, were considerably higher than those obtained for samples tested using a 5.1 cm gage length. This higher strength can probably be attributed to the effect of using a shorter gage length in testing. For example, "as received" HTS graphite yarn failed at an average load of 1152 N (260 lbs), considerably higher than the average failure load of 643 N (145 lbs) for the 5.1 cm gage length specimen. The data for the 2.5 cm length specimens from runs SC1, SC2, SC5 and SC6 show that these specimens do not undergo degradation relative to the untreated fibers. It is also apparent that fiber from runs SC3 and SC4 failed at loads considerably

lower than untreated fiber, an indication that these treatments cause degradation of the fiber. Based on the combined data for electrical resistance, oxidation resistance, and tensile strength, the processing conditions which appear to have promise in producing yarn with high electrical resistances without compromise of the tensile strength of the fiber are represented by runs SC1 and SC2. These represent the lowest treatment temperature ranges studied (903-963 K) and (1093-1173 K).

Scanning Electron Microscope Analysis

Scanning electron micrographs (SEMS) were taken of pyrolyzed organo-silicone coated HTS produced from the continuous coating apparatus. Examples of these are illustrated in Figs. 38-43. Untreated "as received" HTS graphite yarn is illustrated in Fig. 38 for comparison with coated fibers. The SEMS of the pyrolyzed organo-silicone coated HTS fiber appear to reflect the behavior of the fibers in composites described in the following section. For example, pyrolyzed organo-silicone coated HTS from run SC5, Fig. 39, has the smoothest coating of the fibers coated. This is illustrated by comparing the SEM of fiber produced from run SC5, with pyrolyzed organo-silicone coated fiber produced from runs SC7 (Fig. 40), SC8 (Fig. 41), SC9 (Fig. 42), and SC10 (Fig. 43). The SEM studies are strong indications that the coating process conditions, drawing rate of 0.91 m/min, ethyl silicate concentration (2.5 w/o), temperature 1093-1173 K, used to prepare pyrolyzed organo-silicone coated HTS in run SC5 has even greater potential in producing coated fiber with increased electrical resistance.

Composite Results

Resin Properties

The procedure used to prepare epoxy resin flexural specimens was described in a previous section. One objective of this phase of the program was to establish conditions for preparing high strength untreated HTS graphite/epoxy composites so that these parameters could be used in the fabrication of coated HTS graphite/epoxy composites. These composites were to be formed using a matrix resin having a composition similar to commercial resins in prepregs, such as Hercules 3501-6, Narmco 5208, Reliabond 6350, etc. The major epoxy resin component in these resin systems is N,N'-tetraglycidyl methylenedianiline (MY 720). The use of this resin was requested by NASA so that the "flash fire" behavior of treated graphite fiber/epoxy resin composites could be compared with data for similar matrix composites being studied by NASA.

A resin formulation containing MY 720, epoxy Novalac DEN 438, curing agent 4,4'-diaminodiphenylsulfone was developed for use in this program. Flexural properties of the MY 720 (N,N'-tetraglycidylmethylenedianiline) containing epoxy resin used in the fabrication of the untreated HTS graphite/epoxy composites are listed in Table XXIII. The good flexural properties of this resin formulation establish a sound base for utilization of this resin in HTS composites.

Composite Properties

The procedure for fabrication of graphite yarn/epoxy composites is described in a previous section. The composition of each composite is listed in Table XXIV. A series of composites were fabricated with "as received" HTS or pyrolyzed organo-silicone coated HTS graphite yarn and the formulated MY 720 containing epoxy. In addition, to verify that composite properties attained with the MY 720 epoxy system were reflecting fiber properties, one composite containing "as received" HTS graphite yarn and a commercial epoxy resin PR-286 obtained from 3M Company was fabricated. The shear and flexural properties of all composites are listed in Appendix B, Tables B-V and B-XIII. Table XXV summarizes the average shear properties of each composite.

A shear strength of approximately 81.2 MPa (12,000 psi) for "as received" HTS graphite fiber is considered acceptable, although HTS fiber can have shear values in composites of up to 103.4 MPa (15,000 psi). The high shear value (81.2 MPa, 12,000 psi) for composites containing either the MY 720 containing epoxy or PR-286 epoxy suggests that the UTRC formulated epoxy resin is functioning adequately as a load transfer matrix, and is able to yield shear strength values that reflect the fiber properties.

Composite 212-12, containing HTS fiber from lot no. 76-8-3 exhibited very poor shear strength, 51.4 MPa (7460 psi). This demonstrates a variability in fiber quality which was previously demonstrated in tensile tests of yarn samples from a similar lot and which is further demonstrated in flexural properties listed in Table XXVI. Therefore, the low shear strength of composite 212-9, containing silica-like coated fiber from run SC7, does not necessarily reflect the performance of the coating in this composite.

The shear strength data listed in Table XXV show that the fiber treatment process parameters affect composite performance. As the process rate increases (drawing rate increases) at a given temperature 1173 K (900°C) and ethyl silicate concentration (2.5 w/o), the shear strength increased. This is illustrated by composite 212-16 prepared from fiber treated at a drawing rate of 0.91 m/min, which has a shear strength of 57.1 MPa (8290 psi), compared to composite 212-15, prepared from fiber treated at a drawing rate of 0.61 m/min, which has a shear

strength of 31 MPa (4500 psi). However, it should be pointed out that even composite 212-16 with the highest shear strength is 25% lower than the composite prepared from untreated fiber. It should be pointed out that composite 212-16 was fabricated from fiber coated by run SC5, which has the smoothest coating as revealed in SEM photos (Fig. 39), relative to the fiber produced from runs SC7 (Fig. 40), SC8 (Fig. 41), SC9 (Fig. 42) and SC10 (Fig. 43), all of which produced composites of inferior shear strength to 212-16.

It is apparent from the shear data that the silica-like coating has caused a decrease in the adhesion of the epoxy resin to the coated fiber surface. This suggests one of several items: (1) that the coating layer is poorly wetted for the epoxy resin, (2) that the coating is a mechanically weak boundary layer, and (3) that the coating is a mechanically strong boundary layer but poorly wetted by the epoxy resin. The physical appearance of the fiber suggests that the coating is a mechanically weak boundary layer. Additional processing studies are required to improve the silica-like coating to increase the electrical resistance and the shear strength in composites.

The effect of silica-like coated HTS on flexural properties of composites was shown in TableXXVI. The flexural strength of composites containing untreated HTS is shown for comparison. The poor quality of the two lots of HTS fiber used in this study is illustrated by the relatively low flexural strength of each composite, even for composites containing 60 v/o fiber. Composite 212-16, prepared from pyrolyzed organo-silicone coated HTS was shown to exhibit the highest shear strength (TableXXV). This composite also exhibited reasonably good flexural strength relative to composites containing pyrolyzed organo-silica coated HTS from other runs, and compared to composites containing untreated yarn. The condition for preparing yarn in run SC5 appears promising as a result of the composite tests. Continued process studies in the continuous process method could lead to a successful coating process.

CONCLUSIONS

The CVD process for coating graphite yarn with silicon carbide has been shown to be a promising method for increasing the electrical resistance of the as-received yarn. An in-line oxidation furnace was used to oxidize a portion of the SiC coating and found to also increase the electrical resistance. This oxidation furnace temperature was varied from 700 to 875 K with 773 K found to be optimum. The temperature of the deposition chamber was also found to be an important factor in increasing the resistance of the coated yarn. Drawing rates of 30.5 cm/min at reactor temperature of 1398 K with an in-line oxidation furnace operating at 773 K yielded yarn whose electrical resistance was measured to be over 1000 ohms (compared to an untreated yarn resistance of 2 ohm) when measured with the copper block technique.

Coating thickness of 0.04 to 0.14 μm on each fiber has been measured from electron microscope photographs with the latter thickness associated with the slower drawing rates. The highest successful CVD drawing rate used in this program was 46 cm/min. It was also found that on the average the CVD coating of the graphite yarn does not degrade its ultimate tensile strength or Young's modulus as determined by individual filament tests and in-line oxidation furnace temperatures below 773 K at rates up to 30.5 cm/min also do not degrade the untreated yarn.

The organo-silicone method of coating HTS graphite fibers to produce a pyrolyzed organo-silicone coated fiber by a hydrolysis-pyrolysis procedure has been a partial success. The best conditions established as a result of these studies are as follows: concentration of organo-silicone solution (ethyl silicate) 2.5 wt %, yarn drawing rate 0.91 m/min, pyrolysis temperature 820-900°C, nitrogen atmosphere. Pyrolyzed organo-silicone coated fiber, produced by these conditions, exhibited as much as a sevenfold increase in electrical resistance (2 ohms vs 14 ohms), relative to untreated HTS graphite fibers and a much superior resistance to oxidative weight loss than untreated HTS fiber (8-34% vs 99.2%). Composites made from the coated fibers exhibited shear and flexural strength of 51.2 MPa (8290 psi) and 951 MPa (138 ksi) respectively. The flexural strength is equivalent to composites containing untreated fiber because the fiber content was low. Shear strengths are lower than composites containing untreated fiber. Several reasons can account for this decrease. The pyrolyzed organo-silicone coating layer could be poorly wetted by the epoxy resin or the coating could be a mechanically weak boundary layer or the coating could be poorly bonded to the fiber surface. The physical appearance of the coated fiber suggests that the coating may be a mechanically weak boundary layer. Additional process studies to optimize the coherency of the coating are required.

RECOMMENDATIONS FOR FURTHER RESEARCH

Since variations were found in the electrical resistance of the CVD coated fibers for apparently similar experimental conditions, further research should be conducted to optimize the in-line oxidation process and processing parameters to minimize these observed variations. This work should also include studying the CVD SiC process with other sources of graphite yarn besides the HTS yarn used in this program to make sure the process can be widely applied.

Additional studies of the organo-silicone method of coating fibers should involve the optimization of the pyrolysis conditions to produce stronger more adherent coatings. This would also include raising the temperature of the hydrolysis step in fixed increments. Methods of increasing the resistance of the organo-silicone coated fibers by an oxidation treatment following the pyrolysis step should also be investigated. Increasing the resistance of the coated yarn should be the primary objective of further organo-silicone coating studies.

ACKNOWLEDGEMENTS

The authors gratefully acknowledge the following scientists for their contribution in the preliminary part of this program: J. F. Bacon, in the drawing fiber through molten glass approach; S. Holmquist, in the dipping fibers in colloidal silica approach; and H. Roth, in the drawing fiber through organo-silicone compounds approach. The technical guidance of the NASA Technical Program Monitor, Mr. Dennis Dicus, is also appreciated.

REFERENCES

1. United States Department of Commerce News, January 20, 1978.
2. NASA Technical Memorandum 78652, January 1978.
3. NASA Workshop, Hampton, VA, March 23-24, 1978; Dicus, D., NASA Technical Memorandum 78761, Modified Composite Materials Workshop, July 1978.
4. Schile, R. and G. Rosica, Rev. Sci. Instrum., 38, 1103 (1967).

Table I

Materials Selected for Evaluation

Methyltriethoxysilane (MTS)	$\text{CH}_3\text{-Si}(\text{OC}_2\text{H}_5)_3$
Vinyltriacetoxysilane (VTS)	$\text{CH}_2=\text{CH-Si}-(\text{O}-\overset{\text{O}}{\parallel}{\text{C}}-\text{CH}_3)_3$
Silicone resin GE (SR 355)	$\begin{array}{c} \text{CH}_3 \quad \text{CH}_3 \\ \quad \\ \text{-Si-O-Si-O-} \\ \quad \\ \text{CH}_3 \quad \text{CH}_3 \end{array}$
Ethyl silicate prepolymer (ES)	$\left(\begin{array}{c} \text{OC}_2\text{H}_5 \\ \\ \text{-Si-O-} \\ \\ \text{OC}_2\text{H}_5 \end{array} \right)_n$

Table II

Data for Organo-Silicone Coatings on Graphite Fiber

EDAX Analysis: 35 sec count at 100X

<u>Material Deposited</u>	<u># of Coats</u>	<u>SiO₂ Equiv/mole Silane</u>	<u>Condition of tow after dipping</u>	<u>EDAX Analysis Si Deposited/Si Background</u>
CH ₃ -Si-(OC ₂ H ₅) ₃ (methyltriethoxy-silane)	1 5 5	0.33	unchanged unchanged	trace trace
CH ₂ =CH-Si-(O-C(=O)-CH ₃) ₃ (vinyltriacetoxysilane)	1 5	0.24	stiff stiff	230/100 1250/100
Silicone Resin G.E. SR 355	1 5	0.6*	stiff stiff	trace 1100/100
Ethyl Silicate Prepolymer	1 5	0.4**	stiff stiff	675/100 2250/100

*experimental

**manufacturer's claim

Table III

Results of Individual Fiber Tensile Tests
for SiC Coated Graphite Fiber

<u>Production Conditions</u>	<u>Coating</u>	<u>Average Strength</u> MPa	<u>Average Strength</u> (kpsi)	<u>Coefficient of Variation</u>	<u>% Strength Loss</u>
As received HTS	none	2015	(292)	27.1	
12.2 cm/min draw rate (4.8 in/min)	SiC	1711	(248)	28.2	15
As received HTS	none	2829	(410)	18.7	
7.9 cm/min draw rate (3.1 in/min)	SiC	2470	(358)	22.4	13

Table IV

Resistance of SiC Coated and Uncoated Graphite Fibers

	Resistance ¹ (ohms)
HTS (Spool #1) uncoated	2
HTS (Spool #2) uncoated	5
SiC Coated C Fiber (Run 7.6 cm/min)	
N601	80
N602	1200
N599	2500

¹Copper block method.

Table V

% Weight Loss Data for SiC Coated
Graphite Fiber Heated in Air
at Various Temperatures

Run (draw rate)	<u>10 Min Oxidation</u>		
	<u>873 K</u>	<u>973 K</u>	<u>1073 K</u>
5.1 cm/min	-	.6	2.8
10.2 cm/min	0	3.0	7.9
15.3 cm/min	.6	6.0	24.7
	<u>30 Min Oxidation</u>		
5.1 cm/min	-	17.2	51.7
10.2 cm/min	1.9	25.3	76.6
15.3 cm/min	2.1	24.9	99.2
	<u>60 Min Oxidation</u>		
5.1 cm/min	-	44.5	92.0
10.2 cm/min	3.6	49.4	90.4
15.3 cm/min	3.7	81.9	94.0

Table VI

Resistance of SiC Coated and Uncoated Graphite Yarn and Graphite Fiber
Tensile Strength from Individual Fiber Testing

<u>Run Number</u>	<u>Drawing Rate</u> cm/min	<u>In-Line Oxidation</u> T K	<u>Single Filament Average Tensile Strength</u>		<u>Yarn Resistance</u> ¹ ohms
			MPa	(kpsi)	
As received yarn	-	-	2657	(385)	2-5
N 620	7.6	None	2756	(400)	6000
N 564	10.2	None	2599	(377)	200
N 616	15.2	None	2386	(346)	50
N 631	15.2	823	2024	(294)	10,000
N 618	15.2	873	2101	(305)	2000

¹Copper block method

Table VII

Strength and Modulus Results from Individual Fiber Tests
on SiC Coated Graphite Fiber
(Reactor Temperature 1423 K)

<u>Run Number</u>	<u>Drawing Rate</u> cm/min	<u>In-Line Oxidation</u> T K	<u>UTS</u>		<u>E</u>	
			<u>MPa</u>	<u>(kpsi)</u>	<u>GPa</u>	<u>(10⁶ psi)</u>
N675	7.6	773	2431	(353)	236	(34.3)
N674	15.2	773	2759	(400)	252	(36.6)
N673	30.5	773	2320	(337)	240	(34.8)
N678	7.6	None	2269	(329)	210	(30.5)
N677	15.2	None	2223	(323)	214	(31.0)
N680	30.5	None	2422	(352)	229	(33.2)
Average of Coated Yarns			2406	(349)	230	(33.4)
As-Received HTS Yarn	Sampled Before Run N673		2242	(325)	190	(27.7)
	Sampled After Run N680		2545	(369)	227	(32.9)
	Avg As-Received HTS Yarn		2394	(347)	209	(30.2)

Table VIII

Resistance Measurements for SiC Coated Graphite Yarn
(Reactor Temperature 1423 K)

<u>Run Number</u>	<u>Drawing Rate</u> cm/min	<u>In-Line Oxidation</u> T K	<u>Resistance¹</u> ohms			<u>Average Resistance</u> ohms	<u>Resistance Factor</u>
			<u>Top</u>	<u>Middle</u>	<u>Bottom</u>		
N675.	7.6	773	21	6	8	11.7	2.7
N674	15.2	773	7	7	7.5	7.2	1.7
N673	30.5	773	12	13	7	10.7	2.5
N678	7.6	None	10	7.5	7.5	8.3	1.9
N677	15.2	None	7	7	9	7.7	1.8
N680	30.5	None	100	100	70	90	20.9

¹Copper block method

Table IX

Resistance Measurements for SiC Coated Graphite Yarn
773 K In Line Oxidation

7.6 cm/min Drawing Rate

<u>Run Number</u>	<u>Reactor Temperature</u> T K	<u>Resistance¹</u> ohms			<u>Average Resistance</u> ohms	<u>Resistance Factor</u>
		<u>Top</u>	<u>Middle</u>	<u>Bottom</u>		
N692B	1368	7.0	6.5	3.5	6	1.3
N693B	1398	75	55	75	68	15.8
N688B	1398	26	300	275	200	46.5
N685B	1423	13	22	15	17	4.0
N686B	1473	5.0	6.0	6.0	6.0	1.3

15.2 cm/min Drawing Rate

N692A	1368	8.0	7.5	9.5	8	1.9
N688	1398	600	1000	750	783	182.0
N689	1398	120	150	250	173	40.0
N693A	1398	25	55	75	52	12.0
N685	1423	14.5	21	14.5	17	4.0
N686	1473	7.5	9.0	10.0	9.0	2.1

30.5 cm/min Drawing Rate

N692	1368	12	11.5	15.5	13	3.0
N690	1398	58	23	95	59	13.7
N693	1398	375	1000	1500	958	223.0

46 cm/min Drawing Rate

N694	1398	13	14	31	19	4.4
------	------	----	----	----	----	-----

¹Copper block method

Table X
Resistance Measurements for SiC Coated Graphite Yarn
(Reactor Temperature 1398 K)

Run Number	Drawing Rate cm/min	In-Line Oxidation T K	Resistance ¹ ohms			Average Resistance ohms	Resistance Factor
			Top	Middle	Bottom		
N691B	7.6	none	10.5	10	11	10	2.3
N693B	7.6	773	75	55	75	68	15.8
N688B	7.6	773	26	300	275	200	46.5
N691A	15.2	none	15	10.5	14.5	13	3.0
N688	15.2	773	600	1000	750	783	182.0
N689	15.2	773	120	150	250	173	40.0
N693	15.2	773	25	55	75	52	12.0
N691	30.5	none	28	12	21	20	4.7
N690	30.5	773	58	23	95	59	13.7
N693	30.5	773	375	1000	1500	958	223.0

¹Copper block method

Table XI

Average Individual Filament Strength and Modulus Test
Results on SiC Coated Graphite Fibers
(Comparison of Old and New Data)
Reactor Temperature 1423 K

Run Number	When Measured	Drawing Rate cm/min	In-Line Oxidation T K	UTS		Coefficient of Variation (UTS)	E	
				MPa	(kpsi)		GPa	(10 ⁶ psi)
N675	Old	7.6	773	2431	(353)	9.9	236	(34.3)
	New	7.6	773	2242	(325)	20.5	229	(33.2)
N674	Old	15.2	773	2759	(400)	11.7	252	(36.6)
	New	15.2	773	2359	(342)	22.4	225	(32.6)
N673	Old	30.5	773	2320	(337)	14.4	240	(34.8)
	New	30.5	773	2515	(365)	31.2	227	(33.0)
N678	Old	7.6	none	2269	(329)	30.4	210	(30.5)
	New	7.6	none	2584	(375)	21.4	215	(31.3)
N677	Old	15.2	none	2223	(323)	13.8	214	(31.0)
	New	15.2	none	2788	(405)	16.9	223	(32.4)
N680	Old	30.5	none	2422	(352)	8.3	229	(33.2)
	New	30.5	none	2213	(321)	22.4	213	(30.9)
Average	Old			2406	(349)	14.8	230	(33.4)
	New			2451	(356)	22.5	222	(32.2)
As Rec'd	Old			2545	(369)	26.0	227	(32.9)
	New			2242	(325)	33.9	190	(27.7)

Table XII

Individual Fiber Strength and Modulus Test Results on
Individual SiC Coated Graphite Fibers

<u>Run Number</u>	<u>Drawing Rate</u> cm/min	<u>Reactor Temp.</u> T K	<u>In-Line Oxidation Temp.</u> T K	<u>UTS</u>		<u>Coefficient of Variation</u> UTS	<u>E</u>	
				<u>MPa</u>	<u>(kpsi)</u>		<u>GPa</u>	<u>(10⁶ psi)</u>
N691B	7.6	1398	none	2837	(412)	10.8	228	(33.1)
N688B	7.6	1398	773	2564	(372)	22.2	199	(28.8)
N693B	7.6	1398	773	2184	(317)	34.2	234	(34.0)
N691A	15.2	1398	none	2174	(316)	18.2	199	(28.8)
N692A	15.2	1368	773	2311	(335)	33.2	191	(30.0)
N688	15.2	1398	773	1882	(273)	47.3	212	(30.7)
N689	15.2	1398	773	2242	(325)	25.4	227	(32.9)
N693A	15.2	1398	773	2067	(300)	16.0	222	(32.2)
N685	15.2	1423	773	1774	(258)	30.3	220	(32.0)
N685C	15.2	1448	773	2253	(327)	25.1	228	(33.1)
N686	15.2	1473	773	2506	(364)	17.0	182	(26.5)
N691	30.5	1398	none	2086	(303)	29.8	214	(31.1)
N690	30.5	1398	773	2311	(335)	18.9	206	(29.9)
N693	30.5	1398	773	2671	(388)	24.2	226	(32.7)
N694	45.7	1398	773	2272	(330)	20.2	217	(31.4)

Table XIII

Results of Arcing Tests on SiC Coated and Uncoated Graphite Fibers

<u>Run Number</u>	<u>Spot Flash</u> (VAC)	<u>Slow Glow</u> (VAC)	<u>Burn</u> (VAC)	<u>White Arc</u> (VAC)
As received graphite yarn	20-25	-	-	45-50
Run N616 CVD SiC coated yarn	35-40	60-75	-	90
Run N620 CVD SiC coated yarn in line oxidized at 873 K	50	80	120	-

Table XIV

Thickness Measurements from Electron Photomicrographs
of SiC Coating on Graphite Fibers

<u>Run Number</u>	<u>Drawing Rate</u> cm/min	<u>Width of Coating Range μm</u>	<u>Average Thickness μm</u>
N648	7.6	0.04 \rightarrow 0.14	0.1
N688B	7.6	0.06 \rightarrow 0.10	0.08
N693B	7.6	0.04 \rightarrow 0.14	0.09
N688	15.2	0.04 \rightarrow 0.07	0.06
N693	30.5	0.03 \rightarrow 0.06	0.04

Table XV

Experiments Performed on Coatings of HTS Graphite Fibers

<u>Sample No.</u>	<u>Solution Conc.</u>	<u>No. of Coatings</u>	<u>Pyrolysis Treatment in Nitrogen</u>	<u>SEM Surface Observations</u>
S 1	3.5% MTS ¹	8	783 K, 1 hr	smooth
S 2	3.5% MTS	8	none	smooth
S 3	5.7% MTS	3	783 K, 1 hr	rough
S 4	5.7% MTS	3	none	smooth
S 5	5.7% MTS	5	783 K, 1 hr	thick
S 6	5.7% MTS	5	none	bridging
S20	9.1% MTS	3	783 K, 1 hr	smooth
S21	9.1% MTS	3	none	smooth
S22	9.1% MTS	5	783 K, 1 hr	smooth
S23	9.1% MTS	5	none	rough
S24	9.1% MTS	8	783 K, 1 hr	smooth
S25	9.1% MTS	8	none	smooth
S 7	1.7% VTS ²	1	783 K, 1 hr	bridging (rough)
S 8	1.7% VTS	1	none	bridging (rough)
S 9	1.7% VTS	5	783 K, 1 hr	bridging (smooth)
S10	1.7% VTS	5	none	bridging (rough)
S26	2.3% VTS	1	783 K, 1 hr	smooth
S27	2.3% VTS	1	none	smooth
S28	2.3% VTS	5	783 K, 1 hr	bridging
S29	2.3% VTS	5	none	bridging (rough)
S11	1.15% SR 355 ³	1	783 K, 1 hr	bridging (rough)
S12	1.15% SR 355	1	none	smooth
S13	1.15% SR 355	3	783 K, 1 hr	smooth
S14	1.15% SR 355	3	none	bridging (rough)
S30	2.3% SR 355	1	783 K, 1 hr	smooth
S31	2.3% SR 355	1	none	bridging (rough)
S32	2.3% SR 355	3	783 K, 1 hr	rough
S33	2.3% SR 355	3	none	bridging (rough)
S34	2.3% SR 355	5	783 K, 1 hr	smooth
S35	2.3% SR 355	5	none	rough
S15	1.27% ES ⁴	1	783 K, 1 hr	smooth
S16	1.27% ES	1	none	smooth
S17	1.27% ES	3	783 K, 1 hr	smooth
S18	1.27% ES	3	none	bridging (rough)
S36	2.5% ES	1	none	smooth
S37	2.5% ES	1	783 K, 1 hr	smooth
S38	2.5% ES	3	783 K, 1 hr	smooth
S39	2.5% ES	3	none	smooth
S40	2.5% ES	5	783 K, 1 hr	smooth
S41	2.5% ES	5	none	smooth
S42	2.5% ES	8	783 K, 1 hr	smooth
S43	2.5% ES	8	none	bridging (rough)

¹MTS is methyltriethoxysilane²VTS is vinyltriacetoxysilane³SR 355 is GE SR 355 silicone resin⁴ES is ethyl silicate (R&R silicate #18)

Table XVI

SIMS Spectra of Graphite Fibers
 % Relative Peak Intensity¹
 He (1500 volts)

Fiber No.	Coating	Penetration Depth 13-16 ^o Å			
		% due to C	% due to O	% due to F	% due to Si
Untreated		28	none	19	42
S1	MTS	-	none	-	-
S2	↓	21	none	8.2	75
S3		10	10	26	41
S4		31	none	7.6	56
S5		15	none	13	65
S6	↓	30	none	-	70
S7	VTS	11	2.8	13.3	70
S8	↓	12	1.0	10.0	77
S9		13	none	14	70
S10	↓	16	none	8	76
S11	SR 355	19	3.7	7.1	70
S12	↓	25	none	-	75
S13		16	none	4.3	79
S14	↓	20	none	-	79
S15	ES	17	4.4	2.7	38
S16	↓	27	none	22	42
S17		33	none	-	64
S18	↓	19	22	-	78

¹Based as a percentage of the total counts/sec of all species with mass numbers 12, 13, 14, 15, 16, 19, 23, 27 and 28

Table XVII

Electrical Resistance and Oxidative Stability of
Pyrolyzed Organo-Silicone Coated Graphite Fibers

Sample No.	Silane Coating Followed By Pyrolysis at 783 K, 1 hr	Resistance ohms (2.5 cm length)	Oxidation at 783 K, 8 hrs in Air Wt Loss, %
S19	HTS untreated (control)	2-5	99
S 3	5.7% MTS ¹ 3 dips	20	-
S 4	5.7% MTS 5 dips	20	-
S20	9.1% MTS 3 dips	10	80
S22	9.1% MTS 5 dips	20	78
S24	9.1% MTS 8 dips	20	71
S 7	1.7% VTS ² 1 dip	20	78
S 8	1.7% VTS 5 dips	40	86
S26	2.3% VTS 1 dip	30	40
S27	2.3% VTS 3 dips	12	
S28	2.3% VTS 5 dips	30	40
S29	2.3% ES 5 dips	12	
S11	1.15% SR 355 ³ 1 dip	30	90
S13	1.14% SR 355 3 dips	30	55
S30	2.3% SR 355 1 dip	15	32
S32	2.3% SR 355 3 dips	30	15
S33	2.3% SR 355 3 dips	13	-
S34	2.3% SR 355 5 dips	15	75
S15	1.27% ES ⁴ 1 dip	25	88
S17	1.27% ES 3 dips	20	35
S36	2.5% ES 1 dip	35	45
S38	2.5% ES 3 dips	20	42
S40	2.5% ES 5 dips	70	10
S42	2.5% ES 8 dips	40	75
S43	2.5% ES 8 dips	60	75

¹ Methyltriethoxysilane, wt % in toluene

² Vinyltriacetoxysilane, wt % in toluene

³ GE silicone resin SR 355, wt % in toluene

⁴ Ethyl silicate prepolymer, wt % in isopropanol

Table XVIII

Tensile Strength of Graphite Tows After
Surface Coating and Pyrolysis
(5 cm gage length)

<u>Sample No.</u>	<u>Treatment</u>	<u>P_{max}</u>	
		<u>N</u>	<u>lbs</u>
A-1	Untreated	334	77
-2	"	334	77
-3	"	352	80
S8-1	VTS	334	77
-2	VTS	656	149
S12	SR 355	374	85
S15	ES	524	119
S17	ES	528	120
S42	ES	88	20
S43	ES	163	37

Table XIX

Conclusions from Static Tests

	<u>Oxidation Results</u>	<u>Resistance Results</u>	<u>SEM Observations</u>	<u>Tensile Results</u>
MTS	Poor	Good	Good	-
VTS	Poor	Good	Poor	Good
SR 355	Good	Good	Fair	Good
ES	Good	Good	Good	Good

ES > SR 355 > MTS > VTS

Table XX

Pyrolyzed Organo-Silicone Coated Graphite Fiber
Produced by a Continuous Coating Process

Conditions of Runs

Run No.	Yarn Drawing Rate m/min	Yarn Treatment Conditions		
		Ethyl Silicate Conc Wt %	Temp K	Pyrolysis Atmosphere
SC1	0.91	2.5	903-963	N ₂
SC2	0.91	2.5	1093-1173	"
SC3	0.91	2.5	1223-1303	"
SC4	0.91	2.5	1393-1453	"
SC5	0.91	2.5	1093-1173	"
SC6	0.91	2.5	"	"
SC9	0.91	3.0	"	"
SC10	0.91	4.6	"	"
SC7	0.76	2.5	"	"
SC8	0.60	2.5	"	"

Table XXI

Properties of Pyrolyzed Organo-Silicone Coated Graphite
Yarn Produced by Continuous Process
(N₂ atmosphere)

Run No.	Yarn Treatment Conditions			Electrical Resistance ohms	Loss at 783 K 8 hrs in air Wt %
	Yarn Drawing Rate m/min	Ethyl Silicate Conc Wt %	Temp K		
untreated HTS	-	-	-	2.0	99.2
SC1	0.91	2.5	903-963	13.0	8.0
SC2	0.91	2.5	1093-1173	16.0	15.0
SC3	0.91	2.5	1223-1303	10	7.0
SC4	0.91	2.5	1393-1453	11	11.0
SC5	0.91	2.5	1093-1173	14.0	34
SC6	0.91	2.5	"	11.5	16
SC9	0.91	3.0	"	13.0	17
SC10	0.91	4.0	"	6.8	22
SC7	0.76	2.5	"	16	16
SC8	0.60	2.5	"	18	13

Table XXII

A Summary of Tensile Tests on
Coated Graphite Yarn

<u>Fiber Lot</u>	<u>Fiber Treatment/Run</u>	<u>Gage Length (cm)</u>	<u>Failure Load</u>	
			(N)	(lbs)
76-8-1	untreated HTS	5.1	643	145
76-8-1	SC1	5.1	745	167
76-8-1	SC2	5.1	1102	248
76-8-1	SC3	5.1	828	186
76-8-1	untreated HTS	2.5	1152	260
76-8-1	SC1	2.5	999	225
76-8-1	SC2	2.5	1332	299
76-8-1	SC3	2.5	668	150
76-8-1	SC4	2.5	587	132
2-98-1	untreated HTS	2.5	1302	300
2-98-1	SC5	2.5	1152	260
2-98-1	SC6	2.5	962	217
76-8-3	SC7	2.5	1175	265
76-8-3	SC8	2.5	1152	260
2-98-1	SC9	2.5	1159	267

Table XXIII

Flexural Properties Containing MY720 Epoxy Resin
 General Composition MY720/DEN 438/DDS
 (UTRC 89-Z)

Flexural Properties¹

Specimen No.	Strength		Modulus	
	MPa	psi	GPa	10 ⁶ psi
1	81.7	11,800	3.15	0.46
2	109	15,800	3.05	0.44
3	96.2	14,000	3.18	0.46
4	95.6	13,900	3.52	0.51
5	76.5	11,100	3.59	0.52

¹Four point flex, span-to-depth ratio 20/1

Table XXIV

Composition of Untreated and Treated
(Pyrolyzed Organo-Silicone Coated)
HTS/Epoxy Composites

<u>Composite No.</u>	<u>Fiber Condition/Run No.</u>	<u>Density g/cc</u>	<u>Vol %</u>	
			<u>Fiber</u>	<u>Resin</u>
212-1	untreated	1.45	61.4	38.3
212-4	treated/SC5	1.38	45.9	54.0
212-9	treated/SC7	1.38	49.2	50.7
212-10	treated/SC8	1.48	54.7	43.4
212-11	untreated	1.43	60.0	40.0
212-12	untreated	1.46	62.0	38.3
212-14	treated/SC9	1.49	55.8	42.3
212-15	treated/SC7	-	-	-
212-16	treated/SC6	1.47	49.2	49.9
212-17	untreated	1.51	60	40.0

Table XXV

Shear Strengths of Untreated and Treated (Pyrolyzed Organo-Silicone Coated)
HTS/Epoxy Composites

Composite No.	Treatment/Run Condition/No.	Yarn Lot Number	Fiber Treatment			Fiber Vol %	Shear Strength ³	
			Yarn Drawing Rate m/min	Ethyl Silicate Conc Wt %	Temp K		MPa	psi
212-1 ¹	untreated	76-8-1	-	"as received"	-	61	81.7	11,850
212-11 ¹	untreated	76-8-1	-	"as received"	-	60	83.3	12,075
212-18 ¹	treated/SC1	76-8-1	0.91	2.5	963	52	53.4	7,745
212-4 ¹	treated/SC5	76-8-1	0.91	2.5	1173	46	46.8	6,790
212-17 ²	untreated	2-98-1	-	"as received"	-	60	88.0	12,760
212-12 ¹	untreated	76-8-3	-	"as received"	-	62	51.4	7,460
212-16 ¹	treated/SC6	2-98-1	0.91	2.5	1173	49	51.2	8,290
212-9 ¹	treated/SC7	76-8-3	0.76	2.5	1173	49	46.0	6,670
212-10 ¹	treated/SC8	2-98-1	0.60	2.5	1173	55	31.0	4,500
212-14 ¹	treated/SC9	2-98-1	0.91	3.0	1173	56	40.6	5,890

¹MY720 containing epoxy (see Table XXIII)

²Contains epoxy resin PR-286 (3M Co.)

³Short beam shear strength, S/D = 4/1

Table XXVI

Flexural Properties of Untreated and Treated (Pyrolyzed Organo-Silicone Coated)
HTS/Epoxy Composites

Composite No.	Treatment / Run Condition / No.	Yarn Lot	Fiber Treatment			Fiber Vol %	Flexural Properties			
			Yarn Drawing Rate m/min	Ethyl Silicate Conc Wt %	Temp K		Strength		Modulus	
							MPa	10 ³ psi	GPa	10 ⁶ psi
212-1 ¹	untreated	76-8-1	-	"as received"	-	61	1037	150 ³	112	16.2
212-11 ¹	untreated	76-8-1	-	"as received"	-	60	1117	162 ³	139	20.2
212-12 ¹	untreated	76-8-3	-	"as received"	-	62	783	114 ³	128	18.6
212-17 ²	untreated	2-98-1	-	"as received"	-	60	1184	173 ³	135	19.4
212-18 ¹	treated/SC1	76-8-1	0.91	2.5	963	50	629	91.2 ³	86.2	12.5
212-16 ¹	treated/SC6	2-98-1	0.91	2.5	1173	49	951	138 ⁴	-	-
212-15 ¹	treated/SC7	2-98-1	0.60	2.5	1173	55	586	85 ⁵	119	17.3
212-14 ¹	treated/SC9	2-98-1	0.91	3.0	1173	56	1115	162 ⁶	-	-

¹MY720 containing epoxy (see Table XXIII)

²Contains epoxy resin PR-286 (3M Co.)

³4-point flexural strength, S/D = 20/1

⁴3-point flexural strength, S/D = 20/1

⁵4-point flexural strength, S/D = 32/1

⁶3-point flexural strength, S/D = 28/1

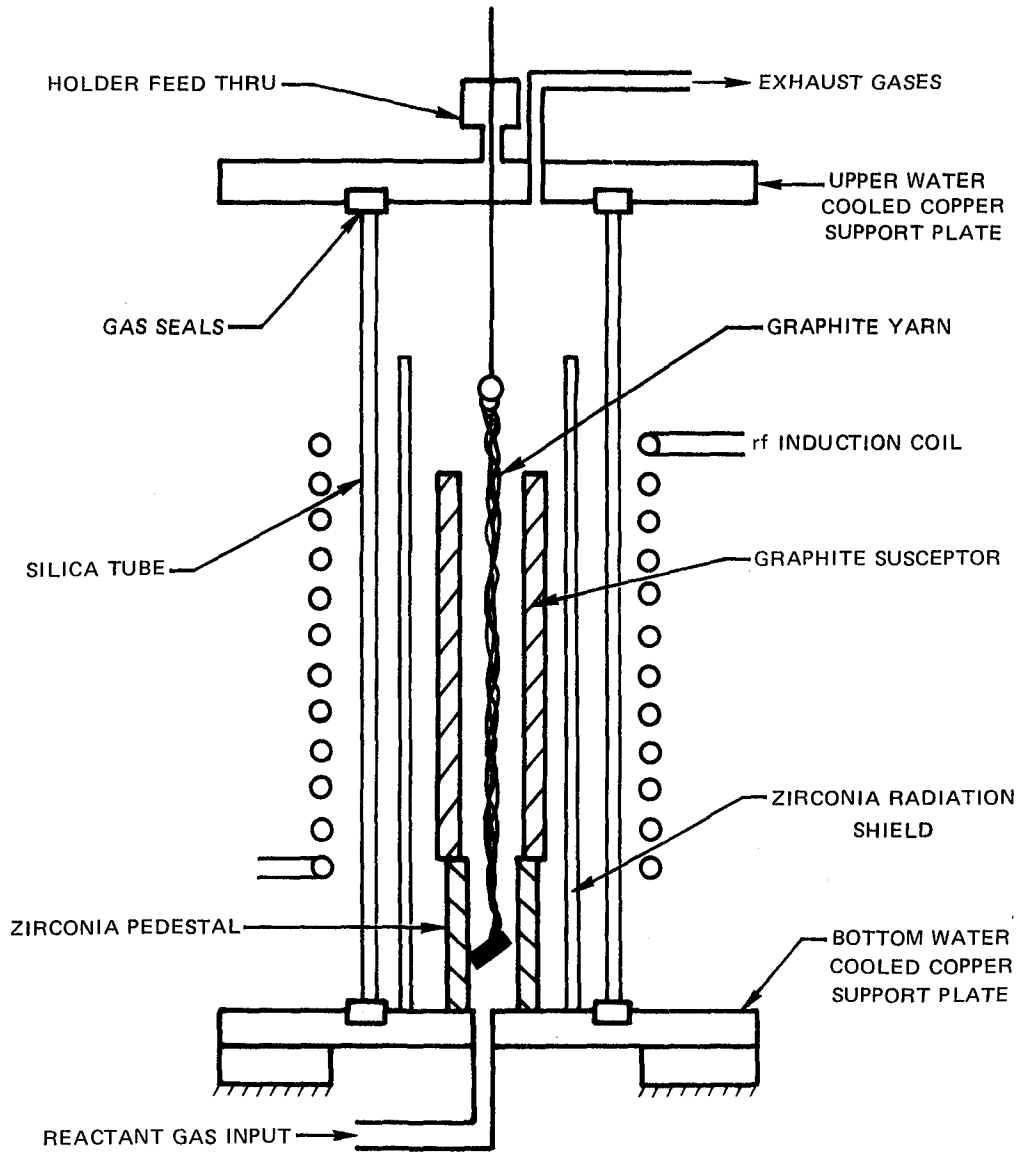

Fig. 1 Typical CVD Static Apparatus

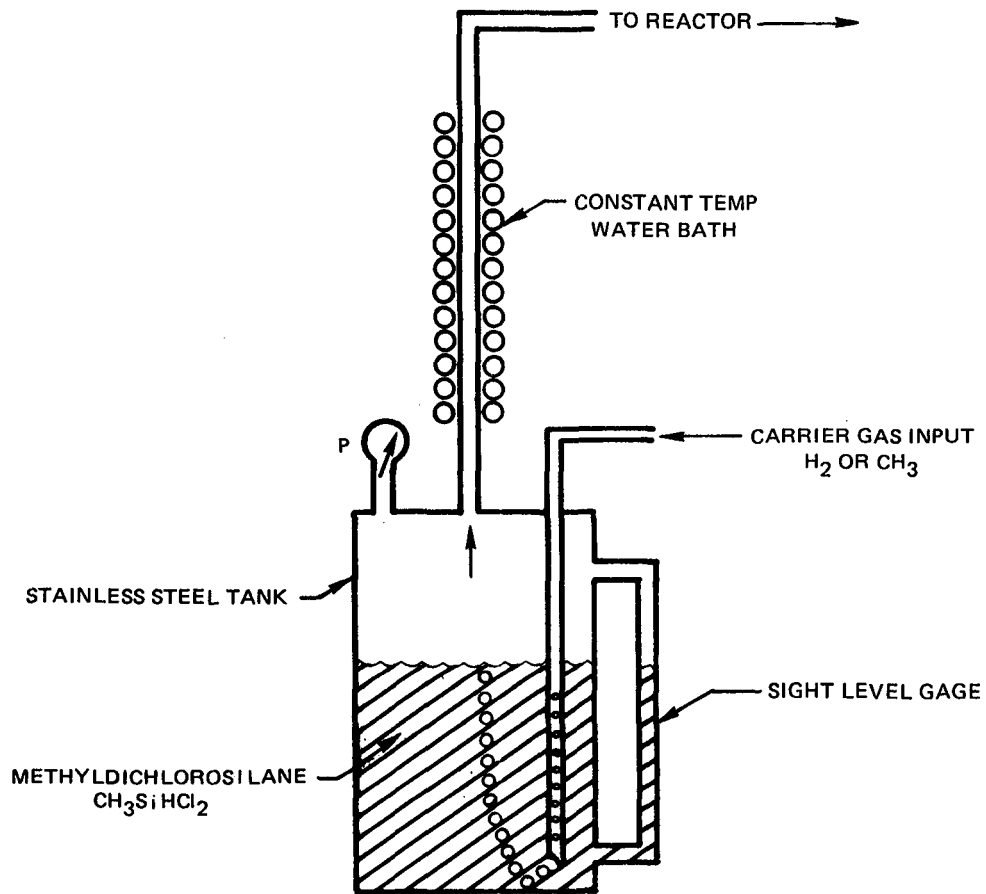

Fig. 2 Silane Evaporator

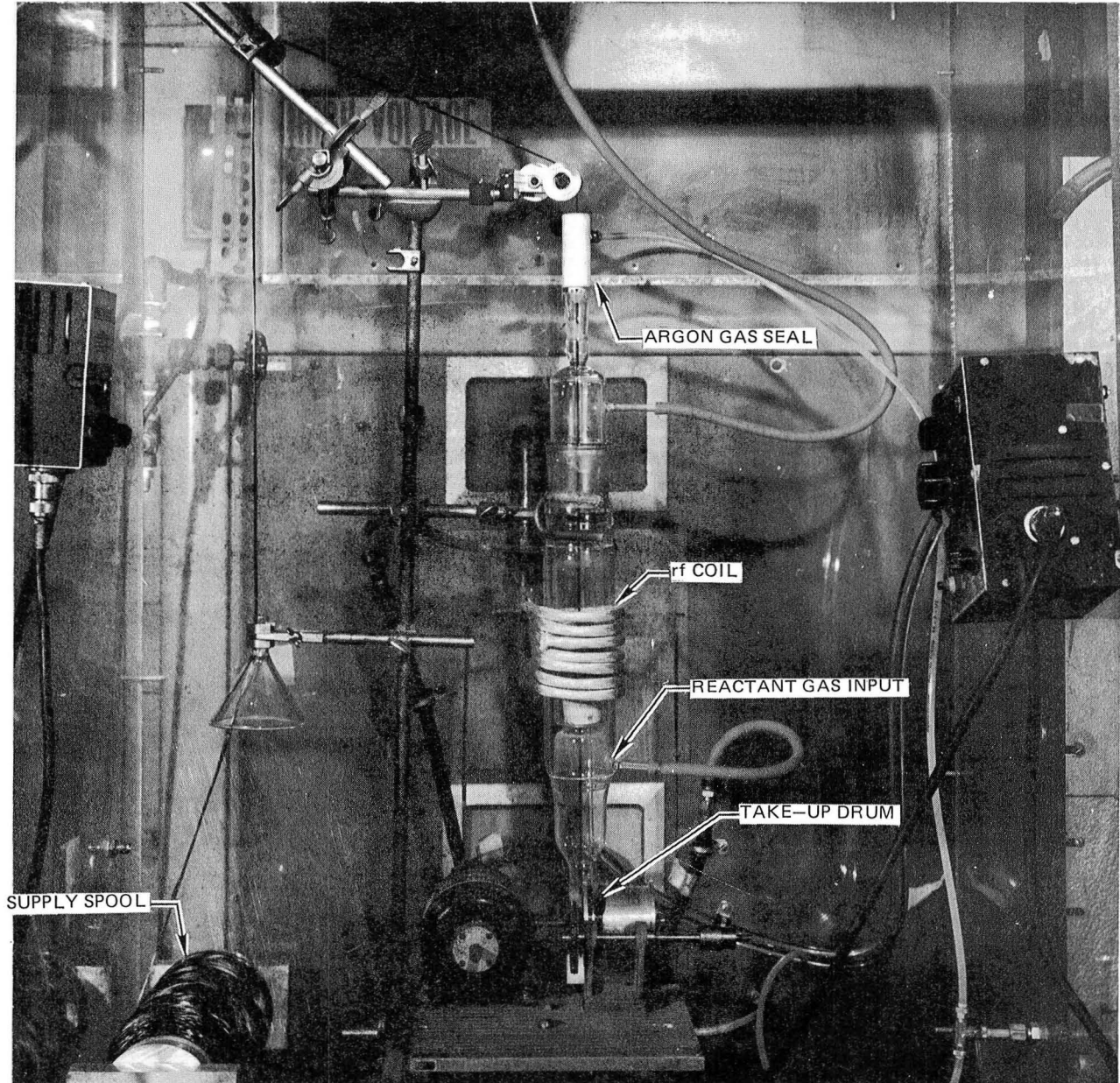

Fig. 3 Vertical CVD SiC Apparatus

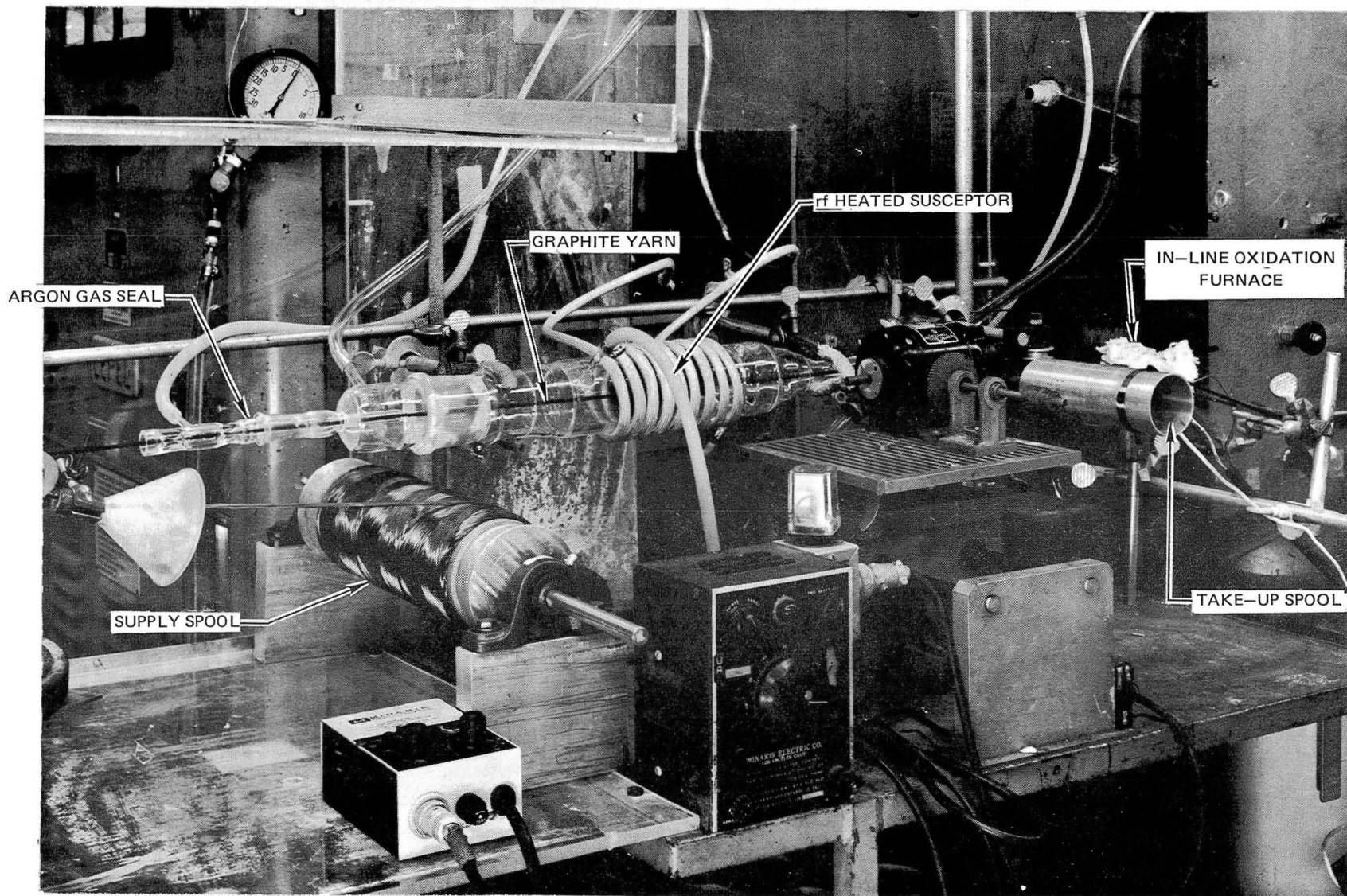

Fig. 4 Horizontal CVD SiC Apparatus

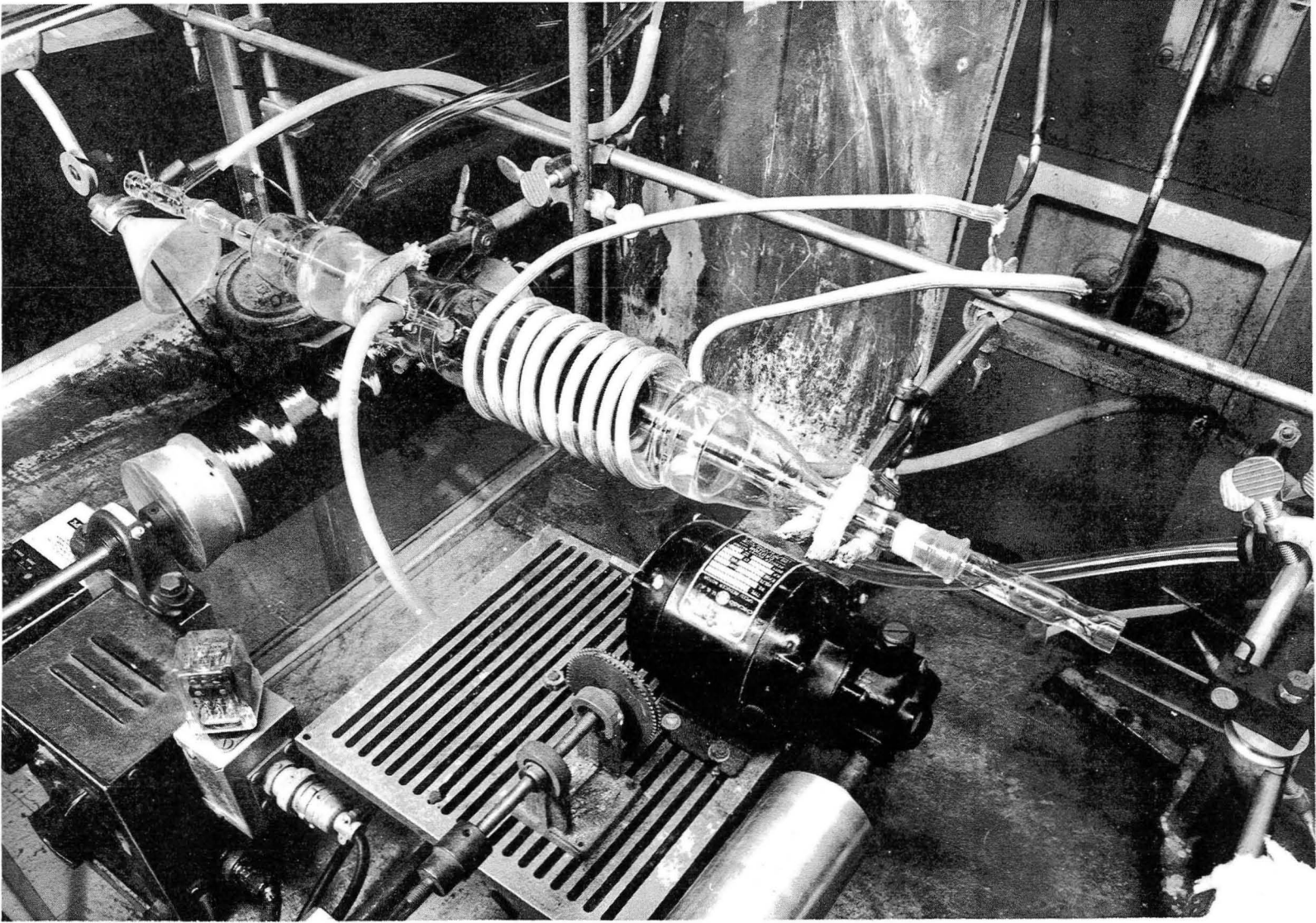

Fig. 5 Horizontal CVD SiC Apparatus

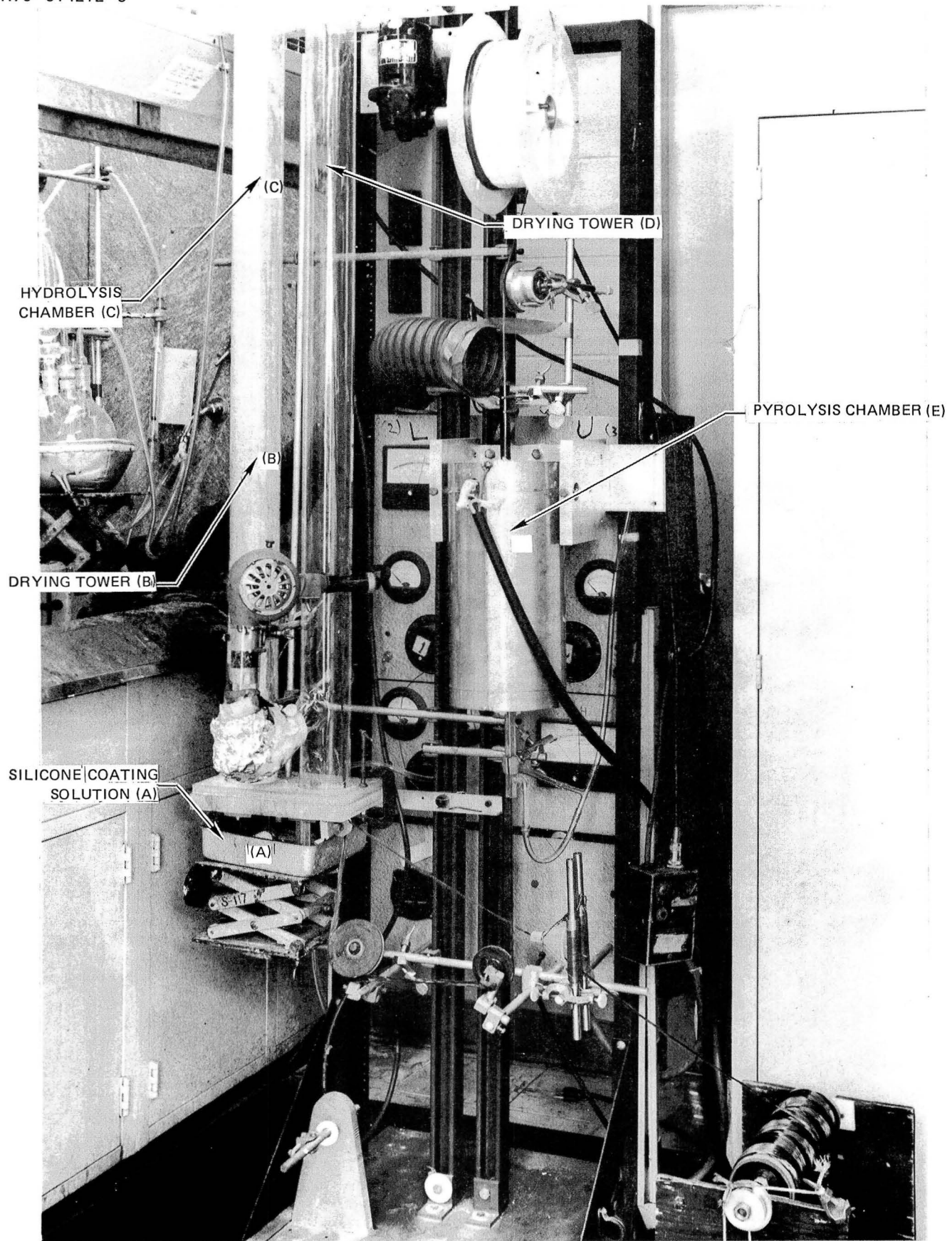

Fig. 6 Photograph of Organo-Silicone Coating Apparatus for Continuous Processing

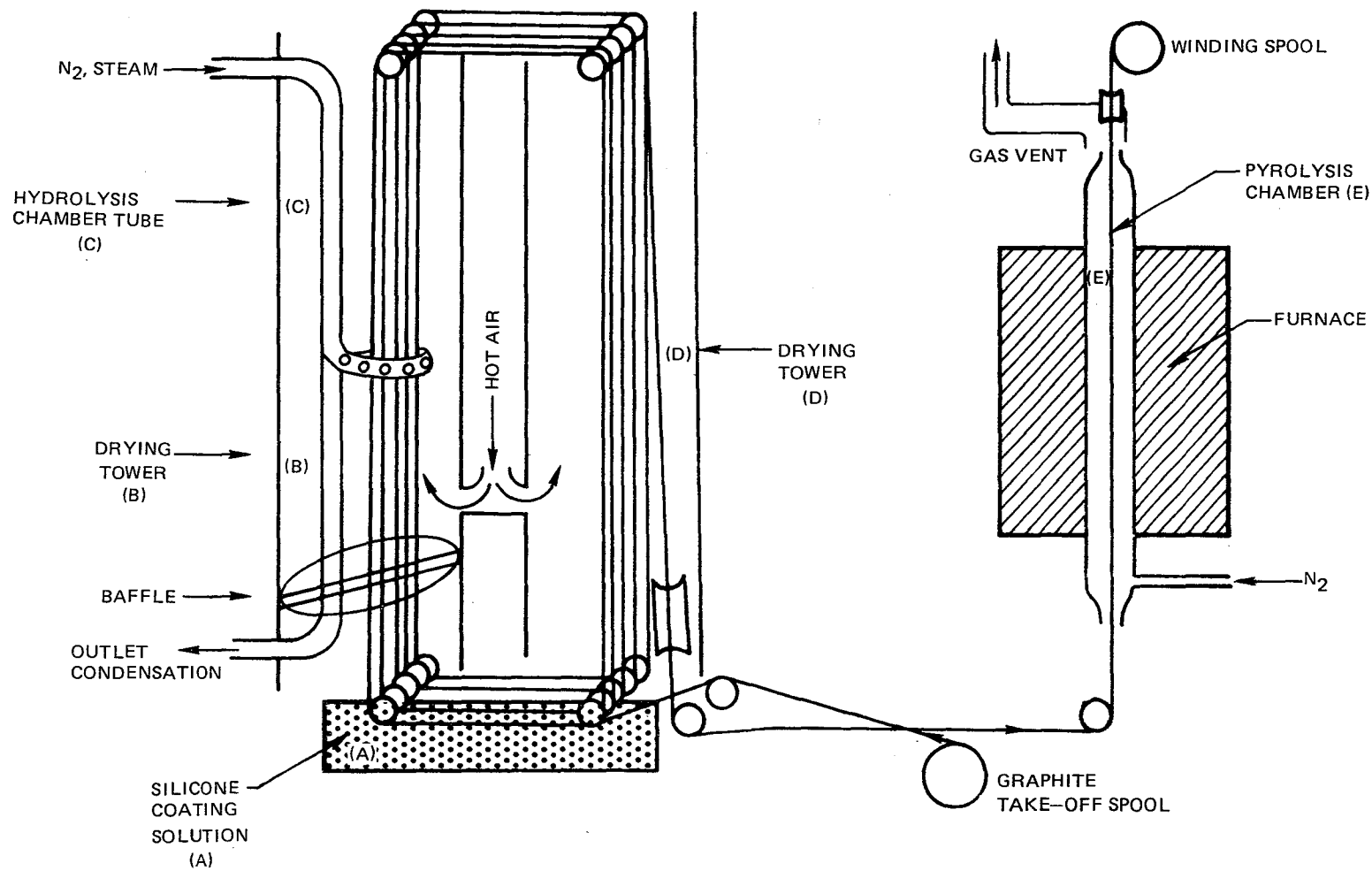

Fig. 7 Schematic of Organo-Silicone Coating Apparatus for Continuous Processing

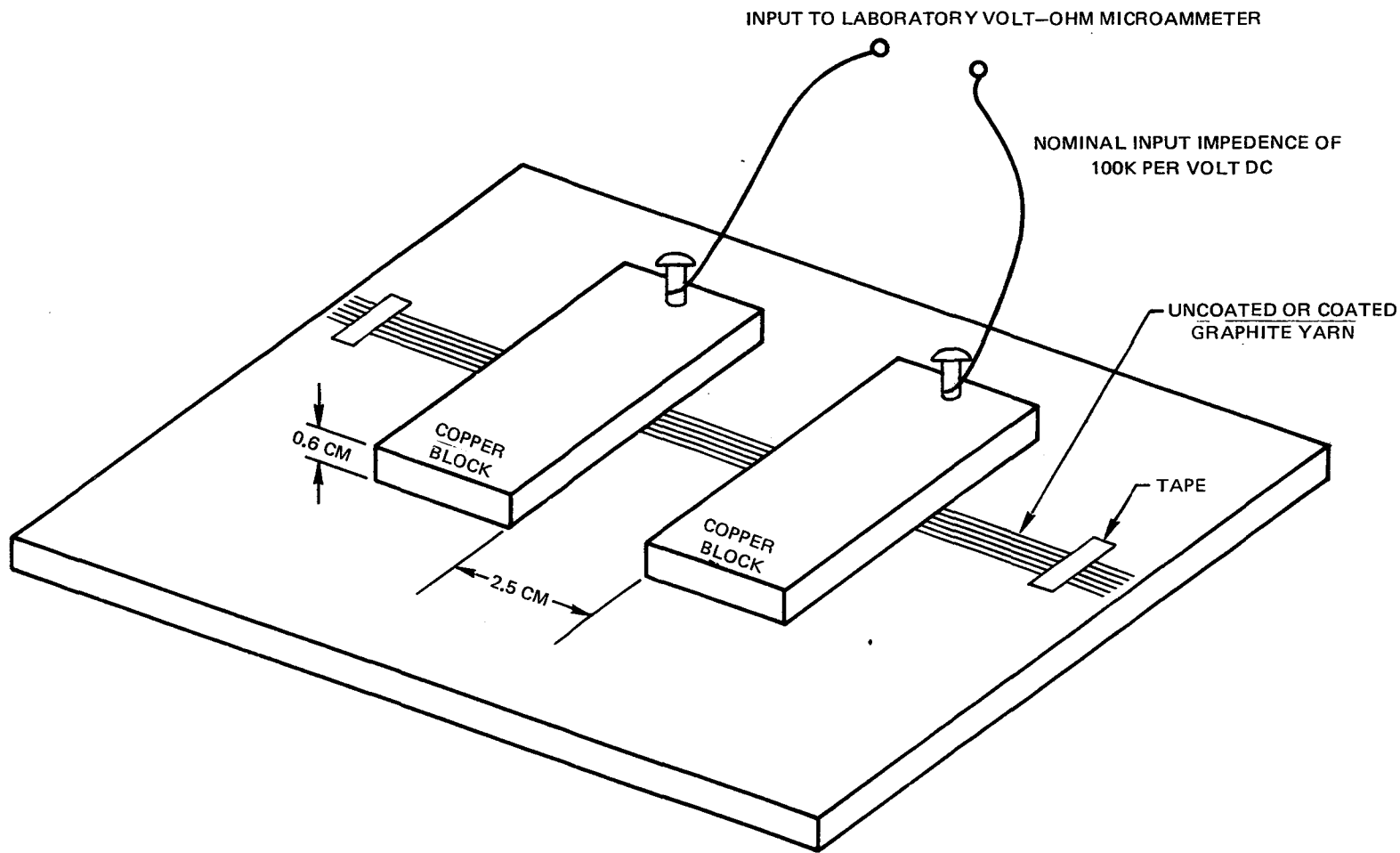

Fig. 8 Copper Block Resistance Measurement Technique

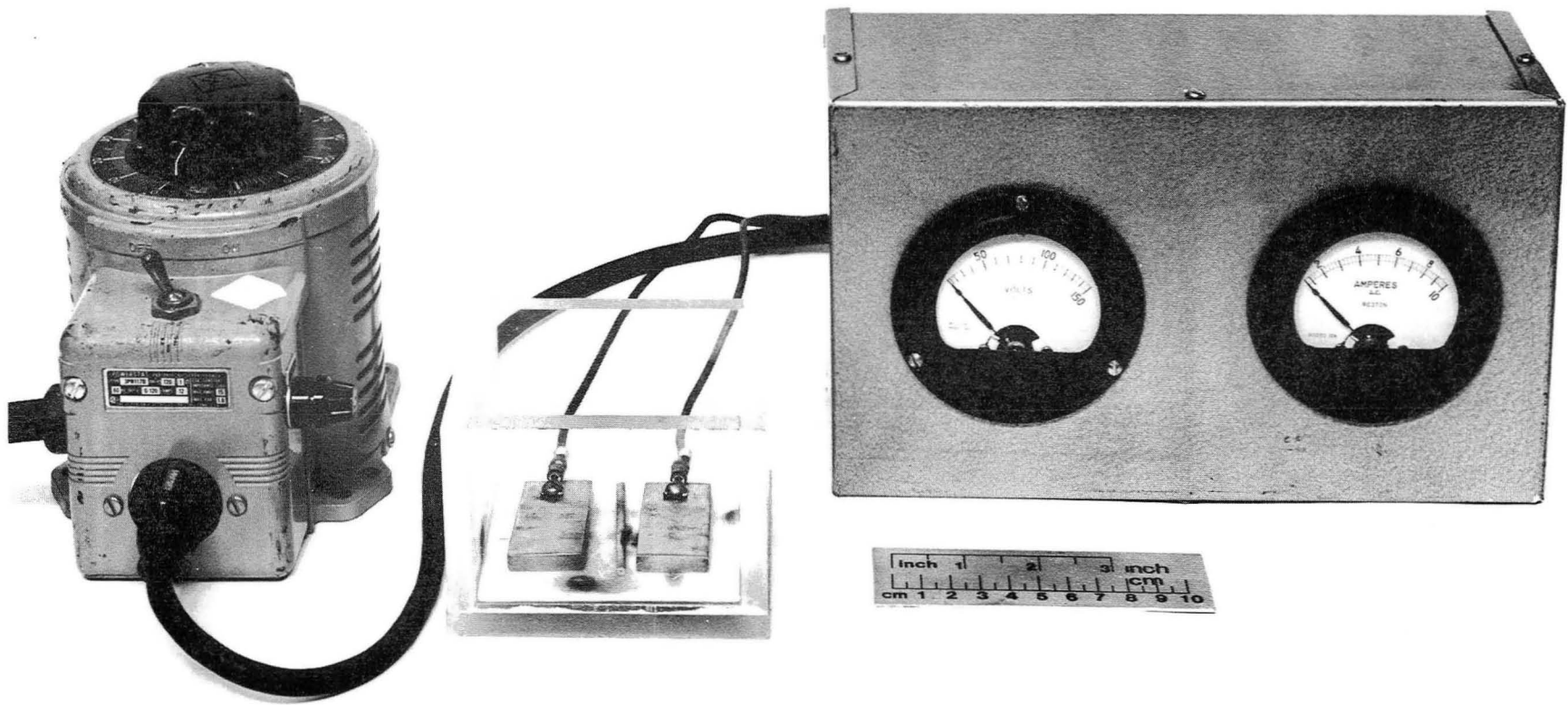

Fig. 9 Experimental Set-up for Arcing Test

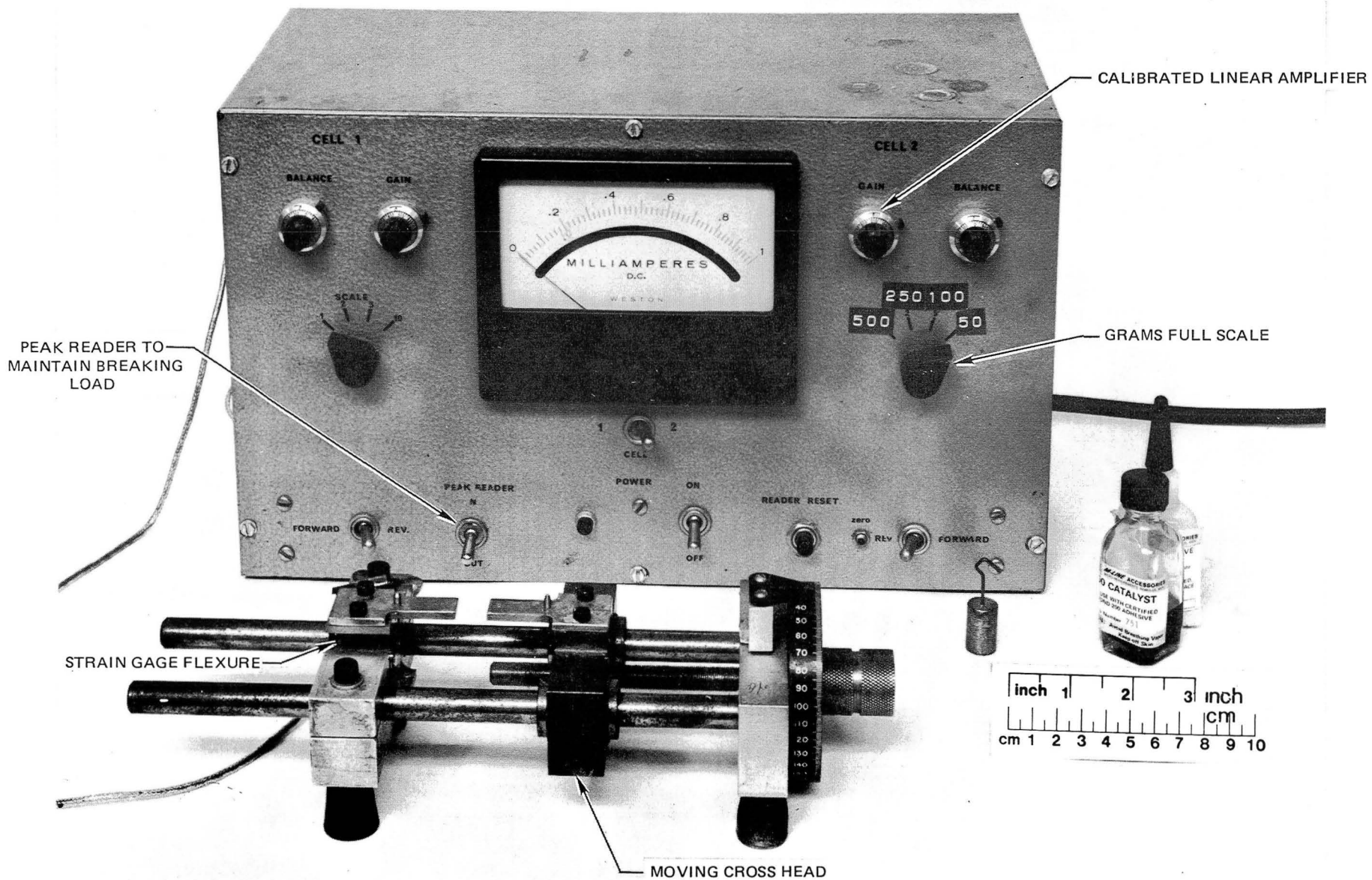
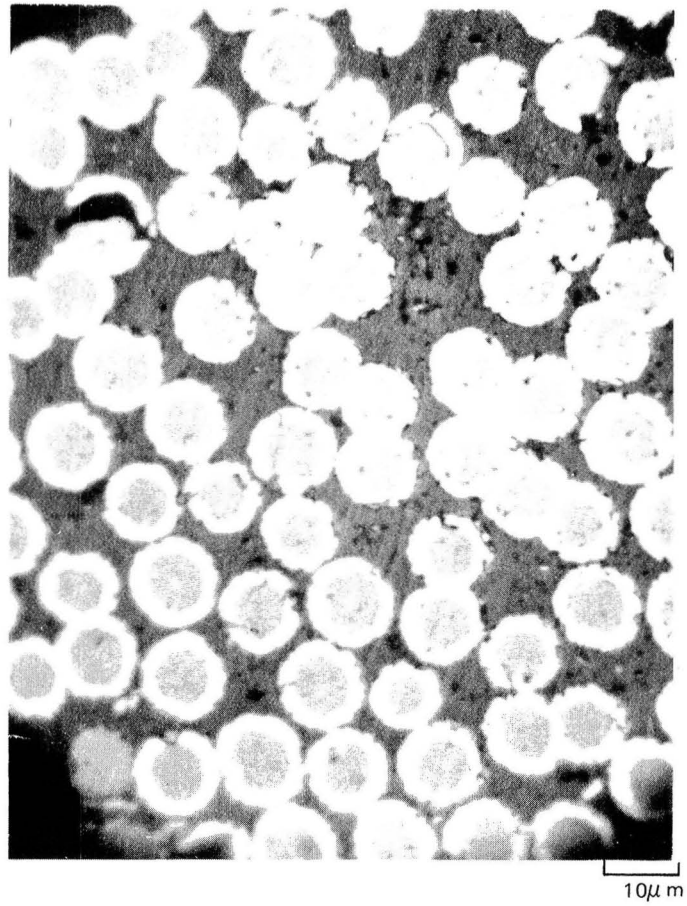

Fig. 10 Single Filament Tensile Tester



STATIC RUNS

Fig. 11 SiC Coated Graphite Fiber Static Runs

TEMP 1323 K

ATMOSPHERIC PRESSURE

STATIC RUNS

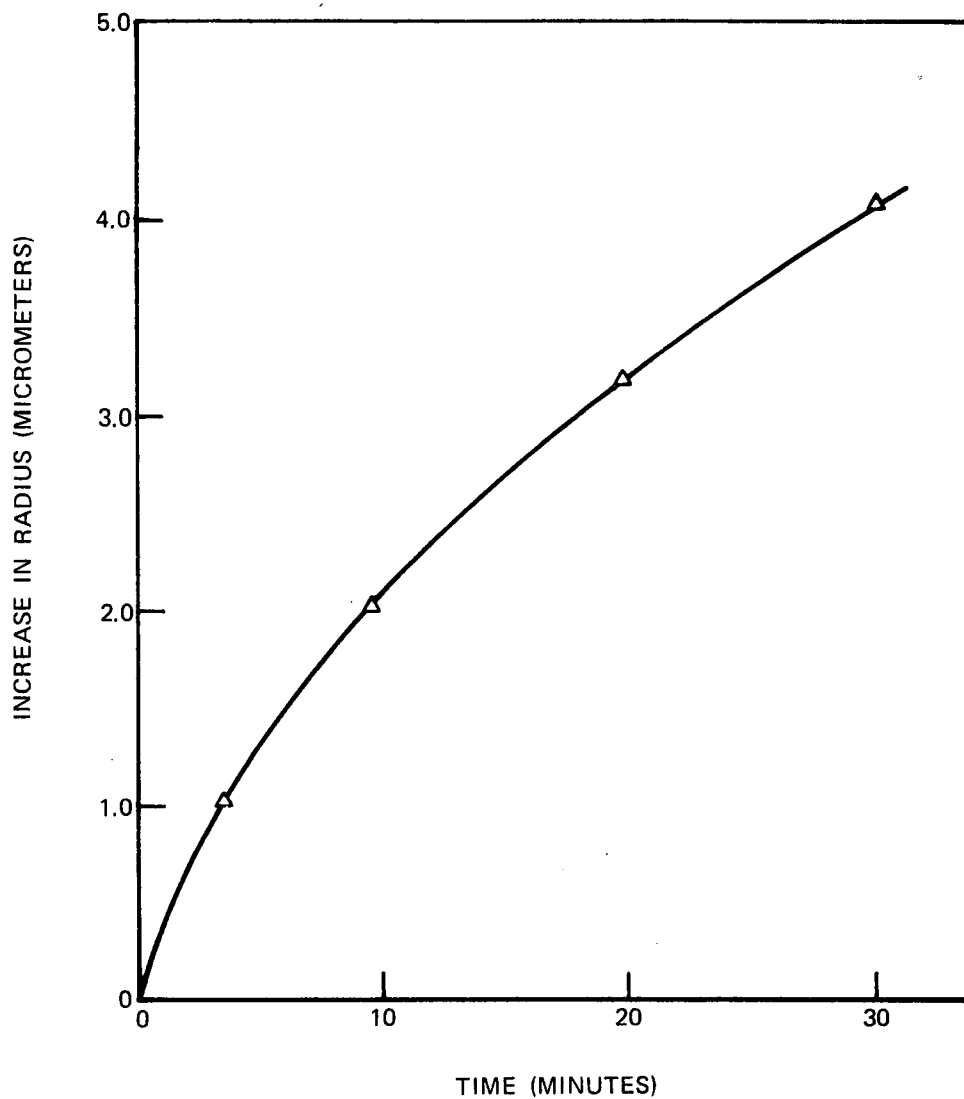

Fig. 12 Increase in Radius of SiC Coated HTS Fiber as a Function of Time

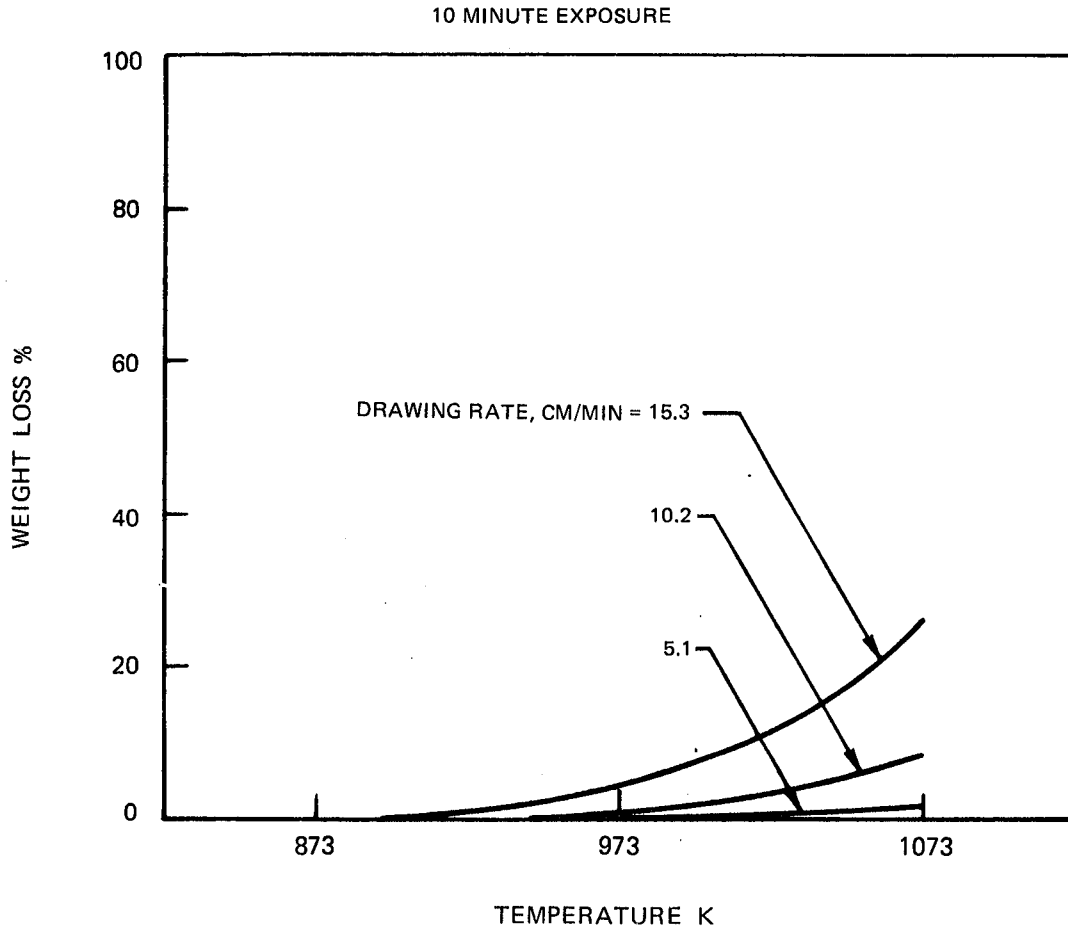

Fig. 13 Percent Weight Loss for SiC Coated HTS Fiber Heated in Air

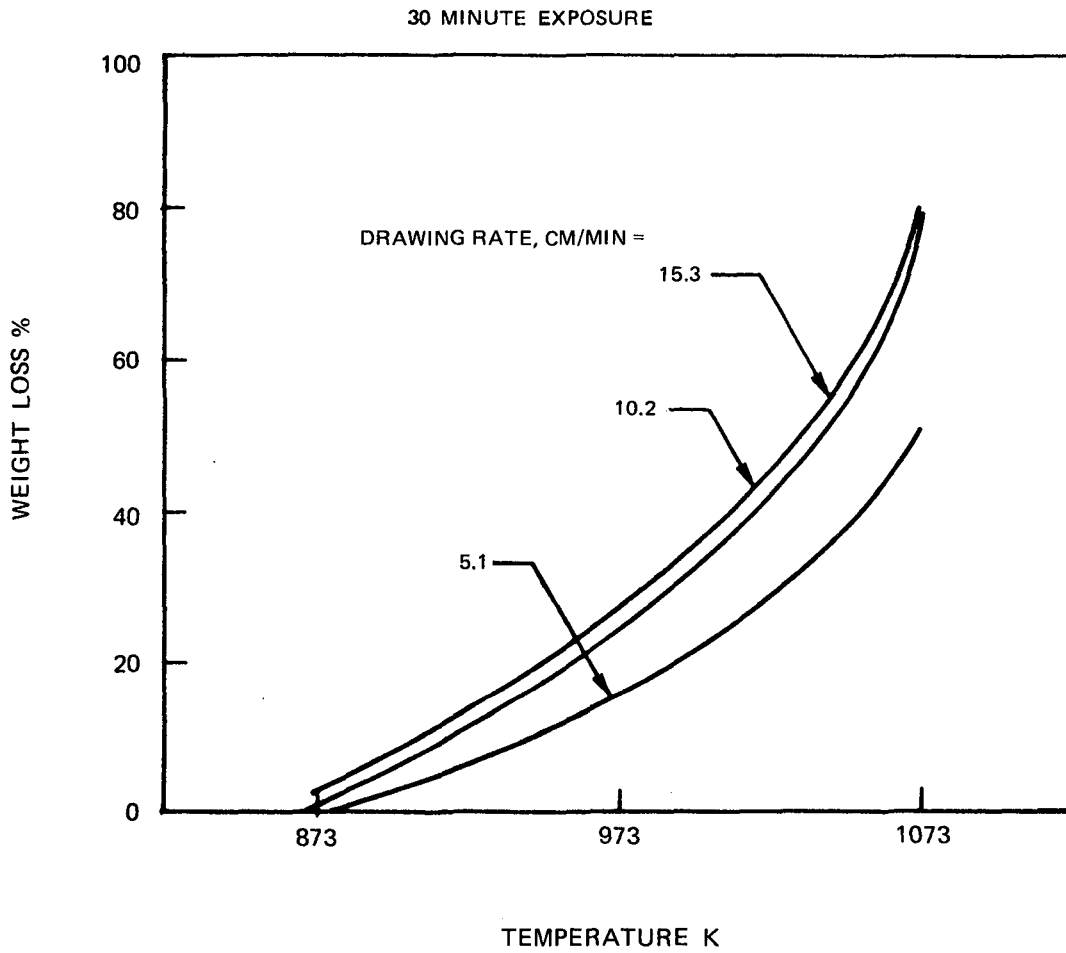

Fig. 14 Percent Weight Loss for SiC Coated HTS Fiber Heated in Air

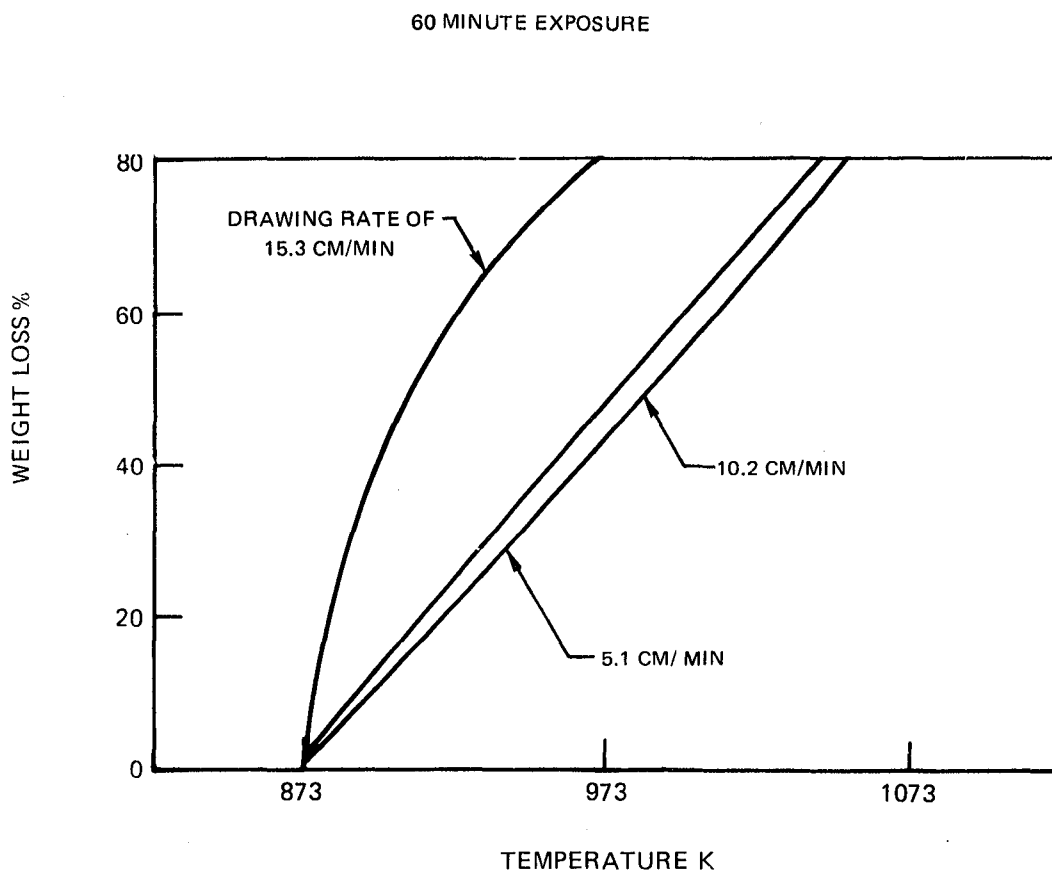

Fig. 15 Percent Weight Loss for SiC Coated HTS Fiber Heated in Air

30 MINUTE EXPOSURE

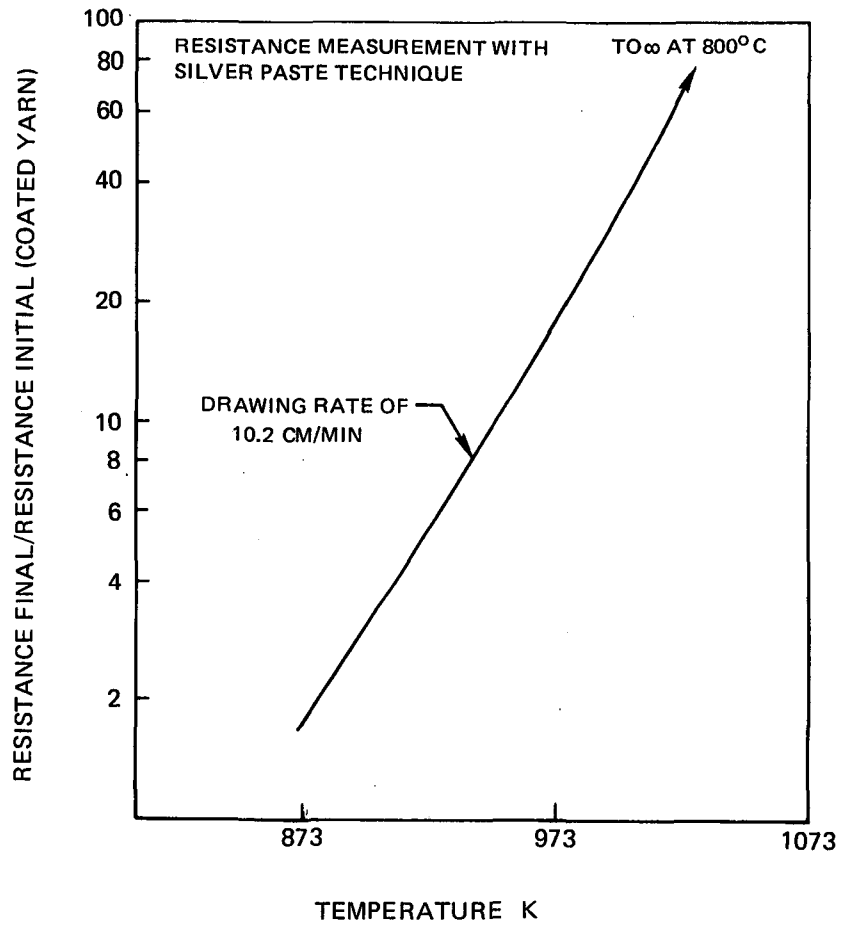

Fig. 16 Final to Initial Resistance Ratio for SiC Coated HTS Fiber Heated in Air

7.6 CM/MIN DRAWING RATE

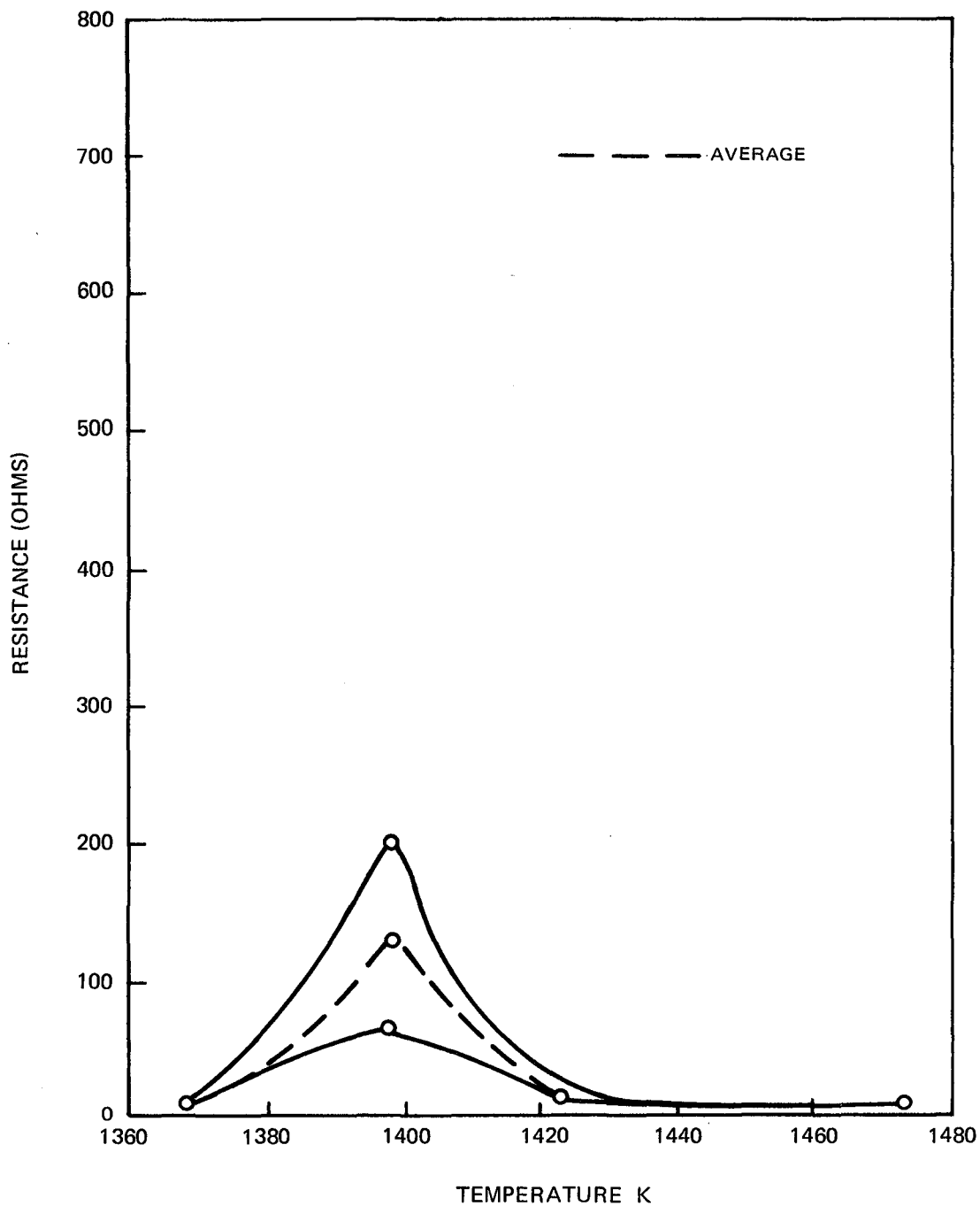

Fig. 17 Resistance vs Temperature for SiC Coated Graphite Yarn

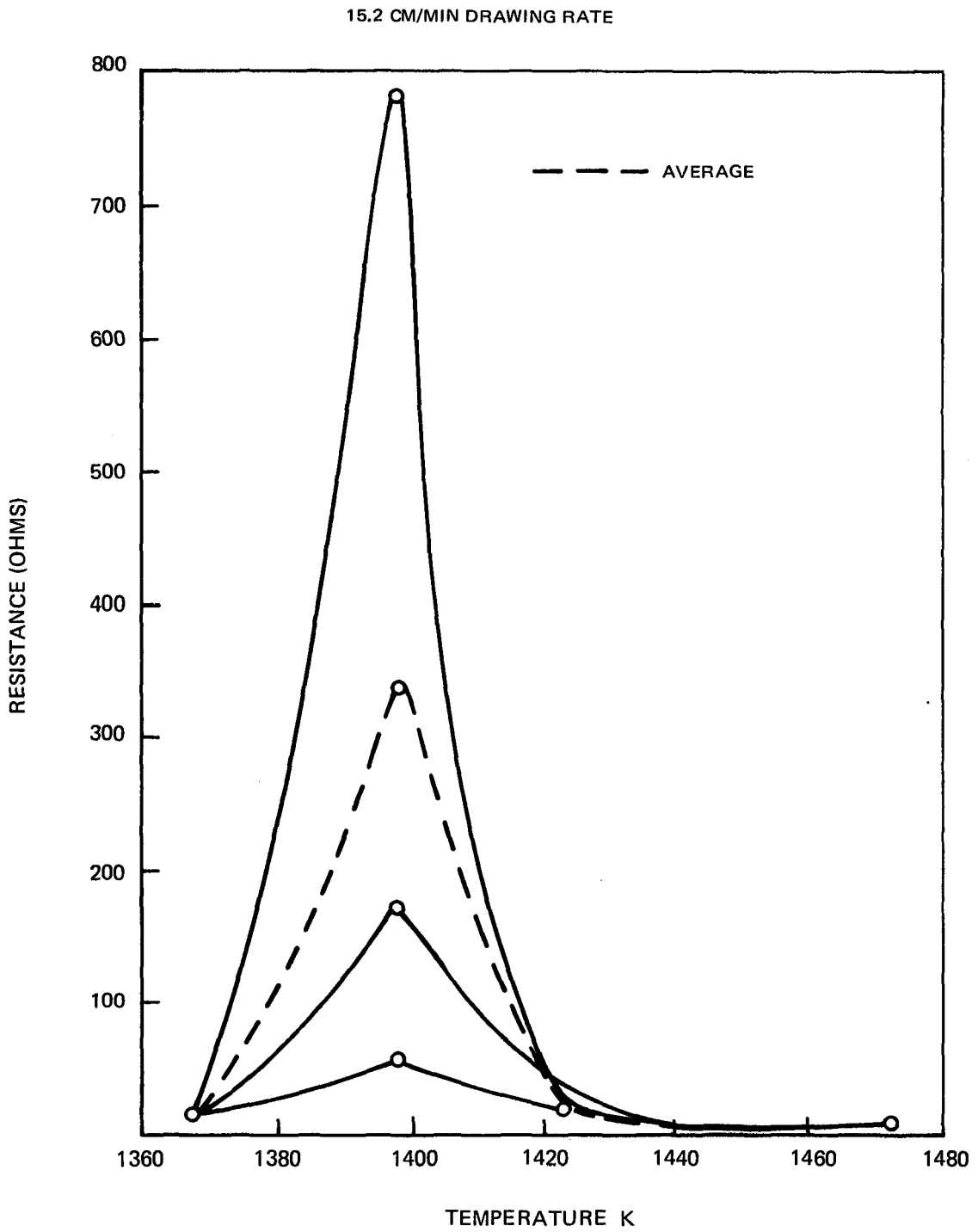

Fig. 18 Resistance vs Temperature for SiC Coated Graphite Yarn

30.5 CM/MIN DRAWING RATE

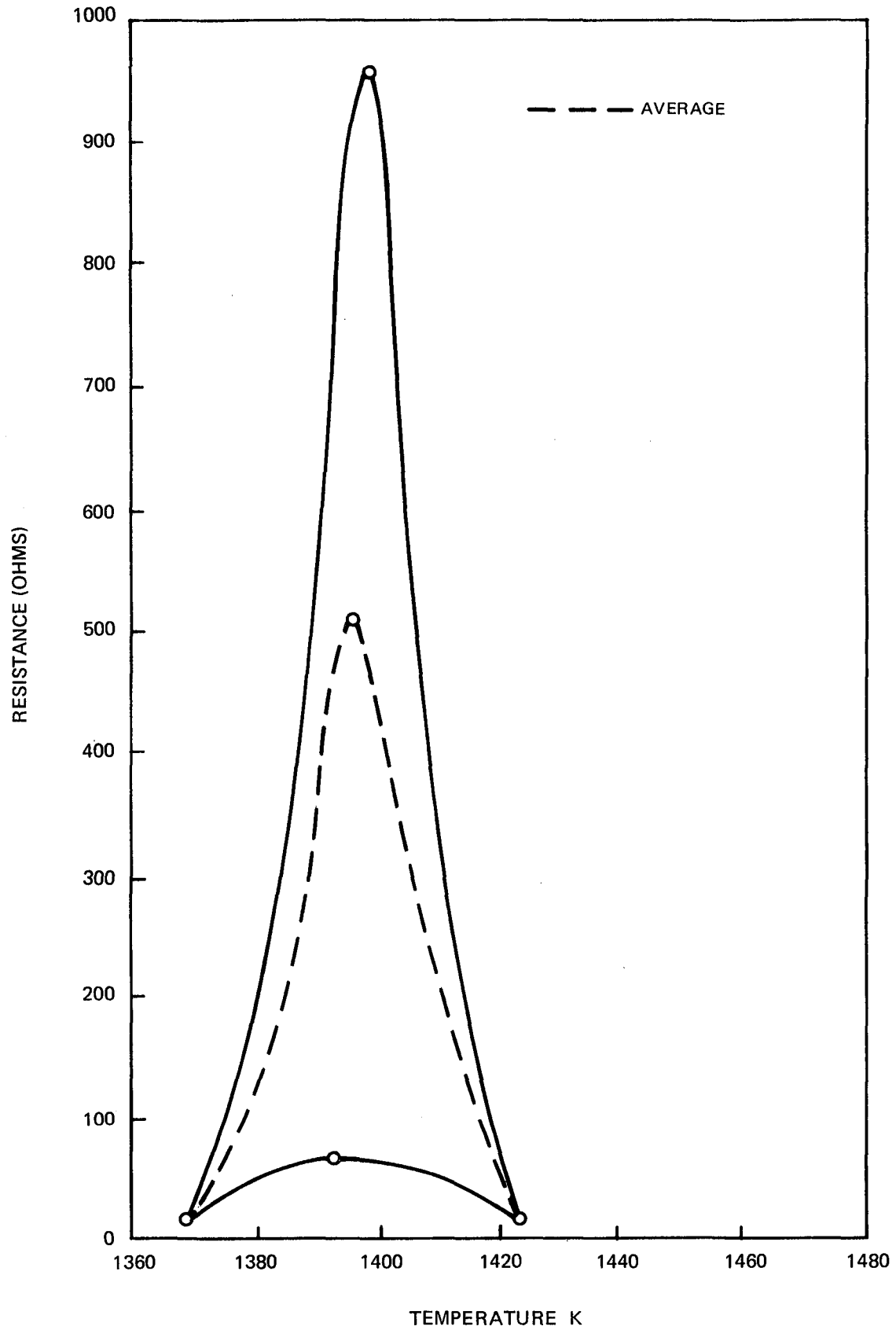

Fig. 19 Resistance vs Temperature for SiC Coated Graphite Yarn

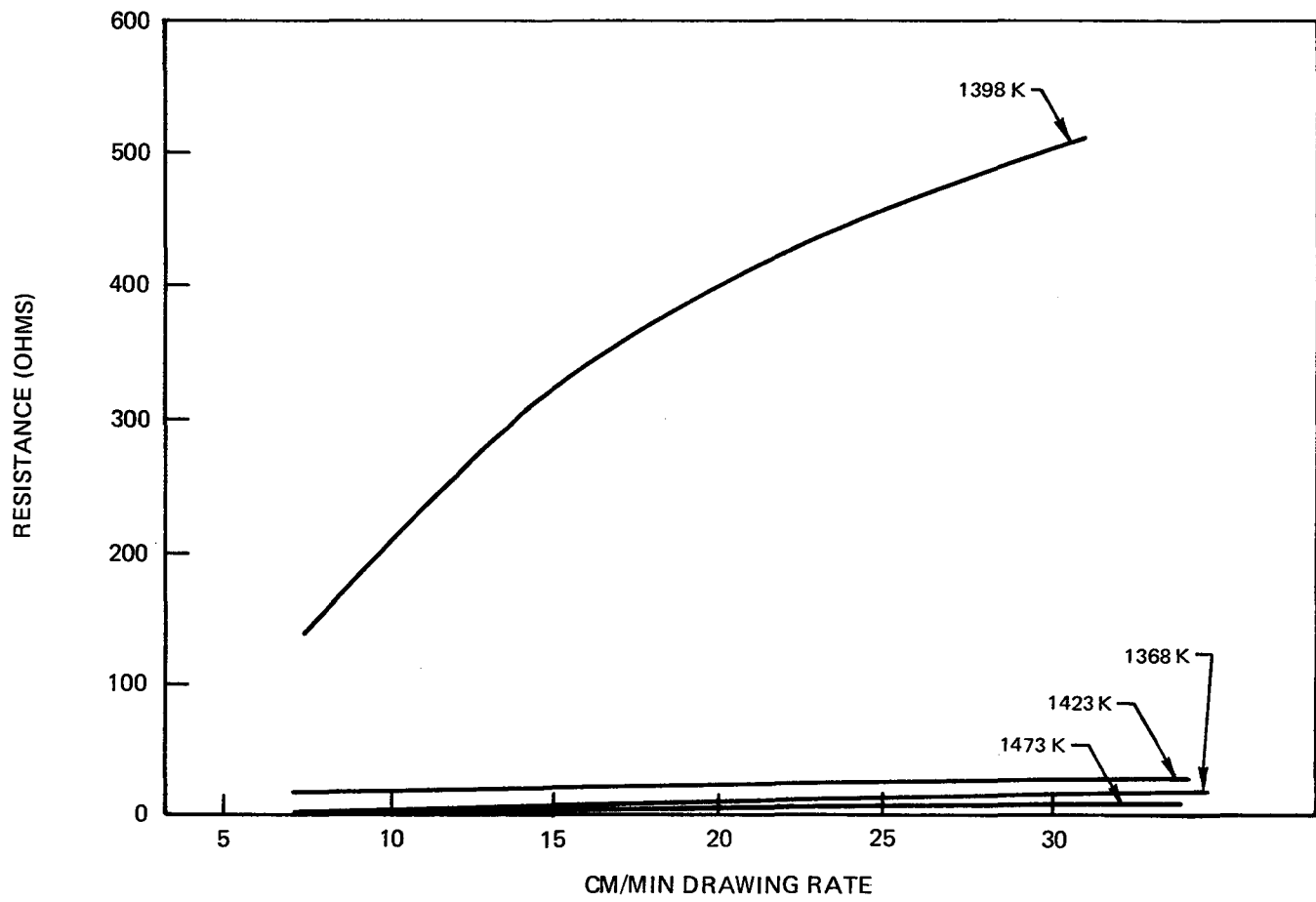

Fig. 20 Resistance vs Drawing Rate for SiC Coated Graphite Yarn

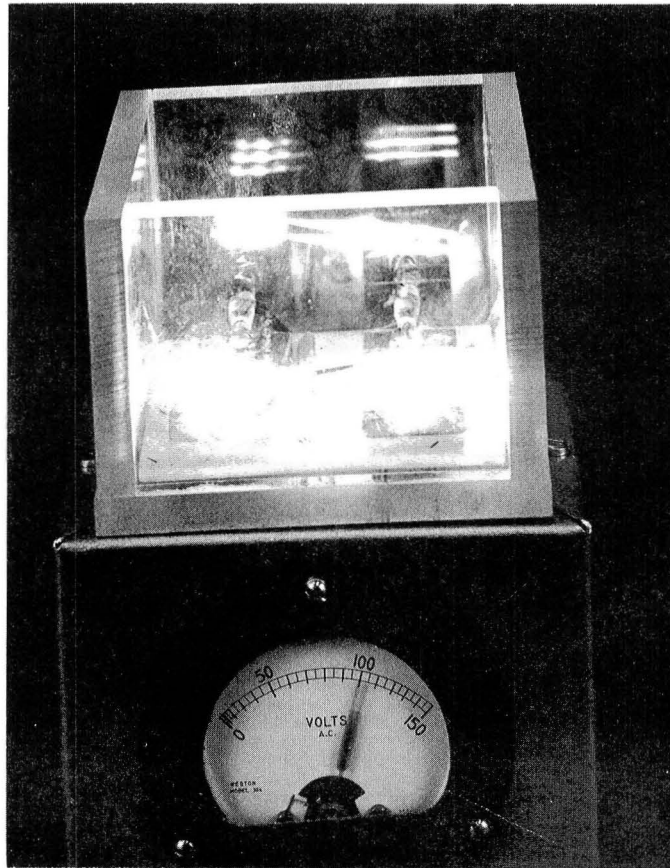

Fig. 21 As Received HTS Graphite Fiber Dropped onto 120 VAC Potential Copper Electrodes

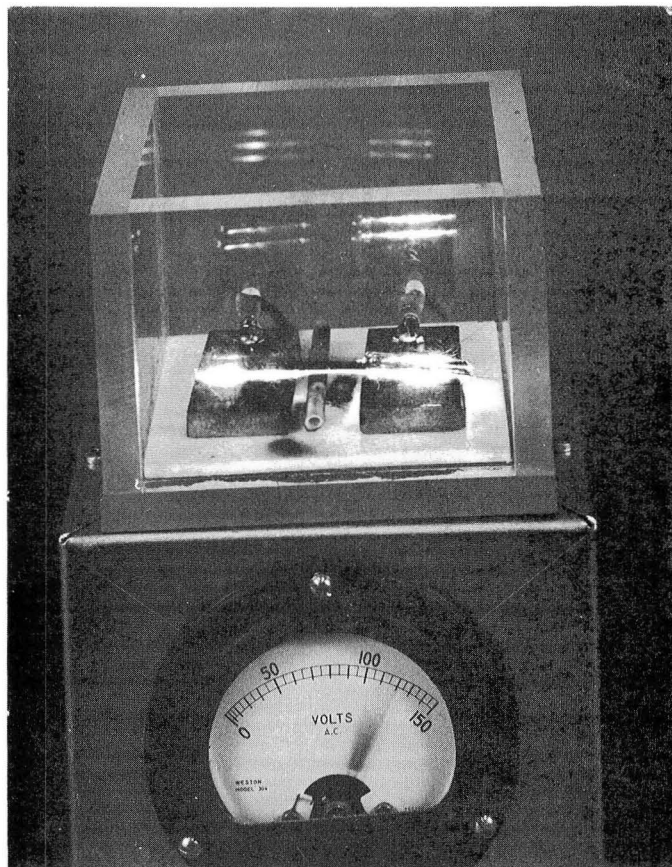

Fig. 22 An Oxidized CVD SiC Coated HTS Graphite Yarn Dropped onto 120 VAC Potential Copper Electrodes

AS POLISHED

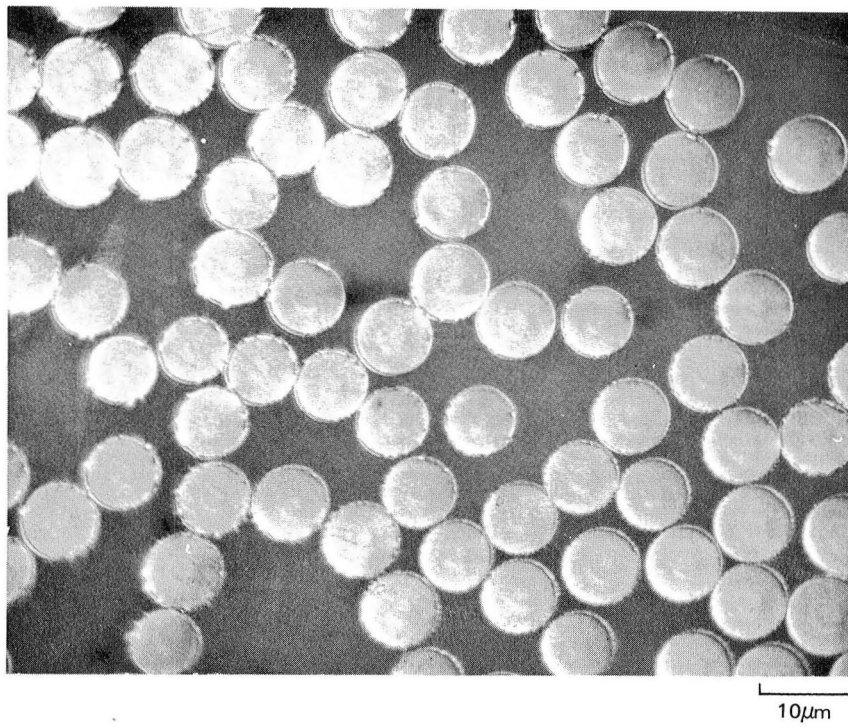

Fig. 23 CVD SiC Coated Graphite Yarn

ION MILLED

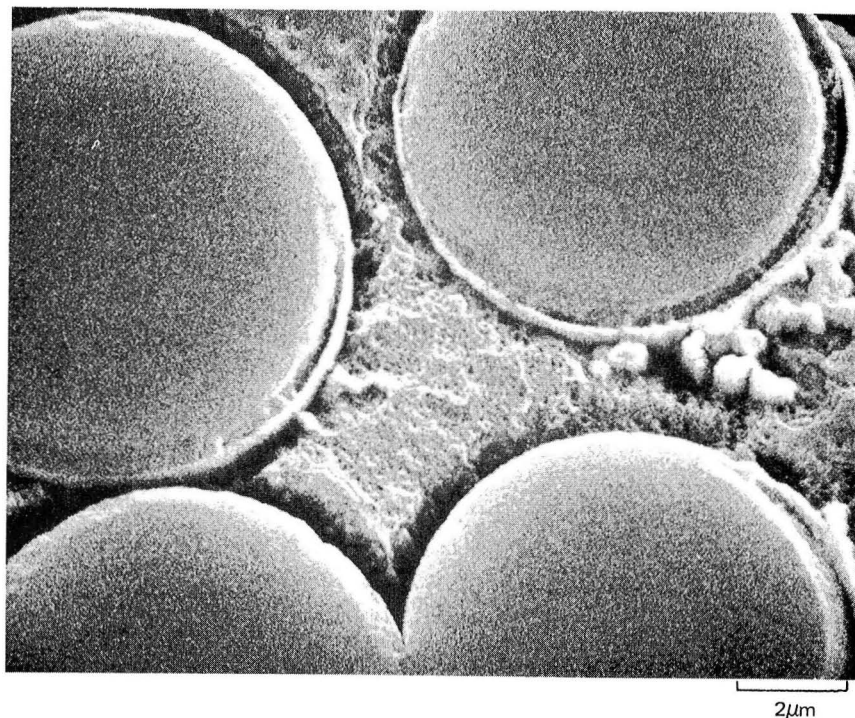
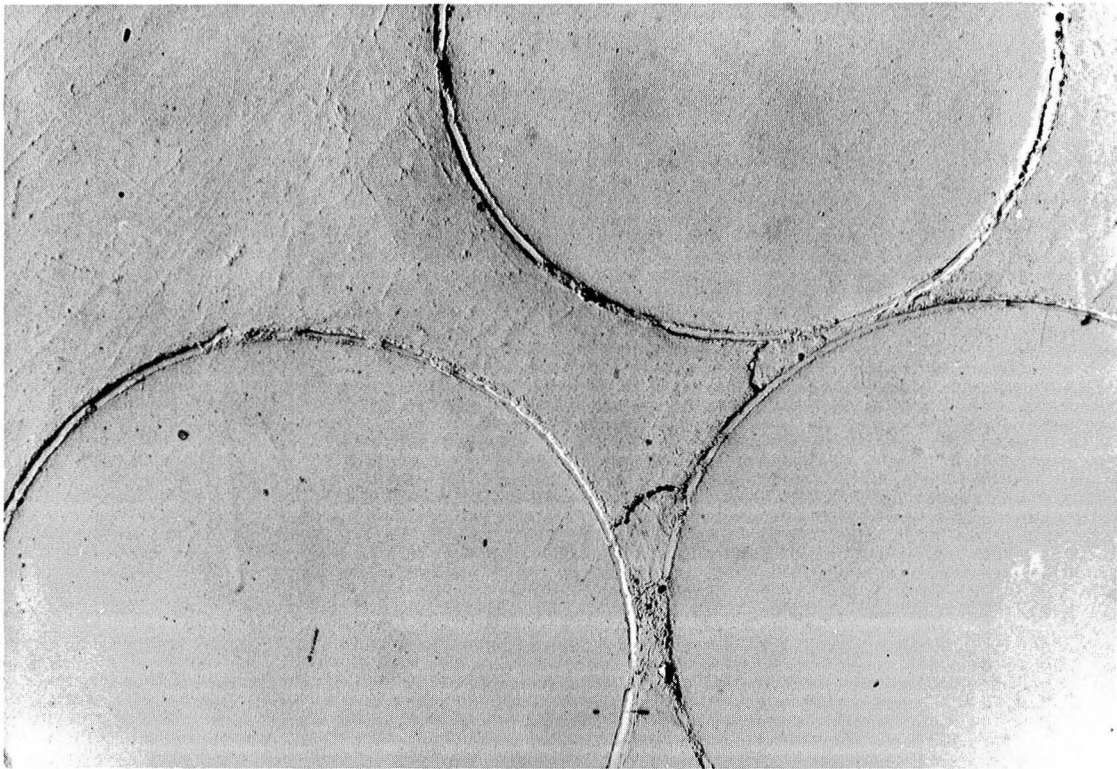

Fig. 24 SEM Photograph of CVD SiC Coated Graphite Yarn

7.6 CM/MIN
10000 X



1 μ m

Fig. 25 CVD SiC Coated Graphite Yarn

7.6 CM/MIN
14 000 X

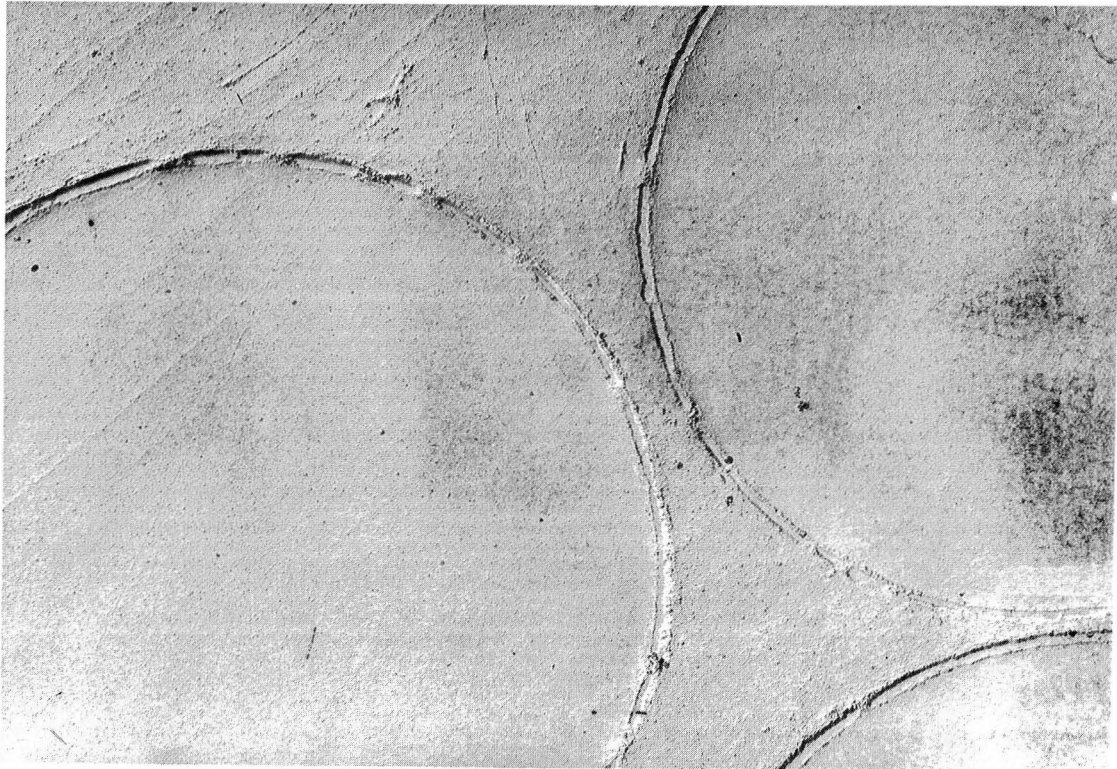

1 μ m

Fig. 26 CVD SiC Coated Graphite Yarn

7.6 CM/MIN
2 2000 X

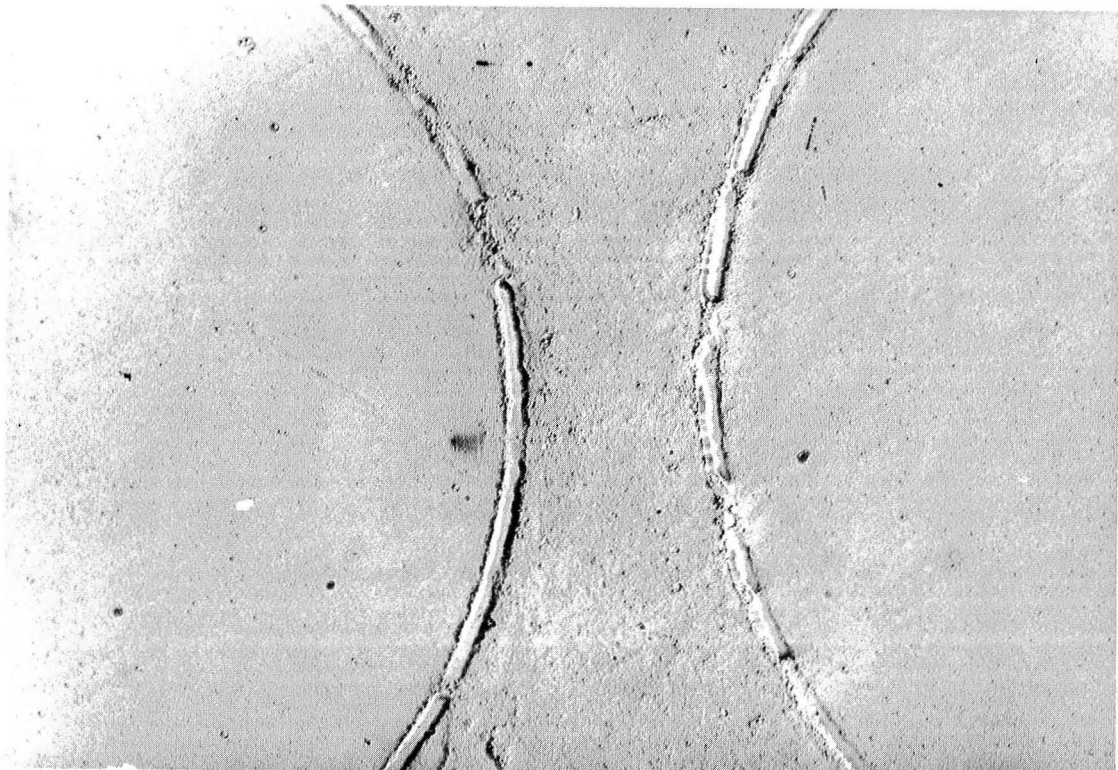

1 μ m

Fig. 27 CVD SiC Coated Graphite Yarn

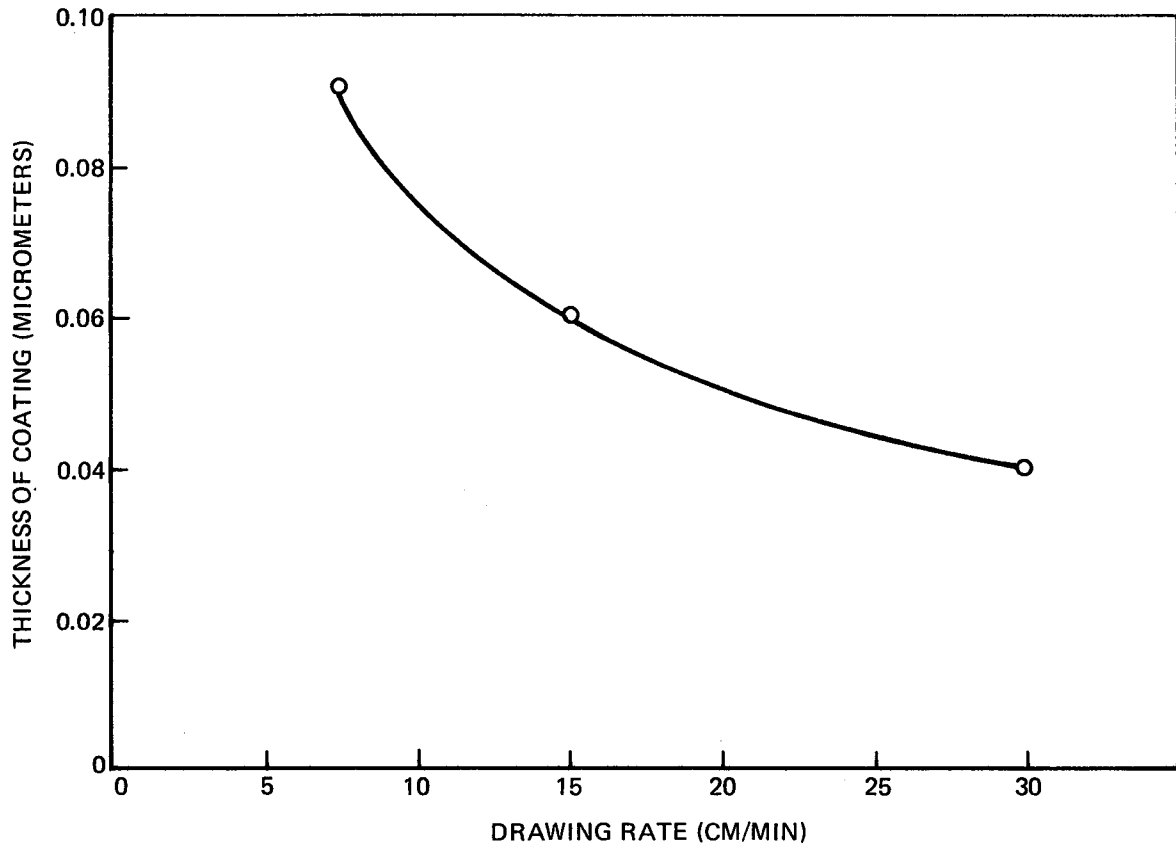
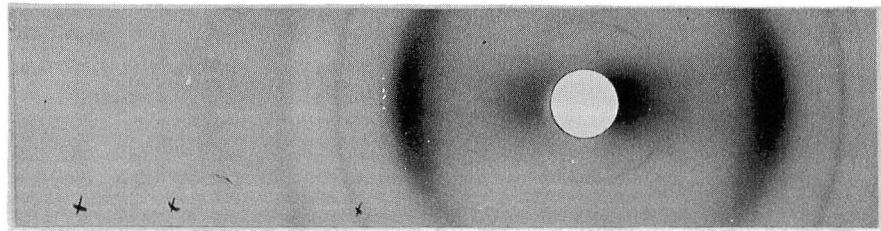
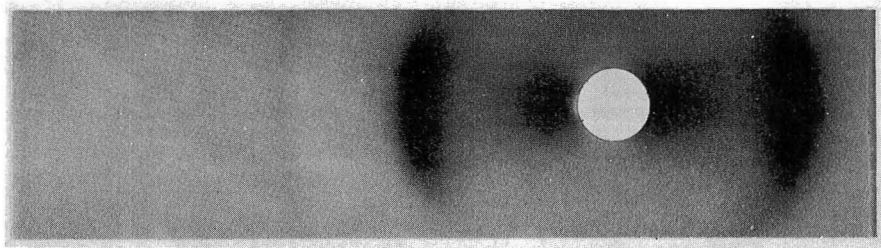

Fig. 28 Average SiC Coating Thickness on Graphite Fiber vs Drawing Rate



NOTE β SiC LINES

a) TYPICAL PATTERN FROM FIBERS COATED AT 7.5 AND 15 CM/MIN



b) TYPICAL PATTERN FROM FIBERS COATED AT 30 CM/MIN

Fig. 29 X-Ray Diffraction Photographs

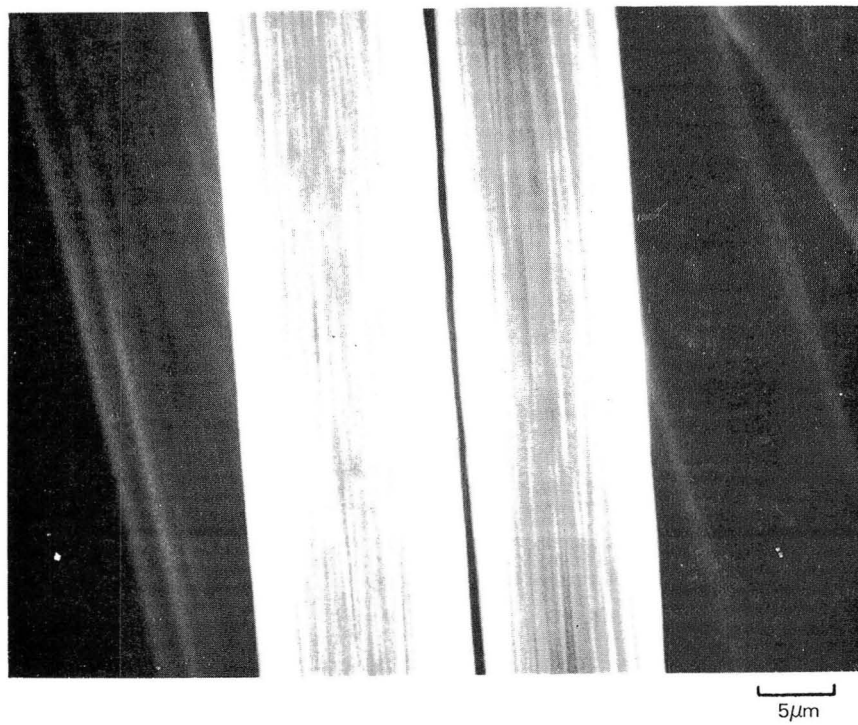
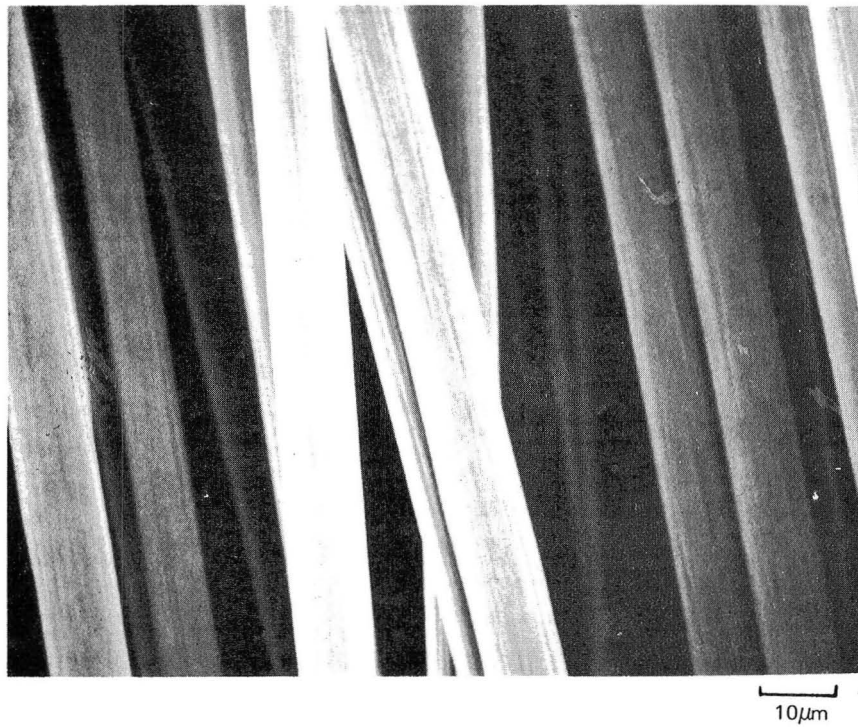

Fig. 30 SEM Photomicrographs of "As Received" HTS Graphite Fibers

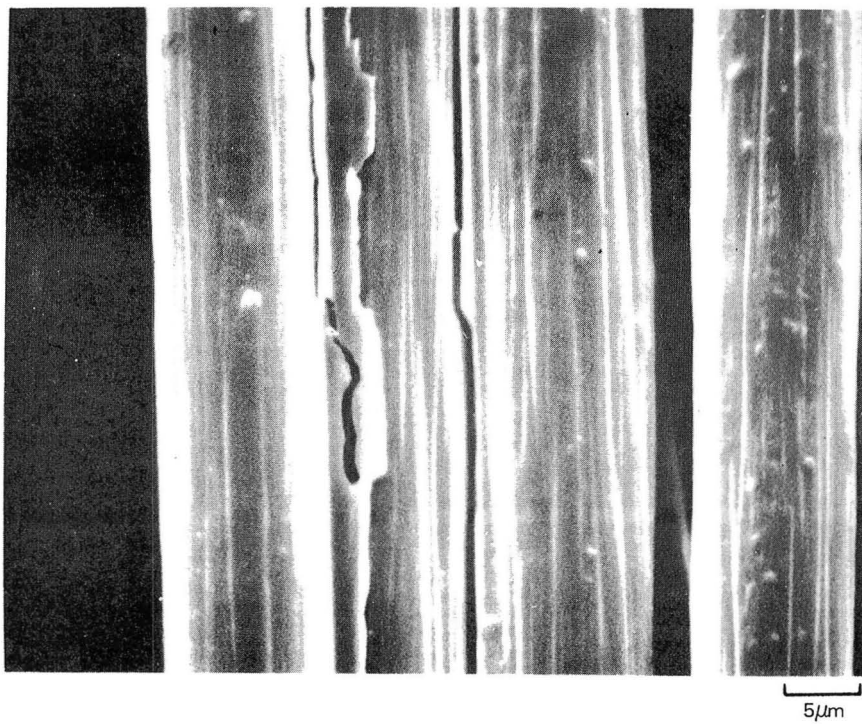
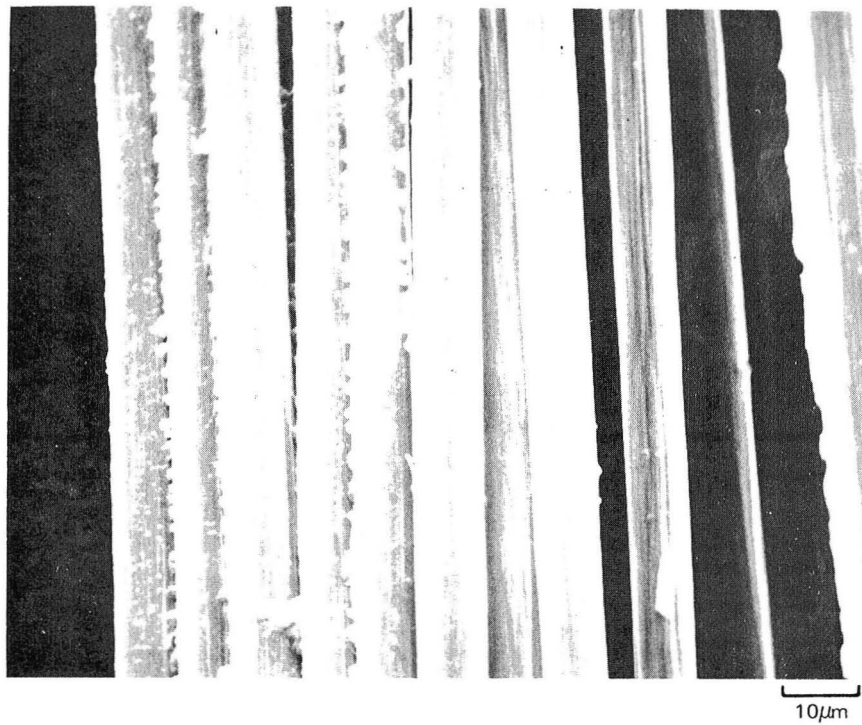

Fig. 31 SEM Photomicrographs of Pyrolyzed VTS Coated HTS Graphite Fibers

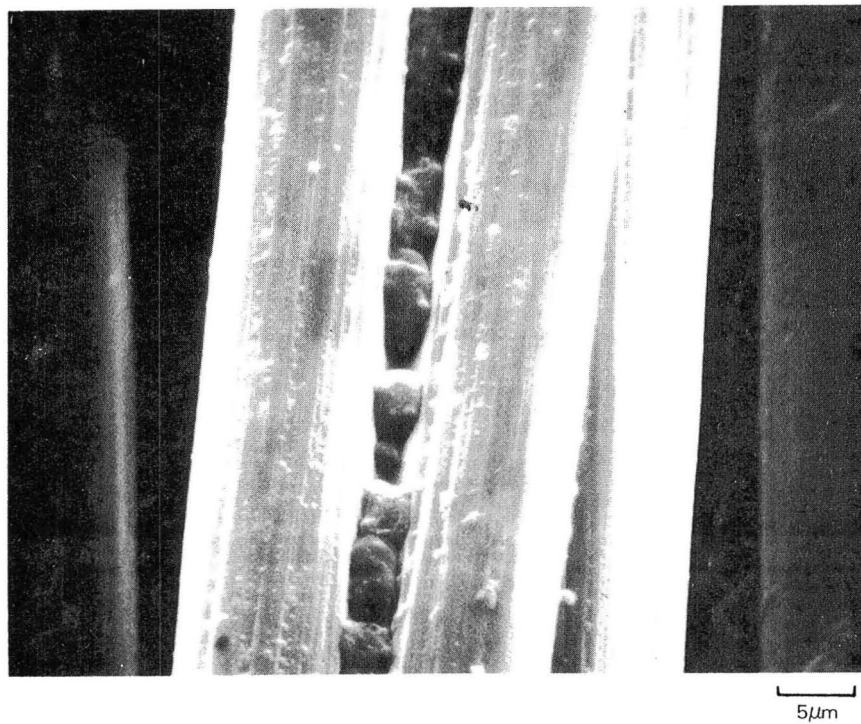
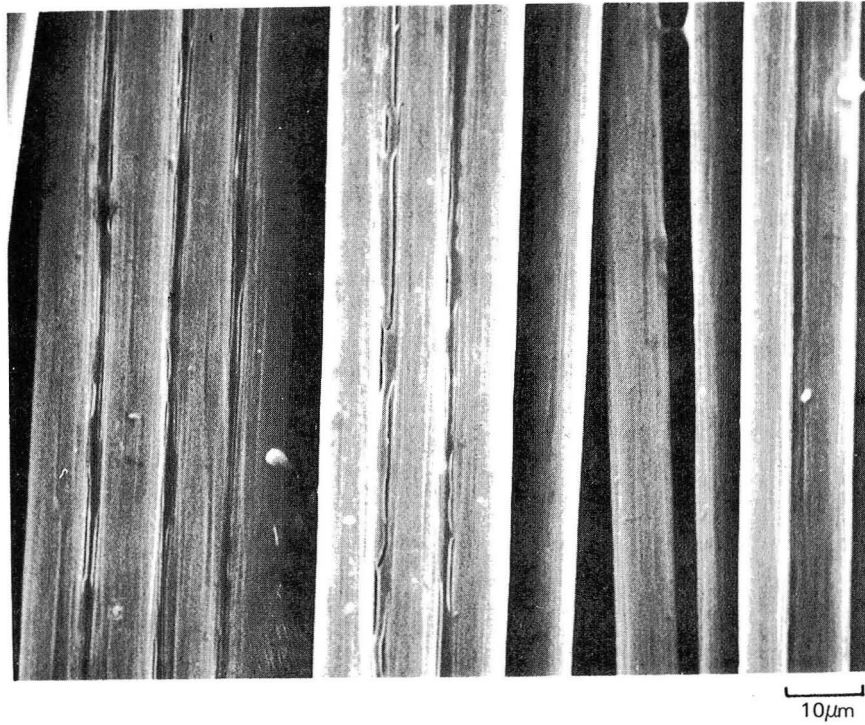

Fig. 32 SEM Photomicrographs of Pyrolyzed SR355 Silicone Resin Coated HTS Graphite Fibers

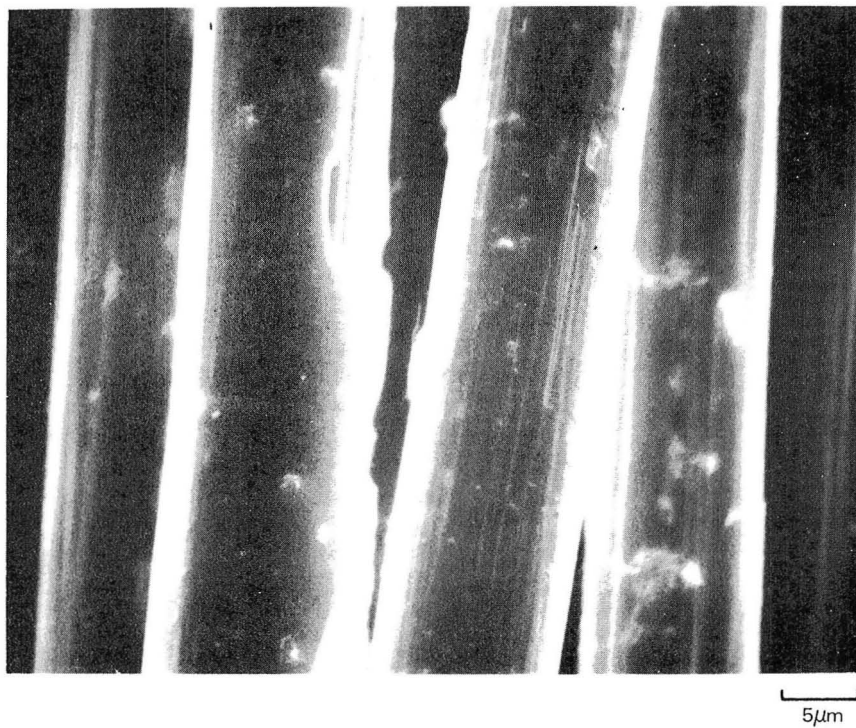
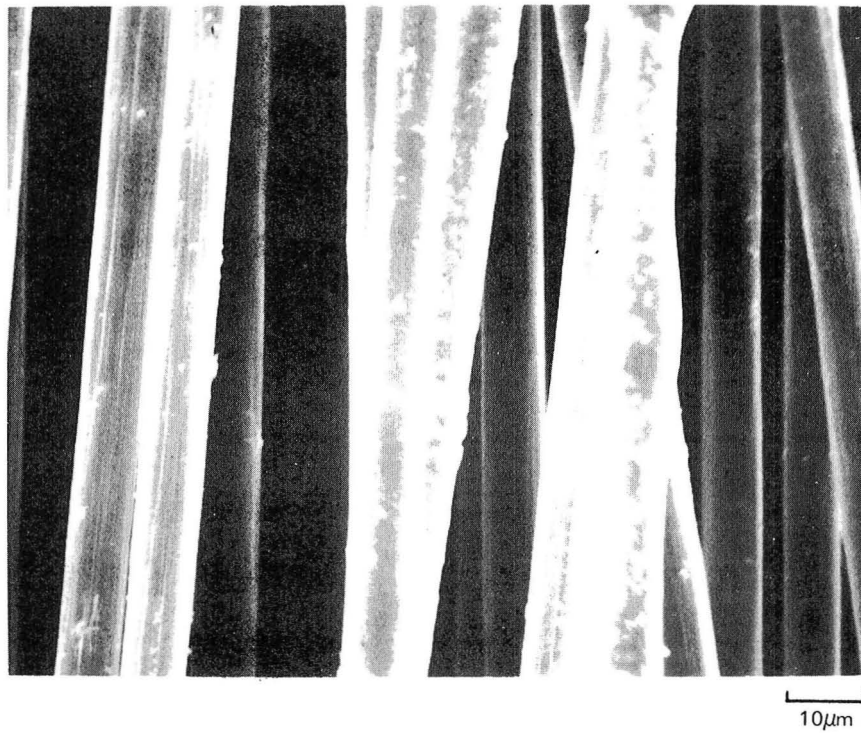
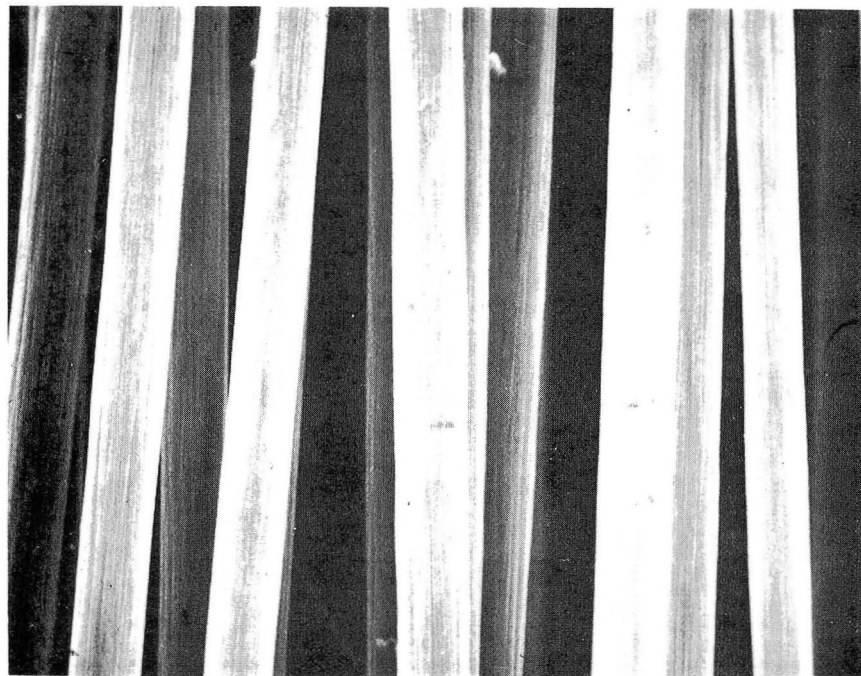
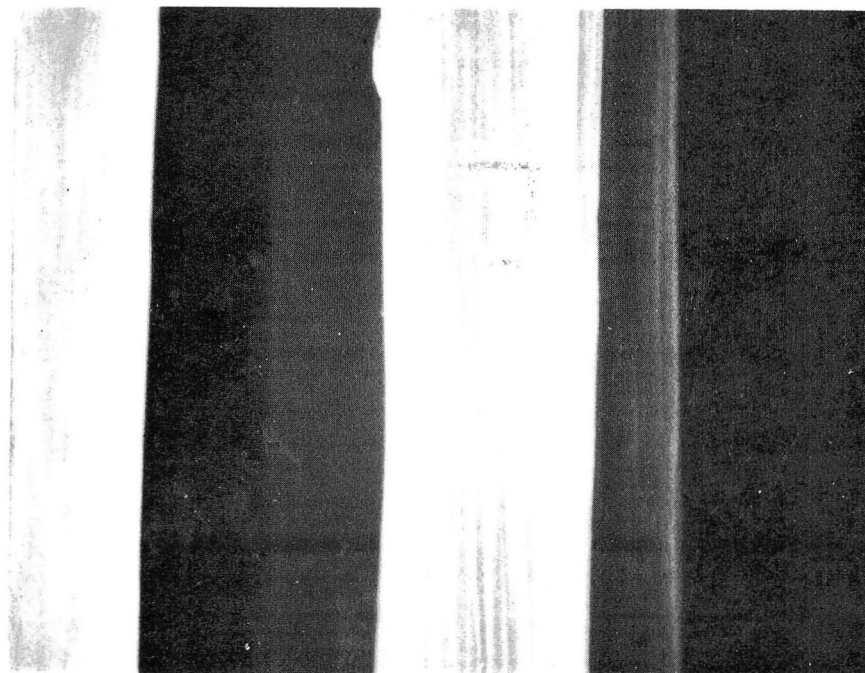

Fig. 33 SEM Photomicrographs of Pyrolyzed SR355 Silicone Resin Coated HTS Graphite Fibers



10 μ m



5 μ m

Fig. 34 SEM Photomicrographs of Pyrolyzed ES Coated HTS Graphite Fibers

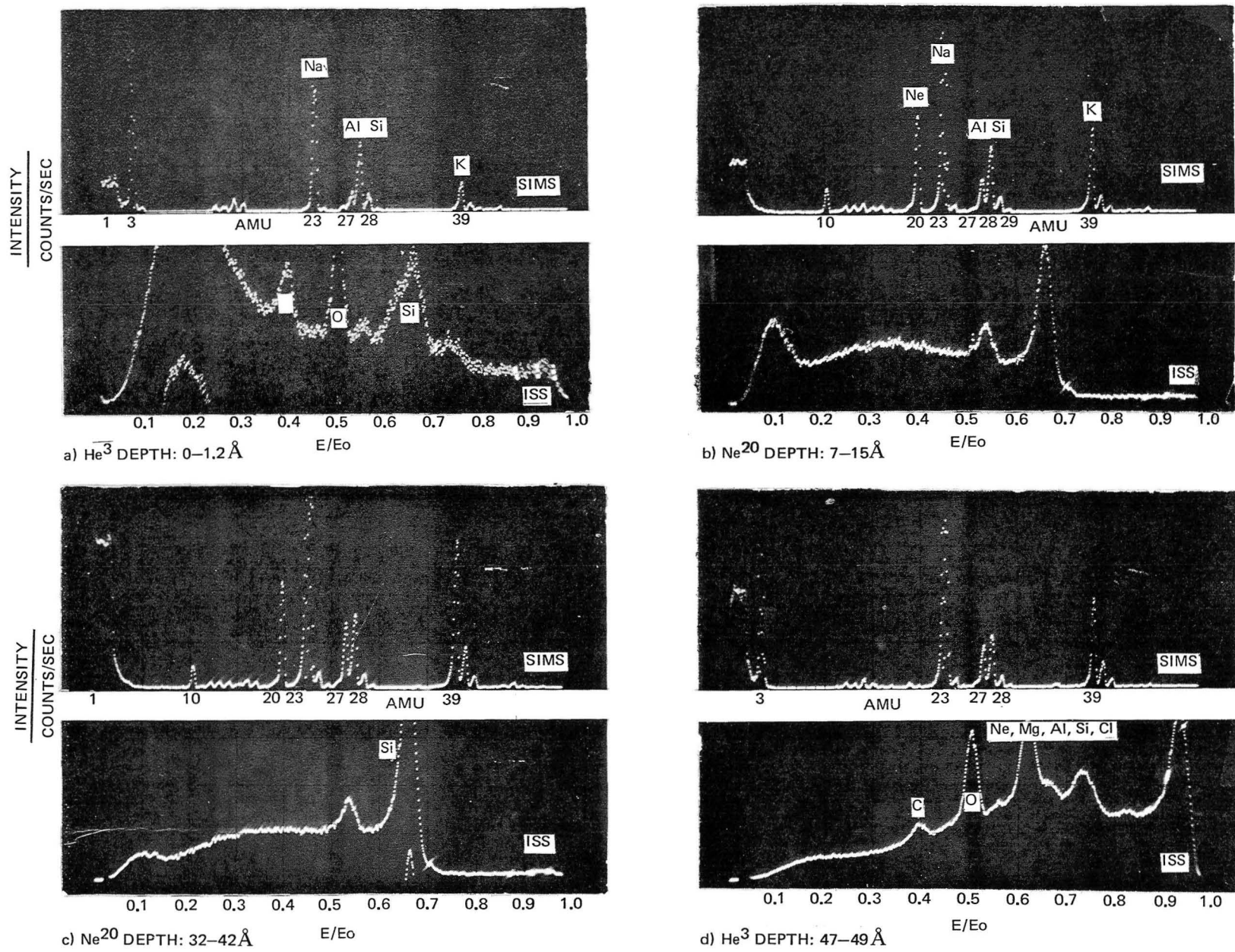

Fig. 35 Ion Scattering Spectroscopy/Scattered Ion Mass Spectrometry (ISS/SIMS) Spectra of "As Received" HTS Graphite Fibers (1500 Volts)

He³ (1500 VOLTS)
DEPTH: 15Å

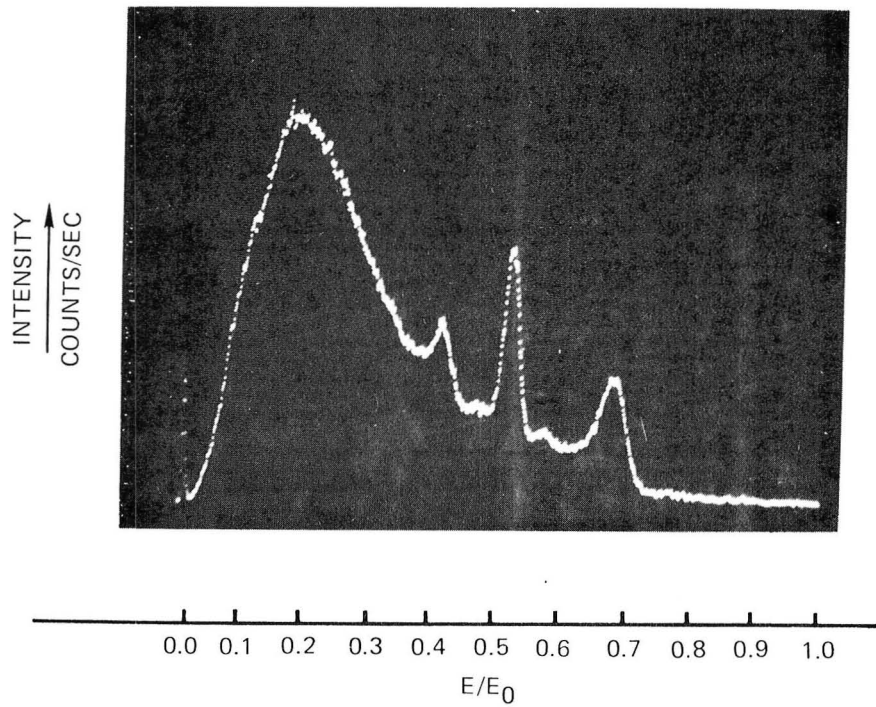

Fig. 36 Ion Scattering Spectroscopy (ISS) Spectra of A-1100 Silane Coated S-Glass

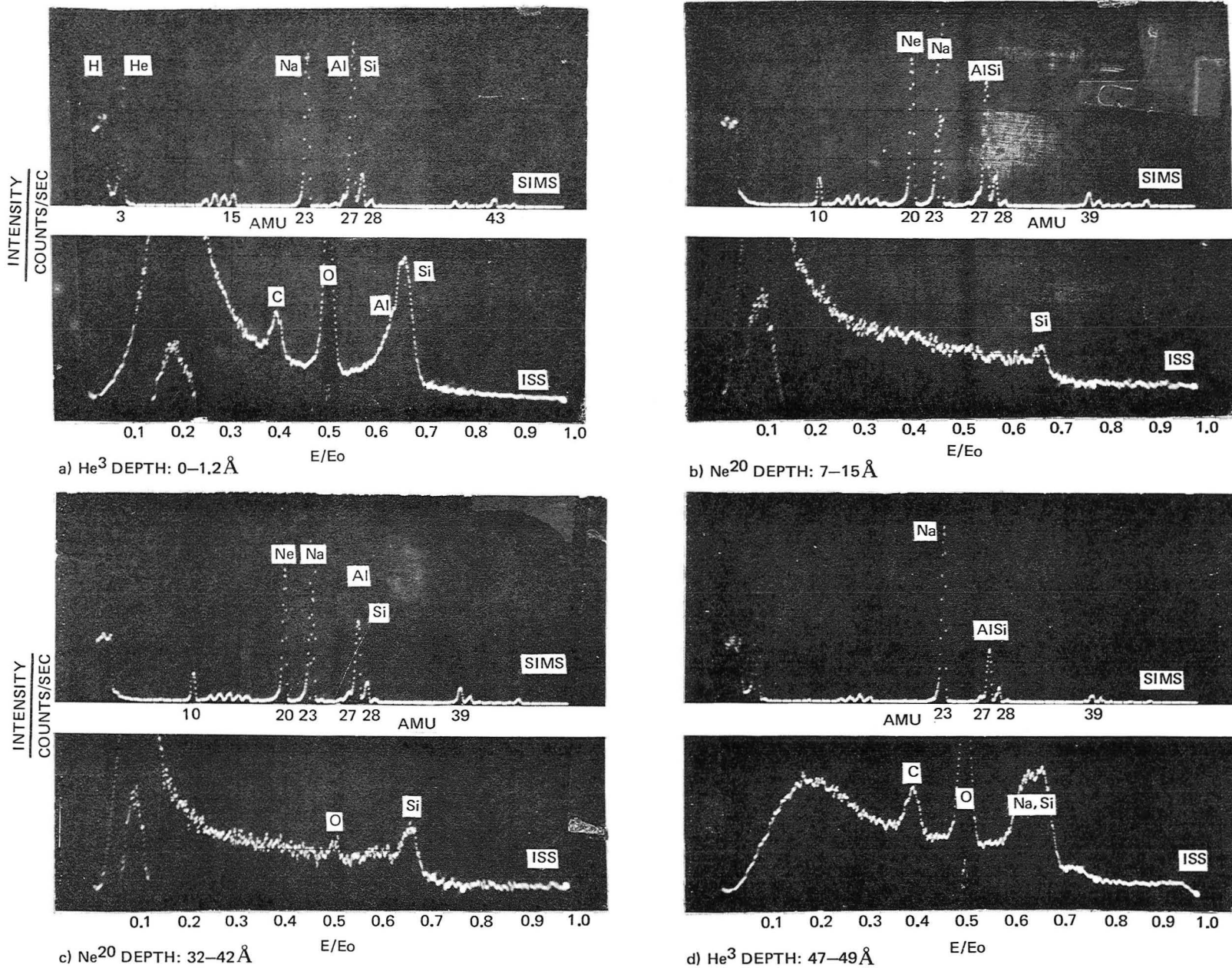

Fig. 37 Ion Scattering Spectroscopy/Scattered Ion Mass Spectrometry (ISS/SIMS) Spectra of Pyrolyzed Ethyl Silicate Coated HTS Graphite Fibers (1500 Volts)

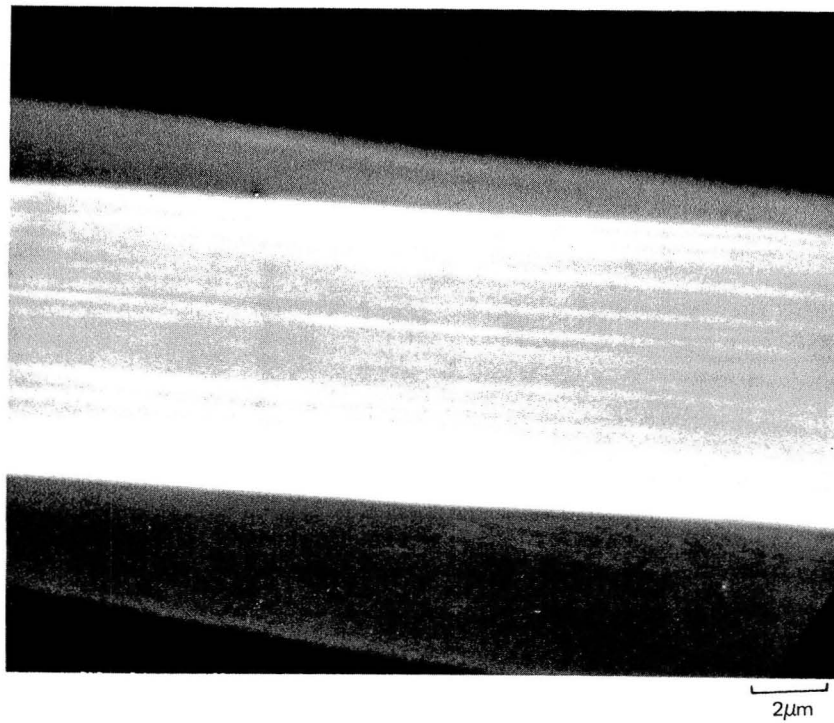
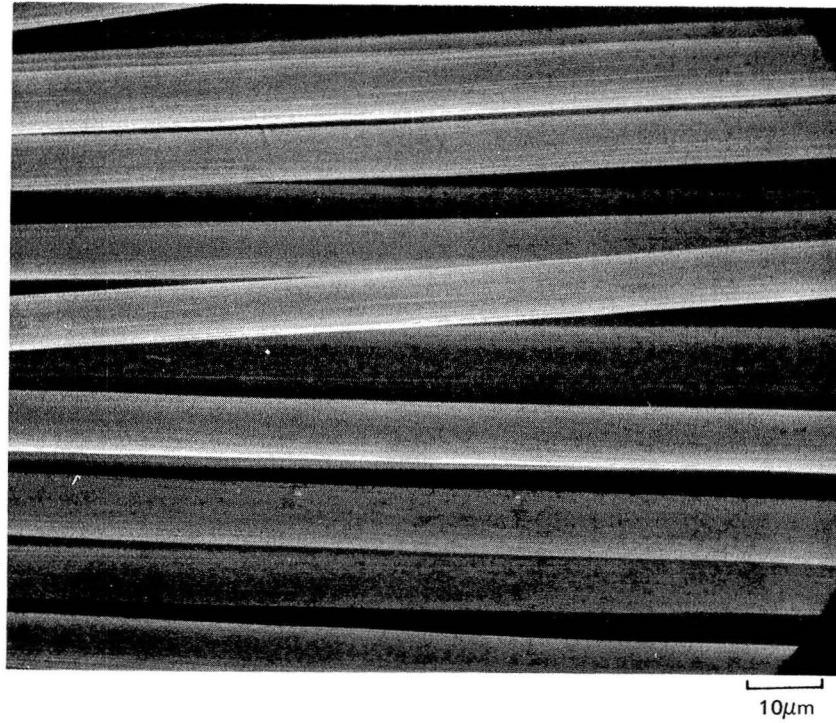

Fig. 38 SEM of "As Received" HTS Graphite

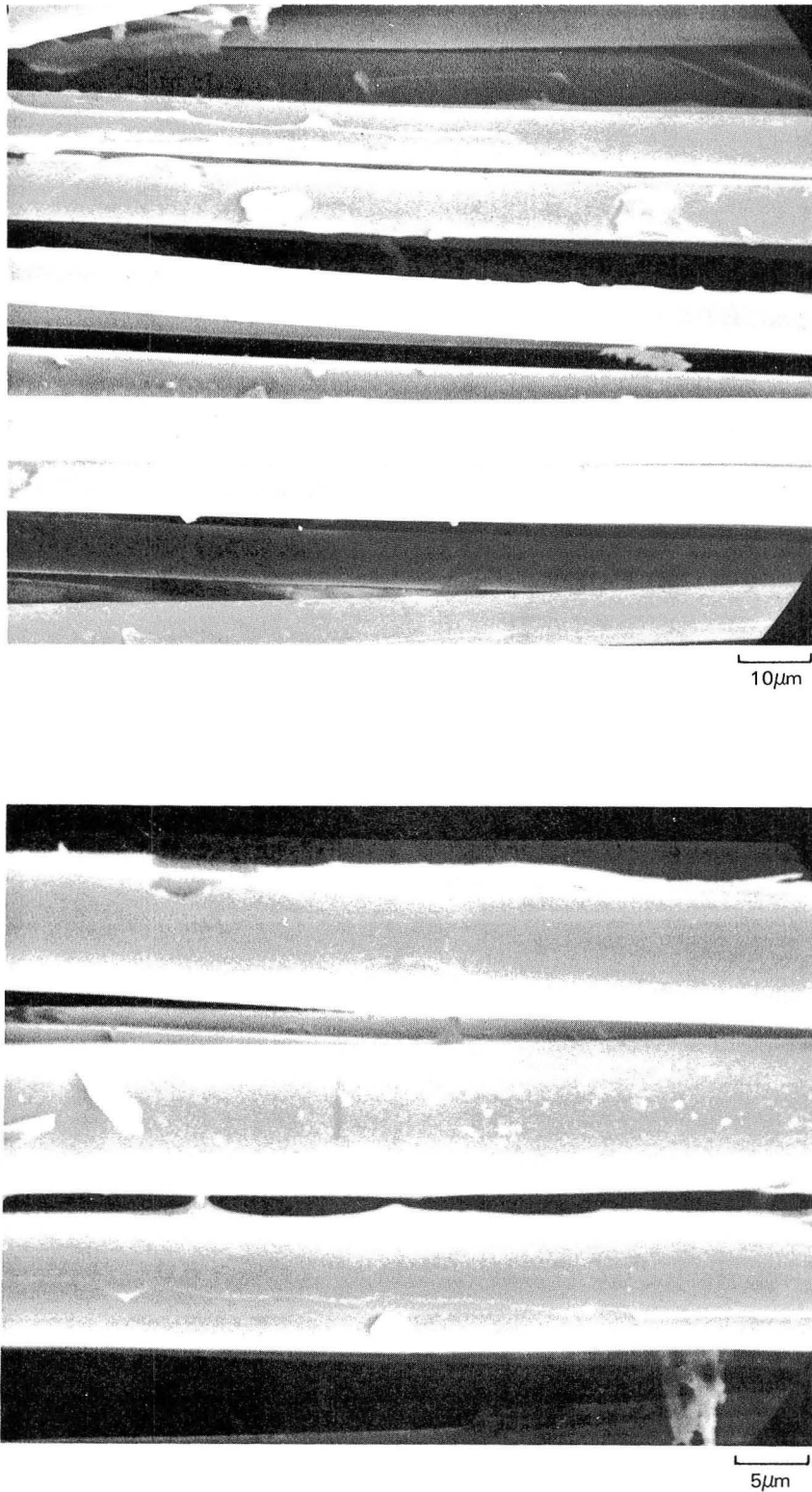
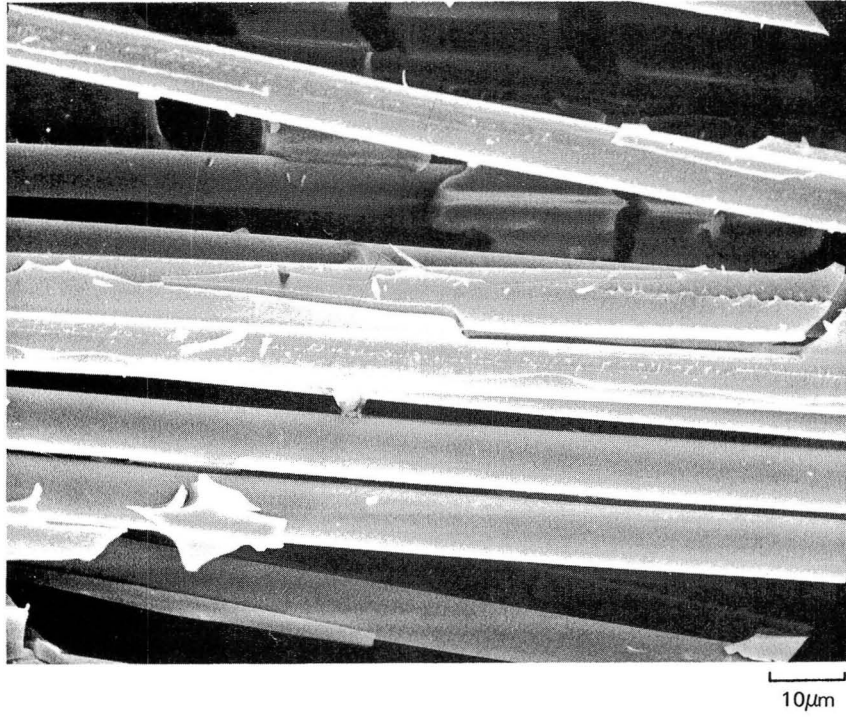

Fig. 39 SEM of Silica-Like Coated HTS From Continuous Coating Process, Run (SC 5)

a)



b)

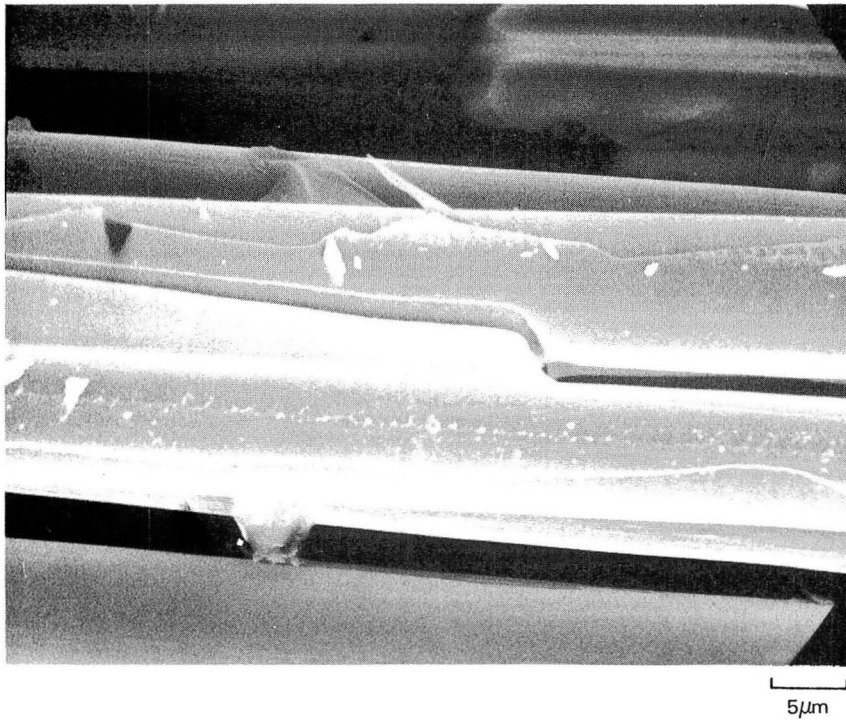
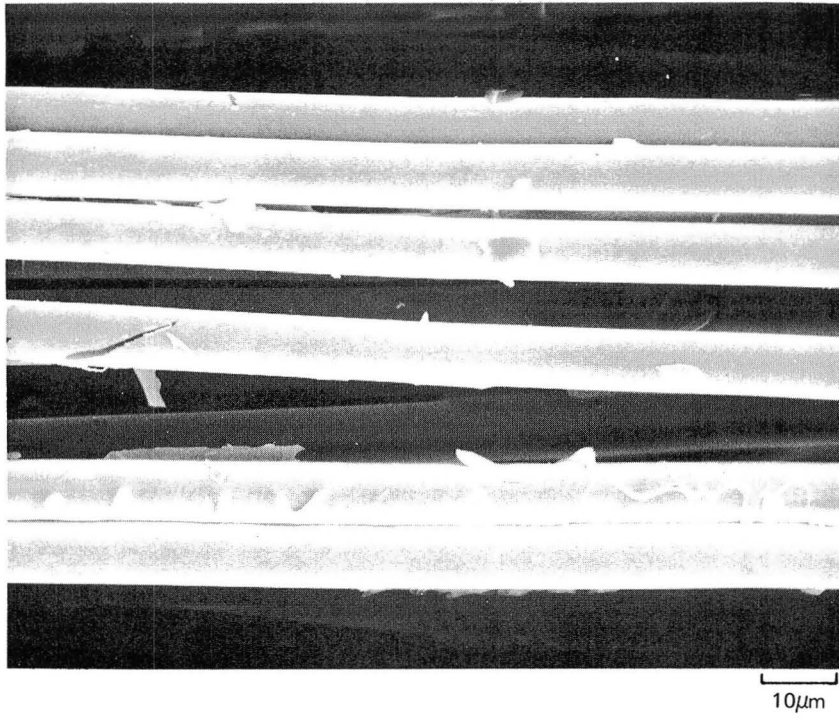

Fig. 40 SEM of Silica-Like Coated HTS From Continuous Coating Process, (Run SC 7)

a)



b)

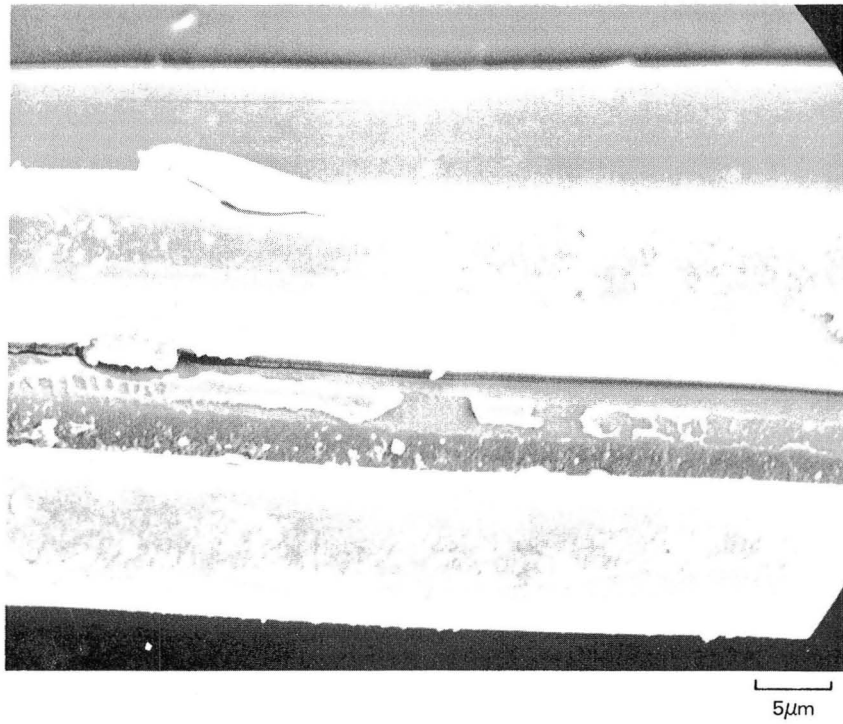
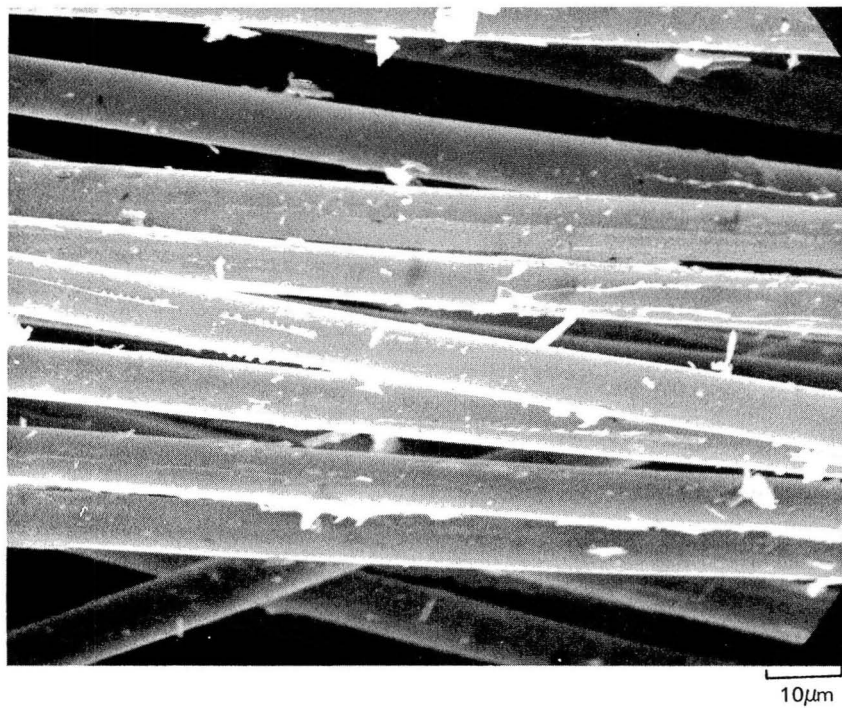

Fig. 41 SEM of Silica-Like Coated HTS From Continuous Coating Process, (Run SC 8)

a)



b)

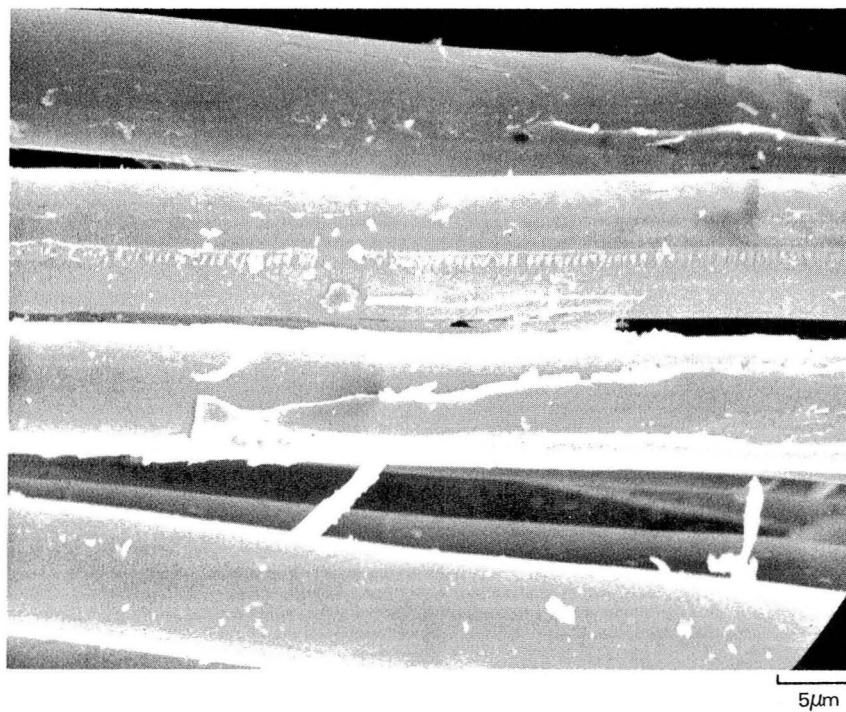
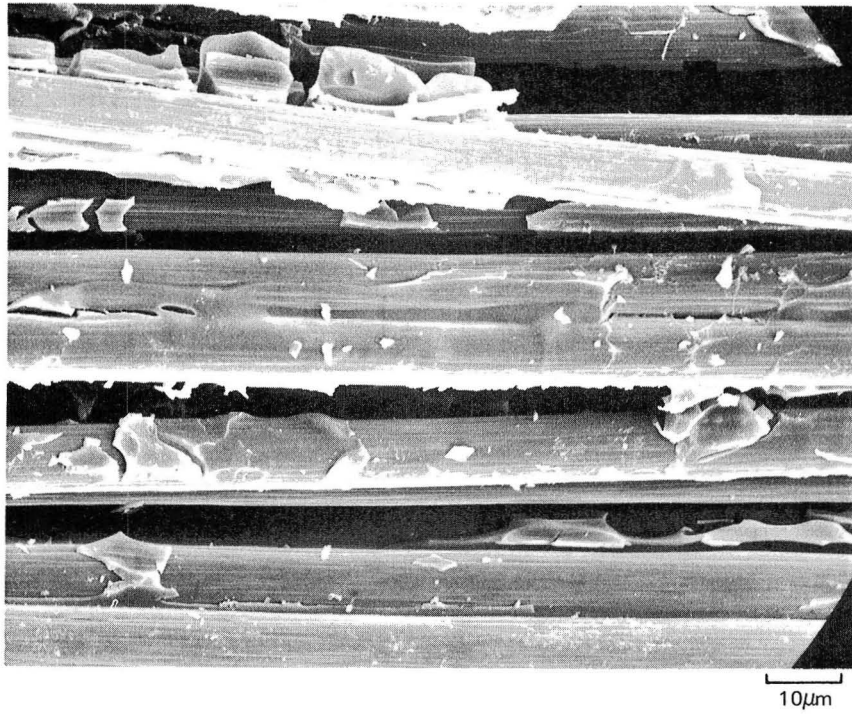

Fig. 42 SEM of Silica-Like Coated HTS From Continuous Coating Process, (Run SC 9)

a)



b)

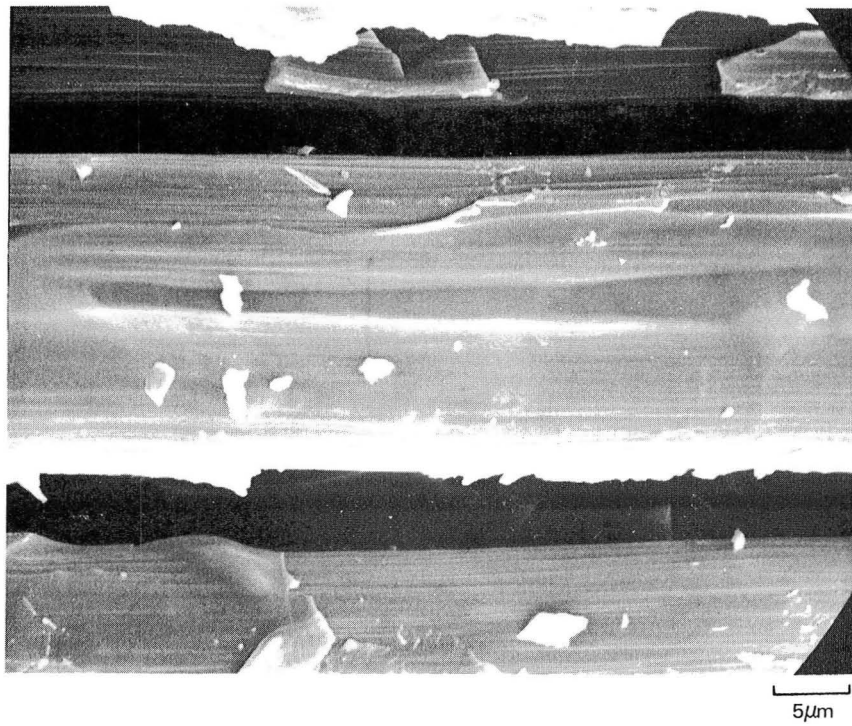

Fig. 43 SEM of Silica-Like Coated HTS From Continuous Coating Process (Run SC10)

APPENDIX A

PRELIMINARY EXPERIMENTS AND RESULTS

Hercules HTS graphite fibers were selected for use in the development of electrically resistant coatings because of the wide range of NASA programs in which this fiber is being evaluated.

Glass Coating Approach

In the glass coating experiments, a tungsten resistance furnace was modified so that graphite fiber could be introduced into the heating chamber, passed through molten glass and reeled up on a drum (see Fig. A-1). The glass, which was initially selected to be E glass, was held in a molybdenum crucible and a molybdenum rod with a track was used to hold the fiber below the surface of the molten glass. The temperature was raised as high as possible without driving the glass off composition and the graphite fiber was run through. It was found that the glass, even at the highest temperature used, was still too viscous. As a result, a tube of glass was formed completely around the fiber bundle (Fig. A-2) but not around the individual fibrils. Similar results were attained with a low temperature melting glass. Because of these results, a decision was made not to continue this approach.

Colloidal SiO₂ Coating Approach

In the colloidal SiO₂ experiments, the graphite fiber was dipped in 30% suspension colloidal silica. A crusty coating was obtained. In an attempt to prevent this, dilutions of 1/2 to 1/100 were made and the experiments were repeated. The coatings produced were still found to be either crusty and stiff or not observable at all. SEM photographs were taken of fibers which were flexible and on which the presence of a coating was questionable. These photographs indicated that no visible coating was present on any of the flexible fibers.

In further experiments, two carbon rods were placed in a colloidal solution and 10V, 5V and 3V were applied in order to study an electrophoretic approach. When negatively charged particles were used, the particles were attracted to the positive electrode, and positive charged particles in other solutions were attracted to the negative electrode. In both cases coatings were formed, but the evolution of oxygen or hydrogen gas at the electrodes disrupted the coatings indicating that the technique did not appear to be suitable for coating graphite fibers, at least not from the present work. These data are summarized in Table A-1.

CVD Boron Coating Approach

Static Experiments

In the static runs, graphite tow was hung vertically in a graphite susceptor and an rf coil was used to heat the susceptor. The reactant gases BCl_3 , H_2 and CH_4 were then introduced into the reactor. Methane was added because it was felt that it would prevent the growth phenomenon observed in boron fiber formation; that is, an elongation of boron during deposition which has a tendency to stretch the core material. After a few static experiments, the fibers were coated continuously.

Continuous Coating Experiments

Some continuous experiments were also conducted using CH_4 additions to the BCl_3 and H_2 and a few without. It appears that enough carbon was present in the environment to produce an amorphous B/C alloy in either case. SEM and X-ray maps of a typical coated fiber are shown in Fig. A-3.

The strength of these coated fibers was shown to be equal to or greater than that of the "as received" HTS fiber, but no significant improvements in electrical resistance and oxidation resistance were observed. Therefore, no further studies were conducted on the boron coated fibers.

Table A-I

Data for Colloidal SiO₂ Coating Experiments

Dip Coating

Dilutions

as received

1/2

1/4

1/9

1/20

1/50

1/100

Results

Crusty coating
(stiff)Coating
not observed

Electrophoresis

Voltage

10v

5v

3v

Results

Coating
with O₂
given off at electrode

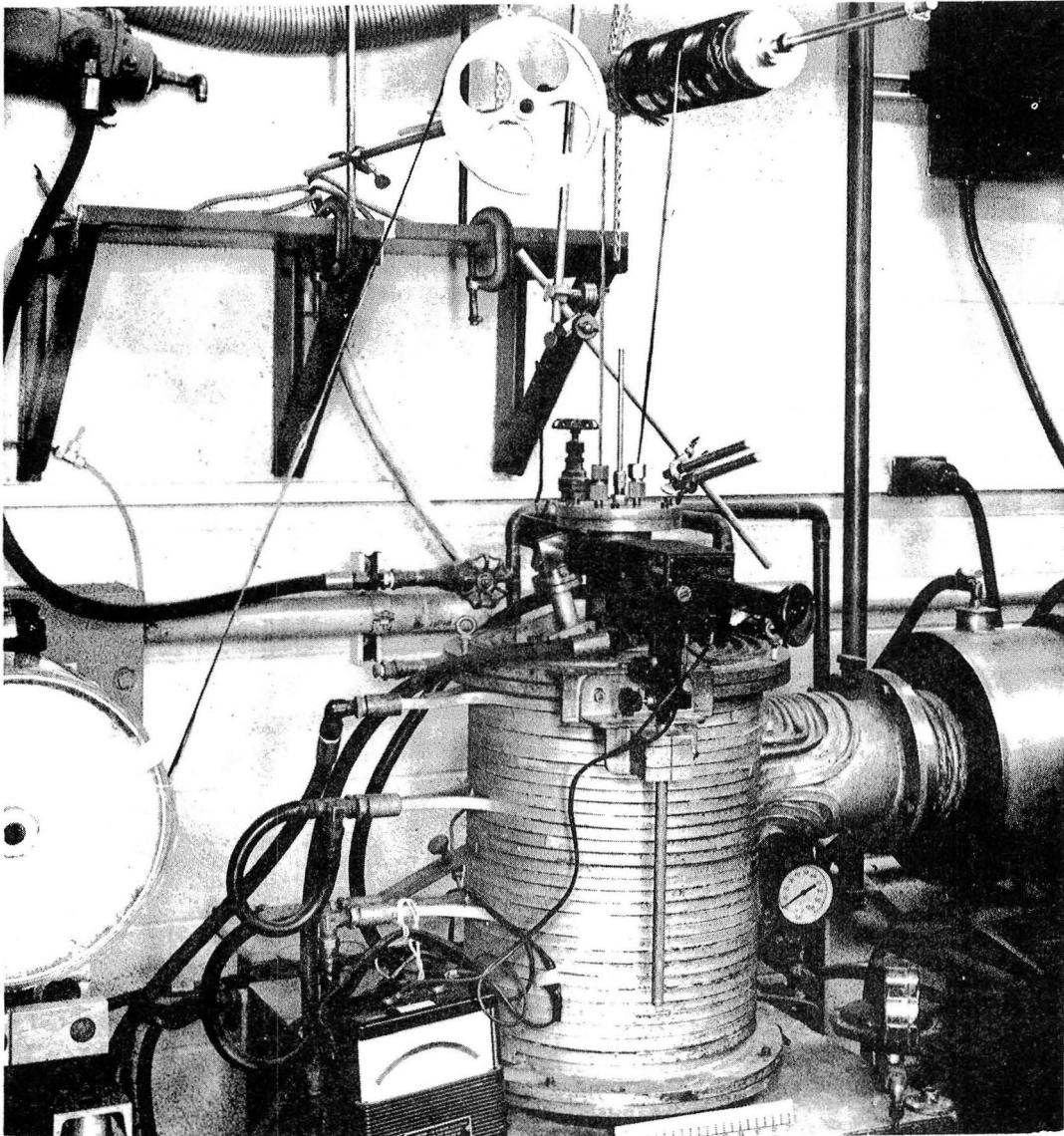

Fig. A-1 Continuous Glass Coating Apparatus

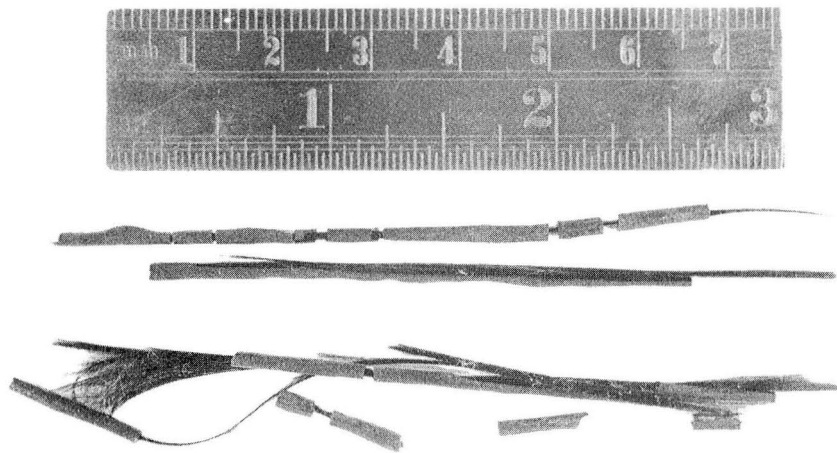

Fig. A-2 Graphite Yarn Drawn Through E-Glass

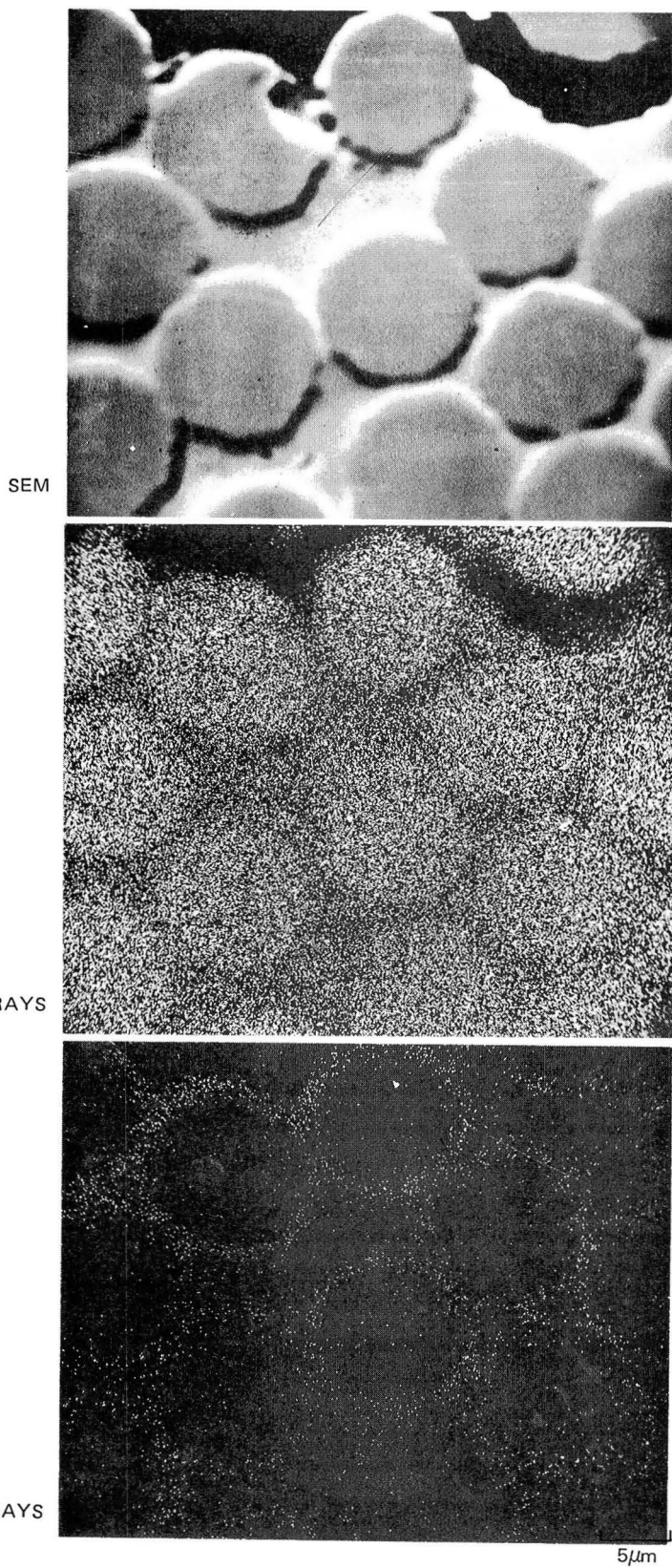

Fig. A-3 SEM and X-Ray Maps of the B Coated HTS Graphite Fibers

APPENDIX B

Table B-I

Initial SiC Continuous Coating Runs in Vertical Reactor

Run Number	Date	H ₂	CH ₄	CH ₃ SiHCl ₂	Temperature		Drawing Rate		Remarks
		ℓ/min	ℓ/min	ℓ/min	K	°C	cm/min	cm/min	
N513	2/20/78	0.110	0.110	0.015	1373	1100	12.7	5.0	
N515	2/20/78						4.3	1.7	
N517	2/22/78						4.7	1.87	
N518	2/24/78						5.8	2.3	New design glass seals
N519	2/27/78						7.2	2.83	
N520	2/27/78						7.2	2.83	
N521	2/28/78						2.8	1.12	To NASA
N523	3/1/78						7.1	2.78	To NASA
N525	3/6/78						12.3	4.86	
N541	3/28/78						5.1 10.2 15.2	2.0 4.0 6.0	
N547	4/5/78						5.1	2.0	
N548	4/7/78		0.050				5.1	2.0	Discard
N564	5/23/78		0.110				10.2	4.0	
N573	6/6/78						7.6	3.0	
N574	6/7/78						7.6	3.0	
N598	6/17/78						10.2	4.0	
N599	6/17/78						7.6	3.0	
N601	7/19/78						7.6	3.0	
N602	7/20/78						7.6	3.0	

Table B-II

SiC Continuous Coating Runs
Vertical Reactor In-Line Oxidation Furnace in Place

Run Number	Date	In-Line Oxidation Temp. K	H ₂	CH ₄	CH ₃ SiHCl ₂	Temperature		Drawing Rate		Remarks
			ℓ/min	ℓ/min	ℓ/min	K	°C	cm/min	in/min	
N605	7/25/78	773	0.110	0.110	0.015	1373	1100	7.6	3.0	Discard
N608	7/28/78	873	↓	↓	↓	↓	↓	10.2	4.0	
N609	7/31/78	873	↓	↓	↓	↓	↓	10.2	4.0	
N610	8/1/78	873	↓	↓	↓	↓	↓	10.2	4.0	
N611	8/16/78	none	↓	↓	↓	↓	↓	15.2	6.0	
N612	8/16/78	773	↓	↓	↓	↓	↓	↓	↓	
N613	8/17/78	773	↓	↓	↓	↓	↓	↓	↓	
N616	8/21/78	none	↓	↓	↓	↓	↓	↓	↓	Start weight collection data
N617	8/21/78	773	↓	↓	↓	1423	1150	↓	↓	
N618	8/28/78	873	↓	↓	↓	1373	1100	↓	↓	
N619	8/29/78	873	↓	↓	↓	↓	↓	↓	↓	
N620	8/31/78	873	↓	↓	↓	↓	↓	↓	↓	New susceptors
N626	9/11/78	873	↓	↓	↓	↓	↓	↓	↓	
N628	9/18/78	873	↓	↓	↓	↓	↓	↓	↓	
N629	9/27/78	923	↓	↓	↓	↓	↓	↓	↓	Discard
N631	9/28/78	823	↓	↓	↓	↓	↓	↓	↓	
N636	10/18/78	none	↓	↓	↓	↓	↓	↓	↓	Discard
N639	10/19/78	none	↓	↓	↓	↓	↓	↓	↓	
N640	10/19/78	none	↓	↓	↓	↓	↓	↓	↓	Discard
N641	10/19/78	none	↓	↓	↓	↓	↓	↓	↓	

Table B-III

SiC Continuous Coating Runs
Horizontal Reactor - In Line Oxidation Furnace in Place

Run Number	Date	In-Line Oxidation Temp. K	H ₂ ℓ/min	CH ₄ ℓ/min	CH ₃ SiHCl ₂ ℓ/min	Temperature		Drawing Rate		Remarks
						K	°C	cm/min	in/min	
N642	10/26/78	none	0.110	0.110	0.015	1393	1120	15.2	6.0	
N643	10/27/78	none						15.2	6.0	
N644A	10/30/78	none						15.2	6.0	New susceptor
N644B	10/30/78	none						15.2	6.0	
N645	10/31/78	none				1423	1150	7.6	3.0	
N646	11/3/78	none							3.0	
N647A	11/6/78	none							3.0	
N647B	11/6/78	none							3.0	
N647C	11/7/78	none							3.0	
N648	11/8/78	none							3.0	
N649A	11/8/78	none							3.0	New susceptor
N649B	11/9/78	none							3.0	Discard
N649C	11/9/78	none							3.0	
N650	11/10/78	773							3.0	
N651	11/13/78	773							3.0	
N652A	11/13/78	773							3.0	New susceptor
N652B	11/13/78	773							3.0	
N652C	11/14/78	773							3.0	
N652D	11/14/78	773							3.0	
N653	11/15/78	773							3.0	
N654	11/16/78	873							3.0	New susceptor
N655	11/17/78	873							3.0	
N656	11/17/78	773							3.0	Discard
N657	11/20/78	773							3.0	Discard
N660	11/21/78	773							3.0	
N661	11/22/78	773							3.0	
N662	11/22/78	773							3.0	Discard

Table B-III (Cont'd)

Run Number	Date	In Line Oxidation Temp.	H ₂	CH ₄	CH ₃ SiHCl ₂	Temperature		Drawing Rate		Remarks
			ℓ/min	ℓ/min	ℓ/min	K	°C	cm/min	in/min	
N663A	11/27/78	773	0.055	0.055	0.008	1423	1150	7.6	3.0	
N663B	11/27/78	773						15.2	6.0	
N663C	11/27/78	773						22.9	9.0	
N663D	11/27/78	773						30.5	12.0	
N664	11/29/78	773						7.6	3.0	New susceptor
N665	11/30/78	none						30.5	12.0	To NASA
N666	12/1/78	none						30.5	12.0	To NASA
N667	12/1/78	none						30.5	12.0	To NASA
N668	12/1/78	773						30.5	12.0	To NASA
N669	12/4/78	773						30.5	12.0	To NASA
N670	12/4/78	773						30.5	12.0	To NASA
N671A	12/4/78	773						30.5	12.0	
N671B	12/4/78	773						30.5	12.0	
N672	12/7/78	773						30.5	12.0	To NASA
N673	12/7/78	773						30.5	12.0	
N674	12/7/78	773						15.2	6.0	
N675	12/7/78	773						7.6	3.0	
N677	12/8/78	none						15.2	6.0	New susceptor
N678	12/11/78	none						7.6	3.0	
N679	12/11/78	none						15.2	6.0	
N680	12/11/78	none						30.5	12.0	
N682	12/11/78	none	0.110	0.110	0.015			30.5	12.0	
N685	1/2/79	773						15.2	6.0	
N685A	1/2/79	773						10.2	4.0	
N685B	1/2/79	773						8.4	3.3	
N685C	1/2/79	773				1448	1175	15.2	6.0	
N685D	1/2/79	773				1448	1175	10.2	4.0	
N685E	1/2/79	773				1448	1175	10.2	4.0	
N685F	1/2/79	773				1448	1175	7.6	3.0	
N686	1/3/79	773				1473	1200	15.2	6.0	
N686A	1/3/79	773				1473	1200	10.2	4.0	
N686B	1/3/79	773				1473	1200	8.4	3.3	

Table B-III (Cont'd)

Run Number	Date	In-Line Oxidation Temp. K	H_2 l/min	CH_4 l/min	$\text{CH}_3\text{SiHCl}_2$ l/min	Temperature		Drawing Rate		Remarks
						K	$^{\circ}\text{C}$	cm/min	in/min	
N688	1/4/79	773	0.110	0.110	0.015	1398	1125	15.2	6.0	New susceptor
N688A	1/4/79	773						10.2	4.0	
N688B	1/4/79	773						8.4	3.3	
N689	1/4/79	773						15.2	6.0	
N690	1/4/79	773						30.5	12.0	
N691	1/5/79	none						30.5	12.0	
N691A	1/5/79	none						15.2	6.0	
N691B	1/5/79	none						7.6	3.0	
N692	1/5/79	773				1373	1100	30.5	12.0	
N692A	1/5/79	773				1373	1100	15.2	6.0	
N692B	1/5/79	773				1373	1100	7.6	3.0	
N693	1/8/79	773				1398	1125	30.5	12.0	New susceptor
N693A	1/8/79	773				1398	1125	15.2	6.0	
N693B	1/8/79	773				1398	1125	7.6	3.0	
N694	1/8/79	773				1398	1125	45.7	18.0	

Table B-IV

Tensile Loads of Graphite Yarn Containing
a Pyrolyzed Coating from Ethyl Silicate

<u>Roll Number</u>	<u>Specimen No.</u>	<u>Run No.</u>	<u>Gage Length (cm)</u>	<u>Failure Load</u>	
				<u>(lbs)</u>	<u>(N)</u>
76-8-1	HTS-1	"as received"	5.1	141	627
			5.1	152	676
			5.1	141	627
				Avg 145	Avg 643
76-8-1	SC1-1	SC1	5.1	159	708
			5.1	169	752
			5.1	174	774
				Avg 167	Avg 745
76-8-1	SC2-1	SC2	5.1	250	1113
			5.1	252	1121
			5.1	241	1072
				Avg 248	Avg 1102
76-8-1	SC3-1	SC3	5.1	153	681
			5.1	219	975
				Avg 186	Avg 828
76-8-1	SC4-1	SC4	5.1	102	454
			5.1	66	294
			5.1	78	347
				Avg 82	Avg 365
76-8-1	SC1-4	SC1	2.5	207	921
			2.5	242	1077
			2.5	214	952
			2.5	222	988
			2.5	224	997
			2.5	230	1024
			2.5	252	1121
			2.5	205	912
				Avg 225	Avg 999

Table B-IV (Cont'd)

<u>Roll Number</u>	<u>Specimen No.</u>	<u>Run No.</u>	<u>Gage Length (cm)</u>	<u>Failure Load</u>	
				<u>(lbs)</u>	<u>(N)</u>
76-8-2	HTS-1	"as received"	5.0	240	1068
	-2			133	592
	-3			223	992
	-4			228	1014
				Avg 206	Avg 916
76-8-2	HTS-1	"as received"	2.5	336	1495
	-2			384	1708
	-3			348	1548
	-4			330	1468
	-5			285	1268
	-6			360	1601
	-7			354	1575
	-8			255	1134
				Avg 332	Avg 1477
76-8-1	HTS-1	"as received"	5.0	165	734
	-2			200	890
	-3			219	974
	-4			175	778
	-5			205	912
				Avg 192	Avg 854
76-8-1	HTS-1	"as received"	2.5	177	787
	-2			262	1165
	-3			219	974
	-4			234	1028
	-5			207	921
	-6			234	1041
				Avg 260	Avg 1157

Table B-IV (Cont'd)

<u>Roll Number</u>	<u>Specimen No.</u>	<u>Run No.</u>	<u>Gage Length (cm)</u>	<u>Failure Load</u>	
				<u>(lbs)</u>	<u>(N)</u>
76-8-1	SC2	SC2	2.5	294	1308
			2.5	318	1415
			2.5	237	1055
			2.5	300	1335
			2.5	336	1495
			2.5	258	1148
			2.5	342	1522
			2.5	309	1375
				Avg 299	Avg 1332
76-8-1	SC3-4	SC3	2.5	180	801
			2.5	165	734
			2.5	180	801
			2.5	153	681
			2.5	126	561
			2.5	162	721
			2.5	132	587
			2.5	101	449
	Avg 150	Avg 668			
76-8-1	SC4-4	SC4	2.5	117	521
			2.5	140	623
			2.5	132	587
			2.5	134	596
			2.5	125	556
			2.5	138	614
			2.5	151	672
			2.5	126	561
	Avg 132	Avg 587			

Table B-IV (Cont'd)

<u>Roll Number</u>	<u>Specimen No.</u>	<u>Run No.</u>	<u>Gage Length (cm)</u>	<u>Failure Load</u>	
				<u>(lbs)</u>	<u>(N)</u>
2-98-1	HTS-1	"as received"	2.5	223	992
	-2			103	458
	-3			367	1632
	-4			285	1268
	-5			310	1379
	-6			305	1357
	-7			313	1392
					Avg 300
2-98-1	SC5-1	SC5	2.5	295	1312
				190	845
				258	1148
				277	1232
				255	1134
				280	1245
				290	1290
				248	1103
					Avg 260
2-98-1	SC6-1	SC6	2.5	230	1023
				173	770
				172	765
				162	721
				203	903
				218	970
				253	1125
				205	912
				276	1228
					Avg 217

Table B-IV (Cont'd)

<u>Roll Number</u>	<u>Specimen No.</u>	<u>Run No.</u>	<u>Gage Length (cm)</u>	<u>Failure Load</u>			
				<u>(lbs)</u>	<u>(N)</u>		
76-8-3	SC7-1	SC7	2.5	275	1223		
				280	1246		
				235	1045		
				270	1201		
				210	934		
				263	1110		
				288	1281		
				273	1214		
				288	1281		
				Avg 265		Avg 1179	
				76-8-3	SC8-1	SC8	2.5
268	1192						
255	1134						
260	1157						
285	1268						
220	979						
230	1023						
286	1272						
Avg 260		Avg 1157					
2-98-1	SC9-1	SC9	2.5	240	1068		
				270	1201		
				270	1201		
				243	1081		
				277	1232		
				295	1312		
				253	1125		
				268	1192		
				290	1290		
				Avg 267		Avg 1188	

Table B-V

Short Beam Shear Strength of Untreated
HTS/MY720 Containing Epoxy Composite

<u>Composite No.</u>	<u>Yarn Lot No.</u>	<u>Shear Strength</u> ¹	
		<u>psi</u>	<u>MPa</u>
212-1	76-8-1	12,000	83.0
-2		11,900	82.0
-3		11,000	75.9
-4		<u>12,200</u>	<u>84.0</u>
	Avg	11,775	81.2

¹Span to depth = 4/1

Table B-VI

Short Beam Shear Strength of Untreated
HTS/PR-286 Epoxy Composite

<u>Composite No.</u>	<u>Yarn Lot No.</u>	<u>Shear Strength</u> ¹	
		<u>psi</u>	<u>MPa</u>
212-11-1	2-98-1	12,800	88.1
-2		13,800	95.0
-3		11,800	81.3
-4		12,500	86.5
-5		11,700	80.5
-6		<u>14,000</u>	<u>96.6</u>
	Avg	12,760	88.1

¹Span to Depth = 4/1

Table B-VII

Short Beam Shear Strength¹ of Untreated
HTS/MY720 Containing Epoxy Composite

<u>Composite No.</u>	<u>Yarn Lot No.</u>	<u>Shear Strength</u>	
		<u>psi</u>	<u>MPa</u>
212-12-1	76-8-3	8,440	58.2
-2		7,620	52.5
-3		7,100	48.9
-4		7,010	48.3
-5		<u>7,150</u>	<u>49.3</u>
	Avg	7,460	51.4

¹Span to depth = 4/1

Table B-VIII

Short Beam Shear Strength¹ of Pyrolyzed Organo-Silicone
Coated HTS/MY720 Containing Epoxy Composites

<u>Composite No.</u>	<u>Yarn Lot No.</u>	<u>Run No.</u>	<u>Shear Strength</u>	
			<u>psi</u>	<u>MPa</u>
212-18-1	76-8-1	SC1	7500	51.7
-2			7530	52.0
-3			8030	55.4
-4			<u>7920</u>	<u>54.6</u>
		Avg	7745	53.4
212-9-1	76-8-1	SC5	6260	43.2
-2			6610	45.6
-3			<u>750</u>	<u>51.4</u>
		Avg	6790	46.8
212-9-1	76-8-1	SC7	7000	48.3
-2			6820	47.0
-3			<u>620</u>	<u>42.7</u>
		Avg	6670	46.0
212-10-1	2-98-1	SC8	4510	31.1
-2			4500	30.8
-3			<u>4480</u>	<u>30.9</u>
		Avg	4500	31.0
212-16-1	2-98-1	SC6	8620	59.4
-2			7860	54.6
-3			8610	59.4
-4			<u>8080</u>	<u>55.7</u>
		Avg	8290	57.3
212-14-1	2-98-1	SC9	5940	41.0
-2			5750	40.0
-3			5480	37.8
-4			5690	39.3
-5			<u>6610</u>	<u>45.6</u>
		Avg	5890	40.6

¹Span to Depth ratio = 4/1

Table B-IX

Flexural Strength of Untreated HTS Graphite
Yarn/MY720 Containing Epoxy Composite

<u>Composite No.</u>	<u>Yarn Lot No.</u>	Flexural Properties ¹				
		<u>Strength</u>		<u>Modulus</u>		
		ksi	MPa	10 ⁶ psi	GPa	
212-12-1	76-8-3	109	754	17.6	117	
-2		116	801	19.6	135	
-3		102	700	18.8	130	
-4		123	850	18.0	124	
-5		<u>118</u>	<u>812</u>	<u>19.6</u>	<u>135</u>	
		Avg	113.6	783	18.6	120

¹4-point flexural strength S/D = 20/1

Table B-X

Flexural Properties of Untreated
HTS/MY720 Containing Epoxy

<u>Composite No.</u>	<u>Yarn Lot No.</u>	Flexural Properties ¹			
		<u>Strength</u>		<u>Modulus</u>	
		10 ³ psi	MPa	10 ⁶ psi	GPa
212-1-1	76-8-1	138	953	16.3	112
-2		173	1190	15.8	109
-3		147	1017	16.3	113
-4		<u>143</u>	<u>988</u>	<u>16.3</u>	<u>112</u>
	Avg	150	1037	16.1	112

¹4-point flexural strength S/D = 20/1

Table B-XI

Flexural Strength of Untreated HTS/MY720
Containing Epoxy Composite

Sample No.	Flexural Properties ¹				
	Strength		Modulus		
	ksi	MPa	10 ⁶ psi	GPa	
212-11-1	141	968	20.0	137	
-2	144	996	20.4	141	
-3	175	1204	20.6	142	
-4	188	1300	20.0	138	
	Avg	162	1117	20.2	139

¹ 4-point flexural test, span to depth ratio, 20/1

Table B-XII

Flexural Strength of Untreated HTS/PR-286
Epoxy Composite

Specimen No.	Yarn Lot No.	Flexural Properties ¹			
		Strength		Modulus	
		ksi	MPa	10 ⁶ psi	GPa
212-17-1	2-98-1	178	1222	15.7	108
-2		171	1174	20.5	141
-3		182	1250	20.1	138
-4		173	1188	20.6	141
-5		180	1236	20.9	143
-6		154	1057	20.7	142
		Avg	173	1184	19.4

¹4-point flexural test, span to depth ratio, 20/1

Table B-XIII

Flexural Properties of Pyrolyzed Organo-Silicone Coated
HTS/MY720 Containing Epoxy Composites

Composite No.	Yarn Lot No.	Run No.	Flexural Properties			
			Strength		Modulus	
			10^3 psi	MPa	10^6 psi	GPa
212-18-1	76-8-1	SC1	82.0 ¹	565	12.8	88.4
-2			89.0	613	13.0	89.8
-3			97.5	672	11.6	80.1
-4			<u>96.4</u>	<u>665</u>	<u>12.6</u>	<u>86.6</u>
		Avg	91.2	629	12.5	86.2
212-16-1	2-98-1	SC6	136 ²	938	-	-
-2			133	914	-	-
			136	936	-	-
			<u>147</u>	<u>1016</u>	-	-
		Avg	138	951		
212-15-1	2-98-1	SC8	95.6 ³	659	14.8	102
-2			62.7	432	17.3	119
-3			<u>96.8</u>	<u>668</u>	<u>19.7</u>	<u>136</u>
		Avg	85.0	586	17.3	119
212-14-1	2-98-1	SC9	137 ⁴	944	-	-
-2			169	1162	-	-
-3			151	1041	-	-
-4			176	1216	-	-
-5			<u>176</u>	<u>1210</u>	-	-
		Avg	162	1115		

¹4-point flexural strength S/D = 20/1

²3-point flexural strength S/D = 20/1

³4-point flexural strength S/D = 32/1

⁴3-point flexural strength S/D = 28/1

1. Report No. NASA CR-159078		2. Government Accession No.		3. Recipient's Catalog No.	
4. Title and Subtitle STUDY OF HIGH RESISTANCE INORGANIC COATINGS ON GRAPHITE FIBERS				5. Report Date June 1979	
				6. Performing Organization Code	
7. Author(s) F. S. Galasso, R. D. Veltri and D. A. Scola				8. Performing Organization Report No. R79-914212-9	
9. Performing Organization Name and Address United Technologies Research Center East Hartford, CT 06108				10. Work Unit No.	
				11. Contract or Grant No. NAS1-14346	
				13. Type of Report and Period Covered Contractor Report	
12. Sponsoring Agency Name and Address National Aeronautics and Space Administration Washington, DC 20546				14. Army Project No.	
15. Supplementary Notes Contract Monitor: Dennis Dicus, NASA Langley Research Center					
16. Abstract It has been reported that the release of graphite fibers from composites into the environment might have serious effects on electrical and electronic equipment. In an attempt to find a solution to this problem, several coatings to increase the resistance of the graphite fiber were investigated. These coatings were boron, silicon carbide and silica or silica-like materials. The most promising results were attained by (1) chemical vapor depositing silicon carbide on graphite fiber followed by oxidation and (2) drawing graphite fiber through ethyl silicate followed by appropriate heat treatments. In the silicon carbide coating studies no degradation of the graphite fibers was observed and resistance values as high as three orders of magnitude higher than that of the uncoated fiber was attained. The strength of a composite fabricated from the coated fiber had a strength which compared favorably with those of composites prepared from uncoated fiber. For the silica-like coated fiber prepared by drawing the graphite fiber through an ethyl silicate solution followed by heating, coated fiber resistances about an order of magnitude greater than that of the uncoated fiber were attained. Composites prepared using these fibers had flexural strengths comparable with those prepared using uncoated fibers, but the shear strengths were lower.					
17. Key Words (Suggested by Author(s)) Boron coating Organosilane coating Chemical vapor deposition Silica-like coatings Silicon carbide coating			18. Distribution Statement Unclassified - Unlimited		
19. Security Classif. (of this report) Unclassified		20. Security Classif. (of this page) Unclassified		21. No. of Pages 120	22. Price*

