

NASA CONFERENCE PUBLICATION

NASA CP-2091

PROCEEDINGS OF WORKSHOPS TO DEFINE ENGINEERING
REQUIREMENTS FOR A SPACE VACUUM RESEARCH FACILITY

The Summary of a Series of Workshops Held in 1978
at Marshall Space Flight Center

Edited by W. A. Oran, S. T. Wu, and R. W. Hoffman

June 1979

Prepared by

NASA - George C. Marshall Space Flight Center
Marshall Space Flight Center, Alabama 35812

1. REPORT NO. NASA CP-		2. GOVERNMENT ACCESSION NO.		3. RECIPIENT'S CATALOG NO.	
4. TITLE AND SUBTITLE Proceedings of Workshops to Define Engineering Requirements for a Space Vacuum Research Facility			5. REPORT DATE June 1979		6. PERFORMING ORGANIZATION CODE
7. AUTHOR(S) Edited by W. A. Oran, S. T. Wu,* and R. W. Hoffman**			8. PERFORMING ORGANIZATION REPORT #		
9. PERFORMING ORGANIZATION NAME AND ADDRESS George C. Marshall Space Flight Center Marshall Space Flight Center, Alabama 35812			10. WORK UNIT NO.		
			11. CONTRACT OR GRANT NO.		
			13. TYPE OF REPORT & PERIOD COVERED Conference Publication		
12. SPONSORING AGENCY NAME AND ADDRESS National Aeronautics and Space Administration Washington, D. C. 20546			14. SPONSORING AGENCY CODE		
15. SUPPLEMENTARY NOTES Prepared by Space Sciences Laboratory, Science and Engineering *The University of Alabama in Huntsville, Huntsville, Alabama **Case Western Reserve University, Cleveland, Ohio					
16. ABSTRACT This document summarizes the results of a series of workshops held at the Marshall Space Flight Center during 1978 to help define the engineering requirements for a space vacuum research facility. Presented are the results of a Workshop on Outgassing and Workshops on Wake Shield Models.					
17. KEY WORDS			18. DISTRIBUTION STATEMENT <i>W. A. Oran</i> Unclassified—Unlimited		
19. SECURITY CLASSIF. (of this report) Unclassified		20. SECURITY CLASSIF. (of this page) Unclassified		21. NO. OF PAGES 154	22. PRICE NTIS

TABLE OF CONTENTS

	Page
I. SUMMARY	I-1
II. NASA WORKSHOP ON OUTGASSING	II-1
III. NASA WORKSHOPS ON WAKE SHIELD MODELS	III-1
Interim Report	III-1
Report of April 3-4, 1978, Meeting	III-7

SECTION I
SUMMARY

SUMMARY

W. A. Oran

It is possible to obtain very high vacuum levels in the wake region of orbiting spacecraft. Of the upper atmospheric particles, atomic hydrogen is the only species which has a sufficiently high thermal velocity that a significant fraction of the population can overtake a spacecraft. Calculations show that the flux of H to a wake-facing surface can be $\lesssim 10^7/\text{cm}^2 \text{ sec}$ (equivalent to $\sim 10^{14}$ torr pressure).

This ultra-high vacuum level could be maintained under a large outgassing load and/or high heat dissipation. Both of the preceding experimental conditions can seriously degrade a vacuum obtained in either conventionally pumped or cryo pumped systems. However, the vacuum levels actually obtained in an orbiting facility will depend upon several parameters. Perhaps chief among these are: (1) the outgassing of the facility itself and (2) the collision kinematics between these particles and the atmospheric particles whereby additional atoms/molecules can be scattered into the wake region. Designing a facility which can minimize the effect of these two conditions at a low cost will be one of the major engineering system tasks.

A series of workshops was held at the Marshall Space Flight Center (MSFC) during 1978 to determine the state of art/technology in these (and related) areas and to help define the engineering requirements of a space vacuum research facility. Dr. S. T. Wu of the University of Alabama in Huntsville coordinated and moderated workshops to investigate models depicting the collision dynamics in the near vicinity of a body orbiting the upper atmosphere; Dr. R. W. Hoffman of Case Western Reserve University was responsible for organizing a workshop to investigate degassing techniques for a vacuum facility.

The specific details regarding various technical questions can be found in the text; however, the following is a brief summation of the pertinent conclusions:

(1) A Monte-Carlo model of the collision-induced phenomena around an orbiting vehicle has been developed by NASA/Langley Research Center (LaRC). While a Monte-Carlo method is intrinsically an accurate technique, some of the assumptions of the LaRC model may not be valid. Preliminary results of a deterministic model developed by MSFC indicate discrepancies in the vacuum levels calculated around the Shuttle. Therefore, it appears desirable to develop several models using various approaches to describe this upper atmospheric spacecraft interaction and to compare the results of the different models together with any experimental data that are available.

(2) One of the inaccuracies in any model is the uncertainty in collision cross sections, and additional experiments should be performed to more accurately determine these values.

(3) Potential contamination created by ionospheric ions attracted to the wake zone by the plasma-induced charging of a facility should be determined.

(4) With the caveat that measurements generally give the net and not the true outgassing rate, a number of metals, alloys, and ceramics appear to satisfy the outgassing requirements of a vacuum facility (i.e., $\lesssim 10^7/\text{cm}^2$ sec).

(5) If the system were thoroughly degassed on the ground, a secondary, low-temperature thermal outgassing could be accomplished in orbit, resulting in an outgassing rate comparable to that obtained in an ultra-high vacuum system. This would eliminate the need for transporting the facility to orbit in an ultra-high vacuum chamber.

SECTION II

NASA WORKSHOP ON OUTGASSING

**Space Sciences Laboratory
Marshall Space Flight Center
Huntsville, Alabama
June 12-13, 1978**

NASA WORKSHOP ON OUTGASSING

Fourteen persons participated in a NASA Workshop on Outgassing held at MSFC on June 12-13, 1978. The purpose of the workshop was to consider the materials and processing constraints that would be involved in construction of a molecular wake shield (MWS) for the Shuttle Orbiter. The vacuum goal was to reach particle densities of 10^3 particles cm^{-3} in the region behind the shield with ground or in-orbit treatments (or some combination thereof) at contemplated power levels. Excluding contamination from the experiments themselves, it is the conclusion of the workshop that such goals may be reached with known techniques.

SUMMARY

The attendees of the workshop, together with their affiliations, are given in Appendix I of this section, including the scheduled paper titles. The first part of the program was concerned with the Orbiter environment and contamination fluxes. The concept of a space vacuum research facility with the advantages of adequate power and less contamination was presented by Don Perkinson (MSFC). M. Sinha (JPL) discussed an assembly which would allow the separate outgassing of the wake shield and electronics portions as well as the container and deployment. Although our consideration was only with the shield, it is recognized that the presence of the experiment may indeed be much more significant to the ultimate vacuum environment. The NASA/Langley Research Center representatives, F. Brock, L. Melfi, and J. Heuser, did not make formal presentations but provided valuable information from their vast pool of experience.

The visual material presented by all speakers, as well as the extended abstracts and references, are given in Appendix II of this section. It was concluded that the Orbiter was itself a major source of contamination. Furthermore, for those experiments requiring significant power or freedom from contamination bursts, a free-flying system might be required.

K. Mauersberger (U. Minnesota) reviewed the present status of species detection by mass spectrometry. Existing magnetic or quadrupole spectrometers with open source geometry now possess a lower detection limit of approximately $2 \times 10^3 \text{ cm}^{-3}$. It was felt the sensitivity could be increased by several techniques, such as multiple collectors or extended integration times, to provide useful measurements in the 10^2 cm^{-3} sensitivity range.

The workshop then considered four presentations on outgassing of various materials. Pete Hobson (NRC Canada) pointed out that many materials having outgassing rates less than the required 10^{-12} Torr-liters cm^{-2} sec^{-1} are available. Both transportation into orbit under UHV and secondary thermal outgassing at temperatures of 150° C are technically feasible. G. Lewin, (Princeton Plasma Laboratory) discussed the importance of the hydrogen in stainless steels, and F. Brock pointed out its presence in aluminum alloys as well. Wall thicknesses should be as small as possible, and high-temperature, long-time ground treatments are necessary to reduce the hydrogen dissolved. Limitations for thick sections were discussed.

Y. Strausser (HP) presented a great deal of data on outgassing rates correlated with different heat treatments, surface finishes, and processing. He confirmed that hydrogen is the major gas of concern in the MWS application and presented data indicating that the rates of all other constituents can be made less than 10^{-14} Torr lcm^{-2} sec^{-1} . After H_2 , CO and N_2 generally are the most common constituents. L. Beavis (Sandia Laboratories) discussed thermal desorption measurements and presented data for Mo, CuBe, and some ceramics. Surface species bound with energies of 25 to 35 kcal mol^{-1} would be the most troublesome.

CONCLUSIONS AND RECOMMENDATIONS

Outgassing Rates

Total equilibrium outgassing rates of less than 10^{-12} Torr lcm^{-2} sec^{-1} should be readily attainable by a combination of ground and in-orbit treatments. The outgassing rate of common gaseous constituents except H_2 may be reduced to less than 10^{-14} Torr lcm^{-2} sec^{-1} . Hydrogen present in the volume of the material used to fabricate the shield is expected to be the most troublesome constituent. For the case of stainless steel a treatment of vacuum firing at 1000° C for approximately 8 hours followed by an argon ion scrubbing at temperatures of approximately 350° C is suggested prior to launch. Further heating in orbit to approximately 150° C for a period of approximately 20 hours would be necessary to reduce the outgassing to the required levels. Although it is believed that packing the shield in UHV during the flight into orbit would not be required from the point of view of the shield, it is recommended in order to decrease the outgassing time in orbit and may, in fact, be required by the experiment.

Materials

Stainless steels, such as 304L, are suggested primarily because there are more experience and data available on their cleaning and outgassing rates. Because weight is not a major factor, their use would not be prevented. Aluminum alloys, such as 6061, should receive serious consideration. However, the dissolved hydrogen may form bubbles during heat treatment, and there is not as much data available on different processing treatments. For Al, it is believed that the oxide layer which forms would not necessarily be bad and would give rise to less water absorption. Ceramics are to be avoided because of outgassing and electrical charging considerations, in addition to the low thermal and mechanical shock resistance. Glass-to-metal seals may be needed; long-term corrosion from the H₂O may exist with Kovar. MoMn seals are recommended because there is little hydrogen and no water problem.

Surface Barriers

The high temperature firing of stainless steel enriches the surface in iron which then oxidizes. It is possible to enhance the CrO₂ on the surface and provide a diffusion barrier against hydrogen and oxygen with a wet hydrogen firing at 700° C for 2 to 3 hours. This places a barrier approximately 1000° Å thick on the surface which is structurally sound.

The surface of the wake shield facing the experiment may also be coated with a getter material. In particular, this would be useful for certain experiments which might have a heavier gas load or to provide a backup. If such a treatment were used, several elements, such as Ti, Zr, Er, or Y, should be considered. The Ti or Zr would serve well for oxygen, whereas the Y would tie up hydrogen in the form of stable hydrides. Thus, specific pumping materials may be used, but interferences are possible. For instance, the oxides on Er give a diffusion barrier which limits the oxygen uptake to about a monolayer and would stop the getter action. The use of coatings applied in space may reduce pretreatment requirements.

Reliability of Recommendations

Essentially all the outgassing data presented are defined as a net outgassing rate. That is, the equilibrium pressure of the various constituent gasses is measured as a function of treatment or time. These measurements effectively neglect the fact that the surface may adsorb species and hence act like a pump. Hence, it is possible that the actual outgassing flux may be much larger than one would

conclude from these equilibrium experiments. More properly stated, the outgassing rates quoted in the literature represent a net rather than a gross rate. Some of the desorption experiments may give results that are closer to total, but even here the measurements are difficult if an outgassing rate is desired. As pointed out by Hobson and Earnshaw, J. Vac. Sci. Technol. 4, 257 (1967), the true outgassing rate may be measured only if one evaluates the pumping speed of the surface. In actual systems the reabsorption of a particular species may affect the ejection of a second gas, making the problem more complicated. From the point of view of the outgassing of the wake shield it is important to establish whether the equilibrium numbers quoted in the literature may be used in practice even though they are wrong in principle. As seen in Appendix III of this section, arguments were presented that because of the geometry of the wake shield and the assumed infinite pump seen by the surface, the actual pressures achieved should not exceed those based on conventional outgassing data.

It should be pointed out that thermal absorption measurements with a specially constructed system using mass spectrometric sensing would be well suited for a good direct measurement of the outgassing flux rather than the net rates.

There is an apparent inconsistency in the data reported by Calder, et al., in Vienna using argon scrubbing and the experience of surface composition observed with AES. The former experiments determine the coefficient of η , which is the number of molecules per incident ion that are released under high energy bombardment. It appears as though the equivalent of perhaps 70 or 80 monolayers in total are released before η is reduced to 0.01. In contrast, the Auger data suggest that only a few monolayers of gas may be adsorbed at the surface. This inconsistency was not resolved and is perhaps related to the depth distribution of the gas.

Orbital and Environmental Effects

Limitations must be placed on the environment seen by the shield while in orbit.

Pressure bursts at the experimental site will be seen when water is dumped from the Shuttle or gasses from the stabilizing thrusters are used. From the point of view of the MWS, this contamination could be removed from the surface by the 150° C outgassing, although it might take hours. However, if the contamination is so severe that it would affect the experiment, it may be necessary to place the wake shield and experiment into a vacuum shell to avoid

contamination during the period of extreme contamination. Alternatively, the wake shield may fly from a power module which would provide not only sufficient power for outgassing purposes but also eliminate a great deal of contamination.

A second environmental consideration is the temperature fluctuation. From outgassing considerations alone it might be desirable to run the shield continuously at 150° C until just prior to experimentation. Power would have to be supplied in the neighborhood of 2 kW on the dark side, but two advantages would result. The shield would remain continuously outgassed. The oxygen migration around the edge of the shield may be significant and could be eliminated by keeping the edge hot. It is also necessary to avoid severe temperature fluctuations so that gasses would not be absorbed during a cold period and readmitted later. Atomic oxygen is expected to be the worst offender since it is readily absorbed at temperatures less than 300 K. In general, ions also stick and would not be reflected.

In-orbit measurements will be required to determine the contamination effects and give reliable data for the density fluctuations.

Additional Observations

It should be pointed out that although equivalent pressures may be obtained in earth laboratories, generally the production of 10^{-14} Torr vacuum levels requires cryogenic pumping and hence is difficult to achieve with experiments with high thermal loads. The wake shield does not have this restriction and might have an advantage.

Many of the experiments described imply that complete surface analysis instrumentation must be carried aboard the Orbiter. We suggest that ultra-high vacuum transfer devices exist and should be suitable to transport specimens from earth to orbit and, perhaps more importantly, return. Comparison experiments would be needed for the demonstration, but the use of such a device might make it possible to reduce the orbiting analysis equipment and hence increase the useful payload in the future.

Appendix I - Program and Attendees

NASA Workshop on Outgassing

Space Sciences Laboratory
Marshall Space Flight Center
Huntsville, Alabama
12-13 June, 1978

Program

Orbiter Environment and Molecular Shield
Constraints

William Oran
Space Sciences Laboratory
Marshall Space Flight Center
Huntsville, AL 35812
(205)453-3090

Space Vacuum Research Facility

Don Perkinson
Space Sciences Laboratory
Marshall Space Flight Center
Huntsville, AL 35812

Furlable Wake Shield

Mahadeva Sinha
Jet Propulsion Laboratory
Pasadena, CA 91103
(213)449-2451

In Orbit Measurements

Konrad Mauersberger
Department of Physics
University of Minnesota
Minneapolis, MN 55455
(612)373-5458

On Minimizing Outgassing of the Wake Shield

J. Peter Hobson
Electron Physics Section
National Research Council of Canada
Ottawa, Ontario K1A028 - Canada
(613)993-9196

Fundamentals of Outgassing: Theory

Gerhard Lewin
Consultant, Princeton Plasma Lab.
21 Yale Terrace
West Orange, NJ 07052
(201)731-7186

Outgassing and H₂ Diffusion in Fe Base
Alloys

Yale Strausser
Hewlett-Packard Laboratories
1501 Page Mill Road
Palo Alto, CA 94304
(415)856-1501

Thermal Desorption in Mo and Cu Base
Alloys

Leonard C. Beavis
Sandia Laboratories
Division 2353
Albuquerque, NM 87115
(505)264-2231 or 1258

Summary and Recommendations
An Open Discussion

Richard W. Hoffman, Moderator
Department of Physics
Case Western Reserve University
Cleveland, Ohio 44106
(216)368-4012

Attendees

NASA Workshop on Outgassing

<u>Name</u>	<u>Affiliation</u>
Richard W. Hoffman	Case Western Reserve University
Gerhard Lewin	Princeton Plasma Physics Laboratory
Leonard Melfi	NASA - Langley Research Center
F. J. Brock	NASA - Langley Research Center
J. E. Hueser	NASA - Langley Research Center
Mahadeva Sinha	Jet Propulsion Laboratory
William Oran	Marshall Space Flight Center
Peter Hobson	N.R.C., Canada
Don Perkinson	Marshall Space Flight Center - PD33
Walter H. Stafford	Marshall Space Flight Center - PD33
Charles E. Mundie	Marshall Space Flight Center - PD24
Ilmars Dalins	Marshall Space Flight Center - ES-71
Konrad Mauersberger	University of Minnesota
Yale Strausser	Hewlett-Packard

APPENDIX II

Excerpts from Papers

		Page
Space Vacuum Research Facility	Don Perkinson	II-10
Furlable Wake Shield	Mahadeva Sinha	II-33
In Orbit Measurements	Konrad Mauersberger	II-38
On Minimizing Outgassing of the Wake Shield	J. Peter Hobson	II-45
Fundamentals of Outgassing: Theory	Gerhard Lewin	II-61
Outgassing and H ₂ Diffusion in Iron Base Alloys	Yale Strausser	II-66
Thermal Desorption from Mo, Cu, Be and Some Ceramics	Leonard Beavis	II-87

SPACE VACUUM RESEARCH FACILITY

DON PERKINSON

ORGANIZATION:

PROGRAM DEVELOPMENT

1187-78

MARSHALL SPACE FLIGHT CENTER

SPACE VACUUM RESEARCH FACILITY

NAME:

PD33/PERKINSON

DATE:

MAY 1978

FUNCTIONAL ELEMENTS

COVER PLATE TO PROTECT EXPERIMENT FROM THE "DIRTY" SHUTTLE ENVIRONMENT UNTIL SHIELD IS DEPLOYED, COVER PLATE IS THEN REMOVED.

EXPERIMENT

SHIELD TO PROTECT EXPERIMENT DURING OPERATION FROM THE "POOR" VACUUM OF SPACE.

UHVC REQUIRES A HIGH VACUUM SEAL AND HIGH CLOSING FORCE.

IF BAKEOUT IS PERFORMED PRIOR TO LAUNCH, THE SHIELD MUST BE PROTECTED FROM THE ATMOSPHERE BY AN ULTRA HIGH VACUUM CHAMBER (UHVC).

COVER PLATE MUST BE OPEN OR VENTED WHILE SHIELD AND EXPERIMENT IS IN UHVC TO ALLOW PUMPING OF INTERIOR, MUST BE SEALED DURING DEPLOYMENT, AND MUST BE REMOVED DURING EXPERIMENT OPERATION.

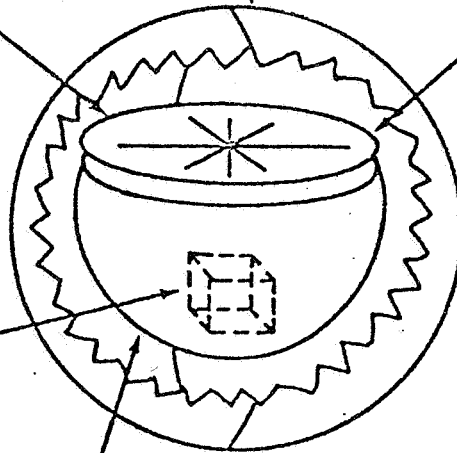

<p>ORGANIZATION:</p> <p>PROGRAM DEVELOPMENT</p>	<p>MARSHALL SPACE FLIGHT CENTER</p> <p>MOLECULAR WAKE SHIELD STUDY</p> <p><u>GUIDELINES</u></p>	<p>NAME:</p> <p>PD33/PERKINSON</p> <p>DATE:</p> <p>JANUARY 1978</p>
<p><u>SHIELD</u></p> <p>Size</p>	<p>3 M</p>	<p>No experiment size requirements yet.</p>
<p>Material</p>	<p>1100 Al.</p>	<p>Stainless steel may have advantages.</p>
<p>Geometry</p>	<p>Hemisphere</p>	<p></p>
<p>Cover Plate</p>	<p>1 μ seal required</p>	<p>Alternate method has been identified.</p>
<p><u>POSITION</u></p> <p>Distance from Shuttle</p>	<p>100 M</p>	<p>LaRC is checking this.</p>
<p>Altitude</p>	<p>TBD</p>	<p>LaRC checking.</p>
<p><u>ATTITUDE</u></p> <p>Orientation</p>	<p>1°</p>	<p>Other requirements indicate 5° -20°</p>
<p>Use of cold gas jets</p>	<p>O. K.</p>	<p></p>
<p>Use of hypergolics</p>	<p>No</p>	<p>Yet to be proved. Propellant expended is of same magnitude as ambient atmosphere.</p>
<p><u>OTHER AREAS</u></p> <p>Max Temp. Excursion</p>	<p>± 100° C</p>	<p></p>
<p>Experiment power</p>	<p>2 kW</p>	<p>Lower for many experiments.</p>
<p>Data Rate</p>	<p>TBD</p>	<p>Should be low, 4 K bits/sec used.</p>
<p>Experiment Requirements</p>	<p>TBD</p>	<p>Weight ≤ 400 lb. (JPL)</p> <p>Time 1-5 Days</p>

MARSHALL SPACE FLIGHT CENTER
 MOLECULAR WAKE SHIELD
 (MWS) STUDY

NAME C. FRITZ

DATE JAN 1978

PD22

ORGANIZATION

OBJECTIVE

* SELECT A MATERIAL WHICH WILL MAINTAIN MWS TEMPERATURE EXCURSION BELOW 180°F (100°C).

MOLECULAR WAKE SHIELD
 ANTICIPATED TEMPERATURES

$\frac{\alpha}{c}$	SURFACE TYPE	SHELL THICKNESS (IN)	MAX. °F TEMP. (DAY)	MIN. °F TEMP. (NIGHT)	DELTA
$\frac{.14}{.04}$	POLISHED AL	1/16	+395	+255	140
		1/8	+371	+294	77
		1/4	+356	+317	39
$\frac{.62}{.25}$	SAND BLAST AL	1/16	+347	+41	306
		1/8	+345	+116	229
		1/4	+331	+184	147
$\frac{.21}{.80}$	PLASMA SPRAY	1/16	+10	-66	66
		1/8	-2	-50	48
		1/4	-8	-37	29

CONCLUSION

* NO PROBLEM MAINTAINING MWS TEMPERATURE EXCURSION BELOW 180°F. (100°C) BY SELECTING PROPER SURFACE FINISH.

SPACE VACUUM RESEARCH FACILITY CONCEPT OPTIONS

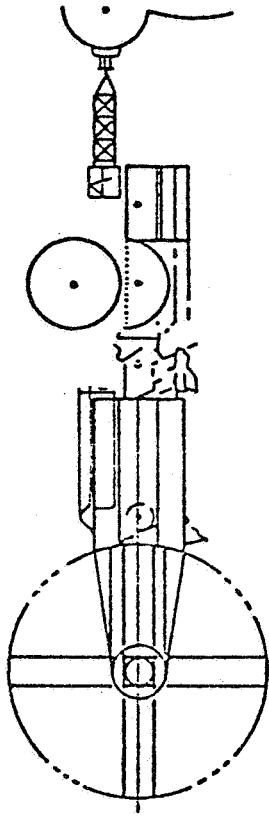
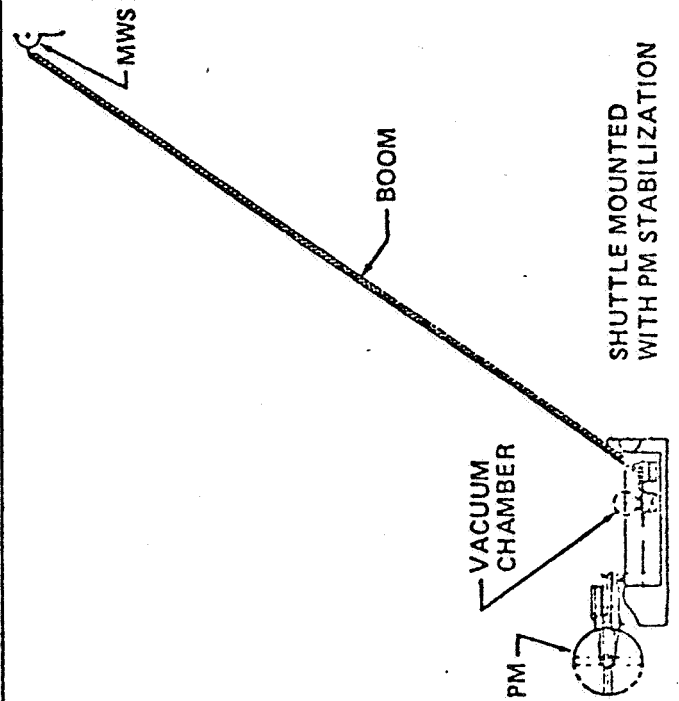
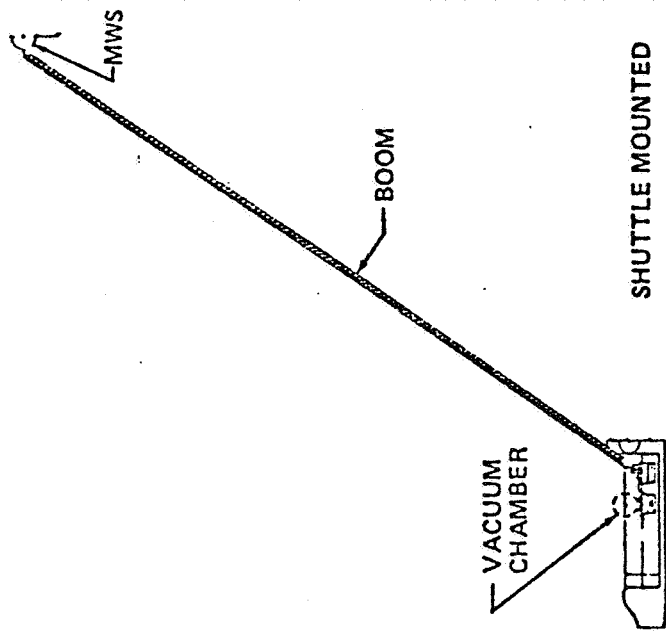

POWER MODULE MOUNTED FREE FLYER

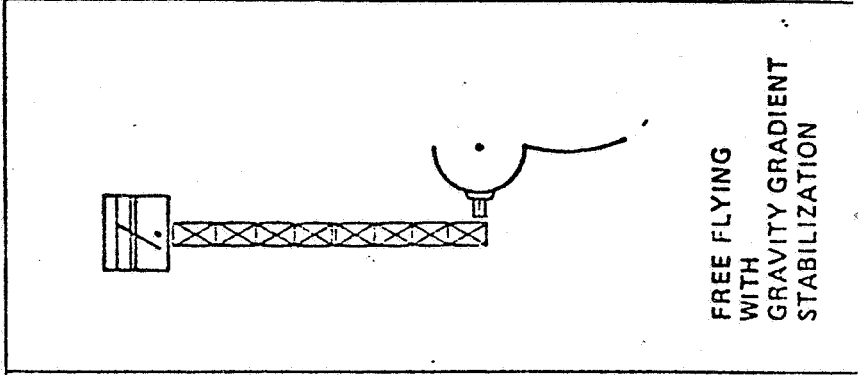

FREE FLYING WITH GRAVITY GRADIENT STABILIZATION

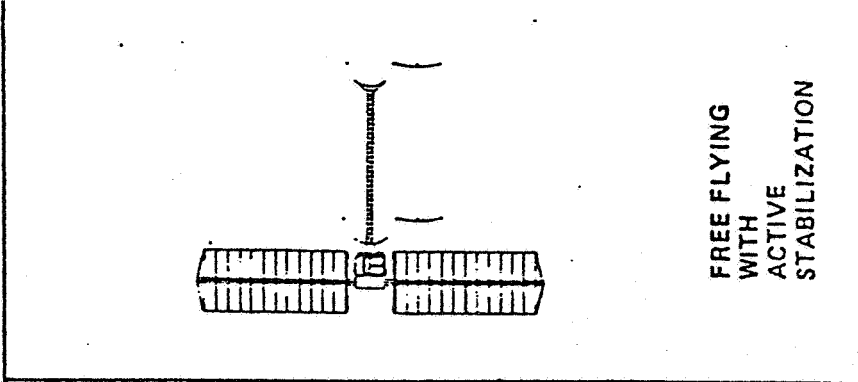

FREE FLYING WITH ACTIVE STABILIZATION

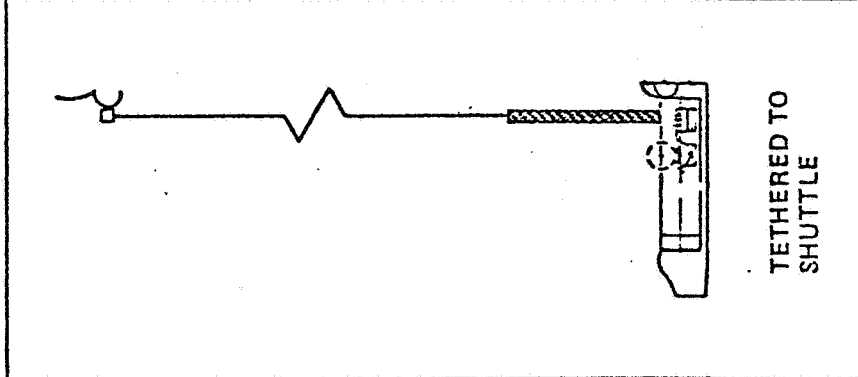

MARSHALL SPACE FLIGHT CENTER
 MOLECULAR WAKE SHIELD
 (MWS) STUDY

NAME
 B. LAWSON

DATE
 JAN 1978

PD23

ORGANIZATION

SHIELD CONCEPT

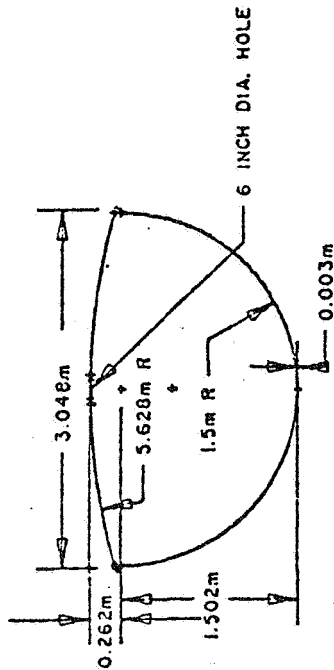

UHVC CONCEPT

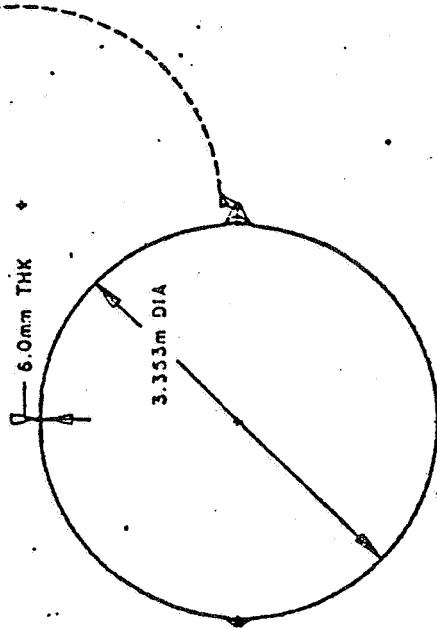

MWS SHOWING MOUNTING CONCEPT

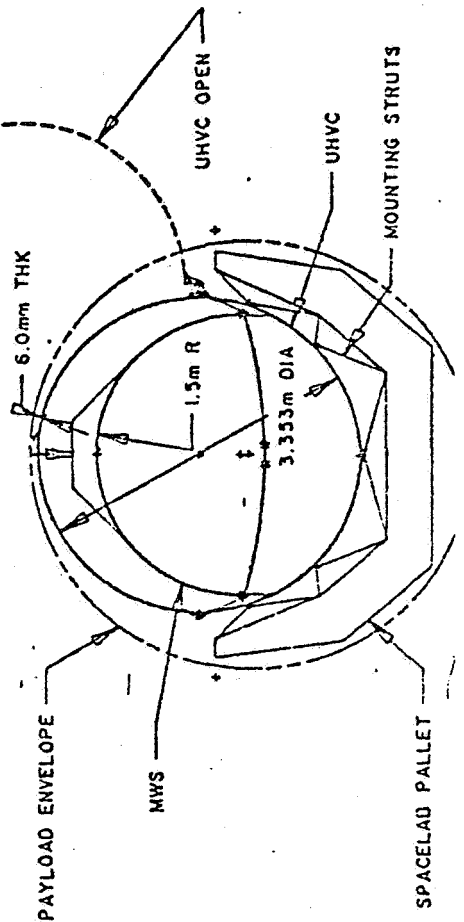

PD23 ORGANIZATION	MARSHALL SPACE FLIGHT CENTER MOLECULAR WAKE SHIELD (MWS) STUDY	NAME	B. LAWSON
		DATE	JAN 1978

SEALING CONCEPTS

MWS SEAL CONCEPT

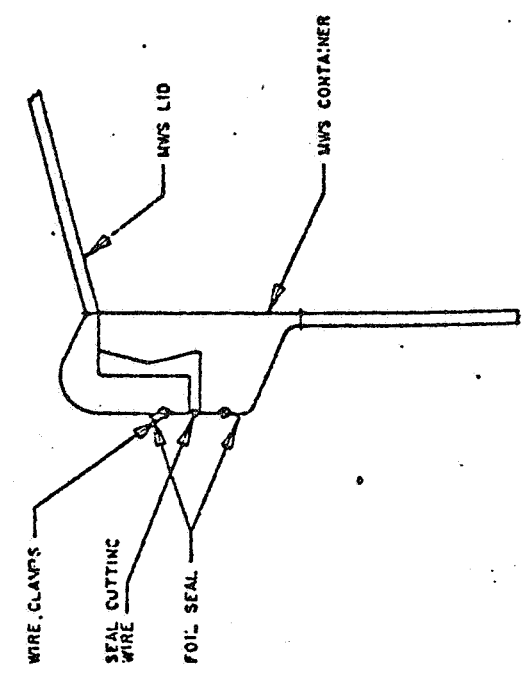

VACUUM EQUALIZATION PORT CLOSURE CONCEPT

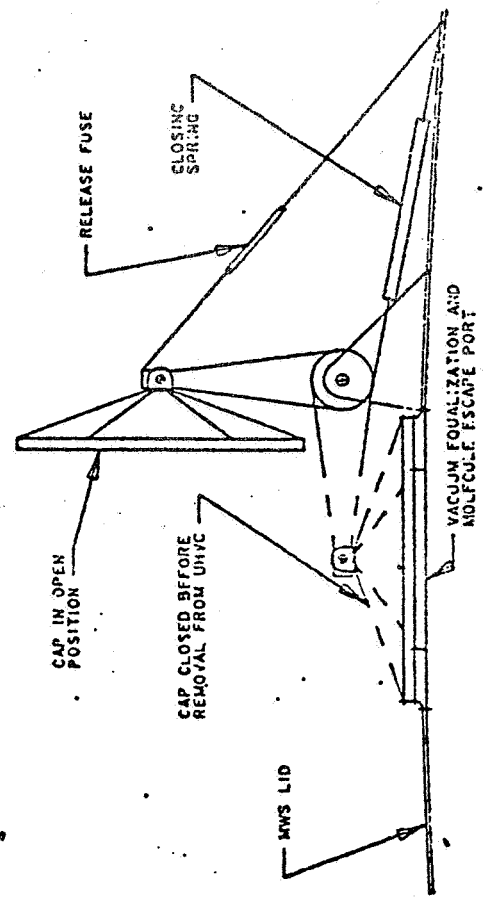

LATCH ASSEMBLY

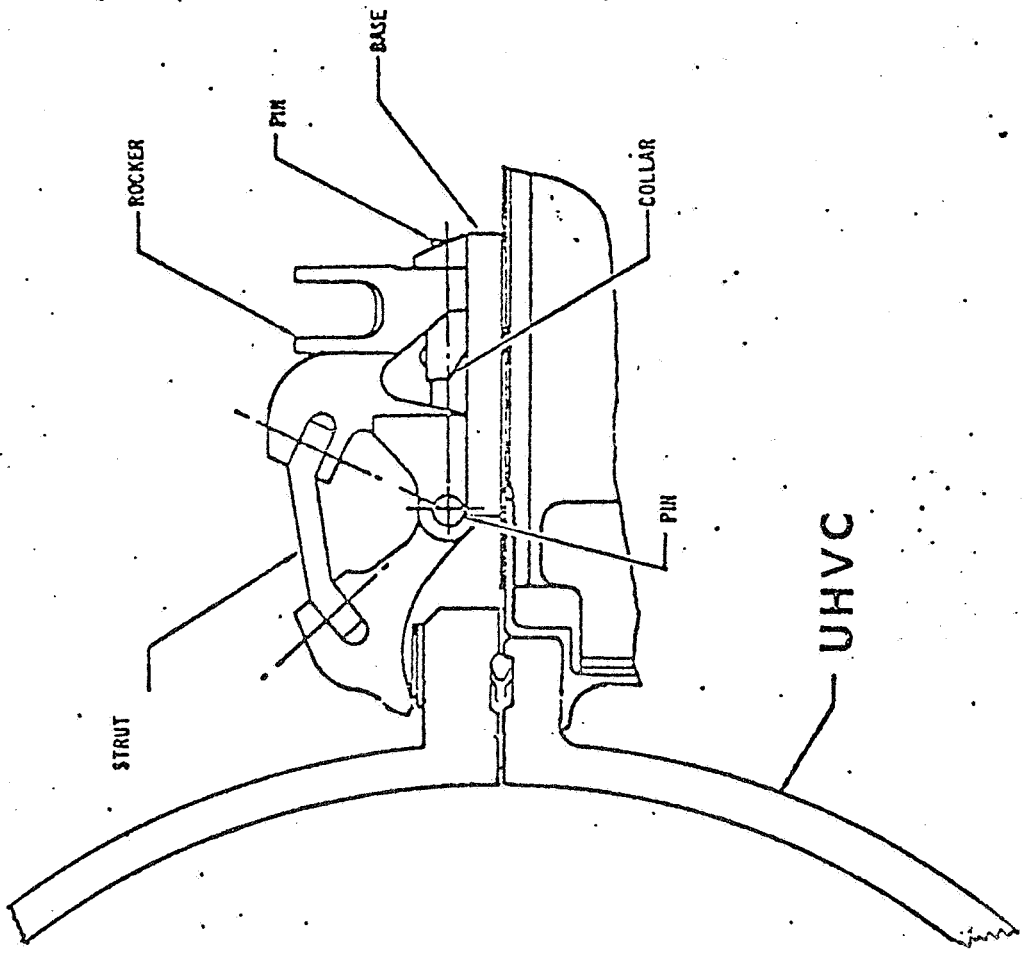

OPEN POSITION

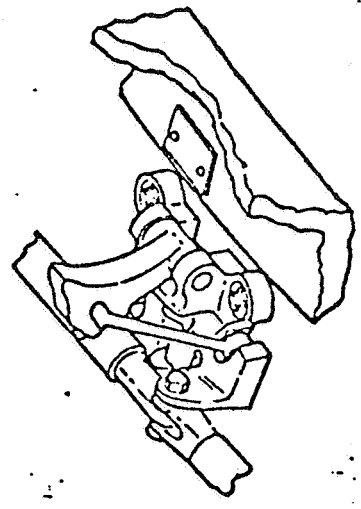

CLOSED POSITION

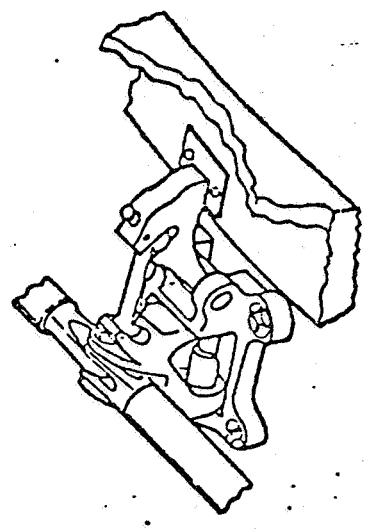

ORGANIZATION: PD23	MARSHALL SPACE FLIGHT CENTER MOLECULAR WAKE SHIELD (MWS) STUDY	NAME: B. Lawson DATE: January 1978
-----------------------	--	---

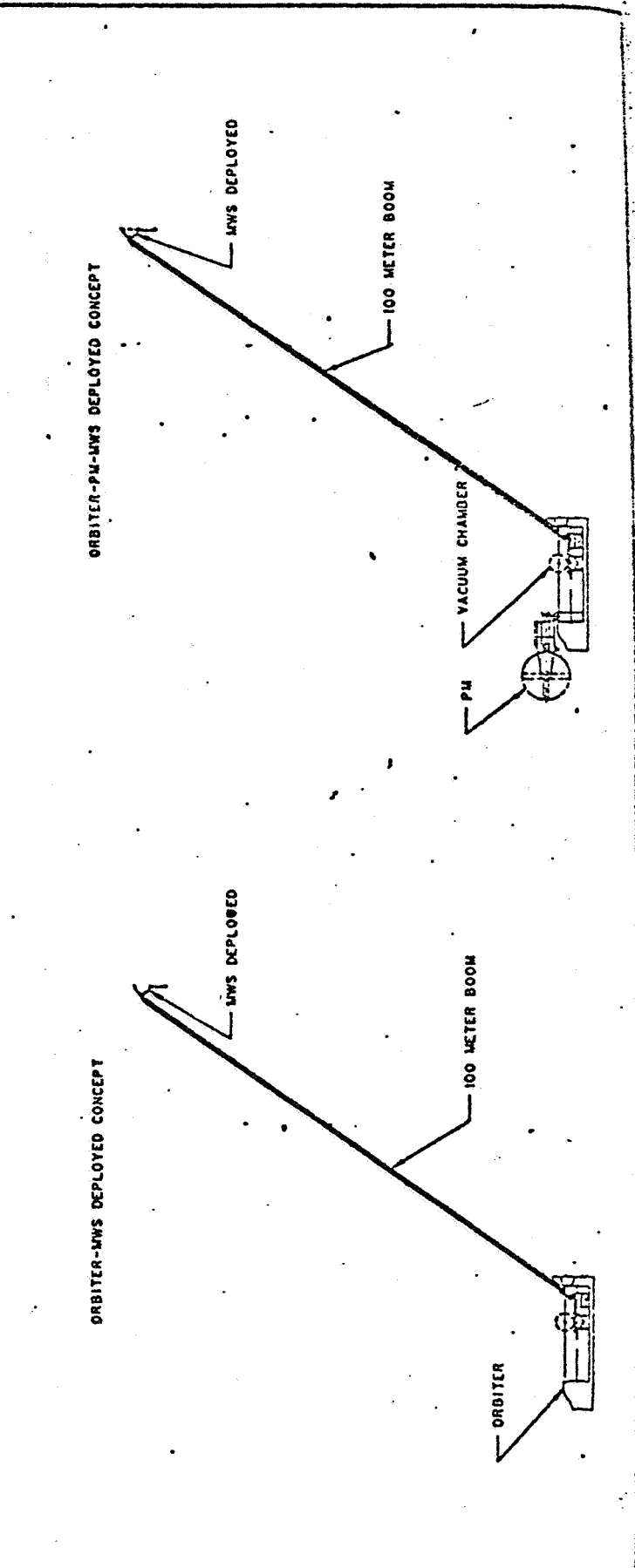
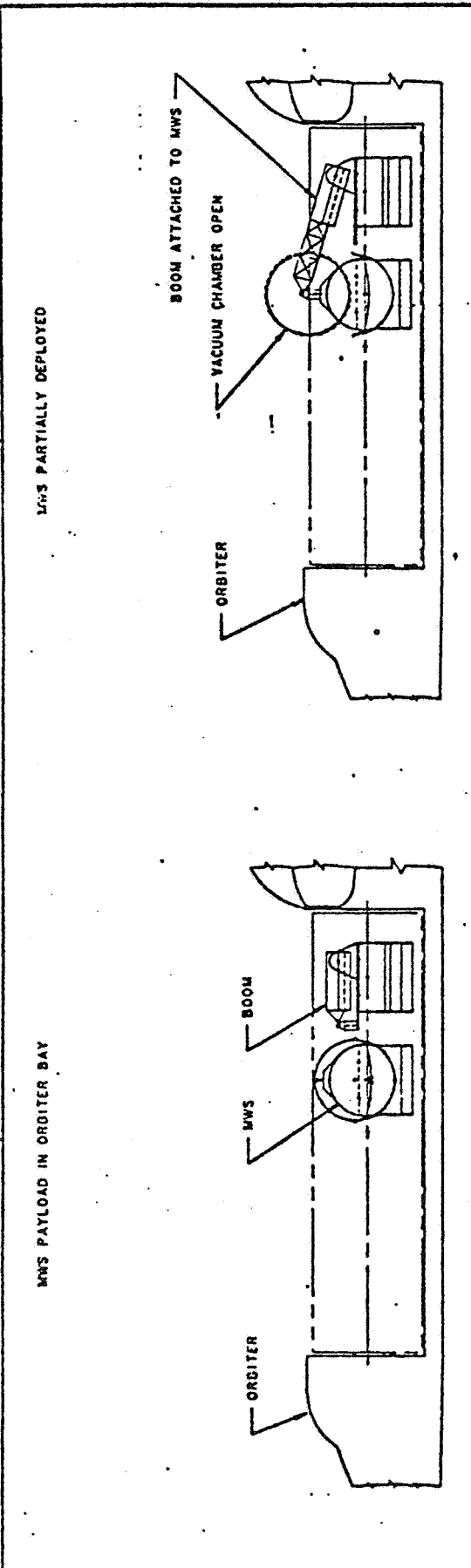

ORGANIZATION: PD12 1341-78	MARSHALL SPACE FLIGHT CENTER SPACE VACUUM RESEARCH FACILITY	NAME: NICAISE
		DATE: MAY 78

MOI X 10 ⁶ N.M.S ²		
IX	STS ONLY	STS + MWS
Iy...	1.200	4.067
Iz	8.658	14.117
	9.267	11.860

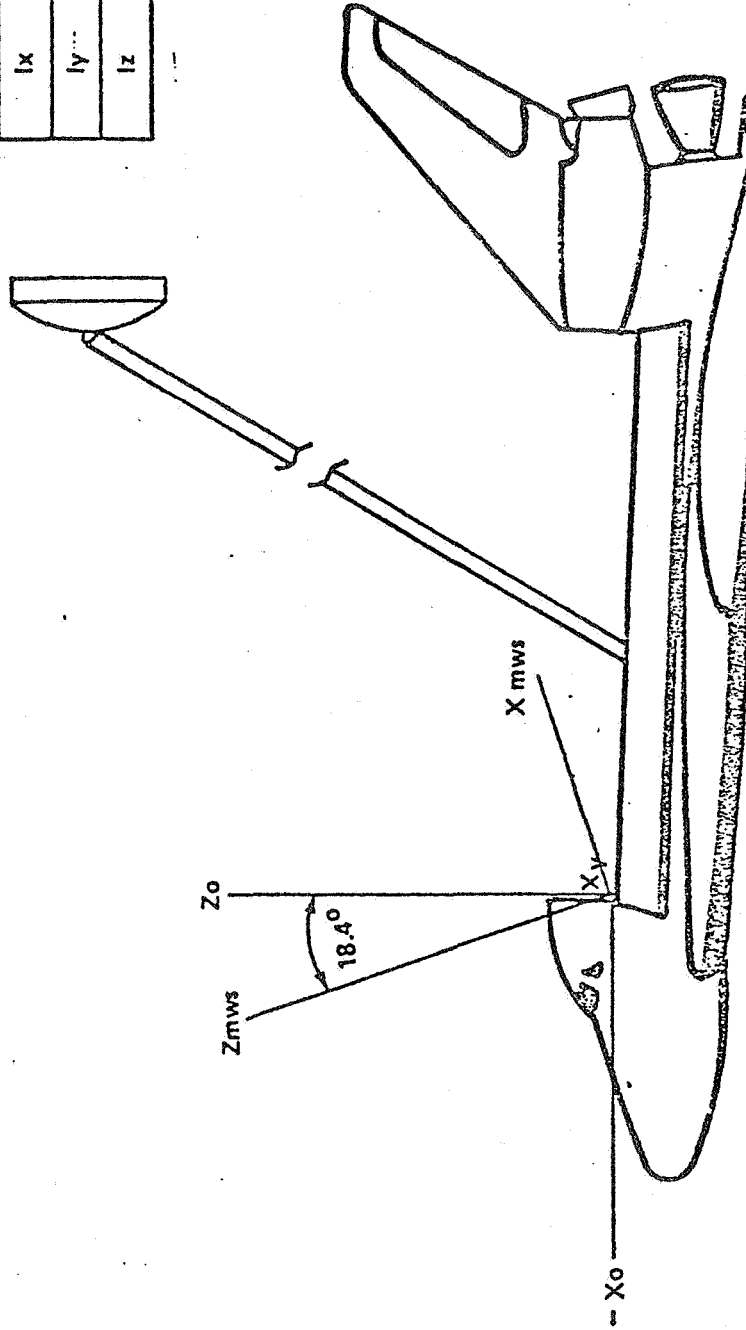

ROTATED PRINCIPLE AXES DUE TO MOLECULAR
WAKE SHIELD

PD23 ORGANIZATION	MARSHALL SPACE FLIGHT CENTER MOLECULAR WAKE SHIELD (MWS) STUDY	NAME	B. LAWSON
		DATE	NOV 1977

BOOM FREQUENCY

f_b = FREQUENCY OF BOOM (Hz)
 l_b = LENGTH OF BOOM (INCHES)
 w_b = WEIGHT OF BOOM (POUNDS)
 w_T = WEIGHT AT END OF BOOM (POUNDS)
 $EI = 5.76 \times 10^8$ FOR 40 INCH DIAMETER BOOM WITH 0.4 INCH RODS

$$f_b = \frac{3.13}{\sqrt{\frac{(w_T + 0.236w_b)l_b^3}{3 \times EI}}}$$

100 METER BOOM	$f_b = 0.01623$ Hz	(61.6 S/C)
75 METER BOOM	$f_b = 0.0253$ Hz	(39.5 S/C)
50 METER BOOM	$f_b = 0.047$ Hz	(21.3 S/C)
30 METER BOOM	$f_b = 0.102$ Hz	(9.8 S/C)

ORGANIZATION: PD 12	MARSHALL SPACE FLIGHT CENTER SPACE VACUUM RESEARCH FACILITY	NAME: NICAISE DATE: MAY 78
------------------------	--	-------------------------------------

FREE DRIFT MODE: INITIAL RATES 0.01 DEG/SEC

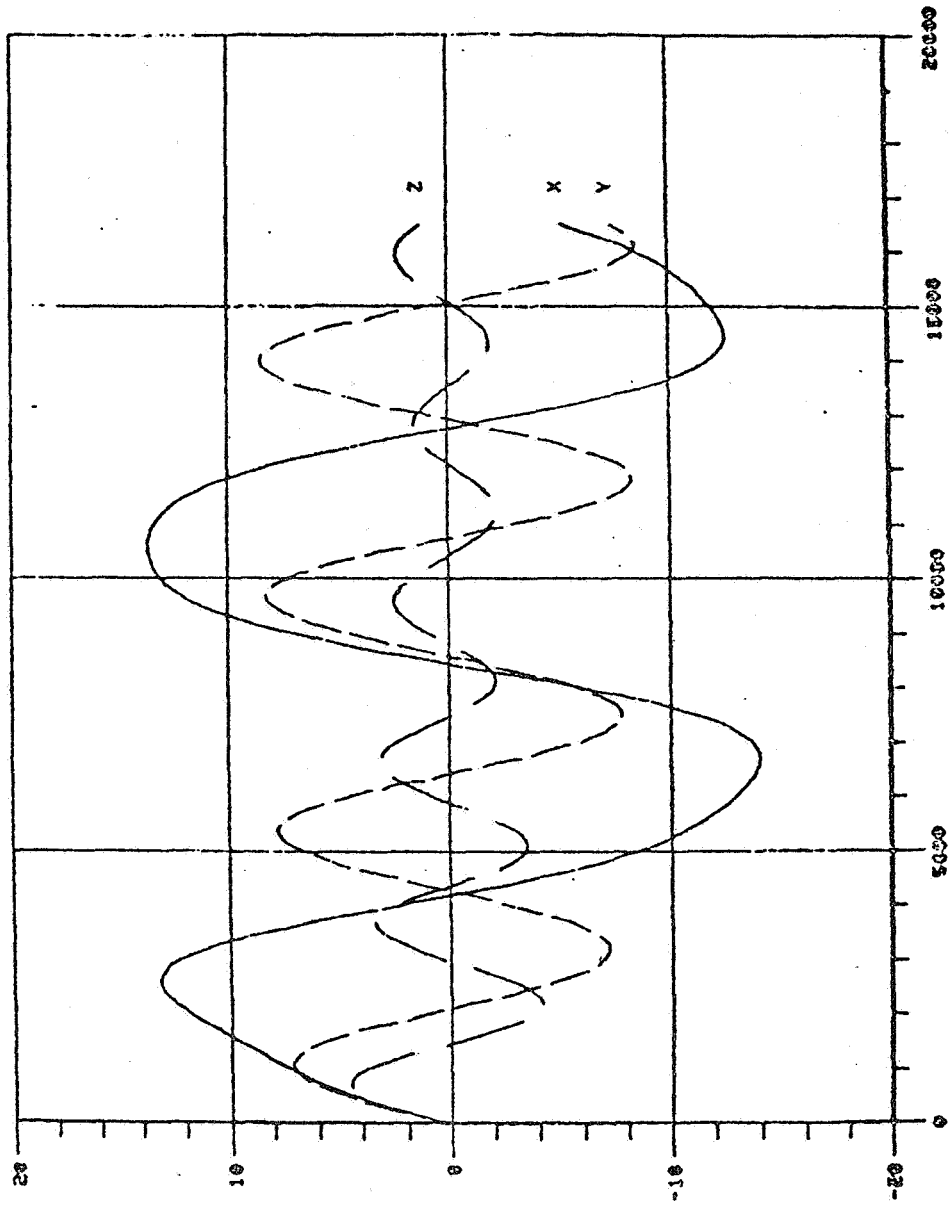

A T T I T U D E E R R O R X D E G

TIME - SEC

<p>ORGANIZATION:</p> <p>PROGRAM DEVELOPMENT</p>	<p>MARSHALL SPACE FLIGHT CENTER</p> <p>SPACE VACUUM RESEARCH FACILITY</p>	<p>NAME: PD33 / PERKINSON</p> <p>DATE: MAY 1978</p>
<p style="text-align: center;"><u>SHUTTLE THERMAL CONSTRAINTS</u></p> <p>SHUTTLE HAS ORIENTATION CONSTRAINTS DUE TO:</p> <ul style="list-style-type: none"> o HEAT REJECTION CAPABILITY o TPS SYSTEM TEMPERATURE LIMITS o HYDRAULIC SYSTEM TEMPERATURE LIMITS <p>CONCLUSION:</p> <p>SHUTTLE ORIENTATION MAY HAVE TO BE VARIED TO MEET SHUTTLE CONSTRAINTS</p> <p style="text-align: center;"><u>SVRF CONTAMINATION CONSTRAINTS</u></p> <p>SVRF EXPERIMENTS REQUIRE VERY LOW CONTAMINATION LEVEL</p> <ul style="list-style-type: none"> o FLASH EVAPORATOR USE RESTRICTED o SHUTTLE ACS USE RESTRICTED o OTHER EXPERIMENTS CONTAMINATE LIMITS UNKNOWN <p>CONCLUSION:</p> <p>EXTENT OF RESTRICTIONS BEING WORKED BY LaRC</p>		

ORGANIZATION

PD12

MARSHALL SPACE FLIGHT CENTER

MOLECULAR SHIELD ON A
GIMBALLED BOOM

NAME:

NICAISE

DATE:

MAY 1978

MINIMUM
INERTIA
AXIS

GIMBALLED
BOOM
BASE

SHUTTLE
DEADBAND
+ 0.5 DEG.

100 M
BOOM

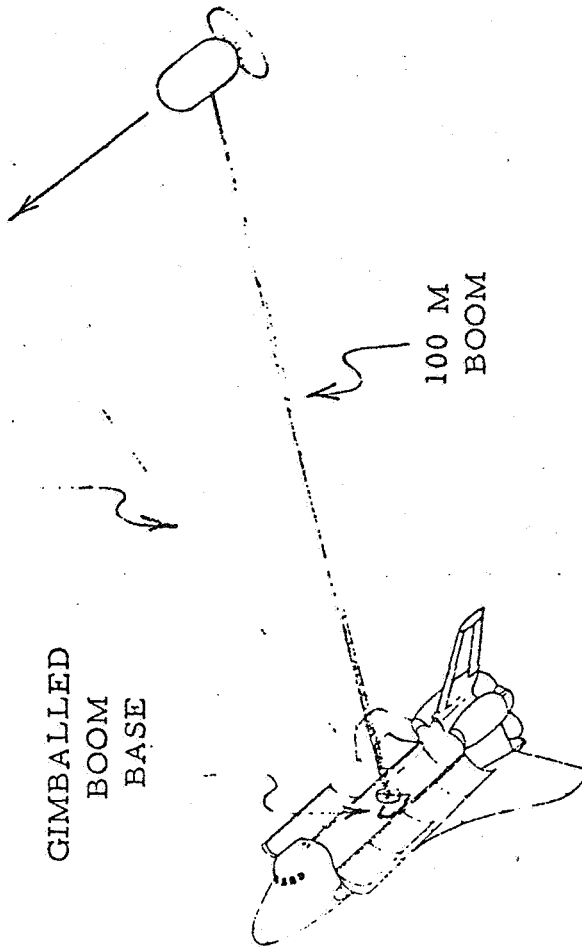

NOTE: SHUTTLE MAY BE REORIENTED FOR THERMAL CONSIDERATIONS WITHOUT INTERRUPTING THE EXPERIMENT. ANGLES BETWEEN SHUTTLE AXIS AND BOOM CAN BE SELECTED TO MINIMIZE THRUSTER OPERATION.

ORGANIZATION:

PD23

MARSHALL SPACE FLIGHT CENTER
MOLECULAR WAKE SHIELD
(MWS) STUDY

NAME:

B. Lawson

DATE:

January 1978

MWS FREE FLYING CONCEPT

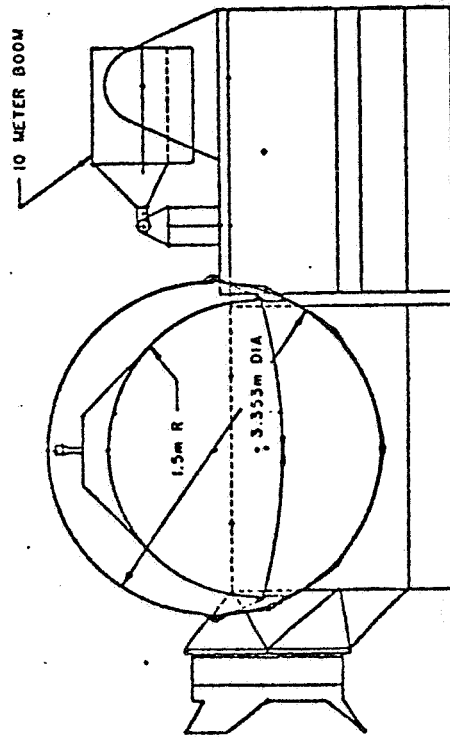

ORBITER WITH MWS FREE FLYING PAYLOAD

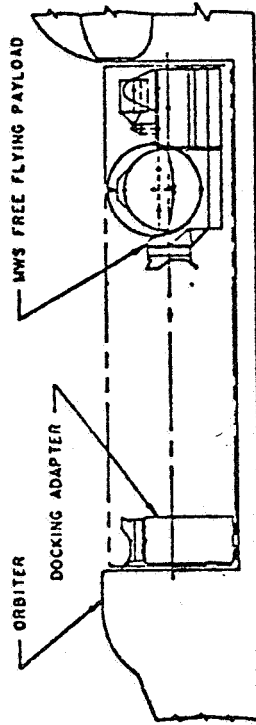

ORBITER DOCKED TO PM WITH
MWS FREE FLYING PAYLOAD

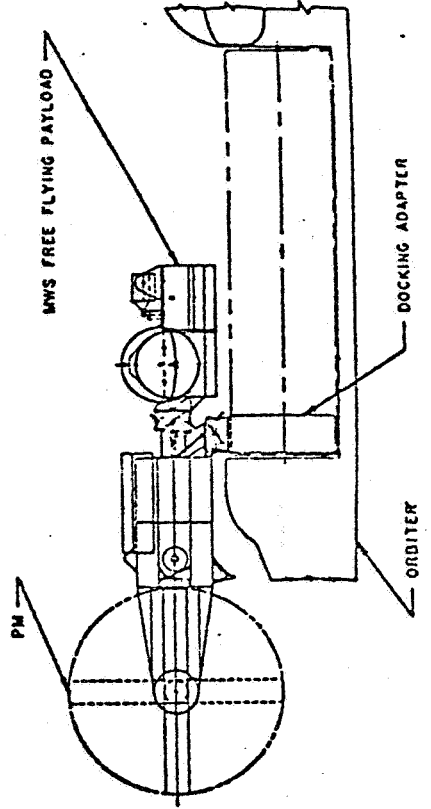
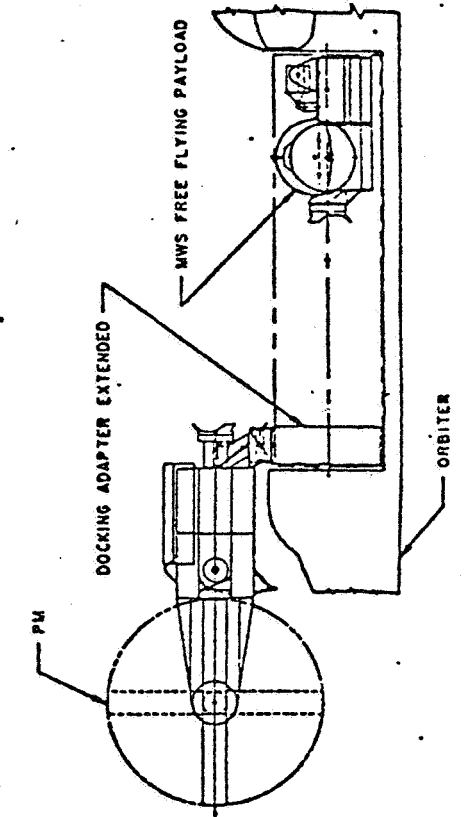

ORGANIZATION: PD23	MARSHALL SPACE FLIGHT CENTER MOLECULAR WAKE SHIELD (MWS) STUDY	NAME: B. Lawson DATE: January 1978
---------------------------	--	---

MWS FREE FLYING WITH PM

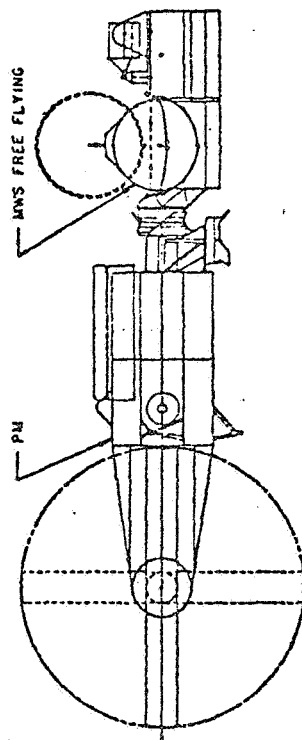

MWS FREE FLYING WITH PM
MWS DEPLOYED

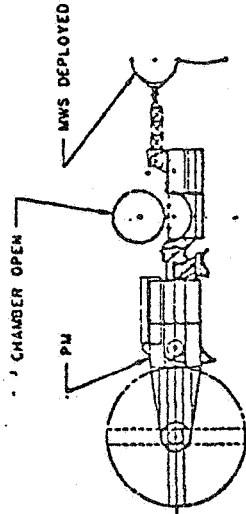

MARSHALL SPACE FLIGHT CENTER

C. FRITZ

NAME

MOLECULAR WAKE SHIELD
(MWS) STUDY

PD22

JAN. 1978

DATE

ORGANIZATION

ON ORBIT BAKEOUT POWER REQUIREMENTS

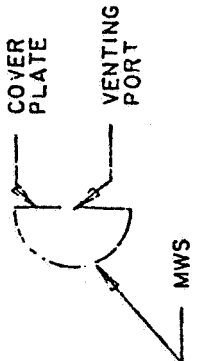
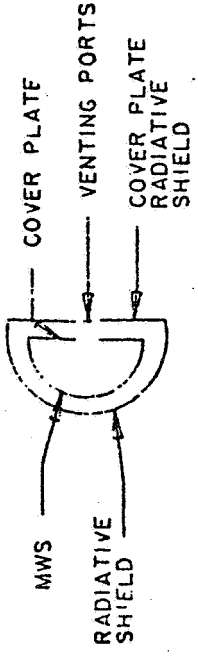
BAKEOUT TEMPERATURE	$\frac{\sigma}{\epsilon}$	BASIC MWS 	MWS WITH RADIATIVE SHIELD 
300° C	$\frac{.24}{.80}$	71 KW	9.3 KW *
	$\frac{.62}{.25}$	22 KW	8.6 KW * 4.1 KW **
400° C	$\frac{.62}{.25}$		25.2 KW * 12 KW **

SHIELD = .10

CONCLUSION

POWER MODULE CAN SUPPLY SUFFICIENT POWER TO BAKEOUT MWS ON ORBIT AND ELIMINATE UHVC REQUIREMENT.

* ASSUME RADIATIVE SHIELD TEMPERATURE OF -273° C

** ASSUME RADIATIVE SHIELD TEMPERATURE OF 10° C

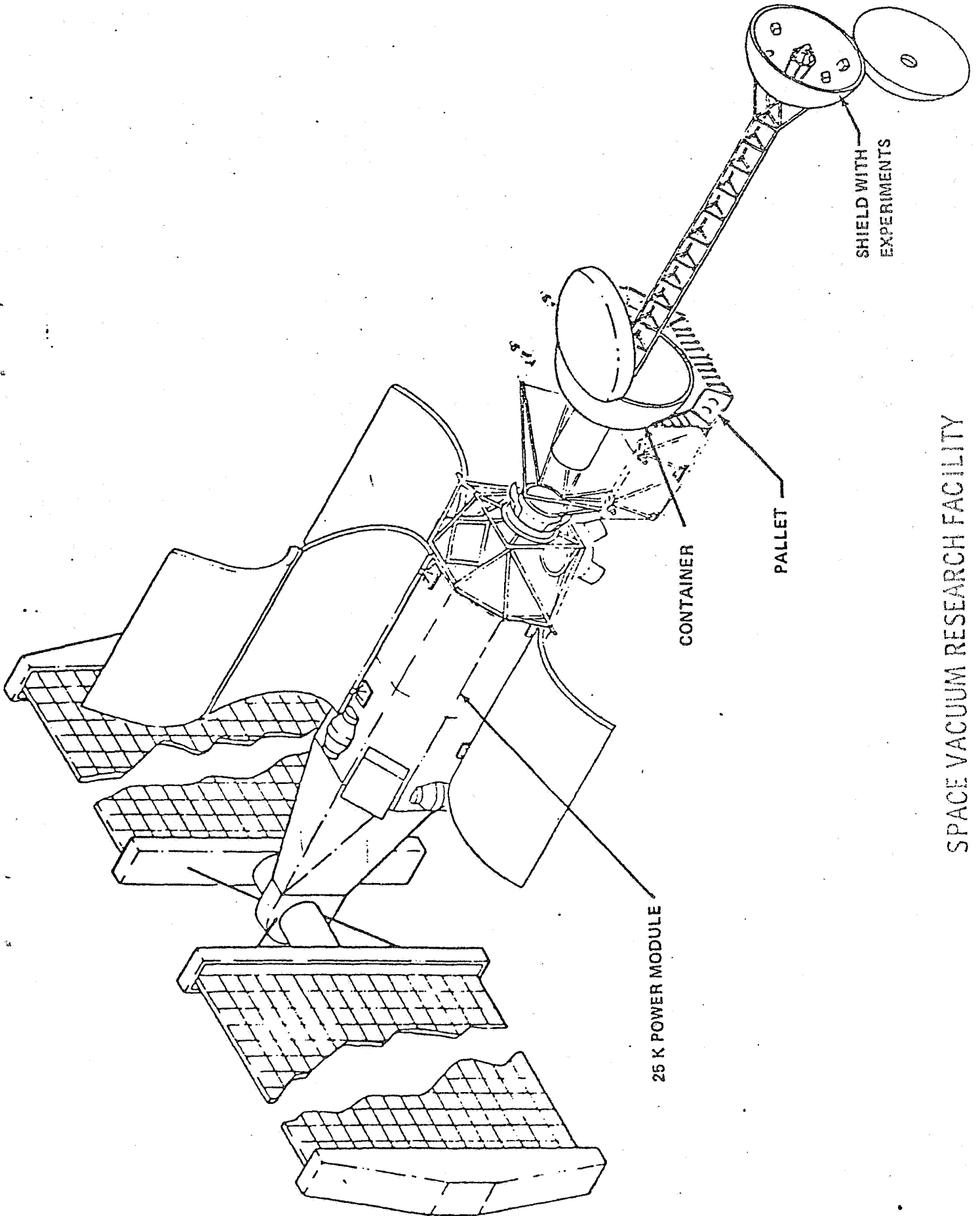

SPACE VACUUM RESEARCH FACILITY

ORGANIZATION:	MARSHALL SPACE FLIGHT CENTER		NAME:
PROGRAM DEVELOPMENT	SPACE VACUUM RESEARCH FACILITY		PD24/MUNDIE
			DATE: MAY 1978
	SHUTTLE PLATFORM VEHICLE (LBS)	SHUTTLE/PM (LBS)	PM PLATFORM VEHICLE (LBS)
SHIELD	547	547	547
EXPERIMENTS	400	400	400
BOOM SYSTEM (100 METER)	905	905	
BOOM SYSTEM (10 METER)			447
GIMBAL SYSTEM	500	500	
ULTRA-HIGH VACUUM CHAMBER	1450	1450	1450
UHVC SUPPORT STRUCTURE	130	130	130
DOCKING MECHANISM			930
DM SUPPORT STRUCTURE			100
SPACELAB SUPPORT EQUIPMENT	2805	2805	1252
PAYLOAD RETENTION MECHANISM	837	837	132
AVIONICS	220	220	220
EPS KIT	1663		
TOTAL	9457	7794	5608
DOCKING MODULE		3777*	3777*

NOTE - 0% CONTINGENCY FOR SVRF PECULIAR EQUIPMENT
 - ASSUMES ONE SET OF PAYLOAD RETENTION MECHANISM ARE ORBITER PROVIDED

* MAY OR MAY NOT BE SVRF CHARGEABLE

ORGANIZATION: PD12	MARSHALL SPACE FLIGHT CENTER	NAME: NICAISE
MOLECULAR SHIELD FREE FLYING MODE		DATE: JAN 78

GRAVITY GRADIENT STABILIZED IN TWO AXES

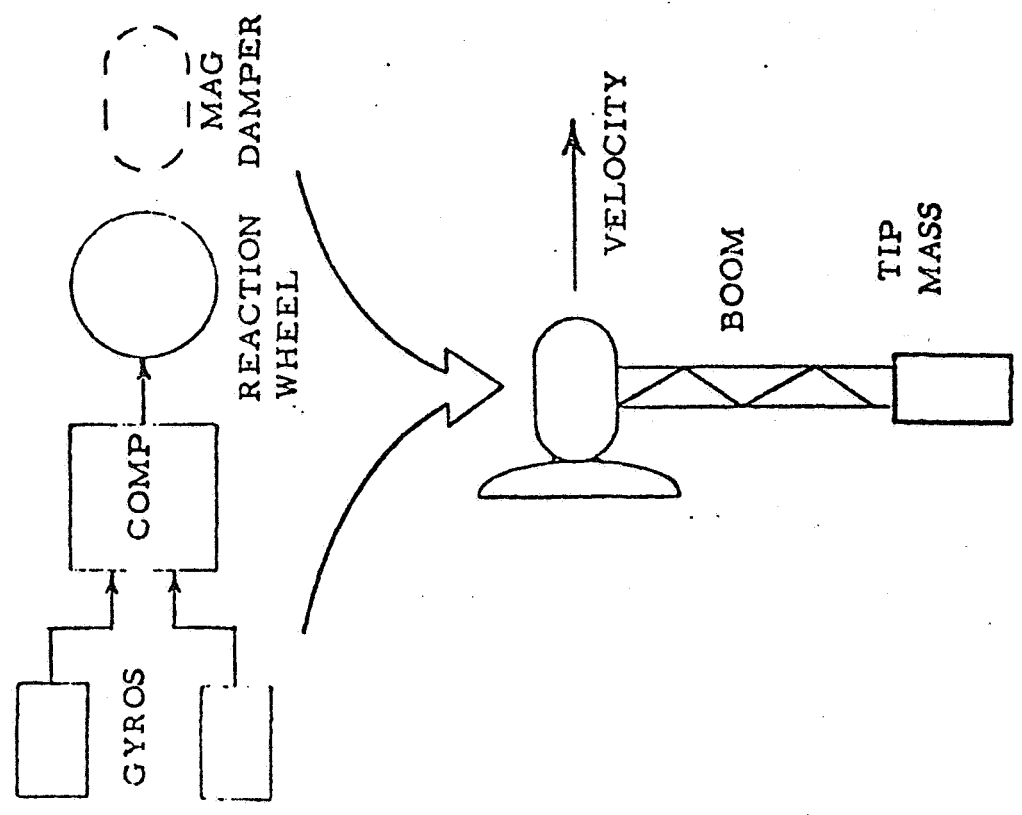

ACTIVE CONTROL IN THREE AXES

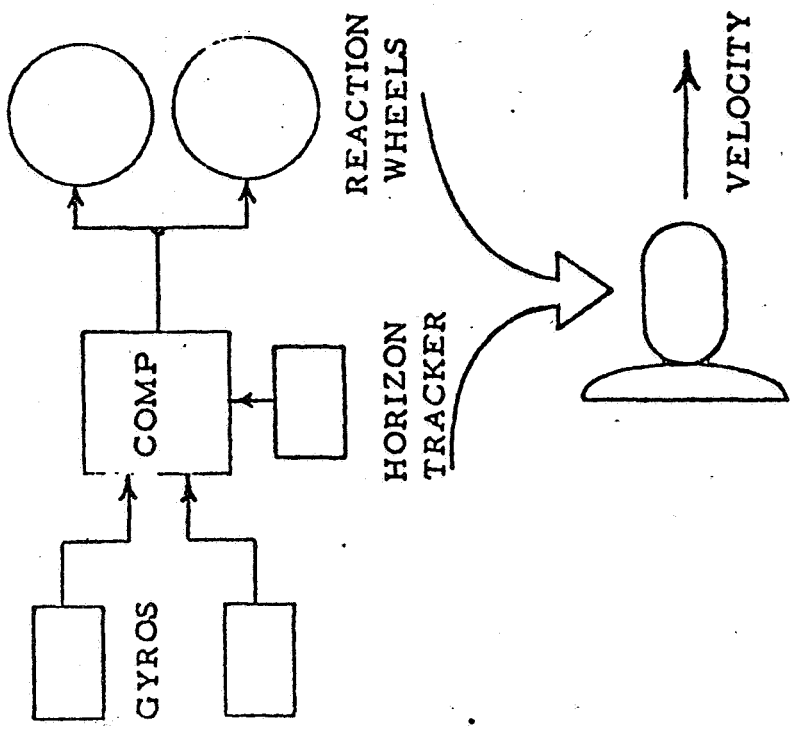

ORGANIZATION

PROGRAM DEVELOPMENT

MARSHALL SPACE FLIGHT CENTER

SPACE VACUUM RESEARCH FACILITY
FREE FLYING WITH MMS SUBSYSTEMS

NAME:

PD33 / PERKINSON

DATE:

MAY, 1978

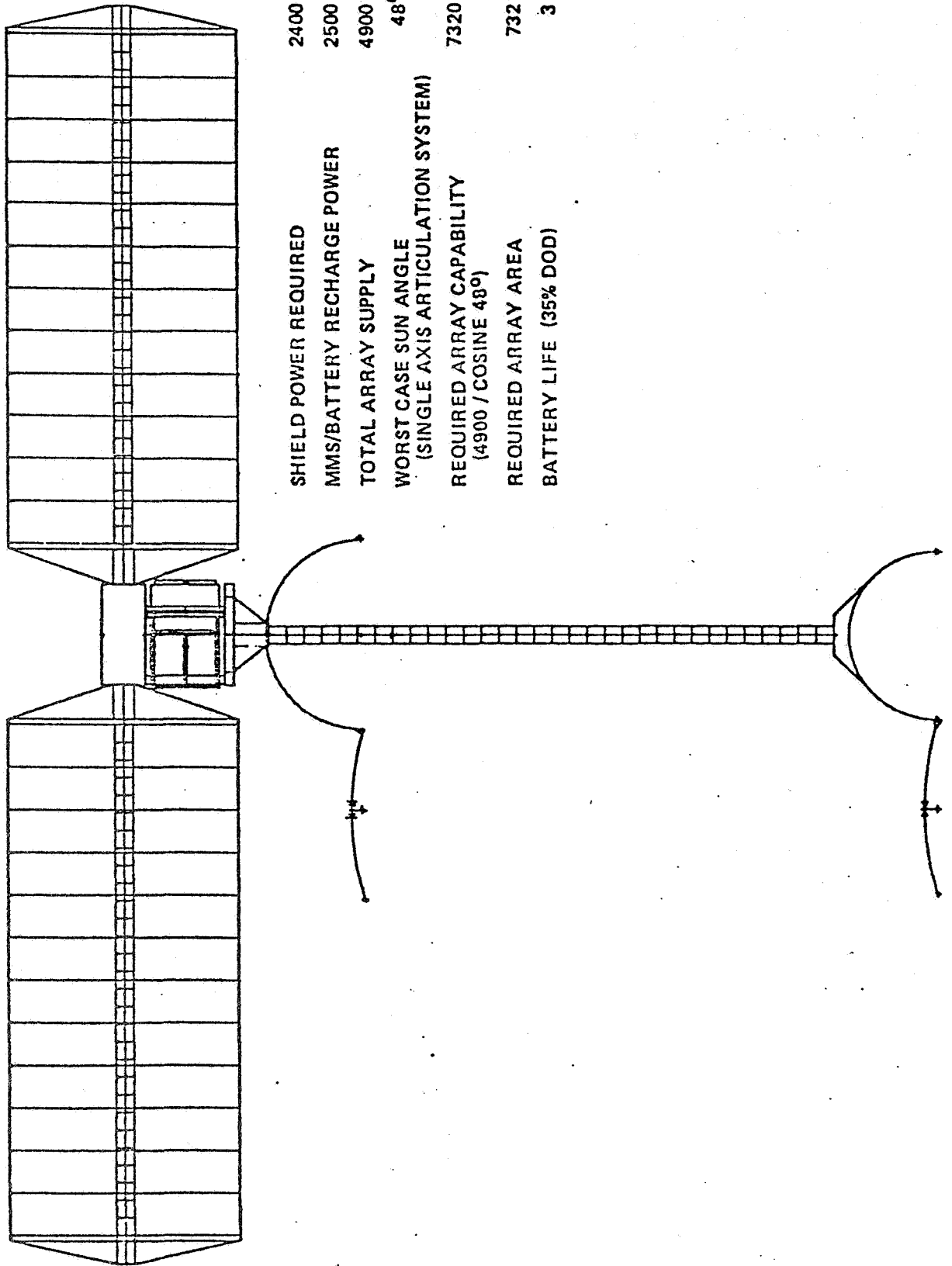

SHIELD POWER REQUIRED 2400 W
 MMS/BATTERY RECHARGE POWER 2500 W
 TOTAL ARRAY SUPPLY 4900 W
 WORST CASE SUN ANGLE 48°
 (SINGLE AXIS ARTICULATION SYSTEM)
 REQUIRED ARRAY CAPABILITY 7320 W
 (4900 / COSINE 48°)
 REQUIRED ARRAY AREA 732 FT²
 BATTERY LIFE (35% DOD) 3 YR.

MOLECULAR WAKE SHIELD

INCL 28.5°
AREA 57.6 M²
620 ft²

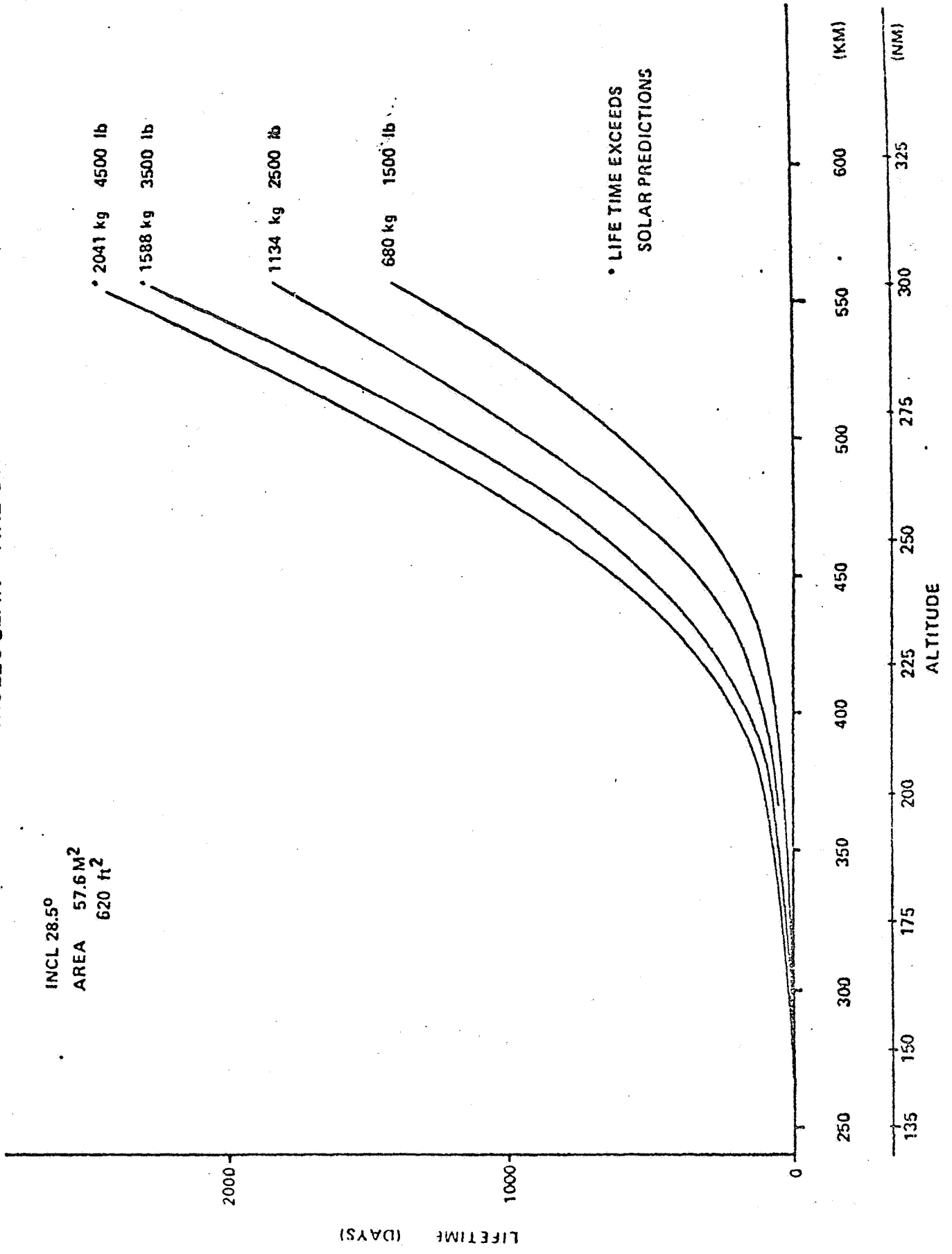

• LIFE TIME EXCEEDS
SOLAR PREDICTIONS

ORGANIZATION: MARSHALL SPACE FLIGHT CENTER	NAME: PD32/SKINNER
PROGRAM DEVELOPMENT	DATE: MAY 1978
SPACE VACUUM RESEARCH FACILITY	

EFFECT OF ALTITUDE AND SOLAR ACTIVITY ON LIFETIME

NOMINAL SOLAR ACTIVITY

	<u>1985</u> <u>DAYS</u>	<u>1980</u> <u>DAYS</u>	<u>ALTITUDE</u>		<u>DELTA</u> <u>DAYS</u>
			<u>KM</u>	<u>N. MI.</u>	
	3.9	2.6	278	150	1.3
	51.9	29.4	370	200	22.5
	450.3	176.9	463	250	273.4
	1803.9	966.9	556	300	837.1

+2σ SOLAR ACTIVITY

	3.0	1.7	278	150	1.3
	35.0	14.3	370	200	20.7
	261.9	70.6	463	250	191.3
	1163.0	313.1	556	300	849.9

FURLABLE WAKE SHIELD

MAHADEVA SINHA

A CONCEPT FOR MWS DEPLOYMENT AND RETRIEVAL

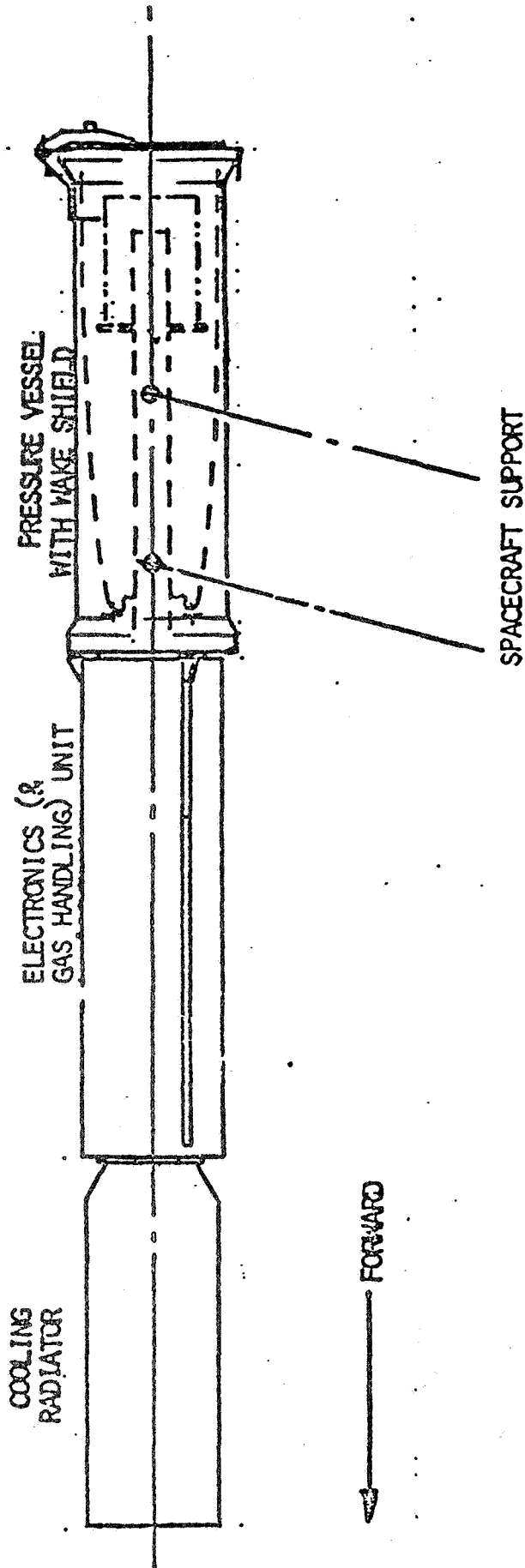

MAIN FEATURES:

1. A FURLABLE WAKE SHIELD (DESIGN BASE: JPL BUILT AND TESTED HIGH-GAIN ANTENNA)
2. VACUUM CONTAINER (PRESSURE VESSEL) HAS SMALL VOLUME, IS EASY TO BAKE OUT ON GROUND (MUFFLE OVEN OR CLAM-SHELL STRIP HEATERS)
3. UNSEALABLE AND RESEALABLE IN SPACE

HNN - 11
78-05-12

TWO MAJOR ASSEMBLIES:

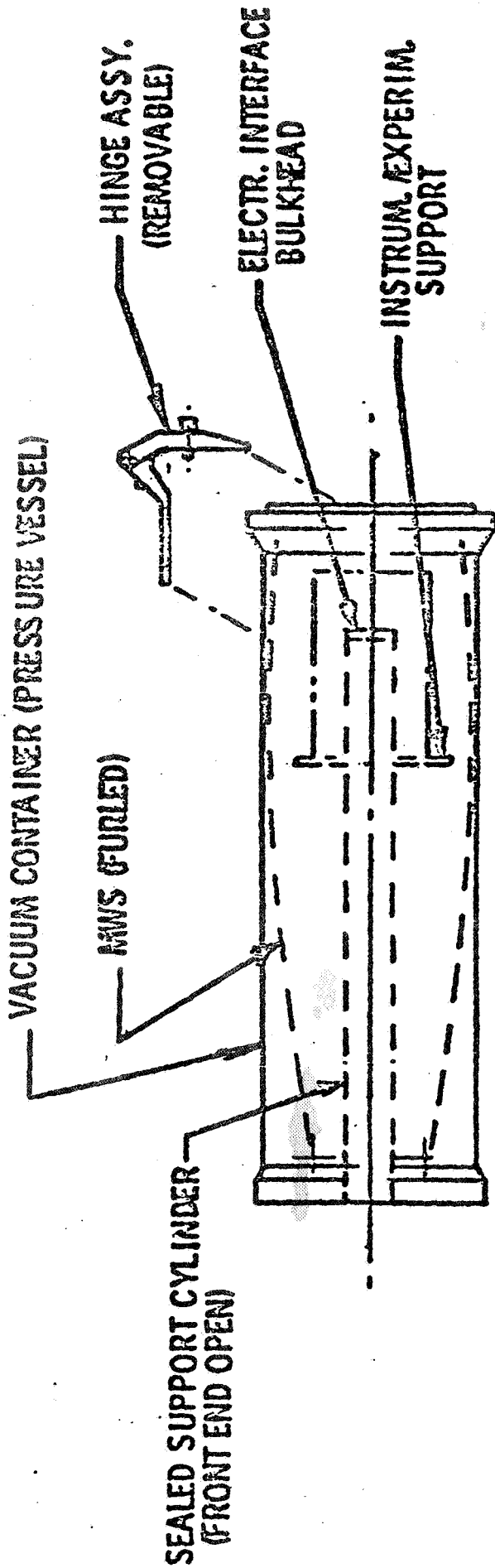

BAKE-OUT ASSEMBLY

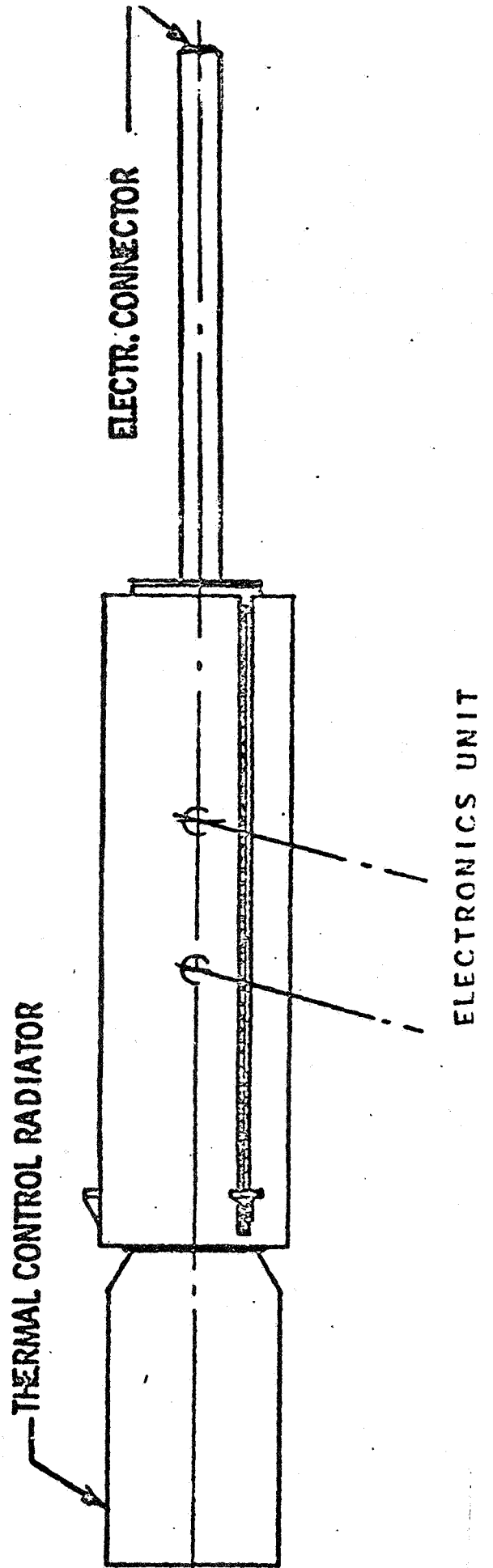

DEPLOYMENT AND RETRIEVAL SEQUENCE

1. SEALS RELEASED, REAR COVER ROTATES

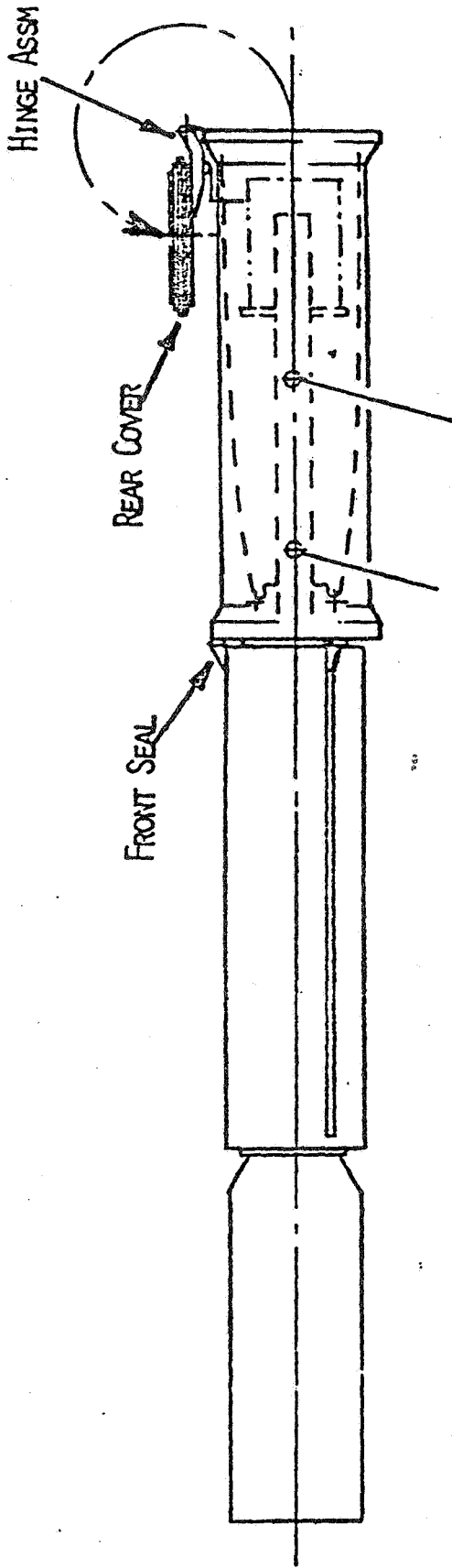

2. PRESSURE VESSEL IS PULLED FORWARD, OVER ELECTRONICS ASSEMBLY

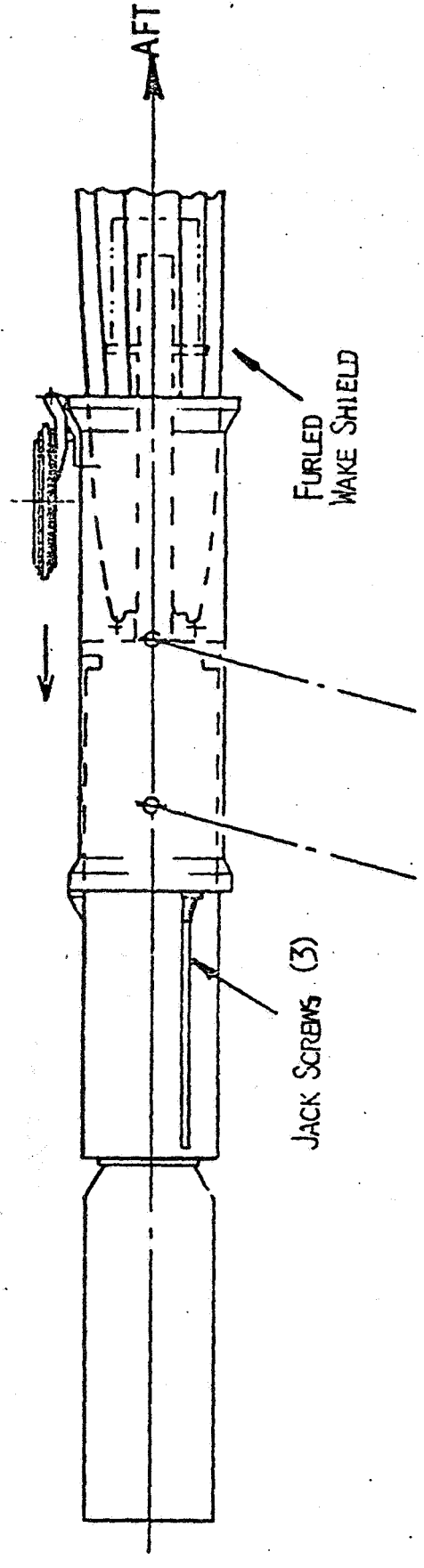

3. MWS FULLY DEPLOYED

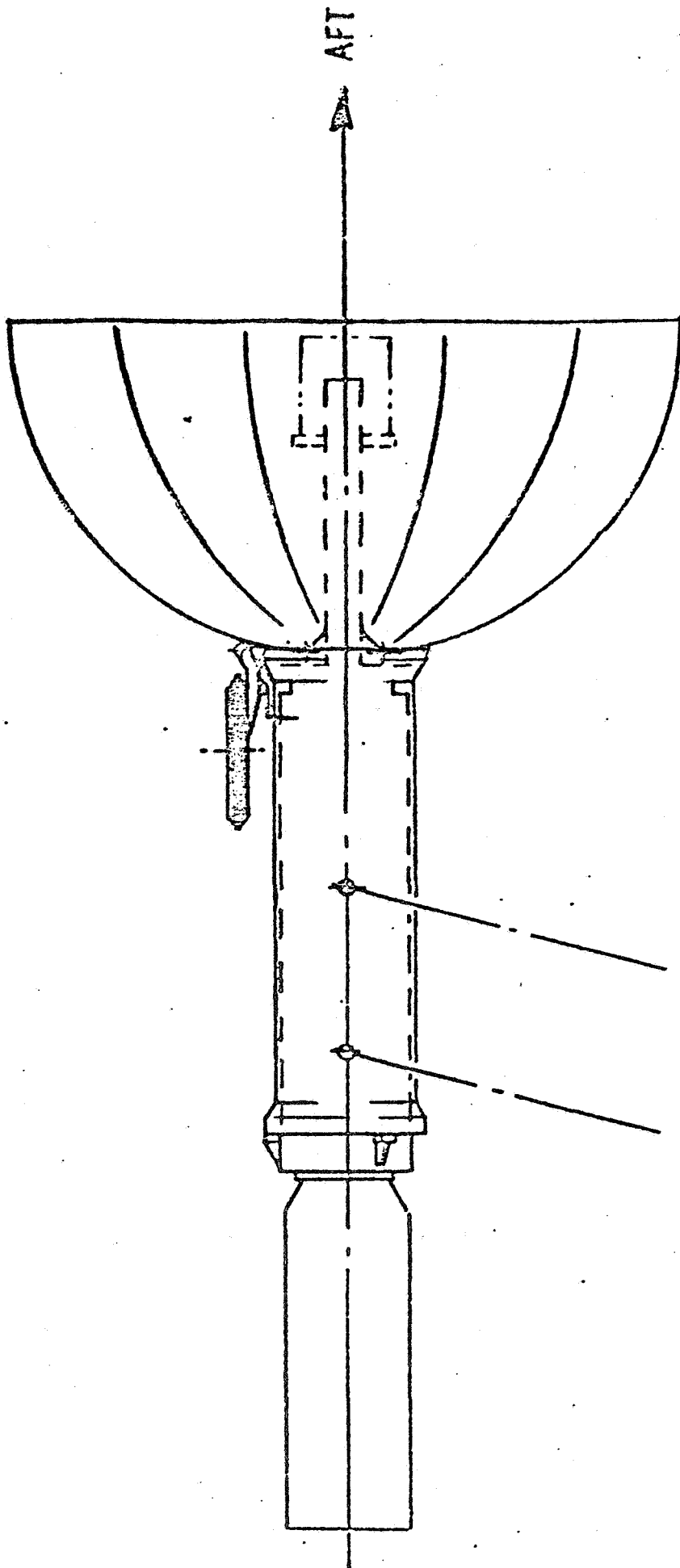

IN ORBIT MEASUREMENTS

KONRAD MAUERSBERGER

In order to verify the very low gas concentration behind the molecular shield, an analysis of the constituents appears to be highly desirable. The only suitable instrument for such an application is a mass spectrometer. It is capable of providing, when properly calibrated, a quantitative analysis of the environment near the molecular shield. Due to the very low concentration of gases expected, a highly sensitive instrument is required.

Over the past decade a number of laboratories have developed and flown instruments on rockets, satellites and planetary probes (Table 1). With some modifications it will be possible to use some of the mass spectrometers as gas analyzers behind the molecular shield. Thus, basically the instrumentation and associated technology is available, however, a number of special features are required which are listed below (see also Table 2):

- 1) The instruments must have an extremely low (self)-outgassing rate in order to obtain true ambient densities. This can be accomplished by using an open source geometry with a small heated filament, and a vacuum sealed electronics.
- 2) In order to detect extremely low ambient densities a multiplier with very low background counts is required. Recently 'Spiraltron' multipliers have shown a long term gain stability with low background count rates.
- 3) Most of the gases to be measured will be within the mass range 1 through about 50 amu (e.g., H_2O , CO , CO_2). This is the range where most of the existing mass spectrometers operate. An extension to higher mass numbers should be possible without extensive developments. Mass peak stepping rather than scanning is required.
- 4) Weight, power and surface area of the mass spectrometer should be small in order to minimize its influence on the operation of the experiments behind the molecular shield.
- 5) Laboratory calibrations should be performed at comparable pressures in order to test the stability and sensitivity of the instrument under low density conditions.
- 6) In the normal mode of operation the mass spectrometer will point toward the molecular shield. Since the instrument itself will produce background gases, a turnable-mount would permit the determination of the background when the mass spectrometer faces into the wake, away from the shield.

Figure 1 shows a magnetic mass spectrometer developed for a high altitude satellite mission (Dual Air Density satellites, Langley Research Center/Univ. of Minnesota). The weight of the instrument was about 11 lb, its power consumption nearly 3 watts. Particle densities below 10^4 cm^{-3} were detected in the laboratory. Similar instruments operating under low pressure conditions were built at the University of Dallas and carried during the Apollo-mission to the surface of the moon.

In Orbit Measurements

Task: Identification of constituents with abundances of
 10^5 to 10^3 cm^{-3}

Constituents: atmospheric: H, (H_2), O, (O_2)
shield: H_2O , CO, CO_2 , hydrocarbon, others

Instrument: Mass Spectrometer:
Magnetic (single or double focussing)
Quadrupole
Monopole

Laboratories: University of Dallas (J, Hoffman)
(with Space University of Michigan (G, Carignan)
Flight Experience) University of Minnesota (A, O, Nier/ K, Mauersberger)
Goddard Space Flight Center (N, Spencer/ H, Niemann)

University of Bonn, Bonn
MPI Heidelberg Germany

Instrument Development: Mass spectrometers have been flown on:
Rockets
Satellites: AE-C, D and E, DADS
Planetary Probes; Pioneer Venus mission

Table 1

Instrument Performance Summary

(Measurements behind molecular shield)

Type: Magnetic or quadrupole mass spectrometer

Ion Source: Open source geometry, electron impact ionization,
variable electron energies, high emission current,
low outgassing material for construction

Collector: Counting multiplier (Spiraltron)

Sensitivity: 3×10^{-5} A/torr (N_2) - typical sensitivity of present instruments

Count Rate: Assume 10^5 cm^{-3} or 3×10^{-12} torr
Current at collector $\approx 10^{-16}$ A
or ≈ 600 C/sec

Background counts of multiplier: Few counts/min

Lower detection limit: 100 C/10 sec or $\approx 2 \times 10^3$ cm^{-3}

Increase of sensitivity: multiple collector system (magnetic instrument)
extended integration time
increased emission current

Reduction of mass spectrometer contamination:

Electronics outside molecular shield

Electronics in vacuum sealed container

Ultra-clean ion source (vacuum cap, source, heater,
small filament)

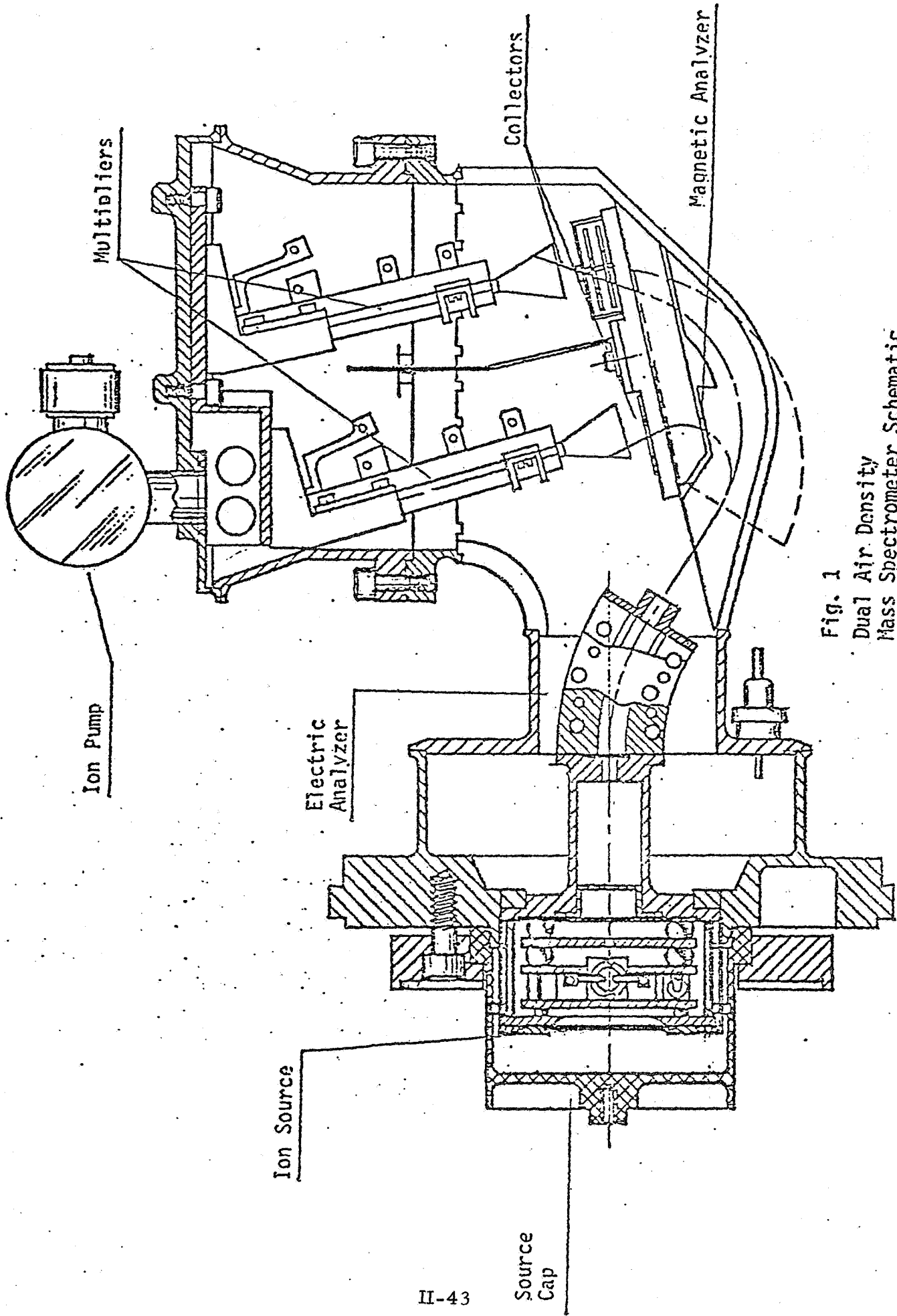

Fig. 1
 Dual Air Density
 Mass Spectrometer Schematic

List of References

- 1) Thorness, R. B. and Nier, A. O., "Device for Remote Opening of a Vacuum System," Rev. Sci. Instrum. 33, 1005, 1962.
- 2) Moe, M. M. and Moe, K., "The Roles of Kinetic Theory and Gas-Surface Interactions in Measurements of Upper Atmosphere Density," Plan. Space Sci. 17, 917, 1969.
- 3) Potter, W. E., and Mauersberger, K., "Spiral Electron Multiplier Characteristics Using Positive Ions," Rev. Sci. Instrum. 43, 1327, 1972.
- 4) Mauersberger, K., and Olson, D. H., "Mass Spectrometer Ion Source Filament Lifetimes in the Presence of Oxygen," Int. J. Mass Spectrom. and Ion Phys. 11, 72-74, 1973.
- 5) Nier, A. O., Potter, W. E., Hickman, D. R., and Mauersberger, K., "The Open-Source Neutral-Mass Spectrometer on Atmosphere Explorer-C, -D, and -E," Radio Sci. 8, 271, 1973.
- 6) Pelz, D. T., Reber, C. A., Hedin, A. E., and Carignan, G. R., "A Neutral Atmosphere Composition Experiment for the Atmosphere Explorer-C, -D, -E," Radio Sci. 8, 277, 1973.
- 7) Hoffman, J. M., Hodges, R. R., Johnson, F. S. and Evans, D. E. "Lunar Atmospheric Composition Results from Apollo 17," Proceed. of 4, Lunar Sci. Conf., 3, 2865, 1973.
- 8) Mauersberger, K., Kayser, D. C., Potter, W. E. and Nier, A. O., "Seasonal Variation of Neutral Thermospheric Constituents in the Northern Hemisphere," J. Geophys. Res. 81, 7, 1976.
- 9) von Zahn, U., Krankowsky, D., Nier, A. O., Mauersberger, K., and Hunten, D., "A Gas Analyzer for the Investigation of the Venus Upper Atmosphere," Space Science Review 20, 451, 1977.
- 10) Mauersberger, K., "Mass Spectrometer Beam System for Application in the Stratosphere," Rev. Sci. Instrum., 48, 1169, 1977.

ON MINIMIZING OUTGASSING OF THE WAKE SHIELD

J. PETER HOBSON

ON MINIMISING OUTGASSING OF THE WAKE SHIELD

J.P. Hobson

Division of Electrical Engineering

National Research Council of Canada

Ottawa, Canada K1A 0R8

I. INTRODUCTION

The Wake Shield will be assumed to be a hemispherical shell 3 metres in diameter of material 3mm thick. When in orbit it is to produce a density of less than 10^3 particles cm^{-3} or 3×10^{-14} Torr at the centre of the hemisphere (assuming room temperature). Its altitude will be 500 Km. According to the calculations of Melfi et al¹ an outgassing rate of 10^{-12} Torr-litres $\text{cm}^{-2}\text{sec}^{-1}$ leads to a pressure of 2×10^{-14} Torr. Thus nominally to achieve 3×10^{-14} Torr an outgassing rate of 1.5×10^{-12} Torr-litres $\text{cm}^{-2}\text{sec}^{-1}$ is tolerable. It should be possible to achieve outgassing rates of this order.

One of the unknowns at this stage are the solar flux conditions to be experienced by the wake shield. These could have a major effect on the outgassing properties of the shield in orbit. Heating could be used for additional outgassing or might cause unwanted increases in density at times. Conversely operation outside direct sunlight for prolonged periods could create temperatures well below 300°K and major reductions in gas density. Here we will assume a temperature in orbit of 300°K (i.e. normal temperature on earth).

II. CHOICE OF MATERIAL

Many materials after bake-out under vacuum reach outgassing rates below 10^{-12} Torr-litres $\text{cm}^{-2}\text{sec}^{-1}$. Yoshikawa et al² gives the

the following values after bake-out at 500°C for 50 hours.

Material	Outgassing at Room Temperature Torr litres cm ⁻² sec ⁻¹
Stainless Steel SS-304L	5 x 10 ⁻¹² H ₂
Stainless Steel YUS 170	6.6 x 10 ⁻¹³ H ₂
Inconel 625	5.5 x 10 ⁻¹³ (mainly H ₂)
Hastelloy - X	2.7 x 10 ⁻¹³ H ₂
Molybdenum	3.8 x 10 ⁻¹³ (H ₂ and N ₂)
Pyrolytic Graphite	1 x 10 ⁻¹² H ₂
SiC coated on to graphite	low but not given

Nuvolone³ reports 5 x 10⁻¹⁴ Torr litres cm⁻²sec⁻¹ for 316L type stainless steel after outgassing at 800°C for 2 hours. However baking in various atmospheres of oxygen at 400°C for 2 hours gave values in the range 3 x 10⁻¹¹ - 3 x 10⁻¹³ Torr litres cm⁻²sec⁻¹. Halama and Herrera⁴ report < 1 x 10⁻¹⁴ Torr litres cm⁻²sec⁻¹ for Aluminum 6061 after discharge cleaning in Ar and O₂; outgassing was almost entirely H₂.

The conclusion is that a number of metals and alloys can be found which satisfy the outgassing requirements for the wake shield after suitable treatments which can be performed on earth. Much supporting evidence exists for this conclusion.⁵ Polymers and rubbers show higher outgassing rates than metals by several orders of magnitude⁵ and unless other compelling considerations intervene these materials can be rejected for the wake shield. Ceramics and glasses are a possibility but would seem to offer no obvious advantages over metals or alloys.

H₂ is the most prevalent gas in the residual outgassing from metals.

From the vacuum viewpoint perhaps aluminum offers the best prospects for the wake shield at present. Outgassing at say 500°C under vacuum for several hours should remove most of the hydrogen from aluminum.

III THE EARTH TO ORBIT VOYAGE

The residual outgassing rates quoted in Section II were measured after substantial processing on earth usually in the same vacuum chambers in which the main outgassing was done. It would in principle be possible to duplicate these chambers on the space shuttle, but since these are relatively elaborate and at times require substantial power this would seem to be unwise unless otherwise dictated. Certainly the possibility of performing the main bulk of the outgassing on earth followed by the voyage from earth to orbit and the subsequent deployment of the wake shield needs to be examined.

It is well known to all vacuum workers that after a vacuum system which has been pumped down is re-exposed to air and repumped it takes some time (hours or perhaps days) to reach the original pressure levels. Yoshikawa et al² report that they outgassed their sample of molybdenum at 500°C for 200 hours in vacuum before subjecting it to their standard measurements of 20 hours pump-down, 50 hour vacuum bake at 500°C, followed by 20 hours pumping. The molybdenum sample behaved essentially as samples of other materials which had received no pre-processing. Nuvolone³ found that samples of stainless steel which were exposed to

atmosphere for 5 months following thorough outgassing required a vacuum bake at 150°C for 20 hours before the original residual outgassing rates were reestablished. The processes involved are probably a combination of physical adsorption, chemical adsorption and solution of gas in the outgassed material upon reexposure to the atmosphere. Nuvolone³ measured an increased concentration of oxides in the residual gas (H₂O, CO, CO₂). It seems likely that most materials will behave in much the same way after reexposure to the air.

The important conclusion from the viewpoint of the wake shield is that if it is thoroughly outgassed on earth, and exposed to the atmosphere during the voyage from earth to orbit it will acquire a gaseous layer which will have to be removed in some way if the original outgassing rates are to be reestablished. There would appear to be two general solutions to this problem:

- (1) To transport the outgassed wake shield under vacuum during the voyage from earth to orbit.
- (2) To transport the wake shield under some type of atmosphere during the voyage from earth to orbit, and to remove the surface layer acquired by the wake shield during the voyage.

These options will now be discussed further.

IV OPTIONS FOR FINAL REDUCTION OF OUTGASSING OF WAKE SHIELD IN ORBIT

(a) Transport of Wake Shield under Ultrahigh Vacuum into Orbit

There is no doubt that the transfer of the outgassed wake shield in the container in which it was outgassed on earth under ultrahigh vacuum, if need be, is technically feasible. A relatively simple

extrapolation of the results of Hobson and Kornelsen⁶ permit this statement to be made with some confidence. All that would be required would be suitable enlarged transfer vessels, gate valves and portable pumps. A sketch of the principle is shown in Fig. 1 and Fig. 2. During outgassing on earth the wake shield would be pumped through an UHV 6" gate valve (which are available commercially) while baking of the transfer vessel and internal heating of the wake shield took place. Following completion of these tests the 6" gate valve would be closed and the transfer vessel disconnected at the mating flange. The uhv in the transfer vessel would be maintained by a small ion pump with an evaporable getter. In this condition the wake shield would make the voyage from earth to orbit. Once in orbit the transfer vessel still under uhv would be deployed into position by the remote manipulator arm or other suitable mechanism. Once in position hinged flange B would be unlocked and deployed to the position of Fig. 2. The wake shield would now be ready for use. The pressure at the target should be at least as low as 10^{-14} Torr. In the event that the oxygen beam in space was needed flange A could be slid aside to permit entry of the beam to the target. Upon completion of experiments flanges A and B could be resealed and the transfer vessel returned to earth under uhv. If need be suitable mechanical design would ensure transfer of targets used in the wake shield to a network of earth-bound surface analytic stations as visualised by Hobson and Kornelsen⁶ maintaining the targets under uhv at all times.

Some uncertainties remain in this conceptual design. The outgassing from the outside of the transfer vessel will cause an

effective increase in local pressure in the vicinity of the wake shield adding to the normal pressure in space at this point. To enter the wake shield molecules from this source must be scattered at least once from gas molecules in the wake of the shield. This source of additional pressure in the wake shield will decline with time (probably at t^{-1}) since it is being pumped away by the space pump of infinite capacity. Further the transfer vessel can remain closed during this time. However mild heating of the transfer vessel or judicious use of solar heating and heat transfer design might aid the process. Conversely at some points in orbit solar heating may make the problem worse. While the repeated use of the uhv seals on a flange as big as flange B may not have been tested in practice there seems no reason in principle why a suitable design cannot be developed. UHV gold seal valves operate reliably after repeated closures. Close positioning tolerances are, however, important.

(b) Secondary thermal outgassing in orbit

This option assumes transfer of the wake shield into orbit with no vacuum protection following primary outgassing. Secondary thermal outgassing is then performed in the deployed position in orbit. Following Nuvolone³ we may estimate that the requirement is for 20 hours at 150°C. A significant fraction of this may be supplied by solar heating but an additional source of power of order 1.5 KW will be required during this period. After this step evaporation of a clean getter film such as Titanium over the whole interior surface of the wake shield might be effective.

(c) Ion Sputtering of Surface Layers

Since ion guns may be part of the surface analytic equipment associated with experiments in the wake shield and hence may make the voyage into orbit independently of any vacuum considerations, it is perhaps worth examining their possible use in removing any surface layers acquired by the wake shield during the voyage.

It is important to have some idea of the thickness of such a layer. If the dominant mechanism of surface contamination is either physical or chemical adsorption then only a few (say 3) atomic layers will be formed. The total material to be sputtered away will be about 3×10^{15} atoms/cm². On the other hand if the dominant mechanism is solution of gas in the solid then the depth of penetration may be much more than a few layers.

Taking the diffusion coefficient of H₂ in stainless steel at room temperature as 10^{-13} cm²/sec and posing the question of the depth of penetration of dissolved H₂ into stainless steel in 24 hours we find from

$$x^2 = Dt$$

$$x = 10^{-4} \text{ cm} = 10^4 \text{ \AA} .$$

Thus in this case we must eliminate H₂ from several thousand atom layers of material and it is quite likely that dissolved gas contributes in a major way to the re-outgassing always found after exposure of outgassed material to the atmosphere. Several thousand layers of material represents some 10^{18} atoms/cm². Area of inside surface of wake shield is 2.8×10^5 cm² giving a total of 2.8×10^{23} atoms to be sputtered. Assuming

an ion beam of 1 mA (i.e. 6.2×10^{15} ions/sec) and a sputtering coefficient of unity it would take some 3×10^7 secs \approx 1 year to sputter clean the surface. Following this step some annealing would be required to remove the sputtering gas. The latter operation would be comparable to the secondary thermal outgassing in orbit considered briefly under (b) above. Thus we conclude that sputtering of the contaminated layer does not show promise.

V CONCLUSION

It is concluded that a density of 10^3 particles cm^{-3} in the wake shield is practical by vigorous outgassing of the shield on earth under vacuum, by shipping the wake shield into orbit under ultrahigh vacuum, and if necessary performing minor thermal treatments in situ in the deployed position. Evaporation of a thin layer of clean getter material on the inside surface of the shield might be effective. Aluminum would be a promising material for the wake shield itself.

Return of the wake shield to earth under ultrahigh vacuum together with samples from its experiments to be examined in earth based uhv surface analytic systems is within the current state of the art.

REFERENCES

- 1) L.T. Melfi, Jr., R.A. Outlaw, J.E. Hueser and F.J. Brock, J. Vac. Sci. Technol. 13, 698, 1976.
- 2) H. Yoshikawa, Y. Gokay, Y. Sugiyama, M. Mizuno, S. Komiya, and T. Tazima. Proc. 7th Internat. Vac. Congr. and 3rd Internat. Conf. Solid Surf. (ed. R. Dobrozemsky) p.367, Vienna, 1977.
- 3) R. Nuvolone, Proc. 7th Internat. Vac. Congr and 3rd Internat. Conf. Solid Surf. p.217 (ed. R. Dobrozemsky) Vienna, 1977.
- 4) H.J. Halama and J.C. Herrera, J. Vac. Sci. Technol. 13, 463, 1976.
- 5) R.J. Elsey, Vacuum 25, 347, 1975.
- 6) J.P. Hobson and E.V. Kornelsen. Proc. 7th Internat. Vac. Congr. and 3rd. Internat. Conf. Solid Surf. p. 2663 (ed. R. Dobrozemsky), Vienna, 1977.

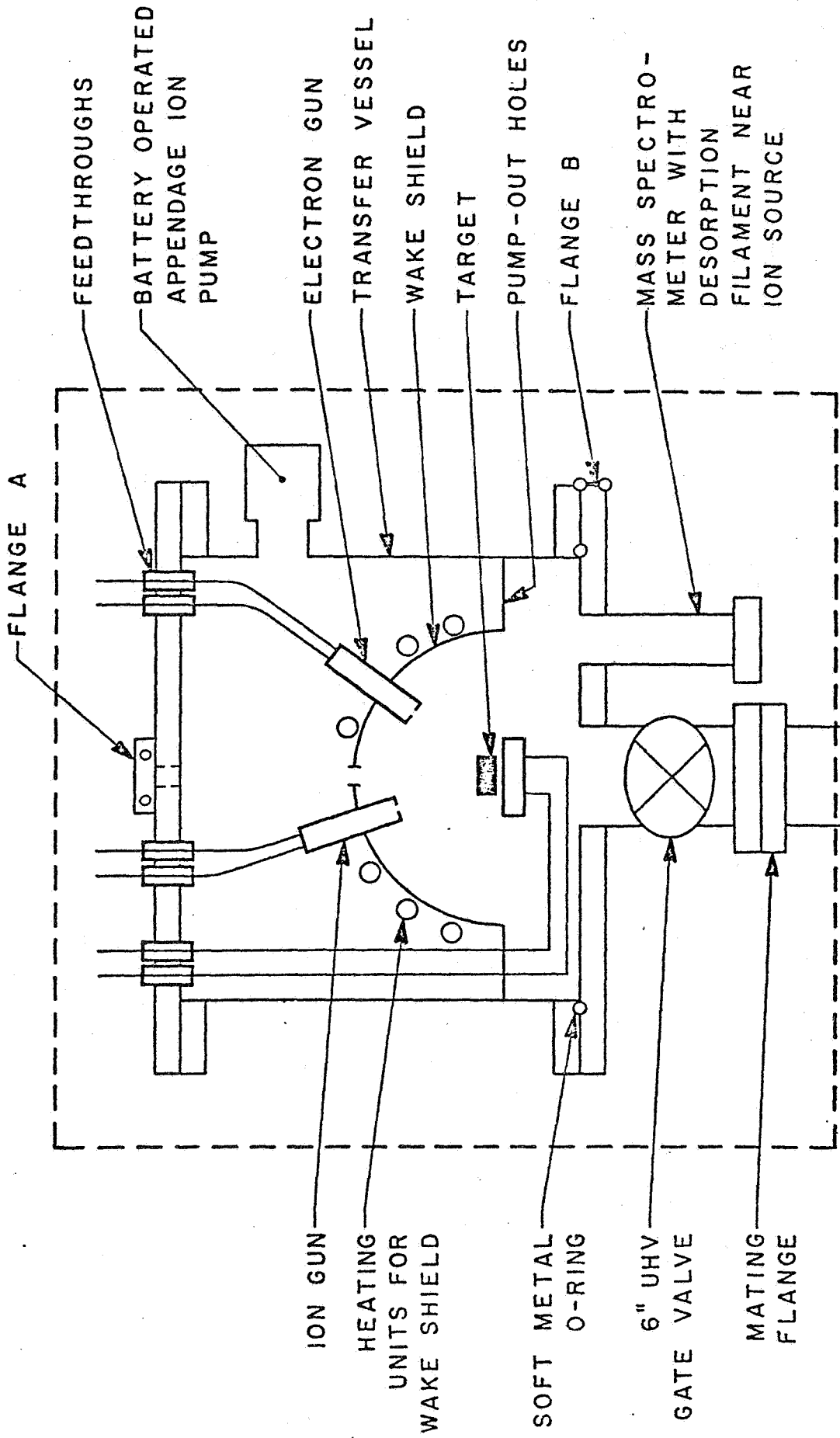

TO UHV
PUMPING STATION
FIGURE 1

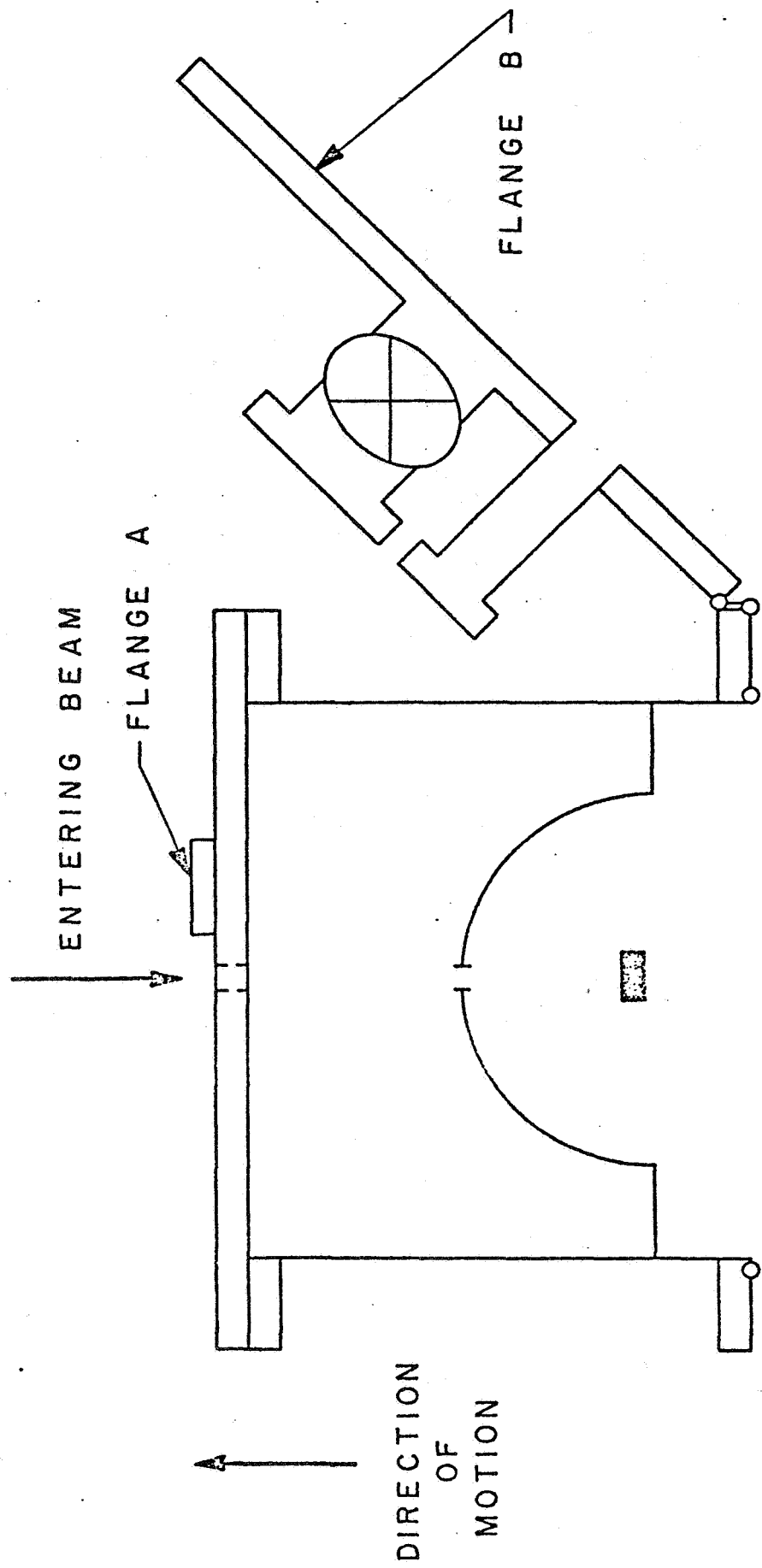

Figure 2

A TARGET TRANSFER SYSTEM AT ULTRAHIGH VACUUM

J.P. Hobson and E.V. Kornelsen

National Research Council of Canada, Ottawa, Canada K1A 0R8

Abstract: A system permitting the transfer of a target from one ultrahigh vacuum (uhv) system to another while maintaining the target at a pressure $<10^{-9}$ Torr at all times has been developed. Both uhv systems have base pressures $<10^{-10}$ Torr while the excursions to 10^{-9} Torr are of short duration, being caused mainly by mechanical motions, and consist primarily of methane. Transfers currently take about 3 - 4 hours. The objective of the transfer system is to permit surface analysis by a multiplicity of techniques on the same target with minimal change in target surface conditions. The conventional approach to this problem suitable for a single experimenter, is to build several techniques in the same uhv system (the multiport concept). However as the number of techniques and experimenters increases a transfer system provides many advantages, which will be described in the paper. The system as developed, is not limited to transfers between systems in the same laboratory, but permits transfers between systems in remote laboratories anywhere on earth and even, in principle, between earth and space.

INTRODUCTION

The typical modern ultrahigh vacuum (uhv) surface analytic system is a multiport chamber each port introducing a different facility for the analysis or treatment of a small sample or target under investigation¹. In a laboratory with several investigators each tends to demand such a multiport system containing as many ports as possible in order to have as many options as possible. There exists in principle an alternative to this situation, suitable for several experimenters, which to date has received little development. This alternative is to transfer the target from one uhv surface analytic system to another keeping the target under uhv at all times. This concept has several powerful advantages:

- 1) The number of techniques that can be brought to bear on the sample is in principle very large, exceeding the capability of any multiport system or even several such systems.
- 2) Only one apparatus of each type used in analysis or treatment is necessary in the laboratory thus reducing expense.
- 3) All systems can be used simultaneously improving the efficiency of use of manpower and apparatus.
- 4) Repair of an existing system or the building of a new system can be done independently of the others.

5) The systems are not constrained to be close together, permitting examination of a sample with minimal contamination by laboratories anywhere in the world equipped to accept a transfer. This feature could be of importance in standardizing surface measurements.

6) In addition to the use of the transfer system in local applications there are several related applications to which the system might be readily adapted. These include: The preparation of a surface in a large facility (e.g. an accelerator or a neutron generator) and its subsequent transfer to a surface analytic facility, the transfer of a sample from a small laboratory (e.g. a university professor's laboratory) to a surface analytic facility, the transfer of a sample from earth to a space shuttle and vice-versa, the transfer of a sample from one manufacturing chamber to another.

7) There are also potential possibilities of using the system as a versatile tool under ultrahigh vacuum (e.g. as a screwdriver or as a welding electrode).

There are also serious disadvantages:

- 1) The transfer system introduces technical complexity and risk.
- 2) Constraints are imposed on the design and accessibility of sample mounts in the users system.
- 3) It is not known whether the necessary degree of cooperation to make the

transfer system effective will be found amongst any typical group of experimental researchers.

4) Criteria for making the system worth while in actual practice are not known.

After weighing the advantages against the disadvantages the authors decided to attempt to build such a target transfer system at ultrahigh vacuum. This paper reports the results achieved to date.

A TARGET TRANSFER SYSTEM AT UHV

Three new surface analytic systems were designed to be compatible with the transfer device. They were an ion bombardment apparatus, an advanced version of an apparatus developed over several years by Kornelsen², a Reflection High Energy Electron Diffraction (RHEED) apparatus combined with Auger Electron analysis (AES) of the type developed by Armstrong³ and an Ultraviolet Photoelectron Spectroscopy (UPS) apparatus⁴, a new research area for the laboratory being developed by Moore. In our laboratory the concept is visualized in Fig. 1. To date the ion bombardment apparatus is complete, the RHEED-AUGER and UPS apparatus are perhaps 80% complete, while the first working prototype of the vacuum transfer device is complete and has been used to transfer targets between the ion bombardment apparatus and the general purpose test apparatus adapted to accept transfers. The

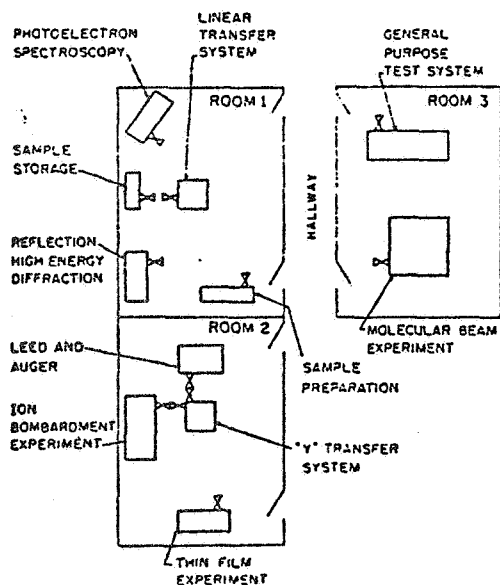

Fig. 1. Futuristic concept of UHV facility at N.R.C. showing surface analytic systems adapted to accept vacuum transfer device.

Y-transfer system shown in Fig. 1 represents a future development of the system not yet designed in detail in which a target is transferred in a relatively short time (~ 5 min) between two systems sharing the same ultrahigh vacuum environment. The transfer system itself is shown schematically in Fig. 2. Suppose that the gate valves are closed and the vacuum transfer device, the intermediate chamber and the analytic apparatus (at the right in the diagram) are all at uhv. The

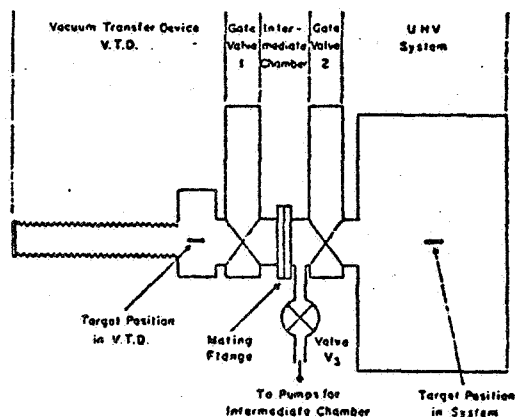

Fig. 2. Simplified schematic of Vacuum Transfer Device coupled to an Ultrahigh Vacuum System typically containing surface analytic equipment.

problem is to extract a target in the uhv apparatus and put it into another uhv apparatus. The first step is to open the gate valves which yields a physical opening of 1.4" diameter (3.5 cm). The tweezers attached to the long bellows then move from the V.T.D. to the target, suitably mounted on a ring, pick up the target and retract it back into the V.T.D. The gate valves are then closed, the intermediate chamber isolated from its pump and the system broken physically at the mating flanges, allowing the atmosphere to enter the intermediate chamber. At this moment the pressure ratio across the gate valves is some 10^{13} and they must have a leakage conductance for helium of less than 10^{-13} litres sec^{-1} . The achievement of this conductance has been one of the major problems of the development to date but the three valves constructed have been achieving these conductances most of the time since June 1976. With the system broken at the mating flanges the V.T.D. can be transported to a remote location where it is coupled with a gold O-ring to an uhv system equipped with a matching mating flange. The intermediate chamber must now be pumped from

atmosphere to uhv before the gate valves can be opened and the target transferred from the V.T.D. to the new system. This pumpdown is done with a series of pumps of increasing low-pressure capability operating sequentially while the intermediate chamber is heated to 200°C for several minutes. During heating it is necessary to cool the downstream sides of the gate valves to prevent the pressure rising too high in the uhv systems. The pump-down of the intermediate chamber from atmosphere to 10^{-10} Torr has been achieved in one hour but a more typical time is 1 1/2 hours. Automation of the pump-down should reduce this time and make it reproducible. The results of a typical run including the steps described above is shown in Fig. 3. Note that the pressures in the V.T.D. and the apparatus at all times stayed below 10^{-9} Torr and that excursions near this value occurred in pulses which pumped away in a few seconds. These pulses arise from mechanical motions

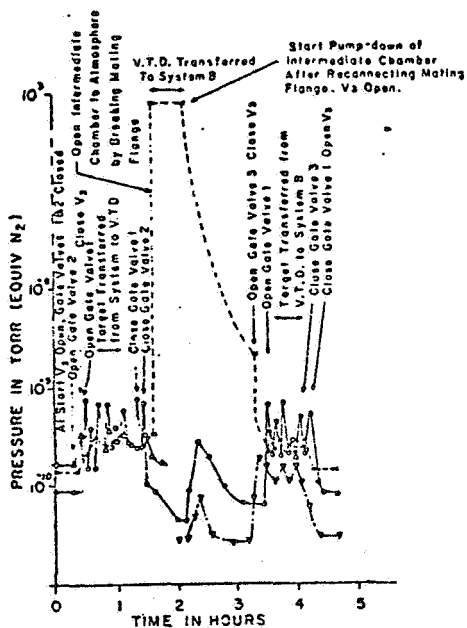

Fig. 3. Pressure variations in the sections of Fig.2 during a transfer: o Vacuum Transfer Device; x Intermediate Chamber; Δ Ultrahigh Vacuum System A; ∇ Ultrahigh Vacuum System B.

and the gas contained in them is 95% methane which is not readily chemisorbed on metal surfaces. Note also that exposure of the intermediate chamber to atmosphere produced no apparent effect on the pressures in either the V.T.D. or the uhv system indicating that the gate valve

conductances when closed were adequately low. The procedures have been refined so that an exchange of targets between two separate systems is being achieved in a full working day with pressure conditions comparable to those shown in Fig. 3. An exchange involves two pick-ups, two deposits and two pump-downs, roughly twice the number of operations shown in Fig. 3.

While the total pressure is a useful indication of the performance of the target system, the state of the target surface is in general more important. This was checked in the experiment in Fig. 3 by flash desorption. While the target was in the uhv apparatus a standard series of flash pulse heights as a function of the target cold time were taken allowing the smooth curve of Fig. 4 to be plotted. The desorbing gas was found to be almost all H_2 . The target was flashed clean just before the transfer and then flashed again after its return to the system 7 hours later. The result is plotted as a circle in Fig. 4. This circle lies below the smooth curve indicating that the target adsorbed

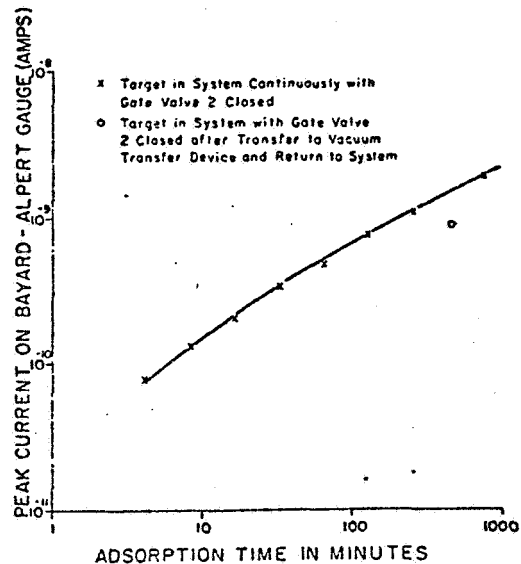

Fig. 4. Flash Desorption of Target in Ultrahigh Vacuum Systems - x Target remaining continuously in system; o after complete transfer

less during all the steps of the transfer than it would have adsorbed if it had stayed in the same uhv apparatus for 7 hours. This result has not always been obtained, but it can be said in general that no more than a monolayer of H_2 is currently being adsorbed on a target during a transfer from one stainless steel

system to another. For experiments in which this degree of contamination is important some means must be present to remove this monolayer. Normally a flash to 500°C is sufficient.

PHYSICAL CHARACTERISTICS OF THE TRANSFER SYSTEM

The standard item physically transferred from one system to another is a disc 2.3 cm in diameter and 1 mm thick. Every uhv system capable of being part of the transfer network must be able to accept either this disc or an item geometrically similar to it. The disc is gripped and released by tweezers as shown in Fig. 5. In our system the target is mounted on the disc as also shown in Fig. 5. However the exact method of mounting the target on the disc is not dictated by the transfer system. It is likely to depend on each

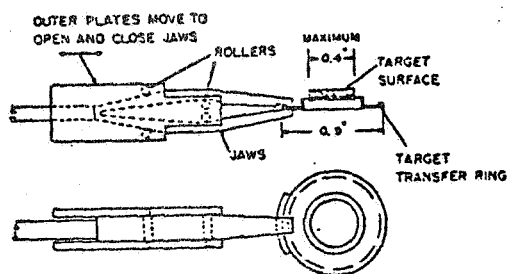

Fig. 5. Target Ring and Tweezers

specific apparatus and the operations to be performed on the target in that apparatus. While the transfer tweezers have several degrees of motion for deposition (or removal) of the target disc from a platform in the system it is not intended, in general, that experiments be performed with the target still in the tweezers. Complex target motions and electrical supplies are to be built into each specific apparatus as they are at present. The only new feature introduced by the target transfer system is the capability of accepting a transfer. This requires a port along the line of the transfer axis, generally (but not necessarily) horizontal. The system is designed for a 7 cm (2 7/8") standard conflat port allowing a "throw" from the face of the flange of 10 cm (4"). A special but quite simple port allows this throw to be increased to 15 cm (6").

To the left of the mating flange in Fig. 2 is the true vacuum transfer device. It is 89 cm (35") long, 38 cm (15") wide and 30 cm (12") high. The evacuated volume

is ~ 0.52 . It is a portable uhv system pumped by a small battery-operated ion pump and a titanium getter. Total weight is 23 Kg (50 lbs) and it can be carried by one person. It can easily be put into an automobile or aircraft for transport to a remote location. Stable pressures below 10^{-10} Torr have been maintained for weeks. There are two storage positions for targets in the V.T.D. For transfers internal to our laboratory the V.T.D. rests on top of a pumping station on wheels which rolls between rooms. The transfer axis is 112 cm (44") from the floor, although once again this is not a rigid constraint: our test system has a transfer axis 53" from the floor, and gives no difficulty. The pumping station which has to be attached to Valve V3 in Fig. 2 must have uhv capability for pumping the intermediate chamber. The exact design of this pumping station is not dictated by the transfer system and it is anticipated that users might well have local pumping equipment which could be adapted to the task.

SUMMARY

The first working prototype of a target transfer system at ultrahigh vacuum has been demonstrated. While a period of modification is anticipated, it is clear that a technological base has been established which could eventually lead to a worldwide (and even space-wide) network of ultrahigh vacuum systems. Within this network, samples could be transferred with a minimum of contamination to undergo a large variety of procedures of interest in the study and utilization of surface phenomena.

REFERENCES

- /1/ E.E. Chaban and H.D. Hagstrum: Rev. Sci. Inst. 47 (1972) 828.
- /2/ E.V. Kornelsen: Radiation Effects 13 (1972) 227.
- /3/ R.A. Armstrong: Surf. Sci. 50 (1972) 615.
- /4/ E.W. Plummer: Topics in Appl. Phys. 4 (1975) 144 (Springer Verlag).

ACKNOWLEDGEMENT

The authors wish to thank many of their colleagues, both professional and technical whose skills have contributed to this project.

FUNDAMENTALS OF OUTGASSING: THEORY

GERHARD LEWIN

Desorption of Absorbed and Adsorbed Gas

Gerhard Lewin

Experience shows that hydrogen diffusion into vacuum is not affected by adsorbed gas. Hence we assume linear superposition of these gas sources. In UHV in ferrous metals hydrogen diffusion from the bulk is main gas source. St. St. contains about 30 to 40% H₂ (STP) by volume, accumulated during manufacture, esp. high temperature annealing in H₂. At room temperature diffusion of other gases in st. st. and diffusion of all gases in non-ferrous metals is very small.

For a quantitative appraisal Fick's law of transient gas flow (Fig. 1) has to be solved for a large slab of thickness d exposed to vacuum on both sides. The concentration is initially uniform throughout. This is shown on Fig. 2 where D is the diffusion coefficient and Dt/d^2 the dimensionless time. As long as the concentration in center remains large enough, the gassing rate is the same as the one of a semi-infinite slab, which is proportional to the square root of time. On the log-log plot of Fig. 3 the solid curve is the gassing rate of a finite slab. It begins to deviate from the 45° line when Dt/d^2 becomes larger than 0.05. For larger values the approximation of the semi-infinite slab is not valid. Since D increases exponentially with temperature, a slab can be depleted much faster by a high temperature degassing in a vacuum furnace. After cooling the gassing rate is virtually constant and reduced in proportion to the ratio of the diffusion coefficients at room and furnace temperature. The effect is more pronounced in the finite slab where the gas supply is finite too. Examples are given in the tables of Figs. 4 and 5. The initial uniform concentration in Fig. 4 is 0.3 torr liter/cm³. Another approach is to use a surface

barrier, e.g. to oxidize the st. st. or to coat with soft solder, but there may be cracks in the barrier.

Gas molecules are adsorbed at the surface of a solid. The maximum binding energy is about 10 eV. For less than a monolayer, the desorption rate is proportional to the coverage, and inversely proportional to the sojourn time t_s . The sojourn time is proportional to $\exp(E_D/RT)$ where E_D is the energy of desorption. The constant of proportionality was originally assumed to be 10^{-13} sec, the period of oscillation of a molecule normal to the surface, but its value is now in doubt. However this value is assumed for the graph of Fig. 6. $1 \text{ eV} = 23 \text{ kcal/mol}$. The sojourn time varies over many order of magnitude depending on E_D ! How this affects the gassing rate in conjunction with a bake is shown in the Fig. 7. At any given temperature molecules with low and high binding energies, are removed rapidly or not at all. Only molecules of intermediate desorption energy cause protracted moderate gassing. As the temperature is raised, 'moderate energy' becomes 'low energy' and these disturbing molecules are rapidly removed. Certain gases such as water vapor form many monolayers, however the vapor pressure remains still lower than the true vapor pressure of water vapor at this temperature.

Even after a bake a large amount of gas remains adsorbed bound with higher energies. If the surface is exposed to a high energy flux e.g., ions, this gas is removed. Therefore gas discharge cleaning is a must for storage rings and fusion devices. Tens of additional monolayers of H_2 , CH_4 , CO_2 and especially CO are thereby removed from st. st. Perhaps this gives a clue why CO is always found. Subsequent exposure to the atmosphere does not populate these states again.

Gassing can be effectively avoided by evaporation of Ti onto the surface in situ in vacuum.

Fick's Laws of Diffusion

D diffusion coefficient, c concentration
Q flow rate

Stationary flow

$$Q = -D \frac{dc}{dx}$$

Transient flow

$$D \frac{\partial^2 c}{\partial x^2} = \frac{\partial c}{\partial t}$$

Figure 1

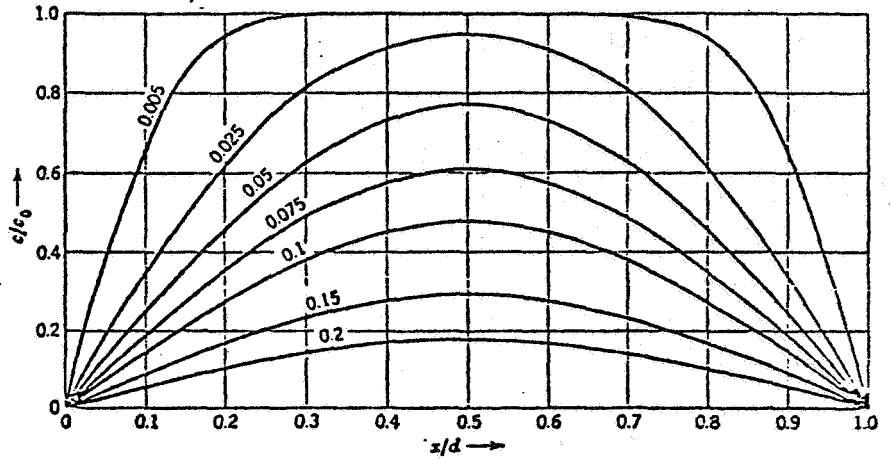

Relative concentration in a finite slab of thickness d for various (dimensionless) times Dt/d^2 as parameter.

Figure 2

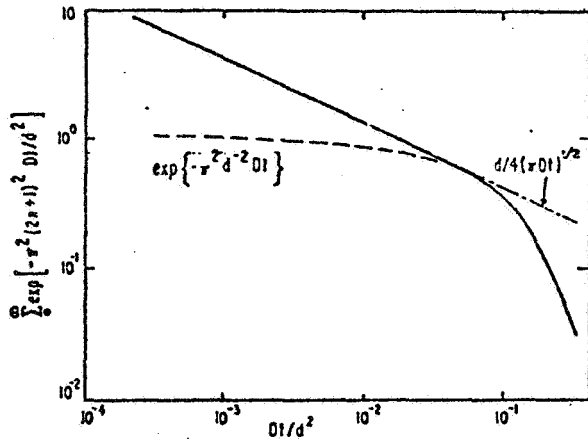

Plot of the infinite series of Eq. (12) and of its approximations for large (>0.025) and small (<0.05) values of Dt/d^2 .

Figure 3

Bakeout Times of 2 mm Thick Sheet at Various Temperatures for $\dot{Q}_R = 10^{-16}$ torr liter/cm² sec

t_{sec}	$D \text{ cm}^2/\text{sec}$	T_{C}
1.0×10^6 (11 days)	3.5×10^{-8}	300
8.6×10^4 (24 hours)	3.8×10^{-7}	420
1.1×10^4 (3 hours)	3.0×10^{-6}	570
3.6×10^3 (1 hour)	9.0×10^{-6}	635

Figure 4

TABLE I. Specific gassing rates Q at room temperature for a semi-infinite slab with a uniform initial hydrogen concentration standard cm^3/cm^3 after vacuum degassing at various temperatures for the specified times.

Temp. (°C)	D (cm^2/sec)	Time t (sec)	(h)	Dt (cm^2)	Q (Torr liter/ cm^2sec)
20	5.0×10^{-14}	3.6×10^5	100	1.8×10^{-8}	6.3×10^{-11}
300	3.5×10^{-8}	3.6×10^4	10	1.3×10^{-3}	2.4×10^{-13}
1000	8.7×10^{-5}	3.6×10^4	10	3.0	4.9×10^{-13}

Figure 5

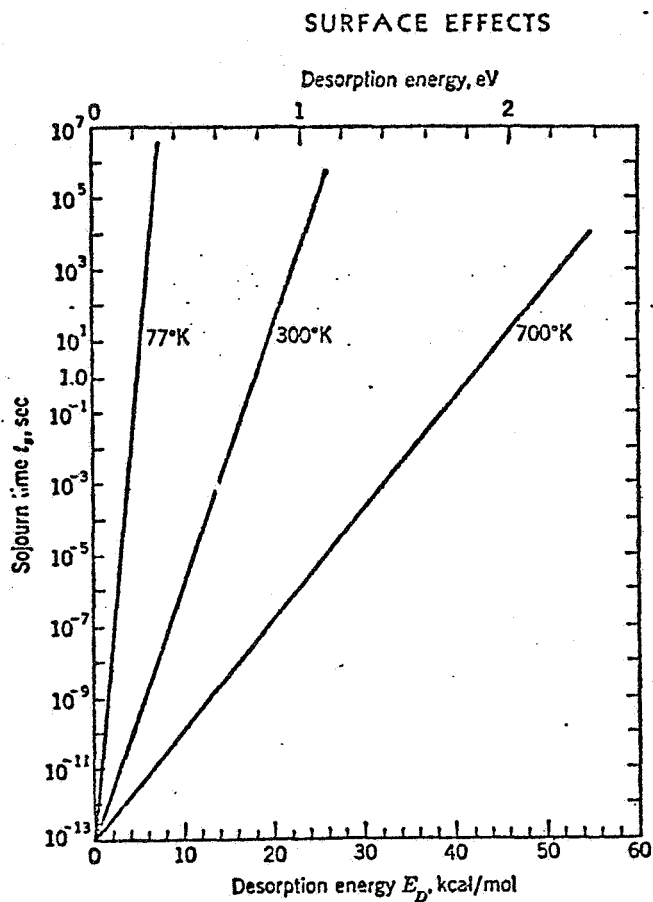

Dependence of sojourn time on desorption energy at various temperatures. (From E. Apgar, Plasma Physics Summer Institute, 1962, Princeton University.)

Figure 6

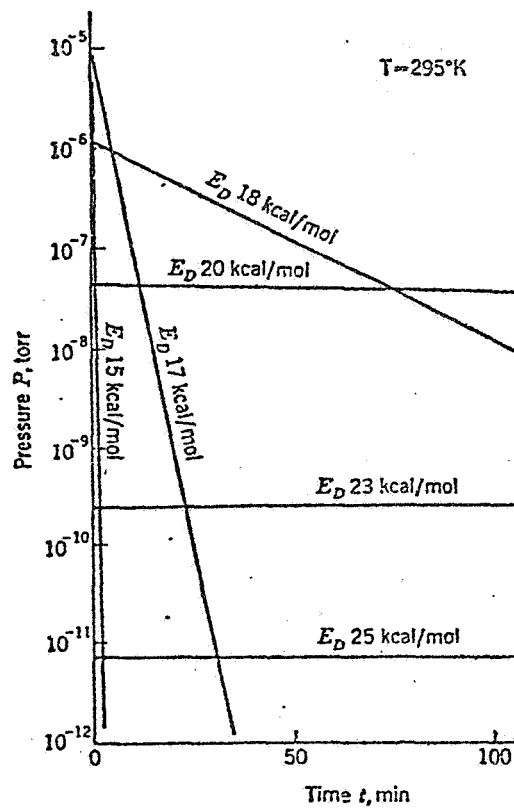

Evacuation of system; $V = 1$ liter, $D = 10^{-8}$ liter/sec, $T = 295^\circ\text{K}$, $A = 100$ cm^2 covered with a monolayer. (From J. P. Hobson, 1961 *Vacuum Symp. Trans.*, p. 26, 1962.)

Figure 7

OUTGASSING AND H₂ DIFFUSION IN IRON BASE ALLOYS

YALE STRAUSSER

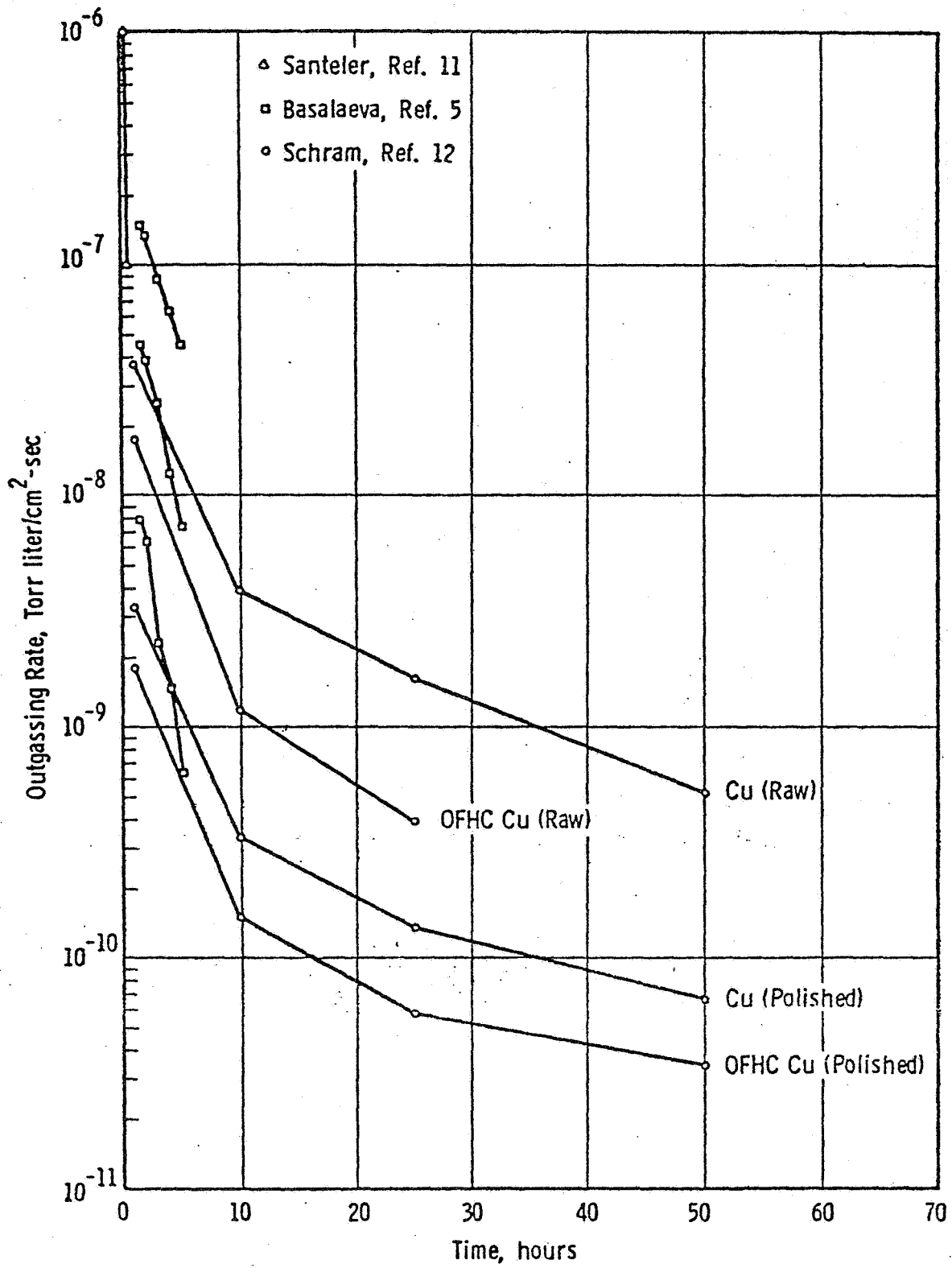

Figure 1. Compilation of Copper Outgassing Rates

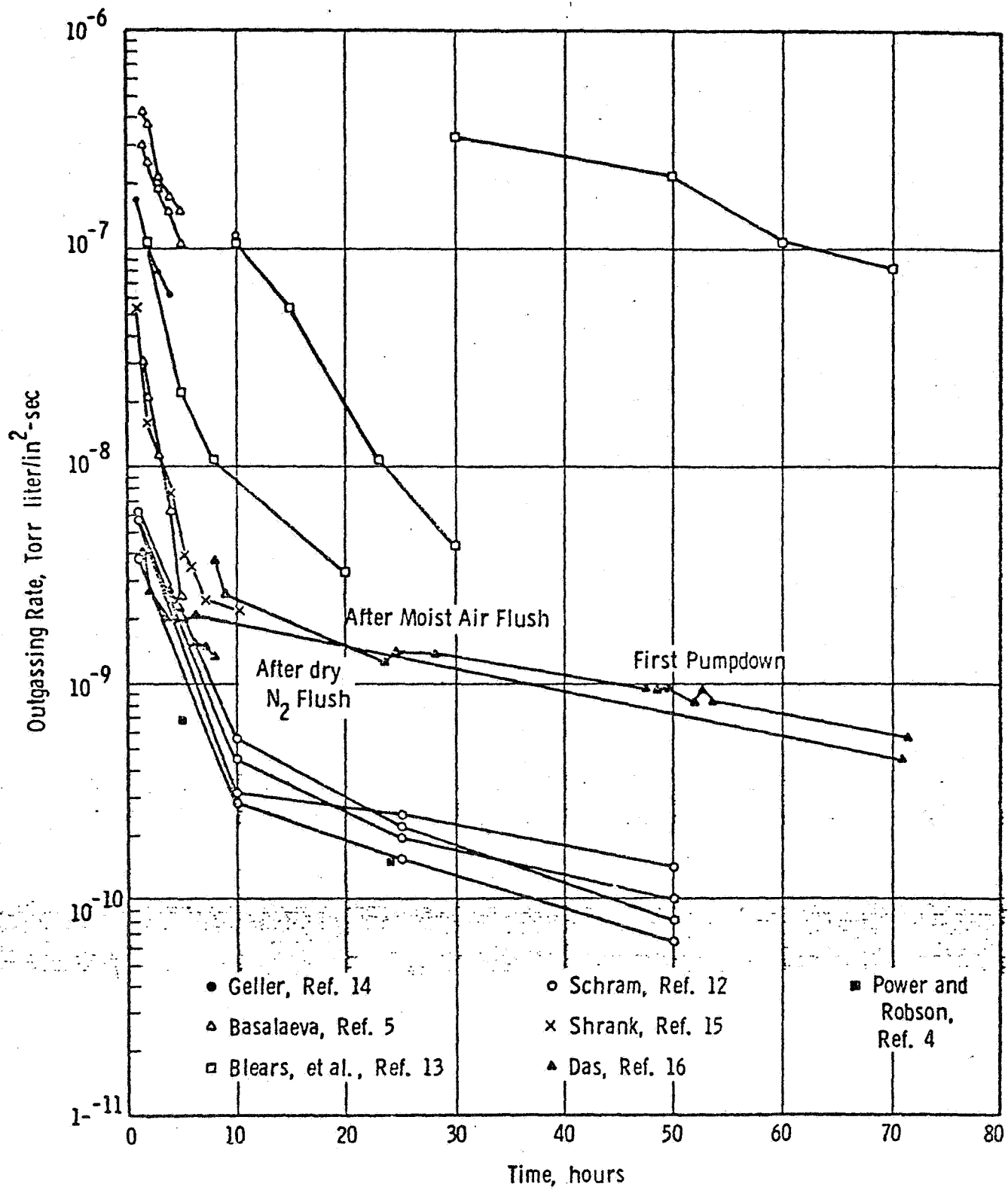

Figure 2 Compilation of Aluminum Outgassing Rates

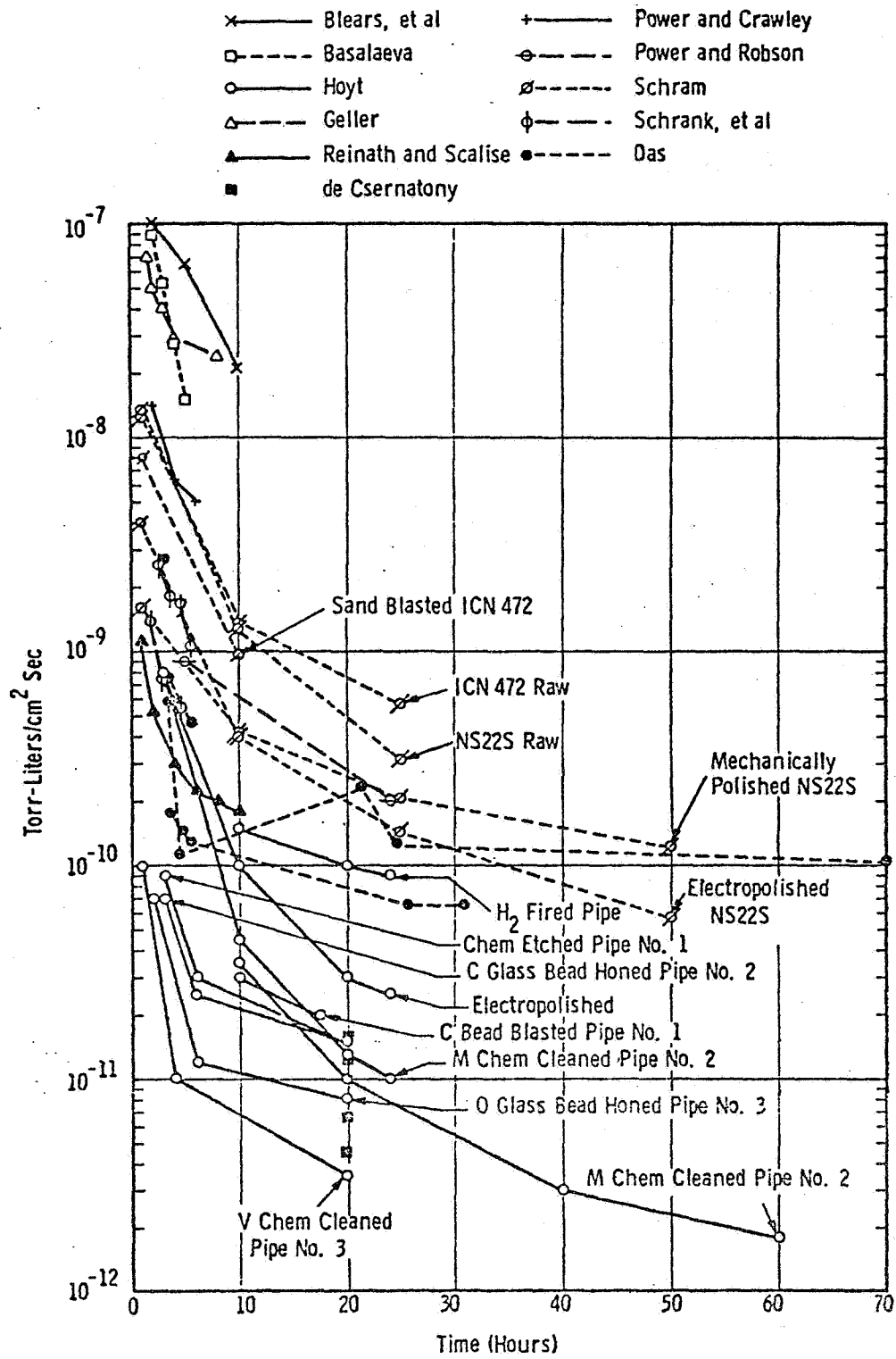

Figure 3 Compilation of Stainless Steel Outgassing Rates

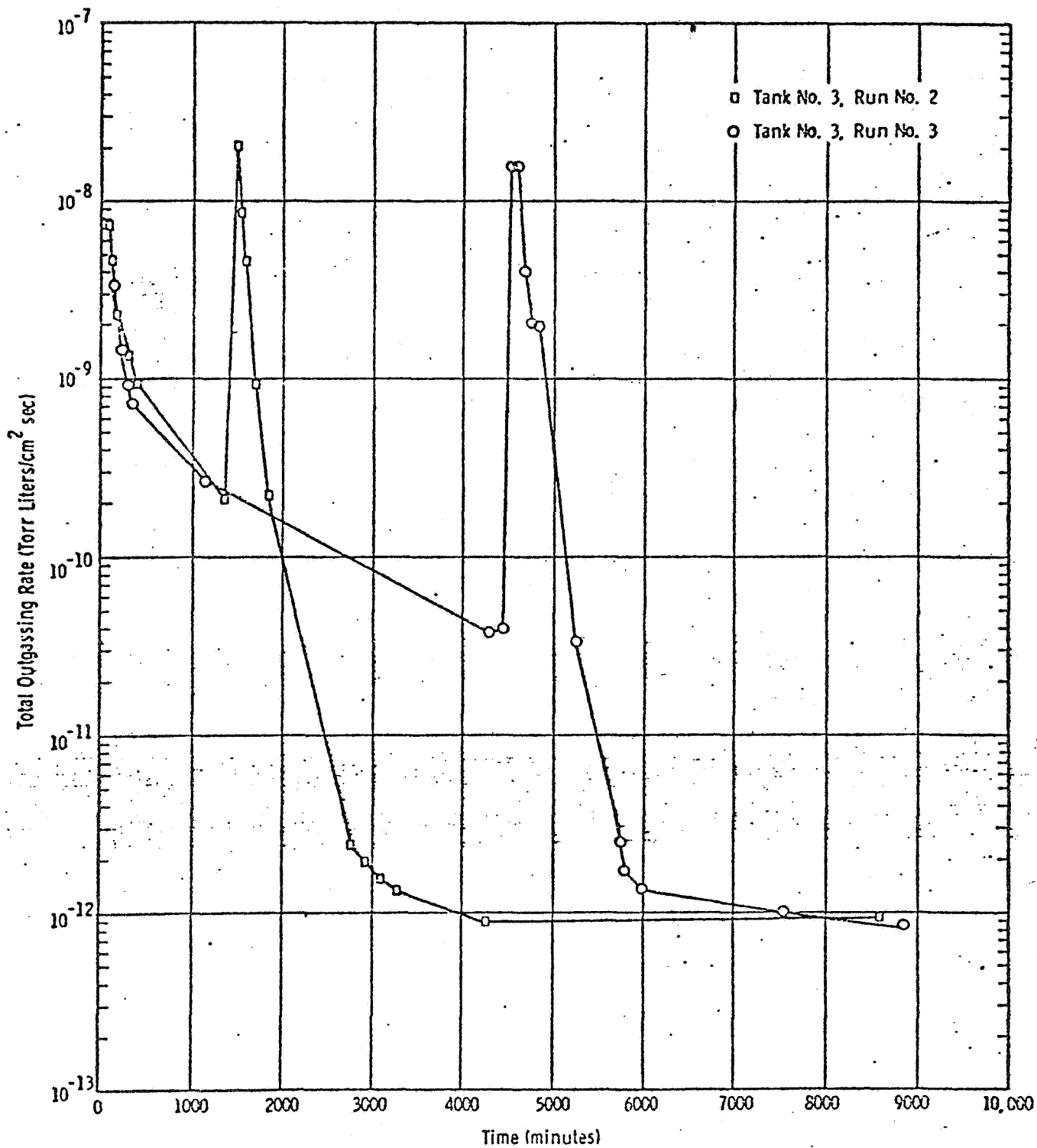

Figure 4

SURFACE PRE-TREATMENTS

- 1) AS-RECEIVED STAINLESS STEEL
- 2) DEGREASED
- 3) DRY HONED
- 4) ACID-ETCHED
- 5) MACHINED AND DECREASED
- 6) ELECTRO POLISHED
- 7) DS-9
- 8) PLASMA TORCH
- 9) PETERMANN

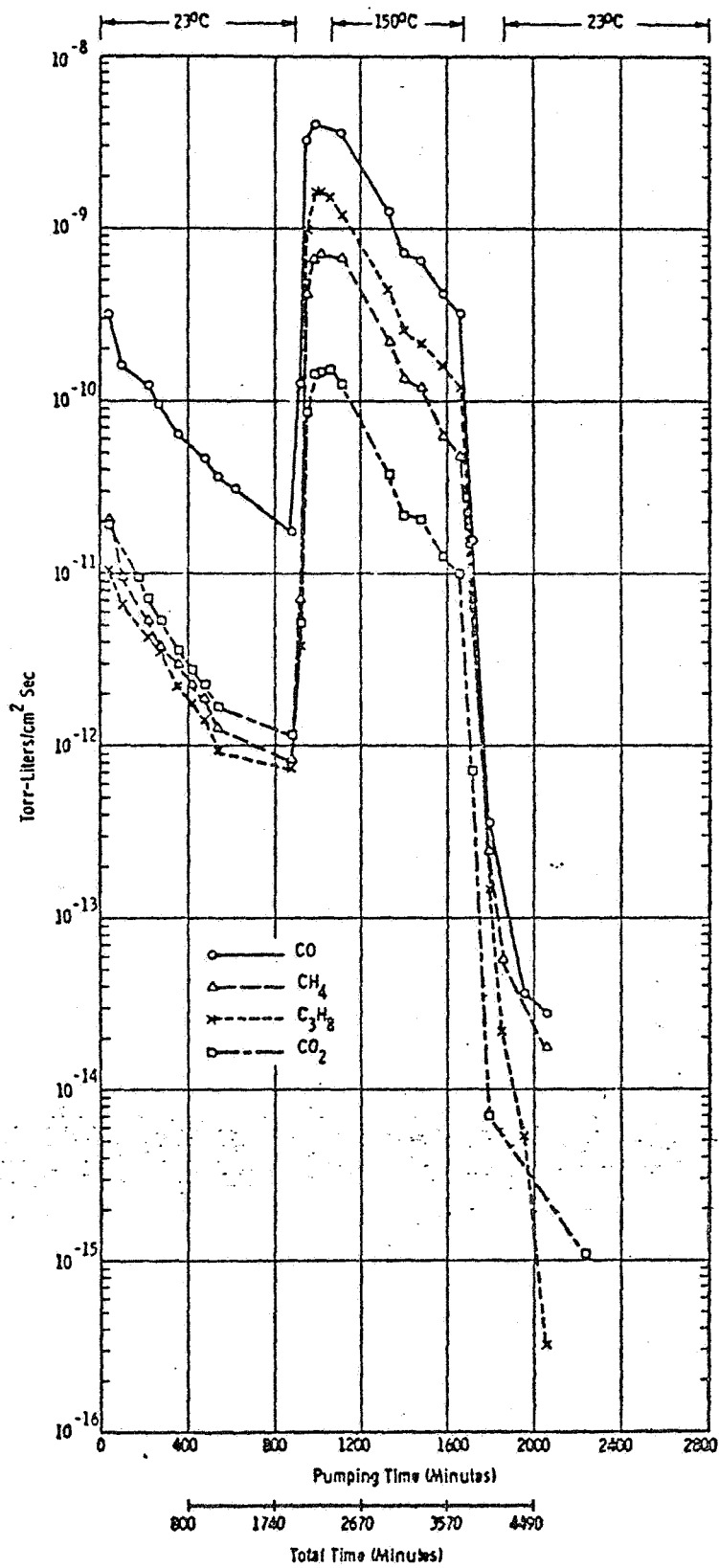

Figure 5 Outgassing Rates for CO, CH₄, C₃H₈, CO₂ from Sample with Only-Degreasing

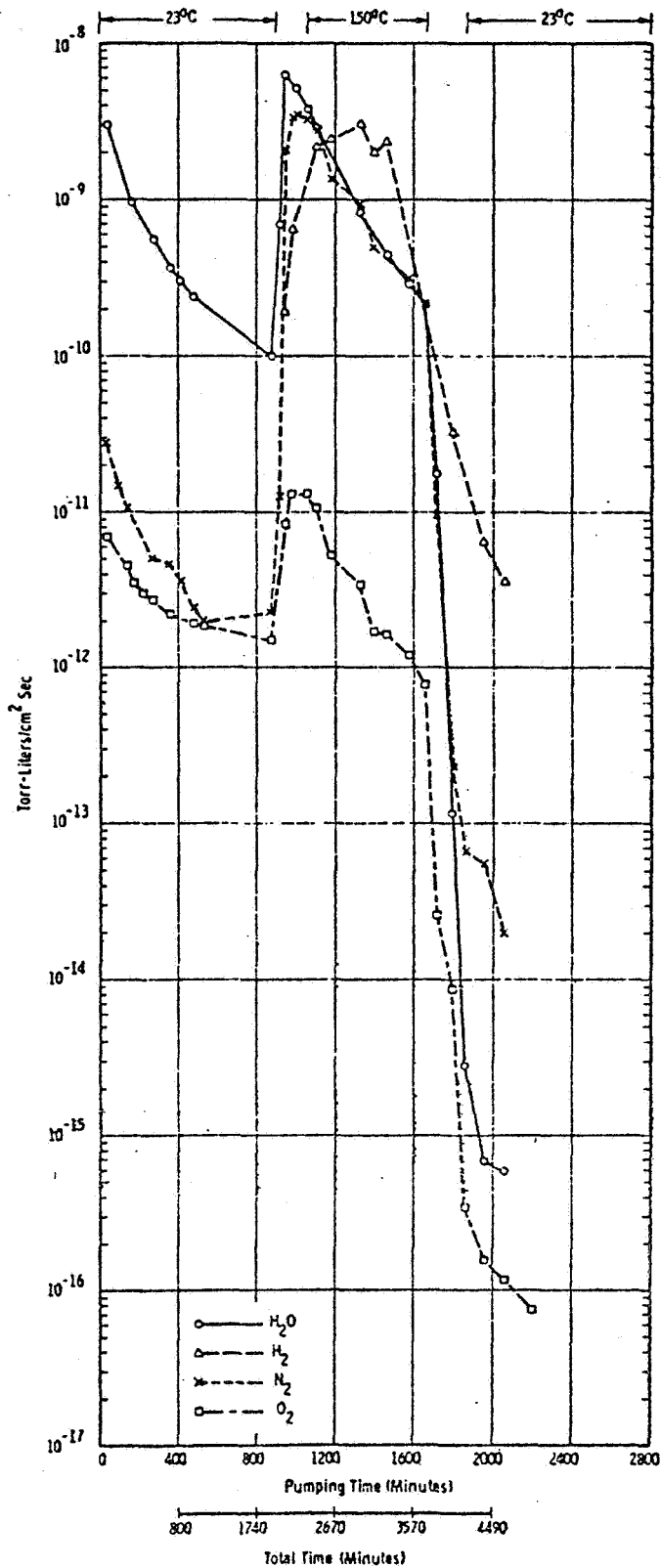

Figure 6 Outgassing Rates for H₂O, H₂, N₂, O₂ from Sample with Only-Degreasing

Total Quantity of Gas Removed from Sample
Which was Only Degreased

<u>Gas</u>	<u>Q₁, Quantity Removed from Standard Cleaned Sample</u>	<u>Q₂, Quantity Removed from Only-Degreased Sample</u>	<u>Q₂/Q₁</u>
H ₂	2.88×10^{15}	2.84×10^{15}	1
H ₂ O	2.4×10^{15}	3.64×10^{15}	1.5
CO	1.07×10^{15}	2.80×10^{15}	2.6
C ₃ H ₈	1.05×10^{15}	9.91×10^{14}	0.94
N ₂	7.25×10^{14}	1.94×10^{15}	2.7
CH ₄	1.95×10^{14}	5.02×10^{14}	2.6
CO ₂	4.4×10^{13}	1.00×10^{14}	2.3
O ₂	6.8×10^{12}	1.17×10^{13}	1.7

Figure 7

Outgassing Results from Barton and Govier

<u>Sample Pre-treatment</u>	<u>Surface Finish (μ inches)</u>	<u>Total Gas Evolved (Torr-Liters/cm²)</u>	
		<u>1st Bake</u>	<u>2nd Bake</u>
Electropolishing	14	247×10^{-5}	21×10^{-5}
Machining using cutting fluid	31	345×10^{-5}	32×10^{-5}
Vapor Blasting	36	290×10^{-5}	60×10^{-5}
Dry Machining	46	960×10^{-5}	68×10^{-5}
Baking in air at 450°C	78	310×10^{-5}	164×10^{-5}
Course machining using cutting fluid	160	1400×10^{-5}	80×10^{-5}

Figure 8

TOTAL QUANTITY REMOVED ($\times 10^{14}$ MOLE./CM²)

	Only Degreased	Standard Cleaning	Al Coated	Petermann	Machined
H ₂	28.4	28.8	5.05	3.09	9.10
H ₂ O	36.4	24.0	82.1	26.1	11.0
CO ₂	1.00	0.44	3.91	1.53	0.249
CO	28.0	10.7	0.892	0.908	.570
O ₂	0.017	0.068	0.164	0.0622	.012
N ₂	19.4	7.25	0.138	3.03	.564
CH ₄	5.02	1.95	0.147	0.296	.130
C ₃ H ₈	9.91	10.5	0.0733	0.0416	.098

Figure 9

ACTIVATION ENERGY FOR DESORPTION (kcal/mole)

	Only Degreased	Standard Cleaning	Al Coated	Petermann	Machined
H ₂	3.51	13.4	11.8	9.22	11.9
H ₂ O	2.51 [?]	22.4	26.9	26.8	21.6
CO ₂	17.5	15.8	20.1	12.6	13.9
CO	16.0	17.7	17.3	11.5	15.9
O ₂	15.7	17.0	14.3	24.4	13.2
N ₂	15.4	16.6	12.4	15.1	15.6
CH ₄	13.3	17.8	17.5	13.1	17.4
C ₃ H ₈	17.2	17.4	19.4	20.0	16.4

Figure 10

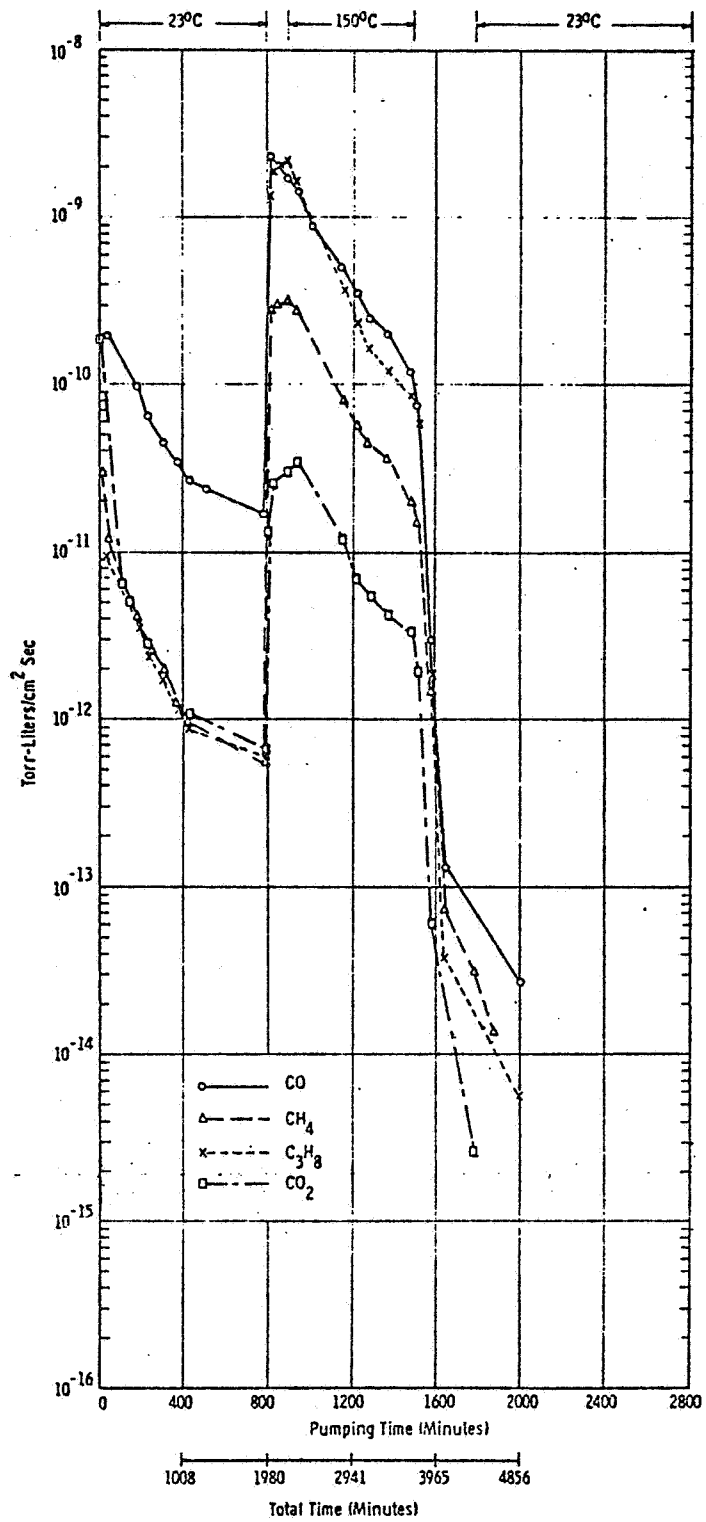

Figure 11 Outgassing Rates for CO, CH₄, C₃H₈, CO₂ from Sample with 33% HF Cleaning

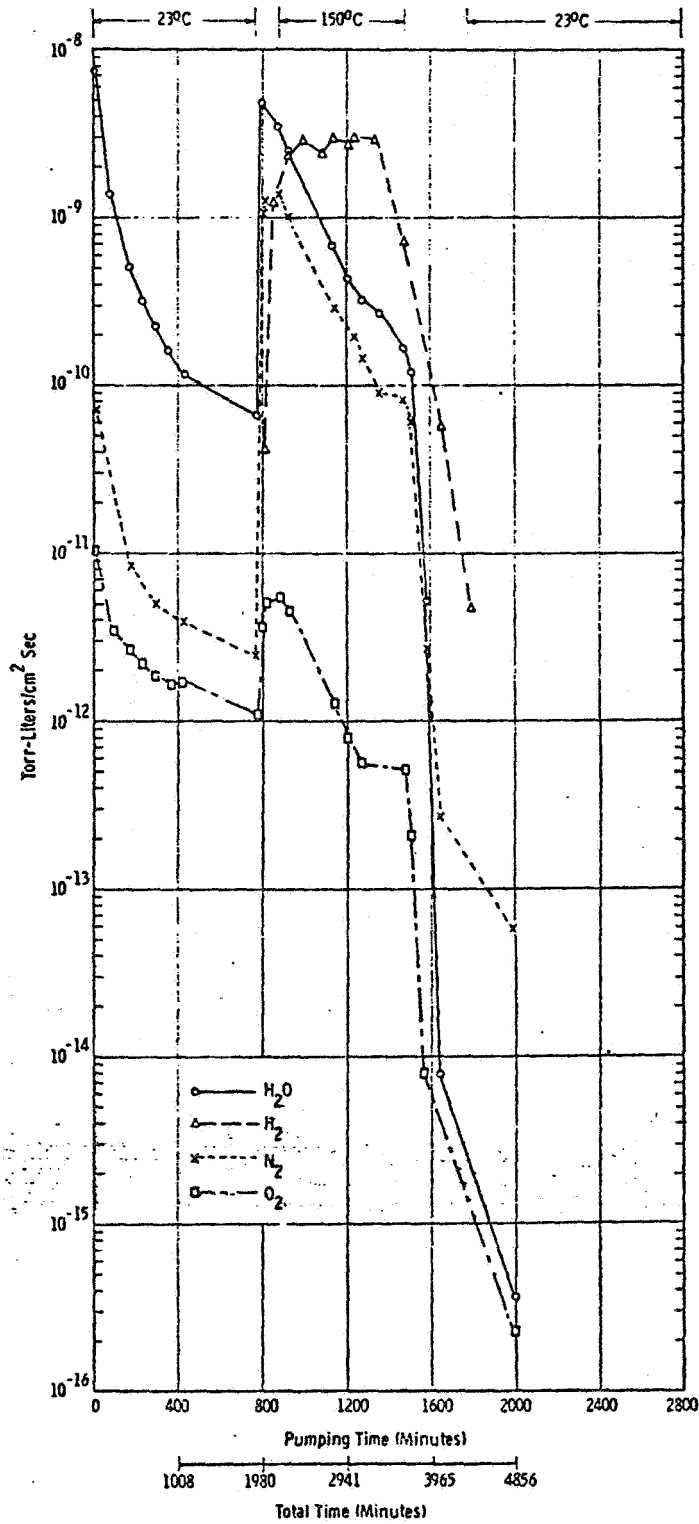

Figure 12 Outgassing Rates for H₂O, H₂, N₂, O₂ from Sample with 33% HF Cleaning

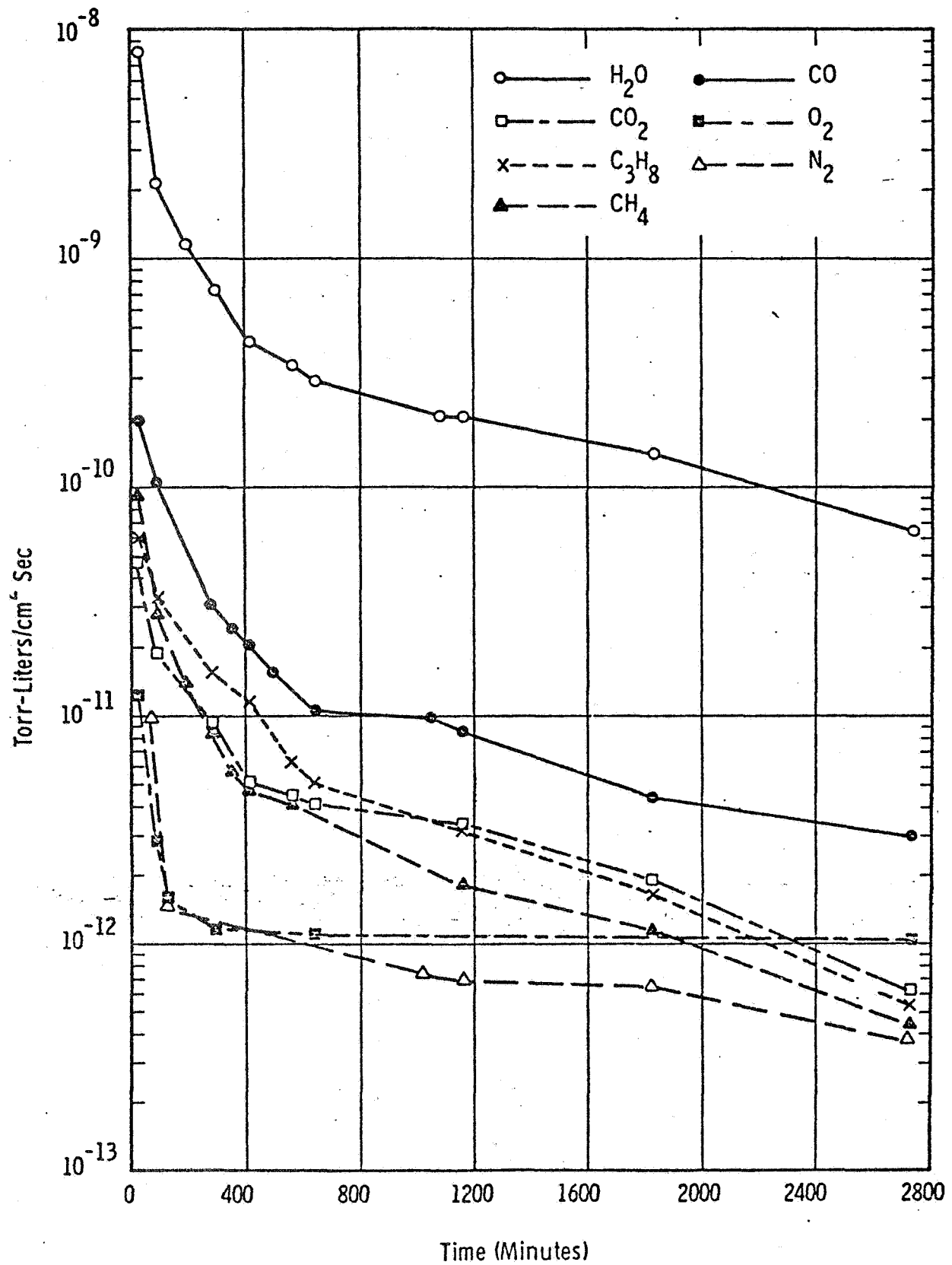

Figure 13 Outgassing Rates for Sample Cleaned by Diversey DS-9 Cleaning

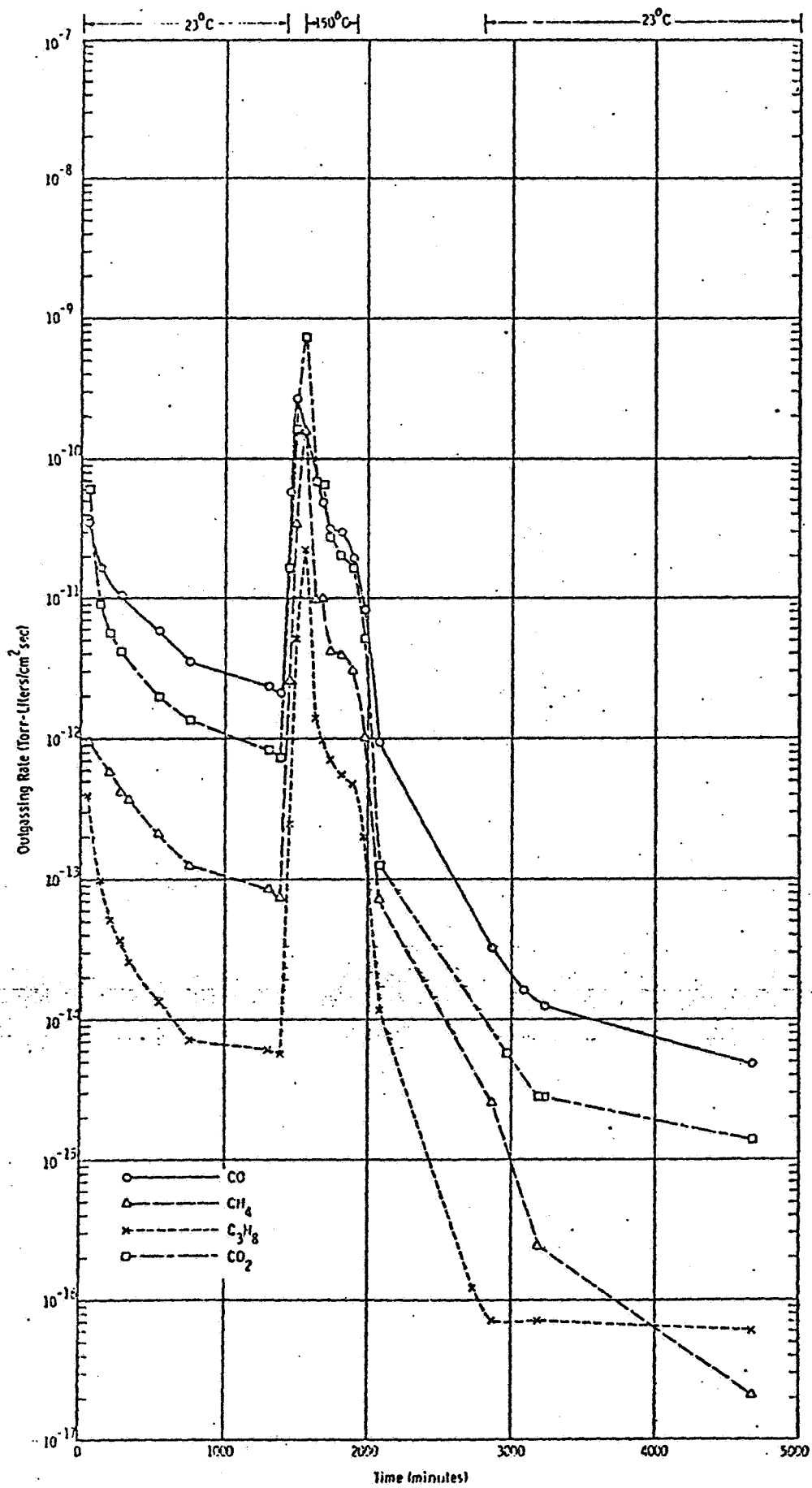

Figure 14
II-80

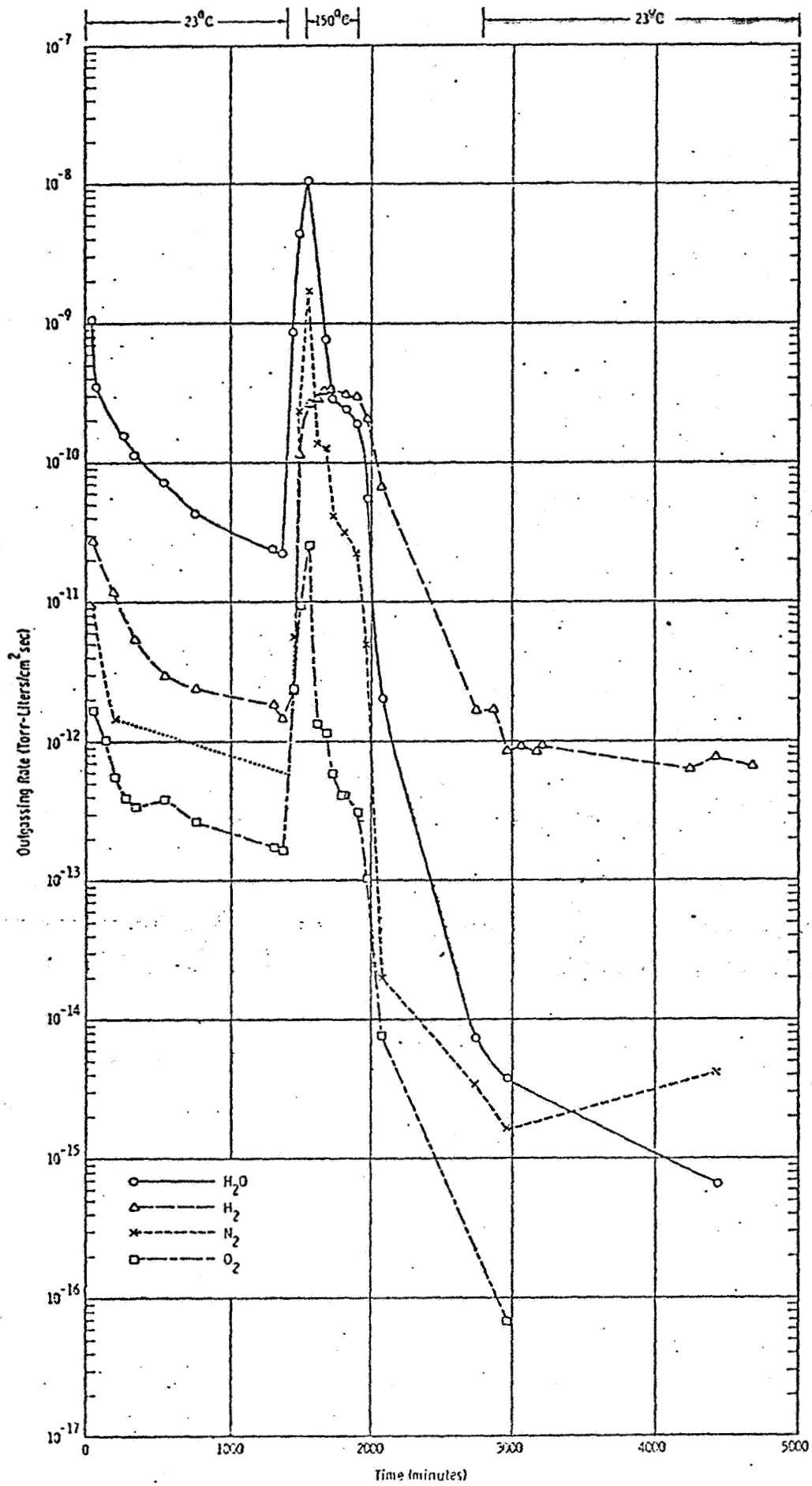

Figure 15

Varian Standard Cleaning
Pumpdown with 150°C - 8 Hr Bakeout

Oxidized Sample
Pumpdown with 150°C - 8 Hr Bakeout

Gas	Q_{∞} ($T \cdot U/cm^2 \cdot sec$)	$\Delta\sigma$ (molec./ $cm^2 \times 10^{-14}$)	E_B (kcal/mole)	Gas	Q_{∞} ($T \cdot U/cm^2 \cdot sec$)	$\Delta\sigma$ (molec./ $cm^2 \times 10^{-14}$)	E_B (kcal/mole)
H ₂ O	4×10^{-16}	25.0	22.0	H ₂ O	5×10^{-16}	15.0	24.0
N ₂	3×10^{-14}	0.3	16.0	N ₂	1×10^{-15}	0.1	14.0
H ₂	5×10^{-12}	10.0	13.0	H ₂	4×10^{-13}	4.0	9.8
O ₂	3×10^{-16}	0.05	-----	O ₂	5×10^{-17}	0.05	15.0
CO ₂	1×10^{-15}	1.4	23.0	CO ₂	1×10^{-15}	1.0	13.0
CO	2×10^{-14}	0.3	17.0	CO	5×10^{-15}	0.2	11.0
C ₃ H ₈	5×10^{-16}	0.15	17.0	C ₃ H ₈	1×10^{-16}	0.02	20.0
CH ₄	1×10^{-15}	0.1	17.0	CH ₄	1×10^{-16}	0.05	12.0
Total	5.05×10^{-12}	37.3		Total	4.07×10^{-13}	20.4	

Figure 16

Table 2. Specimen A: outgassing rates (torr l. cm⁻² sec⁻¹)

Specimen preparation	Measurement temperature (°C)	H ₂	H ₂ O	CO-N ₂	O ₂	CO ₂
Degassed several times—total of 45 h at 360°C	24	{1.3-12†}	—	—	—	—
		2.6-12	—	—	—	—
		2.3-12	—	—	—	—
	100	2.1-11	—	{4.7-15}	—	2.5-13
	0	1.3-12	—	—	—	—
Exposed to atmosphere for 3 h. Pumped under vacuum for 40 h	19	2.7-12	6.4-12	1.9-12	2.2-12	1.2-12
Pumped under vacuum for further 4 days at room temperature	19	2.6-12	1.0-12	6.4-13	8.4-14	3.6-13
Baked at 360°C for 24 h	19	9.9-13	—	{2.6-15}	—	—

Table 3. Specimen B: outgassing rates (torr l. cm⁻² sec⁻¹)

Specimen preparation	Measurement temperature (°C)	H ₂	H ₂ O	CO-N ₂	O ₂	CO ₂
Baked under vacuum for 25 h at 300°C	20	3.9-12†	—	1.7-14	—	1.9-14
	20	4.5-12	—	—	—	2.0-14
	20	{2.6-12}	—	6.1-14	—	1.5-14
Temperature of specimen raised	40	1.3-11	—	—	—	—
	100	2.1-10	1.0-13	4.7-13	1.8-12	1.7-12
Baked under vacuum for 25 h at 300°C	20	3.0-12	—	—	—	1.7-14
	20	3.0-12	—	—	—	—
	20	3.0-12	—	—	—	—
	20	2.8-12	—	{8.6-15}	—	1.1-14
Temperature of specimen raised	35	5.6-12	{7.8-15}	(--)	—	2.5-14
	53	1.6-11	{6.4-15}	(--)	—	3.3-14
	75	4.4-11	4.6-14	—	—	5.8-14
Baked under vacuum for 25 h at 300°C	20	1.5-12	—	—	—	—
	20	1.5-12	(--)	{1.6-13}	—	(--)
	20	1.4-12	—	—	—	—
Temperature of specimen raised	47	5.3-12	—	{5.2-15}	—	{1.7-15}
	72	1.5-11	—	2.8-14	—	{5.4-15}
	105	3.9-11	—	6.3-14	—	{8.7-15}
	145	9.2-11	3.1-13	1.4-13	—	1.0-14
	200	2.5-10	6.1-13	2.6-13	—	3.6-14
Baked under vacuum for 25 h at 300°C	20	1.1-12	—	—	—	—
	20	1.2-12	—	{4.3-15}	—	—

Table 4. Specimen C: outgassing rates (torr l. cm⁻² sec⁻¹)†

Specimen preparation	Measurement temperature (°C)	H ₂	H ₂ O	CO-N ₂	O ₂	CO ₂
Degassed at 1000°C for 3 h in a vacuum furnace, then <i>in situ</i> bake at 360°C for 25 h	20	1.3-14†	—	1.0-14	—	1.9-15
	20	{6.9-15}	—	1.2-15	—	1.9-15
	20	1.3-14	—	(--)	—	{4-15}
Raise temperature of specimen	100	1.2-14	—	2.1-14	—	2.3-15
Baked for 72 h at 200°C under vacuum	20	1.0-14	—	—	—	—
Raise temperature of specimen	100	8.7-15	—	(--)	—	—
	200	1.9-14	—	3.1-14	—	—

Table 5. Specimen D: outgassing rates (torr l. cm⁻² sec⁻¹)†

Specimen preparation	Measurement temperature (°C)	H ₂	H ₂ O	CO-N ₂	O ₂	CO ₂
Baked <i>in situ</i> at 360°C for 24 h	20	2.7-14†	—	[1.5-10]	—	(---)
	20	2.5-14	—	(---)	—	(---)
	20	2.6-14				
Exposed to 1 torr of H ₂ for 12 days, then pumped under vacuum for 3 days at room temperature	20	6.8-12				
	20	5.0-12				
	20	2.6-12	3.3-13	(---)	—	7.9-15
Baked <i>in situ</i> at 350°C for 24 h	20	6.0-15		1.9-14	—	[3.4-16]
	20	2.7-14	—	2.0-15	—	[1.9-16]
	20	3.8-14	—	(---)	—	1.6-15

IV. SUMMARY AND CONCLUSIONS

Outgassing rate measurements on copper, aluminum, and stainless steel samples have been summarized and reviewed including a critical discussion of the experimental procedures used to make the measurements. Table 10 is a summary of values which are believed by the author to be representative of relatively good surfaces under typical conditions. In addition, the comparison of the many existing measurements of outgassing rates of these metals leads to the conclusion that variations in outgassing rate of a particular base material are due, to a significant degree, to variations in the extent of the oxide layer present on the surface. Furthermore, this effect is primarily a result of the ratio of the true surface area of the sample to the geometric area. The significance of the various cleaning treatments that have been used is simply to reduce this ratio. Thus, the most desirable treatment would be that which minimizes the true surface area by producing a smooth, flat surface.

Other properties which this optimum surface treatment should possess are that it should seriously impede or completely stop the diffusion of hydrogen from the bulk of the material and that the surface should be left free of carbon to inhibit the production of CO and CO₂ from adsorbed O₂.

From: Review of Outgassing Results by Yale Strausser
Varian Associates Report VR-51

REFERENCES

1. R. P. Henry, *LeVide*, No. 82, 226 (1959).
2. C. W. Oatley, *Brit Journ Appl. Phys.* 5, 358 (1954).
3. J. J. Thibault, J. Roussel, M. Jourdan, *LeVide*, No. 132, 309 (1967).
4. B. D. Power and F. C. Robson, *Proc. of the Eighth National Vacuum Symposium of the AVS*, 1175 (1961).
5. N. Ia. Basalaeva, *Soviet Physics - Tech. Phys.* 3, 1027 (1958).
6. T. D. Kirkendall, P. F. Varadi, and H. D. Doolittle, *Jour. Vac. Sci. and Tech.* 3, 214 (1966).
7. R. Calder and G. Lewin, *Brit. Journ. of Appl. Phys.* 18, 1459 (1967).
8. Y. E. Strausser, Presented at the 14th National Vacuum Symposium of the AVS, Kansas City, Mo. (1967).
9. Y. E. Strausser, *Proc. of the 4th International Vacuum Congress, Manchester, England* (1968). To be published.
10. R. S. Barton and R. P. Govier, Report No. CLM-R93, Culham Laboratory, Abingdon Berkshire, England (1968).
11. D. J. Santeler, *Trans. of the Fifth National Symposium of Vacuum Technology*, pp 1-8, Pergamon Press (1959).
12. A. Schram, *LeVide*, No. 103, 55 (1963).
13. J. Blears, E. J. Greer, and J. Nightingale, *Advances in Vacuum Science and Technology II*, 473, Pergamon Press, Oxford (1960).
14. R. Geller, *LeVide*, No. 74, 71 (1958).
15. M. P. Shrank, F. C. Benner, and D. K. Das, Report No. AEDC-TDR-64-53, Arnold Engineering and Development Center, Arnold Air Force Station, Tennessee (1964).
16. D. K. Das, Report No. AEDC-TDR-62-19, Arnold Engineering and Development Center, Arnold Air Force Station, Tennessee (1962).
17. E. Hoyt, Report No. SLAC-TN-64-5, Stanford Linear Accelerator Center, Stanford, California (1964).
18. F. S. Reinath and D. T. Scalise, Report No. UCRL-11808, Univ. of Calif. Lawrence Radiation Laboratory, Berkeley, Calif. (1965).
19. R. Geller, *Le Vide*, No. 69, 194 (1957).

THERMAL DESORPTION FROM Mo, Cu, Be AND SOME CERAMICS

LEONARD BEAVIS

THERMAL DESORPTION FROM MOLYBDENUM, COPPER
BERYLLIUM AND SOME CERAMICS*

L. C. Beavis
Sandia Laboratories
Albuquerque, N.M. 87185

Thermal desorption measurements have been made for about 20 years.¹ Initially, these were primarily concerned with the relationship between the temperature at which the thermal desorption rate was maximum and the binding energy. Redhead² in his rather definitive paper gave the relationship in Figure 1 for first order rate controlled desorption under the rapidly pumped condition. The typical early experiment consisted of mounting a foil which was outgassed by passing a current through it. A doping gas was then bled into the system and the foil once again heated in either a closed or pumped system while an ionization gauge and the temperature were observed. The peak temperature was then related to the binding energy of the rate limiting step (e.g., Figure 1).

More recently the significance of the entire peak shape has been studied (e.g., Ref. 3). In this fashion, it is possible by proper analysis of the desorption rate versus temperature data to determine rate limiting mechanism(s) in addition to the activation energy for such steps.

Figure 2 shows the apparatus we use for thermal desorption measurements. A gas analyzer is directly over the sample so as to measure the gas as it leaves. The time constant for the vacuum system is 0.01 second. Ramp rates of 1 k/s to 100 k/s are achievable. Data are sampled and the analyzer scanned under computer

*This work was supported by the U.S. Department of Energy.

control (Digital PDP-11/40). A given mass peak and the temperature are measured approximately once every 1-2 seconds. Typically, 6-10 mass peaks are monitored throughout a run. The UHV chamber is capable of being cooled with water or liquid nitrogen. The gas analyzer is calibrated using calibrated leaks for varied gases (CO, CH₄, CO₂, H₂) and the water values used are those noted for methane. Experiments have been run using foils resistively heated as well as thin metal and insulator samples which are indirectly heated in a long cylindrical heater with radiation shields.

Figure 3 gives a pictorial representation of the rate limiting mechanisms we will be discussing further below. If the rate limiting step only requires the breaking of a bond of a molecule (CO) in order for it to be desorbed, from either bulk or surface, then the rate is said to be first order--top panel. If the molecules formation is the process which limits the rate of desorption, assuming equal and random concentration of both species, then the process would be second order limited. Finally, if the rate is limited by the diffusion of a species, then the process can be thought of as that portrayed in the third panel.

The desorption rate equation for first and second order are given in the first line of Figure 4, where for i a (1) or (2) must be substituted. The second line gives the diffusion equation (Fick's law) which must be solved if the desorption process is diffusion limited.

These equations give solutions for the desorption rate as a function of temperature (time) as seen in Figure 5. On occasion, it is useful to confirm the rate limiting mechanism by heating a sample rapidly to the point there it is outgassing at a significant rate and then holding the temperature and observing the outgas rate decay. The rate of decay will behave as seen in Figure 6 depending upon the rate limiting step. Again, it should be noted that

this technique differentiates rather nicely between the various rate limiting mechanism. In Figure 7 (top), is a schematic of typical desorption spectra. The temperature at which the peak rate occurs is the same in all three instances. The narrowest peak is that due to first order desorption kinetics, the next widest from second order kinetics, and the widest peak typical of diffusion limited kinetics. The middle panel cross hatching, Figure 7, shows the part of the peak from which we normally analyze data during a desorption ramp and the bottom panel cross hatching shows the portion over which we analyze data when we raise the temperature and hold it during desorption.

Figure 8 is spectra of CO desorption from molybdenum; the coverage is about 10^{16} molecules/cm² in the two peaks 5% of the gas occurs in the low temperature peak.

Figure 9 shows the desorption of CO from CU 2% Be alloy after various treatments. The maximum amount of CO seen is 6×10^{14} molecules/cm². Approximately 10% of this amount of CO₂ is seen and 1% of O₂ is also seen during a desorption run.

Figures 10, 11, and 12 are of water, hydrogen, and methane desorption from molybdenum sealing glass ceramic before and after silica blasting. Coverages are 2×10^{15} , 2×10^{16} , and 10^{14} cm², respectively.

Figures 13 and 14 are from 94% alumina ceramic. The hydrogen coverage is about 10^{17} /cm² while the methane is 1×10^{15} /cm².

Figure 15 is the first order predicted outgassing rates from the various materials upon which we have run thermodesorption measurements. Along with predicted values for water desorption from itself and glass.

It is clear that well-bound species will not desorb very quickly from these materials whereas gases bound with less than 20 kcal/mol energy will desorb in a vacuum in a day or less at room temperature. Only those species found with

about 25-35 kcal/mol are likely to be of concern in terms of long time low-level desorption. Water binds with this energy to several oxides. A mild vacuum bake shall remove it, however.

References:

1. Journal of Physical Chemistry 1958, Smith and Aranoff.
2. Vacuum 12, 203-211 (1962), P. A. Redhead.
3. International Journal of Heat and Mass Transfer, 13, 1559-1570 (1970), W. W. Brandt.

$$E = RT_p \left[\ln \left(\frac{\nu T_p}{\beta} \right) - 3.64 \right]$$

for $T = T_0 + \beta t$

$$T_p \geq 2 T_0$$

Figure 1

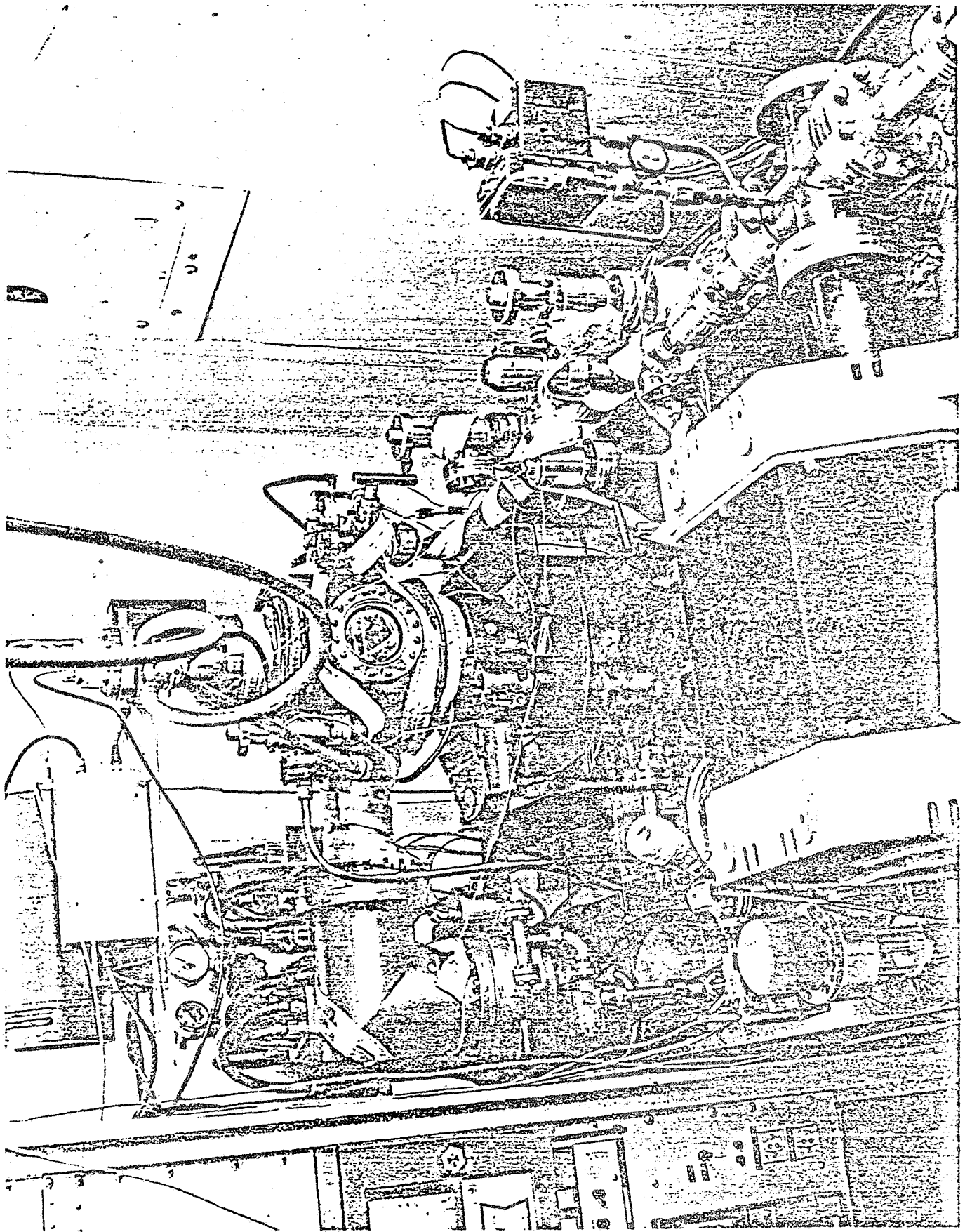
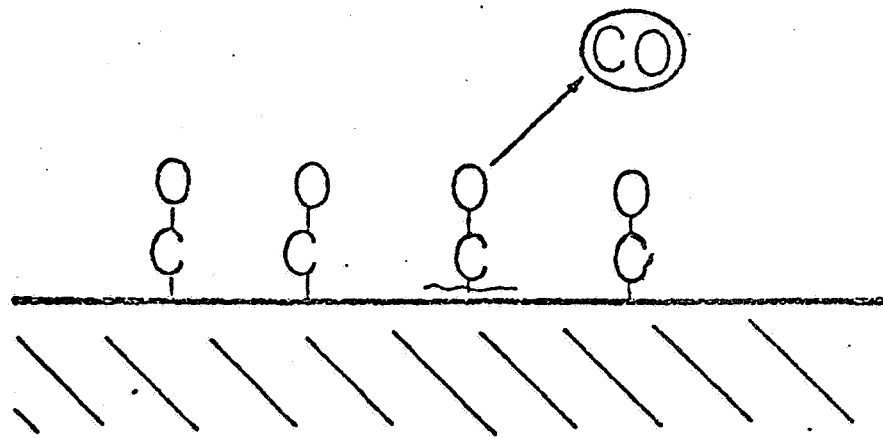
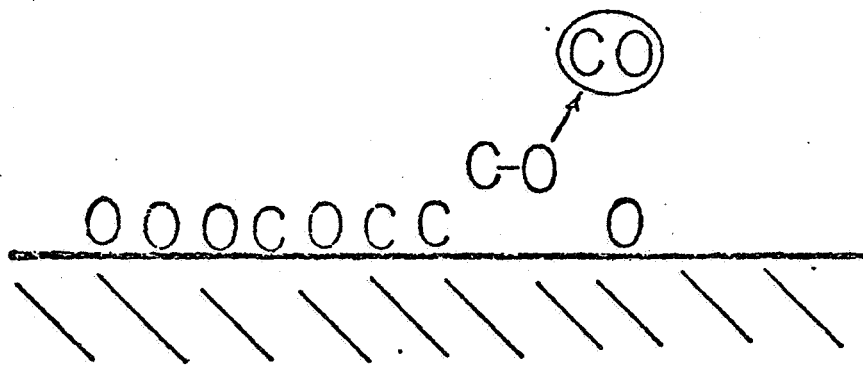

FIGURE 2



1st Order



2nd Order

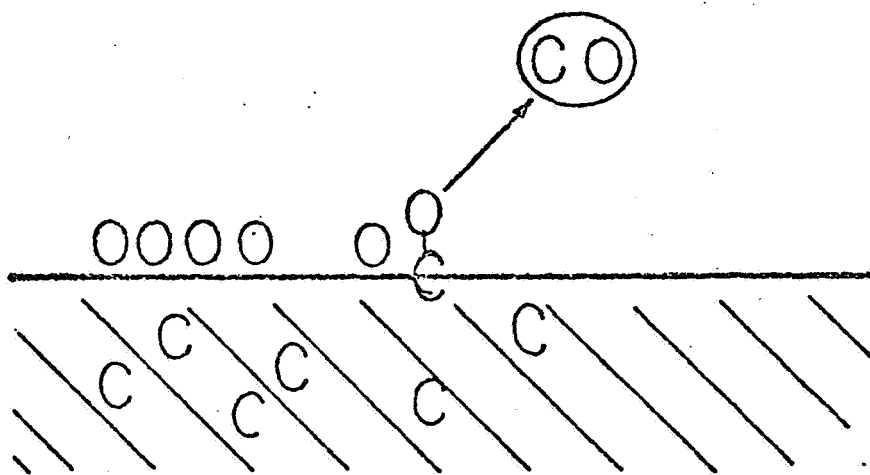

Diffusion

Figure 3

$$-\dot{N}_i = \nu_i N_i \exp(-E_i/RT)$$

$$\frac{\partial c}{\partial \tau} = \frac{\partial^2 c}{\partial x^2}$$

for conditions of linear temperature ramp

$$T = T_0 + \beta t$$

$$\tau = \int_0^t D(t) dt \quad D(t) = D_0 \exp(-E_d/RT)$$

Figure 4

$$\frac{\dot{N}_j}{N_p} = \exp \left[\frac{E}{R} \left(\frac{1}{T_p} - \frac{1}{T_j} \right) + f_{j,p} \right]$$

1st Order 50/nc

$$\frac{\dot{N}_j}{N_p} = \exp \left[\frac{E}{R} \left(\frac{1}{T_p} - \frac{1}{T_j} \right) / \left(1 + N_p f_{p,j} \right) \right]$$

2nd Order

Where $f_{j,k} = \frac{v_i}{\beta} \int_{T_k}^{T_j} \exp(-E/RT) dT$

And $\left(\frac{1}{N_p} \right) = \left(\frac{1}{N_0} \right) + f_{0,p}$

$$\dot{N}_j = \frac{2D(j)C_0}{\ell} \sum_{i=0}^{\infty} \exp \left[-(2i+1)^2 \frac{\pi^2 \tau_j}{4\ell^2} \right] \text{ For diffusion}$$

$$\tau_j = \frac{1}{\beta} \int_{T_0}^{T_j} D_0 \exp(-E/RT) dt$$

Figure 5

AT CONSTANT TEMPERATURE

$$\dot{N}(t) = \gamma_1 N_0 \exp(-\gamma_1 t) \quad \text{1st. Order}$$

$$\dot{N}(t) = -\gamma_2 / \left(\gamma_2 t + 1/N_0 \right)^2 \quad \text{2nd. Order}$$

$$\dot{N}(t) = \frac{D C_0}{(\pi D t)^{1/2}} \left[1 + 2 \sum_{n=1}^{\infty} (-1)^n \exp(-n^2 l^2 / Dt) \right] \quad \text{Diffusion}$$

Where $\gamma_i = \nu_i \exp(-E/RT)$

Figure 6

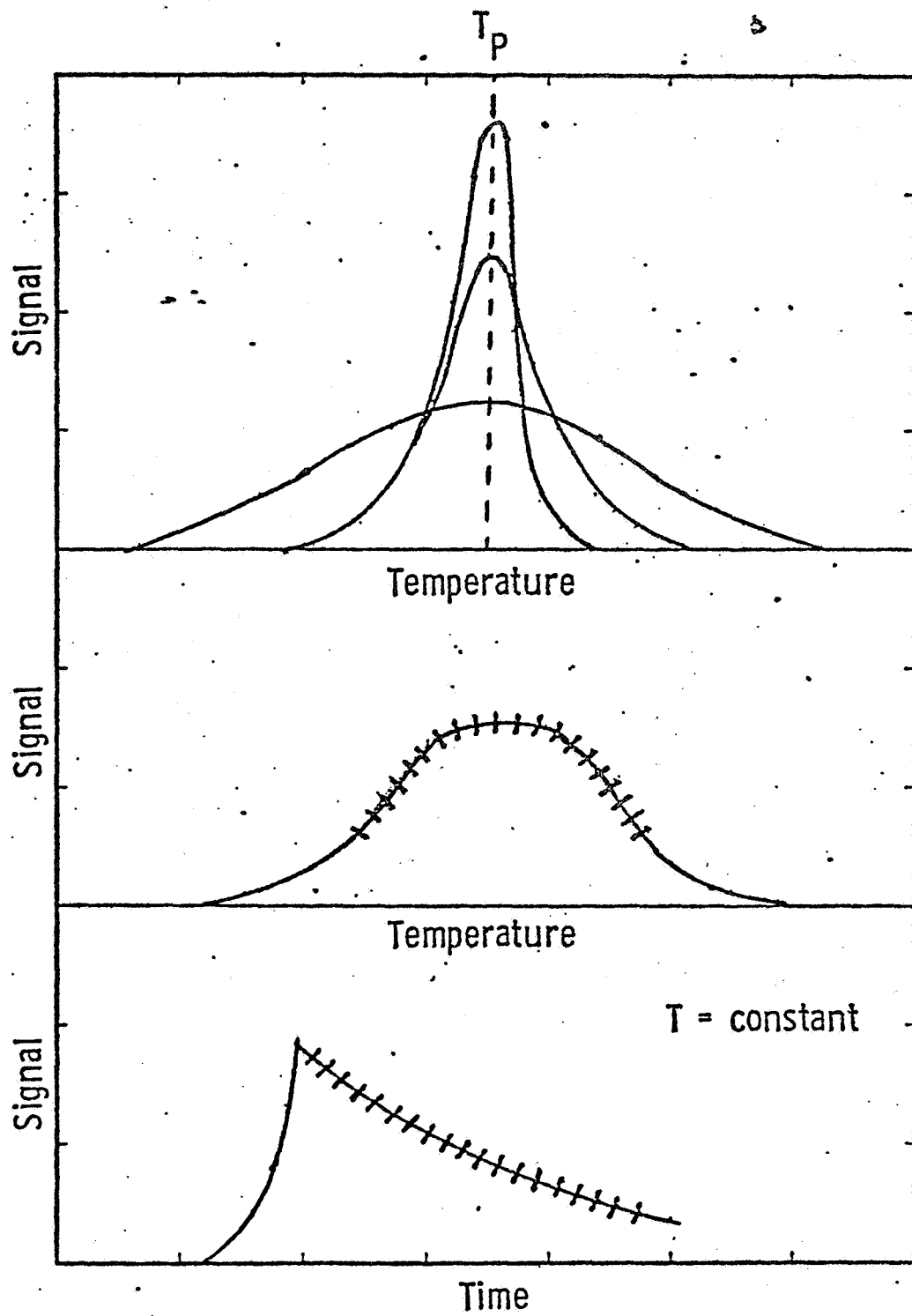

Figure 7

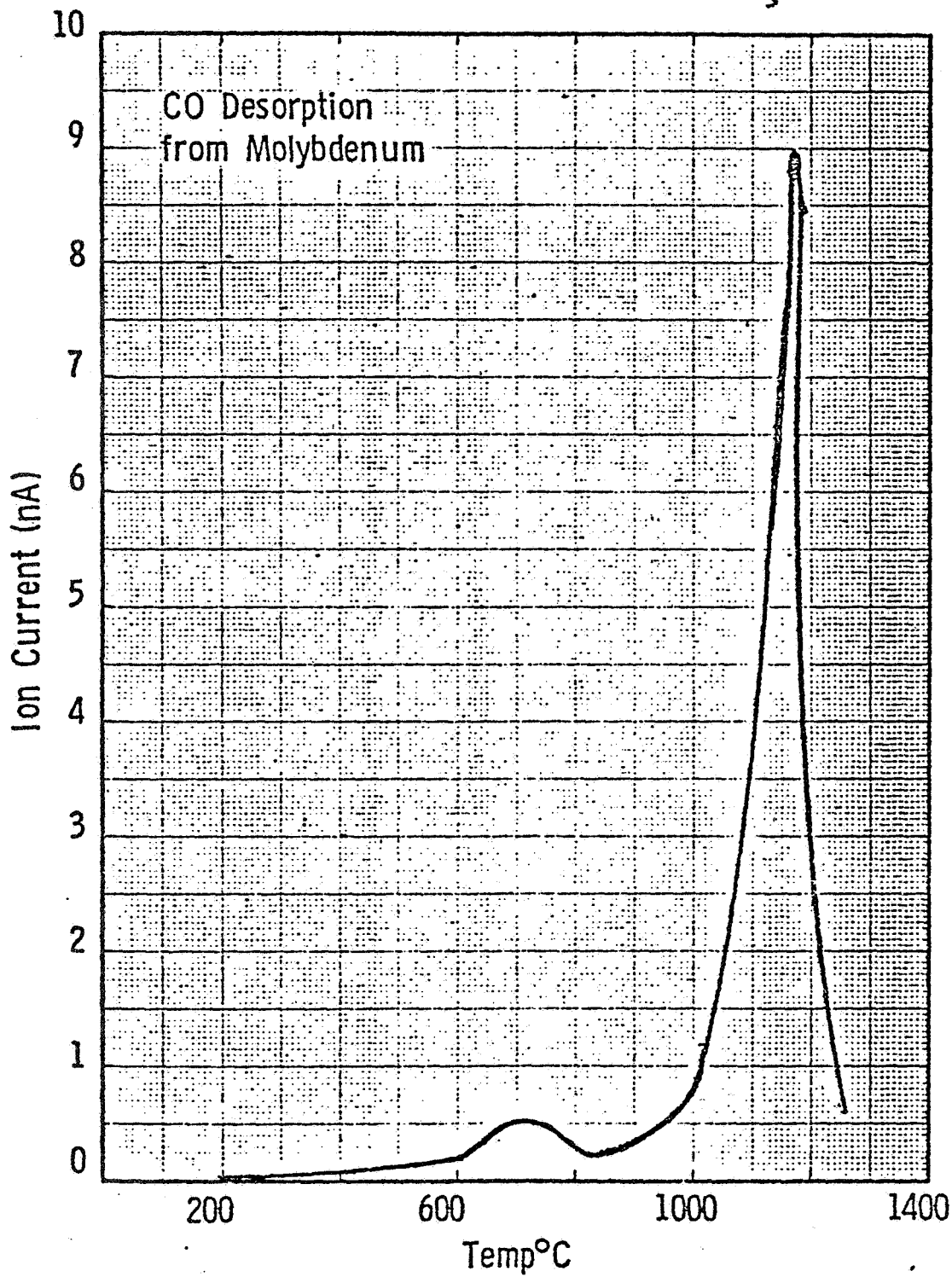

Figure 8

Cu 2% Be Alloy CO Desorption

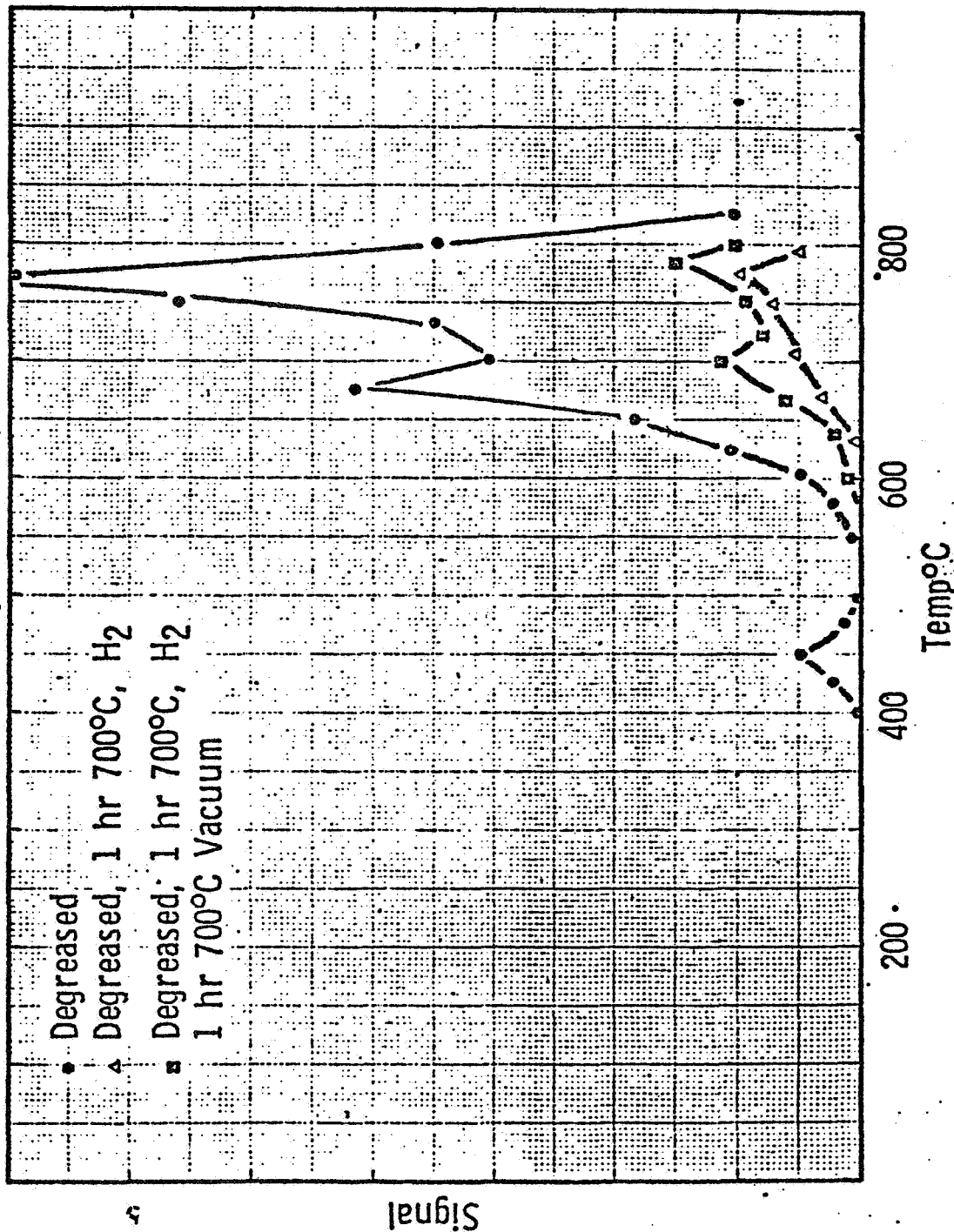

Figure 9

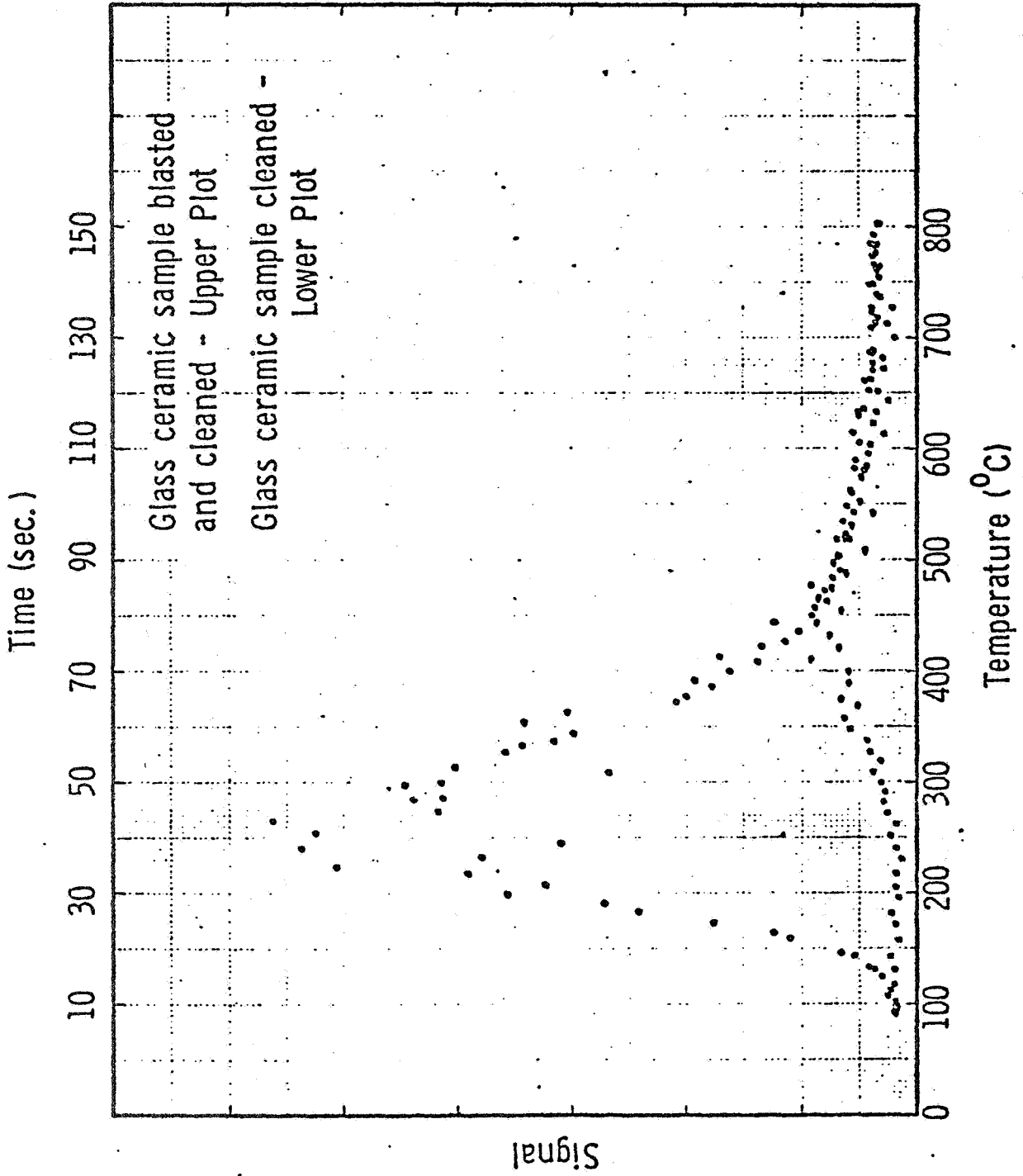
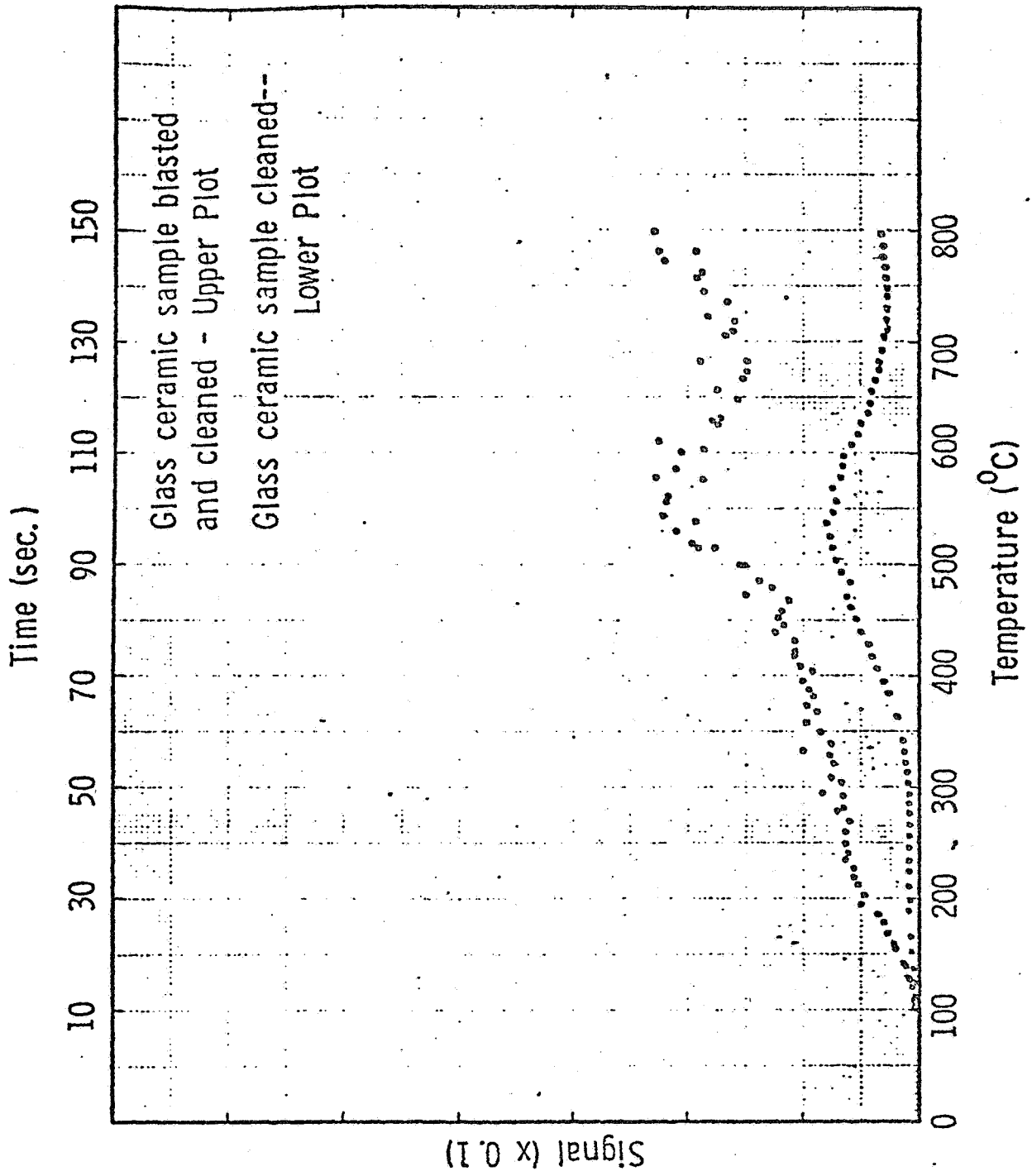
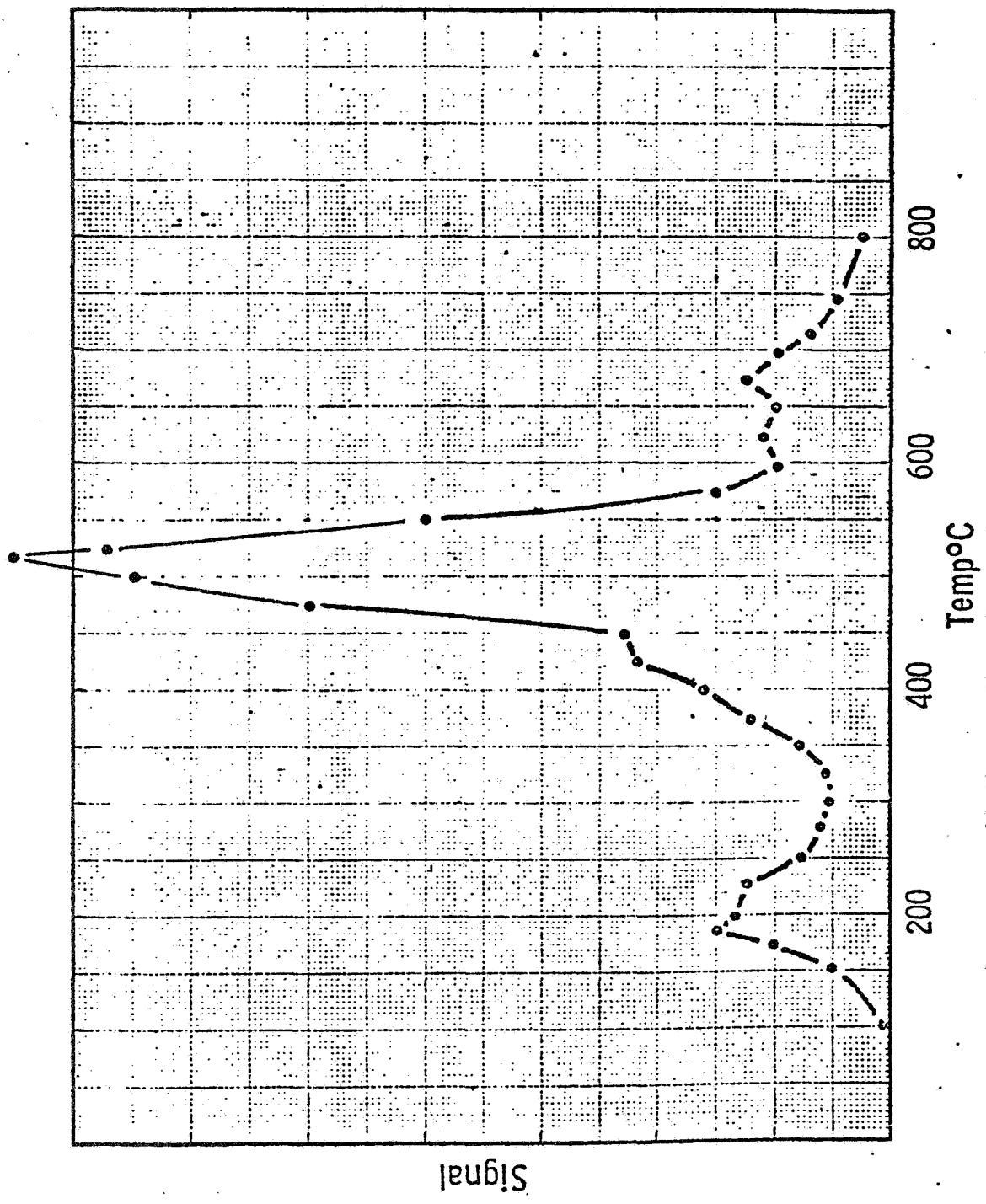

Figure 10



H₂ Flow

Figure 11



Methane Flow from Glass Ceramic

Figure 12.

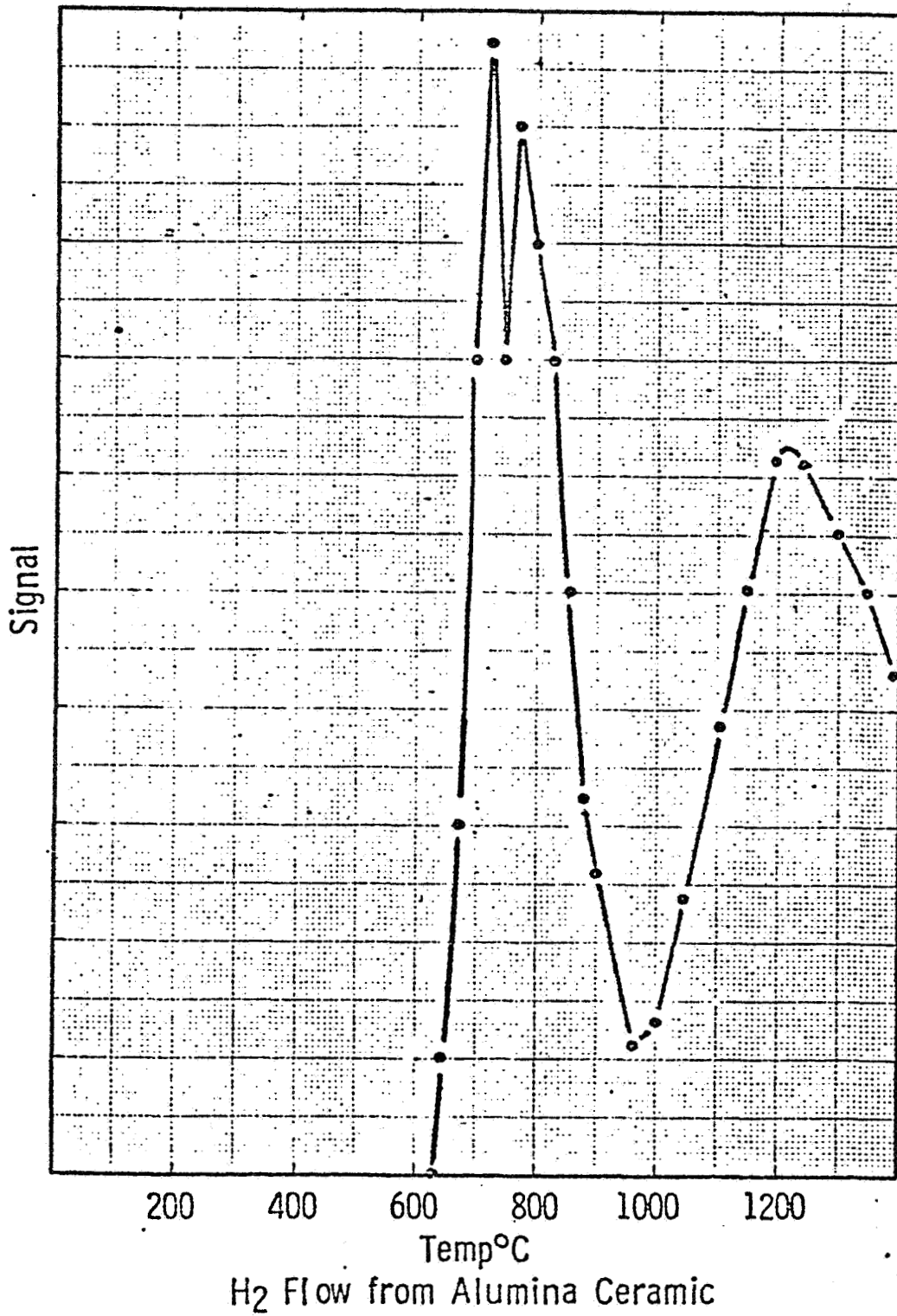

Figure 13

II-103

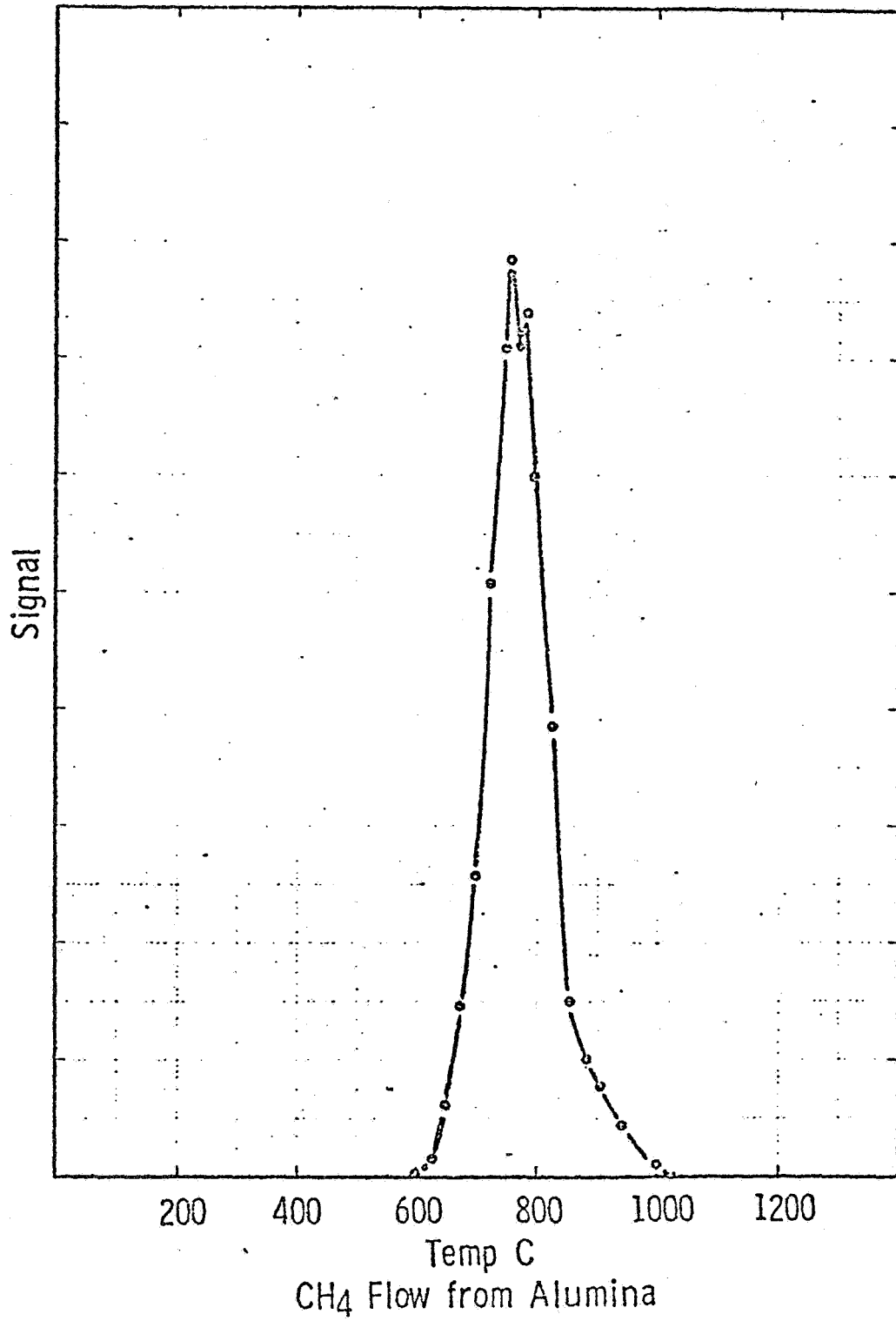

Figure 14
II-104

Projected 1st Order Outgassing Rate at 300 K
Molecules/cm² s

Material	Gas	at t = 0	at t = 10 ⁵ s	C T _p	kcal E	molecule cm ² No
Molybdenum	CO	2 x 10 ⁻¹⁸	2 x 10 ⁻¹⁸	690	62.3	5 x 10 ¹⁴
Cu 2% Be	CO	3 x 10 ⁻¹⁶	3 x 10 ⁻¹⁶	675	59.4	6 x 10 ¹⁴
Mo Sealing	H ₂ O	2.2 x 10 ⁵	2.2 x 10 ⁵	240	31.5	2 x 10 ¹⁵
Glass Ceramic	H ₂	2.3 x 10 ⁻⁸	2.3 x 10 ⁻⁸	540	50.7	2 x 10 ¹⁶
Abraded	CH ₄	8 x 10 ⁵	7.9 x 10 ⁵	185	28.0	2 x 10 ¹³
Ceramic 94%	H ₂	2 x 10 ⁻¹⁶	2 x 10 ⁻¹⁶	710	61.7	2 x 10 ¹⁶
Alumina	CH ₄	5.2 x 10 ⁻²⁰	5.2 x 10 ⁻²⁰	760	64.9	1 x 10 ¹⁵
Water on Water	H ₂ O	5.2 x 10 ²⁰	0	---	10.0	1 x 10 ¹⁵
Water on Glass	H ₂ O	2.7 x 10 ¹³	0	---	20.0*	1 x 10 ¹⁵

Figure 15

*"The Properties of Glass Surfaces"
by L. Holland (Wiley) 1964

Appendix III

The paper below was taken from the 1975 Isabelle Summer Study at Brookhaven. Pete Hobson points out that the important feature is the readsorption of gas on the walls of the system, and only when the sticking coefficients truly zero are the actual q 's equal to the measured (net) q_m . His paper follows.

ALTERNATIVE INTERPRETATION OF THE MEASUREMENTS OF SPECIFIC OUTGASSING RATES OF MATERIALS

J. P. Hobson
National Research Council
Ottawa, Canada

I. Introduction

In vacuum design it is often important to design for a particular value of the background pressure. The problem often presents itself in the form that it is found in ISABELLE, namely: If material X is used in a certain geometry what pumps are needed to give an upper limit of p_{max} at a certain point in the structure? The answer depends upon the properties of material X, in particular, upon a quantity called the specific outgassing rate q (Torr liters $cm^{-2} sec^{-1}$), which is the rate of desorption of gas per cm^2 of surface. Often assumed, as in the ISABELLE tests,¹ is that the rate of readsorption of gas onto the surface is zero. When this assumption is made the measured outgassing rate tends to be the net outgassing rate of the surface which is invariably lower than the true outgassing rate, and can lead to design errors. This general problem is illustrated in a simple example in which the calculations can all be made explicitly.

II. Simple Example of Outgassing Measurement

Consider a vessel of spherical form with surface area A made of the material X whose outgassing is to be measured so that a pump may later be added to the vessel to achieve p_{\max} at its center. The test set-up contains a valve leading to a pump of known speed C_0 liters sec^{-1} , small compared to the valve conductance and

1. H.J. Halama and J.C. Herrera, "Thermal Desorption of Gases from Aluminum Alloy Al 6061, Their Rates and Activation Energies," these Proc. p. 640.

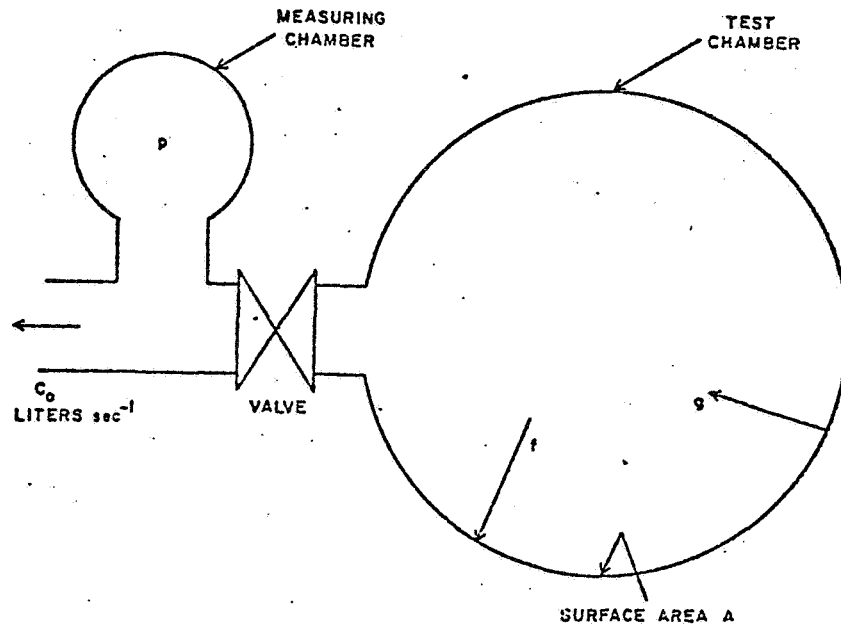

Fig. 1. Test chamber for measuring rate of gas flow from wall.

associated piping. A pressure gauge measures the pressure p as close to the vessel as possible. Two equilibrium measurements are made: p_1 with the valve open and p_2 with the valve closed.

$$p_2 = \frac{Q_M}{C_0} \text{ Torr} \quad (1)$$

where Q_M is the net outgassing load in the measuring chamber in Torr liters sec^{-1}

$$p_1 = \frac{Q_M + Q_T}{C_0} \text{ Torr} \quad (2)$$

Q_T is the gas passing from the test chamber through the valve to the measuring chamber and coming from the walls of the test chamber.

Elimination of Q_M from (1) and (2) yields

$$Q_T = C_0 (p_1 - p_2) \text{ Torr liters sec}^{-1} \quad (3)$$

Equation (3) is used¹ to obtain the rate of gas flow coming from the walls of the test chamber and should be a valid measure. With the valve open the pressure in the test chamber is p_1 since it is measured. Thus there is a molecular flux striking the walls

$$f = \text{Molecular Flux} = \frac{10^3}{\sqrt{MT}} p_1 \text{ Torr liters sec}^{-1} \text{ cm}^{-2} \quad (4)$$

where M is the molecular weight of the gas (2 for ISABELLE since gas is H_2 and T = temperature in test chamber = 300 K for ISABELLE). Assume this flux has a sticking coefficient on the wall of s . Total number disappearing from the gas phase by this mechanism is

$$\text{Rate of Pumping} = fAs \text{ Torr liters sec}^{-1} \quad (5)$$

At equilibrium

$$Q_T = qA - fAs \text{ Torr liters sec}^{-1} \quad (6)$$

$$q = \frac{Q_T + fAs}{A} \text{ Torr liters sec}^{-1} \text{ cm}^{-2} \quad (7)$$

$$q = \frac{Q_T}{A} + \frac{10^3}{\sqrt{MT}} sp_1 \text{ Torr liters sec}^{-1} \text{ cm}^{-2} \quad (8)$$

This is the equation needed to calculate q from Q_T .

Consider various values of s .

$$(a) \quad s = 0$$

$$q = \frac{Q_T}{A} \text{ Torr liters sec}^{-1} \text{ cm}^{-2} \quad (9)$$

This is the assumption made in Ref. 1 and the values of q so obtained (for a different geometry to be sure; discussed below) are quoted in Tables I and II of Ref. 1.

The values of q depend on surface treatment and fall as low as 3×10^{-14} Torr liters $\text{sec}^{-1} \text{ cm}^{-2}$ (for true H_2 quantities). The values of p_1 measured are not quoted because they are not used in Eq. (9). However they become of importance in Eq. (8) if $s \neq 0$. Actually $p_1 \approx 3 \times 10^{-11}$ Torr (H_2).² Let us now look at this case

$$(b) \quad s = 1$$

$$\begin{aligned} q &= 3 \times 10^{-14} + \frac{10^3 \times 3 \times 10^{-11}}{24.5} \\ &= 3 \times 10^{-14} + 1.2 \times 10^{-9} \text{ Torr liters sec}^{-1} \text{ cm}^{-2} \\ &= 1.2 \times 10^{-9} \end{aligned} \quad (10)$$

Note that the second term completely dominates and raises the specific outgassing rate by 5 orders of magnitude.

$$(c) \quad s = 10^{-5}$$

$$\begin{aligned} q &= 3 \times 10^{-14} + \frac{10^{-2} \times 3 \times 10^{-11}}{24.5} \\ &= 4.2 \times 10^{-14} \text{ Torr liters sec}^{-1} \text{ cm}^{-2} \end{aligned}$$

Hence the sticking probability must be as low as 10^{-5} to reduce the error in the specific outgassing rate to 30%.

2. Private communication.

Complete neglect of this term in Eq. (8) can therefore be a risky assumption.

III. Suggested Methods for Measuring s

It is clear that what is needed is a method for assessing the approximate magnitude of s . In Fig. 1 this is fairly easy to do by installing a gauge in the test chamber and recording its reading when the valve is open (it should be p_1) and when closed. If when the valve is closed the pressure does not change at all then the total

Internal Pumping Speed = $10^3 sA/\sqrt{MT}$ liters sec^{-1} (11)
completely dominates C_0 and a lower bound can be placed on s .

Note that to lower the pressure significantly in the test chamber it needs an external pump large compared to Eq. (11). For $s = 1$ and $A = 6000 \text{ cm}^2$, this is 250 000 liters sec^{-1} and is totally impractical.

If when the valve is closed the pressure rises quickly to a new equilibrium value p_{eq} , one can write from Eq. (8)

$$q = \frac{10^3 s}{\sqrt{MT}} p_{eq} \quad (12)$$

Equations (8) and (11) then provide two simultaneous linear equations from which both q and s can be obtained.

In practice such a measurement does not usually lead to a clear equilibrium value p_{eq} but a quasiequilibrium value drifting up slowly with time. It is not known how to analyze this curve quantitatively.³ One can only hope that the quick initial rise is sufficiently clearly defined to be identifiable. Further a quick drop of the same type should be seen when the valve is opened quickly and should be correlated in magnitude with the quick rise.

3. J.P. Hobson and J.W. Earnshaw, J. Vac. Sci. Technol. 4, 257, 1967.

Perhaps a more certain method is to add another pump of known speed quickly to the test chamber perhaps through another valve. In this case sharp pressure drops have been observed³ which can be used to yield values of s .

IV. The ISABELLE Geometry

The ISABELLE geometry is complicated by being a long pipe rather than the sphere of Fig. 1. However it is possible to place gauges at both ends of the pipe¹ and to perform the tests suggested in Section III above. The results should indicate whether $s \neq 0$ has to be considered. In the event that this is so, then a complete computer analysis with outgassing and readsorption the full length of the pipe is advised, coupled with pressure measurements down the pipe to test the analysis.

Conclusion

It is possible to interpret the measurements on the specific outgassing rate of Al in terms of a sticking coefficient of H_2 on the walls. Semiquantitative tests are suggested to establish whether this is true or not. If it is true, then the calculation of pressures achievable in the bore are altered in a way which will require further detailed analysis. The conclusion that Al tubing is satisfactory for ISABELLE is not necessarily vitiated in this event. The practical situation could conceivably be either better or worse. Nor are the ISR results on outgassing completely⁴ free from this change of interpretation.

4. R. Calder and G. Lewin, Br. J. Appl. Phys. 18, 1459, (1967).

Accepting that the actual outgassing rate may be several orders of magnitude greater than the net values as given in the pages of Appendix II, we must consider the effect of the geometry of the wake shield. Consider a semi-infinite plane, with an actual outgassing flux q . Unlike the spherical

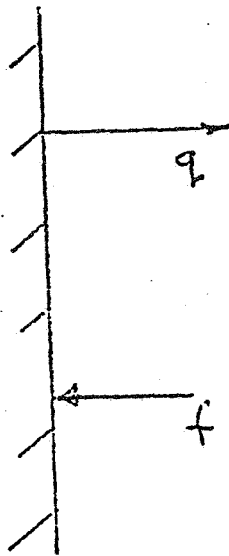

geometry of the test chamber treated in the previous paper, the flux striking the walls is determined by collisions from space craft contamination as well as the outgassing flux q . However, all molecules not involved in molecular collisions (except those hitting an experiment) will be removed from the wake shield site, and it is reasonable to assume that the flux f is proportional to q with a numerically small coefficient $\sim 10^{-3}$. The

differential equation for the number of molecules hitting the surface per unit area per unit time for a single species is:

$$f - fs = n_0 v_e e^{-\frac{E_B}{kT}}$$

or

$$g(1 - \alpha_s) = n_0 v_e e^{-\frac{E_B}{kT}}$$

In a closed system at steady state q is a constant and hence determines the equilibrium surface concentration n_0 . Part of n_0 can be thought of as "new" gas coming from the body of the wall and part from the "returning" flux f . It is easy to see if the portion of f that is retained on the surface,

fs, as in equation 8 of the previous paper,¹ equals 0, then q and n_o are the measured "net" values.

Under the conditions that $s \neq 0$, q may in reality be several orders of magnitude larger than the measured q_{net} implying that $n_o > n_o^{net}$. Unlike the previous case,² the return flux is small even if the sticking coefficient is close to unity as a result of the infinite pump of space. Thus $n_o \approx n_o^{net}$ and the measured rates will approximately apply. Even if α is not as small as 10^{-3} , an increase in n_o would imply a longer time would be needed to reduce the surface contaminants.

Only if the time constants were long would a problem result for the wake shield application, and meager data suggests a time constant of minutes.^{3,4}

References.

1. J. P. Hobson, Proc. of the 1975 Isabelle Summer-Study. Brookhaven National Laboratory.
2. J. P. Hobson and J. W. Earnshaw, J. Vac. Sci. Tech. 4, 257 (1967).
3. L. G. Mullins and M. J. Itiza, J. Vac. Sci. Tech. 4, 219 (1967).
4. G. Lewin, Appendix E-II-51.

THE IMPLICATIONS OF "TRUE" and "NET" OUTGASSING
 RATES FOR THE WAKE SHIELD EXPERIMENT

J.P. Hobson
 National Research Council,
 Ottawa, Canada

Here the specific question is posed: Given the experimental measurements of Halama and Herrera¹ on the outgassing of Aluminum Alloy Al 6061 in which they measure the "net" outgassing to be $Q_T = 3 \times 10^{-14}$ Torr litres $\text{sec}^{-1} \text{cm}^{-2}$ of H_2 would we conclude that this material is suitable for the wake shield? The selection of this particular data rather than a multitude of other possibilities occurs only because of the author's familiarity with the data. It is believed that similar conclusions would have been drawn from many other sources. The fact that Halama and Herrera¹ made measurements on a pipe rather than a sphere alters detailed numbers but not the main qualitative point of our argument.

Assume that the wake shield is just the sphere of the test chamber of Fig. 1/cut in half. Hence half the source of gas is removed and the pumping speed of the half removed is replaced by the pumping speed of space which will be the maximum allowable. We will assume that no molecules are scattered back into the wake shield from space since this is a consideration which although important, is additional to the present question. The wake shield then becomes a hemispherical shell (radius r) with the following properties:

- (1) Source of gas $q \times 2\pi r^2$ torr litres sec^{-1}
- (2) Wall pumping $\frac{10^3}{\sqrt{MT}} 2\pi r^2 s p$ torr litres sec^{-1}
- (3) Space pumping $\frac{10^3}{\sqrt{MT}} \pi r^2 p$ torr litres sec^{-1}

For simplicity the pressure p has been assumed uniform throughout. This is not a correct assumption but will not detract from our major conclusions.

p will reach a steady value such that

$$2\pi r^2 q = \frac{10^3}{\sqrt{MT}} 2\pi r^2 s p + \frac{10^3}{\sqrt{MT}} \pi r^2 p$$

q is the "true" outgassing rate of the wall s is the sticking coefficient of the wall. We take $M = 2$ for H_2 and $T = 300^\circ K$, i.e. $\sqrt{MT} = 24.5$.

$$\text{Thus } p = \frac{.024 q}{(s + .5)} \quad (1)$$

In the previous paper we deduced pairs of values of s and q consistent with the measured "net" outgassing value of 3×10^{-14} Torr litres $\text{sec}^{-1} \text{cm}^{-2}$ by assuming various values of s . We add to these below and work out the resulting values of p from equation (1),

Assumed Sticking Coefficient	s	0	10^{-5}	10^{-4}	10^{-3}	10^{-2}	10^{-1}	1
True out-gassing Torr litres $\text{sec}^{-1} \text{cm}^{-2}$	q	3×10^{-14}	4.2×10^{-14}	1.5×10^{-13}	1.23×10^{-12}	1.2×10^{-11}	1.2×10^{-10}	1.2×10^{-9}
Pressure at centre of wake shield Torr	p	1.5×10^{-15}	2.0×10^{-15}	7.2×10^{-15}	5.9×10^{-14}	5.6×10^{-13}	4.8×10^{-12}	1.8×10^{-11}

Thus it can be seen that if the density at the centre of the wake shield must be held to 10^3 molecules/ cm^3 ($p = 3 \times 10^{-14}$ Torr) it is important that the sticking probability for H_2 on Al 6061 was less than about 10^{-3} in the measurements of Halama and Herrera.¹ If this condition was satisfied then Al 6061 is suitable for the wake shield and if it was not then Al 6061 is not suitable for the wake shield. There is

no way from the published paper alone to establish the magnitude of s in the measurement, i.e. to tell the difference between the "true" and the "net" outgassing rates.

However in a paper concerned largely with measurements of residual pumping effects in a uhv system Hobson and Earnshaw² found a H_2 pumping speed of a few litres sec^{-1} where pumping speeds based on $s = 1$ could easily have been several thousand litres sec^{-1} or more. Thus values of $s < 10^{-3}$ in typical systems have been measured and may be fairly general, although to date they have not been the subject of extensive study.

References:

1. H.J. Halama and J.C. Herrera, J.Vac. Sci. Technol. 13, 463, 1976.
2. J.P. Hobson and J. W. Earnshaw, J. Vac. Sci. Technol. 4, 257, 1967.

SECTION III
NASA WORKSHOPS ON WAKE SHIELD MODELS

Interim Report of the
Ad Hoc Committee on the Assessment
of Models of a Wake Shield Environment Around Various Spacecraft
Universities Space Research Association

Committee Members:

Dr. Manfred A. Biondi
University of Pittsburgh

Dr. Sherman Deforest
University of California at San Diego

Dr. Lewis Linson
Science Application, Inc., LaJolla, California

Dr. Elden Whipple
University of California at San Diego

Dr. S. T. Wu
The University of Alabama in Huntsville

Dr. Shei Meng Yen
University of Illinois

Prepared by Dr. S. T. Wu, The University of Alabama in Huntsville

On January 23, 1978, an ad hoc committee of the Universities Space Research Association (USRA) met at Space Sciences Laboratory. The general objective of this committee was to evaluate the assumptions and theories of models depicting the potential environment seen around a wake shield environment. There were six subject areas discussed in this one day working session: possible changing effects on the wake shield environment, possible utilization of the IECM (Induced Environmental Contamination Monitor), present state-of-the-knowledge of the parameters used to describe the intermolecular collisions, the possibility of using simple models to describe the wake shield environment, possible errors associated with using kinetic theory to calculate that part of the atmosphere overtaking the shield, and a general assessment of the Monte Carlo techniques used to calculate the shield environment. A brief summary of these subjects is as follows:

I. MODELS OF THE SHIELD ENVIRONMENT

A. The LaRC group uses kinetic theory to calculate that fraction of the ambient atmosphere which can overtake the shield. In the region where the mean free path (mfp) is an appreciable fraction of the scale height (possibly ≥ 400 km), the particle trajectories are ballistic in nature which can lead to a significant distortion of the Maxwellian distribution. However, the distortion would appear to be such as to reduce the number of particles in the high energy tail and consequently reduce the flux of particles to the shield.

In the altitude at which the shield operates, the atmospheric density varies from 10^{10} to $10^8/\text{cm}^3$. Assuming a collision cross section of $\sim 3 \times 10^{-15} \text{ cm}^2$ and a velocity of ~ 400 m/sec, a rough table of the mfp versus altitude is given below:

<u>Altitude</u>	<u>Atmospheric Density</u>	<u>mfp</u>
200 km	$10^{10}/\text{cm}^3$	~ 16 meter
300 km	$10^7/\text{cm}^3$	~ 160 meter
400 km	$10^8/\text{cm}^3$	~ 1600 meter

Since even at 300 km the mfp is greater than the characteristic dimension of the spacecraft and boom assembly, the group feels

that a simple linear (one) collision model appears suitable to calculate the flux scattered back to the open end of the shield. This certainly seems true for altitudes greater than 300 km and may well be true for altitudes less than 300 km, depending upon the length of the spacecraft and boom.

B. Combining a one collision model with a program depicting the emitted molecular density around the spacecraft would be useable to give preliminary estimates for the backscattered flux. Such an outgassing program has apparently been developed by Martin Marietta Corporation for the shuttle and seems useable in describing the flux scattered to the shield for certain shuttle orientations.

One of the difficulties in any modeling effort is created by the lack of data on the parameters of the intermolecular collision process.

The bulk of the interparticle collision, which we are interested in for the meantime, in general involves atomic oxygen striking a relatively stationary emitted molecule with a speed of ~ 8 km/sec. This collision process can strongly excite rotational and/or vibrational levels in the molecule. Under these conditions there is no data available to specify collision characteristics (i.e., collision cross-section, effective masses and the degree of inelasticity of the collision). Because of the lack of accurate numerical values and probable inaccuracies in outgassing rates of a spacecraft, the calculated backscattered values are probably inaccurate to a factor of 5 no matter what model is used.

C. From the theoretical point of view, it is natural that the Monte Carlo method is generally the most proper method to deal with this kind of problem. However, due to the limitation of the number of particles which can be used in simulation because of the constraints of the computing time and memory of the computer, the Monte Carlo method becomes impractical for the problem we encounter. The group questioned whether the results obtained from any current Monte Carlo model was worth the extra expense incurred in the long run times.

D. Concerning the LaRC (Langely Research Center) Monte Carlo model, the group believes that the complexities of the cell configuration which make the computation extremely difficult and time-consuming is not necessarily enhancing the accuracy of the results because of the limitations we have mentioned before. Therefore, the group felt that it would be possible to reduce the intrinsic run time of the LaRC model in part by simplifying geometry and cell configuration. However, it is worth it to perform a Monte Carlo calculation with simple geometry to compare the one-collision model. From these results, we should be able to assess the situation more realistically.

Because of time limitations, this problem could not be discussed in detail, however, this group will investigate this problem further. In particular, Dr. Yen will make a special effort in this area.

II. ASSESSMENT OF CHARGING EFFECTS ON SPACECRAFT

It is recognized that the surface of the spacecraft can be charged up to ~ 100 volts, therefore, the possibility that this potential can attract ions must be investigated. The group felt that it would be wise to make a preliminary computation based on the models of Dr. Whipple and Lee Parker estimating the importance of the charging effects anticipated.

III. ASSESSMENT AT THE POTENTIAL APPLICABILITY OF THE IECM MEASUREMENTS

Some of the details of the IECM measurements of the shuttle environment were presented. It seemed that the general objective of the IECM to measure shuttle outgassing characteristics would benefit calculations of shield environment since it would help reduce some of the uncertainty in knowing spacecraft emission levels. The IECM will also be involved in a (N_e^{22} , H_2O^{18}) gas release to help determine the interaction of spacecraft emitted molecules with the atmosphere whereby the emitted molecules are scattered back to the spacecraft. Since there is a lack of data on the scattering of O/molecules at 8 km/sec, these results can be used to improve the accuracy of the modeling calculations. However, models of shield vacuum levels are really concerned with the backscattering of atomic oxygen and it appears that some modification of the apparatus

could give data of a more pertinent use for model calculations. One of the difficulties in using the IECM apparatus to measure vacuum environment in space, related to the shield, is the closed source collimated nature of the IECM mass spectrometer. This instrument is probably insensitive for measuring trace quantities of atomic oxygen.

In summary, some of the committee efforts in the near future involve having Dr. Yen look in more detail at the LaRC Program and Dr. Wu look into the possibility of generating data on wake environment charging effects with a code developed by L. Parker.

It would also appear desirable for this group to meet with other people, such as scientists and engineers from LaRC and MSFC, to further discuss the assumptions in the modeling effort. We have tentatively scheduled a workshop for April 3 and 4. Please review the date and when I call you to discuss this report, we can determine if it is suitable.

1978 April 3 and 4 Meeting Report of the
Ad Hoc Committee on the Assessment
of Models of a Wake Shield Environment Around Various Spacecraft
Universities Space Research Association

Committee Members:

Dr. Manfred A. Biondi
University of Pittsburgh

Dr. Sherman DeForest
University of California at San Diego

Dr. Lewis Linson
Science Application, Inc., LaJolla, California

Dr. Elden Whipple
University of California at San Diego

Dr. S. T. Wu
The University of Alabama in Huntsville

Dr. Shei Meng Yen
University of Illinois

Compiled by: Dr. S. T. Wu, The University of Alabama in Huntsville

On April 3 and 4, 1978, the Ad Hoc Committee on the Wake Shield Environments met at the SSL-MSFC conference room. This meeting was attended by Dr. W. A. Oran from NASA/MSFC, Drs. L. T. Melfi, Frank J. Brock and J. E. Hueser of the LRC/NASA group, as well as all of the committee members with the exception of Dr. Sherman DeForest. The agenda of this two-day meeting and the attendance list are included as Appendices I and II, respectively, of this section.

A detailed account of the meeting is given in the following sections. Section I will discuss the general principles of the Monte Carlo method and its potential. Section II will discuss the Langley Code for the prediction of the Space Shuttle flow field under orbital conditions. Section III will discuss the estimation of back scattering flux. Section IV will discuss the collisional processes and other related problems being discussed during the meeting. Section V will discuss the problem of the electric potential of the shuttle (i.e., charging effects). The final one, Section VI, includes specific recommendations.

I. General Principles of the Monte Carlo Method for Molecular Flow Simulation

In general, there are four Monte Carlo simulation techniques; they are (i) trace technique, (ii) field technique, (iii) tracer-field technique, and (iv) full technique. The tracer technique is that which uses a small number of simulated particles representing the field molecules, to complete the flow field. On the other hand, the full technique uses all the molecules in the field to simulate the flow field. The other two techniques fall between these. Choosing the technique merely depends on the nature of the problem. The tracer-field is found to be useful in dealing with mixtures of gases of different molecular weights. In any computational method for molecular flows, it is necessary to incorporate the realistic collision laws and gas surface interaction laws as well as geometric requirements of the problem. In order to deal with the complex geometry of flow (such as Shuttle), one requires the accommodation of surface geometry and the careful discretization of computational domain. The basic steps in direct simulation of the collision processes are the same for all the techniques. One selects the collisions and moves the tracer particles. The difference between various techniques lies in the resolution in updating the distribution functions of the collision partners. Further, we should realize that all Monte Carlo methods have statistical scatters which need to be controlled.

In the following, we shall discuss some specifics concerning the molecular shield problem.

(i) Formulation of the Molecular Shield Problem - The molecular shield problem determines the flux of upstream-moving molecules at far field locations. The molecular interactions that produce these molecules

involve gases of large differences in density as well as in mass. Small amounts of molecules of large mass could play an important role in the interactions. Molecules scattered from and emitted by the shuttle surface may undergo several collisions before reaching the far field.

(ii) Computational Requirements

(a) It is important to have a sufficiently large sample of the simulated particles in the cells in the far field in order to minimize the statistical scatters.

(b) In order to evaluate accurately the effect of collisions on the distribution function of the scattered molecules that reach the far field, the entire computational domain should be discretized according to the local gradient of the properties.

(c) It is necessary to treat accurately the interactions between gases of large differences in density and in mass.

(d) The realistic collision cross sections should be selected in calculating the collisions.

(e) The accuracy of calculations degrades near the boundaries; therefore, it is necessary to set out boundaries at relatively large distances from the shield so that the boundary error is minimized.

II. Langley Code - A Monte Carlo Direct Simulation Program For the Space Shuttle Flow Field Under Orbital Conditions

The basic procedures for the Langley code in the calculation of the shuttle environment presented by Dr. Brock appear to be satisfactory. This is a numerical code of a FORTRAN program for the computation of the three-dimensional transition regime flow past the Space Shuttle Orbital Vehicle. It employs the direct simulation Monte Carlo method which models the flow by some thousands of simulated molecules. These are followed through representative collisions and boundary interactions in simulated physical space. The geometry of the orbital vehicle has been approximated by a number of quadric surface elements. In principle, this code is based on the tracer technique. The results obtained for the shuttle problem using this code are of great interest. However, it would be difficult to apply the present results to the molecular shield problem for the following reasons:

- (i) The discretization of computational domain is arbitrary and crude,
- (ii) Weighting factors are used to build up sample size in the far field,
- (iii) The accuracy of the calculation degrades near the boundaries, and
- (iv) The molecular interaction model used in the code is not accurate; for example, the interaction between the gases in large differences in mass have not been taken into account.

Because of these reasons, we believe the following methods may deserve some attention for the molecular shield problem:

- (a) Langley Code - This code can be used for solving the molecular shield with several revisions, as was commented above.

(b) To develop a new code based on a tracer-field technique - In this technique, a sufficient sample of tracer particles will be used to follow the motion of molecules of each gas in order to deal with a mixture of large differences in mass and in density. Collision partners will be selected from the field molecules in order to increase the fidelity of calculating the collisions. This technique will also facilitate the discretization of the computational domain and the control of the boundary errors.

(c) Linear methods - Linear methods require no large computational effort and needs to satisfy fewer requirements (accurate treatment of all possible collisions and interactions and use of realistic collision cross-sections).

(d) Hybrid method - In the hybrid method, the calculations are decoupled and made in two explicit steps: (1) to determine the far field molecular distributions from a Monte Carlo code and (2) to determine the upstream moving flux using a linear model. This method, therefore, depends on accurate Monte Carlo solutions.

(e) A semi-analytic method for approximating the up-streaming flux - The Langley Monte-Carlo calculations appear to show that the dominant source of oxygen atoms behind the wake shield are due to streaming ambient atoms which scatter off out-gassing molecules which have come from the shuttle. However, the flux of these scattered oxygen atoms is difficult to estimate accurately because of the long computer runs necessary to get adequate statistics. However, the density of the out-gassed molecules from the shuttle appear to be reliable. This suggests an approximate procedure for estimating the scattered flux of oxygen atoms, based on

single, or perhaps double (if necessary) scattering. In this method the scattered oxygen atoms are treated as the unknown, with velocity distribution $f(\vec{v}, \vec{r})$, whereas the outgassing molecules are treated as a known quantity, with a known velocity distribution as a function of position $F(\vec{V}, \vec{r})$. Thus the Boltzmann equation becomes a linear equation for the unknown f . The Boltzmann equation may be written in the following form:

$$\frac{Df}{Dt} = \iiint K(\vec{v}, \vec{v}') f(\vec{v}') d^3 \vec{v}' - N(v) f(\vec{v}).$$

Here, the left-hand-side of the equation is the streaming operator, describing the rate of change of the distribution function f caused by collisions along the trajectory. In our problem of the wake shield, the appropriate trajectory is a straight line since there are no important large-scale forces present. The right-hand-side describes the scattering terms. The scattering kernel K and the collision frequency depend only on the scattering laws and on the (known) distribution function of the outgassed molecules. (For a reference on the scattering kernel, see E. Whipple, "Use of the Scattering Kernel Approach in Certain Gas Kinetic Problems," *Phys. Fluids*, 15, 988, 1972.) Consequently the scattering kernel and the collision frequency may be evaluated once and for all, in this approximation.

The equation may then be solved for f by successive approximation. Let $f = f_0 + f_1 + f_2 + \dots$. The subscripts refer to the number of collisions that an oxygen atom has had after entering the region of interest.

Thus trajectories may be assumed to start at the surface of this volume, where the initial f_0 is given by the ambient conditions. As the trajectory is followed inward, f is changed by collisions. Substitution of the expanded series for f gives a set of recursion equations for f_j :

$$\frac{Df_0}{Dt} = -Nf_0$$

$$\frac{Df_1}{Dt} = \iiint K f_0 d^3v' - Nf_1$$

$$\frac{Df_2}{Dt} = \iiint K f_1 d^3v' - Nf_2 .$$

It should be fairly straightforward to obtain terms up through f_1 , which should give the dominant back-streaming flux in the region behind the shield. It is possible to get f_2 , although the amount of work necessary for each successive term increases. The advantage of this method is that the integral term containing the contributions to f from scattering into the trajectory depends completely on known quantities.

III. Estimation of Back Scattering Flux

A single collision code was developed to help determine the upstream flowing flux around the Shuttle. The model assumes a cold neutral flow to simulate the atmosphere sweeping by the Shuttle and collision centers are provided by spacecraft outgassed molecules. The density of outgassed species was precalculated using the SPACE (Shuttle/Payload Contamination Evaluation) program produced by MMC (Martin Marietta Corp.). The collision itself is assumed to be hard sphere, isotropic in the center of mass (COM), and has a single algebraic formula relating the scattered flux in the COM to the spacecraft reference frame. To obtain the outgassed species density the conditions of high average temperature and the 10 hour point from the mission start were chosen. The first condition introduces a larger than average amount of heavy long chain molecule (i.e., ~ 100 AMU) outgassing from the non-metallic surfaces. The second condition produces a great deal of light molecules and desorption from the surfaces. This desorption rate supposedly decays quickly with a characteristic constant of ~ 18 hrs. The SPACE code is a phenomenological program, and in order to compare its results to that of other codes, we have plotted in Figure 1 the column densities above the Shuttle bay for the long chain (100 AMU) molecules and H_2O and N_2 (the predominant molecules of early desorption). The MMC code depicts only the unperturbed column densities due to material outgassing which is probably valid for the higher altitudes and for the shuttle orientation shown in Figure 1.

* Contribution from Dr. W. Oran

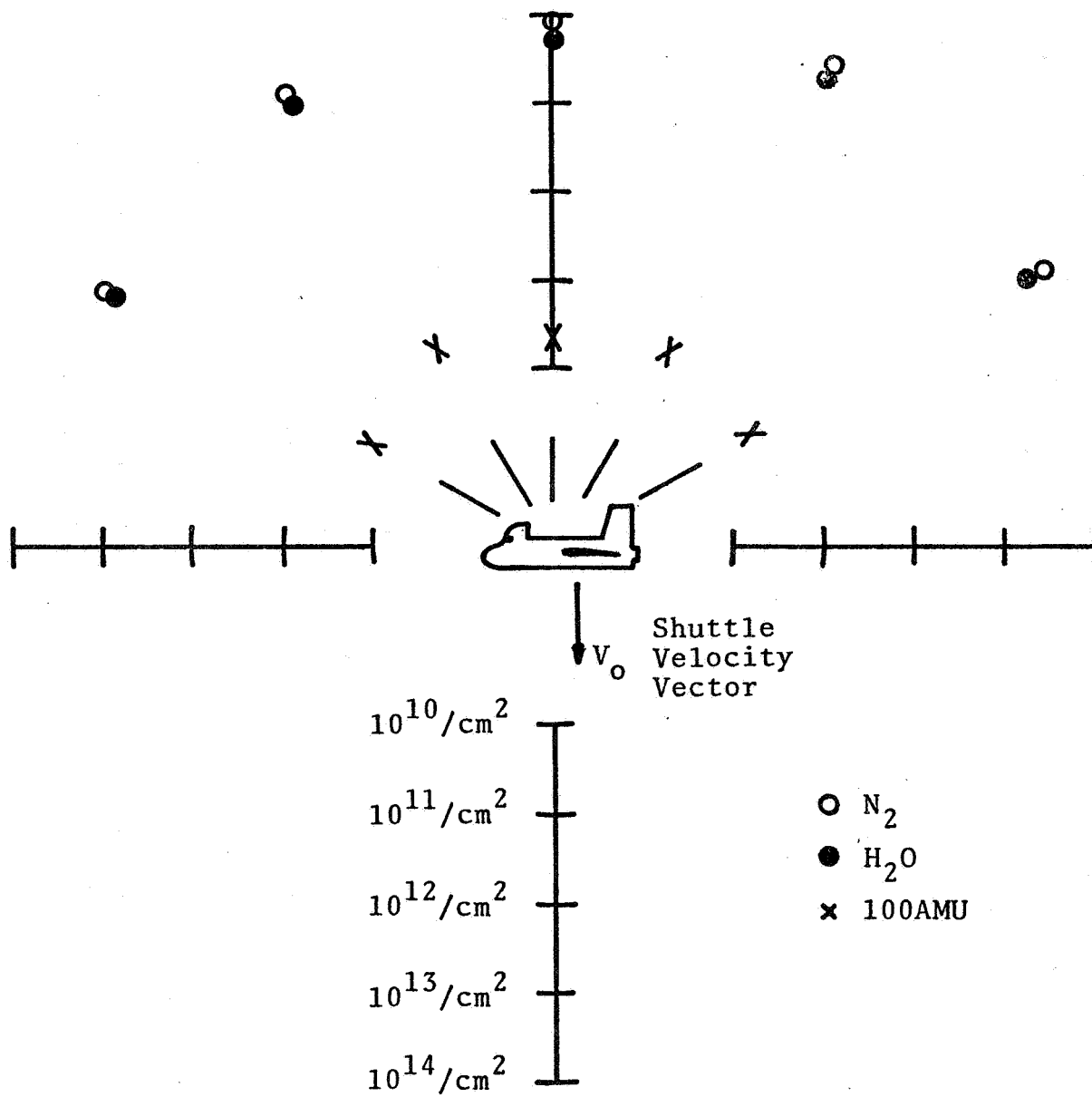

Figure 1

The single collision code then uses this density pattern for the scattering centers to calculate the upstream flowing flux due to the interaction of the atmospheric molecules with these centers. In Figure 2 we have plotted the flux of atmospheric atomic oxygen which is scattered back upstream as a function of distance above the Shuttle bay for the Shuttle orientation shown in Figure 1. This upstream flux is normalized to the quiescent flux $\bar{n}\bar{u}/4$ where ($\bar{u} \sim 10^5$ cm/sec for O at 1000°K). Other parameters used in calculations are:

<u>Interaction</u>	<u>Cross Section</u>	<u>Effective Mass of Scatterer</u>
O → 100 AMU	$9 \times 10^{-15} \text{ cm}^2$	100 AMU
O → N ₂	$4.5 \times 10^{-15} \text{ cm}^2$	28 AMU
O → H ₂ O	$3 \times 10^{-15} \text{ cm}^2$	18 AMU

The results of Figure 2 have some important implications. The slow decrease of upstream flux with distance from the shuttle would seem to indicate that this distance is not that important in determining the potential environment to the shield. The most critical parameter would appear to be the emissive characteristics of the body itself. For example, in Figure 2 we see that the large flux of early desorbed light molecules will dominate in the backscattering processes. However, within a couple of days into the mission these fluxes will be decreased substantially. The fluxes due to cabin leakage, flash evaporators, etc., have not been included in this output of the SPACE code. The engineering limit for cabin leakage alone is ~ 3 kgm/day, which is on the order of total early desorption flux from the upper surfaces of the Shuttle. One wonders

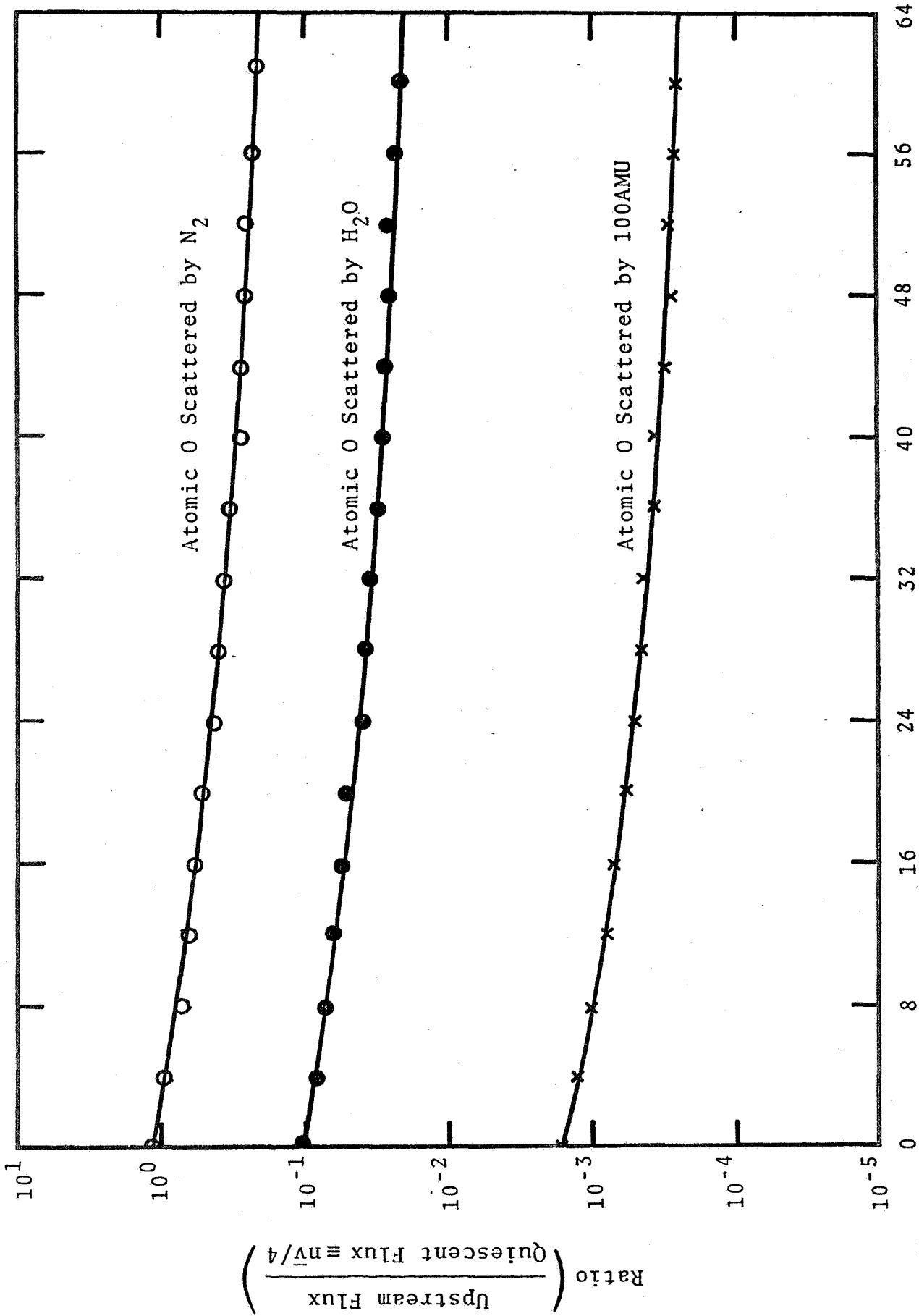

Figure 2.

whether there is any hope of even remotely achieving the 10^{-14} Torr vacuum levels targeted for the shield if the Shuttle is used as a carrier at lower altitudes.

IV. Collisional Processes in the Model for the Prediction of Molecular Shield Environment

In order to improve the accuracy of the models to predict the shuttle and molecular shield environment, some procedures concerning the collision physics need to be noted.

(i) Inclusion of proper masses for the collision partners.

(a) Atomic O free-stream particles reflected from the shuttle surface probably are converted to O₂ during accommodation.

(b) Small amounts of CO₂, NO_x, etc., in the "outgassing" may have a pronounced effect on backscattering free-stream O atoms into the shield.

(ii) For large relative velocities of collision (~ 8 km/sec) a more realistic center-of-mass scattering pattern should be used. (Available data suggests that the differential cross section, $\sigma(\theta)$, (in units of Å²/sr) may decrease sharply with angle; ~ 10⁴ at 0°, ~ 10³ at 3°, ~ 10² at 8°; ~ 10¹ at 16° and continue to fall as θ increases.) This forward peaking may have implications for the multiple-collision contribution to the back-scattered flux. The total collision cross section, defined by $\sigma_T \equiv 2\pi \int \sigma(\theta) \sin \theta d\theta$, for the above example is ~ 80 Å²; however, the momentum transfer cross section, σ_m , which gives a measure of the ability of the collision to turn the collision partners through large angles (for single collision effects) weights the integral by a (1-cos θ) factor and would have a much smaller value. If one uses a "hard-sphere" cross section in the scattering model for the fast collisions, it should probably not exceed 10Å².

(iii) For binary collisions among the possible permutations between outgassed molecules and spacecraft deflected (accommodated) free-stream molecules, a value of $\sigma_m \approx 30\text{\AA} [\sigma_m \equiv (N\lambda)^{-1}]$ is probably appropriate, since these are slow particles, $T \sim 3000\text{-}400\text{ K}$ (more information on this can be obtained if neutral molecule diffusion coefficients are available). Here the angular scattering pattern may be more isotropic (e.g., for permanent dipole-permanent dipole long range forces).

If the outgassing rates are really as high (10^{15} to 4×10^{15} $\text{cm}^{-2} \text{sec}^{-1}$) as assumed in the model calculations presented, the slowly moving (relative to the shield/shuttle) "accommodated" molecules - H_2O , O_2 , CO_2 , NO_x will probably provide the major scattering centers for deflecting free stream O and spacecraft reflected O_2 molecules into the shield. If the outgassing rates are much smaller, then spacecraft reflected (and accommodated) slow-moving O_2 may be the important source of the scattering centers.

V. Electric Charging Effects on Molecular Shield

To analyze this problem, we should understand the electric charging problem around the shuttle. The electric charging problem around the shuttle can be classified in two categories.

1. The Electric Potential of the Shuttle

This problem has been addressed in some detail in a report by Harold Liemohn when he was at the Battelle Institute (P. O. Box 999, Richland, WA 99352). He was especially concerned with occasions when the ion-electron beam experiments on the payload would be activated. Under these conditions large potentials (approaching the beam potential) could develop on the surface of the shuttle. The large amount of surface areas covered with dielectric material made it difficult to arrive at quantitative results however.

In general, the surface charge on a satellite is determined by current balance; the potential will change until the net current vanishes. For a conducting portion of the surface, the net current to that portion must vanish; for a dielectric (i.e., insulating) surface, the current density at each point must vanish for equilibrium conditions. The important currents at ionospheric altitudes are the plasma electron and ion currents. Because of the higher electron thermal velocities, the electron current density is larger than the ion current density due to the ram motion of the vehicle moving through the ionospheric plasma. The result is that a spacecraft tends to be driven negative until the reduced electron current is equal to the ion current.

For example, the ion current is approximately $neVA_p$, where n is the local plasma density, e the unit ion charge, V the spacecraft

velocity, and A_p the cross-sectional area of the spacecraft projected in the direction of motion. The electron current is approximately $\frac{neA_T c}{2\pi^{1/2}}$ $\exp(\phi e/kT)$ where A_T is the total area of the spacecraft, c is the electron thermal velocity, and ϕ is the spacecraft potential, and T the electron temperature. Therefore, for a conducting spacecraft, the potential may be estimated by equating the currents, with the result that

$$\phi = (kT/e) \ln(2\pi^{1/2} A_p V/A_T c) .$$

Thus the potential of a conducting body is usually negative on the order of the equivalent electron temperature, multiplied by a weakly varying function of the spacecraft shape and velocity ratio.

For a spacecraft with large areas of insulating material the situation can be quite different. For example, on surfaces at the rear of the vehicle where the streaming ions cannot readily be incident at small potentials, the potential may become quite negative due to the incident electrons which are coming in roughly isotropically. Hence the potential on such surfaces may go quite negative in order to reduce the electron current and also to bring in some ions by deflecting their trajectories. I would expect this to be true for surfaces at the rear of the shuttle. It may also occur on the rear of the wake shield if its material is not conducting.

2. The Electrical Wake Behind the Shuttle

There is a finite, roughly cone-shaped region behind the spacecraft which is depleted of ambient ionospheric ions because of the relative motion of the spacecraft with respect to the ionospheric plasma. However, ionospheric electrons can penetrate this region --

usually denoted as an electrical wake -- and will acquire a negative space charge. This induced electric potential distribution will act to deflect ambient ions into the wake region. The potential in this region can be roughly estimated by first calculating the density of the free-streaming ions assuming straight line trajectories. This density $n(\vec{r})$ can then be set equal to the reduced electron density one would obtain by assuming the Boltzmann factor: $n = n_0 \exp \left[\frac{e\phi(\vec{r})}{kT} \right]$. If the potential one obtained by this calculation is large enough (in the negative direction) to affect the trajectories of the streaming ions, then one has a way of estimating how many ions could penetrate to this wake region, by computing the deflections in the ion trajectories.

From these two reasons, we realize that the changing effects are important to the prediction of the shuttle environment. Consequently, its effects will become roughly important to the molecular shield problem.

VI. Recommendations

After lengthy discussions, the committee reaches the following conclusions:

1. The Langley code is a very useful code; it can accurately predict the shuttle environment. However, we feel that it is not accurate enough for the molecular shield problem. The reasons are stated in the previous sections.

2. Electric charging effect is an important problem in the prediction of molecular shield environment. It certainly deserves a detailed investigation. Therefore, we recommend the following:

a. Development of an analytical-numerical linear model, including the proper steps in accordance with realistic collisional physics (see Section III), as a supplementary model for the Langley code. The essential reason such a model is needed can be stated as follows: (i) the upstream scattered flux aft of the orbiter is small and can be accurately calculated by analytical-numerical techniques, (ii) the scaling with ambient density, gas outflux rate, assumed cross sections, and assumed masses of particles can be obtained, and (iii) the accuracy of the calculation can be compared with the calculations performed by the Monte Carlo technique in other regions.

b. Attention should be given to the charging problem based on the reasons outlined in Section IV. However, before attempting to apply a complicated numerical code (such as Lee Parker's code), we feel that it would be more important to spend some time defining the problem with the next step being to evaluate the effects that may be produced.

3. Since the physical collision parameters are not well known in terms of cross sections and effective masses for the present problem, we therefore recommend that some laboratory experiments be undertaken to measure these parameters under conditions expected.

Appendix I

2nd Meeting of
the
Ad Hoc Committee on the Assessment
of Models of a Wake Shield Environment Around Various Spacecraft
Universities Space Research Association
April 3 and 4, 1978
Space Sciences Lab/MSFC
Huntsville, Alabama

AGENDA

Monday, April 3, 1978

- 9:00 a.m. Welcome
 W. A. Oran, NASA/MSFC
 Summary of Last Meeting's Discussion
 S. T. Wu, The University of Alabama in Huntsville
- 9:30 a.m. Discussion of Monte Carlo Methods
 S. M. Yen, University of Illinois, Urbana-Champaign
- 10:30 a.m. Discussion on Langley Code on Simulation Program for the
 Space Shuttle Flowfield under Orbital Conditions
 Leonard T. Melfi, Jr., NASA/Langley Research Center
 Frank J. Brock, Old Dominion University
- 1:00 p.m. Lunch
- 2:00 p.m. Discussion of Langley Code
- 6:00 p.m. Adjourn

Tuesday, April 4, 1978

- 8:30 a.m. Summary of the Discussion of Langley Code
- 9:00 a.m. An Analytic Model of Back Scattering Flux
 W. A. Oran, NASA/MSFC
- 9:30 a.m. Charging Effects on Shield Environment and a Semi-Analytic
 Method for Approximating the Up-Streaming Flux Due to
 Scattering
 Elden C. Whipple, University of California, San Diego
- 10:30 a.m. Collisional Process
 M. A. Biondi, University of Pittsburgh

11:30 a.m. Release of Cloub from Spacecraft
Lewis Linson, Science Applications, Inc.

12:00 N Lunch

1:00 p.m. Discussions (Committee Members)

2:30 p.m. Adjourn

Appendix II

Attendance List

<u>Name</u>	<u>Address</u>	<u>Phone</u>
Elden Whipple	Physics Department, B-019 UCSD, LaJolla, CA 92093	(714) 452-3315
Manfred (Fred) A. Biondi	Department of Physics & Astronomy University of Pittsburgh Pittsburgh, PA 15260	(412) 624-4354
Shee-Mang Yen	Coordinated Science Lab University of Illinois Urbana, Illinois 61801	(217) 333-6360
Frank J. Brock/160 Jos. E. Hueser/160 L. T. Melfi/160	NASA/Langley Research Center Hampton, VA 23665	(804) 827-3781
Shi Tsan Wu	Department of Mechanical Engineering The University of Alabama in Huntsville P. O. Box 1247 Huntsville, AL 35807	(205) 895-6413
W. A. Oran	NASA/MSFC Alabama, 35812	(205) 453-3090
Lewis M. Linson	Science Applications, Inc. P. O. Box 2351 LaJolla, CA 92037	(714) 459-0211 Ext. 349

APPROVAL

PROCEEDINGS OF WORKSHOPS TO DEFINE ENGINEERING
REQUIREMENTS FOR A SPACE VACUUM RESEARCH FACILITY

Edited by W. A. Oran, S. T. Wu, and R. W. Hoffman

The information in this report has been reviewed for technical content. Review of any information concerning Department of Defense or nuclear energy activities or programs has been made by the MSFC Security Classification Officer. This report, in its entirety, has been determined to be unclassified.



ROBERT J. NAUMANN
Chief, Space Processing Division



CHARLES A. LUNDQUIST
Director, Space Sciences Laboratory