

# REPORT No. 116.

## APPLICATIONS OF MODERN HYDRODYNAMICS TO AERONAUTICS.

By L. PRANDTL.

### PART I.

#### FUNDAMENTAL CONCEPTS AND THE MOST IMPORTANT THEOREMS.

1. All actual fluids show internal friction (viscosity), yet the forces due to viscosity, with the dimensions and velocities ordinarily occurring in practice, are so very small in comparison with the forces due to inertia, for water as well as for air, that we seem justified, as a first approximation, in entirely neglecting viscosity. Since the consideration of viscosity in the mathematical treatment of the problem introduces difficulties which have so far been overcome only in a few specially simple cases, we are forced to neglect entirely internal friction unless we wish to do without the mathematical treatment.

We must now ask how far this is allowable for actual fluids, and how far not. A closer examination shows us that for the interior of the fluid we can immediately apply our knowledge of the motion of a nonviscous fluid, but that care must be taken in considering the layers of the fluid in the immediate neighborhood of solid bodies. Friction between fluid and solid body never comes into consideration in the fields of application to be treated here, because it is established by reliable experiments that fluids like water and air never slide on the surface of the body; what happens is, the final fluid layer immediately in contact with the body is attached to it (is at rest relative to it), and all the friction of fluids with solid bodies is therefore an internal friction of the fluid. Theory and experiment agree in indicating that the transition from the velocity of the body to that of the stream in such a case takes place in a thin layer of the fluid, which is so much the thinner, the less the viscosity. In this layer, which we call the boundary layer, the forces due to viscosity are of the same order of magnitude as the forces due to inertia, as may be seen without difficulty.<sup>1</sup> It is therefore important to prove that, however small the viscosity is, there are always in a boundary layer on the surface of the body forces due to viscosity (reckoned per unit volume) which are of the same order of magnitude as those due to inertia. Closer investigation concerning this shows that under certain conditions there may occur a reversal of flow in the boundary layer, and as a consequence a stopping of the fluid in the layer which is set in rotation by the viscous forces, so that, further on, the whole flow is changed owing to the formation of vortices. The analysis of the phenomena which lead to the formation of vortices shows that it takes place where the fluid experiences a retardation of flow along the body. The retardation in some cases must reach a certain finite amount so that a reverse flow arises. Such retardation of flow occurs regularly in the rear of blunt bodies; therefore vortices are formed there very soon after the flow begins, and consequently the results which are furnished by the theory of nonviscous flow can not be applied. On the other hand, in the rear of very tapering bodies the retardations are often so small that there is no noticeable formation of vortices. The principal successful results of hydrodynamics apply to this case. Since it is these tapering bodies which offer specially small resistance and which, therefore, have found special consideration in aeronautics under similar applications, the theory can be made useful exactly for those bodies which are of most technical interest.

<sup>1</sup> From this consideration one can calculate the approximate thickness of the boundary layer for each special case.

For the considerations which follow we obtain from what has gone before the result that in the interior of the fluid its viscosity, if it is small, has no essential influence, but that for layers of the fluid in immediate contact with solid bodies exceptions to the laws of a nonviscous fluid must be allowable. We shall try to formulate these exceptions so as to be, as far as possible, in agreement with the facts of experiment.

2. A further remark must be made concerning the effect of the compressibility of the fluid upon the character of the flow in the case of the motion of solid bodies in the fluid. All actual fluids are compressible. In order to compress a volume of air by 1 per cent, a pressure of about one one-hundredth of an atmosphere is needed. In the case of water, to produce an equal change in volume, a pressure of 200 atmospheres is required; the difference therefore is very great. With water it is nearly always allowable to neglect the changes in volume arising from the pressure differences due to the motions, and therefore to treat it as absolutely incompressible. But also in the case of motions in air we can ignore the compressibility so long as the pressure differences caused by the motion are sufficiently small. Consideration of compressibility in the mathematical treatment of flow phenomena introduces such great difficulties that we will quietly neglect volume changes of several per cent, and in the calculations air will be looked upon as incompressible. A compression of 3 per cent, for instance, occurs in front of a body which is being moved with a velocity of about 80 m./sec. It is seen, then, that it appears allowable to neglect the compressibility in the ordinary applications to technical aeronautics. Only with the blades of the air screw do essentially greater velocities occur, and in this case the influence of the compressibility is to be expected and has already been observed. The motion of a body with great velocity has been investigated up to the present, only along general lines. It appears that if the velocity of motion exceeds that of sound for the fluid, the phenomena are changed entirely, but that up close to this velocity the flow is approximately of the same character as in an incompressible fluid.

3. We shall concern ourselves in what follows only with a nonviscous and incompressible fluid, about which we have learned that it will furnish an approximation sufficient for our applications, with the reservations made. Such a fluid is also called "the ideal fluid."

What are the properties of such an ideal fluid? I do not consider it here my task to develop and to prove all of them, since the theorems of classical hydrodynamics are contained in all textbooks on the subject and may be studied there. I propose to state in what follows, for the benefit of those readers who have not yet studied hydrodynamics, the most important principles and theorems which will be needed for further developments, in such a manner that these developments may be grasped. I ask these readers, therefore, simply to believe the theorems which I shall state until they have the time to study the subject in some textbook on hydrodynamics.

The principal method of description of problems in hydrodynamics consists in expressing in formulas as functions of space and time the velocity of flow, given by its three rectangular components,  $u, v, w$ , and in addition the fluid pressure  $p$ . The condition of flow is evidently completely known if  $u, v, w$ , and  $p$  are given as functions of  $x, y, z$ , and  $t$ , since then  $u, v, w$ , and  $p$  can be calculated for any arbitrarily selected point and for every instant of time. The direction of flow is defined by the ratios of  $u, v$ , and  $w$ ; the magnitude of the velocity is  $\sqrt{u^2 + v^2 + w^2}$ . The "streamlines" will be obtained if lines are drawn which coincide with the direction of flow at all points where they touch, which can be accomplished mathematically by an integration. If the flow described by the formulas is to be that caused by a definite body, then at those points in space, which at any instant form the surface of the body, the components of the fluid velocity normal to this surface must coincide with the corresponding components of the velocity of the body. In this way the condition is expressed that neither does the fluid penetrate into the body nor is there any gap between it and the fluid. If the body is at rest in a stream, the normal components of the velocity at its surface must be zero; that is, the flow must be tangential to the surface, which in this case therefore is formed of stream lines.

4. In a stationary flow—that is, in a flow which does not change with the time, in which then every new fluid particle, when it replaces another particle in front of it, assumes its velocity, both in magnitude and in direction and also the same pressure—there is, for the fluid particles lying on the same stream line, a very remarkable relation between the magnitude of the velocity, designated here by  $V$ , and the pressure, the so-called Bernouilli equation—

$$p + \frac{\rho}{2} V^2 = \text{const.} \quad (1)$$

( $\rho$  is the density of the fluid, i. e., the mass of a unit volume). This relation is at once applicable to the case of a body moving uniformly and in a straight line in a fluid at rest, for we are always at liberty to use for our discussions any reference system having a uniform motion in a straight line. If we make the velocity of the reference system coincide with that of the body, then the body is at rest with reference to it, and the flow around it is stationary. If now  $V$  is the velocity of the body relative to the stationary air, the latter will have in the new reference system the velocity  $V$  upon the body (a man on an airplane in flight makes observations in terms of such a reference system, and feels the motion of flight as “wind”).

The flow of incident air is divided at a blunt body, as shown in figure 1. At the point  $A$  the flow comes completely to rest, and then is again set in motion in opposite directions, tangential to the surface of the body. We learn from equation (1) that at such a point, which we shall call a “rest-point,” the pressure must be greater by  $\frac{\rho}{2} V^2$  than in the undisturbed fluid. We shall call the magnitude of this pressure, of which we shall make frequent use, the “dynamical pressure,” and shall designate it by  $q$ . An open end of a tube facing the stream produces a rest point of a similar kind, and there arises in the interior of the tube, as very careful experiments have shown, the exact dynamical pressure, so that this principle can be used for the measurement of the velocity, and is in fact much used. The dynamical pressure is also well suited to express the laws of air resistance. It is known that this resistance is proportional to the square of the velocity and to the density of the medium: but  $q = \frac{\rho}{2} V^2$ ; so the law of air resistance may also be expressed by the formula

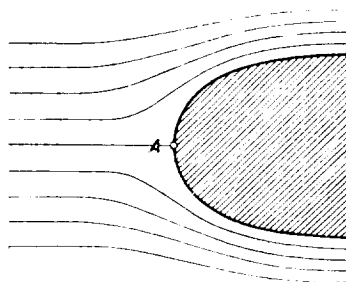

FIG. 1.—FLOW AROUND A BLUNT BODY.

$$W = c \cdot F \cdot q \quad (2)$$

where  $F$  is the area of the surface and  $c$  is a pure number. With this mode of expression it appears very clearly that the force called the “drag” is equal to surface times pressure difference (the formula has the same form as the one for the piston force in a steam engine). This mode of stating the relation has been introduced in Germany and Austria and has proved useful. The air-resistance coefficients then become twice as large as the “absolute” coefficients previously used.

Since  $V^2$  can not become less than zero, an increase of pressure greater than  $q$  can not, by equation (1), occur. For diminution of pressure, however, no definite limit can be set. In the case of flow past convex surfaces marked increases of velocity of flow occur and in connection with them diminutions of pressure which frequently amount to  $3q$  and more.

5. A series of typical properties of motion of nonviscous fluids may be deduced in a useful manner from the following theorem, which is due to Lord Kelvin. Before the theorem itself is stated, two concepts must be defined. 1. The circulation: Consider the line integral of the velocity  $\int V \cos (V, ds) \cdot ds$ , which is formed exactly like the line integral of a force, which is called “the work of the force.” The amount of this line integral, taken over a path which returns on itself is called the circulation of the flow. 2. The fluid line: By this is meant a line which is always formed of the same fluid particles, which therefore shares in the motion of the

fluid. The theorem of Lord Kelvin is: In a nonviscous fluid the circulation along every fluid line remains unchanged as time goes on. But the following must be added:

(1) The case may arise that a fluid line is intersected by a solid body moving in the fluid. If this occurs, the theorem ceases to apply. As an example I mention the case in which one pushes a flat plate into a fluid at rest, and then by means of the plate exerts a pressure on the fluid. By this a circulation arises which will remain if afterwards the plate is quickly withdrawn in its own plane. See figure 2.

(2) In order that the theorem may apply, we must exclude mass forces of such a character that work is furnished by them along a path which returns on itself. Such forces do not ordinarily arise and need not be taken into account here, where we are concerned regularly only with gravity.

(3) The fluid must be homogeneous, i. e., of the same density at all points. We can easily see that in the case of nonuniform density circulation can arise of itself in the course of time if we think of the natural ascent of heated air in the midst of cold air. The circulation increases continuously along a line which passes upward in the warm air and returns downward in the cold air.

Frequently the case arises that the fluid at the beginning is at rest or in absolutely uniform motion, so that the circulation for every imaginable closed line in the fluid is zero. Our theorem then says that for every closed line that can arise from one of the originally closed lines the circulation remains zero, in which we must make exception, as mentioned above, of those lines which are cut by bodies. If the line integral along every closed line is zero, the line integral for an open curve from a definite point  $O$  to an arbitrary point  $P$  is independent of the selection

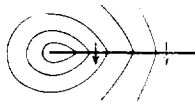

FIG. 2.—Production of circulation by introduction and withdrawal of flat plate.

of the line along which the integral is taken (if this were not so, and if the integrals along two lines from  $O$  to  $P$  were different, it is evident that the line integral along the closed curve  $OPO$  would not be zero, which contradicts our premise). The line integral along the line  $OP$  depends, therefore, since we will consider once for all the point  $O$  as a fixed one, only on the coordinates of the point  $P$ , or, expressed differently, it is a function of these coordinates. From analogy with corresponding considerations in the case of fields of force, this line integral is called the "velocity potential," and the particular kind of motion in which such a potential exists is called a "potential motion." As follows immediately from the meaning of line integrals, the component of the velocity in a definite direction is the derivative of the potential in this direction. If the line-element is perpendicular to the resultant velocity, the increase of the potential equals zero, i. e., the surfaces of constant potential are everywhere normal to the velocity of flow. The velocity itself is called the gradient of the potential. The velocity components  $u, v, w$  are connected with the potential  $\Phi$  by the following equations:

$$u = \frac{\partial \phi}{\partial x}, \quad v = \frac{\partial \phi}{\partial y}, \quad w = \frac{\partial \phi}{\partial z} \quad (3)$$

The fact that the flow takes place without any change in volume is expressed by stating that as much flows out of every element of volume as flows in. This leads to the equation

$$\frac{\partial u}{\partial x} + \frac{\partial v}{\partial y} + \frac{\partial w}{\partial z} = 0 \quad (4)$$

In the case of potential flow we therefore have

$$\frac{\partial^2 \phi}{\partial x^2} + \frac{\partial^2 \phi}{\partial y^2} + \frac{\partial^2 \phi}{\partial z^2} = 0 \quad (4a)$$

as the condition for flow without change in volume. All functions  $\Phi(x, y, z, t)$ , which satisfy this last equation, represent possible forms of flow. This representation of a flow is specially convenient for calculations, since by it the entire flow is given by means of the one function  $\Phi$ . The most valuable property of the representations is, though, that the sum of two, or of as many as one desires, functions  $\Phi$ , each of which satisfies equation (4a), also satisfies this equation, and therefore represents a possible type of flow ("superposition of flows").

6. Another concept can be derived from the circulation, which is convenient for many considerations, viz, that of rotation. The component of the rotation with reference to any axis is obtained if the circulation is taken around an elementary surface of unit area in a plane perpendicular to the axis. Expressed more exactly, such a rotation component is the ratio of the circulation around the edge of any such infinitesimal surface to the area of the surface. The total rotation is a vector and is obtained from the rotation components for three mutually perpendicular axes. In the case that the fluid rotates like a rigid body, the rotation thus defined comes out as twice the angular velocity of the rigid body. If we take a rectangular system of axes and consider the rotations with reference to the separate axes, we find that the rotation can also be expressed as the geometrical sum of the angular velocities with reference to the three axes.

The statement that in the case of a potential motion the circulation is zero for every closed fluid line can now be expressed by saying the rotation in it is always zero. The theorem that the circulation, if it is zero, remains zero under the conditions mentioned, can also now be expressed by saying that, if these conditions are satisfied in a fluid in which there is no rotation, rotation can never arise. An irrotational fluid motion, therefore, always remains irrotational. In this, however, the following exceptions are to be noted: If the fluid is divided owing to bodies being present in it, the theorem under consideration does not apply to the fluid layer in which the divided flow reunites, not only in the case of figure 2 but also in the case of stationary phenomena as in figure 3, since in this case a closed fluid line drawn in front of the body can not be transformed into a fluid line that intersects the region where the fluid streams come together. Figure 3 shows four successive shapes of such a fluid line. This region is, besides, filled with fluid particles which have come very close to the body. We are therefore led to the conclusion from the standpoint of a fluid with very small but not entirely vanishing viscosity that the appearance of vortices at the points of reunion of the flow in the rear of the body does not contradict the laws of hydrodynamics. The three components of the rotation  $\xi$ ,  $\eta$ ,  $\zeta$  are expressed as follows by means of the velocity components  $u$ ,  $v$ ,  $w$ .

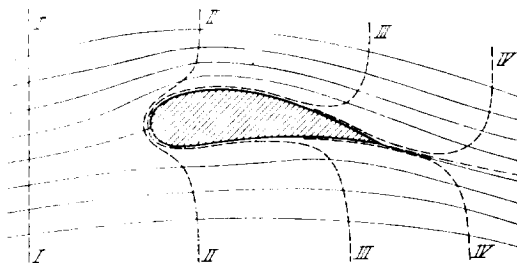

FIG. 3.—Successive positions of a fluid line in flow around a solid body.

$$\xi = \frac{\partial w}{\partial y} - \frac{\partial v}{\partial z}, \quad \eta = \frac{\partial u}{\partial z} - \frac{\partial w}{\partial x}, \quad \zeta = \frac{\partial v}{\partial x} - \frac{\partial u}{\partial y} \quad (5)$$

If the velocity components are derived from a potential, as shown in equation (2), the rotation components, according to equation (5) vanish identically, since  $\frac{\partial^2 \Phi}{\partial z \partial y} = \frac{\partial^2 \Phi}{\partial y \partial z}$

7. Very remarkable theorems hold for the rotation, which were discovered by v. Helmholtz and stated in his famous work on vortex motions. Concerning the geometrical properties of the rotation the following must be said:

At all points of the fluid where rotation exists the direction of the resultant rotation axes can be indicated, and lines can also be drawn whose directions coincide everywhere with these axes, just as the stream lines are drawn so as to coincide with the directions of the velocity. These lines will be called, following Helmholtz, "vortex lines." The vortex lines through the points of a small closed curve form a tube called a "vortex tube." It is an immediate consequence of the geometrical idea of rotation as deduced above that through the entire extent of a vortex tube its strength—i. e., the circulation around the boundary of the tube—is constant. It is seen, in fact, that on geometrical grounds the space distribution of rotation quite independently of the special properties of the velocity field from which it is deduced is of the same nature as the space distribution of the velocities in an incompressible fluid. Consequently a vortex tube, just like a stream line in an incompressible fluid, can not end anywhere in the interior of the fluid; and the strength of the vortex, exactly like the quantity of fluid passing per second through the tube of stream lines, has at one and the same instant the same value

throughout the vortex tube. If Lord Kelvin's theorem is now applied to the closed fluid line which forms the edge of a small element of the surface of a vortex tube, the circulation along it is zero, since the surface inclosed is parallel to the rotation axis at that point. Since the circulation can not change with the time, it follows that the element of surface at all later times will also be part of the surface of a vortex tube. If we picture the entire bounding surface of a vortex tube as made up of such elementary surfaces, it is evident that, since as the motion continues this relation remains unchanged, the particles of the fluid which at any one time have formed the boundary of a vortex tube will continue to form its boundary. From the consideration of the circulation along a closed line inclosing the vortex tube, we see that this circulation—i. e., the strength of our vortex tube—has the same value at all times. Thus we have obtained the theorems of Helmholtz, which now can be expressed as follows, calling the contents of a vortex tube a "vortex filament": "The particles of a fluid which at any instant belong to a vortex filament always remain in it; the strength of a vortex filament throughout its extent and for all time has the same value." From this follows, among other things, that if a portion of the filament is stretched, say, to double its length, and thereby its cross section made one-half as great, then the rotation is doubled, because the strength of the vortex, the product of the rotation and the cross section, must remain the same. We arrive, therefore, at the result that the vector expressing the rotation is changed in magnitude and direction exactly as the distance between two neighboring particles on the axis of the filament is changed.

8. From the way the strengths of vortices have been defined it follows for a space filled with any arbitrary vortex filaments, as a consequence of a known theorem of Stokes, that the circulation around any closed line is equal to the algebraic sum of the vortex strengths of all the filaments which cross a surface having the closed line as its boundary. If this closed line is in any way continuously changed so that filaments are thereby cut, then evidently the circulation is changed according to the extent of the strengths of the vortices which are cut. Conversely we may conclude from the circumstance that the circulation around a closed line (which naturally can not be a fluid line) is changed by a definite amount by a certain displacement, that by the displacement vortex strength of this amount will be cut, or expressed differently, that the surface passed over by the closed line in its displacement is traversed by vortex filaments whose strengths add up algebraically to the amount of the change in the circulation.

The theorems concerning vortex motion are specially important because in many cases it is easier to make a statement as to the shape of the vortex filaments than as to the shape of the stream lines, and because there is a mode of calculation by means of which the velocity at any point of the space may be determined from a knowledge of the distribution of the rotation. This formula, so important for us, must now be discussed. If  $\Gamma$  is the strength of a thin vortex filament and  $ds$  an element of its medial line, and if, further,  $r$  is the distance from the vortex element to a point  $P$  at which the velocity is to be calculated, finally if  $\alpha$  is the angle between  $ds$  and  $r$ , then the amount of the velocity due to the vortex element is

$$dv = \frac{\Gamma ds \sin \alpha}{4 \pi r^2}; \quad (6)$$

the direction of this contribution to the velocity is perpendicular to the plane of  $ds$  and  $r$ . The total velocity at the point  $P$  is obtained if the contributions of all the vortex elements present in the space are added. The law for this calculation agrees then exactly with that of Biot-Savart, by the help of which the magnetic field due to an electric current is calculated. Vortex filaments correspond in it to the electric currents, and the vector of the velocity to the vector of the magnetic field.

As an example we may take an infinitely long straight vortex filament. The contributions to the velocity at a point  $P$  are all in the same direction, and the total velocity can be determined by a simple integration of equation (6). Therefore this velocity is

$$v = \frac{\Gamma}{4\pi} \int_{-\infty}^{+\infty} \frac{ds \cdot \sin \alpha}{r^2}$$

As seen by figure 4,  $s = h \operatorname{ctg} \alpha$ , and by differentiation,  $ds = -\frac{h}{\sin^2 \alpha} d\alpha$ . Further  $r = \frac{h}{\sin \alpha}$ ; so that

$$v = \frac{\Gamma}{4\pi h} \int_0^\pi \sin \alpha d\alpha = -\frac{\Gamma}{4\pi h} [\cos \alpha]_0^\pi = \frac{\Gamma}{2\pi h} \quad (6a)$$

This result could be deduced in a simpler manner from the concept of circulation if we were to use the theorem, already proved, that the circulation for any closed line coincides with the vortex strength of the filaments which are inclosed by it. The circulation for every closed line which goes once around a single filament must therefore coincide with its strength. If the velocity at a point of a circle of radius  $h$  around our straight filament equals  $v$  then this circulation equals "path times velocity"  $= 2\pi h \cdot v$ , whence immediately follows  $v = \frac{\Gamma}{2\pi h}$ . The more exact investigation of this velocity field shows that for every point outside the filament (and the formula applies only to such points) the rotation is zero, so that in fact we are treating the case of a velocity distribution in which only along the axis does rotation prevail, at all other points rotation is not present.

For a finite portion of a straight vortex filament the preceding calculation gives the value

$$v = \frac{\Gamma}{4\pi h} (\cos \alpha_1 - \cos \alpha_2) \quad (6b)$$

This formula may be applied only for a series of portions of vortices which together give an infinite or a closed line. The velocity field of a single portion of a filament would require rotation also outside the filament, in the sense that from the end of the portion of the filament vortex lines spread out in all the space and then all return together at the beginning of the portion. In the case of a line that has no ends this external rotation is removed, since one end always coincides with the beginning of another portion of equal strength, and rotation is present only where it is predicated in the calculation.

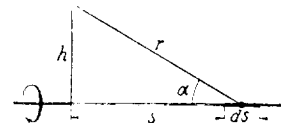

FIG. 4.—Velocity-field due to infinite rectilinear vortex.

9. If one wishes to represent the flow around solid bodies in a fluid, one can in many cases proceed by imagining the place of the solid bodies taken by the fluid, in the interior of which disturbances of flow (singularities) are introduced, by which the flow is so altered that the boundaries of the bodies become streamline surfaces. For such hypothetical constructions in the interior of the space actually occupied by the body, one can assume, for instance, any suitably selected vortices, which, however, since they are only imaginary, need not obey the laws of Helmholtz. As we shall see later, such imaginary vortices can be the seat of lifting forces. Sources and sinks also, i. e., points where fluid continuously appears, or disappears, offer a useful method for constructions of this kind. While vortex filaments can actually occur in the fluid, such sources and sinks may be assumed only in that part of the space which actually is occupied by the body, since they represent a phenomenon which can not be realized. A contradiction of the law of the conservation of matter is avoided, however, if there are assumed to be inside the body both sources and sinks, of equal strengths, so that the fluid produced by the sources is taken back again by the sinks.

The method of sources and sinks will be described in greater detail when certain practical problems are discussed; but at this point, to make the matter clearer, the distribution of velocities in the case of a source may be described. It is very simple, the flow takes place out from the source uniformly on all sides in the direction of the radii. Let us describe around the point source a concentric spherical surface, then, if the fluid output per second is  $Q$ , the velocity at the surface is

$$v = \frac{Q}{4\pi r^2}; \quad (7)$$

the velocity therefore decreases inversely proportional to the square of the distance. The flow is a potential one, the potential comes out (as line-integral along the radius)

$$\Phi = \text{const.} - \frac{Q}{4\pi r} \tag{7a}$$

If a uniform velocity toward the right of the whole fluid mass is superimposed on this velocity distribution—while the point source remains stationary—then a flow is obtained which, at a considerable distance from the source, is in straight lines from left to right. The fluid coming out of the source is therefore pressed toward the right (see fig. 5); it fills, at some distance from the source, a cylinder whose diameter may be determined easily. If  $V$  is the velocity of the uniform flow, the radius  $r$  of the cylinder is given by the condition  $Q = \pi r^2 \cdot V$ . All that is necessary now is to assume on the axis of the source further to the right a sink of the same strength as the source for the whole mass of fluid from the source to vanish in this, and the flow closes up behind the sink again exactly as it opened out in front of the source. In this way we obtain the flow around an elongated body with blunt ends.

10. The special case when in a fluid flow the phenomena in all planes which are parallel to a given plane coincide absolutely plays an important rôle both practically and theoretically.

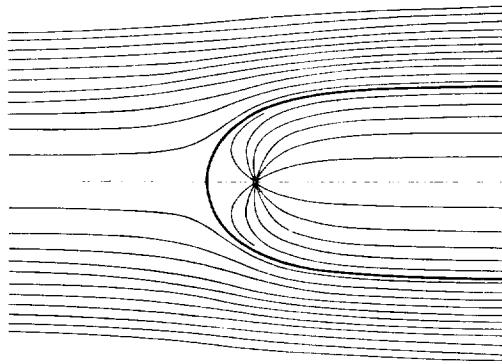

FIG. 5.—Superposition of uniform flow and that caused by a source.

If the lines which connect the corresponding points of the different planes are perpendicular to the planes, and all the streamlines are plane curves which lie entirely in one of those planes, we speak of a uniplanar flow. The flow around a strut whose axis is perpendicular to the direction of the wind is an example of such a motion.

The mathematical treatment of plane potential flow of the ideal fluid has been worked out specially completely more than any other problem in hydrodynamics. This is due to the fact that with the help of the complex quantities ( $x + iy$ , where  $i = \sqrt{-1}$ , is called the imaginary unit) there can be deduced from every analytic function a case of flow of this type which is incompressible and irrotational.

Every real function,  $\Phi(x, y)$  and  $\Psi(x, y)$ , which satisfies the relation

$$\Phi + i\Psi = f(x + iy), \tag{8}$$

where  $f$  is any analytic function, is the potential of such a flow. This can be seen from these considerations: Let  $x + iy$  be put  $= z$ , where  $z$  is now a "complex number." Differentiate equation (8) first with reference to  $x$  and then with reference to  $y$ , thus giving

$$\begin{aligned} \frac{\partial \Phi}{\partial x} + i \frac{\partial \Psi}{\partial x} &= \frac{df}{dz} \frac{\partial z}{\partial x} = \frac{df}{dz} \\ \frac{\partial \Phi}{\partial y} + i \frac{\partial \Psi}{\partial y} &= \frac{df}{dz} \frac{\partial z}{\partial y} = i \frac{df}{dz} = i \frac{\partial \Phi}{\partial x} - \frac{\partial \Psi}{\partial y} \end{aligned}$$

In these the real parts on the two sides of the equations must be equal and the imaginary parts also. If  $\Phi$  is selected as the potential, the velocity components  $u$  and  $v$  are given by

$$u = \frac{\partial \Phi}{\partial x} = \frac{\partial \Psi}{\partial y}; \quad v = \frac{\partial \Phi}{\partial y} = - \frac{\partial \Psi}{\partial x} \tag{9}$$

If now we write the expressions  $\frac{\partial u}{\partial x} + \frac{\partial v}{\partial y}$  (continuity) and  $\frac{\partial v}{\partial x} - \frac{\partial u}{\partial y}$  (rotation) first in terms of  $\Phi$  and then of  $\Psi$ , they become



$$\left. \begin{aligned} \frac{\partial u}{\partial x} + \frac{\partial v}{\partial y} &= \frac{\partial^2 \Phi}{\partial x^2} + \frac{\partial^2 \Phi}{\partial y^2} = \frac{\partial^2 \Psi}{\partial y \partial x} - \frac{\partial^2 \Psi}{\partial x \partial y} \\ &= 0 \\ \frac{\partial v}{\partial x} - \frac{\partial u}{\partial y} &= \frac{\partial^2 \Phi}{\partial y \partial x} - \frac{\partial^2 \Phi}{\partial x \partial y} = - \frac{\partial^2 \Psi}{\partial x^2} - \frac{\partial^2 \Psi}{\partial y^2} \\ &= 0 \end{aligned} \right\} \quad (10)$$

It is seen therefore that not only is the motion irrotational (as is self-evident since there is a potential), but it is also continuous. The relation  $\frac{\partial^2 \Phi}{\partial x^2} + \frac{\partial^2 \Phi}{\partial y^2} = 0$  besides corresponds exactly to our equation (4a). Since it is satisfied also by  $\Psi$ , this can also be used as potential.

The function  $\Psi$ , however, has, with reference to the flow deduced by using  $\Phi$  as potential, a special individual meaning. From equation (8) we can easily deduce that the lines  $\Psi = \text{const.}$  are parallel to the velocity; therefore, in other words, they are streamlines. In fact if we put

$$d\Psi = \frac{\partial \Psi}{\partial x} dx + \frac{\partial \Psi}{\partial y} dy = 0, \text{ then } \frac{dy}{dx} = - \frac{\frac{\partial \Psi}{\partial x}}{\frac{\partial \Psi}{\partial y}} = v$$

which expresses the fact of parallelism. The lines  $\Psi = \text{const.}$  are therefore perpendicular to the lines  $\Phi = \text{const.}$  If we draw families of lines,  $\Phi = \text{const.}$  and  $\Psi = \text{const.}$  for values of  $\Phi$  and  $\Psi$  which differ from each other by the same small amount, it follows from the easily derived equation  $d\Phi + id\Psi = \frac{df}{dz}(dx + idy)$  that the two bundles form a square network; from which follows that the diagonal curves of the network again form an orthogonal and in fact a square network. This fact can be used practically in drawing such families of curves, because an error in the drawing can be recognized by the eye in the wrong shape of the network of diagonal curves and so can be improved. With a little practice fairly good accuracy may be obtained by simply using the eye. Naturally there are also mathematical methods for further improvement of such networks of curves. The function  $\Psi$ , which is called the "stream function," has another special meaning. If we consider two streamlines  $\Psi = \Psi_1$  and  $\Psi = \Psi_2$ , the quantity of fluid which flows between the two streamlines in a unit of time in a region of uniplanar flow of thickness 1 equals  $\Psi_2 - \Psi_1$ . In fact if we consider the flow through a plane perpendicular to the  $X$ -axis, this quantity is

$$Q = \int_{y_1}^{y_2} u dy = \int_{y_1}^{y_2} \frac{\partial \Psi}{\partial y} dy = \int_{y_1}^{y_2} d\Psi = \Psi_2 - \Psi_1.$$

The numerical value of the stream function coincides therefore with the quantity of fluid which flows between the point  $x, y$  and the streamline  $\Psi = 0$ .

As an example let the function

$$\Phi + i\Psi = A(x + iy)^n$$

be discussed briefly. It is simplest in general to ask first about the streamline  $\Psi = 0$ . As is well known, if a transformation is made from rectangular coordinates to polar ones  $r, \varphi$ ,  $(x + iy)^n = r^n (\cos n\varphi + i \sin n\varphi)$ . The imaginary part of this expression is  $ir^n \sin n\varphi$ . This is to be put equal to  $i\Psi$ .  $\Psi = 0$  therefore gives  $\sin n\varphi = 0$ , i. e.,  $n\varphi = 0, \pi, 2\pi$ , etc. The streamlines  $\Psi = 0$  are therefore straight lines through the origin of coordinates, which make an angle  $\alpha = \frac{\pi}{n}$  with each other, the flow is therefore the potential flow between two plane walls making the angle  $\alpha$  with each other. The other streamlines satisfy the equation  $r^n \sin n\varphi = \text{const.}$  The velocities can be obtained by differentiation, e. g., with reference to  $x$ :

$$\frac{\partial \Phi}{\partial x} + i \frac{\partial \Psi}{\partial x} = u - iv = An(x + iy)^{n-1} = Anr^{n-1} \{ \cos(n-1)\varphi + i \sin(n-1)\varphi \}$$

For  $r=0$  this expression becomes zero or infinite, according as  $n$  is greater or less than 11, i. e., according as the angle  $\alpha$  is less or greater than  $\pi (=180^\circ)$ . Figures 6 and 7 give the streamlines for  $\alpha = \frac{\pi}{4} = 45^\circ$  and  $\frac{3}{2}\pi = 270^\circ$ , corresponding to  $n=4$  and  $\frac{2}{3}$ . In the case of figure 7 the velocity, as just explained, becomes infinite at the corner. It would be expected that in the case of the actual flow some effect due to friction would enter. In fact there are observed at such corners, at the beginning of the motion, great velocities, and immediately thereafter the formation of vortices, by which the motion is so changed that the velocity at the corner becomes finite.

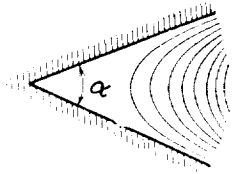

FIG. 6.—Uniplanar flow between plane walls making an angle  $\alpha=45^\circ$  with each other.

It must also be noted that with an equation

$$p + iq = \varphi(x + iy) \tag{11}$$

the  $x$ - $y$  plane can be mapped upon the  $p$ - $q$  plane, since to every pair of values  $x, y$  a pair of values  $p, q$  corresponds, to every point of the  $x$ - $y$  plane corresponds a point of the  $p$ - $q$  plane, and therefore also to every element of a line or to every curve in the former plane a linear element and a curve in the latter plane. The transformation keeps all angles unchanged, i. e., corresponding lines intersect in both figures at the same angle.

By inverting the function  $\varphi$  of equation (11) we can write

$$x + iy = \chi(p + iq)$$

and therefore deduce from equation (8) that

$$\Phi + i\Psi = f[\chi(p + iq)] = \tilde{F}(p + iq) \tag{12}$$

$\Phi$  and  $\Psi$  are connected therefore with  $p$  and  $q$  by an equation of the type of equation (8), and hence, in the  $p$ - $q$  plane, are potential and stream functions of a flow, and further of that flow which arises from the transformation of the  $\Phi, \Psi$  network in the  $x$ - $y$  plane into the  $p$ - $q$  plane.

This is a powerful method used to obtain by transformation from a known simple flow new types of flow for other given boundaries. Applications of this will be given in section 14

11. The discussion of the principles of the hydrodynamics of nonviscous fluids to be applied by us may be stopped here. I add but one consideration, which has reference to a very useful theorem for obtaining the forces in fluid motion, namely the so-called "momentum theorem for stationary motions."

We have to apply to fluid motion the theorem of general mechanics, which states that the rate of change with the time of the linear momentum is equal to the resultant of all the external forces. To do this, consider a definite portion of the fluid separated from the rest of the fluid by a closed surface. This surface may, in accordance with the spirit of the theorem, be considered as a "fluid surface," i. e., made up always of the same fluid particles. We must now state in a formula the change of the momentum of the fluid within the surface. If, as we shall assume, the flow is stationary, then after a time  $dt$  every fluid particle in the interior will be replaced by another, which has the same velocity as had the former. On the boundary, however, owing to its displacement, mass will pass out at the side where the fluid is approaching, and a corresponding mass will enter on the side away from which the flow takes place. If  $dS$  is the area of an element of surface, and  $v_n$  the component of the velocity in the direction of the outward drawn normal at this element, then at this point  $dm = \rho dS \cdot v_n dt$ . If we wish to derive the component of the "impulse"—defined as the time rate of the change of momentum—for any direction  $s$ , the contribution to it of the element of surface is

$$dJ_s = v_s \frac{dm}{dt} = \rho dS \cdot v_n v_s \tag{13}$$

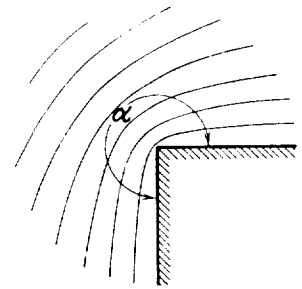

FIG. 7.—Uniplanar flow around plane walls making an angle  $270^\circ$  with each other.

With this formula we have made the transition from the fluid surface to a corresponding solid "control surface."

The external forces are compounded of the fluid pressures on the control surface and the forces which are exercised on the fluid by any solid bodies which may be inside of the control surface. If we call the latter  $P$ , we obtain the equation

$$\Sigma P_s = \iint p \cdot \cos(n, s) \cdot dS + \rho \iint v_n v_s dS \quad (14)$$

for the  $s$  component of the momentum theorem. The surface integrals are to be taken over the entire closed control surface. The impulse integral can be limited to the exit side, if for every velocity  $v_s$  on that side the velocity  $v_s'$  is known with which the same particle arrives at the approach side. Then in equation (13)  $dJ$  is to be replaced by

$$dJ - dJ' = (v_s - v_s') \frac{dm}{dt} = \rho dS v_n (v_s - v_s') \quad (13a)$$

The applications given in Part II will furnish illustrations of the theorem.

# REPORT No. 116.

## APPLICATIONS OF MODERN HYDRODYNAMICS TO AERONAUTICS.

By L. PRANDTL.

### PART II.

### APPLICATIONS.

#### A. DISTRIBUTION OF PRESSURE ON AIRSHIP BODIES.

12. The first application of hydrodynamical theory to be tested by experiment in the Göttingen Laboratory referred to the distribution of pressure over the surface of models of airships. We can construct mathematically the flow for any number of varieties of sectional forms of bodies of revolution of this kind if we place along an axis parallel with the direction of the air current any suitable distribution of sources and sinks, taking care that the total strength of the sources and sinks are the same. According to the intensity of the uniform motion which is superimposed upon the flow from the sources, we obtain from the same system of sources and sinks bodies of different thicknesses. In order to obtain the smoothest possible

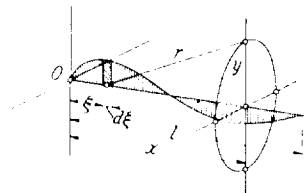

FIG. 8.—Explanation of quantities used in calculation of streamline shapes.  
Abscissae: Position of source.  
Ordinates: Intensity of source per unit length, i. e.  $f(\xi)$ .

shapes, the sources and sinks are generally distributed continuously along the axis, although single-point sources are allowable.

In the case of continuously distributed sources and sinks the method of procedure is briefly this: The abscissae of the single sources are denoted by  $\xi$ , the intensity of the source per unit of length by  $f(\xi)$ , in which positive values of  $f(\xi)$  denote sources, negative values sinks. The condition that makes the stream from the sources self-contained is expressed by the equation

$$\int_0^l f(\xi) d\xi = 0.$$

By simply adding the potentials due to the single elementary sources  $f(\xi) d\xi$ , i. e., in this case by integrating them, the total flow due to the sources will be given by the potential defined by the following formula

$$\Phi_1(x, y) = -\frac{1}{4\pi} \int_0^l \frac{f(\xi) d\xi}{r} \quad (15)$$

in which  $r = \sqrt{(x - \xi)^2 + y^2}$ , and  $y$  is the perpendicular distance from the axis of the point for which the potential is calculated,  $x$  is the abscissa along the axis measured from the same origin as  $\xi$ . (See fig. 8.) There must be added to this potential that due to the uniform flow with the velocity  $V$ , viz,  $\Phi_2 = Vx$ . The total potential is then  $\Phi = \Phi_1 + \Phi_2$ ; and therefore the velocity parallel to the axis is  $u = \frac{\partial \Phi}{\partial x} = V + \frac{\partial \Phi_1}{\partial x}$  and the sidewise (radial) velocity is  $v = \frac{\partial \Phi}{\partial y} = \frac{\partial \Phi_1}{\partial y}$ .

In order to calculate the streamlines one could perform an integration of the direction given by  $u$  and  $v$ . These lines are obtained more conveniently, in this case also, by means of the stream function. (See sec. 10.) In the case of flow symmetrical with reference to the axis, such as is here discussed, one can take as stream function the quantity of fluid flowing inside the circle drawn through the point  $x, y$  in a plane perpendicular to the axis and having its center

on the axis. The amount of fluid delivered by the sources which lie up the stream is purposely deducted from this. It is not difficult to see that all points of the  $X$ - $Y$  plane, through whose parallel circles the same amount of fluid flows per second—after deduction of the sources—must lie on one and the same streamline, for evidently there is no flow, either in or out, through the surface formed by the streamlines drawn through the points of any one parallel circle (since the flow is along the surface); therefore the quantity of fluid flowing within this surface is constant, so far as it is not increased by the sources. From the meaning of the stream function, to determine which the velocity must be integrated over a surface, it follows that the stream function of a flow due to two or more causes is at every point the sum of the stream functions of the several partial flows. For a continuous distribution of sources therefore the stream function  $\psi$  is obtained by an integration exactly as was the potential. According to our premise the surface of the body is designated simply by the value  $\psi = 0$ . The formulas are obtained as follows:

The flow from a simple source through a circle passing through a point lying to the right of the source is, writing  $r = \sqrt{x^2 + y^2}$ ,

$$\Psi' = \int_0^y u \cdot 2\pi y dy = \int_0^y \frac{Qx}{4\pi r^3} \cdot 2\pi y dy = \frac{Qx}{2} \int_0^y \frac{y dy}{r^3} = \frac{Q}{2} \left(1 - \frac{x}{r}\right)$$

From this, in accordance with what has been said, the quantity  $Q$  must be subtracted, so that

$$\Psi = \Psi' - Q = -\frac{Q}{2} \left(1 + \frac{x}{r}\right) \tag{16}$$

For points lying to the left of the source we obtain from the integral

$$\Psi'' = -\frac{Q}{2} \left(1 + \frac{x}{r}\right)$$

which coincides with formula (16); this holds, then, everywhere.

For the assumed continuous distribution of sources we obtain

$$\Psi_1 = -\frac{1}{2} \int_0^x f(\xi) \left(1 + \frac{x-\xi}{r}\right) d\xi \tag{17}$$

in which  $r = \sqrt{(x-\xi)^2 + y^2}$ . To this stream function of the sources must now be added that due to the parallel flow

$$\Psi_2 = V\pi y^2 \tag{18}$$

Putting the total stream function  $\Psi_1 + \Psi_2 = \Psi$  equal to zero, gives the equation of the surface of the body around which the flow takes place. Putting  $\Psi_1 + \Psi_2 = C$  gives any other streamline. It is evident that, with the same distribution of sources, a whole group of body surfaces can be obtained, depending upon the choice of the ratio of the intensity of the sources to the strength of the parallel flow.

The determination is best made practically by graphical methods, for instance, by laying off the curves  $x = \text{const.}$  in a system of coordinates consisting of  $y$  and  $-\Psi$ , which can be obtained at once from a calculation by tables for the stream function  $\Psi_1$ . If we intersect these curves by parabolas corresponding to the equation  $-\Psi = V\pi y^2 - C$ , we obtain at once a contour (for  $C = 0$ ), or some external or internal streamline (for  $C > 0$  or  $C < 0$ ). The parabola may be drawn upon transparent paper, and then by displacing the parabola along the  $\Psi$  axis we can at once obtain from figure 9 the values of  $y$  corresponding to any  $x$ .

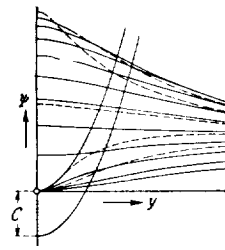

FIG. 9.—The curves are for different values of  $x = \text{const.}$

In this manner a former colleague of mine, who unfortunately fell immediately at the beginning of the war, Dr. G. Fuhrmann, calculated the shapes of bodies corresponding to a series of source distributions, and on the one hand he determined the distribution of pressure over the surface of these bodies by means of the Bernoulli equation (see sec. 4)

$$p = p_0 + \frac{\rho}{2} \{ V^2 - (u^2 + v^2) \}^{\frac{1}{2}} \tag{19}$$

<sup>1</sup> The velocities  $u$  and  $v$  may be obtained from the potential, but also from the stream function  $\psi$ ; for  $u = \frac{1}{2\pi y} \frac{\partial \psi}{\partial y}$  and  $v = -\frac{1}{2\pi y} \frac{\partial \psi}{\partial x}$ .

and on the other he constructed models according to these drawings and measured the pressure distribution over them when placed in a wind tunnel. The agreement was altogether surprisingly good, and this success gave us the stimulus to seek further relations between theoretical hydronamics and practical aeronautics. The work of Fuhrmann was published in *Jahr-b. der Motorluftschiff-Studien Gesellsch.*, Volume V, 1911-12 (Springer, Berlin), and contains a large number of illustrations. Four of the models investigated are shown here. The upper halves of figures 10 to 13 show the streamlines for a reference system at rest with reference to the undisturbed air, the lower halves the streamlines for a reference system attached to the body. The distribution of the source intensities is indicated on the axis. The pressure distributions are shown in figures 14 to 17. The calculated pressure distributions are indicated by the lines which are drawn full, the individual observed pressures by tiny circles.<sup>2</sup>

It is seen that the agreement is very complete; at the rear end, however, there appears a characteristic deviation in all cases, since the theoretical pressure distribution reaches the full dynamical pressure at the point where the flow reunites again, while actually this rise in pressure, owing to the influence of the layer of air retarded by friction, remains close to the surface.

As is well known there is no resistance for the theoretical flow in a nonviscous fluid. The actual drag consists of two parts, one resulting from all the normal forces (pressures) acting on the surface of the body, the other from all the tangential forces (friction). The pressure resistance, which in this case can be obtained by integration of the pressure distribution over the surface of the body, arises in the main from the deviation mentioned at the rear end, and is, as is known, very small. Fuhrmann's calculations gave for these resistances a coefficient, with reference to the volume of the body, as shown in the following table:<sup>3</sup>

Model.....	I	II	III	IV
$k_1$ ..... =	0.0170	0.0123	0.0131	0.0145

This coefficient is obtained from the following formula:

$$\text{Drag } w_1 = k_1 U^{2/3} q$$

where  $U$  designates the volume and  $q$  the dynamical pressure.

The total resistance (drag) was obtained for the four models by means of the balance; the difference between the two quantities then furnishes the frictional resistance. The total drag coefficients were:<sup>3</sup>

Model.....	I	II	III	IV
$k$ ..... =	0.0340	0.0220	0.0246	0.0248

With greater values of  $VL$  than were then available for us, the resistance coefficients become nearly 30 per cent smaller. For purposes of comparison with other cases it may be mentioned that the "maximum section" was about  $2/5$  of  $U^{2/3}$ . The surface was about seven times  $U^{2/3}$ ; from which can be deduced that the total resistance of the good models was not greater than the friction of a plane surface having the same area. The theoretical theorem that in the ideal fluid the resistance is zero receives in this a brilliant confirmation by experiment.

#### B. THEORY OF LIFT.

13. The phenomena which give rise to the lift of an aerofoil may be studied in the simplest manner in the case of uniplanar motion. (See sec. 10.) Such a uniplanar flow would be expected obviously in the case that the wing was unlimited at the sides, therefore was "infinitely

<sup>2</sup> In the wind tunnel there was a small pressure drop in the direction of its length. In order to eliminate the effect of this, the pressures toward the fore had to be diminished somewhat and those aft somewhat increased.

<sup>3</sup> After deduction of the horizontal buoyancy.

APPLICATIONS OF MODERN HYDRODYNAMICS TO AERONAUTICS.

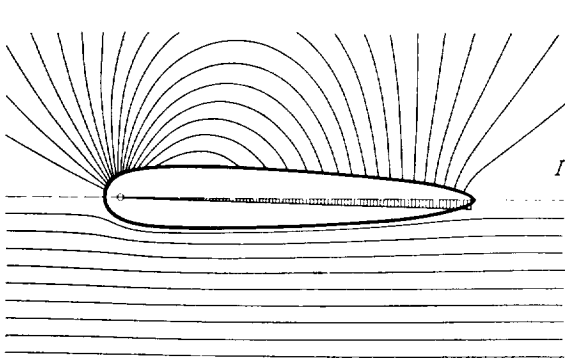

FIG. 10.

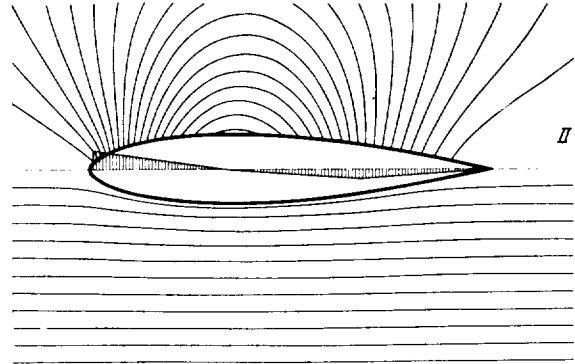

FIG. 11.

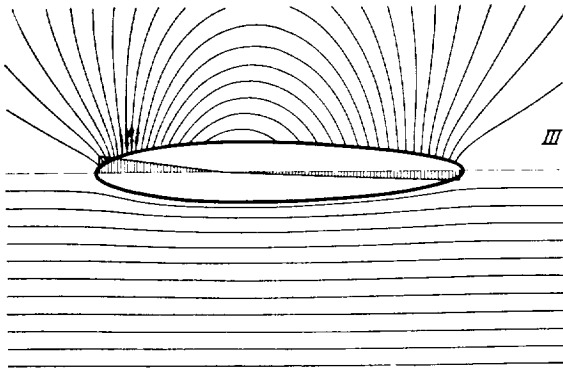

FIG. 12.

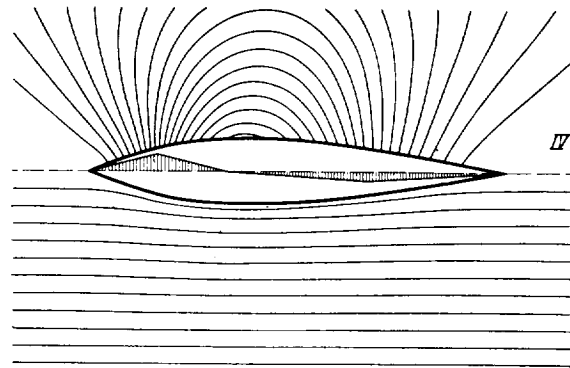

FIG. 13.

Four airship models as derived by Fuhrmann by combination of sources and uniform flow. Distribution of sources indicated on axis. Upper half: Streamlines relative to undisturbed air. Lower half: Streamlines relative to airship.

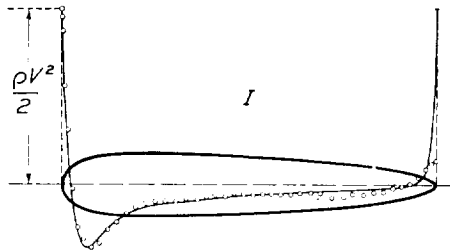

FIG. 14.

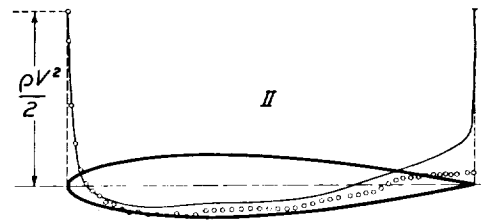

FIG. 15.

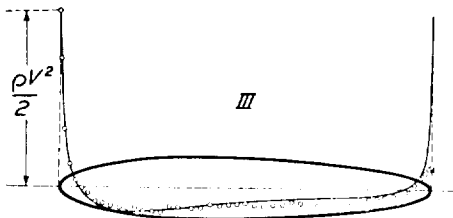

FIG. 16.

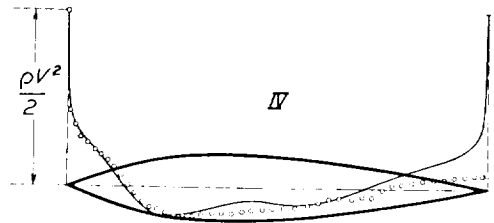

FIG. 17.

Pressure distribution over airships of figures 10 to 13. Full lines represent calculated values; small circles, points as found by observation in a wind-tunnel.

long," and throughout exhibited the same profile and the same angle of attack. In this case all the sections will be alike in all respects and each one can be considered as a plane of symmetry. The infinitely long wing plays an important part therefore in the considerations of the theoretical student. It is not possible to realize it in free air, and marked deviations from the infinitely long wing are shown even with very long wings, e. g., those having an aspect ratio of 1:10. In laboratories, however, the infinitely long wing, or uniplanar flow, may be secured with good approximation, if a wing having a constant profile is placed between plane walls in a wind tunnel, the walls running the full height of the air stream. In this case the wing must extend close to the walls; there must be no gap through which a sensible amount of air can flow. We will

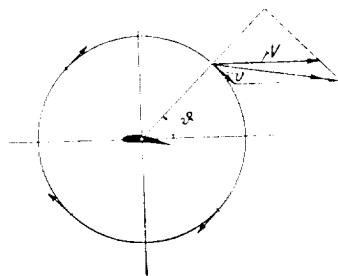

FIG. 18.—Deduction of the Kutta formula, uniplanar flow around infinite wing.

now discuss such experiments, and first we shall state the fundamental theory of uniplanar flow.

Since, as explained in section 4, in a previously undisturbed fluid flow, the sum of the static and dynamic pressures is constant:  $p + \frac{\rho}{2} V^2 = \text{const.}$ , in order to produce lift, for which the pressure below the surface must be increased and that above diminished, such arrangements must be made as will diminish the velocity below the wing and increase it above. The other method of producing such pressure differences, namely, by causing a vortex region above the surface placed h<sub>ere</sub> a kite oblique to the wind, by which a suction is produced, does not

come under discussion in practical aeronautics owing to the great resistance it sets up. Lanchester has already called attention to the fact that this lifting current around the wing arises if there is superimposed upon a simple potential flow a circulating flow which on the pressure side runs against the main current and on the suction side with it. Kutta (1902) and Joukowski (1906) proved, independently of each other, the theorem that the lift for the length  $l$  of the wing is

$$A = \rho \Gamma V l \tag{20}$$

in which  $\Gamma$  is the circulation of the superimposed flow. It may be concluded from this formula that in a steady fluid flow lift is not possible unless there is motion giving rise to a circulation. In uniplanar flow in an ideal fluid this lift does not entail any drag.

The proof of the Kutta-Joukowski formula is generally deduced by applying the momentum theorem to a circular cylinder of large radius whose axis is the medial line of the wing. The circulatory motion, which could be obtained numerically close to the wing only by elaborate mathematical processes, is reduced at a great distance from the wing to a motion which agrees exactly with the flow around a rectilinear vortex filament (see sec. 8), in which, therefore, the single particles describe concentric circles. The velocity around a

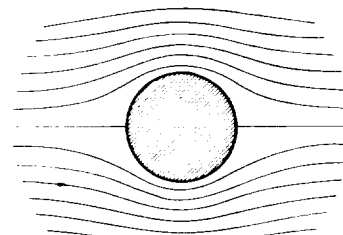

FIG. 19.—Uniplanar uniform flow around circular cylinder.

circle of radius  $R$  is, then,  $v = \frac{\Gamma}{2\pi R}$ . For an element of surface  $l \cdot R d\theta$  (see fig. 18) the normal component of the velocity is  $V \cos \theta$ , the mass flowing through per second  $dm = \rho l R V \cos \theta d\theta$ . If we wish to apply the momentum theorem for the vertical components, i. e., those perpendicular to the direction of  $V$ , then this component of the velocity through the element of surface must be taken. This, obviously, is  $v \cos \theta$ , taken positive if directed downward; the total impulse, then, is

$$J = \int v \cos \theta dm = \rho l R V \int_0^{2\pi} \cos^2 \theta d\theta.$$

The integral equals  $\pi$ , and therefore introducing the value of  $v$

$$J = \frac{1}{2} \rho V \Gamma l.$$



Since the resulting impulse is directed downward (the upward velocity in front of the wing is changed into a downward one behind the wing), this means that the reaction of the fluid against the wing is a lift of the wing upward. The amount of the impulse furnishes, as is seen by referring to formula (20), only half the lift. The other half comes from the pressure differences on the control surfaces. Since, for a sufficiently large  $R$ ,  $v$  can always be considered small compared with  $V$ , neglecting  $\frac{\rho}{2} v^2$ , the pressure  $p$  is given, according to the Bernoulli equation, by

$$p = p_0 + \frac{\rho}{2} V^2 - \frac{\rho}{2} \{ (V + v \sin \theta)^2 + v^2 \cos^2 \theta \} \approx p_0 - \rho V v \sin \theta.$$

A component of this, obtained by multiplying by  $\sin \theta$ , acts vertically on the surface element  $lRd\theta$ . The resulting force  $D$  is, then,

$$D = \rho l R V v \int_0^{2\pi} \sin^2 \theta d\theta.$$

This integral also equals  $\pi$ , so that here also

$$D = \frac{1}{2} \rho V \Gamma l$$

its direction is vertically up. The total lift, then, is

$$A = J + D = \rho V \Gamma l.$$

14. For the more accurate analysis of the flow around wings the complex functions (see sec. 10) have been applied with great success, following the procedure of Kutta. Very different

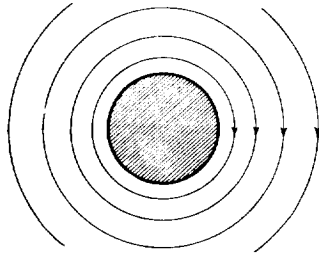

FIG. 20.—Uniplanar flow around circular cylinder considered as a columnar vortex of strength  $\Gamma$ .

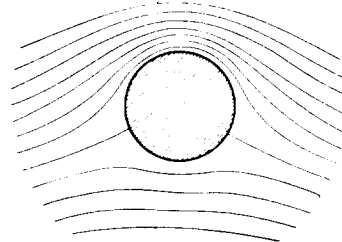

FIG. 21.—Superposition of two preceding flows.

methods have been used. Here we shall calculate only one specially simple case, in which the flow will be deduced first around a circular cylinder and then calculated for a wing profile by a transformation of the circular cylinder and its flow, using complex functions.

The flow around a circular cylinder has long been known. If the coordinates in the plane of the circle are  $p$  and  $q$ , and if we write  $p + iq = t$ , the potential and stream functions for the ordinary symmetrical flow around the circular cylinder are given by the very simple formula

$$\Phi_1 + i\Psi_1 = V \left( t + \frac{a^2}{t} \right) \tag{21}$$

It is easily seen by passing to polar coordinates that, for  $r = a$ ,  $\psi_1 = 0$ , and that therefore the circle of radius  $a$  is a streamline. Further, for the  $p$  axis,  $\psi_1 = 0$ , i. e., this is also a streamline. The whole flow is that shown in figure 19. To this flow must be added the circulation flow expressed by the formula

$$\Phi_1 + i\Psi_2 = \frac{i\Gamma}{2\pi} \log t \tag{22}$$

which, as shown in figure 20, is simply a flow in concentric circles with the velocity  $\frac{\Gamma}{2\pi r}$ . The combination of the two flows, i. e., the flow for the sum of the expressions in equations (21) and (22), is shown in figure 21. It is seen that the rest point is moved down an amount  $de$ . By a suitable choice of the circulation this can be brought to any desired point.

$$t + \frac{a^2}{t} = \left( r + \frac{a^2}{r} \right) \cos \theta + i \left( r - \frac{a^2}{r} \right) \sin \theta$$

$$i \log t = -\theta + i \log r.$$

We must now discuss the transformation of this flow to a wing profile. For this purpose manifold means are possible. The simplest is furnished by a transformation according to the equation

$$z = x + iy = t + \frac{b^2}{t}$$

By this the circle of diameter  $AB = 2b$  in the  $t$  plane (as we shall for brevity's sake call the  $p, q$  plane) is transformed into a straight line  $A'B'$  of the length  $4b$  along the  $X$  axis, and concen-

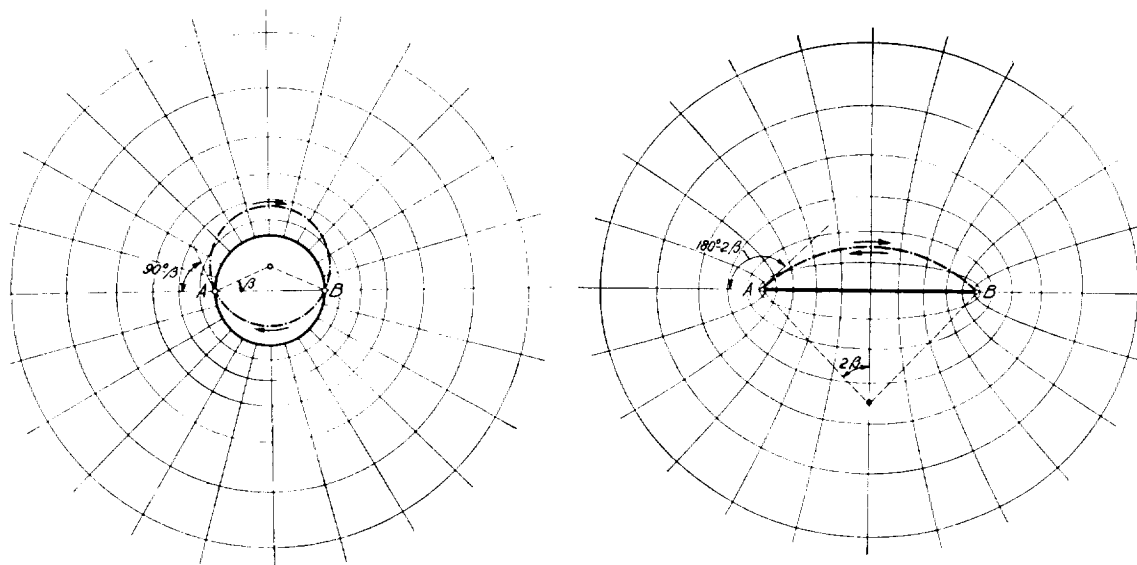

FIG. 22.

FIG. 23.

Conformal transformation of  $z$  plane into  $t$  plane by  $z = t + \frac{b^2}{t}$ .

tric circles around the former become ellipses, the radii become hyperbolas. All the ellipses and hyperbolas have their foci at the ends of the straight line, this forming a confocal system. Figures 22 and 23 illustrate the transformation. It may be mentioned, in addition, that the interior of the circle in figure 22 corresponds to a continuation of the meshwork in figure 23 through the slit  $A'B'$ , whose form agrees with the meshwork as drawn. Any circle through

the points  $AB$  is thereby transformed into an arc of a circle passed over twice, having an angle subtended at the center equal to  $4\beta$ .

Many different results may now be obtained by means of this mapping, according to the position which the circle, around which the flow takes place according to equations (21) and (22), bears to the diameter  $AB$  of the circle of figure 22. If the diameter  $AB$  is made to coincide with any oblique diameter of the circular section of the cylinder, we obtain a flow around an oblique plate whose angle of attack coincides with the inclination of the line  $AB$ . If the di-

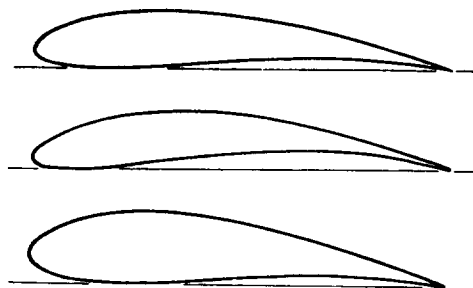

FIG. 24.—Illustrations of Joukowski sections.

ameter  $AB$  is selected somewhat smaller, so that both points lie inside the circle symmetrically on the diameter, the flow around ellipses is obtained. If, however, the diameter  $AB$  coincides with a chord of the circle around which the original flow was, which, for example, may lie below the center, the flow around a curved plate forming an arc of a circle is obtained. By selection of various points in the interior of the original circle forms of diverse shapes are obtained. The recognition of the fact that among these forms very beautiful winglike profiles may be found we

owe to Joukowski. These are obtained if the point *B* is selected on the boundary of the original circle and the point *A* inside, and somewhat below the diameter through the point *B*. Figure 24 gives illustrations of such Joukowski profiles.

In order that the flow may be like the actual one, in the cases mentioned the circulation must always be so chosen that the rear rest point coincides with the point *B*, or, respectively, with the point on the original circle which lies nearest this point. In this case there will be, after mapping on the *z* plane, a smooth flow away from the trailing edge, as is observed in practice. It is therefore seen that the circulation must be taken greater according as the angle of attack is greater, which agrees with the observation that the lift increases with increasing angle of attack.

The transformation of the flows shown in figures 19 to 21 into wing profiles gives illustrations of streamlines as shown in figures 25 to 27—figure 25, simple potential flow; figure 26, circulation flow; figure 27, the actual flow around a wing obtained by superposition of the two previous flows.

We are, accordingly, by the help of such constructions, in the position of being able to calculate the velocity at every point in the neighborhood of the wing profile, and with it the pressure. In particular, the distribution of pressure over the wing itself may be calculated.

My assistant, Dr. A. Betz, in the year 1914 worked out the pressure distribution for a Joukowski wing profile, for a series of angles of attack, and then in a wind tunnel measured the pressure distribution on a hollow model of such a wing made of sheet metal, side walls of the height of the tunnel being introduced so as to secure uniplanar flow

The results of the measurements agreed in a very satisfactory manner with the calculations, only—as could be well explained as due to friction—the actual circulation was always slightly less than that calculated for the same angle of attack. If the pressure distributions would be compared, not for the same angles of attack, but for the same amount of circulation, the agreement would be noticeably better. The pressure distributions are shown in figures 28 to 30, in which again the full curves correspond to the measurements and the dashes to the calculated pressures. Lift and drag for the wing were also obtained by the wind-tunnel balance. In order to do this, the middle part of the wing was isolated from the side parts, which were fastened to the walls of the tunnel by carefully designed labyrinths, so that within a small range it could move without friction. The result of the experiment is shown in figure 31. The theoretical drag is zero, that obtained by measurement is very small for that region where the wing is “good,” but sensibly larger for too large and too small angles of attack. The lift is correspondingly in agreement

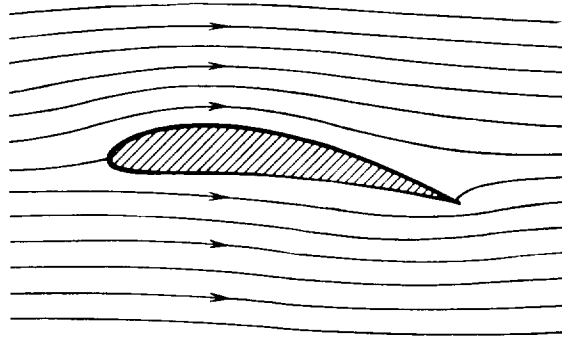

FIG. 25.—Transformation of simple potential flow, figure 19.

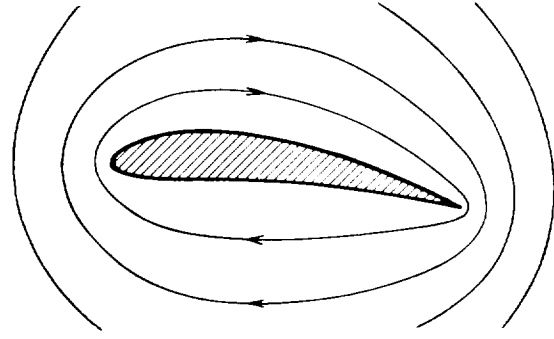

FIG. 26.—Transformation of circulatory flow, figure 20.

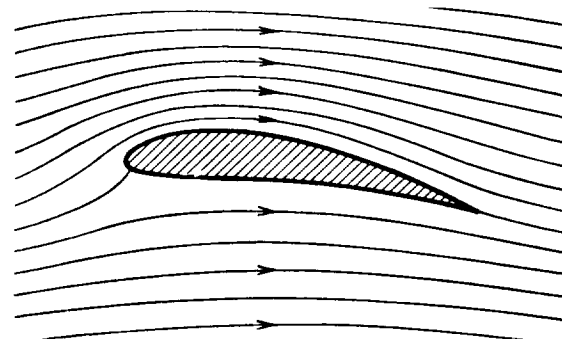

FIG. 27.—Transformation of superposition of the two flows, figure 21.

with the theoretical value in the good region, only everywhere somewhat less. The deviations of drag as well as of lift are to be explained by the influence of the viscosity of the fluid. The agreement on the whole is as good as can be expected from a theory which neglects completely the viscosity.

For the connection between the angle of incidence  $\alpha$  and the circulation which results from the condition discussed above calculations give the following result for the lift:

(1) The Kutta theory gives for the thin plane plate the formula

$$A = bt \cdot \pi \rho V^2 \sin \alpha \quad (23)$$

The lift coefficient  $C_a$  is defined by the equation

$$C_a = \frac{A}{Fq} \quad \text{where } q = \frac{1}{2} \rho V^2$$

and therefore

$$C_a = 2\pi \sin \alpha \quad (24)$$

(2) For the circularly curved plates having an angle of arc  $4\beta$  subtended at the center (see figure 23) we have, according to Kutta, if  $\alpha$  is the angle of attack of the chord,

$$C_a = 2\pi \frac{\sin(\alpha + \beta)}{\cos \beta} \quad (25)$$

which, for small curvatures, becomes  $2\pi \sin(\alpha + \beta)$ ; this can be expressed by saying that the lift of the circularly curved plate is the same as that of a plane which touches the former at a point three-fourths of the distance around the arc from its leading edge.

For the Joukowski profiles and for others the formulas are less simple. v. Mises showed in 1917 that the increase of  $C_a$  with the angle of attack, i. e.,  $\frac{dC_a}{d\alpha}$ , is greater for all other profiles than for the flat plate, and is the greater the thicker the profile. But the differences are not marked for the profiles occurring in practice.

The movement of the center of pressure has also been investigated theoretically. With the plane plate, in the region of small angles, it always lies at one-fourth of the width of the plate; with circularly curved thin plates its position for small angles is given by the following law:

$$x_o = -\frac{t}{4} \frac{\tan \alpha}{\tan \alpha + \tan \beta} \quad (26)$$

in which  $t$  is the chord of the plate, and  $x_o$  is the distance measured from the center of the plate. The

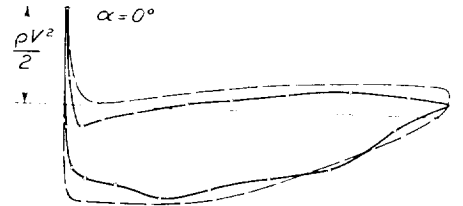

FIG. 28.

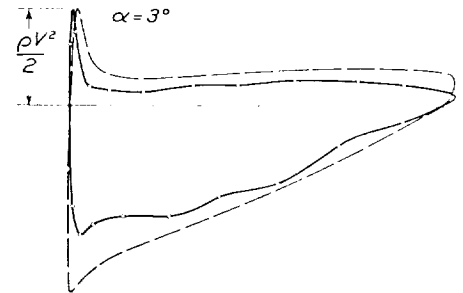

FIG. 29.

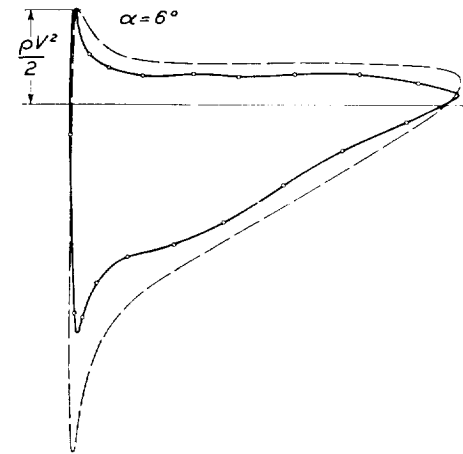

FIG. 30.

Pressure distribution over a Joukowski wing, different angles of attack. Full lines give results of wind-tunnel tests; dashed lines, calculated values.

fact that the movement of the center of pressure in the case of "good" angles of attack of the profiles agrees with theory is proved by the agreement of the actual pressure distribution with that calculated. In the case of thin plates a less satisfactory agreement as respects pressure distribution is to be expected because with them in practice there is a formation of vortices at the sharp leading edges, while theory must assume a smooth flow at this edge.

15. That a circulatory motion is essential for the production of lift of an aerofoil is definitely established. The question then is how to reconcile this fact with the proposition that

the circulation around a fluid line in a nonviscous fluid remains constant. If, before the motion begins, we draw a closed line around the wing, then, so long as everything is at rest, the circulation certainly is zero. Even when the motion begins, it can not change for this line. The explanation of why, in spite of this, the wing gains circulation is this: At the first moment of the motion there is still no circulation present, the motion takes place approximately according to figure 25, there is a flow at high velocity around the trailing edge. (See sec. 10.) This motion can not, however, continue; there is instantly formed at the trailing edge a vortex of increasing intensity, which, in accordance with the Helmholtz theorem that the vortex is always made up of the same fluid particles, remains with the fluid as it passes on. (See fig. 32.) The circulation around the wing and vortex, taken together, remains equal to zero; there remains then around the wing a circulation equal and opposite to that of the vortex which has gone off with the current. Therefore vortices will be given off until the circulation around the wing is of such a strength as to make the fluid flow off smoothly from the trailing edge. If by some alteration of the angle of attack the condition for smooth flow is disturbed, vortices are again given off until the circulation reaches its new value. These phenomena are completed in a comparatively short distance, so the full lift is developed very quickly.

In the pictures of flow around a wing, e. g., figure 27, one sees that the air in front of the wing flows upward against the reaction of the lift. The consideration of momentum has shown that half of the impulse is due to the oncoming ascending current. This fact needs some further explanation. The best answer is that given by Lanchester,<sup>7</sup> who shows that for the production of lift the air mass at any time below the wing must be given an acceleration downward. The question he asks is: What kind of a motion arises if for a short time the air below the wing is accelerated downward, then the wing is moved forward a bit without pressure, then the air is again accelerated, and so on? The space distribution of the accelerations is known for the case of a plane plate, infinitely extended at the sides, accelerated from rest; the pattern of the acceleration direction is given in figure 33. It is seen that above and below the plate the acceleration is downward, in front of and behind the plate it is upward opposite to the acceleration of the plate, since the air is escaping from the plate. Lanchester asks now about the velocities which arise from the original uniform velocity relative to the plate owing to the fact that the

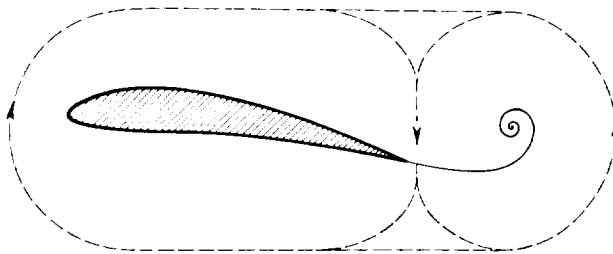

Fig. 32.—Production of circulation around a wing due to vortices leaving trailing edge.

plate, while it gives rise to the accelerations as shown in figure 33, gradually comes nearer the air particle considered, passes by it, and finally again moves forward away from it. The picture of the velocities and streamlines which Lanchester obtained in this way and reproduced in his book was, independently of him, calculated exactly by Kutta. It is reproduced in figure 34. It is seen that as the result of the upward accelerations of the flow away from the wing

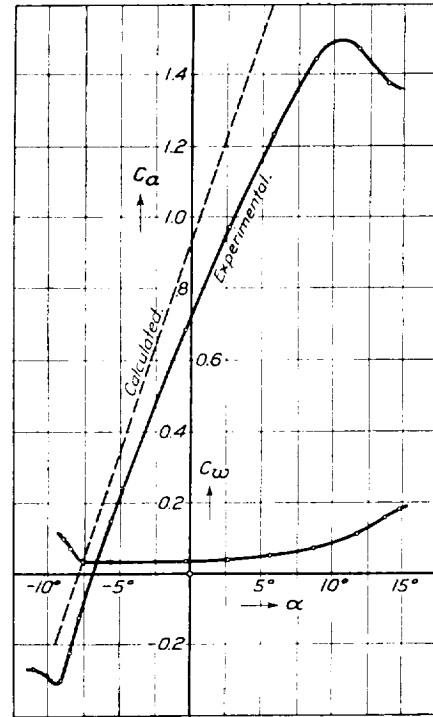

Fig. 31.—Values of lift and drag coefficients of a Joukowski wing as obtained in wind-tunnel tests and by theory.

<sup>7</sup> Aerodynamics I, § 110-118.

there is an upward velocity in front of the plate, a uniform downward acceleration at the plate itself due to which the upward velocity is changed into a downward one, and finally behind the plate a gradual decrease of the downward velocity on account of the acceleration upward.

C. THE FINITE WING.

16. It has been known for a long time that the aspect ratio of an aerofoil had a great effect on its properties. One could therefore have expected that, on account of the vanishing of pressure at the side edges, the intensity of the lift must decrease toward the edge, so that its average value for the same angle of attack must be smaller for small values of the aspect ratio than for large ones. But the observed influence of aspect ratios is sensibly greater than could be explained in this way. We must therefore investigate whether an explanation of this phenomenon can be found, if we apply to the finite aerofoil in some proper manner the results which are known to hold for uniplanar flow.



FIG. 33.—Acceleration diagram around an infinitely long flat plate accelerated at right angle to its surface.

It is easily seen that vortices in the free fluid must here be taken into account. For it is certain that circulation is present around the middle of the wing, because no lift is possible without circulation. If a closed line drawn around the middle of the wing, around which, therefore, there is circulation, is displaced sideways over the end of a wing, it will certainly no longer show circulation here when it is beyond the wing. From the theorem that the circulation along a closed line only changes if it cuts vortex filaments, and that the amount of the change of the circulation equals the sum of the strengths of the vortex filaments cut (see sec. 8), we must conclude that from each half of a wing vortex filaments whose strengths add up to  $\Gamma$  must proceed, which are concentrated mainly near the ends of the wing. According to the Helmholtz theorem we know further that every vortex produced in the fluid continues to move with the same fluid particles. We may look upon the velocities produced by the wing as small compared with the flight velocity  $V$ , so that as an approximation we may assume that the vortices move away from the wing backwards with the rectilinear velocity  $V$ . (If it is wished, we can also improve the considerations based upon such an assumption if the motion of the vortices of themselves relative to the air is taken into account. This will, however, be seen to be unnecessary for practical applications of the theory.)

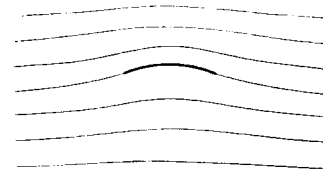

FIG. 34.—Streamlines around an infinitely long curved plate.

In order now to obtain the simplest possible scheme, we shall assume that the lift is uniformly distributed over the wing; then the total circulation will arise only at the ends, and continue rearwards as free vortices. The velocity field of an infinitely long wing, as we saw,

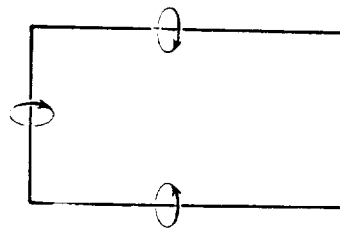

FIG. 35.—A finite wing, considered as due to vortices replacing the wing.

was the same at great distances as that of a rectilinear vortex filament instead of the wing. We shall assume that the corresponding statement holds for the finite wing. We thus obtain, for the velocity field around a finite wing, a picture which is somewhat crude, it is true, if we take for it the velocity distribution due to a vortex filament of corresponding shape.

It may be mentioned here that, on account of there being the same laws for the velocity field of a vortex filament and the magnetic field of an electric current (see sec. 8), the velocity near a finite wing can also be investigated numerically by calculating the direction and intensity of the magnetic field produced near an electrical conductor shaped as shown in figure 35 due to an electrical current flowing in it.

The principles for the calculation of this velocity field have been stated in section 8; the total velocity is made up out of three partial velocities which are caused by the three rectilinear vortex portions. As is seen without difficulty, for the region between the vortices the flow is downward, outside it is upward.

17. This approximation theorem is specially convenient if the conditions at great distances from the wing are treated. With its help we can explain how the weight of an airplane is transferred to the ground. In order to make the flow satisfy the condition that at the ground components of velocity normal to it are impossible, we apply a concept taken from other branches of physics and superimpose the condition of an image of the airplane, taking the earth as the mirror. On account of symmetry, then, all velocity components normal to the earth's surface will vanish. If we use as our system of coordinates one attached to the airplane, we have then the case of stationary motion. If we take the  $X$  axis in the direction of the span of the wing, the  $Y$  axis horizontal in the direction of flight and the  $Z$  axis vertically down, and if  $u, v, w$  are the components of the additional velocity due to the vortices, then calling  $p_0$  the undisturbed pressure and  $p'$  the pressure difference from  $p_0$ , and neglecting the weight of the air, Bernoulli's equation gives us

$$p_0 + p' + \frac{\rho}{2} [u^2 + (v - V)^2 + w^2] = p_0 + \frac{\rho}{2} V^2$$

If this is expanded and if  $u^2, v^2,$  and  $w^2$  are neglected as being small of a higher order, there remains the simple equation

$$p' = \rho V v \quad (27)$$

For the determination of the pressure distribution on the ground we must now calculate the value of  $v$ . Let us assume the vortices run off the wing in an exactly horizontal direction (actually, their path inclines downward slightly), in which case they do not contribute to  $v$ . There remains then only the "transverse vortex" of the length  $l$  (effective span) and the circulation  $\Gamma$ . We will assume that the span of the wing is small in comparison with the distance  $h$  of the airplane from the ground. In that case we can treat the transverse vortex as if it were a single vortex element. We obtain, then—see figure 36—at a point  $A$ , with the coordinates  $x$  and  $y$ , a velocity perpendicular to the plane  $ABF$ , of the amount

$$v_1 = \Gamma l \frac{\sin \alpha}{4 \pi R^2}$$

The image of the airplane furnishes an equal amount perpendicular to the plane  $ABF'$ . If  $\beta$  is the angle between the plane  $ABF$  and the  $XY$  plane, then the actual velocity at the ground, as far as it is due to the transverse vortex, will be the resultant of  $v_1$  and  $v_2$ . It is therefore  $v = 2v_1 \sin \beta$ , or, if we write  $\sin \alpha = \frac{R'}{R}$ ,  $\sin \beta = \frac{h}{R'}$  (see fig. 36)

$$v = \frac{\Gamma l h}{2 \pi R^3} \quad (28)$$

If we take into account the fact that, according to the Kutta-Joukowski formula (20),  $\rho \Gamma V l = A$ , equations (27) and (28) lead to the relation

$$p' = \frac{A h}{2 \pi R^3} \quad (29)$$

If this is integrated over the whole infinite ground surface, it is seen that the resultant force due to the pressures on the ground has exactly the amount  $A$ . It is thus proved that the

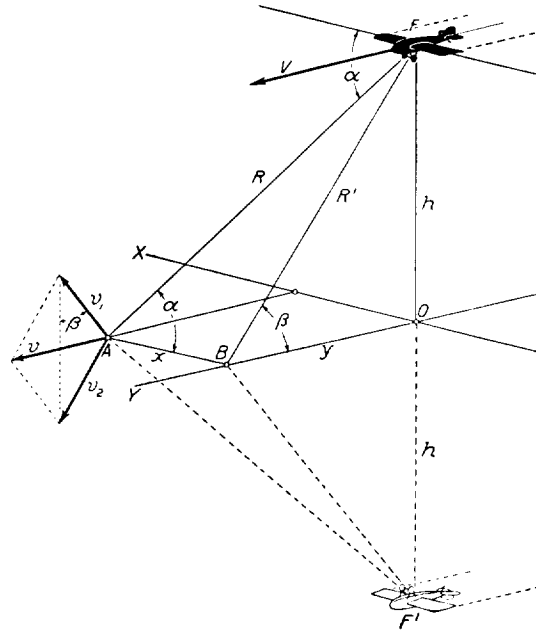

FIG. 36.—Application of method of images to airplane flying near the ground.

pressure distribution due to the circulation motion transfers to the ground exactly the weight of the airplane. The distribution of the pressure, which according to formula (29) is axially symmetrical with reference to the foot of the vertical line drawn from the airplane, is shown in figure 37. The pressure maximum is  $p_1 = \frac{A}{2\pi h^2}$ . Its amount, even for low heights of flight, is very small, since the surface over which the pressure is distributed is very large.

18. Applications of an entirely different kind may be made of the velocity field which belongs to the vortex of figure 35. For instance, an estimate may be made as to the magnitude of the downward velocity component at any point of the tail surfaces, and in this manner the influence of the wings upon the tail surfaces may be calculated. If in accordance with the Kutta-Joukowski formula the lift is written  $A = \rho \Gamma V l$ , in which, taking account of the fact that a

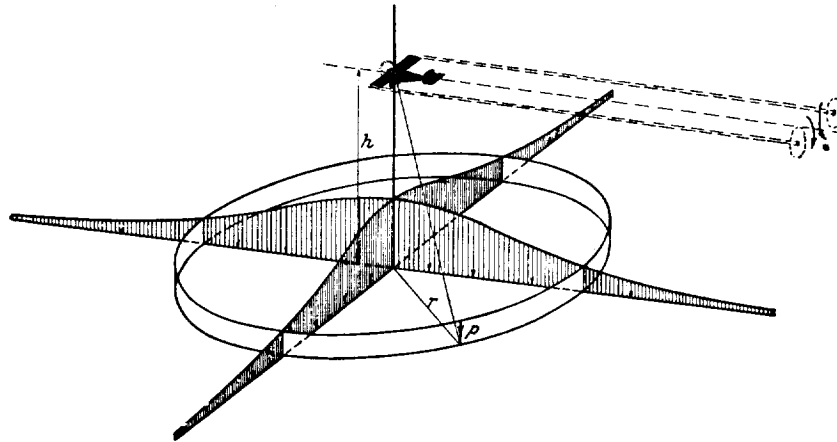

FIG. 37.—Distribution of pressure on ground caused by airplane flying near it.

portion of the vortices flow off within the ends of the wing,  $l$ , can be taken somewhat less than the actual span  $b$ , then at a distance  $d$ , behind the wing, the velocity component downward is

$$w = 2 \frac{\Gamma}{4\pi} \left\{ \frac{1}{2} \left( 1 + \frac{d}{a} \right) + \frac{1}{d} \frac{l/2}{a} \right\} = \frac{\Gamma}{\pi l} \left( 1 + \frac{a}{d} \right) \quad (30)$$

in which  $a = \sqrt{\left(\frac{l}{2}\right)^2 + d^2}$ .

If the flight velocity is  $V$ , this gives for the inclination of the downward sloping air-current  $\tan \varphi = \frac{w}{V}$ . We proved this relation in the year 1911 and found an approximate agreement with observation.

The principle made use of above has been applied with profit to the calculation of the influence of one wing of a biplane upon the other wing and has given a method for the calculation of the properties of a biplane from the properties of a single wing as found by experiments. The fundamental idea, which is always applied in such calculations, is that, owing to the vortex system of one wing, the velocity field near the wing is disturbed, and it is assumed that a wing experiences the same lift as in an undisturbed air stream if it cuts the streamlines of the flow disturbed by the other wing in the same manner as a monoplane wing cuts the straight streamlines of the undisturbed flow. As is easily seen, the wing profile must in general be slightly turned and its curvature slightly altered, as is shown in figures 38 and 39. By the rotation of the wing the direction of the resultant air force acting on it is turned through an equal angle. If the magnitude of the velocity as well as its direction is also changed, this must be expressed by a corresponding change in the resultant air force.



As an illustration we will treat briefly the case of a biplane without stagger. The most important component of the disturbance velocity  $w$  is again the vertical one; in the plane of the mean lift lines of the biplane it is affected only by the pair of vortices running off the wings, since the transverse vortex of one wing causes only an increase (or decrease) of the velocity of flow at the other wing. We are concerned here only with the calculation of that downward disturbance velocity due to the vortices from the wing not under investigation, since the other vortex system is present with the monoplane and its influence has already been taken into account in the experiments on a monoplane.

The total velocity due to a portion of a vortex proceeding to infinity in one direction, in the plane perpendicular to the vortex at its end, is, as may be deduced easily from the formula in section 8, exactly half of the corresponding velocity in the neighborhood of a rectilinear vortex filament extending to infinity in both directions. This can also be easily seen from the fact that two vortex filaments, each extending to infinity in only one direction—but oppositely in the two cases—form, if combined, a single filament extending to infinity in both directions. The total velocity caused at the point  $P$  by the vortex  $A$ , see figure 40, is  $\frac{\Gamma_1}{4\pi r}$ , where  $r = \sqrt{x^2 + h^2}$ ; its vertical component is

$$w_A = \frac{\Gamma_1}{4\pi r} \cdot \frac{x}{r}$$

The vertical component due to the vortex  $B$  is

$$w_B = \frac{\Gamma_1}{4\pi r'} \cdot \frac{l_1 - x}{r'}$$

where  $r' = \sqrt{(l_2 - x)^2 + h^2}$ .

Therefore the vertical component due to both vortices is

$$w = \frac{\Gamma}{4\pi} \left( \frac{x}{r^2} + \frac{l_1 - x}{r'^2} \right) \quad (31)$$

If we assume that the lift is uniformly distributed over the effective span  $l_2$ , which again we shall take as somewhat less than the actual span, then, since every element of the wing must be turned through the angle  $\varphi$  according to the formula  $\tan \varphi = \frac{w}{V}$ , the direction of the air force must be turned also, which means a negligible change in the lift, but an increase in the drag of this wing which must be taken into account.

It is essential then in this calculation that we pass from a condition for a monoplane to one in which the wing when part of a biplane has the same lift as when considered as a monoplane. The angle of attack for which this condition will arise can be estimated afterwards from the average of the angles  $\varphi$ .

19. The contribution of vortex  $A$  to the increase of the drag of the upper wing in figure 40 is evidently

$$W' = \int_0^{l_2} \frac{w}{V} \frac{A_2}{l_2} dx = \frac{A_2}{l_2} \frac{\Gamma}{4\pi V} \int_0^{l_2} \frac{dx}{r^2} = \frac{A_2}{l_2} \frac{\Gamma}{4\pi V} \log \frac{r_2}{r_1}$$

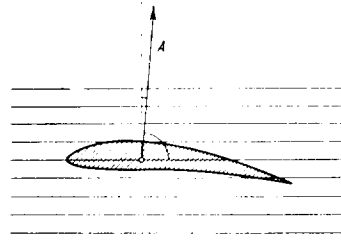

FIG. 38.

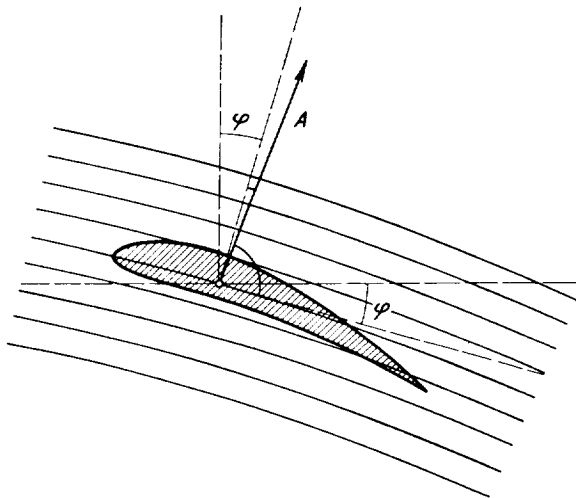

FIG. 39.

Influence of one wing of a biplane upon the other; rotation of wing profile, alteration of its curvature.

The contribution of vortex  $B$  is, by symmetry, the same. In accordance with equation (20), we can put  $\Gamma = \frac{A_1}{l_1 \rho} V$  and thus obtain for the increase of the drag of the upper wing

$$W_{12} = \frac{A_1 A_2}{l_1 l_2} \frac{\log r_2 / r_1}{2\pi \rho V^2} \quad (32)$$

By the symbol  $W_{12}$  is meant that it is the drag produced by wing 1 upon wing 2. One can convince himself easily that the drag  $W_{21}$  which wing 2 produces upon wing 1 has the same magnitude. Therefore the total increase of drag due to the fact that two monoplates which produce the lifts  $A_1$  and  $A_2$  are combined to form a biplane, the two lifts remaining unchanged (the angles of incidence of course being changed), is

$$W_{12} + W_{21} = 2 W_{12} = \frac{A_1 A_2}{2\pi l_1 l_2} \log \frac{r_2}{r_1} \quad (33)$$

in which, as always  $q = \frac{1}{2} \rho V^2$ .\*

Upon the change in the magnitude of the velocity, which in accordance with the approximation used depends only upon the disturbance velocity  $v$  in the direction of flight, only the transverse vortex of the other wing has an influence. For any point this influence, according to our formula, is given by

$$v = \frac{\Gamma}{4\pi h} \left( \frac{x}{r} + \frac{l-x}{r'} \right) \quad (34)$$

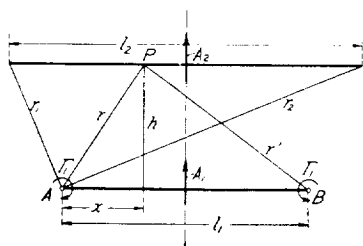

Fig. 40.—Velocity at a point  $P$  due to the tip vortices.

in which  $r$  and  $r'$  have the same meaning as before. The upper wing experiences due to the lower an increase in velocity, the lower one experiences due to the upper a decrease in velocity, to which correspond, respectively, an increase or a decrease in lift as shown by the usual formulæ. If we wish to keep the lifts unchanged, as required in the treatment given

above, it is necessary to change the angles of attack correspondingly.

The effective change in the curvature<sup>9</sup> of the wing profile will, for simplicity's sake, be discussed here only for the medial plane of the biplane, i. e., for  $x = \frac{l_1}{2}$ . It is obtained in the simplest manner by differentiating the angle of inclination of the air current disturbed by the other wing, which is, remembering that  $\tan \varphi = \frac{w}{V}$ ,

$$\frac{1}{R} \frac{d}{dy} (\tan \beta) = \frac{1}{V} \frac{dw}{dy} \quad (35)$$

Outside of the vertical plane, owing to the disturbing wing, three vortices contribute to the magnitude of  $w$ . A side vortex contributes, at a point at the height  $h$  and the distance  $y$  in front of the transverse plane, a velocity  $v'$  perpendicular to  $r''$  of the amount  $\frac{\Gamma_1}{4\pi r} \left( 1 - \frac{y}{r''} \right)$ , and therefore its share of  $w$  is

$$w_1 = \frac{\Gamma_1 x}{4\pi r^2} \left( 1 - \frac{y}{r''} \right) = \frac{\Gamma_1 l_1}{8\pi r^2} \left( 1 - \frac{y}{r''} \right)$$

The transverse vortex contributes

$$w_2 = -\frac{\Gamma_1}{4\pi r} \cdot \frac{l_1 y}{r'' r'''}$$

in which the meaning of  $r''$  and  $r'''$  may be seen from figure 41. The total  $w$  is, accordingly,

$$w = 2w_1 + w_2 = \frac{\Gamma_1 l_1}{4\pi} \left( \frac{1}{r^2} - \frac{y}{r^2 r''} - \frac{y}{r'' r'''} \right)$$

\* The mutual action of two wings placed side by side can also be calculated from the considerations stated above, and results in a decrease of the drag. This decrease is of a similar kind to that which arises in the theory of a monoplane by an increase in the aspect ratio.

<sup>9</sup> By change in curvature of the wing is meant that if the flow were to be kept straight and the curvature changed, the forces on the wing would be changed exactly as they are on the actual wing owing to the change in the flow.—Tr.

The differential of this with reference to  $y$ , for the value of  $y=0$ , is, since then  $r' = r$  and  $r'' = h$

$$\left(\frac{dw}{dy_0}\right) = -\frac{\Gamma l_1}{4\pi r} \left(\frac{1}{r^2} + \frac{1}{h^2}\right).$$

the curvature sought is, then, according to equation (35),

$$\frac{1}{R} = \frac{\Gamma}{4\pi V r} \frac{l_1}{r} \left(\frac{1}{r^2} + \frac{1}{h^2}\right) \tag{36}$$

Calculations of the preceding nature were made in 1912 by my assistant, A. Betz, so as to compare experiments with monoplanes and biplanes and to study the influence of different angles of attack and different degrees of stagger of the two wings of a biplane upon each other. The influence upon the drag was not known to us at that time, and the calculation was carried out so as to obtain the changes in the lift due to  $w$ , to  $v$  and to the curvature of the streamlines. In this connection the change of the lift of a monoplane when flying near the earth's surface was also deduced, by calculating the influence of the "mirrored wing" exactly as was that of the other wing of a biplane. All that was necessary was to change some algebraic signs, because the mirrored wing had negative lift. The theory of these calculations was given by Betz in the *Z. F. M.*, 1914, page 253.

The results of the theory of Betz, from a more modern standpoint, such as adopted here, were given in the *Technische Berichte*, volume 1, page 103 et seq. There one can find the discussion requisite for the treatment of the most general case of a biplane having different spans of the two wings and with any stagger. In the case of great stagger it appears, for example, that the forward wing is in an ascending air current caused by the rear wing; the latter is in an intensified descending current due to the forward wing and the vortices flowing off from it. Corresponding to this, if the angle of attack is unchanged, the lift of the forward wing is increased, and that of the rear one weakened; at the same time the ratio  $\frac{\text{Drag}}{\text{Lift}}$  experiences a decrease for the forward wing and a marked increase for the rear one.

For a wing in the neighborhood of the ground, owing to the influence of  $v$  there is a decrease of lift, and conversely there is an increase of lift due to the influence of  $w$ , provided the angle of attack is kept constant, but as the result an evident decrease in the ratio  $\frac{\text{Drag}}{\text{Lift}}$ . Owing to this last it is seen why in the early days of aeronautics many machines could fly only near the ground and could not rise far from it. Their low-powered engines were strong enough to overcome the diminished drag near the ground but not that in free air.

**D. THEORY OF THE MONOPLANE.**

20. If we extend the principles, which up to this point have been applied to the influence of one wing upon another, to the effect upon a single wing of its own vortices, it can be said in advance that one would expect to find in that case effects similar to those shown in the influence of one wing of a biplane upon the other, i. e., the existence of lift presupposes a descending flow in the neighborhood of the wing, owing to which the angle of attack is made greater and the drag is increased, both the more so the closer to the middle the vortices flowing off at the ends are, i. e., the smaller the aspect ratio is. One might propose to apply the theory previously given for biplanes by making in the formulas of this theory the gap equal to zero. Apart from the fact that the formulas developed do not hold for the immediate neighborhood of the vortex-producing wing, but must be replaced by more accurate ones, this certainly is not the proper path to follow, for, in the earlier treatment, we have taken the undisturbed monoplane as the object with which other cases are to be compared and have asked what drag, what change in angle of attack, etc., are caused by adding a second wing to this monoplane. To proceed

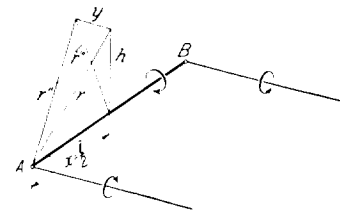

FIG. 41.—Curvature of wing-profile at its middle point due to velocities caused by transverse and tip vortices.

according to the same method, we must seek for the theory of monoplane another suitable object of comparison. As such, the infinitely long wing will serve. Where the discussion previously was about change of angle of attack, increase of drag, etc., we intend now to refer these to the infinitely long wing as a starting point. Since in the theoretical nonviscous flow the infinitely long wing experiences no drag, the total drag of such a wing in such a fluid must be due to vortices amenable to our calculations, as the following treatment will show. In a viscous fluid drag will arise for both wings, infinitely long or not, which for those angles of attack for which the profile is said to be "good" is, according to the results of experiment, of the order of magnitude of the frictional resistance of a plane surface.

The carrying out of this problem is accompanied with greater difficulties than the calculation for a biplane as given. In order to obtain the necessary assistance for the solution of the problem, we shall first be obliged to improve the accuracy of our picture of the vortex system.

The density of the lift (lift per unit length) is not constant over the whole span, but in general falls off gradually from a maximum at the middle nearly to zero at the ends. In accordance with what has been proved, there corresponds to this a circulation decreasing from within outward. Therefore, according to the theorem that by the displacement of the closed curve the circulation  $\Gamma$  can change only if a corresponding quantity of vortex filaments are cut, we must assume that vortex filaments proceed off from the trailing edge wherever  $\Gamma$  changes.

For a portion of this edge of length  $dx$  the vortex strength is therefore to be written  $\frac{d\Gamma}{dx} dx$ , and

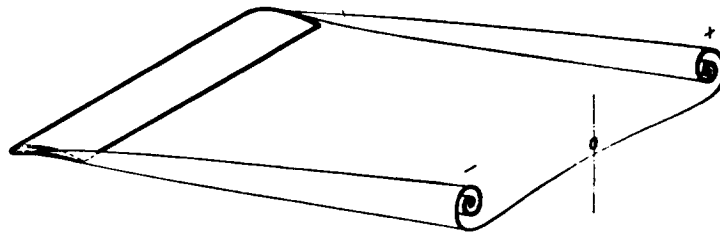

FIG. 42.—Change in shape of vortex ribbons at great distances behind the wing.

hence per unit length of the edge is  $\frac{d\Gamma}{dx}$ . These vortex filaments flowing off, closely side by side, form, taken as a whole, a surface-like figure, which we shall call a "vortex ribbon."

For an understanding of this vortex ribbon we can also approach the subject from an

entirely different side. Let us consider the flow in the immediate neighborhood of the surface of the wing. Since the excess in pressure below the wing and the depression above it must vanish as one goes beyond the side edges of the wing in any manner, there must be a fall in pressure near these edges, which is directed outward on the lower side of the wing and inward on the upper. The oncoming flow, under the action of this pressure drop, while it passes along the wing, will receive on the lower side an additional component outward, on the upper side, one inward, which does not vanish later. If we assume that at the trailing edge the flow is completely closed again, as is the case in nonviscous flow, we will therefore have a difference in direction between the upper and lower flow; the upper one has a relative velocity inward with reference to the lower one, and this is perpendicular to the mean velocity, since on account of the Bernoulli equation in the absence of a pressure difference between the two layers the numerical values of their velocities must be the same. This relative velocity of the two flows is exactly the result of the surface distribution of vortices mentioned above (as the vortex theory proves, a surface distribution of vortices always means a discontinuity of velocity between the regions lying on the two sides of the surface). The relative velocity is the greater, the greater the sidewise pressure drop, i. e., the greater the sidewise change in lift. The picture thus obtained agrees in all respects with the former one.

21. The strengths of our vortex ribbon remain unchanged during the whole flight, yet the separate parts of the ribbon influence each other; and there takes place, somewhat as is shown in figure 42, a gradual rolling up of the ribbon, as a closer examination proves. An exact theoretical investigation of this phenomenon is not possible at this time; it can only be said that the two halves of the vortex ribbon become concentrated more and more, and that finally at great distances from the wing there remain a pair of vortices with rather weak cores.

For the practical problem, which chiefly concerns us, namely, to study the reaction of the vortices upon the wing, it is not necessary to know these changes going on at a great distance, for the parts of the vortex system nearest the wing will exercise the greatest influence. We shall therefore not consider the gradual transformation of the vortex ribbon, and, in order to make the matter quite simple, we shall make the calculation as if all the vortex filaments were running off behind in straight lines opposite to the direction of flight. It will be seen that, with this assumption, the calculations may be carried out and that they furnish a theory of the monoplane which is very useful and capable of giving assistance in various ways.

If we wish to establish the method referred to with greater mathematical rigor, we can proceed as follows: Since the complete problem is to be developed taking into account all circumstances, we shall limit ourselves to the case of a very small lift and shall systematically carry through all calculations in such a manner that only the lowest power of the lift is retained, all higher powers being neglected. The motion of the vortex ribbon itself is proportional to the total circulation, therefore also proportional to the lift; it is therefore small if the lift is small. If the velocities caused by the vortex ribbon are calculated, first for the ribbon in its actual form, then for the ribbon simplified in the manner mentioned, the difference for the two distributions will be small compared with the values of the velocity, therefore small of the second order, i. e., small as the square of the circulation. We shall therefore neglect the difference. Considerations of this kind are capable of deciding in every case what actions should be taken into account and what ones may be neglected. By our simplifications we have therefore made the problem linear, as a mathematician says, and by this fact we have made its solution possible. It must be considered a specially fortunate circumstance that, even with the greatest values of the lift that actually occur with the usual aspect ratios, the independent motion of the vortex ribbon is still fairly small, so that, in the sense of this theory, all lifts which are met in practice may still be regarded as small. For surfaces having large chords, as, for instance, a square, this no longer holds. In this case there are, in addition, other reasons which prove that our theory is no longer sufficiently accurate. This will be shown in the next paragraph.

It has already been mentioned that the infinitely long wing will serve as an object of comparison for the theory of the monoplane. We shall formulate this now more exactly by saying: Every separate section of the wing of length  $dx$  shall bear the same relation to the modified flow due to the vortex system as does a corresponding element of an infinitely long wing to the rectilinear flow. The additional velocities caused by the vortex system vary from place to place and also vary in the direction of the chord of the wing, so that again we have to do with an influence of curvature. This influence is in practice not very great and will for the sake of simplicity be neglected. This is specially allowable with wings whose chords are small in comparison with their spans, i. e., with those of large aspect ratio. If one wishes to express with mathematical exactness this simplifying assumption, it can be said that the theory of an actual wing of finite chord is not developed, but rather that of a "lifting line." It is clear that a wing of aspect ratio 1:6 may be approximated by a lifting line, specially if one considers that actually the lift is concentrated for the greatest part in a region nearer the leading edge. It is easily seen, however, that a surface in the form of a square can be approximated only poorly by a lifting line.

If we assume a straight lifting line, which lies in a plane perpendicular to the direction of flight, the flow due to the vortices, which according to the Biot-Sarvart law, is caused by its own elements, will not produce any velocities at the lifting line itself except the circulation flow around it, which would also be present for an infinitely long lifting line having the same circulation as at the point observed. All disturbance velocities at a point of the lifting line, which are to be looked upon as deviations from the infinitely long lifting line, are due therefore to the vortices which run off and hence can be calculated easily by an integration.

A qualitative consideration of the distribution to be expected for the disturbance velocities along our lifting line shows at once that—just as was the case for a biplane—the chief thing is the production of a descending current of air by the vortices. If we wish to retain the lift of the same intensity as with the infinite wing, the angle of attack must be increased, since the descend-

ing air stream added to the wind due to flight causes a velocity obliquely downward. In addition, the air force, as before, must be turned through the same angle, so that a drag results. The rotation will be the greater, the greater the lift and the closer to the middle of the wing

the main production of vortices is. The drag must therefore increase both with increasing lift and with decreasing span.

A picture of what occurs with a wing of finite but small chord is given in figure 43. There the change is shown of the vertical velocity component along a straight line parallel to the direction of flight through the middle of the wing; in the upper part of the diagram, for the infinitely long wing, in the lower part, for the finite wing. We see from Curve I the rising flow in front of the wing, its transformation into a descending one at the wing itself and the gradual damping of the descending component due to the upward pressure drop behind the wing. (See sec. 15.) The corresponding curve for the finite wing is Curve III. It is derived from I by adding to the latter the descending velocity II. We recognize the rotation of the profile as well as that of the lifting force, which was originally perpendicular,

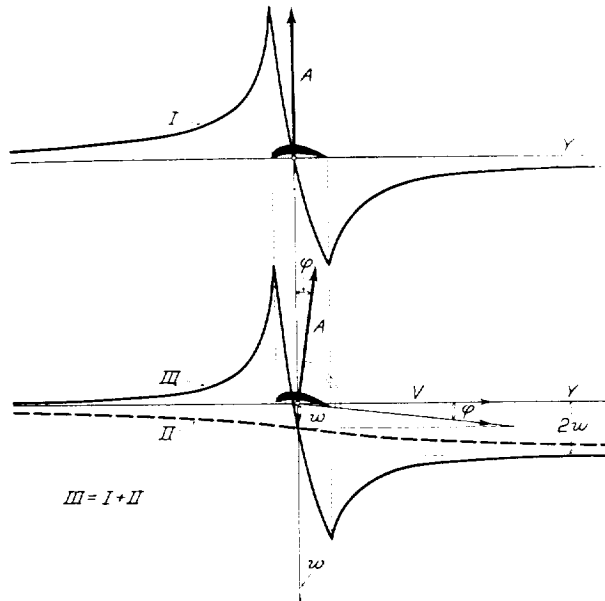

FIG. 43.—Wing having finite, but small, chord. Distribution of vertical velocity component along a line parallel to direction of flight.

- I. Infinitely long wing.
- II. The downward velocity produced by vortices flowing off.
- III. Finite wing, sum of I and II.

through the angle  $\phi$  where  $\tan \phi = \frac{w}{V}$  and

$w$  is the velocity downward at the location of the center of pressure (i. e., at the lifting line). If we follow the method of Lanchester, as described in section 15, the downward velocity  $w$  can also be looked upon as a diminution of the ascending flow at the leading edge of the wing due to the absence of the sidewise prolongation of the wing, i. e., to the deviation from an infinitely long wing which was the basis of the treatment in section 15. Discussions very similar to this are given in Lanchester, Volume I, section 117.

It may be seen from the figure that at great distances behind the wing the descending velocity is  $2w$ , which agrees with the relation already mentioned that the velocities due to a straight vortex filament extending to infinity in both directions are twice those due to a filament extending to infinity in one direction only, for points in the plane perpendicular to this vortex passing through its end point.

22. The mathematical processes involved in carrying out the theory outlined above become the most simplified if one considers as known the law, according to which the lift is distributed over the wing. We shall call this the "first problem." The calculation is made as follows: The distribution of lift is the circulation expressed as a function of the abscissa  $x$ . The strength of the vortex filament leaving an infinitely small section  $dx$  is then  $\frac{d\Gamma}{dx} \cdot dx$ . This produces at a point  $x'$ , according to what has been already explained, a vertical velocity downward or upward of the amount

$$dw = \frac{1}{4\pi} \cdot \frac{d\Gamma}{dx} \cdot \frac{dx}{x' - x}$$

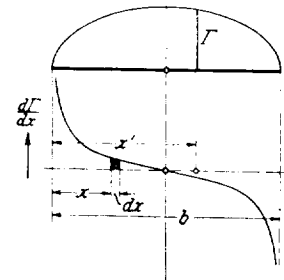

FIG. 44.—Velocity at a point  $x'$  due to vortex leaving wing at point  $x$ .

In this  $x' - x$  takes the place of  $r$  in section 8. If the circulation falls to zero at the ends of the wing, as is actually the case, then all the vortices leaving the wing are of this kind. The whole added velocity at the position  $x'$ , assuming that the function  $\Gamma(x)$  is everywhere continuous, is

$$w = \frac{1}{4\pi} \int_0^b \frac{d\Gamma}{dx} \cdot \frac{dx}{x' - x} \quad (37)$$

We must take the so-called "chief value" of the integral, which is indeterminate at the point  $x = x'$ , i. e., the limiting value

$$\lim_{\epsilon \rightarrow 0} \left( \int_0^{x'-\epsilon} + \int_{x'+\epsilon}^b \right)$$

must be formed, as a closer examination shows. We can do this by calculating, instead of the value of the velocity at the lifting line, which is determined by the preponderating influence of the nearest elements, the value of  $w$  for a point a little above or below the lifting line. It is seen that this last is not indeterminate and that by passing to a zero distance from the lifting line it reaches the above limit. Concerning this excursus, important in itself, the preceding brief remarks may be sufficient.

After the calculation of the integral of (37), the downward velocity is known as a function of the abscissa  $x'$  (which we later shall call  $x$ ). We then also know the inclination of the resultant air flow,  $\tan \varphi = \frac{w}{V}$ ; the lift  $dA = \rho \Gamma V dx'$ , acting on the section  $dx'$ , therefore contributes to the value of the drag

$$dW = \tan \varphi \cdot dA = \rho \Gamma(x') \cdot w(x') dx'$$

since it is inclined backward by the small angle  $\varphi$ . The total drag is therefore

$$W = \rho \int_0^b \Gamma(x') \cdot w(x') \cdot dx' = \frac{\rho}{4\pi} \int_0^b \int_0^b \frac{\Gamma(x')}{x' - x} dx dx' \quad (38)$$

For a long time it was difficult to find suitable functions to express the distribution of lift, from which a plausible distribution of  $w$  would be obtained by equation (37). After various attempts it was found that a distribution of lift over the span according to a half ellipse gave the desired solution. According to this, if the origin of coordinates is taken at the center of the wing,

$$\Gamma = \Gamma_0 \sqrt{1 - \left(\frac{x}{b/2}\right)^2}, \text{ hence } \frac{d\Gamma}{dx} = \frac{-\Gamma_0 x}{2 \sqrt{\left(\frac{b}{2}\right)^2 - x^2}}$$

The "chief value" of the integral

$$\int_0^{x'} \frac{t dt}{(t' - t) \sqrt{1 - t^2}} \text{ is equal to } \pi$$

and therefore the integral of equation (37) is equal to  $\frac{\Gamma_0 \pi}{b/2}$ , and thus is independent of  $x'$  and constant over the whole span. Hence

$$w = \frac{\Gamma_0}{2b}$$

The value of  $\Gamma_0$  is obtained from

$$A = \rho V \int_{-b/2}^{+b/2} \Gamma dx = \rho V \Gamma_0 \int_{-b/2}^{+b/2} \sqrt{1 - \frac{x^2}{(b/2)^2}} \cdot dx = \rho V \Gamma_0 \frac{\pi}{4} b,$$

giving

$$\Gamma_0 = \frac{4A}{\pi \rho V b}.$$

Hence

$$w = \frac{2A}{\pi \rho V b^2} \quad (39)$$

Since  $w$  is constant there is no need of calculating the drag by an integral, for it is simply

$$W = \frac{w}{V} A = \frac{2A^2}{\pi \rho V^2 b^2} = \frac{A^2}{\pi q b^2} \quad (40)$$

The calculation can also be performed for distributions of circulation given by the following general formula:

$$\Gamma = \sqrt{1 - \xi^2} (\Gamma_0 + \Gamma_2 \xi^2 + \Gamma_4 \xi^4 + \dots) \tag{41}$$

in which  $\xi = \frac{x}{b/2}$ .

According to the calculations of A. Betz

$$w = \frac{1}{2b} \sum_n \left\{ \Gamma_{2n} \sum_{m=0}^{m=n} \xi^{2m} [(2n+1) p_{n-m} - 2n p_{n-m-1}] \right\} \tag{42}$$

and

$$W = \frac{\pi \rho \sum_i \Sigma_k}{4} \left\{ \Gamma_{2i} \Gamma_{2k} \sum_{m=0}^{m=k} q_{i+m} [(2k+1) p_{k-m} - 2k p_{k-m-1}] \right\} \tag{43}$$

in which the numbers  $p$  and  $q$  have the meaning

$$p_n = \frac{1.3 \dots (2n-1)}{2.4 \dots 2n}; \quad q_n = \frac{p_n}{2n+2}; \quad p_0 = 1, \quad p_{-1} = 0$$

The elliptical distribution of lift, apart from its simplicity, has obtained a special meaning from the fact that the drag as calculated from equation (40) proved to be the smallest drag that is imaginable for a monoplane having given values of the total lift, the span and the velocity. The proof of this will be given later.

It was desirable to compare this theoretical minimum drag with the drags actually obtained. As far back as 1913 this was done, but, on account of the poor quality of the profiles then investigated, all that was done was to establish that the actual drag was greater than the theoretical. Later (1915) it was shown, upon the investigation of good profiles, that the theoretical drag corresponds very closely to the relation giving the change of the observed drag as a function of the lift.

If we plot in the usual manner the theoretical drag, as given in formula (40) as a function of the corresponding lift, we obtain a parabola, which runs parallel with the measured "polar curve" through the entire region for which the profile is good. (See fig. 45.)

This process was repeated for wings of different aspect ratios, and it was proved that for one and the same profile the difference between the measured and the theoretical drags for one and the same value of the lift coefficient had almost identically the same value in all cases.

This part of the drag depends, however, upon the shape of the profile, and we have therefore called it "profile drag." The part of the drag obtained from theory is called "edge drag," since it depends upon the phenomena at the edges of the wings. More justifiably the expression "induced drag" is used, since in fact the phenomena with the wings are to a high degree analogous to the induction phenomena observed with electric conductors.

Owing to this fact that the profile drag is independent of the aspect ratio, it became possible from a knowledge of the actual drag for one aspect ratio to calculate it for another. To do this, we pass from the formula (40) for the drag to the dimensionless lift and drag coefficients, by letting  $\frac{A}{Fq} = c_a$  and  $\frac{W}{Fq} = c_w$ ; we obtain then for the coefficient of the induced drag the relation

$$c_{wi} = \frac{c_a^2}{\pi b^2} \tag{44}$$

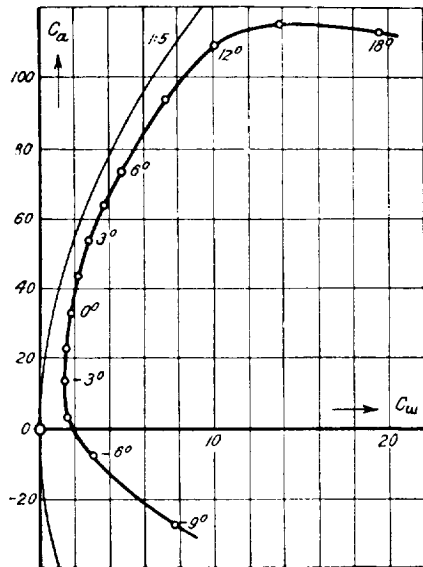

FIG. 45.—Polar diagram showing theoretical drag and observed drag.



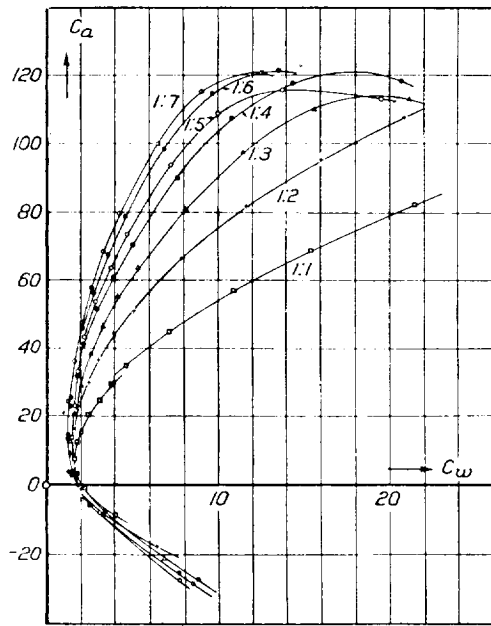

FIG. 46.—Polar diagrams for seven wings, aspect ratios 1.7, 1.6, etc., 1.1.

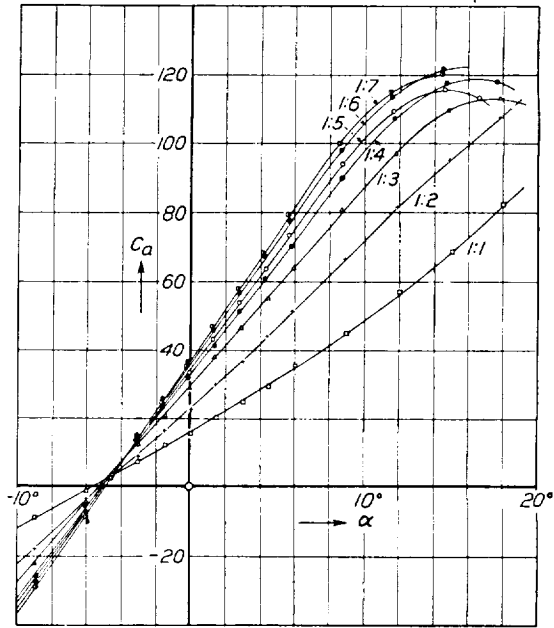

FIG. 47.—Lift coefficients plotted as function of angle of attack for aspect ratios 1.7 to 1.1.

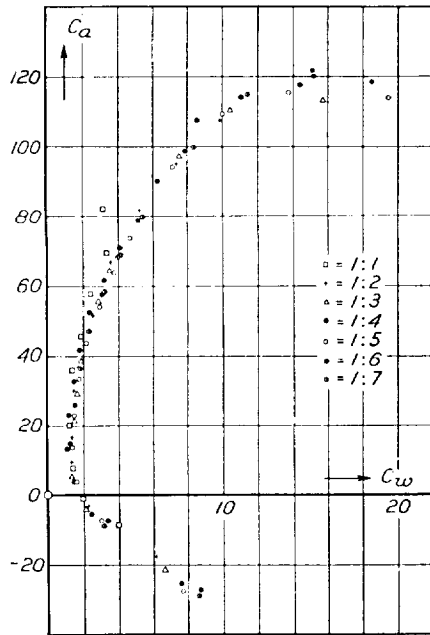

FIG. 48.—Polar diagrams reduced from observations on aspect ratio 1.5.

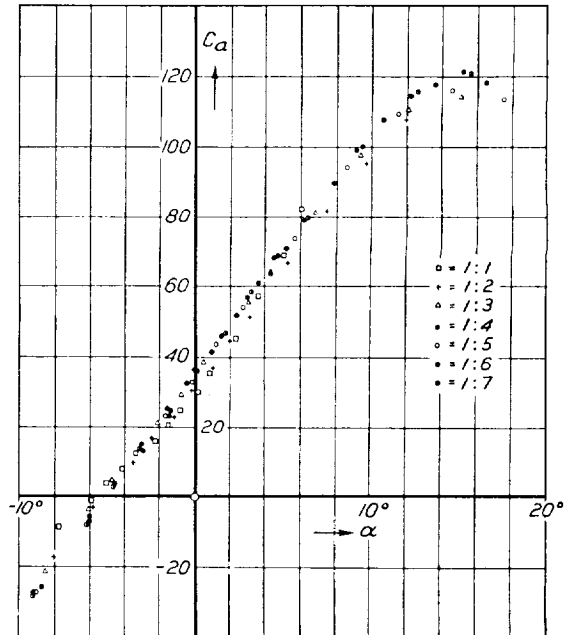

FIG. 49.—Lift coefficients as function of angle of attack, reduced for aspect ratio 1.5.

20167-23-13

The profile drag may then be written  $c_{w0} = c_w - c_{w1}$ . If this drag coefficient depends only upon the lift coefficient, then it would be evident, since it would be the difference between the measured and the theoretical drag coefficients, that, for the polar curves of two different wings having  $c_{a1} = c_{a2} = c_a$ ,

$$c_{w1} = \frac{c_a^2 F_1}{\pi b_1^2} = c_{w2} = \frac{c_a^2 F_2}{\pi b_2^2},$$

and therefore

$$c_{w2} = c_{w1} + \frac{c_a^2}{\pi} \left( \frac{F_2}{b_2^2} - \frac{F_1}{b_1^2} \right) \tag{45}$$

In a similar manner a calculation for the angle of attack may be made if we presuppose an elliptical distribution of lift. According to our assumption there is a close connection between the lift of the separate elements of the wing and the "effective" angle of attack, which is the same as the angle of attack of an infinitely long wing. This effective angle of attack, according to our earlier considerations, is the angle of attack of the chord with reference to the resultant air current. It is therefore  $\alpha' = \alpha - \phi$ . If we substitute  $\tan \phi = \frac{W}{V}$  for  $\phi$ , and introduce in equation (39) again the lift coefficient, instead of using the lift, we obtain for the comparison of two wings, expressing the fact that the effective angle of attack is to be the same for two equal lift coefficients, the relation

$$\alpha_1 + \frac{c_a}{\pi} \frac{F_1}{b_1^2} = \alpha_2 + \frac{c_a}{\pi} \frac{F_2}{b_2^2},$$

which leads to the transformation formula

$$\alpha_2 = \alpha_1 + \frac{c_a}{\pi} \left( \frac{F_2}{b_2^2} - \frac{F_1}{b_1^2} \right) \tag{46}$$

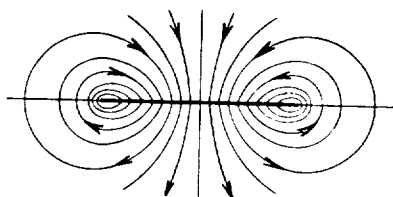

FIG. 49a.—Uniplanar flow in case of elliptic distribution of lift on a lifting line.

These formulas have been found to hold for distributions of lift which do not deviate too much from elliptical ones, although strictly speaking they apply only to the latter. The fact that the type of distribution does not have a marked effect is based upon the consideration that both in the calculation of drag and in that of the mean effective angles of attack we are concerned with average results. For the calculation of the drag one can also introduce the thought that no quantity varies much in the neighborhood of its minimum. Closer investigation of the square cornered wing has shown that, if the aspect ratio is not too small, the lift distribution does not deviate greatly from the elliptic type, and that the theoretical drag for usual aspect ratios at the most is 5 per cent greater than for the elliptic distribution. As an example of these formulas we shall take four figures from the book published by the Göttingen Institute (*Ergebnisse der Aerodynamischen Versuchsanstalt*, 1, Lieferung, 1921). The first and second figures show the polar curves, and the connection between lift coefficient and angle of incidence for seven wings of aspect ratio<sup>10</sup> 1:7 to 1:1. The last two figures give the results of calculating these experimental quantities from the results for the wing having the aspect ratio 1:5. It is seen that, apart from the aspect ratios 1:1 and 1:2 practically no deviations are present. The fact that the square can not be correctly deduced from the aspect ratio 1:5 need not excite surprise, since the theory was developed from the concept of the lifting line, and a square or a wing of aspect ratio 1:2 can scarcely be properly approximated by a lifting line. On the other hand it is a matter of surprise that an aspect ratio of 1:3 can be sufficiently approximated by the imaginary construction of a lifting line. The deviations in the case of the square are moreover in the direction one would expect from a lift distribution expanded over the chord. A quantitative theory is not available in any case at the present time.

23. If the lift distribution is not given, but, for example, the downward velocity, then the method of treatment followed hitherto may be used, by developing the downward velocity in a power series and determining the constants of the series given above for the lift from the constants

<sup>10</sup>The American practice is to define aspect ratio as the ratio of span to chord, which would involve taking the reciprocals of the ratios given in the text. Tr.

of this power series, by the solution of linear equations. By this the lift distribution and everything else are known.

Another method for the solution of this "second problem" will be obtained by the following consideration: The velocities at a distance behind the wing, on account of the connection mentioned so often between a vortex filament extending to infinity in one direction only and one extending to infinity in both directions, are twice as great as those in the cross section of the lifting line, if we do not take into account the change in shape of the vortex ribbon. We therefore have here, neglecting this change in shape, an illustration of a two-dimensional fluid flow (uniplanar flow), for which the vertical velocity components at the point where the wing is reached are specified. For the simple case that the vertical velocity  $w$  is constant, as was found to be true for the elliptical lift distribution, the shape of the flow that arises has been known for a long time. It is given in figure 49a. It is the same as that already considered, in another connection, in section 15. The picture of the streamlines show clearly the velocity discontinuity between the upper and lower sides of the vortex ribbon, indicated by the nick in the streamlines, and also the vortical motion around the two extreme points of the vortex ribbon, corresponding to the ends of the wing.

Any problems of this kind can therefore be solved by means of the methods provided by the potential theory for the corresponding problem of two-dimensional fluid flow. We can not go into these matters more closely at this time; by a later opportunity some special relations will be discussed, however.

A "third problem" consists in determining the lift distribution for a definite wing having a given shape and given angle of attack. This problem, as may be imagined, was the first we proposed; its solution has taken the longest, since it leads to an integral which is awkward to handle. Dr. Betz in 1919 succeeded after very great efforts in solving it for the case of a square-cornered wing having everywhere the same profile and the same angle of attack. The way the solution was obtained may be indicated briefly here. We start, as before, from the relation

$$\alpha = \alpha' + \phi \cong \alpha' + \frac{w}{V}$$

By equation (37)  $w$  is expressed in terms of the circulation. The effective angle of attack  $\alpha'$  can be expressed in terms of  $\Gamma$ , since, according to the assumptions made before the lift distribution, which is proportional to  $\Gamma$ , depends directly upon  $\alpha'$ . The relation between  $\alpha'$  and  $\Gamma$  can be assumed to be given sufficiently exactly for our purposes by a linear expression

$$\Gamma = Vt (c_1 \alpha' + c_2) \tag{47}$$

in which  $t$  is the length of the chord (measured in the direction of flight). By the introduction of the factor  $Vt$ ,  $c_1$  and  $c_2$  are made pure numbers. The numerical value of  $c_1$ , which is the more important, can be expressed, if  $c_{a_z}$  is the lift coefficient for the infinitely long wing at the angle of attack  $\alpha'$ , by the relation

$$c_1 = \frac{1}{2} \frac{dc_{a_z}}{d\alpha'}$$

In fact

$$c_{a_z} = \frac{A}{Fq} = \frac{\rho \Gamma Vt}{lt \cdot \frac{1}{2} \rho V^2} = \frac{2\Gamma}{Vt} = 2 (c_1 \alpha' + c_2)$$

For a flat-plate theory proves that  $c_1 = \pi$ , for curved wings it has a slightly greater value.

If, according to what has gone before, we express  $\alpha'$  by  $\Gamma$  and  $w$  by  $\frac{d\Gamma}{dx}$  and write

$$\frac{d\Gamma}{dx} = f(x) \text{ and therefore } \Gamma = \int_0^x f(x) dx$$

we obtain after a simple calculation the integral equation

$$\int_0^x f(x) dx + \frac{c_1 t}{4\pi} \int_0^b \frac{f(x') dx'}{x - x'} = Vt (c_1 \alpha + c_2) = \text{const.} \tag{48}$$

A solution of this equation can be obtained by expanding  $\Gamma$  as in equation (41) and developing then all the expressions in power series of  $\xi = \frac{x}{b/2}$ . For every power of  $\xi$  there is then a linear equation between the quantities  $\Gamma_0, \Gamma_2,$  etc. There is a system of equations, then, with an indefinite number of equations for an infinite number of unknowns, the solution of which in this form is not yet possible. The aspect ratio of the wing appears in these equations as a parameter, and it is clear that the solution for a small aspect ratio, i. e.,  $\frac{b}{t}$  is easier than for a large one. Dr. Betz proved that a development in powers can be made for the unknowns in terms of a parameter containing the aspect ratio. The calculations which are contained in the dissertation<sup>11</sup> of Dr. Betz (1919) are very complicated and can not be reproduced here; but certain results will be mentioned. The Betz parameter  $L$  has the meaning

$$L = \frac{2b}{c_1 t} = \frac{4b}{t} \frac{d\alpha'}{dc_{a\infty}}$$

In the application to surfaces which are investigated in wind tunnels the value  $\frac{dc_a}{da}$  is known, not  $\frac{dc_{a\infty}}{d\alpha'}$ . For this case theory gives a relation which can be expressed approximately

$$L \approx 3.85 \frac{b}{t} \frac{da}{dc_a} - 1.3.$$

We can thus obtain the value of  $\frac{d\alpha'}{dc_{a\infty}}$  from the connection mentioned.

The distribution of lift density over the span is elliptical for very small aspect ratios and for greater ratios becomes more and more uniform; for

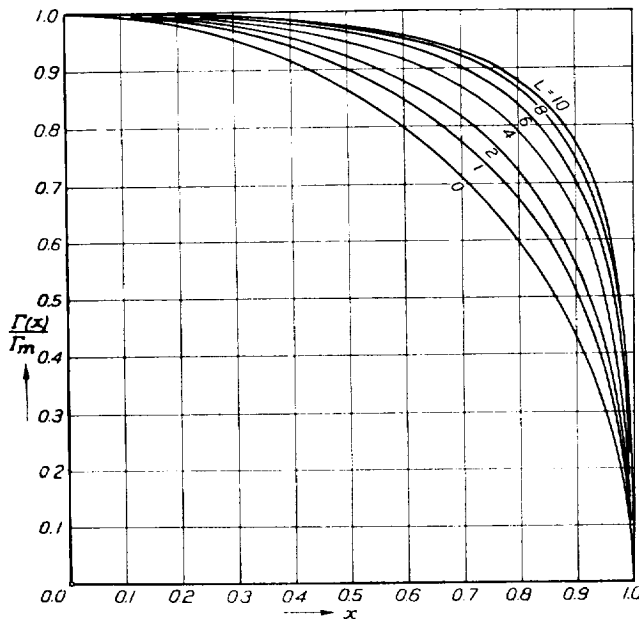

FIG. 50.—Change in distribution of lift, as a function of  $L$ , the parameter of Betz.

very elongated wings it approaches gradually a rectangular distribution. Figure 50 shows this change in the distribution depending upon  $L$ .

The drag of the wing with the rectangular distribution is greater naturally than with the elliptic distribution, since this gives the minimum of drag, yet the differences are not very great; for instance, for  $L=4$ , ( $\frac{b}{t} \approx 6$ ) it is about 5 per cent greater than that of the elliptical distribution. An approximation formula, according to the values obtained by Betz, is

$$W \approx \frac{A^2}{\pi q b^3} (0.99 + 0.015 L).$$

This is applicable for values of  $L$  between 1 and 10.

The distribution of lift, downward velocity, and drag upon a very elongated wing is shown qualitatively in figure 51. It is seen that the downward velocity and the drag gradually accumulate at the ends of the wing. This gives also the correct transition to an infinitely long wing, with which for interior positions the lift is constant, and the downward velocity and the drag are equal to zero, while, as we know, near the ends these last quantities always assume finite values.

<sup>11</sup> Printed in extracts in Heft 2 of the "Berichte u. Abh. der Wiss. Ges. f. Luftf." Munich, 1920 (R. Oldenbourg).

**E. IMPROVED THEORY OF AIRPLANES HAVING MORE THAN ONE WING.**

24. The knowledge obtained in the theory of a monoplane can be applied also to multiplanes and furnishes here a series of remarkable theorems. We shall limit ourselves to the theory of the first order, as designated in the theory of monoplanes, therefore we shall neglect the influences of  $v$ . Further, we shall not take into account the effect of curvature i. e., we shall consider the separate wings replaced by "lifting lines." For the sake of simplicity we shall limit ourselves to multiplanes with wings which are straight and parallel to each other. The generalization of the theorems for nonparallel wings, corresponding to the deduction given in "Wing theory II," will then be stated without proof.

Let us first solve the introductory problem of calculating the vertical velocity  $w$  produced by a lifting line at a point  $A$  which lies off the lifting line. At the beginning let us assume that this point lies in the same "transverse plane" (plane perpendicular to the direction of flight). According to our assumption as to the location of  $A$ , the action of the transverse vortex is zero: With reference to the longitudinal vortices it is to be remembered that the velocity  $\frac{1}{4\pi} \frac{d\Gamma}{dx} \cdot \frac{dx}{a}$  produced by a longitudinal vortex of strength  $\frac{d\Gamma}{dx}$  is perpendicular to the

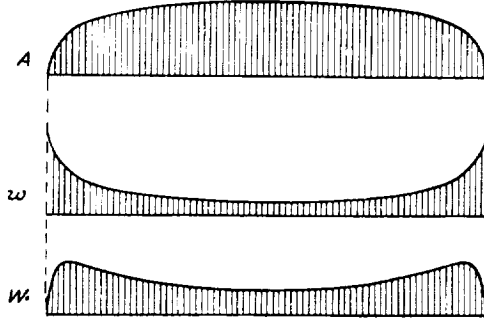

FIG. 51.—Distribution of lift, down-wash and drag for a long wing.

line  $a$  (see fig. 52), and therefore must be multiplied by  $\sin \beta$  to obtain the vertical component. We arrive at the downward velocity, therefore, by integrating over the lifting line, viz:

$$w = -\frac{1}{4\pi} \int_0^b \frac{d\Gamma}{dx} \left( \frac{\sin \beta}{a} \right) dx \tag{49}$$

This relation can be brought into another form by a partial integration. Since at both wing ends  $\Gamma = 0$ , we have

$$w = \frac{1}{4\pi} \int_0^b \Gamma \frac{d}{dx} \left( \frac{\sin \beta}{a} \right) dx$$

But

$$\frac{d}{dx} \left( \frac{\sin \beta}{a} \right) = \frac{d}{dx} \left( \frac{1}{a^2} \right) = \frac{a^2 - 2x^2}{a^4} = \frac{1 - 2 \sin^2 \beta}{a^2} = \frac{\cos 2\beta}{a^2}$$

so that we have

$$w = \frac{1}{4\pi} \int_0^b \Gamma \frac{\cos 2\beta}{a^2} dx \tag{50}$$

With the aid of this relation we can write down immediately the value of the drag which arises owing to a second wing being under the influence of the disturbance caused by the first wing lying in the same transverse plane. Let us call  $w_{12}$  the disturbance velocity at a point  $A$  on the second wing. According to the results of section 22, the drag then is

$$W_{12} = \rho \int_0^{b_2} \Gamma_2 w_{12} dx$$

or, if the value of  $w_{12}$  as given by equation (50) is substituted,

$$W_{12} = \frac{\rho}{4\pi} \int_0^{b_1} \int_0^{b_2} \Gamma_1 \Gamma_2 \frac{\cos 2\beta}{a^2} dx_1 dx_2 \tag{51}$$

The double integral, as one sees, is perfectly symmetrical in the quantities associated with both wings 1 and 2. We conclude from this that the drag which wing 1 experiences owing to the presence of wing 2 is of the same amount as

the drag calculated here, that, therefore,

$$W_{12} = W_{21}.$$

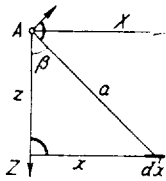

FIG. 52.—Velocity at a point  $A$  off the lifting line, but in the transverse plane, due to the vortex system.

In the more general case of two curved lifting lines lying in a transverse plane, a formula is obtained which differs from equation (51) only in having  $\cos(\beta_1 + \beta_2)$  in place of  $\cos 2\beta$  in which  $\beta_1$  and  $\beta_2$  are the angles which the line  $a$  makes with the normals on the two lifting elements connected by  $a$ , and in having  $ds_1 ds_2$  in place of  $dx_1 dx_2$ . The relation  $W_{12} = W_{21}$  therefore holds in this case also. This mutual relation, which was discovered in a different manner by my assistant, Dr. Munk, is of importance in various applications. Since it plainly is not necessary for the lifting elements taken as a whole to belong to a single surface, the theorem may be stated:

If, out of a lifting system all of whose elements lie in a transverse plane any two groups are selected, the portion of the drag experienced by group 1 due to the velocity field of group 2 is exactly of the same amount as that experienced by group 2 due to the velocity field of group 1.

We can interpret the partial integration performed above by saying that the velocity  $w$  appears by it as built up out of the contributions by merely infinitesimal wings having the length  $dx$  and the circulation  $\Gamma$ , while previously we have always built it up out of the actions of the separate vortices  $\frac{d\Gamma}{dx} dx$ . The integrand of equation (50) in fact agrees with the velocity which is caused by two vortex lines of equal but opposite strengths  $\Gamma$  lying at a distance  $dx$  apart. The double integral in equation (51) can, from this point of view, be looked upon as the sum of the actions of the vortex strips of all the elements  $dx_1$  on all the lifting elements  $dx_2$ .

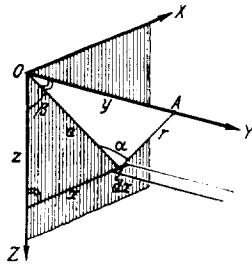

FIG. 53.—Velocity at a point  $A$  not in the transverse plane, due to the vortex system.

The objection might be raised that equations (50) and (51) cease to be applicable if the value  $a=0$  appears, since this gives an expression of the form  $\infty - \infty$ . They are not, therefore, suited for the calculation of the velocity  $w$  at the wing itself. In this case we must return to equation (49), and take the "chief value" of the integral; or, the value of  $w_{12}$  and of  $W_{12}$  for a lifting line that lies very close must be calculated, and then we can obtain our final result by passing to the limit for coinciding lifting lines. As is seen from this, the relations  $W_{12} = W_{21}$  hold also for lifting lines coinciding in space, which, besides, may have any arbitrary lift distribution.

The mutual drag need not, as has already been mentioned, always be positive. For instance, it is negative for two wings placed side by side, since then each wing is in an ascending current caused by the other, and the total drag is therefore less than the sum of the mutual drags which each of the wings would have at a greater distance apart. The behavior of certain birds which in a common flight space themselves in a regular phalanx can be explained by reference to this.

25. In order to be able to treat the case of staggered wing systems, the next problem is to calculate the velocity field due to a lifting element of the length  $dx$  together with its pair of vortices at a point  $A$  which may now lie off the transverse plane, and at a distance  $y$  from it. (See fig. 53.) The origin of coordinates will be taken at the projection of the point  $A$  upon the transverse plane, and the  $X$  axis parallel to the direction of the element. Using the abbreviations

$$a^2 = x^2 + z^2, \quad r^2 = a^2 + y^2,$$

the velocity produced at the point  $A$  by one of the two vortices, by formula (6b), is given by  $\frac{\Gamma}{4\pi a} \left(1 + \frac{y}{r}\right)$ ; the component in the direction of the  $Z$  axis, to which we here again limit ourselves, is, then, putting  $\sin \beta = \frac{z}{a}$ .

$$w_1 = \frac{\Gamma x}{4\pi a^2} \left(1 + \frac{y}{r}\right)$$

The pair of vortices produces then a velocity which may be written as the difference of the effects of two vortices which are close together:

$$dw_1 = \frac{\partial w_1}{\partial x} dx = \frac{\Gamma dx}{4\pi} \left[ \frac{a^2 - 2x^2}{a^4} \left(1 + \frac{y}{r}\right) - \frac{x^2 y}{a^2 r^3} \right]$$

To this must be added the contribution of the transverse vortex

$$dw_2 = \frac{\Gamma dx \cdot y}{4\pi r^3}$$

The sum of these two velocities, if the two angles defined in figure 53 are introduced, amounts to

$$dw = \frac{\Gamma dx}{4\pi} \left\{ \frac{\cos 2\beta}{a^2} (1 + \sin \alpha) + \frac{\sin \alpha \cdot \cos^2 \beta}{r^2} \right\} \quad (52)$$

With the help of this formula we can now calculate at once the drag experienced by a lifting element situated at the point  $A$  and parallel to the former, whose length is  $dx_2$  and circulation  $\Gamma_2$ . If the first element is given the index 1, this drag is

$$d^2 W_{12} = \frac{\rho \Gamma_1 \Gamma_2 dx_1 dx_2}{4\pi} \left[ \frac{\cos 2\beta}{a^2} (1 + \sin \alpha) + \frac{\sin \alpha \cos^2 \beta}{r^2} \right] \quad (53)$$

As is easily seen, the drag produced on the lifting element 1 by the lifting element 2 is obtained if in place of  $\alpha$  and  $\beta$  the values  $\alpha + \pi$  and  $\beta + \pi$  are introduced. Therefore it is

$$d^2 W_{21} = \frac{\rho \Gamma_2 \Gamma_1 dx_2 dx_1}{4\pi} \left[ \frac{\cos 2\beta}{a^2} (1 - \sin \alpha) - \frac{\sin \alpha \cos^2 \beta}{r^2} \right] \quad (53a)$$

It is seen from this that the two parts of the drag are equal only if  $\alpha = 0$ , that is if the two elements lie in the same transverse plane. Yet in the general case the sum  $d^2 W_{12} + d^2 W_{21}$  is independent of  $a$ , therefore independent of the amount of stagger. The sum of the two mutual drags leads thus to the same formula as that already derived for nonstaggered wings. If we again pass to the general case of nonparallel lifting lines, in which again  $ds_1$  and  $ds_2$  are to be written in place of  $dx_1$  and  $dx_2$ , we obtain as may be proved by performing the calculation, the relation

$$W_{12} + W_{21} = \frac{\rho}{2\pi} \iint \frac{\Gamma_1 \Gamma_2 ds_1 ds_2 \cos (\beta_1 + \beta_2)}{a^2} \quad (54)$$

As is evident, this sum remains unchanged if the two lifting groups are displaced in the direction of flight. Since the total drag of a lifting system is composed of such mutual drags as calculated above and of the proper drags of the separate wings, which likewise are not changed by a displacement of the wing in the direction of flight, the following theorem may be stated:

The total drag of any lifting system remains unchanged if the lifting elements are displaced in the direction of flight without changing their lift forces.

This "stagger theorem" was likewise proved by Munk. For a proper understanding of this theorem it must be mentioned expressly that, in the displacement of the separate lifting elements, their angles of attack must so be changed that the effective angles of attack and therefore the lifting forces remain unaltered.

This theorem, which at first sight is surprising, may also be proved from considerations of energy. Let us remember that, by the overcoming of the drag, work is done, and that in a non-viscous fluid, such as we everywhere assume, this work can not vanish. Its equivalent is, in fact, the kinetic energy that remains behind in the vortex motions in the rear of the lifting system. This energy depends only upon the character of these vortices, not upon the way in which they are produced. If we neglect, as we have throughout, any change in shape of the vortex system, then, in fact, the staggering of the separate parts of the lifting system can not have any influence upon the total drag.

26. For the practical calculation of the total drag of a multiplane, we have then the following: The total drag consists of the sum of all the separate drags and of as many mutual drags as there are combinations of the wings in twos. If the nature of the lift distribution over all the separate wings is specified, then the proper drags are proportional to the square of the separate lifts; the mutual drags, to the product of the lifts of the two wings in question. If the coefficients of this mixed quadratic expression are all known, then one can solve without difficulty the problem: For a specified total lift, to determine the distribution of lift over the separate wings which will make the total drag a minimum.

In order to know these coefficients to a certain degree I calculated them for the case of two straight lifting lines whose middle points lie in the same plane of symmetry, with the assumption that the lift over each separate wing is distributed according to a half ellipse. The results are given in my paper "The induced drag of multiplanes" in Volume III, part 7 of the Technische Berichte. For this purpose the velocity  $w$  for the entire neighborhood of a wing in the transverse plane was first calculated by formula (49), and then the integrals for the mutual drags were obtained by planimetry. To show the analogy with equation (40) this may now be expressed by the formula

$$W_{12} = \sigma \frac{A_1 A_2}{\pi q b_1 b_2} \tag{55}$$

by means of which the numerical factor  $\sigma$  can be expressed as a function of the two variables  $\frac{h}{2(b_1 + b_2)}$  and  $\frac{b_2}{b_1}$ . Calculation gave the following table:

TABLE I.—Values of  $\sigma$

$\frac{2h}{b_1 + b_2}$	0	0.05	0.1	0.15	0.2	0.3	0.4	0.5
$b_2/b_1 \rightarrow$	1.0	0.780	0.655	0.561	0.485	0.370	0.290	0.230
	.8	.690	.600	.523	.459	.355	.282	.225
	.6	.540	.485	.437	.394	.315	.255	.210

The curve of the function  $\sigma$  is given in figure 54. For the most important case, viz, for two wings of equal span, I have developed an approximation formula which is

$$\sigma = \frac{1 - 0.66 \frac{h}{b}}{1.055 + 3.7 \frac{h}{b}} \tag{56}$$

It may be used from  $\frac{h}{b} = 0.05$  to 0.5.

The total induced drag of a biplane is then, if  $b_1$  is the greater span and if the ratio  $\frac{b_2}{b_1}$  is designated by  $\mu$

$$W = W_{11} + 2 W_{12} + W_{22} = \frac{1}{\pi q b^2} (A_1^2 + 2\sigma \mu A_1 A_2 + \mu^2 A_2^2) \tag{57}$$

Simple calculation shows that for a given  $A_1 + A_2$  this drag is a minimum for

$$A_2 : A_1 = (\mu - \sigma) : \left( \frac{1}{\mu} - \sigma \right) \tag{58}$$

The value of the minimum is found to be

$$W_{\min} = \frac{(A_1 + A_2)^2}{\pi q b_1^2} \cdot \frac{1 - \sigma^2}{1 - 2\sigma\mu + \mu^2} \tag{59}$$

The first factor of this formula is the drag of a monoplane having the span  $b_1$  and the lift  $A_1 + A_2$ . Since  $\sigma < \mu$ , the second factor of the formula is always less than 1, i. e., the induced drag of a biplane is less than that of a monoplane which in the same span carries the same load. For a "tandem," i. e., an arrangement of two wings one behind the other, the stagger theorem shows an equivalence with two coinciding wings, i. e., a monoplane. Among the different biplanes having prescribed span  $b_1$  and prescribed gap  $h$ , that one is the most favorable in which the second wing also has the span  $b_1$ . The most favorable ratio of the two lifts is then 1 : 1 and the second factor of equation (59) becomes equal to  $\frac{1}{2} (1 + \sigma)$ .

These statements must not, however, be misunderstood; they refer only to the comparison of such wing systems as have the same value for the greatest span. Naturally, for every biplane a monoplane may be found with somewhat greater span than that of the biplane, which at the same total lift has the same induced drag as the biplane.



This last remark leads us to apply also to the biplane the deduction formulas obtained for monoplanes. All that is necessary is to replace the biplane of span  $b_1$  by a monoplane of a somewhat greater span  $kb_1$ , which with reference to the drag—and, on the whole, with reference to the angle of attack—is equivalent to the biplane. If again we pass from the lift and drag to their coefficients  $c_a$  and  $c_w$ , the formula connecting the drags of any two lifting systems 1 and 2 is

$$c_{w1} - c_{w2} = \frac{c_a^2}{\pi} \left( \frac{F_1}{(k_1 b_1)^2} - \frac{F_2}{(k_2 b_2)^2} \right) \quad (60)$$

in which, as is easily seen, the factor  $k$ , for a biplane having the most favorable distribution of lift, is the reciprocal of the square root of the second factor in formula (59).

The tests of this formula with biplanes have shown that, when by giving a special shape to the wing the lift distribution was made elliptical, there was good agreement with the calculations from monoplane experiments; with biplanes having the usual square-cornered wings, on the other hand, there was a discrepancy, which is to be attributed to the fact that the lift distribution on these biplanes deviates too far from an elliptic one. We can, however, retain the same transformation formula if the factor  $k$  is determined empirically for every wing system; it is found to be somewhat smaller than according to the theory given above. The experiments on this point are not yet completed, so more accurate values can not as yet be given. The earlier Göttingen experiments were worked up by Dr. Munk, to whom this last idea is due, in the paper "Contribution to the aerodynamics of the lifting parts of airplanes" in the Technische Berichte, Volume II, page 187.

27. In the previous section I have treated the problem of finding the minimum of the induced drag of a multiplane, under very definite assumptions concerning the distribution of lift over each separate wing. The strict minimum problem is however different, viz:

To determine for a given front view of a lifting system that distribution of lift over all the lifting elements which will make the induced drag a minimum for a specified total lift.

In this statement of the problem the expression "a given front view"—i. e., more exactly stated, a given projection of the lifting system upon a plane perpendicular to the direction of flight—is used to mean that the wing chord is of secondary consideration, and does not need to be determined until later when the selection of suitable angles of attack is made.

The general solution of this problem was also given by Dr. Munk. It will be deduced here in a simpler manner than that given in Munk's dissertation, where the solution was obtained by the calculus of variations. By means of the stagger theorem mentioned in section 25 the wing system will be referred back to the corresponding nonstaggered system. For this, as we showed, the relation  $W_{12} = W_{21}$  holds. We shall now introduce—with the simplifying assumption that all the lifting elements are parallel to each other—a variation of the lift distribution by adding at any one place a lift  $\delta A$  and at the same time taking away an equal amount at some other place, so that on the whole the lift, which is prescribed, remains unchanged. We must now consider the change in the induced drag caused by this variation. If there is superimposed upon the lift distribution an additional air force  $\delta A$  distributed over a short portion  $dx$ , there arises therefrom, in addition to the drag proper of the added lift—which, however, if sufficiently small is of the second order—a mutual drag, because on the one hand the added lift finds itself

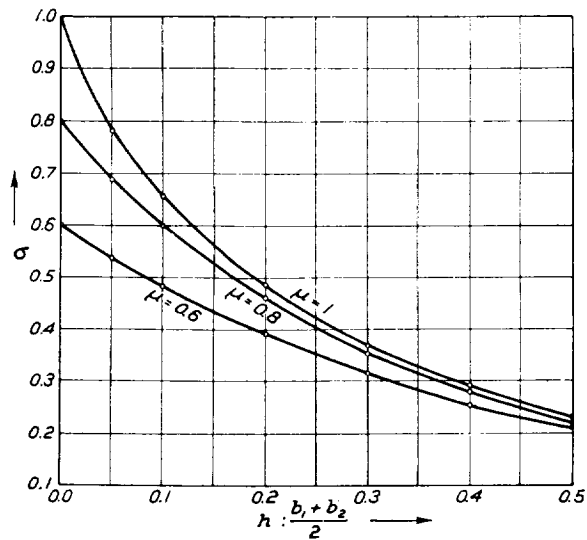

Fig. 51.—Curve of the function  $\sigma$  for biplanes whose span ratio,  $\mu = \frac{b_2}{b_1}$ , is varied.

in a flow having the downward velocity  $w$ , which is due to the lifting system, and on the other the lifting system is in the velocity field of the added lift. The first of these two drags, as is easily seen, is  $\delta A \frac{w}{V}$ ; the other part, according to our theorem, has the same value; so the total drag is twice this. What condition, now, must be satisfied by the sum of the mutual drags caused by our twofold change of the lift distribution in order to obtain the absolute minimum of the induced drag? The answer is, evidently, that we will have the minimum only if by no change of this kind can the drag be further diminished. The sum of the induced drags, therefore, can in no case be negative; also it may not be positive, because in that case by a reversal of the signs of the changes which we selected we could make the sum negative. Only the value zero is therefore allowable. Hence, if  $w$  is the vertical velocity at point 1 and  $w_2$  that at point 2, we have the relation

$$\delta A_1 \frac{w_1}{V} + \delta A_2 \frac{w_2}{V} = 0$$

and, therefore, since  $\delta A_1 = -\delta A_2$ ,

$$w_1 = w_2.$$

Since this holds for all the lifting elements, we have obtained the answer. The lift distribution which in the given wing system, for a specified total lift, causes a minimum of drag is that which leads to the same downward velocity at all the lifting elements. With monoplanes the elliptical lift distribution leads to a constant downward velocity  $w$ . We recognize from this that the elliptical distribution in fact is that distribution of lift which causes the least drag for a monoplane.

The theorem can, besides, be extended easily to the case of nonparallel lifting elements lying in a transverse plane. If  $w_n$  is the velocity in the transverse plane perpendicular to the lifting element and  $\epsilon$  is the angle between the direction of  $w_n$  and that of the given total lift, then, as may be shown without difficulty,  $w_n = w_o \cos \epsilon$  for all the elements. (If  $\epsilon = 0$ , and hence  $\cos \epsilon = 1$ , the statement made above again appears.)

28. A way to solve the problem of finding the lift distribution for a prescribed distribution of the vertical velocity has been indicated already in section 23. The velocity field left behind in the air by the lifting surface is, approximately, according to the remark made before, a uniplanar flow around the vortex system produced by the lifting system in its motion, and this vortex system may be regarded, as a first approximation, as a solid body in the fluid. In the minimum case this figure, according to the results of section 27, moves like a *rigid* body, not alone in the case of parallel lifting elements, but also in the general case, for the general minimum condition,  $w_n = w_o \cos \epsilon$ , expresses directly that the normal velocity of the fluid at an element of the rigid figure moving in the direction of the lift coincides with the normal component of the velocity  $w_o$  of the rigid figure itself. The problem is thus reduced to a perfectly definite one treated in the hydrodynamics of uniplanar fluid motion.

This uniplanar flow can be brought into relation, in a specially clear manner, with the pressure distribution existing on the wing system. The wing system, during its motion along its path, imparts to one portion of the air after the other the velocities which we have learned to know as the result of the vortices flowing off from the wings. This transmission of velocity is the result of the spreading out of the pressure field of the wing system over the air particles one after another. In order to simplify the phenomenon for ourselves we can now imagine that these velocities are produced at the same moment by a sort of impulse phenomenon over the whole path of the lifting system. To produce this impulse it is necessary to have a solid figure of the shape of the geometrical region passed over by the lifting system (i. e., of the shape of the vortex surfaces which it leaves behind). If we are concerned with a system of least drag, this figure moves as a rigid body; otherwise it would also experience a change of shape due to the impulse. The final velocity  $w^*$  of the figure coincides with the motion of the vortex surfaces at a great distance from the lifting system, and is therefore to be put equal to  $2w$ . For a monoplane having elliptical distribution our figure is therefore an infinitely long flat plate of the breadth  $b$ .

By the production of the velocity during the impulselike acceleration an increase in the pressure  $p_1$  arises below the plate (in the case of multiplanes, under each of the plates corresponding to the separate wings) and at the same time a decrease in pressure  $p_2$  above the plate (or the plates). We can now compare in a very simple manner the total action of the pressure differences at each point of a plate during the time of the impulse with the total action of the pressure differences of the wing in its forward movement at the point of the medium in question. If the resulting motion is the same in both cases, then the pressure differences integrated through the proper times must have the same values. If in the impulse phenomenon lasting a time  $\tau$  a portion of the fluid of length  $l$  is considered, and if therefore the action of the lift  $\frac{dA}{dx} dx$  in the time  $t = \frac{l}{V}$  required to pass over the length  $l$  is to be compared, the following relation must hold for the conditions on a strip of width  $dx$ :

$$l dx \int_0^\tau (p_1 - p_2) dt = \frac{dA}{dx} dx \cdot \frac{l}{V} \quad (61)$$

A formula connected with our previous relations can be obtained by a transformation of the left-hand term. According to a known extension of the Bernouilli equation for accelerated motion we have

$$\rho \frac{\partial \Phi}{\partial t} + \frac{\rho v^2}{2} + p = f(t).$$

For our impulse phenomenon the arbitrary time function  $f(t)$  is a constant, since at the points of the fluid lying far away from the impinging plate the pressure does not change. If the impulse is sufficiently quick, then during the short time of impulse  $\tau$  the acceleration and the pressure differences will be very large, and therefore the term  $\frac{\rho v^2}{2}$  may be neglected in comparison with the other two, since it itself does not exceed moderate values. We obtain therefore the simplified relation

$$\rho \frac{\partial \Phi}{\partial t} + p = \text{const.} = p_0$$

which, if at the beginning everything is at rest, ( $\Phi_0 = 0$ ) may be integrated to

$$\rho \Phi = \int_0^\tau (p_0 - p) dt \quad (62)$$

we can therefore write, in equation (61), the expression  $\rho(\Phi_2 - \Phi_1)$  in place of  $\int_0^\tau (p_1 - p_2) dt$ . The potential differences  $\Phi_2 - \Phi_1$  which here appears is, according to the connection between potential and circulation (see sec. 5), nothing but the circulation  $\Gamma$  for a closed curve which passed around one edge of the vortex ribbon and intersects our vortex ribbon at  $x$ , the point considered. This circulation is again nothing but the circulation around the wing at the point  $x$ . If the factor  $l dx$  is omitted from both sides of equation (61), it takes, as a result of this transformation, the form

$$\frac{dA}{dx} = \rho(\Phi_2 - \Phi_1) V = \rho V \Gamma \quad (63)$$

We have thus proved in an entirely independent way, as we see, the Kutta-Joukowski theorem for a wing element, which previously we took over, without proof, from the infinitely long wing.

The relations deduced in the previous paragraphs permit, in the case of a constant  $w$ , the formation of general theorems for  $w$  and  $W$  in place of (39) and (40). By integration of (63) the total lift is at once obtained

$$A = \rho V \Sigma \int (\Phi_2 - \Phi_1) dx \quad (64)$$

The values of  $\Phi$  in this formula are proportional to the velocity  $w^*$  of the vortex ribbon, that is, are dependent upon  $A$ . Quantities which are independent of  $A$  are derived if the potentials  $\Phi$  are divided by  $w^*$ . In this way we obtain the potentials for a velocity of the vortex

ribbon equal to 1. The potential, being the line integral of the velocity, has the dimension velocity times length; the potential  $\phi$  for  $w^*=1$  has therefore the dimension of a length, and hence

$$\Sigma \int (\phi_2 - \phi_1) dx$$

is a surface, which will in what follows be called  $F'$ , which depends only upon the geometrical properties of the projection of the wing system upon a plane perpendicular to the direction of flight, therefore upon the front view of the wing system; and which evidently for geometrically similar front views is proportional to the square of the span. By introducing  $F'$  into equation (64) we have, since  $\Phi = \phi w^*$ ,

$$A = \rho V w^* F' \tag{65}$$

From this we may immediately deduce  $w^*$ , and thereby also the downward velocity at the point of the wing system

$$w = \frac{1}{2} w^* = \frac{A}{2\rho V F'} \tag{66}$$

If this value is introduced into the relation  $W = \frac{w}{V} A$ , we have

$$W = \frac{A^2}{2\rho V^2 F'} = \frac{A^2}{4q F'} \tag{67}$$

The evaluation in the manner of the flow of figure 49 gives a potential  $\Phi$ , if the span of the wing is set equal to  $b$ , which has the value  $\sqrt{(b/2)^2 - x^2}$  at the plate. The geometrical expression of this value gives a circle having the span  $b$  as diameter, therefore  $F' = \frac{\pi b^2}{4}$ . Using this value formula (67) passes over in fact into formula (40).

It may also be noted that a uniform velocity can be superimposed upon the uniplanar flow here discussed, whose discontinuity in potential at the rigid figure representing the vortex ribbon causes the surface  $F'$ , without thereby changing the relation for  $F'$ , for the potential discontinuity between the lower and upper sides, with which we are here concerned, is not changed by the superimposed uniform motion. We may now choose the velocity of the uniform motion exactly opposite and equal to the velocity  $w^*$  of the rigid figure, and thereby secure the condition that in the new flow the rigid figure is at rest and is surrounded by a flow which at infinity has the velocity  $w$ . The forces which the rigid figure experiences by the production of this motion, and which are connected intimately with the so-called "apparent mass," are what we have here set in parallel with the wing-lift.

The surface  $F'$  supplies in addition a very simple mechanical connection between the velocity  $w$  on the one hand and the lift and drag on the other. According to equation (65)

$$A = \rho F' V w^*$$

$$WV = Aw = \rho F' V \frac{w^{*2}}{2}$$

where in the second equation use has again been made of the relation  $w^* = 2w$ . Now  $\rho F' V$  is the mass of air flowing per second through the section  $F'$ . If in order to simplify the whole problem it is once assumed that all the air particles within the section  $F'$  experience the full deviation  $w^*$  but that all outside are entirely undeviated, then exactly the correct lift and the correct work due to drag are obtained by application of the impulse theorem and the energy theorem. For the lift is now equal to the mass of the fluid deviated per second times the vertical velocity imparted to it, therefore equal to the impulse imparted to the medium. Also, in the same manner, the work done per second by the drag  $WV$  is the product of the mass of the fluid passing per second times the half square of the deflection velocity, and therefore equal to the kinetic energy left behind in the medium. This relation is indeed best suited to establish the phenomena of the theory of airplanes in a course for students who are only slightly skilled in mathematics. The fact that for a monoplane the circle having a diameter equal to the span comes out as the surface  $F'$  is one that will appear most plausible to the laity.

29. Of the theory pictured in the preceding section, according to which the determination of the induced drag in the case of the most favorable lift distribution is reduced to a problem of the potential theory, manifold applications have already been made. Especially, Dr. Grammel and K. Pohlhausen have treated, at my instigation, the case of the biplane made up of two straight monoplates of the same span, and also, on the other hand, that of a monoplate having a longitudinal slot. The calculations in both cases are solved by means of elliptic integrals. I have given the formulas in my Wing Theory II. It may be sufficient here to state the practical final result, which is referred to the magnitude of the surfaces  $F'$ . These surfaces are best expressed for biplanes in terms of the corresponding surfaces of the monoplate having the same span. In fact, the ratio  $F' : \frac{\pi}{4} b^2$ , as is easily seen, equals the square of the factor  $k$ , introduced in section 26, by which the span must be increased in order to have a monoplate of the same induced drag. The values of  $k^2$  for the biplane are obtained from the following table. The gap of the biplane, i. e., the distance apart of the two wings, is designated by  $h$ .

TABLE 2.  
Values of  $k^2 = F' : \frac{\pi}{4} b^2$

$h/b = \dots$	0.	0.05	0.10	0.15	0.2	0.3	0.4	.....	0.5	$\infty$
$k^2 = \dots$	1.000	1.156	1.212	1.289	1.352	1.461	1.550	.....	1.626	2.000

The values given in the table may be expressed by the approximation formula

$$k^2 \approx \frac{1.027 + 3.84h/b}{1 + 1.63h/b} \tag{68}$$

In the case of the monoplate having a slot a suitable comparison wing is obtained by showing the two halves of the monoplate together until the slot is closed. If  $b$  is the original span and  $d$  is the width of the slot, this monoplate has evidently the span  $b-d$ . We shall therefore form the ratio  $F' : \frac{\pi}{4} (b-d)^2$  and again designate it by  $k^2$ . Calculations gave the following values:

TABLE 3.  
Values of  $k^2 = F' : \frac{\pi}{4} (b-d)^2$ .

$\frac{d}{b} \dots$	0.000	0.001	0.010	0.0316	0.100	0.250	0.500	1.000
$k^2 \dots$	1.000	0.762	0.676	0.6200	0.568	0.528	0.506	0.500

It is seen that even very narrow slots produce an important increase in the induced drag. For a very wide opening  $k^2$  falls to one-half, as may be deduced easily from the fact that now, instead of one monoplate, we have two monoplates of half the span. The values given in the table may be expressed by the approximation formula

$$k^2 = 1 - \frac{1}{2\sqrt{1 + 0.35(\log_{10} b/d)^2}} \tag{69}$$

Figures 55-57 show, at the left, the uniplanar  $w^*$ -flow and, at the right, the surfaces  $F'$ , for a monoplate, a biplane, and a monoplate with a slot.

**F. AEROFOILS IN A TUBE OR IN A FREE JET.**

30. To draw conclusions from the experimental results obtained in a tube bounded by solid walls or in a free jet from a nozzle, it is very useful to know the influence of the neighboring walls and of the boundaries of the jet upon the phenomena at the aerofoil. We wish indeed to know the behavior of the aerofoil in an air space infinitely extended in all directions; and the problem therefore arises to introduce a method for passing by calculation from the case which prevails in the experiments to that of the unlimited air space. For this purpose we shall next state clearly the boundary conditions which exist at solid walls parallel to the direction of the

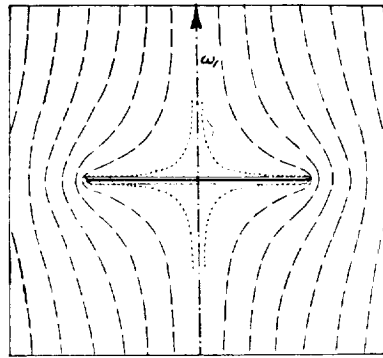

FIG. 55.

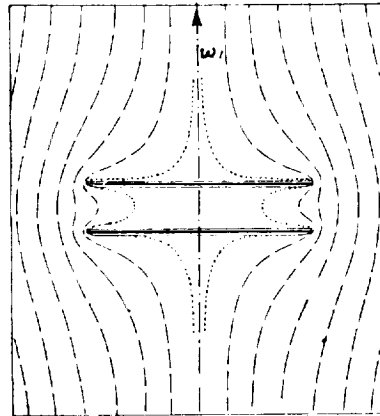
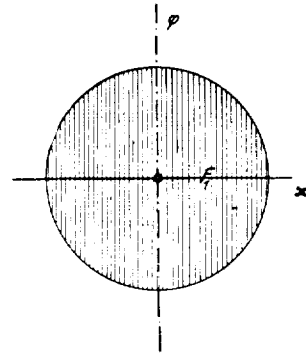

FIG. 56.

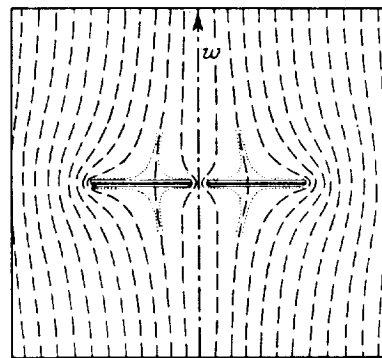
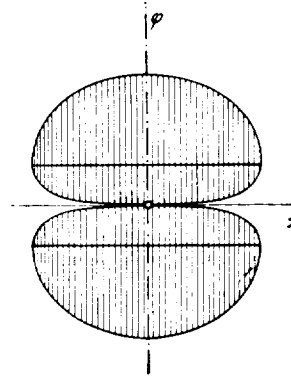
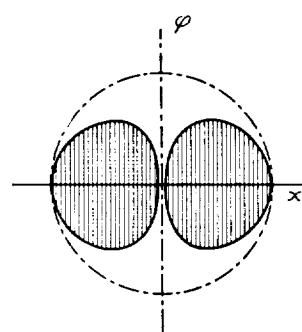

FIG. 57.



Left: Flow behind a monoplane, a biplane, and a monoplane with a slot, with reference to an observer moving downwards with the velocity  $W^*$  of the vortex system.  
 Right: Corresponding surfaces  $F_1$ .

wind and at the free boundary of a jet. At solid walls, the velocity components normal to the wall,  $w_n$ , must equal zero; on a free jet boundary, on the other hand, the pressure is to be put equal to that of the surrounding quiescent air layer, and therefore is constant. We can transform these last relations as follows, keeping within our theory of the first order. According to the Bernoulli theorem, if  $V$  is the undisturbed wind velocity, and  $u$ ,  $v$ , and  $w$  are the additional velocities

$$p + \frac{\rho}{2} \left[ u^2 + (V+v)^2 + w^2 \right] = p_0 + \frac{\rho}{2} V^2$$

or, since  $p = p_0$ ,

$$u^2 + v^2 + w^2 + 2Vv = 0.$$

If we neglect the squares of the disturbance velocities as being small of the second order, we have as the approximate initial condition for the free jet  $v = 0$ . We proceed a step farther upon the path indicated to us by the approximation theory of the first order if we prescribe the value  $v = 0$ , not for the actual jet boundary, but for that cylinder which is given by the surface of the undeviated jet. By doing this the boundary condition for the free jet becomes very similar, in a formal way, to that for the solid walls.

The two problems can now be solved in the following manner: We consider first the velocity field for the unlimited air space, according to the exposition previously given. This field offers, both in the case of the tube and in that of the free jet, contradictions with our boundary conditions at the walls or the jet boundary. We must superimpose a velocity field which in the interior of the region considered is free of singularities and which on the boundaries has velocities opposite to those velocity components, the vanishing of which is prescribed by the boundary condition. It is easily seen that by the superposition of this second velocity field on the original one the boundary conditions are satisfied exactly. The influence of this second field upon the aerofoil is now exactly that influence which we are seeking, and which we can calculate from the results of the theory of aerofoils as soon as this second field is known.

The additional velocity field corresponds to a pure potential motion; we have, therefore, the problem of determining its potential  $\Phi$ . In the case of solid walls we are thus led to the problem of finding the potential for a given region (the interior of the tube) when the normal component  $w_n$  of the flow is given at the boundary of the region. This is the so-called "second boundary value problem" of the potential theory. The corresponding problem for a jet, as we shall see at once, leads to the "first boundary value problem," in which at the boundary the values of the potential itself are prescribed. According to what has been said above our region is a cylinder whose generating lines are parallel to the velocity  $V$ , hence, parallel to the  $Y$  axis, and for each point on the boundary the relation  $\frac{\partial \Phi}{\partial y} = -\bar{v}$  (in which the dashes indicate boundary values) is prescribed. Integrating this relation for each generating line gives

$$\Phi(y) = - \int_{-\infty}^y v dy$$

If we go sufficiently far upstream every influence of the aerofoil vanishes; therefore for  $y = -\infty$ ,  $\Phi = 0$ ; and hence  $y = -\infty$  is taken as the lower limit of the integral. By this, then, we obtain the boundary values of the potential  $\Phi(y)$ .

The complete calculation of the added potential  $\Phi$  for the entire interior of the tube or jet is fairly difficult. If we concern ourselves, however, only with our main problem, to determine the corrections which must be applied to our experimental results, then we can again assume that the velocity components perpendicular to the axis of the tube in the plane of our aerofoil are half as large as at a great distance behind it. This consideration, which proceeded from the comparison of a vortex filament proceeding to infinity in one direction only with one proceeding to infinity in both directions, holds here exactly as well as in the cases discussed previously. We can therefore pass here as before from the space problem to a uniplanar one if we calculate the phenomena far behind the aerofoil. Our boundary conditions for the uniplanar problem are, for the tube,  $w_n = 0$ , for the free jet,  $\Phi = \text{const.}$  The last condition may be interpreted specially

conveniently if use is made of the method of treatment of section 28. Since in this, for the end of the impulse phenomenon,  $\Phi = \int_0^{\tau} (p_0 - p) dt$ ,  $\Phi = \text{const.}$  means simply that  $\bar{p} = \text{const.}$ , which, indeed, was the original boundary condition for the free jet.

31. The conditions stated in the preceding section can be secured most easily for a jet, or tube, of a circular cross section. In this case the added motion is obtained very simply by assuming for every vortex flowing off an equally strong one outside the circle, at the point outside corresponding to the one inside according to the reciprocal radii. If the direction of rotation of the external vortex is taken the same as that of the interior one, then at the points of the circle the boundary condition for a free jet is obtained; and, if opposite directions of rotations are taken, then the boundary condition for a tube is satisfied. This may be expressed by saying that there is combined with the aerofoil another obtained by reflexion according to reciprocal radii, whose circulation at corresponding points is the same in absolute value as that of the actual aerofoil, and for the jet it has the same sign, but for the tube the opposite sign.

The exact calculation has been made for a straight monoplane in the middle of the jet, assuming the lift to be distributed according to a half ellipse. If  $b$  is the span of the monoplane and  $D$  the diameter of the jet, then the disturbance velocity  $w'$  caused by the jet boundary at the distance  $x$  from the middle of the jet is

$$w' = \frac{A}{\pi D^2 \rho V} \left( 1 + \frac{3}{4} \xi^2 + \frac{5}{8} \xi^4 + \frac{35}{128} \xi^6 + \text{etc.} \right) \quad (70)$$

in which  $\xi = 2xb/D^2$ .

The added drag calculated from this velocity according to equation (38) is found to be

$$W' = \frac{A^2}{\pi D^2 \rho V^2} \left[ 1 + \frac{3}{16} \left( \frac{b}{D} \right)^4 + \frac{5}{64} \left( \frac{b}{D} \right)^8 + \dots \right] \quad (71)$$

A similar calculation for a uniform lift distribution gave for the first term in the formula for the drag the same value as in equation (71). It appears that the other terms of the series have but little importance with the usual ratios, so that we can limit ourselves to the first term. An approximation treatment shows, further, that any small wing system, in the middle of the circular jet gives rise to the same expression. We can therefore write for the total induced drag of the wing system in a jet of cross section  $F_0$ , if the surface  $F'$  is again introduced from section 28,

$$W = \frac{A^2}{4q} \left( \frac{1}{F'} + \frac{1}{2F_0} \right) \quad (72)$$

For a tube of circular cross section the same disturbance effect is found, but with the opposite sign; and therefore we have the approximation formula for the drag

$$W = \frac{A^2}{4q} \left( \frac{1}{F'} - \frac{1}{2F_0} \right) \quad (72a)$$

The correction, owing to the consideration of the finite cross section of the jet, is for the ratios ordinarily used not small. For  $\frac{b}{D} = \frac{1}{2}$ , it is already one-eighth of the induced drag. Formula (71) gives 0.1262 instead of 0.125; the corresponding formula for uniform distribution gives 0.127. It is seen, therefore, that the differences are not great, and that the approximation formula (72) is satisfactory for most cases.

For a tube of rectangular cross section the calculations would have to be made in such a manner that the aerofoil was mirrored at all the walls an infinite number of times, like a check-board. Further development of the calculation leads to elliptic functions. It has not yet been carried through. One can assume, however, that for a tube having a square cross section the influence of the walls will be of about the same magnitude as for the circle having an equal area.



## G. APPLICATION OF THE THEORY OF AEROFOILS TO THE SCREW PROPELLER.

32. The fundamental ideas of the aerofoil theory can be applied step by step to the screw propeller. For the elements of the blades the Kutta-Joukowski formula holds, viz, that the air force is perpendicular to the velocity  $c$  of the element with reference to the air and that, per unit length of the blade, it has the value  $\rho Fc$ . Corresponding to what has gone before, vortices will arise at the blade, having a vortex strength per unit length equal to  $\frac{d\Gamma}{dx}$ . If we wish again to construct a theory of the first order, that is, if we agree to consider as small the air forces and the velocities produced by them, then again the proper motion of the vortices will be small and therefore in a first approximation may again be neglected. The vortices then have the shape of screw lines and form vortex ribbons which—if for the sake of simplicity we assume straight radial blades—have the shape of ordinary screw surfaces.

The calculation of the velocity field of a screw vortex is markedly more complicated than that of a rectilinear vortex and leads to functions which thus far have not been studied in detail. In spite of this it is possible, as Dr. Betz has shown, to prove a series of general theorems very similar to those of Munk for multiplanes. Since the velocity  $c$  is not the same at the separate blade elements, we must speak of the "work lost" where Munk speaks of drag. The work applied for the motion of the propeller is composed of two parts—useful work + work lost. The latter in our ideal case, where friction is excluded, is transformed completely into kinetic energy of the air. The kinetic energy stands again in close connection with the vortex system produced by the propeller. Betz proved, among others, the following theorems:

(1) If two elements of a propeller blade lie upon the same radius at distances  $x$  and  $\xi$  from the axis, then the work lost at the point  $\xi$  due to the disturbance velocity caused by the air force at the point  $x$  is equal to the work lost at the point  $x$  owing to the disturbance velocity caused by the air force at the point  $\xi$ .

(2) This theorem must be somewhat modified for two elements which do not lie on the same radius. It reads: The work lost at the point  $\xi$  due to the disturbance velocity caused by the air force at the point  $x$  is of the same amount as the work which would be lost at the point  $x$  if the screw vortex proceeding from the element at  $\xi$  were to pass out forward in the prolongation of the actual vortex instead of going backward.<sup>12</sup>

(3) This last theorem leads at once to the following relation for the sum of the two amounts of work lost: The total work lost due to the mutual action of the air forces by two blade elements at points  $x$  and  $\xi$  is the same as the work which would be lost at one point alone if the screw vortex proceeding from the other point were to extend to infinity both forward and backward.

It is easily seen that this theorem is perfectly analogous to the stagger theorem of section 25, for if the vortex of the inducing element extends in both directions, then the position of the element itself on its own vortex strip is immaterial as far as the velocity field produced is concerned.<sup>13</sup> It is therefore true of screws that nothing is changed in the total energy-loss if blade elements are displaced in any way, without change of their air forces, along the relative streamlines passing through them (i. e., in this case, screw lines). This naturally is connected again with the fact that the total amount of the energy loss depends only upon the final distribution of the vortex systems, not upon the relative position of the places where the separate vortices arise.

Theorem No. 3 will be of use to us also in what follows. It can be made clearer by the following consideration. The field of the vortex ribbon of a lifting element dies away very quickly forward of the element, but in the rear it extends over the entire length of the path traversed. If the sum is formed of the two mutual losses in work of two elements at the points  $x$  and  $\xi$ , we can proceed, owing to the stagger theorem, to displace one of the two elements along its screw line so far backward that its velocity field is no longer appreciable at the position of the other

<sup>12</sup> In this the sense of rotation of the transverse vortex is to be reversed.

<sup>13</sup> The transverse vortex in this case cancels out completely in the determination of the velocity field, since it appears twice with opposite senses of circulation.

undisplaced element. At the same time, however, the influence of the latter element upon the first is increased since its vortex ribbon, viewed from the new position of the first element, extends as far forward as backward. The sum of the two mutual losses in work is reduced in this manner to the loss which the velocity field of the front element produces upon the displaced one.<sup>14</sup>

(4) The most important of Betz's theorems, from a practical standpoint, furnishes the complete analogy to Munk's theorem concerning the wing system having the least drag, and, corresponding perfectly to the statements in sections 27 and 28, may be expressed thus: The flow behind a propeller having the least loss in energy is as if the screw surfaces passed over by the propeller blades were solidified into a solid figure and this were displaced backward in the nonviscous fluid with a given small velocity. The potential difference between the front and rear sides of a screw surface at one and the same point furnishes, then, again the circulation  $\Gamma$  of the corresponding point of the propeller blade.

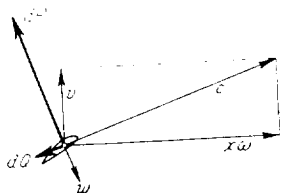

FIG. 58.—Velocity field near a blade of a screw-propeller.

A short proof of theorem 4 will be given. For this purpose the principal equations for the action of a screw must first be deduced. The screw is imagined to be displaced with the velocity  $v$  relative to the air, and to rotate at the same time with the angular velocity  $\omega$ . A blade element at the distance  $x$  from the axis has then, with reference to the air which in the theory of the first order may be assumed to be at rest, the velocity  $c$ , with the components  $v$  and  $x\omega$ . (See fig. 58.)

If no vortex were produced, then, with the assumption of a nonviscous fluid, an air force  $dP$  would arise, which, according to the Kutta-Joukowski theorems, would be perpendicular to the velocity  $c$  and would have the value, for a blade element of length  $dx$ ,

$$dP = \rho \Gamma c dx \quad (73)$$

The force  $dP$  is decomposed into two components, of which the one in the direction of  $v$  interests us specially, since it is applied to the screw. This component is

$$dS = dP \cdot \cos \epsilon = \rho \Gamma x \omega dx \quad (74)$$

The total thrust, if there are  $n$  blades, is then

$$S = \rho \omega \sum_1^n \int_0^r \Gamma x dx \quad (75)$$

The other component

$$dT = dP \sin \epsilon = \rho \Gamma v dx \quad (76)$$

furnishes a contribution as a torque to the rotation moment. It is seen at once that  $dS \cdot v = dT \cdot x\omega$ , i. e., the useful thrustwork is equal to the work done by the torque hitherto used in our calculations. This depends immediately upon our assumption that the force  $dP$  is perpendicular to the velocity  $c$ . But the screw blades actually produce a vortex system and we must ask as to the reaction of the vortex system upon the phenomena of a screw. We shall assume, exactly as in the aerofoil theory, that we turn the blade profile in such a manner that the lifting forces desired by us actually come into play. Since we are interested here merely in the loss in work caused by the vortex system, we have to do only with the drag component perpendicular to the velocity of motion of the element, which in this case equals  $c$ . We shall again designate it by  $w$ . The added velocity component  $w$  furnishes a drag in the direction of motion equal to

$$dQ = dP \frac{w}{c} = \rho \Gamma w dx \quad (77)$$

The loss of work per second is therefore

$$dQ \cdot c = \rho \Gamma dx \cdot w \cdot c (= dP \cdot w)$$

<sup>14</sup> This process of thought can be applied, naturally, in the same way to aerofoils and furnishes a convenient deduction for the sum of the drags  $W_{12} + W_{21}$ .

If now, according to figure 58, we put  $c = v/\sin \epsilon$ , our problem is to make a minimum the total loss of work

$$L = \rho v \sum_1^n \int_0^r \frac{\Gamma w dx}{\sin \epsilon} \tag{78}$$

The variation of this quantity must therefore be put equal to zero. We shall proceed, for this purpose, similarly to the way Munk's theorem was deduced in section 27. We shall change by small amounts the circulation at two places, which may reach from  $x_1$  to  $x_1 + dx_1$  and from  $x_2$  to  $x_2 + dx_2$ , in such a manner that the total thrust remains unchanged. According to equation (75) we must make

$$\delta \Gamma_1 \cdot x_1 dx_1 + \delta \Gamma_2 \cdot x_2 dx_2 = 0 \tag{79}$$

Exactly as before the condition for the minimum is obtained if the loss of energy due to our added circulation remains unchanged. In order to calculate the loss, let us make use of theorem No. 3 and assume that the added wing forces are brought into action far behind the propeller so that the loss is merely the product of the added air force by the velocity  $w^*$  which arises from the vortices of the propeller, and therefore for the first element is equal to  $\rho v \delta \Gamma_1 \frac{w_1^*}{\sin \epsilon} dx_1$ . Omitting the constant factor, we obtain as the minimum condition—

$$\delta \Gamma_1 \frac{w_1^*}{\sin \epsilon_1} dx_1 + \delta \Gamma_2 \frac{w_2^*}{\sin \epsilon_2} dx_2 = 0,$$

from which is derived, making use of equation (79)

$$\frac{w_1^*}{x_1 \sin \epsilon_1} = \frac{w_2^*}{x_2 \sin \epsilon_2} = \text{const.} \tag{80}$$

We must compare this condition with that obtained for the velocity components normal to a rigid screw surface, when this surface is moved backward with the velocity  $w'$ . We then have (see fig. 59):

$$w_n = w' \cos \epsilon.$$

But on a screw surface the pitch  $h$  is connected with the angle of pitch  $\epsilon$  and the radius  $x$  by the relation  $h = 2\pi x \tan \epsilon$ .

Multiplying this last equation with that for  $w_n$ , and solving, we get

$$w_n = \frac{2\pi w' x \sin \epsilon}{h}$$

and therefore

$$\frac{w_n}{x \sin \epsilon} = \text{const.} \tag{81}$$

On comparing (81) with (80) it is seen that by a suitable choice of  $w'$  the value of  $w_n$  can always be made to agree with that of  $w^*$ , which proves Betz' theorem.

33. In order to learn more accurately the nature of the distribution of circulation which we are seeking, we shall proceed as if the velocity field at great distances from the screw is produced by having the velocity  $w'$  in the direction of the axis imparted impulsively to the rigid figure composed of the screw surfaces. In a purely qualitative way one can see that with any system of screw surfaces having a small pitch the air in the interior of the system is actually accelerated backward, with, of course, the appearance of tangential velocity components whose intensity is a function of the angle  $\epsilon$  and is greatest for  $\epsilon = 45^\circ$ . At the axis itself there is neither an axial nor a tangential acceleration. Less simple are the conditions near the outer boundary of the screw surface where a flow around the edges of the surfaces occurs.

In order to obtain a quantitative statement, we shall for simplicity's sake next think of a screw having a large number of blades. Our rigid figure consists, then, of a very large number

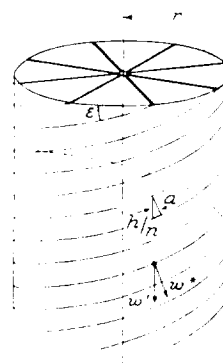

FIG. 59.—Idealized vortex system of a screw-propeller.

of screw surfaces, lying close together, and therefore the air is led with difficulty into the interior. When the impulse occurs it escapes in the direction of the normals to the screw surface. The radial velocity components  $w_r$  will be appreciable only in the neighborhood of the outer boundary of the screw surfaces; further in, we may put it equal to zero approximately. For the tangential components  $w_t$  and the axial components  $w_a$ , the relations hold, as is easily seen,

$$w_t = w^* \sin \epsilon = w' \cos \epsilon \sin \epsilon$$

$$w_a = w^* \cos \epsilon = w' \cos^2 \epsilon.$$

The angle may be expressed by writing

$$\tan \epsilon = \frac{h}{2\pi x} = \frac{v}{x\omega} = \frac{r'}{x} \tag{82}$$

In this, for brevity's sake,  $\frac{h}{2\pi} = \frac{v}{\omega}$  is put equal to  $r'$  ( $r'$  is that radius for which the pitch of the screw,  $\tan \epsilon$ , = 1). Then

$$\sin \epsilon = \frac{r'}{\sqrt{r'^2 + x^2}} \text{ and } \cos \epsilon = \frac{x}{\sqrt{r'^2 + x^2}} \tag{83}$$

and hence

$$w_t = w' \cdot \frac{r'x}{r'^2 + x^2} \text{ and } w_a = w' \frac{x^2}{r'^2 + x^2} \tag{84}$$

We must now determine the circulation around the separate blades as a function of the radius  $x$ . For a screw with  $n$  blades the total circulation of the vortices inside the circle of radius  $x$  coincides with the line integral for the closed circle of radius  $x$ ; this circulation must evidently equal  $n\Gamma$ , where  $\Gamma$  is the circulation of one of the screw blades at the point  $x$ . From this we have

$$\Gamma = \frac{2\pi x \cdot w_t}{n} = \frac{2\pi r' w'}{n} \cdot \frac{x^2}{r'^2 + x^2} \left( = \frac{hw_a}{n} \right) \tag{85}$$

The curve for  $\Gamma$  according to equation (85) is shown in curve I of figure 62.

At the ends of the blades we would expect to have a decrease of the circulation of the same character as found for aerofoils. An approximate treatment can be devised in the following way: We imagine an infinite series of aerofoils which have a distance apart  $a$  and are not staggered and which extend infinitely far toward the left. We inquire what is the most favorable distribution of lift near the ends of these aerofoils. The distance  $a$  is then to be made equal to the perpendicular distance apart of the edges of two consecutive blades of the screw, i. e., according to figure 59,

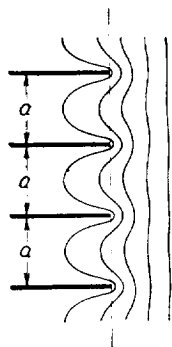

FIG. 60.—Conformal transformation

$$z = \frac{a}{\pi} \log \frac{1}{2} \left( t + \frac{1}{t} \right).$$

$$a = \frac{h}{n} \cos \epsilon_1 = \frac{2\pi r'}{n} \frac{r^2}{r'^2 + r^2} \tag{86}$$

The problem now, according to the procedure of section 28, may be solved by seeking the potential flow around the edges of the corresponding family of planes and by determining the discontinuity of potential at the planes. This problem may be solved without difficulty by means of conformal representations. (See sec. 10.) It can be shown that the plane with the straight cuts as shown in figure 60, which we shall call the  $z$  plane, may be transformed into the unit circle ( $t$  plane) by the formula

$$z = \frac{a}{\pi} \log \frac{1}{2} \left( t + \frac{1}{t} \right) \tag{87}$$

The flow of figure 58 is transformed thereby into circulation flow around the unit circle; in fact

$$\Phi + i\Psi = iC \log t$$

After a short calculation, by elimination of  $t$ , we have

$$z = \frac{a}{\pi} \log \cos \frac{\Phi + i\Psi}{C} \tag{88}$$

For the surface around which the flow takes place, and which is given by the streamline  $\psi = 0$ , we have, therefore,

$$x = \frac{a}{\pi} \log \cos \frac{\Phi}{C}$$

or

$$\Phi = \pm C \cos^{-1} e^{\frac{x\pi}{a}} \tag{89}$$

which gives the real values for negative values of  $x$ . The potentials thus obtained or the velocity equal to 1 of the free flow (to obtain which  $C$  must be put equal to  $\frac{a}{\pi}$ ), which, according to what has gone before, give us the surface  $F'$ , form a picture such as is shown in figure 61. By means of this one can form a definite judgment as to how the circulation, and with it the thrust also, decreases at the blade tips. We can replace the shaded portions of Figure 61 by a straight line, having an equal area below it which, in accordance with the integration performed, must lie behind the blade tips at the distance

$$a' = a \log \frac{2}{\pi} = 0.2207a \tag{90}$$

We conclude from this that, with screws also, the decrease of circulation at the blade tips has about the same effect as if the screw had a radius diminished by  $0.2207a$ , and then the air would be considered uniform in every circle of radius  $x$  (as would be the case for a screw having an infinite number of blades).

The properties found for the inner portion of the screw and for its edge may be combined into a single formula, which can be applied as an approximation formula also for screws having a small number of blades. This formula is obtained by multiplying the value in equation (85) by the expression  $\frac{2}{\pi} \cos^{-1} e^{-\frac{\pi(r-x)}{a}}$ , which for large values of  $\frac{r-x}{a}$  takes the value 1. (For  $-x$  of formula (89)  $r-x$  is here substituted, as is obvious.) Thus we obtain the formula

$$\Gamma = \frac{4w'r'}{n} \cdot \frac{x^2}{r'^2 + x^2} \cdot \cos^{-1} e^{-\frac{\pi(r-x)}{a}} \tag{91}$$

The curve of  $\Gamma$  according to equation (91) is given in figure 62, for a 4-blade screw and for  $r':r = 1:5$ , which correspond to average conditions in practice.

The whole deduction holds, as has already been remarked, for screws which are not heavily loaded. For screws with heavy loads an improvement can be introduced by calculating the pitch of the screw surfaces formed by the vortices, corresponding to the state of flow prevailing in the circular plane of the screw. Instead of writing  $\tan \xi = \frac{v}{x\omega}$ , we must write, more

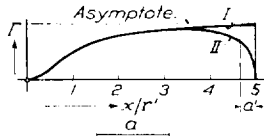

FIG. 62.—Distribution of circulation. I. Infinite number of blades. II. Four blades  $a$  is the distance of two vortices. (See Fig. 59.)

exactly,  $\tan \xi = \frac{V + \frac{w_a}{2}}{x\omega - \frac{w_t}{2}}$ , in which  $V$  is the velocity of flight, since in

the screw disk plane half of the final disturbance velocities is already present. A useful approximation is obtained if, retaining our formulae,  $v$  is put equal to  $V + \frac{w'}{2}$ ,

and therefore  $r'$  is put equal to  $\frac{w'}{\omega}$ .

After the circulation is known, the distribution of thrust and torque may be calculated easily by means of equations (74) and (76), and thus, following the method used in the aerofoil theory, the requisite widths of the blades and angles of attack may be determined in order that for a given working condition (i. e.,  $r'$  and  $w'$  given), in which the screw is to have the most favorable performance, all the information may be deduced from the theory. By taking into

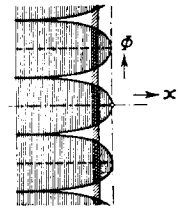

FIG. 61.—Potential obtained by the flow of figure 60.

account the more exact velocity relations in the propeller-disk plane this information may be improved.

The aerofoil theory has numerous further applications. An investigation of curved flights specially of the moment—important in discussions of stability—around the longitudinal axis in the case of a wing moved in a circle, is at present being made, also the calculation of the moment of a warped wing. A series of not unimportant single questions must wait for a further improvement of the theory, e. g., various conclusions specially concerning properties of profiles, influence of curvature, etc., can be reached, if we pass from the lifting line to the case of a load distributed also along the chord; for the treatment of a wing set oblique to the direction of flight the assumption of a load distributed along the chord is necessary since in this case the conditions contradict the “lifting line.” Investigations of this kind, which can be accomplished only by very comprehensive numerical calculations, were begun during the war but since then, owing to a lack of fellow workers, have had to remain unfinished. A similar statement also applies to the calculations of a flapping wing already begun, in which one is likewise forced to assume the lift distributed along the chord, since otherwise the result is indefinite. Therefore much remains to be done.

#### MOST IMPORTANT SYMBOLS.

$\rho$	=density.
$V$	=velocity of the airplane.
$u, v, w$	=velocity components in the $X, Y, Z$ directions. (In the case of an airplane $X$ is in the direction of the span of the wings, $Y$ is in the direction of flight, $Z$ is vertical.)
$q = \frac{\rho}{2} V^2$	=dynamical pressure.
$b$	=span of a wing (“Breite”).
$t$	=chord of a wing (“Tiefe”).
$h$	=gap of a biplane (“Höhe”).
$F$	=area of surface (= $b \cdot t$ ) (“Fläche”).
$A$	=lift (“Auftrieb”).
$W$	=drag (“Widerstand”).
$c_a = \frac{A}{Fq}$	=lift coefficient (= $2 K_y$ “absolute”).
$c_w = \frac{W}{Fq}$	=drag coefficient (= $2 K_x$ “absolute”).
$\alpha$	=angle of attack.
$\Gamma$	=circulation.
$\Phi$	=velocity potential.
$\psi$	=stream function.

#### LIST OF THE MOST IMPORTANT LITERATURE.

Abbreviations: Z. F. M. = Zeitschrift für Flugtechnik und Motorluftschiffahrt.  
TB = Technische Berichte der Flugzeugmeisterei.

##### A. GÖTTINGEN PUBLICATIONS.

- L. PRANDTL: Tragflügeltheorie I. und II. Mitteilung. Nachr. von der Kgl. Gesellschaft der Wissenschaften. Math.-phys. Klasse 1918, S. 451. u. 1919, S. 107. (Aerofoil Theory, I and II Communications. Nachr. Kgl. Gesellschaft der Wissenschaft. Math.-phys. Classe, Göttingen, 1918, p. 451. and 1919, p. 107.)  
 —— Tragflächen-Auftrieb und -Widerstand in der Theorie. Jahrb. der Wissenschaftlichen Gesellschaft f. Luftfahrt, V. 1920, S. 37. (Aerofoil Lift and Drag in Theory. Jahrb. d. Wissens. Gesells. f. Luftfahrt, V. 1920, p. 37.)  
 —— Der induzierte Widerstand von Mehrdeckern. TB Bd. III. S. 309. (The Induced Drag of Multiplanes. TB. Vol. III, p. 309.)  
 G. FUHRMANN: Theoretische und experimentelle Untersuchungen an Ballonmodellen. Jahrbuch 1911/12 der Motorluftschiff-Studiengesellschaft, S. 65. (Theoretical and Experimental Investigations of Models of Airship Bodies. Jahrb. 1911/12 d. Motor Luftschiff-Studiengesells, p. 65.)

- A. BERZ: Die gegenseitige Beeinflussung zweier Tragflächen. Z. F. M., 1914, S. 253. (The Mutual Influence of Two Aerofoils. Z. F. M., 1914, p. 253.)  
 — Untersuchung einer Joukowski'schen Tragfläche. Z. F. M., 1915, S. 173. (Investigation of a Joukowski Aerofoil. Z. F. M., 1915, p. 173.)  
 — Einfluss der Spannweite und Flächenbelastung auf die Luftkräfte von Tragflächen. TB, Bd. I, S. 98. (Influence of Span and Wing-Loading upon the Air forces of Aerofoils. TB, Vol. I, p. 98.)  
 — Beiträge zur Tragflügeltheorie mit besonderer Berücksichtigung des einfachen rechteckigen Flügels. Dissertation, Göttingen, 1919. Auszug in Beiheft II der Z. F. M., 1920, S. 1. (Contributions to the Theory of Aerofoils with Special Reference to the Simple Rectangular Wing. Dissertation, Göttingen, 1919. Extract in Beiheft. II Z. F. M., 1920, p. 1.)  
 — Schraubenpropeller mit geringstem Energieverlust, mit einem Zusatz von L. Prandtl, Nachr. v. d. Kgl. Gesellschaft der Wissenschaften, Math.-phys. Klasse 1919, S. 193. (The Screw Propeller having the Least Loss of Energy, with an Appendix by L. Prandtl. Nachr. Kgl. Gesellschaft der Wissenschaft, Math.-phys. Class, Göttingen, 1919, p. 193.)  
 — Eine Erweiterung der Schraubenstrahltheorie. Z. F. M., 1920, S. 105. (An Extension of the Theory of Screw Jets. Z. F. M., 1920, p. 105.)  
 M. MUNK: Beitrag zur Aerodynamik der Flugzeugtragorgane. TB, Bd. II, S. 187. (Contribution to the Aerodynamics of Lifting Airplane Members. TB., Vol. II, p. 187.)  
 — Isoperimetrische Aufgaben aus der Theorie des Fluges. Dissertation, Göttingen, 1919. (Isoperimetric problems from the Theory of Flight. Dissertation, Göttingen, 1919.)  
 C. WIESELSBERGER: Beitrag zur Erklärung des Winkelfluges einiger Zugvögel. Z. F. M., 1914, S. 225. (Contribution to the Explanation of the Formation Flight of Migratory Birds. Z. F. M., 1914, p. 225.)  
 — Experimentelle Prüfung der Umrechnungsformeln. In "Ergebnisse der Aerodynamischen Versuchsanstalt 1. Lieferung," München, 1921, S. 50. (Experimental Examination of the Formulae for Relations between Aerofoils. In "Ergebnisse der Aerodynamischen Versuchsanstalt," Part I, Munich, 1921, p. 50.)

**B. WORKS ON THE TWO DIMENSIONAL PROBLEM.**

- W. M. KURTA: "Auftriebskräfte in strömenden Flüssigkeiten." Illustr. aeronaut. Mitteilungen, 1902, S. 133. Ausführlichere Abhandlungen in den Sitzungsber. der Bayr. Akad. d. Wiss., Math.-Phys. Klasse 1910, 2. Abh. und 1911, S. 65. (Forces of Lift in Flowing Fluids. Illustr. aeronaut. Mitteilungen, 1902, p. 133. More detailed papers in the reports of the proceedings of the Bavarian Acad. of Sciences, Math.-Phys. Class 1910, 2d report, and 1911, p. 65.)  
 N. JOUKOWSKI: Ueber die Konturen der Tragflächen der Drachenflieger. Z. F. M., 1910, S. 281. "Aerodynamique" aus dem Russischen übersetzt von Drzewiecki, Paris, 1916. (On the Contours of Airplane Wings. Z. F. M., 1910, p. 281. "Aerodynamics" translated from the Russian by Drzewiecki, Paris, 1916.)  
 R. GRAMMEL: "Die hydrodynamischen Grundlagen des Fluges." Braunschweig, 1917. (The Hydrodynamic Principles of Flight. Brunswick, 1917.)  
 R. v. MISES: Zur Theorie des Tragflächenauftriebs. Z. F. M., 1917, S. 157, 1920, S. 68 und 87. (The Theory of Lift of Wings. Z. F. M., 1917, p. 157, 1920, pp. 68 and 87.)

After this memoir was written, two papers, by R. Fuchs and E. Trefftz, on the theory of aerofoils appeared, both of which discuss the theory of a monoplane and that of airplanes of least drag. These papers are published in the "Zeitschrift für Angewandte Mathematik und Mechanik," 1921, Heft 2 u. 3, Berlin.

