



NASA CONTRACTOR FINAL REPORT

NASA-CR-159182
19800010929

QUALITY CONTROL DEVELOPMENTS FOR GRAPHITE / PMR 15 POLYIMIDE COMPOSITES MATERIALS

C.H. Sheppard, J.T. Hoggatt and W.A. Symonds

BOEING AEROSPACE COMPANY

Seattle, Washington

Contract NAS1-15009

LIBRARY COPY
FEB 26 1980
Langley Research Center
Hampton, Virginia



National Aeronautics and
Space Administration

Langley Research Center
Hampton, Virginia 23665
AC 804 827-3966

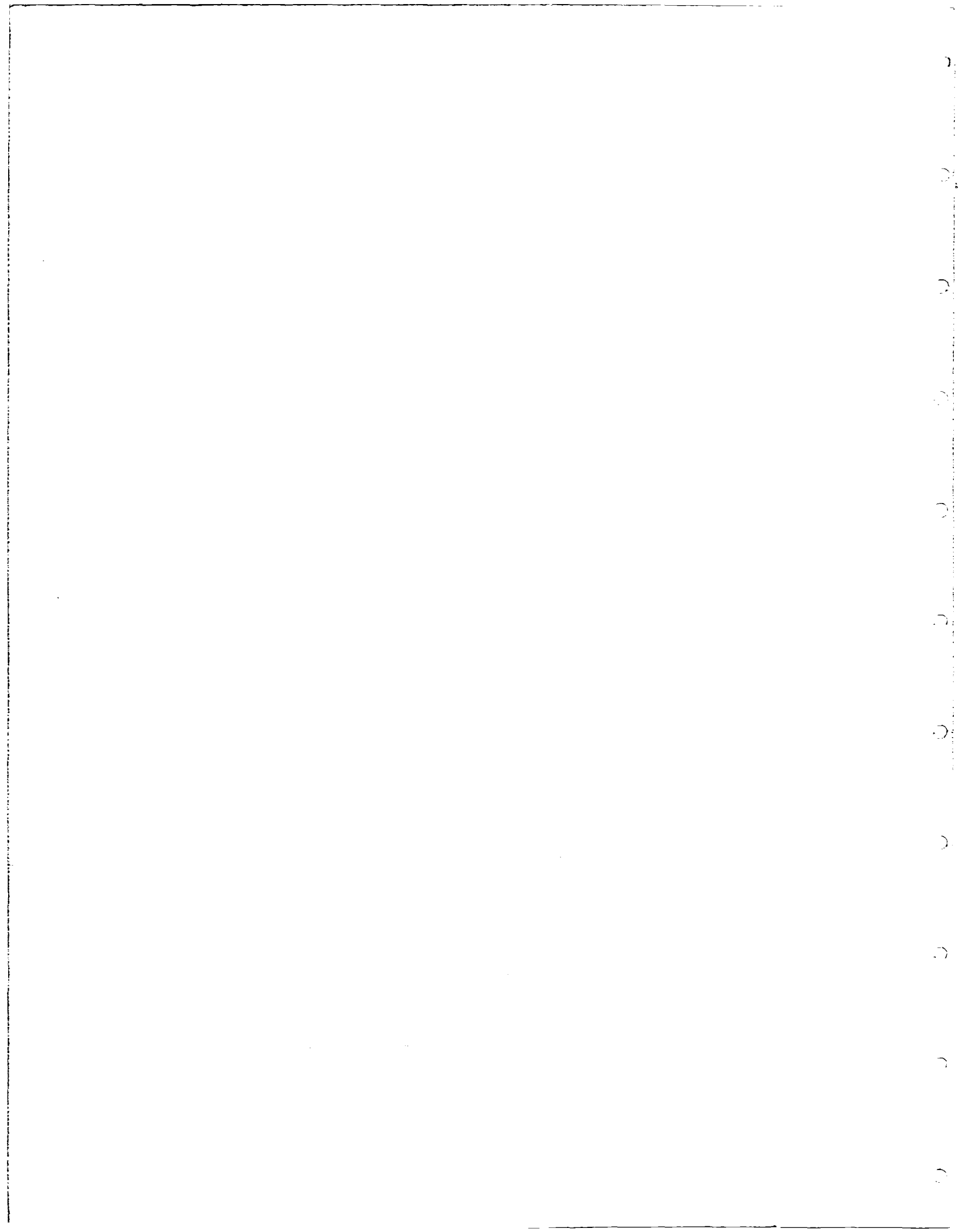

NASA CR-159182

NASA CONTRACTOR FINAL REPORT

**QUALITY CONTROL DEVELOPMENTS
FOR GRAPHITE / PMR15 POLYIMIDE
COMPOSITES MATERIALS**

C.H. Sheppard, J.T. Hoggatt and W.A. Symonds

***BOEING* AEROSPACE COMPANY
Seattle, Washington**

Contract NAS1-15009

NASA

National Aeronautics and
Space Administration

Langley Research Center
Hampton, Virginia 23665
AC 804 827-3966

N 80-19206 #



QUALITY CONTROL DEVELOPMENTS FOR GRAPHITE/
PMR-15 POLYIMIDE COMPOSITE MATERIALS

Contract NAS1-15009

Prepared for:

NATIONAL AERONAUTICS AND SPACE ADMINISTRATION
LANGLEY RESEARCH CENTER
HAMPTON, VIRGINIA

June 1979

BOEING AEROSPACE COMPANY
Seattle, Washington 98124

TABLE OF CONTENTS

<u>Section</u>		<u>Page</u>
1.0	Summary	
2.0	Introduction	
3.0	NASA Contract NAS1-15009 Task A Data Analysis	
3.1	Evaluation of HPLC Data	
3.2	Evaluation of Infrared Spectra Data	
4.0	Effects of Prepreg Equipment on PMR-15 Resin	
4.1	Evaluation of Monomers by Infrared Spectrometry	
4.2	Evaluation of Monomers by HPLC	
4.3	Evaluation of PMR-15 Resins by Infrared Spectrometry	
4.4	Evaluation of PMR-15 Resins by HPLC	
4.5	Summary of Chemical Testing	
4.6	Processing Studies Using Graphite/PMR-15 Prepreg Lots 2W4388 Rolls 3 and 4	
5.0	PMR-15 Resin Manufacturing Studies	
5.1	PMR-15 Resin Studies	
5.1.1	Chemical Characterization of Monomers by Infrared Spectrometry	
5.1.2	Chemical Characterization of NE Study	
5.1.3	PMR-15 Resin in Manufacturing Studies	
5.2	Manufacturing Verification	
5.2.1	Chemical Characterization of NE Study	
5.2.1.1	Characterization of NE by Infrared Spectrometry	
5.2.1.2	Characterization of NE by HPLC	
5.2.1.3	Characterization of PMR-15 Resin by IR	
5.2.1.4	Characterization of PMR-15 Resin by HPLC	
5.2.1.5	Graphite/PMR-15 Prepreg Processing	
5.2.2	Chemical Characterization of BTDE Study	

TABLE OF CONTENTS (Continued)

<u>Section</u>	<u>Page</u>
5.2.2.1	Chemical Characterization by HPLC
5.2.2.2	Processing Studies Using Graphite/PMR-15 Prepreg
5.2.3	Monomer Manufacturing at Company B
5.2.3.1	Chemical Characterization by HPLC
5.3	Aging Characteristics of PMR-15 Materials
6.0	Celion 6000/PMR-15 Reproducibility Studies
6.1	Quality Control Using Chemical Characterization Techniques
6.2	Processing of Materials Received in Processing Studies
7.0	Conclusions and Recommendations
7.1	Conclusions
7.2	Recommendations
8.0	References
Appendix A	Test Procedures for Chemical Characterization of Materials Used in Task J Variability Program
Appendix B1	Material Specification for Graphite/PMR-15 Prepreg
Appendix B2	Process Specification for Graphite/PMR-15 Prepreg
Appendix C	Test Procedures for Characterization of Graphite Tape and Composites

LIST OF TABLES

<u>Table</u>		<u>Page</u>
I	Summary of HPLC Properties	
II	IR Spectra of Selected Resins and Fractions From Original Program	
III	Task J Summary of Materials	
IV	IR Chemical Characteristics of Graphite Prepregs	
V	Comparison of PMR-15 Resin Before and After Manufacturing Prepregs	
VI	Comparison of Graphite/PMR-15 Prepreg Using Different Stoichiometries	
VII	Summary Property Data Using Lot 2W4388 Roll 3	
VIII	Summary of Manufacturing Experiments	
IX	Chemical Characteristics of Monomers Used in Manufacturing Study	
X	Chemical Characteristics of Materials Used in NE Study	
XI	Summary HPLC Data on Prepreg From NE Study	
XII	Summary Property Data NE Study	
XIII	Chemical Characteristics of BTDE	
XIV	Summary HPLC Data on PMR-15 Resins BTDE Study	
XV	Summary Property Data BTDE Study	
XVI	Receiving Inspection Tests for PMR-15 Materials	
XVII	Summary Property Data Reproducibility Study	
XVIII	Summary Report Data Reproducibility Study Company A Tested	
XIX	Company A Qualification Data Reproducibility Study	

LIST OF FIGURES

<u>Figure</u>		<u>Page</u>
1	HPLC Chromatogram of PMR-15 Monomers Used in Prepreg Machine Study	
2	NDI Scan of Company A and Unmodified PMR-15 Stoichiometry	
3	HPLC Chromatograms BTDE From Manufacturing Study @ 254 Wavenumber	
4	HPLC Chromatograms Samples From Manufacturing Study at 210 Wavenumber	
5	HPLC Chromatograms of PMR-15 Resins From Manufacturing Study at 254 Wavenumber	
6	HPLC Chromatograms of Materials on NE Study	
7	NDI Scans NE Study	
8	NDI Scans BTDE Study	
9	Company B PMR-15 Monomers	
10	HPLC Chromatograms of Aging Study BTDE	
11	HPLC Chromatograms of Resin Aging Study	
12	HPLC Chromatograms of NE From Reproducibility Study	
13	HPLC Chromatograms of BTDE From Reproducibility Study	
14	HPLC Chromatograms of PRM-15 Resin From Reproducibility Study	
15	HPLC Chromatograms of Graphite Prepreg From Reproducibility Study	
16	TGA Data Graphite Prepreg	
17	Gas Chromatogram/Mass Spectra Data Graphite Prepreg	
18	Infrared Spectra Graphite Prepreg	
19	NDI Test Results Graphite Composites	
20	Comparison Manufacturing of PMR-15 Resin Before and After Task J Variability Program	

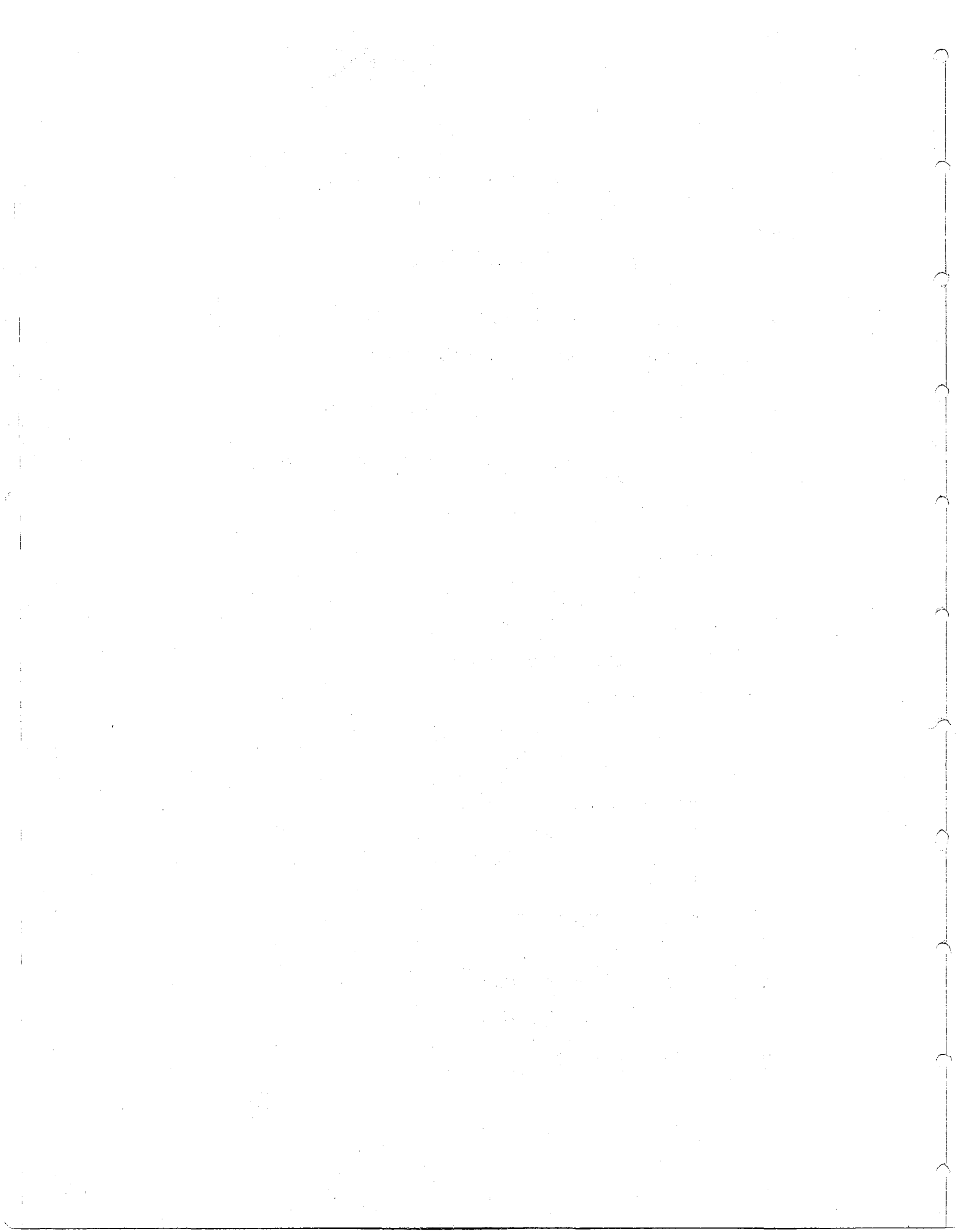

BOEING AEROSPACE COMPANY

1.0 SUMMARY

This report is the final program report document describing work performed by BAC for the National Aeronautical and Space Administration, under NAS1-15009 Task J. The program was structured to determine the cause and resolve the problem of the lot-to-lot and within lot variability of graphite/PMR-15 prepreg. The overall objective of the program was to obtain a manufacturing process and accept/reject criteria associated with the quality control of the monomers, resin and graphite prepreg preparation, and storage.

The program was divided into three technical phases which are summarized below.

Phase I consisted of the evaluation of the PMR-15 chemical characterization data generated under Task A of the original program (ref. 1).

Phase II effort was directed at the processing conditions deemed essential in controlling the manufacture of the PMR-15 resin and monomers.

Phase III effort was directed to selecting the processing conditions that yielded a graphite prepreg that could be processed into acceptable structural elements and possessed the highest possibility of being consistently reproduced. That set of processing conditions was then replicated three times to demonstrate reproducibility. During this phase of the program efforts were made to obtain the graphite/PMR-15 prepreg from more than one source, with marginal success.

During Task J studies, various controlled materials were obtained from Company A and chemically characterized. These materials represented the raw materials, monomers made using different processing conditions,

PMR-15 resin made using those monomers, and finally graphite prepreg using the PMR-15 resins. Flat panel composites were then manufactured using one process and selected properties measured. Once the prepreg processing conditions were determined, three lots of prepreg were obtained to determine if the accept/reject criteria previously established were valid. After this determination was made, the manufacturing procedures were transmitted to another prepregger (Company B) to determine if they could prepare PMR-15 prepreg using the conditions established under Phase II and III. This part of the effort was not successful due to inability of Company B to make the esters and/or resins.

Summary points of each phase follow:

Phase I

NAS1-15009A data review showed that both lot to lot and within lot variation existed.

Phase II

The procedures used in prepreg manufacture were evaluated and modified to eliminate variability detected in Phase I.

Phase III

A prepreg manufacturing procedure was selected from Phase II and used to make 3 lots of prepreg. These lots were fabricated into acceptable panels indicating the variability problem was resolved.

2.0 INTRODUCTION

This work was conducted under the technical direction of Mr. E. L. Hoffman of Langley Research Center and Dr. Tito Serafini of Lewis Research Center. The Materials Technology Department of The Boeing Aerospace Company was responsible for the work performed on the program. Mr. W. A. Symonds was the Program Manager, Mr. J. T. Hoggatt was the Technical Leader and Mr. C. H. Sheppard was the Principal Investigator. Acknowledgement is made of the technical assistance provided during the program by the following BAC and Company A personnel:

Boeing Aerospace Company

A. B. Hunter
Frank Horan
Bill Dumars
Julie Jaquish
Oscar Davis
Dr. Murray E. Taylor
Leroy Hause

Company A

Don Beckley, Technical Director
Sidney Street, Research Manager

The program was structured to determine the cause and resolve the problem of the lot-to-lot variability of graphite/PMR-15 prepreg. During the performance of Contract NAS1-15009, "Development and Demonstration of Manufacturing Processes for Fabricating Graphite/PMR-15 Polyimide Structural Elements," a material variability problem was encountered. Details of the problem are documented in the NAS1-15009 final report (ref. 1). Concisely stated, the chemical makeup of the PMR-15 matrix varied both within a lot

and between lots of prepreg tape received from the material supplier, Company A (Table I). Because of the variability, it was necessary to develop several cure cycles in order to produce structurally sound laminates. While undesirable, such a situation could be accommodated during a production run by requiring that chemical characterization performed during incoming-receiving inspection be used to select the correct cure cycle from several listed in the controlling fabrication specification. The shortcomings of such an arrangement are readily apparent; it is not a well-controlled or cost effective manufacturing procedure.

A better approach leading to a well-controlled, predictable graphite/PMR-15 prepreg was to determine the cause of the variability and resolve the problem so that all material could be fabricated into structural parts using one standard cure cycle.

The program was divided into three separate phases which consisted of:

Phase I Review of NAS1-15009 Data

Phase II Prepreg Manufacturing Studies

Phase III Graphite/PMR-15 Reproducibility

The objective of the program was to determine the cause of prepreg variability, develop manufacturing and quality control procedures to alleviate the resin variability, and finally to demonstrate that the manufacturing and quality control procedures would function on a production basis. Consequently, during the first part of the program, work was concentrated on discovering the causes for the resin variability. Once the major causes had been identified, controlled manufacturing procedures were developed and evaluated until a single suitable process for manufacture of the esters, resin, and prepreg was finalized. During the development

of the process, care was taken to develop quality control procedures which would ensure that a reproducible product would be manufactured.

Use of commercial products or names of manufacturers in this report does not constitute official endorsement of such products or manufacturers, either expressed or implied, by the National Aeronautics and Space Administration.

3.0 PHASE I--NASA CONTRACT NAS1-15009 TASK A DATA ANALYSIS

This task of the program was devoted to the evaluation of the chemical characterization data obtained during Task A of the original program (NAS 1-15009). Once the causes of resin variability became apparent, a technical approach to solving those problems was developed. Details of this study are presented below.

3.1 EVALUATION OF HPLC DATA

During the original program (i.e. Tasks A-H, ref. 1) major emphasis was placed on the chemical characterization of incoming materials. One of the selected tests used on that program was High Pressure Liquid Chromatography (HPLC). The data obtained during the program (ref. 1) is summarized in Table I. It was readily apparent from the data that the graphite PMR-15 prepreg varied and those variations fell generally into four major groupings. There were no specific patterns in the variations except that numerous reactions products were present in varying amounts. The exact identification of these reactions products were not obtained because of the scope of the program. The presence of these reaction products indicated the variability problem was caused either in the resin preparation or in the graphite tape prepregging step. Both possibilities were subsequently studied in detail. (See sections 4.0 and 5.0 for more detailed descriptions.)

3.2 EVALUATION OF INFRARED SPECTRA DATA

The second analytical tool used during Task A through H of the contract to characterize the graphite/PMR-15 prepreg on the original program was the Fourier Transform Infrared Spectrophotometer (FT-IRS). The spectra obtained yield more detailed information regarding the chemical structure of the PMR-15 resins than the HPLC data. It detects the different functional groups present in the material versus the HPLC separation by molecular size and polarity. These groups when compared yield information regarding the degree of reaction of the monomers which make up the PMR-15 resin.

The infrared (IR) spectra of the PMR-15 resin and in some cases the separated fractions obtained from the HPLC were examined to determine, if possible, the composition and variations between fractions. A method of ratios between the peaks of reactive functional groups was used to detect and measure small but possibly significant differences between batches of reactants and between chromatographically separated fractions of batches. It was not adequate to determine presence of the significant functional groups because the variability was most probably a variability in reaction conditions or impurities with resultant small variations in the amounts of the reactive chemical groups present. For ease of presentation, Table II is a sample of the data analysis and illustrates the identification of the problem.

The data strongly indicated that in some cases reaction had proceeded to partial imidization. In one instance a resin had been reacted to the extent that an appreciable amount of imidization had occurred. This could be demonstrated by the amine/acid ratio. This ratio is an indicator of imidization (smaller amounts of amine present with a corresponding increase in the imide functional group). The only possible explanation could be

erratic reactant concentrations (either smaller or larger amounts of amine present with no corresponding change in imide functional group concentration). In either case variability between batches would result. Another key indicator was the ester/acid ratio. To a limited extent, this ratio is a measure of the completeness of the esterification reaction that produces two key monomers for the resin.

In summary, it was found that variations in composition did exist between batches of PMR-15 resins that resulted in variations in the intermediate products. In addition, variations were found in the intermediate products that could best be explained by changes in reaction conditions. Those conditions could be caused by (1) the reactant ratios varying from batch to batch, (2) impurities existed at different levels from batch to batch, or (3) the conditions of reaction, such as time, temperature, and mix conditions, were different.

4.0 EFFECTS OF PREPREG EQUIPMENT ON PMR-15 RESIN (PHASE II, PART 1)

This phase of the program was devoted to the evaluation of the effects of both resin stoichiometry and the prepreg equipment on the PMR-15 resin. Evaluation of the chemical data obtained on Task A of the original program (ref. 1) indicated two possible areas that could cause variability in the PMR-15 resin: 1) PMR-15 resin stoichiometry and 2) graphite prepreg manufacture. The PMR-15 resin stoichiometry used for Company A material was slightly different than the stoichiometry used by NASA Lewis Research Center. The difference was the amount of BTDE used in the PMR-15 resin. Specifically, Company A's materials contained approximately 8 percent less BTDE than the NASA Lewis material. This was caused by the manufacturing method used by Company A in making BTDE. The purpose of this effort was to evaluate both variables (i.e. resin stoichiometry and the prepreg manufacturing). To accomplish this, materials were procured from Company A and subjected to detailed analysis. (The materials procured throughout the entire program are summarized in Table III.) In addition to the basic materials, samples of the resin flash from the graphite prepreg were also obtained. Details of this study are given below. For convenience of reporting, this section is divided into chemical characterization of the materials and into process studies using the graphite/PMR-15 prepreg. Specific chemical testing procedures are given in Appendix A.

4.1 EVALUATION OF MONOMERS BY INFRARED SPECTROMETRY

The chemistry of the two resins (i.e. Company A and NASA Lewis PMR-15 stoichiometry, Section 4.0) were controlled as nearly as possible by using the same monomers for both resins and obtaining a good chemical data base of the raw materials. Spectra of samples of nadic anhydride (NA), 3,3',4,4'-benzophenone tetracarboxylic dianhydride (BTDA), and p,p'-methylenedianiline (MDA) were obtained using Fourier transform infrared spectroscopy (FTIR). The purity of the starting reagents was assessed by analyzing specific IR absorption characteristics caused by the starting reagents functional groups.

The MDA used in the resin studies was lot 20849. Infrared (IR) spectra were obtained and compared with Sadtler Research Laboratory spectrum D544K, p, p'methylene dianiline (MDA), F.P. 363K (194°F), B.P. 535-541K (504-514°F), Specific Gravity at 277K (39°F) 1.056, source: Dow Chemical Company. The sample appeared to be pure compared with the Sadtler spectrum. To determine lot to lot consistency, a second sample of MDA was analyzed. On comparing the IR of the two samples of MDA they were exactly the same and appeared to be pure when compared to the Sadtler spectra. These data led to the conclusion that there was no variation between samples and the purity was high enough to cause no problems in the resin. However, when the Material Specification was written it was determined that the purity of MDA would be determined by DSC (see para. 5.7.1.3 Appendix B) in place of IR spectra.

The BTDA used in preparation of the BTDE used in this experiment was lot 2034. Infrared spectra were obtained and compared to the Sadtler Research Laboratory spectrum D5338P 3,3',4,4' benzophenonetetracarboxylic dianhydride, source: Gulf Oil Corporation. This sample was very similar to

the Sadtler spectrum. However, the spectrum gave evidence of the presence of a small amount of acid, probably due to hydrolysis of the anhydride. A second sample lot 1952 was also analyzed and found to contain a moderate amount of impurities present such as another anhydride and some carboxylic acid, probably hydrolyzed BTDA. There was a small variation between the two samples. However, the purity judged by attributing the absorptions of the principal functional groups and comparing with the Sadtler spectrum was high enough to conclude that the impurities would cause a minimum of problems.

The nadic anhydride (NA) used in preparation of the mono ester (NE) was Company A lot 20890. Infrared spectra were obtained and compared to the Sadtler Research laboratory spectrum D4570, nadic anhydride, source: Allied Chemical Corporation. The results of the comparison indicated the material to be impure. The principal and key absorptions were attributed to an acid and anhydride other than nadic anhydride. The compounds appeared to be open chained rather than cyclic. Due to the scope of the program, no effort was made to identify impurities in the PMR-15 monomers, and no correlation could be made between the resins and the impurities in the starting materials. A second sample of NA was also analyzed (vendors lot 654835) with essentially the same results as the first sample.

4.1 EVALUATION OF MONOMERS BY HPLC

Monomers were evaluated by liquid chromatography. The system used was a DuPont High Pressure Liquid Chromatograph model 850 with a variable wavelength detector. (See Appendix A for a full description of experimental method.) Initially analyses were made using a UV detector with a setting on 254 nm. However it was determined that the NE could not be detected at 254 nm. Other detectors were evaluated during the program with similar negative

results. Refractive index and other UV wavelengths were then evaluated with the procedure finally being optimized using a UV detector at 210 nm. All of the possible anhydrides, esters, resins, and reaction products can be detected at 210 nm.

The monomer data obtained during this phase was used only as baseline data (see Figure 1).

4.2 EVALUATION OF PMR-15 RESINS BY INFRARED SPECTROMETRY

The effect of the prepreg equipment on PMR-15 resin was evaluated by comparing the infrared (IR) spectra of the resin before the prepregging operation and the flash material obtained from the graphite/PMR-15 prepreg. The specific lots of resin used in this evaluation were WR 4389 and WR 4390. When the functional groups of the resins were compared, the materials were assessed as being the same within experimental limits. It should be noted, however, that the amine concentration varied between the two resins. The resulting conclusion was that the prepreg experiment did not produce significant changes in the PMR-15 materials. For comparison of the infrared spectra of the prepreps see Table IV.

4.4 EVALUATION OF PMR-15 RESINS BY HPLC

As previously described, two separate resins were made from the monomers described in paragraphs 4.1.2 and 4.1.3. The first resin (i.e. WR 4390) used the mixing ratios developed by Company A. The second resin (i.e. WR 4389) used the PMR-15 stoichiometry of NASA Lewis. Differences were detected by the HPLC between the two stoichiometries (Table V). Additional minor variations were also noted on the prepreg (Table VI). To

evaluate the effects of the graphite prepregging operation the HPLC data was compared using resin WR 4390 and graphite/PMR-15 prepreg 2W 4388 roll 3 (Table VI).

The retention times of the two variations were within a maximum standard deviation of 0.03 and a maximum coefficient of variation of 0.34. The area ratio did vary which would probably cause some processing difference, but at this time sufficient history to establish limits on area ratio variability was not available. The next comparison made was between the resin before and after prepregging, and that analysis was the same as the IR (para. 4.2) conclusion that the prepreg machine didn't significantly alter the PMR-15 resin (Tables V and VI). It should be noted at this time that throughout the variability program extensive column calibration was required to assure reproducibility of data over long periods of time. The calibration procedure developed from this program is given in Appendix A.

4.5 SUMMARY OF THE CHEMICAL TESTING

Summarized below are the conclusions reached during this phase of the program.

1. Differences were noted in the chemistry of the PMR-15 resins using the two different stoichiometries. The amine content of the NASA Lewis system appeared to be less than the amine content of the Company A system.
2. There were some minor differences in the PMR-15 resin after the prepregging operation. It appeared that the monomers of the PMR-15 resins were reacting to produce some intermediate amide acids of varying molecular weights.

3. There were some significant impurities in the NA, which identified the resulting monomer (i.e., NE) as a potential cause for PMR-15 resin variability. The identification of the impurities was beyond the scope of this program.

4.6 PROCESSING STUDIES USING GRAPHITE/PMR-15 PREPREG LOTS 2W4388 ROLLS ROLLS 3 AND 4

The graphite prepregs (i.e., lot 2W4388, rolls 3 and 4) were processed into composites using the process document of original program (D180-20545-5 Methods I and IA, ref. 1). Both composites fabricated using Method IA failed the NDI test. Composites fabricated using Method I were NDI tested with the results being given in Figure 2. (See Table VII for mechanical properties.) Results of the study demonstrated that the processing of the modified PMR-15 material using Company A stoichiometry provides a system with acceptable properties, whereas the unmodified PMR-15 could not be processed into laminates with acceptable NDI characteristics using the processes described in the D180-20545-5 document. However, unmodified PMR-15 stoichiometry prepreg has been processed into quality laminates when prepreg manufacture was by the solvent impregnation technique.

5.0 PHASE II--PMR-15 RESIN MANUFACTURING STUDIES

5.1 PMR-15 RESIN STUDIES

This task of the program was devoted to the evaluation of the effects of manufacturing conditions on monomer and resin preparation. Samples of the monomers were obtained during the various phases of manufacture (for summary see Table VIII). The materials evaluated during the study are summarized in Table III. As done in section 4.0, this section is divided into chemical characterization of materials and process studies. Details of the study are given below.

5.1.1 Chemical Characterization of Monomers by Infrared Spectrometry

The study of the variation of the starting materials (see discussion in Section 4.1.1) revealed that the p,p'-methylenedianiline (MDA) and 3,3',4,4'-benzophenone tetracarboxylic dianhydride (BTDA) were relatively free of impurities and could be considered good commercial grade chemicals. However, the nadic anhydride (NA) proved to be very impure. Both the anhydrides offered the possibility for secondary reactions during the esterification process which produces the monomers of the PMR-15 resin. In addition the esterification of the impure NA would be expected to produce by-products that could possibly influence the polymerization process in a random manner depending upon type and concentration of impurities.

The amine does not participate in an intermediate reaction, but the anhydrides are converted by reaction with alcohols to form in-situ acid esters. Thus, the partially esterified products (BTDE and NE) of the two anhydrides were chemically characterized by infrared (IR) spectrophotometry.

The results are described in Table IX. The BTDE materials used in this study and described in Table IX were ranked in order of purity from the least to the most pure in the following order: Samples 10, 7, and 12. The NE materials described in Table IX were ranked in order of purity from the least to the most pure in the following order: Samples 1, 4, and 6. The evidence suggests that until attention was given to chemical characterization for purity by means of infrared analysis, the esters used for the PMR-15 resin were relatively impure. That condition naturally affected the quality of the finished prepreg materials.

5.1.2 Chemical Characterization of Monomers by HPLC

The BTDE samples were also analyzed using HPLC techniques. BTDE ester samples 9, 10, and 12 were significantly different (Figure 3). The data strongly indicates potential problems in the resin system could easily be caused by BTDE synthesis procedures. Based on the difference between sample number 10 and 12 the selection of the method of manufacturing the BTDE was determined by: 1) highest diester content detected by IR, 2) ease of manufacture and quality control of product, and 3) ease of processing of graphite/PMR-15 prepreg into composites. The HPLC chromatogram of the BTDE (Figures 1 and 3) clearly shows five peaks and was used as a baseline in the BTDE manufacturing quality control.

The NE samples were also analyzed using HPLC techniques. Again it should be noted that after much testing development work it was found that the NE chromatograms should be measured at 210 wave number. NE samples 3, 4, and 6 (see Table VIII and Figure 4) are identical. Sample 1 indicates an additional peak on the chromatograph which was found to be the anhydride indicating incomplete conversion to the mono methyl ester. Results of these

experiments indicate that the process for making NE was not overly critical, hence the process was dictated by: 1) absence of anhydride as detected by IR and 2) ease of manufacturing and quality control of the product.

5.1.3 PMR-15 Resins In Manufacturing Studies

During this study three resins were made using materials obtained in the manufacturing process studies. Only HPLC data was obtained on these resins (see Figure 5). The HPLC data was obtained only at 254 nm so the absence of the characteristic NE peak is obvious. However, the data does show reaction products in both resins 2 and 3 which have previously been shown to be bad with respect to processability (ref. 1). Hence the procedure for manufacturing the resin was changed to provide minimum temperature during mixing of the PMR-15 resin. (See D180-20545-4A) (Appendix B1)

5.2 MANUFACTURING VERIFICATION

Based on previous data (para. 5.1.2) the manufacturing procedures for the monomers (NE and BTDE) and PMR-15 were selected based on processability of the resulting prepreg, the ease of manufacturing of monomers, ease of manufacture of PMR-15 resins, and quality control procedures of both monomers and PMR-15 resins. During the verification phase two sets of experiments were conducted. The first set was the comparison of the Company A prepared NE with the commercially available NE (Burdick and Jackson) holding the BTDE and MDA constant. The second set of experiments evaluated different BTDE esters prepared by Company A holding the NE and MDA constant. Following is a detailed description of the chemical characteristics of the

monomers, resin, and graphite prepreg along with the processing studies using the graphite prepreg.

5.2.1 Chemical Characterization of NE Study

5.2.1.1 Characterization of NE by IR

Two nadic esters, 1) commercially prepared NE (Burdick and Jackson) and 2) Company A prepared baseline NE, were characterized by themselves and in their effect on two resins and two prepregs. The two resins were WR4614 and WR4615. The prepregs were 2W-4443 and 2W-4444.

The Burdick and Jackson nadic ester was Lot AC7231. By analysis of the IR spectra the NE appeared to be a pure monoester. There was no evidence in the IR spectrum for anhydride or diacid. It appeared to be as pure as an other nadic ester, a specially prepared NE (WR4534), 376-377.5K (217-220°F) which gave no evidence for anhydride, diester, or diacid impurities. The baseline nadic ester preparation, WR4613, was a white, moist, crystalline mass. The IR showed no evidence for anhydride or diester and appeared to be pure nadic ester. For summary of data see Table X.

5.2.1.2 Characterization of NE by HPLC

Two NE's were analyzed by HPLC at 210 nm. The Company A material was prepared by the newly developed process and the other sample was the commercially available material made by Burdick and Jackson. The Company A material was determined to be of slightly higher quality than the Burdick and Jackson based on the HPLC chromatogram (see Figure 6).

5.2.1.3 Characterization of the PMR-15 Resin by IR

The first resin (WR4614) was prepared using the Burdick and Jackson NE and BTDE lot WR4612. The resin appeared to be relatively pure, however the intensity of the ester group was greater than the acid on a ratioed basis (see Table X). The second resin (WR4615) was prepared using the NE WR4613 and the same BTDE WR4612. This resin was WR4615 which when characterized by IR showed more absorptions than resin WR4614. Furthermore, the absorptions were not resolved. This would lead to the conclusion that more side reactions had occurred and more impurities were present (see Table X). However, the processability of the graphite prepreg accepting criteria and the IR proved to be far too sensitive for use as an acceptance criteria.

5.2.1.4 Characterization of PMR-15 Resin by HPLC

The Burdick and Jackson NE with the above mentioned BTDE was used in manufacturing resin WR4614 which eventually went into prepreg 2W-4443. The Company A NE was used in resin WR4615 with the above mentioned BTDE. Prepreg 2W-4444 was made from WR4615 resin. LC analysis at 254 nm indicates no significant difference in the two resins. The prepregs also seem to be the same. The LC chromatograms are shown in Figure 6 with the BTDE and PMR-15 resin data being presented in Table XI. It was therefore concluded that variability of the resin is not caused by normal variation in purity of NE and either commercially available or vendor made material would be acceptable in PMR-15 resins.

5.2.1.5 Graphite/PMR-15 Prepreg Processing

The graphite prepregs were processed into composites using the D180-20545-5A (Appendix B2) processing procedure. The composites were NDI inspected (Figure 7). Test coupons were then machined and property determinations were made (Table XII). The resulting data demonstrated that the materials were essentially identical with Lot 2W4444 having a slight advantage in the overall processing characteristics. This data confirms the data obtained during chemical characterization testing.

5.2.2 Chemical Characterization of BTDE Study

5.2.2.1 Chemical Characterization by HPLC

During this experiment it was decided to use mainly HPLC as the chemical test because as described in para. 5.2.1.1 the infrared technique appeared to be overly sensitive and show chemical differences that didn't affect the graphite prepreg processability. The limited IR data generated during the study are given in Table XIII. Three resins were manufactured from a single batch of NE (WR4739) and three different batches of BTDE resin (i.e., WR4713, WR4715, and WR4714). The resins were compared by HPLC. The tabulated data are presented in Table XIV. The data demonstrate the materials were essentially the same with only negligible differences.

5.2.2.2 Processing Studies Using Graphite/PMR-15 Prepreg

The graphite prepregs (i.e. 2W4487, 2W4489, and 2W4490) were processed into composites using the D180-20545-5A (Appendix B2) processing procedure except cure temperature was 589K (600°F). The composites were NDI inspected (Figure 8) and then machined into test coupons. The properties of the composite were then obtained and are reported in Table XV. Results of the study indicated that Company A was able to reproducibly manufacture BTDE along with the three separate resins.

5.2.3 Monomer Manufacturing at Company B

With the excellent results obtained using the manufacturing procedures developed, the next major step was to provide the essential processes to another vendor and determine if a second source could be qualified in the production of graphite/PMR-15 prepreg. Toward this end the essential manufacturing procedures were given to Company B. Analysis of their materials are detailed below.

5.2.3.1 Chemical Characterization by HPLC

At the present time Company B has been unsuccessful in their attempts to manufacture NE. Consequently they have elected to use the commercially available NE from Burdick and Jackson. Several attempts have been made to manufacture the BTDE, but upon analysis using the HPLC standards Company B has been unsuccessful. Attempts using another source were also made with the same result. (See Figure 9 for HPLC of NE and BTDE.)

5.3 AGING CHARACTERISTICS OF PMR-15 MATERIALS

Aging characteristics of BTDE and the PMR-15 resin were evaluated by HPLC. Materials that met specification requirements and processed in a satisfactory manner were stored under refrigeration. Portions of these samples were aged at room temperature for 45 days. With respect to the BTDE, no detectable change was observed (Figure 10). However with respect to the PMR-15 resin, significant changes did occur (Figure 11). The resin was evaluated at 210 and 254 nm. Note the NE peak is detected at 210 nm but not at 254 nm. Also note after aging there is a significant depletion of NE and also reaction products begin to appear. This limited testing indicates proper storage must be maintained on the PMR-15 resin. The testing also indicates a potential problem with resin and/or prepreg stability. Even though the test was conducted at ambient temperature, some aging advancing could also be expected at 255K (0°F). The amount of aging and the effects of aging on processability and/or composite properties were beyond the scope of the program.

5.4 SUMMARY OF PMR-15 RESIN MANUFACTURING STUDIES

During the performance of the Phase II resin manufacturing studies, certain goals were established to ensure that once a process was developed that the resulting graphite/PMR-15 prepreg could be reproducibility manufactured. The goals could be summarized as follows:

1. The mono and diester monomers could be reproducibly made in available equipment.
2. The PMR-15 prepreg would possess essentially the same chemical characteristics.

3. Graphite/PMR-15 prepreg would possess essentially the same chemical characteristics.
4. Graphite/PMR-15 prepreg could be fabricated into structural components using one autoclave process.

Based on the data reported above these goals were believed to have been obtained. Consequently the program proceeded into its final phase, that of determining the process reproducibility.

6.0 PHASE III--CELION 6000/PMR-15 REPRODUCIBILITY STUDIES

After the selection of the best overall process (para. 5.4), a total of three different lots of material were evaluated by BAC using the Material Specification (D180-20545-4A) and Process Specification (D180-20545-5A) procedures. Toward this end, three lots of prepreg (i.e., Lots 2W4515, 2W4516, and 2W4517) were manufactured using previously prepared monomers (BTDE and NE) and fresh PMR-15 resin. The freshly prepared PMR-15 was used to impregnated Celion 6000 graphite fiber. (See Table III for material makeup.) The materials were chemically characterized using the procedures of the revised Material Specification and the prepreg fabricated into composites for property determinations. A more detailed description of experimental results is given below.

6.1 QUALITY CONTROL USING CHEMICAL CHARACTERIZATION TECHNIQUES

All of the materials received during this study were analyzed per the applicable section of the Material Specification (Table XVI). All materials passed the chemical characterizations tests with the three sets of materials being almost identical. See Figures 12 through 18.

6.2 PROCESSING OF MATERIALS RECEIVED IN PROCESSING STUDIES

After obtaining chemical properties of the PMR-15 material (para. 6.1) composite panels were fabricated using D180-20545-5A Process Specification (Appendix B2). The panels were NDI inspected (Figure 19), machined into flexural and shear coupons, and mechanical properties obtained at ambient and 589K (Table XVII). The remaining portion of each panel was submitted to Company A for comparative testing (see Table XVIII).

As part of the qualification effort, Company A fabricated an additional panel from each lot of prepreg and submitted their test data (see Table XIX). On analysis, the properties obtained by Company A and Boeing were somewhat different but in most cases the material met the requirements of the D180-20545-4A Specification. Some disparity exists in the vendor versus BAC data but until the "fiber" problem attributed to Celion 6000 has been corrected a definite correlation is not possible. Company A qualification data yielded higher than mechanical properties for the cured composite than BAC's mechanical properties, but difference is attributed to autoclave processes and/or testing methods.

7.0 CONCLUSIONS AND RECOMMENDATIONS

Summarized below are the conclusions reached during the program to eliminate variability in graphite/PMR-15 polyimide resin systems. Based on the findings of this program, recommendations are given for future actions.

7.1 CONCLUSIONS

The objective of Task J studies were accomplished by isolating the causes of the resin variability experienced on the Task A-H effort of NAS1-15009 program and developing manufacturing techniques to eliminate those causes. During initial Task J studies (Phase II) the problem was isolated to manufacture of the esters and/or PMR-15 resin. In addition, preliminary data indicated that the storage time and/or temperature of the mix resin was also a problem. Improved prepreg manufacturing techniques were developed to eliminate or control these variables. The improved techniques were then demonstrated in the final study (Phase III) reported herein. Differences in the two manufacturing methods are schematically shown in Figure 20.

7.2 RECOMMENDATIONS

1. A study needs to be performed concerning the resin chemistry of PMR-15 with respect to undesirable reaction products and monomer stoichiometry. The effect of these variables should be determined with respect to the graphite/PMR-15 prepregs' aging and processing characteristics as measured by mechanical properties.

2. A study needs to be performed to refine the present HPLC testing procedures. Data generated during this program indicates the present testing procedure is overly sensitive to minor variations in the PMR-15 resin and/or HPLC test apparatus. The new procedures should be less discriminating with respect to various ester isomers but the sensitivity to reaction products should be comparable or superior to the current procedure.
3. A study should be conducted to optimize the present autoclave processing conditions for the graphite/PMR-15 prepreg developed on this program. The process should be based on mechanical properties both before and after a specified aging condition.
4. Efforts should be made to qualify a second source for the manufacturing of graphite/PMR-15 prepreg materials. The effort should be coordinated with the study to refine the HPLC procedures.

8.0 REFERENCES

1. Sheppard, C.H., J. T. Hoggatt, W.A. Symonds, "Manufacturing Processes for Fabricating Graphite/PMR-15 Polyimide Structural Elements", NASA Contract NAS1-15009, Final Report, NASCR-159129.

TABLE I
SUMMARY OF HPLC PROPERTIES

Elution Time 1/	Lot (Elution Volume (% Area))											
	2W4169*	2W4170*	2W4215*	2W4240	2W4251	2W4280	2W4282	2W4301	2W4317	2W4364	2/ 2W4388	2/ 2W4444
6.83	-	0.58	0.29	-	-							
7.23	5.30	5.64	5.60	4.91	7.87	5.59	6.35	10.10	8.60			
7.82	17.77	15.36	17.44	15.67	23.02	24.52	24.40	10.20	8.80			
								22.00	17.80			
8.67	20.78	14.13	11.06	14.41	38.67	43.08	38.10	38.40	32.00			
			11.30									
9.33	3.54	8.68	3.33	12.59								
9.81	13.61	12.55	12.80	16.32								9.67
10.90	8.63	11.29	12.15	9.71	16.78	16.96	17.57	19.21	22.90		9.20	11.36
11.69	3.75	2.75	-		1.01	0.89	1.60			9.30		35.76
12.45	0.42	0.48	0.23		1.57	0.85	1.35			14.38	33.35	
12.94	0.28	0.38	-		0.20					36.07	7.25	31.96
13.91	1.12	0.62	0.68		1.57							
14.62	-	1.01	0.56		-					27.63	22.97	9.29
15.11	2.78	0.75	1.41		0.20							
16.30	-	1.81	0.46		0.43						11.18	
16.79	0.76	-	0.30		0.19					9.43		
18.19	0.86	8.77	6.44	2.81	3.98	3.39	3.92	0.40	0.40			1.96
	2.82		0.93		2.42	1.29	3.90				16.04	
20.18	-	2.11	0.73		-	0.72				1.98		
20.90	13.57	9.18	14.90	5.60	3.87	2.72	2.80	9.60	9.60	1.22		
22.58	-	0.74	-		-							

1/ Normalized for comparative purposes

2/ Materials received on Task J, Material Variability Program

* HTS-2 fibers, remaining fiber Celion 6000 NR150B2 sized

TABLE II

IR SPECTRA DATA OF SELECTED RESINS AND FRACTIONS FROM ORIGINAL PROGRAM

Material	Date	Frac- tion	Functional Group Ratios			
			Amine Acid	Ester Acid	Ketone Acid	Imide Acid
PMR-15 WR3737	3/29/78	#1	0.216	1.07	0.659	0.0
		#2	0.302	1.03	0.698	0.0
		#3	0.234	1.11	0.702	0.0
PMR-15 B-4125-1	3/27/79	#1	0.242	1.21	0.673	0.0
		#2	0.243	1.22	0.645	0.0
		#3	0.260	1.14	0.684	0.0
		#4	0.241	1.16	0.694	0.0
		#5	0.216	1.22	0.661	0.0
PMR-15 HTS II 2W-4168	1/19/78		0.274	1.04	0.726	0.0
PMR-15 WR3533	1/8/78		0.261	0.989	0.723	0.049
PMR-15 2W4173 (Celion 6000)	3/16/78		0.235	1.06	0.743	0.017
PMR-15 2W-4083	10/10/78		0.150	1.14	0.667	0.0
Company A PMR-15	8/8/77		0.393	0.871	0.627	0.080
Company A Lot 2W4138 (Celion 6000)	2/8/78		0.286	0.938	0.724	0.094
PMR-15 3582-2	3/16/78		0.272	0.960	0.748	0.149
PMR HTS/Company A	8/8/77		0.233	0.845	0.596	0.062

TABLE III

TASK J SUMMARY OF MATERIAL

Material Usage

Prepreg Equipment
Study

MDA - 20849
NA - 20890
BTDA - 2034
NE - WR4369
BTDE - WR4370

Company A Resin - WR4390
NASA Lewis Resin - WR4389

Company A Graphite Prepreg 2W4388 Roll 3
NASA Lewis Prepreg 2W4388 Roll 4

NE Study

Prepreg	Resin	NE	BTDE
2W4443	WR4614	B&J	WR4612
2W4444	WR4615	WR4613	WR4612

BTDE Study

Prepreg	Resin	NE	BTDE
2W4487	WR4615	WR4739	WR4713
2W4489	WR4801	WR4739	WR4800
2W4490	WR4713	WR4739	WR4714

Reproducibility Study

Prepreg	Resin	NE	BTDE
2W4515	WR4928	WR4735	WR4815
2W4516	WR4929	WR4814	WR4715
2W4517	WR4927	WR4739	WR4713

TABLE IV
CHEMICAL CHARACTERISTICS OF GRAPHITE PREPREGS

Material	Description
2W 4388 Rolls #3 and #4	The material on all of the rolls appeared to be uniform and relatively pure. However, the BTDE used appeared not to be completely esterified. The amine concentration decreased from Roll #3 to Roll #4, which could affect the imidization.
2W 4388 Rolls #3 and #4 (Flash)	The flash material appeared to be essentially the same as the spectra of resins WR 4390 and WR 4389.

TABLE V
COMPARISON OF RESIN BEFORE AND AFTER MANUFACTURE OF PREPREG

WR4389		WR4390		WR4389F <u>1/</u>		WR4390F <u>1/</u>	
Elution Time Seconds	Elution Volume % Area	Elution Time Seconds	Elution Volume % Area	Elution Time Seconds	Elution Volume % Area	Elution Time Seconds	Elution Volume % Area
608	13.9	622	--	607	14.3	607	7.2
704	38.0	744	44.6	703	37.0	707	36.9
833	5.5	815	9.0	832	12.4	801	4.5
1169	20.1	870	9.4	1169	14.22	835	23.5
		962	13.4	1731	11.4	1185	11.6
		1051	1.8			1776	16.4
		1412	22.0				

1/ Material obtained from Flash of the prepreg 2W4388 Roll 3 (WR4390F) and 2W4388 Roll 4 (WR4389F)

TABLE VI

COMPARISON OF PMR-15 RESIN BEFORE AND AFTER MANUFACTURING PREPREG

Before Prepreging WR 4390		After Prepreging 2W 4388 Roll 3	
Elution Time (min)	Elution Volume (% Area)	Elution Time (min)	Elution Volume (% Area)
11.37	12.0	11.43	11.2
12.93	36.8	12.96	40.8
14.60	22.3	14.63	21.2
16.09	12.2	16.10	10.8
19.48	16.7	19.50	16.0

TABLE VII

SUMMARY OF PROPERTY DATA USING LOT 2W4388 ROLL 3

Composite	Roll 3 2W4388
Flexural Stress Ult MPa (ksi)	
Ambient	1480 (215)
589K [600°F]	792 (115)
Flexural Modulus GPa (msi)	
Ambient	130 (18.9)
589K [600°F]	119 (17.3)
Short Beam Shear MPa (ksi)	
Ambient	97 (14.1)
589K [600°F]	44 (6.4)
Resin Content (%)	36.8
Specific Gravity (g/cc)	1.53
Fiber Volume (%)	55
Void Volume (%)	1.7

TABLE VIII
SUMMARY OF MANUFACTURING EXPERIMENTS

EXP 'T	ANHYD/MEOH	TEMP SOLN	VAPOR	SAMPLE TAKEN WHEN SOLN CLEARS OR TEMP CONSTANT	SAMPLE TAKEN 3 HOURS LATER	SAMPLE TAKEN 6 HOURS LATER
1 NE	50/50	156	156	#1 (Immediate PPT)	#2 (No PPT initially, start PPT in 24 hrs)	#3 (No PPT initially, start PPT in 24 hrs)
2 NE	75/25	202	156	#4 (PPT after 24 hours)	#5 (24 Hr. PPT)	#6 (WR4369) (24 Hr. PPT)
3 BTDE	50/50	156	156	#7	#8	#9
4 BTDE	75/25	210	156	#10	#11	#12
5 NE/BTDE	75/25	212	152	#13	#14 (Sample taken 1 hour later instead of 3)	--

PMR-15 Resin Mixes

#1 RT Solution of NE and BTDE @ 50/50
and MDA @ 50/50
(Esters from EXPT #1 & 3 above)

#2 NE/BTDE Ester @ 75/25 plus MDA
(Esters from EXPT #5)

#3 STD NE & BTDE mi
MDA solution @ 140°F then cool
rapidly and dump

Esters mixed at 80° added solution of MDA 50/50
slight exotherm 80 89°F 24 min.
85°F @ 50 minutes

Reflux Anhydrides-MeOH for one hour then
added MDA/MeOH solution and cooled

STD NE/BTDE mix at 150°F (NE used only crystals)
added solution of MDA/MeOH @ 140°F and cooled to
110-120°F took 15 minutes.

TABLE IX
 CHEMICAL CHARACTERISTICS OF MONOMERS USED IN MANUFACTURING STUDY

Material	Comments
BTDE #7 - 50% Temperature Stable	The material was a diester. However, the carboxylic acid group concentration was abnormally high, indicating incomplete esterification. A large amount of alcohol was present, probably as alcohol of crystallization.
BTDE #10 -	The IR spectrum indicated a moderately pure diester.
BTDE #12	The IR spectrum indicated a nearly pure diester.
NE #1 50/50	The IR spectra showed almost an equal mixture of NA and NE.
NE Standard #4	The material was reacted to form the monoester completely. No evidence of the presence of unreacted anhydrides.
NE Standard #6	The sample contained a small amount, ca. 5-10% of unreacted anhydride.

TABLE X
CHEMICAL CHARACTERISTICS OF MATERIALS USED IN NE STUDY

Material	Comments
Burdick and Jackson Lab AC 7231	The material appeared to be pure monoester. There was no evidence for anhydride or diester. The IR spectrum showed that the material was exactly the same on WR4534 XA909-35.
BTDE Short Cook WR4613 DE6500	The IR spectrum indicated a pure diester.
WR4614 NE/BTDE/MDA	The IR spectrum indicated that the expected functional groups had been formed in the reactants, which were relatively pure.
2W 4443	The IR spectrum indicated that all expected functional groups were present in the usual ratios and the reactants were relatively pure.
NE WR4613	The material appeared to be pure monoester. Some solvent (methanol) and product (H ₂ O) had not been removed.
BTDE WR4612	The IR spectrum indicated a pure diester.
WR4615 NE/BTDE/MDA USP	The IR spectrum showed more absorptions than could be accounted for from a pure mixture. The absorptions were not resolved and it was concluded that the material was impure.
2W 4444	The IR spectrum was within experimental error the same as 2W 4443-1.

TABLE XI
SUMMARY HPLC DATA ON PREPREG FROM NE STUDY

BTDE		WR4614		WR4615		2W-4444	
Elution Time Minutes	Elution % Area	Elution Time Minutes	Elution % Area	Elution Time Minutes	Elution % Area	Elution Time Minutes	Elution % Area
8.74	14.47	9.00	15.00	9.02	14.66	9.81	9.67
9.82	48.34	9.97	49.77	10.00	47.73	10.90	11.36
11.47	33.22	11.44	32.33	11.54	29.97	11.69	35.76
13.32	1.26	12.93	2.57	12.87	2.33	12.94	31.96
20.59	2.71	14.39	0.17	17.52	2.19	14.62	9.29
		41.90	0.16	17.13	2.12	18.19	1.96

TABLE XII
SUMMARY PROPERTY DATA FROM NE STUDY

Property	Lot	
	2W4443	2W4444
Prepreg		
Resin Content	34.0	36.5
Volatile Content	10.0	10.6
Gel Time (secs)	45	50
Composite		
Flexural Stress Ult MPa (ksi)		
Ambient	1350 (196)	1433 (208)
589K [600°F]	779 (113)	785 (114)
Flexural Modulus GPa (msi)		
Ambient	116 (16.9)	114 (16.5)
589K [600°F]	124 (18.0)	108 (15.7)
Short Beam Shear Ult MPa (ksi)		
Ambient	101 (14.6)	105 (15.3)
589K [600°F]	41 (5.9)	45 (6.6)
Resin Content (%)	31.0	33.6
Specific Gravity (g/cc)	1.57	1.57
Void Volume (%)	1.0	1.0
Fiber Volume (%)	61.6	59.2

TABLE XIII
CHEMICAL CHARACTERISTICS OF BTDE

Material	Comments
BTDE WR4713	Principal functional groups indicate a nearly pure diester.
BTDE WR4714	Principal functional groups indicate a nearly pure diester.
BTDE WR4715	This is purer than either WR4713 or WR4714.

TABLE XIV
SUMMARY HPLC DATA ON PMR-15 RESINS BTDE STUDY

WR4790		WR4801		WR4800	
Elution Time Seconds	Elution % Area	Elution Time Seconds	Elution % Area	Elution Time Seconds	Elution % Area
485	16.4	485	16.0	486	16.6
535	39.2	534	38.8	535	39.7
615	19.8	615	18.9	616	19.9
631	10.7	631	9.9	631	11.0
794	6.0	796	6.4	796	6.8
852	8.0	853	10.0	853	6.2

TABLE XV
SUMMARY PROPERTY DATA FROM BTDE STUDY

Property	Lot		
	2W4487	2W4489	2W4490
Prepreg			
Resin Content %	35.7	35.7	36.8
Volatile Content %	10.0	9.9	10.2
Gel Time (secs)	50	45	55
Composite			
Flexural Stress Ult MPa (ksi)			
Ambient	1344 (195)	1323 (192)	1344 (195)
589K [600°F]	703 (102)	682 (99)	620 (90)
Flexural Modulus GPa (msi)			
Ambient	138 (20)	131 (19)	124 (18)
589K [600°F]	117 (17)	124 (18)	124 (18)
Short Beam Shear Ult MPa (ksi)			
Ambient	89 (12.9)	94 (13.7)	85 (12.3)
589K [600°F]	39 (5.7)	39 (5.3)	34 (5.0)
Glass Transition (T _g) K (°F)	582K (590°F)	619K (657°F)	572K (572°F)
Resin Content (%)	36.9	36.3	31.6
Specific Gravity (g/cc)	1.54	1.55	1.55
Fiber Volume (%)	55.1	56.2	60.0
Void Volume (%)	1.2	>1	1.7

TABLE XVI

RECEIVING INSPECTION TESTS FOR PMR-15 MATERIALS

Material	Test	Material Document Reference D180-20545-4A
NE	HPLC	5.7.1.1
BTDE	HPLC	5.7.1.2
PMR-15 Resin	HPLC	5.7.2
Graphite/PMR-15 Prepreg	HPLC	5.7.3.1
	Gas Chromatograph	5.7.3.2
	Infrared Spectra	5.7.3.3
	Thermal Gravimetric Analysis	5.7.3.4

TABLE XVII
SUMMARY PROPERTY DATA REPRODUCIBILITY STUDY

Property	Lot		
	2W4515	2W4516	2W4517
Prepreg			
Resin Content (%)	39.4	36.9	38.4
Volatile Content (%)	11.8	11.5	11.6
Gel Time (secs)	65	55	40
Composite			
Flexural Stress Ult MPa (msi)			
Ambient	1350 (196)	1474 (214)	1481 (215)
589K [600°F]	593 (86)	772 (112)	827 (120)
Flexural Modulus Ult GPa (msi)			
Ambient	115 (16.7)	123 (17.8)	119 (17.3)
589K [600°F]	107 (15.6)	117 (17.0)	109 (15.8)
Short Beam Shear MPa (ksi)			
Ambient	92 (13.3)	88 (12.7)	88 (12.7)
589K [600°F]	43 (6.3)	41 (6.0)	43 (6.2)
Glass Transition Temp (T _g) K (°F)	599 (646)	608 (662)	621 (684)
Resin Content (%)	39.3	37.8	36.6
Specific Gravity (g/cc)	1.54	1.54	1.54
Fiber Volume (%)	55	54	56
Void Volume (%)	>1	1.0	>1

TABLE XVIII

SUMMARY PROPERTY DATA REPRODUCIBILITY STUDY TESTED AT COMPANY A

Property	Lot 2W4515	Lot 2W4516	Lot 2W4517
Composite			
Flexural Stress Ult MPa (ksi)			
Ambient	1660 (241)	1674 (243)	1798 (261)
589K [600°F]	696 (101)	723 (105)	806 (117)
Flexural Modulus Ult GPa (msi)			
Ambient	121 (17.6)	128 (18.6)	125 (18.2)
589K [600°F]	105 (15.2)	92 (13.4)	110 (16.0)
Short Beam Shear MPa (ksi)			
Ambient	107 (15.6)	104 (15.1)	109 (15.8)
589K [600°F]	54 (7.8)	38 (5.5)	43 (6.3)
Glass Transition Tg K (°F) <u>1/</u>	599 (646)	608 (662)	621 (684)
Resin Content (%)	38.3	35.4	34.1
Specific Gravity (g/cc)	1.58	1.57	1.57
Fiber Volume (%)	55	58	59
Void Volume (%)	1.0	1.0	>1

1/ Data point obtained at Boeing.

TABLE XIX
 COMPANY A QUALIFICATION DATA REPRODUCIBILITY STUDY

Property	Lot 2W4715	Lot 2W4715	Lot 2W4717
Prepreg			
Resin Content (%)	38.5	34.7	39.1
Volatile Content (%)	10.6	10.0	11.8
Composite			
Flexural Stress (Ult) MPa (ksi)			
Ambient	2032 (295)	2005 (291)	2012 (292)
589K [600°F]	944 (137)	1089 (158)	1143 (166)
Flexural Modulus GPa (msi)			
Ambient	143 (20.7)	141 (20.4)	145 (21.0)
589K [600°F]	132 (19.2)	141 (20.4)	137 (19.9)
Short Beam Shear MPa (ksi)			
Ambient	99 (14.3)	98 (14.3)	103 (14.9)
589K [600°F]	56 (8.2)	51 (7.4)	55 (8.0)
Resin Content (%)	35.2	32.4	33.6
Specific Gravity (g/cc)	1.53	1.59	1.58
Fiber Volume (%)	57	61	61
Void Volume (%)	2.1	>1	>1

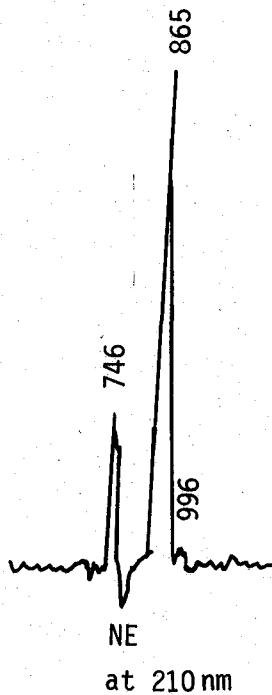
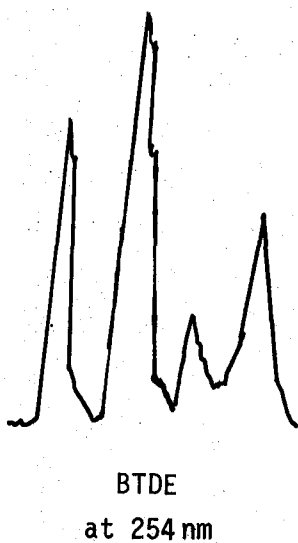
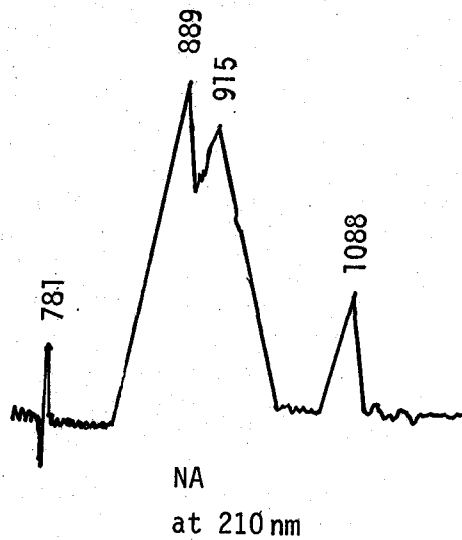
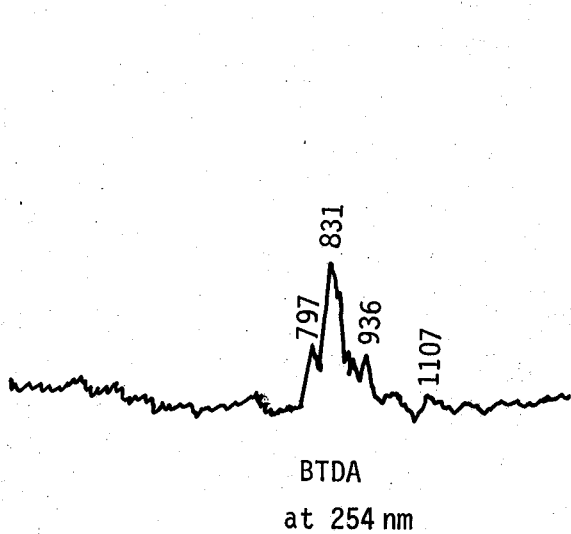
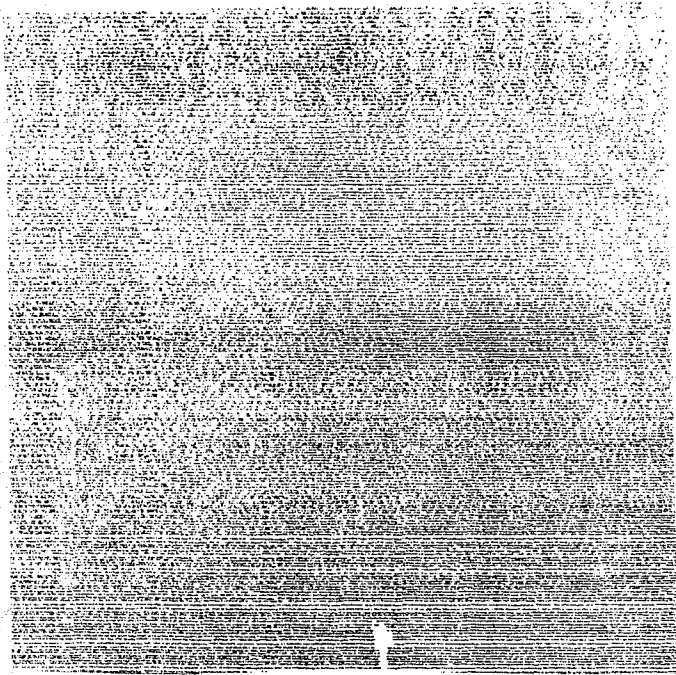
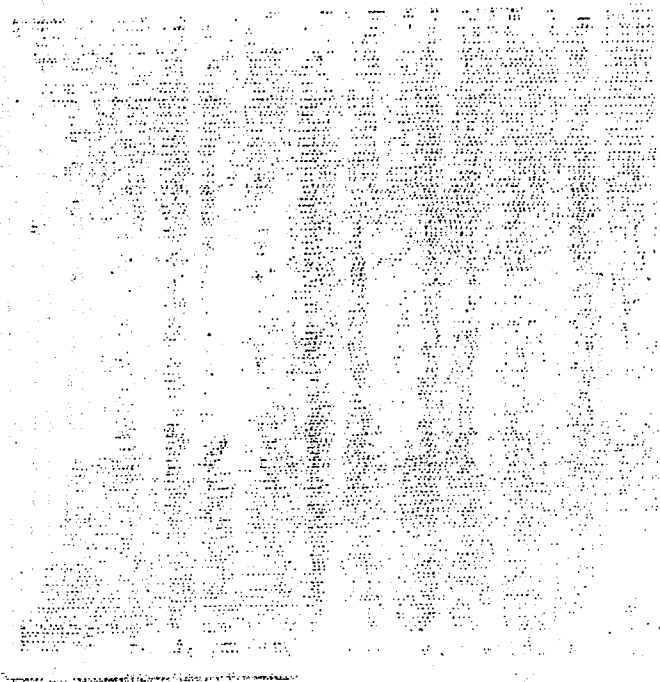

FIGURE 1

HPLC CHROMATOGRAM OF PMR-15 MONOMERS
USED IN PREPREG MACHINE STUDY



Lot 2W4388 Roll 3



Lot 2W4388 Roll 4

FIGURE 2

NDI SCAN OF COMPANY A AND UNMODIFIED PMR/15 STOICHIOMETRY

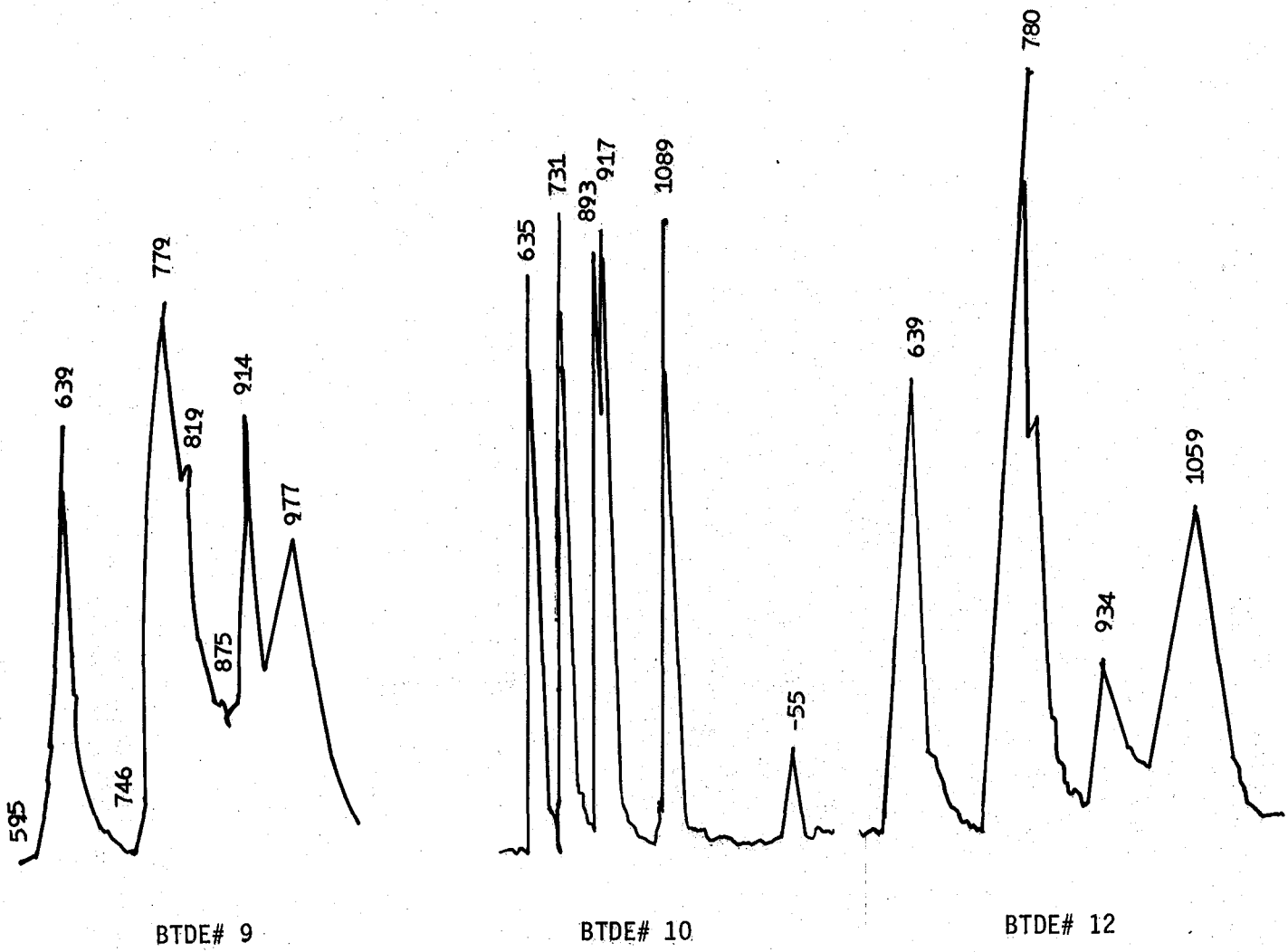

FIGURE 3
 HPLC CHROMATOGRAMS FROM MANUFACTURING STUDY
 AT 254 nm

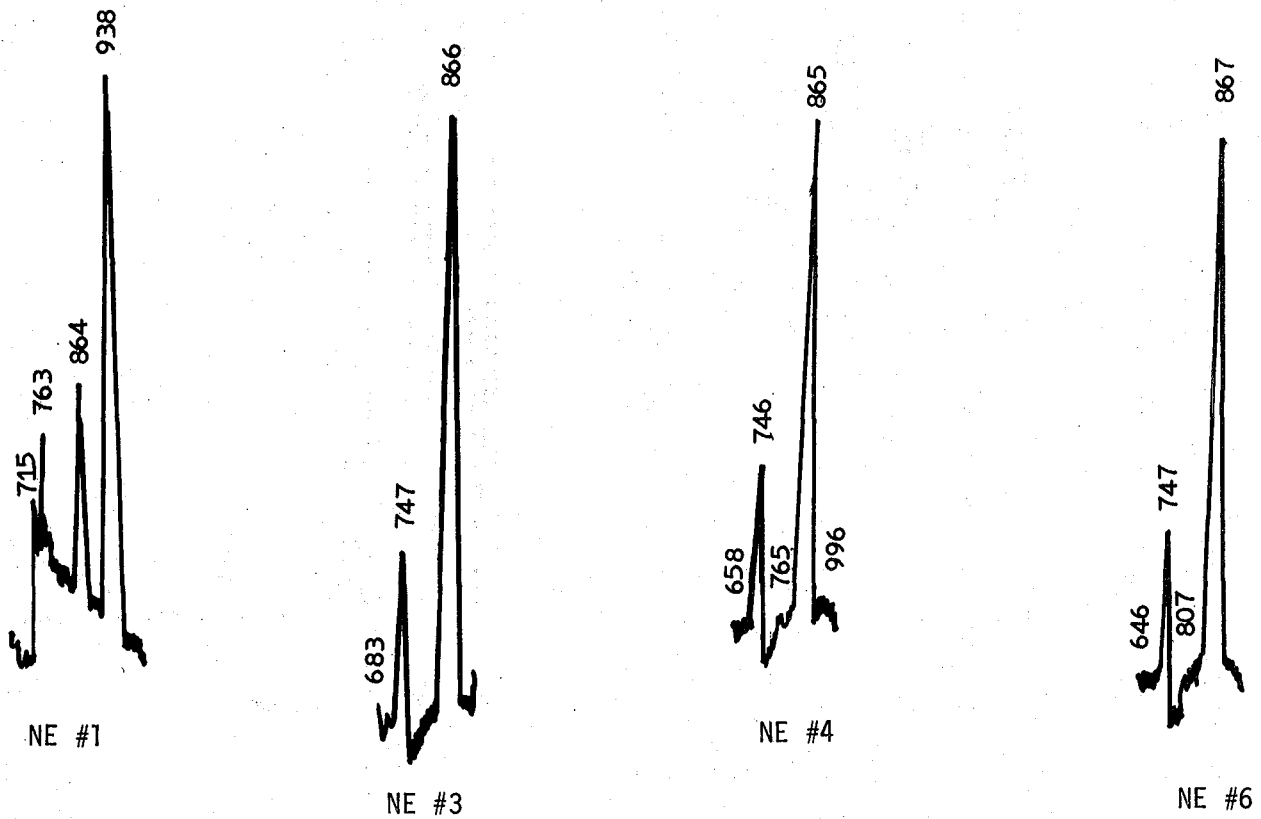

FIGURE 4

HPLC CHROMATOGRAMS SAMPLES FROM MANUFACTURING STUDY AT 254 nm

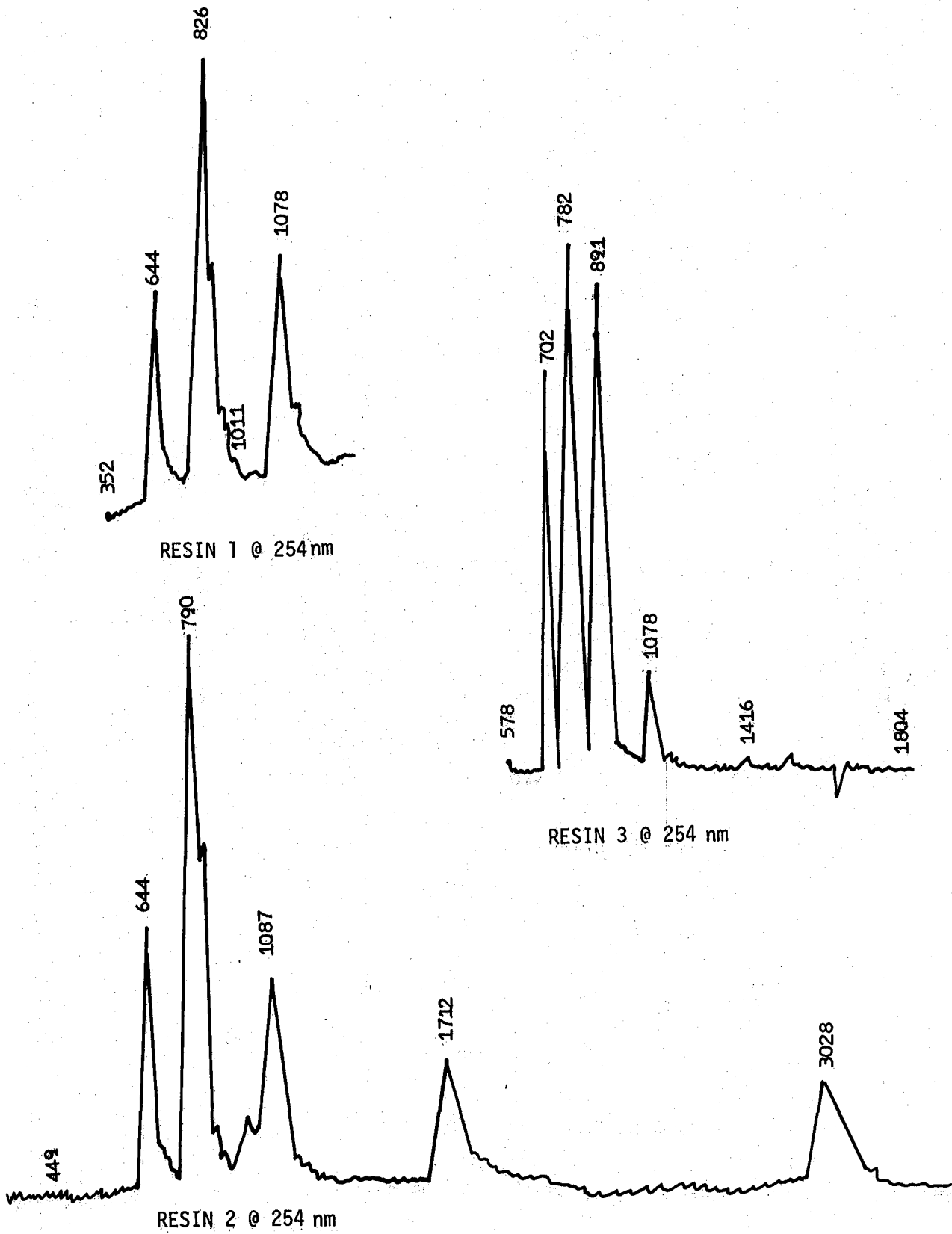

FIGURE 5
HPLC CHROMATOGRAMS OF PMR-15 RESINS FROM MANUFACTURING STUDY

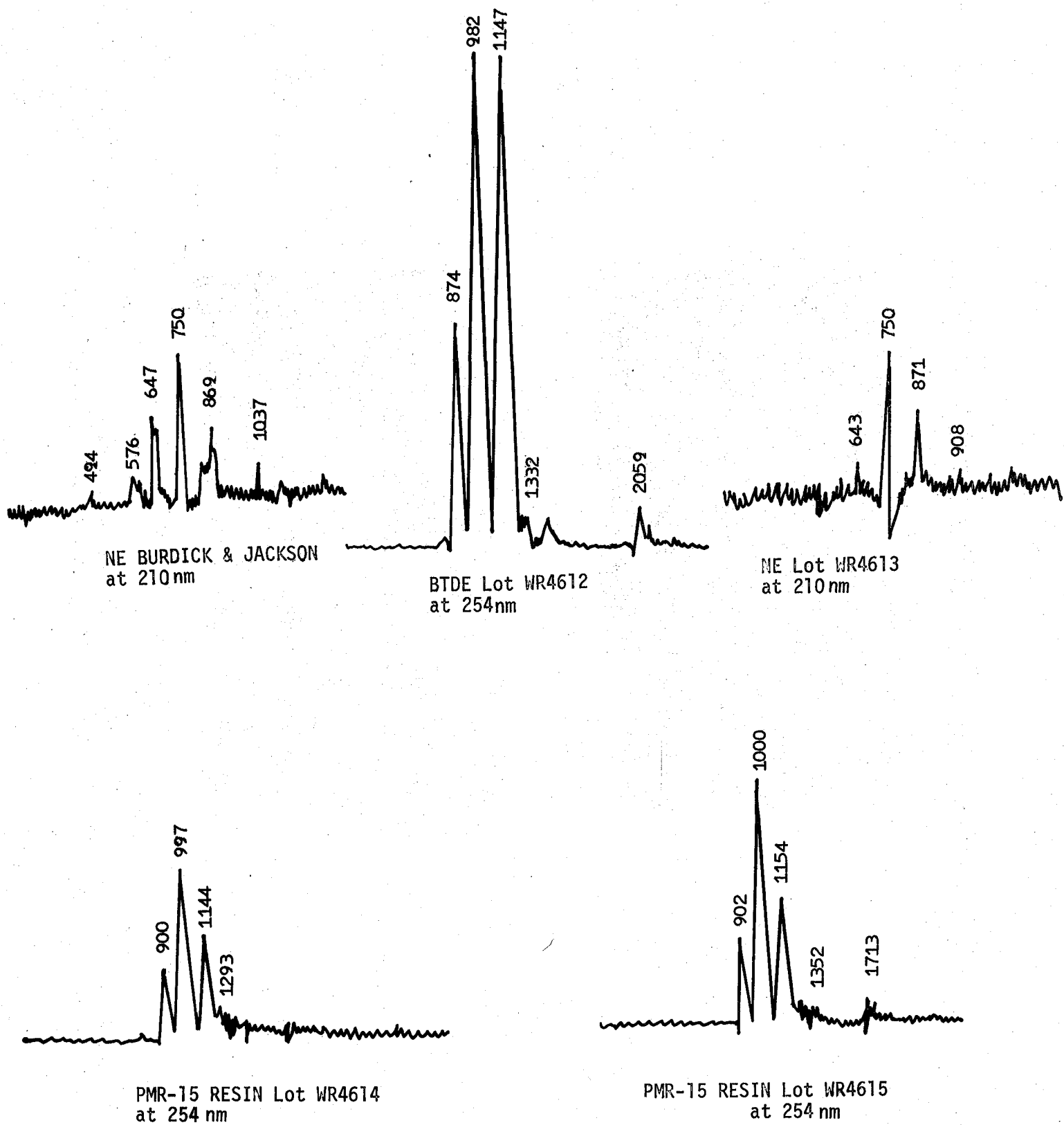

FIGURE 6

HPLC CHROMATOGRAMS OF NE STUDY

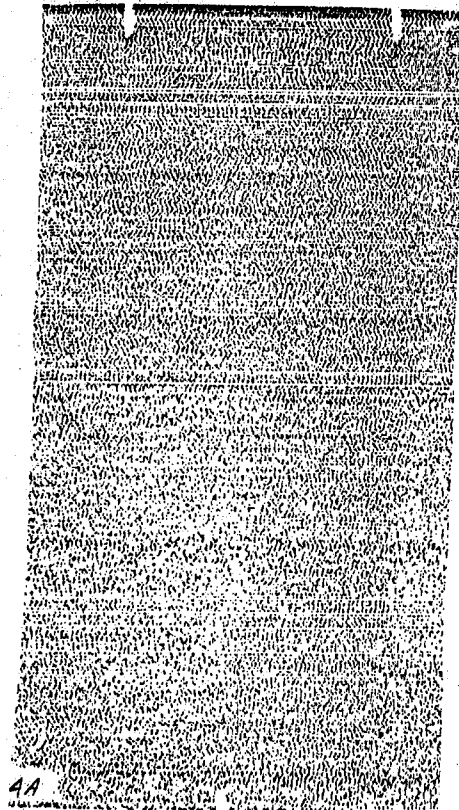
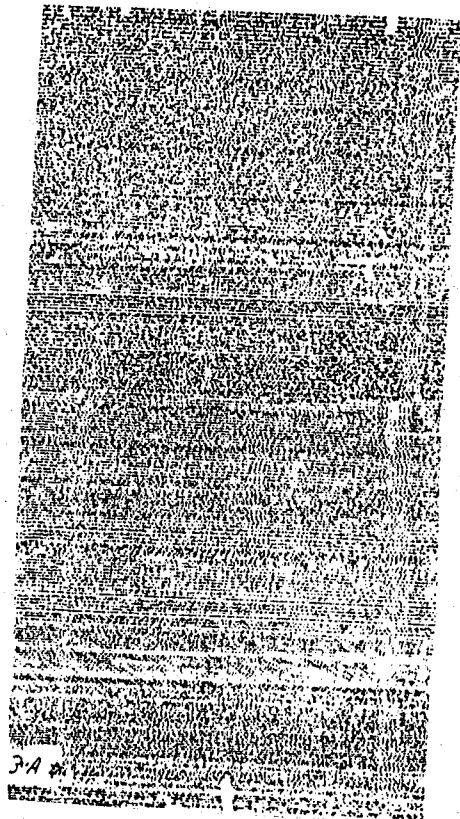
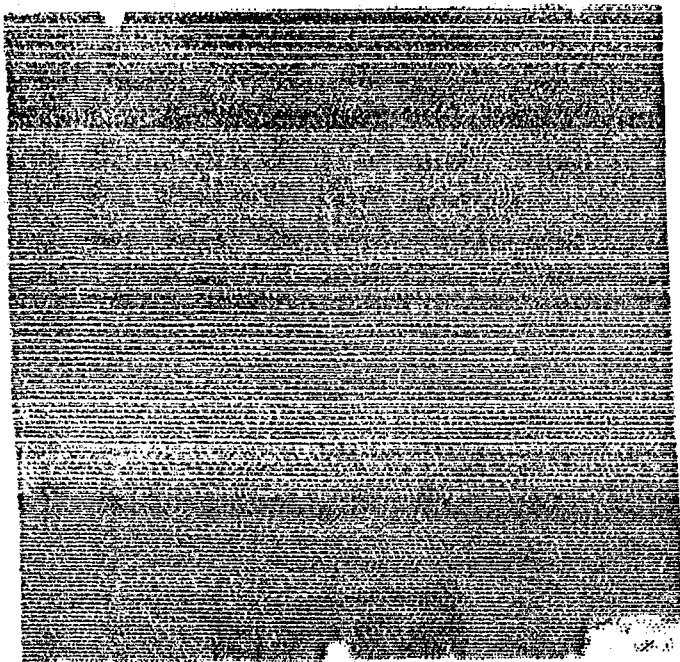
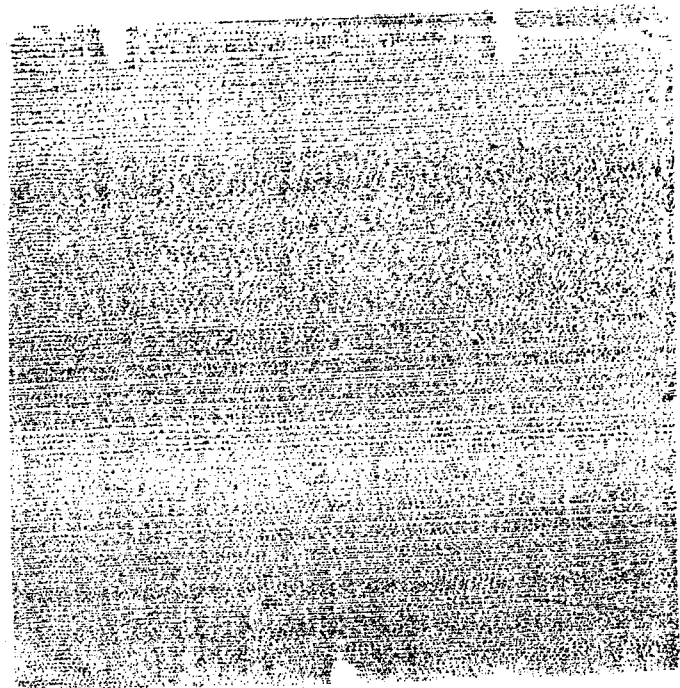

FIGURE 7
NDI SCANS NE STUDY



2W4487



2W4489

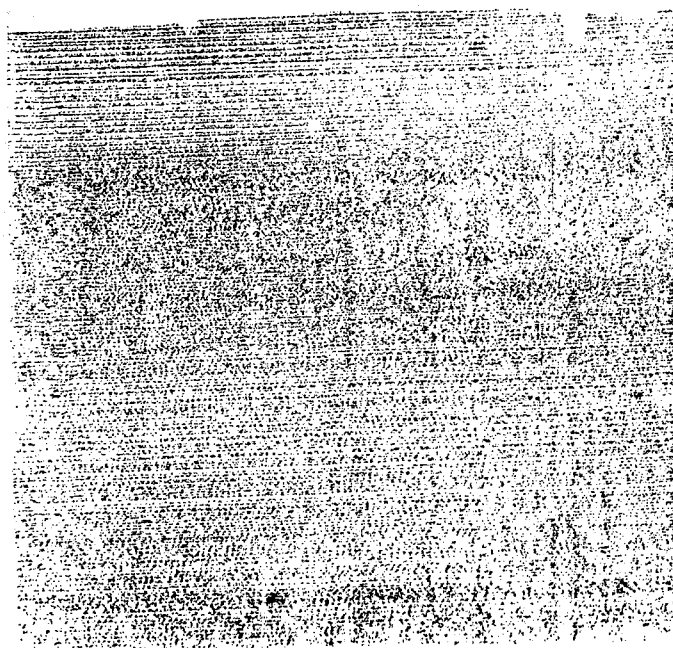

2W4490

FIGURE 8

NDI SCAN OF BTDE STUDY

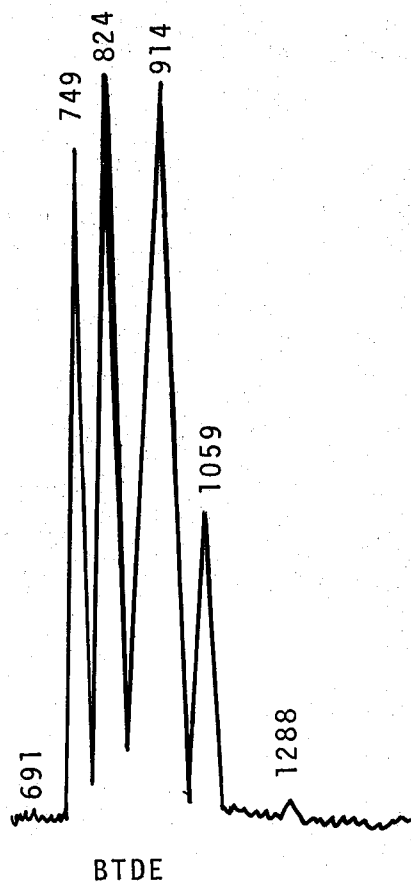
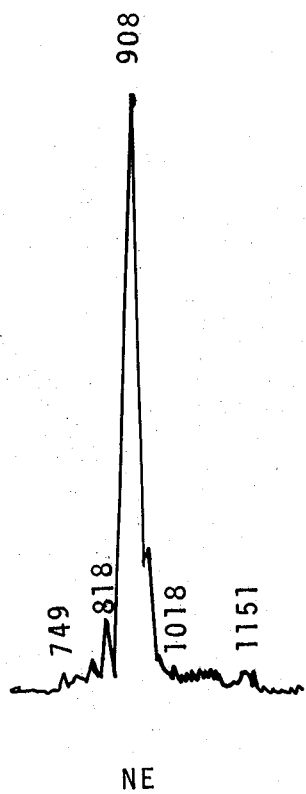

FIGURE 9

COMPANY B PMR-15 MONOMERS

ROOM TEMPERATURE AGED 45 DAYS REFRIGERATOR AGED 254K (0°F) 45 DAYS

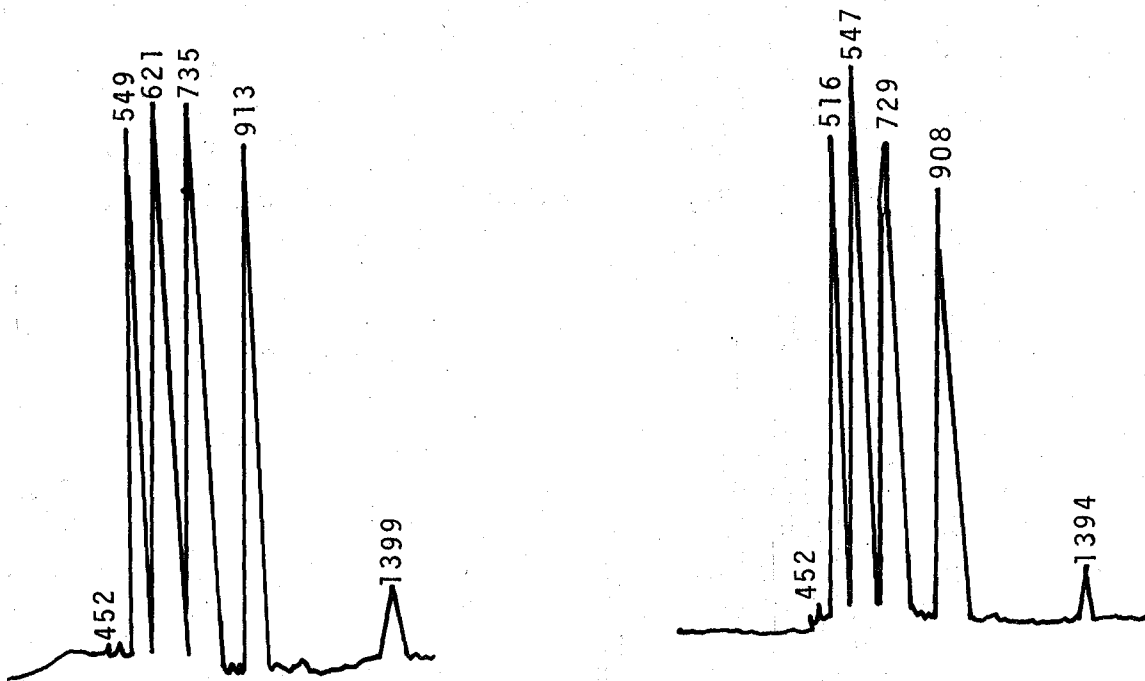

FIGURE 10

HPLC CHROMATOGRAM OF AGING STUDY BTDE

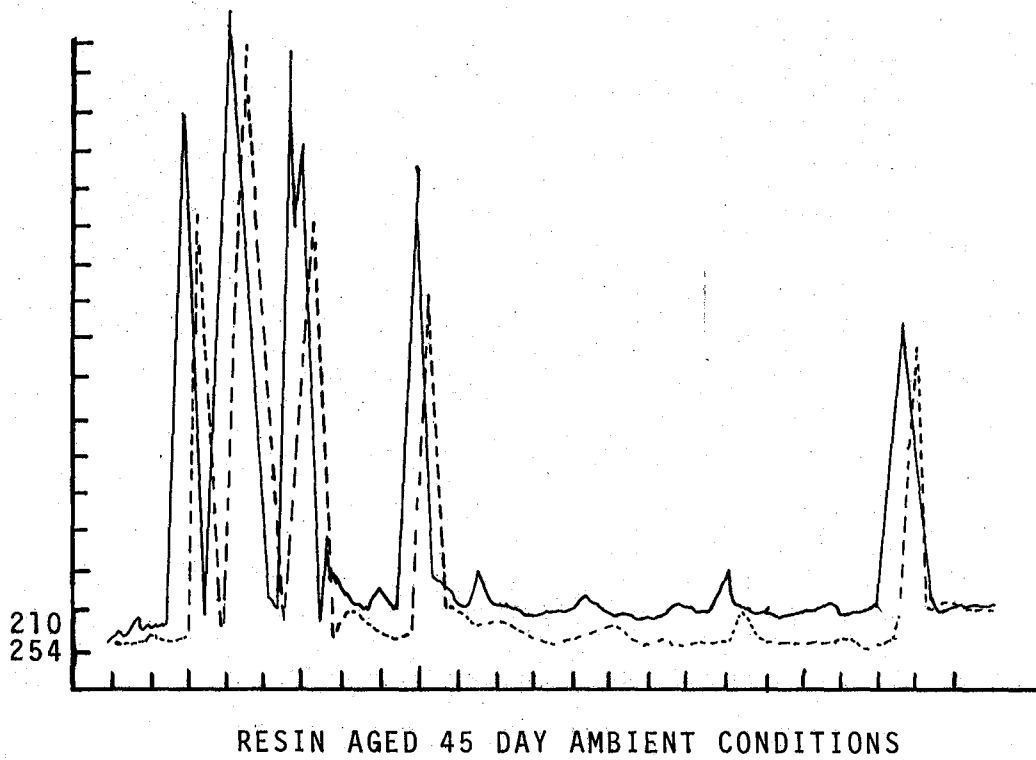
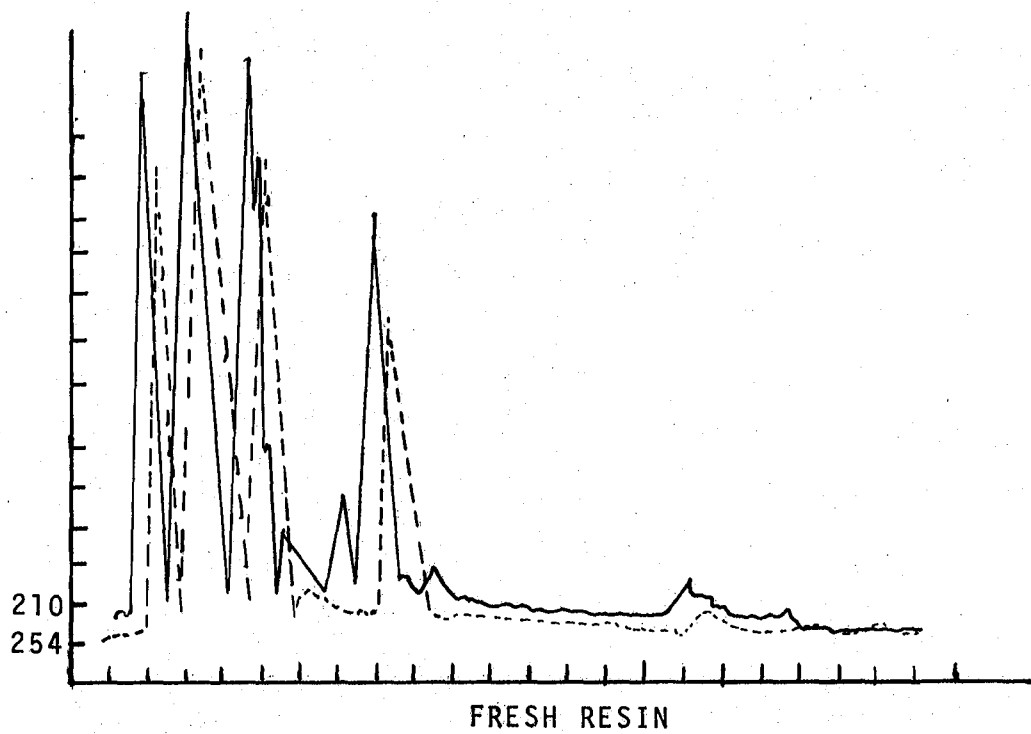

FIGURE 11
HPLC CHROMATOGRAMS OF RESIN AGING STUDY

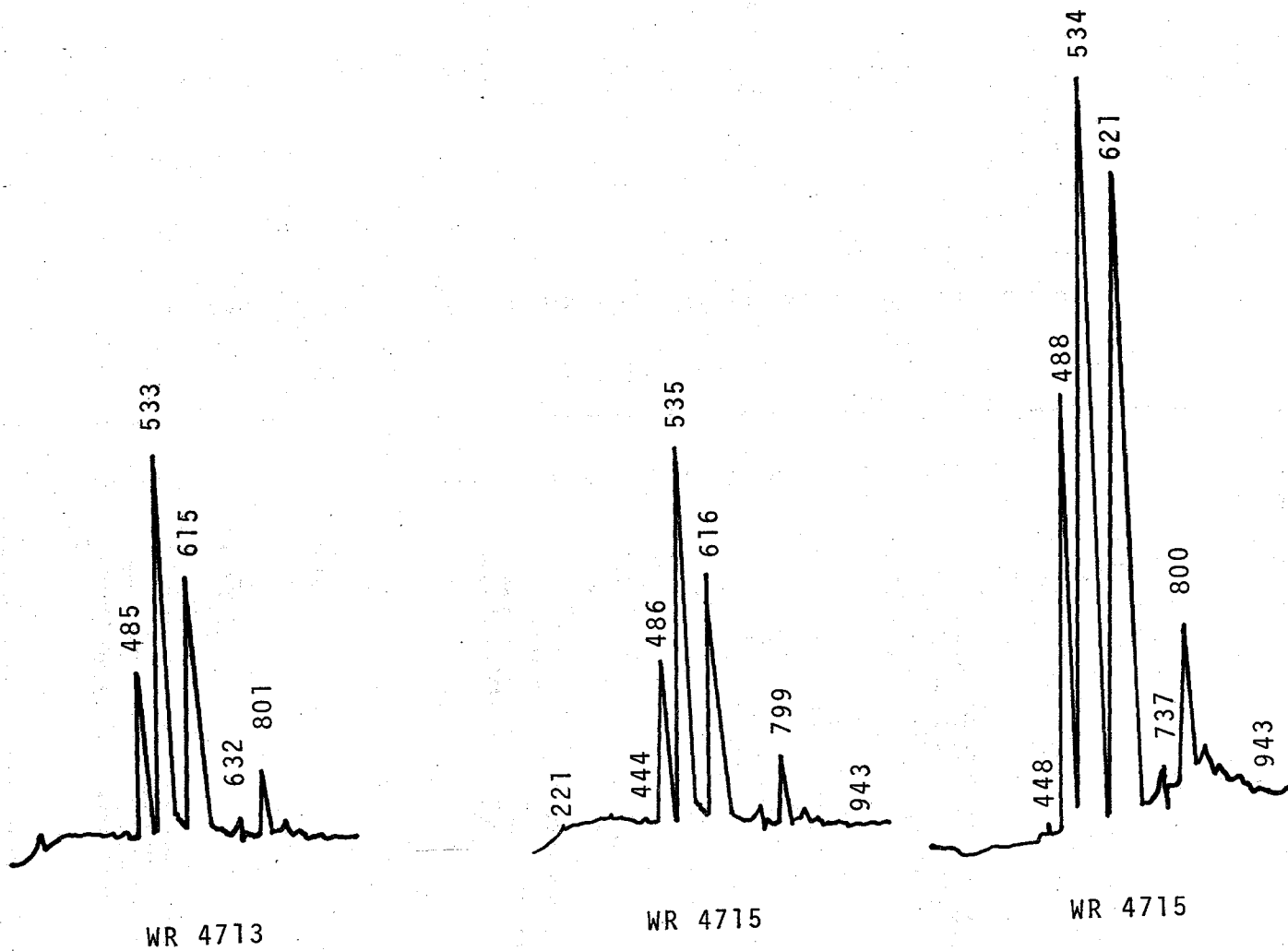

FIGURE 13

HPLC CHROMATOGRAM BTDE MONOMER FROM REPRODUCIBILITY STUDY

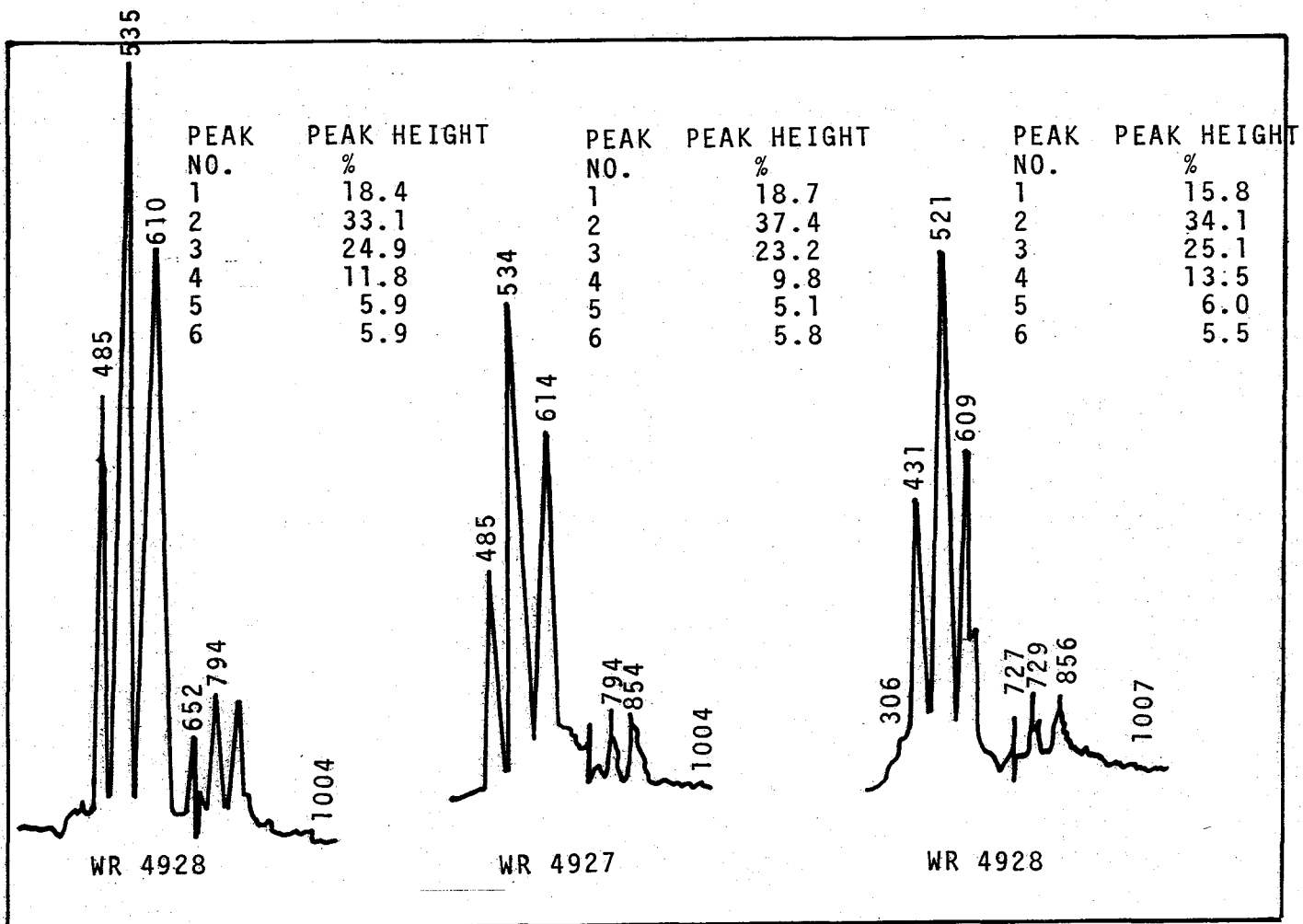

FIGURE 14

HPLC CHROMATOGRAM OF PMR-15 RESIN FROM REPRODUCIBILITY STUDY

AREA %	RT	AREA
10.53	544	2686
31.03	613	7915
20.83	727	5314
10.12	753	3346
10.25	783	2618
0.39	800	1911
0.936	975	1004
2.828	1109	719
99.98		25513

AREA %	RT	AREA
10.13	545	3799
29.87	613	11199
18.04	730	6764
13.3	754	4987
10.8	782	4051
9.341	901	3503
5.586	974	2095
.613	1085	230
2.339	1107	877
99.99		37505

AREA%	RT	AREA
.039	293	13
10.05	544	3317
27.49	611	9077
18.02	728	5971
15.42	754	5092
13.72	702	4531
9.122	899	3012
4.367	972	1442
.342	1082	113
1.369	1108	452
99.97		33020

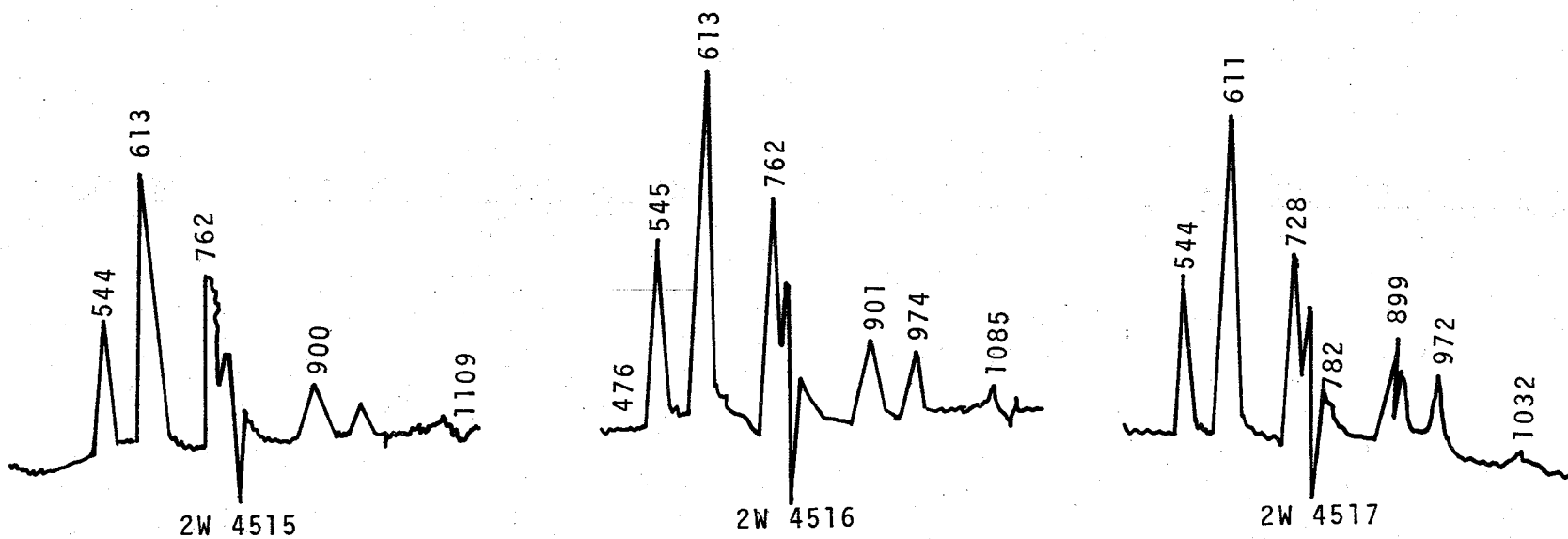

FIGURE 15

HPLC CHROMATOGRAM GRAPHITE PREPREG FROM REPRODUCIBILITY STUDY

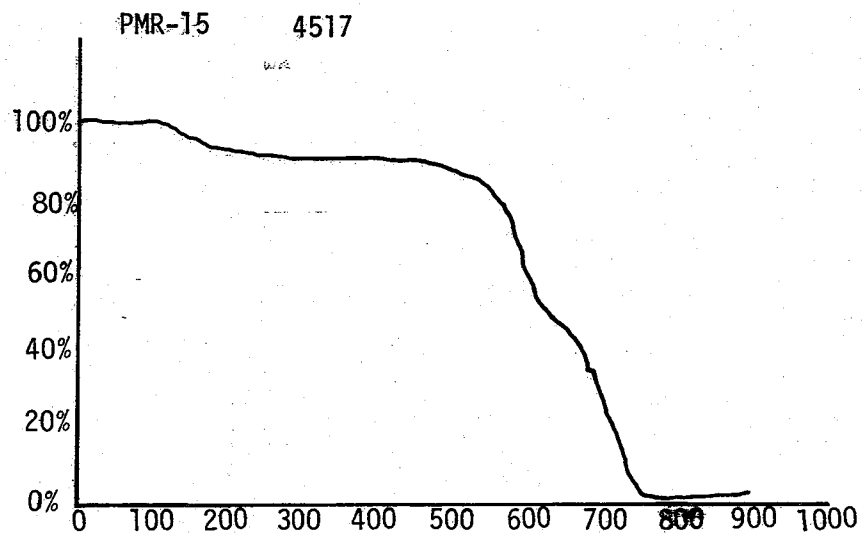
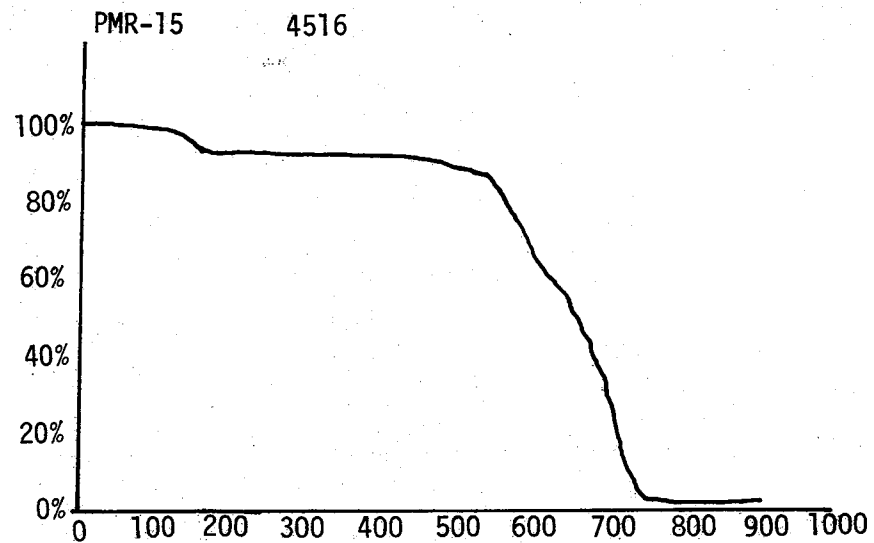
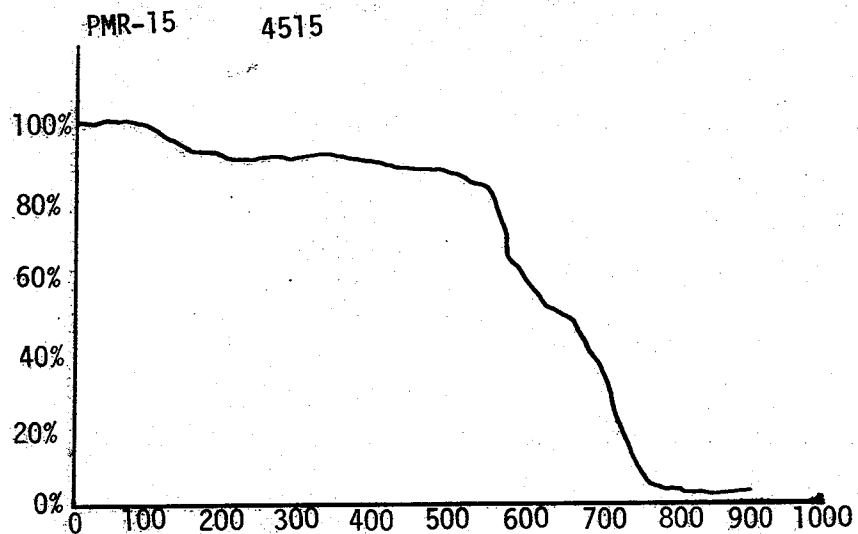

FIGURE 16

TGA DATA GRAPHITE PREPREG

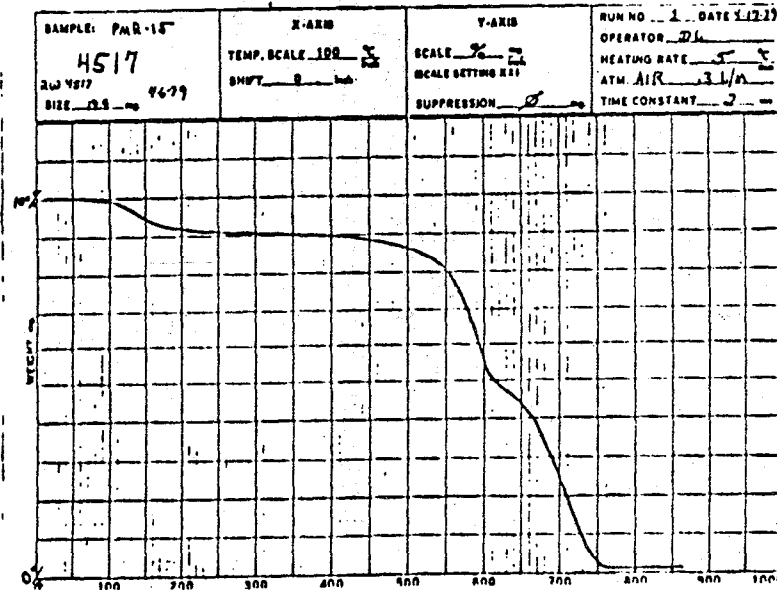
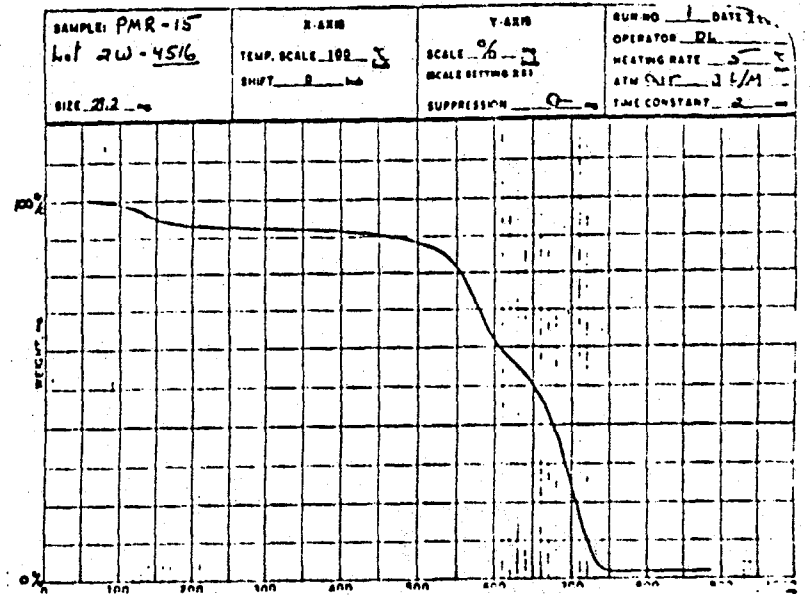
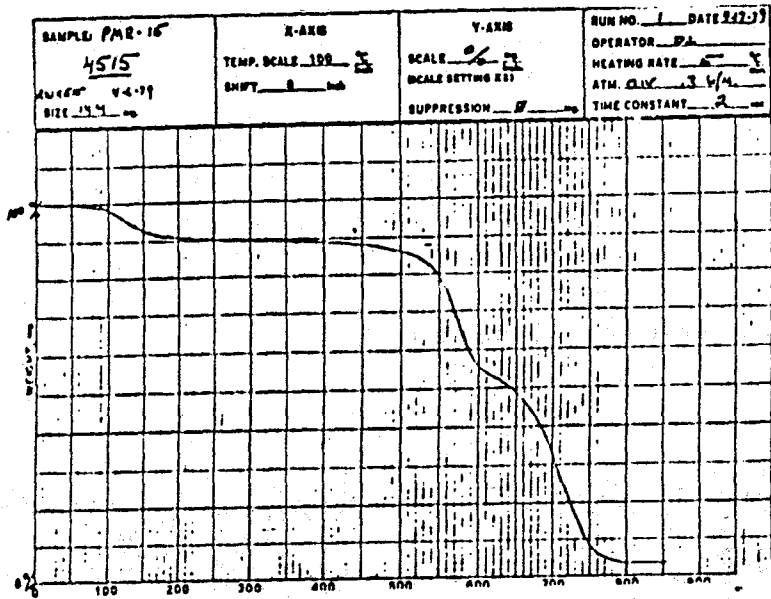
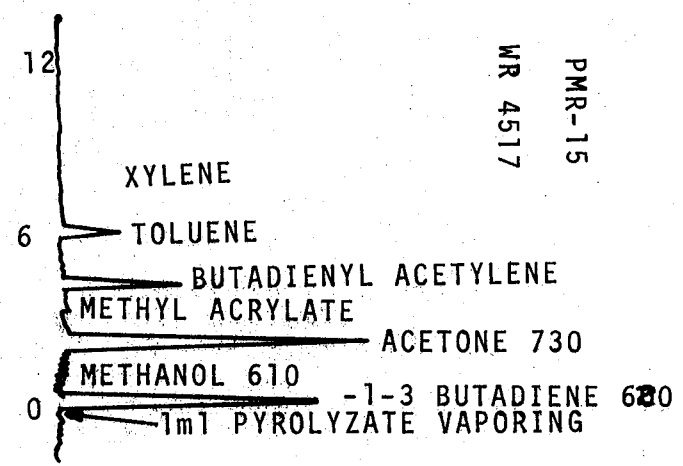
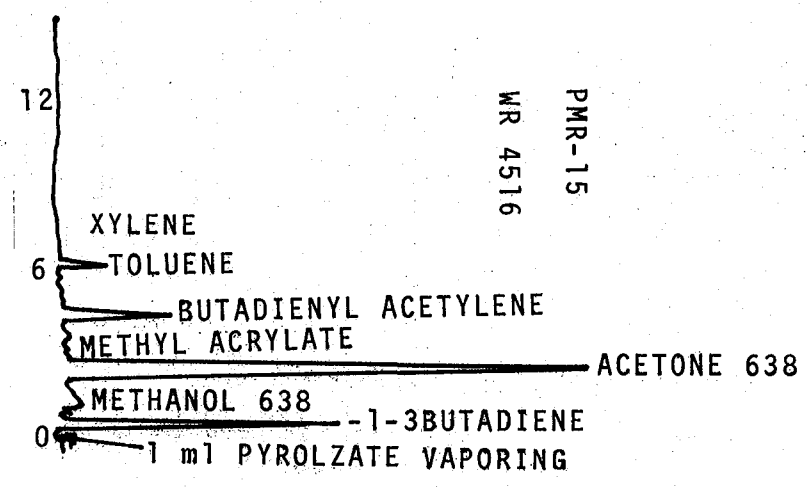
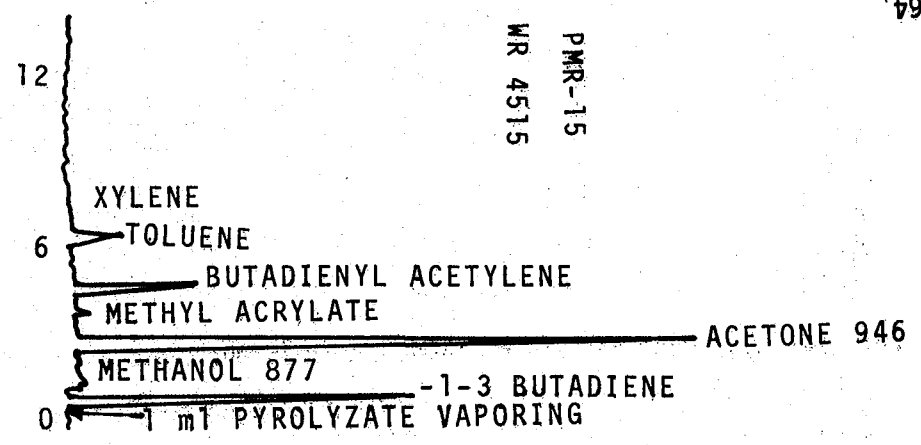

FIGURE 16

TGA DATA GRAPHITE PREPREG



GAS CHROMATOGRAM/MASS SPECTRA DATA GRAPHITE PREPREG

FIGURE 17

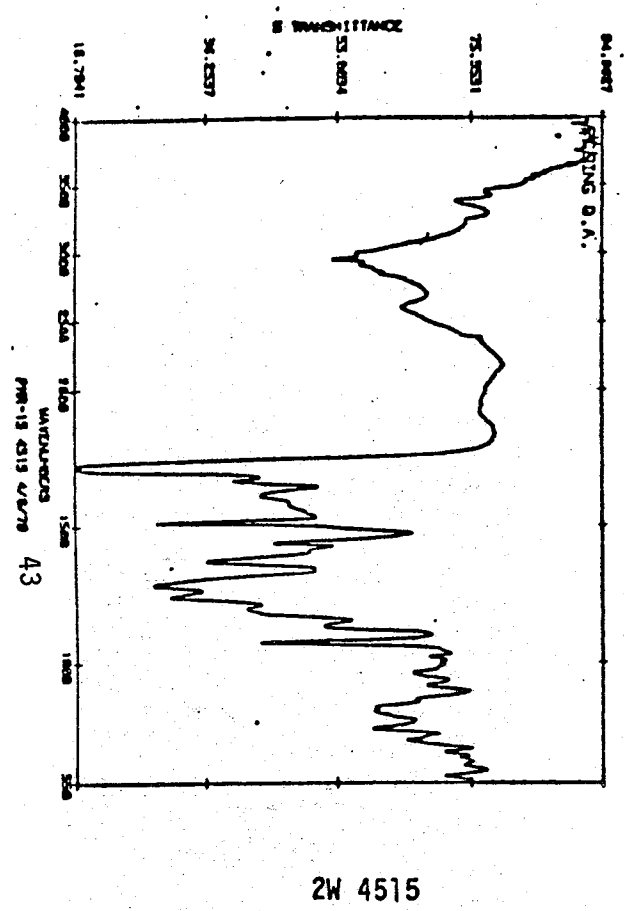
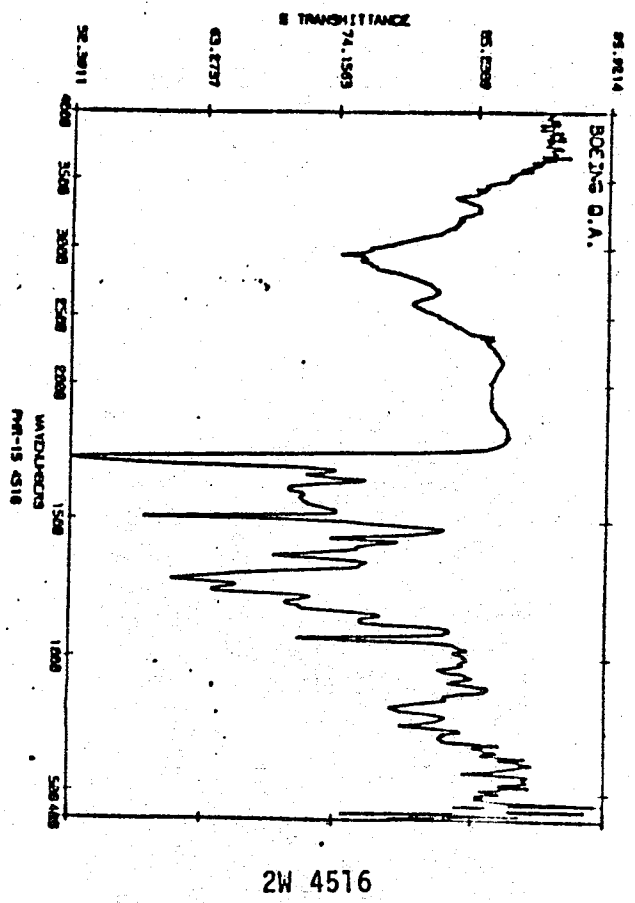
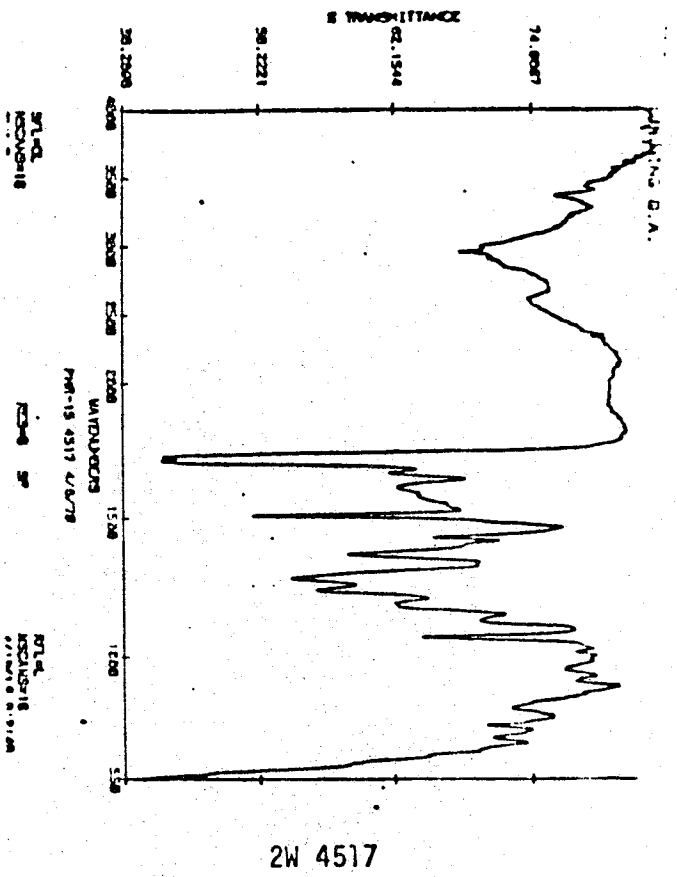

FIGURE 18
INFRARED SPECTRA GRAPHITE PREPREG



PANEL 2W 4515

X - AIR BUBBLE ON
SURFACE OF COMPOSITE



PANEL 2W 4516

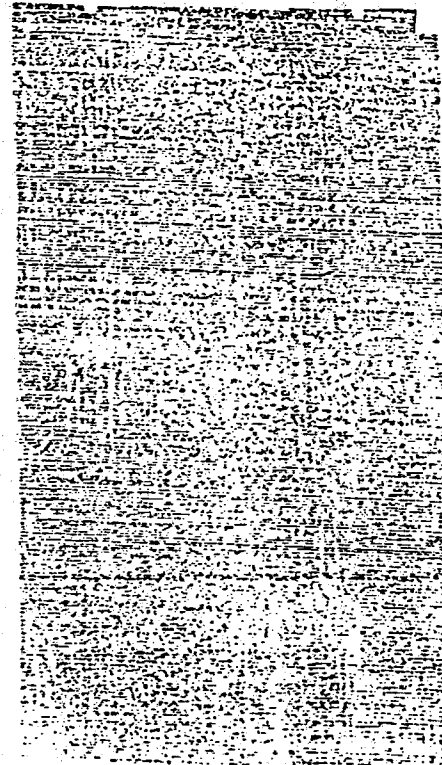

PANEL 2W 4517

FIGURE 19

NDI TEST RESULTS GRAPHITE COMPOSITES

BEFORE TASK J VARIABILITY PROGRAM

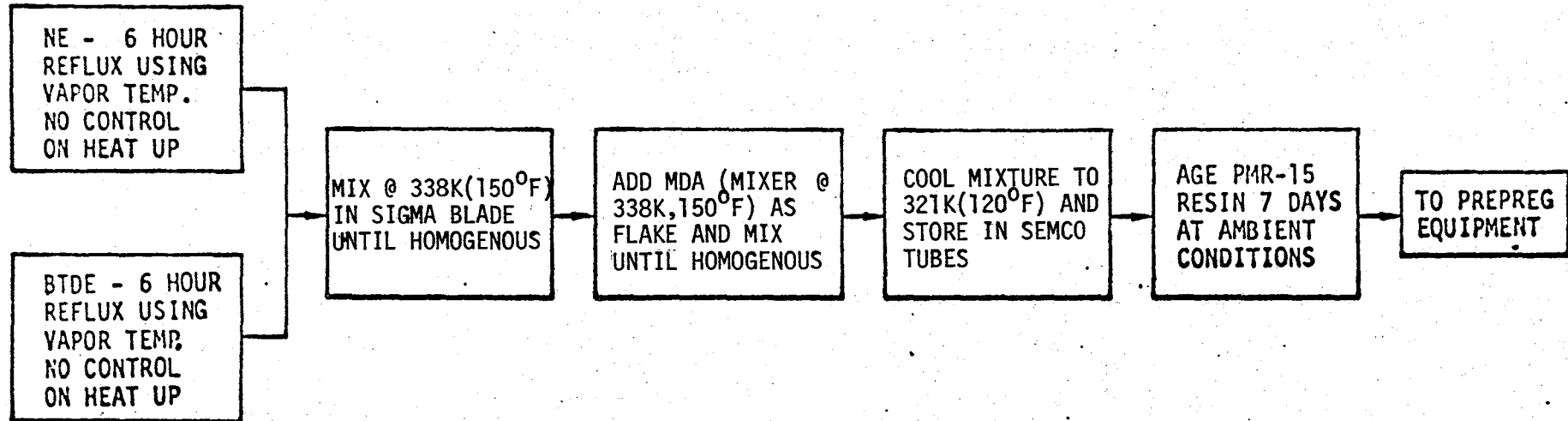

AFTER TASK J VARIABILITY PROGRAM

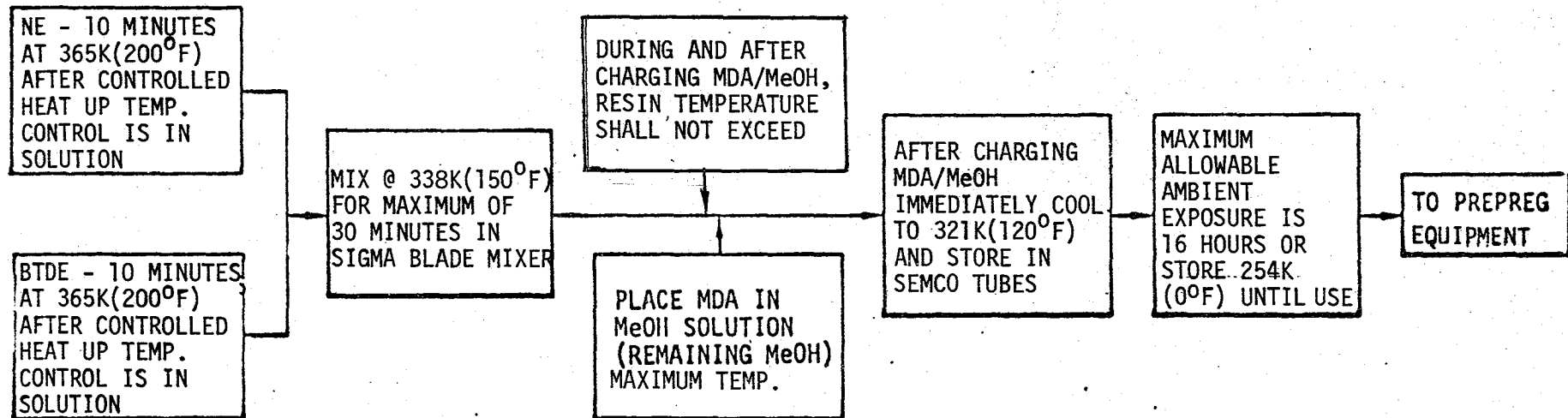

FIGURE 20

COMPARISON MANUFACTURING OF PMR-15 RESIN
BEFORE AND AFTER TASK J VARIABILITY PROGRAM

APPENDIX A

TEST PROCEDURES FOR CHEMICAL CHARACTERIZATION OF
MATERIALS USED IN TASK J VARIABILITY PROGRAM

Analytical Method for Infrared (IR) Analysis

1. Preparation of samples for IR

Those materials that were crystalline solids such as nadic anhydride were ground with KBr until completely dispersed in the salt. The mixture was compressed into a pellet.

The samples that were received as liquids or slurries of liquids were filtered and the filtrate was allowed to evaporate slowly on a NaCl window. It was then placed in a vacuum dessicator which was evacuated for about 15 minutes to remove the last trace of solvent.

Samples received as a resin mix or that were received on tape were solubilized with acetone at room temperature, placed on a NaCl window to form a film, and then evacuated in vacuo for about 15 minutes before obtaining a spectrum.

Spectra of all samples were obtained using a Nicolet Series 7000 Fourier Transform Infrared Spectrometer System. The transmittance of the samples was adjusted to the range 50-97% for all spectra used to the determination of ratios of functional groups.

The identification of a material can generally be accomplished by inspection and identification of principal functional groups. However, when one is seeking to identify small changes in the same type of material a method must be found to compare the absorptance (or transmission) of those groups on a numerical basis. This cannot be done by arbitrarily drawing a baseline and measuring the height of the peak because the thickness of an organic film cannot be controlled to reproducible thicknesses.

A partial solution to the problem, short of making solutions of accurately controlled concentrations with non-interfering solvents, is to select a functional group in a reactant, product, or mixed resin that will not change under the preparation conditions. Then a ratio can be set up using the height of that peak as the denominator of a fraction with the height of a questionable peak as the numerator. The procedure allowed the use of a number to express changes in functional groups due to either impurities or reactions on a comparative basis between similar materials.

Receiving Inspection Control of PMR-15 Gas Chromatography/
Mass Spectrometry

1.0 Scope

This specification describes the procedures and requirements for receiving inspection control of PMR-15 by gas chromatography/mass spectrometry.

2.0 Classification

None

3.0 References

Except where a specific issue is indicated, the current issue of the following references shall be a part of this standard to the extent indicated herein.

4.0 Facilities

4.1 A gas chromatograph interfaced with a mass spectrometer that has capability of continuously scanning over a preset mass range within preset time intervals. The gas chromatograph must be programmable within the specification limits. A DuPont 21-490 computerized GC/MS or equivalent is acceptable.

4.2 A pyrolyzer with capability of pyrolyzing material in a vacuum under controlled temperature. A Barnes pyrolyzer or equivalent is acceptable.

5.0 Procedure

Pyrolyze a small sample under vacuum by increasing the temperature of the pyrolyzer from room temperature to 1272K (1832°F) within 15 seconds. Continue heating until vacuum is broken. Immediately withdraw one milliliter of pyrolyzate into a syringe and inject into the gc/ms under the following conditions:

- | | |
|-------------------------------|----------------------------------|
| a. Sample size | 1 ml |
| b. Column | 6' x 1/8" W98 @ 10% |
| c. Column temperature | Room temperature to 448K (347°F) |
| d. Injection port temperature | 498K (437°F) |
| e. Detector | Flame Ionization Detector |
| f. Detector temperature | 523K (482°F) |
| g. Range | 10-11 |
| h. Attenuation | X256 |
| i. Chart speed | 6.4 mm (0.25 in) /min. |
| j. Source temperature | 473K (392°F) |
| k. Mass scan | 500 to 14 |
| l. Scan rate | 2 secs per decade |
| m. Acquisition rate | 2 |
| n. Threshold | 1 |

NOTE: Make sure baseline is stabilized before injecting sample. Also continue the scan until all of the sample has cleared the column and the baseline has once again stabilized.

Identify all components eluted.

6.0 Requirements

Components present should be xylene, toluene, butadienyl acetylene, 1-3 cyclopentadiene, methanol, and 1-3 butadiene. Trace amounts of other materials are allowed as long as there are no other alcohols present.

Receiving Inspection Control of PMR-15 by Infrared Analysis

1.0 Scope

This specification describes the procedures and requirements for receiving inspection control of PMR-15 by infrared analysis.

2.0 Classification

None

3.0 References

Except where a specific issue is indicated, the current issue of the following references shall be a part of this standard to the extent indicated herein.

3.1 ASTM E275-67, Describing and Measuring Performance of Spectrophotometers

4.0 Facilities

The instrument shall be capable of performing per Reference 3.1. A Digilab Fourier Transform Spectrometer (FTS-15) or instrument capable of producing equivalent spectra is acceptable.

5.0 Procedure

Extract a fresh 1 x 1 inch sample of prepreg with acetone at room temperature. Make sure all of the resin is extracted by manipulating the fibers with a probe. Place a portion of the resin/solvent solution on a salt block. Allow the acetone to evaporate and obtain an infrared scan. The resin film should be of such a thickness to give a transmittance of 10 to 20% at 1730 cm^{-1} .

6.0 Requirements

The spectrum shall match the standard spectrum. In addition, there shall be no evidence of imidization taking place as noted by the presence of the band at 1770 cm^{-1} and/or 1380 cm^{-1} .

Receiving Inspection Control of PMR-15 by Thermal Gravimetric Analysis

1.0 Scope

This specification describes the procedures and requirements for receiving inspection control of PMR-15 by thermal gravimetric analysis.

2.0 Classification

None

3.0 Facilities

The instrument shall be capable of measuring quantitatively the weight loss occurring in a material as a function of time or temperature. A DuPont 951 or equivalent is acceptable.

4.0 Procedure

Place a small fresh sample of prepreg in the thermal gravimetric analyzer chamber. The sample should not be rolled up but should be kept open on all sides as much as possible. Make the analysis using the following parameters:

- | | |
|----------------------|------------------------------------|
| a. Sample size | 25 ± 5 mg |
| b. Heating rate | 5K (90°F/min) |
| c. Temperature range | Room temperature to 1073K (1472°F) |
| d. Atmosphere | Air |
| e. Flow rate | 0.3 L/Minute |
| f. Y-axis scale | 100% |
| g. X-axis scale | 100K (180°F)/division |

5.0 Requirements

The thermogram shall have the following percent residues remaining at the indicated temperatures.

- a. 363 (194°F) 99%
- b. 473K (392°F) $94 \pm 2\%$
- c. 673K (752°F) $92 \pm 2\%$
- d. 923K (1202°F) 1%

Calibration of Adsorption Columns for Liquid Chromatography

1.0 SCOPE

This method describes a procedure for the calibration of adsorption columns for use in liquid chromatography.

2.0 CLASSIFICATION

2.1 Type I DuPont SE 60 non-silanized columns.

3.0 REFERENCES

Except where a specific issue is indicated, the current issue of the following reference shall be a part of this method to the extent indicated herein.

4.0 FACILITIES

A liquid chromatograph instrument, such as the DuPont Model 850 or equivalent.

5.0 REQUIREMENTS

5.1 Sample conditions

- a. Mobile Phase: Methylene Chloride 98.5%
Methanol 1.0%
Water 0.5%
NOTE: %'s are all by volume using reagent grade methylene chloride, UV grade methanol, and ultrapure water.
- b. Columns: See Sec 2.0 (Calibrate one column at a time)
- c. Column temperature: Ambient
- d. Sample: 1/ Benzanilide
2/ 4-Bromacetanilide
Toluene
- e. Flow: 1.0 mls/min

- f. Detector UV at 254 nm (atten x64)
- g. Injection: 2 μ l
- h. Chart speed: 2 in/min

5.2 Sample Preparation

Make up three solutions of the following:

- a. 0.020g benzanilide in 5 mls mobile phase
- b. 0.020g 4-bromoacetanilide in 5 mls mobile phase
- c. one part toluene in 10 parts mobile phase

Blend 1.0 parts Benzanilide solution with 1.3 parts 4-Bromoacetanilide solution with 0.9 parts toluene solution.

Inject 2 μ l into column.

5.3 Procedure

This evaluation is made by determination of:

- N = Theoretical plate number
- α = Column selectivity
- k' = Capacity factor
- R_s = Resolution

The determination is made from the chromatogram

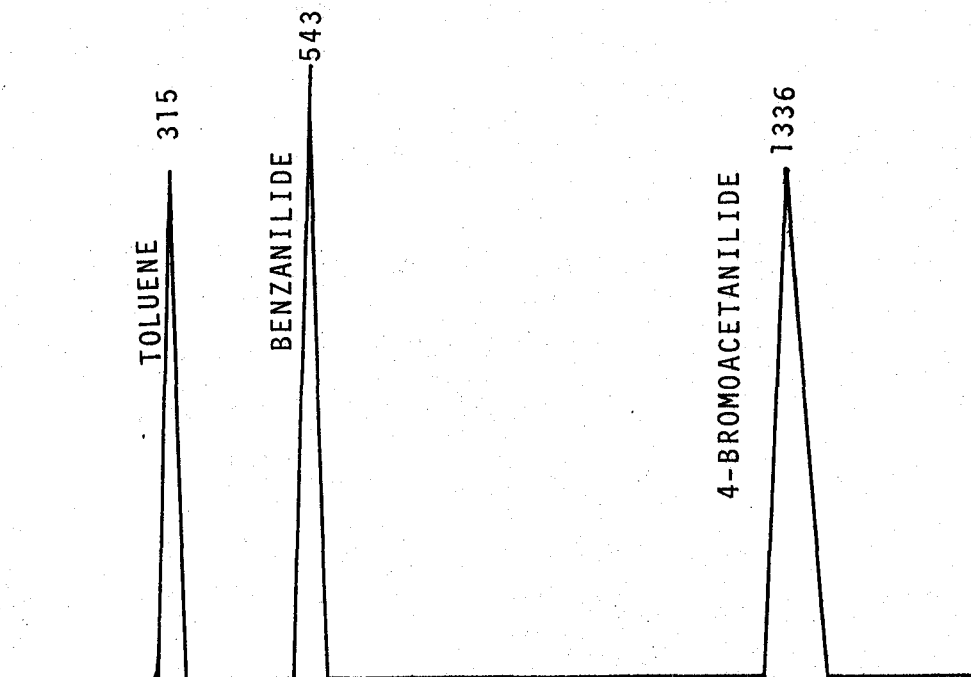

Calculate N as follows for toluene

$$N = 16 \frac{(V_0)^2}{t_w}$$

where V_0 = elution volume in seconds

t_w = baseline of extrapolated triangle in seconds

Calculate k' for both benzanilide and 4-bromoacetanilide

$$k' = \frac{t_r - t_0}{t_0}$$

where t_r = elution volume in seconds for each compound respectively

t_0 = elution volume in seconds for toluene

Calculate α

$$\alpha = \frac{k'_2}{k'_1}$$

where k'_1 = k' for benzanilide

k'_2 = k' for 4-bromoacetanilide

Calculate R_s

$$R_s = 1/4 \frac{(\alpha-1)}{\alpha} \sqrt{N} \frac{k'_2}{k'_2 + 1}$$

6.0 REPORTING

Record N, k'_1 , k'_2 , α , and R_s , column identity and conditions.

-
- 1/ N-benzoylaniline $C_6H_5CONHC_6H_5$ mp 435-437K (324-327°F) from Tridon Chemical Inc., 255 Oser Ave, Hauppauge, NY, 11787.
 - 2/ N-Acetyl-4-bromoaniline $CH_3CONHC_6H_4$ Br mp 439-442K (331-336°F) from Tridon Chemical Inc.

Liquid Chromatography Method of Analysis for the Esters of PMR-15

1.0 SCOPE

This method describes a procedure for analyzing the esters of PMR-15 by Liquid Chromatography.

2.0 CLASSIFICATION

Ty I Monomethyl ester of 5-norbornene-2, 3-dicarboxylic acid hereafter referred to as NE

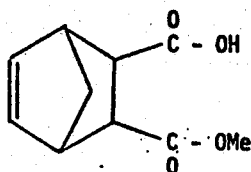

Ty II Dimethyl ester of 3,3', 4,4'-benzophenone-tetracarboxylic acid hereafter referred to as BTDE

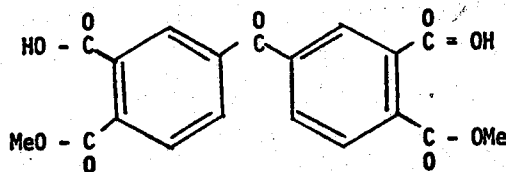

3.0 REFERENCE

Except where a specific issue is indicated, the current issue of the following references shall be a part of this method to the extent indicated herein.

3.1 See procedure for "Calibration of Adsorption columns for Liquid Chromatography".

4.0 FACILITIES

A liquid chromatograph instrument such as the DuPont Model 850 or equivalent.

5.0 REQUIREMENTS

5.1 Sample conditions

- a. Mobile phase: 2:1 Water: Tetrahydrofuran +0.1%
Acetic Acid
Note: Ultrapure water and UV grade THF.
- b. Columns: 2 at PSM 60
- c. Column Temp: Ambient
- d. Sample: Ty I 0.1g/5 mls THF
Ty II 0.1g/5 mls THF
- e. Flow: 1.00 ml/min
- f. Detector: UV at 210 nm x 8
- g. Injection: 3 μ l
- h. Chart speed: 50.8 mm (2 in)/min

5.2 Procedure

Inject the sample into the columns. The individual columns must be calibrated per reference 3.1. The following column requirements must be met:

$$k'_1 = 0.70 \pm 0.03$$

$$k'_2 = 3.25 \pm 0.20$$

$$\alpha = 4.67 \pm 0.49$$

$$N = 6000 \text{ minimum}$$

$$R_S = 12 \text{ minimum}$$

5.3 Results

Typical chromatograms are as illustrated.

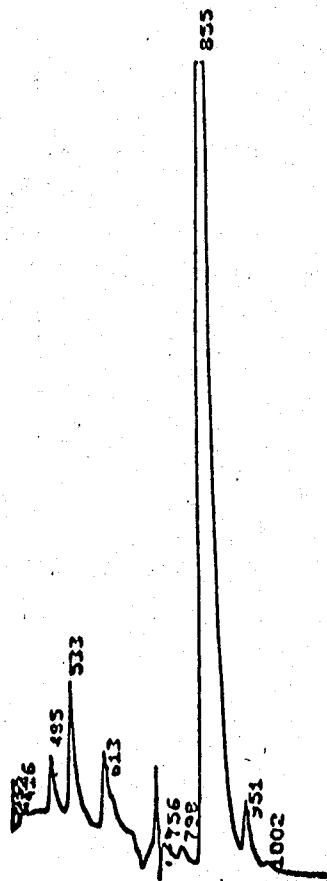

LIQUID CHROMATOGRAPH
Ty I

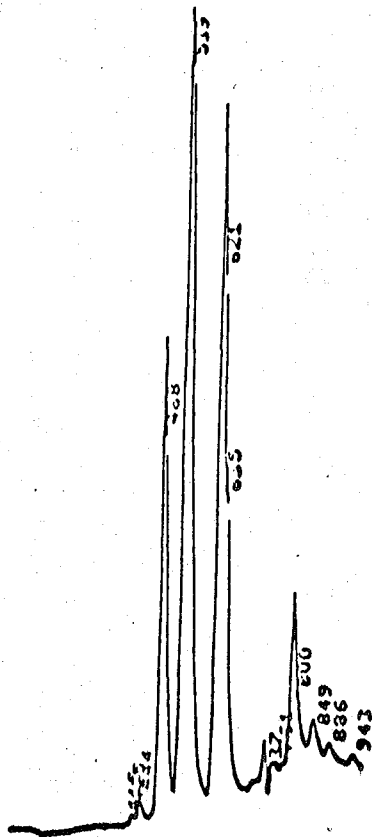

LIQUID CHROMATOGRAPH
Ty II

5.4 Calculations

Ty I Must be a single peak. The elution time requirement is determined by multiplying the elution time of THF by 1.15. The actual elution time must be within 2%.

Ty II Must be five peaks. Elution time requirement is determined by multiplying. The elution time of peak 5 by the appropriate factors. The variance allowed is 2%.

1	1.10
2	1.27
3	1.30
4	1.64

The ratio of each of the five peaks to the total area of the five peaks must be as follows:

peak	area ratio
1	15 ± 3%
2	48% ± 4%
3	25% ± 4%
4	7% ± 2%
5	4% ± 1%

Liquid Chromatography Method of Analysis for PMR-15

1.0 SCOPE

This method describes a procedure for analyzing PMR-15 by Liquid Chromatography.

2.0 CLASSIFICATION

None.

3.0 REFERENCE

Except where a specific issue is indicated, the current issue of the following references shall be a part of this method to the extent indicated herein.

- 3.1 D180-18869-3 "Polymer Analysis Handbook" method CCM 1-009 "Calibration of Adsorption columns for Liquid Chromatography."

4.0 FACILITIES

A liquid chromatograph instrument such as the DuPont Model 850 or equivalent.

5.0 REQUIREMENTS

5.1 Sample conditions

- a. Mobile phase: 2:1 Water: Tetrahydrofuran +.1% Acetic Acid
NOTE: Ultrapure water and UV grade THF.
- b. Columns: 2 PSM 60 type columns
- c. Column Temp: Ambient
- d. Sample: 0.1g/5 mls THF
- e. Flow: 1.00 ml/min

- f. Detector: UV at 210 nm x 8
- g. Injection: 3 μ l
- h. Chart speed: 2 in/min

5.2 Procedure

Inject the sample into the columns. The individual columns must be calibrated per reference 3.1. The following column requirements must be met:

$$k_1' = 0.70 \pm 0.03$$

$$k_2' = 3.25 \pm 0.20$$

$$\alpha = 4.67 \pm 0.49$$

$$N = 6000 \text{ minimum}$$

$$R_s = 12 \text{ minimum}$$

5.3 Results

Typical chromatograms are as illustrated.

5.4 Calculations

The chromatogram should contain five components of BTDE and one of NE. There should be no reaction products present. The elution time requirement for BTDE components is determined by multiplying the elution time of peak 1 by the appropriate factors. The variance allowed is 2%.

Peak	Factor
2	1.12
3	1.27
4	1.31
5	1.63

Peak 6 is NE. The elution time requirement for NE is determined by multiplying the elution time of THF by 1.15. The actual elution time must be within +2%.

The ratio of each of the five peaks to the total area of the five peaks must be as follows:

peak	area ratio
1	15 + 3%
2	48% + 4%
3	25% + 4%
4	7% + 2%
5	4% + 1%
6	--

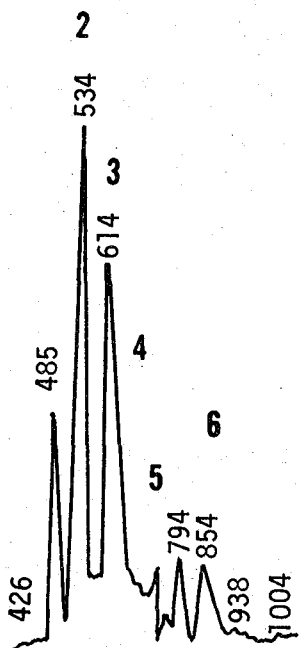

Liquid Chromatography Method
For Graphite/PMR-15 Polyimide Resins

1.0 Scope

This method describes a procedure for the analysis of polyimide resins by Size Exclusion Chromatography.

2.0 Classification

None

3.0 Facilities

A Liquid Chromatograph such as DuPont 850 or equivalent.

A UV detector such as DuPont Spectral 2 or equivalent.

4.0 Requirements

4.1 Conditions

Control the following parameters as specified:

- | | |
|-------------------|---|
| a. Sample size | 3 μ l |
| b. Solvent | 2:1 Water: Tetrahydrofuran plus
0.1% acetic acid (V/V) |
| c. Elution rate | 1 ml/minute |
| d. Chart speed | 1.0 cm/min. or 0.4 in/min. |
| e. UV wavelength | 210 nm |
| f. UV attenuation | x8 |
| g. Columns | 2 - SE 60 DuPont size exclusion
columns |
| h. Temperature | 295 \pm 2K (73 \pm 3.6 $^{\circ}$ F) |

5.0 Procedure

5.1 Prepare a composite sample by using a sharp 1/4 punch to remove a circle of material. Discard any backing. Weigh and place in an 8 ml vial. Add 5.0 mls of tetrahydrofuran and close vial with a polyseal cap. Place on a mechanical shaker for 10 to 15 minutes. Remove solid material. Filter with a Millipore or Waters Associates solvent clarification kit into a clean 8 ml vial.

5.2 Inject 3 μ l of solution into column.

5.3 The chromatogram should contain seven peaks. There should be no reaction products present. The elution times are determined by multiplying the elution time of peak 1 by appropriate factors. The variance allowed is 2%. Peak 6 is NE. The elution time requirement for NE is determined by multiplying the elution time of THF by 1.15. The actual elution time must be within 2%.

6.0 Reporting

Record material identification, instrument parameters, and date.

Note: Water must be ultra-pure and tetrahydrofuran should be uninhibited, distilled in glass, filtered through to 0.45 microns filter paper.



APPENDIX B1

DOCUMENT NO. D180-20545-4A

TITLE: MATERIAL SPECIFICATION FOR
GRAPHITE/PMR-15 PREPREG

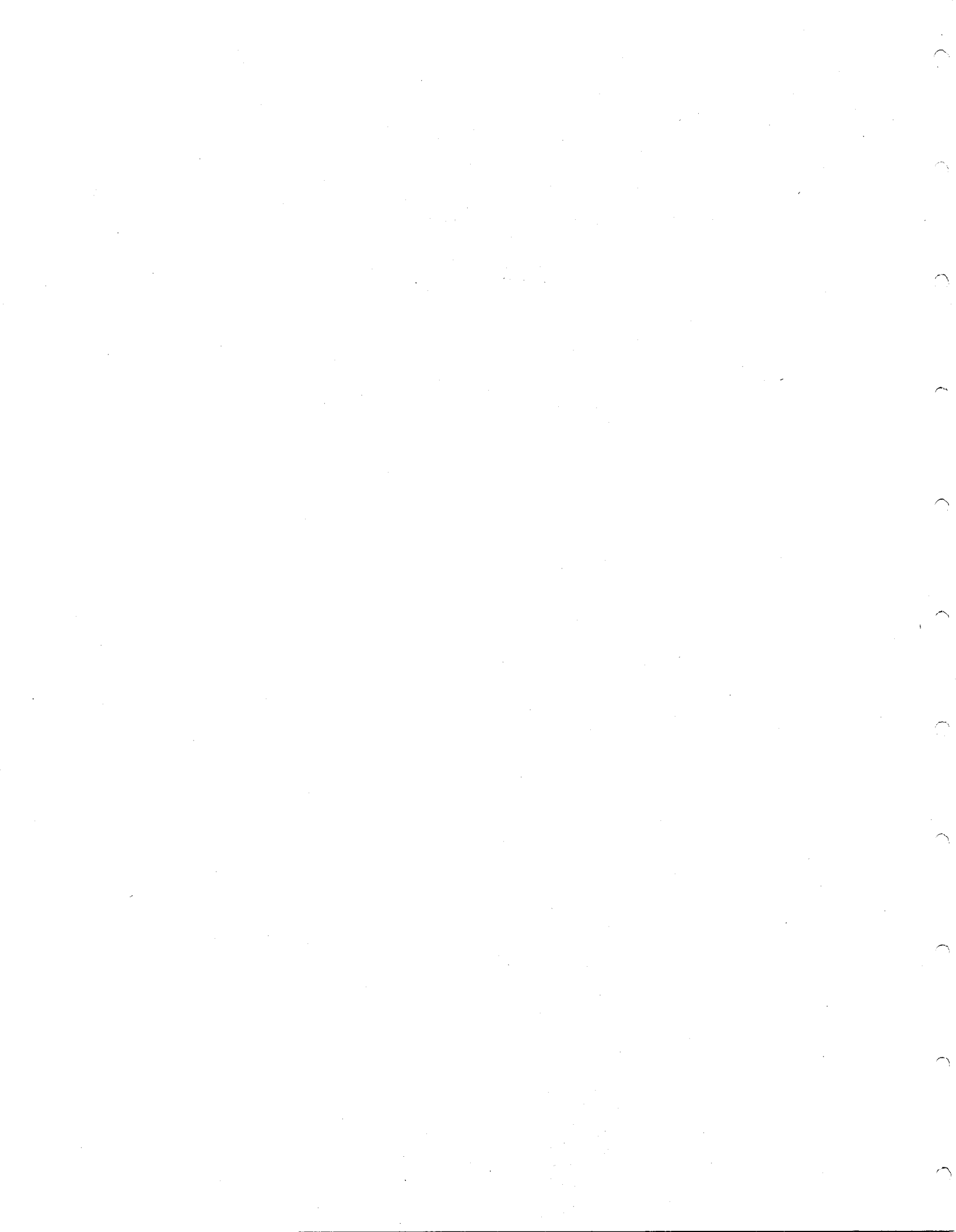

ABSTRACT

Material requirements are specified for Graphite/PMR-15 polyimide prepreg. The requirements include the formulation for making the PMR-15 resin, its chemical characteristics along with its chemical, physical, and mechanical properties which it is impregnated using various forms of graphite requirements.

KEY WORDS

PMR-15 Resin Varnish
PMR-15 Monomers
Dimethyl ester of 3,3',4,4'-benzophenonetetracarboxylic acid (BTDE)
4,4' methylenedianiline (MDA)
Monomethyl ester of 5-Norborene-2,3-dicarboxylic acid (NE)
Graphite Prepreg
Graphite Fiber
Graphite Composite
Chemical Characteristics
High Pressure Liquid Chromatograph
Wet Resin Content
Dry Resin Content

TABLE OF CONTENTS

<u>PARAGRAPH NO.</u>	<u>TITLE</u>	<u>PAGE</u>
1.0	Scope	
2.0	Classification	
2.1	Types	
2.2	Class	
2.3	Grade	
2.4	Form	
3.0	References	
4.0	Definitions	
5.0	Material Requirements	
5.1	Workmanship	
5.2	Visual	
5.3	Dimensional	
5.4	Storage and Working Life	
5.5	Manufacturing Procedures Graphite/PMR-15 Prepreg	
5.5.1	Manufacture of NE	
5.5.2	Manufacture of BTDE	
5.5.3	Manufacture of PMR-15 Resin	
5.5.4	Manufacture of Graphite/PMR-15 Prepreg	
5.5.5	Graphite/PMR-15 Prepreg Physical Properties	
5.6	Composite Mechanical Properties	
5.7	Chemical Properties of Monomers, Resin, and Prepreg	
5.7.1	Chemical Characterization of Monomers, Resins, and Prepreg	
5.7.1.1	HPLC of NE	
5.7.1.2	HPLC of BTDE	
5.7.1.3	Differential Scanning Calorimeter (DSC) of MDA	
5.7.2	Chemical Characterization of PMR-15 Resin	
5.7.2.1	HPLC of PMR-15 Resin	
5.7.2.2	Infrared Spectroscopy of PMR-15 Resin	
5.7.3	Chemical Characterization of Graphite/ PMR-15 Resin	
5.7.3.1	HPLC of Extracted PMR-15 Resin	
5.7.3.2	Gas Chromatograph Analysis of Extracted PMR-15 Resin	
5.7.3.3	IR Analysis of Extracted PMR-15 Resin	
5.7.3.4	Thermal Gravimetric Analysis of Extracted PMR-15 Resin	
5.7.4	Resin Solvent	
5.7.5	Foreign Material	
5.7.6	Graphite Yarn	
5.7.6.1	Physical and Mechanical Properties of of Graphite Yarn	
6.0	Qualification	
7.0	Qualification Control	
7.1	Supplier Quality Control	
7.1.1	Quality Control of PMR-15 Monomers	
7.1.2	Quality Control of PMR-15 Resin	
7.1.3	Quality Control of Graphite/PMR-15 Prepreg	

TABLE OF CONTENTS (Continued)

<u>PARAGRAPH NO.</u>	<u>TITLE</u>	<u>PAGE</u>
7.2	Supplier Certification on Test Results	
7.3	Purchaser Quality Control	
8.0	Material Test Methods.	
8.1	Sampling	
8.2	High Pressure Liquid Chromatograph Analysis of NE, BTDE, and PMR-15 Resin	
8.3	DSC Analysis of MDA Monomer	
8.4	Infrared Analysis of PMR-15 Resin	
8.5	Liquid Chromatograph Analysis Graphite/PMR-15 Prepreg	
8.6	Gas Chromatograph Method for Graphite/PMR-15	
8.7	Infrared Analysis of Graphite/PMR-15 Prepreg	
8.8	Thermal Gravimetric Analysis of Graphite/PMR-15 Prepreg	
8.8.1	Thermal Degradation	
8.8.2	Percent Volatiles	
8.8.3	Outgassing Temperature	
8.9	NE and BTDE Solids Content	
8.10	Prepreg Volatile Content	
8.11	Prepreg Resin Content	
8.11.1	Resin Content Acid Digestion	
8.11.2	Resin Content by Soxhlet Extraction	
8.12	Gel Time	
8.13	Composite Fabrication for Test (Types I, II, or III, Class 1)	
8.14	Composite Fabrication for Test (Types I, II, or III, Class 3)	
8.15	Composite Mechanical Properties	
8.15.1	Flexural Properties	
8.15.2	Interlaminar Shear Properties	
8.15.3	Tensile Properties	
8.15.4	Isothermal Aging Properties	
8.16	Composite Physical Properties	
8.16.1	Specific Gravity	
8.16.2	Resin Content	
8.16.3	Fiber Volume	
8.16.4	Fiber Volume	
8.16.5	Procedure for Tg Determination of Multilayer Laminates	
8.16.5.1	Equipment	
8.16.5.2	Equipment Parameters	
8.16.5.3	Sample Parameters	
8.16.5.4	Data	
8.17	Calibration of Adsorption Columns for Liquid Chromatography	
8.17.1	Scope	
8.17.2	Equipment	
8.17.3	Sample Conditions	
8.17.4	Sample Preparation	
8.17.5	Procedure	
8.17.6	Requirements	
9.0	Material Identification	
10.0	Packing and Marking	

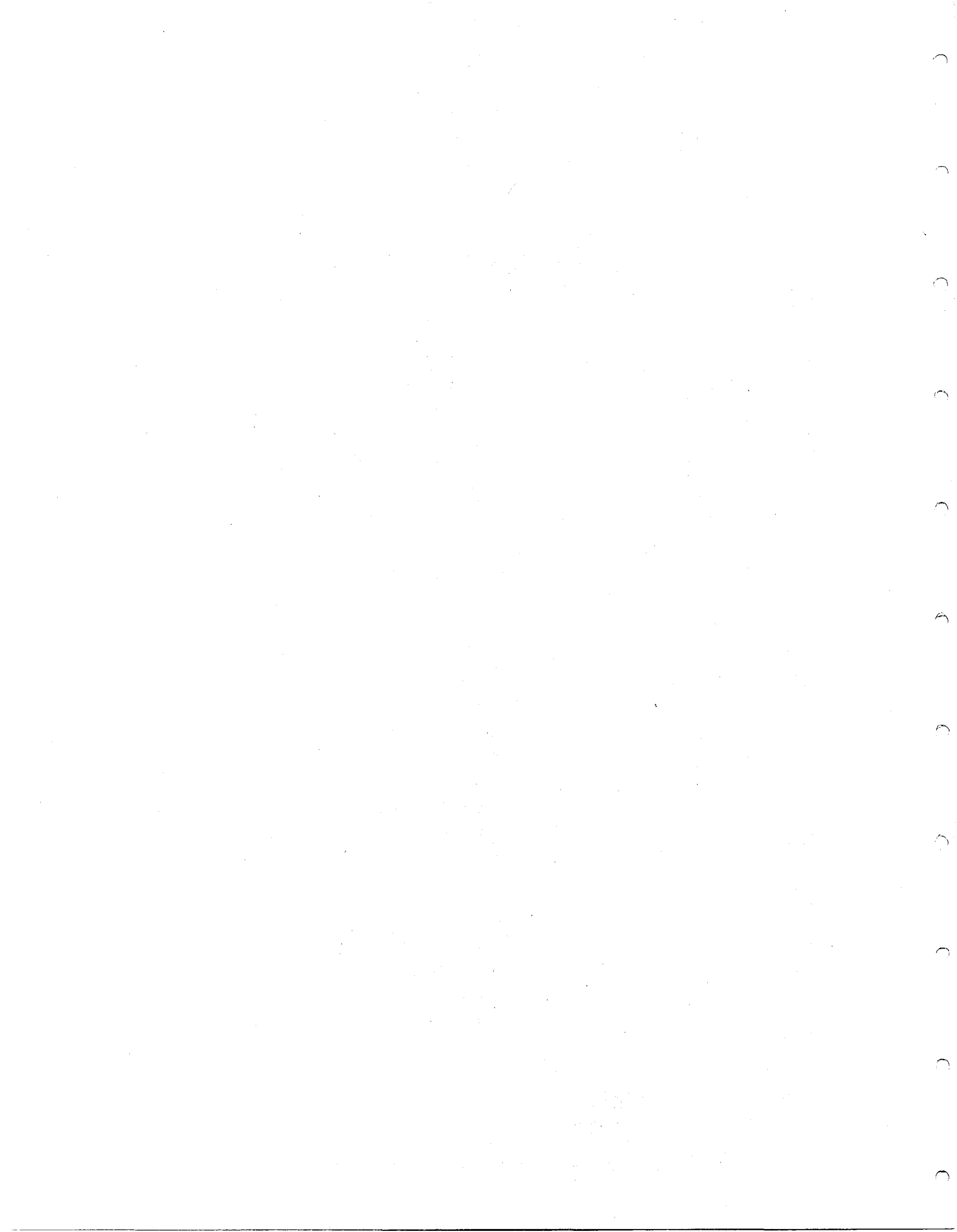

LIST OF FIGURES

<u>FIGURE NO.</u>	<u>TITLE</u>	<u>PAGE</u>
1	Cook Temperature Profile of NE	
2	Cook Temperature Profile of BTDE	
3	Standard HPLC Chromatogram of NE	
4	Standard HPLC Chromatogram of BTDE	
5	Standard DSC SCAN of MDA Monomer	
6	Standard HPLC Chromatogram of PMR-15 Resin	
7	Standard IR Spectra of PMR-15 Resin	
8	Standard HPLC Chromatogram of Extracted PMR-15	
9	Standard Gas Chromatogram of Graphite/PMR-15 Prepreg	
10	Standard FTS IR Curves of Graphite/PMR-15 Prepreg	
11	Graphite/PMR-15 Composite Cure Cycle	
12	Vacuum Bag Schematic	



1.0 SCOPE

This document covers PMR-15 impregnated graphite prepreg for use in the fabrication of high temperature resistant graphite structures.

2.0 CLASSIFICATION

This document covers unidirectional tape, woven fabric, and chopped graphite fiber impregnated with PMR-15 thermosetting polyimide resin. The preimpregnated materials shall be of the following Types, Classes, and Grades.

2.1 TYPES

Type shall specify graphite fiber strength and modulus properties.

Type I - Graphite prepreg made from high strength fibers having a minimum strength of 2.76 GN/m^2 (400 ksi) and modulus 235 GN/m^2 (34 ksi).

Type II - Graphite prepreg made from high modulus fiber having a minimum strength of 2.20 GN/m^2 (320 ksi) and modulus of 345 GN/m^2 (50 ksi).

Type III - Graphite prepreg made from extremely high modulus fiber having a nominal fiber stiffness of 483 GN/m^2 (70 ksi).

2.2 CLASS

The class shall specify the graphite form.

Class 1 - Unidirectional Tape

Class 2 - Woven Fabric

Class 3 - Chopped Fiber

2.3 GRADES

Grades shall specify the tape widths and/or fiber length.

Class 1

Grade 3 - Graphite tape width of 7.6cm (3 inches)

Grade 6 - Graphite tape width of 15.2cm (6 inches)

Grade 12 - Graphite tape width of 30.5cm (12 inches)

Class 3

Grade 3 - Fiber length of 0.8cm (0.3 inch)

Grade 5 - Fiber length of 1.3cm (0.5 inch)

Grade 1 - Fiber length of 2.5cm (1.0 inch)

2.4 FORM

The PMR-15 graphite tape material is to be furnished on spools in required widths with a minimum of 30 meters (32.8 yards) for Types I, II, or III Class I Grade 12 or equivalent in other grades.

Class 3 chopped graphite fiber molding compound will be in quantities not less than 2 kilograms (4.4 lbs).

Rolls of prepreg shall be supported by a core which is not deformed by the material weight. The core diameter shall be 200mm (8 inches) minimum. Core length shall be 0 to 150mm (0 to 6 inches) longer than the carrier width.

3.0 REFERENCES

Except where a specific issue is indicated, the issue of the following references in effect on the data of invitation for bid shall form a part of this document to the extent herein indicated.

- a. ASTM D790 Flexural Properties of Plastics
- b. ASTM D2344 Apparent Horizontal Shear Strength of Reinforced Plastics by Short-Beam Shear Method
- c. ASTM D792 Specific Gravity and Density of Plastics by Displacement
- d. ASTM 638 Tensile Properties of Plastics
- e. MIL-B-117 Bags, Sleeves, and Tubing - Interior Packaging

4.0 DEFINITIONS

- a. Bleeder - Porous material used to absorb excess resin during cure or to provide a path for reaction products removal.
- b. Prepreg Batch - Prepreg containing reinforcement impregnated with one batch of resin in one continuous operation.
- c. Chopped Graphite Fiber Batch - A molding compound containing chopped fiber reinforcement impregnated with one batch of resin in one continuous operation.
- d. Resin Batch - Resin mixed in one mixer in one operation with traceability to individual monomer lots.
- e. Roll - A roll is defined as any section from the batch of prepreg furnished as a continuous roll of a length specified in Section 2.2.
- f. Storage Life - That period of time which the material may be kept so that it retains the properties within the limits of this document.

5.0 MATERIAL REQUIREMENTS

5.1 WORKMANSHIP

- a. The material shall be uniform in quality and condition, and clean and free from foreign materials, and shall not have characteristics which are detrimental to fabrication, appearance, or performance. These defects shall be acceptable only to the limits given in Sections 5.2 and 5.3.
- b. Material containing defects shall be allowed if each defect is flagged, and replacement yardage is added to the roll for every defect occurring in that roll. Additionally, no more than one defect may occur in any 5 meters (16.0 ft) of material, or 6 defects per roll.

5.2 VISUAL

a. Class 1

The material shall be essentially free from crimped fibers, gelled resin particles, twists, fiber balling, unwetted fibers and dry or boardy areas. Individual tows shall be parallel to the tape or sheet centerline direction within ± 5 degrees.

b. Class 2

Impregnated cloth furnished to this document shall be of quality workmanship. Indications of impurities, dry areas, areas of nonuniformity, incomplete impregnation, gelled resin, hard spots, or localized color difference in impregnated cloth shall be marked by tape as nonconforming area.

c. Class 3

The graphite fiber molding compound shall be essentially the same as specified in Section 5.2.a.

5.3 DIMENSIONAL EXAMINATION

- a. Open spaces between fibers or tows on the unidirectional tape shall not be more than 0.76mm (0.03 in) wide nor more than 25.4 continuous centimeters (10 in) long for each one square meter (10 sq. ft.) of tape. Gaps in the tape shall not exceed 0.76 millimeter (0.03 in).
- b. The alignment of the warp and fill yarns in the graphite fabric shall be perpendicular to each other and shall be parallel to the warp and fill direction of the cloth.

5.4 STORAGE AND WORKING LIFE

- a. While not in use, the tape shall be stored at $254 \pm 5 \text{ K}$ ($0 \pm 10^\circ\text{F}$) in heat-sealed bags meeting the requirements of MIL-B-117. (See Section 10.)
- b. A rigid cardboard spacer with a metal or plastic plug shall be placed over each end of the core and press fitted tightly into the tube.
- c. The material shall be capable of meeting the qualification requirements of this document after 50 days of storage at $254 \pm 5 \text{ K}$ ($0 \pm 10^\circ\text{F}$) plus additional exposure of 240 hours at ambient temperature in a sealed bag. Storage life starts at date of shipment.

5.5 MANUFACTURING PROCEDURES GRAPHITE/PMR-15 PREPREG

The PMR-15 graphite prepreg is composed of PMR-15 resin matrix and graphite fiber or fabric as the reinforcement. The PMR-15 polyimide resin varnish shall be chiefly composed of monomers and various very low molecular weight polyamide esters. The monomers used are detailed below, with the following stoichiometries:
(Note: Weight of monomer shall be based on a measured solids value (Section 8.9).)

	Moles
BTDE	2.084
MDA	3.084
NE	2.000

Dimethyl ester of 3,3', 4,4' benzophenonetetracarboxylic acid (BTDE)

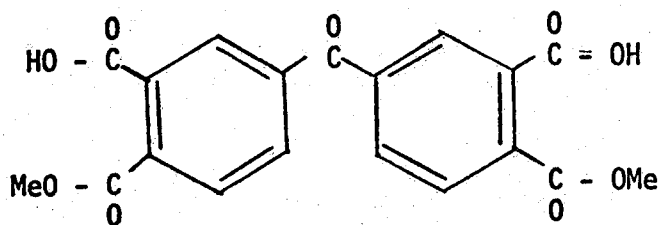

4,4' methylenedianiline (MDA)

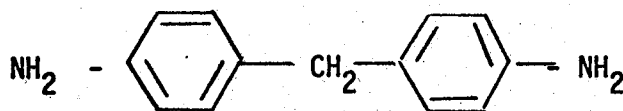

Monomethyl ester of 5-norbornene 2,3 dicarboxylic acid (NE)

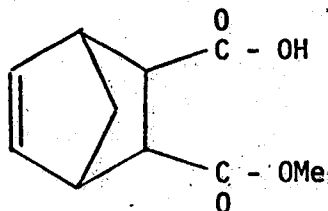

5.5.1 Manufacture of NE

The materials used in the manufacture of NE shall be commercially available nadic anhydride and anhydrous methyl alcohol. The reaction mixture shall consist of 90 + 3 theoretical percent solids of the monomethyl ester of nadic anhydride. The NE shall be made in a suitable reaction vessel, fitted with a mechanical stirrer capable of maintaining a uniform temperature throughout the reaction vessel, a reflux condenser, and a temperature measuring device to monitor solution temperatures. The temperature profile of the mixture shall follow the temperature curve given in Figure 1. The chemical properties of the NE shall be as specified in Section 5.7.1.1 before the monomer is used in a PMR-15 resin.

5.5.2 Manufacture of BTDE

The raw materials used in the manufacture of BTDE shall be commercially available benzophenonetetracarboxylic dianhydride (BTDA) and anhydrous grade methyl alcohol. The reaction mixture shall consist of 90 + 3 theoretical percent BTDE methyl ester. The BTDE shall be made in a suitable reaction vessel, fitted with a mechanical stirrer capable of maintaining a uniform temperature through out the reaction vessel, a reflux condenser, and a temperature measuring device to monitor solution temperatures. The temperature profile of the mixture shall follow the temperature curve given in Figure 2. The chemical properties of BTDE shall be as specified in Section 5.7.1.2 before the monomer is used in a PMR-15 resin.

5.5.3 Manufacture of PMR-15 Resin

The PMR-15 resin consists of a mixture of three separate monomers and their subsequent reaction products. Prior to their combination the three monomers (i.e. NE, BTDE, and MDA) shall meet the requirements specified in a previous section. The proper weight of BTDE and NE (weights to be determined base on solids determination as described in Section 8.9) shall be charged in a sigma blade or equivalent mixer preheated to a temperature not to exceed 333K (140°F). The materials are then blended a maximum of 30 minutes or until homogenous. The mixture is then cooled to below 325K (125°F) and a 77 percent methyl alcohol/MDA solution preheated to 340K (150°F) is then added and sigma blade mixer immediately cooled to 323K (120°F) and resin stored in polyethylene containers. (Note: The maximum temperature shall not exceed 333K (140°F) during addition of MDA/MEOH.) The maximum exposure of the PMR-15 resin shall be 16 hours at ambient conditions. When not in use the PMR-15 resin shall be stored at 254 ± 5 K (0 + 100°F). The chemical properties of the PMR-15 shall be as specified in Section 5.7.2 before being used to make graphite/PMR-15 prepreg.

5.5.4 Manufacture of Graphite/PMR-15 Prepreg

Any suitable graphite prepreg making machine can be utilized in making the graphite/PMR-15 prepreg as long as the prepreg requirements of the document are maintained.

5.5.5 Physical Properties

The physical properties of tape supplied to this document shall meet the requirements of Table I.

TABLE I
PREPREG PHYSICAL PROPERTY REQUIREMENTS

	Resin Content Percent	Volatile Content Percent	Gel Time Seconds
1 Class 1	34^{+4}_{-2} <u>1/</u>	10 ± 2	50 ± 10
	41^{+4}_{-2} <u>2/</u>		
Class 3	60^{+1}_{-4}	10 ± 2	100 ± 10
	66^{+1}_{-4}		
Test Method	Sec. 8.11	Sec. 8.10	Sec. 8.12

1/ Based on dry resin solids (Method 8.11.1 or 8.11.2)

2/ Based on wet resin solids (Method 8.11.2)

5.6 COMPOSITE MECHANICAL PROPERTIES

When the composite is laminated as described in Sections 8.13 and 8.14, material must meet the requirements of Table II.

TABLE II

Composite Mechanical Property Requirements

Material Type	Heat Aging	Test Temp K(°F)	Mechanical Properties			Physical Properties						
			Ult Stress MPa(KSI)	Flexural Modulus GPa(MSI)	Horizontal Shear MPa(KSI)	Resin Content % W	Specific Gravity g/cc(lbs/in ³)	Fiber Volume % V 2/	Void Volume % V 2/	Ply Thickness mm (inch)	Composite Thickness mm (inch)	Composite T _g
I Class 1	0	294(70)	1515(220)	117(17.0)	96(14.0)	30 + 3 -1	1.55+.03 (0.056+.001)	60 ± 2	1	.127(.005)	(1.78-2.0) (.070-.080)	602K(625°F)
	1/2hr @589K(600°F)	589(600)	757(110)	103(15.0)	41(6.0)							
	125hr @589K(600°F)	589(600)	757(110)	103(15.0)	41(6.0)							
Class 3	0	294(70)	138(20)	1860(.27)	55(8.0) 1/	58 + 3 -1	1.40+.02 (.051+.001)	32 ± 2	1	NA	3.18 (.125)	TBD
	1/2hr @589K(600°F)	589(600)	69(10)	1378(.20)	28(4.0)							
	125hr @589K(600°F)	294(70)	138(20)	1860(.27)	55(8.0)							
	125hr @589K(600°F)	589(600)	69(10)	1378(.20)	28(4.0)							
TEST METHOD			Section 8.15.1	Section 8.15.2	Section 8.16.2	Section 8.16.1	Sec. 8.16.3	Sec. 8.16.4	Section 8.16.5			

1/ Tensile properties in place of Horizontal Shear Properties (Section 8.11.3)

2/ Assume Specific Gravity of PMR-15 Resin to be 1.30 g/cc.

Assume Specific Gravity of Celion 6000 graphite fiber to be 1.76 g/cc.

Assume Specific Gravity of HTS-2 graphite fiber to be 1.66 g/cc.

5.7 CHEMICAL PROPERTIES OF MONOMERS, RESIN, AND PREPREG

5.7.1 Chemical Characterization of Monomers

5.7.1.1 High Pressure Liquid Chromatography (HPLC) of NE

Using Method 8.2 the composition is acceptable if the material meets the requirements of Figure 3.

5.7.1.2 High Pressure Liquid Chromatography (HPLC) of BTDE

Using Method 8.2 the composition is acceptable if the material meets the requirements of Figure 4.

5.7.1.3 Differential Scanning Calorimetry (DSC) of MDA

Using Method 8.3 the composition is acceptable if the material meets the requirements of Figure 5.

5.7.2 Chemical Characterization of PMR-15 Resin

5.7.2.1 High Pressure Liquid Chromatography (HPLC) of PMR-15 Resin

Using Method 8.2 the composition is acceptable if the material meets the requirements of Figure 6.

5.7.2.2 Infrared Spectroscopy (IR) of PMR-15 Resin

Using Method 8.4 the composition is acceptable if the material meets the requirements of Figure 7.

5.7.3 Chemical Characterization of Graphite/PMR-15 Resin

5.7.3.1 High Pressure Liquid Chromatography (HPLC) of Extracted PMR-15 Resin

Using Method 8.5 the composition is acceptable if the material meets the requirements of Figure 8.

5.7.3.2 Gas Chromatograph Analysis of Extracted PMR-15 Resin

The extracted resin varnish shall meet the following criteria using Method 8.6.

- a. The retention time of the peaks shall be comparable to the time obtained from standard systems.
- b. The only common solvent present that is not associated with decomposition products of PMR-15 resin shall be methanol.

5.7.3.3 IR Analysis of Extracted PMR-15 Resin

Using Method 8.7, the adsorption bands of the sample shall be superimposable on the IR spectrum shown in Figure 10. (Note: No imidization should be visible.)

5.7.3.4 Thermal Gravimetric Analysis Extracted PMR-15 Resin

The TGA properties of the extracted resin varnish supplied to this document shall meet the requirements of Table III when tested in accordance with Methods 8.8.1 through 8.8.3.

TABLE III

TGA PROPERTIES OF RESIN VARNISH

<u>Types</u>	<u>Thermal Degradation K (°F)</u>	<u>Weight Loss During Volatilization Percent</u>	<u>Outgassing Temperature K (°F)</u>
Type I Class 1,2,3	622 (660) min	14 max	525 (480) min

5.7.4 Resin Solvent

The use of methanol as a solvent to aid in obtaining suitable graphite prepreg is permissible. No other solvent system may be present in graphite prepreg.

5.7.5 Foreign Material

There shall be no foreign or gelled material present in the PMR-15 resin.

5.7.6 Graphite Yarn

5.7.6.1 Physical and Mechanical Properties of Graphite Yarn

The graphite used as the reinforcement in this document are designated by types (Section 2.1). The fibers used shall exhibit the properties shown in Table IV and may contain an approved sizing. The prepreg manufacturer shall submit in writing verifying that the fibers used in tape manufacture meet the values of Table IV. (Note: The actual test values on fiber lots can be obtained from the fiber manufacture.)

TABLE IV
MINIMUM STRENGTH AND MAXIMUM WEIGHT LOSS PROPERTIES OF GRAPHITE FIBERS

Properties	Type I	Type II	Type III
Modulus (GPa) (msi)	235 (34)	320 (50)	520 (70)
Specific Modulus (10 ⁶ m) (10 ⁶ in)	13.5 (515)	16.5 (730)	29 (1106)
Tensile Strength (MPa) (ksi)	2760 (400)	2200 (320)	1860 (270)
Specific Tensile Strength (10 ⁵ m) (10 ⁶ m)	160 (6.0)	0.90 (5.0)	0.9 (5.0)
Density (g/cc) (lb. cu. in)	1.75 (.0106)	1.90 (.09067)	2.07 (0.071)
Weight Loss After 125 Hours 589 (600°F) % W/W	1.0	1.0	1.0
Weight Per Unit Length of Tow (Kg/m) (lbs./in) x 10 ⁻⁶	780 (46)	760 (46)	800 (48)

6.0 QUALIFICATION

A manufacturer may begin to supply material only after qualification samples have been approved for all requirements of this document. In addition, each prepreg manufacturing facility must be qualified individually. The adequacy of the manufacturing facility may be verified, as deemed necessary, by company representatives, by a survey of such facilities. All requests for qualification shall be directed to the company's Materiel Department which will request data and samples when desired for qualification purposes.

- a. The qualification samples shall consist of one representative production sample roll (at least 1.5 kg (3.5 lbs.)) of the particular type from each of a minimum of three separate resin mixes. Each type must be qualified individually.
- b. The qualification sample submitted for approval shall be accompanied by a certified test report in duplicate which shows that the sample supplied meets the prepreg physical and chemical requirements and composite property requirements of this document. The supplier qualification report must contain:
 - (1) Supplier product designation
 - (2) Prepreg type in accordance with document
 - (3) Test results including individual test values

- c. All suppliers shall have test facilities or access to test facilities required to test in accordance with this document. (The chemical characterization requirements are included). The adequacy of test facilities may be verified, as deemed necessary, by company representatives by a survey of such facilities.
- d. Qualification testing shall consist of a demonstration of the conformance of the sample supplied in accordance with Section 6.a to all of the requirements of this document.
- e. This document requires approved supplier listing in the Qualified Products List Supplement to this document for preimpregnated materials and thereafter the materials and method of manufacture must not be changed without prior notification and approval in writing. A supplier's product designation is required for a specific formulation and any change in formulation requires a change in this designation as well as approval. Requalification after any change in formulation may be required, as deemed necessary.

7.0 SUPPLIER QUALITY CONTROL

Material purchased to this document will be subjected to inspection to determine conformance to the requirements stated herein.

7.1 SUPPLIER QUALITY CONTROL

Supplier Quality Control shall provide a system of in-process records which assure product integrity. These records shall be made available to authorized company representatives.

7.1.1 Quality Control of PMR-15 Monomers

The supplier shall certify the monomers to meet all requirements of this document. The following tests shall be performed on each master batch or lot of monomer prior to use in the PMR-15 resin.

- a. High Pressure Liquid Chromatography (HPLC) (NE and BTDE only)
- b. Differential Scanning Calorimetry (DSC) (MDA only)

7.1.2 Quality Control of PMR-15 Resin

The supplier shall certify the resin to meet all requirements of this document. The following tests shall be performed on each master batch or lot of resin prior to use on graphite requirements.

- a. High Pressure Liquid Chromatography (HPLC)
- b. Infrared Spectroscopy (IR)

7.1.3 Quality Control of Graphite/PMR-15 Prepreg

- a. The following tests shall be performed on each sample of prepreg obtained in accordance with Section 8.1.a.
 - Percent Volatile Content - Test in accordance with Section 8.10
 - Percent Resin Content - Test in accordance with Section 8.11
- b. The following test shall be performed on the samples obtained from the first roll of each batch of prepreg.
 - Gel Time - Test in accordance with Section 8.12
 - IR - Test in accordance with Section 8.7
 - TGA - Test in accordance with Section 8.8
 - HPLC - Test in accordance with Section 8.5
 - GC - Test in accordance with Section 8.6

7.2 SUPPLIER CERTIFICATION OR TEST RESULTS

The supplier must state, with each production shipment, that the materials and methods of manufacture have not changed from those used in the qualification sample (Section 6.a). A test report on the production batch shall also be supplied which contains test values demonstrating conformance of the tape to the requirements of this specification. Traceability of individual rolls of prepreg to master batches of graphite yarn shall also be provided. Actual weight and yardage of individual prepreg rolls shall be shown on the test report.

7.3 PURCHASER QUALITY CONTROL

- a. Reject any rolls which are improperly packaged, i.e., punctured or poorly sealed bags.
- b. Prepreg rolls must be allowed to warm to a temperature at which condensation will no longer form on the sealed bag prior to opening.
- c. The areas where prepreg is exposed (for sampling and testing) shall conform to BSS 7001, Class 400,000.
- d. Open the packaging bag only long enough to take the material sample required in accordance with Section 8.1.d and then heat seal the bag.

- e. Quality Control tests shall consist of those tests listed in Table I through IV except when material fails the chemical characterization tests, then the 125 hour, 589K (600°F) flexural ultimate stress and modulus and horizontal shear are final acceptance criteria. In the case of Class 3 material, the tensile ultimate and modulus are required.
- f. Additional tests will be performed as deemed necessary to assure production shipments meet the requirements of this document, and that no changes have been made to the system since initial qualification.
- g. All test data and records must be kept on file and be readily available for review.

8.0 MATERIAL TEST METHODS

8.1 SAMPLING

- a. The supplier and/or purchaser shall obtain a minimum 25 gram sample of each monomer (i.e., N.E., BTDE, and MDA) master batches that are used in PMR-15 resin.
- b. The supplier and/or purchaser shall obtain a minimum 25 gram sample of each batch of PMR-15 resin varnish that is made from monomers sampled in Section 8.1.a and is used in the manufacture of graphite/PMR-15 prepreg.
- c. The supplier shall obtain a 2 meter (6 ft.) swatch at the start of roll No. 1 and from the end of each roll of prepreg.
- d. The purchaser shall obtain a sample from a prepreg roll representing each unit of product included in the shipment. Multiple shipments from the same batch shall be treated as separate batches. Identify the sample by prepreg batch number and roll number. Sample size shall be:

Type I Class 1 - 2 meters (6 ft.)

Type I Class 3 - 0.5 Kg (1.1 lb.)

8.2 HIGH PRESSURE LIQUID CHROMATOGRAPH ANALYSIS OF NE, BTDE, AND PMR-15 RESIN

From a sample of material obtained in Section 8.1 make a 0.1g/5 ml of NE solution using THF. Inject a 3 l of solution into the instrument with the liquid chromatograph containing the following columns and settings:

Column - 2 calibrated SE 60 DuPont size exclusion columns
(See Section 8.17)

Sample Size - 3 1

Solvent - 2:1 Water: THF (water must be ultra pure and THF
is uninhibited distilled in glass, filtered to
.45)

Elution Rate - 1 ml/minute

Chart Speed - 25.4 mm/minute (1.0 in/minute)

UV Wavelength - 210 nm

UV Attenuation - X 8

Temperature - $295 \pm 2\text{K}$ ($73 \pm 3.6^{\circ}\text{F}$)

8.3 DSC ANALYSIS OF MDA MONOMER

A DuPont 990 instrument or equivalent using the control variables.

- a. Sample size - 7.0 mg
- b. Temperature - ambient to 150°C
- c. Rate of heating - $10^{\circ}\text{C}/\text{min}$
- d. X-axis - $20^{\circ}\text{C}/\text{min}$
- e. Y-axis - 1 m cal/sec/in
- f. Reference - empty pan
- g. Atmosphere - air

The melt temperature shall be defined as the point of intersection of two lines; one drawn tangent to the baseline and the other drawn tangent to the transition at its point of maximum slope.

8.4 INFRARED ANALYSIS OF PMR-15 RESIN

A Fourier transform spectrophotometer or equivalent using the following IR scan parameters:

- a. resolution - 8.0 cm^{-1}
- b. number of scans in sample beam - 16
- c. number of scans in reference beam - 16
- d. wave numbers per in. - 200
- e. spectral range $500\text{-}4000\text{ cm}^{-1}$ (standard plot)

Place a portion of the resin/solvent solution on a NaCl or KCl salt block. The sample shall be of sufficient thickness to produce a spectrum whose strongest bond indicates 15^{+5} %T. Allow solvent to evaporate and scan the sample. -10

8.5 LIQUID CHROMATOGRAPH ANALYSIS GRAPHITE/PMR-15 PREPREG

Prepare a composite sample by using a sharp 64mm (0.25 inch) punch to remove a circle of material. Discard any backing. Weigh and place 0.3g in an 8ml. vial (Van Water and Rogers per 66011-085). Add 5.0mls of tetrahydrofuran and close vial with polyseal cap. Place on a mechanical shaker for 10 to 15 minutes. Remove solid material. Filter with a Millipore or Waters Associates Solvent Clarification Kit into a clean 8ml vial. Inject 3 μ l of solution into column with the Liquid Chromatograph containing the following columns and settings:

Columns - 2 SE 60 DuPont size exclusion columns
(See Section 8.17)

Sample Size - 3 μ l

Solvent - 2:1 Water: tetrahydrofuran (water must be ultra pure and THF is uninhibited distilled in glass, filtered to .45) plus 0.1% acetic acid.

Elution Rate - 1 ml/minute

Chart speed - 25.4 mm/minute (1 in/minute)

UV wavelength - 210 nm

UV attenuation - x8

Temperature - $295 \pm 2K$ ($73 \pm 3.6^{\circ}F$)

8.6 GAS CHROMATOGRAPH METHOD FOR GRAPHITE/PMR-15 PREPREG

A Hewlett Packard FM Scientific 5750 gas chromatograph or equivalent using the following parameters:

a. Sample size - 1 ml

b. Column - 61 x 1/8 W98 @ 10%

c. Oven temperature - RT to 175°C

d. Detector - Flame Ionization Detector

e. Detector port temperature - 523K (482°F)

f. Injection port temperature - 498K (437°F)

g. Carrier gas - Helium (Ultrapure)

- h. Range - 10-11
- i. Attenuation - 1256
- j. Chart speed - .25 in/min

Before injecting the sample, stabilize the baseline. When the baseline is stabilized, inject the sample and mark the injection event as time zero. Allow time for all of the sample to clear the column and the baseline to stabilize again. Once the analysis is complete, program the column at 20K/min to upper limits of the column to assure that none of the sample is retained in the column.

8.7 INFRARED ANALYSIS OF GRAPHITE/PMR-15 PREPREG

A Fourier transform spectrophotometer or equivalent using the following IR scan parameters:

- a. Resolution - 8.0 cm^{-1}
- b. Number of scans in sample beam - 16
- c. Number of scans in reference beam - 16
- d. Wave numbers per in. - 200
- e. Spectral range 500-4 cm^{-1} (standard plot)

Place a portion of the resin/solvent solution on a NaCl salt block after extracting from graphite tape using acetone. The sample shall be of sufficient thickness to produce a spectrum whose strongest bond indicates $15^{+5} \%T$. Allow solvent to evaporate and scan the sample.

8.8 THERMAL GRAVIMETRIC ANALYSIS GRAPHITE/PMR-15 PREPREG

8.8.1 Thermal Degradation

This test shall be performed using a DuPont 951 or equivalent while controlling the following variables:

- a. Sample - size 25-30 mg
- b. Heating rate - 5K/min (90F/minute)
- c. Temperature range - 273-1273K (32-1832OF)
- d. Air flow rate - 0.3L/minute, air
- e. Y axis scale - percent weight loss 0-100

The temperature of degradation is determined as the point of deviation from an extended baseline.

8.8.2 Percent Volatiles

This test shall be performed using a DuPont 951 or equivalent while controlling the following variables:

- a. Sample size - 25-30 mg
- b. Heating rate - 5K/minute
- c. Temperature range - 273-1273K (32-1832°F)
- d. Air flow rate - 0.3L/minute, air
- e. Y-axis scale - percent weight loss 0-100

The percent volatiles lost is determined to the temperature of degradation.

8.8.3 Outgassing Temperature

This test shall be performed using a DuPont 951 or equivalent while controlling the variable per paragraph 8.8.1.

The outgassing is determined as the point of deviation from an extended baseline.

8.9 NE AND BTDE SOLIDS CONTENT

- a. Obtain tare weights of three samples of ester and weight to the nearest milligram. The aluminum dish with ester is placed in an air circulating oven regulated to 311K (100 ± 10°F).
- b. After 16 hours the aluminum dishes shall be removed and placed in a desiccator to cool. The specimens shall be weighed to the nearest milligram.

$$\text{Percent Solids} = \frac{B}{A} \times 100$$

A = Weight of specimen before test

B = Weight of specimen after volatile removal

8.10 PREPREG VOLATILE CONTENT

- a. Obtain three specimens (2.0 to 4.0g) from each swatch obtained in accordance with Section 8.1 in a pattern that will be representative of the entire swatch.

The specimens taken near the edge must be at least one inch from the edge of tape. The specimens shall be identified by tape batch number, roll number, and specimen number.

- b. Remove the release paper backing from each specimen, place in a tared aluminum dish, and weigh to the nearest milligram. The aluminum dish with specimen is placed in an air-circulating oven regulated to $589 \pm 5K$ ($600 \pm 10^{\circ}F$).
- c. Close the oven door and start a clock. After 30 minutes the aluminum dishes shall be removed and placed in a desiccator to cool. The specimens shall then be weighed to the nearest milligram.

$$\text{Percent Volatiles} = \frac{A - B}{A} \times 100$$

A = Weight of specimen before test

B = Weight of specimen after volatile removal

- d. Report the average of three specimens.

8.11 PREPREG RESIN CONTENT

Use either of the following methods for determining tape resin content.

8.11.1 Resin Content Acid Digestion

- a. Transfer portions of the specimens accurately weighed (0.4 to 0.7g) after the determination of volatile content in accordance with Section 8.10 to a 80 ml glass beaker.
- b. Carefully measure 50 mls of concentrated sulfuric acid into the beaker containing the devolatilized sample. Cover the beaker with a watch glass, place on hot plate and heat until white fumes are visible above the acid solution.
- c. Maintain this condition for a minimum of 20 minutes or until the solution turns black. At this point, carefully add dropwise a 30 percent solution of hydrogen peroxide until the solution turns clear. Continue heating beaker for a minimum of one hour. During this period, add dropwise the hydrogen peroxide solution to clear the acid whenever the acid turns black. Cool the acid solution to room temperature, add 2 mls of hydrogen peroxide and heat until the white fumes appear. Continue heating for 10 minutes, then cool to room temperature. If acid turns black repeat the procedure until acid remains clear. (Note: This process shall be accomplished in a fume hood with air exchange.)
- d. Filter the acid solution using a fritted glass crucible (coarse), wash a minimum of three times with either distilled or dionized water, and then with acetone. The glass crucibles are then dried at $338K$ ($150^{\circ}F$) in an air-circulating oven a minimum of 30 minutes, cooled to room temperature in a desiccator, and weighed. The graphite yarn is then removed and the crucible weight obtained.

$$W_r = \frac{W_1 - W_2}{(W_1)} \times 100$$

W_r = Weight content of resin solids, % W/W

W_1 = Weight of devolatilized sample

W_2 = Weight of graphite yarn after acid digestion of the resin matrix

- e. Report the average of three specimens.

8.11.2 Resin Content by Soxhlet Extraction

- a. Take three specimens (2.0 - 4.0g) from the swatch obtained with Section 8.1 in a pattern that will be representative of the entire swatch. The specimens taken near the edge must be at least one inch from the tape's edge if the material is Type I, II, or III Grades 6 and 12. If the tape is Type I Grade 3 the sample must be the full width of the tape. If the sample is Class 3 of any type a random sample of molding compound shall be tested. The specimens shall be identified by tape or molding compound batch number, roll number, and specimen number.
- b. Remove the release paper from each specimen, and weigh in a tared soxhlet extraction thimble to the nearest milligram.
- c. Place the soxhlet extraction thimble into a soxhlet extraction apparatus. Fill the soxhlet flask three-fourths full of acetone and heat until acetone is gently refluxing. Continue heating until the acetone surrounding the extraction thimble is clear but no less than 60 minutes.
- d. Remove the extraction thimble from the apparatus and dry in an air-circulating oven for 30 minutes, then after cooling in a desiccator, reweigh to the nearest milligram. (Note: Since the dried extraction thimble gains weight, take reading 20 secs. after removing from desiccator.)

$$\text{Wet Resin Content } W_{DR} = \frac{W_2}{W_1} \times 100$$

$$\text{Dry Resin Content } W_{DR} = \frac{W_2 - W_1V}{W_1 - W_1V}$$

W_{WR} = Weight content of wet resin solids %

W_1 = Weight content of original sample

W_2 = Weight content of extract

W_{DR} = Weight content of dry resin solids %

V = Volatile matter content of graphite tape (Section 8.2)

8.12 GEL TIME

- a. Preset the temperature on a Fisher-Johns melting point apparatus to 477K (400°F).
- b. Insert a 6.35m x 6.35mm (0.25 x 0.25 in) sample of prepreg between two cover glasses and place on the heated platform of the Fisher-Johns apparatus.
- c. Start a stopwatch or timer and begin to probe on the top of the coverglass with a wooden pick.
- d. Record the time when the resin gels. The gel point is reached when no resin movement is observed through the coverglass when moderate pressure is applied.
- e. Report the gel time as the average of three or more determinations.

8.13 COMPOSITE FABRICATION FOR TEST (CLASS 1 TYPES I, II, OR III)

- a. The number of plies in the test composite shall be such that its cured thickness will be $1.90 \pm .127\text{mm}$ ($.075 \pm .005$ in).
- b. Each composite shall be of sufficient size to permit testing to the requirements of the document.
- c. For prepreg material, cut the prepreg plies and stack them on a non-porous Teflon release fabric which has been previously placed on a metal caul plate.
- d. Place on the top of the layup a layer of porous Teflon (Taconic # 7015 or equiv.) followed by 3 plies of Style 120 glass fabric, 3 plies of Style 181 glass fabric, a pressure plate, and two additional plies of 181 glass fabric as a vent layer on top of the layup. Place metal bars parallel to fiber on the edge of the stacked prepreg to prevent fiber washing.
- e. Seal the above assembly in a vacuum bag (Figure 12) in such a manner that no leaks occur and the vacuum source is in contact with the bleeder. Reduce vacuum level to 130mm (5 inches) Hg.
- f. Cure in an autoclave in accordance with the temperature, pressure, and vacuum profile shown in Process Specification D180-20545-5A. (See Figure 11)
- g. Remove vacuum bagging and bleeder materials from cured part, and postcure in an air-circulating for 6 hours, at 602K (625°F). Restraint of the laminate is required during postcure.

8.14 COMPOSITE FABRICATION FOR TEST (CLASS 3 TYPES I, II, OR III)

- a. The quantity of chopped fiber molding compound in the test panel shall be such that its cured thickness will be $3.18 \pm .32\text{mm}$ ($.125 \pm .010$ inch).
- b. The chopped fiber molding compound shall be introduced into a compression mold whose dimensions are 152 x 314cm (6 x 12 inches). The material shall be spread evenly over the mold and 0.7cm (0.275) stops installed around the mold cavity. The mold is then introduced into a heated press at 373K (212°F) and the mold closed to stops. Slowly raise the temperature to 477K (400°F), remove stops after 60 minutes, and apply sufficient pressure to close the mold. Heat the molds to 602K (625°F) and hold for 2 hours. Cool press to below 336K (145°F) and remove pressure.
- c. Post cure the panel in an air-circulating oven 4 hours at 602K (625°F). Note: Part shall be restrained during post curing cycle.

8.15 COMPOSITE MECHANICAL PROPERTIES

Test the composites prepared in accordance with Section 8.13 as follows to demonstrate conformity to the requirements of Table II. Test a minimum of five specimens for each mechanical property.

8.15.1 Flexural Properties

Determine ultimate flexural strength modulus of elasticity in accordance with ASTM D790 as modified below. The flexural test specimen consists of a straight-sided rectangular cross section having the specified thickness. Span/thickness ratio is maintained constant at 32 to 1. Nominal specimen length is 96.5 mm (4 inches) but varies with thickness. The specimen width remains constant at 12.7 mm (0.5 in). The flexural specimens are loaded at quarter span points. Ultimate flexural strength is calculated with the following equation:

$$F_b = \frac{3PS}{4bt^2}$$

F_b = Stress in the outer fiber at failure,

P = Maximum load carried by specimen Newtons (lbs.)

S = Major span

b = Width of specimen

t = Thickness of specimen

The modulus of elasticity is calculated as follows:

$$E_b = \frac{11}{64} \frac{S^3}{bt^3} m$$

E_b = Modulus of elasticity in flexure

S = Span

b = Width of specimen

t = Thickness of specimen

m = Slope of the initial straight line portion of the loading deflection curve. N/m (lb/in)

8.15.2 Interlaminar Shear Properties

Determine ultimate interlaminar strength in accordance with ASTM D2344 as modified below. The interlaminar shear test specimens are short, rectangular cross-section bars that are loaded in a three-point flexure. Nominal specimen dimensions are the width of 6.4 mm (.25 in.) and the length of 25.4 mm (1 in).

The testing is accomplished on a flexure testing fixture using three-point loading with the span being equal to 4 times the specimen thickness. Interlaminar shear stress at failure is computed from the following equation:

$$T_i = \frac{3P}{4A}$$

T_i = Interlaminar shear stress

P = Total load at failure Newton (lbs)

A = Cross-sectional area

8.15.3 Tensile Properties

Determine ultimate tensile strength in accordance with ASTM D638. The tensile properties are computed using the following equation:

$$F_T = \frac{P}{A}$$

F_T = Ultimate tensile stress MPa (KSI)

P = Total load at failure Newton (lbs)

A = Cross section area, square meter (square inches)

8.15.4 Isothermal Aging Properties

Isothermal aging tests shall consist of aging flexural specimens (Section 8.15.1) and interlaminar shear specimens (Section 8.15.2) at 589K (600°F) for periods up to 125 hours in an air-circulating oven.

8.16 COMPOSITES PHYSICAL PROPERTIES

Test the composites prepared in accordance with Section 8.15 as follows to demonstrate conformity to the requirements of Table II. Test a minimum of five specimens for each physical property.

8.16.1 Composite Specific Gravity

Determine the specific gravity of the composite in accordance with ASTM D792.

8.16.2 Composite Resin Content

Determine the resin content of the composite as described by Section 8.11.1, para. b through e.

8.16.3 Composite Fiber Volume

Fiber content is determined from the results of Composite Specific Gravity (Section 8.16.1) and Composite Resin Content (Section 8.16.2) using the following equation:

$$F_V = (1 - R_C) \left(\frac{D_C}{D_F} \right) 100$$

F_V = Fiber volume on a percent basis

R_C = Weight percent resin in composite (Section 8.16.2)

D_C = Specific Gravity of composite (Section 8.16.1) g/cc

D_F = Density of Fiber (Celion 6000-1.76 grams/cu cm)

8.16.4 Composite Void Volume

The composite void volume is determined from the results of Composite Specific Gravity (Section 8.16.1) and Composite Resin Content (Section 8.16.2) using the following equation:

$$V_V = 100 - D_C \left[\frac{R_C}{D_R} + \frac{100 - R_C}{D_F} \right]$$

D_C = Specific Gravity of Composite in grams/cubic centimeter

R_C = Weight percent resin in composite

D_R = Density of PMR-15 resin (1.30 gram/cubic centimeter)

D_F = Density of Graphite Fiber (Celion 6000 1.76 grams/cu cm)

8.16.5 Procedure for T_g Determination of Multi-Layer Laminates

8.16.5.1 Equipment

- a. DuPont Model 990 Thermal Analyzer
- b. DuPont Model 943 Thermomechanical Analyzer (TMA)

8.16.5.2 Equipment Parameters

- a. X-Axis
 - (1) Scale ($^{\circ}\text{C}/\text{inch}$): 50
 - (2) Programmed Heating Rate ($^{\circ}\text{C}/\text{minute}$): 5
 - (3) Shift (inches): 0
- b. Y-Axis
 - (1) Scale (mils/inch) 1.0 (Attenuate as Needed)
 - (2) Probe Load (grams) 5
- c. Expansion Probe - Quartz with .100 inch diameter Flat End

8.16.5.3 Sample Parameters

- a. Nominal Face Size: 3/16" X 3/16" or comparable
- b. Number of Layers: 4 or more
- c. Top and Bottom Faces should be parallel with no burred edges

8.16.5.4 Data

- a. On a typical thermogram of a laminate sample, the T_g is taken as the extrapolated value where the sample undergoes an increase in its apparent thermal expansion.
- b. All measurements are made in air.

8.17 CALIBRATION OF ADSORPTION COLUMNS FOR LIQUID CHROMATOGRAPHY

8.17.1 Scope

This method describes a procedure for the calibration of adsorption columns for use in liquid chromatography.

8.17.2 Equipment

- a. A liquid chromatograph instrument, such as the DuPont Model 850 or equivalent.
- b. Type I DuPont SE 60 non-silanized columns.

8.17.3 Sample Conditions

- a. Mobile Phase: Methylene Chloride 98.5%
Methanol 1.0%
Water 0.5%
NOTE: %'s are all by volume using reagent grade methylene chloride, UV grade methanol, and ultrapure water.
- b. Columns: See Section 8.17.2b
- c. Column temperature: Ambient
- d. Sample: 1/ Benzanilide
2/ 4-Bromacetanilide
Toluene
- e. Flow: 1.0 mls/min
- f. Detector UV @ 254 nm atten x64
- g. Injection: 2 μ l
- h. Chart speed: 2"/min

8.17.4 Sample Preparation

Make up three solutions of the following:

- a. 0.020g Benzanilid in 5 mls mobile phase
- b. 0.020g 4-Bromoacetanilide in 5 mls mobile phase
- c. one part toluene in 10 parts mobile phase

Blend 1.0 parts Benzanilide solution with 1.3 parts 4-Bromoacetanilide solution with 0.9 parts toluene solution.

Inject 2 μ l into column.

8.17.5 Procedure

This evaluation is made by determination of:

N = Theoretical plate number
 α = Column selectivity
k' = Capacity factor
R_S = Resolution

The determination is made from the Chromatogram

Calculate N as follows for toluene

$$N = 16 \frac{(V_0)^2}{t_w}$$

where V_0 = elution volume in seconds

t_w = baseline of extrapolated triangle in seconds

Calculate k' for both Benzanilide and 4-Bromoacetanilide

$$k' = \frac{t_r - t_0}{t_0}$$

where t_r = elution volume in seconds for each compound respectively

t_0 = elution volume in seconds for toluene

Calculate α

$$\alpha = \frac{k'_2}{k'_1}$$

where $k_1 = k'$ for Benzanilide

$k_2 = k'$ for 4-Bromoacetanilide

Calculate R_s

$$R_s = 1/4 \left(\frac{\alpha - 1}{\alpha} \right) \sqrt{N} \frac{k_2}{k_2 + 1}$$

18.17.6 Requirements

$$\alpha = 4.67 \pm .49$$

$$N = 6000 \text{ (min)} \quad R_s = 12 \text{ (min)}$$

$$k'_1 = 0.7 \pm .03$$

$$k'_2 = 3.25 \pm .20$$

- 1/ N-Benzoylaniline $C_6H_5CONHC_6H_5$ mp 435-437K (324-327°F) from Tridon Chemical Inc., 255 Oser Ave, Hauppauge, NY, 11787.
- 2/ N-Acetyl-4-bromoaniline $CH_3CONHC_6H_4$ Br mp 439-442K (331-336°F) from Tridon Chemical Inc.

9.0 MATERIAL IDENTIFICATION

Each roll of tape shall be permanently and legibly marked with a tag placed on the roll core. The tag shall contain all of the items listed in Section 10.c, except the date of shipment.

10.0 PACKING AND MARKING

- a. Individual rolls of material shall be packaged in sealed bags meeting the requirements of MIL-B-117.
- b. Additional packaging (shipping containers) shall be sufficient to assure safe delivery of the material. Material shall be maintained at 254 K (0°F) maximum during shipment.
- c. Each roll of graphite shall be permanently and legibly marked on the container to give the following information:
 - (1) PMR-15 Resin preimpregnated graphite tape
 - (2) Boeing Document D180-20545-4A and Type Number, Class Number, and Grade
 - (3) Batch Number
 - (4) Roll Number
 - (5) Graphite Fiber Master Lot Number(s)
 - (6) Graphite Tape Width
 - (7) Boeing Purchase Order Number
 - (8) Manufacturer
 - (9) Manufacturer's Product Designation
 - (10) Date of Impregnation
 - (11) Date of Shipment (on container tag only)
 - (12) Volatile Content
 - (13) Gel Time (first and last rolls only)
 - (14) Resin Content

In addition, each package roll must bear in red letters, at least 1.9 cm (0.75 in) high, the following statement:

"TEMPERATURE MUST BE MAINTAINED AT 254 K (0°F) OR BELOW"

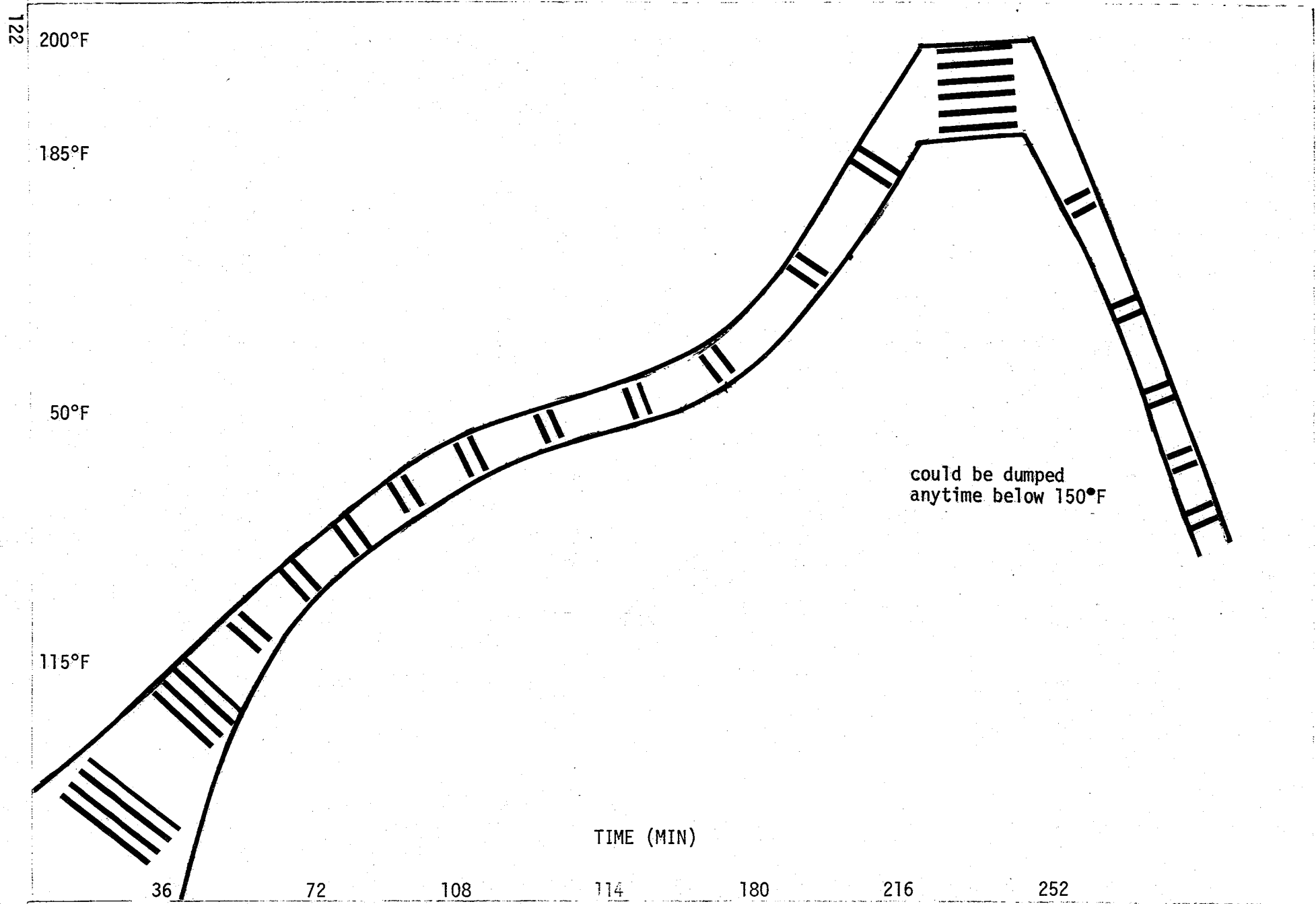

TIME (MIN)

could be dumped
anytime below 150°F

36 72 108 114 180 216 252

FIGURE 1

COOK TEMPERATURE TILE NE

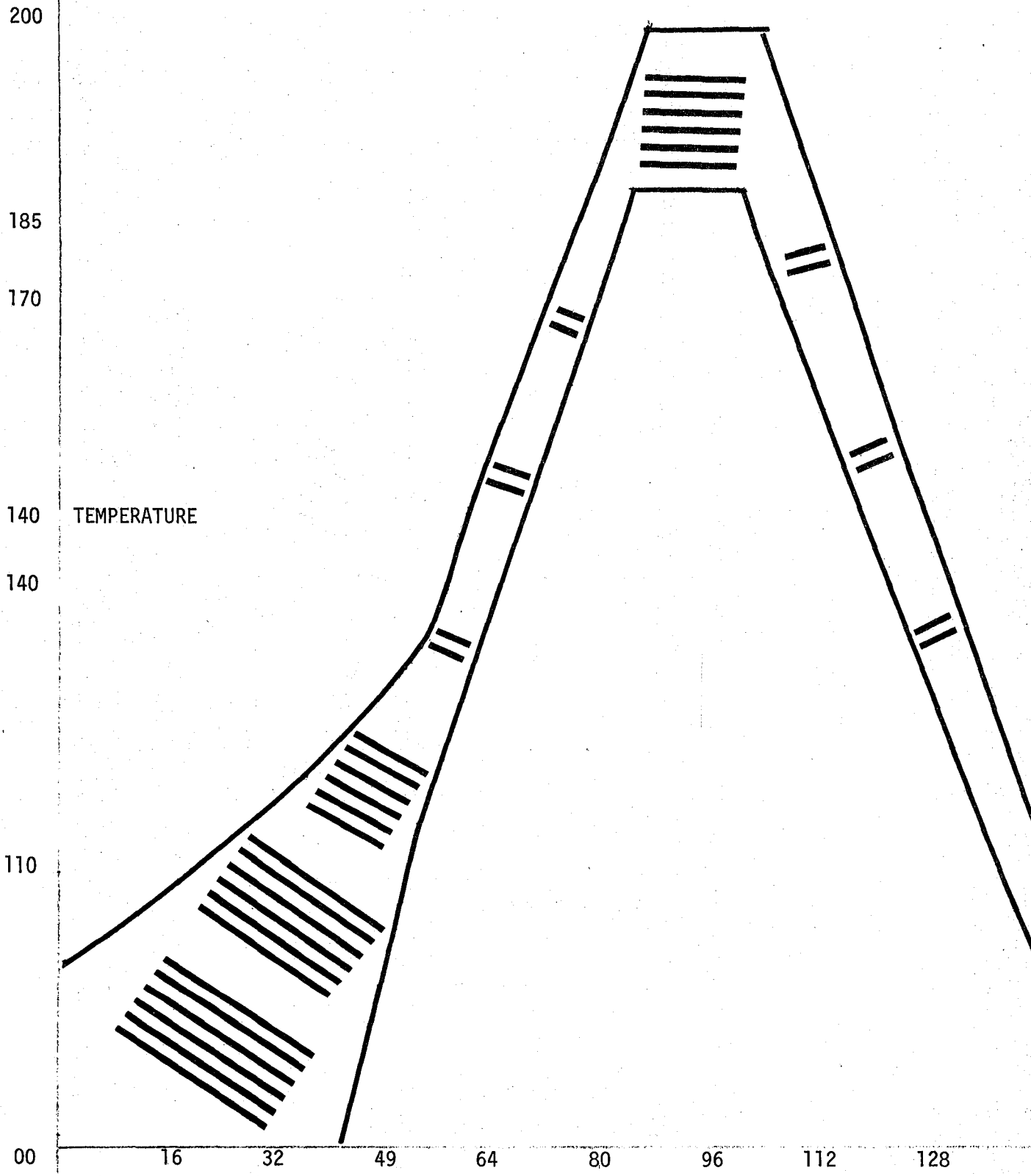

FIGURE 2
 COOK TEMPERATURE PROFILE BTDE

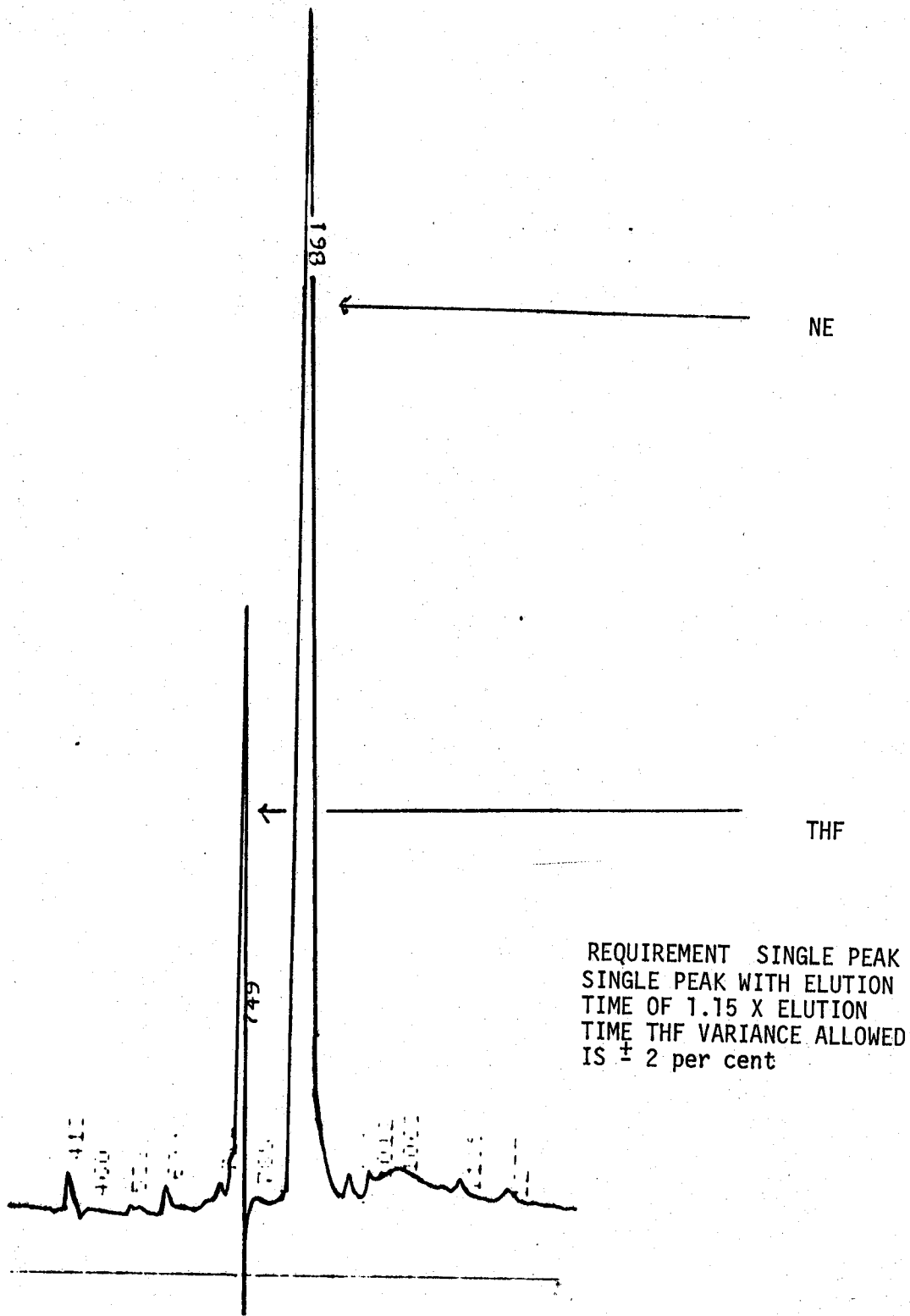
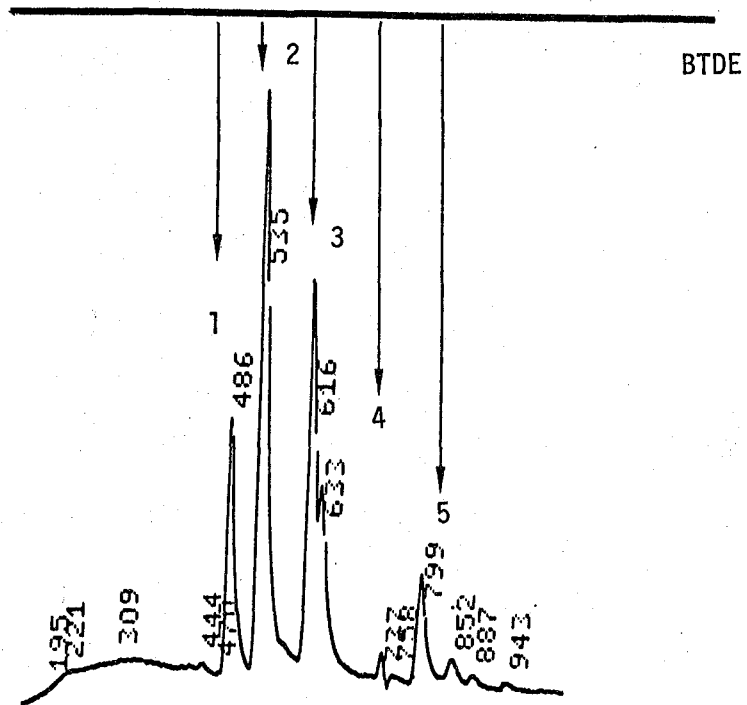

FIGURE 3
STANDARD HPLC CHROMATOGRAM NE



REQUIREMENT

	ELUTION TIME	ELUTION VOLUME (% AREA)
2. PEAK	1 X 1.10	48 ± 4%
3. PEAK	1 X 1.27	25 ± 4%
4. PEAK	1 X 1.30	7 ± 2%
5. PEAK	1 X 1.64	4 ± 1%
1.	-----	15 ± 3%

NOTE: ELUTION TIME VARIANCE ALLOWED IS 2%

FIGURE 4
STANDARD HPLC CHROMATOGRAM BTDE

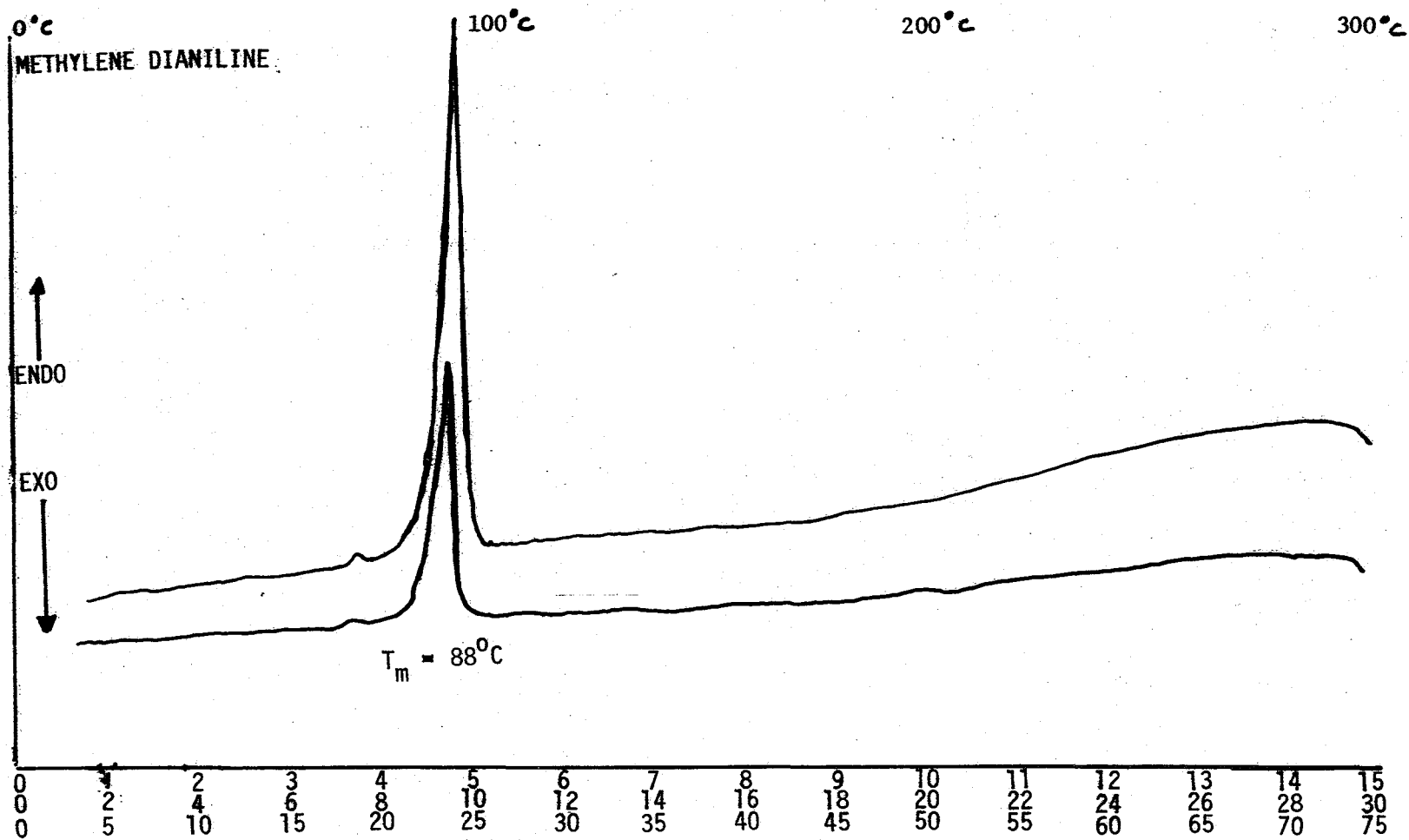
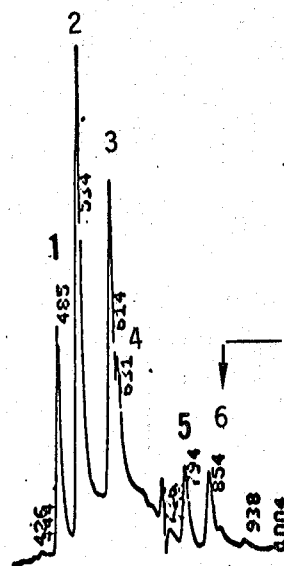

FIGURE 5

STANDARD DSC SCAN OF MDA MONOMER



ELUTION TIME		ELUTION VOLUME % AREA	
NE	PEAK		
	6	1.15 X ELUTION TIME THF	5.7 ± 1%
BTDE	1	-----	17.0 ± 2%
	2	PEAK 1 X 1.12	35.0 ± 3%
	3	PEAK 1 X 1.27	24.0 ± 2%
	4	PEAK 1 X 1.31	11.5 ± 2%
	5	PEAK 1 X 1.63	5.6 ± 1%

VARIANCE ALLOWED IS 2%

FIGURE 6
STANDARD HPLC CHROMATOGRAM PMR-15 RESIN

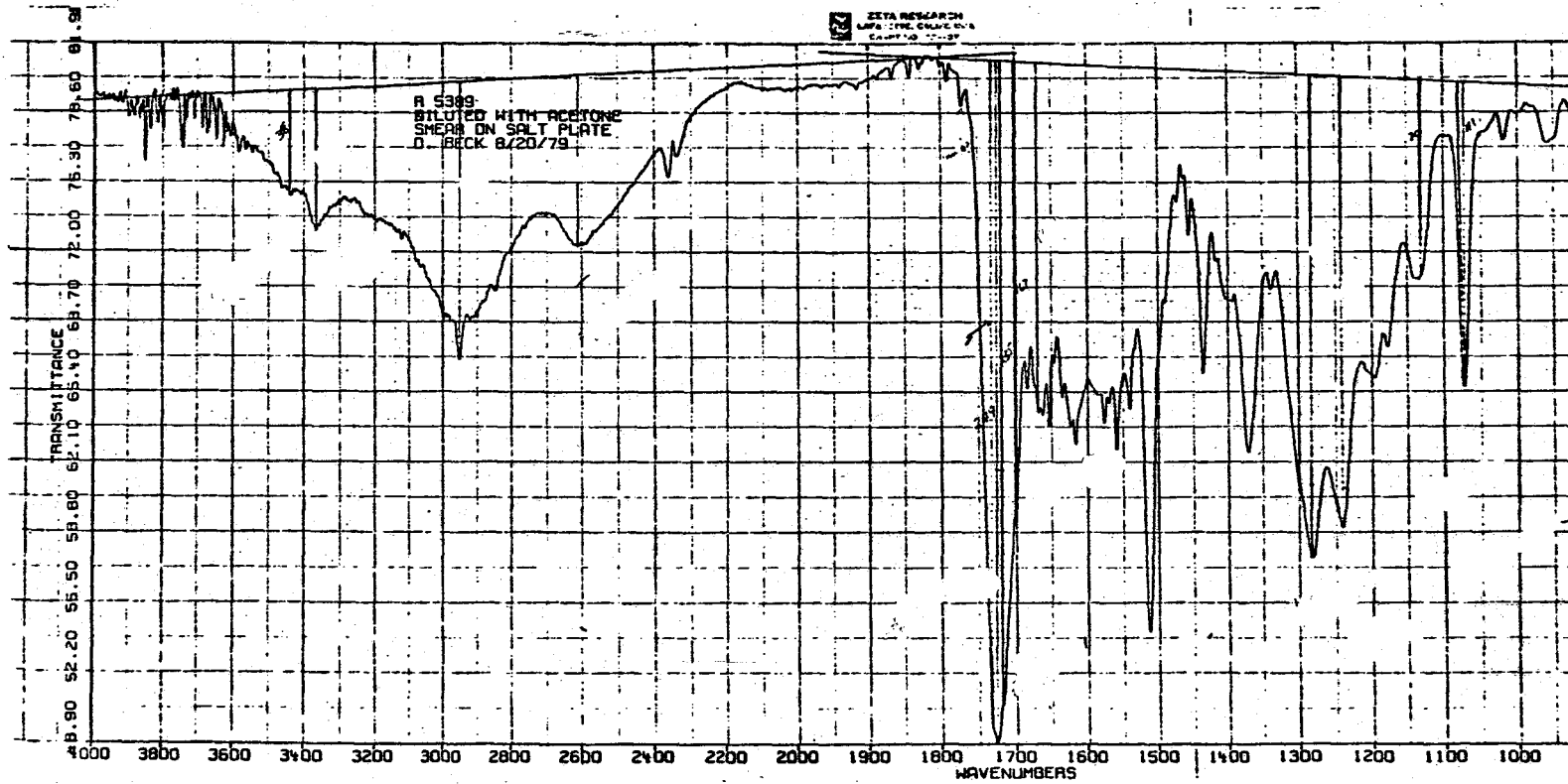
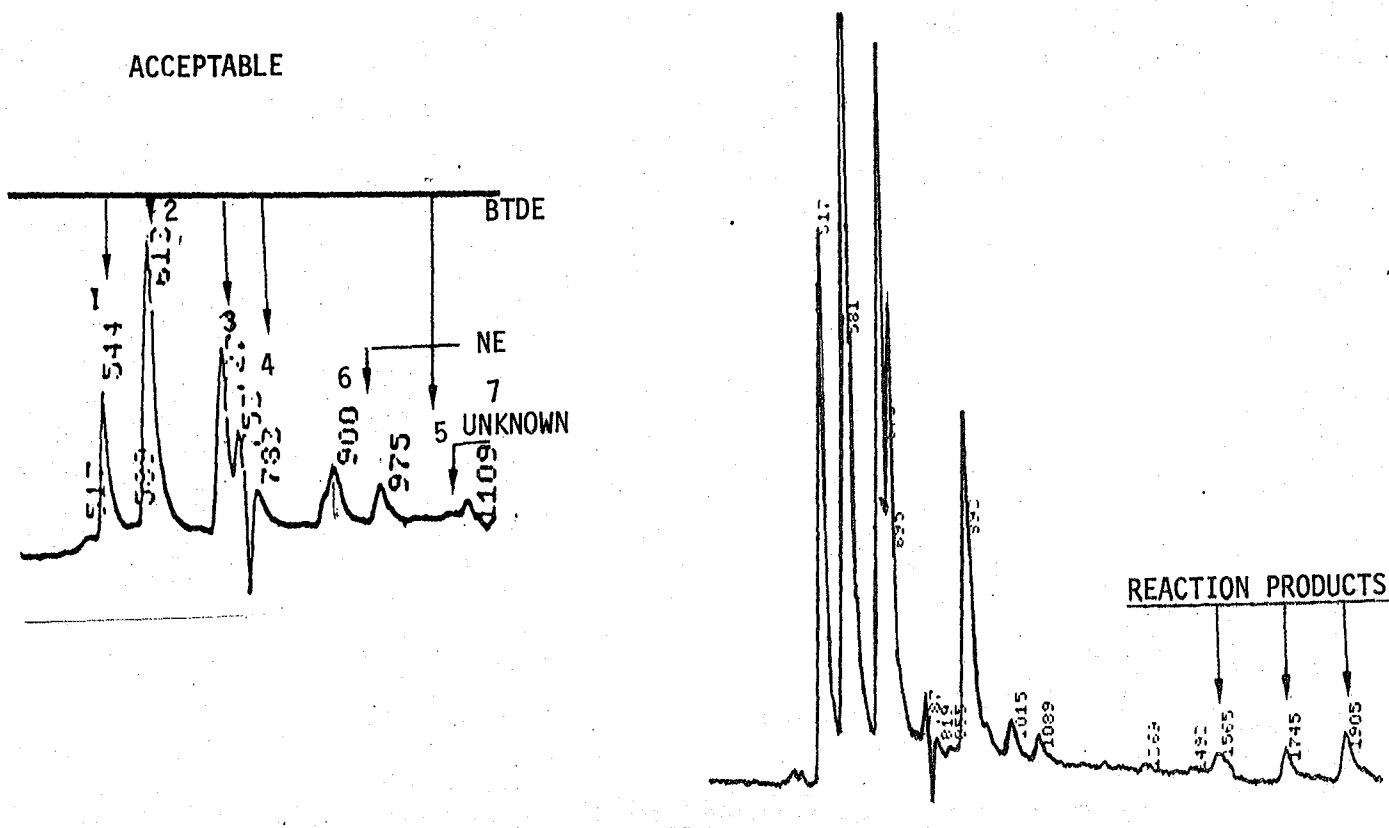

FIGURE 7
STANDARD IR SPECTRUM PMR-15 RESIN

NOT ACCEPTABLE

ACCEPTABLE



	PEAK	ELUTION TIME	ELUTION VOLUME	
NE	6	1.15 X ELUTION TIME THF	8.7 ±	2.0%
BTDE	1		10.5 ±	0.7%
	2	PEAK 1 X 1.12	29.5 ±	3.5%
	3	PEAK 1 X 1.34	18.0 ±	3.0%
	4	PEAK 1 X 1.38	14.0 ±	2.0%
	5	PEAK 1 X 1.79	4.6 ±	1.4%
UNKNOWN	7	PEAK 1 X 2.04	2.2 ±	1.4%

VARIANCE ALLOWED IS 2%

FIGURE 8
STANDARD HPLC CHROMATOGRAMS EXTRACTED PMR-15

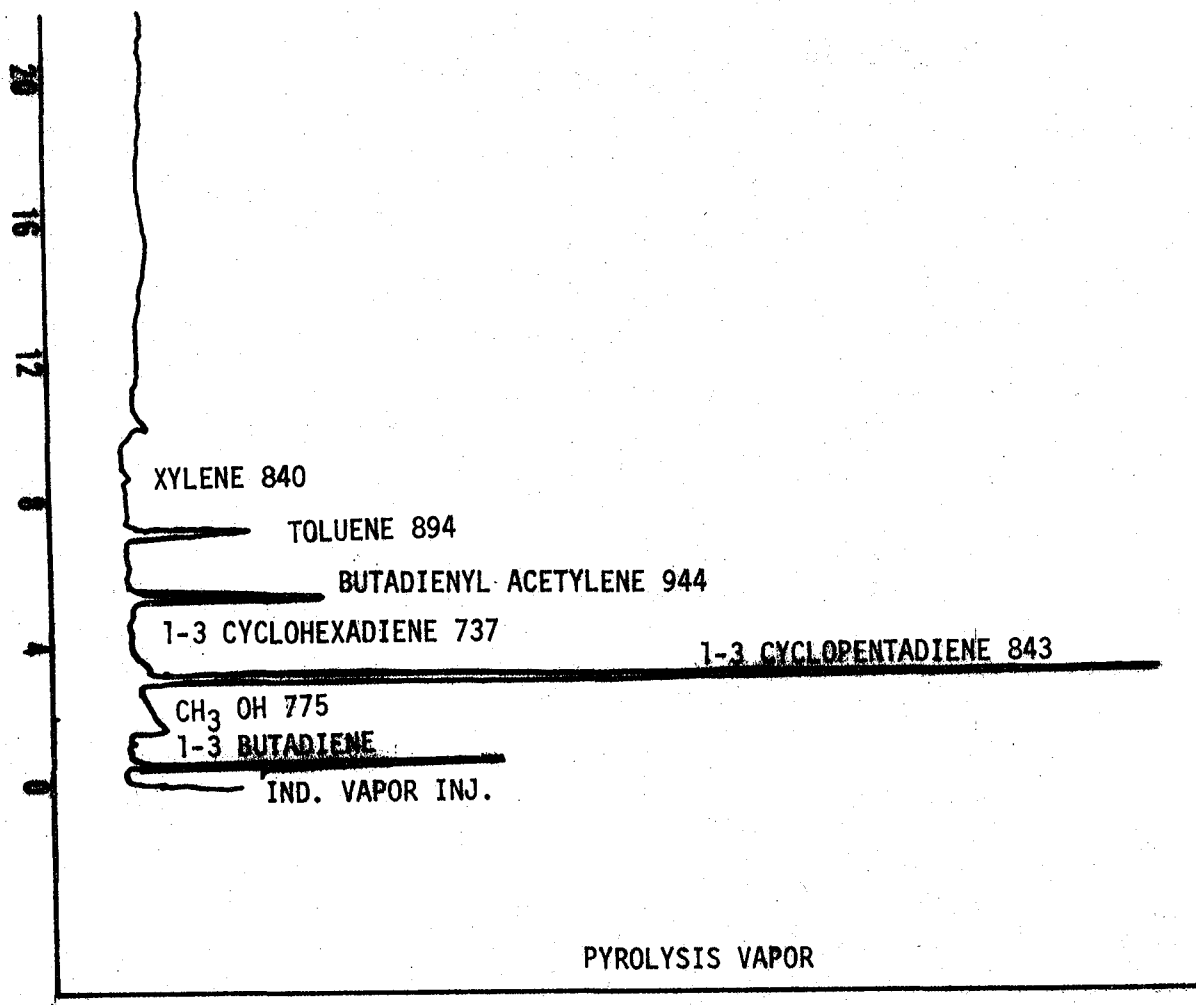

FIGURE 9

SANDARD GAS CHROMATOGRAM
GRAPHITE/PMR-15 PREPREG

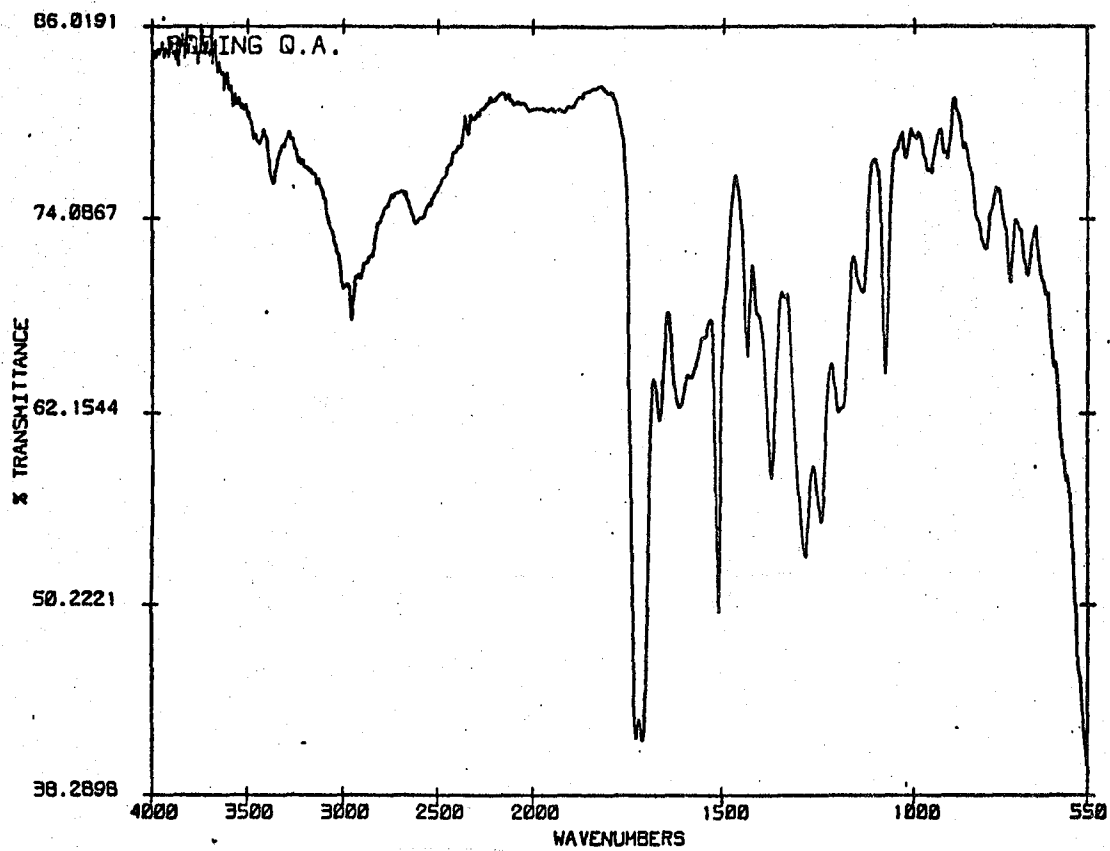

FIGURE 10
STANDARD FTS IR CURVES GRAPHITE/PMR-15 PREPREG

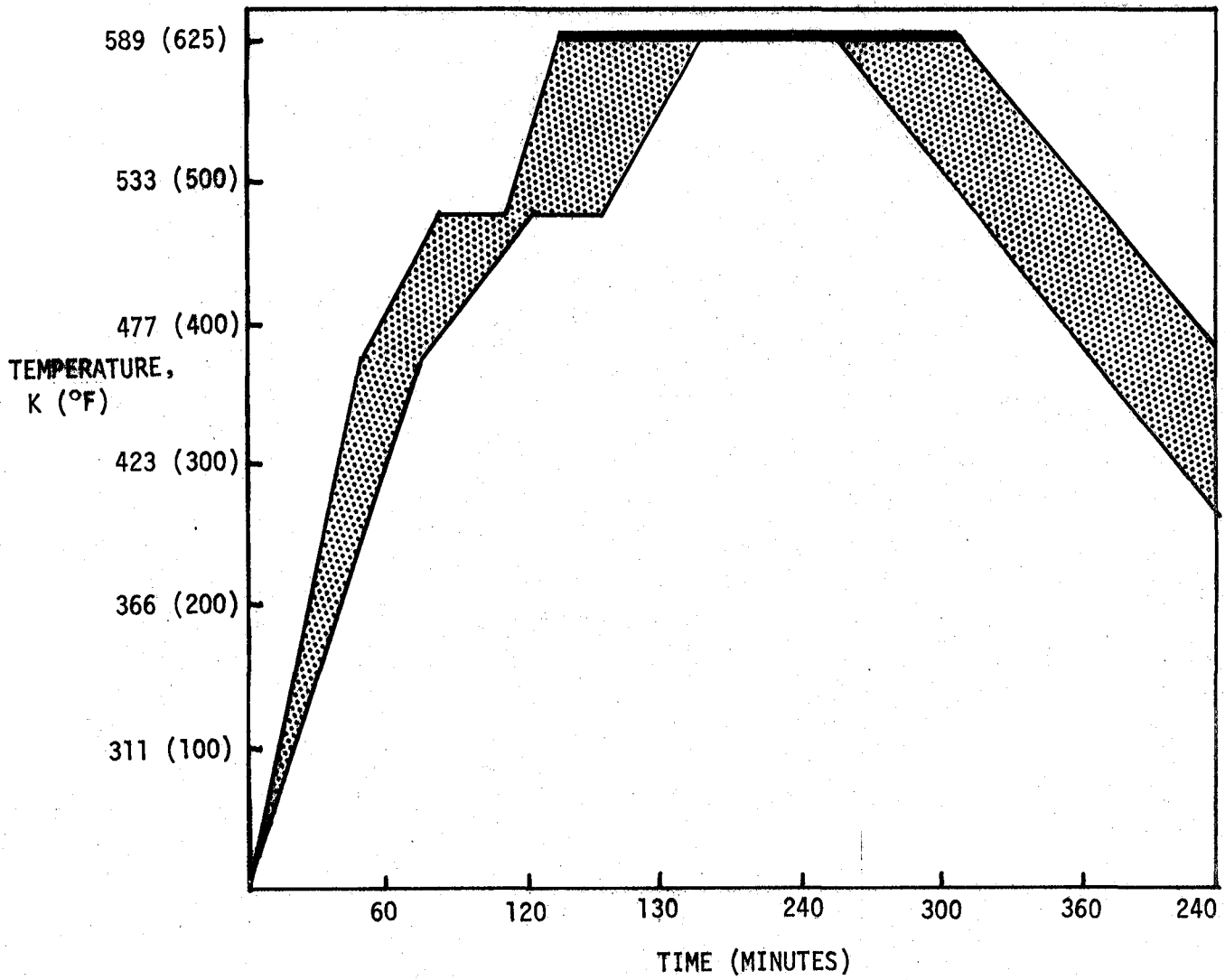

FIGURE 11

GRAPHITE/PMR-15 COMPOSITE CURE CYCLE

STAUFFER WACKER
7220 GUM STOCK
OR EQUIVALENT

RTV 106 OR
EQUIVALENT

VACUUM
SOURCE

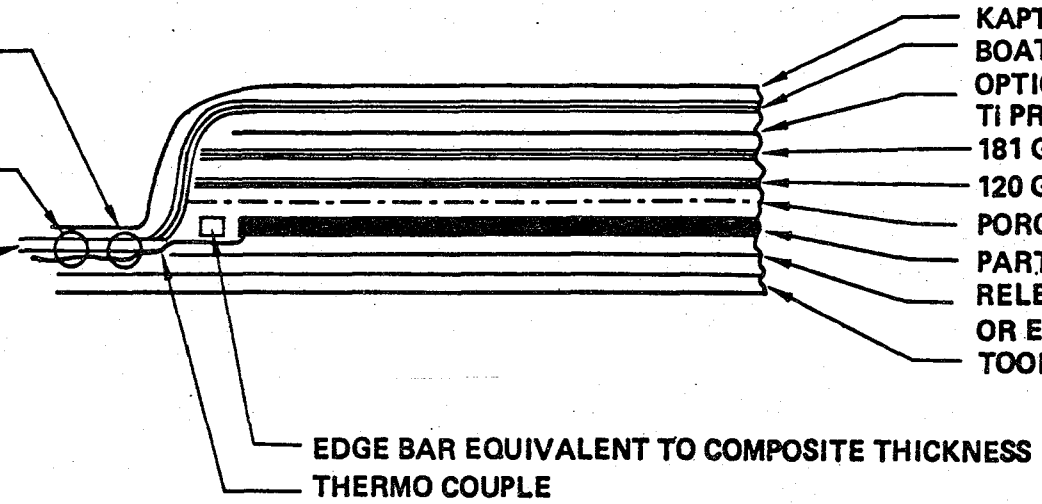

KAPTON FILM
BOAT FABRIC OPTIONAL
OPTIONAL (0.060-in
TI PRESSURE PLATE)
181 GLASS FABRIC
120 GLASS FABRIC
POROUS ARMALON
PART/ASSEMBLY
RELEASE KAPTON FILM
OR EQUIVALENT
TOOL

EDGE BAR EQUIVALENT TO COMPOSITE THICKNESS
THERMO COUPLE

FIGURE 12

VACUUM BAG SCHEMATIC

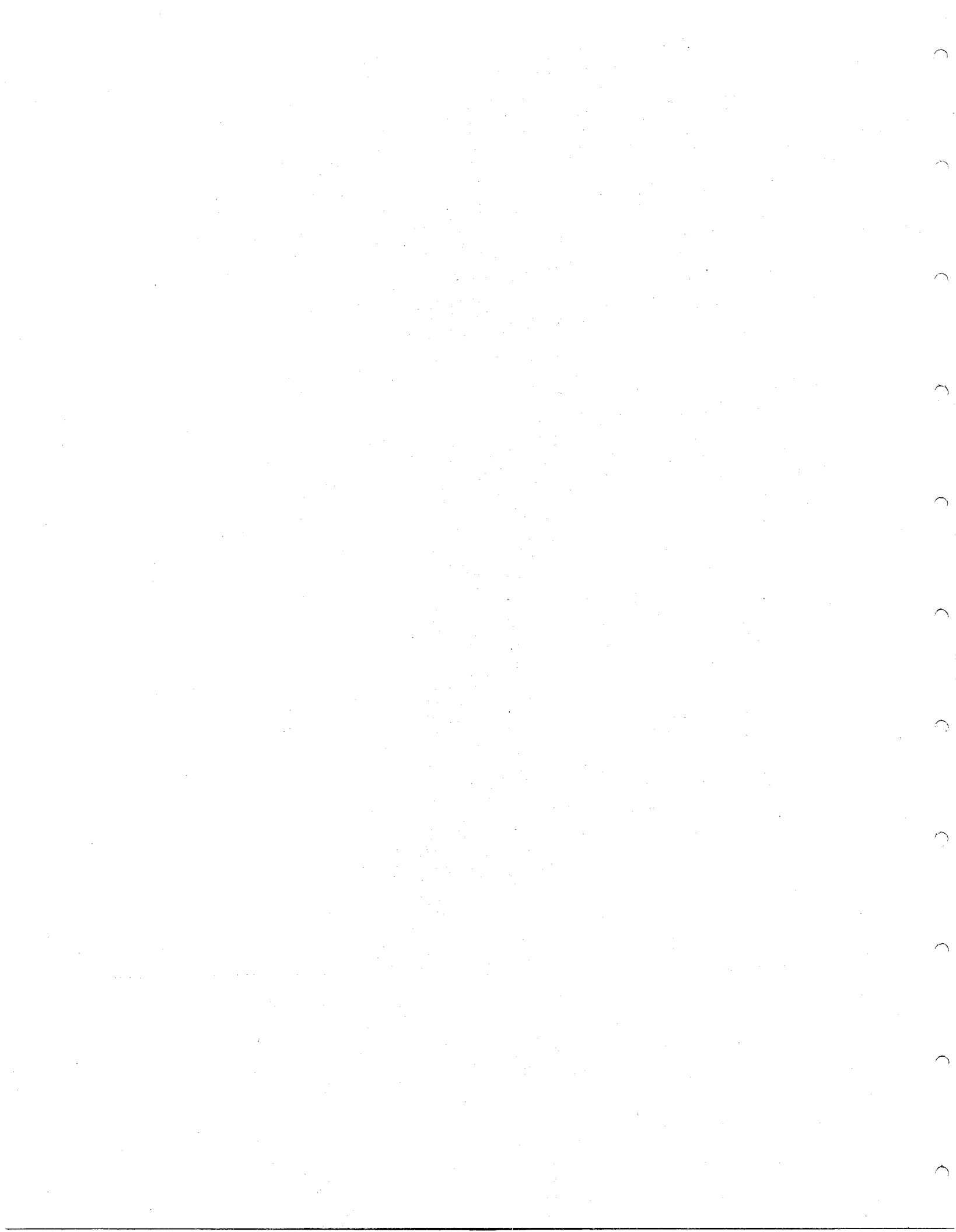

APPENDIX B2

DOCUMENT NO. D180-20545-5A

TITLE: PROCESS SPECIFICATION FOR PMR-15/GRAPHITE PREPREG

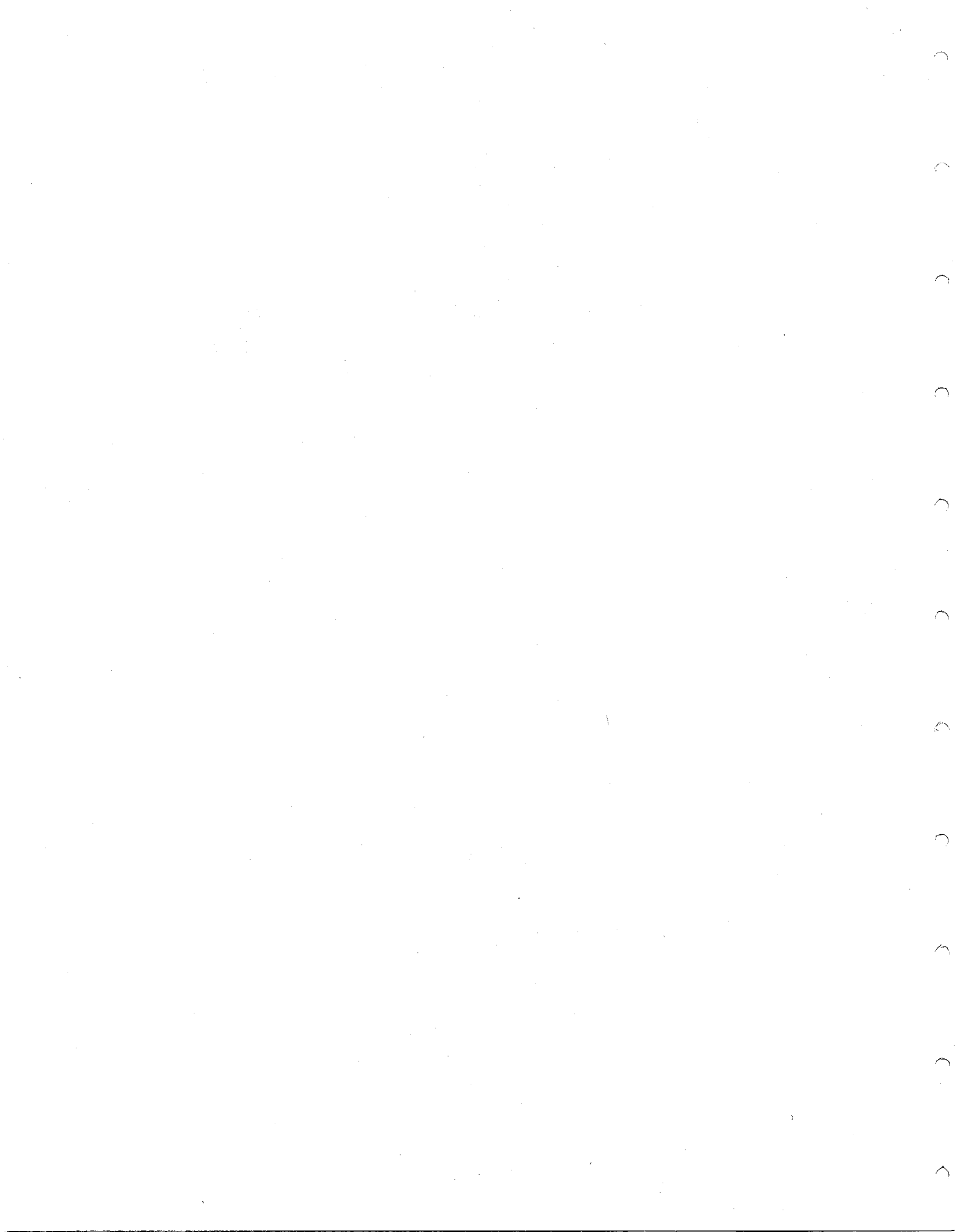

ABSTRACT

Process requirements are specified for Graphite/PMR-15 polyimide prepreg. The requirements include the materials, facilities, and equipment required for the fabrication of structural elements. The structural elements includes flat laminates contoured parts such as Hat sections, Corrugations, "I" Beam Sections, and sandwich panels from unidirectional prepreg or woven graphite fabric prepreg. Also included is a method for fabrication for Graphite/PMR-15 chopped fiber molded parts. Quality control requirements are also included in this document.

KEY WORDS

PMR-15 Polyimide

Graphite Tape

Graphite Fabric

Chopped Fiber Molding Compound

Structural Elements

Laminates

Polyimide Honeycomb Core

Processing

Fabrication

TABLE OF CONTENTS

<u>Paragraph</u>	<u>Title</u>	<u>Page</u>
1.0	SCOPE	
2.0	CLASSIFICATION	
3.0	REFERENCES	
4.0	DEFINITIONS	
5.0	MATERIALS CONTROL	
5.1	Deliverable Materials	
5.2	Controlled Expendable Materials	
6.0	FACILITIES CONTROL	
6.1	Layup Area	
6.2	Equipment	
6.3	Molds	
6.4	Refrigerated Storage	
7.0	MANUFACTURING CONTROL	
7.1	Storage and Handling of Materials	
7.2	Production Part Identification	
7.3	Preparation of Materials	
7.3.1	Adhesives	
7.3.2	Prepreg Material	
7.4	Preparation of Mold	
7.5	Fabrication Requirements	
7.5.1	General Requirements	
7.5.2	Laminate Fabrication -- Method I	
7.5.3	Laminate Fabrication -- Method II	
7.5.4	Cocure Skin Sandwich -- Method I	
7.5.5	Precure Facing Sandwich -- Method I	
7.6	Finishing	
8.0	QUALITY CONTROL	
8.1	Materials	
8.2	Process	
8.3	Completed Parts	
8.4	Process Control Test Panels	
8.4.1	Test Panel Fabrication Frequency	
8.4.2	Test Panel Configuration and Fabrication Requirements	
8.4.3	Process Control Panel	
9.0	PROCESS QUALIFICATION	
10.0	DISCREPANCY ACCEPTANCE AND REJECTION	

LIST OF TABLES

<u>Table No.</u>	<u>Title</u>	<u>Page</u>
1	Process Control Panel Requirements	

LIST OF FIGURES

<u>Figure No.</u>	<u>Title</u>	<u>Page</u>
1	Cure Cycle Graphite/PMR-15 Graphite Polyimide Prepreg (D180-20545-4, Types I, II, or III Class 1 or 2) Method I	
2	Typical Graphite/PMR-15 Polyimide Layup	
3A	Vacuum Bag Schematic Hat Section Layup	
3B	Hat Section Kapton Vacuum Bag Schematic	
4A	Vacuum Bag Schematic Corrugated Section Layup-End View	
4B	Vacuum Bag Schematic Corrugated Section Layup-End View	
5A	"I" Beam Layup for Secondary Bonding	
5B	Vacuum Bag Schematic for "I" Beam Bonding	
6	Sandwich Assembly Edge View	
7	Vacuum Bag Schematic	
8	Cure Cycle Graphite/PMR-15 Polyimide Honeycomb Panel	
9	Sandwich Process Control Panel	
10	Laminate Process Control Panel	

1.0 SCOPE

This document establishes the requirements for fabrication of unidirectional tape and woven fabric graphite/PMR-15 polyimide autoclave cured structural parts.

In case of conflict between this document and engineering drawing, the engineering drawings shall have precedence.

2.0 CLASSIFICATION

This process document for structural composite parts shall consist of the following methods:

Method I Graphite Prepreg (D180-20545-4A) Type I, II, or III Class 1 or 2	Unidirectional graphite prepreg or woven graphite fabric preimpregnated with PMR-15 polyimide resin requiring surface bleed for laminate structure and a polyimide adhesive for honeycomb sandwich bonding. (Note: The type of prepreg designates the reinforcement modulus whereas the class designates unidirectional or woven fabric prepreg.) Use D180-20545-4A Material.
---	---

Method II Graphite Prepreg (D180-20545-4A), Type I, II, or III, Class 1	Chopped graphite fiber preimpregnated with PMR-15 polyimide resin requiring compression molding techniques for fabricating composite parts. (Note: The type of molding compound designates the reinforcement modulus whereas the class designates the chopped fiber prepreg.)
---	---

3.0 REFERENCES

Except where a specific issue is indicated, the current issue of the following references shall be considered a part of this document to the extent indicated herein:

- a. ASTM D790 Test for Flexural Properties of Plastics
- b. ASTM D2344 Test for Apparent Horizontal Shear Strength of Reinforced Plastics by Short-Beam Method
- c. D180-20545-4 Material Specification for PMR-15/Graphite Prepreg
- d. D6-44613 Qualification of Sources for Advanced Composite Parts
- e. MIL-STD-401 Military Standard Sandwich Construction and Core Materials: General Test Methods

4.0

DEFINITIONS

- a. Batch of Prepreg - Prepreg containing reinforcement impregnated with one batch of resin in one continuous operation.
- b. Bleeder - A porous material used to absorb excess resin during cure or to provide a path for reaction products removal.
- c. Bridging - A condition where one or more plies of prepreg tape or fabric span a radius, step, or chamfered edge of core without full contact.
- d. Buckle Line - A line of collapsed cells, two to three cells wide, with undistorted cells on either side. (Buckle lines generally appear on the inner radius of the formed core.)
- e. Core Crush - A collapse, distortion, or compression of the core.
- f. Core Depression - A localized indentation or gouge in the core.
- g. Core Separation - A partial or complete breaking of the core node bond.
- h. Core Splicing - The joining of segments of core by overlapping each segment two to four cells and then drawing them together.
- i. Delamination - A separation of graphite plies from each other and/or facing plies from core which can occur during cure or finishing operations.
- j. Doubler Ply - Partial plies which extend to areas over honeycomb in sandwich structures.
- k. Inclusions - Foreign material particles, chips, films, etc. of varying sizes which are not desired and/or are detrimental to part integrity.
- m. Inner Facing - That side of the panel which is cured against the vacuum bag.
- n. In-Process Control Form - An outline of the fabrication steps and materials used to prepare a part.
- o. Layup Area - The fabrication area where prepreg is cut, plies, assembled or kitted.
- p. Prepreg Lot - Material from one batch, submitted for acceptance at one time.

- q. Outer Facing - That side of the panel which is cured against the tool (mold, mandrel, etc.).
- r. Pin Holes - Small cavities that penetrate the surface of a cured part.
- s. Ply Wrinkle - A condition where one or more of the plies are permanently formed into a ridge, depression, or fold.
- t. Process Control Record - A record of the materials, process, and process control panel test results.
- u. Resin Richness - An area of excess resin, usually occurring at radii, steps, and the chamfered edge of core.
- v. Resin Ridge - A sharp buildup of resin on the surface of a part.
- w. Resin Starved - An area deficient in resin, usually characterized by excess voids and/or loose fibers.
- x. Telegraphing - The dimpling of the composite plies into the core cells.
- y. Void - An empty, unoccupied space in an assembly. Voids are associated with bridging, resin starved areas, and processing conditions.

5.0 MATERIALS CONTROL

5.1 DELIVERABLE MATERIALS

The materials listed below are incorporated into the part during fabrication, and must be procured from approved sources.

	<u>Material</u>	<u>Source</u>
a.	D180-20545-4A, "Material Specification for Graphite Prepreg/PMR-15"	QPL
b.	Polyimide Adhesive, A7F, "Polyimide Paste Adhesive"	QPL
c.	Honeycomb Core, HRH 327, 1.8 kg/m ³ (5.0 lb/ft ³) Density, "Reinforced Plastics Honeycomb Core for Continuous Elevated Temperature Service 505-589°K (450-600°F)"	Hexcel

5.2 CONTROLLED EXPENDABLE MATERIALS

	<u>Material</u>	<u>Source</u>
a.	Parting Film Materials	
	(1) FEP Film, 1 mil thick	E.I. DuPont de Nemours
	(2) Teflon Film, Nonperforated	E.I. DuPont de Nemours
	(3) Teflon Release Fabric, Porous, Type 7015	Taconic
	(4) Teflon Release Fabric, Nonporous Type 382-3	Port Plastics
	(5) Celgard 4410 Microporous Film	Celanese
b.	Mold Release Materials	
	(1) Frekote FR 33	Frekote, Inc.
	(2) Mold Release, R671	Dow Corning
c.	Protective Hand Cream (Personnel Protection)	
	(1) Liquid Glove	Physicians Formula, Inc.
	(2) Kerodex Hand Cream	Ayerst Lab., Inc.
	(3) SP 128	Pacific Chemical
	(4) Gloves, Teflon or Nylon, knitted	W.S. Shamban Corp. Newberry Park, CA
d.	Vacuum Bag Material	
	(1) Kapton Film, 2 mil (200H)	Fralock Lockwood Industries Van Nuys, CA or DuPont
	(2) Stauffer Wacker 7220 Gum Stock or equivalent	Stauffer Wacker
	(3) RTV-102	General Electric
	(4) Extruded Sealing Compound	Schnee-Moorehead Chemicals, Inc.

	<u>Material</u>	<u>Source</u>
e.	Solvents	
	(1) Acetone, in accordance with military specification O-A-5	QPL
	(2) Methyl Ethyl Ketone in accordance with military specification TT-M-261	QPL
	(3) Dimethylformamide, Reagent Grade	Wilshire Chemical
	(4) N methyl pyrrolidinone, Reagent Grade	Wilshire Chemical
	(5) Methanol, Absolute	Open
f.	Bleeder and Breather	
	(1) Type 120 Glass Fabric (Bleeder Only)	Open
	(2) Type 181 Glass Fabric (Bleeder Only)	Open
	(3) Fiberglass Tape	Open

6.0 FACILITIES CONTROL

6.1 LAYUP AREA

The layup area shall be controlled, as a minimum, to the following:

- a. Operation of internal combustion engines within the area is prohibited.
- b. Motors and equipment which distribute, in any way (spray, throw, etc.) visible droplets of oil, grease, or other lubricants onto the hardware or surfaces which contact the hardware, are prohibited.
- c. Operations that generate nonvolatile hydrocarbons are prohibited.
- d. Seal and/or cover floors with nonflaking, easily cleaned material, such as plastic, paint, tile, etc.
- e. The floors shall be cleaned at least once each working day by vacuum in which the exhaust air is vented outside the work area or filtered, or with polyethylene glycol treated or water damp mops.

- f. Waxes, compounds containing uncured silicone, or any material detrimental to adhesion are not allowed in the layup area.
- g. All materials, tools, parts, or equipment taken into the area shall be free of dirt, grease, oil, or other contaminants detrimental to adhesion.
- h. No eating or smoking is allowed in the layup areas.
- i. Personnel (handling prepreg and details that have not completed cure or bond fabrication steps) who do not use the protective creams specified in Section 5.2.c shall at all times keep their hands clean and free of materials detrimental to adhesion.
- j. Layup areas shall be separated or isolated from operations or conditions that generate excessive particulate matter (machining and sanding operations, open outside doors, etc.).
- k. It is recommended that the temperature in layup and holding areas be maintained at 287 to 304 K (60 to 90°F) and 50% maximum relative humidity.

6.2 EQUIPMENT

- a. Autoclave - Use a heated air or gas circulating autoclave to provide the temperatures, heat-up rates, vacuum, and pressure required by this document.
- b. Oven - Use a circulating air heated oven equipped with vacuum facilities to provide the vacuum and temperatures required by this document.
- c. Temperature Recording Device - Use a multipoint temperature recording device to provide for recording the thermal history of a part while undergoing cure and/or postcure as required by this document.

6.3 MOLDS

- a. The mold surface must be nonporous, and free of cracks, pits, and any other irregularities that would affect the quality of the part.
- b. The mold must be capable of withstanding indefinitely a temperature of 615K (650°F) at 760mm (28 inches) of mercury vacuum pressure without warping and must not hinder the part on the mold from meeting the cure cycle of this document.

6.4 REFRIGERATED STORAGE

A storage area capable of maintaining temperatures at $254 \pm 5\text{K}$ ($0 \pm 10^\circ\text{F}$) is required for storage of the prepreg and adhesive.

7.0 MANUFACTURING CONTROL

7.1 STORAGE AND HANDLING OF MATERIALS

7.1.1 Prepreg Materials

- a. Store rolls or precut kits of prepreg material in sealed polyethylene bags in accordance with D180-20545-4A material specification. An identification label must accompany the material, inside the bag, with the following information: material type, class, grade, supplier name and designation, batch number, roll number, and date of kit preparation.
- b. Methods I and II materials shall be allowed 240 hours work life at room temperature before being retested to the requirements of the applicable specification. Retest shall be identical to original receiving inspection tests. Requalified material shall be allowed 160 hours work life before another set of requalification tests is required.
- c. When removed from cold storage for use, the prepreg shall remain sealed until it reaches near ambient temperatures (i.e., such that no condensation forms on the outside of the film wrapper).
- d. Prepreg rolls that have been partially used can be refrozen only if placed in sealed polyethylene bags. Follow Sections 8.1.1.b and 8.1.1.c for future use.

7.1.2 Honeycomb Core

- a. The honeycomb core shall be stored in an original shipping or other suitable container prior to its use in the fabrication of details.
- b. Once the core has been cut to size for fabrication, and clearly identified as specified by drawing, the core must be stored in a manner that does not cause core damage or contamination from grease, oil, dirt, and other foreign material detrimental to bonding.

7.1.3 Adhesive Materials

Adhesive materials shall be stored and handled for production use as required by their respective specifications.

7.2 PRODUCTION PART IDENTIFICATION

- a. Identify each production part with the following information:
 - (1) Drawing or part number

- (2) Unit serial number
- (3) Date of manufacture
- (4) Manufacturer's identification
- b. Maintain traceability of the completed part to specific processing information and material identification used in the fabrication of that part.
- c. Record processing information and material identification used in fabrication on the Process Control Record specified in Section 9.2.d.

7.3 PREPARATION OF MATERIALS

7.3.1 Adhesives

Prepare the adhesives for assembly as instructed in their applicable process specification.

7.3.2 Prepreg Material

Note: To prevent dermatitis, clean, white, lint-free gloves or approved protective hand creams should be used.

- a. After removal from freezer, keep prepreg material in polyethylene bags until condensation does not form on the exterior when wiped.
- b. Prepreg material must remain free of contaminants during handling.
- c. Do not remove prepreg backing until the prepreg is used.

7.4 PREPARATION OF MOLD

Mold surfaces shall be prepared by first cleaning with methyl ethyl ketone (MEK). Parting films described in Section 5.2.1 or mold releases described in Section 5.2.b are applied to mold surface prior to part fabrication. Mold releases that are applied to a clean mold shall be baked for 30 minutes at 393K (250°F) prior to start of layup. Mold releases may be air dried for 30 minutes minimum at ambient temperature when applied to a tool surface that has had a 393K (250°F) baked mold release applied previously.

Note: Do not MEK wipe a mold surface on which a mold release has been applied and is to be used for immediate part fabrication. MEK will remove the mold release.

7.5 FABRICATION REQUIREMENTS

7.5.1 General Requirements

- a. Cloth splices in laminates and all sandwich facings - Graphite fabric prepreg lap splices shall be $12.7^{+12.7}_{-0}$ mm ($0.50^{+0.50}_{-0}$ inch). Stagger splices of individual plies within a layup at a minimum of 25.4 mm (1.00 inch). Butt splices are not allowed unless specified by drawing.
- b. End tape splices - Cut end tape splices in laminates and over minimum gage sandwich facings and doublers shall be overlapped a minimum of 1.27mm (0.05 in.) and separated/staggered in individual plies a minimum of 25.4 mm (1 inch). Butt end tape splices are not allowed unless specified by drawing.
- c. Over Lapping Butt Splices - Exterior (tool surface) unidirectional tape used in sandwich face skins shall have an overlap parallel to the fiber direction of $2.54 + 2.54$ mm ($0.10 + 0.10$ inch). Such overlaps shall be separated by a minimum of 25.4 mm (1 inch) between individual plies.
- d. Gaps in Butt Splices - Graphite prepreg splices shall be made from tape with a squared edge and shall be butt jointed with the aid of methyl alcohol or application of heat. The butt splices shall have a maximum gap of 0.25 mm (0.010 inch).
- e. Adhesive splices - Adhesive film shall be butt spliced maximum gap 1.5 mm (0.060 inch).
- f. Ply orientation - All angularity specified shall be based on fabric warp direction or parallel to tape fiber direction. Orient the warp direction fabric or unidirectional tape as specified with respect to the direction indicator on each detail. The tolerance of each fabric warp ply shall be $+5$ degrees and $+3$ degrees for unidirectional tape plies unless otherwise specified on the drawing. The drawing shall also specify options, such as (0 degrees/90 degrees), (+45 degrees or -45 degrees), etc. Individual ply directional tolerances shall not be enforced around corners, sharp contours, and highly complex compound contoured parts.
- g. Autoclave pressure - Autoclave pressure for laminate structure shall be 1378^{+65}_{-0} Pa (200^{+10}_{-0} psi). Autoclave pressure for sandwich structures shall be 689^{+65}_{-0} Pa (100^{+10}_{-0} psi). Pressure for all structures shall be maintained until temperature is reduced to below 338 K (150°F) upon completion of cure.

- h. The use of methyl alcohol is permitted to facilitate layup. If methyl alcohol is used, allow layup to stand at ambient conditions for a minimum of 16 hours. The use of a heat gun or heat blanket is also permitted if part temperature does not exceed 316K (110°F).
- i. Do not cut previously applied plies during layup of new plies. Trim upon completion of layup.
- j. Application of Vacuum Pressure
 - (1) Apply vacuum pressure to the part. Approved vacuum bag materials and rubber pressure pads shall not come in direct contact with the prepreg layup, but shall be separated by one of the parting films listed in Section 5.2.a.
 - (2) Apply full vacuum 650mm (24 inches) of Hg minimum and make the bag conform to the shape of the part. Then check for leaks by disconnecting the vacuum line. The vacuum gage reading must not drop more than 135mm (5 inches) in 5 minutes.
- k. Cure - Follow cure cycles for each material as specified in Sections 7.5.1.n and 7.5.1.o.
- m. Thermocouple Requirements
 - (1) A minimum of one thermocouple in the thickest area of the part or tool shall be required for each 1 square meter (10 square feet) or fraction thereof. Each part shall contain a minimum of two thermocouples.
 - (2) If a thermocouple failure occurs (as indicated by erratic temperature response), that thermocouple shall be discounted.
- n. Cure Cycle Requirements (Method I) (Also See Figure 1)
 - (1) Place layup (Figure 2) in an autoclave and attach a vacuum source capable of maintaining 100-170mm (4-6 inches) Hg vacuum level.
 - (2) Heat the part/assembly to 463^{+5}_{-0} K (375^{+10}_{-0} °F) at the rate of 2.0-3.0°K (4 to 6°F) per minute. Change heating rate at 463^{+5}_{-0} K (375^{+10}_{-0} °F) to 1.1-1.7K (2-3°F) per minute to 522^{+5} K (480^{+10} °F).

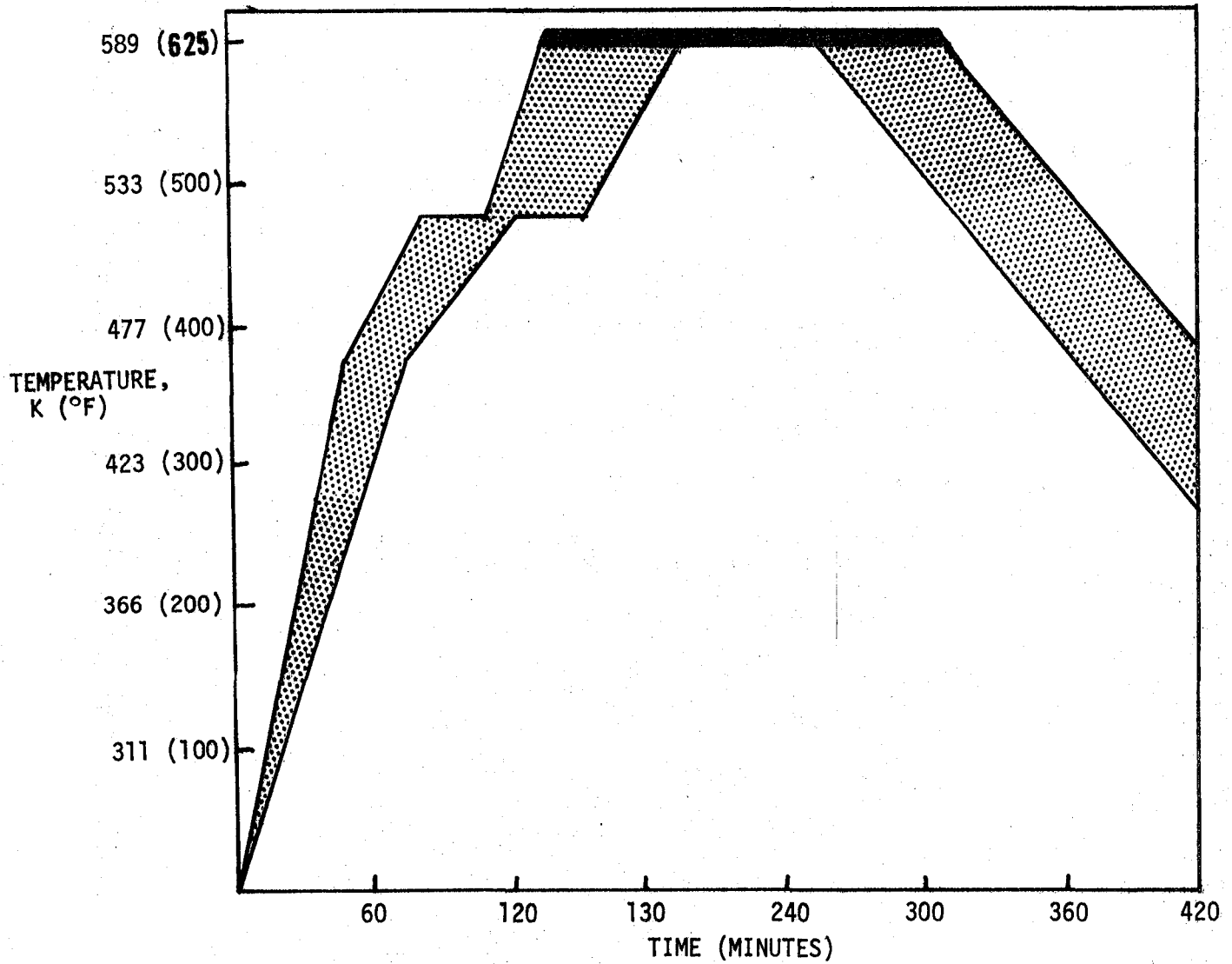

Cure Cycle Graphite/PMR-15 Graphite Polyimide prepreg
 (D180-20545, Type I, II or II Class 1 or 2) Method I

FIGURE 1

GRAPHITE/PMR-15 COMPOSITE CURE CYCLE

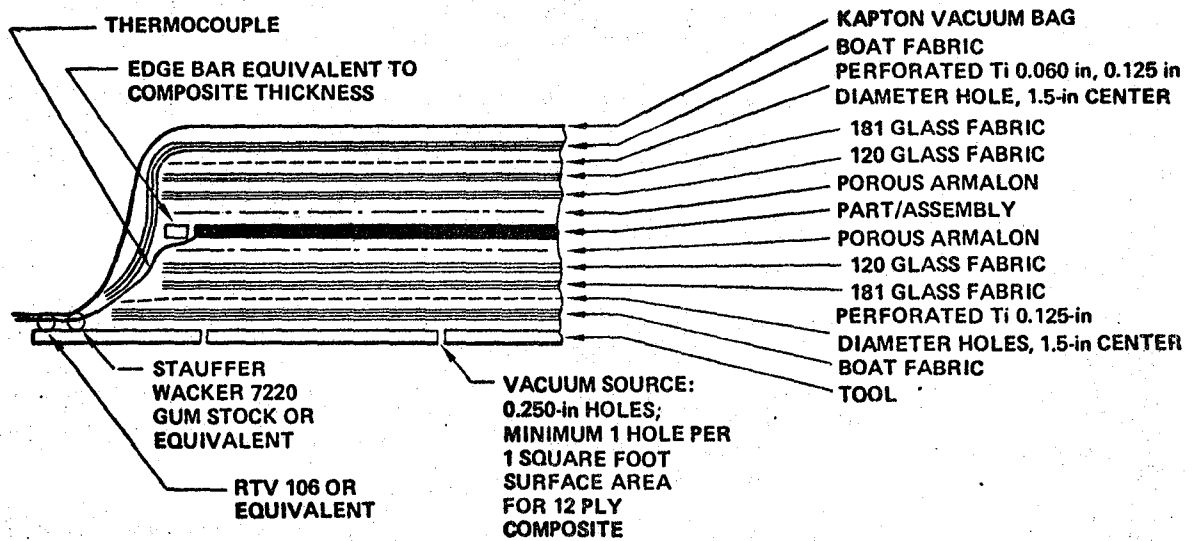

FIGURE 2A DOUBLE BLEED SYSTEM* FOR COMPOSITES

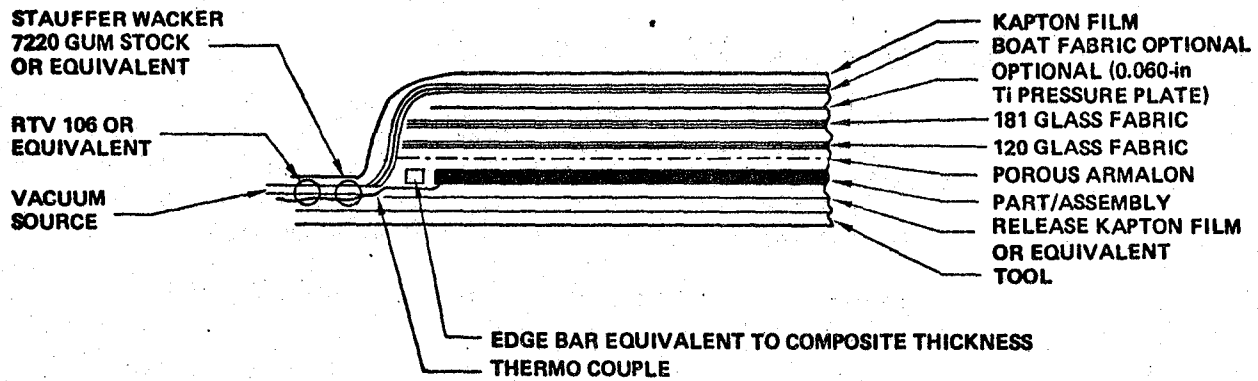

FIGURE 2
TOP BLEED SYSTEM FOR COMPOSITES

* DOUBLE BLEEDER SYSTEM REQUIRED ON PARTS EXCEEDING 9 SQ. FT. OF 8 PLY LAMINATE, 6 SQ. FT. OF 12 PLY LAMINATE, AND 1 SQ. FT. OF 24 PLY LAMINATE.

- (3) After the part/assembly has been held for 30 minutes at 522^{+5}_{-0} K (480^{+10}_{-0} °F), apply 650mm (24 inches) vacuum minimum and 1379 Pa (200 psi) positive pressure for the remainder of the cure cycle.
- (4) After the 1379 Pa (200 psi) positive pressure has been applied, heat part/assembly at the rate of 1.5-2.5 K (3-5°F) per minute to $602^{+0}_{-2.2}$ K (625^{+0}_{-10} °F). Hold at 602 K (625°F) under pressure for 120^{+10}_{-0} minutes.
- (5) Cool the part/assembly under pressure at the maximum of 1.1K (2°F) per minute.
- (6) When the part temperature falls below 322K (120°F) pressure can be released and the part removed from the autoclave.
- (7) After removal of the part/assembly from vacuum bag, postcure in an air circulating oven 6 hours at 602K (625°F). (Note: Part shall be restrained during postcure cycle with Armalon release fabric and minimum of 3 plies 181 glass fabric in contact with part/assembly.) Heat up rate to 602K (625°F) shall be 2.0-3.0K (4-6°F) per minute with the cool down rate not to exceed 1.1K (2°F) per minute. Part/assembly temperature shall not exceed 322°K (120°F) before restraining devices are removed.

o. Cure Cycle Requirements (Method II)

- (1) The chopped fiber molding compound shall be introduced into a compression mold. (There shall be a compression mold for each part type.) The material shall be spread evenly over the mold and stops part thickness plus 6.4mm (0.250 inch) installed around the mold cavity.
- (2) The mold is then introduced into a heated press 373 K (212°F) and closed to stops.
- (3) Raise the temperature to 491^{+14}_{-0} K (425^{+25}_{-0} °F) at the rate of 2.0-3.0 K (4-6°F) per minute. Hold part at 491°K (425°F) for 50 minutes then remove stops and apply 2758^{+172}_{-0} Pa (400^{+25}_{-0} psi) positive pressure. Raise temperature to 602^{+0}_{-6} K (625^{+6}_{-10}) and hold for 120 minutes.
- (4) Cool part under pressure to below 322 K (120°F).

- (5) Postcure the composite/part in an air circulating oven 4 hours at 602K (625°F). (Note: Part shall be restrained during postcure cycle.). Heat up rate to 602K (625°F) shall be 2.0-3.0K (4.0-6.0°F) per minute with the cool down rate not to exceed 1.1K (2°F) per minute.

7.5.2 Laminate Fabrication - Method I

7.5.2.1 Flat Laminates

- a. Assemble the PMR-15 graphite polyimide laminate structures with proper ply orientation in accordance with the general fabrication requirements specified in Section 7.5.1.a through i and process.
- b. Cure laminates in accordance with method described in 7.5.1 section n.

7.5.2.2 Hat Sections

Processing cycles are given in Section 7.5.1.m.

- a. Assemble the graphite/PMR-15 polyimide laminate with proper ply orientation in accordance with general fabrication requirements specified in 7.5.1.a through m on provided tools.
- b. During the layup sequence, a vacuum bag is required after the assembly of every three piles for compaction. The tool may be heated with the temperature not to exceed 316K (110°F). Install a vacuum bag as illustrated in Figure 3A. Care shall be exercised to ensure the bottom radii of the layup is compacted along with the flat portion of the element.
- c. The above assembly is then heated to 316K (110°F) under vacuum pressure of 663mm (24 inches) minimum and held for 10 minutes maximum.
- d. When the proper number of plies have been completed the top bleeder is placed on top of part (See Figure 3B).
- e. Cure the assembly in accordance with the methods specified in Section 7.5.1.n using $1379^{+69} \frac{\text{kN}}{\text{Pa}^2} (200+10 \text{ psi})$
-0 m -0

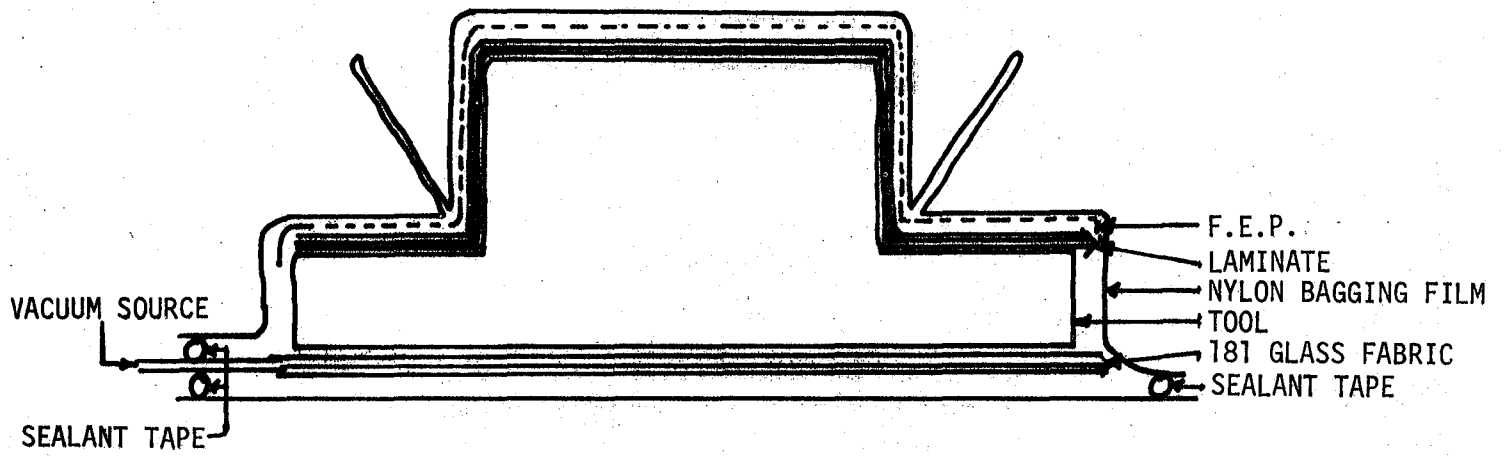

FIGURE 3A
 VACUUM BAG SCHEMATIC HAT SECTION LAYUP

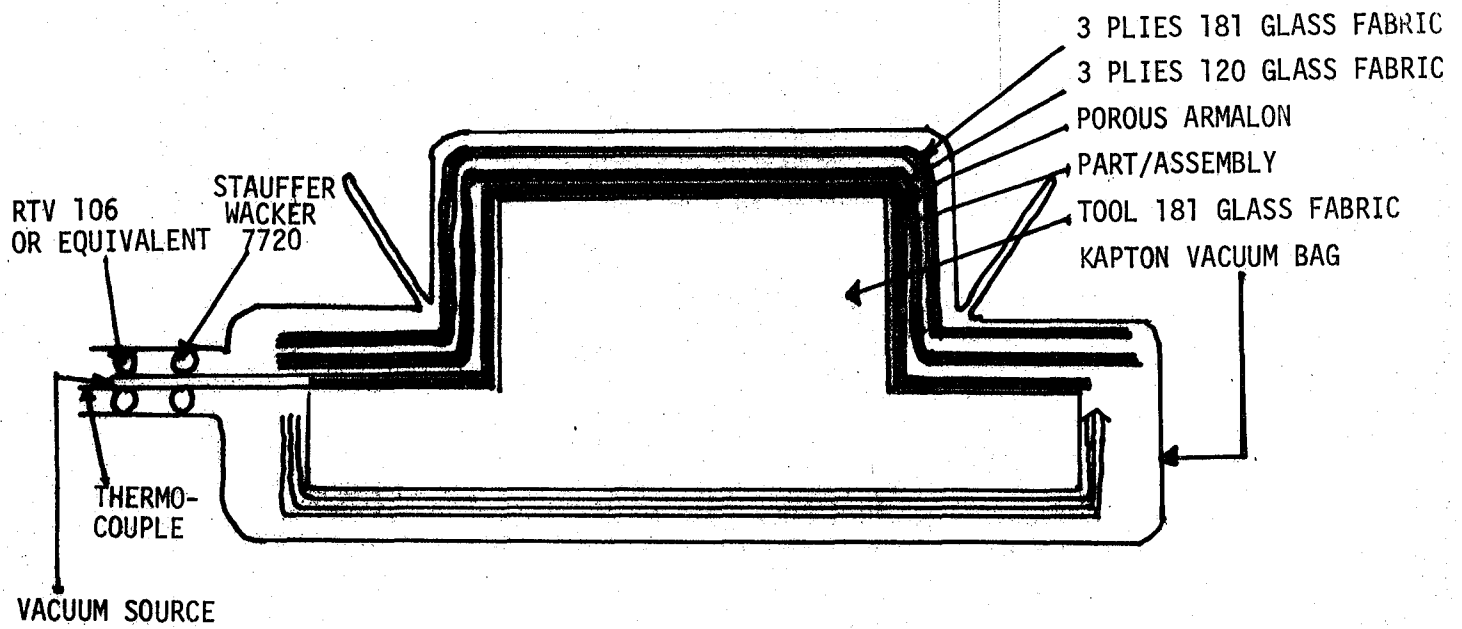

FIGURE 3B
 HAT SECTION KAPTON VACUUM BAG SCHEMATIC

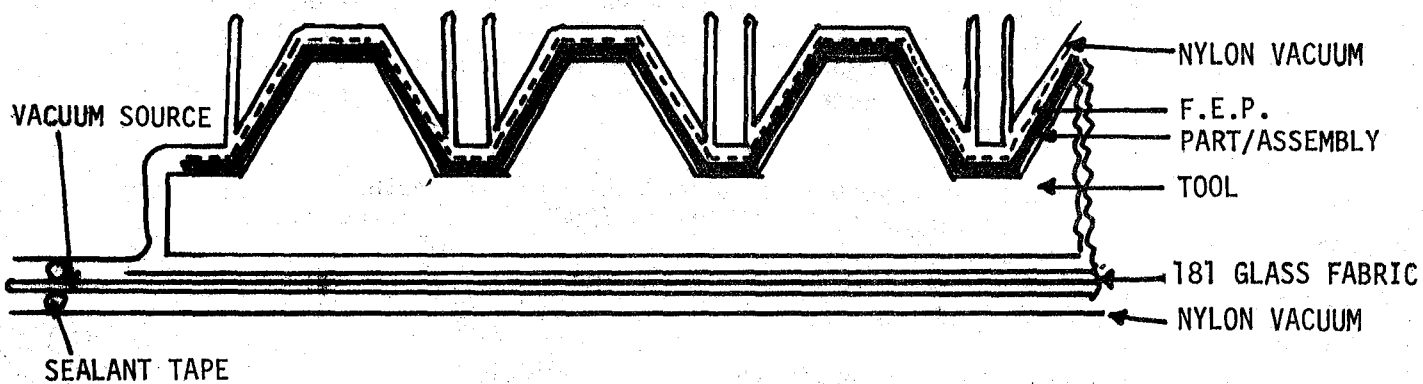

FIGURE 4A VACUUM BAG SCHEMATIC CORRUGATED SECTION LAYUP- END VIEW

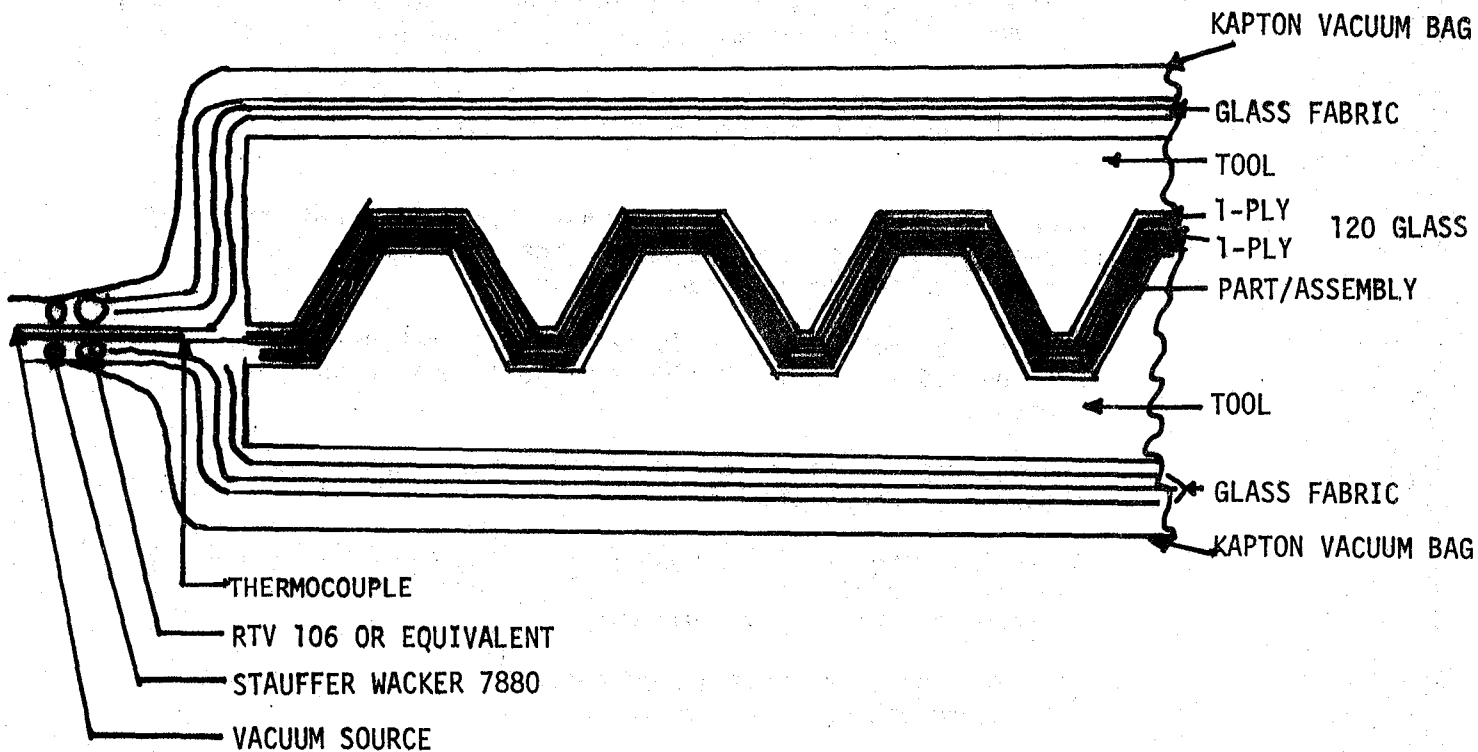

FIGURE 4B VACUUM BAG SCHEMATIC CORRUGATED SECTION LAYUP- END VIEW

7.5.2.3 Multiple Hat Section

- a. Assemble the graphite/PMR-15 polyimide laminate with proper ply orientation in accordance with general fabrication requirements specified in 7.5.1.a through 1.
- b. During the layup sequence a vacuum bag is required after assembly of every two plies for compaction. Procedures described in paragraph 7.5.2.2.a through d are applicable with the bleeder and vacuum bag requirements given in Figures 4A and 4B.
- c. Cure the assembly in accordance with the methods as specified in Section 7.5.1.m 1379^{+69}_{-0} Pa (200^{+10}_{-0} psi) autoclave pressure.

7.5.2.4 "I" Beam Elements

Processing cycles are given in Section 7.5.1.n.

- a. Assemble with proper ply orientation in accordance with general fabrication requirements specified in 7.5.1.a through m or provided tools.
- b. During the layup sequence a vacuum bag is required after the assembly of every two to three plies for compaction. The tool may be heated with temperature not to exceed 36K (110°F). Install vacuum bag as illustrated in Figure 3A.
- c. The above assembly is then heated to 316K (110°F) under vacuum pressure 663mm (24 inches) minimum and held for 10 minutes.
- d. When the proper number of plies have been completed, the top bleeder is placed on top of part (See Figure 3B). Use curing cycle described in paragraph 7.5.1.n.
- e. Cure the assembly in accordance with the methods specified in Section 7.5.1.m using 1379^{+69}_{-0} Pa (200^{+10}_{-0} psi) autoclave pressure.
- f. Process cap strips in accordance with paragraph 7.5.2.2 with proper ply orientation.
- g. After trimming two C sections fabricated in 7.2.2.4.e and two cap strips fabricated in 7.2.2.4.f prepare the faying surfaces for bonding as follows:
 - (1) Solvent clean faying surfaces with solvents listed in paragraph 5.2.e.(1) or (2).

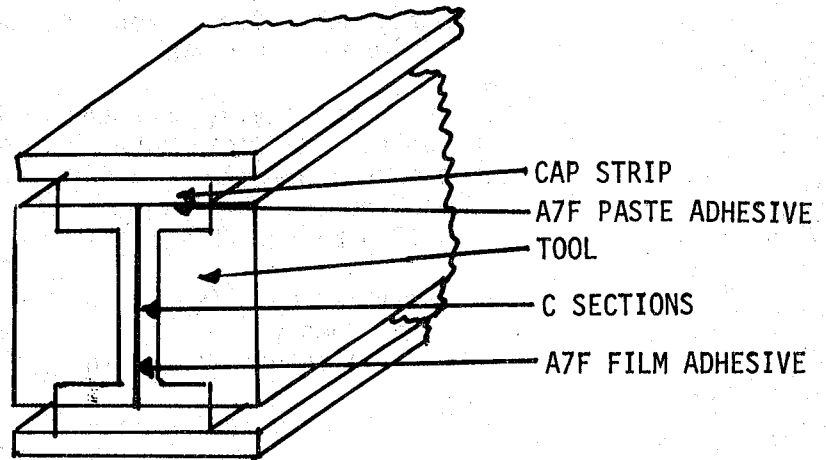

FIGURE 5A "I" BEAM LAYUP FOR SECONDARY BONDING

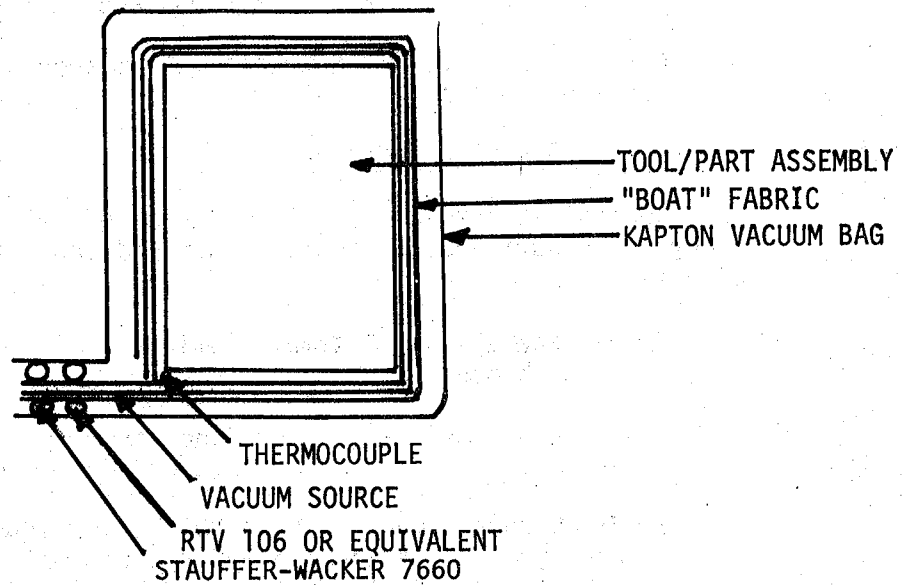

FIGURE 5B VACUUM BAG FOR "I" BEAM BONDING

- (2) Lightly abrade faying surface with "scotch brite" pads and/or 400 grit emery paper taking care not to disturb the graphite fibers.
 - (3) Solvent clean faying surfaces with solvents listed in paragraph 5.2.e. Then oven dry at 316K (110°F) a minimum of 10 minutes.
 - (4) Prime the faying surfaces with A7F paste adhesive. (Note: A7F paste adhesive may be diluted with dimethylformamide.) Air dry primed surfaces for 30 minutes and then place in K (150°F) oven for 15 minutes, K (275°F) for 30 minutes and K (375°F) 30 minutes.
 - (5) Assemble the primed C sections and cap strips with A7F film adhesive per Figure 4. Apply A7F paste adhesive to fill in depression where C channels meet.
 - (6) Envelope bag entire tool with bag per Figure 5.
- h. Cure the assembly in accordance with the methods specified in Section 7.5.5.e using 1379^{+69}_{-0} Pa (200^{+10}_{-0} psi) autoclave pressure.

7.5.3 Laminate Fabrication - Method II

- a. Premeasure sufficient quantity of PMR-15/graphite molding compound into mold cavity for desired part thickness.
- b. Cure parts in accordance with this method as specified in Section 7.5.1.n.

7.5.4 Cocure Skin Sandwich - Method I

This section is intended for fabrication of PMR-15/graphite honeycomb sandwich with cocured inner and outer skins requiring adhesives.

- a. Skin preparation - Assemble laminates as specified in Section 7.5.2.a through m.
- b. Sandwich assembly - Assemble the sandwich components as illustrated in Figure 6 for square edge configurations.
- c. Sandwich cure - Honeycomb sandwich assemblies shall be cured in accordance with Section 7.5.1.n (Method I). (Use 1379^{+69}_{-0} Pa (100^{+10}_{-0} psi) pressure.)

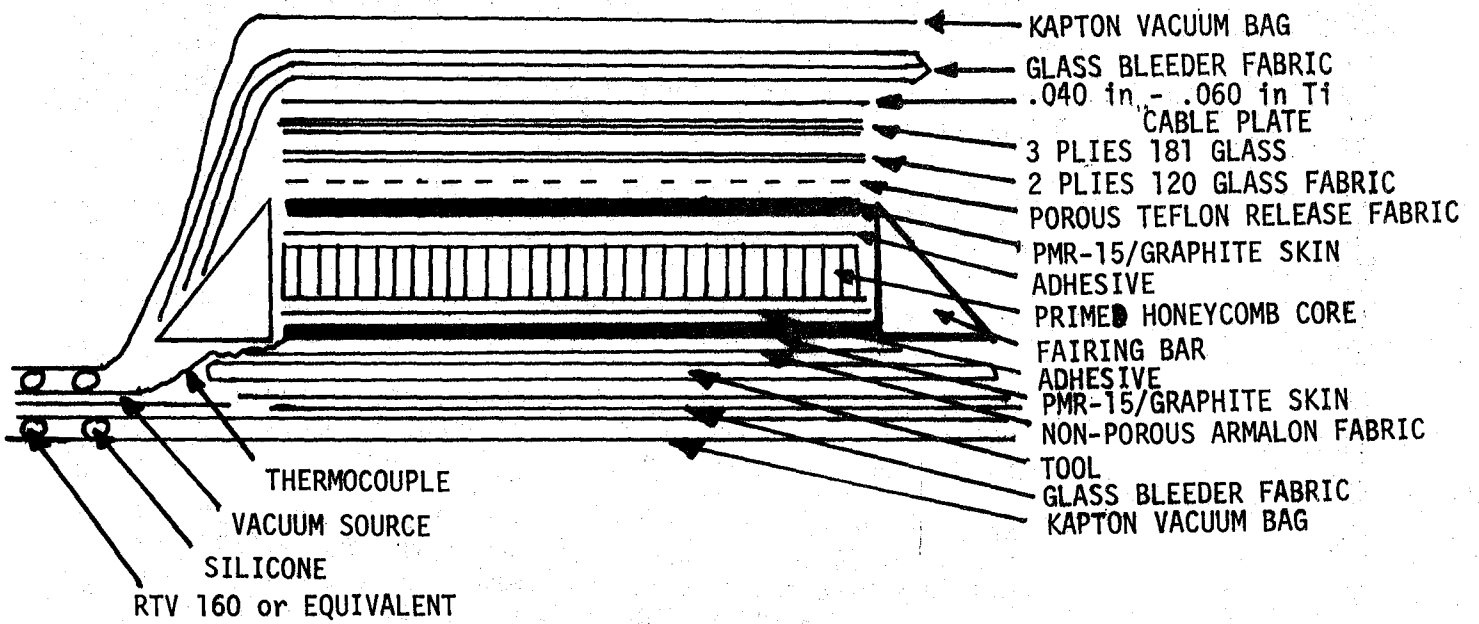

FIGURE 6
SANDWICH ASSEMBLY EDGE VIEW

7.5.5 Secondary Bonded D180-20545-4A Graphite Polyimide Honeycomb Sandwich Panel

- a. Process the PMR-15 graphite polyimide skin laminates with proper ply orientation in accordance with the flat laminate fabrication techniques described in Section 7.5.1.a through n.
- b. Vapor degrease honeycomb core (Note: All honeycomb core except those made from titanium alloys) and dry 30 minutes at 380°K (225°F). Roller coat the core with A7F adhesive, air dry 30 minutes at ambient conditions, 60 minutes at 338°K (150°F) and 15 minutes at 408°K (275°F).
- c. Trim laminates to same size as honeycomb core, lightly abrade with Scotch Brite pads, and primer .05mm (.002 inch) with A7F adhesive.
- d. Assemble honeycomb panel using .03mm (.012 inch) A7F adhesive film and vacuum bag as illustrated in Figure 7.

(NOTE: A7F adhesive formulation: 50 Pbw LARC 13 and 50 Pbw Amoco's A1130L resin blend formulated at 40 percent resins solids with 60% Alcoa 101 aluminum powder.)

- e. Cure the assembly using the following cure cycle, see Figure 8.
 - (1) Place layup in autoclave with vacuum source capable of maintaining a minimum of 650mm (24 inches) vacuum throughout the curing cycle.
 - (2) Heat the part/assembly to 477K (400°F) at the rate of 2.0-3.0 K (4 to 6°F) per minute and apply 689 Pa (100 psi) positive pressure for the remainder of the cure cycle. Hold at 477K (400°F) for a period of 60 minutes.
 - (3) Heat part/assembly at the rate of 2.0-3.0K (4 to 6°F) per minute to 589K (600°F) and hold at 589K (600°F) under pressure for 120 minutes.
 - (4) Cool the part/assembly under pressure at the maximum of 1.1K (2°F) per minute.
 - (5) When the part temperature falls below 322 K (120°F) pressure can be released and the part removed.

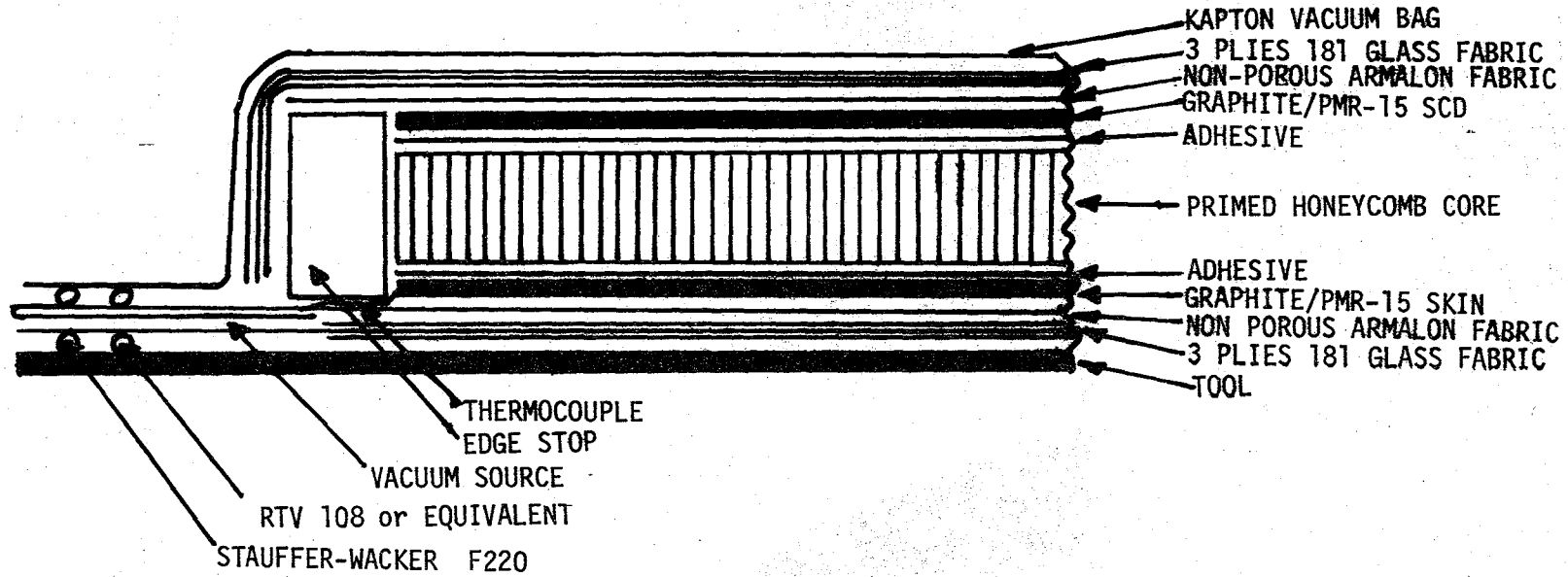

FIGURE 7
VACUUM BAG SCHEMATIC

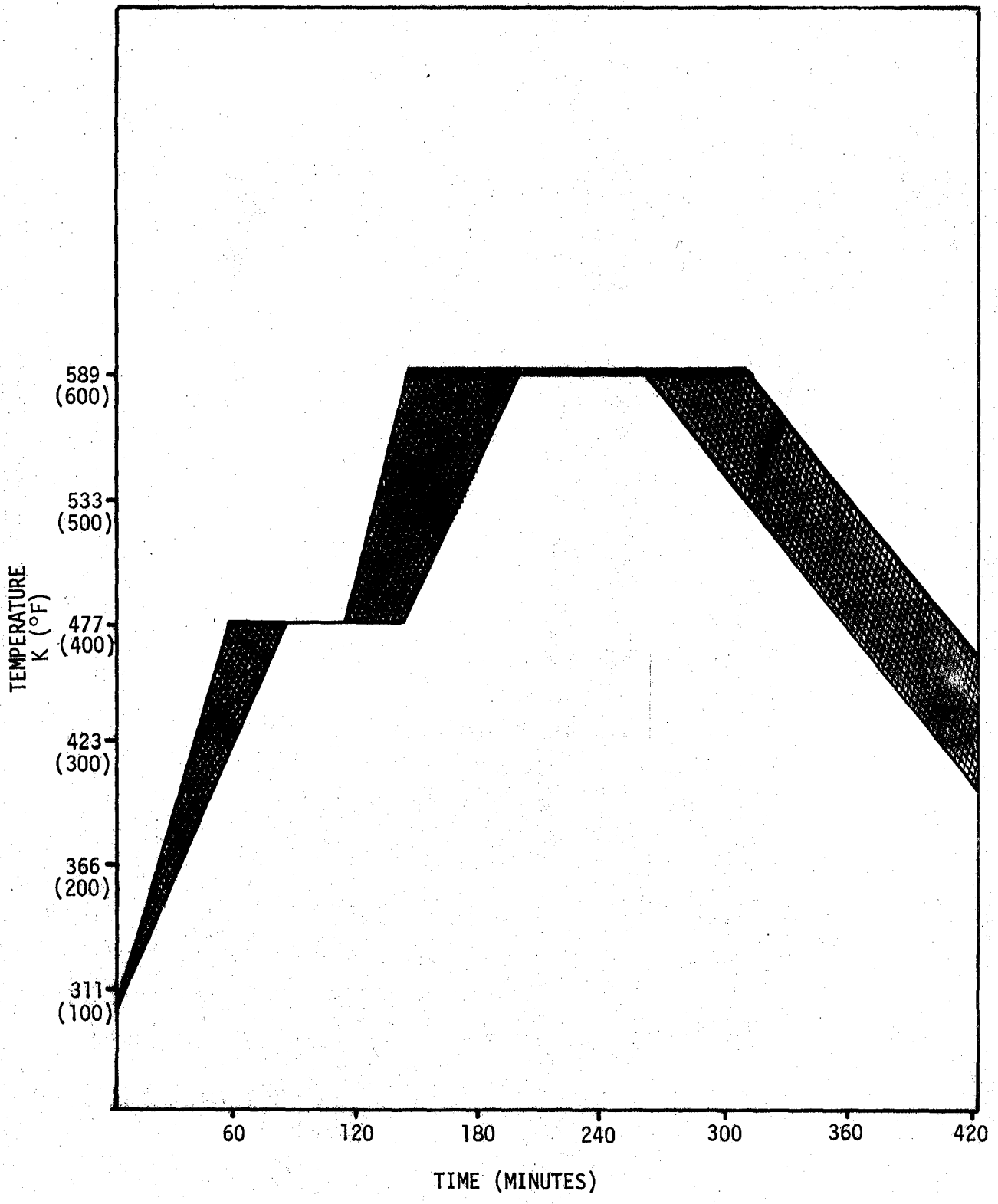

FIGURE 8

CURE CYCLE GRAPHITE/PMR-15 POLYIMIDE HONEYCOMB PANEL

- (6) After removal of the part/assembly from vacuum bag, postcure in an air circulating oven 6 hours at 602K (625°F). (Note: Part shall be restrained during the postcure cycle with porous Armalon release fabric and 181 glass fabric in contact with part/assembly. Heat up rate to 602K (625°F) shall be 2.0-3.0K (4 to 6°F) per minute with the cool down rate not to exceed 1.1K (2°F) per minute. Part/assembly temperature shall not exceed 322K (120°F) before restraining devices are removed.

7.6 FINISHING

- a. Trimming shall be accomplished in such a manner that delamination and scorching of the part edges do not occur. There shall be no fraying of the surface ply at a trimmed edge where the surface will be subsequently bonded.
- b. Drilling shall be accomplished so as to result in the class of hole specified by drawing.
- c. Use only filtered (non-oil containing) air, CO₂ or H₂O in drilling operations.

8.0 QUALITY VERIFICATION

Quality Control shall enforce all requirements of this section.

8.1 MATERIALS

- a. Verify that materials incorporated into the part during fabrication comply with applicable specifications and sources listed in Section 5.1.
- b. Verify that materials not incorporated into the part, but falling under the controlled expendable materials category, comply with the requirements of Section 5.2.
- c. Verify storage and handling of composite prepreg materials, honeycomb core, and adhesives as noted in Section 7.1.

8.2 PROCESS

- a. Verify that materials preparation and component requirements are as required in Section 7.3.
- b. Verify that mold preparation has been done in accordance with Section 7.4.
- c. Verify that part fabrication is accomplished in accordance with the applicable sequence in Section 7.5.

d. Review each part process control record (manufacturing plan) to verify that at least the following information is maintained:

- (1) Composite prepreg manufacturer, batch number, roll number, date of manufacture, and total exposure time out.
- (2) Honeycomb core block number.
- (3) The molding pressure, cure temperatures, and times.
- (4) Process control panel test results.
- (5) Part number and serial number.
- (6) Discrepancy corrections accomplished.

8.3 COMPLETED PARTS

- a. Verify that results from test panels in the same autoclave load as the part meet the mechanical requirements of the document (Section 8.4.3).
- b. Verify that there are no quality defects that exceed acceptable limits as listed in Section 10.
- c. Verify that all discrepancy corrections have been accomplished in accordance with Section 10 and that the discrepancies that were corrected fell within the correctable limits.

8.4 PROCESS CONTROL TEST PANELS

8.4.1 Test Panel Fabrication Frequency

Process panels representative of part structure laminate or sandwich shall be cured with each autoclave load.

8.4.2 Test Panel Configuration and Fabrication Requirements

Additional process control test panel configurations and requirements different from those described in Sections 8.4.2 and 8.4.3 shall be specified by the engineering drawing.

a. Sandwich Panel (Cocured Facing Sandwich)

One flat sandwich test panel must be laid up and cured with each autoclave cure load of production parts containing sandwich details. The test panels shall be fabricated using the same type, batch, and class of acceptable prepreg material as the predominant facing material of the details being cured and shall have been exposed to and fabricated under the same environmental conditions as details being cured. The process control panel must be bagged using the same materials and procedures as those used in preparation of production parts and must be cured in the same autoclave load as the parts which it represents.

b. Sandwich Panel (Precured Facing Sandwich)

The process control panel must be prepared using the predominant adhesive batch and procedures as used in preparation of the production parts and must be cured in the same autoclave load as the parts which it represents. One flat test panel must be assembled and cured with each autoclave load of production parts. Precured facing shall be fabricated from the same type, class, and grade of facing material used in the production parts.

c. Laminate Panel

One solid laminate test panel must be laid up and cured with each autoclave cure load of laminate production parts. The test panel shall be fabricated using the same type, batch, and class of acceptable prepreg material as the predominant material used in the parts being cured, and shall have been exposed to and fabricated under the same environmental conditions as the details being cured. If the part contains both tape and woven fabric prepreps, then the process control panel shall be constructed from the predominant material.

d. Test Panel Configurations

(1) The honeycomb core and panel shall be as shown in Figure 9.

(2) Laminate

The size of the test panel shall be 15.2cm (6 inches) x 15.2cm (6 inches) x 2.54mm (0.1 inch) thick. Tape laminates shall be unidirectional. Fabric laminates shall be oriented (0/90) or warp in the 0 degree direction. See Figure 10.

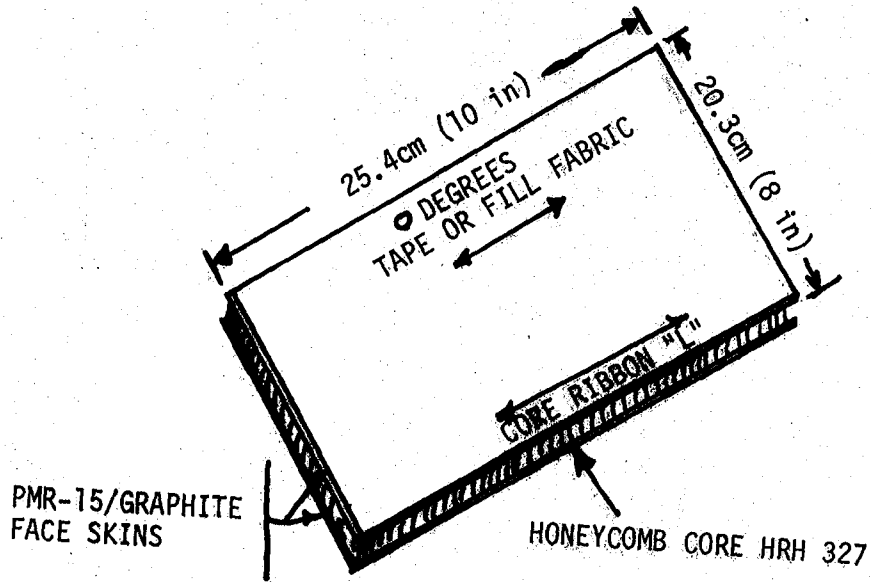

FIGURE 9
SANDWICH PROCESS CONTROL PANEL

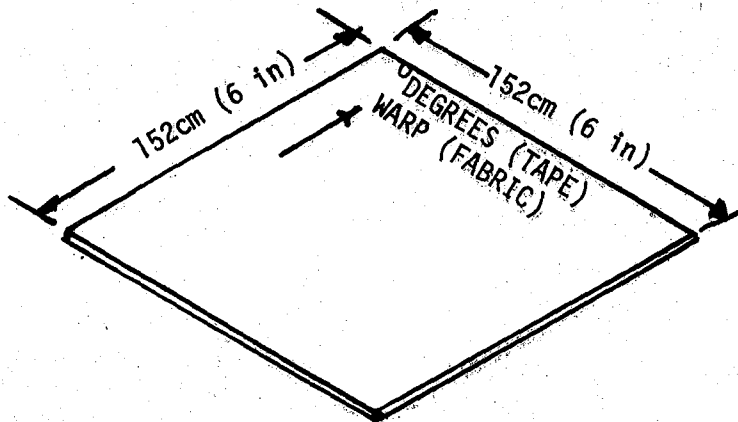

FIGURE 10
LAMINATE PROCESS CONTROL PANEL

e. Test Specimens

(1) Sandwich

- (a) Machine edgewise compression test specimens 5.1cm (2 inches) wide x 7.6cm (3 inches long), parallel to the 0 degree direction. Test a minimum of three specimens. The test procedure shall be in accordance with MIL-STD-401. Report ultimate load.
- (b) Obtain three flatwise tensile specimens 5.1cm (2 inches) square and bond them to flatwise tensile blocks using a suitable adhesive. Test in accordance with MIL-STD-401. Report the ultimate load in Pascals (pounds per square inch).
- (c) Obtain four each specimens 1.3cm (0.5 inch) square, two from bag side and two from tool side. (In case of precured skins, use two from each face sheet.) Determine density and resin content using the procedure described in D180-20545-4.

(2) Laminate

The test methods and number of tests required for laminate control panels are as follows:

<u>Test</u>	<u>No. of Specimens</u>
Short Beam Shear (D180-20545-4A)	5
Flexural (D180-20545-4A)	5
Density (D180-20545-4A)	3
Resin Content (D180-20545-4A)	3
Void Volume (D180-20545-4A)	3
Fiber Volume (D180-20545-4A)	3

Short Beam Shear

This method is applicable to the determination of interlaminar shear strength of a cured, resin-impregnated graphite composite.

Determine ultimate interlaminar shear strength in accordance with ASTM D2344 as modified below. The interlaminar shear test specimens are short, rectangular cross-section bars that are loaded in a three-point flexure. Nominal specimen dimensions are width of 0.64cm (0.25 inch) and length of 2.54cm (1 inch).

The testing is accomplished on a flexure testing fixture using three-point loading with the span being equal to 4 times the specimen thickness. Interlaminar shear strength at failure is computed from the following equation:

$$T_i = \frac{3P}{4A}$$

T_i = interlaminar shear stress, MPa (ksi)

P = total load at failure, Newtons (lbs)

A = cross-sectional area (square meters) (m^2)

Flexural Strength and Modulus

This method is applicable for the determination of flexural strength and flexural modulus of a cured, resin-impregnated graphite composite.

Determine ultimate flexural strength and modulus of elasticity in accordance with ASTM D790 as modified below. The flexural test specimen consists of a straight-sided rectangular cross-section having a nominal thickness of 1.8mm (.070 inch). Span thickness ratio is maintained at 32 to 1. Nominal specimen length is 96.5mm (4 inches), but varies with thickness, and the specimen width remains constant at 12.7 mm (0.5 inch). The flexural specimens are loaded at quarter-span points. Ultimate flexural strength is calculated with the following equation:

$$F_b = \frac{3PS}{4bt^2}$$

F_b = stress in the outer fiber at failure, MPa (ksi)

P = maximum load carried by specimen, Newtons (lbs)

S = major span meters (inches)

b = width of specimen meters (inches)

t = thickness of specimen meters (inches)

The modulus of elasticity is calculated as follows:

$$E_b = \frac{11 S^3}{64 bt^3}$$

E_b = modulus of elasticity in flexure, GPa (Msi)

S = span, meters (inches)

b = width of specimen, meters (inches)

t = thickness of specimen, meters (inches)

m = slope of initial straight line portion of the loading deflection curve, Newtons (lbs/inch)

These methods are applicable for the determination of the physical properties of a cured, resin-impregnated graphite composite:

Composite Specific Gravity

Determine the specific gravity of the composite in accordance with ASTM D792.

Composite Resin Content

Determine the resin content of the composite as described in D180-20545-4.

Composite Fiber Volume

Fiber content is determined from the results of composite specific gravity and composite resin content using the following equation:

$$F_v = (1 - R_c) \left(\frac{D_c}{D_f} \right) 100$$

F_v = fiber volume on a percent basis

R_c = weight percent resin in composite

D_c = specific gravity of composite, g/cc

D_f = density of fiber obtained from fiber manufacturer (Celion 6000 - 1.76 g/cc)

Composite Void Volume

The composite void volume is determined from the results of composite specific gravity and composite resin content using the following equation:

$$V_V = 100 - D_C \frac{R_C}{D_R} + \frac{100 - R_C}{D_F} F$$

D_C = specific gravity of composite in g/cc

R_C = weight percent resin in composite

D_R = density of PMR-15 resin (1.30 g/cc)

D_F = density of graphite fiber (Celion 6000, 1.76 g/cc)

(3) Adhesive

Prior to use, each adhesive system shall be tested for compliance to its applicable process specification.

(4) Honeycomb

Prior to use, the honeycomb shall be qualified to its applicable material document.

8.4.3 Process Control Panel Test Requirements

The mechanical test requirements for sandwich and laminate process control panels are listed in Table I.

9.0 PROCESSOR QUALIFICATION

Qualification of suppliers to this document shall be accomplished by BAC in accordance with Boeing Document D6-44613.

10.0 DISCREPANCY ACCEPTANCE AND REJECTION

- a. A process discrepancy in a part prior to completion may be accepted without correction within the limits described in Section 10.e.
- b. Enter all discrepancies and corrective action accomplished in each part process control record.
- c. Nondestructive testing shall be accomplished on each completed part. Defects listed below that are found in completed parts are not allowed.
- d. Corrective procedures shall, in general, be applied on an individual basis depending upon the type of structure and type of defect present.

e. The following defects are not allowed:

- (1) Surface scratches
- (2) Surface depressions on tool side of part
- (3) Delaminations
- (4) Voids
- (5) Surface resin ridges
- (6) Material inclusions
- (7) Frayed, burned, scorched, or delaminated areas due to machining or drilling operations
- (8) Resin starved areas
- (9) Resin rich areas
- (10) Ply wrinkles or distortion over flat or simple curved areas
- (11) End splice gaps in tape ply
- (12) Honeycomb core splice gaps

TABLE I
PROCESS CONTROL PANEL REQUIREMENTS

	REQUIREMENT	
	Tape Prepreg (Unidirectional)	Fabric Prepreg
Sandwich Panel		
Edgewise Compression Ultimate strength MPa (ksi)	<u>1/</u>	<u>1/</u>
Flatwise Tension MPa (psi)	2.75 (400)	
Density, g/cc <u>2/</u>	1.55 + .03 - 0	
Resin Content, % W/W <u>2/</u>	30 + 3 - 1	
Laminate Panel		
Flexural Strength MPa (ksi)	1515 (220)	
Flexural Modulus GPa (msi)	117 (17.0)	
Short Beam Shear		
Ultimate, MPa	83 (14.0)	
Density, g/cc	1.55 + .03 - 0	
Resin Content, % W/W	30 + 3 - 1	
Void Volume, % V/V	>1	
Fiber Volume, % V/V	60 + 2	
TMA, Tg	602K (625°F)	<u>1/</u>

1/ Requirements have not been determined

2/ Determined of Facing Only

APPENDIX C

TEST PROCEDURES FOR CHARACTERIZATION OF
GRAPHITE TAPE AND COMPOSITES

Each lot of prepreg used on the program was tested for prepreg properties using the following testing procedures:

C.1 GRAPHITE/PMR-15 PREPREG TEST PROCEDURES

C.1.1 PREPREG VOLATILE CONTENT

- a. Obtain three specimens (2.0 to 4.0 g) from each sample obtained in a pattern that was representative of the entire sample.

The specimens taken near the edge must be at least one inch from the edge of tape. The specimens shall be identified by tape batch number, roll number, and specimen number.

- b. Remove the release paper backing from each specimen, place in a tared aluminum dish, and weigh to the nearest milligram. The aluminum dish with specimen is placed in an air-circulating oven regulated to $589 \pm 5K$ ($600 \pm 10^{\circ}F$).
- c. Close the oven door and start a clock. After 30 minutes the aluminum dishes shall be removed and placed in a desiccator to cool. The specimens shall then be weighed to the nearest milligram.

$$\text{Percent Volatiles} = \frac{A - B}{A} \times 100$$

A = Weight of specimen before test

B = Weight of specimen after volatile removal

- d. Report the average of three specimens.

C.1.2 PREPREG RESIN CONTENT

Use either of the following methods for determining tape resin content.

C.1.2.1 RESIN CONTENT ACID DIGESTION

- a. Transfer 0.4 to 0.7g portions of the specimens accurately weighed after the determination of volatile content in accordance with Section C.1.1 to an 80 ml glass beaker.
- b. Carefully add approximately 50 mls of concentrated sulfuric acid into the beaker containing the devolatilized sample. Cover the beaker with a watch glass, place on hot plate, and heat until white fumes are visible above the acid solution.
- c. Maintain this condition for a minimum of 20 minutes or until the solution turns black. At this point, carefully add dropwise a 30 percent solution of hydrogen peroxide until the solution turns clear. Continue heating beaker for a minimum of one hour. During this period, add dropwise the hydrogen peroxide solution to clear the acid whenever the acid turns black. Cool the acid solution to room temperature, add 2 mls of hydrogen peroxide, and heat until the white fumes appear. Continue heating for 10 minutes, then cool to room temperature. If acid turns black, repeat the procedure until acid remains clear.
(Note: This process shall be accomplished in a fume hood with adequate air exchange to prevent fumes from entering laboratory area.)

- d. Filter the acid solution using a fritted glass crucible (coarse), wash a minimum of three times with either distilled or deionized water and then with acetone. The glass crucibles are then dried at 338K (150°F) in an air-circulating oven a minimum of 30 minutes, cooled to room temperature in a desiccator, and weighed. The graphite yarn is then removed and the crucible weight obtained.

$$W_r = \frac{W_1 - W_2}{(W_1)} \times 100$$

W_r = Weight content of resin solids, % W/W

W_1 = Weight of devolatilized sample

W_2 = Weight of graphite yarn after acid digestion of the resin matrix

- e. Report the average of three specimens.

C.1.2.2 RESIN CONTENT BY SOXHLET EXTRACTION

- a. Take three specimens (2.0 - 4.0g) from the swatch obtained per Section 8.1 of D180-20545-4 in a pattern that will be representative of the entire swatch. The specimens taken near the edge must be at least one inch from the tape's edge if the material is Type I, II, or III Grades 6 and 12. If the tape is Type I Grade 3 the sample must be the full width of the tape. If the sample is Class 3 of any type a random sample of molding compound shall be tested. The specimens shall be identified by tape or molding compound batch number, roll number, and specimen number.

- b. Remove the release paper from each specimen (if applicable) and weigh the prepreg in a tared soxhlet extraction thimble to the nearest milligram.
- c. Place the soxhlet extraction thimble into a soxhlet extraction apparatus. Fill the soxhlet flask three-fourths full of acetone and heat until acetone is gently refluxing. Continue heating until the acetone surrounding the extraction thimble is clear but no less than 60 minutes.
- d. Remove the extraction thimble from the apparatus and dry in an air-circulating oven for 30 minutes then after cooling in a desiccator, reweigh to the nearest milligram. (Note: Since the dried extraction thimble gains weight, take reading 20 seconds after sample is removed from the dessicator.)

$$\text{Wet Resin Content } W_{WR} = \frac{W_2}{W_1} \times 100$$

$$\text{Dry Resin Content } W_{DR} = \frac{W_2 - W_1V}{W_1 - W_1V}$$

W_{WR} = Weight content of wet resin solids %

W_1 = Weight content of original sample

W_2 = Weight content of extract

W_{DR} = Weight content of dry resin solids %

V = Volatile matter content of graphite tape (Section C.1.1)

C.1.3 GEL TIME

- a. Pr set the temperature on a Fisher-Johns melting point apparatus to 477K (400 F).
- b. Insert a 6.35m x 6.35mm (0.25 x 0.25in) sample of prepreg between two cover glasses and place on the heated platform of the Fisher-Johns apparatus.
- c. Start a stopwatch or timer and begin to probe on the top of the coverglass with a wooden pick.
- d. Record the time when the resin gels. The gel point is reached when no resin movement is observed through the coverglass when moderate pressure is applied.
- e. Report the gel time as the average of three or more determinations.

C.2 GRAPHITE/PMR-15 COMPOSITE MECHANICAL PROPERTIES

Composites prepared during the course of the program were tested as follows. A minimum of three specimens were generally tested for each mechanical property.

C.2.1 FLEXURAL PROPERTIES

Determine ultimate flexural strength and modulus of elasticity in accordance with ASTM D790 as modified below. The flexural test specimen consists of a straight-sided rectangular cross section having the specified thickness. Span to thickness ratio is maintained constant at 32 to 1. Nominal specimen length is 96.5 mm (4 inches) but varies with thickness. The specimen width remains constant at 12.7 mm (0.5 in). The flexural specimens are loaded at quarter span points. Ultimate flexural strength is calculated with the following equation:

$$F_b = \frac{3PS}{4bt^2}$$

F_b = Stress in the outer fiber at failure

P = Maximum load carried by specimen Newton (lbs)

S = Major span

b = Width of specimen

t = Thickness of specimen

The modulus of elasticity is calculated as follows:

$$E_b = \frac{11}{64} \frac{S^3 m}{bt^3}$$

E_b = Modulus of elasticity in flexure

S = Span

b = Width of specimen

t = Thickness of specimen

m = Slope of the initial straight line portion of the loading deflection curve Newton per meter (lbs/inch)

C.2.2 INTERLAMINAR SHEAR PROPERTIES

Determine ultimate interlaminar strength in accordance with ASTM D2344 as modified below. The interlaminar shear test specimens are short, rectangular cross-section bars that are loaded in a three-point flexure. Nominal specimen dimensions are the width at 6.4 mm (0.25 in.) and the length being 25.4 mm (1 in.).

The testing is accomplished on a flexure testing fixture using three-point loading with the span being equal to 4 times the specimen thickness. Interlaminar shear stress at failure is computed from the following equation:

$$T_i = \frac{3P}{4A}$$

T_i = Interlaminar shear stress

P = Total load at failure

A = Cross-sectional area

C.2.3 ISOTHERMAL AGING PROPERTIES

Isothermal aging tests shall consist of aging flexural specimens (C.2.1) and interlaminar shear specimens (C.2.2) at 589K (600°F) for periods up to 125 hours in an air-circulating oven.

C.3 COMPOSITES PHYSICAL PROPERTIES

Test the composites prepared in accordance with Section 8.11 of D180-20545-4 as follows to demonstrate conformity to the requirements of Table II of D180-20545-4. Test a minimum of five specimens for each physical property.

C.3.1 COMPOSITE SPECIFIC GRAVITY

Determine the specific gravity of the composite in accordance with ASTM D792.

C.3.2 COMPOSITE RESIN CONTENT

Determine the resin content of the composite as described by Section C.1.1.

C.3.3 COMPOSITE FIBER VOLUME

Fiber content is determined from the results of Composite Specific Gravity (Section C.3.1) and Composite Resin Content (Section C.3.2) using the following equation:

$$F_V = (1 - R_C) \left(\frac{D_C}{D_F} \right) 100$$

F_V = Fiber volume on a percent basis

R_C = Weight percent resin in composite (Section C.3.2)

D_C = Specific Gravity of composite (Section C.3.1)

D_F = Density of Fiber obtained from Fiber Manufacturer

C.3.4 COMPOSITE VOID VOLUME

The composite void volume is determined from the results of Composite Specific Gravity (Section C.3.1) and Composite Resin Content (Section C.3.2) using the following equation:

$$V_V = 100 - D_C \left[\frac{R_C}{D_R} + \frac{100 - R_C}{D_F} \right]$$

D_C = Specific Gravity of Composite in grams/cubic centimeters

R_C = Weight percent resin in composite

D_R = Density of PMR-15 resin (1.30 gram/cubic centimeters)

D_F = Density of Graphite Fiber (Celion 6000 1.76 grams/cu cm)

1. Report No. NASA CR-159182		2. Government Accession No.		3. Recipient's Catalog No.	
4. Title and Subtitle Quality Control Developments for Graphite/PMR-15 Polyimide Composites Materials				5. Report Date September 1979	
				6. Performing Organization Code 2-3621	
7. Author(s) C. H. SHEPPARD, J. T. HOGGATT, W. A. SYMONDS				8. Performing Organization Report No. P180-20545-2A	
9. Performing Organization Name and Address BAC P. O. Box 3999 Seattle, Washington 98124				10. Work Unit No.	
				11. Contract or Grant No. NAS1-15009	
12. Sponsoring Agency Name and Address National Aeronautics and Space Administration Washington, D. C. 20546				13. Type of Report and Period Covered Contractor Sept. '78-Sept. 79	
				14. Sponsoring Agency Code	
15. Supplementary Notes					
16. Abstract <p>Investigations were conducted to determine the cause and resolve the problem of the lot-to-lot and within lot variability of graphite/PMR-15 prepreg. The overall objective of the program was to obtain a manufacturing process and accept/reject criteria associated with the quality control of the monomer, resin and graphite prepreg preparation and storage.</p> <p>The program was divided into three technical phases; the first consisted of the evaluation of the chemical characterization data of tasks A-H; the second was directed at evaluating the processing conditions controlling the manufacture of PMR-15 resin and monomers; the third effort was directed at selecting the manufacturing conditions and demonstrating their reproducibility.</p> <p>Conclusions derived from the studies were that the new manufacturing procedures for the PMR-15 monomers and resin yielded prepreg from which excellent structural composites could be fabricated and that the prepreg could be manufactured reproducibly.</p>					
17. Key Words (Suggested by Author(s)) PMR-15 Resin Chemical Characterization Monomers Graphite Prepreg Graphite Composite High Pressure Liquid Chromatography			18. Distribution Statement Unclassified Unlimited and Subject Category 24		
19. Security Classif. (of this report) Unclassified		20. Security Classif. (of this page) Unclassified		21. No. of Pages	22. Price*

