



NASACR-159,233

NASA Contractor Report 159233

NASA-CR-159233
19800018384

1979 SOUTHEASTERN VIRGINIA URBAN PLUME
STUDY (SEV-UPS): SURFACE AND AIRBORNE
STUDIES

J. H. White, W. C. Eaton, M. L. Saeger,
R. B. Strong, and J. B. Tommerdahl

RESEARCH TRIANGLE INSTITUTE
Research Triangle Park, North Carolina 27709

NASA Contract NAS1-15827
May 1980

NASA

National Aeronautics and
Space Administration

Langley Research Center
Hampton, Virginia 23665

62

17

1
2

3
4

1979 SOUTHEASTERN VIRGINIA URBAN PLUME STUDY (SEV-UPS):

SURFACE AND AIRBORNE STUDIES

By

J. H. White
W. C. Eaton
M. L. Saeger
R. B. Strong
J. B. Tommerdahl

Research Triangle Institute
Systems and Measurements Division
Research Triangle Park, North Carolina 27709

Contract No. NAS1-15827

NASA Project Officer: G. L. Gregory

Prepared for

NATIONAL AERONAUTICS AND SPACE ADMINISTRATION
Langley Research Center
Hampton, Virginia 23665

May 1980

N80-26883 #

1

2

3

4

PREFACE

This project was conducted by the Research Triangle Institute, Research Triangle Park, North Carolina, under Contract No. NAS 1-15827 for the National Aeronautics and Space Administration (NASA). The efforts of NASA personnel, especially Dr. G. Gregory and Mr. D. McDougal, are gratefully acknowledged. The aid of Mr. John Salop and his staff, Virginia State Air Pollution Control Board, in site selection and performance audits is also recognized.

The cooperation of Dr. Jason K. S. Ching and Mr. John Clarke (both of EPA, Environmental Sciences Research Laboratory) during the Northeast Oxidant Study portion of this contract is also acknowledged.

Work on this project was performed by staff members of the Systems and Measurements Division, Energy, Engineering and Environmental Sciences Group of RTI, under the direction of Mr. J. B. Tommerdahl, Division Director. RTI staff members who participated in the data collection effort were Mr. J. B. Tommerdahl, Mr. J. H. White, Dr. W. C. Eaton, Mr. R. B. Strong, Mr. M. B. Lee and Mr. M. L. Saeger. The report was prepared by Mr. J. B. Tommerdahl, Mr. J. H. White, Dr. W. C. Eaton, Mr. R. B. Strong, and Mr. M. L. Saeger. Other RTI staff members who contributed technical and secretarial support to this project include Ms. J.C. Sharpe, Ms. D. M. Jewell, Mr. S. R. Stille, Mr. E. F. Peduto, Ms. D. L. Payne, Ms. S. K. Joyner, and Mr. J. M. Harden. In addition, special recognition is given to Mr. D. A. Pasquini and Dr. W. C. Eaton, who conducted the instrument performance audits at SEV-UPS sites during the program.

Special recognition is also given to Mr. M. Allen and Mr. D. Hill from Mountain Flying Service of West Virginia, who piloted the Navajo aircraft during the program.

ABSTRACT

This report describes RTI's participation in the 1979 Southeastern Virginia Urban Plume Study (SEV-UPS), which was conducted from August 13 to August 31, 1979. RTI was responsible for operating two surface monitoring stations during that time and also for collecting approximately 40 hours of aircraft measurements from August 20 through August 31, 1979. In addition, RTI provided several technical services including instrument calibrations, quality assurance audits, and preliminary data analysis in support of SEV-UPS.

Section 1 presents a brief background describing some of the air pollution problems that were addressed by this study, the specific objectives of RTI's involvement in SEV-UPS, and the overall objectives of SEV-UPS in general. In Section 2 the set up, operating, and data handling procedures followed by RTI for the surface stations are presented. The operation of the aircraft sampling platform is described in Section 3. In Section 4 the procedures of the aircraft sampling program specific to SEV-UPS are discussed. Finally, in Section 5 a preliminary descriptive analysis of the RTI aircraft data is presented. Appendices to the report give data listings or plots for: surface site data base; airborne data base; hydrocarbon species data base; results of the performance audits.

A separate report describes RTI's participation in an airborne monitoring program as part of the Environmental Protection Agency's 1979 Northeast Oxidant Study during the period August 3-13, 1979. A description of the program as well as graphical data sets are given for thirteen flights. This study was conducted at the request of the Environmental Protection Agency through NASA Contract No. NAS1-15827. Copies of this report may be obtained by contacting Mr. John Clarke, U. S. Environmental Protection Agency, Atmospheric Modeling Section, Research Triangle Park, N.C. 27711.

CONTENTS

	<u>Page</u>
Preface	iii
Abstract	iv
Figures	vii
Tables	ix
List of Symbols and Abbreviations.	x
1.0 INTRODUCTION	1
1.1 Background	1
1.2 Research Objectives of the 1979 SEV-UPS Program	2
2.0 SURFACE MONITORING PROGRAM	5
2.1 Description of Surface Monitoring Network	5
2.2 Surface Site Instrumentation	5
2.3 Calibration of Surface Site Instrumentation	7
2.4 Quality Control and Quality Assurance at Surface Sites	9
2.4.1 Preliminary Considerations	9
2.4.2 Quality Control	11
2.4.3 Quality Assurance Performance Audits	11
2.5 Hydrocarbon Species Sampling and Analysis	19
2.5.1 Rationale	19
2.5.2 Hydrocarbon Species Collection Procedures	20
2.5.3 Hydrocarbon Species Analysis Procedures	22
2.5.4 Hydrocarbon Species Data; Validation and Comments	25
2.6 Data Processing	29
3.0 AIRBORNE AIR QUALITY MEASUREMENT SYSTEM	31
3.1 Measurement System	31
3.1.1 Aircraft	31
3.1.2 Instrumentation System	33
3.2 Instrument Calibration and Characterization	46
3.2.1 Instrument Calibration	46
3.2.2 Altitude Characterization of Gas Analyzers	51
3.3 Procedures	53
3.3.1 Pre-flight Procedures	55
3.3.2 Flight Operations	56
3.3.3 Post-flight Procedures	56
3.4 Data Processing and Presentation	57
4.0 AIRCRAFT PROGRAM SUMMARY	65
4.1 Types of Experiments	65
4.2 SEV-UPS Operations	69
4.3 Summary of Flights	70

CONTENTS (Continued)

	<u>Page</u>
5.0 DATA ANALYSIS AND INTERPRETATION	83
5.1 Specific Analyses of RTI Aircraft Data	83
5.1.1 RTI Navajo, NASA Cessna 402 Comparison Flight	83
5.1.2 LAS Correlative Flight	84
5.1.3 Richmond-Norfolk Urban Plume Comparison Flight	85
5.2 Case Studies	89
5.2.1 Urban Plume Experiment of August 24	91
5.2.2 Urban Plume Experiment of August 25	94
5.2.3 Urban Plume Experiment of August 30	96
5.2.4 Photochemical Box Experiment of August 31	99
5.3 Summarizing Remarks	101
6.0 REFERENCES	103
 APPENDIXES	
Appendix A. RTI Surface Site Data Base	A-1
Appendix B. RTI Aircraft Data Base	B-1
Appendix C. Hydrocarbon Species Data Base	C-1
Appendix D. Results of SEV-UPS Instrument Performance Audits	D-1

FIGURES

<u>Figure</u>		<u>Page</u>
1	Map of Southeast Virginia study area	6
2	Injection system for chromatographic analysis of hydrocarbons	23
3	Chromatograph of automobile exhaust; micropacked phenylisocyanate column	26
4	RTI aircraft, Piper Navajo B	32
5	System diagram, airborne air sampling system	34
6	Layout of instrumentation in cabin area	35
7	Physical layout of air sampling system	37
8	Details of forward section, air sampling system	38
9	Flow diagram, air sampling system	40
10	Aircraft instrumentation power system	44
11	Typical signal interface, sensor-data recording data	45
12	Calibration system	47
13	Calibration gas feeding system used to supply known concentrations to instruments during altitude tests	52
14	Ozone analyzer response versus altitude.	54
15	Sequence of data processing activities	58
16	Example listing of aircraft engineering unit data	60
17	Example plot of aircraft data	61
18	Path of RTI Navajo and NASA Queen Air on the LAS box face experiment	68
19	Flight tracks for flights on August 20 and August 23	72
20	Flight track for flight on August 24 - early morning	73

FIGURES

<u>Figure</u>		<u>Page</u>
21	Flight track for flight on August 24 - late morning . .	74
22	Flight track for flight on August 25 - early morning . .	75
23	Flight track for flight on August 25 - late morning . .	76
24	Flight track for flight on August 27	77
25	Flight track for flight on August 29	78
26	Flight track for flight on August 30 - early morning . .	79
27	Flight track for flight on August 30 - late morning . .	80
28	Flight track for flight on August 31 - early morning . .	81
29	Flight track for flight on August 31 - late morning . .	82
30	Ozone profiles measured by RTI on each of four vertical segments of LAS box face experiments	86
31	Mean vertical ozone profile as measured by the RTI aircraft in the LAS box face experiment	87
32	Ozone profiles upwind of Richmond and Norfolk on the Norfolk-Richmond urban plume comparison flight	88
33	Ozone concentration on horizontal legs at 310 m altitude upwind and downwind of Norfolk and Richmond in Norfolk- Richmond Urban Plume Comparison flight	88
34	Ozone profiles upwind and downwind of Richmond on Norfolk-Richmond urban plume comparison flight	90
35	Ozone profiles upwind and downwind of Norfolk on Norfolk- Richmond urban plume comparison flight	90

TABLES

<u>Table</u>		<u>Page</u>
1	Operating Characteristics for Surface Site Instrumentation	8
2	Calibration/Span Standards Used by RTI in 1979 SEV-UPS Study	10
3	Results of Performance Audits: Ozone	13
4	Results of Performance Audits: Oxides of Nitrogen . . .	14
5	Results of Performance Audits: Hydrocarbons and Carbon Monoxide	15
6	Results of Performance Audits: Sulfur Dioxide	16
7	Results of Performance Audits: Wind Speed and Direction	16
8	1979 SEV-UPS Hydrocarbon Species Samples	19
9	Hydrocarbon Species, 1979 SEV-UPS	21
10	Comparison of NMHC as Determined by Two Methods	27
11	Comparison of Rural and Urban Hydrocarbon Samples, ppbC	28
12	Aircraft Instrumentation	36
13	Standards Used in Field Calibration	49
14	Final RTI Aircraft Data Format	62
15	Data Flights Performed by the RTI Aircraft	71
16	Mean and Standard Deviation of Selected Parameters Measured on the Cessna/Navajo Comparison Flight by the RTI Navajo Aircraft	84

LIST OF SYMBOLS AND ABBREVIATIONS

BCD	binary coded decimal	μ	micron
CP	chemically pure	mph	miles per hour
DVM	digital voltmeter	mv	millivolts
EDT	eastern daylight time	N/m^2	Newtons per square meter
FID	flame ionization detector	ppm	parts per million (volume)
FPD	flame photometric detector	ppmC	parts per million carbon
GC	gas chromatography	psia	pounds per square inch absolute
LAS	laser absorption spectrometer		
MSL	mean sea level	psig	pounds per square inch gauge
NAS	Naval Air Station site	P-M tube	photomultiplier tube
NBS	National Bureau of Standards	sec	second
NCC	Naval Communication Center site	360°	360 degrees (north)
RTI	Research Triangle Institute	0°	zero degrees (calm)
SAPCB	State Air Pollution Control Board		
SEV-UPS	Southeastern Virginia Urban Plume Study	CH_4	methane
SRM	standard reference material	CO	carbon monoxide
UV-DIAL	ultraviolet differential absorption lidar	CO_2	carbon dioxide
VAC	volts, alternating current	CN	condensation nuclei
VDC	volts, direct current	H_2	hydrogen
VOR	very-high-frequency-omnirange	N_2	nitrogen
		NO	nitric oxide
		NO_2	nitrogen dioxide
		NO_x	total oxides of nitrogen (NO + NO_2)
b_{scat}	back scatter	NMHC	nonmethane hydrocarbons
cc	cubic centimeter	O_3	ozone
ft	foot	SO_2	sulfur dioxide
km	kilometer	THC	total hydrocarbons
L	liter	C_2-C_6	Hydrocarbons with carbon content 2 through 6
m	meter		
mL	milliliter	C_6-C_{10}	Hydrocarbons with carbon content 6 through 10
mm	millimeter		

1.0 INTRODUCTION

1.1 Background

Ambient ozone concentrations in excess of the national ambient air quality standard (NAAQS) of 0.12 ppm, as an hourly average, are observed in many urban areas of the United States at some time during the summer months. There are three major contributions to the ozone concentration observed at any time in any location: background ozone, ozone transported from other urban areas, and ozone photochemically generated from the interaction of local emissions of oxides of nitrogen (NO_x) and nonmethane hydrocarbons (NMHC) in the presence of sunlight. The relative contributions of these three sources of ozone are dynamic in space and time, and our understanding of the interplay between these sources in the ambient atmosphere is limited. The development of nocturnal radiation inversions at the surface severely restricts mixing near the surface. Nighttime emissions of nitric oxide in the surface layer chemically destroy ozone, and further destruction of ozone occurs as it reacts with the surface features in a process known as dry deposition. These ozone-destructive mechanisms are more active within the surface layer than above the inversion top. Therefore, ozone transport at night occurs above the surface and surface monitors alone do not measure the full effect of nocturnal ozone transport. To completely characterize the impact of the three ozone sources in any urban area using conventional in-situ instrumentation at surface stations and aboard aircraft is a costly and difficult task.

NASA Langley Research Center (LaRC) is presently conducting a program to evaluate remote sensors for ozone and other trace atmospheric constituents. The Southeastern Virginia Urban Plume Study, SEV-UPS, 1979, was part of this program, providing field measurements and air quality studies to evaluate the performance of an ozone remote sensor, the Laser Absorption Spectrometer (LAS) which was installed in a Queen Air aircraft. The nadir viewing LAS measures the total ozone burden between the aircraft and the surface.

The potential of remote sensors to provide a more complete data base than can be obtained by the use of conventional aircraft mounted in-situ instrumentation is obvious. These new and developing instrumental methods first need to be tested and characterized under field use conditions. NASA LaRC used the 1979 SEV-UPS as an in-field test program for the LAS remote sensor for ozone.

1.2 Research Objectives of the 1979 SEV-UPS Program

The Research Triangle Institute (RTI) participated in the data collection effort of the 1979 SEV-UPS program with the following primary objectives: 1) to set up and operate two of the monitoring stations in the surface network in and around the Norfolk, Virginia area from 13 August to 31 August, and 2) to provide a Piper Navajo B aircraft instrumented for air monitoring with conventional in-situ instrumentation for acquisition of in-flight data as directed by NASA. The data collection effort was undertaken to produce a high quality data base of air quality measurements from these three measurement platforms.

One surface site was located at the Naval Air Station (NAS) in Norfolk, where continuous measurement of ozone, sulfur dioxide, nitric oxide, total oxides of nitrogen (as NO), total hydrocarbons, methane, nonmethane hydrocarbons, carbon monoxide, solar radiation, and temperature were obtained. The second surface site at the Naval Communications Center (NCC), near Northwest, Virginia and to the south of Norfolk, obtained continuous measurements of all the parameters listed above, as well as dewpoint temperature, throughout the measurement period. The Piper Navajo was instrumented with conventional in-situ monitors for ozone, sulfur dioxide, oxides of nitrogen (NO, NO_x), condensation nuclei, temperature, dewpoint, and backscatter coefficient, b_{scat} .

In addition, other technical support was provided to the SEV-UPS program. Prior to the beginning of data collection, RTI calibrated

seven ozone analyzers and one nitrogen oxides analyzer that were to be used in the measurement program. During the data collection effort, RTI also conducted an extensive quality assurance performance audit program covering many of the surface stations, the RTI aircraft, as well as the instrumented aircraft that were operated by NASA. RTI also supplied equipment for collection and analysis of air samples for hydrocarbon species determination. Approximately 30 samples were analyzed by RTI for some 59 separate compounds. Following the data collection effort, RTI completed a preliminary data analysis and interpretation effort describing the characteristics of and likely causes for the distribution of pollutants as measured by the RTI measurement platforms; this descriptive analysis effort was chiefly concerned with the aircraft data.

A principal objective of the 1979 SEV-UPS program was to conduct tests to verify the performance and utility of the LAS remote sensor for ozone in an urban area. This was accomplished in part by conducting correlative flights in which the LAS sensor, mounted in the Queen Air aircraft, and the in-situ instruments, mounted in the Piper Navajo aircraft on one occasion and in the Cessna 402 on six other occasions, made simultaneous measurements over the same airspace. In addition to this effort, the SEV-UPS program utilized the LAS remote sensor for measurement of ozone in several other flight plans to demonstrate the potential of remote sensing technology for various field measurement tasks. Flight plans were designed to use the LAS sensor in various applications including urban plume identification, regional coverage, and characterization of boundary conditions for use in regional and urban modelling efforts. A further effort of the SEV-UPS program was to acquire a comprehensive data base (surface effluent monitoring network, four separate aircraft platforms, and extensive surface and airborne meteorological data) that can be used to characterize the boundary conditions upwind of Norfolk (the major source area of the region), the emission of pollutants in the source area, and the impact of the Norfolk urban area on the air quality within and downwind of the Norfolk area. Modeling of this data base allows an assessment of the usefulness of remotely sensed ozone data in an air quality model.

2.0 SURFACE MONITORING PROGRAM

2.1 Description of Surface Monitoring Network

For several years the Virginia State Air Pollution Control Board (SAPCB) has been interested in the ozone formation potential of the Norfolk urban area. For this reason a surface monitoring network of 8 sites was operated in support of the 1979 SEV-UPS study. In addition to these sites, NASA maintains two surface monitoring stations in the area. From August 13 through August 31 RTI operated another two surface monitoring stations, in the area, thus completing the 12-site surface monitoring network discussed here. Figure 1 is a map of the southeast Virginia area showing the locations of all these surface monitoring sites and the organizations responsible for their operation.

One of the two stations maintained by RTI was located at the Naval Air Station in Norfolk, just north of the central business district. Since the area is normally influenced by southerly winds, this location was chosen so that the diurnal variation in ozone precursors emitted within Norfolk could be quantified. The other RTI site was located at the Naval Communications Center near the town of Northwest, Virginia, approximately 1.5 kilometers north of the Virginia, North Carolina border. This location was selected to quantify the concentration of trace species being transported into the southeast Virginia area at the surface. Also of interest to NASA and SAPCB was the possible influence of naturally emitted ozone precursors from the Great Dismal Swamp. The monitoring site at the Naval Communications Center was on the northern fringe of the swamp and therefore, the hydrocarbon measurements made there were evaluated to determine contributions to the hydrocarbon concentrations entering Norfolk from the swamp.

2.2 Surface Site Instrumentation

At both of the surface sites operated by RTI continuous measurements were made of ozone, oxides of nitrogen, sulfur dioxide, total

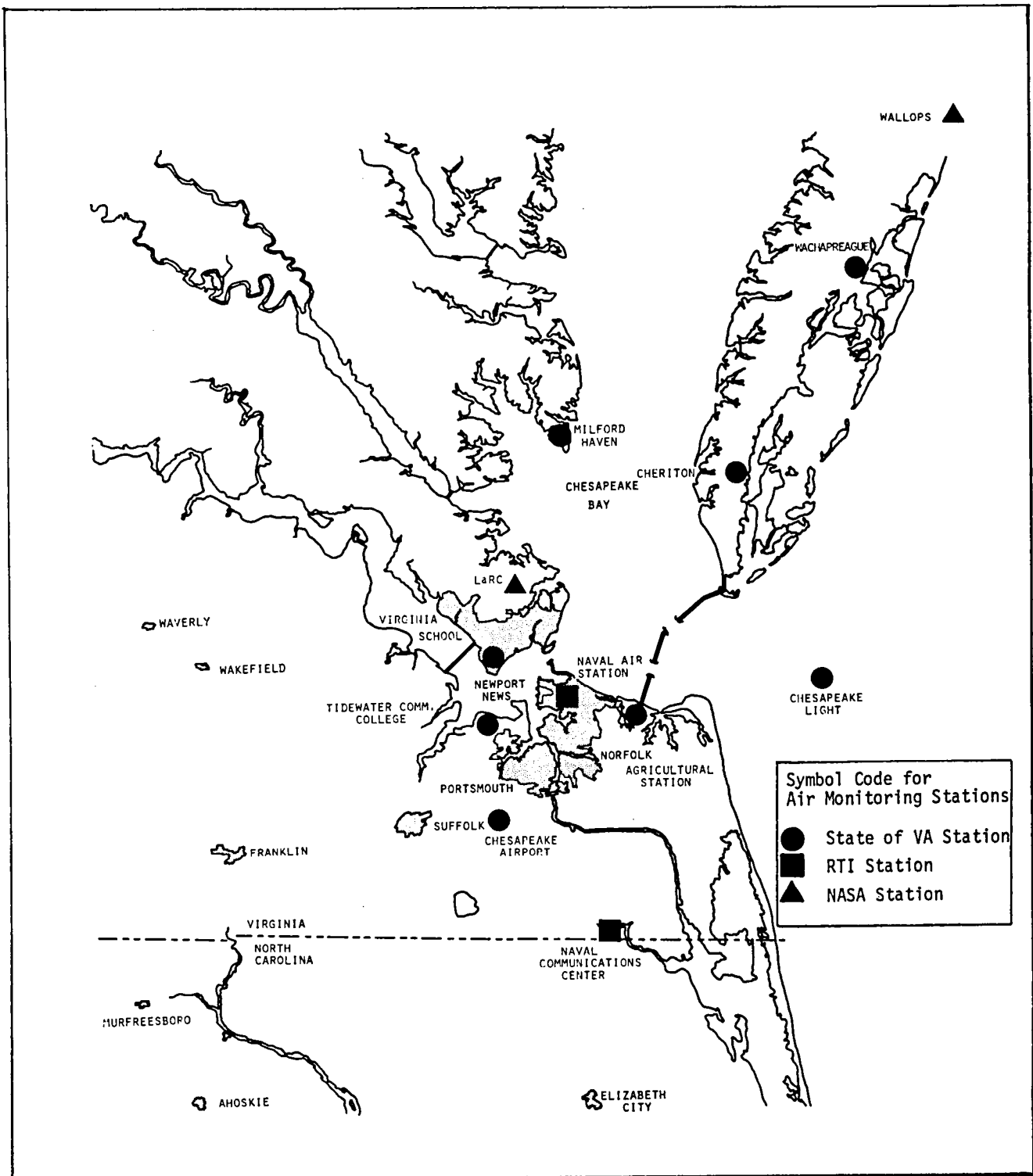

Figure 1. Map of Southeast Virginia Study Area

hydrocarbons, methane, nonmethane hydrocarbons, carbon monoxide, wind speed and direction, solar radiation, and temperature. Dew point temperature was also measured at the Naval Communication Center. Table 1 lists the parameters measured, the type of instruments used, the detection principle employed by each instrument, and the minimum detectable limit of each instrument.

2.3 Calibration of Surface Site Instrumentation

Multipoint calibrations were carried out on all of the ambient air analyzers at the sites prior to any data collection. The ozone analyzers were calibrated by adjusting their output to match the output of a Dasibi UV photometer that was established as a transfer standard at the EPA in Research Triangle Park. Clean air was supplied to a stable ozone generator and the station instrument and photometer sampled the output of the ozone source. The standard calibration procedures described for ozone¹ were followed.

The gas phase titration technique was used for the dynamic calibration of the chemiluminescent NO-NO₂-NO_x analyzers.² The technique is based on the rapid gas-phase reaction between nitric oxide and ozone to produce a stoichiometric quantity of electronically excited nitrogen dioxide. A certified tank of nitric oxide (of an approximate concentration of 50 ppm by volume) in nitrogen was diluted with zero air to provide NO concentrations in the range of 0.05 to 0.30 ppm. Nitrogen dioxide concentrations were produced by introducing ozone in the diluent air. The ozone and nitric oxide then react to form nitrogen dioxide. Primary calibration of the nitric oxide in nitrogen cylinder concentration was accomplished by reference to a National Bureau of Standards standard reference material (SRM), in this case a reference cylinder of nitric oxide in nitrogen.

Calibration of the Beckman 6800 Air Quality Chromatograph was accomplished using cylinders containing known concentrations of methane, propane and carbon monoxide in air according to procedures described in the Federal Register.³ Two cylinders containing mixtures of methane, propane, and carbon monoxide at different concentrations for use in the calibration, were obtained and referenced to appropriate standards prior to use in the field.

Table 1. Operating Characteristics for Surface Site Instrumentation

<u>Instrument</u>	<u>Parameter</u>	<u>Location</u>	<u>Detection Principle</u>	<u>Minimum Detectable Concentration</u>	<u>Range</u>	<u>Precision % of Indicated Concentration</u>
Bendix Model 8002	O ₃	NAS ¹	Chemiluminescence	2ppb	0-0.5ppm	± 2
Monitor Labs 8410	O ₃	NCC ²	Chemiluminescence	2ppb	0-0.5ppm	± 2
Bendix Model 8101-B	NO,NO ₂ , NO _x	NAS	Chemiluminescence	5ppb	0-0.5ppm	± 2
∞ Monitor Labs 8440	NO,NO ₂ , NO _x	NCC	Chemiluminescence	5ppb	0-0.5ppm	± 2
TECO 43	SO ₂	NCC	Pulsed Fluorescence	9ppb	0-0.5ppm	± 2
Meloy 185A	SO ₂	NAS	Flame Photometric	10ppb	0-1.0ppm	± 0.2
Beckman 6800	THC, CH ₄ , NMHC, CO	NAS NCC	Flame Ionization	20ppbC	0-10.0ppm	± 10

¹ Naval Air Station

² Naval Communications Center

The sulfur dioxide analyzer at the Naval Air Station was calibrated by dilution of a cylinder of known concentration of SO₂ in air, with a cylinder of air containing carbon dioxide at a typical ambient concentration of approximately 350 ppm.⁴ The carbon dioxide was necessary since there is a carbon dioxide interference in instruments using flame photometric detection. The sulfur dioxide cylinder at the Naval Communications Center was diluted with clean air since the carbon dioxide interference is not a problem with the pulsed fluorescence instrument.

The meteorological sensors were referenced to NBS-SRM prior to the field measurement program.

2.4 Quality Control and Quality Assurance at Surface Sites

2.4.1 Preliminary Considerations

Prior to leaving Research Triangle Park for the Norfolk area, RTI outfitted each of the vehicles that was to be used eventually as the site shelter in the SEV-UPS study. Each ambient air analyzer and data recording system was set up, zeroed, spanned, and operated for a period of time. During this time, the two RTI staff members who were to be responsible for the field sites on a daily basis were instructed in the day-to-day operation of the site and were instructed in the conduct of the gas phase titration method of NO by O₃ as a means for calibrating and span checking the oxides of nitrogen analyzers, the ultraviolet photometry method for calibration of ozone analyzers, and dilution methods for calibration and span checking SO₂ and NMHC/CO analyzers. Also during this time, the proper operation of two different ozone generator/gas phase titration calibration systems was verified in RTI laboratories.

Finally, all gaseous calibration and/or span check cylinder gases were compared to NBS-SRM's, where applicable, thus establishing their traceability. Methods used in establishing the traceability were these: NO and SO₂ cylinders, direct comparison to NBS-SRM via a calibration chemiluminescence NO_x source monitor (in the case of NO) and

use of a calibrated pulsed fluorescence SO₂ source monitor (in the case of SO₂); mixtures of methane and propane in cylinders, comparison to NBS standards for methane and propane via a calibrated gas chromatograph with flame ionization detection; and cylinders containing carbon monoxide, referenced to NBS standards via use of a nondispersive infrared analyzer. Table 2 lists the gaseous calibration/span standards employed by RTI at the Naval Communications Center and Naval Air Station (Inner Norfolk) sites during the 1979 SEV-UPS study.

Field personnel were instructed in procedures for reducing strip chart and data logger output to engineering units of ppm. The coding and reporting requirements to put hourly data into the format specified by the NASA SEV-UPS Data Manager were also discussed.

Table 2. Calibration/Span Standards Used by RTI
in 1979 SEV-UPS Study

Cylinder Number, Airco	Pollutant	Location	Validated or Accepted Concentration, ppmV
CC 14786	NO/N ₂	Navy CC	NO, 50.0/NO _x , 50.6
CC 14342	NO/N ₂	Inner Norfolk	NO, 48.4/NO _x , 51.2
CC 14336	SO ₂ /air	Navy CC	46.9
CC 14338	SO ₂ /air	Inner Norfolk	51.0
CC 14641	CH ₄ /air CH ₃ CH ₂ CH ₃ CO	Navy CC	1.99 0.48 2.14
CC 14628	CH ₄ /air CH ₃ CH ₂ CH ₃ CO	Navy CC	5.55 0.48 7.97
CC 14646	CH ₄ /air CH ₃ CH ₂ CH ₃ CO	Inner Norfolk	1.96 0.46 2.08
CC 14638	CH ₄ /air CH ₃ CH ₂ CH ₃ CO	Inner Norfolk	5.60 0.92 8.14
FF 1595	SO ₂ /air	RTI Navajo B	23.0
FF 5883	NO/N ₂	RTI Navajo B	47.5

2.4.2 Quality Control

To maintain a high level of confidence in the air quality data, RTI routinely monitored critical instrument parameters in addition to performing the multipoint calibrations discussed in Section 2.3. Daily checksheet entries indicated consistency or variability of instrument parameters such as flow rate, pressure, and temperature. Daily zeros and spans were performed on the ozone, NO/NO_x, SO₂, and NMHC/CO analyzers. Zero and span gases for the ozone analyzer were provided from the instrument's internal scrubber and ultraviolet lamp. Zero and span gases for the NO/NO_x analyzers were provided from an external calibrator by dilution of certified NO in N₂ mixtures and by gas phase titration of NO by ozone. Zero gas for the SO₂ analyzers was provided from a cylinder of clean air; in the case of SO₂ analysis by flame photometry, the zero and diluent air also contained 350 ppm CO₂ to approximate the CO₂ content of ambient air and thus eliminated possible signal quenching problems. SO₂ span gas was provided by dilution of a cylinder of SO₂ in air at approximately 50 ppm concentration. Span gases for CH₄, NMHC, and CO were metered directly to a manifold without dilution; the Beckman 6800 then sampled from the manifold.

The zero and span checks served as indicators of instrument drift. Adjustments were made to the zero settings if zero drift exceeded ± 3 percent of the full scale range. The multipoint calibration was repeated and adjustments were made if a span drift of ± 15 percent of full scale was discovered.

2.4.3 Quality Assurance Performance Audits

2.4.3.1 Procedure and Results

During the week of August 12 through 19, an RTI audit team visited the two RTI-operated sites, eight additional surface sites, and four aircraft of the SEV-UPS network to conduct a quality assurance performance audit. The objective of the onsite performance audit was to collect information on the accuracy of the study's measurements of ozone, oxides of nitrogen, total hydrocarbon, methane, carbon monoxide,

and sulfur dioxide. In addition, for selected sites, comparative audits were conducted on wind speed and wind direction sensors.

The auditors employed in this study were different from the persons who conducted the day-to-day operation of the RTI sites. They used a set of calibration equipment and gaseous standards independent from those in use at any of the sites audited. All gaseous standards and meteorological equipment for comparison were traceable, insofar as possible, to NBS standards. Methods used for establishing traceability of the gaseous audit standards were identical to those used with the calibration standards.

Gaseous analyzer audits were conducted in the following manner: (1) set up auditing devices and references inside the site shelter or immediately adjacent to or inside the aircraft; (2) allow instrumentation to warm up and equilibrate; (3) remove the analyzer sampling line from the station or aircraft manifold, leaving length of line, filter, and all instrument parameters unchanged; (4) challenge the analyzer with zero air and five upscale concentrations that fall within the range of the instrument; (5) record instrument description and operating conditions and record audit concentrations and instrument response as read from strip chart recorder or digital data logger; (6) with audit concentration = x and analyzer response = y , calculate slope, intercept, and correlation for the set of points; (7) complete audit report, return analyzer sampling line to previous configuration.

Windspeed was audited at several points in time with an independent anemometer held as close as possible to the station anemometer. The averages were compared. Wind direction was audited by holding the station's wind vane in a fixed position and comparing the station output to the direction indicated by an engineering compass aligned with the wind vane.

Results of the performance audits are summarized in Tables 3 through 6 for ozone, oxides of nitrogen, hydrocarbons/carbon monoxide, and sulfur dioxide, respectively. Table 7 summarizes the meteorological audits. Complete records of the audit reports are given in Appendix D.

Table 3. Results of Performance Audits: Ozone

<u>Surface Site</u>	<u>Slope</u>	<u>Intercept</u>	<u>Correlation</u>
Inner Norfolk	1.0102	-0.004	0.9999
Chesapeake Light	1.0239	-0.003	0.9999
Virginia School	1.0142	-0.003	0.9998
Chesapeake Airport	1.0646	-0.001	0.9999
Wallops Flight Center	1.0086	0.004	0.9999
Cheriton	1.0706	-0.002	0.9999
Wachapreague	1.0077	0.004	0.9999
Navy CC, Northwest	1.0101	-0.002	0.9999
Agricultural Station	1.0118	0.000	0.9998
NASA-Langley	1.030	-0.002	0.999
<u>Aircraft</u>			
Cessna 402, ML	1.5249	0.0018	0.9981
Cessna 402, Dasibi	0.9696	0.0002	0.9983
C-54, Dasibi	1.0289	-0.002	0.9995
LAS, Dasibi	1.0101	-0.001	0.9999
RTI, Navajo	1.0478	0.003	0.9998

Table 4. Results Of Performance Audits: Oxides Of Nitrogen

<u>Surface Site</u>	<u>NO</u>			<u>NO₂</u>			<u>NO_x</u>		
	<u>Slope</u>	<u>Intercept</u>	<u>Corr.</u>	<u>Slope</u>	<u>Intercept</u>	<u>Corr.</u>	<u>Slope</u>	<u>Intercept</u>	<u>Corr.</u>
Inner Norfolk	0.4798	-0.002	0.9999	1.0792	0.007	0.9996	1.0880	-0.008	0.9998
Navy CC, Northwest	1.0640	0.001	0.9995	1.0207	0.007	0.9960	1.1426	0.000	0.9998
NASA, Langley	0.648	-0.0005	0.998	0.517	0.002	0.9975	0.513	-0.004	0.9953
<u>Aircraft</u>									
Cessna 402	1.0083	0.002	0.9995	0.9508	-0.002	0.9995	0.9892	0.001	0.9999
RTI Navajo	0.9975	0.001	0.9995	0.9795	-0.004	0.9999	0.9584	0.002	0.9996

Table 5. Results of Performance Audits: Hydrocarbons and Carbon Monoxide

Surface Site	Total Hydrocarbon			Methane			Carbon Monoxide		
	Slope	Intercept	Corr.	Slope	Intercept	Corr.	Slope	Intercept	Corr.
Inner Norfolk	1.036	0.040	0.9981	1.001	0.021	0.9982	1.048	0.111	0.9999
Virginia Research Station	0.891	0.078	0.9999	0.925	-0.075	0.9999	0.969	-0.319	0.9997
NASA, Langley	0.358	1.74	0.626	0.960	0.030	0.9994	---	---	---
Navy CC, Northwest	0.958	-0.026	0.9998	0.984	-0.065	0.9998	1.0486	0.103	0.9991
<u>Aircraft*</u>									
NASA C-54	Propane: 1.32;1.44;-8.3%			Methane: 1.95;1.99;-2.0%			Carbon monoxide: not applicable		
	Total Hydrocarbon: 3.27;3.43;-4.7%								

*Results reported are for a single concentration audit by the chromatograph operator using undiluted contents of a cylinder containing propane and methane in synthetic air (21.5% oxygen, balance nitrogen). Results are reported as follows. Pollutant: analyzer response, ppmC; audit cylinder concentration, ppmC; percent difference.

$$\text{Where percent difference} = \frac{(\text{analyzer response} - \text{audit concentration})}{(\text{audit concentration})} \times 100$$

Table 6. Results of Performance Audits: Sulfur Dioxide

<u>Surface Site</u>	<u>Slope</u>	<u>Intercept</u>	<u>Correlation</u>
Inner Norfolk	0.8056	-0.008	0.9995
Navy CC, Northwest	0.8030	-0.0009	0.9997
<u>Aircraft</u>			
RTI Navajo	0.9810	-0.005	0.9974

Table 7. Results of Performance Audits: Wind Speed and Direction

<u>Site</u>	<u>Audit WD</u>	<u>Site WD</u>	<u>Variation</u>
Inner Norfolk	various	agree within 10°	+ 10°
Chesapeake Light (initial)	360°	75°	+ 75°
Chesapeake Light (final)	180°	180 + 5°	+ 5°
Navy CC, Northwest	180°	175°	- 5°
<u>Site</u>	<u>Audit WS</u>	<u>Site WS</u>	<u>Variation</u>
Inner Norfolk	3.3 mph	2 mph	-1 mph
Chesapeake Light	10.7	14	+ 3.3
Navy CC, Northwest	9.0	8.3	- 0.7

2.4.3.2 Audit Results Commentary

Most of the results of the instrument performance audits in the SEV-UPS system were excellent or satisfactory when the slope and intercept of the least squares linear regression equation are considered. Based on many audits of ambient air analyzers, the following categorizations of instrument performance have been made.

<u>Excellent</u>	$0.95 < \text{slope} < 1.05$, and intercept $\leq \pm 3\%$ of instrument full scale range. That is to say, there is no more than $\pm 5\%$ variation in slope between analyzer response and audit concentration and no more than a 0.015 ppm offset, if the range is 0.5 ppm.
<u>Satisfactory</u>	$0.85 < \text{slope} < 0.95$ or $1.05 < \text{slope} < 1.15$ and intercept $\leq \pm 3\%$ of instrument full scale range.
<u>Unsatisfactory</u>	Slope and/or intercept are outside the limits specified for the satisfactory category. Analyzer/system demands troubleshooting, problem correction, and recalibration.

The correlation coefficient is a measure of how well the best fit line actually fits the data points. A satisfactory finding is a correlation between 0.995 and 0.9999 and is indicative of a linear analyzer response to the audit concentrations. An unsatisfactory finding is a correlation less than 0.995 and is indicative of a non-linear analyzer response.

The performance audits of ozone analyzers indicate that, with three exceptions, the accuracy of the analyzers was excellent. Two analyzers were quite satisfactory and only one (Cessna 402, Monitor Labs) was classified as unsatisfactory and corrective measures were taken as noted below.

About a week prior to the audits, the SEV-UPS project staff notified RTI that the chemiluminescent O_3 instrument (Cessna 402, ML) on board its aircraft was not responding according to the initial calibration curve supplied from laboratory calibration; both NASA (prior to

audit) and the RTI independent audits confirmed an instrument calibration change, and determined similar calibration coefficients. As reported to RTI by the SEV-UPS project staff, additional (after the audit) checks of this instrument's calibration showed no further calibration changes through August 31. The cause of the observed calibration change is not known, but occurred between laboratory calibration of the instrument by RTI (July) and installation on board the aircraft (August).

Audits of oxides of nitrogen analyzers showed two instruments of five to be unsatisfactory. In one case the problem was traced to a partially clogged sample inlet critical orifice. The other analyzer was recalibrated.

One particularly poor result was found when hydrocarbon/carbon monoxide instrumentation was audited. The total hydrocarbon channel at the Langley site gave a consistently low output, whatever the audit concentration. A malfunctioning electronic board was possibly the problem. In addition, the carbon monoxide channel of this instrument did not give an electronic signal output to the data acquisition system, although the chromatographic curve appeared when a strip chart was employed. One hydrocarbon instrument, which was aboard the C-54 aircraft, could not be audited with multiple concentrations since the sample intake requirement of 10 Lpm exceeded the capacity of the auditing device. Instead a satisfactory single point audit was determined using a cylinder containing methane and propane in air.

Two of the three sulfur dioxide analyzers gave an unsatisfactory audit. The response time of the instrument at the Naval Communications Center site was very slow (in itself indicating a problem) and inadequate time may have been given before analyzer stability occurred. The Inner Norfolk site sulfur dioxide analyzer read 20 percent less than the audit concentration. The instrument was recalibrated.

Results of the meteorological audits were satisfactory for the most part. The initial audit of wind direction at the Chesapeake Light site was unsatisfactory. After adjustment of the sensor, a satisfactory audit was obtained. Low wind speeds at the Inner Norfolk site prohibited a satisfactory comparison.

2.5 Hydrocarbon Species Sampling and Analysis

2.5.1 Rationale

Hydrocarbons, in concert with oxides of nitrogen, have been shown through smog chamber and ambient air measurements to be involved in the photochemical processes leading to the formation of ozone. It has been shown that certain classes of hydrocarbons, notably alkenes, are more prone to react to produce ozone quickly than classes such as alkanes. Studies have also shown that hydrocarbons such as acetylene and 2-methylbutane are associated with gasoline internal combustion engine emissions and gasoline evaporation, respectively. Other compounds such as isoprene and α -pinene are associated with natural emissions from forested areas.

There are several program elements of the August 1979 SEV-UPS study that might benefit from a knowledge of individual hydrocarbon identities and concentrations. Examples are the Dismal Swamp vegetation experiments, the irradiation chamber studies, and photochemical model studies.

For these reasons, some 29 different samples were collected in the SEV-UPS study area and analyzed by gas chromatography in RTI laboratories for some 59 different hydrocarbon species. Table 8 categorizes

Table 8. 1979 SEV-UPS Hydrocarbon Species Samples

<u>Rural Samples</u>	<u>Number of Samples</u>
Dismal Swamp, Vegetation study (maple gum)	7
Dismal Swamp, Smog Chamber studies	4
Dismal Swamp, Ambient Air 30 M (100 ft) Tower	4
Ambient air, Navy Communications Center, Northwest, VA, ambient air (surface)	3
<u>Urban Samples</u>	
Hampton Roads Bridge Tunnel, tunnel exhaust	2
Inner Norfolk Site, Naval Air Station, ambient air (surface)	4
NASA, Building 1273 (calibration/quality control)	5

the samples as described by NASA. Table 9 lists the specific compounds sought and divides them into the classes alkane, alkene, aromatic, and alkyne. Tabulated results of the analyses are contained in Appendix C.

2.5.2 Hydrocarbon Species Collection Procedures

Samples were collected in 2L-capacity stainless steel containers having electropolished interiors. The containers are cylindrical in shape, and heliarced to the top of each container is a 0.63 cm o.d. x 5.0-cm-length stainless steel tube. Attached to the end of the tube is a stainless steel metal bellows valve. The containers are identified by letter/number codes engraved in the metal top. Prior to use, the cylinders are leak-tested by air pressurization to 60 psig and immersion in water. Cleanup procedures for the cylinders followed these steps: (1) connect cylinder to vacuum, open valve, evacuate to 0.5 mm Hg; (2) close bellows valve, torque; (3) loosely connect cylinder valve to clean air supply, flush clean air lines and compression fittings with clean air for 60 seconds; (4) tighten fitting, open bellows valve, pressurize container to 60 psig with clean air; (5) disconnect clean air supply; (6) allow container to stand 20 minutes at room temperature, connect container to vacuum lines, open valve, heat surface to >100°C with heat gun, and evacuate to 0.5 mm Hg, then close bellows valve; (7) repeat steps 3 through 6; (8) attach paper tag for field notes and ship container to site.

A metal bellows pump (Model MB 41) was used to pressurize the container with sample air. This type of pump is free of lubricants or polymeric material that might release vapors that would contaminate the hydrocarbon sample. The containers were filled by pumping air through 1.6 mm (1/16 inch) o.d. stainless steel tubing that had been sized so that the container was pressurized in 3 minutes. An instruction sheet accompanied the pumps and listed six steps:

1. Assemble sample inlet and outlet lines on the pump. A 1.6 mm (1/16 inch) line is supplied to go from the pump outlet to the sample container. A 6.3 mm (1/4 inch) flexible SS line is supplied to help facilitate adapting the on-site sampling manifold to the pump inlet.

Table 9. Hydrocarbon Species, 1979 SEV-UPS

<u>ALKANE</u>	<u>ALKENE</u>	<u>AROMATIC</u>
Ethane	Ethylene	Benzene
Propane	Propylene	Toluene
Isobutane	1-Butene	Ethylbenzene
n-Butane	t-2-Butene	p-Xylene
2,2-Dimethylpropane	Isobutene	m-Xylene
2-Methylbutane	cis-2-Butene	o-Xylene
2,3-Dimethylbutane	2-Methyl-2-Butene	1,3,5-Trimethylbenzene
2-Methylpentane	1,4-Pentadiene	o-Ethyltoluene
n-Hexane	1,3-Pentadiene	t-Butylbenzene
3-Methylpentane	4-Methyl-1-Pentene	1,2,4-Trimethylbenzene
2,4-Dimethylpentane	2-Methyl-1-Pentene	sec-Butylbenzene
2-Methylhexane	1-Hexene	1,2,3-Trimethylbenzene
3-Methylhexane	α -Pinene	n-Butylbenzene
n-Heptane	β -Pinene	
2,2,4-Trimethylpentane	d-Limonene	
2,5-Dimethylhexane	l-limonene	<u>ALKYNE</u>
2,3,4-Trimethylpentane		
2-Methylheptane		Acetylene
3-Methylheptane		Propyne
n-Octane		
n-Nonane		
n-Decane		

2. Plug in pump and allow to warm up for 15 minutes. While pump is warming up, loosely attach fitting to sample container and allow to flush with air for at least one minute. Leave container valve closed.
3. Without turning off pump, tighten fitting and open cylinder valve.
4. The container will fill very quickly with a loud report as the bottom of the can swells out. Sample for exactly 3 minutes.
5. Close valve, and tighten to 2.26 Newton meters (20 in-lbs) with supplied torque wrench. Remove from pump setup, and turn off pump.
6. The tags on the sample cans may be filled out as necessary.

2.5.3 Hydrocarbon Species Analysis Procedures

In this project, each sample was analyzed for two major groups of compounds: C_2-C_6 light hydrocarbons and C_6-C_{10} aliphatics and aromatics. A micropacked column was used for the C_2-C_6 light hydrocarbons analyses, while the aliphatic and aromatic mixtures were separated on a capillary column. The hydrocarbon compounds were detected by a flame ionization detector (FID). The detector response was transmitted to a Hewlett-Packard Model 1865A analog-to-digital converter and this signal was then transmitted to a Hewlett-Packard Model 3352B laboratory data system. All chromatograms were also displayed on Linear Model 225 M or Perkin-Elmer Model 56 strip chart recorders. The Hewlett-Packard data system has capability for storing and applying response factors for each individual compound selected for quantification as well as identifying compounds on the basis of retention time.

Air samples were transferred from the sample cylinder to the gas chromatographic column by use of the injection system illustrated in Figure 2. The operation of the system can best be explained by following a sample flow through the system. The sample container is placed in the heated box (110°C) and is loosely connected to the inlet line Swagelok fitting. Valve A is opened and the inlet line is purged with clean air. At this point, the entire system can also be purged. After the lines have been purged, valve A is closed and the inlet fitting immediately tightened. The multiposition valve is turned to the desired GC sample loop, and the corresponding outlet valve (C) is

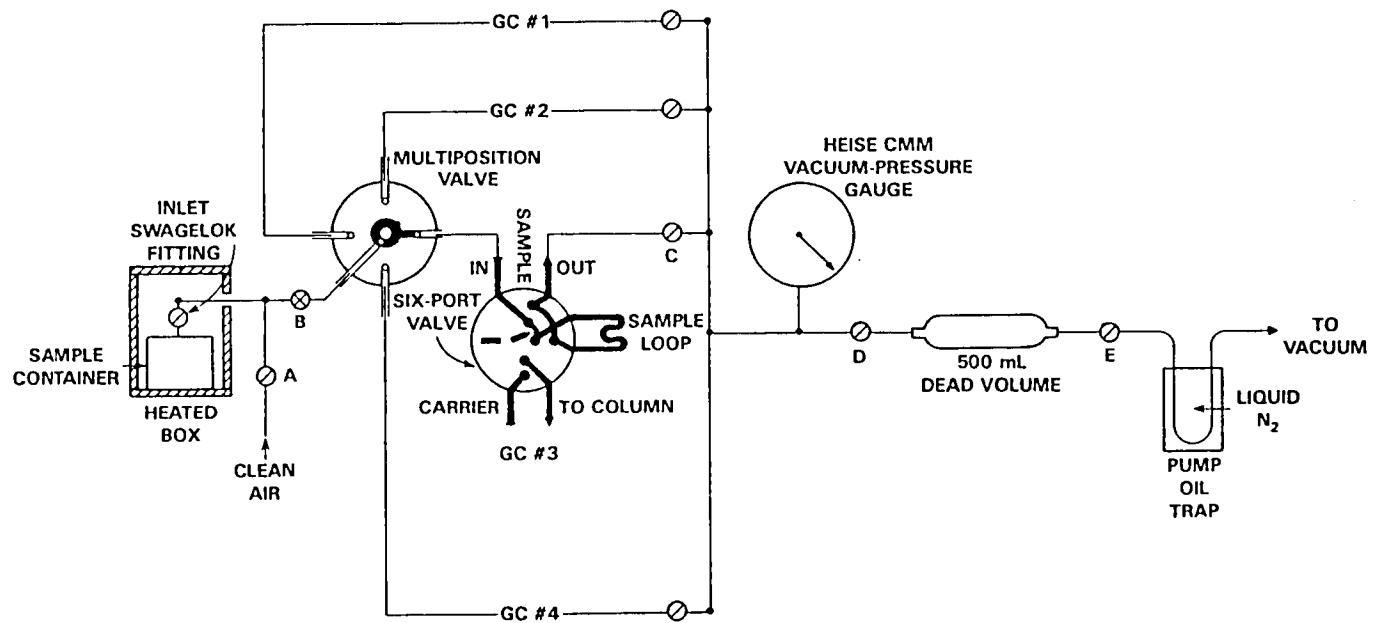

Figure 2. Injection System for Chromatographic Analysis of Hydrocarbons

opened. Valves D and E are opened to evacuate the entire system. Then, depending upon whether cryogenic trapping or an open loop is used, either valve D or E is closed, the container valve is opened, and the metering valve (B) is opened to allow sample to enter the system with the SEV-UPS samples. When cryogenic trapping with liquid oxygen is used, valve D, remains open and valve E is closed. This allows the sample to flow through the trap and into the 500-mL dead volume.

The amount of sample in either the open loop or the cryogenic trap is determined by the pressure change registered on the Heise gauge. For cryogenically trapped samples, the following equation relates the volume of gas passed through the loop to the pressure change:

$$V = \frac{V_d P}{P_a}$$

- V = gas volume passed through trap (mL),
- V_d = total dead volume in the system (mL),
- P = pressure change registered on gauge (mmHg), and
- P_a = ambient barometric pressure (mmHg).

A sample volume of 100 cc was taken for most of the samples in this program. After the sample was trapped in the cryogenic loop, the liquid oxygen dewar was removed and a heated silicone oil bath (200°C) was substituted. This sudden heating caused flash volatilization of the trapped hydrocarbons. Valve switches made at the same time caused carrier gas to push the sample onto the column and analysis began.

2.5.3.1 C₂-C₆ Light Hydrocarbons Analysis

The C₂-C₆ light hydrocarbon analysis system was made up of a Perkin-Elmer model 900 gas chromatograph equipped with a 3m x 6.4 mm nickel micropacked column packed with 100-120 mesh Durapak® phenylisocyanate. The column was maintained at 45°C during the analysis which took approximately 50 minutes (25 for analysis, 25 for backflush). The backflushing was assumed to be complete when the FID response returned to baseline. This column was capable of separating ethane and ethylene

at 45°C. One of the drawbacks of the column is the poor separation of pentane, trans-2-butene and isobutene. These three compounds are reported as one component.

2.5.3.2 C₆-C₁₀ Aliphatic and Aromatic Analyses

The C₆-C₁₀ aliphatic and aromatic analysis system consisted of a Tracor model 560 gas chromatograph equipped with a 50 m length WCOT SE-30 column. The analysis was started by injecting the sample into the column at 45°C. This temperature was maintained for 8 min, then the column was temperature-programmed at a rate of 8°C/minute until it reached 175°C. The column was held at this temperature until the analysis was completed. The analysis ran for approximately 30 minutes; there was no need for backflush afterwards.

2.5.4 Hydrocarbon Species Data; Validation and Comments

During day-to-day analysis by GC/FID, the retention times of eluting compounds shift slightly. The data acquisition system computer of course senses the peaks and integrates the area but may misidentify individual compounds since their time of appearance in the chromatograph shifts outside the pre-assigned "window". For this reason, all chromatographic traces were visually examined and handvalidated for correctness of identity by comparison to mixtures of known compounds. Usually, certain patterns of peaks are recognizable and can be used to establish peak identity. Figure 3 is a trace of a typical chromatograph of automobile exhaust as analyzed by the C₂-C₆ micropacked phenylisocyanate column. In this chromatograph the two sharp peaks labeled 2-methylbutane and n-pentane are characteristic of an urban sample and serve as a frame of reference for other compounds.

A critical examination of the chromatographs and the results allows some general statements to be made about the quality of the chromatographic analysis and the reasonableness of the SEV-UPS hydrocarbon species data. First, it was noted that overlap or co-elution of four sets of compounds occurred: (1) n-pentane + trans-2-butene + isobutene; (2) p-xylene + m-xylene; (3) t-butylbenzene + 1,2,4-trimethylbenzene; and (4) n-decane + 1,2,3-trimethylbenzene.

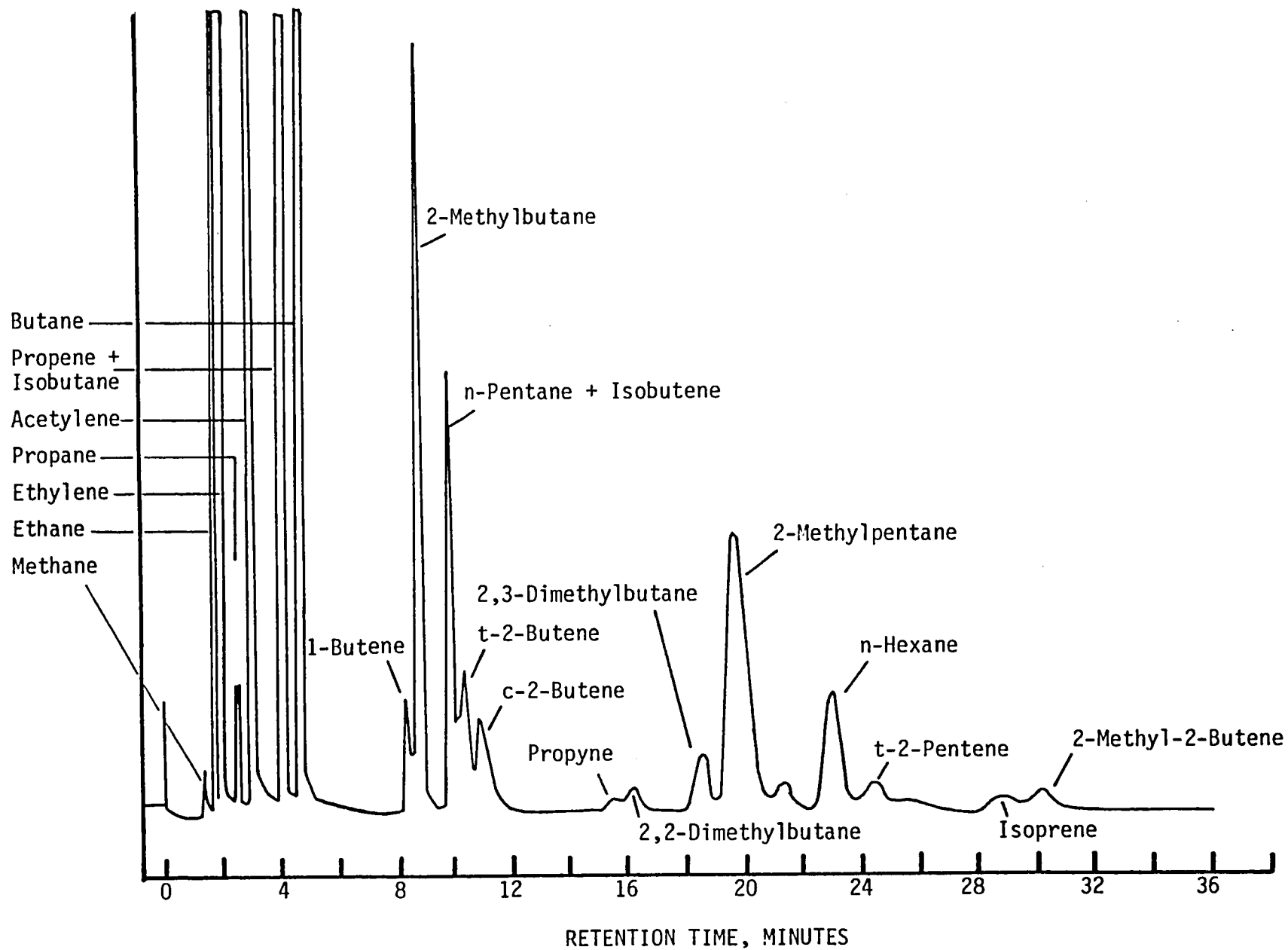

Figure 3. Chromatograph of Automobile Exhaust; Micropacked Phenylisocyanate Column

This overlap made individual quantification of these compounds impossible; instead, the concentration of the entire peak was reported by using the response factor for the first compound listed in each group.

Another finding was that, quite often, the benzene concentration seemed to be inordinately high as compared to other compounds in the sample that might have been expected to have a common source with benzene.

There were a few, small unidentified peaks in the C₂-C₆ analysis column. Their concentration was small, on the order of 5 percent, as compared to the identified peaks. There were approximately 15 "unknown" peaks in the C₆-C₁₀ column chromatograph that lie beyond the elution time of benzene. In a typical urban sample it is estimated that their area sum is about 10 percent of the sum of areas of identified peaks.

When all the hydrocarbon species for a particular sample are added, the sum may be termed nonmethane hydrocarbons or NMHC. Tower and surface samples taken in the Dismal Swamp, near the Naval Communications Center, were relatively higher in NMHC than those obtained by an automated chromatograph at the Communications Center that often registered zero ppmC NMHC.

However, when NMHC by automated chromatograph and by sum of species were compared for samples taken at the Inner Norfolk urban site on August 31, the agreement was much better in three of four examples, as shown in Table 10 below. It should be noted that 3-minute collection times for hydrocarbon species are being compared to a one-hour average from the automated chromatograph.

Table 10. Comparison of NMHC as Determined by Two Methods

Hour, EDT	NMHC, Species	NMHC, Beckman 6800	<u>Species</u> Beckman
0600	597 ppbC	250 ppbC	2.4
0800	173	150	1.2
1000	231	210	1.1
1200	139	150	0.9

Most of the urban hydrocarbon samples had species and concentrations that were typical of city emissions, especially automobile exhaust. Samples taken from the exhaust of the Hampton Roads Tunnel were practically identical in compound composition to a sample of automobile exhaust. Samples taken in rural areas contained many of the same compounds, but usually at greatly reduced concentrations. (Two rural samples, A-36 and A-62, were unusually high in gasoline-type compounds; this may indicate contamination at some point in collection and/or analysis). Table 11 compares the contents of a rural and an urban sample taken at the same hour (0600 EDT) on August 31, 1979.

Table 11. Comparison Of Rural and Urban Hydrocarbon Samples, ppbC

	Rural, A-152 100 ft. Tower Dismal Swamp	Urban, A-6 Inner Norfolk, Navy Base
Acetylene	1.4	13.6
Ethylene	5.2	24.6
Propane	7.2	115.8
2-Methylbutane	6.0	43.2
Alkanes	94.3	363.3
Alkenes	56.0	45.2
Aromatics	73.4	174.7
All Compounds	225	597
% Attributed to Vehicle Exhaust	10%	35%

Table 11 shows that the urban sample A-6 has concentrations of acetylene and ethylene (compounds associated with vehicular exhaust) much higher than rural sample A-152. The compound 2-methylbutane (isopentane), which is associated with gasoline evaporation, is also at a higher concentration in the city sample. The sum of alkanes, sum of aromatics, and sum of all compounds are higher in the city samples. Unexpectedly, the sum of alkenes is lower in the city sample. The percentage of total NMHC attributed to vehicular exhaust, as calculated by the equation below⁵,

$$\% \text{ exhaust} = \frac{\text{acetylene, ppbC} \times 15.5}{\text{total NMHC, ppbC}} \times 100$$

is higher for the city sample, although 35 percent seems to be somewhat low. Perhaps the rather high concentration of propane in sample A-6 is due to a source other than vehicular exhaust.

The data also show that concentrations of the naturally emitted hydrocarbons α -pinene, isoprene, and d- and l-limonene are quite low in most cases. These compounds are probably among the most reactive species analyzed. Some degradation of samples may have occurred during the time interval between sampling and analysis (a period of three or four weeks).

2.6 Data Processing

The output of the instruments for the ozone, oxides of nitrogen, and sulfur dioxide analyzers, as well as the data from wind speed, wind direction, and solar radiation sensors from the Naval Communications Center site were monitored and recorded at ten-minute intervals by a data logger. The temperature, dewpoint, total hydrocarbon, methane, and carbon monoxide data at the Naval Communications Center and all of the data from the Naval Air Station site were recorded by strip charts. The data recorded by the data logger at the Naval Communications Center were reduced into hourly averages by numerically averaging the six monitored values representing each hour. These hourly averages of instrument output were then converted into concentration units by applying the appropriate calibration equations. These data were then transferred to coding forms and keypunched onto computer-readable card decks in the format described by NASA. The card decks were then copied onto a 9-track magnetic tape and both the card decks and the magnetic tape were submitted to NASA.

Throughout the process of data reduction, conversion, and coding, the information was reviewed for anomalies with respect to the magnitude of individual hourly averages and the changes between successive hours. Any data that appeared abnormal were investigated by referring to either the appropriate data logger or strip chart record, and when possible, these data were corrected. Any data that were obviously suspect were invalidated and reported as missing data.

3.0 AIRBORNE AIR QUALITY MEASUREMENT SYSTEM

Although ground-based environmental measurements yield important information about outdoor exposure levels, measurements must be made up to the top of the mixing layer and beyond to determine information which will provide insight into transport mechanisms. To provide this information, an airborne air sampling system was designed, fabricated and installed aboard a twin-engine aircraft which would provide spatial distribution information of gas and particulate concentrations and meteorological data. This system was designed based on experience gained with smaller systems flown earlier on a C-45 aircraft and with aerodynamic engineering support from consulting personnel experienced in aerodynamic design. The system was fabricated in 1975, and in that year, collected over 250 hours of airborne data. Since then the system has been operated on two other field programs, totalling approximately 280 data hours prior to its utilization in the SEV- UPS.

Modifications were made in both the instrumentation system hardware and operational procedures during each previous program, as necessary, to improve the quality of the data taken with the aircraft. Changes were made only in those portions of the system where improvement was necessary, leaving those portions of the system which were proven satisfactory untouched. This evolutionary process produced an aircraft system whose reliability is well documented through tests performed during the recent programs.

The remainder of this section describes the airborne monitoring system and briefly describes the procedures for its operation.

3.1 Measurement System

3.1.1 Aircraft

The aircraft used in the program was a Piper Navajo B, shown in the photograph, Figure 4. The aircraft operates at a typical cruise speed of 290 km/hr (180 mph), which, with a normal crew complement (pilot and instrument operator) and instrumentation package, allows



Figure 4. RTI Aircraft, Piper Navajo B

for an operational time of 3.5 hours with 45 minutes of fuel reserve. The maximum operational altitude is 7,600 m (25,000 ft.) with an initial climb rate capability exceeding 305 m/min (1000 ft/min). It is equipped with instrumentation for day and night VFR and IFR operations. Communications and navigation equipment include Dual VOR and VHF Communication, DME, ADF, Transponder, and an Altitude Reporting Altimeter.

3.1.2 Instrumentation System

Figure 5 illustrates in block form the overall instrumentation system installed aboard the RTI aircraft. This diagram illustrates the various subsystems mounted in the nose compartment, the cabin, and on the wing. A physical layout of the instrumentation system is shown in Figure 6, and a listing of the parameters measured is provided in Table 12, including the instrumentation used to measure each parameter, analysis technique, range of operation, and nominal response time. A detailed description of each subsystem is given in the following paragraphs.

3.1.2.1 Air Sampling System

A physical layout of the air sampling system is shown in Figure 7 and a functional diagram of the system is shown in Figure 8. The air intake system consists of two 2.54-cm (1-inch) Teflon tubes inserted in steel tubes mounted to the nose cone of the aircraft and extending approximately 61 cm (2 feet) in front of the nose of the aircraft. One of the Teflon probes terminates in an expansion manifold located in the nose compartment of the aircraft, supplying a clean air sample to an integrating nephelometer and a 47-mm filter system mounted in the nose compartment.

The second Teflon probe extends to the cabin area of the aircraft and attaches to a 12.7-cm (5-inch) diameter sample manifold, constructed of aluminum and coated internally with heat-cured Teflon. The manifold is designed with an inlet diverging diffuser section to allow deceleration of flow to a more controllable velocity, typically in the range of 3 m/sec.

Analyzer sample lines, temperature sensors, dew point probes,

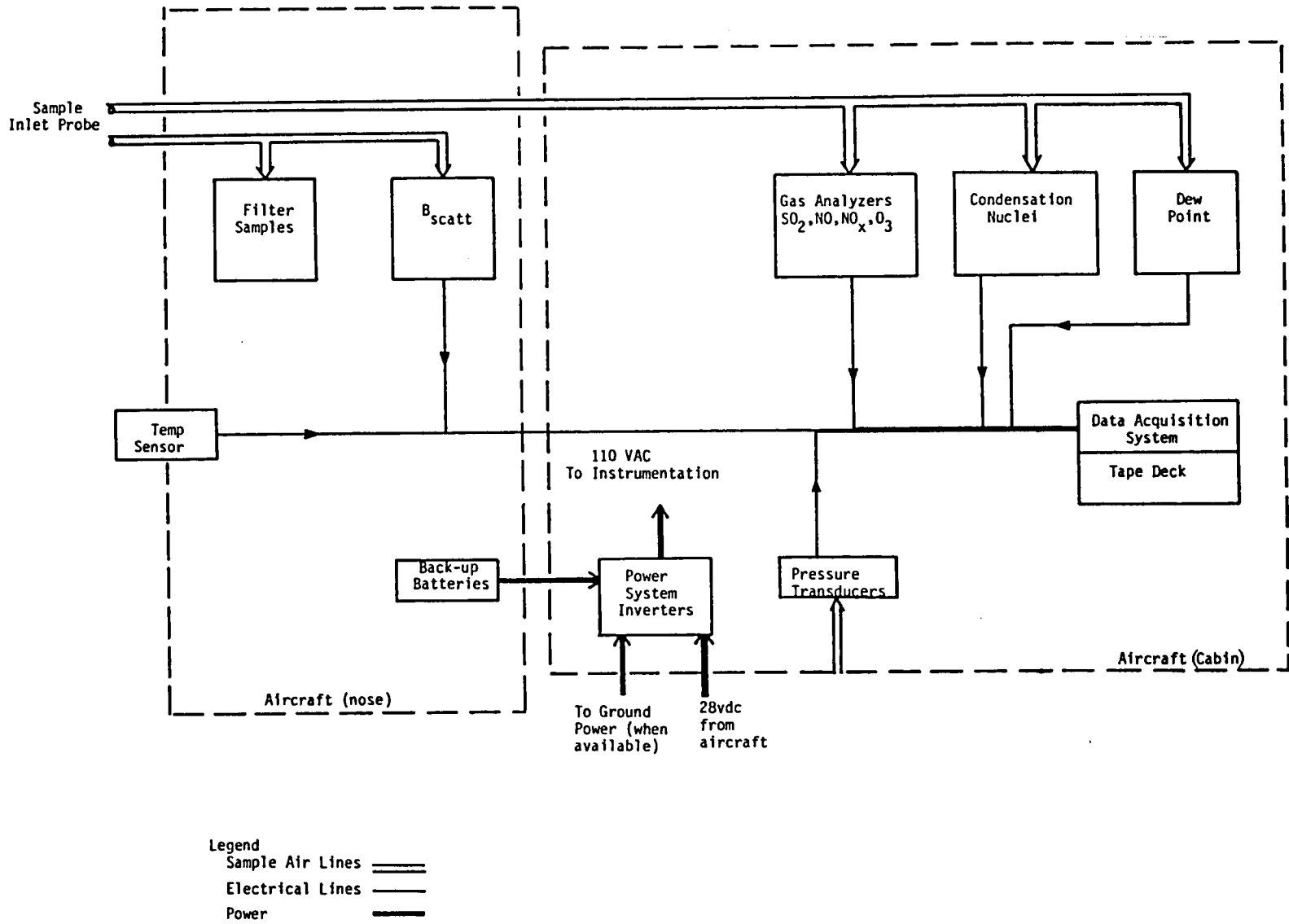

Figure 5. System Diagram, Airborne Air Sampling System

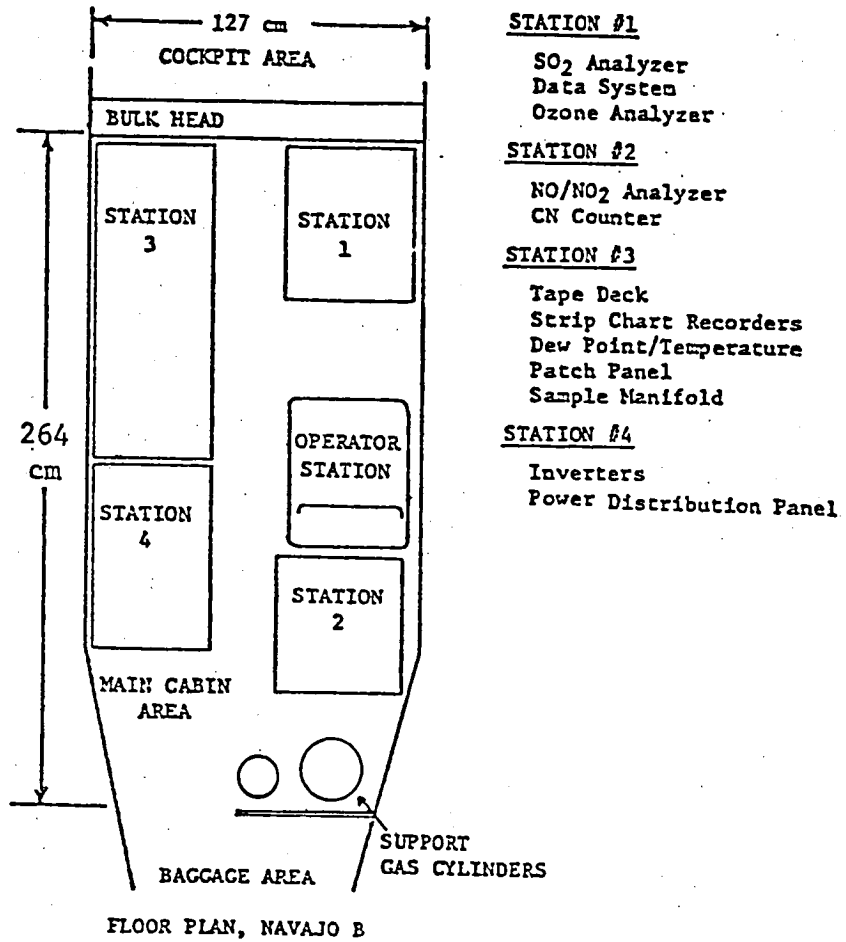

Figure 6. Layout of Instrumentation in Cabin Area

Table 12. Aircraft Instrumentation

Parameter	Instrument Manufacturer and Model	Analysis/Collecting Technique	Measurement Range (1)	Continuous	Time Response
Sulfur Dioxide	Meloy 285	Flame Photometric	50 ppb	Yes	2 min.
Nitric Oxide and Nitrogen Dioxide	Monitor Labs 8440	Chemiluminescence	0.2 ppm	Yes	20 sec.
Ozone	Bendix 8002	Chemiluminescence	0.2 ppm	Yes	5 sec.
Condensation Nuclei	Environment One Rich 100	Cloud Chamber	100,000 CN/cm ³	*	5 sec**
Light Scattering Coefficient (b _{scat})	MRI 1550B	Integrating Nephelometer	10x 10 ⁻⁴ m ⁻¹ *	*	1 sec.**
Air Temperature	Rosemount 102	Platinum Wire	-73 to 93°C	Yes	<0.1 sec.
Dew Point	EG&G 880	Cooled Mirror	-50 to +50°C	Yes	0.5 sec./°C
Altitude	Sensotec	Abs. Pressure Transducer	10 ⁵ N/m ² (0 to 15 psia) (all altitudes above sea level)	Yes	<1 sec.
True Airspeed	Sensotec	Diff. Pressure Transducer	1.3x10 ⁴ N/m ² (0 to 2 psia)	differential Yes	<1 sec.
Time of Day/Date	Data Acquisition System FLUKE 2240B				

*Available all ranges

**Samples over successive intervals of one second or less resulting in output signal which appears continuous.

(1)Range at which instrument set during measurement program.

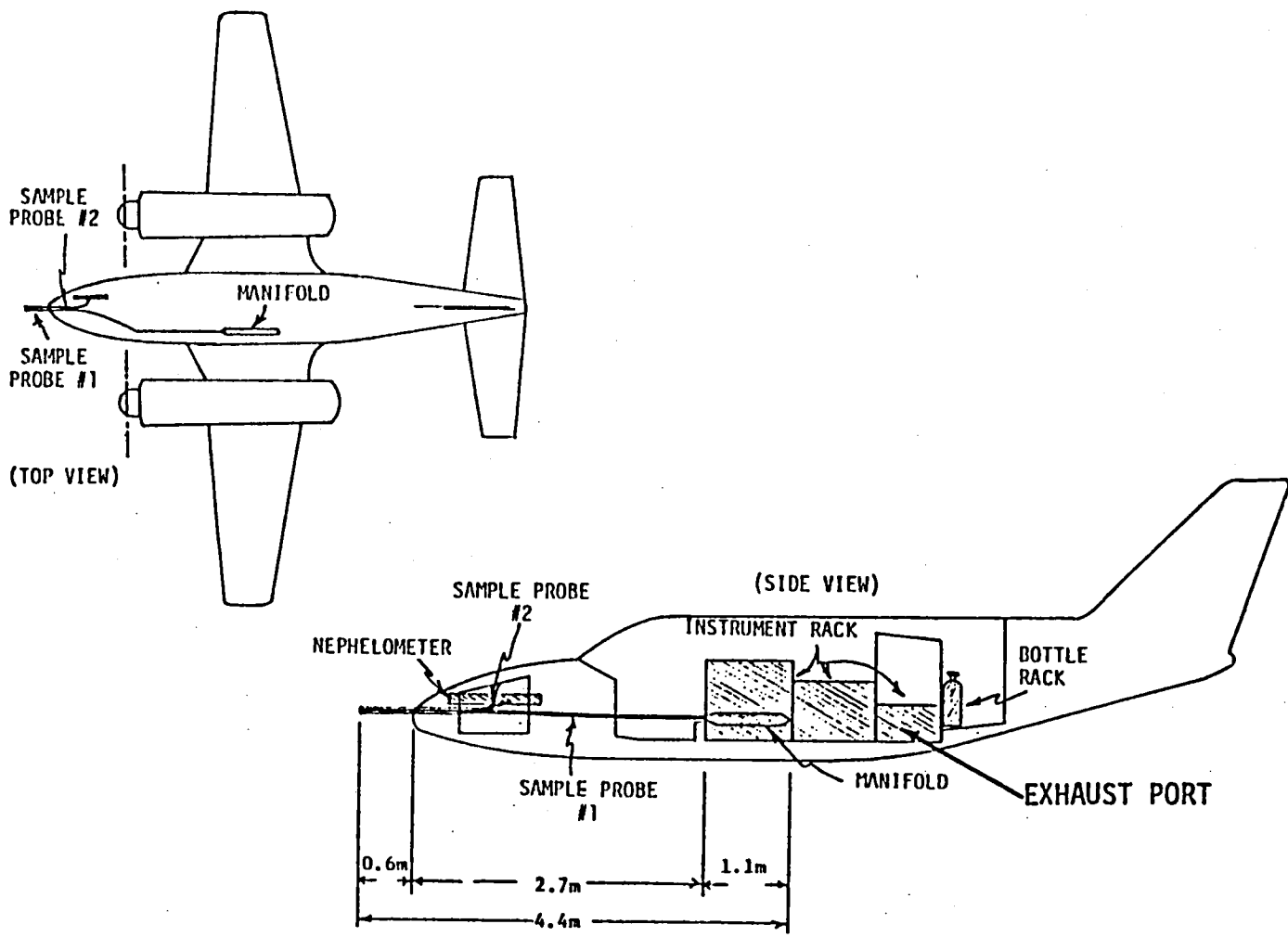

Figure 7. Physical Layout of Air Sampling System

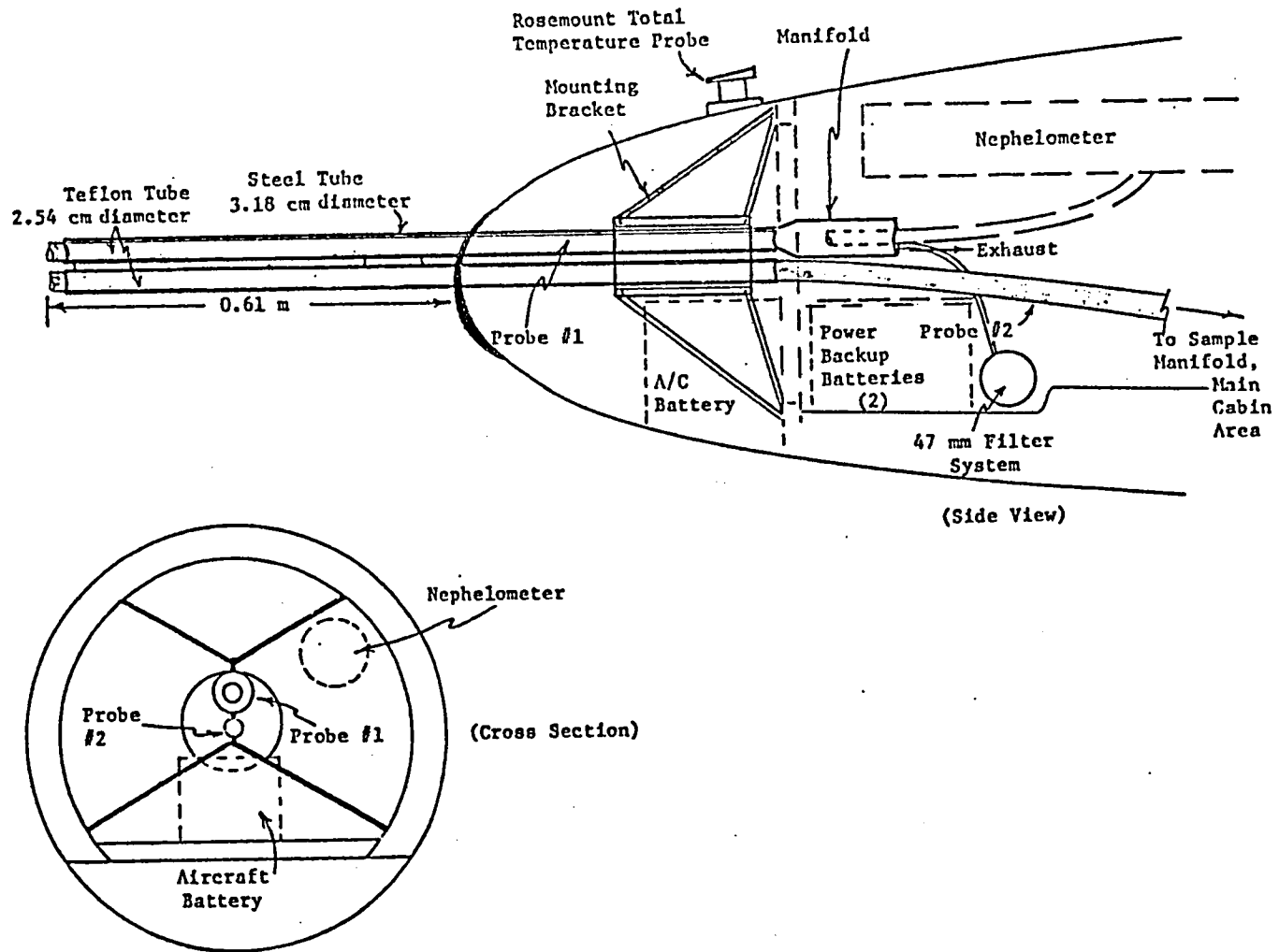

Figure 8. Details of Forward Section, Air Sampling System

etc., are situated along the main body of the manifold, an adequate distance from the diffuser, to allow unobstructed, isentropic flow of air sample. A minimum flow velocity of 2-3 m/sec is maintained to insure relatively rapid air sample exchange. The manifold exhaust design includes a diverging diffuser section which results in an increased exit velocity from the manifold, minimizing the possibility of contamination from the aircraft cabin. Connections to both manifolds are illustrated in Figure 9.

3.1.2.2 Gas Analyzers: SO₂, NO_x, O₃

Sulfur dioxide was measured with a Meloy SA285 flame photometric analyzer. Sample air was drawn into the analyzer by a self-contained pump and mixed with hydrogen supplied from a size-2 cylinder located in the rear of the aircraft. The mixture was burned in front of a photomultiplier tube. SO₂ in the air causes emission of certain wavelengths from the flame which are detected by the P-M tube. Several modifications were made to this analyzer to allow it to operate in the aircraft environment. First, the vacuum pump was replaced with a single stage Thomas pump because of the original unit's inability to start on inverter power. The other modification consisted of bypassing the linearizing circuit of the SA285. This allowed variations in background level due to pressure effects to be compensated for off-line before application of the linearizing function. This processing is now done off-line during the data reduction phase. The instrument, when operated in this fashion, has a full scale sensitivity on the most sensitive range of approximately 60-70 ppb.

Ozone was measured with a Bendix Model 8002 gas phase chemiluminescent ozone analyzer, operated continuously on the 0.2 ppm range. C.P. grade ethylene support gas for the analyzer was supplied from a size-3A gas cylinder. The instrument exhaust was routed through plastic tubing and dumped overboard through a bulkhead panel, to the rear and underneath the aircraft.

Oxides of nitrogen were measured with a Monitor Labs gas phase chemiluminescent NO-NO₂-NO_x analyzer, Model 8440. The instrument was operated continuously on the 0.2 ppm range for both NO and NO_x simultaneously.

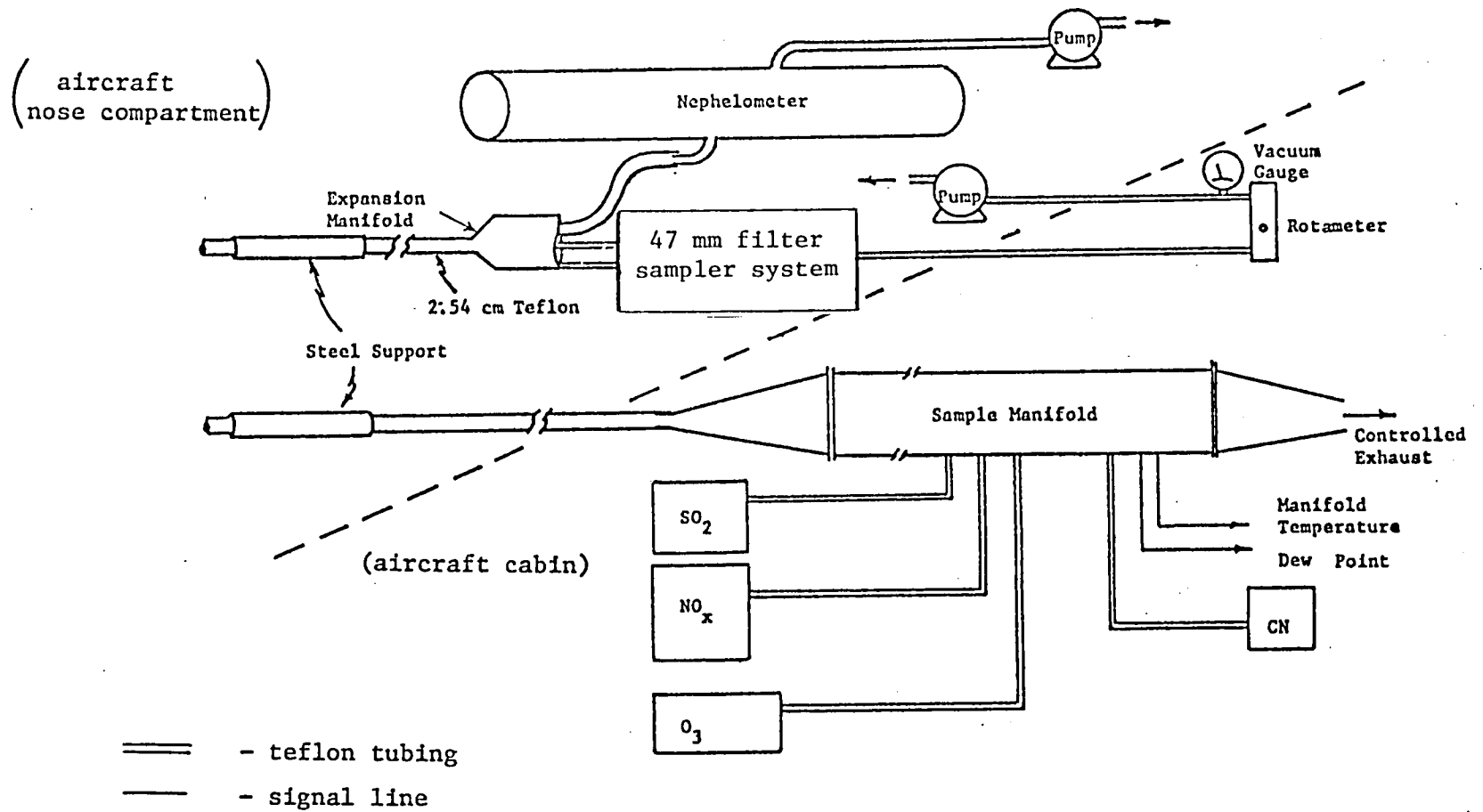

Figure 9. Flow Diagram, Air Sampling System

3.1.2.3 Aerosol Measurements

Aerosols were continuously monitored with a condensation nuclei counter and an integrating nephelometer. Visibility (b_{scat}) was measured with an MRI Model 1550B integrating nephelometer. The optical assembly and air sample pump were mounted in the nose compartment of the aircraft and the electronics console was located in the aircraft cabin. Sample air for the nephelometer was drawn through a 1.2-cm plastic hose from the expansion cone described earlier. The sample air drawn into the optical chamber of the nephelometer was illuminated with a high intensity pulsed flash lamp, the scattered light was detected by a photomultiplier, and the resulting signal was amplified and scaled to read out in Scattering Coefficient (10^{-4} m^{-1}).

Smaller particles, as small as .0025 microns, were sampled once per second by an Environment One auto-ranging condensation nuclei counter. This unit draws sample air from the intake manifold located in the aircraft cabin. The Environment One instrument operates on the principle of a cloud chamber, where water is condensed onto the submicroscopic particles producing micron-sized droplets. These droplets are then measured with a light source-detector assembly whose output is amplified and scaled to represent particles/cc.

3.1.2.4 Pressure and Temperature Measurement Systems

Pressure sensors aboard the aircraft included two absolute pressure transducers used for sensing static pressure and manifold pressure and a differential pressure unit connected to a Pitot tube for determining air speed. These units, all Sensotec transducers, were located in the aircraft cabin and mounted in a foam-lined container to isolate them from vibration of the airframe. The static pressure transducer, a 0 to 10^5 N/m^2 (0 to 15 psia) unit, and the differential pressure, a 0 to $1.3 \times 10^4 \text{ N/m}^2$ (0 to 2 psia) unit, were connected to ports of a pitot-static probe mounted on the sample intake probe forward of the aircraft nose. The manifold pressure transducer, also a 0 to 10^5 N/m^2 (0 to 15 psia) unit, was simply connected to one of the outlets on the sample manifold.

Temperature sensors incorporated on the aircraft include total temperature, manifold temperature, and dew point.

The total temperature (stagnation temperature) was measured by a Rosemount Model 102 total temperature probe mounted on the top of the aircraft nose. This unit has an extremely fast response time (much less than one second) and a precise output (low noise) which allowed even small inflections in the vertical temperature profiles to be observed.

Dew point of the air was sensed by an EGG 880 dew point sensor which operates on the cooled mirror principle. Sample air for this sensor was taken from the sample manifold and pulled through the instrument by a small metal bellows pump. The temperature of air in the manifold was measured by a standard Thermilinear thermistor bead manufactured by Yellow Springs Instruments. This thermistor was inserted directly into the sample manifold airstream downstream of all analyzer sample ports. Air velocity in this manifold was only 2 to 3 meters per second and therefore compression or frictional heating is not a problem.

3.1.2.5 Power System

Power for the aircraft instruments was supplied by the aircraft alternators while the aircraft was in flight. Total primary drain with all systems operating was about 50 amps from the 28 VDC supply. Power is converted to 110 VAC for line-operated instruments by inverters. Six separate inverters, 3-500 watt square and 3-300 watt stepped wave, furnished 2400 watt capability. The division of total load between the six inverters lessened the likelihood of total loss of data in the event of inverter failure since power could usually be restored to all instruments by redistribution of loads between inverters.

Back-up 28 VDC power was supplied by automobile storage batteries during those times when neither ground power nor aircraft power were available, such as while starting engines. These batteries were housed in a sealed container mounted in the nose of the aircraft and were vented to the outside to prevent buildup of potentially explosive gases in the forward compartments of the aircraft.

Ground operation of gas analyzers was maintained with externally supplied 110 VAC power from normal ground sources. A power distribution control panel contained relays for automatic switchover between 110 VAC sources (from inverter to ground power) when ground power became available. A schematic diagram of the power system is shown in Figure 10.

3.1.2.6 Data Acquisition System

Data acquisition was performed by a Fluke 2240B Data Logger interfaced with a Cipher 85H 7-track magnetic tape recorder. This microprocessor based system accepts up to 30 channels of analog inputs and digital data from 10 BCD digit switches. Scan rates and number of contiguous channels scanned may be easily changed by front panel controls on the system; however, with the aircraft, the data system was always run at 13 channels of data scanned 6 times per minute. Faster scan rates with this number of channels was not possible because approximately 8-9 seconds are required for each scan. The data logger accepts analog inputs with programmable voltage ranges of 0 to 40 mv, 400 mv, 4 volts or 40 volts. Digitization is performed by an integrating type digitizer, so short duration noise spike effects are minimized and line frequency noise is cancelled. In addition to data being stored on magnetic tape, it was also printed out on a column printer for examination during flight, preliminary processing in the field, and for use as backup in case of an unnoticed tape deck failure.

All analog input lines to the data logger were connected to a panel mounted junction box which allowed installation of signal conditioning circuits in selected input lines and patching of signals of any channel to either a digital voltmeter or one of three strip chart recorders. Figure 11 illustrates the typical signal interface between sensor/instrument and data recording systems. Push button event markers are also provided which caused markers to be placed on all three strip chart records simultaneously so the strip charts could be synchronized.

Time information was maintained by the data system and was synchronized to the incoming frequency. The inverter utilized for this data system incorporated a 60-Hz crystal-controlled time base for high frequency stability and accurate time information.

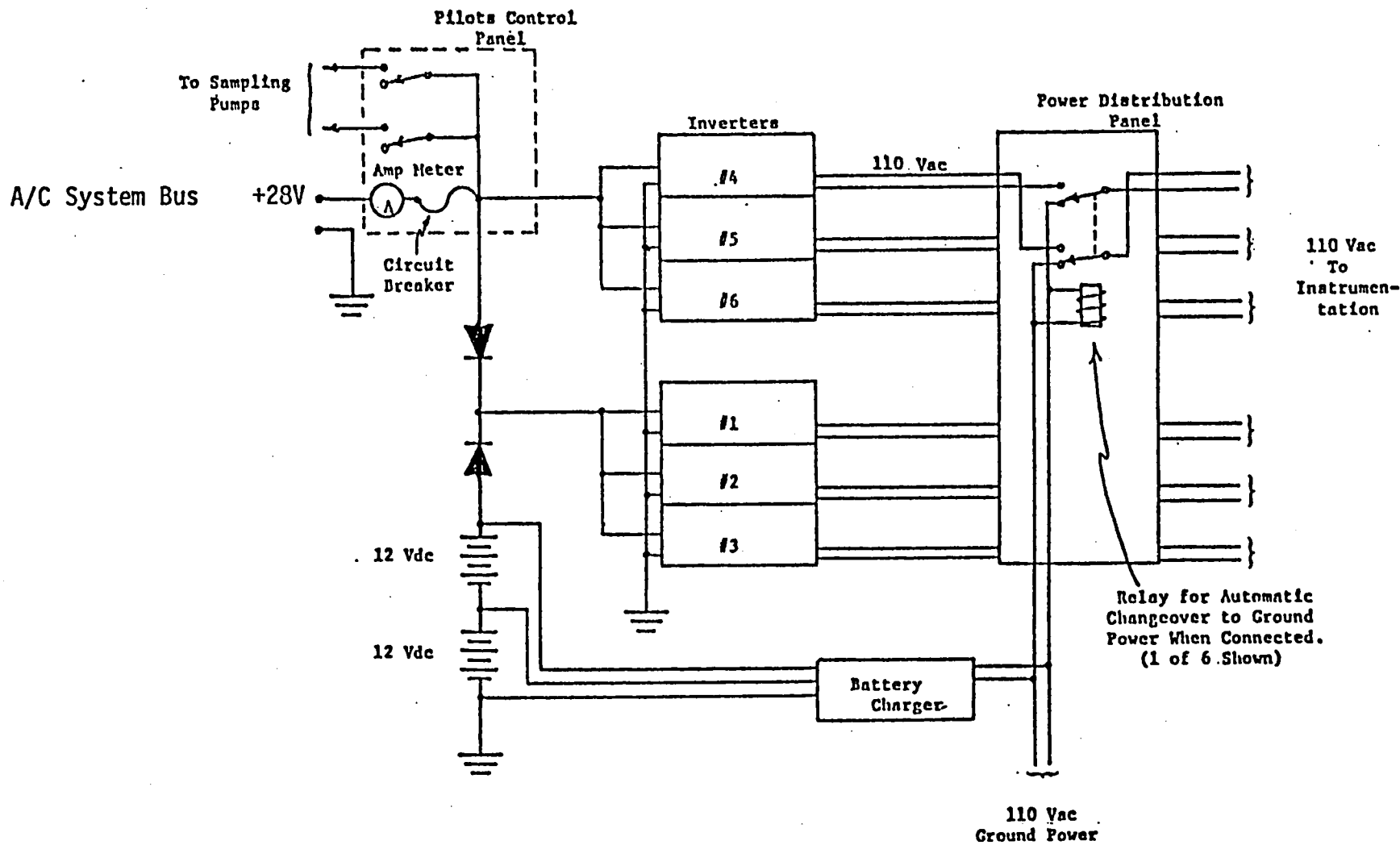

44

Figure 10. Aircraft Instrumentation Power System

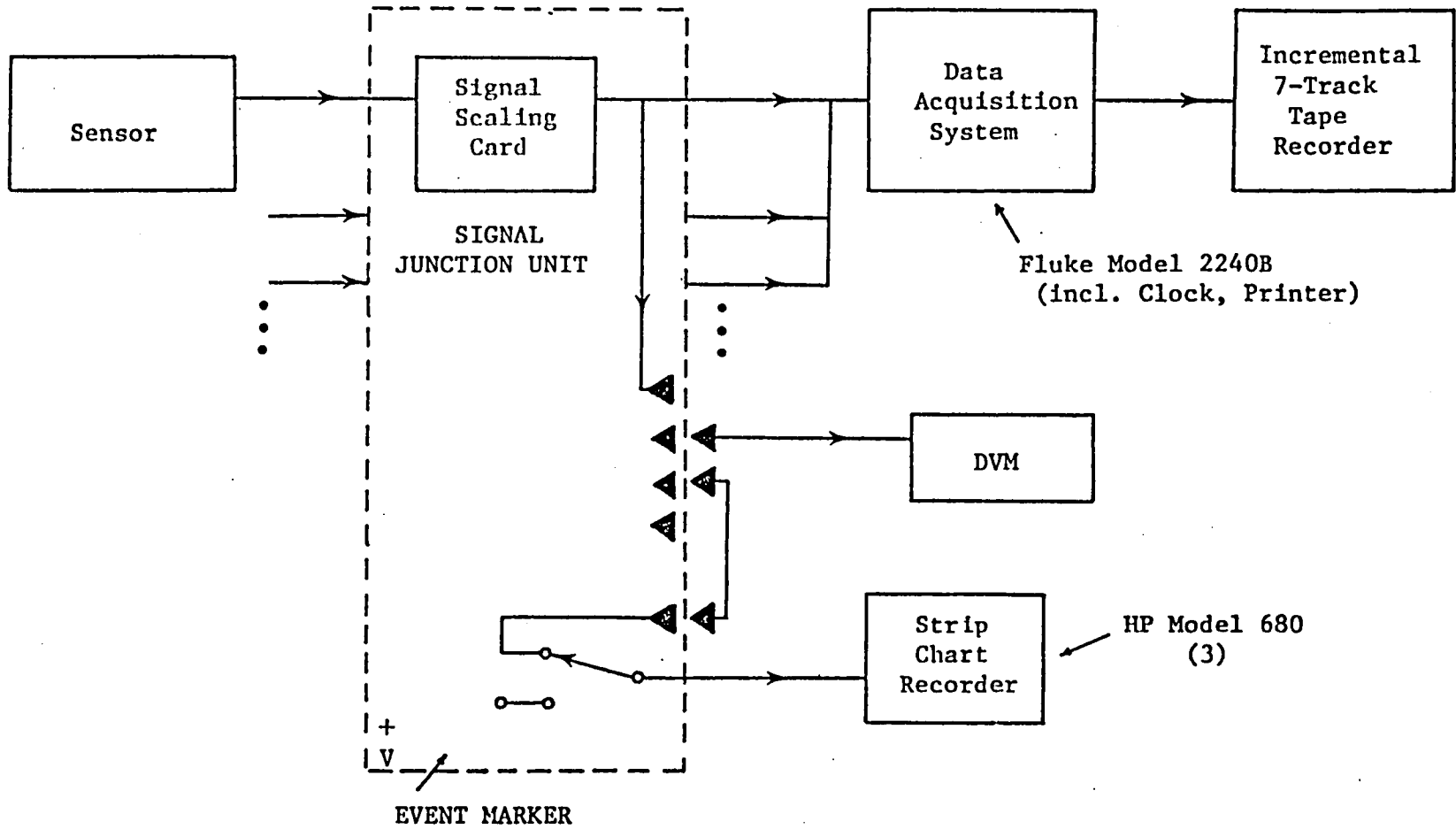

45

Figure 11. Typical Signal Interface, Sensor-Data Recording System

3.2 Instrument Calibration and Characterization

The purpose of calibration of an analyzer is to determine the relationship between the input (measured parameter) and its output. The techniques for performing calibrations however may also be used to check instrument operation, i.e., verify linearity, check for change of sensitivity and even detect significant changes in response time. Gaseous analyzers require more frequent calibration than most other instrumentation. Even under ideal conditions in a ground station environment, calibrations may be performed about every two weeks, with zero-span checks performed between calibrations. Aircraft system operation, however, is considerably more costly than ground operation and therefore larger losses result from even small amounts of lost data. The calibration philosophy for the aircraft is, therefore, to run full multipoint calibrations as often as possible to detect and correct problems as they occur before significant amounts of data are invalidated and lost. Consequently, calibrations for gas analyzers were usually performed every two to three days during the field program. The procedures and techniques used for calibrations are described in Section 3.2.1.

In addition to high operating costs, utilization of instrumentation in an airborne environment is complicated by changing environmental pressure. Instruments must be characterized for changes in baseline, sensitivity or linearity with changes in pressure. Tests to determine these changes are most easily performed in an altitude chamber where parameters are closely controlled. All gaseous analyzers used on the aircraft were tested and characterized in altitude chambers. A summary of the procedures used for the conduct of these tests are contained in Section 3.2.2.

3.2.1 Instrument Calibration

A single calibration system was used for both SO₂ and NO_x and ozone calibrations. This system, shown schematically in Figure 12, incorporates dilution systems for SO₂ and NO and ozone generator for ozone and NO₂ by reaction with NO. Flows are regulated by mass flow meters. Air is supplied to the system from a two-stage diaphragm pump through a cleanup system designed to remove ambient levels of the gas

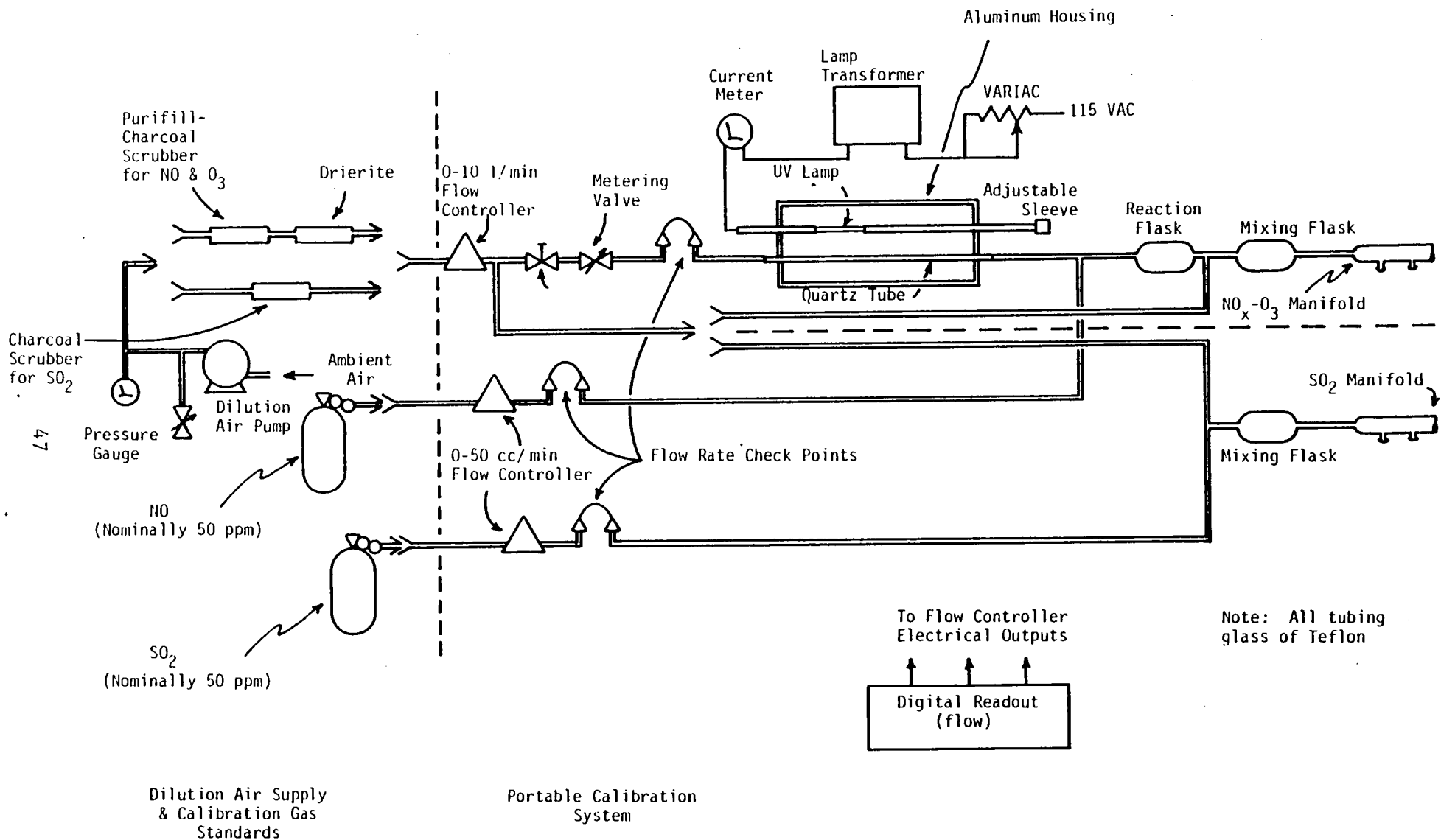

Figure 12. Calibration System

being measured. Separate mixing/outlet manifold systems are utilized to minimize the number of internal connections which must be changed during normal field operation of the system, thereby decreasing the likelihood of internal air leaks developing. The total system, except for the gas cylinders, is packaged in compact cases for portability and to facilitate operation within the confined quarters of the aircraft cabin.

Field calibration standards used for calibration of gases and temperatures are listed in Table 13. This table also lists the laboratory standards used for determination of the level of the field calibration standard, e.g., the concentration of NO in the calibration gas cylinder as well as the method used for determining the level and any checks used in the field to verify the levels. The following paragraphs outline the calibration methods for the analyzers and aerosol monitors.

3.2.1.1 SO₂ Analyzer

SO₂ calibration gas at levels likely to be encountered during ambient measurements are generated by dilution of gas from a 25 ppm SO₂ cylinder. Dilution air consists of air taken from the normal environment and filtered with charcoal. The charcoal filter removes all SO₂ but leaves CO₂ levels unaffected.

During calibrations of the SO₂ analyzer, front panel zero and span pots were not disturbed once set to correct nominal values. The zero setting was maintained by careful adjustment of H₂ flow while making sure that the rotameter indication of that flow did not change. Calibration concentrations in the ambient range were generated and applied to the instrument through a manifold. Voltage levels were monitored by the data system DVM or a multimeter type DVM and recorded on a standard calibration form. The linearizing electronics of the SO₂ analyzer were bypassed to allow off-line compensation for zero shift with altitude. Therefore, the voltage output was no longer linear with concentration. To reduce the calibration data to mathematical form for computer processing, a numerical regression was performed on the logarithms of voltage and concentration data to determine the coefficients of the calibration equation:

$$\text{Conc} = K(V - V_0)^m$$

Table 13. Standards Used in Field Calibration

Parameter	Field Calibration Standard	Reference Standard Used to Establish Field Calibration Standard Level	Method of Referencing	Verification of Calibration System
SO ₂	Gas Cylinder approximately 25 ppm SO ₂ in air	NBS Standard Reference Material - permeation tube	Laboratory comparison of diluted Field Calibration Standard with concentration generated from permeation tube - performed prior to each intensive	Comparison of Aircraft Calibration System with that of independent audit team from RTI. Conducted in field at start of each intensive
NO	Gas Cylinder approximately 50 ppm NO in N ₂	NBS Standard Reference Material - gas cylinder 48.8 ppm NO in N ₂ NBS #FF3193	Laboratory comparison of diluted Field Calibration Standard and Reference on ambient NO analyzer. Performed prior to each intensive	
Temp	Mercury Thermometer 0.1° C graduations	HP Model 2833 temperature probe	Comparison of readings from bath temperature sensing units in stirred temperature controlled bath	

3.2.1.2 Nitric Oxides Analyzer

Gas phase dilution of NO with clean air is used as a source. The same reference cylinder of NO was used for both the ozone and oxides of nitrogen calibrations. This cylinder was referenced to an NBS cylinder of NO (NBS FF3193) before the SEV-UPS flight program began.

3.2.1.3 Ozone Analyzer

An ultraviolet ozone generator verified by gas phase titration of NO¹ is used as a calibration source.

3.2.1.4 Condensation Nuclei Counter

The CN counter is factory-calibrated by the manufacturer by comparing instrument response to that of a Pollak Counter simultaneously sampling the same air source. The Environment One instrument was adjusted to give comparable readout as the Pollak Counter.

3.2.1.5 Nephelometer

The nephelometer is carefully calibrated with clean (filtered) air and Freon 12 prior to the beginning of the program. During this calibration, a reference span point was identified and used along with clean air for daily zero and span checks throughout the program.

3.2.1.6 Temperature Sensors

The thermistors used to measure ambient and manifold temperature were calibrated at the beginning and throughout the program by submerging the sensors in a water bath maintained over a range of temperatures and referenced to a laboratory-type mercury thermometer. The reference thermometer was calibrated in the laboratory against a Hewlett-Packard quartz thermometer, Model 2801A.

3.2.1.7 Dew Point

Recommended calibration of substitution of standard resistors in place of the sensing thermistor was performed prior to the beginning of the program. Calibration was verified by observing the relationship between temperature and dew point while in flight, particularly near clouds where temperature should equal dew point.

3.2.1.8 Pressure System

Pressure transducer response was calibrated against a mercury or water manometer at the beginning of the program and spot-checked routinely against aircraft instruments during each flight. Also, during an earlier program, repeated low passes were conducted over a runway of known length during a time when the meteorological conditions were reasonably stable. Several low passes were made from different directions, varying the aircraft speed over a maximum safe range. Each pass was accurately timed over the known length of the runway and the aircraft true airspeed was determined. Using airport temperature and barometric pressure readings, and time and distance measurements, the differential and total pressure sensor outputs were checked for proper indications of ambient static pressure and true airspeed.

3.2.2 Altitude Characterization of Gas Analyzers

In addition to routine calibrations performed on the gas analyzers, the effects of changing altitude on instrument response has been investigated during every flight program at RTI. A gas phase chemiluminescent ozone analyzer, a gas phase chemiluminescent oxides of nitrogen analyzer, and an FPD-type sulfur dioxide analyzer have been tested repeatedly in an altitude chamber located at the EPA Environmental Monitoring and Support Laboratory, Las Vegas, Nevada. Prior to the beginning of this program, the Meloy 285 analyzer was tested along with several NASA instruments at the test facility. The results of these tests, along with the description of procedures, are given in another report.⁶

The instruments were tested by placing them in the altitude chamber and initially calibrating them at ambient pressure. The chamber was then sealed and partially evacuated simulating a higher altitude environment. Calibration gases were generated externally from a calibration system operating at a constant ambient pressure and drawn into the chamber to the gas analyzer inputs by the vacuum of the chamber (see Figure 13). Tests were run over the range of pressures corresponding to ground level to an altitude of approximately 7,620 meters (25,000 feet) for the ozone analyzer and 3,060 meters (10,000 feet) for the NO_x and sulfur analyzers. The tests showed that all instruments responded in a repeatable manner to variations in pressure. From these

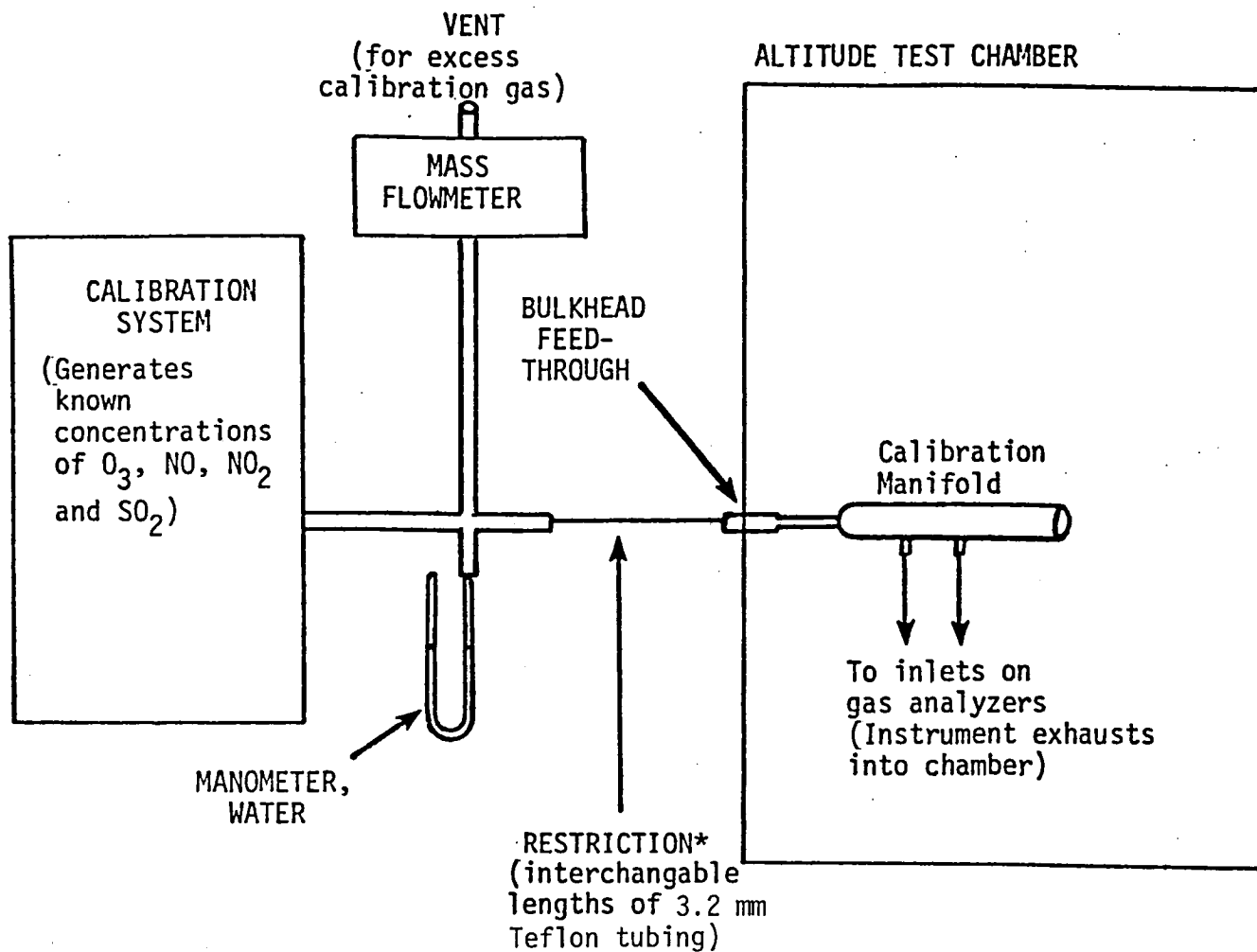

*The length of the restriction line required changes with pressure within the chamber. The length was selected to allow a sufficient flow of test gas into the chamber while drawing no more gas than produced by the calibration system. Several pieces of different lengths were used and changed as required during the test.

Figure 13. Calibration Gas Feeding System Used to Supply Known Concentrations to Instruments During Altitude Tests

data, graphs were constructed whereby a single correction factor could be determined for each instrument at any given altitude over a test range. The effects of altitude on the instrument then could be compensated for by multiplying by the proper correction factor. Figure 14 shows a typical altitude compensation curve for the Bendix 8002 ozone analyzer.

One of the reasons for utilizing altitude chamber testing for determination of altitude characteristics of analyzers lies in the difficulty in reliably generating test atmospheres at changing altitudes (changing pressure), which prohibits the use of standard calibration systems in an aircraft while in flight. However, it is still important to take all possible steps to verify that the altitude effects remain unchanged over the period of a study. The most critical parameter in most analyzers is baseline shift, particularly for those gases where concentrations measured are usually near minimum-detectable. For these parameters, particularly SO_2 , zero concentrations of a test gas are generated periodically and applied to the instrument at the inlet at various altitudes during a flight. For the SO_2 analyzer, a curve is fitted to this data relating the baseline level to altitude. This curve is then used in the computer processing of the data. Zero tests are also periodically performed on other analyzers but, different than for SO_2 , these tests are performed only to ensure that the baseline of these analyzers has not shifted. There has been no noticeable baseline change with altitude for ozone or NO_x analyzers.

3.3 Procedures

The philosophy behind the design of operational procedures for use in aircraft instrumentation systems differs somewhat from that of ground stations. The differences are primarily due to two causes: First, the environment of an aircraft is somewhat hostile to instrumentation because of vibration and line voltage variations. Instrumentation problems are more likely to occur and more attention must be given to detect these problems before significant data losses occur. Also, the cost of instrumentation operation is significantly higher; it is therefore well worth the extra effort from an economic point of view to perform extra tests for the early detection of instrumentation problems and to apply corrective action before data is lost. Secondly, since

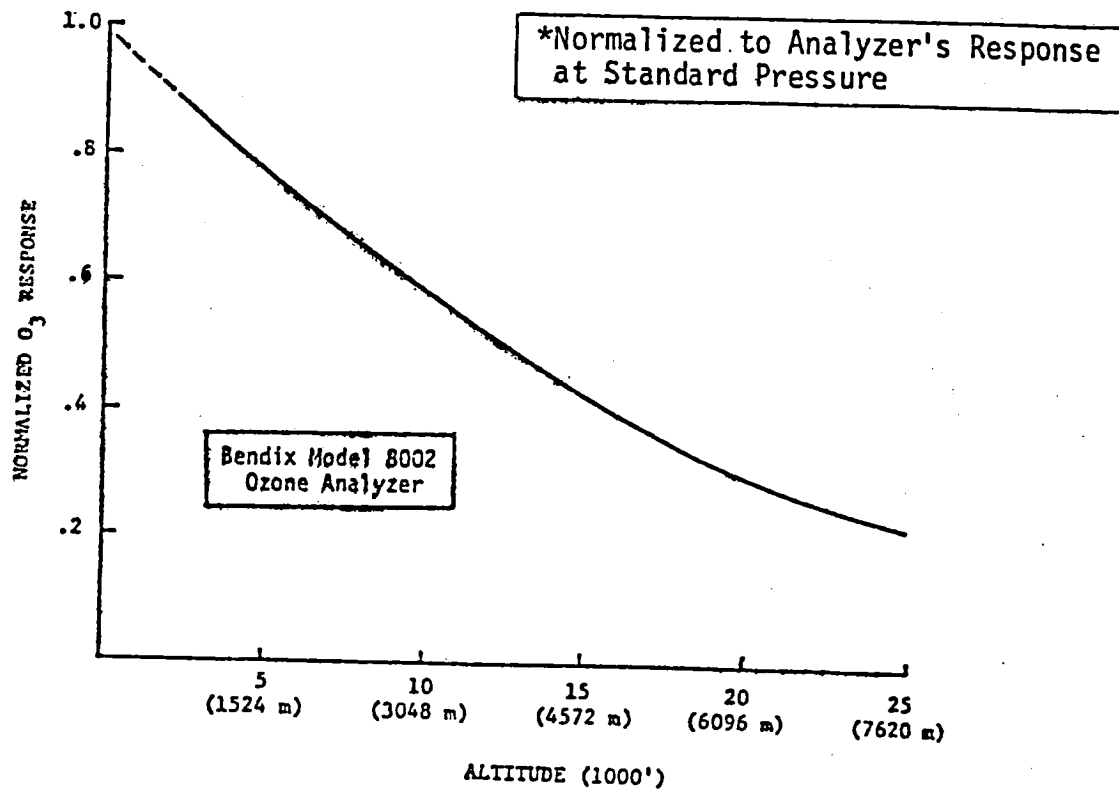

Figure 14. Ozone Analyzer Response* Versus Altitude

the aircraft instrumentation system is a mobile monitoring system, some attention must be given toward monitoring its position with time such that the data, when reduced, can be correlated to the proper location and altitude.

3.3.1 Pre-flight Procedures

Approximately 30 minutes before the scheduled take-off time, a series of checks and tests were performed on the instrumentation system to ensure that the system was operational. These tests were performed while the aircraft instrumentation was still connected to ground power and before the aircraft engines were started. Specific activities accomplished at this time were: 1) levels of expendible supplies were checked including water in the condensation nuclei counter and support gases, hydrogen and ethylene, for the NO_x and ozone analyzers, respectively; 2) routine internal zero and span checks were performed for each of the gaseous analyzers and the nephelometer, electronic checks on condensation nuclei and dew point sensors, zero checks on each of the recorders; 3) instrumentation was inspected to make sure that all selector switches, function switches, etc. were in the proper position for operation and all plumbing for inlet lines and support gases was intact; and 4) the data system was readied for flight by installation of a clean magnetic tape, paper supplies for the printer were checked, and the stored program of channels to be monitored with their corresponding ranges was verified.

All of these activities were performed under the guidance of the checklist to ensure that each activity was performed prior to each takeoff. Electrical responses to tests and pressure/vacuum readings were recorded to provide a permanent record which might be useful later for problem diagnosis.

A few minutes before the desired departure time, the aircraft instrumentation system was switched over to battery backup and the ground power cord was disconnected from the aircraft. The aircraft engines were then started and the instrumentation system was then switched to the aircraft electrical system. At this time the data acquisition system was energized again and its program reverified to ensure that no changes occurred during the power switchover.

3.3.2 Flight Operations

A flight crew of three personnel operated the aircraft and instrumentation system onboard the RTI aircraft during data flights. This crew consisted of the pilot, an instrument operator and an observer. The instrument operator performed some various inflight instrumentation checks. The observer maintained the inflight log containing the position and time information and instrument observations made by the instrument operator and dictated to him. The observer also assisted the pilot by providing information as necessary about the flight plan being flown.

The sequence of operations performed by the crew from the time of takeoff was as follows:

1. Immediately after takeoff, the tape deck on the acquisition of data was initiated. The column printer output from the data acquisition system was reviewed for reasonable values on each channel being monitored.
2. The system power status was checked by logging the voltage levels of each of the six inverters, as well as the current drain from the aircraft battery/electrical system.
3. Throughout the remainder of the flight, frequent positional observations were made by the observer and recorded carefully in the flight log along with the time (to the second) at which they were crossed. This information was used later during data processing to supply positional information to the data. The observer also recorded deviations from the planned flight pattern and the reason(s) for them, and noted meteorological conditions including mixing layer height, haze layer, plume orientations, and any other information which might prove useful during a review of data.
4. The SO₂ analyzer was periodically connected to a zero air source during the flight at various altitudes to take data for the determination of its baseline/altitude characteristics during that flight.

3.3.3 Post-Flight Procedures

Immediately after the aircraft reached the tiedown point on the ramp, the instrumentation system was switched to the internal battery backup system until ground power could be reconnected (usually within

2-3 minutes). The data taken during the flight, both on magnetic tape and printer paper, and the logs from that flight were removed from the aircraft.

Sometime later after the completion of the flight, the data tapes were reviewed to determine if there were any unnoticed problems with any of the aircraft instrumentation. If any problems were noted, the corrective action was immediately initiated so that the instrumentation could be brought back on line before the next flight. Also at this time, a flight track was drawn on an area map annotating the times of crossing certain identifiable landmarks or pattern checkpoints. A data information sheet was prepared containing calibration information, a summary of start and stop times for the data to be processed, and any noted problems during the flight which might impact the routine data processing sequence. This sheet, along with the data tape, was forwarded to the RTI systems research computer facility for the processing of the data.

3.4 Data Processing and Presentation

The digitized data from the RTI aircraft were recorded on seven-track magnetic tape. Each record of this tape consists of the scan of all analog voltages, the date and time of the scan, and certain manually input digital information such as barometric pressure. This tape, along with certain supplemental information such as calibration data and time/position data, form a complete data set from which plots of the various parameters may be produced. The data reduction procedure which operated on this data consisted of a sequence of several computerized operations to produce magnetic tape containing validated engineering unit data and a set of plots showing the data in graphical form. The sequence of events taking place during this reduction phase are outlined in the flowchart in Figure 15.

The tape is first processed utilizing a comprehensive data processing program run on RTI's own PDP 11/60 computer. This program was written during the period of performance of this project; however, it

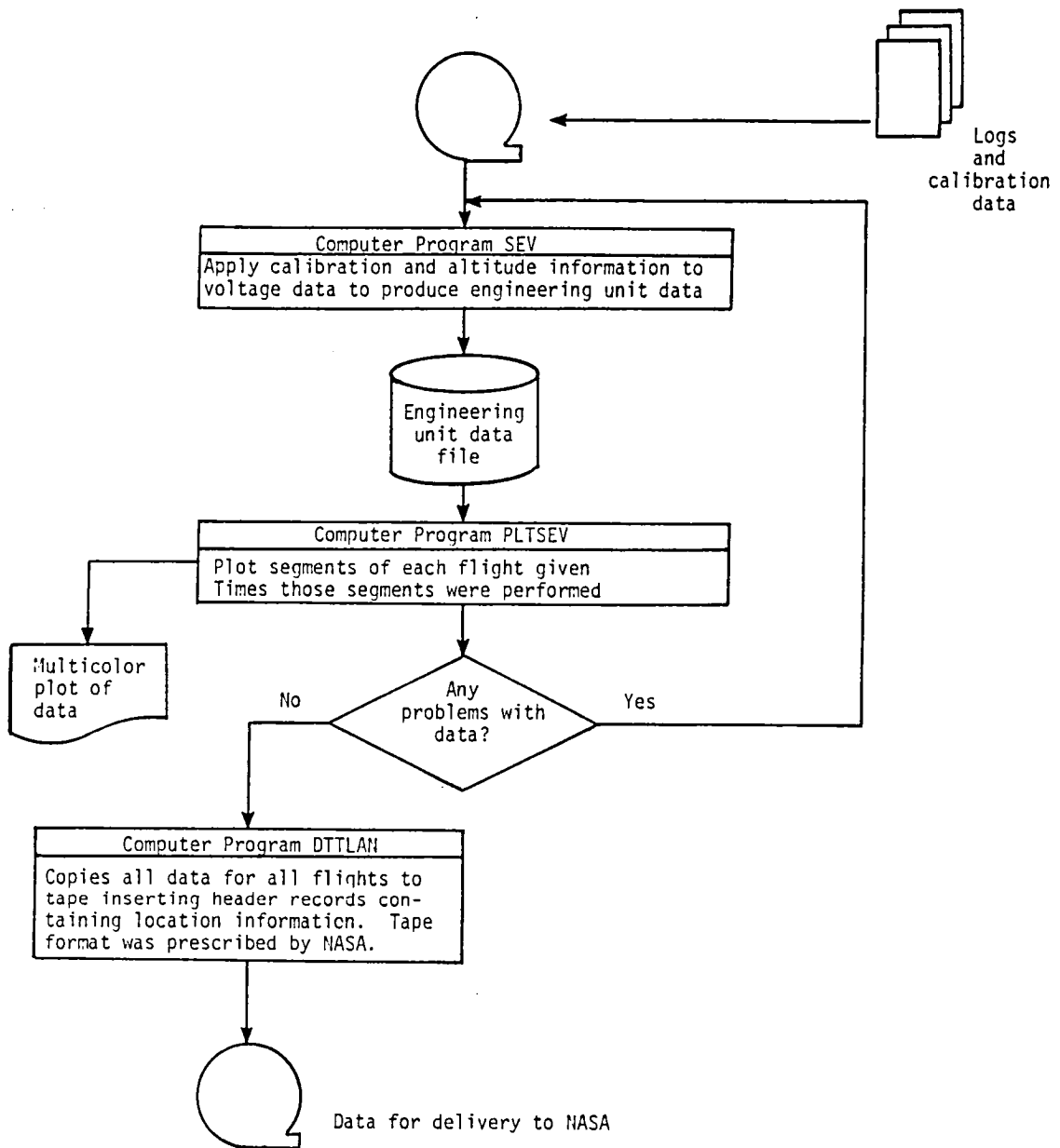

Figure 15. Sequence of Data Processing Activities

used rationale developed during earlier studies when similar data reductions were conducted on another computer. The output of this program consists of a tabular listing of the engineering unit data (see Figure 16) and the creation of files on disks containing that data. From these files data were plotted by means of the program PLTSEV to produce a four-color plot (see Figure 17) to be used in presentation of the data for review. These plots were inspected by meteorologists, atmospheric chemists, and personnel from the flight crew to determine if any of the data appeared to be questionable. If suspicious data were found, the data processing steps were reviewed to determine if any processing error occurred. If the attributing errors were found the appropriate correction was taken and the data rerun, generating a corrected printout and plot of the data. This procedure was iterated until everyone was satisfied that the data was either corrected or marked as invalid and removed.

After the data validation process was completed, a final tape was produced by the computer program DTTLAN. This tape was formatted as specified by NASA for compatibility with their computer systems. The format of this tape is described in Table 14. To convey positional information with the data, header records were inserted at the point in the data corresponding to the beginning of each identifiable segment of the flight plan. The location of these header records was determined from the times recorded in the flight logs at the beginning and end of each leg or segment.

DATE	HR:MN:SEC	O3 PPB	NO PPB	NOX PPB	SO2 PPB	CN K/CC	BSCAT 10**-4/M	TEMP *C	DEW PT *C	ALT M
8/31	12: 6:20	99	0	5	9	23	6.1	26.6	21.3	328
8/31	12: 6:30	98	2	2	8	22	6.6	26.1	21.6	344
8/31	12: 6:40	97	3	4	9	3	6.5	26.6	21.5	330
8/31	12: 6:50	98	0	0	10	4	6.5	26.4	21.5	330
8/31	12: 7: 0	95	0	1	9	14	6.8	26.7	21.8	330
LEG EF: PASS 2										
8/31	12: 7:10	96	0	7	9	2	7.2	26.5	21.7	325
8/31	12: 7:20	97	0	0	10	6	6.9	26.4	21.7	321
8/31	12: 7:30	100	0	0	10	13	7.0	26.4	22.1	321
8/31	12: 7:40	99	0	0	9	15	7.3	26.4	21.9	323
8/31	12: 7:50	103	0	1	11	3	7.9	26.5	22.1	323
8/31	12: 8: 0	102	0	0	9	16	7.6	26.3	22.3	332
8/31	12: 8:10	103	2	2	10	3	7.9	26.2	21.8	353
8/31	12: 8:20	105	0	0	10	6	7.8	26.0	21.7	362
8/31	12: 8:30	99	0	0	10	43	8.1	26.1	21.9	350
8/31	12: 8:40	99	3	3	10	7	8.0	26.0	22.2	359
8/31	12: 8:50	99	3	7	9	5	8.3	25.9	21.6	371
8/31	12: 9: 0	105	6	7	11	10	8.9	26.4	21.1	357
8/31	12: 9:10	101	0	6	10	0	8.5	26.0	22.1	362
8/31	12: 9:20	101	3	3	9	1	8.0	26.0	21.8	362
8/31	12: 9:30	101	0	0	8	3	7.2	26.1	21.8	355
8/31	12: 9:40	103	0	0	7	2	6.8	26.4	21.7	352
8/31	12: 9:50	105	0	0	9	0	6.9	26.6	21.5	354
8/31	12:10: 0	105	0	0	7	8	6.9	25.9	21.9	375
8/31	12:10:10	106	0	0	8	12	7.1	26.1	21.7	364
8/31	12:10:20	103	0	0	8	2	7.6	26.2	22.2	359
8/31	12:10:30	105	0	2	8	35	7.2	26.0	22.1	364
8/31	12:10:40	103	0	2	6	26	7.4	26.2	21.3	361
8/31	12:10:50	105	0	0	8	12	7.5	26.2	21.7	359
8/31	12:11: 0	100	2	2	8	15	7.2	26.2	22.0	366
8/31	12:11:10	102	5	5	14	3	7.4	25.7	21.8	384
8/31	12:11:20	90	0	4	26	4	9.3	25.6	21.9	391
8/31	12:11:30	97	0	11	29	5	8.9	26.0	21.6	377
8/31	12:11:40	105	3	12	18	0	7.9	25.9	21.6	375
8/31	12:11:50	105	0	9	10	6	8.1	26.2	21.4	363
8/31	12:12: 0	104	0	6	10	51	7.7	26.2	22.1	355
8/31	12:12:10	105	0	0	10	7	6.8	26.2	21.5	342
8/31	12:12:20	103	0	2	9	5	6.3	26.1	22.6	328
8/31	12:12:30	102	0	3	12	11	7.0	26.6	22.3	323
8/31	12:12:40	103	2	2	11	9	6.9	26.0	22.3	322
SPIRAL AT F: PASS 2										
8/31	12:12:50	104	0	11	11	29	6.9	26.0	22.5	240
8/31	12:13: 0	106	5	9	12	133	7.0	27.4	22.4	176
8/31	12:13:10	104	8	8	11	2	7.0	28.0	23.0	130

Figure 16. Example Listing of Aircraft Engineering Unit Data

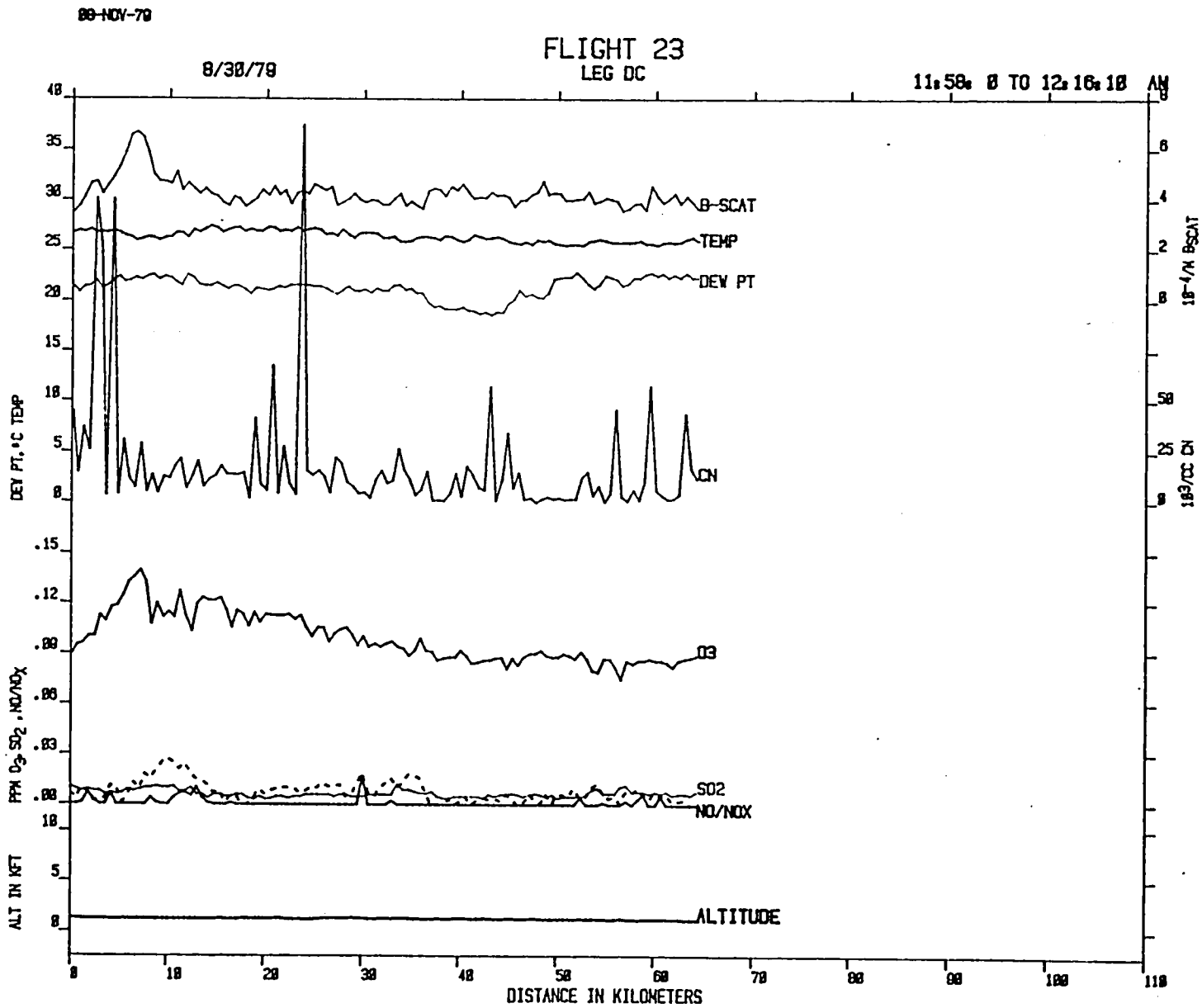

Figure 17. Example Plot of Aircraft Data

Table 14. Final RTI Aircraft Data Format

TAPE FORMAT

(Order of Records on Tape -
description of record formats on Page 2 of this table)

Header Record (1st segment)

Data Identifier Record

Data Exponent Record

1st segment of flight

Data Record #1

Data Record #2

o

o

o

Data Record #n

Header Record (2nd segment)

Data Identifier Record

2nd segment of flight

o

o

o

(Last data record for flight)

End of File

Data for Second Flight (same format as above)

End of File

Data for Third Flight (same format as above)

o

o

o

Data for Twelfth Flight (same format as above)

End of File

End of File

(Continued on Next Page)

Table 14. Final RTI Aircraft Data Format
(continued)

<u>HEADER RECORD</u>		
Column	Contents	Format
1-8	'1 HEADER'	8A1
9-38	Flight Path	30A1
39-43	Start time (sec)	I5
44-48	Stop time (sec)	I5
49-53	Averaging time (sec- always 10)	I5
54-55	Number of Channels (always 9)	I2
56-80	Blanks	25X
<u>DATA IDENTIFIER RECORD</u>		
Column	Contents	Format
1-18	'03NONXSOCNNET DP Z '	9A2
19-80	Blanks	62X
<u>DATA EXPONENT RECORD</u>		
Column	Contents	Format
1-27	' 0 0 0 0 0 -1 -1 -1 0'	9I3
28-80	blanks	57X
<u>DATA RECORD</u>		
Column	Contents	Format
1-6	Time (sec)	I6
7-12	Ozone (ppb)	I6
13-18	NO (ppb)	I6
19-24	NO _x (ppb)	I6
25-30	SO ₂ (ppb)	I6
31-36	CN(1000/cc)	I6
37-42	B _{scat} (10 ⁻⁴ /M x 10)	
43-48	Temperature (°C x 10)	I6
49-54	Dew Point (°C x 10)	I6
55-60	Altitude (M)	I6
61-70	Blanks	10X
71-76	Time (HHMMSS)	3I2
77-80	Blanks	4X

4.0 AIRCRAFT PROGRAM SUMMARY

4.1 Types of Experiments

A total of fifteen specific experiments involving aircraft measurements were identified by NASA personnel in preparation for the 1979 SEV-UPS program. These fifteen experiments are listed below:

1. Photochemical box (7 options)
2. Urban plume (8 options)
3. Regional traverse
4. Swamp characterization
5. Norfolk Richmond plume comparison
6. Diurnal ozone experiment
7. LAS super spiral
8. LAS box face
9. UV Dial comparison spiral
10. LAS - UV Dial comparison
11. Cessna - Navajo comparison
12. Cessna - C54 comparison
13. Aircraft-tethered balloon comparison
14. Aircraft-surface site comparison
15. Ozone in cloud

Of these fifteen proposed experiments, all but four were completed during the 1979 SEV-UPS program. The two experiments designed to compare the output of the UV Dial instrument to the measurements of other types of instrumentation could not be flown, because the aircraft that was to house the UV Dial instrument (NASA - Electra) was not available at the time of the program. Due to considerations of time, experiment priority, weather, and aircraft coordination, the Regional Traverse and Diurnal Ozone Experiments were also not performed. A description of the experiments in which RTI participated, the dates the experiments were flown, and the specific goals of each of those experiments are listed below.

The RTI aircraft participated in the Photochemical Box Experiment on August 31, 1979. The goal of this particular experiment was to

generate a data base from both the surface monitoring network and several aircraft that could be used to define the initial and boundary conditions for input to a photochemical box model. In addition, both aircraft and surface measurements continued throughout the photochemically active portion of the day, which provided a comparison data base that can be used to test the predictions of the photochemical box model. The flight pattern and coordination of the aircraft were designed to provide a relatively continuous, three-dimensional distribution of important photochemical species on the upwind side of, over, and just downwind of Norfolk. An emissions inventory for the region covered by the photochemical box was also generated by NASA and is available as input to the model. The several options associated with this particular experiment were proposed so that the data required for input to the model and for comparison to the model's results could be obtained regardless of the wind direction on the day chosen for this experiment.

The urban plume experiment was designed to provide information of primary importance to the overall purpose of the SEV-UPS program. This particular experiment was completed in two parts. Morning flights were flown that concentrated on characterizing the distribution of pollutant species upwind of and over the Norfolk metropolitan area. Afternoon flight plans were designed to provide data to describe the temporal and spatial evolution of an urban plume downwind of Norfolk. There were eight possible options for this experiment, all intended to provide the necessary information to describe the urban plume, regardless of the mean wind direction. The timing and prescribed locations of constant altitude horizontal traverses were intended to produce a data base that followed a single cross section of air as it was transported downwind from Norfolk by the mean wind speed. The meteorological scenario capable of creating an urban plume (steady moderate winds, clear skies, and high temperature) occurred frequently and this particular experiment was performed on three separate occasions. The dates of these experiments and the upwind-downwind orientation of the flight plans were August 24 SW-NE, August 25 SW-NE, and August 30 SW-NE.

The Norfolk-Richmond plume comparison experiment was designed to provide data that could be used to identify any differences that may exist between the downwind plumes of those two cities. This experiment was performed on August 27, 1979. Since Norfolk is located so close to the Atlantic Ocean shoreline, it is possible that maritime influences, such as a seabreeze, could have significant impacts on the development of the Norfolk plume, and therefore, on the resulting distribution of pollutants downwind of Norfolk. The data set generated by this experiment provided upwind and downwind distributions of pollutant species at nearly the same time of day for both Norfolk and Richmond. Richmond is located sufficiently inland to be out of the influence of the Atlantic Ocean. Therefore, any differences in the appearance of the downwind urban plumes from these two cities may be caused by differences in the local circulation patterns.

Another of the primary goals of the SEV-UPS program was to test the NASA-developed LAS remote sensor for ozone under actual field conditions. The LAS box face experiment was designed specifically to provide a separate data set that could be used to compare the measurements of the LAS to measurements made using standard in situ measurement devices. The RTI aircraft flew the flight pattern shown in Figure 18 on August 23, 1979, while NASA flew its LAS ozone instrument in the Queen Air aircraft over the same airspace. The two remaining experiments in which RTI participated were designed to provide data useful in comparing the several data sets generated during SEV-UPS. On August 20, 1979, the RTI Navajo and the NASA Cessna flew a simple flight pattern along side one another. The flight pattern consisted of a horizontal traverse from Cape Charles VOR to Accomack County Airport at 1540 m MSL, a descending spiral to 270 m, and a horizontal traverse along the same path at a lower altitude. Comparison of these data will determine how well the instrumentation on the two aircraft agree over the altitude range of interest in SEV-UPS.

On August 29 RTI flew another simple flight plan that included several low passes, that is, descents to altitudes very close to the surface and in close proximity to a surface station. The measurements

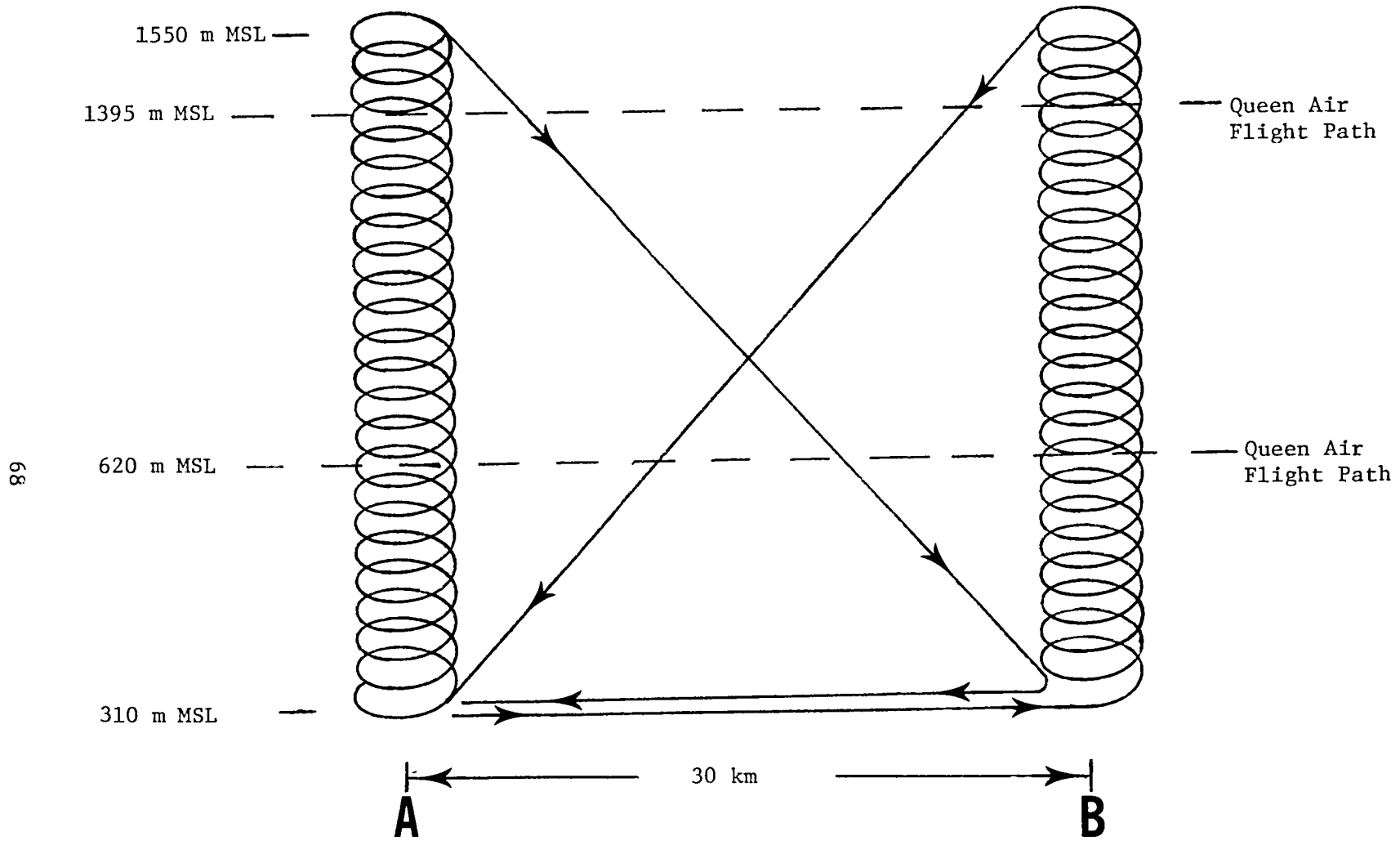

Figure 18. Path of RTI Navajo (solid line) and NASA Queen Air (dash line) on the LAS Box Face Experiment.

made onboard the aircraft during the time that the aircraft was close to the surface station can be compared to the measurement obtained at the surface station, thus providing a link between the two data sets. In addition, these low pass flights provided information on the vertical distribution of pollutant species in the boundary layer near the surface. Two or three low pass flybys were made at several surface stations including NASA Langley, NAS, NCC, Chesapeake Light, and the Chesapeake Airport.

4.2 SEV-UPS Operations

Flight plans for all experiments to be performed and procedures for coordination of all the field crews were provided by NASA. Communication between the RTI field crew and NASA project personnel was conducted primarily by telephone. Each afternoon between 1600 and 1700 EDT a member of the RTI field crew called the operations center at NASA to receive information on what flight was to be performed, what option of that flight, and any special considerations to be observed during the flight. Specifics such as time, location, etc. were already specified in the flight plans which had been distributed to all program participants prior to the program. No further contact was made prior to beginning the experiment unless an unanticipated change of the weather conditions occurred. However, for all of the flights in which RTI participated, no changes were necessary between the 1600-1700 briefing and the takeoff usually early the next morning.

At the completion of each flight a member of the field crew onboard the aircraft made a call to the SEV-UPS operation center to convey observations made during the flight and to receive information about possible modifications to be made during the next flight. If any plans for the second flight of the day were not finalized, still another contact was made at a later time, after additional forecasting information had been received and a final decision had been made on the specific option of the flight plan to be performed.

Once a flight was begun, the flight was flown to completion according to the original plan. Provisions were not made by the RTI field crew for changing a pattern in flight because of the possible confusion and missed data that might result. However, changes were made in the specific option to be flown at any time up until takeoff, upon receiving information over the phone. A specific example of this occurred on the photochemical box experiment when a wind shift some time between the early and midmorning flights, caused a switch from Option 5, which was the original forecast option, to Option 7.

4.3 Summary of Flights

During its participation in the SEV-UPS program the RTI aircraft and crew performed a total of 12 flights using approximately 36.5 hours of flight time. These flights, performed on eight different days, included eight of the flight plans originally specified by NASA. These flights are tabulated in Table 15. The individual flight tracks are shown on the maps in Figures 19 through 29.

Processed data from each of the flights was transferred to magnetic tape and furnished to NASA for analysis and generation of plots or listings. Plots were also generated at RTI for each of the flights and are included in Appendix B of this report.

TABLE 15. DATA FLIGHTS PERFORMED BY THE RTI AIRCRAFT

Date	Flight Number*	Pattern	Time of Available Data (EDT)
8/10/79	14	NASA Cessna/RTI Navajo Comparison	1046-1205
8/23/79	15	LAS Box Face	1310-1420
8/24/79	16	Urban Plume SW flow (Option 1)	0531-0831
8/24/79	17	Urban Plume SW flow (Option 1)	1048-1407
8/25/79	18	Urban Plume SW flow (Option 1)	0537-0834
8/25/79	19	Urban Plume SW flow (Option 1)	1033-1345
8/27/79	20	Norfolk/Richmond Urban Plume Comparison	1108-1408
8/29/79	21	Low Pass Comparison	1005-1248
8/30/79	22	Urban Plume SW flow (Option 1)	0532-0836
8/30/79	23	Urban Plume SW flow (Option 1)	1047-1412
8/31/79	24	Photochemical box SW flow (Option 7)	0503-0817
8/31/79	25	Photochemical box Western flow (Option 5)	1049-1430

*Sequentially assigned number for each RTI flight used for internal flight identification purposes.

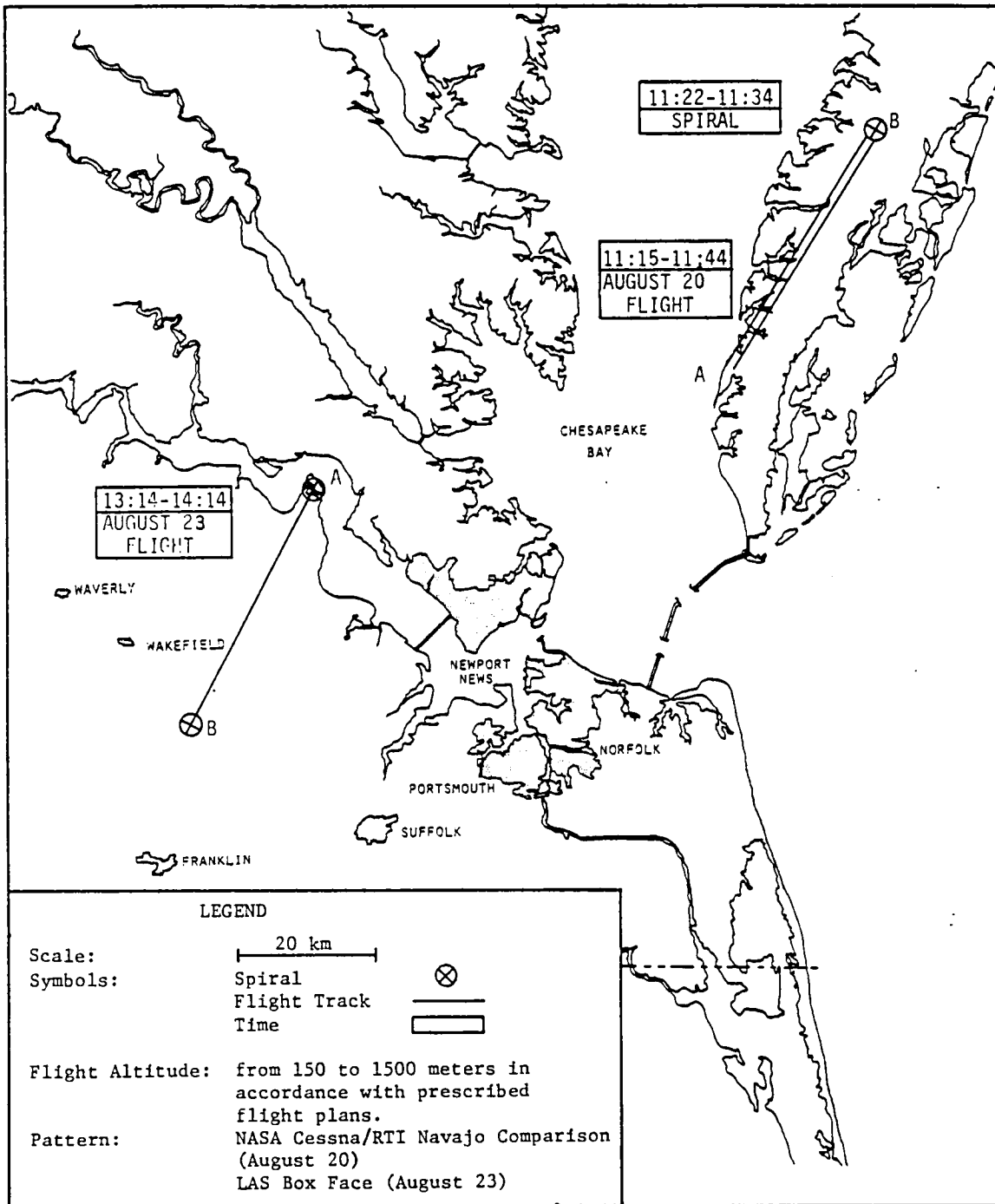

Figure 19. Flight Tracks for Flights on August 20 and August 23

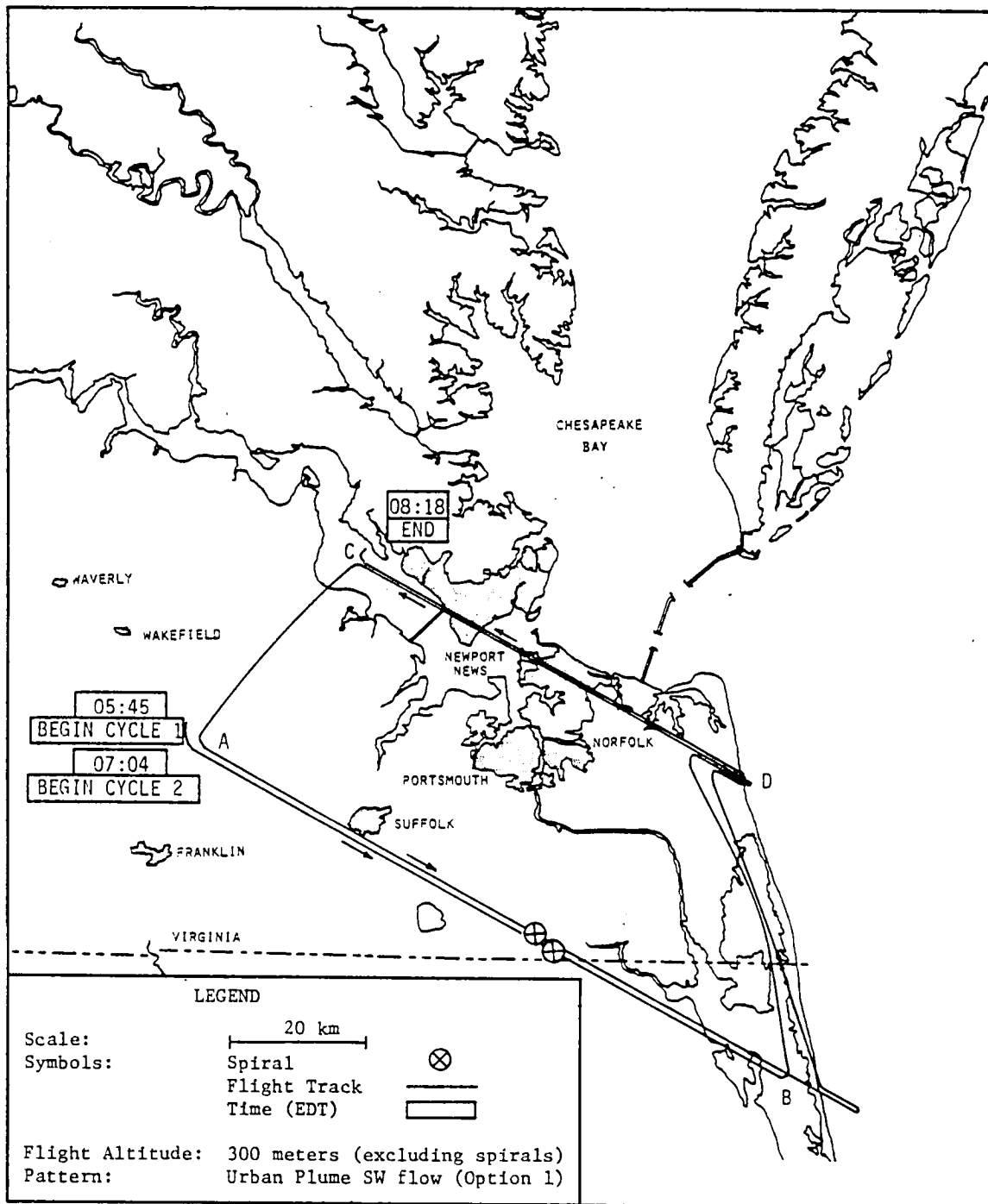

Figure 20. Flight Track for Flight on August 24 - Early Morning

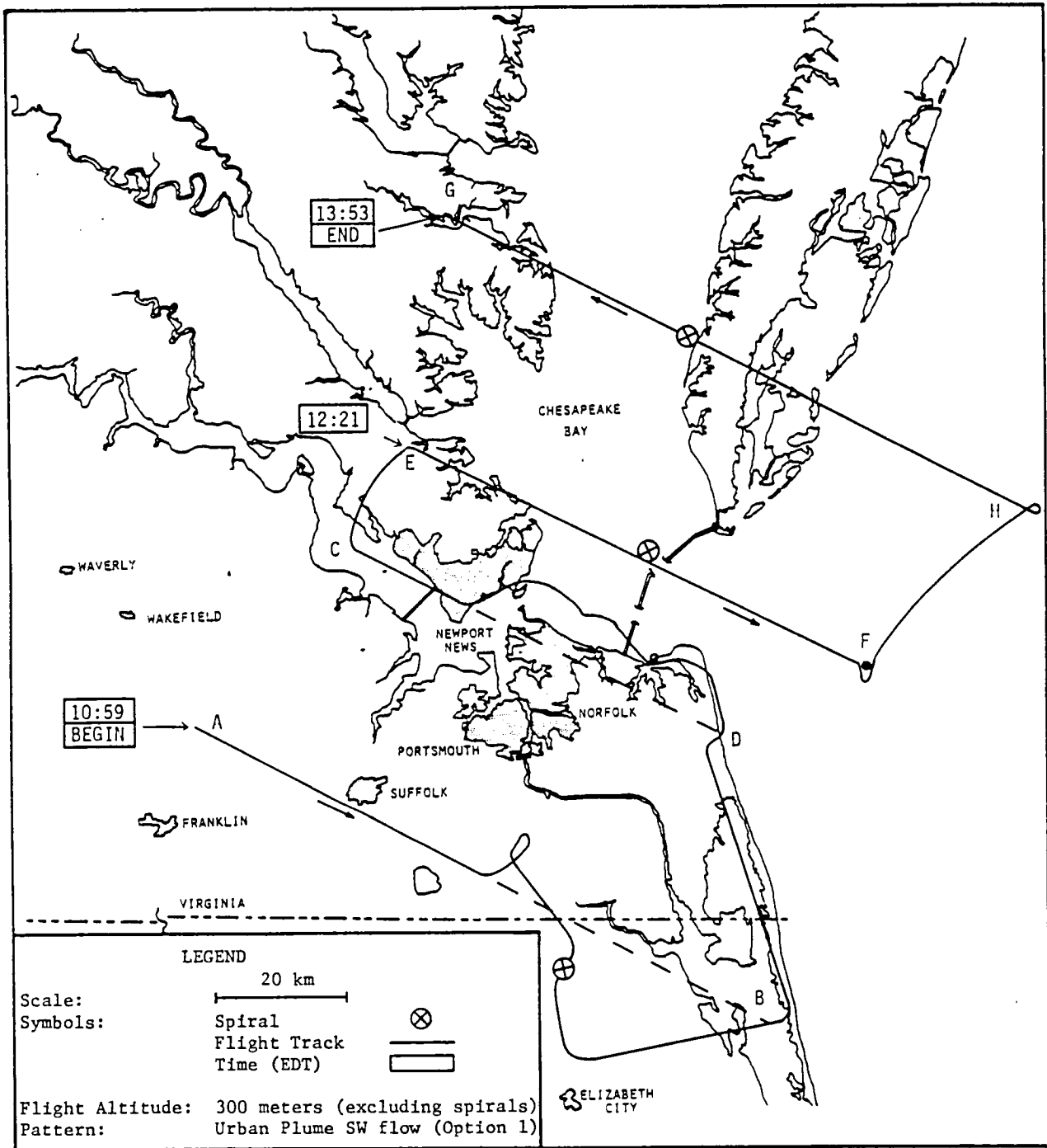

Figure 21. Flight Track for Flight on August 24 - Late Morning

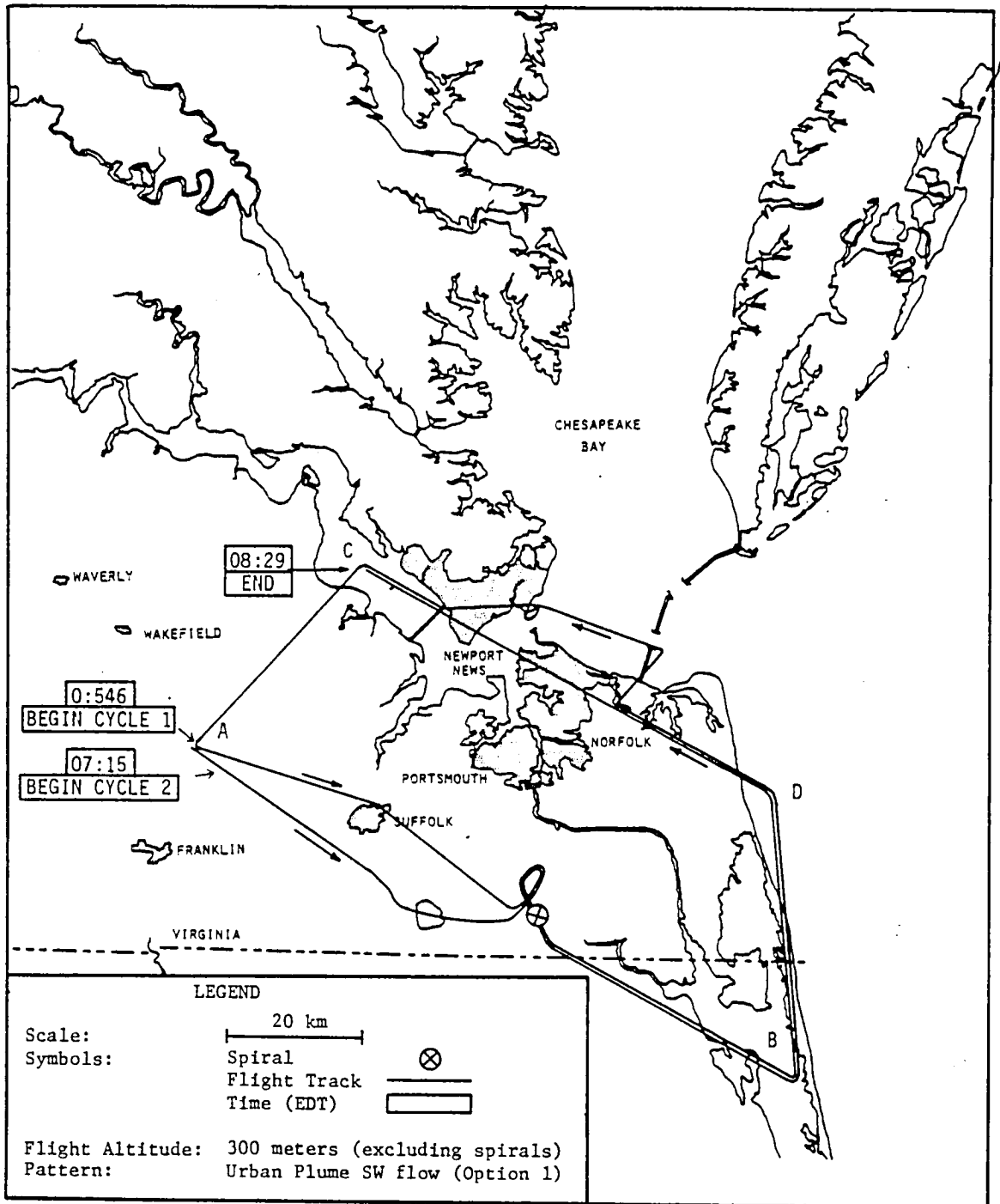

Figure 22. Flight Track for Flight on August 25 - Early Morning

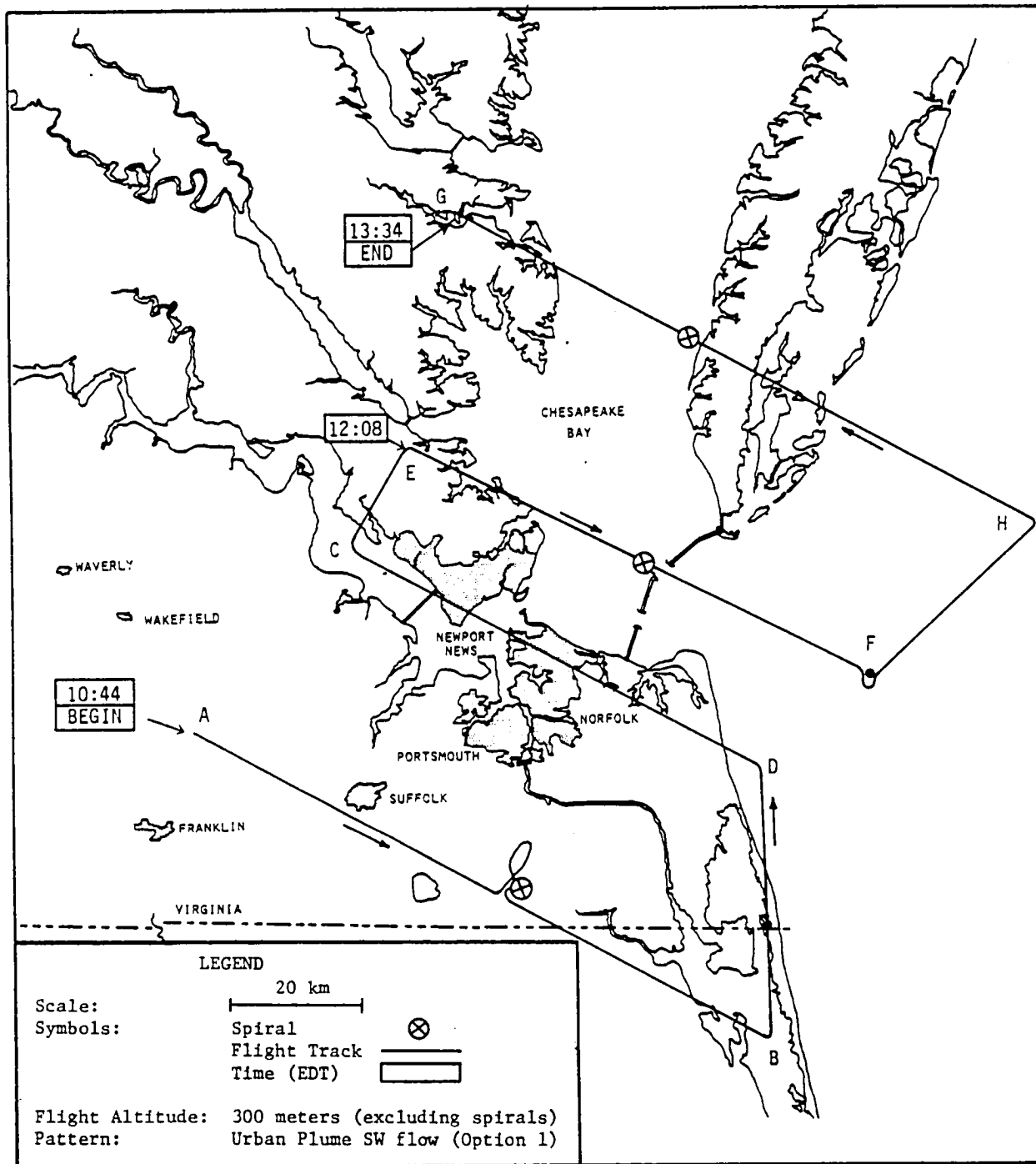

Figure 23. Flight Track for Flight on August 25 - Late Morning

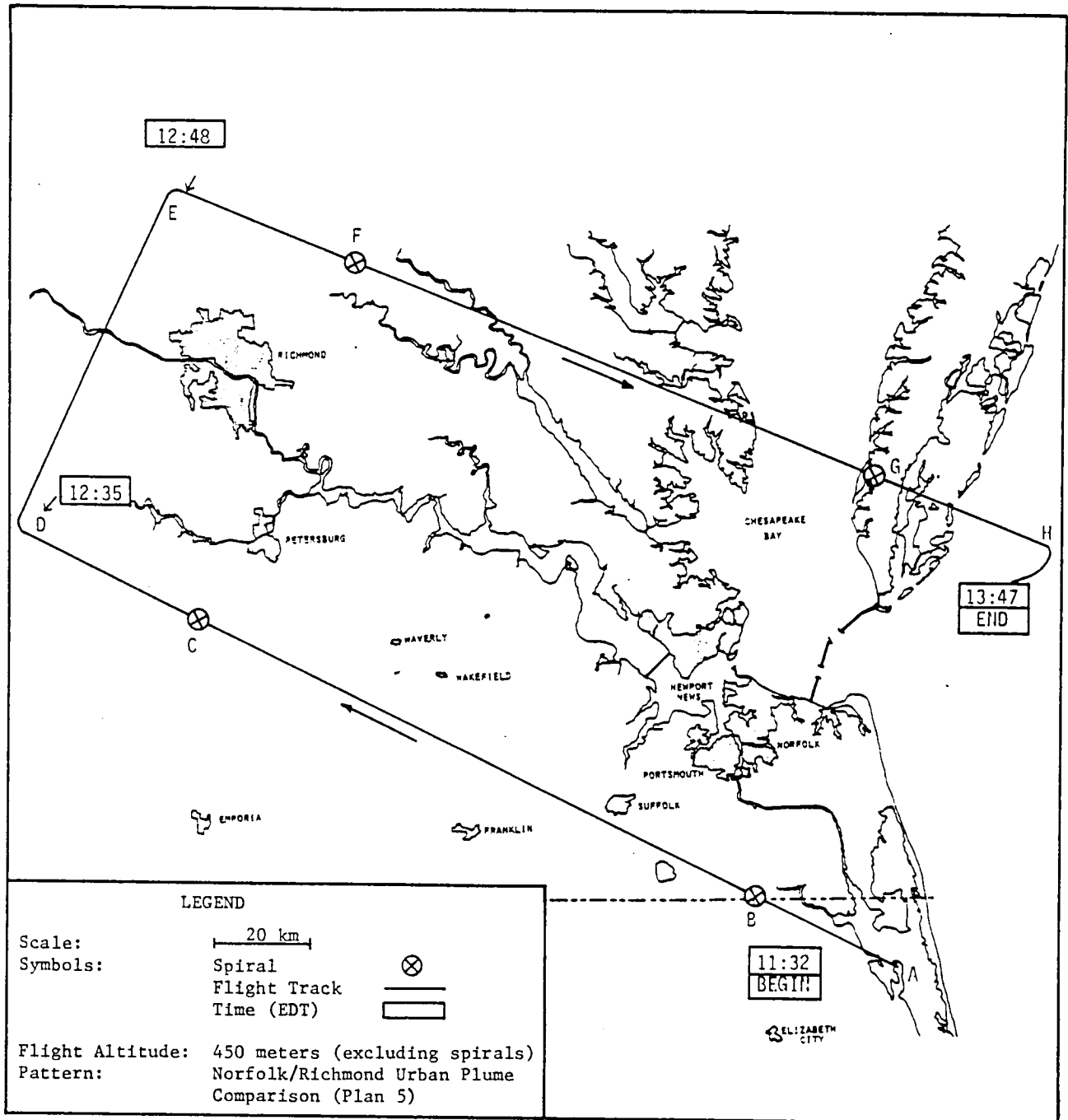

Figure 24. Flight Track for Flight Track on August 27

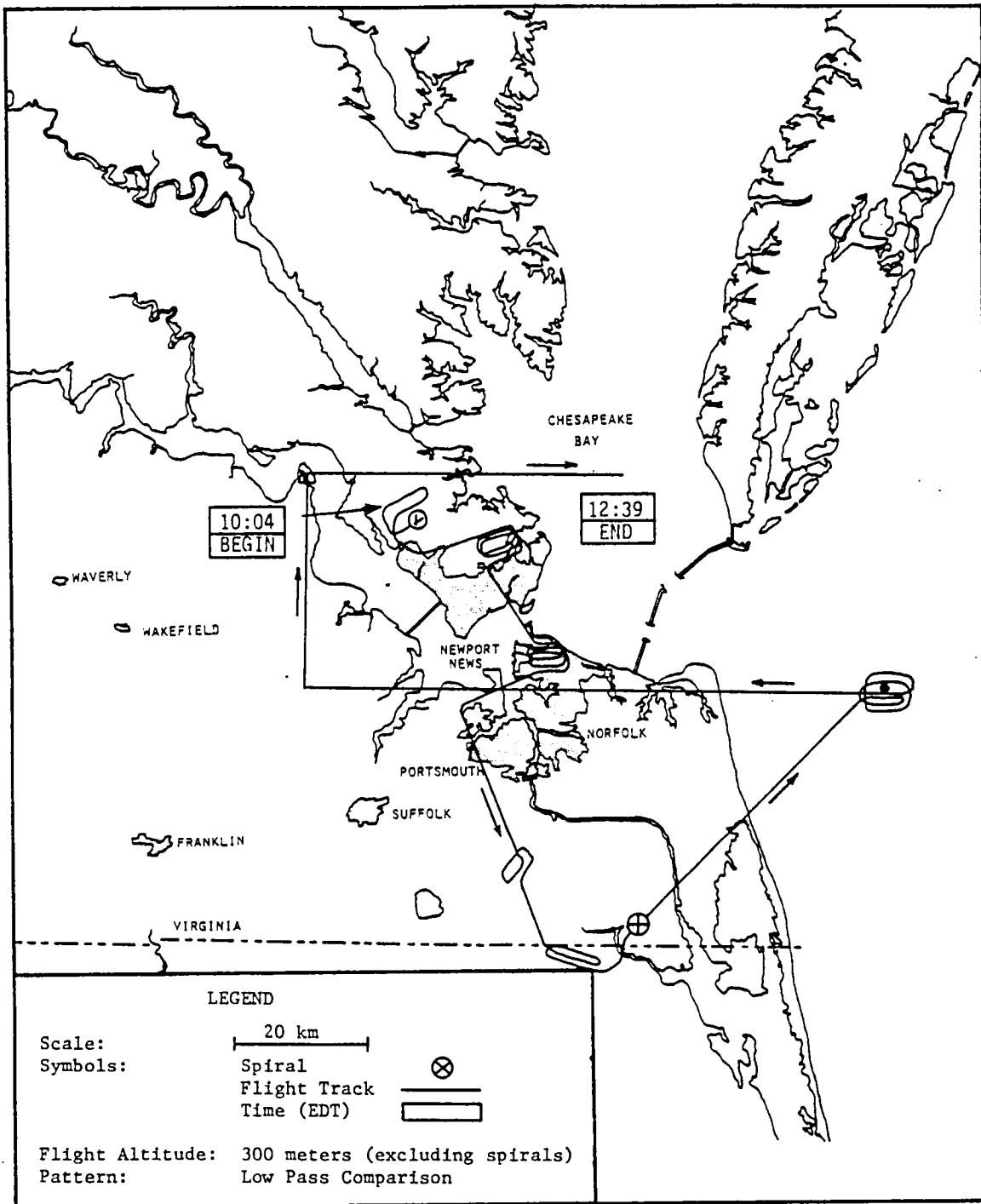

Figure 25. Flight Track for Flight on August 29

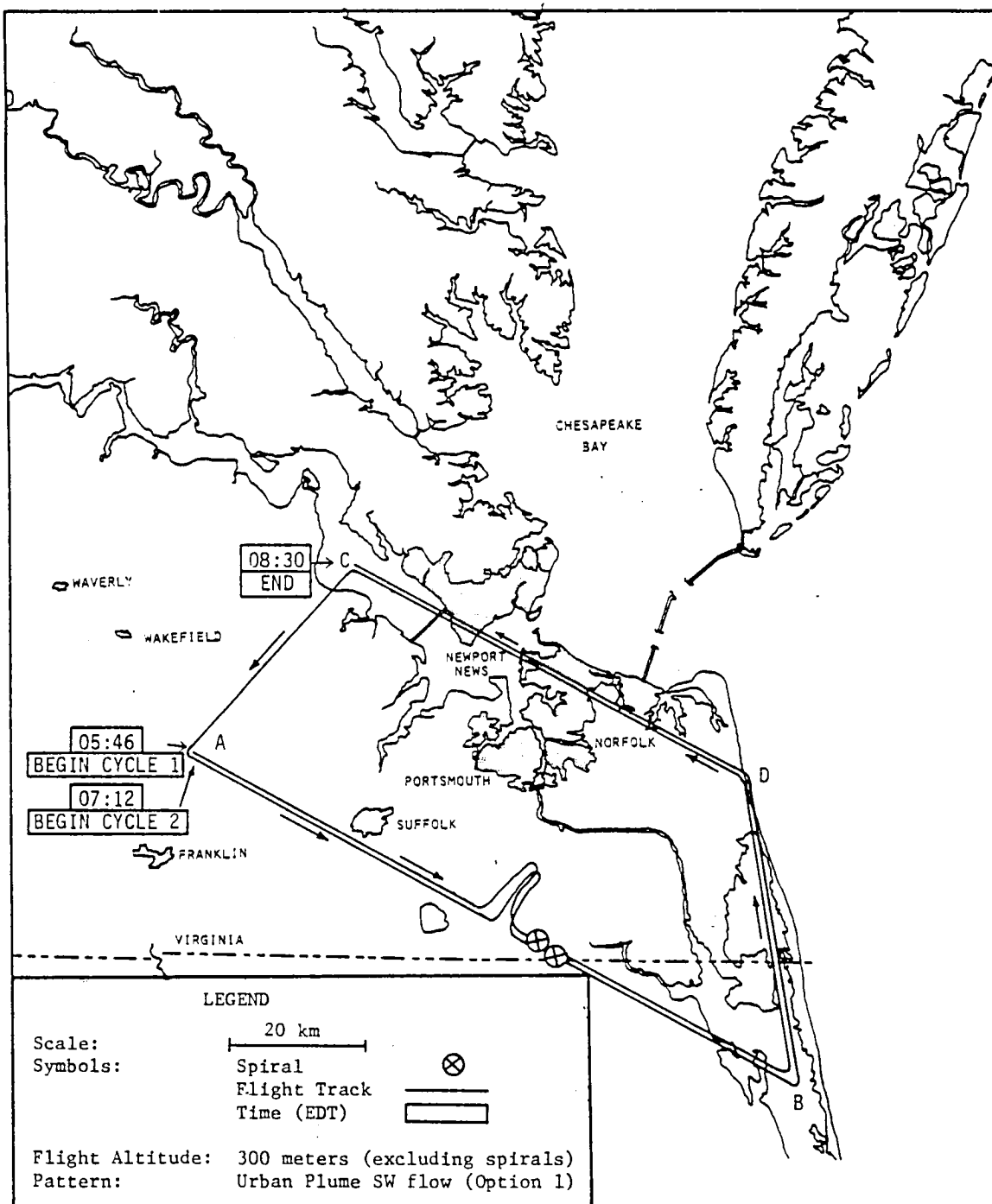

Figure 26. Flight Track for Flight on August 30 - Early Morning

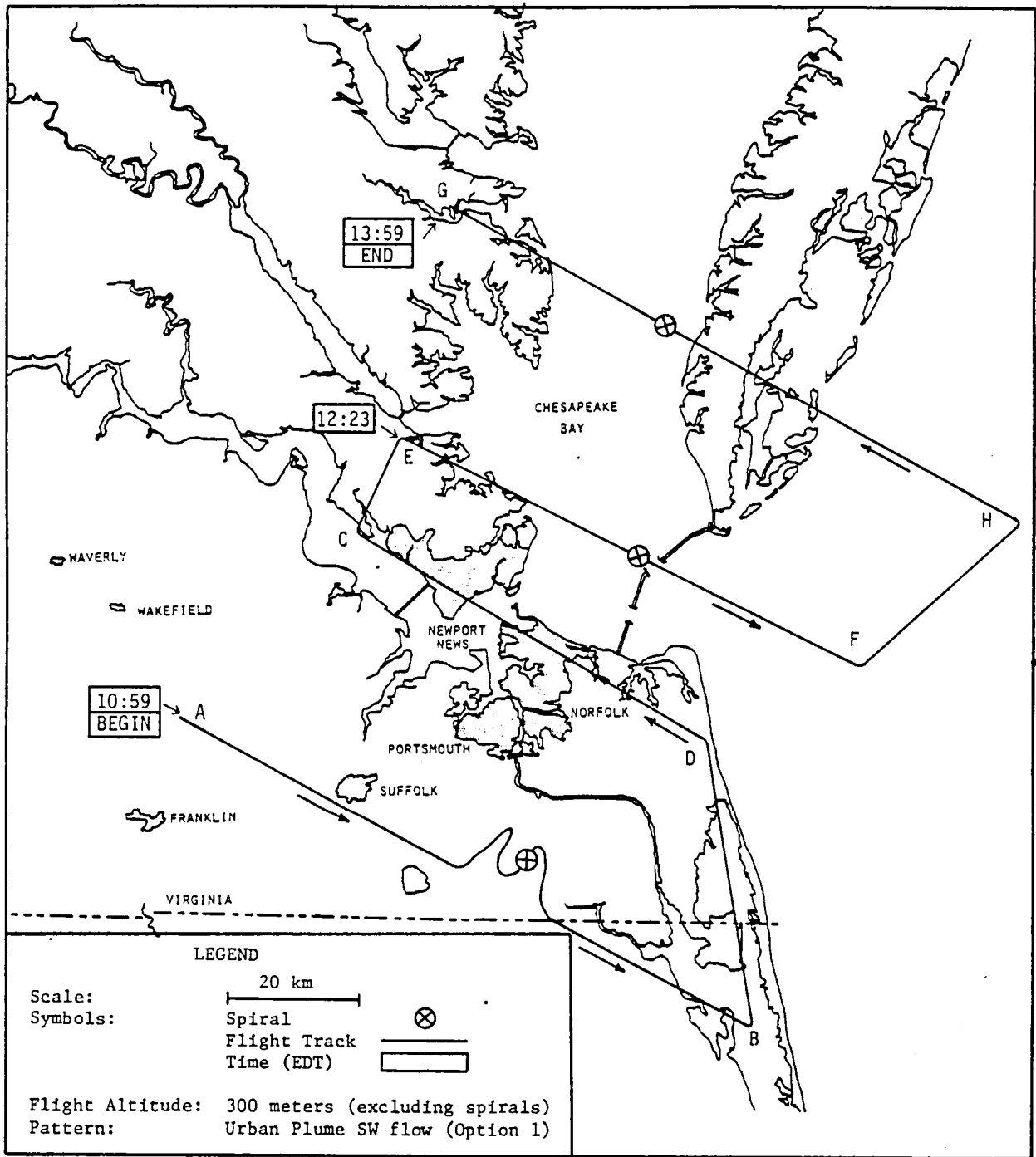

Figure 27. Flight Track for Flight on August 30 - Late Morning

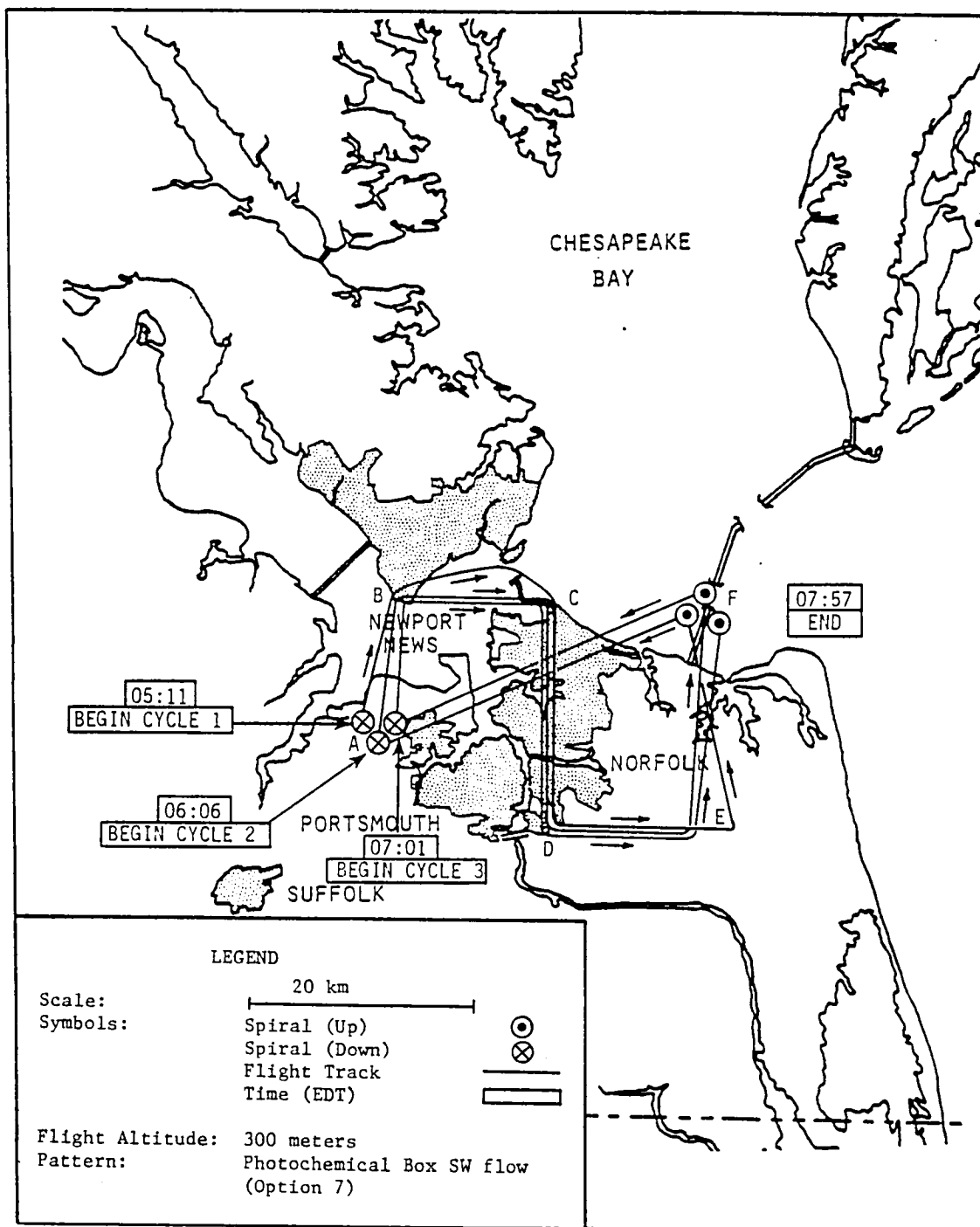

Figure 28. Flight Track for Flight on August 31 - Early Morning

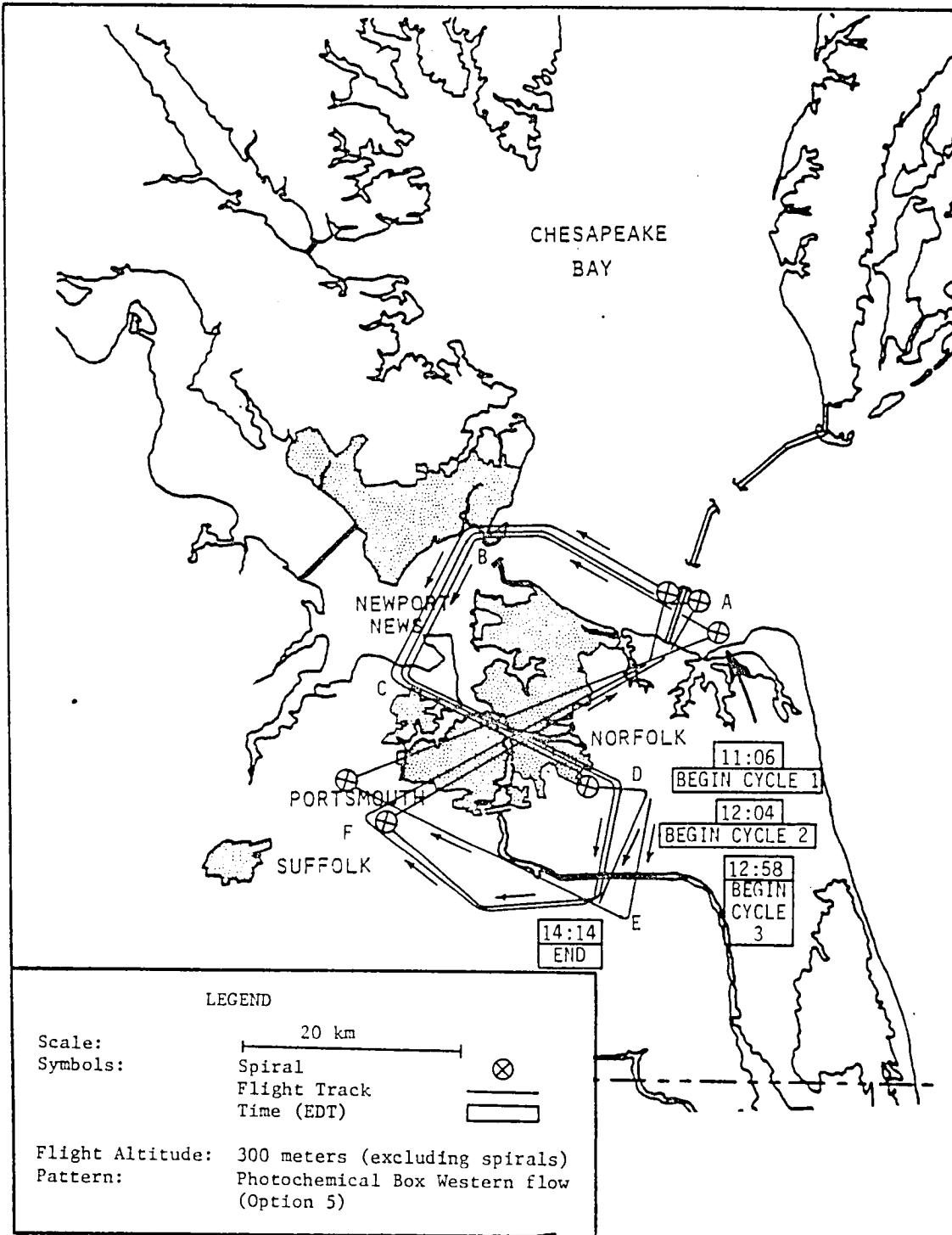

Figure 29. Flight Track for Flight on August 31 - Late Morning

5.0 DATA ANALYSIS AND INTERPRETATION

Throughout the 1979 SEV-UPS program individual groups were responsible for various parts of the data collection effort. NASA-Langley was responsible for organizing the data into a single consistent data base. In order to facilitate the initial data handling and to identify interesting features in the data for subsequent analysis, a preliminary descriptive summary of the data collected by RTI is presented below. Plots of the data collected on each airborne experiment have been drawn and appear in Appendix B of this report.

First, a review of the data collected by RTI on some of the specific experiments completed during SEV-UPS is presented. This includes summaries of the NASA Cessna/RTI Navajo comparison flight on 20 August, the LAS box face experiment on 23 August, and the Norfolk-Richmond urban plume comparison flight of 27 August. In all of these preliminary analyses only the ozone data were considered in any detail. The remaining flights were conducted as part of three urban plume experiments and one photochemical box experiment. These experiments are more important and complex from a scientific standpoint than the comparison type flights. Therefore, the data from the urban plume and photochemical box experiments are presented in a case study format and in more detail. Finally, some speculations as to the causes for observed pollutant distributions in and around Norfolk are offered. It should be pointed out that some of these speculations may prove to be irrelevant when a complete analysis of the entire data base is completed.

5.1 Specific Analyses of RTI Aircraft Data

5.1.1 RTI Navajo, NASA Cessna 402 Comparison Flight

On August 20, 1979 both the RTI Navajo and the NASA Cessna aircraft, instrumented with in-situ measurement, devices completed a simple flight path simultaneously. The flight consisted of a horizontal traverse at approximately 1500 meters MSL from the Cape Charles VOR to

the Accomack County Airport, a spiral down to 140 m MSL, and a return traverse at approximately 270 m MSL. During the early part of this flight at the higher altitude, the two aircraft flew in a wingtip-to-wingtip formation. At the lower altitudes, however, decreased visibility due to a cloud layer forced the two aircraft to separate somewhat. The NASA aircraft then followed the RTI Navajo by approximately two minutes. The data collected on this flight are shown in Figure B-1 of Appendix B. The mean and standard deviation of altitude, temperature, dew point, NO, NO_x, b_{scat}, and ozone measured by the RTI aircraft along the horizontal tracks are listed in Table 16.

TABLE 16. Mean And Standard Deviation Of Selected Parameters Measured on the Cessna/Navajo Comparison Flight by the RTI Navajo Aircraft

<u>Parameter</u>	<u>First Horizontal Leg</u>	<u>Second Horizontal Leg</u>
Altitude	1544 ± 230m	258 ± 23m
Temperature	15.2 ± 0.3°C	23.0 ± 0.5°C
Dew Point	14.0 ± 0.5°C	22.5 ± 0.2°C
NO	0.0 ± 1.5ppb	2.6 ± 3.4ppb
NO _x	2.85 ± 2.2ppb	6.7 ± 3.4ppb
b _{scat}	1.68 ± 0.2 × 10 ⁻⁴ m ⁻¹	4.39 ± 1.19 × 10 ⁻⁴ m ⁻¹
O ₃	72.4 ± 0.6ppb	75.6 ± 9.2ppb

5.1.2 LAS Correlative Flight

The LAS correlative flight was flown on August 23, 1979 to provide a data set that could be used to test and verify the output of the LAS remote sensor for ozone developed by NASA. The data plots for this flight appear in Figure B-2. The flight plans of the RTI Navajo and the NASA Queen Air, which housed the LAS ozone sensor, are shown in Figure 18. The entire flight was confined to a single vertical plane and extended from Ivor to the James River on a thirty-five degree

heading from the Franklin VOR. Figure 30 shows the ozone data as a function of altitude measured on the two true spirals and on the two diagonal legs superimposed on one another. The figure clearly displays the homogeneous nature of the ozone distribution, both spatially and temporally, in the volume sampled.

A mean vertical distribution of ozone concentration as measured by the RTI in-situ ozone monitor was constructed by averaging the ozone concentrations in 50 m intervals over each spiral and then averaging the corresponding values over the four spirals. The mean vertical ozone profile is shown in Figure 31. The overall mean ozone concentration, including the mean ozone concentrations measured on the two horizontal legs, was 0.066 ± 0.0024 ppm. The surface ozone concentrations averaged over the 1200-to-1300 hour were 0.038 ppm at Tidewater Community College and 0.040 ppm at Virginia School in Hampton. These surface sites were not directly underneath the flight location, but the large discrepancy between the mean ozone concentration as measured by the aircraft and at the surface would indicate that some surface-based ozone destruction was present.

5.1.3 Richmond-Norfolk Urban Plume Comparison Flight

The Richmond-Norfolk urban plume comparison flight which was flown on August 27, 1979 was designed to provide information that could be used to identify any differences in the distributions of ozone upwind and downwind relative to the two cities. The flight began southeast of Norfolk and a leg was flown at an altitude of approximately 480 m MSL to a point southwest of Richmond. A spiral was flown south of both cities to characterize the vertical distributions of pollutants upwind of the two cities. A similar horizontal traverse was flown north of the two cities and once again vertical spirals downwind of both cities were flown. Plots of each segment of the flight appear in Figure B-7. The most important concern among these data is the distribution of ozone, however, and this analysis will concentrate on a discussion of the ozone data. Figure 32 is the ozone concentration data from both upwind spirals superimposed on one another. It is evident from these data that the upwind boundary conditions were nearly the same for both

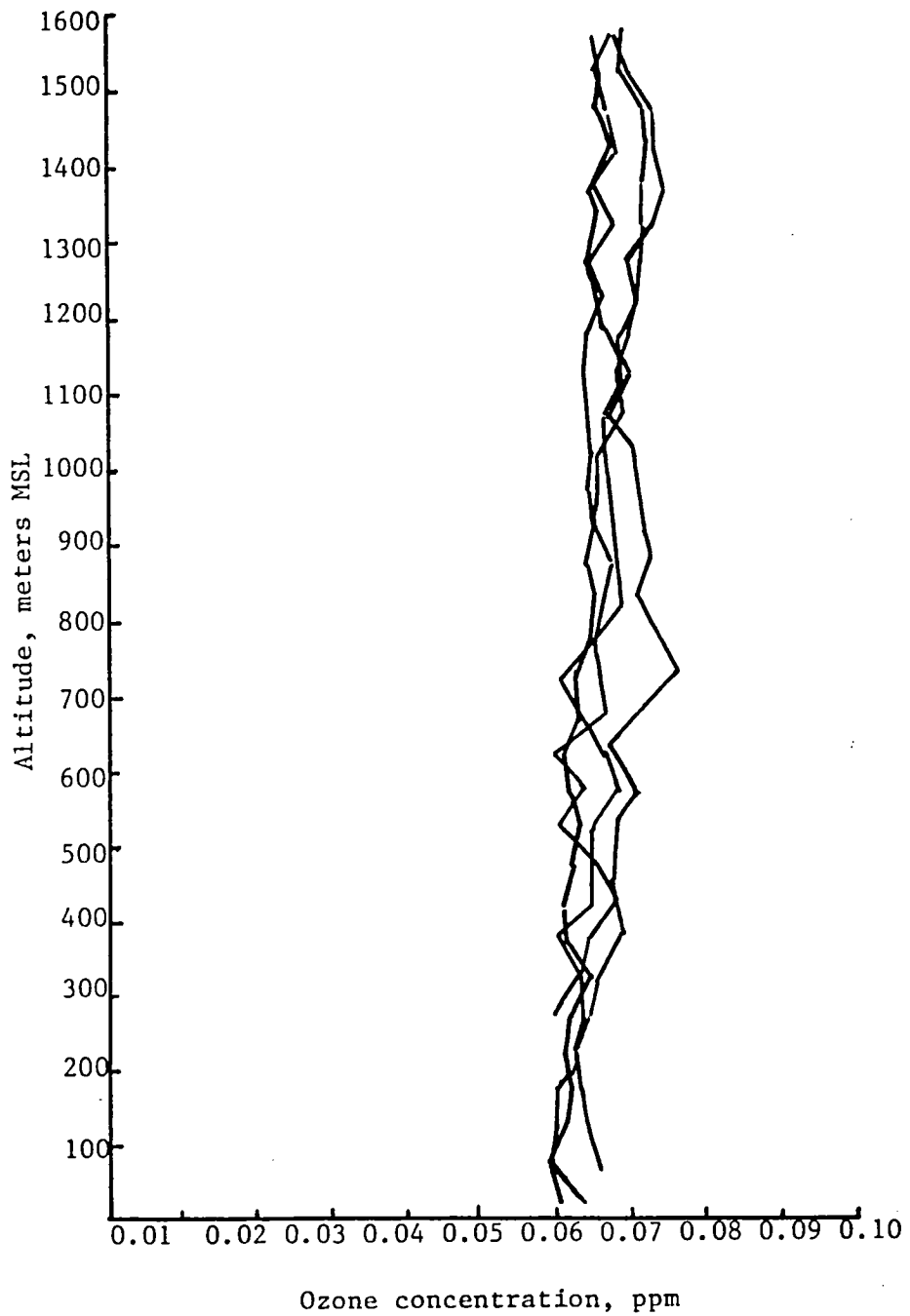

Figure 30. Ozone profiles measured by RTI on each of four vertical segments of LAS Box Face Experiments.

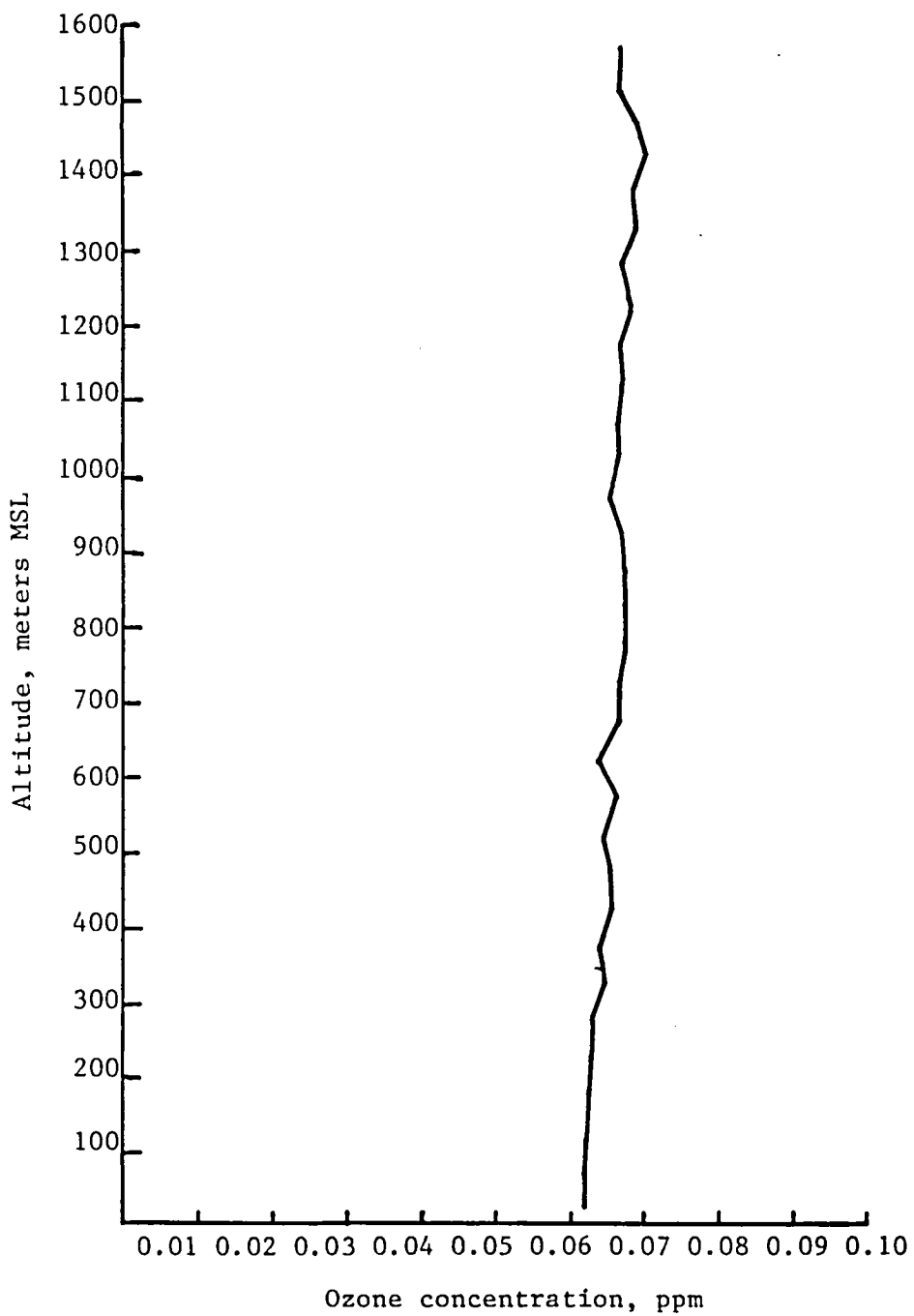

Figure 31. Mean vertical ozone profile as measured by the RTI aircraft in the LAS Box Face Experiment.

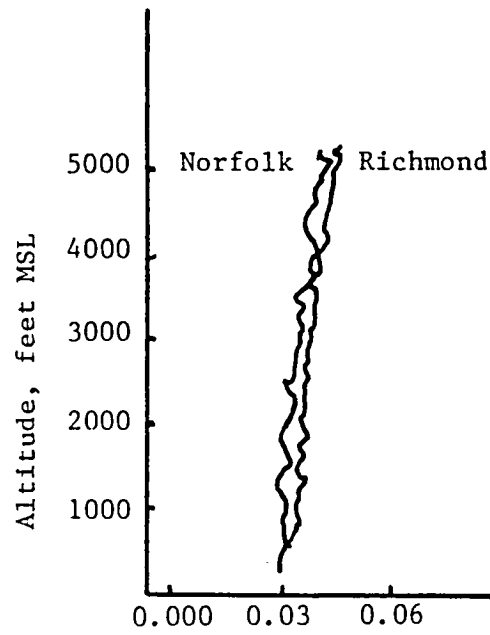

Figure 32. Ozone profiles upwind of Richmond and Norfolk on the Norfolk-Richmond Urban Plume Comparison Flight.

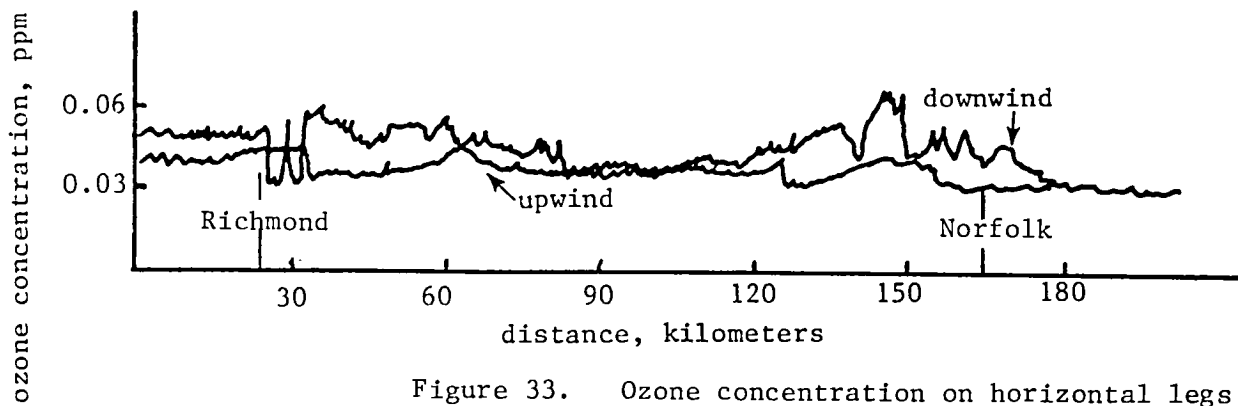

Figure 33. Ozone concentration on horizontal legs at 310 m altitude upwind and downwind of Norfolk and Richmond in Norfolk-Richmond Urban Plume Comparison Flight.

cities. Downwind of the two cities between 1248 and 1347 EDT, however, the situation was much different. Figure 33 shows the ozone data from both the upwind and downwind traverses superimposed on one another. The impact of the cities is clearly evident. At the far edges of each traverse and in the area between the two urban areas the ozone concentrations are strikingly similar; however, directly downwind of both cities the ozone concentrations are high relative to the background ozone concentrations. The plume downwind of Norfolk appears to have more definition than the plume downwind of Richmond. In Figures 34 and 35 the upwind and downwind ozone profiles from Richmond and Norfolk, respectively, are superimposed on one another. The total increase in ozone (the area between the two curves) appears to be very similar in both locations; however, the increase is confined to a region below 930 m (3000 ft) downwind of Norfolk, whereas downwind of Richmond the increase in ozone concentration was more uniform through the entire altitude range. The maritime influence of the Norfolk area evidently prevented vertical mixing from developing beyond 930 m MSL. Evidence of this discrepancy in mixing heights is also present in the temperature and b_{scat} data from the two downwind vertical profiles (see Figure B-7). It is interesting to note here that similar ozone plumes downwind of Norfolk observed during the urban plume experiments also show this relatively limited mixing volume for ozone.

5.2 Case Studies

Three separate urban plume experiments were performed during the 1979 SEV-UPS program. The mean wind was from the southwest prior to the start of the operations on each of these occasions and, therefore, the orientation of the flight tracks was the same in each case. In Section 4, (Figures 20 and 21) there are maps of the Norfolk area, with the flight plans followed by the RTI aircraft on the first and second flights drawn on the maps. The dates and times covered by each of the flights of the urban plume experiments are listed in Table 15. The vertical spirals were begun, whenever time and atmospheric conditions permitted, by descending from the 310 m (1000 ft) MSL altitude of the horizontal traverses to an altitude approximately fifteen meters above the ground at a suitable point near the spiral location. On the upwind

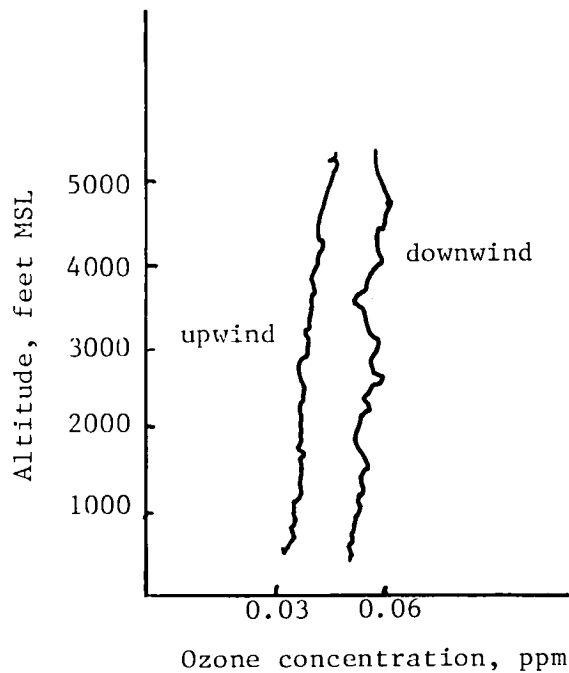

Figure 34. Ozone profiles upwind and downwind of Richmond on Norfolk-Richmond Urban Plume Comparison Flight.

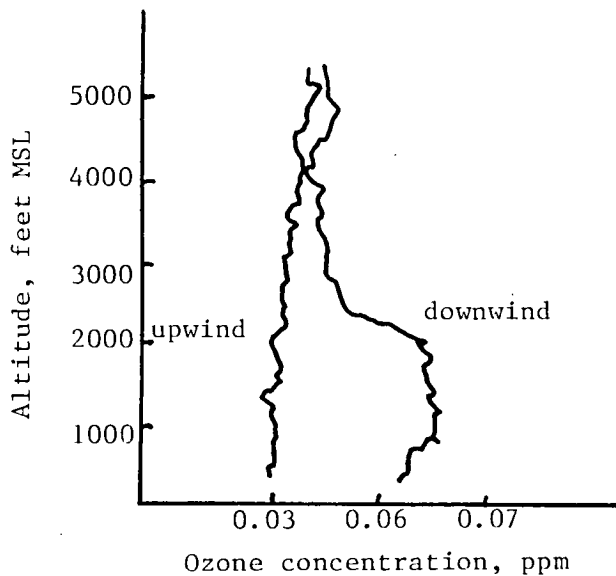

Figure 35. Ozone profiles upwind and downwind of Norfolk on Norfolk-Richmond Urban Plume Comparison Flight.

leg this low altitude spiral extension was done at the Chesapeake airport, and for the downwind spirals over the water the spiral extensions were flown at the location of the spirals. All spirals were flown up to an altitude of at least 1540 m (5000 ft) MSL and further, if time permitted.

On August 31 an experiment was conducted that was intended to provide information that could be used to determine the necessary boundary conditions required to run a photochemical box model for the Norfolk urban area. Two flights were flown by the RTI aircraft for this experiment. In Section 4 there are maps of the Norfolk area showing the flight tracks followed by RTI on the first and second flights for this experiment. An unexpected wind shift occurred on this day and for that reason the orientation of the flight plan was changed between the flights.

5.2.1 Urban Plume Experiment of August 24

Data plots from the early morning flight of August 24 are shown in Figure B-3 in Appendix B. The data of both spirals, flown approximately one hour apart, indicated that a strong surface temperature inversion was present with a height of approximately 185m MSL. The ozone concentration below the top of the inversion decreased rapidly toward the surface. The hourly average surface ozone concentrations at the Naval Communications Center at the time of the two spirals were 0.021 and 0.019 ppm for spirals one and two, respectively. There were no strong gradients observed in the profiles of any other parameter below the inversion height.

Since the altitude of the horizontal traverses (310 m MSL) was above the height of the inversion, little change in the concentration of any of the parameters was expected and none were measured. The horizontal profiles of NO, NO_x, and SO₂ were within the minimum detectable limit of the analyzers used except for minor excursions of NO_x on the second DC leg over the City of Norfolk. The ozone concentrations measured on all of the horizontal legs of the early flight consistently averaged approximately 0.06 ppm. The consistency observed in all of the data from the horizontal legs of the early flight indicate that the early morning atmosphere above the inversion height was

homogeneous on August 24.

The data plots from the second flight of August 24 are shown in Figure B-4. On this flight an upwind spiral was flown over the Naval Communications Center on the AB leg between 1113 and 1133 EDT. The strong surface inversion was no longer present, and atmospheric mixing near the surface caused the ozone profile to become more constant with altitude than was observed on the earlier flight. The mixing layer height, as determined by the temperature profile, was at approximately 800 m (2600 ft MSL). The hourly average surface ozone concentration at the Naval Communications Center at the time of the spiral was 0.043 ppm. The data from the upwind horizontal traverse along leg AB were nearly the same as those measured on the earlier upwind traverses.

On the horizontal leg DC, the RTI aircraft was forced off the intended flight path due to a high density of air traffic in the area at the time. Figure 21 shows the actual flight path followed by the RTI aircraft on this leg. The position of the aircraft was actually 7 km north of Norfolk at the point directly downwind of the city. The data collected along this leg presented some interesting information. An ozone plume is evident from these data: the width of this plume was approximately 12 km at that distance downwind; the maximum ozone concentration in the plume at that downwind distance was approximately 0.095 ppm; there were also increased concentrations of nitrogen dioxide, sulfur dioxide, and b_{scat} in the same location as the ozone plume. These data indicate that at 7 km travel distance the nitrogen dioxide and sulfur dioxide had not yet had enough time to be depleted to background concentrations; however, ozone synthesis had begun to dominate any ozone destructive processes. The short amount of travel distance downwind of Norfolk, the remaining nitrogen dioxide and sulfur dioxide concentrations in the plume, and the sharp increase and decrease of b_{scat} all indicate a very young urban plume at 7 km distance downwind of the city.

On leg EF, approximately 20.4 km downwind of Norfolk, the distribution of pollutants was much different. The maximum ozone concentration had reached levels approaching 0.12 ppm, and the ozone plume had widened considerably to approximately 18 km. Also, the increased

concentrations of nitrogen dioxide and sulfur dioxide that were measured on the DC leg accompanying the ozone plume were not measured on leg EF. This observation indicated that in traveling the 20 km downwind the air mass had aged sufficiently to cause a depletion of those species to concentrations closer to the background concentrations.

A spiral was flown on this leg over the Chesapeake Bridge Tunnel and although the spiral was flown between 1231 and 1254 EDT, a surface inversion with a height of approximately 250 m (800 ft) MSL was measured on this spiral. The water surface was cooler than the land surface at midday due to differential heating rates. The air near the water surface was cooled by contact with the water, and the warm air from over the land surface rose above the cool air over the water and the destruction of the inversion was inhibited. A very strong gradient of decreasing ozone concentrations toward the surface was observed in that inversion layer. The nitrogen dioxide concentration increased toward the surface, which probably was a result of titration of surface nitric oxide emissions by ozone.

Another inversion layer was measured at approximately 800 m (2600 ft) MSL which represented the mixing height of the air mass above the surface inversion. This mixing layer height was in agreement with that measured on the upwind spiral.

Ozone concentrations in excess of the morning and afternoon upwind background concentrations were measured over most of the HG horizontal leg. There appeared to be three distinct ozone plumes interacting with one another. These plumes appeared to have originated from Virginia Beach, Norfolk and the Hampton-Newport News area. The maximum ozone concentration measured on the traverse of approximately 0.135 ppm was in the plume downwind of Norfolk. The oxides of nitrogen and sulfur dioxide concentrations measured on this leg were low and the b_{scat} profile showed very little structure, although there were large excursions of condensation nuclei. These data once again indicate an aged plume. The condensation nuclei concentrations possibly reflect gas-to-particle conversion processes that had occurred in the plume.

The spiral flown along this leg occurred near Cape Charles over the water. Once again a near-surface temperature inversion was observed. A layer in which the ozone concentration averaged approximately 0.12 ppm was measured from the surface to approximately 525 m (1700 ft) MSL. The temperature and dewpoint profiles also indicated that the mixing height at that location was at 525 m MSL. Above the mixing height the ozone concentrations dropped off rapidly to the assumed background levels of 0.06 ppm.

The mixing height at Cape Charles was considerably lower than the mixing height measured on the other two spirals. This was caused by the increased maritime influence on the air mass during its transport 50 km downwind over water.

All other parameters were low in concentration and nearly constant with altitude on the spiral, except for two large excursions of condensation nuclei well above the mixing height. The data do not provide any explanation for those excursions.

5.2.2 Urban Plume Experiment of August 25

The same flight plan followed on the early flight of August 24 was repeated on August 25. The data plots for the early flight of August 25 appear in Figure B-5. On both of the upwind spirals a strong surface inversion was measured with a height of approximately 310 m (1000 ft) MSL. The ozone concentrations decreased from approximately 0.03 ppm at 310m to 0.01 ppm near the surface. The surface hourly average ozone concentrations measured at the Naval Communications Center at the times of the spirals were 0.009 and 0.007 ppm, respectively, for spirals one and two. Both of the early spirals were extended to altitudes above 2150 m (7000 ft) MSL. The ozone concentrations increased steadily from 0.03 ppm at 310 m to approximately 0.06 ppm, the background concentration on the preceding day, above 2150 m MSL. The mixing height above the surface inversion, as determined by the temperature and dewpoint profiles, was 675 m MSL. On both of these spirals the b_{scat} values were also decreased from the values measured on August 24 by approximately the same proportion as the decrease in ozone concentrations between the two days. The concentration data for

all of the pollutants measured on the horizontal legs were consistent over both time and space. The ozone concentrations averaged approximately 0.03 ppm, approximately one half of the background concentrations measured on August 24 at 310 m MSL. The proportional decrease in both ozone and b_{scat} measurements indicates that the area was influenced by a cleaner air mass than that of August 24.

The same flight plan followed on the second flight of August 24 was also followed on August 25 and the data plots of the second flight appear in Figures B-6. A slight increase of approximately 0.01 ppm in the ozone concentrations was measured on leg AB of the later flight over that measured on the early flight. The upwind spiral data show that the surface inversion had been destroyed and vertical mixing restored in the near surface layer. The data do not offer any evidence of whether this increase was due to downward mixing of ozone from the reservoir of higher ozone concentrations above the surface inversion or from background ozone synthesis. Nevertheless, the upwind ozone concentrations observed on August 25 were considerably less than the background ozone measured on August 24.

The DC horizontal leg of the second flight was flown as intended in the flight plans on August 25. An increase in the background ozone concentrations similar to that observed on leg AB between the two flights was also observed on leg DC. In addition, a small but recognizable increase in ozone concentrations of approximately 0.01 ppm was observed directly over the Norfolk area. That increase was probably caused by ozone synthesis from ozone precursor emissions from the city and subsequent vertical mixing. Relatively little change was observed in any of the other parameters between the flights.

On leg EF an ozone plume of approximately the same width as the ozone plume observed on leg EF of August 24 was again evident. The center of the plume was shifted approximately 15 km to the east of the position of the ozone plume of August 24. The surface winds had shifted slightly toward westerly with respect to the winds measured on August 24. This difference in wind direction accounted for the shift in the location of the plume on August 25. The maximum ozone concen-

tration measured on the EF leg was approximately 0.075 ppm. A point source plume, presumably originating from the VEPCO Yorktown Power Plant was clearly evident on the extreme westward portion of the leg.

The temperature data on the spiral near the Chesapeake Bay Bridge Tunnel did not show the strong surface inversion that was measured on the spiral of August 24 in the same location. However, the near-surface temperature structure was nearly isothermal to about 275 m (900 ft) MSL and a steep ozone gradient was measured in that stable layer. The mixing height was at approximately 830 m (2700 ft) MSL, and a layer of high ozone concentrations relative to the rest of the spiral, with maximum concentrations of approximately 0.07 ppm, was measured between the stable surface layer and the mixing height.

On leg HG the ozone plume had spread out horizontally and was shifted well to the east of the position of the plume on leg HG of August 24. The maximum ozone concentration in that cross section of the plume was approximately 0.08 ppm. The surface winds had shifted even more toward westerly by the time of the HG traverse. If the ozone plume was being transported to the east, the flight path would not have crossed the plume axis perpendicularly and the plume would appear to be wider than those observed on other horizontal traverses at that distance downwind of Norfolk. With the exception of a slight increase in b_{scat} in the same position as the ozone plume, all other parameters were at low concentrations across the traverse.

On the final spiral over Cape Charles a nearly isothermal layer was measured below 215 m MSL and the mixing height was at approximately 710m MSL. As was observed in the spiral, on leg EF, a layer of relatively high ozone concentrations with a maximum of approximately 0.075 ppm was measured between the stable surface layer and the mixing height.

5.2.3 Urban Plume Experiment of August 30

The RTI aircraft flew the same flight plans on both flights of the August 30 experiment as were flown on August 24 and 25. An unexpected wind shift had occurred, however, and the winds were westerly to

northwesterly during the experiment. The data plots from both of the flights on August 30 are shown in Figures B-9 and B-10.

On both of the spirals of the early flight a surface temperature inversion was measured with a height of approximately 245 m MSL. The ozone concentrations decreased sharply below the height of the inversion. The hourly average ozone concentrations measured at the Chesapeake Airport and Naval Communications Center surface stations were below the minimum detectable limit of the analyzers at the time of both spirals. Temperature inversions were also measured at 585 m MSL and at 1660 m MSL on both spirals. In the layer between those inversions both the ozone and b_{scat} concentrations were higher than those observed on the remainder of the spiral.

The ozone concentrations measured on the horizontal traverses of the early flight averaged approximately 0.06 ppm throughout the flight. The concentrations of oxides of nitrogen and sulfur dioxide were low through most of the flight. The effluent from a large point source was measured, however, on each of the DC traverses. The position of the plume shifted from west of Norfolk to east of Norfolk between the two traverses. Backtracking from the location of the plume as measured by the aircraft instrumentation to the VEPCO Power Plant in Yorktown, which was the likely source of that plume, will give a good indication of the wind direction at 310 m MSL during the flight.

On the AB leg of the second flight the ozone concentrations were approximately 0.01 ppm greater than those measured on the earlier flight. The temperature profile measured on the vertical spiral on leg AB no longer indicated the presence of a surface inversion. The ozone profile was nearly constant at 0.06 ppm up to approximately 370 m MSL. The small increase in ozone concentration at 310 m could be, as was mentioned in the discussion of the other urban plume experiments, a result of either chemical reaction or vertical mixing.

High concentrations of ozone, b_{scat} , oxides of nitrogen, and sulfur dioxide were measured on the extreme eastern part of leg DC on the second flight. The northwesterly winds caused the Norfolk area urban plume to be transported toward the east. The data collected in

transit between the horizontal legs were also plotted for this experiment. Increasing concentrations of ozone were also measured on the transition leg between point B and point D. This wide area of high ozone concentrations would appear to be the result of ozone generation from the Norfolk urban area.

The data collected on leg EF were difficult to interpret. Large point source plumes were measured in two separate locations along the traverse, and the concentrations of oxides of nitrogen and sulfur dioxide were higher on the western half of the leg than were commonly observed on leg EF during the other experiments. Westerly to northwesterly winds may have transported the power plant plume to the east, and the aircraft may have been sampling along the direction of plume movement. Several layers with high concentrations of SO_2 , NO_x , b_{scat} , and CN, and low concentrations of ozone were observed in the lowest 770 m MSL of the vertical spiral at the Chesapeake Bay Bridge Tunnel. The aircraft circled with a radius of approximately one kilometer and, therefore, the several layers observed on the spiral may appear as a result of the aircraft entering a single plume several times. A surface inversion was present over the water and the mixing height was at approximately 740 m MSL.

High concentrations of ozone and b_{scat} were measured on the western part of leg HG. High concentrations of those two parameters together often indicate the presence of an aged polluted air mass. The general wind flow from the northwest requires that the source of the polluted air mass measured on the western portion of leg HG be somewhere west of Norfolk.

The temperature data from the spiral over Cape Charles indicated a temperature inversion with a height of 154 m MSL and a mixing height of approximately 710 m MSL. As observed on some spirals of the previous urban plume experiments, high concentrations of both ozone and b_{scat} were measured in the layer between the surface inversion height and the mixing height. The structure of the ozone layer was similar to that of the ozone layers that were thought to be associated with the Norfolk urban plume. The ozone data from both the horizontal traverses and vertical spirals north of Norfolk indicate that an urban

plume may have been observed there; however, the source of that plume must have been some urban area other than Norfolk. The upper air wind data should help determine the urban area that was most likely the source of that ozone plume.

5.2.4 Photochemical Box Experiment of August 31

The flight plans followed by the RTI aircraft for the photochemical box experiment have been presented in Figures 28 and 29. The orientation of the flight plan was changed midway through the experiment because an unexpected wind shift occurred. As a result of the change in plans and an apparent area wide increase in ozone concentrations that may have masked any influence of the Norfolk area, it is unlikely that all of the goals of the experiment will be achieved.

The data plots for the early flight are shown in Figure B-11. A layer of stable air was measured near the surface on all of the spirals. The ozone concentrations appeared to decrease toward the surface on all of the spirals. There was also a shallow layer between 310 m and 615 m with high ozone concentrations relative to the average ozone concentrations on the spirals. The ozone concentrations on the first two horizontal tracks showed some structure to the south and southwest of Norfolk. This structure, however, is probably due to altitude fluctuation of the ozone layer and not a result of transport. By the time of the third cycle around the horizontal pattern at 0730 the ozone concentration was more uniform. Perhaps enough mixing had occurred by that time to smooth out the inhomogeneities observed on the earlier cycles.

A large point source plume was measured on each spiral at point F near the Chesapeake Bay Bridge Tunnel. This plume was measured at 925 m. The probable source of that plume was the VEPCO Power Plant at Yorktown. If the power plant was the source of the plume, it would indicate that the wind shift had already started before the experiment was begun. A point source plume was also measured at 925 m on the last spiral at point A. The sulfur dioxide and nitrogen dioxide concentrations measured in that plume were much smaller than those measured on

the spirals at F. Once again, inspection of the upper air winds should help determine the actual source or sources of those point source plumes measured on the morning spirals. The concentration changes associated with the plume structure on the third spiral at F were smaller than on the first two spirals at F. The decrease in maximum concentrations associated with the plume could have been a result of a shift in plume location, a shift in the spiral location, or by the spiral motion of the aircraft, causing it to miss the center of the plume.

On each of the morning horizontal patterns, as well as the spirals, there was considerable structure in the b_{scat} data. Without additional information concerning the history of the air mass, it is difficult to explain the variation observed in the b_{scat} measurements. High b_{scat} values are generally associated with aged polluted air masses, and the structure in the b_{scat} values measured on this flight may indicate that the air mass over Norfolk on August 31 had been transported from some other urban area.

Plots of the data collected on the second flight on August 31 are shown in Figure B-12. On the second flight, which began at 1100, point A was in nearly the same location as point F of the earlier flight. All of the spirals at point A on the second flight were over water and near-surface inversions were measured, although the ozone concentrations did not show any large decreases near the surface. The ozone concentrations increased with time through the lower altitudes of the spirals at both point A and point F. Since the winds shifted from westerly through northeasterly during the day, this ozone was not a result of urban activities in Norfolk alone. In general, ozone concentrations increased with time over the entire horizontal pattern. This general increase in ozone over the entire area may have been the result of a regional ozone increase, in which the direct impacts of the Norfolk area were masked. The area wide high b_{scat} values, which continued through the second flight, were also indicative of an area-wide polluted air mass.

5.3 Summarizing Remarks

The data analysis effort in this report was based almost entirely on the RTI aircraft data set. The overall SEV-UPS program included several other aircraft and surface-based data sets that, when joined together into a consistent data base, will provide additional information concerning the behavior of air pollutants in and around the Norfolk, Virginia area. Since this preliminary analysis effort was based on an incomplete data set, it is inappropriate to offer any conclusions concerning the program objectives at this time. To facilitate the ultimate data analysis of the 1979 SEV-UPS program, however, some preliminary findings based on the RTI aircraft data are listed below.

1. The data collected by the RTI aircraft on the Cessna/Navajo comparison flight were highly consistent across each of the horizontal legs at 1500 meters and 250 meters MSL. Evidence of this finding is offered by the low standard deviations of all parameters listed in Table 16. This indicates that the flight provided sufficient information to relate the two in-situ aircraft measurement systems to one another.

2. A mean ozone concentration of 0.066 ppm with a standard deviation of 0.0024 ppm was measured on the LAS correlative flight by the RTI aircraft. The overall consistency displayed in these data provide an excellent comparison data set to relate the RTI in-situ measurement system to the remote sensing LAS ozone instrument.

3. The influence of the large water bodies around Norfolk may cause the mixing height to be considerably lower than in areas further inland. Evidence for this finding is provided by the data from the Norfolk-Richmond urban plume comparison flight. Although both cities appeared to have generated approximately the same mass of ozone, the concentration of ozone downwind of Norfolk, near the surface, was higher than downwind of Richmond, due to a smaller mixing volume.

4. In all cases the aircraft measured higher ozone concentrations on low pass flights near the surface than hourly average ozone concentrations measured by the surface stations at the same locations. The temperature data indicate that a stable layer of air was present near

the surface. The presence of stable air would limit vertical mixing and, thus, effectively divide the two measurement regimes into two separate chemical regimes. During the late morning hours (when this flight was conducted) in areas removed from any maritime influences stable air generally is not observed. Therefore, this finding may again be specific to coastal areas.

5. The urban plume experiments provided evidence of downwind transport of ozone generated as a result of activities in Norfolk. Upwind ozone concentrations as measured by the RTI aircraft remained nearly constant with time during these experiments. Increased ozone concentrations were measured downwind of Norfolk in the direction of the mean wind flow.

6. The mixing heights observed downwind of Norfolk during the urban plume experiments were similar to that observed on the Norfolk, Richmond comparison flight, indicating that a decreased mixing volume near the coast, relative to inland area, is common.

7. The width of the urban plume was approximately 20-25 km after 50 km of travel distance. Similar plume widths, relative to the width of the city from which the plume originated, have been observed near Tulsa, Oklahoma.⁷

8. A power plant plume was observed in many cases on both horizontal traverses and on vertical spirals. The likely source of the observed plume was the VEPCO Power Plant at Yorktown. Back tracking from the measured location of the plume to the source will provide additional upper air wind direction information.

9. It is likely that an area wide increase in ozone concentrations observed over the entire area on August 31 masked any direct impact of the Norfolk area during the photochemical box experiment.

10. An unexpected wind shift also complicated the results of the photochemical box experiment.

6.0 REFERENCES

1. R. J. Paur and F. McElroy, Technical Assistance Document for the Calibration of Ambient Ozone Monitors. U.S. Environmental Protection Agency Publication No. EPA-600/4-79-057. April, 1979.
2. "Measurement Principle and Calibration Procedure for the Measurement of Nitrogen Dioxide in the Atmosphere (Gas Phase Chemiluminescence)", 40 CFR, Part 50, Appendix E.
3. "Reference Method for the Determination of Hydrocarbons Corrected for Methane," 40 CFR, Part 50, Appendix E.
4. W. C. Eaton, Use of the Flame Photometric Detector Method for Measurement of Sulfur Dioxide in Ambient Air: A Technical Assistance Document. U.S. Environmental Protection Agency Publication No. EPA-600/4-78-024. April, 1978.
5. S. L. Kopczynski, W. A. Lonneman, T. Winfield, and R. Seila, "Gaseous Pollutants in St. Louis and Other Cities," J. Air Pollution Control Association 25, 251 (1975).
6. J. H. White, R. B. Strong and J. B. Tommerdahl, Altitude Characteristics of Selected Air Quality Analyzers. NASA CR-159165, November, 1979.
7. W. C. Eaton, M. L. Saeger, W. D. Bach, J. E. Sickles, II, and C. E. Decker, Study of the Nature of Ozone, Oxides of Nitrogen, and Non-Methane Hydrocarbons in Tulsa, Oklahoma. U.S. Environmental Protection Agency Publication No. EPA-600/4-79-057. September 1979.

APPENDIX A •
RTI SURFACE SITE DATA BASE

This appendix, "RTI Surface Site Data Base," lists hourly average data collected at the two RTI-operated surface sites, Inner Norfolk (Naval Air Station) and Naval Communications Center (Northwest) during the period August 13 through 31, 1979.

All data for each individual pollutant or parameter is compiled in a single block of results. Each data block includes: station and pollutant identification; time (EDT), numbered from 1 (midnight to 1 a.m.) to 24 (11 p.m. to midnight); date of measurement; and individual hourly values of the parameter. Units used for parameters are: parts per billion (ppb) - ozone, oxides of nitrogen, nitric oxide, nitrogen dioxide, and sulfur dioxide; parts per million (ppm) - methane, carbon monoxide, total hydrocarbons, and nonmethane hydrocarbons; degrees of compass - wind direction; miles per hour - wind speed; degrees celsius - temperature and dew point; Langleys per minute - solar radiation.

The symbol **** that appears in the data listings indicates one of two things. (1) There was no data collected during this period (i.e. the analyzer was off-line or undergoing a span check, a calibration, or an audit) or (2) the data was invalidated (generally when a span check or recalibration showed a greater than 15 percent departure from the expected value or when a malfunction in the analytical system occurred).

Wind direction is sometimes given as 0 (zero) degrees. This corresponds to a calm condition (average wind speeds of 1 m/sec (2 mph) or less for that hour). When winds are out of the north, wind direction is expressed as 360°.

The data base is generally of good quality as reflected in the results of quality control checks and the performance audits. Two comments should be made, however. (1) The nonmethane hydrocarbon - concentration, as measured by the automated chromatograph at the Naval Communications site, is very low, usually zero. These values are probably unrealistically low but correspond to the best performance the instrument was giving during the measurement period. (2) The probe used to sense the ambient temperature and dew point temperature at the Naval Communications site was mounted inside the station's air sampling manifold which is itself inside the station. It is apparent that these

measurements were influenced by the interior temperature of the station and the readings are not representative of ambient air temperature.

NAVAL COMMUNICATIONS CENTER, NORTHWEST
OZONE, O3, (PPB)

HOUR EDT	AUGUST 1979																			
	13	14	15	16	17	18	19	20	21	22	23	24	25	26	27	28	29	30	31	
1	26.0	23.0	37.0	35.0	10.0	19.0	38.0	38.0	6.0	31.0	28.0	27.0	23.0	19.0	12.0	14.0	10.0	12.0	6.0	
2	25.0	31.0	32.0	26.0	7.0	31.0	34.0	20.0	11.0	42.0	26.0	25.0	21.0	16.0	10.0	12.0	10.0	5.0	3.0	
3	24.0	28.0	30.0	25.0	7.0	36.0	25.0	15.0	9.0	40.0	27.0	16.0	18.0	13.0	8.0	11.0	9.0	3.0	1.0	
4	22.0	26.0	31.0	22.0	9.0	25.0	29.0	11.0	13.0	43.0	28.0	19.0	14.0	11.0	8.0	11.0	9.0	2.0	0.0	
5	22.0	22.0	33.0	19.0	5.0	19.0	44.0	7.0	14.0	43.0	24.0	19.0	12.0	11.0	5.0	9.0	9.0	1.0	5.0	
6	23.0	23.0	30.0	19.0	11.0	16.0	47.0	4.0	20.0	42.0	27.0	21.0	9.0	9.0	4.0	5.0	6.0	3.0	5.0	
7	20.0	21.0	32.0	16.0	13.0	9.0	34.0	4.0	22.0	43.0	30.0	19.0	7.0	2.0	2.0	2.0	4.0	1.0	0.0	
8	22.0	21.0	28.0	14.0	18.0	10.0	30.0	4.0	24.0	42.0	32.0	15.0	7.0	5.0	3.0	4.0	2.0	2.0	6.0	
9	23.0	33.0	29.0	16.0	31.0	31.0	24.0	29.0	30.0	41.0	31.0	21.0	13.0	16.0	11.0	****	12.0	12.0	20.0	
10	29.0	47.0	32.0	22.0	31.0	36.0	32.0	57.0	40.0	37.0	45.0	30.0	18.0	24.0	17.0	****	18.0	28.0	34.0	
11	37.0	54.0	41.0	27.0	43.0	****	37.0	60.0	43.0	38.0	47.0	43.0	24.0	28.0	18.0	****	24.0	41.0	54.0	
12	45.0	60.0	53.0	39.0	55.0	****	48.0	71.0	44.0	41.0	48.0	45.0	29.0	30.0	20.0	****	28.0	45.0	66.0	
13	51.0	****	****	50.0	64.0	62.0	56.0	72.0	55.0	45.0	51.0	47.0	****	52.0	23.0	****	28.0	48.0	69.0	
14	56.0	70.0	72.0	45.0	68.0	63.0	66.0	73.0	57.0	45.0	53.0	50.0	****	30.0	23.0	28.0	24.0	50.0	76.0	
15	46.0	73.0	77.0	44.0	73.0	63.0	69.0	65.0	55.0	46.0	50.0	49.0	35.0	29.0	19.0	25.0	22.0	47.0	82.0	
16	56.0	77.0	72.0	54.0	71.0	56.0	69.0	52.0	54.0	44.0	34.0	48.0	37.0	30.0	27.0	25.0	22.0	49.0	82.0	
17	****	79.0	72.0	48.0	62.0	49.0	74.0	49.0	46.0	43.0	45.0	45.0	33.0	30.0	26.0	26.0	21.0	59.0	76.0	
18	51.0	82.0	72.0	46.0	62.0	62.0	73.0	50.0	55.0	45.0	45.0	45.0	33.0	31.0	25.0	26.0	20.0	59.0	80.0	
19	50.0	84.0	66.0	44.0	57.0	61.0	68.0	44.0	37.0	45.0	43.0	43.0	32.0	34.0	23.0	26.0	19.0	43.0	77.0	
20	41.0	54.0	57.0	46.0	50.0	57.0	58.0	41.0	37.0	42.0	41.0	39.0	29.0	29.0	20.0	20.0	25.0	18.0	****	
21	28.0	34.0	47.0	33.0	41.0	48.0	48.0	33.0	36.0	37.0	37.0	27.0	27.0	25.0	17.0	19.0	18.0	31.0	****	
22	16.0	47.0	44.0	24.0	25.0	43.0	55.0	20.0	36.0	36.0	34.0	20.0	23.0	20.0	19.0	18.0	16.0	32.0	****	
23	23.0	40.0	43.0	21.0	20.0	47.0	55.0	11.0	32.0	33.0	30.0	30.0	21.0	13.0	18.0	9.0	12.0	22.0	****	
24	28.0	40.0	43.0	14.0	15.0	45.0	42.0	9.0	34.0	32.0	30.0	26.0	20.0	13.0	17.0	11.0	16.0	11.0	****	

SULFUR DIOXIDE, SO2, (PPB)

1	2.0	1.0	1.0	9.0	1.0	0.0	0.0	0.0	0.0	0.0	****	0.0	****	****	****	****	****	****	****
2	2.0	1.0	1.0	7.0	****	0.0	0.0	0.0	0.0	0.0	****	0.0	****	****	****	****	****	****	****
3	1.0	1.0	1.0	17.0	****	0.0	0.0	0.0	0.0	0.0	****	0.0	****	****	****	****	****	****	****
4	1.0	1.0	1.0	19.0	****	0.0	0.0	0.0	0.0	0.0	****	0.0	****	****	****	****	****	****	****
5	2.0	1.0	2.0	24.0	0.0	0.0	0.0	0.0	0.0	0.0	****	0.0	****	****	****	****	****	****	****
6	2.0	1.0	1.0	25.0	1.0	0.0	0.0	0.0	0.0	0.0	****	0.0	****	****	****	****	****	****	****
7	1.0	2.0	4.0	12.0	****	0.0	0.0	0.0	0.0	0.0	****	0.0	****	****	****	****	****	****	****
8	2.0	2.0	5.0	6.0	****	0.0	0.0	0.0	0.0	0.0	****	0.0	****	****	****	****	****	****	****
9	2.0	1.0	19.0	10.0	2.0	0.0	0.0	0.0	0.0	0.0	****	0.0	****	****	****	****	****	****	****
10	2.0	2.0	18.0	27.0	4.0	0.0	0.0	0.0	0.0	0.0	****	0.0	****	****	****	****	****	****	****
11	2.0	1.0	9.0	27.0	9.0	0.0	0.0	1.0	0.0	0.0	****	0.0	****	****	****	****	****	****	****
12	2.0	****	8.0	19.0	****	0.0	0.0	4.0	0.0	0.0	****	0.0	****	****	****	****	****	****	****
13	3.0	****	8.0	15.0	12.0	0.0	0.0	4.0	****	****	****	0.0	****	****	****	****	****	****	****
14	2.0	2.0	11.0	9.0	7.0	0.0	****	****	0.0	0.0	****	0.0	****	****	****	****	****	****	****
15	2.0	1.0	****	****	4.0	****	****	****	0.0	0.0	****	0.0	****	****	****	****	****	****	****
16	2.0	2.0	****	****	3.0	****	0.0	0.0	0.0	0.0	****	0.0	****	****	****	****	****	****	****
17	1.0	2.0	7.0	****	2.0	0.0	0.0	0.0	0.0	0.0	****	0.0	****	****	****	****	****	****	****
18	****	3.0	6.0	4.0	****	0.0	0.0	0.0	0.0	0.0	****	0.0	****	****	****	****	****	****	****
19	****	2.0	7.0	4.0	1.0	0.0	0.0	0.0	6.0	0.0	****	0.0	****	****	****	****	****	****	****
20	1.0	1.0	5.0	3.0	****	0.0	0.0	0.0	0.0	0.0	****	0.0	****	****	****	****	****	****	****
21	1.0	1.0	4.0	7.0	****	0.0	0.0	0.0	0.0	0.0	****	0.0	****	****	****	****	****	****	****
22	1.0	1.0	3.0	1.0	****	0.0	0.0	0.0	0.0	0.0	****	0.0	****	****	****	****	****	****	****
23	1.0	1.0	3.0	0.0	****	0.0	0.0	0.0	0.0	0.0	****	0.0	****	****	****	****	****	****	****
24	0.0	3.0	4.0	0.0	****	0.0	0.0	0.0	0.0	0.0	****	0.0	****	****	****	****	****	****	****

NAVAL COMMUNICATIONS CENTER, NORTHWEST
OXIDES OF NITROGEN, NOX, (PPB)

HOUR EDT	AUGUST 1979																		
	13	14	15	16	17	18	19	20	21	22	23	24	25	26	27	28	29	30	31
1	****	****	****	****	****	****	3.0	5.0	3.0	5.0	0.0	4.0	2.0	2.0	1.0	1.0	2.0	1.0	4.0
2	****	****	****	****	****	****	3.0	1.0	5.0	3.0	2.0	0.0	0.0	1.0	0.0	1.0	1.0	2.0	3.0
3	****	****	****	****	****	****	0.0	3.0	1.0	5.0	1.0	5.0	2.0	1.0	0.0	1.0	1.0	2.0	4.0
4	****	****	****	****	****	****	4.0	0.0	1.0	3.0	1.0	2.0	3.0	0.0	0.0	0.0	1.0	2.0	****
5	****	****	****	****	****	****	4.0	2.0	3.0	2.0	3.0	4.0	0.0	0.0	3.0	3.0	2.0	4.0	****
6	****	****	****	****	****	****	3.0	2.0	1.0	3.0	3.0	4.0	3.0	2.0	3.0	4.0	1.0	3.0	****
7	****	****	****	****	****	****	3.0	3.0	2.0	0.0	7.0	1.0	0.0	5.0	0.0	5.0	2.0	2.0	****
8	****	****	****	****	****	****	3.0	7.0	10.0	4.0	4.0	0.0	1.0	2.0	3.0	2.0	4.0	4.0	****
9	****	****	****	****	****	****	5.0	7.0	4.0	6.0	0.0	1.0	4.0	0.0	0.0	****	3.0	2.0	****
10	****	****	****	****	****	****	4.0	6.0	6.0	13.0	1.0	3.0	3.0	1.0	3.0	****	0.0	31.0	****
11	****	****	****	****	****	****	4.0	5.0	4.0	11.0	0.0	4.0	2.0	1.0	2.0	****	1.0	5.0	****
12	****	****	****	****	****	****	5.0	6.0	6.0	7.0	3.0	1.0	2.0	3.0	2.0	****	2.0	2.0	8.0
13	****	****	****	****	****	****	7.0	6.0	2.0	4.0	****	2.0	****	4.0	****	****	1.0	4.0	5.0
14	****	****	****	****	****	****	6.0	4.0	****	3.0	1.0	2.0	****	****	0.0	****	0.0	2.0	6.0
15	****	****	****	****	****	3.0	2.0	3.0	1.0	6.0	5.0	2.0	1.0	0.0	0.0	****	3.0	0.0	7.0
16	****	****	****	****	****	2.0	6.0	4.0	3.0	3.0	0.0	5.0	5.0	1.0	1.0	****	1.0	2.0	5.0
17	****	****	****	****	****	****	4.0	6.0	4.0	2.0	2.0	0.0	4.0	3.0	****	5.0	2.0	4.0	
18	****	****	****	****	****	****	7.0	6.0	5.0	2.0	3.0	1.0	0.0	1.0	2.0	****	2.0	5.0	8.0
19	****	****	****	****	****	5.0	4.0	4.0	17.0	3.0	3.0	5.0	2.0	2.0	1.0	****	5.0	2.0	6.0
20	****	****	****	****	****	3.0	4.0	7.0	11.0	2.0	3.0	2.0	0.0	2.0	2.0	****	2.0	5.0	****
21	****	****	****	****	****	2.0	8.0	6.0	9.0	2.0	4.0	2.0	2.0	1.0	0.0	****	1.0	6.0	****
22	****	****	****	****	****	2.0	6.0	3.0	7.0	0.0	4.0	1.0	1.0	2.0	2.0	****	3.0	1.0	****
23	****	****	****	****	****	5.0	8.0	7.0	3.0	1.0	2.0	4.0	4.0	3.0	3.0	****	0.0	4.0	****
24	****	****	****	****	****	2.0	9.0	7.0	5.0	0.0	2.0	2.0	2.0	2.0	1.0	****	2.0	8.0	****

NITRIC OXIDE, NO, (PPB)

1	****	****	****	****	****	****	0.0	1.0	3.0	2.0	0.0	0.0	0.0	1.0	0.0	0.0	1.0	0.0	0.0
2	****	****	****	****	****	****	2.0	1.0	0.0	0.0	0.0	1.0	0.0	0.0	0.0	0.0	0.0	1.0	1.0
3	****	****	****	****	****	****	0.0	0.0	0.0	1.0	0.0	0.0	0.0	0.0	0.0	0.0	0.0	2.0	1.0
4	****	****	****	****	****	****	1.0	0.0	0.0	0.0	0.0	0.0	0.0	1.0	1.0	0.0	0.0	0.0	1.0
5	****	****	****	****	****	****	2.0	2.0	0.0	0.0	0.0	0.0	0.0	0.0	0.0	0.0	0.0	0.0	0.0
6	****	****	****	****	****	****	0.0	0.0	2.0	1.0	0.0	0.0	0.0	1.0	1.0	1.0	0.0	0.0	1.0
7	****	****	****	****	****	****	0.0	3.0	0.0	0.0	0.0	2.0	0.0	4.0	1.0	1.0	0.0	0.0	2.0
8	****	****	****	****	****	****	2.0	0.0	0.0	0.0	0.0	1.0	0.0	1.0	2.0	4.0	0.0	0.0	4.0
9	****	****	****	****	****	****	3.0	0.0	1.0	0.0	0.0	0.0	0.0	0.0	0.0	****	0.0	0.0	1.0
10	****	****	****	****	****	****	1.0	2.0	3.0	2.0	0.0	0.0	0.0	1.0	0.0	****	0.0	23.0	2.0
11	****	****	****	****	****	****	0.0	0.0	2.0	0.0	0.0	3.0	0.0	0.0	0.0	****	0.0	0.0	****
12	****	****	****	****	****	****	1.0	0.0	0.0	1.0	0.0	0.0	0.0	0.0	0.0	****	3.0	0.0	0.0
13	****	****	****	****	****	****	0.0	0.0	0.0	1.0	****	0.0	****	0.0	****	****	0.0	0.0	0.0
14	****	****	****	****	****	****	2.0	0.0	****	0.0	0.0	3.0	****	****	****	****	0.0	0.0	1.0
15	****	****	****	****	****	0.0	1.0	0.0	0.0	1.0	0.0	0.0	0.0	0.0	0.0	****	0.0	0.0	2.0
16	****	****	****	****	****	0.0	2.0	1.0	1.0	0.0	0.0	1.0	0.0	0.0	0.0	****	0.0	0.0	0.0
17	****	****	****	****	****	****	2.0	0.0	0.0	0.0	0.0	0.0	0.0	0.0	2.0	****	1.0	0.0	0.0
18	****	****	****	****	****	****	0.0	2.0	1.0	0.0	0.0	0.0	0.0	0.0	1.0	****	1.0	0.0	0.0
19	****	****	****	****	****	3.0	2.0	0.0	0.0	0.0	0.0	0.0	4.0	0.0	1.0	****	0.0	0.0	0.0
20	****	****	****	****	****	0.0	0.0	0.0	1.0	0.0	0.0	0.0	0.0	0.0	0.0	****	0.0	0.0	****
21	****	****	****	****	****	2.0	0.0	1.0	0.0	1.0	0.0	1.0	0.0	0.0	1.0	****	0.0	0.0	****
22	****	****	****	****	****	1.0	0.0	0.0	1.0	0.0	0.0	0.0	1.0	2.0	1.0	****	0.0	0.0	****
23	****	****	****	****	****	1.0	0.0	2.0	0.0	0.0	1.0	2.0	0.0	0.0	0.0	****	0.0	2.0	****
24	****	****	****	****	****	0.0	0.0	0.0	0.0	0.0	0.0	0.0	0.0	0.0	0.0	****	0.0	0.0	****

NAVAL COMMUNICATIONS CENTER, NORTHWEST
NITROGEN DIOXIDE, NO2, (PPB)

HOUR EDT	AUGUST 1979																		
	13	14	15	16	17	18	19	20	21	22	23	24	25	26	27	28	29	30	31
1	****	****	****	****	****	****	3.0	4.0	0.0	3.0	0.0	4.0	2.0	1.0	1.0	1.0	1.0	1.0	4.0
2	****	****	****	****	****	****	1.0	0.0	5.0	3.0	2.0	0.0	0.0	1.0	0.0	1.0	1.0	1.0	2.0
3	****	****	****	****	****	****	0.0	3.0	1.0	4.0	1.0	5.0	2.0	1.0	0.0	1.0	1.0	0.0	3.0
4	****	****	****	****	****	****	3.0	0.0	1.0	3.0	1.0	2.0	3.0	****	****	0.0	1.0	2.0	****
5	****	****	****	****	****	****	2.0	0.0	3.0	2.0	3.0	4.0	0.0	0.0	3.0	3.0	2.0	4.0	****
6	****	****	****	****	****	****	3.0	2.0	0.0	2.0	3.0	3.0	0.0	0.0	3.0	3.0	2.0	4.0	****
7	****	****	****	****	****	****	3.0	0.0	2.0	0.0	7.0	****	0.0	1.0	****	4.0	2.0	2.0	****
8	****	****	****	****	****	****	1.0	7.0	10.0	4.0	4.0	****	1.0	1.0	1.0	****	4.0	2.0	****
9	****	****	****	****	****	****	2.0	7.0	3.0	6.0	0.0	2.0	1.0	4.0	0.0	****	3.0	2.0	****
10	****	****	****	****	****	****	3.0	4.0	3.0	11.0	1.0	3.0	3.0	0.0	3.0	****	0.0	8.0	****
11	****	****	****	****	****	****	4.0	5.0	2.0	11.0	0.0	1.0	2.0	1.0	2.0	****	1.0	5.0	****
12	****	****	****	****	****	****	4.0	6.0	6.0	6.0	3.0	1.0	2.0	3.0	2.0	****	****	2.0	8.0
13	****	****	****	****	****	****	7.0	6.0	2.0	****	****	2.0	****	4.0	****	****	1.0	4.0	5.0
14	****	****	****	****	****	****	4.0	4.0	****	3.0	1.0	****	****	0.0	****	0.0	2.0	5.0	****
15	****	****	****	****	****	****	3.0	1.0	3.0	5.0	5.0	2.0	1.0	0.0	****	3.0	0.0	5.0	****
16	****	****	****	****	****	****	2.0	4.0	3.0	2.0	3.0	0.0	4.0	5.0	1.0	1.0	****	1.0	5.0
17	****	****	****	****	****	****	****	2.0	6.0	4.0	2.0	2.0	0.0	4.0	1.0	****	4.0	2.0	4.0
18	****	****	****	****	****	****	7.0	4.0	4.0	2.0	3.0	1.0	0.0	1.0	1.0	****	1.0	5.0	8.0
19	****	****	****	****	****	****	2.0	2.0	4.0	17.0	3.0	3.0	5.0	****	2.0	0.0	****	5.0	2.0
20	****	****	****	****	****	****	3.0	4.0	7.0	10.0	2.0	3.0	2.0	0.0	2.0	2.0	****	2.0	6.0
21	****	****	****	****	****	****	0.0	8.0	5.0	9.0	3.0	4.0	1.0	2.0	1.0	****	****	1.0	6.0
22	****	****	****	****	****	****	1.0	6.0	3.0	6.0	0.0	4.0	0.0	0.0	1.0	****	3.0	1.0	****
23	****	****	****	****	****	****	4.0	8.0	5.0	3.0	1.0	1.0	2.0	4.0	3.0	****	0.0	2.0	****
24	****	****	****	****	****	****	2.0	9.0	7.0	5.0	0.0	2.0	2.0	2.0	1.0	****	2.0	8.0	****

TOTAL HYDROCARBONS, THC, (PPM)

1	1.86	1.82	1.77	1.81	1.78	1.72	1.66	1.80	2.26	1.67	1.58	1.56	1.55	1.51	1.49	1.54	1.53	1.49	1.64	
2	1.80	1.79	1.80	1.82	1.89	1.72	1.67	1.82	2.51	1.65	1.58	1.56	1.55	1.54	1.51	1.54	1.52	1.56	1.72	
3	1.81	1.80	1.80	1.78	1.83	1.75	1.68	1.89	2.34	1.67	1.60	1.60	1.53	1.58	1.53	1.54	1.54	1.65	1.68	
4	1.79	1.89	1.78	1.79	1.85	1.75	1.69	1.97	2.07	1.62	1.62	1.60	1.54	1.61	1.53	1.55	1.53	1.72	1.70	
5	1.77	1.91	1.80	1.78	1.87	1.75	1.70	1.89	2.01	1.64	1.63	1.66	1.56	1.63	1.50	1.56	1.50	1.69	1.74	
6	1.75	1.88	1.79	1.79	1.84	1.79	1.69	2.16	1.92	1.66	1.61	1.64	1.60	1.66	1.62	1.64	1.58	1.61	1.85	
7	1.73	1.88	1.80	1.76	1.87	1.85	1.70	2.26	1.99	1.60	1.60	1.64	1.63	1.66	1.62	1.64	1.58	1.61	2.35	
8	1.73	1.83	1.82	1.76	1.83	1.81	1.70	2.16	1.98	1.60	1.61	1.69	1.59	1.69	1.63	1.64	1.58	1.65	2.50	
9	1.74	1.79	1.85	1.80	1.79	1.79	1.70	1.85	1.84	****	1.58	1.65	1.51	1.55	1.56	****	1.56	1.60	2.34	
10	1.72	1.75	1.89	1.84	1.78	1.80	1.71	1.67	1.67	****	1.51	1.62	1.46	1.48	1.50	****	1.45	1.52	2.12	
11	1.72	1.77	1.80	1.85	1.79	1.75	1.72	1.69	1.59	****	1.51	1.49	1.49	1.44	1.46	****	1.43	1.48	1.70	
12	1.72	****	1.83	****	****	****	1.69	1.73	1.69	1.59	****	1.50	1.48	1.48	1.49	1.50	1.43	1.45	1.59	
13	1.73	1.74	****	****	1.83	****	1.76	****	1.91	****	****	1.51	1.48	1.46	1.50	****	1.47	1.50	1.59	
14	1.73	1.71	1.83	1.83	1.78	****	****	1.73	****	****	1.50	1.48	1.49	1.49	1.50	1.43	1.45	1.52	1.59	
15	1.73	1.71	1.81	1.76	1.76	****	1.74	1.66	1.60	1.57	1.49	1.51	1.50	****	1.54	1.43	1.44	1.50	1.53	
16	1.73	1.69	1.78	1.77	1.75	****	1.71	1.63	1.57	1.56	1.48	1.52	1.50	****	1.48	1.45	1.41	1.42	1.49	1.55
17	1.75	1.76	1.76	1.79	1.71	1.70	1.73	1.60	1.58	1.54	1.48	1.52	1.49	1.49	1.47	1.45	1.44	1.45	1.58	1.58
18	****	1.74	1.76	1.78	1.70	1.70	1.72	1.67	1.58	1.54	1.49	1.51	1.49	1.49	1.47	1.45	1.44	1.56	1.63	
19	1.71	1.73	1.80	1.77	1.70	1.73	1.79	1.68	1.68	1.54	1.49	1.51	1.34	1.50	1.48	1.44	1.42	1.52	1.64	
20	1.69	1.73	1.80	1.80	1.74	1.79	1.76	1.66	1.75	1.58	1.50	1.50	1.49	1.49	1.49	1.45	1.43	1.53	****	
21	1.71	1.75	1.81	1.81	1.72	1.71	1.89	1.68	1.74	1.57	1.52	1.53	1.50	1.49	1.52	1.56	1.45	1.60	****	
22	1.80	1.75	1.82	1.78	1.79	1.69	1.86	1.88	1.69	1.57	1.53	1.52	1.51	1.49	1.49	1.50	1.46	1.59	****	
23	1.79	1.77	1.87	1.81	1.80	1.67	1.86	2.00	1.67	1.57	1.55	1.52	1.54	1.50	1.49	1.64	1.45	1.54	****	
24	1.77	1.79	1.81	1.81	1.72	1.64	1.84	2.06	1.66	1.58	1.57	1.52	1.53	1.49	1.50	1.54	1.45	1.54	****	

NAVAL COMMUNICATIONS CENTER, NORTHWEST
METHANE, CH4, (PPM)

HOUR EDT	AUGUST 1979																			
	13	14	15	16	17	18	19	20	21	22	23	24	25	26	27	28	29	30	31	
1	1.82	1.78	1.73	1.70	1.72	1.67	1.70	1.84	2.27	1.70	1.67	1.64	1.64	1.64	1.61	1.63	1.62	1.61	1.71	
2	1.81	1.73	1.75	1.73	1.77	1.67	1.72	1.89	2.52	1.70	1.66	1.67	1.65	1.66	1.62	1.61	1.62	1.65	1.72	
3	1.77	1.73	1.75	1.69	1.77	1.69	1.74	1.93	2.36	1.71	1.70	1.70	1.62	1.68	1.62	1.62	1.65	1.74	1.72	
4	1.76	1.82	1.74	1.69	1.79	1.71	1.75	1.94	2.09	1.68	1.71	1.53	1.65	1.71	1.63	1.62	1.66	1.74	1.73	
5	1.74	1.82	1.75	1.68	1.78	1.71	1.77	1.94	2.03	1.68	1.71	1.75	1.65	1.72	1.67	1.63	1.64	1.72	1.79	
6	1.72	1.81	1.74	1.67	1.78	1.75	1.79	2.23	1.95	1.73	1.69	1.73	1.67	1.73	1.69	1.63	1.72	1.68	1.86	
7	1.71	1.80	1.74	1.68	1.81	1.81	1.79	2.27	2.02	1.67	1.67	1.73	1.67	1.88	1.69	1.69	1.71	1.68	2.20	
8	1.71	1.78	1.75	1.69	1.78	1.77	1.80	2.22	2.00	1.67	1.67	1.78	1.67	1.74	1.69	1.70	1.72	1.73	2.20	
9	1.70	1.73	1.74	1.69	1.75	1.75	1.79	1.91	1.89	****	1.65	1.74	1.62	1.67	1.65	****	1.68	1.68	2.19	
10	1.69	1.70	1.74	1.70	1.74	1.74	1.78	1.75	1.75	****	1.61	1.66	1.59	1.62	1.62	****	1.60	1.62	2.07	
11	1.68	1.69	1.71	1.70	1.72	1.67	1.79	1.73	1.68	****	1.61	1.61	1.59	1.60	1.58	****	1.57	1.60	1.74	
12	1.67	****	1.71	****	****	1.65	1.77	1.71	1.67	****	1.61	1.62	1.59	1.59	1.60	****	1.57	1.60	1.65	
13	1.68	1.66	****	****	1.70	****	1.78	****	1.67	****	****	1.61	1.57	1.59	1.59	1.56	1.57	1.60	1.66	
14	1.67	1.66	1.73	1.67	1.69	****	****	1.71	****	1.63	1.61	1.61	1.58	****	1.60	1.56	1.56	1.61	1.62	
15	1.67	1.66	1.71	1.67	1.69	****	1.76	1.70	1.64	1.63	1.60	1.61	****	1.60	1.60	1.56	1.55	1.59	1.66	
16	1.67	1.63	1.68	1.67	1.69	****	1.75	1.67	1.62	1.62	1.61	1.61	1.60	1.61	1.57	1.55	1.59	1.65	1.65	
17	1.65	1.71	1.68	1.69	1.66	1.66	1.75	1.67	1.45	1.61	1.60	1.62	1.59	1.60	1.60	1.58	1.55	1.60	1.69	
18	****	1.71	1.68	1.70	1.65	1.65	1.73	1.71	1.61	1.61	1.60	1.62	1.55	1.60	1.63	1.58	1.55	1.62	1.72	
19	1.66	1.68	1.70	1.69	1.65	1.69	1.83	1.72	1.65	1.62	1.61	1.61	1.65	1.59	1.61	1.58	1.56	1.65	1.72	
20	1.64	1.68	1.72	1.72	1.68	1.84	1.81	1.71	1.72	1.63	1.61	1.61	1.61	1.61	1.61	1.59	1.57	1.67	****	
21	1.67	1.69	1.74	1.75	1.67	1.83	1.90	1.71	1.70	1.64	1.63	1.62	1.61	1.61	1.64	1.63	1.58	1.71	****	
22	1.72	1.70	1.75	1.72	1.73	1.75	1.88	1.89	1.68	1.65	1.63	1.63	1.62	1.60	1.63	1.61	1.58	1.68	****	
23	1.72	1.71	1.77	1.74	1.71	1.72	1.86	2.01	1.68	1.65	1.64	1.62	1.63	1.62	1.63	1.70	1.57	1.65	****	
24	1.75	1.73	1.70	1.75	1.69	1.70	1.85	2.06	1.67	1.66	1.63	1.62	1.63	1.61	1.63	1.65	1.57	1.67	****	

NONMETHANE HYDROCARBONS, NMHC, (PPM)

1	0.04	0.04	0.04	0.11	0.06	0.05	0.00	0.00	0.00	0.00	0.00	0.00	0.00	0.00	0.00	0.00	0.00	0.00	0.00
2	0.00	0.06	0.05	0.09	0.12	0.05	0.00	0.00	0.00	0.00	0.00	0.00	0.00	0.00	0.00	0.00	0.00	0.00	0.00
3	0.04	0.07	0.05	0.09	0.06	0.06	0.00	0.00	0.00	0.00	0.00	0.00	0.00	0.00	0.00	0.00	0.00	0.00	0.00
4	0.03	0.07	0.04	0.10	0.06	0.04	0.00	0.03	0.00	0.00	0.00	0.00	0.00	0.00	0.00	0.00	0.00	0.00	0.00
5	0.03	0.09	0.05	0.10	0.09	0.04	0.00	0.00	0.00	0.00	0.00	0.00	0.00	0.00	0.00	0.00	0.00	0.00	0.00
6	0.03	0.07	0.05	0.11	0.06	0.04	0.00	0.00	0.00	0.00	0.00	0.00	0.00	0.00	0.00	0.00	0.00	0.00	0.00
7	0.02	0.08	0.06	0.08	0.06	0.04	0.00	0.00	0.00	0.00	0.00	0.00	0.00	0.00	0.00	0.00	0.00	0.00	0.15
8	0.02	0.05	0.07	0.07	0.05	0.04	0.00	0.00	0.00	0.00	0.00	0.00	0.00	0.00	0.00	0.00	0.00	0.00	0.30
9	0.04	0.06	0.11	0.11	0.04	0.04	0.00	0.00	0.00	****	0.00	0.00	0.00	0.00	0.00	****	0.00	0.00	0.15
10	0.03	0.05	0.15	0.14	0.04	0.06	0.00	0.00	0.00	****	0.00	0.00	0.00	0.00	0.00	****	0.00	0.00	0.05
11	0.04	0.08	0.09	0.15	0.07	0.08	0.00	0.00	0.00	****	0.00	0.00	0.00	0.00	0.00	****	0.00	0.00	0.00
12	0.05	****	0.12	****	****	0.04	0.00	0.00	0.00	****	0.00	0.00	0.00	0.00	0.00	****	0.00	0.00	0.00
13	0.05	0.08	****	****	0.13	****	0.00	****	0.00	****	****	0.00	0.00	0.00	0.00	****	0.00	0.00	0.00
14	0.06	0.05	0.10	0.16	0.09	****	****	0.02	****	0.00	0.00	0.00	0.00	0.00	0.00	****	0.00	0.00	0.00
15	0.06	0.05	0.10	0.09	0.07	****	0.00	0.00	0.00	0.00	0.00	0.00	0.00	0.00	0.00	****	0.00	0.00	0.00
16	0.06	0.06	0.10	0.10	0.06	****	0.00	0.00	0.00	0.00	0.00	0.00	0.00	0.00	0.00	****	0.00	0.00	0.00
17	0.10	0.05	0.08	0.10	0.05	0.04	0.00	0.00	0.13	0.00	0.00	0.00	0.00	0.00	0.00	****	0.00	0.00	0.00
18	****	0.03	0.08	0.08	0.05	0.05	0.00	0.00	0.03	0.00	0.00	0.00	0.00	0.00	0.00	****	0.00	0.00	0.00
19	0.05	0.05	0.10	0.08	0.05	0.04	0.00	0.00	0.03	0.00	0.00	0.00	0.00	0.00	0.00	****	0.00	0.00	0.00
20	0.05	0.05	0.08	0.08	0.06	0.00	0.00	0.00	0.04	0.00	0.00	0.00	0.00	0.00	0.00	****	0.00	0.00	0.00
21	0.04	0.06	0.07	0.06	0.05	0.00	0.00	0.00	0.01	0.00	0.00	0.00	0.00	0.00	0.00	****	0.00	0.00	0.00
22	0.08	0.06	0.07	0.06	0.06	0.00	0.00	0.00	0.00	0.00	0.00	0.00	0.00	0.00	0.00	****	0.00	0.00	0.00
23	0.07	0.06	0.10	0.07	0.09	0.00	0.00	0.00	0.00	0.00	0.00	0.00	0.00	0.00	0.00	****	0.00	0.00	0.00
24	0.02	0.06	0.11	0.06	0.03	0.00	0.00	0.00	0.00	0.00	0.00	0.00	0.00	0.00	0.00	****	0.00	0.00	0.00

8-A

NAVAL COMMUNICATIONS CENTER, NORTHWEST
CARBON MONOXIDE, CO, (PPM)

HOUR EDT	AUGUST 1979																			
	13	14	15	16	17	18	19	20	21	22	23	24	25	26	27	28	29	30	31	
1	0.36	0.30	0.34	0.32	0.33	0.33	0.42	0.48	0.42	0.34	0.28	0.27	0.32	0.26	0.23	0.28	0.31	0.23	0.35	
2	0.33	0.29	0.36	0.33	0.32	0.33	0.36	0.47	0.41	0.32	0.28	0.29	0.30	0.26	0.26	0.29	0.28	0.23	0.33	
3	0.32	0.29	0.36	0.30	0.31	0.34	0.35	0.46	0.40	0.31	0.28	0.29	0.30	0.28	0.29	0.29	0.27	0.26	0.32	
4	0.32	0.41	0.36	0.29	0.31	0.31	0.34	0.46	0.39	0.30	0.28	0.28	0.29	0.46	0.25	0.33	0.26	0.75	0.32	
5	0.32	0.58	0.37	0.28	0.32	0.31	0.37	0.44	0.38	0.29	0.27	0.29	0.29	0.55	0.24	0.35	0.24	0.69	0.32	
6	0.30	0.55	0.35	0.27	0.33	0.30	0.37	0.44	0.36	0.31	0.27	0.29	0.43	0.61	0.24	0.33	0.24	0.42	0.41	
7	0.28	0.50	0.34	0.27	0.32	0.33	0.38	0.44	0.39	0.31	0.27	0.30	0.53	0.72	0.27	0.41	0.27	0.38	0.61	
8	0.28	0.50	0.35	0.28	0.33	0.39	0.40	0.50	0.43	0.32	0.29	0.37	0.47	0.68	0.31	0.36	0.30	0.39	0.78	
9	0.28	0.35	0.41	0.33	0.35	0.39	0.41	0.51	0.39	****	0.29	0.48	0.31	0.38	0.34	****	0.43	0.38	0.64	
10	0.28	0.30	0.46	0.37	0.33	0.40	0.42	0.39	0.34	****	0.25	0.37	0.25	0.28	0.35	****	0.26	0.32	0.57	
11	0.27	0.29	0.38	0.37	0.34	0.37	0.43	0.36	0.33	****	0.27	0.30	0.24	0.24	0.27	****	0.22	0.30	0.43	
12	0.25	****	0.37	****	****	0.34	0.43	0.38	0.31	****	0.27	0.30	0.23	0.25	0.26	****	0.22	0.27	0.41	
13	0.25	0.29	****	****	0.36	****	0.44	****	0.32	****	****	0.30	0.23	0.26	0.26	0.26	0.21	0.28	0.41	
14	0.25	0.30	0.37	0.33	0.36	****	****	0.37	****	0.29	0.26	0.29	0.23	****	0.24	0.27	0.20	0.29	0.40	
15	0.25	0.31	0.36	0.30	0.35	****	0.44	0.34	0.31	0.28	0.26	0.30	****	0.24	0.23	0.22	0.20	0.28	0.42	
16	0.24	0.29	0.34	0.31	0.32	****	0.44	0.33	0.29	0.29	0.27	0.29	0.27	0.23	0.24	0.22	0.19	0.28	0.39	
17	0.23	0.33	0.34	0.33	0.29	0.36	0.45	0.33	0.29	0.29	0.27	0.30	0.25	0.23	0.27	0.23	0.20	0.28	0.41	
18	****	0.33	0.34	0.34	0.28	0.33	0.45	0.34	0.28	0.28	0.27	0.29	0.25	0.23	0.47	0.24	0.20	0.31	0.43	
19	0.24	0.32	0.38	0.33	0.28	0.35	0.48	0.37	0.39	0.27	0.27	0.29	0.26	0.25	0.29	0.22	0.21	0.30	0.44	
20	0.23	0.34	0.39	0.33	0.29	0.40	0.48	0.39	0.48	0.29	0.26	0.28	0.27	0.23	0.26	0.23	0.22	0.31	****	
21	0.27	0.33	0.36	0.33	0.30	0.37	0.51	0.40	0.44	0.28	0.28	0.32	0.27	0.23	0.38	0.61	0.24	0.33	****	
22	0.30	0.32	0.35	0.33	0.39	0.37	0.48	0.42	0.40	0.28	0.28	0.34	0.28	0.24	0.27	0.35	0.23	0.31	****	
23	0.30	0.34	0.36	0.33	0.34	0.37	0.55	0.50	0.38	0.29	0.30	0.31	0.31	0.27	0.24	0.68	0.25	0.33	****	
24	0.30	0.34	0.34	0.32	0.32	0.36	0.52	0.46	0.34	0.28	0.29	0.25	0.28	0.26	0.24	0.52	0.22	0.36	****	

WIND SPEED, (MPH)

1	9.3	0.0	0.0	4.1	0.0	0.0	11.1	0.0	0.0	8.6	2.8	2.5	3.1	4.3	4.0	5.8	3.5	0.0	0.0
2	8.9	0.0	2.0	3.9	0.0	0.0	9.1	0.0	0.0	7.4	2.6	0.0	3.2	0.0	0.0	3.6	4.7	0.0	0.0
3	6.8	0.0	0.0	6.3	0.0	0.0	4.7	1.3	0.0	9.9	4.5	0.0	5.4	0.0	4.7	0.0	3.6	1.2	0.0
4	8.8	0.0	6.9	6.4	0.0	0.0	5.2	0.0	0.0	6.4	3.3	0.0	2.9	1.2	3.0	2.4	3.7	0.0	0.0
5	15.3	0.0	5.1	5.2	1.8	0.0	9.0	0.0	0.0	8.5	0.0	0.0	3.0	0.0	0.0	2.2	0.0	0.0	0.0
6	9.2	0.0	5.2	6.2	3.8	0.0	6.9	1.2	0.0	5.0	5.3	0.0	3.1	0.0	0.0	0.0	0.0	0.0	0.0
7	7.8	0.0	5.6	5.2	2.4	0.0	8.6	0.0	0.0	6.6	5.6	0.0	0.0	0.0	0.0	1.3	0.0	1.7	0.0
8	9.7	3.1	4.3	6.4	3.1	0.0	3.8	0.0	1.2	8.3	5.8	0.0	1.8	0.0	0.0	3.5	0.0	1.6	1.8
9	11.5	8.6	5.5	7.9	7.9	0.0	6.1	0.0	2.4	12.4	6.4	3.0	7.4	4.0	6.8	****	3.6	5.3	5.2
10	11.3	13.4	6.4	10.8	6.9	3.2	7.9	2.2	3.2	12.1	11.5	2.4	10.0	7.5	12.1	****	5.4	4.7	5.8
11	13.7	15.3	11.9	10.9	5.5	7.3	8.1	2.0	8.4	12.6	10.9	5.1	9.6	8.3	12.2	****	9.4	2.6	6.7
12	12.4	8.1	13.4	11.1	4.6	8.5	7.4	0.0	4.3	10.0	14.4	9.4	9.9	4.1	9.7	4.0	8.1	0.0	6.8
13	13.9	10.3	8.1	8.5	6.8	13.0	8.9	2.0	7.0	13.0	12.3	9.1	****	4.3	13.1	2.1	7.4	1.8	10.5
14	7.9	16.1	6.4	10.1	5.2	11.7	3.0	1.2	7.0	10.5	12.0	6.3	11.2	6.2	11.4	9.0	6.7	1.4	10.7
15	8.2	17.7	8.5	9.0	9.0	10.5	1.4	3.3	6.8	11.4	12.7	8.2	10.4	7.7	11.5	10.2	8.4	5.1	13.1
16	9.2	18.1	5.4	8.9	6.4	5.1	4.0	5.3	7.8	9.0	11.2	9.8	9.8	11.2	15.0	10.0	7.3	2.9	13.1
17	7.3	15.7	10.7	10.0	7.5	7.8	3.6	2.6	7.7	16.5	11.9	9.0	10.5	10.8	14.2	15.9	8.8	0.0	8.4
18	7.6	14.9	7.4	5.6	8.2	10.9	0.0	5.6	12.2	16.1	11.9	10.7	12.4	11.7	10.9	13.7	9.2	7.0	6.7
19	5.8	8.6	7.6	4.7	6.4	9.7	2.9	0.0	3.8	14.0	9.0	9.3	12.2	8.8	7.6	12.4	6.9	7.3	1.6
20	0.0	0.0	4.0	3.1	2.4	6.7	1.4	1.5	2.4	12.3	7.0	9.0	6.9	7.8	6.9	4.4	6.3	7.0	****
21	0.0	0.0	22.3	0.0	0.0	6.1	3.9	0.0	4.5	7.1	3.5	5.3	6.9	4.1	5.1	7.6	3.7	1.6	****
22	0.0	0.0	5.0	0.0	0.0	8.3	1.2	0.0	4.3	5.9	2.5	5.4	6.0	3.3	5.3	1.4	1.2	0.0	****
23	0.0	0.0	5.3	0.0	0.0	6.9	0.0	0.0	6.7	4.7	3.0	5.9	6.9	3.8	5.0	0.0	0.0	0.0	****
24	0.0	0.0	6.6	0.0	0.0	9.4	0.0	0.0	7.8	4.3	2.3	3.8	5.6	6.9	1.3	0.0	2.1	0.0	****

NAVAL COMMUNICATIONS CENTER, NORTHWEST
WIND DIRECTION, (DEG)

HOUR EDT	AUGUST 1979																		
	13	14	15	16	17	18	19	20	21	22	23	24	25	26	27	28	29	30	31
1	310	0	0	230	0	0	190	0	0	280	70	0	190	160	190	150	170	0	0
2	250	0	230	260	0	0	200	0	0	240	20	0	190	0	0	190	160	0	0
3	280	0	0	280	0	0	240	230	0	190	30	0	170	0	170	0	150	270	0
4	280	0	230	270	0	0	240	0	0	60	40	0	200	0	160	160	140	0	0
5	280	0	260	230	260	0	220	0	0	120	30	0	190	0	0	170	0	0	0
6	290	0	270	290	260	0	200	160	0	200	40	0	200	0	0	0	0	0	0
7	280	0	280	280	260	0	200	0	0	20	50	0	0	0	0	0	0	270	0
8	270	190	270	280	270	0	210	0	110	20	50	0	220	0	0	160	0	230	70
9	270	210	200	250	300	0	220	0	90	30	60	210	190	240	190	***	160	250	30
10	200	220	360	150	300	240	240	170	120	30	100	200	210	210	180	***	170	270	40
11	150	220	30	150	170	220	250	130	130	30	90	220	190	210	190	***	150	250	50
12	250	220	20	80	170	220	270	0	130	40	90	210	190	190	180	200	170	0	40
13	110	230	90	80	170	200	240	90	190	50	100	100	***	150	190	210	160	210	60
14	200	210	80	30	80	220	140	120	210	40	100	150	190	150	180	140	130	230	60
15	100	220	30	30	110	200	160	110	220	50	100	150	180	130	180	120	140	230	80
16	160	230	100	100	100	180	90	180	220	50	100	170	170	160	170	160	170	230	80
17	170	240	120	50	100	170	90	100	140	70	100	150	160	160	170	180	150	0	90
18	220	230	110	60	100	150	0	80	110	70	120	150	150	160	190	180	110	160	100
19	260	240	50	50	110	140	50	0	80	70	100	150	150	160	180	180	120	60	80
20	0	0	60	60	130	150	90	100	150	60	110	150	140	160	180	170	110	190	***
21	0	0	60	0	0	140	60	0	230	50	100	190	150	150	190	190	110	110	***
22	0	0	40	0	0	160	100	0	260	40	100	180	150	170	170	150	170	0	***
23	0	0	20	0	0	170	0	0	260	30	100	170	140	180	180	0	0	0	***
24	0	0	60	0	0	190	0	0	270	50	80	150	160	190	160	0	140	0	***

TEMPERATURE, (DEG C)

1	22.0	27.8	27.6	27.2	26.5	25.8	24.5	26.3	29.0	27.9	24.6	23.5	27.2	25.6	****	****	****	26.7	26.0
2	21.7	27.8	27.6	27.0	26.6	25.8	24.0	26.2	29.0	27.9	24.4	24.0	27.2	25.6	****	****	****	26.7	26.0
3	21.8	27.8	27.5	27.0	26.8	26.0	24.5	26.0	29.0	28.0	24.8	24.4	27.2	25.0	****	****	****	26.7	26.0
4	21.8	27.6	27.5	27.0	26.8	26.0	24.5	26.0	29.0	27.9	24.5	24.5	27.1	24.7	****	****	****	26.7	26.0
5	22.0	27.6	27.5	27.0	26.8	26.0	24.4	26.0	29.2	28.0	24.5	24.5	27.0	24.4	****	****	****	26.6	26.0
6	21.8	27.6	27.3	27.0	26.8	26.0	24.4	26.0	29.7	28.0	24.5	24.0	27.0	24.2	****	****	****	26.6	26.0
7	21.9	27.6	27.3	27.0	26.8	26.4	24.2	26.0	29.7	27.9	24.6	24.0	27.0	24.3	****	****	****	26.6	26.0
8	21.8	28.0	27.4	27.0	26.9	26.2	24.0	26.0	29.3	28.0	24.6	24.0	27.0	24.0	****	****	****	25.0	26.5
9	22.0	28.2	27.5	27.4	27.4	25.4	24.4	26.2	29.1	28.0	24.5	23.6	27.3	24.9	****	****	****	24.3	26.7
10	22.0	28.6	27.6	27.6	27.7	25.0	24.1	27.0	29.3	28.3	24.2	25.5	28.1	26.2	****	****	****	25.0	26.0
11	22.0	28.9	28.0	28.0	27.4	26.4	23.8	27.5	29.7	27.0	24.5	26.4	28.3	26.5	25.3	24.5	****	26.4	25.0
12	22.0	27.4	25.0	24.5	24.6	26.0	24.5	27.4	28.5	24.6	25.0	26.5	28.0	26.8	25.3	26.3	****	26.5	25.0
13	21.4	28.0	24.0	24.2	24.0	25.8	24.0	26.2	24.6	25.0	25.8	27.5	28.6	27.0	25.2	****	26.0	26.8	25.9
14	21.8	26.0	23.4	24.5	23.9	25.2	24.1	25.6	25.0	25.5	26.0	27.5	27.5	27.0	25.0	****	25.8	27.0	26.5
15	22.0	25.0	24.0	24.5	23.2	25.0	24.8	25.5	25.6	25.5	26.0	27.5	26.9	27.0	****	****	25.8	27.2	27.5
16	22.0	26.0	23.8	24.5	24.0	25.1	25.4	27.0	30.0	25.0	26.0	27.5	26.7	27.0	****	****	25.0	27.5	27.6
17	25.2	28.4	26.3	24.5	24.0	25.0	27.2	28.5	28.9	24.3	26.6	27.5	26.3	****	****	****	26.8	27.5	28.0
18	25.4	28.6	28.0	****	24.0	25.4	26.6	29.0	28.5	23.8	27.2	27.5	26.3	****	****	****	27.1	27.0	28.4
19	25.4	28.6	28.0	23.5	24.5	24.5	27.0	29.0	28.3	23.4	27.0	27.5	26.5	****	****	****	27.4	27.0	28.4
20	27.8	28.8	28.0	24.0	24.4	23.8	27.7	29.0	28.2	24.0	26.2	28.4	26.5	****	****	****	27.8	27.4	****
21	28.0	28.3	27.6	24.8	25.0	24.0	26.8	29.0	28.0	24.0	25.2	28.0	26.3	****	****	****	27.0	27.6	****
22	28.0	28.0	27.4	25.0	25.5	24.5	26.6	29.0	28.0	24.2	24.5	27.4	26.0	****	****	****	26.9	26.9	****
23	27.8	27.8	27.0	25.0	25.5	24.2	26.5	29.0	28.0	24.2	24.0	27.4	25.9	****	****	****	26.8	26.0	****
24	27.7	27.7	27.2	26.0	25.5	24.4	26.4	29.0	27.8	24.5	23.8	27.4	25.9	****	****	****	26.8	26.0	****

A-10

NAVAL COMMUNICATIONS CENTER, NORTHWEST
DEW POINT, (DEG C)

HOUR EDT	AUGUST 1979																			
	13	14	15	16	17	18	19	20	21	22	23	24	25	26	27	28	29	30	31	
1	15.7	14.2	17.6	10.0	11.7	13.8	19.0	20.0	19.4	19.3	20.6	22.0	22.0	22.6	****	****	****	****	****	
2	15.0	13.5	17.6	12.3	11.0	13.0	18.7	19.5	19.6	19.1	20.6	21.0	22.4	22.2	****	****	****	****	****	
3	14.7	13.2	17.5	11.3	10.0	13.0	18.6	19.0	19.4	18.9	20.5	21.0	22.2	22.0	****	****	****	****	****	
4	14.9	13.4	17.3	11.2	10.0	13.4	18.8	18.4	19.8	18.4	20.5	20.0	21.9	21.8	****	****	****	****	****	
5	14.7	13.5	17.0	11.3	10.0	13.0	18.5	18.4	20.3	18.6	20.0	20.5	21.9	21.8	****	****	****	****	****	
6	14.4	13.5	16.8	11.3	11.0	12.5	19.0	18.0	20.8	19.1	20.5	21.5	21.6	21.3	****	****	****	****	****	
7	14.5	13.5	16.8	11.3	11.0	13.5	18.7	17.8	20.8	19.9	20.8	21.0	21.5	20.9	****	****	****	****	****	
8	14.4	15.6	17.0	11.0	12.9	14.4	19.0	18.8	21.0	19.8	21.3	21.5	22.2	21.8	****	****	****	****	****	
9	14.4	17.2	16.8	12.5	15.5	14.5	19.0	21.8	22.4	20.0	22.0	22.5	23.5	24.0	****	****	****	****	****	
10	14.4	15.8	17.0	12.6	15.8	14.0	19.0	22.7	23.5	20.2	21.8	23.5	23.5	24.6	****	****	****	****	****	
11	13.9	14.9	15.0	12.5	14.4	13.8	19.2	20.4	24.8	20.2	21.5	24.0	22.4	22.6	22.8	22.2	****	****	****	
12	13.7	15.0	14.5	11.0	12.2	14.0	19.3	20.5	24.2	20.5	****	22.0	21.5	21.9	22.4	22.0	****	****	****	
13	11.6	16.6	14.0	10.4	11.0	12.5	19.5	19.5	21.0	20.6	21.8	22.0	21.3	21.5	22.0	****	****	****	****	
14	11.5	17.0	14.0	10.6	11.5	12.4	19.5	20.0	20.0	20.7	22.0	21.5	21.2	21.3	22.1	****	****	****	****	
15	11.5	17.2	12.8	11.5	12.4	13.6	20.5	20.5	21.5	20.6	22.0	22.0	20.5	22.0	****	****	****	****	****	
16	11.5	16.8	11.8	11.2	12.0	15.0	21.0	21.0	21.4	21.8	22.9	21.0	21.3	22.0	****	****	****	****	****	
17	12.0	15.6	14.0	11.5	11.0	15.0	21.0	22.5	21.6	21.3	22.5	22.0	21.8	****	****	****	****	****	****	
18	12.0	14.5	13.5	****	10.5	15.0	21.6	22.0	20.5	20.4	22.5	22.0	21.8	****	****	****	****	****	****	
19	12.5	15.6	14.4	12.7	10.0	16.0	21.9	22.6	20.8	20.4	22.6	23.0	22.6	****	****	****	****	****	****	
20	14.0	19.0	15.0	13.0	11.2	16.3	22.3	22.4	20.4	20.4	22.4	22.5	23.0	****	****	****	****	****	****	
21	15.0	19.0	15.2	13.7	12.2	16.5	21.4	21.6	20.0	20.0	22.0	22.5	23.0	****	****	****	****	****	****	
22	14.5	18.4	14.6	13.5	13.0	17.2	20.8	21.0	19.4	20.2	22.0	22.0	22.9	****	****	****	****	****	****	
23	14.4	18.4	13.5	12.4	13.5	18.2	20.8	19.5	19.5	20.5	22.0	22.5	22.0	****	****	****	****	****	****	
24	14.4	17.9	11.0	12.0	13.9	19.0	20.2	19.8	19.3	20.5	22.0	22.0	22.6	****	****	****	****	****	****	

SOLAR RADIATION, (LANGLEYS/MIN)

1	0.00	0.00	0.00	0.00	0.00	0.00	0.00	0.00	0.00	0.00	0.00	0.00	0.00	0.00	0.00	0.00	0.00	0.00	0.00
2	0.00	0.00	0.00	0.00	0.00	0.00	0.00	0.00	0.00	0.00	0.00	0.00	0.00	0.00	0.00	0.00	0.00	0.00	0.00
3	0.00	0.00	0.00	0.00	0.00	0.00	0.00	0.00	0.00	0.00	0.00	0.00	0.00	0.00	0.00	0.00	0.00	0.00	0.00
4	0.00	0.00	0.00	0.00	0.00	0.00	0.00	0.00	0.00	0.00	0.00	0.00	0.00	0.00	0.00	0.00	0.00	0.00	0.00
5	0.00	0.00	0.00	0.00	0.00	0.00	0.00	0.00	0.00	0.00	0.00	0.00	0.00	0.00	0.00	0.00	0.00	0.00	0.00
6	0.00	0.00	0.00	0.00	0.00	0.00	0.00	0.00	0.00	0.00	0.00	0.00	0.00	0.00	0.00	0.00	0.00	0.00	0.00
7	0.01	0.01	0.00	0.01	0.01	0.00	0.00	0.00	0.00	0.00	0.00	0.00	0.00	0.00	0.00	0.00	0.00	0.00	0.00
8	0.06	0.18	0.12	0.20	0.19	0.05	0.11	0.11	0.06	0.06	0.11	0.09	0.14	0.12	0.14	0.13	0.13	0.11	0.08
9	0.32	0.44	0.21	0.46	0.40	0.33	0.19	0.35	0.22	0.13	0.20	0.33	0.34	0.38	0.40	****	0.41	0.35	0.30
10	0.61	0.69	0.46	0.58	0.71	0.32	0.28	0.57	0.36	0.27	0.56	0.62	0.66	0.69	0.71	****	0.68	0.60	0.54
11	0.73	0.91	0.48	0.67	0.92	0.71	0.43	0.80	0.83	0.27	0.66	0.67	0.94	0.71	0.77	****	0.95	0.81	0.68
12	1.11	1.06	0.68	0.90	0.64	0.97	0.70	0.51	0.78	0.26	0.93	0.74	1.13	0.94	0.74	0.53	1.05	0.98	0.63
13	1.25	1.14	0.71	0.97	0.76	0.78	0.91	0.45	0.73	0.55	0.85	0.84	****	1.12	0.86	0.86	1.07	1.05	0.64
14	1.14	1.20	0.97	1.15	0.84	0.72	0.73	0.45	0.79	0.41	0.98	0.75	0.87	1.17	0.83	0.62	0.98	0.86	0.88
15	1.17	1.00	1.00	1.02	1.22	0.42	0.78	0.72	0.80	0.38	0.28	0.72	0.75	1.09	0.71	0.62	1.17	0.55	0.82
16	0.82	0.69	1.00	0.62	0.63	0.24	0.66	0.14	0.72	0.26	0.51	0.86	0.79	0.74	0.96	0.35	0.92	0.66	0.42
17	0.71	0.78	0.70	0.72	0.42	0.40	0.67	0.30	0.28	0.48	0.69	0.52	0.70	0.71	0.58	0.30	0.66	0.69	0.13
18	0.36	0.36	0.35	0.25	0.66	0.31	0.40	0.03	0.03	0.27	0.32	0.37	0.41	0.45	0.14	0.17	0.41	0.44	0.13
19	0.31	0.27	0.24	0.11	0.21	0.19	0.18	0.09	0.05	0.20	0.17	0.14	0.18	0.18	0.16	0.11	0.14	0.11	0.09
20	0.06	0.06	0.05	0.03	0.05	0.04	0.02	0.04	0.02	0.03	0.02	0.02	0.02	0.02	0.02	0.02	0.02	0.05	****
21	0.00	0.00	0.00	0.00	0.00	0.00	0.00	0.00	0.00	0.00	0.00	0.00	0.00	0.00	0.00	0.00	0.00	0.00	****
22	0.00	0.00	0.00	0.00	0.00	0.00	0.00	0.00	0.00	0.00	0.00	0.00	0.00	0.00	0.00	0.00	0.00	0.00	****
23	0.00	0.00	0.00	0.00	0.00	0.00	0.00	0.00	0.00	0.00	0.00	0.00	0.00	0.00	0.00	0.00	0.00	0.00	****
24	0.00	0.00	0.00	0.00	0.00	0.00	0.00	0.00	0.00	0.00	0.00	0.00	0.00	0.00	0.00	0.00	0.00	0.00	****

A-11

INNER NORFOLK, NAVAL AIR STATION
OZONE, O3, (PPB)

HOUR EDT	AUGUST 1979																		
	13	14	15	16	17	18	19	20	21	22	23	24	25	26	27	28	29	30	31
1	****	0.0	45.0	24.0	0.0	15.0	20.0	3.0	10.0	38.0	26.0	4.0	****	****	0.0	0.0	0.0	0.0	0.0
2	****	2.0	48.0	22.0	0.0	21.0	25.0	0.0	34.0	39.0	25.0	4.0	****	****	4.0	0.0	0.0	0.0	0.0
3	****	3.0	40.0	16.0	0.0	28.0	22.0	5.0	33.0	37.0	24.0	3.0	****	****	3.0	0.0	3.0	0.0	0.0
4	****	15.0	42.0	15.0	0.0	31.0	31.0	0.0	35.0	36.0	24.0	15.0	****	****	3.0	0.0	3.0	0.0	0.0
5	****	22.0	35.0	13.0	0.0	26.0	45.0	0.0	25.0	37.0	27.0	12.0	****	****	1.0	0.0	2.0	0.0	0.0
6	****	21.0	36.0	13.0	20.0	33.0	43.0	0.0	14.0	34.0	22.0	4.0	****	****	0.0	2.0	0.0	0.0	13.0
7	****	14.0	34.0	****	8.0	30.0	30.0	0.0	0.0	27.0	9.0	0.0	****	****	0.0	0.0	0.0	0.0	9.0
8	****	8.0	30.0	****	4.0	22.0	22.0	0.0	0.0	20.0	10.0	0.0	****	****	0.0	0.0	0.0	0.0	****
9	****	15.0	29.0	13.0	****	25.0	25.0	8.0	6.0	22.0	17.0	5.0	****	****	0.0	0.0	7.0	5.0	20.0
10	****	39.0	33.0	15.0	33.0	****	29.0	42.0	27.0	23.0	****	17.0	****	****	5.0	9.0	14.0	24.0	24.0
11	****	53.0	30.0	21.0	45.0	39.0	36.0	****	43.0	21.0	26.0	24.0	****	****	****	15.0	****	****	40.0
12	****	54.0	40.0	26.0	48.0	44.0	40.0	56.0	****	****	28.0	****	****	****	13.0	****	23.0	62.0	59.0
13	34.0	62.0	45.0	32.0	48.0	46.0	41.0	75.0	53.0	27.0	29.0	****	****	****	35.0	15.0	27.0	27.0	72.0
14	42.0	62.0	46.0	34.0	50.0	44.0	58.0	65.0	48.0	29.0	30.0	****	****	****	32.0	6.0	35.0	26.0	79.0
15	45.0	63.0	50.0	37.0	49.0	47.0	72.0	99.0	46.0	27.0	24.0	****	****	****	30.0	5.0	15.0	17.0	84.0
16	43.0	62.0	46.0	38.0	48.0	45.0	67.0	72.0	45.0	27.0	23.0	****	****	****	24.0	0.0	0.0	14.0	80.0
17	****	59.0	48.0	39.0	50.0	45.0	70.0	40.0	46.0	24.0	20.0	****	****	****	17.0	0.0	0.0	8.0	88.0
18	****	55.0	49.0	40.0	45.0	46.0	76.0	21.0	45.0	23.0	20.0	****	****	****	18.0	7.0	2.0	3.0	82.0
19	34.0	49.0	44.0	40.0	38.0	43.0	62.0	46.0	39.0	23.0	13.0	****	****	****	17.0	9.0	5.0	0.0	73.0
20	29.0	42.0	44.0	39.0	19.0	36.0	35.0	26.0	34.0	22.0	4.0	****	****	****	13.0	4.0	0.0	0.0	64.0
21	20.0	23.0	44.0	32.0	0.0	33.0	0.0	0.0	39.0	21.0	0.0	****	****	****	6.0	0.0	0.0	0.0	60.0
22	0.0	6.0	42.0	20.0	0.0	30.0	0.0	0.0	36.0	20.0	0.0	****	****	****	6.0	2.0	4.0	1.0	66.0
23	0.0	14.0	34.0	37.0	5.0	24.0	0.0	0.0	36.0	19.0	0.0	****	****	****	3.0	3.0	0.0	0.0	75.0
24	0.0	17.0	26.0	14.0	6.0	24.0	0.0	0.0	37.0	23.0	0.0	****	****	****	0.0	0.0	0.0	0.0	78.0

SULFUR DIOXIDE, SO2, (PPB)

1	****	23.0	13.0	1.0	0.0	0.0	5.0	3.0	2.0	0.0	0.0	0.0	32.0	****	23.0	15.0	13.0	0.0	0.0
2	****	21.0	11.0	0.0	4.0	0.0	7.0	1.0	1.0	0.0	0.0	0.0	25.0	****	7.0	15.0	11.0	0.0	0.0
3	****	19.0	11.0	0.0	7.0	0.0	4.0	0.0	0.0	0.0	0.0	0.0	9.0	****	7.0	22.0	1.0	0.0	0.0
4	****	20.0	11.0	0.0	0.0	0.0	7.0	5.0	2.0	0.0	0.0	0.0	3.0	****	5.0	25.0	1.0	0.0	0.0
5	****	5.0	13.0	0.0	0.0	3.0	5.0	0.0	8.0	0.0	0.0	0.0	3.0	****	11.0	14.0	1.0	0.0	7.0
6	****	3.0	6.0	0.0	1.0	7.0	11.0	0.0	7.0	0.0	1.0	0.0	3.0	****	13.0	0.0	0.0	0.0	0.0
7	****	3.0	2.0	0.0	7.0	3.0	13.0	7.0	2.0	0.0	2.0	0.0	3.0	****	7.0	0.0	8.0	0.0	4.0
8	****	4.0	6.0	6.0	4.0	1.0	11.0	11.0	0.0	2.0	6.0	3.0	****	****	3.0	10.0	12.0	0.0	****
9	****	0.0	0.0	4.0	19.0	0.0	10.0	12.0	0.0	0.0	0.0	7.0	****	****	3.0	14.0	7.0	0.0	5.0
10	****	****	0.0	2.0	****	0.0	1.0	16.0	0.0	0.0	0.0	3.0	****	****	3.0	5.0	5.0	0.0	2.0
11	****	9.0	11.0	5.0	****	****	9.0	****	0.0	0.0	****	4.0	****	****	1.0	7.0	13.0	****	5.0
12	****	****	4.0	4.0	****	6.0	10.0	15.0	0.0	****	1.0	****	****	****	****	****	****	1.0	7.0
13	****	11.0	****	1.0	****	3.0	****	12.0	****	0.0	0.0	3.0	****	****	5.0	0.0	4.0	0.0	7.0
14	****	4.0	9.0	0.0	****	2.0	14.0	10.0	0.0	0.0	0.0	3.0	****	****	5.0	5.0	0.0	5.0	0.0
15	****	11.0	5.0	1.0	0.0	3.0	11.0	7.0	0.0	0.0	0.0	1.0	****	****	6.0	5.0	0.0	5.0	0.0
16	****	9.0	4.0	5.0	0.0	0.0	9.0	1.0	0.0	0.0	0.0	0.0	****	****	3.0	5.0	0.0	0.0	7.0
17	****	4.0	2.0	****	0.0	3.0	13.0	0.0	0.0	0.0	0.0	0.0	****	****	0.0	5.0	0.0	0.0	5.0
18	****	4.0	2.0	****	0.0	7.0	12.0	0.0	0.0	1.0	0.0	0.0	****	****	0.0	5.0	0.0	0.0	5.0
19	****	4.0	0.0	0.0	0.0	3.0	10.0	0.0	0.0	0.0	0.0	0.0	****	****	0.0	7.0	0.0	0.0	5.0
20	****	3.0	0.0	0.0	0.0	0.0	2.0	0.0	0.0	0.0	0.0	0.0	****	****	0.0	9.0	0.0	0.0	5.0
21	****	4.0	0.0	0.0	1.0	0.0	9.0	0.0	0.0	0.0	0.0	0.0	****	****	0.0	10.0	1.0	0.0	0.0
22	****	9.0	0.0	0.0	0.0	0.0	8.0	0.0	0.0	0.0	0.0	0.0	****	****	0.0	7.0	0.0	0.0	0.0
23	****	15.0	0.0	0.0	0.0	14.0	7.0	0.0	0.0	0.0	0.0	11.0	****	****	0.0	13.0	14.0	0.0	0.0
24	****	21.0	0.0	0.0	0.0	8.0	7.0	0.0	1.0	0.0	0.0	10.0	****	****	26.0	14.0	24.0	0.0	0.0

INNER NORFOLK, NAVAL AIR STATION
OXIDES OF NITROGEN, NOX, (PPB)

HOUR EDT	AUGUST 1979																			
	13	14	15	16	17	18	19	20	21	22	23	24	25	26	27	28	29	30	31	
1	0.0	57.0	9.0	0.0	145.0	53.0	5.0	48.0	27.0	2.0	3.0	20.0	24.0	14.0	15.0	17.0	12.0	38.0	54.0	
2	0.0	28.0	4.0	0.0	115.0	47.0	10.0	53.0	5.0	0.0	2.0	27.0	17.0	3.0	4.0	12.0	12.0	19.0	104.0	
3	0.0	30.0	0.0	0.0	58.0	28.0	10.0	27.0	8.0	0.0	1.0	20.0	4.0	2.0	5.0	11.0	4.0	13.0	145.0	
4	0.0	9.0	0.0	0.0	61.0	25.0	8.0	33.0	3.0	0.0	0.0	0.0	4.0	3.0	1.0	3.0	16.0	2.0	11.0	44.0
5	0.0	3.0	0.0	0.0	46.0	25.0	4.0	41.0	10.0	0.0	1.0	5.0	2.0	3.0	5.0	6.0	4.0	9.0	24.0	
6	0.0	5.0	0.0	0.0	24.0	18.0	5.0	95.0	27.0	4.0	6.0	22.0	1.0	4.0	4.0	2.0	9.0	13.0	4.0	
7	0.0	22.0	0.0	0.0	38.0	23.0	10.0	178.0	69.0	11.0	34.0	50.0	7.0	10.0	10.0	27.0	57.0	40.0	5.0	
8	7.0	28.0	0.0	4.0	47.0	31.0	12.0	131.0	116.0	18.0	33.0	51.0	11.0	12.0	19.0	73.0	54.0	67.0	16.0	
9	7.0	25.0	0.0	0.0	47.0	31.0	6.0	86.0	80.0	14.0	20.0	28.0	7.0	6.0	19.0	35.0	30.0	30.0	12.0	
10	6.0	7.0	0.0	0.0	21.0	24.0	6.0	58.0	39.0	15.0	***	13.0	7.0	4.0	9.0	13.0	17.0	14.0	6.0	
11	3.0	3.0	****	0.0	7.0	16.0	****	37.0	15.0	13.0	23.0	11.0	****	3.0	****	9.0	****	10.0	9.0	
12	****	3.0	****	0.0	7.0	****	****	****	****	13.0	15.0	11.0	3.0	3.0	6.0	6.0	12.0	****	****	
13	****	****	0.0	0.0	8.0	****	15.0	44.0	10.0	****	15.0	****	2.0	****	5.0	****	11.0	9.0	12.0	
14	****	20.0	1.0	0.0	8.0	13.0	11.0	18.0	7.0	9.0	17.0	11.0	2.0	11.0	10.0	8.0	10.0	5.0	13.0	
15	****	11.0	2.0	****	13.0	14.0	15.0	11.0	6.0	12.0	22.0	14.0	3.0	5.0	20.0	12.0	17.0	4.0	12.0	
16	0.0	10.0	7.0	****	18.0	15.0	16.0	12.0	10.0	14.0	32.0	19.0	3.0	6.0	45.0	42.0	19.0	3.0	13.0	
17	0.0	10.0	5.0	3.0	17.0	16.0	16.0	35.0	5.0	14.0	33.0	25.0	8.0	9.0	57.0	43.0	31.0	11.0	15.0	
18	2.0	9.0	0.0	1.0	23.0	17.0	14.0	46.0	0.0	11.0	34.0	36.0	9.0	8.0	29.0	25.0	37.0	22.0	15.0	
19	1.0	10.0	0.0	3.0	37.0	17.0	21.0	16.0	3.0	10.0	32.0	24.0	10.0	9.0	11.0	18.0	43.0	46.0	26.0	
20	18.0	17.0	0.0	2.0	66.0	21.0	54.0	38.0	4.0	10.0	42.0	21.0	11.0	14.0	12.0	20.0	64.0	64.0	29.0	
21	36.0	39.0	0.0	5.0	122.0	22.0	95.0	72.0	0.0	13.0	52.0	18.0	13.0	15.0	19.0	24.0	65.0	58.0	29.0	
22	41.0	46.0	0.0	16.0	70.0	18.0	154.0	46.0	0.0	13.0	45.0	16.0	14.0	11.0	9.0	11.0	27.0	39.0	27.0	
23	189.0	36.0	0.0	0.0	70.0	24.0	188.0	93.0	0.0	15.0	51.0	21.0	13.0	12.0	10.0	20.0	22.0	46.0	18.0	
24	192.0	23.0	0.0	34.0	64.0	16.0	72.0	65.0	0.0	9.0	61.0	22.0	20.0	22.0	12.0	19.0	34.0	41.0	13.0	

NITRIC OXIDE, NO, (PPB)

1	****	0.0	0.0	0.0	100.0	4.0	0.0	8.0	1.0	0.0	0.0	3.0	0.0	2.0	0.0	0.0	3.0	17.0	29.0
2	****	0.0	0.0	0.0	62.0	0.0	0.0	16.0	0.0	0.0	0.0	1.0	0.0	0.0	0.0	1.0	1.0	3.0	83.0
3	****	0.0	0.0	0.0	25.0	0.0	0.0	5.0	0.0	0.0	0.0	0.0	0.0	0.0	0.0	2.0	0.0	2.0	82.0
4	****	0.0	0.0	0.0	26.0	0.0	0.0	8.0	0.0	0.0	0.0	0.0	0.0	0.0	0.0	0.0	0.0	1.0	24.0
5	****	0.0	0.0	0.0	13.0	0.0	0.0	19.0	0.0	0.0	0.0	0.0	0.0	0.0	0.0	0.0	0.0	1.0	3.0
6	****	0.0	0.0	0.0	0.0	0.0	0.0	79.0	1.0	0.0	0.0	4.0	0.0	0.0	0.0	1.0	1.0	6.0	0.0
7	****	0.0	0.0	0.0	3.0	0.0	0.0	148.0	30.0	1.0	10.0	27.0	2.0	3.0	3.0	17.0	45.0	33.0	0.0
8	****	0.0	0.0	0.0	13.0	2.0	0.0	95.0	78.0	3.0	7.0	21.0	4.0	4.0	11.0	58.0	34.0	40.0	4.0
9	****	0.0	0.0	0.0	13.0	4.0	0.0	37.0	29.0	2.0	4.0	4.0	3.0	2.0	4.0	16.0	10.0	11.0	4.0
10	****	0.0	0.0	0.0	3.0	3.0	0.0	13.0	3.0	3.0	****	1.0	0.0	2.0	2.0	5.0	5.0	6.0	2.0
11	****	0.0	****	0.0	0.0	1.0	****	9.0	2.0	2.0	6.0	1.0	****	0.0	****	4.0	****	2.0	2.0
12	****	0.0	****	0.0	0.0	****	****	****	****	2.0	1.0	0.0	0.0	0.0	1.0	1.0	3.0	****	****
13	****	****	0.0	0.0	0.0	****	0.0	9.0	1.0	****	3.0	****	0.0	****	0.0	****	2.0	1.0	1.0
14	****	0.0	0.0	0.0	0.0	0.0	6.0	9.0	0.0	1.0	4.0	1.0	0.0	0.0	1.0	1.0	3.0	0.0	1.0
15	****	2.0	0.0	****	0.0	1.0	0.0	7.0	0.0	4.0	5.0	0.0	0.0	0.0	8.0	5.0	5.0	0.0	1.0
16	0.0	0.0	0.0	****	1.0	0.0	0.0	7.0	0.0	4.0	11.0	1.0	0.0	2.0	31.0	19.0	7.0	0.0	0.0
17	0.0	0.0	0.0	0.0	4.0	0.0	0.0	9.0	0.0	3.0	9.0	2.0	0.0	4.0	28.0	23.0	14.0	0.0	0.0
18	0.0	0.0	0.0	0.0	3.0	1.0	0.0	14.0	0.0	2.0	11.0	13.0	0.0	4.0	11.0	10.0	22.0	0.0	0.0
19	0.0	0.0	0.0	0.0	5.0	0.0	0.0	6.0	0.0	1.0	10.0	5.0	0.0	4.0	1.0	5.0	25.0	6.0	0.0
20	0.0	0.0	0.0	0.0	19.0	0.0	5.0	10.0	0.0	0.0	16.0	1.0	1.0	3.0	1.0	4.0	35.0	14.0	0.0
21	10.0	0.0	0.0	0.0	53.0	0.0	28.0	27.0	0.0	0.0	21.0	1.0	1.0	4.0	0.0	5.0	40.0	17.0	0.0
22	43.0	0.0	0.0	0.0	25.0	0.0	87.0	19.0	0.0	0.0	19.0	0.0	2.0	2.0	0.0	4.0	6.0	5.0	0.0
23	166.0	0.0	0.0	0.0	7.0	0.0	117.0	54.0	0.0	0.0	18.0	0.0	0.0	2.0	0.0	4.0	5.0	0.0	0.0
24	135.0	0.0	0.0	6.0	6.0	0.0	43.0	35.0	0.0	0.0	24.0	0.0	3.0	13.0	4.0	4.0	12.0	12.0	0.0

INNER NORFOLK, NAVAL AIR STATION
NITROGEN DIOXIDE, NO2, (PPB)

HOUR EDT	AUGUST 1979																		
	13	14	15	16	17	18	19	20	21	22	23	24	25	26	27	28	29	30	31
1	****	49.0	9.0	0.0	45.0	49.0	5.0	40.0	26.0	2.0	3.0	17.0	24.0	12.0	15.0	17.0	9.0	21.0	25.0
2	****	28.0	4.0	0.0	53.0	47.0	10.0	37.0	5.0	0.0	2.0	26.0	17.0	3.0	4.0	11.0	11.0	16.0	21.0
3	****	30.0	0.0	0.0	33.0	28.0	10.0	22.0	8.0	0.0	1.0	20.0	4.0	2.0	5.0	9.0	4.0	11.0	63.0
4	****	9.0	0.0	0.0	35.0	25.0	8.0	25.0	3.0	0.0	0.0	4.0	3.0	1.0	3.0	16.0	2.0	10.0	20.0
5	****	3.0	0.0	0.0	33.0	25.0	4.0	22.0	10.0	0.0	1.0	5.0	2.0	3.0	5.0	6.0	4.0	8.0	21.0
6	****	5.0	0.0	0.0	24.0	18.0	5.0	16.0	26.0	4.0	6.0	18.0	1.0	4.0	4.0	1.0	8.0	7.0	4.0
7	****	22.0	0.0	0.0	35.0	23.0	10.0	30.0	39.0	10.0	24.0	23.0	5.0	7.0	7.0	10.0	12.0	7.0	5.0
8	****	20.0	0.0	4.0	34.0	29.0	12.0	36.0	38.0	15.0	26.0	30.0	7.0	8.0	8.0	15.0	20.0	27.0	12.0
9	****	25.0	0.0	0.0	34.0	29.0	6.0	49.0	51.0	12.0	16.0	24.0	4.0	4.0	15.0	19.0	20.0	19.0	8.0
10	****	7.0	0.0	0.0	18.0	21.0	6.0	45.0	36.0	10.0	****	12.0	7.0	2.0	7.0	8.0	12.0	8.0	4.0
11	****	3.0	****	0.0	7.0	15.0	****	28.0	13.0	13.0	17.0	10.0	****	3.0	****	5.0	****	8.0	7.0
12	****	3.0	****	0.0	7.0	****	****	****	****	11.0	14.0	11.0	3.0	3.0	5.0	5.0	9.0	****	****
13	****	****	0.0	0.0	8.0	****	15.0	35.0	9.0	****	12.0	****	2.0	****	5.0	****	9.0	8.0	11.0
14	****	12.0	1.0	0.0	8.0	13.0	11.0	9.0	7.0	8.0	13.0	10.0	2.0	11.0	9.0	7.0	7.0	5.0	12.0
15	****	9.0	2.0	****	13.0	13.0	15.0	4.0	6.0	8.0	17.0	14.0	3.0	5.0	12.0	7.0	12.0	4.0	11.0
16	8.0	10.0	7.0	****	17.0	15.0	16.0	5.0	10.0	10.0	21.0	18.0	3.0	4.0	14.0	23.0	12.0	3.0	13.0
17	8.0	10.0	5.0	3.0	13.0	16.0	16.0	26.0	5.0	11.0	24.0	23.0	8.0	5.0	29.0	20.0	17.0	11.0	15.0
18	2.0	9.0	0.0	1.0	20.0	16.0	14.0	32.0	0.0	9.0	23.0	23.0	9.0	4.0	18.0	15.0	15.0	22.0	15.0
19	1.0	10.0	0.0	3.0	32.0	17.0	21.0	10.0	3.0	9.0	22.0	19.0	10.0	5.0	10.0	13.0	10.0	4.0	26.0
20	10.0	17.0	0.0	2.0	47.0	21.0	49.0	28.0	4.0	10.0	26.0	20.0	10.0	11.0	11.0	16.0	29.0	5.0	29.0
21	26.0	39.0	0.0	5.0	69.0	22.0	67.0	45.0	0.0	13.0	31.0	17.0	12.0	11.0	19.0	19.0	25.0	41.0	29.0
22	0.0	46.0	0.0	16.0	45.0	18.0	67.0	27.0	0.0	13.0	26.0	16.0	12.0	9.0	9.0	7.0	21.0	24.0	27.0
23	23.0	36.0	0.0	0.0	63.0	24.0	71.0	39.0	0.0	15.0	33.0	21.0	13.0	10.0	10.0	16.0	17.0	38.0	18.0
24	57.0	23.0	0.0	28.0	50.0	16.0	29.0	30.0	0.0	9.0	37.0	22.0	17.0	9.0	8.0	15.0	22.0	29.0	13.0

TOTAL HYDROCARBONS, THC, (PPM)

1	1.76	3.30	2.36	1.02	2.47	2.15	1.79	2.42	2.19	1.69	1.68	1.92	1.96	1.82	1.74	1.97	1.84	2.48	2.78
2	1.79	2.49	1.95	1.83	3.20	2.47	1.81	3.34	1.83	1.70	1.69	1.88	1.96	1.75	1.67	1.93	1.93	2.66	3.08
3	1.71	2.63	2.00	1.84	3.48	2.53	2.07	3.37	1.85	1.68	1.70	1.91	1.79	1.76	1.67	1.91	2.15	2.43	3.23
4	1.70	2.26	1.94	1.83	3.41	2.40	1.87	3.44	1.87	1.69	1.73	1.82	1.78	1.76	1.66	1.99	2.07	1.87	2.72
5	1.69	2.05	1.87	1.81	3.50	2.47	1.82	3.13	1.93	1.68	1.69	1.92	1.78	1.77	1.66	1.85	2.05	1.94	2.52
6	1.74	2.04	1.83	1.82	2.08	2.24	1.89	3.78	2.00	1.68	1.70	2.58	1.79	1.79	1.78	1.81	1.97	1.88	2.06
7	1.77	2.08	1.84	1.82	2.02	2.17	1.93	4.81	2.26	1.69	1.84	3.28	1.79	1.93	1.84	1.97	2.43	1.94	1.85
8	1.78	2.23	1.85	1.84	2.00	2.24	1.90	4.53	2.42	1.71	1.77	2.50	1.81	1.88	1.98	3.56	2.49	2.14	1.83
9	1.77	2.07	1.84	1.83	2.11	2.13	1.99	4.01	2.22	1.71	1.72	2.04	1.82	1.80	1.83	2.19	2.07	2.36	1.96
10	****	****	1.82	1.82	****	2.07	1.88	3.09	1.98	1.69	1.76	1.95	1.69	1.81	1.68	1.81	1.87	1.80	1.88
11	****	2.00	1.83	****	1.82	2.01	1.88	3.03	1.86	1.68	1.72	1.82	1.65	1.72	1.66	1.75	1.90	1.72	1.79
12	****	1.88	1.82	1.80	1.79	1.89	1.83	2.55	1.92	1.69	1.67	1.81	1.68	1.70	****	1.68	1.83	1.78	1.84
13	****	1.93	1.93	1.80	1.79	1.90	1.89	2.35	1.90	1.73	1.67	1.86	1.65	1.70	1.74	1.77	1.87	1.76	1.84
14	****	1.80	1.84	1.79	1.67	1.88	1.86	1.91	1.83	1.69	1.69	1.87	1.68	1.72	1.70	1.68	1.82	1.69	1.86
15	****	1.82	1.84	1.80	1.81	1.88	1.92	1.99	1.79	1.67	1.68	1.84	1.71	1.70	1.70	1.68	1.79	1.71	1.90
16	****	1.81	1.86	1.82	1.90	1.85	1.91	1.84	1.76	1.67	1.75	1.88	1.69	1.70	1.78	1.92	1.86	1.69	1.84
17	****	1.85	1.82	1.83	1.81	1.87	1.87	1.92	1.73	1.67	1.73	1.89	1.69	1.68	2.05	2.12	1.83	1.71	1.86
18	****	1.89	1.82	1.81	1.83	1.93	1.90	2.25	1.69	1.67	1.76	1.89	1.73	1.74	1.91	1.96	1.87	1.80	1.85
19	1.81	1.85	1.81	1.89	1.85	1.92	1.92	2.03	1.75	1.66	1.74	1.91	1.73	1.77	1.69	1.87	1.85	1.86	1.89
20	1.86	1.94	1.79	1.82	1.95	1.92	2.14	2.40	1.71	1.70	1.83	2.04	1.93	1.85	1.85	1.91	2.04	1.99	1.95
21	2.03	2.14	1.81	1.84	2.27	2.02	2.51	2.42	1.70	1.71	1.90	2.30	2.19	1.97	1.96	2.09	1.89	2.18	2.00
22	2.52	2.20	1.81	1.88	2.47	2.04	2.84	2.40	1.70	1.69	1.94	1.96	2.16	1.93	1.81	1.86	1.84	2.14	1.98
23	3.14	2.89	1.82	1.84	2.27	1.86	3.15	2.52	1.69	1.73	2.01	1.49	1.87	1.88	1.81	1.91	1.73	2.44	1.87
24	3.93	2.61	1.83	2.03	2.22	1.85	3.10	2.58	1.69	1.69	1.96	2.04	1.85	1.83	1.76	1.89	2.16	2.80	1.84

INNER NORFOLK, NAVAL AIR STATION
METHANE, CH4, (PPM)

HOUR EDT	AUGUST 1979																		
	13	14	15	16	17	18	19	20	21	22	23	24	25	26	27	28	29	30	31
1	1.66	2.50	2.15	1.73	1.92	1.80	1.68	1.94	1.88	1.67	1.66	1.72	1.32	1.79	1.65	1.76	1.70	2.03	2.17
2	1.65	2.03	1.79	1.74	2.50	2.06	1.73	2.79	1.76	1.67	1.66	1.76	1.74	1.71	1.65	1.75	1.80	2.26	2.23
3	1.65	2.23	1.81	1.74	2.90	2.18	1.97	2.87	1.78	1.67	1.67	1.80	1.68	1.72	1.65	1.77	1.98	2.08	2.31
4	1.64	2.06	1.81	1.75	2.88	2.04	1.78	2.77	1.82	1.66	1.69	1.77	1.72	1.74	1.66	1.78	1.92	1.76	2.13
5	1.64	1.93	1.78	1.73	2.95	2.12	1.77	2.57	1.85	1.66	1.67	1.83	1.72	1.73	1.66	1.73	2.00	1.84	2.04
6	1.65	1.90	1.77	1.70	1.88	1.93	1.83	2.87	1.87	1.66	1.67	2.32	1.73	1.76	1.72	1.70	1.87	1.79	1.81
7	1.65	1.85	1.76	1.72	1.79	1.94	1.85	3.51	1.90	1.66	1.69	2.78	1.70	1.88	1.71	1.77	1.94	1.73	1.74
8	1.64	1.86	1.77	1.75	1.77	1.96	1.80	3.31	1.87	1.65	1.67	2.02	1.73	1.84	1.74	2.18	1.89	1.58	1.68
9	1.65	1.85	1.75	1.73	1.80	1.86	1.89	3.08	1.84	1.66	1.66	1.82	1.73	1.77	1.67	1.86	1.75	2.10	1.67
10	****	****	1.76	1.71	****	1.82	1.77	2.37	1.72	1.65	1.66	1.83	1.69	1.78	1.64	1.66	1.68	1.65	1.67
11	****	1.85	1.74	****	1.69	1.83	1.78	2.32	1.80	1.66	1.65	1.68	1.63	1.66	1.61	1.67	1.66	1.65	1.69
12	****	1.80	1.74	1.70	1.66	1.78	1.77	1.99	1.80	1.66	1.65	1.73	1.64	1.69	****	1.65	1.66	1.63	1.69
13	****	1.78	1.74	1.70	1.66	1.76	1.80	2.01	1.78	1.65	1.64	1.69	1.64	1.63	1.63	1.65	1.67	1.65	1.71
14	****	1.73	1.76	1.69	1.66	1.76	1.79	1.79	1.75	1.65	1.64	1.67	1.63	1.64	1.63	1.63	1.69	1.63	1.76
15	****	1.77	1.75	1.70	1.66	1.69	1.77	1.83	1.69	1.65	1.65	1.67	1.64	1.65	1.63	1.63	1.66	1.64	1.73
16	****	1.75	1.75	1.70	1.67	1.69	1.79	1.73	1.69	1.64	1.65	1.68	1.63	1.65	1.63	1.68	1.65	1.63	1.69
17	****	1.77	1.74	1.68	1.68	1.70	1.78	1.72	1.66	1.64	1.65	1.68	1.63	1.66	1.65	1.67	1.66	1.63	1.68
18	****	1.75	1.75	1.69	1.67	1.71	1.78	1.86	1.67	1.64	1.65	1.69	1.64	1.66	1.64	1.69	1.65	1.63	1.69
19	1.74	1.73	1.76	1.69	1.66	1.73	1.77	1.81	1.67	1.64	1.66	1.69	1.64	1.69	1.62	1.66	1.64	1.64	1.71
20	1.78	1.77	1.68	1.70	1.71	1.72	1.82	1.97	1.66	1.65	1.66	1.76	1.72	1.73	1.67	1.69	1.65	1.66	1.76
21	1.80	1.78	1.70	1.73	1.75	1.80	1.88	1.93	1.66	1.66	1.67	2.02	1.97	1.82	1.70	1.89	1.65	1.69	1.68
22	1.91	1.83	1.74	1.74	1.85	1.86	1.89	1.86	1.66	1.66	1.68	1.81	1.98	1.81	1.65	1.70	1.64	1.71	1.78
23	2.21	1.99	1.72	1.74	1.79	1.71	2.09	1.74	1.66	1.65	1.72	1.79	1.70	1.76	1.65	1.71	1.73	1.96	1.76
24	2.49	2.34	1.72	1.76	1.80	1.71	2.15	2.04	1.65	1.66	1.74	1.85	1.72	1.66	1.65	1.71	1.82	2.20	1.71

NONMETHANE HYDROCARBONS, NMHC, (PPM)

1	0.10	0.80	0.19	0.09	0.55	0.35	0.11	0.48	0.31	0.02	0.02	0.20	0.64	0.03	0.09	0.21	0.14	0.45	0.61
2	0.14	0.46	0.16	0.09	0.70	0.41	0.08	0.55	0.07	0.03	0.03	0.12	0.22	0.04	0.02	0.18	0.13	0.40	0.85
3	0.06	0.30	0.19	0.10	0.58	0.35	0.10	0.50	0.07	0.01	0.03	0.11	0.11	0.04	0.02	0.14	0.17	0.35	0.92
4	0.06	0.20	0.13	0.08	0.53	0.36	0.09	0.67	0.05	0.03	0.04	0.05	0.06	0.02	0.00	0.21	0.15	0.11	0.59
5	0.05	0.12	0.09	0.08	0.55	0.35	0.05	0.56	0.08	0.02	0.02	0.09	0.06	0.04	0.02	0.12	0.05	0.10	0.48
6	0.09	0.14	0.06	0.12	0.20	0.31	0.06	0.91	0.13	0.02	0.03	0.26	0.06	0.03	0.06	0.11	0.10	0.09	0.25
7	0.12	0.23	0.08	0.10	0.23	0.23	0.08	1.30	0.36	0.03	0.15	0.50	0.09	0.05	0.13	0.20	0.49	0.21	0.11
8	0.14	0.37	0.08	0.09	0.23	0.27	0.10	1.22	0.55	0.06	0.10	0.48	0.08	0.04	0.24	1.38	0.60	0.56	0.15
9	0.12	0.22	0.09	0.10	0.31	0.27	0.10	0.93	0.38	0.05	0.06	0.22	0.09	0.03	0.16	0.33	0.32	0.26	0.29
10	****	****	0.06	0.11	****	0.25	0.11	0.72	0.26	0.04	0.10	0.72	0.00	0.03	0.04	0.15	0.21	0.15	0.21
11	****	0.15	0.09	****	0.13	0.18	0.10	0.71	0.06	0.02	0.07	0.14	0.02	0.06	0.05	0.08	0.24	0.07	0.10
12	****	0.08	0.08	0.10	0.13	0.11	0.06	0.56	0.08	0.03	0.02	0.08	0.04	0.01	****	0.03	0.17	0.15	0.15
13	****	0.15	0.19	0.10	0.13	0.14	0.09	0.34	0.12	0.08	0.03	0.17	0.01	0.07	0.11	0.12	0.20	0.11	0.13
14	****	0.07	0.08	0.10	0.01	0.12	0.07	0.12	0.08	0.04	0.05	0.20	0.05	0.08	0.07	0.05	0.13	0.16	0.10
15	****	0.05	0.09	0.10	0.15	0.19	0.15	0.16	0.10	0.02	0.03	0.17	0.07	0.05	0.07	0.05	0.13	0.07	0.17
16	****	0.06	0.11	0.12	0.23	0.16	0.12	0.11	0.11	0.03	0.10	0.20	0.06	0.05	0.15	0.24	0.21	0.06	0.15
17	****	0.08	0.08	0.15	0.13	0.17	0.09	0.20	0.07	0.03	0.08	0.21	0.06	0.02	0.40	0.45	0.17	0.08	0.18
18	****	0.14	0.07	0.12	0.16	0.22	0.12	0.39	0.02	0.03	0.11	0.20	0.09	0.08	0.27	0.27	0.22	0.17	0.16
19	0.07	0.12	0.06	0.20	0.19	0.19	0.15	0.22	0.08	0.02	0.08	0.22	0.09	0.08	0.07	0.21	0.21	0.22	0.18
20	0.08	0.17	0.11	0.12	0.24	0.20	0.32	0.43	0.05	0.05	0.17	0.28	0.21	0.12	0.18	0.22	0.39	0.33	0.19
21	0.23	0.36	0.11	0.11	0.52	0.22	0.63	0.49	0.04	0.05	0.23	0.28	0.22	0.15	0.26	0.20	0.24	0.49	0.32
22	0.61	0.45	0.07	0.12	0.62	0.18	0.95	0.54	0.04	0.03	0.26	0.15	0.18	0.12	0.16	0.16	0.20	0.43	0.20
23	0.93	0.90	0.10	0.10	0.48	0.15	1.06	0.78	0.03	0.08	0.29	0.70	0.09	0.12	0.16	0.20	0.00	0.48	0.11
24	1.44	0.27	0.11	0.27	0.42	0.14	0.95	0.54	0.04	0.03	0.22	0.19	0.12	0.17	0.11	0.18	0.32	0.60	0.13

INNER NORFOLK, NAVAL AIR STATION
CARBON MONOXIDE, CO, (PPM)

HOUR EDT	AUGUST 1979																		
	13	14	15	16	17	18	19	20	21	22	23	24	25	26	27	28	29	30	31
1	0.21	1.02	0.38	0.20	1.37	0.71	0.46	1.18	0.54	0.20	0.20	0.59	0.40	0.25	0.21	0.65	0.31	0.83	1.38
2	0.20	0.70	0.31	0.21	1.66	0.69	0.45	1.24	0.33	0.20	0.21	0.46	0.55	0.25	0.25	0.39	0.47	0.52	1.79
3	0.19	0.34	0.26	0.21	0.91	0.54	0.24	0.91	0.31	0.20	0.18	0.40	0.25	0.23	0.14	0.26	0.41	0.37	1.75
4	0.19	0.30	0.25	0.20	0.82	0.47	0.22	0.87	0.27	0.19	0.17	0.27	0.25	0.21	0.16	0.28	0.28	0.25	0.96
5	0.19	0.24	0.25	0.21	0.64	0.49	0.24	0.85	0.31	0.19	0.18	0.29	0.21	0.21	0.18	0.30	0.26	0.25	0.73
6	0.20	0.29	0.27	0.20	0.38	0.36	0.26	1.28	0.47	0.22	0.26	0.67	0.21	0.21	0.22	0.41	0.35	0.29	0.32
7	0.20	0.74	0.26	0.23	0.42	0.45	0.28	3.07	1.02	0.27	0.64	1.32	0.27	0.24	0.51	0.82	1.12	0.63	0.26
8	0.27	0.94	0.28	0.27	0.58	0.62	0.33	2.94	1.50	0.33	0.52	1.32	0.29	0.23	0.83	2.11	1.68	1.37	0.45
9	0.26	0.57	0.28	0.25	0.61	0.56	0.28	2.18	0.80	0.27	0.38	0.65	0.23	0.20	0.51	0.86	0.88	0.92	0.28
10	****	****	0.23	0.21	****	0.54	0.33	1.53	0.76	0.30	0.33	0.36	0.20	0.21	0.28	0.50	0.48	0.34	0.24
11	****	0.26	0.19	****	0.21	0.31	0.31	1.24	0.42	0.29	0.35	0.36	0.19	0.20	0.21	0.32	0.42	0.27	0.29
12	****	0.27	0.25	0.19	0.20	0.32	0.31	0.95	0.42	0.27	0.32	0.33	0.20	0.19	****	0.22	0.32	0.36	0.38
13	****	0.29	0.25	0.19	0.20	0.33	0.40	0.97	0.37	0.23	0.33	0.33	0.19	0.21	0.30	0.33	0.46	0.31	0.36
14	****	0.24	0.28	0.19	0.19	0.29	0.39	0.50	0.32	0.23	0.31	0.20	0.23	0.25	0.30	0.37	0.25	0.40	0.36
15	****	0.25	0.25	0.20	0.21	0.34	0.53	0.60	0.28	0.25	0.38	0.43	0.21	0.24	0.31	0.30	0.33	0.21	0.42
16	****	0.31	0.31	0.23	0.25	0.35	0.55	0.45	0.32	0.24	0.43	0.48	0.24	0.27	0.59	0.83	0.57	0.21	0.38
17	****	0.40	0.26	0.25	0.24	0.36	0.45	0.80	0.27	0.28	0.41	0.77	0.25	0.32	1.18	1.29	0.61	0.33	0.29
18	****	0.32	0.24	0.27	0.34	0.48	0.46	1.04	0.24	0.27	0.66	0.69	0.26	0.27	0.89	0.83	0.74	0.63	0.44
19	0.19	0.32	0.23	0.27	0.34	0.48	0.60	0.59	0.26	0.24	0.54	0.88	0.40	0.37	0.25	0.64	0.73	0.84	0.51
20	0.34	0.44	0.22	0.30	0.63	0.54	0.96	1.04	0.24	0.27	0.76	0.63	0.52	0.40	0.62	0.73	0.85	1.00	0.68
21	0.59	0.70	0.21	0.29	1.30	0.58	1.78	1.35	0.23	0.27	0.86	0.71	0.65	0.56	0.61	0.68	0.93	1.30	0.73
22	1.53	0.80	0.20	0.46	1.37	0.47	2.50	1.35	0.22	0.27	0.91	0.51	0.50	0.35	0.35	0.43	0.93	1.20	0.67
23	2.52	0.70	0.21	0.33	1.00	0.33	3.15	1.65	0.22	0.28	0.99	0.59	0.37	0.35	0.28	0.37	0.44	1.17	0.51
24	2.85	0.50	0.21	0.49	0.94	0.35	2.51	1.49	0.20	0.25	0.80	0.59	0.30	0.25	0.29	0.38	0.77	1.23	0.46

WIND SPEED, (MPH)

1	9.9	3.1	6.8	12.4	2.6	4.0	9.0	2.4	3.0	13.8	6.3	****	****	8.6	8.6	6.7	6.1	3.7	0.0
2	12.0	3.6	6.7	11.4	2.3	4.5	6.3	2.8	3.3	15.4	5.8	****	****	8.2	8.9	5.9	6.2	4.1	0.0
3	12.0	5.1	6.0	12.0	1.7	3.5	6.4	1.5	5.5	13.9	6.1	****	****	7.8	9.4	5.9	4.6	4.4	0.0
4	15.9	4.8	7.3	11.9	1.6	3.1	11.9	1.0	2.4	14.5	5.9	****	****	7.4	7.9	5.1	5.8	4.1	1.4
5	16.6	6.1	10.4	11.2	2.1	4.1	8.5	1.7	3.6	14.7	10.5	****	****	6.2	7.3	6.0	4.3	3.3	3.2
6	10.8	6.7	9.8	11.2	2.5	4.4	7.1	3.2	2.3	12.1	7.7	****	****	5.2	6.2	5.4	3.8	3.6	4.3
7	10.8	7.9	10.6	10.8	4.5	5.1	5.8	2.4	3.2	13.1	7.6	****	****	5.1	6.2	4.3	4.1	4.0	3.5
8	8.6	6.7	10.8	12.3	5.4	5.0	6.2	3.2	7.4	11.6	9.8	****	****	5.8	6.9	7.3	4.3	2.5	3.2
9	9.0	9.6	12.2	12.3	6.0	7.1	6.9	4.0	7.9	11.3	10.4	****	****	6.9	8.4	8.2	5.9	4.6	5.3
10	9.3	8.5	13.4	11.6	12.3	9.3	7.6	3.0	10.8	11.7	12.8	****	****	7.8	9.1	5.9	8.4	4.5	7.4
11	11.3	8.1	12.1	12.2	11.6	****	7.7	3.0	8.2	11.3	****	****	****	6.7	9.4	5.3	7.4	5.5	9.9
12	11.3	8.2	10.5	12.9	8.1	****	5.4	4.7	7.0	11.2	****	****	****	5.2	9.4	2.5	7.1	3.2	10.6
13	8.6	****	11.6	12.0	8.4	****	3.3	5.2	8.4	12.9	****	****	7.8	6.1	8.1	10.8	10.1	3.8	11.1
14	7.7	15.8	11.4	10.5	8.5	7.3	3.5	4.3	8.1	13.7	****	****	7.8	7.1	8.5	9.8	9.1	6.7	11.4
15	9.9	11.4	8.2	11.2	8.8	7.6	3.3	8.2	8.1	13.7	****	****	8.2	8.3	7.6	12.0	7.4	7.0	10.7
16	12.4	11.4	8.4	12.0	8.5	8.2	5.2	7.8	9.4	14.6	****	****	9.1	12.4	6.1	6.9	9.4	7.1	10.8
17	15.9	11.2	10.1	11.1	7.8	11.9	5.5	6.0	7.7	12.4	****	****	10.6	14.7	6.8	10.6	9.7	5.8	10.4
18	11.6	9.7	10.8	8.4	6.4	11.4	5.0	5.9	8.8	13.0	****	****	12.0	15.5	9.9	10.5	10.8	6.7	10.2
19	5.5	7.3	10.8	6.9	8.2	13.7	3.7	4.1	10.6	10.6	****	****	13.4	14.0	10.6	9.7	14.5	8.1	8.6
20	1.7	4.0	9.8	3.8	7.8	11.9	3.6	3.5	11.1	10.1	****	****	9.4	10.8	7.8	4.5	11.5	9.1	5.4
21	1.4	4.0	13.9	2.0	6.4	11.2	2.4	3.8	13.0	10.1	****	****	9.4	10.7	6.7	7.7	10.7	7.9	5.4
22	2.4	3.2	15.8	2.1	6.0	10.1	3.2	2.0	12.2	7.4	****	****	9.4	9.7	7.6	8.4	7.9	5.3	5.0
23	4.8	3.5	16.2	4.0	6.4	10.1	2.8	3.0	12.3	6.9	****	****	8.0	8.5	7.6	6.7	6.7	3.6	5.9
24	4.3	5.1	14.7	1.5	5.1	11.2	4.6	3.3	15.5	8.5	****	****	8.8	7.7	6.9	7.1	3.6	2.5	6.2

INNER NORFOLK, NAVAL AIR STATION
WIND DIRECTION, (DEG)

HOUR EDT	AUGUST 1979																		
	13	14	15	16	17	18	19	20	21	22	23	24	25	26	27	28	29	30	31
1	340	170	280	330	170	180	220	190	100	30	110	***	***	200	200	160	160	160	0
2	320	200	270	320	220	180	230	190	120	30	110	***	***	220	190	180	150	190	0
3	330	210	290	340	190	170	220	200	120	20	100	***	***	210	200	180	170	220	0
4	330	200	320	350	200	200	240	190	100	30	90	***	***	220	190	170	170	230	330
5	320	200	10	340	240	210	220	90	110	50	80	***	***	230	200	190	170	240	330
6	320	200	350	340	310	200	230	150	100	40	110	***	***	220	200	200	180	250	350
7	330	210	350	340	320	190	210	160	130	30	100	***	***	220	190	190	170	260	340
8	320	220	360	350	310	200	230	150	140	20	100	***	***	230	210	170	190	260	350
9	320	240	10	330	330	220	240	200	160	40	110	***	***	220	210	210	190	260	360
10	320	250	20	360	350	230	280	70	160	60	130	***	***	230	210	250	190	250	10
11	310	240	20	340	360	***	290	360	180	60	***	***	***	240	190	280	170	290	10
12	330	250	30	350	40	***	280	30	190	60	***	***	***	240	200	270	170	280	50
13	310	***	40	10	50	***	300	30	290	70	***	***	250	190	200	70	180	250	60
14	310	270	30	30	70	230	30	70	210	70	***	***	240	160	280	80	190	300	50
15	330	280	40	40	60	220	20	70	220	80	***	***	210	180	330	110	180	290	40
16	330	260	50	40	70	210	10	70	280	70	***	***	200	160	250	180	150	330	60
17	300	270	10	50	80	200	10	160	360	90	***	***	190	160	210	160	160	290	70
18	300	280	360	30	90	180	30	190	350	90	***	***	190	160	190	160	150	80	70
19	310	270	10	30	130	170	90	190	30	100	***	***	180	170	200	180	140	130	80
20	270	290	360	20	150	160	90	140	30	110	***	***	180	170	170	220	140	130	60
21	180	280	10	40	160	180	110	170	50	110	***	***	170	170	190	200	130	140	70
22	210	260	350	10	160	220	140	110	50	110	***	***	170	180	190	180	140	160	80
23	180	270	340	330	160	230	140	90	40	120	***	***	190	180	190	200	190	180	80
24	170	240	360	260	170	230	170	90	30	120	***	***	180	190	180	180	170	160	70

TEMPERATURE, (DEG C)

1	16.1	16.7	23.3	18.9	15.6	18.3	21.7	21.1	21.7	21.1	23.9	****	****	26.1	25.6	24.4	23.3	23.9	25.0
2	15.8	17.2	22.8	17.8	15.0	17.8	20.6	21.1	21.7	21.7	22.8	****	****	26.1	25.0	23.3	22.8	23.3	21.4
3	15.6	17.2	21.7	16.7	15.0	17.2	20.0	20.6	21.7	21.7	22.2	****	****	25.6	25.0	22.8	22.8	23.3	23.3
4	16.1	17.2	22.2	16.7	15.6	17.8	19.4	20.0	21.1	21.7	22.2	****	****	25.0	24.4	22.8	22.8	23.3	23.9
5	16.1	17.2	22.2	16.1	16.7	18.3	19.4	19.4	21.1	22.2	22.2	****	****	24.4	23.9	22.8	22.8	22.8	24.4
6	16.7	17.8	22.2	15.6	17.2	18.3	19.4	20.0	21.1	22.2	22.2	****	****	23.9	23.9	22.2	22.8	22.8	24.4
7	17.2	19.4	21.7	15.6	17.2	18.9	20.0	20.6	21.7	21.1	22.2	****	****	23.4	23.9	22.2	23.3	22.8	24.4
8	17.2	22.2	21.7	16.1	17.8	20.0	21.1	22.8	23.3	21.7	23.3	****	****	25.6	25.6	23.9	25.6	23.3	25.0
9	16.7	25.0	21.1	17.2	19.4	21.7	22.2	26.7	25.6	21.1	25.6	****	****	27.2	27.2	26.1	26.7	26.1	25.6
10	17.2	26.7	21.7	18.9	21.7	23.9	23.9	30.0	26.7	20.6	27.2	****	****	29.4	28.9	27.2	27.8	27.8	26.7
11	18.9	28.3	23.3	19.4	22.8	****	24.4	28.9	29.4	21.1	****	****	****	31.1	31.1	28.3	29.4	28.9	27.2
12	19.4	29.4	23.3	20.0	23.3	****	24.4	26.7	30.6	22.2	****	****	****	32.2	31.7	29.4	30.6	31.7	28.3
13	20.6	****	22.8	20.6	23.9	****	25.6	27.2	32.2	25.0	****	****	****	32.2	33.9	32.8	30.0	31.1	28.9
14	21.7	30.6	23.3	21.1	24.4	26.1	27.2	29.4	31.7	25.0	****	****	****	33.3	34.4	27.8	28.4	32.2	29.4
15	22.8	31.1	23.9	21.1	23.9	25.0	20.9	20.9	31.7	25.6	****	****	****	34.4	33.3	25.0	29.4	32.8	29.4
16	23.3	31.7	24.4	21.1	23.3	25.0	26.1	26.1	30.0	26.1	****	****	****	33.9	32.8	25.6	25.6	31.7	28.9
17	24.4	31.7	23.9	21.1	23.3	24.4	26.7	24.4	21.1	25.6	****	****	****	33.3	32.2	26.1	25.6	31.7	28.9
18	25.0	31.1	23.3	21.1	22.2	24.4	26.7	25.0	20.6	25.0	****	****	****	32.0	31.7	28.9	25.6	31.1	27.8
19	24.4	30.0	22.8	20.6	21.7	25.6	26.1	25.0	20.0	25.0	****	****	****	31.1	30.6	27.8	25.0	30.0	31.1
20	20.6	28.3	21.7	19.4	20.6	24.4	25.0	23.9	19.4	24.4	****	****	****	28.9	28.3	26.7	23.9	28.3	26.7
21	18.9	25.6	21.1	18.9	20.0	22.8	22.8	22.2	19.4	24.4	****	****	****	27.8	26.7	26.1	23.9	26.7	25.6
22	17.8	24.4	20.6	18.9	19.4	22.2	22.2	21.7	20.0	24.4	****	****	****	27.2	26.1	25.6	24.4	26.1	24.4
23	18.3	23.3	20.6	18.3	19.4	21.7	22.2	21.1	20.6	24.4	****	****	****	26.7	25.6	25.0	24.4	25.6	24.4
24	17.8	83.3	20.0	16.7	19.4	21.7	21.7	21.7	21.1	24.4	****	****	****	26.7	25.6	24.4	23.3	25.0	24.4

INNER NORFOLK, NAVAL AIR STATION
SOLAR RADIATION, (LANGLEYS/MIN)

HOUR EDT	AUGUST 1979																		
	13	14	15	16	17	18	19	20	21	22	23	24	25	26	27	28	29	30	31
1	****	0.00	0.00	0.00	0.00	0.00	0.00	0.00	0.00	0.00	0.00	0.00	0.00	0.00	0.00	0.00	0.00	0.00	0.00
2	****	0.00	0.00	0.00	0.00	0.00	0.00	0.00	0.00	0.00	0.00	0.00	0.00	0.00	0.00	0.00	0.00	0.00	0.00
3	****	0.00	0.00	0.00	0.00	0.00	0.00	0.00	0.00	0.00	0.00	0.00	0.00	0.00	0.00	0.00	0.00	0.00	0.00
4	****	0.00	0.00	0.00	0.00	0.00	0.00	0.00	0.00	0.00	0.00	0.00	0.00	0.00	0.00	0.00	0.00	0.00	0.00
5	****	0.00	0.00	0.00	0.00	0.00	0.00	0.00	0.00	0.00	0.00	0.00	0.00	0.00	0.00	0.00	0.00	0.00	0.00
6	****	0.00	0.00	0.00	0.00	0.00	0.00	0.00	0.00	0.00	0.00	0.00	0.00	0.00	0.00	0.00	0.00	0.00	0.00
7	****	0.02	0.00	0.01	0.01	0.00	0.01	0.01	0.01	0.00	0.00	0.01	0.02	0.01	0.01	0.01	0.01	0.01	0.00
8	****	0.20	0.10	0.20	0.10	0.05	0.11	0.11	0.12	0.02	0.07	0.14	0.15	0.15	0.17	0.16	0.18	0.14	0.10
9	****	0.51	0.17	0.53	0.35	0.16	0.28	0.38	0.28	0.03	0.25	0.43	0.44	0.43	0.46	0.40	0.47	0.42	0.36
10	****	0.79	0.38	0.82	0.73	0.38	0.52	0.67	0.57	0.11	0.72	0.81	0.67	0.73	0.69	0.52	0.77	0.69	0.61
11	****	1.06	0.42	1.11	1.05	0.58	0.57	0.75	0.93	0.11	0.82	0.95	0.88	0.98	0.93	0.77	1.00	0.96	0.81
12	****	1.26	0.62	1.29	1.11	0.60	0.48	0.28	1.07	0.16	0.72	0.77	1.04	0.82	1.13	0.61	1.20	1.14	1.10
13	****	1.19	1.07	1.20	0.98	0.71	0.40	0.65	0.91	0.73	0.81	0.74	0.96	0.96	0.75	0.70	1.13	1.11	1.00
14	1.51	1.42	1.31	1.39	1.42	0.49	0.60	0.73	0.78	0.72	0.72	1.00	1.25	1.06	0.40	1.06	0.98	1.29	1.22
15	1.12	1.15	0.96	1.00	1.26	0.42	0.75	0.97	0.84	0.52	0.61	0.51	0.94	0.62	0.22	0.49	0.66	1.00	1.09
16	1.00	1.01	1.01	1.05	0.98	0.28	0.34	0.52	0.52	1.00	0.68	0.62	0.75	0.60	0.23	0.07	0.43	0.84	0.81
17	0.96	0.92	0.73	0.92	0.91	0.35	0.68	0.10	0.03	0.62	0.75	0.51	0.75	0.52	0.40	0.15	0.36	0.77	0.72
18	0.66	0.63	0.58	0.60	0.59	0.50	0.49	0.23	0.15	0.41	0.49	0.36	0.51	0.53	0.38	0.07	0.31	0.36	0.41
19	0.29	0.28	0.27	0.25	0.24	0.22	0.20	0.21	0.14	0.23	0.25	0.07	0.19	0.21	0.25	0.02	0.11	0.17	0.16
20	0.05	0.05	0.05	0.04	0.06	0.02	0.02	0.04	0.02	0.03	0.04	0.02	0.02	0.01	0.01	0.00	0.00	0.01	0.01
21	0.00	0.00	0.00	0.00	0.00	0.00	0.00	0.00	0.00	0.00	0.00	0.00	0.00	0.00	0.00	0.00	0.00	0.00	0.00
22	0.00	0.00	0.00	0.00	0.00	0.00	0.00	0.00	0.00	0.00	0.00	0.00	0.00	0.00	0.00	0.00	0.00	0.00	0.00
23	0.00	0.00	0.00	0.00	0.00	0.00	0.00	0.00	0.00	0.00	0.00	0.00	0.00	0.00	0.00	0.00	0.00	0.00	0.00
24	0.00	0.00	0.00	0.00	0.00	0.00	0.00	0.00	0.00	0.00	0.00	0.00	0.00	0.00	0.00	0.00	0.00	0.00	0.00

APPENDIX B
RTI AIRCRAFT DATA BASE

Data plots are presented in this appendix, "RTI Aircraft Data Base," for airborne measurements conducted by RTI for SEV-UPS, during the period from August 20 through August 31, 1979. Data plots for the twelve (12) flights conducted during this period are shown in chronological order. Flights are tabulated in the "List of Figures" included in this Appendix. Each figure is composed of several graphs illustrating data for a single flight.

In addition to data for each measured parameter, the graphs include time of flight, altitude of sampling, and sampling location information. Measured parameters shown on each graph include Ozone (O_3), Sulfur Dioxide (SO_2), Oxides of Nitrogen (NO/NO_x), Condensation Nuclei (CN), Temperature, Dew Point and b_{scat} .

The data plots illustrate data for specific flight segments. Graphs of data for horizontal flight segments are interspersed with graphs of vertical "spiral" data as they occurred in time during the flight.

LIST OF FIGURES

<u>Figure No.</u>	<u>Title</u>	<u>Page</u>
B-1	Data from flight on August 20 NASA Cessna/RTI Comparison Flight (3 graphs).B-5
B-2	Data from flight on August 23 LAS Box Face (6 graphs).B-8
B-3	Data from flight on August 24 - early morning - (Urban Plume-SW flow) (6 graphs). . .	.B-14
B-4	Data from flight on August 24 - late morning - (Urban Plume-SW flow) (7 graphs). . .	.B-20
B-5	Data from flight on August 25 - early morning - (Urban Plume-SW flow) (6 graphs). . .	.B-27
B-6	Data from flight on August 25 - late morning - (Urban Plume-SW flow) (7 graphs). . .	.B-33
B-7	Data from flight on August 27 Norfolk/Richmond Urban Plume Comparison (Plan 5) (11 graphs).B-40
B-8	Data from flight on August 29 Low Pass Comparison (6 graphs).B-51
B-9	Data from flight on August 30 - early morning - (Urban Plume-SW flow) (10 graphs)B-57
B-10	Data from flight on August 30 - late morning - (Urban Plume-SW flow) (11 graphs)B-67
B-11	Data from flight on August 31 Photochemical box-SW flow (9 graphs).B-78
B-12	Data from flight on August 31 Photochemical box-Western flow (9 graphs)B-87

18-APR-88

8/20/79

FLIGHT 14
35 DEG RADIAL CAPE CHARLES VOR

11:15:00 TO 11:22:30 AM

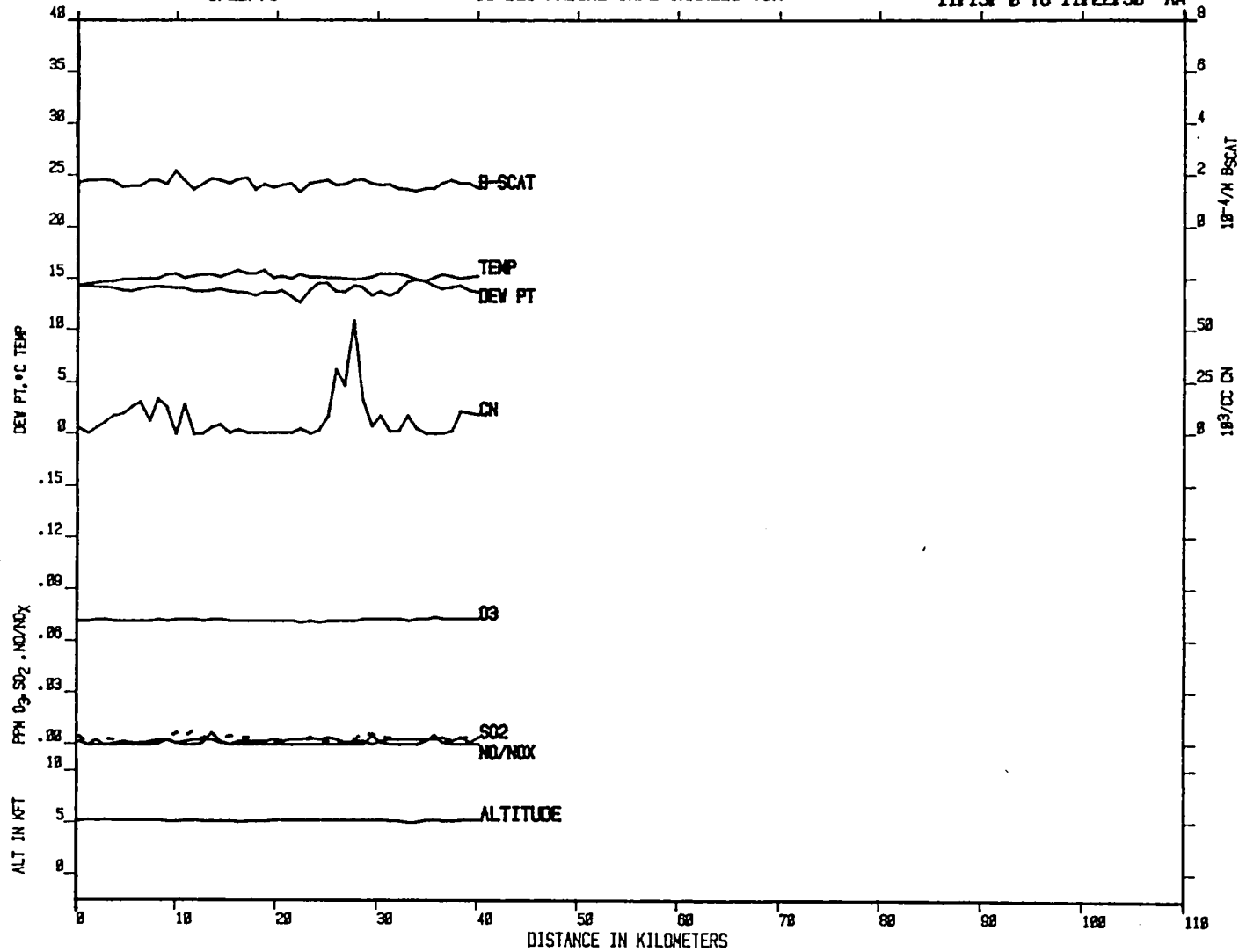

B-5

Figure B-1 Data from flight on August 20 NASA Cessna/RTI Comparison Flight
Page 1 of 3

84 MAY 85

FLIGHT 14 SPIRAL 1

8/28/79

ACCOMACK CO AIRPORT

11:21:38 TO 11:34:08 AM

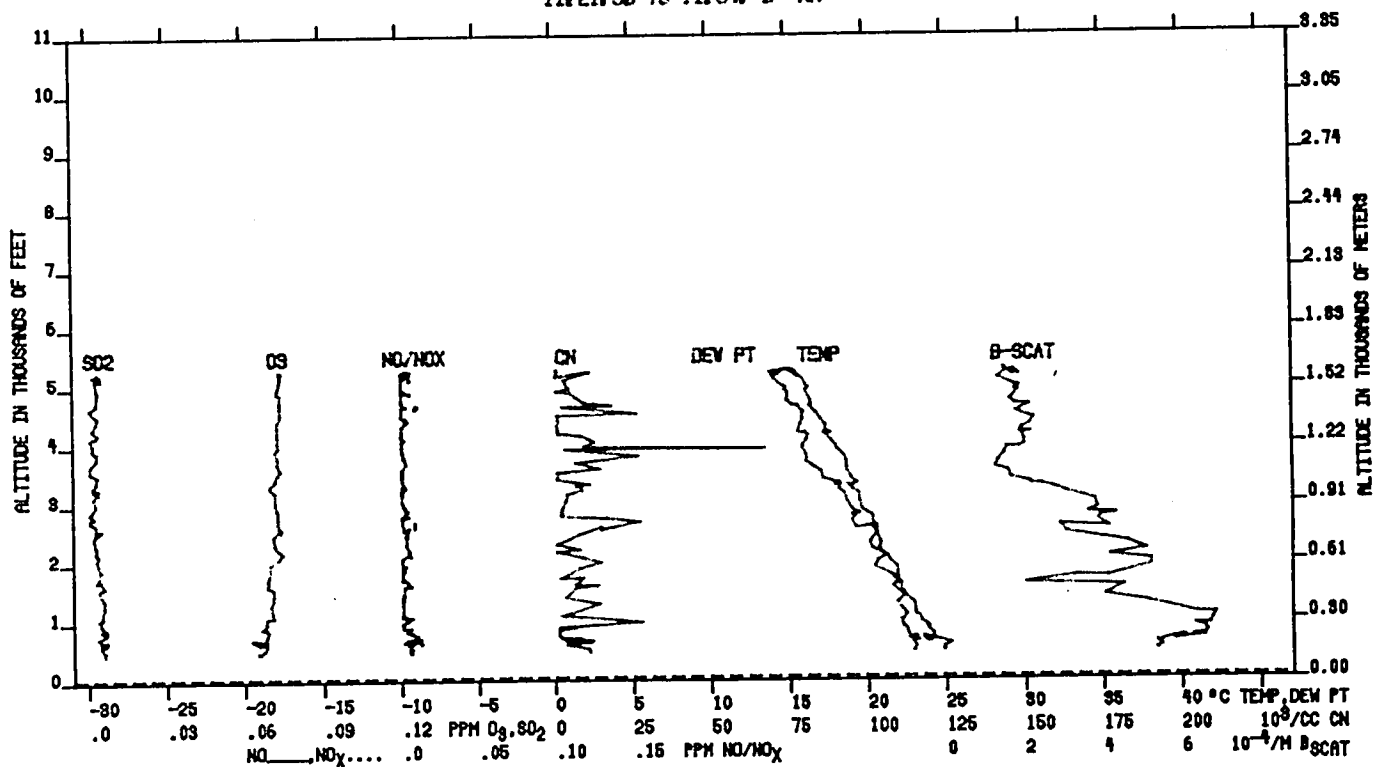

B-6

Figure B-1 Data from flight on August 20 NASA Cessna/RTI Comparison Flight
Page 2 of 3

18-APR-88

FLIGHT 14

8/28/79

35 DEG RADIAL CAPE CHARLES VOR

11:34:48 TO 11:44:28 AM

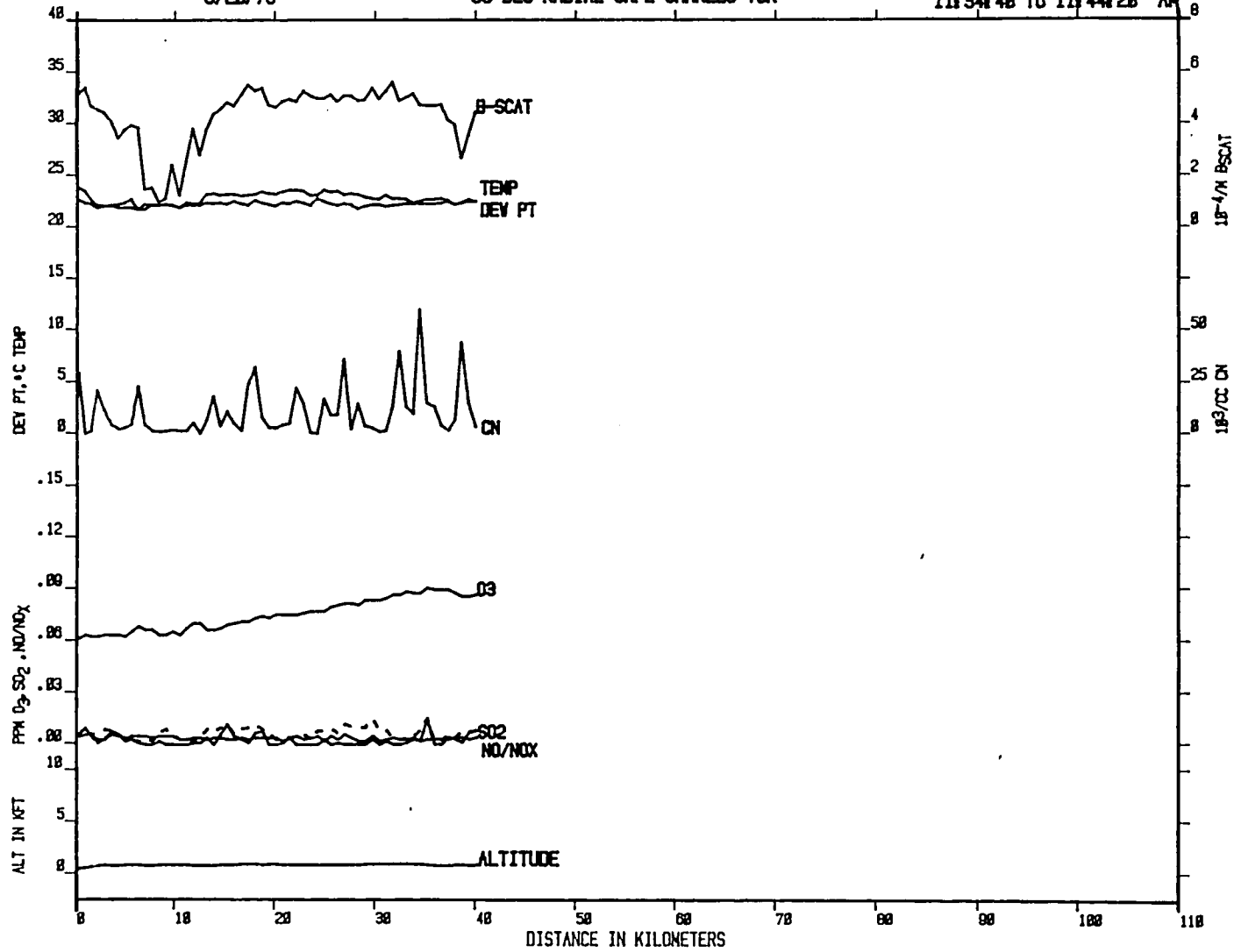

B-7

Figure B-1 Data from flight on August 20 NASA Cessna/RTI Comparison Flight
Page 3 of 3

18-APR-88

8/23/79

FLIGHT 15 JAMES RIVER TO IVOR

13:14:08 TO 13:21:18 PM

B-8

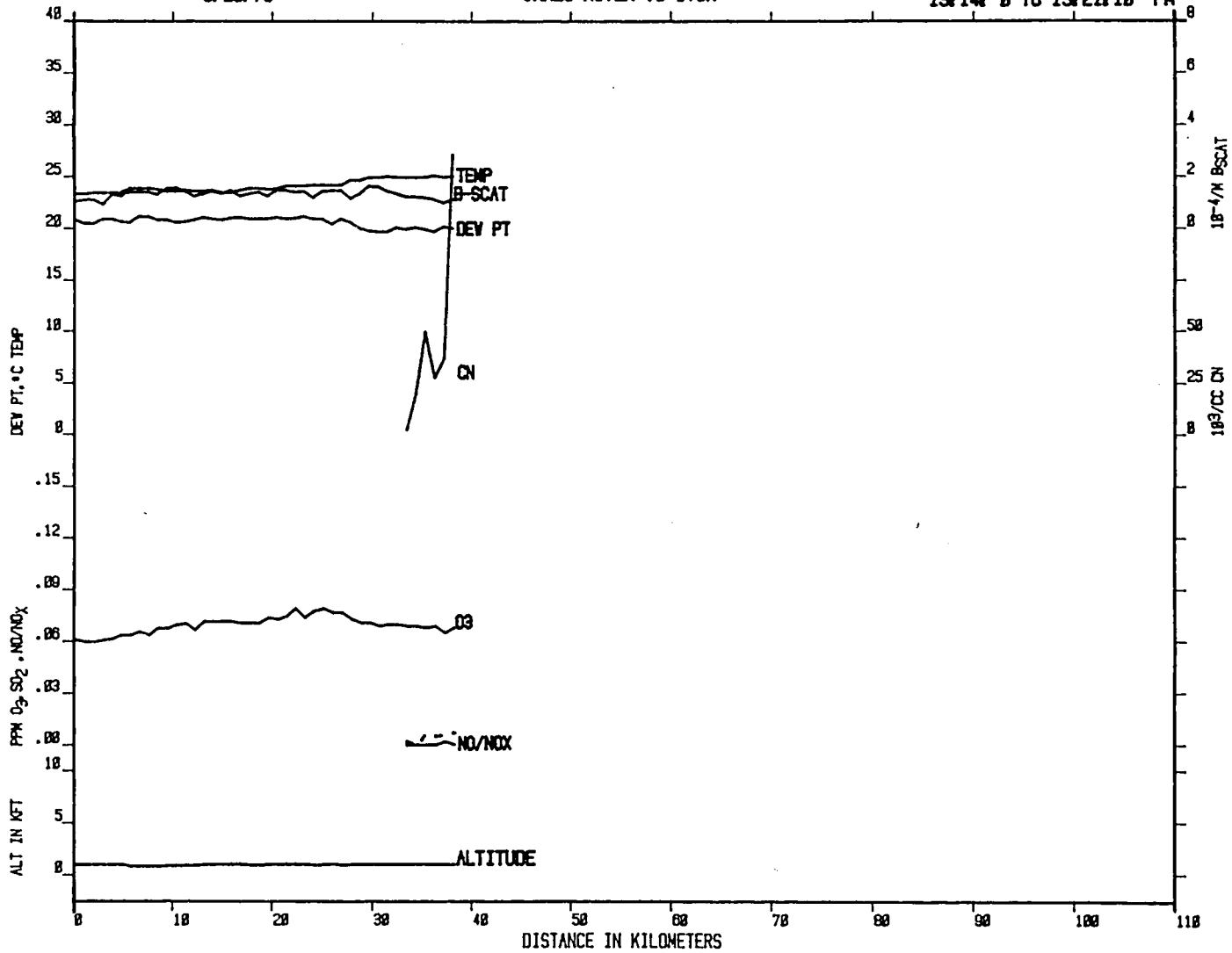

Figure B-2 Data from flight on August 23 LAS Box Face - Page 1 of 6

82-MAY-88

FLIGHT 15 SPIRAL 1

8/23/79

IVOR

13:23:00 TO 13:35:10 PM

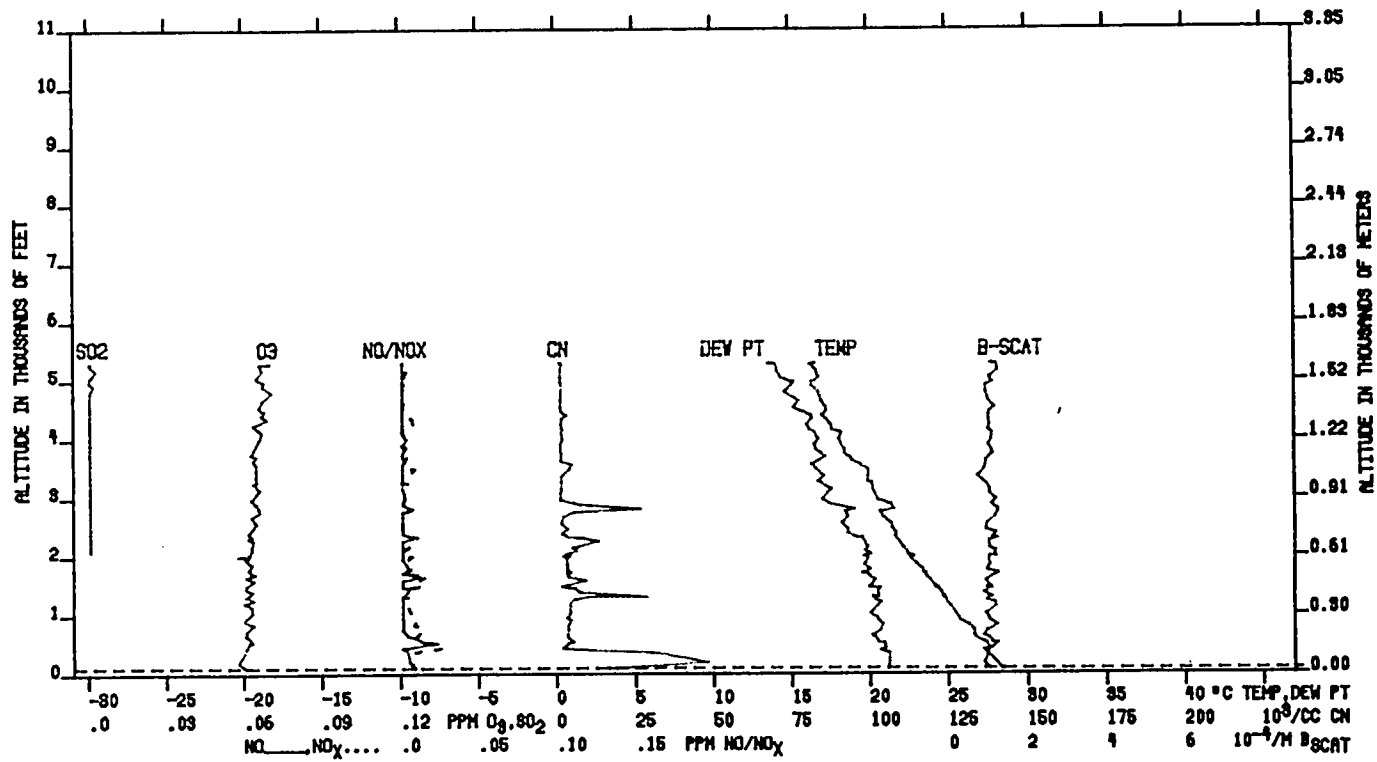

B-9

Figure B-2 Data from flight on August 23 LAS Box Face - Page 2 of 6

82-MAY-88

FLIGHT 15 SPIRAL 2
8/23/78
IVOR TO JAMES RIVER
13:35:20 TO 13:44:48 PM

B-10

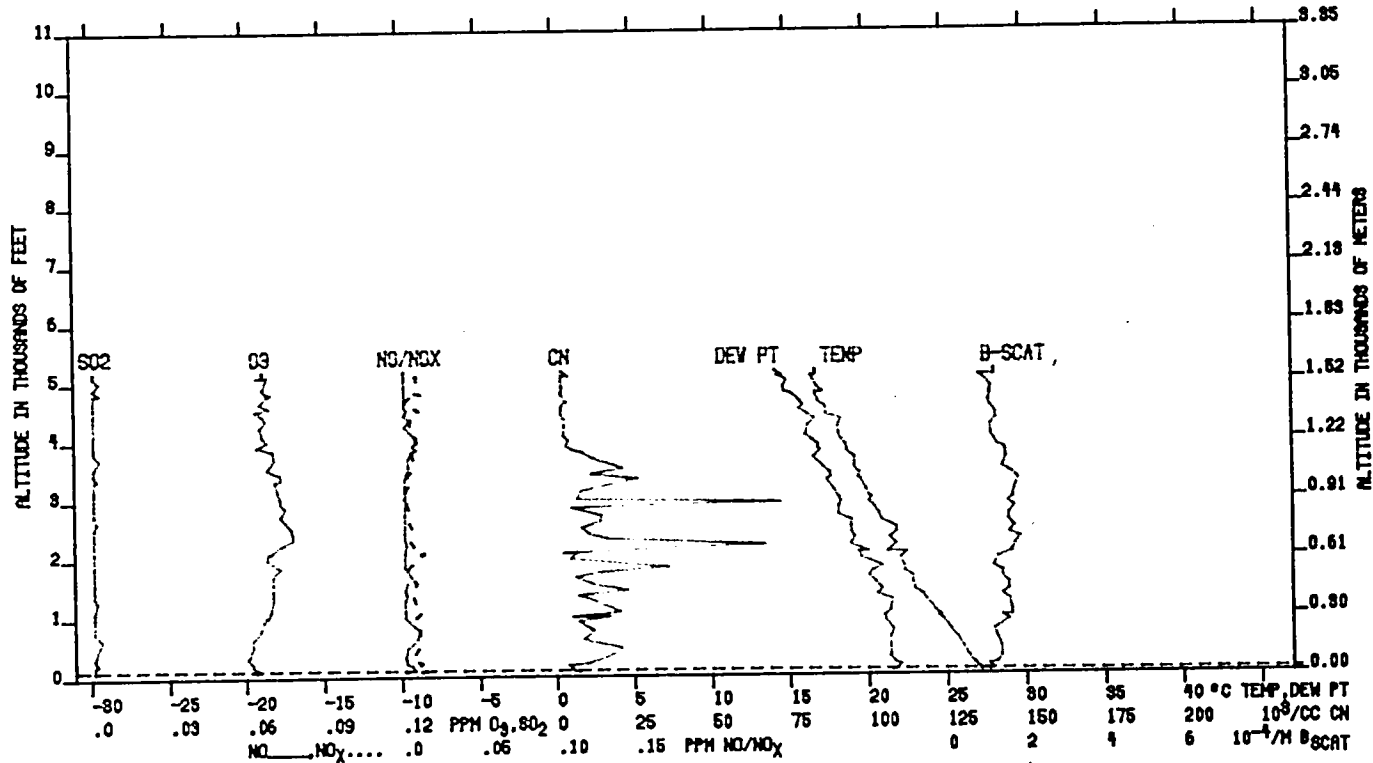

Figure B-2 Data from flight on August 23 LAS Box Face - Page 3 of 6

22-MAY-68

FLIGHT 18 SPIRAL 9

8/23/78

JAMES HENNER

19:44:50 TO 19:55:30 PM

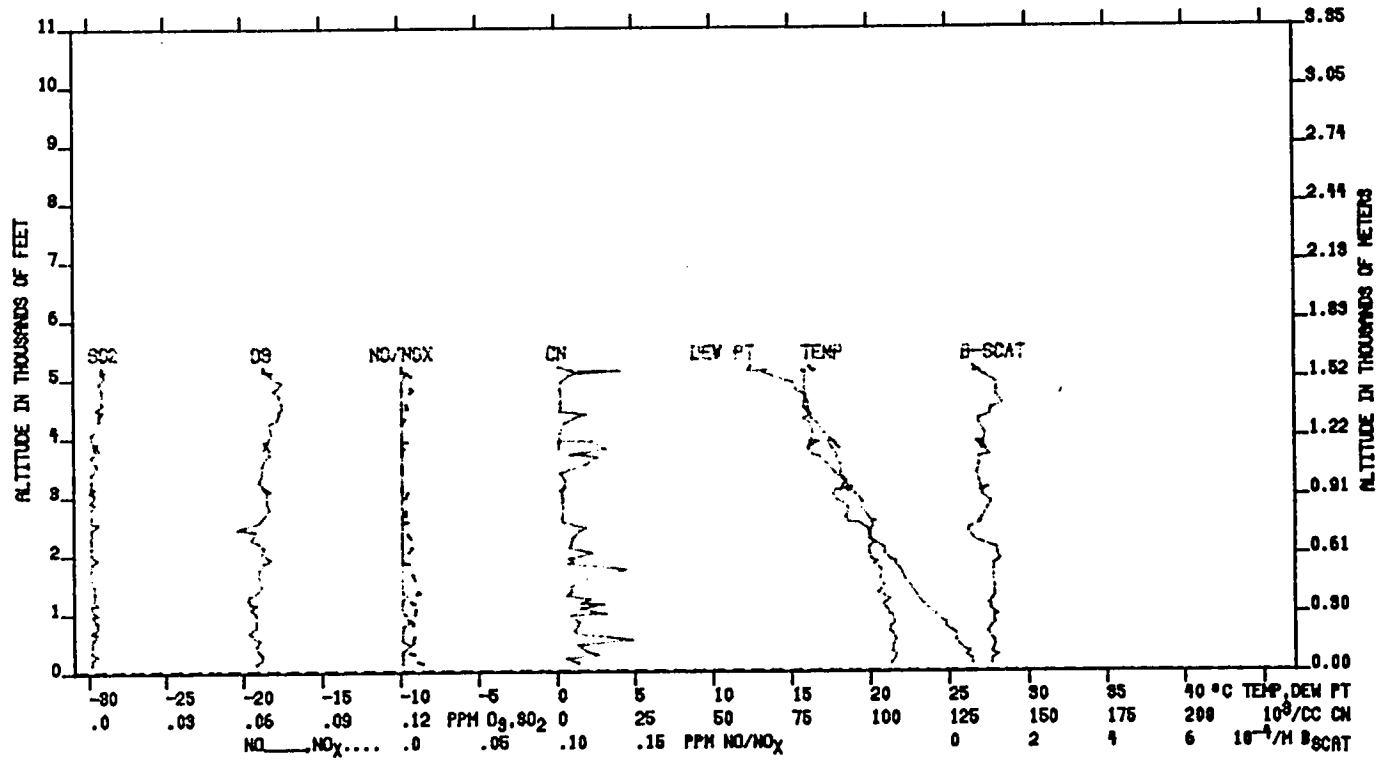

B-11

Figure B-2 Data from flight on August 23 LAS Box Face - Page 4 of 6

02-MAY-68

FLIGHT 15 SPIRAL 4
8/23/68
JAMES RIVER TO INAR
12:50 P TO 14:40 PM

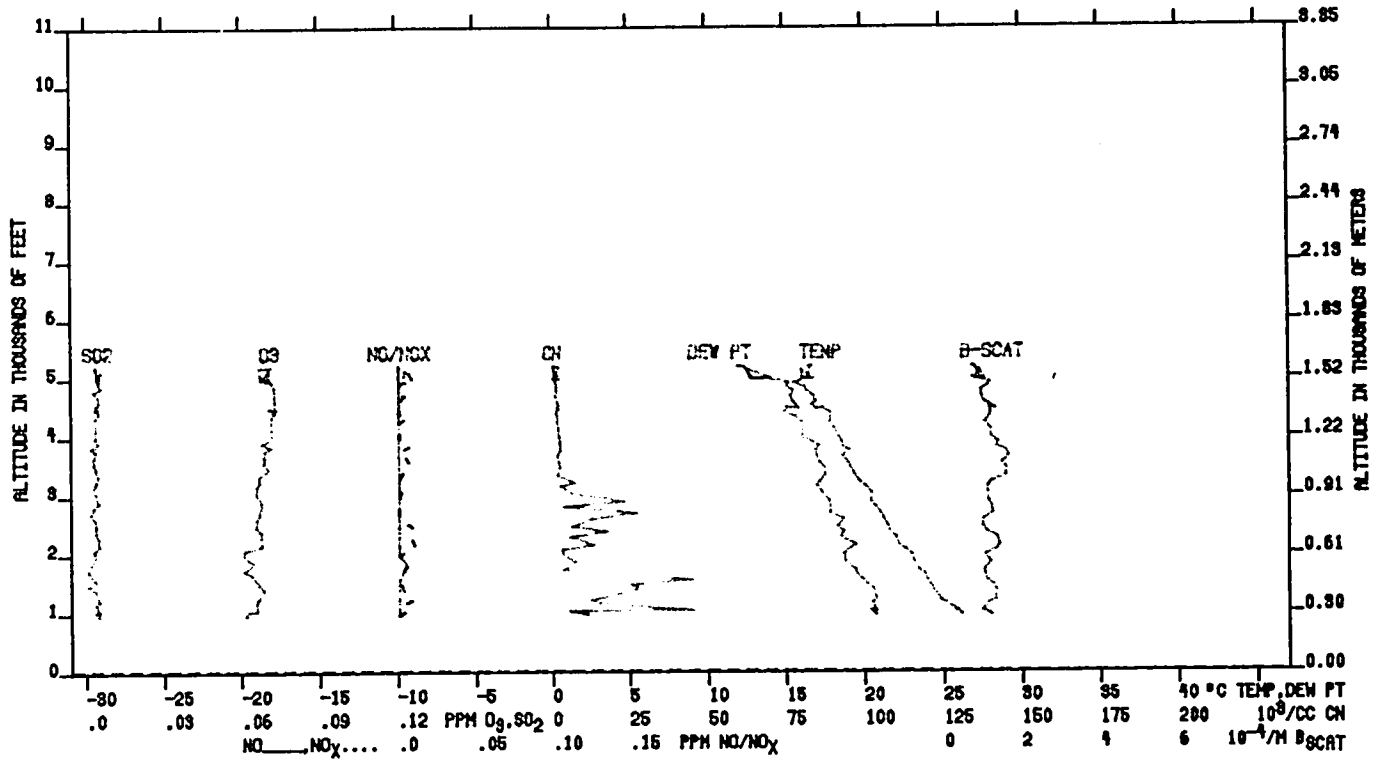

B-12

Figure B-2 Data from flight on August 23 LAS Box Face - Page 5 of 6

19-APR-68

8/23/78

FLIGHT 15
IVOR TO JAMES RIVER

14:52:28 TO 14:14:48 PM

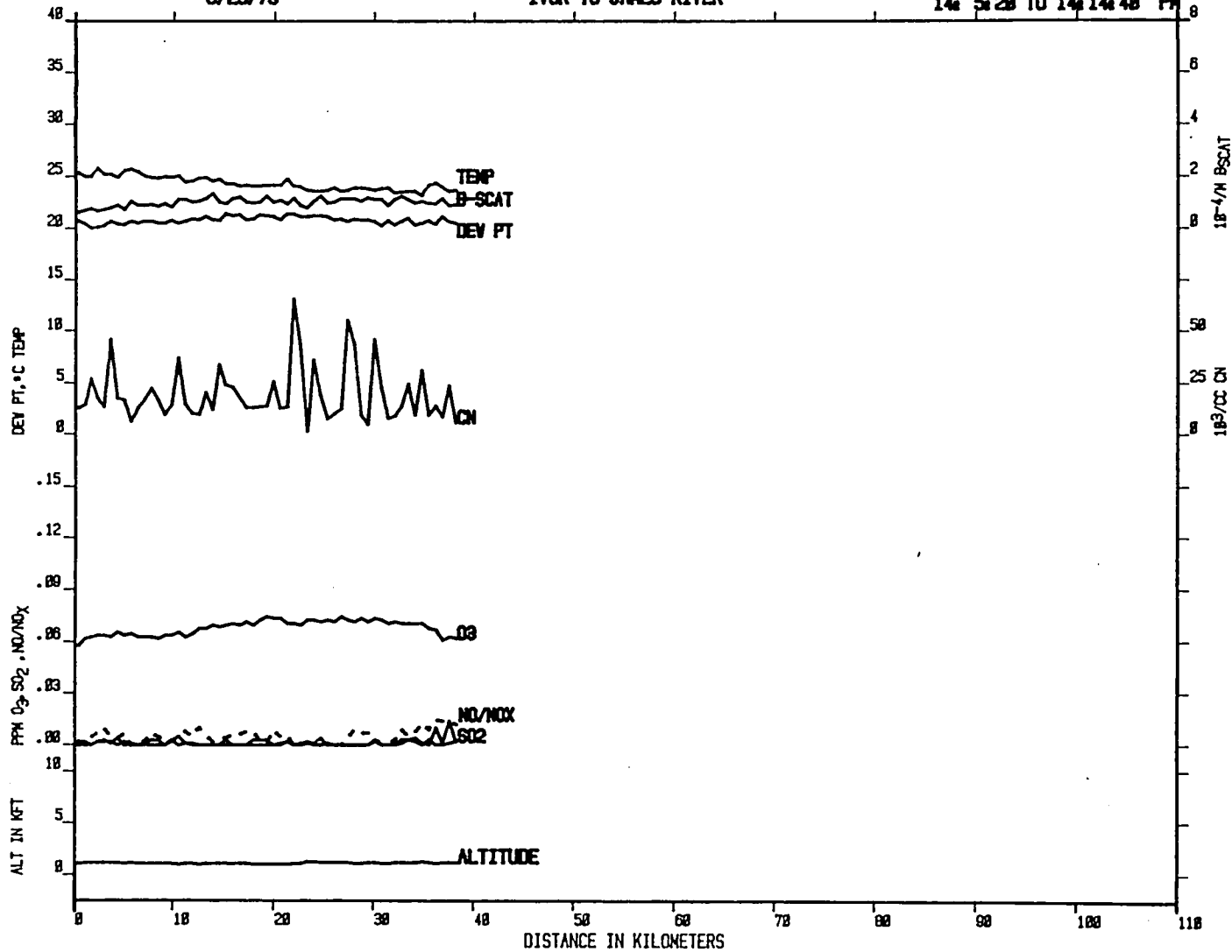

B-13

Figure B-2 Data from flight on August 23 LAS Box Face - Page 6 of 6

18-APR-68

8/24/78

FLIGHT 16 LEG AB

5:45:38 TO 5:59:38
6:15:48 TO 6:24:58 AM

B-14

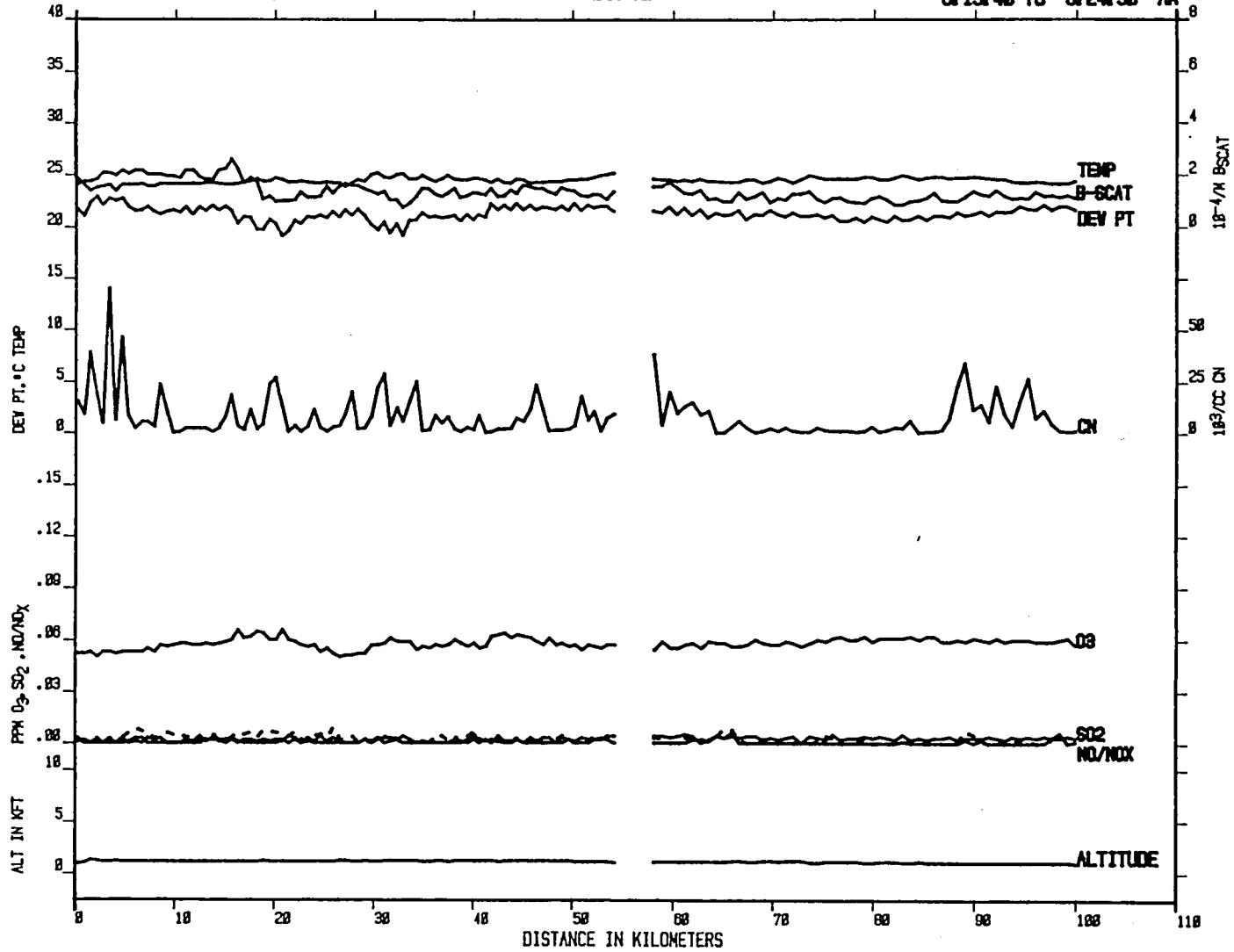
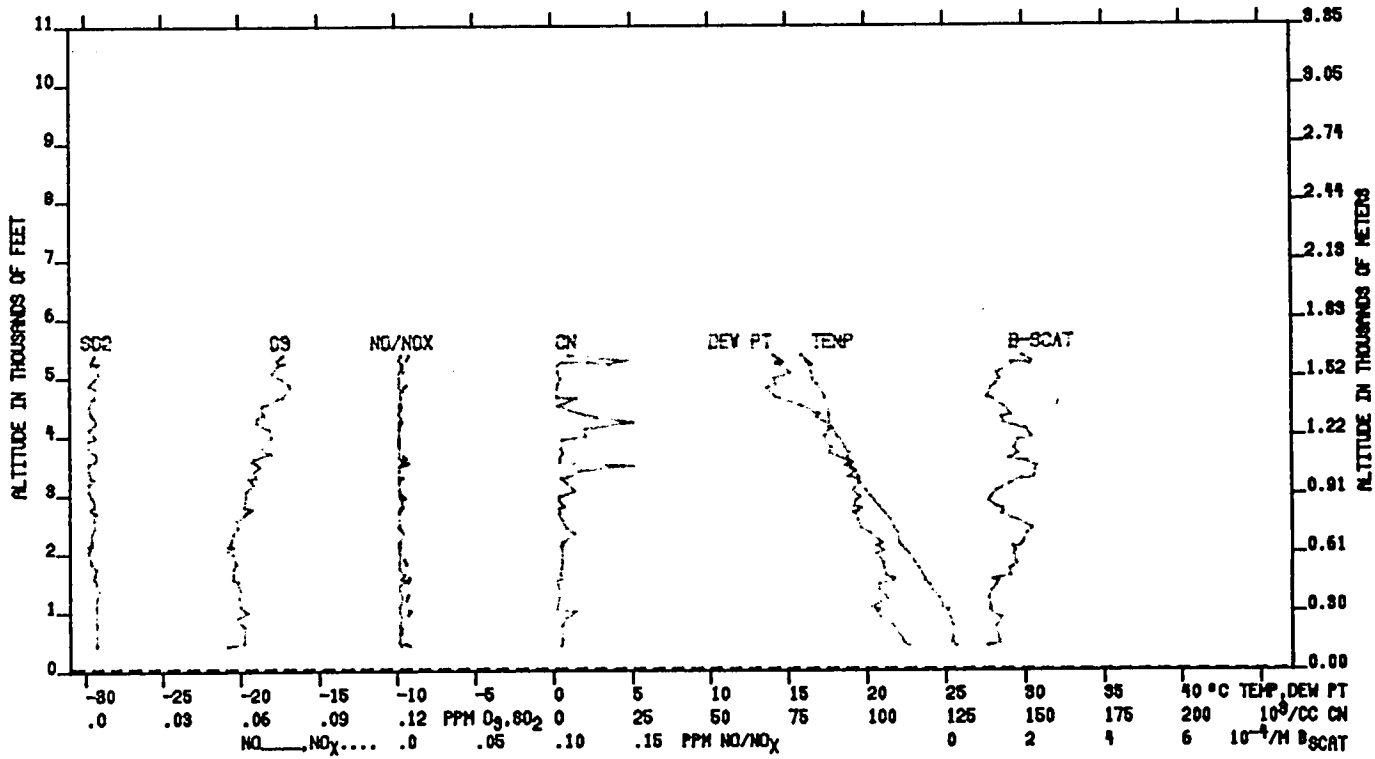

Figure B-3 Data from flight on August 24 - early morning - (Urban Plume-SW flow)
Page 1 of 6

82-MAY-88

FLIGHT 16 SPIRAL 1
R. 04.78
NAVAL CONCENTRATION CENTER
G 1 2 3 4 5 6 7 8 9 10 11



B-15

Figure B-3 Data from flight on August 24 - early morning - (Urban Plume-SW flow)
Page 2 of 6

B-16

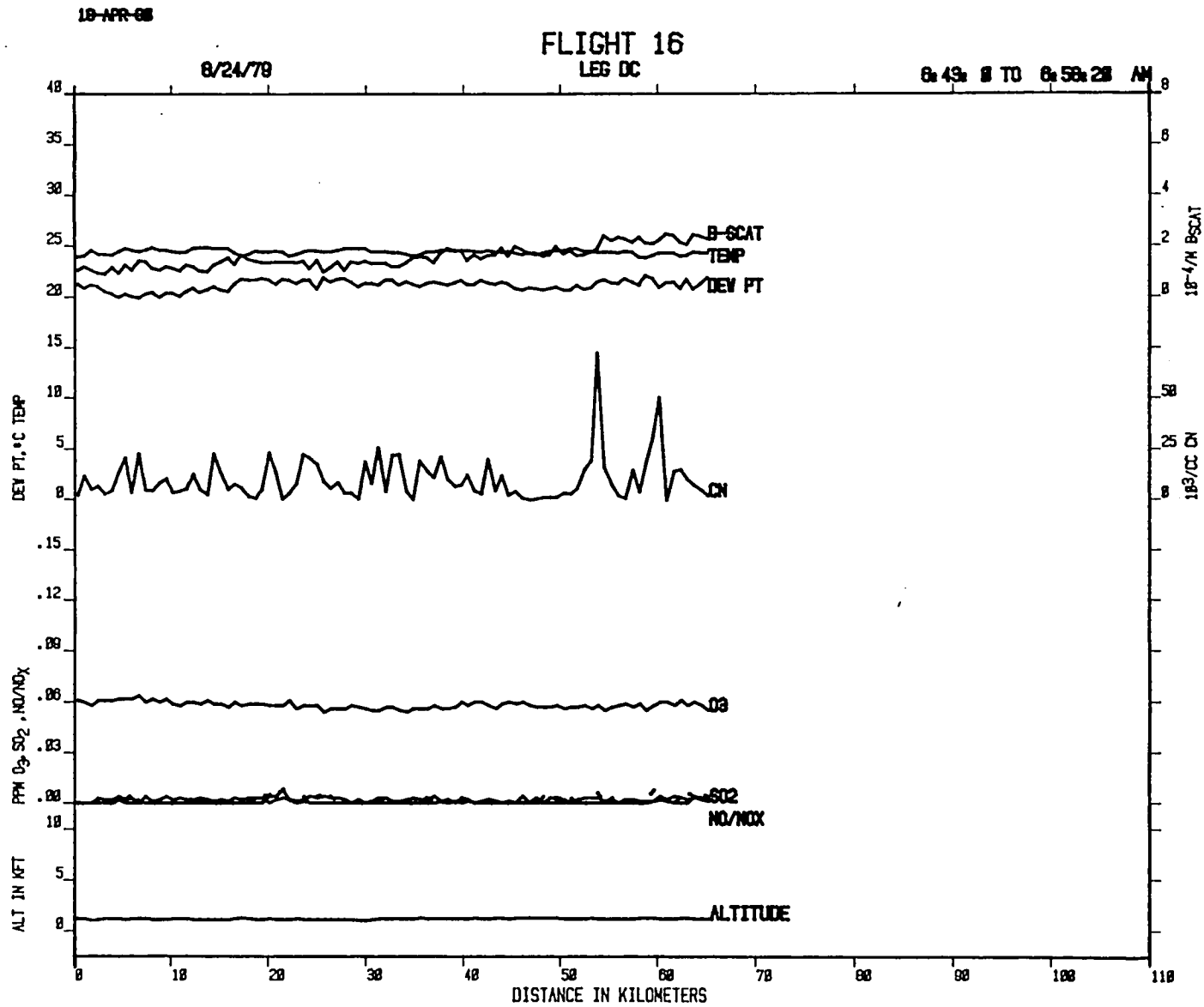

Figure B-3 Data from flight on August 24 - early morning - (Urban Plume-SW flow)
Page 3 of 6

19-APR-80

8/24/79

FLIGHT 16
LEG AB

7: 4:30 TO 7:17:28
7: 33:40 TO 7:45: 8 AM

B-17

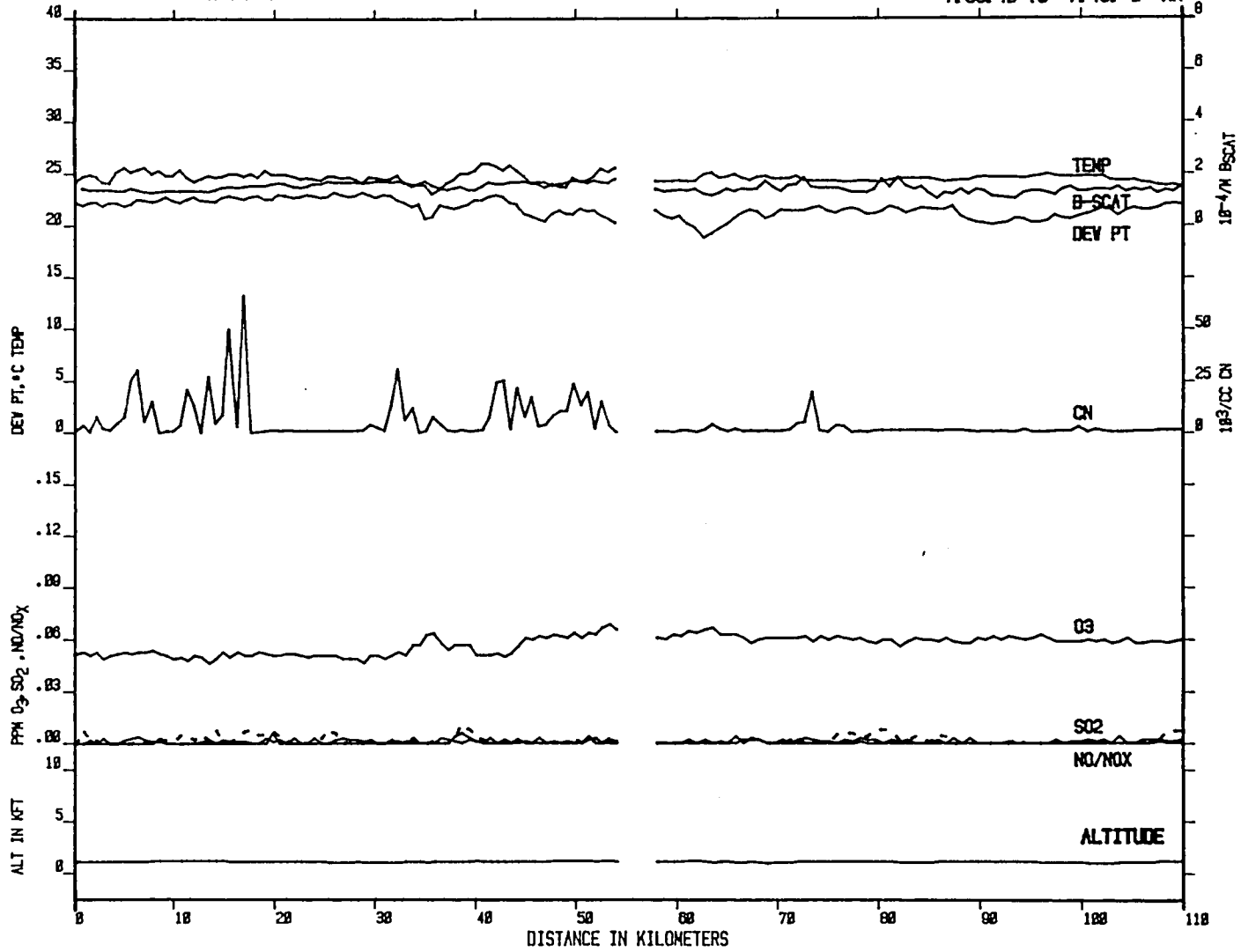

Figure B-3 Data from flight on August 24 - early morning - (Urban Plume-SW flow)
Page 4 of 6

22-MAY-88

FLIGHT 18 SPIRAL 2
8/24/70
NAVAL COMMUNICATION CENTER
07:00 Z TO 07:30 AM

B-18

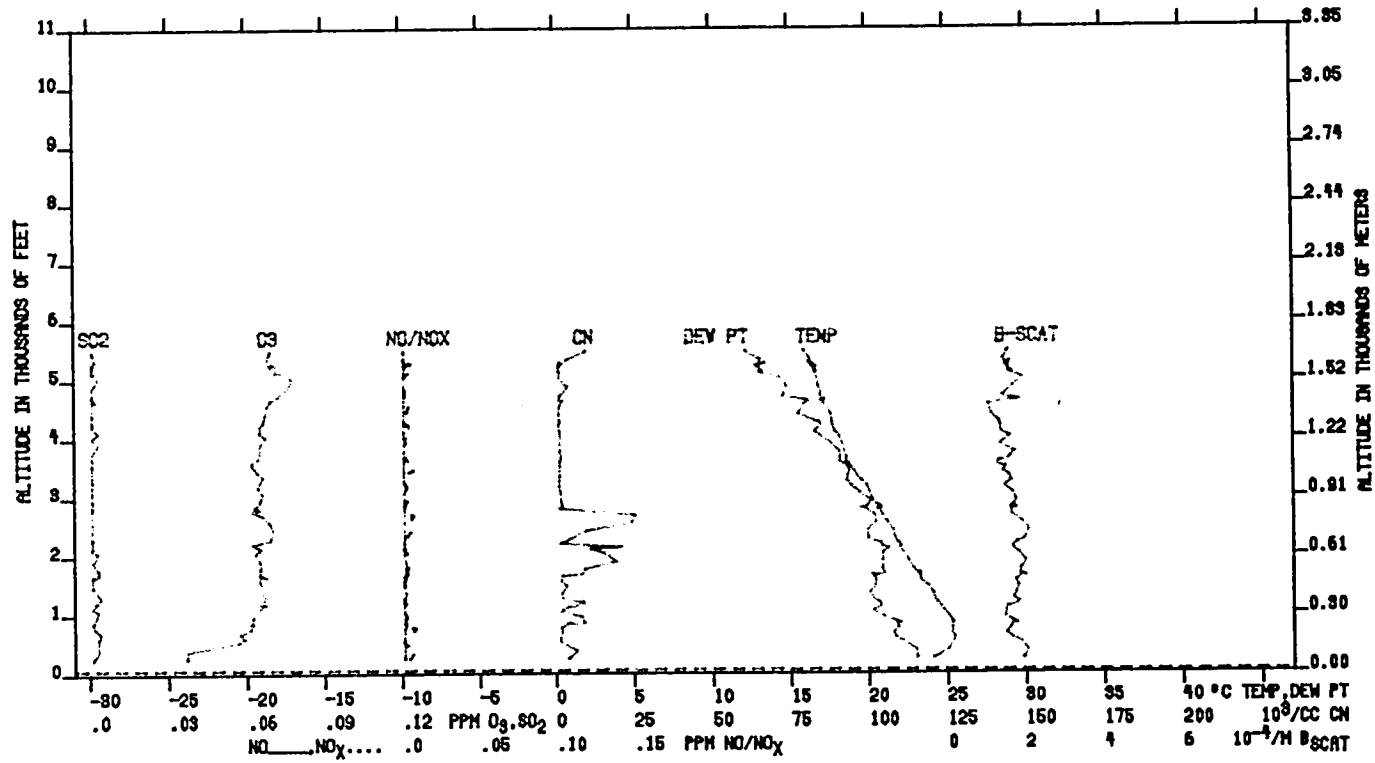

Figure B-3 Data from flight on August 24 - early morning - (Urban Plume-SW flow)
Page 5 of 6

B-19

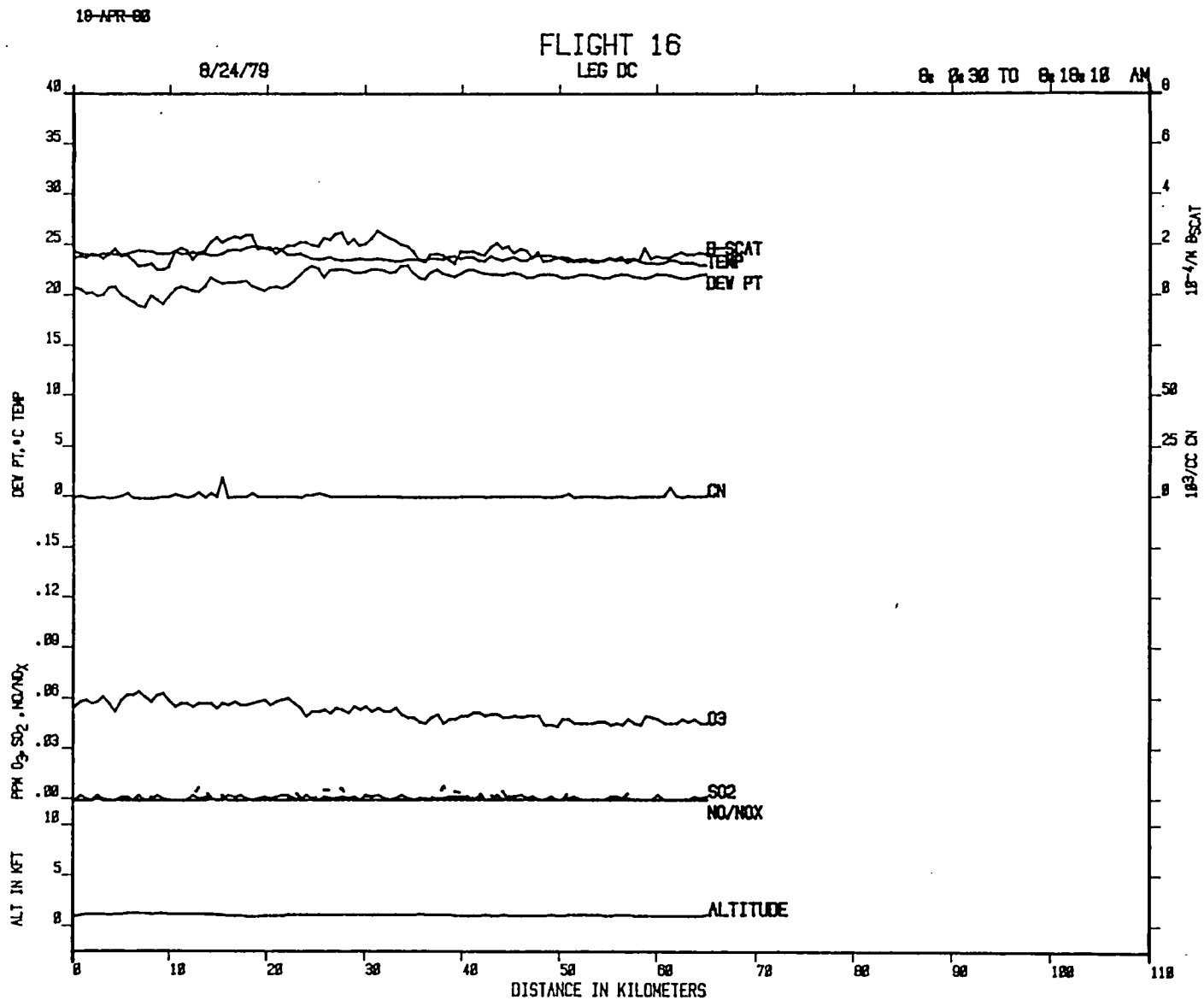

Figure B-3 Data from flight on August 24 - early morning - (Urban Plume-SW flow)
Page 6 of 6

18-APR-88

8/24/79

FLIGHT 17 LEG AB

10:59:28 TO 11:13: 8
11:34: 8 TO 11:43: 8 AM

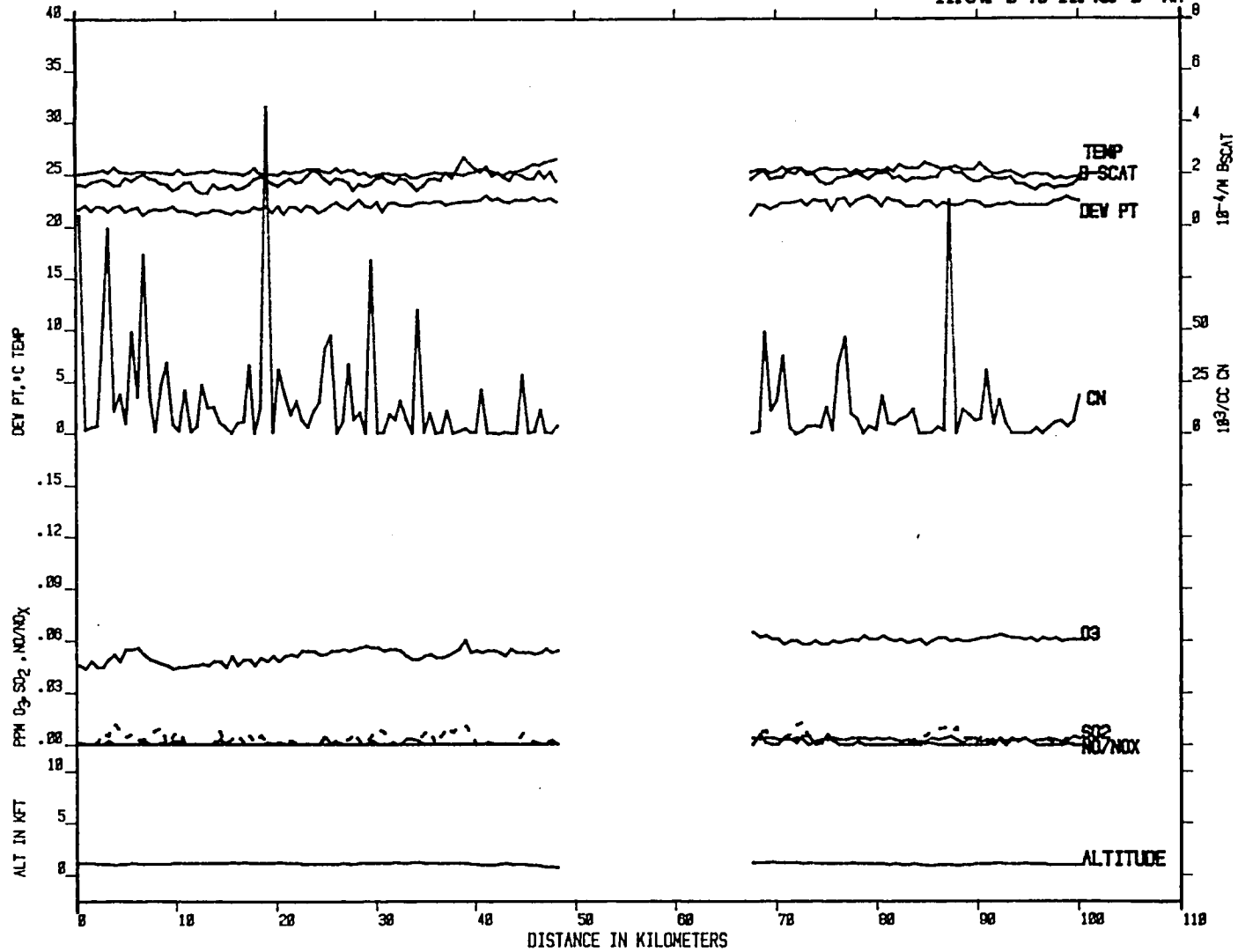

B-20

Figure B-4 Data from flight on August 24 - late morning - (Urban Plume-SW flow)
Page 1 of 7

82-MAY-82

FLIGHT IN SPIRAL 1
P. 24.78
NAVAL COMBINATION CENTER
11:15:12 TO 11:24:02 AM

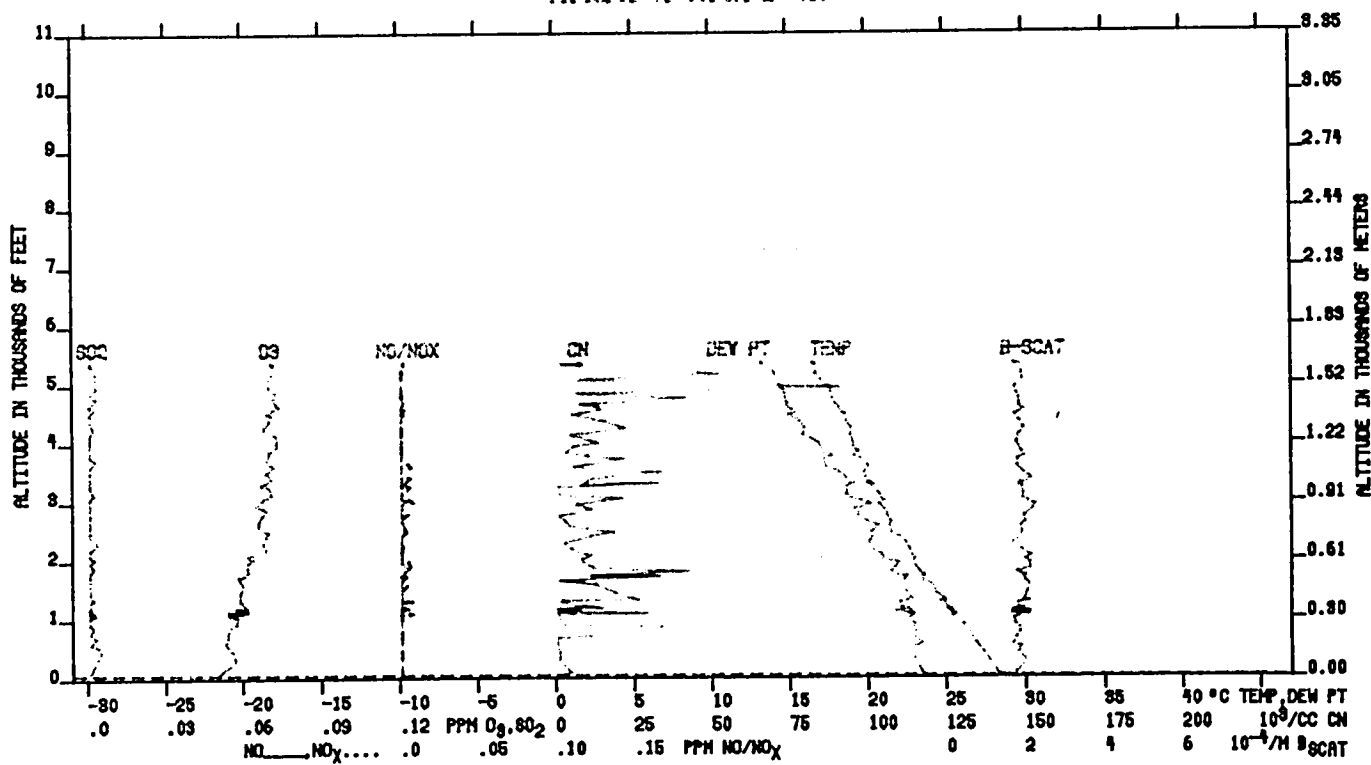

B-21

Figure B-4 Data from flight on August 24 - late morning - (Urban Plume-SW flow)
Page 2 of 7

18-APR-88

8/24/79

FLIGHT 17 LEG DC

11:55 AM TO 12:14:38 AM

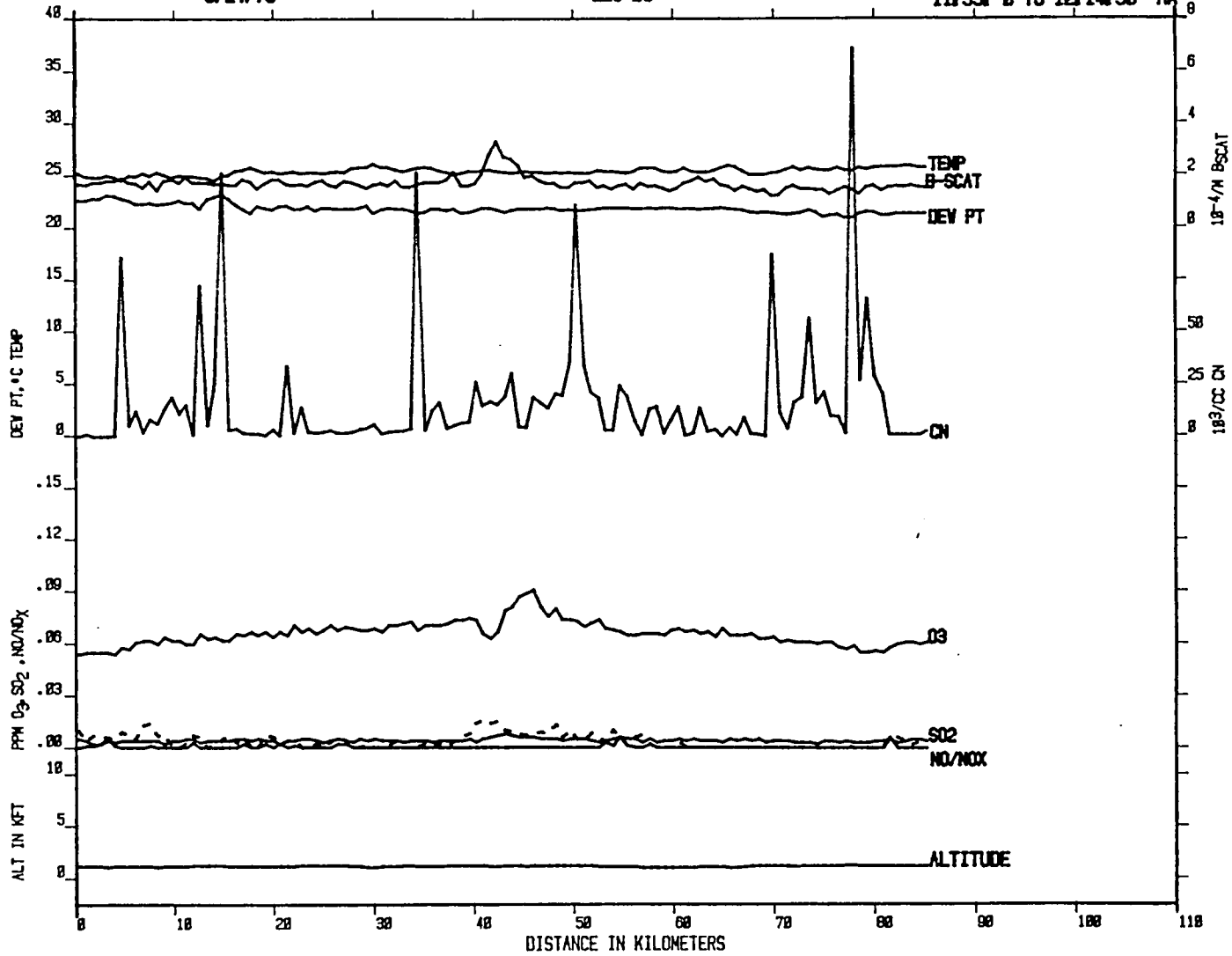

B-22

Figure B-4 Data from flight on August 24 - late morning - (Urban Plume-SW flow)
Page 3 of 7

18 APR 88

8/24/78

FLIGHT 17 LEG EF

12:21:28 TO 12:31:28
12:54:48 TO 13: 4:48 PM

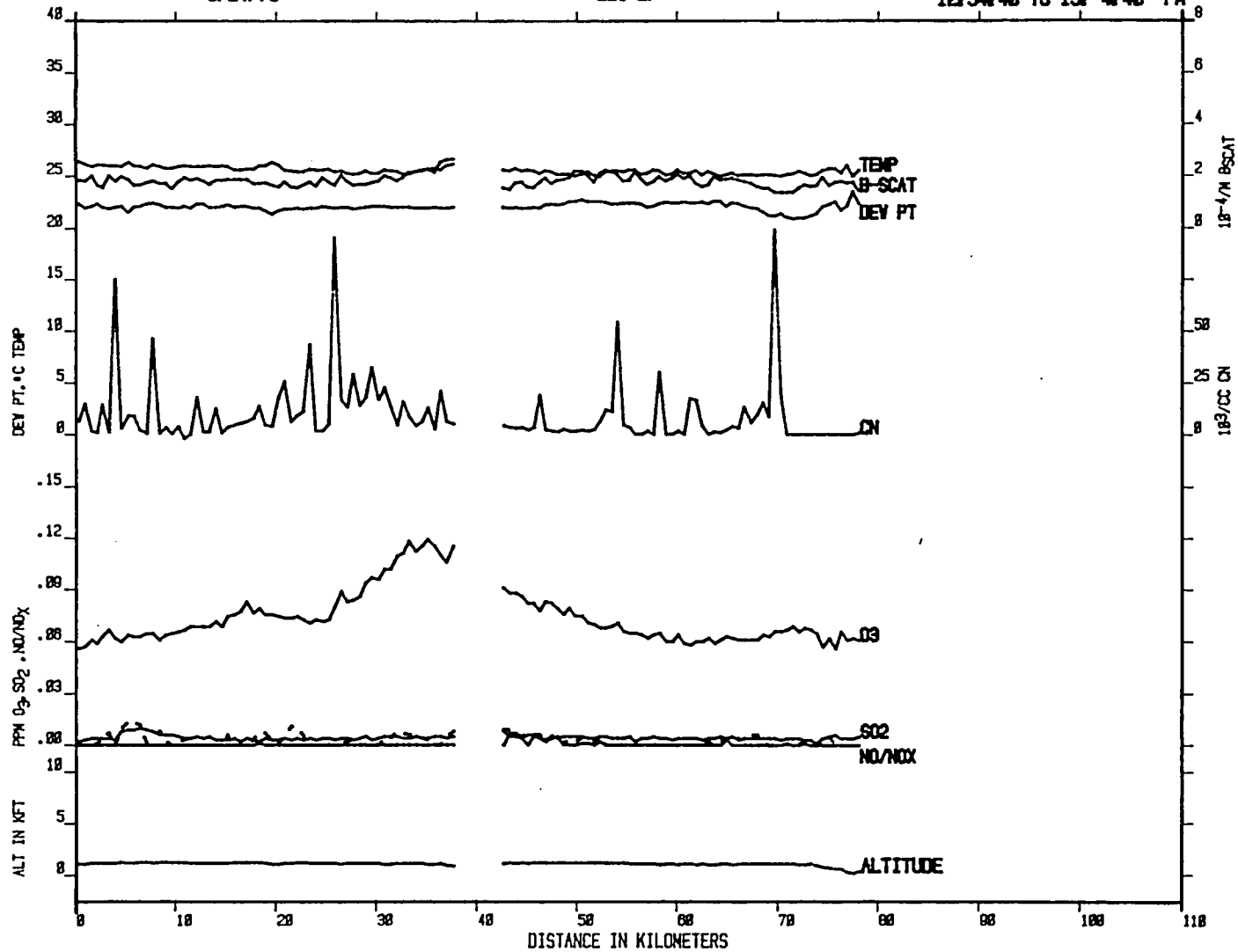

B-23

Figure B-4 Data from flight on August 24 - late morning - (Urban Plume-SW flow)
Page 4 of 7

FLIGHT 17 SPIRAL 2
9/24/78
CHESAPEAKE BRIDGE TUNNEL
12:32:42 TO 12:46:38 PM

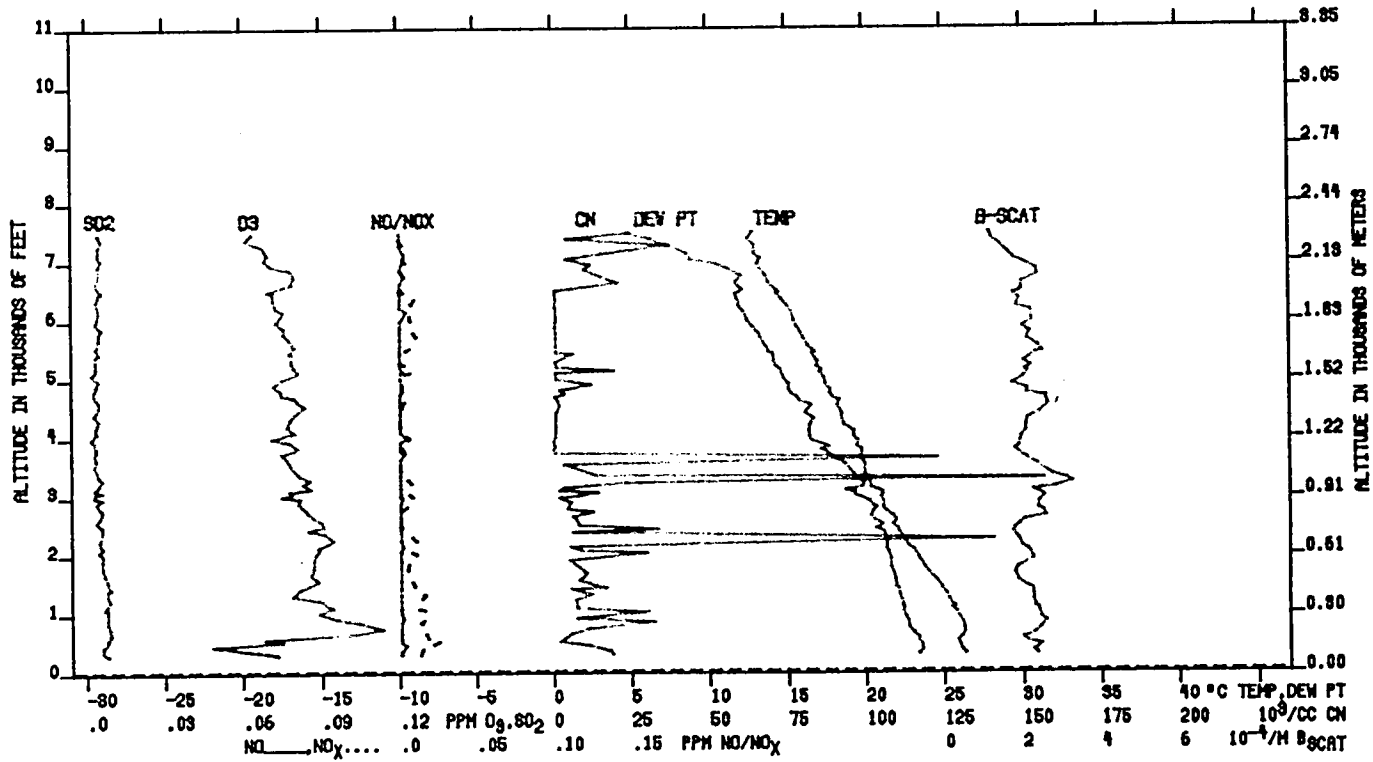

Figure B-4 Data from flight on August 24 - late morning - (Urban Plume-SW flow)
Page 5 of 7

18-APR-88

8/24/79

FLIGHT 17
LEG HG

13:13:30 TO 13:22:20
13:40:30 TO 13:53:50 PM

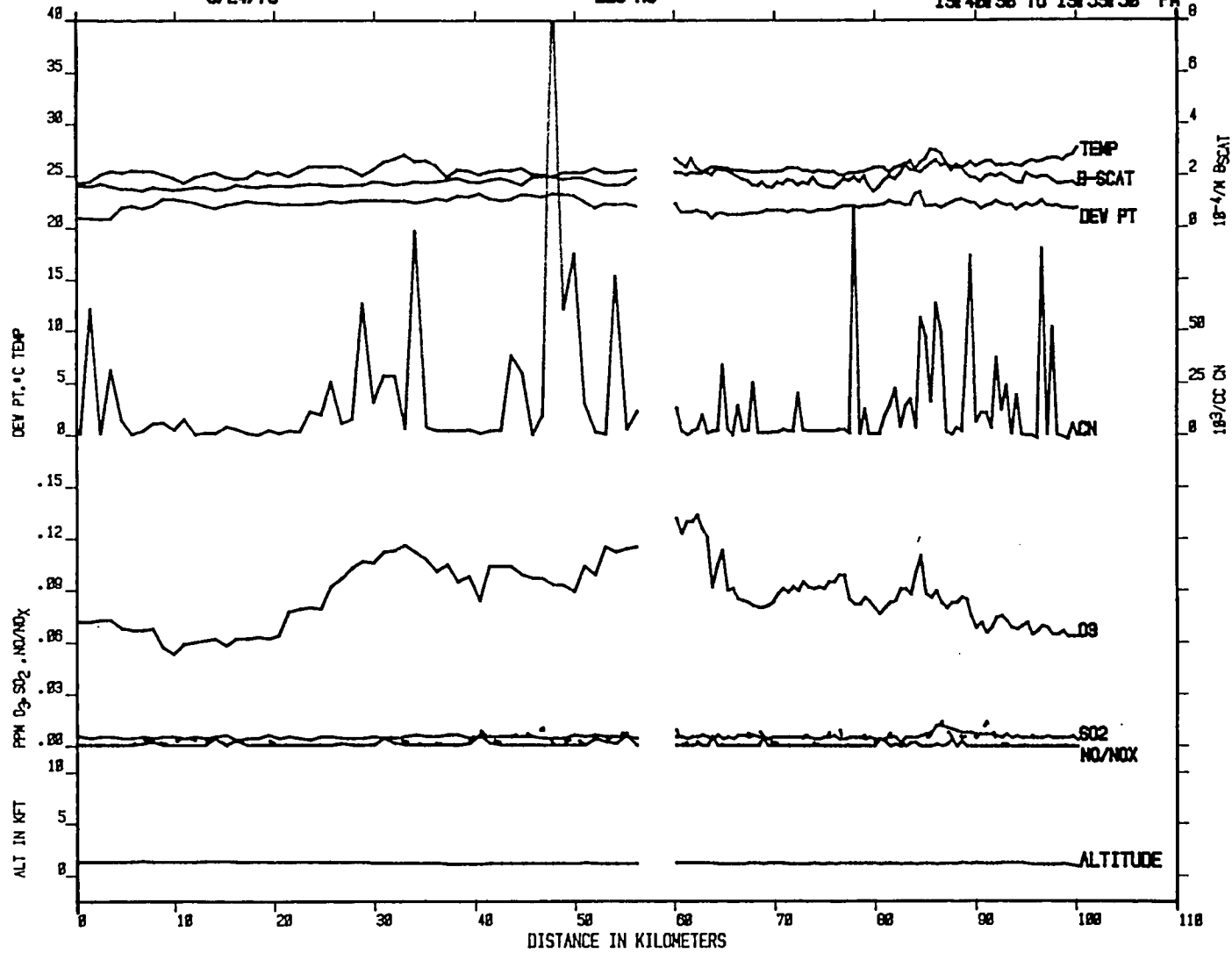

B-25

Figure B-4 Data from flight on August 24 - late morning - (Urban Plume-SW flow)
Page 6 of 7

82-MAY-68

FLIGHT 11 SPIRAL 8

B/0470

CAPE STRATUS

13:24 Z TO 14:35 Z PM

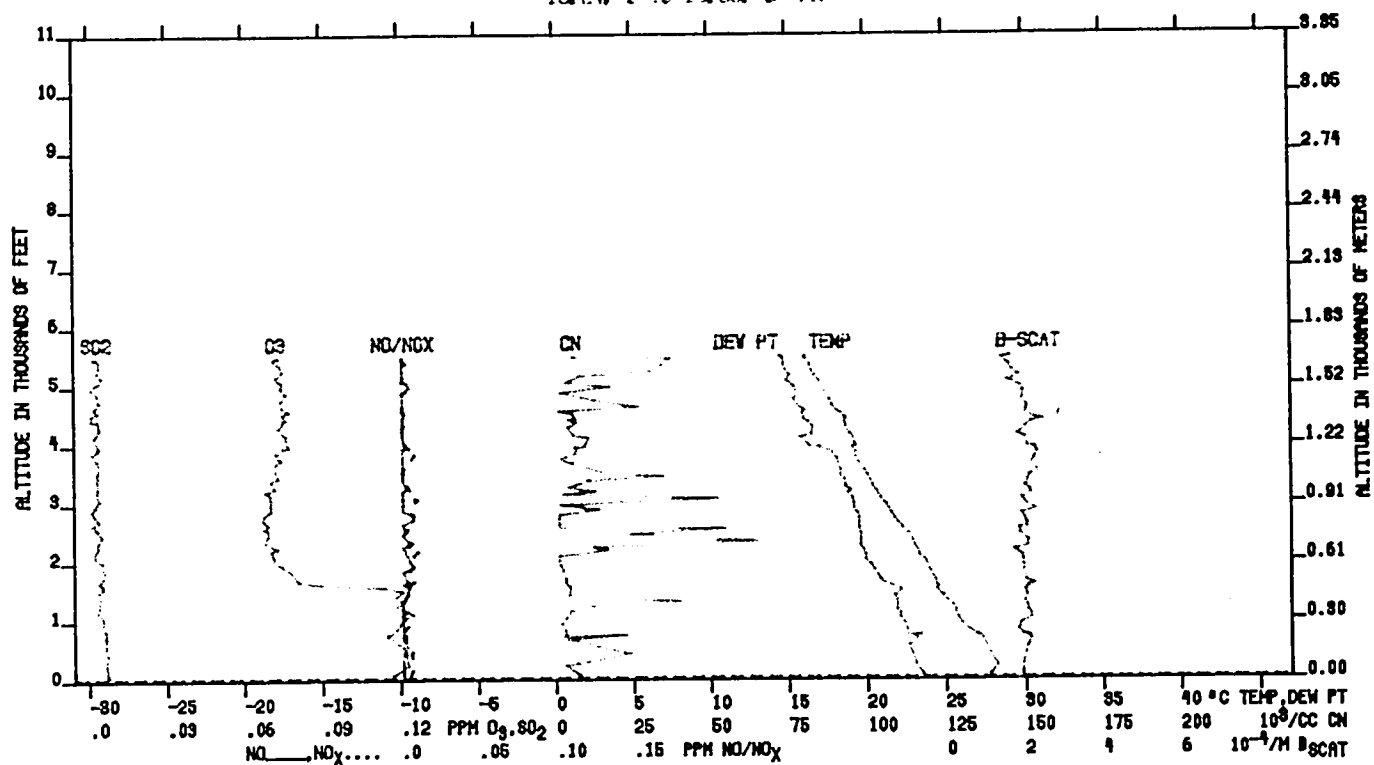

B-26

Figure B-4 Data from flight on August 24 - late morning - (Urban Plume-SW flow)
Page 7 of 7

18-APR-88

8/25/79

FLIGHT 18

LEG AB

5:46:38 TO 5:58:48
6:27:00 TO 6:36:18 AM

B-27

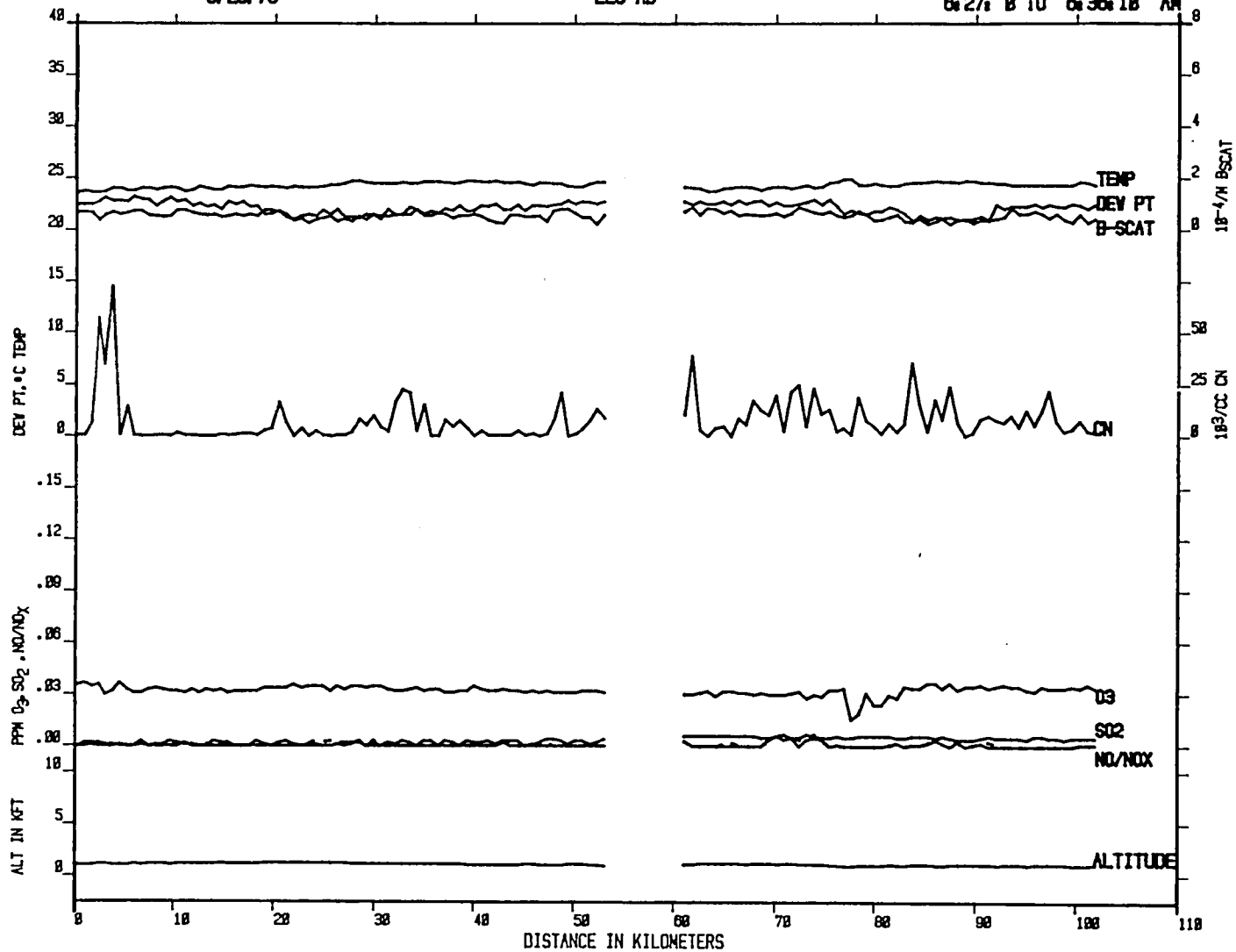
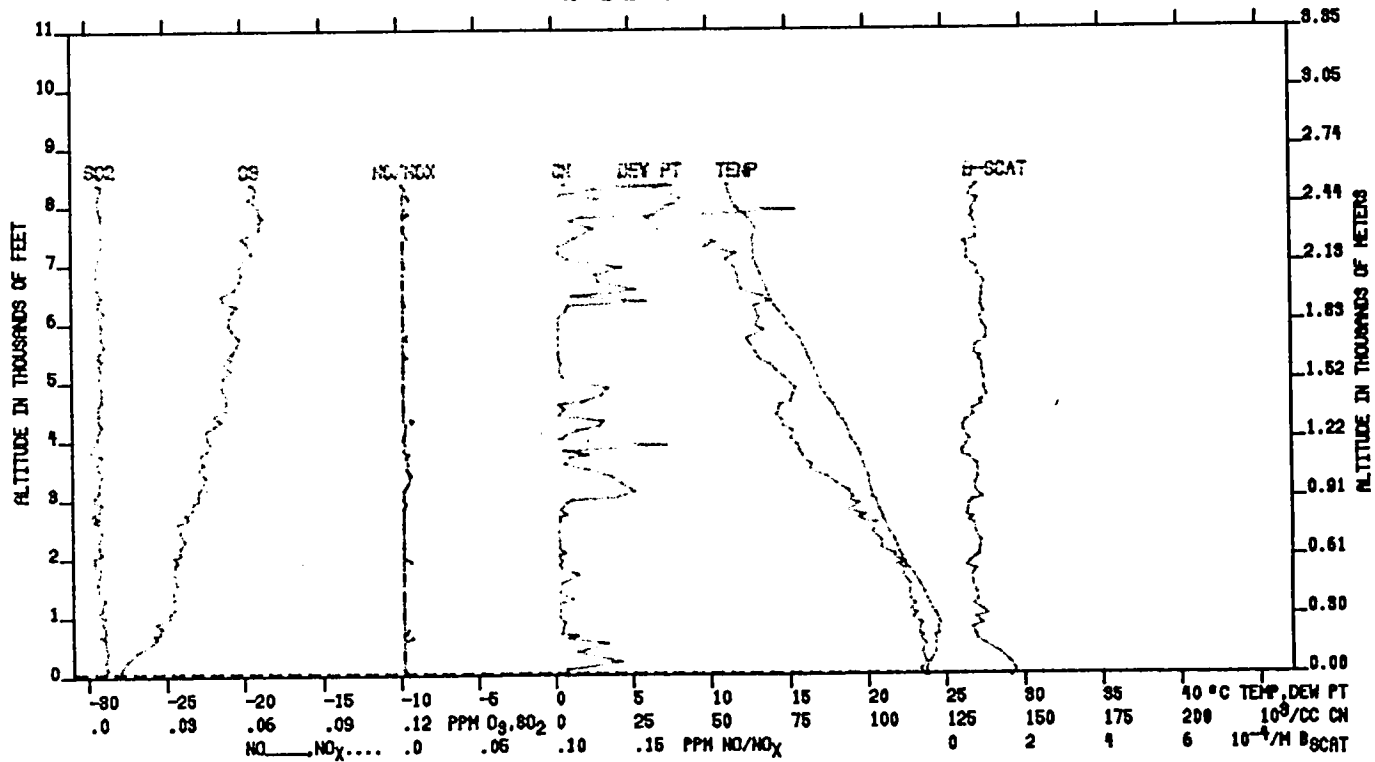

Figure B-5 Data from flight on August 25 - early morning - (Urban Plume-SW flow)
Page 1 of 6

82-MAY-88

FLIGHT 18 SPIRAL 1
8/25/78
NAVAL COMMUNICATION CENTER
6:52Z TO 6:17Z 2 AM



B-28

Figure B-5 Data from flight on August 25 - early morning - (Urban Plume-SW flow)
Page 2 of 6

18 APR 88

FLIGHT 18 LEG DC

8/25/79

6:48:30 TO 7:09:18 AM

B-29

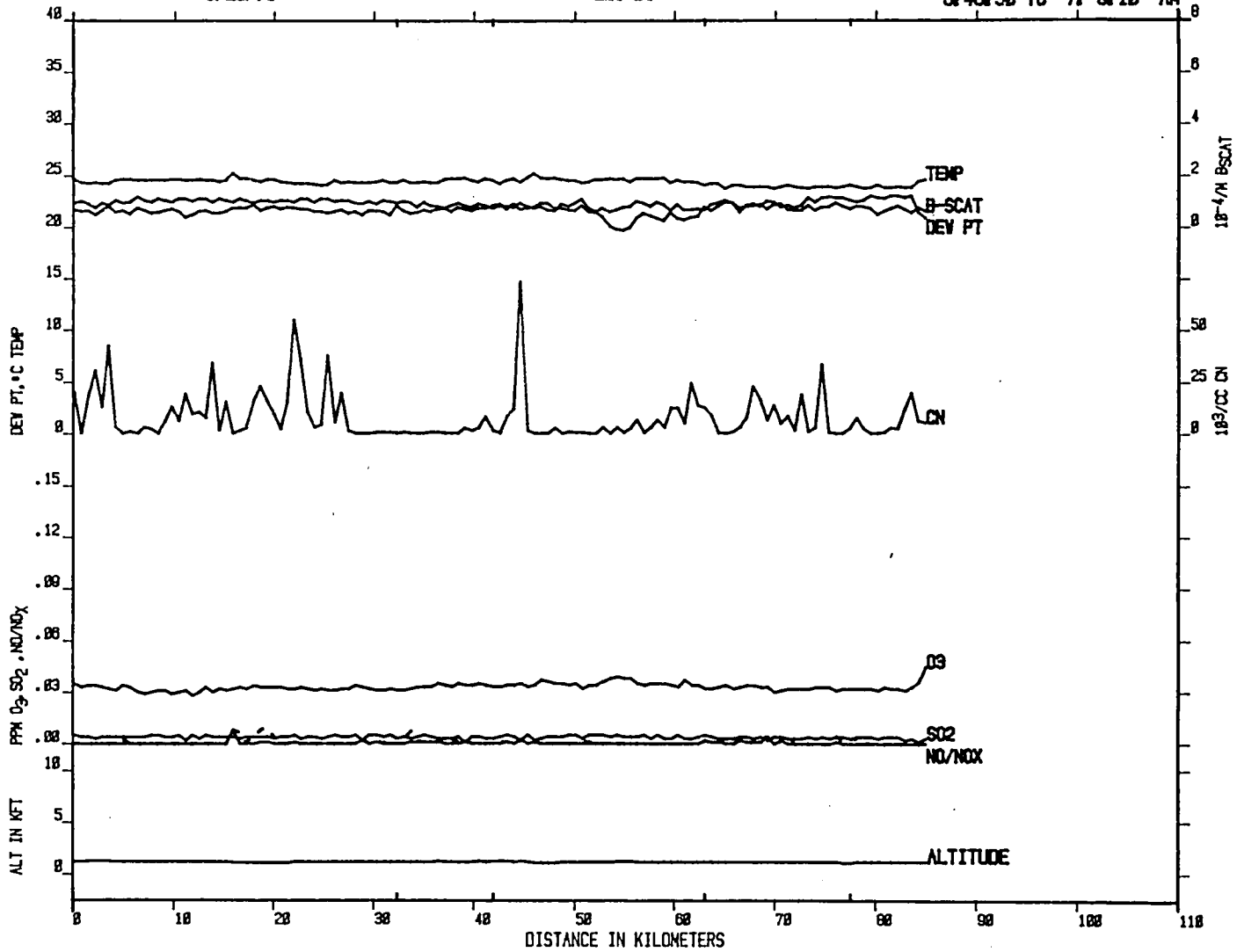

Figure B-5 Data from flight on August 25 - early morning - (Urban Plume-SW flow)
Page 3 of 6

18-NFR-88

8/25/79

FLIGHT 18
LEG AB

7:15:48 TO 7:27:58
7:53:48 TO 8:1:38 AM

B-30

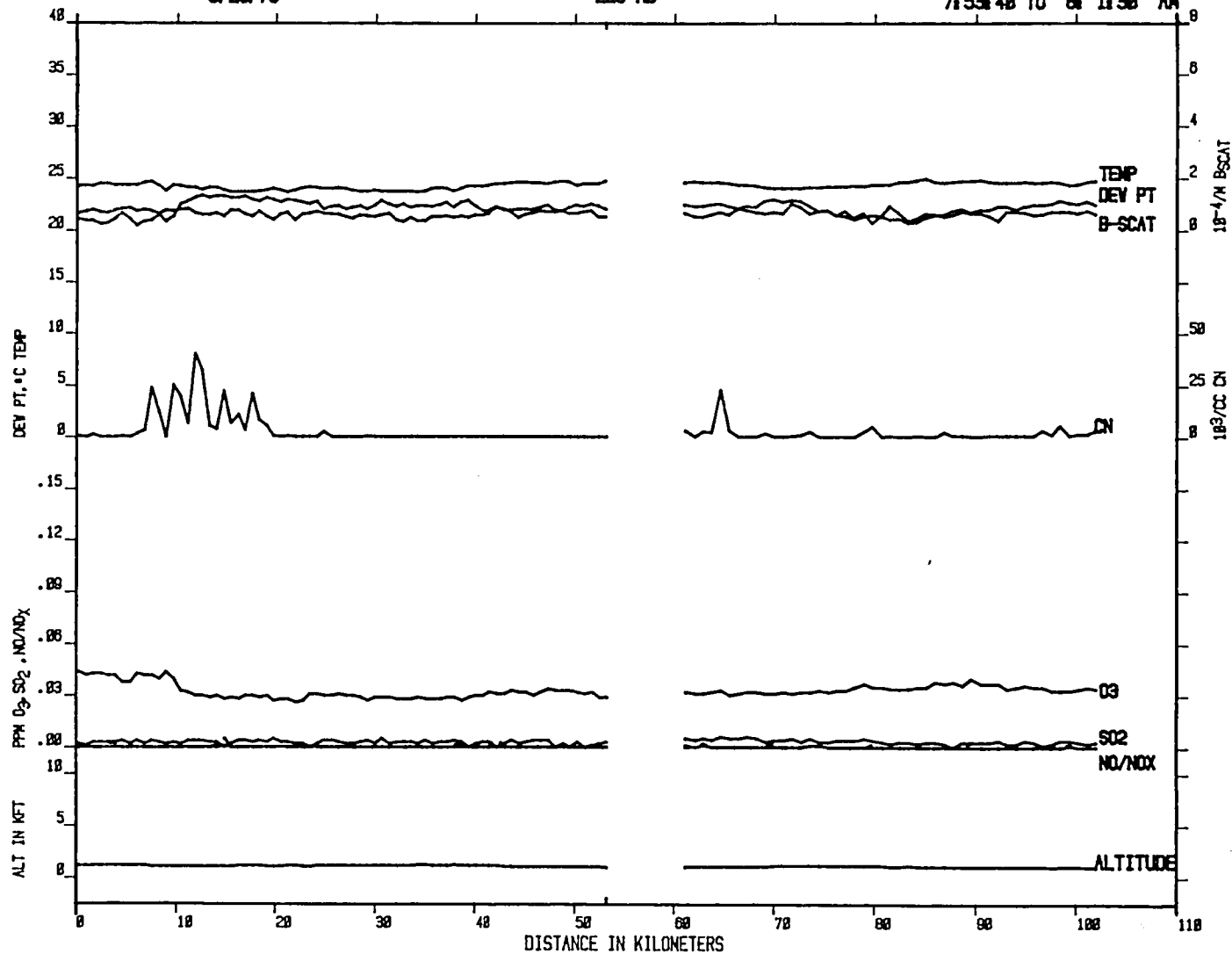
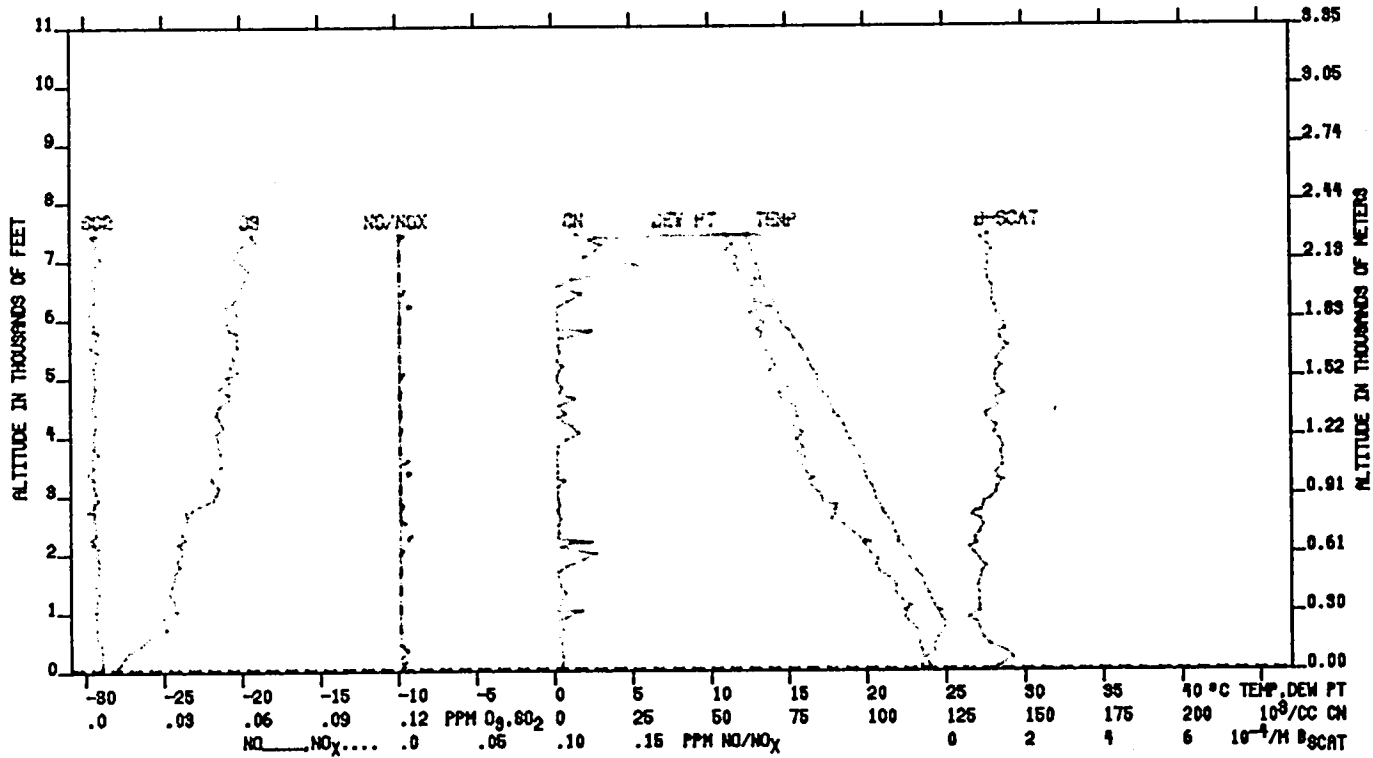

Figure B-5 Data from flight on August 25 - early morning - (Urban Plume-SW flow)
Page 4 of 6

82 MAY 88

FLIGHT IN SPIRAL 3
11:50 TO
NAVAL OPERATIONS CENTER
11:50 TO 11:55 AM '88



B-31

Figure B-5 Data from flight on August 25 - early morning - (Urban Plume-SW flow)
Page 5 of 6

19-APR-88

FLIGHT 18 LEG DC

8/25/78

8:12:30 TO 8:29:00 AM

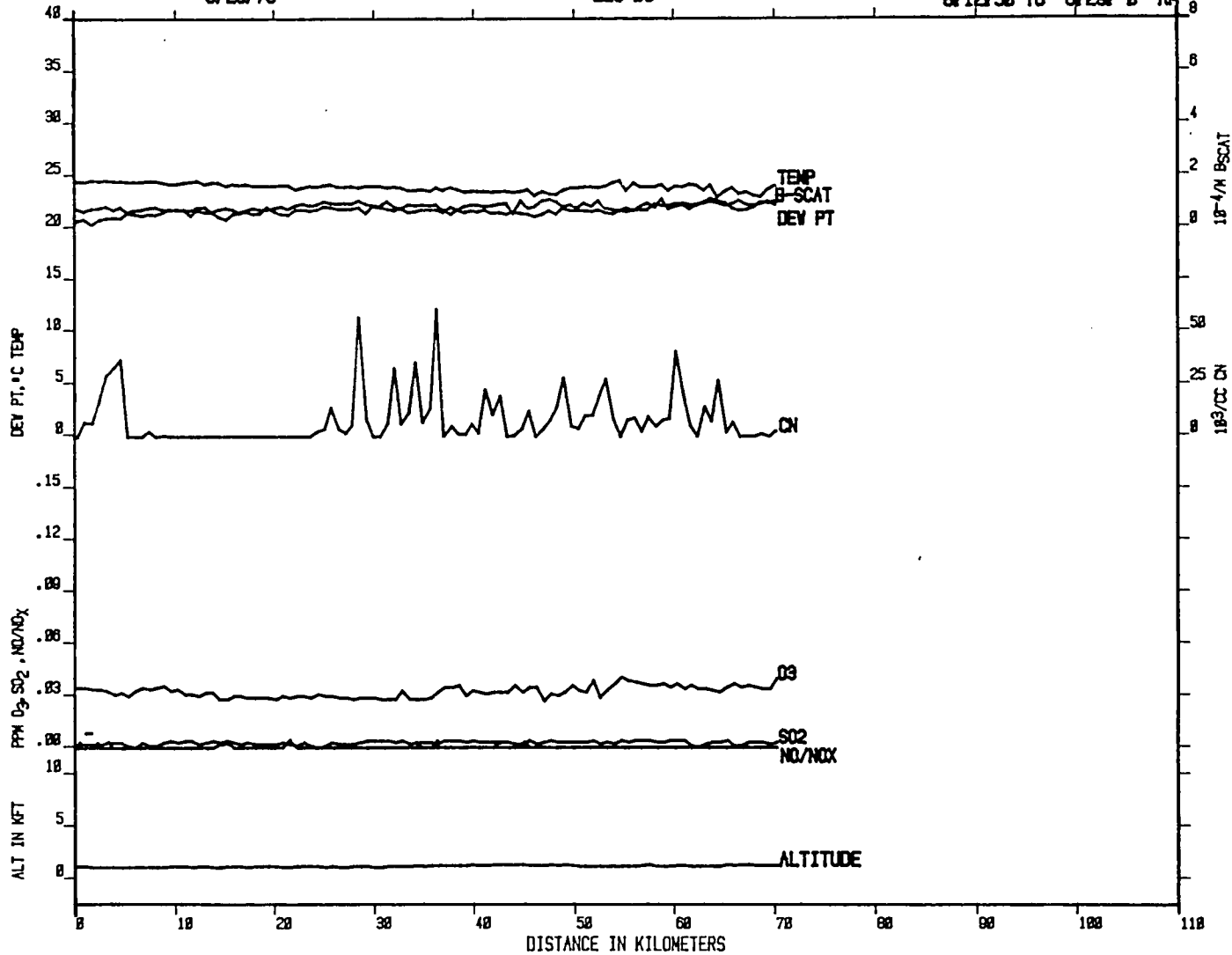

B-32

Figure B-5 Data from flight on August 25 - early morning - (Urban Plume-SW flow)
Page 6 of 6

19-APR-88

8/25/78

FLIGHT 19 LEG AB

10:44:48 TO 10:56:08
11:28:08 TO 11:29:28 AM

B-33

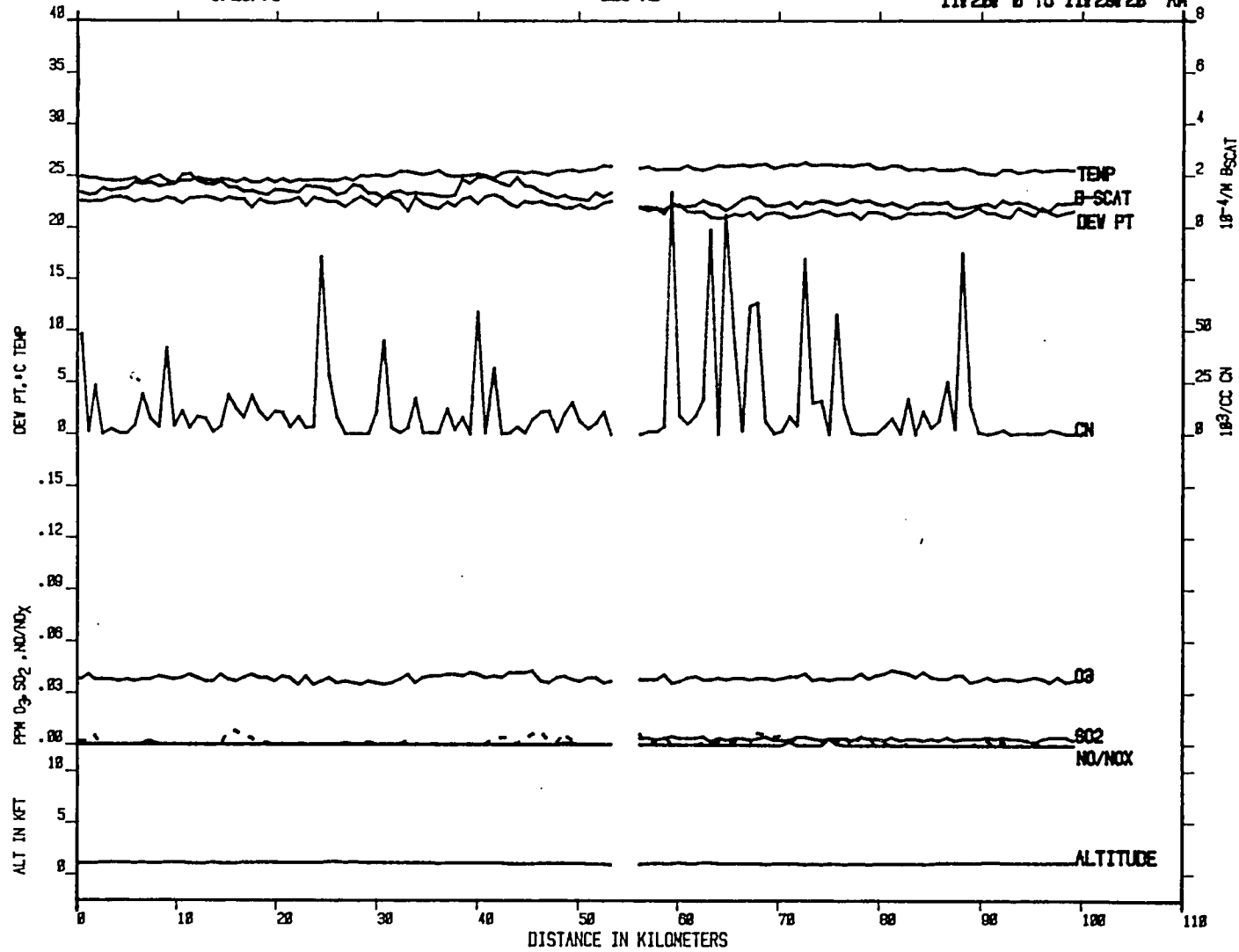
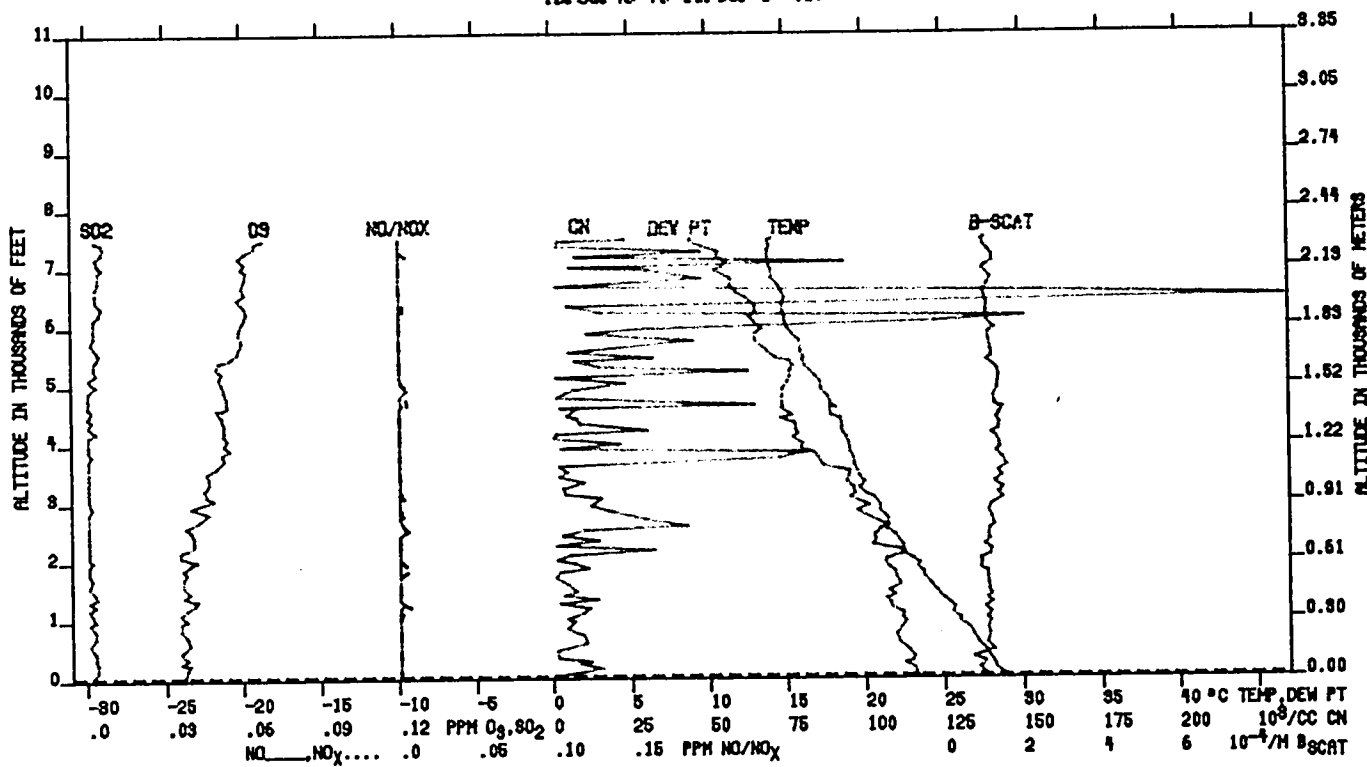

Figure B-6 Data from flight on August 25 - late morning - (Urban Plume-SW flow)
Page 1 of 7

84 MAY 68

FLIGHT 19 SPIRAL 1
8/25/79
NAVAL COMMUNICATION CENTER
10:50:48 TO 11:19:08 AM



B-34

Figure B-6 Data from flight on August 25 - late morning - (Urban Plume-SW flow)
Page 2 of 7

B-35

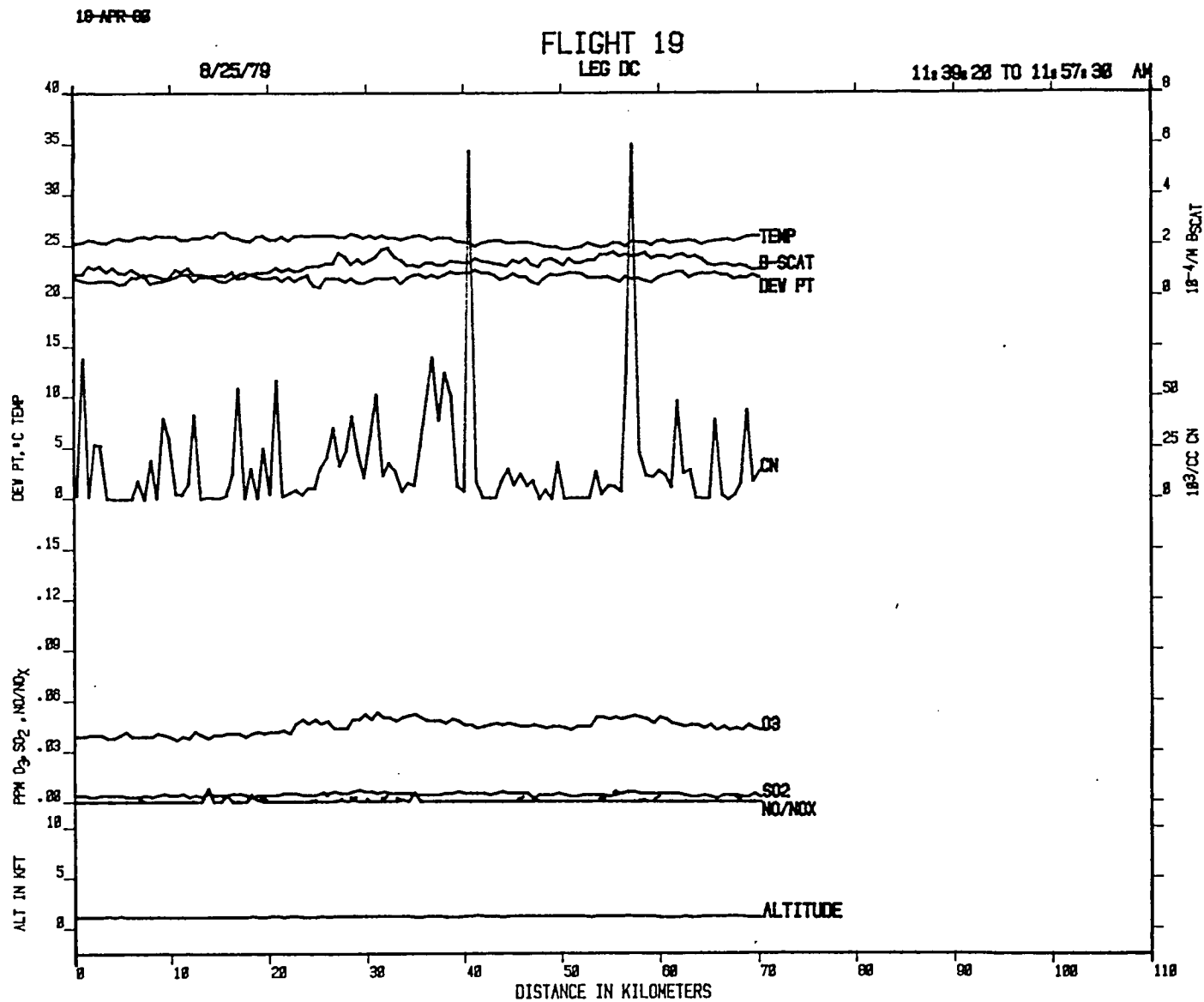

Figure B-6 Data from flight on August 25 - late morning - (Urban Plume-SW flow)
Page 3 of 7

B-36

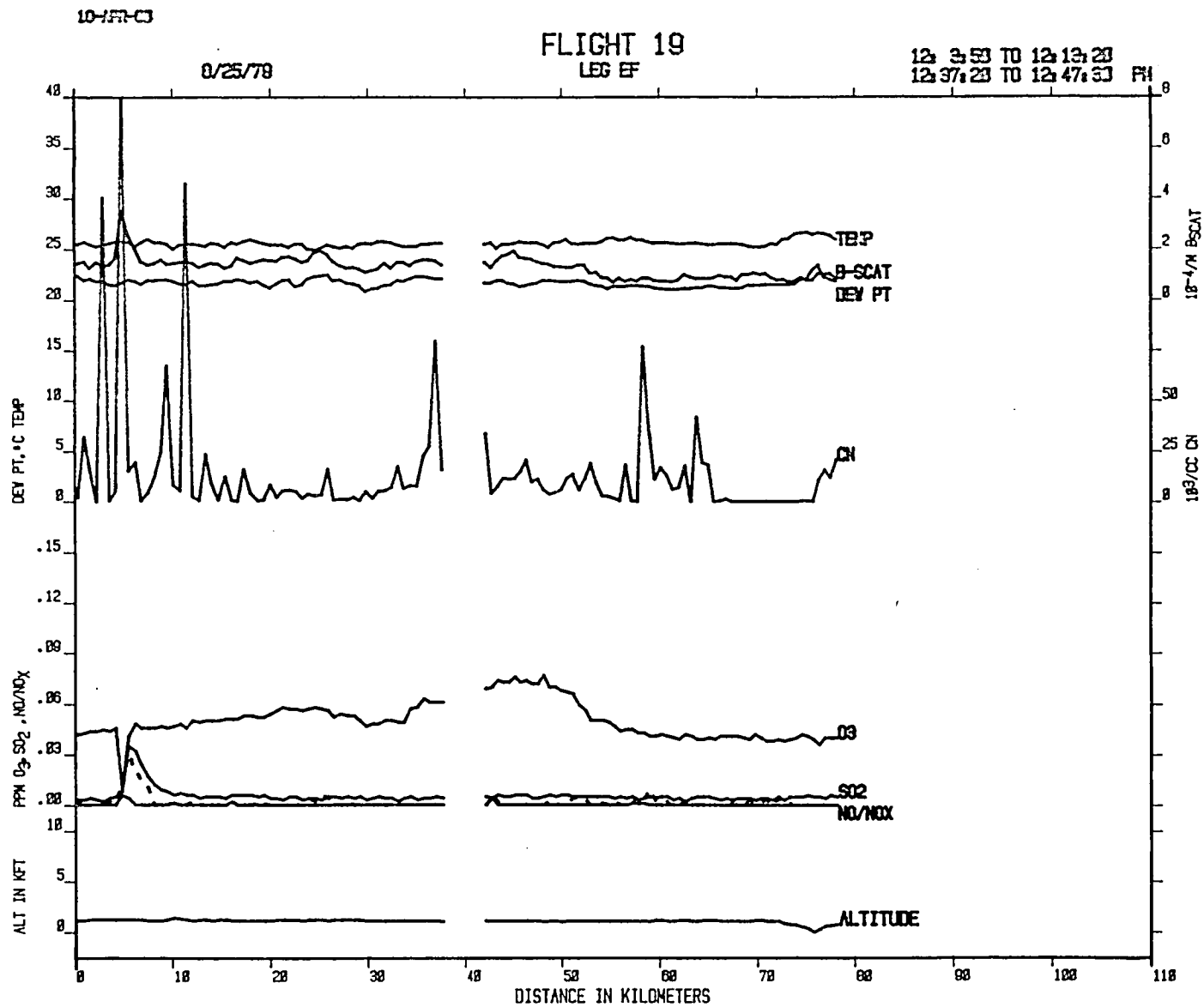
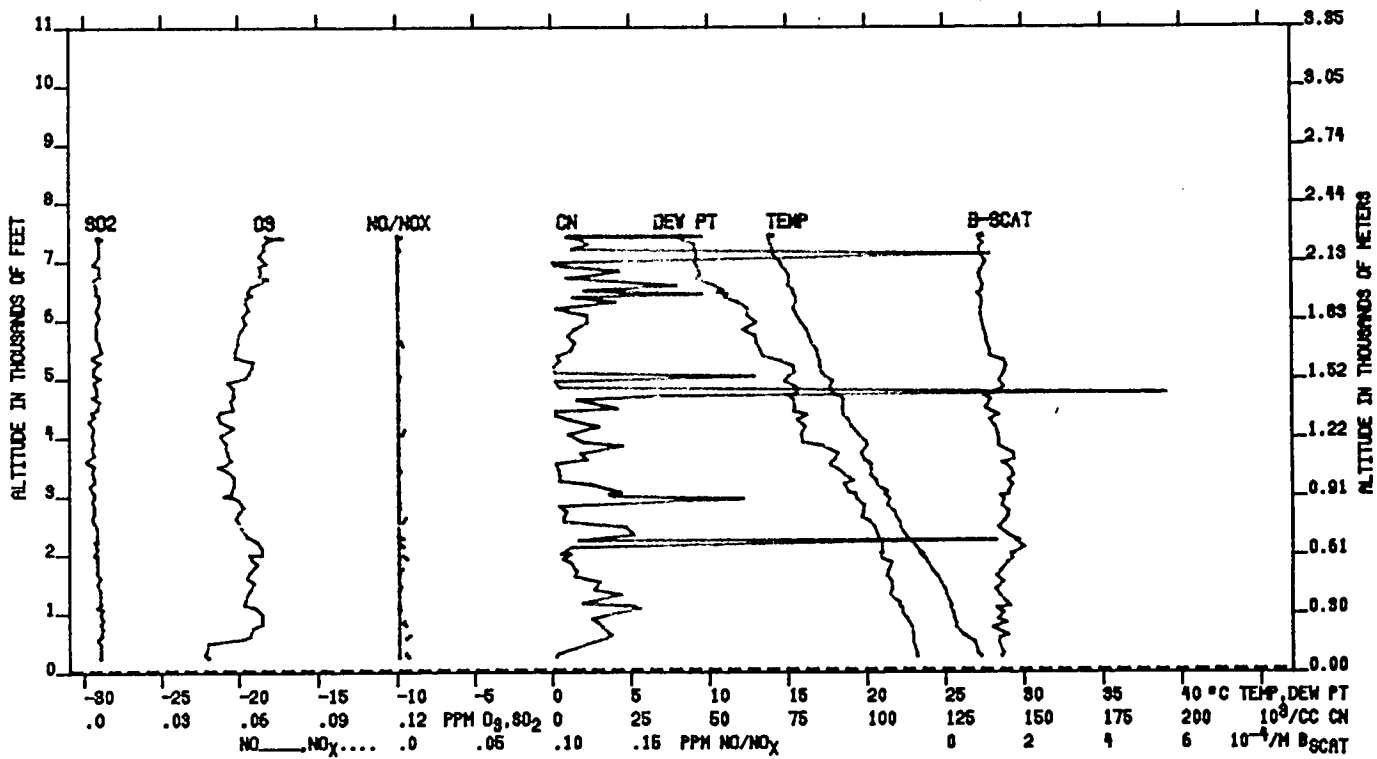

Figure B-6 Data from flight on August 25 - late morning - (Urban Plume-SW flow)
Page 4 of 7

84-MAY-68

FLIGHT 19 SPIRAL 2
8/25/78
CHESAPEAKE BRIDGE TUNNEL
12:15:30 TO 12:29:48 PM



B-37

Figure B-6 Data from flight on August 25 - late morning - (Urban Plume-SW flow)
Page 5 of 7

B-38

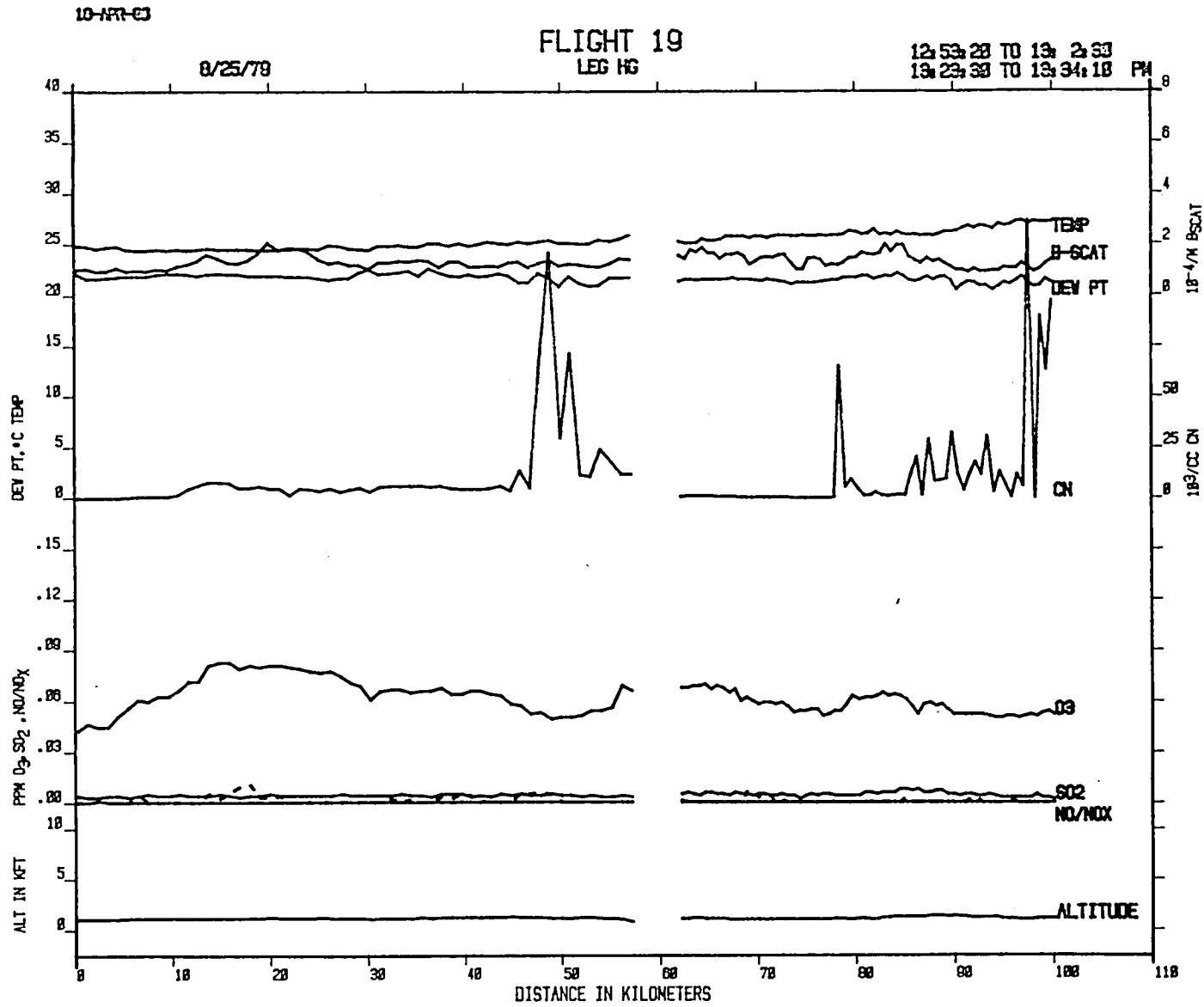
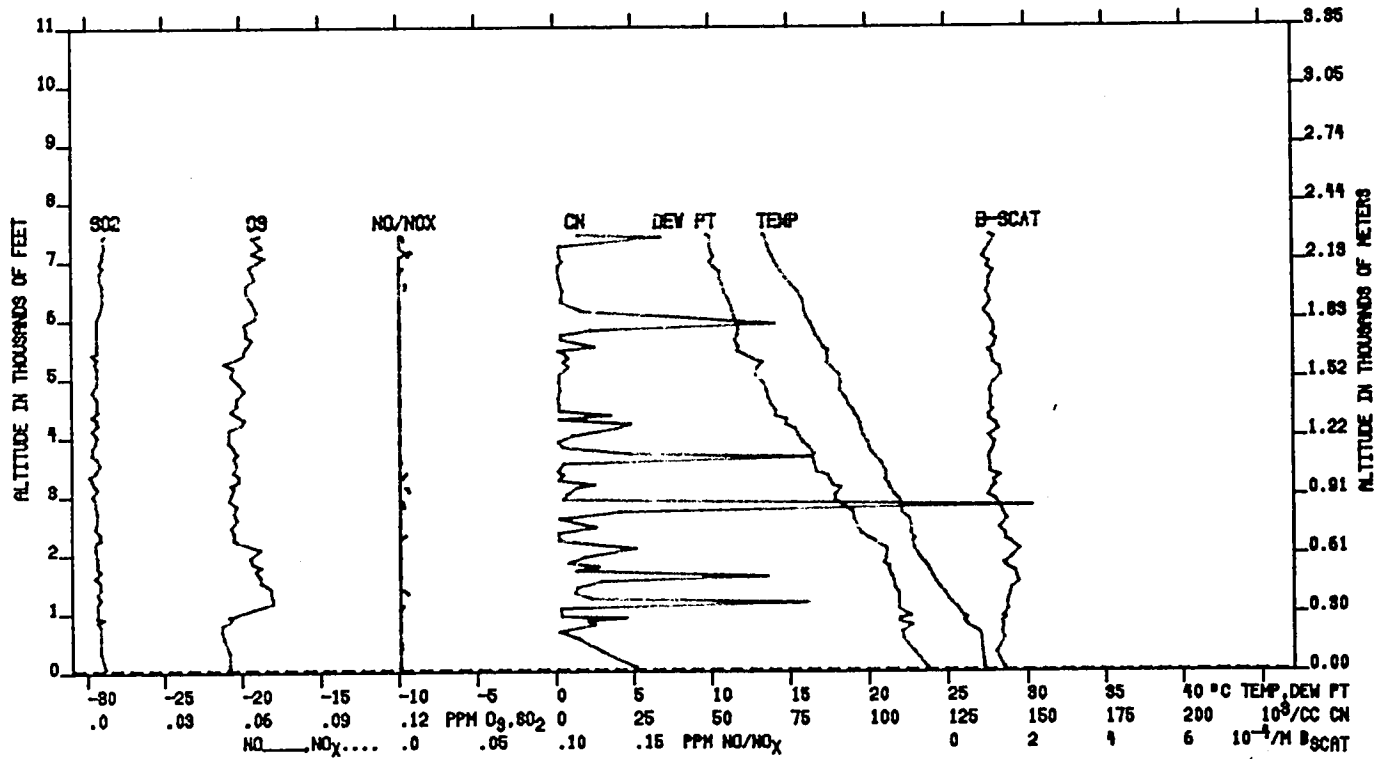

Figure B-6 Data from flight on August 25 - late morning - (Urban Plume-SW flow)
Page 6 of 7

84-MAY-88

FLIGHT 19 SPIRAL 3
8/25/79
CAPE CHARLES
13: 3:52 TO 13:16: 8 PM



B-39

Figure B-6 Data from flight on August 25 - late morning - (Urban Plume-SW flow)
Page 7 of 7

B-40

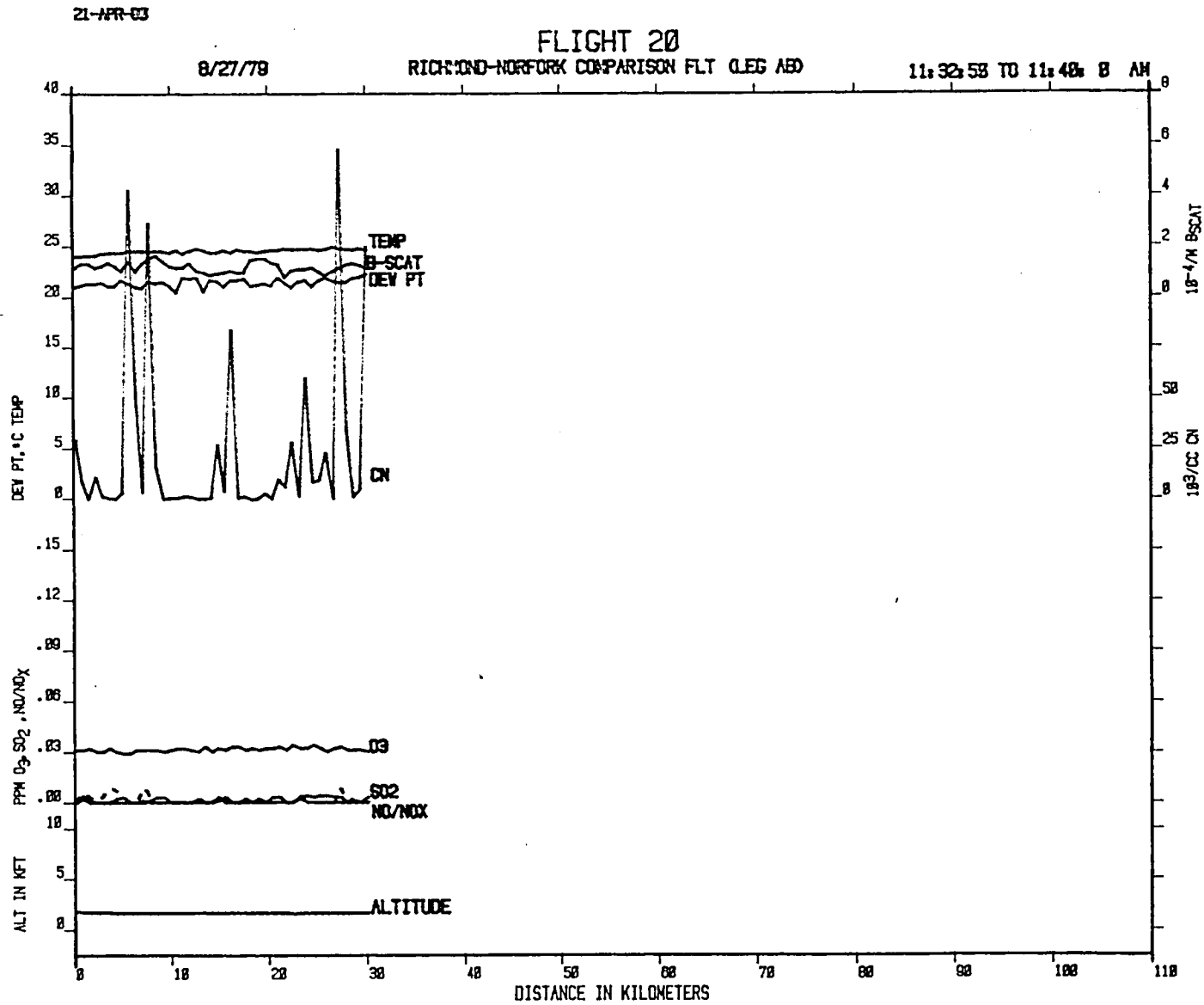
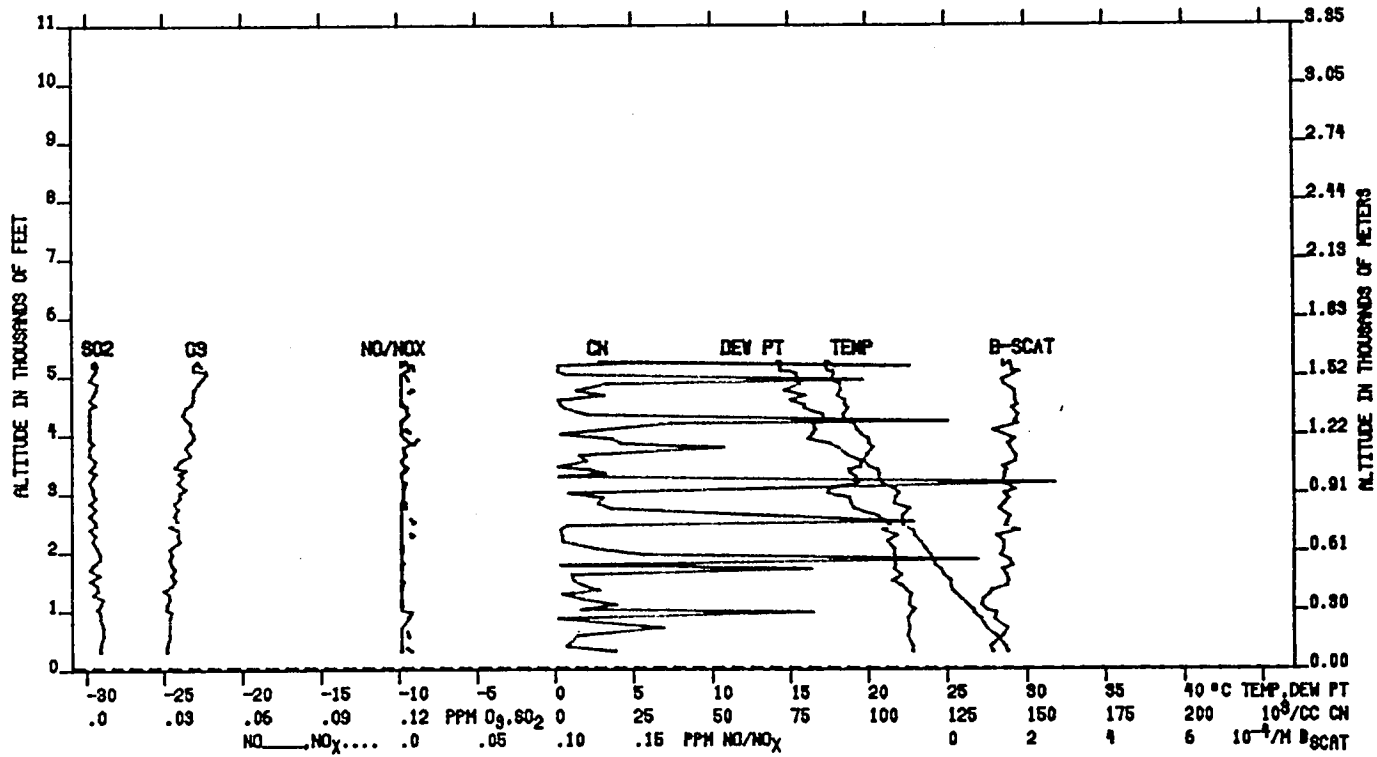

Figure B-7 Data from flight on August 27 - Norfolk/Richmond Urban Plume Comparison (Plan 5)
Page 1 of 11

84-NAT-03

FLIGHT 20 SPIRAL 1
8/27/79
SOUTH OF NORFOLK
11:42:18 TO 11:51:58 AM



B-41

Figure B-7 Data from flight on August 27 - Norfolk/Richmond Urban Plume Comparison (Plan 5).
Page 2 of 11

21-42-C3

FLIGHT 20

8/27/79

RICHMOND-NORFOLK COMPARISON FLT (LEG BC) PART (1 OF 2)

11:52: 8 TO 12: 7:48 AM

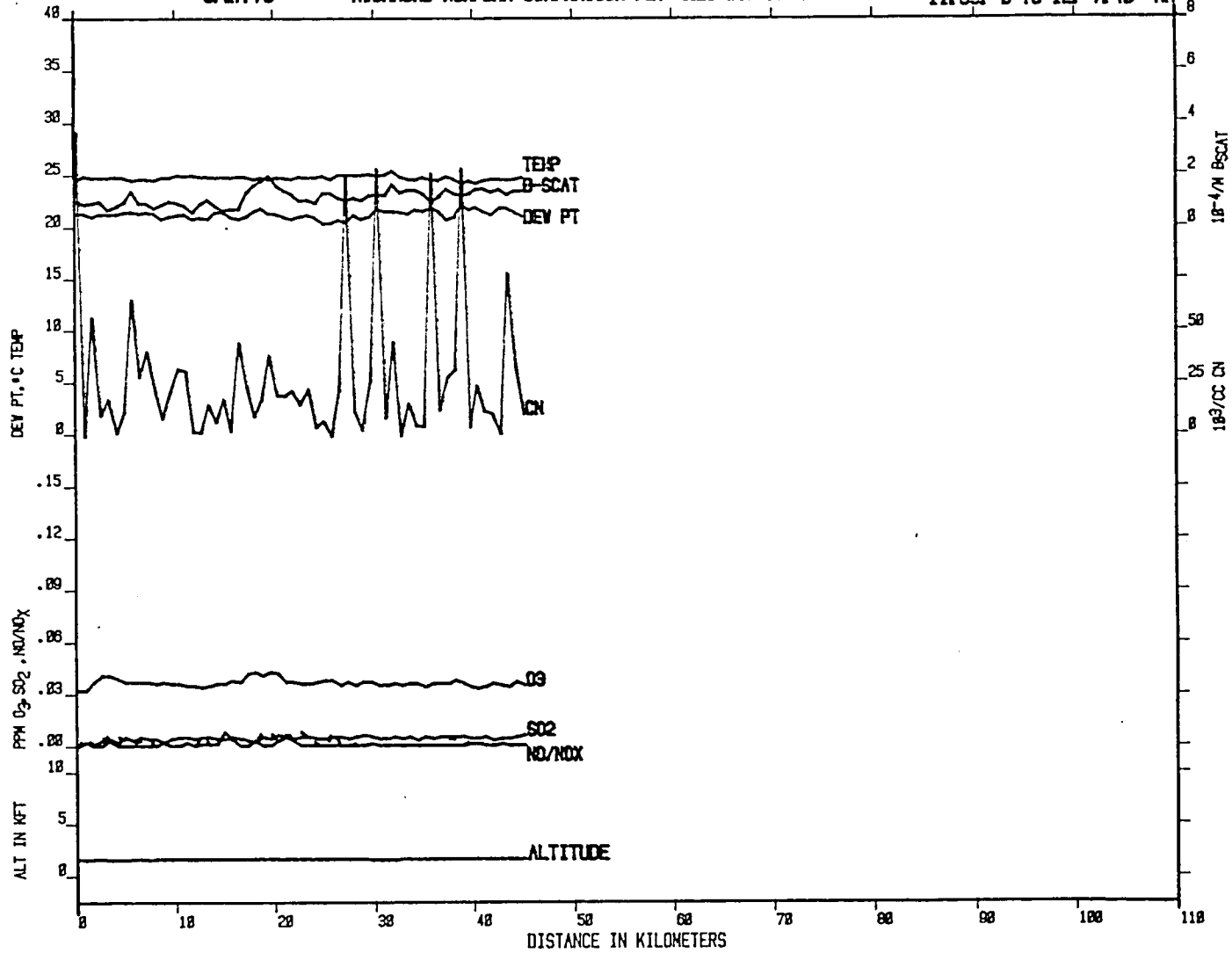

B-42

Figure B-7 Data from flight on August 27 - Norfolk/Richmond Urban Plume Comparison (Plan 5)
Page 3 of 11

21-APR-88

8/27/79 FLIGHT 20
RICHMOND-NORFOLK COMPARISON FLT (LEG BC) PART (2 OF 2) 12: 7:58 TO 12:17:28 PM

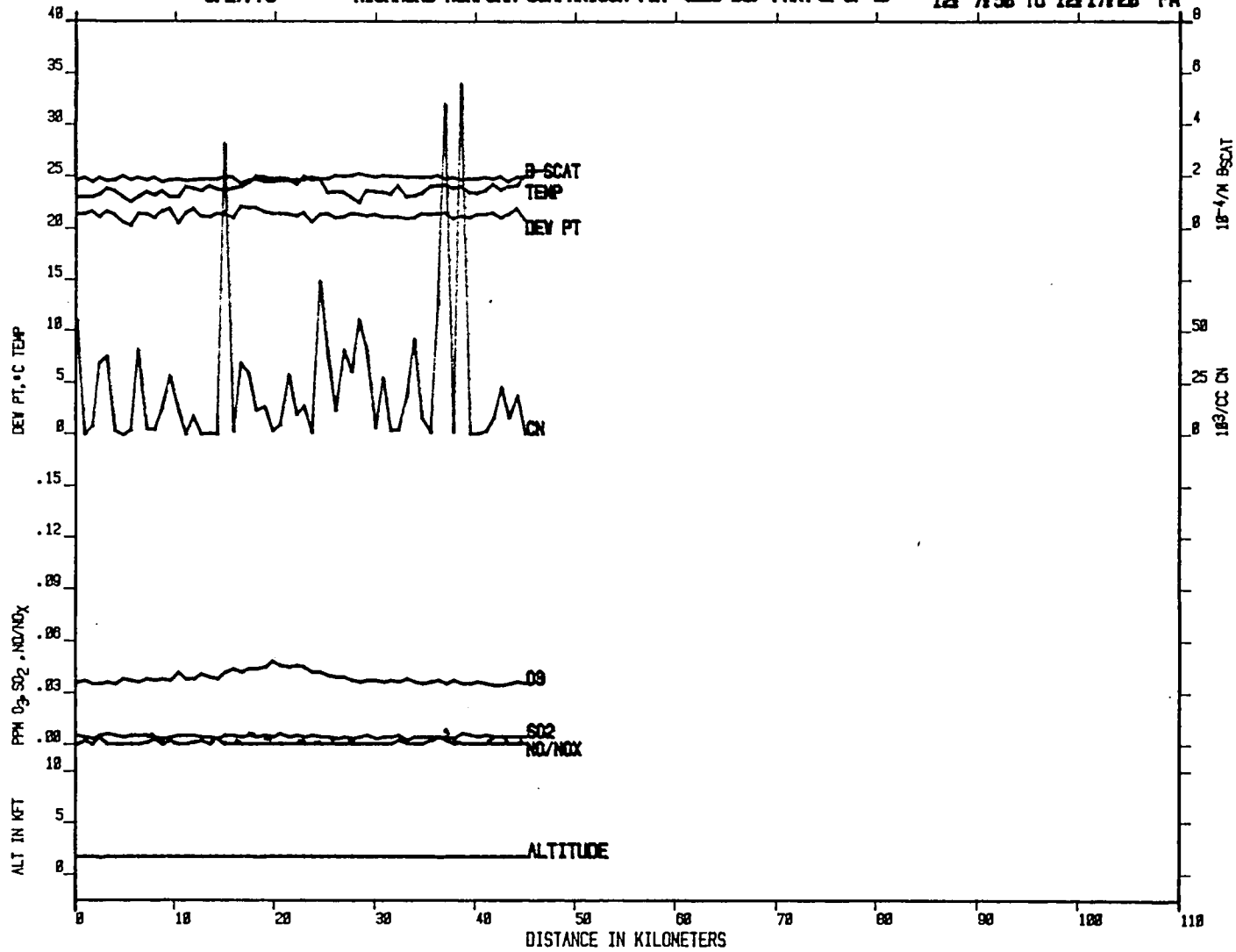

B-43

Figure B-7 Data from flight on August 27 - Norfolk/Richmond Urban Plume Comparison (Plan 5)
Page 4 of 11

82 MAY-68

FLIGHT 28 SPIRAL 2
8/27/70
SOUTH OF RICHMOND
12:16:58 TO 12:27:12 PM

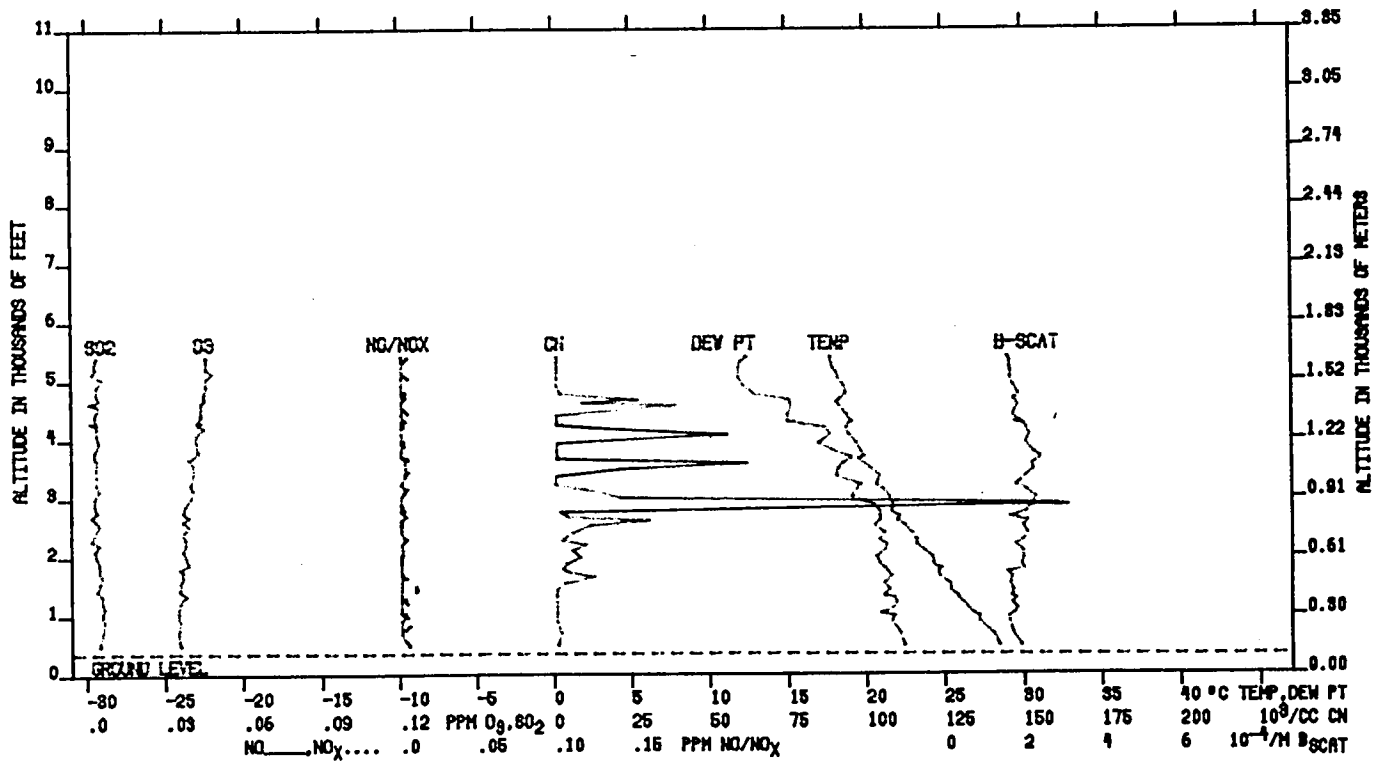

B-44

Figure B-7 Data from flight on August 27 - Norfolk/Richmond Urban Plume Comparison (Plan 5)
Page 5 of 11

21-APR-68

8/27/78

FLIGHT 20

RICHMOND-NORFOLK COMPARISON FLT (LEG C/D)

12:32:48 TO 12:35:38 PM

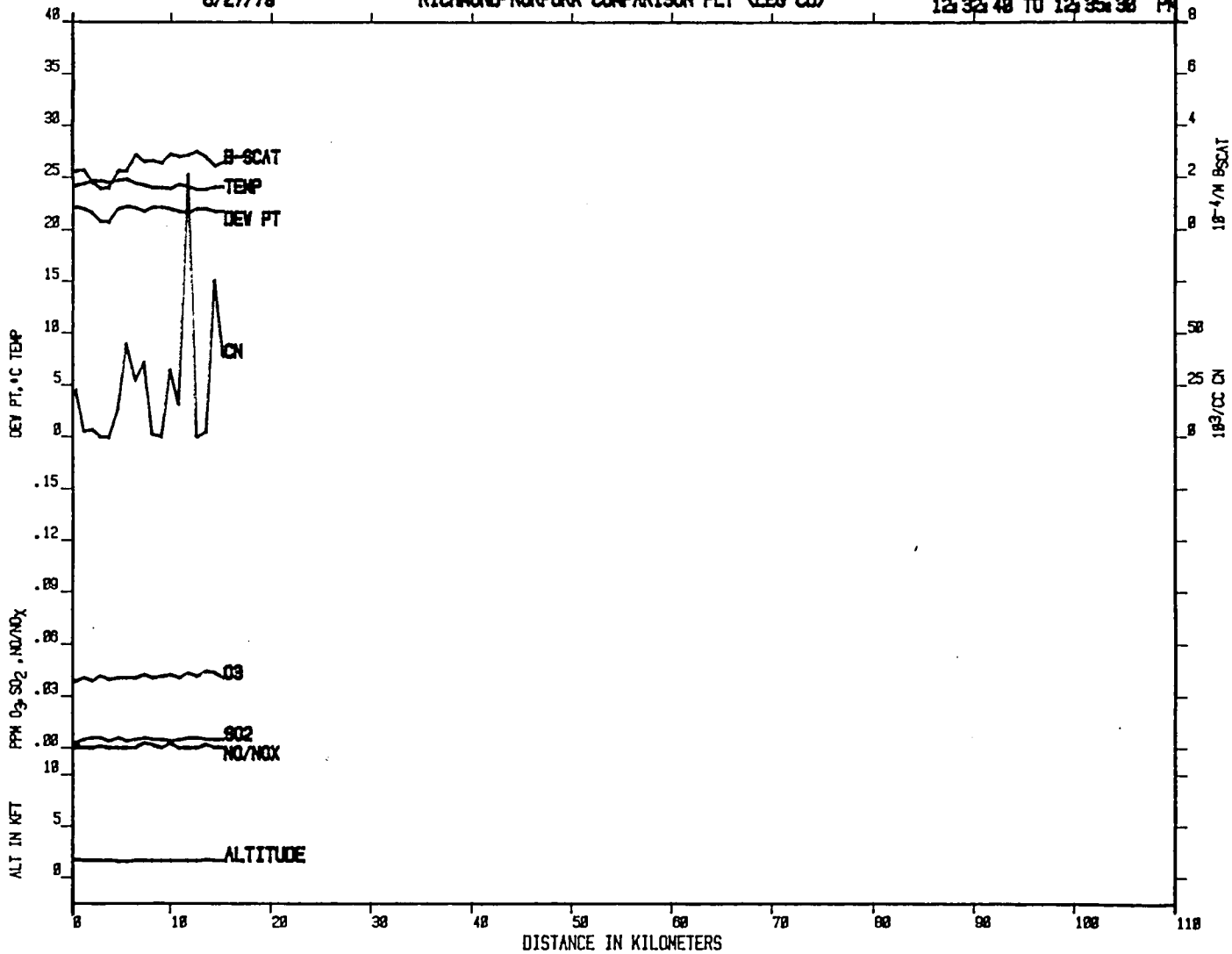

B-45

Figure B-7 Data from flight on August 27 - Norfolk/Richmond Urban Plume Comparison (Plan 5)
Page 6 of 11

21-APR-88

8/27/78

FLIGHT 20 RICHMOND-NORFOLK COMPARISON FLT (LEG EF)

12:48:48 TO 12:57:38 PM

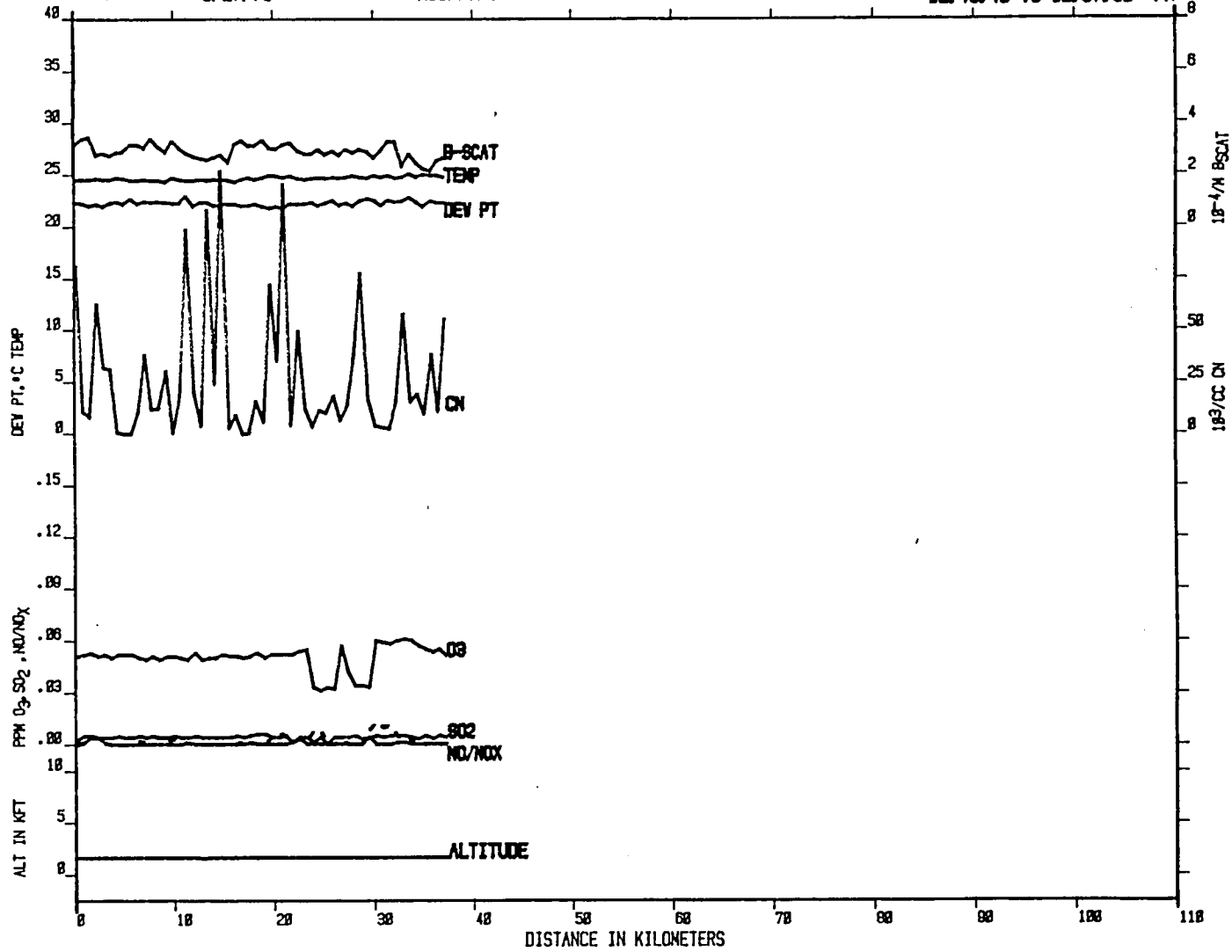

B-46

Figure B-7 Data from flight on August 27 - Norfolk/Richmond Urban Plume Comparison (Plan 5)
Page 7 of 11

82-NAY-88

FLIGHT 221 SPIRAL 3
8/27/78
NE OF RICHMOND
12:50:28 TO 13:04:53 PM

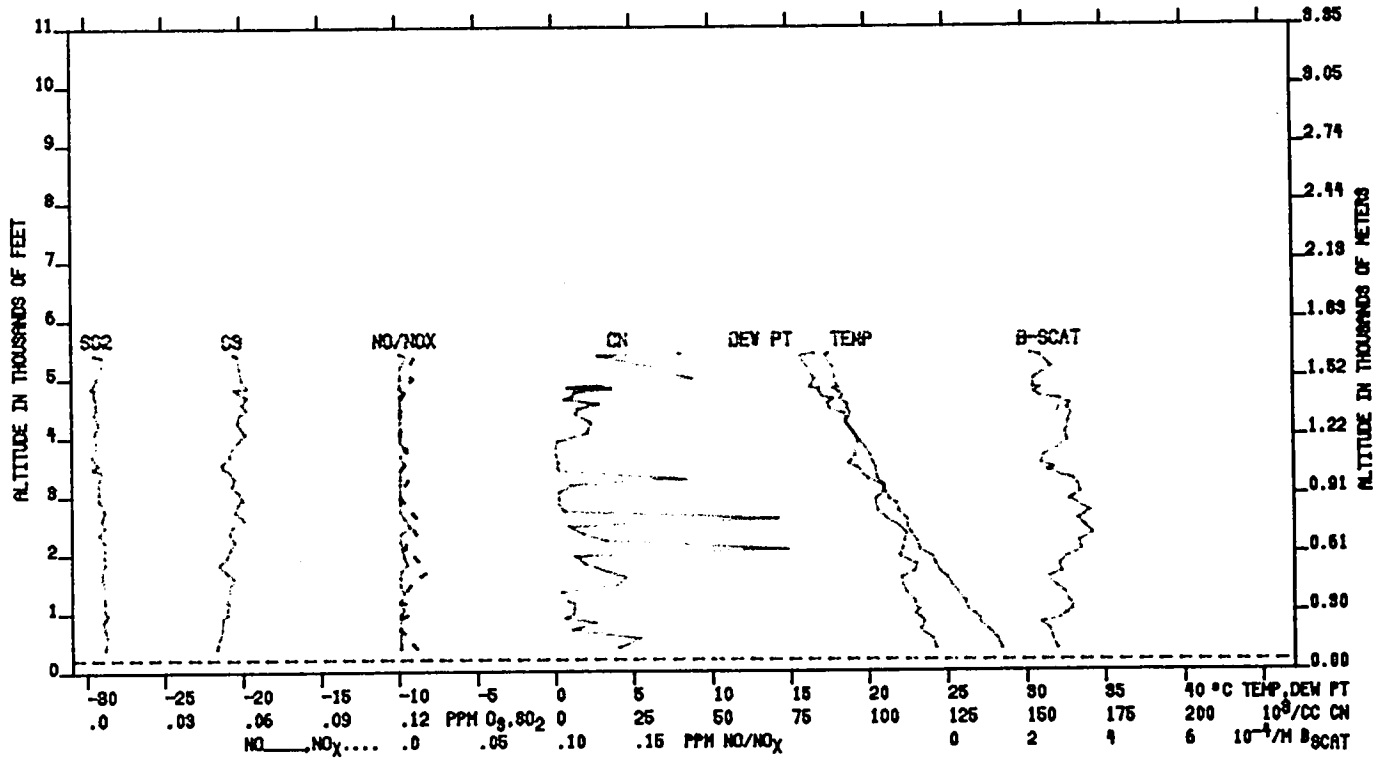

B-47

Figure B-7 Data from flight on August 27 - Norfolk/Richmond Urban Plume Comparison (Plan 5)
Page 8 of 11

21-APR-88

8/27/79

FLIGHT 20 RICHMOND-NORFORK COMPARISON FLT (LEG FG)

13:12:28 TO 13:26:28 PM

B-48

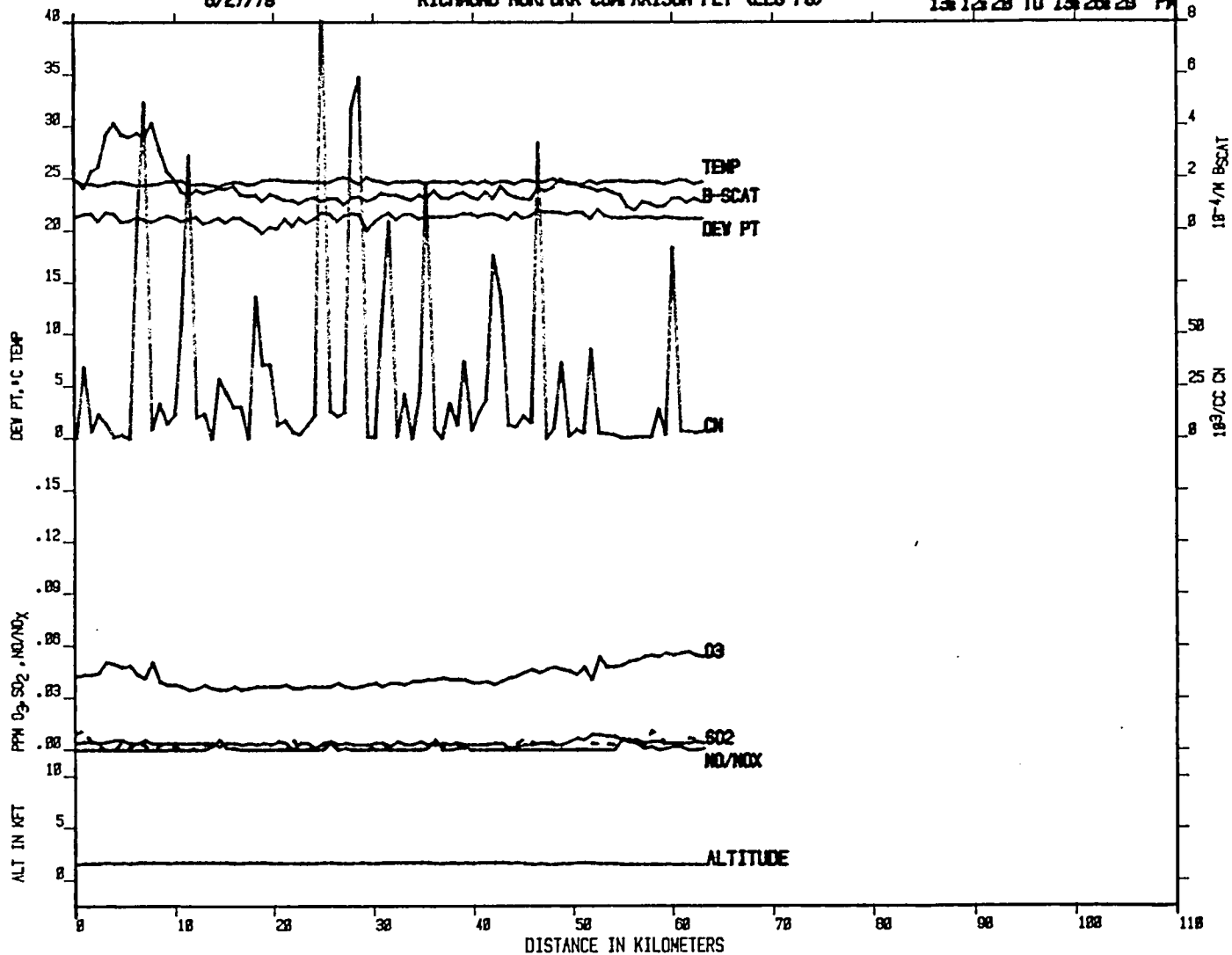
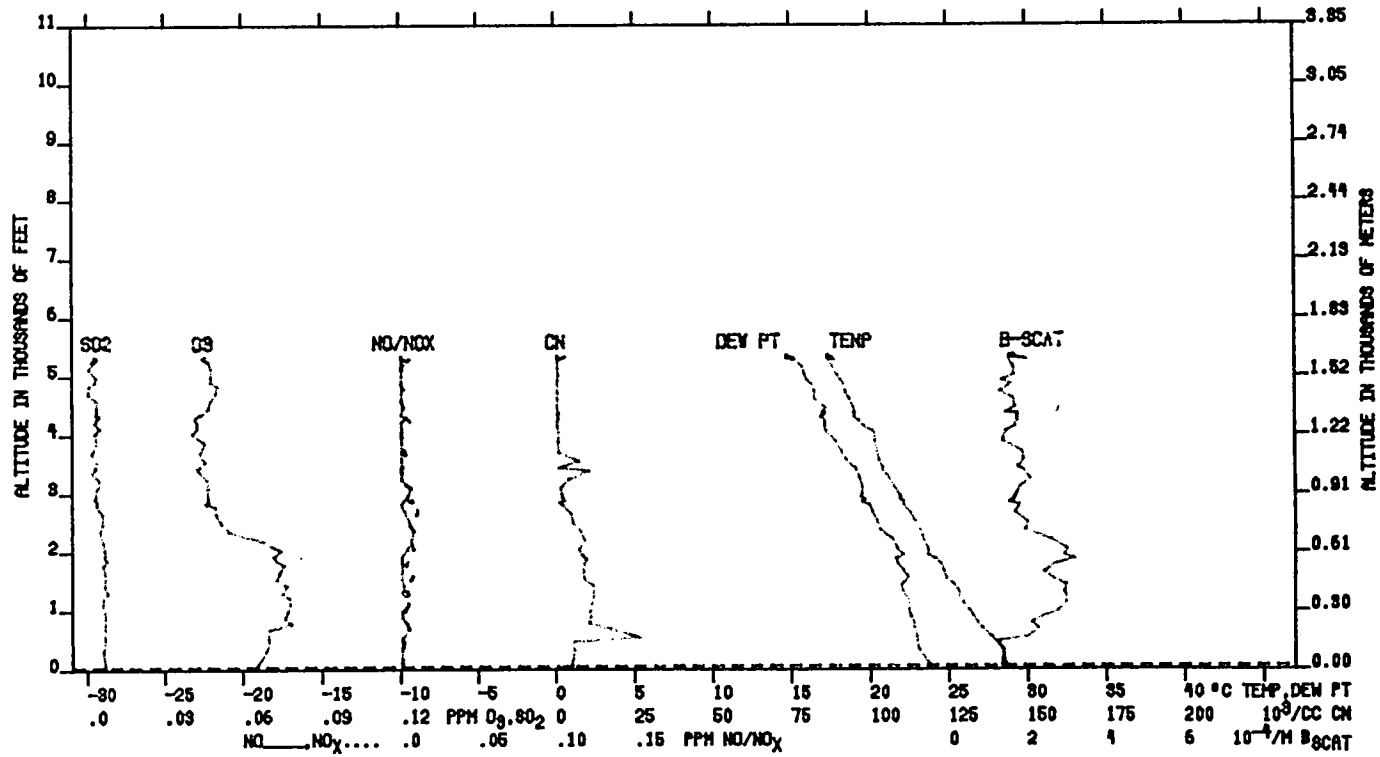

Figure B-7 Data from flight on August 27 - Norfolk/Richmond Urban Plume Comparison (Plan 5)
Page 9 of 11

22-MAY-88

FLIGHT 02 SPIRAL 4
8.27.79
NE OF NORFOLK
12:00:42 TO 12:50:22 PM



B-49

Figure B-7 Data from flight on August 27 - Norfolk/Richmond Urban Plume Comparison (Plan 5).
Page 10 of 11

21-APR-68

8/27/79

FLIGHT 20
RICHMOND-NORFOLK COMPARISON FLT (LEG GD)

13:42:38 TO 13:47:58 PM

B-50

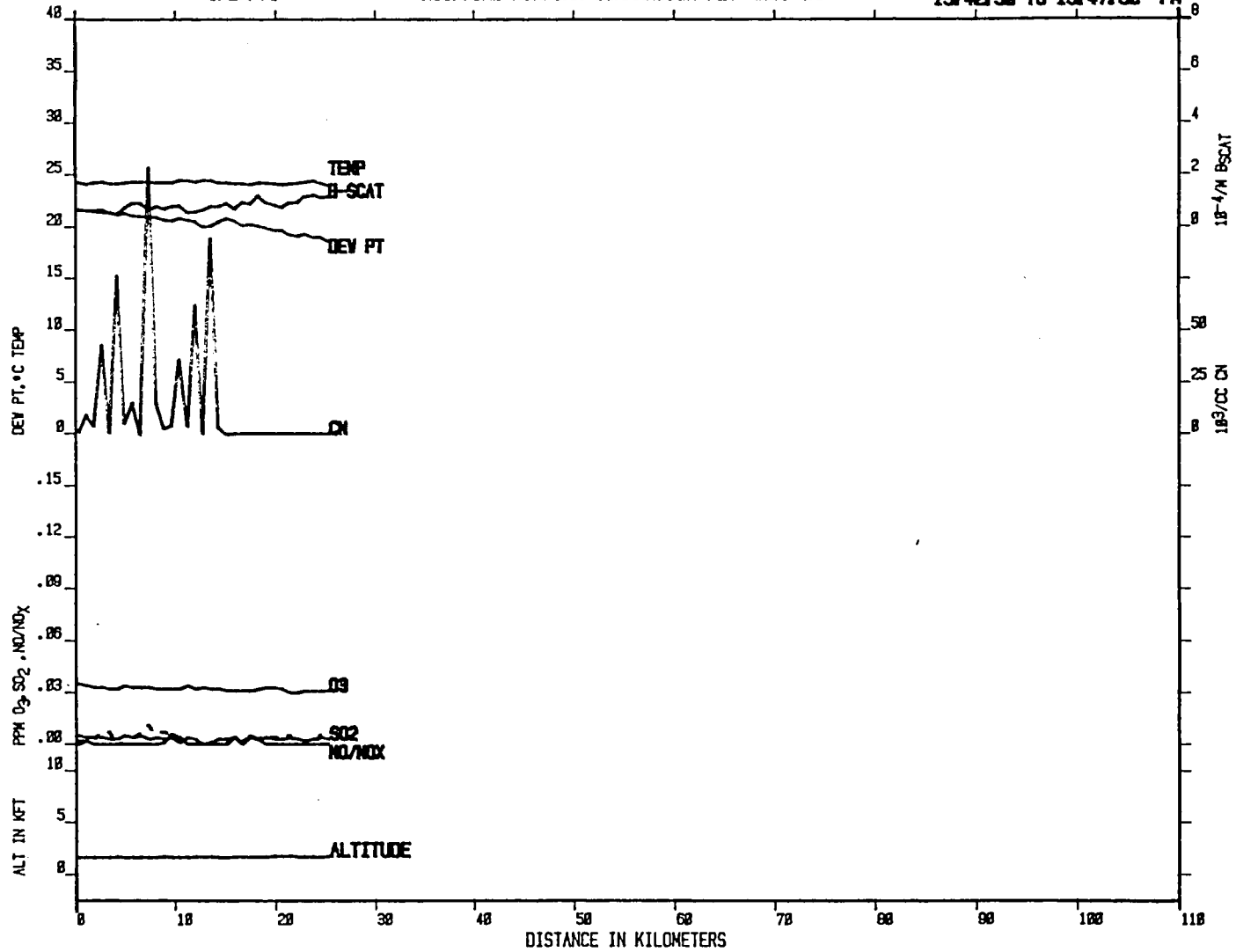

Figure B-7 Data from flight on August 27 - Norfolk/Richmond Urban Plume Comparison (Plan 5)
Page 11 of 11

19-APR-88

8/29/78

FLIGHT 21 PATRICK HENRY AIRPORT TO NAS

18: 0: 18 TO 18: 54: 58 AM

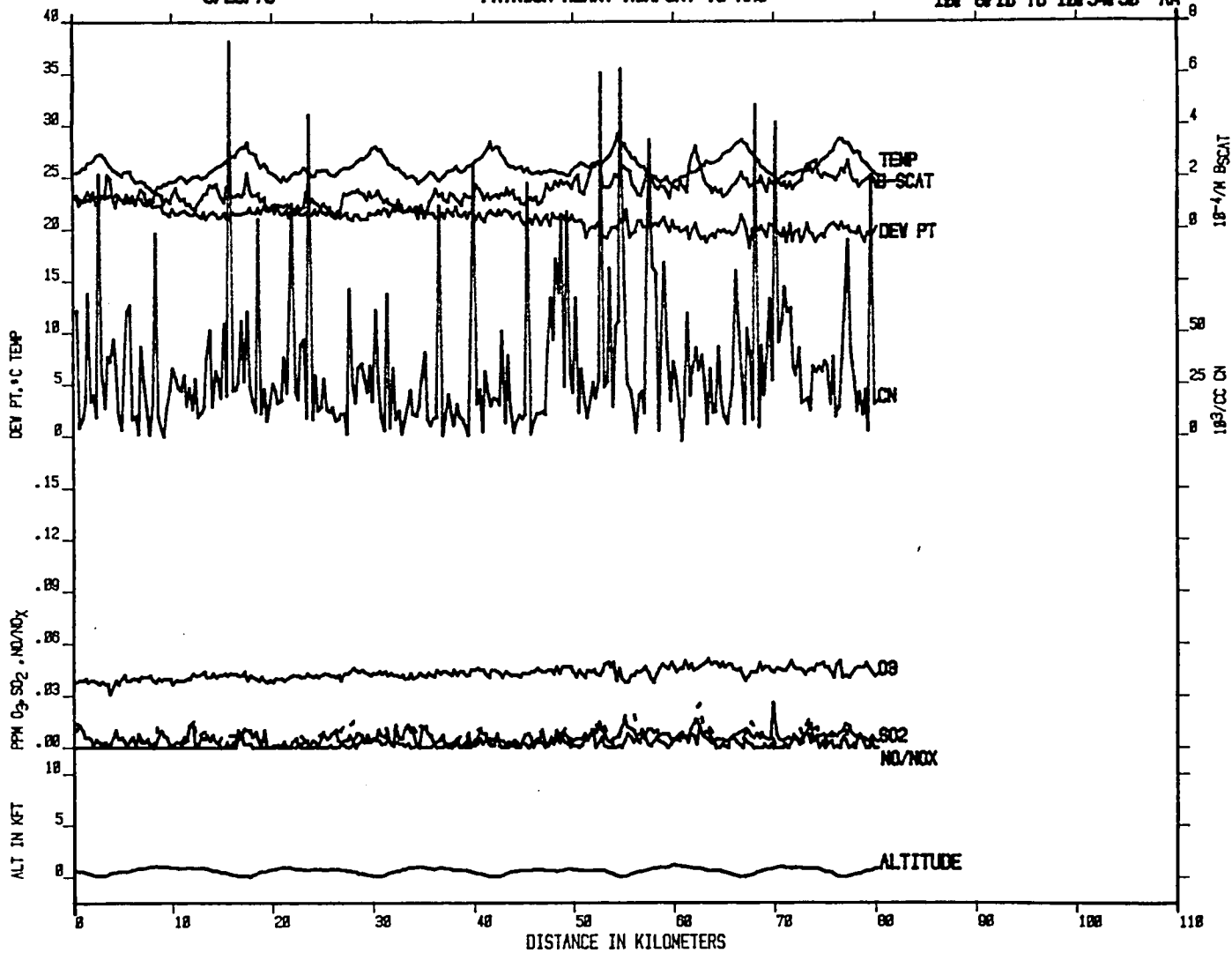

B-51

Figure B-8 Data from flight on August 29 - Low Pass Comparison - Page 1 of 6

21-APR-88

8/29/79

FLIGHT 21 NAS TO NAVAL COMMUNICATIONS CENTER

18:55: 8 TO 11:27: 8 AM

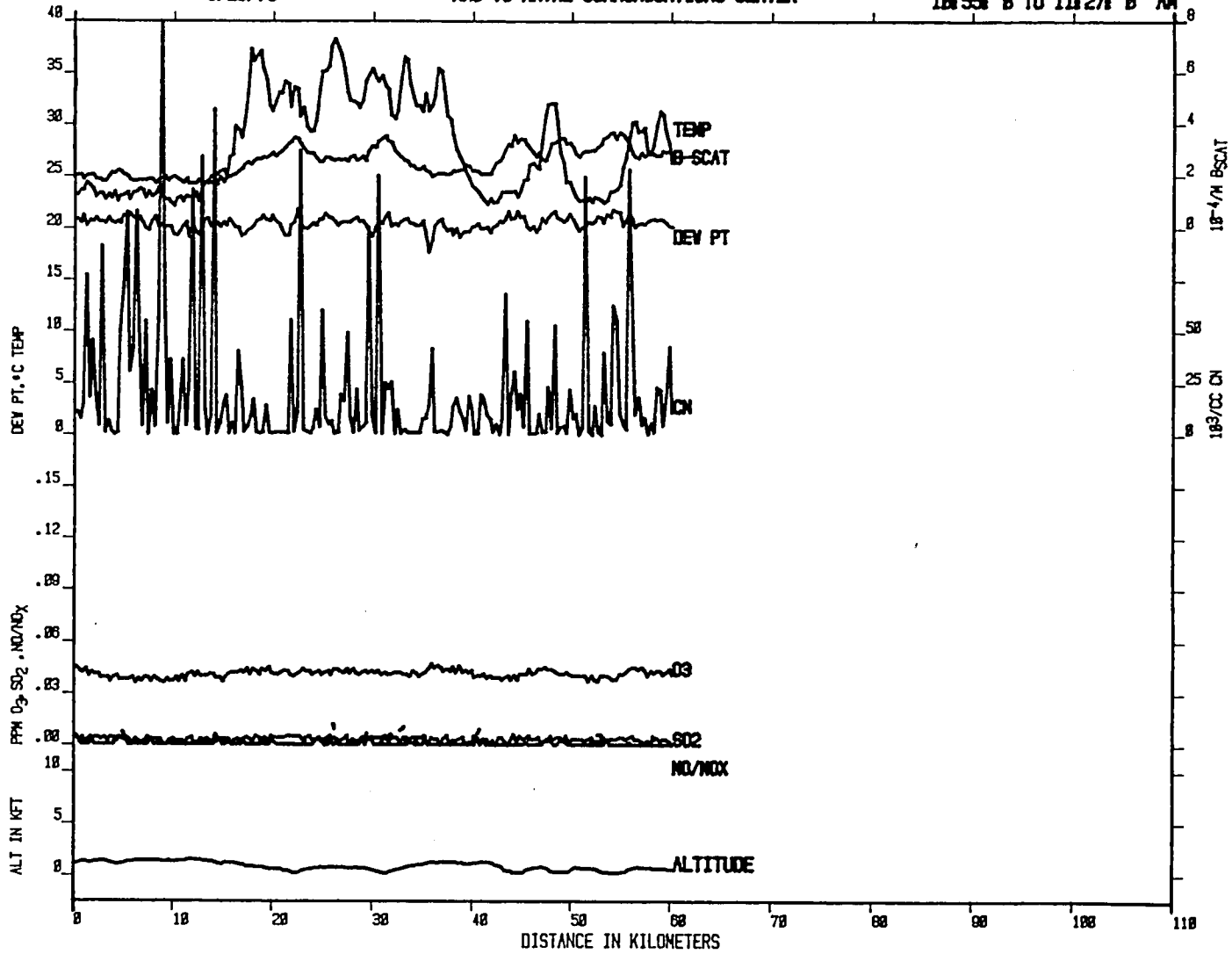

B-52

Figure B-8 Data from flight on August 29 - Low Pass Comparison - Page 2 of 6

B2-MAY-68

FLIGHT 21 SPIRAL 1
8/29/78
NAVAL COMMUNICATION CENTER
11:27:18 TO 11:34:08 AM

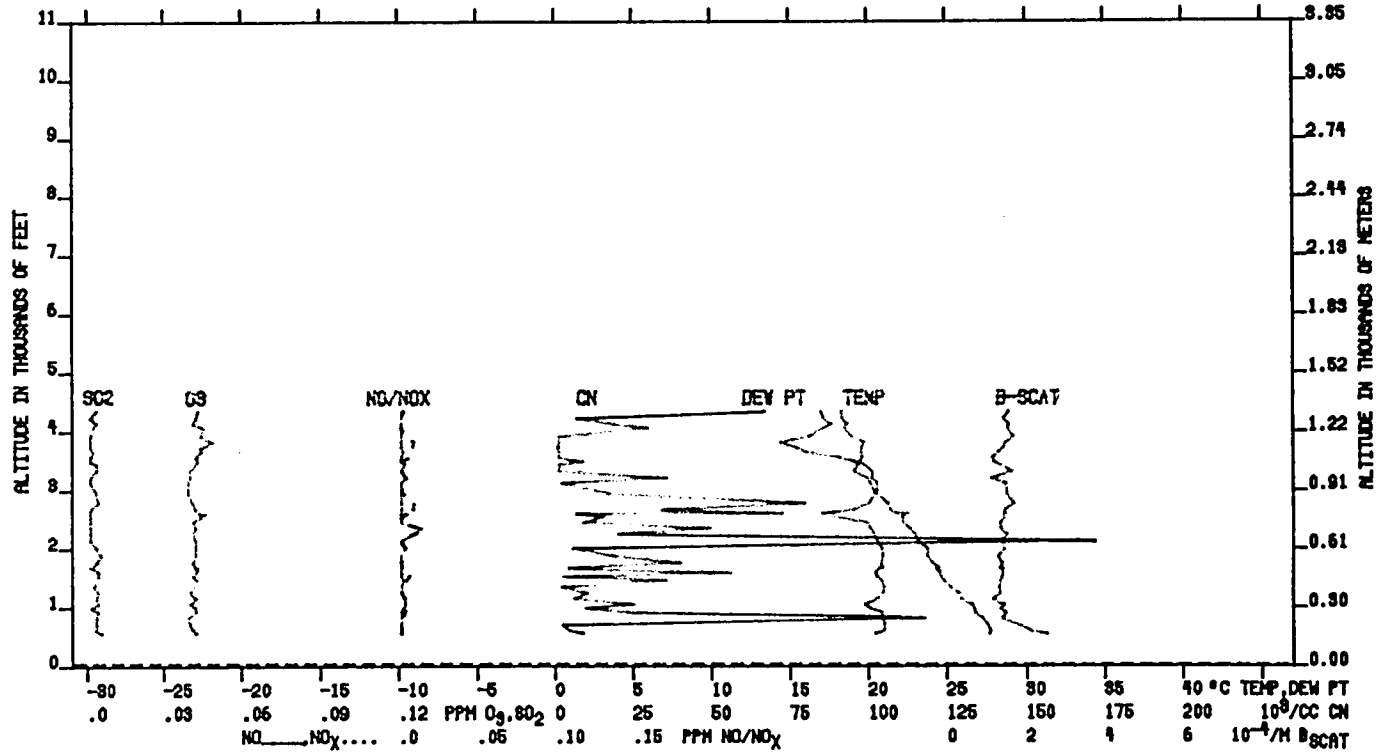

B-53

Figure B-8 Data from flight on August 29 - Low Comparison - Page 3 of 6

18-APR-83

8/29/79

FLIGHT 21

NAVAL COMM CENTER TO CHESAPEAKE LIGHT

11:34:18 TO 12:06:58 AM

B-54

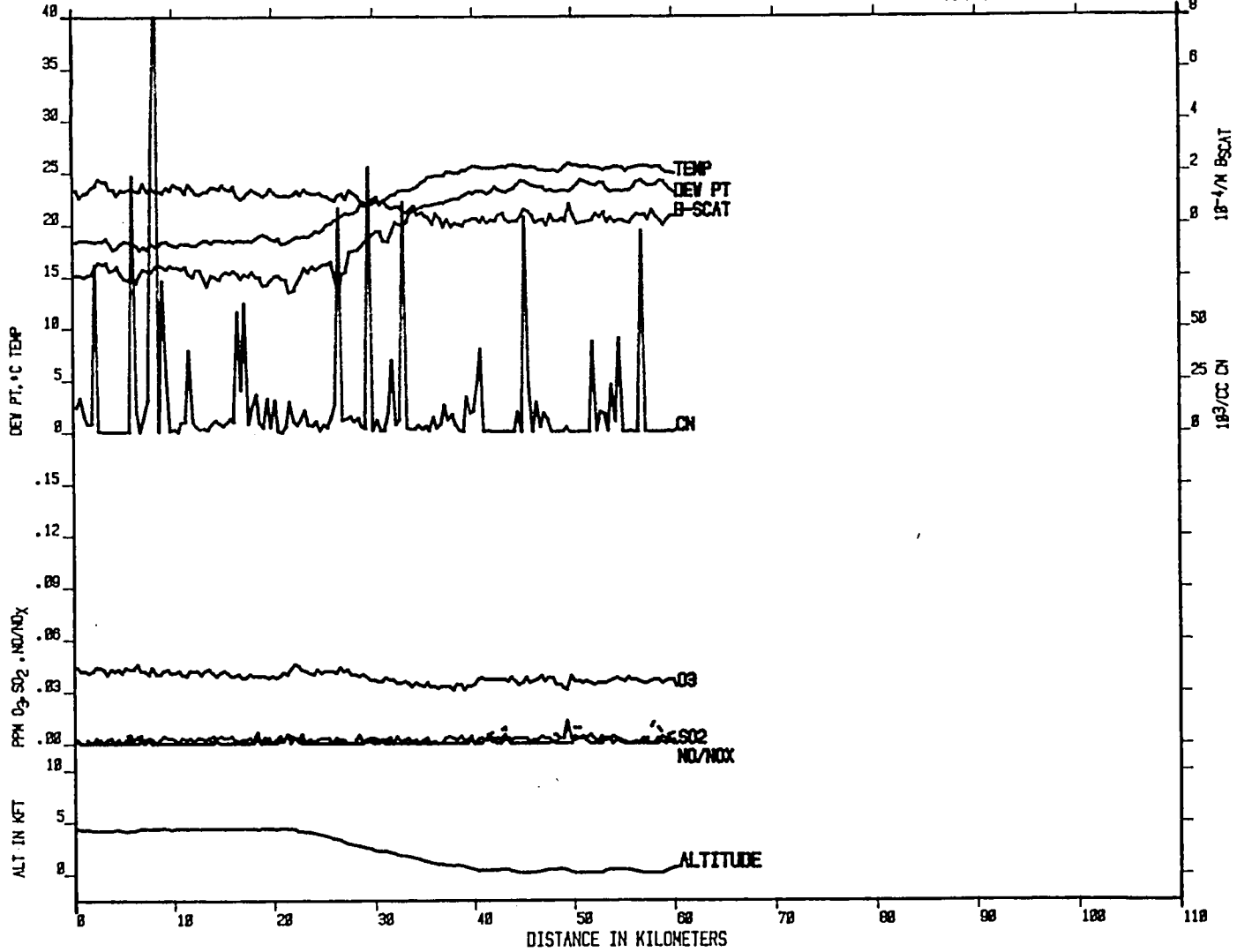

Figure B-8 Data from flight on August 29 - Low Pass Comparison - Page 4 of 6

18-APR-88

8/29/79

FLIGHT 21

CHESAPEAKE LIGHT TO ISLE OF WIGHT

12: 1: 8 TO 12: 19: 58 PM

B-55

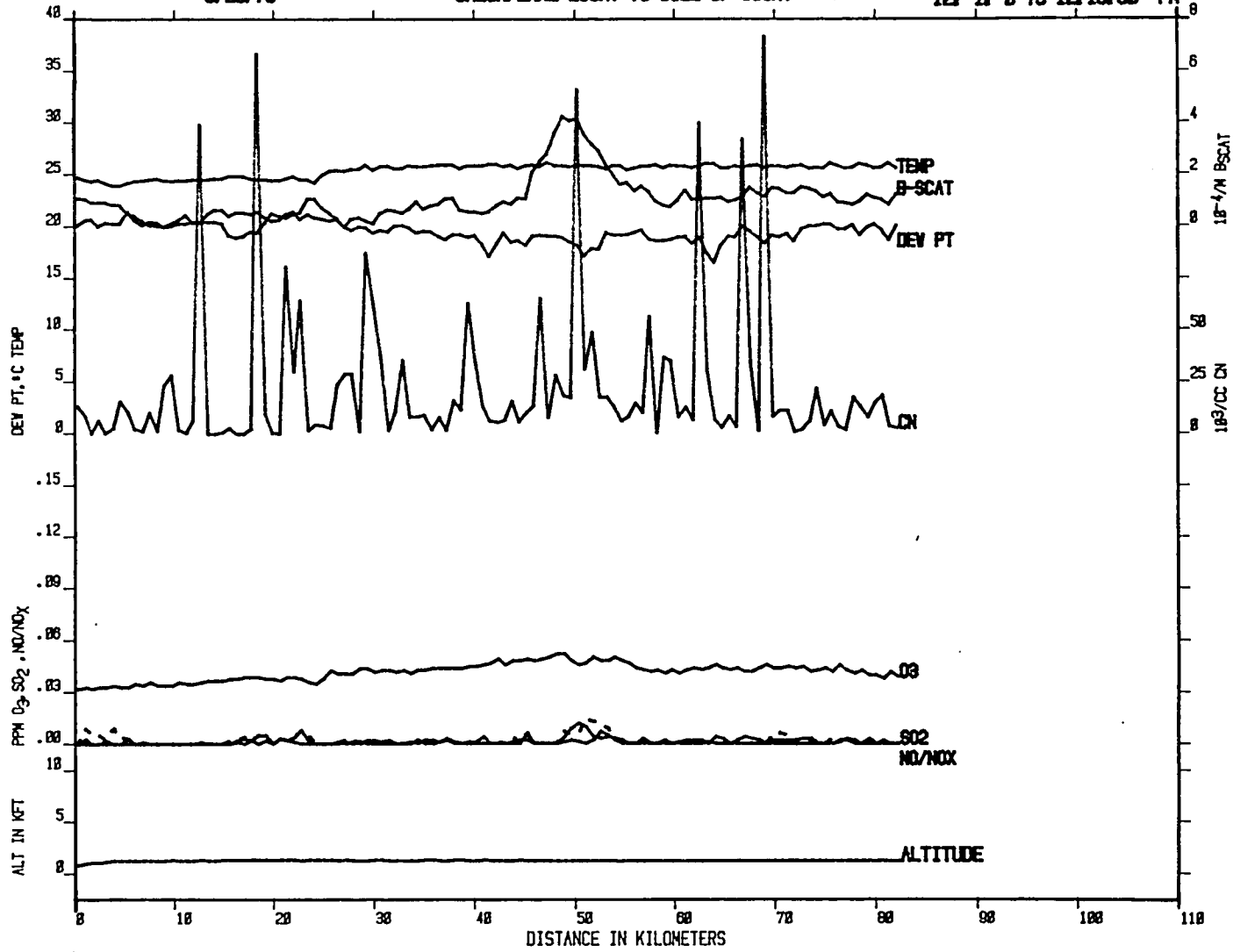

Figure B-8 Data from flight on August 29 - Low Pass Comparison - Page 5 of 6

18-APR-88

8/29/79

FLIGHT 21 ISLE OF WIGHT TO CHESAPEAKE BAY

12:28: 8 TO 12:39: 28 PM

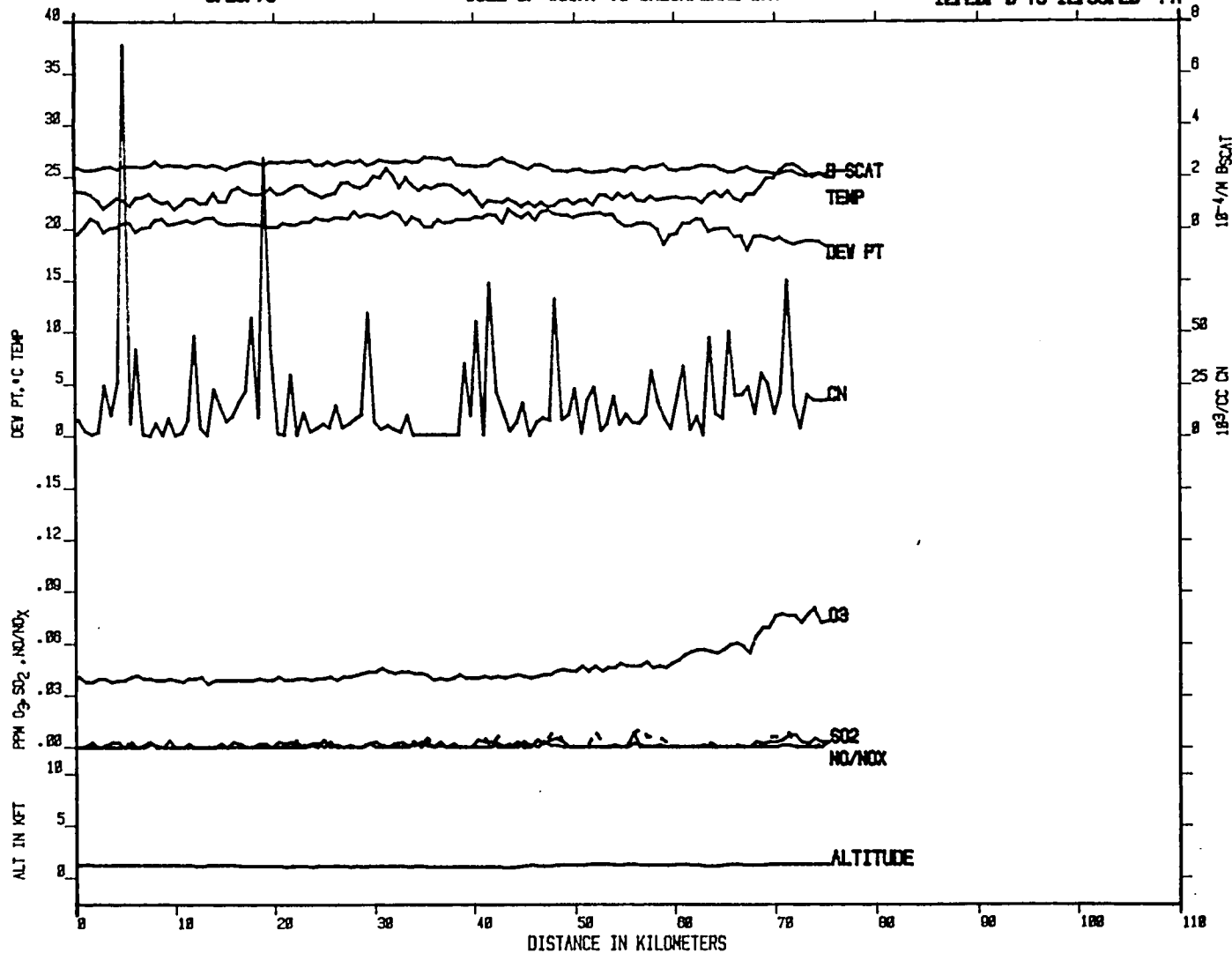

B-56

Figure B-8 Data from flight on August 29 - Low Pass Comparison - Page 6 of 6

B-57

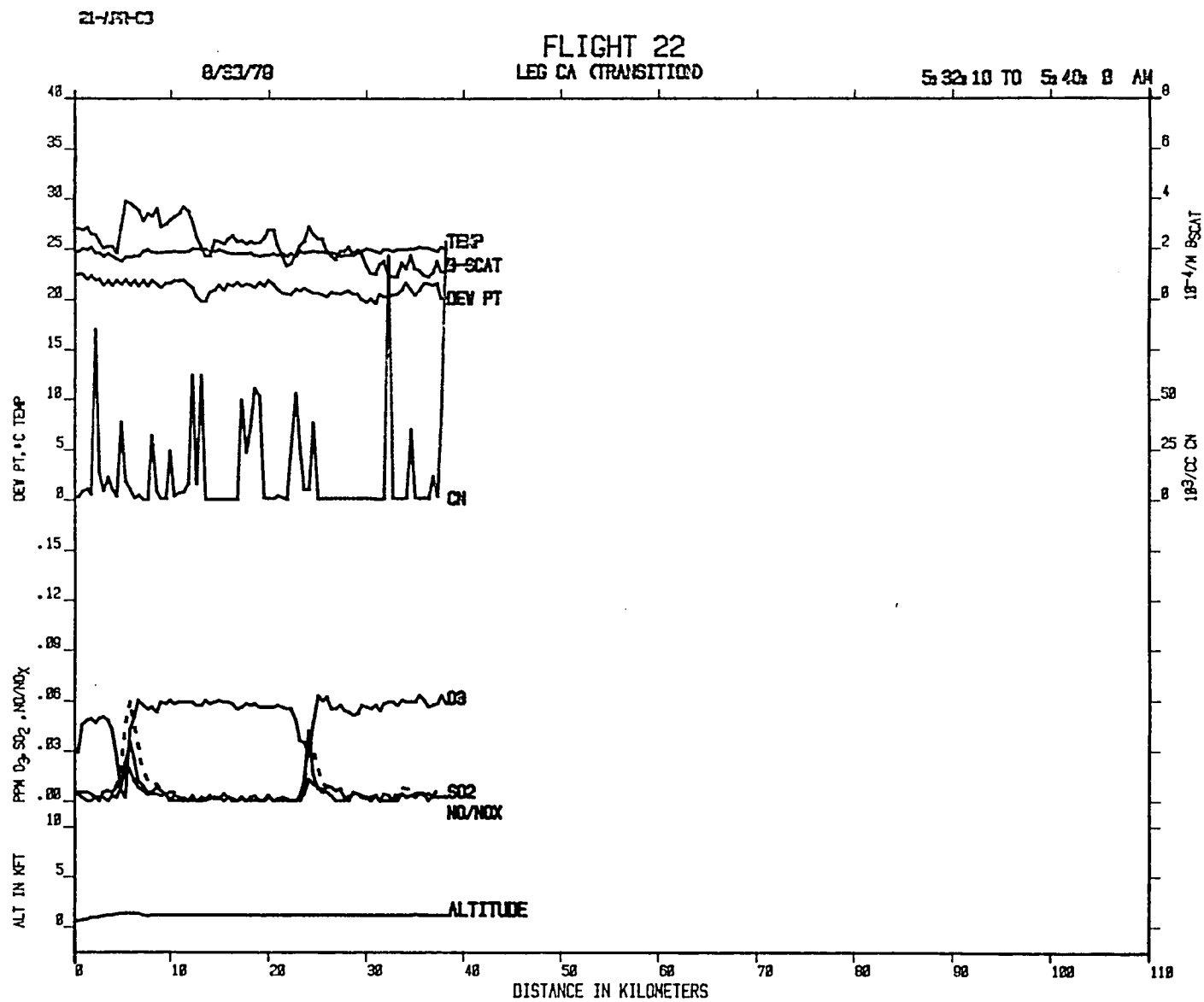

Figure B-9 Data from flight on August 30 - early morning - (Urban Plume-SW flow)
Page 1 of 10

18-APR-88

8/30/79

FLIGHT 22
CYCLE 1: LEG AB

5:46:18 TO 5:58:28
6:22:00 TO 6:34:38 AM

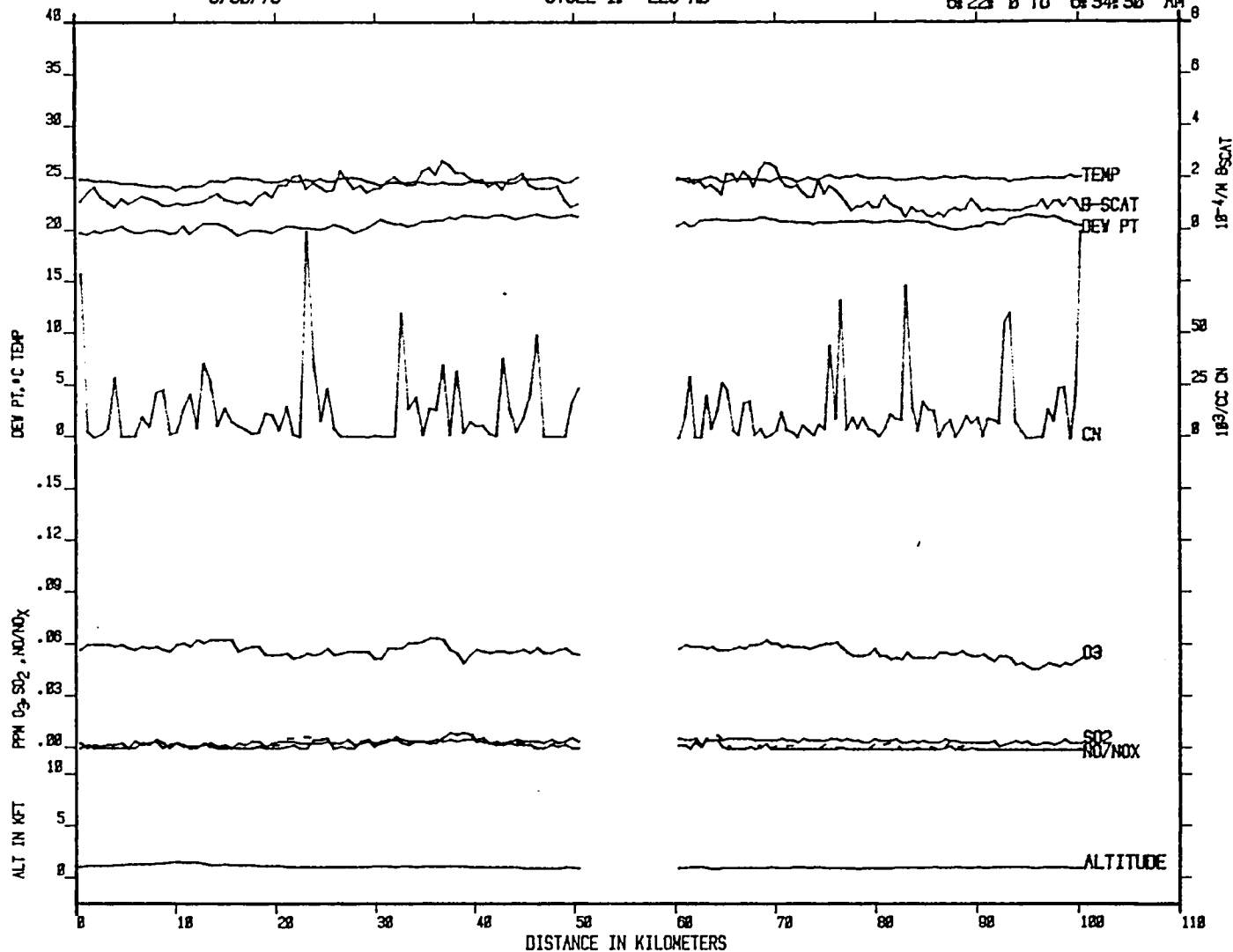

B-58

Figure B-9 Data from flight on August 30 - early morning - (Urban Plume-SW flow)
Page 2 of 10

82-WAY-83

FLIGHT 02 SPIRAL 1
8/30/79
NAVAL COMMISSION CENTER
6:40 TO 8:12 AM

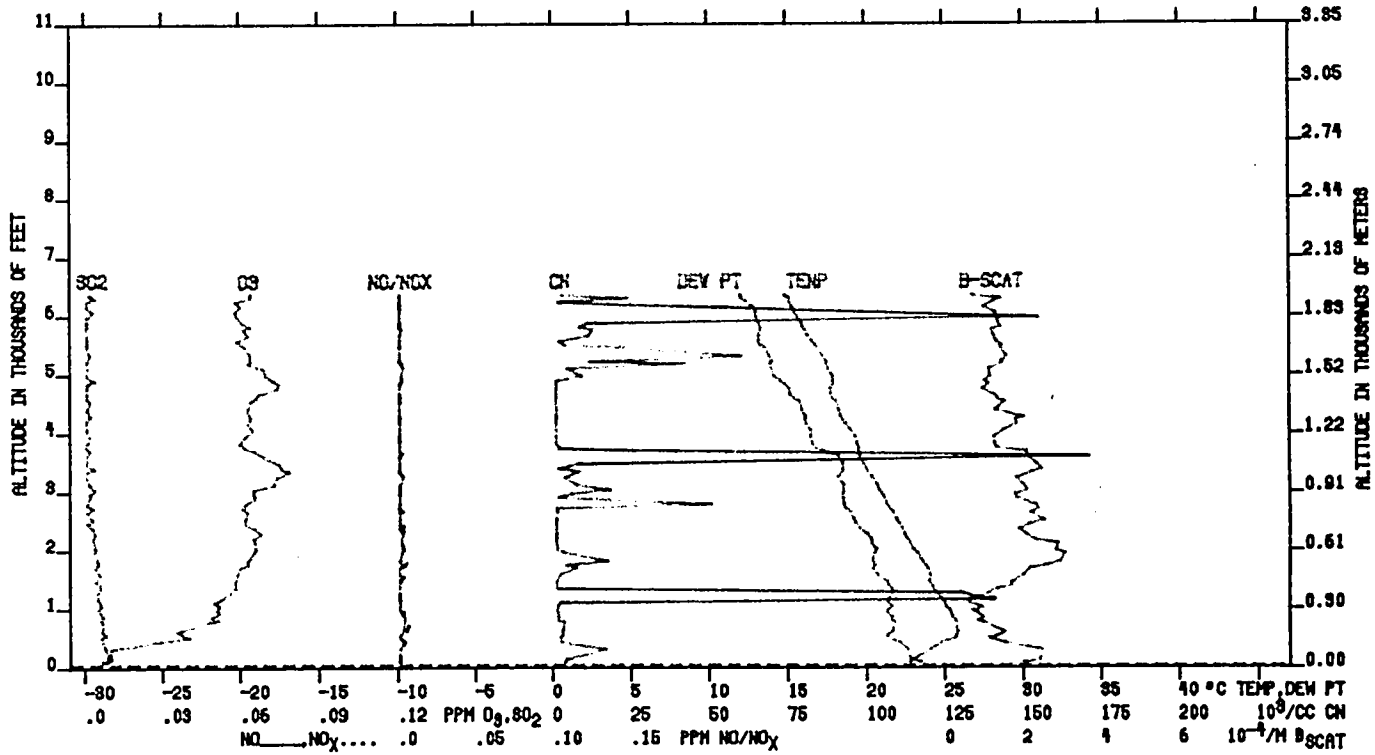

B-59

Figure B-9 Data from flight on August 30 - early morning - (Urban Plume-SW flow)
Page 3 of 10

21-APR-88

FLIGHT 22 LEG BD (TRANSITION)

8/30/78

0:34:48 TO 0:45:28 AM

B-60

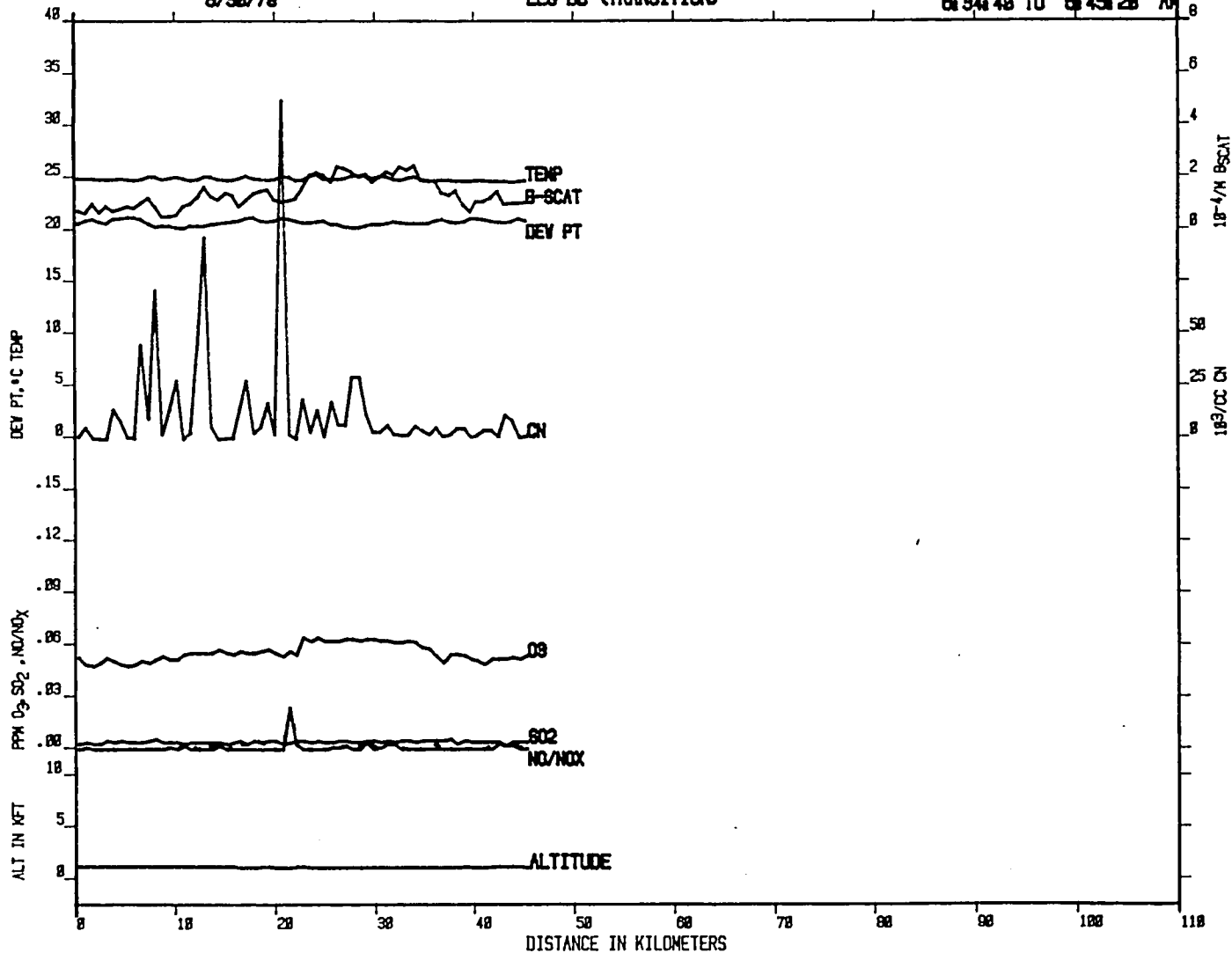

Figure B-9 Data from flight on August 30 - early morning - (Urban Plume-SW flow)
Page 4 of 10

B-61

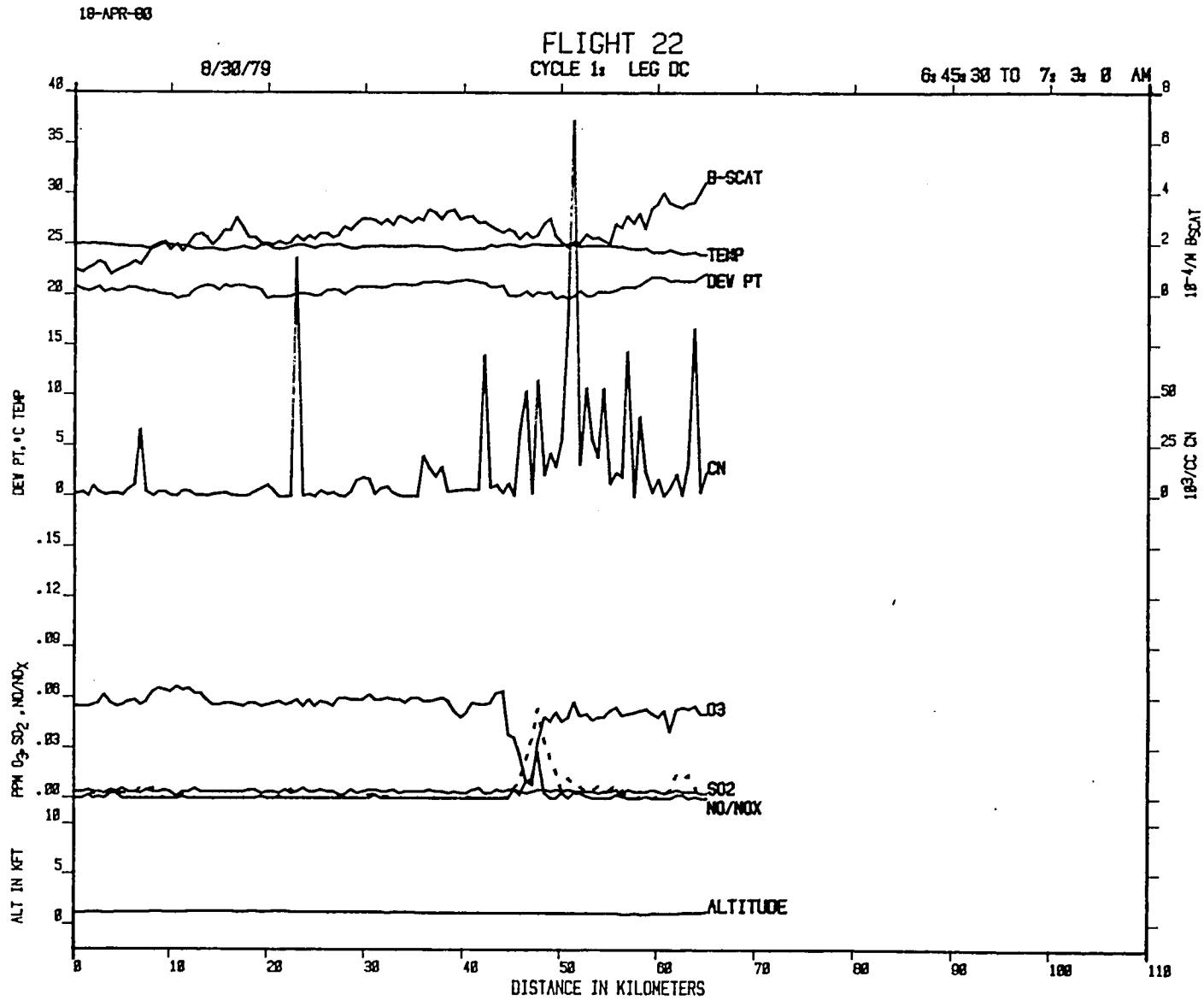

Figure B-9 Data from flight on August 30 - early morning - (Urban Plume-SW flow)
Page 5 of 10

21-APR-88

8/30/79

FLIGHT 22 LEG CA (TRANSITION)

7: 9:18 TO 7: 12:28 AM

B-62

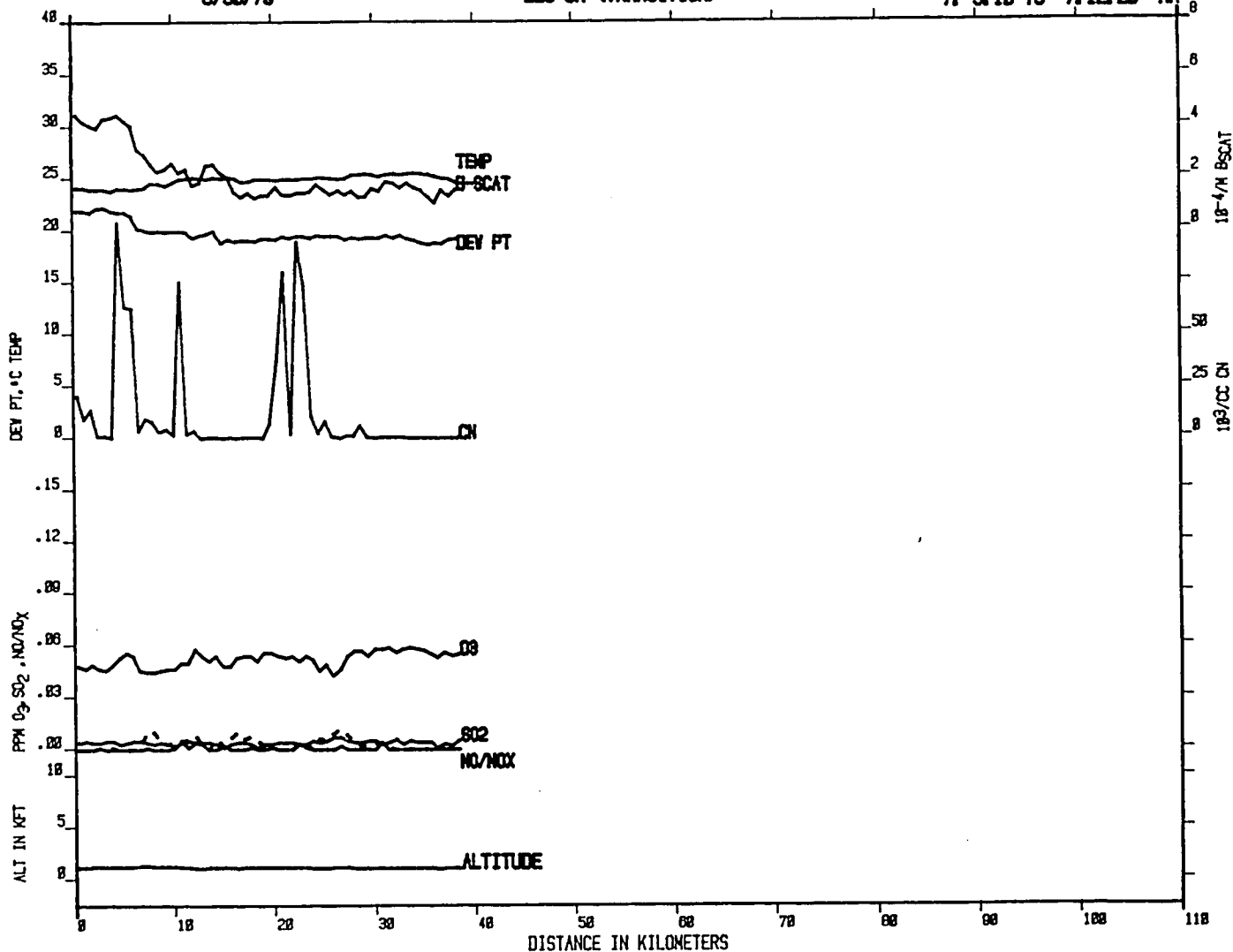

Figure B-9 Data from flight on August 30 - early morning - (Urban Plume-SW flow)
Page 6 of 10

B-63

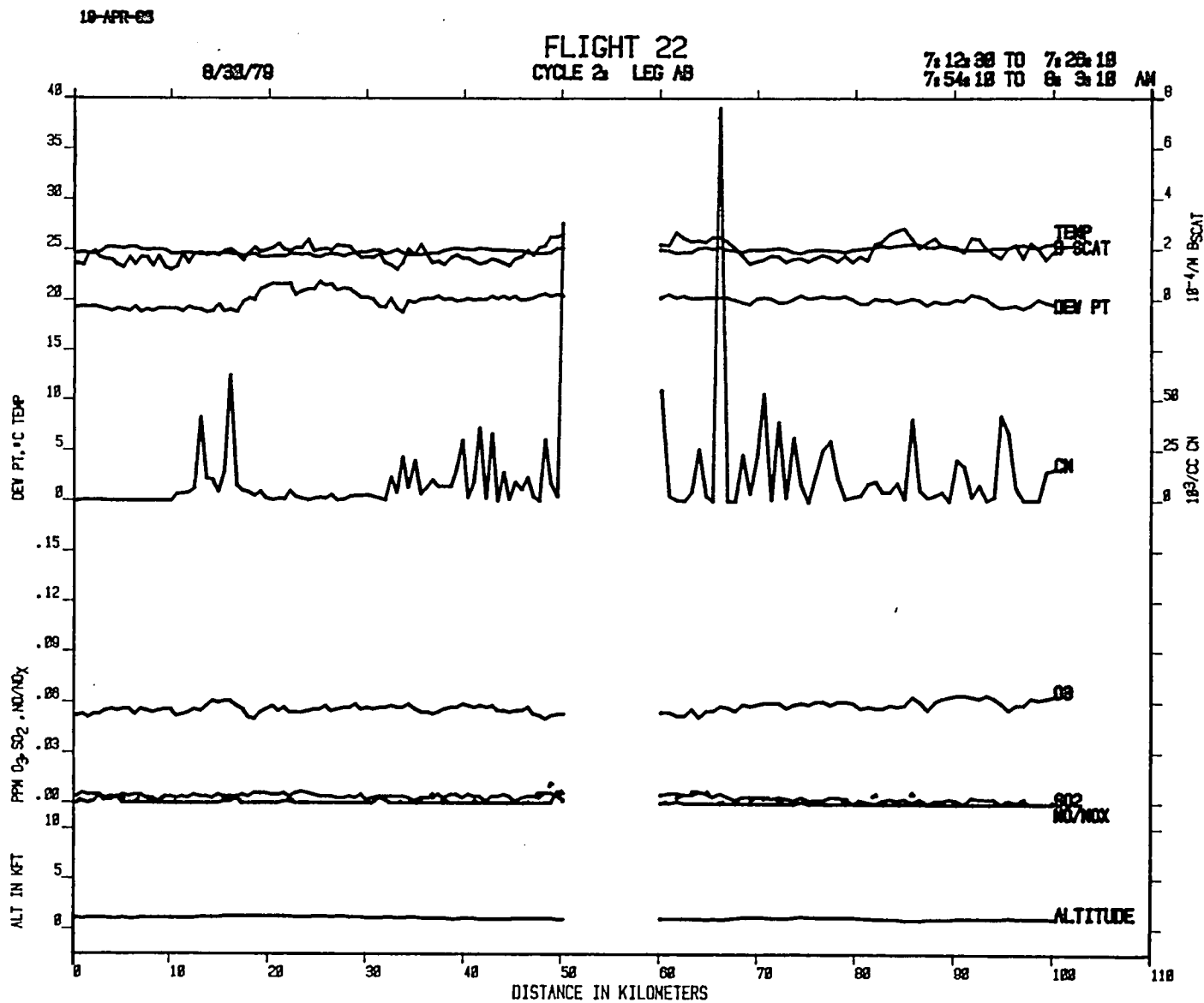

Figure B-9 Data from flight on August 30 - early morning - (Urban Plume-SW flow)
Page 7 of 10

84-MAY-68

FLIGHT 22 SPIRAL 2
8/30/79
NAVAL COMMUNICATION CENTER
7:29:38 TO 7:43:58 AM

B-64

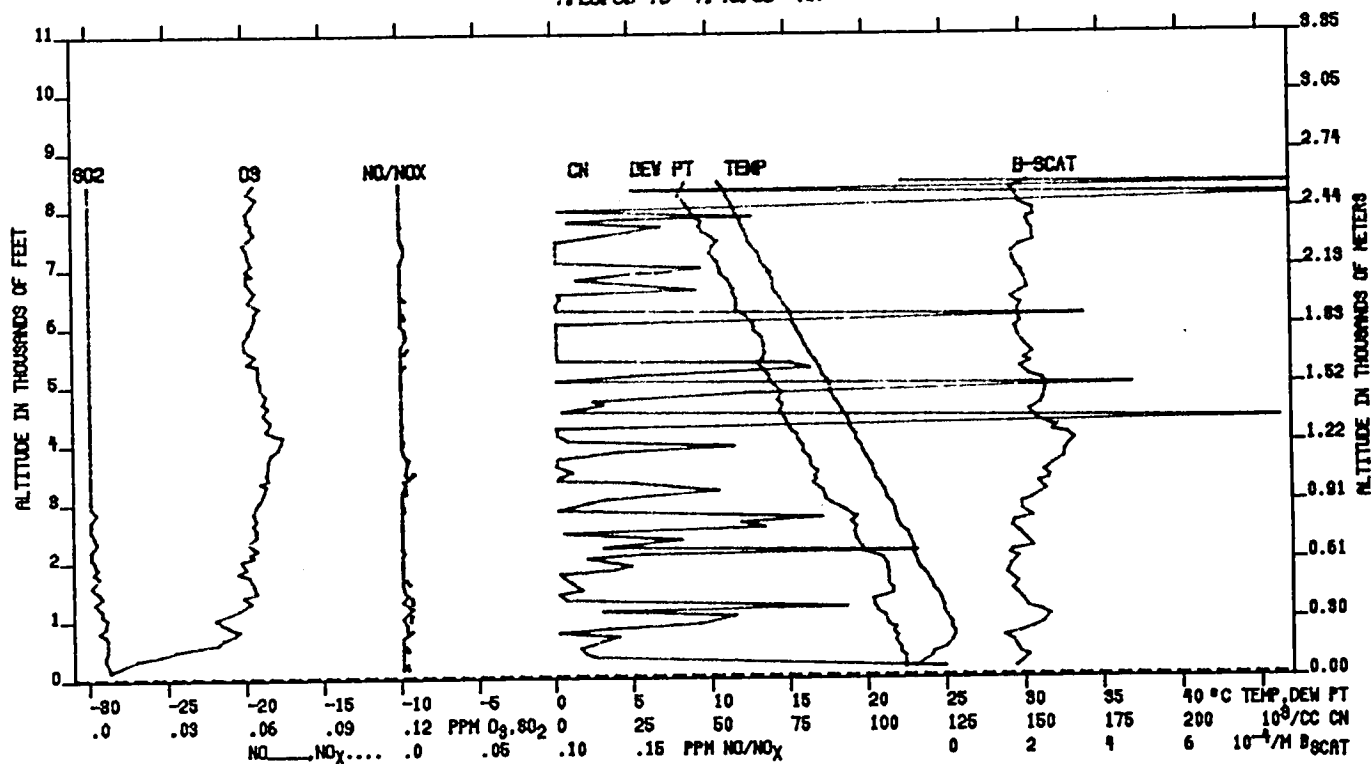

Figure B-9 Data from flight on August 30 - early morning - (Urban Plume-SW flow)
Page 8 of 10

Z1-APR-68

8/30/79

FLIGHT 22 LEG BD (TRANSITION)

8:32:28 TO 8:14:18 AM

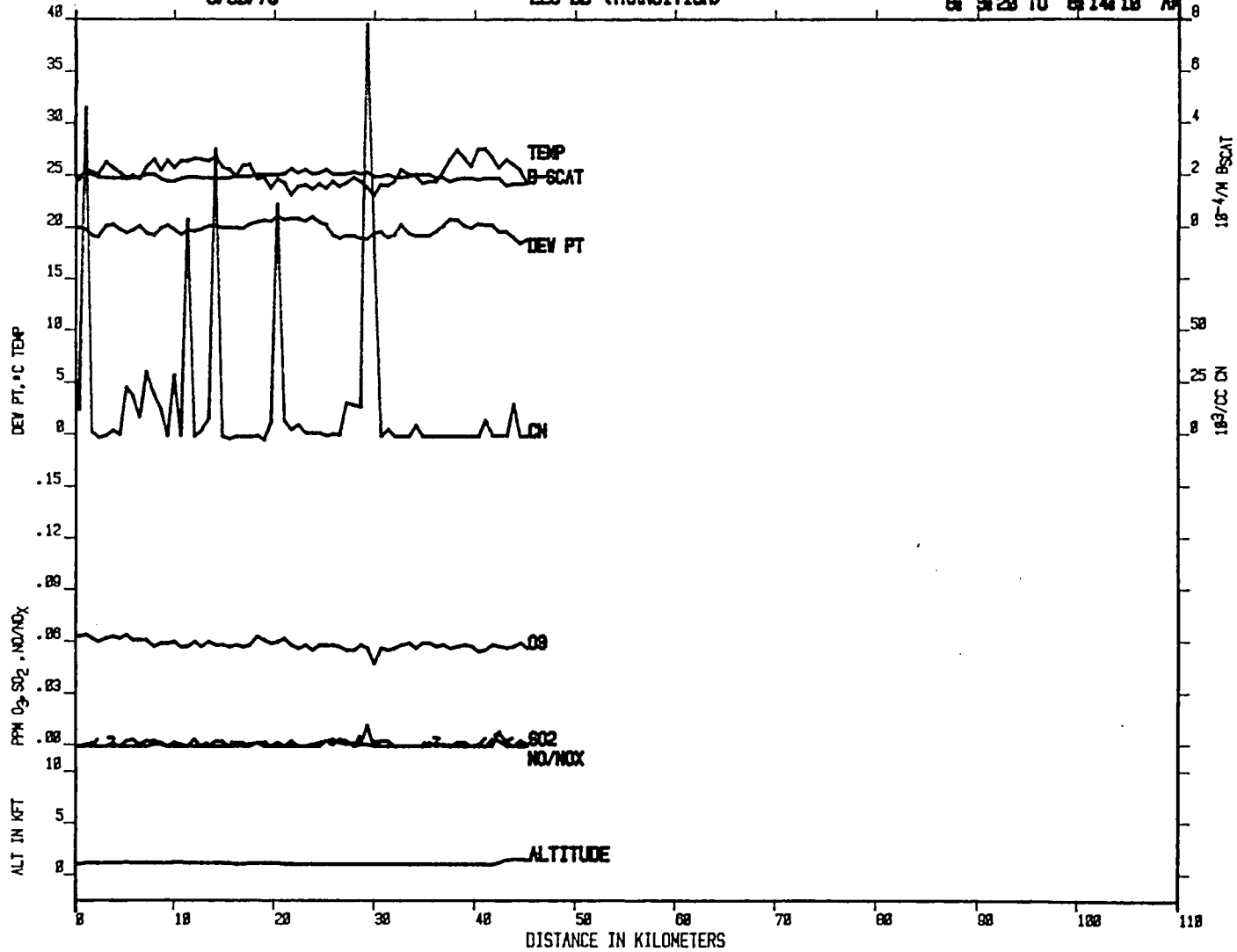

B-65

Figure B-9 Data from flight on August 30 - early morning - (Urban Plume-SW flow)
Page 9 of 10

18-APR-88

8/30/79

FLIGHT 22
CYCLE 2 LEG DC

8:14:28 TO 8:30:18 AM

B-66

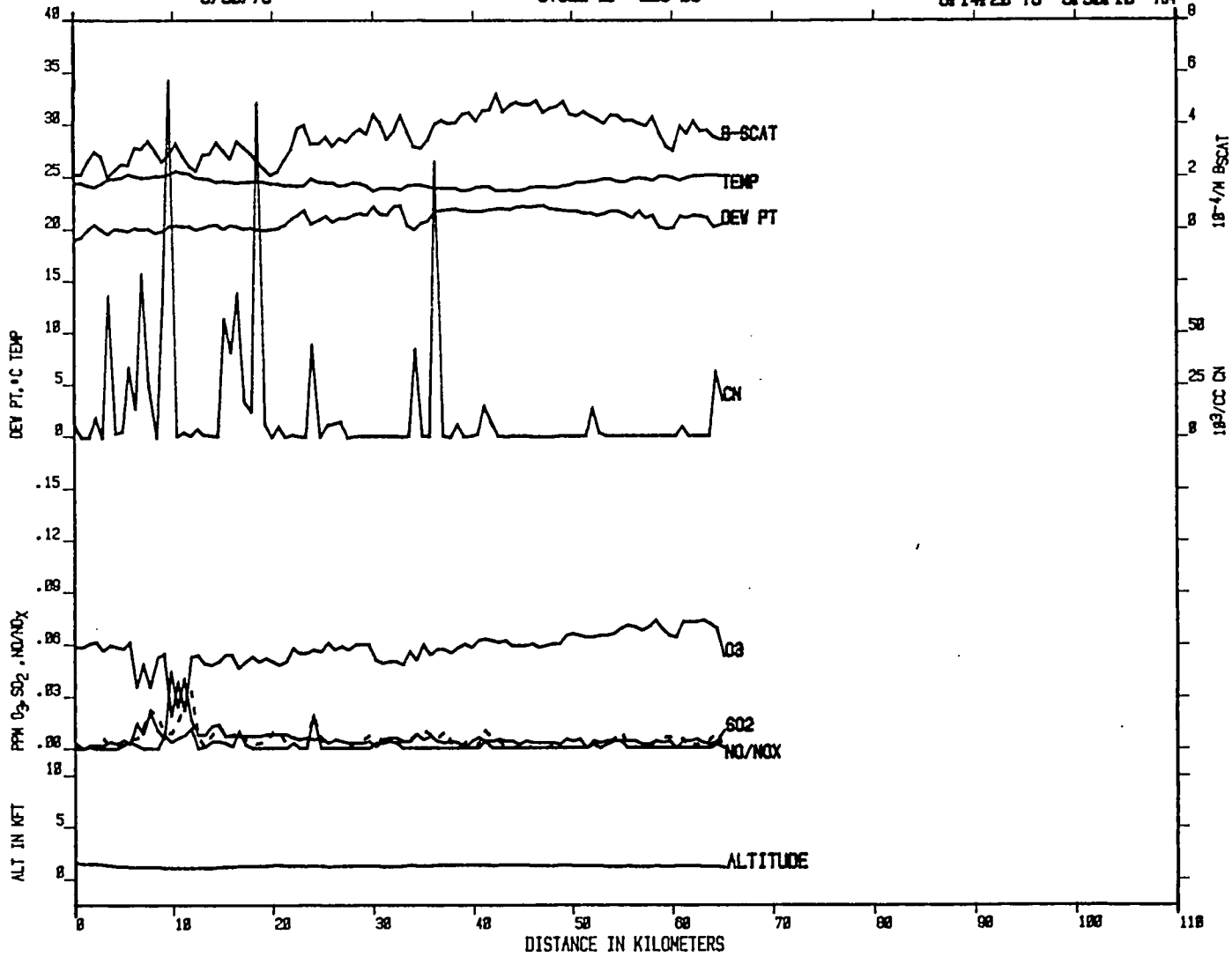

Figure B-9 Data from flight on August 30 - early morning - (Urban Plume-SW flow)
Page 10 of 10

21-APR-88

8/30/79

FLIGHT 23
LEG CA (TRANSITION)

10:47:10 TO 10:59:50 AM

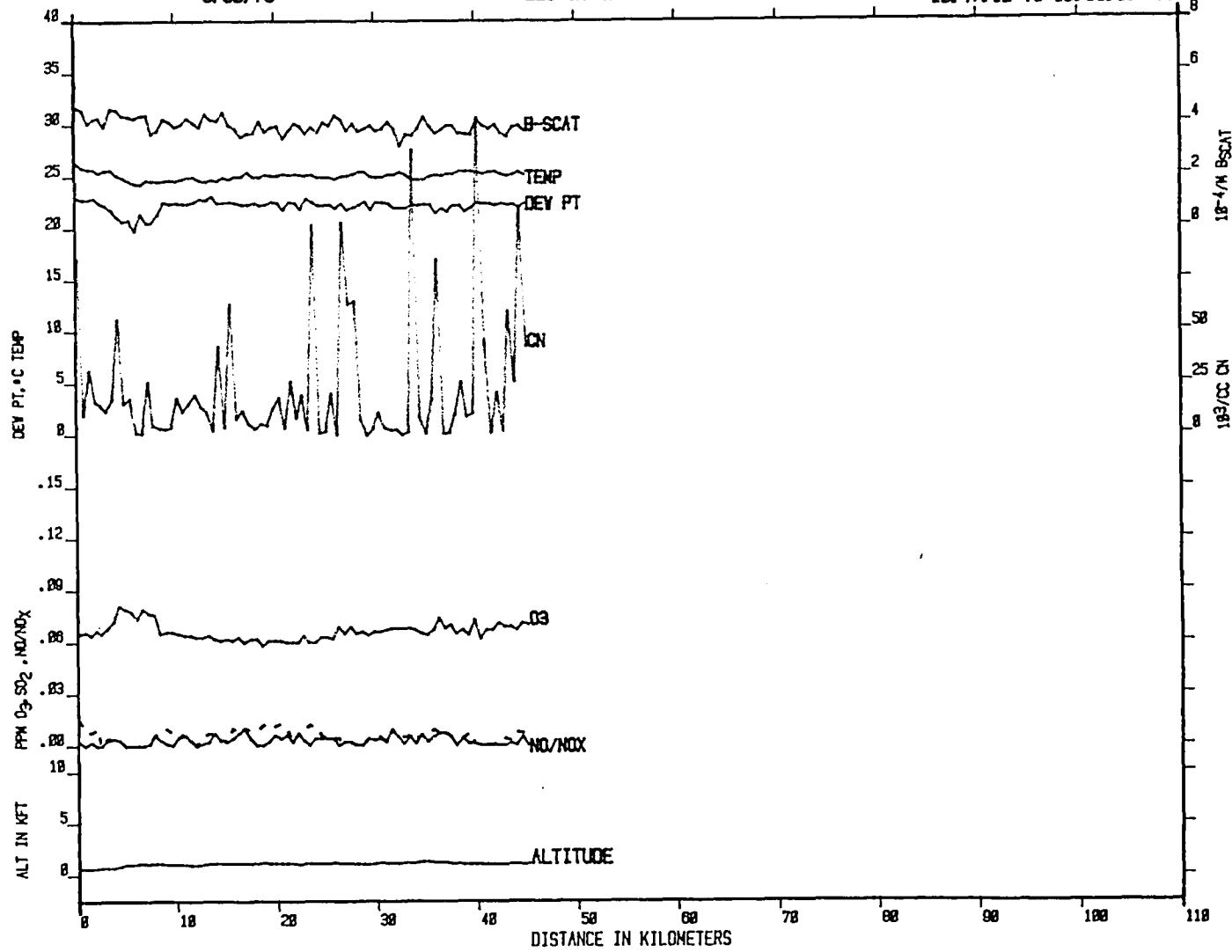

B-67

Figure B-10 Data from flight on August 30 - late morning - (Urban Plume-SW flow)
Page 1 of 11

18-APR-68

8/30/79

FLIGHT 23
LEG AB

10:59:58 TO 11:13:48
11:37: 8 TO 11:48:48 AM

B-68

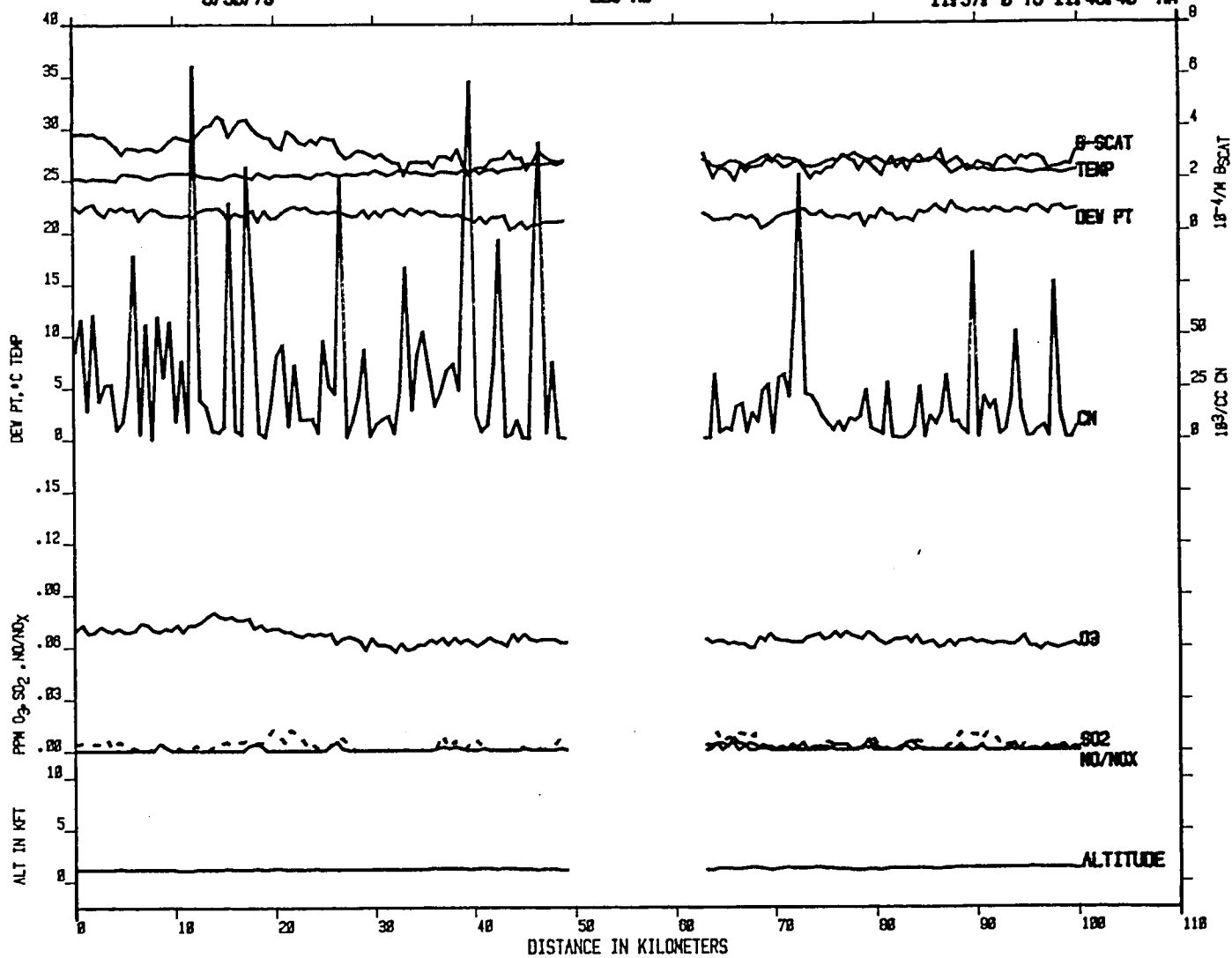
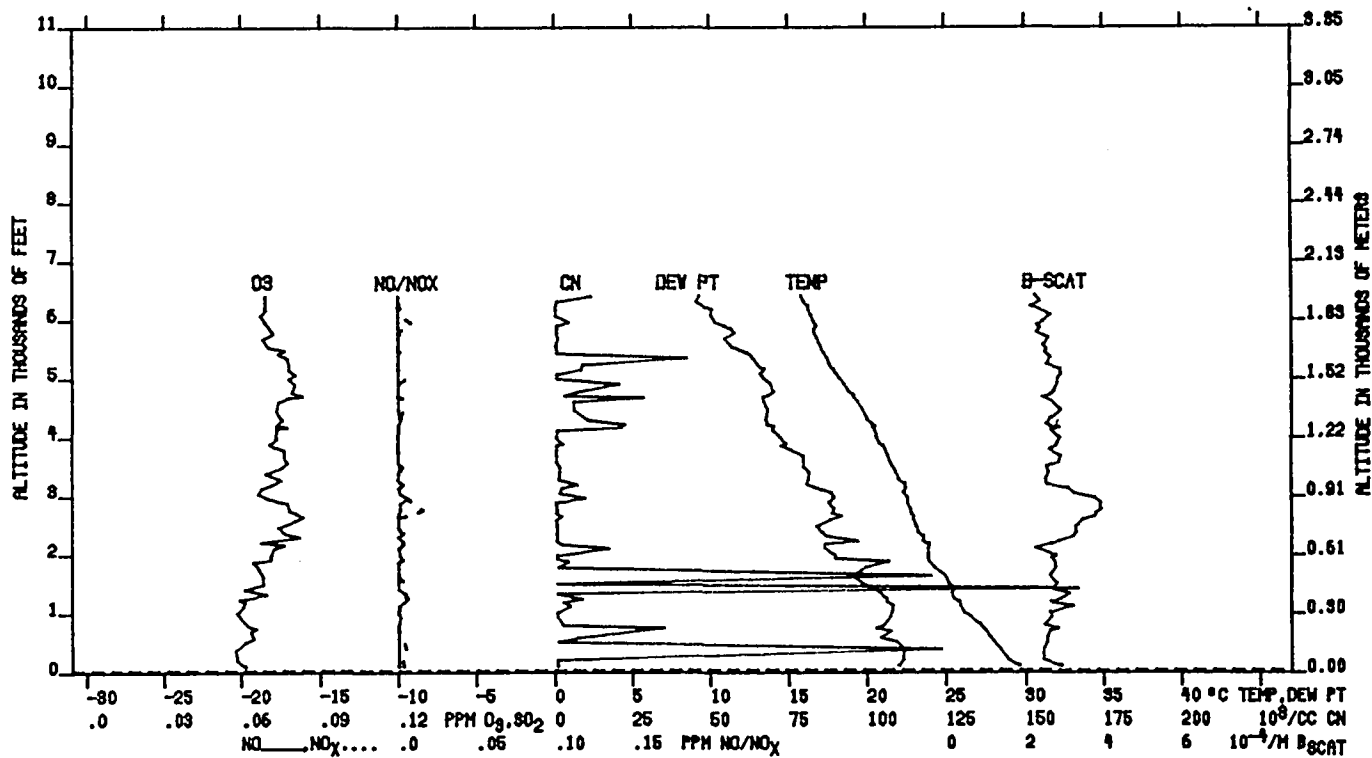

Figure B-10 Data from flight on August 30 - late morning - (Urban Plume-SW flow)
Page 2 of 11

84-MAY-88

FLIGHT 23 SPIRAL 1
8/30/78
NAVAL COMMUNICATION CENTER
11:16:30 TO 11:28:40 AM



B-69

Figure B-10 Data from flight on August 30 - late morning - (Urban Plume-SW flow)
Page 3 of 11

21-APR-88

FLIGHT 23
LEG B0 (TRANSITION)

11:48:58 TO 11:57:58 AM

8/30/79

B-70

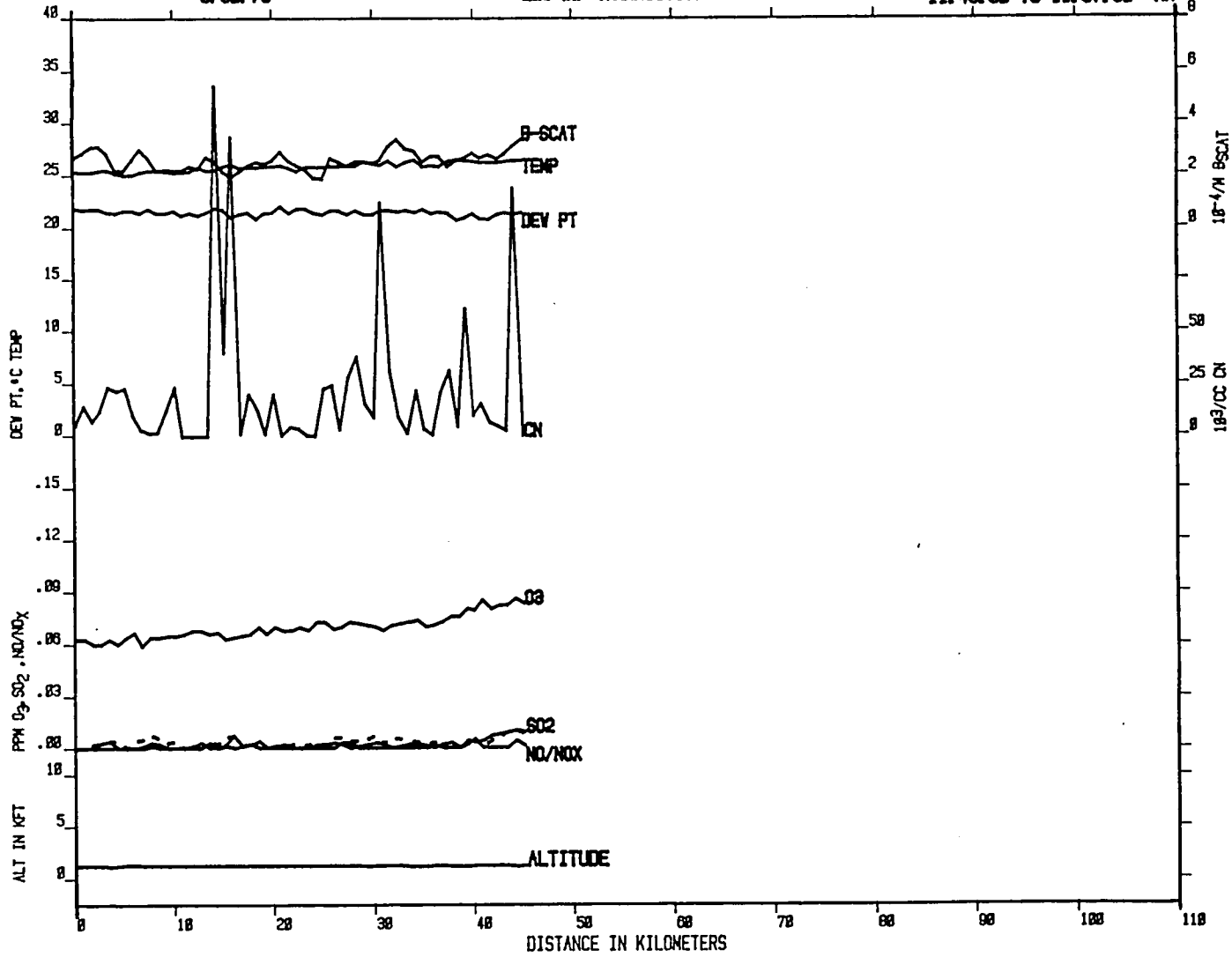

Figure B-10 Data from flight on August 30 - late morning - (Urban Plume-SW flow)
Page 4 of 11

B-71

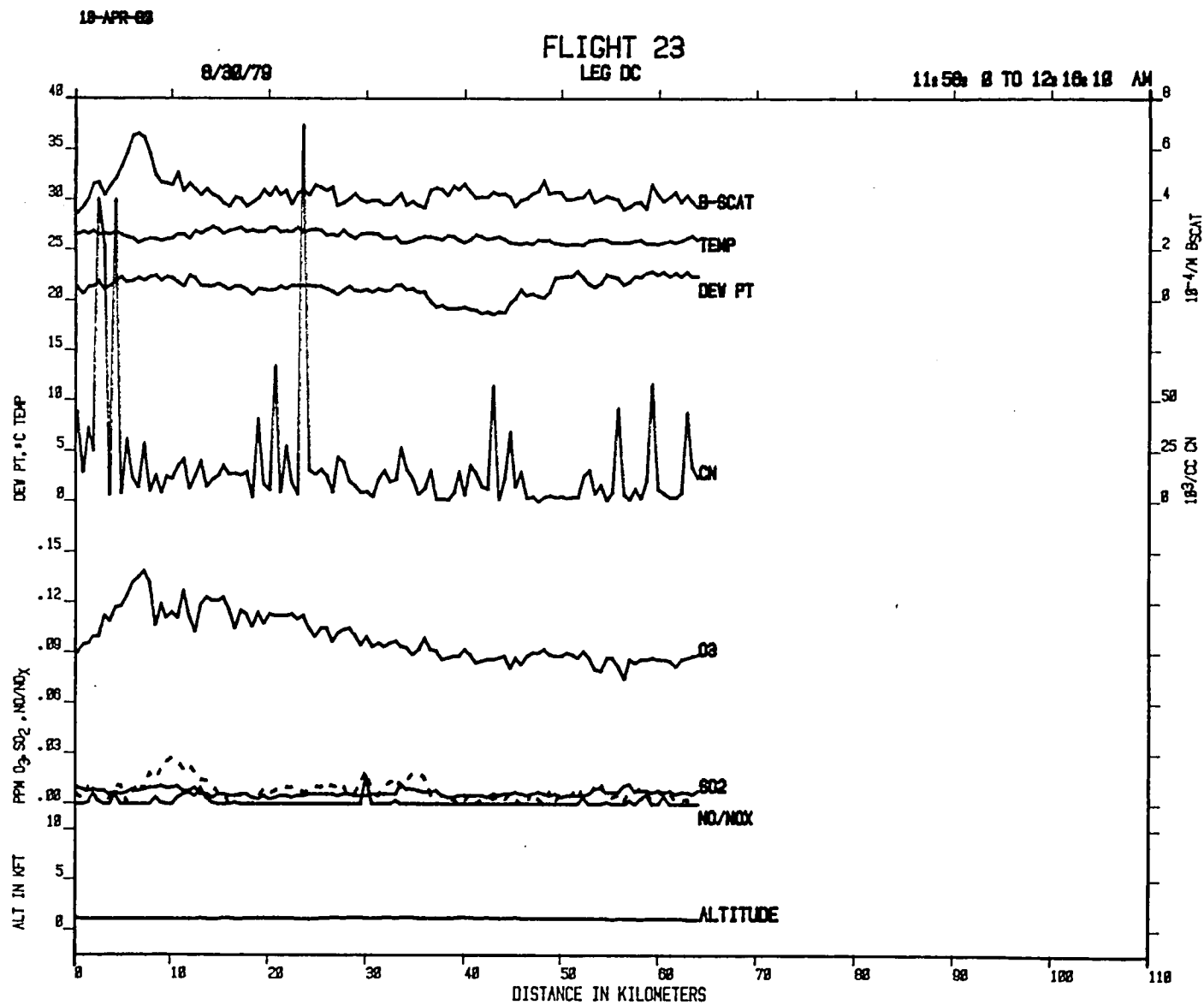

Figure B-10 Data from flight on August 30 - late morning - (Urban Plume-SW flow)
Page 5 of 11

21-APR-68

FLIGHT 23
LEG CE (TRANSITION)

8/30/78

12:16:18 TO 12:22:58 PM

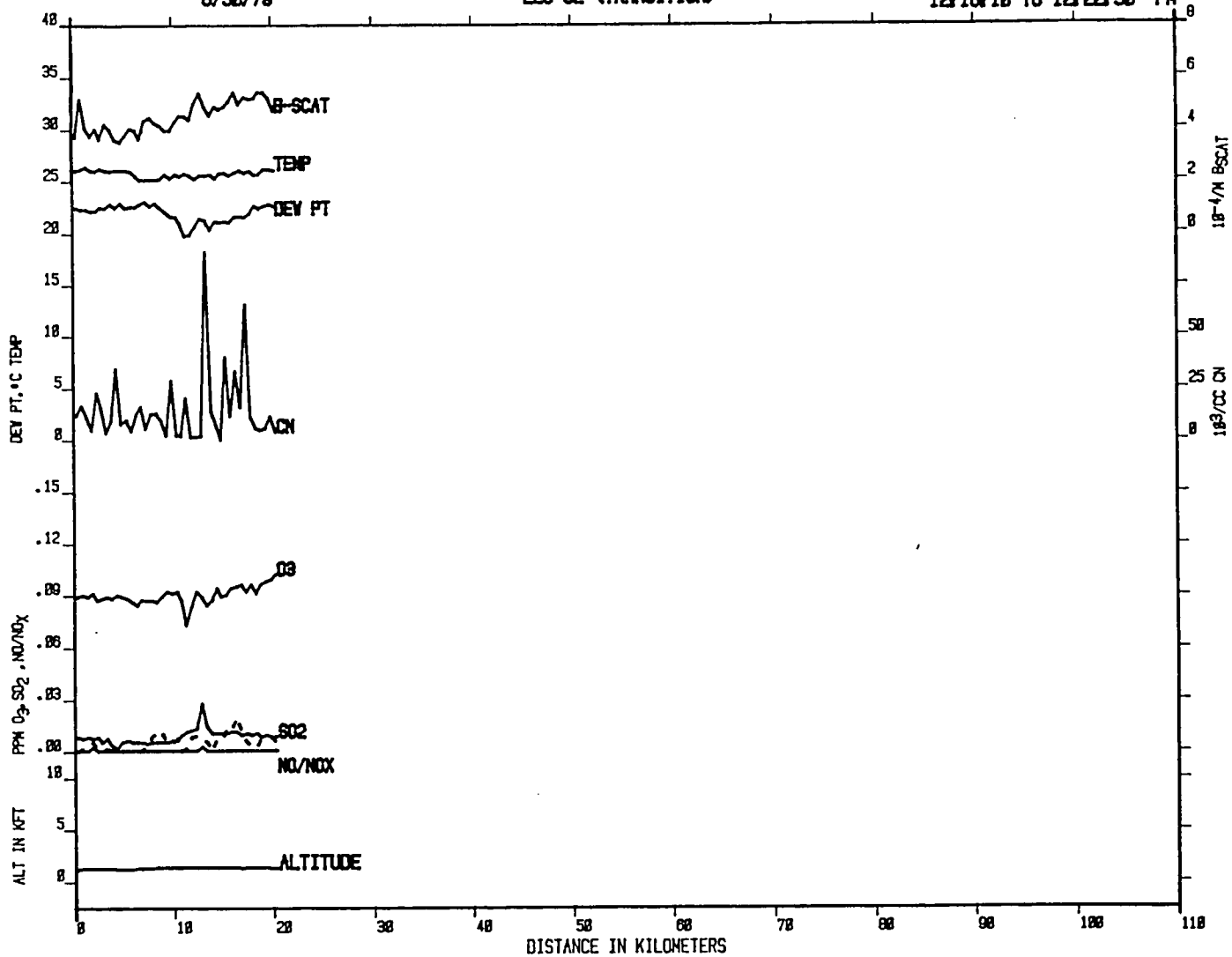

B-72

Figure B-10 Data from flight on August 30 - late morning - (Urban Plume-SW flow)
Page 6 of 11

B-73

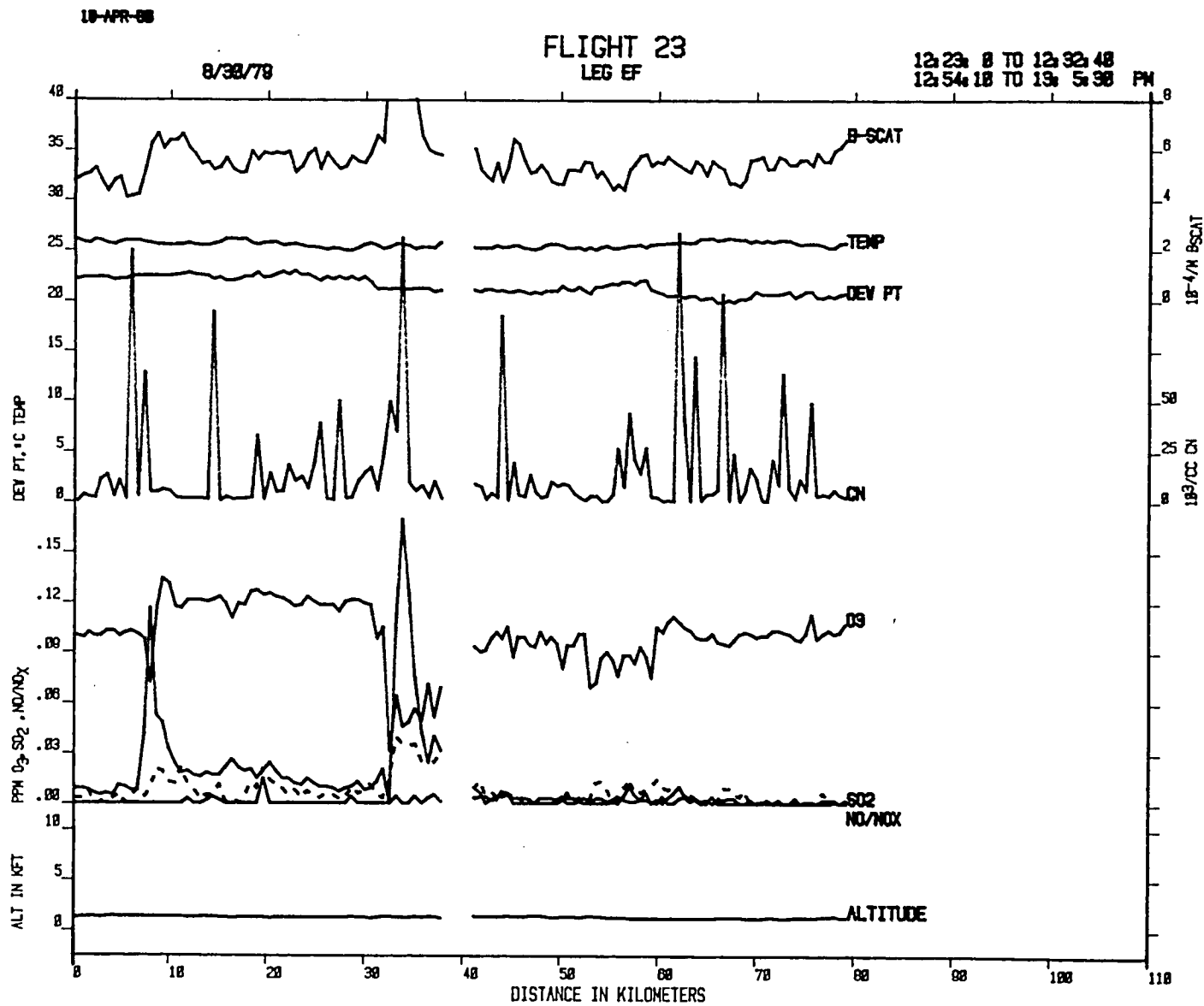

Figure B-10 Data from flight on August 30 - late morning - (Urban Plume-SW flow)
Page 7 of 11

84-MAY-68

FLIGHT 23 SPIRAL 2
8/30/79
CHESAPEAKE BRIDGE TUNNEL
12:34:10 TO 12:45:38 PM

B-74

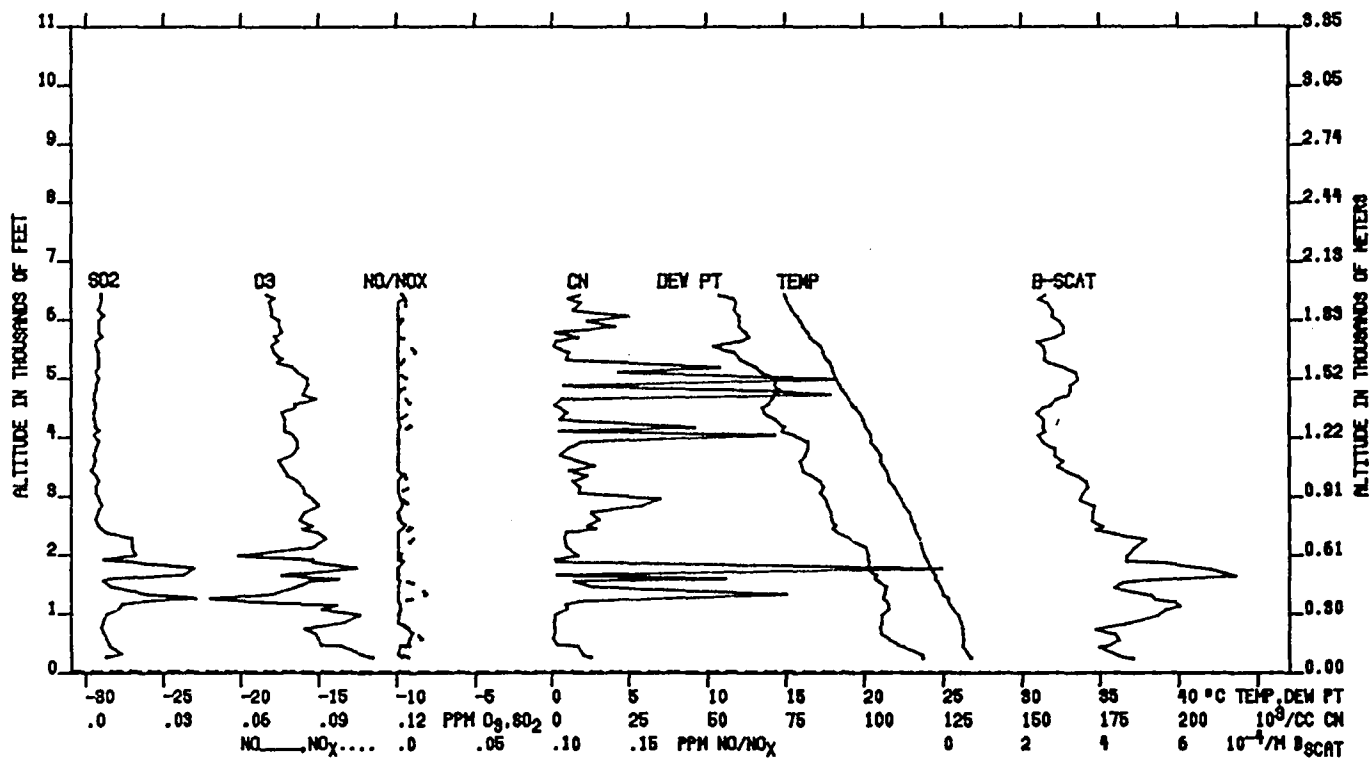

Figure B-10 Data from flight on August 30 - late morning - (Urban Plume-SW flow)
Page 8 of 11

21-APR-88

FLIGHT 23
LEG FH (TRANSITION)

8/30/79

13: 5:48 TO 13: 13:28 PM

B-75

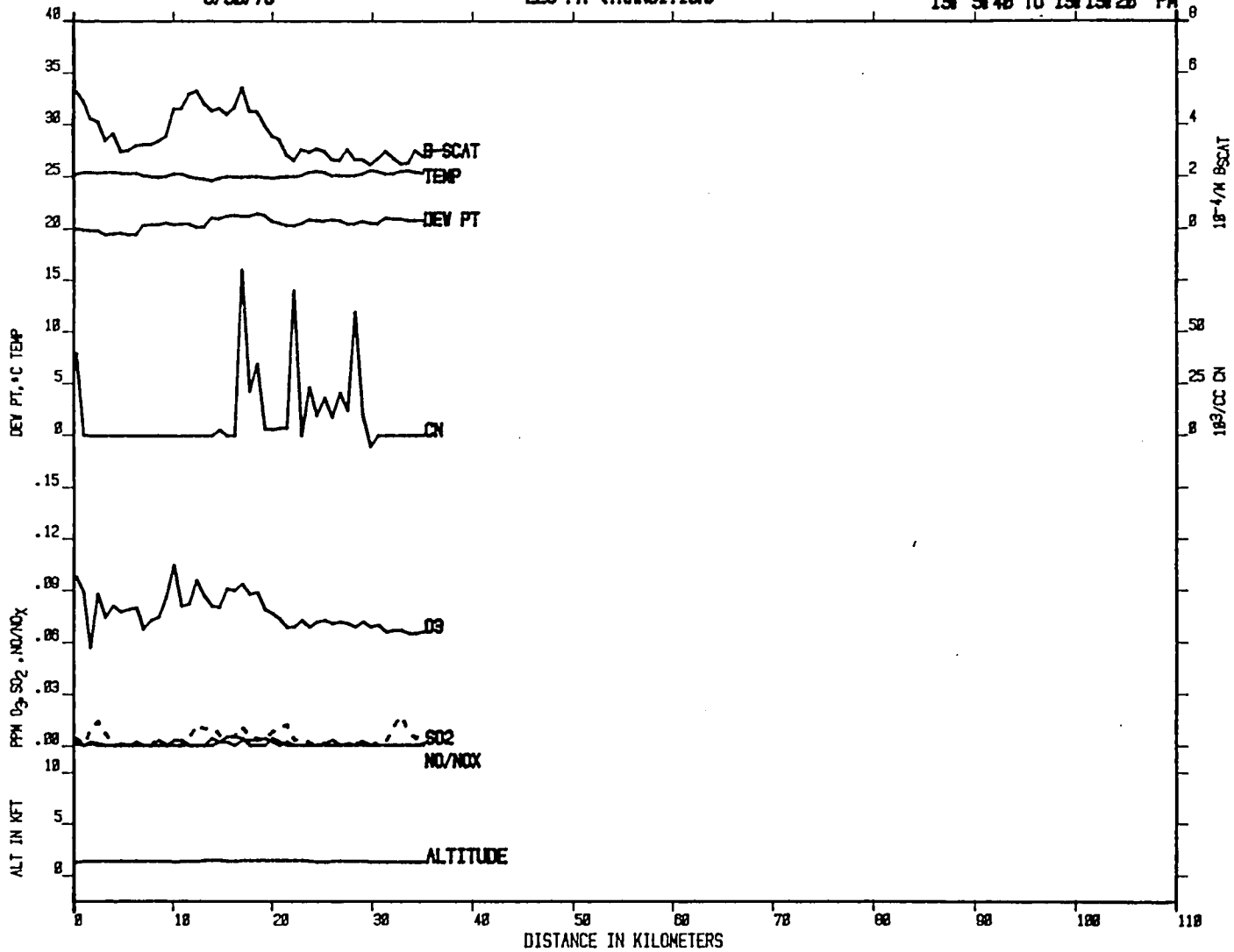

Figure B-10 Data from flight on August 30 - late morning - (Urban Plume-SW flow)
Page 9 of 11

18-APR-68

8/30/79

FLIGHT 23 LEG HG

13:13:38 TO 13:29: 8
13:49:18 TO 13:59:58 PM

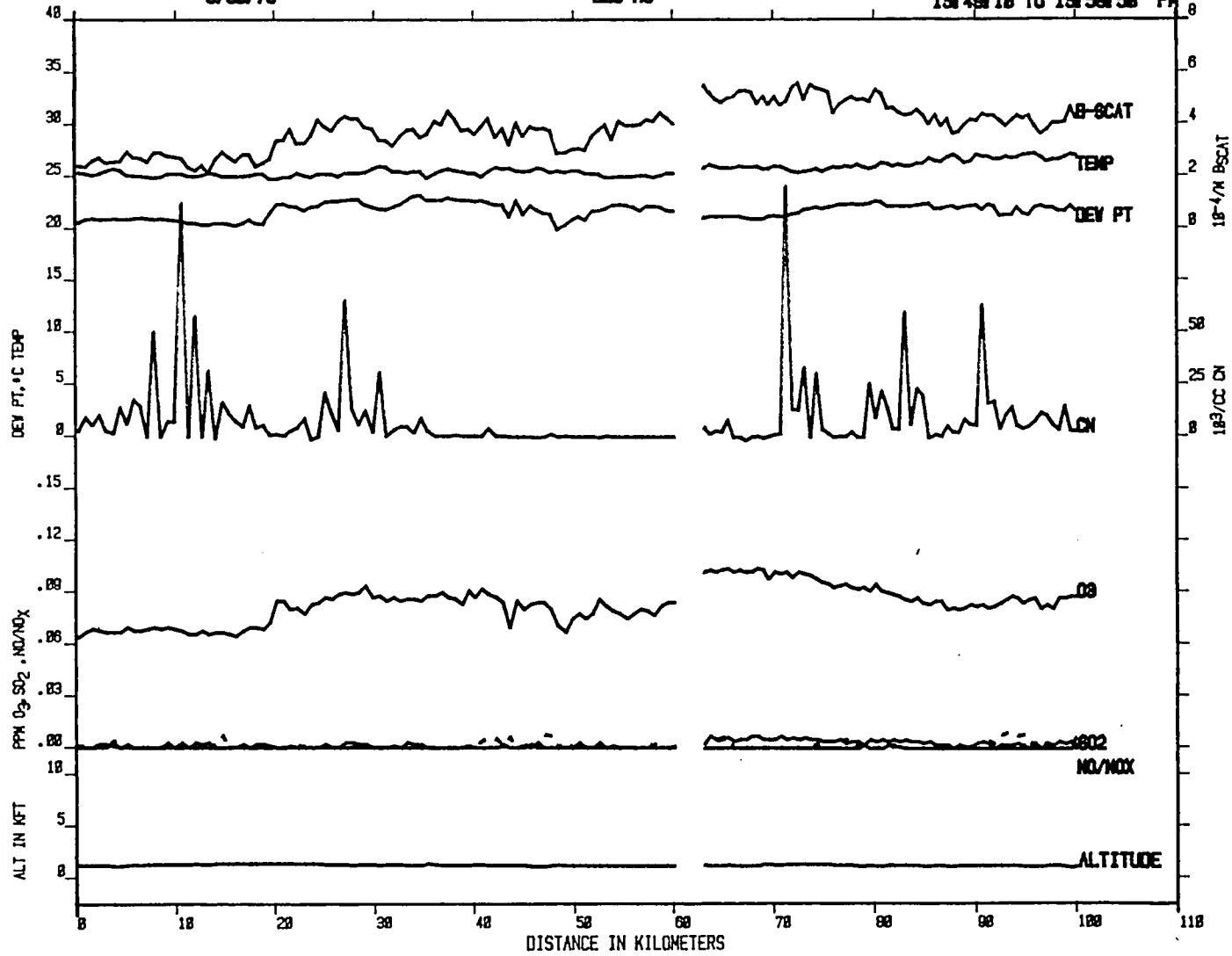

B-76

Figure B-10 Data from flight on August 30 - late morning - (Urban Plume-SW flow)
Page 10 of 11

84-MAY-68

FLIGHT 23 SPIRAL 3

8/30/79

CAPE CHARLES

13:38:18 TO 13:48:48 PM

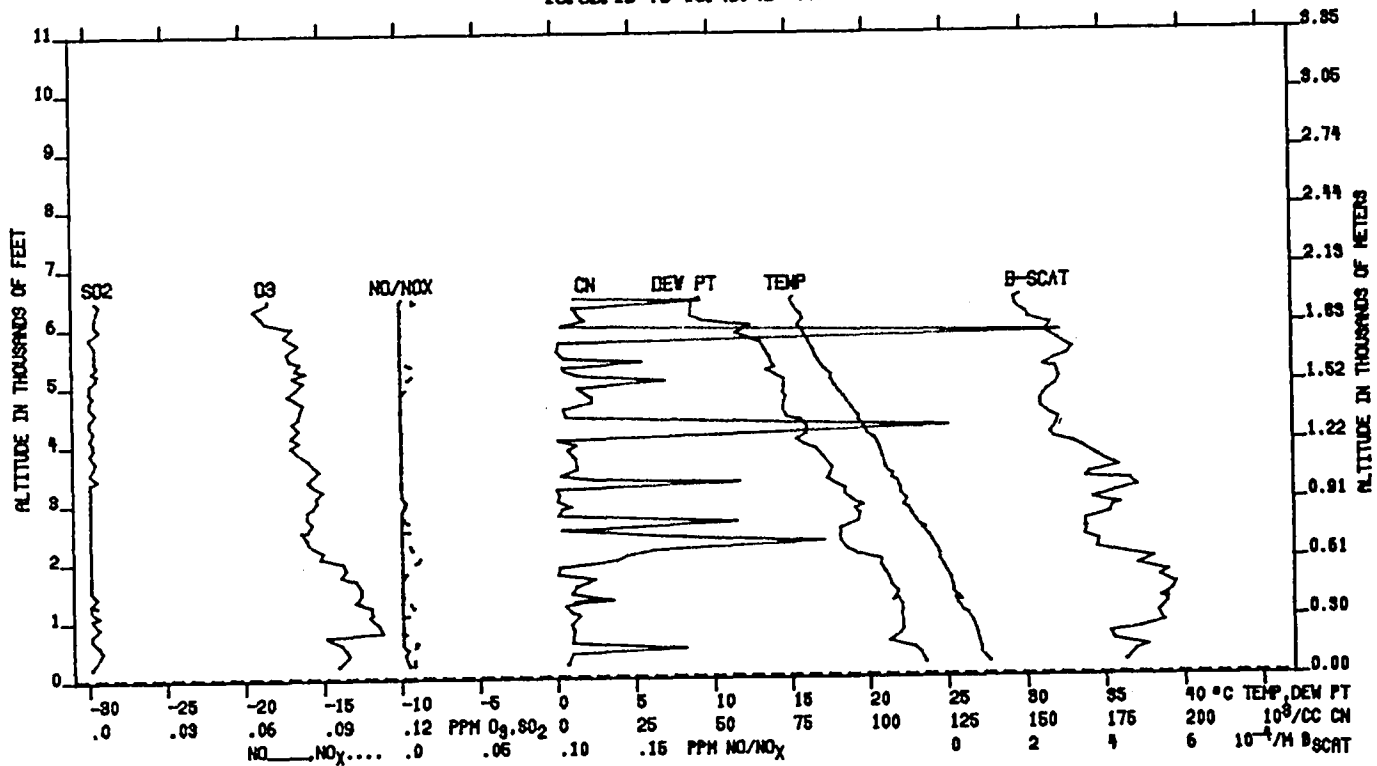

B-77

Figure B-10 Data from flight on August 30 - late morning - (Urban Plume-SW flow)
Page 11 of 11

84-MAY-88

FLIGHT 24 SPIRAL 1
8/31/79
PHOTOCHEMICAL BOX SPIRAL AT A₂ CYCLE 1
5:11:58 TO 5:25:18 AM

B-78

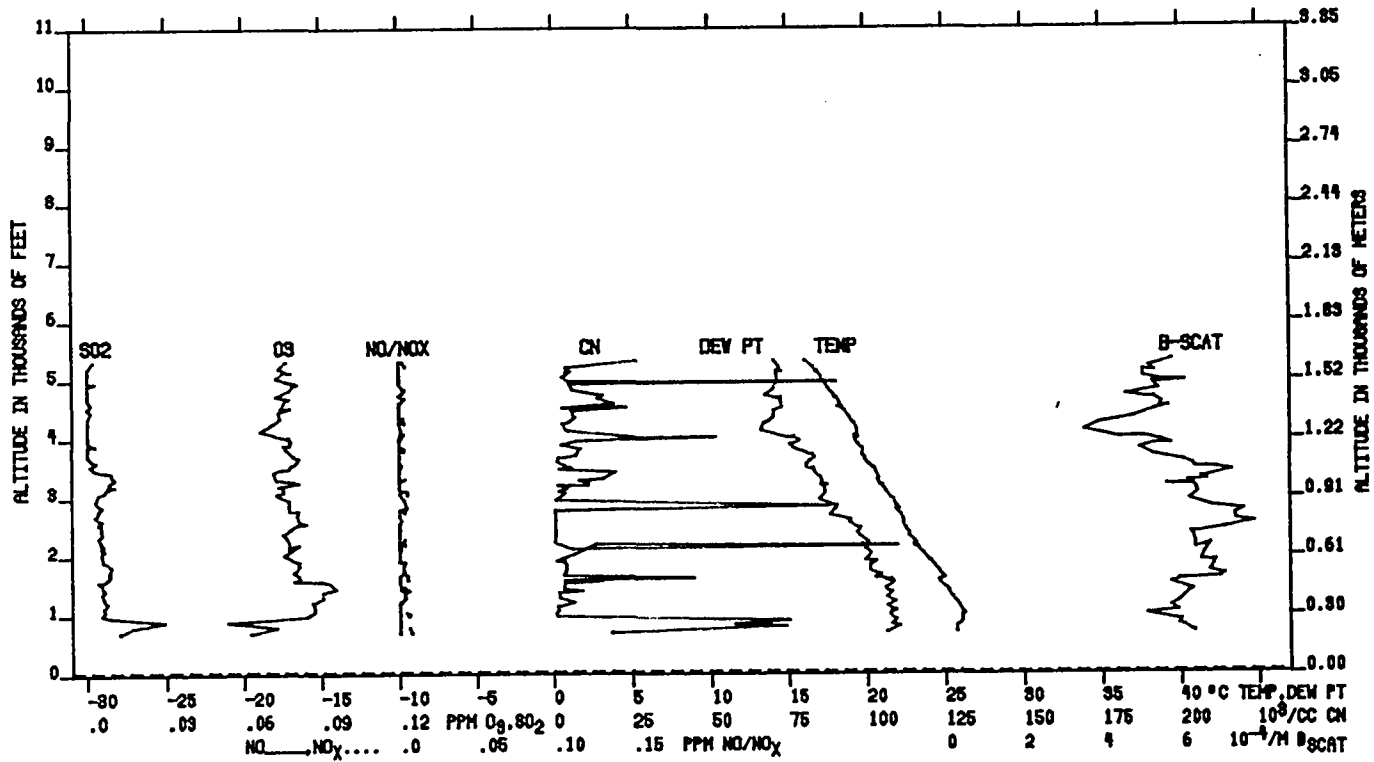

Figure B-11 Data from flight on August 31 - Photochemical box-SW flow - Page 1 of 9

B-79

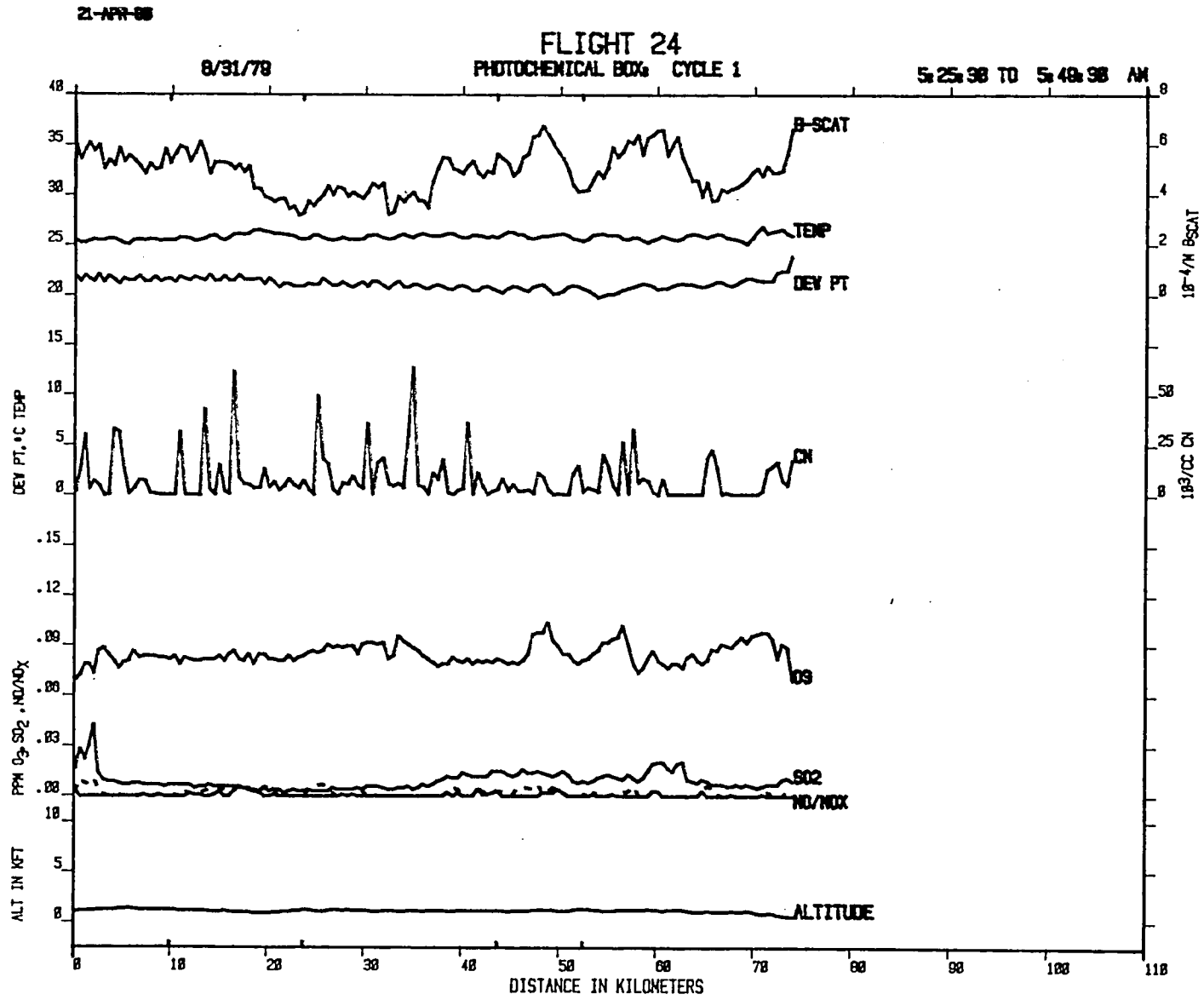

Figure B-11 Data from flight on August 31 - Photochemical box-SW flow - Page 2 of 9

84-MAY-88

FLIGHT 24 SPIRAL 2
8/31/79
PHOTOCHEMICAL BOX: SPIRAL AT F₁ CYCLE 1
5:40:48 TO 5:58:28 AM

B-80

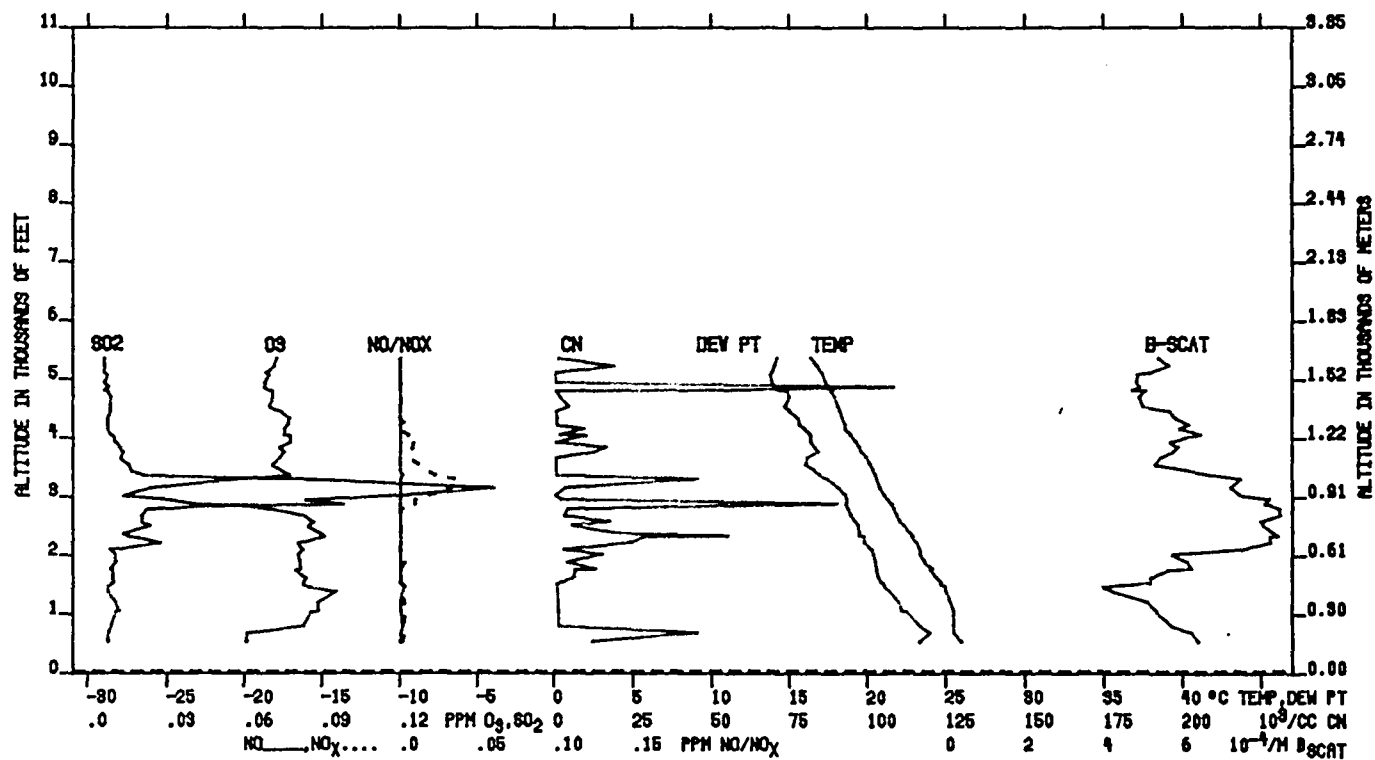
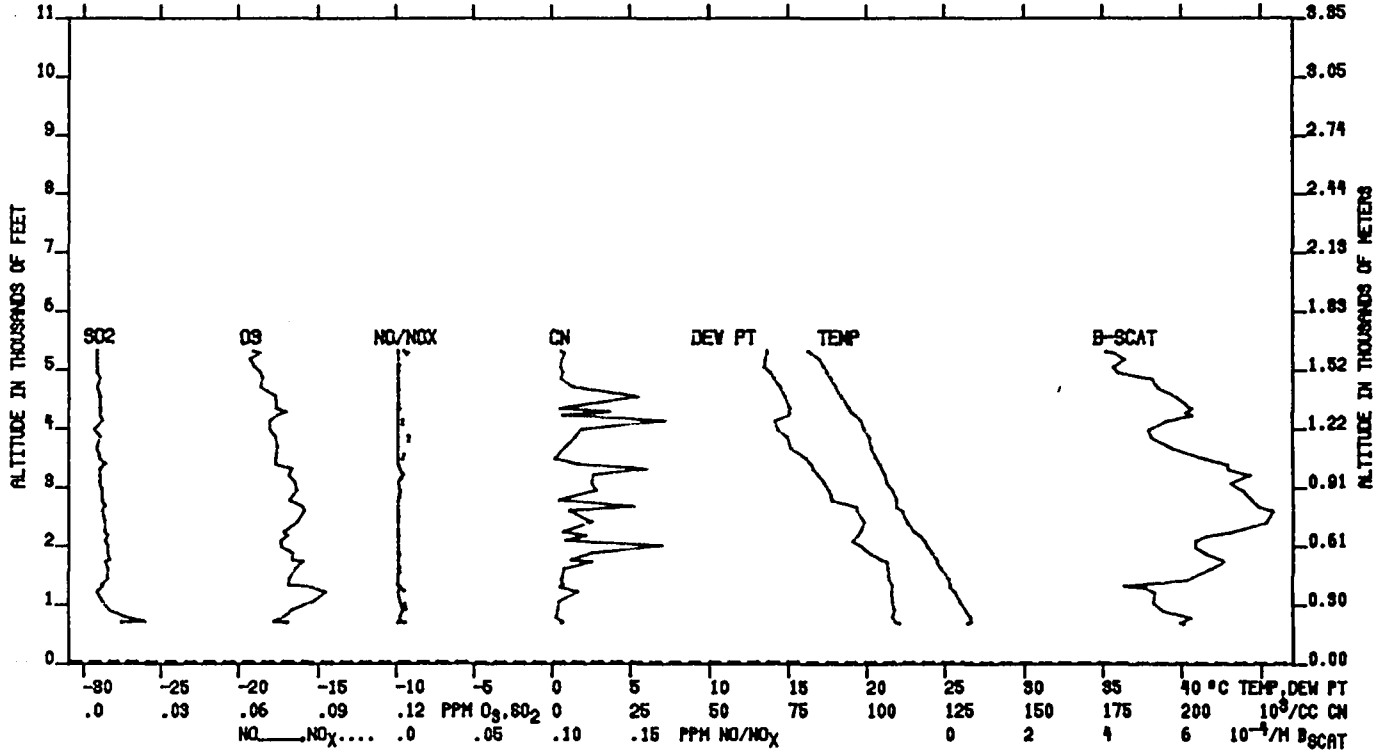

Figure B-11 Data from flight on August 31 - Photochemical box-SW flow - Page 3 of 9

84-MAY-88

FLIGHT 24 SPIRAL 3
8/31/79
PHOTOCHEMICAL BOX SPIRAL AT A₀ CYCLE 2
6:08 P TO 6:12:58 AM



B-81

Figure B-11 Data from flight on August 31 - Photochemical box-SW flow - Page 4 of 9

21-APR-88

FLIGHT 24

8/31/79

PHOTOCHEMICAL BOX: CYCLE 2

0:19:18 TO 0:36:48 AM

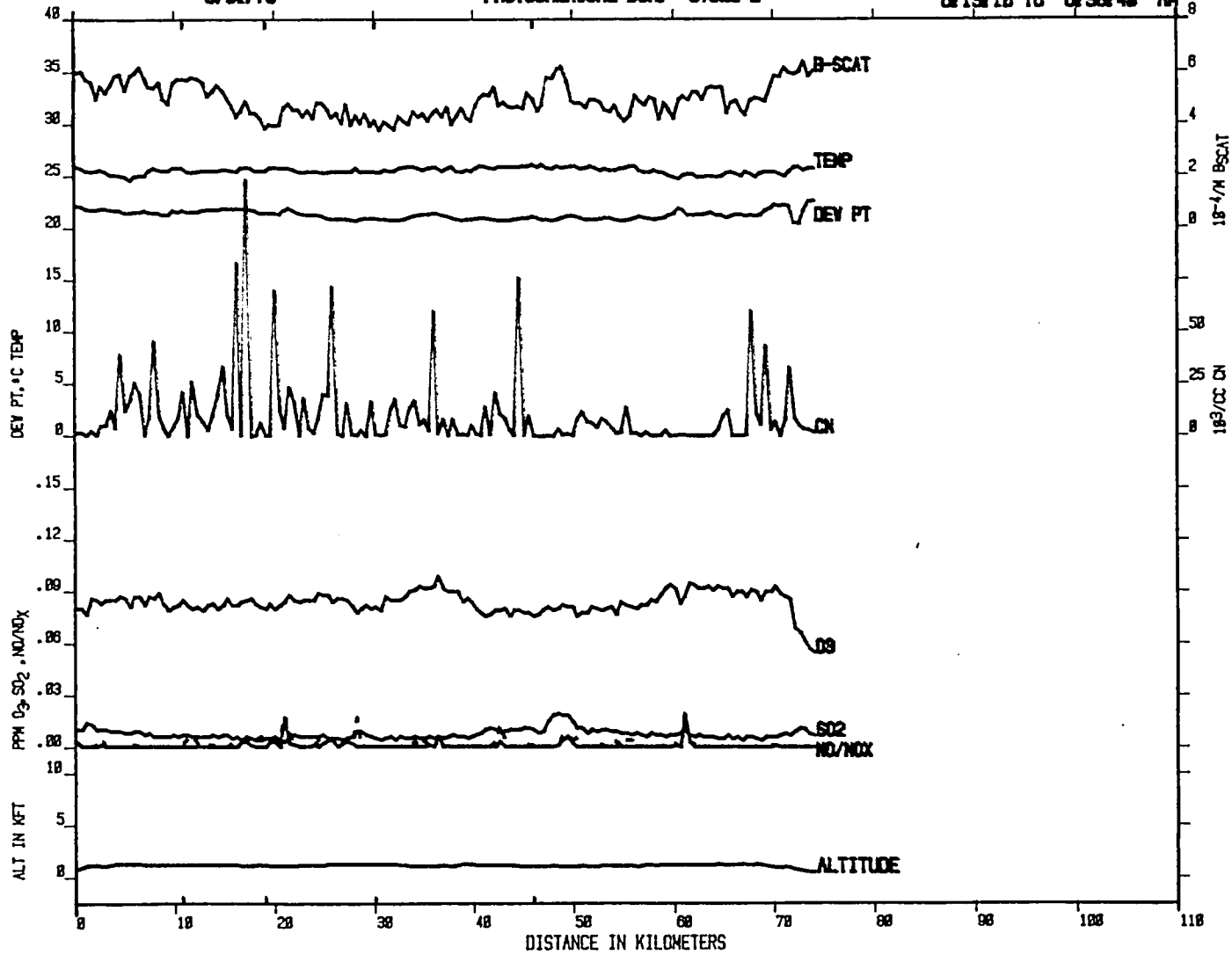

B-82

Figure B-11 Data from flight on August 31 - Photochemical box-SW flow - Page 5 of 9

84-MAY-68

FLIGHT 24 SPIRAL 4
8/31/79
PHOTOCHEMICAL BOX SPIRAL AT F₉ CYCLE 2
6:38:48 TO 6:50:58 AM

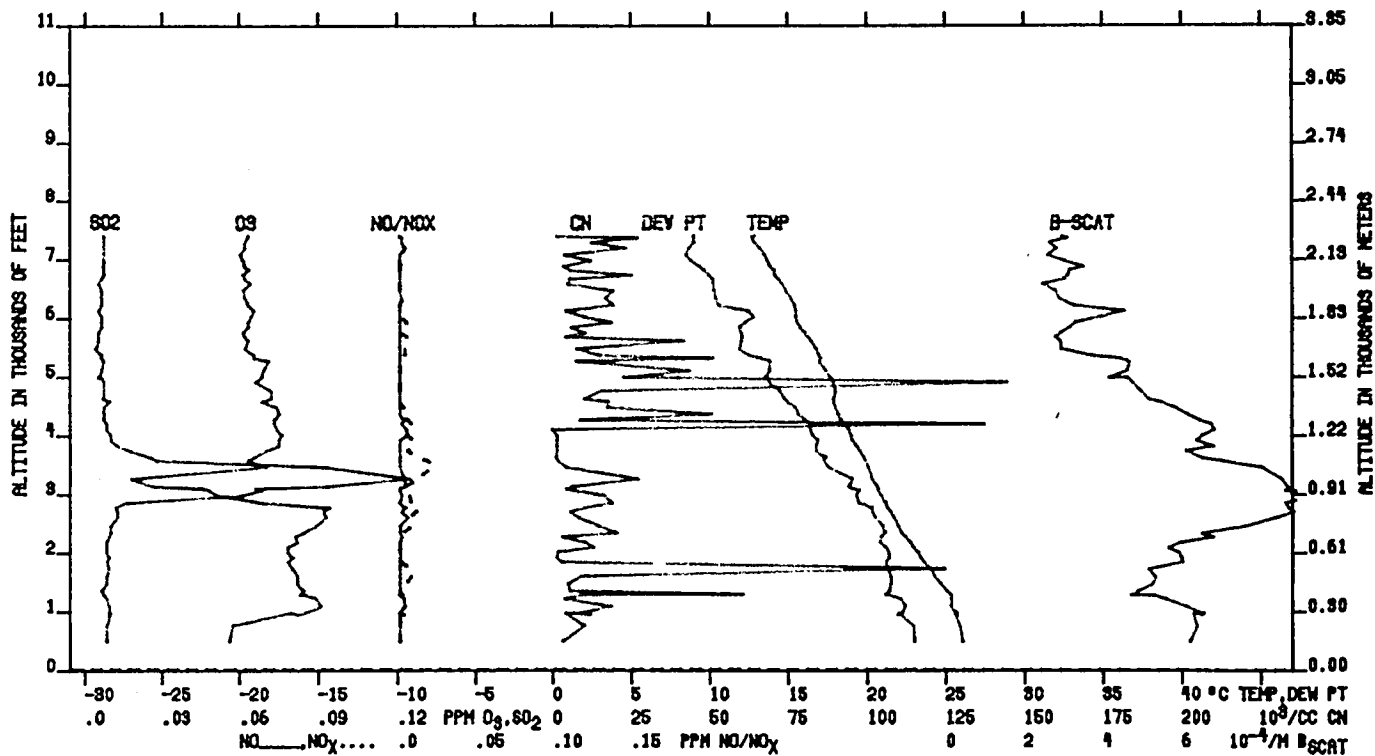

B-83

Figure B-11 Data from flight on August 31 - Photochemical box-SW flow - Page 6 of 9

84-NAY-68

FLIGHT 24 SPIRAL 5
8/31/79
PHOTOCHEMICAL BOX SPIRAL AT A₀ CYCLE 3
7: 1:38 TO 7:28:38 AM

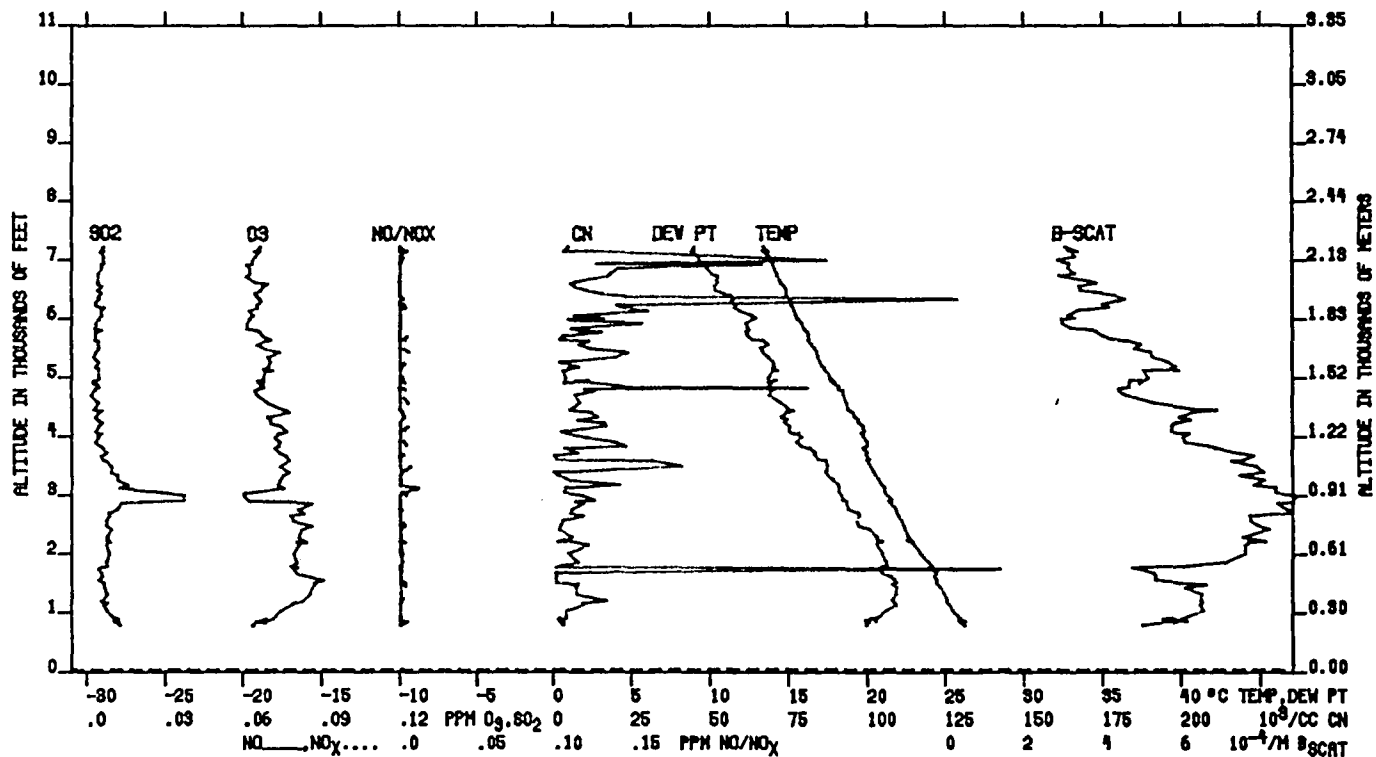

B-84

Figure B-11 Data from flight on August 31 - Photochemical box-SW flow - Page 7 of 9

B-85

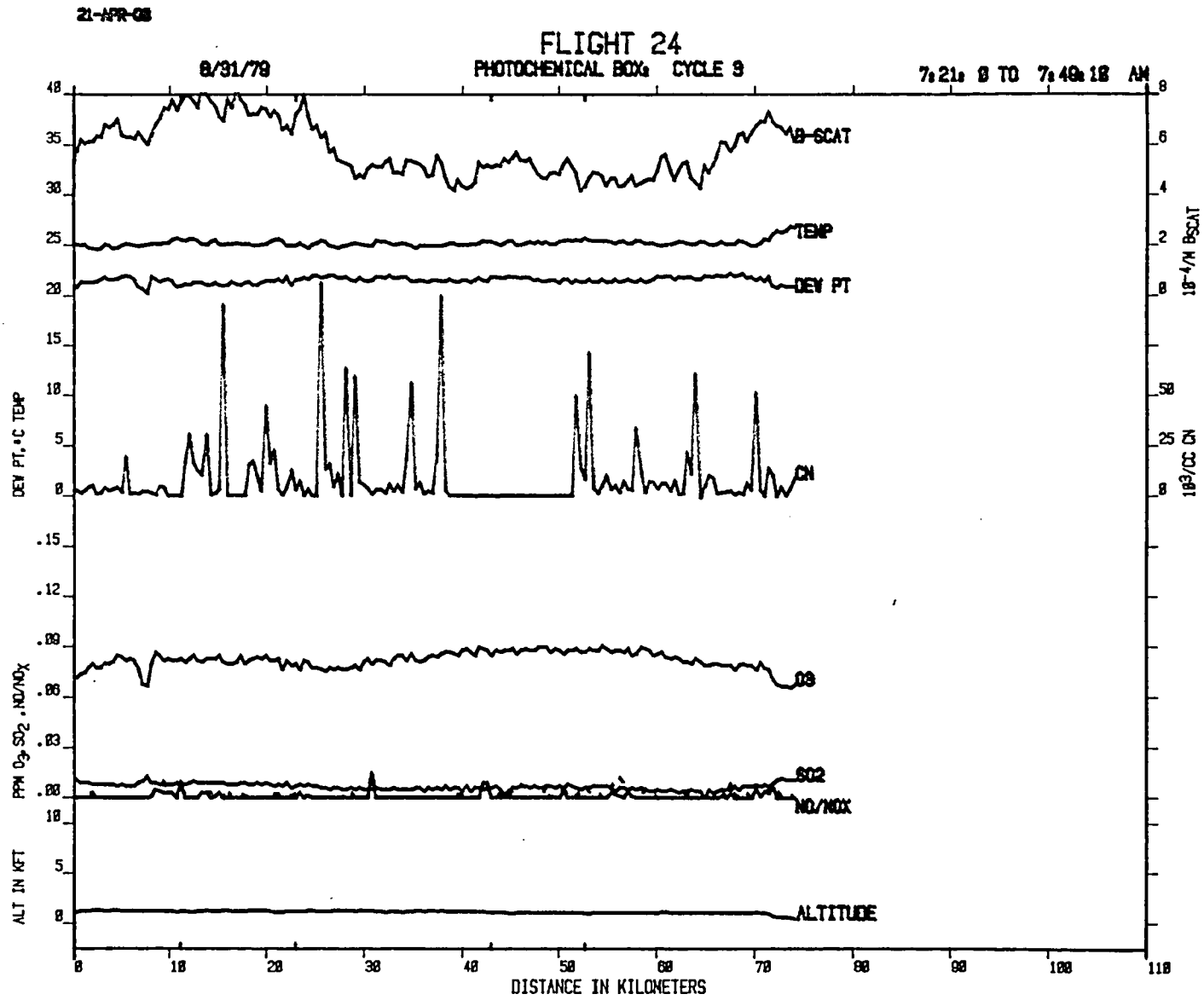

Figure B-11 Data from flight on August 31 - Photochemical box-SW flow - Page 8 of 9

84-MAY-88

FLIGHT 24 SPIRAL 6
8/31/79
PHOTOCHEMICAL BOX: SPIRAL AT F, CYCLE 3
7:49:18 TO 7:57:48 AM

B-86

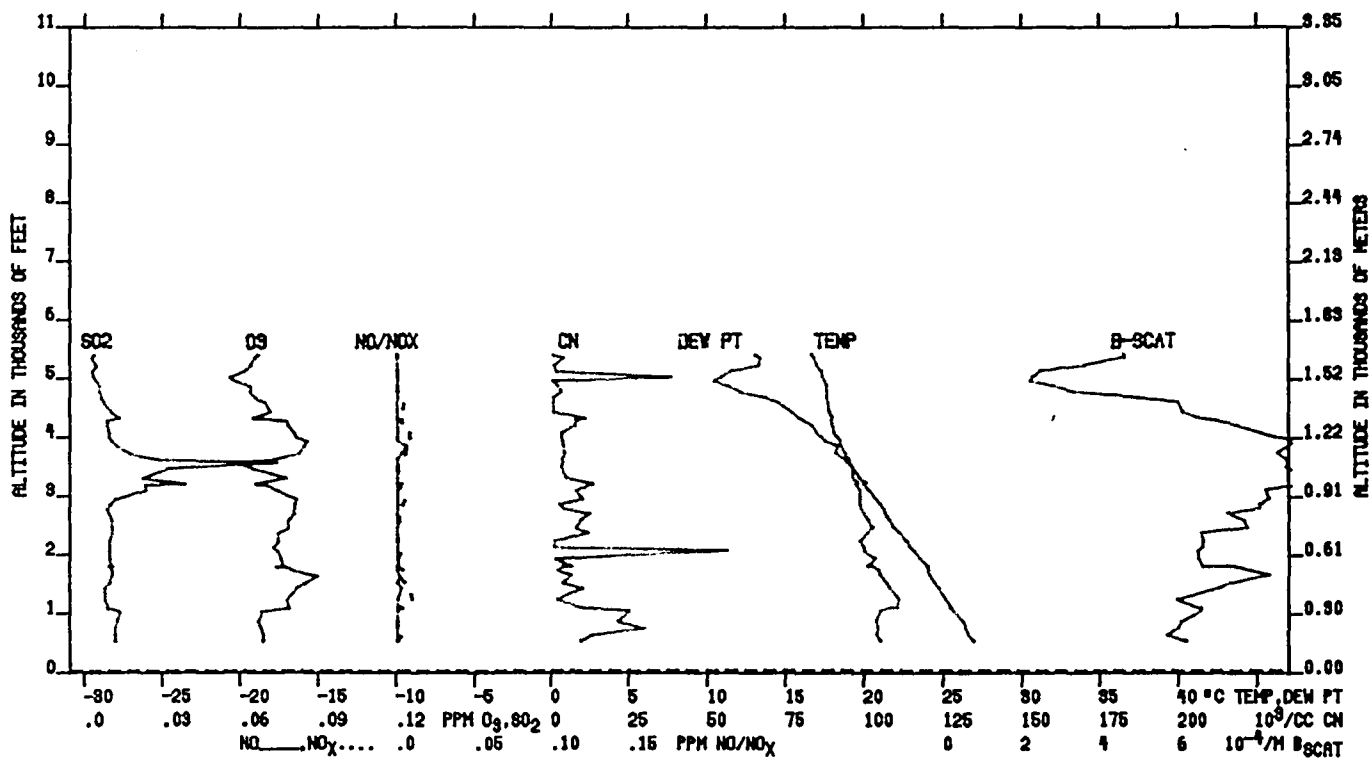

Figure B-11 Data from flight on August 31 - Photochemical box-SW flow - Page 9 of 9

B-87

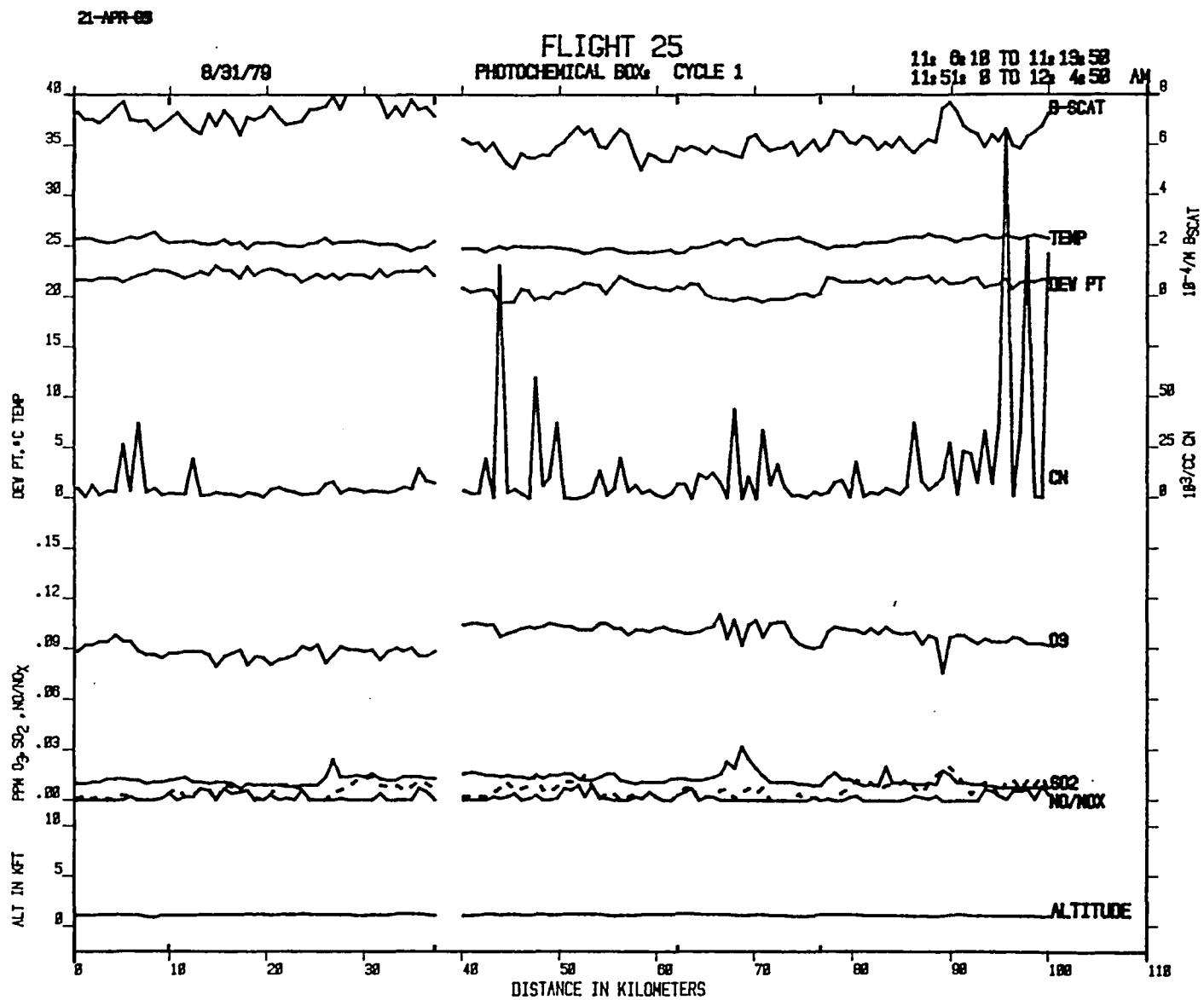
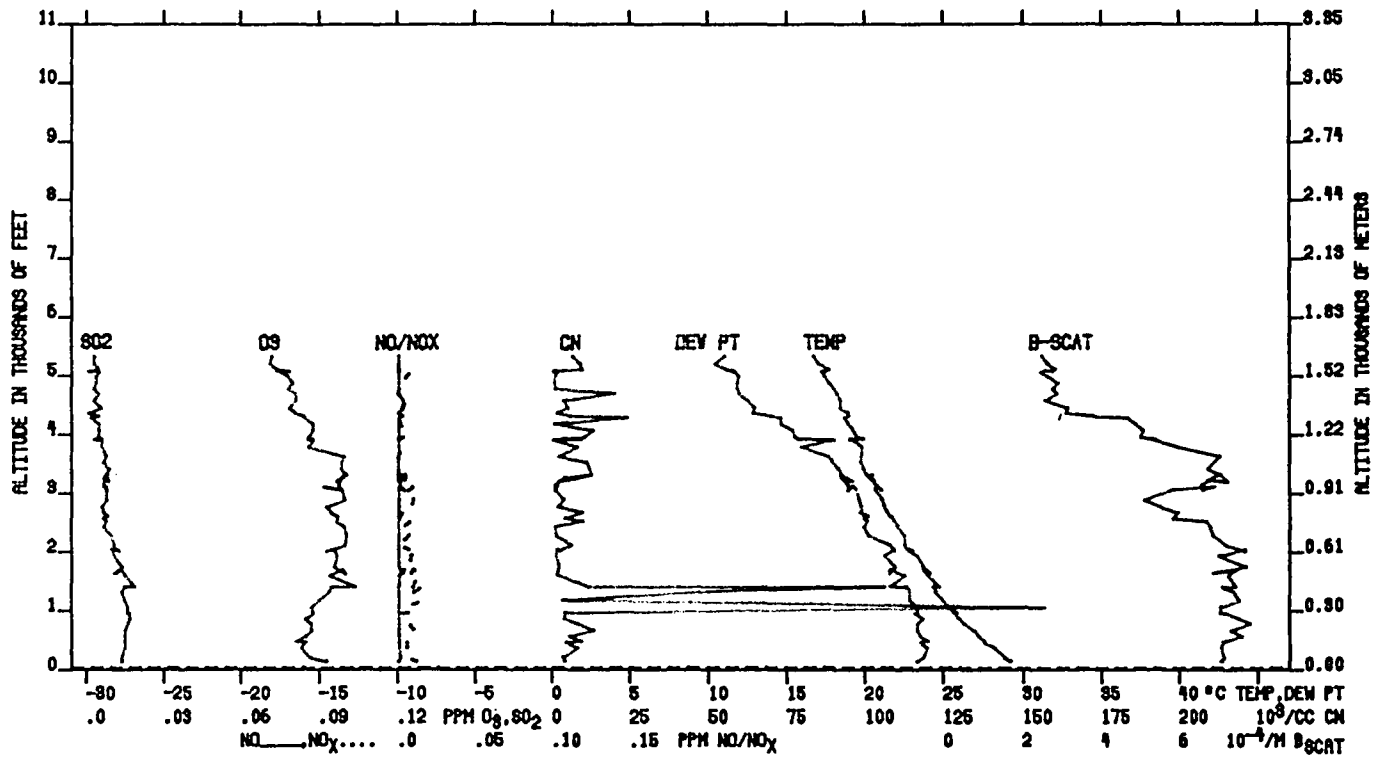

Figure B-12 Data from flight on August 31 - Photochemical box-Western flow - Page 1 of 9

84-MAY-68

FLIGHT 25 SPIRAL 1
8/31/79
PHOTOCHEMICAL BOX SPIRAL AT F₃ CYCLE 1
11:16:48 TO 11:27:38 AM



B-88

Figure B-12 Data from flight on August 31 - Photochemical box-Western flow - Page 2 of 9

84-MAY-88

FLIGHT 25 SPIRAL 2
8/31/79
PHOTOCHEMICAL BOX SPIRAL AT A₉ CYCLE 1
11:30:18 TO 11:50:08 AM

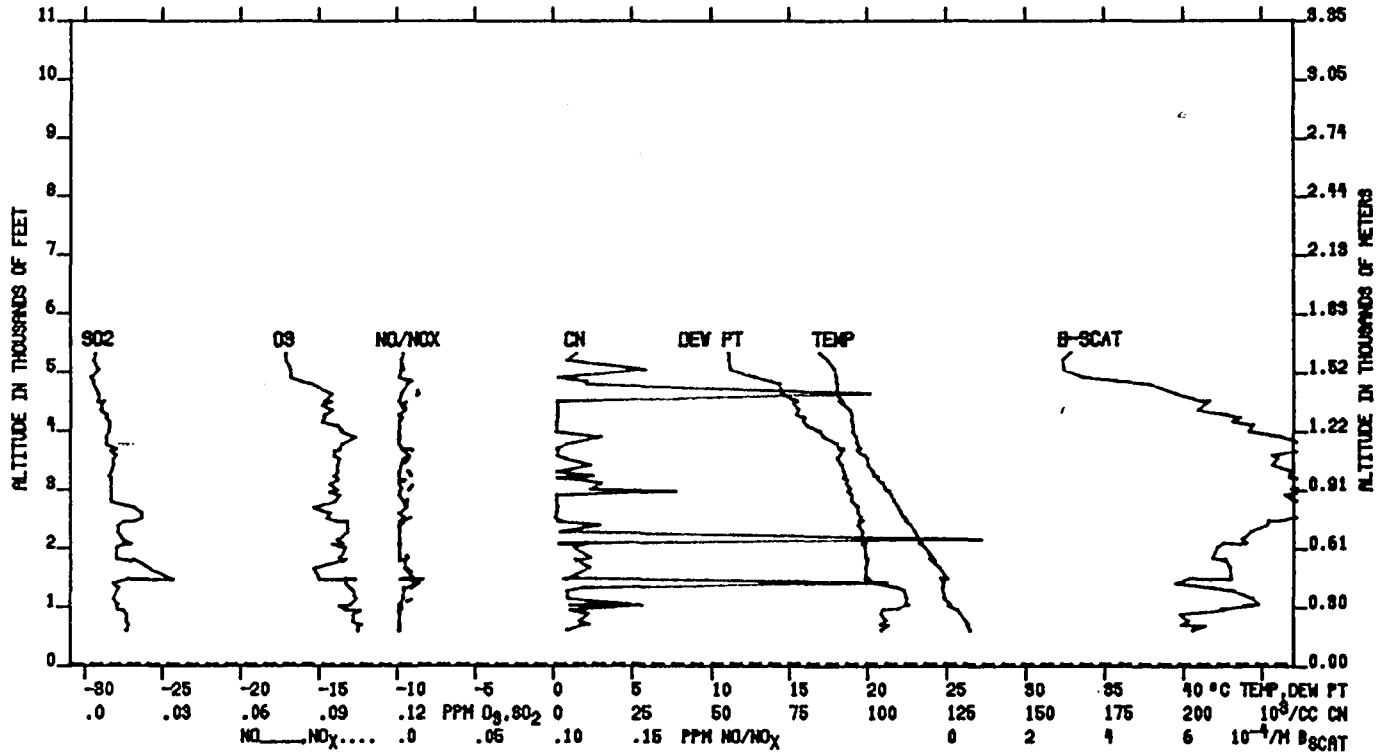

B-89

Figure B-12 Data from flight on August 31 - Photochemical box-Western flow - Page 3 of 9

B-90

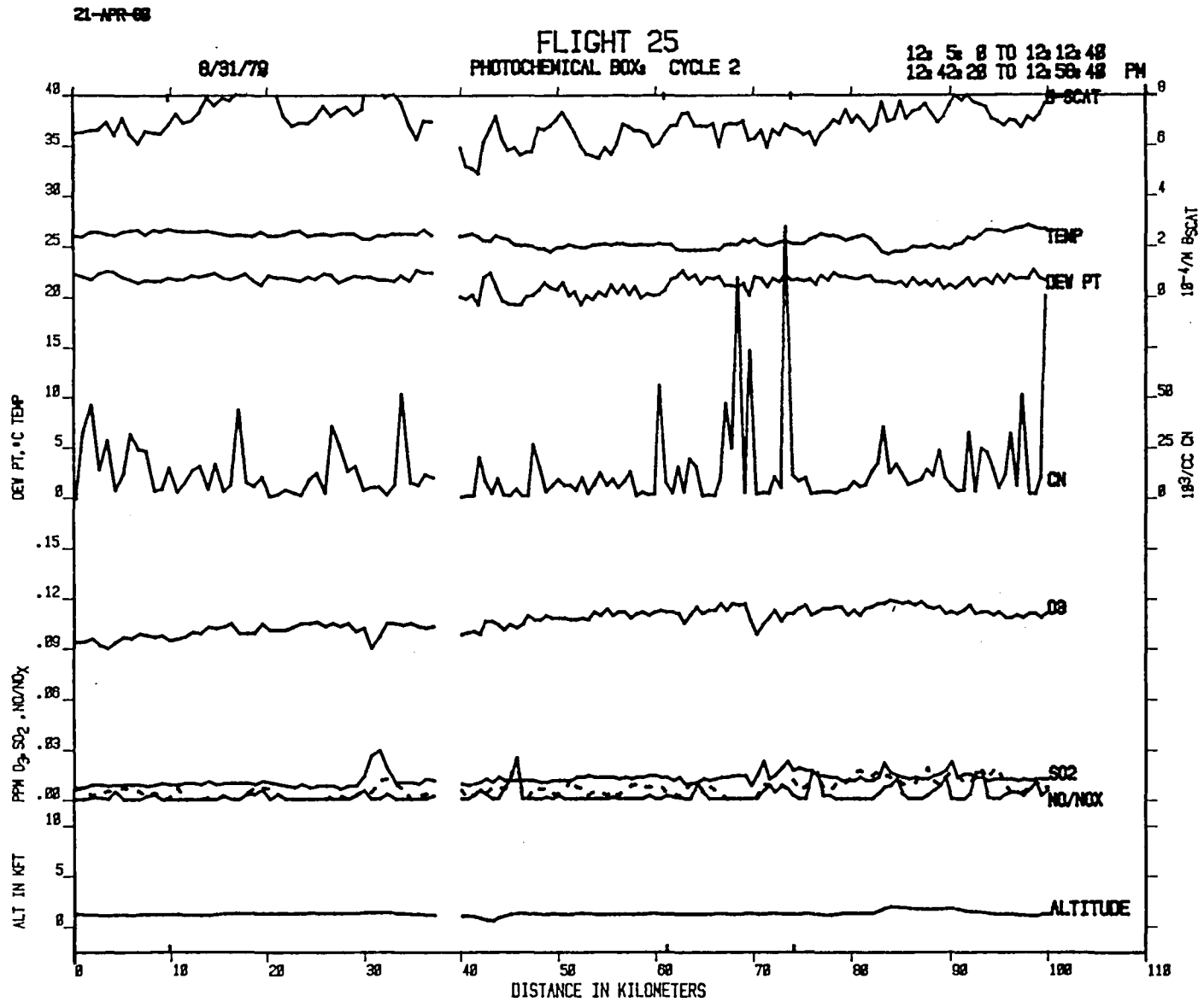
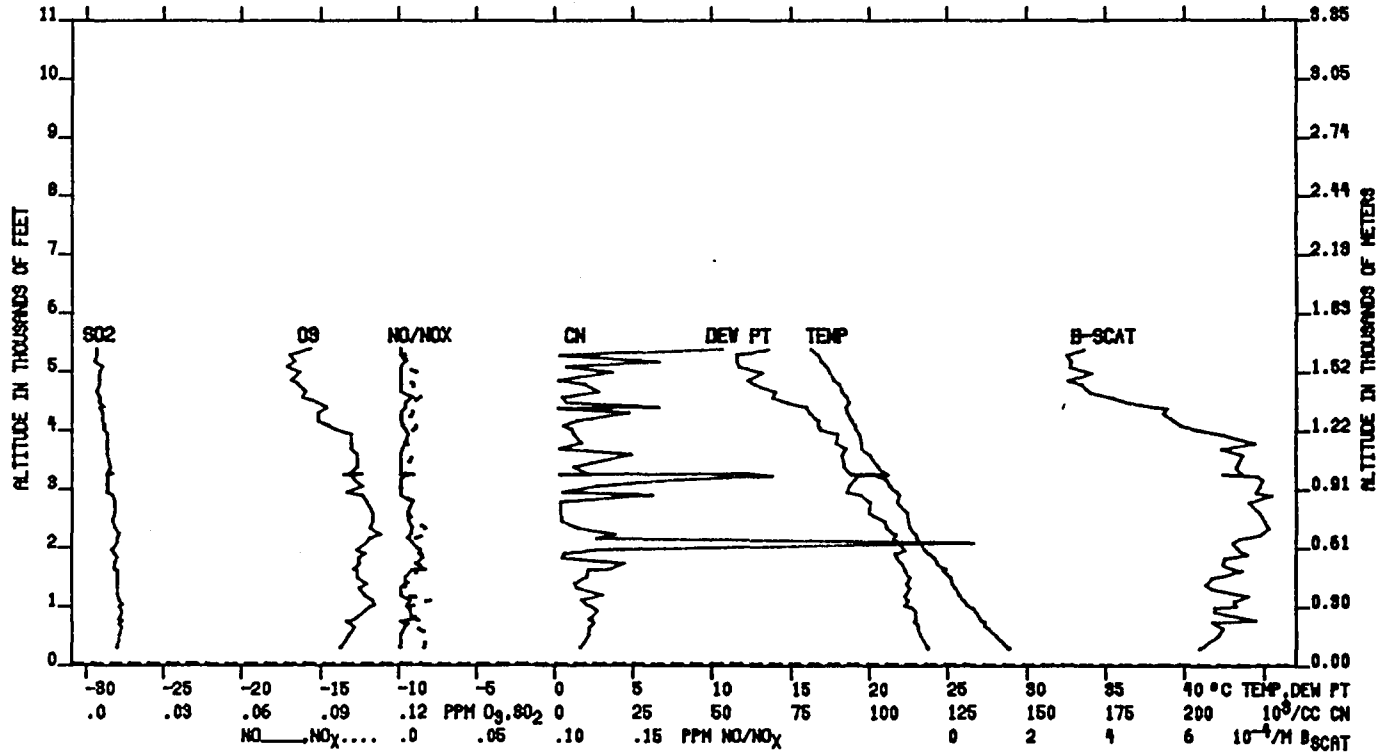

Figure B-12 Data from flight on August 31 - Photochemical box-Western flow - Page 4 of 9

B4-WAY-88

FLIGHT 25 SPIRAL 3
8/31/79
PHOTOCHEMICAL BOX SPIRAL AT F, CYCLE 2
12:13:58 TO 12:23:08 PM



B-91

Figure B-12 Data from flight on August 31 - Photochemical box-Western flow - Page 5 of 9

84-MAY-68

FLIGHT 25 SPIRAL 4
8/31/79
PHOTOCHEMICAL BOX SPIRAL AT A₂ CYCLE 2
12:33:18 TO 12:43:28 PM

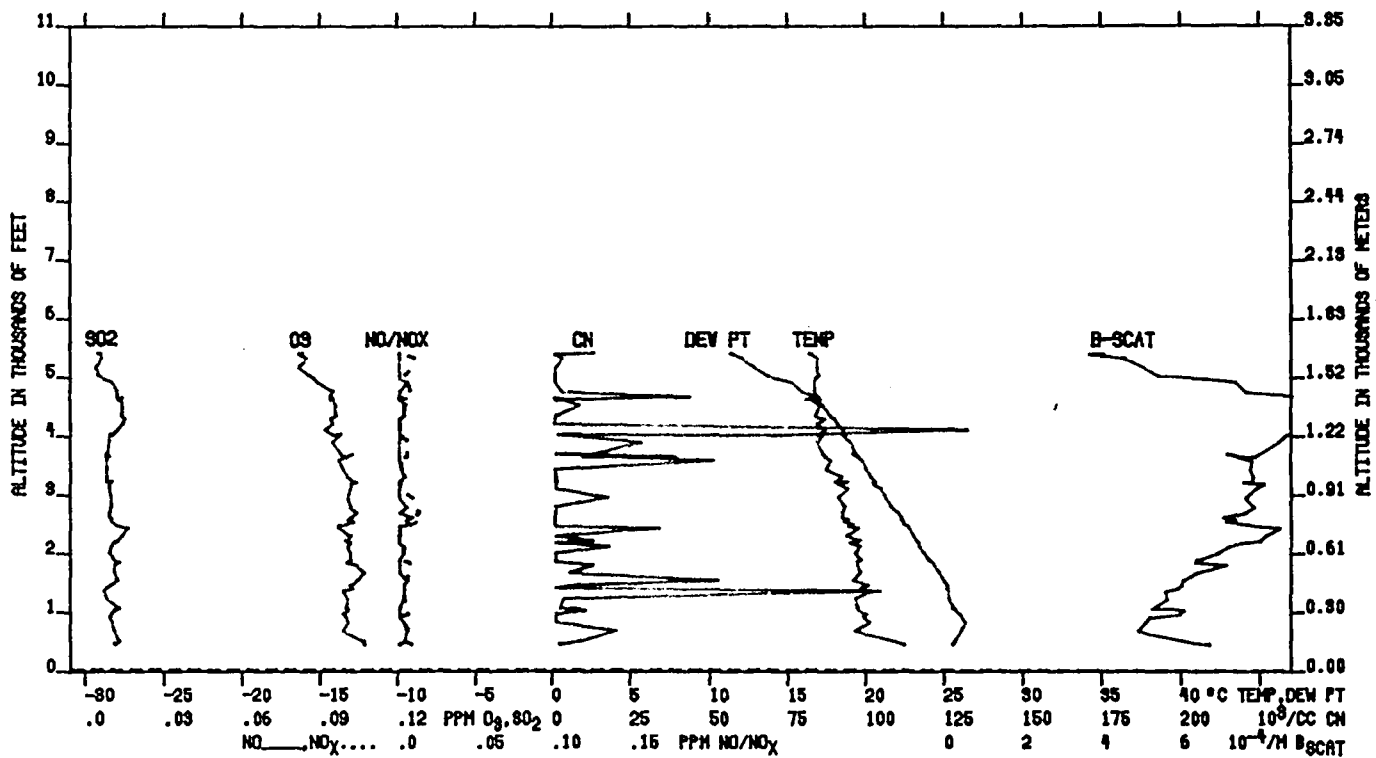

B-92

Figure B-12 Data from flight on August 31 - Photochemical box-Western flow - Page 6 of 9

84 MAY 68

FLIGHT 25 SPIRAL 5
8/31/79
PHOTOCHEMICAL BOX SPIRAL AT F, CYCLE 3
13: 7:38 TO 13: 25:38 PM

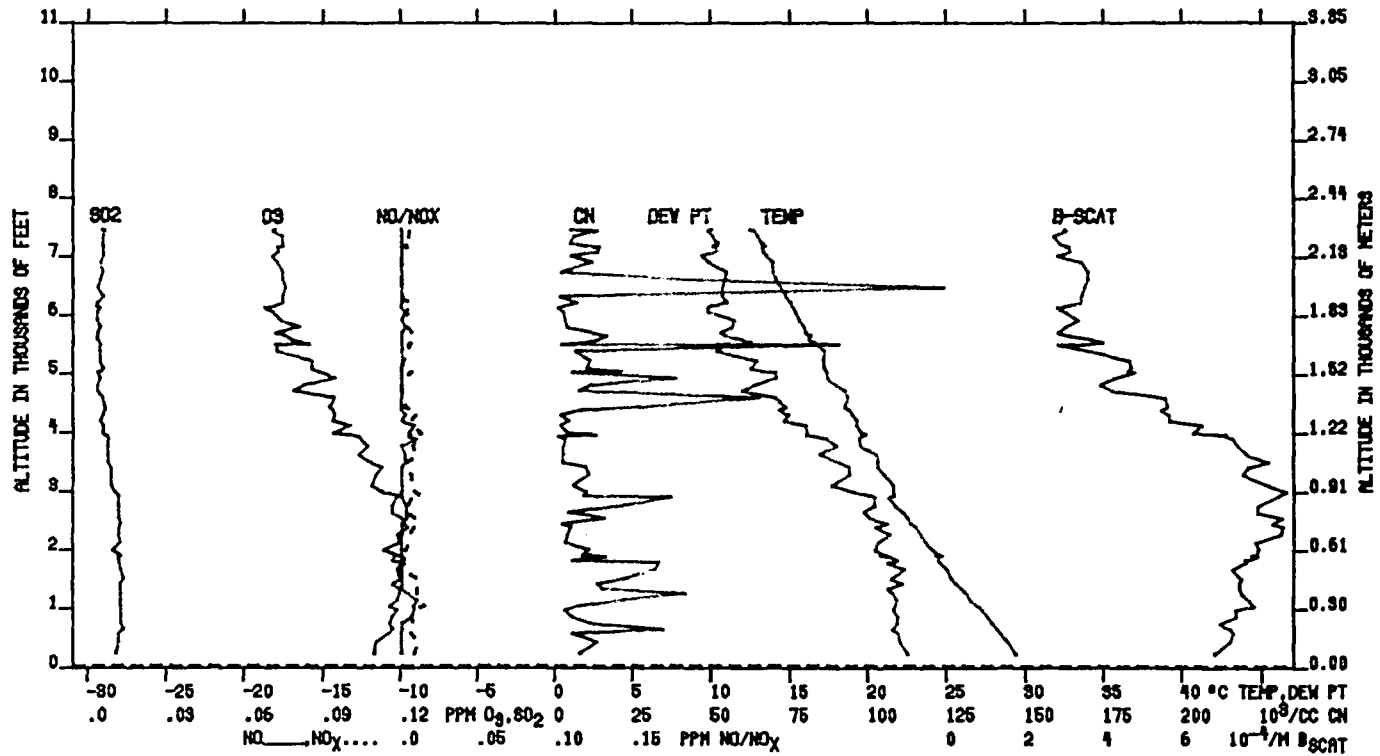

B-94

Figure B-12 Data from flight on August 31 - Photochemical box-Western flow - Page 8 of 9

84-MAY-68

FLIGHT 25 SPIRAL 6
8/31/79
PHOTOCHEMICAL BOX SPIRAL AT A₉ CYCLE 3
12:31:58 TO 12:47:58 PM

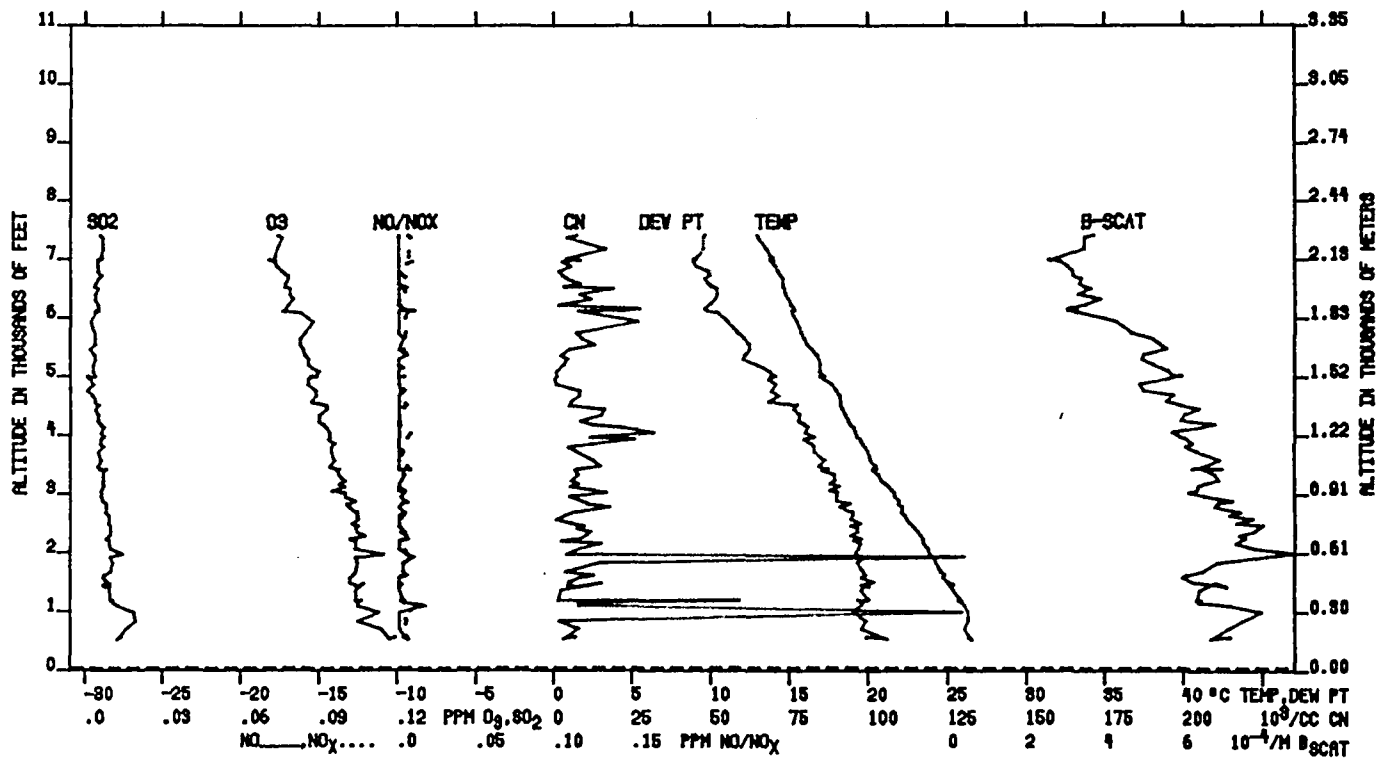

B-95

Figure B-12 Data from flight on August 31 - Photochemical box-Western flow - Page 9 of 9

APPENDIX C
HYDROCARBON SPECIES DATA BASE

Appendix C, "Hydrocarbon Species Data Base", tabulates the concentration in parts per billion by carbon (ppbC) for each hydrocarbon compound searched for in the samples, as determined by gas chromatography with flame ionization detection. Each column of data gives the following information: sampling site (e.g. "Dismal Swamp"); sampling date; sampling time in EDT (each sample was collected over a three minute interval); and sample container number (2 L stainless steel cylinders were used).

The compounds are divided into two major groups corresponding to the two chromatographic columns used in the analysis. The first group begins with ethane and ends with 2-methyl-2-butene. The second group begins with 1,4-pentadiene and ends with n-butylbenzene. The order in which the compounds are listed corresponds to their order of elution. Note that some compounds eluted at the same time and thus cannot be separately quantified.

The dash symbol (-) indicates that the concentration was below the minimum detectable limit of the analytical system. The letter "t" denotes that a peak representing a trace of the compound was visually evident on the chromatograph, but that the integrating system did not detect and quantify the compound. Such trace concentrations are generally less than 1 ppbC.

The final entry, "Sum of NMHC, ppmC" is the parts per million by carbon summation of all nonmethane hydrocarbons quantified in the sample.

The first five pages of this appendix list chronologically the samples collected at the generally upwind rural site or in the adjacent Dismal Swamp. The remaining pages list samples taken in urban regions.

Hydrocarbon Species Data
1979 Southeastern Virginia Urban Plume Study

Sampling Site	Dismal Swamp Maple-Gum	Dismal Sw. Maple-Gum T=72°F	Dismal Swamp Maple-Gum	Dismal Sw. Chamber 1-4 3 days, 67°F
Sampling Date	8-13-79	8-13-79	8-13-79	8-16-79
Sampling Time, EDT	1000/1003	1408/1411	1610/1613	0935/0938
Sample Container No.	A-109	A-179	A-194	A-105
Ethane	ppbC 2.2	ppbC 2.2	ppbC 3.2	ppbC 1.2
Ethylene	3.0	0.6	5.8	6.6
Propane	2.7	3.0	3.6	2.1
Acetylene	0.6	0.5	4.6	-
Propylene	1.5	4.2	5.1	1.2
Isobutane	1.2	1.2	1.2	0.8
n-Butane	2.8	3.2	2.8	1.6
2,2-Dimethylpropane	-	t	-	-
1-Butene	-	4.0	2.0	-
2-Methylbutane	2.4	11.6	6.8	1.0
n-Pentane + trans-2-Butene + Isobutene	4.0	5.5	2.0	5.5
cis-2-Butene	-	-	-	-
Propyne	-	-	-	-
2,2-Dimethylbutane	-	-	t	t
2,3-Dimethylbutane	-	1.8	2.4	1.2
2-Methylpentane	14.4	-	-	1.2
n-Hexane	t	105.6	4.8	-
trans-2-Pentene	-	-	6.5	-
Isoprene	11.0	2.0	2.0	1.5
2-Methyl-2-Butene	-	5.5	5.0	-
1,4-Pentadiene	-	-	-	-
1,3-Pentadiene	-	-	-	-
4-Methyl-1-Pentene	-	-	t	t
3-Methylpentane	4.2	2.4	2.4	1.8
2-Methyl-1-Pentene	-	-	-	-
1-Hexene	-	-	-	-
2,4-Dimethylpentane	t	t	t	t
benzene	30.0	94.2	46.2	-
2-Methylhexane	1.4	1.4	t	t
3-Methylhexane	4.9	2.8	3.5	2.1
n-Heptane	-	2.1	t	t
2,2,4-Trimethylpentane	t	-	-	-
2,5-Dimethylhexane	-	-	-	-
2,3,4-Trimethylpentane	-	-	-	-
Toluene	2.1	-	t	-
2-Methylheptane	4.0	-	-	-
3-Methylheptane	-	-	-	-
n-Octane	12.8	-	-	-
Ethylbenzene	t	-	-	-
para + meta-xylenes	t	-	-	-
ortho-Xylene	-	-	-	-
n-Nonane	10.8	12.6	-	-
α-Pinene	-	-	-	-
n-Propylbenzene	-	-	-	-
β-Pinene	-	-	-	-
meta-Ethyltoluene	1.8	-	-	-
1,3,5-Trimethylbenzene	-	-	-	-
ortho-Ethyltoluene	-	-	-	-
tert-Butylbenzene + 1,2,4-Trimethylbenzene	3.6	-	-	-
sect-Ethylbenzene + n-Decane	1.9	-	-	-
1,2,3-Trimethylbenzene	-	-	-	-
d + l-Limonene	-	-	-	-
n-Ethylbenzene	6.9	-	-	-
Sum of NMHC, ppmC	0.130	0.266	0.110	0.028

Hydrocarbon Species Data
1979 Southeastern Virginia Urban Plume Study

Sampling Site	Northwest; Exhaust Port of Chamber	Northwest; Chamber Exh. Port	Northwest; Area Around Trailer	Northwest; Area Around Trailer
Sampling Date	8-24-79	8-24-79	8-25-79	8-25-79
Sampling Time, EDT	0802/0805	0816/0819	0952/0955	1335/1338
Sample Container No.	A-170	A-155	A-241	A-67
Ethane	ppbC 2.5	ppbC 0.4	ppbC 1.6	ppbC 1.2
Ethylene	5.8	1.6	6.8	3.2
Propane	3.0	1.8	4.2	1.2
Acetylene	1.6	.8	0.4	0.2
Propylene	-	1.5	2.4	2.4
Isobutane	-	2.8	1.2	-
n-Butane	18.0	13.6	4.8	0.8
2,2-Dimethylpropane	-	-	-	-
1-Butene	-	-	t	1.5
2-Methylbutane	23.2	27.2	3.2	0.8
n-Pentane + trans-2-Butene + Isobutene	30.0	17.5	7.0	2.0
cis-2-Butene	-	-	-	-
Propyne	-	-	-	-
2,2-Dimethylbutane	-	-	-	-
2,3-Dimethylbutane	-	-	1.8	-
2-Methylpentane	12.0	6.0	1.8	10.0
n-Hexane	8.4	3.6	1.2	-
trans-2-Pentene	-	-	-	-
Isoprene	2.0	2.0	1.0	11.5
2-Methyl-2-Butene	3.5	3.5	-	-
1,4-Pentadiene	-	-	-	-
1,3-Pentadiene	-	-	-	-
4-Methyl-1-Pentene	-	-	4.8	-
3-Methylpentane	4.8	8.4	-	-
2-Methyl-1-Pentene	4.8	5.4	-	-
1-Hexene	-	-	-	-
2,4-Dimethylpentane	4.2	4.9	-	t
Benzene	17.4	49.8	35.4	24.0
2-Methylhexane	4.2	5.6	3.5	t
3-Methylhexane	4.2	8.4	5.6	t
n-Heptane	-	3.5	-	-
2,2,4-Trimethylpentane	-	4.0	-	-
2,5-Dimethylhexane	-	3.2	-	-
2,3,4-Trimethylpentane	-	-	-	-
Toluene	13.3	2.1	-	2.8
2-Methylheptane	-	2.4	-	-
3-Methylheptane	-	2.4	-	-
n-Octane	-	5.6	-	-
Ethylbenzene	-	6.3	-	-
para + meta-xylenes	-	-	-	-
ortho-Xylene	-	-	-	-
n-Nonane	-	10.8	-	-
α-Pinene	-	-	-	-
n-Propylbenzene	-	-	-	-
β-Pinene	-	-	-	-
meta-Ethyltoluene	-	0.9	7.2	-
1,3,5-Trimethylbenzene	-	-	5.4	-
ortho-Ethyltoluene	-	-	-	-
tert-Butylbenzene + 1,2,4-Trimethylbenzene	-	t	-	-
sec-Butylbenzene + n-Decane	-	-	-	-
1,2,3-Trimethylbenzene	-	-	-	-
d + l-Limonene	-	-	-	-
n-Butylbenzene	-	-	-	-
Sum of NMHC, ppmC	0.163	0.206	0.099	0.062

Hydrocarbon Species Data
1979 Southeastern Virginia Urban Plume Study

Sampling Site	Dismal Sw. Maple-Gum Chamber 4 days		100 ft. Tower	Northwest; Area Around	Northwest; Exhaust Port of Chamber
	Moist Soil	Dismal Sw.	Trailer		
Sampling Date	8-28-79	8-29-79	8-30-79	8-30-79	8-30-79
Sampling Time, EDT	0930/0933	1200/1203	1142/1145	1607/1610	1607/1610
Sample Container No.	A-225	A-148	A-62	A-99	A-99
Ethane	ppbC 32.8	ppbC 3.2	ppbC 1.8	ppbC 1.2	
Ethylene	-	4.6	4.2	4.4	
Propane	7.5	5.4	6.0	3.0	
Acetylene	-	1.8	1.0	0.6	
Propylene	2.1	2.1	3.3	2.4	
Isobutane	-	3.2	27.2	4.4	
n-Butane	1.2	9.2	123.2	13.2	
2,2-Dimethylpropane	-	-	-	-	
1-Butene	-	3.5	5.5	4.5	
2-Methylbutane	-	6.8	168.8	13.2	
n-Pentane + trans-2-Butene + Isobutene	40.0	7.0	189.5	13.0	
cis-2-Butene	-	4.0	8.8	-	
Propyne	-	-	-	-	
2,2-Dimethylbutane	-	-	13.2	-	
2,3-Dimethylbutane	-	-	37.8	-	
2-Methylpentane	19.2	1.2	142.8	3.0	
n-Hexane	t	t	73.2	2.4	
trans-2-Pentene	-	-	-	-	
Isoprene	3.0	5.5	2.5	2.5	
2-Methyl-2-Butene	-	4.0	12.0	-	
1,4-Pentadiene	-	-	-	-	
1,3-Pentadiene	-	-	-	-	
4-Methyl-1-Pentene	-	-	3.6	-	
3-Methylpentane	5.4	-	31.6	6.0	
2-Methyl-1-Pentene	-	-	3.0	-	
1-Hexene	-	-	-	-	
2,4-Dimethylpentane	t	2.8	-	2.8	
benzene	15.0	22.8	36.6	28.8	
2-Methylhexane	9.1	2.1	27.3	2.8	
3-Methylhexane	3.5	2.8	46.2	8.4	
n-Heptane	-	t	32.2	t	
2,2,4-Trimethylpentane	-	-	44.8	4.0	
2,5-Dimethylhexane	-	4.0	-	-	
2,3,4-Trimethylpentane	-	-	-	-	
Toluene	t	2.1	168.7	5.6	
2-Methylheptane	-	t	-	9.6	
3-Methylheptane	-	-	-	-	
n-Octane	6.4	-	21.6	4.0	
Ethylbenzene	-	t	25.6	-	
para + meta-xylenes	-	-	76.8	-	
ortho-Xylene	-	248.0	32.0	-	
n-Nonane	12.6	-	13.5	5.4	
α-Pinene	-	-	-	-	
n-Propylbenzene	-	-	16.2	-	
β-Pinene	-	-	-	-	
meta-Ethyltoluene	t	2.7	36.9	t	
1,3,5-Trimethylbenzene	-	-	20.7	-	
ortho-Ethyltoluene	-	-	16.2	-	
tert-Butylbenzene + 1,2,4-Trimethylbenzene	-	-	63.2	-	
sect-butylbenzene + n-Decane	-	-	18.1	-	
1,2,3-Trimethylbenzene	-	-	-	-	
d + 1-Limonene	-	-	-	-	
n-Butylbenzene	t	-	20.0	3.5	
Sum of NMHC, ppmC	0.158	0.349	1.596	0.149	

Hydrocarbon Species Data
1979 Southeastern Virginia Urban Plume Study

	100 ft. Tower Dismal Sw.	100 ft. Tower Dismal Sw.	100 ft. Tower Dismal Sw.	Dismal Sw. Maple-Gum Ambient Air
Sampling Site	<u>8-31-79</u>	<u>8-31-79</u>	<u>8-31-79</u>	<u>9-18-79</u>
Sampling Date	<u>0600/---</u>	<u>0800/0803</u>	<u>1000/1003</u>	<u>1105/1108</u>
Sampling Time, EDT	<u>A-152</u>	<u>A-59</u>	<u>A-169</u>	<u>A-240</u>
Sample Container No.				
Ethane	ppbC <u>3.2</u>	ppbC <u>3.6</u>	ppbC <u>6.0</u>	ppbC <u>2.4</u>
Ethylene	<u>5.2</u>	<u>2.4</u>	<u>5.4</u>	<u>3.8</u>
Propane	<u>7.2</u>	<u>6.9</u>	<u>11.4</u>	<u>5.7</u>
Acetylene	<u>1.4</u>	<u>0.6</u>	<u>2.4</u>	<u>1.0</u>
Propylene	<u>3.0</u>	<u>2.7</u>	<u>4.2</u>	<u>2.1</u>
Isobutane	<u>3.2</u>	<u>2.8</u>	<u>6.8</u>	<u>1.6</u>
n-Butane	<u>8.8</u>	<u>6.8</u>	<u>12.8</u>	<u>3.6</u>
2,2-Dimethylpropane	-	-	-	-
1-Butene	<u>1.5</u>	-	<u>6.5</u>	-
2-Methylbutane	<u>6.0</u>	<u>5.6</u>	<u>10.8</u>	<u>3.6</u>
n-Pentane + trans-2-Butene + Isobutene	<u>9.0</u>	<u>5.5</u>	<u>11.5</u>	<u>35.5</u>
cis-2-Butene	-	-	-	-
Propyne	-	-	-	-
2,2-Dimethylbutane	-	-	-	-
2,3-Dimethylbutane	<u>3.0</u>	-	-	<u>9.0</u>
2-Methylpentane	<u>3.0</u>	<u>7.5</u>	<u>4.2</u>	<u>9.0</u>
n-Hexane	<u>1.8</u>	<u>4.2</u>	<u>3.0</u>	<u>2.4</u>
trans-2-Pentene	<u>17.0</u>	-	-	-
Isoprene	<u>12.0</u>	<u>5.0</u>	<u>8.5</u>	<u>3.0</u>
2-Methyl-2-Butene	<u>12.5</u>	-	-	-
1,4-Pentadiene	-	-	-	-
1,3-Pentadiene	-	-	-	-
4-Methyl-1-Pentene	<u>4.8</u>	-	-	-
3-Methylpentane	<u>3.0</u>	<u>6.0</u>	<u>11.4</u>	<u>4.8</u>
2-Methyl-1-Pentene	-	<u>t</u>	<u>3.0</u>	-
1-Hexene	-	-	-	-
2,4-Dimethylpentane	<u>3.5</u>	<u>2.1</u>	<u>2.8</u>	<u>2.8</u>
Benzene	<u>38.4</u>	<u>27.6</u>	<u>29.4</u>	<u>12.0</u>
2-Methylhexane	<u>7.7</u>	<u>30.8</u>	<u>5.6</u>	<u>2.8</u>
3-Methylhexane	<u>10.5</u>	<u>2.1</u>	<u>t</u>	<u>4.2</u>
n-Heptane	<u>2.1</u>	<u>t</u>	<u>t</u>	-
2,2,4-Trimethylpentane	<u>1.6</u>	-	<u>t</u>	-
2,5-Dimethylhexane	-	-	-	-
2,3,4-Trimethylpentane	-	-	-	-
Toluene	<u>5.6</u>	<u>3.0</u>	<u>2.1</u>	<u>t</u>
2-Methylheptane	-	<u>7.2</u>	-	-
3-Methylheptane	-	-	-	-
n-Octane	-	<u>6.4</u>	<u>12.8</u>	-
Ethylbenzene	<u>1.8</u>	<u>t</u>	<u>3.2</u>	-
para + meta-xylenes	<u>3.2</u>	-	-	-
ortho-Xylene	<u>6.4</u>	-	-	-
n-Nonane	<u>1.8</u>	-	<u>45.9</u>	-
α-Pinene	-	-	-	-
n-Propylbenzene	<u>1.8</u>	-	-	-
β-Pinene	-	-	-	-
meta-Ethyltoluene	<u>2.7</u>	<u>t</u>	<u>t</u>	-
1,3,5-Trimethylbenzene	<u>1.8</u>	-	-	-
ortho-Ethyltoluene	<u>2.7</u>	-	<u>4.5</u>	-
tert-Butylbenzene + 1,2,4-Trimethylbenzene	<u>9.0</u>	<u>t</u>	-	-
sect-Butylbenzene + n-Decane	<u>18.9</u>	-	-	-
1,2,3-Trimethylbenzene	-	-	-	-
d + l-Limonene	-	-	-	-
n-Butylbenzene	-	-	-	-
Sum of NNHC, ppmC	<u>0.225</u>	<u>0.139</u>	<u>0.214</u>	<u>0.109</u>

Hydrocarbon Species Data
1979 Southeastern Virginia Urban Plume Study

Sampling Site	Dismal Sw. 46 1/2 hr.		_____
	Maple-Gum in Chamber		
Sampling Date	Chamber 19.5 hrs. Maple-Gum		_____
Sampling Time, EDT	Moist Soil Dismal Sw.		
Sample Container No.	9-18-79	9/20	_____
	1105/1108	--/1300	_____
	A-175	A-36 #1	A-36 Repeat #2
Ethane	ppbC 24.4	ppbC 5.6	ppbC 6.2
Ethylene	19.4	14.4	12.8
Propane	5.7	27.0	26.1
Acetylene	2.2	72.0	68.4
Propylene	3.6	9.6	10.2
Isobutane	2.8	8.8	10.0
n-Butane	3.6	28.0	28.0
2,2-Dimethylpropane	-	-	-
1-Butene	-	2.5	6.0
2-Methylbutane	2.4	46.4	45.6
n-Pentane + trans-2-Butene + Isobutene	16.0	66.5	58.0
cis-2-Butene	-	-	-
Propyne	-	-	-
2,2-Dimethylbutane	-	70.8	65.4
2,3-Dimethylbutane	-	10.8	9.6
2-Methylpentane	9.0	28.8	27.0
n-Hexane	0.6	21.6	18.6
trans-2-Pentene	-	-	-
Isoprene	2.5	8.5	6.5
2-Methyl-2-Butene	t	20.0	22.0
1,4-Pentadiene	-	-	-
1,3-Pentadiene	-	-	-
4-Methyl-1-Pentene	-	-	-
3-Methylpentane	3.0	7.2	13.8
2-Methyl-1-Pentene	-	-	-
1-Hexene	-	-	-
2,4-Dimethylpentane	t	5.6	9.8
Benzene	11.4	13.2	13.2
2-Methylhexane	2.1	14.7	24.5
3-Methylhexane	2.1	13.3	14.7
n-Heptane	t	t	5.6
2,2,4-Trimethylpentane	-	18.4	10.4
2,5-Dimethylhexane	-	-	-
2,3,4-Trimethylpentane	-	-	-
Toluene	-	35.0	37.8
2-Methylheptane	-	-	-
3-Methylheptane	-	-	-
n-Octane	-	6.4	4.8
Ethylbenzene	-	88.8	92.8
para + meta-xylenes	1.6	10.4	11.2
ortho-Xylene	t	32.0	33.6
n-Nonane	-	41.4	45.0
α-Pinene	-	-	-
n-Propylbenzene	t	18.0	21.6
β-Pinene	-	-	-
meta-Ethyltoluene	t	t	13.5
1,3,5-Trimethylbenzene	t	26.1	27.0
ortho-Ethyltoluene	-	226.8	230.4
tert-Butylbenzene + 1,2,4-Trimethylbenzene	2.4	99.0	101.0
sec-Butylbenzene + n-Decane	8.9	42.0	72.9
1,2,3-Trimethylbenzene	-	t	3.1
d + l-Limonene	-	-	-
n-Butylbenzene	t	83.0	82.9
Sum of NMHC, ppmC	0.124	1.223	1.29

Hydrocarbon Species Data
1979 Southeastern Virginia Urban Plume Study

Sampling Site	HMT Roads		HMT Roads	
	Bridge Tunnel	Bridge Tunnel	Inner	Inner
Sampling Date	Reactor Exhaust	Reactor Exhaust	Norfolk	Norfolk
Sampling Time, EDT	0650/0653	0655/0658	0600/0603	0600/0603
Sample Container No.	A-159	A-34	A-6	A-104
Ethane	ppbC 20.2	ppbC 12.4	ppbC 6.8	ppbC 4.8
Ethylene	189.8	112.8	24.6	5.6
Propane	8.7	5.4	115.8	7.2
Acetylene	94.4	57.0	13.6	2.8
Propylene	145.5	87.6	5.1	4.2
Isobutane	43.2	25.2	15.6	3.2
n-Butane	189.2	111.6	41.2	10.8
2,2-Dimethylpropane	2.0	-	-	-
1-Butene	25.6	16.0	2.5	3.0
2-Methylbutane	260.5	152.9	43.2	8.8
n-Pentane + trans-2-Butene + Isobutene	190.0	148.4	41.5	11.5
cis-2-Butene	52.4	31.6	-	-
Propyne	11.1	-	-	-
2,2-Dimethylbutane	16.8	11.0	0.6	-
2,3-Dimethylbutane	39.6	23.8	3.6	1.8
2-Methylpentane	126.6	75.9	9.6	4.8
n-Hexane	48.0	28.3	10.8	1.8
trans-2-Pentene	55.5	29.4	-	-
Isoprene	23.0	24.0	4.0	2.5
2-Methyl-2-Butene	34.0	40.9	9.0	-
1,4-Pentadiene	-	-	-	-
1,3-Pentadiene	-	-	-	-
4-Methyl-1-Pentene	8.3	7.2	-	-
3-Methylpentane	32.2	28.8	8.4	4.8
2-Methyl-1-Pentene	-	39.9	-	-
1-Hexene	-	-	-	-
2,4-Dimethylpentane	12.4	9.9	7.0	2.1
Benzene	59.9	50.7	41.6	68.4
2-Methylhexane	27.9	23.4	8.4	4.2
3-Methylhexane	35.6	26.8	10.5	4.2
n-Heptane	30.0	26.0	5.6	3.5
2,2,4-Trimethylpentane	31.0	25.0	6.4	2.4
2,5-Dimethylhexane	17.9	14.5	-	-
2,3,4-Trimethylpentane	12.0	8.7	-	8.8
Toluene	41.0	79.1	11.9	1.4
2-Methylheptane	24.5	30.6	-	-
3-Methylheptane	17.0	14.1	-	-
n-Octane	12.2	11.8	-	-
Ethylbenzene	19.3	16.1	15.2	-
para + meta-xylenes	62.2	67.9	5.6	-
ortho-Xylene	19.6	17.6	2.4	-
n-Nonane	8.1	6.3	2.7	-
α-Pinene	-	-	-	-
n-Propylbenzene	5.5	5.5	5.4	-
β-Pinene	-	-	-	-
meta-Ethyltoluene	22.4	17.0	4.5	-
1,3,5-Trimethylbenzene	11.2	7.7	2.7	-
ortho-Ethyltoluene	7.8	2.2	4.5	-
tert-Butylbenzene + 1,2,4-Trimethylbenzene	37.9	27.9	13.0	-
sec-Butylbenzene + n-Decane	7.1	11.4	25.6	-
1,2,3-Trimethylbenzene	11.5	7.9	64.8	-
d + l-Limonene	-	-	-	-
n-Butylbenzene	11.0	4.3	3.1	-
Sum of NHC, ppmC	2.231	1.582	0.597	0.173

Hydrocarbon Species Data
1979 Southeastern Virginia Urban Plume Study

Sampling Site	Inner Norfolk	Inner Norfolk	Bldg. 1273 NASA	Bldg. 1273 NASA
Sampling Date	8-31-79	8-31-79	9-27-79	9-27-79
Sampling Time, EDT	1000/1003	1200/1203	0935	0937/same
Sample Container No.	A-41	A-124	A-118	A-201
Ethane	ppbC 4.6	ppbC 5.4	ppbC 0.4	ppbC 0.4
Ethylene	3.2	4.2	31.8	29.6
Propane	5.4	6.0	1.2	1.2
Acetylene	1.4	1.6	-	-
Propylene	1.5	1.8	1.2	1.8
Isobutane	2.0	2.8	10.4	10.0
n-Butane	6.4	7.6	4068.8	3862.0
2,2-Dimethylpropane	-	-	1559.0	1470.5
1-Butene	-	0.5	6.4	-
2-Methylbutane	4.8	5.6	-	9.2
n-Pentane + trans-2-Butene + Isobutene	5.5	6.5	-	-
cis-2-Butene	t	-	-	-
Propyne	-	-	-	-
2,2-Dimethylbutane	t	t	-	-
2,3-Dimethylbutane	4.2	2.4	-	-
2-Methylpentane	1.5	3.0	2.4	-
n-Hexane	1.8	1.2	t	-
trans-2-Pentene	-	-	-	-
Isoprene	3.5	1.5	2.5	-
2-Methyl-2-Butene	8.0	2.0	21.0	-
1,4-Pentadiene	-	-	-	-
1,3-Pentadiene	-	-	-	-
4-Methyl-1-Pentene	2.5	t	-	-
3-Methylpentane	2.4	4.2	1.2	-
2-Methyl-1-Pentene	-	-	-	-
1-Hexene	-	-	-	-
2,4-Dimethylpentane	2.8	t	-	-
benzene	40.2	56.0	-	4.2
2-Methylhexane	2.8	4.2	-	-
3-Methylhexane	6.3	3.5	-	-
n-Heptane	t	t	-	-
2,2,4-Trimethylpentane	4.0	-	-	-
2,5-Dimethylhexane	-	-	-	-
2,3,4-Trimethylpentane	-	-	-	-
Toluene	3.5	1.4	-	-
2-Methylheptane	-	-	-	-
3-Methylheptane	-	-	-	-
n-Octane	104.0	-	-	-
Ethylbenzene	2.4	-	-	-
para + meta-xylenes	-	-	-	-
ortho-Xylene	6.4	-	-	-
n-Nonane	-	2.7	-	-
α-Pinene	-	-	-	-
n-Propylbenzene	t	-	-	-
β-Pinene	-	-	-	-
meta-Ethyltoluene	t	-	-	-
1,3,5-Trimethylbenzene	-	3.6	-	-
ortho-Ethyltoluene	-	2.7	-	-
tert-Butylbenzene + 1,2,4-Trimethylbenzene	-	-	-	-
sect-Butylbenzene + n-Decane	-	8.8	-	-
1,2,3-Trimethylbenzene	-	-	-	-
d + l-Limonene	-	-	-	-
n-Butylbenzene	-	-	-	-
Sum of NHHC, ppmC	0.231	0.139		

Hydrocarbon Species Data
1979 Southeastern Virginia Urban Plume Study

Sampling Site	Bldg. 1273	Bldg. 1273	Bldg. 1273	Bldg. 1273
	NASA	NASA	NASA	NASA
Sampling Date	9-27-79	9-27-79	9-27-79	9-27-79
Sampling Time, EDT	1031/1034	1041/1044	1024/1027	1036/1039
Sample Container No.	A-30	A-145	A-33	A-180
Ethane	ppbC 5.2	ppbC 6.0	ppbC Sample	ppbC 6.6
Ethylene	4.8	6.0	Lost	4.4
Propane	11.1	14.1		14.4
Acetylene	3.0	0.2		2.4
Propylene	9.9	7.5		10.8
Isobutane	5.2	14.4		6.8
n-Butane	10.4	47.2		13.6
2,2-Dimethylpropane	-	-		-
1-Butene	t	2.5		7.6
2-Methylbutane	10.4	35.6		-
n-Pentane + trans-2-Butene				
+ Isobutene	15.0	38.0		11.0
cis-2-Butene	-	2.4		-
Propyne	-	-		-
2,2-Dimethylbutane	-	2.4		-
2,3-Dimethylbutane	-	7.2		13.2
2-Methylpentane	13.5	15.0		6.0
n-Hexane	3.0	9.0		2.4
trans-2-Pentene	-	-		-
Isoprene	2.0	3.5		1.5
2-Methyl-2-Butene	5.6	-		-
1,4-Pentadiene	-	-		-
1,3-Pentadiene	-	-		-
4-Methyl-1-Pentene	-	-		-
3-Methylpentane	7.8	14.4		1.8
2-Methyl-1-Pentene	2.4	6.6		-
1-Hexene	-	-		-
2,4-Dimethylpentane	2.8	7.0		2.1
Benzene	26.4	13.8		13.8
2-Methylhexane	4.2	-		4.2
3-Methylhexane	4.9	3.5		4.9
n-Heptane	t	11.2		-
2,2,4-Trimethylpentane	3.2	5.6		3.2
2,5-Dimethylhexane	-	2.4		-
2,3,4-Trimethylpentane	-	-		-
Toluene	-	13.3		1.4
2-Methylheptane	3.2	5.6		-
3-Methylheptane	-	-		-
n-Octane	3.2	4.0		-
Ethylbenzene	t	1.6		t
para + meta-xylenes	-	t		t
ortho-Xylene	-	5.6		-
n-Nonane	6.3	5.4		t
α-Pinene	-	-		-
n-Propylbenzene	-	t		-
β-Pinene	-	-		-
meta-Ethyltoluene	t	-		-
1,3,5-Trimethylbenzene	-	-		-
ortho-Ethyltoluene	-	-		-
tert-Butylbenzene +				
1,2,4-Trimethylbenzene	4.0	t		-
sect-Butylbenzene + n-Decane	-	-		t
1,2,3-Trimethylbenzene	-	-		-
d + 1-Limonene	-	-		-
n-Butylbenzene	-	-		-
Sum of NPHC, ppmC	0.162	0.311		0.132

APPENDIX D

RESULTS OF SEV-UPS INSTRUMENT
PERFORMANCE AUDITS

Appendix D, "Results of SEV-UPS Instrument Performance Audits" lists the individual performance audit challenge concentrations, (X), and the corresponding instrument responses (Y) for each of the instruments tested in the SEV-UPS study. Regression equations and correlation coefficient are also given to aid in determining the accuracy of the instrument response.

There are eight separate tables. They contain audit information as follows:

<u>Table</u>	<u>Site Name</u>
D-1	Naval Air Station, Inner Norfolk
D-2	Navy Communications Center
D-3	NASA-Langley Environmental Trailer
D-4	Agricultural Station, Norfolk
D-5	Chesapeake Light, Virginia School, and Chesapeake Airport
D-6	Cheriton, Wallops, and VA Institute of Marine Science
D-7	NASA Aircraft (Cessna 402, C-54) and LAS Aircraft
D-8	RTI Aircraft; Navajo

Given for each audit are: audit date; name and pollutant measured; analyzer serial number; and concentration range in use.

Table D-1. SEV-UPS Audit Results: Inner Norfolk Site, Naval Air Station

Audit Date Parameter Analyzer Ser. No.	Analyzer Range and Units	Audit Concentration X	Analyzer Response Y	Difference: Analyzer - Audit	Regression of analyzer response on audit concentration: $Y = mX + b$		
					m	b	r
8-13-79 Ozone Bendix M 8002 301469-1	0 to 0.5 ppm	0.000	-0.004	-0.004	1.0102	-0.004	0.9999
		0.060	0.055	-0.005			
		0.113	0.110	-0.003			
		0.182	0.180	-0.002			
		0.276	0.275	-0.001			
		0.386	0.385	-0.001			
8-13-79 Sulfur Dioxide Meloy Labs	0 to 1.0 ppm	0.000	0.002	0.002	0.8056	-0.008	0.9995
		0.358	0.277	-0.081			
		0.776	0.620	-0.156			
		0.578	0.460	-0.118			
		0.288	0.219	-0.069			
		0.195	0.140	-0.055			
8-13-79 Nitric Oxide, NO Bendix 8108 B 29892-5	0 to 0.5 ppm	0.000	0.000	0.000	0.9798	-0.002	0.9999
		0.322	0.311	-0.011			
		0.257	0.248	-0.009			
		0.174	0.169	-0.005			
		0.101	0.096	-0.005			
		0.390	0.384	-0.006			
8-13-79 Nitrogen Dioxide, NO ₂ Bendix 8108B 29892-5	0 to 0.5 ppm	0.000	0.001	0.001	1.0792	0.007	0.9996
		0.100	0.119	0.019			
		0.265	0.290	0.025			
		0.373	0.410	0.037			
		0.062	0.079	0.017			

Table D-1. SEV-UPS Audit Results: Inner Norfolk Site, Naval Air Station (continued)

Audit Date Parameter Analyzer Ser. No.	Analyzer Range and Units	Audit Concentration X	Analyzer Response Y	Difference: Analyzer - Audit	Regression of analyzer response on audit concentration: $Y = mX + b$		
					m	b	r
Oxides of N, NO _x	0 to 0.5 ppm	0.000	-0.010	-0.010	1.0880	-0.008	0.9998
		0.322	0.337	0.015			
		0.257	0.272	0.015			
		0.174	0.184	0.010			
		0.101	0.104	0.003			
		0.390	0.419	0.029			
8-13-79 Methane Beckman 6800 1000390	0-10 ppm	8.09	7.99	-0.10	1.001	0.021	0.9982
		5.77	5.83	0.06			
		4.65	4.80	0.15			
		2.40	2.73	0.33			
		2.17	2.16	-0.01			
		2.03	1.96	-0.07			
		1.54	1.47	-0.07			
		0.69	0.59	-0.10			
8-13-79 Total Hydrocarbon Beckman 6800	0-10 ppm	8.09	8.28	0.19	1.036	0.040	0.9981
		5.77	6.08	0.31			
		4.65	5.00	0.35			
		2.40	2.84	0.44			
		2.17	2.25	0.08			
		2.03	2.06	0.03			
		1.54	1.52	-0.02			
		0.69	0.64	-0.05			
8-13-79 Carbon Monoxide Beckman 6800	0-10 ppm	7.41	7.89	0.48	1.048	0.111	0.9999
		6.67	7.06	0.39			
		0.00	0.10	0.10			

Table D-2. SEV-UPS Audit Results: Navy Communications Center, Northwest VA

Audit Date Parameter Analyzer Ser. No.	Analyzer Range and Units	Audit Concentration X	Analyzer Response Y	Difference: Analyzer - Audit	Regression of analyzer response on audit concentration: $Y = mX + b$		
					m	b	r
8-18-79 Ozone Monitor Labs 8410E NASA 183343	0 to 0.5 ppm	0.000	0.000	0.000	1.0101	-0.002	0.9999
		0.048	0.046	-0.002			
		0.103	0.100	-0.003			
		0.185	0.185	0.000			
		0.245	0.247	-0.002			
0.387	0.389	0.002					
8-18-79 Sulfur Dioxide TECO 43 NASA 183472	0 to 1.0 ppm	0.000	-0.024	-0.024	0.803	-0.0009	0.9997
		0.426	0.340	-0.086			
		0.327	0.266	-0.061			
		0.232	0.181	-0.051			
8-18-79 Nitric Oxide, NO Monitor Labs 8440 197	0 to 0.5 ppm	0.000	0.000	0.000	1.064	0.001	0.9995
		0.102	0.112	0.010			
		0.174	0.189	0.015			
		0.078	0.083	0.005			
		0.196	0.206	0.010			
8-18-79 Nitrogen Dioxide, NO ₂	0 to 0.5 ppm	0.000	0.018	0.014	0.9363	0.019	0.9998
		0.052	0.068	0.016			
		0.113	0.127	0.014			
		0.182	0.188	0.006			

Table D-2. SEV-UPS Audit Results: Navy Communications Center, Northwest VA (continued)

Audit Date Parameter Analyzer Ser. No.	Analyzer Range and Units	Audit Concentration X	Analyzer Response Y	Difference: Analyzer - Audit	Regression of analyzer response on audit concentration: $Y = mX + b$		
					m	b	r
8-18-79 Oxides of N, NO _x Monitor Labs 8440 197	0 to 0.5 ppm	0.000	0.000	0.000	1.1426	0.000	0.9998
		0.102	0.119	0.017			
		0.174	0.198	0.014			
		0.078	0.087	0.009			
		0.196	0.224	0.028			
8-18-79 Methane Beckman 6800 1000371	0 to 10 ppm	0.69	0.71	-0.02	0.9843	-0.065	0.9998
		1.10	1.00	-0.10			
		1.50	1.39	-0.11			
		1.95	1.82	-0.13			
		2.27	2.13	-0.14			
		3.57	3.42	-0.15			
		6.78	6.62	-0.16			
4.93	4.82	-0.11					
8-18-79 Total Hydrocarbon Beckman 6800	0 to 10 ppm	0.69	0.71	-0.02	0.9582	-0.026	0.9998
		1.10	1.00	-0.10			
		1.50	1.39	-0.11			
		1.95	1.82	-0.13			
		2.27	2.11	-0.16			
		3.57	3.42	-0.15			
		6.78	6.47	-0.31			
4.93	4.71	-0.22					
8-18-79 Carbon Monoxide	0 to 10 ppm	0.00	0.25	0.25	1.0486	0.103	0.9991
		2.02	2.12	0.10			
		4.05	4.24	0.19			
		6.29	6.61	0.32			
		7.87	8.51	0.64			

Table D-3. SEV-UPS Audit Results: NASA-Langley Environmental Trailer

Audit Date Parameter Analyzer Ser. No.	Analyzer Range and Units	Audit Concentration X	Analyzer Response Y	Difference: Analyzer - Audit	Regression of analyzer response on audit concentration: $Y = mX + b$		
					m	b	r
8-17-79 Ozone Dasibi 1003 AH NASA 179875	0-1 ppm	0.000	(1) 0.000	0.000	1.030	-0.002	0.999
		0.412	0.429	0.017			
		0.333	0.333	0.000			
		0.242	0.246	0.004			
		0.156	0.159	0.003			
		0.073	0.072	-0.001			
8-17-79 Nitric Oxide, NO TECO 14 D/E NASA 182133	0-0.5 ppm	0.000	(2) 0.002	0.002	0.648	-0.005	0.998
		0.354	0.220	-0.134			
		0.302	0.192	-0.110			
		0.280	0.180	-0.100			
		0.417	0.280	-0.137			
8-17-79 Nitrogen Dioxide, NO ₂	0-0.5 ppm	0.000	0.000	0.000	0.513	-0.0044	0.9953
		0.073	0.023	-0.050			
		0.242	0.125	-0.117			
		0.333	0.165	-0.168			
8-17-79 Oxides of N, NO _x	0-0.5 ppm	0.000	0.003	0.003	0.517	0.0019	0.9975
		0.354	0.194	-0.160			
		0.302	0.174	-0.128			
		0.280	0.164	-0.116			
		0.417	0.248	-0.169			

(1) Station analyzer gave 0.0118 ppm response to zero air. This was set equal to zero, and 0.0118 ppm was subtracted from all subsequent analyzer responses to audit gas.

(2) Initially, there was no response on NO_x analyzer. Station operator corrected problems and audit was re-started.

Table D-3. SEV-UPS Audit Results: NASA-Langley Environmental Trailer (continued)

Audit Date Parameter Analyzer Ser. No.	Analyzer Range and Units	Audit Concentration X	Analyzer Response Y	Difference: Analyzer - Audit	Regression of analyzer response on audit concentration: $Y = mX + b$		
					m	b	r
8-17-79 Methane Beckman 6800 1000153	0-10 ppm	0.69	0.702	0.012	0.960	0.030	0.9994
		7.62	7.28	-0.34			
		5.01	4.98	-0.03			
		2.58	2.42	-0.16			
8-17-79 Total hydrocarbon Beckman 6800	0-10 ppm	0.69	0.618	-0.072	0.358	1.74	0.626
		7.62	3.82	-3.80			
		5.01	3.80	-1.21			
		2.58	4.40	-1.82			
8-17-79 Carbon Monoxide Beckman 6800	?		(1)				

(1) CO channel of analyzer was not responding during the audit.

Table D-4. SEV-UPS Audit Results: Agricultural Station, Norfolk

Audit Date Parameter Analyzer Ser. No.	Analyzer Range and Units	Audit Concentration X	Analyzer Response Y	Difference: Analyzer - Audit	Regression of analyzer response on audit concentration: $Y = mX + b$		
					m	b	r
8-16-79 Ozone Dasibi 1003 AH 1108	0-1 ppm	(1) 0.000	0.000	0.000	1.0118	0.0001	0.9998
		0.412	0.420	0.008			
		0.333	0.333	0.000			
		0.242	0.245	0.003			
		0.156	0.158	0.002			
		0.073	0.075	0.002			
8-16-79 Methane Beckman 6800 1000029	0-10 ppm	0.69	0.55	-0.14	0.925	-0.075	0.9999
		8.96	8.18	-0.78			
		6.20	5.72	-0.48			
		3.17	2.85	-0.32			
8-16-79 Total Hydrocarbon Beckman 6800	0-10 ppm	0.69	0.71	0.02	0.891	0.078	0.9999
		8.96	8.05	-0.91			
		6.20	5.65	-0.55			
		3.17	2.86	-0.31			
8-16-79 Carbon Monoxide Beckman 6800	0-100 ppm	0.000	0.05	0.05	0.969	-0.319	0.9997
		41.3	39.8	-1.5			
		27.5	26.5	-1.0			
		12.4	11.1	-1.3			

(1) Ozone audit concentrations via ozone generator transfer standard.

Table D-5. SEV-UPS Audit Results: Chesapeake Light, Virginia School, Chesapeake Airport

Audit Date Parameter Analyzer Ser. No.	Analyzer Range and Units	Audit Concentration X	Analyzer Response Y	Difference: Analyzer - Audit	Regression of analyzer response on audit concentration: $Y = mX + b$		
					m	b	r
8-15-79 Ozone Dasibi NASA 175055 Chesapeake Light	0-1.0 ppm	0.000 0.046 0.110 0.198 0.263 0.400	-0.001 0.040 0.108 0.199 0.263 0.409	-0.001 -0.006 -0.002 0.001 0.000 0.009	1.0184	-0.005	0.9999
8-16-79 Ozone Dasibi 1283 Virginia School	0-2.0 ppm	0.000 0.049 0.106 0.191 0.260 0.425	0.000 0.045 0.100 0.195 0.260 0.428	0.000 -0.004 -0.006 0.004 0.000 0.003	1.0142	-0.003	0.9998
8-16-79 Ozone Dasibi 1749 Chesapeake Airport	0-1.0 ppm	0.000 0.046 0.096 0.198 0.262 0.422	0.000 0.048 0.099 0.209 0.279 0.448	0.000 0.002 0.003 0.011 0.017 0.006	1.0646	-0.001	0.9999

Table D-6. SEV-UPS Audit Results: Cheriton, Wallops, VA Institute Marine Science

Audit Date Parameter Analyzer Ser. No.	Analyzer Range and Units	Audit Concentration X	Analyzer Response Y	Difference: Analyzer - Audit	Regression of analyzer response on audit concentration: $Y = mX + b$		
					m	b	r
8-17-79 Ozone Dasibi SAPCB 1278 Cheriton	0-1.0 ppm	0.000	0.002	0.002	1.0706	-0.002	0.9999
		0.041	0.040	-0.001			
		0.102	0.105	0.003			
		0.165	0.175	0.010			
		0.251	0.268	0.017			
0.401	0.428	0.027					
8-17-79 Ozone Dasibi NASA 26714 Wallops	0-0.2 ppm	0.000	0.003	0.003	1.0086	0.004	0.9999
		0.045	0.050	0.005			
		0.114	0.118	0.004			
		0.152	0.157	0.005			
		0.079	0.084	0.005			
8-17-79 Ozone Dasibi 2391 VA Institute	0-0.5 ppm	0.000	0.003	0.003	1.0077	0.004	0.9999
		0.051	0.053	0.002			
		0.112	0.120	0.008			
		0.204	0.212	0.008			
		0.269	0.275	0.006			
0.431	0.437	0.006					

Table D-7. SEV-UPS Audit Results: NASA Aircraft; Cessna 402, C-54, and LAS Craft

Audit Date Parameter Analyzer Ser. No.	Analyzer Range and Units	Audit Concentration X	Analyzer Response Y	Difference: Analyzer - Audit	Regression of analyzer response on audit concentration: $Y = mX + b$		
					m	b	r
8-14-79 Ozone Dasibi 1003 AAS NASA 180280 Cessna 402	0 to 0.2 ppm	0.000	(1) 0.00	0.000	0.9696	0.0002	0.9983
		0.145	0.138	-0.007			
		0.119	0.119	0.000			
		0.086	0.083	-0.003			
		0.029	0.028	-0.001			
8-14-79 Ozone Monitor Labs NASA 183369 Cessna 402	0 to 0.5 ppm (2)	0.000	0.000	0.000	1.5249	0.0018	0.9981
		0.145	0.220	0.075			
		0.119	0.182	0.063			
		0.086	0.140	0.054			
		0.029	0.045	0.016			
8-14-79 Nitric Oxide, NO Monitor Labs 8440 NASA 180895-1 Cessna 402	0 to 0.2 ppm	0.000	0.002	0.002	1.0083	0.002	0.9995
		0.118	0.121	0.003			
		0.080	0.085	0.005			
		0.157	0.158	0.001			
8-14-79 Nitrogen Dioxide, NO ₂ Monitor Labs Cessna 402	0 to 0.2 ppm	0.000	0.000	0.000	0.9508	-0.002	0.9995
		0.065	0.057	0.008			
		0.117	0.110	0.007			
		0.132	0.125	0.007			
		0.153	0.144	0.009			

(1) A zero offset of 0.073 was subtracted from all analyzer responses.

(2) Audited on 0 - 0.5 ppm range; in use on 0 - 0.2 ppm range.

Table D-7. SEV-UPS Audit Results: NASA Aircraft; Cessna 402, C-54, and LAS Craft (continued)

Audit Date Parameter Analyzer Ser. No.	Analyzer Range and Units	Audit Concentration X	Analyzer Response Y	Difference: Analyzer - Audit	Regression of analyzer response on audit concentration: $Y = mX + b$		
					m	b	r
8-14-79 Oxides of N, NO _x Monitor Labs Cessna 402	0 to 0.2 ppm	0.000	0.000	0.000	0.9892	0.001	0.9999
		0.118	0.118	0.000			
		0.080	0.081	0.001			
		0.157	0.155	-0.002			
8-14-79 Ozone Dasibi 1003 AAS W-24091 C-54	0 to 0.2 ppm	0.000	0.000	0.000	1.0289	-0.002	0.9995
		0.048	0.045	-0.003			
		0.098	0.101	0.003			
		0.158	0.160	0.002			
		0.134	0.136	0.002			
		0.044	0.041	-0.003			
8-16-79 Ozone Dasibi 1003 PC J-270(F)- 93636 LAS Aircraft	0 to 0.5 ppm	0.000	-0.002	-0.002	1.0101	-0.001	0.9999
		0.046	0.045	-0.001			
		0.102	0.101	-0.001			
		0.187	0.191	0.004			
		0.248	0.251	0.003			
		0.400	0.401	0.001			

(1) All readings corrected for a 0.063 offset reading.

Table D-8. SEV-UPS Audit Results: RTI Aircraft; Navajo

Audit Date Parameter Analyzer Ser. No.	Analyzer Range and Units	Audit Concentration X	Analyzer Response Y	Difference: Analyzer - Audit	Regression of analyzer response on audit concentration: $Y = mX + b$		
					m	b	r
8-19-79 Ozone Bendix M8002 SO 3865	0 to 0.2 ppm	0.000 0.045 0.103 0.150 0.072 0.020	0.002 0.048 0.112 0.159 0.078 0.025	0.002 0.003 0.009 0.009 0.006 0.005	1.0478	0.003	0.9998
8-19-79 Nitric Oxide, NO Monitor Labs 8440 EB 584	0 to 0.2 ppm	0.000 0.087 0.117 0.156 0.191	-0.001 0.091 0.117 0.158 0.189	-0.001 0.004 0.000 0.002 -0.002	0.9975	0.001	0.9995
8-19-79 Nitrogen Dioxide, NO ₂	0 to 0.2 ppm	0.000 0.052 0.115 0.172	-0.004 0.046 0.109 0.164	-0.004 -0.006 -0.006 -0.008	0.9795	-0.004	0.9999
8-19-79 Oxides of N, NO _x	0 to 0.2 ppm	0.000 0.087 0.117 0.156 0.191	0.003 0.082 0.116 0.152 0.185	0.003 -0.005 -0.001 -0.004 -0.006	0.9589	0.002	0.9996
8-19-79 Sulfur Dioxide Meloy SA 285 584	0 to 0.2 ppm	0.000 0.149 0.116 0.094 0.075 0.041	0.000 0.145 0.108 0.086 0.065 0.031	0.000 -0.004 -0.008 -0.008 -0.010 -0.010	0.9810	-0.005	0.9974

D-16

1. Report No. NASA CR-159233		2. Government Accession No.		3. Recipient's Catalog No.	
4. Title and Subtitle 1979 SOUTHEASTERN VIRGINIA URBAN PLUME STUDY (SEV-UPS): SURFACE AND AIRBORNE STUDIES				5. Report Date May 1980	
				6. Performing Organization Code	
7. Author(s) J. H. White, W. C. Eaton, M. L. Saeger, R. B. Strong, and J. B. Tommerdahl				8. Performing Organization Report No. RTI/1816/01-F	
9. Performing Organization Name and Address Research Triangle Institute Systems and Measurements Division Research Triangle Park, North Carolina 27709				10. Work Unit No. 146-20-10-07	
				11. Contract or Grant No. NAS1-15827	
12. Sponsoring Agency Name and Address National Aeronautics and Space Administration Washington, DC 20546				13. Type of Report and Period Covered Contractor Report	
				14. Sponsoring Agency Code	
15. Supplementary Notes Contract Monitor: G. L. Gregory, NASA - Langley Research Center					
16. Abstract This report describes Research Triangle Institute (RTI) participation in the 1979 Southeastern Virginia Urban Plume Study (SEV-UPS), which was conducted from August 13 to August 31, 1979. RTI was responsible for operating two surface monitoring stations (one in downtown Norfolk, Virginia, one south of the city near the Great Dismal Swamp) and collecting 40 hours of airborne measurements. Surface site measurements of ozone, oxides of nitrogen, sulfur dioxide, temperature, dew point, b ^{scat} , and condensation nuclei were made. RTI also provided instrument calibrations, quality assurance audits, and preliminary data analysis in support of SEV-UPS. Section 1 describes some of the air pollution problems that were addressed by this study, the specific objectives of RTI involvement in SEV-UPS, and the overall objectives of SEV-UPS. In Section 2 the set up, operating, and data handling procedures followed by RTI for the surface stations are presented. The operation of the aircraft sampling platform is described in Section 3. In Section 4 aircraft sampling procedures are discussed. Section 5 contains a preliminary descriptive analysis of the RTI aircraft data. Appendices to the report give data or plots for: surface sites; airborne studies; hydrocarbon species; instrument performance audits. Several of the aircraft flights clearly show the presence of an urban ozone plume downwind of Norfolk in the direction of the mean wind flow.					
17. Key Words (Suggested by Author(s)) Air pollution, ambient air Aircraft platform Monitoring Ozone, ambient air			18. Distribution Statement Unclassified - Unlimited Subject Category 45		
19. Security Classif. (of this report) Unclassified		20. Security Classif. (of this page) Unclassified		21. No. of Pages 256	22. Price*

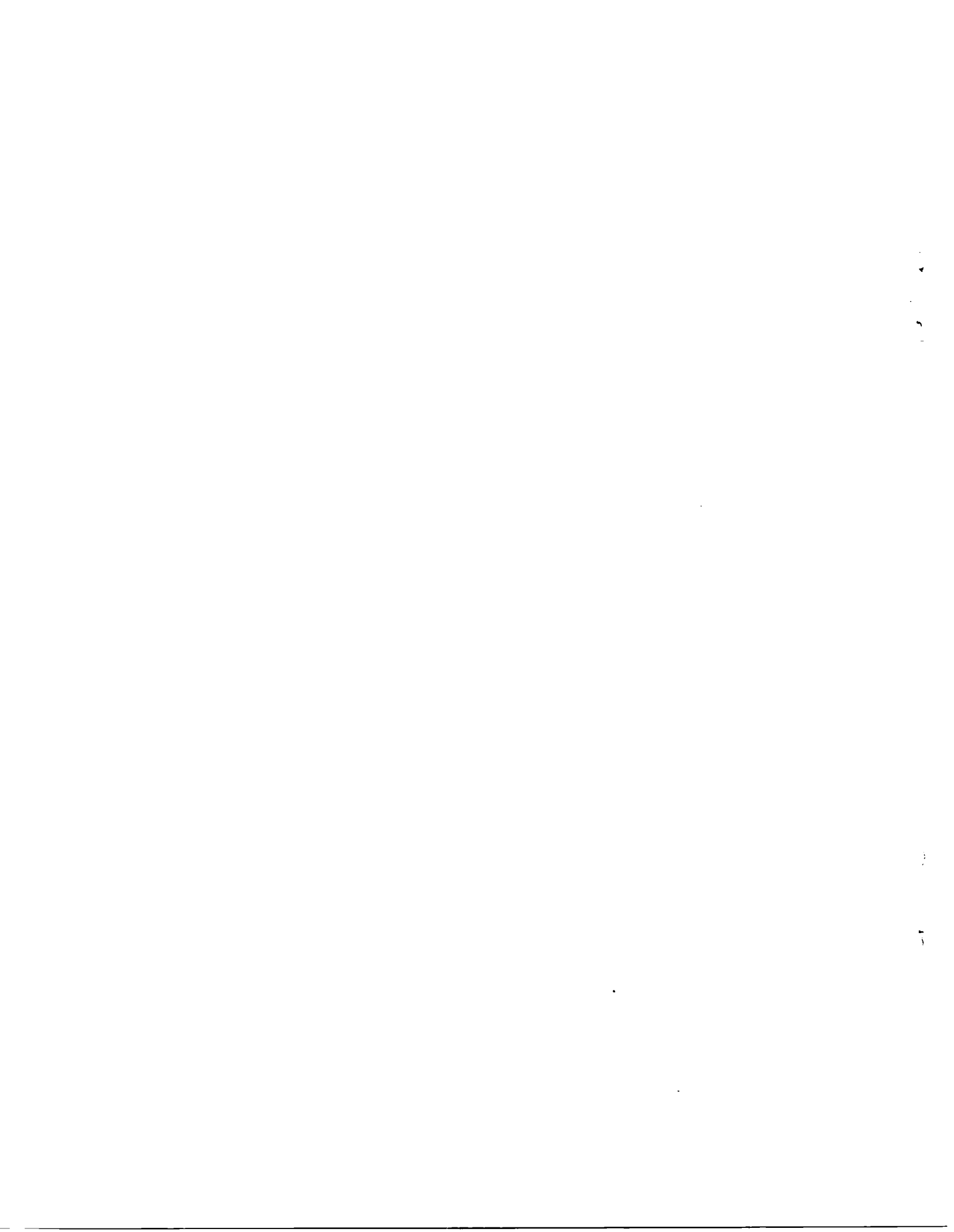

1000

1000

