

NASA Contractor Report 3348

Solar Power Satellite  
Offshore Rectenna Study

CONTRACT NAS8-33023  
NOVEMBER 1980

**NASA**

NASA Contractor Report 3348

# Solar Power Satellite Offshore Rectenna Study

*Rice University  
Houston, Texas*

Prepared for  
Marshall Space Flight Center  
under Contract NAS8-33023

**NASA**

National Aeronautics  
and Space Administration

**Scientific and Technical  
Information Branch**

1980

SOLAR POWER SATELLITE  
OFFSHORE RECTENNA  
STUDY

PERFORMED BY  
RICE UNIVERSITY  
BROWN AND ROOT DEVELOPMENT, INC.  
ARTHUR D. LITTLE, INC.

FOR  
THE MARSHALL SPACE FLIGHT CENTER  
CONTRACT NAS8-33023

FINAL REPORT  
MAY 1980

Rice University  
Houston, Texas 77001

  
John W. Freeman  
Study Director

The primary contributors to this report include:

Rice University:

John W. Freeman

William L. Wilson, Jr.

Loren D. Lutes

Greg Greenwell

Martin Burdeaux

Herbert K. Beckman

Frank Fisher

Wayne Smith

Brown and Root Development Inc:

Don Hervey

Engin Keyder

Gary Goldman

Peter Dove

Arthur D. Little Inc:

Peter E. Glaser

Philip K. Chapman

## Table of Contents

Abstract	4
Executive Summary	5
1. Introduction and Background	6
2. Approach	7
2.1 Site Selection	7
2.2 Environmental Data	8
2.3 Icing Studies	12
2.3.1. The Monopole	12
2.3.2. Monopole Results	14
2.3.3. Dipole Results	16
2.4 Rectenna Directional Sensitivity	18
2.5 Rectenna Design	19
3. Structural Design and Cost Estimates	26
(The Brown and Root Development Inc. Final Report)	
4. Cost Comparisons	154
5. Secondary Uses, Design Requirements and Sea Defense	156
(The Arthur D. Little Final Report)	
6. Summary of Results	219
7. Conclusions	223
Appendix A.--Detailed Environmental Data	224

## Abstract

Rice University, Brown and Root Development Inc., and Arthur D. Little Inc. have jointly conducted a feasibility study of an offshore rectenna serving the Boston/New York area. We found that an offshore rectenna is feasible and cost competitive with land rectennas but that the type of rectenna which is suitable for offshore use is quite different from that specified in the present reference system. We began by engineering the reference system rectenna to the offshore location. When we estimated costs for the resulting system we found that the cost was prohibitively high. We then searched for modifications to the design which would allow significant cost reduction. The result is a non-ground plane design which minimizes the weight and greatly reduces the number of costly support towers. This preferred design is an antenna array consisting of individually encapsulated dipoles with reflectors or yagis supported on feed wires. We find that such a 5 GW rectenna could be built at a 50 m water depth site to withstand hurricane, winter storm and icing conditions for a one time cost of \$5.7 billion. Subsequent units would be about 1/3 less expensive. It is important to note that the east coast site chosen for this study represents an extreme case of severe environmental conditions. More benign and more shallow water sites would result in substantially lower costs. Secondary uses such as mariculture appear practical with only minor impact on the rectenna design. The potential advantages of an offshore rectenna such as no land requirements, removal of microwave radiation from populated areas and minimal impact on the local geopolitics argue strongly that further investigation of the offshore rectenna should be vigorously pursued.

## Executive Summary

The salient results of this study may be summarized as follows:

1. An offshore rectenna is feasible along the central and northeast coast at a first unit cost of about \$5.7 billion.
2. The environmental constraints are very severe and dictate a fully encapsulated receiving element.
3. The reference system ground plane design is not suitable for offshore.
4. A non-ground plane design is preferred.
5. Of four types of support towers studied, a piled guyed tower is the least expensive.
6. Secondary uses, in particular mariculture and wave energy extraction appear promising at a minimum impact to the rectenna design.
7. The preferred design offered here has not been optimized for cost or efficiency.
8. The offshore rectenna offers significant advantages and should be investigated further.

## 1. Introduction/Background

The Solar Power Satellite (SPS) concept involves the conversion of solar energy to microwaves. The microwaves are then beamed to earth using a high power phased array transmitter. The microwave beam is intercepted and converted to D. C. electricity at the surface of the earth using a large area receiver and rectifier referred to as a rectenna. For the NASA reference SPS design the total beam energy is delivery rate is 5 GW. In order to avoid a thermal overload on the ionosphere the beam area at the earth must be approximately  $100 \text{ km}^2$  for the anticipated frequency of 2.45 GHz.

A central question has been the availability of rectenna sites near major load centers. Rice University [Blackburn and Bavinger, satellite power system white paper on mapping of exclusion areas for rectenna sites, DOE/NASA SA-13,1979] performed a preliminary study to locate potential rectenna sites within the U.S. A principal finding of this study was that, when certain exclusion criteria were examined, there were no eligible sites along the highly populated east coast. If it is assumed that transmission of electrical power over long distances will not be practical in the time frame when the SPS comes on line, this would exclude the east coast electrical load centers from enjoying the benefits of the SPS.

A solution to this problem would be the location of rectennas offshore. In addition to the solution of the land availability problem, an offshore rectenna would have the



following additional advantages:

1. The legal aspects of land acquisition are simplified.
2. Land clearing and maintenance costs are eliminated.
3. The peripheral microwave radiation is removed from populated areas.
4. The rectenna is "out of sight" from the general public minimizing regional political impact.
5. Various secondary uses such as aquaculture become possible.
6. On-site hydrogen generation becomes a logical possibility making the SPS system a fuel source as well as electrical source.

Counterbalancing these advantages are the disadvantages of the more severe offshore weather environment, the more complicated construction logistics and support tower increased height.

## 2. Approach

### 2.1 Site Selection

Based on the idea that the SPS would better serve the U.S. if an offshore rectenna could be built to service major load centers on the east coast, six candidate sites were selected for a rectenna. The criteria used for selection were as follows:

1. Capable of serving the New York and Boston Metropolitan areas [approximately 320 km (200 miles) as an outer limit].

2. Avoid shipping lanes.
3. Maximize distance from shore but do not exceed about 64 km (40 miles) out.
4. Avoid recreational boat traffic areas.
5. Avoid heavy fishing areas.
6. Avoid hazardous areas such as shoals or rip tides.
7. Stay on the continental shelf.
8. Avoid petroleum exploration areas.
9. Avoid waste disposal areas.
10. Level seabed.

Initially six candidate sites were examined. Based on the above criteria, this list was narrowed to a single site (site III). The general data for this site are as follows:

Location: 40°59' N, 70°44' W

Distance to N. Y.: 280 km

Distance to Boston: 121 km.

Distance to Martha's Vineyard: 40 km.

Seabed: coarse sand and scattered gravel

Water Depth: 50 m

Tidal Currents: about 1 km/hr.

Annual Tides: 1.1 m

Figure 2-1 is a map showing the location of this site. An important feature of this site is the uniform water depth which does not vary by more than about 10 meters over the entire site.

Figure 2-2 gives the rectenna dimensions for this site.

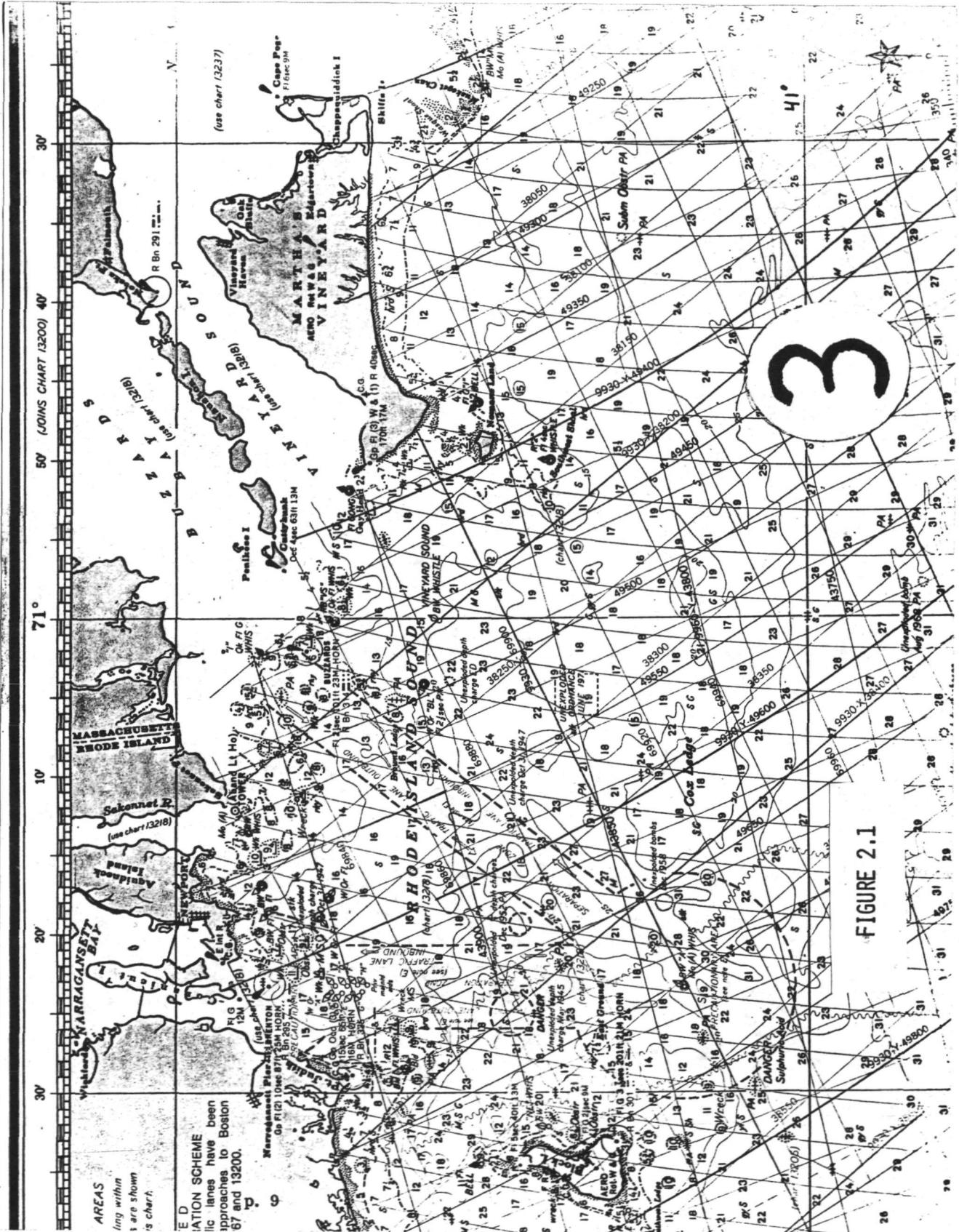

3

FIGURE 2.1

AREAS  
 lying within  
 1 are shown  
 2 is chart.

ED  
 IATION SCHEME  
 lic lanes have  
 been  
 approaches to Boston  
 67 and 13200.

RECTENNA DIMENSIONS AND  
 PANEL ANGLES FOR SITE AT  
 40° 59' N, 70° 44' W

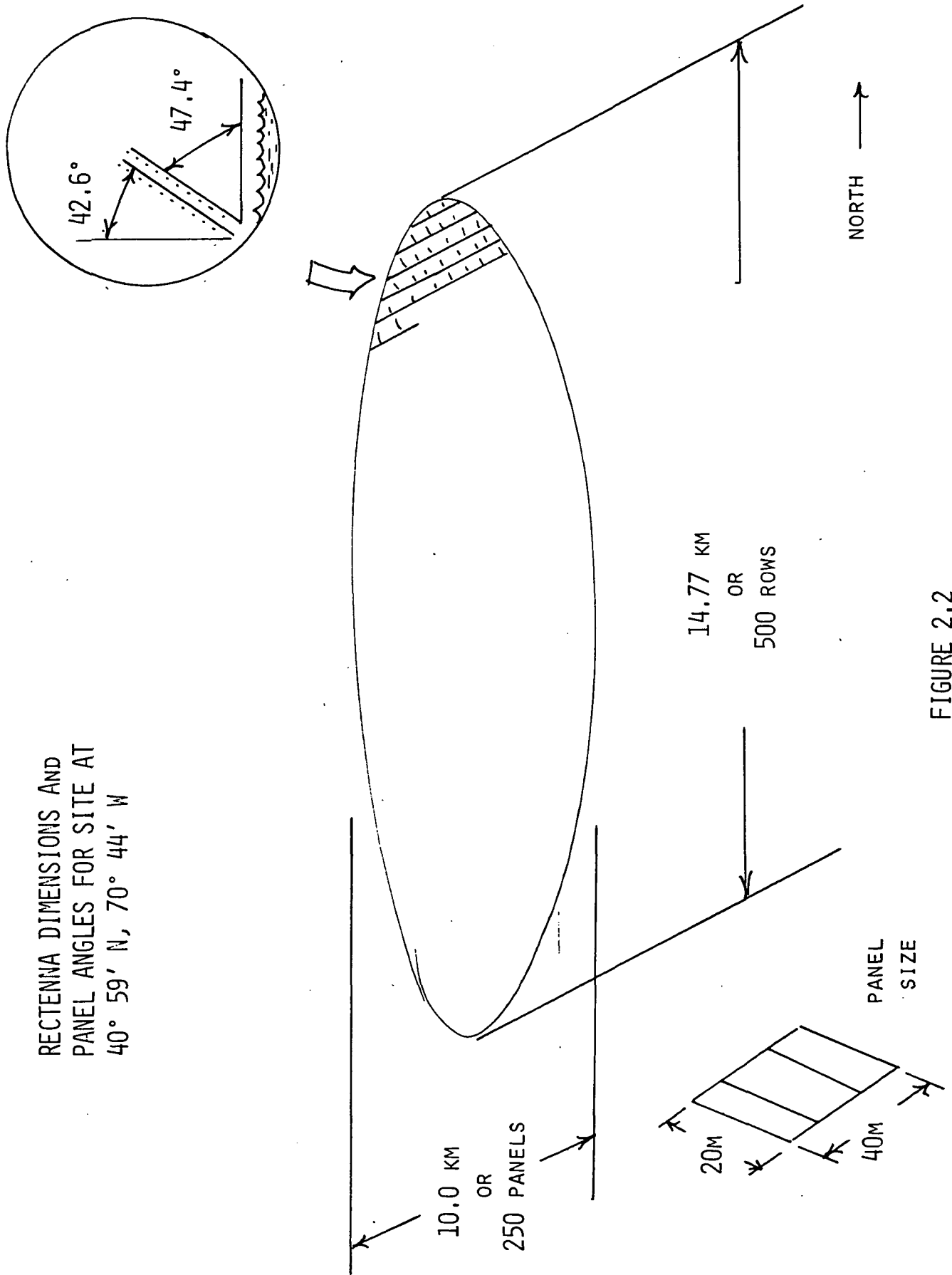

FIGURE 2.2

## 2.2 Environmental Data

When the favored site was chosen, Rice began collecting environmental data on that site. The full collection of data on this site is given in appendix A of this report.

A summary of the severe or worst case design data is as follows:

### Storm Winds:

Extreme wind speeds: 67 m/sec (150 MPH) (sustained hurricane storm wind 1 minute).

Winter storm windspeeds: 31.3 m/sec (70 MPH)

Three second gust velocity: 85 m/sec (188 MPH)

### Storm Waves:

100 year recurrence maximum wave height: 26.5 m (87.0 ft)

Significant storm wave height: 13.6 m (44.6 ft) storm surge tide: 1 meter

### Icing:

Average monthly frequency of moderate superstructure Icing: December, 12.5%; January, 22.5%; February, 15%. Estimated icing, less than 1.3 cm

### Snow:

Weight: 65 kg/m<sup>2</sup>

Based on years of experience as an industrial consultant, Professor Herb Beckman estimated that a conservative design would allow the reduction of the above 67m/sec (150 mph) 100 year storm extreme wind speed to 49 m/sec (110 mph) and the maximum wave

height from 26.5 m (87.0 ft) to a 19.8 m (65 ft) non-breaking wave. These lower values were their used throughout the study.

Icing is of particular importance because of possible efficiency loss to the rectenna when it occurs. We were unable to locate any quantitative estimates of the thickness of icing to be expected, merely the probability of "moderate super structure icing". Potential Moderate Icing is defined as the simultaneous combination of an air temperature less than  $-2^{\circ}\text{C}$  and a wind speed greater than 6.7 m/sec (15 mph). It seemed likely that an icing thickness greater than several millimeters could occur and therefore an estimate of the efficiency loss due to ice buildup on the rectenna was necessary.

## 2.3 Icing Studies

Rice conducted a systematic study to determine the effects of ice on the properties of a simple antenna. These tests also determined the size and type of protective cover or radome necessary to protect the antenna from severe icing effects.

### 2.3.1. The Monopole

The initial tests were conducted with a quarter wavelength monopole projecting through a ground plane which was about 2 wavelengths in diameter. The antenna element was driven with a 50 ohm coaxial line connected to a Hewlett-Packard 8410 microwave network analyzer.

The antenna was mounted in a microwave anechoic chamber with dry ice to provide the subfreezing temperatures. Figure 2-3 shows the test setup.

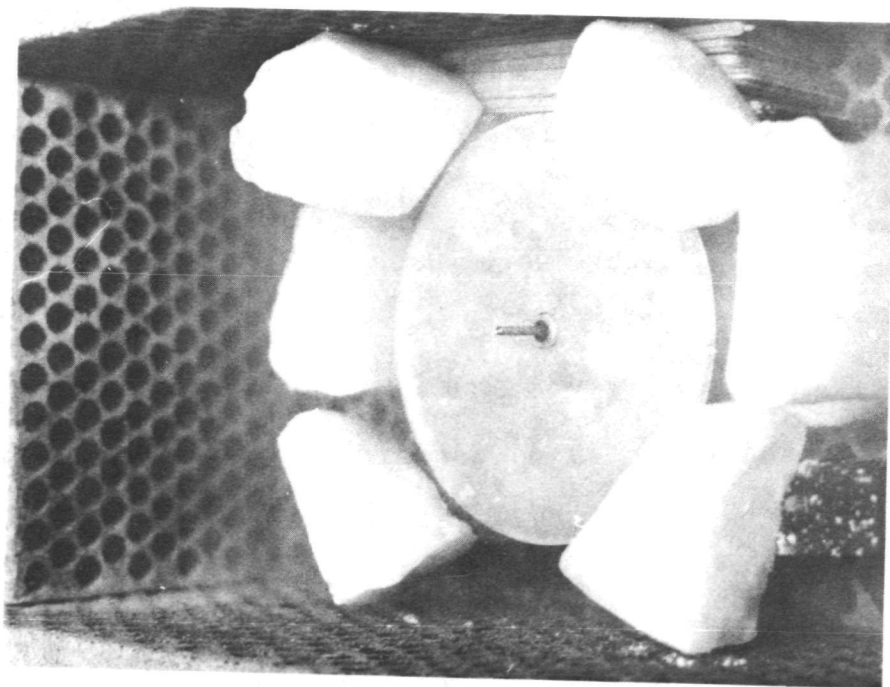

FIGURE 2.3 MICROWAVE TEST SETUP

With the antenna mounted in the test chamber, the frequency of the microwave source was adjusted for the resonant frequency of the antenna, about 2.45 GHz. Resonance was determined by a minimum in the signal reflected from the antenna, usually not more than 2%.

Distilled water, or salt water was then sprayed in a fine mist over either the antenna element or ground plane or both and allowed to freeze. Once the water was frozen completely, a measurement was made of the reflection coefficient and the thickness of the ice determined. The reflection coefficient is the amplitude of the reflected wave relative to that of the incident wave. It is a good measure of the electrical mismatch caused by the ice.

Two kinds of salt water were used. One was "Ringer's solution" which is about 1/3 as salty as sea water - to simulate a salt water - rain water mix as would occur in a storm. The other was simulated sea water which contains a very close approximation to the ion content of actual sea water.

Once the effect of ice and salt ice on the antenna performance had been determined, a series of plexiglass covers were made for the active antenna element. These were placed over the antenna and the tests repeated. Covers of several thicknesses were used in an attempt to find the minimum size cover which would ameliorate the effects of ice.

### 2.3.2. Monopole Results

Figure 2-4 illustrates the measured reflection coefficient vs ice thickness. It is seen that as the ice thickness builds up



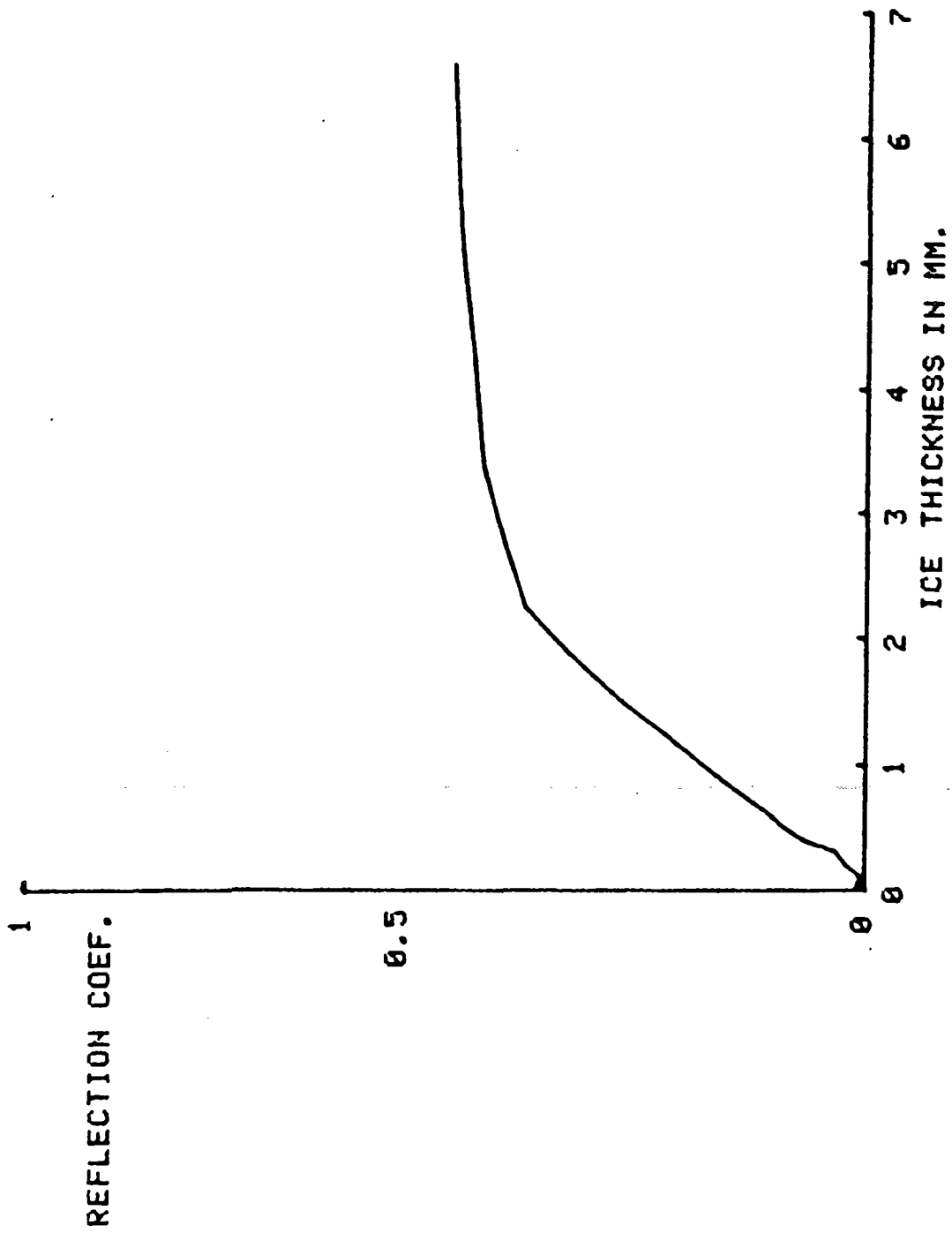

FIGURE 2.4

to about 0.005 m (5mm) the reflection coefficient approaches 0.5.

Another important result is that there was very little change in the reflection coefficient as the water froze, indicating rain water is as bad as ice.

Clearly a protective covering is required over the active element.

Figure 2-5 illustrates the effect on the reflection coefficient of various thickness covers. A 0.01 m (10 mm) radius cover on the active element reduces the reflection coefficient to 0.1. A thicker cover yields no significant advantage.

We can summarize the monopole icing test results as follows:

1. With no cover, the reflection coefficient asymptotically approaches 0.5 at an ice thickness of about 0.005 m (5 mm).
2. 0.01 m (10 mm), radius cover on the active element reduces the reflection coefficient to 0.1. Thicker covers yield no significant improvement.
3. Rainwater is as bad as ice.

### 2.3.3. The Dipole Results

Following the monopole icing tests, there was some uncertainty that the results would apply equally well to a dipole configuration. To verify this, a balanced feed dipole antenna was set up. Time and fiscal constraints did not permit a complete test, but preliminary tests indicated:

1. Icing on the active element is as bad as for the monopole.

REFLECTION COEF. VS. COVER DIAMETER WITH 3MM ICE ON COVER, 2.45 GHZ.

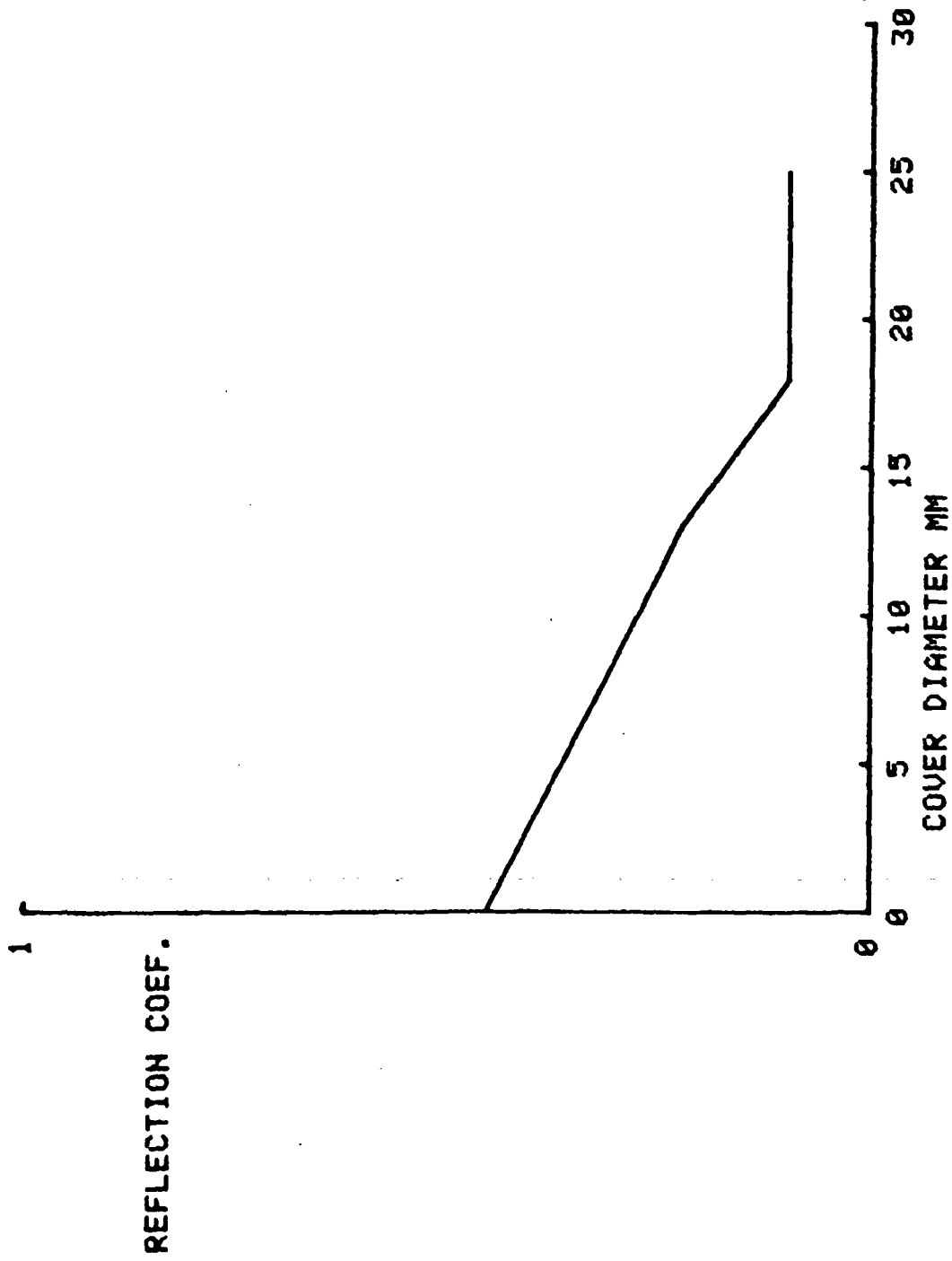

FIGURE 2.5

2. Ice on the ground plane is also a problem. In fact 0.002 m (2 mm) of ice on the ground plane produces a reflection coefficient of 0.3.

There was no time to run tests of covers.

The overall conclusion from the icing studies is that an insulating cover at least 0.01 m (10 mm) thick is necessary for the rectenna active elements and ground plane.

#### 2.4. Rectenna Directional Sensitivity.

Possible suggestions for the rectenna support included semisubmersible or fully submersible floats, hence a tethered floating structure. This would lead to pitch, roll and yaw motion of the rectenna relative to the direction to the transmitter. (Here a yaw change is defined as an angular offset in the plane of the dipole element axis and a pitch change is an angular offset in the plane orthogonal to the dipole element axis, i.e., the fundamental direction is from the rectenna looking directly backwards to the transmitter with the dipole active elements as aircraft wings.) It was therefore necessary to have as a design input to the support structure group the allowable angular discrepancy from perfect pointing.

Professor Wilson's group from the Rice Electrical Engineering Department undertook the calculation of loss of rectenna efficiency with angular misalignment. Misalignment in two planes was studied; misalignment in the plane including the axis of the dipole elements and misalignment in the plane orthogonal to the plane including the dipole. The results for

the half-wave dipole with ground plane are as follows:

		<u>Angle of</u> <u>Misalignment</u>	<u>Power</u> <u>Loss</u>
<u>Yaw</u>	{ In the plane of the dipole axis	{ 5° 22°	{ 1% 5%
<u>Pitch</u>	{ Perpendicular to Dipole axis	{ 19° 29°	{ 1% 5%

It was considered desirable to keep the power loss as close as possible to 1%. If the rectenna is designed with the dipole axes horizontal, rather than with a vertical component, the rotation about the most sensitive angle can be minimized. This assumes that the structure allows pitch changes more readily than yaw changes. Roll changes should not effect the efficiency. Accordingly the receiver panel is allowed to rotate up to 11° in yaw or 19° in pitch. The 5° yaw angle necessary to achieve the 1% loss as indicated above was considered unrealistic.

As seen in figure 2-2 the angle of the receiver ground plane relative to the local vertical must be 42.6° for the latitude of the chosen site.

## 2.5 Rectenna Design

When the environmental constraints dictated hurricane velocity winds, it became clear that wind loading on the rectenna panels would be a significant factor. For this reason, it was decided early to employ the open rectenna which is part of the

reference system. [Satellite Power System Reference System Report, DOE/ER-0023 1978]. This design consists of discrete half-wave dipoles mounted above a steel mesh ground plane. The diodes feed low-pass filters and Schottky by barrier diodes. The rectenna panels form a series of serrated rows of panels with each face perpendicular to the beam; the row long axis oriented east-west.

There were two other reasons for selecting this basic rectenna configuration:

1. Land rectennas of this design had already been costed [Boeing Aerospace Co. SPS System Definition Study, Phase II, Final Report, DI80-25461-1, Rev A, Feb, 1980] and hence, once the offshore study was complete, direct comparison would be possible with land rectenna costs.

2. Don Hervey of Brown and Root Development Inc. had already begun work on a submersible floating support structure designed around the reference system rectenna.

The Brown and Root submersible float concept is illustrated in figure 3.1.1. Submerged float tanks which are anchored by gravity anchors support towers which in turn support the receiver diode panels. Because this system is floating, it is desirable to have a non-rigid support for the diode panels, allowing them to remain pointed in the beam direction. To accomplish this, Don Hervey of Brown and Root developed a double mass pendulum design which allows the panels one degree of rotational freedom. (see figure 3.2.5). Considerable effort was spent optimizing the dimensions of this design.

At the midterm design review held at Rice November 6, 1979, it was brought out that the submerged float system held numerous problems not first appreciated. Brown and Root then began a serious study of alternative support structures. The results of this study are documented in section 2-6 structure design.

Four types of structures were evaluated. These were:

1. The submerged bouyant platform.
2. The piled structure.
3. The gravity base structure.
4. The piled guyed tower.

Of these, the piled guyed tower (figure 5.2.1) was found to be the least expensive, with the material and fabrication cost alone approximately \$400,000 per tower. For the double mass pendulum panel reference system type rectenna 25,000 towers are required. Peter Dove of Brown and Root Development, Inc. determined the total rectenna cost, including installation, at \$36.6 billion for a piled guyed tower rectenna.

Since this total cost was considered prohibitively expensive, cost sensitivity calculations were conducted on water depth, type of soil and wind loads. The conclusion from these cost calculations was that the only way to substantially reduce the cost was to reduce the number of towers required. Furthermore, it was concluded that this could not be done without greatly reducing the basic weight of the receiver panels themselves.

Accordingly, Rice began a search for a new rectenna receiver element concept which would greatly reduce both the dead weight

and the wind and snow load weight of the receiver panels. The resulting design, referred to as the clothesline or non-ground plane design is pictured in figures, 2-6, 2-7, and 2-8.

In this design, the ground plane is eliminated and replaced by a reflecting passive dipole element. Both the active element and passive element, together with a harmonic wave trap and rectifier may be printed on a P.C. board and encapsulated within an oval of dielectric foam as shown in figure 2-7. This foam provides the required protection against icing and rain. Power is conducted away from the diode by horizontal rods which also provide the mechanical support. A concept similar to this but without the foam encapsulant was investigated by Ron Guttman and Jose Barrego of Rensselaer Polytechnic Institute in connection with a study of higher gain rectennas for the Johnson Space Center [Solar Power Satellite Rectenna Design Study: Directional Receiving Elements and Parallel Series Combining Analysis, Contract NAS9-15453 final report, 1978]. Numbers for the cost per square meter used in our study were taken from the Guttman-Barrego report and doubled to accommodate the cost of foam and other contingencies. This cost is  $\$10/\text{m}^2$ .

The mass estimate for the diode receivers is  $2.5 \text{ kg}/\text{m}^2$ , not including the support cables. This is about one tenth the dead weight load of the ground plane design. With the clothesline concept, the structure is considered sufficiently open that no snow load need be considered.



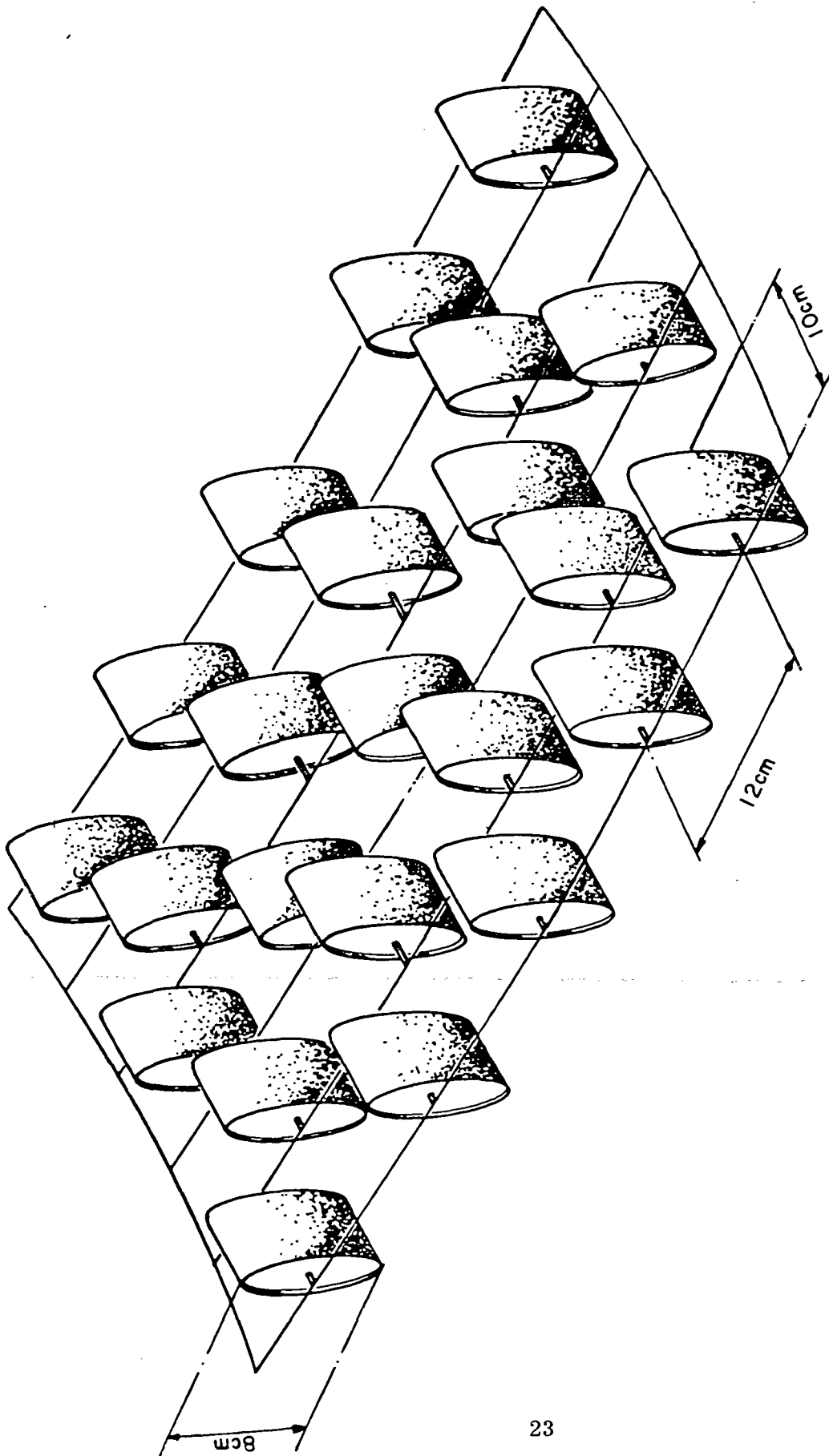
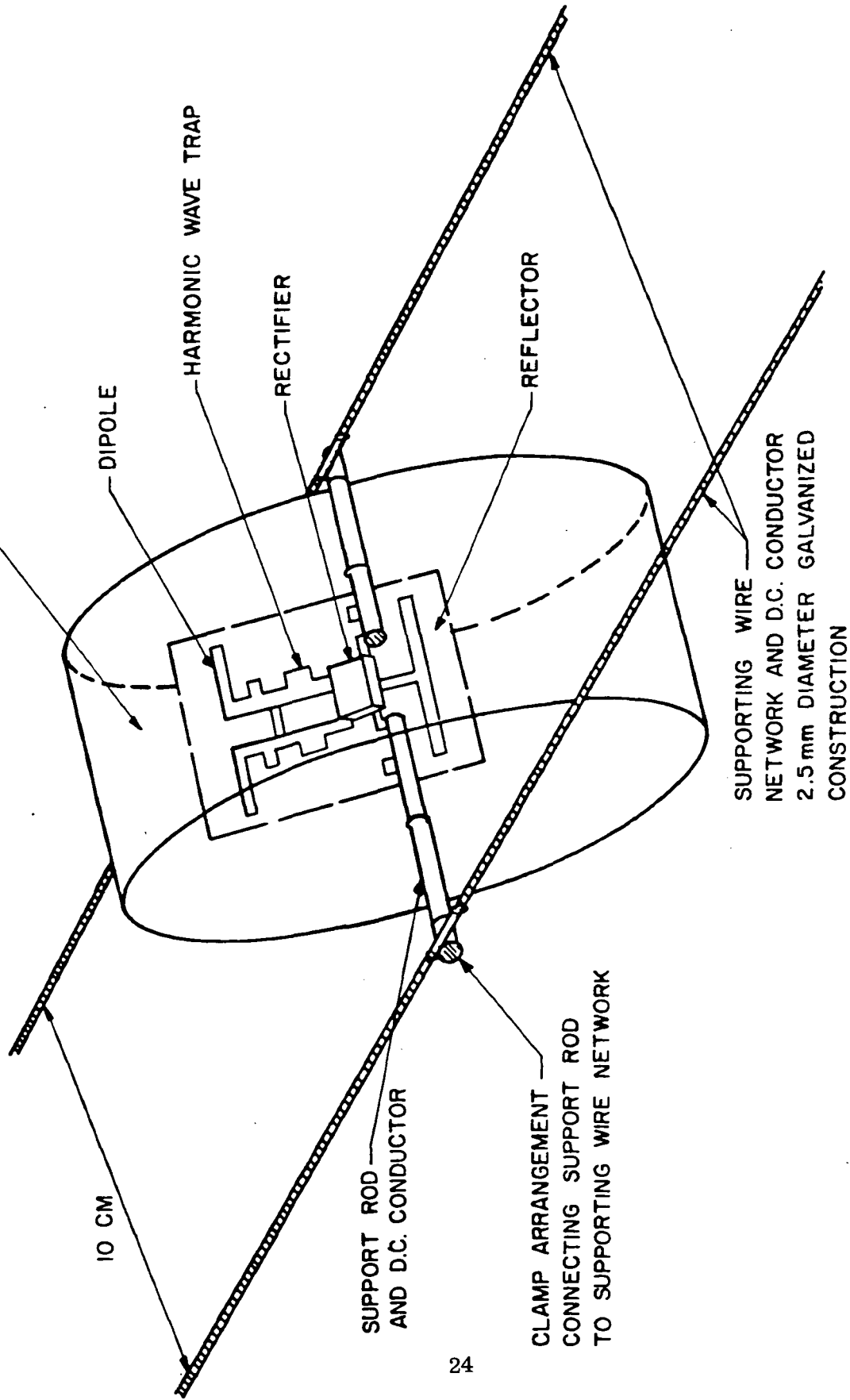

FIGURE 2.6 DIAGRAM SHOWING SECTION OF 100FT X 100FT NON-GROUND PLANE DIPOLE MICROWAVE RECEIVING ARRANGEMENT

SOLID SYNTHETIC ENCAPSULATION MATERIAL



10 CM

SUPPORT ROD  
AND D.C. CONDUCTOR

CLAMP ARRANGEMENT  
CONNECTING SUPPORT ROD  
TO SUPPORTING WIRE NETWORK

SUPPORTING WIRE  
NETWORK AND D.C. CONDUCTOR  
2.5 mm DIAMETER GALVANIZED  
CONSTRUCTION

FIGURE 2.7 DIAGRAM SHOWING ENCAPSULATED NON-GROUND PLANE DIODE AND  
DETAILING ELECTRONICS AND SUPPORTING ARRANGEMENT

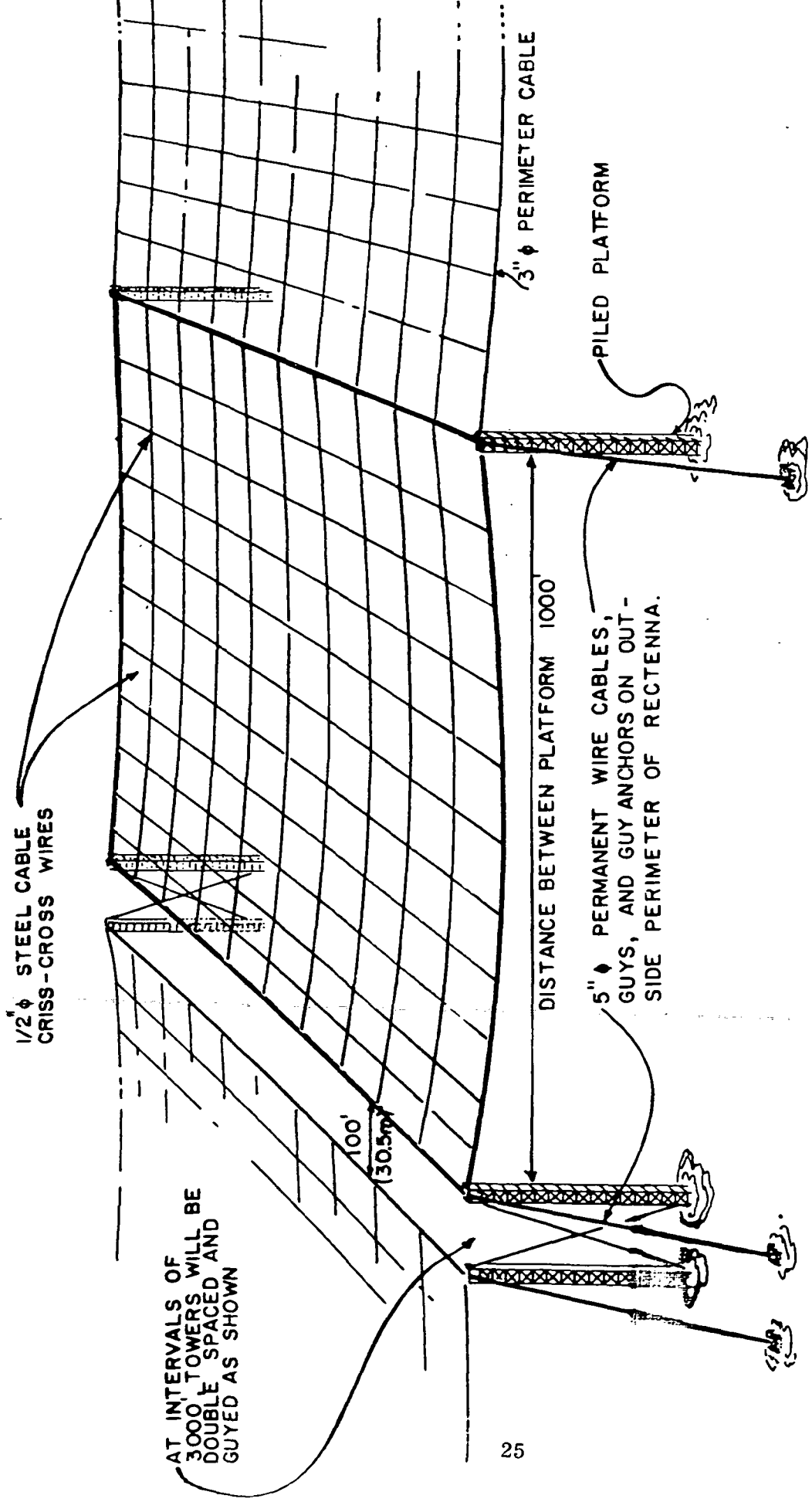

FIGURE 2.8 DIAGRAM SHOWING PLATFORM AND TAUT-WIRE SUPPORT ARRANGEMENT FOR FLEXIBLE NON-GROUND PLANE DIPOLES

With this lower dead weight and snow load, the dipole array can be supported by a network of 0.0127m (0.5 in.) diameter cables at 30.5 m (100 ft) spacing in a square criss-cross network with 0.0762m (3 in.) diameter cables every 305 m (1000 ft). Support towers are located every 305m (1000 ft) (See figure 2-8). This permits the number of support towers to be reduced to 3000; down from 25,000 required for the ground plane configuration.

The total cost for the first unit 5 G W rectenna is \$5.7 billion, about 17% of that for the ground plane configuration. Subsequent rectennas are estimated by Brown and Root at \$3.8 billion.

It is probable that if this clothesline concept were applied to a land rectenna considerable cost saving could be realized here as well. Moreover, as has been pointed out by Alan Kotin [private communication], the rectenna site selection criteria for terrain conditions and land clearing could probably be relaxed due to the fewer number of towers required.

Time and fiscal constraints did not permit an investigation of the efficiency of the clothesline concept; however, the R. P. I. study referenced above evaluated the printed circuit yagi for efficiency. The clothesline design could easily be adopted to a multiple element yagi with very little cost impact.

### 3. Structural Design and Cost Estimates

A subcontract was let to Brown and Root Development Inc. to

perform a structural design and cost analysis on the offshore rectenna given the site and design constraints specified by Rice University. The site location and environmental data were determined early in the program; however, the receiver element design remained fluid and the switch to the non-ground plane configuration was made late after cost estimates from the reference system type antenna showed that this system was inappropriate for an offshore rectenna.

The Brown and Root Development Inc. subcontract final report, which follows, gives the details of the structural design and cost estimate.

OFFSHORE RECTENNA STUDY  
FINAL REPORT

EF-0079

MARCH, 1980

PREPARED BY:

BROWN & ROOT DEVELOPMENT, INC.  
UNDER SUBCONTRACT NO. 437135A

TO

RICE UNIVERSITY

FOR NASA

## FOREWORD

The Offshore Rectenna Structural Design Study was performed for Marshall Space Flight Center under Subcontract No. 4371854 to provide conceptual offshore rectenna designs and their preliminary evaluation. Rice University is the prime contractor while Brown & Root Development, Inc. and Arthur D. Little, Inc. are the subcontractors.

# OFFSHORE RECTENNA

## EXECUTIVE SUMMARY

## TABLES & FIGURES

1. INTRODUCTION
  - 1.1 OBJECTIVES
  - 1.2 SCOPE
  - 1.3 DEFINITION OF TERMS
2. DESIGN CRITERIA
  - 2.1 SITE SELECTION AND ENVIRONMENTAL CONDITIONS
  - 2.2 OPERATING REQUIREMENTS
3. CONCEPTUAL DESIGNS
  - 3.1 SUPPORT SYSTEMS
    - 3.1.1 STRUCTURAL CONFIGURATIONS
      - 3.1.1.1 SUBMERGED BUOYANT PLATFORM
      - 3.1.1.2 PILED STRUCTURE
      - 3.1.1.3 PILED GUYED TOWER WITH PANELS
      - 3.1.1.4 GRAVITY STRUCTURE
      - 3.1.1.5 PILED GUYED TOWER WITH IMAGE DIPOLES
    - 3.1.2 MATERIALS
    - 3.1.3 FABRICATION, INSTALLATION AND MAINTENANCE
    - 3.1.4 DESIGN EVALUATIONS
  - 3.2 RECEIVER PANEL & TAUTLINE SYSTEMS
    - 3.2.1 STRUCTURAL CONFIGURATIONS
    - 3.2.2 MATERIALS
    - 3.2.3 FABRICATION, INSTALLATION AND MAINTENANCE



## OFFSHORE RECTENNA (Cont'd)

### 3.2.4 DESIGN EVALUATION

#### 3.2.4.1 RECEIVER PANEL

#### 3.2.4.2 TAUTLINE

4. PRELIMINARY COST ESTIMATES
    - 4.1 COST VS. SUPPORT SYSTEM TYPE
    - 4.2 COST VS. WATER DEPTH
    - 4.3 COST VS. WIND LOAD
    - 4.4 COST VS. SOIL CONDITIONS
    - 4.5 TOTAL COST
  5. PRIME SITE POINT DESIGN
    - 5.1 STRUCTURAL CONFIGURATION
    - 5.2 FABRICATION DEPLOYMENT AND INSTALLATION
    - 5.3 MAINTENANCE
    - 5.4 COSTS
  6. PREFERRED DESIGN
    - 6.1 STRUCTURAL CONFIGURATIONS
    - 6.2 FABRICATION DEPLOYMENT AND INSTALLATION
    - 6.3 MAINTENANCE
    - 6.4 COSTS
  7. SUMMARY
    - 7.1 CONCLUSIONS
    - 7.2 RECOMMENDATIONS
- APPENDIX A SUPPORT SYSTEMS DESIGN CALCULATIONS
- APPENDIX B RECEIVER PANEL AND TAUTLINE DESIGN CALCULATIONS

## EXECUTIVE SUMMARY

Preliminary designs and cost estimates for two types of offshore rectenna have been developed during the present study. Considerations include fabrication, deployment and installation schemes for the designs. Important findings include:

- . The baseline offshore rectenna design consisting of panel receivers and guyed tower supports is feasible for an Atlantic coast site.
- . Alternate conceptual designs (e.g. submerged buoyant platform, piled structure, gravity structure) for supporting receiver panels result in a costlier rectenna.
- . Changing the receiver configuration from panels to image dipoles greatly reduce costs in materials, support systems and installation.

## LIST OF FIGURES

<u>FIGURE NO.</u>	<u>TITLE</u>	<u>PAGE NO.</u>
2.1.1	Primary Site Location	9
2.1.2	Wave Spectrum	11
3.0.1	Wave Height vs. Tower (Wave + Wind Loads)	13
3.0.2	Soil Conditions vs. Tower Base	14
3.1.1	Submerged Buoyand Platforms	17
3.1.2	Piled Jacket Type Offshore Platform	19
3.1.3	Piled Guyed Tower Structure with Panel Receivers	21
3.1.4	Gravity Platforms	23
3.1.5	Piled Guyed Tower Structure with Dipole Receivers	25
3.2.1	Single Mass Pendulum Design	32
3.2.2	Single Mass Pendulum Model	33
3.2.3	Above M.W.L. Single Mass Pendulum System	34
3.2.4	Submerged Single Mass Pendulum System	35
3.2.5	Double Mass Pendulum Design	36
3.2.6	Double Mass Pendulum Model	37
3.2.7	Receiver Panel Configurations	39
3.2.8	Tower Pivot Point Location Tautline Design	41
3.2.9	Receiver Panel Structural Configuration	49
3.2.10 (a)	Dynamic Condition-Mass vs. Pendulum Arm Length	52
3.2.10 (b)	Dynamic Condition - Period vs. Mass Ratio	52
3.2.11	Pivot Point Location Criteria	54
3.2.12	Pivot Point Location	55
3.2.13	Single Panel Tautline Models	56
4.2.1	Cost vs. Water Depth for Piled Guyed Tower with Panels	60
5.1.1	Prime Site Guyed Tower Structure	65
5.2.1	Side Elevation of Jack-up Units Showing Installation of Columns and Panels in Channels	76
5.2.2	Possible Layout of Typical Staging Port	77

LIST OF FIGURES (Continued)

<u>FIGURE NO.</u>	<u>TITLE</u>	<u>PAGE NO.</u>
5.2.3	Site Elevation of Column Deployment Jack-up Showing Dynamically Positioned Column Transporting Vessel Discharging Columns	78
5.2.4	Equipment and Arrangements for Deploying and Piling Columns	79
5.2.5	Plan of Column Deployment Jack-up Barge Showing Column Transporting Vessel	80
5.2.6	A Jack-up Panel Barge in Position Between Columns Prior to Jacking Out	87
5.2.7	Jack-up Panel Barge - Jacked Clear of Water and Deck Raised So That Panel Line Can Be Connected and Tensioned	88
5.2.8	Jack-up Panel Barge - Cargo Deck Lowered	89
5.2.9	Jack-up Panel Barge - Jacked Back Into Water and Legs Raised Off Seabed in Preparation for Moving to Next Pair of Columns	90
5.2.10	Jack-up Barges Setting Panel Sections in Consecutive Columns	91
5.2.11	Installation of Panels Over Columns	92
6.1.1	Platform and Taut-Wire Support Arrangement for Flexible Non-Ground Plane Dipoles	101
6.1.2	Configuration of Support Towers and Perimeter Taut Line Cables in Preferred Design	102
6.1.3	Typical Non-Ground Plane Flexible Dipole Arrangement	103
6.1.4	Encapsulated Non-Ground Plane Diode, and Detailing Electronics and Supporting Arrangement	104
6.1.5	Section of 100' By 100' Non-Ground Plane Dipole Microwave Receiving Arrangement	105
6.2.1	Dipole Network Installation	115
6.2.2	Dipole Network Installation on Tautlines	116

LIST OF TABLES

<u>TABLE NO.</u>	<u>TITLE</u>	<u>PAGE NO.</u>
3.1.1	Support Systems	16
3.2.1	Panel Structural Weight	50
4.1	Preliminary Costs For Supporting Systems	58
4.2	Pile Stresses versus Wind Loads	61
4.3	Cost versus Soil Conditions For a Gravity Structure	62
4.4	Total Costs For Piled Guyed Tower Structures	63
5.1	Cost Summary For Prime Site Point Design	94
5.2	Itemized Costs For Prime Site Point Design	94
6.1	Cost Summary For Preferred Design	111
6.2	Itemized Costs for Preferred Design	112

## 1. INTRODUCTION

The Solar Power Satellite System (SPS) is an energy conversion system; receiving solar energy, converting it to microwaves, which in turn becomes electrical energy to be sent through utilities power grids. The solar energy is collected by a 5 to 10 gigawatt (GW) satellite in (geostationary) orbit about the earth using solar cells (or perhaps mirrors or photoklystrons) typically made of silicon or gallium arsenide. The geostationary orbit permits the satellite to receive continuous sunlight except for brief eclipses at the equinoxes. The microwaves are generated using klystrons, amplitrans, or solid state devices. The energy transmission beam from the satellite to earth is a phase controlled microwave beam at 2.45 GHz (frequency selected for maximum transparency of the atmosphere). The microwaves are received on earth by a rectifying antenna termed a rectenna, which is an array of dipole elements connected to rectifier and filter circuits. The rectenna encompasses an oval which is approximately 10.00 kilometers by 14.77 kilometers (based on prime site location). The dipole rectifiers convert the microwaves to direct current to interphase with existing ground based utility grids.

One main reason behind siting a rectenna offshore is the difficulty in finding an acceptable site on land near large power users. Rice University performed a study in an effort to screen rectenna sites in the 48 contiguous states. Using various levels of exclusion criteria it was concluded that less than 11% of the geographic area of the 48 states was not excluded as possible rectenna sites. There were no eligible sites along the east coast. Since electricity cannot be

transmitted economically over long distance, an SPS with a land based rectenna would not serve the electrical needs of this region (based on the exclusion variables in the Rice Study).

There are other reasons for considering siting a rectenna offshore. An offshore site can be located closer to many power load centers than a site on land. It would tend to minimize the environmental and political impact of the microwave beam in the vicinity of the rectenna. Since the utilities would not have to use the right of eminent domain, the lead time to obtain the land for the rectenna could be substantially reduced. With no clearing problems site development costs would be minimal.

The primary problem with an offshore site is the increased environmental loadings on the rectenna structure. Land based rectennas do not have to deal with wave and current forces and high velocity offshore winds. There are significant differences in potential economic design concepts. A land based rectenna can have frequent supports to the ground while an offshore design must use supports sparingly because materials and installation costs for such supports to the seabed (even in moderate water depths) are large. For offshore construction an efficient installation plan is necessary (requiring minimizing offshore construction). Offshore construction is especially susceptible to down time due to bad weather conditions and to the high expense of offshore equipment. These add design and construction problems which must be overcome to produce a rectenna which is competitive in cost to land based versions.

During the course of the study various panel, tautline, and support systems were developed and costed. Detailed structural analyses were not performed due to the conceptual nature of the study and the many designs evaluated. Cost analyses were performed on all concepts to determine which design to investigate further.



## 1.1 OBJECTIVES

This study was performed to evaluate the feasibility of constructing a rectenna structure offshore. A specific site was chosen by Rice University and environmental information from that site was used in the analysis. Environmental criteria were then varied and a parametric study was performed to investigate cost drivers. Rectenna specifications were developed by Rice University and changed (from a rigid receiver panel to a flexible, non-ground plane receiver network) during the latter stages of the study. BARDI costed all concepts in an effort to get a cost competitive offshore rectenna design.

## 1.2 SCOPE

This study is of conceptual nature only. The emphasis of the study was on systems design and costing. Design evaluations were performed first to establish technical feasibility of any given design and then to the point of developing material requirements and installation and fabrication scenario in order to get a complete cost estimate.

### 1.3 DEFINITION OF TERMS

The following terms from the text are defined as follows:

- . Prime Site - The site chosen by Rice (with BARDI consultation) to conduct a specific, point design, conceptual offshore rectenna study (see further details in Section 2.1).
- . Support Systems - structures which support the rectenna microwave receiver elements (panels) and tautline systems above the sea surface.
- . Receiver Panel - an array of diode on a groundplane, supported by an arrangement of rigid panel sections encompassing a 20 x 40 meter area at a 47.4° angle with the horizontal.
- . Image Dipole Receiver - networks of dipoles encapsulated in synthetic material, supported on small steel cables forming a "web-like" array.
- . Tautline - a pretensioned line that suspends the receiver elements between support structures.
- . Guys - lines which act as horizontal restraints by connecting the top of a tower to the ocean floor (e.g. permanent seabed anchors, adjacent tower footings, etc.).
- . Piled Guyed Tower (PGT) - support structures which are piled into the seabed with guys attached to the tower tops and the base of adjacent towers to give additional support.
- . PGT Rows - lines of towers as placed at the offshore field site.
- . PGT Channels - rows of space between towers running in the direction (east-west) of the receiver panels and tautline.
- . Staging Port - the area on land for the collection of components prior to final assembly (as required), loading and dispatch to field site.
- . Field site - the location for placement of the offshore rectenna.

- . "Purpose-built" Equipment - equipment which has been specifically designed and built for the task to be undertaken.
- . Jack-up units - equipment which has the capability of lifting itself out of the water using self-elevating support legs.
- . Semi-submersible units - equipment which has the capability of increasing or decreasing its draft by ballasting or de-ballasting procedures.
- . Linear Winches - winches which are capable of leaving or laying out wire cable in a straight line without spooling the cable on a drum or reel.

## 2. DESIGN CRITERIA

Design criteria development was a joint effort between Rice University and BARDI. Both rectenna specifications and environmental conditions were reformulated during the study in order to obtain a cost effective rectenna structure, while maintaining a conservative design approach.

### 2.1 SITE SELECTION AND ENVIRONMENTAL CONDITIONS

The factors considered by Rice in the site selection study include: close proximity to New York City and Boston, environmental conditions, and avoidance of shipping lanes, commercial fishing areas and migratory fowl flight paths. Due to the unavoidable harsh weather conditions in the area, a different site would be a more cost effective choice. The site chosen, as shown in Figure 2.1.1 is 40° - 59N latitude and 70 -44W longitude (175 miles from New York City and 75 miles from Boston). It is considered the prime site for this study. Rice and BARDI collected environmental data from the area and developed a design premise. Subsequent changes have altered the environmental loadings, reducing them to more realistic values for that region. The (hurricane) design wind velocity was reduced from 150 to 110 mph (240-176 km/hr) for the 100 year storm. The maximum wave height from 87.0 (26.5 m) feet breaking wave to a 64.8 feet (19.8 m) non-breaking wave. These new values were provided by industry consultant and Rice University Professor Dr. Herb Beckman, and are considered to be conservative values. The following are the critical prime site environmental criteria:

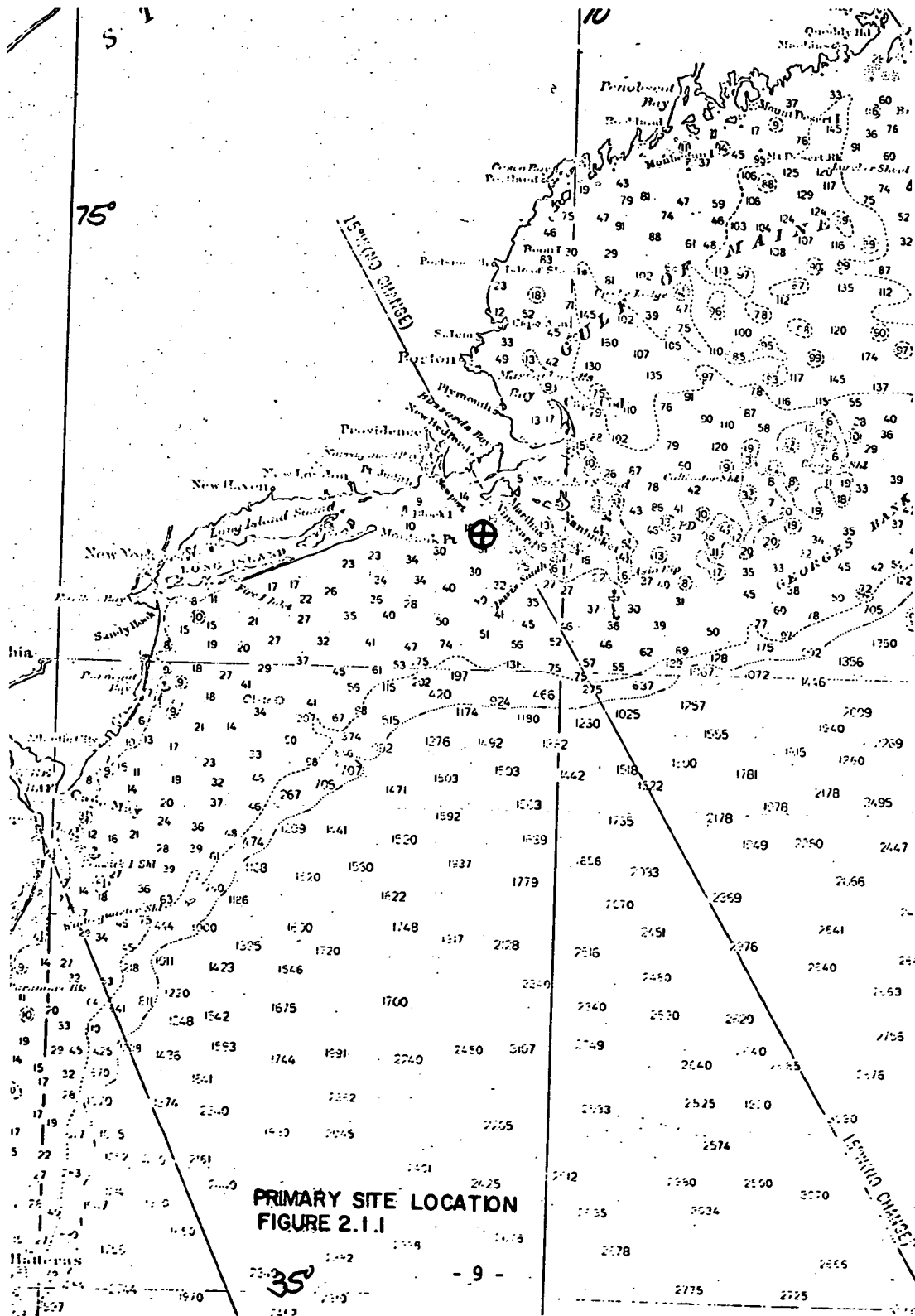

PRIMARY SITE LOCATION  
FIGURE 2.1.1

Water Depth - 162.0' (49.4m)

Storm Wave Height - 64.8' (19.8m)

Wave Spectrum - Figure 2.1.2 (greater than 25 sec. structure natural frequency will minimize response to high energy area - based on 87 ft. (26.5m) wave height

Storm Wind: Hurricane - 110 mph (176 km/hr)

Winter Storm: 70 mph (112 km/hr)

Snow Load: 13.6 psf (.65 kpa)

Ice Load: 2.9 psf (0.12 kpa)

## 2.2 OPERATING REQUIREMENTS

The operating requirements (developed by Rice University) include the following for the prime site design:

- . The receiver panel is a rigid structure.
- . The receiver panel is tilted at  $47.4^{\circ}$  to the horizontal and cannot rotate more than  $11^{\circ}$  along the row nor more than  $19^{\circ}$  about the row axis.
- . Microwave reception ability must remain high during storm conditions.
- . Materials in the microwave path must not interfere with microwave reception.

## 3. CONCEPTUAL DESIGNS

Conceptual designs were developed considering either site specific or generalized data. Thus, point designs were developed for the prime site but critical parameters were varied to provide cost versus parameter information (e.g. cost versus water depth).

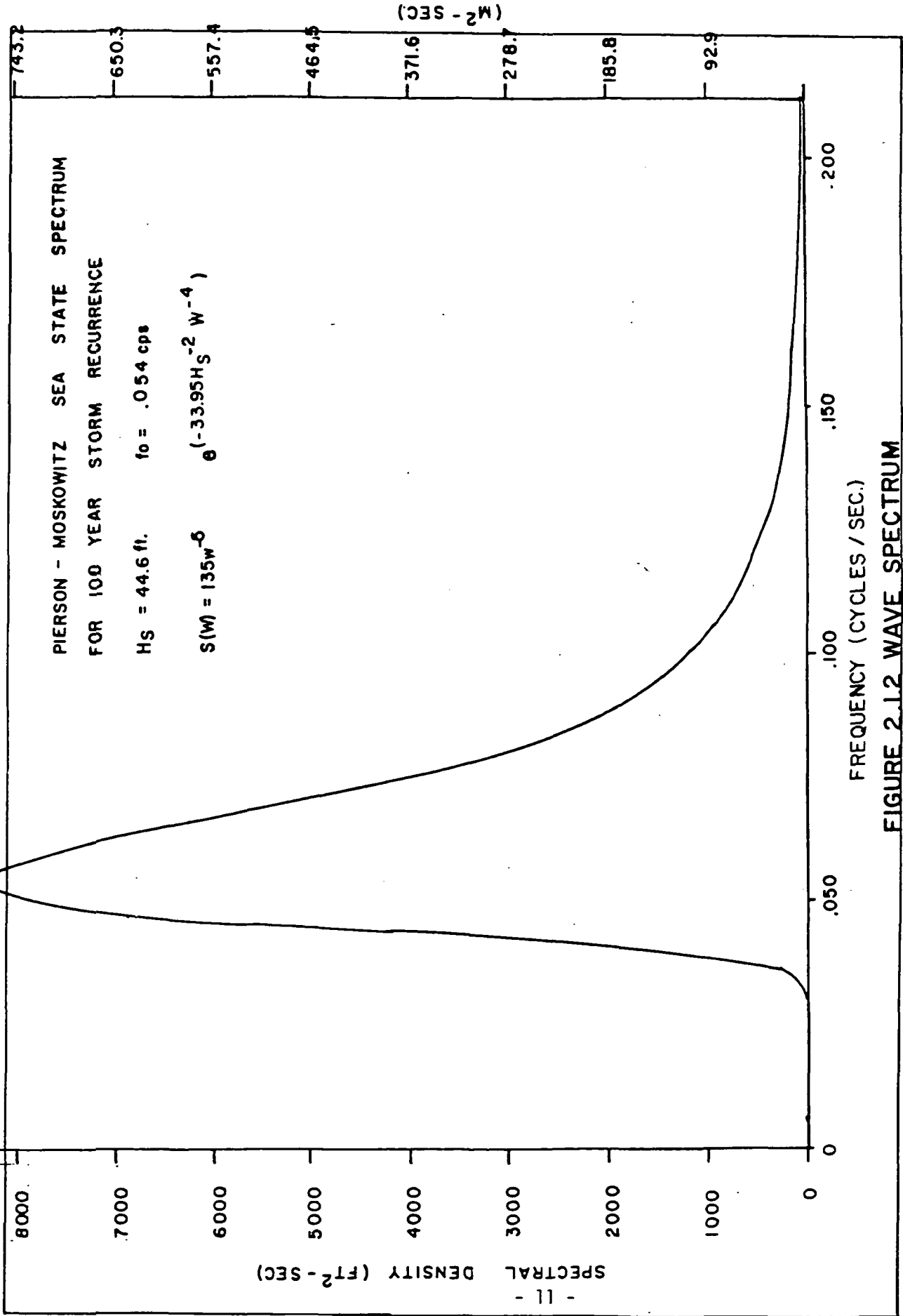

FREQUENCY (CYCLES / SEC.)

FIGURE 2.1.2 WAVE SPECTRUM



Varying design parameters significantly impacts the support structure economics. Wave heights and thus loads change with water depth and dictate the support structure height. This height effects material requirements and establishes magnitude of the overturning moment which bends the structure due to wind as shown in Figure 3.0.1. The size of the base of the supporting structure is determined by the soil conditions as illustrated in Figure 3.0.2. The soil strength controls an important trade off between material requirements and installation cost. A gravity structure is easily installed without the expense and time necessary for piling, yet poor soil conditions create the need for extensive bases and thus increased structural materials.

Receiver panel and tautline designs change little for the different environmental loads considered. Wind, snow, ice and dead loads determine the weight to be supported by each panel. However, the conceptual design is dependent upon dynamics and efficient force distribution to the support structures.

### 3.1 SUPPORT SYSTEMS

The supporting system for panels with a reflecting ground plane should safely carry the weight of the panels while the structure is subjected to 100 year wind and wave loads. An alternate design condition is the panel weight plus the winter storm snow, wind and wave loads. The 100 year storm is a hurricane which cannot occur in conjunction with the snow load.

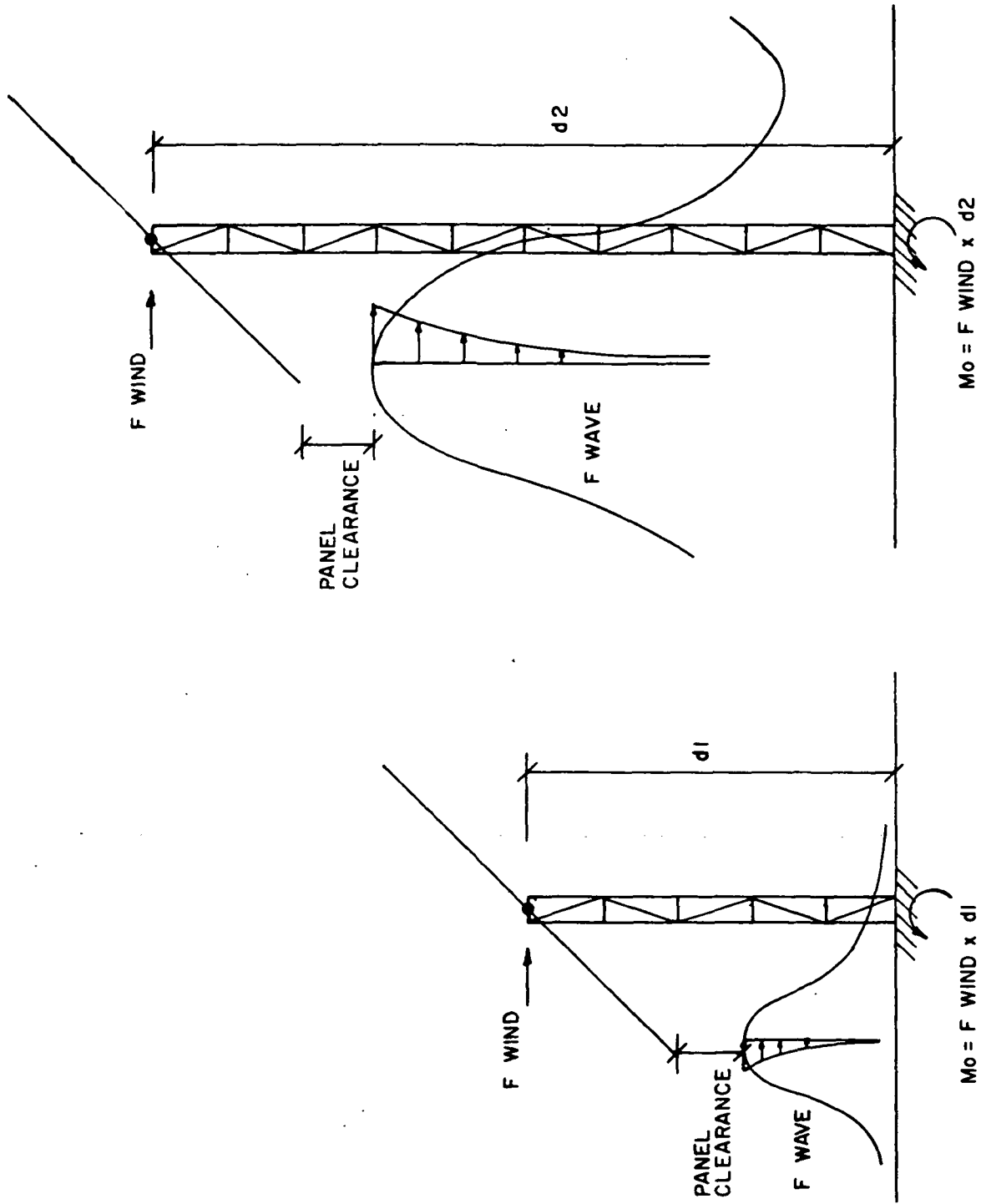

FIGURE 3.0.1 WAVE HEIGHT VS TOWER HEIGHT (WAVE + WIND LOADS)

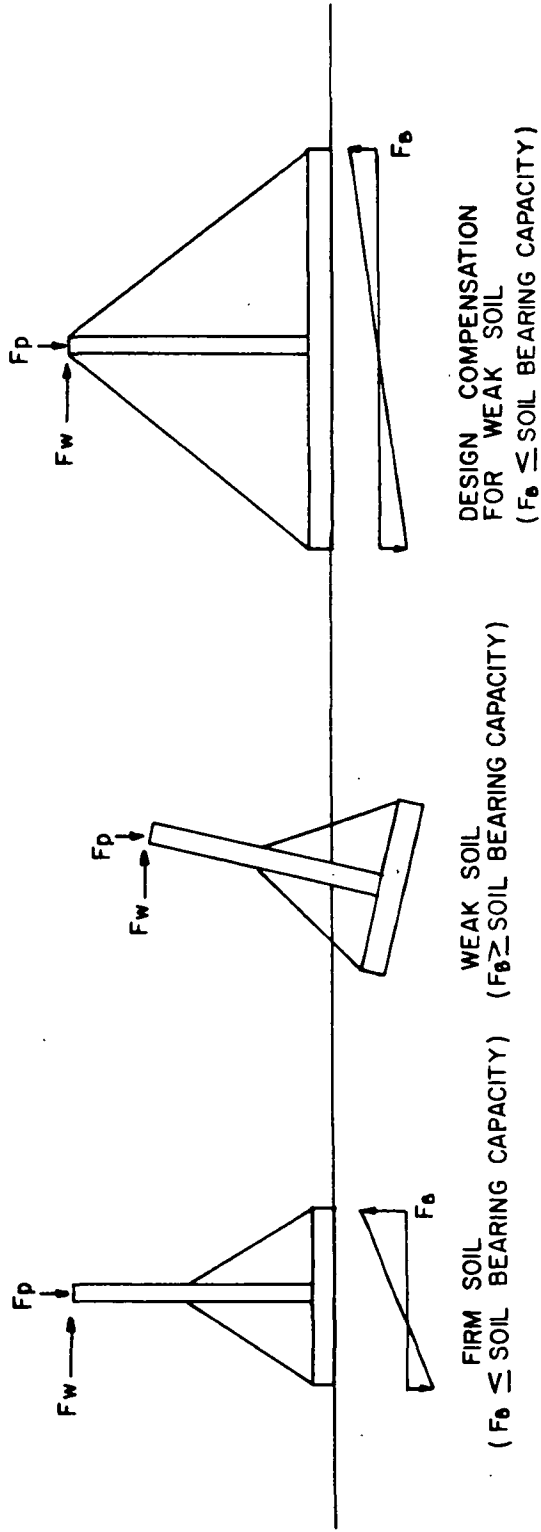

FIGURE 3.0.2 SOIL CONDITIONS VS. TOWER BASE

### 3.1.1 Structural Configurations

BARDI considered five different support systems in the study. Four preliminary designs were developed using the conditions of the prime site (162 ft. - 49 m - water depth) as design criteria. The support systems considered are shown in Table 3.1.1.

#### 3.1.1.1 Submerged Buoyant Platform

The submerged buoyant platform design employs buoyancy tanks to support tower structures. Two panels can be supported by the taut line between towers. The towers, supported by buoyancy tanks can be anchored with cables to either dead weight anchors or to piled anchors in the seabed as shown in Figure 3.1.1.

Since the tower structure does not extend to the mudline, the resulting shear and overturning moments in the tower are reduced. Further reduction of the tower member sizes can be achieved by connecting the top of the tower to anchors with additional cables as shown in Figure 3.1.1.

TABLE 3.1.1 SUPPORT SYSTEMS

SUPPORT CONFIGURATION	RECEIVER TYPE
SUBMERGED BUOYANT	PANELS
PILED STRUCTURE	PANELS
PILED GUY TOWER	PANELS
GRAVITY STRUCTURE	PANELS
PILED GUYED TOWERS	IMAGE DIPOLES

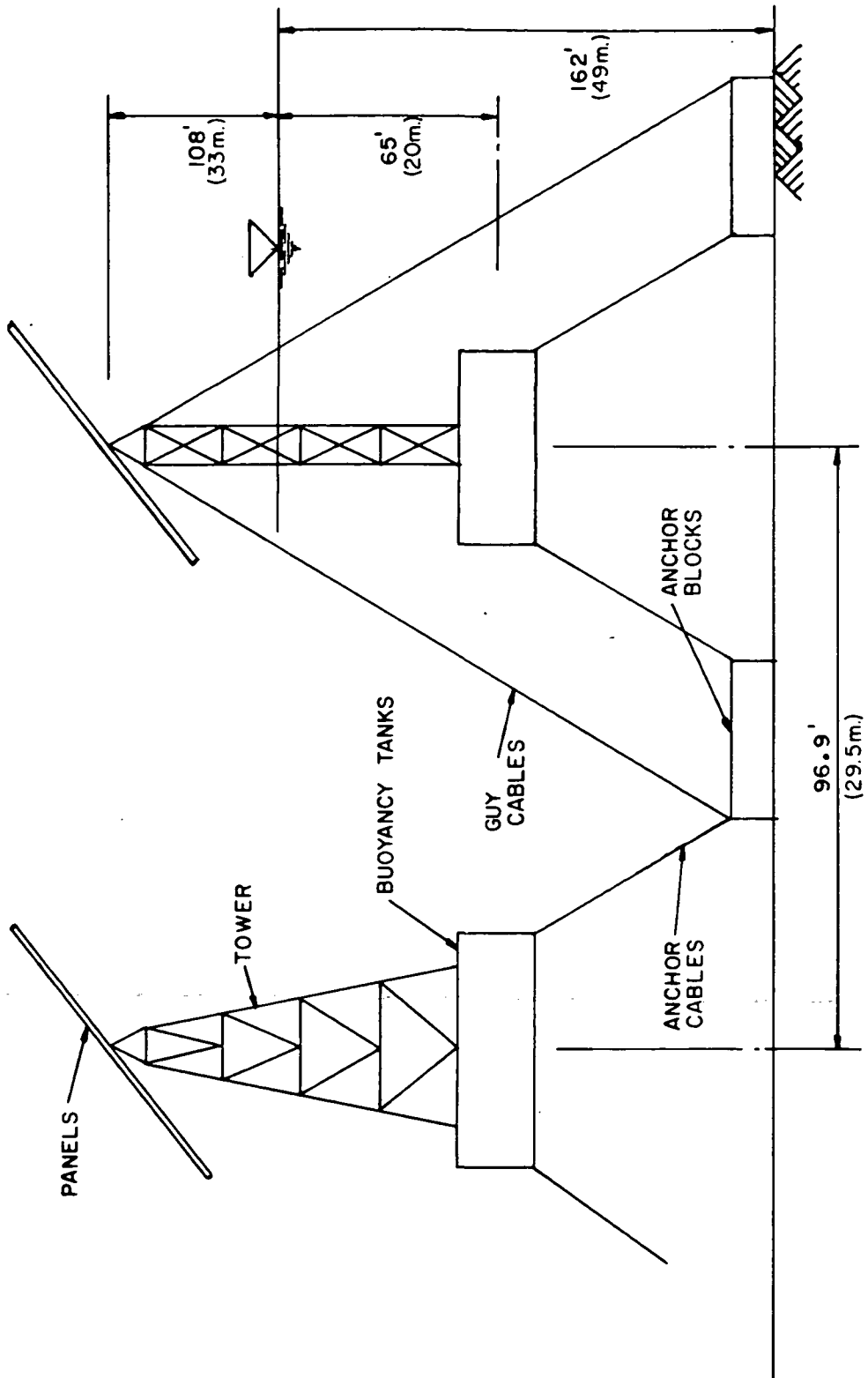

FIGURE 3.1.1 SUBMERGED BUOYANT PLATFORMS

Preliminary studies indicate that five tanks 8 feet in diameter are needed to support the tower and the panels. In the case of using guys at the top of the tower, the tower may consist of a single pipe of 36 inches (91.4 cm.) in diameter.

#### 3.1.1.2 Piled Platforms

A design employing a standard, jacket type offshore platforms forms a basis for comparison of other systems. When a jacket structure is installed, piles are driven through the legs to fix the structure to the sea bed. The jacket transfers the wind and wave loads and the panel weight to the piles as shown in Figure 3.1.2. The jackets can be spaced in rows, 96.9 feet (29.5 m.) apart and 530 feet (161 m.) apart along the taut line. Each tower is designed to carry the load of four panels.

Preliminary sizing of four legged fixed platforms yields 48 inch (122 cm.) diameter legs with 46 inch (117 cm.) diameter piles and 24 inch (61 cm.) diameter braces. (penetrating 100 feet (30.5 m.) below the mudline).

#### 3.1.1.3 Piled Guyed Tower Supporting Panels

A piled guyed tower system uses the guys to resist part of the lateral loads. Thus a lighter structure is obtained.

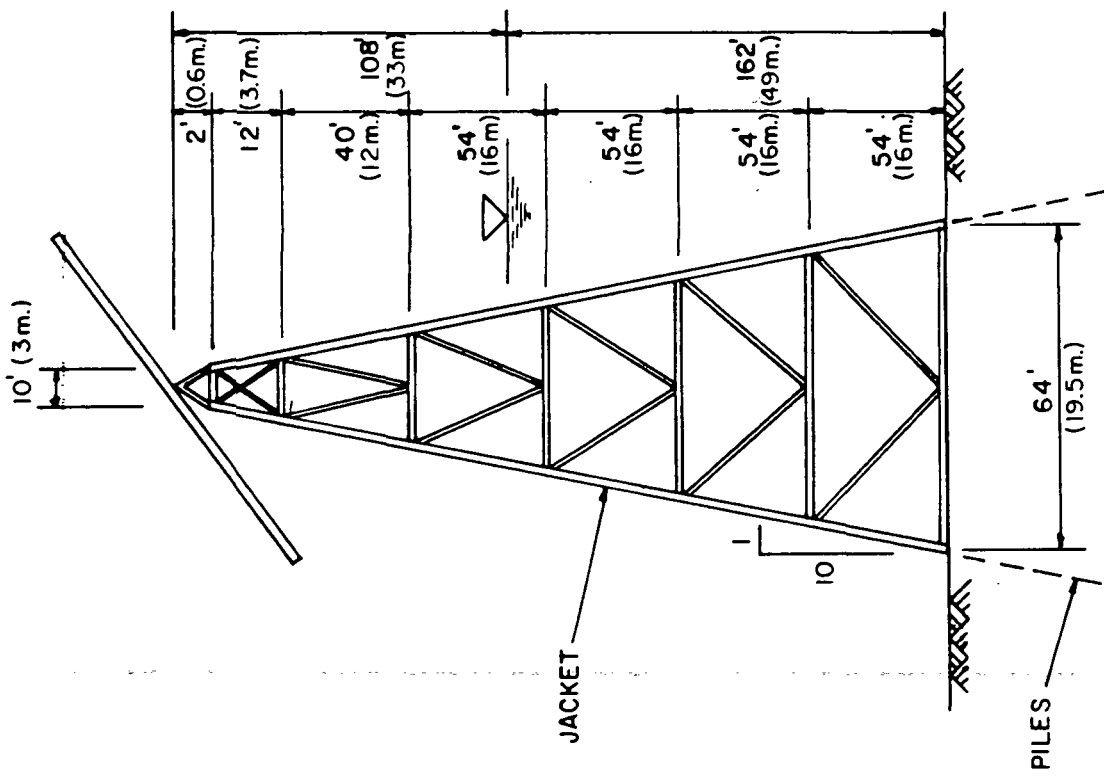

**PILED JACKET TYPE OFFSHORE PLATFORM**

**FIGURE 3.1.2.**



Each guyed tower in the BARDI design concept supported four panels. The tower is supported on four piles driven through the tower leg. Wind loads are resisted by guy cables which extend from the top of one tower to the bases of the neighboring towers as shown in Figure 3.1.3.

The guy cables are prestressed to 750 kips (3333 kn) to keep them in tension under all loading conditions. The piles are designed to withstand the pull-out loads coming from the cables which are partly compensated by the weights acting on the platform.

Preliminary designs were done for water depths of 162 feet (49 m.) 101.5 feet (31 m.) and 75 feet (23 m.). 162 foot (49 m.) water depth structure was checked against different load conditions with proprietary BARDI computer program.

Preliminary sizing of the Guyed Tower Structure results in 26 inch (66 cm.) diameter legs with a 0.5 inch (1.3 cm.) wall thickness. The horizontal and diagonal bracing are 16 inches (41 cm.) in diameter with a one inch wall thickness and 112 feet (34 m.) penetration.

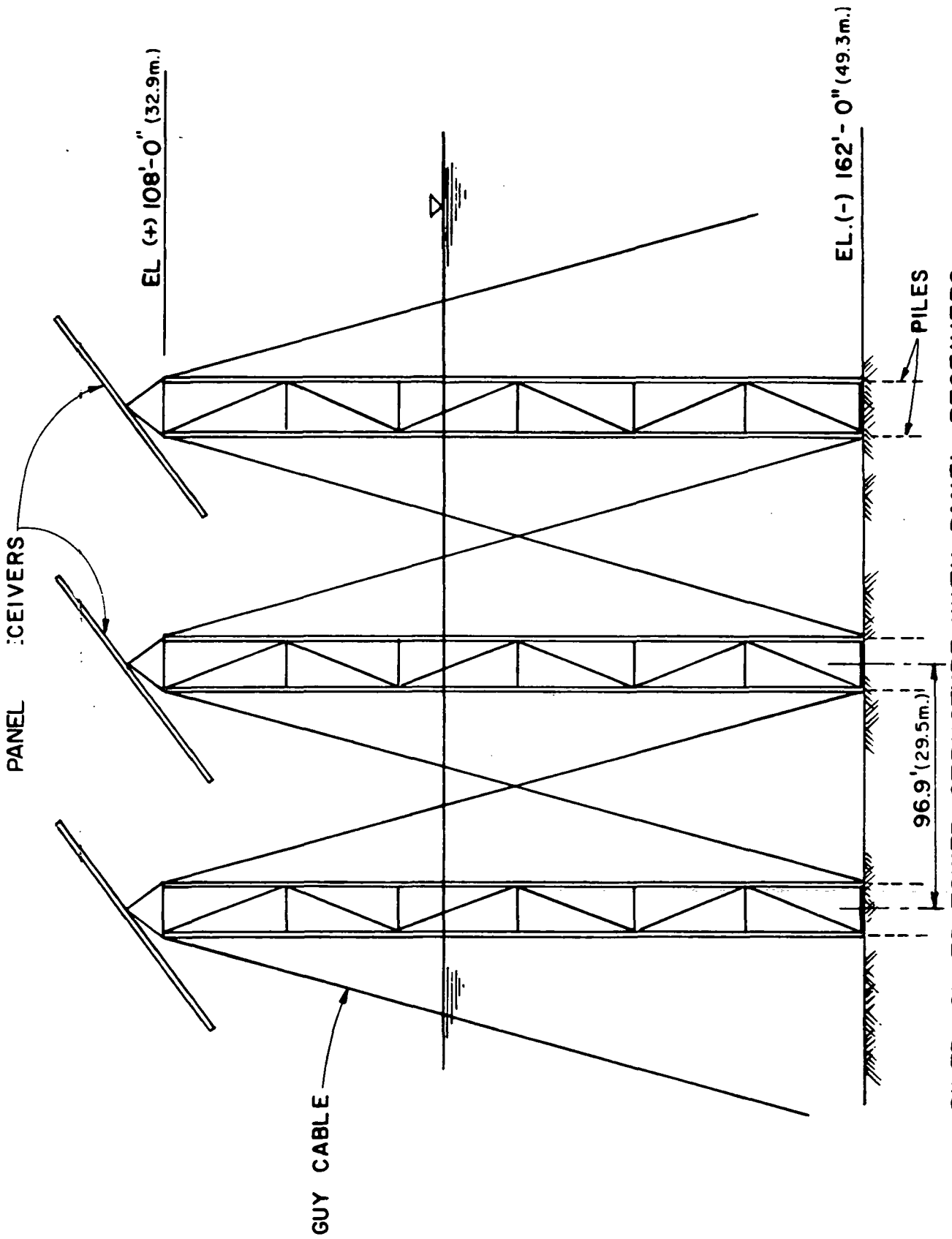

PILED GUYED TOWER STRUCTURE WITH PANEL RECEIVERS  
 FIGURE 3.1.3

For the prime site and for the design considered in this study, the guyed tower design is the most economical support system for the panel-rectenna configuration. Improved bottom soil conditions and/or sheltered water could render gravity platforms more economical.

#### 3.1.1.4 Gravity Platforms

Gravity platforms are considered because of the ease and thus cost of installation and their suitability for shallow water.

Initially a heavy platform was considered to resist all wind and wave loads. The platform base transferred the loads and overturning moments to the soil. For the given site (162 feet - 49 m - water depth) the combination of wind and wave forces resulted in an expensive, heavy platform.

To eliminate the large base, a guyed gravity platform was considered as shown in Figure 3.1.4. Guy wires connected to the top of platform, transfer the wind forces directly to the base and thereby eliminate the need for heavy legs and bracing of the platform.

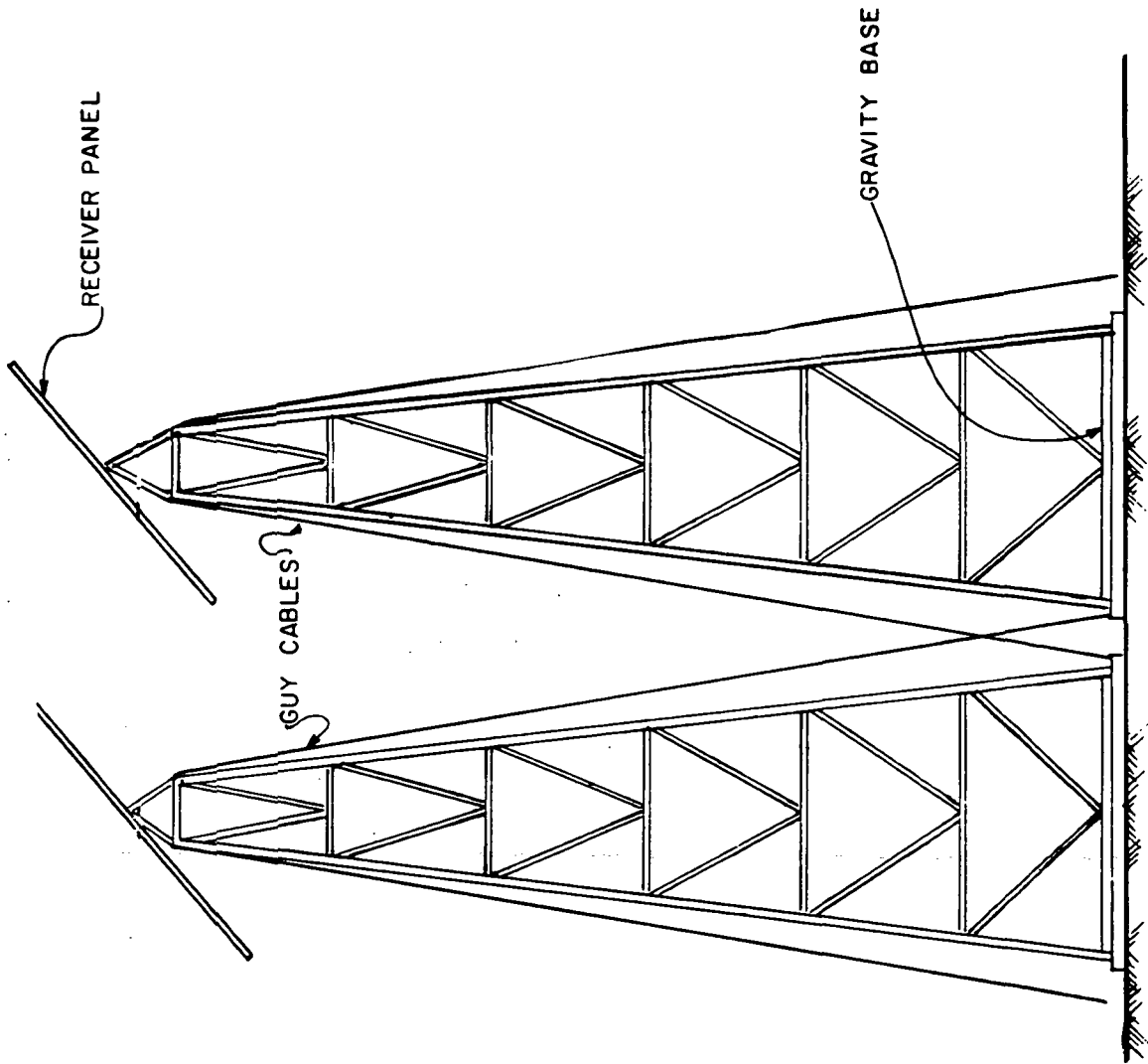

FIGURE 3.1-4 GRAVITY PLATFORMS

The base is a rectangular box (95 ft. x 50 ft. x 5 ft.) (19 m. x 15 m. x 1.5 m.) to accommodate the larger wind loads in the direction perpendicular to the panel lengths. Structurally the base works like a box girder with 1/2 inch - 1.2 cm. - plates for the flanges and webs.

Preliminary sizing of the gravity platform results in 26 inch (66 cm.) diameter legs and 16 inch (41 cm.) diameter braces. The guy cables are connected to the base of the neighboring platform. The high strength steel guy cables which are pre-tensioned to 750 kips (333 KN) are 4 inches (10 cm.) in diameter.

#### 3.1.1.5 Piled Guyed Tower With Image Dipoles

The high cost of the four support systems discussed in Sections 3.1.1.1 through 3.1.1.5 led to the search for a new microwave receiver configuration with fewer supporting platforms.

In this system instead of using fixed panels, image dipoles supported by wires are used to collect microwaves as shown in Figure 3.1.5. A net of cables stretching over an area of 1000 feet (305 m.) by 1000 feet (305 m.) is supported by platforms at the corners. The outer cables are pretensioned every 2000 (610 m.) feet. The towers resist the weight of the

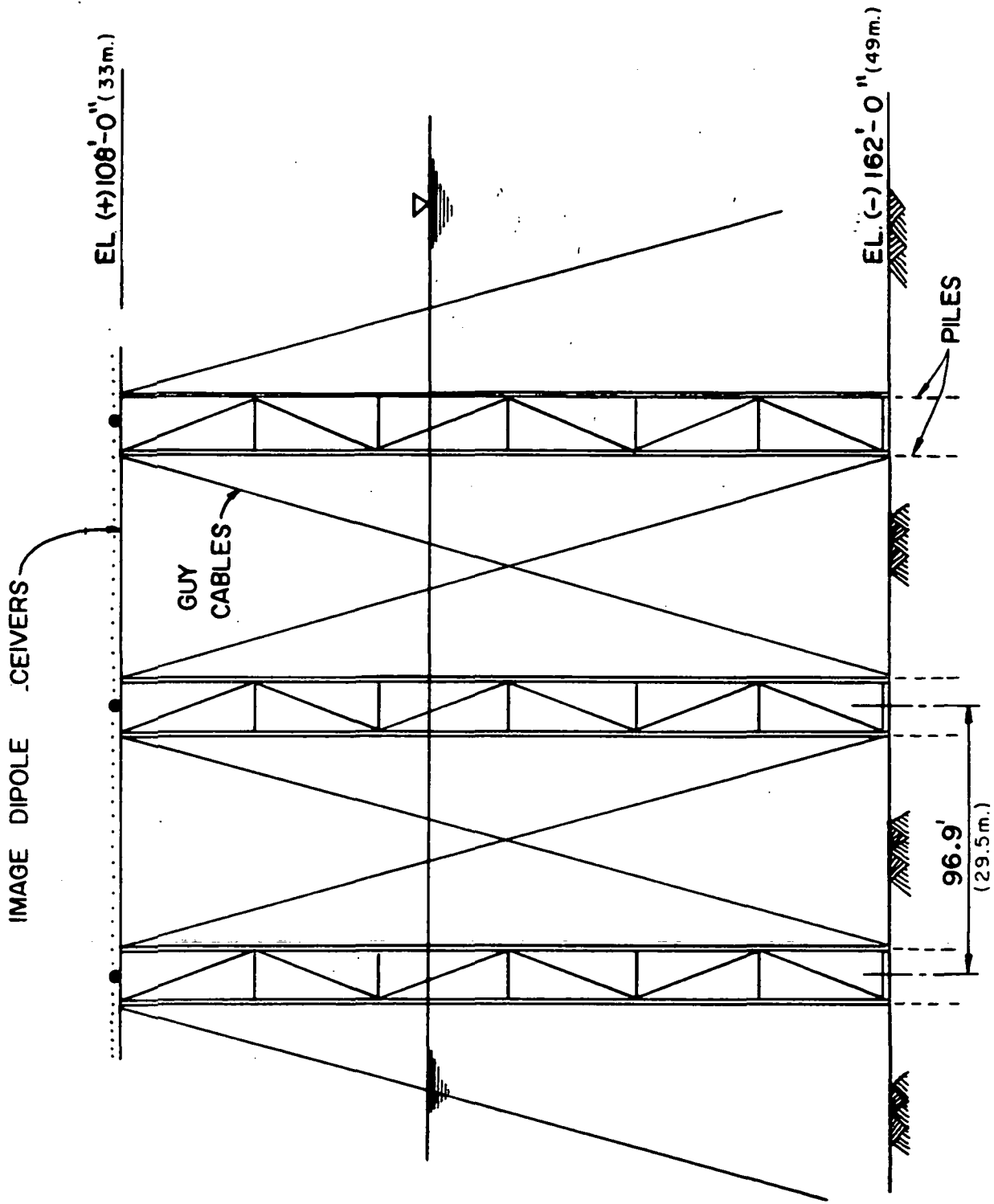

PILED GUYED TOWER STRUCTURE WITH DIPOLE RECEIVERS

FIG 3.1.5

supporting wires, the wave forces and the components of the tensioning force in the cables.

The towers will be guyed as in the guyed tower configuration. The piles will resist the dynamic uplift forces coming from the cables (the static forces are self equilibrating), the vertical component of cable forces at the top and the overturning moments due to waves.

The supporting net for the dipoles consists of 3 inch diameter cable taut lines which join the four towers at the corners of a 1000 feet (305 m.) by 1000 feet (305 m.) module. The taut line will support 1/4 inch diameter cables which are laid across. At every 100 feet (30.5 m.) the taut line will need to be pretensioned to approximately 250 kips (111 kn). Similarly, 1/4 inch (0.64 cm.) cable will need tensioning of approximately 1 to 1.5 kips (4-5 kN).

Preliminary sizing of the net is based on the assumption that the flexible diode panels will be designed so that no snow will accumulate on panels to cause significant loads.

### 3.1.2 Materials

In all support systems considered, platforms or towers will be made of A-36 type of steel. A-36 steel will also be used for buoyancy tanks and piles.

The guy cables for the towers will be made of high strength steel wires with a minimum breaking strength of 200 kips per square inch ( $1.4 \text{ kN/mm}^2$ ). Similar strength steel cables will be used for the net support system of the flexible image dipole receivers.

### 3.1.3 Fabrication Installation and Maintenance

Fabrication, installation and maintenance for all the support systems considered are within the present state of the art.

Installation of gravity platforms will be easier than the installation at guyed towers or piled structures since time for driving the piles is eliminated.

The deployment, installation and maintenance of a guyed tower structure is discussed in detail in Sections 5.2, 5.3, 6.2, and 6.3.

### 3.1.4 Design Evaluations

The submerged buoyant platform is the lightest of the support system configurations considered. In fact, when guyed at the top, it can consist of a single pipe section. The weights acting



on the platform require the use of large buoyancy tanks which are nearly twice as expensive to fabricate as jacket structures. Thus, the resulting total cost of a submerged buoyant platform is higher than for a guyed tower structure.

The dynamic behavior of such a structure warrants a model study since little information and experience is available at present. The practicality of such a flexible system should be investigated before substantial further effort is expended.

At the prime site, the total height of the piled structure is 280 feet (85.3 m.). A piled structure which resists the wind loads which act at the top and the current and wave forces along its length, result in the heaviest tower structure among all the systems studied. The high cost of fabrication is partly compensated by the ease in installation of the piled structure since there are no guy cables.

A guyed tower is a lightweight structure. Since wind loads are resisted by pretensioned guys, the tower is designed to withstand the weights and the wave loads only. Thus, slenderer sections are used in the tower. For example, tower jacket leg size is 26 inches (66 cm.) in diameter with 0.5 inches (1.2 cm.) wall thickness which compares with a jacket leg of 60 inches (152 cm.) in diameter with a one (1.0) inch (2.5 cm.) wall thickness in the case of the piled structure. The main disadvantages of a piled guyed tower structure are the following:

- The use of guy cables and their tensioning present additional installation work.
- The guy cables will restrict the access to the towers.
- Information with respect to the life cycle costs of underwater cables is limited.

The piled guyed tower configuration as a support system for panels or image dipoles is the least costly of the systems.

A gravity structure is the simplest to install of the support systems considered. There are no piles to be driven. Thus, on the average two days of installation work per platform are eliminated.

The main disadvantage of a gravity structure is the large size of the base. For the prime site, a gravity structure of 280 feet (85 m.) height requires a base which is 130 feet by 50 feet (40 m. x 15 m.). This is greater than the 96.9 feet (29.5 m.) spacing between the rows of platforms. The use of tensioned guyed wires reduces the base dimensions to 90 feet by 50 feet (27 m. by 15 m.), but even then the resulting fabrication costs for the base are comparatively uneconomic.

Gravity platforms may be competitive for shallower water in the 50 feet to 75 feet (15 to 23 m.) water depth range. Smaller bases may be obtained with concrete bases. Deployment and installation of such a structure will be more costly than for a steel base platform.

For the prime site, the guyed tower configuration is the preferred support system design.

## 3.2 RECEIVER PANEL AND TAUTLINE SYSTEMS

### 3.2.1 Structural Configurations

Receiver panel and tautline systems were developed to maintain structural integrity during severe environmental conditions. The following essential criteria were considered in formulating these configurations:

- . Static load support (for wind, snow, etc.)
- . Dynamic response (with wave frequencies).
- . Panel isolation from support structure movement.

Once these essential criteria were met, other parameters such as ease of fabrication and installation and cost were considered.

The receiver panel is a stiff plane supporting the diode and groundplane network. It is suspended between the support structures by a tautline system. To optimize microwave reception efficiency, the receiver panels were designed to encompass as large an active area as possible (reducing edge losses) and tilted  $47.4^\circ$  (in the prime site design) in order for the receiving elements to be normal to the microwave beam. The reception area contains 98,175 panels in the 10 kilometer by 14.77 kilometer reception area.

In one conceptual design the receiver panel is stiffly attached to a single mass pendulum, as illustrated in Figure 3.2.1. The pendulum serves as both a resistant mass to the environmental loads and as a dynamically tunable mechanism (as illustrated in Figure 3.2.2) to avoid resonance in the range of the wave periods. Two major problems exist with this configuration. The pendulum mass must be significantly larger than the panel mass (or the panel mass must essentially be at the pivot point) which results in increased material requirements including the pendulum mass and the extra structural material required to support its weight. The greater problem with this configuration is the required length of the pendulum arm which is necessary to attain a 25 second natural period (as described in Section 1.1). Using the period equation for small oscillations of a simple pendulum,  $T = 2\pi (L/g)^{1/2}$ , the required length of the pendulum arm is 508.8 feet (155.4 m.). This is too long to practically design an above water mass as shown in Figure 3.2.3. For a deep water location it may be possible to obtain the required length by submerging the pendulum mass as shown in Figure 3.2.4. In this configuration the wave and current forces on the arm and mass will cause motion and stress in the panels.

A second conceptual design configuration is the double mass pendulum concept which is illustrated in Figure 3.2.5. Both the dynamic and static models are illustrated in Figure 3.2.6. Static environment and dead loads are balanced considering the ratios between upper and lower panel areas and masses. The

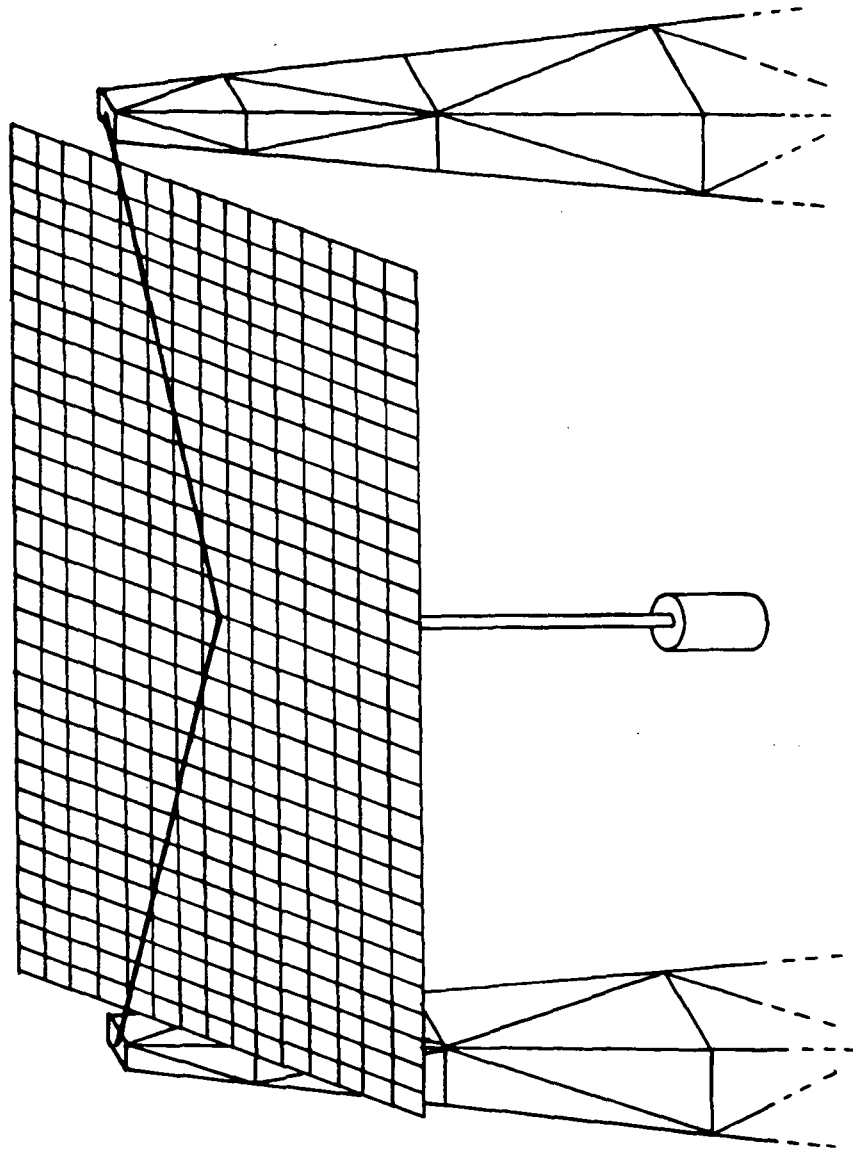

FIGURE 3.2.1 SINGLE MASS PENDULUM DESIGN

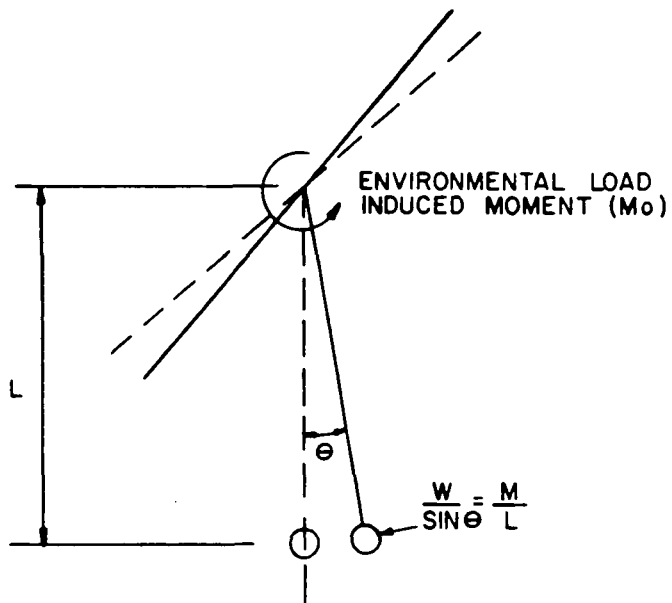
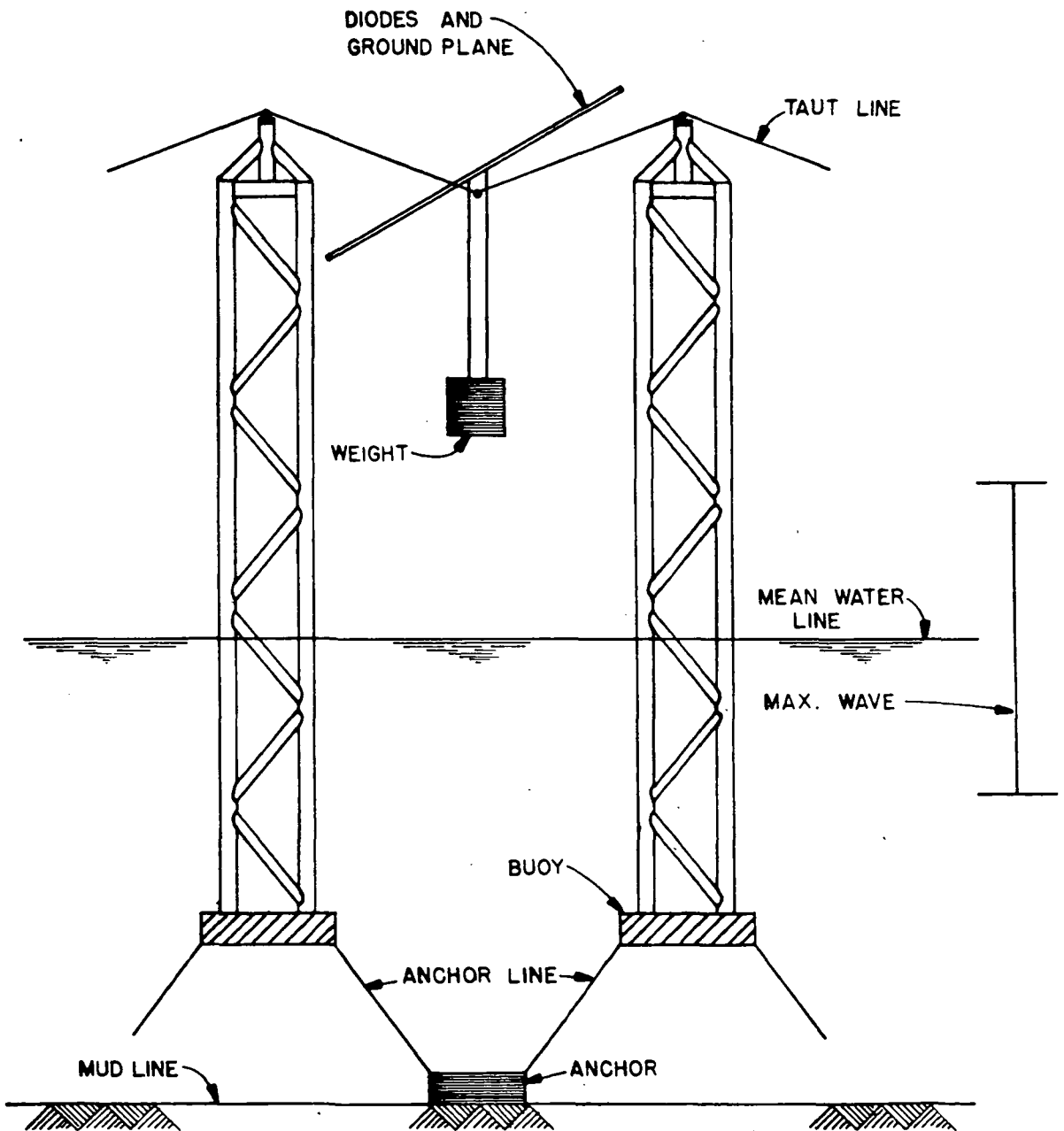

FIGURE 3.2.2 SINGLE MASS PENDULUM MODEL



**FIGURE 3.2.3 ABOVE M.W.L. SINGLE MASS PENDULUM SYSTEM**

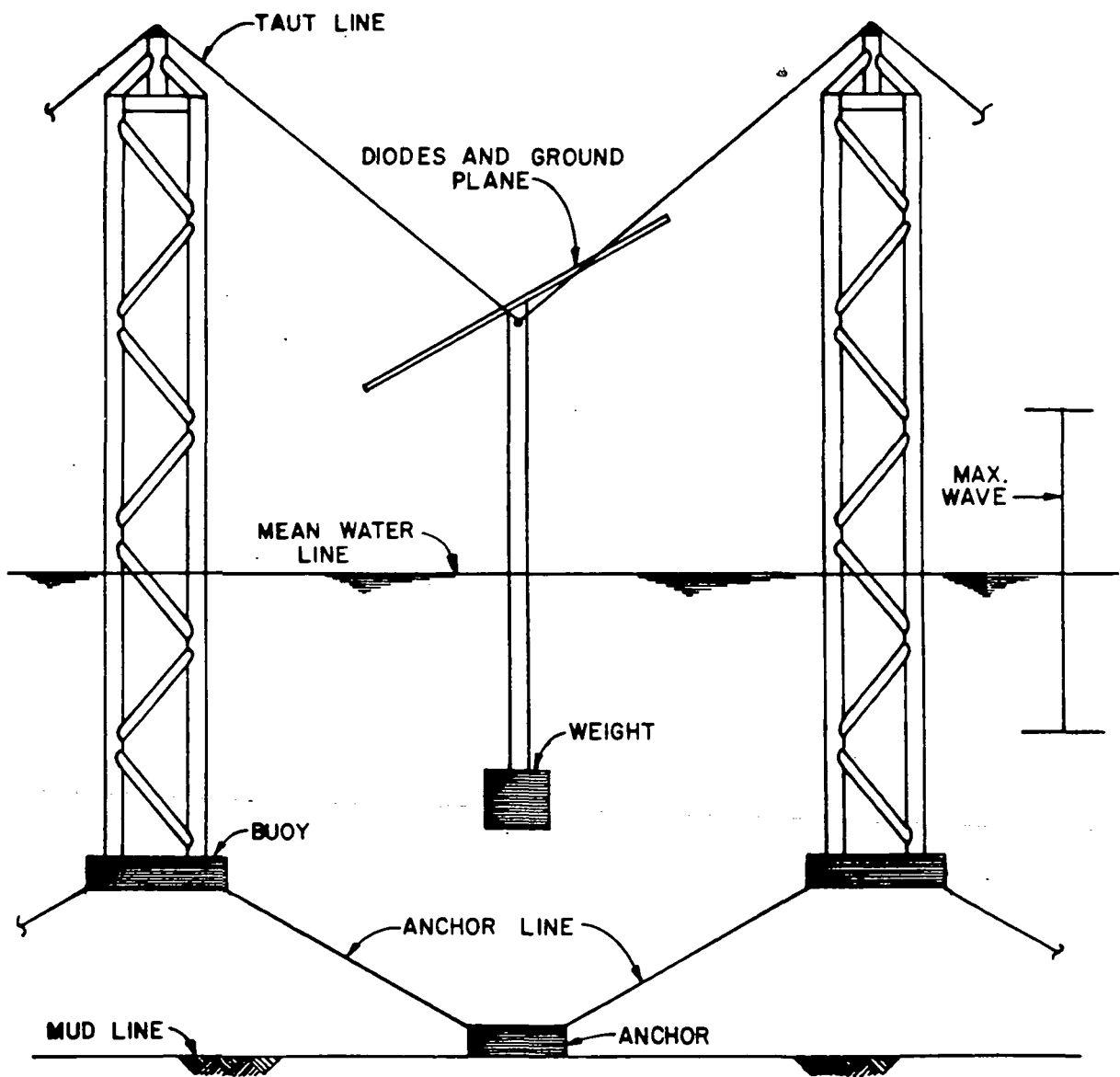

FIGURE 3.2.4 SUBMERGED SINGLE MASS PENDULUM SYSTEM



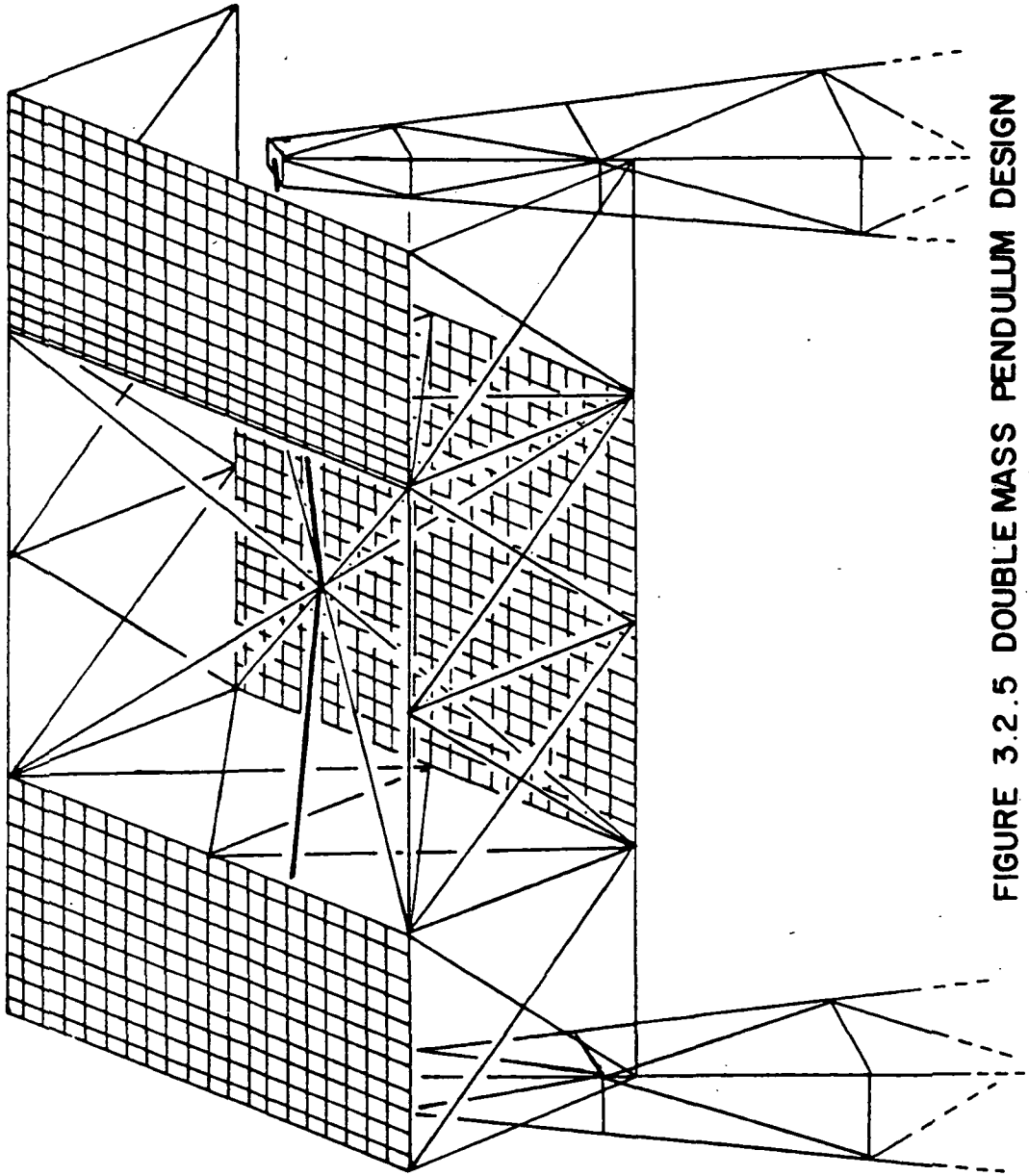
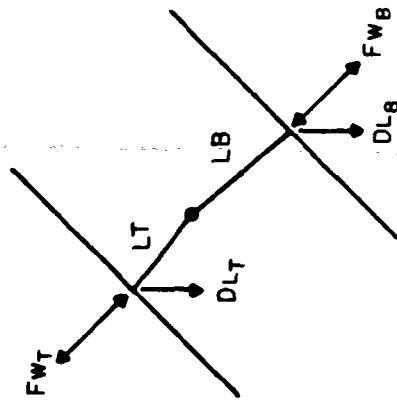
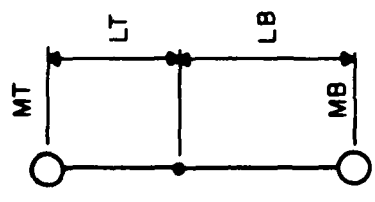

FIGURE 3.2.5 DOUBLE MASS PENDULUM DESIGN



STATIC MODEL



DYNAMIC MODEL  
 $T \geq 2.5$  seconds

FIGURE 3.2.6 DOUBLE MASS PENDULUM MODELS

dynamic model is a double mass pendulum. By adjusting the top and bottom panel mass, the pivot point, and the mass length ratios, the desired natural periods can be attained.

Within this concept various configuration possibilities exist. Figure 3.2.7 illustrates three of these possibilities. The first two (a and b) represent the extreme situations which are felt to encompass all others. The first configuration with the panels vertically aligned has good mass and area distribution about the pivot point. This results in less rotational sensitivity to eccentric loads on the panels. A drawback in this design is the large height required between panels which increases the support tower height and its material requirements. The second configuration with the panels horizontally aligned has contrasting properties to the first. There is minimal height between the panels (none) but there is poor mass and area distribution about the pivot point (i.e. the increase in panel moment arm about the pivot point makes the system sensitive to loads inducing rotation). The third configuration is a compromise between the first two with a significant installation advantage. The top and bottom panel edges are aligned with the microwave beam path which eliminates alignment concerns in the direction of the panels along a row (alignment normal to the panels must still be in this acceptable tolerances). This eases installation providing substructural savings on installation costs. Of the three designs, the third configuration (illustrated in Figure 3.2.7c) is considered to have the

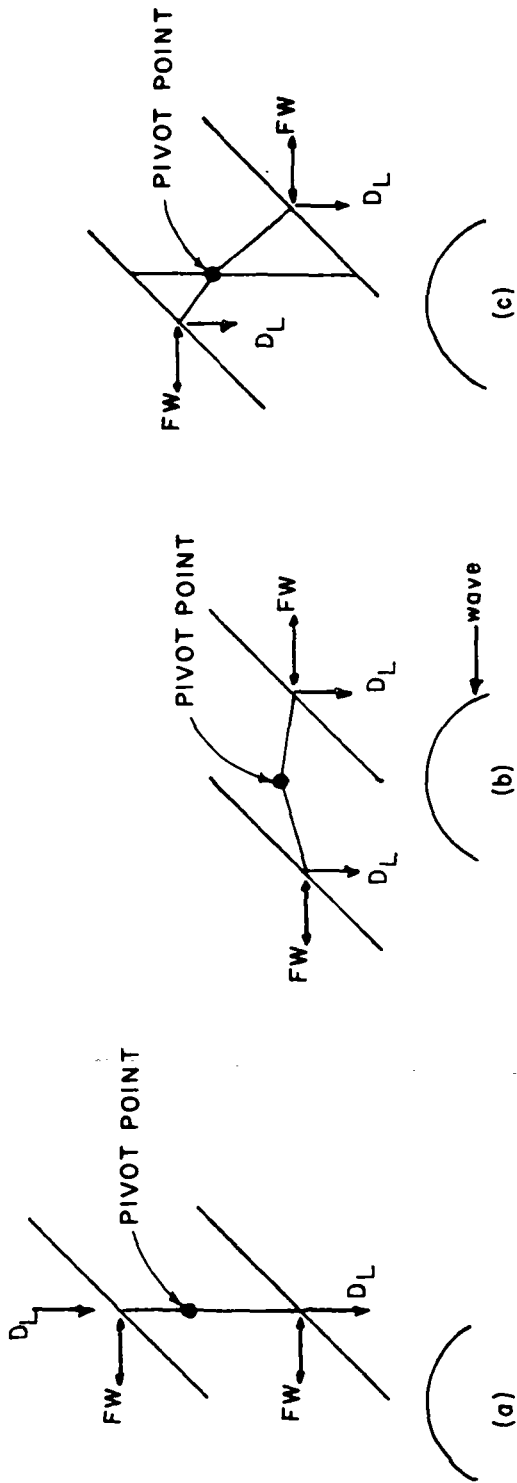

FIGURE 3.2.7 RECEIVER PANEL CONFIGURATIONS

greatest potential as far as performance and costs are concerned and its design is further evaluated in Section 3.2.3.

A prestressed tautline system is the only cost effective way found to support the panel arrangements considered because of the large span between towers. Two primary tautline designs were investigated. The principle difference in the tautline designs (Figures 3.2.8 and 3.2.5) is the pivot point location.

Figure 3.2.5 shows the pivot point centrally located above the lower panel. The panels are connected by cables to the main tautline. This cable is in the microwave path. Thus it is desirable to have a cable material which will not interfere significantly with microwave reception. From a structural and deployment standpoint, the central pivot point allows for large distances between towers (which is critical for reducing costs) because the cable alone supports the entire (tower to tower) span.

Each panel connects directly to the tautline and supports only the panel span. The deflection of the main tautline (which influences tower clearance and dynamics), the installation practicalities and costs are the primary limiting factors of this concept.

Figure 3.2.8 illustrates the tower pivot point location concept for a single panel span. This arrangement uses a composite panel

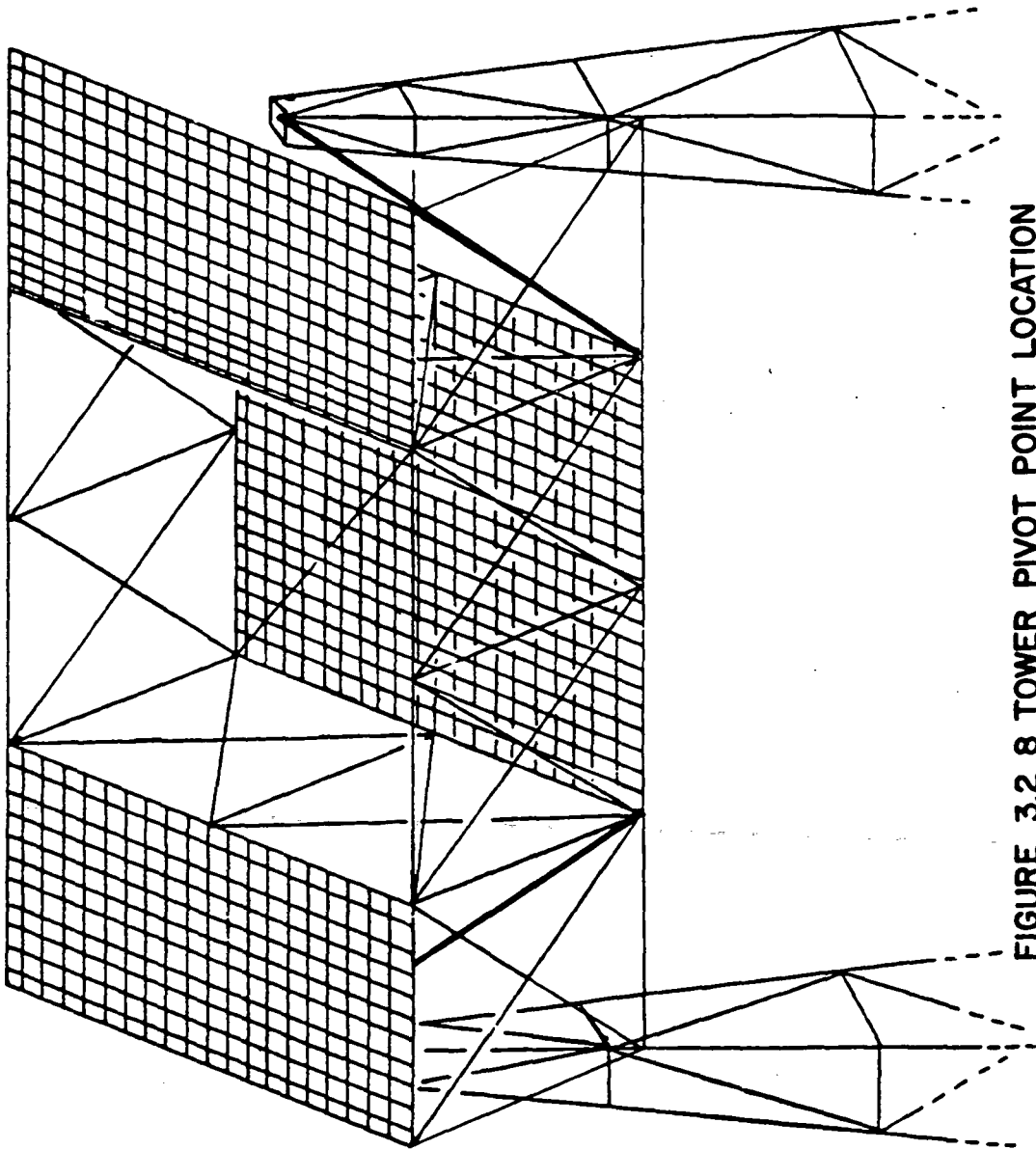

**FIGURE 3.2.8 TOWER PIVOT POINT LOCATION  
TAUTLINE DESIGN**

tautline support system between towers to eliminate the need for a cable system in the path of the microwaves. This reduces the material cost of the tautline dramatically (since steel may be used instead on an aramid fiber material). The dynamics of the double mass pendulum with the pivot point on the towers are more troublesome since the pendulum period changes with the movement of the support towers. This side to side movement of the tower (caused by waves) causes vertical motion of the panels due to varying tension in the tautlines. In turn, the distance from the center of mass of the panels to the pivot point (at the tower tops) changes causing the natural period of the pendulum to vary. This increases the dependency of the dynamic response of the panel system on the environment. A second and perhaps more significant problem is the panel span distance. The concept works easily for a single span (40 meters) between towers with a slight increase in structural material. When two or four panel spans are considered, the increase in panel material is substantial and uneconomical (e.g. an inefficient span truss). For these reasons the center pivot point design was chosen to be evaluated in greater detail.

### 3.2.2 Materials

Materials for various panel and tautline components were selected with consideration given to their specific structural function, performance in the offshore environment, availability in usable form in great quantities, and unit cost. The unit weight of the material will be considered only if a net cost

saving is realized. Environmental loadings such as wind and snow govern structural design, not material weight (e.g. the towers can quite easily support vertical loads but horizontal forces resulting from winds and wave cause bending in the structure and large uneven soils loadings). There is no justification for increasing panel and tautline material costs in order to decrease structural dead weight. Structural materials considered for the panels include fiberglass, aluminum, and steel. Future studies should again examine possible uses of fiberglass as structural members in the rectenna design, but considering present availability, fabrication techniques, and at sea experience, steel is the preferred material.

The member sizes required are large due to the unsupported length of the panels. To reduce the panel size increases costs significantly. Fiberglass efficiency as a compression member is limited, which considering of the load reversals makes fiberglass unsuitable for use as truss members.

Aluminum has performed well in the marine environment when it is above the splash zone. One area of cost savings exists in the area of corrosion protection. All aluminum alloys are protected from corrosion by a thin, dense, inert film of aluminum oxide. Thus, the painting of aluminum is unnecessary. Corrosion of aluminum is a problem when other metals are used in combination with it (e.g. steel washers and nuts used to connect aluminum parts). This corrosion is twofold in that due to the contact of



the dissimilar metals, crevice corrosion (due to stress) and electrical corrosion (due to the comparative electrical properties of the attached metals) will eat away the aluminum locally. Corrosion resulting from this type of situation can be extensive, especially if steel or copper bearing metals are involved, and can lead to failure. Attention to details can readily overcome problems of this nature. The dissimilar metal couple should be avoided by using all aluminum materials or by placing only passive materials such as stress corrosion resistant stainless steels in contact with aluminum. The crevice occurrence can be avoided through careful design use of non-wickup gaskets, and use of resilient sealants.

By using aluminum alloys for primary structural elements, a weight savings of at least 50 percent can be realized over steel. Yet the overriding problems with aluminum are its cost in dollars and energy consumption (in production) and unavailability of high strength alloys in quantity (if the need exists in the design). As weight again does not seem to be critical, aluminum will be considered used only for the ground plane and not for structural members in the support structure.

Steel is the preferred structural material to use in the fabrication of the panels. Steel is susceptible to corrosion in the marine environment, but a protective coating of the structure in the splash coupled with a state-of-the-art cathodic protection system can achieve the desired 30 year design life.

During design, attention paid to details and elimination of areas of possible water collection and ponding will aid in corrosion protection. Steel is a heavy material (490 pcf or 7849 kg/m<sup>3</sup>), yet it can easily be managed during installation with moderate present day lift capacities. Steel availability is good with a proven offshore applications history. The present design employs A36 steel but the weight can be reduced using various high strength steels (e.g. if 50 ksi - 344 N/mm<sup>2</sup> steel at a 10% cost increase is used more than 13% of steel by weight is saved).

The preferred tautline material is steel cable for cost and termination schemes presently available. This may not be acceptable in areas exposed to the microwaves. In such cases, other materials such as polyethylene, nylon and kevlar which are less affected by the microwaves but are substantially more expensive may be used.

Kevlar (an aramid fiber) can withstand the high tensile stress in the line with the low deflection required (necessary for tower clearance and avoiding dynamic resonance with sea waves). Kevlar 29 (or Kevlar 49 which has a higher modulus) meets the strength and elongation requirements and has been tested for retention of its original properties when exposed to the marine environment, ultra-violet rays, and fluctuating loads (fatigue and creep overtime) and approaches the properties of steel in some cases. Technology is proceeding in developing suitable

terminations for Kevlar cable but presently, abrasion resistance (which is the basis for many steel cable terminations) is the limiting factor. Kevlar is expensive (approximately \$300 per foot for the tautline strength required), even when projecting reduced costs when manufacturing huge quantities.

### 3.2.3 Fabrication, Installation and Maintenance

Fabrication, installation and maintenance of receiver panel and tautline systems is discussed in Sections 5.2 and 5.3.

### 3.2.4 Design Evaluation

The prime site receiver panel and tautline design were evaluated in this section. Costs and support systems designs are based on this receiver panel and tautline configuration. Refer to Appendix B for all calculations concerning receiver panel and tautline design.

#### 3.2.4.1 Receiver Panel

Figure 3.2.5 illustrates the point design evaluated for the prime site. The design winds are as follows:

Hurricane wind velocity = 110 mph (49.2 m/sec).

Winter storm wind velocity = 70 mph (31.3 m/sec).

The design assumptions include:

- . Panel will resist normal and tangential wind forces (due to panel makeup of small tubular members).
- . Wind will act uniformly over panel area.
- . Wind velocity remains constant with elevation.

- . A 57% reduction in wind force, according to the DNV code, will exist on interior panels due to the shielding effects of the exterior panels (pertains to tautline and tower design only).
- . The panels are 65% opaque to winds during hurricane conditions and 100% opaque (iced over) during the design winter storm.
- . One panel area is 65.6 by 131.2 feet (20 by 40 m).

The design snow and ice loads are as follows:

Snow load = 13.6 psf (65.9 kg/m<sup>2</sup>).

Ice load = 2.4 psf (11.6 kg/m<sup>2</sup>).

Snow and ice loads are assumed to be uniformly distributed over the entire panel (snow drifts are not considered).

The design dead load of the receiving elements is:

Ground plane and diode dead load = 4.6 psi

(22.3 kg/m<sup>2</sup>).

Panel structural members were sized considering critical static loadings. The following assumptions were used in sizing members:

- . Members are of A36 or A572 GR.50 steel

- . Dynamic mass ratios and the pivot point location are not taken into account (panel period tuning does not effect panel structural make-up appreciably).
- . Installation and transportation loads were not considered critical for the conceptual designs performed but would have to be considered in a final design.

The members were sized using conservative assumptions without taking into account the panel structure acting as a system to redistribute stresses. Figure 3.2.9 and Table 3.2.1 show the final results of this analysis. For all analyses a 90,000 pound (400 KN) panel weight was assumed. As shown in Table 3.2.1, a weight of 114,211 pounds (508 KN) was in fact attained after the member analysis was performed. This weight difference is not critical because of the conservatism employed in the analysis (if a computer analysis of the structure were performed the structural weight would probably reduce to nearly 90000 pounds - 400 kN) and the general insensitivity of design concerning panel weight.

#### PANEL DYNAMIC ANALYSIS

The panel configuration, consisting of one or two panels per tower, will act dynamically as a double

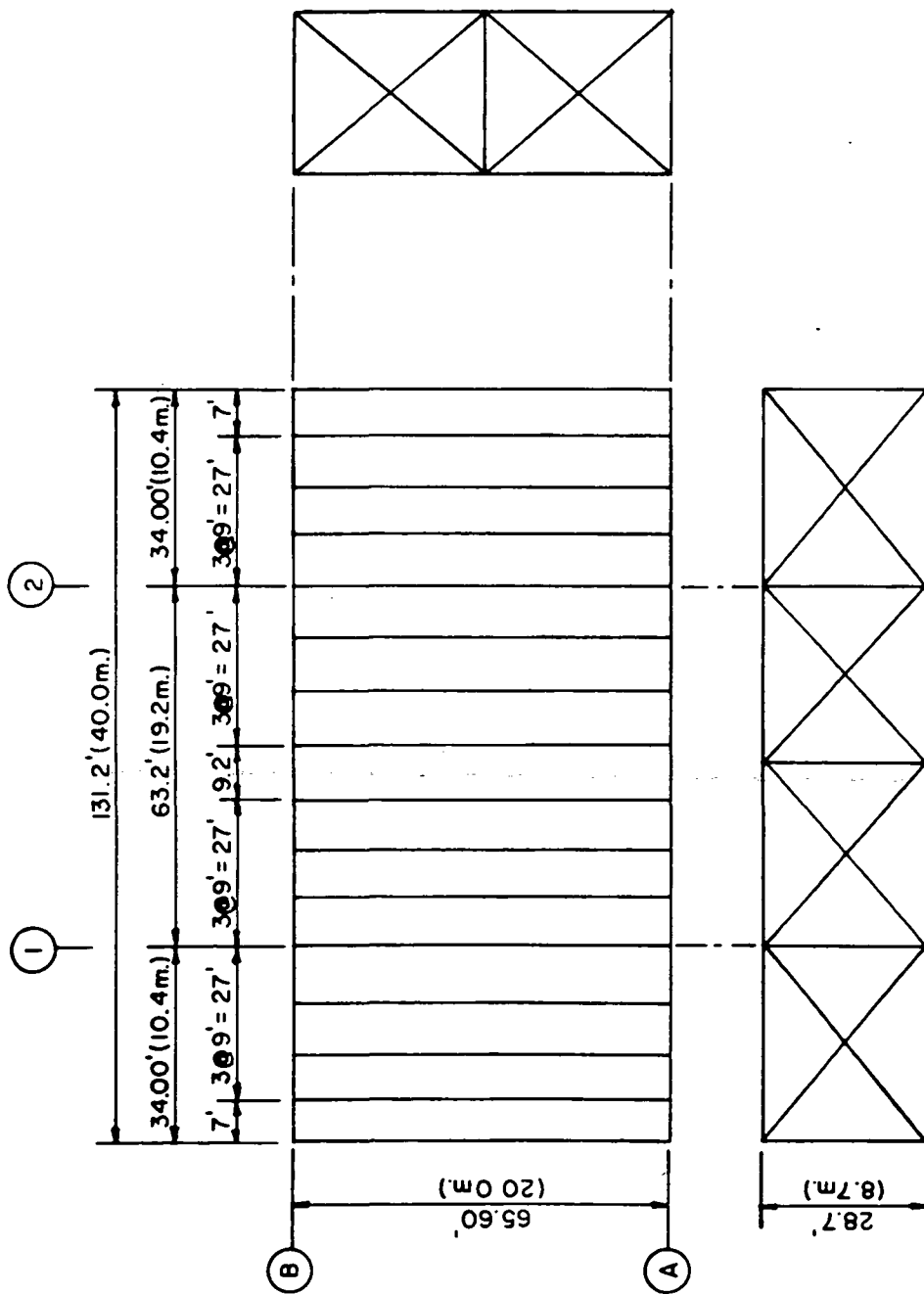

FIGURE 3.2.9 RECEIVER PANEL STRUCTURAL CONFIGURATION

MEMBER DESCRIPTION	YIELD STRENGTH KSI (N/MM <sup>2</sup> )	#1FT (N/M)	LENGTH REQ. FT (M.)	WEIGHT REQ. # (KN)
JOIST GIRDER	50 (344)	21.0 (306.4)	918.4 (279.9)	19286 (85.8)
LONG DIRECT LOAD BEARING GIRDER	50 (344)	129.3 (1886.9)	262.4 (80.0)	33928 (151.0)
NON DIRECT LOAD BEARING GIRDER	36 (248)	68.0 (992.3)	524.8 (160.0)	35686 (158.8)
DIAGONALS & VERTICALS	36 (248)	19.0 (277.3)	1271.4 (387.5)	24157 (107.5)
COLUMNS (AT CABLE SUPPORTS)	36 (248)	28.5 (415.9)	124.4 (37.9)	3545 (15.8)
				116602 (518.9)

PANEL STRUCTURAL WEIGHT

TABLE 3.2-1

mass pendulum. For a larger panel to tower ratio a more detailed examination of the tautline slope effect on the panel (integral to its performance as a pendulum) pivot point location should be undertaken. A natural period of at least 25 seconds must be attained in the design of this system in order to minimize movement induced by wave action. Only the first mode of vibration has been considered. Assumptions employed in the panel dynamic analysis are:

- . All mass is lumped at the center of mass of the panels.
- . Panels are rigidly connected to the pivot point.
- . Pivot point is free to rotate with no damping.

The natural period of the receiver panel structure dictates the distance between top and bottom panel parts, the pivot point location, and the panel mass ratios (top to bottom). Figure 3.2.10a illustrates the relationship between the pivot point to panel center of mass distance and the panel mass ratios. The choice of 1.03 as the LB/LT and MB/MT ratios gives a design and fabrication tolerance allowance on either side, while retaining a reasonable distance between top and bottom panels. It will be possible to actually tune the panel response after fabrication, if necessary, by adjusting the panel masses. Figure 3.2.10b illustrates this mass versus period relationships.



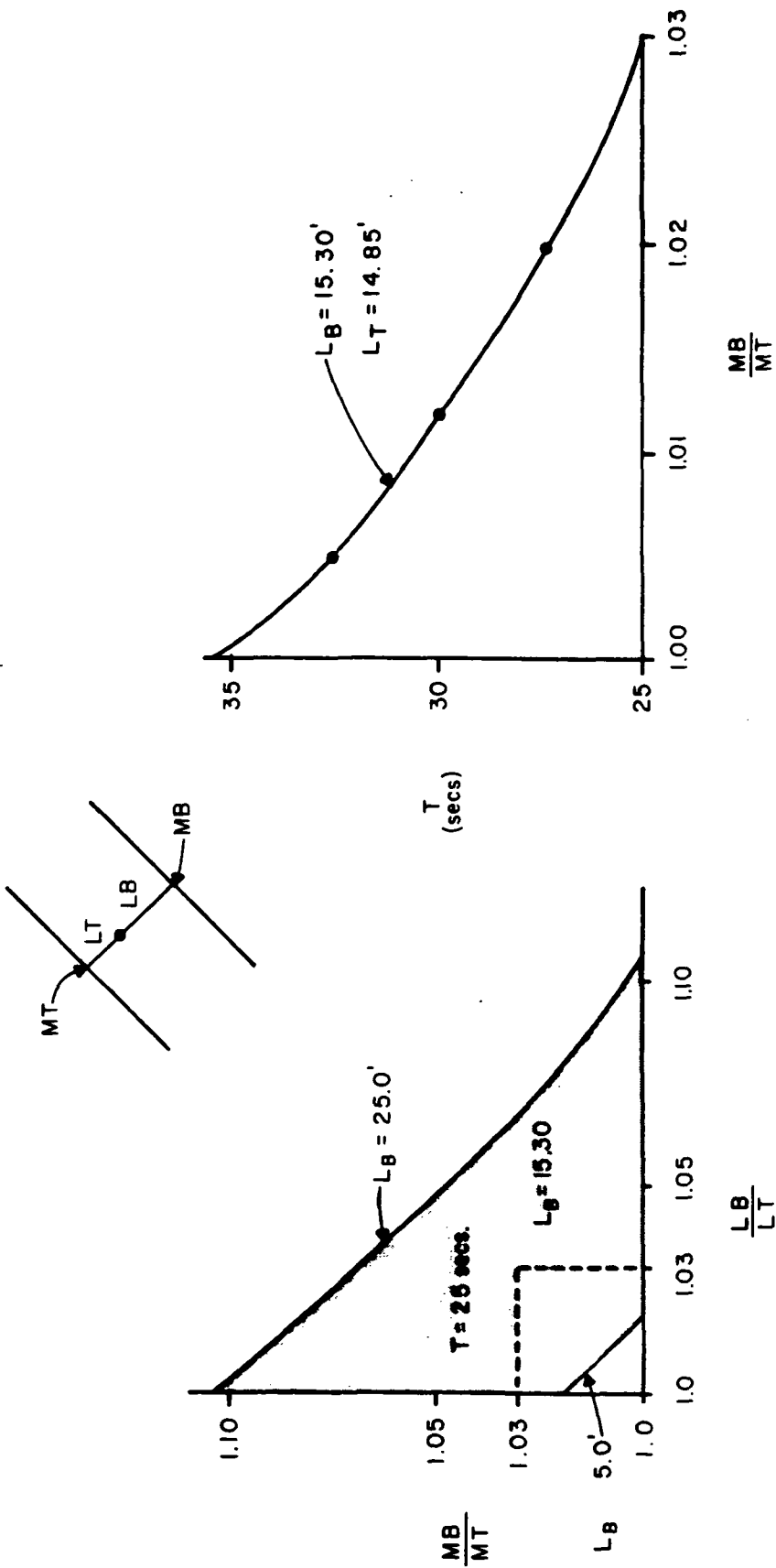

DYNAMIC CONDITION  
 MASS VS. PENDULUM ARM LENGTH  
 RATIOS (a)

DYNAMIC CONDITION  
 PERIOD VS MASS RATIO  
 (b)

FIGURE 3.2.10

The pivot point location is critical to static equilibrium and to the dynamic response. It is a function of the upper and lower panel ratios of area, mass, and distance to panel center of mass as shown in Figure 3.2.11. The panels must be in static equilibrium under the assumed loadings and the dynamic response must be within acceptable bounds of reception performance and materials limitations. Area loadings (wind, snow, and ice) are applied at the geometric and center of panels. While balancing these loads, the panel masses (or dead weight) must be balanced yet the center of mass can be adjusted to act at any necessary location on the panel. This will be done by adjusting the structural steel location (i.e. top and bottom panels structural member layout will not be identical) or by adding small masses (e.g. concrete weights). In taking all these variables into account, Figure 3.2.12 shows the pivot point location in the design being considered.

#### 3.2.4.2 Tautline

The static and dynamic models for the single panel span tautline are shown in Figure 3.2.13. Tautline tensile strength, deflection, and dynamic response requirements were determined. It was concluded that a 9 inch (0.23 m) diameter Kevlar cable would be required. This includes a factor of safety of 4 which

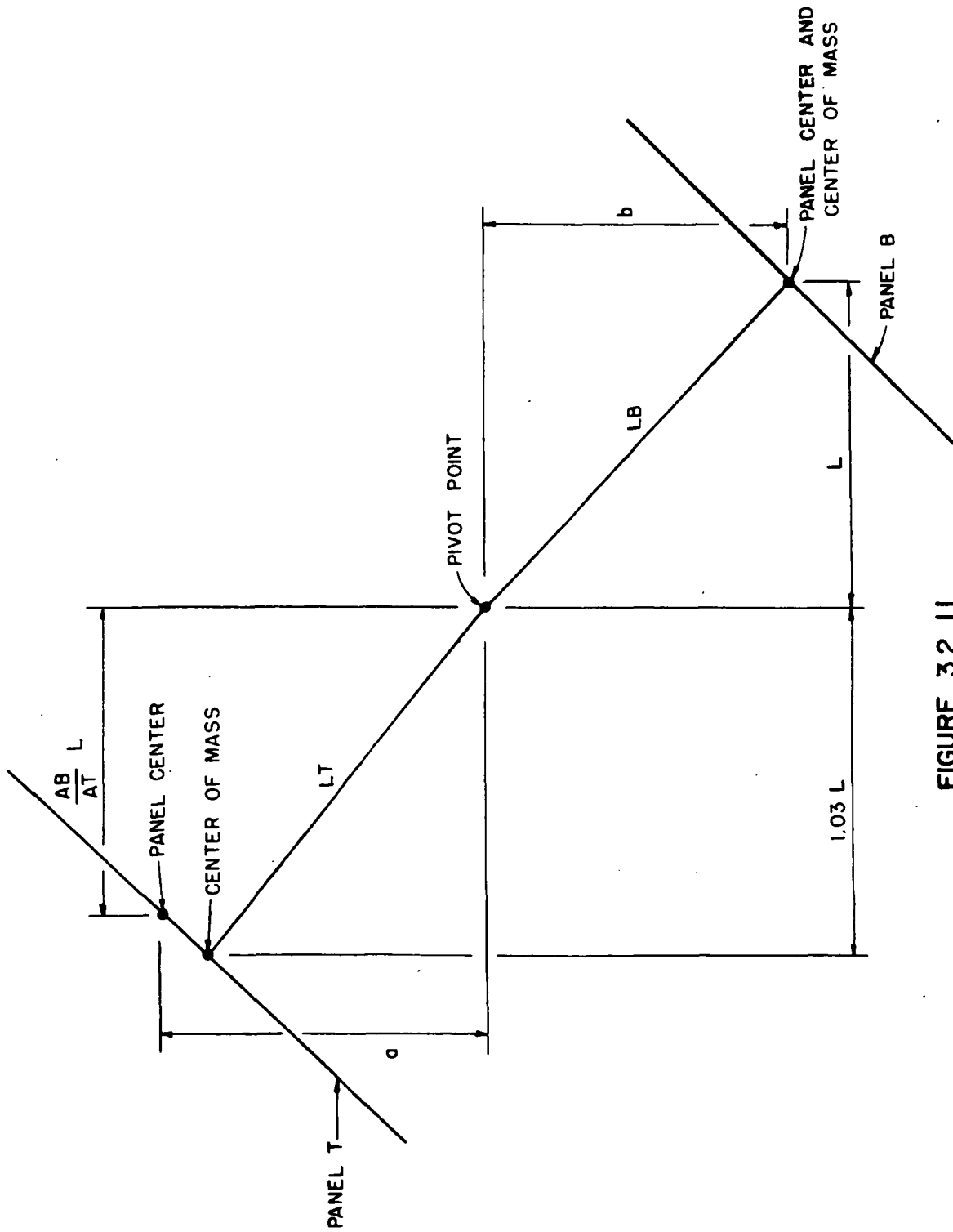

**FIGURE 3.2.11**  
**PIVOT POINT LOCATION CRITERIA**

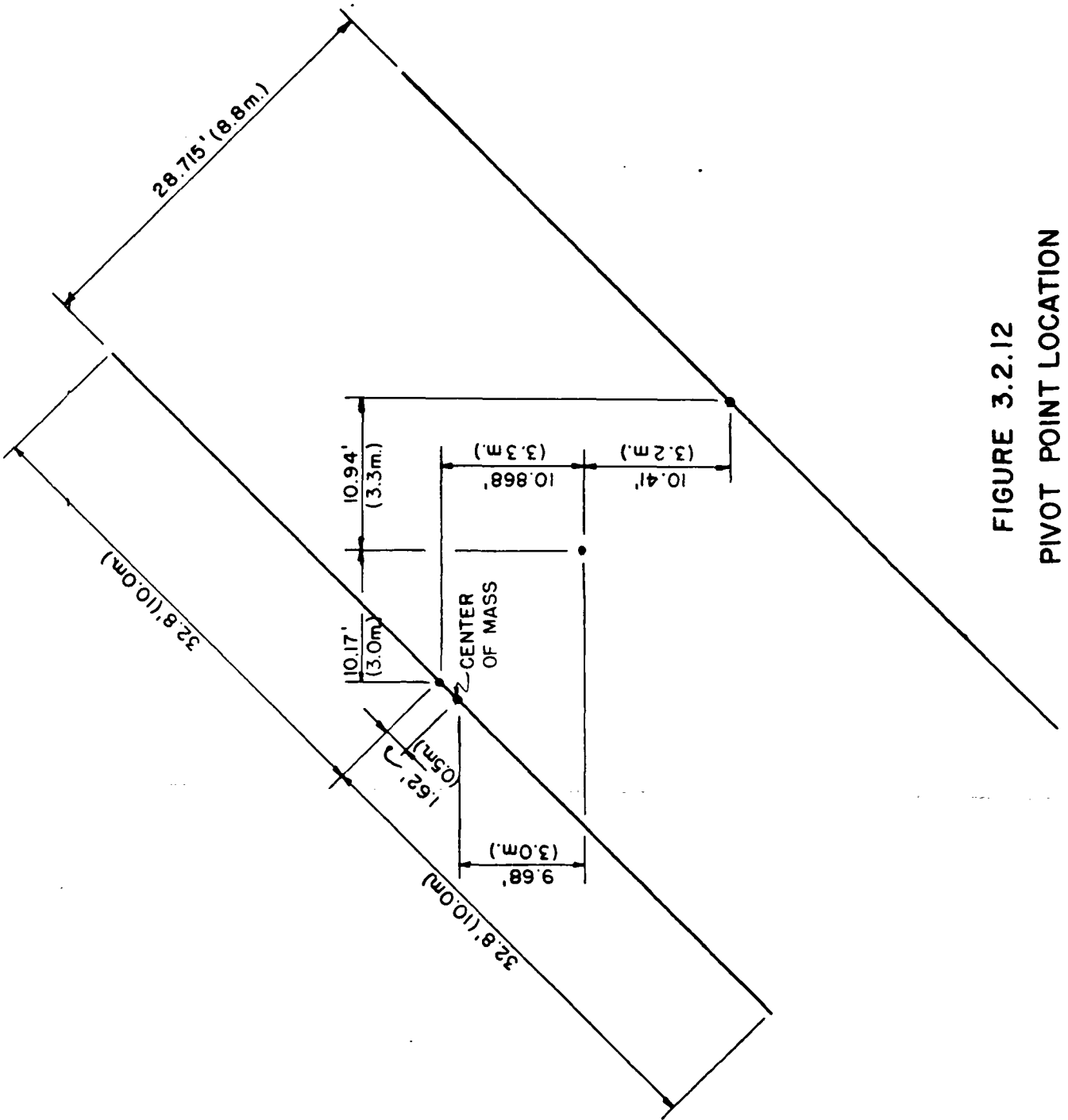
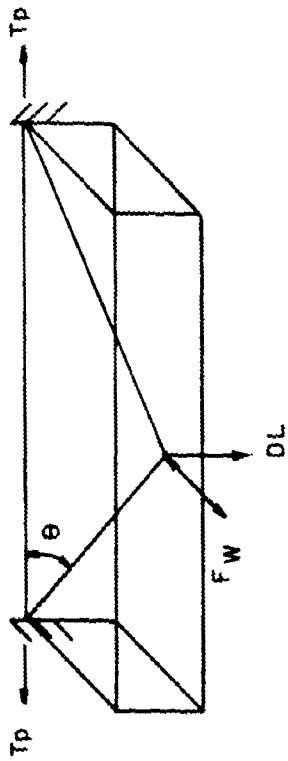
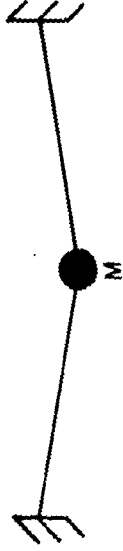

FIGURE 3.2.12  
PIVOT POINT LOCATION



STATIC MODEL  
(a)



DYNAMIC MODEL  
(b)

FIGURE 3.2.13 SINGLE PANEL TAUTLINE MODELS

is typical of offshore practices. A 1,000,000 pounds (4448 KN) prestress load would be needed to keep the deflection within the allowed tolerance necessary to clear the support structure during winter conditions (snow and ice loads). Dynamically, the tautline has a low enough period (0.69 seconds) so as not to resonate with wave induced oscillations.

When considering multiple panel spans the relationship between panel and tautline stiffness becomes critical. In order for the tautline to accept loads it must deflect. The panel would start to take the loads if the tautline is constrained from deflecting by it. In order to minimize the chance of this occurring, the panels could be built in the deflected shape of the loaded tautline. When snow and ice loads are applied, both panels and tautline must be considered as a single system and analyzed, but such an analysis is beyond the scope of this study.

4. PRELIMINARY COST ESTIMATES

4.1 Preliminary cost estimates versus type of support systems are summarized in Table 4.1. In the panel receiver configuration there are 100,000 panels to support. A submerged buoyant platform carries two panels and the other platform types are designed to support four panels each. The total material and fabrication costs in Table 4.1 do not include the costs of the panels or cables.

Table 4.1  
Preliminary Costs For Supporting Systems

Supporting System	Material Fabrication Cost per Platform \$	Total Material Fabrication Cost for all Platforms \$x10 <sup>9</sup>
Submerged Buoyant Platform	496,000	24.8
Piled Structure	1,300,000	32.5
Piled Guyed Tower with Panels	348,000	8.7
Gravity Structure	564,100	14.10
Piled Guyed Tower with Image Dipoles	200,000	0.6

#### 4.2 Cost Versus Water Depth

The 162 feet water depth at the prime site was considered as a potential cost driver of support systems. The effect of water depth was studied on the piled guyed tower with panels design. Figure 4.2.1 shows the variation in cost per guyed tower structure for water depths of 162, 150, 100 and 75 feet (49 m., 45 m., 31m., 23 m.).

There is a linear relationship between the cost and the water depth. This is due to the use of guy cables in the system. Guy cables, by greatly reducing the lateral load effects on the structure, change the normal exponential increase in cost due to water depth, to a linear one.

#### 4.3 Cost Versus Wind Load

The effect of wind load variation was investigated for the piled guyed tower design. Since all wind forces are transferred by guy cables to the piles of the neighboring platforms, the jacket structure is not significantly effected by wind load variation. The jacket is subject to the vertical component of the cable forces. These combined with panel weights, dead weights and overturning moment reactions due to waves determine the design axial load on the jacket. The variation of cable forces does not significantly alter the total axial force.



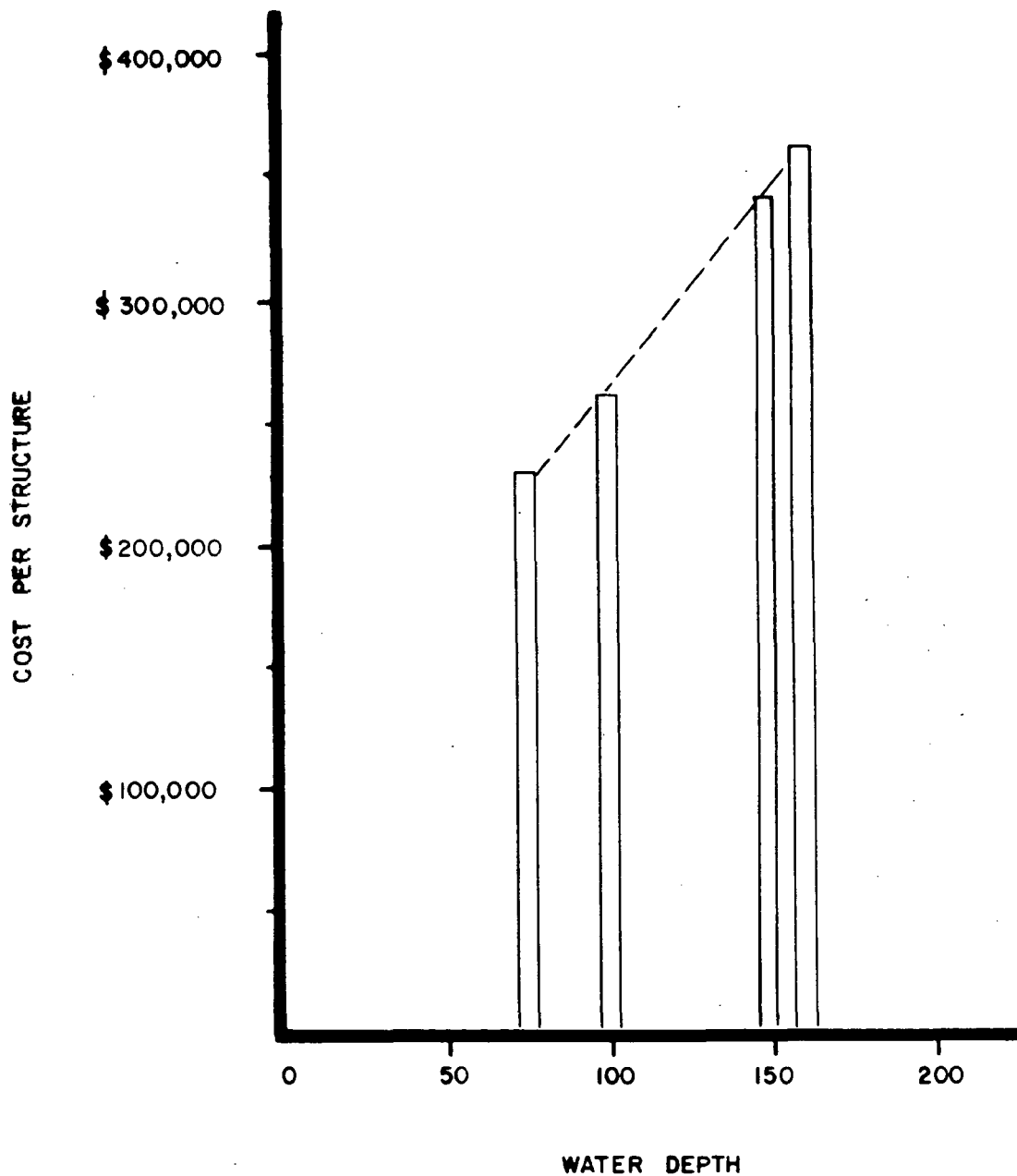

**FIGURE 4.2-1 COST VS WATER DEPTH FOR PILED GUYED TOWER WITH PANELS**

When the pretensioning force in cables are reduced along with the wind forces, the pile loading changes. The pull-out load in the piles may change from 754 kips (3427 kN) to 130 kips (591 kN) corresponding to a 75% reduction in wind loads. This does not affect pile design appreciably since in this case the design load for the piles become the winter storm compressive loads. Variation in pile pull-out loads and pile stresses corresponding to reductions in wind and pretensioning loads is presented in Table 4.2. It may thus be concluded that reduction in wind load does not effect the cost of a piled guyed tower to any significant degree. For a fixed platform or a gravity platform, however, variations in wind loading may effect costs considerably.

Table 4.2

Pile Stresses Versus Wind Loads

Total Wind Load (kips) (kN)	Pretensioning Force (kips) (kN)	Pull-out Load (kips) (kN)	Stresses in Piles (ksi) (N/mm <sup>2</sup> )
238 (1082)	750 (3409)	754 (3427)	24.77 (174.5)
212 (964)	562.5 (2557)	522 (2373)	21.56 (151.9)
184 (836)	375 (1705)	287 (1305)	18.30 (128.9)
156 (709)	265 (1205)	130 (591)	16.10 (113.4)

#### 4.4 Cost Versus Soil Conditions

In all the piled systems considered (Sections 3.1.1.2, 3.1.1.3, and 3.1.1.5) the cost of piling constitutes only 7-10% of the total material and fabrication costs. Thus, variations in the soil conditions which will effect the piling can not influence their costs to any significant degree.

Gravity structures on the other hand are greatly affected by soil conditions. The size of the gravity base is dictated by soil bearing capacity. Table 4.3 gives the cost of a guyed gravity structure for two different types of soil. The size of the base is reduced by 1/2 for favorable soil conditions which corresponds to a 17% reduction in costs.

Table 4.3

Cost Versus Soil Conditions for a Gravity Structure

Type of Soil	Cost per Structure \$
Weak Soil $\sigma_b = 0.55 \text{ kip/ft}^2$ ( $\sigma_b = 2.69 \text{ t/m}^2$ )	565,000
Medium Strength Soil $\sigma_b = 1.10 \text{ kip/ft}^2$ ( $\sigma_b = 5.38 \text{ t/m}^2$ )	470,000

The relationship between the base size and soil conditions is not linear. The total weight of the structure and overturning moments are additional significant parameter

#### 4.5 Total Costs

Cost estimates including all materials, fabrication, deployment and installation were made for piled guyed tower designs. Details for costing the piled guyed tower with panels and the tower with image dipoles are given in Sections 5.4 and 6.4. Total costs for these configurations are summarized in Table 4.4. It should be noted that the panel receiver configuration involves 25,000 towers, whereas image dipole receivers require a total of only 3000 supporting structures.

Table 4.4

Total Costs for Piled Guyed Tower Structures

Structure Type	Receiver Type	Total Cost in $\$ \times 10^9$
Piled Guyed Tower	Panel	36.30
	Image Dipoles	5.69

#### 5. PRIME SITE POINT DESIGN

##### 5.1 Structural Configuration

The piled guyed tower as a support system is discussed in Section 3.1.1.3. The analysis of the guyed tower for the prime site was made for two major loading conditions; the 100 year hurricane loading and the winter storm loading. A BARDI proprietary computer program was used in the analysis and design check. Maximum bending stresses in the tower were under 25,000 psi (176 N/mm<sup>2</sup>) which is below the allowable stresses for A=36 steel for 100 year storm conditions.

The weakest soil conditions at the site were assumed to be the prevailing soils properties. This meant that the piles had little pull-out resistance for the first 55 feet (16.8 m) of penetration. The piles designed for 112 feet (34.1 m) penetration were required.

Computer analysis revealed that the structure behaved as predicted in the preliminary design. The largest deflection was 6.2 inches (15.7 cm) occurring at 27.5 feet (8.37 m) below the mean sea level. Thus the tower was acting as a beam supported by piles at one end and guy cables at the other. Figure 5.1.1 illustrates the prime site piled guyed tower structure in detail.

## 5.2 Fabrication Installation and Deployment

### 5.2.1 Support Systems

The following sequence describes the assumed order of activities, for the rectenna subsystems.

- . Initial fabrication
- . Transportation to staging port
- . Final assembly at staging port
- . Deployment to field site
- . Installation at field site

The study includes consideration of the following components:

- . Support pile guyed towers
- . Permanent and temporary guy lines
- . Pilings
- . Equipment required for transportation and deployment

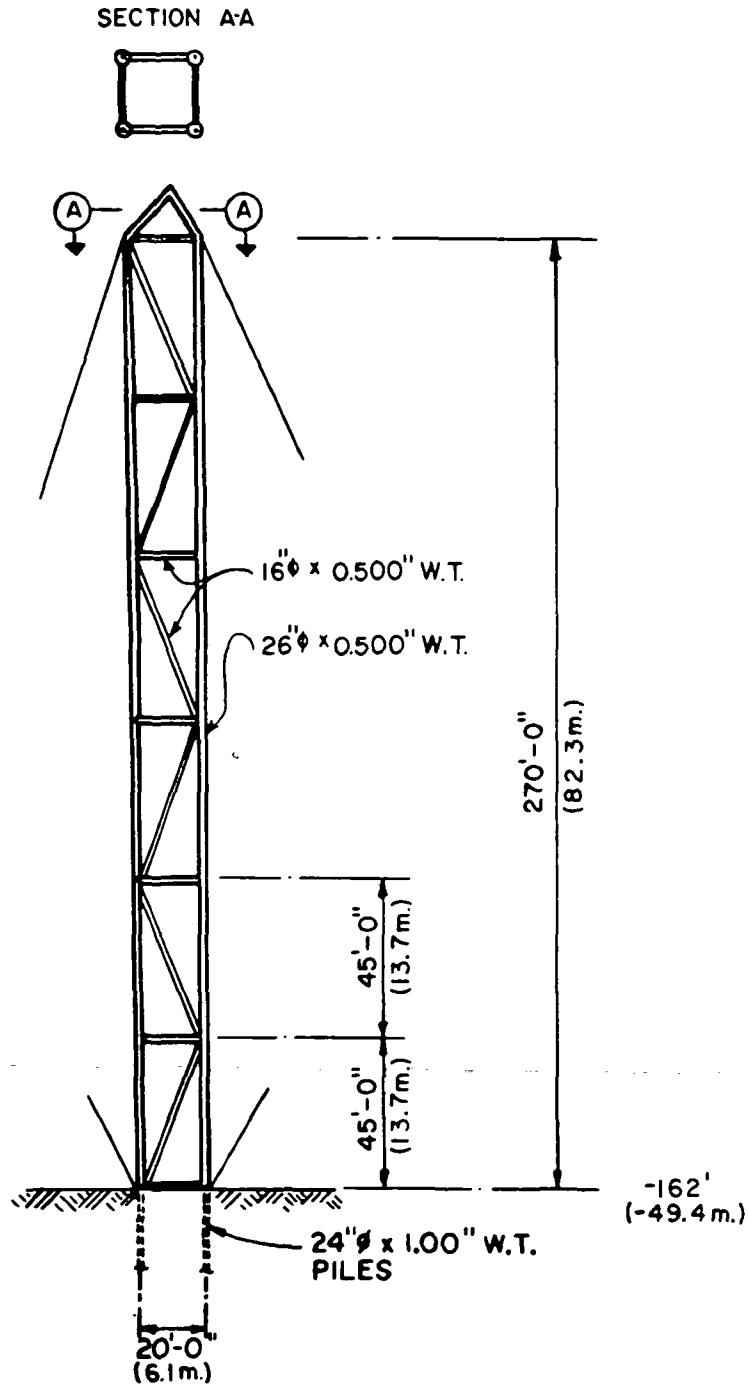

**FIGURE 5.1.1 PRIME SITE GUYED TOWER STRUCTURE**

#### 5.2.1.1 Initial Fabrication

The United States offers ample suitable sites for the fabrication of the Piled Support Towers. Fabrication will not involve problems in view of the simple design and material specifications. Transportation problems for tower components are eased by using none longer than 50 feet (15 m). Suitable joining arrangements can ensure effective interfacing of the tower components at the staging port.

Guy lines are most likely to be constructed of wire cable. Typical construction was considered to be:

- . 6 strands with 37 individual wires per strand
- . Independent wire rope center core (IWRC)
- . High strength galvanized steel (180 ksi - 1268 N/mm<sup>2</sup>)

The permanent guys attaching the columns to the sea-floor, or outside ends of each row or at any junction in the overall pattern, will be 4 inches (10 cm) in diameter. The permanent guys attaching the adjacent column top to piled feet in the channel lines will be 3 inches (7.5 cm) in diameter. The temporary guys, where required, will be 4 inches (10 cm) in diameter. All guys will be fabricated in predesigned predetermined lengths with special reinforced hard eyes, machine spliced in each end to facilitate connection. Wires of the above mentioned construction and diameter are presently only available as special order items and are very expensive. Only a few manufacturers are able to meet these specifications.

Pre-tensioning of guy lines prior to installation will ensure that design tensions are obtained without further tensioning.

Due to the high vertical loadings to be imposed on guy line anchors, piled moorings are used for the prime site point design. Other possibilities include displacement anchors and a combination pile/fluke type anchor which is presently under development. Careful consideration must be given to deployment methods for any permanent guy anchors due to the large quantity to be employed.

The piles for the support towers are 24 inches (61 cm) in diameter. Fabrication is common state-of-the-art and many steel manufacturers can meet the overall requirements of the project.

In the point design BARDI has required that all links, swivels and manual tensioning devices (e.g. turn buckles) have a safety factor of five to one. This is common practice within the offshore industry and fabrication will involve forged alloy steel construction. Many fabricators of this equipment can comply. The tensioning devices are of simple construction to facilitate tensioning operations



after an extended period of service. One preferred tensioning concept is a hydraulic cylinder arrangement that locks in several positions to bleed off pressure after pretensioning. By reconnecting the hydraulic cylinder arrangement, retensioning is accomplished. The tensioning device will be big enough to allow for tolerances in the guy line manufacturing to ensure that design tensions are achieved.

#### 5.2.1.2 Transportation to Staging Port

Several ports along the coast in close proximity to the field site of the rectenna will be assigned as staging ports for the collection, final assembly, loading and dispatch of the components to the field site.

Due to the relatively large areas required for the handling and assembly of the components at the staging port, it will be necessary to develop areas specifically for the task. The overall planning will include provision for continuous production of components by manufacturers, to meet field installation requirements. Overstorage of large dimension components at staging port areas must be avoided. In this way storage area requirements (where space is probably at a premium) can be minimized. Sufficient storage margin will be maintained to allow for a nominal shut down period in the field while fabrication and transportation of components is continued.

Transportation of components to staging port can be anticipated as follows:

- Tower sections - by coastal or inland barges. By truck or rail with some development of transportation and arterial road and rail systems.
- Other items - by rail or truck with no extension within the state of the art. Guy lines will be stowed on specially designed re-usable storage reels. A 40 foot (12.2 m) maximum pile segment length would ease transportation problems but 60 foot (18.3 m) segments are transportable.

#### 5.2.1.3 Staging Port Assembly of Support Towers

The staging ports near the rectenna site will provide convenient locations for the final assembly of the components of the support towers thus alleviating transportation difficulties. A staging port, equipped with a network of overhead gantry cranes can handle the large components of the towers. Final assembly will include welding the large components together and installing anodes or other anti-corrosion measures.

Special cranes can lift the towers onto the transportation vessels. Proper design of the staging area will assure a smooth flow of the components to the rectenna site. Warehouses can protect small components prior to assembly or transportation to the

rectenna. Figure 5.2.2 illustrates a possible layout of a staging port. Roads, railroads and access from the sea will afford the necessary transportation to the staging area to maintain the supply of components and required materials.

#### 5.2.1.4 Deployment at Field Site

Purpose built vessels can be used to carry the rectenna components from the staging port to the field site. The size of the components and the need for minimizing the installation in the field will dictate the requirement for special vessels. These vessels should have open, clean decks for facilitating unloading operations at field site. Such a vessel could nominally carry ten complete towers at a time. Figure 5.2.3 shows one such vessel unloading at the jack-up tower installation barge. Design criteria for these vessels will include bow and stern thrusters, and fixed propulsion in order to facilitate maneuvering during loading and unloading operations in the limited spaces between towers.

Another alternative includes the use of special vessels with the propulsion and living section separate from the cargo section. Thus, procurement of fewer "power" sections is necessary and the turn around time for the cargo sections is minimized.

The "power" sections can work on other tasks (returning empty cargo sections) while unloading or loading operations proceed. Soviet ocean and river timber trade employs a development of this kind of equipment.

A third option is to use regular "oil field" type supply vessels, equipped with thrusters for versatile maneuvering and with open decks for facilitating loading and unloading operations. They could accomplish the transportation of other components (e.g. guys, swivels, connecting links) to field site.

#### 5.2.1.5 Field Installation of Support Systems

The installation of the towers at field site provides certain difficulties. There are listed as follows:

- . Requirements for high accuracy during tower positioning
- . Proximity of tower spacing
- . Installation of a high volume of structures
- . ~~Consideration of overall time and costs~~

In our preliminary selection of the best method for installation of the prime site point design, all of the above points were considered by BARDI.

Environmental conditions at the prime site are a difficulty which must be taken into account. Wind, sea

height and storm frequency are hinderances which will cause delays during deployment and installation. Conventional state-of-the-art equipment can operate in hostile areas of the world on a limited basis. For instance in the North Sea the maximum available working time on an annual average is no more than 30% of the time. The Prime Site will provide hostile weather conditions. Working limitations and increased time and costs will impact any final selection of a rectenna location.

For the purpose of this study, the primary criterion for evaluation of potential deployment and installation methods and equipment (including purpose built equipment) was that it must meet the above listed points in a practical manner. The criterion was not that it solve the problems caused by environmental conditions.

The installation plans for the structure were developed considering the following equipment:

- . Conventional barges
- . Conventional semi-submersibles
- . Conventional jack-up units
- . Purpose built or converted barges
- . Purpose built semi-submersibles
- . Purpose built jack-up units

Although some conventional equipment might be successfully employed to install the rectenna components, their high costs particularly due to anticipated long installation times preclude recommending them for this work. Availability of sufficient conventional units to complete the task in a timely, cost effective manner is unlikely. Daily hire costs for such equipment is high so the capital expenditure for the design and fabrication of specially built units to meet the listed criteria is not only justified, but a requirement for economic project feasibility.

In the determination of the type of unit to be used for tower installation at the prime site, a purpose built jack-up barge was selected for the following reasons:

- . Jack-up operations are feasible at the prime site (water depth approx. 150 feet - 45.7m.)
- . Positioning on site with thrusters, tug assistance and acoustic positioning equipment, is feasible to within the small tolerances required.
- . Proximity of towers at prime site prohibits the use of conventional moorings during installation.

- . Absence of dynamic forces in the barge in its elevated condition and the use of overhead gantry cranes, both facilitates the positioning and piling of towers at both ends of the barge.
- . Movement from one tower row to the next row can be facilitated by raising legs off seabed and moving the barge with thrusters and tugs.
- . On site unloading of towers from supply vessels is possible.

Moored semi-submersibles, although having certain motion advantages over floating jack-up units (but not jacked-up barges), require complex mooring systems to eliminate high excursions. Tower positioning requires minimal excursion of the deployment platform and mooring of a semi-submersible would be difficult within the complex maze of towers.

The patented "Slo-Rol" system can increase the operational capabilities of jack-up barges. Testing to date on this system (both model and full size) indicates that the capabilities of jack-up units when operating in marginal sea conditions, will substantially increase (by about 100%).

It is estimated that one jack-up barge can install and pile two towers per day (one at each end of the barge) once initial problems are ironed out. Thus, the following deductions are made:

- . 20 barges can install 25,000 towers in approximately 1.7 years (no weather down time)
- . Allowing for problems installation may take 2 years.
- . When accounting for the anticipated hostile weather conditions at the prime site of this study actual installation may take a minimum of 4 years.

Figures 5.2.1, 5.2.3, 5.2.4 and 5.2.5 show details of installation of towers at a field site.

While the jack-up barge is accomplishing the tower installation, it can be used to make the connection of guy lines between adjacent columns. Divers and diving support facilities will set any required underwater guy connections but where feasible, such connections will be made prior to subsea placement of components since divers and their support facilities are rather expensive. Both jack-up barges and diving tender vessels will be leased on a long term basis. Piling vessels or barges will set and pile permanent guy anchors and should be leased on a long term basis. Hydraulically operated linear winches will tension all guys as required. Because of the high cost of long term usage, these winches should be purchased.



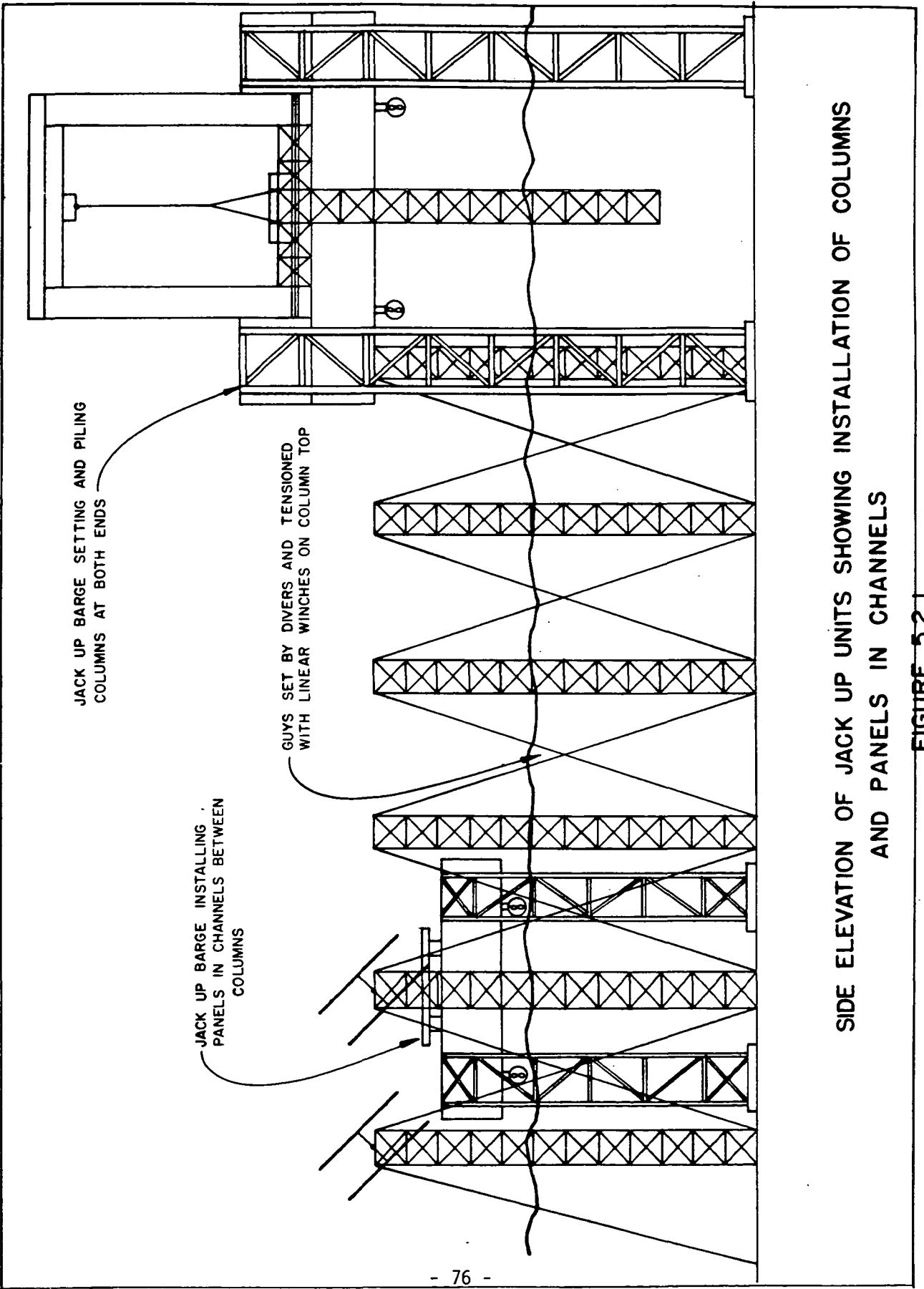

JACK UP BARGE SETTING AND PILING  
COLUMNS AT BOTH ENDS

JACK UP BARGE INSTALLING  
PANELS IN CHANNELS BETWEEN  
COLUMNS

GUYS SET BY DIVERS AND TENSIONED  
WITH LINEAR WINCHES ON COLUMN TOP

SIDE ELEVATION OF JACK UP UNITS SHOWING INSTALLATION OF COLUMNS  
AND PANELS IN CHANNELS

FIGURE 5.2.1.

AREAS OF COLLECTION  
ASSEMBLY AND LOADING  
OF PANEL SECTIONS

OVERHEAD  
GANTRY CRANES

AREAS OF COLLECTION  
ASSEMBLY AND LOADING  
OF 300' COLUMNS

RAIL TRACKS

PANEL TRANSPORTING BARGES

RIVER, ESTUARY OR HARBOR

TO OPEN SEA

COLUMN TRANSPORTING  
VESSEL.

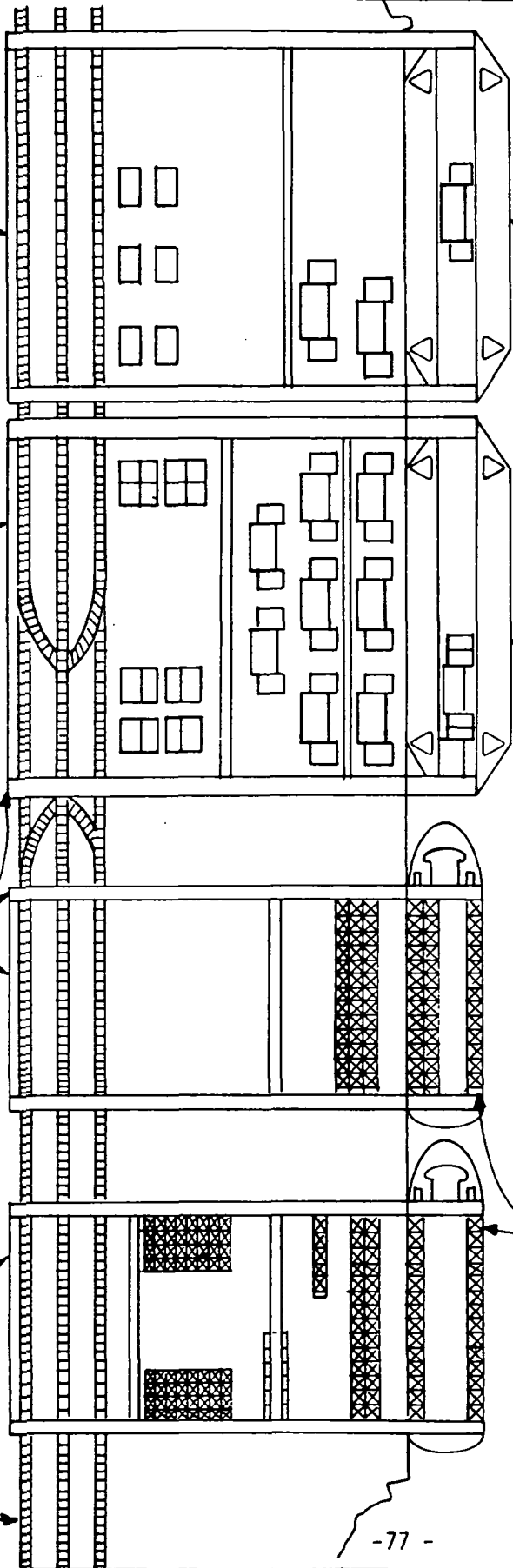

POSSIBLE LAYOUT OF TYPICAL STAGING PORT

FIGURE 5.2.2.

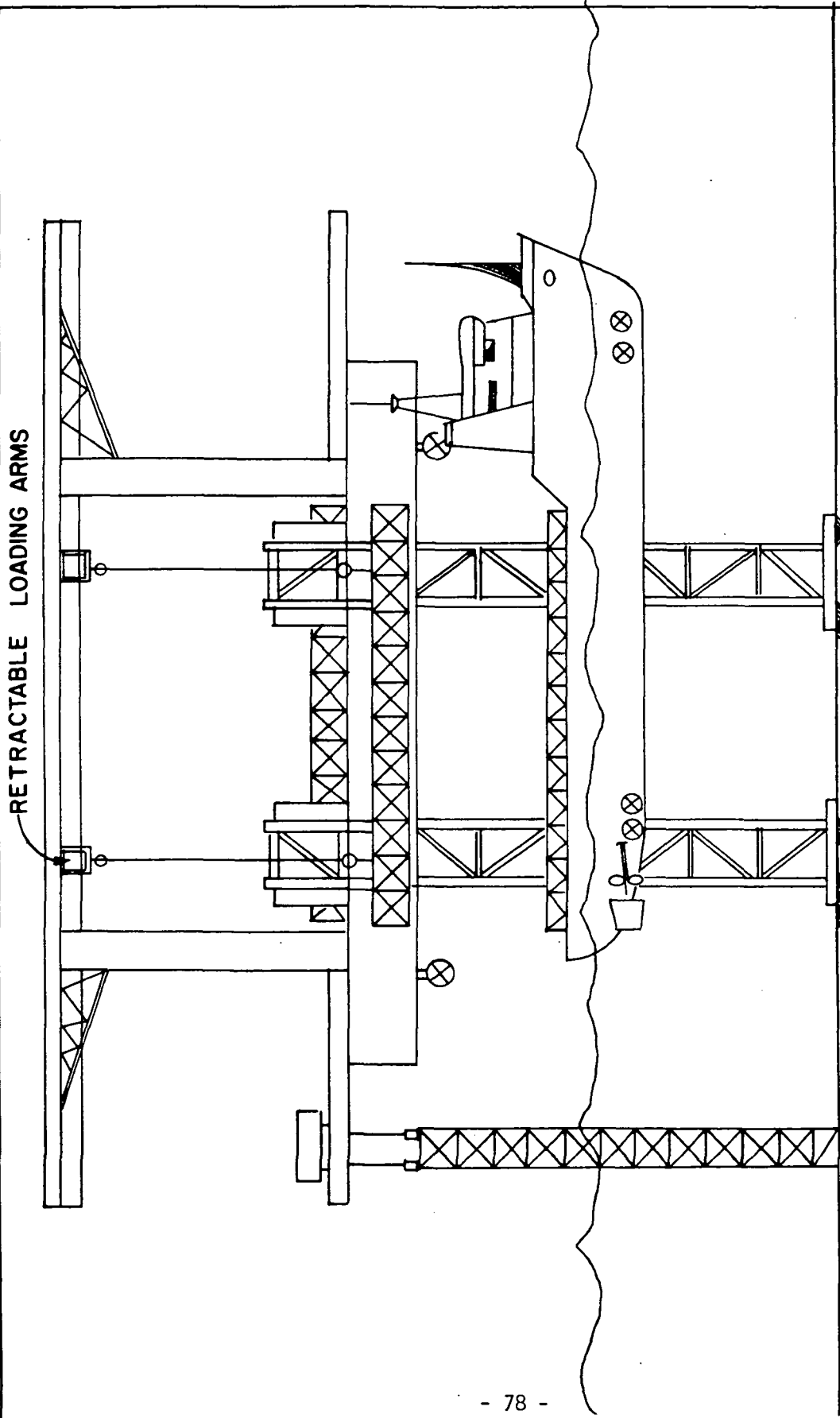

RETRACTABLE LOADING ARMS

SIDE ELEVATION OF COLUMN DEPLOYMENT JACK-UP SHOWING DYNAMICALLY POSITIONED COLUMN TRANSPORTING VESSEL DISCHARGING COLUMNS.

FIGURE 5.2.3.

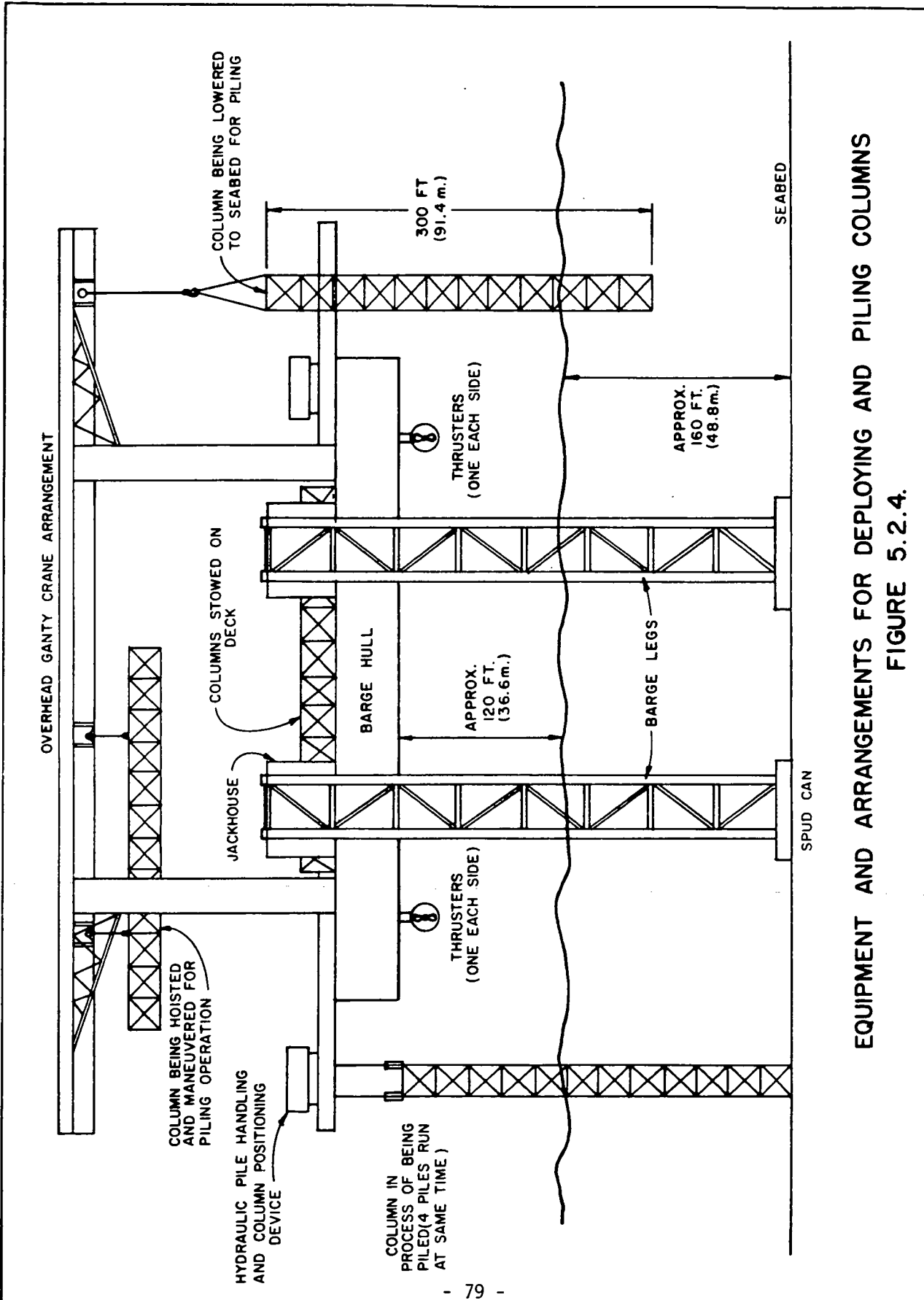

EQUIPMENT AND ARRANGEMENTS FOR DEPLOYING AND PILING COLUMNS  
 FIGURE 5.2.4.

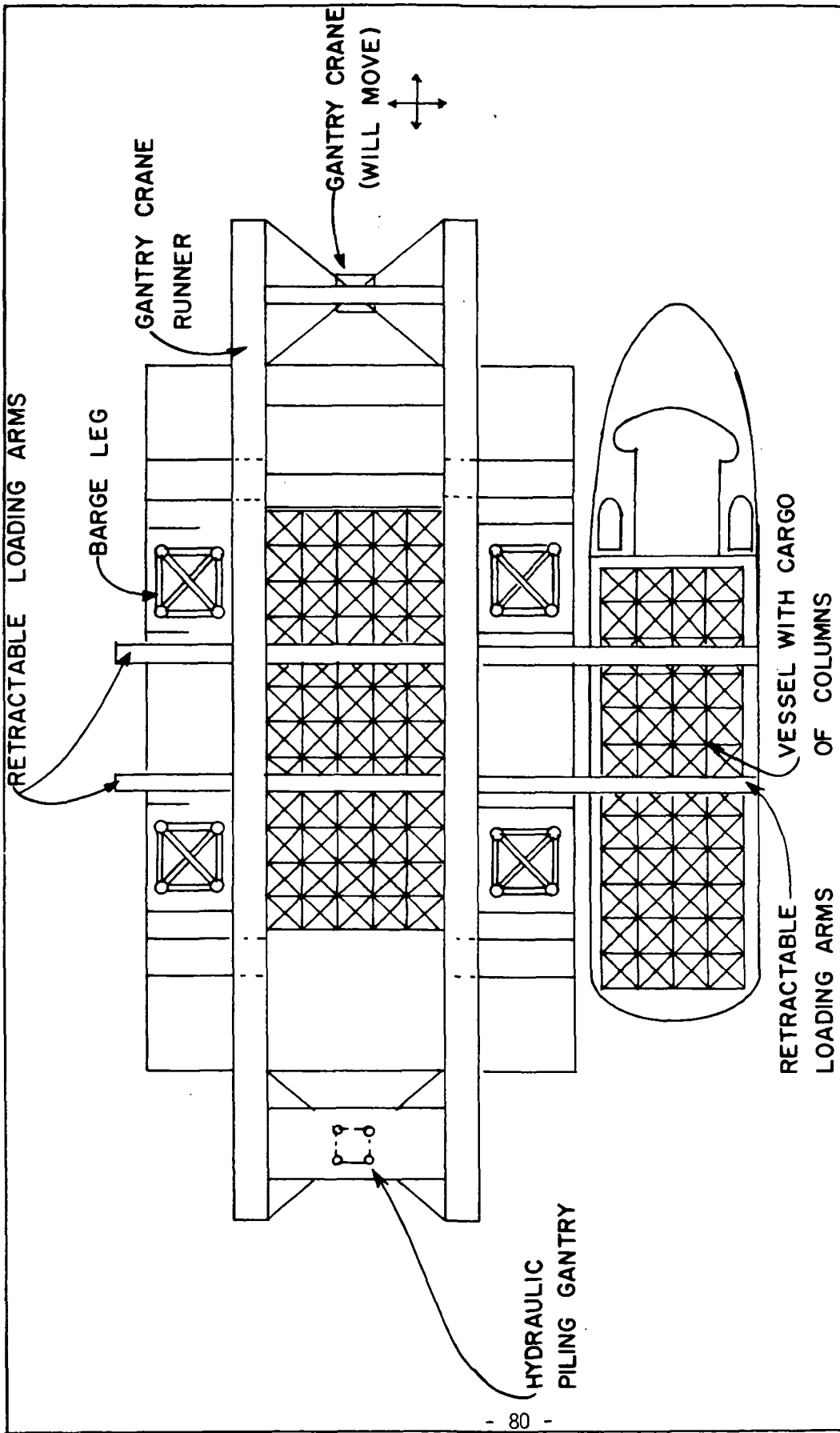

PLAN OF COLUMN DEPLOYMENT JACK-UP BARGE SHOWING COLUMN TRANSPORTING VESSEL

FIGURE 5.2.5.

## 5.2.2 Receiver Panel and Taut Line System

For the purpose of this study, the following sequence is employed in the formulation of plans:

- . Initial fabrication
- . Transportation to staging port
- . Final assembly at staging port
- . Deployment to field site
- . Installation at field site

The components of the receiver panel and the taut lines which will be considered in the following sections include steel truss members, aluminium ground planes, steel or Kevlar taut tension lines, and the equipment required for transportation and deployment.

### 5.2.2.1 Initial Fabrication

Many steel prefabrication yards and workshops throughout the United States are capable of producing steel truss members on short notice and at competitive prices. Components of the trusses consist of tubular and box girder members manufactured from A36 or A572 steel. Discussions relating to the use of steel over other materials are included in Section 3.2.2.

Aluminium groundplane screens will not provide problems in fabrication. Many companies which manufacture a high volume of aluminium products are

capable of meeting design and delivery specifications at competitive prices. The design must include effective corrosion prevention measures.

Design and manufacturers capabilities will govern the selection of tension line materials which in turn will determine the appropriate installation methods. Kevlar is still in the development stage and its costs are high. Kevlar does not have good abrasion resistance so handling it is currently difficult and uncertain. During the next ten years, development may be expected to take place which will reduce costs and handling difficulties. The use of wire rope evokes problems with microwave reception if the lines pass above a section of the receiver panel (as in the case of the point design). Cost factors may warrant the use of wire over kevlar. Present cost comparisons of lines strong enough to carry the design loads shows wire cable with a substantial advantage:

- . Kevlar (9 inch -23 cm diameter) is quoted at \$300/foot. 2500 miles (4500 km) are required at a total approximate cost of  $\$4.5 \times 10^9$ .
- . Wire (5 inch -12.7 cm diameter) is estimated at \$90/foot. The total cost of wire is  $\$1.35 \times 10^9$ .

BARDI recommends further development of this aspect of the rectenna project.

#### 5.2.2.2 Transportation to Staging Port

Referring to Section 5.2.1.2 in which the question of staging ports is discussed, the same criteria will apply for the collection, final assembly, loading and dispatch of the components of the panel and taut line systems. Transportation of components to the staging port which will ensure continuous loading and dispatch to the field site, is accomplished by road, rail or sea. Special transporters will overcome difficulties in the shipment of the trusses.

#### 5.2.2.3 Final Assembly at Staging Port

The selected staging ports will include suitable areas for the assembly of the panel sections. Completion of assembly at the staging port is carried out because:

- . Large dimensions of completed panel units (approximately 131' x 65' x 28' - 40 m x 20 m x 8.5 m) inhibit their transportation by road or rail to the staging port.
- . Since the completed panel units are relatively fragile, handling (lifting, loading, and eventually installing) will be somewhat complex and should be avoided when possible.

A network of overhead gantry cranes will facilitate the movement and loading of panel units onto barges. Figure 5.2.2 shows a possible plan lay out of a staging port area and the assembly and loading of panel units.



#### 5.2.2.4 Field Deployment and Installation

The selection of special purpose built jack-up barges for the deployment and installation of panel sections at field site is made for the following reasons:

- . A one time lift of panel units onto a barge will allow final joining and securing of completed units onboard.
- . The complete accessible panel units will permit the taut line sections to be threaded and secured to swivel unions on the barge, leaving the end connection eyes clear for easy connection to tensioning wires.
- . Use of the barge for transportation of panel units and the jacking units for pinning and raising the barge will facilitate the positioning of the complete panel sections between towers.
- . Dynamic forces caused by vessel excursion are eliminated.
- . Panel unit taut line connections can be made without lifting or moving operations.
- . Tensioning of taut line and lowering of the barge will allow weight of units to be taken by the taut line in a controlled manner.
- . Immediate return of barge to staging port will permit access by the next panel barge.

. Such a work pattern for the barges will provide a relatively continuous production of the panel unit installation after the towers have been installed. The limitations of jack-up barge operations in marginal sea conditions, as discussed in Section 5.2.1.5 applies to jack-up panel installation barges. The patented "Slo-Rol" system specifically designed for installation on such barges can minimize down time due to weather condition.

It is estimated that one jack-up panel barge could install a set of panels between one pair of towers in six hours. The same barge can return to port (six hours), load next panel section (six hours) and return to site in a total of 18 hours. Forty barges can install the total estimated 24,000 panel sets in under two years.

The setting of panel sections over the tops of towers provides problems with lifting and access. Helicopters provide a possible solution. A converted conventional semi-submersible drilling unit could suffice as a storage unit and flight base for panel sections and helicopters. Supply vessels could provide transport to satisfy requirements for continuous installation operations of tower top panels from a staging port. It

is estimated that one helicopter could install 12 panels a day (during daylight hours only). Therefore 5 helicopters could install 24,000 panel sections in less than two years. Figures 5.2.6 through 5.2.11 show installation steps of panel sections.

### 5.3 Maintenance

Design criteria for the offshore rectenna will permit the operation of the system over a 30 year life span with minimal maintenance. Cathodic protection schemes must include consideration of sea currents, salinity and sea temperature to provide the electrical current density to meet the design requirements. Aluminium ground screens must incorporate effective measures for the prevention of electrolytic action. Anti-corrosion measures for piled towers will include special coatings especially in the splash zone. Careful monitoring of corrosion through instrumentation will permit maximum life span of the components.

Certain components will require replacement in less than the 30 year design life. Wire cable which is presently available will not provide service for longer than 10 years. Large diameter cable corrosion factors in different environmental conditions over long periods are not fully understood and require further investigation. (Activity in this area should be undergoing rapid development in the next few years as the offshore oil industry pursues the development of guy lines for guyed towers for deep water applications.) Galvanization and special sheathings under development might retard corrosion and increase cable

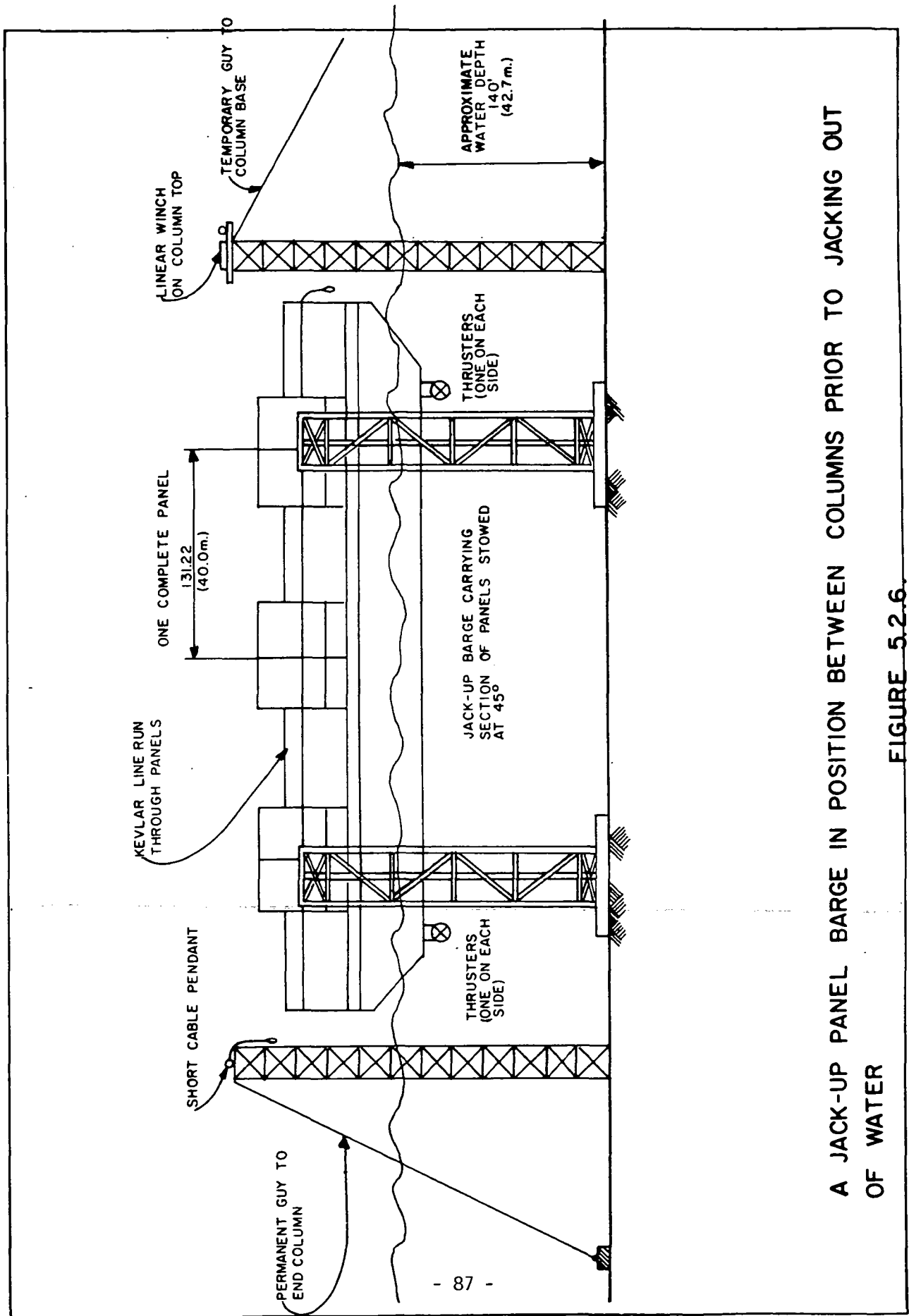

A JACK-UP PANEL BARGE IN POSITION BETWEEN COLUMNS PRIOR TO JACKING OUT OF WATER

FIGURE 5.2.6.

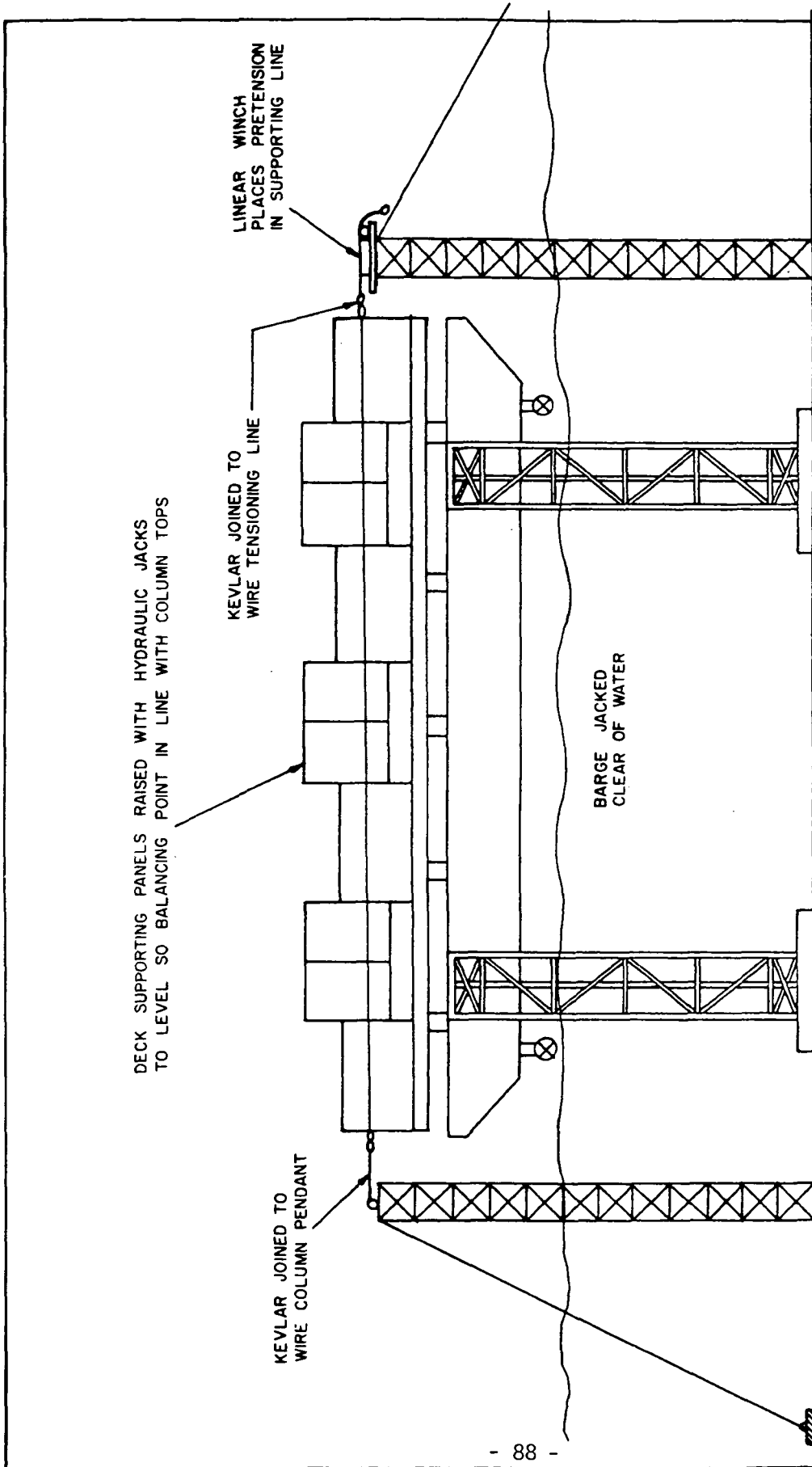

JACK UP PANEL BARGE - JACKED CLEAR OF WATER AND DECK RAISED SO THAT PANEL LINE CAN BE CONNECTED AND TENSIONED

FIGURE 5.2.7.

DECK SUPPORTING PANELS LOWERED ON HYDRAULIC JACKS,  
TENSIONED SUPPORT LINE TAKES - WEIGHT OF PANELS,  
PANELS JOINED AFTER MAXIMUM DEFLECTION OBTAINED.

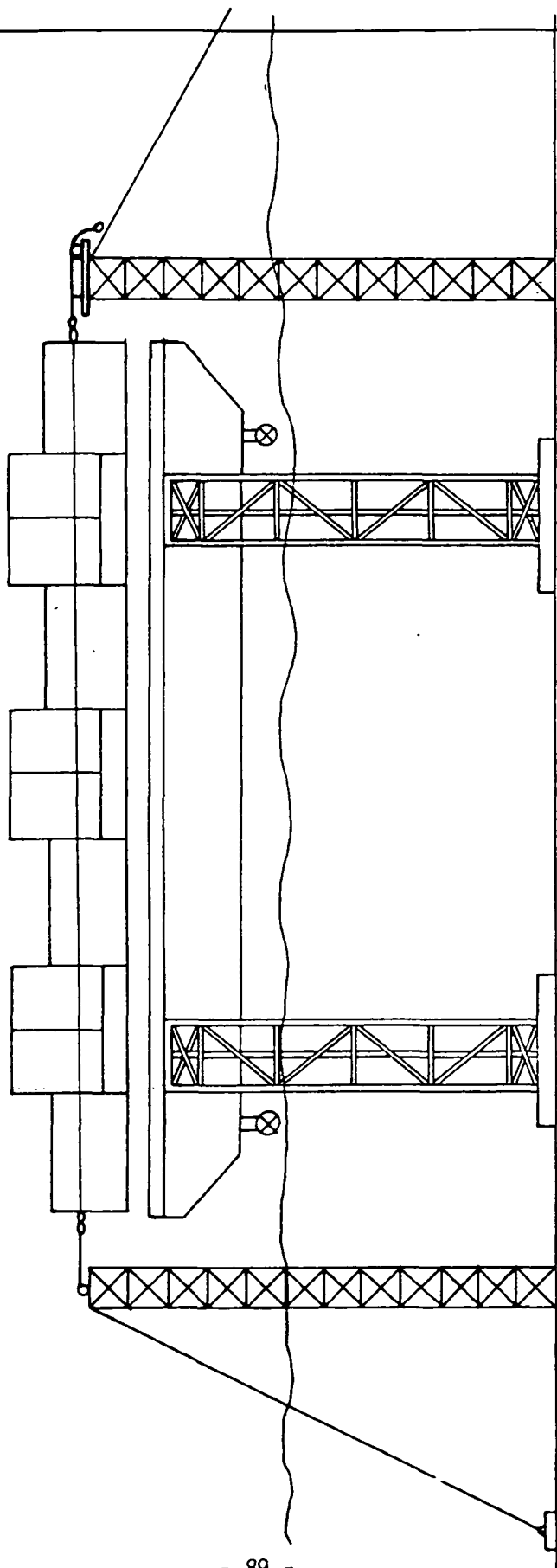

JACK UP PANEL BARGE - CARGO DECK LOWERED

FIGURE 5.2.8.

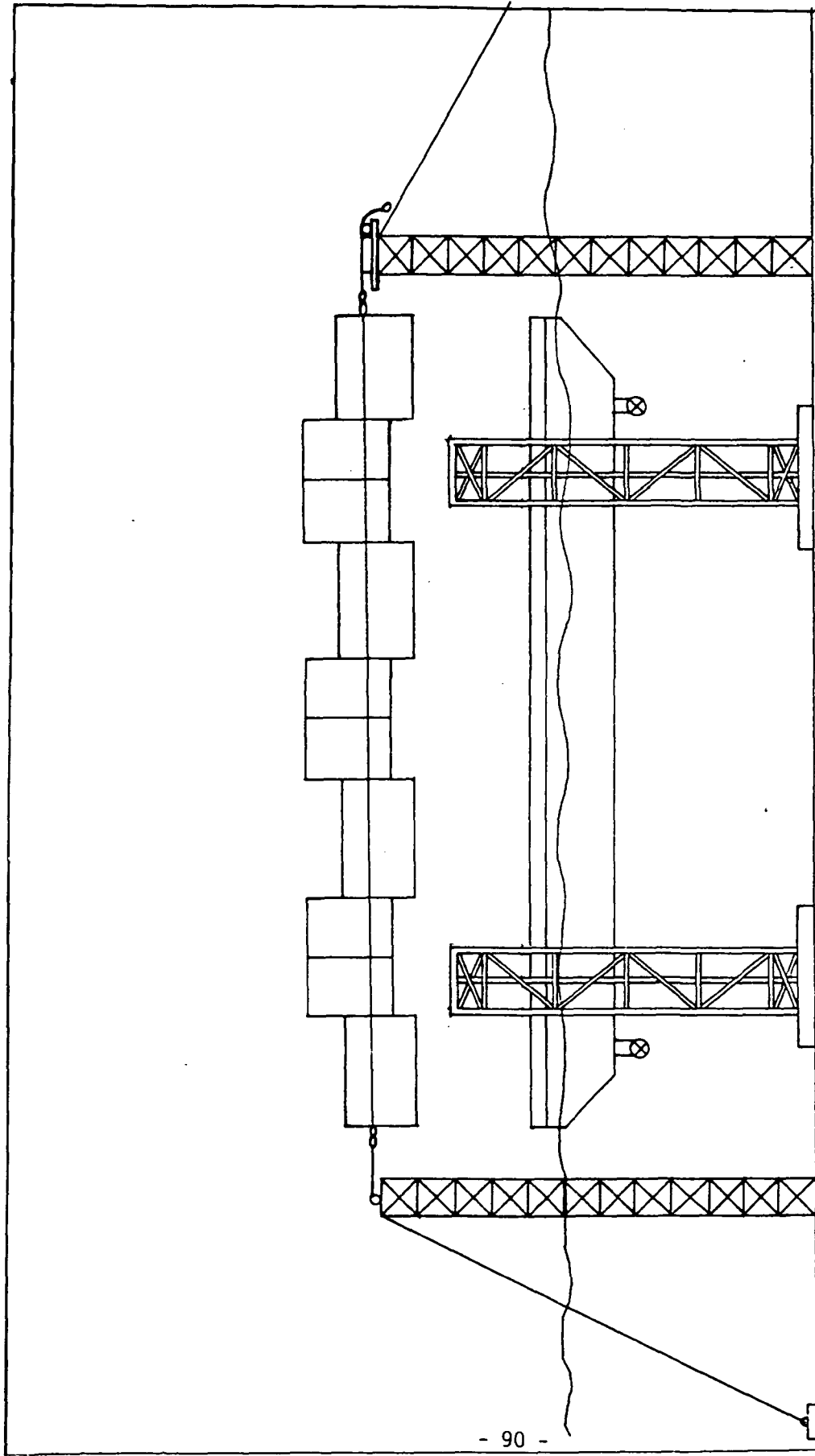

JACK UP PANEL BARGE - JACKED BACK INTO WATER AND LEGS RAISED OFF SEABED IN PREPARATION FOR MOVING TO NEXT PAIR OF COLUMNS.

FIGURE 5.2.9

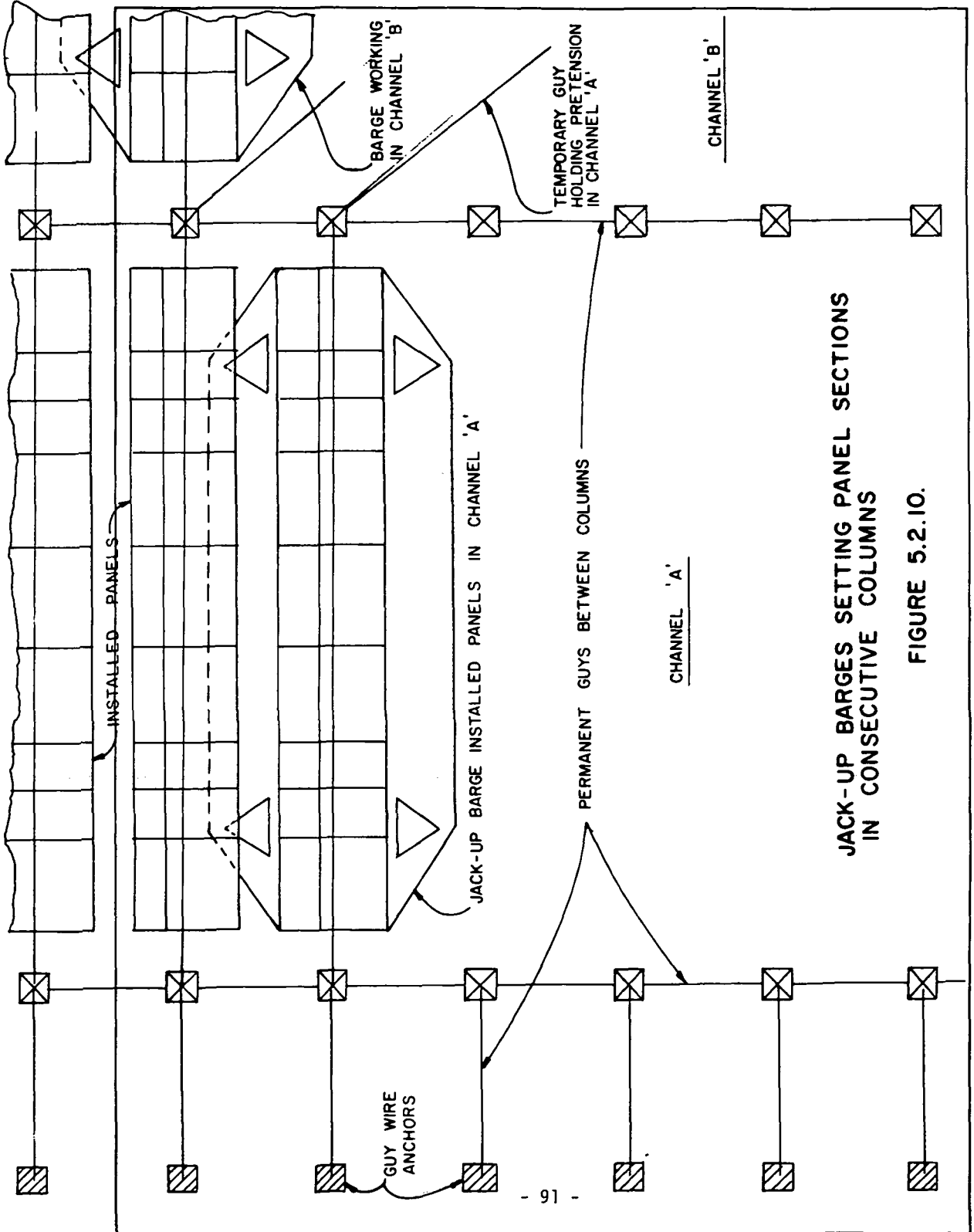

JACK-UP BARGES SETTING PANEL SECTIONS  
IN CONSECUTIVE COLUMNS

FIGURE 5.2.10.



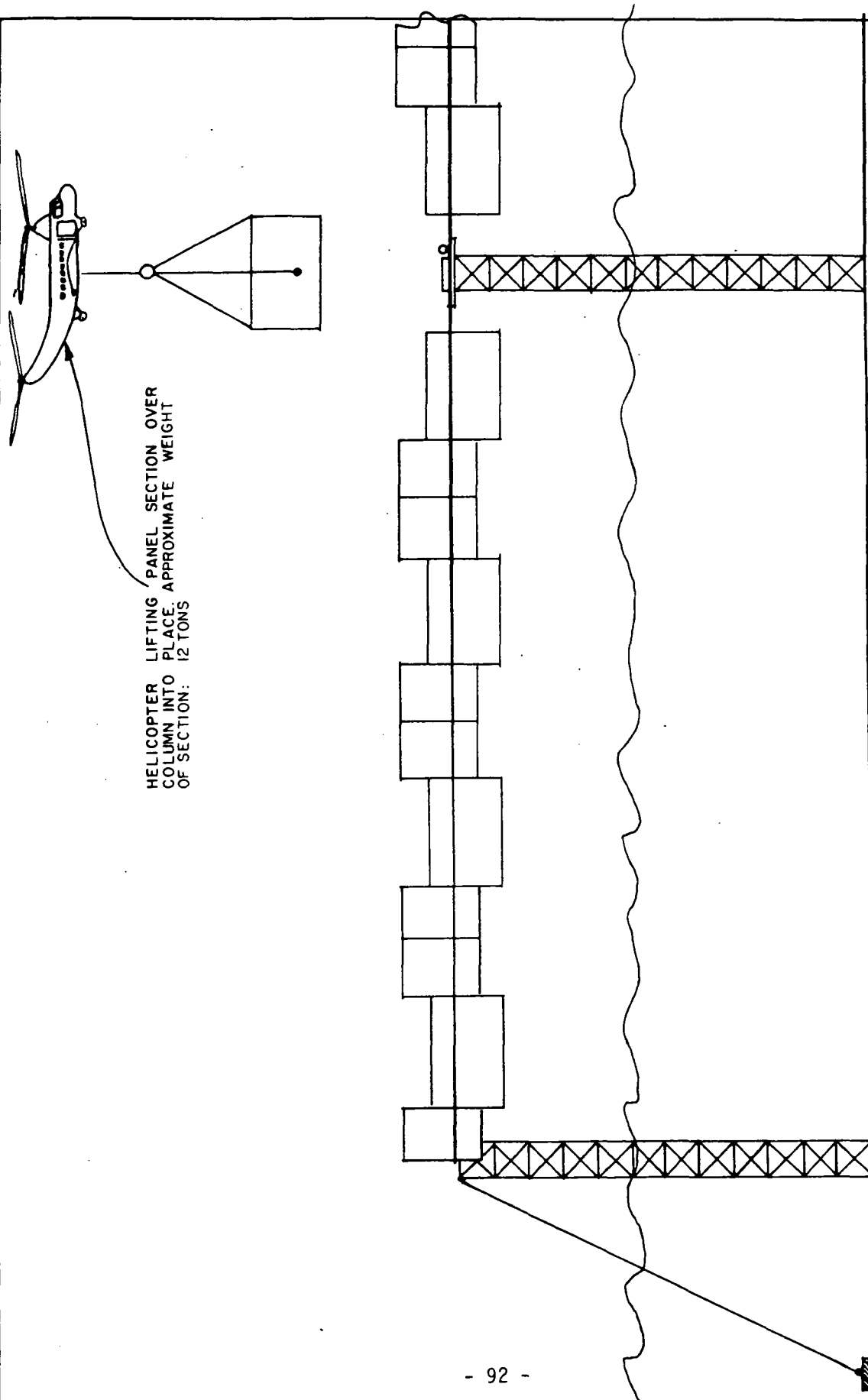

HELICOPTER LIFTING PANEL SECTION OVER  
COLUMN INTO PLACE. APPROXIMATE WEIGHT  
OF SECTION: 12 TONS

INSTALLATION OF PANELS OVER COLUMNS  
FIGURE 5.2.11.

life span but these items may prove to be uneconomical. Periodic change-out of cable is therefore presently envisaged. Accomplishment of taut line and guy wire cable change-out could involve the use of the following equipment:

- . Diving support capability (for underwater guy lines)
- . Installation of temporary guys to support loads
- . Use of jack-up panel installation barges to support panels
- . Auxiliary vessel support

Kevlar taut lines (if used) may require replacement due to chafing damage. Complete change-out of permanent guy anchors and support towers could involve the use of special maintenance equipment including:

- . Diving support capability
- . Use of jack-up piling and tower installation barges
- . Installation of temporary anchors and guys to support loads
- . Auxiliary vessel support

Maintenance of the offshore rectenna will require the formation of a program which will include the following main points:

- . What equipment will be used for the program and how can it be obtained.
- . What personnel will be required for the maintenance program
- . Inspection and maintenance frequency
- . Post casualty contingency plans
- . Overall budgeting

#### 5.4 Costs

Prime site point design costs are summarized in Table 5.1. Cost details are itemized in Table 5.2.

Table 5.1

## Cost Summary for Prime Site Point Design

Design Subsystem	Cost in $\$ \times 10^9$
Piled tower and support systems	11.6
Panel and taut wire systems	23.6
Miscellaneous	1.3
Combined total point design for prime site	36.5

Table 5.2

## Itemized Costs for Prime Site Point Design

Design Subsystem	Description	Cost in $\$ \times 10^9$
Piled tower and support systems	Material, labor and fabrication costs ( $\$3.2 \times 10^5$ /tower x 25,000 towers)	8.0
	Material fabrication of jack-up barges for tower installation ( $\$5.0 \times 10^7$ /barge x 20 barges)	1.0

Table 5.2 (Continued)

## Itemized Costs for Prime Site Point Design

Design Subsystem	Description	Cost in \$x10 <sup>9</sup>
	Material, Fabrication of miscellaneous hardware (guys, connecting links, linear winches, guy anchors or pilings)	1.2
	Leasing of diving, piling vessels and associated equipment (\$5.0x10 <sup>4</sup> /day x 730 days x 10 vessels)	0.4
Piled tower and support systems	Operation of jack-up barges setting towers including piling, mobilization and fuel (\$6.8x10 <sup>4</sup> day x 730 days x 20 barges)	1.0
	Total for piled tower and support systems	11.60

Table 5.2 (Continued)  
Itemized Costs for Prime Site Point Design

Design Subsystem	Description	Cost in \$x10 <sup>9</sup>
Panel and taut wire systems	Panels, material, labor and fabrication costs (\$1.4x10 <sup>5</sup> /panel x 107,000 panels)	15.0
	Material, fabrication of jack-up barges for panel installation (\$5.0x10 <sup>7</sup> /barge x 40 barges)	2.0
	Operation of jack-up barges installing panel sections including fuel costs (\$6.8x10 <sup>4</sup> /day x 730 days x 40 barges)	2.0
Panel and taut wire systems	Tower top panel installation (using helicopters) -semi submersible barge rental \$3.0x10 <sup>4</sup> /day x 730 days -two supply vessels \$1.0x10 <sup>4</sup> /day x 730 days x 2 vessels -helicopters \$2.0x10 <sup>3</sup> /hr. x 43,800 hrs x 5 helicopters	0.1

Table 5.2 (Continued)  
Itemized Costs for Prime Site Point Design

Design Subsystem	Description	Cost in \$x10 <sup>9</sup>
	Taut lines -9 in. (23 cm) diameter Kevlar \$300/ft x 15x10 <sup>6</sup> ft. -or- -5 in. (12.7 cm) diameter wire cable \$80/ft x 15x10 <sup>6</sup>	4.5
	Total for panel and taut wire systems	23.6
Miscellaneous	Auxiliary supply vessels/tugs for supplying and moving jack-up barges (\$1.0x10 <sup>4</sup> /day x 730 days x 20 vessels)	0.2
Miscellaneous	Staging port alteration costs including installation of gantry cranes - 3 ports -	1.0

Table 5.2 (Continued)

## Itemized Costs for Prime Site Point Design

Design Subsystem	Description	Cost in \$x10 <sup>9</sup>
Miscellaneous	Staging port operational costs inclusive of labor (\$2.0x10 <sup>4</sup> /day x 730 days x 3 ports)	0.04
	Transportation of components and other miscellaneous costs	0.1
	Total Miscellaneous Costs	1.3
Total		36.5

## 6. PREFERRED DESIGN

### 6.1 Structural Configuration

The preferred design configuration was conceptualized after the study on the prime site point design indicated that problems exist. These problems include:

- . Complicated and lengthy deployment procedures
- . High overall costs

Consideration was therefore given to a configuration that is:

- . Efficient in its generation of electrical power
- . Light enough to reduce the volume of supporting towers
- . Relatively durable
- . Comparatively inexpensive to manufacture

The preferred design involves the use of light weight dipoles encapsulated in synthetic material to form a module measuring 8 cm by 8 cm. Each dipole uses support rods around a horizontal axis which act both as a means to hold the module in position at the correct angle and as a means of conducting generated electrical power to the main artery of support cables.

A network of the dipoles measuring 100 feet (30.5m) by 100 feet (30.5m) (or as deemed to be the most efficient from a cost and deployment viewpoint) forms a unit. These units of dipoles are supported by a network of criss crossed wires which are attached to perimeter wires. These wires are supported between a 1000 (305m) feet square of towers.



The support towers have a similar configuration as used in the prime site point design and as described in Section 5.1. The reduced design loads permit smaller steel sections to be used. At 3000 foot (915 m) intervals, the tower configuration is broken and a 100 foot (30.5 m) wide channel is introduced. This channel permits extra guying from top to base of adjacent towers to be installed, thus providing the necessary tower support for the network. The channels also permit access. This is illustrated in Figure 6.1.1 and Figure 6.1.2.

Figures 6.1.3, 6.1.4, and 6.1.5 show the configuration of the dipoles and how they are supported. The use of permanent guys and piled guy anchors on the perimeter of the rectenna will give additional support to the tower pilings.

## 6.2 Fabrication Deployment and Installation

For the purpose of this study, the following sequence is used for the components of the preferred design:

- . Initial fabrication
- . Transportation and assembly at staging port
- . Collection and assembly at staging port
- . Deployment to field
- . Installation at field site

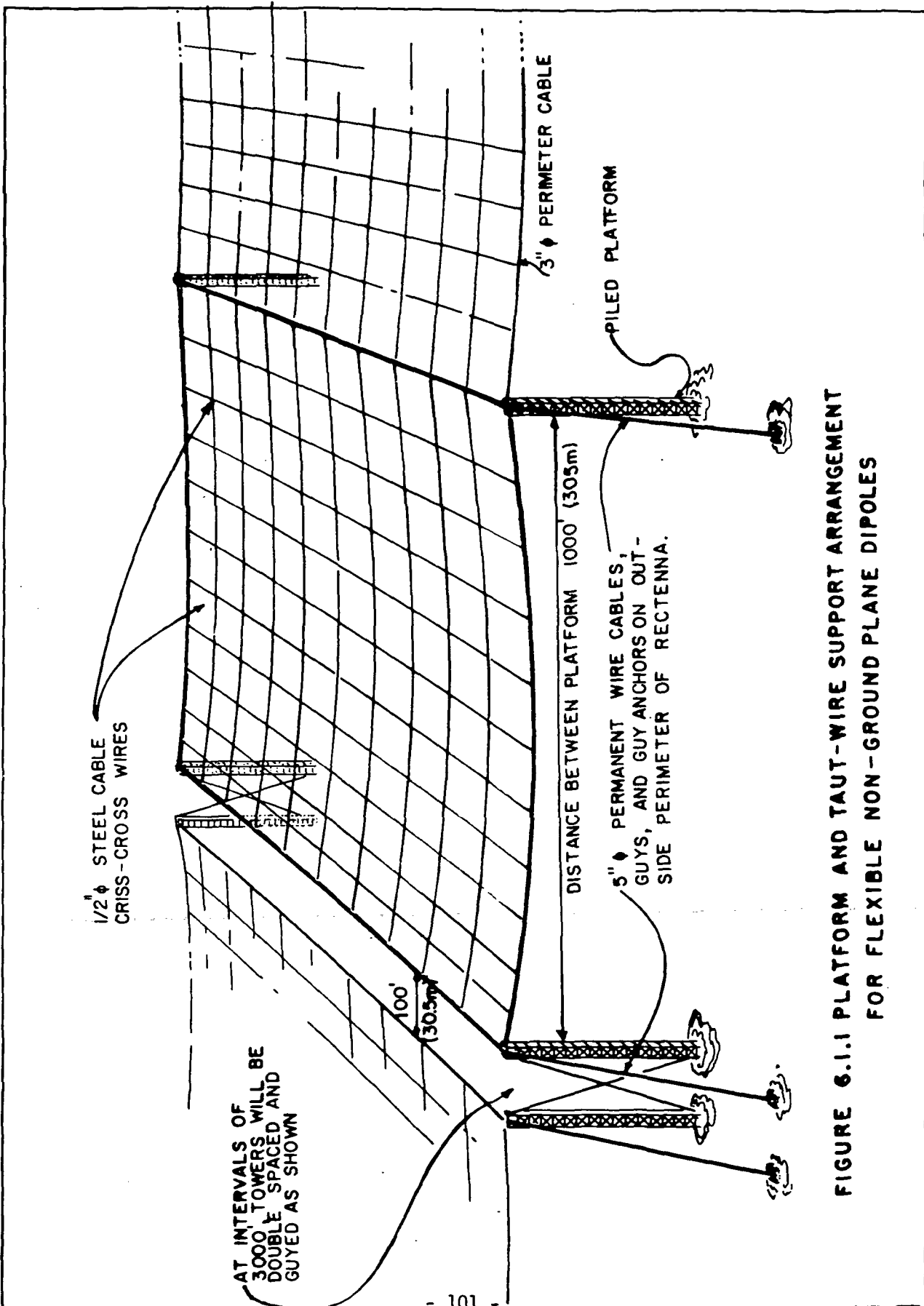

**FIGURE 6.1.1 PLATFORM AND TAUT-WIRE SUPPORT ARRANGEMENT  
FOR FLEXIBLE NON-GROUND PLANE DIPOLES**

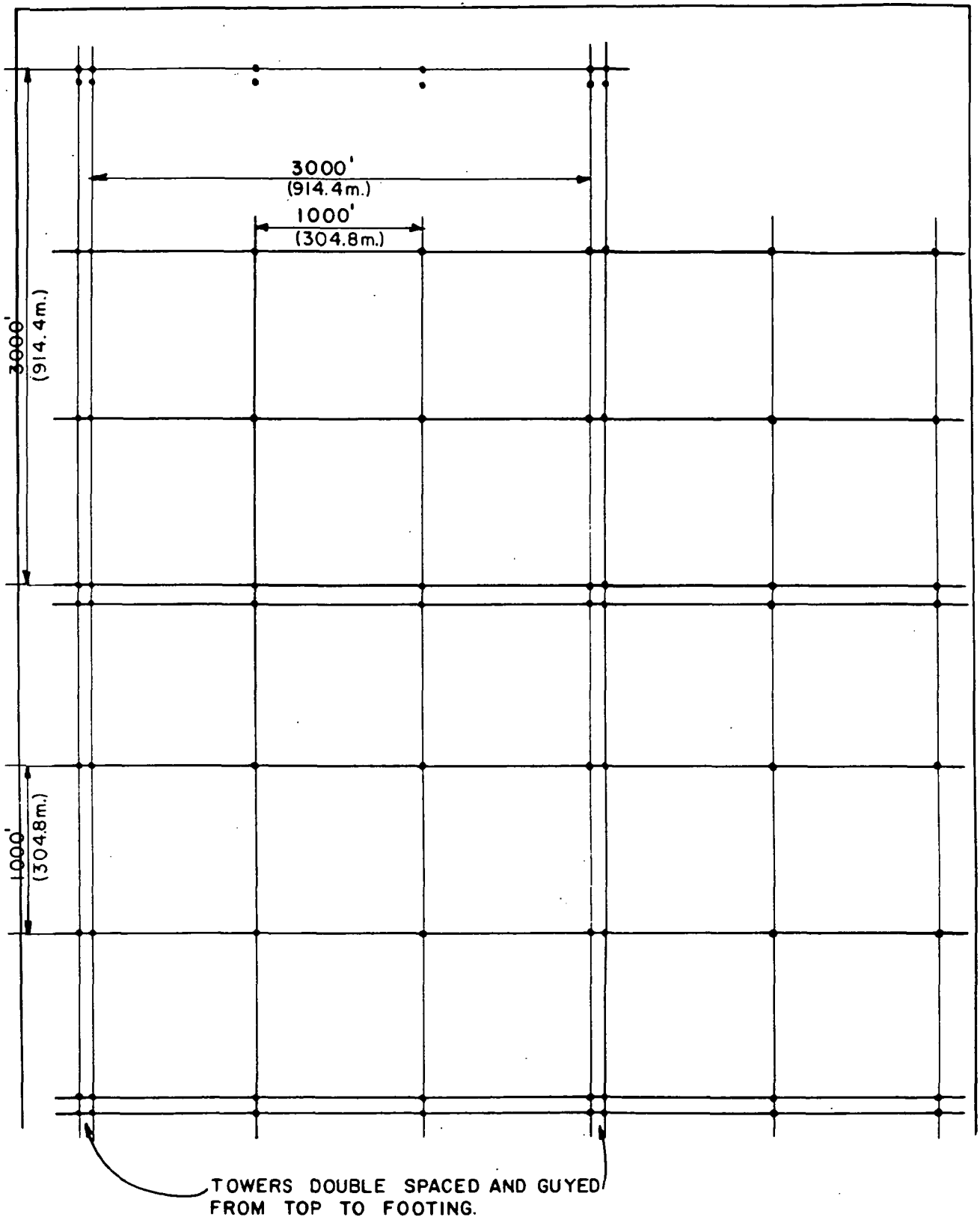

FIGURE 6.1.2 CONFIGURATION OF SUPPORT TOWERS AND PERIMETER TAUT LINE CABLES IN PREFERRED DESIGN.

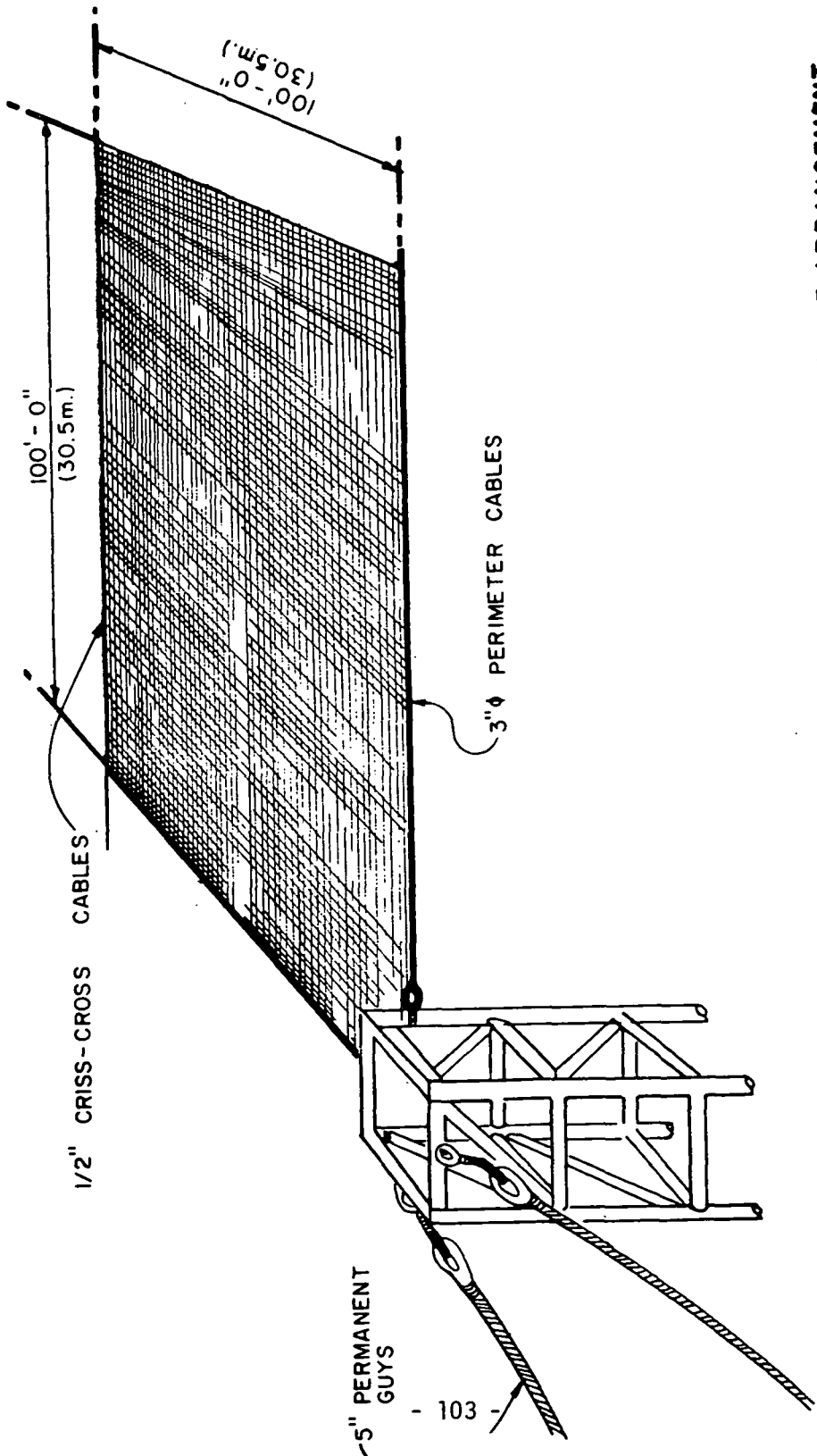

FIGURE 6.1.3 TYPICAL NON-GROUND PLANE FLEXIBLE DIPOLE ARRANGEMENT

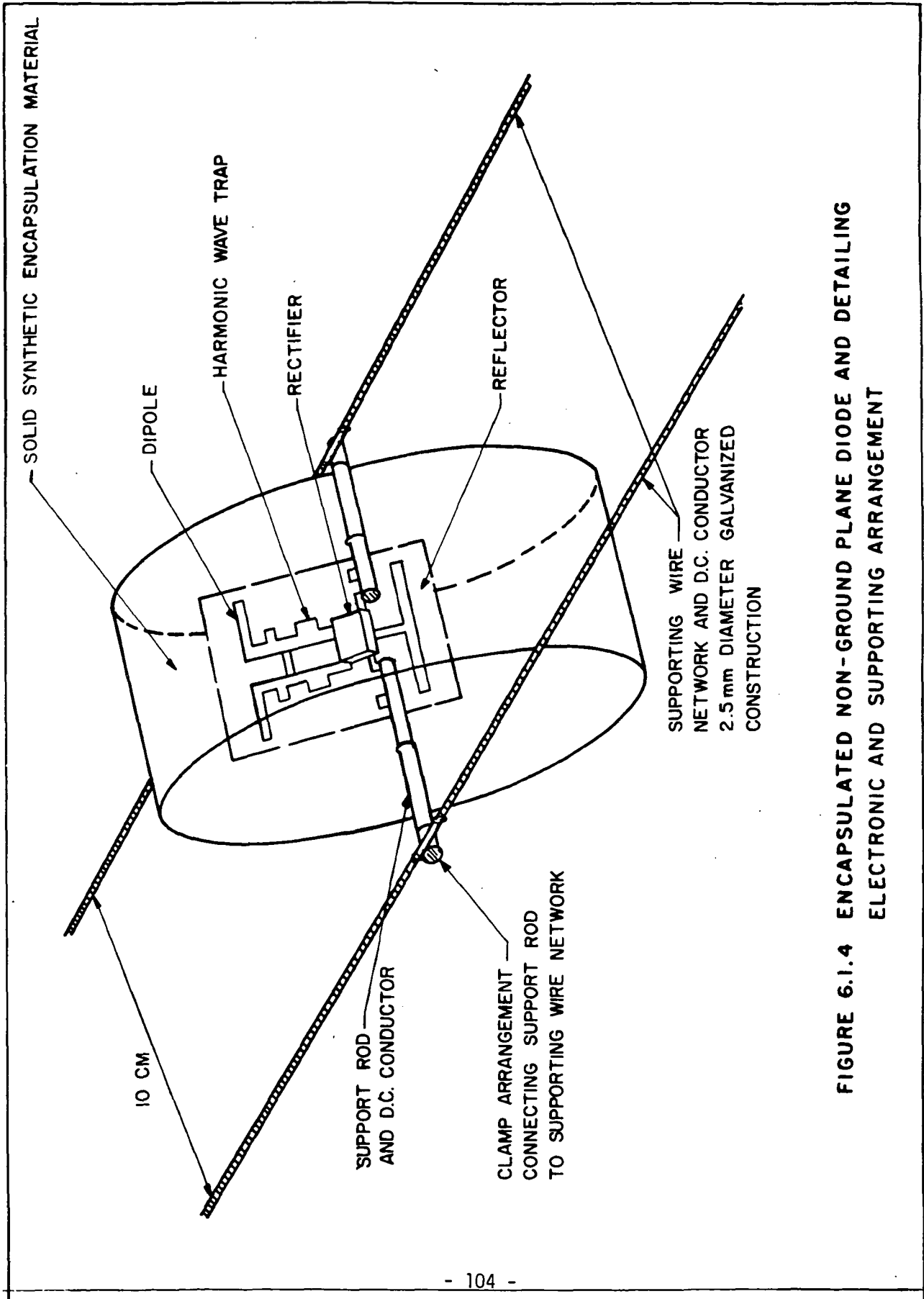

FIGURE 6.1.4 ENCAPSULATED NON-GROUND PLANE DIODE AND DETAILING  
ELECTRONIC AND SUPPORTING ARRANGEMENT

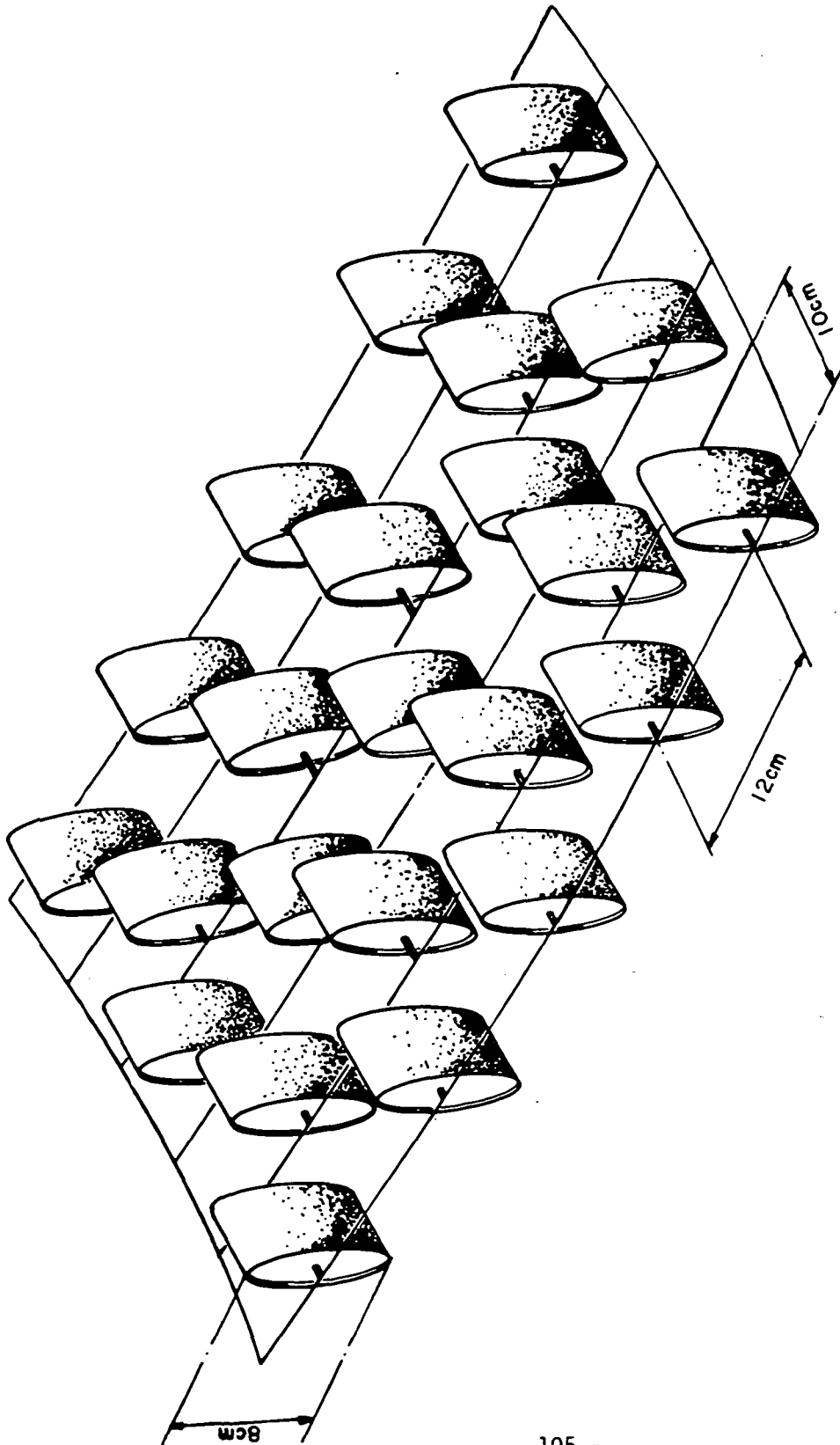

FIGURE 6.1.5 SECTION OF 100' BY 100' NON-GROUND PLANE DIPOLE  
MICROWAVE RECEIVING ARRANGEMENT

The following components are considered:

- . Piled support towers
- . Permanent and temporary guy wires
- . Guy wire anchors
- . Pilings
- . Taut wire lines
- . Encapsulated dipole networks
- . Equipment required for transportation and deployment

#### 6.2.1 Initial Fabrication

Reference is made to Section 5.2.1.1 in which fabrication of the piled support towers for the prime site design is discussed.

Design loadings for the preferred design will allow smaller dimensions of the tower components. The towers need only be 200 feet (61m) long instead of 300 feet (91.5m), but 50 foot (15.3m) long components would ease transportation to staging port.

The preferred design concept allows guy lines to be of similar construction, materials and dimensions as for the prime site point design. It is discussed in Section 5.2.1.1.

The design loadings will permit pilings of 20 inches (51 cm) in diameter to be used for securing support towers. Fabrication provides no problems. Pilings produced in 40 foot (12.2 m) lengths would ease transportation.

Wire cables can be used exclusively in the taut line network. The perimeter lines are of similar construction to guy lines. They will be 4 inches (10 cm) in diameter while the network of criss-cross lines only 1/2 inch (1.2 cm) in diameter. The perimeter lines need not be longer than 1000 feet (305 m) which provides no problems with fabrication. The use of galvanization in the fabrication of the taut line network would probably deter corrosion and prolong service life.

The fabrication of the encapsulated dipole networks will provide the greatest problem in the fabrication of the preferred design. The scheme allows networks of these dipoles (measuring 100 feet by 100 feet -30.5m by 30.5m) to be supported between the network of taut lines. The dipoles will incorporate a central axis which will act as support and means for conduction of electrical current to the network which in turn will conduct the generated power of all dipoles to collection points. Small diameter wires which support the dipoles can also serve as conductors. Small clamps will attach the central axis of the dipoles to the support wires, ensuring that the 45° reception angle of the dipole is maintained. The fabrication and encapsulation of the electronic components of the dipoles must be planned with the following considerations:

- . Low unit fabrication costs
- . Low unit encapsulation costs
- . Speed in performing fabrication



Purpose built machines for encapsulating the dipoles will connect the central axis to the wire networks. Units packaged in 100 foot by 100 foot (30 m by 30 m) sections for transportation to field site are envisaged. Although it is considered that the methodology and technology for achieving the above mentioned functions is well within the state-of-the-art, further research and development into the details of materials and fabrication methods will enable accurate costing and production planning to be formulated.

The remarks as included in Section 5.2.1.1 of the prime site point design will apply to the miscellaneous components of the system. The requirement for lower pretensioning in perimeter taut lines will effect the size and power requirements of linear winches thus reducing costs (from those of the point design). Manually operated "come along" tensioning devices (as employed for tensioning the smaller criss-cross wires) will be easy and inexpensive to manufacture.

#### 6.2.2 Component Transportation and Assembly

The assignment of staging ports in the proximity of the field site will be necessary for the preferred design (as with the prime site point design). The transportation and assembly of components at staging ports will follow similar methods to those described in Section 5.2 with the following main differences:

- . Support towers of smaller dimensions will require smaller areas for assembly
  - . The elimination of the large, unwieldy panel section will reduce the overall assembly area requirements and the need for the costly network of overhead gantry cranes. This in turn will reduce overall staging port development and operating costs.
  - . The smaller dimensions of the major components will facilitate transportation and deployment as well as reducing costs.
- Encapsulated dipole networks, carefully stowed in re-usable wire taut line and guy line reels, are expected to further reduce costs (from those of the point design).

### 6.2.3 Deployment and Installation at Field Site

The overall design changes of the preferred design over the prime site point design will minimize the requirements for purpose built transportation vessels to field site. Conventionally designed supply vessels will meet the main requirements, although tower transportation will be facilitated by using vessels as described in Section 5.2.1.4.

For installation of the preferred design at field site, the use of semi-submersible and jack-up units is possible. Jack-up units can set and pile towers at both ends in the channels between the 1000 foot by 1000 foot (305m by 305m) tower configurations. This is described in detail in Section 5.2.1.5 and shown in Figures 5.2.3 and 5.2.4. The requirement for less tower installation and reduction in tower dimensions will reduce the overall dimensions and therefore building costs of the jack-up units.

The use of semi-submersible units for the installation of encapsulated dipole networks is possible for the following reasons:

- . Increased tower spacing will allow barge moorings to be employed
- . Reduced weights in components will permit components to be carried and deployed without stability problems (which are common on semi-submersible units)
- . Reduced height of towers will allow access to taut line network from underneath without the necessity of raising the unit
- . Configuration of encapsulated dipole networks will allow installation without completely eliminating excursions.

The advantages of using semi-submersibles for the installation of the dipole networks are:

- . Easier and faster deployment. Spread moorings will permit an installation unit to move as required while setting the dipoles. Work boats can reset anchors as required (similarly to a conventional pipe leg barge) thus allowing the continuous installation of networks over the rectenna as the towers and taut lines are installed.
- . It may be possible to convert existing semi-submersible drilling units to fulfill the proposed installation tasks. If the availability of units does not permit the conversion, then specially built units could be converted for other tasks (such as crane barges, drilling units, etc.) or used for other rectennas after installation is completed.

Figure 6.2.1 and 6.2.2 show how the encapsulated dipole networks are installed using semi-submersible units

### 6.3 Maintenance Preferred Design

Section 5.3 covers maintenance of towers and miscellaneous items. The question of maintenance of the network of dipoles is pertinent. The system design will allow for a percentage of failure throughout the network. When this percentage is exceeded, changeout of sections of the dipole network can be accomplished using the semi-submersible installation barges. Planning for a maintenance program therefore will include:

- . Equipment for maintenance
- . Personnel requirements
- . Inspection and maintenance frequency
- . Component replacement
- . Overall budget

### 6.4 Costs

Total costs for preferred design is summarized in Table 6.1. Costs are itemized in Table 6.2.

Table 6.1

Cost Summary for Preferred Design

Design Subsystem	Cost in $\$ \times 10^9$
Piled tower and support systems	2.1
Dipole network and taut lines	2.8
Miscellaneous	0.7
Total	5.6

Table 6.2

## Itemized Costs for Preferred Design

Design Subsystem	Description	Cost in \$ $\times 10^9$
Piled tower and support systems	Towers, material labor and fabrication ( $\$2.0 \times 10^5$ /tower x 3000 towers)	0.6
	Material fabrication of jack-up barges for tower installation ( $\$5.0 \times 10^7$ /barge x 10 barges)	0.5
	Material and fabrication of miscellaneous hardware: - guys ( $\$3.0 \times 10^8$ ) - connecting links ( $\$1.0 \times 10^5$ ) - linear winches (20) ( $\$4.0 \times 10^6$ ) - Guy anchors or pilings ( $\$3.0 \times 10^7$ )	0.3
	Leasing of diving, piling vessels and operating equipment ( $\$5.0 \times 10^4$ /day x 730 days x 5 vessels)	0.2
	Operation of jack-up barges setting towers including piling mobilization and fuel ( $\$6.8 \times 10^4$ /day x 730 days x 10 barges)	0.5
	Total for piled tower and support systems	2.1

Table 6.2 (continued)  
Itemized Costs for Preferred Design

Design Subsystem	Description	Cost in \$x10 <sup>9</sup>
Dipole network and taut line system	Dipole network: material labor and fabrication cost ( $\$10/m^2 \times 900m^2/module \times 10000$ modules)	0.9
	Material fabrication of semi-submersible barges for dipole network installation cost ( $\$5.0 \times 10^7/barge \times 20$ barges)	1.0
	Operation of semi-submersible barges installing dipole network ( $\$5.0 \times 10^4/day \times 730$ days $\times 20$ barges)	0.7
	Tautlines: 3 in. (7.5 cm) diameter perimeter lines ( $\$30/ft \times 4 \times 10^6$ ft.) 1/2 in. (1.2 cm) diameter criss-cross lines ( $\$5/ft. \times 16 \times 10^6$ ft.)	0.2
	Total for Dipole network and tautline system	2.8

Table 6.2 (Continued)  
Itemized Costs for Preferred Design

Design Subsystems	Description	Cost in \$x10 <sup>9</sup>
Miscellaneous	Auxiliary supply vessel/tugs for supplying and moving units ( $\$1.0 \times 10^4$ /day x 730 days x 15 vessels)	0.1
	Staging port alteration costs 3 ports	0.5
	Staging port operational costs inclusive of labor ( $\$1.5 \times 10^4$ /day x 730 days x 3 ports)	0.03
	Transportation of components and other miscellaneous costs	0.1
	Total for miscellaneous costs	0.7

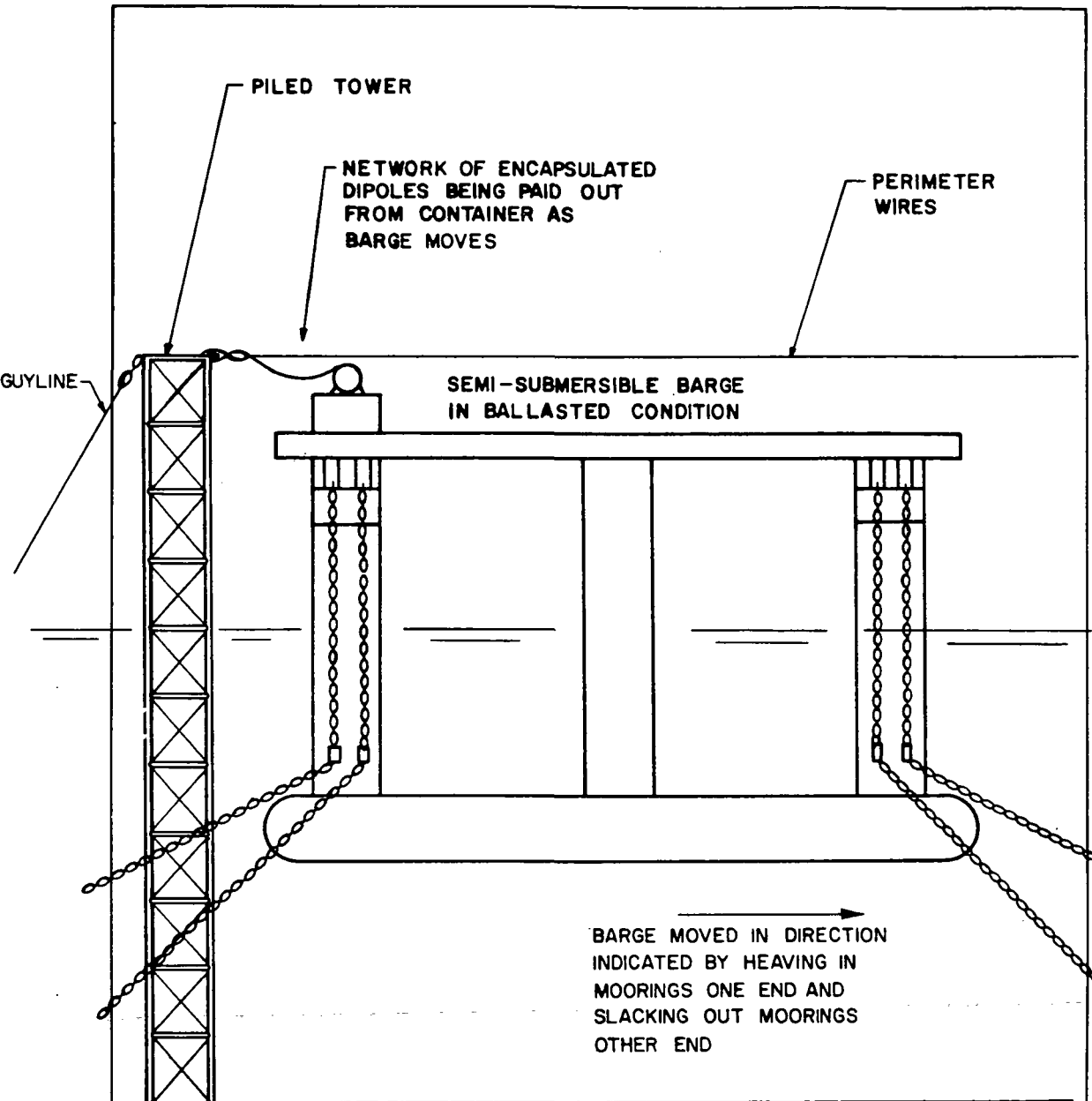

FIGURE 6.2.1 DIPOLE NETWORK INSTALLATION



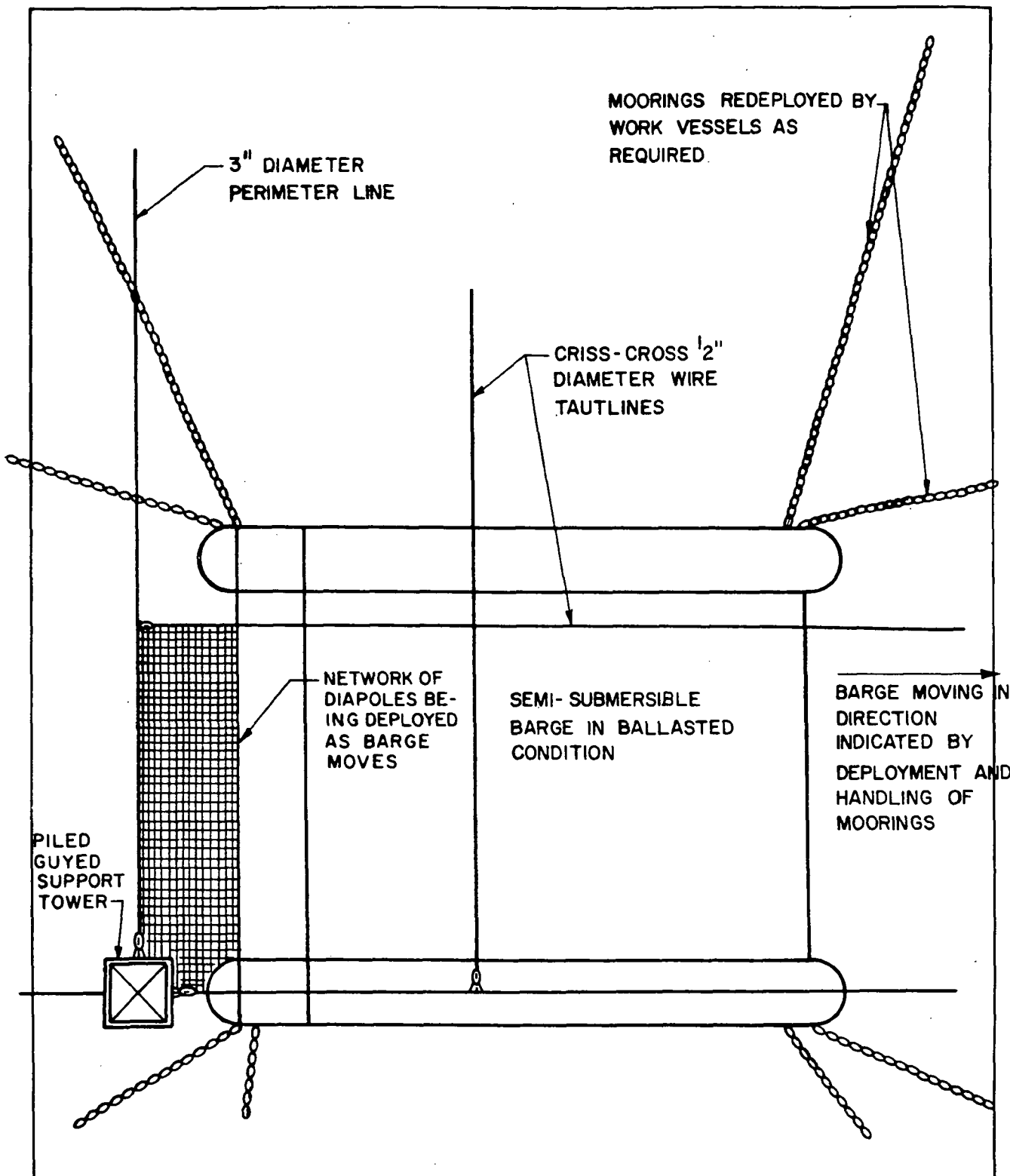

FIGURE 6.2.2 DIPOLE NETWORK INSTALLATION ON TAUTLINES

## 7. SUMMARY

### 7.1 Conclusions:

- Constructing an offshore rectenna to convert solar energy from space to electrical energy on earth is feasible in view of today's technology and costs.
- For the considered prime site, the point design had the following disadvantages:
  - Difficult transportation
  - Difficult installation
  - High costs (Total cost =  $\$36.9 \times 10^9$ )
  - High susceptibility to weather down time
- For the considered prime site, a preferred design using image dipole receiving is selected for the following reasons:
  - Relative ease in construction and transportation
  - Realistic methods for deployment and installation
  - Drastic cost savings over other methods (Total Cost =  $\$5.6 \times 10^9$ )
  - Less area for snow and ice to form build-ups.
- Among the support systems considered, piled guyed tower structures are the most economical in design, construction and installation for the prime site.

### 7.2 Recommendations:

- Change of site for shallower water depth will help to further reduce costs.

- Significant downtime for weather can be expected with all methods of installation and deployment at the prime site. Changing the site to a more benign weather area will minimize down time and reduce installation and deployment costs.
- In the design of image dipole receiver networks, it must be ensured that no heavy build-up of snow and ice will occur. This will be accomplished by diode network component spacing. This will be true for any areas subject to snow whether on land or at sea.

**"Page missing from available version"**

*p. 119 to p. 153*

#### 4. Cost Comparisons

The latest estimate for the cost of a land rectenna is \$2578 million [Boeing Aerospace Co., Solar Power Satellite System Definition Study, Phase II Final Report. Volume I, Rev. A, February, 1980]. The estimate from our study is \$5700 million for the first offshore rectenna at the candidate site. Brown and Root estimates that this will drop by 33% to \$3800 million after one time costs have been incurred. These include the purchase of custom equipment necessary for the fabrication and installation.

The costs of the two types of rectenna are not directly comparable for the following reasons:

1. Considerable attention has been given to the ability of an offshore rectenna to withstand severe weather, including icing. The preferred design is a fully weatherproof system. We suspect similar weather protection will have to be incorporated in the land rectenna as well.
2. The offshore rectenna is sited at about 41° N latitude and has a N-S axis 14.77 km for a total area of 116 km<sup>2</sup>; about 15% greater than the reference system rectenna.
3. The preferred offshore rectenna design was conceived late in the study and has not been fully optimized for cost. Also, efficiency data on the antenna is not yet available.

4. The present offshore rectenna cost estimate does not include transmission to shore or power pool interface equipment.
  
5. We believe there may be considerable cost saving potential in adopting the clotheline concept to a land rectenna.

For additional comparison, Collins [Feasibility of Siting SPS Rectennas over the Sea, Spa. Sol. Powr. Rev.,1, 133-144, 1980] has done a rough parametric analysis estimate of several types of offshore rectennas. Collins estimates that a floating rectenna could be built for about \$6000 million. We feel, however, that he has underestimated installation costs, which of course is possible with a parametric analysis.

## 5. Secondary Uses, Design Requirements, and Sea Defense

A subcontract was let to Arthur D. Little, Inc. to investigate various secondary uses of our offshore rectenna and to specify the design requirements and constraints connected with these. During the various design reviews Arthur D. Little personnel also became interested in the problems of protecting the rectenna against wave and wind damage. They also investigated this area.

The Arthur D. Little final report constitutes this section of this report.

ANCILLARY USES AND DESIGN REQUIREMENTS  
FOR AN OFF-SHORE RECTENNA

by

Philip K. Chapman  
Sara E. Bysse  
Gerard D. Downing

Peter E. Glaser  
Charles B. Cooper

and

William Sargent  
(Francis B. Sargent Productions, Inc.)

Kenneth A. Youngstrom  
(Manomet Bird Observatory)

Subcontract No. 437185B

March 1980

Final Report

Prepared by

Arthur D. Little, Inc.  
Cambridge, Massachusetts 02140

Prepared for

Rice University Space Solar Power Research Program  
Houston, Texas 77058

83570

Arthur D Little Inc



## TABLE OF CONTENTS

List of Figures

List of Tables

### CHAPTER I: POTENTIAL SECONDARY USES OF AN OFF-SHORE RECTENNA ISLAND

1. Introduction
2. Fishery Uses of an Off-Shore Rectenna Island
3. Ancillary Energy-Related Uses of the Rectenna Island
4. Industrial Uses of the Rectenna Island
5. Conclusions and Recommendations

### CHAPTER II: SEABIRDS AND THE RECTENNA ISLAND

1. Introduction
2. Marine Bird Species to be Expected at the Rectenna Site
3. Marine Bird Interaction with Vessels
4. General Considerations

### CHAPTER III: SITE SELECTION AND DESIGN IMPLICATIONS

1. Introduction: Siting Criteria for Off-Shore Rectennas
2. Sea Defense
3. Aerodynamic Design
4. Conceptual Designs for an Off-Shore Rectenna
5. Conclusions

## LIST OF FIGURES

Figure No.		Page
I	Potential Mariculture Systems at the Rectenna Island	168
II	Salmonid Grow-Out Facility	177
III	The Horizontal-Billboard Rectenna	213

## LIST OF TABLES

Table No.		Page
I	Productivity of U.S. Mariculture	170
II	Mariculture Criteria	181
III	Cost Factors for Industrial Uses	189
IV	Relative Abundance of Inshore Bird Species at Georges Bank	195
V	Relative Abundance of Off-Shore Bird Species at Georges Bank	196
VI	Size Data for Marine Birds	198

## Chapter I: Potential Secondary Uses

### Of An Off-Shore Rectenna Island

#### 1. Introduction

There is generally a strong correlation between population density and electric power demand, so that in regions which might make best use of the power supplied by the Solar Power Satellite (SPS) difficulties in assembling sufficiently large tracts of land for installation of rectennas may be encountered. For example, significant problems may be encountered in finding acceptable rectenna sites in the Northeast and Mid-Atlantic states, where about half the U.S. population live on 14% of the land area.

The options available for supplying SPS power to the most populous regions of the nation include the following:

1. Accepting the impact of rectennas, in terms of displacing the present population and restricting uses of the required tracts of land. This is of course what must be done when major hydropower facilities are built, so there is precedent for this approach. The land requirements for hydropower are generally much larger than for the SPS -- for example, power-producing dams controlled by the Tennessee Valley Authority (TVA) cover, on the average, about 30 times as much land area, per kilowatt of installed capacity, as would a rectenna.

2. Utilizing long transmission lines (>800 miles) to bring in power from regions where rectenna sites are more readily available (mostly west of the Mississippi). Unless underground transmission lines become practical, the land pre-empted for rights of way may be quite comparable in area to rectennas of equivalent capacity, and land use problems may be equally severe.
3. Building rectennas in rough terrain, in mountainous or swampy areas, or in areas now heavily forested, all of which impose additional costs. Moreover, it is highly desirable to preserve many of these areas, not now intensively utilized, in as close to their natural state as possible.
4. Designing rectennas as desirable facilities, incorporating multiple land uses. For example, it may be possible to utilize the waste heat from a rectenna to delay the onset of frost for crops grown beneath it; or the rectenna structure might be integrated with greenhouses, making large-scale greenhouse agriculture economically feasible.
5. Building rectennas off-shore. This option may be of particular interest because most populous areas are relatively close to coasts (Atlantic Ocean, Gulf of Mexico, Pacific Ocean, or the Great Lakes), and because land-use requirements will be greatly relaxed. In several areas of the world (e.g., Japan and perhaps Europe), off-shore rectennas may be essential to the utilization of the SPS, because of the unavailability of on-shore sites.

If appropriately designed, an off-shore rectenna island could support a variety of ancillary uses in addition to its principal function. Such secondary uses may be important, not only because the revenues from them could offset to a limited degree the increased construction and operational costs which an off-shore site might involve, but because they could improve the acceptability of the structure to other interests such as the fisheries industry which might be impacted by it.

The primary purpose of the present study was to examine briefly a number of ancillary uses of a rectenna island, with emphasis on estimating the costs and benefits involved and on suggesting design requirements or features of the structure to facilitate such uses. In addition, a single ecological issue was considered: the probable effects of the structure on seabirds, and vice versa.

## 2. Fishery Uses of the Rectenna Island

### 2.1 Overview of the U.S. Fishing Industry

In order to provide a context for possible fishery uses of the rectenna island, and to allow estimates of its probable impacts, it is useful to review briefly the present magnitude of U.S. fisheries.

Total catches from all areas by U.S. commercial fishermen, together with catches by foreign fishermen in the U.S. Fishery Conservation Zone (FCZ)\*, amounted to 4.6 million metric tons (MT) in 1978, up 11% from 1977. This total excludes the weight of mollusk shells and estimated catches by recreational fishermen. The increase was due to a moderate increase in U.S. landings and a slight increase in the foreign catch.

---

\* The area of the "200-mile limit".

In 1978 the foreign catch of fish (excluding tunas) and shellfish in the U.S. FCZ was about 1.8 million MT, up 3% from 1977. The FCZ off Alaska was by far the most important, accounting for 91% of the total. The Pacific zone accounted for 6%, with only 3% from the Atlantic zone. About 97% of the foreign catch was finfish, of which 62% was Alaskan pollock.

Landings by U.S. commercial fishermen at domestic ports were a record 2.8 million MT (round weight); they were valued at \$1.9 billion, also a record. Thus for all species, the simple average value was \$0.69/kg, round weight. The increased quantity was due in large part to an increase in landings of menhaden, used for fish meal and other industrial purposes. This upsurge in the U.S. landings, together with a reported downturn in the Norwegian catch, probably will put the United States into fourth place in world landings in 1978, behind Japan, the U.S.S.R. and mainland China.

Commercial landings of edible species in 1978 were 1.5 million MT, valued at a record \$1.7 billion (\$1.17/kg), an increase of 10% in quantity and 23% in value over 1977. This was the largest catch of edible fish and shellfish since 1951. The principal reason for the increase was higher landings of tuna, salmon, cod and other groundfish, crabs and oysters. Landings of shrimp and clams declined. The price index compiled by the National Marine Fisheries Service for edible fish stood at 384.4 in 1978 (1967 = 100), up 12% from 1977.

As would be expected, records were also established in the foreign trade aspect of U.S. fisheries. The total value of U.S. imports of edible and non-edible fishery products was \$3.1 billion, up 18% from the previous year. Edible imports were 1.1 million MT, valued at \$2.3 billion (\$2.11/kg). Total exports were valued at \$906 million, a 74% increase from 1977. Edible exports totalled 200,000 MT, up 35%, and were valued at \$832 million (\$4.10/kg), up 76%.

The U.S. per capita consumption of fishery products in 1978 was also a record, 6.1 kg of edible meat per person, an increase of 4% over 1977.

#### 2.1.1 Species of Potential Interest: Cod, Haddock, Halibut and Lobster

Total U.S. trawl landings of the principal North Atlantic groundfish species in 1978 were 170,000 MT, up 12%, valued at \$109.1 million (\$0.64/kg), up 26%. Domestic landings of cod were 39,000 MT, with an average value of \$0.55/kg. The value of U.S.-produced cod fillets was \$2.91/kg, manufacturers' level, an increase of 15%.

Domestic landings of haddock were 18,000 MT, with an average value of \$0.70/kg, a 39% increase in quantity over 1977 and the highest since 1969. The values of U.S.-produced haddock fillets was \$3.33/kg, manufacturers' level, up 9%.

The U.S. fishery for cod and haddock (as well as yellowtail flounder) has been under a Fishery Management Plan (FMP) since March, 1977, which has involved quarterly quotas, allocations by vessel size, etc., in response to a rapid influx of vessels into this fishery and strong market demand for catches.

The U.S. halibut fishery showed 1978 landings of 8000 MT, with an average value of \$2.31/kg. The Atlantic fishery accounted for only 93 MT, with a value of \$3.13/kg. Halibut steaks were valued at \$5.75/kg, an increase of 10% at the manufacturers' level.

Finally, U.S. lobster landings in 1978 amounted to 15,600 MT with an average value of \$4.14/kg.

## 2.2 Use of the Rectenna Island as an Artificial Reef (Fish Habitat)

The rectenna island, especially if it is a bottom-mounted design, may be expected to provide a habitat which will attract many pelagic and reef-dwelling fish species, generating recreational as well as commercial fishing possibilities. On a much smaller scale, improvement in fishing has often been noted in the vicinity of other off-shore structures, such as oil-drilling platforms. Some enhancement of the natural fishery may be obtained in the waters around the rectenna, but the structure covers such a large area that the majority of the increased fish population would generally be found within its borders. To maximize the productivity of this use, the underside of the rectenna should thus be far enough above mean water level and the support masts far enough apart to permit fishing vessels to operate beneath it. Shielding must be provided to prevent exposure of the crews of such vessels to unacceptable levels of microwave radiation either as part of the rectenna structure or as a design feature of the vessels themselves. Since trawling is likely to be more productive than line-fishing, the underwater structure of the support masts should preferably be designed to avoid snagging nets.



To some extent, this may conflict with maximizing the attractiveness of the island to desirable fish species by designing the structure to provide refuge against predatory species. Design to create an effective fish habitat may increase drag on the island due to tides or currents, as would the encouragement of marine growth to provide food. In order to maintain a healthy fish population, care must be taken to avoid leaching toxic chemicals from the rectenna; in particular, this could impose restrictions on the use of anti-fouling paints. Finally, an increased fish population would naturally attract seabirds to the island.

It is difficult to estimate the fish catch which might be expected from this simple use of the rectenna island, but it is likely to be minor compared to some of the more complex fishery systems discussed in the following sections, which involve more direct intervention in control of the fish population or more efficient catching techniques. The productivity is also likely to be quite strongly site-dependent, being higher in southern waters where reef-breeding species are more common.

### 2.2.1 Conclusion

Limited improvement of fishing around the rectenna could be achieved with little design impact other than enhancement of fish habitat features of the peripheral part of the system. To give access to substantially increased fish populations under the rectenna would involve significant design impacts, which are probably not worthwhile unless the required features can be provided in connection with a more profitable ancillary use (see below).

### 2.3 Fish Weir/Fish Trap

A suitable net suspended from the rectenna, around part of the periphery or across an internal diameter, could be used as a fish weir to direct local or migratory fish into a fish trap, as shown in Fig. I (a). To be effective in harvesting pelagic fishes, a depth of about four meters would suffice. The size of the rectenna island would permit construction of a fish weir which would be very extensive by current standards. If the site were in an area (e.g., offshore between Cape Cod and the Carolinas) regularly traversed by migratory fishes, the catch produced might be quite comparable to that presently obtained by conventional harvesting techniques such as trawling. The fish traps attached to the weir could also be constructed of netting, closed at the bottom to allow harvesting by hauling up the net; however, careful management would be required to assure release unharmed of species not immediately required or of fish below a desired size, since otherwise serious depletion of natural fish stocks could occur.

A fish weir would be a relatively minor addition to the rectenna and would have a significant design impact only in restricted areas, to permit manipulation of the fish traps and packing of the catch for transportation ashore. It might be desirable to establish a fish processing plant on the rectenna island, to allow maximum freshness of the product and to minimize transportation requirements, but this too would incur only a localized impact on the rectenna design. The underwater netting would cause a slight increase in the drag on the structure, and some restrictions on leached chemicals might also be required. Seabirds would be attracted to the site, but would tend to concentrate near the

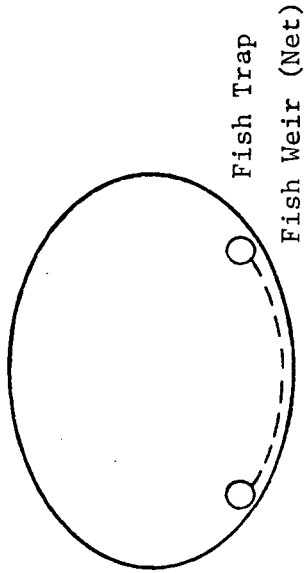

Fig. I (a): Fish Weir/Fish Trap

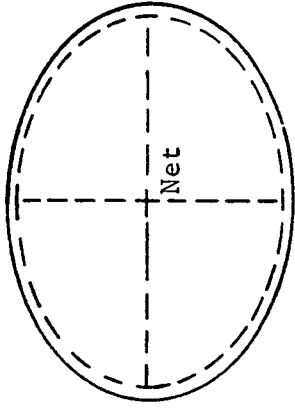

Fig. I (b): Mariculture (Range Operation)

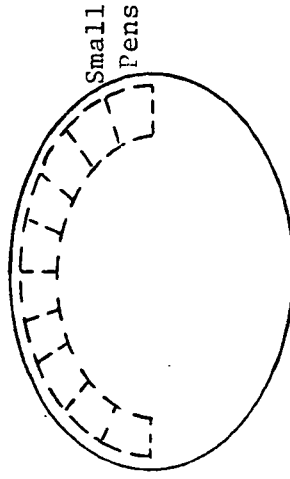

Fig. I (c): Mariculture (Feedlot Operation)

FIG. I: POTENTIAL MARICULTURE SYSTEMS AT THE RECTENNA ISLAND

fish traps and/or processing plant; it would be possible to design these areas to deny birds access, reducing the incentive to congregate there.

### 2.3.1 Conclusion

A fish weir/fish trap would have a modest design impact but could substantially improve harvesting in the natural fishery, and may therefore be very cost-effective. The catch could exceed considerably that presently obtained by conventional methods in the general area of the rectenna site. However, this use is likely to be regarded as undesirable competition by the local fishing industry, especially as it would be a large-scale operation with presumably little opportunity for small entrepreneurs. This would be especially true for species covered by a FMP: if the total catch is regulated to preserve stocks, then fishing is a zero-sum game, in which the catch at the rectenna island would reduce the harvest allowed to existing fishermen.

### 2.4 Mariculture

The rectenna island could provide the basic structure for a large facility which has many aspects in common with other proposed mariculture systems, although the scale of the island is considerably larger than is common in such proposals. The magnitude of the mariculture system which could be integrated with the rectenna is likely to be limited, not by the available area, but by the natural flow of water through the system and hence the supply of oxygen and nutrients to the fish.

Table I, showing yields from U.S. mariculture systems<sup>1</sup>, illustrates the remarkable productivity which is achievable; in some instances, foreign

TABLE I

## Yields from U.S. Mariculture Systems

---

Species	Live Weight (Metric Tons/Hectare/Year)
Oysters	5
Mussels	55
Shrimp	6 - 16
Yellowtail	30
Salmonids	8 - 30

---

mariculture has provided yields up to an order of magnitude higher. Assuming an average yield of edible species of 15 MT/hectare/year, and that the entire rectenna area could be used for fish farming, an annual harvest of 170,000 MT would result. This is about 11% of the annual U.S. fish catch. A single rectenna island could thus have a significant market impact, especially when compared to a regional fishery. If relatively high-value species were raised, with an average value of \$1.00/kg (round weight, manufacturers' level) such mariculture operation could gross \$170 million per year, approaching 15% of the value of the electric energy produced by the rectenna. A considerable investment might thus be justified in modifying the rectenna design to suit mariculture needs.

Mariculture is based on raising a controlled fish population under optimal conditions, with predators and undesired species excluded. The catch does not deplete natural fish stocks, and thus should not be subject to any FMP in force. In fact, insofar as a FMP implies an excess of demand over supply, species covered by it would be good candidates for mariculture.

#### 2.4.1 Mariculture Range Operations

The simplest type of mariculture which could be undertaken at the rectenna island would involve the construction of several large pens, as illustrated schematically in Fig. I (b). For surface-dwelling species, the pens could have net bottoms as well as sides, but, in reasonably shallow water, it would probably be cheaper to extend the net sides to the bottom, thereby accommodating bottom-dwelling species as well. The

principal objective in this type of mariculture would be to exclude predators and trash fish from the area under the rectenna, while providing a fairly natural environment for the desirable species, with a relatively small impact on the design of the rectenna. Without extensive stocking of the pens each season, the useable species would be limited to those which can tolerate annual variations in water temperature at the site and do not require long-distance migration for breeding purposes; in general, this type of operation would thus be most suitable at sites in lower latitudes.

Controlled fish traps would provide the most convenient means for harvesting, perhaps using the pens as fish weirs to direct fish into them. Some form of intrarectenna freight transportation (e.g., barges) would be required, implying sufficient clearance between the bottom of the rectenna and the water surface. If the pens were large enough, the additional drag on the structure would be modest. To provide reasonably calm conditions beneath the rectenna, some form of surface-wave damping would be desirable, and operations would be simplified if the mean distance from the rectenna to the water surface were controlled in the presence of tides, etc., which suggests a floating rather than a bottom-mounted rectenna (the design possibilities in this regard are discussed in Sec. III.4, below). If the nets forming pens extended to the bottom from a floating structure, they would of course need sufficient slack to accommodate the maximum water depth expected.

It would be appropriate to locate at the rectenna a facility for processing fish (cleaning, freezing, canning, etc.), especially as much of the waste produced in processing could be utilized as high-protein

feed in the mariculture system. The processing plant would also reduce waste and improve the quality of fish delivered to the consumer by eliminating the current practice of storing in the hold of a fishing vessel for up to several days before reaching shore.

To maximize the fish population which could be maintained in this type of fenced range, without artificial aeration and with minimal feeding requirements, the rectenna should preferably be located in an area of reliable water flow (either a steady current or tides). In choosing a site, a trade-off study is however required because high flow through the structure implies high drag and hence increased mooring or pylon costs.

#### 2.4.2 Mariculture Feedlot Operations

A much more intensive type of mariculture may be feasible at the rectenna island, in which carefully selected species are raised from eggs or fingerlings to commercial size in relatively small, highly productive pens, as illustrated in Fig. I (c). Because the requirements depend rather strongly on the species involved, hypothetical scenarios were constructed for several such grow-out facilities.

##### 2.4.2.1 Pollock

Pollock are indigenous to continental shelf waters off New England and adapted to the cool temperatures found there. While larger adults are typically found in 40 to 200 meters of water, younger fish (in the age range of interest here) inhabit depths at the shallower end of this range. It is assumed that pollock would be grown in the lower third of



the water column under the rectenna. Enclosures made of nylon or polypropylene netting would form cages, extending from the bottom to some middle depth (with a net cover to prevent escapes) or preferably from the bottom to the surface. A reasonable surface area for each enclosure would be 4 million square meters.

Assuming that young pollock could be raised in salt-water hatcheries (either near shore or at the rectenna island) to one year of age, the grow-out pens would be stocked with fish 13 to 18 cm in length. Pollock reportedly grow to about 30 cm in the second year, representing a 0.4 kg fish which would be marginally marketable. Each fish would require about a square meter of bottom area, so each pen would produce some 4 million fish each year, or about 1500 tons (round weight). At a retail value of \$3.30/kg (reduced because of size), the gross value of the harvest from each pen could thus reach \$5 million per year.

A second possibility would be to grow the fish for two years, when they could be expected to average 44 cm in length and approach 1 kg in weight, so that each pen would produce 4000 MT each two years, or 2000 MT annually. At a retail value of \$4.40/kg for these larger fish, the gross annual revenues from each pen would thus approach \$9 million, so that this seems a preferable mode of operation.

The number of pollock pens which could be installed at a rectenna is likely to be limited primarily by market demand. In 1976 (the latest year for which data are available), the harvest of pollock in New England waters amounted to 11,000 MT. Thus six pens (in the two-year-growth scenario), covering 20% of the rectenna area, might be sufficient to

double the harvest of this fish. The demand for this desirable species could be expected to increase if larger supplies were available, but too large an increment would be expected to depress prices, at least initially, so that pollock mariculture could arouse opposition from existing fishermen.

The pollock pens assumed here are sufficiently large so that their impact on rectenna design would be relatively modest, and the discussion of range operations, above, applies to this case also. Because of the homogenous population, wastage in fish traps or other harvesting techniques would be less in this application.

The overall conclusion is that pollock pens at a single rectenna island could significantly increase the harvest of this fish. The gross revenues from the operation could conceivably approach \$50 million annually.

#### 2.4.2.2. Salmonids

Anadromous salmonids (Atlantic or Pacific) are another candidate for intensive mariculture at an offshore rectenna site in the New England area. The pens for this surface-dwelling species would need to extend to a depth of only 5 meters, so that they would be equipped with net bottoms as well as sides. Young salmonids (smolts) between 1 and 2.5 years of age would be obtained from onshore (freshwater) hatcheries (or from on-site hatcheries using rainwater) and stocked in grow-out facilities at the rectenna island. A three-stage grow-out, using pens of increasingly larger surface area, would increase the efficiency of space utilization because the smaller fish require proportionately less space. Thus, a

series of three suspended pens might be used for each 20,000 fish produced, with surface areas of 400 m<sup>2</sup>, 1200 m<sup>2</sup>, and 4200 m<sup>2</sup>, as sketched in Fig. II. The last pen is designed to accommodate 20,000 adults, each weighing about 0.5 kg, at a density of one fish per cubic meter.

Anadromous salmon reportedly gain 1.5 to 3 kg during their first year at sea. Assuming that 0.5 kg salmon are marketable and that the crowding in the pens assumed here slows growth somewhat, it is reasonable to estimate that the three grow-out areas would be sequentially occupied for 2, 2 and 4 months, respectively, to produce fish ready for harvest.

Thus, at a minimum, each series of three pens could be harvested every 8 months (1.5 harvests per year), yielding 10 MT of fish. At an average retail price of \$8.50/kg, the gross value of this harvest could approach \$120,000 per year.

The smaller pens would be designed to allow hauling up the net bottom from one end, in order to herd the fish into the next larger pen, when this is required. Harvesting would be effected by hauling up the net of the largest pen.

The design impact on the rectenna (e.g., on the drag of the structure) of this type of mariculture clearly increases with the scale of the operation. To provide an upper bound, the U.S. salmon catch in 1967 amounted to about 130,000 MT; to match this yield with the facilities described here would require nearly 9000 sets of pens, with a total surface area nearly half that of the rectenna. It is almost certainly

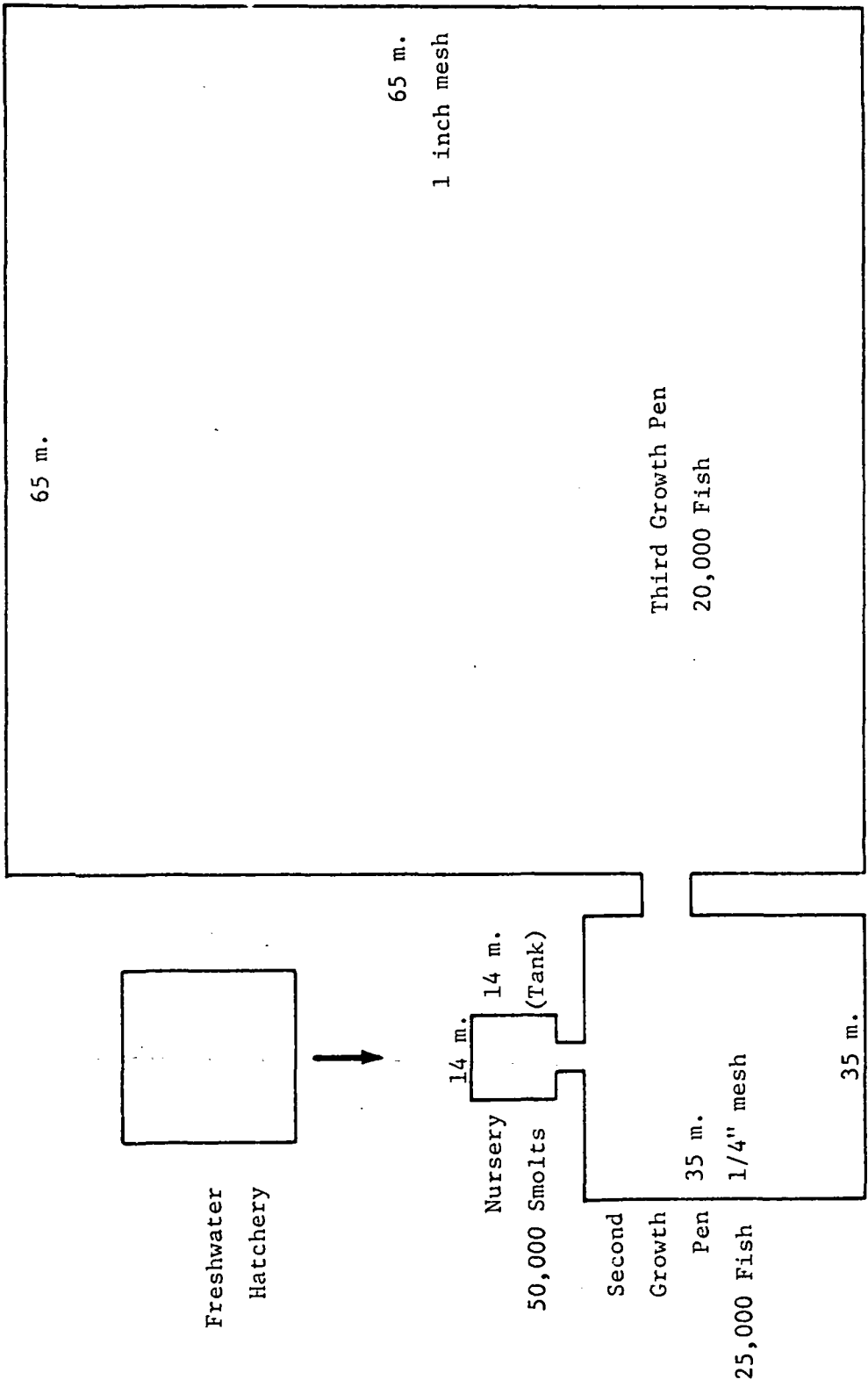

Fig. II: SALMONID GROW-OUT FACILITY

not possible to operate at this density, even if all nutrients are provided by the operators of the system, because of problems with aeration and the build-up of waste products. A more reasonable estimate is 500 sets of pens at each rectenna, providing a harvest with a gross retail value of \$60 million per year and a tonnage of about 5% of the U.S. salmon catch.

It would be feasible to locate this number of sets of pens around the periphery of the rectenna, minimizing the design impact and, in particular, providing access without the need to penetrate far beneath it. However, it is obviously essential that these shallow pens move up and down with the water surface (e.g., by using floating supports for them), and it is highly desirable that wave action be attenuated to prevent undue stress to the growing salmon.

#### 2.4.2.3 Lobsters

Lobster culture is a particularly interesting use of a rectenna island in New England waters. Since lobsters are bottom-dwelling territorial animals, it may be possible to keep them in the vicinity of the rectenna without artificial restraints; but, if necessary, a net fence about 1.5 meters high and attached to the bottom, surrounding the benthic area set aside for lobster grow-out, would be sufficient to avoid losses.

Infant lobsters can be supplied by existing shoreside hatcheries and the stock could also be supplemented by "berried" females, which have eggs clinging to the swimmerets on their abdomens. It is illegal to

market these females, so that they could be supplied at a minimal fee by lobstermen who catch them in existing traps. If a fish processing plant is located at the rectenna island, waste products from it could supply most or all of the food required by the lobsters during grow-out.

In this scenario, clusters of lobster habitats would be lowered on cables from the rectenna to the bottom, with a density of perhaps 100 clusters per square kilometer. A small fraction of the lobster population on the bottom would occupy these habitats, and could be harvested simply by raising the cluster. Based on experience with lobster traps, it is reasonable to expect a harvest of about 50 kg of lobster per cluster, and the harvest could be taken twice a month throughout the year, giving an annual yield of 120 MT/km<sup>2</sup>.

The design impact of such a lobster ranch would be quite modest: the primary requirement is passage for relatively small vessels under the rectenna for harvesting and transportation of the lobsters to a central packing facility. It is not clear what fraction of the benthic area under the rectenna could be utilized for this purpose without problems due to aeration, waste products, etc.; but, if it were possible to use the entire rectenna area, the calculated annual harvest would be about 13,000 MT, or more than 80% of U.S. lobster landings in 1978. The value at manufacturer's level of this harvest would approximate \$50 million, and about \$115 million at retail. While it may be feasible to achieve only a fraction of this harvest, it is clear that lobster ranching could be a very cost-effective use of the rectenna island.

### 2.4.3 Summary and Conclusions

Much further work will be required to demonstrate the technical and economic feasibility of mariculture uses of the rectenna island -- for example, there is very little experience as yet with culturing of pollock (or of other useful species such as cod and haddock). Range operations, a pollock grow-out facility, and lobster ranching appear to require relatively modest impact to the design of the island, while a salmonid grow-out facility is expected to have a larger impact, but only over a relatively small fraction of the rectenna area, around the periphery. In any case, it appears quite possible that mariculture at the rectenna could yield gross revenues (at retail) well in excess of \$100 million. Whether or not this is considered a significant contribution to the overall revenues (including electricity) from the rectenna, it is clear that mariculture may represent a promising industry in its own right, if it can be accommodated without major increases in rectenna costs. The effects on the design of the rectenna are discussed in more detail in Chapter III.

Designing a mariculture system on the scale envisaged here amounts essentially to developing a controlled but not entirely closed ecological system. Table II lists some of the criteria which might be used in developing the system, starting with the species which is to be raised, and some of the problem areas which must be expected. In addition to the pollock, salmonids and lobsters discussed specifically here, other species which might be considered for culture at an off-shore New England site include cod, haddock, flounder, sole and halibut; this particular selection is based primarily on available markets. For most of these

## TABLE II

### MARICULTURE CRITERIA

- SPECIES SELECTION
  - Season/Temperature Requirements
  - Predator/Prey/Competitor Relations
  - Population Density
  - Habitat Requirements
  
- HATCHERY FACILITIES
  - In Situ or Onshore
  
- FOOD SOURCES
  - Open Water Sources
  - Species Specific
  - Life Stage Requirements
  - Food Recycling
  - Artificial Reefs
  
- DISEASE AND PREDATION
  - Baterial/Viral Diseases
  - Predator Exclusion
  
- WATER QUALITY
  - Pollution (Oil Spills)
  - Contamination (Antifouling Agents)
  - Waste Product Removal



species, very little is as yet known about such important factors as their probable response to a somewhat artificial environment, the population density which can be achieved, or the risks of disease under these conditions. It would therefore be premature to attempt a more detailed design of the system at this time. For present purposes, it is sufficient to note that the design requirements on the rectenna imposed by mariculture, although quite species-specific, may be tolerable, and the potential revenues are in a significant range.

Beyond the revenue potential of mariculture operations, the possible provision of a new source of fish protein for a hungry world may become of increasing importance as the number of off-shore rectennas grows and the productivity of open-ocean fishing declines.

## 2.5 Other Fishery-Related Uses of the Rectenna Island

Fish Processing Facility. A fish processing plant at the rectenna island would be desirable to support mariculture operations, but such a plant could also serve conventional fishing fleets, especially if the rectenna were located closer to fishing grounds than the home ports of the vessels. This would improve the productivity of the fishing fleets, allowing them to spend more time fishing and less in travel; as an example, fishing vessels operating in the Georges Bank area now often spend two days out of each week in travel to and from port. The vessels would not need freezing plants to avoid spoilage and deterioration in the quality of the product during travel back to port. As a result, smaller boats would be able to stay on station for longer periods, reducing capital costs and allowing them to compete more effectively with the large, blue-water

vessels used by foreign fishermen, which are often equipped with processing plants. In this connection, it should be pointed out that floating processing facilities are under consideration or development in several areas around the world, notably to serve the Alaskan FCZ. Because the rectenna island would provide the foundation for such a plant, as well as the electricity needed to run it, combining it with the rectenna would significantly reduce the cost involved.

Overnight Docking Facility/Fuel Supply Depot. An artificial harbor built into the rectenna island could provide fishermen with a comfortable and safe overnight docking facility, especially if the fishing grounds were reasonably close. Restaurants and other recreational facilities (perhaps even family accommodations) could be provided on the island, leading eventually to a small town (effectively shielded from microwaves) which would improve the attractiveness of the island for other rectenna workers. If the harbor were protected by wave-damping devices (or if the entire rectenna island were so protected), the docking facility could also provide fishing vessels and other small craft with a refuge in the event of a storm, without having to return to shore harbors. Fuel and other supplies for fishing and other vessels at the rectenna island would be another valuable service, improving efficiency and reducing energy expenditures.

International Fish Marketing Facility. It is conceivable that the rectenna island could provide facilities where foreign and domestic fishermen could market their catch, not only to the fish processing plant. This would allow U.S. fishermen to sell to foreign entrepreneurs that portion of their catch for which there is little market in this country, and it

would also enable U.S. wholesale fish merchants to buy seafood which can be caught more efficiently by the larger bluewater fleets of foreign nations, without incurring the transportation costs to and from foreign markets which are now involved in such transactions. Since 42% by weight and 58% by value of edible fish products consumed in the United States are imported, this could lead to a significant reduction in the average retail price of fish.

### 3. Ancillary Energy-Related Uses of the Rectenna Island.

#### 3.1 Wave Power

One of the principal problems with extracting energy from ocean waves is that of converting wave motion into a form suitable for the generation of electric power. A variety of systems have been devised for this purpose, using bottom mounted or submerged structures to provide a stable reference, resonant hydrodynamic devices to produce a unidirectional jet of water, and gyro-stabilization of reference members in floating systems designed to undergo rotary oscillations due to wave action. Since the rectenna, whether floating or bottom-mounted, may provide a stable base at the wave frequencies of interest, it is possible that wave energy systems used in conjunction with it could be simplified. Moreover, the large size of the rectenna island presents an opportunity to extract power at a significant level despite the diffuse character of the wave energy resource.

The velocity of propagation of a wave (whose amplitude is much smaller than the depth) is given by elementary hydrodynamics<sup>2</sup> as

$$c^2 = \lambda^2 v^2 = \frac{g\lambda}{2\pi} \tanh \frac{2\pi d}{\lambda} \quad [1]$$

where  $\lambda$  and  $\nu$  are the wavelength and frequency of the wave,  $d$  is the water depth and  $g$  is the acceleration due to gravity. The power crossing a line of length  $L$ , due to waves of amplitude  $a$ , is then

$$P = \frac{1}{4} L g \rho a^2 c \left[ 1 + \frac{4\pi d}{\lambda} \operatorname{cosech} \frac{4\pi d}{\lambda} \right] \quad [2]$$

Given the frequency, [1] can be solved for the wavelength and propagation velocity: for example, for typical surface waves (with the wavelength much shorter than the depth), with periods of 2 to 3 seconds, the wavelength is 3 to 4.5 meters. If it is assumed that these waves have a height of 1.5 m, and that the minimum diameter of the rectenna is 10 km, the power impinging on it is calculated to be 85 to 130 MW. Quite simple devices, for example using the relative motion of floating collars around the rectenna support masts along the periphery, could be used to convert this energy to electricity.

After taking into account conversion efficiency, it appears probable that surface wave energy could contribute an average of at least 50 MW to the power output of the rectenna. Although this is a fairly small contribution to the overall power from the system, and would vary considerably with the amplitude and frequency of the waves, it would contribute about \$13 million per year (at \$0.03/kWh) to the gross revenues, and would provide an ancillary source of power for rectenna housekeeping functions, navigation beacons, etc., during SPS outages (for maintenance or during occultations of the satellite, etc.). Moreover, energy taken from the waves would of course reduce their amplitude and the system could thus be integrated with wave-damping to give smooth conditions under the

rectenna, which is highly desirable for most of the fishery applications discussed previously.

The energy contained in ocean swells is much greater than in surface waves. For example, if the water depth is 30 m and swells of height 5 m and period 18 seconds are incident on the rectenna, the calculated power passing beneath it exceeds 8 GW. Because of the lower frequency, it is much more difficult to extract useful power from swells, but it may not be impossible, given the size of the rectenna structure. If a suitable means could be found, at selected sites the average swell energy output might be comparable to that from the rectenna, so that this is clearly an interesting area for research.

It is also more difficult to damp swells than surface waves, and perhaps less important to do so. Chapter III gives a more detailed discussion of possible sea-defense systems, intended to protect the rectenna from damage, simplify its design, and ensure sea-state conditions compatible with ancillary uses of the structure.

### 3.2 Other Energy-Related Uses.

At suitable sites, adjacent to cold, deepwater areas but with warm surface water temperatures, an ocean thermal energy conversion (OTEC) system could be colocated with the rectenna. Apart from the provision of common support services and the capability of using a common power transmission system to the shore, there does not seem great motivation for this use of the rectenna island.

A more interesting possibility is to build a deepwater port in conjunction with the rectenna, adapted especially to very large super-tankers, in areas where no natural deepwater harbors exist on the adjacent coastline or where there are environmental objections to offloading tankers at shore ports. In such a case, an oil refinery could also be built on the rectenna island; this would be particularly desirable in regions such as New England, where no refinery now exists and acceptable on-shore sites have not been found. Crude or refined petroleum would be transported ashore by pipeline. Neither a deepwater port nor a refinery would be expected to impose significant design constraints on the rectenna, because of their limited extent, relative to the area of the island.

#### 4. Industrial Uses of the Rectenna Island.

An off-shore rectenna island offers significant advantages for a variety of industrial activities, compared to an on-shore site. They include:

- The availability of port facilities for very large vessels.
- The lack of existing property rights or other land-use problems.
- Little or no property tax.
- Isolation from population centers
- The ample availability of seawater for cooling purposes in industrial processes.
- An ample supply of electric power from the rectenna.
- Use of the ocean to disperse or neutralize solid or liquid effluents (although the effects of effluents on marine flora and fauna and the impact on fishery uses must be carefully considered).
- Possibly relaxed atmospheric emission standards.
- Removal of aesthetically undesirable facilities from shore areas.
- Improved safety (due to such factors as the availability of seawater for controlling fires) and reduced impact of major accidents.

The probable disadvantages are essentially:

- Increased personnel costs (especially transportation).
- The need to protect workers from microwaves.
- Lack of fresh process water<sup>\*</sup>.
- Physical separation of management and production.
- If implemented on a large scale, major impact on the rectenna design.

The industrial activities for which the rectenna island might provide an attractive site include the following:

- Deepwater port.
- Oil refinery.
- Port and storage facilities for liquefied natural gas (LNG).
- Chemical and petrochemical plants.
- Aluminum plant (for refining imported bauxite)<sup>\*\*</sup>.
- Liquid gas and air separation<sup>\*\*</sup>.

Table III, adapted from a feasibility study<sup>3</sup> of an artificial island for industrial purposes in the North Sea (off the Hook of Holland) lists the probable advantages and disadvantages of the rectenna island, compared to an on-shore site, which respect to cost factors in production. The referenced study considered an island measuring 10 km by 6 km (i.e., an area about half that of the rectenna island), and the basic construction costs were estimated as \$2.6 billion (1976 dollars). In the present case, some of the construction cost could be amortized by sale of electricity from the rectenna, probably improving the economics of an artificial industrial island.

Individual plants of limited area could be accommodated at the rectenna without major impact to the overall structure, but decisions would have to be taken regarding the fraction of the total area which could eventually be adapted to industrial purposes. The areal density of industrial facilities would in most cases be much greater than that of the rectenna itself, and provision would be needed for locating the plants beneath the groundplane

---

\* Even if the entire rectenna island were used as a catchment area, the average available flow of fresh water would only amount to a fraction of a cubic meter per second, depending on the rainfall.

\*\* Taking advantage of electric power from the rectenna.

TABLE III

Cost Factors in Industrial Production  
at a Rectenna Island

Product Cost Factor	Expense Relative to On-Shore Site*
Real Estate Costs	+ +
Real Estate Taxes	-
Insurance	+
Maintenance	+
Compliance with Environmental Standards	-
Raw Materials	0
Labor	+
Process Heat**	0
Cooling Water (Salt)	-
Electricity	-
Process Water (Fresh)	+
Petrochemical Feedstock**	-
Steam	0
Harbor Costs	+
Ship Transport	+
Pipeline Transport	+
Hazard Prevention (Public)	-
Worker Safety and Health	+
Port Infrastructure	+

\* More expensive at rectenna island: +

No significant difference: 0

Less expensive at rectenna island: -

\*\*With refinery on site.



of the rectenna and for transportation of personnel and materials to them. Areas reserved for industrial use would thus require a much more rugged and complex structure than those to be used for the rectenna alone.

More detailed estimates of the design impact of these uses of the rectenna island requires a study of potential industrial facilities on a case-by-case basis.

## 5. Conclusions and Recommendations

In order of increasing design impact, the most promising ancillary uses of the rectenna island appear to be wave-energy systems, a fish weir/ fish trap, mariculture using pens around the periphery, support facilities for conventional fisheries, a deepwater port and/or oil refinery, mariculture using more of the rectenna area, and some other industrial uses. In order to facilitate these uses, especially those requiring access to the interior of the rectenna, consideration should be given to the following design features:

- Shielding of the area under the rectenna from hazardous levels of microwave radiation.
- Providing sufficient clearance between the underside of the rectenna and the water surface and sufficient distance between support masts to permit relatively unrestricted passage by vessels of modest displacement.
- Wave-damping or other sea-defense systems to prove sea-state conditions under the rectenna which would not impede operations.
- Adapting at least a limited area of the rectenna to heavy construction, to provide port facilities for fishing boats and perhaps much larger vessels, living quarters for fishermen, recreational and other support facilities, and probably some industrial plants.

The secondary uses discussed here should be regarded only as preliminary suggestions. Demonstration of the technical feasibility of many of them will require research (e.g., with respect to the culturing of appropriate fish species for mariculture) and/or detailed analysis of the specific design requirements. In terms of economics, it appears that some uses (e.g., the fish weir/fish trap and a lobster ranch) may be very cost-effective, without necessarily contributing greatly to revenues from the island; if many of these uses were implemented, the gross annual revenues generated could easily amount to several hundred million dollars, justifying quite extensive modifications to the rectenna design and perhaps providing a useful contribution to amortization of construction costs.

## CHAPTER II: Seabirds and the Rectenna Island.

### 1. Introduction

This report is a preliminary assessment of the interactions of birds with an ocean-based rectenna for the solar power satellite system. The postulated rectenna position is 41°N lat, 70°30'W long, or about 40 km south of Martha's Vineyard, Massachusetts. The location is on the continental shelf with water depths of about 50 m.

The report will discuss (a) the avian species which can be expected in the area together with descriptions of these birds, (b) observed behavior patterns which might serve as predictors of reactions to the SPS rectenna structure, and (c) the difficulties of making predictions of the quality level traditionally utilized in assessing environmental impacts of various technologies.

The source data are derived from the Manomet Bird Observatory's continuing program to map the distribution of marine birds on the mid- and north-Atlantic outer continental shelf of the United States. This effort has been underway for four years under various sponsors; currently it is funded by the United States Department of Energy under DOE contract no. EE-78-S-02-4706. The study utilizes trained observers on ships-of-opportunity, i.e., cruise tracks are determined not by the specific needs of the seabird research program, but by the goals of the individual ships concerned. This precludes a statistically rigorous survey plan, but does allow for a great deal of coverage at relatively low cost. Seabirds away from their breeding colonies or before they are sexually mature (3-10 years in various species) are highly mobile in response to food resources which are locally only available for short periods of time. Therefore, these birds are heterogeneous populations that must be sampled by a stratified scheme. A ships-of-opportunity scheme allows most strata to be sampled, given sufficient observers.

Finally, much of the information presented herein is heavily weighted by expert opinion. The data from over 100 cruises consisting of over 10,000 transect censuses are currently being reduced to computer codes

for machine analysis. It is anticipated that summary distribution maps detailing birds in any specific area will soon be available which incorporate all of the program data to date. In the interim, the seabird observers have been queried in detail to generate these findings.

## 2. Marine Bird Species To Be Expected At The Proposed Rectenna Site

This listing includes only those species expected to occur at the proposed rectenna site reasonably frequently. Rarely sighted species are not included. Migrant land and shorebirds will be in the vicinity of the rectenna site especially during fall migration. Several passerine species are transatlantic migrants, moving from Cape Cod to Tobago, and many shorebirds migrate annually to South America. For these birds, the rectenna would be utilized as a stopping place when fog or overcast skies obscure the star fields needed for orientation. When conditions improved, the birds would be on their way once again. On the other hand, adverse winds (either headwinds or offshore winds) might force these and other migrants which do not normally migrate over the ocean to seek the rectenna as a refuge. If the energy reserves of these birds are depleted, the rectenna will not, of course, provide the necessary sustenance for replenishment, and these birds will probably perish.

Tables IV and V listing expected species at the rectenna site are derived from a pilot study of Georges Bank. The proposed rectenna site is essentially similar with respect to species composition and temporal distribution, with the exception that terns (Sterna hirunda in particular during the summer) are more likely at the rectenna. Table VI presents size data for 21 probable site residents or visitors.

## 3. Marine Bird Interaction With Vessels

During the four years of seabird research cruises by the staff of the Manomet Bird Observatory, with the single exception of gulls, none of the marine birds listed in the accompanying tables have been observed attempting to land on any parts of the survey vessel under normal weather conditions. These vessels have included fisheries research ships hauling trawl nets and processing catches much as do commercial fishing vessels.

Unfortunately, then, no clues are provided as to structural design of the SPS rectenna which might minimize landing of marine birds.

TABLE IV: Status, relative abundance, and time of status of 16 species of inshore birds recorded on Georges Bank, February 1976 - June 1977.

<u>Species</u>	<u>Status</u>	<u>Relative Abundance</u>	<u>Seasonality (Season)</u>
Common Loon	Migrant	Uncommon	Spring - fall
Red-throated Loon	Migrant	Uncommon	Spring - fall (?)
Great Cormorant	Migrant	Uncommon	Spring
Double-crested Cormorant	Migrant	Uncommon	Spring
Canada Goose	Migrant	Uncommon	Fall
Snow Goose	Migrant	Uncommon	Spring
Oldsquaw	Migrant	Uncommon	Fall
Common Scoter	Migrant	Uncommon	Fall
White-winged Scoter	Migrant	Uncommon	Fall
Surf Scoter	Migrant	Uncommon	Fall
Red-breasted Merganser	Migrant	Uncommon	Fall
Ring-billed Gull	Visitor	Uncommon	Winter-spring
Laughing Gull	Migrant	Uncommon	Summer
Common Tern	Migrant Migrant	Uncommon Rare (?)	Late spring - early summer Fall
Arctic Tern	Migrant Migrant	Uncommon Rare ( )	Late spring - early summer Fall
Sooty Tern	Visitor	Accidental	Summer - Fall

TABLE V: Status, relative abundance, and time of status of 26 species of off-shore birds recorded on Georges Bank, February 1976 - June 1977.

<u>Species</u>	<u>Status</u>	<u>Relative Abundance</u>	<u>Seasonality (Month)</u>
Yellow-nosed Albatross	Visitor	Accidental	June
Northern Fulmar	Visitor	Common-abundant	October - June
	Visitor	Rare	July - August
	Visitor	Uncommon	September
Cory's Shearwater	Visitor	Common-abundant	June - October
	Visitor	Uncommon	November
Greater Shearwater	Visitor	Abundant	May - November
	Visitor	Rare	December (?) - April
Sooty Shearwater	Visitor	Uncommon	April, August - October
	Visitor	Common-abundant	May - July
	Visitor	Rare	November - March
Manx Shearwater	Resident (?)	Uncommon	April - October
Audubon's Shearwater	Visitor	Uncommon	May - September
Leach's Storm-Petrel	Resident	Uncommon-Common	April - November
	Resident	Absent - Rare	December - March
Wilson's Storm-Petrel	Visitor	Uncommon-Common	April, September - October
	Visitor	Abundant	May - August
Gannet	Migrant	Common- Abundant	February - May, September - November
	Visitor	Uncommon	December-January, June - August
Red Phalarope	Migrant	Common-Abundant	April - June
	Migrant	Uncommon (?)	October - November
Northern Phalarope	Migrant	Uncommon	April - June
		Uncommon (?)	October - November
Pomarine Jaeger	Migrant	Uncommon	April - November (?)
Parasitic Jaeger	Migrant	Uncommon	April - November (?)

TABLE V: (continued)

<u>Species</u>	<u>Status</u>	<u>Relative Abundance</u>	<u>Seasonality (Month)</u>
Long-tailed Jaeger	Migrant	Rare	June, September
Skua spp.	Visitor-Migrant (?)	Rare-Uncommon	January - December
Glaucous Gull	Visitor	Rare	November - May
Iceland Gull	Visitor Visitor	Uncommon-Common Rare	November - March April - May
Great Black-backed Gull	Resident Resident	Abundant Common	September - April May - August
Herring Gull	Resident Resident	Abundant Common	October - May June - September
Sabine's Gull	Migrant	Accidental (?)	March, October
Black-legged Kittiwake	Visitor Visitor Visitor	Abundant Uncommon Rare	October - February March - June, September (?) July - August
Razorbill	Visitor	Uncommon	November (?) - April
Common Murre	Visitor	Uncommon	November (?) - April
Thick-billed Murre	Visitor	Uncommon	November (?) - May
Dovekie	Visitor	Uncommon	December (?) - April
Common Puffin	Visitor	Uncommon	December (?) - May



TABLE VI: Size Data for Marine Birds Expected to Occur at Proposed Rectenna Site.

Species	Size (cm)	
	Wing Span	Body Length
Northern Fulmar ( <i>Fulmarus glacialis</i> )	110	45
Cory's Shearwater ( <i>Puffinus diomedea</i> )	110	50
Greater Shearwater ( <i>P. gravis</i> )	115	45
Audubon's Shearwater ( <i>P. lherminieri</i> )	66	30
Manx Shearwater ( <i>P. puffinus</i> )	80	35
Sooty Shearwater ( <i>P. griseus</i> )	110	40
Wilson's Petrel ( <i>Oceanites oceanicus</i> )	40	15
Leach's Petrel ( <i>Oceanodroma leucorhoa</i> )	50	20
Gannet ( <i>Morus bassanus</i> )	180	80
Double-crested Cormorant ( <i>Phalacrocorax penicillatus</i> )	130	70
Red Phalarope ( <i>Phalaropus fulicarius</i> )		17
Northern Phalarope ( <i>Lobipes lobatus</i> )		15
Parasitic Jaeger ( <i>Stercorarius parasiticus</i> )	115	40
Pomarine Jaeger ( <i>S. pomarinus</i> )	120	45
Skua ( <i>Catharacta skua</i> )	40	45
Great Black-backed Gull ( <i>Larus marinus</i> )	165	60
Herring Gull ( <i>L. argentatus</i> )	140	50
Laughing Gull ( <i>L. atricilla</i> )	105	35
Common Tern ( <i>Sterna hirunda</i> )	80	35
Royal Tern ( <i>Thalasseus maximus</i> )	110	45
Common Puffin ( <i>Fratercula arctica</i> )		28

#### 4. General Considerations

Although it appears that there is nothing unique in the seabird use of the area planned for the sea-based rectenna, it must be recognized that the presence of the rectenna per se will create uniqueness. The itinerant seabird is in nearly constant flight in pursuit of its transient food resource. Areas of oceanic upwellings and fishing fleet activity serve to establish concentrations which are exploited by the birds as long as the resource remains abundant.

Even without an attendant mariculture operation, the underwater support and anchoring structures of the rectenna will inevitably support marine fouling organisms and the attendant food chain will appear. However, with the immense size of the rectenna, this fouling-based food chain will cause the stabilization of a major animal population normally given to nearly constant movement throughout a wide area of ocean. This fixed food resource will surely attract significant numbers of seabirds to the area to utilize the food resource. On the assumption that a mariculture activity cannot be operated without some loss of nutrients to the areas outside the boundaries of the fish farm, the increase in prey species will become more pronounced as the intensity of the mariculture efforts grow, and thus the bird population will grow as well.

To a great extent, this marks the end of the predictions one can make with some confidence. The appearance of fishing fleets and/or relatively small localized structures such as oil well platforms represent a rather small intrusion into a very large space. In addition, both the fishing boats and the oil-associated structures generally experience constant and significant levels of human activity which act as a deterrent to birds landing on them. The SPS rectenna, on the other hand, will not only be many orders of magnitude larger than any other man-made oceanic structure, but may also exhibit little continuous human activity.

Thus two very significant changes will be made in the environment of the seabird. First, food resources which have been mobile and somewhat dispersed in schools of various sizes suddenly (over a few years)

become concentrated and fixed in location. Second, birds which spend their entire lives, with the exception of a brief annual breeding period; on or above the surface of the open ocean may suddenly be presented with the opportunity to come to rest on a structure immediately above or adjacent to a major food source. It is difficult to predict responses to these conditions, representing, as they do, significant adaptive opportunities to the birds affected. The Larus gull species will rapidly exploit these opportunities; they spend a great deal of time resting on appropriate structures and are known to be clever and adaptive. Terns also may attempt to perch on the rectenna. Breeding sites for the Common Tern are not far away, and non-breeders forage at sea. Terns are known to perch on wharves, piers and pilings.

Other species not known to perch or rest may adapt quite rapidly. The Blue-faced Booby (Sula dactylatra) is not known as a perching bird, but the proliferation of oil platforms in the Gulf of Mexico has seen an accompanying change in the booby's habits in that it frequently rests on the platforms between fishing forays. Although the boobies are not found in the area under discussion here, the gannets, also a member of the family Sulidae, are common during seasonal migrations. One can thus suggest that, given appropriate structures, the perching of gulls, terns, and gannets (a wing-span range of 75 to 175 cm) is likely on an ocean-based platform.

Considering the list of birds likely to be present at the rectenna site as enumerated in Section 2 of this Chapter, it appears that any preventive measures should be effective for a group of birds whose wing spans range from 30 to 200 cm. (body lengths of 15 to 90 cm). Active measures, e.g., brightly flashing lights or frequent non-cyclical noises, are probably not worth considering due to (a) the complexity and maintenance required, especially in a structure the size of the SPS rectenna, and (b) their generally demonstrated ineffectiveness over long periods with a stable bird population -- in other words, the learning experience of the birds negates the effect of the devices.

Passive measures designed to prevent landing appear to be the best approach to the potential problem of birds landing on the rectenna faces. Vertical rods of microwave-transparent material spaced to prevent the smallest birds landing (probably about 20-25 cm. on center) and long enough to inconvenience the largest birds (about 30 cm) would seem to be worthy of further study and field testing.

Testing of such an exclusion device on land would seem to be both valid and cost effective. Gulls, of course, can be found at most dump sites; a suitably placed mock-rectenna section could be built and left unprotected until its use by birds was established. Protective measures could then be taken and the results observed, establishing the effects on the largest birds to be expected. In the same manner, a site at which starlings or blackbirds were active could be used to determine the effects on birds at the smallest size to be expected.

It is difficult to conceive of performing this study at sea for a number of reasons. First, it is the presence of the rectenna itself and its resultant enrichment of the food resources that will provide the attractant for the birds. We cannot predict whether some critical minimum area of structure might be necessary below which no significant accretion of food resources and birds might occur. This is not true on land where the food resources and the bird populations are already present and are subject to considerable manipulation by the experimenter. Second, the costs of establishing the experimental structures and of maintaining observers on the scene seem prohibitive. Given the unique behavioral patterns of the seabirds, spending most of their lives soaring through an obstacle-free environment, counter measures which prove effective for land birds, living as they do in an environment requiring them to have great agility in avoiding obstacles, should be clearly effective on the seabirds.

## CHAPTER III: Site Selection and Design Implications.

### 1. Introduction: Siting Criteria for Off-Shore Rectennas

A review of the current studies of the off-shore rectenna suggests that the design is strongly driven by wave height considerations and wind-loading during occasional severe storm conditions. To reduce the impact of these factors, attention should be paid to the aerodynamic design of the structure and to techniques for attenuating waves under it. An appropriate sea defense system could provide relatively calm water under most of the rectenna, allowing the height of the structure above the mean sea surface and, hence, the lever arm through which wind-loading forces act on it to be minimized.

If ancillary uses for the rectenna island (e.g., for fisheries) are to be seriously considered, it is highly desirable to provide reasonably calm conditions in the presence of external disturbances. Many of these uses would require a specified clearance between the rectenna and the sea surface, but it appears unlikely that this would be high enough to conflict with the requirement for a low profile to minimize wind-loading. Some ancillary uses also impose design requirements on the structure below the waterline - for example, an uncluttered design may be necessary to avoid snagging nets, etc.

It should be noted that it is not essential that the rectenna remains operational in all conceivable weather conditions. For example, it is clearly mandatory that the rectenna be capable of surviving a hurricane (particularly if it is located in hurricane-prone areas), but it may be possible to shut the system down during such rare events without seriously affecting the loss-of-load probability (LOLP). In any case, there may be significant attenuation of the microwave beam due to atmospheric water vapor during a hurricane.

A first approach to the problem of sea defense is to locate it in relatively protected waters. To maximize the availability of such sites, it is assumed here that visual pollution criteria can be adequately met if no part of the rectenna is within 15 km of a shoreline. Preferred

sites are thus those which offer oval areas of water approximately 40 km in the E-W direction and 45 km in the N-S direction, surrounded, as far as possible, by land. Where exposure to the ocean cannot be avoided, broad coastal bays may be preferable to straight coastlines, so as to reduce the length of rectenna perimeter which must be protected from ocean waves.

The primary purpose in finding sheltered waters is, of course, to reduce the fetch over which wind can generate surface waves. The wave height (trough to crest, in meters) produced by a wind speed  $V$  (in knots) is given by the empirical relationship<sup>4</sup>

$$h = 0.0075 V^2 \quad [3]$$

but the maximum wave height which can be produced over a fetch of length  $X$  (in nautical miles) is

$$h_m = 0.46 X^{1/2} \quad [4]$$

Combining these relations, winds in excess of

$$V_m = 7.8 X^{1/4} \quad [5]$$

will not be effective in increasing the height of the waves.

For example, if the fetch is 15 km (8.1 n.m.), the maximum wave height will be 1.3 meters, produced by any sustained winds in excess of about 13 knots.

An additional advantage of sheltered waters is that the expected wave spectrum (at least in limited - fetch directions) is of the JONSWAP type, peaking at periods of a few seconds. These short-period waves are much easier to attenuate than ocean waves, where the spectrum is of the Pierson-Moskowitz type, peaking at periods approaching 20 seconds (swells).

Based on these considerations, sites along the eastern seaboard of the United States which may merit further investigation include: Cape Cod

Bay and Nantucket Sound in Massachusetts; Delaware Bay; Chesapeake Bay; Pamlico Sound (behind Cape Hatteras); Florida Bay (protected by the Florida Keys); Apalachee Bay, near Tallahassee; and Chandeleur Sound, near New Orleans. Lake Okeechobee in Florida and Lake Ponchartrain in Louisiana are marginal possibilities, although recreational uses of these waters may preclude rectenna installations there. Finally, there are a variety of potential sites in the Great Lakes, although winter freezing of the lake and/or ice accretion on the structure may cause problems.

There are relatively few sheltered sites on the West Coast, but fortunately there is little difficulty in finding good on-shore sites in that area.

Choosing an actual site of course would involve consideration of a broad variety of other factors. Some of the above sites may suffer abnormally high tides or amplification of ocean waves due to shoaling water or coastline constrictions. The depth of water at the site will, of course, have an important influence on the choice between floating and bottom-mounted structures. The distance to the intended major load will control transmission costs. The rectenna island may pose a hazard to navigation, so that maritime traffic patterns must be taken into account. The structure may affect (beneficially or adversely) existing uses of the site such as fisheries or spawning grounds. The suitability of the rectenna for ancillary uses will also depend on its location. For present purposes, however, it is sufficient to note that the optimal rectenna design is very likely to be site-specific. It, therefore, does not seem reasonable to attempt a generalized conceptual design of an off-shore rectenna; instead, a specific site should be carefully chosen and its characteristics evaluated as an input to the design.

## 2. Sea Defense

In general, the rectenna must be designed to operate in the presence of tides, ocean swells and surface waves. It must also be capable of surviving rare events such as surge from a nearby hurricane or, in some

areas (e.g. Japan), even a tsunami. Tides are of little consequence to floating structures (apart from possible mooring problems) but a bottom-mounted rectenna clearly must have sufficient clearance above the water for both the maximum expected tide and waves.

As noted in Chapter I, Sec. 3.1, the velocity of propagation of a (small amplitude) wave is given by

$$c^2 = \lambda^2 \nu^2 = \frac{g\lambda}{2\pi} \tanh \frac{2\pi d}{\lambda} \quad [6]$$

where  $\lambda$  and  $\nu$  are the wavelength and frequency of the wave,  $d$  is the water depth and  $g$  is the acceleration due to gravity. For surface waves ( $\lambda \ll d$ ), the wavelength is thus given by

$$\lambda = g/2\pi\nu^2 \quad [7]$$

and for long waves ( $\lambda \gg d$ ) by

$$\lambda = \sqrt{gd}/\nu \quad [8]$$

As an example, ocean swells in deep water, with a typical period of 18 seconds, have a wavelength of about 500 meters. As the water shoals, the swell wavelength decreases (to about 250 meters in 20 meter depth), the waves assume a steeper, trochoidal shape and the amplitude increases slowly. On the other hand, the surface waves generated over a limited fetch, with typical periods of 2 to 3 seconds, have wavelengths which are only of order 10 meters.

There are three possible approaches to rectenna swell defense:

- i) In sufficiently shallow water, a conventional massive breakwater, built up from the bottom, could conceivably be used. A rough estimate of the cost of this alternative may be obtained from a feasibility study<sup>3</sup> of an artificial island for industrial purposes off the Hook of Holland. The proposed island is comparable in its dimensions to a rectenna and the chosen site has a water depth of about 25 meters. The cost of the sea



defense is quoted as about \$900 million. While this figure is rather high for the rectenna application (a capital burden of \$180/kw), it could conceivably be reduced to an acceptable level by building in shallower water and using this type of breakwater only along the part of the rectenna periphery which is exposed to the open ocean.

A variant of this approach, perhaps useable in very shallow water, is the "polder" type of construction, in which a dyke is built around the entire area and water pumped out (as in the Zuyder Zee in the Netherlands), leaving a dry surface for rectenna construction. As an example of the potential cost, a study of this technique (in connection with off-shore airports)<sup>5</sup> leads to an estimate of about \$200 million for the rectenna application, if the water depth is 5 meters.

- ii) If the rectenna is floating, it could be designed so that the surface follows the contour of ocean swells. The angular frequency of vertical bobbing of a spar buoy is given by

$$\omega^2 = gA_s/V_b \quad [9]$$

where  $A_s$  is the cross-sectional area of the spar and  $V_b$  the (steady-state) submerged volume. For example, a bobbing period of 12 seconds requires that  $V_b/A_s \approx 36$  meters, an easily attainable value. With appropriate damping (e.g., by suspending a disc on a cable below the buoy, as in a wave staff), it should be possible to design a spar buoy which follows swells up and down, but which is relatively unaffected by surface waves. The buoy would exhibit reduced response to swell motions at harmonics of the fundamental swell frequency - in other words, the rectenna surface should have a sinusoidal profile, even if the swells are beginning to crest. The maximum slope in this profile, for swells of wavelength of 250 meters and height 10 meters, is only about  $7^\circ$ , so cosine losses due to misalignment of the rectenna elements would be small even under quite extreme swell conditions.

iii) The seaward periphery of the rectenna could be designed as a massive floating breakwater. There are two distinct classes of floating breakwater: those which dissipate wave energy and those which attenuate by reflection of the incident wave, as well as combinations of those types. As far as is known, there has been relatively little work as yet on floating breakwaters for swell defense, but some general conclusions may be drawn.

At first sight, dissipative floating breakwaters (DFB's) for swell defense appear impractical, because of the low frequencies involved. However, the peak vertical velocity in a wave is of course proportional to the product of amplitude and frequency, so this parameter for a swell may be comparable to that for a surface wave, the higher amplitude offsetting the lower frequency. It may thus be possible to extract energy from the swell, at least during part of the cycle, using dissipative devices of the same generic type as those used for attenuating surface waves. The energy in the swell is, however, so much greater than that in a surface wave that the relative attenuating effect of a single device will be very small. In other words, a much larger number of dissipative devices would be required for swell attenuation. It is probable that the first few hundred meters of the rectenna, a distance comparable to the swell wavelength, would need to be equipped with such devices.

A possible dissipative device consists of a floating collar around the shaft of a spar buoy (with a bobbing period considerably longer than the swell period) or bottom-mounted spar. A simple means for extracting energy from the relative motion of the collar and shaft is hydrodynamic (i.e., using water jets or induced turbulence). However, as noted in Chapter I, Sec. 3.1, average power passing under the rectenna due to ocean swells of height 5 meters amounts to perhaps 8 gigawatts (it varies as the square of the wave height). If a means could be found to extract this energy in useful form, it would significantly increase the power output of the system and the increased revenues might justify an elaborate swell-attenuation system.

Reflective floating breakwaters (RFB's) must have a beam comparable to the wavelength, so that the first several hundred meters of the rectenna would need to be a massive floating raft. Although part of the cost might be charged to the rectenna itself, as the RFB could support rectenna elements, it appears probable that the cost of this approach would be prohibitive. Surface-wave RFB's exhibit annual costs of order \$1000/meter<sup>6</sup> (including amortization of capital and maintenance); extended over a semi-perimeter of the rectenna (19 km), the estimated annual cost of such a small RFB would thus be of order \$19,000,000, amounting to about one half mill for each kilowatt-hour produced by the rectenna. The cost of a swell-defense RFB would surely be orders of magnitude greater.

The technical feasibility of these systems requires much further investigation but the tentative preliminary conclusion is that the most cost-effective approach to the problems of tides, heavy storm surges, and ocean swells is to use a floating rectenna whose surface conforms to the contour of the sea. However, given the scale of the rectenna and the fact that its defense against swells can justify part of the cost, extraction of swell energy with a DFB is an intriguing possibility. If combined with electric power generation, this could be one of the promising ancillary uses of the rectenna.

The obvious defense against surface waves is a floating breakwater. The dissipative type is preferred because it may provide broader spectral bandwidth and may consist of nothing more complex than floating collars around the first few rows of spars which are needed anyway for support of the rectenna elements. The total power incident on the rectenna diameter in the form of surface waves of period 2 seconds and height 1.5 meters is calculated as about 100 MW, which may be too small a contribution to system power output to justify anything other than the simplest hydro-dynamic loss mechanisms. However, if means were provided for extracting at least some of the energy as electric power, it could provide an auxiliary source for powering rectenna housekeeping functions,

navigation beacons, etc., during SPS outages (e.g., during occultations of the satellite).

Techniques for extracting surface wave and possibly swell energy as an ancillary use of the rectenna island are worthy of detailed study.

It should not be difficult to provide an order of magnitude attenuation of surface waves with a simple DFB giving quite calm water under most of the rectenna. If swell defense is of type (ii), swells will still be present, but the rectenna structure will move up and down with them, so that relative motion of boats or other systems working under the rectenna may be minimized.

### 3. Aerodynamic Design

One of the principal purposes of the sea-defense systems is to allow the rectenna island to have a low exposed profile, to minimize wind loading effects. A complementary approach to this problem is to optimize the aerodynamic characteristics of the rectenna.

The overall drag on the rectenna is primarily important to the design of the mooring system. It is the local forces which determine the structural requirements for individual rectenna modules (spar buoys, towers, etc.).

Even if a "conventional" billboard array is used for the rectenna, it is clearly unduly pessimistic to assume that each billboard will be subjected to the full force of the wind; depending on the wind direction, each billboard, except those on the windward periphery, will be to some extent in the wind shadow of others. However, the conventional array is very likely to generate strong turbulence over the rectenna in strong winds, leading to billboard buffeting even if the wind is steady. Because of the billboard orientation, these problems would probably be most severe in northerly winds.

Several techniques might be suggested for alleviating wind-loading problems:

- i) Billboards could be designed as open structures, so as to minimize wind resistance. Resonant dipoles behind each dipole rectifier could be used to eliminate the groundplane, but an open mesh groundplane may provide better microwave shielding for workers under the rectenna.
- ii) A roof over the whole structure, transparent to microwaves and sunlight, would eliminate local wind-loading problems. At least in areas where ice accretion is not a problem, the

roof could be relatively fragile except near the periphery where wind loading forces, spray and perhaps occasional very large breaking waves would have the greatest effect. Cutouts in the roof would provide drainage and equalization of aerodynamic pressure differentials. One difficulty with this approach is that the roof must be capable of accommodating flexing of the rectenna and local disturbances such as sway of the supporting masts (especially in the swell-conforming design, using spar buoys as supports). The roof might also be used to help protect the dipole rectifiers from corrosion and salt and guano accretion, perhaps reducing unit costs. However, the roof constitutes an additional major element in the rectenna design so that this solution may be relatively costly.

- iii) The billboards could be horizontal instead of perpendicular to the microwave beam, thereby reducing the frontal area exposed to wind. The total area of active elements would, of course, be increased by the secant of the zenith angle of the satellite, but this could be offset by increasing the antenna gain of individual elements (e.g., using simple yagi antennas), thereby reducing the density of elements required. The beamwidth of each yagi-rectifier must be broad enough to accommodate deflections of the system, but this is not expected to constitute a constraint because the gain required to compensate for the cosine effect is so low.
  
- iv) As noted earlier, it may be sufficient to design the rectenna to survive severe storms without being operational during them. For a floating rectenna in deep water, a radical approach to hurricane defense which may be worth consideration is to submerge it. For this to be feasible, major rectenna systems, dipole rectifiers, wiring, etc., must be waterproof rather

than just splashproof. Sensitive special systems (e.g., the pilot-beam transmitter, high voltage switchgear, etc.) might be installed in sealable waterproof compartments or dismantled on definite prediction of weather conditions beyond design limits. Some systems (e.g., crew housing) could be built on barges, ready to be towed away.

In order to sink the rectenna, flotation must be reduced by a volume greater than that normally above water. This can be achieved by having some of the flotation in the form of air-filled tanks, open at the bottom, connected by hoses to centrally-located valves. If the water is of reasonable depth and bottom conditions permit, the rectenna could rest on the bottom during a hurricane; alternatively, it could be moored above the bottom. A rough estimate of the work required to pump air back into the flotation system, in 50 meters of water (5 atmospheres) is 11000 kwh, so that bringing the rectenna back to the surface would take about 4 hours if an air compressor of output 3000 hp were used.

#### 4. Conceptual Designs for Off-Shore Rectennas

Based on the above considerations, a tentative conceptual design is proposed for a floating rectenna in deep water, consisting of a checker-board of square, horizontal billboards. A portion of the layout is shown in Figure III. Every second billboard (white squares in the figure) is mounted on a tabular buoy, i.e., it consists of a square constructed from a truss framework, supported at each corner by a spar buoy. The intervening billboards (cross-hatched in the figure) are suspended on cables from the tabular buoys, sufficiently far below them to avoid interference with the yagi-rectifiers on the lower billboard, during flexing of the system under wave and wind forces. All billboards have cut-off corners, to avoid interference at these points; if economically justified, the microwave radiation falling on the corner areas could be intercepted by yagi-rectifiers mounted on raised "ears" attached to the northern corners of the tabular buoys.

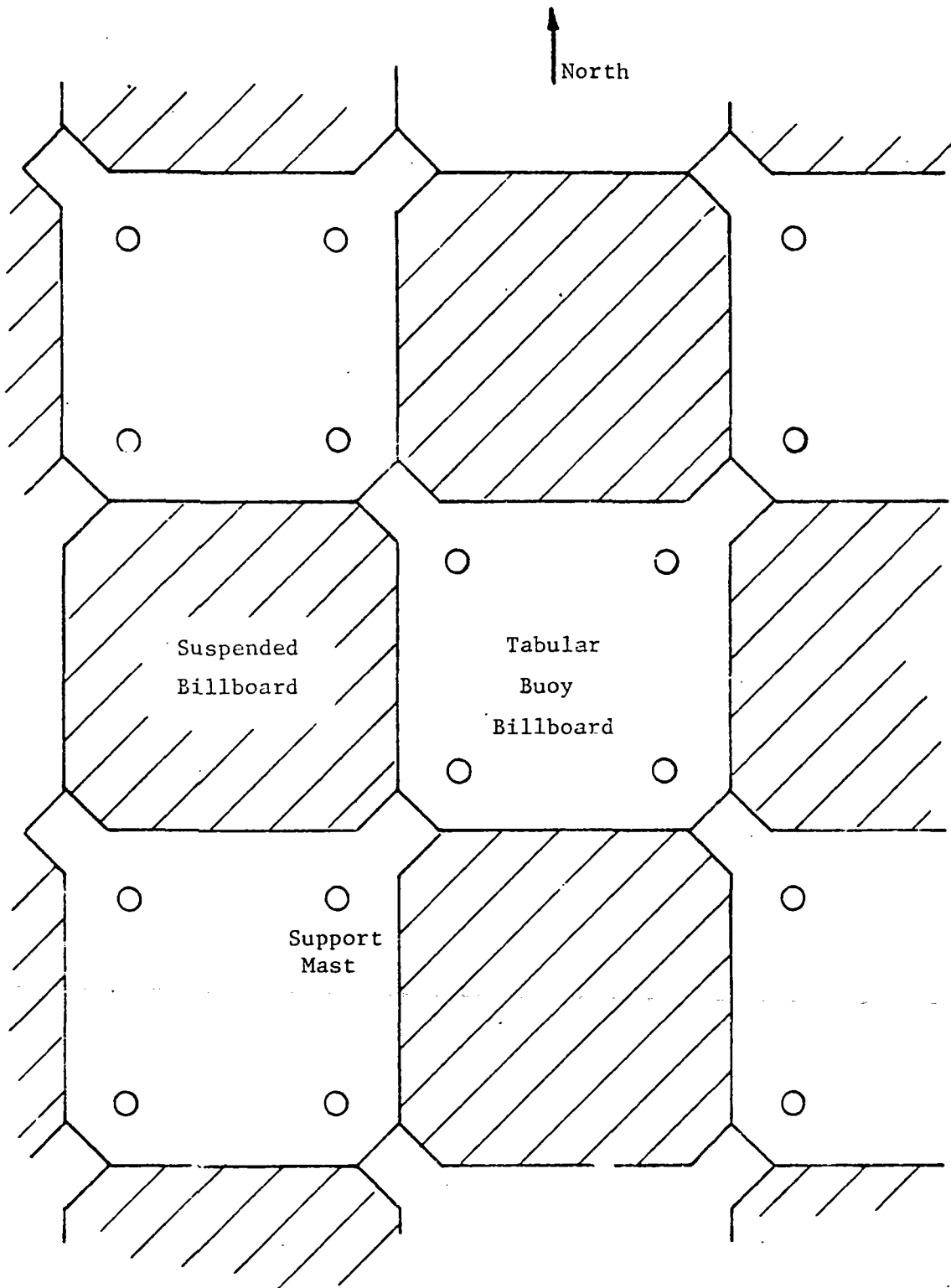

Fig. III: SWELL CONFORMING HORIZONTAL BILLBOARD RECTENNA



The billboards in this system are constructed from trusses supporting an open mesh groundplane, the yagi-rectifiers, and power-conditioning and distribution networks. Flexible connections (perhaps hinged, so as to avoid fatigue problems) are needed to transfer power from one billboard to another and eventually to the cable-head for transmission ashore.

The individual volumes of the floats supporting the tabular buoys are determined by the mass of the system, and the cross-sectional area of the shafts supporting the tabular billboards are then chosen to give a wave-response characteristic frequency which is high compared to swell frequencies, but low compared to surface wave frequencies. The rectenna is thus of the swell-conforming type. Surface waves are attenuated by damping devices along the periphery of the rectenna, especially in directions exposed to a significant fetch.

This design offers low wind resistance, and an uncluttered area under the rectenna for ancillary uses. The underwater structures may also be clean, facilitating fishing operations, etc., although the intended use needs to be taken into account in designing mooring systems. With appropriate design, the forest of yagi antennas may provide few roosting places for web-footed sea birds.

Much further work is needed to establish the optimal size of the individual billboards in this system (so as to minimize mass and cost, subject to constraints imposed by operations beneath the rectenna), to analyze the dynamical response to wind and waves, to determine a mooring system and pattern of anchors to avoid unacceptable compressive stresses across the rectenna while minimizing interference with ancillary uses, to design the yagi-rectifiers and the power distribution system, to develop appropriate surface-wave damping devices, and to calculate the stresses imposed by severe weather. The purpose of this note is only to suggest that it is conceptually possible to design a floating rectenna with a

relatively low clearance above the water and an open deck which may not be much more than a meter thick.

Any rectenna floating on an array of spar buoys is dynamically similar to a flexible sheet suspended by springs, and will exhibit a variety of oscillation modes. Short wavelength modes will have higher natural frequencies than the fundamental mode, in which the rectenna moves vertically as a unit. It may therefore be possible for surface waves which penetrate beneath the rectenna to excite resonant oscillations of large amplitude. It may be possible to reduce response in at least one of these modes by choosing the separation between buoys as an integral multiple of the surface wavelength at the corresponding frequency (as given by [7]); waves at this frequency would then be in phase at each of the buoys, tending to excite only the fundamental mode. It should also be possible to provide heavy hydrodynamic damping of high-frequency modes.

Mooring lines of reasonable scope can accommodate motions of the rectenna in response to swells, but it may be necessary to provide constant-tension devices on the lines to allow for tidal variations in water depth.

Swell-conforming spar buoys could also be used to support a taut-wire rectenna of the type recently proposed by Rice University. The principal apparent differences include the following:

- The above-water spars may need to be somewhat taller in order to give adequate clearance above the water surface at the lowest point of the catenary nets hanging between supports.
- Each buoy should be designed to have as much rigidity in roll and pitch as possible, to prevent instabilities due to the fact that the center of buoyancy is well below the point on the spar where the load is attached.
- The structure will exhibit more complex modes of oscillation, and those which primarily involve motions of the above-water cables may be difficult to damp.

- The rectenna would probably be considerably lighter than the horizontal-billboard design.
- Failure of a mooring line or of one of the perimeter cables could result in heavy unbalanced horizontal forces on the nearest spar buoy, causing it to tip over. This could unbalance the horizontal forces on adjacent spars, leading to collapse of an entire independent section of the rectenna. Avoidance of this failure mode may require redundant mooring or support cables, increasing costs.

Floating rectennas are essential in very deep water, but pile-mounted masts could be used to support either the taut-wire or horizontal-billboard rectenna in shallower water -- for example, in most of the sheltered-water sites suggested earlier in this chapter. Compromise designs are also possible, in which some of the compressive stress on underwater, bottom-mounted masts is carried by submerged floats or perhaps by using buoyant structural members. For either design, the support masts must be taller if they are bottom-mounted, in order to allow sufficient clearance between the rectenna and the water surface in the presence of tides, surge from distant hurricanes, etc., and waves (both surface waves and swells), and this will to some extent offset the advantages of these designs in terms of aerodynamic loading. Bottom-mounted systems thus seem most appropriate in shallow waters exhibiting small tidal variations in depth, protected from ocean swells (unless swell-defense/swell-energy systems prove practical). If it is intended to permit operations beneath the rectenna in support of secondary uses, low-profile boats (e.g., without tall masts) could be used, reducing the necessary clearance. It may also be possible to suspend such operations at times of exceptionally high water (neap tides, hurricane surges, etc.), in order to minimize the clearance under normal conditions.

If appropriately designed for a specific site, both taut-wire and horizontal-billboard rectennas seem readily adaptable to proposed secondary

uses of the structure. The taut-wire design may have an advantage for some applications (e.g., trawling beneath the rectenna), because of the wider separation between support masts.

## 5. Conclusions

Careful attention is needed to site selection to allow realistic work on off-shore rectenna design and hence estimation of the costs and benefits involved. The extent of the structure, the number of repetitive elements, and the costs for each rectenna are sufficient so that a standard design is unnecessary: different types could be used at different sites. Shallow, well-protected waters are probably the first choice, where simple pile-mounted structures may be used, although alternatives such as polder construction may be competitive in some cases. The second choice is a deep-water site, where a floating system is needed; swell-conforming designs are indicated unless there is economic justification for conversion of swell energy to electric power as an ancillary use of the system. It is particularly important to avoid shoal water exposed to the open ocean, so that the rectenna need not be designed to withstand large, steep, breaking waves during storm conditions.

Aerodynamic and hydrodynamic considerations must be taken into account in the conceptual phase of design, as well as the range of expected ancillary uses. Measures can be taken to minimize wind-loading and the lever arm through which these forces act on underwater structures. The type of sea-defense employed will have a significant impact both on the design and on its suitability for secondary uses; research is therefore needed at the device level on wave damping and energy extraction systems before drawing firm conclusions about the overall system or the potential of off-shore rectennas.

## REFERENCES

1. Sargent, W., Private Communication.
2. Coulson, C. A., Waves, 7th Ed., Oliver & Boyd (London, 1955), p. 60.
3. Stuiver, M., and Steyn, B., "Design of an Artificial Island for Industrial Purposes in the North Sea," Proceedings of the 1976 Off-Shore Technology Conference, Vol. II, Houston, Texas, May 1976.
4. Van Nostrand's Scientific Encyclopedia, 5th Ed., Van Nostrand Reinhold (N.Y., 1979), p. 228.
5. Grey, J. (Ed.), Proceedings of the First International Conference on Offshore Airport Technology, April 1973, AIAA, N.Y.
6. Adey, B. H., "A Review of Developments and Problems in Using Floating Breakwaters," Proceedings of the 1976 Offshore Technology Conference, Vol. II, Houston, Texas, May 1976.

## 6. Summary of Results

Rice University with subcontracts to Brown and Root Development Inc. and Arthur D. Little Inc. has performed a Preliminary study of the feasibility and cost of an offshore rectenna to serve the upper metropolitan east coast. The study proceeded by first locating a candidate site at which to build a 5 GW rectenna. The site was selected on the basis of proximity to load centers, avoidance of shipping lanes, sea floor terrain, and soil conditions, etc. Several types of support structures were selected for study based initially on the reference system rectenna concept of a wire mesh ground screen and dipoles each with its own rectifier and filter circuits. The study also looked at possible secondary uses of an offshore rectenna.

The principal results of this study are as follows:

1. Suitable candidate sites exist off the northeast coast and probably all along the east coast and Gulf of Mexico.
2. Hurricane and winter storm conditions were examined for this area and a set of environmental criteria were established.
3. The winter storm criteria plus tests done at Rice University under icing conditions lead to the conclusion that a protective radome will be required over the active elements of the rectenna including a portion of the ground plane. This conclusion probably also holds for land rectennas located everywhere except perhaps in the desert southwest.

4. For the reference system rectenna (using a wire mesh ground plane and individual dipoles), a double pendulum, two level rectenna panel, which can swing freely is suitable.
5. Approximately 25,000 support towers would be required for a 5 GW antenna using the above reference system rectenna.
6. Four different types of support tower structures were studied and costed. The least expensive of these was the piled guyed tower.
7. For the 49.4 m (162 ft) water depth site examined the total cost of a 5 GW rectenna using the piled guyed tower and reference rectenna panel is estimated at \$36 billion. This is considered too expensive for serious consideration. The reference system is not suitable for offshore use.
8. The water depth, wind loading and soil condition cost sensitivities were examined. None of these factors could be altered sufficiently to significantly reduce the cost.
9. Based on the foregoing, the only substantial way to reduce the cost of the offshore rectenna is to reduce the number of support towers or go to a fully surface floating system. Reducing the number of support towers requires a change in the type and mass of the rectenna panels.

10. The number of support towers can be reduced from 25,000 to 3,000 by eliminating the ground screen and adopting an image dipole reflector antenna where each of the dipole plus reflector elements are supported individually by cables which also carry the power from the dipoles. This is called the clothesline concept. Each dipole plus reflector is individually encapsulated to protect it from the weather.
11. The cost of this clothesline concept for the 49.4 m water depth site is estimated at \$5.7 billion (first unit cost).
12. This demonstrates the cost reduction potential possible with new rectenna concepts. The clothesline concept is only one of several possible concepts. Time and fiscal constraints have prevented us from examining other concepts such as a surface floating rectenna.
13. Secondary uses, in particular mariculture, appear promising adjuncts to the offshore rectenna. The possibility of wave energy extraction has also been examined briefly. Such secondary uses do not appear to constrain the basic rectenna design significantly.
14. A major problem identified with the reference rectenna offshore version is the sea birds which will be attracted to the vicinity of the rectenna and will land and roost on it. This requires further study, but it appears that the more open structure of the clothesline concept will reduce the bird problem somewhat.



The following areas require further study:

1. We have not yet determined the optimum design from the standpoint of cost and reliability. A surface floating system has not yet been studied. Because of the different cost per unit area for a sea antenna the optimum size may not be 10km.
2. A great deal of research needs to be done on the efficiency of various types of receiving elements. We do not know the conversion efficiency of the dipole without a ground plane. A Rensselaer Polytechnic Institute study looked at higher gain antennas and suggested that they might have substantial advantages for land rectennas. They need to be examined for offshore rectennas as well.
3. Much remains to be done in the area of survivability and environmental protection of the rectenna, particularly against birds and corrosion.
4. Secondary use potential needs further research. A careful study should be performed on the feasibility of combining the rectenna with a hydrogen generation plant. The electricity from the rectenna could be used to generate hydrogen via electrolysis. The wave energy extraction adjunct needs further study. Also, mineral extraction from sea water should be examined.

## 7. Conclusions

We have demonstrated that an offshore rectenna near east coast load centers is feasible and cost competitive with land rectennas, however, the ground plane reference design is not an appropriate design. An alternate design of the non-ground plane type has been investigated. Other designs such as a floating design may also be feasible and cost effective. The secondary and fuel generation uses remain to be fully explored.

We believe that this study demonstrates that feasibility is sufficiently great and cost sufficiently low that, with the significant advantages of no land requirements and removal of the radiation from populated areas, further investigation of the offshore rectenna should be vigorously pursued. Also, the alternative designs suggested for the offshore rectenna should be applied to land rectennas to see if cost savings can be realized.

Appendix A

Detailed Environmental Data

ENVIRONMENTAL DATA FOR SITE III

I. LOCATION - 40° 59' N 70° 44' W

II. DISTANCE FROM NEW YORK ≈ 175 miles (282 km)

DISTANCE FROM BOSTON ≈ 75 miles (121 km)

\*From NOAA Chart #12300

III. CLOSEST DISTANCE TO NEAREST LAND ≈ 25 miles (40km)

\*From NOAA Chart #12300

IV. WATER DEPTH ≈ 27 fathoms (49.4 m)

\*From NOAA Chart #12300

V. WIND SPEED (ANNUAL AVERAGE)

	38.0° N	71.0° N
(METERS/SEC)	WINDSPEED	PER CENT
	<u>(KNOTS)</u>	<u>FREQUENCIES</u>
<2.1	<4	4.5%
2.1 - 5.1	4 - 10	21.8%
5.7 - 10.8	11 - 21	40.1%
11.3 - 17.0	22 - 33	24.2%
17.5 - 24.2	34 - 47	8.6%
>24.2	>47	0.9%

\*averaged from data obtained by ocean weather station HOTEL and compiled in Mariner's Weather Log, years 1973-1977.

MEAN: 18.6 knots (9.6 m/s)

MAXIMUM: 78.0 knots (40.1 m/s)

V. WIND SPEED (ANNUAL AVERAGE)

(Continued)

<u>(METERS/SEC)</u>	<u>39.0° N</u> <u>WINDSPEED</u> <u>(KNOTS)</u>	<u>70.0° W</u> <u>PER CENT</u> <u>FREQUENCIES</u>
<2.1	<4	3.0%
2.1 - 5.1	4 - 10	21.7%
5.7 - 10.8	11 - 21	52.4%
11.3 - 17.0	22 - 33	20.4%
17.5 - 24.2	34 - 47	2.7%
>24.2	>47	0.0%

\*averaged from data obtained from NOAA ocean buoy 44004 and compiled in Mariner's Weather Log, years 1977 and 1978.

MEAN: 16.7 knots (8.6 m/s)

MAXIMUM: 46.0 knots (23.7 m/s)

V. WIND SPEED (ANNUAL AVERAGE)

(Continued)

	40.1° N	73.0° W
(METERS/SEC)	WINDSPEED	PER CENT
	<u>(KNOTS)</u>	<u>FREQUENCIES</u>
<2.1	<4	4/6%
2.1 - 5.1	4 - 10	36.4%
5.7 - 10.8	11 - 21	50.5%
11.3 - 17.0	22 - 33	8.4%
17.5 - 24.2	34 - 47	0.2%
>24.2	>47	0.0%

\*averaged from data obtained from NOAA ocean buoy 44002 and compiled in Mariner's Weather Log, years 1976-1978.

MEAN: 13.1 knots (6.7 m/s)

MAXIMUM: 43.0 knots (22.1 m/s)

V. WIND SPEED (ANNUAL AVERAGE)

(Continued)

	40.8° N	68.5° W
(METERS/SEC)	WINDSPEED	PER CENT
	<u>(KNOTS)</u>	<u>FREQUENCIES</u>
<2.1	<4	10.2%
2.1 - 5.1	4 - 10	45.7%
5.7 - 10.8	11 - 21	40.4%
11.3 - 17.0	22 - 33	3.6%
17.5 - 24.2	34 - 47	0.2%
>24.2	>47	0.0%

\*averaged from data obtained from NOAA ocean buoy 44003 and compiled in Mariner's Weather Log, years 1977-1978.

MEAN: 10.9 knots (5.6 m/s)

MAXIMUM: 35 knots (18.0 m/s)



VI. WIND DIRECTION (ANNUAL AVERAGE)

<u>DIRECTION*</u>	<u>PER CENT FREQUENCY**</u>
N	13.0%
NE	8.8%
E	5.3%
SE	4.4%
S	9.3%
SW	13.9%
W	18.5%
NW	25.4%

\*the direction refers to where the wind is blowing from

\*\*averaged from data obtained by ocean weather station HOTEL and compiled in Mariner's Weather Log years 1973-1977.

VI. WIND DIRECTION (ANNUAL AVERAGE)

(Continued)

<u>39.0° N</u>	<u>70.0° W</u>
<u>DIRECTION*</u>	<u>PER CENT FREQUENCY**</u>
N	12.1%
NE	10.2%
E	12.2%
SE	8.5%
S	11.9%
SW	11.8%
W	18.6%
NW	15.0%

\*direction refers to where the wind is blowing from

\*\*averaged from data obtained from NOAA ocean buoy 44004 and compiled in Mariner's Weather Log years 1977 and 1978.

VI. WIND DIRECTION (ANNUAL AVERAGE)

(Continued)

40.1° N	73.0° W
<u>DIRECTION*</u>	<u>PER CENT FREQUENCY**</u>
N	9.3%
NE	8.4%
E	8.0%
SE	5.3%
S	18.7%
SW	21.6%
W	17.2%
NW	11.4%

\*direction refers to where the wind is blowing from

\*\*averaged from data obtained from NOAA ocean buoy 44002 and compiled in Mariner's Weather Log years 1976-1978.

VI. WIND DIRECTION (ANNUAL AVERAGE)

(Continued)

<u>40.8° N</u> <u>DIRECTION*</u>	<u>68.5° W</u> <u>PER CENT FREQUENCY**</u>
N	9.8%
NE	7.9%
E	7.9%
SE	6.4%
S	11.4%
SW	20.2%
W	22.7%
NW	13.4%

\*direction refers to where the wind is blowing from

\*\*averaged from data obtained from NOAA ocean buoy 44003 and compiled in Mariner's Weather Log, years 1977 and 1978.

VII. MONTHLY AND ANNUAL SCALAR MEAN WINDSPEED AND PREVAILING DIRECTION FOR THE GEORGES BANK/NANTUCKET SHOALS AREA

MONTH	WINDSPEED (KNOTS) (m/s)	PREVAILING DIRECTION
January	17.0 (8.7)	NW
February	16.2 (8.3)	NW
March	15.2 (7.8)	W
April	12.8 (6.6)	W
May	10.6 (5.5)	SW
June	9.9 (5.1)	SW
July	8.9 (4.6)	SW
August	9.6 (4.9)	SW
September	11.1 (5.7)	SW
October	13.1 (6.7)	W
November	15.1 (7.8)	W
December	17.2 (8.8)	NW
ANNUAL	13.1 knots	West

\*From "Wind and Wave Statistics for the North American Atlantic and Gulf Coasts", Robert G. Quayle and Daniel C. Fulbright, Mariner's Weather Log, January, 1977, Vol. 21, #1.

## VIII. WIND GUSTS

We were not able to acquire any empirical data on the frequency, strength or direction of wind gusts for site III.

However, it was stated in one of the sources of meteorological data\* that gusts usually average about 1.4 times the sustained windspeed.

\*From "Extreme Wind and Wave Return Periods for the U. S. Coast", Robert G. Quayle and Daniel C. Fulbright, Mariner's Weather Log, March, 1975, Vol. 19, #2.

IX. WAVE HEIGHT (ANNUAL AVERAGE)

38.0° N	71.0° W
WAVE HEIGHT	PER CENT
<u>(METERS)</u>	<u>FREQUENCY</u>
/	
< 1	4.6%
1 - 1.5	39.4%
2-2.5	26.5%
3-3.5	16.3%
4-5.5	10.4%
6-7.5	2.4%
8-9.5	0.4%
> 9.5	0.0%

MEAN: 2.3 meters

MAXIMUM: 9.0 meters

\*averaged from data obtained by ocean weather station HOTEL and compiled in Mariner's Weather Log, years 1973-1977.

IX. WAVE HEIGHT (ANNUAL AVERAGE)

(Continued)

39.0° N WAVE HEIGHT <u>(METERS)</u>	70.0° W PER CENT <u>FREQUENCY</u>
< 1	1.7%
1 - 1.5	14.7%
2 - 2.5	34.8%
3 - 3.5	29.2%
4 - 5.5	15.3%
6 - 7.5	4.4%
8 - 9.5	0.1%
> 9.5	0.0%

MEAN: 3.0 meters

MAXIMUM: 8.0 meters

\*averaged from data obtained from NOAA ocean buoy 44004 and compiled by Mariner's Weather Log, years 1977 and 1978.



X. WAVE HEIGHTS (ANNUAL AVERAGE) FOR THE GENERAL GEORGES BANK/NANTUCKET SHOALS AREA

WAVE HEIGHT <u>(METERS)</u>	PER CENT <u>FREQUENCY</u>
0	12.1%
0.5	23.3%
1	27.2%
1.5	15.7%
2	8.9%
2.5	4.7%
3	3.3%
3.5	1.6%
4 - 4.5	2.1%
5 - 5.5	0.5%
6 - 6.5	0.4%
7 - 7.5	0.1%
8 - 9.5	0.1%
10 - 12	< 0.05%

\*from "Wind and Wave Statistics for the North American Atlantic and Gulf Coasts", Robert G. Quayle and Daniel C. Fulbright, Mariner's Weather Log, January, 1977, Vol. 21, #1.

XI. WAVE DIRECTION (ANNUAL AVERAGE) .

<u>WAVE DIRECTION</u>	<u>PER CENT FREQUENCY</u>
N	11.8%
NE	9.2%
E	4.7%
SE	4.5%
S	11.2%
SW	13.8%
W	14.1%
NW	23.3%

\*direction refers to from where the wave are approaching.

\*\*averaged from data obtained by ocean weather station HOTEL and compiled in Mariner's Weather Log, years 1973-1977.

XII. WAVE PERIODS (ANNUAL AVERAGE)

38.0° N	71.0° W
PERIOD	PER CENT
<u>(SECONDS)</u>	<u>FREQUENCY</u>
< 6	30.3%
6 - 7	42.1%
8 - 9	17.6%
10 - 11	2.0%
12 - 13	0.5%
> 13	0.1%

MEAN: 5.7 seconds

\*averaged from data obtained by ocean weather station HOTEL and compiled in Mariner's Weathert Log, years 1973-1977.

XIII. MEAN WAVE PERIODS FOR CERTAIN WAVE HEIGHT RANGES (ANNUAL AVERAGES)

38.0° N	71.0° W
WAVE HEIGHT	MEAN PERIOD
<u>(METERS)</u>	<u>(SECONDS)</u>
< 1	4.9
1 - 1.5	5.5
2 - 2.5	6.3
3 - 3.5	6.9
4 - 5.5	7.7
6 - 7.5	9.1
8 - 9.5	10.4

\*averaged from data obtained by ocean weather station HOTEL and compiled in Mariner's Weather Log, years 1973-1977.

XIV. EXTREME WINDSPEEDS AND WAVE HEIGHTS FOR THE GENERAL GEORGES BANK/NANTUCKET SHOALS AREA

A.

Extreme Sustained Windspeed Estimate for 100 year Return Period  $\approx$  100 knots (51.4 meters/second)

Significant Wave Height Estimate for 100 year Return Period  $\approx$  18.0 meters

Extreme Wave Height Estimate for 100 year Return Period  $\approx$  32.6 meters

\*From "Extreme Wind and Wave Return Periods for the U. S. Coast", Robert G. Quayle and Daniel C. Fulbright, Mariner's Weather Log, March 1975, Vol. 19, #2.

B.

Extreme Wave Height Estimate Caused by Hurricane for 100 year Return Period  $\approx$  24.7 meters

Significant Wave Height Estimate for Hurricane Generated Waves for 100 year Return Period  $\approx$  13.1 meters

XIV. EXTREME WINDSPEEDS AND WAVE HEIGHTS FOR THE GENERAL GEORGES BANK/NANTUCKET SHOALS AREA (Continued)

C.

Extreme wave height estimate for winter storm (extra tropical cyclone) generated waves for a 100 year return period  $\approx$  25.3 meters

D.

Extreme wave height estimate for waves due to both, hurricanes and winter storms, for a 100 year return period  $\approx$  26.5 meters

\*from "Extreme Wave Heights Along the Atlantic Coast of the United States", E. G. Ward, Shell Development Co., and D. J. Evans and J. A. Pompa, Evans-Hamilton, Inc., Offshore Technology Conference Paper 2846, 1977.

## XV. TIDAL CURRENTS AND RANGES

### A.

Tidal currents rotate clockwise at  $\approx$  2.5 km/hour

\*from WESTERN NORTH ATLANTIC OCEAN: Topography, Rocks, Structure, Water, Life and Sediments, K. O. Emery and Elazar Uchupi, 1972.

### B.

The mean range (the difference in height between mean high water and mean low water)  $\approx$  1 meter

During the Spring the tide range is about 10 centimeters more.

### C.

The tide is SEMIDIURNAL.

\*From S. D. Hicks, A. J. Goodheart, and C. W. Iseley, Journal of Geophysical Research, Vol. 70, No. 8, April 15, 1965.

XVI. AVERAGE MONTHLY FREQUENCY OF POTENTIAL "MODERATE"  
SUPERSTRUCTURE ICING

MONTH	LOCATION	
	<u>38.7° N 73.6° W</u>	<u>40.1°N 73.0° W</u>
January	24.0%	22.5%
February	9.4%	15.0%
March	0.4%	1.5%
November	0.6%	0.8%
December	6.0%	12.5%

\*Data was sparse and showed great variation from year to year.

\*\*from data recorded by NOAA ocean buoys EB-07 and 44002 and compiled in Mariner's Weather Log, years 1965-1977.

\*\*\*"Potential Moderate Icing" is defined by the simultaneous combination of an air temperature of  $\lt -2^{\circ}\text{C}$  and windspeeds  $\gt 13$  knots.



XVII. AVERAGE MONTHLY FREQUENCY OF PRECIPITATION FOR THE GEORGES  
BANK/NANTUCKET SHOALS AREA

<u>MONTH</u>	<u>PER CENT FREQUENCY</u>
January	18.9%
February	20.9%
March	13.9%
April	10.2%
May	8.9%
June	8.0%
July	4.1%
August	5.3%
September	6.1%
October	6.1%
November	11.9%
December	21.3%

ANNUAL: 11.3%

\*from United States Coast Pilot No. 2, Atlantic Coast: Cape Cod  
to Sandy Hook, January 1979, C55. 422: 2114

## XVIII. SEAFLOOR SEDIMENT AND SLOPE

### A.

The seafloor sediment predominantly consists of coarse sand and scattered patches of gravel.

\*From "Sediments on the Continental Margin Off Eastern United States", Elazar Uchupi, U. S. Geological Survey, Professional Papers, 475-C: c132 - c137, 1963.

### B.

The seafloor slope off Martha's Vineyard is about 3 feet/mile or 0.03°.

\*From "Structure of Continental Shelf Off Southern New England", Marine Geology, vol. 4, p. 273-289 (1966), L. E. Garrison and R. L. McMaster.

## XIX. SUB-SEAFLOOR COMPOSITION

A lithologic log of a well drilled near site III, in Nantucket Shoals, indicates the existence of alternating layers of medium or fine and silty sand and gravel or coarse sand up to a depth of about 40 meters.

However, another well drilled just southwest of this first well (no more than 50 km away) revealed a deep layer of gravel and coarse sand extending 27 meters from the seafloor followed by a layer of clay or clayey silt and shale at least 18 meters thick.

XX. CURRENT PROFILE AT 39° 20' N 70°0' W

DEPTH <u>(METERS)</u>	MEAN CURRENT <u>(METERS/SEC<sup>-1</sup>)</u>
0	0.13
100	0.07
500	0.04
1000	0.04
2000	0.02
2600	0.03

\*all currents are directed to the WEST.

\*\*From Fofonoff and Webster, Philosophical Transactions of the Royal Society (A), Vol. 270, pp. 423-436 (1971).

1. REPORT NO. NASA CR-3348		2. GOVERNMENT ACCESSION NO.		3. RECIPIENT'S CATALOG NO.	
4. TITLE AND SUBTITLE Solar Power Satellite Offshore Rectenna Study				5. REPORT DATE November 1980	
				6. PERFORMING ORGANIZATION CODE	
7. AUTHOR(S)				8. PERFORMING ORGANIZATION REPORT #	
9. PERFORMING ORGANIZATION NAME AND ADDRESS Rice University Houston, Texas 77001				10. WORK UNIT NO. M-310	
				11. CONTRACT OR GRANT NO. NAS8-33023	
				13. TYPE OF REPORT & PERIOD COVERED Contractor Report	
12. SPONSORING AGENCY NAME AND ADDRESS National Aeronautics and Space Administration Washington, DC 20546				14. SPONSORING AGENCY CODE	
15. SUPPLEMENTARY NOTES NASA Marshall Technical Monitor: Charles Guttman Final Report					
16. ABSTRACT Rice University, Brown and Root Development, Inc., and Arthur D. Little, Inc. have jointly conducted a feasibility study of an offshore rectenna serving the Boston/New York area. We have found that an offshore rectenna is feasible and cost-competitive with land rectennas but that the type of rectenna which is suitable for offshore use is quite different from that specified in the present reference system. We began by engineering the reference system rectenna to the offshore location. When we estimated costs for the resulting system, we found that the cost was prohibitively high. We then searched for modifications to the design which would allow significant cost reduction. The result is a non-ground plane design which minimizes the weight and greatly reduces the number of costly support towers. This preferred design is an antenna array consisting of individually encapsulated dipoles with reflectors supported on feed wires. Such a 5 GW rectenna could be built at a 50m water depth site to withstand hurricane and icing conditions for a one-time cost of 5.7 billion dollars. Subsequent units would be about 1/3 less expensive. The east coast site chosen for this study represents an extreme case of severe environmental conditions. More benign and more shallow water sites would result in lower costs. Secondary uses such as mariculture appear practical with only minor impact on the rectenna design. The potential advantages of an offshore rectenna, such as no land requirements, removal of microwave radiation from populated areas and minimal impact on the local geopolitics argue strongly that further investigation of the offshore rectenna should be vigorously pursued.					
17. KEY WORDS Offshore rectennas encapsulated dipoles			18. DISTRIBUTION STATEMENT Unclassified - Unlimited  Subject Category 44		
19. SECURITY CLASSIF. (of this report) Unclassified		20. SECURITY CLASSIF. (of this page) Unclassified		21. NO. OF PAGES 257	22. PRICE A12

National Aeronautics and  
Space Administration

Washington, D.C.  
20546

Official Business

Penalty for Private Use, \$300

SPECIAL FOURTH CLASS MAIL  
BOOK

Postage and Fees Paid  
National Aeronautics and  
Space Administration  
NASA-451



**NASA**

POSTMASTER: If Undeliverable (Section 158  
Postal Manual) Do Not Return

---