

# Materials Processing in Space—Future Technology Trends

Neville J. Barter  
*TRW Defense and Space Systems Group*  
*Redondo Beach, California*

The United States National Aeronautics and Space Administration (NASA) is currently sponsoring a Materials Processing in Space (MPS) program. This program involves both ground and space-based research and looks to frequent and cost effective access to the space environment for necessary progress. The MPS program has its origins in research, but its eventual aim is directed at the utilization of space for product demonstrations and commercial ventures. Figure 1 calls out the four classes of materials research and indicates that demonstrations of space and ground-made products, from space processed material, are an integral part of the program.

NASA's goals and roles for the MPS program are shown in figure 2. The goals pertain to understanding, applying, and exploiting the microgravity of space to materials processing; the roles relate to the actions NASA intends to take for sponsorship of research, development of experimental equipment, and conduct of the pioneer steps to pave the way for industry/commercial initiatives.

The first generation payloads for research are under active design and development. They will be hosted by the Space Shuttle/Spacelab on Earth orbital flights in the early 1980's. These missions will focus on the acquisition of materials behavior research data, the potential enhancement of Earth-based technology, and the implementation of space-based processing for specialized, high-value materials. Some materials to be studied in these payloads may provide future breakthroughs for stronger alloys, ultrapure glasses, superior electronic components, and new or better chemicals.

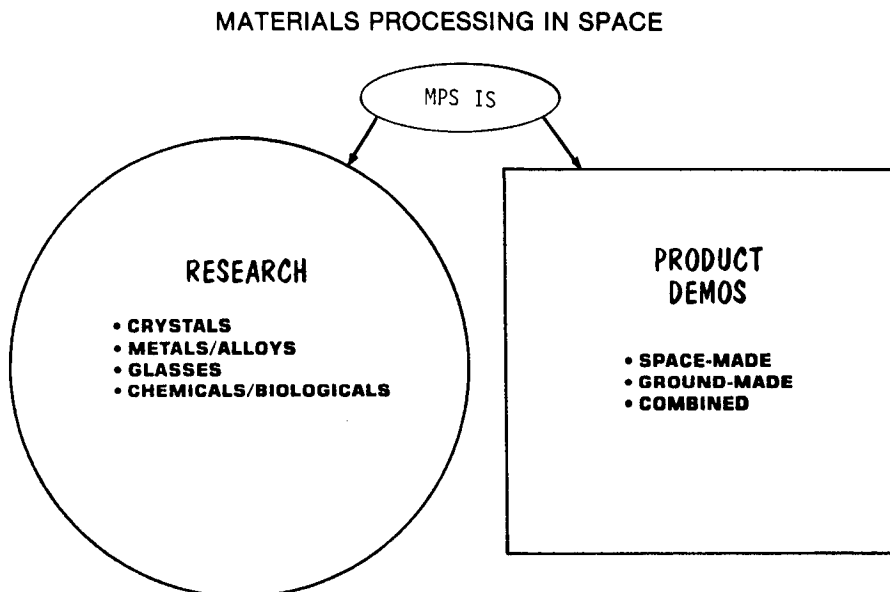

Figure 1

## NASA' GOALS AND ROLES IN THE MPS PROGRAM

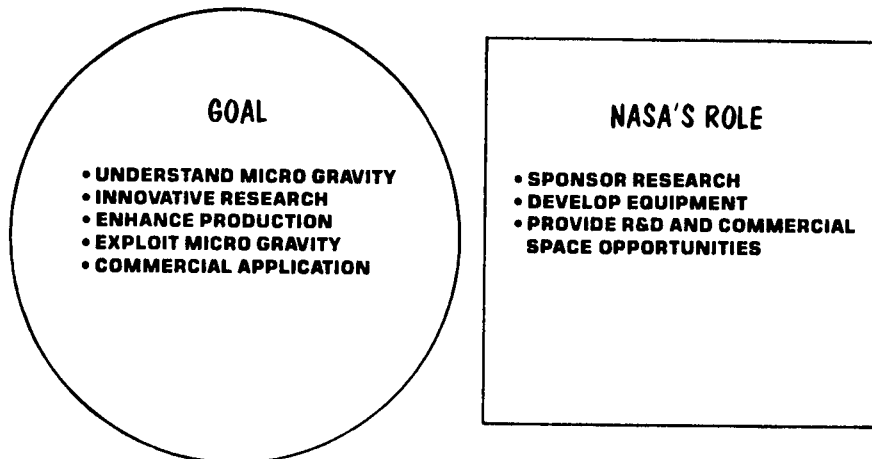

Figure 2

## MPS Program Evolution

The Materials Processing in Space program has conducted approximately 70 flight experiments in space on Apollo, Skylab, ASTP, and Space Processing Applications Rocket (SPAR) flights (fig. 3). The results of these experiments demonstrated that the weightlessness of the space environment provides some dramatic effects on key phenomena involved in technologically important processes. This experimental work will be conducted on Space Shuttle flights starting as early as 1982 through the integration of SPAR experiment apparatus in the Materials Experiment Assembly (MEA).

The MPS program has initiated the MPS Spacelab Payloads Project. Currently three MPS payloads are being developed for flights on Space Shuttle missions in 1983. These payloads will be accommodated in the Spacelab module or on the Spacelab pallet.

Payload hardware is being designed to conduct solidification experiments using high temperature furnaces. To take advantage of the high power available due to the absence of the pressurized Spacelab module, this payload will be located on the pallet in the Shuttle bay.

A fluids experiment system and a vapor crystal growth experiment are also being developed. These experiments will be conducted with the aid of the payload specialist in the habitable environment of the Spacelab module.

The three Shuttle Spacelab MPS payloads are shown in their flight configuration in figure 4.

There are several other efforts under study for consideration as first-generation Shuttle/Spacelab hosted MPS payloads. They are the Polymer Latex Reactor, Acoustic Containerless, and Analytical Float Zone Systems.

The three first-generation payloads, now under hardware development, are described below.

### Solidification Experiment System

The solidification experiment system (SES) is a Shuttle bay pallet-mounted payload which automatically melts, refines, and resolidifies a broad range of materials (fig. 5). It is a copassenger on a Shuttle mission with communication satellites which will be deployed early in the mission, allowing the SES payload to use all available electric power from the Shuttle's fuel cell to operate MPS experiments for the remainder of the 7-day Shuttle mission. The SES involves directional solidification, gradient freeze, and isothermal processing.

# MPS EVOLUTION

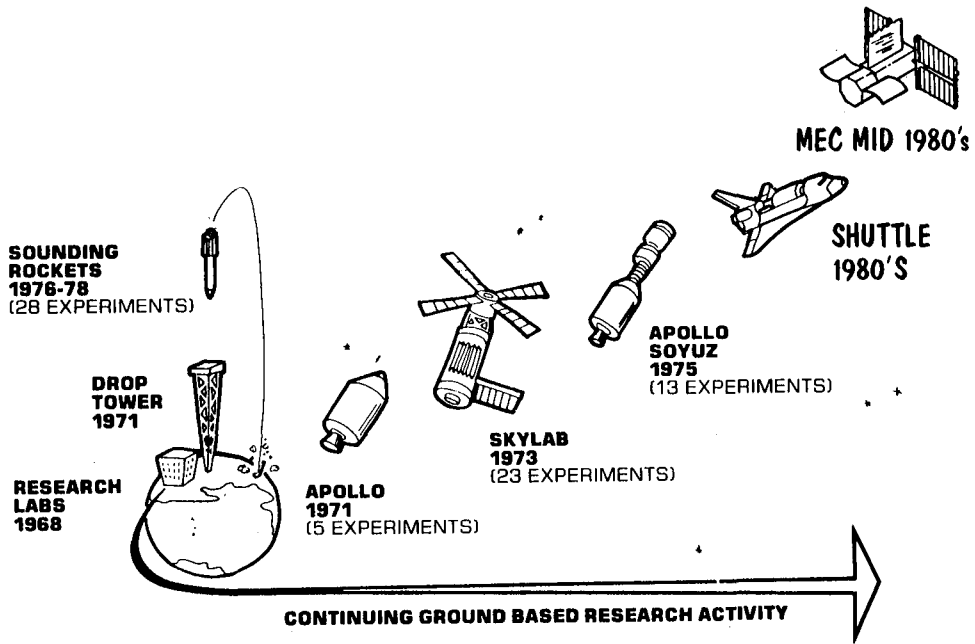

Figure 3

## MPS/SPACELAB 1983 FLIGHTS

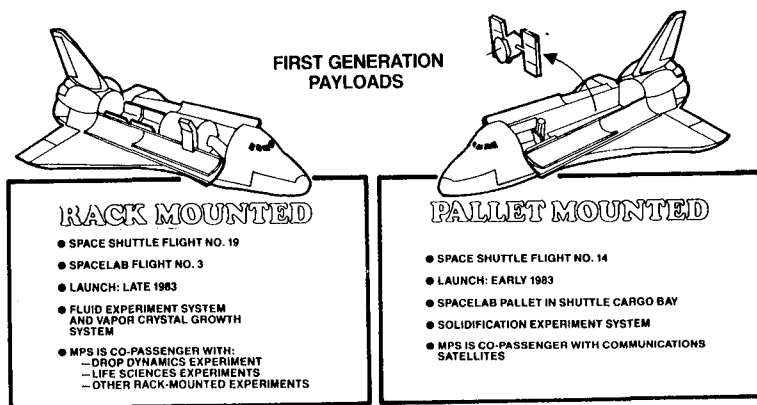
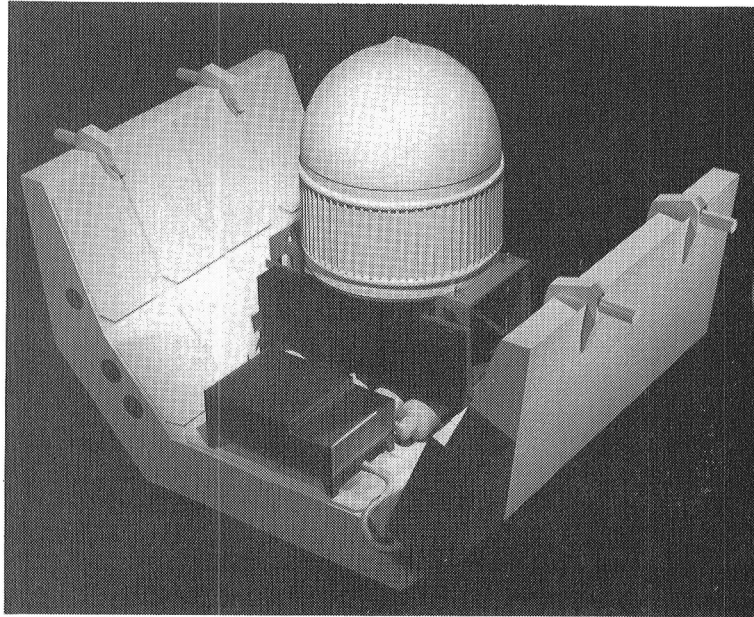

Figure 4

## SOLIDIFICATION EXPERIMENT SYSTEM CONFIGURATION



*Figure 5*

Directional solidification processing is designed for the production of highly uniform crystalline solids from a melt. A furnace for directional solidification processing must provide a uniformly high temperature environment in one end and a low temperature in the other end. A test specimen of the desired composition is inserted into the hot end, allowed to melt, and is then slowly withdrawn at a controlled rate. Crystal growth occurs at the solid-liquid interface which lies in the gradient zone, between the hot and cold ends. All SES experiments have as their goal the production of extremely uniform crystals of a degree of homogeneity which cannot be achieved in a terrestrial environment where the inevitable convection currents distort crystal growth.

Materials technology researchers have maintained a high level of interest in space solidification processing from the viewpoints both of the scientist desirous of using space as a new tool to study basic phenomena and of the materials engineer seeking to develop a commercial product which might benefit from a space environment in its manufacture. The objectives and investigative areas of solidification processing are given in figure 6.

There are four areas of study which will allow an assessment of the space environment for commercial solidification processing.

Geometry—because casting is a “net shape” process which provides objects in their final geometrical form.

Porosity—because castings must be sound (free from voids) and the absence of gravity alters traditional feeding mechanisms.

Nucleation—because natural convection, which plays a major role in crystal nucleation on Earth, is absent in space.

Dispersed nonmetallics—because they can represent either inclusions (which are deleterious), nuclei (which may or may not be beneficial) or a deliberately added dispersed phase, which opens a new class of materials: dispersion hardened solidification structures.

Gradients that can be achieved in a given test specimen will depend on the geometric and physical properties of the space specimen and on the properties of its container as well as on the thermal

characteristics of the furnace. One of the goals of experiment design will be to adjust hot and cold temperatures in the furnace so as to achieve a liquid-solid interface (at the melt temperature) which lies at a point of maximum gradient within the adiabatic zone. While these principles are common to all of the experiments, each also has its own peculiarities which must be considered in the experiment design.

### Fluids and Vapor Crystal Growth Experiment System

A fluids experiment system (FES) and a vapor crystal growth (VCG) experiment system are also being developed to conduct crystal growth studies under weightless condition (fig. 7).

Crystals can be grown from fluids, from vapors, or from melts of solid materials. Payloads are planned to allow each of these phenomena to be investigated in Earth orbit. For growth from fluids (FES) there is an interchangeable experiment cell that allows crystals to be grown under controlled

## SOLIDIFICATION STUDIES

### OBJECTIVES

- SPACE AS A MANUFACTURING ENVIRONMENT
- SPACE PROCESSING APPLICATIONS TO EARTH SOLIDIFICATION PROBLEMS
- NEW MATERIALS

### AREAS OF INVESTIGATION

- CASTING GEOMETRY
- CASTING POROSITY
- CRYSTAL NUCLEATION
- DISPERSED NON-METALLICS

Figure 6

## FES/VCG CONFIGURATION

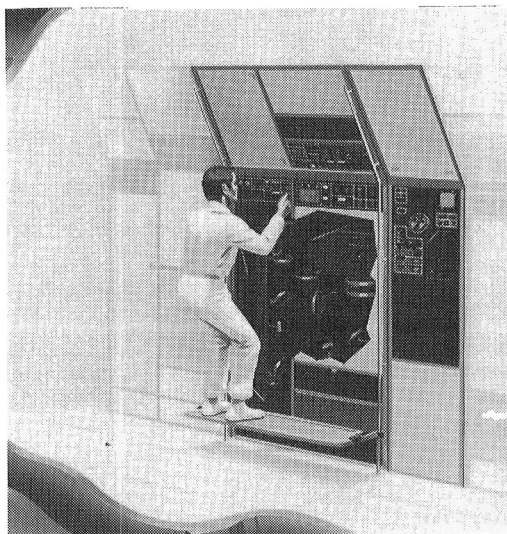

Figure 7

conditions while being observed by the on-board payload specialist and scientists on the ground. The cell is closely temperature controlled and has windows to permit halographic and video recording of the crystal as it is grown. Operation of the experiment is initiated by a payload specialist with seed crystal insertion. The halographic film and grown crystal are returned to Earth for data analysis.

The recording of holograms in-flight for the analysis of the Spacelab fluids experiment system allows the study of the in-flight image in a ground based analysis situation.

Figure 8 shows the essentials of the FES halographic system. The laser light is split into an object beam and a reference beam. The object beam illuminates the scene and then impinges on the film plane. The reference beam is a pure light beam that has the same path length as the object beam. The

## THE FES HOLOGRAPHIC DATA SYSTEM IS MAJOR TECHNICAL CHALLENGE

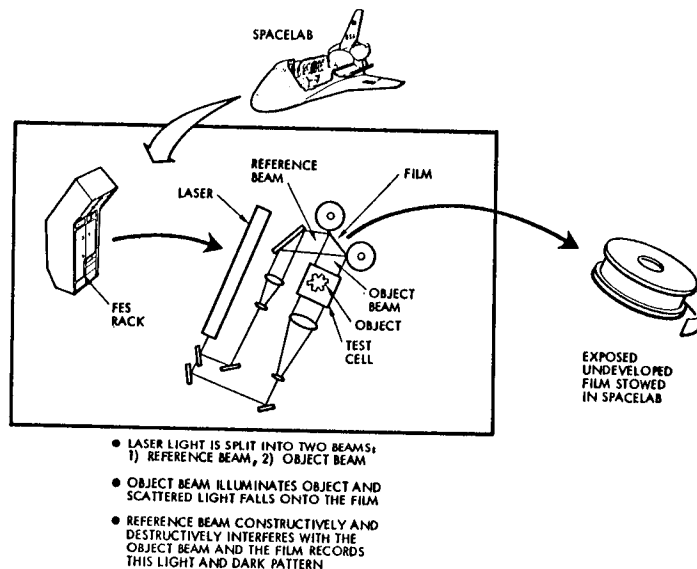

### OPERATIONAL MODE

- HOLOGRAPHIC SYSTEM FORMS PREPROGRAMMED DATA SEQUENCE OF EXPERIMENT EVENTS:
  - BOTH PARALLEL AND DIFFUSE LIGHT HOLOGRAMS GENERATED
  - TYPICALLY TWO VIEWS AVAILABLE EACH WITH A FILM TRANSPORT
- MANUAL OVERRIDE ALLOWS HOLOGRAMS TO BE MADE OF SIGNIFICANT EVENTS OUTSIDE PLANNED SEQUENCE
- SINGLE OR MULTI-EXPOSURE HOLOGRAMS CAN BE RECORDED
- UNDEVELOPED HOLOGRAMS ARE STOWED IN-FLIGHT AND DEVELOPED ON THE GROUND

### CAPABILITY

- THE IMAGE CAN BE PROBED BY USING VARIED OPTICAL TOOLS:
  - MICROSCOPY CAN BE PERFORMED
  - INTERFEROMETRIC COMPARISONS BETWEEN SCENES CAN BE MADE
  - ALL IMAGES CAN BE RECORDED ON PERMANENT FILM
- GENERALIZED DATA THAT CAN BE OBTAINED INCLUDE:
  - CONCENTRATION GRADIENTS
  - TEMPERATURE GRADIENTS
  - PARTICLE MOVEMENT
  - BUBBLE MOVEMENT
  - FLOW PATTERNS
  - SOLIDIFICATION PATTERNS
  - INDEX OF REFRACTION CHANGES

*Figure 8*

two beams interfere at the film plane. The interference pattern contains all of the information that is in the object beam. There are two film transport locations. The total object beam falls on the forward film transport. Light scattered from the object falls on the transverse film. Both films contain the information regarding the object (i.e., crystal) such as changes in morphology and size.

All homograms made during a flight are stored in cassettes on board until landing.

### Advanced Flight Systems

Currently in the definition stage is the materials experiment carrier (MEC) and its MPS payloads. The MEC is intended to fly attached to the NASA 25-kW power system on long missions starting in the mid-1980's. Figure 3 shows the MEC/25-kW power system as part of the MPS evolution.

Not shown in figure 3, but further along in the last decade of this century, the MPS program could feature large, manned modules fixed to a permanent materials processing, national space facility for large scale, commercial space processing.

## Second Generation Payloads and Their Host Vehicles

The next major milestone for MPS payloads is anticipated in mid-1986. At this point the planned 25-kW power system is expected to become operational, and the projected needs of MPS in terms of numbers of samples, processing time, and power required to support sustained, systematic, MPS activity will exceed Shuttle capabilities. Thus the 25-kW power system capability and MPS needs can be matched. In operational terms the 25-kW power system provides the opportunity to (1) extend the orbital stay time of the Shuttle/Spacelab/pallet while providing a higher power level to the MPS payloads and (2) support experimental and commercial payloads while docked to the 25-kW power system as a free-flyer between Shuttle visits. Both of these capabilities provide significant benefits to the MPS program.

Previous analyses of the cost of performing research in space have shown that longer stay time, together with more power to run experiments, can dramatically reduce the unit cost of experimentation. Furthermore, ground-based research and flight experiments to date have shown that a significant number of samples must be processed in order to isolate, characterize, and develop MPS processes. In addition, the power requirements of MPS research and processing apparatus are typically higher than for other kinds of space activity. It is already apparent that the electrical power and energy resources of the Shuttle/Spacelab system will become a serious limiting factor to the MPS program at the levels of activity that are expected in the mid-1980's. The needs of the MPS program are as follows:

- (1) High electrical power energy
- (2) Long duration missions
- (3) Low g level during processing
- (4) Many samples processed per flight
- (5) Low cost per sample
- (6) Many reflight opportunities
- (7) Provisions for commercial proprietary endeavors

Consequently, the MPS program will become a primary user of the 25-kW power system since it offers increases in orbital stay time, electrical power, and in the free-flying mode microgravity stability at levels of  $10^{-6}$  g or better. The 25-kW power system will be used by MPS in both the advanced Shuttle sortie mode and the free flying mode.

In the advanced Shuttle sortie mode (fig. 9) second and subsequent generation Spacelab Module MPS payloads that require manned participation will be accommodated. In this mode the Shuttle/Spacelab will dock with the 25-kW power system and support manned missions of up to 30 days. Payload planning showing payload growth is indicated in figure 10.

In the free-flying mode totally automated versions of the second generation MPS payloads will be

## SHUTTLE BAY SORTIE MODE

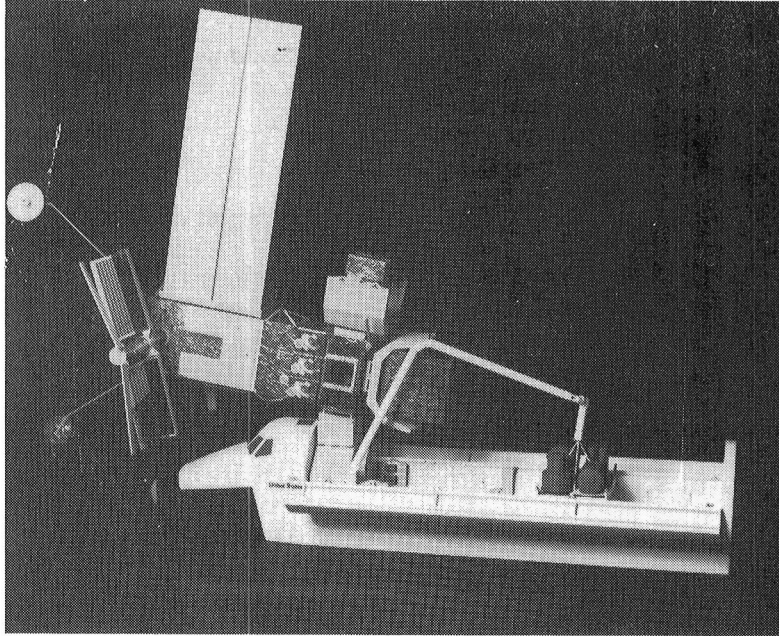

Figure 9

## MPS PAYLOADS PLANNING

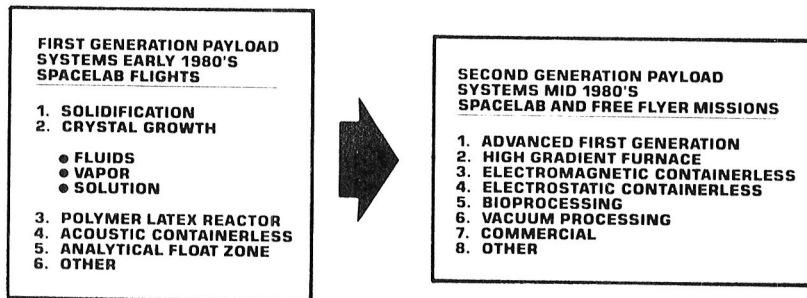

Figure 10

Space flight has opened a new environment in which the effects of gravity are essentially absent. We have only begun to understand or take advantage of this new promising phenomenon.

Space processing objectives are directed to the use of near zero gravity conditions which will prevail on Shuttle flights. The absence of significant gravitational effects over extended periods of time will give new insights into a number of materials processes and will offer a degree of process control not now feasible. We have achieved promising preliminary results on sounding rocket experiments which can provide zero-g environment for 5 or 6 minutes; in drop towers, which provide these conditions for a few seconds; and in experiments that were conducted during the Skylab program. The absence of significant gravitational acceleration suppresses settling sedimentation and buoyancy driven or natural thermal convection, which allows the enhanced control of temperature



fields. This permits production of crystals of increased compositional uniformity and also allows processing of materials in a containerless fashion (fig. 12).

The advantages to be gained by processing materials in space and the determination of what phenomena are important in controlling low-g processes must be understood. Previous space experiments on Apollo, Skylab, and SPAR demonstrated that natural convection arising from either thermal or concentration gradients could be adequately suppressed. Such flows are important because they give rise to nonuniform diffusion boundary layers as well as transient segregation due to temperature and velocity fluctuations during processes such as crystal growth (fig. 13). Indeed, it was demonstrated that crystals with fewer defects and with uniform composition, both on a micro as well as a macro scale, could be grown by taking advantage of the quiescent growth conditions in space. There are, however, other nongravitational flows, such as those induced by surface-tension

## MEC MISSION OPERATIONAL ELEMENTS

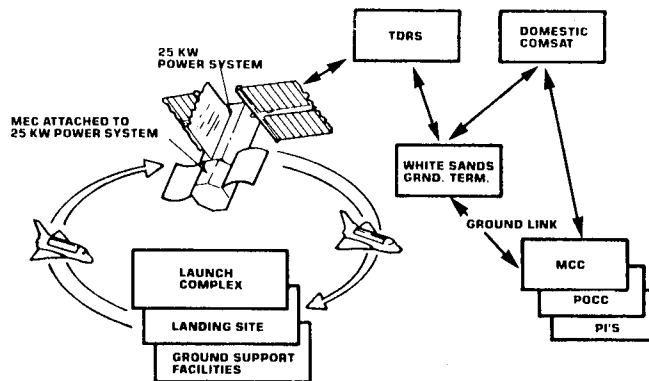

Figure 11

## WHY SPACE?

THE MICRO-GRAVITY ENVIRONMENT OF SPACE GREATLY REDUCES PROBLEMS OF GRAVITY DRIVEN:

- BUOYANCY DRIVEN CONVECTION \*
- SEDIMENTATION AND BUOYANCY SEPARATION \*
- HYDROSTATIC PRESSURE
- CONTAINER EFFECTS

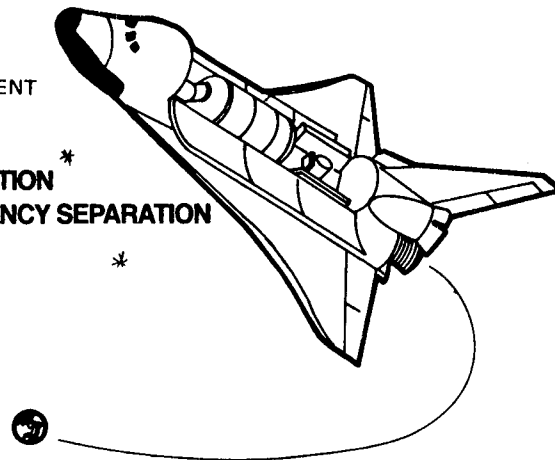

Figure 12

gradients, volume change, or spacecraft (laboratory) motion, that operate in space as well as on Earth. Such flows are often masked by gravity-driven convection and are difficult to study. Experiments in space provide a means of separating gravity-driven from nongravity-driven flows and studying them separately. This information is fundamental to the design of space experiments and processes. Additionally, many terrestrial processes may be improved by a better understanding of flows from which better control strategies can be devised.

The ability to handle liquids and melts in a containerless mode offers unique opportunities to perform a number of scientific experiments (determining thermodynamic properties of chemically active materials at high temperature, studying solidification at extreme undercooling, preparing ultrapure samples of material, and voiding container-induced nucleation of difficult-to-process, amorphous solids such as bulk metallic glasses and a variety of exotic glasses). Figure 14 shows the benefit and application of space processing to glasses and ceramics.

The elimination of sedimentation and Stokes flow in low gravity allows the study of a number of phenomena that cannot be adequately studied terrestrially, such as bubble dissolution by chemical fining agents in glass, bubble centering mechanisms in thin glass shells, bubble deformation and motion in a thermal gradient, ripening of precipitates or flocculates, nucleation and growth of immiscible phases, interaction of solidification fronts with bubbles or second-phase materials, or solidification of composites with large density differences, preparation of phase-separating glasses, and multiphase monotectic solidification.

Figure 15 illustrates the improved structure and homogeneous mixing in the space processing of metals and alloys, while figure 16 depicts the advantages of reduced gravity in the processing of organics and biological materials. Alloys are further discussed in the next section in connection with the NASA-Industry Guest Investigator program.

The separation of biological materials in space holds the promise of producing therapeutic quantities of pure pharmaceuticals not available on Earth. Biological purification processes can benefit from the absence of gravity because convection and sedimentation are essentially absent. Of particular interest are the continuous separation processes which can produce commercial quantities of important biological agents for medical applications and research.

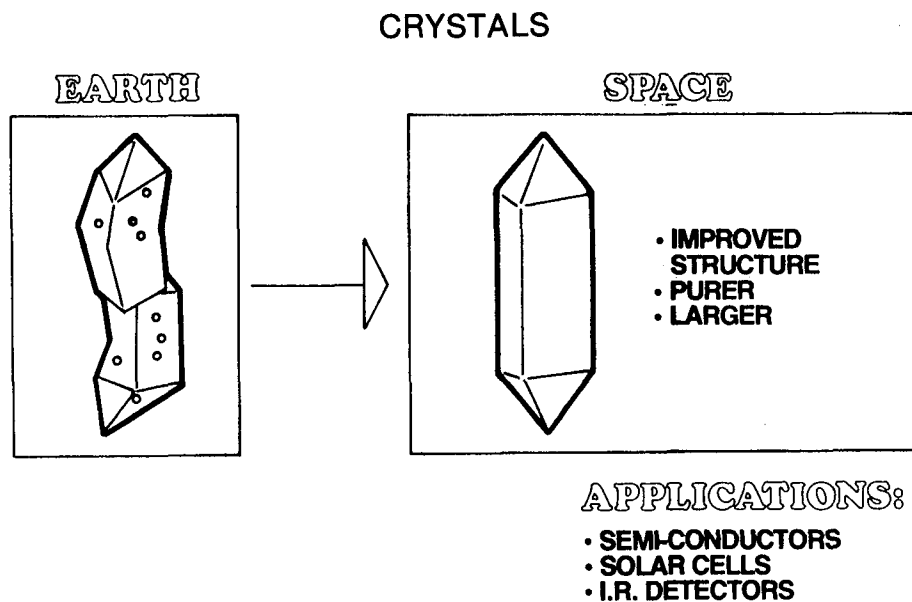

Figure 13

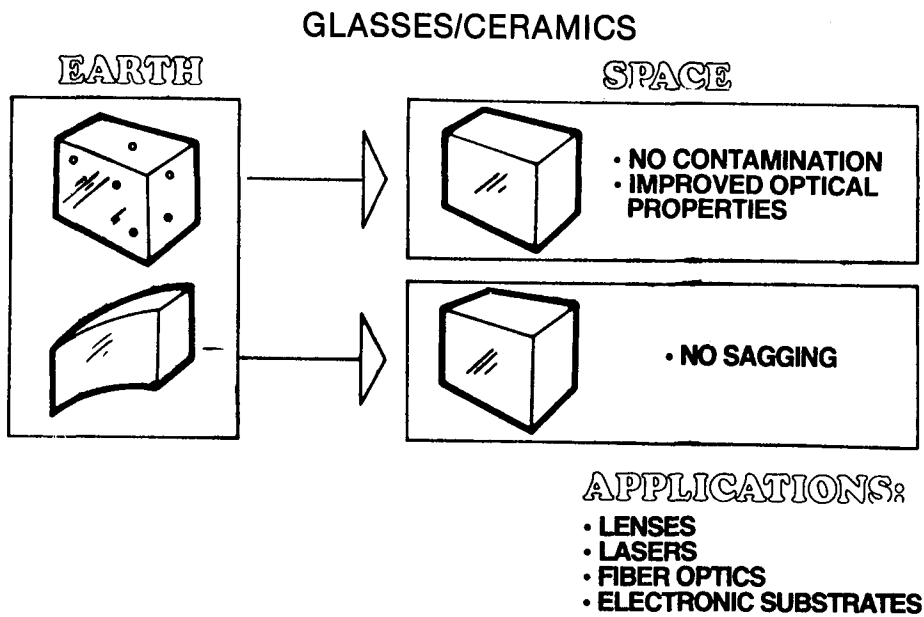

Figure 14

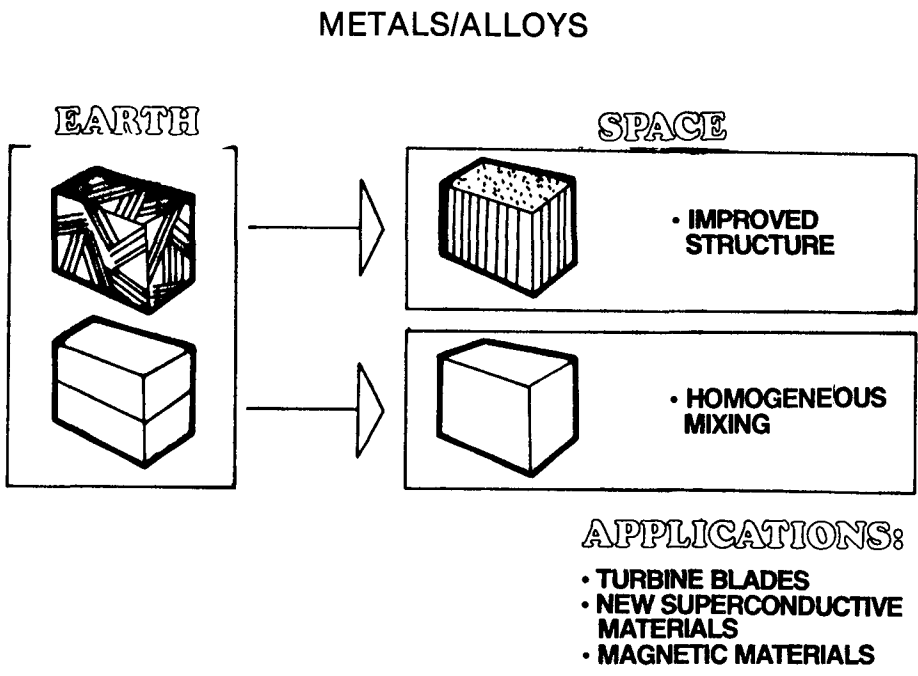

Figure 15

## ORGANICS/BIOLOGICALS

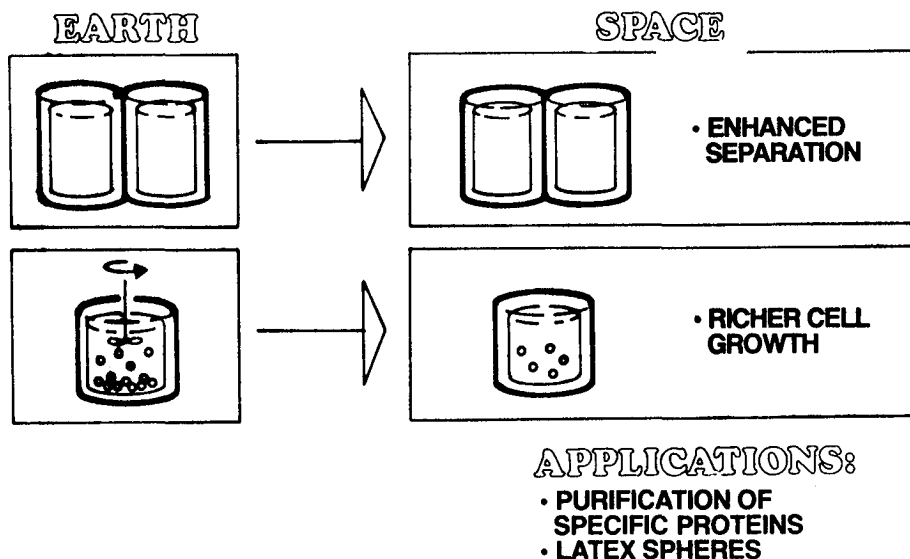

Figure 16

Isoelectric focusing is a type of electrophoresis where biological materials are separated by their differing mobility in an electric field. In isoelectric focusing the materials migrate in the electric field to a point in the nonuniform solution where they are electrically neutral. At this point they cease their migration and form a band. On Earth this band will broaden and overlap with bands of other materials, because of buoyancy and convection.

In continuous-flow isoelectric focusing there is a constant supply of a mixture of biological materials applied to a continuously flowing bed of electrolyte. The materials separate in the electrical field created by the electrodes at either end of the flow cell. They are carried from top to bottom in the cell by flowing electrolyte. At the bottom of the cell the electrolyte and separated biologicals exit the cell and are collected in various tubes. The now purified biologicals are collected in different tubes which, when filled, are stored for the return to Earth.

## NASA'S Industrial Guest Investigator Program

NASA has a unique program underway to involve industrial scientists with NASA's appointed principal investigators. It is termed the "Industrial Guest Investigator" (IGI) program. Figure 17 summarizes the IGI program's characteristics.

NASA has recently approved IGI status for the TRW Equipment Group, Materials Technology Organization of Cleveland, Ohio. This is the first IGI proposal to be approved by NASA. Under this IGI agreement Mr. Jack Alexander, Dr. Tom Piwonka, and Mr. Mike Cybulsky of TRW Materials Technology (Mike Cybulsky is the actual TRW IGI) are working with Dr. Mary Helen Johnston of the NASA MSFC on space processing for solidification structures. Figure 18 provides a brief overview of TRW's IGI role.

### Plan of Investigation

TRW Materials Technology has already embarked on the early stages of the first items singled out for investigation. The alloy that TRW and Dr. Johnston have selected is aluminum-4.5 percent

# INDUSTRIAL GUEST INVESTIGATOR PROGRAM

## WHAT IS AN INDUSTRIAL GUEST INVESTIGATOR?

- INDUSTRIAL SCIENTIST
- NOMINATED BY INDUSTRIAL FIRM; MUTUALLY ACCEPTABLE BY NASA AND THE PRINCIPAL INVESTIGATOR (PI)
- ARRANGEMENTS WORKED ON A CASE-BY-CASE BASIS

## GUEST INVESTIGATOR INVOLVEMENTS

- COORDINATES WITH A NASA PI
- SUGGESTS MATERIALS AND PROCESSES FOR INVESTIGATIONS
- CONDUCTS MPS GROUND-BASED RESEARCH
- INPUTS FUTURE NASA PLANNING
- ANALYZES FLIGHT DATA/SAMPLES

**NO NASA FUNDING OF WORK DONE BY GUEST INVESTIGATOR**

Figure 17

## TRW'S INDUSTRIAL GUEST INVESTIGATOR (IGI) PROGRAM



J.A. ALEXANDER, MGR. MATERIALS RESEARCH  
T.S. PIWONKA, CASTING SECTION MGR.  
M. CYBULSKY, IND. GUEST INVEST.

M.H. JOHNSTON,  
PRINCIPAL INVEST.

<b>MPS DISCIPLINE</b> LOW GRAVITY SOLIDIFICATION PROCESSING	<b>ALLOY SELECTED</b> ALUMINUM-4.5% COPPER
<b>FLIGHT VEHICLES</b> KC-135 AIRCRAFT AND SPAR ROCKET	<b>STATUS</b> EARLY STAGES OF INVESTIGATION
<b>CONCENTRATION OF EFFORT</b> 1. GEOMETRY AFFECTS OF SOLIDIFICATION 2. GAS-INDUCED POROSITY. 3. IMPORTANCE OF GRAIN NUCLEATION 4. BEHAVIOR OF DISPERSED NON-METALLIC INCLUSIONS	

**APPLICATION**  
ADVANCED CASTINGS FOR COMMERCIAL PRODUCTS

Figure 18

copper. This alloy has a melting point of 645° C, which is within the range of melting equipment on KC-135 airplane and SPAR rocket flights (figs. 19 and 20) and has been extensively studied in ground-based experiments. The copper within the alloy segregates during solidification in a straightforward manner which can be easily measured, and the molten alloy dissolves large quantities of hydrogen gas which is relatively insoluble in the solid. The alloy also has a long freezing range (100° C) which makes it particularly prone to the formation of shrinkage porosity, and it is known to respond to a number of nucleating agents which may be used to refine its grain size. It is therefore an

### KC-135 CASTING FURNACE ASSEMBLY

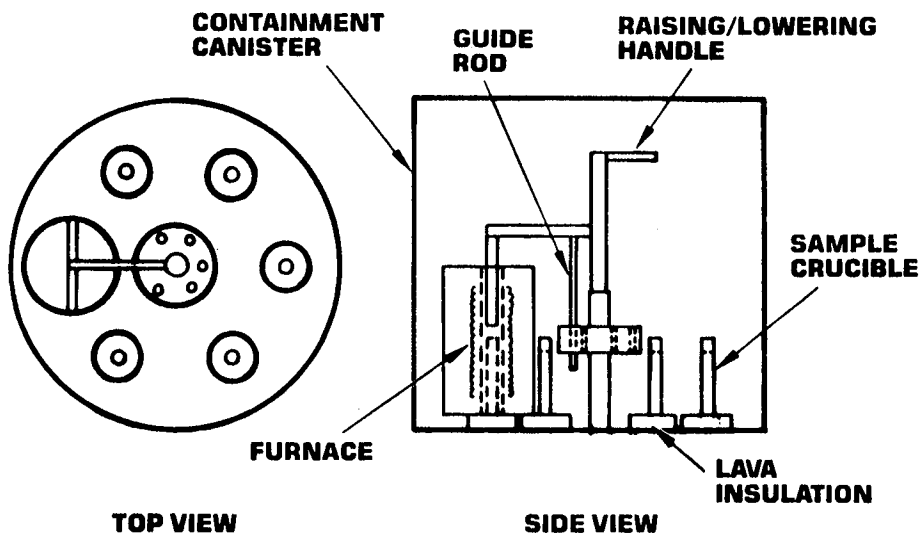

Figure 19

### SPAR CANISTER ASSEMBLY SCHEMATIC

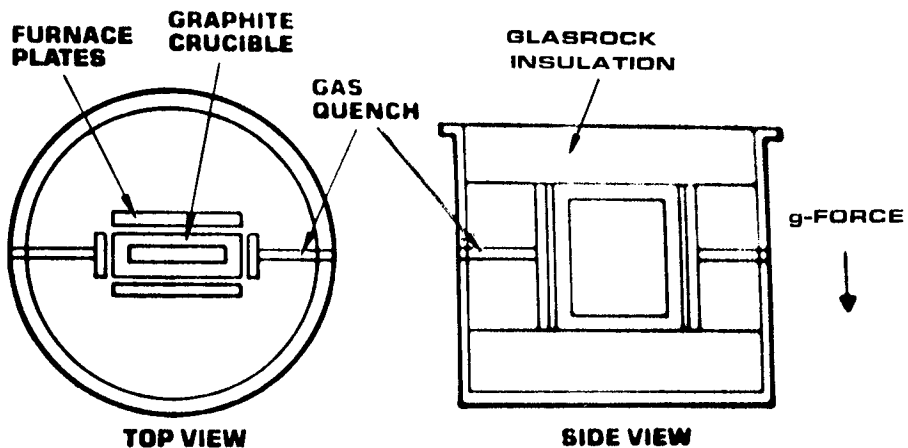

Figure 20

ideal alloy to use in these preliminary experiments. Figure 21 shows the Al-Cu phase diagram and porosity characteristics.

Studies of geometry affects of solidification are underway at present. KC-135 and SPAR flights will be flown in May to obtain baseline data on a straight-sided ingot. A very simple change, use of a tapered ingot instead of a straight-sided ingot, will be evaluated in a SPAR flight in July 1980. More complex section shapes will be introduced in subsequent SPAR flights, combining those experiments with investigations of porosity. These experiments are expected to define the extent to which knowledge of the effect of geometry on terrestrial solidification may be expected to transfer to space.

Gas-induced porosity will be evaluated in July KC-135 flights using Al-4.5%Cu ingot containing high and low levels of hydrogen. The purpose of these experiments is to establish the distribution of hydrogen bubbles as they are precipitated from the liquid-solid interface during solidification.

Shrinkage porosity will be studied by modifying ingot geometry from a straight-sided to a tapered configuration with one end smaller than the other. A second desirable geometry would be an X-shaped casting, because this shape concentrates heat at its center which then acts as a source of liquid to feed the arms of the casting.

Because of the importance of grain nucleation to the commercial foundry industry and the necessity of establishing the feasibility of simple grain refinement techniques for solidification processes, a series of experiments will be designed both to gain insight into current theories of grain nucleation and to act as a screening test for candidate nucleants. A baseline test, in which titanium inoculant is added to bulk sample of Al-4.5%Cu alloy, will be run as the first sample. All experiments will be run first on the ground, and then repeated in space.

The same technique can be used to study the behavior of nonmetallic inclusions during space solidification. A known quantity of oxides (for Al-4.5%Cu, Al<sub>2</sub>O<sub>3</sub> would be used) will be distributed throughout an ingot and its locations recorded. After melting and solidification, both on the ground and in space, the ingots will be examined metallographically to determine what changes, if any, occur in its distribution. Specifically, what indication is there of agglomeration or inclusion movement as a result of gravity or the lack of it.

If it is found that nonmetallic particles remain suspended in their original positions in the ingot melted and solidified in space, then the possibility that space processing may be used to prepare

## AL-4.5%Cu ALLOY SELECTED FOR IGI STUDIES

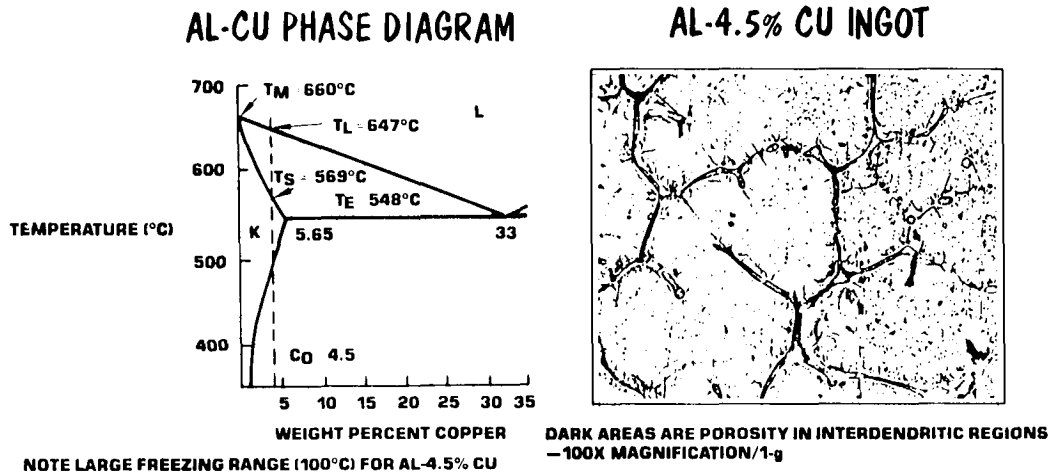

Figure 21

dispersion hardened solidification products (eutectics, single crystals, etc.) may be considered. This could be accomplished by building a directional solidification cell, preparing a powder compact containing the dispersion and the matrix material, placing the compact in the cell, and melting and directionally solidifying the compact. Feasibility of the concept can be demonstrated with Al-4.5%Cu alloy.

After feasibility has been demonstrated, a number of metallic systems will be designed and evaluated. Evaluation will consist of obtaining mechanical property data, corrosion property data, and other data of interest. All that remains then is to demonstrate that shaped castings can be made and an application for space processing is at hand.

### Summary of the IGI Plan

TRW Materials Technology purposes to maintain its involvement with the NASA Space Processing program as guest investigators studying solidification processing. The thrust of our effort will be to study those phenomena which lead to the development of dispersion-hardened solidification structures, such as single crystals, for application in high corrosion, high temperature environments, such as fossile fuel energy generation systems. Specifically, the TRW IGI program with Dr. Johnston of MSFC involves planning to determine

- (1) The effect of geometry on space solidification patterns
- (2) The effect of very low gravity on void and pore formation
- (3) The effect of nonmetallic particles on nucleation of crystals during solidification in low gravity
- (4) The effect of low gravity on the distribution of nonmetallic particles during solidification
- (5) The feasibility of producing a dispersion-hardened solidification structure

## Commercial Ventures

The ultimate goal of the Materials Processing in Space program is to develop commercial interests in using space to (1) perform research to improve industrial technology or to develop new products, (2) to prepare research quantities of material with which to compare current Earth-based technologies, (3) to manufacture limited quantities of a unique product to test market potential or to fulfill a limited but compelling need, and (4) to produce materials in space of sufficient quantity and value to stand on their own economically.

The four stages of implementation of the MPS program are shown in figure 22.

The nature of the fundamental research stage will require sustained flight opportunities by most investigations to satisfy their objectives. For this reason comprehensive government-sponsored investigatory studies rather than single-point or random opportunities are necessary.

A very active learning process will occur, particularly during the initial years (1983-86). Progress in space processing into products will be closely paced by the visibility the scientific and applications investigations afford to further exploitation and avenues of progress.

The process control demonstration stage (1985-88) will require a maturing of the Shuttle/Spacelab MPS payloads for use on longer missions—Shuttle sortie mode of MEC flights—as well as the development of new payload hardware. Before the program can expand, accurate control must occur over all the major processing events and sequences.

The progression into the product development stage (1988-90) must recognize that extension to space ventures will not grow from singular scientific curios. Thus, the thrust of this stage must be to conduct the extensive body of applications and preliminary product development work needed to translate information on novel materials and process inventions into the practical production processes and products. This stage, and the previous stage, should feature strong government and industry joint ventures.

Only the strongest candidates for reduction-to-practice efforts will survive. The present body of technical data is insufficient to rank the potential application areas which have been suggested to



## MPS PROGRAM IMPLEMENTATION

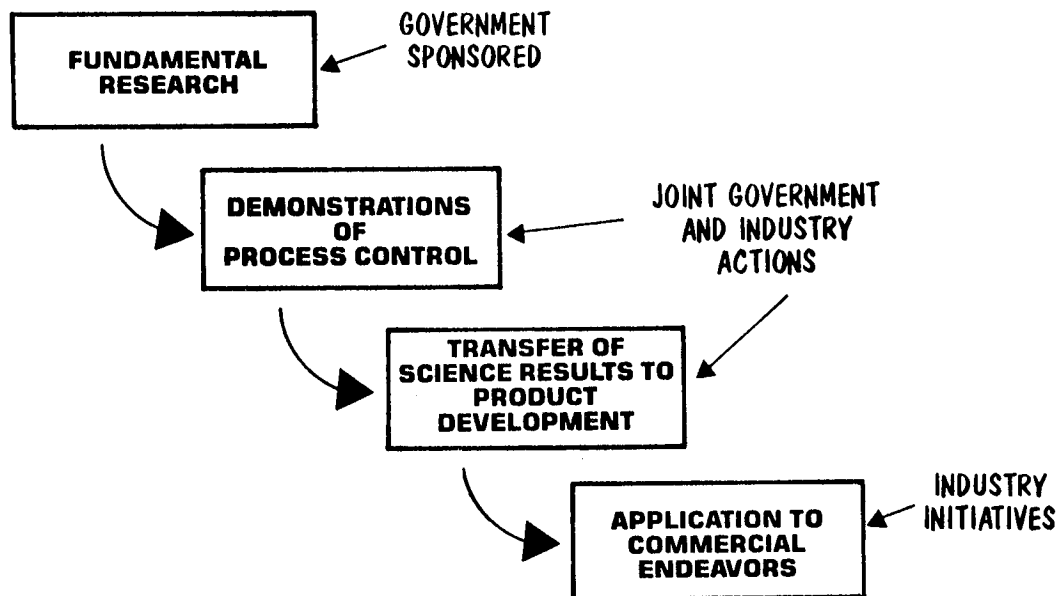

Figure 22

date. What is clear is the need to develop the proper activities during the early part of the product development stage in order to facilitate the selection of those areas in which to proceed. We can expect a follow-the-leader in related industries after the initial favorable result.

The application to commercial endeavors stage (1990–2000) will culminate in expression of commercial manufacturing. Industrialization, applied to space processing, refers to the production of either unique products—those which cannot be made on Earth—or of economic yields of a product which can be obtained in only limited quantities on Earth. Typically, such products would be of high value-added or would be an essential intermediate step in a manufacturing process.

Commercial industry will certainly wish to exploit the cheapest possible way to work in space. Highly specific facilities will be evolved and dedicated to individual product forms rather than general purpose capabilities which were appropriate to the previous stage. Use of the Shuttle for transport, national space facilities, or alternatives such as privately financed systems will undoubtedly be manifest. The evolution of space manufacturing complexes will be dictated by whether government financing or industrial risk capital dominates. Continued dominance of space access through governments will have to be replaced by alternatives in an expanded industrialization era.

The paragraphs above mentioned stages where the government or industry or both should sponsor the efforts. The prime distinction between government and industry can be summed as follows:

### Government

- (1) Recognizes potential benefits and takes leadership
- (2) Sponsors high risk technology development
- (3) Focuses direction.

### Aerospace industry

- (1) Knows and understands space
- (2) Develops, builds, and operates space systems.

### Commercial industry

- (1) Knows the needs of the marketplace
- (2) Makes needs into products
- (3) Derives requirements for space vehicles and processing equipment.

Joint projects involving the government and industrial concerns will surely be the role sought by all parties.

## Government Funding

NASA has sponsored space materials processing activities since the late 1960's. Figure 23 shows the fiscal year funding levels spent up to FY1980 and planned from FY1980 to FY1986. From 1968 to 1978 a total of about \$32 million was spent. The funding level has remained constant at about \$20 million a year for FY1979 to FY1982. Beyond FY1983, NASA plans to significantly increase the U.S. investment in MPS. The expenditures are planned to reach and stay at \$40 million a year in FY1984. This must occur. In fact, the \$40 million level is even considered marginal to foster commercial initiatives, to promote NASA/industry joint ventures, and to keep the U.S. technically competitive with international interests in space processing. Dynamic industrial countries are pursuing MPS, for example,

### West Germany

- Has a comprehensive research program
- Purchased an entire Spacelab/Shuttle flight.

### France

- Flew MPS experiments on Salyut 6
- Is planning an automated Spacelab.

### Japan

- Is following the U.S. space program
- Is part of \$15 billion, 15-year space research allocation for MPS

### USSR

- Obtained most MPS time through Salyut 6
- Has 350 materials scientists active in MPS

## MATERIALS PROCESSING IN SPACE NASA FUNDING

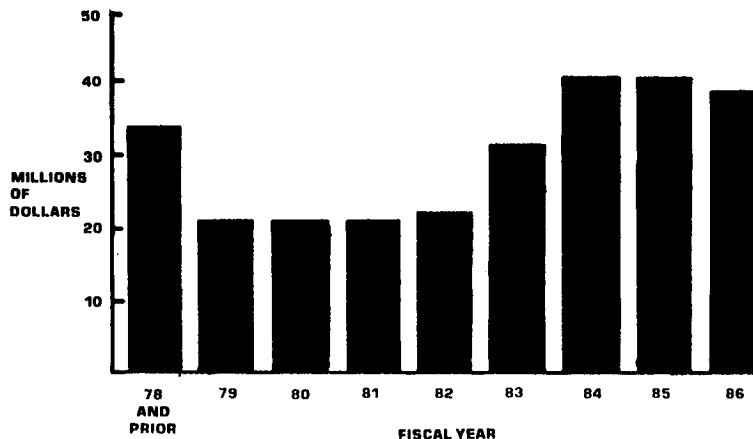

Figure 23

## Summary

The space environment for materials processing should expand our perspectives of both the science and technology of materials. Enhancements in the control over the structure and properties of materials are the primary outputs expected from the processing investigations to be first performed in space on Shuttle/Spacelab 1983 missions. Results will undoubtedly benefit ground-based processes.

The unique capabilities of weightlessness are expected to be of benefit ultimately to a class of new, high value products. However, precursor products must first be made by the commercial sector to test the risks, including the investigation of competitive ground-based technologies, as well as the market demands for such materials. The tentative nature of cooperative opportunities to explore these possibilities is currently under consideration by a growing number of U.S. companies.

The availability of frequent and economical access to the space environment afforded by the Space Shuttle and vehicles to follow, like the Materials Experiment Carrier, will open new opportunities for materials research and new product lines for commercial interests.

A fundamental message is "As our business looks up, we must keep both feet on the ground." With the start of Shuttle/Spacelab MPS flights, there will be some exciting things to do. We will do some research; we will explore. But as the MPS investigations mature from materials development to materials applications, we must not forget that there are some very practical things that we are going to have to accomplish to make space productization a reality.

Planning for space commitments by individuals and organizations are required to implement and sustain such an endeavor. In the face of some skepticism and the always present competition for resources, a spirited endeavor is called for.

Most critical of all the issues is the involvement of industrial participants as soon as possible in the applications area. Their technical progress and business motivations will then lead to the resolution of the other factors.

The need to combine skills of the scientific/engineering community with those of management in government and industry is apparent. To bring focus, to achieve a critical mass of endeavor, and to incorporate industrial support is NASA's principal challenge. Industry must be enlisted to assist NASA in meeting this challenge.