

NASA Technical Paper 1777

Leading-Edge Deflection
Optimization for a Highly
Swept Arrow-Wing Configuration

Paul L. Coe, Jr., Jarrett K. Huffman,
and James W. Fenbert

DECEMBER 1980

CASE FILE
COPY

NASA

NASA Technical Paper 1777

Leading-Edge Deflection
Optimization for a Highly
Swept Arrow-Wing Configuration

Paul L. Coe, Jr., Jarrett K. Huffman,
and James W. Fenbert
*Langley Research Center
Hampton, Virginia*



National Aeronautics
and Space Administration

**Scientific and Technical
Information Branch**

1980

SUMMARY

An investigation has been conducted in the Langley High Speed 7- by 10-Foot Tunnel to determine the influence of an optimized leading-edge deflection on the low-speed aerodynamic performance of a configuration with a low-aspect-ratio, highly swept wing. Tests have also been conducted to determine the sensitivity of the lateral-stability derivative $C_{l\beta}$ to geometric anhedral.

The optimized leading-edge deflection was developed by aligning the leading edge with the incoming flow along the entire span. Owing to the spanwise variation of upwash, the resulting optimized leading edge was a smooth, continuously warped surface for which the deflection varied from 16° at the side of the body to 50° at the wing tip. For the particular configuration studied, levels of leading-edge suction on the order of 90 percent were achieved with the smooth, continuously warped leading-edge contour. Attempts to approximate this smooth contour by a series of discrete deflections of a multisegmented leading-edge system resulted in substantially increased drag. The increased drag, introduced by the surface discontinuities of the multisegmented system, markedly reduced the aerodynamic performance.

Deflecting the leading edge was found to provide a favorable reduction in the inherently high level of $C_{l\beta}$. Comparison of experimental results with simple theoretical estimates of $\partial C_{l\beta} / \partial C_L$ shows that excellent correlation

exists for conditions of attached flow. Furthermore, the results of tests conducted to determine the sensitivity of $C_{l\beta}$ to geometric anhedral indicate values of $\partial C_{l\beta} / \partial \Gamma$ which are in reasonable agreement with estimates provided by simple vortex-lattice theories.

INTRODUCTION

The National Aeronautics and Space Administration is currently investigating the aerodynamic characteristics of advanced aircraft concepts which are capable of cruising efficiently at supersonic speeds. The conceptual designs are representative of future generation commercial and military vehicles and incorporate wing sweeps on the order of 70° to 80° (e.g., refs. 1 and 2). Unfortunately, owing to the high wing sweeps, such configurations have generally exhibited unacceptable low-speed aerodynamic characteristics. The most significant of these unacceptable characteristics are deficiencies in low-speed performance and excessively high levels of effective dihedral ($C_{l\beta}$). The present investigation is intended to yield fundamental information necessary to provide highly swept-wing designs with acceptable low-speed characteristics.

Previous low-speed studies with a configuration having the same wing geometry as the present model are reported in references 3 to 6. The present

study was specifically intended to: (1) provide an assessment of the aerodynamic performance benefits which could be achieved with a suitably optimized leading edge; and (2) determine the sensitivity of the lateral-stability derivative ($C_{l\beta}$) to geometric anhedral.

The tests were conducted in the Langley 7- by 10-Foot Tunnel over an angle-of-attack range from about -6° to 15° for sideslip angles of 0° and $\pm 5^\circ$. The tests were conducted at a Reynolds number (based on the wing mean aerodynamic chord) of about 2.8×10^6 .

SYMBOLS

The longitudinal data are referred to the stability system of axes, and the lateral-directional data are referred to the body system of axes as illustrated in figure 1. The moment reference center for the tests was located at 59.166 percent of the reference wing mean aerodynamic chord. The reference wing area and reference mean aerodynamic chord are based on the wing planform which results from extending the inboard leading-edge sweep angle (74°) and the outboard trailing-edge sweep angle (41.457°) to the model center line. (See fig. 2.)

The dimensional quantities herein are given in both the International System of Units (SI) and the U.S. Customary Units.

A_{fus}	fuselage cross-sectional area, m^2 (ft^2)
R	aspect ratio
b	wing span, m (ft)
C_D	drag coefficient, $\frac{\text{Drag}}{qS_{ref}}$
C_{D_i}	induced drag coefficient
$C_{D_{min}}$	minimum drag coefficient
$C_{D_{sym}}$	drag coefficient of equivalent configuration without twist and camber at zero lift
C_L	lift coefficient, $\frac{\text{Lift}}{qS_{ref}}$
C_l	rolling-moment, $\frac{\text{Rolling moment}}{qS_{ref}b}$

C_m	pitching-moment coefficient, $\frac{\text{Pitching moment}}{qS_{\text{ref}}\bar{c}}$
C_n	yawing-moment coefficient, $\frac{\text{Yawing moment}}{qS_{\text{ref}}b}$
C_y	side-force coefficient, $\frac{\text{Side force}}{qS_{\text{ref}}}$
\bar{c}	reference mean aerodynamic chord, m (ft)
q	free-stream dynamic pressure, Pa (lbf/ft ²)
S	leading-edge suction parameter
S_{ref}	reference wing area, m ² (ft ²)
X, Y, Z	body axes system
x, y, z	body axes coordinates
x_{fus}	fuselage body station, origin at nose, positive rearward, m (ft)
α	angle of attack, deg
β	angle of sideslip, deg
Γ	increment in geometric anhedral, relative to the basic wing geometry, at span station y , deg
Γ_1, Γ_2	increment in geometric anhedral at span stations y_1 and y_2 , respectively, deg (see fig. 2(b))
$\delta_{\text{L.E.}}$	leading-edge deflection, positive when leading edge is down, deg
ϵ	upwash angle, deg
ξ	X-Y projection of the included angle between the local flow direction at the leading edge and a ray normal to the leading-edge hinge line, deg (see fig. 1)

Derivatives:

$$C_{L\alpha} = \partial C_L / \partial \alpha, \text{ per deg}$$

$$C_{L\beta} = \partial C_L / \partial \beta, \text{ per deg}$$

$$C_{n\beta} = \partial C_n / \partial \beta, \text{ per deg}$$

$$C_{y\beta} = \partial C_y / \partial \beta, \text{ per deg}$$

MODEL

The principal dimensional characteristics of the model used in the present study are listed in table I and shown in figures 2 and 3. In addition, a listing of the computer cards required for a numerical model is given in table II. The format for the listing provided in table II is described in reference 7. A photograph of the model in the Langley 7- by 10-Foot Tunnel is presented in figure 4.

Previous studies with configurations having the same wing geometry as the present model are reported in references 3 to 6. The present study was intended to address generic problems associated with highly swept wings; consequently, the model did not incorporate either nacelles or an aft fuselage. The model did, however, incorporate a multisegmented leading edge which permitted continuously variable deflections from 0° to 60° about the 70.688° swept hinge line. (See fig. 2.) This particular hinge line was selected to allow a direct comparison with results from reference 5. The model further incorporated

anhedral breaks at span stations $\frac{y}{b/2} = 0.234$ and 0.736 which permitted the inclusion of additional geometric anhedral.

TESTS AND CORRECTIONS

The investigation was conducted in the Langley 7- by 10-Foot Tunnel. (See ref. 8 for a description of the tunnel.) Forces and moments were measured with a standard six-component strain-gage balance mounted internal to the model. The tests were conducted at a dynamic pressure of 1436.4 Pa (30 lbf/ft²). This value of dynamic pressure resulted in a Reynolds number (based on the wing mean aerodynamic chord) of 2.8×10^6 at a corresponding Mach number of 0.14. The angle of attack ranged from about -6° to 15° for sideslip angles of 0° and $\pm 5^\circ$. Both angle of attack and sideslip have been corrected for the effect of sting and balance bending under aerodynamic load.

The data have been corrected for jet-boundary and blockage effects using the methods outlined in references 9 and 10, respectively. Balance chamber pressure and model base pressure were measured and the drag measurements adjusted to correspond to conditions of free-stream static pressure acting over the base of the model.

In accordance with the method of reference 11, 0.16 cm (0.0625 in.) wide transition strips of No. 70 carborundum grains were placed 3.81 cm (1.5 in.) aft of the leading edges of the wing and outboard vertical tails. Similarly, No. 80 carborundum grains were placed 3.81 cm (1.5 in.) aft of the model nose.

PRESENTATION OF RESULTS

A simplified analysis of the effect of geometric anhedral on $C_{L\beta}$ is presented in appendix A. A data supplement containing a run schedule and tabular listing of data is provided in appendix B. The results and discussion are presented in accordance with the following outline:

	Figure
Longitudinal aerodynamic characteristics	
Configuration with undeflected leading edge	5 to 7
Effect of wing leading-edge deflection	8 to 17
Lateral-directional characteristics	
Configuration with undeflected leading edge	18
Effect of wing leading-edge deflection	19 to 20
Effect of geometric anhedral	21 to 23

RESULTS AND DISCUSSION

The present study was intended to address generic problems associated with highly swept wings; therefore, the model did not incorporate either nacelles or an aft fuselage. In order to provide some insight into the possible effects such configuration components may have on absolute quantities, suitable comparisons are made (where possible) with data obtained for a model which had the same wing geometry, but included both underwing nacelles and an aft fuselage (see ref. 5). It should be noted that, in addition to the nacelle and aft fuselage differences, the model of reference 5 incorporated a fuselage with a different cross-sectional area distribution (see fig. 3). Since the fuselages of both the present model and the model of reference 5 utilized circular cross sections and had the same centroidal axis, the difference in cross-sectional area results in a difference in wing-body intersection.

Longitudinal Aerodynamic Characteristics

Configuration with undeflected leading edge.— Figure 5 presents the longitudinal aerodynamic characteristics for the present configuration with undeflected leading edges ($\delta_{L.E.} = 0$). Also presented for purposes of comparison are corresponding data for the complete configuration reported in reference 5. As can be seen, the data exhibit identical trends. The study of reference 5, in which smoke-flow visualization was used, has indicated that for angles of attack from about 2° to 4° the flow over the main wing panel remains well attached; however, the existence of a tightly wound vortex which formed close to the surface along the leading edge of the outboard wing panel has been observed. As might be anticipated, this tightly wound vortex is found to be accompanied by a small increase in longitudinal stability. At $\alpha > 4^\circ$, the data indicate the existence of a vortex-lift increment and a corresponding pitch-up tendency. This result is attributed to the simultaneous formation of classical wing-apex vortices and to the separation of the tightly wound vortex from the outboard wing panel. (See ref. 5.)

The data of reference 5 exhibit trends which are identical to those of the present model. However, configuration differences result in differences

in the quantitative values. Obviously, the lower value of drag exhibited by the present model results from the reduced skin-friction and interference drag associated with the omission of the aft fuselage and underwing nacelles. The reduction in pitching moment of the present model is attributed to the omission of the down-loaded aft fuselage (see ref. 5). The difference in level of vortex lift for the two configurations is not well understood. However, this difference probably arises from the difference in the wing-body intersection which may, in turn, affect the formation of the wing-apex vortices.

Figure 6 presents theoretical results obtained using a vortex-lattice representation for the isolated twisted and cambered wing of the present model. In addition to the standard potential-flow calculations, this particular vortex-lattice method (see ref. 12) also permits calculation of the aerodynamic characteristics for conditions with leading-edge vortex flows. This is accomplished by incorporating the leading-edge suction analogy developed in reference 13. The results of figure 6 illustrate that the predicted aerodynamic characteristics for conditions of leading-edge vortex flows, are markedly different from those predicted for attached flow conditions. In particular, consideration of the theoretical drag polars (obtained by adding the value of $C_{D_{sym}} = 0.0096$

to the predicted induced drag) indicates that the particular wing geometry, which was designed for attached flow conditions, would have significantly degraded performance for conditions with separated leading-edge vortices.

The vortex-lattice theoretical method used to obtain the results presented in figure 6 does not predict the onset condition or the physical spanwise location of the separated vortex flow; therefore, no one of the theoretical curves is representative over the entire angle-of-attack range considered. Figure 7 presents an adjusted theoretical result obtained by shifting portions of the appropriate curves of figure 6 in an attempt to more closely represent the results for the observed physical flow condition. As can be seen, reasonable agreement exists between this adjusted theoretical result and the experimental result. However, it is recognized that such adjusted theoretical results can only be achieved after the physical flow characteristics have been identified, and hence, may be of limited value.

Effect of wing leading-edge deflection.- Figure 8 presents the longitudinal aerodynamic characteristics for the configuration with a uniform 30° deflection of the entire leading edge (see fig. 2). As has been shown in reference 5, this leading-edge deflection results in fairly well attached flow for angles of attack from about 0° to 8° . For angles of attack greater than 8° , smoke-flow observations showed the onset of a classical leading-edge vortex separation originating at about the midpoint of the wing semispan. It should also be noted that at very low angles of attack ($\alpha < 0^\circ$), deflecting the leading edges apparently results in flow separation on the lower wing surfaces as evidenced by the nonlinearity in C_L versus α . Figure 8 also presents the longitudinal aerodynamic data from reference 5 for the comparable ($\delta_{L.E.} = 30^\circ$) condition. As can be seen, the differences in data for the present tests and reference 5 are generally similar to those previously discussed for the $\delta_{L.E.} = 0^\circ$ condition. As expected, with the leading edges deflected to suppress the leading-edge vortices, excellent agreement in C_L versus α is obtained over the angle-of-attack range tested.

Figure 9 provides a comparison of the data for the conditions of $\delta_{L.E.} = 0^\circ$ and 30° . As has been noted in reference 5, deflecting the wing leading edges to suppress the vortex flow reduces the undesirable vortex induced pitch-up tendency and also reduces the vortex related drag. In order to permit a quantitative evaluation of the performance improvement achieved by leading-edge deflection, figure 9 also presents the conventional theoretical drag polars corresponding to the conditions of: (1) minimum induced drag (100-percent leading-edge suction) and (2) full leading-edge separation (0-percent leading-edge suction). These drag polars are defined for condition (1) as

$$C_D = C_{D_{sym}} + C_L^2/\pi R \quad (1)$$

and for condition (2) as

$$C_D = C_{D_{sym}} + C_L \tan \left(C_L/C_{L\alpha} \right) \quad (2)$$

It should be noted that equations (1) and (2) are valid only for symmetric wings with no twist or camber and are presented herein solely to permit the aerodynamic performance (achieved by the various leading-edge treatments) to be quantified. This is accomplished by introducing the standard leading-edge suction parameter S (see ref. 14 for a comprehensive discussion of leading-edge suction) defined as

$$S = \frac{C_D - [C_{D_{sym}} + C_L \tan (C_L/C_{L\alpha})]}{C_L^2/\pi R - C_L \tan (C_L/C_{L\alpha})} \quad (3)$$

It should be noted that in equations (2) and (3) the quantity $C_L \tan (C_L/C_{L\alpha})$ has been used in place of the more customary $C_L \tan \alpha$. (See ref. 14.) This present notation has been introduced to insure a common basis for comparison of leading-edge suction for the various leading-edge treatments. The value of $C_{D_{sym}}$ has been estimated for the present model tests using the relationship

$$C_{D_{sym}} = C_{D_{min}} - \frac{C_L^2 | C_{D_{min}}}{\pi R} \quad (4)$$

Evaluation of equation (4) yields $C_{D_{sym}} = 0.0096$. The value of $C_{L\alpha}$ has been determined experimentally (for the linear region of C_L versus α) to be 0.037 which is in agreement with theoretical results.

Figure 10 presents values of leading-edge suction calculated from the data of figure 9. As can be seen, the uniform 30° deflection results in substantially increased values relative to the $\delta_{L.E.} = 0^\circ$ condition. This result is similar to the results presented in reference 5, wherein this uniform 30° deflection was initially considered. As pointed out in reference 5, the uniform 30° deflection does not represent an optimum condition. In fact, the uniform 30° deflection is considered to be overdeflected in the apex region while being underdeflected further outboard. This situation developed because the leading-edge system tested in reference 5 was limited to four segments, and attempts to optimize the leading-edge deflection by aligning the leading edge with the local upwash (as will be discussed) resulted in large discontinuities in contour. These large discontinuities were found to result in quite pronounced regions of separated flow, which substantially degraded the performance. Consequently, the uniform 30° deflection was considered an appropriate compromise.

In as much as the present configuration employed a twelve-segmented leading edge (which permitted a more reasonable approximation of a continuously warped surface), an attempt was made to optimize the spanwise variation of leading-edge deflection. The optimal leading edge is considered herein as one in which the leading edge is aligned with the upwash along the entire span. Since $\alpha = 10^\circ$ is representative of the angle-of-attack condition for low-speed operations, attempts were made to obtain attached flow for angles of attack at least up to this condition.

Figure 11 presents the theoretical spanwise variation of upwash ϵ obtained with a vortex-lattice computational model at an angle of attack of 10° (see refs. 5 and 15). In general, for a swept hinge line the angular deflection required to align the leading edge with an upwash angle ϵ would be defined by the standard relationship of sweep theory

$$\delta_{L.E.} = \tan^{-1} \left[\frac{\tan \epsilon}{\cos \xi} \right] \quad (5)$$

However, previous smoke-flow studies (see ref. 5) have shown that the incoming flow is approximately perpendicular to the hinge line ($\xi = 0^\circ$), and therefore, equation (5) yields the simple result that $\delta_{L.E.} = \epsilon$.

With the model at $\alpha = 10^\circ$ and the leading edge deflected to approximate the upwash schedule of figure 11, observations of wool surface tufts revealed

flow separation originating outboard of $\frac{y}{b/2} = 0.5$. This result appears to be

attributable to the fairly sharp corner introduced by rather high deflection about the simple hinge line. Accordingly, the leading-edge deflection was reduced until a condition was reached wherein further reductions resulted in classical leading-edge vortex separation. The multisegmented leading edge was then faired and smoothed to eliminate leading-edge discontinuities. The spanwise variation of leading-edge deflection, as developed above, is compared in

figure 12 with the theoretical upwash. The leading-edge deflection schedule is seen to define a continuously warped surface which varies from 16° inboard to 50° outboard. This leading-edge geometry will hereinafter be designated as $\delta_{L.E.} = 16^\circ-50^\circ$.

Figure 13 presents the longitudinal aerodynamic characteristics obtained with $\delta_{L.E.} = 16^\circ-50^\circ$, while figure 14 presents a comparison of these data with the previously discussed results for the $\delta_{L.E.} = 0^\circ$ and 30° conditions. As can be seen, the data for $\delta_{L.E.} = 16^\circ-50^\circ$ indicate attached flow conditions for angles of attack from about 0° to 10° . At angles of attack above 10° , vortex separation was observed to originate along the leading edge outboard of

$\frac{y}{b/2} = 0.5$. The occurrence of this leading-edge separation is seen to be con-

sistent with the slight pitch-up characteristic exhibited by the data of figure 13. Consideration of the drag polars of figure 14 indicates that $\delta_{L.E.} = 16^\circ-50^\circ$ provides superior aerodynamic performance relative to the other conditions studied. This point is quantified by considering the leading-edge suction parameter obtained for the above continuously warped leading-edge geometry ($\delta_{L.E.} = 16^\circ-50^\circ$) presented in figure 15. As has been seen, $\delta_{L.E.} = 16^\circ-50^\circ$ results in a substantial improvement. In particular, $\delta_{L.E.} = 16^\circ-50^\circ$ is seen to achieve values of suction on the order of 90 percent at representative second segment climb conditions (i.e., $C_L \approx 0.3$). However, at higher values of C_L (corresponding to higher angles of attack) the level of leading-edge suction is substantially reduced for all leading edge geometries tested. It should be noted that the model tested did not employ a trailing edge flap system, which would permit equivalent values of C_L to be achieved at lower angles of attack. Therefore, owing to the adverse effect of increasing α on flow attachment, it would be anticipated that the use of a trailing edge flap system would provide improved drag polars (as shown by fig. 13(c) of ref. 5). Consequently the values of S presented herein for the high lift condition are regarded as conservative.

The effect of Reynolds number on the leading-edge suction parameter has been discussed in reference 14. The results presented therein indicate that increasing the Reynolds number from the low values of the present tests to actual flight values will result in only modest increases in S for the separated flow condition (e.g., the condition discussed herein with $\delta_{L.E.} = 0^\circ$). However, for attached flow conditions (as achieved with $\delta_{L.E.} = 16^\circ-50^\circ$) increasing Reynolds number results in pronounced increases in S . Based on these results, it would appear that the level of S achieved with the attached flow deflection $\delta_{L.E.} = 16^\circ-50^\circ$ is conservative.

It is recognized that while the continuously warped leading edge would provide marked improvements in low-speed aerodynamic performance, the mechanical complexity required to generate this smooth contour from the high-speed cruise shape may limit its practical application. For this reason, tests were conducted in which $\delta_{L.E.} = 16^\circ-50^\circ$ was preserved but the fairing between the adjacent segments of the multisegmented system removed. Figure 16 presents a comparison of the longitudinal data obtained with $\delta_{L.E.} = 16^\circ-50^\circ$ for both faired and unfaired conditions. As can be seen, the impact of removing the leading-edge fairings is largely limited to an increase in drag. This result

correlates well with observations made of wool tufts during the limited flow visualization portion of the tests. Although no large regions of separation could be attributed to the removal of the segment fairings, the tufts were observed to be slightly more unsteady, thereby indicating localized regions of separation. Consideration of the leading-edge suction parameter presented in figure 17 shows that $\delta_{L.E.} = 16^{\circ}$ - 50° exhibits levels of S which are below those values achieved with the simple uniform 30° deflection, thereby indicating the desirability of maintaining continuous leading-edge contour.

Lateral-Directional Characteristics

Configuration with undeflected leading edge.- Figure 18 presents the lateral-directional stability derivatives for the present configuration with undeflected leading edges. Also presented in figure 18 are corresponding results from reference 5 which, as previously mentioned, were obtained with a model which had the same wing geometry but incorporated a different fuselage and included under-wing nacelles. As can be seen from figure 18, both configurations exhibit neutrally stable values of static directional stability $C_{n\beta}$ for angles of attack up to about 4° . For angles of attack greater than 4° (corresponding to the angle of attack for which the wing-apex vortices are first evident), the configuration exhibits a marked increase in $C_{n\beta}$. This phenomenon has been observed previously (see ref. 5) and has been attributed to the interaction of the wing-apex vortices with the forward portion of the configuration.

The data of figure 18 also show that both configurations exhibit high levels of effective dihedral $C_{l\beta}$ at nominal approach conditions of $\alpha = 8^{\circ}$ to 10° , as would be expected for the low-aspect-ratio wing. References 16 and 17 have shown that these high levels of $C_{l\beta}$ typically result in Dutch roll instabilities and reversals in pilot-commanded roll rates. The analysis of reference 4 has also shown that, because of limited lateral-control capabilities (typical of low-aspect-ratio wings) the high values of $C_{l\beta}$ would necessitate excessive approach speeds to meet currently accepted cross-wind landing requirements.

It is interesting to note that although both the present configuration and the configuration of reference 5 exhibit about the same slope of $C_{l\beta}$ versus α , the magnitude of $C_{l\beta}$ for the present configuration is reduced for positive angles of attack. This reduction in $C_{l\beta}$ is believed to be due to the omission of the under-wing nacelles and to a difference in the aft wing-body intersection (e.g., ref. 18).

Effect of wing leading-edge deflection.- Figure 19 presents the lateral-directional stability derivatives for the configuration with $\delta_{L.E.} = 0^{\circ}, 30^{\circ}$,

and 16°-50°. As can be seen by comparison of the results presented, both of the deflected leading-edge geometries resulted in a reduction in $C_{n\beta}$. The reduction in $C_{n\beta}$ at low angles of attack is simply due to the deflected leading edge providing an increased vertical area forward of the moment reference center. At higher angles of attack, the dramatic reduction in $C_{n\beta}$ is, of course, associated with the suppression of the wing-apex vortices. Although this reduction in $C_{n\beta}$ at high angles of attack may appear to be adverse, previous studies (see ref. 19) have shown that positive increments in $C_{n\beta}$, when originating forward of the center of gravity (as is the case considered herein), are accompanied by undesirable reductions in damping in yaw. For the present configuration the influence of leading-edge deflection on damping in yaw is undetermined, and additional tests are required to determine the effect of leading-edge deflection on dynamic stability characteristics.

The data of figure 19 also indicate that deflecting the leading edge yields a favorable increment in $C_{l\beta}$. This result is primarily due to the simple increase in geometric anhedral which accompanies the leading-edge deflections. Figure 20 presents these same data as the variation of $C_{l\beta}$ with respect to C_L for the various leading-edge deflections. Noted on the figures are the regions of separated and attached flow as discussed in connection with figures 5, 8, and 13. Analysis of the results shows that, for the conditions under which attached flow exists, positive increments in $C_{l\beta}$ of 0.00016 and 0.00022 are obtained (relative to $\delta_{L.E.} = 0^\circ$) for $\delta_{L.E.} = 30^\circ$ and 16°-50°, respectively.

It should be noted that for conditions of attached flow, $\partial C_{l\beta} / \partial C_L$ is found to be independent of leading-edge geometry and has a value of -0.0058. This value of $\partial C_{l\beta} / \partial C_L$ is in excellent agreement with the value of -0.0061 obtained from the expression

$$\partial C_{l\beta} / \partial C_L = \frac{2}{3} \times \frac{1}{R} \times \frac{2\pi}{360} \quad (6)$$

which is developed in reference 20. The break in the slope of $C_{l\beta}$ versus C_L is a result of flow separation. Although it is not clearly understood, apparently the nature of the leading-edge separation greatly influences the manner in which the break in slope occurs. In as much as a properly designed configuration would be intended to operate with attached flow, the values of $C_{l\beta}$ for conditions of separated flow may be misleading. Extrapolation of the attached flow results to higher lift coefficients (as could be achieved with a simple trailing-edge flap system) shows that with the leading-edge geometries

studied the configuration would exhibit values of $C_{l\beta}$ of about -0.003 at a nominal approach lift coefficient of 0.6.

Effect of geometric anhedral.- The results of the preceding section indicate that, as expected, high values of $C_{l\beta}$ are inherent to the low-aspect-ratio highly swept wing. Consequently, tests were conducted in order to determine the sensitivity of $C_{l\beta}$ to additional geometric anhedral and to correlate these results with existing theory. These tests were conducted with the geometric anhedral increased at span stations $\frac{y}{b/2} = 0.234$ and 0.736 (see fig. 2).

The leading-edge geometry for the configuration during this phase of the study was limited to the continuously warped $\delta_{L.E.} = 16^\circ$ - 50° condition, which was previously found to exhibit superior longitudinal performance. Examination of the tabulated data (presented in the data supplement at the end of this report) for the various anhedral angles tested shows that the longitudinal variables were not influenced by anhedral. The data further show that the geometric anhedral does not have any significant effect on the directional stability characteristics. Consequently, the discussion is limited to a consideration of the influence of geometric anhedral on $C_{l\beta}$.

Figures 21 and 22 present the variation of $C_{l\beta}$ with C_L for the various anhedral angle combinations tested. From theoretical considerations, it would be expected that the values of $\partial C_{l\beta} / \partial \Gamma$ (as determined by cross plotting the data of fig. 21) would be constant for attached flow conditions. However, analysis of the data of figure 21 shows that $\partial C_{l\beta} / \partial \Gamma$ increases with increasing lift coefficient. To determine the additive nature of the experimental results for $C_{l\beta}$ versus C_L , a selected combination of $\Gamma_1 = 4^\circ$ and $\Gamma_2 = 11^\circ$ was tested. The experimental results (see fig. 22) are seen to compare well with results obtained by adding the experimentally determined incremental values of $C_{l\beta}$ presented in figure 21.

Figure 23 presents the theoretical variation of $\partial C_{l\beta} / \partial \Gamma$ as a function of the corresponding nondimensional semispan location. The theoretical results were obtained with a vortex-lattice computational model which is based on the theory of reference 15. The range of experimental results for $\partial C_{l\beta} / \partial \Gamma$, evaluated from figure 21 at $C_L = 0.2$ and 0.4 are presented for comparison. It is noted that although the experimental values of $\partial C_{l\beta} / \partial \Gamma$ have been shown to increase with increasing C_L , they are in reasonable agreement with the theoretical results. Furthermore, both the vortex-lattice theoretical results and

the experimental results are seen to be in agreement with the approximate values of $\partial C_{l\beta} / \partial \Gamma$ obtained using the simple design chart procedure contained in reference 21.

The results presented in figure 23 indicate that quite substantial reductions in $C_{l\beta}$ may be achieved by introducing geometric anhedral at inboard span locations. However, it should be recognized that a detailed configuration study is required to determine the most effective means of incorporating such additional anhedral.

As an illustration, the simplified analysis presented in appendix A considers the case wherein anhedral is added at an inboard span location. The analysis assumes that the wing-tip clearance remains unchanged as would be required for the case where the landing gear length was held constant. Obviously, under these conditions, adding geometric anhedral at inboard locations necessitates the addition of dihedral at outboard locations. The results presented in appendix A show that for these conditions, the net resulting improvement in $C_{l\beta}$ is negligible.

SUMMARY OF RESULTS

The results of a study to determine the influence of optimized leading-edge deflection and geometric anhedral on the low-speed performance and lateral stability of configurations with highly swept wings may be summarized as follows:

1. Leading-edge deflection is effective in suppressing the formation of wing-apex vortices and promoting attached flow conditions.
2. Due to the spanwise variation of upwash, the optimal leading-edge deflection is a smooth, continuously warped surface. For the particular configuration studied, levels of leading-edge suction in excess of 90 percent are achieved with a smooth, continuously varying leading-edge deflection of 16° at the side of the body and increasing to 50° at the wing tip.
3. Small discontinuities in surface contour, introduced in an attempt to approximate the smooth continuously warped leading edge with a series of discrete deflections of a multisegmented leading-edge system, resulted in large increments in drag (apparently due to flow separation) and corresponding large reductions in the leading-edge suction parameter.
4. A uniform leading-edge deflection of 30° (representing an average value of the continuously warped leading-edge deflection) provided higher values of the leading-edge suction parameter than provided by the discrete multisegmented system. This result is apparently due to the elimination of the small surface discontinuities introduced by deflecting the individual segments through different angles.

5. Deflecting the entire leading edge to achieve attached flow is found to provide a favorable reduction in the inherently high level of $C_{l\beta}$ which is associated with the low-aspect-ratio highly swept wing.

6. The theoretical value of $\partial C_{l\beta} / \partial C_L$ is found to be in excellent agreement with experimental results for conditions where attached flow exists.

7. The inclusion of additional geometric anhedral to reduce the high levels of $C_{l\beta}$ is found to yield values of $\partial C_{l\beta} / \partial \Gamma$ which are in reasonable agreement with theoretical estimates.

Langley Research Center
National Aeronautics and Space Administration
Hampton, VA 23665
November 25, 1980

TABLE I.- GEOMETRIC CHARACTERISTICS OF MODEL

Wing:

Aspect ratio	1.904
Reference area, m ² (ft ²)	0.834 (8.972)
Gross area, m ² (ft ²)	0.919 (9.889)
Span, m (ft)	1.260 (4.133)
Root chord, m (ft)	1.674 (5.492)
Tip chord, m (ft)	0.161 (0.529)
Reference mean aerodynamic chord, m (ft)	0.880 (2.887)
Gross mean aerodynamic chord, m (ft)	1.038 (3.406)
Leading-edge sweep, deg	
At body station 0.388 m (1.272 ft)	74.0
At body station 1.427 m (4.683 ft)	70.5
At body station 1.886 m (6.185 ft)	60.0

Vertical fin (each):

Span, m (ft)	0.107 (0.350)
Root chord, m (ft)	0.326 (1.069)
Tip chord, m (ft)	0.048 (0.158)
Leading-edge sweep, deg	73.4

TABLE II.- NUMERICAL MODEL OF CONFIGURATION

(a) SI Units. All dimensions are in centimeters

1	1	1	1	1	1	13 24	4 25	7 22	9 28	9 27	8	2 10	2 10	1 10	REFA
8335.35															XAF 10
0.	.125	.25	.5	.75	1.0	1.5	2.5	5.0	10.						XAF 20
15.	20.	30.	40.	50.	60.	65.	70.	75.	80.						XAF
85.	90.	95.	100.												WORD 1
56.596	5.111	-3.722	149.382												WORD 2
60.302	6.174	-4.691	145.744												WORD 3
69.065	8.687	-6.209	136.931												WORD 4
81.836	12.349	-7.590	124.084												WORD 5
103.367	18.523	-9.144	102.425												WORD 6
112.115	21.031	-9.711	93.625												WORD 7
124.899	24.697	-10.488	81.832												WORD 8
142.728	29.809	-11.220	65.385												WORD 9
156.394	34.564	-11.659	53.003												WORD 10
163.527	37.046	-11.951	48.143												WORD 11
188.458	45.720	-12.875	31.153												WORD 12
188.458	45.721	-12.875	31.153												WORD 12
218.359	62.992	-14.630	16.496												TZ 1.1
0.000	.001	.001	0.000												TZ 1.2
-1.015	-1.673	-3.164	-4.755												TZ 1.3
-10.570	-11.000	-11.375	-11.704												TZ 2.1
0.000	.001	.002	.003												TZ 2.2
-1.750	-1.308	-2.579	-4.005												TZ 2.3
-9.484	-9.903	-10.269	-10.580												TZ 2A.1
0.000	.003	.006	.012												TZ 2A.2
-1.393	-.805	-1.801	-2.917												TZ 2A.3
-7.590	-7.992	-8.358	-8.678												TZ 3.1
0.000	.005	.009	.018												TZ 3.2
-1.158	-.438	-1.133	-1.933												TZ 3.3
-5.084	-6.051	-6.398	-6.724												TZ 4.1
0.000	.005	.009	.020												TZ 4.2
.157	.031	-.341	-.810												TZ 4.3
-3.363	-3.645	-3.922	-4.192												TZ 5.1
0.000	.008	.014	.026												TZ 5.2
.290	.200	-.074	-.445												TZ 5.3
-2.574	-2.819	-3.059	-3.300												TZ 6.1
0.000	.005	.011	.020												TZ 6.2
.315	.272	.105	-.148												TZ 6.3
-1.732	-1.925	-2.118	-2.309												TZ 7.1
0.000	.004	.007	.016												TZ 7.2
.229	.206	.110	-.003												TZ 7.3
-.969	-1.090	-1.212	-1.326												TZ 8.1
0.000	.003	.005	.009												TZ 8.2
.157	.185	.138	.069												TZ 8.3
-.511	-.593	-.678	-.763												TZ 9.1
0.000	.002	.003	.005												TZ 9.2
.112	.120	.105	.054												TZ 9.3
-.428	-.497	-.569	-.643												TZ 10.1
0.000	0.000	0.000	0.000												TZ 10.2
.086	.091	.076	.037												TZ 10.3
-.256	-.294	-.336	-.375												TZ 11.1
0.000	0.000	0.000	0.000												TZ 11.2
.086	.091	.076	.037												TZ 11.3
-.256	-.294	-.336	-.375												TZ 12.1
0.000	0.000	0.000	0.000												TZ 12.2
0.000	0.000	0.000	0.000												TZ 12.3
0.000	0.000	0.000	0.000												WORD 11
0.00	.182	.253	.345												WORD 1.2
1.115	1.221	1.390	1.440												WORD 1.3
.525	.352	.179	0.												WORD 2.1
0.00	.182	.253	.345												WORD 2.2
1.040	1.175	1.325	1.374												WORD 2.3
.501	.336	.171	0.												WORD 2A.1
0.00	.182	.253	.345												WORD 2A.2
1.015	1.110	1.230	1.281												WORD 2A.3
.470	.315	.161	0.												WORD 3.1
0.00	.182	.253	.345												WORD 3.2
.972	1.035	1.174	1.218												WORD 3.3
.447	.300	.153	0.												WORD 4.1
0.00	.182	.253	.345												WORD 4.2
.980	1.065	1.189	1.230												WORD 4.3
.452	.303	.154	0.												WORD 5.1
0.00	.182	.253	.345												WORD 5.2
1.00	1.090	1.218	1.263												WORD 5.3
.464	.311	.159	0.												WORD 6.1
0.00	.182	.253	.345												WORD 6.2
1.005	1.100	1.229	1.276												WORD 6.3
.468	.314	.160	0.												WORD 7.1
0.00	.198	.275	.371												WORD 7.2
1.010	1.110	1.240	1.293												WORD 7.3
.475	.319	.162	0.												WORD 8.1
0.00	.198	.275	.371												WORD 8.2
1.048	1.152	1.283	1.338												WORD 8.3
.491	.330	.168	0.												WORD 9.1
0.00	.198	.275	.371												WORD 9.2
1.059	1.160	1.304	1.356												WORD 9.3
.498	.334	.170	0.												WORD 10.1
0.00	.198	.275	.371												WORD 10.2
1.070	1.182	1.331	1.388												WORD 10.3
.510	.342	.174	0.												WORD 11.1
0.00	.008	.017	.034												WORD 11.2
.845	1.041	1.302	1.388												WORD 11.3
.510	.342	.174	0.												WORD 12.1
0.0	.008	.017	.034												WORD 12.2
.837	1.031	1.290	1.375												WORD 12.3
.505	.339	.173	0.												XFUS 10
0.0	9.144	18.288	27.432												XFUS 20
59.436	64.008	73.152	82.296												XFUS 30
187.452	196.596	205.740													XFUS 40
0.0	.128	.183	.192												ZFUS 10
-.347	-.686	-1.490	-2.377												ZFUS 20
-10.781	-11.302	-11.695													ZFUS 30
0.0	8.823	25.669	43.646												FUSA 10
96.155	96.321	92.228	90.385												FUSA 20
89.298	82.609	74.499													FUSA 30

TABLE II.- Concluded

(b) U.S. Customary Units. All dimensions are in inches

	1	1	1	1	1	13 24	4 25	7 22	9 28	9 27	8	2 10	2 10	1 10	REFA
1291.98															XAF 10
0.	.125	.25	.5	.75	1.0	1.5	2.5	5.0	10.						XAF 20
15.	20.	30.	40.	50.	60.	65.	70.	75.	80.						XAF
85.	90.	95.	100.												NOR1
22.282	2.012	-1.465	58.812												NOR2
23.741	2.431	-1.847	57.380												NOR3
27.191	3.420	-2.444	53.910												NOR4
32.219	4.862	-2.988	48.852												NOR5
40.696	7.293	-3.600	40.325												NOR6
44.140	8.280	-3.823	36.860												NOR7
49.173	9.723	-4.129	32.217												NOR8
56.192	11.736	-4.417	25.742												NOR9
61.573	13.698	-4.590	20.867												NOR10
64.381	14.585	-4.705	18.954												NOR11
74.196	18.000	-5.069	12.265												NOR12
74.196	18.000	-5.069	12.265												NOR11
85.968	24.800	-5.760	6.494												NOR12
0.000	.000	.000	0.000												TZ 1.1
-.400	-.659	-1.246	-1.872												TZ 1.2
-4.162	-4.331	-4.478	-4.608												TZ 1.3
0.000	.000	.001	.001												TZ 2.1
-.295	-.515	-1.015	-1.577												TZ 2.2
-3.726	-3.899	-4.043	-4.165												TZ 2.3
0.000	.001	.002	.005												TZ 2A.1
-.155	-.317	-.709	-1.148												TZ 2A.2
-2.988	-3.146	-3.290	-3.416												TZ 2A.3
0.000	.002	.004	.007												TZ 3.1
-.062	-.172	-.446	-.761												TZ 3.2
-2.238	-2.382	-2.519	-2.647												TZ 3.3
0.000	.002	.004	.008												TZ 4.1
.062	.012	-.134	-.319												TZ 4.2
-1.324	-1.435	-1.544	-1.650												TZ 4.3
0.000	.003	.005	.010												TZ 5.1
.114	.079	-.029	-.175												TZ 5.2
-1.013	-1.110	-1.204	-1.299												TZ 5.3
0.000	.002	.004	.008												TZ 6.1
.124	.107	.041	-.058												TZ 6.2
-.682	-.758	-.834	-.909												TZ 6.3
0.000	.001	.003	.006												TZ 7.1
.090	.081	.043	-.001												TZ 7.2
-.382	-.429	-.477	-.522												TZ 7.3
0.000	.001	.002	.004												TZ 8.1
.062	.065	.054	.027												TZ 8.2
-.201	-.234	-.267	-.300												TZ 8.3
0.000	.001	.001	.002												TZ 9.1
.044	.047	.041	.021												TZ 9.2
-.168	-.196	-.224	-.253												TZ 9.3
0.000	0.000	0.000	0.000												TZ 10.1
.034	.036	.030	.014												TZ 10.2
-.101	-.116	-.132	-.148												TZ 10.3
0.000	0.000	0.000	0.000												TZ 11.1
.034	.036	.030	.014												TZ 11.2
-.101	-.116	-.132	-.148												TZ 11.3
0.000	0.000	0.000	0.000												TZ 12.1
0.000	0.000	0.000	0.000												TZ 12.2
0.000	0.000	0.000	0.000												TZ 12.3
0.00	.182	.253	.345												WORD 1.1
1.115	1.221	1.390	1.440												WORD 1.2
.525	.352	.179	0.												WORD 1.3
0.00	.182	.253	.345												WORD 2.1
1.040	1.175	1.325	1.374												WORD 2.2
.501	.336	.171	0.												WORD 2.3
0.00	.182	.253	.345												WORD2A.1
1.015	1.110	1.230	1.281												WORD2A.2
.478	.315	.161	0.												WORD2A.3
0.00	.182	.253	.345												WORD 3.1
.972	1.035	1.174	1.218												WORD 3.2
.447	.300	.153	0.												WORD 3.3
0.00	.182	.253	.345												WORD 4.1
.980	1.065	1.189	1.230												WORD 4.2
.452	.303	.154	0.												WORD 4.3
0.00	.182	.253	.345												WORD 5.1
1.00	1.090	1.218	1.263												WORD 5.2
.464	.311	.159	0.												WORD 5.3
0.00	.182	.253	.345												WORD 6.1
1.005	1.100	1.229	1.276												WORD 6.2
.468	.314	.160	0.												WORD 6.3
0.00	.198	.275	.371												WORD 7.1
1.010	1.110	1.240	1.293												WORD 7.2
.475	.319	.162	0.												WORD 7.3
0.00	.198	.275	.371												WORD 8.1
1.048	1.152	1.283	1.338												WORD 8.2
.491	.330	.168	0.												WORD 8.3
0.00	.198	.275	.371												WORD 9.1
1.059	1.160	1.304	1.356												WORD 9.2
.498	.334	.170	0.												WORD 9.3
0.00	.198	.275	.371												WORD10.1
1.070	1.182	1.331	1.388												WORD10.2
.510	.342	.174	0.												WORD10.3
0.00	.008	.017	.034												WORD11.1
.845	1.041	1.302	1.388												WORD11.2
.510	.342	.174	0.												WORD11.3
0.0	.008	.017	.034												WORD12.1
.837	1.031	1.290	1.375												WORD12.2
.505	.339	.173	0.												WORD12.3
0.0	3.6	7.2	10.8												XFUS 1.0
23.4	25.2	28.8	32.4												XFUS 2.0
73.8	77.4	81.0													XFUS 2.3
0.0	.050	.072	.075												ZFUS 1.0
-.137	-.270	-.587	-.936												ZFUS 2.0
-4.244	-4.449	-4.604													ZFUS 2.3
0.0	1.374	3.978	6.765												FUSA 1.0
14.904	14.930	14.450	14.010												FUSA 2.0
13.841	12.804	11.547													FUSA 2.3

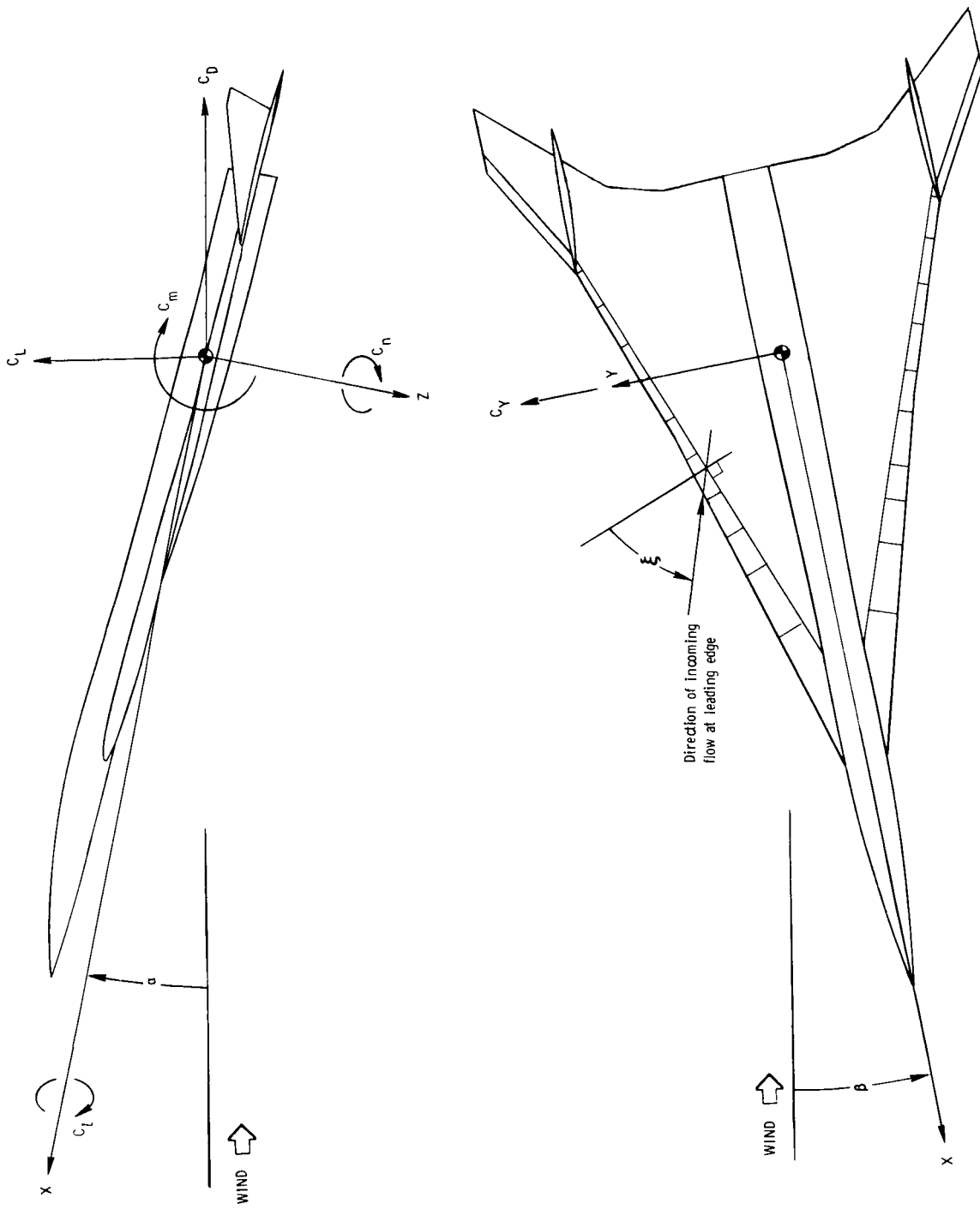
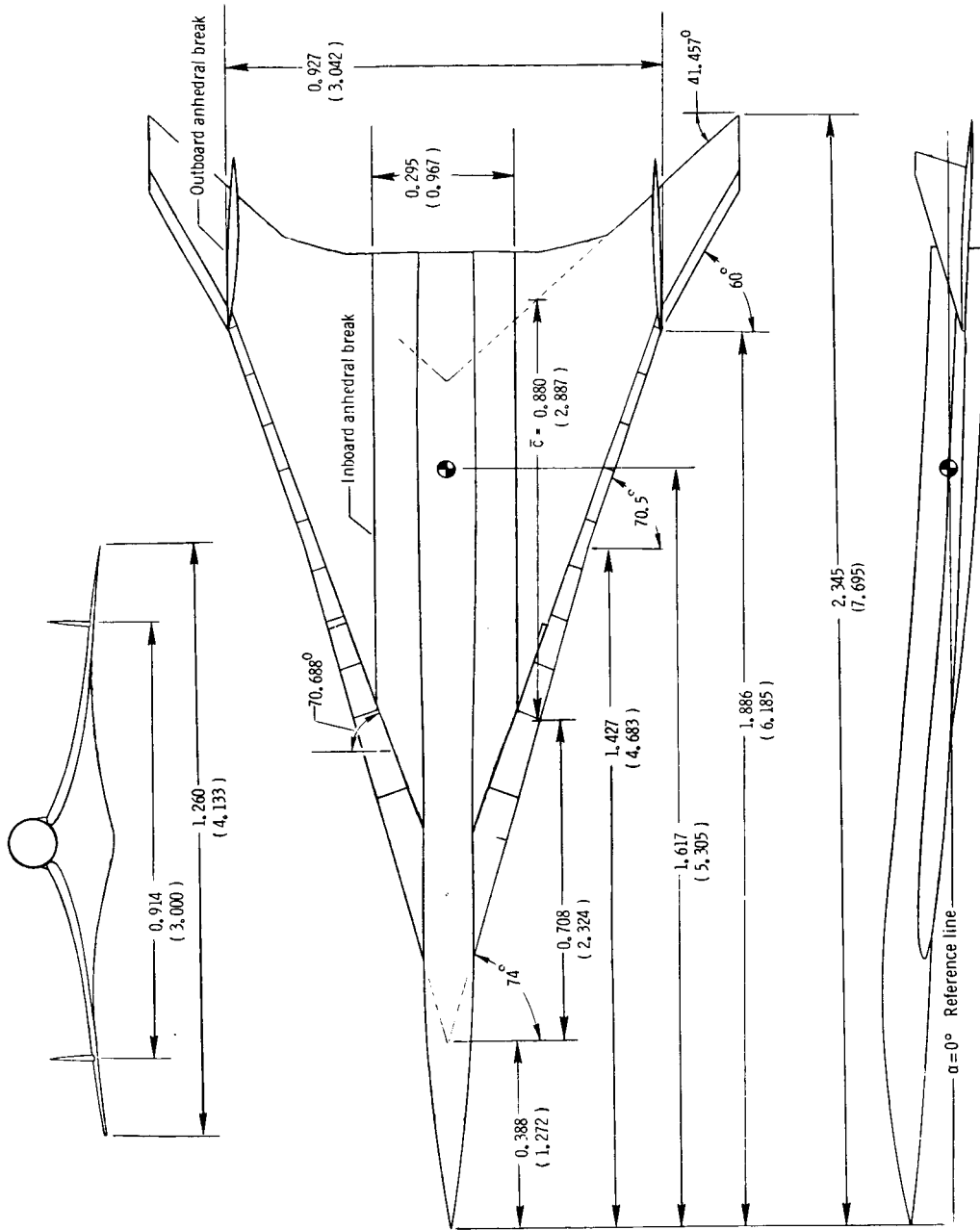
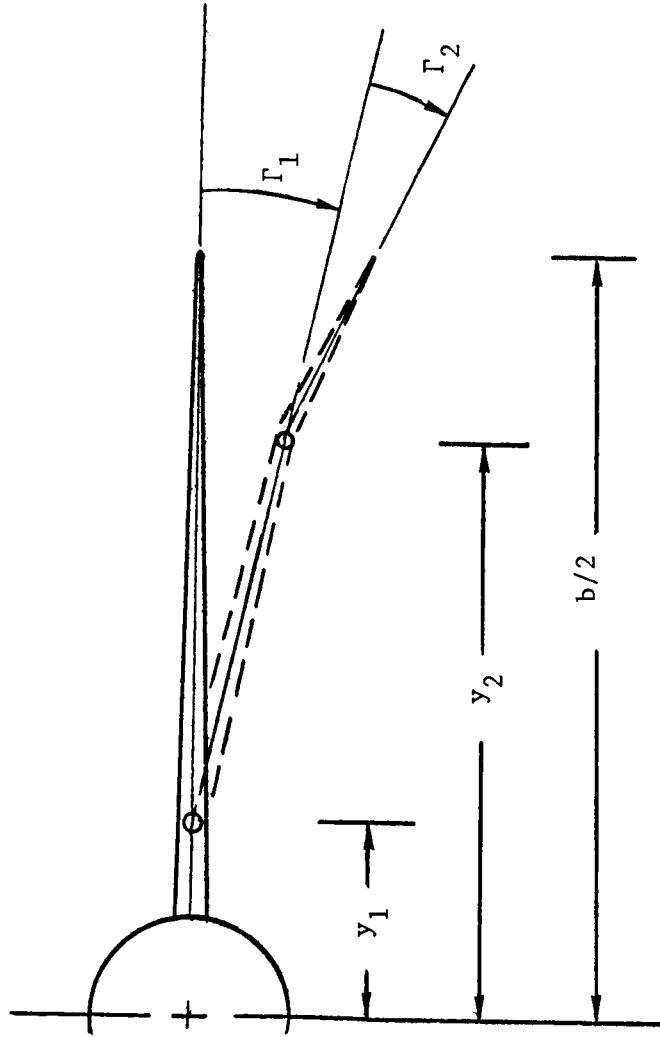

Figure 1.- System of axes and angular notation.



(a) Three-view sketch of model.

Figure 2.- Geometric characteristics. Dimensions are in meters (feet).



(b) Sketch showing anhedral angles.

Figure 2.- Concluded.

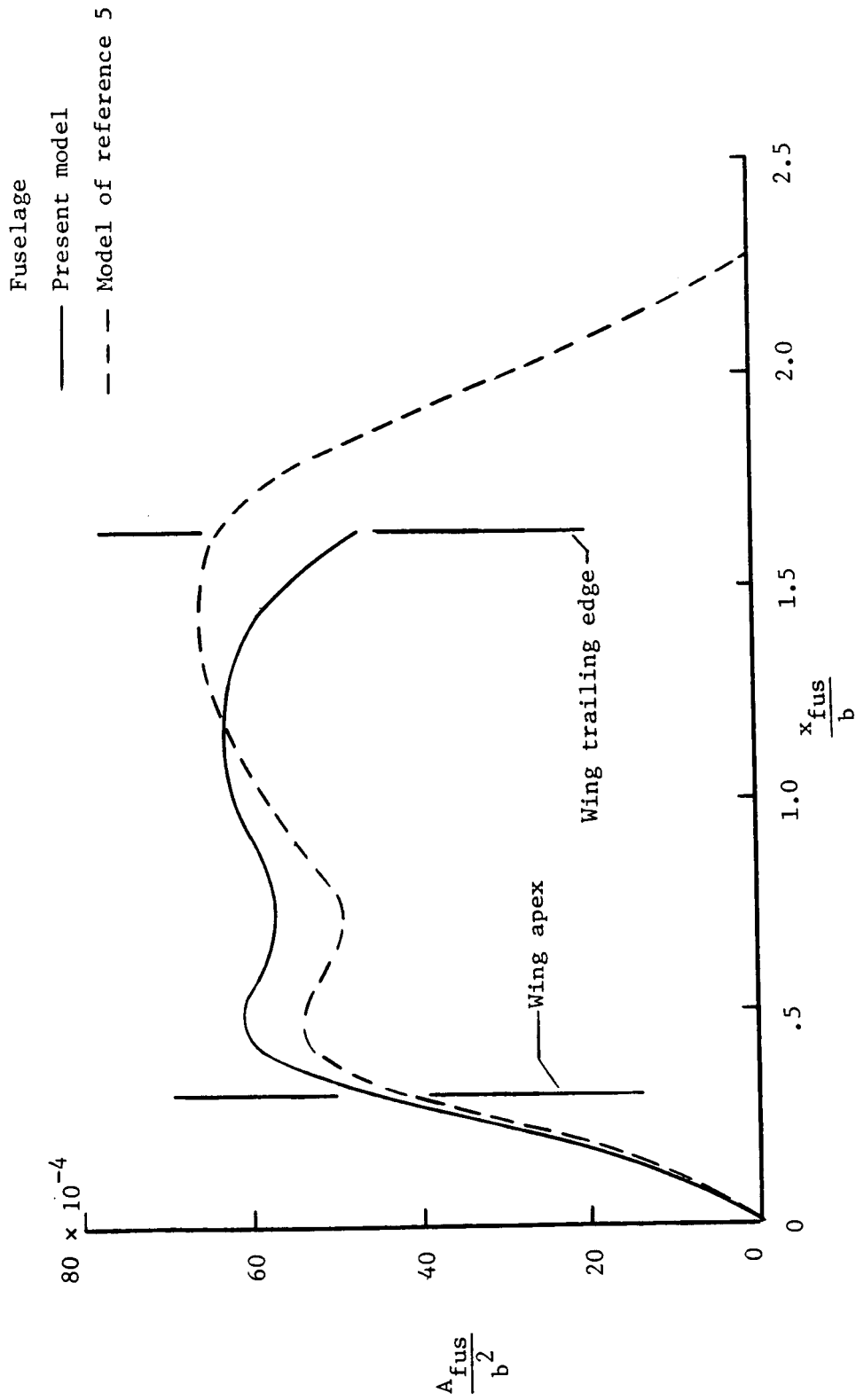
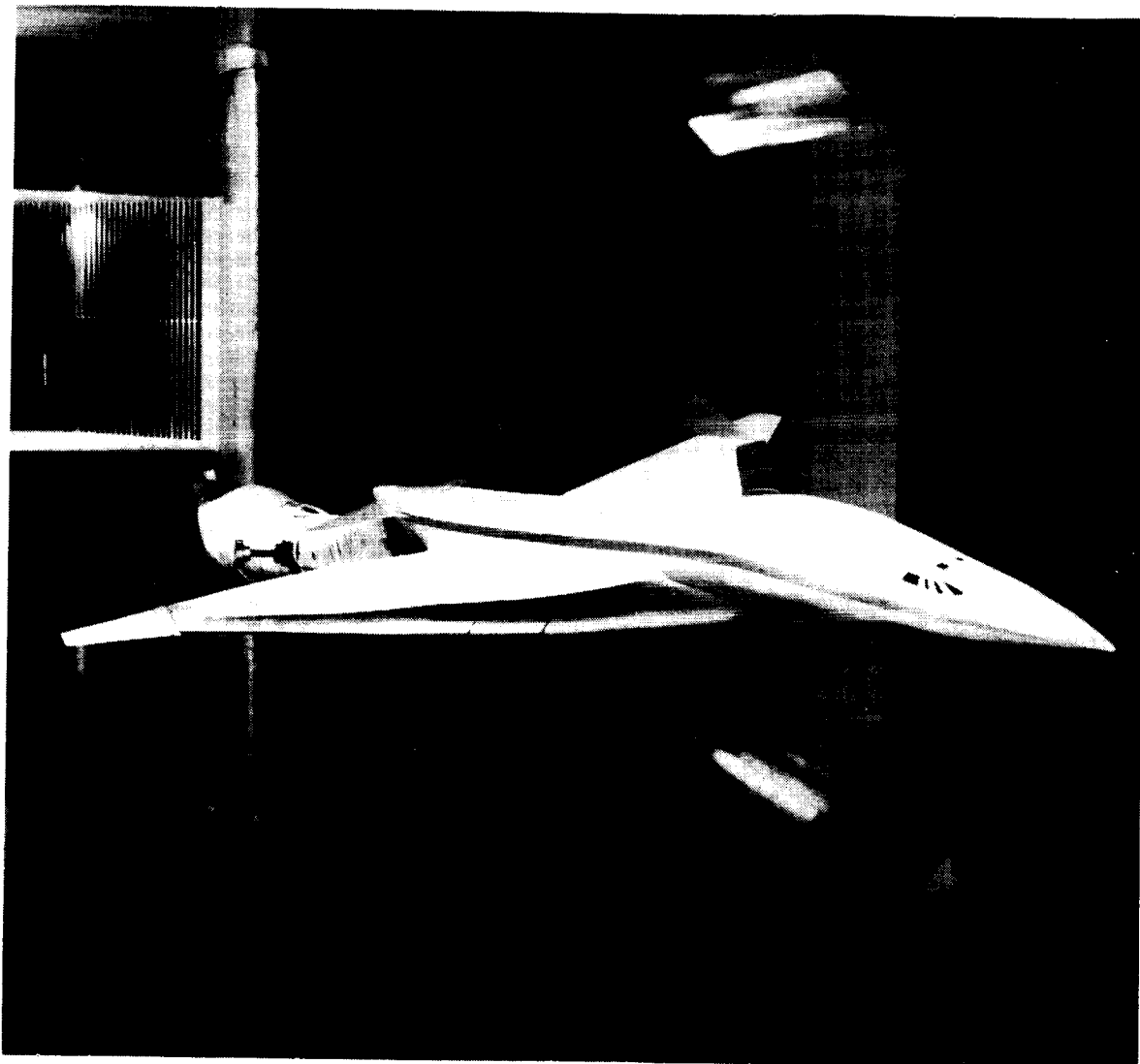

Figure 3.- Comparison of fuselage cross-sectional area distribution of present model and model of reference 5.



L-78-8188

Figure 4.- Photograph of model in Langley High-Speed 7- by 10-Foot Tunnel.

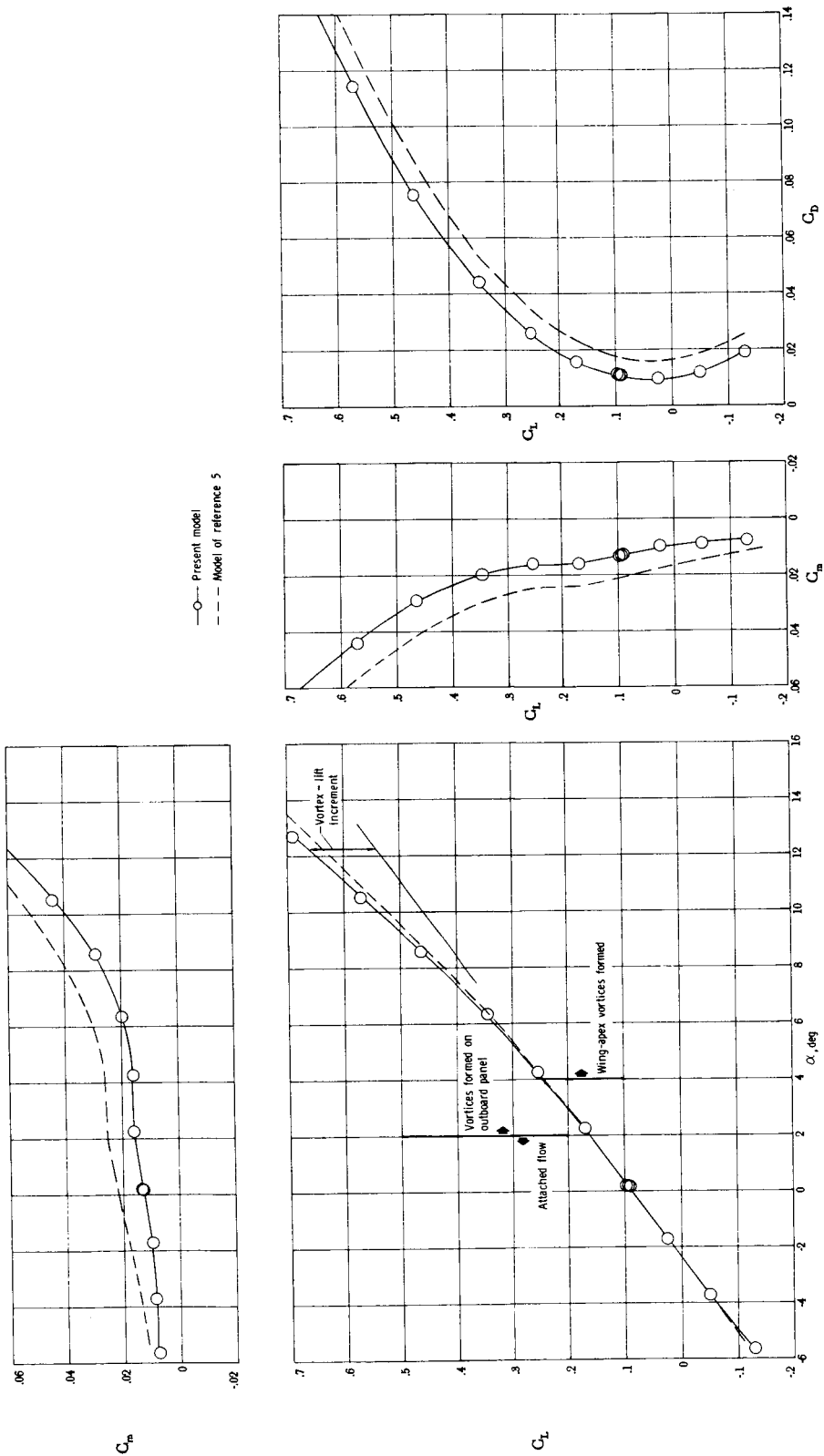

Figure 5.- Comparison of longitudinal aerodynamic data from present tests with data determined for related configuration of reference 5. $\delta L.E. = 0^\circ$.

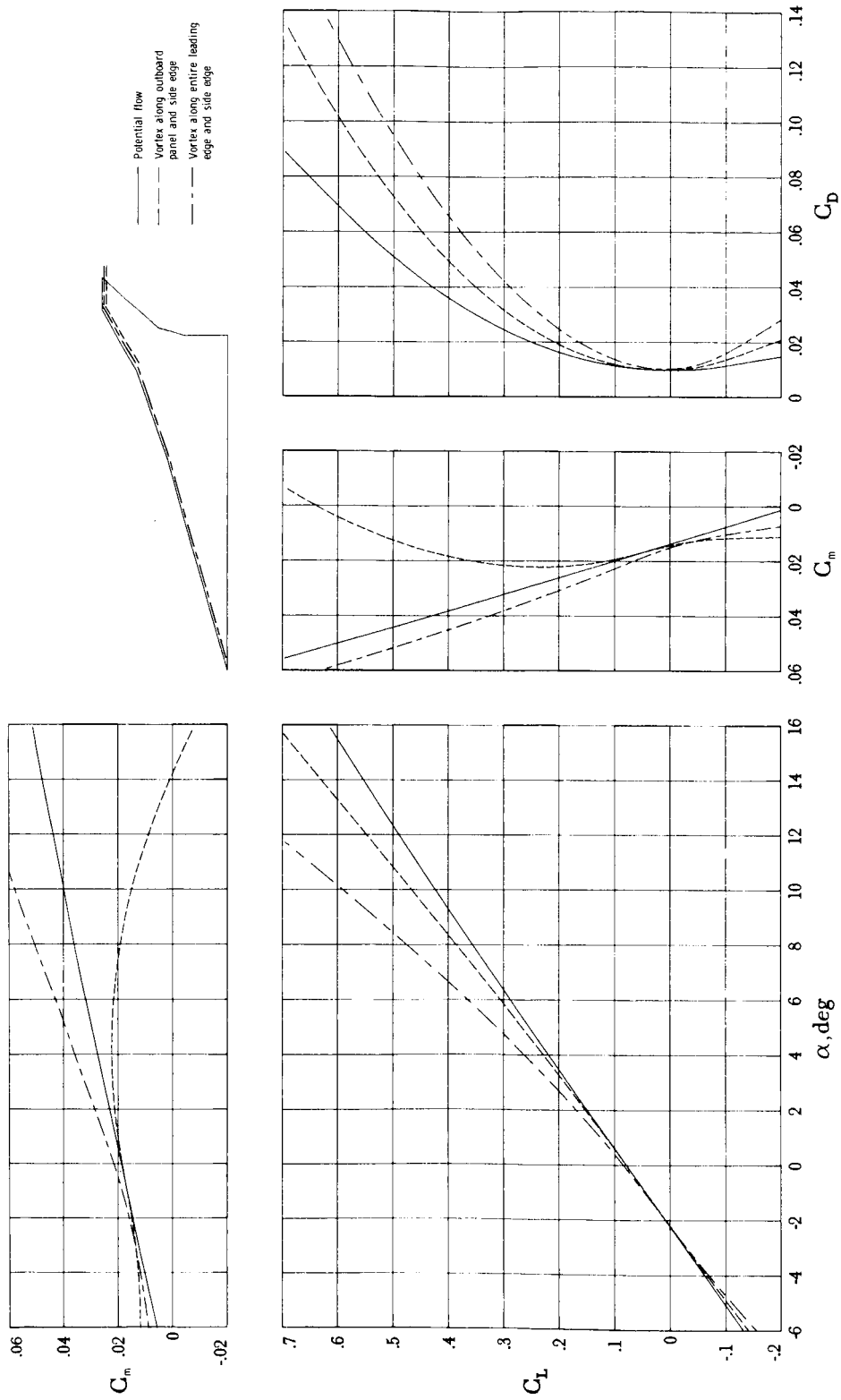

Figure 6.- Longitudinal aerodynamic characteristics predicted for twisted and cambered wing using the vortex-lattice method described in reference 12.

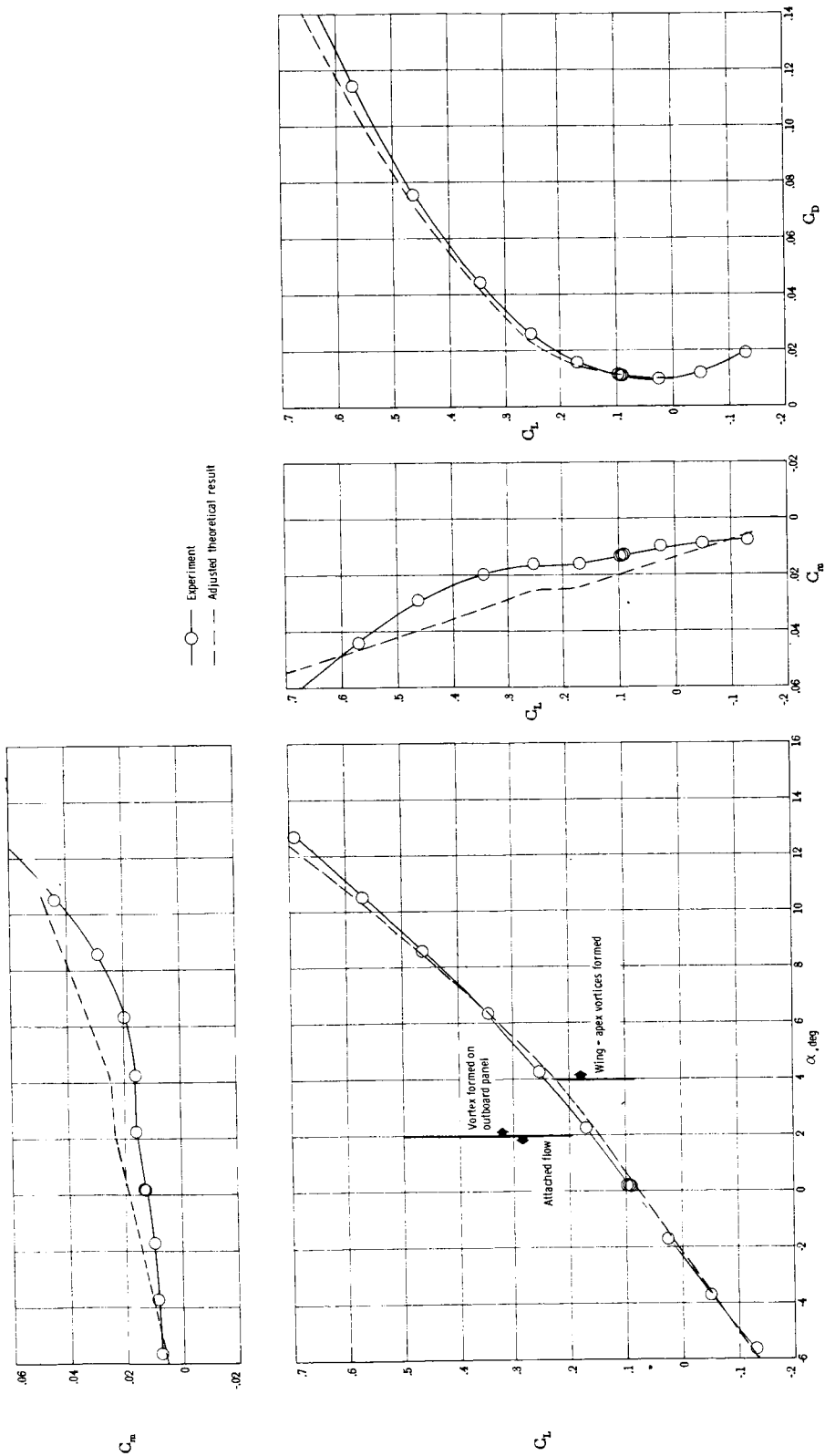
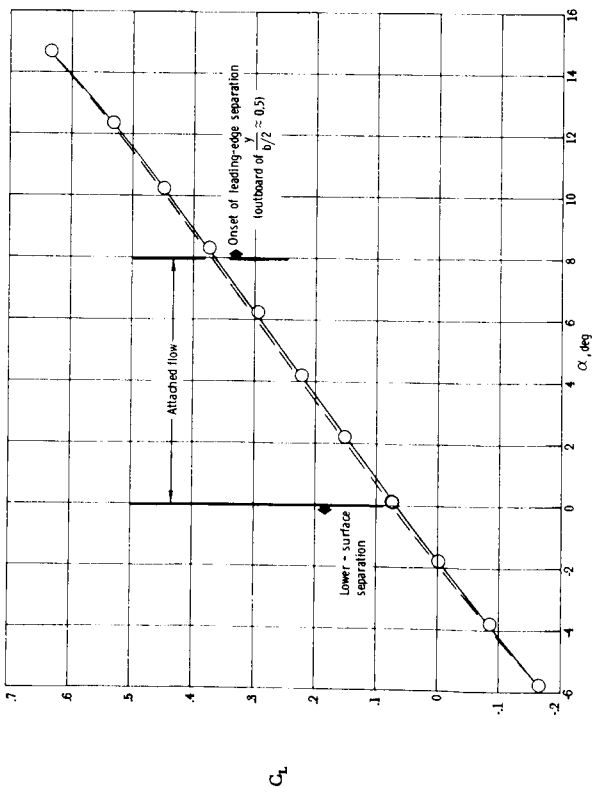
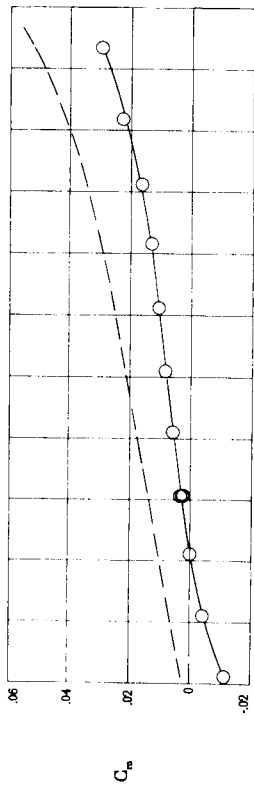

Figure 7.- Longitudinal aerodynamic characteristics of the configuration with $\delta_{L.E.} = 0^\circ$.



—○— Present model
 - - - Model of reference 5

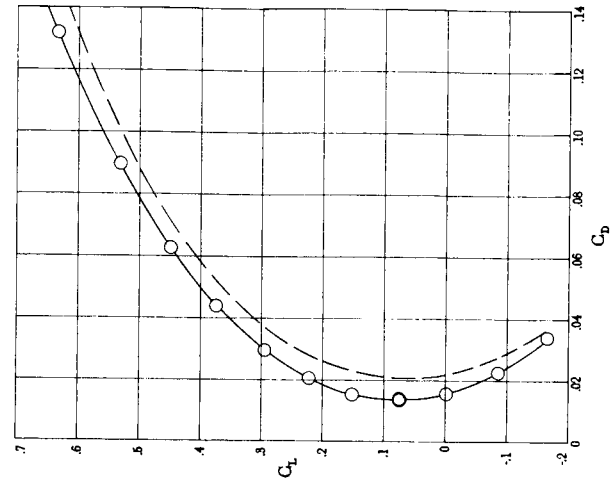
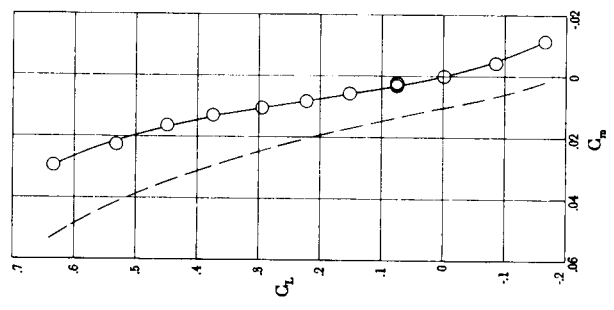

Figure 8.- Comparison of longitudinal aerodynamic data from present tests with data determined for related configuration of reference 5. $\delta_{L.E.} = 30^\circ$.

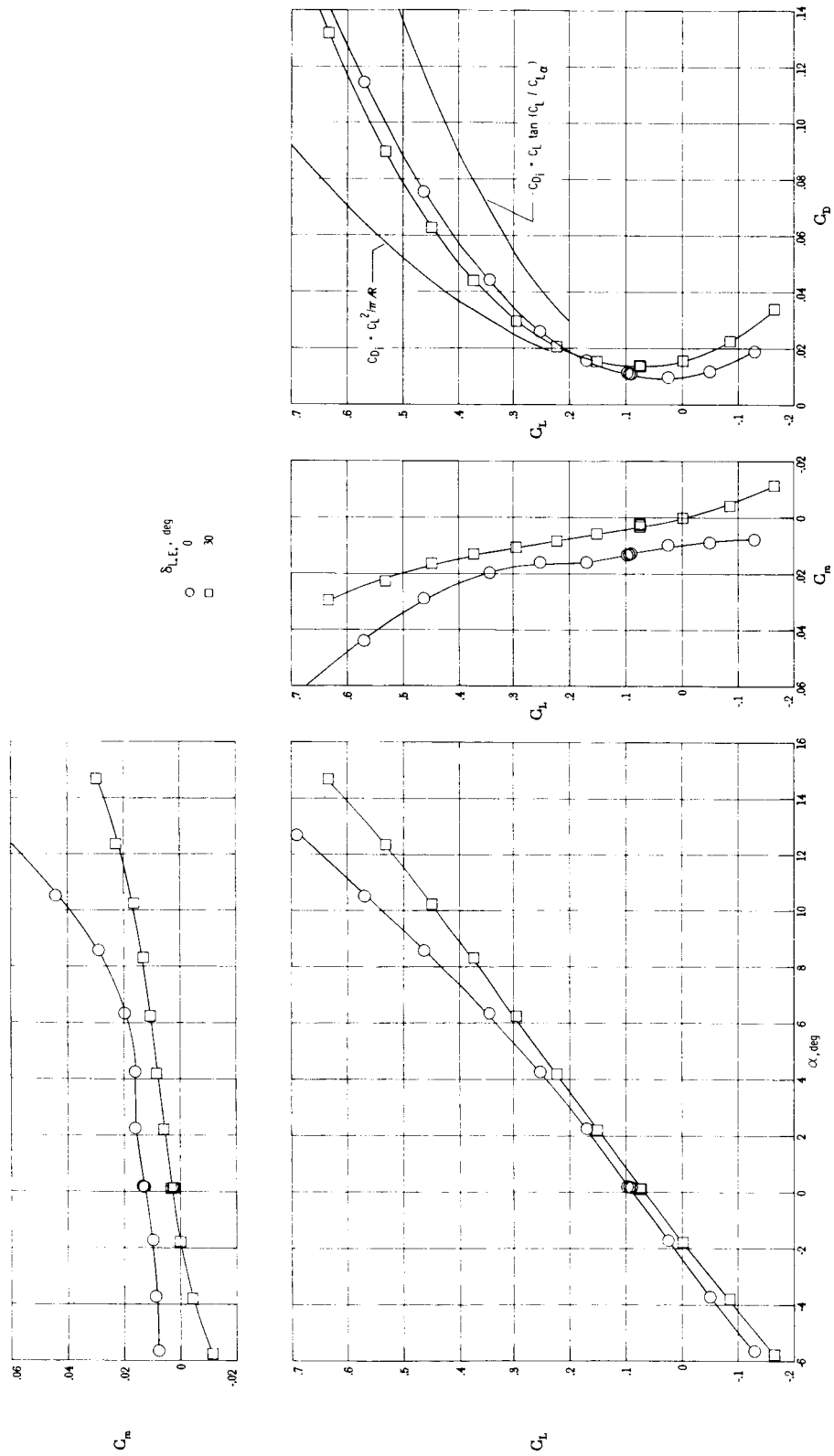

Figure 9.- Effect of wing leading-edge deflection on longitudinal aerodynamic characteristics.

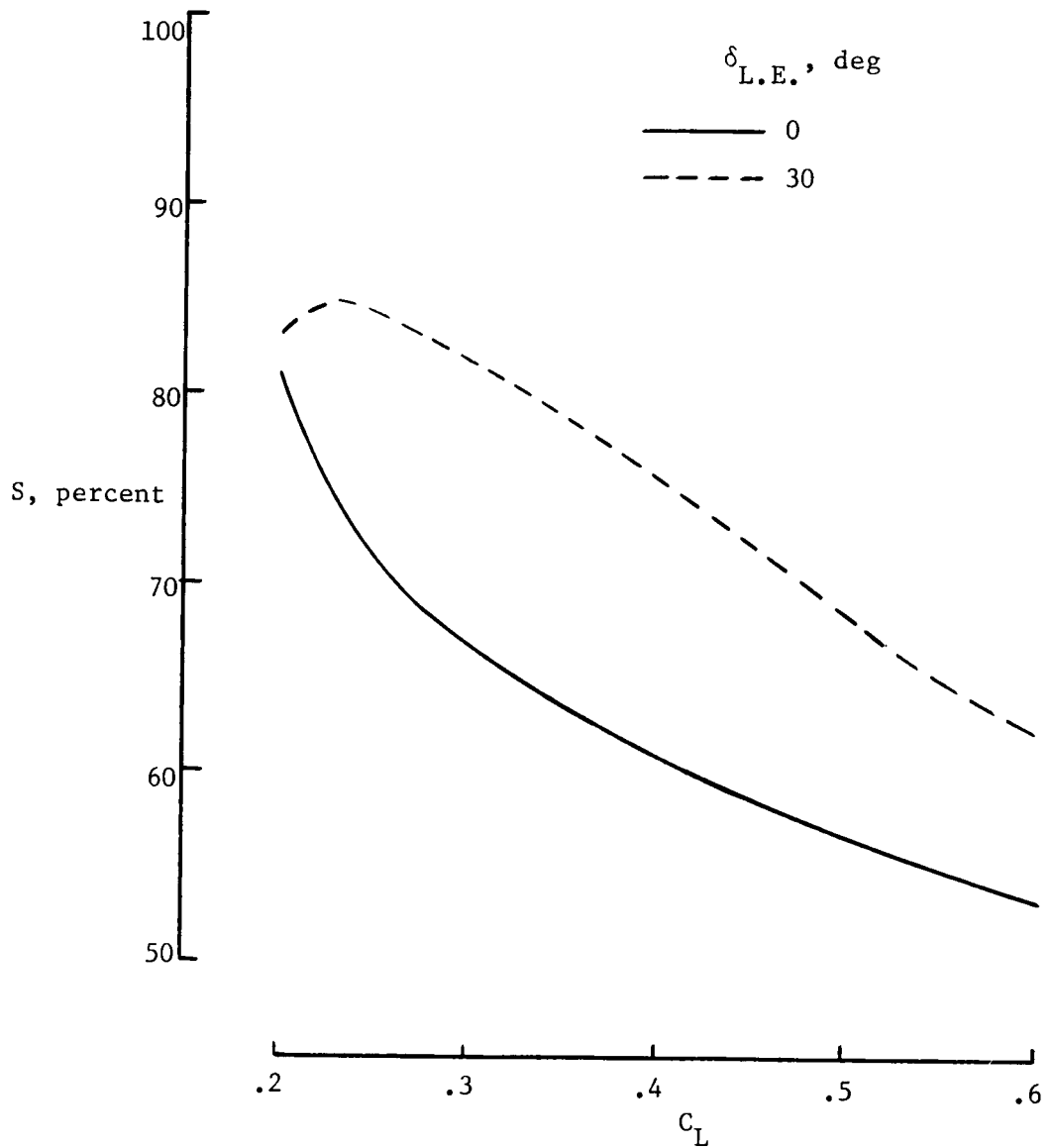

Figure 10.- Effect of leading-edge deflection on leading-edge suction.

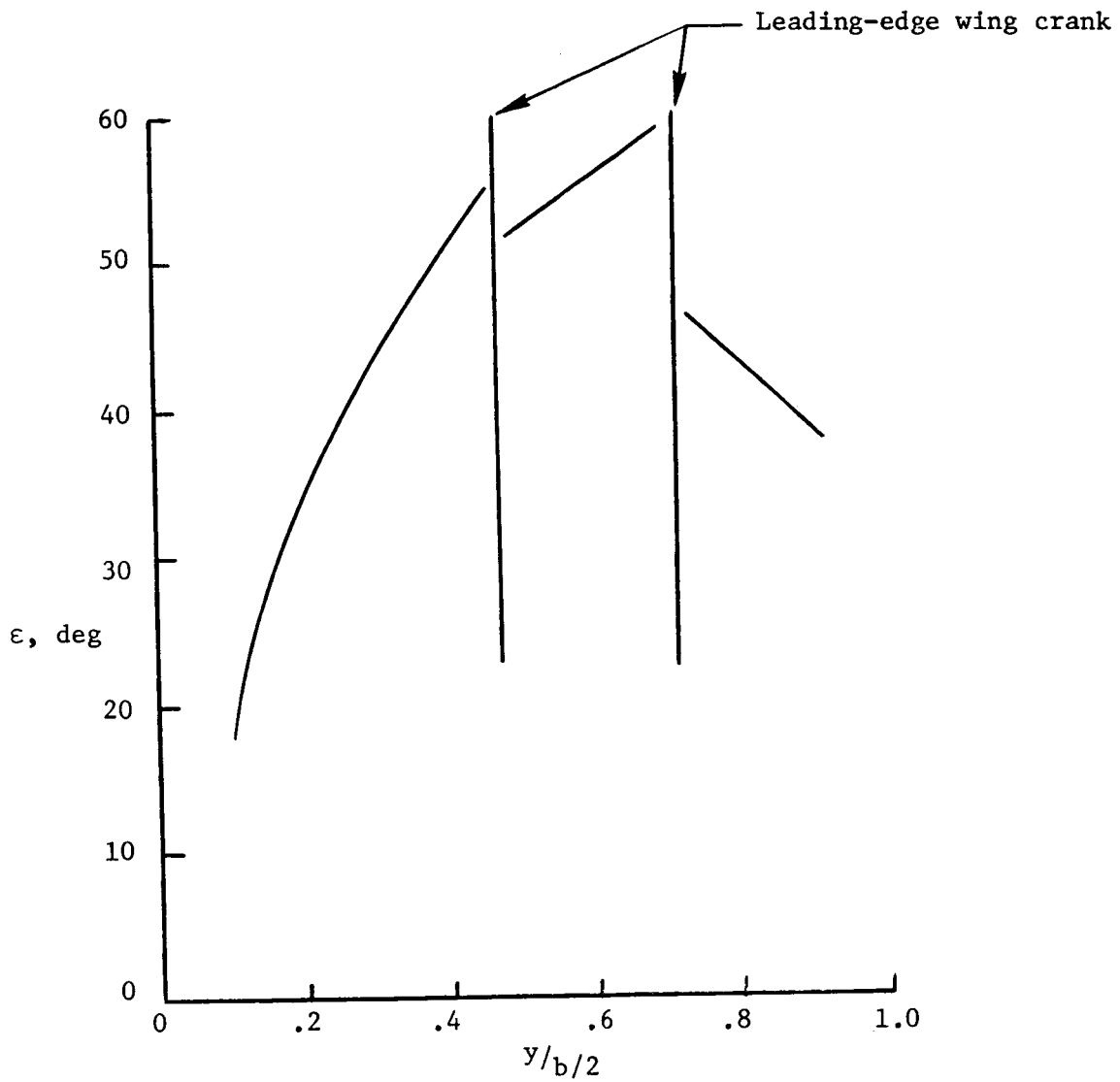

Figure 11.- Variation of theoretical upwash with nondimensional semispan. Theory based on vortex-lattice computational model. $\alpha = 10^\circ$ (ref. 5).

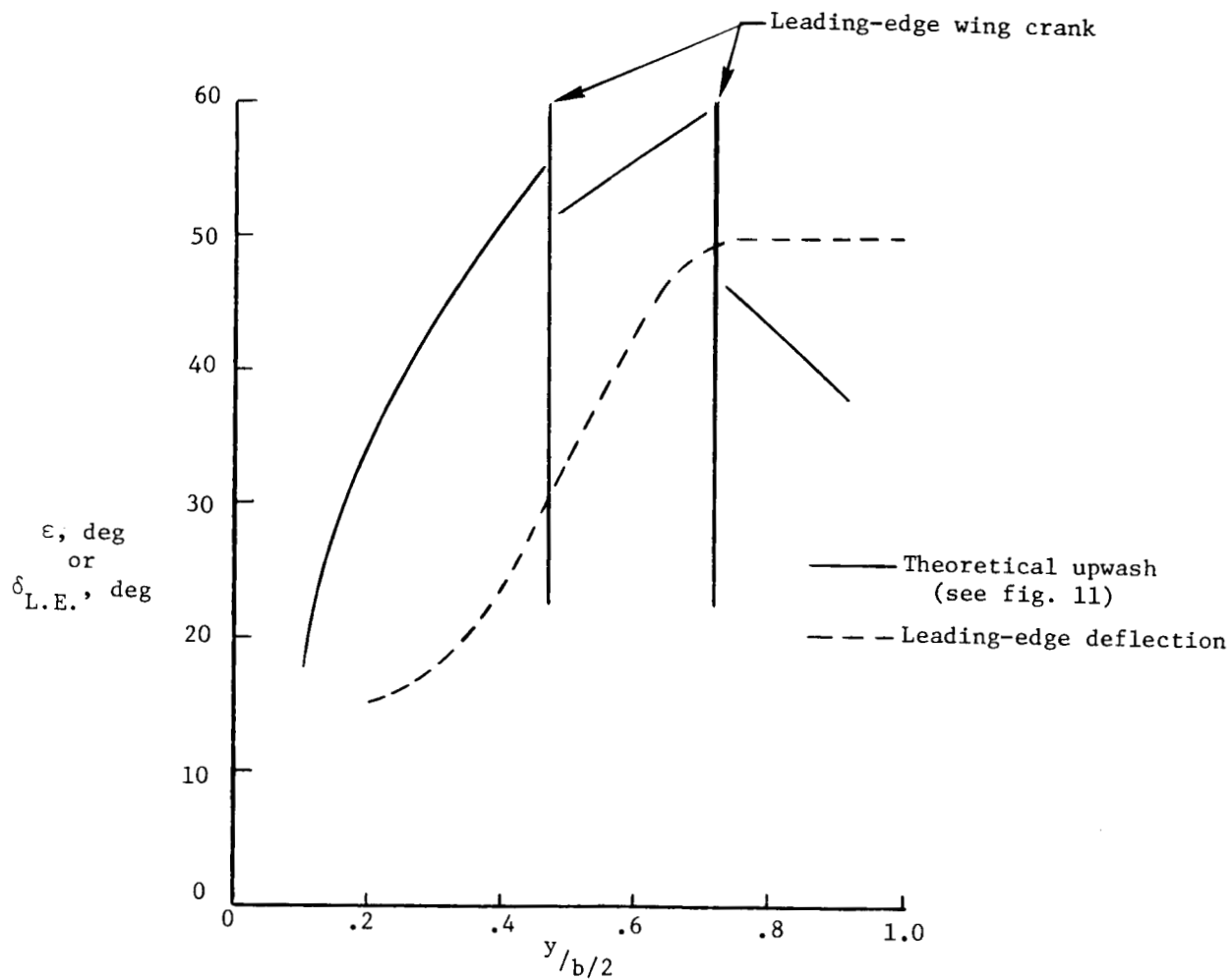

Figure 12.- Comparison of theoretical upwash with optimized leading-edge deflection.

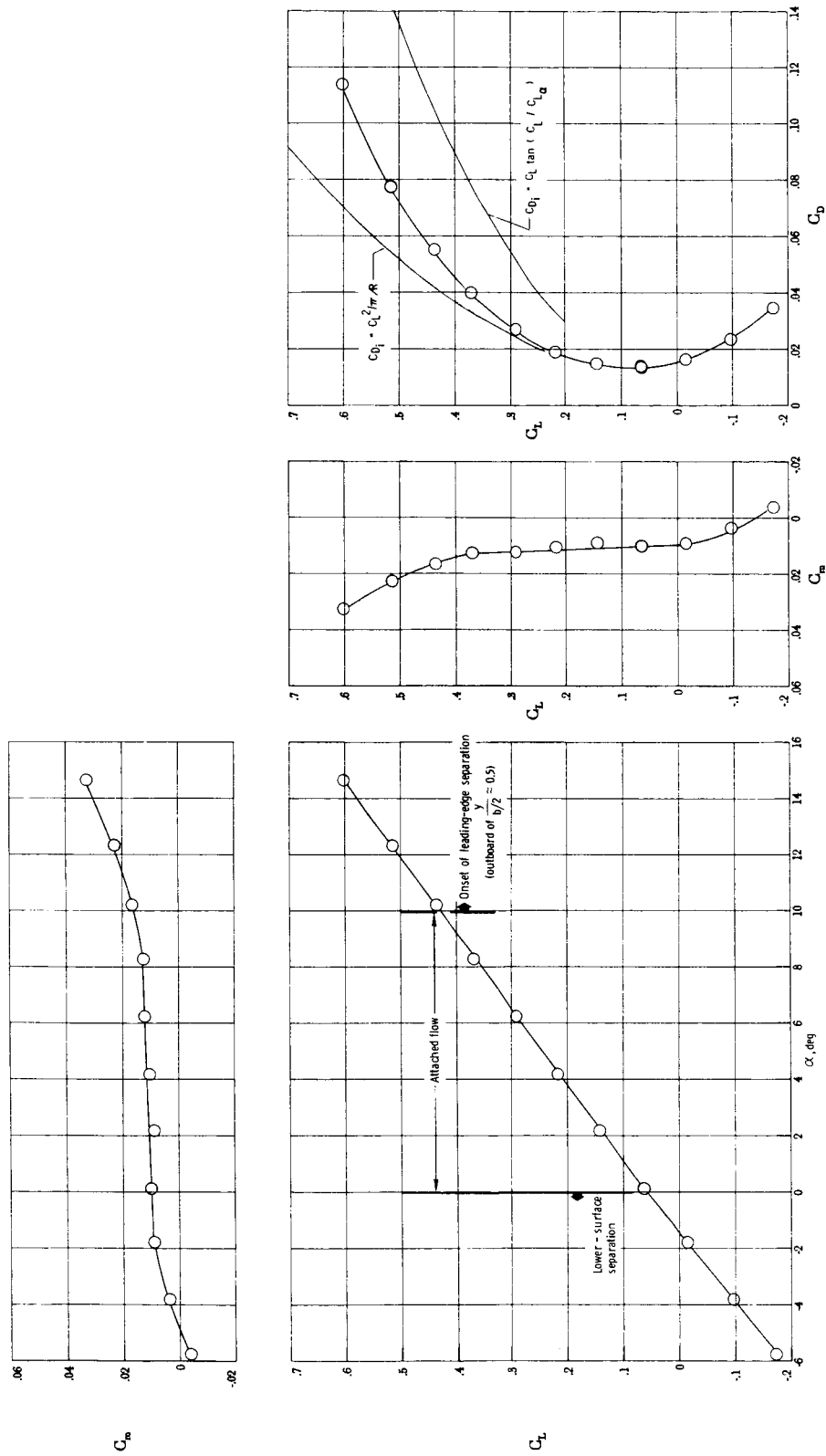

Figure 13.- Longitudinal aerodynamic characteristics for configuration with $\delta_{L.E.} = 160-500$.

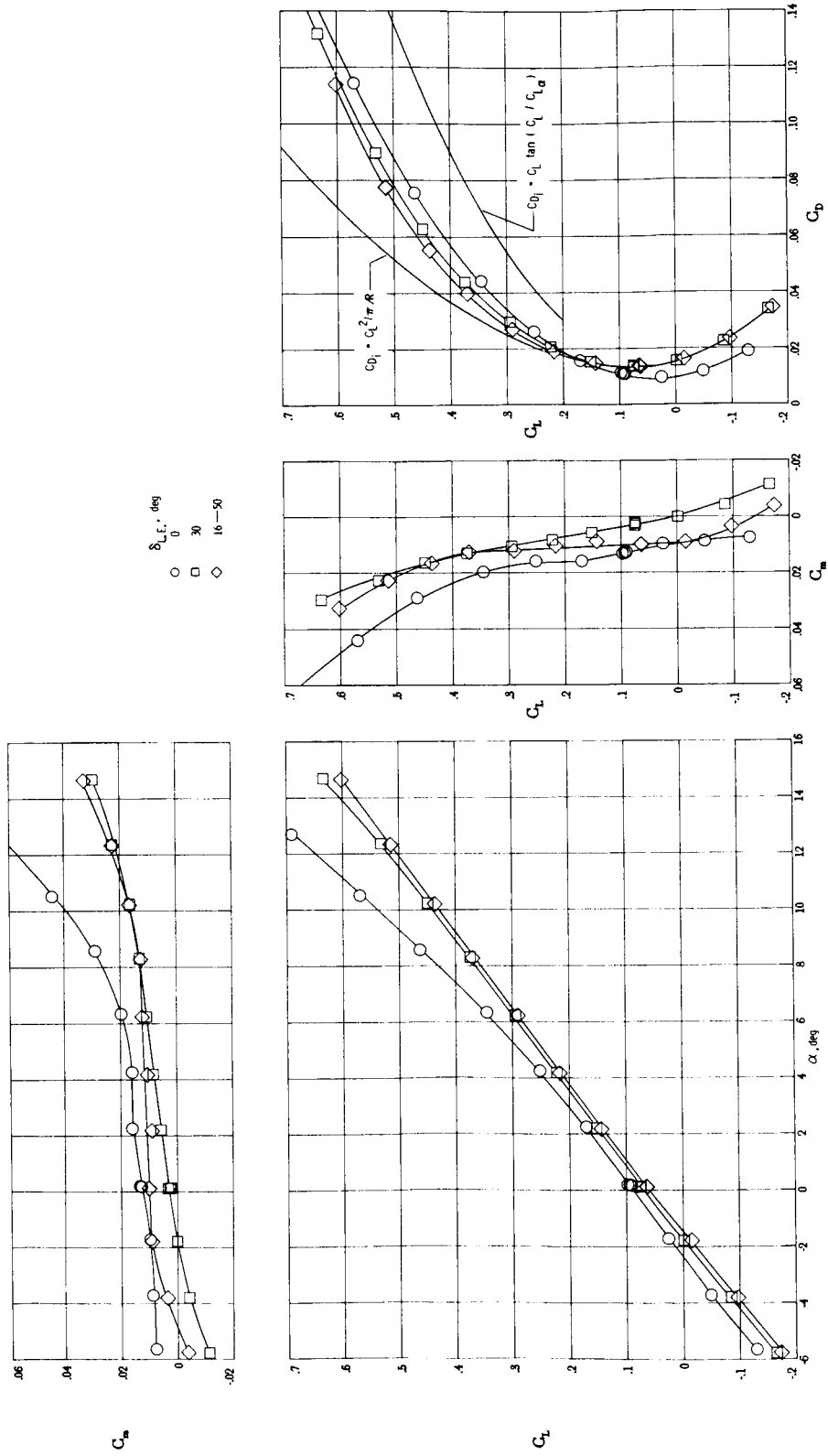

Figure 14.- Effect of wing leading-edge deflection on longitudinal aerodynamic characteristics.

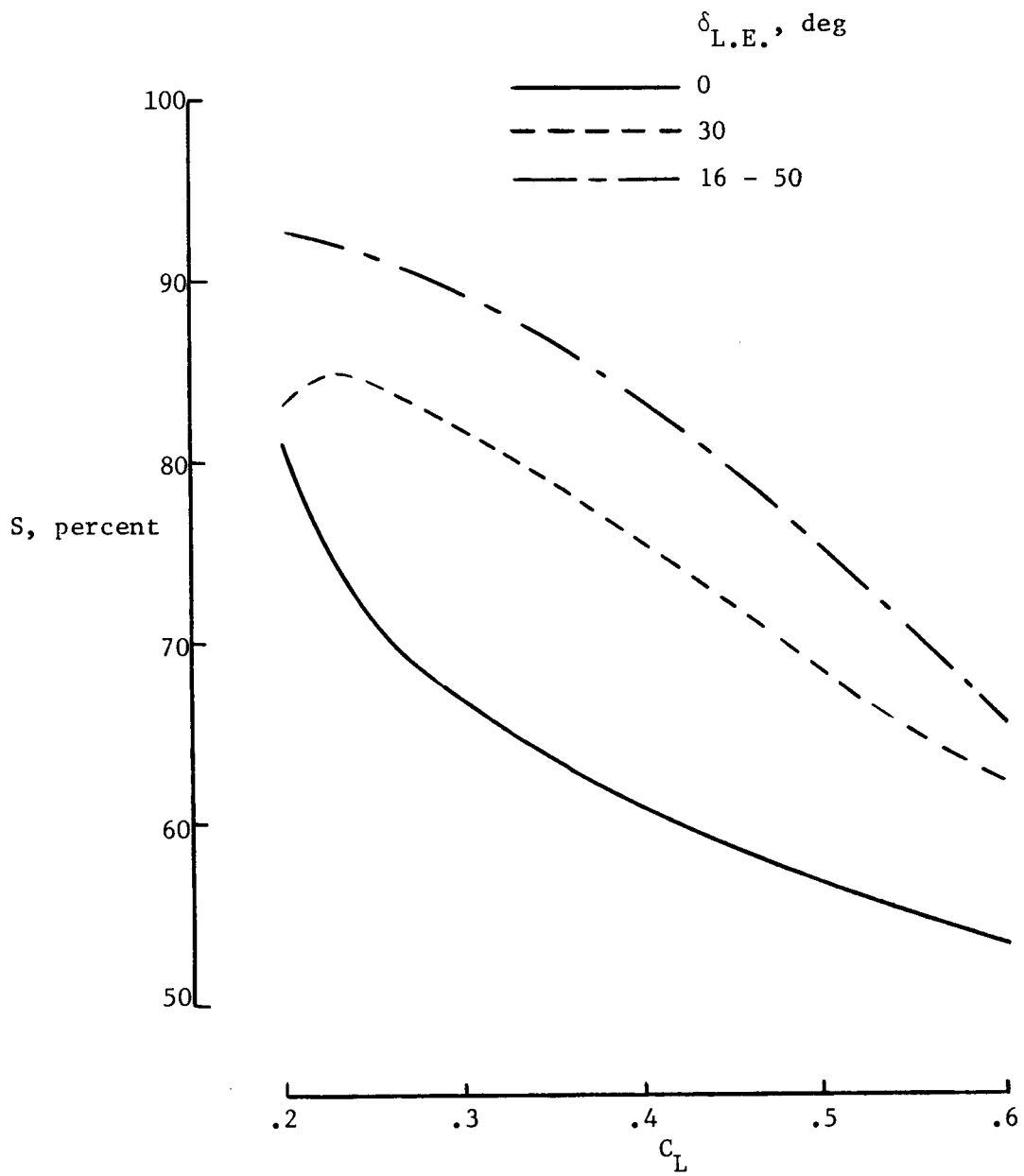
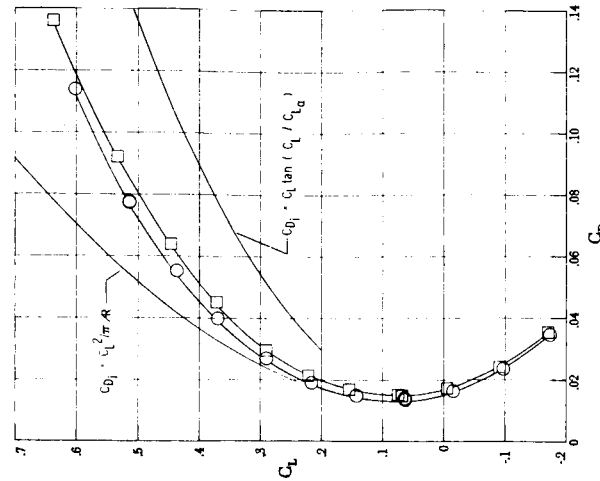
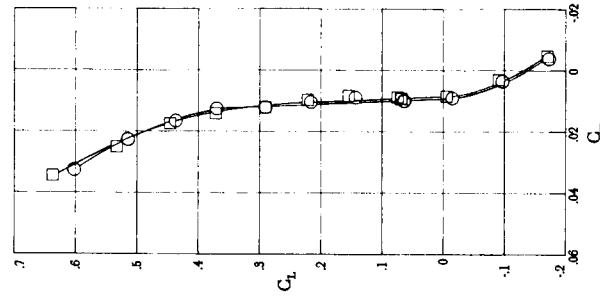
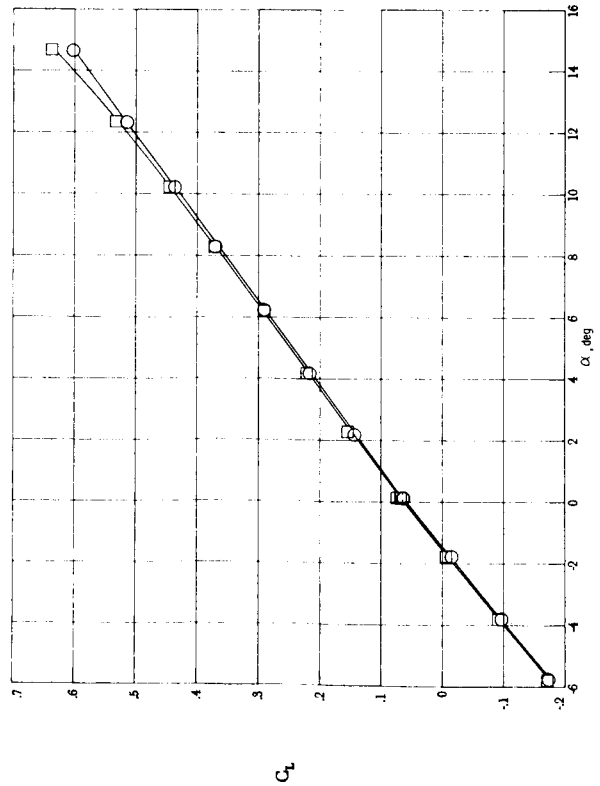
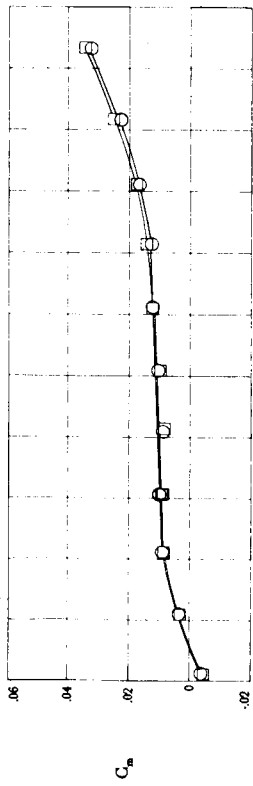

Figure 15.- Effect of continuously warped leading-edge deflection on leading-edge suction.



Leading edge
 Fairing ○
 Unfaired □

Figure 16.- Effect of removing fairings between adjacent segments of continuously warped leading edge. $\delta_{L.E.} = 16^\circ - 50^\circ$.

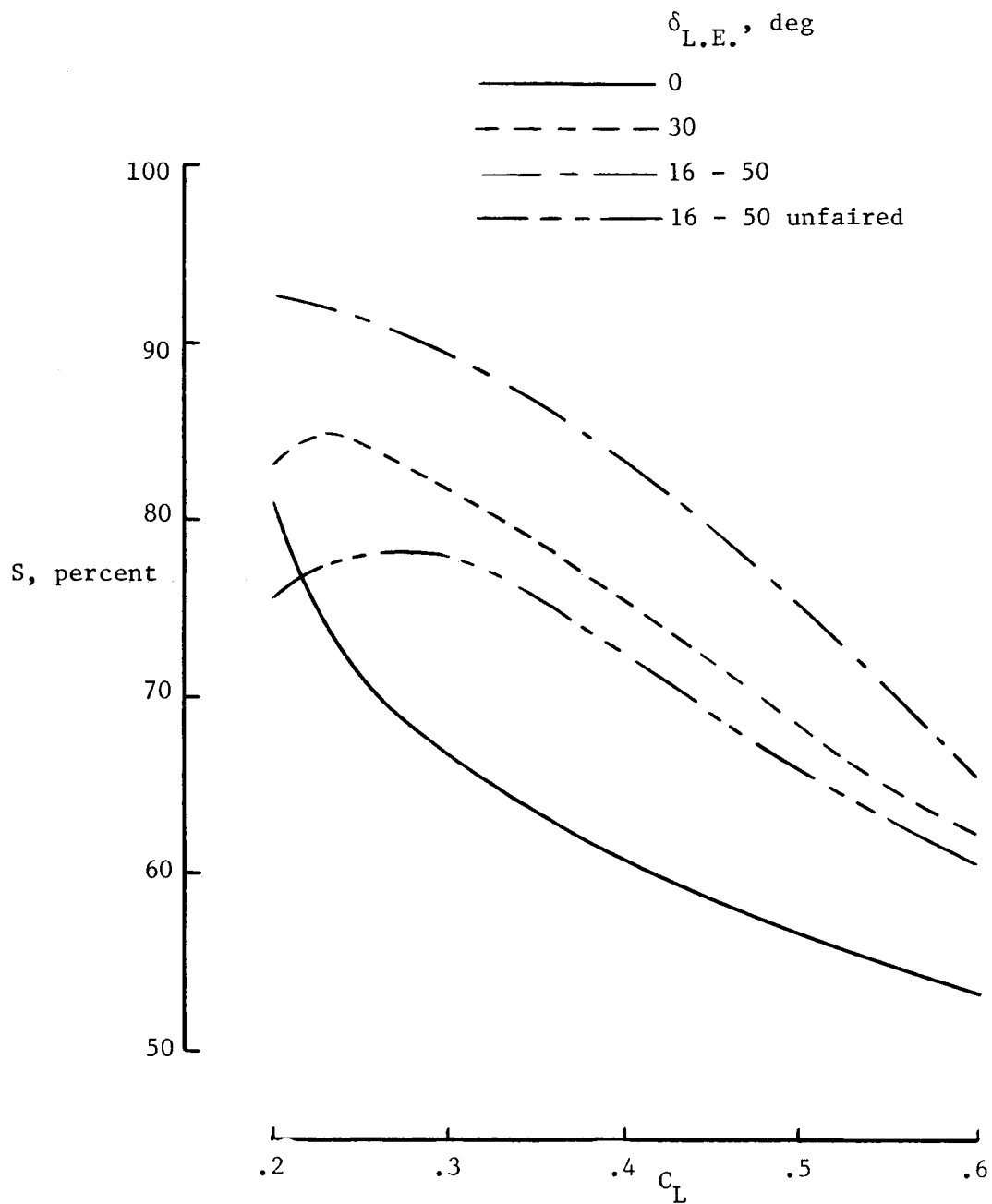

Figure 17.- Effect of removing fairings from adjacent segments of continuously warped leading edge.

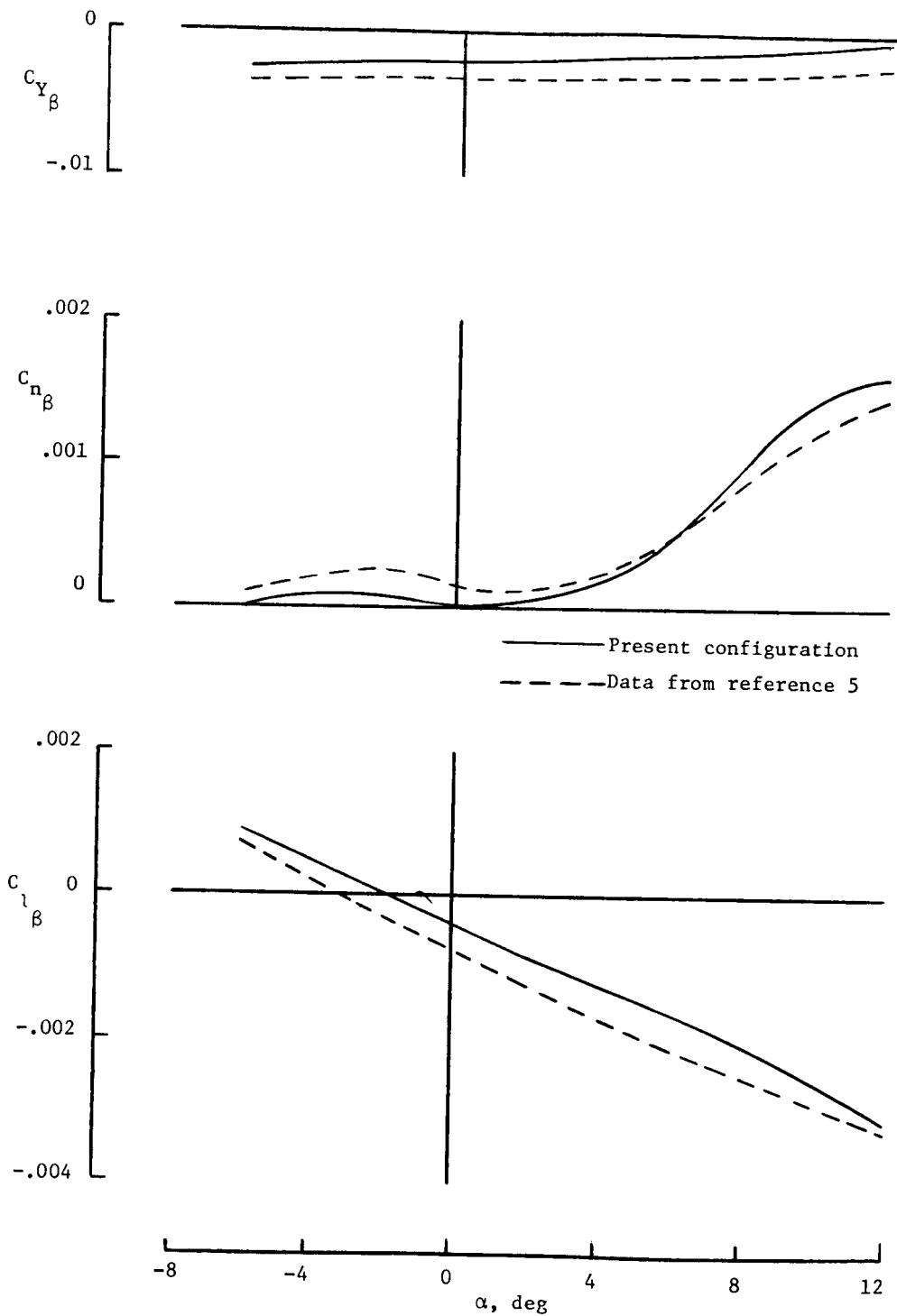

Figure 18.- Variation of lateral-directional stability derivatives with angle of attack. $\delta_{L.E.} = 0^\circ$.

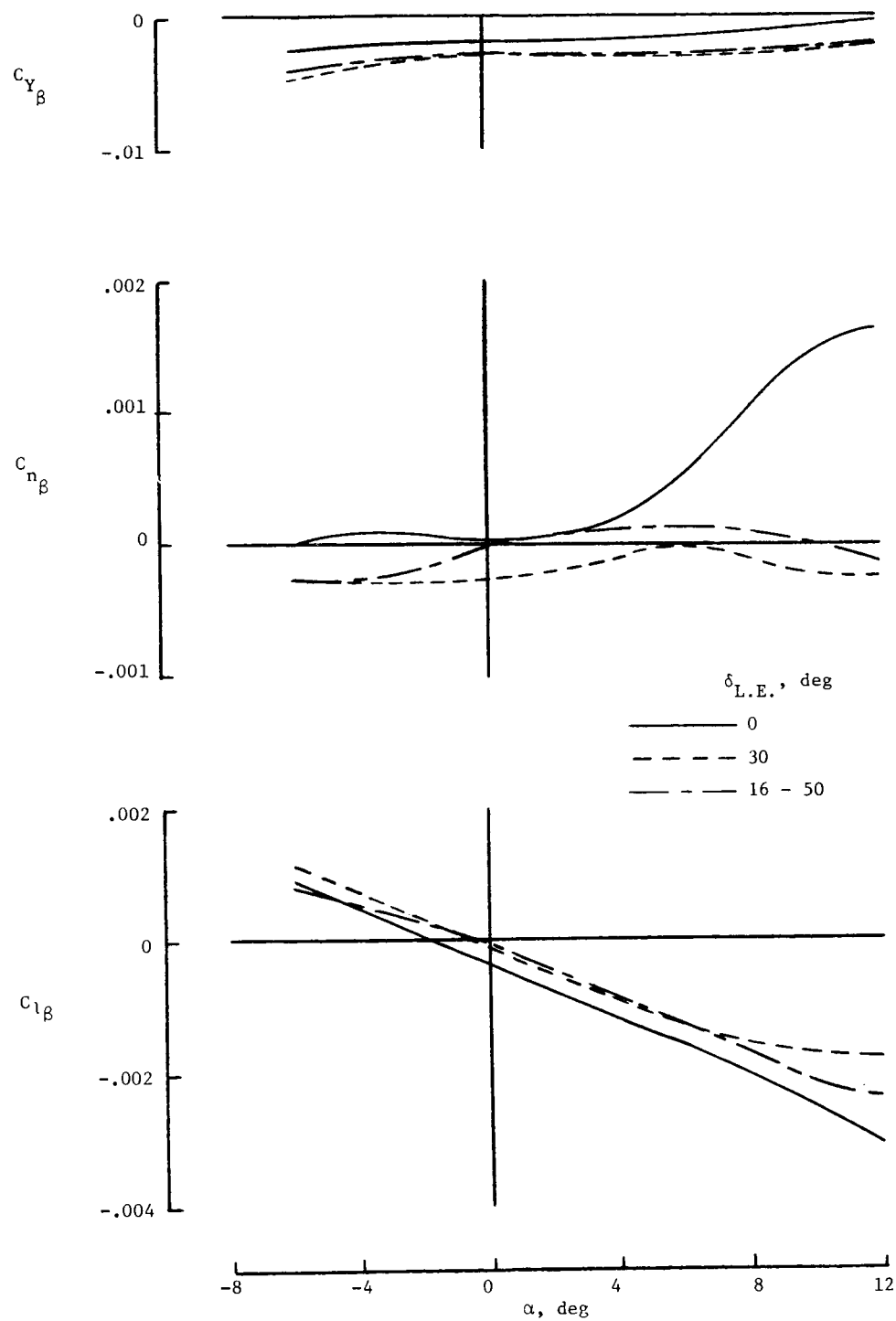

Figure 19.- Effect of leading-edge deflection on lateral-directional stability derivatives.

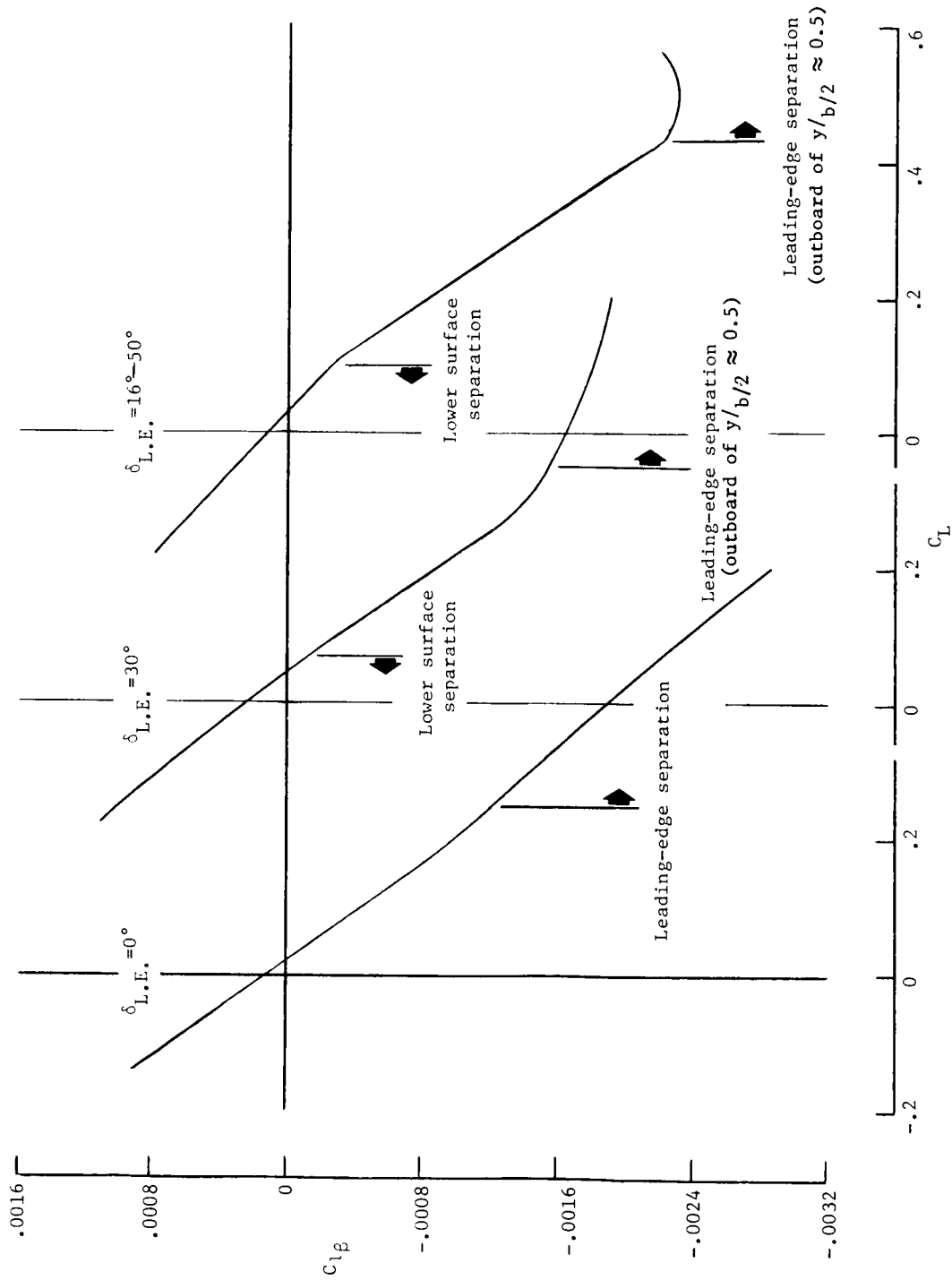
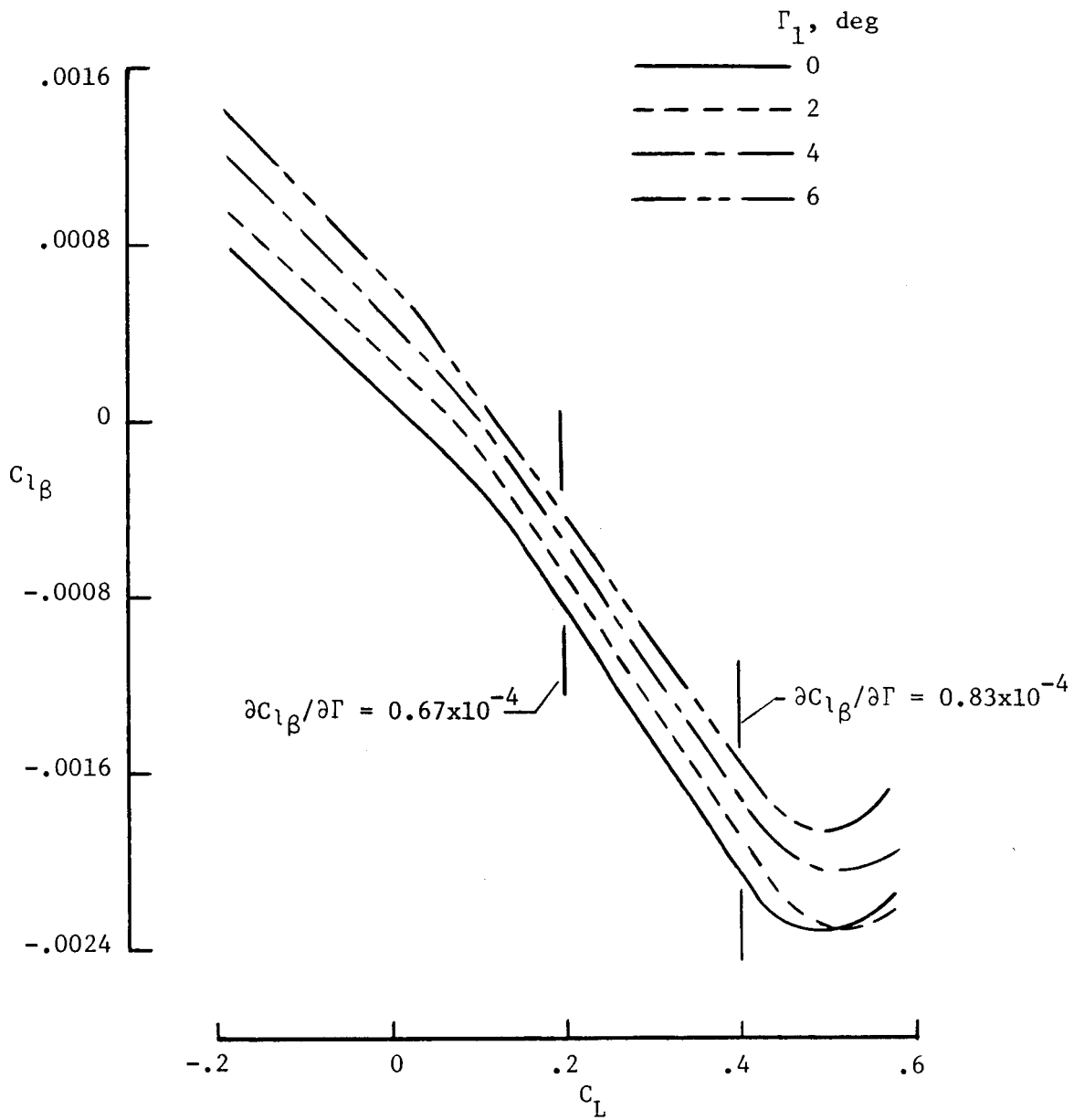
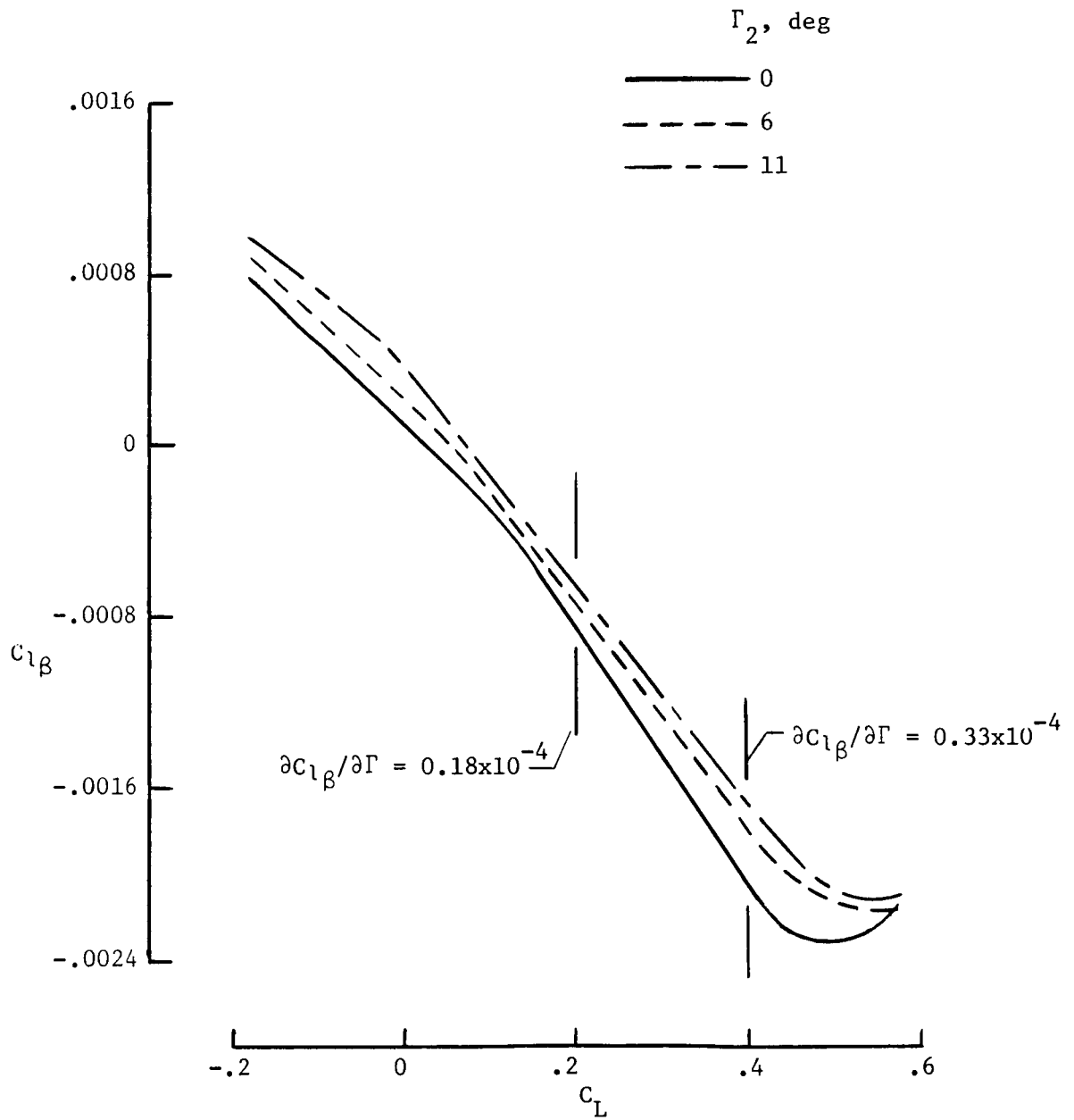

Figure 20.- Effect of leading-edge deflection on $C_{l\beta}$ versus C_L .



(a) Γ_1 varied, $\Gamma_2 = 0^\circ$.

Figure 21.- Effect of geometric anhedral on $C_{l\beta}$.



(b) $\Gamma_1 = 0^\circ$, Γ_2 varied.

Figure 21.- Concluded.

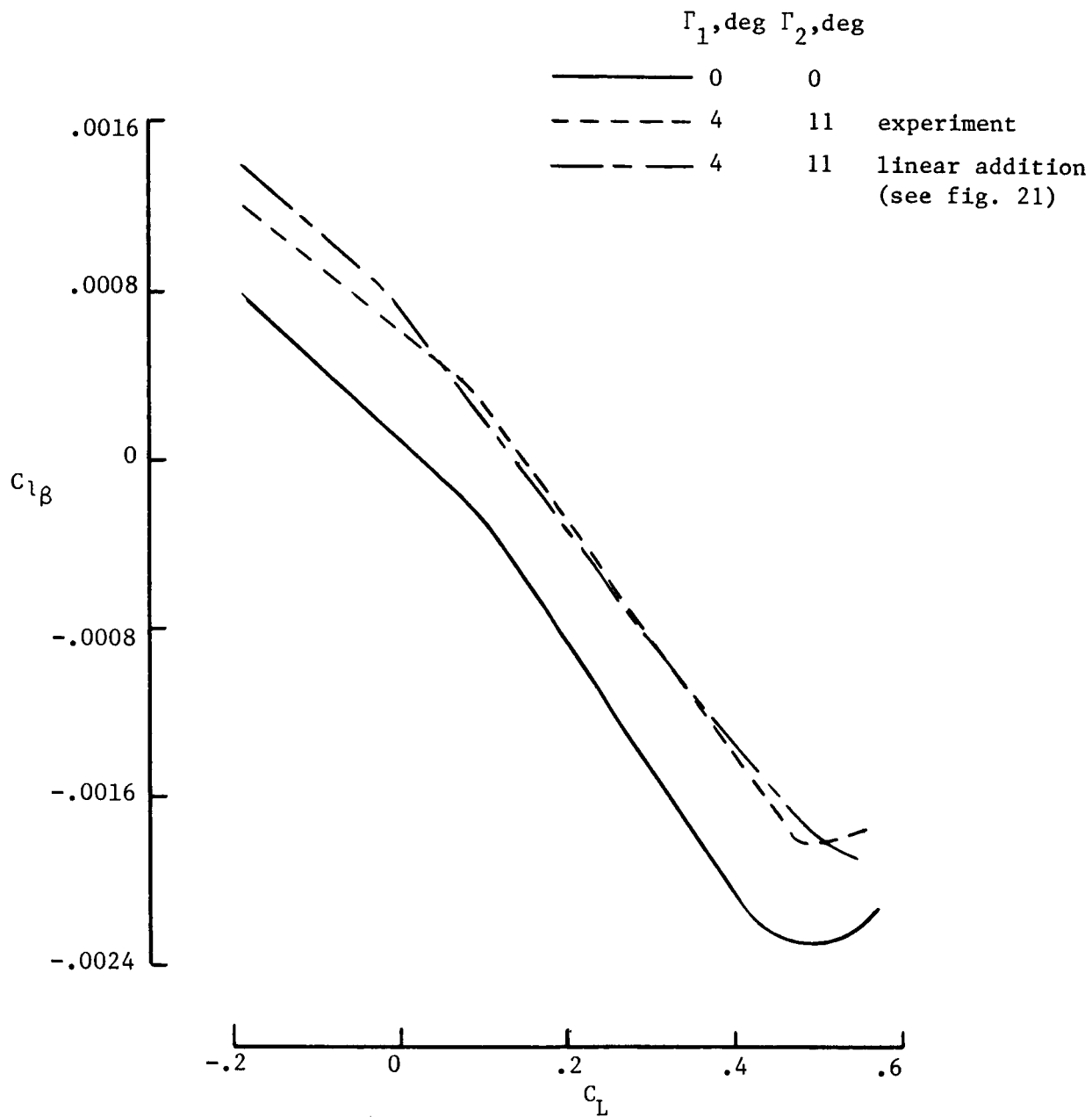

Figure 22.- Effect of geometric anhedra, Γ_1 and Γ_2 in combination, on $C_{l\beta}$.

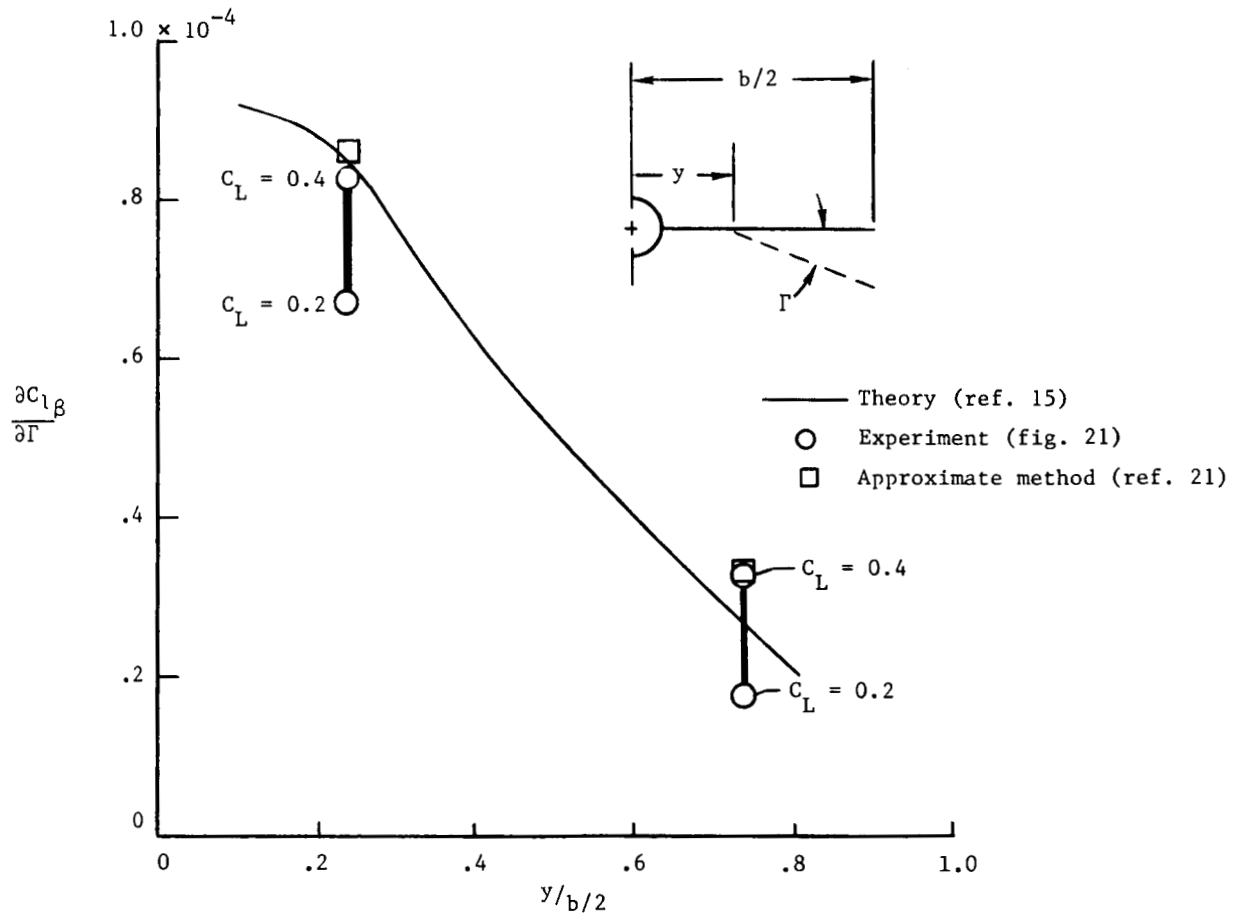

Figure 23.- Values for $\partial C_{L\beta}/\partial \Gamma$ obtained by inclusion of additional geometric anhedral at span station $\frac{y}{b/2}$.

APPENDIX A

EFFECT OF GEOMETRIC ANHEDRAL ON $C_{l\beta}$

The following simple analysis is intended to illustrate the effect on $C_{l\beta}$ of increasing the geometric anhedral of the configuration reported herein. The analysis assumes that the wing-tip clearance remains unchanged, as would be required for the case wherein the landing gear length is held constant.

Consider the wing semispan sketched in figure A1. The spanwise location of the anhedral breaks, and the corresponding anhedral angles define the change in vertical height of the wing tip (Δz_{tip}) as

$$\Delta z_{tip} = \Gamma_i(b/2 - y_i) + \Gamma_o(b/2 - y_o) \quad (A1)$$

where the subscripts i and o refer to the values associated with assumed inboard and outboard locations, respectively. Requiring $\Delta z_{tip} = 0$ and solving for Γ_o yields

$$\Gamma_o = -\Gamma_i \frac{\left(1 - \frac{y_i}{b/2}\right)}{\left(1 - \frac{y_o}{b/2}\right)} \quad (A2)$$

As shown in the body of this report (see figs. 21 and 22), the increment in $C_{l\beta}$ resulting from Γ_i and Γ_o may be determined by linear combination, therefore

$$\Delta C_{l\beta} = \frac{\partial C_{l\beta}}{\partial \Gamma_i} \times \Gamma_i + \frac{\partial C_{l\beta}}{\partial \Gamma_o} \times \Gamma_o \quad (A3)$$

Substituting equation (A2) into equation (A3) yields

$$\Delta C_{l\beta} = \left[\frac{\partial C_{l\beta}}{\partial \Gamma_i} - \left(\frac{1 - \frac{y_i}{b/2}}{1 - \frac{y_o}{b/2}} \right) \times \frac{\partial C_{l\beta}}{\partial \Gamma_o} \right] \Gamma_i \quad (A4)$$

APPENDIX A

Evaluation of equation (A4) shows that, for the variation of $\partial C_{l\beta} / \partial \Gamma$ presented in figure 23, maintaining constant wing-tip clearance would limit the favorable increments in $C_{l\beta}$ to negligible values. For example, consider the result for the spanwise location of anhedral breaks tested on the present configuration.

At span locations $\frac{y_i}{b/2} = 0.234$ and 0.736 , the theoretical results of figure 23

show $\partial C_{l\beta} / \partial \Gamma_i = 0.85 \times 10^{-4}$ and $\partial C_{l\beta} / \partial \Gamma_o = 0.27 \times 10^{-4}$. Assuming the

anhedral at the inboard location is increased by 5° (with no constraint on wing-tip clearance), the increment in $C_{l\beta}$ for this condition would be

$\Delta C_{l\beta} = 4.25 \times 10^{-4}$. However, constraining the change in wing-tip clearance to

zero and assuming the value of $\Delta C_{l\beta} / \partial \Gamma_o$ applicable for increased dihedral

angles, the increment in $C_{l\beta}$ would be only 0.33×10^{-4} .

APPENDIX A

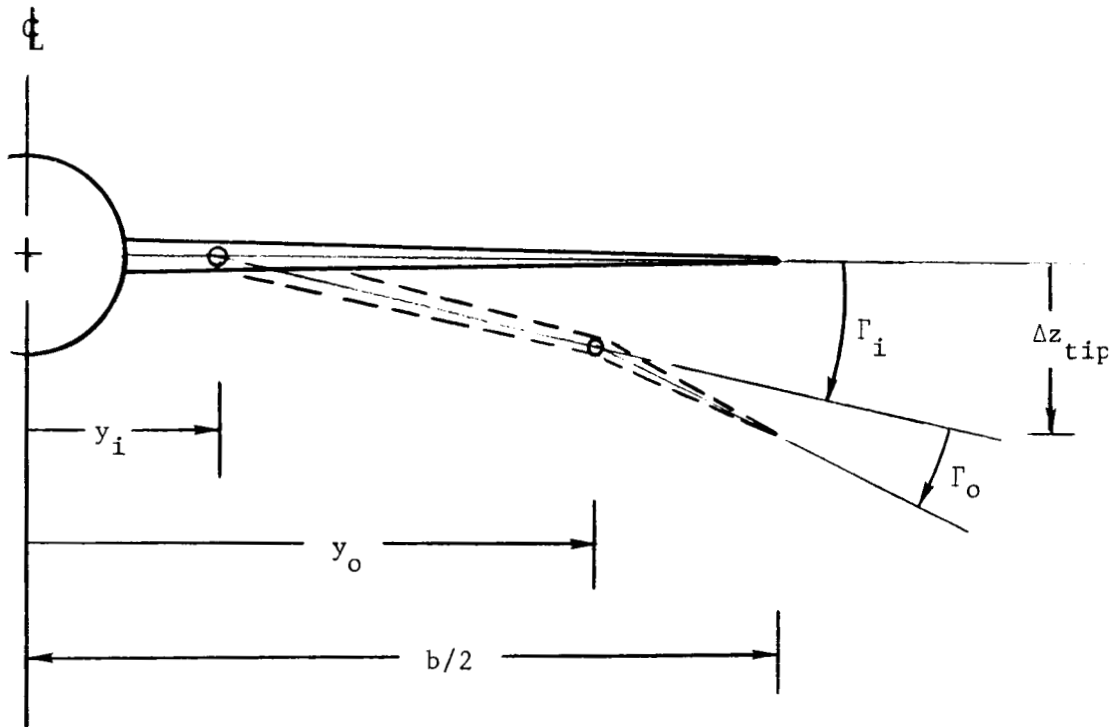

$$\Delta z_{\text{tip}} = \Gamma_i \left(\frac{b}{2} - y_i \right) + \Gamma_o \left(\frac{b}{2} - y_o \right)$$

$$\text{for } \Delta z_{\text{tip}} = 0$$

$$\Gamma_o = -\Gamma_i \frac{1 - \frac{y_i}{b/2}}{1 - \frac{y_o}{b/2}}$$

Figure A1.- Geometric relationship of anhedral angles and wingtip height.

APPENDIX B

DATA SUPPLEMENT

The symbols used in the data tabulation are defined as follows:

ALPHA	angle of attack, deg
BETA	angle of sideslip, deg
CD	drag-force coefficient; stability axis
CL	lift-force coefficient; stability axis
CM	pitching-moment coefficient; stability axis
CRM	rolling-moment coefficient; body axis
CY	side-force coefficient; body axis
CYM	yawing-moment coefficient; body axis

APPENDIX B

TABLE B1.- TEST PROGRAM

Run	β , deg	$\delta_{L.E.}$, deg	Γ_1 , deg	Γ_2 , deg
1	0	0	0	0
2	5	↓	↓	↓
3	-5	↓	↓	↓
4	-5	30	↓	↓
5	5	↓	↓	↓
6	0	↓	↓	↓
12	0	16-50	↓	↓
13	5	↓	↓	↓
14	-5	↓	↓	↓
18	0	↓	6	↓
19	5	↓	↓	↓
20	-5	↓	↓	↓
21	-5	↓	4	↓
22	5	↓	↓	↓
23	0	↓	↓	↓
24	0	↓	↓	11
25	5	↓	↓	↓
26	-5	↓	↓	↓
27	-5	↓	2	0
28	5	↓	↓	↓
29	0	↓	↓	↓
30	0	↓	0	11
31	5	↓	↓	↓
32	-5	↓	↓	↓
33	-5	↓	↓	6
34	5	↓	↓	↓
35	0	↓	↓	↓
39	0	16-50 unfaired	↓	0

APPENDIX B

TABLE B2.- TABULATED DATA

NASA LANGLEY				7 X 10 HIGH SPEED TUNNEL			
TEST 59	RUN 1						
BETA	ALPHA	CL	CD	CM	CRM	CYM	CY
-.06	.17	.0906	.0110	.0128	-.0003	-.0003	.0009
-.08	-5.64	-.1296	.0189	.0078	-.0010	-.0005	.0018
-.08	-3.72	-.0493	.0118	.0088	-.0006	-.0005	.0015
-.07	-1.72	.0256	.0097	.0098	-.0003	-.0003	.0010
-.06	.19	.0939	.0110	.0131	.0003	-.0003	.0014
-.06	2.25	.1700	.0156	.0160	.0000	-.0002	.0015
-.05	4.25	.2521	.0260	.0160	.0001	-.0000	.0006
-.05	6.34	.3456	.0442	.0198	.0003	.0002	.0008
-.04	8.57	.4633	.0754	.0290	.0008	.0005	.0025
-.04	10.51	.5700	.1142	.0441	.0001	.0011	.0034
-.03	12.69	.6907	.1667	.0625	-.0001	.0014	.0048
-.03	14.74	.8019	.2251	.0850	-.0008	.0016	.0064
-.03	15.10	.8195	.2356	.0893	-.0007	.0016	.0065
-.07	.19	.0976	.0114	.0133	-.0001	-.0002	.0025
TEST 59	RUN 2						
BETA	ALPHA	CL	CD	CM	CRM	CYM	CY
4.90	.15	.0926	.0107	.0130	-.0031	.0001	-.0101
4.92	-5.72	-.1304	.0193	.0054	.0031	-.0004	-.0113
4.91	-3.75	-.0468	.0117	.0074	.0020	-.0001	-.0100
4.91	-1.75	.0268	.0095	.0092	-.0006	.0001	-.0094
4.90	.17	.0956	.0108	.0134	-.0032	.0002	-.0099
4.88	2.23	.1706	.0158	.0159	-.0048	.0004	-.0099
4.86	4.24	.2568	.0267	.0181	-.0057	.0012	-.0116
4.81	6.33	.3497	.0457	.0229	-.0087	.0033	-.0089
4.77	8.43	.4559	.0742	.0329	-.0111	.0064	-.0048
4.72	10.45	.5507	.1087	.0462	-.0137	.0083	-.0024
4.67	12.67	.6726	.1612	.0655	-.0179	.0089	-.0007
4.61	14.76	.7923	.2228	.0877	-.0209	.0094	-.0010
4.60	15.01	.8022	.2295	.0905	-.0216	.0095	-.0000
4.90	.15	.0996	.0112	.0136	-.0031	.0001	-.0093
TEST 59	RUN 3						
BETA	ALPHA	CL	CD	CM	CRM	CYM	CY
-5.02	.24	.0918	.0113	.0123	.0023	-.0005	.0100
-5.08	-5.63	-.1305	.0195	.0052	-.0049	-.0006	.0136
-5.06	-3.64	-.0474	.0122	.0077	-.0028	-.0008	.0120
-5.05	-1.66	.0246	.0102	.0094	-.0001	-.0007	.0106
-5.02	.26	.0921	.0113	.0121	.0024	-.0006	.0098
-4.99	2.32	.1677	.0161	.0147	.0035	-.0005	.0102
-4.96	4.36	.2520	.0270	.0166	.0053	-.0005	.0104
-4.91	6.42	.3476	.0459	.0224	.0065	-.0026	.0078
-4.85	8.54	.4481	.0741	.0318	.0092	-.0043	.0060
-4.79	10.57	.5554	.1111	.0444	.0119	-.0063	.0042
-4.73	12.78	.6732	.1634	.0629	.0143	-.0060	.0051
-4.66	14.86	.7961	.2248	.0839	.0198	-.0056	.0037
-4.65	15.21	.8150	.2359	.0904	.0196	-.0054	.0043
-5.02	.26	.0941	.0116	.0126	.0022	-.0007	.0103
TEST 59	RUN 4						
BETA	ALPHA	CL	CD	CM	CRM	CYM	CY
-5.03	.20	.0751	.0141	.0023	.0003	.0008	.0146
-5.10	-5.71	-.1607	.0336	-.0140	-.0061	.0008	.0250
-5.08	-3.72	-.0777	.0221	-.0061	-.0037	.0009	.0213
-5.06	-1.70	.0028	.0158	-.0014	-.0017	.0011	.0172
-5.03	.23	.0784	.0145	.0024	.0001	.0008	.0159
-5.00	2.32	.1564	.0164	.0054	.0031	.0004	.0142
-4.96	4.30	.2282	.0217	.0092	.0053	.0000	.0149
-4.92	6.37	.3049	.0317	.0110	.0073	-.0003	.0162
-4.88	8.45	.3870	.0471	.0130	.0072	.0014	.0158
-4.83	10.37	.4565	.0655	.0173	.0080	.0015	.0129
-4.77	12.53	.5470	.0956	.0237	.0072	.0017	.0129
-4.71	14.51	.6230	.1285	.0323	.0081	.0027	.0150
-4.70	14.85	.6366	.1348	.0333	.0086	.0029	.0143
-5.04	.24	.0886	.0150	.0027	.0003	.0009	.0174

APPENDIX B

TABLE B2.- Continued

NASA LANGLEY		7 X 10 HIGH SPEED TUNNEL							
TEST 59	RUN 5	BETA	ALPHA	CL	CD	CM	CRM	CYM	CY
		4.91	.11	.0780	.0140	.0026	-.0009	-.0017	-.0133
		4.93	-5.79	-.1598	.0336	-.0140	.0048	-.0020	-.0220
		4.93	-3.82	-.0789	.0221	-.0066	.0025	-.0019	-.0181
		4.92	-1.80	.0026	.0158	-.0006	.0009	-.0019	-.0151
		4.91	.14	.0784	.0137	.0027	-.0007	-.0017	-.0138
		4.89	2.21	.1543	.0155	.0060	-.0034	-.0011	-.0119
		4.87	4.20	.2264	.0209	.0089	-.0050	-.0011	-.0134
		4.83	6.27	.2987	.0290	.0121	-.0065	-.0000	-.0128
		4.80	8.30	.3754	.0428	.0154	-.0081	-.0003	-.0108
		4.76	10.27	.4534	.0626	.0164	-.0102	-.0006	-.0110
		4.71	12.47	.5450	.0939	.0223	-.0089	-.0008	-.0097
		4.65	14.64	.6223	.1284	.0332	-.0107	.0004	-.0101
		4.91	.12	.0780	.0141	.0022	-.0010	-.0018	-.0134
TEST 59	RUN 6	BETA	ALPHA	CL	CD	CM	CRM	CYM	CY
		-.06	.11	.0738	.0137	.0027	-.0002	-.0003	.0015
		-.08	-5.76	-.1653	.0340	-.0114	-.0010	-.0006	.0029
		-.08	-3.79	-.0854	.0226	-.0042	-.0008	-.0004	.0026
		-.07	-1.78	-.0013	.0156	.0001	-.0002	-.0004	.0014
		-.06	.13	.0750	.0135	.0023	-.0002	-.0003	.0015
		-.06	2.20	.1516	.0153	.0058	.0000	-.0004	.0016
		-.05	4.19	.2224	.0206	.0084	.0010	-.0004	.0019
		-.04	6.24	.2945	.0296	.0107	.0013	-.0005	.0022
		-.04	8.31	.3744	.0439	.0131	.0005	.0002	.0016
		-.04	10.24	.4488	.0627	.0165	-.0011	.0010	.0033
		-.04	12.36	.5316	.0897	.0227	-.0012	.0022	.0064
		-.03	14.68	.6338	.1318	.0296	-.0030	.0033	.0031
		-.06	.11	.0750	.0140	.0033	-.0001	-.0003	.0015
TEST 59	RUN 12	BETA	ALPHA	CL	CD	CM	CRM	CYM	CY
		-.06	.11	.0632	.0138	.0101	.0009	-.0001	.0011
		-.08	-5.75	-.1733	.0347	-.0038	-.0002	.0001	.0012
		-.08	-3.81	-.0968	.0235	.0036	.0002	.0004	.0011
		-.07	-1.78	-.0151	.0164	.0091	.0007	.0002	.0007
		-.06	.12	.0629	.0135	.0160	.0007	-.0001	.0008
		-.06	2.18	.1432	.0149	.0089	.0009	-.0002	.0019
		-.05	4.17	.2168	.0190	.0105	.0006	-.0003	.0019
		-.05	6.23	.2905	.0269	.0123	.0011	-.0002	.0023
		-.04	8.28	.3703	.0399	.0127	.0009	.0001	.0034
		-.04	10.21	.4366	.0552	.0166	.0002	.0014	.0060
		-.03	12.33	.5145	.0773	.0227	.0003	.0007	.0076
		-.04	12.32	.5144	.0776	.0228	-.0000	.0006	.0085
		-.02	14.64	.6022	.1138	.0327	.0012	.0003	.0078
		-.06	.12	.0640	.0140	.0100	.0011	-.0001	.0008
TEST 59	RUN 13	BETA	ALPHA	CL	CD	CM	CRM	CYM	CY
		4.90	.10	.0651	.0142	.0095	.0004	.0001	-.0136
		4.93	-5.87	-.1744	.0350	-.0066	.0040	-.0012	-.0199
		4.93	-3.90	-.0967	.0237	.0016	.0027	-.0013	-.0165
		4.92	-1.89	-.0137	.0167	.0070	.0011	-.0010	-.0135
		4.90	.06	.0620	.0141	.0099	.0009	.0001	-.0140
		4.88	2.09	.1410	.0146	.0103	-.0022	.0002	-.0131
		4.86	4.11	.2157	.0187	.0113	-.0050	-.0000	-.0140
		4.83	6.15	.2932	.0267	.0116	-.0064	.0008	-.0149
		4.80	8.20	.3621	.0381	.0143	-.0087	.0007	-.0123
		4.76	10.16	.4393	.0555	.0170	-.0110	-.0001	-.0108
		4.71	12.30	.5243	.0823	.0237	-.0111	-.0011	-.0066
		4.65	14.62	.6164	.1188	.0352	-.0122	-.0019	.0015
		4.90	.01	.0620	.0143	.0097	.0007	.0001	-.0131

APPENDIX B

TABLE B2.- Continued

NASA LANGLEY

7 X 10 HIGH SPEED TUNNEL

TEST	59	RUN	14	BETA	ALPHA	CL	CD	CM	CPM	CYM	CY
				-5.03	.20	.0656	.0143	.0084	.0005	-.0001	.0135
				-5.09	-5.73	-.1703	.0346	-.0067	-.0036	.0012	.0206
				-5.08	-3.75	-.0906	.0234	.0009	-.0020	.0013	.0168
				-5.06	-1.74	-.0113	.0166	.0066	-.0005	.0008	.0142
				-5.03	.18	.0649	.0141	.0082	.0006	-.0001	.0133
				-5.00	2.26	.1455	.0154	.0087	.0028	-.0006	.0129
				-4.96	4.28	.2178	.0196	.0108	.0051	-.0007	.0142
				-4.92	6.31	.2934	.0280	.0122	.0068	-.0007	.0158
				-4.87	8.37	.3678	.0404	.0137	.0088	-.0004	.0158
				-4.82	10.31	.4386	.0560	.0167	.0110	-.0001	.0127
				-4.76	12.44	.5202	.0813	.0232	.0103	.0008	.0117
				-4.69	14.81	.6289	.1241	.0331	.0066	.0005	.0095
				-5.03	.19	.0670	.0144	.0087	.0001	-.0001	.0142

TEST	59	RUN	18	BETA	ALPHA	CL	CD	CM	CRM	CYM	CY
				-.07	.13	.0686	.0145	.0103	.0002	.0001	.0014
				-.09	-5.70	-.1606	.0344	-.0027	-.0003	.0005	.0022
				-.08	-3.76	-.0811	.0237	.0036	.0006	.0007	.0014
				-.07	-1.77	-.0034	.0171	.0083	.0006	.0006	.0009
				-.07	.18	.0737	.0146	.0101	.0003	.0001	.0020
				-.06	2.23	.1539	.0163	.0097	.0006	-.0001	.0025
				-.05	4.22	.2262	.0210	.0116	.0004	-.0002	.0029
				-.05	6.26	.2987	.0292	.0131	.0006	-.0003	.0044
				-.04	8.30	.3773	.0426	.0136	.0007	.0001	.0044
				-.04	10.24	.4445	.0583	.0185	.0002	.0013	.0075
				-.04	12.37	.5186	.0806	.0253	-.0000	.0009	.0082
				-.03	14.63	.6026	.1142	.0344	.0001	-.0002	.0089
				-.07	.15	.0791	.0153	.0103	.0003	.0001	.0032

TEST	59	RUN	19	BETA	ALPHA	CL	CD	CM	CRM	CYM	CY
				4.90	.16	.0676	.0145	.0099	.0030	.0005	-.0166
				4.93	-5.79	-.1655	.0344	-.0050	.0067	-.0007	-.0242
				4.93	-3.82	-.0865	.0234	.0012	.0052	-.0008	-.0205
				4.92	-1.81	-.0085	.0169	.0069	.0040	-.0004	-.0174
				4.90	.10	.0651	.0146	.0099	.0028	.0005	-.0159
				4.88	2.18	.1429	.0156	.0112	.0000	.0009	-.0155
				4.86	4.19	.2160	.0196	.0125	-.0025	.0009	-.0160
				4.83	6.23	.2906	.0274	.0125	-.0044	.0016	-.0170
				4.80	8.27	.3605	.0387	.0166	-.0065	.0012	-.0164
				4.76	10.23	.4359	.0558	.0204	-.0089	.0005	-.0142
				4.71	12.35	.5141	.0811	.0266	-.0097	-.0011	-.0094
				4.65	14.61	.6136	.1196	.0364	-.0087	-.0016	-.0029
				4.90	.10	.0650	.0146	.0098	.0032	.0006	-.0168

TEST	59	RUN	20	BETA	ALPHA	CL	CD	CM	CRM	CYM	CY
				-5.03	.18	.0616	.0142	.0085	-.0019	-.0002	.0136
				-5.09	-5.71	-.1693	.0348	-.0050	-.0055	.0016	.0211
				-5.08	-3.72	-.0903	.0236	.0014	-.0040	.0016	.0170
				-5.06	-1.73	-.0140	.0170	.0067	-.0032	.0008	.0149
				-5.03	.21	.0645	.0144	.0086	-.0015	-.0001	.0140
				-5.00	2.25	.1414	.0155	.0094	.0012	-.0007	.0132
				-4.96	4.27	.2124	.0196	.0116	.0031	-.0009	.0141
				-4.92	6.31	.2850	.0274	.0130	.0043	-.0011	.0162
				-4.88	8.36	.3595	.0392	.0160	.0058	-.0006	.0173
				-4.82	10.31	.4330	.0558	.0193	.0088	-.0009	.0144
				-4.76	12.46	.5129	.0800	.0251	.0084	.0001	.0128
				-4.69	14.78	.6129	.1193	.0325	.0051	.0013	.0103
				-5.03	.18	.0601	.0144	.0084	-.0016	-.0001	.0130

APPENDIX B

TABLE B2.- Continued

NASA LANGLEY

7 X 10 HIGH SPEED TUNNEL

TEST 59 RUN 21

BETA	ALPHA	CL	CD	CM	CRM	CYM	CY
-5.03	.19	.0675	.0142	.0063	-.0014	-.0001	.0151
-5.10	-5.70	-.1617	.0337	-.0065	-.0044	.0017	.0220
-5.08	-3.71	-.0828	.0228	.0008	-.0035	.0018	.0178
-5.06	-1.70	-.0032	.0164	.0061	-.0022	.0009	.0157
-5.03	.21	.0713	.0144	.0081	-.0011	-.0001	.0157
-5.00	2.26	.1518	.0161	.0092	.0014	-.0007	.0150
-4.96	4.28	.2250	.0207	.0114	.0035	-.0008	.0169
-4.92	6.31	.2973	.0288	.0119	.0048	-.0010	.0182
-4.88	8.42	.3740	.0418	.0157	.0064	-.0005	.0196
-4.82	10.34	.4475	.0585	.0181	.0098	-.0005	.0152
-4.76	12.48	.5272	.0835	.0242	.0095	.0004	.0128
-4.69	14.82	.6309	.1251	.0323	.0062	.0009	.0101
-5.03	.22	.0774	.0148	.0081	-.0009	.0001	.0165

TEST 59 RUN 22

BETA	ALPHA	CL	CD	CM	CRM	CYM	CY
4.90	.11	.0688	.0143	.0093	.0017	.0003	-.0145
4.93	-5.77	-.1639	.0337	-.0058	.0058	-.0010	-.0217
4.93	-3.79	-.0852	.0231	.0019	.0040	-.0011	-.0179
4.92	-1.78	-.0030	.0162	.0070	.0028	-.0006	-.0156
4.90	.14	.0686	.0141	.0090	.0019	.0004	-.0146
4.88	2.21	.1482	.0153	.0104	-.0009	.0007	-.0139
4.86	4.25	.2251	.0198	.0121	-.0033	.0007	-.0152
4.83	6.27	.2971	.0276	.0121	-.0056	.0012	-.0146
4.80	8.32	.3711	.0397	.0160	-.0074	.0012	-.0157
4.76	10.30	.4451	.0576	.0183	-.0095	.0007	-.0121
4.71	12.40	.5232	.0836	.0253	-.0098	-.0009	-.0085
4.65	14.62	.6118	.1185	.0371	-.0109	-.0019	-.0013
4.90	.15	.0733	.0144	.0101	.0015	.0003	-.0140

TEST 59 RUN 23

BETA	ALPHA	CL	CD	CM	CRM	CYM	CY
-.06	.11	.0620	.0134	.0092	.0005	.0001	-.0000
-.08	-5.76	-.1710	.0341	-.0026	-.0002	.0004	.0004
-.08	-3.79	-.0935	.0230	.0042	.0003	.0004	.0000
-.07	-1.78	-.0125	.0162	.0087	.0005	.0003	.0003
-.06	.14	.0640	.0137	.0092	.0007	.0002	.0003
-.06	2.22	.1460	.0146	.0091	.0007	-.0001	.0004
-.05	4.18	.2165	.0188	.0108	.0004	-.0001	.0008
-.04	6.22	.2858	.0264	.0124	.0011	-.0003	.0010
-.04	8.33	.3708	.0397	.0133	.0007	.0002	.0021
-.04	10.30	.4377	.0550	.0177	.0002	.0015	.0041
-.03	12.33	.5078	.0763	.0239	-.0001	.0004	.0057
-.02	14.62	.5914	.1102	.0336	.0015	-.0004	.0028
-.06	.12	.0635	.0132	.0092	-.0000	.0001	.0005

TEST 59 RUN 24

BETA	ALPHA	CL	CD	CM	CRM	CYM	CY
-.06	.13	.0674	.0139	.0096	.0006	.0000	.0009
-.08	-5.70	-.1557	.0320	-.0060	-.0004	.0001	.0014
-.08	-3.77	-.0843	.0224	.0027	-.0002	.0001	.0019
-.07	-1.78	-.0071	.0163	.0078	.0003	.0002	.0013
-.07	.13	.0693	.0138	.0094	.0005	.0000	.0011
-.06	2.21	.1505	.0153	.0095	.0002	-.0003	.0025
-.05	4.18	.2189	.0195	.0110	.0005	-.0003	.0022
-.05	6.25	.2943	.0276	.0144	.0006	-.0002	.0025
-.04	8.30	.3686	.0409	.0151	.0006	.0001	.0036
-.04	10.22	.4370	.0565	.0199	.0001	.0013	.0062
-.03	12.33	.5085	.0782	.0270	-.0005	.0006	.0075
-.02	14.63	.5960	.1113	.0371	.0005	-.0010	.0076
-.07	.15	.0742	.0140	.0101	.0005	.0001	.0022

APPENDIX B

TABLE B2.- Continued

		NASA LANGLEY				7 X 10 HIGH SPEED TUNNEL			
TEST	RUN	BETA	ALPHA	CL	CD	CM	CRM	CYM	CY
59	25	4.90	.10	.0637	.0138	.0088	.0037	.0017	-.0190
		4.93	-5.78	-.1591	.0325	-.0082	.0061	-.0006	-.0228
		4.93	-3.83	-.0852	.0226	-.0001	.0052	-.0006	-.0194
		4.92	-1.62	-.0076	.0163	.0062	.0043	.0004	-.0181
		4.90	.09	.0636	.0137	.0090	.0036	.0019	-.0191
		4.88	2.16	.1421	.0149	.0111	.0011	.0020	-.0179
		4.86	4.16	.2145	.0188	.0130	-.0018	.0015	-.0185
		4.83	6.24	.2900	.0272	.0133	-.0036	.0026	-.0185
		4.80	8.28	.3629	.0392	.0161	-.0063	.0024	-.0171
		4.76	10.28	.4363	.0566	.0222	-.0081	.0019	-.0161
		4.71	12.35	.5120	.0815	.0280	-.0075	.0008	-.0141
		4.65	14.60	.6003	.1163	.0409	-.0092	-.0001	-.0052
		4.90	.09	.0658	.0139	.0090	.0031	.0017	-.0179
59	26	-5.03	.19	.0635	.0138	.0081	-.0024	-.0016	.0171
		-5.09	-5.70	-.1617	.0327	-.0100	-.0053	.0010	.0225
		-5.08	-3.72	-.0857	.0225	-.0004	-.0040	.0010	.0185
		-5.05	-1.71	-.0088	.0161	.0051	-.0027	.0000	.0168
		-5.03	.20	.0616	.0138	.0080	-.0022	-.0015	.0168
		-5.00	2.26	.1403	.0148	.0099	-.0000	-.0019	.0160
		-4.96	4.30	.2138	.0194	.0114	.0026	-.0019	.0166
		-4.92	6.31	.2870	.0273	.0136	.0040	-.0020	.0175
		-4.88	8.38	.3613	.0399	.0172	.0053	-.0016	.0201
		-4.81	10.44	.4369	.0569	.0209	.0082	-.0019	.0154
		-4.76	12.46	.5092	.0798	.0271	.0091	-.0016	.0139
		-4.69	14.79	.6122	.1194	.0370	.0062	.0001	.0089
		-5.03	.21	.0654	.0139	.0087	-.0025	-.0016	.0170
59	27	-5.03	.19	.0703	.0141	.0070	-.0008	-.0001	.0131
		-5.09	-5.71	-.1632	.0339	-.0075	-.0046	.0015	.0210
		-5.08	-3.73	-.0860	.0230	.0010	-.0028	.0016	.0159
		-5.06	-1.71	-.0045	.0164	.0062	-.0015	.0010	.0144
		-5.03	.24	.0740	.0142	.0077	-.0004	-.0003	.0131
		-5.00	2.27	.1531	.0156	.0086	.0015	-.0005	.0139
		-4.96	4.30	.2264	.0202	.0102	.0040	-.0007	.0142
		-4.92	6.33	.3017	.0289	.0121	.0050	-.0006	.0165
		-4.88	8.41	.3770	.0417	.0137	.0070	-.0002	.0166
		-4.82	10.34	.4482	.0577	.0161	.0093	-.0004	.0129
		-4.76	12.49	.5279	.0830	.0225	.0101	.0001	.0106
		-4.69	14.83	.6362	.1255	.0330	.0062	.0004	.0081
		-5.03	.22	.0775	.0145	.0077	-.0005	-.0001	.0139
59	28	4.90	.10	.0668	.0141	.0091	.0013	.0003	-.0140
		4.93	-5.80	-.1659	.0341	-.0066	.0044	-.0010	-.0202
		4.92	-3.84	-.0884	.0234	.0016	.0033	-.0012	-.0164
		4.92	-1.84	-.0076	.0168	.0065	.0019	-.0007	-.0143
		4.90	.09	.0673	.0141	.0088	.0015	.0003	-.0141
		4.88	2.17	.1478	.0151	.0104	-.0013	.0006	-.0135
		4.86	4.17	.2190	.0189	.0110	-.0044	.0004	-.0142
		4.83	6.22	.2981	.0271	.0115	-.0065	.0008	-.0146
		4.80	8.27	.3698	.0389	.0137	-.0088	.0008	-.0149
		4.76	10.23	.4433	.0566	.0157	-.0113	.0005	-.0113
		4.71	12.39	.5234	.0826	.0224	-.0112	-.0008	-.0088
		4.65	14.62	.6111	.1174	.0353	-.0127	-.0013	-.0009
		4.90	.09	.0672	.0141	.0089	.0010	.0002	-.0142

APPENDIX B

TABLE B2.- Continued

NASA LANGLEY

7 X 10 HIGH SPEED TUNNEL

TEST 59 RUN 29

BETA	ALPHA	CL	CD	CM	CRM	CYM	CY
-.06	.12	.0656	.0138	.0091	.0007	-.0001	-.0001
-.08	-5.76	-.1721	.0345	-.0041	-.0004	.0003	.0008
-.08	-3.80	-.0921	.0233	.0037	-.0005	.0002	.0009
-.07	-1.78	-.0116	.0164	.0076	.0007	.0002	.0002
-.06	.14	.0668	.0138	.0097	.0007	-.0000	.0007
-.06	2.18	.1474	.0147	.0079	.0003	-.0001	.0010
-.05	4.20	.2193	.0189	.0094	.0002	-.0003	.0006
-.04	6.22	.2925	.0267	.0109	.0001	-.0004	.0018
-.04	8.29	.3692	.0397	.0114	.0001	-.0000	.0024
-.04	10.24	.4393	.0555	.0157	-.0006	.0013	.0051
-.03	12.40	.5176	.0784	.0220	-.0009	.0003	.0070
-.02	14.63	.5997	.1116	.0310	.0002	-.0006	.0061
-.06	.12	.0641	.0138	.0089	.0006	-.0001	-.0002

TEST 59 RUN 30

BETA	ALPHA	CL	CD	CM	CRM	CYM	CY
-.06	.12	.0659	.0136	.0088	.0002	-.0001	.0009
-.08	-5.73	-.1628	.0333	-.0085	-.0005	.0002	.0015
-.08	-3.78	-.0896	.0230	.0019	.0000	.0002	.0011
-.07	-1.77	-.0084	.0163	.0071	.0007	.0004	.0005
-.06	.15	.0688	.0138	.0090	.0006	-.0000	.0010
-.06	2.20	.1489	.0148	.0082	.0006	-.0002	.0012
-.05	4.26	.2213	.0194	.0101	.0003	-.0003	.0021
-.05	6.25	.2925	.0272	.0131	.0007	-.0001	.0027
-.04	8.30	.3716	.0408	.0127	.0011	.0001	.0023
-.04	10.25	.4395	.0566	.0179	.0002	.0013	.0057
-.03	12.37	.5129	.0781	.0246	-.0002	.0006	.0056
-.02	14.64	.6013	.1132	.0337	.0007	-.0011	.0064
-.06	.15	.0728	.0138	.0102	-.0003	-.0001	.0013

TEST 59 RUN 31

BETA	ALPHA	CL	CD	CM	CRM	CYM	CY
4.90	.09	.0648	.0136	.0081	.0019	.0014	-.0170
4.93	-5.80	-.1613	.0329	-.0097	.0048	-.0006	-.0212
4.92	-3.81	-.0853	.0225	-.0009	.0038	-.0007	-.0182
4.92	-1.79	-.0060	.0160	.0054	.0025	.0001	-.0169
4.90	.15	.0692	.0136	.0088	.0021	.0014	-.0171
4.88	2.18	.1462	.0146	.0096	-.0012	.0013	-.0160
4.86	4.21	.2191	.0186	.0112	-.0038	.0011	-.0167
4.83	6.24	.2950	.0270	.0121	-.0051	.0018	-.0178
4.80	8.32	.3712	.0396	.0153	-.0078	.0016	-.0164
4.76	10.27	.4419	.0569	.0188	-.0090	.0015	-.0148
4.71	12.44	.5249	.0843	.0265	-.0096	.0001	-.0109
4.65	14.63	.6105	.1183	.0377	-.0116	-.0008	-.0016
4.90	.11	.0686	.0136	.0081	.0021	.0013	-.0177

TEST 59 RUN 32

BETA	ALPHA	CL	CD	CM	CRM	CYM	CY
-5.03	.20	.0666	.0140	.0068	-.0010	-.0011	.0159
-5.09	-5.71	-.1613	.0329	-.0107	-.0049	.0008	.0216
-5.08	-3.76	-.0859	.0226	-.0015	-.0033	.0009	.0177
-5.05	-1.72	-.0075	.0161	.0046	-.0015	.0002	.0156
-5.03	.18	.0662	.0138	.0070	-.0009	-.0010	.0157
-5.00	2.26	.1463	.0151	.0088	.0013	-.0014	.0155
-4.96	4.26	.2174	.0192	.0107	.0038	-.0013	.0165
-4.92	6.28	.2906	.0276	.0121	.0054	-.0011	.0175
-4.88	8.37	.3642	.0401	.0150	.0070	-.0007	.0182
-4.82	10.32	.4386	.0565	.0182	.0093	-.0012	.0155
-4.76	12.48	.5206	.0820	.0239	.0099	-.0005	.0141
-4.69	14.80	.6202	.1211	.0350	.0068	.0005	.0085
-5.03	.17	.0660	.0139	.0073	-.0012	-.0011	.0157

APPENDIX B

TABLE B2.- Concluded

NASA LANGLEY				7 X 10 HIGH SPEED TUNNEL			
TEST 59	RUN 33						
BETA	ALPHA	CL	CD	CM	CRM	CYM	CY
-5.03	.20	.0713	.0143	.0066	-.0002	-.0004	.0142
-5.09	-5.69	-.1583	.0332	-.0099	-.0039	.0011	.0207
-5.08	-3.74	-.0832	.0226	-.0014	-.0025	.0013	.0171
-5.05	-1.71	-.0035	.0163	.0046	-.0008	.0005	.0150
-5.03	.20	.0711	.0141	.0070	-.0005	-.0006	.0149
-5.00	2.30	.1527	.0154	.0076	.0024	-.0007	.0135
-4.96	4.29	.2236	.0201	.0094	.0049	-.0008	.0152
-4.92	6.35	.2978	.0266	.0110	.0061	-.0006	.0158
-4.88	8.41	.3754	.0415	.0141	.0077	-.0002	.0171
-4.82	10.36	.4461	.0580	.0164	.0103	-.0005	.0140
-4.76	12.51	.5278	.0836	.0225	.0101	.0002	.0129
-4.69	14.82	.6275	.1234	.0332	.0074	.0007	.0079
-5.03	.22	.0729	.0142	.0066	-.0003	-.0004	.0146
TEST 59	RUN 34						
BETA	ALPHA	CL	CD	CM	CRM	CYM	CY
4.90	.10	.0694	.0137	.0083	.0015	.0007	-.0145
4.93	-5.81	-.1642	.0337	-.0096	.0045	-.0009	-.0196
4.92	-3.84	-.0868	.0230	-.0003	.0033	-.0011	-.0169
4.92	-1.81	-.0064	.0164	.0054	.0020	-.0005	-.0149
4.90	.14	.0722	.0139	.0087	.0017	.0009	-.0147
4.88	2.18	.1510	.0151	.0092	-.0016	.0008	-.0139
4.86	4.20	.2222	.0194	.0101	-.0042	.0006	-.0138
4.83	6.24	.2984	.0274	.0116	-.0055	.0014	-.0152
4.80	8.30	.3691	.0394	.0138	-.0078	.0013	-.0143
4.76	10.26	.4437	.0573	.0169	-.0089	.0010	-.0125
4.71	12.39	.5247	.0836	.0245	-.0097	-.0003	-.0099
4.64	14.63	.6165	.1195	.0369	-.0122	-.0013	-.0021
4.90	.08	.0691	.0139	.0080	.0016	.0008	-.0146
TEST 59	RUN 35						
BETA	ALPHA	CL	CD	CM	CRM	CYM	CY
-.08	.05	.0677	.0137	.0086	.0005	.0001	.0016
-.10	-5.81	-.1663	.0340	-.0067	-.0004	.0005	.0019
-.09	-3.86	-.0907	.0231	.0021	.0003	.0004	.0020
-.09	-1.85	-.0093	.0165	.0076	.0005	.0004	.0016
-.08	.09	.0697	.0137	.0087	.0009	.0001	.0017
-.07	2.14	.1520	.0148	.0072	.0008	.0000	.0016
-.07	4.14	.2234	.0194	.0091	.0008	.0000	.0023
-.06	6.18	.2948	.0274	.0109	.0008	.0001	.0030
-.05	8.24	.3745	.0407	.0121	.0012	.0005	.0031
-.06	10.16	.4419	.0558	.0164	-.0001	.0013	.0075
-.05	12.29	.5190	.0766	.0221	.0005	.0006	.0073
-.03	14.59	.6077	.1141	.0328	.0017	-.0004	.0054
-.08	.05	.0677	.0138	.0087	.0007	.0001	.0017
TEST 59	RUN 39						
BETA	ALPHA	CL	CD	CM	CRM	CYM	CY
-.07	.12	.0676	.0148	.0094	.0005	-.0001	.0015
-.08	-5.77	-.1708	.0355	-.0046	-.0004	.0001	.0020
-.08	-3.82	-.0912	.0241	.0031	.0001	.0002	.0010
-.07	-1.78	-.0058	.0173	.0086	.0004	.0002	.0016
-.07	.13	.0686	.0149	.0093	.0004	.0000	.0018
-.06	2.28	.1545	.0169	.0084	.0006	-.0002	.0023
-.05	4.18	.2218	.0214	.0098	.0008	-.0001	.0026
-.05	6.19	.2908	.0296	.0123	.0011	-.0001	.0033
-.04	8.28	.3717	.0452	.0143	.0012	.0004	.0020
-.04	10.22	.4458	.0639	.0175	.0005	.0010	.0048
-.04	12.34	.5329	.0921	.0252	-.0000	.0017	.0100
-.02	14.67	.6373	.1361	.0345	.0006	-.0001	.0073
-.07	.13	.0744	.0152	.0089	.0005	-.0000	.0023

REFERENCES

1. Robins, A. Warner; Morris, Odell A.; and Harris, Roy V., Jr.: Recent Research Results in the Aerodynamics of Supersonic Vehicles. *J. Aircr.*, vol. 3, no. 6, Nov.-Dec. 1966, pp. 573-577.
2. Robins, A. Warner; Lamb, Milton; and Miller, David S.: Aerodynamic Characteristics at Mach Numbers of 1.5, 1.8, and 2.0 of a Blended Wing-Body Configuration With and Without Integral Canards. NASA TP-1427, 1979.
3. Coe, Paul L., Jr.; McLemore, H. Clyde; and Shivers, James P.: Effects of Upper-Surface Blowing and Thrust Vectoring on Low-Speed Aerodynamic Characteristics of a Large-Scale Supersonic Transport Model. NASA TN D-8296, 1976.
4. Coe, Paul L., Jr.; Smith, Paul M.; and Parlett, Lysle P.: Low-Speed Wind Tunnel Investigation of an Advanced Supersonic Cruise Arrow-Wing Configuration. NASA TM-74043, 1977.
5. Coe, Paul L., Jr.; and Weston, Robert P.: Effects of Wing Leading-Edge Deflection on Low-Speed Aerodynamic Characteristics of a Low-Aspect-Ratio Highly Swept Arrow-Wing Configuration. NASA TP-1434, 1979.
6. Coe, Paul L., Jr.; and Thomas, James L.: Theoretical and Experimental Investigation of Ground-Induced Effects for a Low-Aspect-Ratio Highly Swept Arrow-Wing Configuration. NASA TP-1508, 1979.
7. Craidon, Charlotte B.: Description of a Digital Computer Program for Airplane Configuration Plots. NASA TM X-2074, 1970.
8. Fox, Charles H., Jr.; and Huffman, Jarrett K.: Calibration and Test Capabilities of the Langley 7- by 10-Foot High Speed Tunnel. NASA TM X-74027, 1977.
9. Gillis, Clarence L.; Polhamus, Edward C.; and Gray, Joseph L., Jr.: Charts for Determining Jet-Boundary Corrections for Complete Models in 7- by 10-Foot Closed Rectangular Wind Tunnels. NACA WROL-123, 1945. (Formerly NACA ARR L5G31.)
10. Pope, Alan; and Harper, John J.: Low-Speed Wind Tunnel Testing, John Wiley & Sons, Inc., c.1966.
11. Braslow, Albert L.; and Knox, Eugene C.: Simplified Method for Determination of Critical Height of Distributed Roughness Particles for Boundary-Layer Transition at Mach Numbers From 0 to 5. NACA TN-4363, 1958.
12. Lamar, John E.; and Gloss, Blair B.: Subsonic Aerodynamic Characteristics of Interacting Lifting Surfaces With Separated Flow Around Sharp Edges Predicted by a Vortex-Lattice Method. NASA TN D-7921, 1975.
13. Polhamus, Edward C.: A Concept of the Vortex Lift of Sharp-Edge Delta Wings Based on a Leading-Edge-Suction Analogy. NASA TN D-3767, 1966.

14. Henderson, William P.: Studies of Various Factors Affecting Drag Due to Lift at Subsonic Speeds. NASA TN D-3584, 1966.
15. Tulinius, J.: Unified Subsonic, Transonic, and Supersonic NAR Vortex Lattice. TFD-72-523, Los Angeles Div., North American Rockwell, Apr. 27, 1972.
16. Grantham, William D.; Nguyen, Luat T.; Deal, Perry L.; Neubauer, M.J., Jr.; Smith, Paul M.; and Gregory, Frederick D.: Ground-Based and In-Flight Simulator Studies of Low-Speed Handling Characteristics of Two Supersonic Cruise Transport Concepts. NASA TP-1240. 1978.
17. Coe, Paul L.; Jr.; and Gilbert, William P.: Application of Low-Speed Aerodynamic Characteristics of Highly Swept Arrow-Wing Configurations to Supersonic Cruise Tactical Fighter Designs. Design Conference Proceedings - Technology for Supersonic Cruise Military Aircraft, Volume I, AFFDL-TR-77-85, Vol. I, U.S. Air Force, 1976.
18. Etkin, Bernard: Dynamics of Flight. John Wiley & Sons, Inc., c.1959.
19. Grafton, Sue B.; Chambers, Joseph R.; and Coe, Paul L., Jr.: Wind-Tunnel Free-Flight Investigation of a Model of a Spin-Resistant Fighter Configuration. NASA TN D-7716, 1974.
20. Ribner, Herbert S.: The Stability Derivatives of Low-Aspect-Ratio Triangular Wings at Subsonic and Supersonic Speeds. NACA TN 1423, 1947.
21. Campbell, John P.; and McKinney, Marion O.: Summary of Methods for Calculating Dynamic Lateral Stability and Response and for Estimating Lateral Stability Derivatives. NACA Rep. 1098, 1952. (Supersedes NACA TN 2409.)

1. Report No. NASA TP-1777		2. Government Accession No.		3. Recipient's Catalog No.	
4. Title and Subtitle LEADING-EDGE DEFLECTION OPTIMIZATION FOR A HIGHLY SWEEPED ARROW-WING CONFIGURATION				5. Report Date December 1980	
				6. Performing Organization Code 533-01-43-02	
7. Author(s) Paul L. Coe, Jr., Jarrett K. Huffman, and James W. Fenbert				8. Performing Organization Report No. L-13820	
				10. Work Unit No.	
9. Performing Organization Name and Address NASA Langley Research Center Hampton, VA 23665				11. Contract or Grant No.	
				13. Type of Report and Period Covered Technical Paper	
12. Sponsoring Agency Name and Address National Aeronautics and Space Administration Washington, DC 20546				14. Sponsoring Agency Code	
15. Supplementary Notes					
16. Abstract An experimental investigation has been conducted to determine the influence of an optimized leading-edge deflection on the low-speed aerodynamic performance of a configuration with a low-aspect-ratio, highly swept wing. Tests have also been conducted to determine the sensitivity of the lateral-stability derivative $C_{l\beta}$ to geometric anhedral. The optimized leading-edge deflection was developed by aligning the leading edge with the incoming flow along the entire span. Owing to the spanwise variation of upwash, the resulting optimized leading edge was a smooth, continuously warped surface. For the particular configuration studied, levels of leading-edge suction on the order of 90 percent were achieved with the smooth, continuously warped leading-edge contour. The results of tests conducted to determine the sensitivity of $C_{l\beta}$ to geometric anhedral indicate values of $\partial C_{l\beta} / \partial \Gamma$ which are in reasonable agreement with estimates provided by simple vortex-lattice theories.					
17. Key Words (Suggested by Author(s)) Arrow wing Leading-edge deflection Subsonic performance			18. Distribution Statement Unclassified - Unlimited Subject Category 02		
19. Security Classif. (of this report) Unclassified		20. Security Classif. (of this page) Unclassified		21. No. of Pages 56	22. Price A04