

N O T I C E

THIS DOCUMENT HAS BEEN REPRODUCED FROM
MICROFICHE. ALTHOUGH IT IS RECOGNIZED THAT
CERTAIN PORTIONS ARE ILLEGIBLE, IT IS BEING RELEASED
IN THE INTEREST OF MAKING AVAILABLE AS MUCH
INFORMATION AS POSSIBLE

ENVIRONMENTAL EFFECTS OFFICE

AN ASSESSMENT OF POTENTIAL WEATHER EFFECTS DUE TO OPERATION
OF THE SPACE ORBITING LIGHT AUGMENTATION REFLECTOR
ENERGY SYSTEM (SOLARES)

NASA CR-

160752

Job Order 54-318

(NASA-CR-160752) AN ASSESSMENT OF POTENTIAL
WEATHER EFFECTS DUE TO OPERATION OF THE
SPACE ORBITING LIGHT AUGMENTATION REFLECTOR
ENERGY SYSTEM (SOLARES) (Lockheed
Electronics Co.) 154 p HC A08/MF A01

N81-15642

Unclass

G3/47 39996

Prepared By

Lockheed Electronics Company, Inc.
Systems and Services Division
Houston, Texas

Contract NAS 9-15200



National Aeronautics and Space Administration
LYNDON B. JOHNSON SPACE CENTER

Houston, Texas

April 1978

LEC-12027

ENVIRONMENTAL EFFECTS OFFICE

AN ASSESSMENT OF POTENTIAL WEATHER EFFECTS DUE TO OPERATION
OF THE SPACE ORBITING LIGHT AUGMENTATION REFLECTOR
ENERGY SYSTEM (SOLARES)

SUBMITTED BY:

Norman C. Allen/LEC

APPROVED BY:

Richard K. Siler/SD6

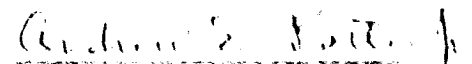
Andrew E. Potter, Jr./SD6

CONTENTS

Section	Page
1. SUMMARY	1-1
2. INTRODUCTION	2-1
3. ATMOSPHERIC HEATING.	3-1
4. CONCLUSION	4-1
5. RECOMMENDATIONS.	5-1

FIGURE

Figure	Page
3-1 Atmospheric heating	3-2

PRECEDING PAGE BLANK NOT FILMED

1. SUMMARY

Implementation of the Space Orbiting Light Augmentation Reflector Energy System (SOLARES) described in Appendix 1 and 2 will input large quantities of heat continuously into a stationary location on the earth's surface. There is no natural process comparable to this situation. The quantity of heat released by each of the SOLARES ground receivers having a reflector orbit height of 6,378 Km exceeds by 30 times that released by large power parks which have been proposed and studied in considerable detail. This large heat input will certainly affect the weather. Existing weather models cannot estimate with any degree of confidence the extent of the effect because the heat quantity involved is so much greater than the maximum experienced conditions. An expensive in-depth effort is required to improve weather models to better predict the magnitude of the changes which SOLARES might cause. Results from such a model could then be used by national policy makers in deciding whether or not to proceed with development of the proposed SOLARES concept.

2. INTRODUCTION

In April of 1977 NASA/Ames Research Center published a NASA Technical Memorandum⁽¹⁾, included as Appendix 1, assessing the feasibility of placing a light weight reflective structure in orbit around the earth capable of redirecting the sun's radiation to a ground-based receiver. There, the radiation would be converted to electrical power. Later in the year NASA/JSC undertook a study of this concept. One important open question of concern involved possible weather effects due to heat liberated at the surface. This situation is similar to that presented by the Solar Power Satellite (SPS) rectenna operation which had been a subject of study⁽²⁾ earlier in the year.

The JSC Environmental Effects Office is supported on a regular basis by Mr. R. K. Siler of the National Weather Service. The Environmental Effects Office requested Mr. Siler to technically coordinate with Lockheed Electronics Company to evaluate the effect this ground receiver may have on weather in the same way as was done for the SPS. This report has been generated in response to that request under Contract NAS9-15200, Job Order 63-1555-4318

The large number of possible system configurations recommended that a statement of work⁽³⁾, included as Appendix 2, be prepared identifying specific situations for investigation by the same firms which had performed the SPS rectenna analysis. Independent studies were performed by the following firms/individuals:

Aeromet, Inc. (Appendix 3)
P. O. Box 45447
Tulsa, OK 74145

Co-investigators: D. Ray Booker Ph.D.
Philip G. Stickel

Center for Environment and Man, Inc. (Appendix 4)
275 Windsor St.
Hartford, Conn. 06120

Principal Investigator: G. D. Robinson Ph.D.
in consultation with: Marshall A. Aikwater

Simpson Weather Associates (Appendix 5)
P. O. Drawer 5508
Charlottesville, VA 22903

Principal Investigator: Roger A. Pielke, Ph.D.
in consultation with: Michael Garstang, Ph.D.
Joanne Simpson, Ph.D., CCM
Robert H. Simpson, Ph.D., CCM

3. ATMOSPHERIC HEATING

The earth receives a large amount of energy from the sun continuously. The diurnal and seasonal variations in the average energy absorbed cause "weather" depending on the geographic location considered. The overall average earth temperature as well as the observed departures from that average depends upon many complicating factors, e.g., variation in that energy reflected from the area (albedo), energy stored and transported in the form of latent heat in water vapor, energy which is absorbed, stored, and transported in dynamic ocean currents etc. Heat energy is of fundamental importance in modelling the dynamic properties of the atmosphere and is the prime mover behind the "weather." Man can affect the release of heat by changing the albedo through irrigation and agricultural operations, building large water impoundments, burning fossil fuels, constructing large power parks or large urban/industrial complexes. Several of these man made situations have been studied in some detail to determine what effect these activities produce on the weather and how they compare with processes where heat is released in nature.

Figure 3-1 relates energy flux to the area over which release nominally occurs. Both natural and man-made sources are indicated. The man-made sources tend to be fixed geographically and constant in time. The natural sources, except for the volcano, tend to change with both time and location. The line of constant flux at 67 MW/Km^2 represents the average continental solar energy absorbed over all latitudes and seasons of the year. Actual values vary considerably from this value and can affect local, synoptic, and global climatic conditions. Weather phenomena are further complicated by the distribution of atmospheric moisture, the general circulation as well as local wind regimes, and the different radiative characteristics of the surface/atmosphere environment. Despite all these variables it is interesting to study figure 3-1 in an effort to get a qualitative estimate of how atmospheric heat input impacts "nominal weather" in and around the area of release.

FIGURE 1 - ATMOSPHERIC HEATING

1. Gilroy, R., Future Energy Production Systems, Vol. 1, p. 55-60 Academic Press 1966.
2. Simon, Steven G., Gifford, Franklin A., Meteorological Effects of Energy Disposition of Large Power Plants, Bull. Amer. Met. Soc. Vol. 48, No. 10, Oct 75, p 1568-1576
3. Harrisburg releasing 1000 tons etc. with 4 in ratio over that area to 24 hr. period
4. Releases amount up to 30 on to 12 hr. period over approx. 1000 mi²

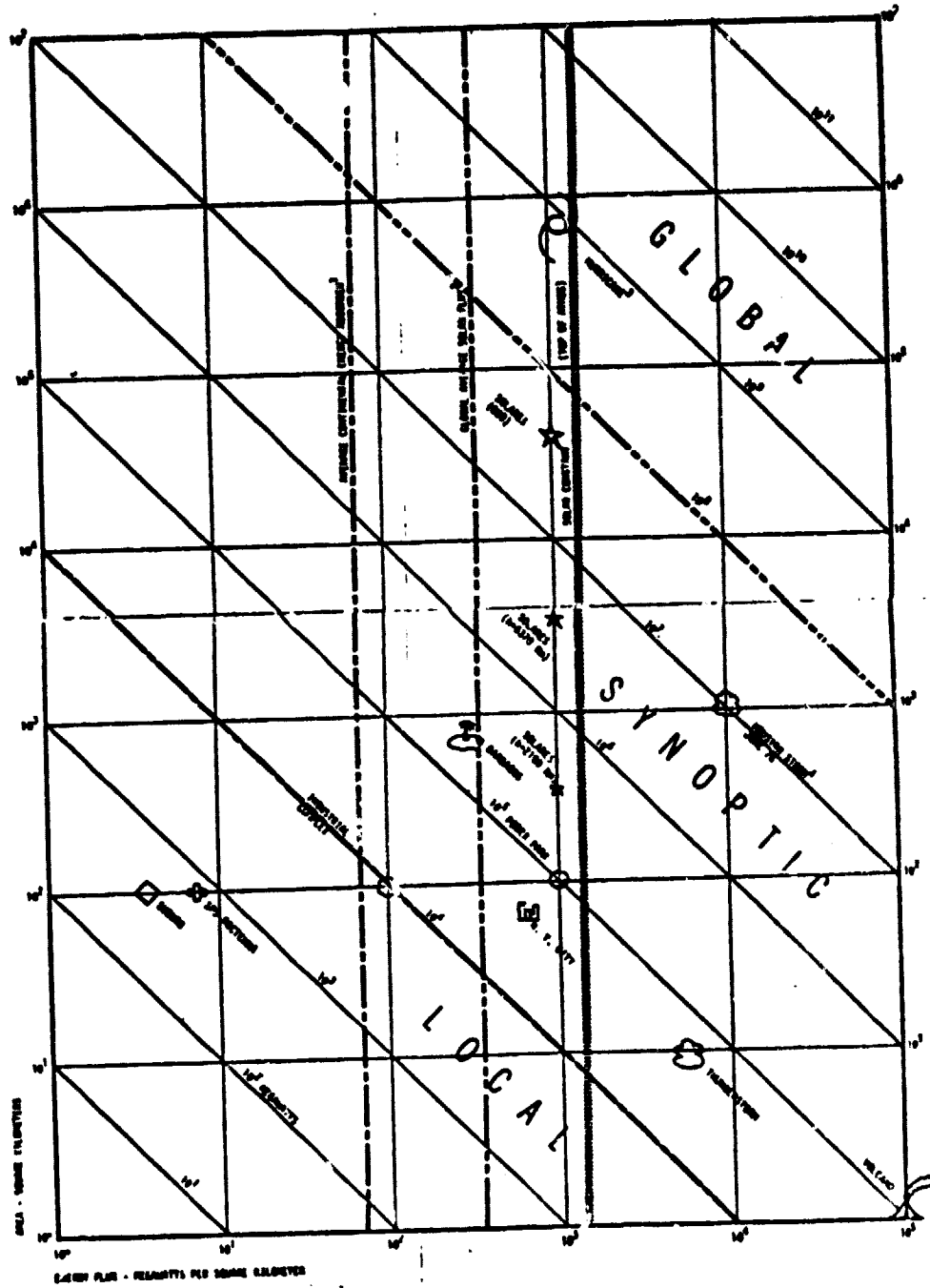

Figure 3-1.- Atmospheric heating.

For purposes of this discussion, we will use these definitions for local, synoptic, and global scale weather effects:

Local Weather Effects — Those changes in temperature, cloudiness, rainfall, etc., that are generally confined to an area measured in 10's of miles and which have no detectable influence on larger scale weather. Examples of such weather phenomena are numerous: A range of low mountains may cause showers along the crest and drying winds on the leeward slopes. Urbanization causes a temperature increase. A small lake or river may be the source of fog under certain conditions.

Synoptic Scale Effects — Those weather changes brought about by forces sufficiently large as to be identifiable on weather maps. These forces are exerted over areas measured in 100's of miles and include fronts and high and low pressure areas. These forces have no detectable influence in modifying weather on a global scale.

Global Scale Effects — Those weather changes brought about by forces sufficiently large so as to cause identifiable changes in weather and climate over a large percentage of the world. A phenomenon that resulted in a change of the average world-wide surface temperature of 1 degree C, would have a significant global scale effect. In light of these definitions, let us now examine figure 3-1.

If we consider that an area of 100 Km^2 (22 miles in diameter) generally typifies the scale of local weather and that agro-industrial cities such as St. Louis, MO releases energy to the atmosphere on the order of 100 MW/Km^2 , we could place an upper limit of an additional continuous release to atmosphere over that size area of 10^4 MW without causing more than local weather effects as defined above. It is evident from figure 3-1 that as the affected area increases, the energy flux decreases and vice versa.

Synoptic, or regional scale weather systems, would include areas up to about 10^6 Km^2 - about 700 statute miles in diameter. Again, using a 100 MW/Km^2 energy flux as an acceptable upper limit, we find that a continuous

energy release, in addition to natural sources, of 10^8 MW over that size area would not cause changes on the global scale, but may very well cause changes in the synoptic scale weather.

The onset of circulation flow around heat islands having area in the order of 600 Km^2 has been observed and simulation models reported.⁽⁴⁾ From this area, represented by Barbados in figure 3-1, up to the areas affected by hurricanes, drastic changes occur in the nature of mass flow and heat balance. The SOLARES receiver configurations lie in this range of area and energy release. This serves as a warning that large regional and perhaps global weather modifications may result from implementation of the SOLARES concept.

4. CONCLUSION

The large percentage of heat released into the atmosphere will raise its temperature causing expansion and vertical motion of the air. A low pressure will appear over the receiver causing increasing winds due to the inflow of air around the perimeter. Convection will increase the probability of clouds, rain, and hail over and downwind of the receiver. The inflowing air may set up circulation flow, vertical motion, and high altitude divergence similar to that observed in hurricane structures. There will probably be high surface winds which will present structural problems, blowing sand, maintenance and servicing difficulties. If sufficient quantities of moisture are available, significant cloud formation could result in limiting the energy available for conversion. The most favorable location for such a receiver would be dry desert regions and then only if the magnitude of effects on the synoptic weather can be tolerated.

5. RECOMMENDATIONS

The extreme amount of waste heat which must be dissipated in the earth's atmosphere by the proposed SOLARES concept potentially will result in high receiver temperatures which will degrade photovoltaic conversion efficiency and will probably produce synoptic weather changes. These are interrelated effects which cannot be addressed by present meteorological models. It is strongly recommended that a comprehensive modelling study be performed (cost estimated between \$150,000 and \$250,000) to gain greater insight and confidence in what impact this energy system may have on the environment.

6. BIBLIOGRAPHY FOR LEC-12027

1. Billman, Kenneth W., Gilbreath, William P., Bowen, Stuart W.; Introductory Assessment of Orbiting Reflectors for Terrestrial Power Generation; published by NASA Ames Research Center Moffett Field, Calif.: NASA TMX-73,230, April 1977.
2. Allen, Norman C.; A Preliminary Study of Possible Weather Effects due to Solar Power Satellite Rectenna Operation; Lockheed Electronics Co., Inc., Doc. No. LEC-10116; NASA/JSC Environmental Effects Office Internal Note JSC-12519; Feb. 1977.
3. Revision A, Statement of Work for Investigation of Weather Modification Due to SOLARES Operations; Lockheed Electronics Co., Inc., Contract NAS 9-15200, dated 1-16-78.
4. Mahner, Y. and Pielke, R. A.; Numerical Simulation of the Airflow Over Barbados; Mon. Wea. Rev., 104, 1976, pp. 1392-1402.

Appendix 1

**NASA TECHNICAL
MEMORANDUM**

NASA TM X-73,230

NASA TM X-73,230

**INTRODUCTORY ASSESSMENT OF ORBITING REFLECTORS
FOR TERRESTRIAL POWER GENERATION**

Kenneth W. Billman, William P. Gilbreath, and Stuart W. Bowen

**Ames Research Center
Moffett Field, Calif. 94035**

April 1977

SYMBOLS USED IN TEXT

A	area, km^2
A_{abs}	minimal absorber area, km^2
A_{sm}	mirror reflecting area, km^2
a	absorption coefficient
B	angle between ℓ and radius vector from Earth, deg
b	reflection coefficient
C	capital costs, 1976 dollars
C	temperature, Celsius
c	velocity of light, $3 \times 10^8 \text{ ms}^{-1}$
D_{m}	mirror diameter, km
D_{s}	beam spot diameter on Earth, km
E	power, kWh yr^{-1}
\vec{E}	electric field vector
F	force, N
F_{abs}	radiation force, absorption, N
F_{ref}	radiation force, reflection, N
F_{g}	gravity gradient force, N
f	$(1 + h/r_{\text{e}})^{-1}$
f'	effective focal length of mirror, km
G	gravitational constant, $\text{Nm}^2\text{kg}^{-2}$
g_0	gravitational acceleration at zero altitude, 9.8 ms^{-2}
H	magnetic field vector
h	altitude, km
I_0	space solar constant, 1.4 kW/m^{-2}

i	inclination, deg
K	error in ground spot position, percent
L	angle subtended by great arc, deg
M	Earth's mass, kg
m'	mass, kg
N_e	reflector points when $\lambda = 1$
N'_c	reflector points when $i = 0^\circ$ or $90^\circ \neq \lambda$
N_i	reflector points when mirrors must transit zenith and $i \neq 0^\circ$ or 90°
N_t	reflector points, minimum theoretical when $i \neq 0^\circ$ or 90°
\hat{n}	unit vector along normal to mirror
P	satellite period, hrs
\vec{p}	wave momentum density, $\text{kgms}^{-1}\text{m}^{-3}$
Q	intensity, theoretical, kWm^{-2}
R	distance from Earth's center, km
R_m	satellite mirror radius, km
r	radius, km
r'	rate of return, percent yr^{-1}
r_e	Earth's radius, km
Δr	linear displacement of ground spot, km
S	distance, mirror to ground spot, km
\vec{S}	Poynting vector
\hat{s}	unit vector along Poynting vector
t	elapsed time, s
Δt	orbit raising time, s
u	acceleration, ms^{-2}
W	radiation concentration

W_{3D}	ideal three dimensional mirror concentration
\bar{W}	orbit-averaged concentration
y	lifetime, yr
α	angle subtended by sun at Earth, 0.0093 rad or 0.53°
γ	orbit inclination to ecliptic, deg
δ	angle of incidence or reflection, deg
$\Delta\delta$	angular deviation of mirror, deg
$\dot{\delta}(t)$	angular velocity of mirror, rad s ⁻¹
$\ddot{\delta}(t)$	angular acceleration of mirror, rad s ⁻²
θ	viewing or elevation angle, deg
$\bar{\theta}$	time average elevation, deg
l	mass separation, km
λ	latitude, deg
ψ	mirror fill factor
ρ	density, kgm ⁻³
σ	areal density, kgm ⁻²
τ	torque, Nm
ϕ	one-half of cone angle, deg
$\bar{\phi}$	zenith angle to mean mirror elevation relative to Earth's center, deg
ϕ_m	ϕ when elevation is 30°, deg
Ω	rim angle, deg
∇	gradient operator

INTRODUCTORY ASSESSMENT OF ORBITING REFLECTORS
FOR TERRESTRIAL POWER GENERATION

Kenneth W. Billman, William P. Gilbreath, and Stuart W. Bowen*

Ames Research Center

SUMMARY

The use of orbiting mirrors for providing energy to ground conversion stations to produce electrical power is shown to be a viable, cost effective and environmentally sound alternative to satellite solar power stations and conventional power sources. This is accomplished with the use of very light weight metal coated polymeric films as mirrors which, after deployment at 800 km, are placed in operational orbit and controlled by solar radiation pressure. Relations are developed showing the influence of a number of parameters - mirror altitude, orbit inclination, period, mirror size and number, and atmospheric effects - on the reflected insolation that may be received at a ground spot as a function of location. Space technology drivers appear to be the pointing and control of such structures, material lifetimes in space, and an advanced earth-to-orbit transport system. The ground station is shown to be the major component of the total system investment, since the cost of reflectors in space is much less than that of the ground station. Some attractive alternative uses of the reflector are briefly discussed as beneficial adjuncts to the system. The environmental issues of principal concern appear to be the possible perpetual twilight that neighboring communities might experience and the land area required, while atmospheric effects are believed to be minimal and perhaps beneficial. Bus electricity costs are shown to range from about 25 to less than 10 mills/kWh, depending on the state of technology employed and the system size. Capital requirements are large for optimum systems, that is, those capable of meeting the U.S. or world power needs. Possibilities are described, however, for adding incrementally to the natural insolation received at existing solar facilities.

INTRODUCTION

The seemingly insatiable need of the world community for energy has recently prompted the examination of many alternate sources to substitute for our increasingly expensive and limited supply of fossil fuel. At first glance, solar energy would appear environmentally attractive and in limitless supply. However, research over many years aimed at exploiting this resource on a large scale for electrical and other high-enthalpy use has not succeeded in replacing the less costly fossil fuel alternatives. This economic disadvantage stems from a number of factors. The first is the "diluteness" or low energy

*NASA Consultant.

ORIGINAL PAGE IS
OF POOR QUALITY

density of solar radiation (amounting at most to 950 W/m^2 when the Sun is at zenith) which demands a very large collection area for meaningful system output power. Second, the radiation source is not stationary in the sky, thus demanding, for effective operation, active tracking by the large area collector. Finally, the solar intensity is not constant - varying according to the day-night cycle, the time of day, the seasons, the weather, and local obscuration phenomena - effects demanding energy storage facilities for continuous power output. These latter factors reduce the continuous solar intensity of 1.4 kW/m^2 (one solar constant) available above our planet's atmosphere to a useful yearly time-averaged intensity in the United States of only 0.2 kW/m^2 . All of the aforementioned factors conspire against the economic viability of this otherwise desirable source of energy.

To avoid many of these problems, an interesting concept has been proposed (ref. 1) to place the energy collection system in space, either a solar cell array or thermal cycle, which provides an almost continuous supply of electrical energy to a phased-array of microwave generators. This radiation is directed, virtually unattenuated, through the atmosphere to a ground station where a rectenna converts the microwaves to usable electrical output power. This satellite solar power system (SSPS) has received much study (ref. 2). Its most serious detractors point to its reliance on considerable technological advancement to achieve electrical output which is cost competitive with alternate nuclear or fossil fuel derived power, and to possible, though as yet not completely assessed, ecological effects. However, as recently suggested (ref. 3), such a space-related solution to our energy dilemma would certainly represent a bonus payoff from our support of space research of the past.

In this document we have examined another space-oriented concept - the possibility and economic viability of using large mirrors in space to reflect solar energy to selected ground sites where the conversion to electrical energy is made. The intent is to provide, by a minimal number of mirrors placed in suitable orbits, both high solar intensity (i.e., concentration) and continuity, thus eliminating most of the aforementioned factors which normally make "solar farming" economically untenable. Although we have found in the preparation of this document that space mirrors have received limited consideration before (refs. 4-6), to our knowledge such a study incorporating a number of innovations made here and directed to the economic generation of electrical power has not been made. Our main goal here is to (1) make an initial technology assessment of this approach, determining the near-term areas and those which present challenges, and (2) to examine the possible environmental and economic payoffs attendant to its implementation.

GENERAL CONCEPT

Before beginning the technological examination of the subelements of the orbiting mirror system, it is useful to examine it as a whole. The desire is to provide concentrated and continuous insolation to one (or more) ground sites. The concentration can be effected by focussing the image of the Sun, by means of refractive or reflective optics located in space at altitude h ,

onto the ground receiver. As can be seen schematically in figure 1, both the angular subtense of the Sun, $\alpha = 1.39 \times 10^6 \text{ km} / 1.5 \times 10^8 \text{ km} = 9.27 \text{ mrad}$ and the large distances of orbital satellites, provide a lower limit to this image size. If a planar mirror of diameter D_m is used, this minimal size is $D_s = D_m \cos \delta + ha$ where δ is the mean angle of incidence (and reflection) of the solar radiation on the mirror. An improvement in concentration can be made by providing at a given orbit position a three-dimensional array of such planar elements (called a Fresnel Field) spatially arranged and individually pointed in such a fashion that each of the reflected images coincides at the receiver. This focussing system provides a minimal Sun image size of $D_s = f'\alpha$ where, to first order, the focal length is equal to the orbital altitude, $f' = h$.

We note two facts from this minimal size. First, the dimension is large - amounting to approximately $h/100$ or 10 km even for an orbit altitude of 1,000 km. Secondly, if we wish to achieve concentrated radiation in this area, that is in excess of ambient terrestrial peak solar values, we must provide a total mirror collection area in space which exceeds this area. Thus, although we can choose to provide a ground station smaller than D_s (based upon the economics of incremental approach to system set-up), the requirement for concentrated radiation sets the minimal scale for the mirror system in excess of $D_s = ha$.

Of course, within limits, large mirror structures are possible in the weightlessness of space. Of particular importance to our study is the recent development of low mass per unit area mirror materials (various plastics) overcoated with reflective metal coatings and the possible development of low mass structural supports and controls. The goal of the Solar Sail Program now being investigated by NASA is to reach with such a system an area density of 3-6 g/m². Using such technology, we assume the feasibility of providing a focussing mirror array, which we call a satellite mirror, of the type discussed above and as shown in figure 1(b). The individual mirrors will be "free-flyers," that is, individually controlled and chosen in size to be consistent with near-term technology. The satellite mirror area will, of course, be the sum of these mirror areas.

The insertion of the mirrors into orbit will be accomplished in two or three stages. Earth to low orbit (LEO) lift can be provided by a Shuttle-like vehicle, or perhaps for cost effectiveness, a new Heavy Lift Launch Vehicle, followed by lift to approximately 800-km altitude with an OMS package on the shuttle or by an orbital transfer vehicle (OTV). Finally, the low area density of the mirror will allow the structure to be lifted to final altitude by means of solar sailing. While in orbit, the possible use of radiation pressure for station-keeping as well as mirror pointing is suggested. This multiple use of radiation pressure will hopefully reduce significantly the need and attendant transportation costs, for expendables required by other propulsive techniques.

A critical consideration in the orbiting mirror concept is the choice, of the many possibilities, of the optimum mirror orbit. This is complicated by many opposing considerations such as minimal spot size (h small) yet continuous

irradiation (the over-site viewing time increases with h) the many possible orbit inclinations, the number and placement of ground sites, and finally, practicality and economic considerations. Clearly, a full parametric study of this is necessary. We have considered certain cases, as seen in figure 2, such as a geo-stationary orbit which, having a period of one sidereal day, provides simple energy continuity since it remains fixed in view of the receiver.

Lower orbits give smaller image size and thus demand smaller mirrors. However, a complication arises because of their shorter periods. This necessitates the use of more than one satellite mirror so arranged that at any time at least one is over the ground site within a useful observation region (chosen to be a right cone of maximum angle relative to the zenith of 60°). Polar, equatorial and other orbits have been examined. The number of satellite mirrors and their requisite area to provide a reflected, continuous insolation of 1.4 kW/m^2 , including atmospheric and geometric effects, has been examined as a function of altitude.

The conversion of this radiation to electrical power is considered by two techniques: the indirect method commonly considered for "solar farming" of a thermal cycle and the direct conversion using a flat array of photovoltaic (cadmium sulfide) solar cells. Both are considered in terms of near-term (1980) technology, allowing realistic cost estimates. Importantly, it is found that even a minimal system will make a significant contribution to the U.S. energy needs and, furthermore, the cost appears competitive with that afforded by fossil and nuclear alternatives.

Finally, the key issues in environmental impact and multiple use aspects of the system are briefly identified. The transmission of solar energy into our ecosphere would appear to be the least obtrusive of possible wavelengths. A positive environmental impact would certainly be to conserve our dwindling supply of fossil fuels as well as to remove the pollution accompanying their use for power generation. These, and similar considerations, would appear to outweigh the possible negative effects of land usage and atmospheric scatter leading to sky-glow in the vicinity of the ground stations. An attempt has been made to examine an attractive feature of this system: its multiple use capability. Thus, in addition to its primary function of producing electrical energy for the industrialized nations, those mirrors which are simultaneously over agrarian countries can be providing concentrated and continuous solar energy for their important needs such as extending the food growth season and yield, and the desalination and pumping of water for irrigation purposes. Such usage may, in fact, be the first as the system is incrementally brought into existence.

ORBIT CONSIDERATIONS

It is apparent from the minimum spot size relation ($0.0093 h$) that orbits nearer to the Earth's surface will require correspondingly smaller Earth receivers (and, as we will see, less complex orbiter reflectors) and thus, by using these lower orbits one can significantly reduce the magnitude of the

required engineering. Besides the lessened capital requirements, transportation and operation costs should be reduced. In this section we consider the relative merits and liabilities of several orbit options. Four classes of orbits considered are shown in figure 2. These are geostationary (GEO), low altitude equatorial, polar (including Sun synchronous) and inclined orbits in general. As the latter class is most useful for mid-latitude ground stations, a large portion of the discussion is devoted to the apparent necessity of an array of equal inclination orbit planes, as shown in figure 3 (termed iso-inclination orbit planes).

An equatorially positioned mirror at GEO has the advantage of being stationary relative to a single ground station and can service it on a continuous basis, except for a 1 percent down time when it is eclipsed by the Earth. Lesser orbits result in shorter periods (varies as the 3/2 power of the radius), decreasing to about 90 min at low Earth orbit (LEO). Since the reflector is not stationary relative to a ground point, it can provide energy to that point only on an intermittent basis, at best only when it is above the local horizon and for practical purposes (as shown below) usually only when its elevation is above 30°. Thus, for continual illumination a number of satellites must be provided. This number depends on the orbit altitude, its inclination, the Sun shadowing period, and the insolation desired.

Although the imaged spot size diminishes with decreasing altitude a lower bound exists, other considerations aside, to the altitude we may employ. This limit is imposed because of atmospheric drag causing orbital decay. The low ballistic coefficient of the proposed structure requires a minimum operation altitude of 1750 km to provide a lifetime of 100 years, an adequate margin for a proposed service duration of thirty years. This is for circular orbits, the option is available of using eccentric orbits, whereby one can achieve 900 km, but with an apogee of 10,000 km, and a 100 year life. Further, as discussed later, solar sailing techniques can perhaps be employed to counter the drag and altitudes as low as 800 km can be used.

Reflectors Required

For energy continuity at the ground spot, it is necessary to establish reflector orbits in such a manner that at least one mirror is in view of a given ground station at all times. Obviously, it is also necessary that this mirror is not shadowed (supportive conditions to this requirement are considered later). Basically, the number required to meet this condition is dependent on the location of the ground station and the orbit altitude. The fraction of sky viewed from one point is limited. Due to a number of effects, discussed later, the reflected radiation received by a ground station diminishes with decreasing elevation angle. An elevation angle of 30° has been chosen as a minimum for receipt of useful quantities of radiation and this value will be assumed in the following, unless otherwise stated. Given this angle, θ , fixed the following evaluation can be employed (see fig. 4) to determine the fraction of an orbit (which passes through the station's zenith) that can be viewed from a single spot:

$$\phi = 90^\circ - [\theta + \sin^{-1}(f \cos \theta)] , \quad f \equiv (1 + h/r_e)^{-1} \quad (1)$$

where ϕ is the angular position of the mirror as seen from the orbit's center, and r_e , the Earth's radius. When $\theta = 30^\circ$, ϕ_m is found to vary from 18.9° to 52.5° as the altitude changes from 2000 to 35,800 km. Thus, ground stations which are fixed relative to a single orbit plane would require only

$$N_e = 360^\circ / 2\phi_m \quad (2)$$

satellites in order to maintain one mirror above 30° at all times. Unfortunately, only at three latitude points is an orbit-fixed ground spot possible. A single equatorial belt with N_e equally spaced mirrors will "fill the sky" above any ground station on the equator as each mirror will rise and set on a true east-west line. Similarly, a single ground station at each pole will be serviced by a north-south belt. At all other latitudes the ground station rotates with respect to a given belt, passing under the belt twice daily, providing that the belts' inclination, i , to the equator is greater than the station's latitude.

Ground stations, located off the equator, could still derive some benefit from a single equatorial reflector belt. However, the mirrors will no longer pass directly overhead, and at stations of increasing latitude the mirrors will be below the chosen elevation minimum of 30° for increasing periods. The latter effect may be compensated for by placing additional mirrors in the belt. For example (as can be found from eq. (3)), ground stations at latitudes of N or S 10° would require nearly two additional mirrors at an h of 2000 km, compared to the 9-1/2 necessary to service equatorial sites. And, for this altitude, at 18.9° N or S each satellite would only be seen for the instant, at 30° elevation, as it passes due S or N of the station, respectively.

As the latitude of the desired ground station becomes larger than ϕ_m , there are two choices.¹ First, the equatorial belt may be retained but the mirrors must be in higher altitude orbits, to increase the cone angle. The equatorial number required for a station at latitude λ may be found from an approximate modified form of equation (2).

$$N'_e = \frac{360^\circ}{2(\phi_m^2 - \lambda^2)^{1/2}} \quad (3)$$

To reach latitude 32° (southwestern United States, for example) with much effectiveness, h could be chosen as 10,000 km, resulting in ϕ_m of 40.3° by equation (1) and $N'_e = 14.7$, instead of the four mirrors required at this altitude for equatorial stations. From this southwest U.S. location, although a mirror would always be above 30° , a maximum elevation of only 41.6° could be obtained.²

The other alternative is to place the reflectors into a number of orbit planes, each with the same inclination but separated inertially by equal

¹Similar arguments apply to the use of the polar belt.

²The maximum elevation may be found from equation (20), discussed later.

degrees of longitude and by equal degrees of anomaly as shown in figure 3. In this situation as the ground station rotates it will pass under new orbit planes. To make use of the satellites in both ascending and descending nodes, the orbit planes at i inclination would be somewhat greater than the sites' latitude. We immediately see, that the number of mirrors required to meet the 30° viewing elevation criterion, is larger than N_e since in the equatorial case each mirror is employed each time it orbits. With inclined orbits a given mirror will only pass directly over a station twice a day; once ascending and once descending as shown in figure 5. (This is rigorously true only if the orbits are "integer," which can be achieved if a given mirror's period in hours is in integer divisor of 24.³ Additionally, the orbit altitude and inclination must be chosen such that a "compatibility"⁴ exists with the ground site during a later orbit as shown for an example 3 hr orbit period in fig. 5.) The number of mirrors required in an inclined orbit, N_i , is given approximately by the ratio of 24 hr to twice the elevation viewing period -- the time each takes to pass through the zenith while transversing the 120° sky angle over a ground station. The period of a circular orbit is given by

$$P = 1.4 f^{-3/2} \text{ hr} \quad (4)$$

so that

$$N_i \approx \frac{24}{4\phi} \cdot \frac{360}{P} = \frac{1543}{\phi} f^{3/2} \quad (5)$$

N_i is found to vary from about 54 at $h = 2000$ km to a little over 9 at 10,000 km. It can be seen that for latitudes moderately removed from the equator, this process is more effective than that governed by equation (3). The equi-longitude array of satellites has the further advantage over the equatorial belt concept for these removed latitudes in that the average elevation angle of the mirror in the former case is higher.

Equation (5) represents the minimum number of mirrors required with the proviso that each passes overhead. (These orbits may be established to meet this criterion for a particular ground spot; they will also exactly match a number of other stations, related to the first by a longitude-latitude relation. Additionally, at times, there may be other mirrors that pass through the viewing cone of a station but do not transit the zenith. The second orbit pass in figure 5 illustrates this case. Because useful reflected radiation (from above an elevation of 30°) may also be received from these nonzenith passes the size of each mirror, needed to produce a given average insolation at the ground station, may be reduced. An estimate of the number of "extra" mirrors may be found by first dividing the global area covered by the set of iso-inclination orbits by the area of a single viewing circle, that is,

³Integer orbits repeat relative to a ground station in a period somewhat different than a sidereal day due to the effects of oblateness.

⁴Compatibility is defined such that a satellite passes through the zenith above a ground site twice a day.

$$N_t = \frac{4\pi r^2 \sin \phi}{2\pi r^2(1 - \cos \phi)} = \frac{2 \sin \phi}{1 - \cos \phi} \quad (6)$$

Thus, a 2000-km orbit of $i = 40^\circ$, radiating between N and S 40° has $N_t \approx 24$, compared to N_i of 54. N_t is both the theoretical number of ground stations and, at a given instant, the number of mirrors in viewing cones that will pass through stations' zeniths -- that is one for each station. $N_i - N_t$ is then the number of extra mirrors while the ratio of this value to N_t is the number of nonzenith passing mirrors within a station's viewing cone on a time-averaged basis.

Orbit Insolation

A real consideration for a reflector providing illumination is the eclipsing effect of the Earth -- at times most orbits will be shadowed. This problem can be dealt with in two ways. First, by development of relay techniques which permit sunlit mirrors to reflect their received radiance to other mirrors and thence through a "master" to the station of interest. This concept is explored in the next section. And, second, we may select orbits that will minimize the shadowing problem.

Orbit elevations providing continuous insolation may be found from the relation

$$h \geq r_e (\csc \gamma - 1) \quad (7)$$

where γ is the inclination of the orbit relative to the Earth-Sun line, as is indicated in figure 6. Since this line will vary $\pm 23.5^\circ$ relative to the equator it is apparent that a polar orbit, for example, may have a γ as small as 66.5° , providing that its east-west axis is maintained roughly normal to the Sun's radiation (i.e., in a Sun synchronous orbit). Any such Sun-synchronous near-polar orbit above 575 km will satisfy equation (7). Although such low orbits provide smaller ground spots which is very advantageous from an initial investment's standpoint, the lifetime is short because of drag. (The drag problem can be circumvented by using an orbit with its perigee, at the pole, of 900 km and an apogee of 10,000 km, but then it services only one pole and the effects of Earth oblateness will gradually shift the line of apsides away from the polar orientation. Alternatively, solar sailing can be used to counter drag down to about 1000 km if mirror usefulness is to be retained.) Higher orbits would permit service to ground stations at much lower latitudes, below the 60th with orbit altitudes of 10,000 km, as much the same arguments apply here as with the equatorial belt case. It is important to emphasize that polar belts, although only passing directly over the two stations, have the great advantage by equation (7) of being continuously sunlit. Actually, to achieve this they must be in zero solar drift rate orbit planes -- the regression of the orbit plane due to the Earth's oblateness just balances the motion of the Earth about the Sun. Such Sun synchronous orbits do not exist for the polar inclination but only for somewhat higher orbit inclinations (retrograde), as may be determined from

$$h + r_e = 12349 \cos^{2/7} i, \quad \text{in km} \quad (8)$$

A 1400-km orbit, with an inclination of 101.43° , is the minimum altitude orbit that satisfies both equations (7) and (8). Although this belt is not fixed with reference to a given ground point, continuous illumination can be provided to the polar points and other near regions where a mirror from the belt is always above the local horizon. More areas could be reached if the belt were higher. Because at greater altitudes the oblateness has a decreasing effect, a maximum Sun synchronous altitude of 5972 km is the limit (the inclination must also increase to maintain Sun synchronous conditions). Besides higher orbits, other possible options exist for continually illuminating the ground station. Partially shadowed planes can be chosen and multiple belts used. Orbits of various solar drift rates as fixed by altitude and inclination can be chosen. The added variable of equal time (longitude) mirrors discussed earlier in this section must also be analyzed for the shadow effect. As can be appreciated, a good deal more study must be done before we can optimize the orbits and the number of mirrors required to service one or more ground stations. (In actuality, even without specially selected orbits the magnitude of the eclipsing effect is not large. For example, with $i = 40^\circ$, 13 percent and 6 percent of the total orbit is shadowed at 4000 and 10,000 km, respectively. Since this is for the whole of the orbit, if only ground stations are considered at the extreme of orbit trace (i.e., $\lambda = 40^\circ$) then the percent occultation is much less than these values.)

ORBITAL REFLECTOR CONSIDERATIONS

The success of this program rests very strongly, of course, with the ability to engineer optimized space mirrors. Fortunately the technology appears within the near-term although the scale is large and in some instances the effects of the space environment have not yet been fully researched.

Solar Concentration

Solar concentration in general becomes necessary when high temperatures are wanted, or when, as in the case with photovoltaic cells, the cost of the absorber is much higher than the cost of the mirrors. From our economic considerations it will be seen that it is indeed desirable to concentrate, that is, use mirror areas which exceed those of the ground spot area, the latter being found approximately from (normal incidence)

$$D_s = f' \alpha = h \alpha \quad (9)$$

where D_s is the spot diameter, f' the effective mirror focal length, h the orbital altitude, and α the subtense angle of the Sun.

The fundamental problem of radiation concentration can be stated as follows: How can radiation which is uniformly distributed over a range of angles, 0 to $\alpha/2$, arriving from the sun and incident on a mirror aperture of area A , be concentrated on a smaller absorber area A_{abs} and what is the value of the concentration $W = A/A_{abs}$? The second law of thermodynamics can be used to

respectively) and which, because of this scale, will need to use component mirrors, as large as is technically feasible. We will consider some restrictions to these dimensions shortly.

Relay Possibilities

A further reduction in mirror size is possible if a "relay" system, as shown schematically in figure 7, can be developed. Here each mirror (or mirror cluster) individually collects solar radiation and relays a focussed beam to its neighbor mirror in the orbital band of satellites encircling the Earth. The neighbor mirror collects solar radiation directly as well as that from the prior mirror and again relays this to the next satellite. Ultimately this relayed power collected by n satellites is sent downward to Earth by a master transmitter, which is suitably over the receiving site of interest. Hence, to achieve a solar constant of radiation in the spot, the required individual mirror area will approach $1/n$ of that demanded by the single reflector scheme times a reflector distance factor which accounts for beam spread. This technique is particularly cost effective, not only in allowing a reduction in the mirror mass to be placed in orbit, but, especially for continuous insolation orbits, to allow all of the orbiting satellites to simultaneously be performing useful work independently of their being over the horizon of the intended receiver sites. It should be cautioned, however, that the exact passive mirror system which accomplishes the dual functions of collecting, relaying, and, when it is over the site, downward transmitting still remains a challenge to the optical designers. It may be necessary to use refractive optics, active optical techniques, or even to incorporate amplifier techniques in some manner similar to those contemplated in lengthy optical communications lines.

Mirror Structure

Some prior work has considered large mirror structures in space. Orberth (ref. 4) originally proposed a mirror constructed on radial and crosslinked guy lines held rigid by the centrifugal forces provided by rotation of a centrally located spaceship. Very thin reflective material, namely, sheet sodium metal prepared in the vacuum of space, was then stretched over and affixed to this frame. Sodium was chosen because of its low density and its ready availability (in the salt of the oceans, etc.). Interestingly, he also suggested the desirability of obtaining structural material from the Moon and from asteroids, a concept which has received much recent study by O'Neill et al. (ref. 7) as a possible means to lower the costs associated with the conventional power satellites. More recent examination of mirrors in space has been made (ref. 5) on the solar concentrators necessary to solar-drive the Brayton Engine power satellite. Concepts examined all made use of low density (Kapton, Mylar, etc.) thin plastic substrate material suitably coated with thin metal films, such as aluminum. Configurations studied have included inflatable, inflatable-rigidized, petal, and faceted mirror types. A problem with the inflatable configuration is gas leakage produced by micrometeorite holes, etc. If the structure can be rigidized quickly after inflation, by polymerization or other techniques, this problem may be avoided. In general, however, it appears that faceted mirrors, that is, those constructed of a

large number of (redundant) individual tensioned plane sections, probably of hexagonal shape, are most consistent with low mass/area, high strength, assembly in space, and long lifetime or, if necessary, maintenance. A schematic configuration is illustrated in figure 8. The facets can be oriented to approximate a parabola with a low mass stressed cable and boom structure. Finally, NASA has recently begun an examination of the possibility of "solar sails" in interplanetary space (to be discussed later) which has evolved new concepts, such as possible mirror configuring with electrostatic forces, and new demands on the development of low mass/area mirrors, structures, and control and guidance systems. Preliminary work indicates a presently available technology-achievable value for this in the range of 3-6 g/m². In the calculations of this section, we shall assume the system mass/area to be $\sigma = 6 \text{ g/m}^2$. The metal overlaid 25- μm film (Kapton, Paralene, etc.) for the solar sail program should be capable of operating continuously with solar intensity of 10 solar constants (14 kW/m²) at temperatures of 350° C, and should provide specular reflectivity in excess of 85 percent. The solar sail mirror is targeted to be an 800 m \times 800 m square mirror. With some modification, the low mass axial mast-spars-and-stays structural configuration of the square solar sail mirror appears usable for the cluster mirrors discussed above.

Orbit Environment Effects

One may well ask whether the environmental demands on such a large structure are compatible with present day materials and technology. Prime concerns are those forces associated with (1) gravity gradient forces, (2) centrifugal forces associated with rotation of the structure, (3) stresses introduced by nonuniform temperatures (such as occur when the structure rotates through the shadow of the Earth), etc. A few calculations have eliminated some concerns here, but further study associated with specific structure designs is necessary.

Gravity gradient forces arise because various elements of a structure are at various distances R from the center of the Earth and hence are subject to forces varying with $1/R^2$. Thus, if for simplicity we consider two masses m and m' at radii R and $R + \delta R$, there will be a net force

$$F_g = \frac{dF}{dR} \cdot \delta R = \frac{2GMm'}{R^3} \delta R \quad (12)$$

acting on the center of mass of the two-mass system, and in general producing a torque about this center of mass given by $\tau \approx F_g l \sin B$ where l is the mass separation and B is the angle between l and the radius vector extending from the center of the Earth. At times these gravity gradient forces can be used to advantage, for example, to keep structures always in a particular orientation relative to the surface of the Earth ("gravity gradient stabilization"). Here we examine how the strength of available materials limits the structural size. If we consider a rod-like structure with $B = 0$, that is, all mass elements lie along their common radius vector, then the gravity gradient stress on the rod is approximately

$$\frac{\rho l^2 g_0 r_e^2}{2R^3} \quad (13)$$

where ρ is the material density, g_0 the zero altitude acceleration due to gravity, r_e the Earth radius, l the length of the structural member, R the distance between Earth center and the closest mass element. For structural integrity, we must demand that this stress does not exceed the "yield stress" for the material, that is, the stress beyond which it inelastically deforms. Considering the possible low density aerospace materials, Ti (6Al-4V) alloy, Al (2024) alloy, and composite $[0^\circ]_{8S}$ laminate, it is found that the gravity gradient stress will not be excessive. In fact, if one computes the "yield lengths" l allowable, they all exceed the conceivable upper-limit mirror structure dimensions (≈ 2 m) by more than a factor of eight at all altitudes. Similar analysis must also investigate the effect on mirror materials. Corresponding calculations were not performed on the gravity gradient torques and temperature effects since, of course, they are closely related to the exact structural mass configuration. However, a successful mirror design (i.e., one which will remain intact and whose figure will remain — by passive or active methods — within tolerance) must incorporate these torques and stresses and their variation.

The durability of such mirrors in space is of some concern. Some experience was attained from the Echo I satellite which was an inflated sphere of 12.5- μ m Mylar overcoated with 0.22 μ m of aluminum. After 4 years, its reflectivity decreased only by 4.7 percent. This loss can be attributed to meteor cratering which removes available reflective area, sputtering by high energy particles in the Van Allen belts and especially blistering caused by the trapping of low energy protons from the solar wind which produce hydrogen bubbles at the plastic-metal interface. Boeing Aerospace Co. (ref. 5) has estimated the meteoroid damage to be minimal for a system at GEO, 3 percent area lost per 30 years. However, the sputtering erosion and hydrogen effects are much less certain. They believe a minimum unattended lifetime of 8 years is achievable; however, further testing is necessary. Hopefully such tests will take place within the year on the materials being assessed for the Solar Sail program. In any event, it will appear reasonable to assume it desirable to provide an in situ technique to recoat the mirrors. A metal evaporator situated at each end of the boom normal to the mirror face should easily, periodically re-evaporate new coatings to both sides of the mirror surface in the ideal vacuum of space. In this way a much longer maintenance-free lifetime, depending only upon micrometeorite area removal and substrate degradation, will ensue.

Another lifetime which must be considered is that presented by the atmospheric drag on such a low ballistic coefficient-structure. As will be discussed later, a reasonable scheme to putting a mirror into space involves the placement of partially constructed structures into low Earth orbit (LEO), assembly or deployment for cluster-mirror size, and then solar sailing the mirror to final altitude. The latter avoids the development of new ion thruster vehicles and the requisite expenditure of fuel. However, the orbital decay because of atmospheric drag puts a lower limit on the altitude where this process may begin. For $\sigma = 6$ g/m², the ratio of drag force to radiation force is ~ 0.1 at 800 and ~ 0.001 at 1000-km altitude. Thus, if rapid

Deployment is possible, a starting altitude of 800 km appears reasonable. Because of the drag, orbit raising will then begin slowly, ideally reaching 1000 km in ~2 days, 5000 km in 23 days, and, if desired, geosynchronous orbit (GEO) of 35,800 km in 64 days.

Solar Sailing

As can be seen from the previous discussion, it is anticipated that solar radiation pressure will play a significant part in the solar mirror concept. For this reason, it is desirable to discuss the characteristics of this phenomenon. As predicted by Maxwell, electromagnetic radiation has been shown to carry momentum: The momentum density of the wave being given by $\vec{p} = \vec{S}/c^2$ where $\vec{S} = \vec{E} \times \vec{H}$ is the Poynting vector (watts/m²) associated with the wave, \vec{E} and \vec{H} are the electric and magnetic field components of the wave, and c is the wave propagation velocity. In general, the momentum imparted to a material will depend upon its absorption a and reflection b coefficients, where $a + b = 1$. Absorbed radiation will impart momentum in the direction \hat{s} of \vec{S} , while reflected radiation inputs momentum normal to the surface, along \hat{n} , as shown in figure 9. The corresponding forces will be

$$\vec{F}_{\text{abs}} = (aI_0A \cos \delta/c)\hat{s} \quad (14)$$

and

$$\vec{F}_{\text{ref}} = (2bI_0A \cos^2 \delta/c)\hat{n} \quad (15)$$

where A is the area irradiated, δ is the angle between \vec{S} and \hat{n} , and I_0 is the intensity of the incident radiation in watts/m². Clearly, these forces are small since we do not notice them in our daily experience. But they are finite (a few mg/m²) and become important when the area is large. Thus, if we consider an object with area mass density σ kg/m², and neglect absorption ($a = 0, b = 1$), the resultant acceleration is seen to be $u = (2I_0 \cos^2 \delta/c\sigma)$. For our mirror structure $\sigma = 6 \times 10^{-3}$ kg/m² and for an intensity of 1.4 kW/m² incident at $\delta = 45^\circ$, $u = 8 \times 10^{-6}$ m/sec². If we compare this with gravitational acceleration at orbital altitude h , $g = (g_0 + h/r_e)^{-2}$, we obtain $u/g = (2I_0 \cos^2 \delta/c\sigma g_0)(1 + h/r_e)^2$ which at an altitude of 10^3 km is only a maximum of 9.2×10^{-5} . For this reason, the orbit raising discussed above proceeds very slowly at the beginning of the process. In this regard, it can be shown that the maximum increase in altitude per revolution (neglecting drag) is very nearly obtained by rotating the mirror at one-half the orbital revolution rate. Then the solar force, averaged over one orbital period, is about one-half of the maximum attainable radiation force (i.e., for $\delta = 0$). The time necessary to attain a final altitude h_f , starting at altitude h_0 in a low thrust spiraling orbit can be shown to be, in this approximation,

$$\Delta t = [\sigma c (g_0 r_e)^{1/2} / I_0] (f_0^{1/2} - f_f^{1/2}) \quad (16)$$

Actually, because eclipsing of the mirror will occur for most orbits (except Sun synchronous) the orbit raising times will generally exceed this minimal value, in some cases by a factor of 2.

Control

Finally, another area needing study is that of pointing and tracking of such large structures in space and the resultant torques which must be exerted and energy expended in this task. For the intermediate Earth orbit altitudes, as discussed earlier, the mirror sweeps across the ground site in a fraction of an hour. Using the nomenclature defined earlier (see fig. 4) the mirror rotates in its orbit at altitude h with a period $P = 1.40 f^{3/2}$ hr, where $f \equiv (1 + h/r_e)^{-1}$, and constant orbital angular velocity $\dot{\phi} = 2\pi/P$. As this rotation occurs, of course, the mirror angle δ , measured between the incident rays of the Sun and the mirror normal, must vary so as to continuously reflect radiation onto the receiving station. This angle is related to the elevation angle θ by $\delta = \theta/2 + \text{constant}$, where the constant is determined by the position of the Sun relative to the orbital plane and the factor of $1/2$ arises because the angle of incidence of the Sun's rays onto the mirror equals the angle of reflection. The angle θ , measured relative to the horizontal, varies between 0° and 180° as the satellite moves across the sky. The elevation angle is related to ϕ by the expression

$$\phi = 90^\circ - [\theta + \sin^{-1}(f \cos \theta)]$$

and thus we have the necessary expressions to evaluate the angular velocity of the mirror, $\dot{\delta}(t) = \dot{\theta}(t)/2$, and angular acceleration $\ddot{\delta}(t)$. In addition we can evaluate the time t the mirror takes to move between θ_0 and θ . These rather complicated expressions will not be given here, however we can state some typical results.

At an altitude of 8000 km, $\dot{\delta}$ is of the order of 10^{-4} rad/sec while $\ddot{\delta}$ is of the order of 10^{-8} rad/sec². This appears to be a moderate requirement although one must be mindful of the very large structures involved. To avoid centrifugal loading it may be desirable to individually rotate mirror facets. This would also minimize the rotational kinetic energy which must be supplied by substantially reducing the mirror moment of inertia. On the other hand certain orbits and arrangements of ground stations may allow a simple integral, almost constant rotational motion so that after the initial investment of the large rotational kinetic energy, very little additional energy would be needed for fine-tuning the mirror angle.

The necessary pointing accuracy of the mirror can be assessed by noting that an angular deviation of the mirror $\Delta\delta$ produces a beam spot center motion of $\Delta r = 2h\Delta\delta$ on the ground. A reasonably tolerable beam spot center on the ground is $\Delta r/r = \text{constant}$, that is, for large receiver stations we tolerate larger (in absolute value) wander. Since the spot radius is $r = h(\alpha/2)$, we then obtain

$$\frac{\Delta r}{r} = \text{constant} = \frac{2h\Delta\delta}{(1/2)h\alpha} = \frac{4\Delta\delta}{\alpha}$$

Thus if the tolerable percentage error in the ground spot position is 10 percent, $\Delta\delta = 250 \mu\text{rad}$, independent of the mirror altitude. Further study will be necessary to assess the pointing accuracy attainable with such structures as those being considered here.

One concept that seems appealing, and needs further analysis, is the possible use of radiation pressure to effect mirror steering. Here one could imagine flywheels, as were shown in figure 8, of composite (low mass but high strength) material affixed to the extreme ends of three mutually orthogonal axes of the structure. The wheels could slowly be accelerated to nominal rotational velocity using radiation pressure before the mirror becomes operational. By braking action, rotational torques could then be applied conveniently to the mirror. Subsequent renewal of the flywheel kinetic energy would be made during a nonuse portion of the mirror's orbit around the Earth. If successful, such orientational techniques using radiation pressure could effectively negate the need for thruster fuel, a significant maintenance or initial payload problem associated with other power satellite schemes.

It should be noted, however, that radiation pressure, which heretofore has been used to advantage for orbit raising and mirror orientation, does present some potential difficulties. These are related to the facts (1) that the radiative force is proportional to the cosine of the angle of incidence of the solar radiation onto the mirror and (2) that in general, the Sun's rays will be at some constant angle relative to the plane of rotation of the mirrors. The first must be carefully assessed for any potential mirror configuration to assure that uncontrollable torques are not produced when the mirror slew angle is changed. There appear to be some simple methods to avoid this situation. The second radiation pressure effect mentioned can lead to a combination of drag, orbit raising, and orbit precession torques. In the special case of the Sun and mirror orbit being in the same plane, and the mirror being rotated to always direct the beam of radiation down normal to the Earth's surface, there is a net average radiation force per revolution acting on the orbit. This, of course, is the force used in orbit raising, as previously discussed. It can also be used to compensate for drag when using low orbit mirrors. However, it will in general lead to an ever increasing orbit radius unless properly compensated. One solution, which appears simplest, is to dedicate part of the mirror rotation cycle (perhaps when the mirror is in the southern hemisphere) to station keeping, namely, rotation of the mirror to provide compensating radiation pressure drag. A similar situation develops for the sunlight making a nonzero angle of incidence onto the orbit plane. In general, a torque will be produced which will precess the orbit plane. The analysis of this, and how to compensate or perhaps use it, is difficult, but Oberth (ref. 4) has concluded that it can be negated by appropriate mirror orientations during the unused portion of the rotational cycle.

An interesting possibility exists that such a precessional torque could be used to obtain Sun synchronous orbits, that is, those for which the orbit plane precesses with a period of one sidereal year and which, therefore, can be arranged so that the mirrors in these orbits are never eclipsed by the Earth. As discussed elsewhere, this presently can only be accomplished by

using the oblateness of the Earth as a perturbative torque on the satellite and the inclination of the plane of rotation must be carefully matched to the orbital altitude. This restraint may be removed if radiation pressure can be used to supply the precessional torque, thus, opening up many new continuous insolation orbit possibilities which are more attractive from the viewpoint of the desired small spot size and the surface location of the ground stations.

GROUND STATIONS

In considering the ground station requirements for receiving and converting the reflected sunlight, one must first assess the solar intensity available in both spacial and temporal dimensions. To increase the efficiency of conventional solar plants, they are designed to concentrate the incident solar radiation to increase the input to output temperature ratio of whatever heat engine is employed in the conversion process. Consistent with this it appears to be most cost effective to use a relatively high intensity from our orbiting reflectors. Such high fluxes would reduce the ground area requirement, the receiver equipment needs and it is also possible that intense beams would prove more penetrating in light cloudiness and fog situations.

Loss Factors I

A number of factors work to reduce both the intensity and total energy received at the ground station. An effective ground receiver must be optimized (design and location) to minimize these effects. Further, the reflector area must be increased to compensate for these losses. As some of these factors require considerable analysis and study, we can at present only point out the effects, their rough magnitude and some possible corrective measures.

1. A number of losses due to geometric factors and absorption, as described above, occur during the in-orbit collection, concentration, relay collection, all requiring an increase in mirror area to maintain a given ground-spot intensity. An analysis of the effect of imperfections, waviness and figure deviation in the mirror on ground spot intensity and continuity needs to be performed.

The orbiting mirror, in order to reflect directly to the ground station cannot be normal to the Sun's rays and thus it intercepts less than a solar constant intensity. The compensating size required is a function of the final design and orbit choice; and, is of lessened importance if some relay technique can be found. At worst (when the Sun is directly overhead, i.e., at noon) it appears that a secondary mirror, approaching the primary in size might be required to maintain a reflected solar constant input to the ground receiver. But, at times these could both serve as primary reflectors producing nearly two solar constants. Thus, the net effect on the energy received by the station may be roughly proportional to the area of the added secondary. As yet we have not determined the increased mirror area required to compensate for this factor. Fortunately, as shown later, in most scenarios the mirror and its transportation to operational orbit is a minor element in the overall system cost.

2. We have already mentioned the spot-size relation to mirror configuration and altitude and the limits on orbits. In general, the mirror will not be at the ground spot's zenith which will result in a beam path length longer than h and a spot size that is proportionally larger. The path length, S , for the beam can be related to the elevation, θ , by

$$S = (r_e^2 \sin^2 \theta + 2r_e h + h^2)^{1/2} - r_e \sin \theta, \quad (18)$$

where r_e is the Earth's radius. At 50° , roughly the time average elevation, this factor increases the path length of mirrors at orbit altitudes of 2000, 5000, and 10,000 km by approximately 20, 15, and 10 percent, respectively.

The minimum spot size for a flat reflector is $D_m + 0.0093S$. For a parabolic dish the optimum figure occurs when it is in focus for the distance at the average viewing angle. At higher angles the receiver is in front of the focus and for smaller angles, after the focal point. There is the possibility that with the parabolic mirror a controlled figure technique could be employed to fix the spot size during the reflector's arc over the station.

3. Except for zenith reflections, the beam from a round reflector will be elliptical (and rectangular from a square), elongated in the direction of the image source. This elongation will be equivalent to $1/\sin \theta$ and thus at our average mirror elevation a 1/3 elongation and dilution will be experienced. Obviously, it would be beneficial to mount our collectors normal to the ray source and actually track the mirror, as is done in the more efficient conventional type solar collection systems. However, as an assist in increasing the amount collected, this does not accomplish much since: (i) even the minimum beam is so wide that we can't construct beam normal collectors tall enough to significantly reduce the land area and fringe collector needs if we are to intercept the total beam. (It is true that such an arrangement can reduce the individual collector size and their area density but this would then leave holes when the reflector is near the zenith, losing energy in these periods. Nevertheless, depending on the ultimate design and conversion method, modified beam normal collectors may prove cost effective.) And (ii) it is likely that this system would be designed to collect energy, a high fraction of the time, from multiple mirrors at different vectors and during most daylight hours from the sun directly. Such multidirectional collection requirements greatly reduce the value of tracking collectors.

4. Absorption and reflection losses in the clear atmosphere allow transmission of only 64 percent of the beam at the zenith and 54 percent at a 30° elevation. This is direct light; there will be a diffuse contribution from low angle scattering that will increase these energy ratios by a few percent at the beam center.

5. Cloud cover seriously affects the amount of transmitted radiation because of water droplet scattering effects. Rough estimates of this effect can be determined from $1/2 \sin \theta$ which gives the insolation received, relative to clear days, for conditions of complete overcast as a function of elevation angle. This relates to lower altitude cumulus formations while cirrostratus clouds would have about half the effect and fog nearly twice as

great. This empirical relation for the Sun's radiation includes diffuse contributions and is certainly an upper bound for the beam value in the reflector case. As water does absorb 10 percent or so of the beam energy, there may be some hope of evaporating and thus, dispersing the otherwise interfering droplets, especially in the case of intense beams. It should be noted that the historical direct insolation data for a site is probably the most important factor in its evaluation. Sites can perhaps be selected where clouds will have about a 10 percent influence on reflector produced insolation. As the occurrence of clouds is independent of conditions 200 km distant, it is effective to establish a power grid containing several separate stations that the reflector would have a choice of powering, depending on local conditions.

6. Dust, smog, nitrogen oxides, and other pollutants act to either absorb or scatter the radiation. Again the avoidance of such areas is important in site selection.

7. The time of year will influence the insolation at the receiver station. First, the Earth-Sun distance causes a ± 3 percent variation in the amount of energy intercepted in orbit. Also, the Earth's equatorial inclination to the ecliptic produces significant differences in the daylight period and if the collectors depend on the ambient sunlight for some of their energy input, then a corresponding variation can occur. Lastly, there is an indirect effect in that the cloud cover over most areas is seasonally variable.

8. We saw that the Earth eclipsing effect on the orbit belt may shadow the mirror, on average, a small fraction of the time. Hopefully, this effect can be avoided by either the relay technique or by proper orbit selection. We will neglect this factor until further analysis can better fix its possible magnitude for a chosen orbit and ground station combination. If, for example, the relay technique which would greatly reduce space reflector needs does not prove viable then short term storage facilities would probably have to be installed at the ground station.

Site Selection

These are the principal factors acting to reduce the ground insolation and which influence mirror and station requirements. Proper site selection for the ground station can lessen the impact of some of these factors. A high desert area at the equator removed from pollution causing industrial/urban areas would be ideal. Unfortunately, since such areas are unattractive places to live and work, the power needs there are minimal. In this country maximum insolation is found in the New Mexico/Arizona region and here, land for large receiving areas would be relatively inexpensive. These advantages would have to be balanced against the transmission costs of power to the users. (The availability of inexpensive power and low land costs would eventually attract many industries.) If a central generating station for the whole United States were located in this area, it would be necessary to develop super-conducting, long-range power lines or go through an electrolysis energy conversion and pipe power as hydrogen. This latter option would be invaluable in damping the

input and demand difference problem discussed below. In selecting a site, consideration should also be given to ocean based stations. Although the construction costs at such a site might be higher, the acquisition cost would be low. Cooling water for a Rankine or Stirling cycle plant, for example, is abundant, the absence of land features provides a maximum horizon, airborne pollution could be low, and the station could be located close to population centers (e.g., off of Long Island). Studies should be made to see if cloud cover is a deterrent to such a sea-based endeavor.

Loss Factors II

Taking the above enumerated factors into account and assuming that we are using a fairly optimum ground site, what sort of reflector produced ground insolation can we expect and how will this influence the mirror and station design? In factor (7), the insolation variation due to changes in the Earth-Sun cannot be avoided unless the orbit height or mirror size is changed seasonally; however, this effect is small. Factor (8), because of the lack of proper analysis at this time and its apparently small contributions, will be neglected. Factor (6) with the proper site will cause minimum difficulties and (1) we will assume has been compensated for by relay, or primary-secondary combinations so that the final mirror is reflecting the equivalent of a solar constant for a mirror of diameter 0.0093 h. Factors (4) and (5), absorption and scattering, act to reduce the total energy. If the mean cloudiness is equivalent to complete cumulus overcast 15 percent of the time, then the two factors combine to transmit from 61 to 49 percent of the beam as the reflector moves from zenith to 30°. To compensate for this, the reflector size can be increased -- approximately doubled. Factors (2) and (3) act to spread the beam and reduce the intensity. The beam spread due to the mirror distance differing from the orbit altitude is given by $(S/h)^2$ and the elongation due to nonzenith elevations is $1/\sin \theta$, so, in order to collect all of the energy the atmosphere transmits requires a ground area of

$$\frac{(0.0093)^2 \pi S^2}{4 \sin \theta} \quad (19)$$

This relation varies by nearly a factor of 5 between the extreme conditions.

Since the intensity and energy inputs depend strongly on the elevation angle and altitude of the reflector, it is necessary, before proceeding further, to determine, at least approximately, what the reflectors' time averaged position, $\bar{\theta}$, may be. These averages vary depending on the orbit option chosen. There are four distinct situations (in each analysis we consider only those mirrors 30° above the site's local horizon): (1) For a geostationary equatorial mirror its elevation, $\bar{\theta}$, remains fixed for a given site latitude and can be determined from a rearranged form of equation (1), in which latitude is substituted for ϕ .

$$\theta = \tan^{-1} \left[\cot \phi - \frac{1}{[(h/r_e) + 1] \sin \phi} \right] \quad (20)$$

(2) For sites depending on a fixed equatorial or polar belt of reflectors the mean elevation is, to a very good approximation, the average of 30° and θ_{\max} . Where θ_{\max} is the highest elevation achieved and is the solution to equation (20) when L , the great circle degrees between the ground spot and the belt's nearest nadir (the spot under the point of apparent highest elevation), is substituted for ϕ . (3) For a site directly under a belt of mirrors which rise and set the mean, $\bar{\theta}$, is again from equation (20) but by substituting $1/2 \phi$ (i.e., $1/4$ of the cone angle) for ϕ . And (4) if the mirrors are in a family of iso-inclination orbits separated by equal longitudes, two subcases will exist. (a) At any given moment one mirror, the prime one, is on a visible path which takes it directly overhead and its average elevation will very nearly be that value found in situation three (it will differ slightly because the ground spot is now moving with respect to the orbit plane so the elevation period will vary slightly). And (b) recalling from the redundancy argument that on the average there will be more than just the prime mirror in view and in fact there will be $(N_1 - N_t)/N_t$ (symbols as defined in eqs. (5) and (6)). If these are random in our mirror viewing hemisphere (a somewhat flattened hemisphere because its origin is the Earth's center) then the $\bar{\phi}$ boundary bisecting our viewing area can be found from setting the ratio of the sphere areas, above $\bar{\phi}$ and above ϕ equal to $1/2$, or

$$\bar{\phi} = 1/2 \cos^{-1} [1/2(\cos 2\phi + 1)] \quad (21)$$

where ϕ is from equation (1) when $\theta = 30^\circ$. On solving equation (21), $\bar{\phi}$ is converted to the site's frame of reference, $\bar{\theta}$, by equation (20).

Table I presents six orbit examples encompassing these four situations and shows the average elevation for both the single or prime mirror cases and for the random mirrors, the latter as discussed in situation four. Additionally, the loss factors associated with the prime or single mirror, only, are also given. First, the energy transmission factor and then the ground spot area as compared to area for a zenith reflection. These values are used later to develop system costing.

Power Plant Design Criteria

Two problems are central to the design, cost and efficiency of the ground station; both are common to any solar energy plant. Ideally, the generating capacity of the plant should be slightly greater than the demand. The first difficulty making this ideal unobtainable is that the demand curve is quite variable, depending as it does on a mix of residential and commercial customers with differing power, air conditioning, and heating requirements on a daily and seasonal basis. The usual practice with power companies is to have a major energy source provide the base load and, at much higher rates, an auxiliary system to meet peak demands. Second, conventional solar conversion plants have the added difficulty of being tied to a very irregular fuel source. These plants are thus very cost sensitive to the need of using energy storage to provide power on a continuous basis. A plant using orbital reflectors for a solar source would always have some input — being minimal at night during

periods of heavy fog and maximum with the reflector directly overhead at the summer solstice.

Several techniques and options are available which will tend to ameliorate the problem of variable energy input in the proposed scheme. A major problem is the factor of three differences in the apparent reflected intensity between a mirror at zenith and at 30° elevation. First, the station may be made larger than the zenith projected spot-size requirement, so although the intensity still varies the collected energy remains more constant. Because of the cost of the ground receiver facilities, there are practical cost effective limits to this solution. (Beyond the cost-effective station range, one may make use of the spill-over, to, for example, enhance crop (fuel or food) yield or provide all-year recreation areas.) Second, a large number of reflectors, but with the same total surface area, would ensure that several were in view at a given period, thus averaging the intensity. As discussed in the orbital consideration section, even a system that is designed to have one in view will frequently have more. It may even be worthwhile to collect the radiation, although weak, coming from below the 30° elevation criterion. The weakness will be made up, in part, by the increased number and viewing times available. And third, since the satellite excursions are relatively rapid, the generating or steam plant connected to the receiver can be ballasted to produce an even output.

Unless the primary orbital collector/reflector is made very much larger than the ground receiver so that several or more solar constants are received, the normal Sun radiation (up to 0.7 solar constants) will contribute a significant and largely variant fraction of the total energy received. If a sizable portion of the plant load is not for air conditioning purposes, then much more energy will be received at noon or early afternoon than can be directly used. As peak demand often occurs at dusk, short-term storage facilities could be installed to better utilize this overage. Another option is the use of excess power from this noon period to generate hydrogen to meet long distance transmission needs or to use it simply as a portable fuel.

The design and even the type of solar conversion plant most compatible with orbital reflector delivered energy is at present unknown. Preliminary assessment shows thermal and photovoltaic conversion to be competitive in the present situation. Analysis of thermal conversion techniques using direct solar input shows the central receiver concept to be, currently, the most cost effective by a margin of at least 20 percent (ref. 8). In this concept a field of solar reflectors (heliostats) redirect the radiation to a cavity or boiler, situated on a high tower, which power a large heat engine. Such systems are predicted to operate at 25 percent overall efficiency (ref. 8). This system, along with others operating at similar efficiencies, employs two-axis tracking. As discussed above, tracking, if we have multidirectional inputs as is the case if the ground stations are at mid-latitudes, is of little benefit. (One should note, however, that the tracking ground station would be of clear value in the early stages of implementation, when only a few satellite mirrors are placed in an inclined belt. These few mirrors could be used to supplement

normal insolation at, say, dusk, or to lessen energy storage requirements in a conventional system.) Flat plate and nontracking systems are far less efficient. In these systems the collectors represent a major portion of the system cost. Because of this high fraction of energy-independent costs large cost reductions in \$/kWe are possible with the reflector system in which the average insolation is six times greater than in conventional systems. The photovoltaic option is quite attractive, both because of its predicted estimated costs and promised low maintenance. In this scheme, flat arrays would be used and direct energy conversion is achieved with a large reduction in the need for moving parts, fluids, plumbing, and other high-maintenance components. Two alternative devices are considered in the costing section: (1) the silicon solar cell with its ERDA projected costs and efficiency, and (2) the cadmium sulfide-cuprous sulfide "spray on" cell which has a present efficiency of 7.8 percent and quite low price.

ECONOMICS

The economic evaluation of the space-based reflector solar power concept as presented below is very preliminary. Two factors are responsible. First, the text was introductory in nature, not containing an in-depth analysis but merely presenting a number of technical options, suggestions, possible problem areas and scenarios related to the development of such a system. Optimization of the orbit possibilities, transportation options, reflector design, materials, structures and control, relay concepts and the ground station configuration requires a systems analysis of considerable magnitude, even to bound the problem. Second, even given the optimum system it is, at this time, impossible to cost the component items with certainty, since many critical areas are virtually unknowns — for example, future transportation and space operation costs are probably not known within a factor of 2. In the following discussion we have attempted to err on the conservative side and to deal with technology growth not breakthroughs.

Reflectors

It is assumed that the solar sail technology which is being developed for application to missions in the early 1980's will prove viable and materials of similar properties will be readily available and applicable for reflector use in the 1990 timeframe. This material, aluminized Kapton or Paralene with the necessary structural support and control, has an area density of 0.003 to 0.006 kg/m². We will assume the latter as a conservative number for this section. (Mylar or an even less expensive material would likely be employed in the present application which calls for differing thermal and lifetime properties than the solar sail application.) Based on information developed in a recent systems overview of the SPS, it appears that the hardware and

construction costs of such reflective materials, structural support and controls will be about \$1.50/m² (ref. 9).⁶

Transportation

It should be appreciated that to obtain equivalent ground bus power the mirror system needs about 1 percent of the orbital mass of the SPS. Therefore, the transportation cost per unit mass to LEO is likely to be somewhat higher than the amortized (development plus operations) transportation component costs for the SPS (ref. 9). Although the transportation requirements will be less in the present case they are still, in order to meet the world's energy needs, between 2000 and 2025, equivalent to 5000 flights of the present day version on the Shuttle. Clearly, the development of an SSTO (single stage to orbit) if not a HLLV (heavy lift launch vehicle) would be cost effective. This would probably mean \$55/kg to LEO compared with the SPS cost estimates of \$33/kg (ref. 9). Orbital transfer costs by TUG or shuttle OMS (orbital maneuvering system) to achieve elevations of 800 km might reasonably add \$30/kg to the system costs. At this altitude solar sailing (following deployment or construction) would be employed to take the reflectors to operational orbit. It is anticipated that the costs, due to the solar sailing option, will be fairly insensitive to the final operation orbit altitude. The transportation costs for crews and supplies would add about \$5/kg to the above. These total to a conservative estimate of \$90/kg, compared with the \$108/kg for the SPS to GEO. This payload cost equates to \$0.54/m² of reflector. As transportation costs are very sensitive to the areal density of the system, it seems prudent to provide an overrun factor and accept \$1/m² as a nominal value.

Ground Station

The central receiver configuration appears to be the most competitive terrestrial solar thermal-electric plant possible and requires capital costs of roughly \$1500/kWe, while the flat plate collector system, which may prove most optimum for reflected insolation, costs \$2000/kWe (ref. 8). With the reflected solar power concept presented herein, several significant reductions, overall perhaps a factor of 5, in these costs are likely. First, the expected average intensity is at least six times greater. Second, since the station will be several orders of magnitude larger than the conventional counterpart, the economics of mass production should prevail. And third, the necessary short term (overnight) energy storage in a conventional system can be responsible for about half of the total system cost — longer storage needs scale directly (ref. 10). Quite similar conversion costs are the goal of ERDA which has set a target of \$500/kWe in 1985 and hopes to reach a market price of \$100 to \$300/kWe by the year 2000 for efficient photoelectric devices — most likely silicon cells.

⁶The referenced report, prepared by Johnson Space Center, is a thorough evaluation of orbital solar conversion and microwave transmission systems. It is conservative in its analysis, relative to other studies in this area, and arrives at bus power costs for the SPS about double those given elsewhere.

Additionally, the CdS cell holds considerable promise for achieving low cost solar conversion. Following the analysis of DeMeo (ref. 11), it appears that shortly solar conversion ground stations for the reflector system could be built for \$300 to \$400/kWe. By 1985 technology is expected to double the efficiency of these cells, while achievements in other areas coupled with the truly large scale usage envisaged with the present concept would greatly reduce even these figures.

It appears from the above that there are two likely cost scenarios for the 1985 time frame for ground stations in support of the reflector concept. One leading to facility costs around \$400/kWe and probably based on thermal conversion, but possibly by the silicon photovoltaic. And, the other with costs of about \$200/kWe and derived from the CdS cell. We will employ both of these models in the system costing. In both models the cost may be conveniently divided into two elements; collection of sunlight and conversion (or conditioning in the case of the CdS) to bus power of the proper cycle and voltage. The following relations are used to derive ground system costs.

$$\text{Model 1 (thermal)} \quad \$25/\text{m}^2 + \$300/\text{kWe}$$

$$\text{Model 2 (CdS)} \quad \$30/\text{m}^2 + \$70/\text{kWe}$$

These costing models are simplified versions derived from reference 11 and use a 15 percent conversion efficiency and 1.65 kW/m^2 time averaged input (1.4 kW/m^2 reflected and 0.25 kW/m^2 direct solar insolation). The 15 percent efficiency is quite reasonable as it is much less than the 25 percent that could now be achieved with a thermal system using tracking with mirrors in a polar or equatorial belt, or fixed plates with a geostationary mirror cluster. On the other hand, if we are at a mid-latitude station and must use an inclined orbit belt with inputs from several directions simultaneously, 10 percent overall conversion may be the lower bound if technology does not significantly advance. Finally, as shown in the costing models, intensity is a strong cost driver which points to the value of using additional mirrors to produce higher concentrations of reflected sunlight.

Design, Development, Test and Evaluation

DDT&E costs encompass all funding from technology development until start of construction of the first reflector. For the SPS, this cost is estimated (ref. 9) to be \$50B. For the reflector system (station, transportation, and orbital construction facilities), because of much lower complexity and lesser transportation needs, DDT&E is expected to be at the lower part of a \$10 to \$20B range. However, as a conservative estimate, we will use the higher figure.

Operation and Maintenance

O&M costs for the SPS are estimated to equal 3 mills/kWe (ref. 9) and as a better analysis is lacking, will be accepted for the reflector system also.

As shown below for the optimal systems, this number is responsible for a large share of the power costs. Thus, its contribution must be carefully analyzed in the future.

System Characteristics and Investment

Table II presents estimates of system characteristics - size, power output and costs - for several different orbit options in accord with the previous discussions. In order to ascertain what the attendant costs might be for each orbit option, we first determined the total area of reflector needed to produce one added solar constant over a 0.0093h diameter ground spot and then what collector (ground station) area was required to intercept a substantial portion of this radiation -- for we have seen that the time averaged beam may be much larger than 0.0093h. Table I and its supportive equations and discussion answers these two questions. There are cost option mixes which will optimize the required reflector and station areas for each orbit but for the purposes of this initial comparison (and the complexities encountered when other variables are added later) we will do the following: The reflector area given in Table II is that needed to provide one solar constant over a $(0.0093h)^2\pi/4$ area, on average. It is based on the mean transmission efficiency of the single or prime plus random mirrors as described earlier. The total reflector area in orbit is the product of the cluster area and N. Thus, one or more mirror clusters of equal area provide a coincidental image at the station at a given moment which produce, when averaged with other mirror cluster inputs at other times of day, the requisite power. Due to beam spread, the intensity is less than I_0 . The ground area given is that needed to intercept roughly 2/3 of the beam energy or that found using the diameter 0.0093h, whichever is larger. The total area of all stations that could be effectively serviced by a single orbit option is the product of the individual area and N_c . Generated power, in gigawatts for the single station was determined from the average reflected and direct solar incidence on the station, assuming a 15 percent conversion efficiency. Investment capital required was derived from the cost per unit area and unit output power relations determined earlier. The hardware, construction and transportation costs for the reflectors are totaled as the components are relatively invariant with orbit choice - transportation is 40 percent of the total. It should be recalled that all the satellite reflectors are required for a given orbit choice whether one or all the stations are put into operation.

Power Costs

Table III presents cost estimates of the various components using four orbit options as examples. Capital recovery data was generated from equation (22) assuming 15 percent return, 30 year lifetime and a 70 percent plant (load) factor.

$$\left[\frac{r'}{1 - \left(\frac{1}{r' + 1}\right)^y} \right] \frac{C}{E} = \$/kWh \quad (22)$$

where r' = rate of return, y = lifetime in years, C = capital costs in dollars, and E = power output in kWh/yr. DDT&E dollars were not discounted but spread over the power produce by a given option in a 30-year life. Costing is provided for both the single and complete ground station situations. Total costing is given for the four possible cases - for single and multiple receiver stations and thermal and CdS photovoltaic conversion - for each orbit where they are applicable. The inexpensive photovoltaic conversion option and full station use produce about equal benefits, each reducing power costs by about 5 mills/kWh. And, because space reflectors appear to be a low cost element in the analysis, ground station improvements are the drivers for reducing power costs. Since present baseload power generating facilities (fossil and nuclear) have bus costs ranging from 12 to 30 mills/kWh, the present concept is more than competitive, as is shown by figure 10. The projected cost range of the various options developed from the orbiting reflector power concept is presented on this figure, taken from reference 9. To put the data illustrated here in context the reader needs to realize several points. First, by around 1990 gas and oil, due to their scarcity, will only be available for electrical power generation at large premium costs. Second, because of expected further social resistance, it is likely that coal- and nuclear-powered plant costs will continue to escalate at several times the rate exhibited by capital, construction, and manufacturing costs - making the advanced systems considerably more attractive (ref. 9).⁷ And third, the cost range shown for conventional plants are for those presently in operation, newly installed facilities give overall costs at the top or above each range. Figure 10 presents the present concept in a very attractive light relative to other alternatives and to be fair, we must again stress the one great potential disadvantage, that is, the orbiting reflector power system can only apparently be optimally established on a large scale. Its greatest potential is realized when all possible ground stations, for a given orbit, are installed. As such, we are speaking of large quantities of power, enough to meet new generating needs for many years. Nonetheless, we must not forget that the capital investment necessary to purchase this large capacity is great (see fig. 11). Since this fact is especially true for the high orbit options it is expected that the lower orbit cases will enjoy an initial advantage even though their unit power cost is somewhat greater.

Selecting one orbit option, 4000 km and 40° inclination, figure 12 provides some cost sensitivities as a function of the development scenario selected. This orbit is chosen from among those of Tables II and III because it provides a reasonable balance between investment and power costs and could provide a majority of the world's electrical needs in the year 2000. Additionally, it is at an inclination which would service the United States as well as most of the other developed nations (i.e., the power users). The area of the "pies" represent unit power costs while the slices indicate contributions from the various cost elements in each scheme. Four of the options shown are from the Table III material and illustrate the reduced costs possible from improving the baselined (solar thermal and a single ground station) system. It is clearly shown that in most cases the cost stemming from the

⁷In passing, it should be noted that the reflector technique, by increasing ocean insolation, can remarkably enhance ocean thermal power perspectives.

ground station is of overriding importance. Thus, ground station improvements even at the expense of increased mirror sizes are probably effective. The last pies show the result of increasing the area of the mirrors in orbit by a factor of 5 - producing about five solar constants, average, to the ground station. The results are beneficial because: (1) power output is five times larger, thus keeping the unit power costs for the mirror and transportation elements about constant, and (2) at the ground station we are, basically, only increasing the energy conversion cost component - not all the collection elements.

APPLICATIONS

It is not the purpose of this report to investigate all of the possible uses of this system which provides solar energy with average high intensity and with minimal diurnal variation. Some possibilities are shown in figure 13. Such uses of solar energy are nicely delineated in a recent book (ref. 12) and include processes which are in use, such as water distillation (desalination) and heating, crop drying, water pumping, heating and cooling of buildings, and those of a more limited usage such as small scale electric power generation, bioconversion into fuels and chemical feedstocks (alcohol, etc.) and industrial process heat. It is generally true that most of these processes could be enhanced by the space mirror system; however, this usage would need to be economically justified when compared with possible large scale electric power generation. One should note that since reflecting area is much less costly than ground power stations, many other applications may be quite attractive.

It is interesting to note, however, that the usage for electric power generation does not necessarily preclude the above applications which can use low temperature heat. Thus, if a number of national energy facilities were located throughout the country, with the primary purpose of "solar farming" the radiation for electrical output, these would in general reject ca. 50 to 80 percent of the incident energy because of the electrical or thermal inefficiencies of the conversion process. Rejection temperatures of high temperature cycles could easily exceed 150° C, thus providing the surrounding communities and industries, which will surely locate near these facilities, with the energy source needed for a community scale total energy system. In addition, the "overload" of electrical energy produced during low electrical demand periods, could well be stored by hydrostorage (pumping reservoirs) or electrolysis of water to produce hydrogen.

There are other applications of a more novel nature in which the mirror system could be applied. Oberth (ref. 4) has discussed some of these such as providing artificial illumination of large metropolitan areas or disaster areas at night. It should be noted, with respect to the recent severe winter and the corresponding shortage of heating fuel, that continuous insolation could also possibly be used to increase the temperature of certain regions. Of particular import may be the prevention of frost on expensive or important crops such as citrus groves, etc. Oberth has suggested the practicality of irradiating frozen navigational waterways; again, this concept must await an

engineering and economic analysis. Water evaporation from the oceans is also a real possibility, thus providing, at least on a local scale, the necessary clouds to provide rain. Alternatively, local heating of the atmosphere may be capable of dissipating high pressure regions which prevent the flow of such naturally occurring moisture from the oceans to the drought area.

It is obvious that some applications mentioned will not survive scientific and economic studies, failing for example because the number of mirrors necessary to achieve the requisite intensities or spot size are unrealistic. However, the point to be made is that the mirror system can be used in a number of useful ways, whereas the normal SPS microwave system can only generate electricity. There are many nations in the world which do not have the insatiable demands on electric power made by the industrial countries. Their needs are more basic: food, desalinated water for drinking and irrigation, and fertilizers. It appears reasonable that the mirror system can provide such items, by extending the insolation period on crops, solar distillation and pumping of water, and perhaps the production of nitrogen compounds, while the mirrors are over these countries. Simultaneously, the companion mirrors can be producing the (exportable) commodity: electrical power for the industrialized nations. It is this multiple use which is unique and attractive with the orbiting mirror system. Further study will be necessary to fully assess the benefits mankind may derive from it.

Incremental Approach to Total Mirror System

This brief discussion on applications should also include some relevant considerations on the time ordering of such application arising from the incremental implementation of such a large system. Clearly the first mirrors placed in space will be used for proof-of-concept studies - to ascertain the technology readiness - and will therefore serve no "external" need. However, as mirrors are added (see fig. 14) definite use can begin before complete system deployment. The first of these would appear to be those not associated with electrical production but rather providing low level artificial illumination or meeting agrarian needs. Because of the capabilities of solar sailing, it should be appreciated that opportunities exist for moving the mirrors into different configurations for different tasks as time progresses. For example, providing continuous illumination would likely use a low reflector density above the Earth's surface. However, these mirrors could then be brought together to a composite cluster or focussing satellite mirror for the possible task of supplying higher insolation to an existing ground thermal station for a short period of time. This may be useful for simply extending the effective energy collection time of the ground station near dusk; a peak load period for the power grid and a time during which contemplated, conventional solar installations must rely solely on stored energy. If the single mirror orbit is chosen properly, it will be possible to effect this dusk or peak-load-following insolation to a number of stations around the world sequentially in synchronism with the terminator. The flexibility inherent in this system as a result of solar sailing, making mirror spacing and altitude (or orbital period) changes possible, is hence a system virtue opening many possible interim uses. Such possibilities have barely begun to be explored and need further study.

Of course the major cost factor in the system — the solar farm — can also be incrementally implemented. The reasonable approach here seems to be that of installing small farms on the outer edges of the useful illuminated ground spot. This allows most of the radiation to impinge unused on the central region but, if suitably located, this "power grid" would probably ensure the nonsimultaneous obscuration of all farms by clouds. As revenues are accumulated, of course, the expansion of these farms, possibly using more advanced conversion methods which were developed in the interim, could be made inward to completely use the available radiation.

The efficacy of completing a single large U.S. ground station, of course, will have to be carefully assessed with respect to electrical transmission losses, the reliance on a single, vulnerable power source for much of the nation's power needs, etc., but in principle this would constitute the next step on the ground. This would simultaneously be accompanied by an expansion of the number of mirrors to the full complement of N satellite mirrors corresponding to the orbit desired.

Finally, the full complement of ground stations would be installed, again very likely at a rate consistent with revenues obtained by the sale of power from the earlier stations. Using nothing more than reasonable guesses at this point in our investigation, the possible dates associated with the series of incremental steps outlined above have been shown in figure 14.

ENVIRONMENTAL IMPACT

As with any technological system of the magnitude of the solar mirror scheme, a critical assessment of its environmental impact must be made. We have begun this task and report here on some crucial areas; others will undoubtedly be discovered. Our conclusion is that there appear to be no major environmental impediments.

In such an assessment it is well to consider both the positive environmental impacts as well as the negative counterparts. Certainly the main system output will be electrical power, although as mentioned above, other beneficial outputs are possible. Hence, the first positive effect will be to conserve fossil fuels which are currently used for electrical power generation. In addition, if the system is large enough, such power may well be used for other applications, such as in transportation, where, again, fossil fuels are presently the only economically viable option. Conservation of fossil fuels would also occur if some of the system were devoted to direct thermal heating, such as for desalination of water, crop frost prevention, the enhancement of rain, or the production of chemicals.

On the negative side, however, the questions of (1) solar heat input, (2) disturbances to the ionosphere, (3) atmospheric photochemistry, (4) land usage, (5) light scattering, and (6) continuous insolation all must be considered.

It is frequently stated that, despite the inefficiency of solar farming techniques, the rejected heat is not an added burden to the Earth's ecosystem since the solar radiation would have deposited that energy on the equivalent area anyway. One must be cautious here, however, since (1) the albedo of the area has been modified (dark solar panels), (2) the rejected heat is now in a concentrated form, and (3) we are here considering a system to bring down solar radiation which would not usually reach the earth. To the first problem we must consider the global scale involved. Even the largest area mirror system considered here (GEO) uses a total ground area of 8.7×10^4 km². This must be compared with the total area of the Earth: 5.1×10^8 km². In addition, other larger areas are now artificially altered — the cultivation of soil in the agricultural regions of the world — without apparent significant albedo-related effects. However, and this is connected to the second possible problem, the existence of large national energy facilities or solar farms, could possibly influence the heat balance locally. As indicated earlier, a properly engineered facility would make use of the rejected heat for community power systems — thus dispersing the energy concentration. Finally, the third question again appears to disappear when considered on a global scale, if effective dispersal is made.

Possible disturbances to the various "-spheres" of the Earth's atmosphere have not yet been analyzed. Again, two facts would appear to obviate problems. Firstly, the transmission of sunlight through these layers is nothing new — it occurs naturally. Secondly, it is again a matter of global scale — assuming no nonlinear effects, this should be a negligible contribution to the average temperature, etc. of these layers. One concern, the possible deleterious effect of removing certain molecular species from the region of the transmitted beam and thus allowing a larger fraction of the ambient sunlight to pass through this region and reach the Earth, is not troublesome. In fact, the best estimates are that the rate of ozone production would be enhanced by the mirror system, thereby making a positive (albeit small) contribution to environmental quality.

The question of land usage is a serious one. In all likelihood the desert regions of the world would be the most advantageous sites. However, if the larger spot sizes discussed in this report (for GEO) were used, it has been estimated that a minimum of 50,000 people would be displaced in any region selected in the U.S. for the solar farm. As discussed earlier, it appears reasonable that the lower orbit schemes would be used, thus demanding little displacement for regions in the Southwestern U.S. and Mexico or possibly allowing the sites to be located over existing water masses. The latter scheme seems, in fact, to be an ideal location based upon other considerations for the technical operation of the solar farm. A typical spot size in this case would roughly occupy the area of the Salton Sea in California. As has also been pointed out, the present increasing area of the world's desert regions, due in part to a lack of irrigation water, could possibly be halted by use of the mirror system. We can, perhaps, look at the desert or over-water area usage of the solar farm as the initial investment on conserving land in the long run. Of course, it is very likely that some displacement of people will be necessary. This unfortunate fact will have to be balanced against the

environmental gains the system provides and, in particular, the long-term continual supply of energy to them and their descendants.

Finally, the general area of light scattering will need careful study. Particulate and Rayleigh scattering of the transmitted beams may lead to the observability of these beams in the night sky even though the observer is many miles from the ground receiver station. A general "night glow" could possibly develop. The seriousness of this would, of course, be a subjective matter. Those living in the northern regions of the Earth have, in fact, lived comfortably with six months of even more intense perpetual daylight per year. It would not appear to be a serious psychological problem to most of us based upon this experience. However, to the astronomer this may indeed present an insurmountable obstacle to his research! Hopefully, study will prove this concern not to be real. But if it is, and the project is carried out, it may necessitate a large scale use of space-based telescopes for the future endeavors of this scheme.

CONCLUSIONS

We have attempted a preliminary assessment of the solar mirror system; its various orbital options, technology needs, uses, environmental effects, and economics. The commitment of the nation, or the world community, to such a means toward ultimate energy self-reliance would be a major undertaking. As such, we should not end this report before considering some of the salient points of comparison between this concept and the other solar alternative - the SPS.

It was shown that the costs of power derived from the reflector system could be much less than that from current fossil and nuclear sources. It also appears that such costs will be 10 to 50 percent of that envisaged with the SPS designs to date. (A similar advantage is shown over other popular advanced systems - wind, conventional ground solar thermal, and ocean thermal.) Further, although the initial investments for the minimal systems (DDT&E, one station and the required satellites for the respective systems) are nearly equal, the reflector system has the edge since it would generate several times more power, thus decreasing the payback period. Also, once the mirrors are in place for the first station, power costs from further stations are much less. It was mentioned that besides producing power the subject system could even be used to improve the environment while the necessary SPS microwave power relay may cause problems. The SPS is only an interim solution to our energy needs since it can provide only several TW to the U.S. due to filling of GEO equatorial belt (other countries in our hemisphere may also demand space in this prime region). One of our reflectors at that orbit could provide 16 TW and leave room in that orbit for many others. Additionally, there are many other orbits available for use with the reflector system. It is of interest to also compare the technical requirements of the reflector system with the SPS. Although both systems require advanced transportation, the traffic demands of the reflector are about 100 times less. Thus, much reduced R&D is required in this area. It does appear that more difficulties will arise with

the mirror concept in the areas of tracking, pointing, and station keeping, which will require advance technology to overcome. The solar cell SPS system requires a two to three order of magnitude reduction in cell prices to make its system economical, attractive while the mirror system could actually use state-of-the-art reflectors. This point has additional importance since the error in coating the reflector system is likely to be much less. At this time structural requirements, simply because they haven't been studied, appear more formidable in the reflector case. In balance it appears that power could be derived from the reflector system at least 5 years prior to that of the SPS simply because the technology is much more in hand.

Of course, as can be seen in a recent interesting book (ref. 12), the history of solar energy usage is filled with the ultimate condemnation afforded each attempt: it is too expensive. In general, the cost of work produced by a solar process is a factor of five over its counterpart fossil fuel alternative. It is frequently stated that this ratio will decrease when the cost of fossil fuels increases; however, since labor and materials costs are closely coupled to fuel costs, the cost of solar systems also rise proportionately. Only when solar techniques become the dominant source of energy and supply, such as would be the case if the solar mirror concept were adopted, will this correlation fail.

If one searches for the more obvious reasons for this excess cost of solar generated power, one finds it intimately tied to the "diluteness" or low solar energy content per unit area, its variation in incidence direction, and its temporal variation. The latter allows few hours per day during which energy may be profitably used and, more important economically, demands expensive thermal storage to prevent the loss of this energy at night. All of these factors lead to (1) low (when compared with fossil fuel driven processes) cycle efficiency and (2) rather large and elaborate opto-mechanical structures. Both combine to give not only a capital intensive system but also one which produces power at costs which are higher than alternative sources.

Our intent here was to make a first assessment of the impact of the solar mirror system on this rather bleak picture. Could it provide higher intensities and less temporal variation consistent with reasonable cost? Could it be effected with present or very near term technology? Finally, would it be environmentally, as well as economically, attractive, especially when compared with other near-term energy solutions?

Obviously, the ultimate answers to these questions will depend upon more complete studies. Crucial technology areas have been delineated to the best of our knowledge, but others may be found. The development of a suitable scheme for relaying energy from mirror to mirror would have a profound effect on the system, especially upon capital investment. It is our belief that the techniques of using radiation pressure for orbit raising, station keeping, and mirror pointing may allow not only substantial cost reductions but also initial and operational energy investment savings as opposed to the SPS which must use propulsive fuels. Finally, a detailed study of the benefits (complexity reduction, increased efficiency, lower costs) which may accrue for solar farms

when they can operate with this effectively new source of solar radiation should be illustrative and sharpen an assessment of the solar mirror concepts.

In spite of some uncertainties at this time, we believe the technique outlined here appears feasible with near-term technology, is cost competitive with alternate sources, and it provides an abundance of energy sufficient for our foreseeable needs. In addition, it has the unique possibility of alternate use for needs other than the generation of electrical power.

ACKNOWLEDGMENTS

The authors wish to acknowledge and thank the many administrators and scientists who have given enthusiastic and time-consuming assistance to the authors during this study and the subsequent preparation of this report. Foremost among these is Dr. Hans Mark, Director, Ames Research Center, who originally proposed a study of SPS technology alternatives to one of the authors (KWB) and has offered much constructive criticism. Dell Williams III has also supported the study and urged the assistance of the second author (WPG). Byron Swenson has been extremely helpful in guiding us along the correct path in orbital mechanics. A large number of others have supplied useful criticism, and in some cases calculations. Among these are R. T. Jones, R. Machol, W. Boruki, J. Parker, C. Coe, H. Lum, F. Mascy, E. DeMeo (EPRI), A. Meinel (University of Arizona), and many of the members of the Materials and Physical Sciences Branch at Ames. We must indicate that, in spite of this excellent assistance, errors and misconceptions may yet remain and are the fault of the authors.

REFERENCES

1. Glaser, P. E.: Power from the Sun: Its Future. Science, vol. 162, Nov. 1968, pp. 857-886.
2. Arthur D. Little, Inc.: Feasibility Study of a Satellite Solar Power Station, NASA CR-2357, NTIS N74-17784, February 1974; ECON, Inc., Space-Based Solar Power Conversion and Delivery Systems, NASA/MSFC Contract No. 8-31308.
3. Ching, B. K.: Space Power System - What Environmental Impact? *Astronautics and Aeronautics*, Feb. 1977, pp. 60-65.
4. Oberth, H.: *Wege Zur Raumschiffahrt*, published by R. Oldenbourg Verlag, Munich-Berlin, 1929 (*Ways to Spaceflight*, NASA Technical Translation, TTF-622); *Man Into Space*, Harper & Brothers Publishers, New York, 1957.
5. Boeing Aerospace Company: Systems Definition, Space-Based Power Conversion Systems. NASA/MSFC Contract NAS8-31628.
6. Ehricke, K. A.: Space Industrial Productivity, New Options for the Future. Presentation to the Committee on Science and Technology, and the Subcommittee on Space Science and Applications, Hearings on Future Space Programs, July 22-30, 1975.
7. O'Neill, G. K.: Engineering a Space Manufacturing Center. *Astronautics and Aeronautics*, October 1976, pp. 20-36; O'Leary, B.: The Construction of Satellite Solar Power Stations from Non-Terrestrial Materials, AIAA Paper 77-354, Washington, D.C., January 10-13, 1977.
8. Caputo, R. S. and Truscillo, V. C.: Solar Thermal Electric Power Plants: Their Performance Characteristics and Total Social Costs, Paper No. 769213, Eleventh Intersociety Energy Conversion Engineering Conference Proceedings, pp. 1216-1223, IEEE, New York, 1976; Woodcock, G. R.; and Gregory, D. L.: Ground-Based Solar Energy Technology Advances, Paper No. 759092, Tenth Intersociety Energy Conversion Engineering Conference Proceedings, IEEE, New York, 1975, pp. 607-612.
9. Initial Technical, Environmental, and Economic Evaluation of Space Solar Power Concepts, vols. I and II, JSC-11568, NASA/Lyndon B. Johnson Space Center, August 31, 1976.
10. Private correspondence with Professor Aden B. Meinel, Optical Sciences Center, University of Arizona.

TABLE I.- CHARACTERISTIC MEAN REFLECTOR ELEVATIONS
AND ASSOCIATED LOSS FACTORS

Orbit		Random mirror	Prime mirror		
Altitude, km	Inclination, deg	Elevation, deg	Elevation, deg	Transmission efficiency	Image area, relative
2,000	40	43.00	54.07	0.55	1.68
4,000	40	44.92	55.96	.56	1.50
10,000	40	47.55	57.92	.56	1.33
35,800	0		52.75	.55	1.34
2,000	0		54.13	.55	1.67
1,400	101.43		34.48	.50	4.00

PRECEDING PAGE BLANK NOT FILMED

TABLE II.- COMPARISON OF REFLECTOR POWER SYSTEM CHARACTERISTICS

Orbit		Mirror clusters	Ground stations	Bus power	Capital costs, \$ Billions	
Altitude, km	Inclination, deg				Each ground station	N clusters
2,000	40	54	24	48	14	30
4,000	40	27	11	185	52	56
10,000	40	9	5	1,170	285	165
35,800	0	1	1	16,250	3750	395
2,000	0	7	7	46	12	8.6
1,400	101.43	19	2	41	13.5	12.6

^aDDT&E amounts to an additional \$20B.

TABLE III.- BUS POWER COSTS OF ORBITAL SOLAR REFLECTOR SYSTEM, MILLS/kWh

ORBIT	4000 km,		10,000 km,		Geo sync equat.	1400 km polar,		
	$i = 40^\circ$		$i = 40^\circ$			sun sync		
	Ground stations used	1	11	1	5	1	1	2
<u>Component</u>								
Reflectors and transportation	7.5	0.7	3.5	0.7	0.6	7.6	3.8	
DDT&E	0.6	---	0.1	---	---	2.6	1.3	
O&M	3	3	3	3	3	3	3	
Receivers solar thermal	11.8	11.8	11.0	11.0	10.8	12.7	12.7	
Photovoltaic, CdS	7.0	7.0	6.0	6.0	5.7	8.2	8.2	
<u>Totals</u>								
Thermal	22.9	15.5	17.6	14.7	14.4	25.9	20.7	
Photovoltaic	18.1	10.7	12.6	9.7	9.3	21.4	16.3	

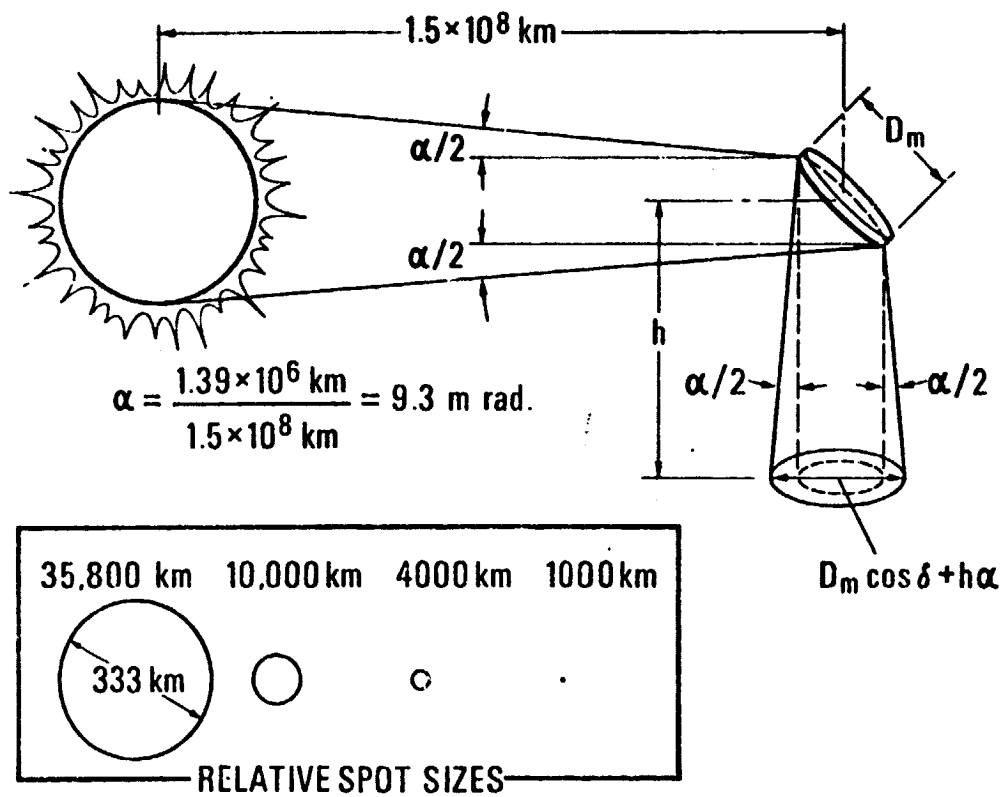

(a) Illustrates the angular subtense of the Sun and its effect on spot size with a nonfocussing (planar) mirror.

Figure 1.- Limitations on the minimal ground spot size arising from the angular size of the Sun.

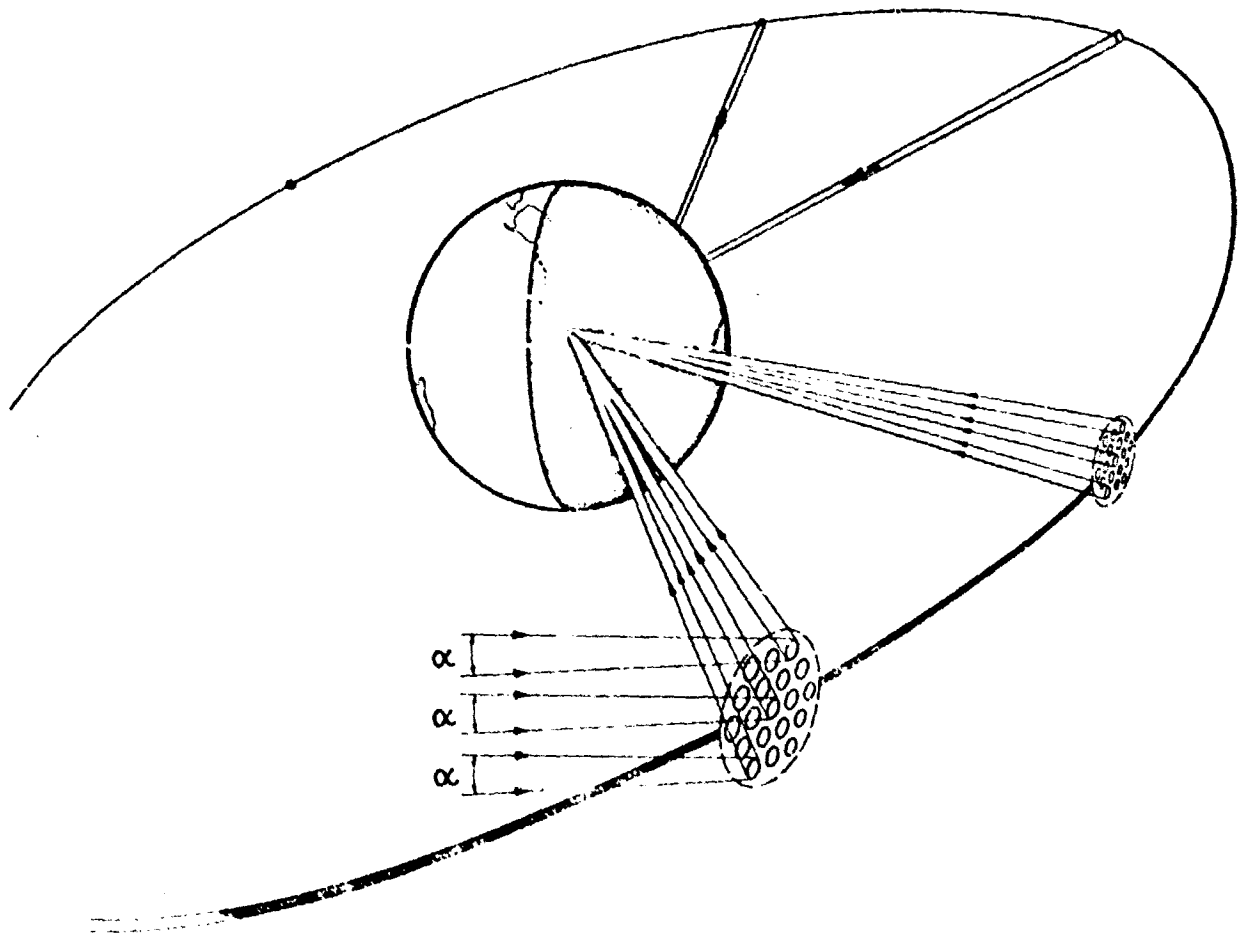

(b) Illustrates how a focussing mirror can be simulated with an array of properly positioned and oriented mirrors.

Figure 1.- Concluded.

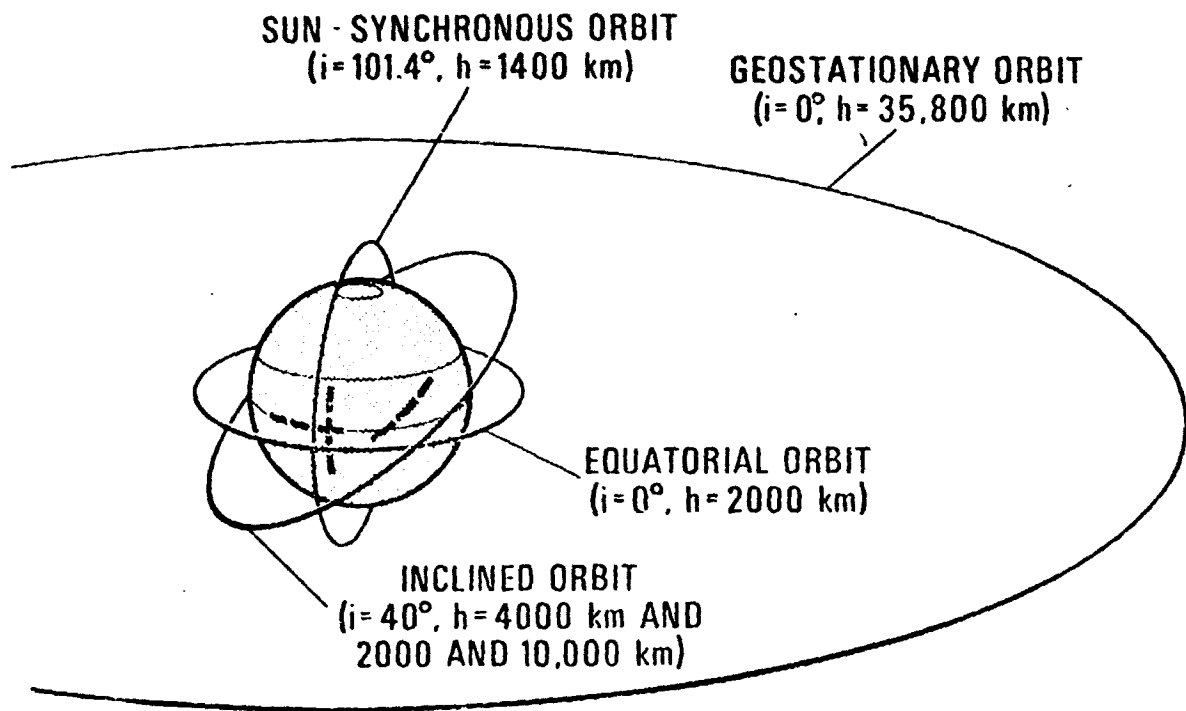

Figure 2.- Orbits examined in this report. Dashed lines indicate partial radial projections onto Earth's surface. For clarity, the geostationary orbit size is shown below scale.

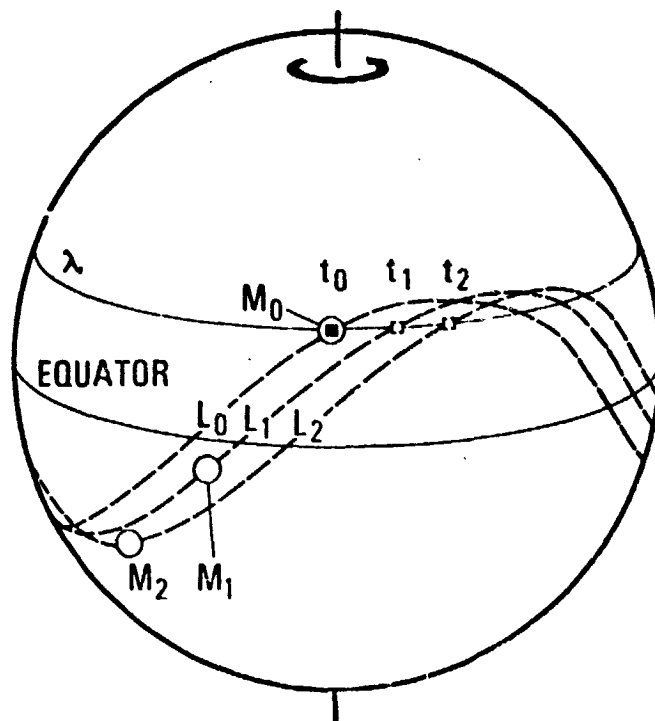

Figure 3.- Ground trace of three equi-longitude (L_0 , L_1 , and L_2) iso-inclination orbits in view hemisphere, each containing a satellite mirror M_0 , M_1 , and M_2 , respectively. Mirror locations shown at time, t_0 and staggered so that a ground station at latitude λ will be intercepted by M_1 at t_1 , M_2 at t_2 , etc. Proper integer orbits insure mirror passage through station's zenith twice daily.

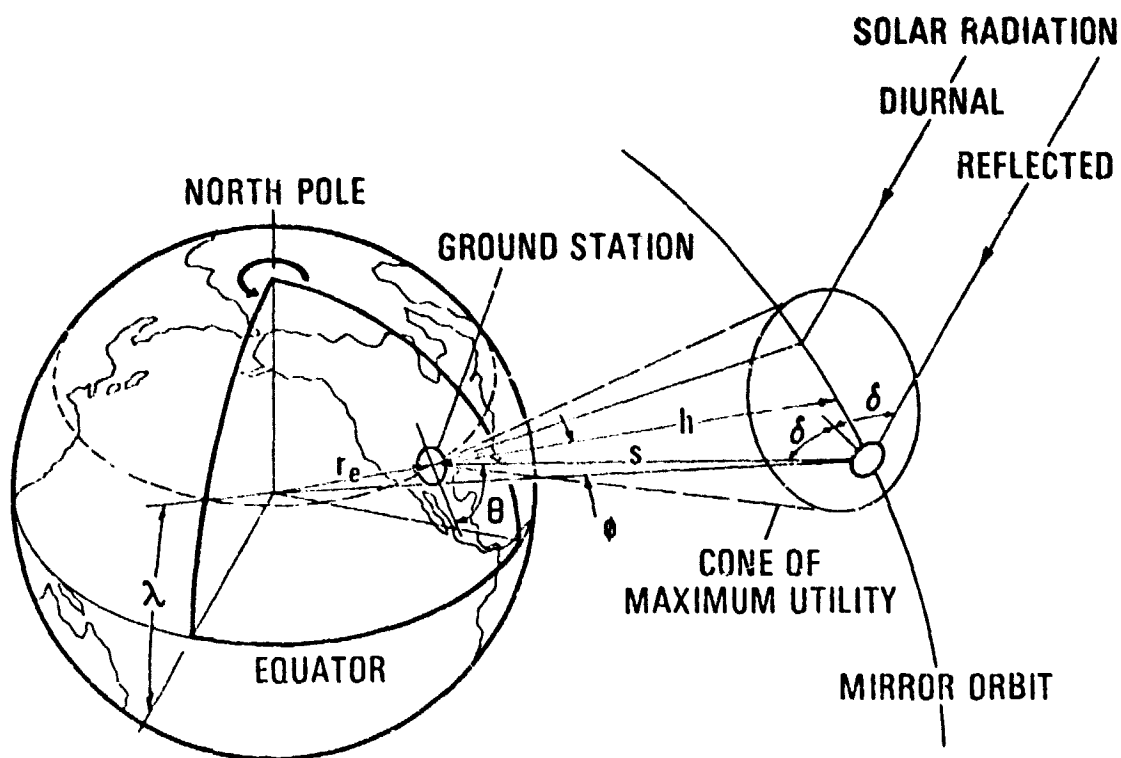

Figure 4.- Orbital geometry. The satellite mirror is described by distance coordinate $r_e + h$ and angle coordinate ϕ measured from the center of the Earth. Corresponding coordinates measured from the ground station, situated at latitude λ , are S and θ , respectively, where θ is measured relative to the local horizon. The orbital altitude, measured from the Earth's surface is h . A cone of maximum utility (defined in the text) is shown; it is characterized by a viewing elevation angle $\theta = \pm |\theta_{\min}| = \pm 30^\circ$ in this report, and a corresponding angle ϕ_m which is a function of θ_{\min} and h .

- 3 hr PERIOD
- 4185 km ALTITUDE
- 45° INCLINATION

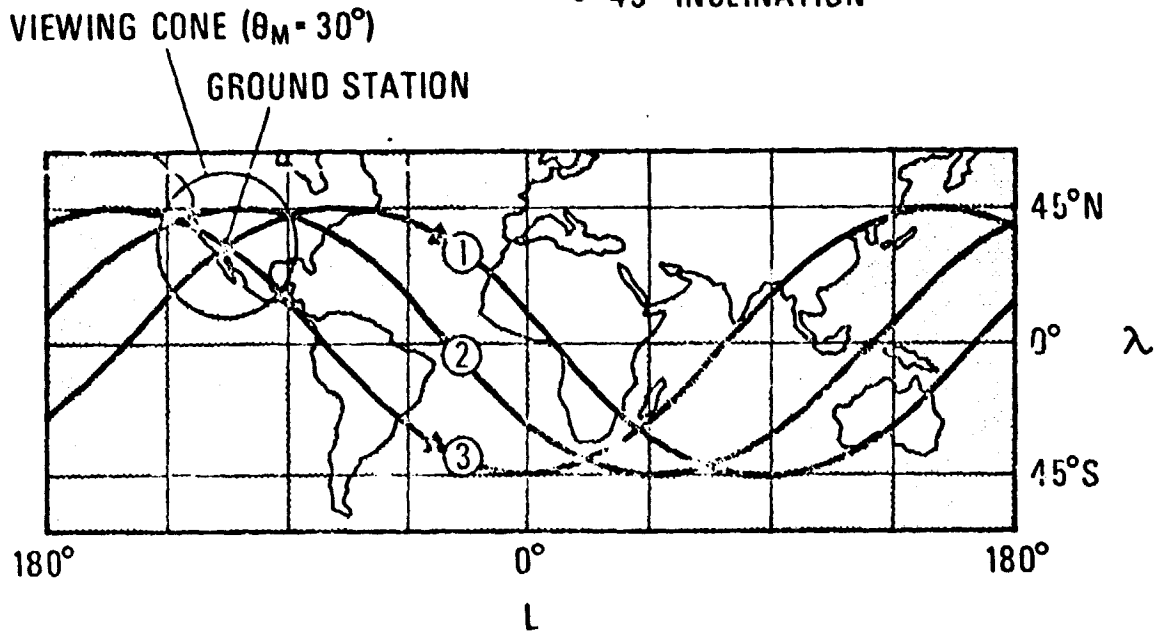

Figure 5.- Ground traces from three successive passes of an integer orbit mirror with a three hour period (45° inclination and 4185-km altitude). As shown, in a 24-hour period, three of the eight orbits will be in view of the ground station and two will pass through its zenith.

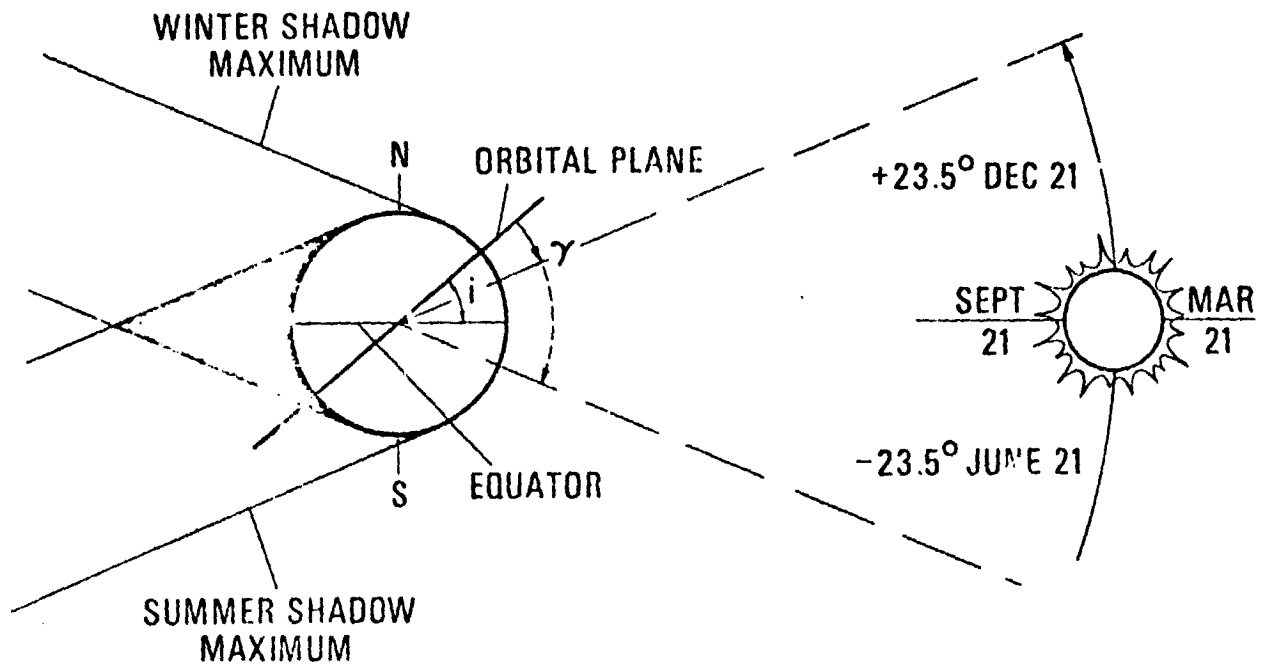

Figure 6.- Orbit relations to Earth and Sun with Earth reference showing apparent seasonal movement of the Earth-Sun line causing the orbit angle γ to change resulting in various fractions of that orbit being eclipsed by the Earth. The orbit inclination, i , to the equator is, to a first order, fixed.

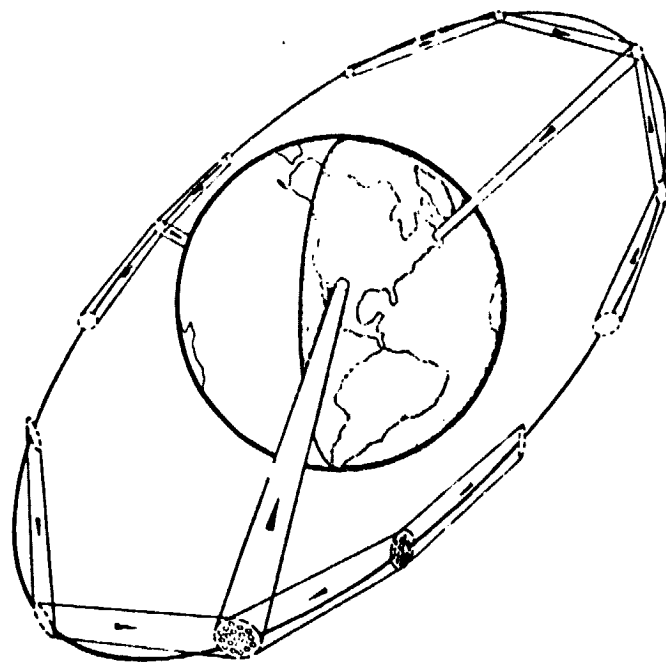

Figure 7.- Relay mirror concept, allowing full utilization of all mirrors for a limited number of receiving stations and a possible reduction in individual mirror size and total system mirror area.

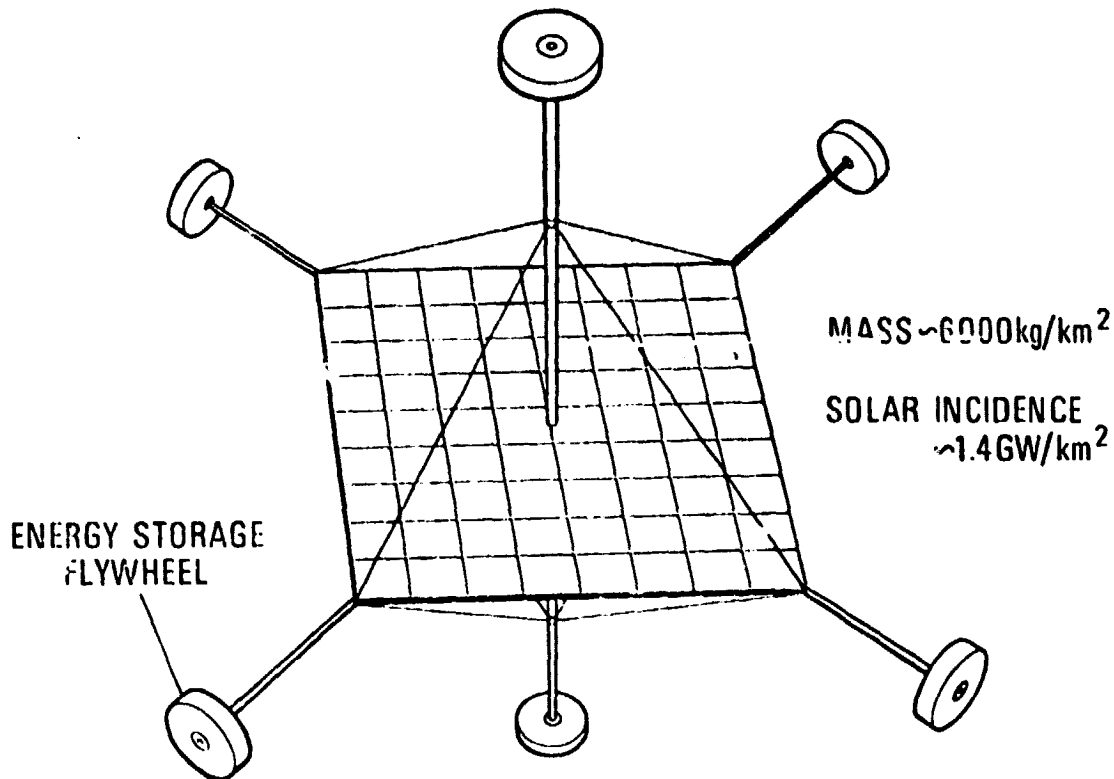

Figure 8.- Schematic of a cluster mirror. Mirror is one of the "free-flyers" which comprise the total array or satellite mirror. Tensional, probably hexagonal mirror elements, form the surface shown. The structure is a low-mass, high strength (probably composite material) boom-stays- and guys-arrangement similar to that under development for the Solar Sail Program. Composite material flywheels, at the ends of the booms, may be used to provide orientational (pointing) torques. Such a structure would be deployed at approximately 800-km altitude and solar sailed to its operational altitude.

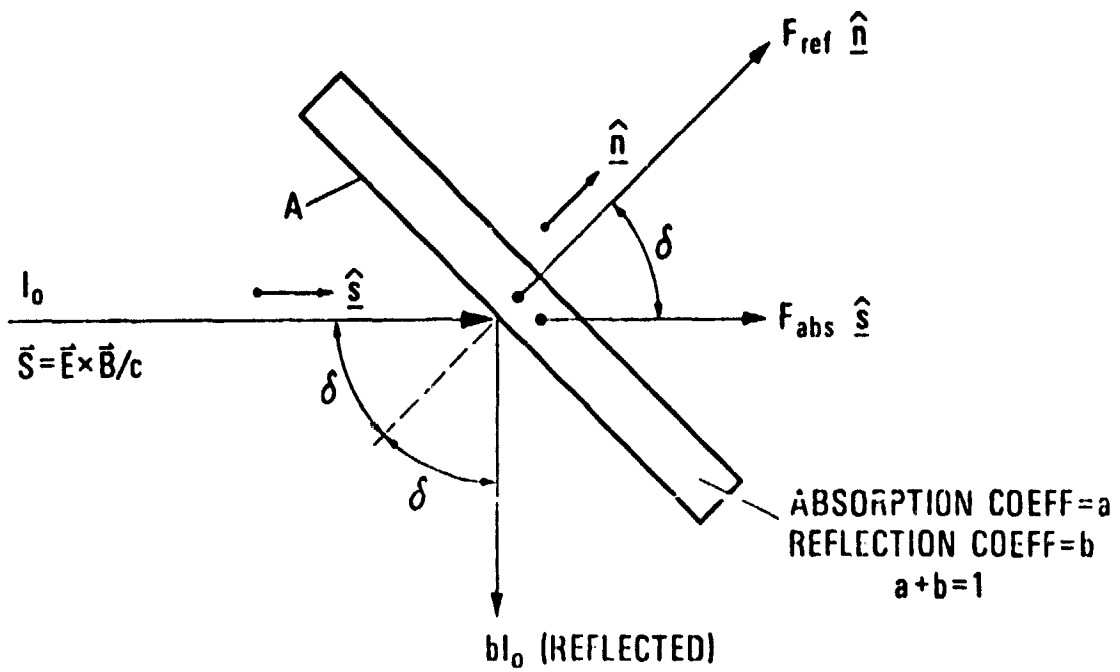

Figure 9.- Radiation pressure forces exerted on a partially absorbing and reflecting material sheet.

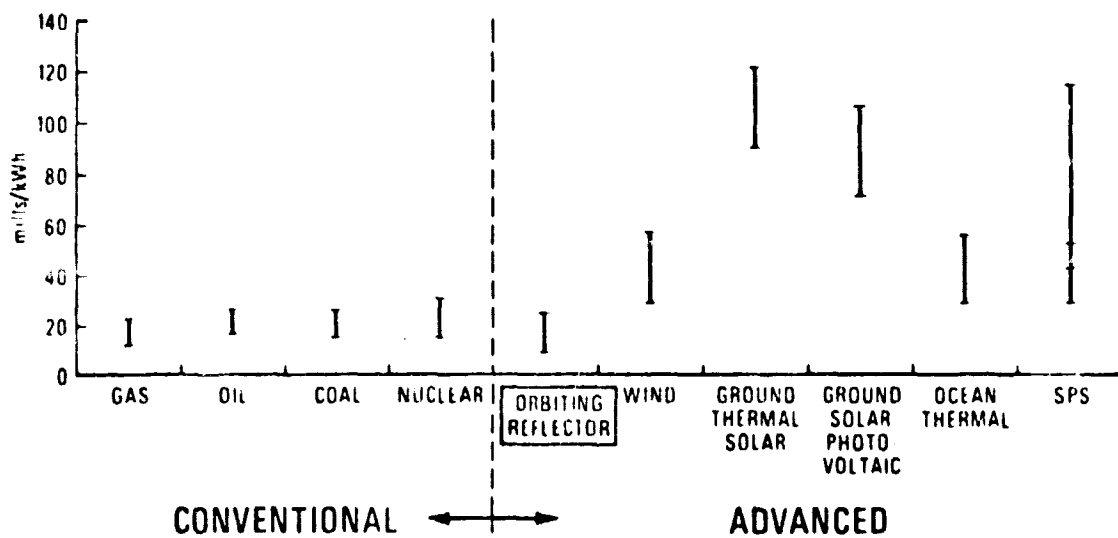

Figure 10.- Comparison of conventional and advanced electric power generation system costs.

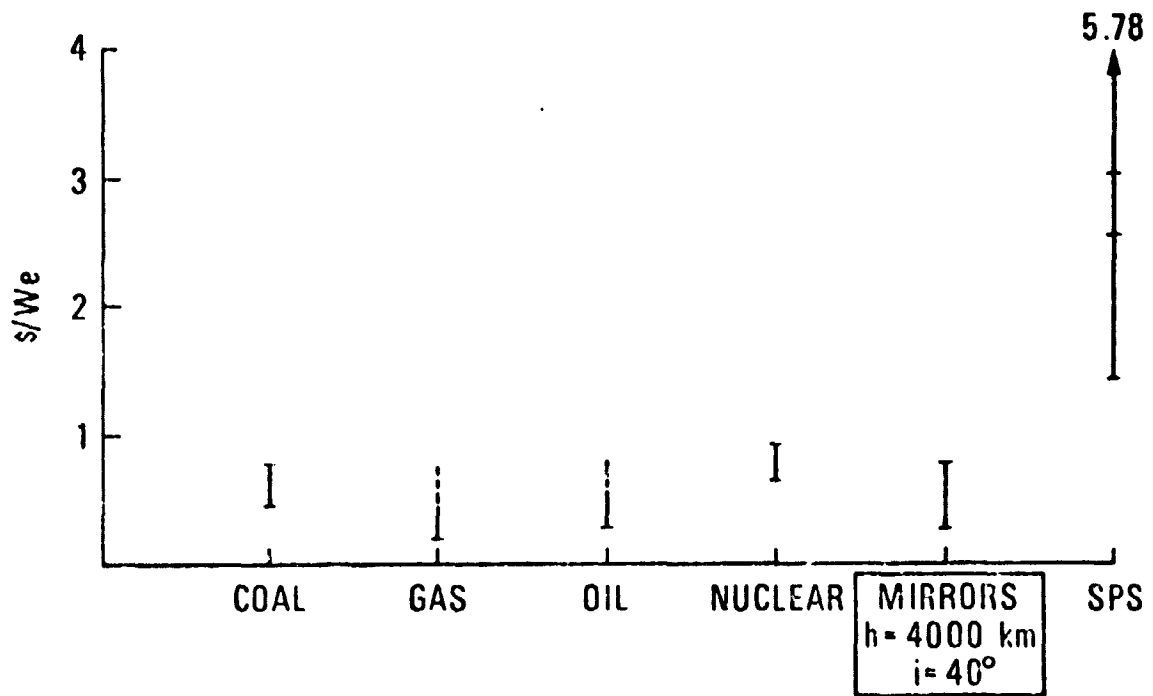
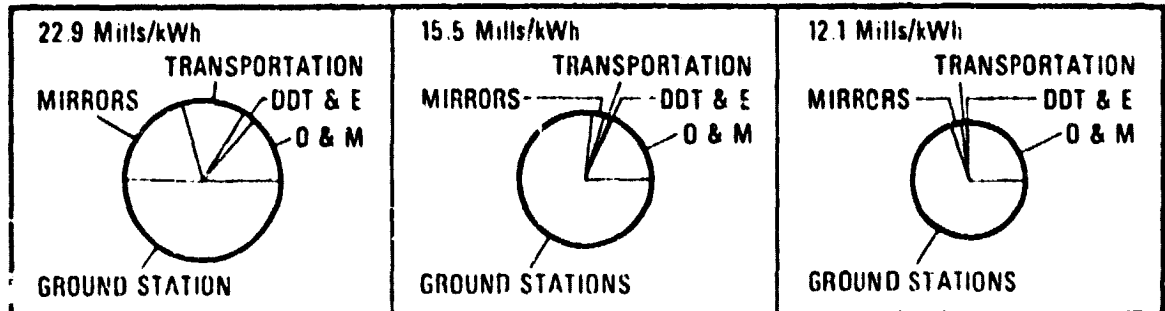

Figure 11.- Capital costs for electric plants in 1976 dollars. Does not include R&D costs.

• 4000km ALTITUDE • 40° INCLINATION

SOLAR THERMAL CONVERSION



CdS-Cu₂S PHOTOVOLTAIC CONVERSION

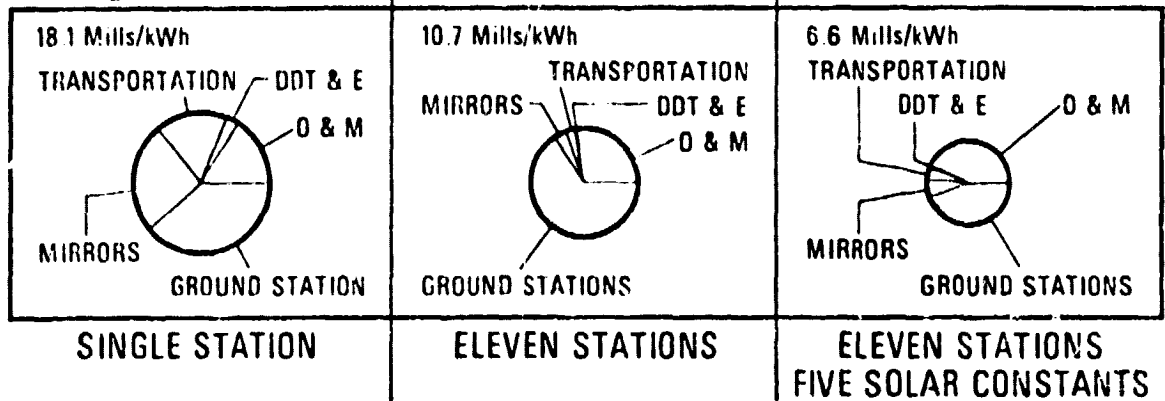

Figure 12.- Cost breakdown for a typical orbit option, 4000-km altitude and a 40° inclination. The effect of multiple ground stations, radiation conversion option and reflected intensity on total bus power cost and its costing elements is shown.

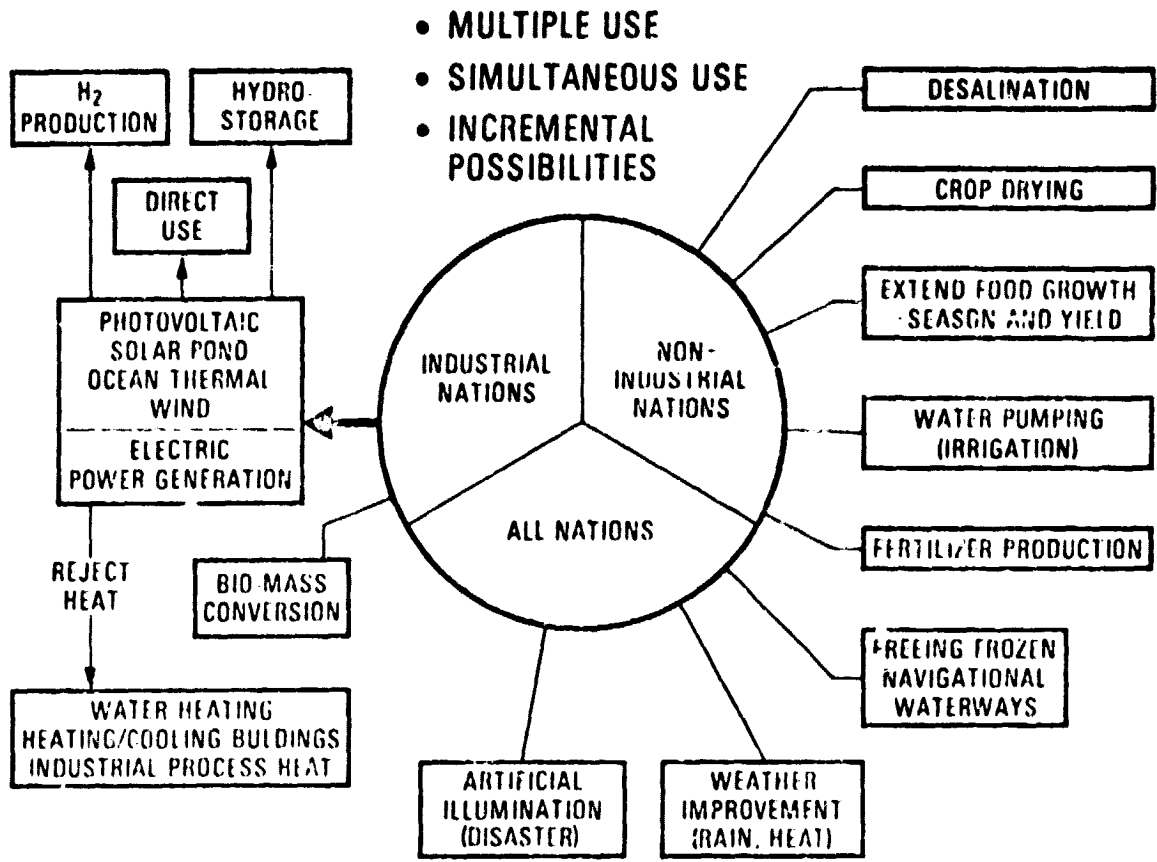

Figure 13.- Mirror system applications, illustrating the multiple use, the simultaneous use, and the incremental possibilities of this system which are not possessed by other solar satellite energy schemes.

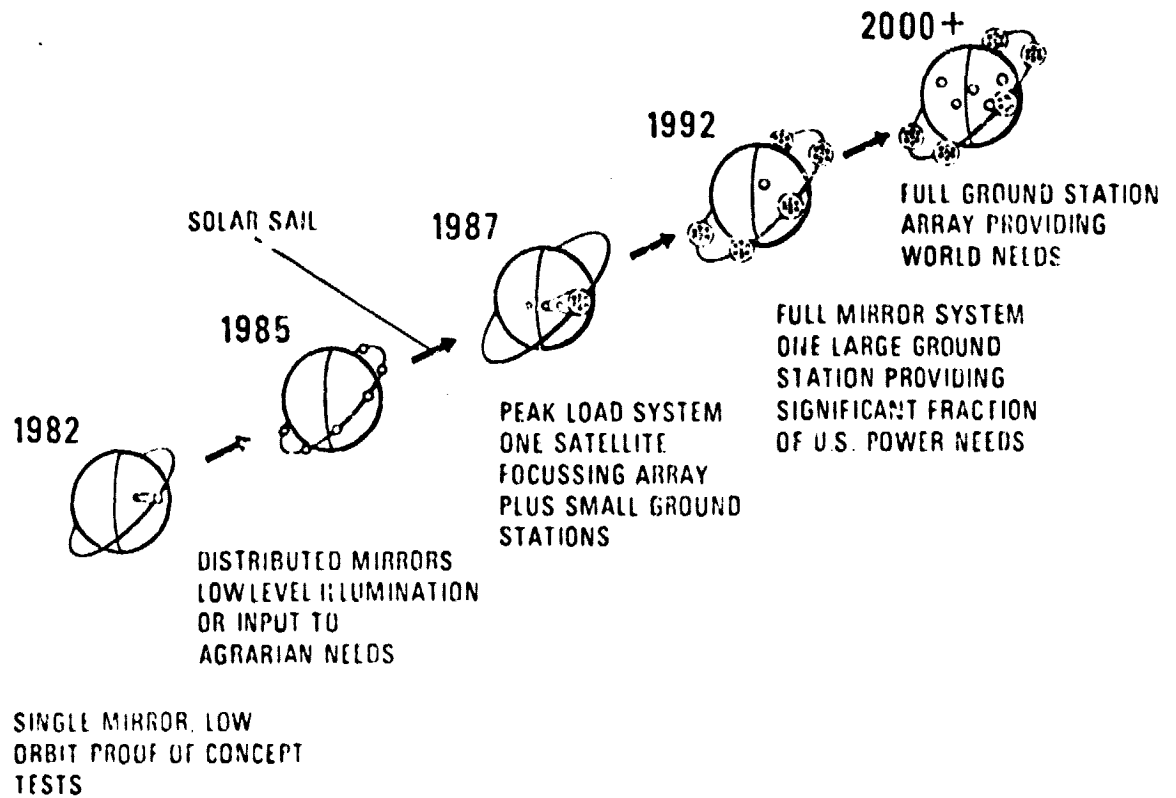

Figure 14.- Incremental implementation approach. Best-guess estimates of how technology readiness, R&D, and economic-political considerations would allow the system employment to attain full supply of world energy needs.

Appendix 2

Investigation of Weather Modification Due to SOLARES Operations

Concepts for the acquisition of solar energy to meet the increasing energy demands of the United States and the world, are being proposed and evaluated. This concept, first proposed in the 1920's, utilizes large mirrors placed in earth orbit to reflect sunlight to collectors on earth for conversion to electrical power. NASA is evaluating the technical, economic, and environmental advantages and impacts associated with this system which is called SOLARES (Space Orbiting Light Augmentation Reflector Energy System). The ground based collectors will receive large amounts of radiant energy, much of which will be reflected or reradiated by the earth or lower atmosphere. The available energy may be sufficient to cause changes in the local weather. Lockheed Electronics Co., Inc., under a NASA Support Contract, has been tasked with preparing a preliminary report addressing what the impact of the earth-based collectors may be on the weather. LEC will contract for consulting services from individuals/organizations with experience relating to the weather phenomena described herein.

1.0 Description of SOLARES

At present, several factors important to this task have not been fully determined. Therefore, it will be necessary to base this assessment on a range of values and circumstances.

The number and size of earth based collectors located in the United States will vary depending upon the orbital altitude of the reflecting mirrors. The higher the orbit the fewer ground stations required, but the larger the reflector and the collector station. For the purpose of this study, it will be assumed that the constant ground track orbit inclination is 40°, the latitudes of sites in the U.S. is 32°N, and the orbital altitude may be either 6400 Km or 35,800 Km (geostationary). The orbit inclination for geostationary orbit is zero. At these altitudes, the ground station area will be approximately 3200 Km² and 40,000 Km² respectively; however, the total illuminated area will be substantially larger. To scope the potential for weather modification using the SOLARES, it is proposed to assess that potential for several ground station configurations, namely:

<u>Number of Stations</u>	<u>Area of Station (Km²)</u>	<u>Station Location</u>
1	3200	Southwest U.S.
1	3200	Georgia Interior
1	40000	Southwest U.S.

The system will be designed such that one solar constant, or about 135 mW/cm² of solar energy, will fall continuously on the collector surface.

The efficiency of the ground station converter is about 12 percent. The remaining energy is either absorbed or reflected by the earth or lower atmosphere, although a portion of this energy may be utilized without release to the environment.

ORIGINAL PAGE IS
OF POOR QUALITY

2.0 SCOPE OF WORK

The consultants will concentrate their attention to the following tasks:

2.1 Task 1

Provide a scientific investigation of the potential effect on the troposphere from the added solar heating resulting from SOLARES. It is well-known that local heat sources can affect noticeable changes in the weather. The broad question is: What weather changes are likely to occur as a result of SOLARES, considering the complete interruption of the day-night cycle in the vicinity of the ground station? Specific questions that should be addressed include, but are not restricted to the following: (A) Assuming ground stations in various topographic and climatological locations, what changes in cloudiness, precipitation, and other manifestations of weather are likely? Would there be a change in the areal distribution of clouds? What is the likely magnitude of local temperature changes? How would air flow processes be altered? (B) What might be the effect of an operation such as SOLARES on the regional climate? If there is such an effect on a region, what about larger areas? Hemispheric? World-wide? (C) Is there a practical limit on the amount of heat that could be radiated or reflected from such sites? Is there such a limit on the number, or the size, of such sites?

2.2 Task 2

Documentation will be provided LEC in preliminary draft form including:

- (1) An assessment of the problems for which answers exist.
- (2) An identification of those problems requiring further study.
- (3) A recommendation as to how further investigations should be conducted and a priority of the recommended investigations.

3.0 PERIOD OF PERFORMANCE

Preliminary draft reports shall be submitted to LEC on or before February 15, 1978.

Appendix 3

SOME ATMOSPHERIC EFFECTS OF SOLARES COLLECTORS
A Preliminary Study

by

D. Ray Booker and Philip G. Sticklel

to

LOCKHEED ELECTRONICS COMPANY, INC.
1830 NASA Road One
Houston, Texas 77058

March 20, 1978

TABLE OF CONTENTS

	<u>Page</u>
LIST OF FIGURES	ii
1.0 INTRODUCTION	1
2.0 TEMPERATURE ANOMALY	2
2.1 Conditions and Assumptions	2
2.2 Equilibrium Temperature Without Atmosphere	2
2.3 Equilibrium Temperature With Atmosphere	3
2.4 Modification of Diurnal Radiation Cycle	6
2.5 Downwind Temperature Increase	8
3.0 PERSPECTIVE OF SOLARES HEAT ISLAND	11
3.1 Compared to Normal Insolation	11
3.2 Compared to Cities	11
3.3 Bushfire Heat Island	12
4.0 EFFECT ON CLOUDS	13
4.1 Cumulus Clouds	13
4.1.1 Air Mass Cumulus	13
4.1.2 Adiabatic Diagrams	14
4.1.3 Shower Lines	14
4.1.4 Imbedded Cumulus	16
4.1.5 Cold Advection Showers	16
4.2 Stratus Clouds and Fog	17
4.3 Enhanced Evaporation	17
4.4 Effect of Wind Speed	18
4.5 Severe Storms	19
4.6 Snow and Frost	19
4.7 Diurnal Effect	19
5.0 LARGE SCALE EFFECTS	21
5.1 Downwind Effects	21
5.2 Long Term or Permanent Effects	21
5.3 Large Scale Climatic Effects	22
5.4 Synoptic Scale Effects	22
6.0 OPPORTUNITY FOR ATMOSPHERIC RESOURCE MANAGEMENT	23
6.1 Cumulus Development	23
6.2 Snow Removal	23
7.0 CONCLUSIONS AND RECOMMENDATIONS	25
7.1 Effects on Clouds and Precipitation	25
7.2 Opportunity	25
7.3 Site Selection	25

LIST OF FIGURES

<u>Number</u>	<u>Title</u>	<u>Page</u>
1	Energy budget for SOLARES collector with no atmosphere. Units are W/m^2	4
2	The incoming short wave and outgoing long wave radiation on a relative scale for a SOLARES collector and for the earth surface under the normal diurnal radiation cycle	7
3	Temperature rise downwind as a function of wind speed s and the PBL depth h	10
4	Summertime sounding for Atlanta, Georgia for 0000Z on 29 August 1977	15

1.0 INTRODUCTION

This is a preliminary survey of the possible effects of SOLARES collectors on weather including clouds and precipitation. The scope of the study involves a brief look at a wide range of possible effects to determine their relative magnitudes. Most of the phenomena would require sophisticated models to handle the many facets of each effect. We have stopped short of attempts to quantify any effect in detail. This study does suggest areas for further study if planning for the SOLARES continues.

2.0 TEMPERATURE ANOMALY

2.1 Conditions and Assumptions

We assumed that the design of the orbiting reflectors would be able to deliver a constant value of radiation at the surface of the earth equal to one solar constant. The specific conditions assumed were:

1. Area of Collector	Collector Location
3,200 km ²	Southwest U.S.
3,200 km ²	Georgia Interior
40,000 km ²	Southwest U.S.
2. Incoming radiation	135 mW/cm ² = day and night
3. Collector albedo	0.1
4. Efficiency	12% of incoming radiation converted to electricity.

The incoming radiation assumes no clouds above the collector. Clouds would greatly complicate the picture and require a more sophisticated model than this study permits, to compute reasonable values for the resulting temperature anomaly.

The atmosphere also adds some complication because of its capacity of absorbing and re-radiating energy and because it acts to transfer heat from the collector in complex ways. We can gain some insight to the problem by computing the temperature the surface of the collector would reach if there were no atmosphere.

2.2 Equilibrium Temperature Without Atmosphere

Using the above assumptions, we can make an energy budget for a collector with no atmosphere as follows.

$$\begin{aligned} \text{Incoming} &= 1350 \text{ W/m}^2 \\ \text{Reflection to space} &= 0.1 (1350 \text{ W/m}^2) \\ &= 135 \text{ W/m}^2 \\ \text{Conversion to electricity} &= 0.12 (1350) = 162 \text{ W/m}^2 \\ \text{Conduction and convection} &= 0 \text{ since there is no medium to} \\ &\text{to space} \qquad \qquad \qquad \text{conduct or convect} \\ \text{Radiation to space} &= 1350 - 135 - 162 \\ &= 1053 \text{ W/m}^2 \end{aligned}$$

This energy budget is shown graphically in Figure 1.

We can then compute the equilibrium temperature of the surface of the receiver. We first convert the outgoing radiation to more convenient units:

$$R_0 = 1053 \text{ W/m}^2 = 1.51 \text{ ly/min.}$$

Then, from the Stefan-Boltzman law:

$$F = \sigma T_{EQ}^4 \text{ or } T_{EQ} = (F/\sigma)^{0.25}$$

where F is the radiant flux density,

σ is the Stefan-Boltzman constant and

T_{EQ} = absolute temperature, °K.

Substituting the above values, we have:

$$T_{EQ} = (1.51 \text{ ly/min} / 8.14 \times 10^{-11} \text{ ly/min} \cdot \text{K}^4)^{0.25}$$

$$T_{EQ} = 369 \cdot \text{K} = 96 \cdot \text{C} = 205 \cdot \text{F}$$

If there were no atmosphere, the collector would heat up to this temperature and remain there since the incoming radiation would be constant. The atmosphere would act as a cooling medium because it offers another way to dissipate the waste energy.

2.3 Equilibrium Temperature With Atmosphere

We assume the same incoming radiation as before and get the following budget, with an atmosphere.

$$\text{Incoming} = 1350 \text{ W/m}^2$$

$$\text{Reflection to space} = 135 \text{ W/m}^2$$

$$\text{Conversion to electricity} = 162 \text{ W/m}^2$$

$$\text{Remaining to account for} = 1053 \text{ Wm}^2$$

The flux due to conduction will be negligible because as the air near the collector is heated, the lapse rate becomes superadiabatic and convection overturns it. Thereby convection becomes the dominant process by which part of the remaining energy is transported away from the collector. This means that less energy will be lost from the collector by

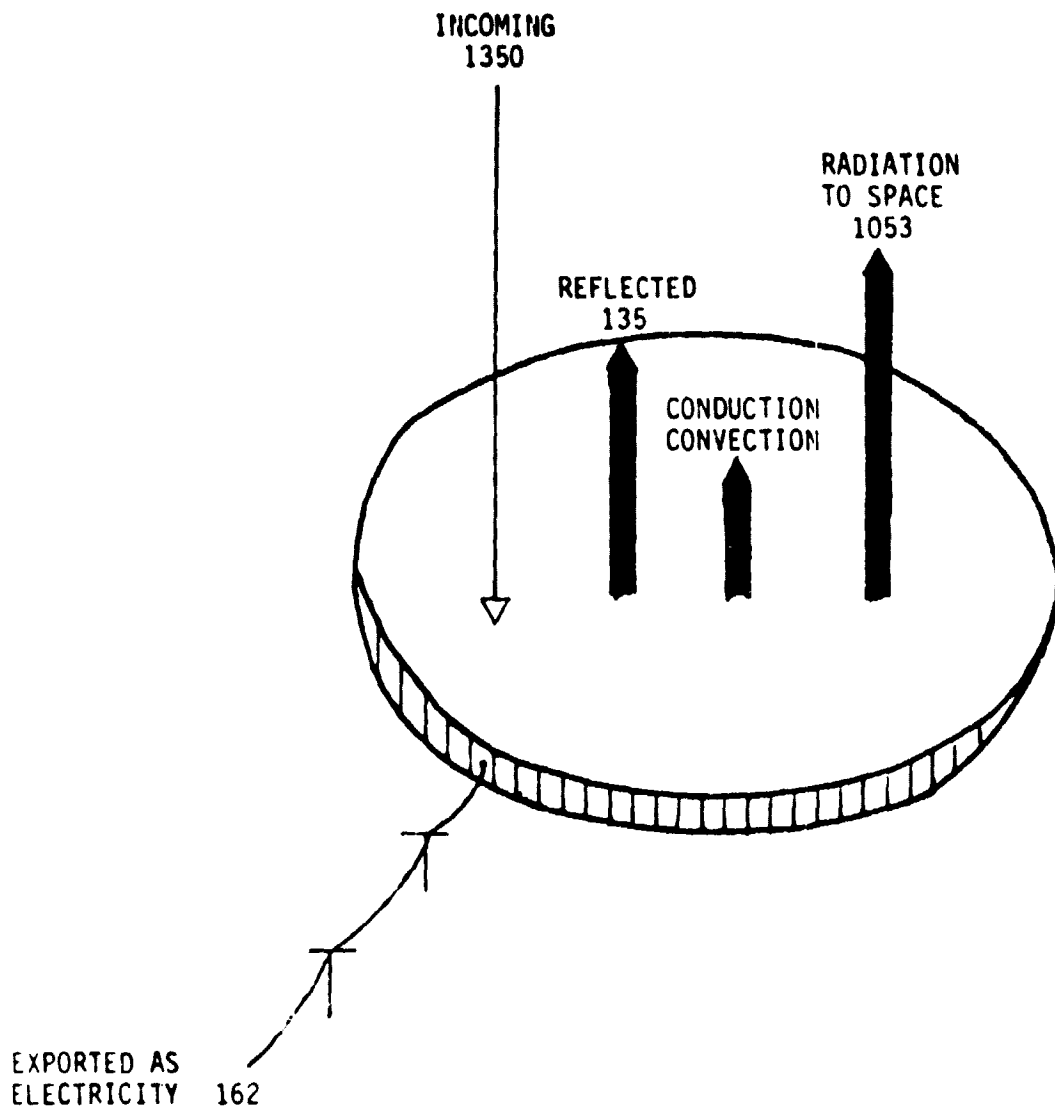

Figure 1 Energy budget for SOLARES collector with no atmosphere. Units are W/m^2 .

radiation than in the non-atmosphere case. Therefore, the equilibrium temperature will be lower. The remaining processes to consider are:

$$\text{REMAINING HEAT FLUX} = \text{CONVECTION} + \text{RADIATION.}$$

Convection is the same as sensible heat flux.

The amount of energy to be transported away by convection depends directly on the difference between the temperature of the collector and the air a few meters above it. The temperature of the collector surface depends on the radiation balance.

An atmosphere with a certain temperature will absorb some of the radiation from the surface and re-radiate downward and upward, depending on the air temperature. If we make some additional assumptions, we can compute an estimate of T_{EQ} based on the flux of radiation between the air and the collector. Consider a typical summer air temperature of 32°C (305°K), an adiabatic lapse rate (10°K/km) in a planetary boundary layer (PBL) of 2 km depth, we get an average PBL temperature of $T_{PBL} = 295^{\circ}\text{K}$.

We can estimate T_{EQ} by assuming the net radiation, F_n up from the surface is some percentage of the remaining heat flux. The equation for the net heat flux, F_n , is:

$$F_n = P(1053 \text{ W/m}^3) = \sigma(T_{EQ}^4 - T_{PBL}^4)$$

where F_n is net radiation flux and

P is percentage of radiative heat flux.

We are assuming that there is no radiation interaction between the collector and the region above the PBL.

In most micrometeorological studies, it has been customary to assume that the radiation term in the energy equation is negligible. However, since the errors become larger for larger values of surface (collector) temperature, we must assume some significant value. We

assume for this case that the radiative heat flux represents 30% of the remaining heat flux. The equation for T_{EQ} then becomes:

$$\begin{aligned}
 T_{EQ} &= (P(1053)/\sigma + T_{PBL}^4)^{0.25} \\
 &= \frac{.3(105.3 \text{ mW/cm}^2) * 1 \text{ ly/min}/69.75 \text{ mW/cm}^2}{8.14 \times 10^{-11} \text{ ly/min}/\text{k}^4} \\
 T_{EQ} &= 358 \text{ K} = 65 \text{ C} = 149 \text{ F}
 \end{aligned}$$

This estimated equilibrium collector temperature would give rise to convection for the assumed mean PBL air temperature, $T_{PBL} = 22 \text{ C} = 295 \text{ K}$. If the air is colder, the collector equilibrium, T_{EQ} would also be lower but the amount of energy to be dissipated into the atmosphere by convection would still be large.

2.4 Modification of Diurnal Radiation Cycle

In the normal radiation cycle, the maximum incoming radiation is received when the sun is at the zenith. However, the maximum surface temperature is not reached for about another 3 hours. The temperature continues upward because the net flux of radiation is still downward until the surface temperature gets high enough to balance the incoming. By this time, the sun is lower and the incoming radiation is decreasing rapidly. The surface then begins to cool as the net radiation becomes upward. This condition continues until the incoming radiation again exceeds the outgoing radiation some time after sunrise the next day. This relationship is shown graphically in Figure 2.

At the collector site, the incoming radiation is assumed to always be the same. Thus, the surface temperature will rise until an equilibrium value is reached, as we have shown above. This equilibrium value will be considerably higher than the value reached during a normal diurnal heating cycle. This relationship is shown qualitatively in Figure 2.

This essentially means that the collector site will always be warmer than the surrounding countryside and that the air arriving at the site will be colder than the temperature of the collector. This fact is significant in considering the effect on clouds.

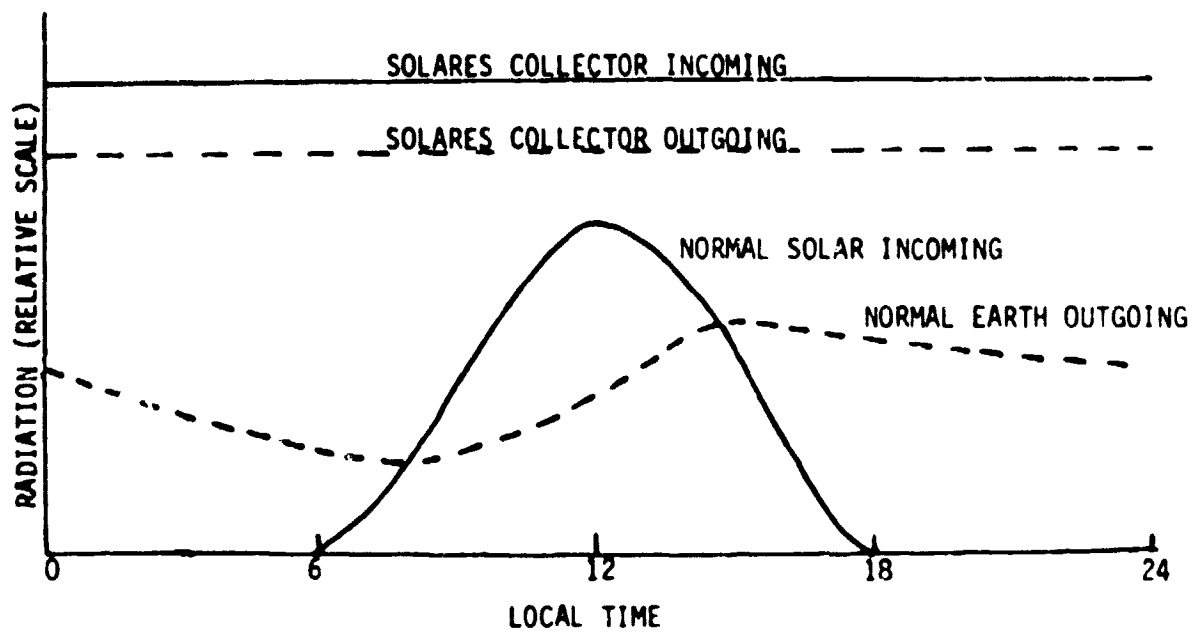

Figure 2 The incoming short wave and outgoing long wave radiation on a relative scale for a SOLARES collector and for the earth surface under the normal diurnal radiation cycle.

2.5 Downwind Temperature Increase

The change in temperature is defined as the heat applied per unit mass per the specific heat of the medium, or:

$$dT = \frac{dH}{\rho C_p V}$$

where T is absolute temperature, °K
 H is heat
 ρ is density of air
 C_p is the specific heat of air at constant pressure and
 V is the volume of air.

We want to find the amount of temperature increase for a volume of air moving across the collector. As the air absorbs heat, it tends to rise. As it rises, and encounters lower and lower pressure, it cools adiabatically and sets up what meteorologists refer to as an adiabatic lapse rate. The depth of this layer is the planetary boundary layer, PBL. It may be quite shallow on stable days and may reach 5 km in the southwestern U.S. in summer. The depth of the PBL determines the volume through which the added heat will be distributed. Thus, we should compute the effect of heating for a variety of PBL values.

We can compute the temperature increase of a volume of height equal to the PBL, h , and unit area as it moves at a speed s across a collector of diameter D . The temperature increase equation above then becomes:

$$\Delta T = \frac{HD}{h\rho C_p s}$$

As h increases, the average value for air density, ρ , decreases. The following are average density ($\bar{\rho}$) values for several values of h . The average density differs from the standard atmosphere because the layer is mixed so it has uniform density throughout.

h , km	\bar{T}	\bar{p}	$\bar{\rho}$, kg/m ³
1	25°C	900mb	1.0516
3	17°C	800mb	0.9605
5	5°C	700mb	0.8767
7	0°C	600mb	0.7652
10	-3°C	500mb	0.6500

The distance, D , can be computed as 63.83 km and 225.7 km for circular collectors of 3,200 and 40,000 km^2 , respectively.

We can now calculate ΔT as a function of s and h . From these computations, we have constructed Figure 3. It can be used to read the maximum ΔT for any desired wind speed s and PBL depth h . The large and small collector are shown on the same Figure. For example, a wind speed of 5 m/s and PBL depth of 2.5 km gives a temperature increase of 4.5°C at the downwind edge.

The shaded areas on the graph show the conditions which would most often occur at the two proposed site locations.

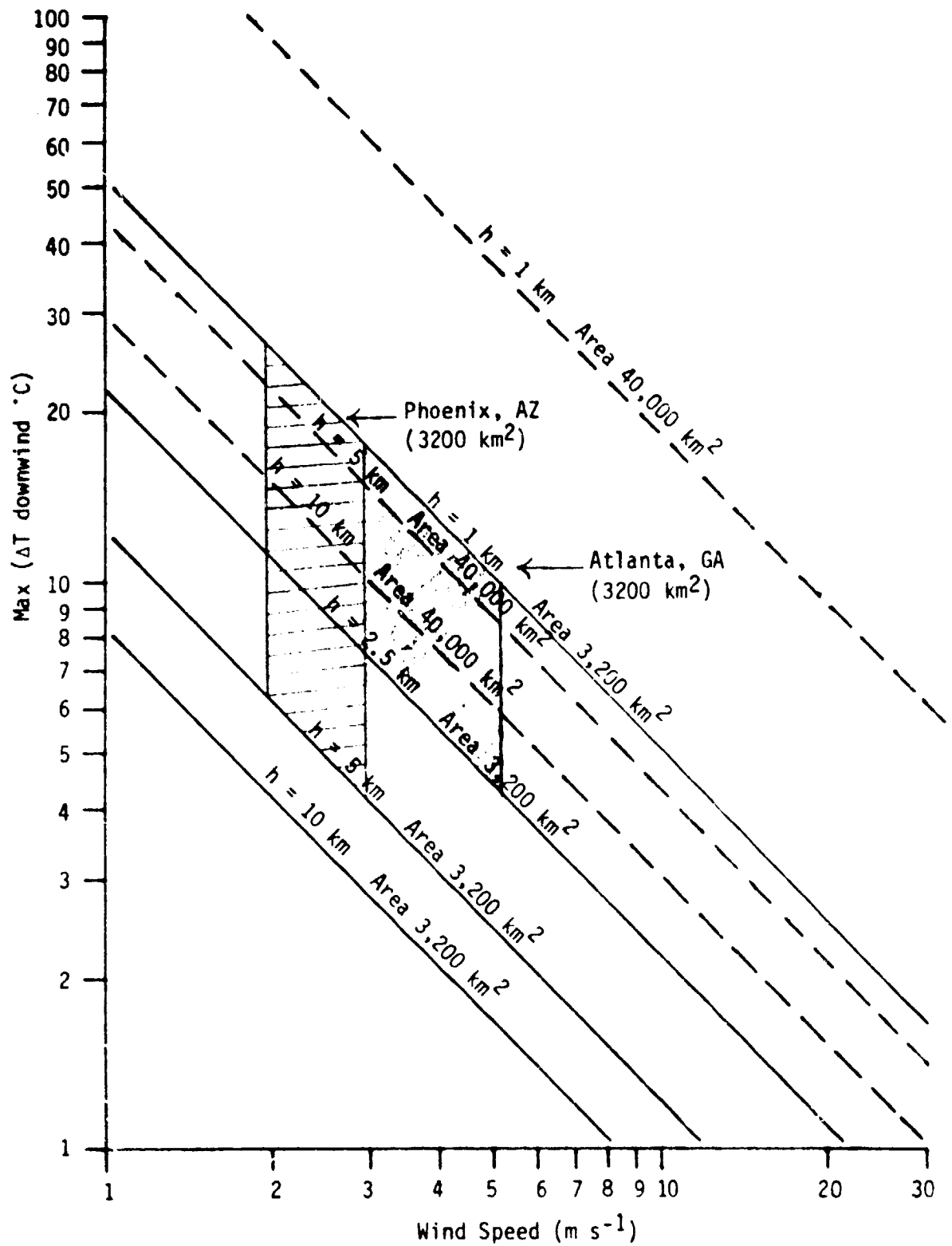

Figure 3 Temperature rise downwind as a function of wind speed s and the PBL depth h .

3.0 PERSPECTIVE OF SOLARES HEAT ISLAND

3.1 Compared to Normal Insolation

The magnitude of normal insolation is one pertinent yardstick for evaluating the heat island effect of SOLARES. The normal insolation in units of mW/cm^2 at solar noon for Phoenix, Arizona are approximately as follows:

Jan	Feb	Mar	Apr	May	Jun	Jul	Aug	Sep	Oct	Nov	Dec	Average
69	81	96	109	116	119	118	113	103	89	74	66	96

The 135 mW/cm^2 for the SOLARES collector would be about 1.4 times the average noontime (maximum diurnal) insolation and 1.13 times the maximum summertime value. The normal insolation is zero for an average of 12 hours. The constant input of 135 mW/cm^2 would be a marked increase for the total daily budget.

3.2 Compared to Cities

Cities have long been recognized as heat islands and have been known to cause significant downwind effects.

Dettwiller and Changnon, 1976, found average heat island effects of Paris, France; Chicago and St. Louis at midday was $1-3^\circ\text{C}$ warmer than surrounding rural areas and extended 500-1,500m above the city. The 100 year precipitation records indicate an increase of 19-38% in warm season rainfall. No change in winter precipitation was evident.

Harnack and Landsberg, 1975, studied several cases where convective precipitation was touched off by the Washington, D.C. metropolitan area. The energetics of the convective clouds were found to be consistent with the heat island effect available from the Washington area.

The urban effect of St. Louis has been studied in great detail by many research groups as a part of Project Metromex. Changnon, et al, 1976, summarized the Metromex studies and urban studies of seven other large cities and found the following urban rainfall anomalies. The six

largest cities, including St. Louis, had a 10-30% summer precipitation increase in and downwind of the city. An increase in thunderstorm and hail frequency was also noted.

3.3 Bushfire Heat Island

Rapid convective activity has been known to develop over large fires. Taylor, et al, 1973, found convective activity to rise to 5.8 km and increased surface air temperatures of $5\frac{1}{2}^{\circ}\text{C}$ to occur at the peak of the fire. Although fires and cities input large amounts of condensation nuclei, the dominant reason for increased shower activity, hail and cloud cover is the thermodynamic effect.

The following is a comparison of the amounts of heat in excess of normal insolation to be released from SOLARES collectors compared to cities and intense brush fires as we have extracted the figures from the above references. The figures for cities, fires and SPS rectenna are normalized to $3,200\text{ km}^2$ for comparison with the smaller collector.

<u>SOURCE</u>	<u>HEAT RELEASE</u>
SOLARES $3,200\text{ km}^2$	$2.74 \times 10^6\text{ MW}$
Solar power satellite rectenna	$3.06 \times 10^4\text{ MW}$
Intense bushfires at peak	$9.92 \times 10^4\text{ MW}$
Large City	$1 \times 10^5\text{ MW}$

These figures show that the total heat to be released is considerably (27 times) greater for SOLARES collectors.

4.0 EFFECT ON CLOUDS

4.1 Cumulus Clouds

The heat to be released from the SOLARES collectors will act to encourage cumulus cloud development. The maximum heat will be realized when there are no clouds present. As clouds increase, the amount of heat available will decrease, so that the minimum heat available will be when thick clouds already exist. Therefore, one would expect the maximum effect to be in the early stages of cumulus development or when a line of cumulus moves over the collector. We should examine these two cases separately.

4.1.1 Air Mass Cumulus. Air mass cumulus clouds form when the air is heated strongly by the ground. In the summer, the ground is relatively cool in the morning and heats up under the influence of insolation. Thermals rise from the warmest spots, setting up an adiabatic lapse rate, as we discussed in the PBL sections above. Cumulus clouds form when the thermals get vigorous enough to penetrate to the convective condensation level (CCL), or the level where the thermals cool to the dewpoint. The resulting clouds are called fair weather cumulus and are of little consequence to man's activities. Such clouds often form over large power generating or other large heat sources.

Further penetration of the thermals can cause them to reach the level of free convection (LFC), or the level at which the latent heat of condensation released by the condensation of water in the thermal above the CCL is enough to warm the thermal above the temperature of the surrounding air. Thermals will continue to rise as long as they are warmer than their environment. The temperature structure of the environmental air determines how far the buoyant plumes can rise. In the summer, the usual air mass thermal structure is such that the hottest thermals often get tall enough to produce showers.

4.1.2 Adiabatic Diagrams. This process can be traced out on adiabatic diagrams as shown in the summertime sounding from Atlanta in Figure 4. Meteorologists use these diagrams to determine the level of cloud bases, the CCL, and the surface temperature at which the clouds will form, as shown by the dashed lines. The dashed arrows indicate the surface temperature required for the thermals to penetrate to the LFC and the predicted top altitude of any clouds reaching it.

The maximum temperature on most summer days in Georgia is near the temperature required to produce air mass showers. An increase of a few degrees due to a SOLARES collector would almost certainly result in some showers when they would not otherwise have formed. This prediction is consistent with the observed effects of St. Louis and Washington D.C. (Section 3.2). Georgia is a more moist climate than either of these cities and the predicted heat island effect is greater. Therefore, we are confident the effect on cumulus would be greater.

4.1.3 Shower Lines. Showers and thunderstorms most often occur in lines because of advancing cold fronts and other reasons. These lines occur in Georgia at any time of day or night. Arizona showers and thunderstorms are less dominated by the line mechanisms because of the influence of mountains and because of Arizona's geographical position relative to polar air advances.

The shower lines usually are preceded by relatively clear skies, then by cirrus anvils from the advancing line, then by the showers themselves. The anvils will decrease the insolation at the collector site and perhaps decrease the heat island effect. However, we think this damping effect could be small since the heat capacity and normally high temperature of the collector surface will make the heat island effect persist for several hours, even if the incoming radiation were almost completely shut off.

The heat island could influence the timing and place of shower line development. Shower lines develop when the air becomes sufficiently unstable. Natural barriers, such as the Black Hills of South Dakota are

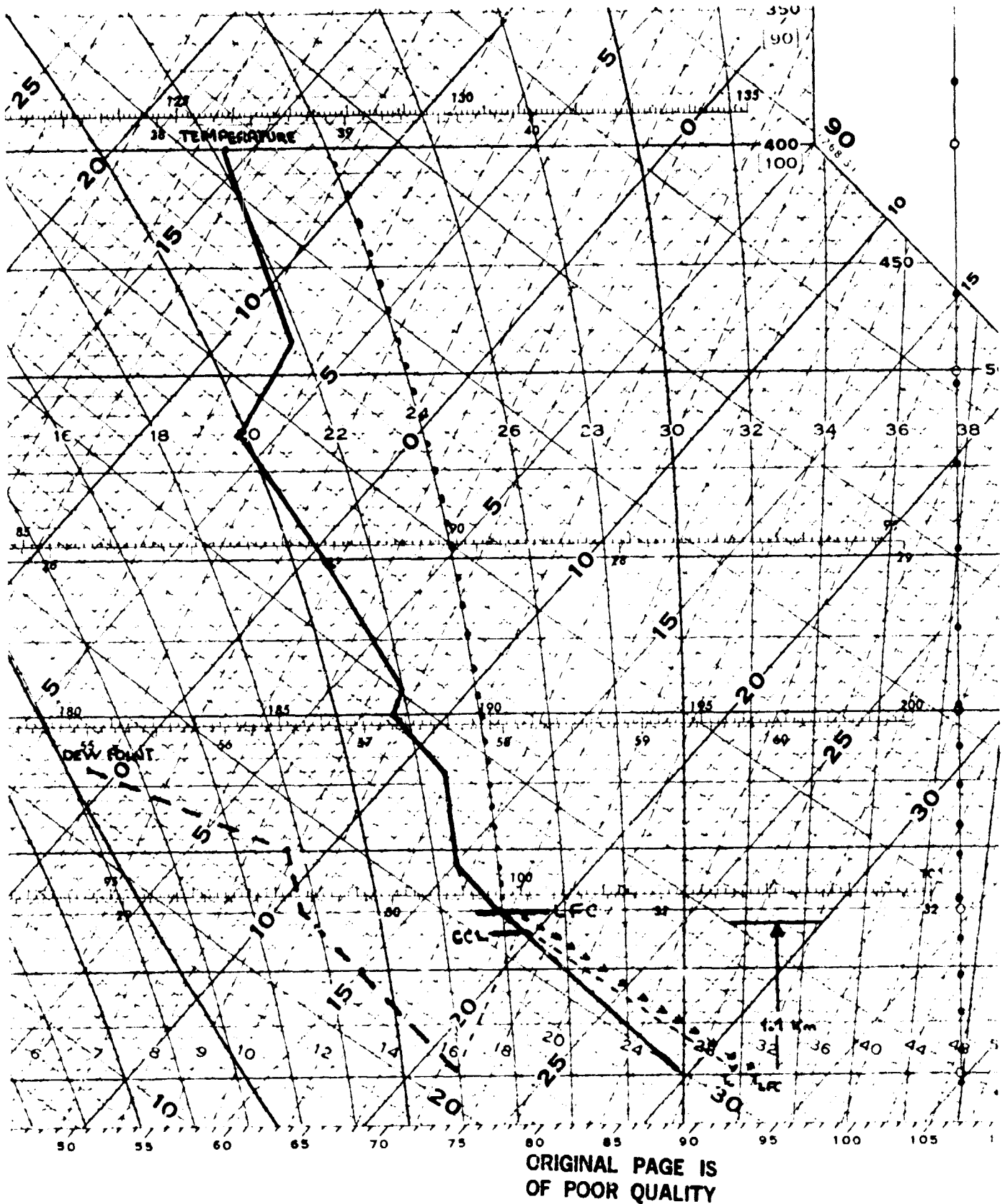

Figure 4 Summertime sounding for Atlanta, Georgia for 0000Z on 29 August 1977. T_{LFC} is the temperature surface must reach for the thermals to penetrate LFC. $T_{LFC} - T = (32.5 - 29.5) = +3'$ with $h = 1.1$ km, wind speed = 7 m s^{-1} SOLARES would yield $\Delta T = 6'$. Therefore showers would be initiated, with cloud tops near 13 km (42,000 ft)

very effective in localizing the instability and causing showers to start there then move eastward with the prevailing wind. This effect is one of the reasons for the pronounced precipitation anomaly associated with the Black Hills. The normal time of occurrence of showers east of the Black Hills is closely related to the diurnal temperature at the Black Hills and the distance east of them. We believe the SOLARES heat island would have a similar but perhaps smaller localizing effect on the formation of shower lines. The modulation of the timing of showers to the east would also be noticeable but for a different reason, which we will discuss in Section 4.7.

4.1.4 Imbedded Cumulus. Georgia cumulus are often imbedded in large sheets of stratiform clouds. This seldom occurs in the southwest. Therefore, the effect of SOLARES on imbedded cumulus will be primarily felt in moist climates, such as Georgia.

Considerable insolation, and therefore waste heat will be available even with cloudy skies. Therefore, the effect on imbedded cumulus could be important.

The lapse rate, or stability of the air is usually near the moist adiabatic value in the cloud layers. This means that the cloudy air has near neutral stability. Small sources of heat can be effective in producing an imbedded cumulus in these cases. Small cumulus protruding above a layer of stratocumulus are a frequently observed example of this sensitivity.

We expect that imbedded cumulus would be encouraged or strengthened as regions favorable to their development them pass over the SOLARES heat island.

4.1.5 Cold Advection Showers. When a cold air mass flows over a warm surface, it is heated by contact with the surface. Thermals form just as they do in the summer air mass case. The snow flurries that

characterize the cold air masses flowing southeastward over the northeastern U.S. are caused by this influence. The strong flurries to the lee of the Great Lakes have the added influence of rapidly evaporating water from the relatively warm lake surface. The result is heavy snow falls a few km downwind of the lakes.

Cold air advection showers are only found in relatively moist air where cloud bases can be under about 1.5 km. They are not an important factor in the southwestern U.S. They occur in Georgia but are not a major climatic influence.

We suggest that cold air advection showers would be enhanced to the lee of a SOLARES collector but the influence would be quite local since these showers are short lived and exist in an atmosphere of strong mechanical mixing. The effect of increased evaporation, discussed in Section 4.3 could add somewhat to the thermal influence of the heat island.

4.2 Stratus Clouds and Fog

Fog would be rare if it could exist at all over a SOLARES collector because most of the waste heat would be carried away by convection. The amount of waste heat available even with clouds would be enough to prevent the formation of fog and lift any fog advected over the site.

Low stratus or stratocumulus bases would be raised over the collector except when enhanced evaporation is a factor. With enhanced evaporation, the bases could be lower and the formation of an imbedded cumulus would be encouraged. Thin low stratus clouds with high stability would be broken into small cumulus, which would admit more insolation to the collector.

4.3 Enhanced Evaporation

The rate of evaporation of water from the surface is governed by the saturation vapor pressure, which increases rapidly with temperature. The rapid evaporation of surface water when the sun comes out immediately after a rain is a commonly observed phenomenon that illustrates this effect.

Any precipitation falling on the collector site will be evaporated at a higher than normal rate because of the higher surface temperature. This will give a lower cloud base and enhanced chances for showers to occur while the high evaporation rate continues. Such a condition could exist in Georgia when rain falls ahead of a line of instability where showers are likely to form or may already exist. It could also occur when rain along a cold front is followed by strong cold air advection.

Because of the enhanced evaporation rate, the surface of the collector would soon become dryer than the surrounding countryside. Thermals rising from this dryer surface would have higher bases and provide some negative feedback to the tendency to form showers.

4.4 Effect of Wind Speed

Figure shows that the amount of temperature increase for air flowing across either size collector is dramatically increased as the wind speed decreases. Thus, the possibility of initiating cumulus clouds and showers is markedly increased in light winds.

This effect is increased by another related factor. Wind increases mechanical mixing and the entrainment of dry air into thermals. Entrainment is one of the greatest dampers for cumulus development. Thus, the increased temperature rise over the collector in light winds acts in the same direction as decreased mixing, so that cumulus development is encouraged both ways.

Convergence in the PBL is more easily organized in light winds. This fact is easily observed in the frequency of a sea breeze front in Florida and the valley breeze in the southwest U.S. Both phenomena are manifested by the cumulus they produce in light wind and strong solar heating situations.

These factors would be effective in both Georgia and the southwest U.S. where light winds are frequent.

4.5 Severe Storms

Natural disasters such as the Rapid City flood of 1972, tornadoes, hailstorms and dam failures create great upheavals in the lives of people. It is important, for many reasons, to avoid even the appearance of contributing to such disasters. The lawsuits following the Rapid City flood based on the idea that cloud seeding could have contributed are an example. The furor over the possibility that the Los Angeles Flood Control District cloud seeding contributed to the disastrous floods there last week is another good example.

We believe the magnitude of the heat island effect is large enough to make some contribution to cumulus development and therefore to natural disasters involving cumulus. If this is so, it may be necessary to take steps to interrupt the operation at times of potential disasters. If this were to include all times when Georgia is under severe storm watches, it could result in perhaps 30 days per year when service would be interrupted.

The magnitude of the danger is very much reduced in the Southwest. It should be possible to select sites where the potential for contributing to natural disasters is essentially zero.

4.6 Snow and Frost

The increase of temperature downwind of the collector would significantly decrease the frequency of snow and frost. The latter would benefit from increased cloudiness as well as decreased air stability, both acting in the direction of decreasing frost. Perhaps this could be of significant agricultural importance. New cropping patterns could be developed to take advantage of the waste heat.

4.7 Diurnal Effect

As we described in Section 2.4, the normal diurnal variation of surface temperature would be replaced by a higher but constant value over the collector. This means that the difference between the collector temperature and that of the surrounding countryside would be at a maximum

near daybreak. It follows that low level convergence and convection over the collector could be at a maximum during this same time.

It is commonly observed that afternoon convective showers begin some time after the peak surface temperature of midafternoon. This is because thermals rising from the remaining hot spots can become better organized without competition after the surface starts to cool.

We suggest that this same phenomenon would act over the collectors and that there would be some time during the night when the contrast of the collector temperature and the surrounding countryside would be most effective in organizing convection. The time of maximum precipitation frequency over the collector and downwind, as referred to in Section 4.1.3, would be determined by this phenomenon.

5.0 LARGE SCALE EFFECTS

5.1 Downwind Effects

Downwind effects from cloud seeding have been demonstrated in several cases. Elliott, et al, found marked increases in precipitation over some 6,000 km² downwind of the target area. Project Whitetop (Braham, 1965) reported rainfall decreases downwind of a seeding target in which precipitation decreases were also registered. Changnon, et al, reported precipitation increases extending as far as 35 km downwind from St. Louis, due to the influence of the city.

We should expect that any effects on cumulus clouds in the vicinity of the collector would extend some distance downwind. One hundred fifty km downwind is a reasonable estimate. Since the effect in the vicinity of the collector would almost certainly be in the direction of increasing precipitation, we should expect the change downwind to also be in the direction of an increase. So far, all reported downwind changes have been in the same direction as the local effect.

5.2 Long Term or Permanent Effects

The effects described above are related to the release of waste heat at the collector site. We should expect that the effects would diminish to some extent if the artificial insolation were stopped. Some permanent effect would result from the very presence of what would undoubtedly be one of the largest public works in the history of man.

To the extent that the existence of the collector would have influence on the environment, the effects would be permanent and irreversible. Since the idea is to produce power, we would assume that the heat island effect would be essentially permanent. Therefore, the changes we have described would be permanent, resulting effectively in a change of climate for the collector site and some distance downwind.



5.3 Large Scale Climatic Effects

We were unable to find reasons for believing that the SOLARES collectors would produce large scale (more than, say 150 km) climatic changes. Essentially, the effect would be similar to adding a small mountain range. Although such ranges can have dramatic local effects, their influence is not felt in the large scale circulation. For example, although the climate of Rapid City is profoundly affected by the Black Hills, there is no apparent reason to think the climate of Minneapolis is affected by them.

5.4 Synoptic Scale Effects

The 40,000 km² collector, and possibly the smaller one is of a scale that coriolis force is a factor. Therefore, we could expect that any convergence associated with the collectors would be organized in a cyclonic pattern. We do not feel that we are competent to judge whether there could be any other synoptic scale influence.

C-2

6.0 OPPORTUNITY FOR ATMOSPHERIC RESOURCE MANAGEMENT

6.1 Cumulus Development

Much of the world, and all of the overpopulated part of it, is dependent on cumulus clouds for its water supply. Great famines, such as the one in western Africa in the early 70's, have hampered mankind for most of recorded history. As mankind continues to live closer and closer to the limits of what the land can produce, and as our abundant energy supply begins to run out, we will become very much more vulnerable to the large fluctuations in rainfall from cumulus clouds.

The probable effects on surface temperature and cumulus cloud development described above present perhaps the greatest opportunity man has ever had to manage his atmospheric resources. This opportunity could be so large as to justify building the reflectors solely for that purpose! The following are only a few of the obvious facets of this opportunity.

As we mentioned in Chapter 2, the normal diurnal heating is very frequently within a few degrees of the temperature at which showers would be initiated. If, by international agreement, we were to employ the reflectors during times they cannot be used for power generation we could perhaps increase the temperature at strategic points enough to initiate or increase showers where they are needed. Once initiated, they would persist long enough to benefit people affected by drought.

6.2 Snow Removal

The effect of light snow cover on the air temperature and energy use in large cities is dramatic. Snow cover reflects sunlight back to space rather than allowing it to be absorbed, so the daytime maximum temperatures are lower. At night, snow cover radiates at a wavelength that is a window in the atmosphere, so the surface cools more than if there were no snow.

Reflectors could be used where the opportunity is available to increase the insolation on large cities. Besides the bonus of the temperature rise, it could melt light snow cover and lead to decreased energy use, greater road safety and other benefits.

Since the opportunities for atmospheric resource management presented by reflectors are almost endless and this is beyond our charter anyway, we will stop.

7.0 CONCLUSIONS AND RECOMMENDATIONS

7.1 Effects on Clouds and Precipitation

The effects of ground based SOLARES collectors on the atmosphere are not insignificant. The estimated surface temperature and the air temperature rise resulting from the waste heat would make significant local changes in the weather. The effects are much more pronounced if moisture is present, which would normally be the case in Georgia. The effects are much greater for light winds, which are frequent in both Georgia and the Southwest.

In general, the effects are likely to be about the same as building a small mountain range. The effect of such a change in the southwest is likely to be relatively small compared to the extremes already existent there. The effect in Georgia could be dramatic and would have significant impacts on the climate in the immediate area and for perhaps 150 km downwind. The effects may be manageable, however, further study and modelling will be required to quantify the effects.

7.2 Opportunity

The effects identified in this study offer a significant opportunity to manage some aspects of our atmospheric resources. Increasing precipitation where it is needed is the greatest apparent opportunity.

7.3 Site Selection

The southwest U.S. appears to be far superior from an environmental impact standpoint, primarily because the air is dry there. This minimizes any cloud or precipitation modification effects. The Georgia site would be under the influence of moist air most of the year, making the climate sensitive to the effects of the heat island. The potential for downwind effects might suggest a coastal site so the downwind effects occur over the sea.

In either case, it would be important to choose sites at which the environmental effects could be of long term benefit, rather than attempt to assure zero environmental effects. In general, windy sites will be better from the viewpoint of minimizing cumulus cloud effects. Sites which do not amplify natural orographic airflow should be sought. Likewise sites where the expected effects could be of benefit, would help.

Appendix 4

FINAL REPORT

to

LOCKHEED ELECTRONICS COMPANY, INC.
a subsidiary of Lockheed Aircraft Corporation
Houston, Texas 77058

Some Environmental Aspects
of the
SOLARES Earth Station

CEM Report 4241-614

G. D. Robinson
Principal Investigator

March 1978

TABLE OF CONTENTS

<u>Section</u>	<u>Title</u>	<u>Page</u>
1.0	SUMMARY OF THE PROBLEM, METHOD OF INVESTIGATION AND CONCLUSION	1
2.0	RELEVANT CLIMATE STATISTICS OF THE PROPOSED SITES	4
3.0	HEAT BALANCE OF THE EARTH'S SURFACE IN NATURAL CONDITIONS	8
4.0	SOLARES BATTERY SURFACE HEAT BUDGET - MAGNITUDES	10
5.0	SIMPLE MODELS OF HEAT REJECTION TO THE ATMOSPHERE BY A SOLARES BATTERY	14
	Model 1. No mean wind	15
	Model 2. Mean wind with no lateral mixing	16
	Model 3. Mean wind with lateral mixing	17
6.0	REACTION OF THE ATMOSPHERE TO THE PRIMARY PERTURBATION BY THE SOLARES BATTERY	18
7.0	CLIMATIC EFFECTS IN THE NEIGHBORHOOD OF THE SOLARES SITE	22
8.0	COMPREHENSIVE MODELING OF THE METEOROLOGICAL SITUATION	25

TABLES

RELEVANT CLIMATIC STATISTICS

1	Bright sunshine duration as fraction of possible	6
2	Surface irradiation as fraction of extraterrestrial	6
3	Surface wind speed. Annual mean and frequencies	6
4	Mean surface dew-point °C	7
5	Mean surface temperature °C	7

FIGURES

1	Monthly mean solar irradiance of the surface. Arizona region.	27
2	Monthly mean solar irradiance of the surface. Georgia region.	28
3	Cooling to space by Simpson's rule	29
4	Illustrating Model 3. (Arizona, summer. 3.200 km ² battery)	30
5	SOLARES Model 3. Inversion required to inhibit vertical mixing.	31

1.0 SUMMARY OF THE PROBLEM, METHOD OF INVESTIGATION AND CONCLUSION

The problem considered in this report is - "A substantial area of the earth's surface (Case (a) 40,000 km², Case (b) 3,200 km²) is covered by material totally absorbing solar radiation. Twelve (12) percent of the absorbed energy is usefully converted and removed, the remainder dissipated by natural processes. By means of a mirror in space, irradiation of the absorbing material is increased to the extent that would maintain an irradiance of about 1350 Wm⁻² if the transmissivity of the atmosphere were not drastically changed. What will be the effect on the atmosphere and surroundings of this operation?"

The perturbation of natural processes here proposed is of much greater magnitude than any other which has yet been imposed or contemplated. The standard method of handling this type of question involves the use of meteorological models based on the equations of atmospheric dynamics and thermodynamics. This, in its most plausible development, is a method of great complexity, which complexity translates into considerable effort and money. The possible extent of this effort is discussed in Section 8 of this report, together with some cautionary remarks on the applicability of current models to a perturbation of the magnitude now faced.

With time and money limited, we take a different approach in this report; attempting to estimate the minimum atmospheric perturbations associated with an efficiently operating system. These estimates turn

out to be not only environmentally unacceptable, but incompatible with efficient operation of a SOLARES-type system with receivers of the size contemplated. The key to this approach is consideration of the surface temperature of the SOLARES battery. In the normal modeling approach, this would be an output of the model, which would adjust surface temperature and atmospheric response to achieve equilibrium. Instead, we assume that the SOLARES system is operating with its designed irradiance. We first demonstrate that for a fixed dissipation rate, disturbance to the atmosphere (except in a thin surface skin) decreases with increasing surface temperature. We choose the highest surface temperature which seems consistent with the efficient operation of the solar battery, considered only as a semi-conductor device. We then estimate the very broad nature of atmospheric perturbations associated with this surface temperature. We find they are severe in two respects.

1. They include wind speeds which would probably be considered unacceptable.
2. Almost certainly in two of the three configurations considered, and probably in the third, they would drastically reduce irradiation of the battery, effectively reducing the perturbation and ending efficient extraction of power.

The conclusion of this argument is that SOLARES batteries of the size proposed could not operate efficiently at the designed irradiation. This conclusion could not be changed by changing the location of the site: the southwestern U.S. is climatically an optimum location.

We do not suggest that it is satisfactory that the fate of an imaginative project of this magnitude should rest on the negative findings of simple indirect arguments such as those we put forward, but emphasize our belief, firstly, that full consideration calls for a considerable meteorological research and development effort and, secondly, that there is little merit in approaches which in level of effort fall between that of this report and comprehensive modeling.

2.0 RELEVANT CLIMATE STATISTICS OF THE PROPOSED SITES

The sites under consideration are -

1. An area of 40,000 km² in the southwestern U.S.
2. An area of 3,200 km² in the southwestern U.S.
3. An area of 3,200 km² in central Georgia.

Table 1, extracted from the "Climatic Atlas of the United States," (U.S. Department of Commerce, 1968)*, shows the duration of bright sunshine, as a fraction of that possible, for sites in Arizona and Georgia. This may be taken as a measure of daytime cloud cover and demonstrates roughly quantitatively the greater suitability of the desert sites for SOLARES-type ground stations at all seasons of the year, should induced cloud formation not occur.

Table 2, which summarizes Figs. 1 and 2, shows the fraction of extraterrestrial solar radiation received at the ground in the same locations. These statistics should be considered as guides, in the absence of satisfactory measurements. The curve of extraterrestrial radiation is the average of that tabulated for latitudes 30° and 40° in 'Smithsonian Meteorological tables', (List, 1963), corrected for the annual variation of solar distance to apply to the Northern Hemisphere. The surface values are those computed by Atwater and Ball, (1976)**, by

*Reprinted by NOAA, 1974. National Climatic Center, Asheville, N.C. 28801

**M. A. Atwater and J. T. Ball, "Regional Variation of Solar Radiation with Application to Solar Energy System Design," CEM Report 4185-550a, 115 pp. Final Report, NSF Grant AER75-14536.

methods, involving the use of actual observations of atmospheric structure, which verify well in the few places where reliable solar observations are available for comparison. Systematic errors of Table 2 are estimated at not more than ± 3 percent. The numbers in Table 2 can be considered a reasonable estimate of that fraction of the radiation reflected from the SOLARES space mirror which would reach the collecting surface for the two sites, if the cloud and dust content of the atmosphere were not modified by the operation.

The atmospheric transmissivity of the Arizona site in spring is remarkably high; a result of altitude, dryness, freedom from substantial man-made pollution, and infrequency of dust-raising winds. It seems unlikely that a more suitable site could be found in the Northern Hemisphere - most desert areas have heavier atmospheric dust loads.

Tables 3, 4, and 5, modified from data in the 'Climatic Atlas' contain information on the sites which is used in Sections 5 and 6 in assessing the atmospheric reaction to the extra insolation of the SOLARES receiver.

RELEVANT CLIMATIC STATISTICS

Table 1. Bright sunshine duration as fraction of possible.

	<u>Year</u>	<u>March</u>	<u>July</u>	<u>Sept.</u>	<u>Dec.</u>
Phoenix, Arizona	.85	.83	.84	.89	.77
Yuma, Arizona	.91	.91	.92	.93	.83
Atlanta, Georgia	.60	.57	.62	.67	.47

Table 2. Surface irradiation as fraction of extraterrestrial

	<u>Year</u>	<u>March</u>	<u>July</u>	<u>Sept.</u>	<u>Dec.</u>
Phoenix, Arizona	-	.90	.73	.77	.67
Atlanta, Georgia	-	.61	.50	.53	.37

Table 3. Surface wind speed. Annual mean and frequencies.

	Annual Mean ms ⁻¹	Frequency in range (ms ⁻¹)				
		<u>0-1.5</u>	<u>1.6-3.0</u>	<u>3.1-5.5</u>	<u>5.6-8.0</u>	<u>>8.0</u>
Phoenix, Ariz.	2.4	.38	.36	.20	.05	.01
Tucson, Ariz.	3.6	.18	.35	.30	.14	.04
Atlanta, Ga.	4.3	.13	.24	.36	.21	.07

Table 4. Mean surface dew-point °C

	<u>Yr</u>	<u>Jan</u>	<u>Feb</u>	<u>Mar</u>	<u>Apr</u>	<u>May</u>	<u>Jun</u>	<u>July</u>	<u>Aug</u>	<u>Sept</u>	<u>Oct</u>	<u>Nov</u>	<u>Dec</u>
Phoenix	5	+1	+1	+1	+2	+2	6	14	16	12	7	2	+1
Tucson	2	-2	-3	-3	-3	-3	2	13	15	9	4	-1	-2
Yuma	4	-3	-2	-2	+7	+2	6	14	16	12	6	0	-2
Atlanta	10	+1	+1	4	9	14	18	20	19	17	11	4	+1

Table 5. Mean surface temperature °C

	<u>Yr</u>	<u>Jan</u>	<u>Feb</u>	<u>Mar</u>	<u>Apr</u>	<u>May</u>	<u>Jun</u>	<u>July</u>	<u>Aug</u>	<u>Sept</u>	<u>Oct</u>	<u>Nov</u>	<u>Dec</u>
Phoenix	-	10	13	13	17	24	29	32	29	27	21	13	11
Atlanta	-	7	8	16	17	21	25	27	25	22	17	11	7

3.0 HEAT BALANCE OF THE EARTH'S SURFACE IN NATURAL CONDITIONS

Part of the sunlight falling on the earth's surface is reflected. Of the heat absorbed, an energetically negligible proportion is used in photosynthesis. The remainder passes to the ground by conduction or is reradiated as terrestrial radiation, predominantly in the wavelength range $5 \mu\text{m} - 100 \mu\text{m}$, or is transferred to the atmosphere by convection, or as the latent heat of evaporated water which is released in precipitating cloud. In the global average the evaporative heat loss is several times the direct convective loss, but in desert conditions it is negligible and it is absent over an artificial dry impervious surface.

The illustrative examples of the annual mean surface heat balance in desert and semi-desert regions which follow are based in the main on measurements taken about 20 years ago (during the International Geophysical Years). The surface reflectivity (albedo) is an estimate based on various other measurements.

a. Desert (near Aden $\sim 10^\circ\text{N}$).

Solar radiation at surface	+	240 Wm^{-2}
" " reflected (estimate)		60 Wm^{-2}
" " absorbed		180 Wm^{-2}
Net radiation (solar and terrestrial) at surface		95 Wm^{-2}
Heat storage in ground		~ 0
Net outward terrestrial radiation		$180 - 95 = 85 \text{ Wm}^{-2}$
Heat to be dissipated by convection and evaporation		95 Wm^{-2}

b. Semi-desert (Tashkent USSR 40°N)

Solar radiation at surface	190 Wm^{-2}
Solar radiation reflected (estimate)	40 Wm^{-2}
Solar radiation absorbed	150 Wm^{-2}
Net radiation (solar and terrestrial) at surface	75 Wm^{-2}
Heat storage in ground	0
Net outward terrestrial radiation	$150 - 75 = 75 \text{ Wm}^{-2}$
Heat to be dissipated by convection and evaporation	75 Wm^{-2}

4.0 SOLARES BATTERY SURFACE HEAT BUDGET - MAGNITUDES

The SOLARES system envisages a continuous irradiance of $\sim 1350 \text{ Wm}^{-2}$ of which 12 percent is converted. Approximately 1200 Wm^{-2} remains to be dissipated. This unit area dissipation rate is more than 10 times the annual mean for a desert region. It is approximately twice the probable maximum transient summer noon dissipation in the desert in natural conditions. It is approximately twice the largest man-made energy dissipation over an extended source: the 50 km^2 of Manhattan Island has been estimated to dissipate about 600 Wm^{-2} .* It is of order 100 times greater than the projected dissipation of an SPS rectenna site and of order 50 times that of extended industrialized cities (order 400 km^2), such as St. Louis, Mo. where man-made weather changes have been studied.

Evaporative cooling

1200 Wm^{-2} is sufficient to evaporate about 3 cm of surface water per day: a substantial fraction of the desert mean annual rainfall. We will assume no natural or artificial water cooling of the SOLARES site.

Cooling by conduction to the ground.

The thermal conductivity of loose soil is of order $1 \times 10^{-5} \text{ Wm}^{-1} \text{ }^\circ\text{C}^{-1}$ that of rock is of order $1 \times 10^{-4} \text{ Wm}^{-1} \text{ }^\circ\text{C}^{-1}$. Removal of 100 Wm^{-2} by conduction from an artifact in good thermal contact with loose soil, therefore,

*This is not a well-authenticated statistic and much of the dissipation is probably to cooling water. "Report of the Study of Man's Impact on Climate (SMIC)," 1971, MIT Press.

calls for a temperature gradient of $10^3 \text{ }^\circ\text{C m}^{-1}$ and with rock for a temperature gradient of $10^2 \text{ }^\circ\text{C m}^{-1}$. Since in a useful efficient system the surface temperature of the artifact is limited (we assume 150°C as the maximum for solar cells), it is clear that the gradients required to remove to the ground only 10 percent of the 'waste' solar heat cannot be maintained, and that conduction to earth would be a negligible factor in a continuously operating installation. Similar arguments rule out significant lateral heat conduction from the perimeter of the installation.

Radiative cooling

A black surface (emissivity 1) at 150°C radiates about 1850 Wm^{-2} , most of which is absorbed in, and heats, the atmosphere. We require to know the fraction of this radiation which passes through the atmosphere and results in 'cooling to space'. This is the only element of the surface heat budget which constitutes a true rejection from the planet of the 88 percent 'waste heat' of the SOLARES system. In the natural heat budgets discussed above it is the term 'net outward terrestrial radiation' of magnitude about 80 Wm^{-2} .

This quantity can be computed with some precision if the state of the atmosphere (temperature and cloud, H_2O , O_3 and CO_2 amounts as functions of height) is known. There is, however, a simple device first used by G. C. Simpson 50 years ago which allows a close estimate, sufficiently accurate for the present purpose. Simpson's rule is that in the absence of cloud all the radiation computed from Planck's formula between $10 \text{ }\mu\text{m}$ and

11 μm , and half of that between 8.5 μm and 10 μm , and between 11 μm and 14.5 μm is transmitted by the atmosphere. (With complete low and medium cloud cover, there is no direct cooling to space.) Within the accuracy of the estimates, this leads to a linear relation between 'cooling to space' and surface temperature for temperatures between about 50°C and 200°C as illustrated in Fig. 3. As an example of the use of this diagram, it shows that for a surface emissivity of 0.9, the annual mean surface temperature at Aden (cooling 85 Wm^{-2} , cloud amounts small) should be about 25°C.

A black surface at 150°C rejects about 370 Wm^{-2} to space. If the SOLARES battery has this surface temperature, it must reject 830 Wm^{-2} of the waste 1200 Wm^{-2} to the atmosphere by radiation and convection. This number cannot be substantially changed by changing surface temperature within reasonable limits, e.g., for a 200°C surface, the required rejection rate to the atmosphere is 660 Wm^{-2} ; for a 100°C surface it is 960 Wm^{-2} . Note that a black surface at temperature 150°C radiates 1825 Wm^{-2} , so that if 1200 Wm^{-2} is supplied to it by the sun, 625 Wm^{-2} must be supplied by the atmosphere, which means an equivalent black-body temperature for the atmosphere of 50°C, and therefore atmospheric temperatures considerably higher than 50°C in the lower layers. There is no simple way of computing the actual surface temperature in any given set of circumstances. If a surface temperature is assumed, there is no simple way of partitioning the rejection to the atmosphere between radiation and convection: computation of the radiative loss to the atmosphere requires

a knowledge of the actual perturbed atmospheric structure. The radiative loss is, however, predominantly to the lowest layers and the convective loss is to the surface 'skin'. The atmosphere is heated from below, with resulting instability, by both the convective and radiative processes, and the disturbance to the atmosphere depends on the rate of dissipation of heat added at the surface by the SOLARES battery, less the cooling to space.

5.0 SIMPLE MODELS OF HEAT REJECTION TO THE ATMOSPHERE BY A SOLARES BATTERY

We proceed to some extremely simplified computations of the amount and nature of the ventilation called for by the need to dissipate heat to a cloudless atmosphere at rates of 800 Wm^{-2} and 960 Wm^{-2} , in terms of the thickness of the atmospheric layer affected and the resultant mean air temperature rise. These computations do not in any way predict the actual effect of the atmosphere on the system, but do suggest certain undoubtable consequences of the system which do not have possible responses.

**ORIGINAL PAGE IS
OF POOR QUALITY**

The major artificial device in the computations is assumption of a surface temperature. For a given solar energy supply, the higher the temperature assumed, the higher the cooling to space and the less the rate of heating of the atmosphere. The figure of 800 Wm^{-2} means that we have assumed a surface temperature of 150°C . If we take a lower temperature the atmosphere's share of the waste heat increases: the figure of 960 Wm^{-2} corresponds to an assumed surface temperature of 100°C . Assumption of the highest reasonable operating temperature minimizes the heat disturbance of the atmosphere by the waste heat rejection. If, with a fully irradiated battery, lower surface temperatures were to occur, it would result in greater power dissipation to and disturbance of the atmosphere. We assume 150°C as the highest reasonable operating temperature and use this temperature and also 100°C in the very simple models.

Model 1. No mean wind.

(a) 40,000 km² array

The rate of heat supply to the atmosphere for surface temperature 150 C is about 800 Wm⁻². The specific heat of air is 1.J.g⁻¹ °C⁻¹. The mass of air heated by δT °C is [(0.8)/δT] Kg m⁻² s⁻¹ or [(3.2 × 10¹⁰)/δT] Kg s⁻¹ for the whole array. The mass of the whole atmosphere is approximately 10⁶ Kg m⁻² and we assume a fraction δp of this mass is heated uniformly by δT °C. The perimeter of the array is 8x10⁵ m, so the mean wind speed across the perimeter to supply the air necessary for heat removal is [3.2x10¹⁰/(10⁶x8x10⁵ δT δp)] ms⁻¹ or [4/(δT δp)] ms⁻¹. If, for example, δp is 0.2 and δT is 10, the mean wind speed normal to the perimeter through the lowest 200 mb (2000 m) of the atmosphere is 5 ms⁻¹. The corresponding pressure anomaly at the surface across the perimeter is (δT/T²K) δp x 1000 mb, that is about 3 mb and the mean upward air flow at pressure 800 mb (height about 1300 m) is 0.2 KG m⁻² s⁻¹, approximately 0.2 ms⁻¹. All the perturbations depend linearly on the assumed rate of dissipation to the atmosphere. For 960 Wm⁻² (100 °C surface temperature), the wind speeds and pressure anomalies increase by a factor 1.2.

(b) 3,200 km² array

The dissipation and, therefore, the mass of air per unit area heated by δT °C is the same as in case (a). The total heated air mass is 2.56x10⁹/δT Kg s⁻¹. The perimeter of the array is 2.26x10⁵m and if

fraction δp of the atmosphere is heated, the cross-perimeter wind is $1.1/(\delta T \delta p) \text{ms}^{-1}$. With $\delta T = 4^\circ\text{C}$, $\delta p = 0.2$, as in case (a), the cross-perimeter wind is 1.4ms^{-1} and the corresponding vertical velocity at the top of the heated layer is 0.2ms^{-1} . The pressure anomaly across the perimeter depends only on the heat rejection rate and is 3 mb, as in case (a). These perturbations increase by a factor 1.2 for an assumed surface temperature of 100°C .

Model 2. Mean wind with no lateral mixing ('wind tunnel' model)

The assumption is that a uniform unchanging ambient wind, speed $V \text{ms}^{-1}$, blows over the SOLARES battery, does not mix laterally with surrounding air, and is uniformly heated to a height which encloses a fraction δp of the atmosphere.

(a) $40,000 \text{km}^2$ array

Each 1 m wide strip of the battery transfers heat to the atmosphere at a rate $800 \times 2 \times 10^5 \text{W}$. The air supply is $V \delta p \times 10^4 \text{Kg s}^{-1}$, so the temperature rise traversing the battery is $16/(V \delta p)^\circ\text{C}$. For a wind of 5ms^{-1} and $\delta p = 0.2$, the temperature rise is 16°C . If the whole troposphere is heated, the temperature rise is about 1.2°C . The mean air temperature excess over the whole array is $1.2/1.2 = 1^\circ\text{C}$. The maximum crosswind pressure anomaly (at the downwind edge) is 10 mb, the mean 5 mb. There is a downwind surface pressure drop of 10 mb across the array. These perturbations increase by a factor 1.2 for an assumed surface temperature of 100°C .

(b) 3,200 km.² array

For the same V and δp , the temperature excess and pressure anomaly are reduced in proportion to the linear dimension of the array, i.e., by a factor 0.28, so that the maximum temperature anomaly becomes 4.5°C for $\delta p = 0.2$ and 1.1°C for the whole troposphere, with a maximum pressure anomaly of 2.8 mb. The anomalous pressure gradient across the area in the direction of the wind remains the same at 5 mb per 100 km. These perturbations increase by a factor 1.2 for an assumed surface temperature of 100°C.

Model 3. Mean wind with lateral mixing.

This model is similar to model 2 but allows lateral mixing with an unchanged mean wind speed. The model is illustrated in Fig. 4a, where AAPB represents the SOLARES site and air leaving the area AACC has been heated to a temperature shown by the profile across CC in Fig. 4b, i.e., the mixing is limited within an angle of 45° from the upwind corners, and the temperature rise decreases linearly across wind from the downwind corners. The effect is the same as if twice the amount of air in the 'no mixing' Model 2 has been heated to half the previous temperature excess. The effective overall mean wind speed in the mixing zone is twice the mean wind speed, V .

The temperature and pressure anomalies are half those for the corresponding case of Model 2. The pressure gradient anomaly, which in these models depends only on the primary dissipation rate per unit mass of air, is 2.5 mb per 100 km. These perturbations increase by a factor 1.2 for an assumed surface temperature of 100°C.

6.0 REACTION OF THE ATMOSPHERE TO THE PRIMARY PERTURBATION BY THE SOLARES BATTERY

As has been emphasized, the models discussed have been highly unrealistic. They represent situations which might be achieved transiently in small-scale wind tunnel investigations. The point of using them has been to estimate the magnitude of the initial perturbation of a dry atmosphere. This, in turn, allows an estimate of the initial reaction of the atmosphere to the pressure gradient accelerations, to the mean vertical motions, and to the instability of the perturbed temperature structure in the vertical.

Wind perturbation in a dry atmosphere

Models 1 and 2 contain pressure discontinuities at the surface of up to 10 mb, and Model 3, a pressure gradient of 1 mb per 40 km for both 40,000 km² and 3,200 km² cases. In estimating the reaction of a dry atmosphere to continuous perturbation by these gradients on these scales, the Coriolis acceleration must be considered dominant. The geostrophic wind at latitude 35° corresponding to 1 mb per 40 km is about 30 ms⁻¹. A similar conclusion can be reached by comparison with a mature hurricane. The model SOLARES site conversion rate of 800 Wm⁻² is about one-fifth of that of a hurricane, (based on precipitation rates) and the linear dimensions are comparable. One would expect the SOLARES winds to be less than those of a hurricane by a factor of about 5^{1/2}, i.e., 2 to 2.5. Winds of this nature completely change the model picture of events, but so long as the SOLARES battery remains illuminated by full sunlight, the energy supply to the atmosphere is not decreased unless the battery surface temperature rises (and then not greatly), and the perturbation pressure gradient depends directly on this energy supply

and inversely on the ventilation rate. If the atmosphere were indeed completely dry, there would be a major dust storm, probably sufficiently intense to reduce the irradiance of the battery area to or below that of the surroundings.

Cloud formation in a moist atmosphere

Model 1

In this model there is a uniform convergence of air into the battery area below a level δp , a steady mean vertical wind through this level, and divergence above. The air passing through level δp has a temperature excess over the environment and there is no lateral mixing. The temperature excess assumed in the example is 4°C . The rising air would cool at dry adiabatic lapse rate. If the water content in the incoming low level air were 2g/Kg , i.e., about 30% RH at 31°C , there would be condensation at about 7°C , (at about 700 mb pressure, see below), requiring a total cooling of 20°C in dry adiabatic ascent, i.e., to a height of about 3000 m, or roughly 700 mb. For a water content of 12.5g/Kg , about 60% RH at 27°C , the condensation temperature (at about 850 mb) is 15°C , requiring a cooling by ascent of 16°C . Condensation would occur at about 1600 m, roughly 850 mb. The first of these examples typifies summer conditions in the southwestern desert, the second summer conditions in central Georgia. In the second (Georgia) example, all the rising air would reach condensation level. If, in the first (desert) example, the upper divergence is spread evenly through the troposphere above the neutral level at δp , about five-sixths of the air ascending through δp would reach the condensation level. In either case, cloud would form over an area comparable with that of the SOLARES battery and, in the 'no mean wind' model, cloud would drastically reduce irradiation of the battery.

Models 2 and 3 consider cooling by a mean wind within a layer of thickness δp , implying no vertical mixing through a 'lid' (i.e., temperature inversion) at this level. In the less artificial model (3), with lateral mixing, the temperature excess of the air at the downwind edge of the battery is $\delta T = (800 L) / 2V\delta p \times 10^7$, where L is the linear dimension of the battery (in m), V the mean wind speed, and δp is expressed as a fraction of the atmosphere. This is the temperature excess over the unheated environment. The model, thus, implies an inversion of temperature of at least δT at the height corresponding to δp : this inversion inhibits further mixing in the vertical. The situation is illustrated schematically in Fig. 4c and the magnitude of the inversion is shown in Fig. 5 as a function of the pressure level corresponding to δp for the two battery sizes. Mixing which, above a surface 'skin', would be on the dry adiabat would be expected up to the lowest level at which the environmental temperature-height curve showed an inversion of appropriate magnitude. If this level were at the condensation level indicated in Fig. 5, cloud would form at the downwind edge of the battery. If the environmental inversion were at a greater height than the indicated condensation levels, which are based on climatological mean surface temperature and humidity, cloud would form within the area of the battery.

It is most unlikely that inversions of the magnitude shown for the $40,000 \text{ km}^2$ battery would be found at the appropriate height at either location, and induced cloud should be expected within the battery area. Existence of an effective 'lid' is considered more likely on this model

for the 3200 km² battery, at both locations but still rare, and induced cloud would occur on most occasions. A search for inversion frequencies within the region of the proposed sites could be made using archived radio-sounding data, but is beyond the scope of this appraisal. It is not recommended as a useful exercise: a further reconsideration should be on radically different lines, (Section 8).

7.0 CLINATIC EFFECTS IN THE NEIGHBORHOOD OF THE SOLARES SITE

The conclusions of Section 6 are that operation of the SOLARES system as envisioned would produce either sufficient cloud over the site to inhibit efficient operation or alternatively, on rare occasions, near-hurricane force dust-raising winds. However, it seems logical to take the same standpoint as in Section 4 and examine consequences to the surrounding area of efficient operation of a fully irradiated battery with surface temperature 150°C . There is no way in which this can be done with any degree of plausibility, short of comprehensive modeling, but some extremely serious effects seem inevitable.

In the first place, it should be noted that the assumed surface temperature of 150°C is not implausible. Isolated artifacts (e.g., vehicles and aircraft) situated in the desert in poor thermal contact with the ground reach surface temperature of $80\text{--}85^{\circ}\text{C}$ when the surrounding desert surface at noon is $55^{\circ}\text{--}60^{\circ}\text{C}$ and air temperature at 1 meter height around 45°C . In contrast to the SOLARES battery, these are not black surfaces and are small and freely ventilated.

Immediate vicinity of the site

A surface at 150°C cooled mainly by convection implies that some air attains this temperature and in the models with an overall mean wind some air leaving the downwind edge of the battery would have temperature 100°C or more in the first few meters above the surface. There would be a zone in which life could not be supported except by elaborate construction and cooling. There is no simple way of estimating the extent of

this zone. Beyond this for a distance downwind comparable with the dimension of the battery, there would, on models 2 and 3, be noticeably elevated surface and 1 meter level temperatures and greatly increased potential evaporation. In the desert situation, there is no obvious agricultural advantage - the extra heat would call for extra water over and above the normal irrigation requirements of an extra crop. In a (natural) storm situation, with the whole region covered with cloud integrated irradiation of the site would be of order three to four times the reduced natural irradiation of the surroundings, but the greatest perturbation in these circumstances would probably come from release of heat stored in the ground below the battery during periods of full irradiation.

Regional and global scales

Adding heat to the atmosphere without adding extra water will not increase rainfall globally. It can redistribute rainfall, and in non-arid regions it can, by increasing evaporation within the region, increase rainfall averaged over the region without greatly affecting the total surface water balance. There is little question that rainfall amounts, thunderstorm frequencies, etc., would increase downwind of a SOLARES battery. For the southwestern sites, this would be at the expense of increased aridity of other parts of the region. For the Georgia site, it could also be at the expense of increased evaporation, both in the area of increased rainfall and in surrounding areas. There is evidence of rainfall increase downwind of major cities, but this may to some extent

be associated with material emissions which are absent in the SOLARES case, (Report of the Third Inadvertent Weather Modification Workshop, 1977)*.

It seems safe to ignore the possibility of any global climate change since operation of one 40,000 km² SOLARES site would increase the total irradiation of the planet by only about 0.03 percent.

* CEM Report 4215-604, 1977, Final Report NSF Grant ENV77-10186.

8.0 COMPREHENSIVE MODELING OF THE METEOROLOGICAL SITUATION

We strongly recommend that any further investigation of environmental effects of a SOLARES battery site of the dimensions now contemplated should be by use of a comprehensive three-dimensional meteorological model based on the 'primitive' dynamical equations, generating cloud cover, and including detailed treatment of the boundary layer. Topography of the actual site surroundings should be included. CEM has experience of this type of work and is in a position to estimate the effort required.

The area modeled should be not less than three times the linear dimensions of the battery site and the 'box' side should be not more than one-fourth of the battery scale. This calls for at least 148 'boxes'. CEM is at present collaborating with the Swiss Federal Institute for Reactor Research on a modeling project which involves development and use of a topographically detailed model with 140 boxes, 20 atmospheric levels, and eight sub-surface levels. (The perturbation envisaged in this exercise is the 'waste heat' from several nuclear power installations.)

The major difficulty foreseen in extending this type of model to the SOLARES problem is the high surface temperatures expected to be associated with efficient operation. These could hardly be less than the 80°C to 90°C associated with small artifacts irradiated by the desert noon sun. In the model, convection in the lower atmosphere is 'parameterized' - certain coefficients being established by reference to experience. There is no experience with surface temperature of order 100°C or higher. The initial

modeling would have an element of extrapolation. Of course, the model might - we consider almost certainly would - develop cloud and high surface winds, reducing the surface temperature into the regime which can be confidently parameterized; if this were the outcome, it would indicate impracticability of the SOLARES concept, in a much more convincing manner than the arguments of Section 6 of this report.

Development, verification, and application of the Swiss model, starting with the framework of the basic model briefly described by Atwater* has already consumed ten (10) hours of computing time on CDC7600 machines. Much of this is, however, associated with the extremely detailed topography required by the particular application. Nevertheless, it indicates the magnitude of this type of problem.

* Atwater, M.A., 1977: "Urbanization and Pollutant Effects on the Thermal Structure in Four Climatic Regimes," JAM, Vol. 16, No. 9, pp.888-895.

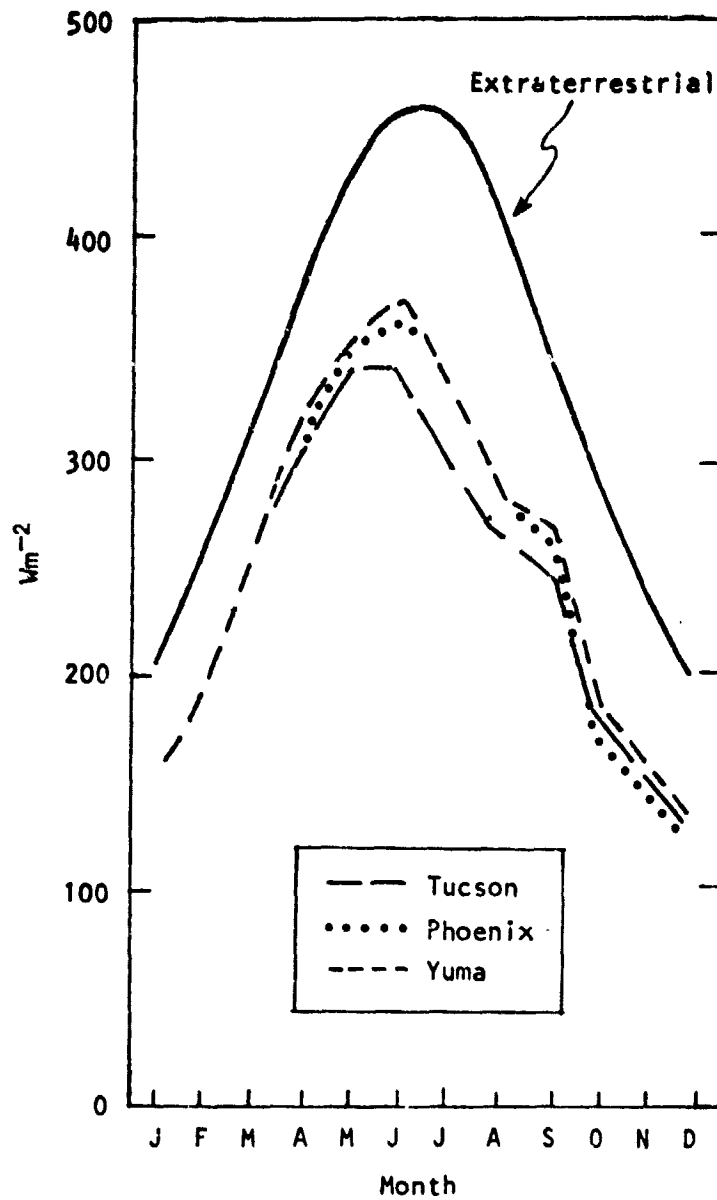

Figure 1: Monthly mean solar irradiance of the surface. Arizona region.

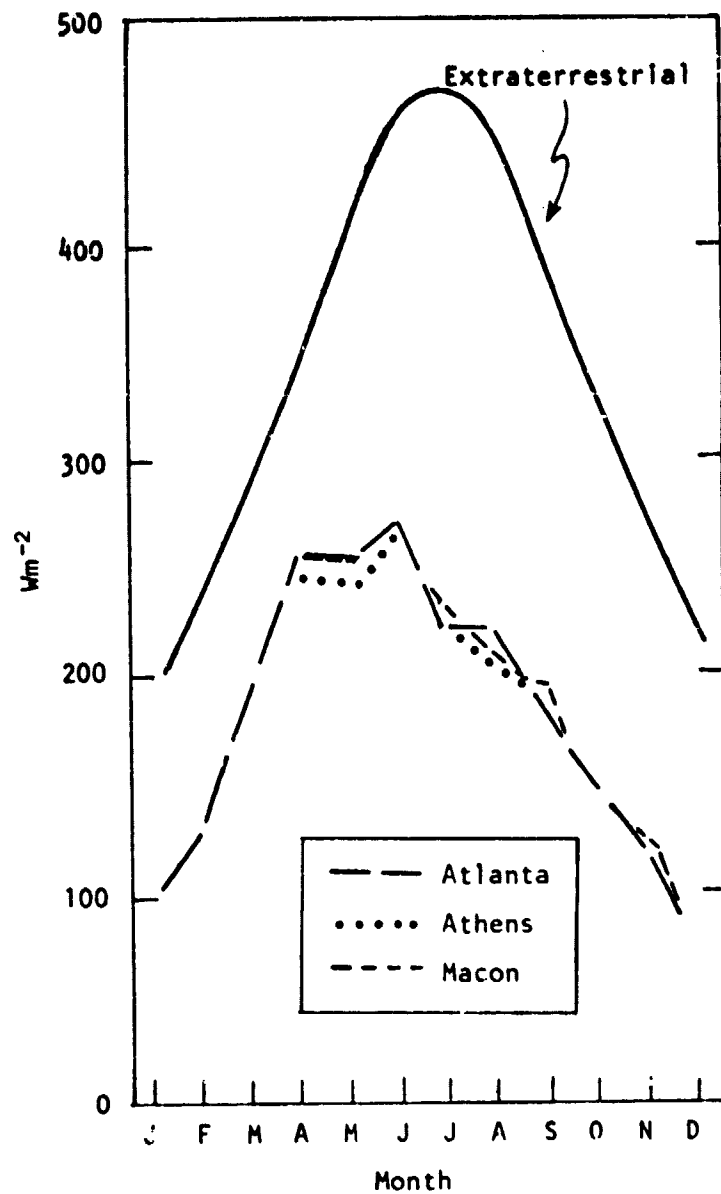

Figure 2: Monthly mean solar irradiance of the surface. Georgia region.

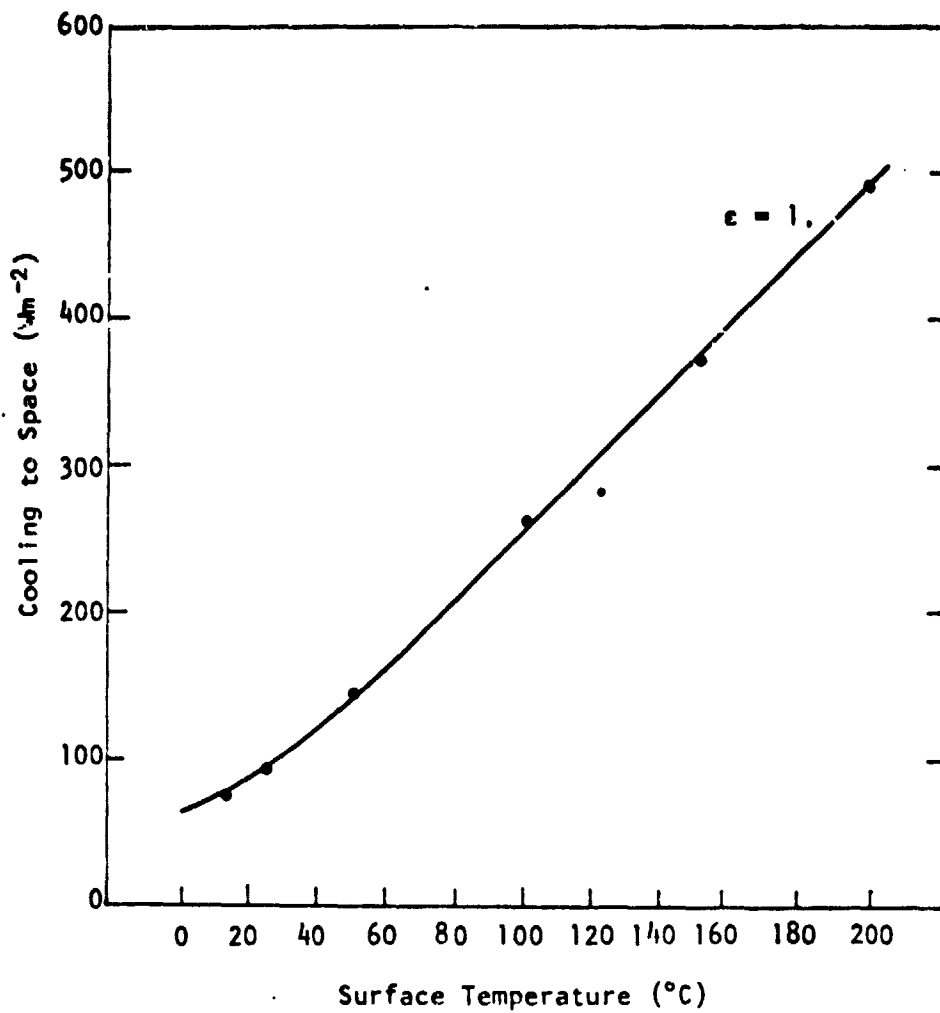
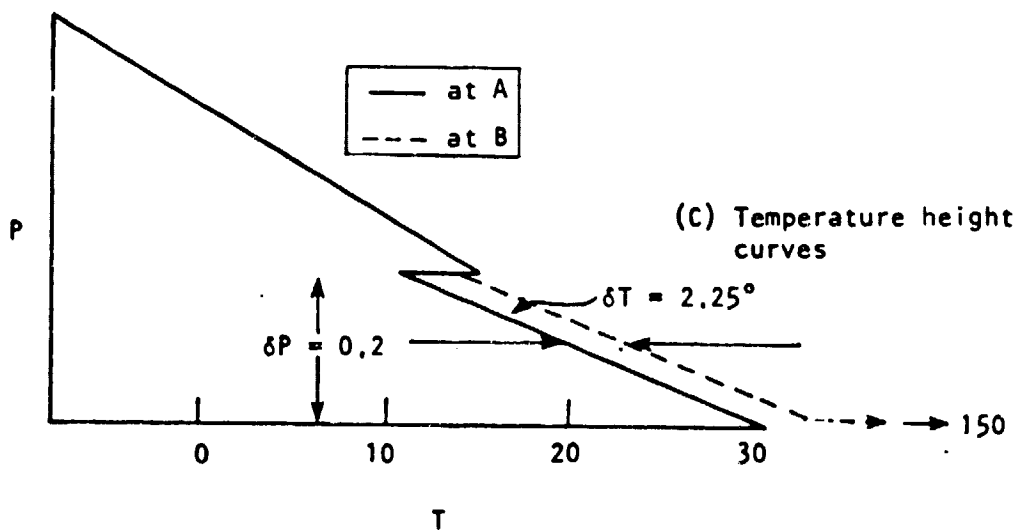
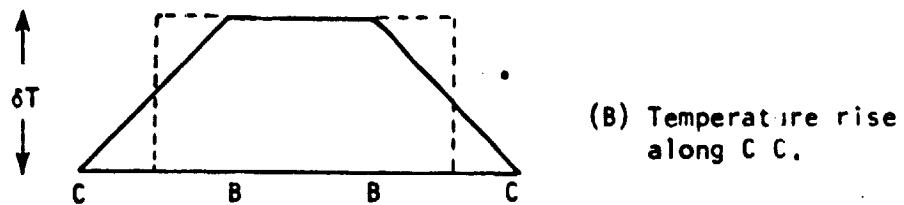
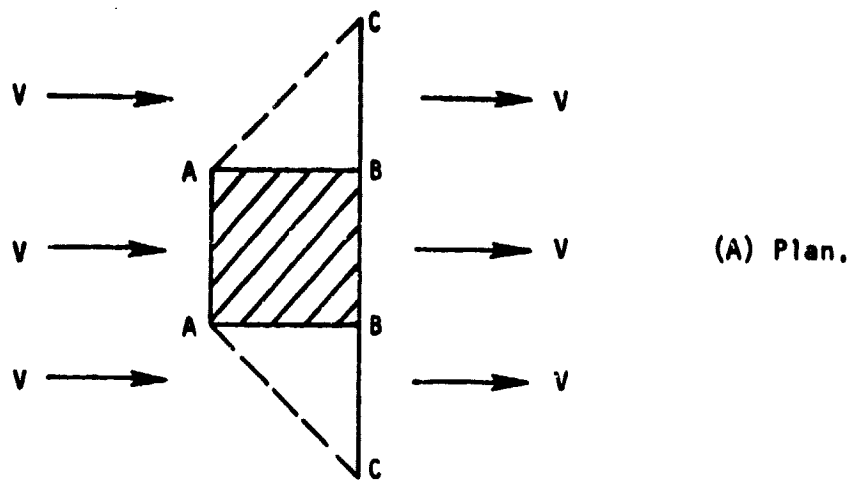

Figure 3: Cooling to space by Simpson's rule



(Arizona summer, 3,200km² battery)

Figure 4: Illustrating Model 3.

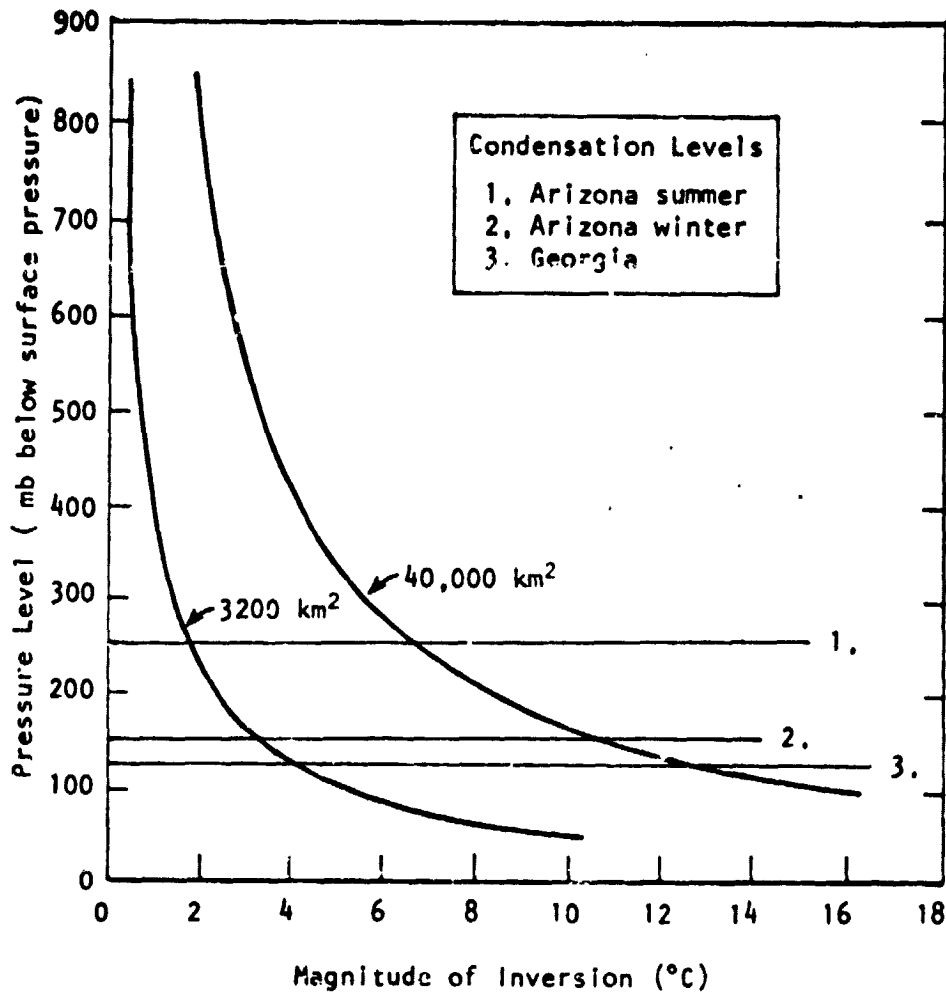

Figure 5: SOLARES. Model 3. Inversion required to inhibit vertical mixing.

Appendix 5

Simpson Weather Associates
Charlottesville, Virginia

Investigation of Weather Modification
Due to SOLARES Operations

by

Roger A. Pielke, Ph.D.

in consultation with: Michael Garstang, Ph.D.
Joanne Simpson, Ph.D., CCM
Robert H. Simpson, Ph.D., CCM

A preliminary draft report of a study conducted
by Simpson Weather Associates for Lockheed
Electronics Company, Inc. under terms
of the purchase order and
Professional Services Agreement
dated January 10, 1978.

Preliminary Draft

February 13, 1978

Investigation of Weather Modification
Due to SOLARES Operations

The purpose of this report is to assess the potential impact of the SOLARES (Spare Orbiting Light Augmentation Reflector Energy System) on local, regional and global climates for several specific geographic configurations. As outlined in the Work Statement these include

- i) 1 ground station with an area of 3200 km² over the southwest United States,
- ii) 1 ground station with an area of 3200 km² over the interior of Georgia,
- iii) 1 ground station with an area of 40,000 km² over the southwest United States,

each with an assumed latitude, as outlined in the Work Statement, of 32°N. The system would be designed to focus one solar constant (1350 watts m⁻²) on the collector surface of which 10% would be reflected, and the remainder (1215 watts m⁻²) absorbed. The efficiency of the ground station conversion to electric power is given as 12%, therefore, 1069 watts m⁻² of heat would be dissipated by the operating system into the environment.

The preliminary draft report prepared by Simpson Weather Associates for Lockheed Electronics Company, Inc. last year (Inadvertant Weather Modification Potential Due to Microwave Transmissions and the Thermal Heating at SPS Rectenna Sites by Roger Pielke in consultation with Michael Garstang, Joanne Simpson and R.H. Simpson) is of considerable use in preparing the current report, as well as in simplifying the analyses of

the possible environmental influences of the proposed system.

The anticipated problems in the reception of beam at the ground and in the dissipation of the unused heat of the system are considered separately, as follows.

I. How much of the beam reaches the receiver

The beam can be reflected as well as absorbed by the atmosphere, and by material in the air, especially clouds. As is well-known, clouds are highly reflective in the visible wavelengths with albedos ranging from 0.4 to 0.8 depending on cloud type and thickness, with an average around 0.55 (Byers, 1959). Thus when clouds are present, over half of the beam will generally be reflected back into space and, thereby, not available for electric power generation. The seriousness of this problem depends on the cloud climatology of a region. Figures 1-3 reproduced from Baldwin (1973), illustrate the mean daily sky cover (in tenths), sunrise to sunset in January, in July and for the entire year over the United States.

Over the southwestern United States (southern Arizona and southeastern California) the mean sky cover during the daylight hours in January is between 0.4 and 0.5 whereas, in July it varies from less than 0.3 near the southern terminus of the Colorado River to above 0.5 over the higher terrain in southeastern Arizona. The nighttime cloud cover during January should be similar to that observed in the day because of the dominance of synoptic scale weather features, whereas, during the summer the cloudiness should be much less at night because of the diurnal nature of summertime cloud activity. In the

MEAN DAILY SKY COVER, SUNRISE TO SUNSET, JANUARY
(In Tenths)

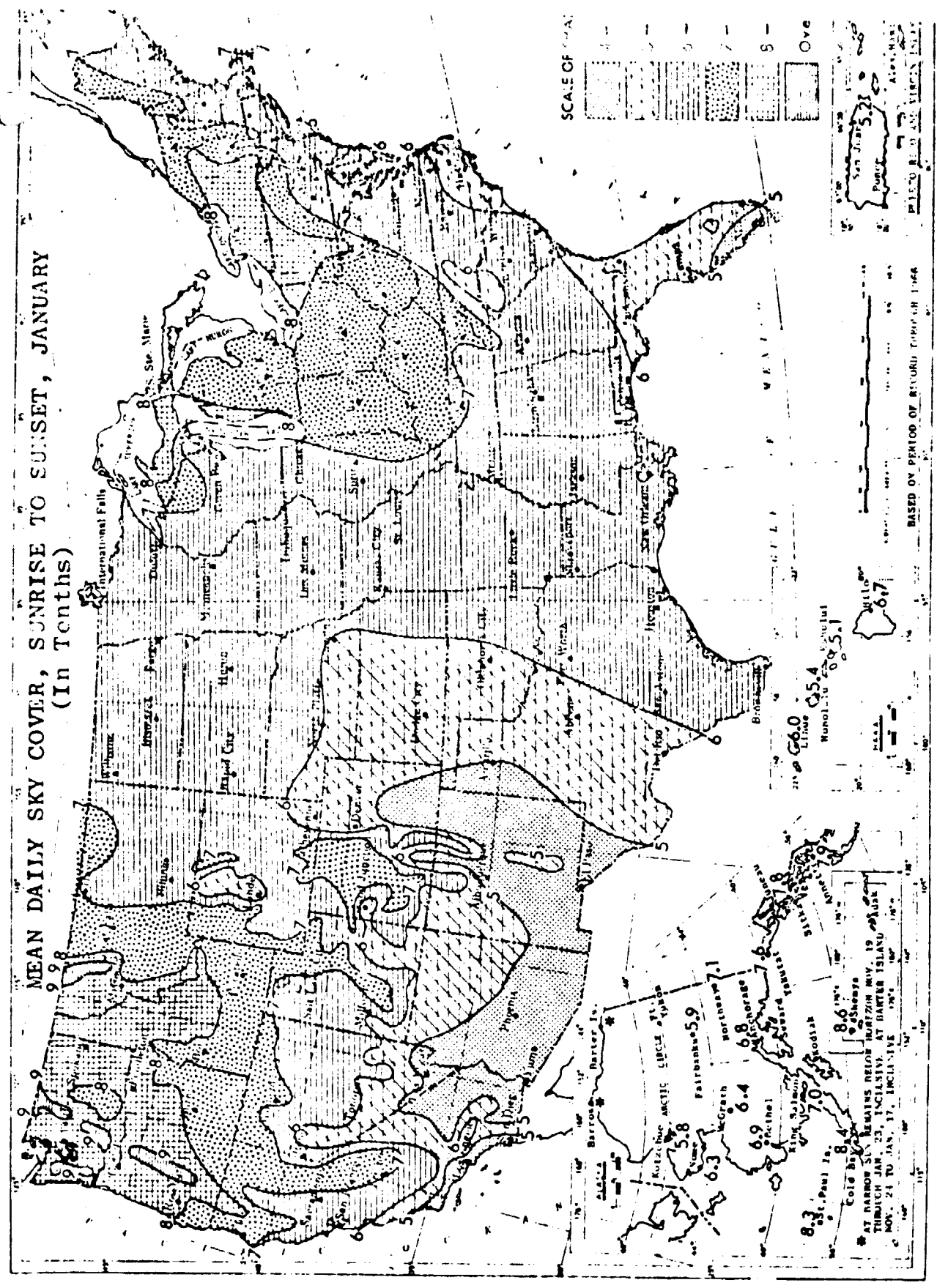

FIGURE 1 ORIGINAL PAGE IS OF POOR QUALITY

11-157



MEAN DAILY SKY COVER, SUNRISE TO SUNSET, JULY
(In Tenths)

SCALE OF SHADES

0-2
2-3
3-4
4-5
5-6
6-7
7-8

100-1000

ORIGINAL PAGE IS
OF POOR QUALITY

FIGURE 2.

MEAN DAILY SKY COVER, SUNRISE TO SUNSET, ANNUAL
(In Tenths)



FIGURE 3

ORIGINAL PAGE IS OF POOR QUALITY

annual mean, the mean sky cover ranges from somewhat less than 0.3 to 0.4. If we use a value of 0.35 as representative of the area for both day and night, and use a mean albedo of 0.55, then the loss of beam due to reflection is about 19% of the amount transmitted.

Over the interior of Georgia the amount reflected is greater. During both January and July the mean sky cover between sunrise and sunset is between 0.6 and 0.7. As for the southwest United States, the cloudiness should be relatively invariant between day and night in the winter, whereas it will be a minimum at night during the summer because of the strong diurnal variability in warm season cloudiness. The annual mean cloud cover is slightly less and, lies between 0.5 and 0.6 (the relatively clear skies in the fall reduce the mean cloud cover from that observed in January and July). If we use a value of 0.55 as representative of the area for both day and night, and use a mean albedo of 0.55, then the loss of beam due to reflection is slightly over 30% of the amount transmitted.

A second and less important sink for the transmitted visible light is due to absorption and scattering by the atmosphere. The reduction of sunlight through the effect can be estimated from Beer's Law as

$$I = I_0 e^{-az}$$

where I_0 is the radiant flux at the top of the atmosphere while I is its flux at the ground. The parameter, a , is an extinction coefficient whose value is given by Rosenberg (1974) as 0.01 km^{-1} in very clear air to 0.03 to 0.05 km^{-1} in turbid air. Its

precise value, as well as its distribution with height, is dependent on the scattering and absorption of the beam by dry air, water vapor, and aerosols during its transit of the atmosphere. The pathlength of the beam is dependent on the angle of the satellite relative to the zenith. If the satellite is overhead, for example, the effective depth of the atmosphere is 8 km so that the beam attenuates about 8% when the air is very clean to about 27% when it is less transparent. Larger attenuations would occur if the satellite is lower in the sky so that the optical pathlength is greater. More precise values for specific atmospheric conditions can be estimated for the southwest United States using the work of Idso (1969), who evaluated the solar attenuation at Phoenix, Arizona. The values given by Rosenberg, however, can be used to estimate the approximate expected effect in both Georgia and in the southwestern United States.

The extinction of the beam is a result of absorption as well as scattering. The latter effect will not directly influence the temperature structure of the air, however, absorption will heat the column through which the beam passes. Such absorption could also play an important role in the photo-dissociation of oxygen and other gases in the stratosphere, as well as near the ground above the receiver. The fraction of light which is absorbed depends on the pathlength as well as the particular material in the air. If we assume, however, that half the extinction is due to absorption, then the clear air and the turbid air attenuation results in a heating rate on the

order of .5 °K/day to 1.6 °K/day. Although this effect could have important environmental ramifications, as we will see in the next section the more substantial impact on the environment would be due to the immense heat dissipated by the ground-based station, after the beam is received.

II. What is the effect of the energy absorbed by the receiver which is not used for electric power generation

As discussed at the beginning of this report, approximately 1069 watts m^{-2} of heat would be dissipated by the operating system. In terms of daily totals this corresponds to about 2280 ly day^{-1} (1 ly = 1 cal $cm^{-2} day^{-1}$). At a latitude of 30°N, the daily normal solar radiation which reaches a horizontal surface at the outside of the atmosphere is (from List (1971))

775 ly day^{-1} on March 21
975 ly day^{-1} on June 22
765 ly day^{-1} on September 23
and 466 ly day^{-1} on December 22.

The amount which reaches the ground depends on the atmospheric transmittance. For a value of p equal to 0.9, or clean, dry air, the values are

651 ly day^{-1} on March 21
831 ly day^{-1} on June 22
641 ly day^{-1} on September 23
362 ly day^{-1} on December 22,

while for $p = 0.7$ or turbid atmospheric conditions, the values are

440 ly day^{-1} on March 21
588 ly day^{-1} on June 22
434 ly day^{-1} on September 23
210 ly day^{-1} on December 22.

Clearly all of the above values are much less than that transmitted by the satellite. Since the area beyond the ground-based

receiver will still receive the normal solar radiation, the resultant differential gradient in heat flux between the receiver and the environment will result in very strong atmospheric forcing.

Over Barbados and south Florida, for example, differences of heat flux between land and water of 400 watts m^{-2} for only a portion of the day, result in well-defined wind circulations and changes in the thermodynamic and associated cloud structures. Over Florida, intense cumulonimbus activity develops in response to this heating when the atmosphere is conditionally unstable and an even more dramatic response could be expected over Georgia as a result of the waste heat from the proposed system. Even over the southwestern United States during certain times of the year, intense thunderstorms and/or mesoscale convective systems could develop in response to the heating by the satellite beam. Even in a dry conditionally stable atmosphere, strong wind circulations would be expected to develop in response to prolonged heating at 1069 watts m^{-2} over either of the receiver sites described in the Work Statement. Since the area of the receiver would cover either 3200 km^2 or 40,000 km^2 the area of effect would be quite large. The area of Barbados is approximately 600 km^2 whereas south Florida is about 10,000 km^2 .

In the study which we prepared for Lockheed last year we concluded that a heat energy dissipation of 7.5 watts m^{-2} was comparable to that given off by a suburban region. In the case described in the present work statement the heat dissipation would be over two orders of magnitude greater and would cover

(a larger area than that proposed for the microwave rectennas. The magnitude of the SOLARES dissipation per unit area is of the same order as a large nuclear power pack or an Australian brushfire, as tabulated during last year's study, but since its area is greater (particularly for the 40,000 km² scenario), its effects would be even more pronounced.

The total energy release of each system is approximately 3.42 x 10¹² watts for the 3200 km² system and 4.28 x 10¹³ watts for the 40,000 km² system. In last year's report, we referenced work which showed that a city (with high heat energy output) has an energy release of about 10¹¹ watts (equivalent for example to an Australian brushfire). The heating of the proposed system is over one order of magnitude greater for the 3200 km² unit and over two orders of magnitude higher for the larger facility. Our conclusion is that regional effects on climate would be unavoidable with this magnitude of waste heat dissipation. Without question, very major alterations in cloud, rain and wind would result over a wide area if the system is developed as described in the work statement.

III. Conclusion

The proposed system of electric power generation dissipates an extremely large amount of waste heat. Operating the beam continuously in one region, therefore, would have a major and dramatic effect on local, regional and perhaps even global weather. As we concluded last year, to minimize the meteorological and climatic effects of waste heat dissipation, it must be constrained to heat energy releases on the order of 10 watts m⁻²

or less over 10^2 km² areas. For larger regions even smaller fluxes of heat may be desirable, but this would have to be studied further.

In terms of electric power generation, we therefore, conclude that the proposed system is environmentally unacceptable when operated in a continuous fashion over one geographic area. This does not, however, rule out an effective use of such a system, namely in its potential use in weather modification. The liability of excessive heat dissipation becomes an asset if one is attempting to affect weather through such mechanisms as the initiation of cumulus clouds and subsequent rain, the melting of snow over a city and the elimination of warm cloud fog. Indeed the potential for the moderation of weather by judiciously locating the satellite beam for short periods of time could be of immense economic and social benefit. We suggest that the program be redirected to the evaluation of these possibilities.

- Baldwin, J.L., 1973: Climates of the United States. Department of Commerce Publication, 113 pp.
- Byers, H., 1959: General Meteorology. McGraw-Hill, 540 pp.
- Idso, S.B., 1969: Atmospheric Attenuation of Solar Radiation. J. Atmos. Sci., 26, 1088-1095, Part 2.
- List, R.J., 1971: Smithsonian Meteorological Tables. Smithsonian Publication 4014, Fifth reprint.
- Rosenberg, N., 1974: Microclimate. Wiley-Intersciences, New York, 315 pp.

Appendix 6

REVIEW COMMENTS

A draft copy of An Assessment of Potential Weather Effects Due to Operation of the Space Orbiting Light Augmentation Reflector Energy System (SOLARES) was distributed for review and comment. Dr. William Gilbreath, Ames Research Center, in telephone conversations with Mr. Richard Siler, had some comments. Those comments and replies are listed below.

1. COMMENT: It is understood that if the entire reject heat from the radiant to electrical conversion process were released to the atmosphere from within the ground spot area, severe microweather changes would occur. What is really required is to determine by modelling and computation, the acceptable level of sensible heat release.

RELAY. Dollarwise, it is well beyond the scope of this investigation to determine with any exactness, the upper level of sensible heat to the atmosphere that would be "acceptable". In the first place, we don't have a definition of acceptable weather change, but irrespective of that problem, the task to be addressed by these investigators was to assess the potential effect of the SOLARES operation on the troposphere.

Without spending additional money a crude method for scoping the problem of tolerable heat release was devised, Figure 3-1 in the report. This figure relates energy flux and total release area to weather modification at various size scales. If we accept the premise that weather effects produced by an agro-industrial complex are tolerable (though many argue to the contrary) it can be argued that a local heat source whose energy flux is greater, or which is released over a larger area, may be intolerable. On this basis, Figure 3-1 would then suggest that an energy flux reduction of orders of magnitude and/or the area over which the release is made must be substantially reduced before a SOLARES site would be tolerable.

2. COMMENT: The contractors have acerbated the heat burden by assuming that SOLARES delivers a constant input of 1.35 KW/m^2 in addition to normal sunlight.

REPLY: The work statement, Appendix 2, states that the system is designed such that about 135 mW/cm^2 of solar energy (one solar constant) will fall continuously on the collector. This was the understanding of the contractors, too. (Appendix 3, page 2; Appendix 4, page 1; Appendix 5, page 1.)

3. COMMENT: Guadalupe Island is frequently cloud free as shown by many Gemini photographs. This must be caused by the difference in insolation between the island and the water.

REPLY: Early Gemini photographs first revealed this phenomenon. Since that time it has been studied in depth. I don't understand the relevance of this comment to the SOLARES site problem because we are not only interested in site weather per se, but any modification produced by the site operation. Guadalupe Island in the Pacific and the Canary Islands in the Atlantic have been photographed cloud-free many times, however, the phenomena of greatest interest to meterologists is not the clear skies over the islands, but rather the formation of the von Karman vortices downstream of those islands. In any event, both the downstream vortices and the clear skies over the islands are caused by kinematic processes and not thermodynamics. Reference reading: Mesoscale Eddies in Wake of Islands, Chopra, Church, and Hubert. Journal of Atmospheric Science, Vol. 22, No. 6, November 1965.

4. COMMENT: There are useful ways in which excess energy may be used, but even though the contractors allude to that fact, they don't really expand on that possibility and that should be done.

REPLY: True, but this is a question that was not asked and is one that requires a great deal of thought and study.