

KC-135 WINGLET FLIGHT RESULTS

Lawrence C. Montoya
NASA Dryden Flight Research Center

ABSTRACT

Winglets are small, nearly vertical aerodynamic surfaces which are designed to be mounted at the tips of aircraft wings. They are found in nature on all soaring birds who cant their tip feathers when attempting to achieve a high-lift flight condition.

Design optimization studies and wind-tunnel tests led by Richard Whitcomb of the NASA Langley Research Center have shown that these extensions can produce significant increases in the lift-to-drag ratios on some of today's transport aircraft. The application of winglets to the U.S. Air Force (USAF) KC-135 tanker aircraft is predicted to increase its cruise lift-to-drag ratio by 8 percent. This increase would result in an average fuel savings of 227.1 kiloliters per airplane per year. If retrofitted to the KC-135 fleet, more than a billion dollars worth of fuel could be saved over the next 20 years. Therefore, the USAF and NASA have embarked on a joint program to obtain a full-scale evaluation of winglets on the KC-135 aircraft. The Boeing Company, under USAF contract, has constructed a set of flight-test winglets. NASA Dryden Flight Research Center has instrumented a test airplane.

To date, three KC-135 winglet configurations have been flight tested for cant/incidence angles of $15^\circ/-4^\circ$, $15^\circ/-2^\circ$, and $0^\circ/-4^\circ$, as well as the basic wing. The flight results for the $15^\circ/-4^\circ$ and basic wing configurations confirm the wind-tunnel-predicted 7-percent incremental decrease in total drag at cruise conditions. The $15^\circ/-4^\circ$ configuration flight-measured wing and winglet pressure distributions, loads, stability and control, flutter, and buffet also correlate well with predicted values. The only unexpected flight result as compared with analytical predictions is a flutter speed decrease for the $0^\circ/-4^\circ$ configuration.

The $15^\circ/-2^\circ$ configuration results show essentially the same incremental drag reduction as the $15^\circ/-4^\circ$ configuration; however, the flight loads are approximately 30 percent higher for the $15^\circ/-2^\circ$ configuration. The drag data for the $0^\circ/-4^\circ$ configuration show only a slight drag reduction.

Present planning through October, which is the projected flight program completion date, will complete the range factor testing for the above configurations. These range factor flights are being performed to fulfill a primary Air Force objective to obtain hard data for the proposed fleet retrofit. Two flutter flights have been proposed for a $7.5^\circ/-4^\circ$ configuration to obtain some insight into the structural dynamics anomaly found at the $0^\circ/-4^\circ$ configuration.

PROGRAM OBJECTIVES

The primary objective of the KC-135 winglet flight program was to define the full-scale performance gains provided by winglets for comparison with wind-tunnel test results. To accomplish this, the airplane was instrumented to measure wing and winglet pressure distributions, total lift and drag, loads, stability and control, flutter, buffet, and range factor. The test conditions covered the Mach number range from 0.30 to 0.82 at altitudes between 10,363 meters and 11,887 meters. The test winglets were designed to investigate a matrix of cant/incidence angles. The design test condition was $M = 0.78$ and $C_L = 0.42$ for a $15^\circ/-4^\circ$ winglet configuration.



WINGLET GEOMETRIC CHARACTERISTICS

The test winglet consisted of an 8-percent thick General Aviation Airfoil and was designed to be tested over a matrix of cant/incidence angles. It had a span of 2.83 meters, a tip chord of 0.60 meter, and a leading-edge sweep angle of 38° . This geometry was derived from the wind-tunnel model coordinates with the exception of some slight wing/winglet juncture fairing differences, which resulted from the addition of the cant/incidence angle mounting hardware to the flight winglets.

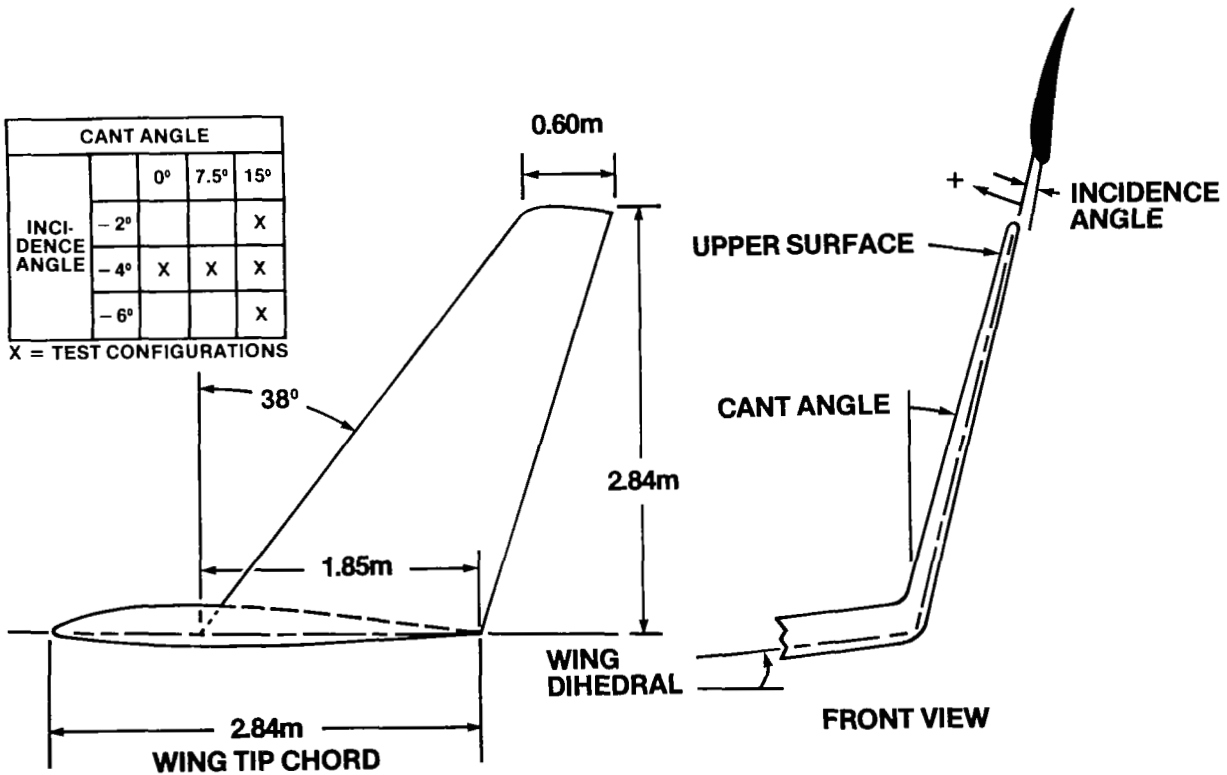

WING AND WINGLET PRESSURE ORIFICE LOCATIONS

Wing and winglet pressure distributions were obtained along four orifice rows on the wing (semispan stations 0.26, 0.77, 0.92, and 0.99) and three orifice rows on the winglet (semispan stations 1.01, 1.03, and 1.05). The number of orifices per row varied from 22 to 33 on the wing and from 21 to 23 on the winglet. All wing orifices except leading-edge orifices were externally mounted; all winglet orifices were mounted flush. The orifice row locations and the number of orifices were essentially the same for the wind-tunnel model and the full-scale airplane.

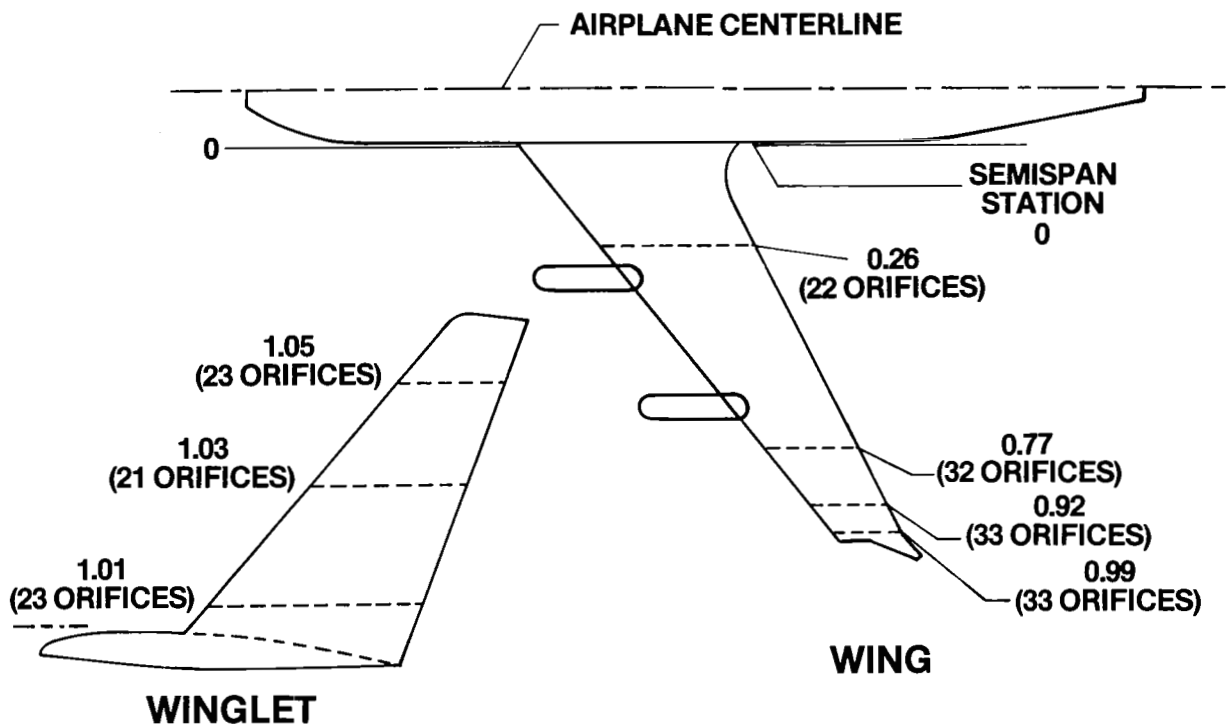

WING PRESSURE DISTRIBUTIONS

At the design test condition of Mach 0.78 and angle of attack of approximately 2° , the flight and wind-tunnel wing pressure distributions show good agreement. Small differences between the measurements of various rows could be attributed to the airplane surface conditions and the fact that the orifices were externally mounted.

In general, the flight and wind-tunnel pressure distributions showed good agreement at all the conditions tested.

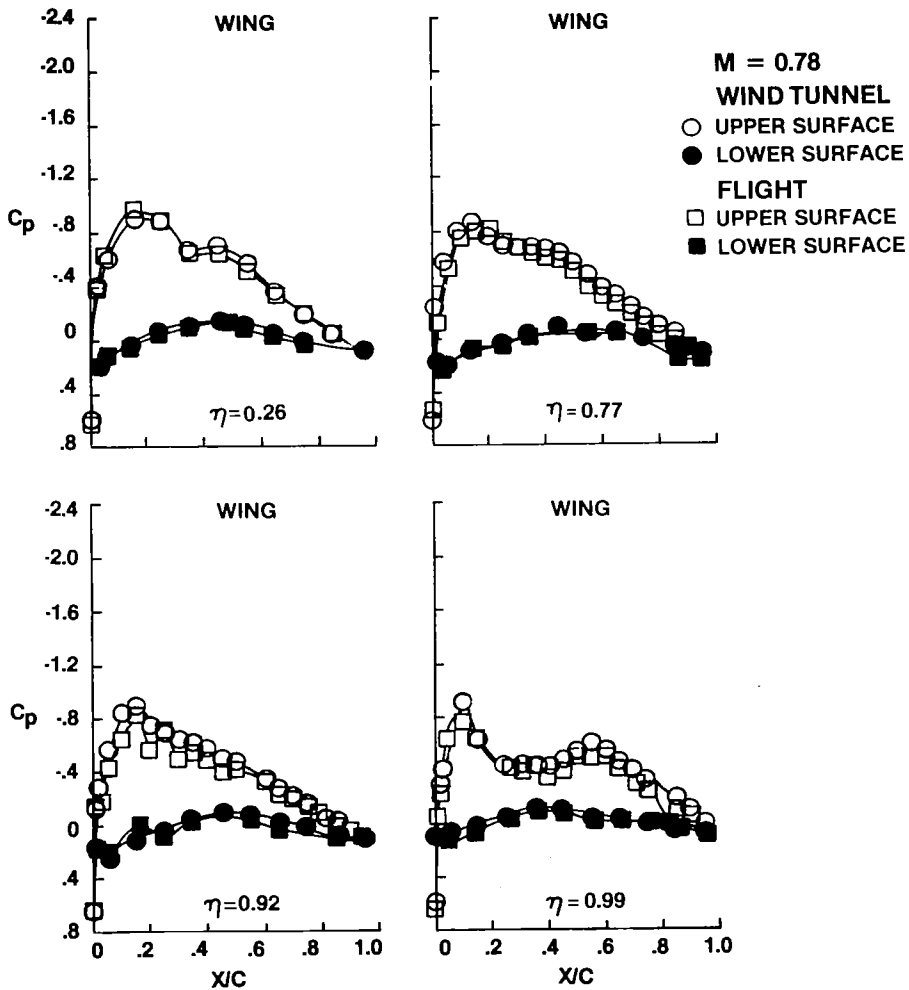

WINGLET PRESSURE DISTRIBUTION

At winglet semispan station 1.01 (winglet span station 0.15) and the design test condition, flight and wind-tunnel pressure distributions show significant differences on the upper surface near the leading edge. These differences are attributed to "oilcanning" (skin deflection) which occurred in flight in this area. Distributions for the remainder of the station show good agreement.

At semispan stations 1.03 and 1.05 (winglet span stations 0.50 and 0.90, respectively) the lower surface flight and wind-tunnel pressure distributions show good agreement; however, differences are noted in the data for the upper surface along the entire chord. These differences are also attributed, at least in part, to "oilcanning." Apart from the "oilcanning," which would not necessarily occur on a production winglet design, flight and wind-tunnel winglet pressure distributions show good agreement.

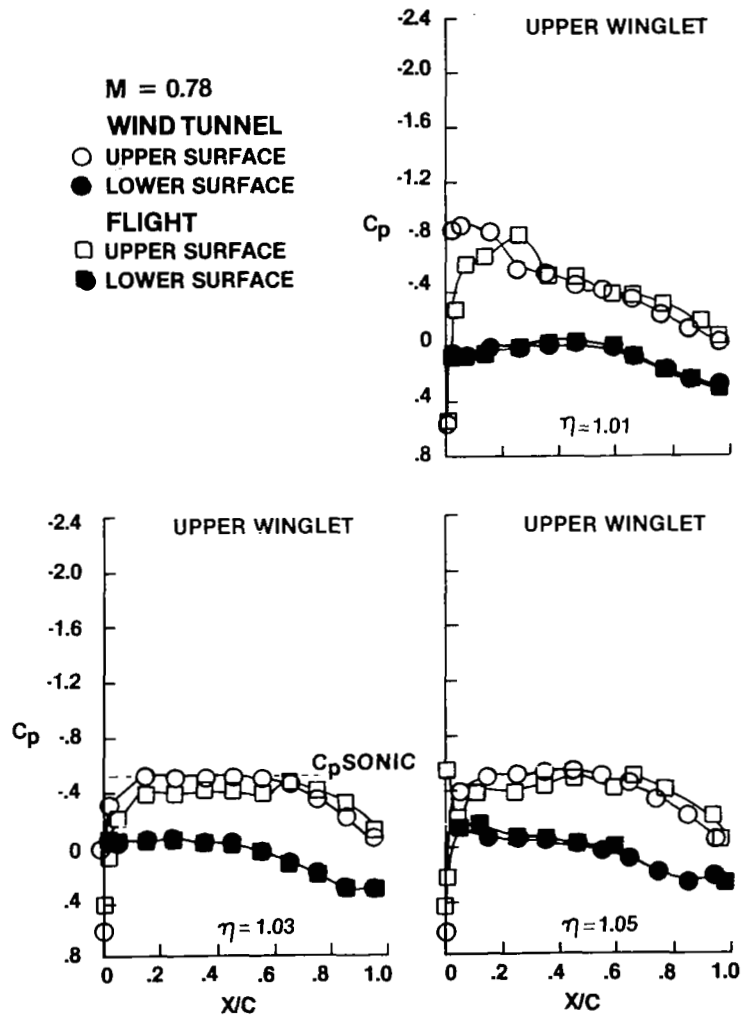

WING AND WINGLETS SPAN LOAD DISTRIBUTION

The flight and wind-tunnel model span load distribution at the design test condition show good agreement. These data are typical of the results obtained at other test conditions indicating that the semispan model provided a good simulation of the full-scale wing deflections.

$M = 0.78, \alpha \approx 2^\circ$

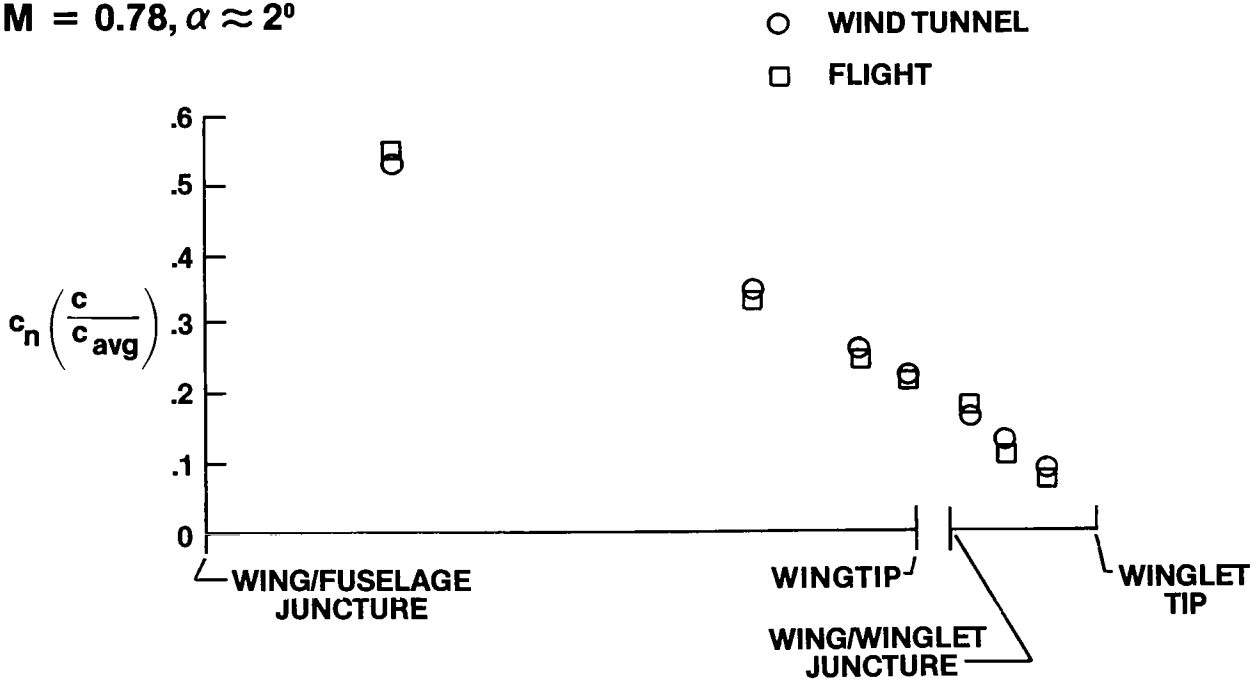

LIFT AND DRAG

Lift and drag data were obtained by measuring gross thrust and ram drag, normal and longitudinal accelerations at the aircraft center of gravity, and appropriate air data parameters.

For all Mach numbers tested, the trends in the data are the same as for the design Mach number. Installation of the winglets does not influence the lift curve slopes. All winglet configurations show a decrease in drag coefficient at a given lift coefficient when compared to the basic wing configuration. The largest decrease in drag coefficient was provided by the 15°/-4° and the 15°/-2° configurations. The 0°/-4° configuration decreases the drag coefficient only slightly.

For Mach numbers greater than 0.70, the data show the drag reduction between winglet configurations and basic wing configuration to increase with increasing lift coefficient.

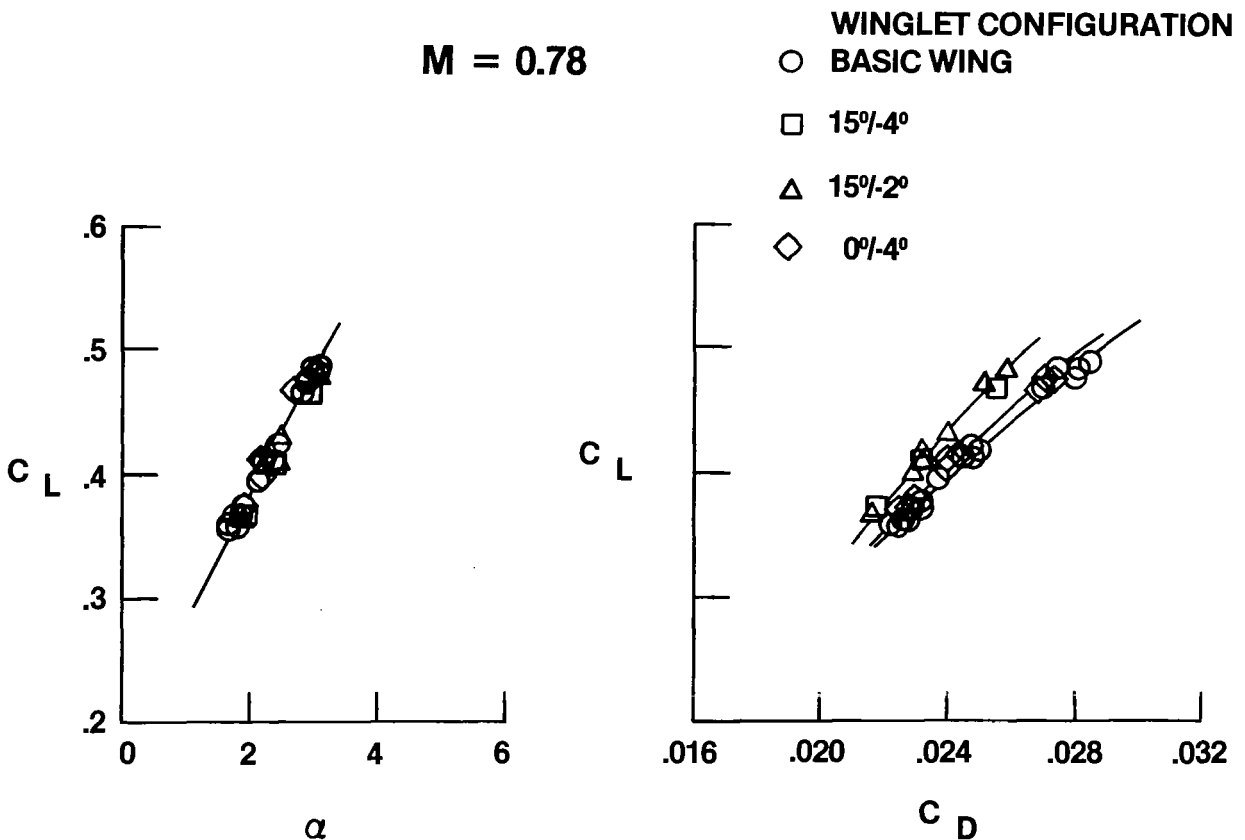

WING/WINGLET JUNCTURE BENDING MOMENT LOADS

The flight wing/winglet juncture bending moment loads as a function of airplane normal force coefficient were compared with Boeing aeroelastic prediction data at the design test condition. The airload at 1 g for the 15°/-2° winglet configuration is about 34 percent higher than the 15°/-4° configuration, indicating the desirability of the 15°/-4° configuration. A comparison of the flight data with the Boeing prediction data shows good agreement at the 1 g condition, but predictions are somewhat higher than flight data at the 1.5 g condition.

ROLLER COASTER DATA, $M = 0.78, 900K W/\delta$

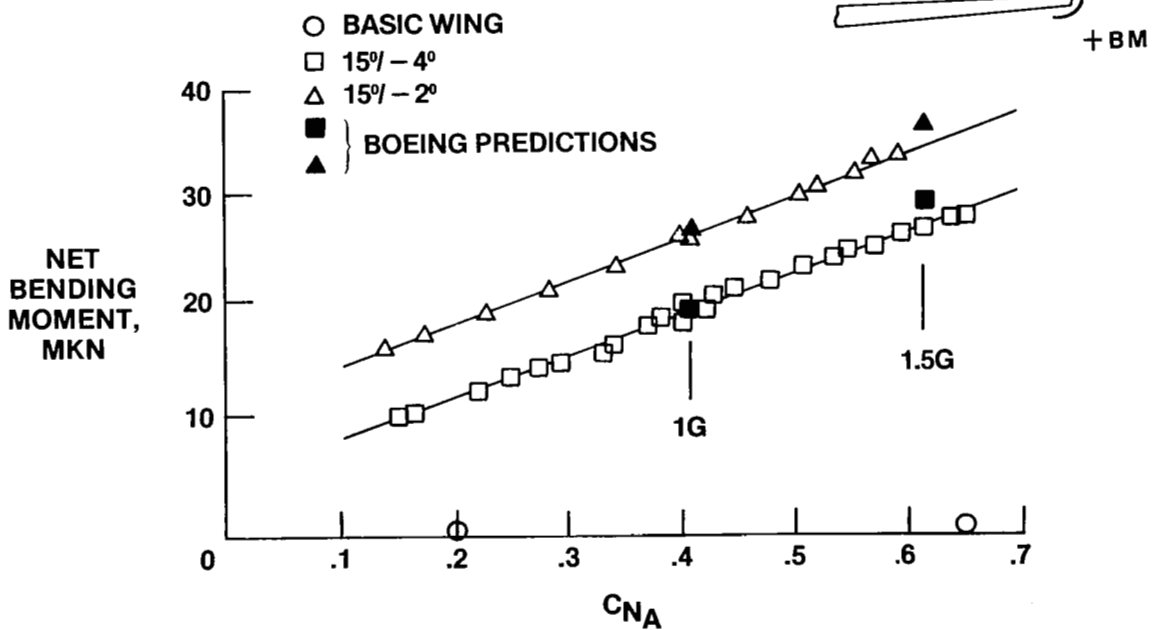

OUTBOARD WING BENDING MOMENT LOADS

The flight wing bending moment loads measured at the outboard wing station as a function of airplane normal force coefficient were compared with Boeing aeroelastic prediction data at the design test condition. At 1 g, the 15°/-4° configuration shows a 32-percent increase in airload over the basic wing while the 15°/-2° configuration exceeds the basic wing by 50 percent. Comparison between the measured flight loads and the Boeing prediction data is considered quite good at both 1 g and 1.5 g. The average bending stresses measured at the wing root for the design winglet configuration (not shown) were only 2.5 percent higher than the basic wing stresses.

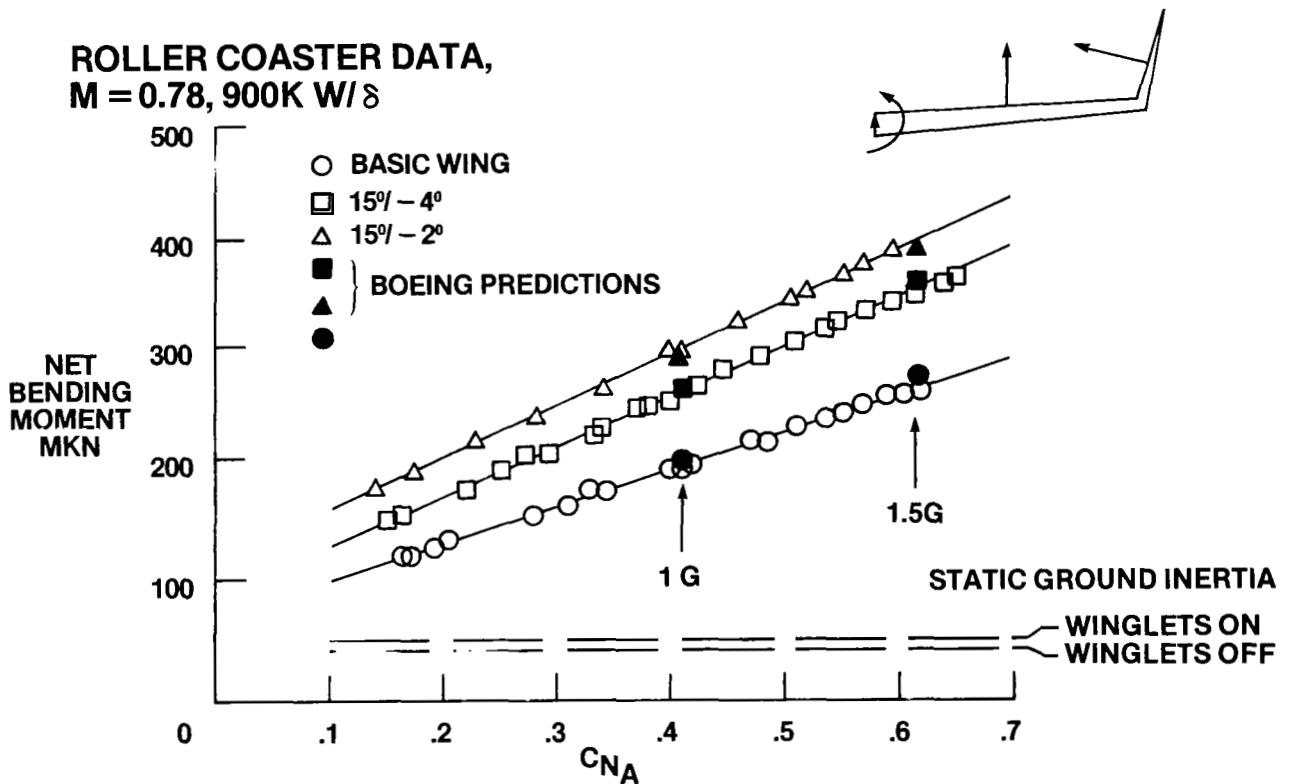

BUFFET CHARACTERISTICS

Buffet characteristics were assessed by analyzing the output of high frequency response accelerometers mounted in the cockpit on the elastic axis of the left and right wingtips at the left and right winglet tips and left and right horizontal tail tips. Both buffet onset boundaries and buffet intensity rise characteristics have been compared between winglet configurations $15^\circ/-4^\circ$, $15^\circ/-2^\circ$, and $0^\circ/-4^\circ$ and the basic wing. The winglets produced only minor variations in the basic wing buffet onset boundary at low subsonic speeds and no significant differences in the cruise Mach number region. Intensity rise characteristics were essentially invariant with winglet configuration. The winglets produced no significant changes in the cockpit and horizontal tail accelerometer outputs.

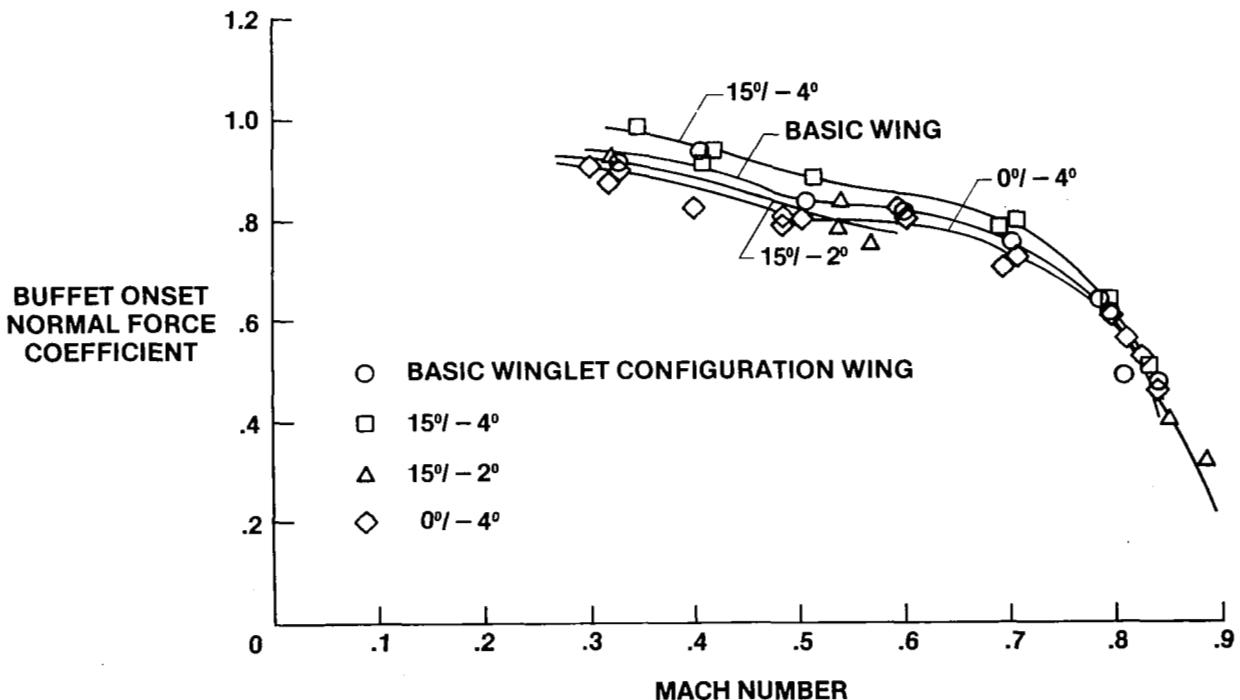

SUMMARY

The KC-135 winglet flight program has shown the following results to date: the wind-tunnel-predicted 7-percent drag reduction was confirmed, the wing and winglet wind-tunnel and flight pressure distributions show good agreement, the predicted and measured flight loads show good agreement, and the winglets produced only minor variations in the buffet onset boundary at low subsonic speeds and no significant differences in the cruise Mach number region.

At present, additional range factor flights are in progress with an expected flight program completion date of October 1980.

