

N O T I C E

THIS DOCUMENT HAS BEEN REPRODUCED FROM
MICROFICHE. ALTHOUGH IT IS RECOGNIZED THAT
CERTAIN PORTIONS ARE ILLEGIBLE, IT IS BEING RELEASED
IN THE INTEREST OF MAKING AVAILABLE AS MUCH
INFORMATION AS POSSIBLE

(NASA-CR-164436) SYNTHESIS AND
CHARACTERISTICS OF POLYARYLENE ETHER
SULFONES Final Report (Virginia Polytechnic
Inst. and State Univ.) 316 p HC A14/MF A01

N81-25169

Unclas
26561



SYNTHESIS AND CHARACTERISTICS
OF
POLYARYLENE ETHER SULFONES

Final Report

to

NASA - Research Grant NSG-1599

R. Viswanathan, B. C. Johnson, T. C. Ward, and J. E. McGrath
Chemistry Department and
Polymer Materials and Interfaces Laboratory
Virginia Polytechnic Institute and State University
Blacksburg, Virginia 24061

May, 1981

SYNTHESIS AND CHARACTERISTICS OF
POLYARYLENE ETHER SULFONES

R. Viswanathan, B. C. Johnson, T. C. Ward, and J. E. McGrath

(ABSTRACT)

The classical route for the synthesis of this family of macromolecules is via nucleophilic aromatic substitution using dimethylsulfoxide (DMSO) as a dipolar aprotic solvent and aqueous sodium hydroxide as a base. High molecular weight homopolymers can be synthesized in a short time (1 hour). However, hydrolytic side reactions can limit its scope for the synthesis of block copolymers. An alternate route using potassium carbonate/dimethyl acetamide as base and solvent respectively has been cited in the patent literature. We have used this method for the synthesis of several homopolymers and copolymers derived from various bisphenols. Our investigation into the kinetics and mechanism of this process has demonstrated that this route deviates from simple second order kinetics. This deviation has been rationalized to be due to the heterogeneous nature of the reaction.

The utility of these polymers is a direct function of their excellent stability (hydrolytic, thermal and dimensional) wide use range and good mechanical properties. However, their poor solvent resistance can be considered an "Achilles heel". We reasoned that the introduction of a

second ordered or crystalline component would vastly improve its solvent resistance. Hydroquinone polysulfone, homopolymer was reported to be semi-crystalline "as made". We thus synthesized and studied "random" copolymers obtained by reacting various mole ratio combinations of bisphenol-A and hydroquinone with dichlorodiphenyl sulfone. The molecular weight (M_n) of these copolymers ranged from 20,000 -40,000. Their glass transition temperature (T_g) increased monotonically from 185°C for pure bis-A homopolymer to 210°C for hydroquinone homopolymer. Two different types of mechanical tests together with DSC and SEM measurements showed that improved solvent resistance (especially to liquids of interest to NASA for aerospace functions) could be achieved via a novel liquid induced crystallization process. ^{13}C and proton NMR spectral assignments were successfully made using model compounds. The composition of the copolymers by NMR accuracy to $\pm 3\%$. Multiblock (-A-B-) copolymer of bisphenol-A polycarbonate and several poly(arylether sulfones) were synthesized from well characterized oligomers. It was possible to prepare one or two phase block copolymers by controlling the molecular weights and/or interaction parameters of the parent oligomers. Surface characterization showed surface segregation even for the single phase material.

Triad distribution of monomers in non-equilibrium copolycondensation was investigated by Monte' Carlo simulation. In the one step process, where the intermonomer and/or comonomers had independent functional group reactivities,

the resulting copolymer was always random irrespective of the reactivity ratio of the comonomers. A non random distribution was obtained when the reactivity ratio of the functional groups in the intermonomer and those of the comonomer were much greater than unit. Monomers that resulted in a random copolymer in a one step process could be made with a non random distribution by a multi-step process.

TABLE OF CONTENTS

	<u>Page</u>
ABSTRACT -----	ii
Chapter	
I. INTRODUCTION -----	1
STEP GROWTH POLYMERS -----	1
COPOLYMER ARCHITECTURE -----	3
SYNTHESIS OF CONDENSATION COPOLYMERS -----	10
GENERAL ASPECTS OF POLYARYLENE ETHERS -----	12
POLYPHENYLENE OXIDE -----	14
MECHANISM -----	16
SCOPE OF REACTION -----	18
OXIDATIVE COUPLING -----	19
OXIDATIVE DISPLACEMENT -----	20
MECHANISM -----	22
SCOPE OF REACTION -----	25
OXIDATIVE COUPLING -----	26
MECHANISM -----	29
SCOPE OF REACTION -----	32
POLY(ARYLENE ETHER SULFONES) -----	33
POLYETHERIFICATION -----	37
MECHANISM -----	38
SCOPE OF REACTION -----	40

POLYSULFONYLATION -----	40
MECAHNISM -----	49
SCOPE OF REACTION -----	49
MISCELLANEOUS SYNTHESIS OF POLYSULFONES -----	53
POLYARYLETHER KETONES -----	54
MISCELLANEOUS POLYARYLETHERS -----	55
ENVIRONMENTAL STRESS CRACKING -----	55
INTRODUCTION -----	55
THEORIES OF ENVIRONMENTAL STRESS CRACKING --	58
SOLVENT INDUCED CRYSTALLIZATION -----	63
INTRODUCTION-----	63
MECHANISM OF THERMAL CRYSTALLIZATION -----	64
SOLVENT INDUCED CRYSTALLIZATION -----	66
TRIAD DISTRIBUTION IN CONDENSATION POLYMERS ---	67
INTRODUCTION -----	67
THEORY OF SEQUENCE DISTRIBUTION -----	70
II. MATERIALS AND METHODS -----	74
GENERAL ASPECTS OF CONDENSATION POLYMERIZATION-	74
PURIFICATION OF MONOMERS -----	76
BISPHENOL-A -----	76
HYDROQUINONE -----	77
BIS-T MONOMER -----	80
BIS-S -----	81
DICHLORODIPHENYL SULFONE -----	82

ORIGINAL PAGE IS
OF POOR QUALITY

ORIGINAL PAGE IS
OF POOR QUALITY

SYNTHESIS AND PURIFICATION OF 4,4 DIFLUORODIPHENYLSULFONE -----	83
POTASSIUM CARBONATE (ANHYDROUS) -----	84
PURIFICATION OF SOLVENTS -----	85
TREATMENT OF MOLECULAR SIEVES -----	88
N,N' DIMETHYLACETAMIDE -----	88
SULFOLANE -----	89
N-METHYLPYROLIDONE -----	90
TOLUENE -----	90
STUDY OF DMAC/TOLUENE AZEOTROPE -----	91
SYNTHESIS OF POLYSULFONE HOMOPOLYMERS -----	92
BIS-A POLYSULFONE -----	92
BIS-T POLYSULFONE -----	95
BIS-S POLYSULFONE -----	96
HYDROQUINONE POLYSULFONE -----	97
SYNTHESIS OF POLYSULFONE COPOLYMERS -----	99
POLYCARBONATE OLIGOMERS -----	101
POLYSULFONE-POLYCARBONATE BLOCK COPOLYMERS ----	101
PERFECTLY ALTERNATING POLYSULFONE-POLYCARBONATE COPOLYMER -----	102
KINETIC STUDIES -----	103
HYDROLYSIS STUDIES -----	104
SYNTHESIS OF MODEL COMPOUNDS-----	105
MONOCHLORIDIPHENYLSULFONE -----	105
4-HYDROXYPHENYL (4'-AMINO PHENYL- 2,2 PROPANE) -----	107
MONOPHENOXYDIPHENYL SULFONE -----	108

4,4 DIPHENOXYDIPHENYLSULFONE -----	109
4,4 DI-P-AMINOPHENOXYDIPHENYLSULFONE -----	110
BENZENE, 1,4-BIS [(4-PHENOXYL)SULFONE]-----	111
PROPANE 2,2-BIS(4-PHENOXY 4-PHENOXY BENZENE -----	112
ATTEMPTED SYNTHESIS OF P-P DICHLORO DI- CHLORO DI-PHENYL SULFONE 1,4 DIOXYBENZENE) -----	114
ATTEMPTED SYNTHESIS OF 4,4 DICHLORO DI- PHENYL SULFONE 4,4-DIPHENYL 2,2 PROPANE -----	115
PREPARATION OF 4-4 DI P-HYDROXY PHENOXY DIPHENYL SULFONE -----	116
PREPARATION OF 4-4 DI (4 ISO PROPYLIDENE (PHENOL) PHENOXYDIPHENYLSULFONE -----	117
CHARACTERIZATION -----	118
DILUTE SOLUTION VISCOMETRY -----	118
MEMBRANE OSMOMETRY -----	119
END GROUP ANALYSIS -----	120
GEL PERMEATION CHROMATOGRAPHY -----	122
NMR ANALYSIS -----	122
INFRARED ANALYSIS -----	122
THERMAL ANALYSIS -----	123
DYNAMIC MECHANICAL MEASUREMENTS -----	123
TENSILE TESTING -----	126
SCANNING ELECTRON MICROSCOPY (SEM) -----	126
WIDE-ANGLE-ANGLE X-RAY DIFFRACTION (WAXD)--	127
ELECTRON SPECTROSCOPY FOR CHEMICAL ANALYSIS (ESCA) -----	127

MONTE CARLO SIMULATION -----	130
DEFINITIONS -----	131
SIMULATION MODEL -----	133
PROGRAM DEBUGGING -----	135
III. RESULTS AND DISCUSSION -----	138
KINETIC AND MECHANISTIC ASPECTS OF THE POTASSIUM CARBONATE/DMAC PROCESS -----	138
HYDROLYTIC SIDE REACTION -----	138
DMAC/TOLUENE AZEOTROPE STUDY -----	140
KINETICS OF BIS-A PHENOXIDE WITH DICHLORODIPHENYL SULFONE IN DMAC/TOLUENE -----	143
SYNTHESIS OF POLYSULFONE OLIGOMERS -----	158
SYNTHESIS AND CHARACTERISTICS OF POLYSULFONE POLYCARBONATE BLOCK COPOLYMERS -----	171
ESCA MEASUREMENTS -----	184
HYDROQUINONE/BIS-A "RANDOM COPOLYMERS" -----	192
PROTON AND CARBON (13) SPECTROSCOPY OF COPOLYMERS -----	221
MONTE CARLO SIMULATION -----	244
CASE I -----	246
CASE II -----	253
IV. CONCLUSIONS -----	258
V. REFERENCES -----	263
VI. APPENDIX	
COMPUTER PROGRAM: MONTE CARLO SIMULATION --	280

Chapter I

INTRODUCTION

The overall goal of this research was to investigate the chemistry and physics of poly(arylene ether sulfones) with the hope of improving their environmental resistance characteristics. Thus the scope of this investigation is multidisciplinary and involves various aspects of polymer synthesis and physical behavior. To introduce the reader to many of the terms used in subsequent sections, the following sections begin with a general discussion of condensation polymers, copolymer types and their characteristics. Since our research here is concerned with poly(arylene ether sulfones), a detailed literature of the synthesis and polymerization mechanisms for polyethers in general has been provided. Sections on solvent induced crystallization (SINC), sequence distribution of monomers in copolymers and environmental effects on mechanical properties are also described.

1-1 STEP GROWTH POLYMERS

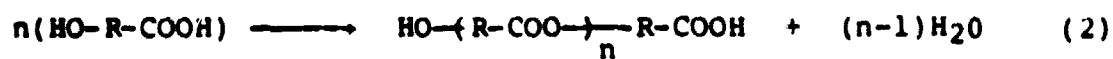
Step growth or condensation polymers are formed by the reaction of two functional groups, with or without the elimination of by-products and the formation of a third functional group. The following esterification reaction will serve as an example.



here the alcohol is shown reacting with an acid to form an ester with elimination of water. However, for the formation of a linear polymer the two reactants must be bifunctional. Thus a polyester can be synthesized by two general methods.

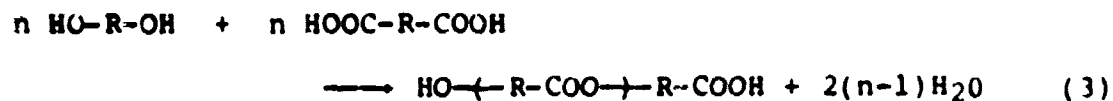
A-B Type

In this approach the bifunctional reactant (monomer) contains both functional groups, that is, the hydroxyl -OH and the carboxy -COOH. The reacting monomer is thus bifunctional.



A-A + B-B Type

The two functional groups here are present in different molecules. Both monomers are bifunctional and the polymer forming reaction is shown below.



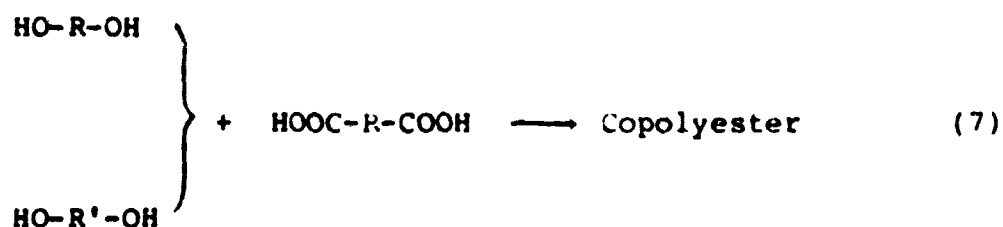
Most polycondensation reaction are reversible and therefore the removal of by-product from the reaction zone is essential for the synthesis of high molecular weight polymers. In general the polymer may be represented as follows.



Here R is a divalent groups such as $-(CH_2)-$ or a phenyl group, etc. and X is a functional linkage like $-O-$, $-CO-$, $NHCO-$, etc. If all Rs and Xs are the same then the polymer is known as a homopolymer and may be represented as:



If there is more than one type of R or X then one may define this system as a copolymer. For example:



1.2 COPOLYMER ARCHITECTURE

The copolymers formed may be random or block copolymers, depending on the distribution of the monomer units in the polymer backbone. A random copolymer is characterized by a statistical distribution of monomer units, while in a block copolymer relatively longer sequences of the two monomer units are terminally connected. Within the general category

of block copolymers, there are several architectural variations that describe the sequential arrangement of the component segments. It is a prime consideration in defining the synthetic technique to be used in preparing a specific block copolymer structure. Furthermore, this factor plays a dominant role in determining the inherent properties attainable with a given pair of segments. Four of the basic architectural forms are shown in Figure 1. The simplest arrangement is the diblock structure, commonly referred to as the A-B block copolymer, which is composed of one block of A repeat units and one block of B repeat units. The second form is the triblock or the A-B-A block copolymer structure, consisting of a single block of B repeat units located between the two blocks of A repeat units. The third basic type is the $(-A-B-)_n$ multiblock copolymer, which contains many alternating A and B blocks. The unique elastomeric behavior of A-B-A and $(-A-B-)_n$ block copolymers is responsible for the development of an entire new technology-thermoplastic elastomers. In these systems, the hard blocks associate to form small morphological domains that serve as physical cross-linking and reinforcement sites. These sites are thermally reversible, i.e., melt-processibility is possible at temperatures above the hard block T_g or T_m . On the other hand, diblock copolymers are incapable of producing network structures, since only one end of the soft block is chemically linked to a domain of hard segments. The fourth type is the radial block

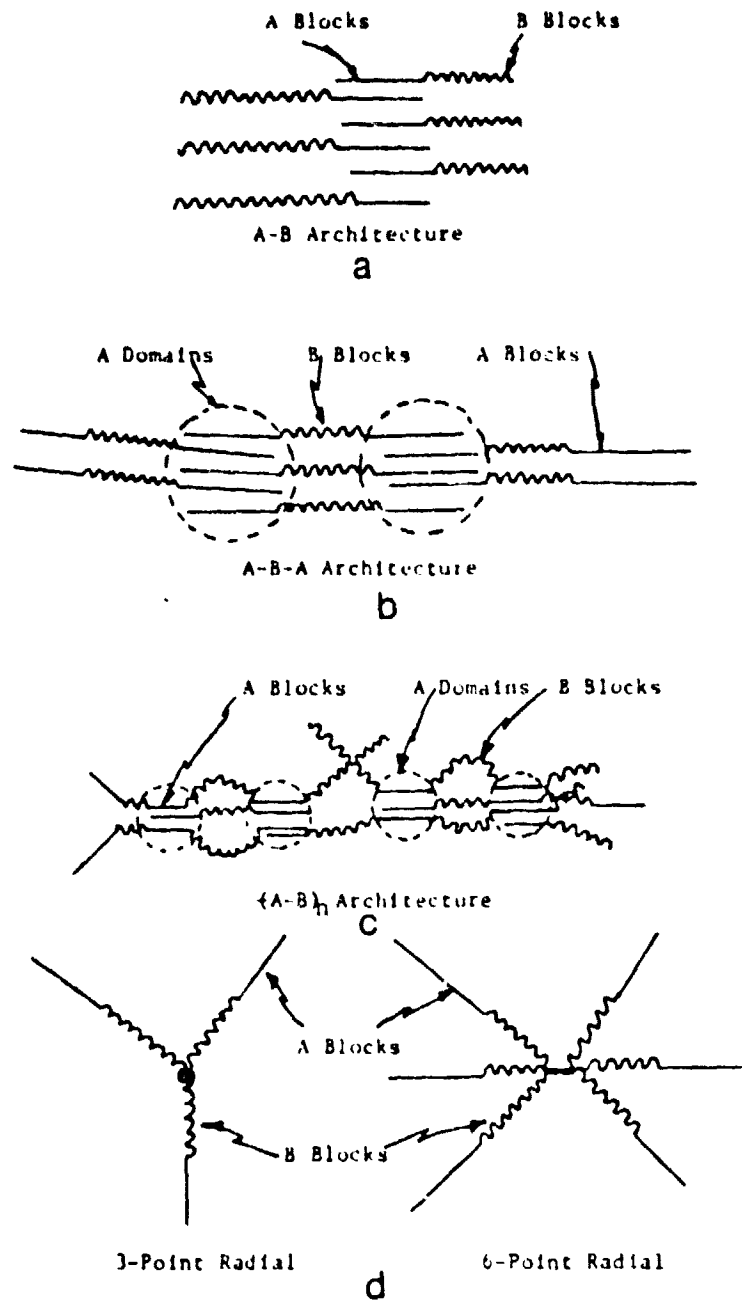


Figure 1. Schematic representation of various block copolymer architectures.

copolymer. This structure takes the form of a star-shaped macromolecule in which three or more diblock sequences radiate from a central hub. Two such arrangements are shown in Figure 1. In these systems, in general, the block molecular weight generally ranges from 10,000 to 100,000 daltons, e.g., as in a typical styrene-butadiene-styrene (SBS) system.

Segmented copolymers may be differentiated from the block copolymers in the following aspects. First, the number of hard and soft segments in a segmented copolymer is often greater than in a block copolymer. Secondly, the molecular weight of both segments is typically low (1000-4000 gm/mole) relative to typical values of 10,000 to 100,000 gm/mole for block copolymers. Thirdly, the segmented systems often have inter and intra-segmented hydrogen bonding (though not necessarily) whereas block copolymers often do not. Figure 2 schematically illustrates the two phase nature in the styrene-butadiene-styrene and segmented polyurethane systems.

An important characteristic of both the block as well as the segmented copolymers is their ability to undergo microphase separation. In a material composed of units of A and B, which have an endothermic heat of mixing, there is a tendency for phase separation. The characteristics of the block copolymer molecules impose a restriction on this segregation and this leads to a microdomain formation. From a thermodynamic point of view, there is a positive surface

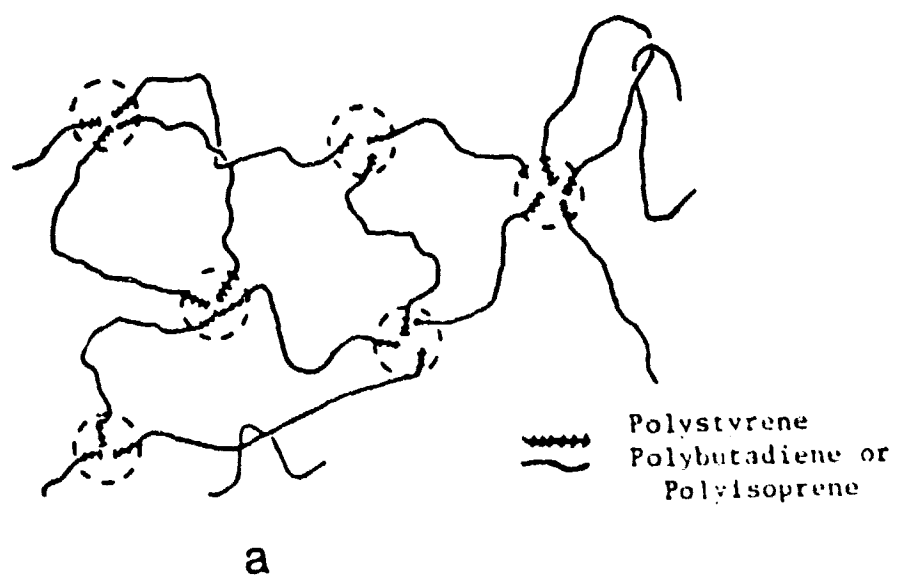


Figure 2 (a). Phase arrangement in SBS and S-I-S block copolymers

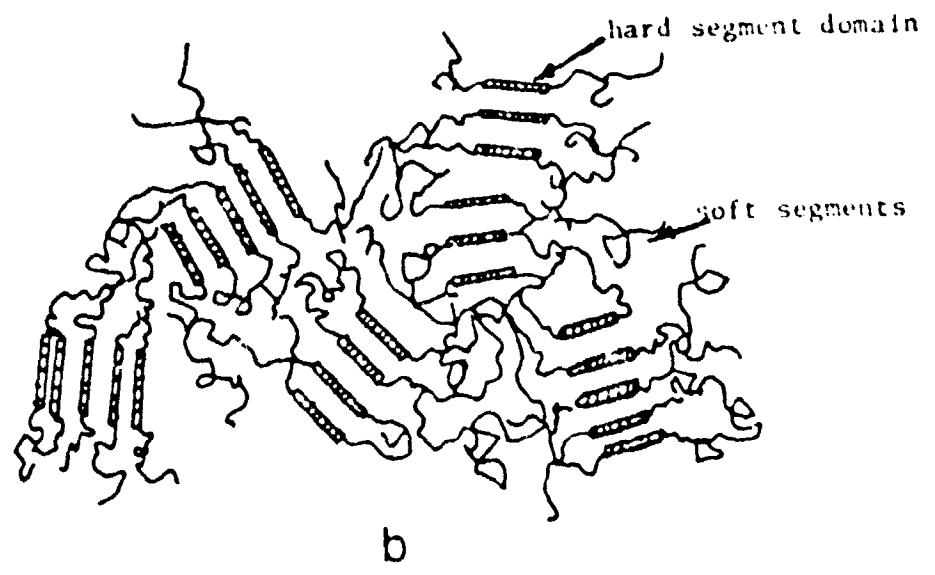


Figure 2 (b). Phase arrangement in segmented polyurethane systems

free energy associated with the interface A and B domains and it is on this basis that the equilibrium domain size and shape is determined. Current thermodynamic theories for phase separation in block copolymers are given by Krause (255-58), Meier (259-63), Helfand (264-66) and LeGrand (267).

Krause analysed the microphase separation from a strictly thermodynamic approach based on microscopic variables and assumed that complete phase separation with sharp boundaries between the phases occurs. Though this analysis fails to predict the type of morphology or enable one to obtain microphase dimensions, it is very useful in demonstrating the influence of the number of blocks on phase separation. On the other hand, Meier developed a criteria for the formation of domains and their sizes in terms of molecular and thermodynamic variables. He treated the constraints that A and B blocks must be placed in separate domains as boundary values in a diffusion problem. His model predicts the size of an assumed spherical domain in terms of the average end-to-end distance of the random flight chain for the constitutive blocks (259). Extending this model in the case of cylindrical lamellar domains, Meier (260-1) predicts the trend of domain formation. With a change in molecular weight of one constituent block, the domains change from spherical to cylindrical lamellar. Helfand's formulation of statistical thermodynamic model, based on the so-called mean-field approach, is similar to that of Meier. However,

this treatment has no adjustable parameters. LeGrand has developed a model to account for domain formation and stability based on the change in free energy which occurs between a random mixture of block copolymer molecules and a micellar domain structure.

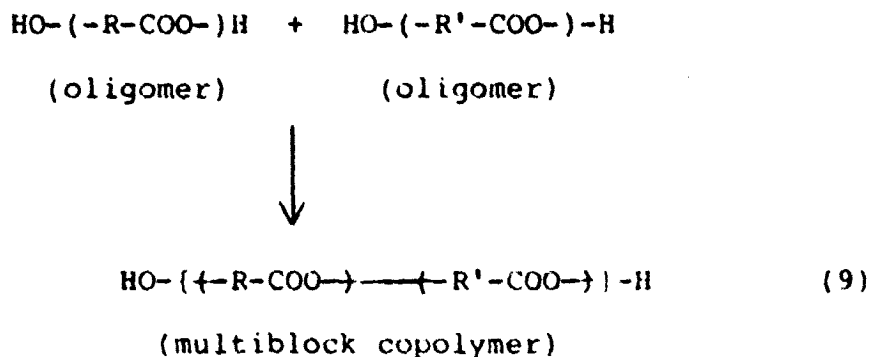
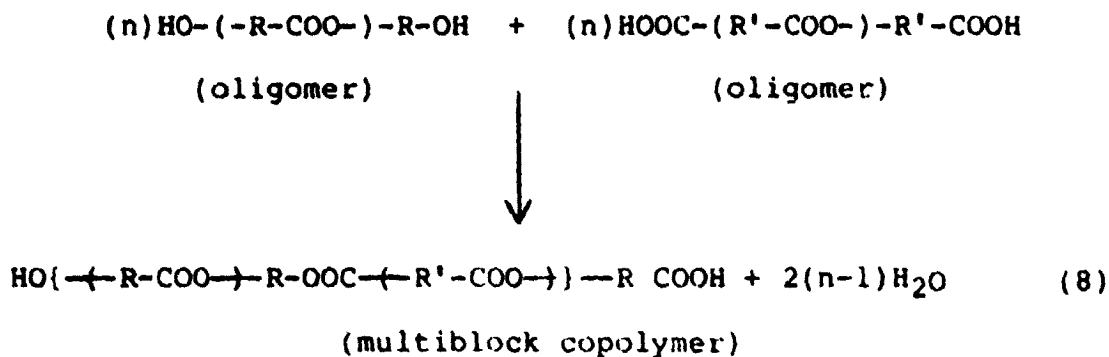
Two important characteristics of these systems which affect phase separation are the solubility parameter of the individual blocks and the average segment length. As a matter of fact, depending on the above characteristics, the properties of segmented copolymers may vary from those of random copolymers to those of thermoplastic elastomers. The former generally has been observed in systems which have either short segment lengths of similar inter- and intra-segmented secondary binding forces or both. The solid-state structure of these compatible segmented polymers is relatively homogeneous, with the copolymers displaying properties approximated by a weighted average of the two segments. However, most of the segmented copolymers exhibit a two-phase structure and may be thermoplastic elastomers. As their name implies, thermoplastic elastomers exhibit some characteristics of chemically crosslinked elastomers yet differ from vulcanized rubbers in that they will soften and flow at elevated temperatures. The resultant simplified processibility of these copolymers is a direct consequence of their unique morphology. At service temperatures, one of the components is viscous or rubbery (soft segments) while the other is of glassy or semicrystalline nature (hard

segment). The usual properties of these copolymers are directly related to their two-phase microstructure, with the hard domain acting as a reinforcing filler and multi-functional cross-link. Because of the relatively short segment length and its molecular weight distribution, micro-phase separations are generally incomplete, suggesting impure domain and interfacial regions comprised of a mixed phase in which there is a gradient of composition. The extent of interphase mixing and how it is affected by sample fabrication methods also can control many of the important properties of segmented copolymers.

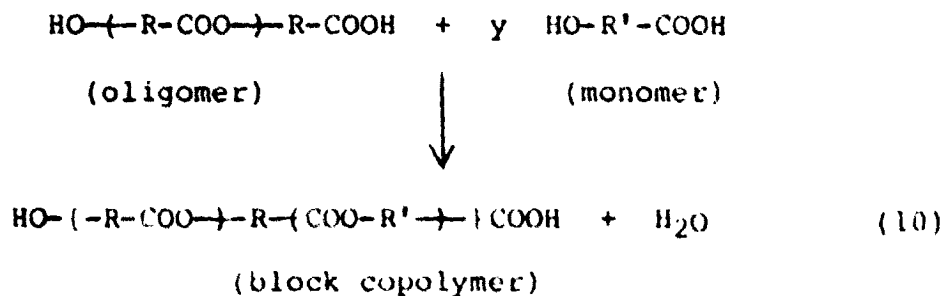
1.3 SYNTHESIS OF CONDENSATION COPOLYMERS

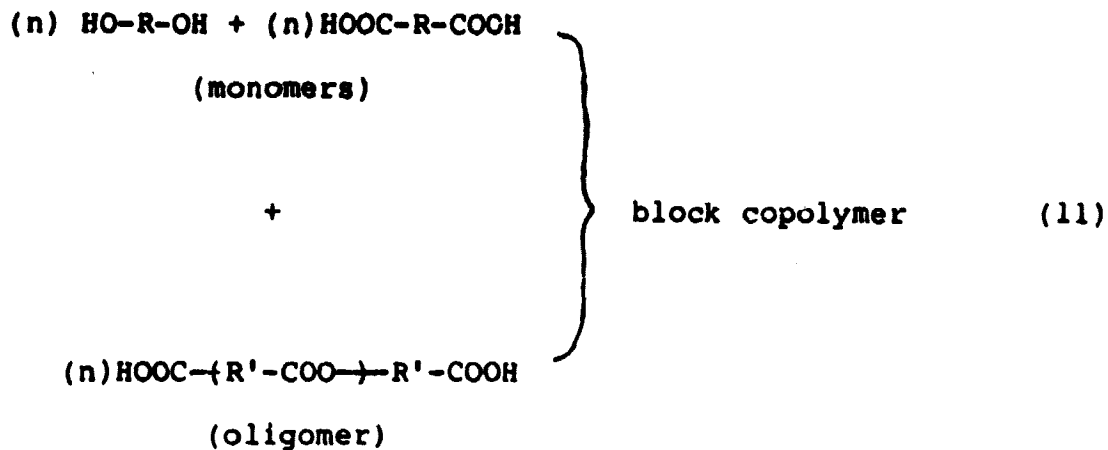
Random copolymers represent the simplest means of introducing two chemically different monomer units into the polymer. The reaction is carried out by reacting a mixture of the two monomers simultaneously. The multiblock copolymers may be synthesized either by reacting preformed oligomers with mutually reactive end groups or oligomers and monomers. Reactions 6 and 7 would be expected to result in random copolymers while reactions 8, 9, 10, and 11 would produce block copolymers.

Oligomer/Oligomer Coupling



Oligomer/Monomer Coupling





Note that the above reactions do not consider ester interchange processes. Reaction (8) gives rise to perfectly alternating copolymers, since it utilizes well characterized mutually reactive oligomers. Therefore, the description of the final architecture of the block copolymer is thus more precise. Most copolymers of poly(arylene ethers) are random in nature due to the ease of synthesis and the equilibrium or redistribution nature of the reaction.

Characteristics of copolymers with special reference to poly(arylene ethers) are described in later sections.

1.4 GENERAL ASPECTS OF POLY(ARYLENE ETHERS)

Poly(arylene ethers) belong to the class of materials known as so called engineering thermoplastics. They are tough rigid materials with good mechanical and thermal properties. They can be used continuously under load bearing conditions over a wide range of temperature perhaps up to 40-50°C below their glass transition temperature is possible

by conventional methods such as injection molding or extrusion techniques, into products having excellent hydrolytic, thermal and dimensional stability. This section reviews the work done in the technical development of polyarylene ethers, their synthetic routes and their structural variability.

Aromatics such as benzene, naphthalene, anthracene, etc., are thermally stable products obtained from the destructive distillation of coal. The search for engineering thermoplastics logically culminated with aromatics in the polymer backbone. If the aryl units are linked with thermally stable functional groups, for example, $>SO_2$, $>CO$, $-O-$, etc., one can also import a controlled amount of flexibility or tractability, which can enhance processing and ductility.

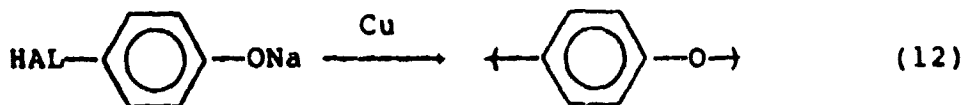
At the same time the introduction of the above groups, can both contribute desirable engineering properties and also provide alternate routes for their synthesis. The ether group is of course the predominant linking group in these polyarylene ethers. In this connection several interesting characteristics of the ether linkage are worth mentioning. The carbon-oxygen bond has a lower potential barrier to rotation, lower excluded volume, and Vander Waals interaction characteristics than the carbon-carbon bond. These factors may contribute to the ease of coiling and uncoiling of the chain and thus impart great chain flexibility. The aryl ether bond is also well known to

display greater hydrolytic stability compared to other polar functional groups such as amides, esters, etc.

The development of synthetic techniques, capable of producing useful high molecular weight polymers, has evolved only in the last twenty years. From a mechanistic point of view, only three synthetic routes to poly(arylethers) are available. These are nucleophilic aromatic substitution, electrophilic aromatic substitution and oxidative coupling. The first two methods permit a wide range of polymers to be prepared whereas the oxidative coupling is restricted to the polymerization of substituted phenols. The three methods are reviewed in this section and specific synthetic procedures are also provided.

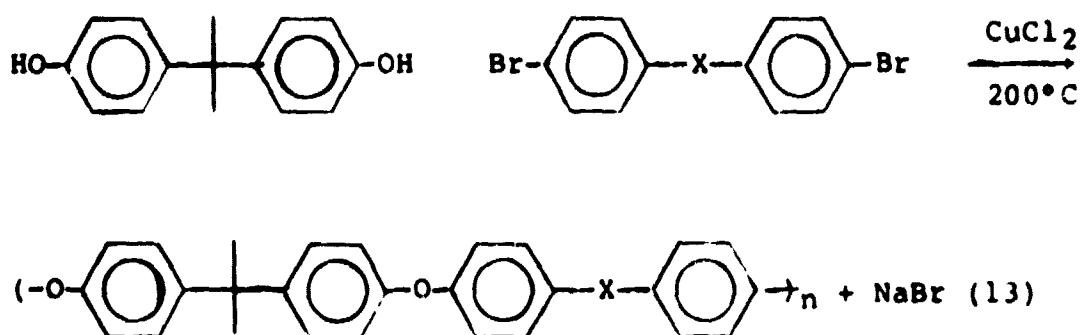
1.5 POLYPHENYLENE OXIDE

This the simplest (least substituted) polymer of the poly(arylene ether) family. Ironically, the commercial synthesis of this polymer might be via the Ullmann ether synthesis of halide substituted phenols (3,4).



However, most investigators have been only able to produce low molecular weight polymers (5-8). Stamatoff (9,10) and others produced high molecular weight polymer by modifying the Ullmann ether condensation of p-bromo-sodium phenolate.

The reaction was catalysed by cuprous chloride and an organic base. High temperatures as well as anhydrous and oxygen free atmosphere were also essential to produce high molecular weight polymers. Inert high boiling compounds such as nitrobenzene, benzophenone, dimethoxybenzenes, etc. were used as solvents. H. M. Van Dort (11) repeated and extended the work of Stamatoff. High molecular weight polymer was obtained even though the Ullmann condensation itself was somewhat unreproducible. Non linear and/or crosslinked polymers seemed to be the major side products. Pankofa (12) reported that even traces of oxygen promoted a free radical side reaction, forming branched and crosslinked products. Robeson et al. (21) successfully synthesized linear high molecular weight polymers by reacting sodium bisphenate with aromatic dihalide under similar conditions (See Table 1). Such a technique had been earlier outlined in the patent literature by Farnham and Johnson (308).



Where X = O, , or a chemical bond. Typical reaction conditions used were as follows. A solution of bisphenol-A disodium salt · 6(H₂O) was refluxed in toluene in a round

bottomed flask fitted with a dean stark trap to remove water. Benzophenone was added and toluene distilled off to a pot temperature of 210°C. After cooling, an equimolar amount of 4,4'-dibromobiphenyl and a catalytic amount of CuCl₂ -pyridine solution was added under strictly nitrogen atmosphere. The mixture was heated for 6 hours at 185-215°C. The product was cooled, diluted with toluene, coagulated in alcohol and dried to give high yields (> 90%) of polymer exhibiting good thermal and mechanical properties. Some of these are shown in Table 1.

1.5 MECHANISM

Although the Ullmann condensation has been known since 1904 (3), it was not until 1951 that Bunnet and Zahler (13) proposed a nucleophilic aromatic substitution for the reaction. Their mechanism was useful, but rather incomplete. A more detailed mechanism was proposed by H. Weingarten (14,15). Several important points were noted.

- (1) Copper (I) was believed to be the catalytically active form.
- (2) The halogen reactivity decreases in the order I>Br>Cl>>F.
- (3) The nature and position of substituent effects were similar to previously studied aromatic nucleophilic substitution.
- (4) The order of the reaction was found to be first order in catalyst and in halobenzenes, respectively, but a variable order was noted for potassium phenoxide.

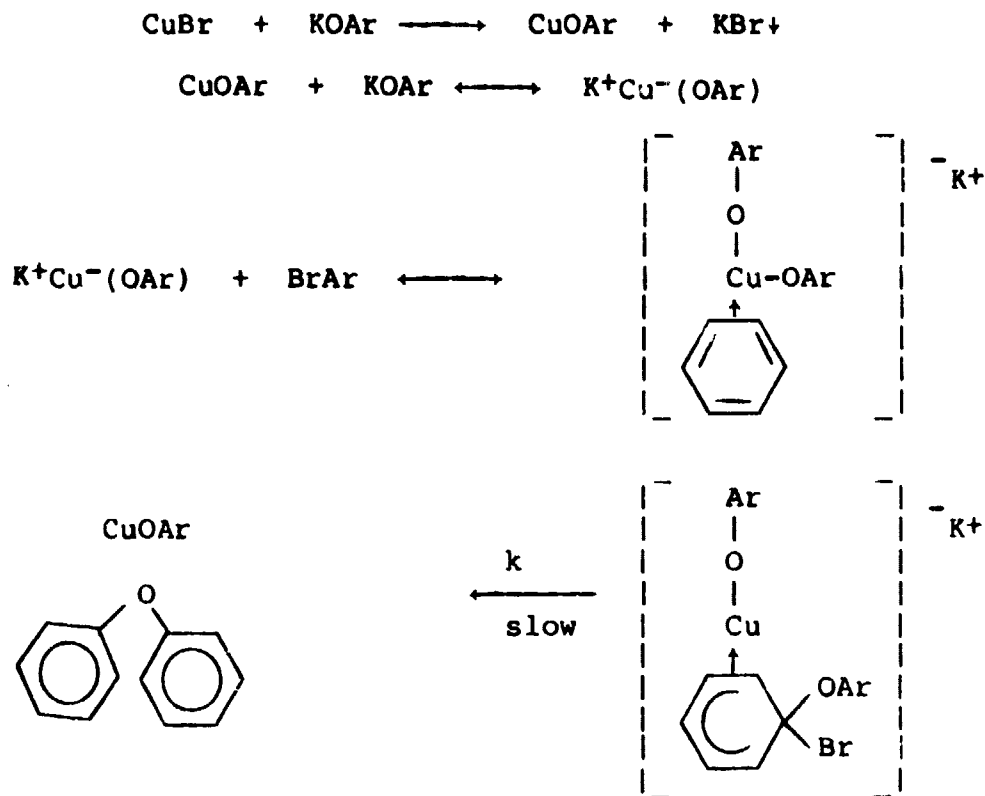
TABLE I
EFFECT OF STRUCTURE ON THE GLASS TRANSITION TEMPERATURE
OF SOME POLY(ARYLETHERS) (ref. 21)

Polymer Unit	$\frac{\eta_{sp}}{C}$ (R.V.) (A)	T _g °C
	0.50	122
	0.70	154
	1.10	182

(A) reduced viscosity measured in CHCl₃ at 25°C and 0.2 gm/deciliter

Scheme I was stated to be consistent with the above observations.

Scheme 1



Here the copper (I) is envisioned to first interact with the electrons of the aromatic halide. The validity of this mechanism has been further substantiated by the isolation of cuprous ion-benzene complexes (16).

Scope of Reaction.

The role of the solvent in the polymer forming reaction is not very critical (21) provided that it is inert and high boiling. The majority of solvents employed contain a heteroatom, having a lone pair of electrons in their molecule. The Ullmann reaction can be accompanied by side reactions,

such as reductive dehalogenation (17), Ullmann coupling (4) and branching or crosslinking, due to the formation of radicals (12). The reaction conditions, solvent and the nature of the aromatic halide play an important role in the relative contributions to the main and side reactions. Shein (18-20) has reported high yields and faster rates of model ethers by the use of potassium carbonate and free phenol instead of preformed phenoxide. Bacon (22,23) and Tomita (24) reported the use of CuO, free phenol and aromatic halide for alkali sensitive compounds. Here Cu (I) oxide was proposed to function as both a base and a catalyst. These observations could well increase the scope of the polymer forming reaction.

1.6 OXIDATIVE COUPLING

The synthesis of unsubstituted polyphenylene oxide via an Ullmann condensation was discussed in the previous section. Chain branching and other side reactions were suggested as being due to free radical intermediates. High molecular weight linear polymers could be obtained by careful exclusion of these reactions. Interestingly, in this section, high molecular weight polymers are obtained by a radical mechanism termed "oxidative coupling". The use of ortho-di-substituted phenols and careful choice of the reaction system permits very high molecular weight linear polymers to be made in a relatively short reaction time.

In 1959, Prof. C. C. Price, at the University of Pennsylvania and Dr. A. S. Hay, at General Electric almost simultaneously and independently reported the synthesis of poly (2,6,dimethyl 1,4 phenyleneoxide). In recognition for their contribution in understanding the reaction and the general behavior of phenoxy radicals, they received awards from the American Chemical Society (1974) and the Society of Plastics Engineering (1975), respectively.

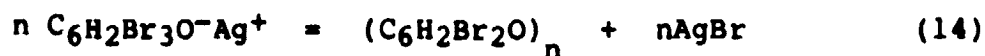
Although the mechanisms of the two methods may well be quite similar, there are some intrinsic characteristics that warrant separate treatments, as discussed below.

1.6.1 OXIDATIVE DISPLACEMENT

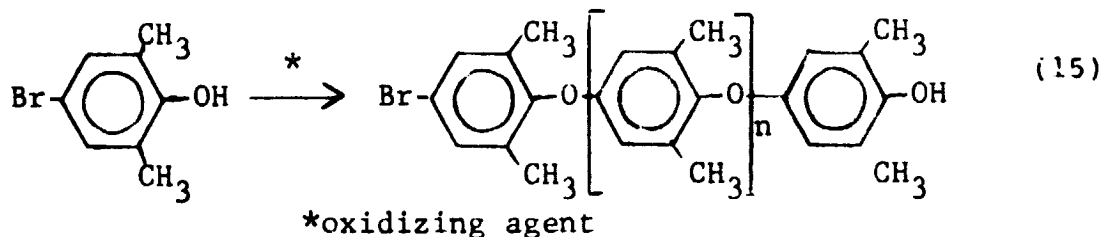
Hunter (25), while extending the scope of the Ullmann ether condensation, reacted ethyl iodide with silver salts of trihalophenols and obtained an amorphous product. After a detailed (26) study of the reaction the following conclusions were reached:

- (1) Only halogen attached directly to the phenol reacted.
- (2) The order of ease of displacement of the halides is I>Br>Cl.
- (3) The para halides were more labile than those at the ortho positions.
- (4) The product formed by the displacement of the halogen was macromolecular in nature.

The polymer forming reaction was summarized as below.



Since then, several workers (27-30) have modified this reaction with the hope of understanding the mechanism and achieving high enough molecular weight for good engineering properties. The choice of highly halogen substituted phenol produced low molecular weight and/or branched polymer. The most notable contribution towards the synthesis of moderately high molecular weight polyether was by Price and coworkers (31). They studied the reaction of 4-bromo 2,6 dimethyl phenolate ion with a number of oxidizing agents which Cook (32) and Dimroth (32) had earlier used to generate stable free radicals. Typically, 1-10% mole percent of the oxidizing agent (Reaction 15) was used and the linearity of the polymer was confirmed by the presence of one bromine atom and one phenol group per chain.



This reaction is extremely rapid and substantially complete in less than one minute. Reactions run to 25-50% conversions produced polymers which had about the same intrinsic viscosity as those carried to 90-95% conversion

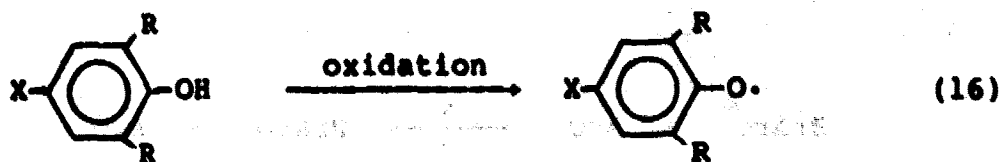
under oxidative coupling conditions. This is reminiscent of oxidative coupling which is discussed in the following section.

A typical procedure utilized by Price et al. is given below. A one liter three-necked flask is fitted with an efficient stirrer, a dropping funnel, and a gas dispersion tube connected to a stream of purified nitrogen. A solution of 5 g of potassium hydroxide in 200 ml of water, 8 g (0.04 moles) of 4-bromo 2,6 xylenol and 200 ml of benzene is introduced. The stirrer is started and 1.3 g of potassium ferricyanide in 20 ml of water is added dropwise over a period of 30 minutes. After an additional 15 minutes of stirring, the mixture is transferred to a separatory funnel and the aqueous phase is drawn off the bottom. The benzene layer is concentrated by evaporation under reduced pressure. This concentrated solution is poured in acidified methanol to coagulate the polymer. The dried polymer obtained in >90% yield had an intrinsic viscosity $[\eta]$ 0.5-0.6 dl/g in benzene.

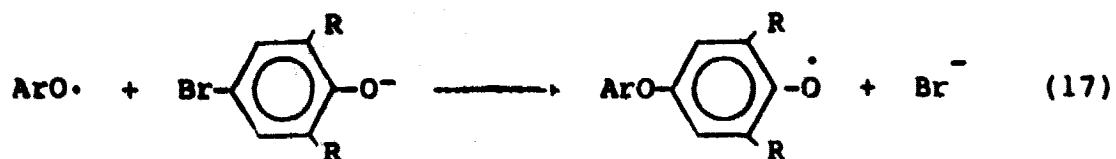
1.6.1.1 MECHANISM

Since oxidizing agents used for polymerization were originally used to produce free radicals, Price (34) suggested the following mechanism.

INITIATION



PROPAGATION



TERMINATION



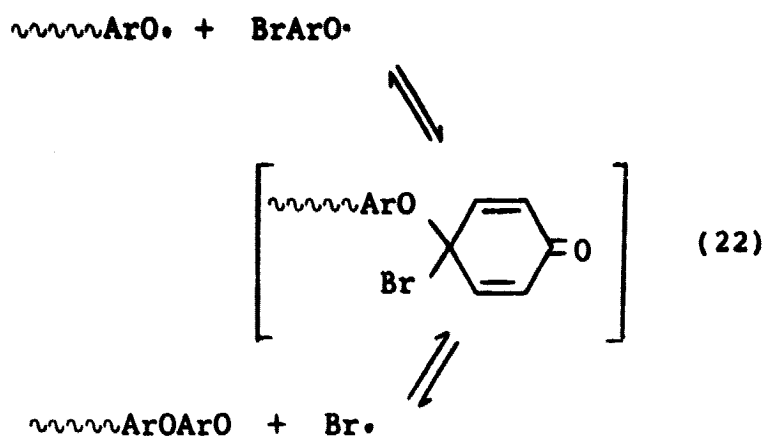
The heterogenous nature of the reaction (benzene/water) complicated the mechanistic interpretation. More recently (35) the following mechanistic steps (Reactions 19-23) were proposed.

MONOMER ACTIVATION





GROWTH:



REDISTRIBUTION:



Reactions 19-21 generate the phenoxy radical. Reaction 21 is reversible and the main factor affecting the equilibrium constant K is the relative stability of the anions. The oligomeric radical is more stable than the monomeric phenoxy radical, which is the reason the system tends to quickly oligomerize. This accounts for the initial chain like behavior.

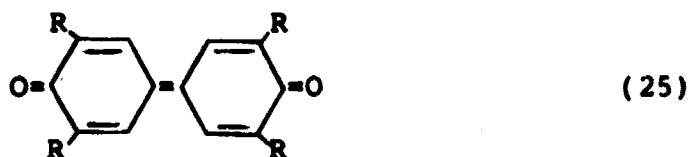
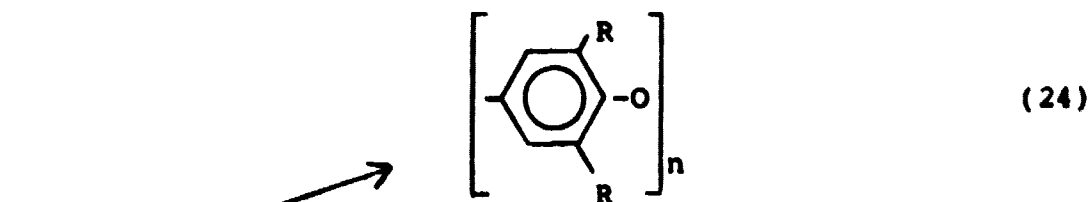
1.6.1.2 SCOPE OF REACTION

The reaction has been initiated by several one electron initiators such as iodine (31,36,37), lead, silver, and copper oxides and their salts (38-42, 44), potassium permanganate (31,34,45) and organic or inorganic peroxides (42,46-48). A wide variety of solvents have also been used. The use of dipolar aprotic solvents such as DMF, HMPT, DMSO, DMAC, etc. gave a higher yield of polymers (49,35,42). Proper combination of initiators and solvents has largely extended the scope of the reaction. Thus phenols with phenyl allyl or n-propyl groups in the ortho position have been used for polymerization (50,51). Surprisingly the allylic double bond is inactive towards the growing radical. Polymerization does not take place with bulky substituents such as t-butyl or strong electron acceptors such as carboxy, fluorine, nitro, etc. Many workers have studied the formation and homolytic decomposition of phenoxo metal complexes (43,44).

1.6.2 OXIDATIVE COUPLING

An important synthesis route to poly(2,6-dimethyl phenylene oxide) is carried out by the oxidative coupling of xylenol. This is partially the basis for the commercially important "NORYL RESINS" of the General Electric Company. Hay (52) extended Terentev and Mogilyanskii's (52) method to the oxidation of phenols. He found that 2,6-dimethyl phenol could be effectively oxidized to yield a tough and flexible product. The structure of the polymer was soon discovered to be poly (2,6-dimethyl 1,4-phenylene oxide).

A general reaction scheme given below shows the polymer forming reaction along with the competitive side reaction.



Diphenylquinones were obtained as the major or minor product depending on the substituents. The effect of several different substituents are shown in Table 2.

TABLE 2
EFFECT OF ORTHO PHENOL SUBSTITUENTS ON THE PRODUCT OF
OXIDATIVE COUPLING (ref. 52)

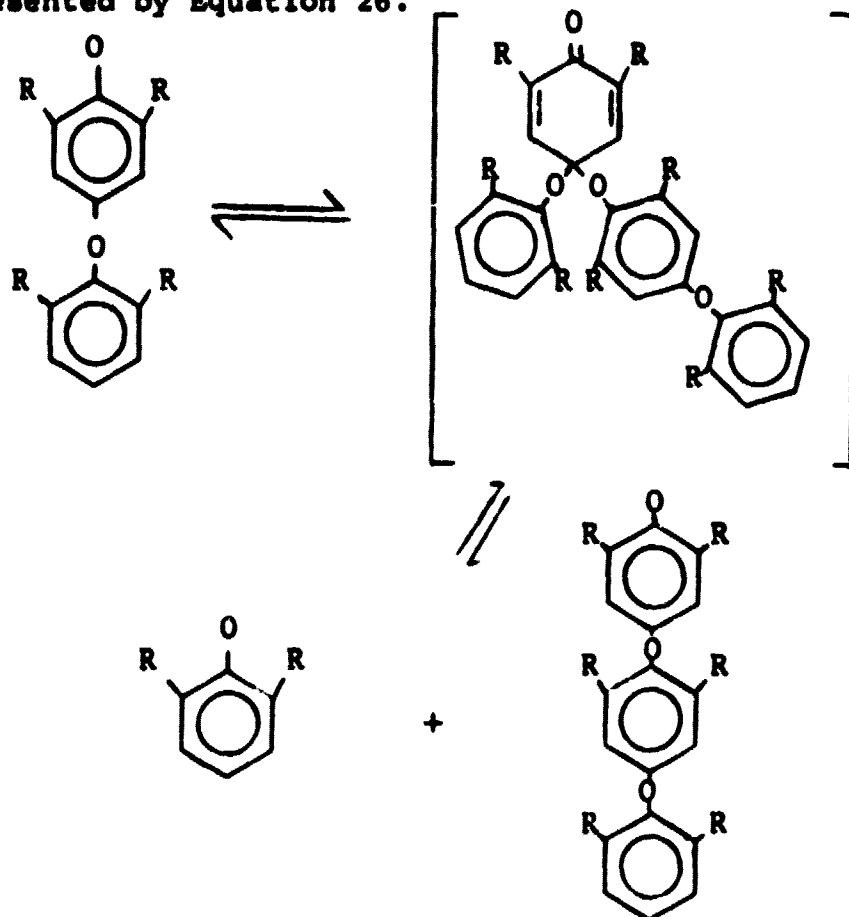
R	R'	Principal product
Methyl	Methyl	Polymer
Methyl	Ethyl	Polymer
Methyl	t-butyl	Diphenquinone
Methyl	Phenyl	Polymer
Methyl	Methoxy	Polymer
Ethyl	Ethyl	Polymer
i-Propyl	i-Propyl	Diphenquinone
t-Butyl	t-Butyl	Diphenquinone
Chloro	Chloro	Polymer
Methoxy	Methoxy	Diphenquinone
Nitro	Nitro	No Reaction

Reactions of unsubstituted and mono substituted phenols yielded crosslinked or branched polymers. The reaction has been most successful with phenols having small electron donating groups in the ortho positions. When bulky groups are present, carbon-carbon coupling predominates and diphenoquinone is the major product. A typical procedure (52) is outlined below.

To a 500 ml wide-mouthed Erlenmeyer flask in a water bath at 30°C equipped with a vibromixer stirrer, an oxygen inlet tube and a thermometer are added nitrobenzene (200 ml), pyridine (70 ml) and copper (I) chloride (1 g). Oxygen (300 ml/min) is bubbled through the vigorously stirred solution and then 2,6 dimethyl phenol (15 g. 0.12 mole) is added. Over a period of sixteen minutes the temperature rises to 33°C and the reaction mixture becomes viscous. The reaction is continued for some more time, then diluted with chloroform (100 ml) and coagulated in methanol (1.1 liter), containing concentrated hydrochloric acid (3 ml). The precipitated polymer is filtered and washed with methanol (250 ml) then with methanol (250 ml) containing concentrated hydrochloric acid (10 ml) and finally with methanol (250 ml). The polymer is dissolved in chloroform (500 ml), filtered and reprecipitated in methanol (1.2 liter) containing concentrated hydrochloric acid (3 ml). After washing with methanol and drying at 100°C (5mm) for 3 hours yield of 13.5 g (91%) of almost colorless polymer is obtained ($[\eta]$ in benzene at 30°C = 0.96).

1.6.2.1 MECHANISM

Initially it was felt that the reaction was probably an "addition type" of polymerization, that is, the reaction proceeded by sequential addition of monomeric phenols to the end of a growing chain. However, Enders (55) showed that kinetically the propagation behaved as a step growth polymerization. Kwaitek (56) confirmed this by polymerizing dimers. Isolated low molecular weight oligomers could also be polymerized to high molecular weight. Although the overall mechanism is still not completely understood, at least in the open literature, the generally accepted propagation mechanism (57-59) is represented by Equation 26.



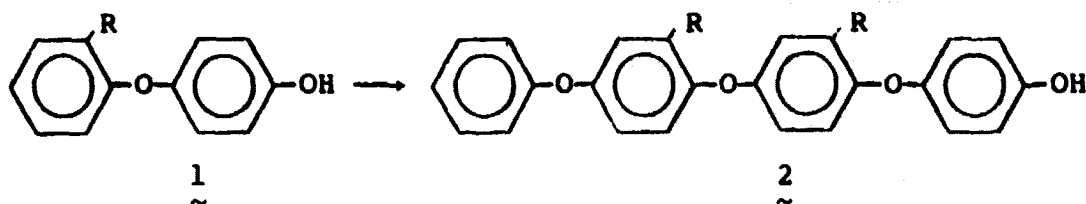
(26)

The quinone ketal intermediate is of course unstable and could dissociate either to give two new aryloxy radicals or the starting dimers. This process eventually leads to polymers. Alternately, the quinone ketal could rearrange directly in a manner analogous to the benzidine rearrangement to give a tetramer. Although this mechanism is more generally accepted, it does not account for various observations. Any mechanism proposed needs to be consistent with a large number of observations.

- (1) Typical free radical scavengers do not inhibit the reaction.
- (2) High activity is obtained with only basic salts of copper.
- (3) Ligands that form strong bonds with the central ion do not catalyse the reactions. The catalytic activity increases as the stability of the ligand decreases.
- (4) Copper compounds capable of combining with two phenoxy ions do not show any catalytic activity. However, basic salts catalyse the reaction only in the presence of oxygen.
- (5) The electronegativity values of phenols and divalent copper are 3.0-3.2 and 2.0 respectively. Therefore the oxidizing agent has to be a complex of Cu^{++} rather than just a Cu^{++} basic salt.
- (6) The head to tail orientation and conditions that dictate C-C coupling versus C-O- coupling.

- (7) The initiation of the polymerization is caused by electron transfer between the xylenol anion and a transition metal ion.
- (8) The formation of monomeric and polymeric phenoxy radical using AgO, PbO, etc.
- (9) Dimers and trimers can also form polymer.
- (10) ESR detectable level of polymeric radicals is not obtained for copper catalytic system.
- (11) Auto-oxidation of copper (I) chloride in pyridine results in the absorption of one mole of oxygen per four moles of copper (I) chloride.
- (12) Copper (II) salts have been found to be inactive as a catalyst.
- (13) Low ratios of ligand to copper yields predominately C-C coupled product. When the ligand ratio is increased to a 10/1 ratio and higher, only minor amounts of diphenquinone are observed.
- (14) When strongly basic bidentate ligand is used, a sharp break occurs at 2N/Cu above which almost exclusive C-O coupling occurs.
- (15) Increasing the size of the ligand coordinate to copper favors C-C coupling.
- (16) Bulky ligands favor the C-O coupling of o-cresols.
- (17) The polymerization reaction behaves as a typical condensation reaction, in the sense that molecular weight increases slowly with conversion.

- (18) Methoxylated phenols were unreactive in the presence or absence of monomers.
- (19) In the oxidative polymerization 2,6 xylenol 3-D and 2,6 xylenol -4D, 16% of the label in the former was lost and 23% of the label in the latter was retained.
- (20) Monomer and trimers are formed from disubstituted dimers but not from unsubstituted or monosubstituted dimers.
- (21) Oxidation of phenols such as 1, yield 2



- (22) Redistribution of xylenol dimers occur with other phenols.
- (23) Replacement of one methyl by t-butyl or both by i-Pr leads to diphenoquinone as the main product.
- (24) The rate of phenol oxidation under Hay conditions (52) is first order in catalyst, first order in oxygen pressure and zero order in phenol.

1.6.2.2 SCOPE OF REACTION

Substituted phenols have been widely used and studied. The ortho disubstituents have been small alkyl and alkoxy groups such as methyl and ethyl (69-152). Other phenols like halogenated xylenol (131), o-cresol (91,135,136),

mono, di and tri halogenated phenols (85,119,124,131) also yield polymers of relatively lower molecular weight. Polymerization of unsubstituted phenols and naphthols have also been attempted (121,132,114). A wide variety of transition metal salts and complexes have been used. Most common salts are of copper (62,75-83,85-96,98,100,104-122, 124), manganese (60-63,68-74,90,97-104,106-8,133-125), cobalt (64,88,128) and nickel (62,98), etc. Organic amines like alkyl (64,65,68,69,79,84,87,93,94,98,106,117,122-127) alkanol (61,66,71,90,97,99,101,108,114,135,139,144) pyridine and pyridine derivatives (60,62,63,75,76,85,95, 100,104,115,121) as well as inorganic bases like NaOH (70) KOH (74,89) and NH_4OH (107) have been used. In all cases the ratio of organic base to metal complex has been high. The most commonly used solvents have been toluene, benzene, chlorobenzene and chloroform. Interestingly, radical acceptors such as styrene (79), vinyl pyridine (75,76), etc. have also been used as a solvent. In the latter case only low molecular weight oligomer was obtained. The reaction is usually carried out at room temperature (30°C) for 3-6 hours. In all processes diphenoquinone is the only major side product. By careful optimization the diphenylquinone content can be reduced to less than 0.01% (62,74, 78,88,92).

1.7 POLY(ARYLENE ETHER SULFONES)

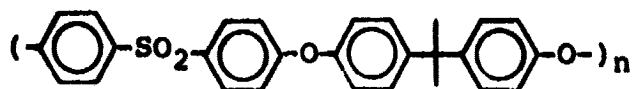
The last two sections dealt with the ether linkage as the principal functional group between the aromatic nucleus

in the polymer backbone. This section reviews macromolecules containing both ether and sulfone groups. The choice of the sulfone group is because of the thermal stability of diphenylsulfones and their sulfonylation chemistry. In principle, the poly(arylene)ethersulfones can be synthesized by either polyetherification or via polysulfonylation. Thus in the early 1960's, Union Carbide Corp (UCC), 3M Co., and ICI (U.K.) independently and almost simultaneously, patented routes for the synthesis of aromatic polysulfones. All of these firms have since commercialized their discoveries under various trade names (Table 3). The 3M product is no longer produced.

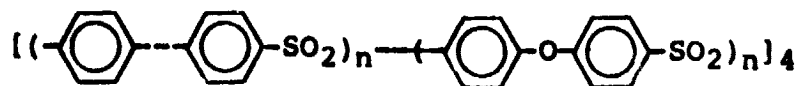
The two methods used to synthesize poly(arylene ether sulfones) are by polyetherification and polysulfonylation as shown in equations (27), (28), (29) and (30). In polyetherification, the sulfone group is already present in one or both of the monomers and the ether linkage is formed via aromatic nucleophilic substitution in a dipolar aprotic solvent. By contrast, polysulfonylation involves the formation of the sulfone linkage between ether containing monomers and proceeds via electrophilic aromatic substitution. The latter reaction is conducted in the presence of a Friedel-Craft catalyst. Some examples are listed in Table 5.

TABLE 3
 PROBABLE STRUCTURES OF COMMERCIAL POLYSULFONES

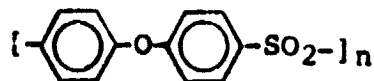
UNION CARBIDE CORP, UDEL



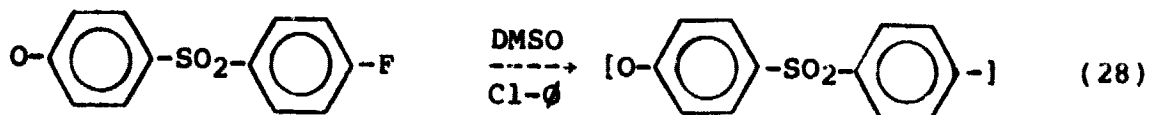
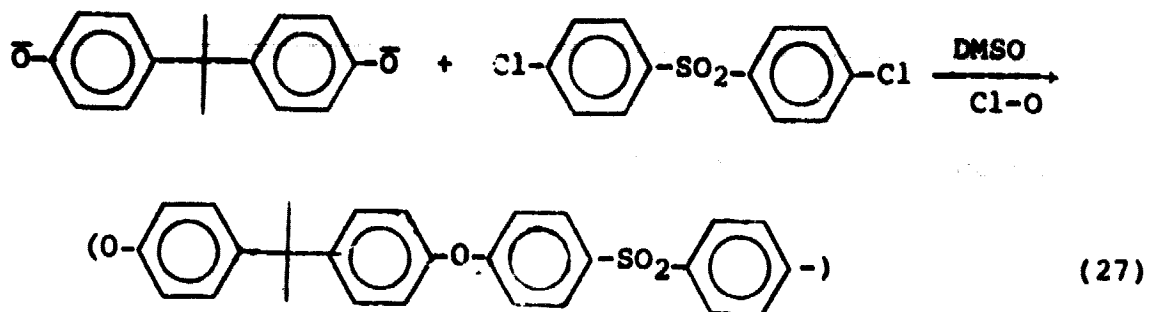
3M; ASTREL 300



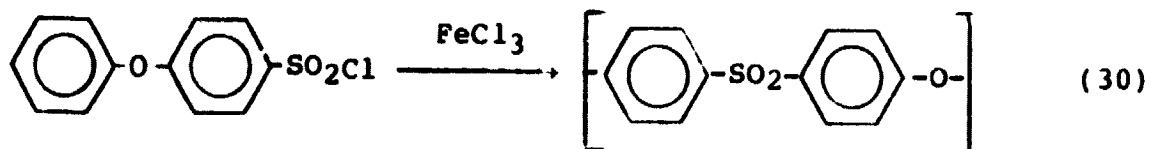
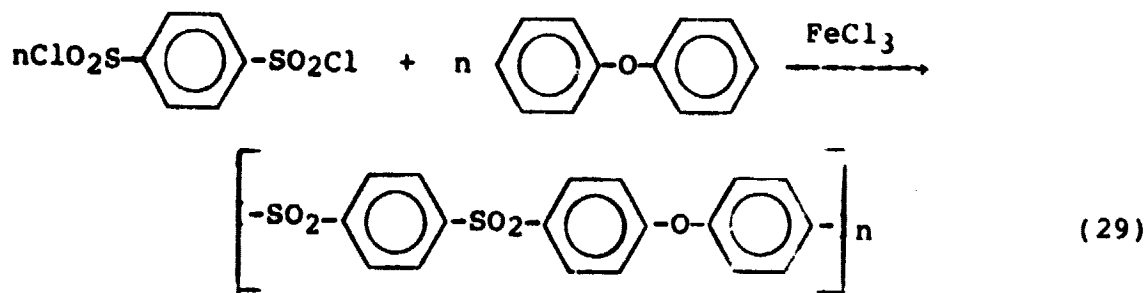
ICI; 200P



POLYETHERIFICATION



POLYSULFONYLATION (ref. 156)



These two reactions complement each other, and will be discussed separately.

1.7.1 POLYETHERIFICATION

In 1967, Johnson et al. (154) described the synthesis of a large number of high molecular weight poly(arylene ether sulfones) via condensation of bisphenates with activated aromatic dihalides. An important consequence of this work was the synthesis of bisphenol-A polysulfone, derived from the disodium salt of bisphenol-A and dichlorodiphenylsulfone and currently marketed by Union Carbide as UDEL POLYSULFONE. In this reaction the ether bond is formed via the displacement of the halide by the phenoxide. Thus although the bisphenol may contain the sulfone group, this group forms an essential part of the dihalide. The electron withdrawing nature of the sulfone group activates the dihalides, thus facilitating displacement. A typical procedure (154) is discussed below.

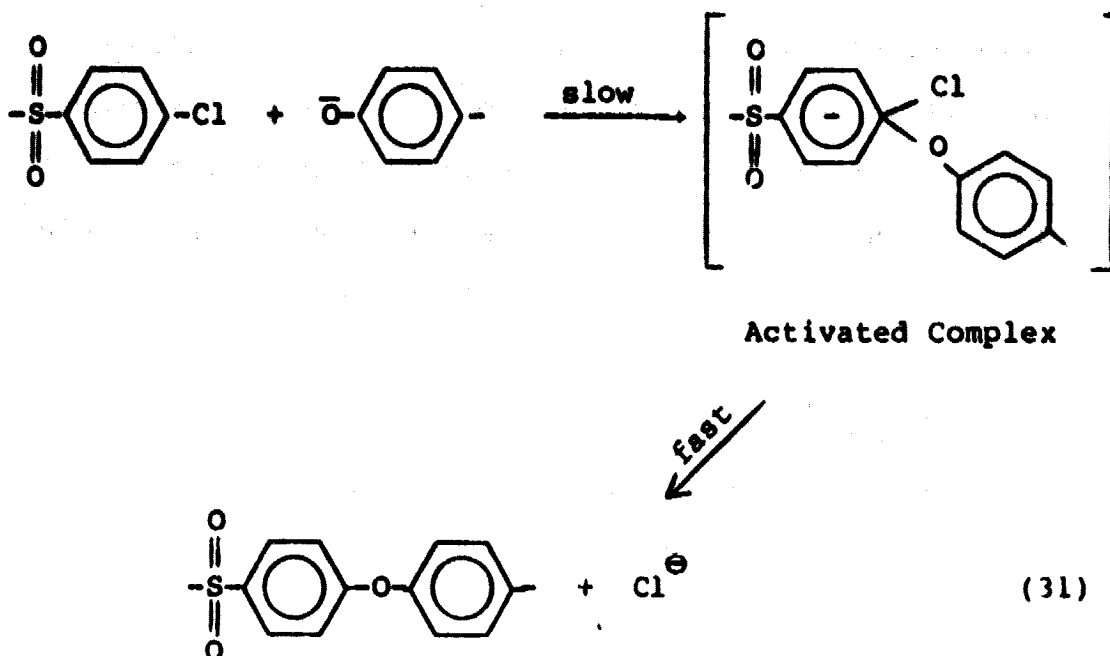
Into a 1 liter stainless steel resin kettle, fitted with an inert gas sparge tube, thermometer, mechanical stirrer, dropping funnel and Dean Stark trap with condensor is placed high purity bisphenol-A (51.36 g 0.225 mole), dimethyl sulfoxide (DMSO) (115 g) and chlorobenzene (330 g). The mixture is heated to 60-80°C and exactly 0.45 mole of 50.0% aqueous sodium hydroxide is added. The system is heated to reflux while sparging inert gas through the reaction mixture. Most of the water is removed as chlorobenzene/water azeotrope. In doing so, the temperature of the reaction mixture rises to 140°C. The temperature is raised to 155-160°C by distilling off chlorobenzene. A 50%

solution of dichlorodiphenylsulfone (64.61 g 0.225 moles) in dry chlorobenzene maintained at 110°C is added over a period of about 10 minutes, the excess solvent being allowed to distill at a rate sufficient to maintain the reaction temperature at 160°C. In one hour at 160°C high molecular weight polymer is formed. The polymerization may be terminated by passing methylchloride into the polymerization mixture when the desired degree of polymerization is reached.

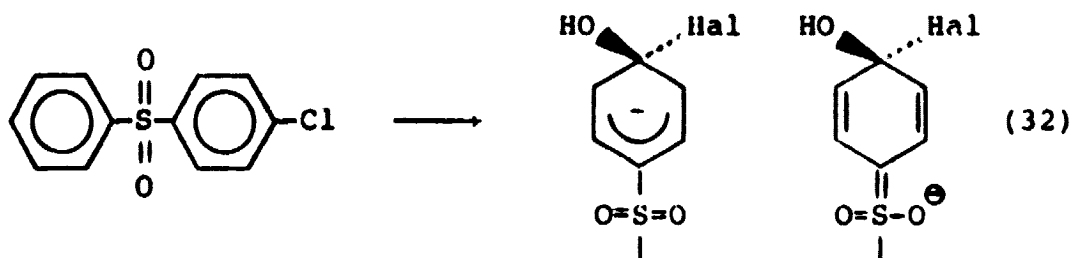
The viscous polymer solution is then cooled and diluted with chlorobenzene (about 700 g) and filtered to remove NaCl. The resulting clear solution is coagulated in 3 or 4 volumes of methanol and dried in a vacuum oven at 130°C for several hours. The yield is nearly quantitative.

1.7.1.1 MECHANISM

Bunnett and Zahler proposed an aromatic nucleophilic substitution for similar monofunctional model compounds. (13) Schulze and Baron (155) studied the kinetics of the polymer forming reaction and concluded that the observed rate constant was first order in phenoxide and activated halide concentrations, respectively. Rose et al. (156) studied the effect of substitution on the polymer forming and hydrolysis reaction. Based on their observation and the above kinetic data they proposed the following mechanism.



The reaction is envisioned to take place in two steps, and involve an activated complex intermediate. The first step is the slow rate determining step. This accounts for the overall second order reaction. The sulfone group plays a very important role in activating (157) the halide and forming the stabilized intermediate complex (158).



The order of reactivities of the halides in the activated systems has been observed to be (156,159) $p > O >> m$ and $F > Cl >> Br, I$. Aromatic halides which do not contain

powerful electron withdrawing groups such as sulfones are unreactive and in the absence of such groups the reaction is not suitable for the synthesis of high polymer (At least without a catalyst). The more basic (less acidic) phenols are more reactive in halide displacement.

1.7.1.2 SCOPE OF REACTION

Table 4 shows the different bisphenates, activated dihalides, solvents and base used in making a wide variety of polymers.

1.7.2 POLYSULFONYLATION

Although the sulphonylation with sulphonylchlorides under Friedel-Craft conditions have been known to give high yields of monomeric sulfones (197), it was only during the last twenty years that this method was reported for the preparation of high molecular weight polymers (198). Two different routes, involving electrophilic aromatic substitution were employed to prepare bisphenol-S polysulfone as shown below (199).

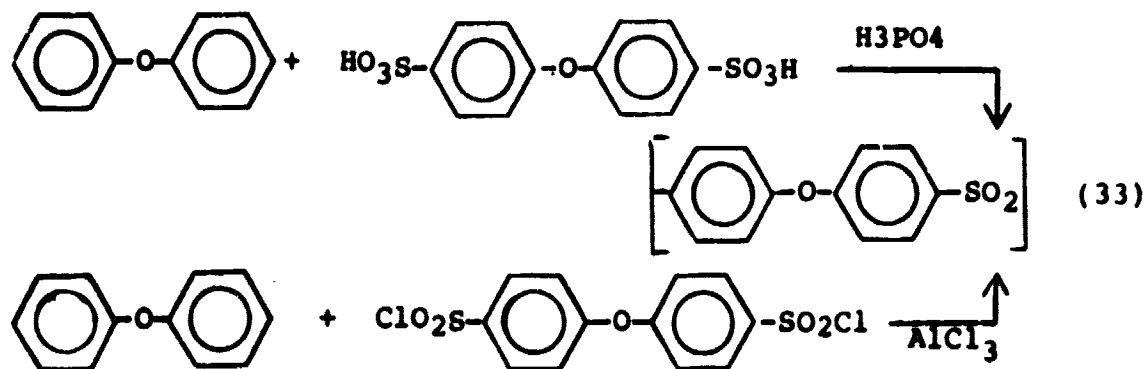


TABLE (4)
 VARIOUS REACTANTS AND REACTION CONDITIONS USED IN SYNTHESIS OF
 POLYARYLETHYER SULFONES











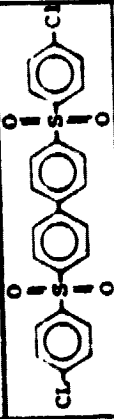

BISPHENOL	DIHALIDE	REMARKS	REFERENCES
		DMSO, KOH, 5 HRS., 130°C. For manufacture of thermo- plastic printing dies.	160,161,162 154,163,164 165
	:		154 154
	.		154
			
	.		
			154,167

TABLE (4)
 VARIOUS REACTANTS AND REACTION CONDITIONS USED IN SYNTHESIS OF
 POLYARYLETHER SULFONES

BISPHENOL	DIMALIC2	REMARKS	REFERENCES
		Sulfolene, KOH, 4-5 hrs., sulfolene decomposes on prolonged heating	
	.		
		T _g 188°C	166
	.		168
	.		169

TABLE (4)
 VARIOUS REACTANTS AND REACTION CONDITIONS USED IN SYNTHESIS OF
 POLYARYLETHER SULFONES

BISPHENOL	DIALIDE	REMARKS	REFERENCES
 	 	<p>$\text{N-CH}_3, \text{Na}_2\text{CO}_3$ 5 hrs., 210°C</p> <p>Solvent Me_2SO 1-18 hrs. at 165-185°C.</p> <p>Introduction of carbo groups raised the poly- ether m.p. by 50-100°C compared to Bis A.</p>	<p>170</p> <p>171</p>

ORIGINAL PAGE IS
 OF POOR QUALITY

TABLE (4)
 VARIOUS REACTANTS AND REACTION CONDITIONS USED IN SYNTHESIS OF
 POLYARYLETHYER SULFONES

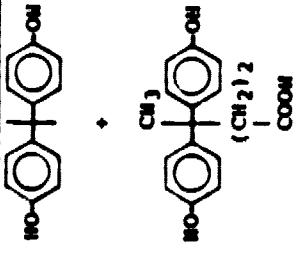




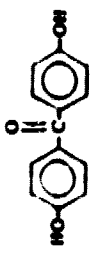
DISPHEENOL	DIMALIDE	REMARKS	REFERENCES
		Solvent Me ₂ SO; NaOH, 3-4 hrs. at 160°C. The copolymer showed good solvent resistance	172
	.	Me ₂ SO; KOH; 6 hrs, 120-160°C. The reaction was further carried out in bulk.	173
		Prepared in the presence of trialkyl(aryl)chlorosilane	174
	.	Ph ₂ SO ₂ as solvent, 16 hrs. at 230°C	175

TABLE (4)
 VARIOUS REACTANTS AND REACTION CONDITIONS USED IN SYNTHESIS OF
 POLYARYLETHER SULFONES







BISPHENOL	DIALIDE	REMARKS	REFERENCE
 Phenolphthalein		Copolymer	176
			177
		4-8 hrs. at 180°C T _g ~210-285°C	178 179

TABLE (4)
 VARIOUS REACTANTS AND REACTION CONDITIONS USED IN SYNTHESIS OF
 POLYARYLETHER SULFONES

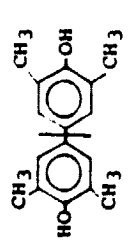
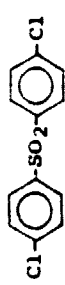

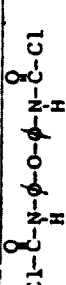

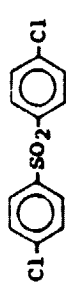




BISPHENOL	DIHALIDE	REMARKS	REFERENCES
		DMAC/K ₂ CO ₃ , T _g = 273°C	180
		Sulfolane as solvent, KOH, 6 hrs. at 220°C	181
		DMAC; K ₂ CO ₃ ; 6 HRS. 150°C No azotropic agent used claims higher R-V than control	182
	.	Ph ₂ SO ₂ as solvent; K ₂ CO ₃ Na ₂ CO ₃ ; Na ₂ CO ₃ ; CsCO ₃ , etc. as bases. 21 hrs. at 320°C	183
 X = S, O, SO ₂ , CO	.	K ₂ CO ₃ , 9 hr., 200-90°C	184 185
		Interfacial synthesis	186

TABLE (4)
 VARIOUS REACTANTS AND REACTION CONDITIONS USED IN SYNTHESIS OF
 POLYARYLETHER SULFONES

BISPHENOL	DIDHALIDE	REMARKS	REFERENCES
		Biphenyl as solvent. 6 hrs. at 300°C	187 191
		Sulfolane; kf as base 48 hrs. at 100°C	188
		DMSO, CaO, NaNH ₂ , MgO, BaO	189
	"	DMAC, K ₂ CO ₃ . 3.5 hrs. at 150-60°C, T _g 270°C	190
		Ph ₂ SO ₂ ; KOH/NaOH	192 193
	"	Ph ₂ SO ₂ ; KHCO ₃ , 3 hrs @ 300°C	194
Bis A	DCDPS	DMSO; Na ₂ CO ₃ , NaNO ₂ low mol. wt.	195
	DCDPS	good molding properties	196

The first process involved the condensation of diphenyl ether with 4,4-diphenyletherdisulfonic acid in an o-chlorobenzene-carbontetrachloride mixture to form short oligomers. Dehydration was then carried out by heating under reduced pressure over phosphorous pentoxide. The dried oligomers were then polymerized in polyphosphoric acid at 240°C for four to eight hours.

In the second process, diphenylether was reacted with 4,4'-dichlorosulfonyldiphenylether in a nitrobenzene solution containing a stoichiometric amount of $AlCl_3$ and crosslinked polymer.

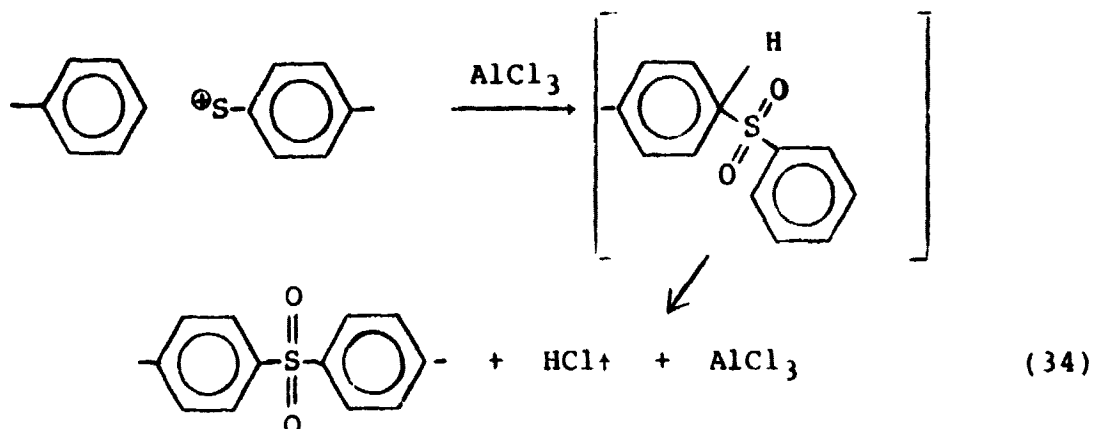
Cudby (200) investigated the synthesis of poly(arylethersulfone) via self condensation of p-phenoxybenzenesulfonylchloride. Contrary to what might be expected, the reaction required only catalytic amounts of catalyst, preferably ferric chloride and was carried out at elevated temperature (<150°C) in the absence of solvent for an extended period of time. The reaction yielded high molecular weight, less catalyst contamination and crosslinked polymer compared to the corresponding two reactant technique. A typical synthesis procedure is provided.

Required amounts of purified anhydrous ferric chloride and the monosulfonylchlorides were melted under a nitrogen atmosphere. The temperature was then raised to 190°C for over 10 to 20 minutes, during which hydrogenchloride was evolved. After cooling, the foamed mass was ground and heated to 250°C under reduced pressure for 2-3 hours.

After cooling, the product was treated with a one percent solution of acetylacetone in dimethylformamide at 100°C for ten minutes, filtered and the filtrate coagulated. The precipitated polymer was washed with acetone and dried under vacuum at 120°C.

1.7.2.1 MECHANISM

The mechanism of sulfonylation is in some ways analogous to that of nucleophilic aromatic substitution, in the sense that an intermediate complex is formed (156).



Again the formation of the intermediate is the rate determining step.

1.7.2.2 SCOPE OF REACTION

Tables 5 and 6 show the various polymers that have been made by this route. The choice of the catalysts for electrophilic aromatic substitution reactions is limited to those compounds which are needed only in catalytic

TABLE 5
POLYSULFONYLATION WITH DISULFONYLCHLORIDES





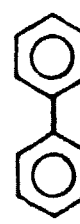



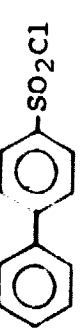



Reactants	Wt. % FeCl ₃	Final temperature °C	% yield
$(\text{ClSO}_2\text{-C}_6\text{H}_4\text{-})_n$ 	1.6	280	40
$(\text{ClSO}_2\text{-C}_6\text{H}_4\text{-})_n$ 	1.2	250	---
$(\text{ClSO}_2\text{-C}_6\text{H}_4\text{-})_n$ 	< 3.0	250	85
$(\text{ClSO}_2\text{-C}_6\text{H}_4\text{-})_n$ 	< 3.0	310	85
$(\text{ClSO}_2\text{-C}_6\text{H}_4\text{-})_n$ 	0.7	230	92
$(\text{ClSO}_2\text{-C}_6\text{H}_4\text{-})_n$ 	0.05	240	---

TABLE 6
 POLYSULPHONYLATION WITH MONOSULPHONYL CHLORIDES IN SOLUTION¹

Sulphonyl Chloride	Solvent*	Reaction Conditions			Polymer RV
		[FeCl ₃] (wt.%)	Temp. (°C)	Time (h)	
	A	0.6	120	4	0.57
	B	0.08	170-190	6	0.59
	C	0.10	160-230	20	0.20
	B	0.08	140-220	15	0.57
	B	0.10	130-210	20	0.22
	B	0.13	150-200	20	0.20

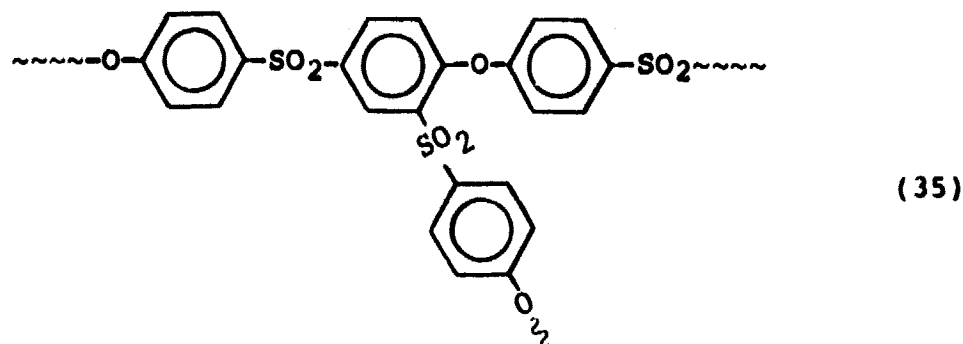
* A = nitrobenzene, B = dimethylsulphone, C = chlorinated biphenyl

quantities. Thus FeCl_3 , SbCl_3 , or IrCl_3 appear to be most widely used (156). The low catalyst levels aid in eliminating side reactions and potential difficulties in purifying the polymer.

As in the case of the nucleophilic condensation reactions discussed earlier, the choice of available solvents is limited. Although melt condensations do not require a solvent, the high viscosities encountered in such processes render control of the reaction difficult. The solvent also allows hydrogenchloride to escape more readily without foaming (201). Solvents such as chlorinated biphenyls and nitrobenzenes are the most effective in this regard.

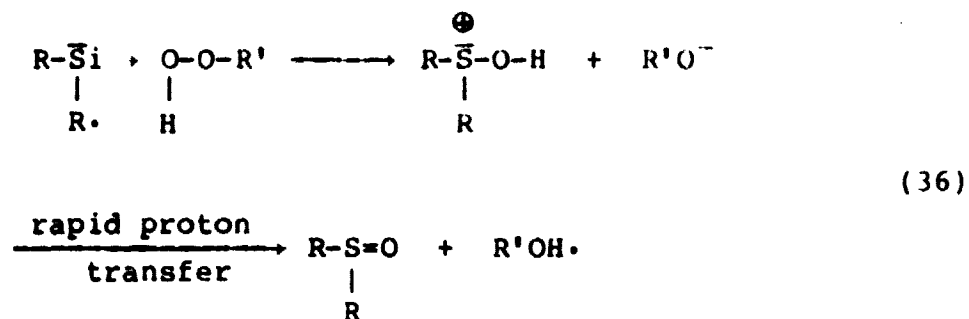
Rose (156) and Cudby (200) have investigated the effect of synthesis on the structure of polymers prepared by electrophilic substitution reactions. As expected, the self condensation of *p*-phenoxybenzenesulfonylchloride yielded only (or at least mainly), the para linked polymer, while the two reactant synthesis produced a mixture of both the ortho and para products. Polymers made by self condensation are shown in Table 6.

Employing NMR analysis, Cudby (200) has found that a significant degree of chain branching may occur during polysulfonylation. The exact mechanism was not clearly defined, but appeared to be the result of disulfonylation of single aromatic ring as shown following.



1.7.3 MISCELLANEOUS SYNTHESIS OF POLYSULFONES

Poly(arylene ether sulfones) have also been obtained by the oxidation of poly(aryltioethers). In principle various oxidizing agents such as hydrogenperoxide (202), iodobenzene dichloride (203) sodiumperiodate (204), t-butoxychloride (205) etc. could be used, however only hydrogen peroxide/ sulphuric acid has been used to oxidize polymers. Two equivalents of the oxidizing agents are required to oxidize the sulfide linkage to sulfone. With proper choice of the oxidizing agent the intermediate sulfoxide may be isolated. When the oxidizing agent is a peroxide, the mechanism (206) of oxidation is as shown below:

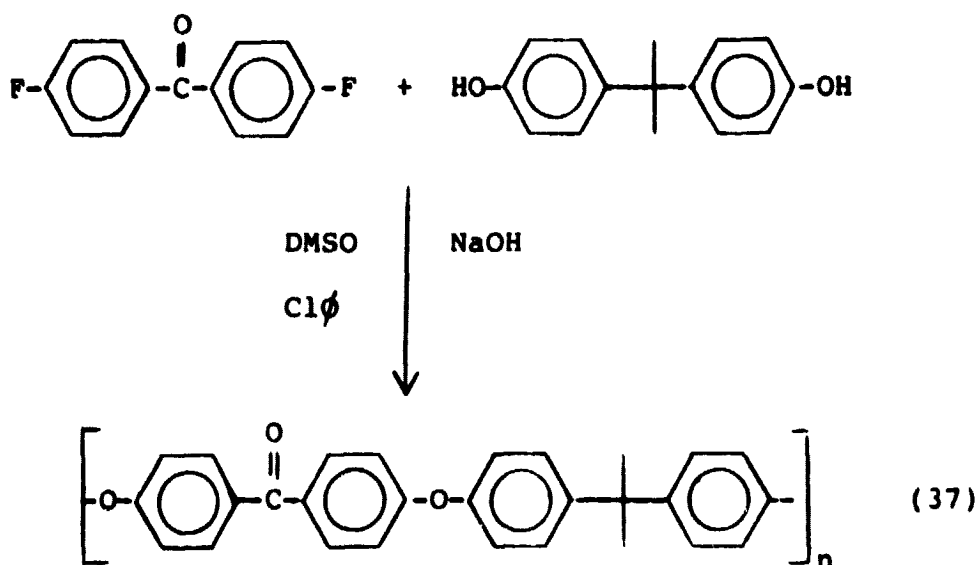


The second oxidation, which is normally slower than the first (207), has the same mechanism in neutral or acid solution, but in basic solution it has been shown that the

conjugate base of the peroxy compound (RCOO) also attacks the S-O group as a nucleophile (208).

1.8 POLY(ARYLEETHERKETONES)

In this section the ether and ketone form the principal functional linkage in the polymer backbone. The ketone group is similar to the sulfone group, in that it activates ortho and para halides and deactivates ortho and para phenoxides. The activating power of the ketone group is reported to be less than the sulfone group (156) in nucleophilic aromatic substitution. Poly(aryletherketones) can be synthesized by polyetherification. They tend to be more crystalline than the analogous sulfones, which could lead to solubility problems.



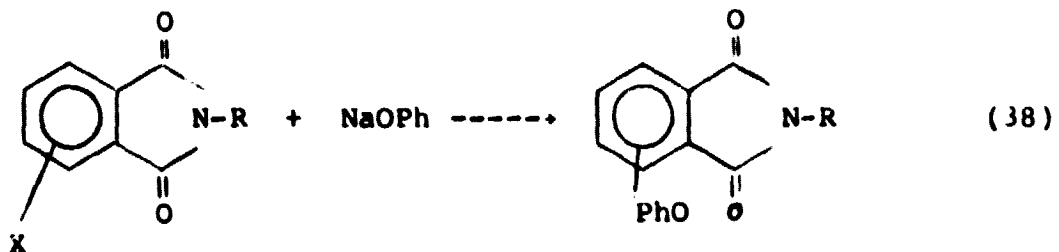
The mechanism of the reaction is identical to the nucleophilic aromatic displacement. The ketone may be

present in the dihalide and/or the diphenoxide (154,171,175,178-9,183-5,209-20).

The polyetherketone has also been synthesized by the Friedel-Craft reaction (253). Dhal polymerized p-phenoxy-benzoyl chloride or fluoride in the presence of diphenylether or biphenyl. As in polysulfonation, branching may take place.

1.9 MISCELLANEOUS POLYARYLETHERS

Oligoarylethers with sulfone/ketone/imido linkages with various end groups have been used as high temperature laminates by Marvel (221-28) and others (229-231). Polyarylether discussed so far have been obtained by the displacement of the activated halide. Other groups such as nitro may also be displaced by phenoxides as in nitro phthalimides (269-71) as shown below:



1.10 ENVIRONMENTAL STRESS CRACKING

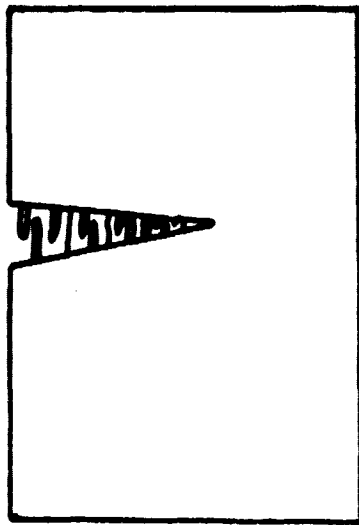
1.10.1 INTRODUCTION

A critical failure mechanism termed environmental stress cracking is a typical mode of failure in application

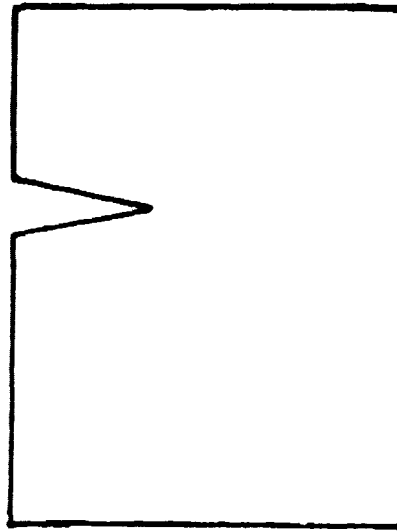
end-use of polymers (240). The presence of organic environments in contact with these materials can lead to formation of microvoids or crazes, which in turn, can coalesce and lead to complete rupture of the polymer. Although crazes appear to be a series of small cracks, microscopically they contain oriented fibrillar polymer. Figure 3 illustrates the two. Crazes can be formed by three different methods:

- 1) stress,
- 2) solvent action
- 3) stress plus solvent

Failure due to stress alone is quite common in metallic materials and is termed stress-corrosion cracking. Crazing due to solvent alone is more common to polymers. The effect of both stress and solvent is dramatically destructive to polymers. It must be noted that in many cases a very small applied stress, such as residual stress in molded parts may be sufficient to even craze or rupture the material in certain environments. This complete failure due to the combined effect of stress and solvent is termed "environmental stress cracking". This material failure is encountered in virtually all areas of polymer end-use. Structure property data has clearly shown that amorphous polymers are far more susceptible to environmental stress failure than their crystalline or crosslinked counterparts. Engineering thermoplastics and their composites offering improved performance in a variety of demanding application



CRAZE



CRACK

FIGURE 3 SCHEMATIC REPRESENTATION OF A CRAZE AND CRACK.

ORIGINAL PAGE IS
OF POOR QUALITY

are replacing metallics. Many of these polymers are amorphous and environmental stress cracking has been the "Achilles Heel" (240). Examples of environment induced failure in application end-use of polymers are listed in Table 7.

1.10.2 THEORIES OF ENVIRONMENTAL STRESS CRACKING

Earlier theories of Nielsen (232) and others (233-235) proposed that organic liquid could reduce the surface free energy for crack formation. The theories were based on the following facts:

- 1) Fracture always creates new surfaces.
- 2) The solid/liquid interfacial tension is always lower than solid/air interface.
- 3) Absorbed molecules can exert surface pressure.
- 4) Gases and vapors concentrate at imperfections in polymers and then exert a two dimensional gas pressure.

While good agreement with the above theory was observed with PMMA-alcohol-water system (234) extension to other organic system was not successful. It was also not particularly possible in predicting a priori from the actual results.

Another criticism of this surface energy reduction scheme is that although a large amount of surface area is formed, the energy consumed in creating the surface is only a small fraction (3%) of the total energy dissipated in

TABLE 7

**TYPICAL EXAMPLES OF ENVIRONMENT INDUCED STRESS RUPTURE
(ref. 240)**

DETERGENTS - POLYETHYLENE (e.g. IGEPAL)

PAINT SOLVENTS - AMORPHOUS THERMOPLASTICS

HEPTANE - POLYSTYRENE (CASE II SORPTION)

FOOD OILS (e.g. MARGARINE) - POLYSTYRENE

ADHESIVES (SOLVENT BASED) - AMORPHOUS THERMOPLASTICS

CLEANING SOLVENTS - AMORPHOUS THERMOPLASTICS

ALCOHOLS - AMORPHOUS POLYAMIDES; PMMA

COOKING OILS - POLYCARBONATE (e.g. POPCORN POPPERS)

UNLEADED GASOLINE - POLYSTYRENE, POLYCARBONATE, NORYL

POLAR SOLVENTS (e.g. ACETONE) - ALL AMORPHOUS POLYMERS

FINGERPRINTS - AMORPHOUS POLYMERS

FINGERNAIL POLISH - POLYCARBONATE; POLYSULFONE

deformation (236). While surface energy probably does play a role in environmental stress cracking, other parameters may well override the surface effects.

The second theoretical approach toward rationalizing environmental stress failure is that the organic stress cracking agent penetrates into the polymer and plasticizes it. The combination of stress and solvent lowers the T_g to the test temperature resulting in the flow or rupture of the polymer (240).

Perhaps the most extensive study of this effect has been undertaken by R. P. Kambour and coworkers (237). They found a general correlation between the solubility parameter of the liquid and the critical strain for crazing. They also clearly demonstrated that the environmental stress crack failure is poorest when the solubility parameter of the environment is equal to that of the polymer. The plots of critical strain versus solubility parameter are not as convincing for the other systems studied as with PPO. This lack of good correlation is easily explained as the solubility parameter does not include effect of hydrogen bonding, dipole-dipole interaction or molecular size (240). Since all of these factors are expected to contribute to the swelling response of the polymer subjected to various environments, the solubility parameter alone should not be able to predict the plasticization and therefore the crazing response. Gent (238,239) proposed a detailed mechanism of crazing in glassy plastics. This mechanism

included the plasticization aspect of solvent crazing and cracking and can perhaps be considered to be the state-of-the-art in environmental stress cracking. Four important considerations of this paper are outlined below.

(1) Stress concentration at a crack.

The region at the tip of a sharp crack or flaw experiences much higher tensile stress than the applied stress.

The stress concentration factor is given by equation 39

$$\sigma/\sigma = K = 1 + 2(l/r)^{1/2} \quad (39)$$

$$= K = 1 + 2(l/r) \quad (40)$$

= applied tensile stress

K = stress concentration factor

l = length of edge flow

r = tip radius

Typical polymer values for k were considered to be 10 to 50.

(2) Glass-to-rubber transition at the flaw tip.

The glass transition temperature T_g increases with increase in normal stress. Conversely, it would decrease under a dilatant stress. The critical dilatant stress (DC) required to lower T_g at the flaw tip to the testing temperature is given by

$$D_c = (T_g - T)(\alpha_2 - \alpha_g) / (C_j - C_g) \quad (41)$$

α_r, α_g = coefficient of thermal expansion in rubbery and glassy state

C_r, C_g = compressibilities of rubbery and glassy state

$$(\alpha_2 - \alpha_g) / (C_2 - C_g) = B \quad (42)$$

Therefore transformation from the glassy state to the rubbery state occurs at a critical value of the applied tensile stress.

$$\bar{\gamma}_c = 3\beta(T_g - T)/K \quad (43)$$

(3) Effect of liquid or vapor environment.

The liquid or vapor environment with moderate to high solubility in the polymer will lower the T_g of the crack tip considerably thus allowing for crack propagation at much lower stresses than in air. The critical stress, required for crack propagation is given by:

$$\bar{\sigma}_c = \bar{\sigma} - 3\beta(T_g - T_g')/K \quad (44)$$

where $\bar{\sigma}$ = stress required to promote crazing of the dry polymer, $T_g' = T_g$ of polymer with sorbed penetrant at the crack tip.

(4) Stress-induced penetrant sorption.

The equilibrium swelling of a solvent-polymer system increases and under proper conditions can increase well over an order of magnitude causing an even further lowering of the T_g required for crack propagation.

Although Gent's approach (238) to quantify environmental stress failure appears to be useful, there are other considerations of importance not presented by the mechanisms proposed by Gent. For example, the internal pressure build up due to diffusion of penetrant and the kinetic approach to failure (240).

1.11 SOLVENT INDUCED CRYSTALLIZATION

1.11.1 INTRODUCTION

One of the most important factors determining the properties of a solid polymer is the packing order. Crystallization is a means to control the degree and morphology of packing. In the molten state the polymer chains are in disordered conformations with the characteristic irregular structures and a great deal of intermolecular entanglement. Despite the differences that must exist in the mechanistic nature of the crystallization of polymers as compared to monomers, formally the process is the same for both kinds of substances. The new state or phase must be initiated within the body of the parent liquid. This initiation process is called nucleation. The nuclei subsequently grow into larger mature crystals. Both of these processes have been identified in polymer crystallization. The crystallization from most monomeric liquids takes place at very rapid rates at temperatures just slightly below the melting temperatures. The crystallization conditions are thus very close to that for equilibrium between the crystal and the liquid. On the other hand polymer crystallization must invariably be conducted at temperatures well below the melting temperatures so that the process can proceed at an appreciable rate. Depending on the polymer, crystallization temperatures anywhere from 15°C to 50°C below the melting temperature are necessary. Consequently, polymer crystallization takes place under conditions well removed from

ORIGINAL PAGE IS
OF POOR QUALITY

equilibrium. The molecular ordering of a polymer chain is a kinetic time-dependent process. In addition, the fact that polymer crystallization is invariably conducted at temperatures well below the melting temperatures will contribute further to the non-equilibrium character of the final state. Because of these problems only a portion of the chain adopts an ordered configuration. Depending on the molecular weight and crystalline conditions, the percentage of crystalline material may vary from 30 to 90 percent. A real polymer system is therefore, of course, semi-crystalline.

1.11.2 MECHANISM OF THERMAL CRYSTALLIZATION

As mentioned previously, crystallization takes place in two states. The first stage is the formation of nuclei. The melt usually has to be supercooled by about 5°K to 20°K below the melting temperature before a significant number of nuclei appear which possesses the critical dimensions required for stability and further growth. The second stage is the growth of the crystalline region, the size of which is governed by the rate of addition of other chains to the nucleus. Measurable rates of crystallization occur between $(T_m - 10^{\circ}\text{K})$ and $(T_g + 30^{\circ}\text{K})$, a range in which thermal motion of the polymer chains is conducive to the formation of stable ordered regions. The growth rate of crystalline areas passes through a maximum in this range as illustrated in Figure 4 for isotactic polystyrene. Close to T_m , the segmental motion is too great to allow many stable nuclei

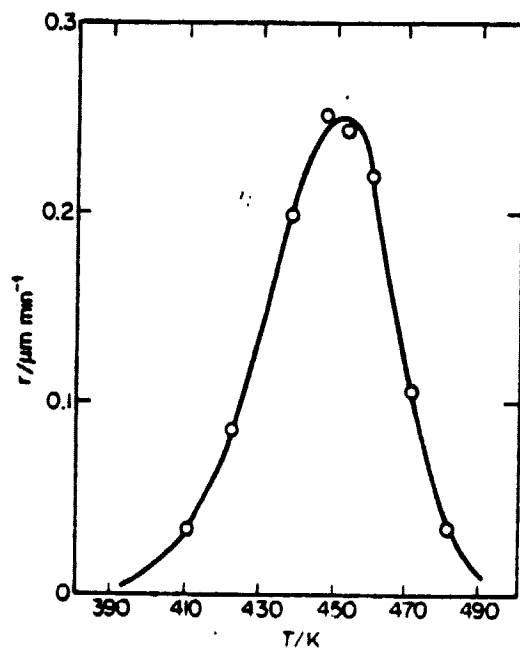


FIGURE 4.
Growth rate of spherulitic crystals of isotactic
Polystyrene as a function of temperature.

ORIGINAL PAGE IS
OF POOR QUALITY

to form, while near T_g the melt is so viscous that molecular motion is extremely slow. As the temperature drops from T_m , the melt viscosity, which is a function of the molar mass, increases and the diffusion rate decreases thereby giving the chains greater opportunity to rearrange themselves to form a nucleus. This means there will exist an optimum temperature of crystallization which depends largely on the interval T_m to T_g and also on the molar mass of the sample. Empirically, it has been observed for most systems that rate of thermal crystallization is maximum at $0.83 T_m^{\circ}K$.

1.11.3 SOLVENT INDUCED CRYSTALLIZATION

It is well known that the presence of a solvent can cause a depression of both T_m and T_g and that the degree of depression depends on the nature of the solvent and its compatibility with the polymer. Several theories (241) have been put forward to explain the depression of T_g and T_m . In a crystallizable polymer the presence of a solvent (plasticizer) may depress T_g to a temperature such that mobility will be adequate to allow crystallization. Due to a greater depression in T_g and T_m the temperature range ($T_m - T_g$) for crystallization widens, resulting in rapid crystallization at lower temperatures. Solvent induced crystallization differs from thermal crystallization in that the process takes place in the presence of another molecular species and at lower temperatures due to the depression of T_g .

1.12 TRIAD DISTRIBUTION IN CONDENSATION POLYMERS

1.12.1 INTRODUCTION

The molecular weight distribution and the degree of polymerization are often sufficient to fully describe a linear homopolymer. However, they are inadequate to characterize a copolymer. Characterization of linear copolymers also requires compositional information and preferably knowledge of the microarchitecture of the copolymer chains, with respect to compositional homogeneity and molecular weight distributions. Microarchitecture is not only important from the characterization point of view, but also because of its important role in determining ultimate properties. Prediction of T_g , the glass transition temperature, is sometimes possible. This is a very important parameter in polymers since it represents a temperature (or temperature interval) where dramatic changes take place in polymer properties. One conventional method of predicting T_g for a random copolymer values is by additive relationships such as the Fox equation (242).

$$1/T_{gp} = W_a/T_{ga} + W_b/T_{gb} \quad (45)$$

Here T_{gp} is the T_g of a copolymer containing weight fractions W_a and W_b of the two monomer units A and B for which the homopolymers have glass transitions of T_{ga} and T_{gb} .

The Fox and other similar relationships (Gordon, Taylor, Wood (243) do not take into consideration the effect of adjacent dissimilar monomer units on steric and

energetic relations in the copolymer backbone and assume that freedom of rotation and free volume contributed to a copolymer by a given monomer will be the same as it contributes to the homopolymer.

As reported by Johnston (244-6), to accurately predict the glass-transition temperature of many copolymers it is necessary to take into consideration the sequence distribution of the copolymer. Homopolymer T_g values usually hold for homo dyads AA because the A units experience much the same interactions as in A homopolymers. The formation of AB dyads results in new interactions and in many cases increases or decreases the T_g contribution of the A unit. Therefore to obtain more accurate T_g predictions, it is necessary to assign AB dyads and other sequence distributions their own T_g values.

$$\frac{1}{T_{gP}} = \frac{W_A}{T_{gA}} + \frac{W_{AB}}{T_{gAB}} + \frac{W_B}{T_{gB}} \quad (46)$$

Here T_{gP} is the T_g of a copolymer containing weight fractions W_A and W_B and W_{AB} . The weight fractions may be calculated from the monomer feed ratio and reactivity ratio. Figure 5 illustrates the experimental, sequence distribution predicted and Fox equation predicted values for methyl styrene/acrylonitrile copolymer T_g s versus the weight % Ms in Ms/AN copolymer. Many copolymers are of interest in which the copolymer molecule consists of long blocks or runs of monomer units capable of participating in

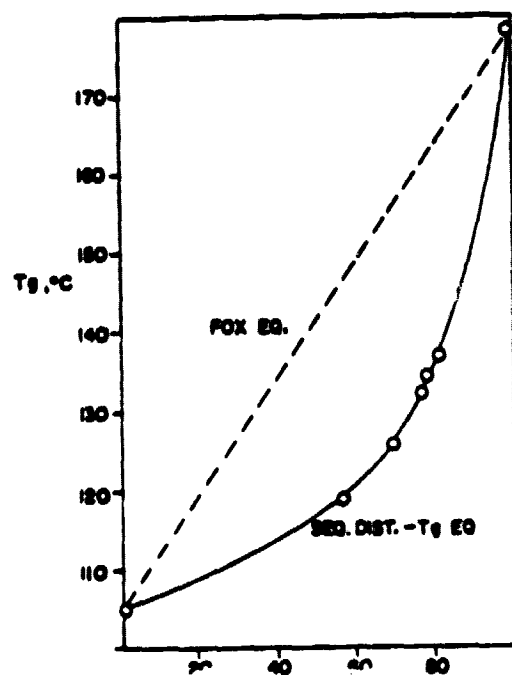
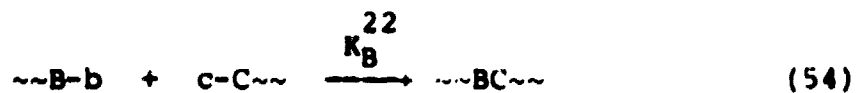
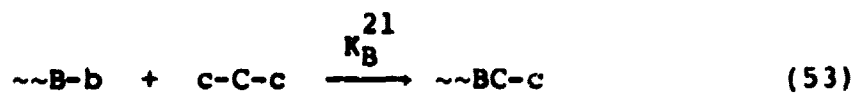
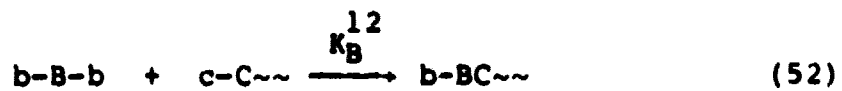
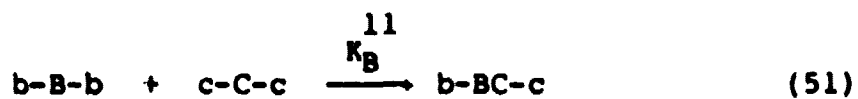
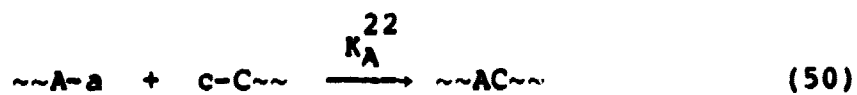
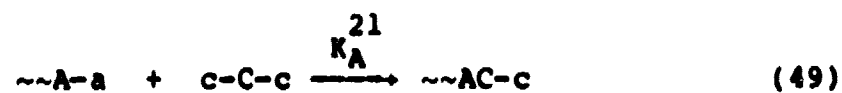
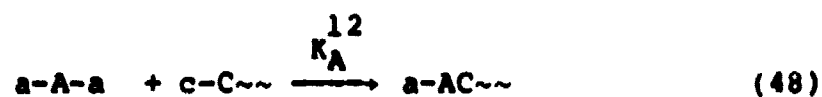
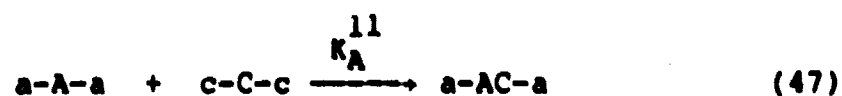


FIGURE 5
Sequence distribution prediction of MS/AN copolymer
 T_g as a function of weight % MS.

glassy or crystalline domains separated by amorphous segments. The possibility of crystalline domains acting as points of physical crosslinks can sometimes produce novel thermoplastic elastomeric properties. Current trends in block and graft copolymers stems directly from these effects. The most common way of describing the microarchitecture of a copolymer is by way of dyad or triad (addition of two or three units). This distribution of monomers in the final copolymer is greatly influenced by the relative monomer reactivities and the nature of the reaction mechanism itself.

1.12.2 THEORY OF SEQUENCE DISTRIBUTION

Lewis and Mayo (247) were the first to correlate the triad distribution to monomer reactivity in radical copolymerization. Later workers (248) improved upon this treatment. The problem was addressed kinetically (251), statistically as a Markov chain (249) and also by Monte' Carlo simulation (250). By contrast, condensation polymers have an intrinsically different reaction mechanism of polymer chain extension as well as differences in the time scales of their formation. Also a matter of great importance is the variation in the reactivity of the second monomer functional groups (155). The reactions involved two comonomers and an intermonomer, with variable functional group reactivity of monomers is schematically shown as follows:



Here a-A-a and b-B-b are comonomer and c-C-c is the intermonomer. $\sim\sim A$, $\sim\sim B$ and $\sim\sim C$ are dimers and oligomers. The reactivity of monomers differ very much from the other reactive species (dimers and oligomers). The resulting reaction between molecules of all sizes with each other can take place throughout the polymerization. The rates of these reactions may be determined by their nature, that is

monomeric or oligomeric and their relative abundance. This makes it harder to visualize and intuitively less obvious to predict the triad distribution.

Only recently have a few theoretical calculations been published with regards to the influence of relative reactivities of monomers to their final distribution in the copolymer. Beste (252) proposed a simple statistical approach to calculate the type of distribution of monomer units in the copolymer, assuming constant reactivities independent of sizes. The use of the approach is rather restricted because of the unrealistic assumptions. Nikonov et al. (253) took into account the variation of functional group reactivity and approached the problem kinetically via numerical analysis. However, they calculated the macro composition of copolymer for various initial comonomer ratios and extent of reaction, while taking insufficient amounts of the intermonomer. More recently, S. I. Kuchanov (254) derived equations for the triad distribution. To simplify the mathematics so as to obtain analytical solutions, he reported the microheterogeneity for various kinetic ratios of the comonomers, but independent functional group rates for the intermonomer and vice versa. He concluded that:

- (1) Final copolymer was always random irrespective of the relative rates of reaction of the comonomers.
- (2) The relative rates of comonomers only influenced at small extents of reactions.

i.e. p less than 0.75. Although this is the most detailed work so far it still is not a realistic model to actual condensation polymerization and further studied should be performed.

CHAPTER II
MATERIALS AND METHODS

2.1 GENERAL ASPECTS OF CONDENSATION POLYMERIZATION

In step growth polymerization a linear chain of monomer residues is obtained by the stepwise condensation or addition of reactive groups in bifunctional monomers. W. H. Carothers, the pioneer of step-growth reactions proposed a simple equation relating D_p the degree of polymerization or number average chain length to a quantity P describing the extent of the reaction.

$$D_p = 1/(1-P) \quad (56)$$

The Carothers equation is particularly enlightening when we examine the numerical relation between D_p and p ; thus for $p = 0.95$ (i.e. 95% conversion) $D_p = 50$ and when $p = 0.99$, then $D_p = 110$. The control of the molar mass (or molecular weight) of the product is obviously very important. Very high molar mass material may be too difficult to process while low molecular weight polymer may not exhibit the properties desired in the end product. Thus one must be able to stop the reaction at the required value of P . Often it is possible to effect control by rapidly cooling the reaction at the appropriate stage or by adding calculated quantities of monofunctional materials.

Most usefully, a precisely controlled stoichiometric imbalance of the reactants in the mixture can provide the desired result. For example, an excess of diamine over an acid chloride would eventually produce a polyamide with two amine end groups incapable of further growth when the acid chloride is totally consumed. This can be expressed as an extension of the Carothers equation as,

$$D_p = (1 + r) / (1 + r - 2rp) \quad (57)$$

where r is the ratio of the number of molecules of the reactants. Thus for a quantitative reaction ($p = 0.999$) between N molecules of bisphenol and $1.05 N$ molecules of activated dihalide to form a poly(arylene ether).

The value of $r = N_a/N_b = 1/1.05 = .952$ and $D_p = (1+0.952)/(1+0.952-2)(0.999)(0.952) = 39$ rather than 1000 for $r=1$. The corresponding equation for a monofunctional additive is similar to equation (57), only now r is defined as the ratio $N_{aa}/(N_{bb}+2N_b)$ where N_b is the number of monofunctional molecules added.

It is evident from the above examples that the reactions are particularly demanding with respect to the purity of the reagent thus accurate control of the amount of each species in the mixture is essential. The next section therefore deals with the purification of the monomers, reagents and solvents used in the study.

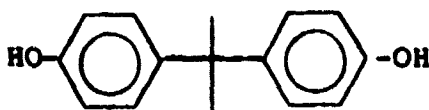
2.2 PURIFICATION OF MONOMERS

2.2.1 BISPHENOL-A SOURCE (Polymer grade, Union Carbide Corp. or Dow Chemical)

Empirical Formula: $C_{15}H_{16}O_2$

Molecular weight: 228

Structure:



APPARATUS: Two 2-liter conical flasks, one 2-liter beaker, two 6-inch diameter powder funnels, large fluted (folded) filter papers, two stirring bars, a Corning hot plate with magnetic field, carbon black, toluene and bisphenol-A.

PROCEDURE: To a 2000 ml conical flask was added 800 ml of toluene and 200 gms of bisphenol-A and the mixture was stirred while heating on the hot plate. As the temperature of the mixture approached $100^{\circ}C$ (boiling point) bisphenol-A began to dissolve (Note 1). At the boiling point ($110^{\circ}C$ - $112^{\circ}C$) about 150 mls of toluene and 2 gms of activated charcoal were added (Note 2). The mixture was allowed to boil for about 2 minutes. In another 2000 ml conical flask 50 mls toluene was heated (Note 3). A large powder funnel with the fluted filter paper was placed in the flask. As soon as the toluene started refluxing, the bisphenol-A solution was filtered in about 50 ml portions. The filtration was complete in about 10 minutes. The clear solution was transferred into a large beaker, which was kept in a water bath. The solution was rapidly cooled under constant

stirring. About two hours later the crystals were filtered and dried under reduced pressure (water aspirator). The crystals were then dried in an oven at 75°C for 12 hours (Note 4) cooled, powdered very well and dried again for 12 hours at 80-90°C (Yield 90%). M.P.152°C.

NOTES.

- (1) Bisphenol-A is not very soluble in toluene at room temperature.
- (2) The solution is near saturation under these conditions. The addition of 150 mls toluene not only dilutes the solution but also saves much time in filtration without much loss in yield.
- (3) The use of large powder funnel in place of the liquid funnel greatly speeds up the filtration process.
- (4) This is particularly important as otherwise a substantial amounts of toluene (0.5%) is trapped in the crystals.

The above procedure is especially important in the purification of dichlorodiphenylsulfone.

2.2.2 HYRDOQUINONE

Source (Eastman Kodak)

Empirical Formula: $C_6H_6O_2$

Structure:



1,4.benzene diol

The purification of commercial grade hydroquinone was carried out in two steps. First it was recrystallized from deoxygenated water and then it was preferably sublimed under reduced pressure (Note 5). The final product was white in color and had a very sharp melting point.

Experimental details are given below:

RECRYSTALLIZATION OF HYDROQUINONE (Eastman Kodak)

MATERIALS. One liter conical flask, one liter beaker, stirring bar, hot plate with magnetic field, decolorizing charcoal, distilled water, nitrogen and hydroquinone, powder funnel and fluted filter paper.

PROCEDURE. In a one liter conical flask with stirrer bar, 600 mls of distilled water is added and heated to boil for at least a minute. It is then cooled slowly under a nitrogen atmosphere. This step is repeated twice. Commercial hydroquinone (125 gms) is added to the above deoxygenated water. This mixture is slowly heated while stirring continuously under a nitrogen atmosphere. When the hydroquinone completely dissolves, 1.0 gms of decolorizing carbon is added carefully, boiled for 5 minutes and filtered into a one liter beaker using a fluted filter paper. The solution was allowed to cool to room temperature overnight under nitrogen atmosphere. The mixture containing the crystals was filtered in a buchner funnel using a water aspirator. The filtrate was washed twice with 75 mls of cold deoxygenated water and allowed to dry. The crystals were then

transferred to a large aluminium pan and dried at 60°C.
Yield = 85-88 gms. of off-white needles, M.P. 172-173°C.

SUBLIMATION OF RECRYSTALLIZED HYDROQUINONE

A specially made sublimator with a 4 inch I.D. was used. It had a capacity to distill about 30 gms of hydroquinone per batch. Experimental procedure for the sublimation is given below.

25 gms of recrystallized hydroquinone was spread uniformly at the bottom of the sublimator. The cold finger trap was cooled with an acetone-dry ice mixture. The sublimator was heated in an oil bath (120°C) under reduced pressure (less than 5 mm mercury) (Note 6), for at least four hours or until most of the hydroquinone sublimed. Then it was cooled to room temperature under reduced pressure. A yield of 15-20 gms of very pure hydroquinone was obtained. The unsublimed or leftover hydroquinone could be reused in the next batch (Note 7).

NOTES:

- (5) It is important to recrystallise before sublimation. Otherwise, the sublimate has a bluish-pink tint.
- (6) Lower reduced pressure or high temperatures melts the hydroquinone and thus sublimation is not effective.
- (7) The recycled yield is about 90% and recycling can be done two or three times. If repeated more often the product is brown in color presumably due to oxidation and has a lower melting point than the recrystallized starting material.

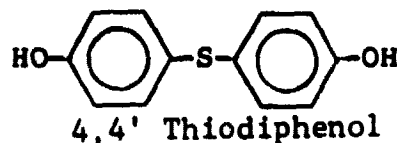
2.2.3 BIS-T MONOMER

Source: Crown Zellerbach Corp.

Empirical Formula: $C_{12}H_{10}SO_2$

Molecular Weight: 218

Structure:



MATERIALS. The same as used for bisphenol-A

PROCEDURE. To a 2000 ml conical flask was added 300 mls of methanol and about 125 gms of bis-T and the mixture was stirred and heated on a hot plate. To the hot solution was added 250-300 mls water in 25 ml increments. The addition of water was stopped when the solution remained turbid on heating. Then just enough methanol was added to clarify. To this solution was added 2.5 gms of activated charcoal, followed by boiling for 2-5 minutes and filtering hot into another large conical flask with fluted filter paper and a powder funnel. The filtration was complete in about 10 minutes. The clear solution was allowed to crystallize overnight, filtered and dried under reduced pressure. The crystals were dried in an oven at 75°C for 12 hours, cooled, powdered very well and dried again for 12 hours at 80-90°C. Yield 100-110 gms. M.P. 154°C.

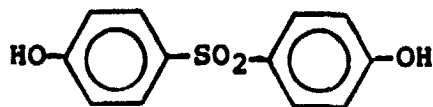
2.2.4 BIS-S

Source: Crown Zellerbach Corp.

Empirical Formula: $C_{12}H_{10}SO_4$

Molecular Weight: 250

Structure:



4,4'- sulfonyldiphenol

MATERIALS. One liter beaker, two 2-liter conical flasks, two powder funnels, stirrer stirring bars, hot plate with magnetic field and buchner funnels.

PROCEDURE. To the one liter beaker was added 500 mls of a 5% $NaHCO_3$ solution and 50 gms of bis-S. The mixture was boiled to dissolve the bisphenol and was filtered hot. Concentrated HCl was added to bring the pH to 5. The precipitated monomer was filtered as dry as possible and dissolved in 250 mmls of 50% aqueous methanol. Next 2 gms of activated charcoal were added. After filtration, the mother liquor was cooled and crystallization was induced by scratching the beaker with a glass rod. After 4-5 hours it was cooled further in an ice bath, filtered, washed twice with 25 mls ice cold water and dried at 100°C under reduced pressure for 24 hours. Yield (80%). M.P. 247°C.

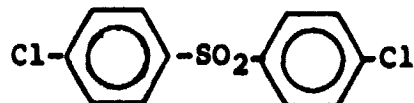
2.2.5 DICHLORODIPHENYLSULFONE

Source: Union Carbide

Empirical Formula: $C_{12}H_{10}SO_2Cl_2$

Molecular Weight: 287

Structure:



APPARATUS. Two 2-liter conical flasks, one 2-liter beaker, two 6-inch diameter powder funnels, large fluted (folded) filter papers, two magnetic stirring bars and a Corning magnetic hot plate.

PROCEDURE. To a 200 ml conical flask was added 800 ml of toluene and 500 gms of dichlorodiphenylsulfone which was stirred and heated over a hot plate. Dichlorodiphenylsulfone dissolved as the temperature of the mixture approached 110°C. About 2 gms of charcoal was added and boiled for about two minutes. In another 2 liter conical flask 50 ml of toluene was heated. A large powder funnel with the fluted filter paper was placed at the top of the flask. As soon as the toluene started refluxing, about 15 ml portions of the solution was filtered. The filtration was complete in about 30 minutes. The clear solution was transferred into a large beaker and rapidly cooled while constantly stirring. After about 6 hours the saturated solution was further cooled by placing in an ice bath for about an hour. This was later filtered and dried by a water aspirator and further dried in an oven at 75°C for about 12 hours. The complete process was repeated twice.

Charcoal was not used in recrystallization. The crystals were finely powdered and further dried at 100°C, under reduced pressure. The crystals were finely powdered, dried in vacuum oven for several hours at 60°C then several hours at 100°C and finally at 120°C for at least 6 hours. The powder was cooled under reduced pressure before use. Yield = 56% (after 3 crystallizations).

2.2.6 SYNTHESIS AND PURIFICATION OF 4,4'
DIFULORODIPHENYLSULFONE

REACTION.



MATERIALS. One liter four necked round bottomed flask, stirrer, reflux condenser, thermometer, powder funnel, blender, buchner funnel and a mini vacuum distillation set up.

PROCEDURE. Anhydrous KF was dried for 24 hours in a vacuum oven at 100°C, then powdered finely in a blender to a particle size less than 350 mesh. It was further vacuum dried for about 10 hours and 200 g (3.5 moles) were added into the reaction assembly which contained 500 mls of purified sulfolane. The mixture was thoroughly stirred until a very fine dispersion was obtained. To this was added crude DCDPS (0.13 moles, 50 gms.). A slow stream of nitrogen was maintained during the subsequent heating. The mixture was refluxed for about 20 hours. The flask was

cooled and the contents poured into 1000 ml water under vigorous stirring. The precipitated powder was washed with water and dried at 60°C for 2 hours and then vacuum distilled at (5 Torr). The main fraction was collected separately and recrystallized from toluene. M.P. 98°C. Yield (78%).

2.2.7 POTASSIUM CARBONATE (ANHYDROUS)

Anhydrous potassium carbonate (Baker Chemicals Analytical Grade) was granular and had about 1% moisture. The following procedure was used to reduce the particle size and moisture content.

TREATMENT. About 40 gms of anhydrous potassium carbonate was finely powdered using a mortar and pestle. The powdered K_2CO_3 was kept in a drying oven at 120°C for 12 hours, repowdered in a Waring blender for about half an hour and passed through a standard sieve. Particle sizes less than 350 mesh were transferred into a large sublimator unit and heated to 100°C under reduced pressure (5 Torr) for at least 24 hours. The base was cooled under reduced pressure before use.

ANALYSIS. A required amount of sample was dissolved in 250 ml of "carbon dioxide free" distilled water to give approximately 0.05 N solution. This solution (50 ml) was potentiometrically titrated using a calibrated pH meter (Orion 601A) in conjunction with a glass electrode (Thomas, No 4092-f15) and a calomel reference electrode (Thomas,

No 4090-B 15). A plot of pH against volume of titrant gives the equivalent point. A typical plot is shown in Figure 6.

An alternate method employing a back titration was also performed as follows. To the 50 ml sample solution was added 25 ml of 0.1 N HCl (solution should be acidic). The resulting solution was boiled for 3-5 minutes to remove carbon dioxide, cooled and the excess acid titrated against standard base to pH (note 8). The purity of the sample was found to be comparable to that found by the potentiometric titration method (note 8). Boiling and cooling the solution while passing nitrogen ensures reproducible values. This method is easier and faster than the potentiometric method but gives only the total base.

2.3 PURIFICATION OF SOLVENTS

Poly(arylene ether sulfones) are synthesized by the reaction of bisphenates with dihalides in a dipolar aprotic solvent, under anhydrous conditions. These solvents are hygroscopic high boiling and usually sensitive to alkali, especially at high temperatures. The solvents used in the study were N,N'-dimethylacetamide (DMAC), N-methylpyrrolidone (NMP) and sulfolane. Methods for their purification are given. All the solvents were distilled in the apparatus assembly shown in Figure 7 and stored under nitrogen and over pretreated molecular sieves.

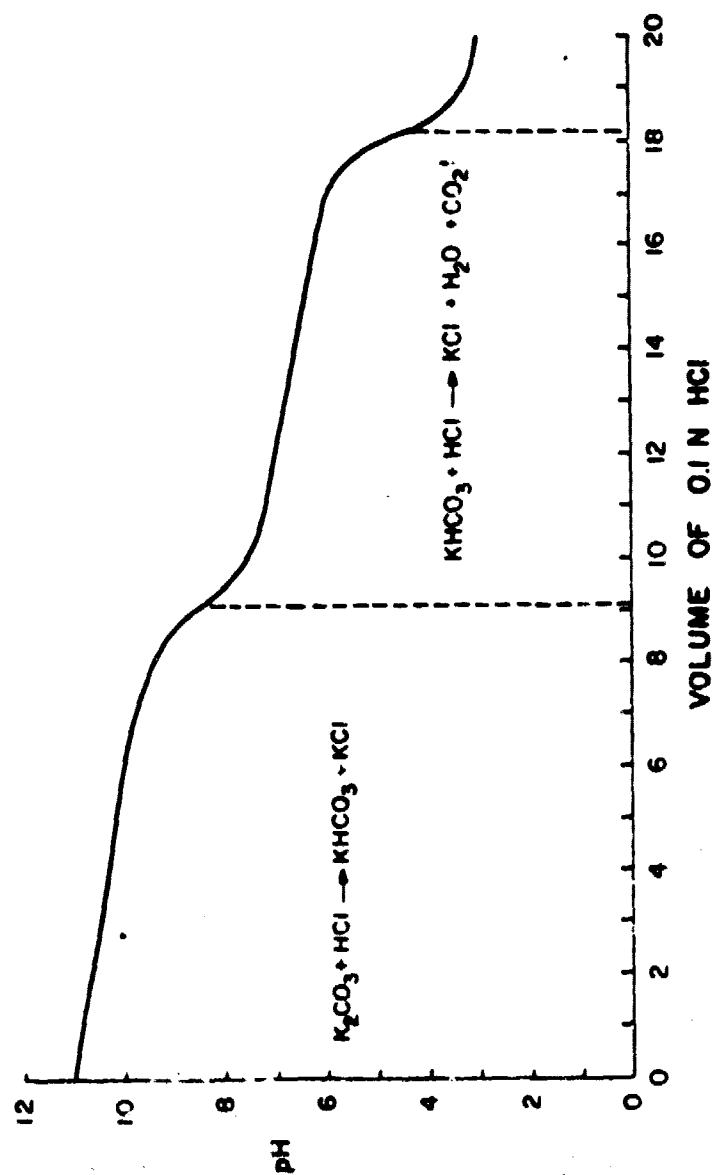
PH TITRATION OF K_2CO_3 WITH 0.1N HCL

FIGURE 6. POTENTIOMETRIC TITRATION CURVE OF POTASSIUM CARBONATE WITH 0.1N HCL

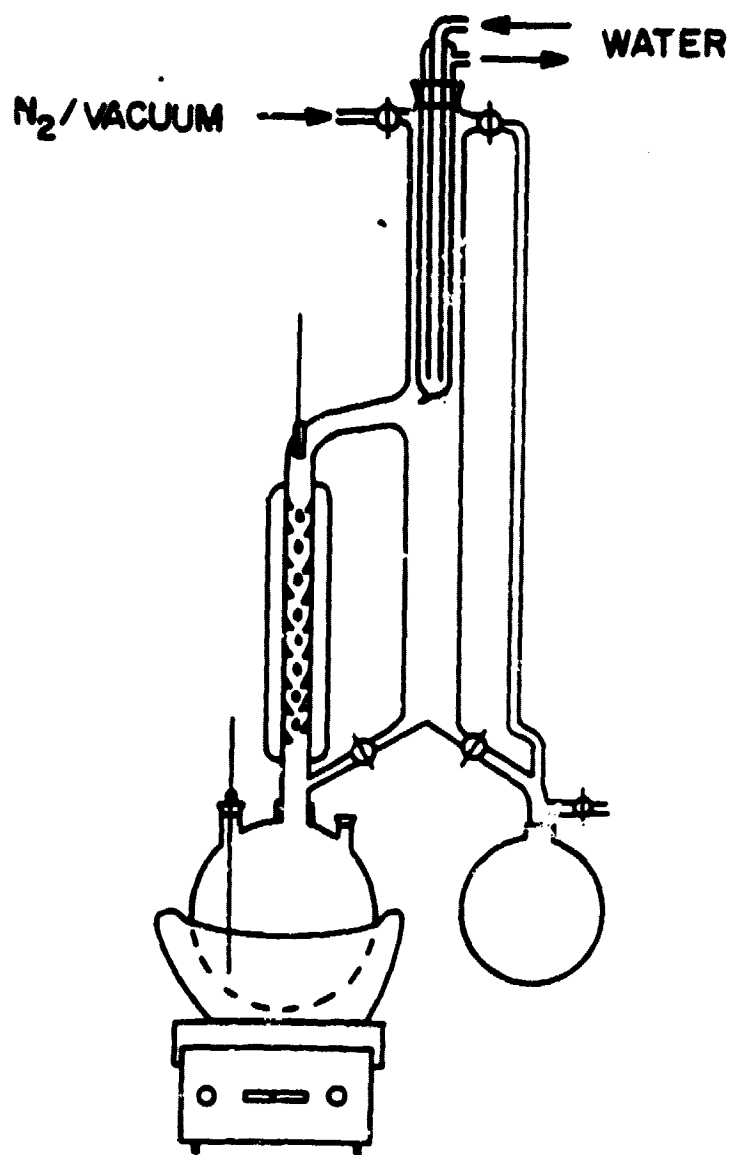


Figure (7) : Apparatus assembly used for solvent distillation and Azeotrope study.

2.3.1 TREATMENT OF MOLECULAR SIEVES

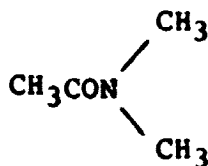
About 25 gms of molecular sieves (4 A) were placed in a two necked round bottomed flask and heated under reduced pressure (5 Torr) to 50°C. In doing so, the moisture absorbed by the sieves condensed on the cooler sides of the round bottom flasks. On heating for about 12 to 14 hours, the molecular sieves were essentially dry. They were next cooled under reduced pressure and finally stored under dry nitrogen. These pre-treated molecular sieves were used to store the solvents dry.

2.3.2 N,N' DIMETHYLACETAMIDE

Source: Eastman Kodak

Molecular weight: 89

Structure:



500 ml of DMAC was stirred over phosphorous pentoxide for 24 hours and distilled under reduced pressure in a nitrogen atmosphere. The constant boiling fraction (80-82°C at 20 Torr) was collected at reflux ratio of 1:1 and stored under nitrogen.

C-2

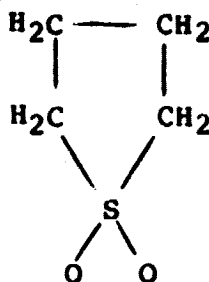
2.3.3 SULFOLANE

Source: Technical grade, Phillips Petroleum Co.

Empirical Formula: $C_4H_8SO_2$

Molecular weight: 120

Structure:



Sulfolane was usually a solid at room temperature and was normally heated to first melt the material. To liquid sulfolane (500 ml) was added 5 gms carbon and 15 gms hiflo (filter aid from John Mansville Co.) followed by filtration. The filtrate was stirred overnight over sodium hydroxide pellets. The solvent was vacuum distilled from a 3-necked round bottomed flask fitted with a 6 inch high Vigreux column. The middle fraction was collected under a reduced pressure of nitrogen at 130°C. The whole process was repeated until the solvent showed a positive test for purity. (1 ml of sulfolane with 1 ml of 100% sulfuric acid should remain colorless for at least 5 minutes) (272). Normally two distillations are sufficient to have a polymer grade solvent.

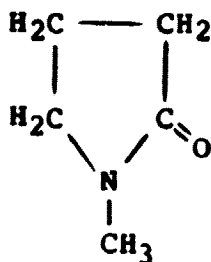
2.3.4 N-METHYLPYROLIDONE

Source: Fisher Chemicals for GAF Corp.

Empirical Formula: C_5H_9NO

Molecular weight: 99.13

Structure:



N-methyl pyrrolidone was stirred over calcium hydride for 24 hours. It was distilled under nitrogen at reduced pressure and stored over molecular sieves.

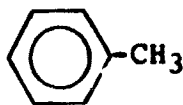
2.3.5 TOLUENE

Source: Fisher Chemicals

Empirical Formula: C_7H_8

Molecular weight: 92

Structure:



Toluene was used as an azeotroping solvent and was stirred over calcium hydride for 24 hours and distilled in a nitrogen atmosphere. The middle constant boiling fraction was stored under nitrogen over pretreated molecular sieves.

2.4 STUDY OF DMAC/TOLUENE AZEOTROPE

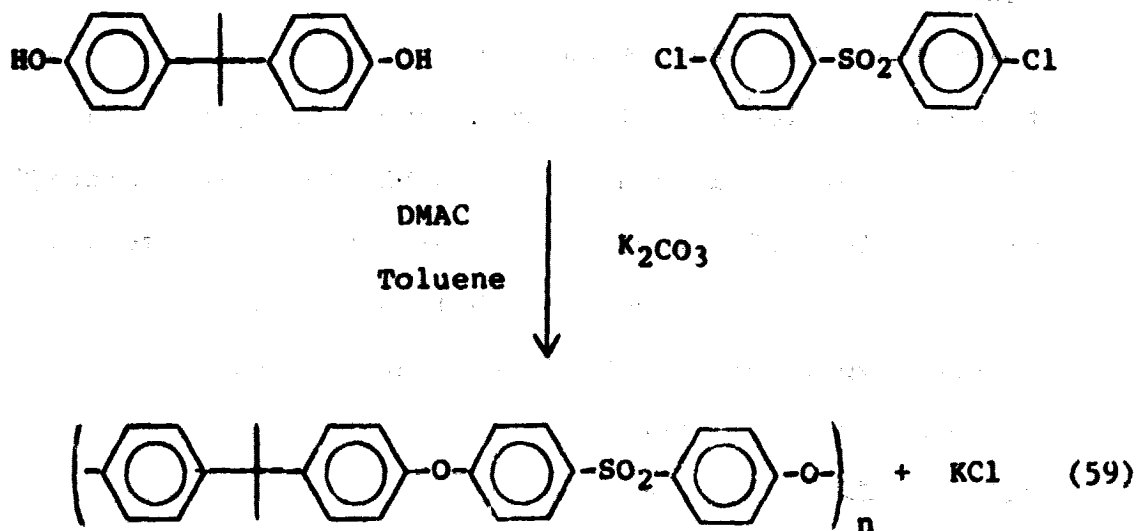
A three necked 250 ml round bottomed flask fitted with thermometer, stirring bar, a Vigreux column and a cold finger with adjustable reflux return capabilities for vacuum and inert atmosphere (as shown in the figure) was used. To this apparatus was added 50 ml of DMAC and 50 ml of toluene and the mixture was heated to equilibrate the two liquids. The temperature in the reaction still and the vapors near the condenser was noted and about 6.3 ml of the condensate were removed, while continuing heating. The system was allowed to equilibrate to the new condition. Again the temperature was noted and the condensate was collected. This was repeated until about 75% of the azeotrope was collected. The samples were analysed by gas liquid chromatography using a GOW-MAC instrument fitted with a column of 15% DC-200 on chromosorb-P for separation. Flow rate of the carrier gas (He) was 40 ml/minute and a column temperature of 150°C gave rapid resolution of toluene and DMAC. The number of theoretical plates per column under these experimental condition were calculated to be about 1600 plates/column. Quantitative analysis was done by measuring the area under the curves. The condensate and reaction still compositions were plotted against the respective temperatures.

2.5 SYNTHESIS OF POLYSULFONE MONOPOLYMERS

The polymers were usually synthesized by reacting 4,4'-dichlorodiphenylsulfone with one or more bisphenols. The functionality and molecular weight of the oligomers were controlled by the molar ratio of the monomers. A typical synthesis for 50 gms of a 5000 $\langle M_n \rangle$ molecular weight hydroxy terminated bisphenol-A polysulfone is described.

2.5.1 BIS-A POLYSULFONE

REACTION



CALCULATION

For the oligomer to have a final molecular weight $\langle M_n \rangle$ of 5000 the D_p must be:

$$D_p = (5000 - 228) / 462 = 4772 / 462 = 10.32$$

The ratio of the two monomers:

$$r = D_p - 1/D_p + 1 = 9.25/11.25 = 0.88$$

As hydroxy terminated polymer is required, bisphenol-A is taken in the larger molar ratio.

APPARATUS. One 500 ml four necked round bottomed flask equipped with a stirrer, thermometer, dean stark trap and condenser, nitrogen dispersion tube oil bath and hot plate (see Figure 8).

PROCEDURE. The reaction assembly is purged with nitrogen, then 150 ml of N,N'-dimethylacetamide (freshly purified) is added along with accurately weight bisphenol-A (22.8 g, 0.1 mole) and DCDPS (25.31 g, 0.099 m). The aluminium weighing pans and powder funnel are rinsed with 75 ml toluene. The reaction mixture is stirred vigorously with a constant purge of nitrogen and heated to reflux. It is maintained at reflux until no more water droplets from the water of reaction are observed. Toluene is removed continuously from the trap until the temperature rises to about 155°C. The reaction mixture appears lightly colored and is maintained at this temperature for nearly 10-12 hours. At this time the reaction is assumed to be complete. The reaction mixture is cooled to about 100°C and about 75 ml of chlorobenzene is added to dilute the solution and precipitate the inorganic salts. The mixture is filtered through a medium pore size sintered glass funnel. The filtrate is neutralized with acetic acid. The clear neutralized solution (in 25 ml portions) is coagulated in a blender containing

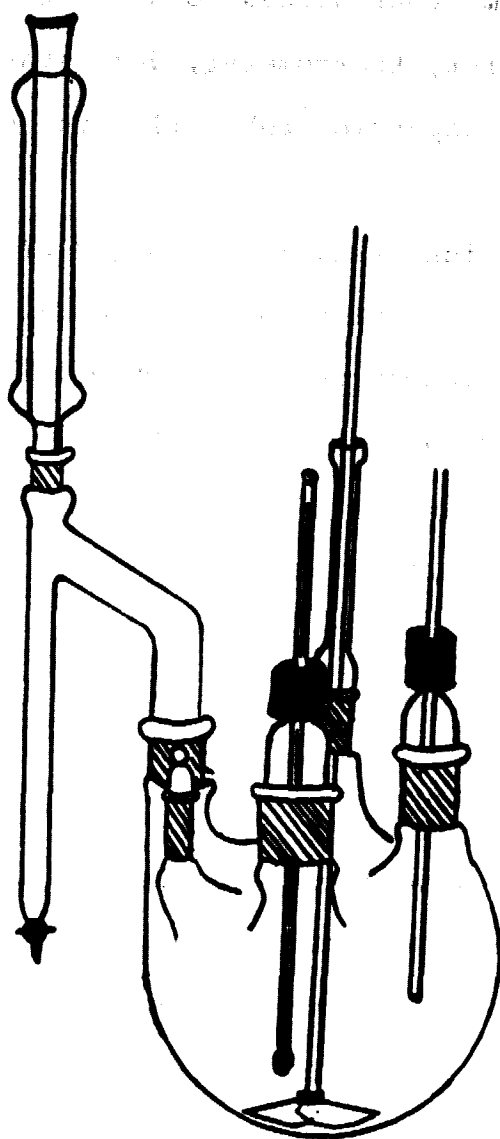
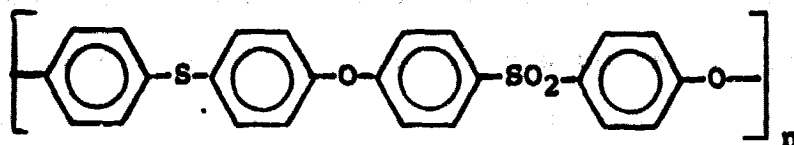


Figure (8) : Typical reaction assembly used for the synthesis of Polymers.

blender containing 250 ml of 1:1 water and methanol. The precipitate is filtered and washed with methanolic water and finally with water. Next it was boiled in distilled water for 1 hour to remove any trapped salts, filtered and dried in a vacuum oven at 100°C. Yield was > 90%. Other bisphenol-A oligomers were similarly prepared using calculated ratios of bisphenol and dichlorodiphenyl sulfone.

2.5.2 BIS-T POLYSULFONE

STRUCTURE:



The bis-T oligomer (10,000 mol. wt.) was prepared using calculated amounts of the required monomers. The synthesis is given below:

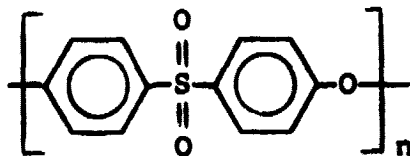
REACTION:

To a similar set up as used for bis-A polysulfone was added bis-T (60 gm, 0.275 moles), 200 ml DMAC and 130 ml toluene. This was purged well with nitrogen for half an hour and heated to 100°C, for about 15 minutes. The reaction mixture was cooled to 60°C, potassium carbonate (75 gms 0.55 moles) was added and heated to 110°C. At this temperature the water/toluene azeotrope started distilling. The distillate was intermittently collected until the

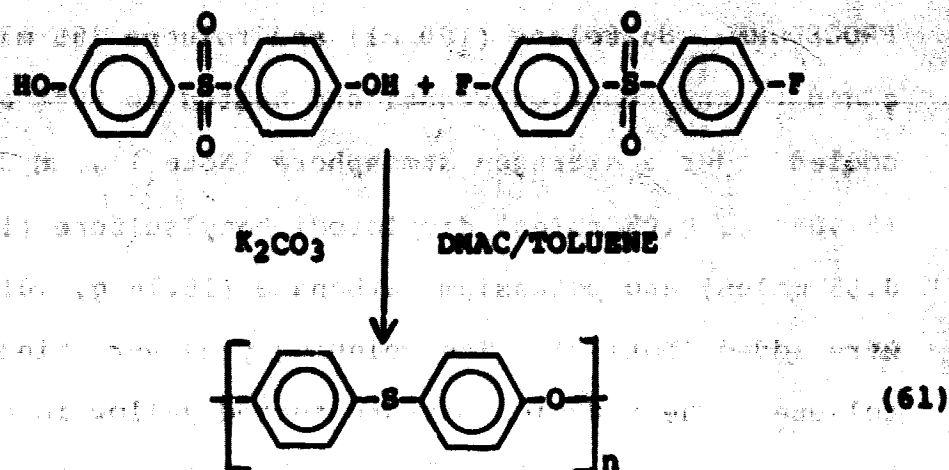
reaction temperature reached 140°C. At this point calculated amount of DCDCPs dissolved in 75 ml of toluene was added. The reaction mixture turned brown in color. More azeotrope was collected and the temperature reached 155°C. The reaction mixture was maintained at this temperature for 12 hours and then cooled to 40°C. The stirring was stopped and the reaction mixture was allowed to settle down. The supernatant layer was decanted and as much of the polymer was extracted thrice with methylene chloride. The volume of the liquid after dilution with methylene chloride was 500cc. The filtrate was acidified with acetic acid, coagulated in aqueous methanol (1:1), filtered, washed with water and dried on a water aspirator for about 2 to 4 hours. This partially dried powder was transferred into a 3 liter beaker with 1.5 liters distilled water and boiled for 1 hour, cooled, filtered and dried in vacuum at 100°C for 24 hours (Yield = 108 gms).

2.5.3 BIS-S POLYSULFONE

STRUCTURE



The bis-S polysulfone oligomers were generally prepared from 4,4'-difluorodiphenylsulfone and 4,4'-sulfonyldiphenol as shown below:

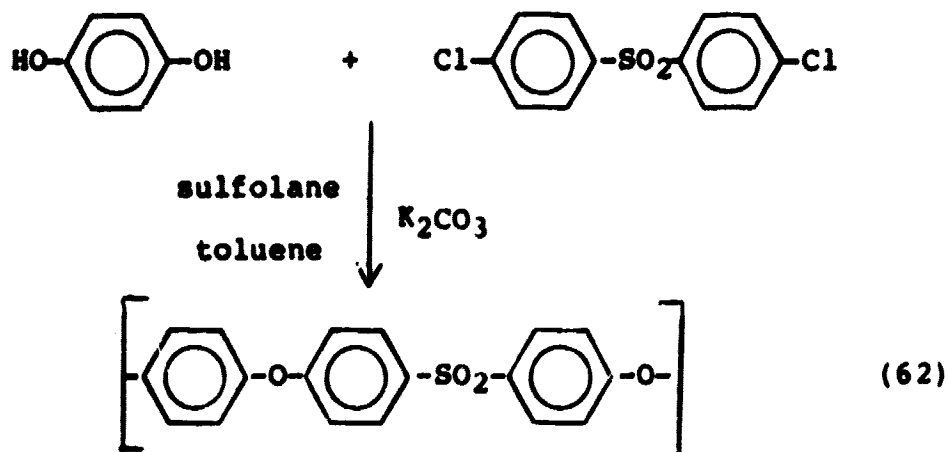


The bis-S oligomer was also synthesized from dichlorodiphenylsulfone and bis-S in sulfolane at 210°C for 8-10 hours. Tetrachloroethane was used as a diluent.

2.5.2 HYDROQUINONE POLYSULFONE

The hydroquinone polysulfone was prepared in both N-methyl pyrrolidone as well as sulfolane at lower concentrations and had to be filtered hot to prevent crystallization. The reaction scheme is shown below, followed by a typical experimental procedure using sulfolane.

REACTION



PROCEDURE. Sulfolane (100 ml) and toluene (85 ml) were added to the reaction vessel and heated to 80°C and then cooled under a nitrogen atmosphere (Note 1). Hydroquinone (5.5055 g, 0.05 moles) dichlorodiphenylsulfone (14.365 g, 0.55 moles) and potassium carbonate (15.16 g, .011 moles) were added (Note 2). The weighing pans were rinsed with toluene. The reaction mixture turned yellow in color. The temperature was slowly raised to keep the system refluxing. Care was taken to keep the stoppers and the neck of the reaction vessel warm by using a heat gun (Note 3). This was important to maintain an anhydrous condition in the system. Enough toluene was distilled to raise the temperature to 180°C. It was maintained at this temperature for 6 hours. Heating and stirring were stopped to let the inorganic salts to settle (Note 4). The super-natant liquid was filtered hot (150°C). The polymer in the residue was extracted with a hot mixture of DMAC: Sulfolane (1:2). The filtrate (450 ml) was neutralized with acetic acid. The color of the solution changed from brown to light yellow. The filtrate was transferred into a round bottomed flask and kept hot in a heating mantle (130-140°C). The solution in 50 ml portions were coagulated in aqueous methanol, filtered and washed with aqueous methanol and finally with water. It was later boiled in distilled water for about 1 hour and filtered. The product was dried in a vacuum oven at 100°C for 12-24 hours (Yield = 14.5 gms, 90%).

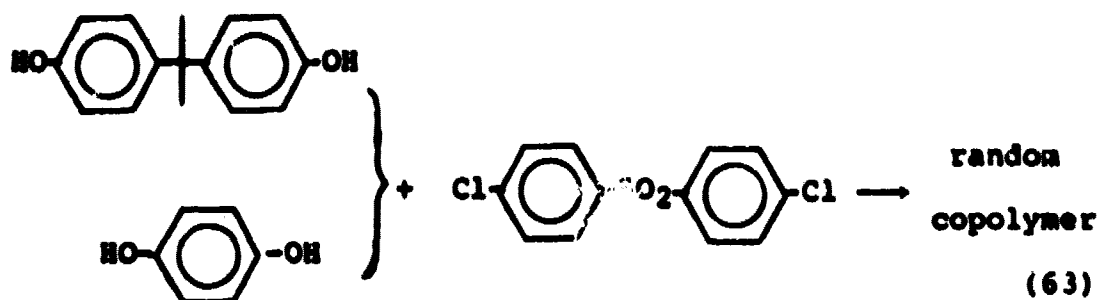
Notes:

- (1) This treatment ensures a better final product in terms of color.
- (2) Although phenoxide could be pre-formed before the addition of DCDPS, the in situ method was preferred so as to minimize the total base contact time with the solvent.
- (3) As the polymer crystallizes out of the reaction mixture at high concentration (25% and above), more dilute reaction conditions were used. This equates to a much lesser amount of water azeotrope, and therefore extreme caution was taken to extract all the water.
- (4) Stopping the stirrer to let the inorganic salts settle results is a much faster and cleaner way of filtering the hot reaction mixture.
- (5) The concentration of the polymer solution before coagulating was less than 5%. This ensured a better form of the polymer for drying.

2.6 SYNTHESIS OF POLYSULFONE COPOLYMERS

Random copolymers of hydroquinone (Hq) and bisphenol-A were synthesized by varying the molar ratios of the two bisphenols. The molar ratio of total phenol to dichloride varied from 1:0.98-1 so that the resulting copolymer was hydroxy terminated. A typical experimental procedure of 75% Hq/Bis-A PSF is given below:

REACTION



PROCEDURE. DNAC (150 ml), bis-A (11g, 0.05 moles), hydroquinone (16.5, 0.15 moles), DCDPS (57.2 g, 0.2 moles) and toluene (150 ml) were added in the above order to the reaction vessel and heated to 100°C. It was maintained at 100°C for half an hour and then cooled to 40°C. Potassium carbonate (30 gms) was added to the reaction mixture. The temperature was gradually increased to 130°C, at which time the reaction mixture started azeotropeing. The side necks of the reaction vessel were constantly heated with a heat gun to remove the condensate. This was done until no more water distilled. At this point the temperature was raised to 150-155°C by removing additional azeotrope. The reaction was maintained at 150°C for 10 hours, then cooled to 120°C and filtered hot through a glass frit. On acidifying, the filtrate developed a much lighter color. It was coagulated in aqueous methanol, filtered, washed and boiled in water for 2 hours. The polymer was filtered and dried in a vacuum oven overnight (Yield = 77 gms).

2.7 POLYCARBONATE OLIGOMERS

Hydroxyl terminated bisphenol-A polycarbonate oligomers were prepared by the well described solution or interfacial techniques (273-5). Methylene chloride and tetraethyl ammonium chloride served as the solvent and phase transfer catalyst respectively.

2.8 POLYSULFONE-POLYCARBONATE BLOCK COPOLYMERS

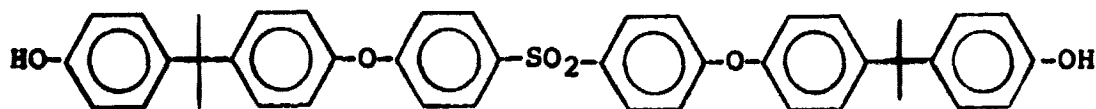
The block copolymers were synthesized interfacially using the same procedure briefly described above, and in the literature for the polycarbonate oligomers. Bisphenol-A polycarbonate oligomers were soluble in methylene chloride and were block copolymerized by simply introducing phosgene. However, in the case of copolymerizations using bis-S polysulfone oligomers, it was necessary to use tetrachloroethane as the organic solvent. A typical synthesis of a 5000/5000 bis-S polysulfone/bis-A polycarbonate copolymer via "interfacial" polymerization is described below.

Bis-S-polysulfone oligomer (5.0 g M_n -5300 by titration) and bis-A polycarbonate oligomer (5.0 g, M_n -5000 by UV) were dissolved in 300 ml of tetrachloroethane in a hood. The solution was somewhat hazy even at these concentrations. Separately, 0.2 gms of sodium hydroxide and 2.0 gms of tetraethyl ammonium chloride were dissolved in 120 ml of distilled water. The oligomer solutions and the aqueous solutions were combined in a Waring blender. The

blender was fitted with a phosgene inlet. A combination pH electrode connected to a digital pH meter (Orion 601) was used to monitor pH during the polymerization. The two layers were rapidly mixed and phosgene addition was started. A reaction time of 30 minutes was used, although high molecular weight could be achieved at considerably shorter times the pH was maintained at about 8.8 via addition of 20% sodium hydroxide solution from a buret. After the phosgene flow was stopped, the reaction product was placed in a separation funnel for 30 minutes. An organic phase and a foamy aqueous layer separated. The two phases were precipitated separately in isopropyl alcohol. The two precipitates were dried for 24 hours at 120°C under an aspirator vacuum. Total weight of the copolymers was 9.92 gms.

2.9 PERFECTLY ALTERNATING POLYSULFONE-POLYCARBONATE COPOLYMER

The synthesis of a perfectly alternating polymer involved the synthesis of the monomer structure given below:



followed by phosgenating the latter under analogous interfacial conditions to yield the polymer.

2.10 KINETIC STUDIES

A five necked 1000 ml round bottomed flask was equipped with a stirrer, nitrogen inlet sparge tube, thermometer, dean stark trap, water condenser with moisture trap, a silicone oil bath with magnetic stirring bar, thermometer and a magnetic hot plate. High purity bisphenol-A (5.14 g, 0.0225 mole) 250 ml N,N'-Dimethyl acetamide (DMAC) and 100 ml of toluene were initially added. The Dean Stark trap was filled with toluene (43-45 mls) by gently heating the above mixture. The reactor was continuously purged with dry nitrogen and slowly heated to 130-140°C to remove residual moisture. The reaction mixture was cooled to about 80°C and exactly 3.19 gms (.023 moles) of uniformly powdered, dry, anhydrous potassium carbonate was added under a constant purge of dry nitrogen. The reaction flask was then reheated to 140°C under nitrogen and good stirring. It was observed that the potassium carbonate particles formed a very fine dispersion in contrast to the monomers which had dissolved immediately. Good stirring was required to maintain a homogeneous dispersion. The temperature was maintained at 130-140°C for 2 hours or long enough until no water distilled into the Dean Stark trap.

Sufficient amount of solvent was continuously distilled to increase the bath temperature to 150°C. When the temperature reached 150°C almost all of the water had already been removed and a very fine suspension of bisphenol-A di potassium salt and/or excess potassium

carbonate appeared. Dichlorodiphenylsulfone (6.46 gms, 0.0225 moles) was then dissolved in 35 ml of dry DMAC and 15 ml toluene and was heated to 140-150°C. The toluene/DMAC mixture was continuously refluxed in order to maintain the reaction temperature at 150°C ± 1°C. The resulting total volume was estimated to be about 300 ml. This figure was arrived at by estimating a 10% volume increase due to expansion from room temperature to 150°C. This allowed us to estimate the alkali concentration as 0.15 equivalent/liter.

ANALYTICAL SAMPLES.

5.0 ml for analysis were withdrawn and emptied immediately into a 125 ml beaker containing 0.1 N HCl in DMAC. The acid reacted immediately with the base thus arresting the reaction. The excess HCl was back titrated with 0.025 N KOH in methanol using a pH meter. The first derivative plot of $\Delta E/\Delta V$ vs. volume permitted the equivalence point to be measured.

2.11 HYDROLYSIS STUDY

It was of interest to study the possible hydrolytic side reactions of dichlorodiphenylsulfone due to an excess of anhydrous potassium carbonate and bicarbonate. The reaction was studied under conditions of polymerization by reacting DCDPS (2.786 gms, 0.01 mole) with potassium carbonate (1.38 gms, 0.01 mole) and bicarbonate (2 gms, 0.02 moles) respectively. After five hours the reaction mixture was cooled to room temperature and the product

analyzed by thin layer chromatography (T.L.C.) comparing against DCDPS and bisphenol-S. The T.L.C. was developed using benzene/ethyl acetate mixture (75:25) and showed no other product than dichlorodiphenylsulfone. This was further confirmed by pouring the reaction mixture in water. Filtering and acidifying the filtrate to pH 6 showed no product. Analogous treatment of 4,4'-diphenoxydiphenylsulfone and high molecular weight methoxy capped polysulfone showed no change in intrinsic viscosities.

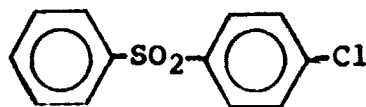
2.12 SYNTHESIS OF MODEL COMPOUNDS

2.12.1 MONOCHLORODIPHENYLSULFONE

Empirical Formula: $C_{12}H_{11}SO_2Cl$

Molecular Weight: 252

Structure:

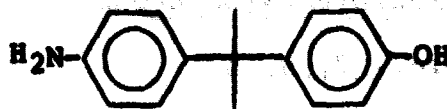


PROCEDURE. In a one liter flask, fitted with a stirrer, separatory funnel, drying tube, and thermometer, is placed 350 gms (3 moles) of chlorosulfonic acid (Note 1). To it is slowly added with continuous stirring 1 mole of chlorobenzene, (Note 2), keeping the temperature between 20 and 25°C by means of cold water. The HCl which is evolved is trapped in a hood. The addition requires 1 hour. When this is complete the mixture is stirred for 1 hour and poured upon 600-700 gms of ice (Note 3). 100 ml of carbon tetrachloride is then added and the oil is separated as

soon as possible (Note 4). The aqueous layer is shaken with 50 ml of carbon tetrachloride. The combined extracts are next washed with dilute sodium carbonate solution and the bulk of the carbon tetrachloride is distilled under atmospheric pressure (Note 5). The pressure is then reduced to 10 mm. and the chlorobenzene sulfonylchloride is collected as a middle fraction. This is dissolved in 250 ml benzene in a round bottomed flask and anhydrous aluminium chloride is added carefully. Constant stirring and bubbling of nitrogen helps remove HCl from the vessel. After about an hour, 250 ml of cold water is added to the reaction from a dropping funnel. The reaction mixture separates into 2 layers and the aqueous layer is shaken with 50 cc benzene. The benzene from the combined extracts is removed by a rota-vap. The residue on double crystallizations from toluene yields a white product melting at 92°C.

Notes.

- (1) If less than 50% excess of chlorosulfonic acid is taken the dichlorodiphenylsulfone is formed at the expense of chlorobenzene sulfonylchloride.
- (2) Chlorobenzene must be added to the acid (not vice versa).
- (3) Although the sulfonylchloride forms a solid on the ice it was not possible to filter.
- (4) Long contact times of sulfonylchlorides with water hydrolyzes it to the acid which can further catalyze the hydrolysis.

2.12.2 4-HYDROXYPHENOL, 4'-AMINOPHENYL-2,2-PROPANE**Empirical Formula:** C₁₅H₁₇ON**Molecular Weight:** 229**Structure:**

MATERIALS. A mixture of bis-A (13.4 gms) and anilinehydrochloride (75 gms) was heated in a round bottomed glass fitted with a stirrer, condenser and dropping funnel, to 180°C and maintained at 180°C for half an hour. It was cooled to 100°C and diluted with water. The solution was transferred to a beaker and treated with aqueous sodium carbonate to produce a basic solution (pH 9). Excess unreacted aniline was extracted with toluene. The aqueous layer was acidified to a pH 6, to precipitate the product. It was filtered, washed with cold water and dried. Crystallization from dioxane/water mixture produced a compound with a sharp melting product of 191°C.(276-277).

Notes.

- (1) Various mole ratios of bis-A and aniline hydrochloride were studied. A mole ratio of 1:3-4 seemed optimum.
- (2) The experiment was carried out at 140°C, 180°C and 210°C. At 140°C, the yield was less than 40% and at 210°C, the diamino derivative was obtained.
- (3) Similarly, a reaction time of half an hour was found sufficient.

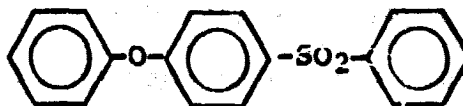
- (4) Carrying out the reaction under slightly reduced pressure proved helpful due to the distillation of phenol obtained as a by-product.

2.12.3 MONOPHENOXYDIPHENYLSULFONE

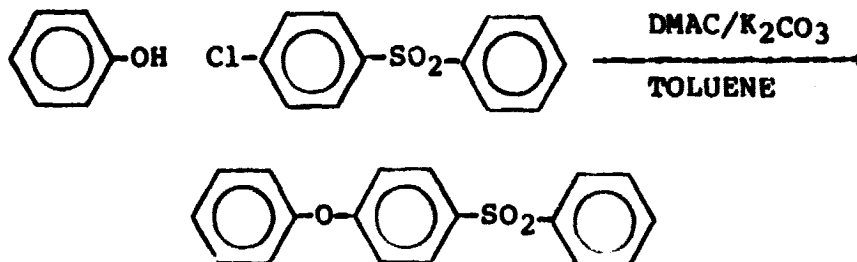
Empirical Formula: $C_{12}H_{14}SO_3$

Molecular weight: 310

Structure:



Reaction:



(67)

PROCEDURE. In a 250 ml round bottomed flask was added monochlorodiphenylsulfone (2.54 gms, 0.01 moles), phenol (1 gm, 0.01 moles) potassium carbonate (1.3 gms, 0.01 moles), DMAC (50 ml) and toluene (50 mls). The system was heated to 110°C and enough azeotrope was distilled to raise the temperature to 145-150°C. It was maintained at this temperature for 6 hours, by which time the reaction was essentially complete. The reaction mixture was concentrated to 25 ml volume by collecting the distillate. This was coagulated in water, filtered, washed and dried. The

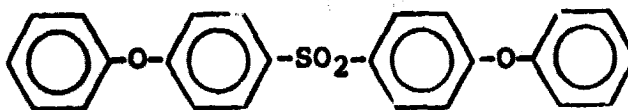
product was recrystallized from toluene (MP 144°C). Yield = 90%. I.R. (C-O-C stretch at 1245 cm^{-1} , O-S-O at 1325, 1298).

2.12.4 4,4' DIPHENOXYDIPHENYLSULFONE

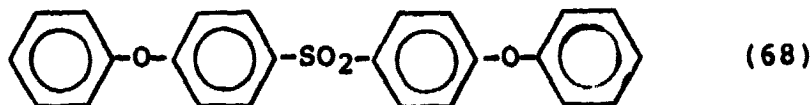
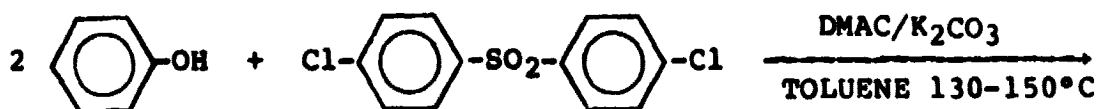
Empirical Formula: $\text{C}_{24}\text{H}_{18}\text{SO}_4$

Molecular weight: 402

Structure:



Reaction:



PROCEDURE. To a 250 ml three necked round bottomed flask, fitted with a condenser, Dean Stark trap, nitrogen inlet, a magnetic stirring bar and an oil bath was added DMAC 50 ml, toluene 50 ml, dichlorodiphenylsulfone (2.87 gms, 0.01 moles), phenol (2 gms, 0.02 moles), and potassium carbonate. The mixture was first heated to 130°C and then to 150°C and maintained for 2 and 6 hours, respectively. The reaction was checked by T.L.C. to demonstrate the absence of starting material. After 2 or more hours at 150°C it

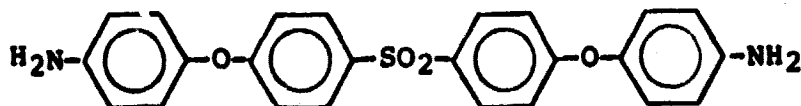
was concentrated by distilling off toluene, then it was cooled and coagulated in water. The precipitate was filtered, washed and dried. The product was crystallized from toluene. MP 136°C and yield 85% (154). I.R. (C-O-C stretch at 1245 cm^{-1} ; O=S=O stretch at 1295, 1320 absence of -OH; ^{13}C shows 8 different carbon environments.

2.12.5 4,4' DI-P-AMINOPHENOXYDIPHENYLSULFONE

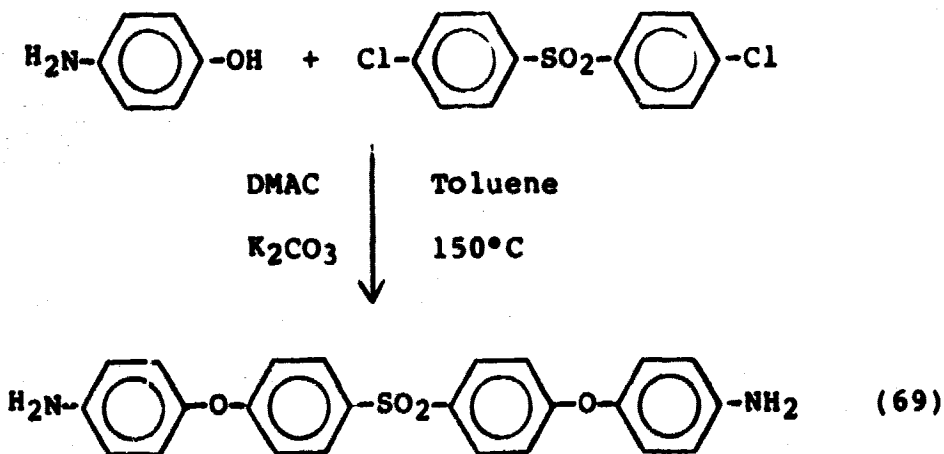
Empirical Formula: $\text{C}_{24}\text{H}_{20}\text{SO}_4$

Molecular weight: 404

Structure:



Reaction:



Testing of p-aminophenol. A T.L.C. of 1% p-aminophenol on a silica gel plate was eluted in diethyl ether and developed in iodine as well as by diazotization and coupling with phenol. The T.L.C. showed a large spot at

0.8 rf (5%). As the impurity remained unchanged on diazotization it was inferred to not have an anilino group. The purity of p-amino phenol was calculated to be at least 95%.

APPARATUS. One 100 ml three necked round bottomed flask, Dean Stark apparatus, condenser, thermometer, magnetic stirrer, nitrogen inlet and oil bath.

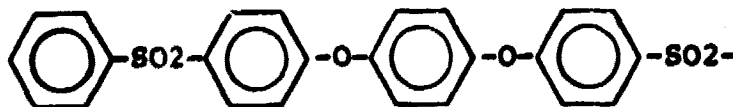
PROCEDURE. To the round bottomed flask was added DMAC (50 ml), p-amino phenol (15.1 gms), DCDPS (21.5 gms, 0.075 moles) and toluene (30 ml). The components were heated to 75°C with continuous purging with N₂. It was maintained at 70-75°C for 5 minutes and cooled to 50°C. Potassium carbonate (9.45 gms) was added and heated to azeotrope water. The reaction was maintained at 150°C for six hours, then cooled, vacuum filtered to remove sodium chloride and coagulated into a solution containing 2% Na Co and 1% sodium sulfite. The diamine was washed with 1% sodium sulfite dried and crystallized from butanol to yield a product with melting point of 192-193°C (231).

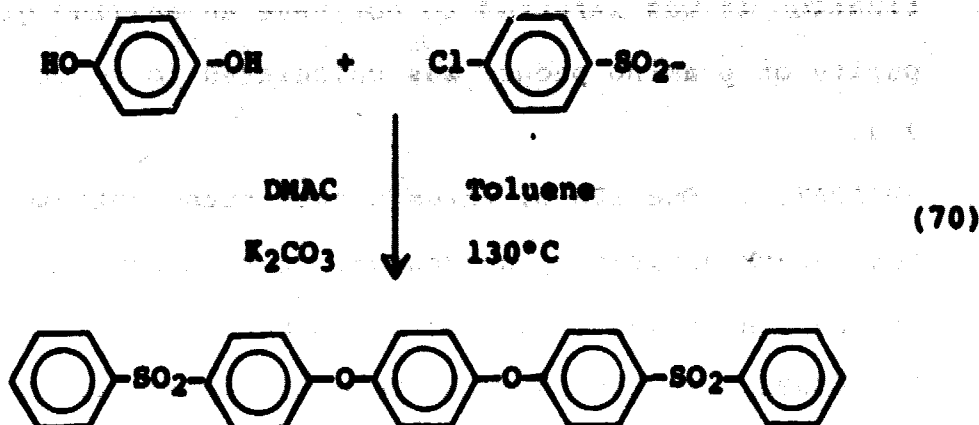
2.12.6 BENZENE, 1,4-BIS ((4-PHENOXYPHENYL) SULFONE)

Empirical Formula: C₃₀H₂₂S₂O₆

Molecular weight: 542

Structure:



Reaction:

APPARATUS. One three necked round bottomed flask, Dean Stark trap, condenser, magnetic stirring bar and oil bath.

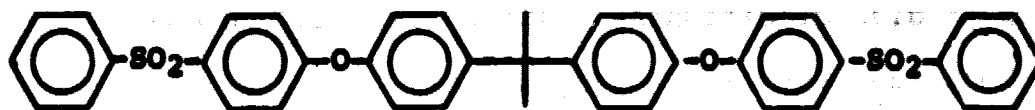
PROCEDURE. To the flask was added monochlorodiphenyl sulfone (MCDPS) (5.04 gm, 0.02 moles), hydroquinone (1.1 gms, 0.01 moles), K_2CO_3 (1.4 gms, 0.01 mole), DNAC (30 ml) and toluene (30 ml). The reaction was heated to reflux ($130^\circ C$) and was maintained at reflux for six hours. It was then concentrated by distillation of toluene and coagulated in aqueous methanol (2:1). The mixture was filtered under vacuum and dried and recrystallized from toluene to yield a product melting at $211^\circ C$, with a yield = 90%. (I.R. C-O-C-AT 1242 cm^{-1} no O-H groups were observed).

2.12.7 PROPANE 2,2-BIS (4-PHENYLSULFONE 4'-PHENOXY BENZENE)

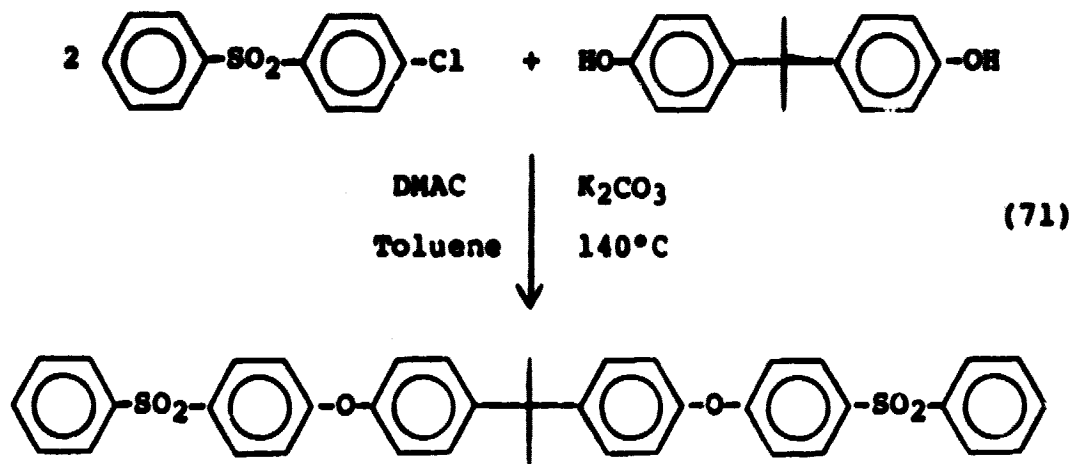
Empirical Formula: $C_{39}H_{32}S_2O_6$

Molecular weight: 660

Structure:



Reaction:



PROCEDURE. To a 100 ml three neck round bottom flask was added DMAC (50 ml), toluene (25 ml), monochlorodiphenyl sulfone (5.09 gms, 0.02 mole), bisphenol-A (2.28 gms, 0.01 mole) and potassium carbonate (1.4 gms, 0.01 mole). The mixture was purged well with nitrogen and heated to 140°C. It was maintained at 140°C until a sample showed no residual starting material on a T.L.C. plate. The reaction was nearly complete in about 8 hours at 140°C. It was cooled to room temperature and coagulated in aqueous methanol (2:1), filtered under vacuum, washed and dried. Recrystallization from toluene yielded 5.6 gms of product with a melting point 188°C. (I.R. C-O-C-at 1445 cm^{-1} ; O=S=O symmetric stretch).

**2.12.8 ATTEMPTED SYNTHESIS OF P-P DICHLORODIPHENYL
SULFONE 1,4 DIOXYBENZENE**

p-p' dichlorodidiphenylsulfone 1,4 dioxylene.

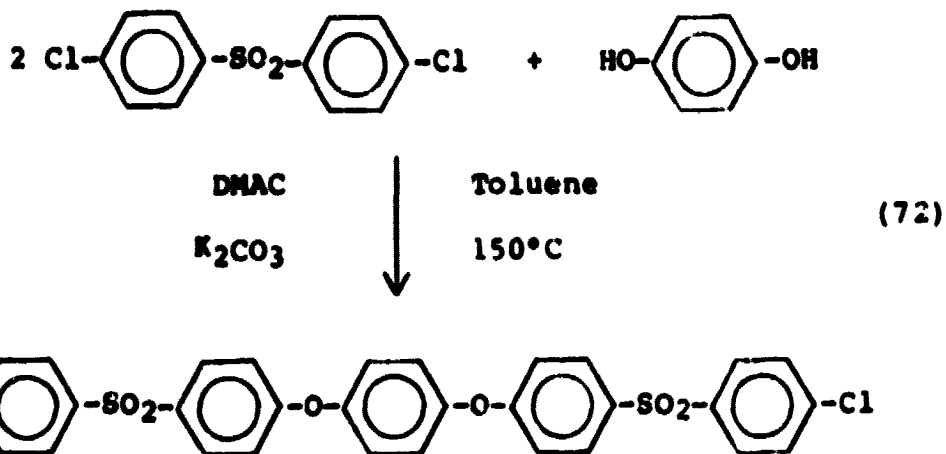
Empirical Formula: $C_{30}H_{20}S_2O_6Cl_2$

Molecular Weight: 611

Structure:



Reaction:



PROCEDURE. To a 250 ml three neck round bottomed flask fitted with a Dean Stark trap, condenser, etc., was added dichlorodiphenyl sulfone (574 gms), hydroquinone (11.0 gms, DMAC (150 ml) and potassium carbonate 14 gms). The reaction was heated to 140-150°C and maintained until sample showed the absence of starting materials on a T.L.C. plate. At completion of the reaction it was cooled and coagulated in aqueous methanol. The product was filtered under reduced pressure, washed with water and dried. A

T.L.C. of the product showed it to be a mixture of compounds. This was further substantiated by G.P.C. Changing the mole ratio of Hq; DCDPS to 1:5 produced higher yields of the required product but removal of the starting material viz DCDPS was very difficult.

2.12.9 ATTEMPTED SYNTHESIS OF 4-4 DICHLORODIPHENYL
SULFONE 4,4'-DIPHENYL 2,2 PROPANE

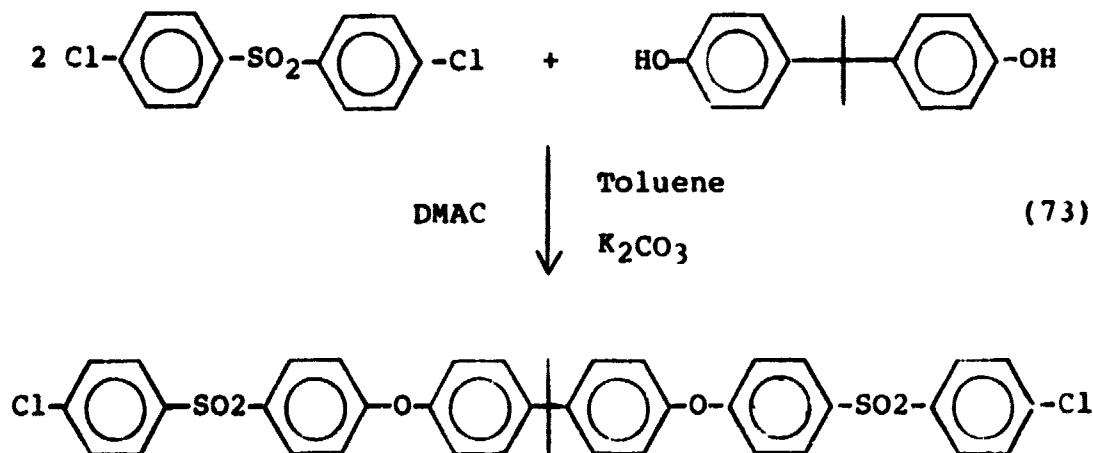
Empirical Formula: $C_{39}H_{30}S_2O_6Cl_2$

Molecular weight: 729

Structure:



Reaction:



PROCEDURE. To a 250 ml three neck round bottom flask was added dichlorodiphenylsulfone (57.4 gms, 0.2 moles) bis-A (22.8 gms, 0.1 mole), DMAC (150 ml), toluene (150 ml) and

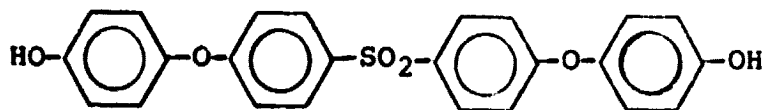
potassium carbonate (14 gms) after heating to 130°C to azeotrope the water from the reaction, the temperature was raised to 150°C and maintained at the same temperature, until no starting materials could be observed on a T.L.C. plate. The product was cooled and coagulated in aqueous methanol, filtered under vacuum and dried. The product melted over a broad temperature range, possibly due to the presence of other oligomers. Purification of the product by recrystallization was impractical.

2.12.10 PREPARATION OF 4-4 DI P-HYDROXYPHENOXYDIPHENYL SULFONE

Empirical Formula: $C_{24}H_{18}SO_6$

Molecular weight: 458

Structure:



PROCEDURE. Into a 500 ml three neck flask was added (22 gms, 0.2 moles) of hydroquinone, DMAC (150 ml) and toluene (100 mls). The reaction temperature was raised to 130°C and maintained at the same temperature, until no additional water azeotroped. To this was added through a dropping funnel DCDPS solution (28.7 gms in 50 ml toluene). The addition was complete in six hours during which time the temperature was gradually raised to 150°C after addition of DCDPS solution. It was then cooled to room temperature, filtered, neutralized and coagulated in aqueous methanol.

The precipitate was filtered under vacuum washed well with water and dried. Crystallization from aqueous methanol (1:9) yielded a product melting at 193°C.

Notes.

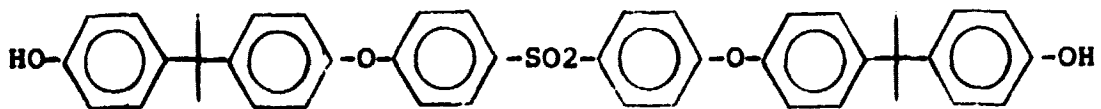
The reaction was also performed using a higher mole ratio of hydroquinone to dichlorodiphenylsulfone. It was observed that the product obtained from a 5:1 mole ratio of hydroquinone:dichlorodiphenylsulfone in the in situ process was comparable to 2:1 in the performed phenoxide and slow addition of dichlorodiphenylsulfone.

2.12.11 PREPARATION OF 4-4 DI (4 ISO-PROPYLIDENE PHENOL) PHENOXYDIPHENYLSULFONE

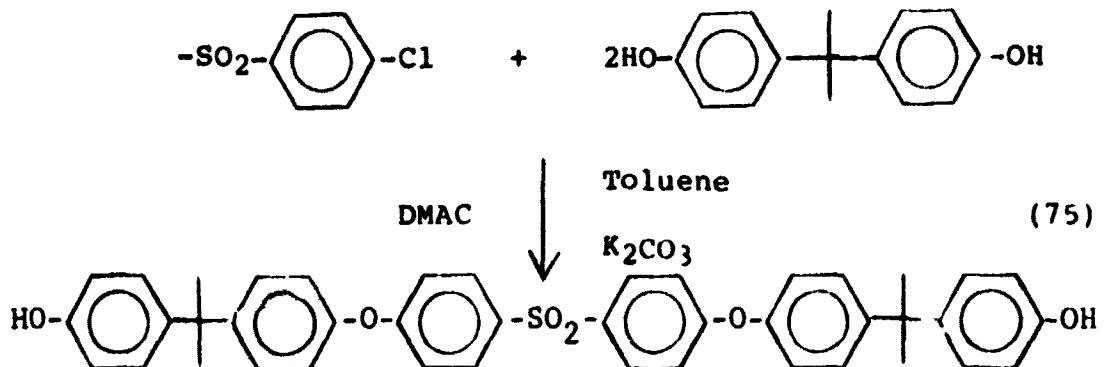
Empirical Formula: $C_{24}H_{18}SO_6$

Molecular weight: 458

Structure:



Reaction:



PROCEDURE. To a three neck 500 ml round bottom flask was added DMAC (150 ml), toluene (100 ml), bis-A (46.2 gms, 0.2 moles), K_2CO_3 (28 gms, 0.2 moles), and heated to 130°C and maintained at this temperature until no more water azeotroped. The temperature was raised to 150°C and a toluene solution of DCDPS (28.7 gms in 100 ml, 0.01 mole) was added dropwise over a period of six hours. After completion of this addition, the reaction was maintained at 150°C for two more hours. It was cooled to room temperature, filtered, acidified and coagulated in aqueous methanol (2:1). The precipitate was filtered under vacuum washed well with water and dried. Melting point 106°C.

2.13 CHARACTERIZATION

2.13.1 DILUTE SOLUTION VISCOMETRY

The theory of dilute solution viscometry has been presented elsewhere (280) and will not be considered here. The intrinsic viscosity $[\eta]$ of the oligomers, homo, random and block copolymers was determined in methylene chloride, THF or O-chlorophenol at 25°C or 30°C depending on the nature of the polymers. A typical experimental procedure is given.

APPARATUS. One semi-micro dilution viscometer (Cannon Instrument Co) thermostatted water bath, nitrogen tank, polymer solution (20 gm/liter).

PROCEDURE. Two ml of the solvent was added to the viscometer and allowed to equilibrate in the thermostatted

water bath for at least ten minutes. Using nitrogen pressure, the solvent was forced up the viscometer tube until the meniscus rose above the upper mark. The solvent was then allowed to drain through the marks under gravity and the time elapsed to pass the two marks was noted to the nearest 0.1 second. At least three readings within 0.2% were taken and the average value noted as the solvent flow time T . Next, two ml of the prepared sample is added to the solvent in the viscometer such that the new concentration was approximately 10g/liter. After equilibrating to temperature, the solution was forced through the viscometer and its flow time determined. The same procedure was employed for at least three other concentrations prepared by continuously diluting the initial solution.

CALCULATION. The relative viscosity (n_{rel}) was taken as the ratio of solution flow time to solvent flow time ($n = t/t_0$). The reduced viscosity ($n_{sp} = (n-1)/C$) and the inherent viscosity ($n_{inh} = \ln n/C$), were calculated for each solution and plotted versus concentration.

Extrapolation of both curves to zero concentration provided the intrinsic viscosity (n). Comparison of the (n) values for a series of similar oligomers provided an approximate idea of their relative molecular weights.

2.13.2 MEMBRANE OSMOMETRY

In membrane osmometry the $\langle M_n \rangle$ is calculated using the following equation:

$$\lim_{c \rightarrow 0} (\Delta/c) = RT/\langle M_n \rangle \quad (76)$$

where Δ is the osmotic pressure, "c" the concentration, R is the gas constant and T is absolute temperature in degrees Kelvin. The membrane osmometer (Wescon 231) was used for determining high molecular weight polymers (20,000-200,000, or higher).

A series of four or more concentrations of the polymer under investigation (2-10 gm/liter) were prepared in chlorobenzene and carefully filtered to remove dust and other debris. An aliquot of solution was injected into the inlet tube of the osmometer and the level set to that established during the calibration steps. The change in pressure with time was followed directly on a strip chart recorder until a constant pressure level was achieved. At least two points were obtained for each concentration. The results were plotted as Δ/c vs. C and extrapolated to zero concentration. Using equation (76) above, $\langle M_n \rangle$ was calculated.

2.14.3 END GROUP ANALYSIS

As the synthesized polymers were hydroxy terminated, a simple and rapid method to determine the absolute number average molecular weight was developed in our laboratory (309). The method involves the potentiometric titration of the end groups in a non-aqueous medium using tetrabutylammonium hydroxide as titrant.

MATERIALS. A pH meter (Orion 601A) with glass and calomel electrodes (Thomas No.4092-f15 and 2090 B-15 respectively), several 40 mm titration vessels, a 2 ml Gilmont microburet (Thomas No.1996-B55), stirring bar (4mm,10mm) purified DMAC and 1% solution of tetraethyl ammonium hydroxide in distilled water.

PROCEDURE. A sample of hydroxyl terminated polysulfone was accurately weighed into titration flask and dissolved in 20 ml DMAC with stirring, while dry carbon dioxide free, nitrogen was passed over the solution. After complete dissolution of the polymer, the electrodes were immersed in the solution and the buret lowered such that the tip just pierced the surface. After recording the initial volume and cell potential, 0.05 ml portions of the titrant were added. The titration was continued until the cell potential dropped steadily with each addition of titrant.

CALCULATION. The molecular weight of the polymer was calculated from the equation:

$$M = 2(W)/(V)(C) \quad (77)$$

where:

- W = weight of sample in grams
- C = concentration of titrant in moles per liter.
- (V) = volume of the titrant which is determined using a second derivative plot of volume of titrants vs. the corresponding millivolt reading.

2.13.4 GEL PERMEATION CHROMATOGRAPHY

The molecular weight distributions of the oligomers and copolymers were determined on a Waters HPLC and Dupont high pressure liquid chromatographs. Tetrahydrofuran (THF) or methylene chloride solution of approximately 0.2 weight percent concentrations were injected into the chromatograph at a flow rate of 10 ml/minute at 25°C, UV and differential refractometer detectors were used.

2.13.5 NMR ANALYSIS

The spectra of homo and copolymers solutions (10% solution in CDCl_3) were recorded at 34°C using a Varian EM-390 Spectrometer. Due to the insolubility of hydroquinone polysulfone in CDCl_3 , N-methyl pyrrolidone was used as the solvent and only the aromatic region was scanned. Tetramethyl silane was used as the internal reference. Copolymers containing a high percentage of hydroquinone (50% and above) were prepared by dissolving the sample in 1% TMS containing chloroform.

2.13.6 INFRARED ANALYSIS

Infrared spectra in the range of 4000-200 cm were measured using a Perkin-Elmer 283 Spectrometer. A 2% KBr-pellet sample was dried under vacuum and the spectra was recorded in the normal mode.

2.14.7 THERMAL ANALYSIS

The transitional properties of the polymers were studied by means of the differential scanning calorimeter (DSC) Perkin-Elmer Model-2. (The instrument was calibrated using an Indium reference ($T_m = 156.6$ C, $H_f = 6.8$ calories/gm). The dried polymer powders were used as samples. Scans were obtained at $40^\circ\text{C}/\text{minute}$ at a sensitivity of 5.20 millicalories/sec. In most cases, the first heating removed any previous thermal history. The second run was recorded. In studying solvent induced crystallization (254°C) or phase separation (300°C) the experiments were extended up to twenty four hours.

2.14.8 DYNAMIC MECHANICAL MEASUREMENTS

Before describing this technique and the experimental set up a brief review of the theory is first appropriate.

Polymer materials are viscoelastic in nature and their mechanical properties exhibit a pronounced dependence on temperature and time. The viscoelastic response to thermo-mechanical excitement can give valuable information regarding molecular motions and even polymer structure, e.g. crystallinity. In the case of dynamic-mechanical testing, often the time factor is held essentially constant by using a constant frequency operation. The viscoelastic response is then studied over the desired temperature range. The frequency is then changed and the experiment may be repeated to obtain information about the time dependence of response.

Dynamic mechanical testing may be performed by many methods. The common ones are, for example, those using the torsion pendulum, resonant rod, ultrasonic techniques and forced oscillation procedures. The rheovibron, which is a forced oscillation procedure, was employed for this study. The sample is held rigidly by clamps, one of which is connected to a strain gauge and the other to a stress gauge. A sinusoidal strain is then applied to the polymer sample.

The relations between the strain ϵ and the angular frequency at any time t is given by " ω " the frequency.

$$\epsilon = \epsilon_0 e^{i\omega t} \quad (78)$$

where ϵ_0 is the strain amplitude and ω the frequency.

The stress σ varies sinusoidally with the same frequency. However, due to the viscous molecular processes, there exists a phase difference between the stress and strain. If the phase angle is represented by δ the expression for σ is given by

$$\sigma = \sigma_0 e^{i(\omega t + \delta)} \quad (79)$$

where σ_0 is the stress amplitude.

$$E^* = \frac{\sigma}{\epsilon} \quad (80)$$

Representation in the complex plan also gives

$$E^* = E' + iE'' \quad (81)$$

where E' and E'' are termed the storage and loss moduli respectively.

Also

$$\frac{E''}{E'} = \tan \delta \quad (82)$$

where $\tan \delta$ is referred to as the dissipation or loss factor.

The significance of these parameters is easily understood by a simple derivative which gives

$$\frac{\Delta W}{W_{st}} = 2 \tan \delta \quad (83)$$

where ΔW = energy dissipated per complete cycle (due to viscous forces) and W_{st} the maximum stored energy (due to elastic force).

Energy dissipation displays a maximum when the frequency of operation corresponds to the relaxation times of the molecular processes. The molecular processes are thermally activated; therefore, variation in t and with respect to temperature or frequency yields useful information regarding the molecular mechanisms. These molecular mechanisms may range from oscillations of pendent groups on side chains of the polymer molecule to the backbone movement of these macromolecules.

All dynamic-mechanical measurements were made on a Rheovibron Visco-Elastomer (Toyo Baldwin Co., Ltd.) supplied by Inass Co. At the start of the experiment was the sample length (distance between the two clamps) was 5 cm in all cases. The sample width varied from 0.45 to 0.50 cm while the thickness varied from 5 mils to 8 mils. A

frequency of 3.5 Hz was employed for all mechanical spectra measurements and liquid nitrogen was used as a refrigerant in order to obtain sub-ambient temperatures. The raw data from the rheovibron experiment was punched on cards and, with the aid of a computer program, plots of E' , E'' and $\tan \delta$ as a function of temperatures were obtained.

2.13.9 TENSILE TESTING

The stress-strain properties of the copolymers were examined on a Scott and an Instron tester. Dog bone shaped specimens were held between the jaws of the pneumatic clamps at a pressure of 90 psi and strained at two inches per minute until they fractured. At least five specimens of each polymer type were tested and average values for the yield stress and elongation as well as the ultimate stress and elongation were calculated.

2.13.10 SCANNING ELECTRON MICROSCOPY (SEM)

Hydroquinone polysulfone and bis-A polycarbonate can be induced to crystallize by certain liquids such as acetone. The surface morphology of the films before and after treatment was observed with the aid of a scanning electron microscopy (Super III-A ISI). The samples were placed on stub and coated with gold using a SPI sputter T.M. model 13131. The coating thickness was approximately 50 A-75 A. In the scanning electron microscope, a very fine electron beam hits the specimen producing secondary electrons.

These back-scattered electrons are collected and produce a signal used to modulate the intensity of the beam in the cathode-ray tube, this forms an image. Photographs of these images can be taken.

2.13.11 WIDE-ANGLE X-RAY DIFFRACTION (WAXD)

Phillips table top X-ray generator pw 1720 was used to obtain wide angle X-ray diffraction patterns for the polymers under study. Samples were about 15-20 mm thick and the exposure time was of the order of eight hours per sample. The operating voltage was 40 kv and the current 25 mA. The sample to film distance was 4.3 cm in all cases. A detailed review of the theory is given in reference (282).

2.13.12 ELECTRON SPECTROSCOPY FOR CHEMICAL ANALYSIS (ESCA)

ESCA is unique as a surface characterization technique because it gives information about elemental composition, oxidation state and molecular structure. In the ESCA technique, the sample is bombarded with X-rays in vacuum. This results in ejection of photoelectrons from the surface. The energy of the absorbed X-ray quanta is partially expended in overcoming the energy which binds an electron to an atom and the rest is converted to kinetic energy of the ejected electron carbon (1s) is arbitrarily assigned a value of (285.0 eV) as a means of binding energy referencing and charge correction.

The data output is in analog form with electron intensity in counts/seconds/centimeter plotted on the ordinate versus apparent binding energy in eV on the abscissa decreasing from left to right and precise to within a tenth of an electron volt. The corrected binding energies were obtained directly from the spectra.

The sample must be mounted on the holder for analysis. Depending on the form of the polymer, this can be accomplished in any one of a number of ways. Films are cut to the size of the holder and mounted using adhesive transfer tape. Powders are impacted onto the sample peg with transfer adhesive tape or double sided adhesive tape. If the sample is in solution or is soluble in a low vapor pressure solvent, it may be cast directly onto the sample peg, thus eliminating the need for an adhesive tape and any interference in the spectra of the polymer that may arise due to incomplete coverage of the tape. Caution was exercised not to introduce any contaminants onto the polymer surfaces during cutting and mounting.

Difficulty may arise with some samples when introducing the material to the analyzer due to the vacuum or the X-rays. If the solvent is not completely evaporated out of the sample or if the material produces by-products upon irradiation (as a result of photolytic decomposition) which will outgas at a pressure of 10^{-7} torr, a loss of vacuum may result. The DuPont 650 is designed so that if

the pressure is greater than 10^{-5} torr, the analyzer voltages will not turn on.

Information about the polymer obtained from the spectrometer is output in an analog form. Charge correction is made by taking the main carbon 1s peak to be at a binding energy of 285.0eV and adjusting the other peaks according to the amount of shift exhibited by the C 1s peak.

The peak intensity which is proportional to concentration can be measured in one of two ways. The area under the peak can be evaluated or the peak height can be measured. In determining the area, the peak shape was cut and weighted after subtraction of a linear base line. In triangulation area measurements the convoluted peak intensity is obtained. Peaks well separated from the main peak such as shake-up satellites can be measured separately.

In evaluating the peak intensity by height, the baseline is constructed and the height measured to the peak maximum. Intensities of shoulders and peaks not completely separated from the main can be evaluated, recognizing that intensities and binding energies so obtained are approximate and as such may have considerable error.

Information available from the ESCA technique, and the principal features observed in ESCA spectra are listed in Table 8 (308).

TABLE 8
PRINCIPAL FEATURES IN THE ESCA SPECTRA OF POLYMERS
(Ref. 308)

SPECTRAL FEATURE	INFORMATION
1. Main peak position	Atom identification
2. Chemical shift	Oxidation State
3. Peak area ratios	Stoichiometry
4. Shake up satellites	$\pi \rightarrow \pi^*$ transition

2.14 MONTE CARLO SIMULATION

As mentioned in the introductory section, the nature of the step-growth mechanism of chain extension combined with variation in the reactivity of the second monomer functional groups renders the system difficult to model mathematically. Analytical solutions are limited only for very simple cases. We have obtained results by Monte Carlo simulation of the reaction. The method is no less ambitious in function but replaces the mathematical analysis by a digital-computer algorithm in which the approximation due to the requirements of the mathematical analysis have been avoided.

2.14.1 DEFINITIONS

The polycondensation reaction considered here is of the type where A-A and B-B monomers react with C-C monomers. A-A and B-B monomers may have the same functional group with different structures, such as bisphenol-A and hydroquinone or different functional groups and structures. However, A-A monomers cannot react with B-B type. These monomers are called comonomers. Both these comonomers can react with the third monomer C-C which we define here as the intermonomer. Typically, this could be phosgene, terephthalic acid chloride etc., for simplicity they may be represented as -A-, -B- and -C-. This structure of the copolymer thus formed can be represented as follows:



(84)

The presence of the intermonomer between the comonomers is an obvious necessity. The possible triads are -A-C-A-, -B-C-B and -A-C-B-. The -A-C-A- and -B-C-B- triads are referred to as homotriads and the -A-C-B- as the hetero triad. It is now possible to describe the microstructure of the copolymer in terms of the proportion of the various triads.

Consider a system of equal amounts of -A- and -B-. A random/statistical copolymer would have -A-C-A- = -B-C-B- = 0.25 = -B-C-A- = 0.5. A block copolymer would have -A-C-A- and -B-C-B- = 0.5 and -A-C-B- nearly zero. A perfectly alternating copolymer would have -A-C-B- nearly equal to one. A more concise way of defining and describing the microheterogeneity is the representation used by the authors in reference (254). They define K_m the coefficient of microheterogeneity as:

$$K_m = P_{AB}/(P_{AB} + 2P_A) + P_{AB}/(P_{AB} + 2P_B) \quad (85)$$

where P_{AA} , P_{BB} , P_{AB} are the fractions of the three triads. For a mixture of two homopolymer $P_{AB} = 0$ and thus $K_m = 0$ for a perfectly alternating copolymer $P_A = P_B = 0$ and $K_m = 2$. Thus the value of K_m would represent the type of distribution.

2.14.2 SIMULATION MODEL

Our model is built to simulate both the A-A, B-B type as well as the A-B type polycondensation. It also has the capabilities of adding different types of monomers at any stage of the reaction at various reaction rate and feed ratios. The mechanism of the simulation technique is to keep track of triads formed at various extents of reaction.

At any stage in the reaction system only the following different combination of functional end groups exist. There are -A-, -B-, -C-, -AC-CA, -AC-BC-, -AC-AC-, -BC-CB-, -BC-BC-, -BC-AC-, -CA-AC-, -CB-BC-, CA-BC-. The probability of a certain type of macromolecules forming depends on the rate of reaction and relative abundance of the reactant molecules. In a similar way the probability of formation of all possible types of macromolecule is calculated and the probabilities normalized. The probability of a certain macromolecule being formed is determined by the "Random Number Generator" (268). The whole process is repeated, one bond formation at a time until the reaction is complete. The Table 6 shows the thirteen different reactive species. The column heads represent molecules that have a comonomer at one or both functional ends and the rows represent molecules that have an intermonomer at one or both ends. A molecule is formed by the reaction of a "column-molecule" with a "row-molecule".

A triad is formed only when a reacted intermonomer (dimer or oligomer) reacts with a comonomer (both monomeric

and oligomeric). In other other words all possible reactions involving other than monomeric intermonomer can produce a triad. Also no triads are formed when monomers react.

For a better clarity of the simulation mechanism, consider a reaction of five -A-s, five -B-s and ten -C-s, with -B-s reacting 100 times faster than -A-s. At the beginning of the reaction we have 5A, 5B and 10C. Thus there are only two different molecules that can form. They are -AC-formed by the reaction of -A-and -C-or -BC-formed by the reaction of -B-and -C-. The probability of their formation is given by the product of the relative abundance of the reactants and their reaction rates. Thus the probability of formation of -AC-and -BC are $10 \times 10 \times 1$ and $10 \times 20 \times 100$, respectively. Thus -BC-is the most probable molecule that will be formed. The following possibilities now exist for the second bond formation. In addition to -AC- and -BC-formed by monomeric reaction, -BC-formed in step one can also react with the monomers. Thus the following possibilities exist (See Table 9), the formation -AC-, -BC-, -BC-A, -BC-B-, -C-BC-, -BC-BC-. Their respective probabilities are $10 \times 18 \times 100 = 1800$ and $1 \times 18 \times 100 = 180$ and $2 \times 1 \times 100 = 200$. Once again -BC-is the most probable molecule to be formed. It is interesting to note here that only the reaction of -BC-with the comonomers results in a triad. The whole process is repeated until completion. One can thus assess the number and type of triads formed.

In the actual simulation reaction 1000 intermonomer molecules with a stoichiometric amount of comonomers were reacted. Each reaction was simulated 25 times, under these conditions the standard error was less than 0.1%.

2.14.3 PROGRAM DEBUGGING

As in all computer programs, debugging is very important, especially when used for Monte Carlo simulation. Credibility of the program was accomplished by testing for known outcomes. The following events were used.

- (1) A reaction with only -A- and -C- -----> Homopolymer.
- (2) A reaction with only -B- and -C- -----> Homopolymer.
- (3) A reaction with no C s -----> No reaction.
- (4) Insufficient Cs -----> No. of triads = No. of C s.
- (5) Equal reactivity ratio -----> Symmetric results.
- (6) Reaction with -A-s, -B-s and -C-s with P=0. ----->
Only -A-C- homopolymer.
- (7) Reaction with -A-s, -B-s and -C-s with Q=0 ----->
Only -A-C- homopolymer.

TABLE 9
REACTIVE SPECIES IN BICOPOLYCONDENSATION

	A (n ₁)	ACB (n ₂)	AC (n ₃)	ACBE (n ₄)	ACA (n ₅)	B (n ₆)	BC (n ₇)	BCAC (n ₈)	BCB (n ₉)
(n ₁₀)	4P ₁ (n ₃)	2P ₃	2P ₃ (M ₁₁)	4P ₃ (n ₁₃)	4Q ₁ (n ₃)	2Q ₂ (n ₇)	2Q (n ₁₂)	2Q (n ₁₃)	4Q ₂ (n ₇)
AC (n ₃)	2P ₂ (n ₅)=M ₁	P (n ₂)=M ₁	2P (n ₃)=M ₁	P (n ₄)=M ₁	2P (n ₅)=M ₁	2Q (n ₂)=M ₂	Q (n ₈)=M ₂	P (n ₈)M ₁	2Q (n ₂)=M ₂
BC (n ₇)	2P ₂ (n ₂)M ₂	Q (n ₅)=M ₂	P (n ₇)M ₂	P (n ₃)=M ₂	2P (n ₂)M ₂	2Q (n ₉)M ₃	Q (n ₄)=M ₂	Q (n ₈)M ₃	2Q (n ₉)M ₃
CAC (n ₁₁)	4P ₂ (n ₃)M ₁	2Q (n ₈)M ₁	2P (n ₁₁)M ₁	4P (n ₁₃)M ₁	4Q ₃ (n ₃)M ₁	2Q (n ₈)M ₂	2Q (n ₁₃)M ₂	2Q (n ₁₁)M ₂	4Q (n ₈)M ₂
BC (n ₁₂)	4P ₂ (n ₄)M ₂	2Q (n ₇)M ₂	2P (n ₁₃)M ₇	4P (n ₁₂)M ₂	4Q (n ₄)M ₂	2Q (n ₇)M ₃	2Q (n ₁₂)M ₃	2Q (n ₁₃)M ₃	4Q (n ₇)M ₃
ACBC (n ₄)	2P ₂ (n ₅)M ₂	P (n ₂)M ₂	2P (n ₄)M ₂	2P (n ₄)M ₂	2P (n ₅)M ₂	2Q (n ₂)M ₃	2Q (n ₂)M ₃	P (n ₇)M ₁	2Q (n ₂)M ₃
BCAC (n ₈)	2P ₂ (n ₂)M ₁	P (n ₉)M ₁			2P (n ₂)M ₁	2Q (n ₉)M ₂		2Q (n ₈)M ₂	2Q (n ₉)M ₂
CABC (n ₁₃)	2P ₂ (n ₃)M ₂	P (n ₈)M ₂	P (n ₁₁)M ₂	2P (n ₁₃)M ₂	2P (n ₃)M ₂	2Q (n ₈)M ₃	Q (n ₁₃)M ₃	Q (n ₁₁)M ₃	2Q (n ₈)M ₃
	2P ₂ (n ₄)M ₁	Q (n ₂)M ₂	P (n ₁₃)M ₁	2P (n ₁₂)M ₁	2P (n ₄)M ₁	2Q (n ₇)M ₂	Q (n ₁₂)M ₂	Q (n ₁₃)M ₂	2Q (n ₇)M ₂

KEY:
M₁=ACA
M₂=BCA
M₃=BCB
P =K_A
Q =K_B

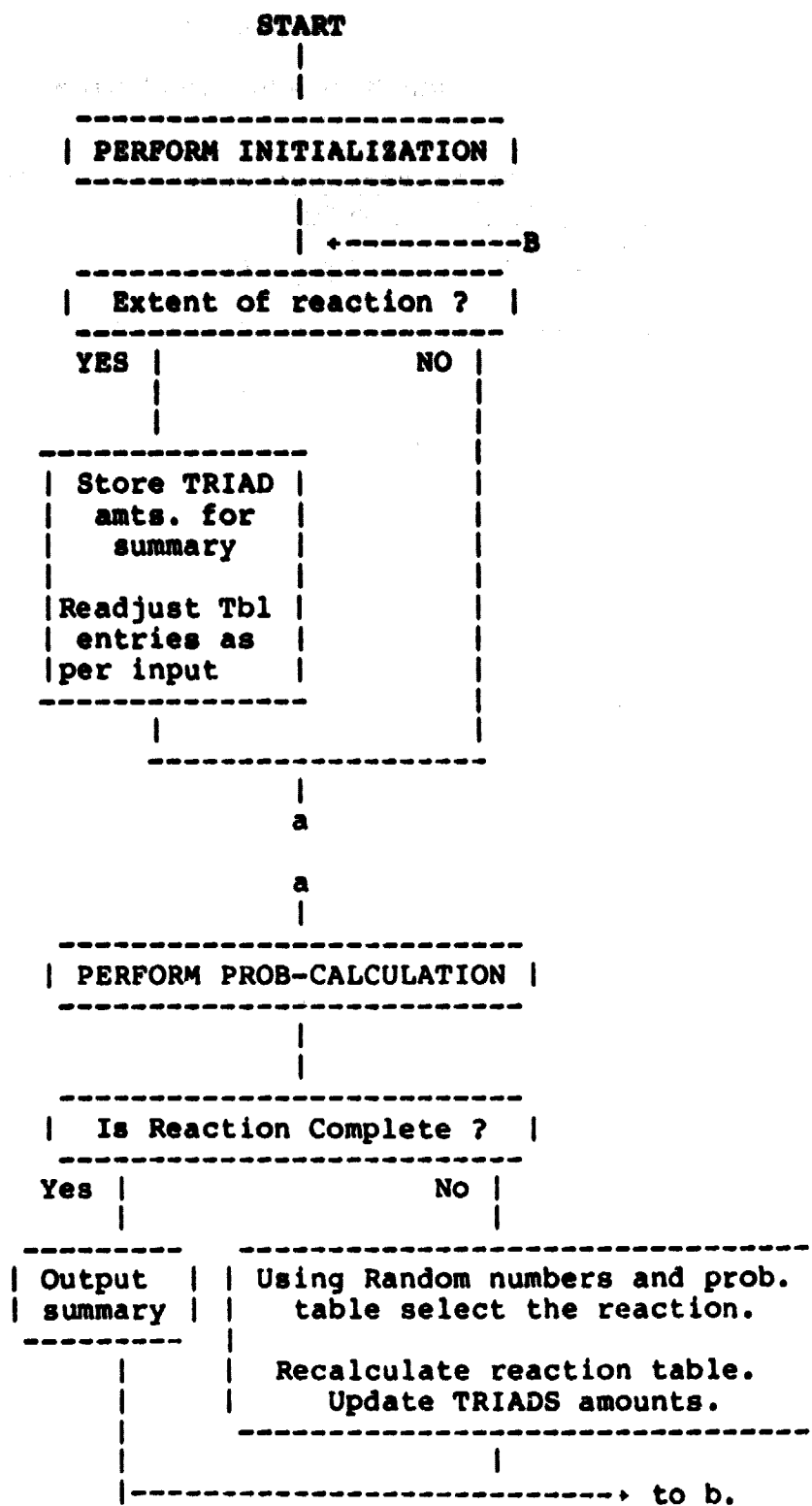


Figure 9

GLOBAL FLOW CHART FOR THE SIMULATION OF TRIAD FORMATION
IN CONDENSATION REACTION

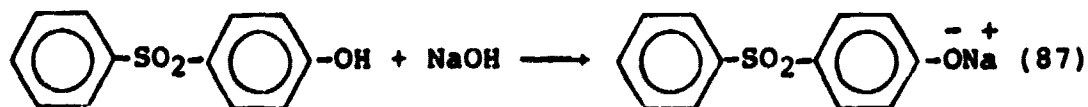
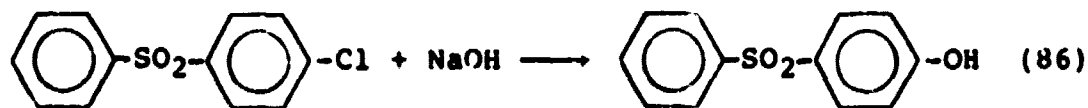
Chapter III

RESULTS AND DISCUSSION

3.1 KINETIC AND MECHANISTIC ASPECTS OF THE POTASSIUM CARBONATE/DMAC PROCESS

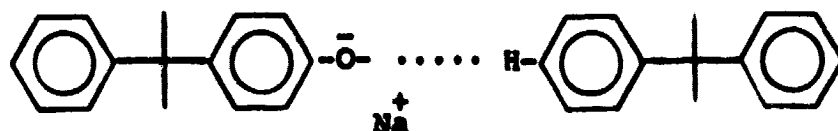
3.1.1 HYDROLYTIC SIDE REACTION

The classical route for the synthesis of polyarylene ethersulfones is via the dimethyl sulfoxide/aqueous sodium hydroxide route (154). This method is not without limitations since it requires the exact stoichiometric amount of sodium hydroxide. Even a modest 1% deviation in the base drastically decreased the reduced viscosity (RV) in chloroform at 25°C of the resultant polymer from 1.8 dl/gm to 0.6 dl/gm. Also the effect of lack of alkali, on the reduced viscosity was greater than the corresponding excess. Decrease in viscosity in the presence of excess base has been attributed to the hydrolytic side reaction of dichlorodiphenylsulfone, resulting in the formation of a relatively inactive phenoxide group (154). Two equivalents of the base are used as shown in the reaction below:



More recently (283) it has been reported that the lack of alkali not only disturbs the stoichiometry of bisphenols

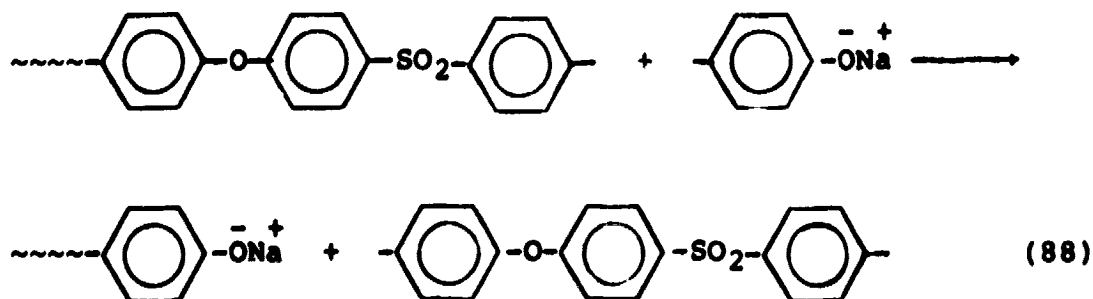
but that the unreacted phenol can hydrogen bond with an equivalent amount of sodium phenate, thereby reducing the nucleophilicity of the phenate by nearly one order of magnitude. The complex formed is believed to be:



HYDROGEN BONDED COMPLEX

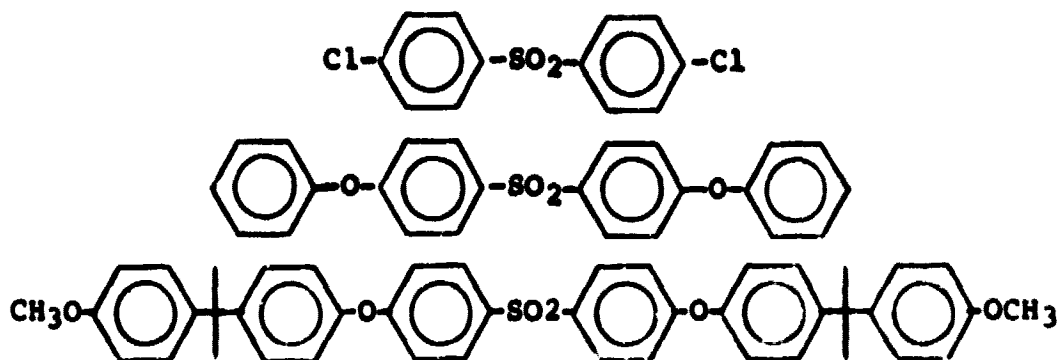
Thus in the presence of excess alkali only half an equivalent of the halide is converted to the unreactive phenoxide while the lack of alkali renders more than an equivalent of phenoxide unreactive. This rationalizes the greater decrease of reduced viscosity when a lack of alkali is used.

Although the ether bond is stable to hydrolysis the presence of excess base under reaction conditions can cleave the activated ether linkage (156). The polymer hydrolysis is shown below:



This hydrolysis reaction particularly limits the scope of the reaction in the synthesis of block copolymers.

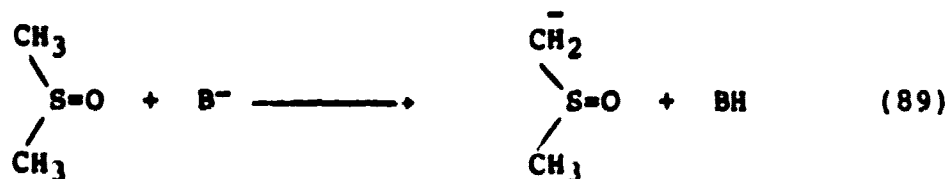
The effect of a modest excess of anhydrous potassium carbonate on the hydrolytic side reactions of the dihalide-diphenoxydiphenylsulfone and methoxy terminated polysulfone were studied, as outlined in the experimental section.



These studies show no hydrolysis of the halide or the polymer in presence of potassium carbonate.

3.1.2 DMAC/TOLUENE AZEOTROPE STUDY

DMSO is sensitive to acidic or basic moieties (284). In the presence of excess alkali or alkaline solution, (e.g., potassium hydroxide or potassium t-butoxide) DMSO is subject to auto oxidation. This is likely to be due to the deprotonation of DMSO to form the methyl-sulphinyl carbanion (285). Acidic substances such as phenol may also react with DMSO.



Our interest in synthesis and study of copolymers required the need for preparing and coupling well characterized oligomers. Although the DMSO/NaOH does produce high molecular weight in a very short time, polymer hydrolysis poses a problem in maintaining block integrity due to the ether interchange reaction.

To reduce the emphasis on the exact amount of alkali, it was of interest to study the anhydrous potassium carbonate/*N,N'* dimethylacetamide route. Although this solvent has a comparable cation solvating power to DMSO, it is not significantly affected by excess anhydrous potassium carbonate. This process has received less attention compared to the DMSO/NaOH route. The literature available on this alternate process is mostly confined to patents (see Table 4). The success of the polymerization reaction using a bisphenate and an activated halide is largely dependent on the ability of the solvent to homogenize both the phenate and the growing polymer end under anhydrous conditions. The solvent composition during the reaction also influences the kinetic or the rate of reaction. Since azeotropic data was not available under the experimental conditions, the DMAC/Toluene azeotrope was studied as outlined in the experimental section. Figure 10 shows the gas chromatography trace of the condensate composition at various temperatures. Using the results obtained from this, the condensate and reactor compositions were calculated and plotted for a

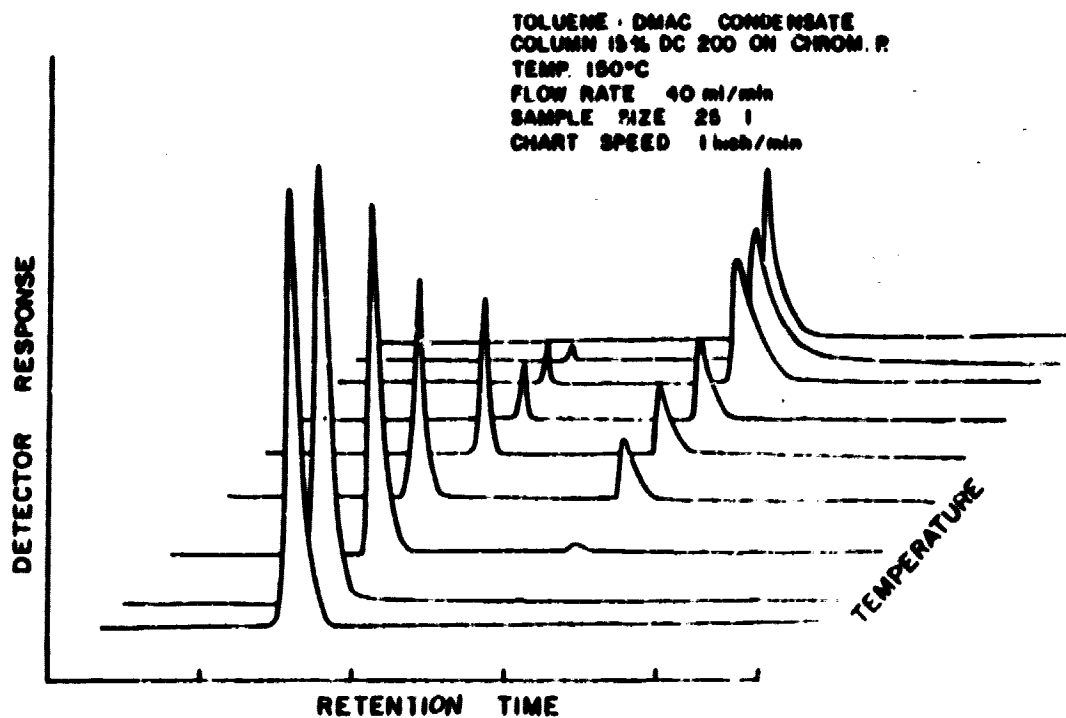


FIGURE 10. GAS CHROMATOGRAPHY TRACE OF CONDENSATE COMPOSITION AS A FUNCTION OF TEMPERATURE

series of temperatures as shown in Figure 11. At all times during the distillation the reactor temperature was, of course, higher than the condensate temperature. However, at any given temperature, the condensate contained more toluene than the reactor, still as one might predict. At 150°C, which was often the temperature used for the polymerization reaction, the reactor composition was found to be 85:15, DMAC:Toluene as indicated in Figure 11.

3.1.3 KINETICS OF BIS-A PHENOXIDE WITH DICHLORODIPHENYL SULFONE IN DMAC/TOLUENE

Both NMR and infrared spectroscopy of model compounds and polymers obtained by reacting dichlorodiphenylsulfone with monophenols and bisphenols (see synthesis of model compounds in the experimental section) via the DMAC/K₂CO₃ were consistent with all para products, i.e., no meta or ortho products were observed, ruling out the possibility of the benzyne mechanism (see section on "NMR of copolymers"). This is of course analogous to the DMSO/aq NaOH procedure (154). The formation of the orange yellow color upon the addition of the sulfone to the phenoxide has been reported to be possible formation of the Meisenheimer type sigma complex formed by the reactants (154). It is likely that the formation of the ether linkage occurs exclusively via a bimolecular process.

The polymer forming reaction between difunctional groups has been shown to be second order with respect to

INITIAL COMPOSITION TOLUENE : DMAC :: 50:50

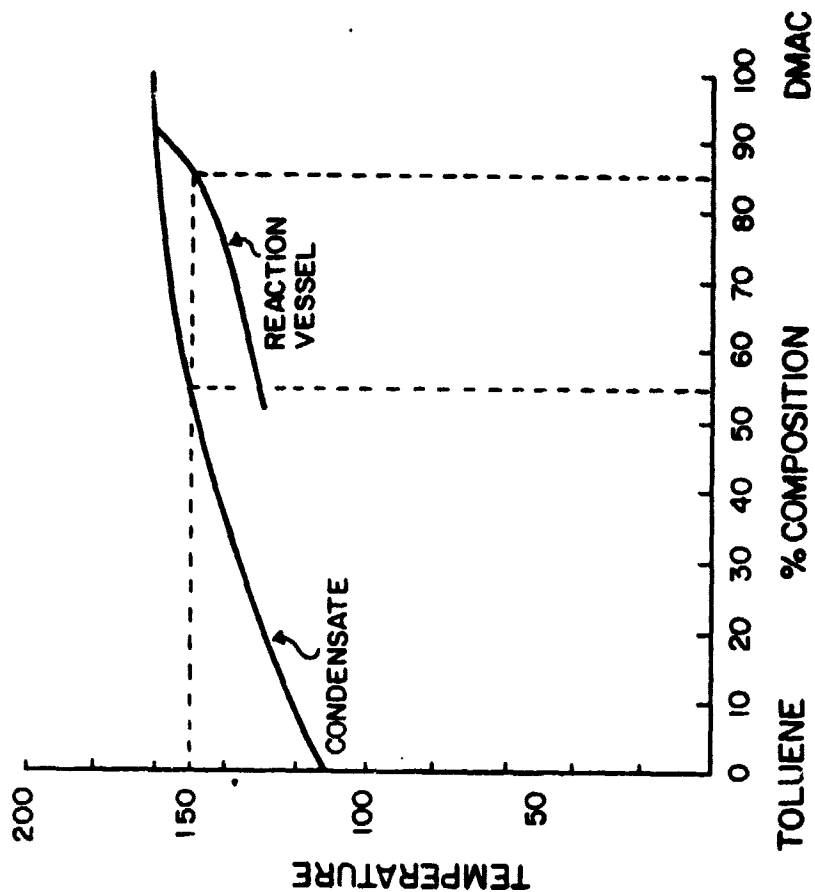


FIGURE 11. PLOT OF COMPOSITION OF CONDENSATE AND REACTOR AS A FUNCTION OF TEMPERATURE

ORIGINAL PAGE IS
OF POOR QUALITY

the concentration of the functional groups (155). The equation representing the rate of reaction is expressed as follows:

$$\frac{d[\text{OH}]}{dt} = K[\text{ArO}^-][\text{ArX}] \quad (90)$$

where $[\text{ArO}^-]$ and $[\text{ArX}]$ represent the concentrations of the phenoxide ion and the activated halide. The integrated form of the above equation is show below for equal initial concentrations of the monomers.

$$\frac{1}{C} = \frac{1}{C_0} + kt \quad (91)$$

where C_0 and C are the concentrations of the phenoxide ion at $t=0$ and at any given "t". Thus a plot of $1/C$ vs. t should yield a straight line with a slope equal to "k" the reaction rate constant. A typical plot of bisphenol-A with dichlorodiphenylsulfone for the DMSO/aq NaOH process obtained by Schulze and Baron (155) is shown in Figure 12. The initial curvature in the plot was reported to be due to the greater reactivity of the monomers. By comparison a similar plot Figure 13 of the reaction of bis-A phenoxide with dichlorodiphenylsulfone via the DMAC/ D_2CO_3 route showed identical behavior. Interestingly, it was not possible to reproduce the result, that is, the plot does not show any portion of completely linear behavior (Figure 14A).

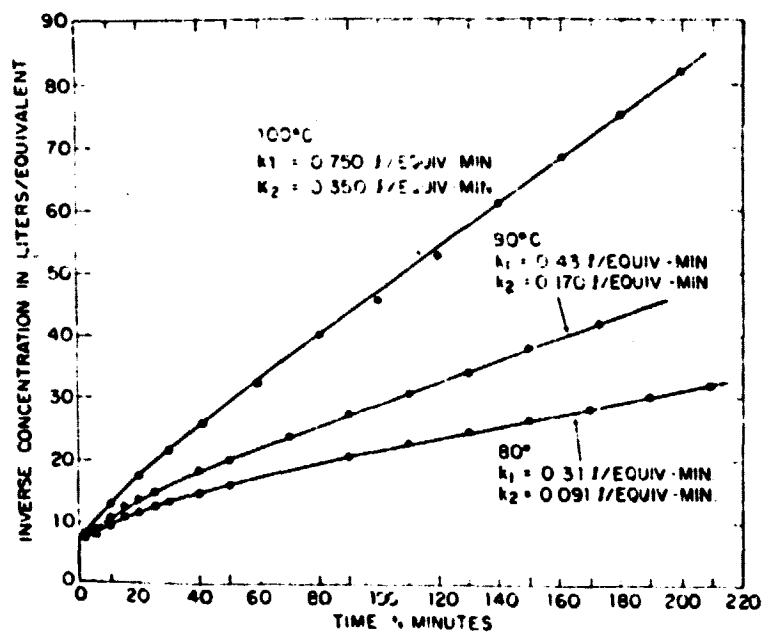


FIGURE 12 POLYMERIZATION OF BISPHENOL-A WITH 4,4'-DICHLORODIPHENYL SULFONE VIA DMSO/NaOH ROUTE (ref 155)

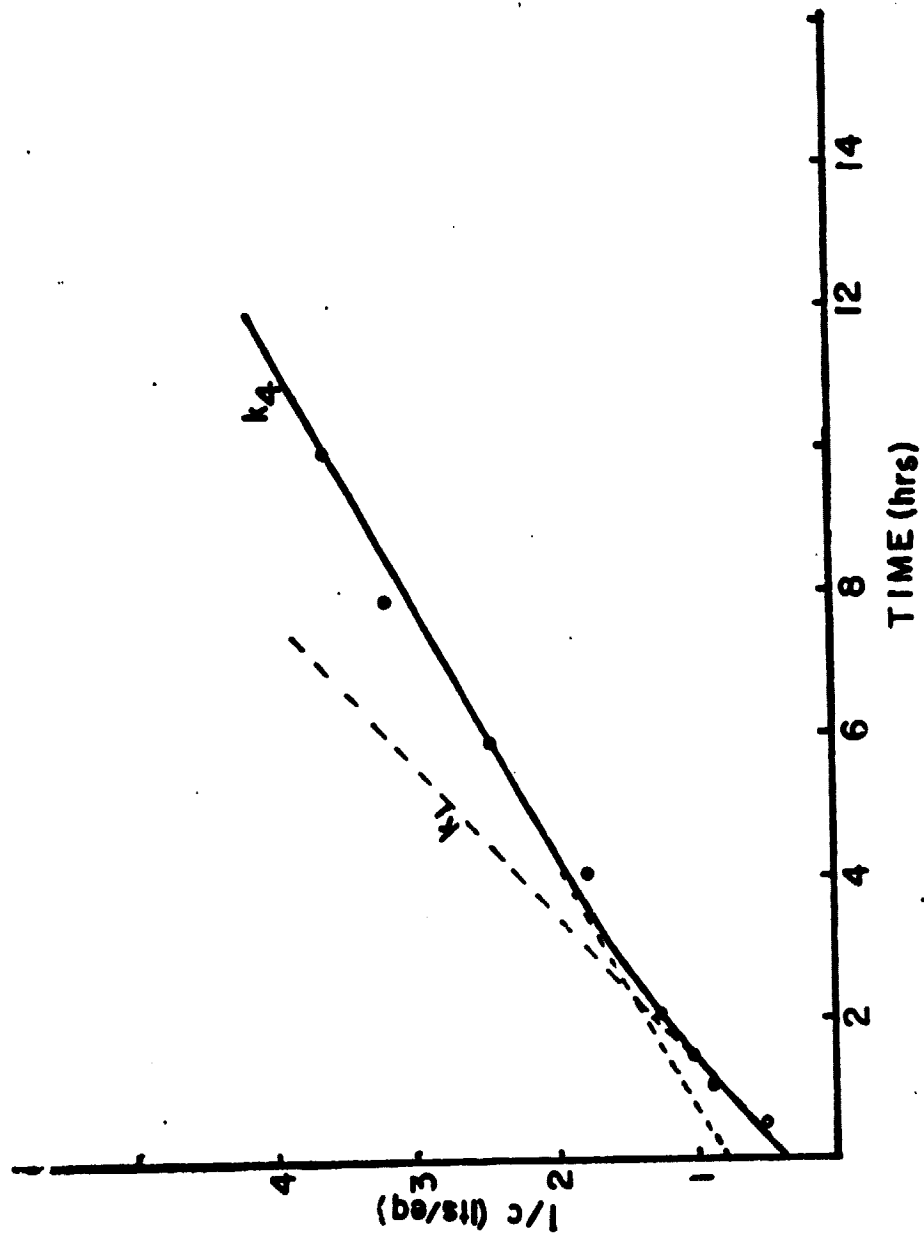


FIGURE 13. KINETIC PLOT OF POLYMERIZATION REACTION OF BISPHENOL-A AND DICHLORODIPHENYL SULFONE (EXPECTED SECOND ORDER PLOT)

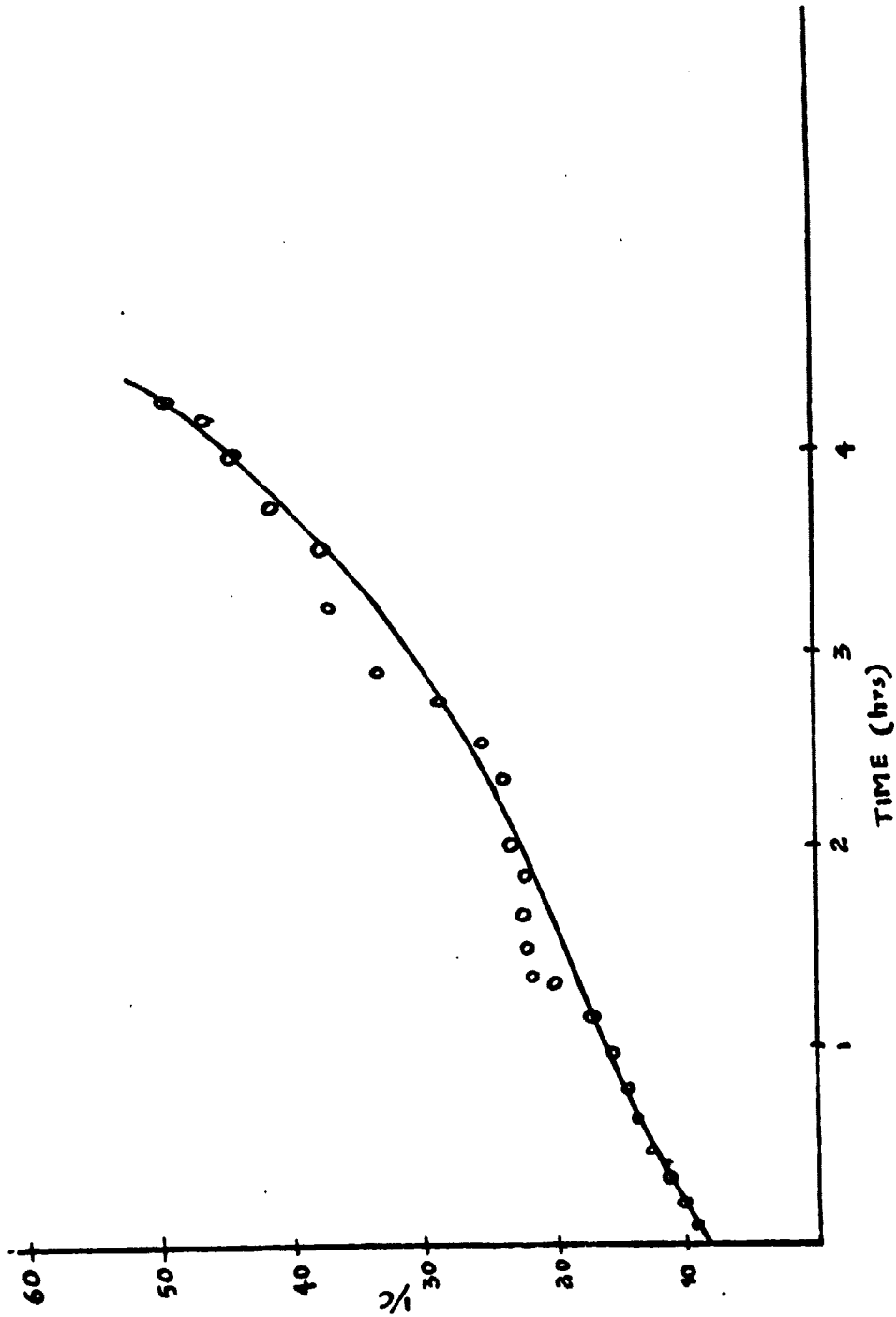


FIGURE 14A. KINETIC PLOT OF POLYMERIZATION REACTION OF BIS-A AND
DICHLORODIPHENYL SULFONE (1/C vs. TIME)

The non-linear nature of the plot suggests that it may not be a second order reaction where $C_A = C_B$. A more meaningful interpretation was sought by plotting C vs. T and taking the slope at various points to obtain the expected differential, dc/dt . The order of the reaction was then obtained by plotting dc/dt vs. C on a log-log scale. The slope of the curve at various C yielded the order of the reaction at the respective concentration C . The order of the reaction for preformed phenoxide at 150°C for various initial concentrations varied from 0.85 to 1.35. See Figure 14B.

As the nature of the reaction seemed complex a model reaction of *p*-(*t*-butyl)phenol, an example of a model monofunctional phenol with dichlorodiphenylsulfone was studied. The reaction conducted in an analogous manner, i.e. preformed phenoxide was reacted with dichlorodiphenylsulfone. A second order plot of $1/C$ versus " t " did not yield a straight line (Figure 15). However, a smooth curve was obtained from a plot of conversion versus time. See Figure 16.

As the expected second order plot was not obtained for both the polymerization (Figure 14B) and the model reaction (Figure 17) at equal concentration of the reactants, it was reasoned that the reactive species (the phenoxide and the halide) were present in non-stoichiometric amounts in the reaction mixture. That is, the phenoxide ion concentration was far less than expected. To verify this, the

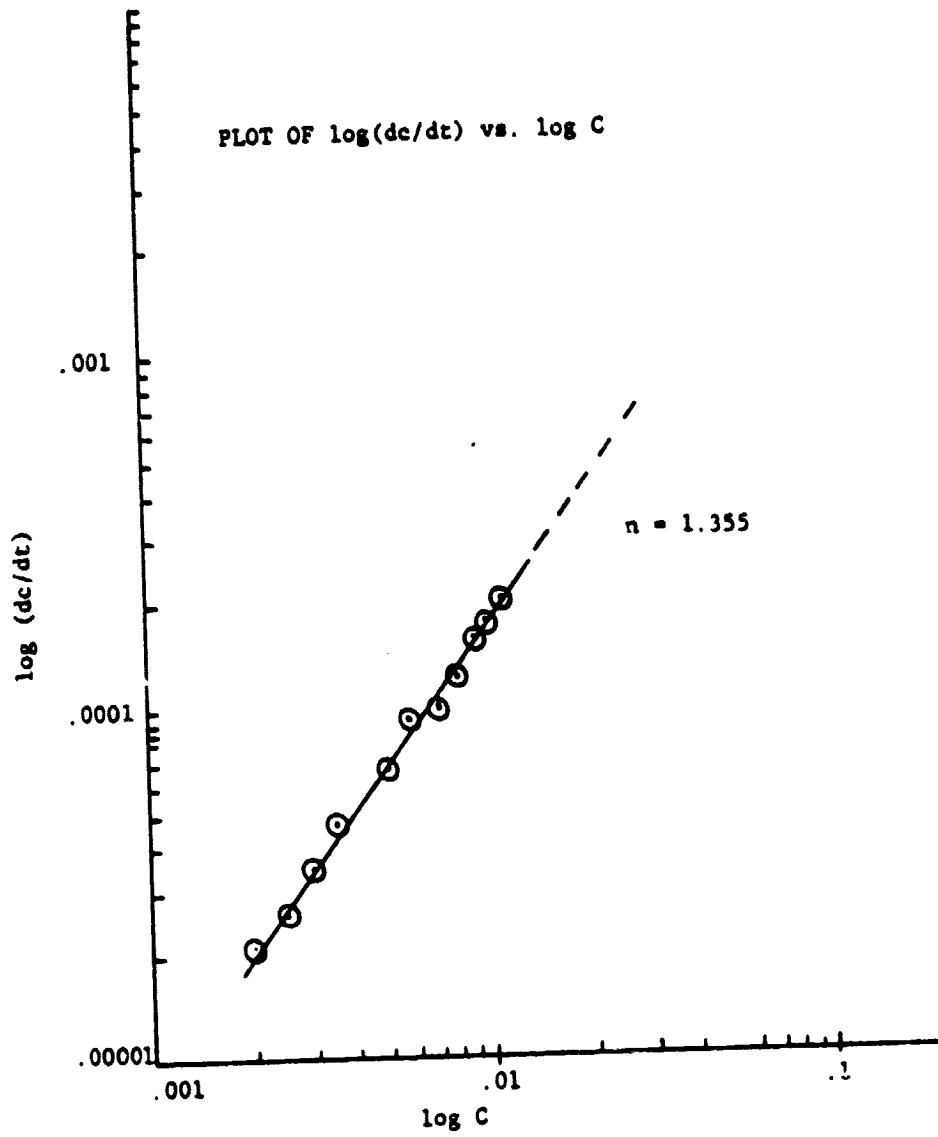


FIGURE 14B. ORDER OF POLYMERIZATION REACTION

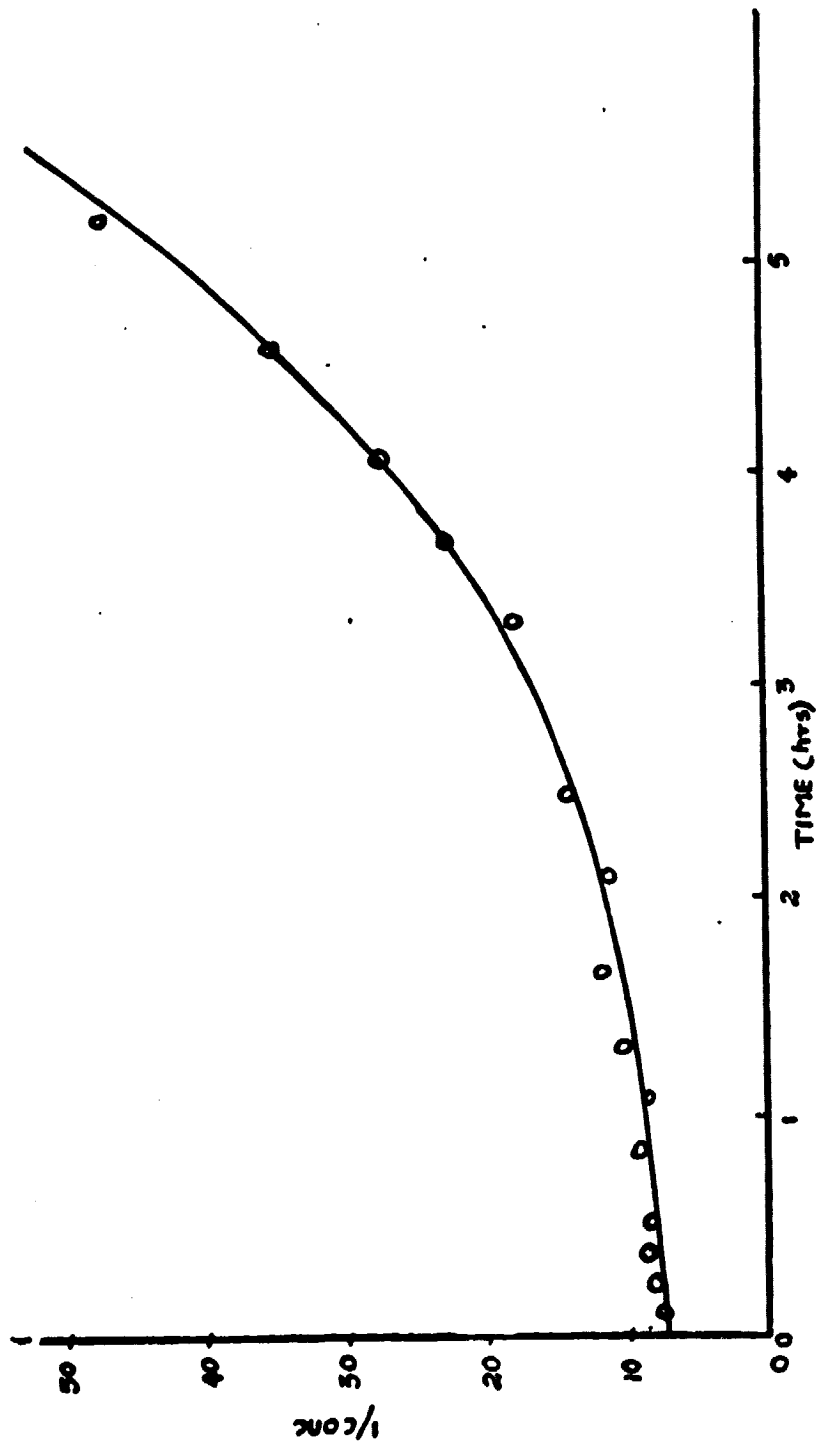


FIGURE 15. KINETIC PLOT OF REACTION OF p-(t-BUTYL)PHENOL AND DICHLORODIPHENYL SULFONE (1/CONC vs. TIME)

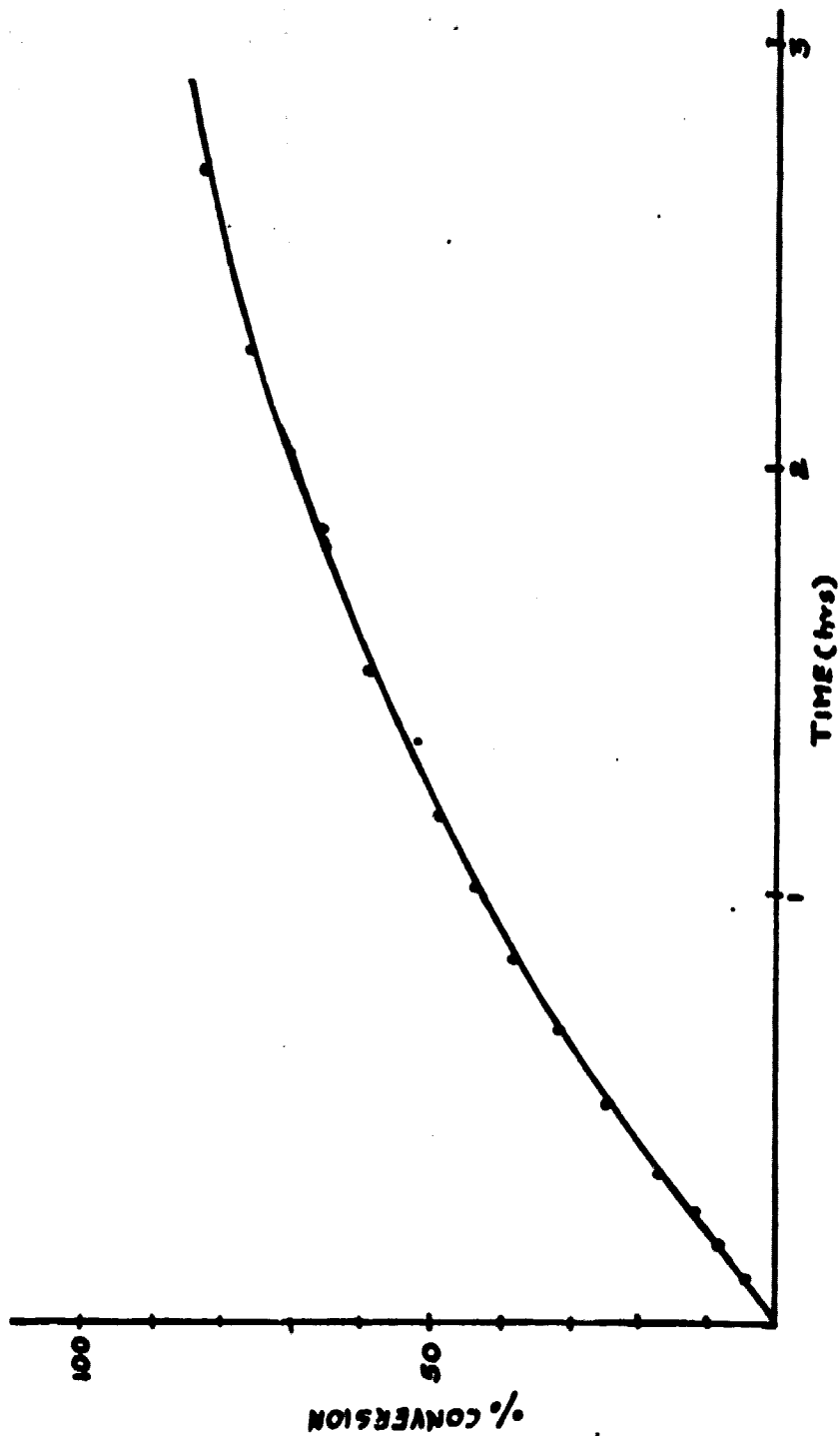


FIGURE 16. KINETIC PLOT OF REACTION OF P-(t-BUTYL)PHENOL WITH DICHLORO
DIPHENYLSULFONE (CONVERSION vs. TIME)

ORIGINAL PAGE 1
OF POOR QUALITY

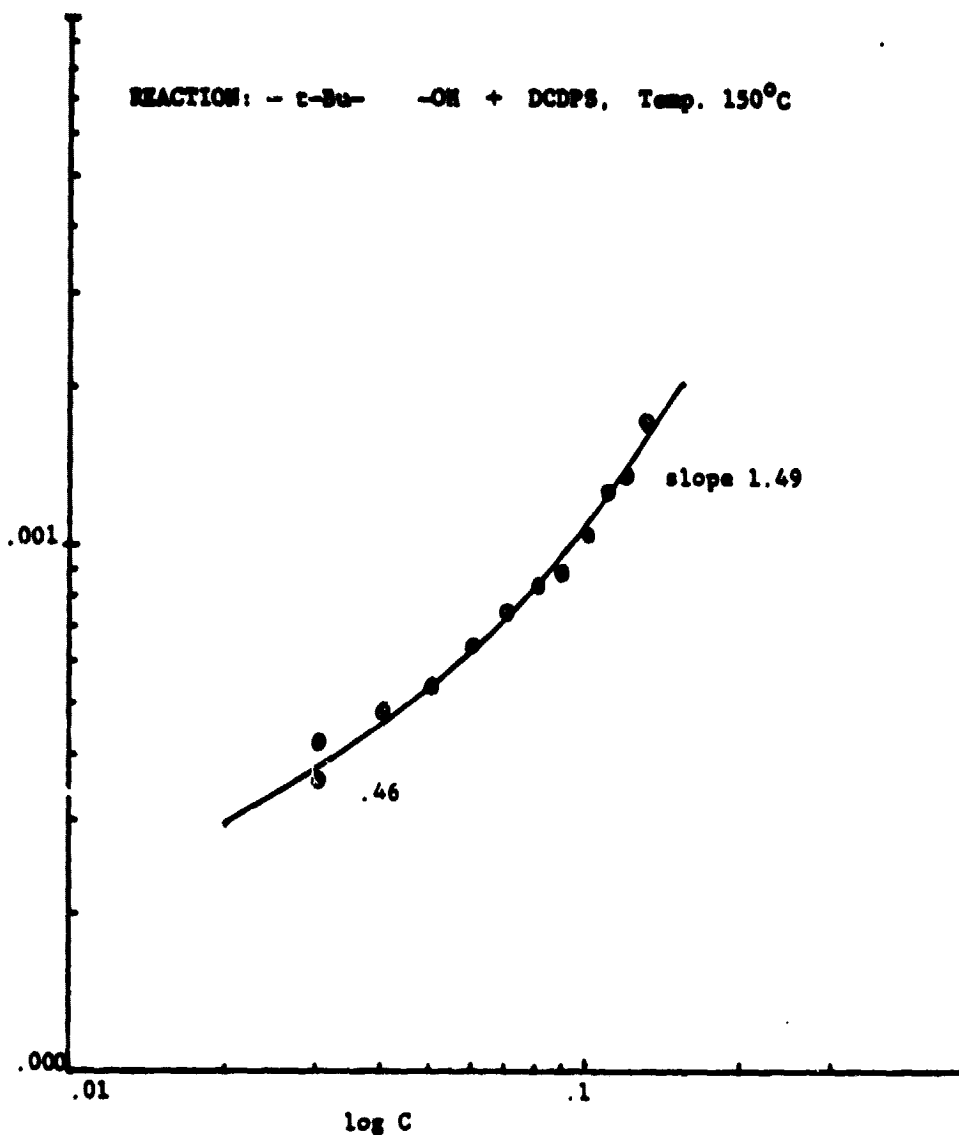
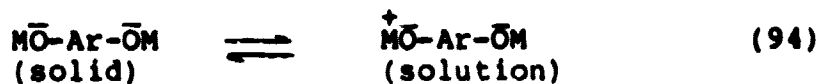
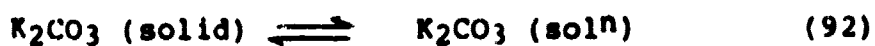


FIGURE 17. ORDER OF REACTION OF p(t-BUTYL)PHENOL AND
DICHLORODIPHENYLSULFONE AT 150°C

concentration of total base in the reaction system at various temperatures were studied as outlined in the experimental section. A plot of total base as a function of temperature is shown in Figure 18. The concentration of total base shows a six-fold increase in solubility (from 0.01 to 0.065 gm eq/liter) as the temperature increases from 130°C to 160°C. Also, the maximum base concentration is 0.07 gm eq/liter at 160°C. As the kinetic study was performed at much higher concentrations than this only a fraction of the total expected phenoxide was present. This could be due to the incomplete formation of the phenoxide caused by the poor solubility of the base under reaction conditions or the insolubility of the diphenoxide formed or both. These possibilities are shown in the equations below:



As DMAC has cation solvating power comparable to DMSO one would expect much higher solubility of the bisphenate than observed. However, under reaction conditions, the azeotropic study shows the presence of a significant portion of the non-polar toluene. This would drastically reduce the solubility of base in DMAC. In addition to the above reactions there is also a rapid acid-base equilibria between phenols and carbonates. Bicarbonate formed by the reaction

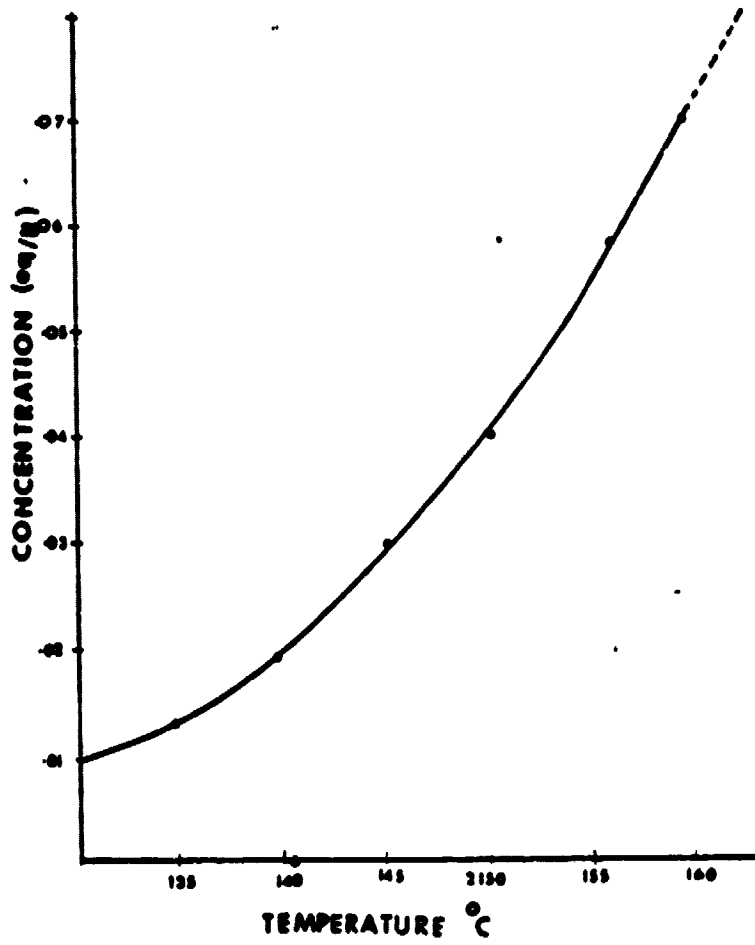
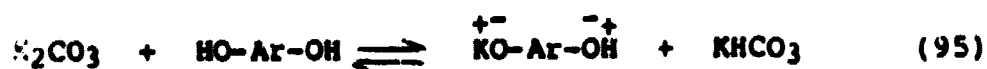
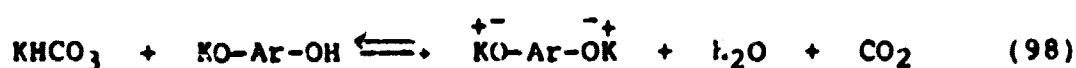
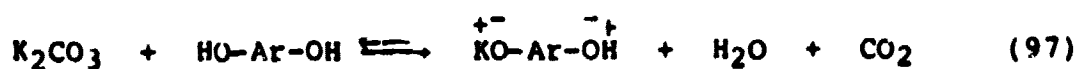


FIGURE 18. CONCENTRATION OF TOTAL BASE AS A FUNCTION OF TEMPERATURE IN DMAC/TOLUENE SYSTEM

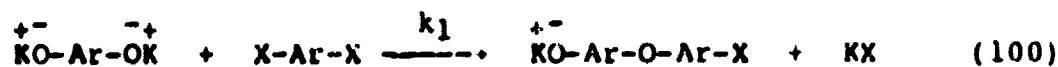
of potassium carbonate and bisphenol can also react with phenol to form phenates. The reaction is accompanied by the evolution of carbon dioxide and formation of water.



The bicarbonate could also undergo decomposition to give carbonate, water and carbon dioxide. The carbonate formed from decomposition of bicarbonate can undergo the same cycle of reactions. The presence of toluene aids the removal of water formed by the reaction of bicarbonates, thus maintaining anhydrous conditions.



Phenoxides formed by the above reactions react with halides to form ether linkages. Due to the greater reactivity of monomers than dimers or oligomers, the following reactions may be envisioned to occur





In the first two reactions the bisphenoxide reacts with monomeric dihalide and a reacted halide respectively. Reaction (102) takes place between an oligomeric phenol and a dihalide. Reaction (103) between an oligomeric phenol and an oligomeric halide truly represents the polymerization reaction. During the initial stages of the reaction, i.e., less than 50% extent of reaction, K^1 , K^2 , and K^3 , will influence the overall observed kinetics. Beyond this point K^4 is the predominant contributor to the observed rate constants. Although K^4 influences only after 50% extent of reaction, from a polymerization point of view only dimer are formed at this stage and the polymerization process has just begun.

Compared to the DMSO/aq NaOH route, this alternate route is nearly 10 times slower. The solubility and acid-base equilibria influence only the concentration of phenoxide and thereby the order of the reaction. The slower reaction rates are due to hydrogen-bonding of the phenoxide with unreacted phenols and the lower dielectric constant of the reaction medium due to the presence of significant amounts of toluene.

From a more practical point of view we have studied the reaction by an in situ method. Here both the monomers and the base were added to the reaction solvent, i.e., the phenoxide was formed in situ. The reaction kinetics were studied at three different temperatures, 140°C, 150°C, and 157°C, respectively. A plot of conversion versus time is shown in Figure 19. Qualitatively one observes that the time taken for 50% extent of reaction to be completed is about 130 minutes, 45 minutes and 25 minutes at 140°C, 150°C and 157°C, respectively. At the end of ten hours at the above condition, the reaction carried out at 157°C produced high molecular weight polymer while the one at 140°C yield only trimer and oligomers. In these cases too the reactions were of fractional order. See Figure 20.

3.2. SYNTHESIS OF POLYSULFONE OLIGOMERS

During the course of investigation several homopolymers of polysulfone were synthesized by the K_2CO_3 /DMAC route as described in the experimental section. Results and discussions of their characteristics are given in this section.

Various number average molecular weight polysulfone oligomers derived from bisphenol-A, bisphenol-T, bisphenol-S and hydroquinone were prepared by using calculated monomer mole ratios. These ratios used were such that the oligomers were always phenoxy terminated. This helped in the characterization of oligomers and also in subsequent

IN-SITU REACTION

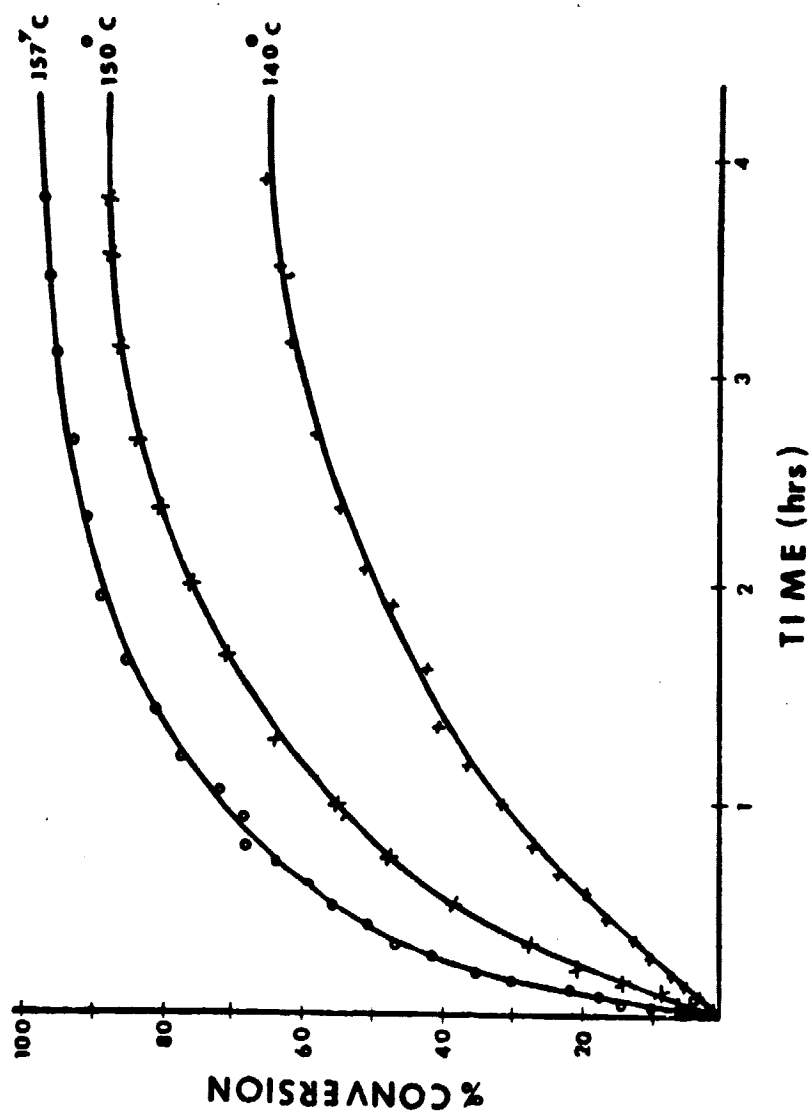


FIGURE 19. KINETICS OF IN-SITU POLYMERIZATION REACTION AT 140°C, 150°C, and 157°C.

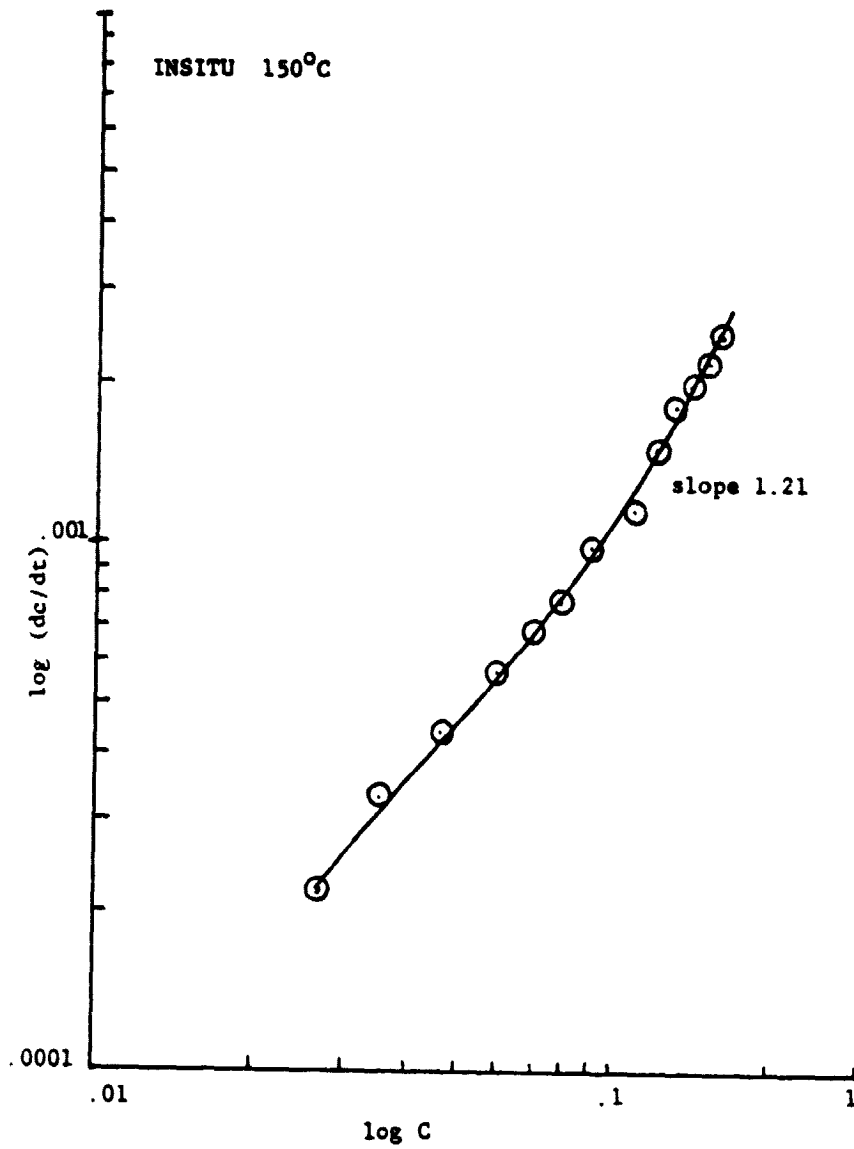


FIGURE 20. ORDER OF POLYMERIZATION REACTION FOR THE INSITU PROCESS

ORIGINAL PAGE IS
OF POOR QUALITY

reactions for the synthesis of block copolymers. The use of a modest excess (10-20%) of anhydrous potassium carbonate did not reduce the intrinsic viscosity of the resultant bis-A polysulfone. Figure 21 shows a plot of intrinsic viscosity (at 25°C in methylene chloride) as a function of mole percent of anhydrous potassium carbonate. Reduction in the intrinsic viscosity due to lack of alkali results in less than calculated amount of phenoxide being formed thereby forming lower molecular weight oligomers.

The IR spectra of all polymers showed peaks at 1245 cm^{-1} characteristic of C-O-C stretching of aryl ether group. Also, doublets in the region of 1280-1320 cm^{-1} resulting from asymmetric O=S=O stretching were observed. Aromatic ring vibrations at 1010 cm^{-1} were consistent with para substituted products. Absorption bands were not found in the regions characteristic of ortho or meta substituted products. Figure 22 shows a typical IR trace of bis-A polysulfone, obtained via the DMAC/ K_2CO_3 route. Table 10 shows the various spectral assignments (288,289).

The NMR spectra of bis-A polysulfone is shown in Figure 23. The protons at 1.7 ppm (TMS=0) are due to the aliphatic protons from the isopropylidene moiety of bisphenol-A. The remaining proton signals are observed in the aromatic region (6.7-8 ppm). For clarity, an expanded aromatic region is shown in Figure 24. The spectrum shows a series of doublets arising from non-equivalent ortho protons as indicated by a typical coupling constant (J value)

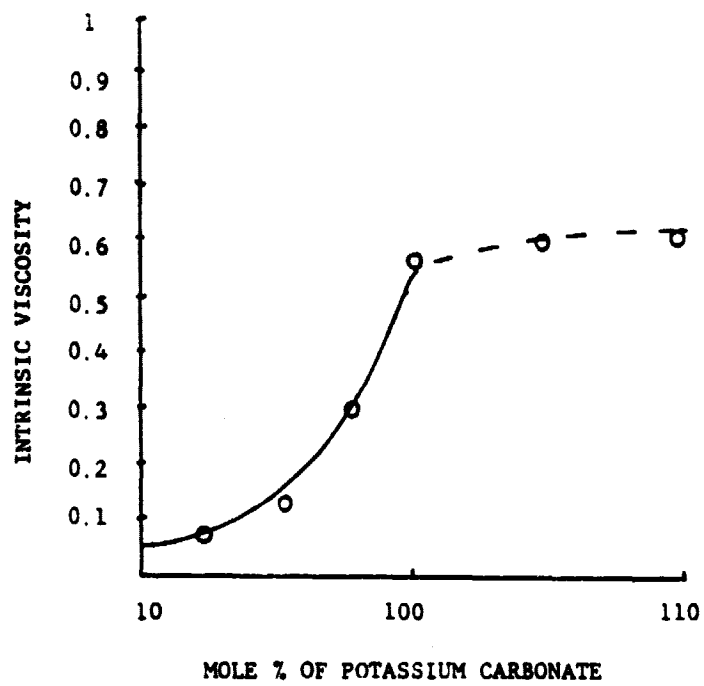


FIGURE 21. EFFECT OF INTRINSIC VISCOSITY AS A FUNCTION OF MOLE % POTASSIUM CARBONATE

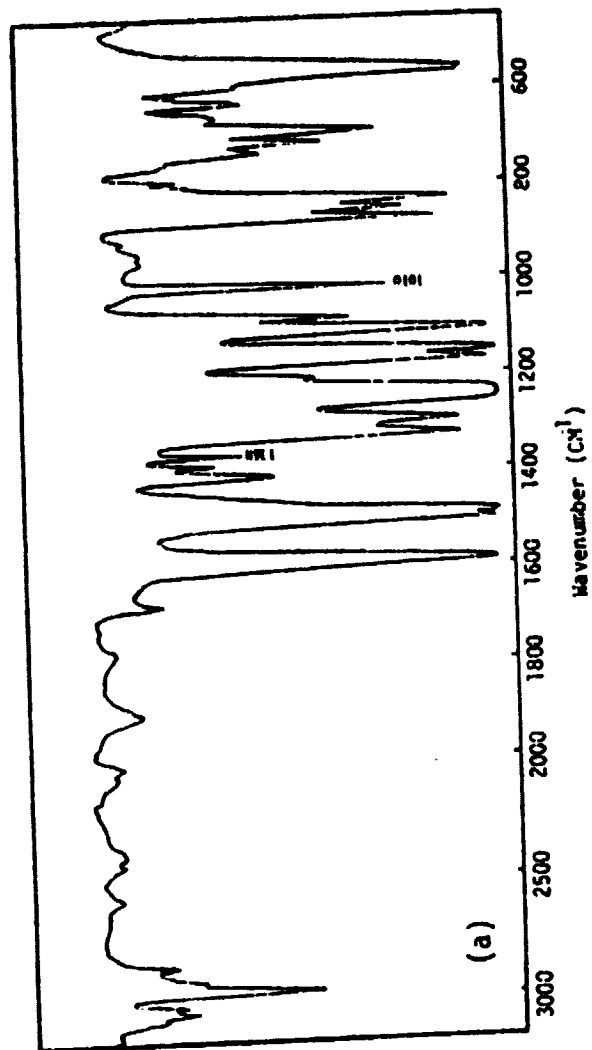


FIGURE 22. IR SPECTRA OF BIS-A POLYSULFONE
OBTAINED BY DMAC/K₂CO₃ PROCESS

TABLE 10
 INFRARED PEAK ASSIGNMENTS FOR POLYSULFONES
 (Ref. 288,289)

Frequency (cm ⁻¹)	Assignments
3310 3200	intermolecularly hydrogen bonded
3078 3052 3040	aromatic C-H stretching
2970	R-H stretch
1610 1577 1510 1465	aromatic C \equiv C stretching
1430	asymmetric C-H bending deformation of methyl group
1390	symmetric C-H bending deformation
1350	in plane O-H bend (these bands result from interaction between O-H bend and C-O stretch
1325 1289	doublet resulting from asymmetric O=S=O stretching

TABLE 10 (con't.)

INFRARED PEAK ASSIGNMENTS FOR POLYSULFONES

Frequency (cm^{-1})	Assignments
1245	asymmetric C-O-C stretching of aryl ether group
1190	C-O stretch
1148	symmetric stretching of O=S=O
1064 993	O=S=O vibration
1010	aromatic ring vibration of p-substituted benzene

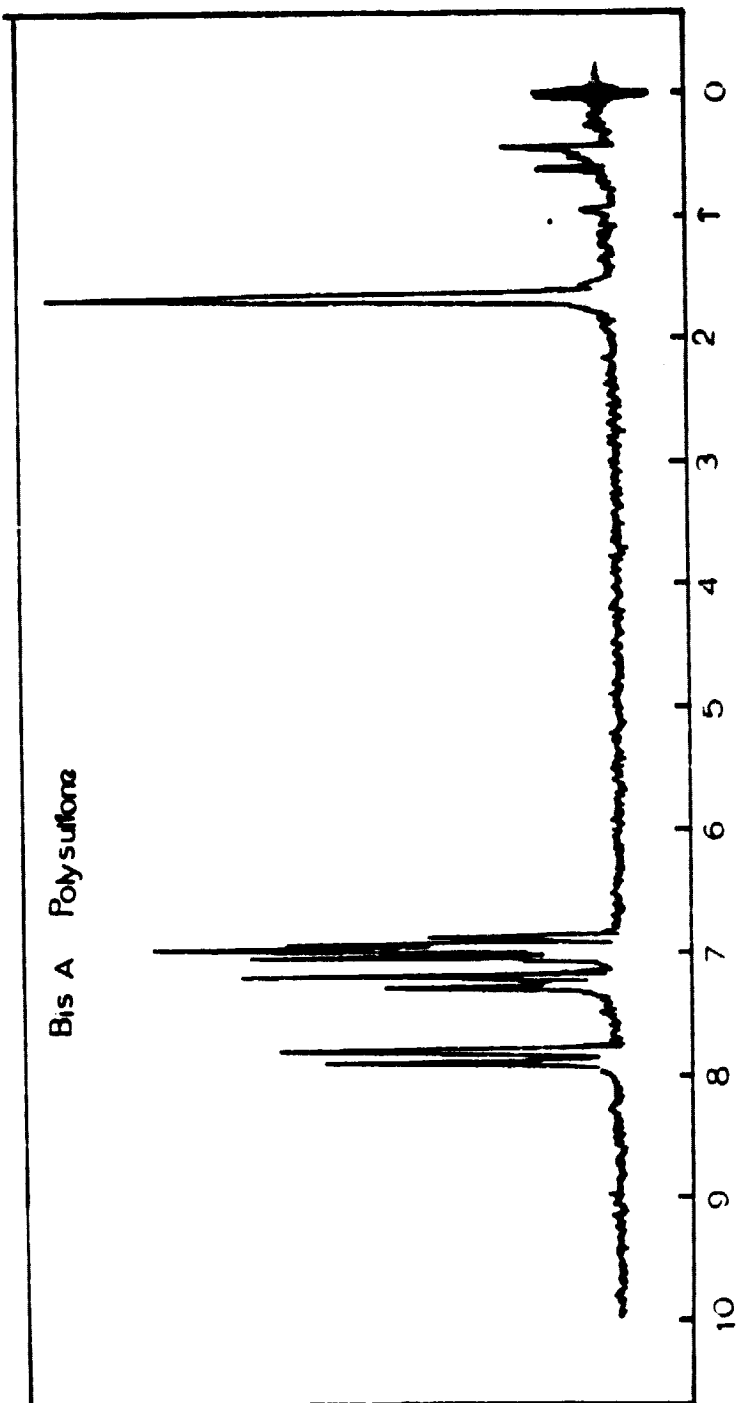


FIGURE 2J. NMR SPECTRA OF BIS-A POLYSULFONE

ORIGINAL PAGE IS
OF POOR QUALITY

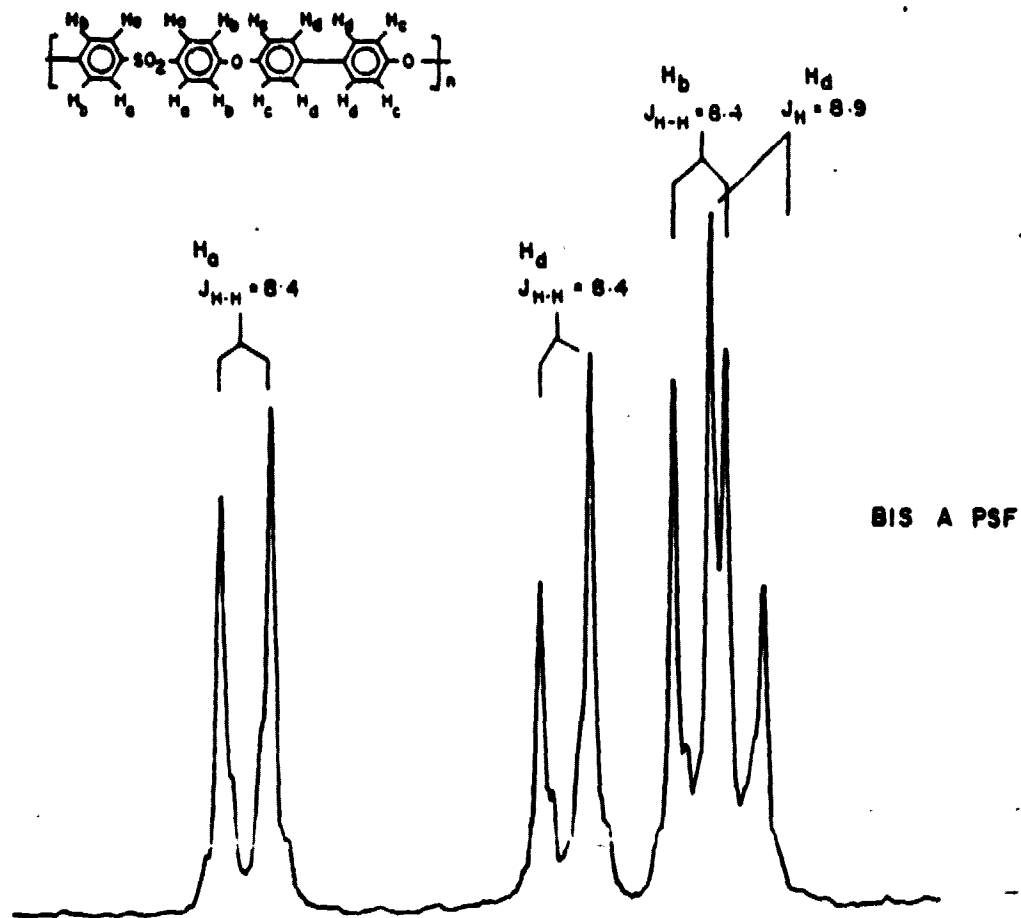


FIGURE 24. PROTON NMR SPECTRA OF BIS A POLYSULFONE
(AROMATIC REGION ONLY)

of 8.2-8.14 d/s. The most downshifted doublet centered around 7.85 ppm (Ha) is due to protons ortho to sulfone. The doublet around 7.25 ppm (He) is due to protons ortho to isopropylidene group and meta to ether linkage. Doublets around 7.00 ppm and 6.92 ppm have been assigned to Hb protons (ortho to ether and meta to sulfone) and Hd protons (ortho to ether and meta isopropylidene). It is very clear from both IR and NMR that the polymer obtained by DMSO/aq NaOH and DMAC/K₂CO₃ are identical.

While bis-T polysulfone could be made in a similar way to bis-A polysulfone, synthesis of bis-S and hydroquinone polysulfone has to be modified. The more acidic bis-S phenol resulted in a lower nucleophilicity and to achieve the desired molecular weight in a reasonable time required the use of relatively higher reaction temperatures or a more reactive dihalide. Sulfolane was used as a high boiling solvent, however, base-contact time was kept short due to a slow base consuming side reactions (154). The reaction could be carried out without much modification by using the more reactive difluorodiphenyl-sulfone instead of the dichloro derivative.

Hydroquinone polysulfone was crystalline and often precipitated out of the solvent under experimental conditions. To overcome this problem the reaction was carried out at a lower concentration (10% wt/vol) in N-methylpyrrolidone at 180°C and filtered hot after completion of reaction.

Since a slight excess of anhydrous potassium carbonate was used for the synthesis, the coagulated polymer was boiled in hot distilled water for a two hours. This minimized the amount of inorganic salts trapped in the polymer. This was specially important as residual potassium carbonate or sulfolane tend to discolor the polymer during compression molding. Since bisphenol-A is known to cleave at high temperatures and pressures in basic conditions (289), it is probable that bis-A polysulfone could degrade during compression milled if care is not taken to neutralize the base.

The number average molecular weight of the oligomers were obtained by potentiometric analysis of the phenolic end groups (281,297). The results are summarized in Table 11. The hydroquinone homopolymer was insoluble in the titration medium and could not be characterized by this method. The results obtained by this technique were comparable to that obtained by dilute solution properties, such as, intrinsic viscosity and vapor pressure osmometry. This was specially so for bisphenol-A polysulfone oligomer as the values of "K" and "a" in Huggins equation in various solvents were known (290). The intrinsic viscosity of hydroquinone polysulfone was measured in o-chlorophenol.

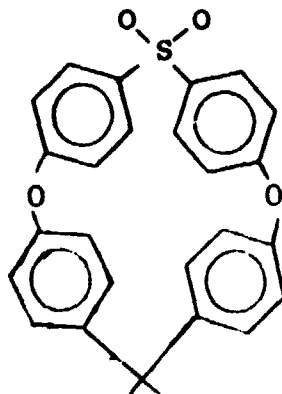
Gel permeation chromatography trace showed a polydispersity of two, characteristic of linear condensation polymers. These results were obtained in comparison to polystyrene standards. In all the chromatogram traces, a

TABLE 11

MOLECULAR WEIGHT (M_n) OF POLYSULFONE OLIGOMERS
BY END GROUP ANALYSIS

POLYMER TYPE	MOLECULAR WEIGHT	
	CALCULATED	OBTAINED
BIS-A POLYSULFONE	2500	2400 \pm 100
	5000	4250 \pm 170
	10000	9000 \pm 300
	25000	25750 \pm 500
BIS-T POLYSULFONE	10000	10250 \pm 50
BIS-S POLYSULFONE	5000	4800 \pm 200
	10000	10250 \pm 200
BIS-A/ $\frac{1}{2}$ POLYSULFONE	20000	17000 \pm 300

small hump was observed at total permeation end of the trace. This has been shown to be due to cyclic dimers (291). The structure of bis-A polysulfone cyclic dimer is shown below:



Glass transition temperatures of the T_g and molecular weight of the oligomers are given in Table 12. T_g values ranged from 180°C for bis-T homopolymer to 231°C for bis-S homopolymer. The thioether in bis-T homopolymer linkage imparts greater chain flexibility compared to the aliphatic carbons of bisphenol-A. The polymer consequently has a lower T_g than bis-A polysulfone. On the other hand the rigid polar sulfone linkage in bis-S polysulfone increases the glass transition temperature of the homopolymers. Only hydroquinone homopolymer shows a crystalline melting point peak at around 310°C (154).

3.3 SYNTHESIS AND CHARACTERISTICS OF POLYSULFONE POLYCARBONATE BLOCK COPOLYMERS

We have been interested in studying the parameter that govern microphase separation in ductile glassy/glassy and

TABLE 12

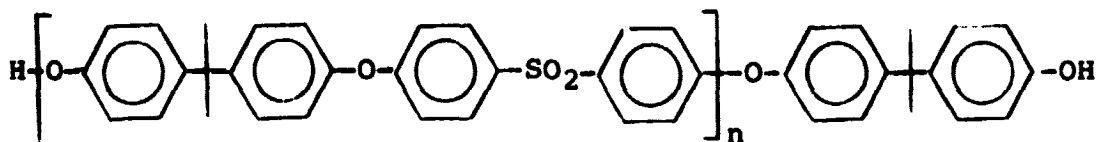
GLASS TRANSITION TEMPERATURE OF POLYSULFONES

OLIGOMER	T_g ($^{\circ}\text{C}$)*
BIS A PSF	190
BIS S PSF	231
BIS T PSF	180
Hq PSF	210**

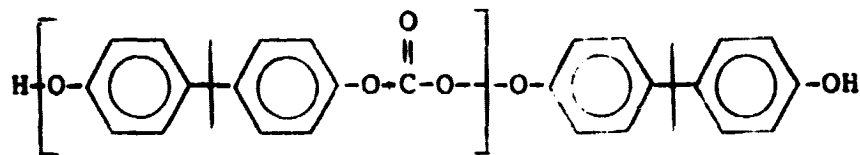
* From Rheovibron at 3.5 Hz.

** From DSC (40 $^{\circ}\text{C}/\text{minute}$), T_m at 310 $^{\circ}\text{C}$ also observed

glassy/crystalline engineering materials. The choice of polycarbonate and poly(arylethers) for initial studies was based on several considerations. Copolymerization is feasible since the end groups in the two oligomers can be identical, as shown in structures 1 and 2.



1



2

Considerable information is available in literature on both homopolymers (292-5). Both polymers are amorphous as prepared, which allows characterization of the polymers and copolymers by solution methods (299). However, the polycarbonate segments subsequently can be crystallized by certain solvents (241). Thus the same copolymer can, in principle, be studied with either a glassy-glassy or glassy-crystalline morphology. Lastly, wide structural variations are possible within the general classes of poly(arylethers) and poly(arylcarbonate) simply by changing

the chemical nature of the bisphenol. These variations, in turn, can be used to model the effect of the "differential solubility parameters" (296) (or other more quantitative expressions) in the development of a multiphase system at constant block molecular weights.

Polycarbonate oligomers were synthesized as outlined in the experimental section. Results of their characterization are given in this section. Potentiometric end group analysis of polycarbonates was not possible due to the instability of the carbonate linkage in the titration medium. However, their number average molecular weights were obtained by UV analysis. Table 13 summarizes the results of the methods used for the molecular weight characterization. The intrinsic viscosities of the polymers at 30°C in THF varied from 0.23-0.53 dl/gm, corresponding to a molecular weight range from 5,000-22,000. The molecular weights were consistent with the calculation. The glass transition temperature of the oligomers increased with increasing molecular weight from 143°C for (5,000) to 158°C (22,000). Thus nearly a fifteen degree difference was obtained in going from 5,000 $\langle M_n \rangle$ to 22,000 $\langle M_n \rangle$. Gel permeation chromatograms of the polymers gave a polydispersity of two. The molecular weights obtained from comparison with polystyrene as well as polycarbonate standards were consistent with those obtained by other methods (297).

The above homo-oligomers were used in the synthesis of block copolymers. The block copolymers were, of course,

TABLE 13

CHARACTERISTICS OF POLYCARBONATE OLIGOMERS

M_n g/mole ^(a)	$[n]_{30^\circ\text{C}}^{\text{THF}}$	T_g ($^\circ\text{C}$) ^(b)
5,000	0.23	143
8,000	0.31	146
10,000	0.32	147
17,000	0.53	153
22,000	0.55	158

(a) UV-visible spectroscopy of the phenol end groups
(see reference 298)

(b) DSC, Perkin-Elmer Model 2, 40°K/min.

multiblock in type with an overall composition adjusted to 1:1 ratio by weight of polysulfone to polycarbonate. For ease of discussion each of the samples has been given a characteristic code to indicate both composition and block lengths (299). The monomers bis-A, bis-T and bis-S are represented as A, T, and S respectively. Polycarbonate and polysulfones are represented by C and S respectively. Thus an oligomer of bis-A polycarbonate is represented as AC, while bis-A polysulfone is represented as AS. A block copolymer consisting of 5,000 g/mole of bis-A polysulfone block coupled with a 5,000 g/mole of bis-A polycarbonate would be designated AS/AC - 5/5. The increased viscosities of the copolymers and the GPC trace indicate the formation of multiblock copolymers.

Based on the above abbreviations, Table 14 shows the thermal characteristics of the seven block copolymers. Figure 25 shows results for copolymer AS/AC - 10/10. A single glass transition is readily apparent at 175°C. In the vicinity of 147°C, a small apparent T_g appeared in some, but not all, samples. Probably this was a result of some residual homopolymer. Recognizing that in these systems kinetic control of domain formation was a possibility, various annealing experiments were conducted. We observe in Figure 25 that repeated annealing of the AS/AC - 10/10 at successively higher temperatures up to 300°C and for 15 minutes in each case followed by a thermal quenching produced no phase separation. In

TABLE 14
GLASSY-GLASSY BLOCK COPOLYMER PROPERTIES
(Ref. 299)

Sample Code	Polysulfone/Polycarbonate Block Molecular Weights, g/mole	Glass Transitions, °C	
		T _g	T _{g,H}
AS/AC-5/5	5000/5000	175	--
AS/AC-10/10	10000/10000	175	--
AS/AC-16/17	16000/17000	--	165 185
AS/AC-26/22	26000/22000	--	162 190
SS/AC-5/5	5000/5000	--	167 229
SS/AC-10/10	10000/10000	--	161 231
TS/AC-10/10	10000/10000	160	--

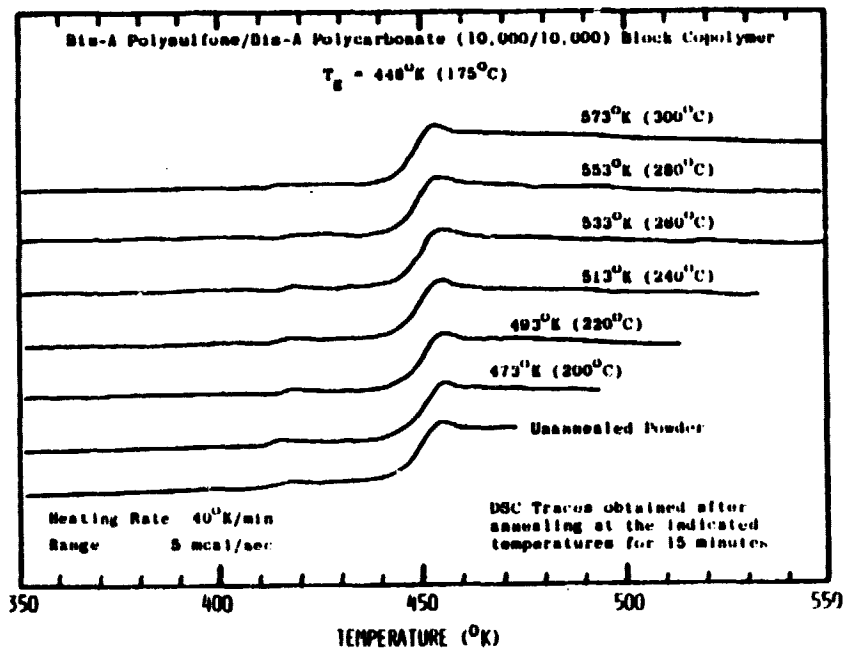


FIGURE 25. DSC THERMOGRAMS OF BIS-A-POLYSULFONE/BIS-A POLYCARBONATE (10,000/10,000) BLOCK COPOLYMER AFTER ANNEALING AT INDICATED TEMPERATURES FOR 15 min. HEATING RATE, 40^oK/min, 5 mcal/sec. (Ref. 299)

ORIGINAL PAGE IS
 OF POOR QUALITY

contrast, the typical thermal behaviour of AS/AC -series two phase solids is represented in Figure 26. In the bottom DSC trace (a), the virgin powder was scanned; only one T_g at 175°C was observed. Just beyond this temperature one notes an exotherm at 207°C, undoubtedly a consequence of crystallization in the carbonate domains of the copolymer. In curve B a one-minute annealing at 220°C followed by quenching produced a sample with latent two-phase behavior. More patient-thermal-annealing treatments at 220°C led to samples where the two glass transitions were readily detected, as illustrated by curves C and D of Figure 26. This clearly indicates the time dependence for formation of microphases (299) in SS/AC copolymers. This series of block copolymers also was investigated in view of determining a critical block length for microdomain formation. In addition, by now examining the same block lengths as in the AS/AC samples above, the opportunity exists to estimate specific interactions influence on phase separation attributable to the large solubility parameter mismatch between blocks. Both 5000/5000 and 10000/10000 average block length materials were studied, however, Figure 26 present data only for the longer block length specimen, as these are representative of the behavior on both samples. A two phase behavior is observed. Again, for the polycarbonate moiety; T_g is elevated (about 15°C) while that of the polysulfone is essentially unperturbed. Although no quantitative conclusions can be drawn, at least the ranges

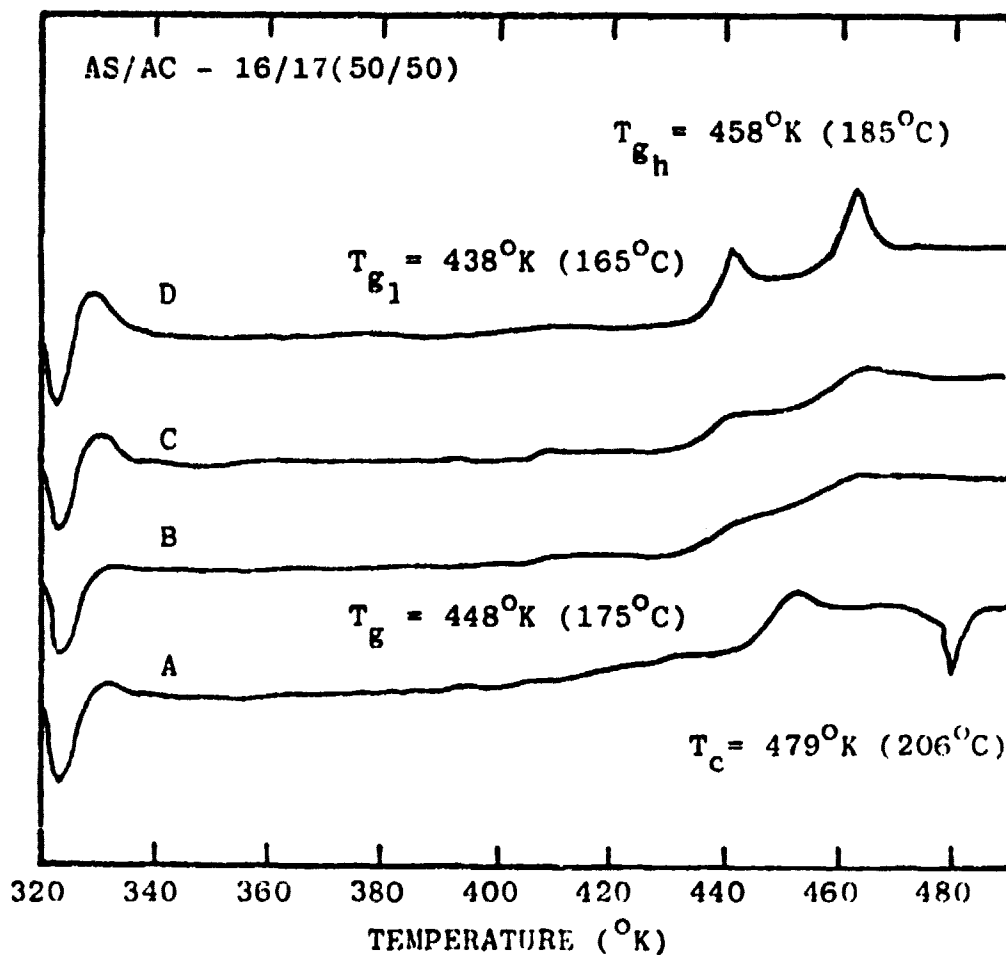


Figure 26. Effect of annealing time (220°C) on the phase behavior of AS/AC-16/17. The DSC traces correspond to (A) dried polymer powder - no pretreatment, (B) annealing 1 minute followed by quenching to 50°C , (C) annealing 30 minutes followed by quenching to 50°C , and (D) annealing 30 minutes followed by slow cooling at $1.25^{\circ}\text{C}/\text{min.}$ to 50°C . (Ref. 297,299)

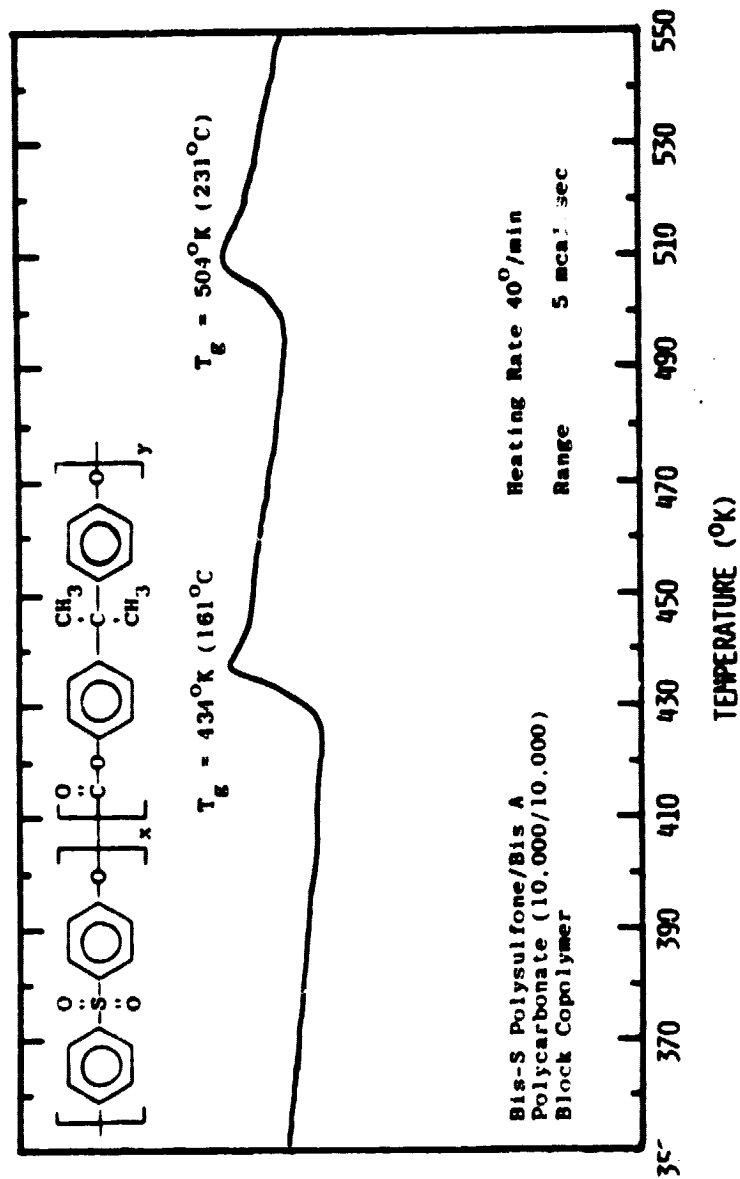


FIGURE 27. DSC THERMOGRAM FOR BIS-S-POLYSULFONE/BIS-A-POLYCARBONATE (10,000/10,000) BLOCK COPOLYMER. HEATING RATE, $40^{\circ}\text{K}/\text{min}$. RANGE, 5 mcal/sec. (Ref. 297,299)

of domination of the two effects, block length and chemical composition, are better defined by comparison of the SS/AC with the AS/AC polymers. Roughly, one third increase in molecular weight was required of the AS/AC -10/10 sample to achieve the phase segregation demonstrated by blocks of one length but differing by two solubility parameter units instead of 0.7 units.

TS/AC COPOLYMERS. As a final composition variation within the 50/50 overall weight-percent framework, tests were run on copolymers based on the bisphenol-T polysulfone oligomer. Recall that this oligomer has a solubility parameter equal to that of the bisphenol-A polysulfone. Only the 10000-10000 g/mol block-size material has been studied. The Figure 28 shows clearly a single transition at 159°C, intermediate between the 140°C and 180°C homopolymer T_g s, as one would expect from a 50/50 copolymer (299).

Perfectly alternating polysulfone polycarbonate copolymer. The glass transition temperature of one phase copolymer system of polysulfone/polycarbonate was reported (297) to be higher than that predicted by the Fox equation. This deviation was more prominent for smaller block lengths. It was reasoned that for smaller block lengths the number of junction points would be much greater and deviation could occur due to their intrinsic nature (higher T_g than the average of the two). To verify this required the synthesis of a copolymer with minimum block length (one unit) and thus maximum junction points of hetero linkage

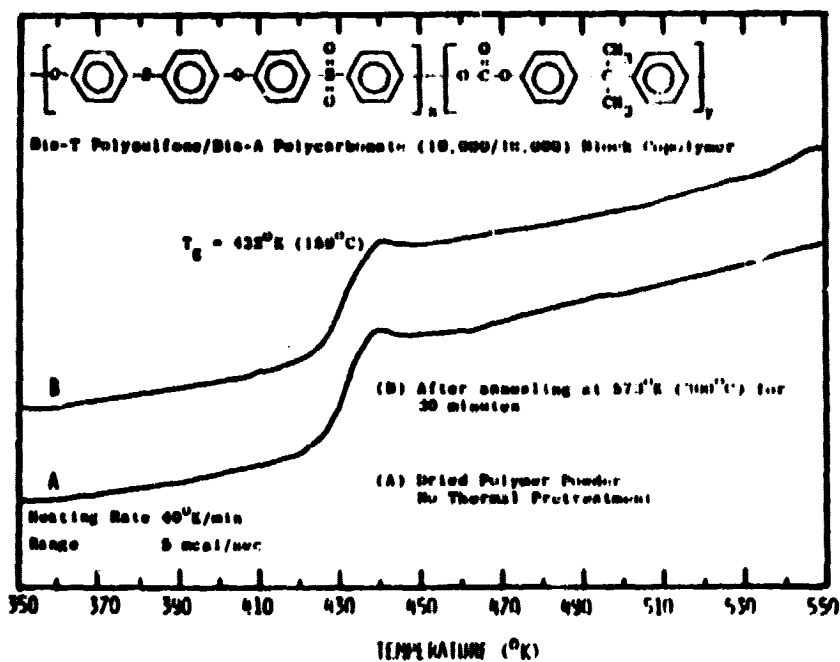


FIGURE 28. DSC THERMOGRAM FOR BIS-T-POLYSULFONE/BIS-A-POLYCARBONATE (10,000/10,000) BLOCK COPOLYMER. HEATING RATE, 40^oK/min. RANGE, 5 mcal/sec, (A) AFTER ANNEALING AT 573^oK (300^oC) FOR 30 MIN, (B) DRIED POLYMER POWDER, NO THERMAL PRE-TREATMENT. (Ref. 297,299)

ORIGINAL PAGE
OF POOR QUALITY

and measure its glass transition temperature. Therefore, a perfectly alternating copolymer was synthesized and its properties studied. See Table 15. The molecular weight by G.P.C. was estimated to be around 60,000. The glass transition temperature of the copolymer measured at 40°C/minute was observed at 180°C. This was indeed more than 5-15°C higher than the average of the two homopolymers thereby confirming the effect of sequence distribution on the T_g of the copolymer. However, rate effects may also be important.

3.3.1 ESCA MEASUREMENTS

The experimentally determined stoichiometries of the homopolymers and block copolymers are given in Table 16 along with the binding energies at which the ESCA peaks appeared. The main carbon 1s photopeak was corrected to 285.0 eV from which shifts due to charging was determined. This allowed adjustment of the other binding energies in the respective spectra.

The oxygen and carbon ESCA peaks for polycarbonate are presented in Figure 29. Both peaks are gaussian shaped approximating the "ideal" ESCA photoelectron peak shape. The broad oxygen peak indicates at least two kinds of oxygen photoelectrons arising from different chemical environments. In examining the polycarbonate structure, it is clear that the oxygen peak arises from the carbonyl oxygen (C=O) and oxygen singly bonded to carbon. The fact that these oxygens are both bonded to carbon are not widely

TABLE 15
 CHARACTERISTICS OF AN ALTERNATING POLYSULFONE
 POLYCARBONATE MODEL COPOLYMER

INTRINSIC VISCOSITY IN METHYLENE CHLORIDE	1.10 g/dl
M_n FROM GPC	60,000
GLASS TRANSITION TEMPERATURE	180°C
SOLUBILITY (A)	
DIMETHYLFORMAMIDE	S
DIMETHYLSULFOXIDE	S
METHYLPYRROLIDONE	S
DIMETHYLACETAMIDE	S
TETREHYDROFURAN	S
DICHLOROMETHANE	S
1,2-DICHLOROETHANE	S
TETRA-CHLOROETHANE	S
ISOPROPANOL	I

(A) SOLUBILITY AT 5 WT %

S = SOLUBLE I = INSOLUBLE

C-3

TABLE 16
ESCA STUDIES

POLYMERS	CARBON 1S		OXYGEN 1s		SULPHUR 2P				
	<u>B-E</u>	<u>Exp</u>	<u>Calc</u>	<u>B-E</u>	<u>Exp</u>	<u>Calc</u>			
Polysulfone Homopolymer [PSF-A]	285.0	0.89	0.84	534.7	0.09	0.13	169.4	0.02	0.03
Polycarbonate Homopolymer [PCG-A]	285.0	0.89	0.84	535.0	0.11	0.16	--	--	--
Polysulfone Polycarbonate Copol. 5K PSFA - PCO - A	285.0	0.75	0.84	531.8	0.25	0.13	NO PEAK OBSERVED	NO PEAK OBSERVED	0.03
Polysulfone Polycarbonate -[20K PSF-A]-PCO-A	285.0	0.79	0.84	532.8	0.21	0.13	NO PEAK OBSERVED	NO PEAK OBSERVED	0.03
Hydroquinone-Bis A Polysulfone (30%)	285.0	0.840	0.83	532.7	0.14	0.14	168.4	.03	0.04

POLYCARBONATE

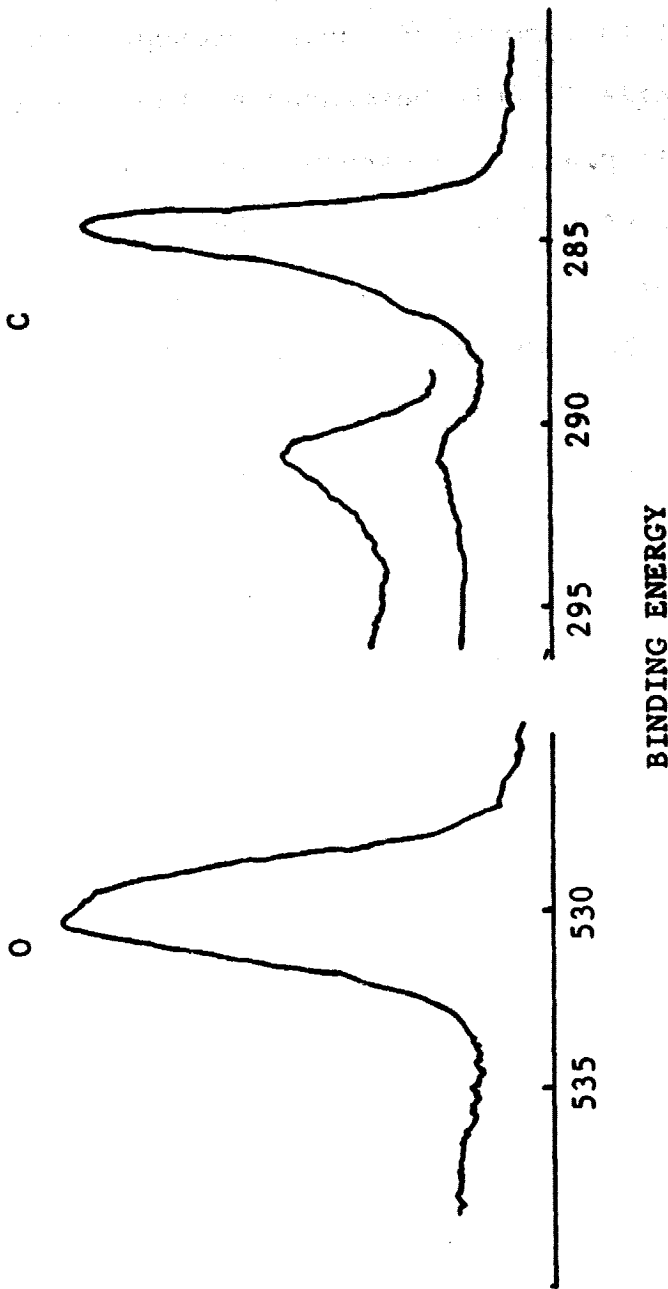
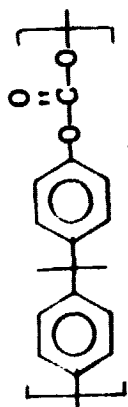


FIGURE 29. ESCA SPECTRA OF BIS-A POLYCARBONATE

ORIGINAL PAGE IS OF POOR QUALITY

dissimilar in electronegativity explains the closeness of the binding energies of each photoelectron line giving rise to the single broad convoluted peak. One would expect that in this situation the height measurement would underestimate the total amount of oxygen present, since it would essentially only be measuring the intensity arising from a single peak. The carbon peak shows a low intensity shake-up satellite due to the aromaticity of benzene in the polymer.

The ESCA spectrum for bis-A polysulfone is shown in Figure 30. The shake up satellite at 294 (eV) arises from the unsaturation of the aromatic ring. The oxygen peak at 534.7 eV is much broader and is the result of two different oxygen environments, e.g. C-O-C and O=S=O. The small shake up satellite is due to the double bonded oxygen with sulfur. In addition to these peaks which were also observed in polycarbonate, there is another peak at a binding energy of 169.4 eV due to sulfur. The observed stoichiometry is consistent with that calculated. In both cases the observed carbon content is slightly higher than that calculated.

Figures 31 and 32 present the spectra of one and two phase polysulfone/polycarbonate block copolymers. Surprisingly no sulphur-peak was observed even at very high sensitivity, thus indicating a predominantly polycarbonate surface even for a bulk-single phase system. This surface segregation, we believe is due to the difference in the

BIS-A POLYSULFONE

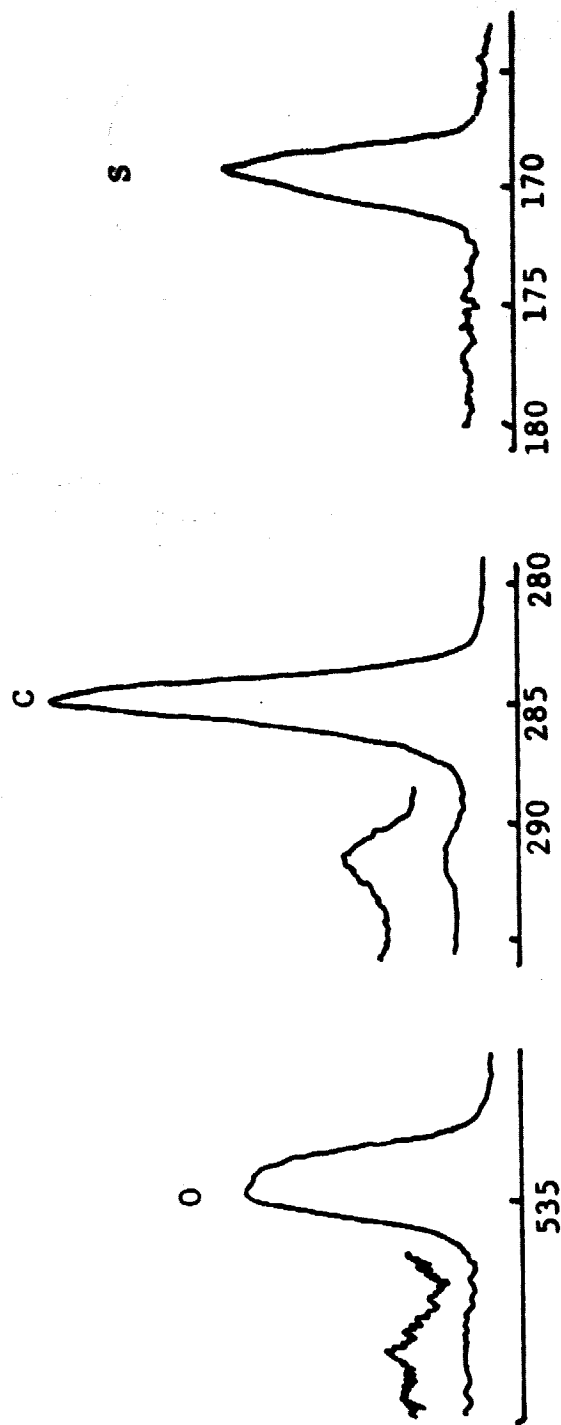
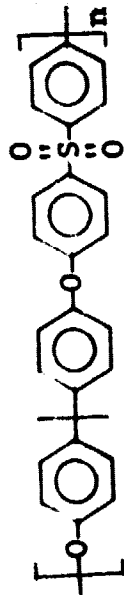


FIGURE 30. ESCA SPECTRA OF BIS-A POLYSULFONE

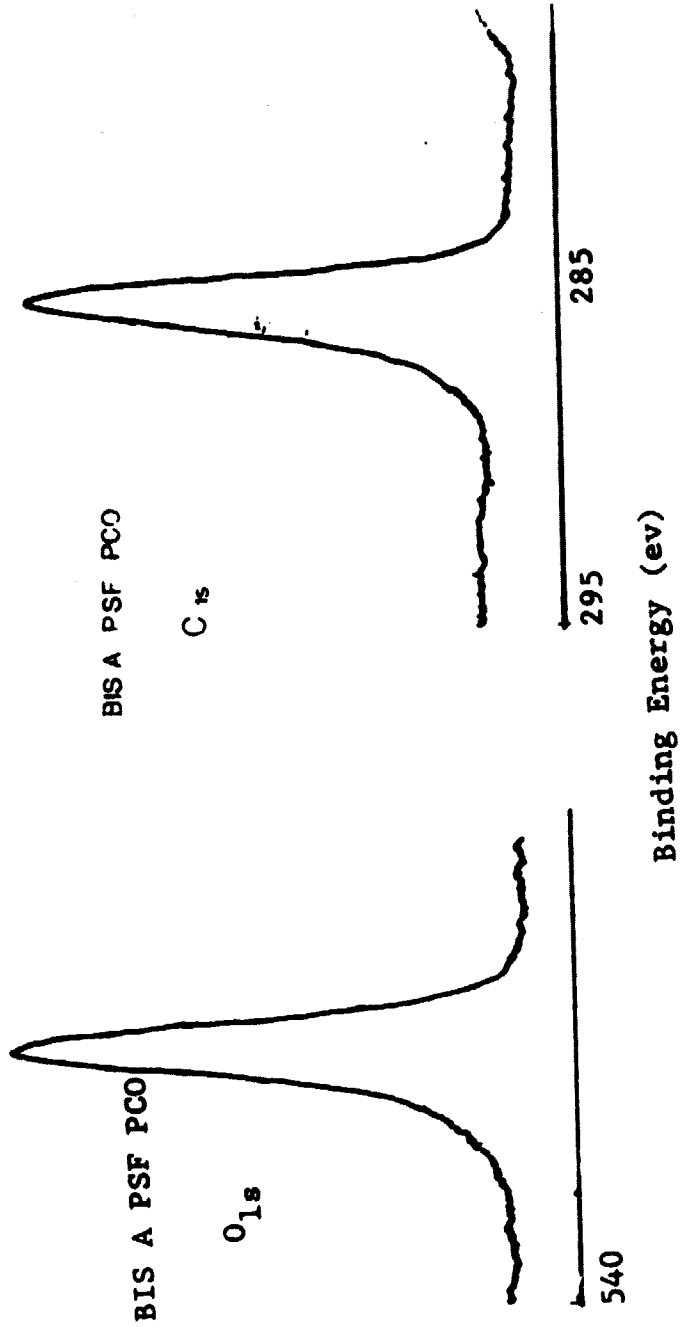


FIGURE 31. BLOCK COPOLYMER (10K-10K)

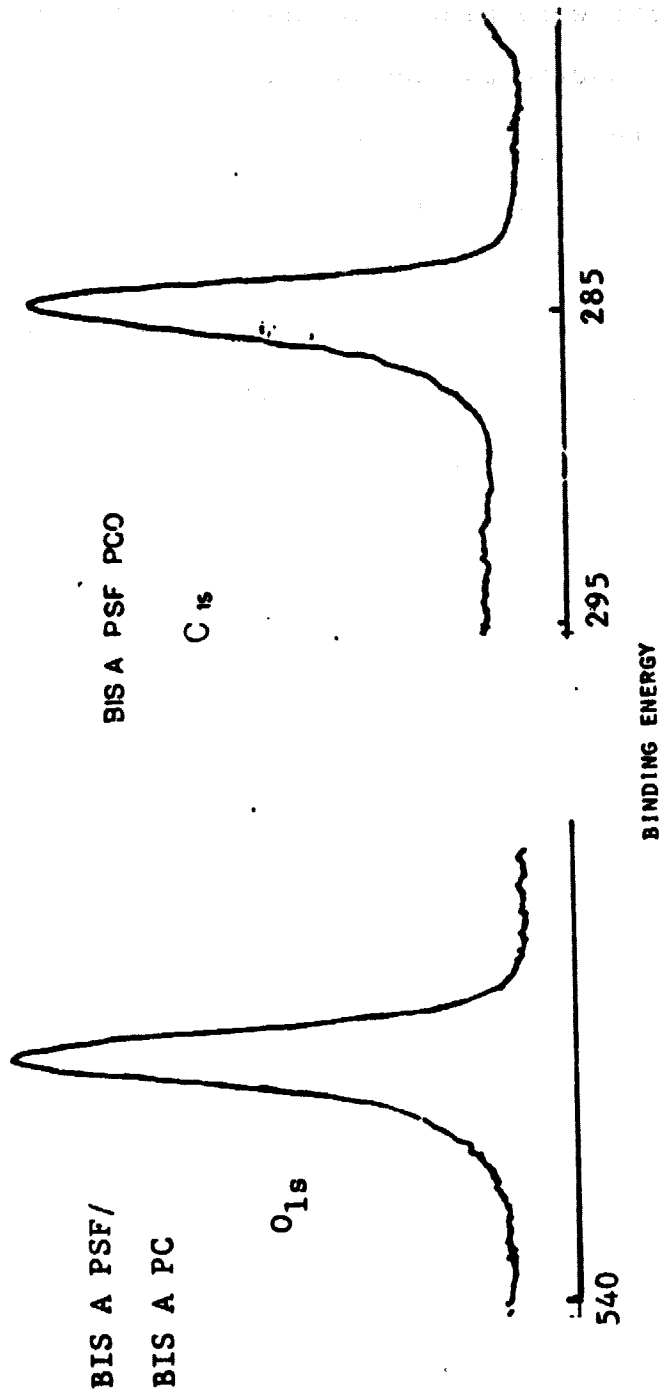


FIGURE 31. ESCA SEPECTRA OF PSF-PC BLOCK COPOLYMER (10,000-10,000)

critical surface tensions of polysulfone (300) and polycarbonate (301), being 41 and 34.5 respectively. To confirm this quantitatively, films of homopolymers and copolymers were cast on a glass plate. Several (4-5) distilled water droplets were placed on the dry film and their contact angle observed by the tilting plate method. The water droplets on the copolymer film and the polycarbonate homopolymer had about the same contact angle and differed from that of the polysulfone homopolymer. This confirmed that surface segregation occurred even for a bulk single phase material. These data suggest that in general, one should expect the surface properties of the lower surface energy segment in a block copolymer.

3.4 HYDROQUINONE/BIS-A SULFONE "RANDOM COPOLYMERS"

Poly(arylene ether sulfones), as mentioned in the introductory section, possess good mechanical and thermal properties. These properties in combination with their excellent stability (hydrolytic, dimensional and thermal) allows these polymers to be used under demanding service conditions over a wide range of temperatures. However, in the presence of a solvent they are known to catastrophically fail while under stress. This has been attributed to their rigid amorphous nature. Typically, the behavior is illustrated in Figure 32. Examples of plastics which behave in this manner include AS impact polystyrene, polycarbonates, polyphenylene oxide and aromatic polyethers.

It was reasoned that the introduction of a second crystalline component would lead to vastly improved material performance. Such a system possessing an A-B-A structure in which the respective blocks are a polysulfone (PSF) and nylon 6 (N6) is schematically depicted in Figure 33. The presence of more than 25% crystalline nylon 6 resulted in an overall enhanced solvent and stress crack resistance (307). This is shown in Figure 34 in which a one minute rupture time vs. applied stress in an acetone environment is plotted.

Although good solvent resistance was obtained, the hydrophilic nature of nylon 6 had undesirable effects on the mechanical and electrical properties of the polymer. To overcome this problem required the use of a second crystalline component of comparable hydrophilicity or hydro-phobicity as polysulfone. A good starting point was to use a semi-crystalline polymer from the polyarylether family. Hydroquinone polysulfone homopolymer obtained by DMSO/NaOH was reported to be semi-crystalline (154). We thus thought it would be of interest to study the new copolymers derived from the reaction of bis-A and hydroquinone with dichlorodiphenylsulfone. The copolymers were synthesized as outlined in the experimental section. The results of their characterization and properties are given in this section.

The intrinsic viscosity of the copolymers was studied in halogenated hydrocarbon or THF at 25°C. The intrinsic

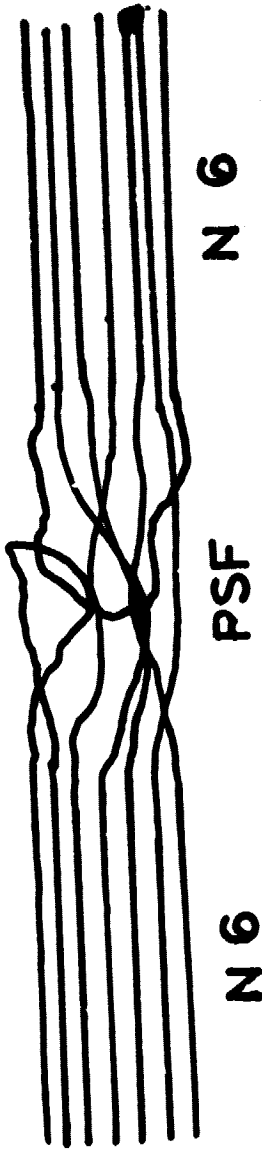


FIGURE 33. SCHEMATIC REPRESENTATION OF NYLON-6 POLYSULFONE
BLOCK COPOLYMER (Ref. 2)

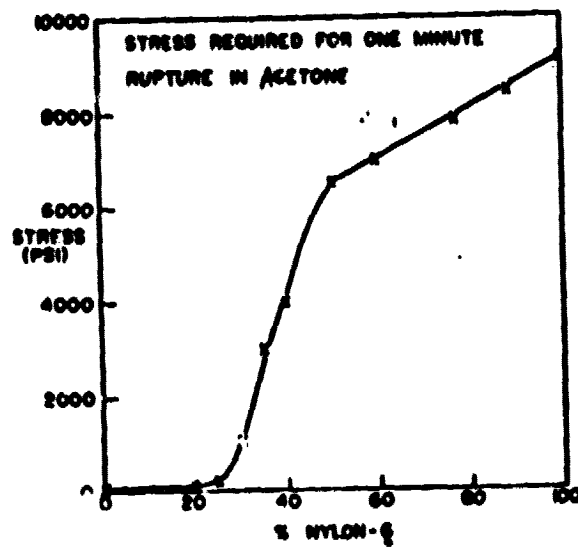


FIGURE 34

Stress Level Required for One Minute Rupture in Acetone Versus Nylon-6 Composition

(Ref. 307)

ORIGINAL PAGE IS
OF POOR QUALITY

viscosity of the copolymers along with their T_g 's is given in Table 17. The intrinsic viscosities varied from 0.38-0.78 dl/gm in methylene chloride at 25°C. The lower intrinsic viscosities resulted due to non-stoichiometric amounts of monomers. To have a rough idea of the number average molecular weight, the copolymer with the lowest intrinsic viscosity was potentiometrically titrated (281) and calculated to be 17,000 daltons. The hydroquinone polysulfone homopolymer was insoluble in all halogenated solvents, so its intrinsic viscosity was measured in orthochlorophenol. As the "K" and "a" values of the Huggins constant were not available it was not possible to obtain the $\langle M_v \rangle$ by intrinsic viscosity. Gel permeation chromatography of the copolymers showed a gaussian distribution. The elution volumes were obtained in the range of 20,000-40,000 $\langle M_n \rangle$, compared to polystyrene standards. All the G.P.C. traces had a characteristic small hump near the total permeation end. As mentioned earlier this is due to the cyclic dimers (Figure 35).

Thermal behavior of the copolymers were studied in a D.S.C. cell (see Figure 36). The glass transition temperature was obtained from the second run. The T_g 's ranges from 185°C for pure bis-A homopolymer to 210°C for pure hydroquinone homopolymer. In all cases the copolymer T_g was much higher than that calculated by the Fox equation. (See Figure 37). Stress-strain properties of the copolymers are shown in Table 18. The Young's modulus of the samples

TABLE 17

INTRINSIC VISCOSITY AND GLASS TRANSITION TEMPERATURES OF
HYDROQUINONE/BISPHENOL A POLYSULFONE COPOLYMERS

Mole Fraction Reactant			[η] CH ₂ Cl ₂ 25°C	T _g **
Hydroquinone	BIS-A	DCDPS		
5	95	98	0.35	187
10	90	99	0.42	193
15	85	99	0.58	195
20	80	99	0.51	196
30	70	99	0.48	197
50	50	98	0.43	200
75	25	100	0.67	203
85	15	100	0.71	204
90	10	100	0.69	205
100	0	100	0.85*	207***

* o-chlorophenol

** DSC 40°K/min, P-E Model 2

*** T_m OF 310°C also observed

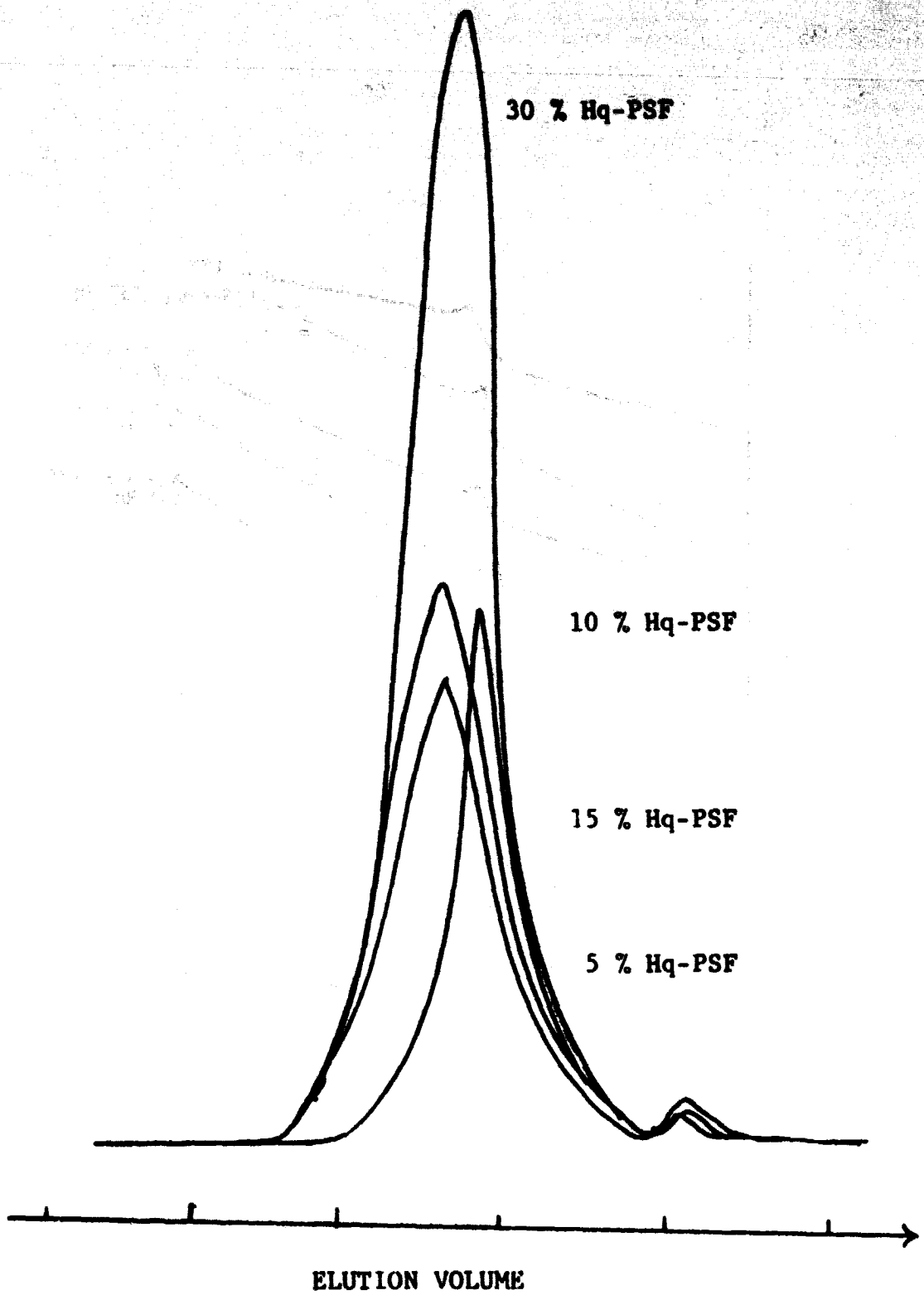


FIGURE 35.GPC TRACE OF BIS-A/Hq-PSF COPOLYMERS

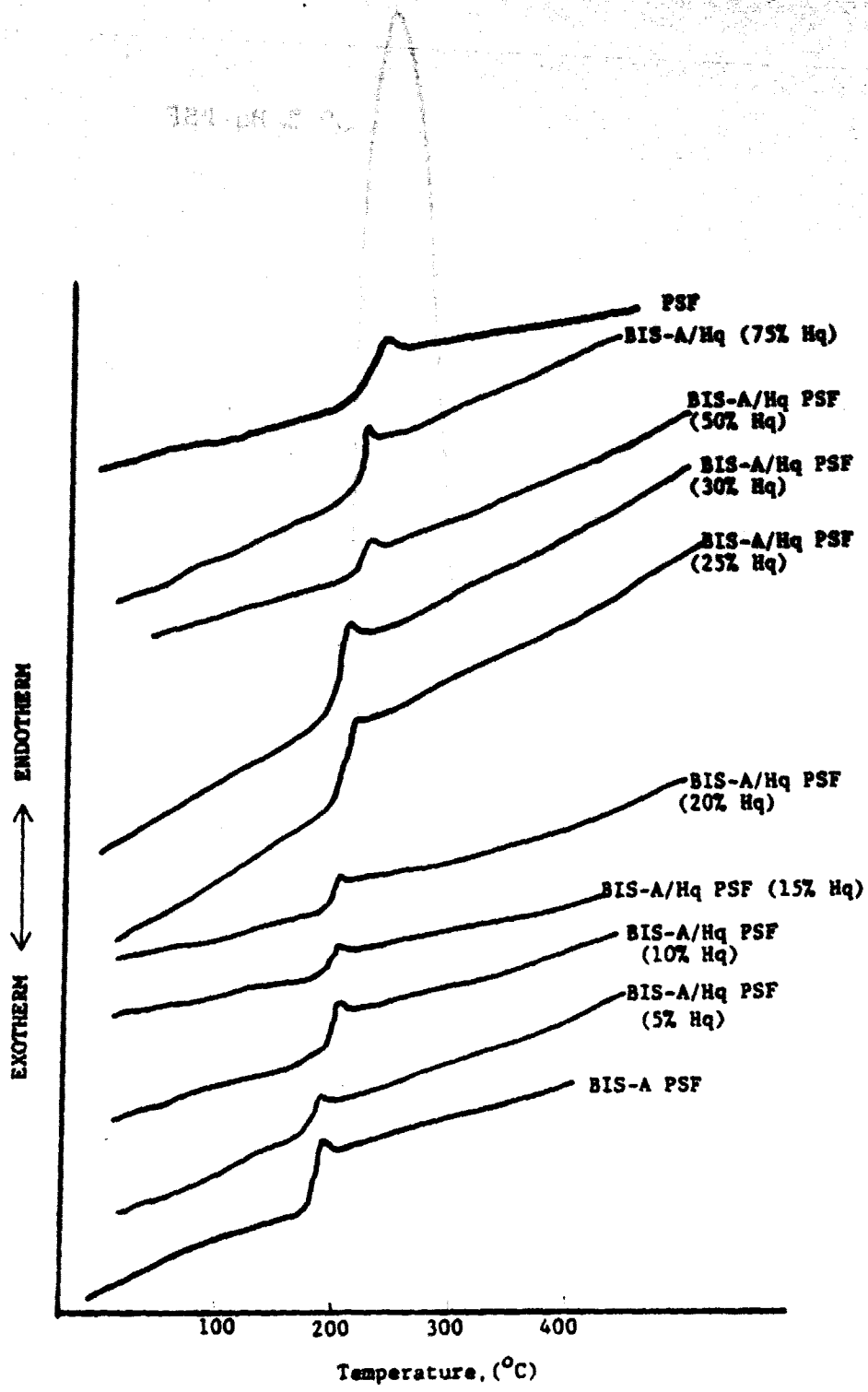


Figure 36 DATA OF COPOLYMERS (HEATING RATE 40°C/min)

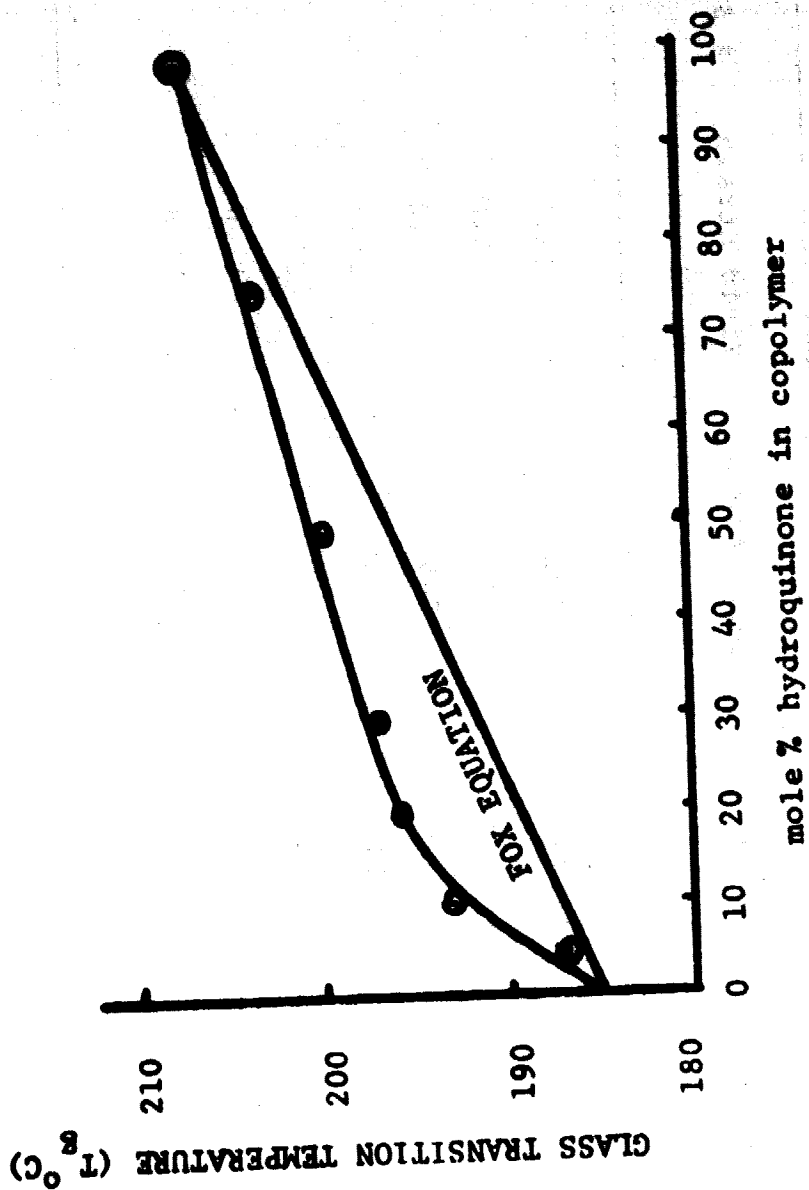


FIGURE 37 . COMPARISON OF BIS-A/Hq COPOLYMER T_g 's TO FOX EQUATION

TABLE 18

STRESS STRAIN DATA* OF BISPHENOL A/HYDROQUINONE COPOLYMER SYSTEMS

Sample (mole % Hq)	Y	kg ----- cm ²	Yield Stress	Yield Strain	% Strain at Break
0	11,700	722	11.0	133	
5	12,000	556	5.6	5.6	
10	10,300	789	12.0	28	
15	11,000	742	12.5	127	
20	13,000	788	10.6	135	
75	11,800	681	11.0	25	
100	12,000	833	13.8	25	

* INSTRON

** STRAIN 2mm/minute

ranged between 11,800-13,00 kgs/cm². The yield stress showed perhaps a slight increase with increasing hydroquinone content.

High-temperature dynamic mechanical measurements showed no decrease in mechanical properties with the incorporation of hydroquinone. This is especially important since for the earlier case of the nylon-6 polysulfone copolymer, solvent resistance was obtained at the cost of a loss in mechanical and electrical properties. The glass transition temperatures obtained from this study were consistent with the D.S.C. results. Figure 38 and 39 show the influence of temperature on tan and storage loss modulus of the copolymer respectively. Low temperature mechanical properties of the copolymers showed a broad β -loss-modulus maximum occurring at round -110°C. The shape and peak position were not much different to those of pure bis-A homopolymer. Good impact strength enhancements have been postulated to this β -transition (302-5), although this does not exclusively determine the toughness of such polymers. A number of workers have rationalized the great breadth of the β -peak the superposition of two different loss peaks having different activation energies (304,306).

The hydroquinone homopolymer was reported to be crystalline (154). This crystalline peak was observed in the first heat in the D.S.C. cell. On cooling it rapidly to room temperature and rerunning it showed no evidence of a T_m but only a sharp T_g at 207°C. Annealing the sample

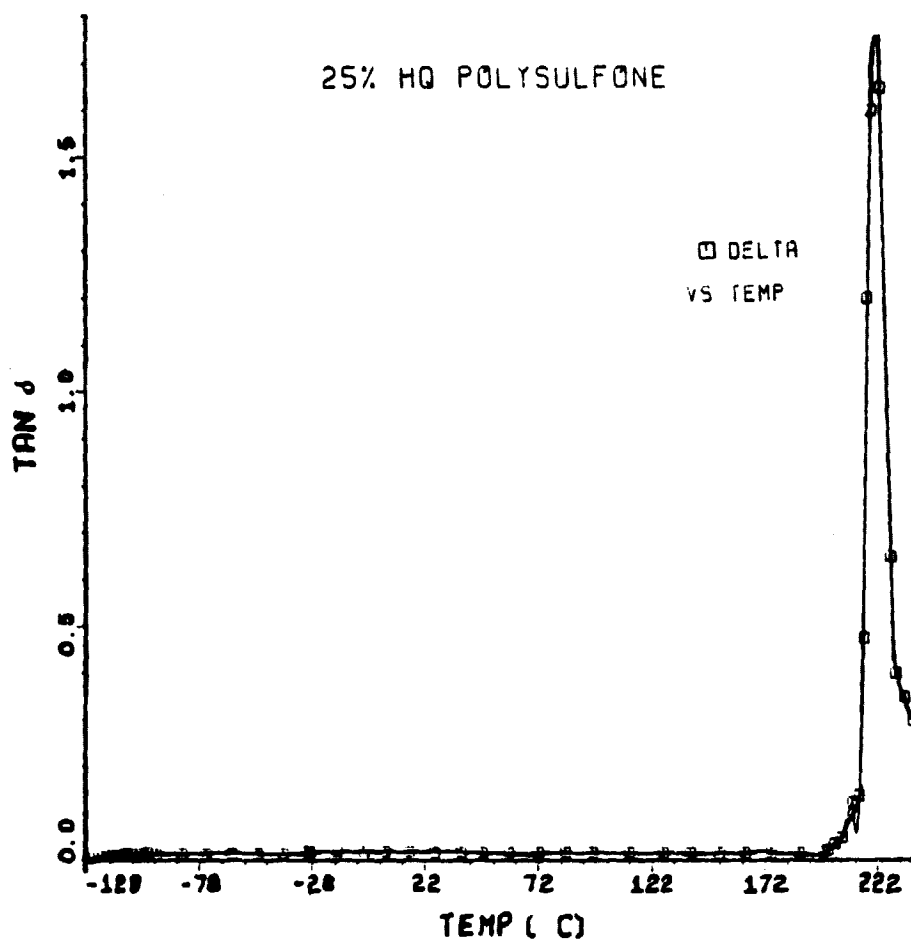


FIGURE 38. DYNAMIC MECHANICAL LOSS BEHAVIOR FOR A 25 MOLE % HYDROQUINONE/BIS-A POLYSULFONE AT 3.5 HERZ.

ORIGINAL PAGE IS
OF POOR QUALITY

25% HQ POLYSULFONE

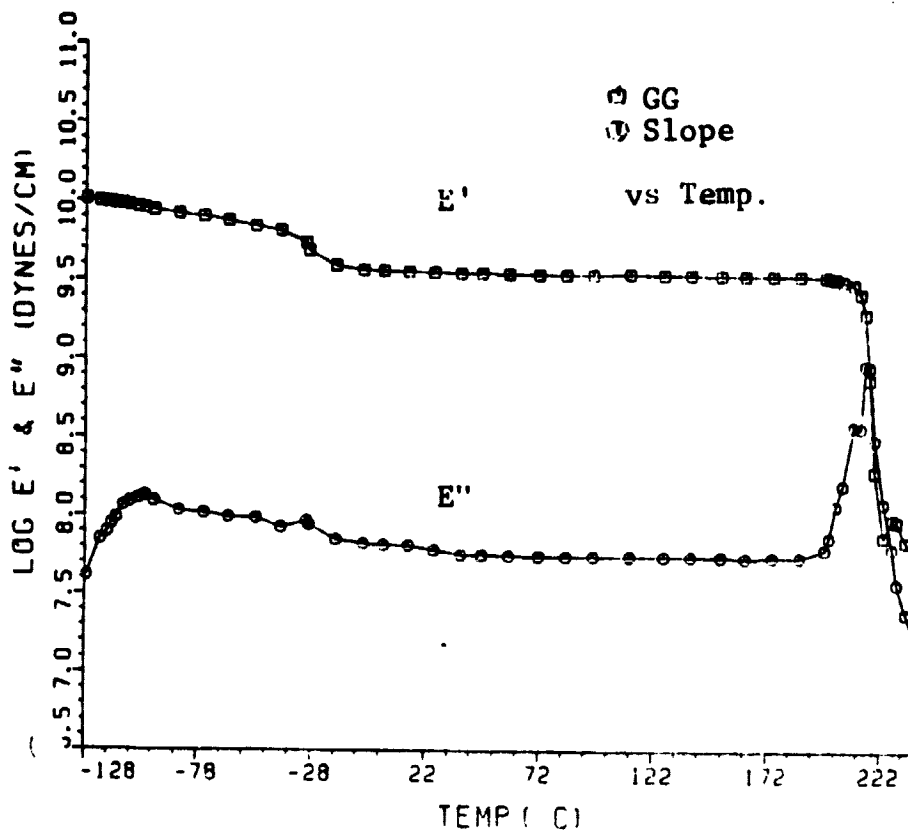


FIGURE 38. HIGH TEMPERATURE MECHANICAL BEHAVIOR OF BISA/HQ POLYSULFONE COPOLYMER

in the D.S.C. cell at 254°C ($0.83T_m$) for various lengths of time, quenching it to room temperature and rescanning failed to crystallize the sample (see Figure 40). Thus it was concluded that crystallization could not be induced thermally. However, because the polymer showed crystallinity "as made", attempts were made to induce crystallinity using liquids. This novel method of inducing crystallinity has been reported for polyesters, polycarbonates etc. (241). In the polyether family, polyphenylene oxides have been crystallized by decalin (307). Two solvents, namely acetone and methylene chloride were used in this study. Typically, acetone is a non-solvent while methylene chloride is a solvent for polysulfones. Hydroquinone polysulfone (compression molded) was soaked in acetone for various lengths of time, removed, dried and a D.S.C. trace was run recording the first heat. Samples that were dip-dried or soaked for less than six hours failed to show bulk crystallinity. A crystalline peak was observed for sample soaked in acetone for more than six hours (see Figure 41). Samples treated in methylene chloride required much less time. Typically, comparable crystallinity was obtained in less than an hour. The rapid rate of crystallization by methylene chloride may be due to the fact that it solvates the polymer segments more easily thereby depressing the T_g to below room temperature and increasing the difference between T_m and T_g .

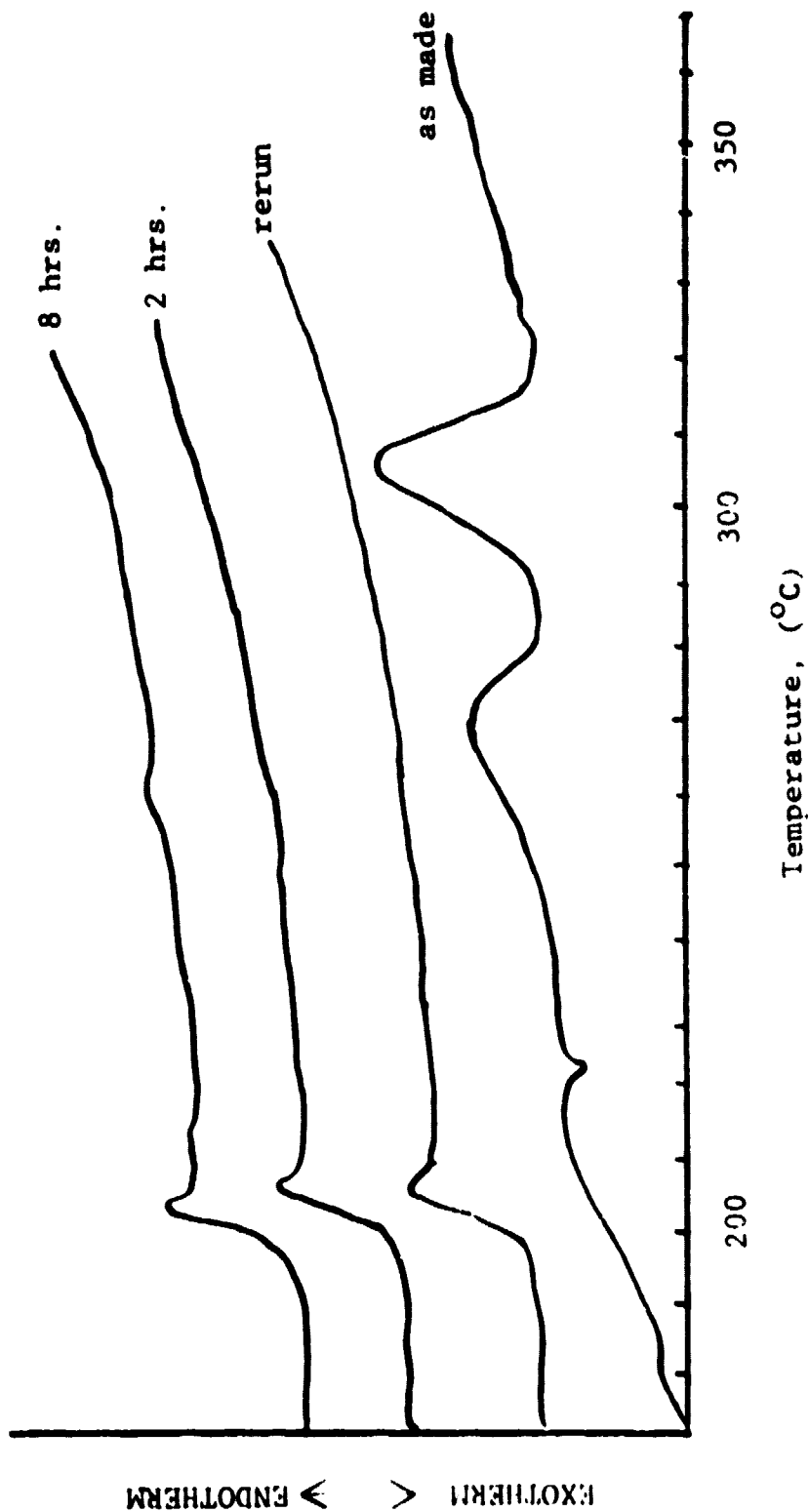


FIGURE 40. EFFECT OF ANNEALING (254°C) ON HYDROQUINONE POLYSULFONE AFTER VARIOUS LENGTHS OF TIME IN THE DSC.

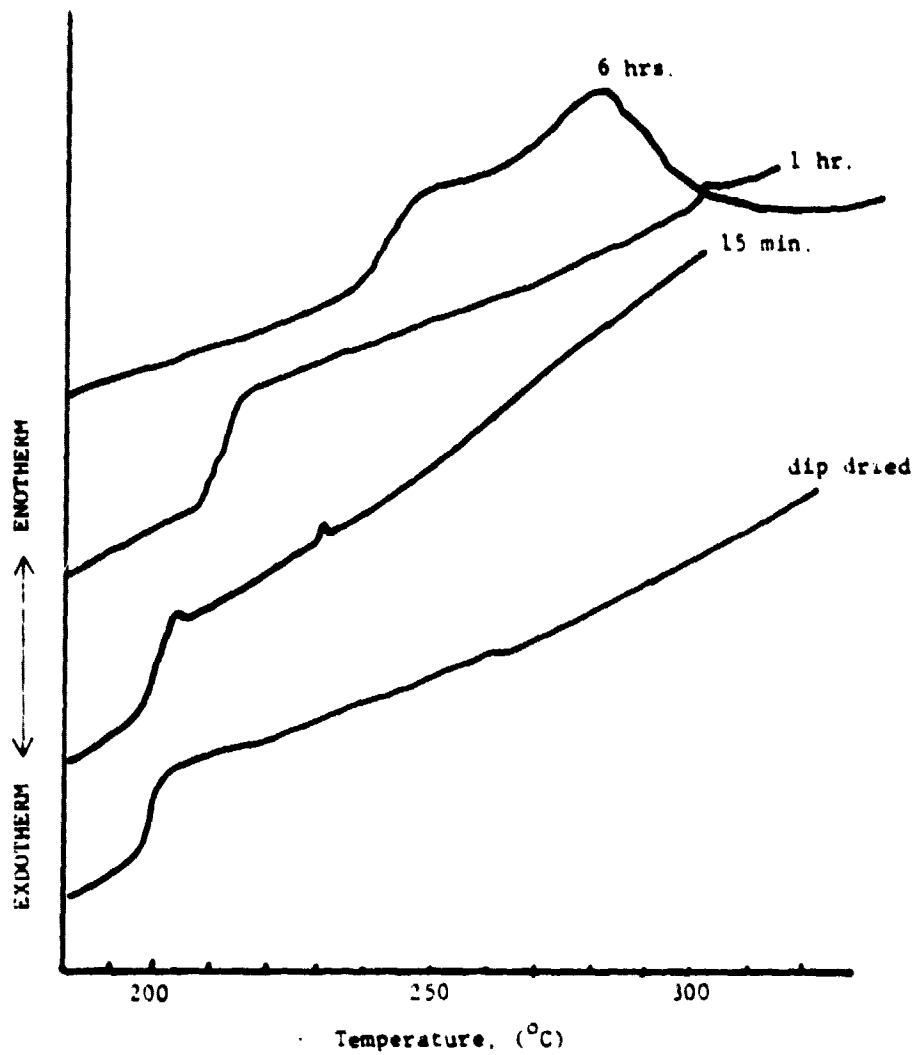


FIGURE 4I DSC CURVES OF HYDROQUINONE POLYSULFONE TREATED WITH ACETONE FOR VARIOUS LENGTHS OF TIME

That crystallization was indeed induced by the liquids was confirmed by both wide angle X-ray and scanning electron microscopy. The wide angle X-ray pictures of the polymer soaked in acetone and methylene chloride for 24 hours and one hour respectively are compared to the sample prior to treatment (see Figure 42). The untreated sample shows a diffuse ring, characteristic of amorphous materials. The other two show sharp rings indicating a semicrystalline nature. The photomicrographs obtained from SEM after acetone treatment of the polymer is shown in Figure 43. Surface modification is clearly observed. The crystallites appear as small fibrillar fragments under high magnification.

The photomicrographs of methylene chloride treated polymer are shown in Figures 44 and 45. In distinct contrast to the acetone treatment both excessive cavitation and spherulitic formation are observed. This is similar to the polyethylene terephthalate-butanol system (241). Thus the two liquids show distinctly different surface modification in the process of crystallization.

Stress-strain behavior of pure hydroquinone polysulfone after treatment with methylene chloride for various lengths of time and drying is shown in Figure 46. All samples exhibit comparable strength (Young's modulus) but have decreasing elongation-at-break. They also exhibit ductile failure. These observations indicate that the homopolymer exhibits properties typical of an amorphous polymer while being potentially semi-crystalline.

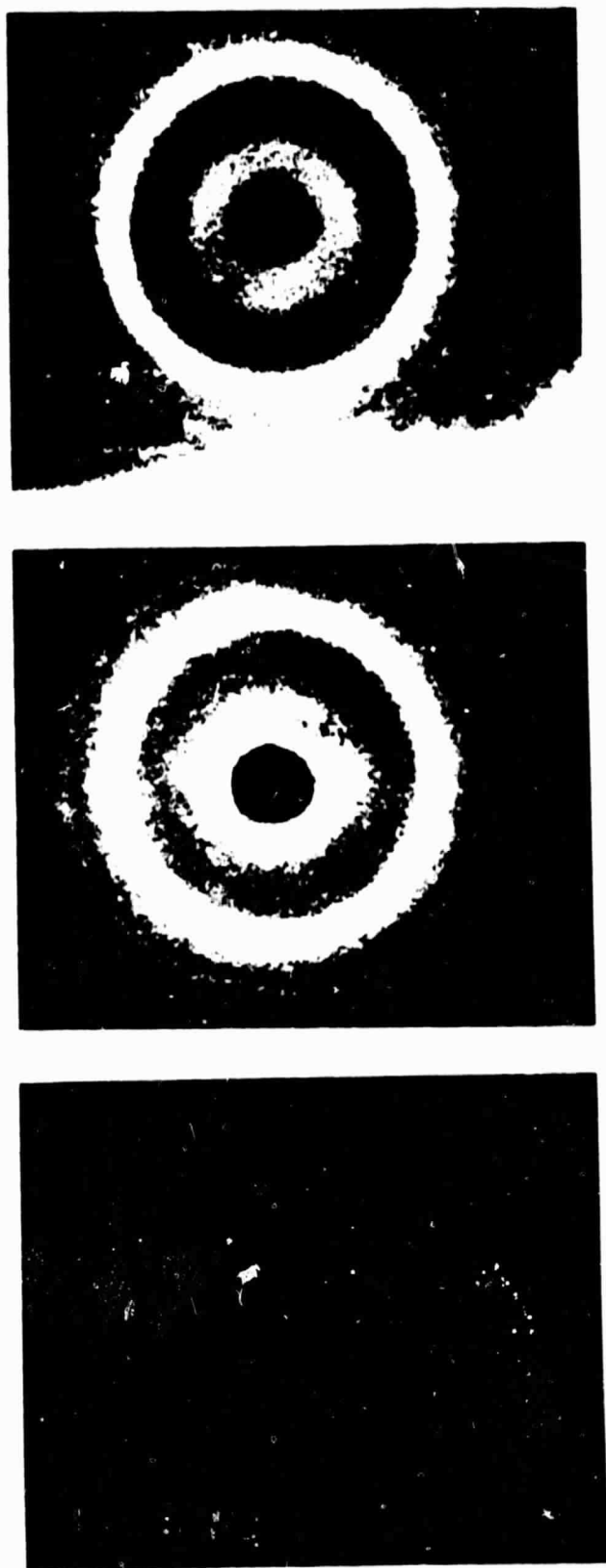


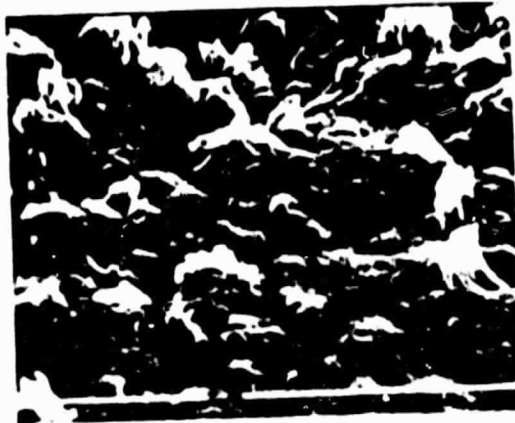
FIGURE 42. WIDE ANGLE X-RAY DIFFRACTION PATTERNS OF Hq-PSF: A, UNTREATED; B, IMMERSSED IN METHYLENE CHLORIDE FOR 1 MINUTE; C, IMMERSSED IN ACETONE FOR 24 HOURS.



A (500X)

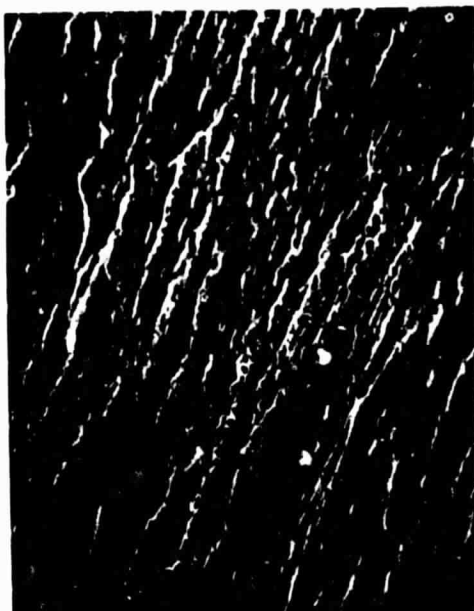


B (5000X)

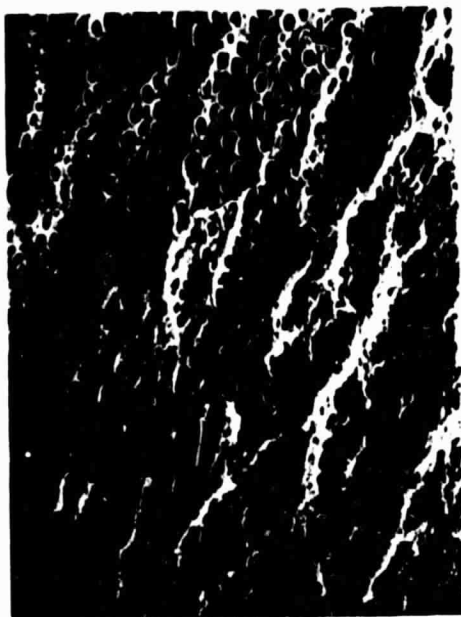


C (20,000X)

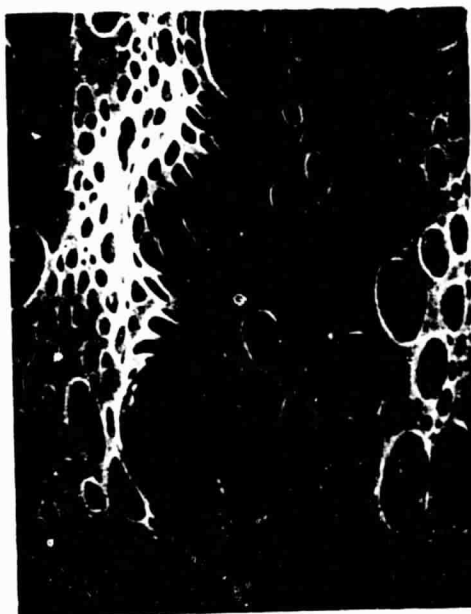
FIGURE 43. SEM MICROGRAPHS OF Hq-PSF IMMERSSED IN ACETONE FOR 24 HOURS.



A (200X)



B (1000X)



C (5000X)



D (5000X)

FIGURE 44 SEM MICROGRAPHS OF HQ PSF IMMERSSED IN METHYLENE-
CHLORIDE FOR ONE MINUTE



A (200X)



B (1000X)



C (5000X)



D (10,000X)

FIGURE 45. SEM MICROGRAPHS OF Hq-PSF IMMERSSED IN METHYLENE-
CHLORIDE FOR SIX HOURS AT ROOM TEMPERATURE

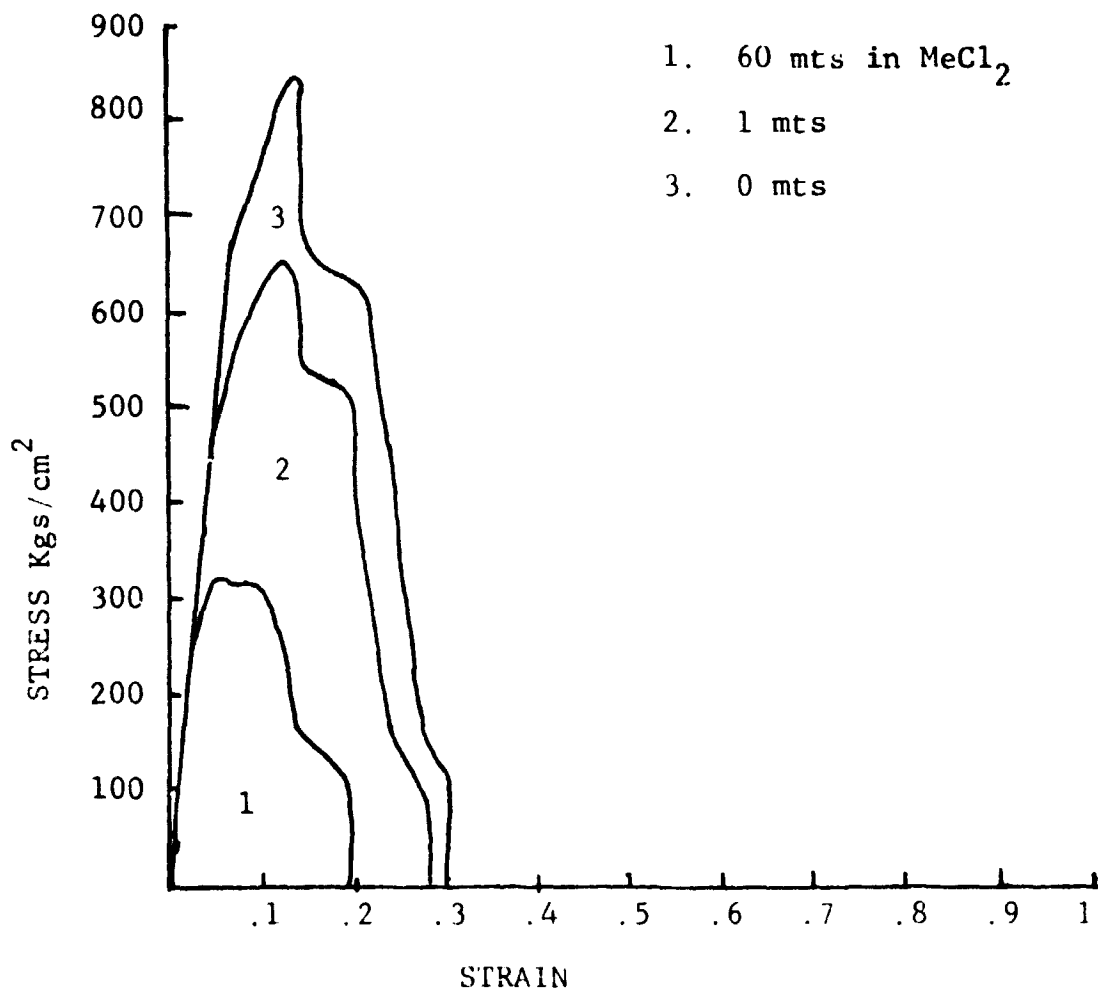


FIGURE 46. STRESS-STRAIN PLOT OF 100% HqPSF IMMERSSED IN METHYLENE CHLORIDE FOR VARIOUS TIMES

The environmental stress crack resistance of the copolymers was studied by a bent-strip constant strain method and a constant stress mode method. In both the methods the samples were dried and compression molded at 300°C, then cut into the shape of a dog bone. The thickness of all samples ranged from 10-11 mils. In the bent-strip method the sample was bent and held in position by placing it between the indents of a glass tube. This ensured approximately equal flexural stress and strain. A drop of a stress-cracking liquid was placed on the sample. The observations are summarized in Table 19 are for acetone as the stress-cracking agent. These results are also typical for many other similar stress cracking agents. The results show higher hydroquinone containing polymers to exhibit sharply better solvent resistance. This method is simple and rapid but gives only qualitative information.

The constant stress method was used to obtain a more semi-quantitative idea on the environmental stress cracking behavior of these copolymers. The results are summarized in Table 20. The ESR behavior was studied for four different stresses. The maximum stress used was 1000 psi, as these orders were typical of residual stress in molded products. The results show considerable improvement in solvent resistance for copolymers having more than 50 % hydroquinone. As expected, the ESR is also a function of the applied stress.

TABLE 19
 ESC Results on Hydroquinone Containing Polysulfone
 under "Bent Strin" Conditions

%	H ₂ O	Observations
7		Failed. Broke into 2 pieces
5%		Failed. Broke into 2 pieces
10%		Failed. Broke into 2 pieces
15%		Crazed. Single piece deformed
20%		Crazed. Single piece deformed
25%		Crazed. Single piece deformed
30%		Failed.
75%		Crazed. Ductile
85%		Crazed. Ductile
90%		Crazed. Ductile
100%		Very little crazing. Ductile

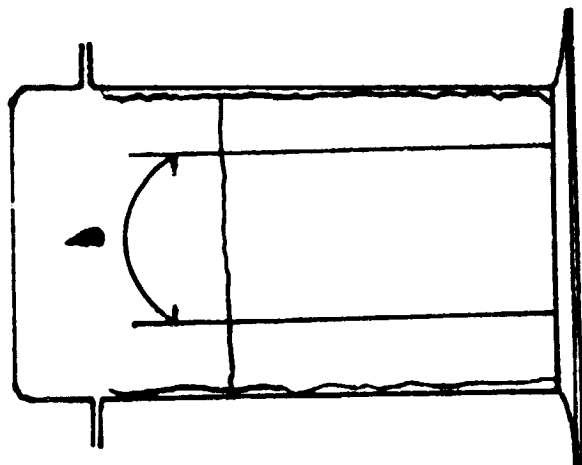
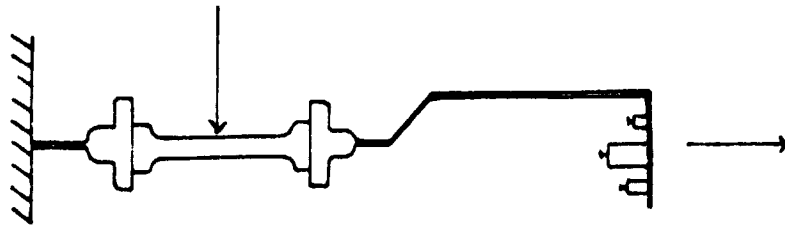


TABLE 20
 ESC Results on Hydroquinone Containing Polysulfones
 under "Constant Stress" Conditions

Percent Composition (Hq.)	100 psi	250 psi	500 psi	1000psi
0	0-1	0	0	0
5	3 secs	0	0	0
10	DNF*	0-1	0	0
15	DNF	0-1	0	0
20	DNF	5 secs	1-1-2	0
25	DNF	18-20 secs	3 secs	2-1 sec
30	DNF	28-30	10-12 secs	2 secs
75	DNF	DNF	DNF	100
85	DNF	DNF	450 secs	15-16 secs
90	DNF	DNF	DNF	18-20 secs
100	DNF	DNF	DNF	128-130 secs

* Does Not Fail Even after 600 secs



ORIGINAL PAGE IS
 OF POOR QUALITY

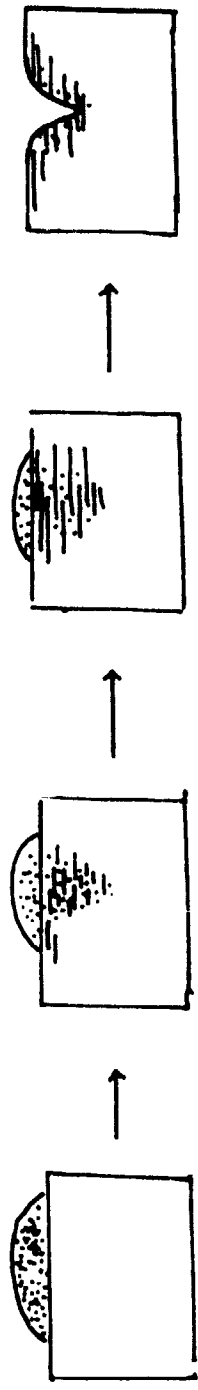
ORIGINAL PAGE IS
 OF POOR QUALITY

The copolymers were compression molded, and any crystallinity that was destroyed, thus producing amorphous test specimen. Thus one would expect to have poor solvent resistance. To rationalize the observed improvement in ESR behavior it is believed that two processes are occurring simultaneously. One is the diffusion of the stress cracking reagent into the amorphous matrix and the other is the crystallization and surface modification in the presence of the stress cracking liquid and the applied stress. The former is destructive and leads to failure of the sample while the latter crystallizes the surface, thereby reinforcing the polymer segments. The ordering of the surface would in principle also decrease the diffusion coefficient of the stress cracking liquid. These effects are schematically represented in Figure 47.

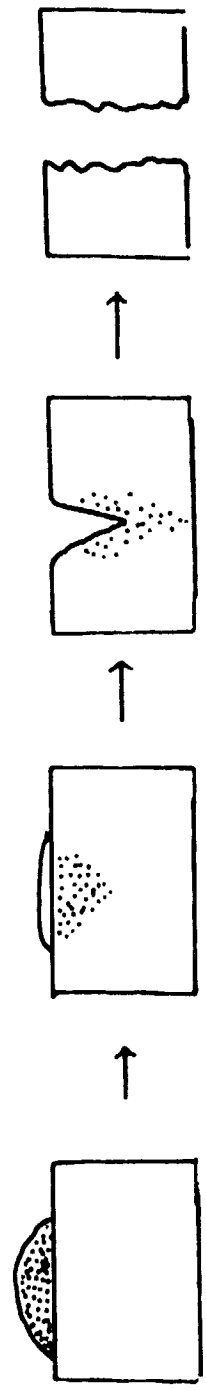
In the hydroquinone containing copolymer the first process predominates resulting in failure even at very low stress (250 psi). However, with increasing hydroquinone content the hydroquinone sequences in the copolymer are long enough to crystallize thereby increasing the solvent resistance.

As surface modification does play an important role in ESR, ESCA was used to study possible surface segregation effects. The results showed no evidence of such phenomena in these copolymers (see Figure 48) possibly due to the relatively short sequences.

SEMI-CRYSTALLINE



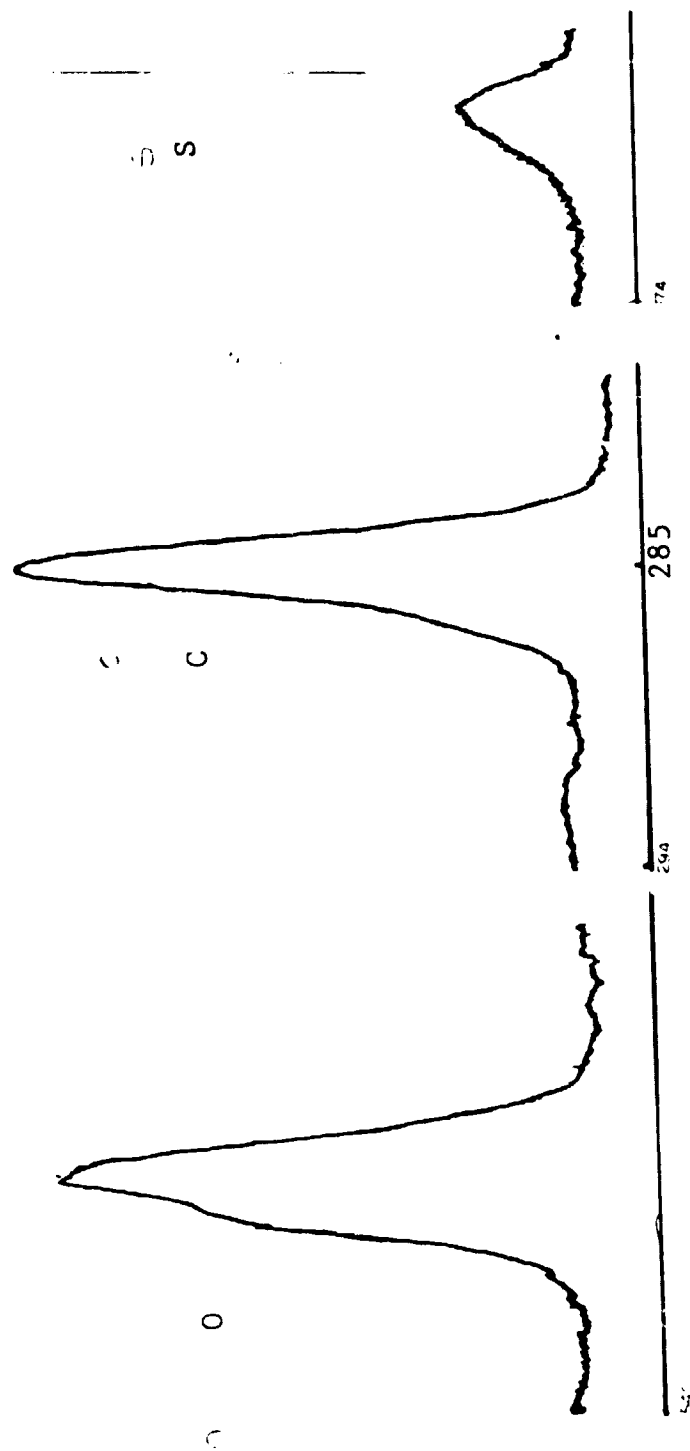
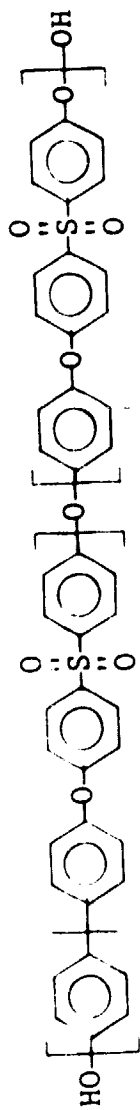
AMORPHOUS



TIME

FIGURE 47. SCHEMATIC REPRESENTATION OF IMPROVED SOLVENT RESISTANCE OF POTENTIALLY SEMI-CRYSTALLINE POLYMER.

BIS-A HYDROQUINONE POLYSULFONE COPOLYMER



BINDING ENERGY (ev)

FIGURE 48 . ESCA SPECTRA OF BIS-A/HYDROQUINONE COPOLYMER

3.5 PROTON AND CARBON (13) SPECTROSCOPY OF COPOLYMERS

As seen in the previous section longer hydroquinone sequences showed improved ESR behavior. It was thus of interest to study the monomer distribution in the copolymers. During the last decade proton and carbon 13 spectroscopy have provided valuable information regarding monomer distribution along the polymer backbone (285-287). This has largely been confined to vinyl polymers with aliphatic carbons. A general rule of thumb in the study of sequence distribution in condensation copolymers is that the intermonomers have iso-magnetic protons while the comonomers have widely different proton signals. Polyesters made from terephthalic acid chloride and a mixture of bisphenol and diol satisfy the above requirements. Thus, sequence distribution studies in step-growth polymers have largely dealt with copolyesters.

No work has been reported regarding sequence distribution of polysulfone copolymers. This is largely due to the proton signals being in the small aromatic region of 6.5 ppm to 8,ppm making even peak assignments rather difficult.

This section therefore deals with an attempt to make peak assignments of proton and carbon-13 spectrum of the copolymers. The NMR spectrum of the two homopolymers along with a 50/50 copolymer is shown in Figure 49. The most downshifted peak at around 7.85 ppm, appearing as a doublet, is due to the protons ortho to the sulfone group. The doublet is due to a non equivalent adjacent proton.

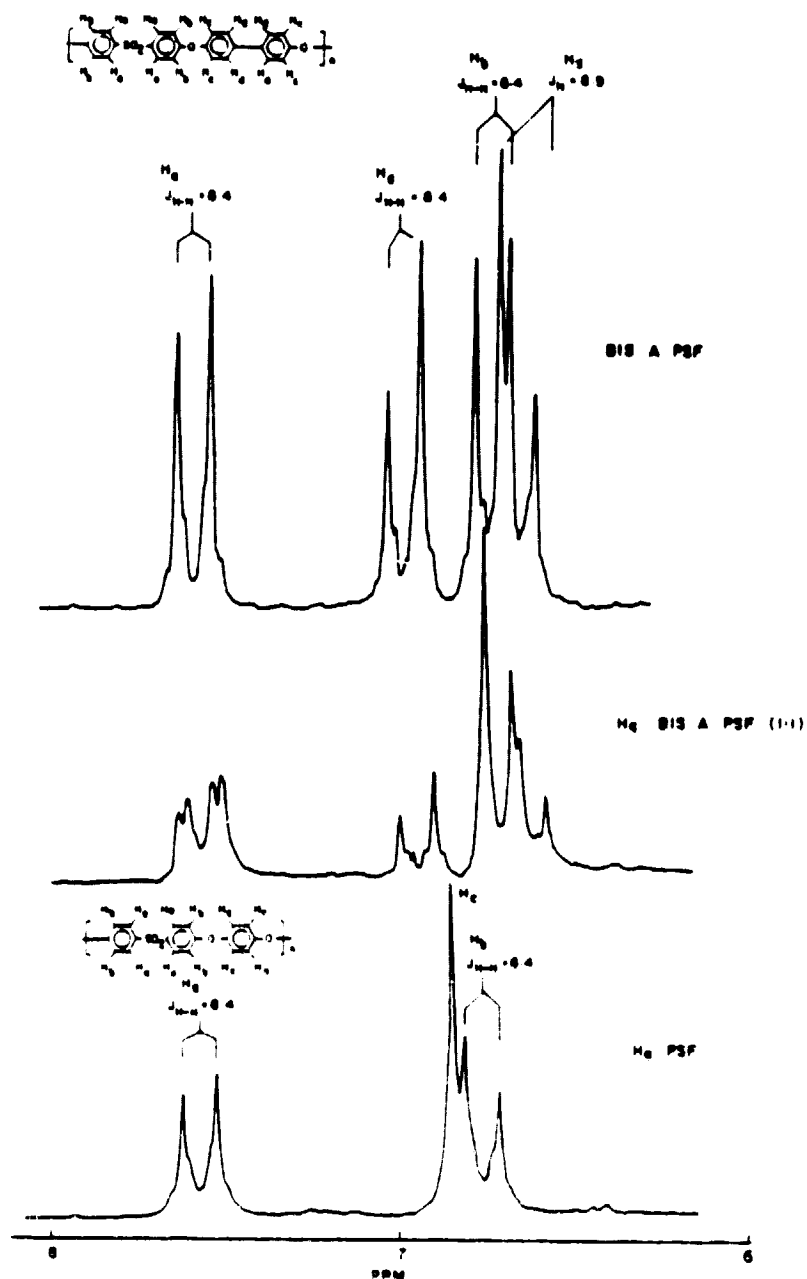


FIGURE 49. PROTON NMR SPECTRA (AROMATIC REGION ONLY) OF BIS-A AND Hq POLYSULFONE HOMOPOLYMER AND BIS-A/Hq POLYSULFONE COPOLYMER

The coupling constant of (J_{H-H}) 8 cycles/sec is characteristic of ortho proton couplings, in this case the protons meta to the sulfone group and ortho to the ether linkage. The next pair of doublets at 7.25 ppm is due to the protons ortho to the isopropylidene group in bisphenol-A. The doublet at 7.0 was assigned to the protons meta to the sulfone group and ortho to the ether linkage. The protons ortho to the ether group and meta to the isopropylidene moiety also occurs as a doublet at 6.9 ppm.

The NMR peak assignments of hydroquinone homopolymer were relatively simpler since the protons from hydroquinone (Hc) are iso-magnetic and appeared as a singlet at 7.26 ppm. The most downshifted doublet at 7.98 ppm was due to the protons ortho to the sulfone group. The protons (Hb) ortho to the ether linkage appeared as a doublet at 7.18 ppm. Both the doublets had the characteristic ortho coupling constant ($J_{H-H} = 8.4$ c/s).

To test the validity of the peak assignments attempts were made to obtain the copolymer compositions via two methods. In one, the ratio of aliphatic to aromatic protons was compared to a calibration curve (see Figure 50). In the other, the ratio of protons ortho to the sulfone and the protons ortho to the isopropylidene group was compared (see Figure 51). Both methods give the composition of the copolymers with a $\pm 3\%$ deviation (see Table 21). However, the second process is preferred since peaks from N-methyl

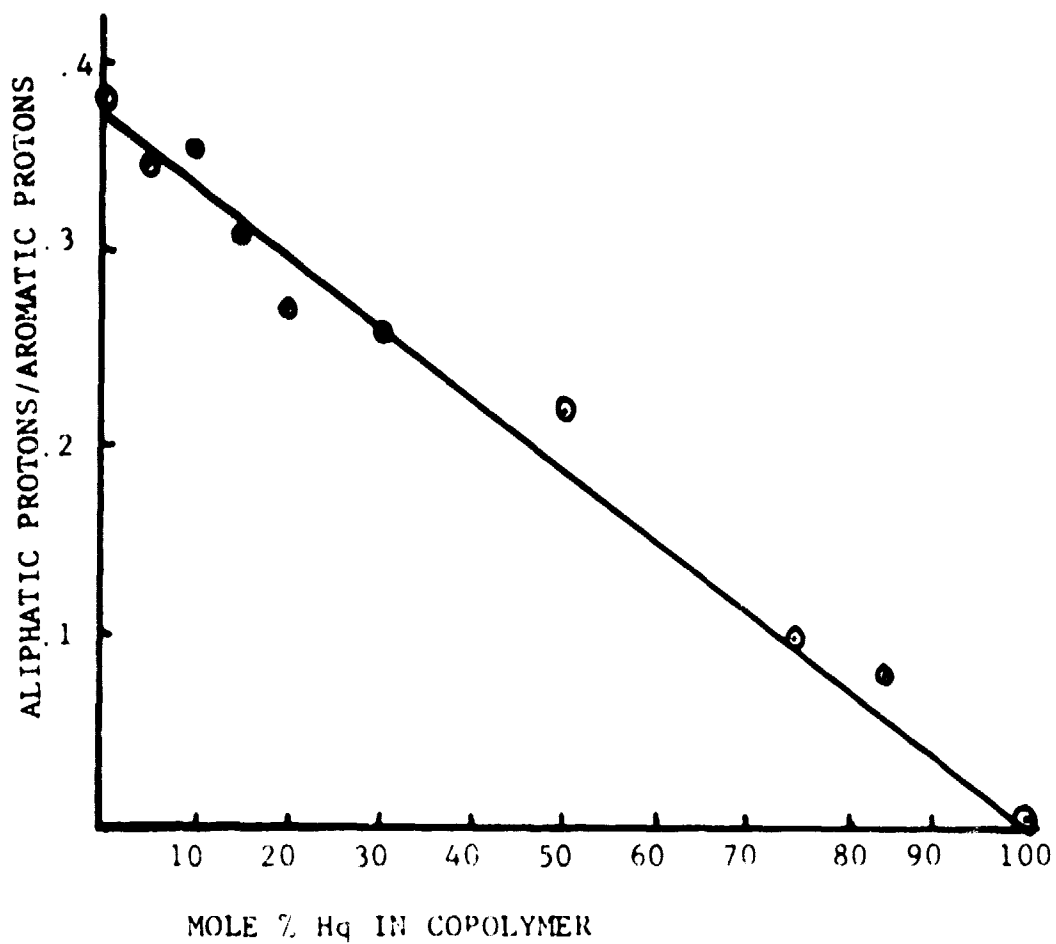


FIGURE 50. COMPOSITION OF COPOLYMER BY PROTON NMR
(ALIPHATIC/AROMATIC)

ORIGINAL PAGE IS
OF POOR QUALITY

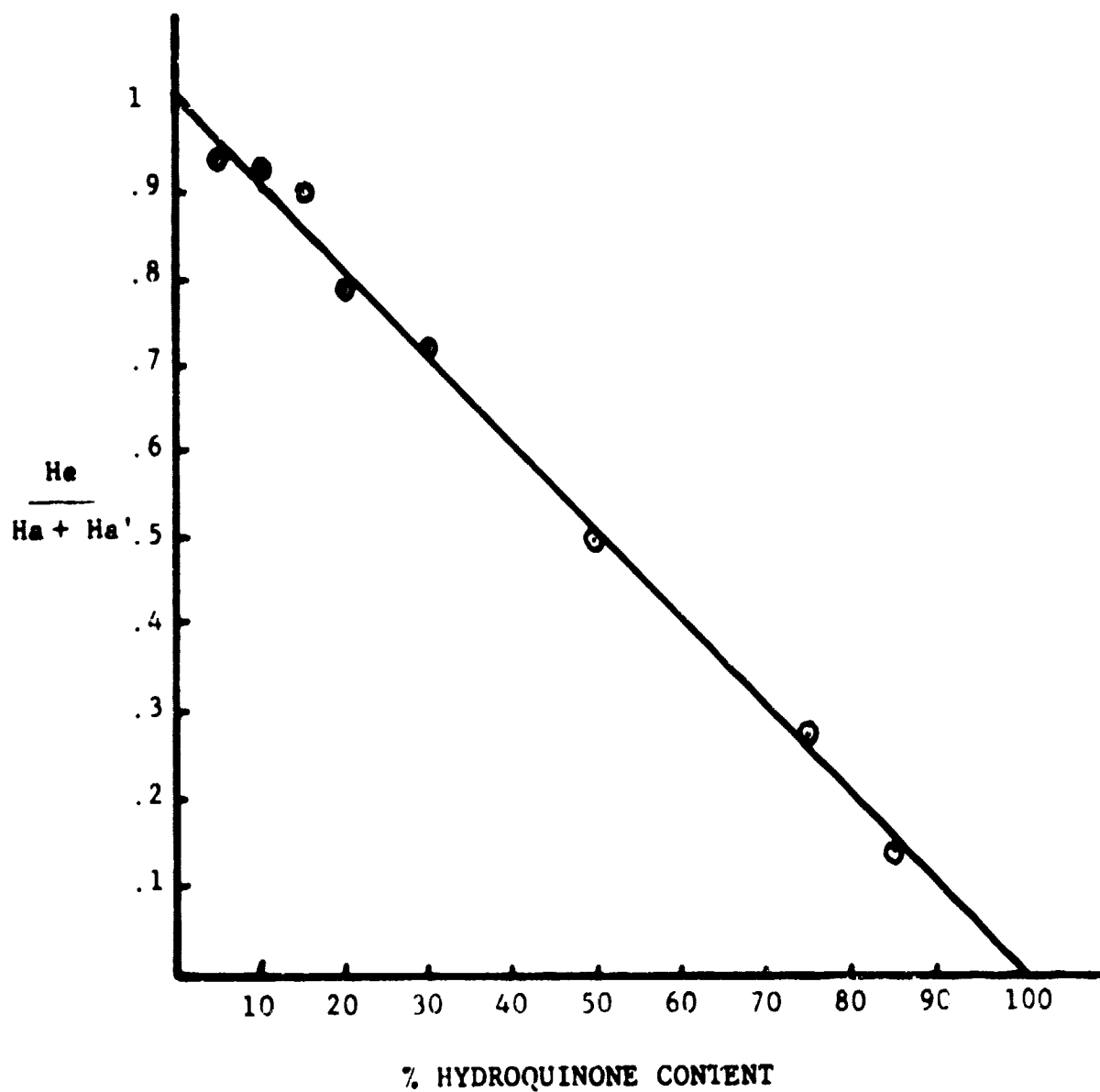


FIGURE 51 COPOLYMER COMPOSITION FROM AROMATIC PROTONS

TABLE 21

COMPOSITION OF COPOLYMERS BY PROTON NMR SPECTROSCOPY

CALCULATED (Mole % of Hydroquinone)	OBTAINED (Mole % of Hydroquinone)		
	I	II	Average
5	5	6	6.5
10	8	8.3	8.15
15	17	11	14
20	27	19	23
30	30	28	29
50	46	50	48
75	75	72	73
85	81	86	83.5
100	100	100	100

* From ratio of aliphatic/aromatic protons

** From aromatic region only

pyrrolidone which was used as a solvent for high hydroquinone content systems does not interfere. Also, higher temperatures (e.g. at 100°C) could be used to better resolve the peak.

Attempts were now made to detect the protons most sensitive to monomer distribution in the copolymer. This naturally led to the examination of intermonomer protons. Indeed, that protons ortho to the sulfone could be influenced by an atom seven atoms away was truly remarkable (see copolymer spectrum in Figure 50). However, one would have expected to see three different proton environments from the three triads respectively but only two were observed. Therefore the results indicate that two of the peaks are unresolved or superimposed.

Since ^{13}C NMR is known to be more informative, attempts were made to study the copolymer by ^{13}C spectroscopy.

The C-13 spectrum of the two homopolymers and the 50/50 copolymer are shown in Figures 52 and 53. Although the peaks seemed well resolved compared to the corresponding proton spectrum, peak assignment was more difficult as no literature data was available for chemical shifts of substituted and unsubstituted phenyl sulfones. This therefore involved systematic synthesis and study of simpler molecular to calculate peak positions.

Initially, monofunctional compounds were synthesized and reacted. Their synthesis and characterization was

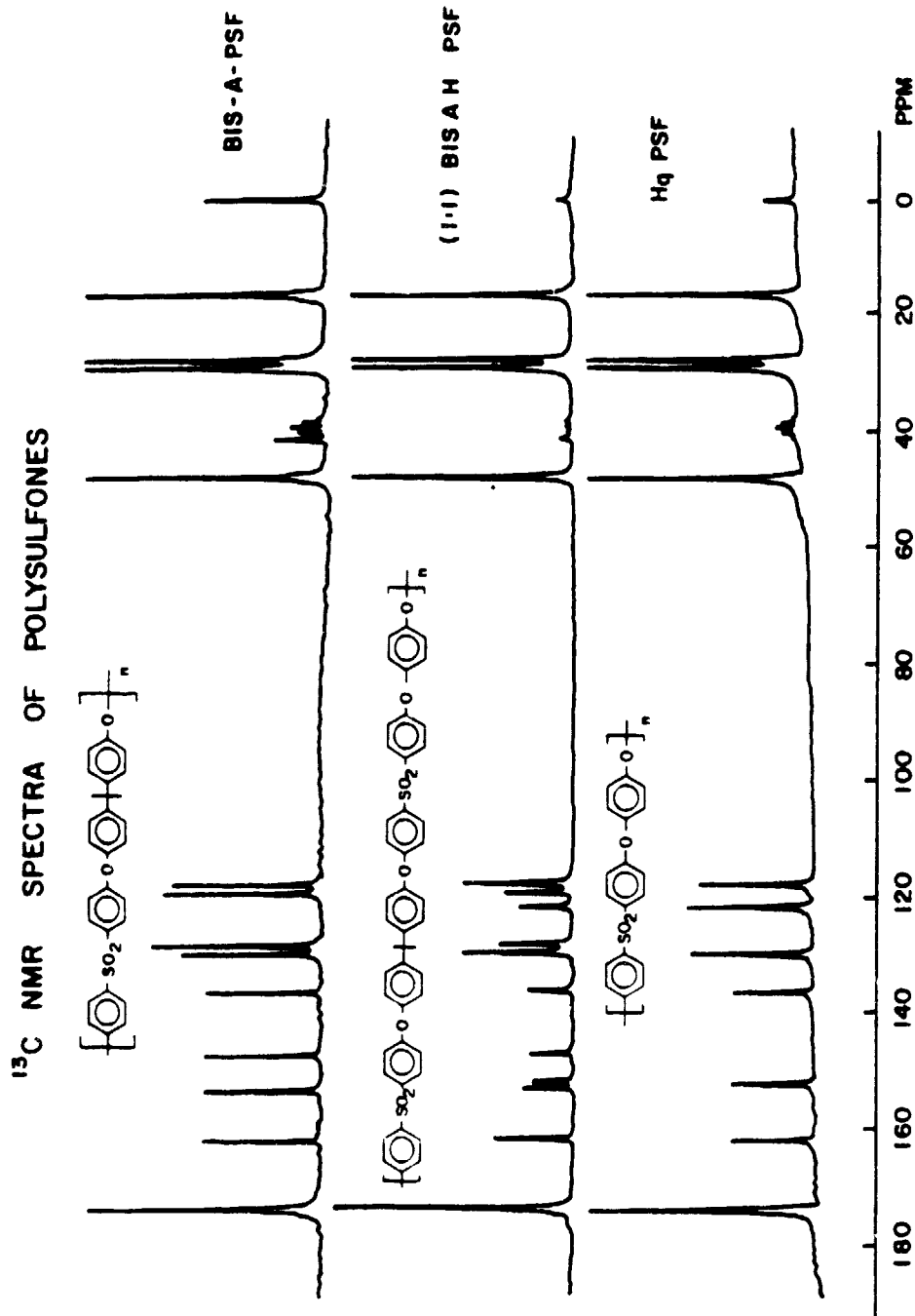


FIGURE 52. ^{13}C NMR SPECTRA OF BIS-A AND HYDROQUINONE POLYSULFONE HOMOPOLYMER AND BIS-A/Hq POLYSULFONE COPOLYMER

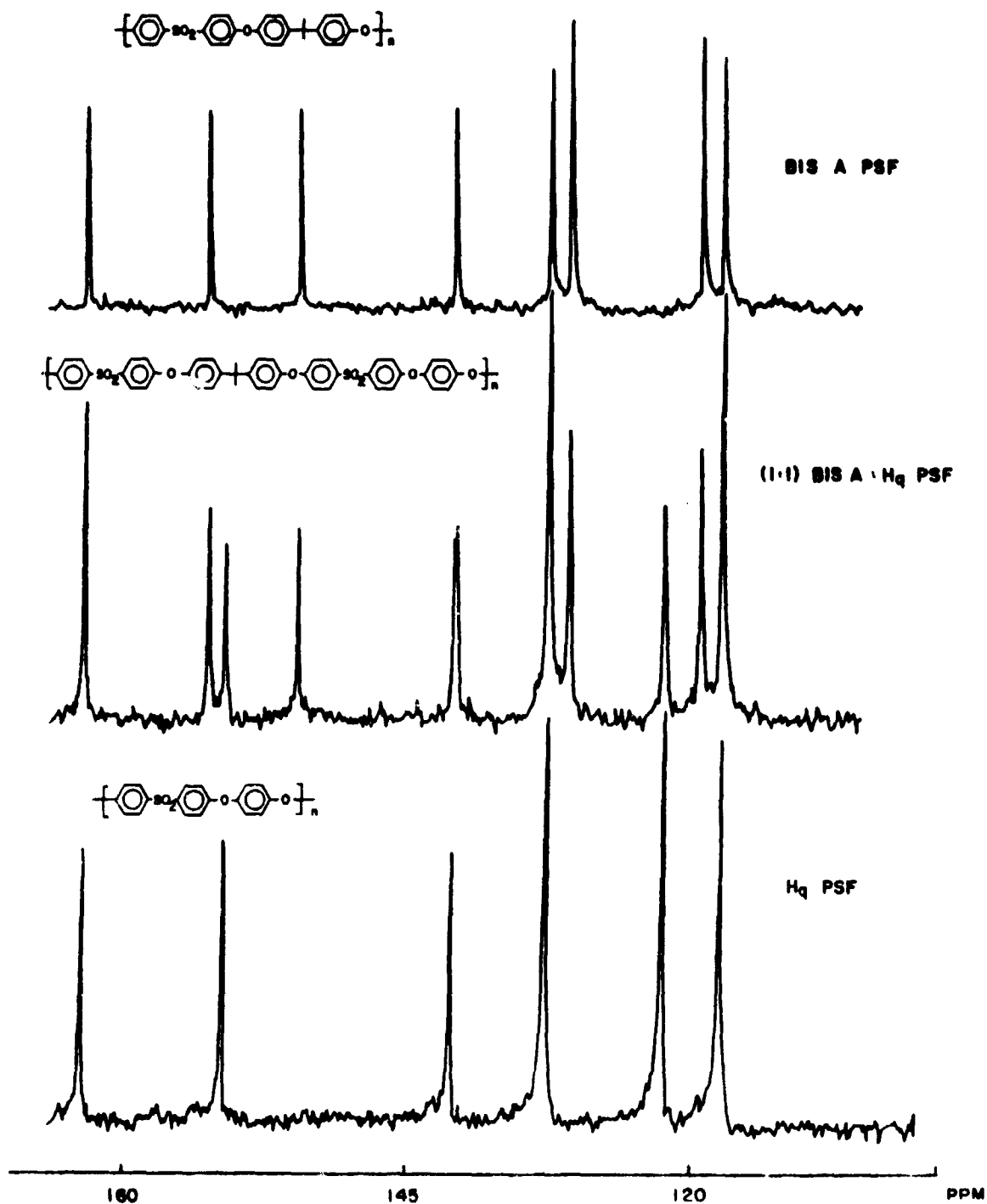
^{13}C NMR SPECTRA OF POLYSULFONES (Aromatic region)

FIGURE 53. ^{13}C SPECTRA OF BISA/Hq COPOLYMERS (AROMATIC REGIONS ONLY)

simple and straight forward. The products were obtained in high yields. Similarly, model compounds involving monofunctional and difunctional reactants were synthesized. The monofunctional reactant was used slightly in excess of stoichiometry to ensure complete conversion to product. Otherwise, a distribution of products is obtained. The compounds were first checked for purity by T.L.C. and the structure then verified later. The synthesis of model compounds from difunctional monomers was relatively more difficult. The use of stoichiometric amounts of the reactants generally produced a statistical distribution of all possible products. Isolation of the required product was not easy and usually resulted in lower yields. Using a large excess of one of the monomers resulted in higher yield of the required product. Considerable improvement in yield was obtained when the lower molar ratio monomer was added very slowly into the reaction. Figures 54 and 55 show the HPLC trace of the products of the reaction of bis-A and hydroquinone with dichlorodiphenylsulfone respectively, at various mole ratios. It is evident from the chromatograms that addition of the lower mole ratio component, dichloro-diphenylsulfone in this case, results in a product comparable to that obtain by using a large excess of bisphenol. In the case of phenoxy terminated model compounds, their structure was also verified by synthesizing the

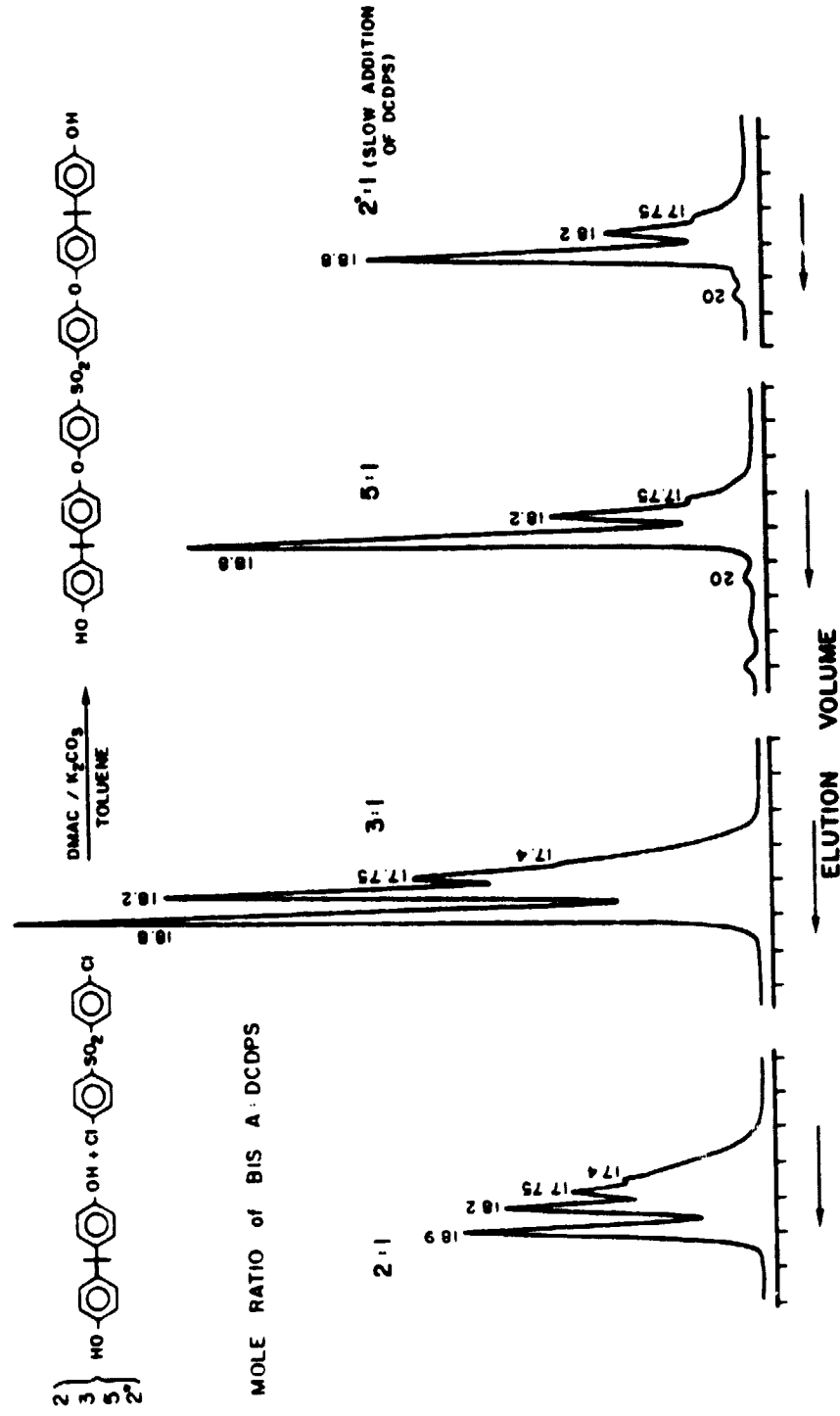
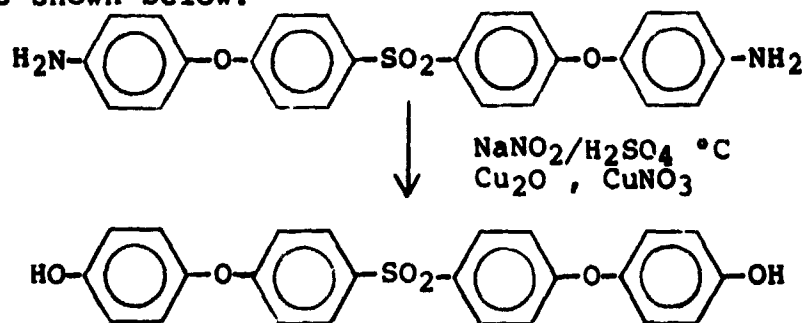


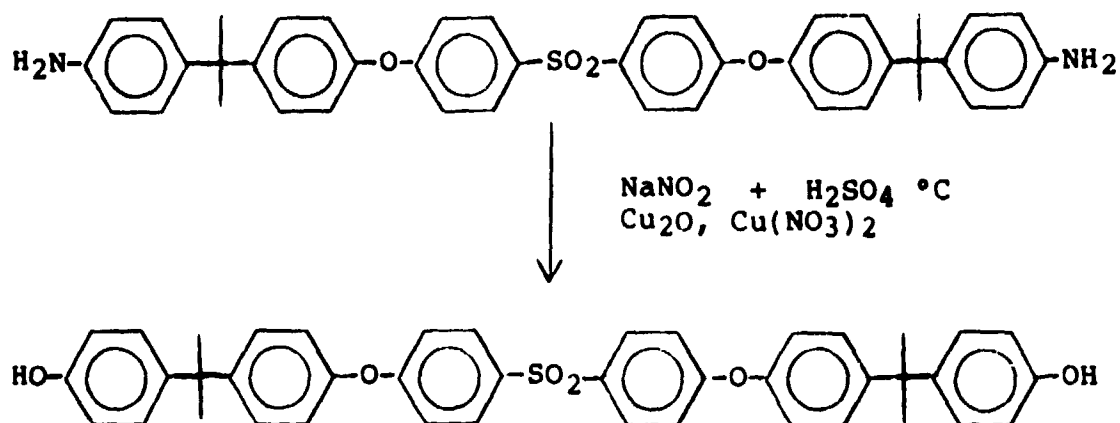
FIGURE 54 GPC TRACES OF REACTION PRODUCTS OF BISPHENOL-A AND DICHLORODIPHENYL SULFONE

ORIGINAL PAGE 1.
OF POOR QUALITY

analogous diamino derivative and diazoting it to a hydroxy group as shown below:

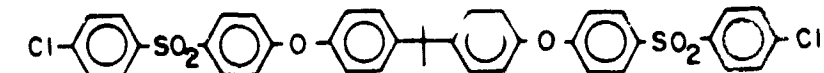
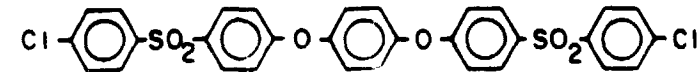
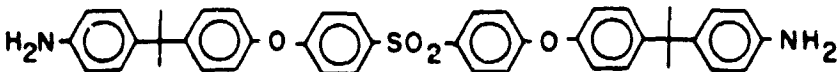
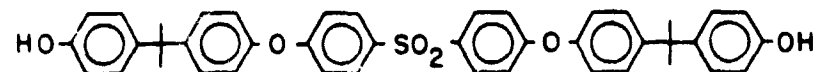
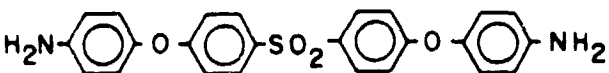
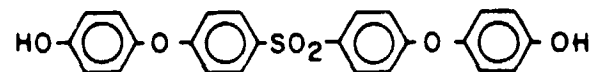
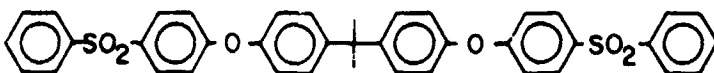
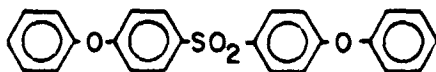
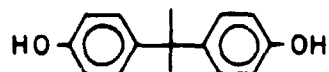
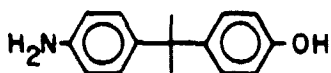
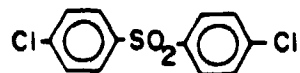
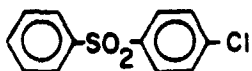
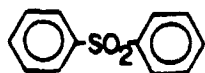


Synthesis of *p,p'*-dichlorodiphenylsulfone 1,4'-dioxy benzene and its bis-A analog was attempted so that a perfectly alternating copolymer of bis-A and hydroquinone could be obtained. However, purification of the product was not possible.



The list of model compounds used for this study are shown in Table 22. The chemical shift of carbons in benzene at 128.5 ppm was used as reference. Chemical shifts for polysubstituted aromatics are for the most part predictable on the basis of the additivity of the chemical shifts of the corresponding monosubstituted benzene.

TABLE 22

MODEL COMPOUNDS

Initially, it was of prime importance to determine the chemical shift values of phenyl sulfone group on an unsubstituted benzene. This was obtained from the C-13 spectra of diphenylsulfone (Figure 56). The spectra shows four different carbon environments at 127.86 ppm, 130.05 ppm, 133.87 ppm and 142.15 ppm respectively. The first two signals were twice as intense as the remaining two and were therefore attributed to the ortho and meta carbons. Literature value of chemical shifts for similar deactivating groups like nitro, sulfonamide etc., show shielding of ortho carbon and deshielding of the meta carbons. Based on this, the peak at 127.86 ppm was assigned to ortho carbons and the one at 130.05 ppm to the meta carbons. The other two peak assignments were relatively simple as the carbon attached to the phenyl sulfone group is the most deshielded. The shift assignments of phenylsulfone were confirmed by comparing the calculated values to the observed values for monochlorodiphenylsulfone and dichlorodiphenylsulfone. Similarly, the effect of various other groups were calculated and confirmed. Table 23 shows the ^{13}C substituent effects on benzenes.

Figures 57-62 show the ^{13}C spectra of the monomers and model compounds along with the peak assignments. The ratio of peak intensities were non integral, possibly due to longer relaxation time and lower NOEs. This made quantitative measurements rather difficult. The carbons attached to the sulfone group were observed to be sensitive to the type of bisphenol attached to the para carbon in the same ring but

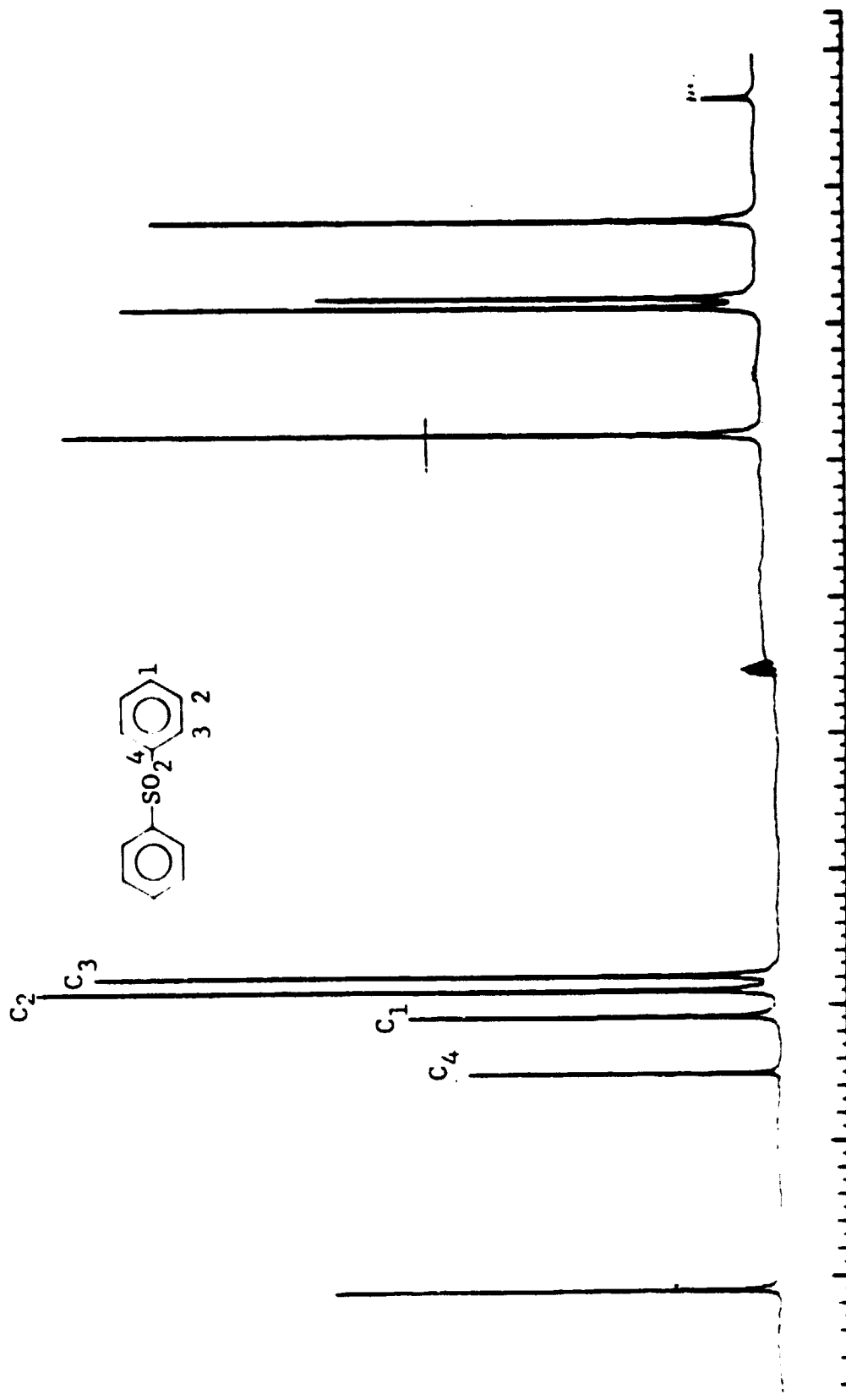
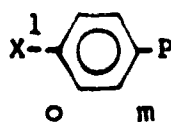
FIGURE 56. ^{13}C SPECTRA OF DIPHENYL SULFONE

TABLE 23
EFFECT OF SUBSTITUENTS IN THE CHEMICAL SHIFT OF BENZENE



X	C-1	ortho	meta	para
	14.35	-0.7	+1.54	+5.37
Cl	+6.2	+0.4	+1.3	-1.9
	12.56	-0.9	+1.52	+5.58
	+29.2	-9.4	+1.6	-5.1
-OH	+26.9	-12.7	+1.4	-7.3
	20.0	-2.83	1.6	-0.82
	22.3	+0.2	-1.4	-3.0

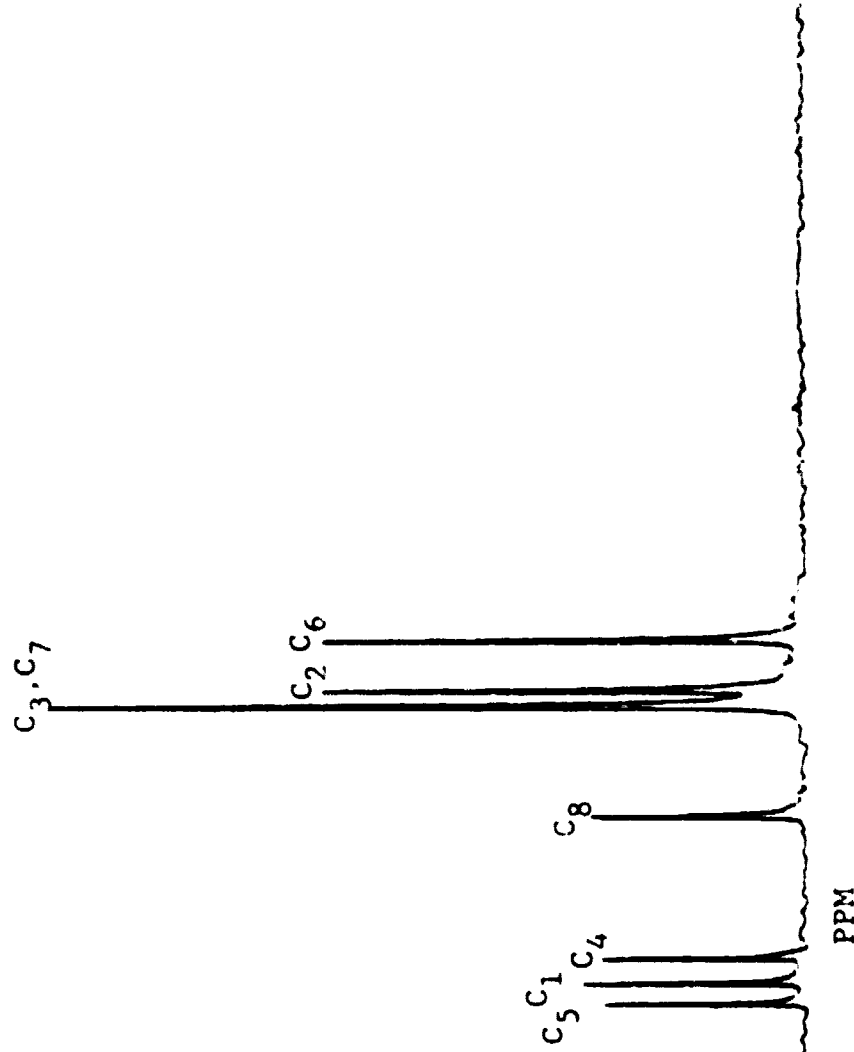
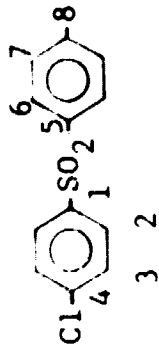
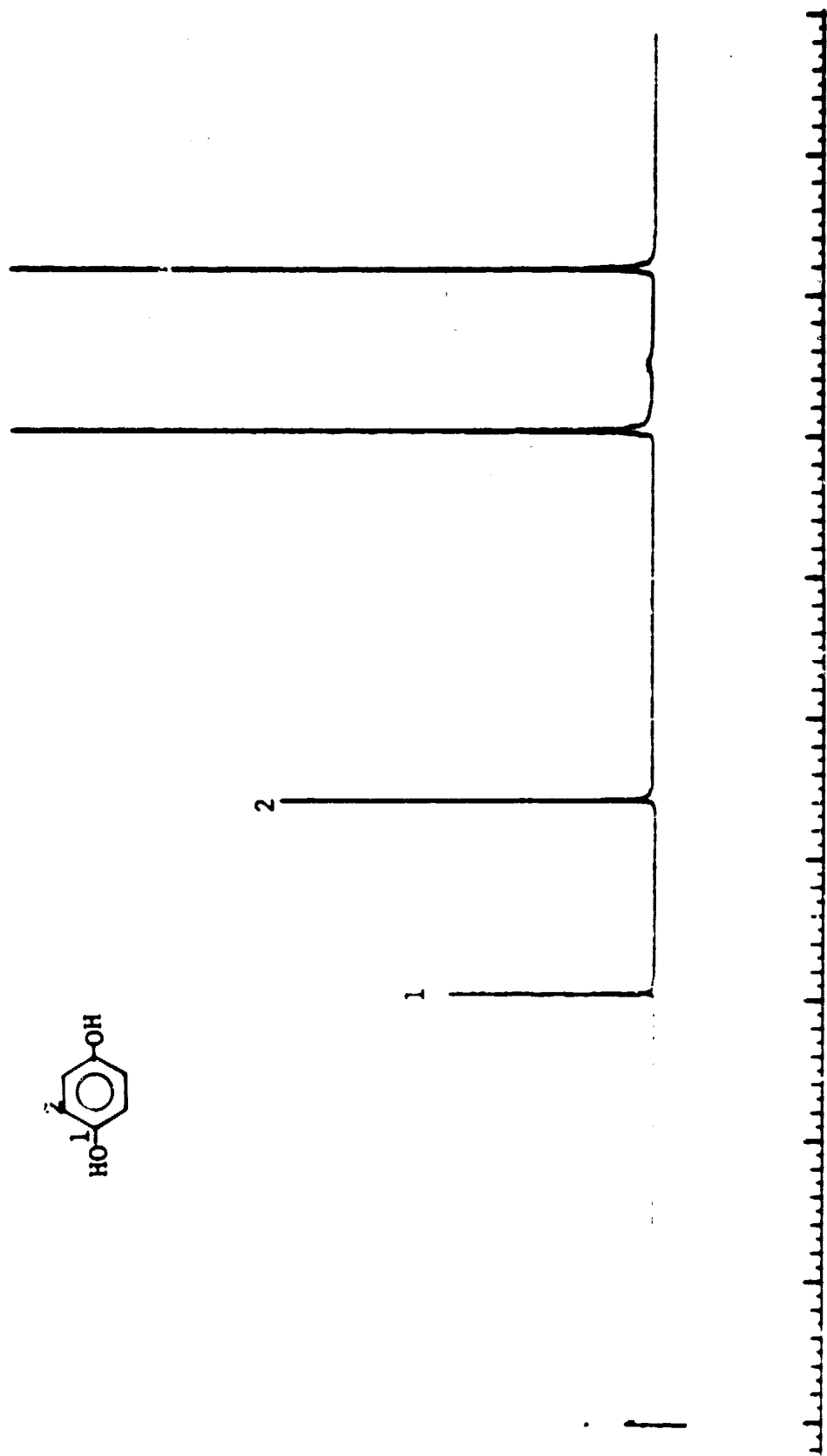
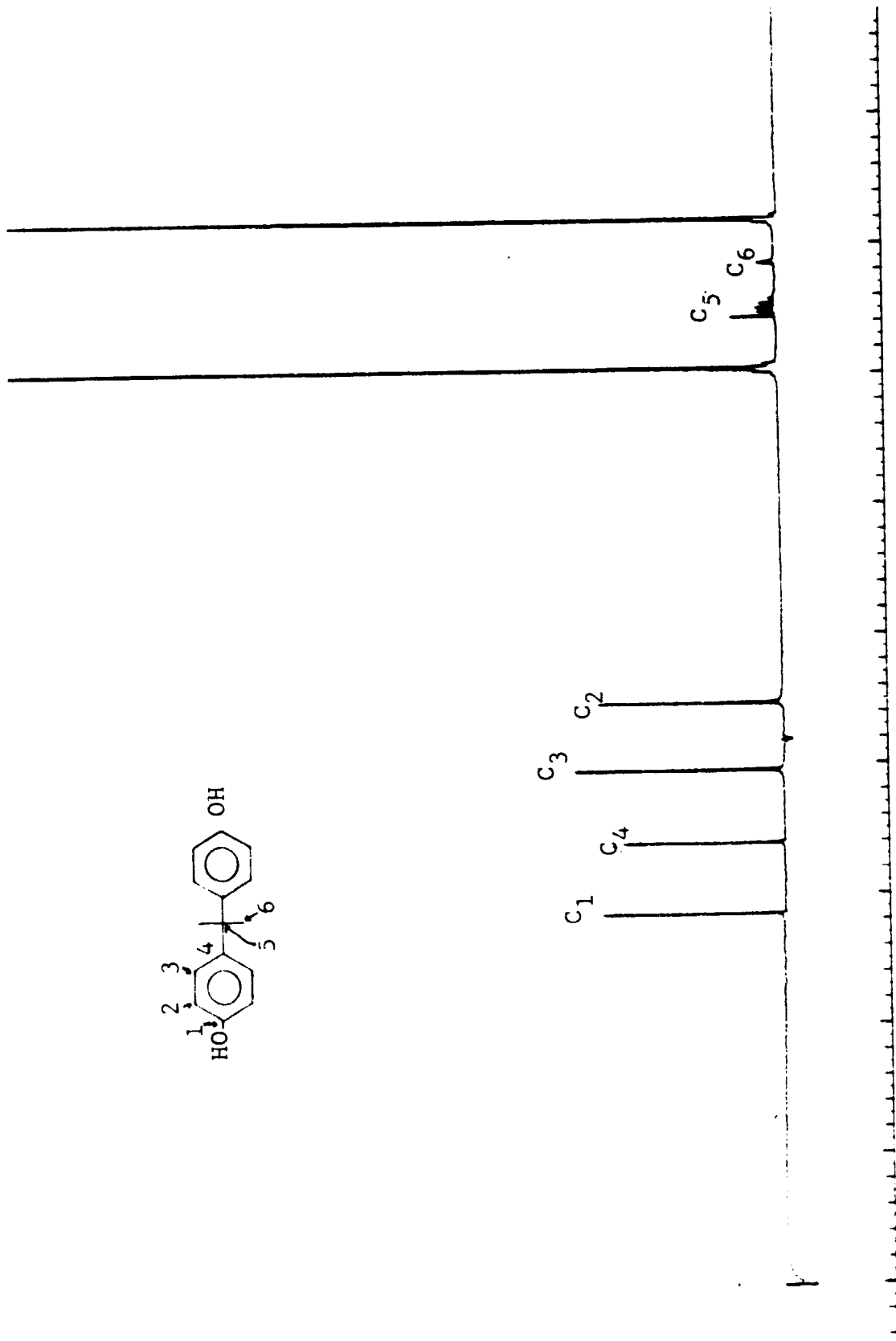


FIGURE 57. ¹³C SPECTRA OF MONOCHLORODIPHENYLSULFONE

FIGURE 58. ^{13}C SPECTRA OF HYDROQUINONE

FIGURE 59 ^{13}C SPECTRA OF BISPHENOL-A

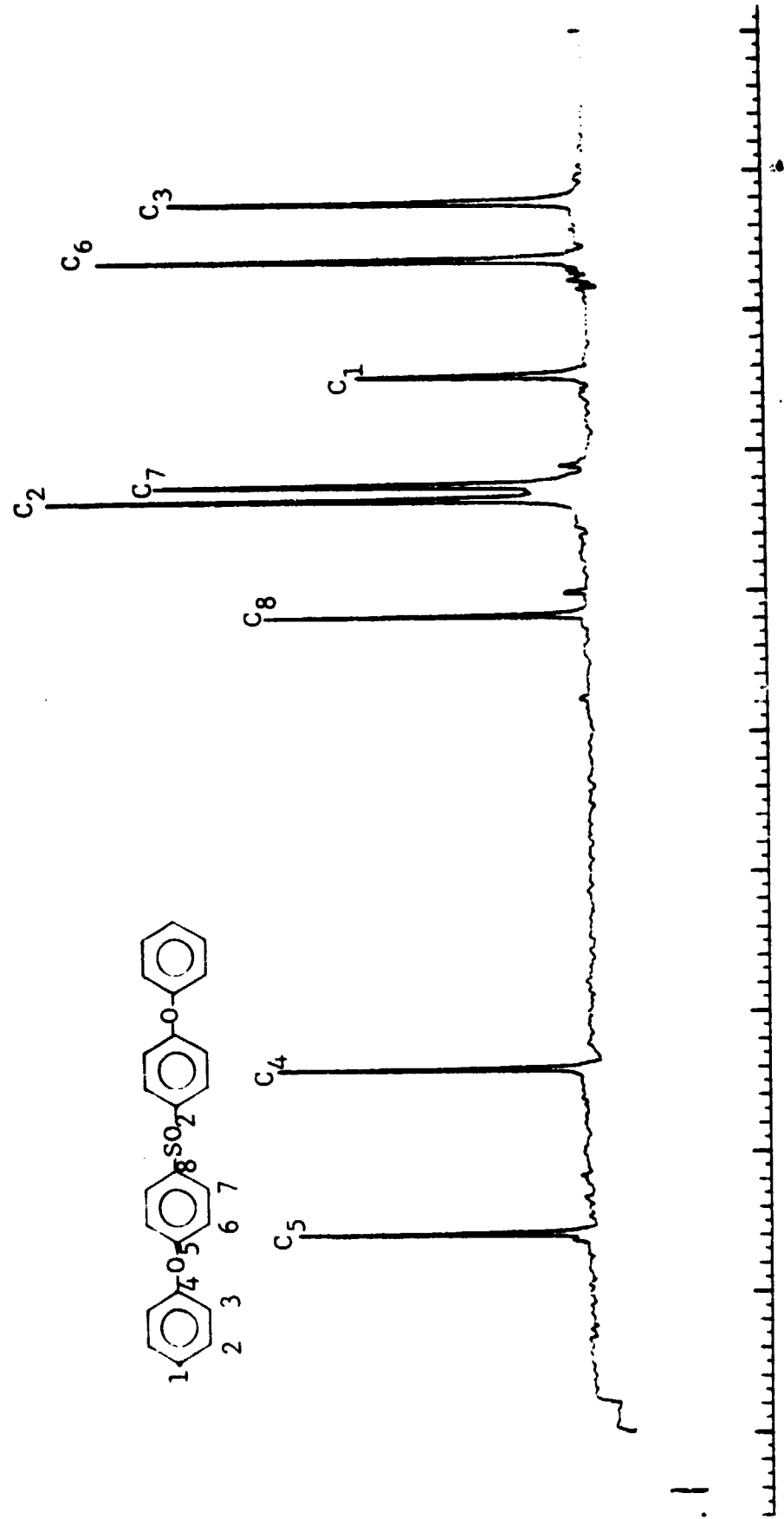
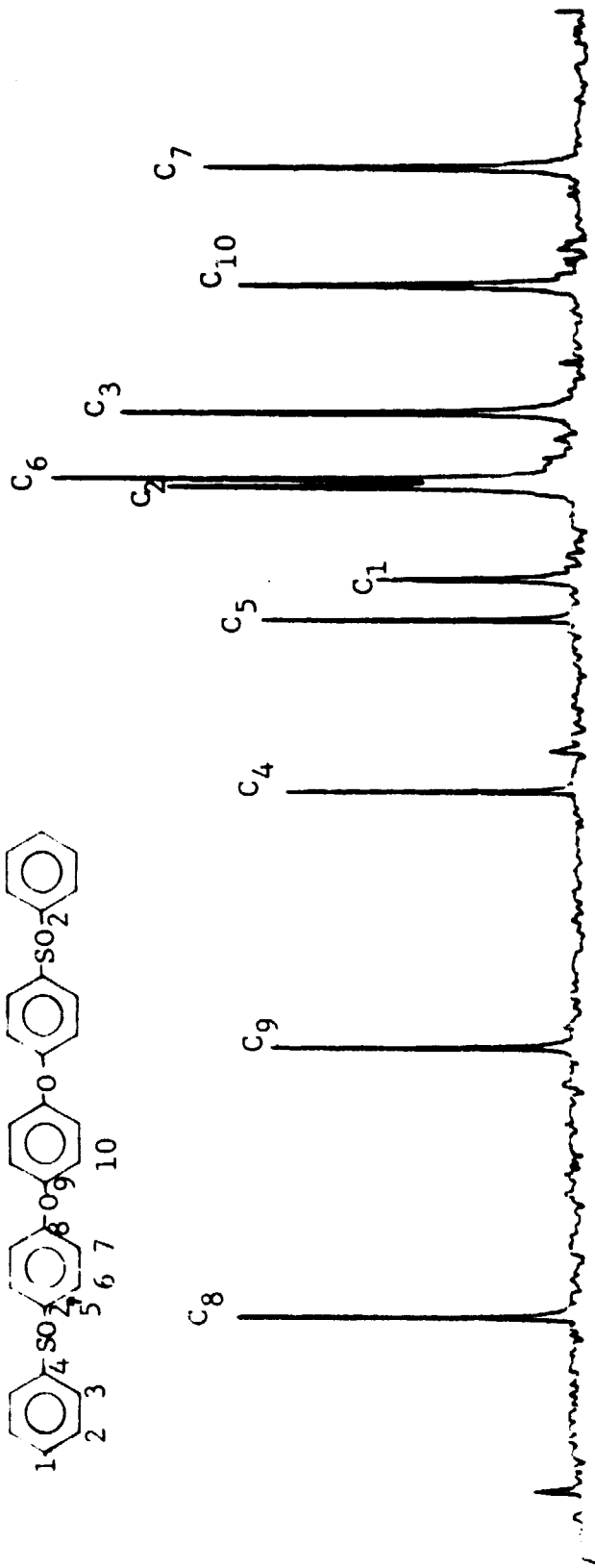
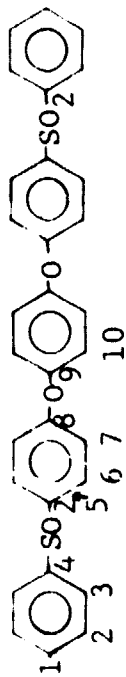


FIGURE 60 ¹³C SPECTRA OF 4,4'-DIPHENOXY DIPHENYL SULFONE (AROMATIC REGION ONLY)

ORIGINAL PAGE IS
OF POOR QUALITY



(PPM)

FIGURE 61¹³C SPECTRA OF BENZENE, 1,4-BIS((4-PHENOXYPHENYL)SULFONE) (AROMATIC REGION ONLY)

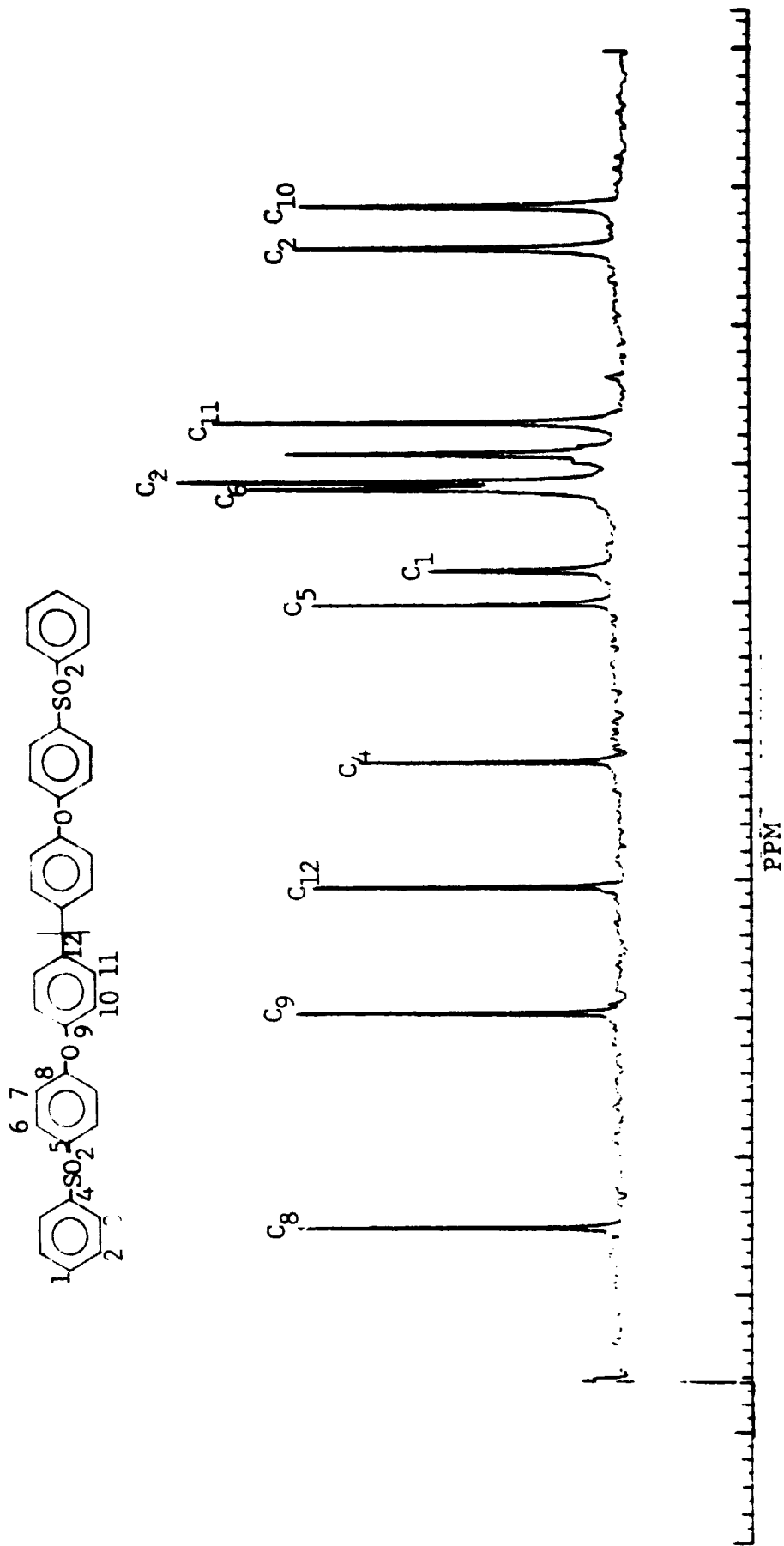


FIGURE 62 ^{13}C SPECTRA OF PROPANE 2,2'-BIS(4'-PHENYLSULFONYL 4-PHENOXY BENZENE

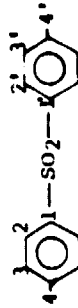
not sensitive to the para substituent in the second ring attached to the same sulfone group, i.e. the carbons were not sensitive past the $>SO_2$ group. See Table 24. Thus the sequence distribution assignment was difficult in this system. Of course, this does not rule out the possibility of ^{13}C NMR for studying sequence distribution, it only suggests that other carbons in the phenyl ring of diphenyl sulfone should be examined.


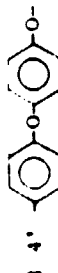

3.6 MONTE CARLO SIMULATION

As mentioned in the previous sections, sequence distribution plays a very important role in the ultimate properties of the polymer. It is of interest to study the various parameters that influence such a distribution. One would, of course, expect the kinetics of the reaction to play a very important role. However, the complex nature of the reaction limits the use of simple mathematical equations. In this section a Monte Carlo method is used to provide information regarding the parameters that influence the sequence distribution of monomer in linear bi-copolycondensation polymers. This section essentially deals with the one stage reaction system in which all the reactants are present from the initiation of the reaction, i.e., no monomer is added during the reaction. Also in all cases a 1:1 comonomer ratio was used.

The results and discussion is divided into three distinct cases, depending on the variation of the functional group reactivity of the monomers.

TABLE 24
EFFECT OF VARIOUS SUBSTITUENTS ON THE CHEMICAL SHIFT OF DIPHENYL SULFONE



SUBSTITUENT 4 4'	1	2	3	4	1'	2'	3'	4'	Solvent	Temp
H	142.15	127.8	130.04	133.87	142.15	127.18	130.04	133.87	NMP	R-T
4-Cl	140.3	129.44	130.018	139.36	141.06	127.62	130.02	134.08	sulfolane	R-T
4-4' Cl	139.51	129.44	130.018	139.36	139.51	129.44	130.02	139.36	--	--
4 4' 	135.48	129.89	120.34	141.75	135.48	129.89	120.34	161.75		
4 4' 	134.68	128.35	120.5	160.2	132.68	128.35	120.5	160.2		
4 4' 	147.75	129.4	120.6	160.2	147.75	129.4	120.6	160.2		

3.6.1 CASE I

Here it is assumed that the reactivity of the monomers do not change during the reaction, i.e., they have independent functional group reactivity. Various reactivity ratios of the comonomers were used and the coefficient of microheterogeneity calculated at various extents of the reaction. Table 25 summarizes the result of the type of polymer obtained for various comonomer reactivity ratios. In all cases the resulting copolymer is random. Under these conditions reactivity ratio does not influence the distribution in the resultant polymer. This result is better represented by Figure 63 a plot of microheterogeneity vs. the extent of reaction for various reactivity ratios. One observes that for high extents of reactions the copolymer tends to have a random distribution. For a better clarity, the percent of unreacted -A-comonomer is plotted as a function of the extent of reaction for $K=1, 10, 1000$ (Figure 64). As the value of K increases more of -A-remains unreacted until 0.5 extent of reaction. At 0.5 extent of reaction when all the -B-comonomers have reacted -A-begins to react. Figures 65 and 66 show the triad distribution vs. extent of reaction for $K=1$ and 1000, respectively. Comparison of these two figures show that at $K=1000$ only -BCB-triads are formed until 0.5 extent of reaction. Beyond this point -ACA- and -ACB-triad begin to form. At completion the random distribution is obtained.

TABLE 25
 TRIAD DISTRIBUTION IN CONDENSATION COPOLYMERS
 CASE I

-A-		-A-		-B-		-B-		REMARKS
K _A ¹¹	K _A ¹²	K _A ²¹	K _A ²²	K _B ¹¹	K _B ¹²	K _B ²¹	K _B ²²	
1	1	1	1	1	1	1	1	random
1	1	1	1	2	2	2	2	"
1	1	1	1	5	5	5	5	"
1	1	1	1	10	10	10	10	"
1	1	1	1	50	50	50	50	"
1	1	1	1	100	100	100	100	"
1	1	1	1	200	200	200	200	"
1	1	1	1	500	500	500	500	"
1	1	1	1	1000	1000	1000	1000	"
1	1	1	1	10,000	10,000	10,000	10,000	"

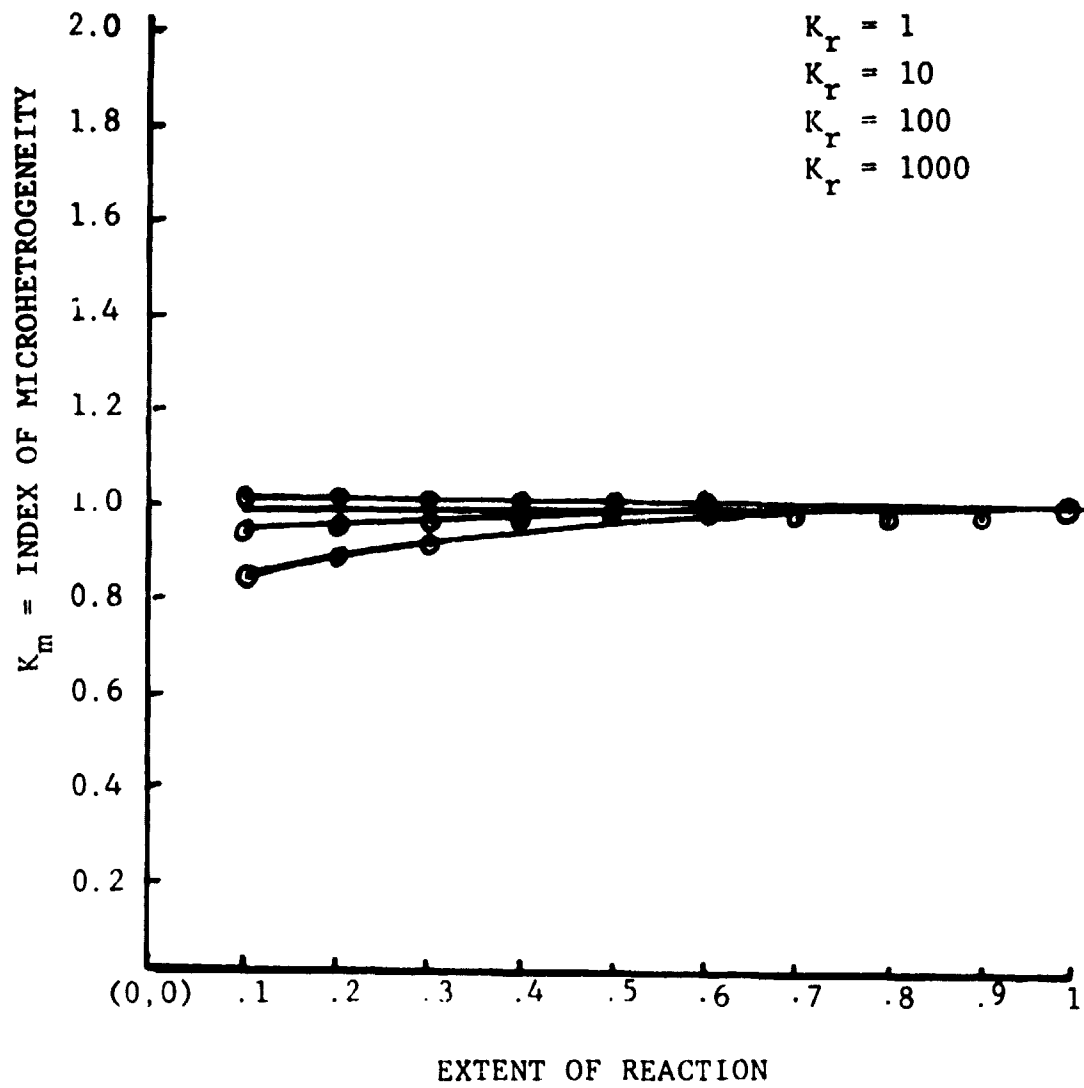


FIGURE 63. CASE I EFFECT OF COMONOMER REACTIVITY RATIO ON MICROHETEROGENEITY.

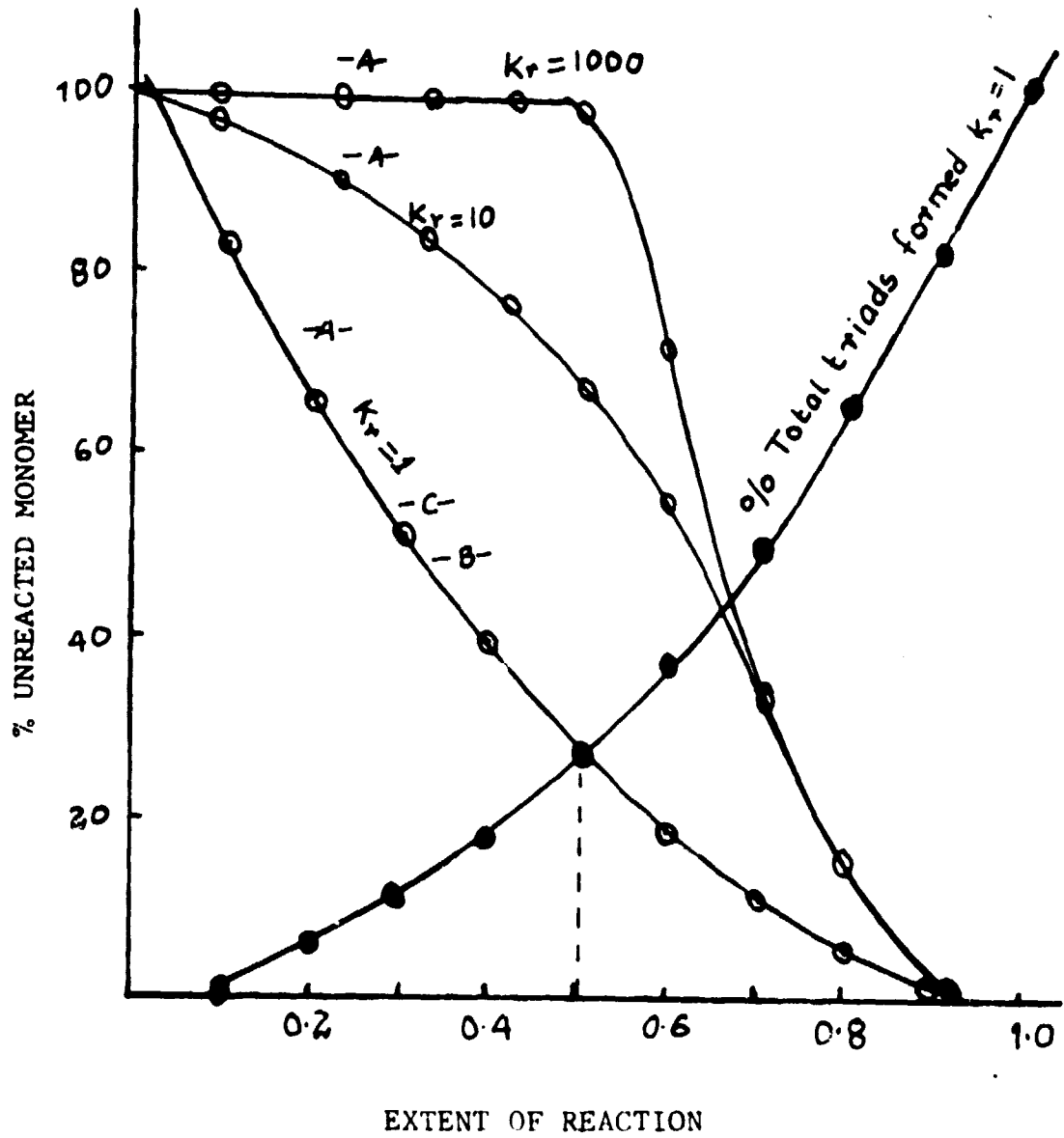


FIGURE 64. PLOT OF MONOMER CONCENTRATION VS EXTENT OF REACTION (CASE I)

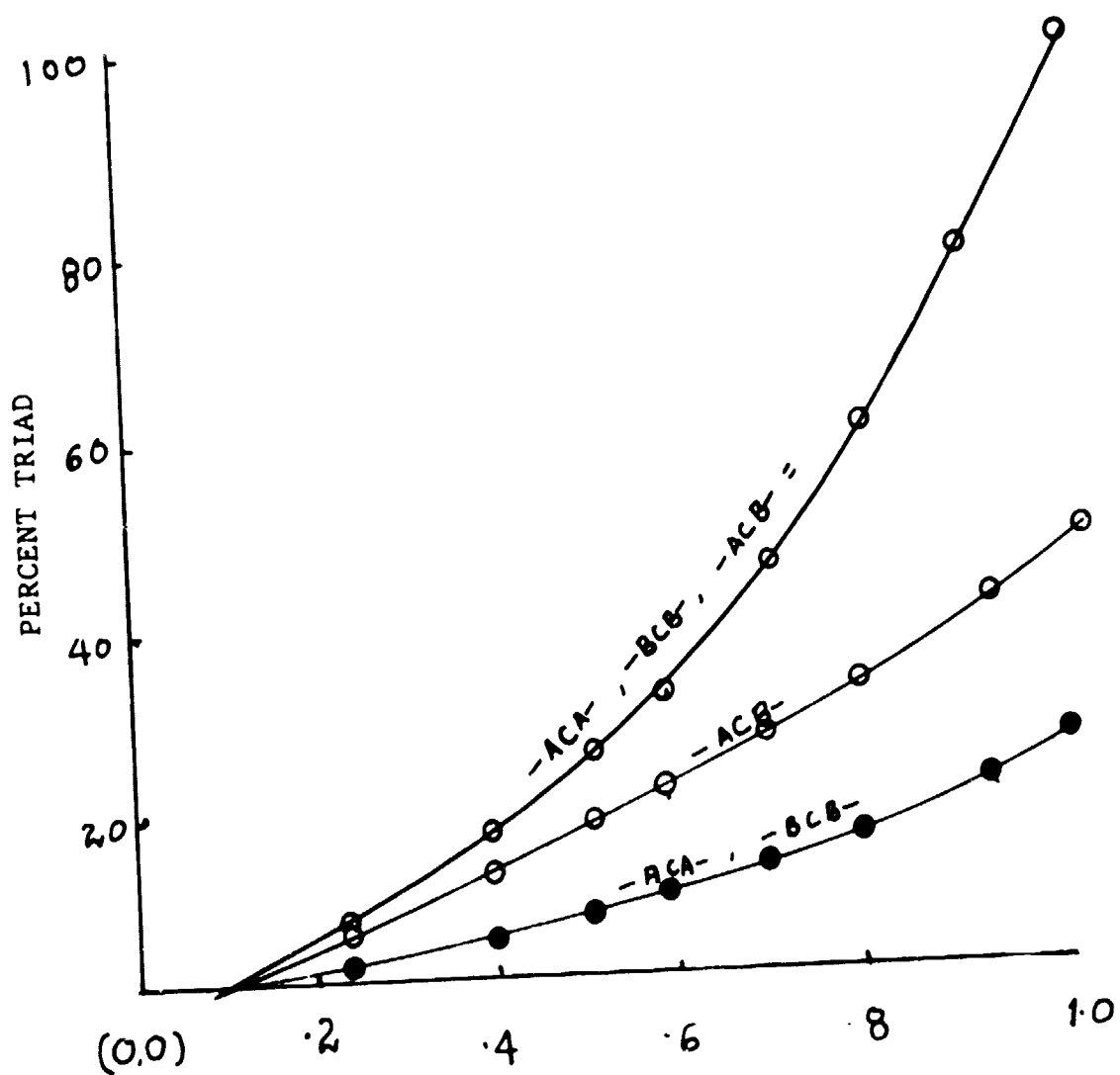


FIGURE 65. PERCENT TRIAD VS EXTENT OF REACTION
CASE I. $K_r = 1$.

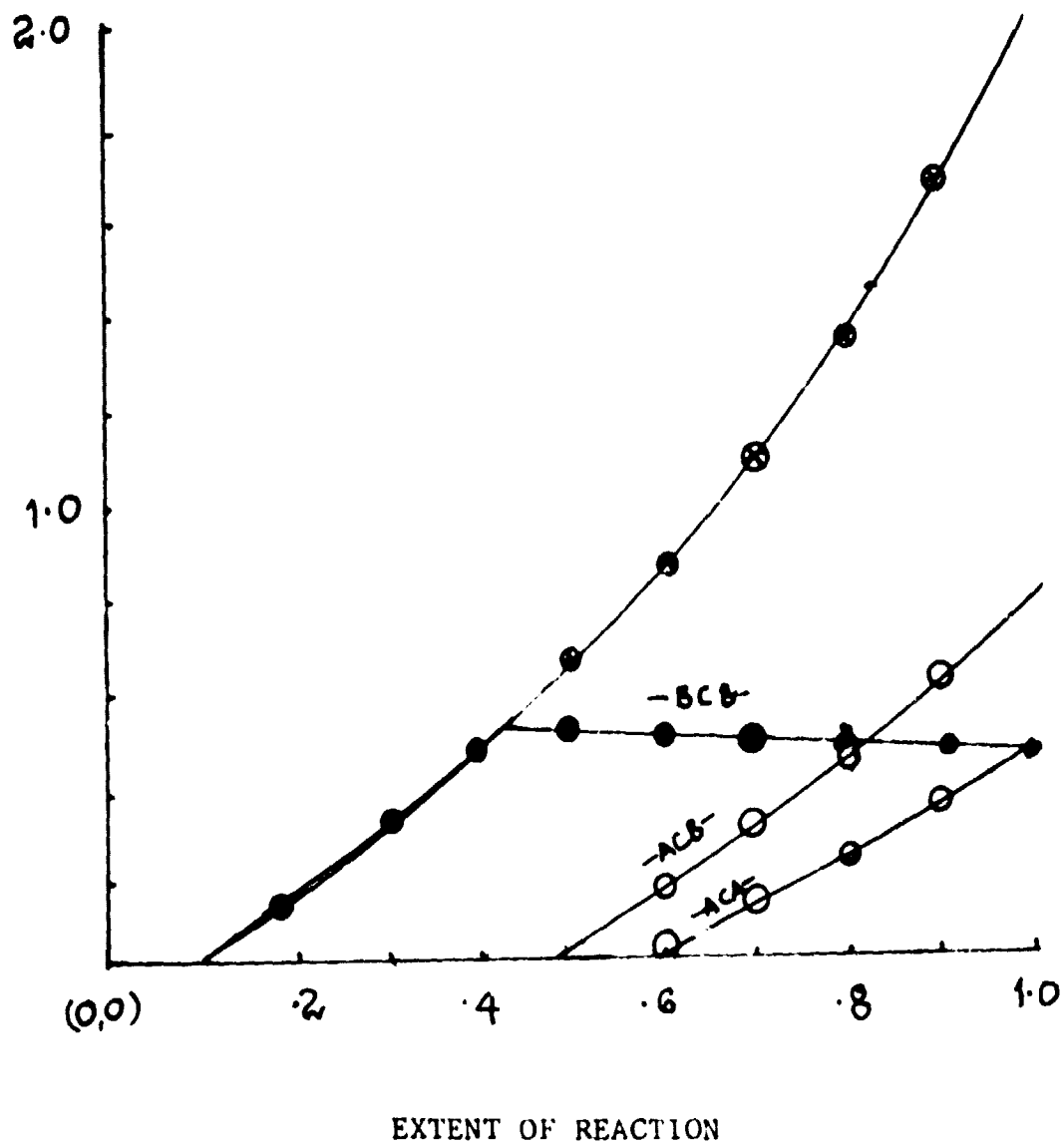


FIGURE 66. MICROHETEROGENIETY (K_M) VS EXTENT OF REACTION. CASE I. $K_r = 1000$.

3.6.2 CASE II

Here, while the comonomers have independent functional group reactivity, the reactivity of the functional group of the intermonomer is varied. The reaction rate constants for this system may be represented as follows:

The type of copolymer obtained depends on the reactivity ratio of the comonomers ($K_r = K_b/K_a$) as well as K_c , as seen in Table 26. When the comonomer reactivity ratio (K_r) is one the polymer is always random irrespective of the value of K_c . Thus random copolymers are obtained when K_r or $K_c = 1$. As the value of K_r increases; alternating copolymer is formed. Here with increasing values of K_c and K_r , the intermonomer essentially behaves as a monofunction molecule and reacts only with comonomer -B-forming -CBC-reactive species. This later reacts with comonomer -A-producing alternating copolymer. The degree of alternation increases as the value of K_c and K_r simultaneously increase (see Figure 67). However, if the ratio of K_c/K_r increases a random copolymer is obtained.

3.6.3 CASE III

In the previous case the value of K_c was 1, in this case the value for K_c is 1. In other words, the dimeric or oligomeric functional group reacts faster than the monomeric one. Table 27 summarizes the type of copolymer. Once again a random copolymer is formed for $K_r = 1$. For increasingly larger values of K_r and K_c a block copolymer is ob-

TABLE 26
 TRIAD DISTRIBUTION IN CONDENSATION COPOLYMERS
 CASE II

K_A		K_B		REMARKS
$K_{11}=K_{21}$ A A	$K_{12}=K_{22}$ A A	$K_{11}=K_{21}$ B B	$K_{12}=K_{22}$ B B	
10	1	10	1	random
100	1	100	1	random
1000	1	1000	1	random
10	1	100	10	alternating
100	1	1000	10	alternating
1000	1	10,000	10	alternating
10	1	1000	100	alternating
100	1	9999	100	alternating
10	1	10,000	1000	alternating

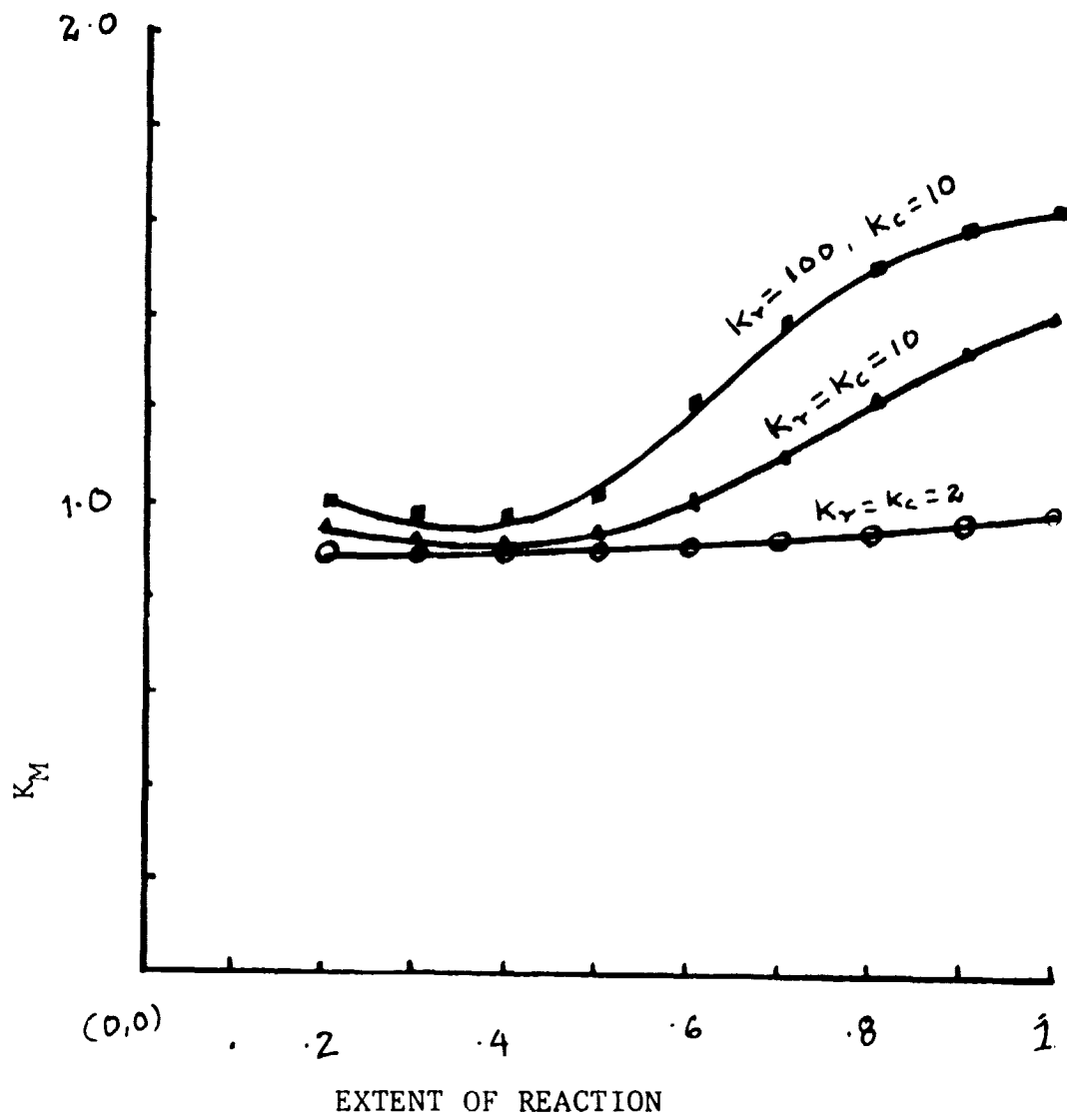


FIGURE 67. PLOT OF K_M VS EXTENT OF REACTION.
CASE II.

TABLE 27
 TRIAD DISTRIBUTION IN CONDENSATION COPOLYMERS
 CASE III

K_A		K_B		REMARKS
$K_{11}=K_{21}$ A A	$K_{12}=K_{22}$ A A	$K_{11}=K_{21}$ B B	$K_{12}=K_{22}$ B B	
1	1000	1	1000	random
1	100	10	1000	block
1	10	100	1000	block

tained. Here, initially formed -CB-species react with B comonomer to form -BCBCB-type species, thus generating long sequences of -BCBB-triad thereby resulting in block copolymers. Figure 68 shows the behavior of K_m vs. the extent of reaction for various values of K_c .

One very interesting observation in this study is that at 0.5 extent of reaction the fraction of unreacted intermonomer is always equal to the fraction of triads formed. This holds true for all cases. A representation plot is shown in Figure 64.

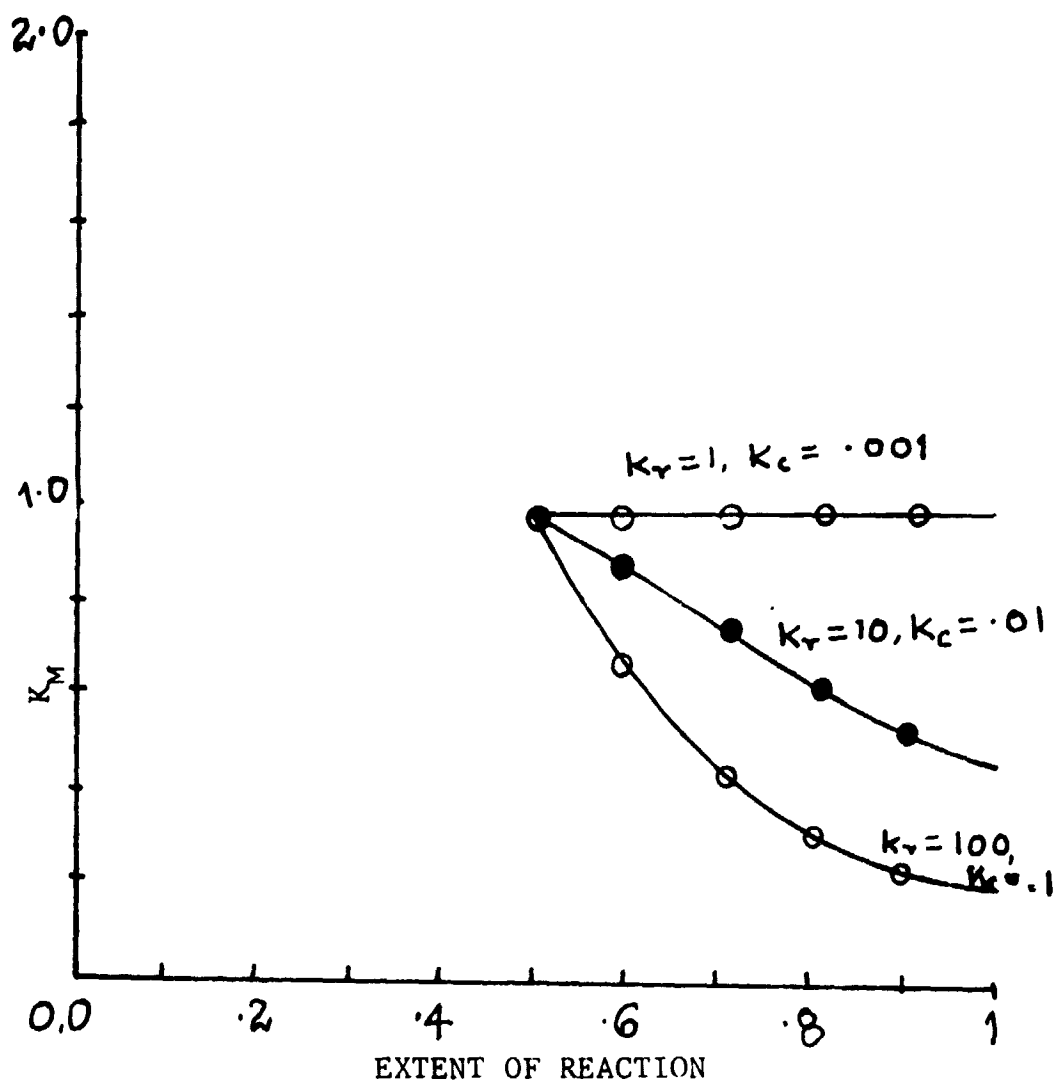


FIGURE 68. PLOT OF K_M VS EXTENT OF REACTION
CASE III.

Chapter IV

CONCLUSIONS

The classical route for the synthesis of poly(arylene ether sulfones) is via nucleophilic aromatic substitution using dimethyl sulfoxide (DMSO) as a dipolar aprotic solvent and aqueous sodium hydroxide as a base.

A wide variety of high molecular weight homopolymers have been synthesized. However, hydrolytic side reactions can limit the scope for the synthesis of block copolymers. An alternate route using dimethylacetamide/potassium carbonate as solvent and base, respectively has been cited in the patent literature. We have used this method successfully for the synthesis of several homopolymers and copolymers. Our results show that a slight excess of potassium carbonate (anhydrous) does not hydrolyse the dihalide or the ether linkage in the polymer. Also the synthesis of oligomers of predetermined molecular weight is easily reproducible. The reaction can be carried out with preformed phenoxide or the in situ method, thereby extending the scope of the technique to the synthesis of block copolymers. Our investigation into the kinetics and mechanism of this process has demonstrated that although the reaction is bimolecular it deviates from simple second order kinetics. An azeotrope study of DMAC/Toluene showed nearly 15% of toluene at the reaction conditions (150°C). This could have a retarding effect on the cation solvating power of the phenoxide. The deviation

from simple second order kinetics has been rationalized to be due to the partially heterogeneous nature of the reaction.

These polymers have the characteristics that include excellent stability (hydrolytic, thermal and dimensional), very good mechanical properties and high T_g 's. However, they undergo catastrophic failure while under stress, in the presence of liquid environments. This failure has been attributed to their amorphous rigid nature. We reasoned that the introduction of a second ordered or crystalline component would vastly improve its solvent resistance.

Since hydroquinone polysulfone was reported to be semi-crystalline "as made", we synthesized and studied "random" copolymers obtained by reacting various mole ratio combinations of bisphenol-A and hydroquinone. The copolymers containing less than about 80 mole% hydroquinone were generally soluble in halogenated solvents and their intrinsic viscosities were measured in methylene chloride. The intrinsic viscosity of pure hydroquinone polysulfone was measured in *o*-chlorophenol. The intrinsic viscosities ranged from 0.4-0.8 dl/gms, which corresponded to 20,000-40,000 (M_n). The G.P.C. traces indicated a polydispersity of 2.0, which is characteristic of linear condensation polymers. A small hump near the total elution volume in the G.P.C. traces, was attributed to the cyclic dimer.

The glass transition temperature (T_g) increased monotonically from 185°C for pure bis-A, sulfone homopolymer

to 10°C for hydroquinone homopolymer. The hydroquinone homopolymer was crystalline "as made" with a T_m of 310°C. It could not be thermally crystallized by annealing at 254°C for several hours. However, the polymer could be crystallized by a novel solvent induced crystallization process. The formation of crystalline domains was further confirmed by scanning electron microscope (SEM) and wide angle X-ray.

Mechanical properties of the copolyemrs were studied on a tensile tester and rheovibron. The incorporation of hydroquinone moeity did not decrease the mechanical properties. The glass transition temperatures were consistent with the thermal studies.

Two different types of mechanical tests were used to study the solvent resistance of the copolymers. Rapid qualitative analysis for various stress cracking liquids was observed by a bent strip method. A more semi-quantitative analysis was studied by a constant stress test. From the above studies it was concluded that the stress crack resistance of these copolymers is a function of the applied stress, the hydroquinone content and the solubility parameter of the solvent. A mechanism for improved solvent resistance of semi-crystalline polymer was thus proposed.

NMR and ^{13}C spectroscopy of the copolymers were studied to further elucidate their micro structure. The composition of the copolymers were obtained within $\pm 3\%$ of the calculated value, by proton NMR. ^{13}C spectral assignments were successfully made based on model compounds. The possibility of

using ^{13}C and proton spectroscopy for determining sequence distribution was investigated. Preliminary results show proton spectroscopy to be more promising.

Multiblock $(-A-B-)_n$ copolymers of bisphenol-A polycarbonate and several poly(arylether sulfones) were synthesized from well characterized oligomers. One of the most interesting aspects of these block copolymers is their ability to undergo microphase separation above a critical block length. It was possible to prepare one or two phase block copolymers by controlling the molecular weights and/or interaction parameters of the parent oligomers. Surface characterization showed a polycarbonate surface even on "one phase" block copolymers. This may be due to the lower critical surface tension of polycarbonate segments compared to those of polysulfones.

Triad distribution of monomers in non equilibrium linear bicopolycondensation was investigated by Monte'Carlo simulation. The simulation technique was used to replace complex mathematical treatments. All theories proposed so far were verified. This also helped in establishing "program credibility" of the technique useful for extending the recent theory.

In the one step process, where the intermonomer and/or comonomers have dependent functional group reactivities, the resulting copolymer was always random irrespective of the reactivity ratio of the comonomers. A non random distribution was obtained when the reactivity ratio of the

functional groups in the intermonomer and those of the comonomer were much greater than unit. Monomers that resulted in a random copolymer in a one step process could be made with a non random distribution by a multi step process. In summary, for a given set of kinetic parameter and feed ratio of the monomers it is possible to see if and how a predetermined micro architecture can be synthesized.

Chapter V

REFERENCES

- (1) Flory P. J. "Principles of Polymer Chemistry", Cornell University Press, Ithaca, New York, 1953.
- (2) Noshay A. and McGrath J. E. "Block Copolymers: Overview and Critical Survey", Academic Press Inc., New York (1977).
- (3) Ullmann F. Ber 37, 853 (1904).
- (4) Moroz A. A. and Shvartsberg M. S.: Russ Chem Rev 43, 679-689 (1974).
- (5) Staudinger H. and Staiger F. Ann., 67, 517 (1935).
- (6) Golden J. H. Soc Chem Ind (London) Monogr No 13, 231 (1961).
- (7) Brown G. P. and Goldman A. Poly Prepr. 5(2), 39 (1963).
- (8) Brown G. P., Poly. Prep., Vol. 6, 195 (1964).
- (9) Stamatoff. Fr. Pat. 1,301,174 (1962); U.S. Pat 3,228,910 (1966).
- (10) Brit. Pat 1,053,053 (1966), Chem. Abst. 66, 56009q.
- (11) Van Dort H. M. et al European Polymer Journal Vol 4 p 275-287 (1968).
- (12) Pankova E. S., Martsenitsena S. V. and Berlin A. A. Vysokomol Soyed A 17: No 7, 1415-1420 (1975).
- (13) Bunnett J. F. and Zahler R. F., Chem. Rev. 49, 273 (1951).
- (14) Weigarten H. J. Org. Chem., Vol. 29, 277 (1964).
- (15) Weigarten H. J. Org. Chem., Vol. 29, 3524 (1964).
- (16) Turner R. W. and Amma E. L. J. Am. Chem. Soc. 5, 4046 (1963).
- (17) Bacon R. G. R. and Stewart O. J., J. Chem. Soc. (C) 301 (1961).
- (18) Shein S. M. and Litvak V. V. Izv. Sibir. Otd. Akad. Nauk SSSR, Ser, Khim, No 2, Issue 1, 104 (1973).

- (19) Litvak V. V. and Shein S. M. Zhur. Org Khim 9,326 (1973).
- (20) Shein S. M. and Litvak V. V. Tezisy Vses. Simp Org. Sint Benzoidnye Armot. Soedin, 1st 1974, 104-5.
- (21) Robeson L. M. et al., Applied Polymer Symposia 26,373 (1975).
- (22) Bacon R. G. R. and Hill H. A. O., J. Chem. Soc, 1108 (1964).
- (23) Bacon R. G. R. and Stewart O. J., J. Chem. Soc, 4953 (1965).
- (24) Tomita M. et al Pharm. Bull (Tokyo), 13, 1341 (1965).
- (25) Torrey H. A. and Hunter W. H., J. Am. Chem. Soc., 33, 194, (1911).
- (26) Hunter W. H. and Dahlen M. A., J. Am. Chem. Soc., 54, 2456 (1932) and J. Am. Chem. Soc., 55, 3701 (1933) and references therein.
- (27) Golden J. H., Soc. Chem. Ind. (London), 13, 231 (1961).
- (28) Muller E. et al Naturforschg., 176, 567 (1962).
- (29) Hedayatullah M. and Deniville L. Compt.rend 254, 2369 (1962).
- (30) Rainford H. S. and Le Rosen, J. Am. Chem. Soc., 68,397 (1946).
- (31) Staffin G. D. and Price C. C., J. Am. Chem. Soc., 82, 3632 (1960).
- (32) Cook C. D. et al., J. Am. Chem. Soc., 78, 4159 (1958).
- (33) Dimroth K. et al. Ann. 624, 57 (1959).
- (34) Butte W. A., Price C. C. and Hughes R. E. J. Polym. Sci., 61 528 (1962).
- (35) Ali S. M. and Price C. C. Macromolecules 10(2), 428-5 (1977).
- (36) Brit. Pat 959 283 (1964) Chem. Abst. 61, 9644 (1964).
- (37) N. V. Polychemie-AKU G. E. Neth. Pat. 6516934 (1966); Chem. Abst. 67, 82564g (1967).
- (38) Lindgren A. J. Acta. Chem. Scand., 14, 2089 (1960).

- (39) Edward J. M. (to Sun Oil Co) U. S. Pat. 3,260,701 (1966) Chem. Abst. 65, 7315 (1966).
- (40) McNelis E., J. Org. Chem., 31, 1255 (1966).
- (41) Shigeru T. and Takashi Y., J. Cat. 58(3), 444-53 (1979) and references therein.
- (42) Masanori H. et al., Nippon Kagaku Kaishi (3) 441-3 (1977).
- (43) Carr B. and Harrod J. F., Chem. Abst. 70,63644d(1969).
- (44) Blanchard H. S. et al., J. Poly. Sci., Vol 58, 469-90 (1962).
- (45) Sasaki J. (to Mitsui Petroleum Industries) Jap 3195 Chem. Abs. 67, 11992 (1967).
- (46) Inoue H. Bull. Chem. Soc. Japan, 35, 1958 (1962).
- (47) U. S. Pat. 3,257,357 (1966), Chem. Abst. 65,9056a.
- (48) Stamatoff G. S., E. I. Dupont De Nemours and Co. Brit. Pat. 1053638 (1967); Chem. Abst. 66, 55983r (1967).
- (49) Fr. Pat. 1,403,987 (1965), Chem. Abst. 64143865.
- (50) Price C. C. J. Poly. Sci., 49, 267 (1961).
- (51) Toyoky T., J. Soc. Org. Synth. Chem., Japan 22, 755 (1964).
- (52) Hay A. S., Advances in Polymer Science Vol 4, p 496-527 (1967).
- (53) Terent'ev and Mogilyanskii Ya.D.Dok, Akad, Nauk, SSR. 103, 91 (1955).
- (54) Hay A. S. J. Poly. Sci., 58, 581 (1962).
- (55) Endres G. F. J. Org. Chem. 28, 1300 (1963).
- (56) Endres G. F.; J. Kwaitek. J. Poly. Sci. 58, 593(1963).
- (57) McNelis. J. Org. Chem. 31, 1255 (1966).
- (58) Cooper G. H., J. Am. Chem. Soc., 87, 3996 (1965) and references therein.
- (59) Mijs. W. J. et al. Tetrahedron 23, 2253 (1967).

- (60) Olander W. K. (G. E. Company) U.S. Pat. 4,184,034. Chem. Abst. 92-147515e (1978).
- (61) Olander W. K. (G. E. Company) U.S. Pat. 4,130,544. Chem. Abst. 90-104674u (1978).
- (62) Tsuyoshi N. Y. (Sumitomo Chemical Corp.) Jap., Tokyo, Koho, 7845840.
- (63) Nakshio Y.; Takemura T. (Sumitomo Chemical Corp.) Jap., 7310959. Chem. Abst. 80-134066m (1973).
- (64) Sugio A., (Mitsubishi Gas Chemical Co.) Ger. Pat. 2913204. Chem. Abst. 92-1359x.
- (65) Cooper G. D., Watson J. W. (G. E. Company) Ger. Pat. 2752867. Chem. Abst. 89-110806n (1978).
- (66) Olander W. K. (G. E. Company) Ger. Pat. 2756416. Chem. Abst. 89-110814y.
- (67) Olander W. K. (G. E. Company) Ger. Pat. 2756323. Chem. Abst. 89-110845z (1978).
- (68) Cooper G. D. (G. E. Company) Fr. Pat. 2362882. Chem. Abst. 89-216074n (1978).
- (69) Kzawa S., Harada K., Mizushira K., Kasai K., Ishiraha M., Nakanishi A. (Asahi Dow Ltd.) Jap. Pat. 73,43,799. Chem. Abst. 80-4058z (1973).
- (70) Walter D., Schott H. (Farbwerke Hoechst A.-G.) Ger. Pat. 2,201,161. Chem. Abst. 80-27083z (1973).
- (71) Kawamoto H., Ohmura H., Takami T., Matsumoto H. (Asahi Chem Ind.) Jap. Pat. 73,17,396. Chem. Abst. 80-83944m (1973).
- (72) Kawamoto H., Ohmura K., Takami T., Matsumoto H. (Asahi Chem Ind.) Jap. Pat. 73,17,396. Chem. Abst. 80-83946p (1973).
- (73) Kawamoto H., Ohmura K., Matsumoto H. (Asahi Chem Ind.) Jap. Pat. 73,17,397. Chem. Abst. 80-83947q (1973).
- (74) Izawa S., Mizushiro T. (Asahi Dow Ltd.) Jap. Pat. 73,17,398. Chem. Abst. 80-109097q (1973).
- (75) Tsuchida E., Nishide H. Jap. Pat. 73,79,900. Chem. Abst. 80-109099s (1973).
- (76) Sekitoda H., Kaneko M., Nishide H. (Research Inst. for Production) Jap. Pat. 73,11,238. Chem. Abst. 80-134065k (1973).

- (77) Isoyawa M., Sakuchi T., Someniya A., Karaki T. (Kane Chem) Jap. Pat. 73,24,520. Chem. Abst. 80-109106s (1973).
- (78) Kase M., Ogasawara Y., Manoura M. (Dainippon Ink and Chem Ltd.) Jap. Pat. 73,75,696. Chem. Abst. 80-121504c (1973).
- (79) Nakanishi A., Izawa S., Sotoyama K., Sato K., Tazaki K. (Asahi Dow Ltd) Jap. Pat. 72,41,102. Chem. Abst. 80-4283u (1972).
- (80) Bennett J. D.; Cooper G. D.; Katcheman A. (G. E. Company) Ger. Pat. 2,446,426. Chem. Abst. 83-80242g.
- (81) Holub F. F., Emerick C. M. (G. E. Company) U.S. Pat. 3,753,946. Chem. Abst. 80-27835q (1973).
- (82) Nakashio S., Maruta I., Hayatsu K., Kono Y. (Sumitomo Chem Co Ltd.) U.S. Pat. 3,767,730. Chem. Abst. 80-83967w. (1973).
- (83) Izawa S., Harada K. (Asahi Dow Ltd) Jap. Pat. 73,17,760. Chem. Abst. 80-134074n (1973).
- (84) Nakashio Y., Yakemura Y., Maruyama T., Ohta K., Seto T. (Sumitomo Chem Ltd) Jap. Pat. 73,10,959. Chem. Abst. 80-134066m (1973).
- (85) Carr B. G., Harrod J. F., Van Gheluwe P. (Chem Dept McGill Univ. Montreal Que.) Can. Pat. Chem. Abst. 80-15239k (1973).
- (86) Tsuchida E., Nishide H. Jap. Pat. 73,100,497 Chem. Abst. 81-4370r (1973).
- (87) Bennett J. G., Katcheman A. (G. E. Company) U. S. Pat. 3,796,689. Chem. Abst. 81-26282r (1974).
- (88) Mizushiro T., Ishihara M. (Asahi Dow Ltd) Jap. Pat. 73,32,795. Chem. Abst. 81-26265n (1970).
- (89) Yonezawa T., Tsuruya S., Nakamae K. (Asahi Dow Ltd) Jap. Pat. 73,32,794. Chem. Abst. 81-26266p (1973).
- (90) Kawamoto H., Ohmura K., Takami T., Matsumoto H. (Asahi Chem Ind. Co) Jap. Pat. 73,27,750. Chem. Abst. 81-26245f (1973).
- (91) Gutsalyuk V. G., Sdobnov E. I., Kholina E. V. U.S.S.R. Chem. Abst. 81-25996g (1973).
- (92) Pol. Pat. 69,125. Chem. Abst. 81-25996j (1973).

- (93) Cooper G. D., Bennett J. G. (General Electric) Can. Pat. 956, 746. Chem. Abst. 82-58585d (1974).
- (94) Shono T. (Mitsubishi Petrochemical Co Ltd) Jap. Pat. 74,41,490. Chem. Abst. 82-31738u (1974).
- (95) Jap. Pat. 74,26,719. Chem. Abst. 82-73656w (1974).
- (96) Jap. Pat. 74,16,120. Chem. Abst. 82-31775d (1974).
- (97) Nakashio A., Oosaka K., Ito S., Toyama K., Kasai Y. (Asahi Dow Ltd) Jap. Pat. 74,69,797. Chem. Abst. 82-17798g (1974).
- (98) Kase M., Ogasawara Y. (Dainippon Ink and Chemicals Inc) Jap. Pat. 73,102,898. Chem. Abst. 82-126043c (1973).
- (99) Nakashio s., Takemura T., Shirane H. (Sumitomo Chem Co Ltd) Jap. Pat. 74,117,599. Chem. Abst. 82-125871j (1974).
- (100) Jap. Pat. 74,14,555. Chem. Abst. 82-4785a (1974).
- (101) Jap. Pat. 74,17,679. Chem. Abst. 82-31895t (1974).
- (102) Kawamoto H., Kimura K. (Asahi Chem Ind Co Ltd) Jap. Pat. 74,48,197. Chem. Abst. 83-11174z (1974).
- (103) Jap. Pat. 74,97,865. Chem. Abst. 82-589k.
- (104) Pravednikov A. N., Kopylov V. V., Cherednichenko V. M. U.S. Pat. 3,843,604. Chem. Abst. 83-59839x (1974).
- (105) Manecke G., Kaneko M. (BASF A.-G.) Ger. Pat. 2,350,312. Chem. Abst. 83-59923v (1975).
- (106) Yonemitsu E., Kashiwa C., Sugio A., Konishi A. (Mitt-subishi Gas Chem Co Ltd) Ger. Pat. 2,451,905. Chem. Abst. 83-11538lf (1975).
- (107) Jap. Pat. 75,09,032. Chem. Abst. 83-115445e (1975).
- (108) Jap. Pat. 74,46,604. Chem. Abst. 83-16486j (1974).
- (109) Jap. Pat. 75,22,096. Chem. Abst. 83-28842p (1975).
- (110) Hay, A. S. (General Electric) Ger. Pat. 2,505,328. Chem. Abst. 84-5674s (1974).
- (111) Khlebnikov B. M., Yudkin B. I. (Novosib Filial, okhtin Nauchno-Proizvod. Ob'edin "Plastpolimer" Novosibirsk) Vysokomol Soedin Ser B 17 (10) 758-61 (1975) Chem. Abst. 84-31610 (1975).

- (112) Ger. Pat. 2,528,045. Chem. Abst. 84-180896n (1976).
- (113) Ger. Pat. 2,527,759. Chem. Abst. 84-180897p (1976).
- (114) Nakashio S., Takemura T., Sirane H. (Sumitomo Chem Co Ltd) Jap Pat 75,104,298. Chem. Abst. 84-44948d (1975).
- (115) Kaneko M. (Nissan Chem Ind Ltd) Jap. Pat. 75,145,497. Chem. Abst. 85-22108y (1974).
- (116) Nikiforova I. S., Mamadzhanova S.Sh., Bronovitskii V. E., Yusupov A. M., Volochkovich M. A. Chem. Abst. 85-22155m (1973).
- (117) Ogasawara Y., Kase M., Matsuura M. (Dainippon Ink and Chem Inc) Jap Pat. 75,18,919. Chem. Abst. 85-6390d (1975).
- (118) Ger Pat. 2,546,621. Chem. Abst. 85-47847b (1976).
- (119) Ishihara K., Sugie T., Ito T. (Dainippon Ink and Chem Co) Jap Pat. 76,38,398. Chem. Abst. 85-63634k (1976).
- (120) Kaneko M. (Nissan Chemical Ind Ltd) Jap Pat. 76,09,119. Chem. Abst. 85-94929g (1976).
- (121) Chujo K., Sawada H. (Daicel Ltd) Jap. Pat. 75,28,999. Chem. Abst. 85-94951r (1976).
- (122) Pol. Pat. 79,453. Chem. Abst. 85-19326x.
- (123) Sugie T., Ishihara K., Honda K. (Dainippon Ink and Chemical Inc) Jap Pat. 76,30,899. Chem. Abst. 85-33707u (1976).
- (124) Hirose M., Imamura Y., Kurahashi T. (Fac. Sci., Sci Univ. Tokyo) Chem. Abst. 86-156072m (1977).
- (125) Stille J. K., Mukamal H. (Univ. Iowa, Iowacity) Chem. Abst. 86-171883v (1976).
- (126) Sugio A., Konishi A., Kawaki T. (Mitsubishi Gas Chem Co) Jap Pat. 76,151,800. Chem. Abst. 86-90626m (1976).
- (127) Olander W. K. (General Electric) Ger Pat. 2,557,333. Chem. Abst. 86-55950r (1976).
- (128) Yonemitsu, E., Sugio A., Kuramoto A., Urabe H. (Mitsubishi Gas Chem Co) Ger Pat. 2,616,746. Chem. Abst. 86-17298b (1976).
- (129) Bennett J. G., Cooper G. D. (General Electric) U.S. Pat. 4,032,512. Chem. Abst. 87-53882s (1977).

- (130) Schouten A. I., Wiedijk D., Borkent I., Challa G. (Lab polmer chem state univ. Groningen Neth.) Chem. Abst. 87-6445s (1977).
- (131) Semsarzade M. A., Price C. C. (Dept. Chem Univ Pennsylvania, Philadelphia, Pa) Chem. Abst. 87-6428p (1977).
- (132) Apostolov S. A., Mikhailova G. F., Monakhova L. A. (North-Western correspondence polytechnic institute) U.S.S.R. pat. 576,325 Chem. Abst. 87-20234lu (1977).
- (133) Yoshimura T., Storck W., Manecke G. (Fritz-Haber inst Max-Planck Ges., Berlin, Germany) Chem. Abst. 87-136442z (1977).
- (134) Olander W. K. (General Electric) Ger. Pat. 2,702,294 Chem. Abst. 87-118730n (1976).
- (135) Jap Pat. 77,144,097 Chem. Abst. 87-122130e (1977).
- (136) Sotoyama K., Kobayashi M., Imamura T., Izawa S., Nakanishi A. (Asahi Dow Ltd) Jap. Pat. 77,144,098 Chem. Abst. 88-122131f (1977).
- (137) Cooper G. D. (General Electric) U.S. Pat. 4,059,568 Chem. Abst. 88-51389h (1976).
- (138) Olander W. K. (General Electric) U.S. Pat. 4,075,174 Chem. Abst. 88-137408a (1978).
- (139) Fujino K. (Mitsubishi Monsanto Chem Co) Jap. Pat. 77,152,498 Chem. Abst. 88-153255d (1977).
- (140) Bennett J. G. Jr., Cooper G. D. (General Electric) Ger. Pat. 2,738,889. Chem. Abst. 88-153543w (1978).
- (141) Cooper G. D., Floryan D. E. (General Electric) Ger Pat. 2,755,937. Chem. Abst. 89-90645d (1978).
- (142) Olander W. K. (General Electric) U.S. Pat. 4,083,828. Chem. Abst. 89-44435n (1978).
- (143) Rutledge T. F. (ICI Americas Inc) U.S. Pat. 4,065,434 Chem. Abst. 89-44421e (1977).
- (144) Kawamoto N., Omura K. (Asahi Chem Ind) Jap. Pat. 78,12558 Chem. Abst. 89-60266p (1978).
- (145) Bennett J. G.; Katchman A. (G. E. Company) U.S. Pat. 3796689. Chem. Abst. 81-26282r (1974).
- (146) Banucci E. G. Olander, W. K. (General Electric) Ger. Pat. 2,756,377 Chem. Abst. 89-90467 (1976).

- (147) Rutledge T. F. (ICI Americas Inc) U.S. Pat. 4,098,766.
Chem. Abst. 89-198273v (1978).
- (148) Cooper G. D. (General Electric) Fr. Pat. 2,362,882.
Chem. Abst. 89-216074n (1978).
- (149) Olander W. K. (General Electric) U.S. Pat. 4,102,865.
Chem. Abst. 89-216075p (1978).
- (150) Banucci E. G., Olander W. K. (General Electric) Ger
Pat. 2,750,699. Chem. Abst. 89-110843x (1978).
- (151) Olander W. K. (General Electric) Ger Pat. 2,756,416.
Chem. Abst. 89-110844y (1976).
- (152) Olander W. K. (General Electric) Ger Pat. 2,756,323.
Chem. Abst. 89-1108452z (1976).
- (153) Tsuchida E.; Nishide H. Japan Kokai, 737990
Chem. Abst. 80-109099 (1974).
- (154) Johnson, R. N. et al J. Poly. Sci. Part A-1 5(9)
2375-2527 (1967).
- (155) Schulze S. R. and Baron A. L. Adv. Chem. Series
91 589 (1969).
- (156) Rose J. B. Polymer, 15, 456 (1974).
- (157) Sykes. P. A. "A guide book to mechanism in organic
chemistry", Halsted Press (1975).
- (158) Heppoletti R. L. and Miller J. J. Chem. Soc. p 2329
(1969).
- (159) Oae, S. and Khim, Y. H. Bull. Chem. Soc. Japan 40
174 (1967).
- (160) Fr. Pat. 1,444,030 Chem. Abst. 66-56298h (1966).
- (161) Neth. Pat. 6,611,726. Chem. Abst. 67-44960a (1967).
- (162) Union Carbide Corporation (by Bruce P. Barth) Fr. Pat.
1,490,081 Chem. Abst. 68-69707g (1968).
- (163) Union Carbide Corporaton (by Bruce P. Barth and
Edward G. Hendricks) Fr. Pat. 1,462,501 Chem. Abst.
68-88283g (1966).
- (164) U.S. Pat. 3,455,868. Chem. Abst. 71-71447c (1969).
- (165) Ger. Pat. 2,436,167. Chem. Abst. 82-171724m (1975).

- (166) O'Shea F. X., Cornell R. J. (Uniroyal Inc) Chem. Abst. 82-86847j (1971).
- (167) Jap. Pat. 75,36,598. Chem. Abst. 83-98396v.
- (168) Cornell R. J. (Uniroyal Inc) Ger. Pat. 2,038,516. Chem. Abst. 75-50012z (1971).
- (169) Attwood T. E., Rose J. B., Lennox A. F. (Imp Chem Ind) U.S. Pat. 905,009. Chem. Abst. 78-44699z.
- (170) Studinka J., Gabler R. (Inventa A.-G. fuer Forschung und patent verwertung) Ger. Pat. 2,220,079. Chem. Abst. 78-44219t
- (171) Vinogradova, S. Y.; Korshak, V. V. and Salazkin, S. N. Soedin Ser A, 14(12) 2534 (1972).
- (172) Khattab G. (Allied Chemical Corp) U.S. Pat. 3,723,389. Chem. Abst. 79-79490x (1973).
- (173) U.S. Pat. 2,436,167. Chem. Abst. 82-171724 (1973).
- (174) Reithurd L. I., Baicher L. A., Semenkova A. E., Kuznetsova A. G., Bychkova V. A. U.S.S.R. Pat. 491668 Chem. Abst. 84-60627d (1975).
- (175) Rose J. B. (Imperial Chem Ind Ltd) Ger. Pat. 2,425,166 Chem. Abst. 82-112453z (1973).
- (176) Akutin M. S., Reithurd L. I., Semenkova A. E., Tikhonova M. A., Korshak V. V., Vinogradova S. V., Salazkin S. N. U.S.S.R. Pat. 495336 Chem. Abst. 84-90779x (1974).
- (177) Hara S., Taketani Y., Mori K., Senoo M. (Teijin Ltd) Jap. Pat. 75,149,799. Chem. Abst. 84-151481t (1974).
- (178) Beridze L. A., Kutateladze M. K., Papava G.Sh., Tsiskarish vili P.D. (Inst Fiz Org. Khim. im. Melikishvili Tbilis) Chem. Abst. 85-160578c (1976).
- (179) Beridze L. A., Kutateladze K. K., Papava G.Sh., Tsiskarish vili P.D. Chem. Abst. 86-107185s (1976).
- (180) Ger. Pat. 2,635,101. (ICI United States Inc.) Chem. Abst. 86-156203e (1977).
- (181) Blinne G., Cordes C. (BASF A.-G.) Ger. Pat. 2,557,652. Chem. Abst. 87-102832m (1977).

- (182) Taylor I.C. (Imperial Chemical Industries Ltd) Ger. Pat. 2,733,905. Chem. Abst. 88-137183y (1978).
- (183) Cinderey M. B., Rose J. B. (Imp Chem Ind) Ger. Pat. 2,803,873. Chem. Abst. 89-147398g (1978).
- (184) Imperial Chemical Industries Ltd. Jap. Pat. 78,12,991. Chem. Abst. 89-44411b (1978).
- (185) Ger. Pat. 2,749,645. Chem. Abst. 90-40110w
- (186) Imai Y., Veda M., Ii M. (Fac. Eng., Yamagata Univ. Yonezawa, Japan) Chem. Abst. 90-187398j J. Poly. Sci. Poly Lett Ed. 17(2) 85-9 (1979).
- (187) Aoyagi T., Yagi N., Matsumura H., Kishi I. (Denki Kagaku Kogyo K. K.) Jap. Pat. 79,18,889. Chem. Abst. 90-205156k (1979).
- (188) Makromol Chem. 1978, #179, (2) p 2989-91.
- (189) Brzozowski Z., Rokicki G. (Politechnika warszawska) Pol. Pat. 85,252. Chem. Abst. 90-39450e (1973).
- (190) Hartmann L. A. (ICI Americans Inc) U.S. Pat. 4,156,068 Chem. Abst. 91-75088x (1979).
- (191) Yagi N., Matsumura H., Aoyagi T., Kishi I. (Denki Kagaku Kogyo K. K.) U.S. Pat. 4,110,314. Chem. Abst. 91-75077t (1978).
- (192) Freeman J. L., Rose J. B. (Imp Chem Ind) U.S. Pat 9,66,006. Chem. Abst. 91-57826g (1975).
- (193) Rose J. B. (Imp Chem Ind Ltd) Brit Pat. 1,558,671. Chem. Abst. 92-181877j (1980).
- (194) Rose J. B., Stainland P. A. (Imp Chem Ind Ltd) Chem. Abst. 92-42599g. Eur. Pat. Appl 1,879 (1977).
- (195) Honda T., Hosono Y. (Mitsui Toatsu Chem Inc) Jap. Pat. 80,13,702 Chem. Abst. 93-27070e (1978).
- (196) Keeley D. E. (General Electric) Ger. Pat. 2,948,642. Chem. Abst. 93-133317a (1978).
- (197) Suter C. M. (1944) "The Organic Chemistry of Sulphur" p 673.
- (198) Vogel H. A. Brit. Pat. 1,060,546 (1963).
- (199) Cohen S. M. and Young R. H. J. Poly. Sci. Part A-1 4-722 (1966).

- (200) Cudby M. E. A. et al. *Polymer*, 6, 589 (1965).
- (201) Ivin K. J. and Rose J. B. *Advances in Macromolecular Chemistry*. Vol 7, p 336 (1968).
- (202) Von R. Gabler and J. Studinka: *Chimia* 28,567 (1974).
- (203) Barbieri G. et al *J. Chem. Soc. C*.659 (1968).
- (204) Hiskey R. G. and Harpold M. A. *J. Org. Chem.*, 32, 3191 (1967).
- (205) Kattebol S. et al *J. Org. Chem.* 32,3111 (1967).
- (206) Modena G. and Todesco P. E. *J. Chem. Soc.*, 4920(1962).
- (207) Henbest H. B. and Khan S. A. *Chem. Comm.* 1036 (1968).
- (208) Ogata Y. and Suyama S. *Chem. Ind. (London)* 707(1971).
- (209) Hoy L. R. J., Rose J. B. (Imp Chem Ind) Ger. Pat. 2,637,403. *Chem. Abst.* 86-156205g.
- (210) Dahl K. J. (Raychem Corp.) Ger. Pat. 2,635,895. *Chem. Abst.* 86-156206h.
- (211) Ger. Pat. 2,425,156. *Chem. Abst.* 82-1224453z.
- (212) Brown H. A., Vogel H. A., Sandberg C. L. (Minnesota Mining and Manufg Co) U.S. Pat. 3,772,248. *Chem. Abst.* 80-83915c.
- (213) U.S. Pat. 904,027. *Chem. Abst.* 30515z.
- (214) *Chem. Abst.* 82-125810p (1974).
- (215) Jap. Pat. 75,36,598. *Chem. Abst.* 83-98396v.
- (216) Brit. Pat. 1,414,423. *Chem. Abst.* 84-151422z (1973).
- (217) Brit. Pat. 1,414,421. *Chem. Abst.* 84-151421y (1973).
- (218) Brit. Pat. 1,414,424. *Chem. Abst.* 84-151423a (1975).
- (219) Ger. Pat. 2,637,403. *Chem. Abst.* 86-156205g (1977).
- (220) GP 2,612,755. *Chem. Abst.* 86-90837f (1976).
- (221) Verborgt, J. Marvel C. S. *J. Poly. Sci.; Poly. Chem. Ed.* 11(1), 261-73 (1973).
- (222) Sivaramakrishnan K. P., Marvel C. S. *J. Poly. Sci.; Poly. Chem. Ed.* 12(9), 1945-52 (1974).

- (223) Bruma, Maria; Marvel C. S. J. Poly. Sci.; Poly. Chem. Ed. 14(1) 1-6 (1976).
- (224) Marvel C. S., Samyn. C. U.S. Pat. 3,935,167. Chem. Abst. 84,151438j (1976).
- (225) Huang F., Marvel C. S. J. Poly. Sci.; Poly. Chem. Ed. 14(11) 2785-90 (1976).
- (226) Frentzel R. L., Marvel C. S. J. Poly. Sci.; Poly. Chem. Ed. 17 1073-87 (1979).
- (227) Swedo, R. J., Marvel C. S. J. Poly. Sci.; Poly. Chem. Ed. 17(9) 2815-24 (1979).
- (228) Marvel C. S. Contemp. Top. Poly. Sci. 3,7-12 (1979).
- (229) U.S. Pat. 3,579,475. Chem. Abst. 75-37327m.
- (230) U.S. Pat. 3,758,436. Chem. Abst. 80-27940v.
- (231) Kwaitkowski G. T. et al. J. Poly. Sci. Poly. Chem. Ed. 13(4) 961-75 (1975).
- (232) Nielsen L. E. J. Appl. Poly. Sci. 1, 24 (1959).
- (233) Stuart H., Markowski, G and Jeshke, D
- (234) Kunststoffe, 54, 618 (1964).
- (235) Hopkins J. L., Baker W. O. and Howard J. J. Appl. Phys. 21,206 (1950).
- (236) Kambour, R. P. J. Poly. Sci. A-2, 4, 349-358 (1966).
- (237) Kambour, R. P. J. Poly. Sci. Macromol Rev. (D) 7 1-151 (1973).
- (238) Gent A. N. J. Material Sci., 5,925 (1970).
- (239) Gent A. N. 19(Mechanical Fracture, ASME, Winter Annual Meeting) 55-68(1976).
- (240) Robeson L. M. Union Carbide Corp. Private Communication.
- (241) Rebenfeld L. Makarewicz.P.J., Weigmann, H. D., Wilkes, G. L. J. Macromol. Sci. Rev. Macromol. Chem. C 15(2), 279 (1976).
- (242) Fox T. G. Bull. Amer. Physics Soc., 2-123 (1966).
- (243) Wood, L. A. J. Poly. Sci. 28, 319 (1958).

- (244) Johnston N. W. and Harwood H. J. *J. Poly. Sci.*, C22 591 (1969).
- (245) Johnston N. W. and Harwood H. J., *Macromolecules*, 2, 221 (1969).
- (246) Johnston N. W. *Poly. Prep.* 10(2), 609 (1969).
- (247) Mayo F. R. and Lewis F. M. *J. Am. Chem. Soc.*, 66 1594 (1944).
- (248) Merz E. Alfrey T. and Goldfinger G. *J. Poly. Sci.* 1, 75 (1946).
- (249) Frensdorf H. K. and Pariser, *J. Chem. Phys.* 39, 462 (1948).
- (250) Frensdorf H. K. *Macromolecules*, Vol 4, No 4 (1971).
- (251) Ham G., *J. Poly. Sci.*, 2A, 3533 (1964).
- (252) Beste L. F. *J. Poly. Sci.*, Vol 36-343 (1959).
- (253) Nikonov V. Z., Sokolov L. B., Babar G. V. et al. *Vysokomol Soyed All*, 739 (1969).
- (254) Kuchanov S. I. *Vysokomol Soyed A15:No.9*, 2140-2152 (1973).
- (255) Krause S. *J. Poly. Sci.*, Part A-2, 1, 249 (1968).
- (256) Krause S. *Macromolecules*, 3, 84 (1970).
- (257) Krause S. and Reismiller P. A. *J. Poly. Sci.*, Part A-2, 13 (1975).
- (258) Krause S. "Block and Graft Copolymers", Burke J. J., Weiss V., Eds., p. 143, Syracuse Univ., Syracuse, (1973).
- (259) Meier D. J. "Block Copolymers", Moacanin J., Holden G. Tschoegl N. W., p. 81, Interscience, New York (1969).
- (260) Meier D. J. *Poly. Prepr.*, Am. Chem. Soc., Div. Poly. Chem. 11, 400 (1970).
- (261) Meier D. J. "Block and Graft Copolymer", Burke J. J., Weiss V., Eds., p. 105, Syracuse Univ., Syracuse (1973).
- (262) Meier D. J. *Poly. Prepr.*, Am. Chem. Soc., Div. Poly. Chem., 14, 280 (1973).
- (263) Meier D. J. *J. Appl. Polym. Symp.*, 24, 67 (1974).

- (264) Helfand E. *Polym. Sci. Technol.*, 4, 141 (1974).
- (265) Helfand E. *Macromolecules*, 8, 552 (1973).
- (266) Helfand E. and Wasserman Z. *Polym. Eng. Sci.*, 17, 582 (1977).
- (267) LeGrand D. G. *Polym. Prepr., Am. Chem. Soc., Div. Polym. Chem.*, 11, 434 (1974).
- (268) Lewis P. A. W., Goodman A. S. and Miller J. M. "Pseudorandom number generator for the system 1360", *IBM System Journal*, 8(2) 1969, 136-46.
- (269) Williams F. J., et al. *J.O.C.*, 42, 3425 (1977).
- (270) Williams F. J. and Donahue P. E., *J.O.C.*, 42, 3414.
- (271) Williams F. J. et al. *J.O.C.*, 42, 3425 (1977).
- (272) Fieser L. F. and Fieser M. *Reagents for Organic Synthesis, Vol 2*, John Wiley Press (1979).
- (273) McGrath J. E., Ward T. C., Shchori E., Wunk A. J. *Poly. Eng. Sci.* (1977) 17(8), 647.
- (274) Morgan P. W., "Condensation Polymers by Interfacial and Solution Methods", Interscience, New York, 1965.
- (275) Morgan P. W., *Macro mol.* (1970) 3,536.
- (276) Belgian Pat. 633,236. *Chem. Abst.* 60-14436f.
- (277) German Pat. 1,251,334. *Chem. Abst.* 68:77956C.
- (278) Cooper S. L. and Estes G., editors, ACS, 1979 "Multiphase Polymers".
- (279) Viswanathan R. and McGrath J. E. Presented at ACS Southeast regional meeting, Oct., 1979.
- (280) Billmeyer F. *Text book of Polymer Science*, Interscience (1971).
- (281) Wnuk A. J.; Davidson T. F. and McGrath J. E. *J. Appl. Poly. Sci., Appl. Symp.*, 34, 89 (1978)
- (282) Alexander, *X-ray diffraction methods in polymer science*, Wiley Interscience, John Wiley and Sons, Inc. (1969).
- (283) Storozhuk I. P. et al, *Vysokomol Soyed.* A19, 8 (800-06) (1977).

- (284) Martin D., Hauthal H. G. Dimethyl sulfoxide, John Wiley and Sons, New York (1975).
- (285) Randall J. C. Polymer Sequence Measurement, Academic, NY (1977).
- (286) Levy G. and Nelson G. C-13 in Organic Chemistry, 2nd edition, Academic, 1981.
- (287) Bovey F., NMR of Macromolecules, Academic, 1972.
- (288) Silverstein R. M., Bassler G. C. and Morrill T. C. Spectrometric Identification of Organic Compounds, John Wiley and Sons, 3rd ed. (1974).
- (289) Auram M., Mateescu G. H. Infrared Spectroscopy, Wiley Interscience, NY (1972).
- (290) Allen G., McAnish J., Strachieloe C. Eur. Polym. J. Vol 5(2), pg 319-34 (1969).
- (291) McGrath, J. E. Personal Communication (1978).
- (292) Ryan J. T., Polym. Eng. Sci. (1978) 18(4), 264.
- (293) Cornes P. L., Smith K., Hayward R. N. J. Polym. Sci. Polym. Lett. Ed. (1977) 15,955.
- (294) Hayward, R. N., ed., The Physics of Glassy Polymers, Halstead, London, 1973.
- (295) Robeson L. M., Farnham A. G., McGrath J. E., Appl. Polym. Symp. (1975) 26,373.
- (296) Matzner M., Noshay A., McGrath J. E., Trans. Soc. Rheol (1977) 21(2), 272.
- (297) Wnuk A. J., Ph.D. Dissertation, VPI and SU, 1980.
- (298) Shchori E. and McGrath J. E. Appl. Poly. Sci.; Appl. Polymer Symposium 34, 103-117 (1978).
- (299) McGrath J. E., Ward T. C., Shchori E., Wnuk A. J. and Viswanathan R., "Multiphase Polymers" Cooper S. and Estes G., editor, ACS Symposium Series, 1979, p 289.
- (300) Lee L. H. "Adhesion of High Polymer IV. Relationships between surface wetting and bulk properties of high polymers" in R. F. Gould Ed., Advances in Chemistry series, 1975.

- (301) Petke F. D. and Ray B. R. J. Colloid Interface Science 31, 216 (1969); *ibid* 33, 195 (1970).
- (302) Kurz J. E., Woodbrey J. C., Ohta M. J. Polym. Sci. Polym. Phys. Ed. (1970) 8, 1169.
- (303) Nielsen L. E. "Mechanical Properties of Polymers" Reinhold, London, 1962.
- (304) Locati G., Tobolsky A. V. Adv. Mol. Relaxation Process (1970), 1, 375.
- (305) Watts D. C., Perry E. P. Polymer (1978) 19, 288.
- (306) Aoki Y., Brittain, J. O. J. Polym. Sci., Polym. Phys. Ed. (1976) 14, 1297.
- (307) McGrath J. E., Matzner M., Robeson L. M., Recent Advances in Polymer Blends, Grafts and Blocks, Sperling L. H., ed., Plenum, NY (1974), p 195.
- (308) Dwight, D. W., McGrath, J. E., Wightman, J. P. J. of Appl. Polym. Sci., Appl. Poly. Sci. Symp., 34, 35-47 (1978).

APPENDIX

COMPUTER PROGRAM:
MONTE CARLO SIMULATION

NC2	AT COMPLETION .	THE REACTION RATES :
2	14	-A- AND -C- ATTACHED
2	14	-A- WITH -C-
2	14	-A- WITH ATTACHED -C-
2	14	ATTACHED -A- WITH -C-
2	14	-B- AND -C- ATTACHED
2	14	-B- WITH -C-
2	14	ATTACHED -B- WITH -C-
2	14	-B- WITH ATTACHED -C-
2	11	IS A MOLECULE ADDED AS
2	11	ONE IS BONDED ?
2	11	0-YES 1-NO
2	11	ARE MOLECULES ADDED
2	11	AFTER A SPECIFIED NO.
2	11	OF BONDS? 0-NO 1-YES
2	13	INTERVALS OF BONDS

C-4

2	INTB	13	AFTER WHICH MOLECULES
2	INTC	13	OF EACH TYPE ARE ADDED.
3	NAB	13	THE NUMBER OF EACH
3	NB3	13	TYPE MOLECULE ADDED AT
3	NC3	13	THE ABOVE INTERVALS.
3	NUSIM	14	NUMBER OF SIMULATIONS
			OF THE REACTION .
3	IRDM	14	SEED FOR THE RANDOM
			NUMBER GENERATOR
3	K(1) - K(5)	14	SUMMARIES ARE PRESENTED
		EACH	AFTER THESE NUMBERS OF
			TRIADS HAVE FORMED .
3	L(1) - L(10)	14	SUMMARIES ARE PRESENTED
		EACH	AFTER THESE NUMBERS
			OF BONDS HAVE FORMED.

CCCCC

```

INTEGER ADD1,ADD2,P,P1,P2,P3,Q,Q1,Q2,Q3
DIMENSION N(13),PR(70),TRIAD(3),AVTRD(6,3),SQTRD(6,3),
1STOTRD(6,3),NO(6),K(6),AV(10,6),SQ(10,6),STD(10,6),L(10),PL(10)
2,TR(10),TSQ(10),TSTD(10),RA(1)
DOUBLE PRECISION DSEED

```

```
READ 100,NORUNS
```

```
100 FORMAT(12)
```

```
NBRUNS=0
```

```
101 NBRUNS=NBRUNS+1
```

```

C
C NBRUNS IS A COUNTER FOR THE NUMBER OF SIMULATIONS TO BE RUN.
C

```

```
DO 2 I=1,6
```

```
DO 2 J=1,3
```

```
AVTRD(I,J)=0
```

```
SQTRD(I,J)=0
```

```
2 STOTRD(I,J)=0
```

```

C
C THE ABOVE ARRAYS ABOVE CONTAIN THE INFORMATION NEEDED FOR THE
C SUMMARY BASED ON THE NUMBER OF TRIADS FORMED.
C

```

```
DO 60 I = 1,10
```

```
PL(I) = 0
```

```
TR(I) = 0
```

```
TSQ(I) = 0
```

```
TSTD(I) = 0
```

```
DO 60 J = 1,6
```

```
AV(I,J) = 0
```

```
SQ(I,J) = 0
```

```
60 STD(I,J) = 0
```

```

C
C THE ARRAYS ABOVE ARE USED FOR THE SUMMARY BASED ON THE NUMBER OF

```

```

C BONUS FORMED.
C
  DO 30 I=1,6
 30 NO(I)=0
  READ 200,NA,NB,NC,NAB,ADD1,NA2,NB2,NC2,P,P1,P2,P3,Q,Q1,Q2,Q3,IA,IB
 2,IC,ADD2,INTA,INTB,INTC,NA3,NB3,NC3,NDSIM,IRDM,(K(I),I=1,5)
 3 *(L(I),I=1,10)
 200 FORMAT(4I4,11,1114,411,3I3,/,3I3,17I4)
  USEED = IRDM
  INUM = IRDM

C
C A CHECK IS MADE TO SEE IF A REACTION IS GIVEN THAT WILL NEVER REACH
C COMPLETION.
C
  IF (INIC.GT.0) GO TO 6000
  IF (IIC.EQ.0) GO TO 6000
  GO TO 6001

6000 IF (IIB.EQ.0) GO TO 7000
  IF (IIA.EQ.0) GO TO 7000
  IF (INTA.GT.0) GO TO 7000
  IF (INIB.GT.0) GO TO 7000
6001 CONTINUE
  COUNTER = 0

C
C COUNTER IS A COUNTER FOR THE NUMBER OF SIMULATIONS OF A REACTION.
C
  DO 4 I=1,13
 4 NO(I)=0
  DO 1 I=1,3
 1 TRIAD(I)=0
  INT=0
C

```


C THE ARRAY N CONTAINS THE NUMBERS OF EACH TYPE OF MOLECULE.
C

```

N(1)=NA
N(2) = NAB
N(6)=NB
N(10)=NC
ADCODE = ADDI
COUNTR = COUNTR + 1
I1=0

```

C THE PROBABILITY OF EACH TYPE OF SYSTEM CHANGE (REACTION) IS
C CALCULATED BELOW.
C

```

5 PR(1)=4*P1*N(10)*N(1)
  PRFAST=2*N(10)*N(2)
  PR(2) = P3 * PRFAST
  PR(3)=Q2*PRFAST
  PRFAST = 2*P3*N(10)
  PR(4) = PRFAST * N(3)
  PR(5)=PRFAST*N(4)
  PR(6)=2*PRFAST*N(5)
  PR(7)=4*Q1*N(10)*N(6)
  PRFAST=2*Q2*N(10)
  PR(8) =PRFAST*N(7)
  PR(9)=PRFAST*N(8)
  PR(10) = 2*PRFAST*N(9)
  PR(11)=2*P2*N(3)*N(1)
  PR(12) = (2*N(3) + N(5) + N(11) - 1 ) + N(2) + N(4) + N(8) +
1 N(13) ) * P * N(3)
  PR(13)=Q*N(3)*N(2)
  PR(14)=(2*(N(12)+N(5)+N(4)-1)+N(3)+N(7)+N(2)+N(13))*P*N(4)
  PR(15)=2*Q3*N(3)*N(6)

```

ORIGINAL PAGE IS
OF POOR QUALITY

PRFAST=N(3)*N(7)
 PR(16)=P*PRFAST
 PR(17)=Q*PRFAST
 PR(18) = (2*(N(11)+N(9)+N(8)-1)+N(3)+N(7)+N(2)+N(13)) *Q*N(8)
 PR(19)=2*Q*N(3)*N(9)
 PR(20)=2*P2*N(7)*N(1)
 PR(21)=P*N(7)*N(2)
 PR(22) = (2*(N(7)+N(12)+ N(9) - 1)+N(2)+N(6)+N(4)+N(13)) *Q*N(7)
 PR(23) = 0.0
 PR(24) = 0.0
 PR(25)=2*P*N(7)*N(5)
 PR(26)=2*Q3*N(7)*N(6)
 PR(27)=4*P2*N(11)*N(1)
 PRFAST=2*N(11)*N(2)
 PR(28)=P*PRFAST
 PR(29)=Q*PRFAST
 PRFAST = L*P*N(11)
 PR(30) = PRFAST*N(4)
 PR(31) = 2*PRFAST*N(5)
 PR(32)=4*Q3*N(11)*N(6)
 PRFAST = 2*Q*N(11)
 PR(33) = PRFAST*N(7)
 PR(34) = 2*PRFAST*N(9)
 PR(35)=4*P2*N(12)*N(1)
 PRFAST=2*N(12)*N(2)
 PR(36)=P*PRFAST
 PR(37)=Q*PRFAST
 PRFAST = 2*P*N(12)
 PR(38) = PRFAST * N(3)
 PR(39) = 2*PRFAST*N(5)
 PR(40)=4*Q3*N(12)*N(6)
 PRFAST = 2*Q*N(12)

PR(41) = PRFAST * N(8)
PR(42) = 2*PRFAST*N(9)
PR(43) = 2*P2*N(4)*N(1)
PR(44) = Q*N(4)*N(2)
PR(45) = 2*Q3*N(4)*N(6)
PRFAST = N(4)*N(8)
PR(46) = P*PRFAST
PR(47) = Q*PRFAST
PR(48) = 2*Q*N(4)*N(9)
PR(49) = 2*P2*N(8)*N(1)
PRFAST = P*N(8)
PR(50) = PRFAST * N(2)
PR(51) = 0.0
PR(52) = 0.0
PR(53) = 2*P*N(8)*N(5)
PR(54) = 2*Q3*N(6)*N(6)
PR(55) = 2*P2*N(13)*N(1)
PR(56) = PR(55)
PR(57) = P*N(13)*N(2)
PR(58) = PR(57)
PR(59) = Q*N(13)*N(2)
PR(60) = PR(59)
PRFAST = P*N(13)
PR(61) = PRFAST*N(3)
PR(62) = PRFAST*N(4)
PR(63) = 2*PRFAST*N(5)
PR(64) = PR(63)
PR(65) = 2*Q3*N(13)*N(6)
PR(66) = PR(65)
PRFAST = Q * N(13)
PR(67) = PRFAST * N(7)
PR(68) = PRFAST * N(8)

```

PR(69) = 2 * PRFAST * N(9)
PR(70) = PR(69)
SUM = 0.0
DO 6 I = 1, 70
  SUM = SUM + PR(I)
  INT = INT + 1
  IN = INT - 1
  IF (SUM.EQ.0) GO TO 11

```

C THE PROBABILITIES MUST SUM TO 1.0 .
C

```

DO 7 I = 1, 70
  PR(I) = PR(I) / SUM
DO 8 I = 2, 70
  PR(I) = PR(I-1) + PR(I)

```

C MOLECULES ARE ADDED AFTER THE APPROPRIATE NUMBER OF BONDS IF
C REQUESTED .
C

```

IF (ADD2.EQ.0) GO TO 11
IF (INTA.EQ.0) GO TO 9
AIN = INT / INTA
IAIN = AIN
IF (IAIN.EQ.AIN) N(1) = N(1) + N(A)
9 IF (INTR.EQ.0) GO TO 10
BIN = INT / INTB
IBIN = BIN
IF (IBIN.EQ.BIN) N(6) = N(6) + N(B)
10 IF (INTC.EQ.0) GO TO 11
CIN = INT / INTC
ICIN = CIN
IF (ICIN.EQ.CIN) N(10) = N(10) + N(C)

```

```

11 CONTINUE
  T=TRIAD(I)+TRIAD(2)+TRIAD(3)
C AFTER THE SPECIFIED NUMBER OF BONDS INFORMATION IS STORED FOR THE
C SUMMARY .
C
  DO 61 I = 1,10
  IF (I1N.EQ.L(I)) GO TO 62
61 CONTINUE
  GO TO 63
62 IF (I1.EQ.0) GO TO 6666
  DU 64 J = 1,3
  AV(I,J) = AV(I,J) + TRIAD(J) / I
64 SQ(I,J) = SQ(I,J) + (TRIAD(J) / I) ** 2
8888 AV(I,4) = AV(I,4) + N(I)
  AV(I,5) = AV(I,5) + N(I)
  AV(I,6) = AV(I,6) + N(I)
  SQ(I,4) = SQ(I,4) + N(I) ** 2
  SQ(I,5) = SQ(I,5) + N(I) ** 2
  SQ(I,6) = SQ(I,6) + N(I) ** 2
  TR(I) = TR(I) + 1
  TSQ(I) = TSQ(I) + I ** 2
63 IF (I1.EQ.0) GO TO 13
  IF (I1.EQ.1) GO TO 13
  I1=I
  DO 12 I=1,5
  I2 = K(I)
  IF (I2.EQ.1) GO TO 14
C AFTER THE SPECIFIED NUMBER OF TRIADS INFORMATION IS STORED FOR THE
C SUMMARY .
C

```

```

12 CONTINUE
   GO TO 13
14 DO 15 J=1,3
   AVTRD(I,J)=AVTRD(I,J)+TRIAD(J)/T
15 SQTRO(I,J)=SQTRO(I,J)+(TRIAD(J)/T)**2
   NO(I)=NO(I)+1
13 IF(SUM.EQ.0)GO TO 400
   NR = 1
   CALL GGUBS(USEED,NR,KA)
   RDM = RA(1)

```

THE CHANGE IN THE SYSTEM IS RANDOMLY SELECTED .

```

IF (RDM.LT.0)GO TO 800
IF (RDM.LE.PR(1)) GO TO 501
IF (RDM.LE.PR(2)) GO TO 502
IF (RDM.LE.PR(3)) GO TO 503
IF (RDM.LE.PR(4)) GO TO 504
IF (RDM.LE.PR(5)) GO TO 505
IF (RDM.LE.PR(6)) GO TO 506
IF (RDM.LE.PR(7)) GO TO 507
IF (RDM.LE.PR(8)) GO TO 508
IF (RDM.LE.PR(9)) GO TO 509
IF (RDM.LE.PR(10))GO TO 510
IF (RDM.LE.PR(11))GO TO 511
IF (RDM.LE.PR(12))GO TO 512
IF (RDM.LE.PR(13))GO TO 513
IF (RDM.LE.PR(14))GO TO 514
IF (RDM.LE.PR(15))GO TO 515
IF (RDM.LE.PR(16))GO TO 516
IF (RDM.LE.PR(17))GO TO 517
IF (RDM.LE.PR(18))GO TO 518

```

IF IRDM.LE.PR(14)IG0 TO 519
IF IRDM.LE.PR(20)IG0 TO 520
IF IRDM.LE.PR(21)IG0 TO 521
IF IRDM.LE.PR(22)IG0 TO 522
IF IRDM.LE.PR(25)IG0 TO 525
IF IRDM.LE.PR(26)IG0 TO 526
IF IRDM.LE.PR(27)IG0 TO 527
IF IRDM.LE.PR(28)IG0 TO 528
IF IRDM.LE.PR(29)IG0 TO 529
IF IRDM.LE.PR(30)IG0 TO 530
IF IRDM.LE.PR(31)IG0 TO 531
IF IRDM.LE.PR(32)IG0 TO 532
IF IRDM.LE.PR(33)IG0 TO 533
IF IRDM.LE.PR(34)IG0 TO 534
IF IRDM.LE.PR(35)IG0 TO 535
IF IRDM.LE.PR(36)IG0 TO 536
IF IRDM.LE.PR(37)IG0 TO 537
IF IRDM.LE.PR(38)IG0 TO 538
IF IRDM.LE.PR(39)IG0 TO 539
IF IRDM.LE.PR(40)IG0 TO 540
IF IRDM.LE.PR(41)IG0 TO 541
IF IRDM.LE.PR(42)IG0 TO 542
IF IRDM.LE.PR(43)IG0 TO 543
IF IRDM.LE.PR(44)IG0 TO 544
IF IRDM.LE.PR(45)IG0 TO 545
IF IRDM.LE.PR(46)IG0 TO 546
IF IRDM.LE.PR(47)IG0 TO 547
IF IRDM.LE.PR(48)IG0 TO 548
IF IRDM.LE.PR(49)IG0 TO 549
IF IRDM.LE.PR(50)IG0 TO 550
IF IRDM.LE.PR(53)IG0 TO 553
IF IRDM.LE.PR(54)IG0 TO 554

```

IF (RDM.LE.PR(55))GO TO 555
IF (RDM.LE.PR(56))GO TO 556
IF (RDM.LE.PR(57))GO TO 557
IF (RDM.LE.PR(58))GO TO 558
IF (RDM.LE.PR(59))GO TO 559
IF (RDM.LE.PR(60))GO TO 560
IF (RDM.LE.PR(61))GO TO 561
IF (RDM.LE.PR(62))GO TO 562
IF (RDM.LE.PR(63))GO TO 563
IF (RDM.LE.PR(64))GO TO 564
IF (RDM.LE.PR(65))GO TO 565
IF (RDM.LE.PR(66))GO TO 566
IF (RDM.LE.PR(67))GO TO 567
IF (RDM.LE.PR(68))GO TO 568
IF (RDM.LE.PR(69))GO TO 569
IF (RDM.LE.PR(70))GO TO 570
GO TO 600

501 N(3)=N(3)+1
N(1)=N(1)-1A
N(10)=N(10)-1C
GO TO 5

502 N(3)=N(3)+1
N(2)=N(2)-1
N(10)=N(10)-1C
GO TO 5

503 N(4)=N(4)+1
N(2)=N(2)-1
N(10)=N(10)-1C
GO TO 5

504 N(11)=N(11)+1
N(3)=N(3)-1
N(10)=N(10)-1C

```



```
GO TO 5
505 N(13)=N(13)+1
   N(4)=N(4)-1
   N(10)=N(10)-1C
GO TO 5
506 N(3)=N(3)+1
   N( )=N(5)-1
   N(10)=N(10)-1C
GO TO 5
507 N(7)=N(7)+1
   N(6)=N(6)-1b
   N(10)=N(10)-1C
GO TO 5
508 N(12)=N(12)+1
   N(7)=N(7)-1
   N(10)=N(10)-1C
GO TO 5
509 N(15)=N(15)+1
   N(6)=N(6)-1
   N(10)=N(10)-1C
GO TO 5
510 N(7)=N(7)+1
   N(9)=N(9)-1
   N(10)=N(10)-1C
GO TO 5
511 N(5)=N(5)+1
   N(3)=N(3)-1
   N(1)=N(1)-1A
   TRIAD(1)=TRIAD(1)+1
GO TO 5
512 N(3)=N(3)-1
   TRIAD(1)=TRIAD(1)+1
```

```
GO TO 5
513 N(5)=N(5)+1
   N(2)=N(2)-1
   N(3)=N(3)-1
   TRIAD(2)=TRIAD(2)+1
GO TO 5
514 N(4)=N(4)-1
   TRIAD(2)=TRIAD(2)+1
GO TO 5
515 N(2)=N(2)+1
   N(6)=N(6)-18
   N(3)=N(3)-1
   TRIAD(2)=TRIAD(2)+1
GO TO 5
516 N(5)=N(6)+1
   N(7)=N(7)-1
   N(3)=N(3)-1
   TRIAD(2)=TRIAD(2)+1
GO TO 5
517 N(4)=N(4)+1
   N(7)=N(7)-1
   N(3)=N(3)-1
   TRIAD(2)=TRIAD(2)+1
GO TO 5
518 N(8)=N(8)-1
   TRIAD(2)=TRIAD(2)+1
GO TO 5
519 N(2)=N(2)+1
   N(9)=N(9)-1
   N(3)=N(3)-1
   TRIAD(2)=TRIAD(2)+1
GO TO 5
```

```
520 N(2)=N(2)+1  
N(1)=N(1)-1A  
N(7)=N(7)-1  
TRIAD(2)=TRIAD(2)+1  
GO TO 5  
521 N(9)=N(9)+1  
N(2)=N(2)-1  
N(7)=N(7)-1  
TRIAD(2)=TRIAD(2)+1  
GO TO 5  
522 N(7)=N(7)-1  
TRIAD(3)=TRIAD(3)+1  
GO TO 5  
523 N(2)=N(2)+1  
N(5)=N(5)-1  
N(7)=N(7)-1  
TRIAD(2)=TRIAD(2)+1  
GO TO 5  
524 N(9)=N(9)+1  
N(6)=N(6)-1  
N(7)=N(7)-1  
TRIAD(3)=TRIAD(3)+1  
GO TO 5  
525 N(3)=N(3)+1  
N(1)=N(1)-1A  
N(11)=N(11)-1  
TRIAD(1)=TRIAD(1)+1  
GO TO 5  
526 N(8)=N(8)+1  
N(2)=N(2)-1  
N(11)=N(11)-1  
TRIAD(1)=TRIAD(1)+1
```

```
GO TO 5
529 N(3)=N(5)+1
   N(2)=N(2)-1
   N(11)=N(11)-1
   TRIAD(2)=TRIAD(2)+1
GO TO 5
530 N(13)=N(13)+1
   N(4)=N(4)-1
   N(11)=N(11)-1
   TRIAD(1)=TRIAD(1)+1
GO TO 5
531 N(3)=N(5)+1
   N(5)=N(5)-1
   N(11)=N(11)-1
   TRIAD(1)=TRIAD(1)+1
GO TO 5
532 N(8)=N(8)+1
   N(6)=N(6)-16
   N(11)=N(11)-1
   TRIAD(2)=TRIAD(2)+1
GO TO 5
533 N(15)=N(13)+1
   N(7)=N(7)-1
   N(11)=N(11)-1
   TRIAD(2)=TRIAD(2)+1
GO TO 5
534 N(6)=N(6)+1
   N(9)=N(5)-1
   N(11)=N(11)-1
   TRIAD(2)=TRIAD(2)+1
GO TO 5
535 N(4)=N(4)+1
```

```
N(1)=N(1)-IA  
N(12)=N(12)-1  
TRIAD(2)=TRIAD(2)+1  
GO TO 5
```

```
536 N(7)=N(7)+1  
N(12)=N(12)-1  
N(2)=N(2)-1  
TRIAD(2)=TRIAD(2)+1  
GO TO 5
```

```
537 N(4)=N(4)+1  
N(12)=N(12)-1  
N(2)=N(2)-1  
TRIAD(3)=TRIAD(3)+1  
GO TO 5
```

```
538 N(13)=N(13)+1  
N(3)=N(3)-1  
N(12)=N(12)-1  
TRIAD(2)=TRIAD(2)+1  
GO TO 5
```

```
539 N(4)=N(4)+1  
N(12)=N(12)-1  
N(5)=N(5)-1  
TRIAD(2)=TRIAD(2)+1  
GO TO 5
```

```
540 N(7)=N(7)+1  
N(6)=N(6)-1B  
N(12)=N(12)-1  
TRIAD(3)=TRIAD(3)+1  
GO TO 5
```

```
541 N(13)=N(13)+1  
N(6)=N(6)-1  
N(12)=N(12)-1
```

```
      TRIAD(3)=TRIAD(3)+1
      GO TO 5
542  N(7)=N(7)+1
      N(9)=N(9)-1
      N(12)=N(12)-1
      TRIAD(3)=TRIAD(3)+1
      GO TO 5
543  N(5)=N(5)+1
      N(4)=N(4)-1
      N(1)=N(1)-1A
      TRIAD(2)=TRIAD(2)+1
      GO TO 5
544  N(5)=N(5)+1
      N(4)=N(4)-1
      N(2)=N(2)-1
      TRIAD(3)=TRIAD(3)+1
      GO TO 5
545  N(2)=N(2)+1
      N(6)=N(6)-1b
      N(4)=N(4)-1
      TRIAD(3)=TRIAD(3)+1
      GO TO 5
546  N(7)=N(7)+1
      N(8)=N(8)-1
      N(4)=N(4)-1
      TRIAD(1)=TRIAD(1)+1
      GO TO 5
547  N(3)=N(3)+1
      N(8)=N(8)-1
      N(4)=N(4)-1
      TRIAD(3)=TRIAD(3)+1
      GO TO 5
```

```
548 N(2)=N(2)+1
    N(9)=N(9)-1
    N(4)=N(4)-1
    TRIAD(3)=TRIAD(3)+1
    GO TO 5
549 N(2)=N(2)+1
    N(1)=N(1)-1A
    N(8)=N(8)-1
    TRIAD(1)=TRIAU(1)+1
    GO TO 5
550 N(9)=N(9)+1
    N(6)=N(8)-1
    N(2)=N(2)-1
    TRIAU(1)=TRIAU(1)+1
    GO TO 5
553 N(2)=N(2)+1
    N(5)=N(5)-1
    N(8)=N(8)-1
    TRIAD(1)=TRIAU(1)+1
    GO TO 5
554 N(9)=N(9)+1
    N(6)=N(6)-1B
    N(8)=N(8)-1
    TRIAD(2)=TRIAD(2)+1
    GO TO 5
555 N(3)=N(3)+1
    N(13)=N(13)-1
    N(1)=N(1)-1A
    TRIAD(2)=TRIAD(2)+1
    GO TO 5
556 N(4)=N(4)+1
    N(1)=N(1)-1A
```

```
N(13)=N(13)-1
TRIAD(1)=TRIAD(1)+1
GO TO 5
557 N(6)=N(8)+1
N(2)=N(2)-1
N(13)=N(13)-1
TRIAD(2)=TRIAD(2)+1
GO TO 5
558 N(7)=N(7)+1
N(13)=N(13)-1
N(2)=N(2)-1
TRIAD(1)=TRIAD(1)+1
GO TO 5
559 N(3)=N(3)+1
N(13)=N(13)-1
N(2)=N(2)-1
TRIAD(3)=TRIAD(3)+1
GO TO 5
560 N(4)=N(4)+1
N(2)=N(2)-1
N(13)=N(13)-1
TRIAD(2)=TRIAD(2)+1
GO TO 5
561 N(11)=N(11)+1
N(3)=N(3)-1
N(13)=N(13)-1
TRIAD(2)=TRIAD(2)+1
GO TO 5
562 N(12)=N(12)+1
N(13)=N(13)-1
N(4)=N(4)-1
TRIAD(1)=TRIAD(1)+1
```

ORIGINAL PAGE IS
OF POOR QUALITY


```
GO TO 5
503 N(3)=N(3)+1
   N(13)=N(13)-1
   N(5)=N(5)-1
   TRIAD(2)=TRIAD(2)+1
GO TO 5
504 N(4)=N(4)+1
   N(13)=N(13)-1
   N(5)=N(5)-1
   TRIAD(1)=TRIAD(1)+1
GO TO 5
505 N(6)=N(6)+1
   N(6)=N(6)-1B
   N(13)=N(13)-1
   TRIAD(3)=TRIAD(3)+1
GO TO 5
506 N(7)=N(7)+1
   N(13)=N(13)-1
   N(6)=N(6)-1B
   TRIAD(2)=TRIAD(2)+1
GO TO 5
507 N(12)=N(12)+1
   N(13)=N(13)-1
   N(7)=N(7)-1
   TRIAD(2)=TRIAD(2)+1
GO TO 5
508 N(11)=N(11)+1
   N(13)=N(13)-1
   N(6)=N(6)-1
   TRIAD(3)=TRIAD(3)+1
GO TO 5
509 N(6)=N(6)+1
```

```

N(9)=N(9)-1
N(13)=N(13)-1
TRIAD(3)=TRIAD(3)+1
GO TO 5
570 N(7)=N(7)+1
N(9)=N(9)-1
N(13)=N(13)-1
TRIAD(2)=TRIAD(2)+1
GO TO 5
400 IF (ADCODE-EQ.0.) GO TO 450

```

C
C MOLECULES ARE ADDED AT COMPLETION IF REQUESTED .
C

```
ADCODE = 0.
```

```

N(1) = NA2 + N(1)
N(6) = NB2 + N(6)
N(10) = NC2 + N(10)
GO TO 5

```

```

450 I=TRIAD(1)+TRIAD(2)+TRIAD(3)
IF (I.EQ.0) GO TO 7050

```

C
C INFORMATION IS STORED AT COMPLETION OF EACH REACTION .
C

```

DO 451 I=1,3
TRIAD(I)=TRIAD(I)/I
AVTRD(6,I)=AVTRD(6,I)+TRIAD(I)
451 SQTRD(6,I)=SQTRD(6,I)+TRIAD(I)**2
7050 IF (COUNT.LT.NJSIM) GO TO 5
NO(6) = NJSIM

```

C
C THE ARRAY NU CONTAINS THE NUMBER OF REACTIONS THAT FORM SPECIFIED
C NUMBERS OF TRIADS.

```

DO 452 I=1,6
DU 452 J=1,3
IF (NO(I)).EQ.0) GO TO 452
IF (NO(I)).EQ.1) GO TO 7051
STDRU(I,J) = (NO(I)*SQTRU(I,J)-AVTRD(I,J)**2) / (NU(I)*NO(I) -1
1 ) )
STDRD(I,J)=SQRT(STDRU(I,J)/ NO(I) )
7051 AVTRD(I,J)=AVTRU(I,J)/NU(I)
452 CONTINUE
DO 65 I = 1,10
TSUD(I) = (NOSIM * TSU(I) - TR(I) ** 2) / (NOSIM*(NOSIM-1))
TSDU(I) = SQRT(TSD(I)/NUSIM)
TR(I) = TR(I) / NOSIM
DO 65 J = 1,6
STD(I,J) = (NUSIM*SU(I,J) - AV(I,J)**2) / (NOSIM*(NOSIM-1))
STU(I,J) = SQRT(STD(I,J)/NOSIM)
65 AV(I,J) = AV(I,J) / NOSIM
WRITE (6,999)
999 FORMAT('1,////,46X,'SIMULATION RESULTS ',//)
WRITE (6,1000) NOSIM
1000 FORMAT (1X,'NUMBER OF SIMULATIONS=',I4,//)
WRITE(6,9797) INUM
9797 FORMAT(1X,'STARTING NUMBER FOR RANDOM NUMBER GENERATOR = ',I4,//)
WRITE (6,1001) NA,NB,NC,NAB
1001 FORMAT (1X,'NUMBERS OF MOLECULES ADDED INITIALLY:', 'A=',
114,4X, 'B=',14,4X, 'C=',14,4X, 'AB=',14,4X, //)
IF (ADU1.EQ.0) GO TO 2000
WRITE (6,1002) NA2,NB2,NC2
1002 FORMAT (1X,'AFTER COMPLETION THESE NUMBERS OF MOLECULES WERE ',
1ADDED:',2X,'A=',14,4X,'B=',14,4X,'C=',14,4X, //)
2000 WRITE (6,1003) P,P1,P2,P3,Q,Q1,Q2,Q3

```

```

1003 FORMAT (1X, 'THE FOLLOWING REACTION RATES APPLY: ', 2X, 'P= ', 14, 4X,
1, 'P1= ', 14, 4X, 'P2= ', 14, 4X, 'P3= ', 14, 4X, //, 36X, 'Q= ', 14, 4X,
2, 'Q1= ', 14, 4X, 'Q2= ', 14, 4X, 'Q3= ', 14, 4X, //)
11A = 1 - 1A
11B = 1 - 1B
11C = 1 - 1C
IF (1A.EQ.0) GO TO 1004
GO TO 1005
1004 WRITE (6,1006) 11A
1006 FORMAT (1X, 'AS A MOLECULE OF A WAS BONDED', 12, 1X,
1, 'OTHER(S) WAS ADDED.', //)
1005 IF (1B.EQ.0) GO TO 1007
GO TO 1006
1007 WRITE (6,1009) 11B
1009 FORMAT (1X, 'AS A MOLECULE OF B WAS BONDED', 12, 1X,
1, 'OTHER(S) WAS ADDED.', //)
1008 IF (1C.EQ.0) GO TO 1010
GO TO 1011
1010 WRITE (6,1012) 11C
1012 FORMAT (1X, 'AS A MOLECULE OF C WAS BONDED', 12, 1X,
1, 'OTHER(S) WAS ADDED.', //)
1011 IF (1A.GT.0) GO TO 1013
GO TO 1014
1013 WRITE (6,1015) 11A, N13
1015 FORMAT (1X, 'AT INTERVALS OF ', 14, 1X, 'SUNDS, ', 14, 1X, 'MOLECULE(S)'.
1, ' OF A WERE ADDED.', //)
1014 IF (11B.GT.0) GO TO 1016
GO TO 1017
1016 WRITE (6,1018) 11B, N13
1018 FORMAT (1X, 'AT INTERVALS OF ', 14, 1X, 'SUNDS, ', 14, 1X, 'MOLECULE(S)'.
1, ' OF B WERE ADDED.', //)
1017 IF (11C.GT.0) GO TO 1019

```

```

GO TO 1020
1019 WRITE (6,1021) INTG,MC3
1021 FORMAT (1X,'AT INTERVALS OF ',14,1X,'BUNDS, ',14,1X,'MOLECULE(S)'.
1,' OF C WERE ADDED.',/)
1020 WRITE(6,2292)
2292 FORMAT(1X,/)
WRITE(6,661)
68 FORMAT(1X,55X,'SUMMARY BASED ON NUMBERS OF TRIADS FORMED',/)
DO 1022 I = 1,5
1022 WRITE (6,1023)N(I),K(I),(AVTRU(I,J),STDRD(I,J),J=1,3)
1023 FORMAT(50X,14,1X,'SIMULATIONS RESULTED IN AT LEAST',14,1X,
1'TRIADS. ',4X,/,5X,'PROPORTIONS OF TRIADS:ACA:',F7.4,2X,
2'STU-ERROR',F7.4,2X,'ACB:',F7.4,2X,'STD-ERROR',F7.4,2X,
3'UC:',F7.4,2X,'STU-ERROR',F7.4,/)
WRITE (6,1024) (AVTRU(6,J),STDKU(6,J),J=1,3)
1024 FORMAT (5X,'AT COMPLETION, TRIADS OCCURED IN THE FOLLOWING ',
1'PROPORTIONS:',/,27X,'ACA:',F7.4,2X,'STD-ERROR',F7.4,
2X,'ACB:',F7.4,2X,'STU-ERROR',F7.4,2X,'UCB:',F7.4,2X,
3'STU-ERROR',F7.4,/)
DO 75 I = 1,10
RINT = INT
75 PL(I) = L(I) / RINT
WRITE(6,69)
69 FORMAT(50X,'SUMMARY BASED UN NUMBERS OF BONDS FORMED',/)
DO 66 I = 1,10
66 WRITE (6,67) L(I),PL(I), (AV(I,J),STDI(J),J=1,6),TR(I),ISTD(I)
67 FORMAT(1X,10X,'AFTER ',14,'BONDS WERE FORMED OR AT',F7.4,1X,'COMP
LETION OF THE REACTION , WE HAVE THE FOLLOWING',/,5X,
1'PROPORTIONS OF TRIADS:ACA:',F7.4,2X,
2'STU-ERROR',F7.4,2X,'ALB:',F7.4,2X,'STD-ERROR',F7.4,2X,
3'BCB:',F7.4,2X,'STU-ERROR',F7.4,/,5X,
4'LEGUCLES UNBUNDED : -A-',1X,F6.2,2X,'STU-ERROR',F6.2,2X,'-B-',1X,

```

ORIGINAL PAGE IS
OF POOR QUALITY

```
5 F8.2,2X,'STD.ERROR',F6.2,2X,'C-',1X,F8.2,2X,'STD.ERROR',F6.2
6 '//,1X,'TIME AVERAGE NUMBER OF TRIADS FORMED WAS',F9.4,1X,'WITH A
7 STD.ERROR OF',F7.4,////)
  IF (NBRUNS.LT.NORUNS) GO TO 101
  GO TO 500
500 WRITE (6,801) RDM
501 FORMAT (1X,'ERROR IN RANDOM NUMBER GENERATOR',2X,F6.4)
  GO TO 500
7000 WRITE (6,7001)
7001 FORMAT (1X,'INVALID INPUT')
500 CONTINUE
  STOP
  ENL
```