

TWO-WAY SEQUENTIAL TIME SYNCHRONIZATION:
PRELIMINARY RESULTS FROM THE SIRIO-1 EXPERIMENT(*)

E. Detoma, S. Leschiutta
Istituto Elettrotecnico Nazionale "Galileo Ferraris"
Torino - Italy

ABSTRACT

A two-way time synchronization experiment was performed in the spring of 1979 and 1980 via the Italian SIRIO-1 experimental telecommunications satellite.

The experiment was designed and implemented by the Istituto Elettrotecnico Nazionale, Torino (Italy), to precisely monitor the satellite motion and to evaluate the possibility of performing a high-precision, two-way time synchronization using a single communication channel, time-shared between the participating sites.

The results of the experiment show that the precision of the time synchronization is between 1 and 5 ns, while the evaluation and correction of the satellite motion effect has been performed with an accuracy of a few nanoseconds or better over a time interval from 1 up to 20 seconds

INTRODUCTION

The principal features of the SIRIO-1 time synchronization experiment can be briefly summarized as follows:

- the experiment was designed to precisely monitor the satellite motion and the effects of this motion on the time synchronization accuracy;

(*) Work supported by the Italian National Research Council.

- the time synchronization is performed using the two-way time synchronization technique and a single communication channel, time-shared between the two sites;
- the experiment tests a new technique that has been proposed to correct for the satellite motion effect while performing the time synchronization;
- by using a single communication channel, no effects affecting the accuracy of the time synchronization at the 1 ns level are due to the space segment (from one ground antenna to the other), thanks to the high frequencies used for the RF carriers;
- the time signals used allow the independent determination of the uncertainties of the time-of-arrival measurements at the two stations, to separate the contribution of each station to the total precision.

This last feature can be important to understand the contribution of local phenomena (ground equipment, atmospheric conditions affecting the signal attenuation, especially rain, etc.) to the synchronization precision.

ORGANIZATION OF THE EXPERIMENT

A detailed description is given in ref. 1. Only a few remarks are given here, mainly for reference purposes.

Two ground stations, Fucino and Lario (fig. 1), participate to the experiment. Both sites are in Italy, in the northern (Lario) and in the central part (Fucino) of the country; one IEN Cesium clock was installed at each site.

Fucino (fig. 2) transmits its time signal at 0 seconds of the synchronization frame (Fucino time), acting as station 'A', while Lario transmits its own signal at 0.5 s (Lario time), acting as station 'B'.

Two times-of-reception are then measured at each site; with reference to fig. 3, these are T_4 and T_3 at Fucino and T_1 and T_5 at Lario (we have no need to measure T_0 and T_2 since these are known).

To simplify the notation and for a better understanding, we may note that $T_4 - T_0$ is the time of propagation of the time signal from Fucino to Fucino, $T_1 - T_0$ is (neglecting for now ϵ) the time of propagation from Fucino to Lario, etc., so we can write:

$$\begin{aligned}
 (1) \quad T(\text{FF}) &= T_4 - T_1 = T_4 \\
 T(\text{FL}) &\approx T_1 - T_0^* \approx T_1 \\
 T(\text{LF}) &\approx T_3 - T_2^* \approx T_3 - 0.5 \\
 T(\text{LL}) &= T_5 - T_2 = T_5 - 0.5
 \end{aligned}$$

(*) local time reference

$T(\text{FF})$, $T(\text{FL})$, $T(\text{LF})$ and $T(\text{LL})$ are the actual results of the time measurements at the two sites [except for the subtraction of 0.1 s, resulting from the hardware implementation, see ref. 1] and will be used in any following computation.

Two data types are considered: pseudo-range data, such as $T(\text{FF})$ and $T(\text{LL})$, that are the time intervals measured against the same time reference, and synchronization data, such as $T(\text{LF})$ and $T(\text{FL})$; the starting and ending times of the latter intervals are measured with reference to different clocks.

Data format

Actually, each one of the values listed in (1) results from the measurement process as the mean over ten independent measurements: a rough data file is shown in fig. 5. Each time of arrival is then evaluated as the arithmetic mean of the measured data. The data is rejected if the associated standard deviation is larger than 100 ns; however, less than 0.5% of the data was rejected because their standard deviation was exceedingly large. On the average, the standard deviation for each of the time-of-arrival evaluations, based on ten data values, is in the range 10 to 50 ns.

The basic synchronization frame lasts 1 s and is repeated every 10 s; during the 1979 series of measurements, small groups of data (10 to 15 measurement frames) were recorded sequentially, to characterize the performance of this technique over time intervals of 100 to 150 seconds: this was actually performed also to verify the assumption of a linear motion of the satellite and the validity of the correction used (see eq. (7) to (15), ref. 1) over this time interval.

During 1980 a second series of measurements were performed over longer time intervals (up to 16 minutes); the comparison between the results obtained via the satellite, the TV method and portable clock trips are shown in fig. 6, where ϵ_t is the difference between the two atomic clocks located at the ground sites. An expanded view over four consecutive days of satellite measurements is given in fig. 7.

The overall accuracy of the clocks comparison was estimated to be between 50 and 100 ns, with reference to some portable clock comparisons.

Synchronization estimate ($\tau = 1$ s)

The clocks difference ϵ_t at the time t , defined as:

$$(2) \quad \epsilon_t = t(B) - t(A) = t(LAR) - t(FUC)$$

is given (see ref. 3), over the basic synchronization frame time interval τ ($\tau = 1$ s), by the equation:

$$(3) \quad \epsilon_t (\tau = 1 \text{ s}) = \frac{T_t(\text{FL}) - T_t(\text{LF})}{2} + (0.5) \cdot C$$

since $(t_2 - t_1)$ is 0.5 s (see fig. 3).

The range-rate correction C to ϵ_t , as defined in ref. 1, is computed as:

$$(4) \quad C = + \frac{1}{2} \frac{[T_{t+10}(\text{FF}) - T_t(\text{FF})] + [T_{t+10}(\text{LL}) - T_t(\text{LL})]}{20}$$

The magnitude of C was usually found to be in the range 2-4 ns/s, yielding a range rate correction of 1 to 2 ns over the basic frame.

An estimate of $\bar{\epsilon}$ is obtained by taking the arithmetic mean of a number of successive data (from 100 s up to 16 minutes). If ϵ would be constant over this measurement interval, then the standard deviation $\sigma(\epsilon)$ of the data would be related to the precision of the method.

The evaluation of $\bar{\epsilon}$ and $\sigma(\epsilon)$ is carried on by applying a 3-sigma width filter; that is, the ϵ_t value is rejected if the residual $|\bar{\epsilon} - \epsilon_t| > 3\sigma$; if any ϵ_t has been rejected, a new

$\bar{\epsilon}$ and $\sigma(\epsilon)$ are evaluated using the remaining data. This procedure is repeated until no more data are rejected; usually this filter rejects less than the 5% of the available data.

Assuming a normal distribution of the data, the one-sided estimated error $|\delta\epsilon|$ in the determination of $\bar{\epsilon}$ is given, with the 99.5% confidence, as:

$$(5) \quad |\delta\epsilon| = \frac{\sigma \cdot t_{0.995}^{(n-1)}}{\sqrt{n}}$$

The magnitude of $\delta\epsilon$, when $\bar{\epsilon}$ is computed over 50 to 100 data ϵ_t , ranges usually between 1 and 5 ns (see fig. 7 and fig. 8).

The capability to look at the precision of the method over short time intervals is demonstrated by fig. 8 and fig. 9, where two-hours data are plotted, together with an unweighted least-squares fit of the available data.

As it can be seen, the average error of the fit is quite small, less than 1.5 ns.

Expanded time synchronization frame ($\tau = 10$ s and $\tau = 20$ s)

As explained in ref. 1, the time synchronization frame can be lengthened by simply rearranging the data.

This shows the capability of the method to synchronize two clocks by using a single communication channel even if a fast switching of the RF carrier at the two sites is not possible and a large effect due to the satellite motion is then expected; however, the amount of the correction due to this motion can be computed very accurately by using the pseudo-range data available.

In this case, the clocks difference ϵ_t can be computed as:

$$(6) \quad \epsilon_t(\tau = 10 \text{ s}) = \frac{T_t^{(FL)} - T_{t+10}^{(LF)}}{2} + (10.5) \cdot C$$

(since now $(t_2 - t_1) \approx 10.5$ s) where C is given by eq. (4).

This is equivalent to have a station transmitting its time signal at t_0 and the other site transmitting at $(t_0 + 10.5)$ s.

Accordingly, to simulate a longer time interval ($\tau = 20$ s) we can write:

$$(7) \quad \epsilon_t(\tau = 20 \text{ s}) = \frac{T_t(\text{FL}) - T_{t+20}(\text{LF})}{2} + (20.5) \cdot C$$

where now C is computed as:

$$(8) \quad C = + \frac{1}{2} \frac{[T_{t+20}(\text{FF}) - T_t(\text{FF})] + [T_{t+20}(\text{LL}) - T_t(\text{LL})]}{40}$$

A comparison of single measurements of ϵ_t , evaluated by using eq. (3), (6) and (7) is presented in fig. 10, over a 200 s time interval. The agreement between the values of ϵ_t for different τ 's is remarkable, if we note that the correction to be applied to eq. (6) and (7) amounts respectively to about 48 and 95 ns in most cases.

Further analysis on the experimental data

Instead of using the differences between the measurement data $T(\text{FL})$ and $T(\text{LF})$ to compute ϵ_t , it is possible to use a polynomial fit of the data and then evaluate ϵ_t over the coefficients of the fitted polynomial.

This procedure has the advantage that less data are exchanged between the two sites (the fit coefficients only) and that also missing data points at one site can be recovered from the fitted curve.

By writing:

$$(9) \quad \begin{aligned} T(\text{FF}) &= \sum_{0}^n a_i (t-t_0)^i \\ T(\text{LL}) &= \sum_{0}^n b_i (t-t_0)^i \\ T(\text{FL}) &= \sum_{0}^n c_i (t-t_0)^i \\ T(\text{LF}) &= \sum_{0}^n d_i (t-t_0)^i \end{aligned}$$

eq. (3) can be written as:

$$(10) \quad \epsilon_t(\tau = 1 \text{ s}) = \frac{1}{2} \sum_{0}^n i (c_i - d_i) (t-t_0)^i + (0.5) \cdot C$$

where:

$$\begin{aligned}
 (11) \quad C &= + \frac{1}{2} \frac{\sum_0^n (a_i + b_i) (t - t_{0+10})^i - \sum_0^n (a_i + b_i) (t - t_0)^i}{20} = \\
 &= + \frac{1}{2} \frac{\sum_1^n (a_i + b_i) \cdot 10^i}{20}
 \end{aligned}$$

If ϵ_t is constant over the measurement interval, then $\epsilon_t = \epsilon_{t_0}$ and eq. (10) becomes:

$$(12) \quad \epsilon_t = \frac{1}{2} (d_0 - c_0) + (0.5) \cdot C$$

If only the linear (velocity) terms are significant and any higher order term (acceleration) of the satellite motion is neglected, then C is given by

$$(13) \quad C = + \frac{a_i + b_i}{4}$$

This procedure was actually carried on over measurements intervals up to 600 s; over time intervals up to 200 s it was found that a linear (first order) fit (as given by eq. (12) and (13)) was usually good enough to evaluate ϵ_t and any further increase in the degree of the polynomial does not improve the fit; obviously this result depends mainly on the clocks and the synchronization process behaviour.

This was also a further check of the correctness of the linear motion assumption as given by eq. (4).

The test of statistical significance (see ref. 2) of the computed coefficients of the polynomials (9) was carried on by computing the standard deviation of the estimated coefficients.

This was done in the following way: the least squares fit is expressed by the normal equations that, in matrix form, are:

$$(14) \quad (X'X)\psi = (X'Y)$$

where: $(X'X)$ is the normal equations matrix (or x-products matrix);

$(X'Y)$ is the cross-products matrix;
 ψ is the vector of the coefficients.

An estimated value of the standard deviation of the fit is computed as:

$$(15) \quad \sigma^2 = \frac{1}{(n-k)} \cdot \sum_i r_i^2$$

where n is the number of data, k is the number of estimated coefficients and r_i is the i -th residual. The estimated standard deviation (ref. 2) of the k -th coefficient is given by:

$$(16) \quad \sigma_k = \sigma \sqrt{c_{kk}}$$

where c_{kk} is the k -th diagonal element of the matrix $(X'X)^{-1}$. Actually the computation of the $(X'X)^{-1}$ matrix was performed with Gauss-Jordan reduction and pivot search to minimize the numerical computation errors. Then an estimated confidence interval for the coefficient can be computed, by using the Student t -distribution at $(n-k)$ degrees of freedom.

Ground-equipment delays measurements

Two types of measurements were performed: test-loop-translator (TLT) measurements and transmitting-chain delay measurements (LARIO site only).

Test-loop-translator measurements

The experimental set-up is shown in fig. 11. The measurements performed showed a precision around 1 ns and a long term (1 month) stability of the delay in the order of 1 to 3 ns, if the ground equipment is operated at the same power level. The measurements were performed in the same operating conditions as during the synchronization sessions.

The loop-delay was found to be 3.776 μ s (LARIO) and 4.618 μ s (FUCINO) on the average.

Transmitter delay measurements (LARIO site only)

The proposed use of a microwave cavity as a frequency discriminator was tested. The cavity was characterized by a Q of 1500 at the transmission frequency. Unfortunately, the only

way to couple the cavity near the TLT was via an existing directional coupler, that attenuates the signal more than 40 dB.

The rectified signal consequently was very small, since the cavity contributed an additional attenuation of about 12 dB, and, under these conditions, the measurement was impossible.

In order to increase the rectified signal, it was necessary to increase the frequency deviation: in these conditions the communication equipment was working outside the range of normal operation and the overall system response degraded noticeably. The measurement jitter, for instance, increased up to 50 ns (1 sigma), as compared to the 1 ns found in the TLT measurements; this was verified by performing the same TLT measurement, but with the larger frequency deviation.

The reproducibility of the measurements, mainly related to the critical setting of the microwave cavity (the cavity resonance was adjusted at the RF carrier frequency when no modulation was applied), was better than 100 ns, even when working in these very critical conditions.

ACKNOWLEDGMENTS

The authors would like to thank the Telespazio personnel at the two ground stations for their assistance in performing the experiment.

We wish also to acknowledge the work of the IEN personnel that actually carried on the measurements; we are especially grateful to V. Pettiti, E. Angelotti, L. Canarelli, F. Cordara, V. Marchisio, G. Moro and L. Pietrelli, to Mr. G. Galloppa for the drawings and to Mrs. M. Castello for the typewriting.

One of the authors (E. Detoma) wishes to dedicate his work to Mrs. Marina Castello, for her constant cooperation, encouragement and sincere friendship: to acknowledge that friendship and loyalty towards the friends are always more important than scientific and personal achievements.

REFERENCES AND NOTES

1. E. Detoma, S. Leschiutta - The SIRIO-1 timing experiment, Proc. of the 11th Precise Time and Time Interval Meeting (PTTI), Nov. 1979 (Washington, D.C.)
2. M.G. Natrella - Experimental statistics, NBS Handbook 91 (1963).
3. The actual computations were carried on by computing ϵ as:

$$\epsilon = t(\text{FUC}) - t(\text{LAR})$$

However, while the data plotted result from these computations, in the text of this paper the same notation is used as in ref. 1.

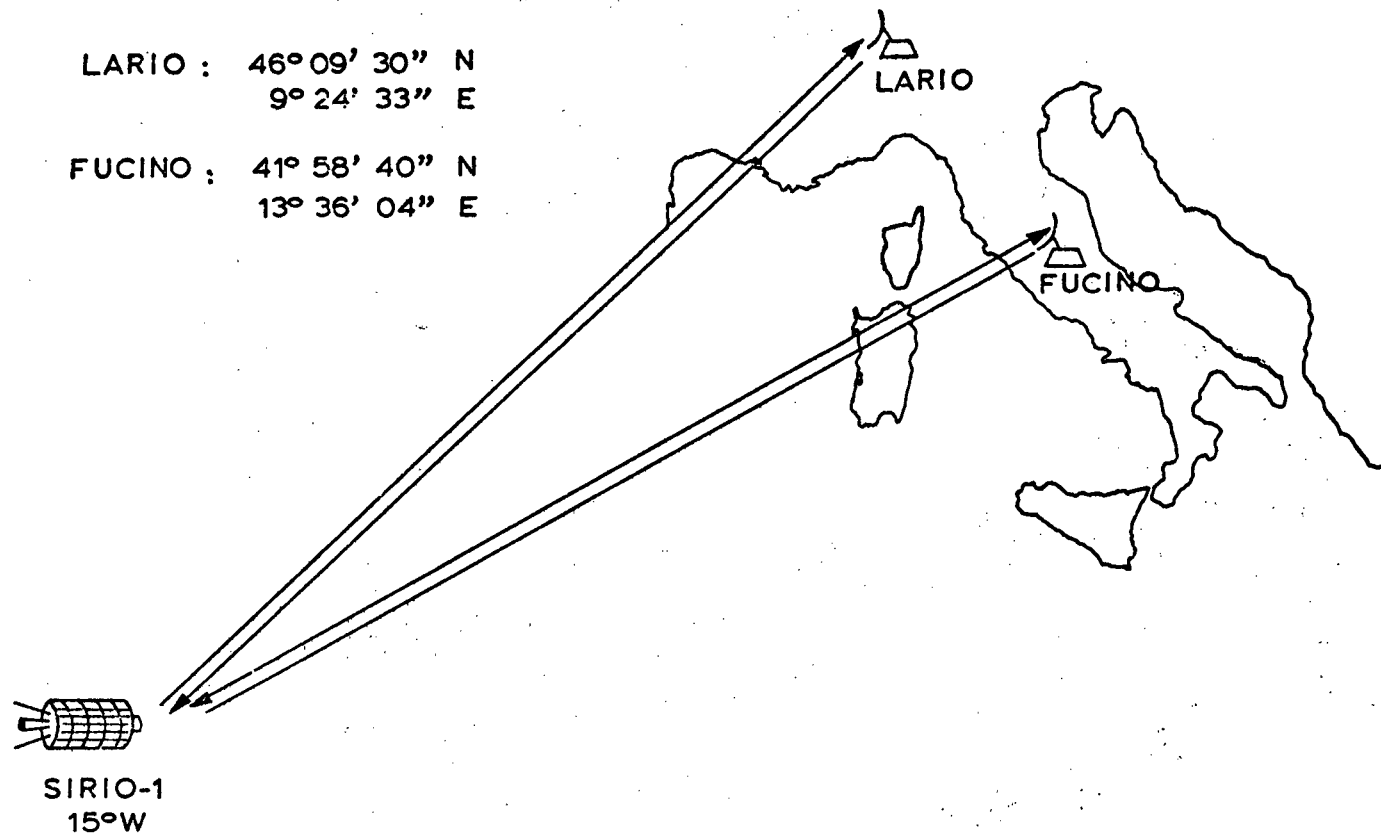

Fig. 1 - Sites geometry

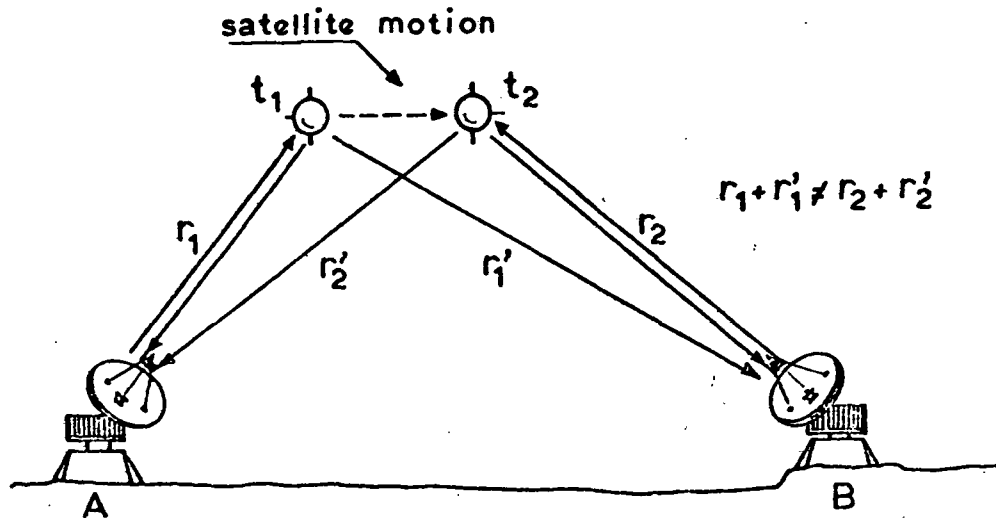

Fig. 2 - Two-way sequential time synchronization

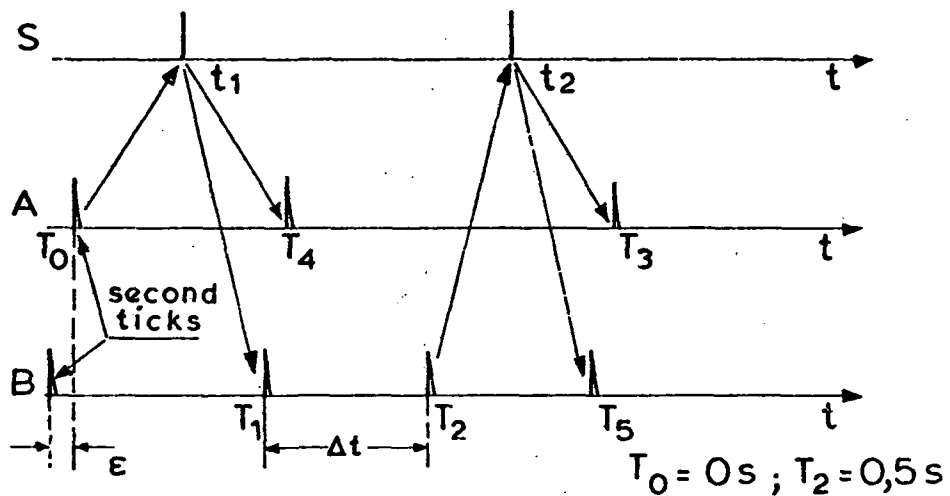

Fig. 3 - Timing diagram

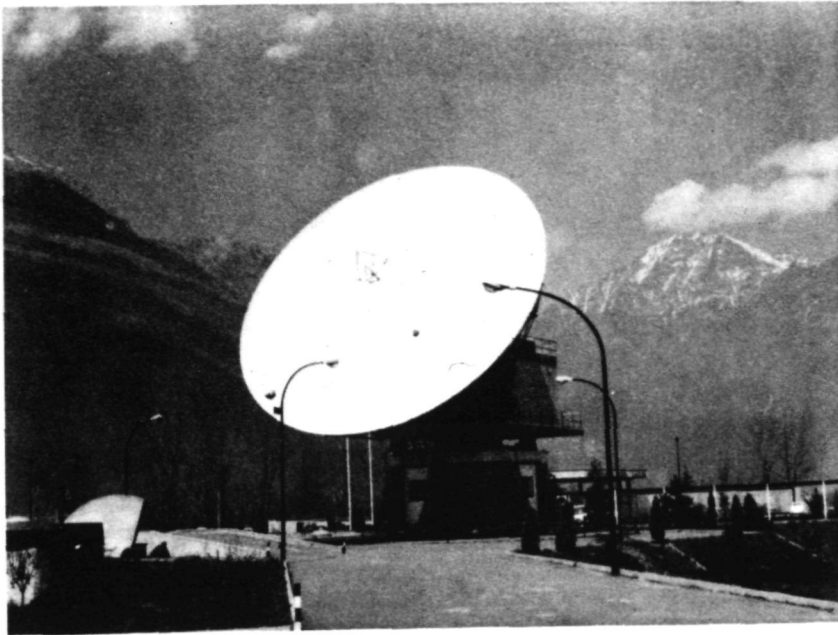

Fig. 4 - The LARIO station antenna

```

FILE N.      21

9.205060000 -04 — Time tag
1.560251000 -01 — T1 - Time of reception--(- 0.1 s)
6.025154000 -03 —
6.025144000 -03 —
6.025124000 -03 — Time measurements
6.025188000 -03 — modulo the repetition
6.025142000 -03 — period
6.025154000 -03 —
6.025242000 -03 —
6.025144000 -03 —
6.025162000 -03 —
1.565590840 -01 — T5 - Time of reception--(- 0.1 s)
6.559078000 -03 —
6.559078000 -03 —
6.559088000 -03 — Time measurements
6.559100000 -03 — modulo the repetition
6.559080000 -03 — period
6.559188000 -03 —
6.559106000 -03 —
6.559094000 -03 —
6.559094000 -03 —

```

Fig. 5 - Sample data file

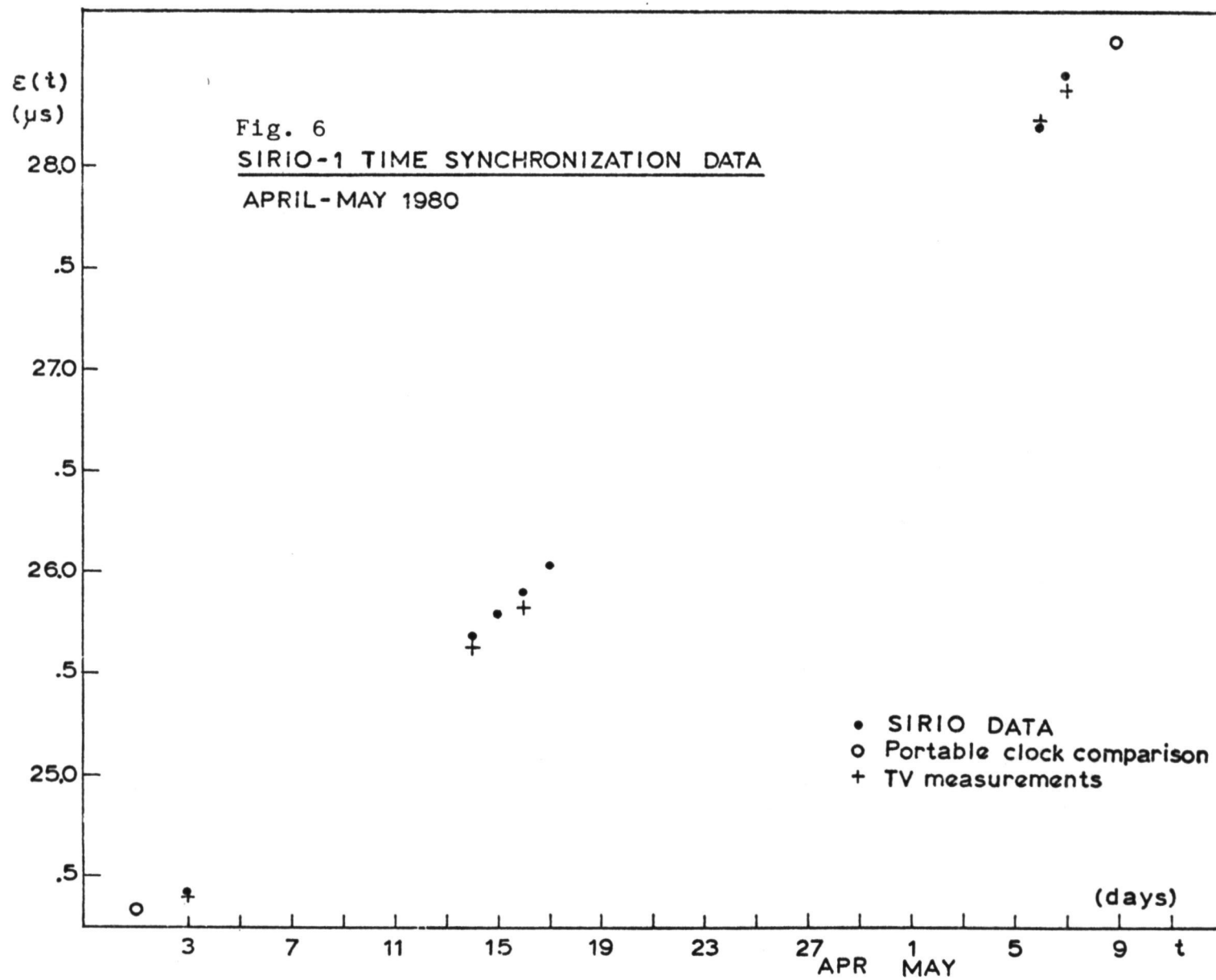

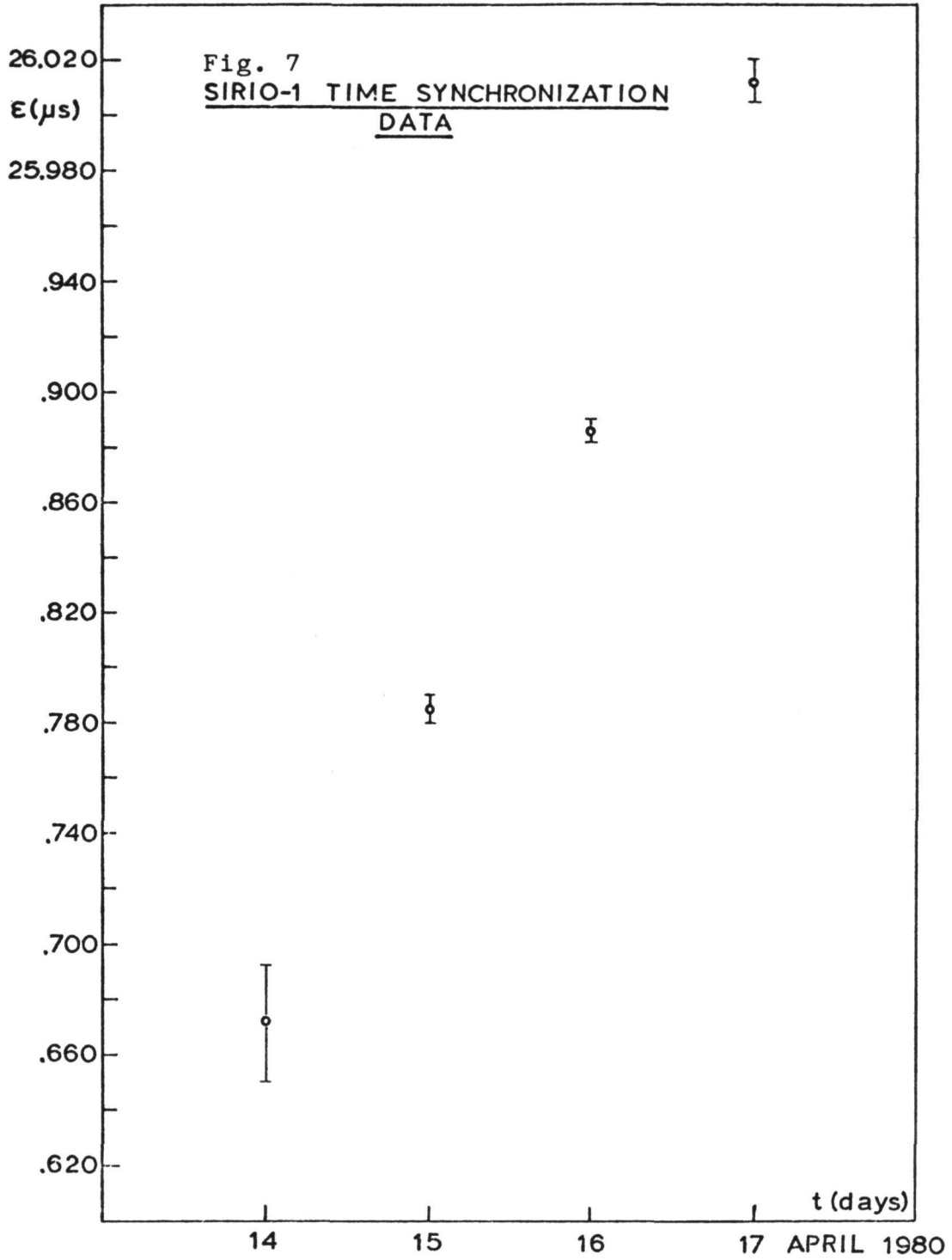

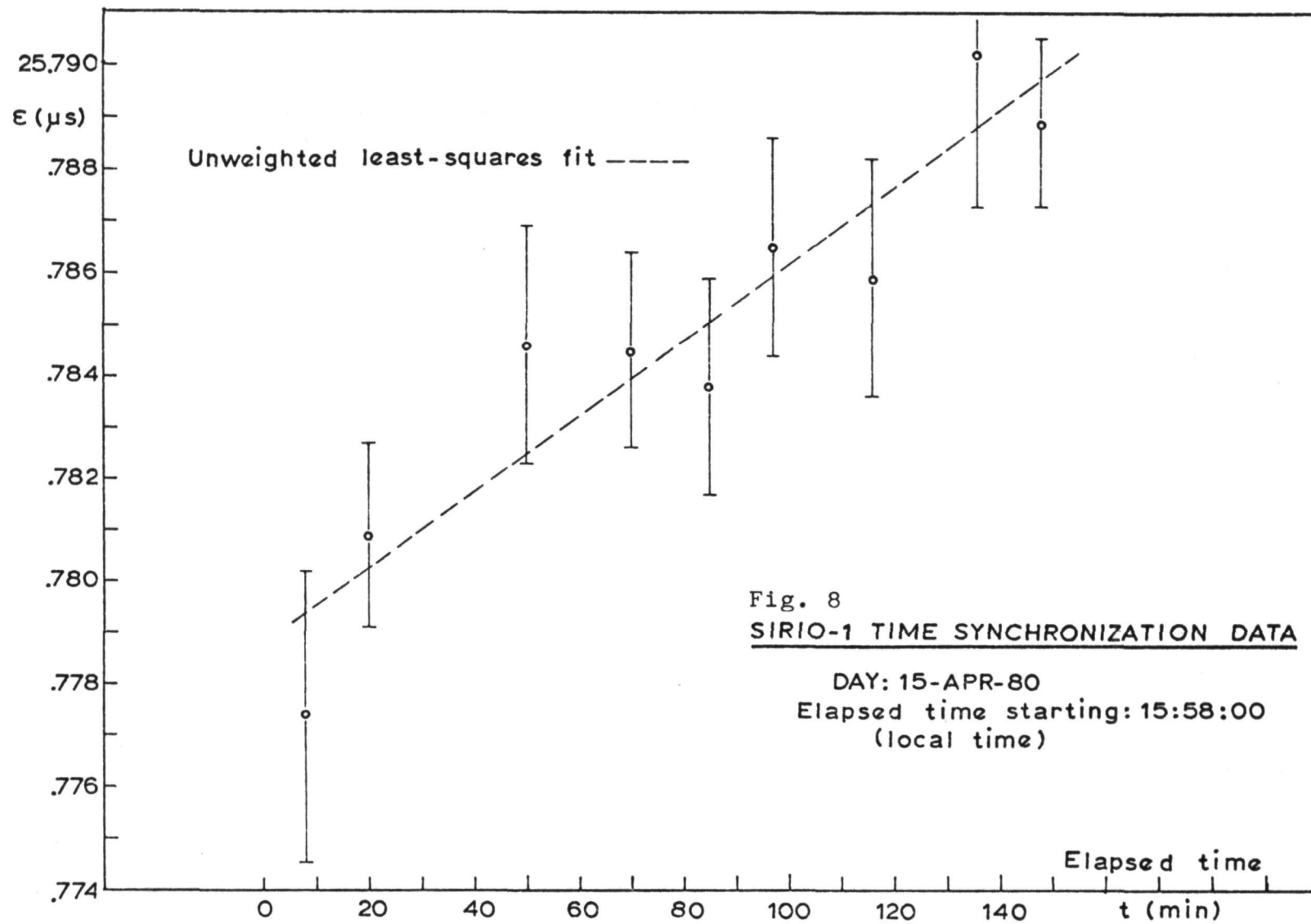

345

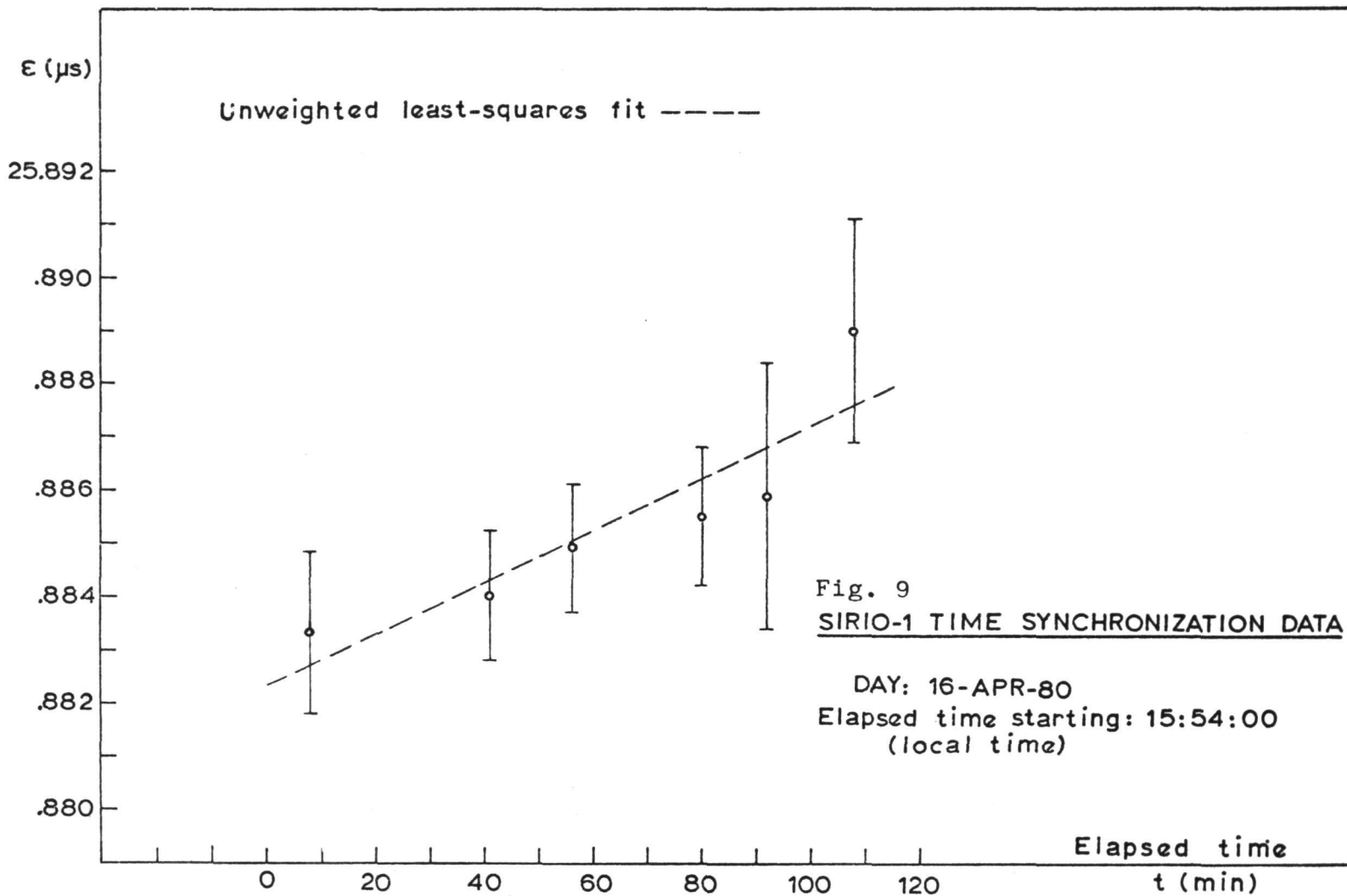

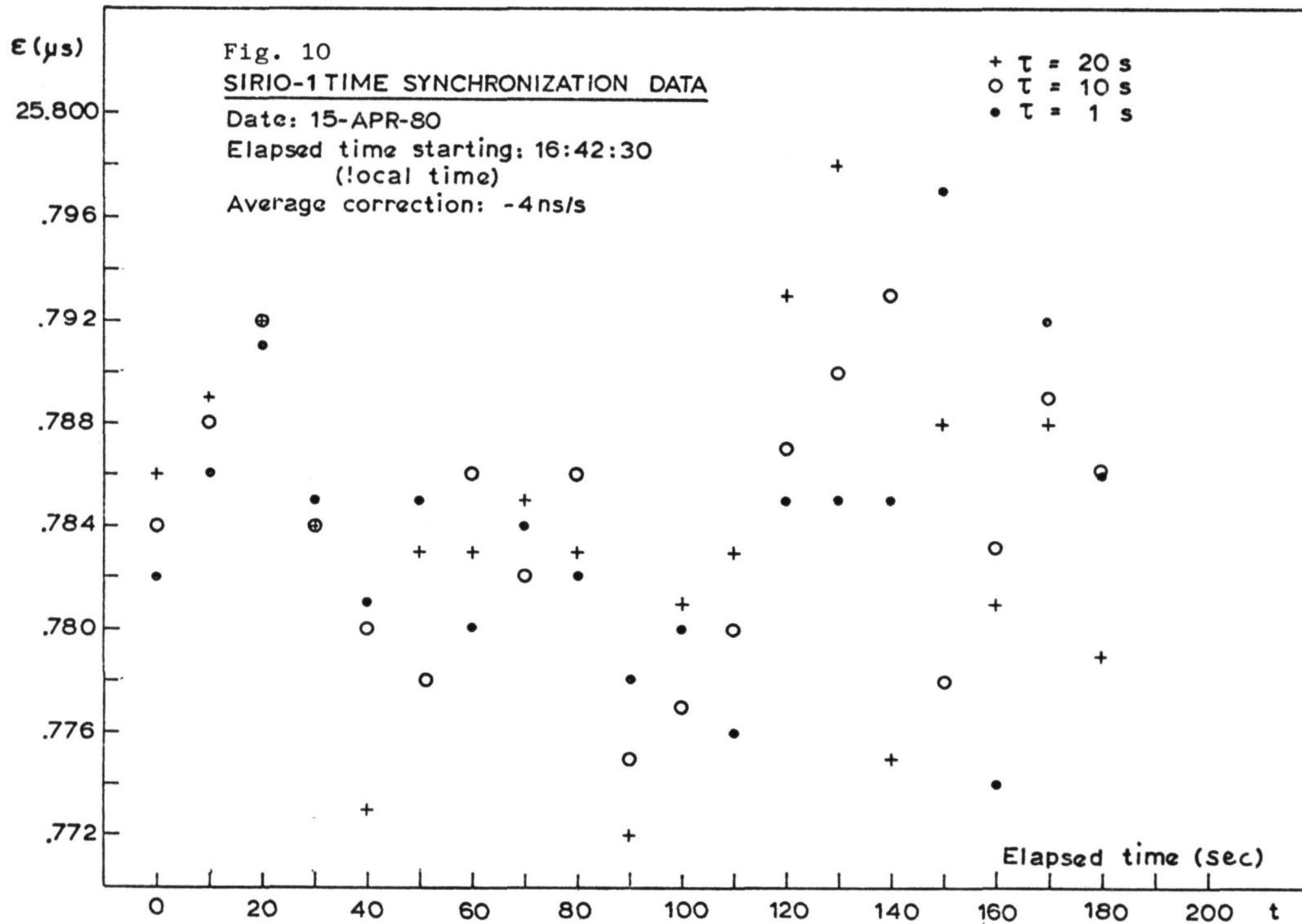

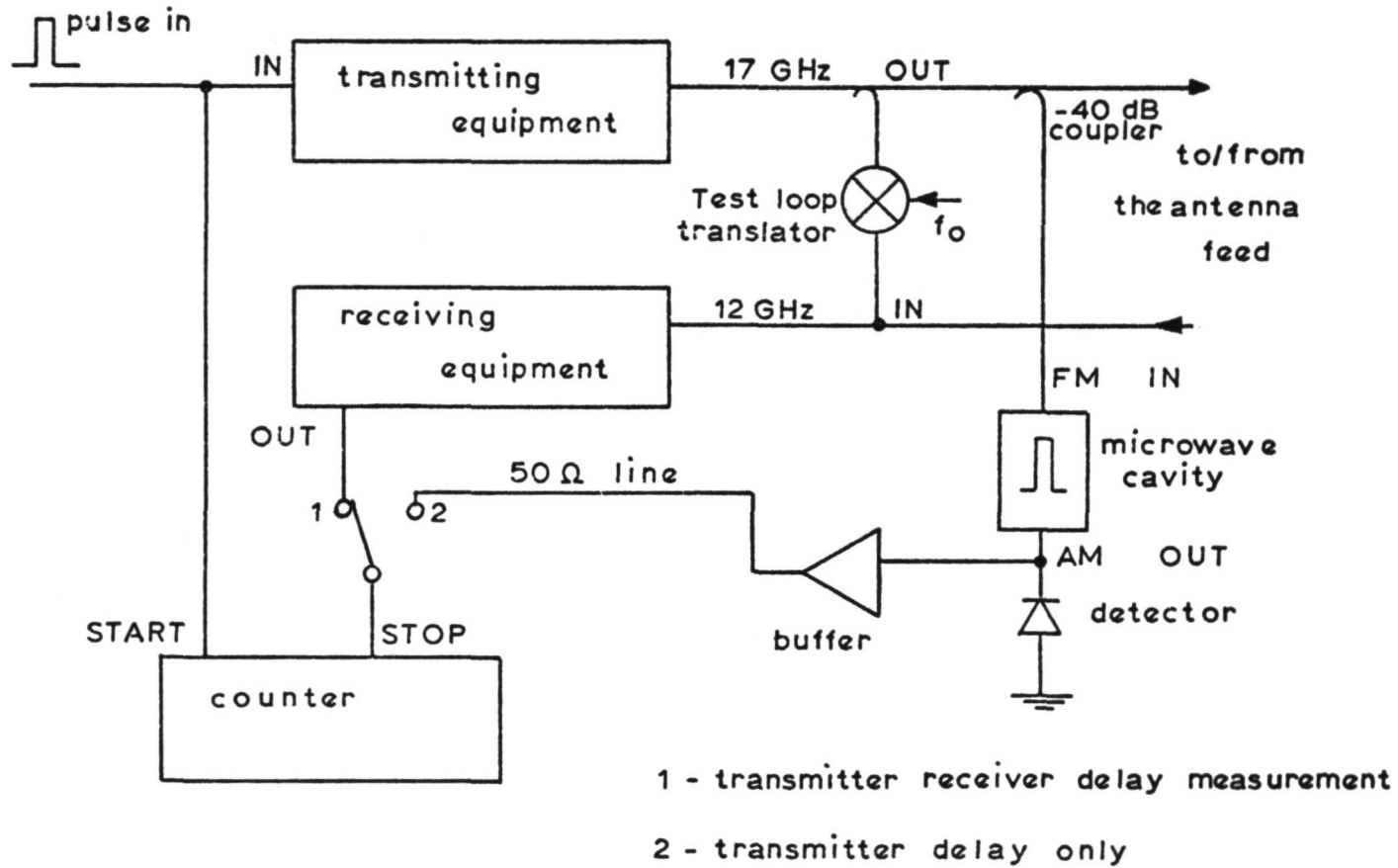

Fig. 11 - Ground equipment delay measurement set-up

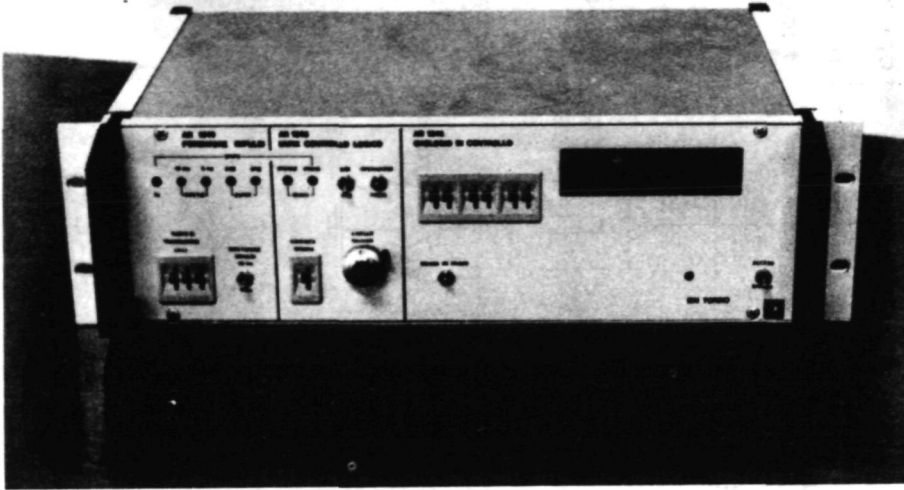

Fig. 12 - The time transfer unit (TTU)

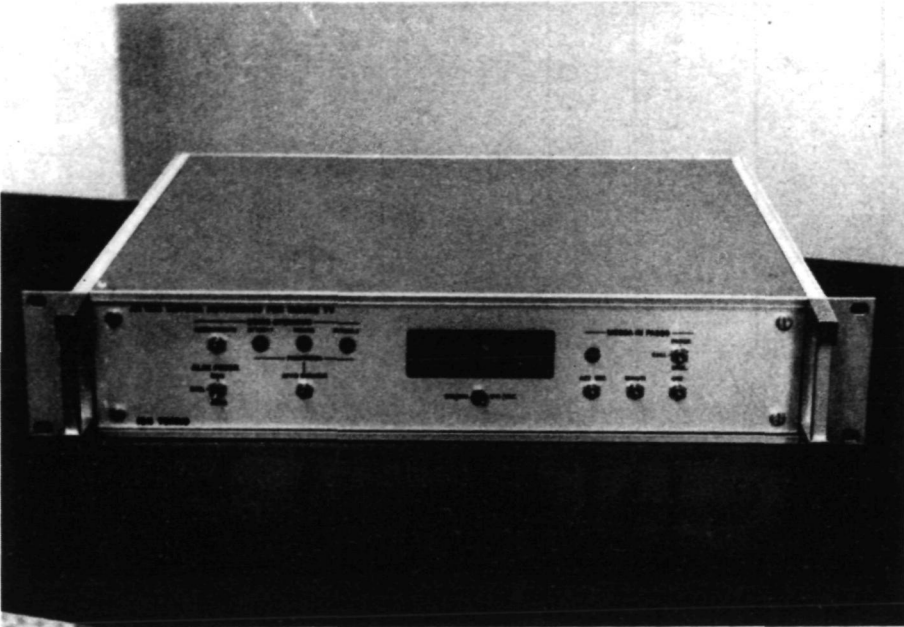

Fig. 13 - Automatic TV measurements subsystem

QUESTIONS AND ANSWERS

MR. DAVID ALLEN, National Bureau of Standards

Two questions; one what is the size of the antenna involved?

PROFESSOR LESCHICUTTA:

Yes, please. In the ground station the size is 17 meters with a true bandwidth -- RF bandwidth of 34 megahertz. Also, in the repeater satellite in the real bandwidth of base band bandwidth of 6 megahertz.

As regards the experiment on the ship, the diameter of the dish is on the order of 2 1/2 meters but the bandwidth is just 1.5 megahertz. So, obviously the precision should be deteriorated.

MR. ALLEN:

I thought it was a very excellent result that you received. I have one question in regard to the equation. Because the stations are basically north/south you would not see any effect due to the SANYAC correction.

PROFESSOR LESCHIUTTA:

Yes, the SANYAC correction is 13.5 nanoseconds, in our case because the area of the path is very small in the equatorial plan.

MR. ALLEN:

The correction was not in the equation?

PROFESSOR LESCHIUTTA:

No, no, it was not included but is in the order of 14 nanoseconds.

MR. ALLEN:

Thank you.

PROFESSOR LESCHIUTTA:

13 foot.

MR. ALLEN:

Very good.

CHAIRMAN BUISSON:

Any other questions?

MR. LAUREN RUEGER, The Johns Hopkins University/Applied Physics Laboratory

Do you ever take advantage of planning your experiments on the satellite motion when the relative changes to the stations are minimized?

PROFESSOR LESCHIUTTA:

There, again, we are not in a position to do so. We just receive for some hours during the day, but we are planning periods of experiments to make all day measurements in order to follow the satellite.

In previous experiments we have seen the maximum relative speed of the satellite is of the order of 3.5, 4 meter per second.