

## USNO GPS PROGRAM

Kenneth Putkovich  
U. S. Naval Observatory, Washington, D. C.

### Abstract

The U. S. Naval Observatory (USNO) has historically been and continues to be at the forefront in the development of new concepts, techniques and equipment for the generation and dissemination of Precise Time and Time Interval (PTTI). With the advent of the Global Positioning System (GPS) and its predicted capability of time transfers on a worldwide basis to a precision of ten nanoseconds or better, the USNO secured funding to develop a GPS Time Transfer Unit (GPS/TTU) and is currently engaged in a program to validate and disseminate PTTI data from GPS.

Initial test results indicated that the GPS/TTU performed well within the  $\pm 100$  nanosecond range required by the original system specification. Subsequent testing involved the verification of GPS time at the Master Control Site (MCS) via portable clocks and the acquisition and tracking of as many passes of the space vehicles currently in operation as possible. A description and discussion of the testing, system modifications, test results obtained, and an evaluation of both GPS and the GPS/TTU are presented. Finally, the content of USNO GPS reports is discussed and current work and future program plans outlined.

### INTRODUCTION

This paper deals specifically with the description, testing, and evaluation of GPS as a means of time transfer at the present time. A brief description of the GPS system is provided as background to aid in achieving some understanding of the overall system. More detailed information is available in the literature.<sup>1</sup>

The GPS, as originally planned, was to consist of a space segment of twenty-four satellites and a ground segment of a Master Control Site (MCS) and five or more Monitor Sites (MS), one of which was to be located at the USNO. At present, the MCS is located at Vandenberg AFB in California and MS are located in California, Hawaii, Alaska, and Guam. The function of the Monitor Sites is to receive transmissions from each of the satellites, referred to a local clock, and to retransmit this information to the MCS over secure data communication links. The function of the MCS is to correlate this information with

other information, perform the calculations necessary to determine current satellite performance characteristics and upload these parameters to the spacecraft on a daily basis, or as needed. This upload provides current information on clock performance, satellite locations, required clock corrections and all other information necessary to allow an accurate extrapolation of performance over the ensuing twenty-four hours.

The satellites were to be equally distributed in three planes inclined to the equatorial plane of the earth by  $63^\circ$  and intersecting the equatorial plane at  $120^\circ$  intervals. Due to funding cutbacks, present plans call for a space segment of eighteen satellites. The elimination of six satellites from the constellation has little adverse affect on PTTI, since at least one satellite will be in view at any time anywhere on earth and only one is necessary for time recovery. Studies are presently underway to determine the best orbital configuration for navigation.<sup>2</sup>

As a further result of funding cuts, the configuration of ground stations has also changed several times and the USNO Monitor Site was apparently eliminated from the plan.

### GPS SATELLITE SIGNAL<sup>3</sup>

Information is transmitted from the satellites on two carrier frequencies, the primary ( $L_1$ ) at 1575.42 MHz and the secondary ( $L_2$ ) at 1227.6 MHz. The  $L_1$  or primary transmission is modulated by both a precision code (P) code and a coarse/acquisition (C/A) code simultaneously. The  $L_2$  or secondary transmission is modulated by either a P or C/A code. The data stream is transmitted at 50 bits per second and is common to both the P and C/A codes on both the  $L_1$  and  $L_2$  bands. All signals are derived from the same onboard clock. A complete data message is a frame of 1500 bits repeated every six seconds. Each frame is divided into five 300-bit subframes which are further subdivided into ten 30-bit words. The first two words of each subframe contain telemetry and code handover information. The last eight words of Subframe 1 contain clock corrections, an age of data word, and ionospheric delay model coefficients. The last eight words of Subframes 2 and 3 contain the space vehicle's ephemeris and the associated age of data words. The last eight words of Subframe 4 contain an alphanumeric message of interest to users. The last eight words of Subframe 5 contain an almanac (an abbreviated version of information in Subframes 2 and 3) for each of the satellites in the constellation. Each Subframe 5 contains information on a single satellite. Thus the complete almanac for the entire satellite constellation requires the reception of a sequence of frames. The length of the sequence is dependent on the number of satellites in orbit with twenty-four being the maximum.

In order to recover time relative to GPS, a user must be able to receive reliably the satellite signal and demodulate and decode the data

stream. Utilizing this information, one can calculate a corrected pseudo-range, compare it to a pseudo-range measured against a reference clock, and from the difference, determine the clock difference.

#### TIME TRANSFER SYSTEM

The GPS/TTU (Figure 1) consists of four major components - the receiver, the processor, the pseudo-range counter and the system software. As the processor (Hewlett-Packard 1000/45) and the counter (Hewlett-Packard 5328A) are off-the-shelf equipment, no description of them will be provided. A detailed description of the GPS/TTU and the Time Transfer Technique is provided in Reference (4); therefore only a brief description of the receiver and software are provided here.

The receiver is a single channel, spread spectrum Doppler tracking receiver capable of tracking and decoding the C/A code on the  $L_1$  frequency. It receives the signal (from an antenna with a nearly hemispherical coverage pattern) through a low noise preamplifier. Preselective filtering in the preamplifier and further filtering at the receiver limit the effect of out-of-band noise. The signal is then down-converted to an IF frequency and fed to a code loop and correlator which track the C/A code and despread the spread spectrum signal. A carrier tracking loop then demodulates the signal and provides both C/A code epochs and navigation data to detection and synchronization circuits which provide the satellite information to both the measurement and computer systems.

The software system consists of an HP RTE-M operating system, two major application programs, and approximately forty-five subroutines for the acquisition, reduction, and recording of GPS data. Three major operational modes - full automatic, semiautomatic, and manual - are supplemented by auxiliary modes which provide access to satellite visibility and Doppler information and allow initialization and updating of data base and almanac files.

Initial operation requires loading the operating system, setting the system clock on time, initializing the data base with the geodetic coordinates of the antenna, receiver delays, satellite constellation, etc., and manually acquiring one satellite. Once successfully completed, the procedure need be repeated only if parameters change or a system malfunction occurs.

Calling up the full automatic mode of operation (after initialization) results in the generation and implementation of a daily tracking schedule based on current satellite constellation visibility as determined from the almanac recovered during the previous satellite pass. The schedule is regenerated daily thereafter until tracking operations are manually terminated. The only constraint imposed on the automatic mode design was that of requiring that each satellite identified in the data

base be tracked at least once per day. A system generated schedule is shown in Figure 2.

Operation in the semiautomatic mode requires the development of a tracking schedule by the system operator. Satellite visibility is determined by utilizing the visibility subroutine, which results in an information display identical to Figure 2. The selected tracking schedule for a twenty-four hour period is entered (utilizing an interactive dialogue between the computer terminal and the operator) as shown in Figure 3. The completed schedule (Figure 4) is presented for verification and is then implemented by a negative response to the "CHANGE (YES/NO)?" query. Daily tracking continues on this schedule until the operator intervenes or the satellite constellation precesses to the point where specified satellites are no longer visible during the scheduled viewing time.

Operation in the manual mode requires the operator to enter a satellite identification number and an estimate of the carrier Doppler frequency. The receiver then goes into an acquisition loop based on this information and continues in this loop until the chosen satellite comes into view. At the point where the Doppler frequency of the satellite signal falls within a window centered on the original estimate, the receiver locks onto the received signal and continues tracking until the satellite sets or the operator intervenes. Daily tracking of the satellite continues indefinitely until the operator intervenes.

In all modes of operation, data in both raw and processed forms are available for viewing on the system console CRT and can be written onto magnetic tape mini-cartridges and an IEEE-488-1975 general purpose instrumentation bus.

#### USNO GPS DATA

Initial test results showed the GPS and GPS/TTU capable of time transfers with a precision of better than 100 nanoseconds (Figure 5).<sup>5</sup> Subsequent tests resulted in the same level of performance but revealed what appeared to be several discontinuities in GPS time (Figure 6). An investigation showed the cause of these steps to be clock changes and failures at the Monitor Sites. The GPS system software as presently implemented can apparently absorb these time discontinuities with little or no degradation of navigational capabilities. However, discontinuities of this type reduce the system's usefulness in the PTTI area to an unacceptable level. This point has been brought to the attention of the GPS Program Office in order to emphasize the importance of a coordinated effort in the timekeeping aspects of the program.

Figures 7 and 8 show GPS performance that has been observed over the past several months. A comparison of these data with Figure 6 shows

some apparent improvement in that the magnitude and frequency of discontinuities appear to be less in the more recent data. These data also show that the GPS clock is ahead of the USNO Master Clock by over thirty-six microseconds and that it is high in frequency by 1.2 parts in  $10^{12}$  at present. The data in Figure 7 show excellent performance capability over the long term if one ignores the outliers due to a poorly performing satellite. The disturbance recorded between day 44572 and 44578 is ill-defined due a combination of a lack of data during that period and an apparent discontinuity in the little data that was recovered during that time. Examination of Figure 8, which is essentially a plot of the residuals to a linear fit of the data, shows a pattern of variation around the linear fit which appears again in later data from individual satellites. The two extremely large outliers between day 44575 and 44577 appear inverted in Figure 8 due to an aberration in the plotting subroutine used.

Figures 9 through 13 provide a comparison of clock performance for each satellite relative to the USNO Master Clock. Linear fits were applied to the data to remove a large part of the offset that exists between the USNO Master Clock and GPS clocks. The data plotted in these graphs are average values of the measured pseudo-range or time of arrival corrected by subtracting a calculated pseudo-range or time of arrival, ionospheric corrections, tropospheric corrections, and receiver system delays. This is analagous to other one-way, synchronized time transmissions (Loran-C, HF, etc.), where a measured time of arrival is corrected by applying corrections for calcaulted or measured propagation and system delays. In both cases, the result consists of the relative clock difference or offset between the local and remote clock, and the uncertainties and instabilities of both clocks, the measurement systems, and the corrections applied. Since in this case the local clock is the USNO Master Clock, all the offset and uncertainties can be attributed to the satellite clock and the measurement process and system. The cause of the large excursions shown in the SV#4, SV#5, and SV#8 plots has yet to be determined - although it is likely that they are due to system adjustments made to these satellites. The more important point illustrated by these plots is that, with the exception of SV#4, the clocks are well-behaved and perform exceptionally well. SV#4's poor performance is due to unpredictable behaviour in the upload or control mechanism rather than in the clock itself. Were it not for the two large perturbations in the SV#5 and SV#8 plots, it is likely that they would be comparable to that of SV#6. This clock exhibits a characteristic signature for a Rubidium frequency standard with uncharacteristically high performance, staying within  $\pm 3$  microseconds of a fixed linear offset for nearly a one hundred day period. SV#9 is the only satellite presently operating from a cesium oscillator. As expected, its transmissions are exceptional in that it has an offset of only 1.5 parts in  $10^{-13}$  and has stayed within 125 nanoseconds of this offset for nearly one hundred days.

Figures 14 through 18 provide a comparison of the performance of the individual satellites and an indication of how well the GPS system is performing from the standpoint of utilizing the full capabilities of the satellite clocks. In these plots an additional correction factor is applied to the clock differences shown in the previous five figures. The message transmitted by each satellite contains a parameter which gives a continuous, real time estimate of the difference between the GPS clock and the satellite clock. This parameter is determined by the MCS using clock differences (between ground clocks and satellite clocks) measured at the monitor sites. Imbedded in this factor are the combined offsets, instabilities, and uncertainties of both clocks. Thus GPS system performance is equally dependent on ground clock and satellite clock performance, the individual contributions of which cannot be separated without reference to a third clock system. As before, the data from SV#4 are poor. Data from the other four satellites show a high degree of correlation which can be directly attributed to the performance of the ground clock. Furthermore, a comparison of Figures 13 and 18 shows that the data from SV#9 suffers considerable degradation due to the application of the GPS clock - satellite clock correction factor.

#### USNO GPS DATA REPORTS

Data from the satellites are recovered daily and made available at present through the USNO Time Service Automated Data Service (ADS). At present, the data are recorded on magnetic mini-cartridge tape cassettes, reduced and entered into the Time Service Data Base daily during the regular workweek (Monday through Friday). Weekend values are entered on Monday. Figure 19 is a typical example of several days of reduced data as available from the ADS. The first line gives the date/time when data collection began for the immediately following listing. The second line gives the date/time when the data were processed. An explanation of the column headings and data is presented in Table 1. Access to the ADS is available to any user over a standard dial-up telephone line, using a modem and terminal combination able to communicate at 300 or 1200 baud in a full duplex mode with even parity. The commercial telephone number is (202) 254-4080 and the AUTOVON number is 294-4080.

#### PROGRAM IMPROVEMENTS

Although the GPS program is in the middle stages of development, it is felt that the potential for time dissemination can be realized much earlier than the full navigational capability. The USNO and the GPS Joint Program Office and Master Control Site are in the early stages of a program to develop the means of linking the GPS clock with the USNO Master Clock with the objective of establishing a high degree of coordination between the two until the system becomes fully operational in the late 1980's. At that time the system should have the inherent

capability to accomplish this coordination since the operational phase specification requires coordination with UTC and USNO. The goal of the present effort is to synchronize the GPS clock in time and frequency with the USNO Master Clock, to eliminate frequency shifts and time jumps in the GPS ground clock system, to maintain the GPS clock in synchronism with the USNO Master Clock, and to disseminate the resultant data to the timekeeping community in a timely and useful manner. Present plans call for the investigation of the time jumps and frequency shifts that have been observed on GPS, the establishment of a link between the ground clocks at the Master Control Site and the USNO, and the establishment of procedures to permit the synchronization of the two. Recent modifications to the USNO/TTU will allow its integration into an automated data acquisition system and provide automated satellite tracking on a programmed basis. This will provide users continuous access, in near real time, to GPS data collected by the USNO.

#### CONCLUSION

The USNO is currently engaged in a program to provide PTTI users on a worldwide basis to an accuracy of 100 nanoseconds or less on a real time basis. In addition to affording all users a worldwide capability heretofore unavailable, successful completion of these programs will mean significant improvements to international efforts in coordinated timekeeping.

#### REFERENCES

1. Global Positioning System, The Institute of Navigation, Washington, D.C., 1980.
2. Book, S. A., Brady, W. F., and Mazaika, P. K., "The Nonuniform GPS Constellation", IEEE Position Location and Navigation Symposium Record, December, 1980.
3. System Specification for the NAVSTAR Global Positioning System, USAF Space and Missile Systems Organization, 31 January 1979.
4. Hua, Q. D. and Bustamante, H. A., "A GPS Time Transfer System", Standord Communications, Inc., 1980.
5. Putkovich, K., "Initial Test Results of USNO GPS Time Transfer Unit", Thirty-Fourth Annual Frequency Control Symposium, May 1980.

TABLE 1

Explanation of Columnar Headings and Data on USNO GPS ADS Message

SV#	- Satellite identifier transmitted in satellite message.
BEG.TRK DDD.ddd	- Beginning of tracking period. Given as a Modified Julian Date minus 44,000 in hundreds of days (DDD) and decimal fractions of a day (ddd) with .500 being 1200 UTC.
BEG TRK D HHMMSS	- Beginning of tracking period. Given in GPS day of week (D) and UTC (HHMMSS). Sunday is day zero.
TRK TIME SSSS	- Length of tracking period in seconds.
MC-GPS US	- Time difference between USNO Master Clock and GPS as determined from satellite transmission. It is referred to BEG TRK time and is given in microseconds. A negative value means GPS is ahead of UTC.
SLOPE PS/S	- Slope of linear fit through all data collected during TRK TIME. Line originates at MC - GPS at BEG TRK.
RMS NS	- Standard deviation of data collected during TRK TIME.
ELV	- Elevation angle of satellite at USNO at BEG TRK.
AZMT	- Azimuth angle at USNO at BEG TRK.
D.AGE DHHMM	- Age of data is the time elapsed since last upload of information to the satellite. It serves as a confidence level value for the time dependent parameters transmitted by the satellite.
MC-SAT NS	- Satellite clock difference in nanoseconds uncorrected for GPS - SV clock difference.



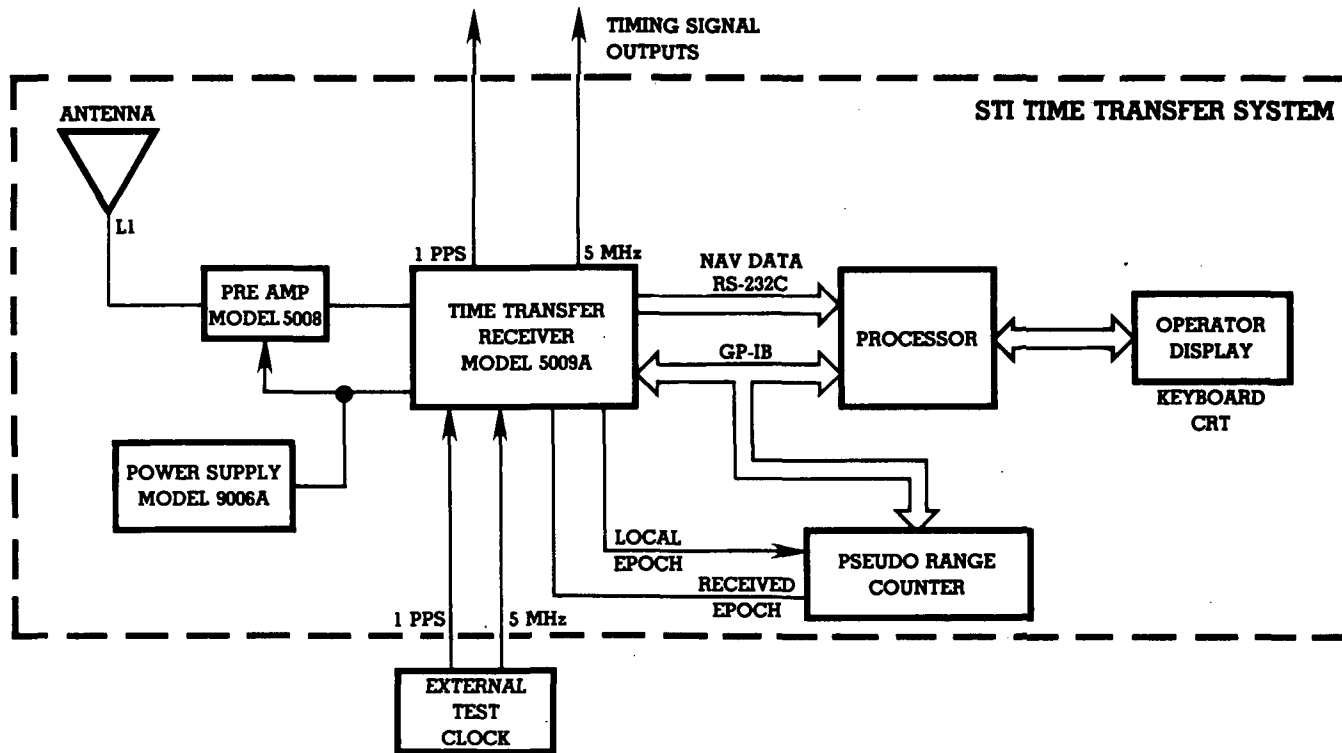

Figure 1. GPS/TTU Block Diagram

VISIBILITY ON MJD : 44610 DAY : 6 YEAR : 1981  
 SV: 4 RISE 13: 0 SET 19:45  
 SV: 5 RISE 14:45 SET 21:30  
 SV: 6 RISE 0: 0 SET 1:30 RISE 12:30 SET 17:15 RISE 23: 0 SET 24: 0  
 SV: -7 RISE 1:15 SET 6: 0 RISE 17: 0 SET 19:30  
 SV: 8 RISE 11:15 SET 17:15  
 SV: 9 RISE 0: 0 SET 3:15 RISE 14:30 SET 18:30 RISE 23:30 SET 24: 0

COMPUTED 24-HOUR SCHEDULE

START TIME	STOP TIME	SV
0: 0	1:30	6
1:30	3:15	9
11:15	16:45	8
16:45	17:15	6
17:15	18:30	9
18:30	19:45	4
19:45	21:30	5
23: 0	24: 0	6

GPSTT : STOP 0000

Figure 2. Visibility Subroutine Output Display

```
24-HR SCHEDULE SETUP
--> START TIME 0: 0
    ENTER STOP TIME(HR,MIN),SVID ? 00:06,6
--> START TIME 0: 6
    ENTER STOP TIME(HR,MIN),SVID ? 01:05,0
--> START TIME 1: 5
    ENTER STOP TIME(HR,MIN),SVID ? 01:11,9
--> START TIME 1:11
    ENTER STOP TIME(HR,MIN),SVID ? 13:50,0
--> START TIME 13:50
    ENTER STOP TIME(HR,MIN),SVID ? 14:02,8
--> START TIME 14: 2
    ENTER STOP TIME(HR,MIN),SVID ? 14:15,6
--> START TIME 14:15
    ENTER STOP TIME(HR,MIN),SVID ? 14:27,4
--> START TIME 14:27
    ENTER STOP TIME(HR,MIN),SVID ? 14:39,9
--> START TIME 14:39
    ENTER STOP TIME(HR,MIN),SVID ? 14:51,5
--> START TIME 14:51
    ENTER STOP TIME(HR,MIN),SVID ? 24:00
```

Figure 3. Interactive Semi-automatic Mode Scheduling Display

24-HOUR SCHEDULE

START TIME	STOP TIME	SV
0: 0	0: 6	6
1: 5	1: 11	9
13: 50	14: 2	8
14: 2	14: 15	6
14: 15	14: 27	4
14: 27	14: 39	9
14: 39	14: 51	5

CHANGE DATA (YES/NO) ?

Figure 4. Semi-automatic Mode Schedule

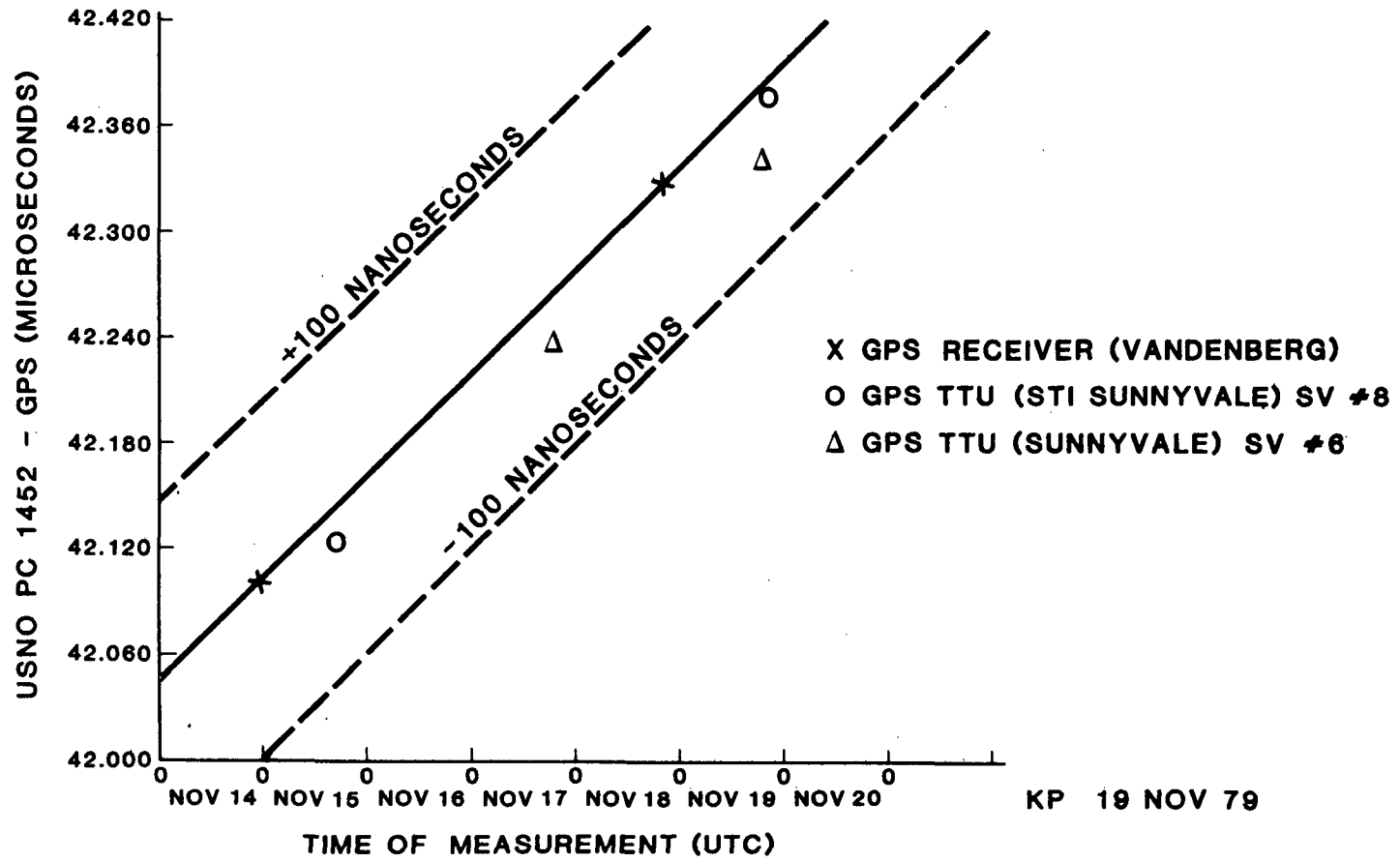

Figure 5. Initial Test Results

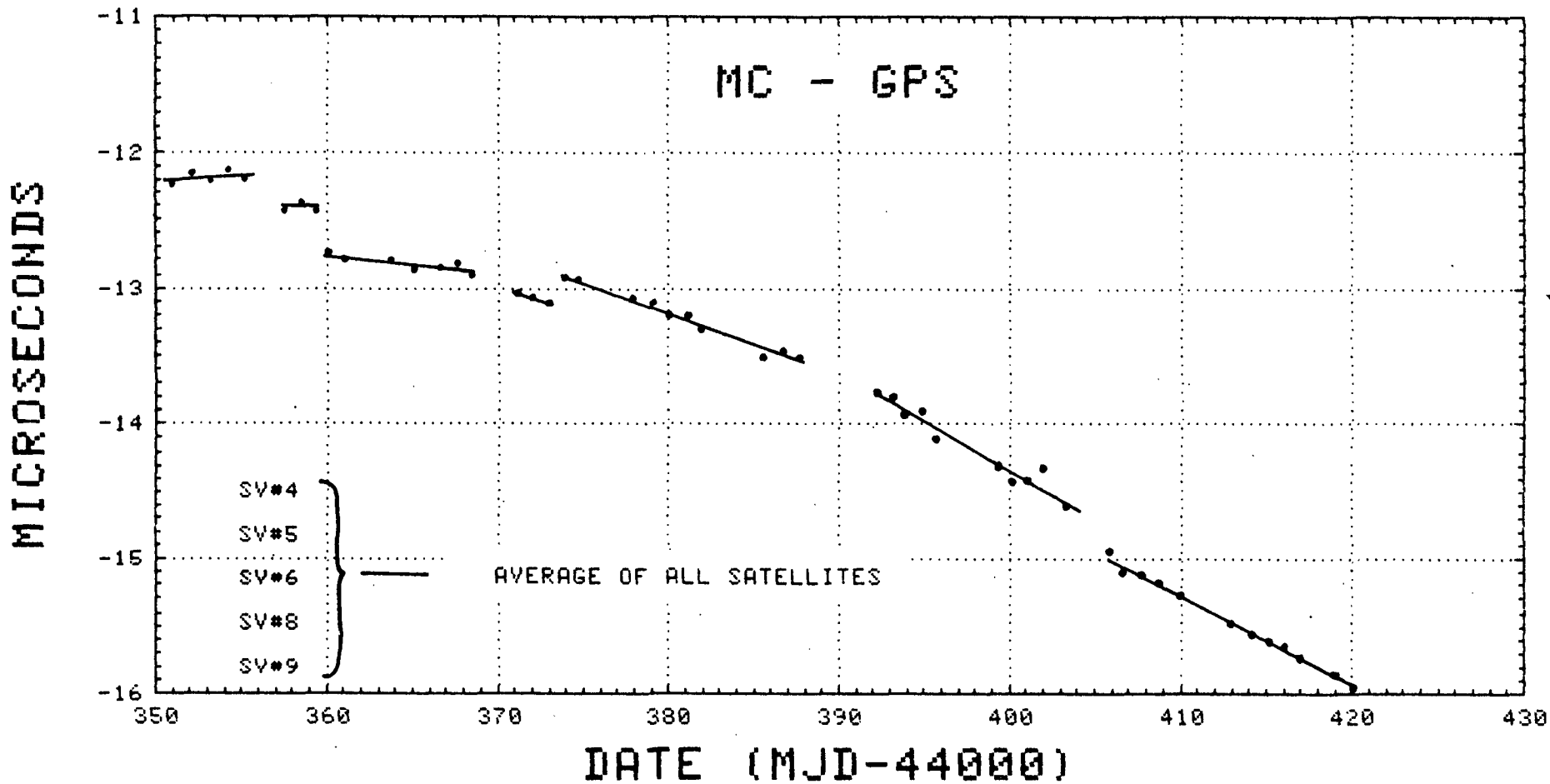

Figure 6. Early Test Results

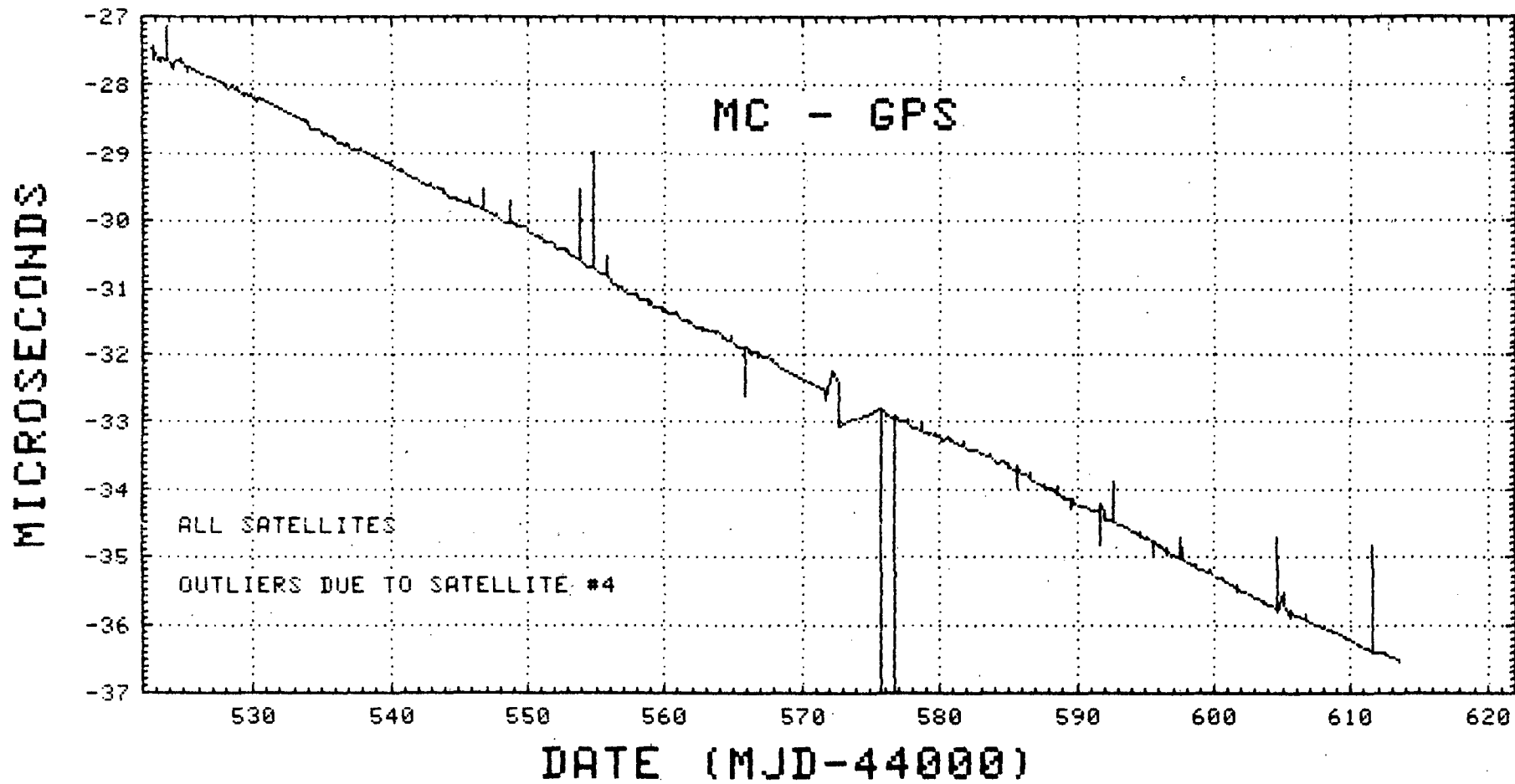

Figure 7. USNO Master Clock (MC) - GPS Utilizing All Satellites

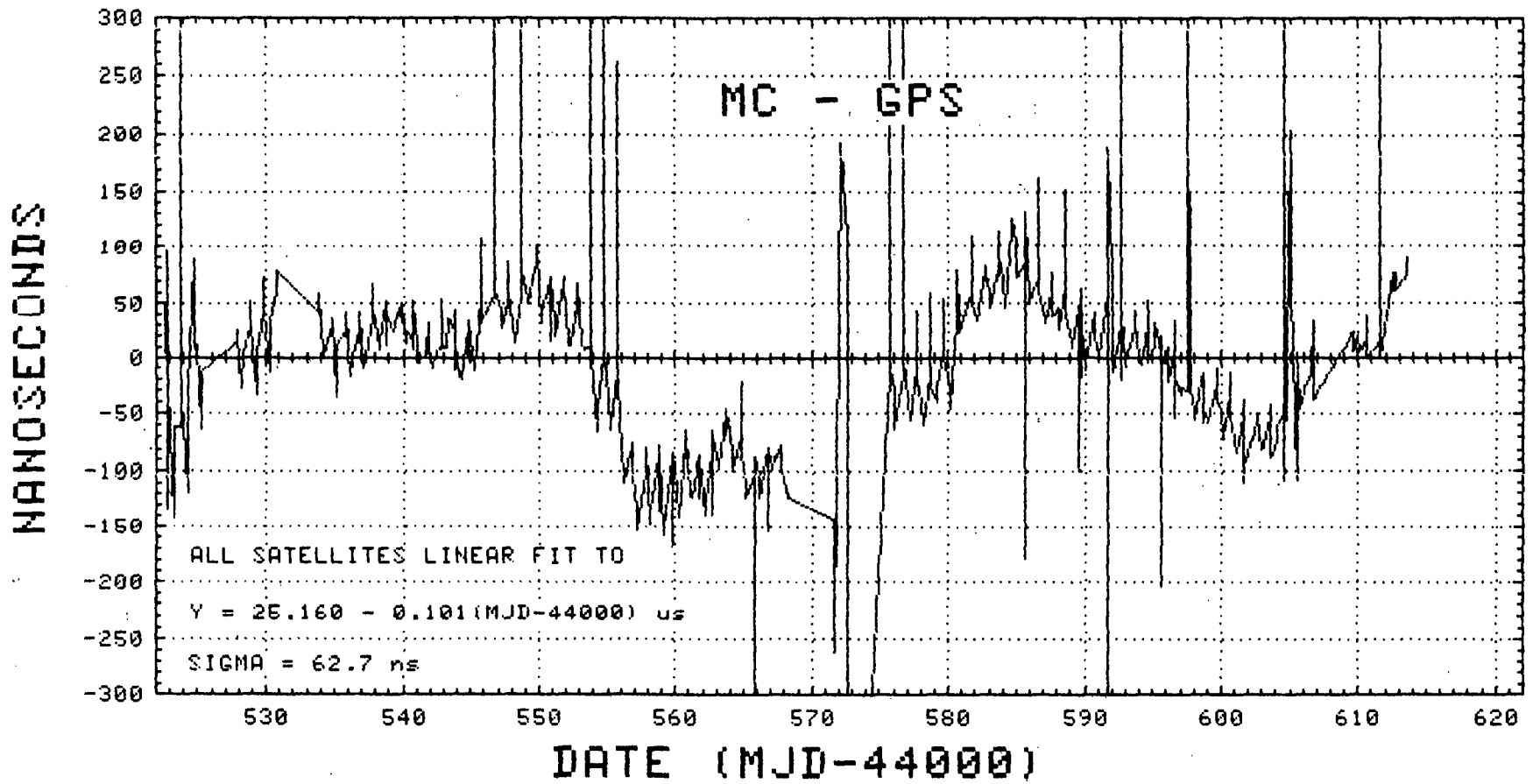

Figure 8. USNO MC - GPS Linear Fit and Residuals Utilizing All Satellites



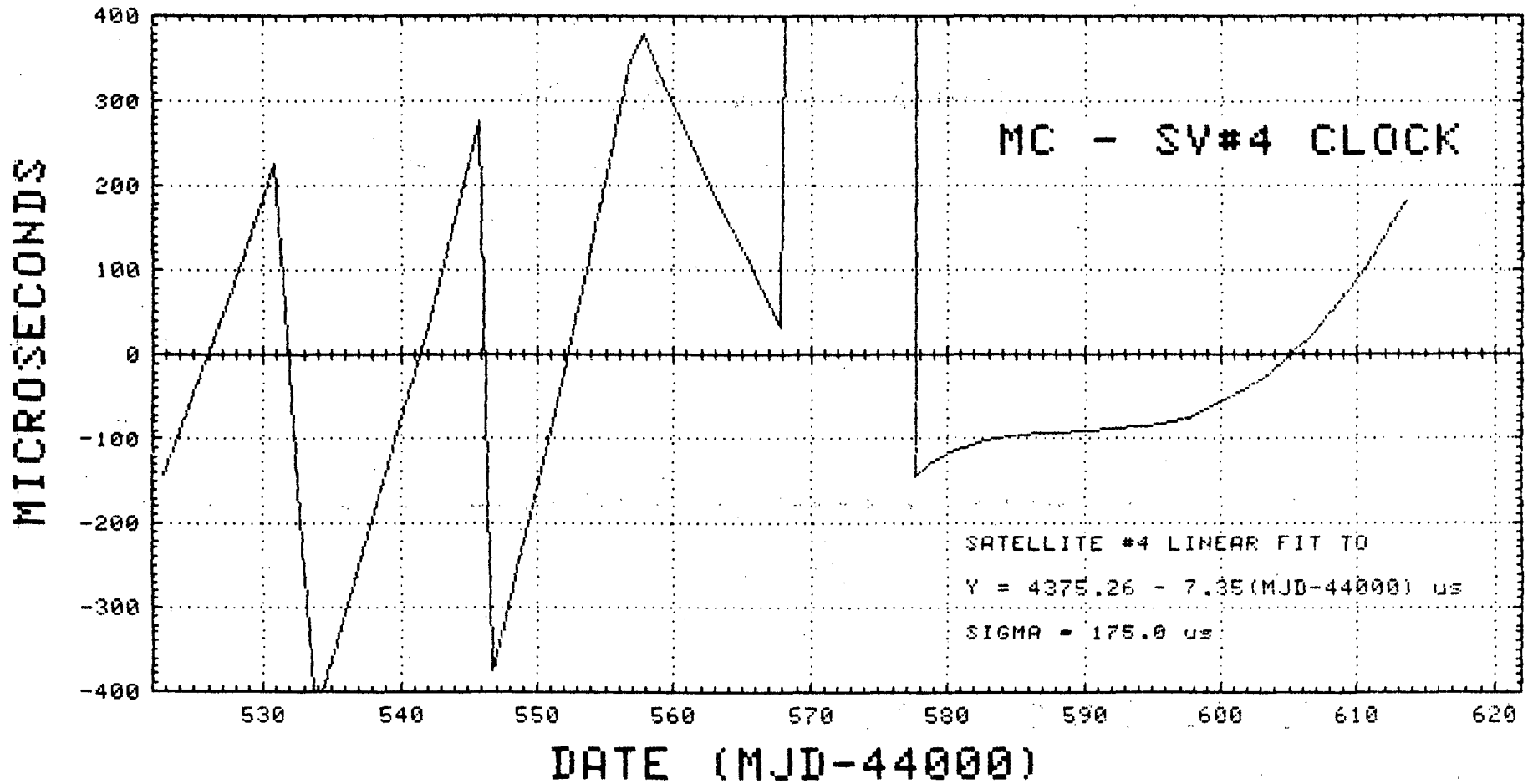

Figure 9. USNO MC - GPS SV#4 Clock Linear Fit and Residuals

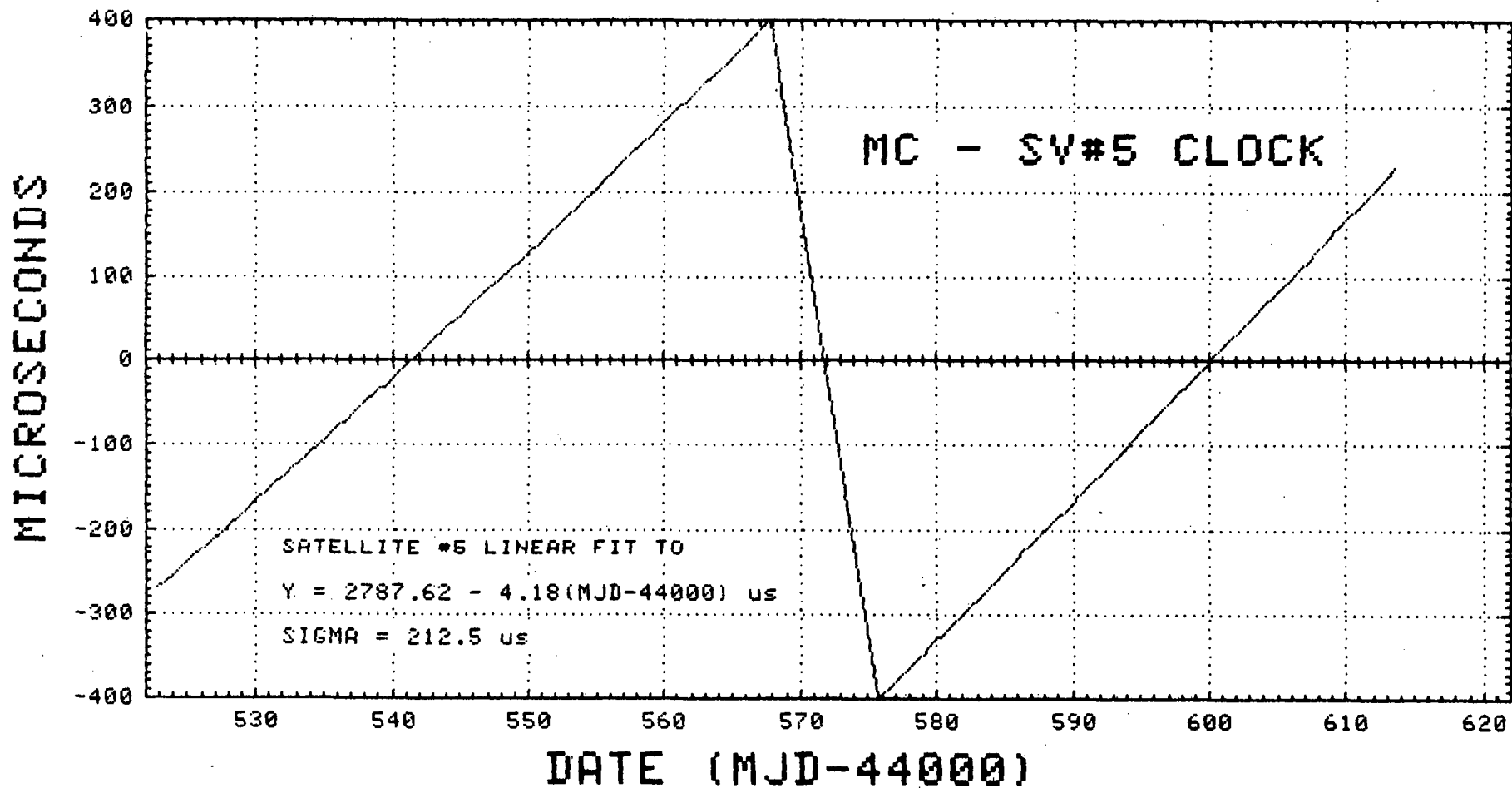

Figure 10. USNO MC - GPS SV#5 Clock Linear Fit and Residuals

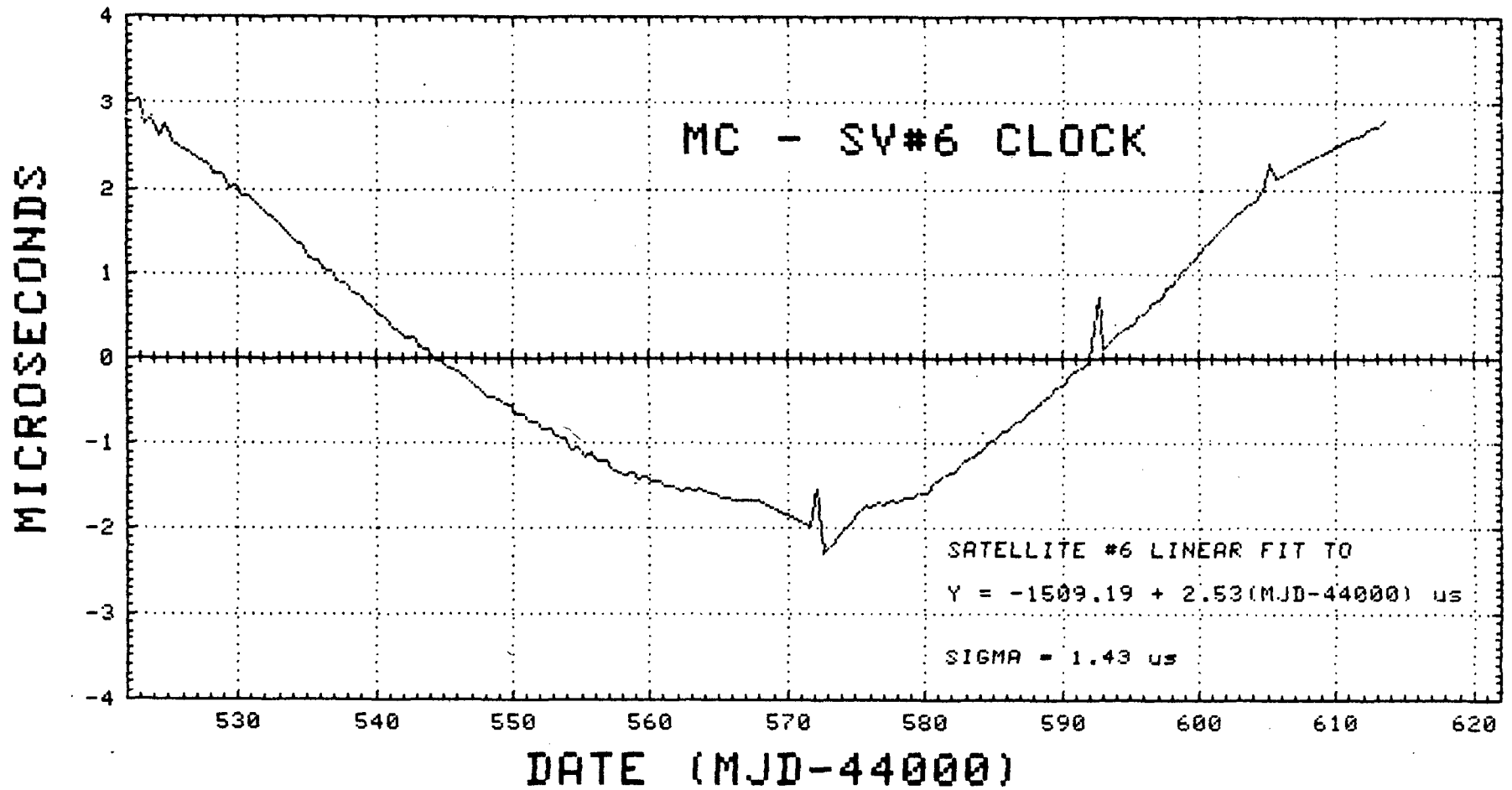

Figure 11. USNO MC - GPS SV#6 Clock Linear Fit and Residuals

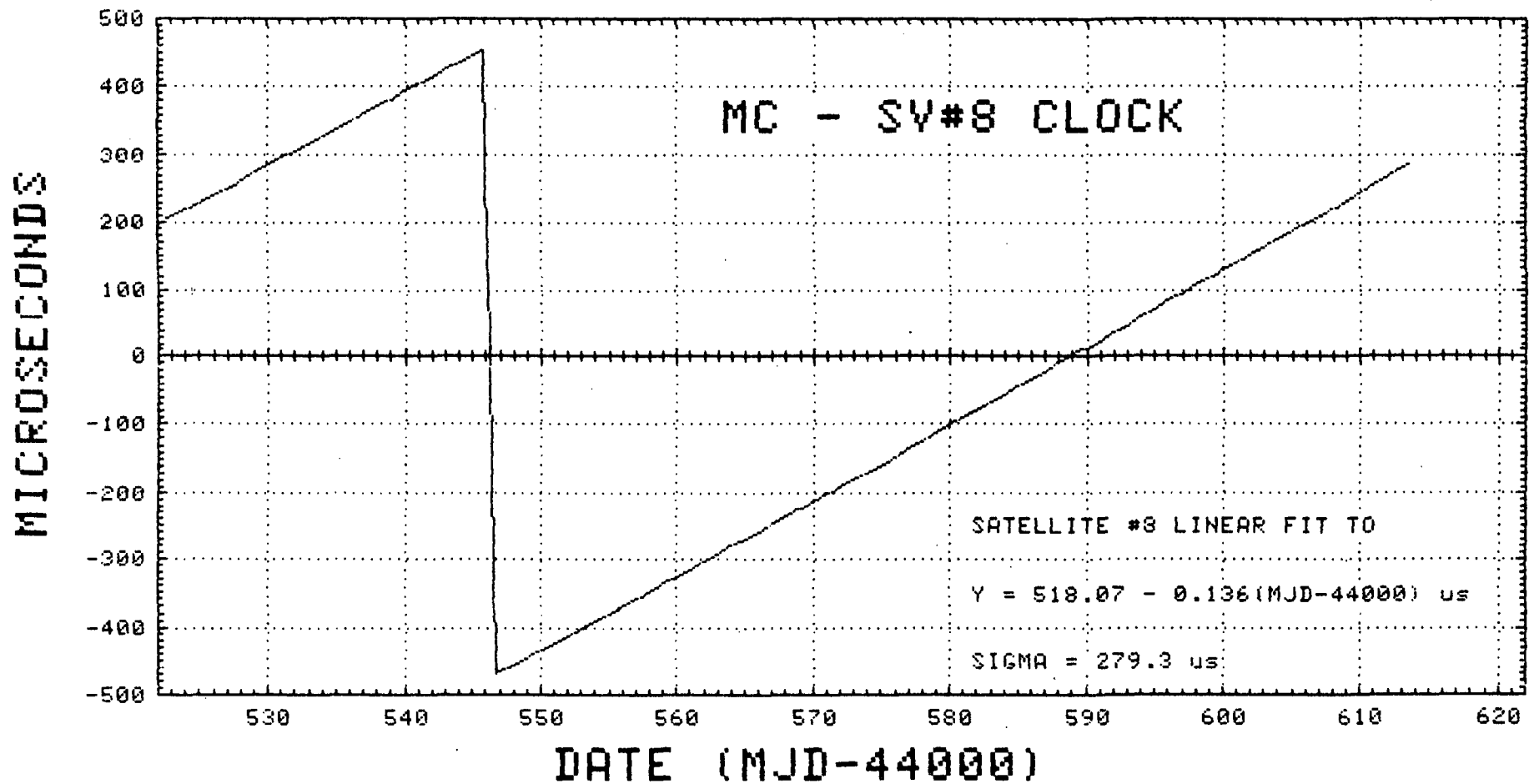

Figure 12. USNO MC - GPS SV#8 Clock Linear Fit and Residuals

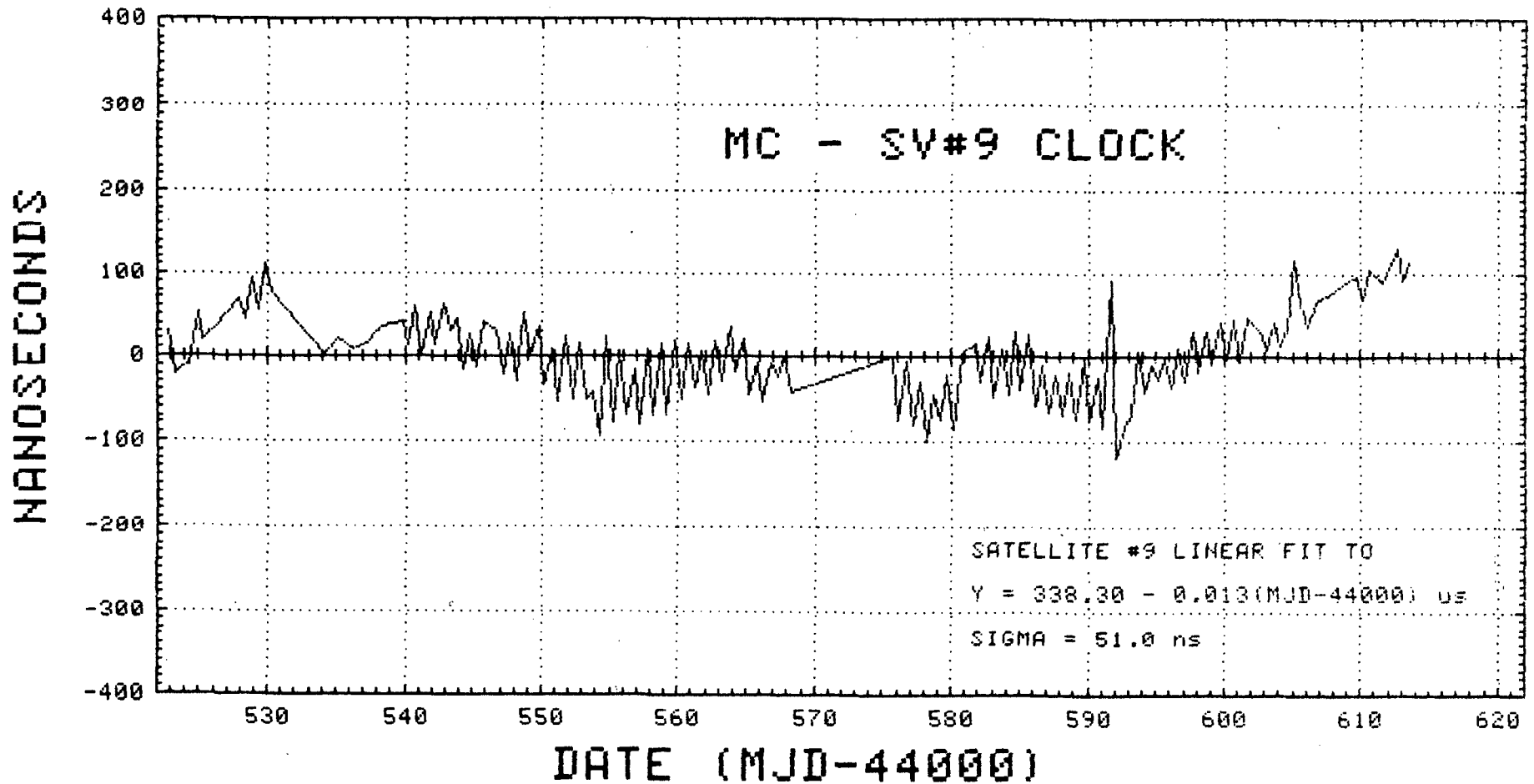

Figure 13. USNO MC - GPS SV#9 Clock Linear Fit and Residuals

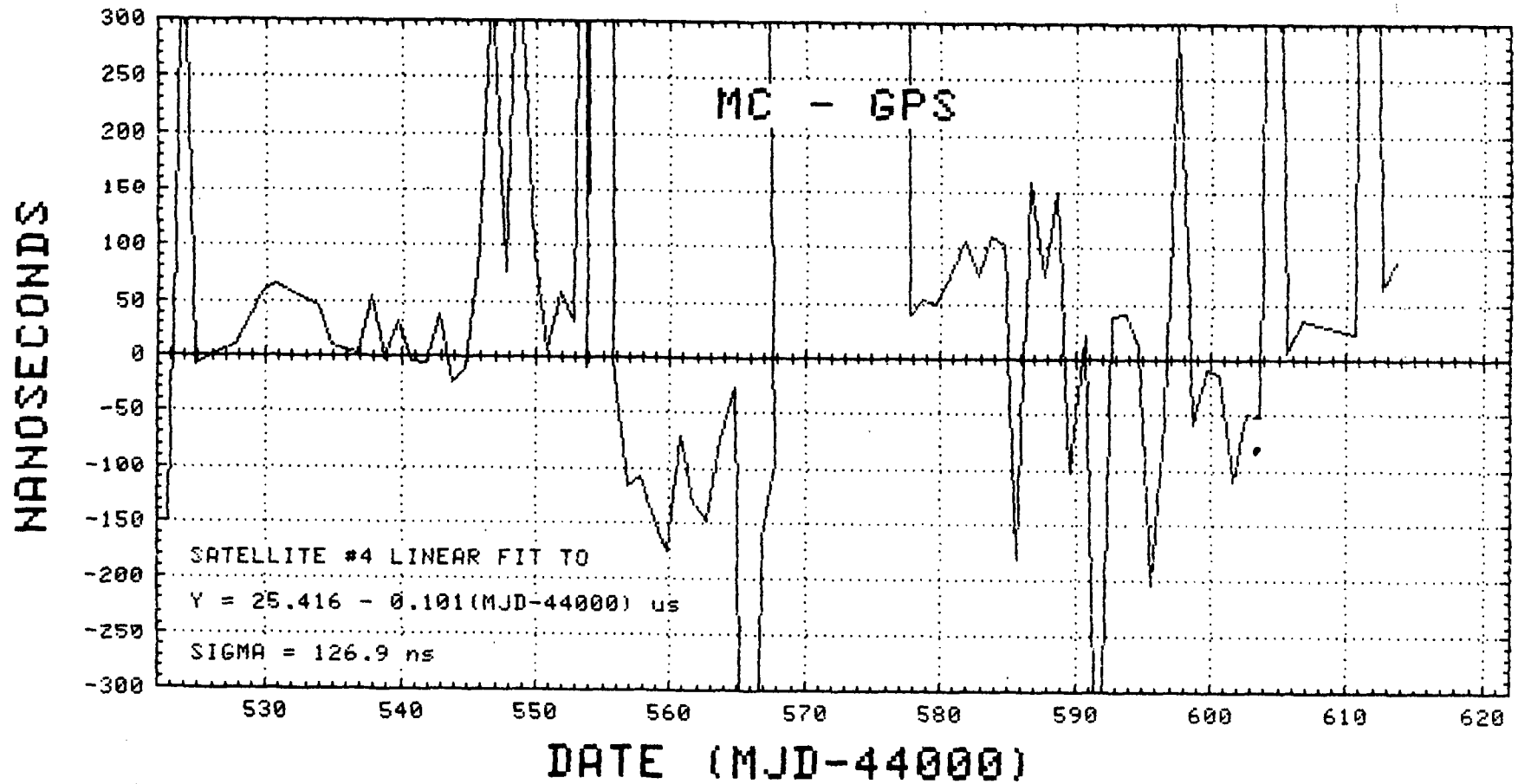

Figure 14. USNO MC - GPS Linear Fit and Residuals for SV#4

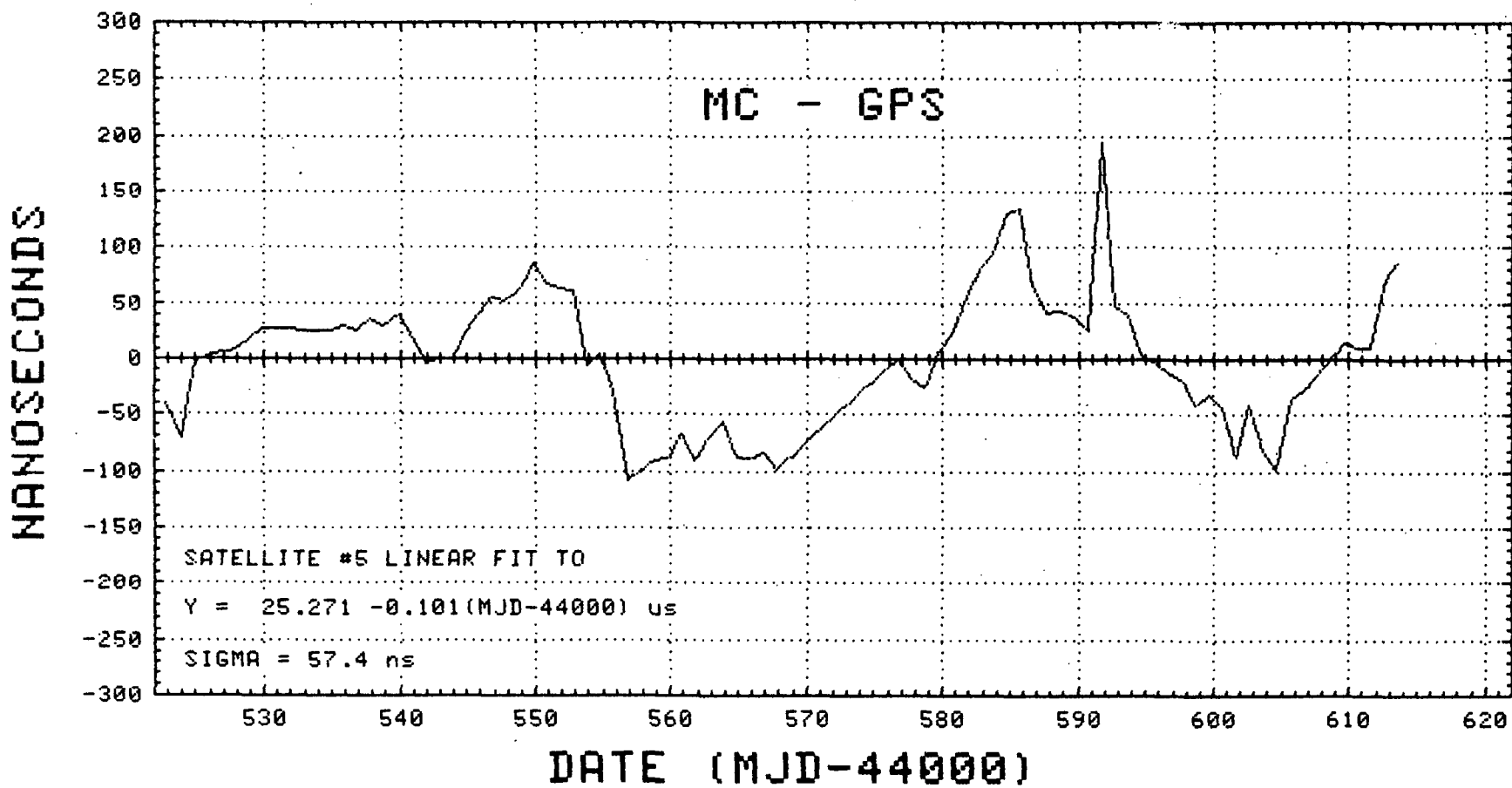

Figure 15. USNO MC - GPS Linear Fit and Residuals for SV#5

410

NANOSECONDS

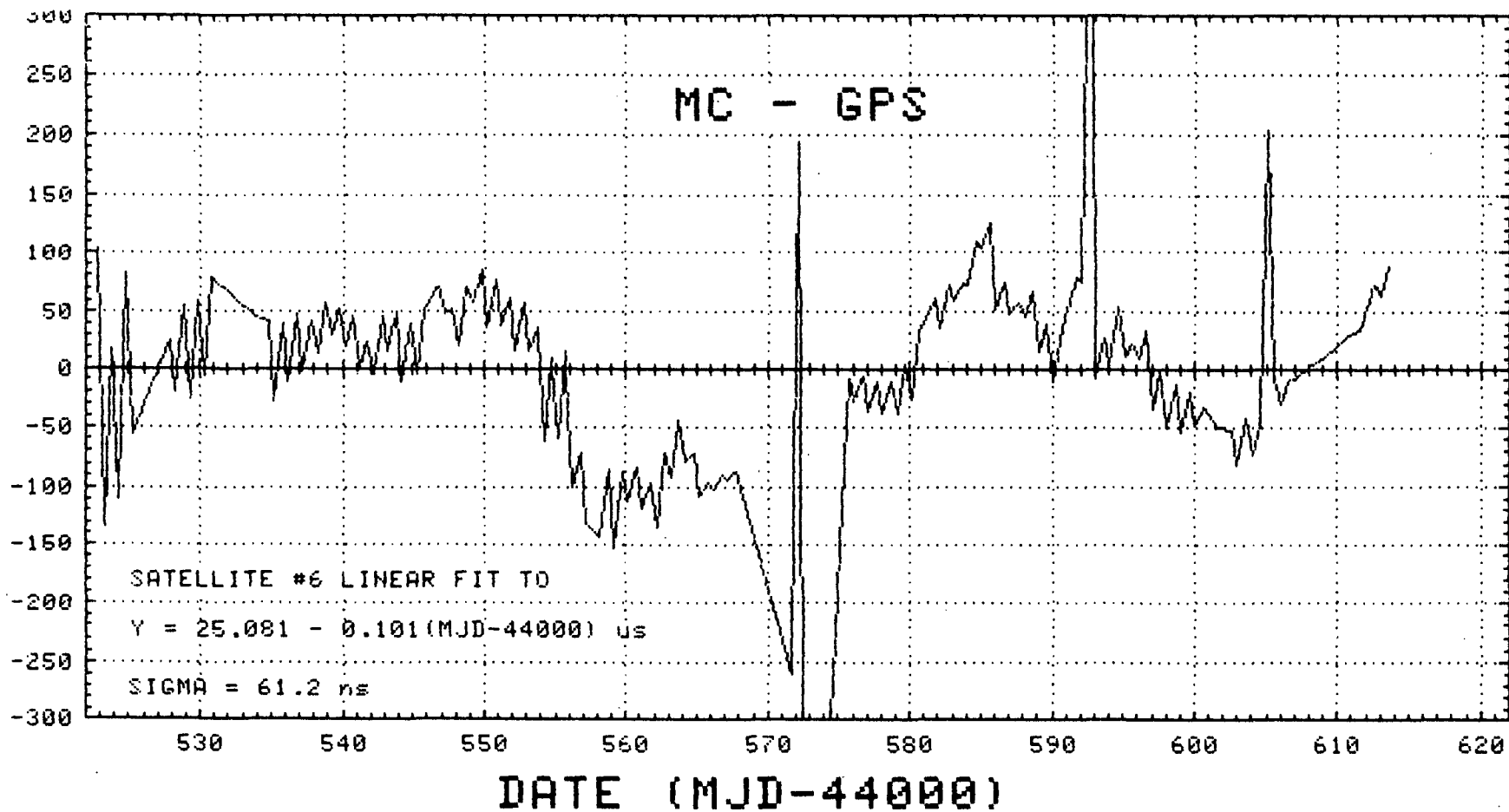

Figure 16. USNO MC - GPS Linear Fit and Residuals for SV#6



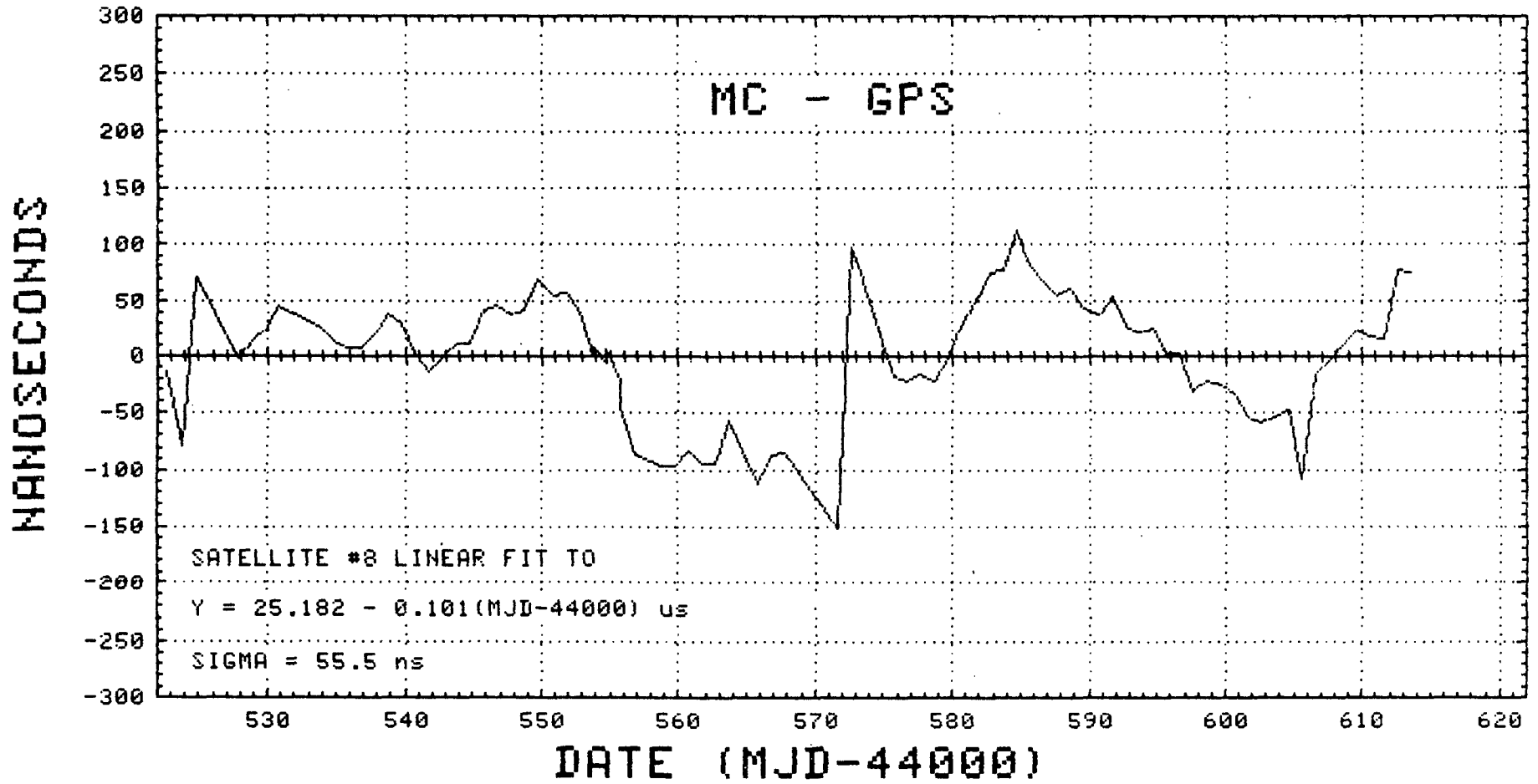

Figure 17. USNO MC - GPS Linear Fit and Residuals for SV#8

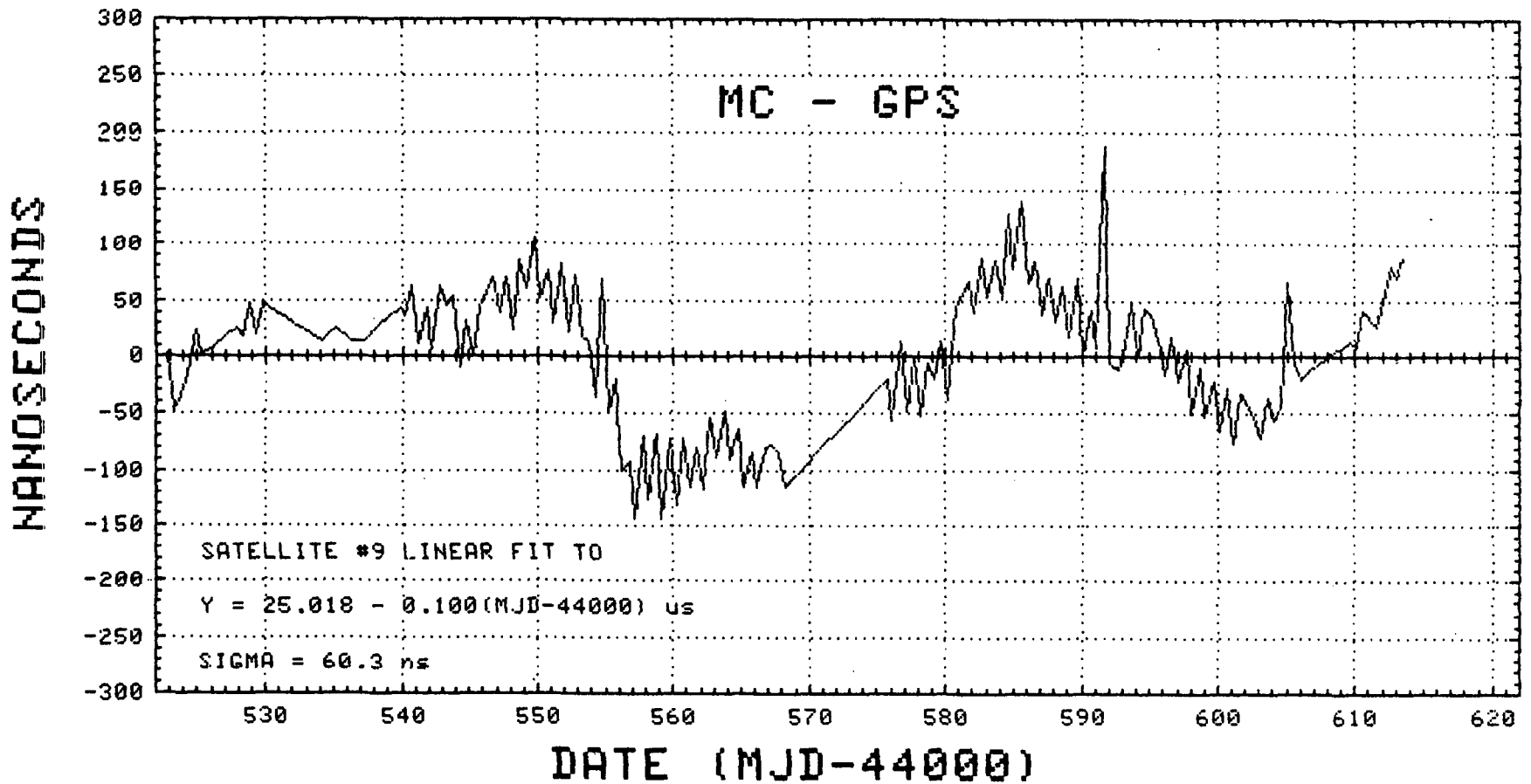

Figure 18. USNO MC - GPS Linear Fit and Residuals for SV#9

DATA COLL. START MJD 44613  
 DATA PROCESSED MJD:44616

WKDAY 5 FR DAY/UT: 9 23 46 11  
 (UT) 8:15 PM MON., 12 JAN., 1981

SV#	BEG. TRK DDD.ddd	BEGTRK D	TRKTIME HHMMSS	SSSS	MC-GPS US	SLOPE PS/S	RMS NS	SAMP N	ELV	AZMT	D. AGE DHHMM	MC-SAT NS
6	613.990	5	234612	354	-36.553	10	19	60	23	59	01019	-34519
9	614.036	6	05148	258	-36.551	-79	13	44	40	84	0 626	346540
8	614.564	6	1332 0	606	-36.612	-7	13	102	77	320	0 2 7	733234
6	614.572	6	134330	816	-36.591	-8	14	137	53	320	0 219	-33003
4	614.583	6	135854	672	-36.896	-15	14	112	42	249	0 048	91072
5	614.601	6	142554	492	-36.622	-19	22	83	12	245	020 5	465293
6	614.991	6	234630	330	-36.613	50	16	56	23	57	712 2	-31905
7	615.036	0	05154	252	-36.651	18	14	43	40	81	0 641	346556
8	615.563	0	133118	642	-36.709	-12	11	108	77	327	0 2 7	744864
6	615.572	0	1344 0	786	-36.687	-2	14	131	55	318	0 219	-30374
4	615.583	0	1359 0	666	-36.738	-7	12	110	43	251	0 048	117036
9	615.592	0	1412 0	606	-36.701	-1	12	102	15	328	020 6	346580
5	615.600	0	142430	570	-36.692	-48	21	95	13	246	01953	478366
6	615.991	0	234630	330	-36.726	-24	16	56	23	55	012 2	-29282
9	616.036	1	05130	276	-36.762	-11	9	46	40	79	0 641	346575
8	616.563	1	133048	672	-36.795	-3	12	111	76	333	0 039	756512
6	616.572	1	134330	810	-36.779	-6	16	134	57	317	0 051	-27749
4	616.583	1	135854	666	-36.774	35	13	111	44	253	0 1 7	144822
9	616.592	1	141242	558	-36.787	-16	14	93	17	328	0 016	346605
5	616.600	1	142354	276	-36.805	-45	22	46	14	247	0 028	491453

413

Figure 19. USNO Automated Data Service Message for GPS

## QUESTIONS AND ANSWERS

MR. VAN WECHEL:

I have three questions. The first is: Did you use the data block information on the ionospheric area to make your corrections, or did you get data externally?

MR. PUTKOVICH:

No, all the data that was taken here was with information derived from the satellite. The only thing that we put into the system is our position location and our time.

MR. VAN WECHEL:

The next question was: Did you have to do anything special as far as eliminating the one millisecond ambiguity, or is the signal-to-noise ratio in the bit detector enough to get rid of that?

MR. PUTKOVICH:

No, we didn't do anything.

MR. VAN WECHEL:

In other words that is automatic, you don't have a one millisecond ambiguity problem?

MR. PUTKOVICH:

I don't understand what the one millisecond ambiguity is that you are talking about.

MR. VAN WECHEL:

Well, the CA code repeats every millisecond and I was wondering if you could be one millisecond off or is that just a problem of the bit sync being reliable?

MR. PUTKOVICH:

We haven't answered that yet. I can't answer that question.

DR. WINKLER:

Each one millisecond is identified by the time code which comes down. So that is taken care of automatically.

MR. VAN WECHEL:

I thought there was a time code only every six seconds.

DR. WINKLER:

Yes, that is true too but you are counting the millisecond segments from that standard moment. Please identify yourself.

MR. VAN WECHEL:

Oh, I am sorry. I am Bob Van Wechel from Interstate.

The last question I had was relative to the intentional degradation of accessibility or denial of access I guess they call it. Do you think that it is likely in the future that a CA code will be degraded so you couldn't get 100 nanoseconds performance anymore?

MR. PUTKOVICH:

I really don't know. The whole GPS program seems to be in such -- I don't want to say disarray, but I don't know what is happening in the program.

One would hope that there is somebody around that knows what is happening, but I don't, and in that particular question I don't know what they will do. That has been kicked around the same way many of the other things have.

CHAIRMAN BUISSON:

Let me just say something about that. I think there is a paper tomorrow on GPS by people from the GPS office.

GPS is not an operational system yet, and I think that some of these points will be discussed in that paper.