

NASA Technical Paper 1913

NASA
TP
1913
c.1

Computer Program To Predict Aircraft Noise Levels



Bruce J. Clark

LOAN COPY: RETURN TO
AFWL TECHNICAL LIBRARY
KIRTLAND AFB, N.M.

SEPTEMBER 1981

NASA



NASA Technical Paper 1913

Computer Program To Predict Aircraft Noise Levels

Bruce J. Clark
Lewis Research Center
Cleveland, Ohio

NASA

National Aeronautics
and Space Administration

**Scientific and Technical
Information Branch**

1981

Summary

Methods developed at the NASA Lewis Research Center for predicting the noise contributions from various aircraft noise sources have been programmed to predict aircraft noise levels either in flight or in ground tests. The noise sources include fan inlet and exhaust, jet, flap (for powered lift), core (combustor), turbine, and airframe (from the NASA Langley Research Center). Noise propagation corrections are available for atmospheric attenuation, ground reflections, extra ground attenuation, and shielding. Outputs can include spectra, overall sound pressure level, perceived noise level, tone-weighted perceived noise level, and effective perceived noise level at locations specified by the user. Footprint contour coordinates and approximate footprint areas can also be calculated. Inputs and outputs can be in either System International or U.S. customary units.

The subroutines for each noise source and propagation correction are described in detail. Inputs required and some sample inputs and outputs are given in tables. A complete listing is given in appendix B. Symbols are defined in appendix A. The program is available through COSMIC to qualified users.

Introduction

In addition to the prediction procedures for aircraft noise available through the Aircraft Noise Prediction (ANOP) program at the Langley Research Center, it is often valuable to have a user-owned prediction procedure that can be run on a modest-sized computer and modified by the user as the need arises. The program described in this report was written in Fortran IV for an IBM 360 machine, but it can be run on any Fortran-language computer with at least 120 000 bytes (30 000 words on IBM 360) of program storage available. The inputs and outputs of the program are straightforward, compact, and easy to understand. It should not be difficult for the user to modify the program or to add subroutines to those described.

Various source noise prediction methods were developed at the Lewis Research Center (refs. 1 to 5) in support of the ANOP program at Langley. During the development of these prediction methods, it

became obvious that computer-programmed versions were required for adequate checkout. By adding to these computer programs the capacity to solve the geometrical relationships between an aircraft in flight and an observer on the ground, these programmed predictions were made useful in evaluating noise estimates and footprints for various proposed engine installations being studied. For example, such studies have included simulated flights of the Quiet Clean Shorthaul Experimental Engine (QCSEE) and of the Quiet Shorthaul Research Aircraft (QSRA) with Avco-Lycoming YF-102 engines that were tested at Lewis (ref. 6). Test stand acoustic measurement results were compared with static predictions for the engine sources. The degree of correspondence between these predicted and measured results indicated the applicability of the predictions to these particular engine systems. Predictions for these engines in flight were then made, with corrections for installation and flight effects contributing most of the uncertainty.

There are two main program versions for using these prediction routines: The first (FOOTPR) is a procedure to calculate at various observer stations the time history of the noise (as spectra, OASPL, PNL, and PNLT) for an aircraft flying a specified set of speeds, orientations, and space coordinates. The various components of the noise are predicted by methods prepared at Lewis under ANOP activity (except for the airframe). For each individual source the levels are free field with no corrections for propagation losses other than spherical divergence. The total spectra can be corrected for the usual effects of atmospheric attenuation, extra ground attenuation, ground reflection, and aircraft shielding, and the corresponding values for overall sound pressure level (OASPL), perceived noise level (PNL), and tone-weighted perceived noise level (PNLT) are then calculated. From the time history at each point, true effective perceived noise levels (EPNL) are calculated. Values of EPNL, maximum PNL, or maximum PNLT are thus found as desired for a grid of specified points on the ground. It is worth noting that time-integrated EPNL's are calculated in this program. This implies that a time history is generated for each desired point on the ground, and hence a substantial amount of calculation time may be required.

The second main program is called RADIUS and is designed to give the usual format of one-third-octave

sound pressure level (SPL) values at a fixed radius for a number of angles selected by the user. This program uses the same noise source subroutines as does FOOTPR and has served as a convenient method for checking the programming accuracy of the predictions.

Each noise source subroutine (except AIRFR) has been checked against the sample problems and calculated results in the source documents. For example, the fan noise predictions made by using RADIUS were compared with the output spectra at each fan speed and microphone angle as plotted in reference 1. Although in a few cases there were discrepancies of up to 2 decibels at some points within a spectrum, these were checked with the author (Heidmann) and the results from the FAN subroutine were judged to be as good as or superior to the published curves. Where no example or reference calculations are shown in the source documents, hand calculations were used to check representative levels from the source subroutines of this program. The results from AIRFR were checked with results from the ANOP program at Langley and were found to be within 1 decibel.

The main programs and their subroutines are discussed in detail in this report. The programs are written to facilitate rapid calculations. Several blocks of COMMON are shared by different parts of the program to avoid repeated transfers of values through calling arguments from one subroutine to another. Fairly consistent patterns are followed for naming inputs and internal variables. Inputs are of the NAMELIST type and are grouped for convenience and clarity. Default values are supplied for many of the variables so that, if no value is given in the NAMELIST block, the default value is used in the calculation. Since data statements are used for some of the default values, the programs must be unloaded and reloaded between problems for any of these defaults to be reset. It is important that the NAMELIST blocks be supplied in the proper order, but any input block will be ignored if not called for. All calculations are made in U.S. customary (English) units of feet, seconds, pounds mass, pounds force, and degrees Rankine. When using the optional input in System International (SI) units, all dimensioned variables must be input in these units, and conversions are then made to U.S. customary units. Dimensions for all inputs are given in the input variable list.

Detailed Program Descriptions

Main programs FOOTPR and RADIUS and their subroutines are discussed in detail, and where

appropriate the basic equations are presented, to give the user a familiarity with the general approach of the programs. Table I presents the equation numbers in the prediction documents for the individual noise sources. It is not intended that the following descriptions give a comprehensive view of the prediction methods themselves; the reader should consult the original documents (see reference list) for a more complete treatment of each subject. In figures 1(a) and (b) flow diagrams are given for programs FOOTPR and RADIUS. The input data namelist blocks and the types of output available are illustrated along with the flow of information between the main programs and the subroutines. Most subroutines read their own namelist block of data the first time they are called. The order of these inputs is shown in table II. A complete list of variables for each of the input data blocks is given in table III. In FOOTPR the individual subroutines can be directed to print their own outputs as shown; total noise outputs come from NOIS and FOOTPR. In RADIUS all outputs from individual subroutines are returned to the calling program, which assembles them in the proper format for printing. In the Fortran coding (appendix B), all read statements for the inputs are identified with device number 5, and all output write statements with device number 6; for example,

```
READ(5,TRAJ)      WRITE(6,117)
```

Main Program FOOTPR

FOOTPR is the main program to calculate the needed geometric parameters between the aircraft source and the observer as a function of time. Observer locations are specified as a grid with NXO values of XO and NYO values of YO and one value of ZO. The aircraft flies past each observer, one at a time, along a path specified in XA, YA, and ZA (fig. 2). As illustrated in the flow diagram of figure 1(a), FOOTPR calls subroutine NOIS for noise predictions at time increments TD along the aircraft path. The user has the option of centering the time history on the closest point of approach of the aircraft to each observer or of starting the history at the first aircraft position given. FOOTPR also finds the maximum noise levels or calls for the EPNL calculation from the time history of the sum of the noise contributions. An iterative approach to finding contour coordinates for specified noise level contours is included in this program although it is not highly developed.

After each time interval the position of the aircraft is calculated with respect to the X, Y, Z coordinate system (fig. 3). The orientation of the aircraft is

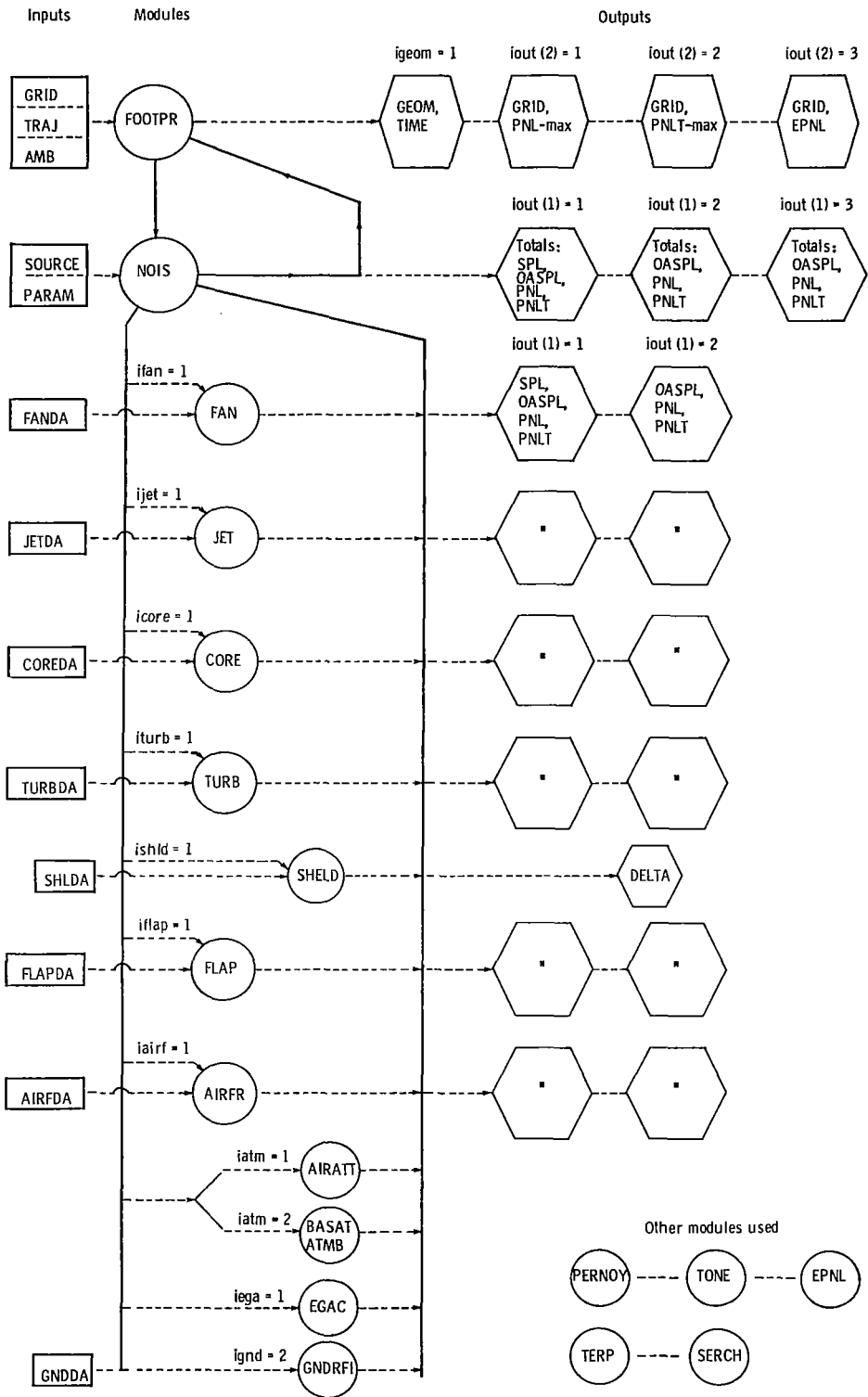

(a) FOOTPR.

Figure 1. - Flow diagrams for programs FOOTPR and RADIUS.

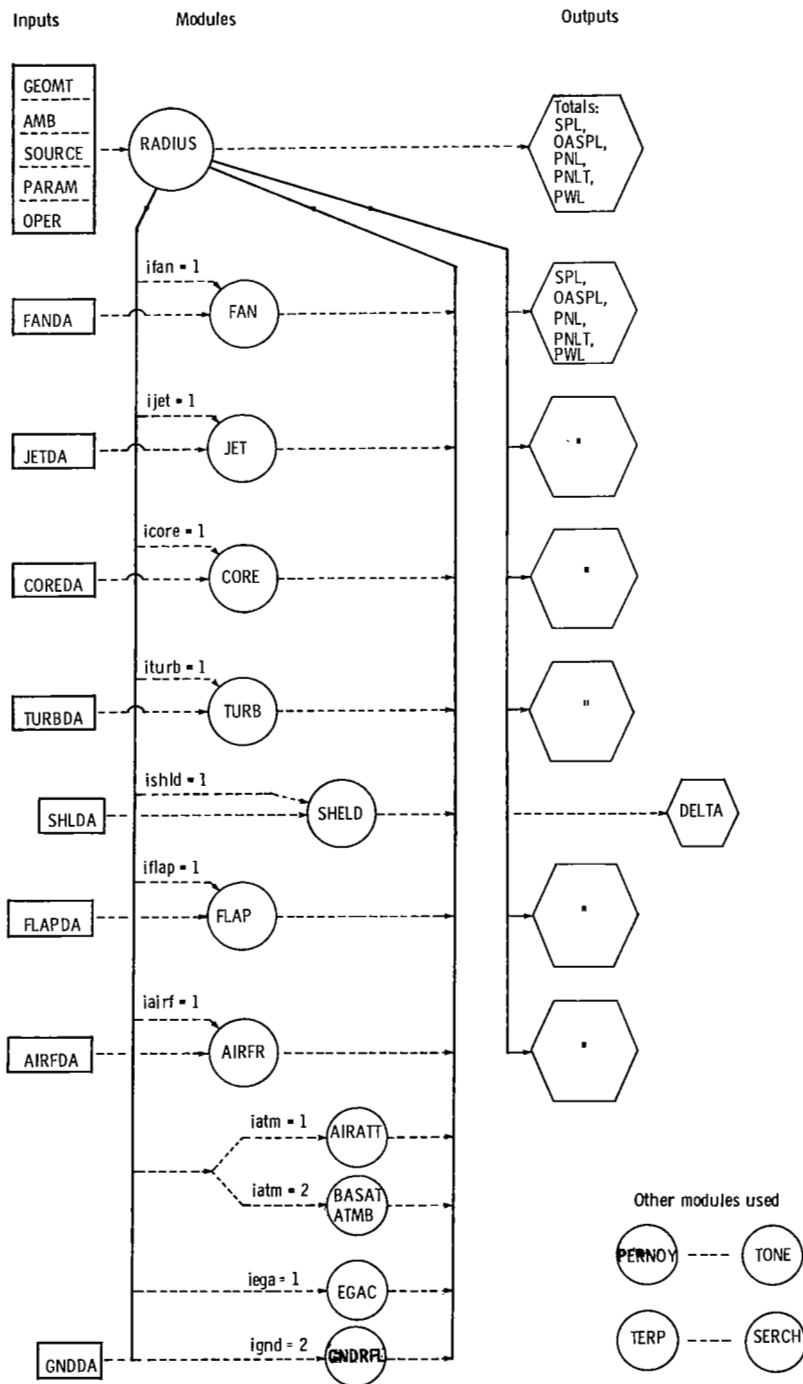

(b) RADIUS.
Figure 1. - Concluded.

- 👤 Sample observer locations
- Specified trajectory points
- Incremental points for noise calculations

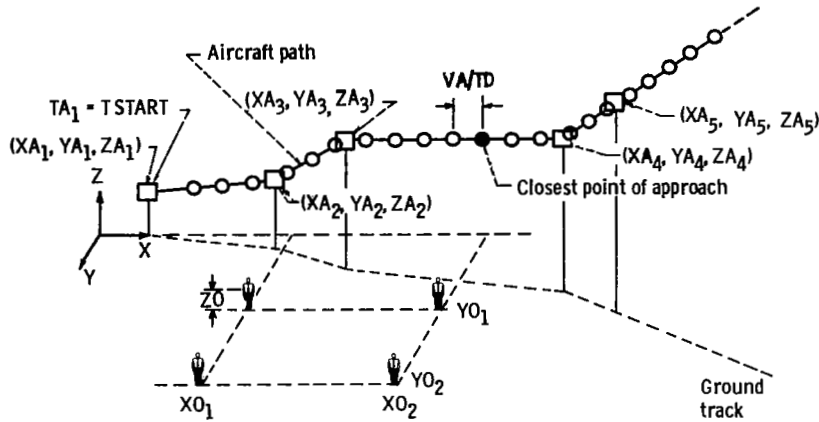

Figure 2. - Observer locations, aircraft trajectory, and points for noise calculations. Number of time increments (NT), 21.

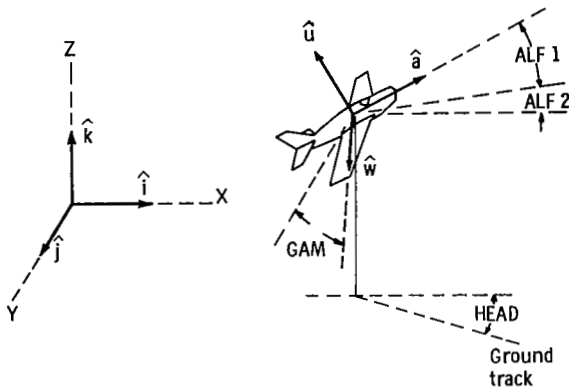

Figure 3. - Aircraft orientation geometry.

defined by its angle of attack (ALF1), the slope (ALF2) and heading (HEAD) of its trajectory, and its banking angle (GAM), where

$$\tan(\text{ALF2}) = dZ/\text{SQRT}(dX^2 + dY^2)$$

and

$$\sin(\text{HEAD}) = dY/\text{SQRT}(dX^2 + dY^2)$$

For convenience, let

$$\text{ALF} = \text{ALF1} + \text{ALF2}$$

Unit vectors (\hat{a} , \hat{w} , and \hat{u}) on the aircraft can then be related to the X,Y,Z coordinate system unit vectors (\hat{i} , \hat{j} , and \hat{k}). Briefly, when \hat{a} is in the engine inlet

direction, \hat{w} is in the direction of the wingtip, and \hat{u} is vertical to the aircraft ($\hat{u} = \hat{w} \times \hat{a}$) (fig. 3), then for HEAD = ALF = GAM = 0,

$$\hat{a} = \hat{i}, \quad \hat{w} = \hat{j}, \quad \hat{u} = \hat{k}$$

for HEAD \neq 0 and ALF = GAM = 0,

$$\hat{a} = \hat{i} \cos(\text{HEAD}) + \hat{j} \sin(\text{HEAD})$$

$$\hat{w} = -\hat{i} \sin(\text{HEAD}) + \hat{j} \cos(\text{HEAD})$$

$$\hat{u} = \hat{k}$$

for HEAD \neq 0, ALF \neq 0, and GAM = 0,

$$\hat{a} = \hat{i} \cos(\text{ALF}) \cos(\text{HEAD}) + \hat{j} \cos(\text{ALF})$$

$$\times \sin(\text{HEAD}) + \hat{k} \sin(\text{ALF})$$

$$\hat{w} = -\hat{i} \sin(\text{HEAD}) + \hat{j} \cos(\text{HEAD})$$

$$\hat{u} = -\hat{i} \sin(\text{ALF}) \cos(\text{HEAD}) - \hat{j} \sin(\text{ALF})$$

$$\times \sin(\text{HEAD}) + \hat{k} \cos(\text{ALF})$$

and for HEAD \neq 0, ALF \neq 0, and GAM \neq 0,

$$\hat{a} = \hat{i} \cos(\text{ALF}) \cos(\text{HEAD}) + \hat{j} \cos(\text{ALF})$$

$$\times \sin(\text{HEAD}) + \hat{k} \sin(\text{ALF})$$

$$\begin{aligned}\hat{w} = & \hat{i}[\sin(\text{ALF}) \cos(\text{HEAD}) \sin(\text{GAM}) - \sin(\text{HEAD}) \\ & \times \cos(\text{GAM})] + \hat{j}[\cos(\text{HEAD}) \cos(\text{GAM}) \\ & + \sin(\text{ALF}) \sin(\text{HEAD}) \sin(\text{GAM})] \\ & - \hat{k} \cos(\text{ALF}) \sin(\text{GAM})\end{aligned}$$

$$\begin{aligned}\hat{u} = & -\hat{i}[\sin(\text{ALF}) \cos(\text{HEAD}) \cos(\text{GAM}) + \sin(\text{HEAD}) \\ & \times \sin(\text{GAM})] + \hat{j}[\cos(\text{HEAD}) \sin(\text{GAM}) \\ & - \sin(\text{ALF}) \sin(\text{HEAD}) \cos(\text{GAM})] \\ & + \hat{k} \cos(\text{ALF}) \cos(\text{GAM})\end{aligned}$$

The position vector to the observer (fig. 4(a)) is $\bar{R} = b\hat{i} + d\hat{j} - h\hat{k}$, where $b = XA - XO$, $d = YA - YO$, $h = ZA - ZO$. Then by letting

$$\text{BPD} = b \cos(\text{HEAD}) + d \sin(\text{HEAD})$$

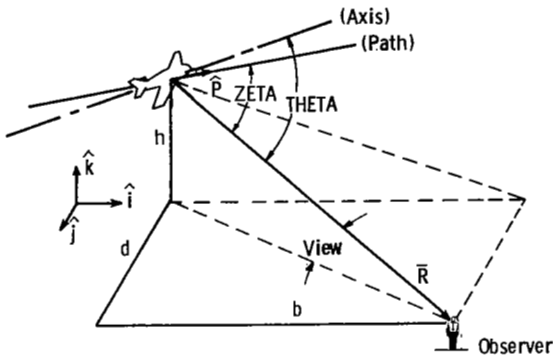

(a) Ground-based coordinate system.

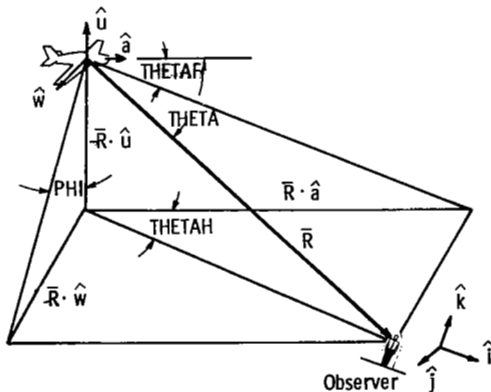

(b) Aircraft-based coordinate system.

Figure 4. - Source-observer geometrical relationships.

$$\text{DMB} = d \cos(\text{HEAD}) - b \sin(\text{HEAD})$$

$$\text{BPDPH} = \text{BPD} \sin(\text{ALF}) + h \cos(\text{ALF})$$

the dot products can be simplified to

$$\bar{R} \cdot \hat{a} = \text{BPD} \cos(\text{ALF}) - h \sin(\text{ALF})$$

$$\bar{R} \cdot \hat{w} = \text{DMB} \cos(\text{GAM}) + \text{BPDPH} \sin(\text{GAM})$$

$$\bar{R} \cdot \hat{u} = \text{DMB} \sin(\text{GAM}) - \text{BPDPH} \cos(\text{GAM})$$

and the source-related angles THETA, THETAH, THETAH, and PHI (fig. 4(b)) are derived from

$$\cos(\text{THETA}) = (\bar{R} \cdot \hat{a}) / R$$

$$\tan(\text{THETAH}) = -(\bar{R} \cdot \hat{u}) / (\bar{R} \cdot \hat{a})$$

$$\tan(\text{THETAH}) = (\bar{R} \cdot \hat{w}) / (\bar{R} \cdot \hat{a})$$

$$\tan(\text{PHI}) = -(\bar{R} \cdot \hat{w}) / (\bar{R} \cdot \hat{u})$$

In these geometrical relationships the assumption is made that the engines are concentrated at a central point on the aircraft with their centerlines coincident with the aircraft centerline. No attempt is made to account for the effects due to the placement of the engines on the aircraft, other than the overall effects applied for shielding. For cases when the engine centerlines are elevated with respect to the aircraft centerline, the inputs ALFI should be given as the engine angle of attack, and a minor error in airframe noise directivity will result.

The factor FDOP is calculated for Doppler corrections to the source frequencies and amplitudes; it is based on the angle ZETA, the direction of aircraft motion with respect to the observer (fig. 4(a)); that is,

$$\begin{aligned}\cos(\text{ZETA}) = \bar{R} \cdot \hat{p} / R = & (b \, dX/dS + d \, dY/dS \\ & - h \, dZ/dS) / R\end{aligned}$$

where

$$dS = \text{SQRT}(dX^2 + dY^2 + dZ^2)$$

and \hat{p} is the unit vector in the direction of aircraft motion. The Doppler shift factor is then

$$\text{FDOP} = 1 - (V/C) \cos(\text{ZETA})$$

Frequencies are divided by FDOP, and predicted levels are divided by FDOP to the EDOP power, where EDOP depends on the type of noise source.

Hence frequencies and levels both are increased as the aircraft approaches the observer and are decreased as the aircraft moves away. The angle VIEW is calculated by FOOTPR for use in calculating extra ground attenuation.

The program includes default values set for a 6° aircraft climb to 5000-foot altitude at an aircraft velocity of 150 feet per second and 100 percent engine power, starting from $XA = YA = 0$, and $ZA = 8$ feet. Two observer default locations are at $XO = 500$ feet, $YO = 500$ and 1000 feet, and $ZO = 4$ feet.

The first input read by FOOTPR is a title line supplied by the user in alphanumeric format (20A4). The remaining user inputs to FOOTPR are made in namelist blocks &GRID, &TRAJ, and &AMB (tables II and III). Block &GRID accepts inputs for the choice of SI or U.S. customary units (UNITS), the coordinates for the grid of observer points, and the number and level of noise contours to be calculated. Block &TRAJ accepts inputs for the number and coordinates of the points used to define the aircraft path. Aircraft orientation, velocity, engine power, flap and landing gear settings, choice of the number and size of time increments, and choice of some printout options are also entered in this block. The ambient conditions of temperature, pressure, and relative humidity are entered in block &AMB. Default values are supplied for many of the inputs to these blocks.

After the program reads the inputs, times are defined along the aircraft path, starting with TSTART (default = 0) at the first aircraft position given (fig. 2). When the aircraft changes velocity between points, the acceleration is assumed to be constant so that the time between points is simply the distance divided by the average of the velocities.

The time history used for noise calculations is controlled by the user's input of the number (NT) and the size (TD) of the time increments and by ICPA: When $ICPA = 0$, the history starts with the first point of the aircraft trajectory. When $ICPA = 1$, the time history is centered on the closest point of approach of the aircraft to the observer. When the closest point of approach is not well defined by the aircraft trajectory (such as in circling the observer), use $ICPA = 0$ to start the time history.

For most aircraft trajectories the noise will maximize somewhere near the closest point of approach to each observer. Using the default value of $ICPA = 1$, the program calculates the coordinates of the closest point of approach. The first point for noise calculations (fig. 2) is then found as half ($NT/2$) of the time intervals (TD) before the closest point of approach. Succeeding noise point calculations are made at intervals of time (TD) along the flight path defined by XA , YA , ZA , and velocities VA . Note in figure 2 that for $NT = 21$ there

are 10 points before and 10 points after the closest point of approach. The maximum number of time increments (NT) is 100.

At time increments between the specified points of the aircraft trajectory, the aircraft velocity (VI) (as well as XI, YI, and ZI) is a calculated value assuming constant acceleration. Other trajectory inputs (as EPP, ALF1, GAM, PSY, FLAPA, ILGR, and IREVR) change only at specified trajectory points where new values are given. FOOTPR checks for changes in EPPI or VI between points, and if both are unchanged, sets ISKIP = 1. ISKIP is used in the NOIS and JET subroutines to skip repeated calculations of variables that are unchanging. Subroutine NOIS returns values of PNL and PNLT to FOOTPR, which then stores the appropriate ones and selects PNL-max or PNLT-max or calculates EPNL as indicated by the user choice of IOUT(2) and IOUT(3) (table III). Note that if $IOUT(3) > 0$, then IOUT(2) must either be zero or agree with IOUT(3).

In the noise contour routine, for each value of XO the program calculates the noise level at two given (or default) values of YO and then extrapolates in a direction in Y for the first approximation for the Y coordinate of that contour level at XO, assuming that the level varies logarithmically with Y. As many as 10 iterative linear interpolations are then made to arrive at within 0.1 decibel of the desired level. The X,Y coordinates of that contour level are printed out, and the program proceeds to the next specified contour level. If the aircraft banks ($GAM \neq 0$) or has a flight path with nonzero YA values, the footprint will be asymmetric about the X axis. In this case the noise contour calculation should be repeated with negative inputs of YO to force the program to converge to the opposite side of the footprint.

In calculating EPNL contours the program will have difficulty in converging for the Y coordinates if the number of time increments is too small or the increment size too large. The convergence routine assumes a smooth dependence of the level on the Y distance. If an inadequate time history is given, the EPNL subroutine extrapolates to the time when the noise history is 10 decibels below the maximum, based on the first two or last two points given. Any scatter or nonuniform behavior at these end points can result in sizable changes in the extrapolated end points for the time history and hence in the time interval over which the EPNL integration occurs. This can result in "wild" estimates being generated in the solution for the Y coordinate of the contour. If the program does not converge in 10 iterations, it prints a warning message and advances to the next point. If the user asks for the Y coordinate of a contour level higher than can be predicted at that XO position, the program cannot converge and prints the

warning. For a well-specified problem the routine usually converges in two to four iterations beyond the initial tries at $YO=500$ and 1000 feet (default values).

Noise contour (or footprint) areas are calculated by integrating the area between the first and last XO points on the contour, assuming that the contour is symmetric about the X axis. Sizable errors in area will occur if an insufficient span of XO locations is specified so that the contour points will not approach the end of the footprint. When the contour calculation fails to converge or erroneously terminates with a negative value for the Y coordinate, the calculated contour area will be in error. When the anticipated contours are not symmetric about the X axis, the user is advised to examine the contour shapes carefully and to be skeptical of the area calculations. In some of these cases, negative coordinates can be calculated (as mentioned earlier) by inserting negative starting values for YO ; the footprint area can be found by averaging the two areas calculated for positive and negative values of Y . It should be obvious that the contour for a level aircraft flyover would extend without limit, and hence its area would be infinite; the calculation would only give the footprint area between the extremes of XO locations.

The noise contour feature of this program should be used with some caution because of these cases where the simple interpolative iterations may not converge or where the area integration can be faulty. For accurate footprint contours and areas it is recommended that these procedures be limited to aircraft flight paths along the X axis. Exploratory calculations should be made by the user to find the noise levels along the X axis near the start and end (closure points) of the noise contours. From these, XO values near the closure points (but within the contour) can be chosen and made inputs, along with up to 18 intermediate XO values, for the footprint contour and area calculations. The number of XO points actually needed will depend on the complexity of the contour. The computer calculation time will be considerably shortened if each contour is separately calculated, with XO values entered that are appropriate to the footprint length of that particular contour.

The indicator $IGEOM$ was initially included when checking for proper geometry calculations in $FOOTPR$. However, the printout for $IGEOM=1$ has frequently been found useful in understanding complex geometry effects during noise calculations. Hence, it has been left available to the user as an option. When $IGEOM=1$ and $ICPA=1$, a printout message indicates the closest point of approach of the aircraft to the observer.

Subroutine NOIS

Subroutine $NOIS$ is called by the main program $FOOTPR$ and then in turn calls the individual noise source subroutines, as shown in figure 1(a). In the input namelist block $\&SOURCE$, $NOIS$ reads the user choices of sources, propagation corrections, and output options. In this input the user may call for suppression to be applied ($ISUPP=1$) to each source where a suppression spectrum is supplied. This choice can be overridden by the input of $ISUPPR$ to each noise source subroutine. This subroutine also reads the input matrix of engine variables in $\&PARAM$ as an "engine map" and interpolates for the specific variables for each noise source. It will make standard corrections to these variables for actual-day conditions of ambient temperature and pressure, if desired. As can be seen for the inputs under $\&PARAM$ in table III, the names of the arrays of variables for the engine map are formed by prefixing "A" to the variable name itself. Because of the interpolation routine used, the engine parameters must be entered in order of increasing engine performance parameter ($AEPP$).

The band center frequencies for other subroutines are generated in subroutine $NOIS$. One-tenth-decade frequency ratios are used rather than either one-third-octave frequency ratios or the "preferred" center frequencies. The frequency range for all calculations is from 50 to 10 000 hertz. Filter characteristics can be modified by entering $FILBW$ in $\&SOURCE$ (default = 1.). $FILBW$ is the fraction of the "ideal" filter bandwidth that has a gain of 1 (fig. 5). In $NOIS$ the frequency ratios where the filter gain is 1 and 0 are calculated for use in the apportionment of tone energy between adjacent bands in the FAN and $TURB$ subroutines.

Each noise source is then called in turn (fig. 1(a)) and results are summed for the total noise spectrum. Propagation corrections for atmospheric attenuation, extra ground attenuation, shielding, and ground reflection are made to the total spectrum as requested by the user, and then PNL and $PNLT$ calculations are made. The propagation corrections are discussed individually later.

Printouts from $NOIS$ depend on the user input in $IOUT(1)$. The choices include the total noise spectrum with $OASPL$, PNL , and $PNLT$ or only $OASPL$, PNL , and $PNLT$ at each trajectory point (table IV). Examples of these printouts are included later in this report.

Main Program RADIUS

The program $RADIUS$ was devised to predict engine noise source levels at a fixed radius and at

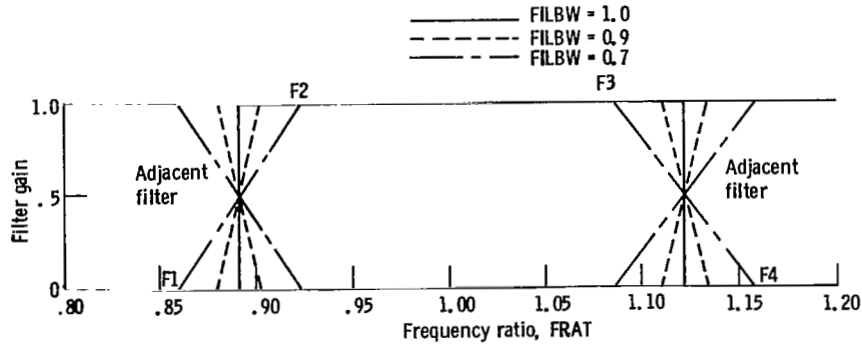

Figure 5. - Idealized filter shapes for apportionment of fan and turbine tones.

various angles, such as would simulate the ground acoustic testing of an engine. This program replaces programs FOOTPR and NOIS in calling the noise source subroutines, as shown in the flow diagram of figure 1(b). The first input is a title line supplied by the user in alphanumeric format. The remaining input data are entered in namelist blocks &GEOMT, &AMB, &SOURCE, &PARAM, and &OPER.

The input block &GEOMT contains variables for defining the geometry (fig. 6) of the noise field. The polar and azimuthal angles are specified as arrays ATHETA and APhi, with NTHETA and NPhi values of each. The user indicates his choice of units also in this input. The angle VIEW can be entered if extra ground attenuation (IEGA = 1) calculations are desired. The source and observer heights (ZI and ZO) are also entered for use in the detailed ground reflection calculations (IGND = 2).

Blocks &AMB, &SOURCE, and &PARAM serve the same purpose and include exactly the same variables as the same input blocks to FOOTPR and NOIS. This simplifies data input when both flyover calculations (by FOOTPR) and constant-radius predictions (by RADIUS) are desired. Ambient conditions of temperature, pressure, and relative humidity are entered in &AMB. In &SOURCE the

user indicates the number of engines and selects the sources and sound propagation corrections to be used. The engine operating map is entered in &PARAM.

The user indicates the operating point for the engine within the engine map by the value of EPPI input in block &OPER. For forward-velocity source level corrections, or for Doppler shift and source motion amplification, a single value of aircraft forward velocity (VI) is also entered in this block. For flap noise predictions the trailing flap angle (PSYI) must also be specified here. For airframe noise calculations the angle (FLAPI) of the slotted flaps (if present) and the indicator (ILG) for landing gear up or down must also be included.

RADIUS interpolates from the engine map in &PARAM for the specific engine variables needed for each noise source and corrects these for actual-day ambient conditions in the same way that NOIS does. The actual input values used in the calculations for each source are listed in the output. Each noise source subroutine is called repeatedly for the angles required. RADIUS constructs a table of SPL values at each angle and frequency; calculates the acoustic power, OASPL, PNL, and PNLt; and prints a page of output for each source. If the data input block

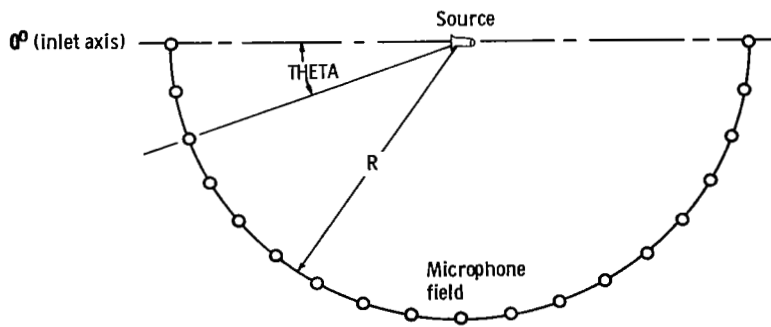

Figure 6. - Typical geometry of noise field for RADIUS predictions. Shown here for default values of NTHETA = 19 microphone or observer positions and ATHETA located every 10° from 0° to 180°.

&OPER is repeated, RADIUS will repeat the previous calculations and printout at a new operating condition specified in &OPER.

The calculated acoustic power spectrum is an area-weighted integration of the SPL values at the specified angles, assuming that the source is axisymmetric. For nonaxisymmetric sources, the levels calculated at the first value of APhi (usually at $\text{PHI}=0^\circ$) are assumed to be axisymmetric and are integrated for an approximation to the acoustic power. True acoustic power for these sources would require a two-dimensional integration over both THETA and PHI. This sophistication is not programmed into RADIUS. The reference level in this program for the acoustic power is 0.1 picowatt, whether U.S. customary or SI units are used. Caution is advised when comparing acoustic power levels from these predictions with published power levels, especially from Europe, where the usual reference level is 1.0 picowatt.

It should be remembered that PHI, the angle in the sideline direction (fig. 4(b)), is defined with respect to the aircraft coordinates. When making acoustic measurements on a static test stand, in the case where the noise source is not axisymmetric, the experimental package is frequently rotated so that the $\text{PHI}=0^\circ$ plane is parallel to the ground. Microphones at the source height are then measuring in the flyover plane. Predictions to simulate this case using RADIUS are made with $\text{PHI}=0^\circ$.

Subroutine FAN

Subroutine FAN is programmed from reference 1 (Heidmann). It predicts the total fan noise from inlet and exhaust ducts. By specifying IEXH the user can choose to exclude inlet or exhaust noise. Combination tones ("buzz" or multiple pure tones) are included when the rotor relative tip speed is supersonic ($\text{TIPM}>1$). Tone and broadband noise contributions are predicted separately and added. For a two-stage fan the noise from both stages is added; no attenuation is applied to first-stage fan exhaust noise because of the second stage.

This subroutine requires that the inputs of fan mass flow (AWAFAN), fan speed (ARPM), and temperature rise (ADELT) or pressure ratio (AFPR) be entered in the &PARAM input to subroutine NOIS. Inputs of the fan tip relative Mach number (ATIPM) (including second-stage ATIPM2, if appropriate) should be made also in &PARAM if available. If DELT is not supplied as ADELTA in &PARAM, the fan pressure ratios (AFPR) are required in &PARAM, and DELT is calculated from FPR and the fan efficiency (FANEFF).

The temperature at the fan face is found by

interpolation based on the specific weight flow and is used to calculate the speed of sound (CX) at the fan face. This is used in the rotor tip (RTSM) and rotor relative tip (TIPM) Mach number calculations. When available, TIPM should be obtained from velocity diagrams for the rotor blades and supplied as ATIPM in &PARAM, especially when the fan has inlet guide vanes ($\text{IGV}=1$). If ATIPM is not supplied, TIPM is calculated as the right-angle vector sum of the inlet air flow (AIRM) and rotor tip (RTSM) Mach numbers. If TIPM2 is not supplied for the second stage, it is approximated as TIPM times the ratio of design relative tip Mach numbers ($\text{TIPM2}/\text{TIPM}$).

The rotor fundamental tone cutoff number is calculated from RTSM and the vane-blade ratio. As prescribed in reference 1, when the cutoff number is below 1.05 and the rotor tip speed is subsonic ($\text{RTSM}<1$), the tone level is reduced 8 decibels.

Combination tones are treated as three broadband sources with spectra peaked at one-half, one-fourth, and one-eighth of the blade passing frequency. These three sources are added for the total combination tone levels. It has been recognized that reference 1 overpredicts the combination tone levels for most fans by as much as 5 decibels. For the convenience of the user an option has been made available to lower the combination tones by specifying a decrement DECMT (in decibels) in the &FANDA input.

In fans without inlet guide vanes ($\text{IGV}=0$), the rotor-stator spacing (RSS) to be entered is the axial spacing between rotor and stator divided by the axial projection of the rotor mean chord, in percent. In fans with inlet guide vanes RSS is the lesser of this rotor-stator spacing and the vane-rotor spacing found by dividing the space between the inlet guide vanes and the rotor by the chord of the vanes (fig. 6(a) of ref. 1). When $\text{IGV}=1$, the broadband and tone levels from the exhaust duct are increased 3 and 6 decibels, respectively; the harmonics above the fundamental in the inlet duct are reduced 6 decibels; and combination tones (if present) are reduced 5 decibels.

Doppler shift and source motion amplification are applied if $\text{IDOP}=1$. The exponents for the source amplification are set at 4 for both the fan first and second stages, assuming that both sources behave as convected compact dipoles; the user can modify these exponents by inputs of EDOP and EDOP2. Values of EDOP are not passed between subroutines so that a change in EDOP in FAN will not affect the default values for EDOP in other subroutines. When there is inlet flow distortion to the fan, IFD should be set equal to 1 and (as prescribed) tone and broadband levels will be modified by allowing no benefit for rotor-stator spacing over 100 percent; tone harmonics will also fall off more rapidly.

Tones and their harmonics (except for combination tones) are sorted by frequency and added to the appropriate band levels. When $FILBW=1.$, the filters for these bands are *ideal*. When $FILBW < 1.$, the energy of the tones that fall near the edge of a band is divided proportionally between that band and the adjacent band (fig. 5). Simple suppression spectra can be applied to the fan inlet and exhaust duct noise levels. The suppression spectra are SUPPIN for the inlet duct and SUPPEX for the exhaust duct; 24 values of each are entered in &FANDA. The indicator ISUPP in &SOURCE, or ISUPPR in &FANDA, must be set equal to 1; if ISUPPR is supplied here, it will override the value of ISUPP from NOIS in controlling suppression imposed on the fan spectra.

The 1979 printing of reference 1 corrects the 1975 printing, which contains two errors in the equations shown in the figures for inlet broadband noise levels and inlet tone levels. In the 1975 printing the third equation in figure 4(a) must be modified by subtracting 0.91515 from the right side. In figure 10(a) the fourth equation should omit the term 20 log MTRD.

Subroutine JET

Subroutine JET is based on reference 2 (Stone), excluding the portion for predicting reverser noise. The user must specify the type of nozzle (simple conical, conical with plug, slot, or coannular). The effects of forward velocity or flight on the source intensity level can be included by setting IFWD = 1. When engine conditions and aircraft velocity are unchanging between calculation points, FOOTPR sets ISKIP = 1 and a shortened set of calculations is used in JET.

For the core flow this subroutine requires inputs of the velocity (AVC) and the temperature (ATC) of the flow from the nozzle to be entered in the &PARAM input. The program can calculate the values of the core specific heat ratio (GAMMAC) and gas constant (GASRC), if the user includes values of the core weight flow (AWCORE) and fuel flow (AFUEL) in &PARAM. This calculation is based on typical values for "A-1" jet fuel (fig. 7), with a hydrogen-carbon ratio of 0.16 and a lower heating value of 43 242 joules per gram (18 600 Btu/lb) of fuel.

The geometry for different types of exhaust nozzles is shown in figure 8. For a plug nozzle the annular height around the plug (ANNHT) must be supplied. For a slot nozzle the hydraulic diameter (DHC) of the nozzle is required.

For coannular flow the fan velocity (AVF) and temperature (ATF) must be included in the &PARAM input. Note that the coannular noise prediction is not valid for a fan flow heated with

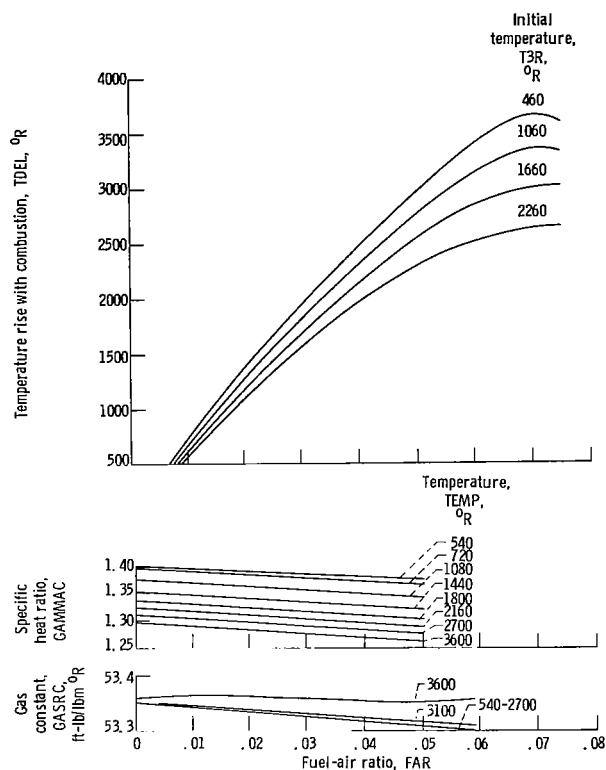

Figure 7. - Properties of burned gas in core flow.

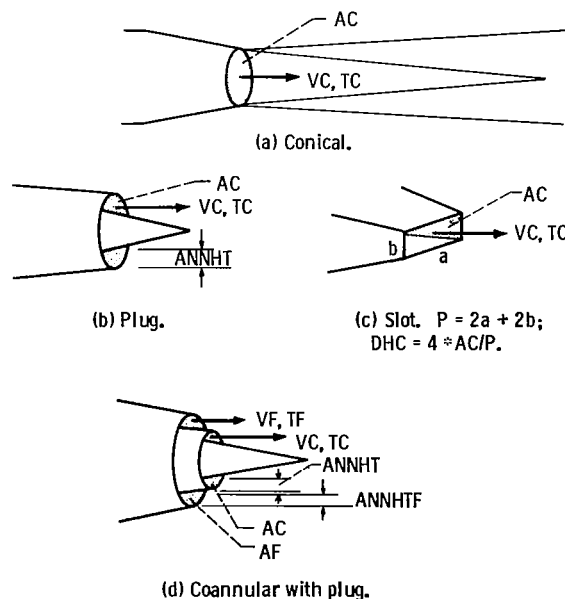

Figure 8. - Nozzle geometries for jet noise calculations.

respect to the core flow. The annulus height (ANNHTF) may be given as input; otherwise it will be calculated from the areas, assuming that the nozzle contours are circular and that the inner fan nozzle wall is of negligible thickness. If the annulus is noncircular, the hydraulic diameter DHF must be given.

For both core and fan flows, when the flow is supersonic, the shock noise is calculated separately and added to the subsonic noise calculation. Source motion amplification (Doppler) is applied to the shock noise contributions if IDOP = 1; the user can modify the exponent for this amplification from its default value of 1 (assumes a distributed monopole source) by inputting EDOP.

Several modifications to this method of jet noise prediction have been suggested by Stone (refs. 7 to 9) but have not yet been incorporated into this programmed version. These modifications include improvements in predicting the effects of flight velocity and a capacity to predict jet noise in the case of a heated fan stream (inverted velocity profile).

Subroutine CORE

Subroutine CORE predicts the low-frequency core noise resulting from the combustor, as in reference 3 (Huff, et al.). Inputs of core flow (AWCORE) and combustor pressure (AP3) are required in &PARAM. Combustor inlet and exit temperatures (AT3 and AT4) should also be supplied in &PARAM if available. If AT3 values are not supplied in &PARAM, the value of T3 will be calculated assuming isentropic compression and using the user-supplied or default value of the core flow specific heat ratio (GAMMA). If AT4 values are not supplied, the temperature rise in the combustor will be calculated from the fuel-air ratio, assuming "A-1" fuel, to give an approximate T4. If desired (setting IMOD = 1), the program will use a modified noise level prediction based on the correlation equation of reference 10 (Matta, et al.). The modified prediction requires the added input of the design temperature drop through the turbine (DTEMD); both methods predict the same levels when DTEMD is 728.62° R. Both versions use the same simple directivity curve and single spectrum. The peak frequency of the spectrum is arbitrarily set at 400 hertz if the calculated peak is less than 300 hertz or greater than 1000 hertz, as recommended in reference 3.

Doppler frequency shift and source motion amplification can be effected by setting IDOP = 1; the exponent on the amplification factor is normally 2 (ref. 2) but can be modified by inputting EDOP. Core suppression can be applied by setting

ISUPP = 1 in &SOURCE input or ISUPPR = 1 in &COREDA and supplying a suppression spectrum (CSUPP).

Subroutine TURB

In subroutine TURB the tones and broadband noise produced by the turbine are calculated by the recommended procedure of reference 4 (Krejsa, et al.). The prediction is basically for the last stage of the turbine but, by proper input of parameters, could apply approximately to any one of the low-pressure turbine stages. Inputs of the turbine exit temperature (ATCTUR), fan speed (ARPM), and core weight flow (AWCORE) are required in &PARAM. The turbine rotor relative tip speed (ATURTS) should also be included in the &PARAM input if available. Otherwise, the program estimates TURTS as 0.7 of the rotor tip speed.

In many cases involving some mixing in the exhaust nozzle, the turbine exit temperature (TCTUR) is not the same as the core nozzle temperature (TC) for jet noise calculations. However, if ATCTUR is omitted in &PARAM, the NOIS subroutine assumes TCTUR = TC for use in the turbine noise prediction.

The turbine rotational speed is obtained from the fan speed (RPM) and the gear ratio between the low-pressure turbine and the fan (GEAR). The levels of the first four harmonics of the rotor blade passing tone are calculated, although some are usually above the frequency range of interest.

As in subroutine FAN the frequency bands into which the tones are sorted are one-tenth decade rather than one-third octave. When FILBW < 1 in &SOURCE, tones near the band edges are split between adjacent bands by applying a gain factor (FR) (fig. 5). The broadband noise peaks at the center frequency of the band containing the fundamental tone, unless this is above 10 000 hertz. In that case the broadband peak is set at the actual fundamental tone frequency; only the lower frequency side of the spectrum is then of importance in the noise predictions.

The level of the turbine tones is decreased by 10 decibels depending on the type of exhaust configuration (fig. 9). For turbojet configurations, or turbofans with the fan nozzle coplanar with or shorter than the core nozzle exit, set ITYPTB equal to 0 and no adjustment will be made. For turbofans with the fan nozzle extending beyond the core nozzle (such as on the JT8D), set ITYPTB equal to 1 and the tone levels will be decreased by 10 decibels. This adjustment is specified in reference 4.

Particular attention should be given the spacing factor CS as used in this program; it is the ratio in

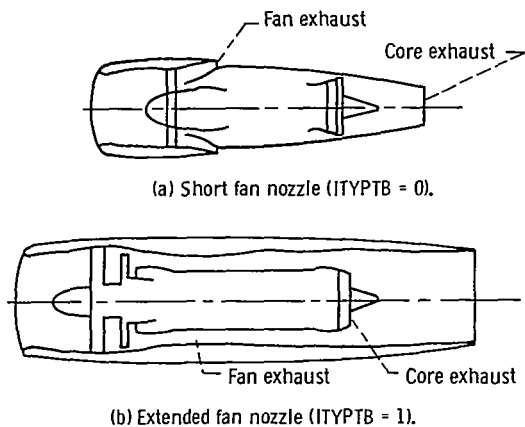

Figure 9. - Types of exhaust nozzle affecting turbine noise levels.

percent of the axial projection of the upstream stator chord to the axial spacing between the stator and the rotor ($100 \times c/s$ in fig. 7 of ref. 4). For most cases, CS in greater than 100 percent.

The exponent on source motion amplification when $IDOP=1$ can be modified from its default value of 4 (ref. 4) by inputting EDOP. If turbine noise suppression is desired ($ISUPP=1$ or $ISUPPR=1$), a suppression spectrum (TSUPP) must be supplied.

The prediction equations and curves of reference 4 include standard-day atmospheric attenuation at a distance of 45.7 meters (150 ft). In TURB the amount of this attenuation is added to the calculated levels to give an output spectrum for free-field "lossless" conditions.

Subroutine SHLD

Subroutine SHLD is a temporary approach for making a shielding correction based separately on shielding by the wings and by the fuselage. This subroutine is not intended as a prescribed method of calculating shielding effects; it only allows the user an option for making some approximate corrections based on his own experience. It is an attenuation approximation in decibels to be applied in certain directions, as a function of frequency. It assumes that only the fan, jet, core, and turbine noise sources can be shielded. This subroutine is called by NOIS or RADIUS.

Fuselage shielding is applied only when the direction (fig. 10) is within 20° of the wingtip direction ($PHI > 70^\circ$). It maximizes at $THETAH=90^\circ$ with a user-supplied maximum of SFUSE in decibels. The width of the intense region of shielding can be specified by SWIDE (figs. 10 and 11(a)), defined as the angle, in degrees, over which the fuselage shielding is within $1/e$ of SFUSE, or

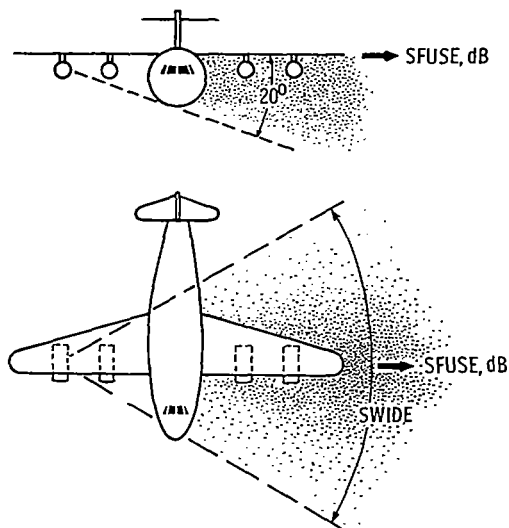
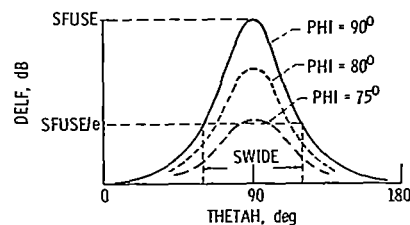
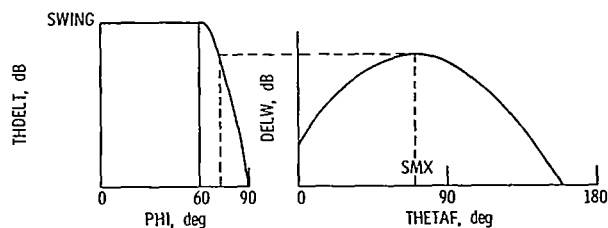

Figure 10. - Region of fuselage-shielding component for approximate shielding calculations.



(a) Fuselage shielding, for $PHI > 70^\circ$.



(b) Wing shielding, for over-the-wing configuration.

Figure 11. - Approximations used for shielding calculations. Total shielding = DELF for fuselage + DELW for wing.

$SFUSE/2.718...$. At low frequencies, when the sound wavelength exceeds a user-supplied characteristic dimension of the fuselage (CFUSE), such as its diameter, the amount of fuselage shielding decreases proportionally to the sound frequency.

Wing shielding approximations apply only in the case of over-the-wing engine installation configurations. Over-the-wing shielding ($IUOTW=1$) (fig. 12) varies with the product of two factors dependent on $THETAFA$ and PHI as shown in figure 12(b); the user supplies the maximum shielding (SWING) and direction of maximum shielding (SMX). When the sound wavelength exceeds the

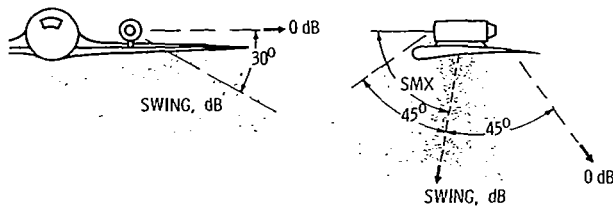

Figure 12. - Regions of wing shielding component for approximate shielding calculations, for over-the-wing configuration only.

user-supplied wing dimension (CWING), such as its chord, the wing shielding decreases proportionally to the frequency.

Subroutine FLAP

Under-the-wing (UTW) or over-the-wing (OTW) powered-lift noise is calculated by subroutine FLAP, which is based on reference 5 (Dorsch, et al.). This source is sometimes called "jet/flap" noise and includes the noise contribution of the free jet as well as any scrubbing and edge noises. Therefore, when subroutine FLAP is called (IFLAP = 1), subroutine JET should not be used, as the jet noise is already included in the flap noise prediction. The flap noise produced is not axisymmetric and requires angles THETA, THETAF, and PHI from FOOTPR (or RADIUS), where THETAF is the projection of THETA on the plane of PHI = 0° (fig. 4(b)).

This subroutine requires values of core flow exhaust velocity (AVC) in the &PARAM input and, if there is a fan flow, values of the fan nozzle exhaust velocity (AVF).

For both UTW (IUOTW = 0) and OTW (IUOTW = 1) cases the overall levels are predicted in the reference direction (THETAF = 90°, PHI = 0°), based on the type of nozzle, the flap angle, and the exhaust velocity. The levels are then modified by appropriate directivity terms. The exhaust velocity used in the calculations depends on the nozzle configuration. For a simple conical nozzle (INOZ = 0)(fig. 13(a)) the exhaust velocity is the average velocity at the nozzle exit; the nozzle area (AC1) is required in the &FLAPDA input. For the unmixed coaxial nozzle (INOZ = 1)(fig. 13(b)) the procedure uses an area-weighted, sixth-power average of the velocities; areas AC1 and AF1 are required input in &FLAPDA. For a mixed-flow exhaust (INOZ = 2)(fig. 13(c)) a bypass-ratio-weighted average velocity is used; in this case the velocities AVC and AVF in &PARAM should be for each stream ideally expanded individually to ambient conditions; AC1, AF1, and the bypass ratio (BPR) are required in &FLAPDA.

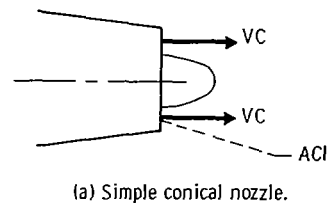

(a) Simple conical nozzle.

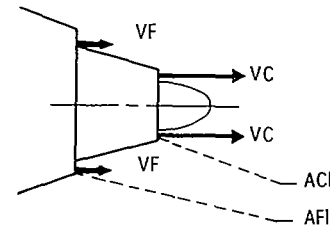

(b) Coaxial nozzle.

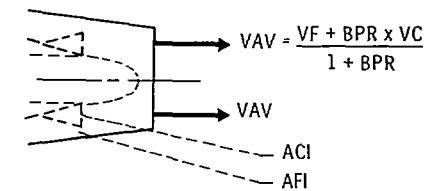

(c) Mixer nozzle.

Figure 13. - Nozzle geometries for flap noise. (BPR = bypass ratio.)

The flap angle (PSYI) is the angle between the wing chord and the trailing flap chord. This angle is entered either as an array PSY in the &TRAJ input when using FOOTPR or as a single input PSYI to the &OPER input when using RADIUS.

The prediction of UTW noise in reference 5 distinguishes between configurations sensitive to the flap angle (PSYI) and those relatively insensitive. The two-flap model configuration of figure 10(a) of reference 5 can be taken as an example of a "sensitive" configuration (INSENS = 0), where the area impinged by the high-velocity exhaust decreases appreciably when the flap angle is reduced from the large value typical of a landing condition to a low value that might represent a typical takeoff condition. In this case the flap angle dependence is given by equation (11) of reference 5. When the impingement area is relatively insensitive to flap angle, as with the three-flap model of figure 10(a) of reference 5, INSENS = 1 in the &FLAPDA input and equation (16) is used for the flap angle dependence.

In the UTW configurations of reference 5 the ratio of wing chord to overall nozzle diameter (WINGD) is roughly 3. For engines with very large bypass ratios, this ratio may be considerably less than 3 so that the wing and flap area impinged by the exhaust flow scales better with nozzle diameter than with nozzle

area. An approximate correction for this case can be made by entering a value of WINGD less than 3; a value of WINGD=2, for example, causes a 1.76-decibel reduction in the predicted levels.

The coefficient BETA for the PHI-angle dependence of the directivity for the UTW configuration (eq. (14) and fig. 14 of ref. 5) changes rapidly near the wingtip direction as originally defined. This programmed prediction uses THETA instead of THETAF for the abscissa of figure 14, because of the anomalies that would be produced by rapid changes in THETA as THETA and PHI approach 90°. Although this involves a reinterpreting of the directivity data, the changes are not large, and disturbing fluctuations in level in the sideline direction are avoided.

The OTW directivity term with PHI-dependence is modified from that of reference 5 to include data for PHI > 90°. In addition, this term is multiplied by sin(THETA) to eliminate PHI-directivity changes as THETA approaches 0° or 180°.

For the UTW configurations, relative airspeed effects on the source noise level can be obtained by setting IFWD = 1. The coefficient CAY for this effect depends on the flap angle (PSY1) and THETA F and is given by figure 18 of reference 5. No relative airspeed effect is made for the OTW configuration.

Doppler frequency shift and source motion amplification are made when IDOP=1. The exponent EDOP for the amplification factor can be modified by the user from the default value of 4.

A suppression spectrum can be applied to the predicted flap noise spectrum by setting ISUPP=1 or ISUPPR=1 and supplying the suppression spectrum (FLSUPP).

Subroutine AIRFR

Subroutine AIRFR calculates the airframe noise resulting from airflow over the wing and tail surfaces, over slotted flaps when deflected, over landing gear when deployed, and from leading-edge slats when present (fig. 14). The prediction method is basically that of reference 11 (Fink), but slight modifications are made in constants and slopes as in the ANOP program, Langley Research Center. This subroutine is only a reprogramming of the ANOP program. For input in &AIRFDA the areas and total spans of the wing, horizontal tail, vertical tail, and deflected flaps are grouped as areas A and spans B, each with four dimensions. The span of the vertical tail is simply its height. The landing gear characteristics of number of landing gear (NG), number of wheels per gear (NW), tire diameter of the wheels (DW), and ratio of strut length to tire diameter (CG) are each two-dimensional, with the value of each for the nose gear to be given first, followed by the value of each for the main gear. Inputs of ICLEAN and ITYPW allow for the adjustments for a "clean" configured aircraft and for a delta or conventional type of wing.

Choices of the type of sources to be included can be indicated by inputs of I WING, I FL, I SLAT, and I LG. Rather than a single choice for landing gear noise (ILG), values of ILGR can be entered in the &TRAJ input to FOOTPR, so that the gear can be lowered or raised during the flight. For the slotted-flap aerodynamic noise, values of the flap angle (FLAPA) must also be entered in &TRAJ. All source frequencies will be Doppler shifted if IDOP=1; source motion amplification is part of the prediction, so no additional FDOP factor is provided for.

Function Subroutine AIRATT

Function subroutine AIRATT calculates atmospheric attenuation of noise according to reference 12 (ARP 866). The program is an adaptation of one written by Dr. Frank Montegani of Lewis Research Center (ref. 13). It assumes that the attenuation of noise in a frequency band is the same as the attenuation of a pure tone at the center frequency of that band. It is called by NOIS or RADIUS when IATM = 1.

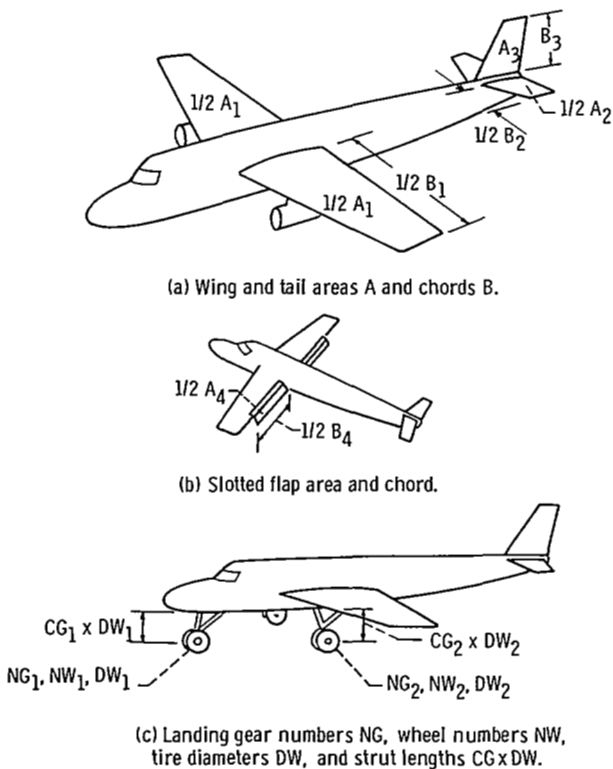

Figure 14. - Airframe noise geometry.

Subroutine ATMB

Subroutine ATMB calculates the atmospheric attenuation of a pure tone by using the method of reference 14 (Bass and Shields). It is called by the subroutine BASAT for band attenuation. Results from this attenuation prediction procedure are more accurate at high frequencies and long distances than those from reference 12. The programming of reference 15 is modified for use here.

Subroutine BASAT

Subroutine BASAT is a general procedure for adding or removing the effect of atmospheric attenuation on a fractional-octave-band spectrum. Approximations are made for the effect of the spectrum gradient in the region of the band being considered. This procedure, rather than ARP 866 (ref. 12), is used for calculating atmospheric attenuation in each band when IATM=2. This subroutine is called by either NOIS or RADIUS. Programming is an adaptation of that detailed in reference 15.

Subroutine EGAC

Subroutine EGAC is adapted from reference 16 (Boeing), which includes a procedure for extra ground attenuation calculation based on the prediction by SAE AIR 923 (ref. 17) for turbulent scattering of noise (downwind direction). The program interpolates for two factors based on the distance R and elevation angle (VIEW) (fig. 4(a)). The predicted attenuation diminishes to zero at VIEW = 45°. This subroutine is called by NOIS or RADIUS when IEGA = 1.

Subroutine GDRFL

Subroutine GDRFL, which calculates the modifications to the spectrum due to ground reflection (fig. 15), is based on reference 18 (Putnam). Broadband noise is treated as white noise, and tone effects will be included if ITONE = 1; an individual spectrum band is then treated as a tone if it protrudes above the surrounding bands by 3 decibels or more. A distributed noise source can be approximated as (NS) discrete sources at several heights (DK) relative to the source center. The ground characteristics are given in terms of its reflectivity (QABS) and the phase shift (FSHIFT) of the reflected sound waves, both as a function of frequency. This subroutine is called by NOIS or RADIUS when IGND = 2.

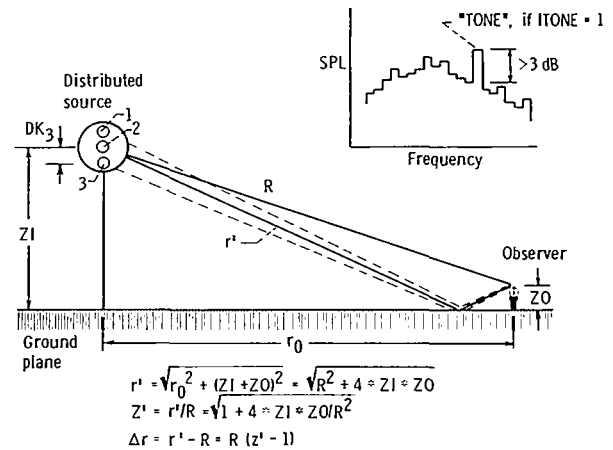

Figure 15. - Geometry of ground reflections.

Function Subroutine PERNOY

Function subroutine PERNOY calculates the perceived noise levels (PNL) from the individual spectra and the total noise spectrum by ARP 865A (ref. 19). It contains a warning if any of the spectrum band levels exceed 150 decibels, which is the upper limit of the procedure. This subroutine is called by each individual noise source subroutine and by NOIS or RADIUS for the total noise.

Function Subroutine TONE

Function subroutine TONE calculates the tone correction to PNL to give PNLT. This is a programmed version of the procedure of FAR 36 (ref. 20). Note that this March 1978 version omits the cutoff at F = 3 of the 1969 version. This subroutine is called by each individual noise source subroutine and by NOIS or RADIUS for the total noise. Pseudotones may be introduced into the spectrum when ground reflections (IGND = 2) are included; no provision is made for eliminating these as contributors to the tone correction.

Function Subroutine EPNL

Function subroutine EPNL integrates the time history of PNLT for effective perceived noise level, as defined by FAR 36 (ref. 20). It assumes that PNLT varies linearly between calculated points (fig. 16). The procedure integrates by Simpson's rule over observer times TAU (resulting from the user's choice of time increment (TD) in &GEOM), rather than summing 1/2-second contributions. It should be noted that TD must be chosen small enough to adequately describe the noise time history near the peak. The

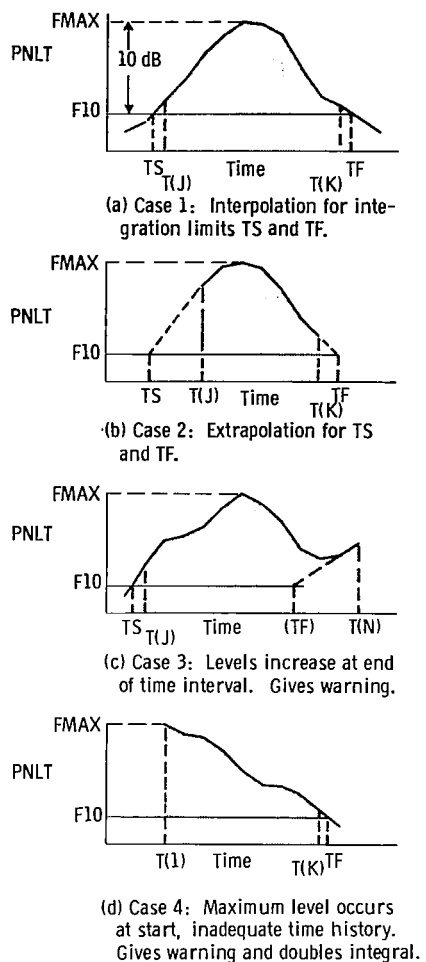

Figure 16. - Time history integrations for EPNL (effective perceived noise levels).

integration is made between the interpolated times TS and TF, between which the level is 10 decibels or less below the maximum (fig. 16(a)). When the first or last point is less than 10 decibels below the maximum PNLT, a straight-line extrapolation is made to the 10-decibels-down point for purposes of integration (fig. 16(b)). Occasionally the time history levels show an upturn at the start or end of the time interval, so that the extrapolated starting or final time (TS or TF) would be erroneous (fig. 16(c)); in this case the extrapolated time is ignored and a warning is issued. If the user has chosen an insufficient time span, so that either the first or last calculated point results in the maximum PNLT, the program gives a warning message and makes an approximation by doubling the area of the integrated history (fig. 16(d)). This function subroutine is called by FOOTPR when either IOUT(2) or IOUT(3) equals 3.

Subroutine TERP

Subroutine TERP is a general linear interpolation routine devised for this program. It extrapolates linearly outside its range; it can handle interpolation for F as a function of three independent variables ($F = f(A, B, C)$), where A is an array of abscissa values common to each of the curves in B and C and B is a set of curves for each value of C, with the same number of B curves for each C (fig. 17). Values of A, B, and C must each be in ascending order. This procedure first calls SERCH to find the coordinates of the nearest lower values of A, B, and C.

Subroutine SERCH

Subroutine SERCH finds the interval in which an independent variable falls within a given set of values and calculates the position within that interval for interpolation purposes. It is called repeatedly for the independent variables used in TERP. The search procedure assumes that the independent variable array is in ascending order.

Outline of Programs

The main programs and their subroutines are outlined in this section. General flow diagrams for main programs FOOTPR and RADIUS are given in figure 1. A checklist of input requirements and a complete list and description of the input variables are given in tables II and III.

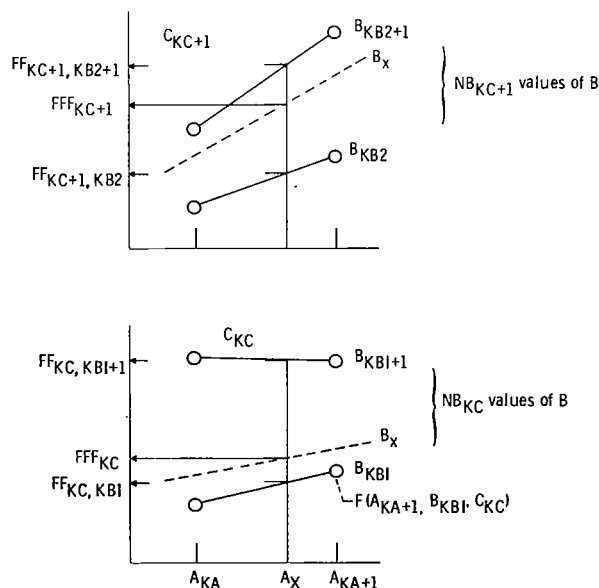

Figure 17. - Scheme for linear interpolation routines TERP and SERCH to find $F(A_x, B_x, C_x)$, where $F = f(A, B, C)$. Symbols correspond to variables in program listing.

Main Program FOOTPR

Trajectories: up to 50 points each allowed for aircraft path and status description; coordinates XA, YA, ZA; engine attack angles ALF1; bank angles GAM; velocities VA; flap angles PSY (for powered lift) and FLAPA (for airframe noise); engine performance (thrust or speed) levels EPP; and ILGR and IREVR for landing gear down or reverser deployed. When $ICPA=1$, the first trajectory point (XA(1),YA(1),ZA(1)) must occur prior to the closest point of approach to any observer points (XO,YO,ZO).

Observers: up to 20 points each for observer ground coordinates XO and YO; one value of observer altitude ZO.

Noise sources: fan (inlet and exhaust), jet, core (combustion), turbine, flap (under or over the wing), airframe (wing, tail, flaps, landing gear, and leading-edge slats). Simple suppression spectra may be applied to each engine source level.

Frequency bands: one-tenth decade (approx one-third octave), 50 to 10 000 hertz for all calculations.

Propagation effects: atmospheric attenuation (by ARP 866 or Bass and Shields), extra ground attenuation (in simplified symmetric form used in Boeing program), ground reflection (+3 dB or Putnam prediction), simple shielding (of fan, jet, core, and turbine). These propagation effects are applied only to total noise values, not to individual sources.

Time history: specified by NT and TD for the number of time increments desired and the time interval between them, starting with TSTART. These points are interpolated along a flight path defined by XA, YA, and ZA. WHEN $ICPA=1$ the middle point occurs at the closest point of approach of the aircraft to the observer. When $ICPA=0$ the first point coincides with the first trajectory point.

Outputs available: controlled by IOUT for individual and total spectra and/or OASPL, PNL, and PNLT at each point in time; PNL-max, PNLT-max, or EPNL at each observer point; and coordinates of chosen contours. The output is preceded by a "COMENT" of the user's choice, and (optionally) by a summary of the observer grid and aircraft trajectory inputs.

Subroutines to FOOTPR

NOIS: called by FOOTPR; interpolates on engine performance level for noise parameters; calls noise source programs; applies atmospheric absorption, extra ground attenuation, ground reflection, and shielding corrections to totals.

FAN: called by NOIS; calculates inlet and exhaust fan noise levels, as spectra, OASPL, PNL, and PNLT; all are free-field values at the specified distance R with no atmospheric attenuation.

JET: called by NOIS; calculates jet noise levels (omit if calling FLAP).

CORE: called by NOIS; calculates low-frequency combustion noise levels.

TURB: called by NOIS; calculates turbine noise levels.

FLAP: called by NOIS; calculates OTW or UTW powered-lift noise levels (includes noise from jet).

AIRFR: called by NOIS; calculates airframe noise (by Fink and ANOP-Langley).

Function PERNOY: called by NOIS and source subroutines; for perceived noise.

Function TONE: called by NOIS and source subroutines; for tone correction.

Function EPNL: called by FOOTPR; for EPNL from time history of PNLT.

Function AIRATT: called by NOIS; for atmospheric absorption correction (by ARP 866).

BASAT and ATMB: called by NOIS; for atmospheric attenuation by Bass and Shields and by Montegani.

EGAC: called by NOIS; for extra ground attenuation correction as function of elevation angle (Boeing).

GNDNFL: called by NOIS; for ground reflection as white noise or tone (by Putnam).

SHLD: called by NOIS; for approximate shielding of total of fan, jet, core, and turbine noise.

TERP: called by most subroutines; a linear interpolation routine.

SERCH: called by TERP; routine to find nearest points in interpolation.

Main Program RADIUS

Up to 20 values of THETA and 10 of PHI to specify microphone or observer locations at constant radius R.

Aerodynamic parameters that vary with engine speed are interpolated from an array of values as a function of engine performance setting EPP.

For each source, the output consists of arrays of free-field, one-third-octave SPL values as a function of frequency and angle in the usual format, with OASPL, PNL, and PNLT given for each angle. Each page is titled by a "COMENT" of the users choice and the variables input to each source prediction. The final output is the SPL array for the total of the sources, modified for atmospheric attenuation, extra ground attenuation, and ground reflection as specified by the user. (This final output may be rejected by setting ITOT = 0 in the &SOURCE input).

Programs for subroutines to RADIUS: FAN, JET, CORE, TURB, FLAP, AIRFR, GNRFL, SHLD, function PERNOY, function TONE, function AIRATT, BASAT and ATMB, EGAC, TERP, and SERCH. Note that subroutines NOIS and EPNL are not used.

Inputs to Main Programs and Subroutines

All data read in for program variables is in namelisted form, except for the first title line, so that order within each set is arbitrary and omissions can be made. Each main and subroutine program for noise sources (and for shielding and ground reflection) has one or more namelist block under which input variable values for that program can be read. A checklist of these input data blocks is given in table II. In table III each main program and subroutine requiring inputs is listed, including the names of the input dataset blocks, and followed by all the variables that can be entered in each block. The maximum number of values that can be entered for each variable is given as its "dimension"; each variable is briefly defined and the prescribed SI and U.S. customary units are listed. Many variables are preassigned default values for the convenience of the user; no input is necessary if the default value is acceptable. These default values correspond to

typical values in U.S. customary units. If the user has specified input in SI units (UNITS=2HSI), the default values may be in error or inappropriate. For some inputs the condition or subroutine for which the input variable is required is also given.

Example One

To illustrate the format of the inputs, several examples are shown in table IV. The order of inputs within any block is immaterial, but the blocks must occur in the order in which they are read, as shown. The first case is for calculation of the noise exposure at six observer stations on the ground (defaults are NYO=2, YO=500 and 1000). The aircraft flies an approach path defined by three points in XA, YA, and ZA. Angle of attack, velocity, engine operating level, and flap settings are defined at each point. Note that the engine and flap settings change at the moment of touchdown. The aircraft comes to a stop at XA = 1500 feet. The user wishes the calculations to span 11 seconds, at 1-second intervals, and asks for a geometry printout (IGEOM=1) at each point. The ambient conditions are nonstandard as shown. The aircraft has four engines and is assumed to generate fan, core, turbine, and flap noise. For this particular calculation, no Doppler frequency shift or source motion amplification is requested (by default). The user wishes to make corrections to the totals of the source noises by a constant 3-decibel addition for ground reflection and for atmospheric attenuation by the method of ARP 866. The printout option IOUT is triggered to print out each source and the total spectra at each point, followed by the maximum PNL at each observer point.

The needed engine-related parameters are supplied at seven engine operating conditions. Note that values of fan exhaust temperature (ATF) are included in this engine map although required only for jet noise calculations, which are omitted here; the extra variable that will be read in will do no harm here. Because the user has set ICORR = 1, this engine map will be treated as values for a standard operating day (288.17 K or 518.7° R and 101.29 kN/m² or 2116 lb/ft² pressure) and will be corrected to the non-standard-day conditions by the usual pressure and temperature factors. Correction of the core temperatures after combustion is not straightforward, and the user has chosen to correct these (T4 and TC) by the ambient air temperature ratio to the 1.022 power.

With the default values the user accepts in the fan data input, the fan is single stage with no inlet guide vanes. Flight conditions are such that there is negligible inlet flow distortion to the fan. Although the user might have chosen for the over-the-wing

aircraft to reject the noise from the fan exhaust duct by setting IEXH=0, he accepts the default of IEXH=2 and includes the fan exhaust contribution. Since fan pressure ratio (AFPR) rather than fan temperature rise (ADELT) was supplied in the engine map, a value of FANEFF is necessary in the fan data for calculating DELT.

Note that data are supplied for calculating jet noise, although they are not used in this particular calculation. The program ignores this line of data in reading inputs.

The core noise prediction input calls for the modified level prediction of reference 10. Hence, a value of DTEMD, the design temperature drop across the complete turbine, must be included. The turbine noise input includes the stator-chord-to-stator-rotor axial spacing of 700 percent. The turbine rpm is derived from the fan RPM and the gear ratio (GEAR) of 2.302. The indicator ITYPTB=1 informs the program that a 10-decibel decrease in turbine noise level is called for since the core exhaust from the turbine is upstream of the fan nozzle (see the section Subroutine TURB).

Data are supplied for making a shielding correction, although no correction has been called for. The program ignores this line of input. The shielding input calls for an over-the-wing case, with a maximum fuselage shielding of 3 decibels in the direction of the wingtip, a shadow zone approximately 60° wide, and a maximum of 5 decibels wing shielding at 80° from the inlet in the plane below the aircraft. The default values for fuselage and wing dimensions affecting shielding are both 10 feet so that wavelengths greater than 10 feet would be shielded less.

The flap noise prediction calls for an over-the-wing case with a mixed nozzle exhaust flow from a bypass ratio of 6:1. Forward-velocity effects on the levels at the source are to be included.

The printout for this example is shown in table V and is discussed later. Other printout options are available by choice of IOUT; these are illustrated in succeeding examples and in table XI.

Example Two

The inputs for this example are abbreviated, assuming that the calculations for this example follow the calculations of Example One without unloading the program. Hence, any parameters omitted in this example will remain the same as in Example One. Six observer stations are defined alongside the takeoff path of the aircraft. The aircraft ground roll commences at XA=0, with liftoff at XA=1500 feet at a velocity of 148.6 feet per second. Engine power and flap settings remain

constant throughout the takeoff. The number of time increments is increased to 21. Geometric information is requested at each point, but only overall levels (rather than spectra) are desired for each source. Following this history, the maximum PNLT at each observer point will be given. Note that each namelist input block must be supplied, but no input variables are given where no change is made from Example One. Program output from this example is shown in table VI and is discussed later.

Example Three

The landing and takeoff calculations of Examples One and Two are combined here for one observer point at XO=-2000 feet and YO=500 feet. The inputs again assume that the program has not been unloaded since the calculations of Example One. The aircraft is assumed to go from landing settings and velocity to full takeoff power at touchdown, accelerating to the takeoff velocity at XA=1500 feet. Figure 18 is a graph of the aircraft geometry and power settings. By choice of IOUT the output will give only the total corrected noise at each calculation point. This example is included to illustrate a caution to the user. Note that the number of time intervals has been increased to 41; the need for this longer time history is discussed later. Program output is shown in table VII.

Example Four

In this example engine noise levels are predicted for comparison with acoustic test stand measurements using the program RADIUS. The program-supplied default values for observer positions happen to correspond to all the microphone locations for the test data, so that &GEOMT requires no input. The experimental data were corrected to "lossless" (no atmospheric attenuation) values, so that &AMB requires no input. No powered-lift flaps were used in this series of tests, so a jet noise prediction is called for (IJET=1) rather than flap noise as in Example One. By using the default value for IATM, no atmospheric attenuation is applied. The engine characteristics for &PARAM are the same as those for Example One.

Program RADIUS requires &OPER input for each engine condition desired. Note that the first &OPER input is read before the source input data are read. The second operating condition (and any subsequent conditions) is read after the source inputs. Values of VI and PSYI are read in but are not used.

The fan source input (&FANDA) is the same as for Example One, except that, because inlet flow distortion occurs in these ground tests, IFD=1. Fan

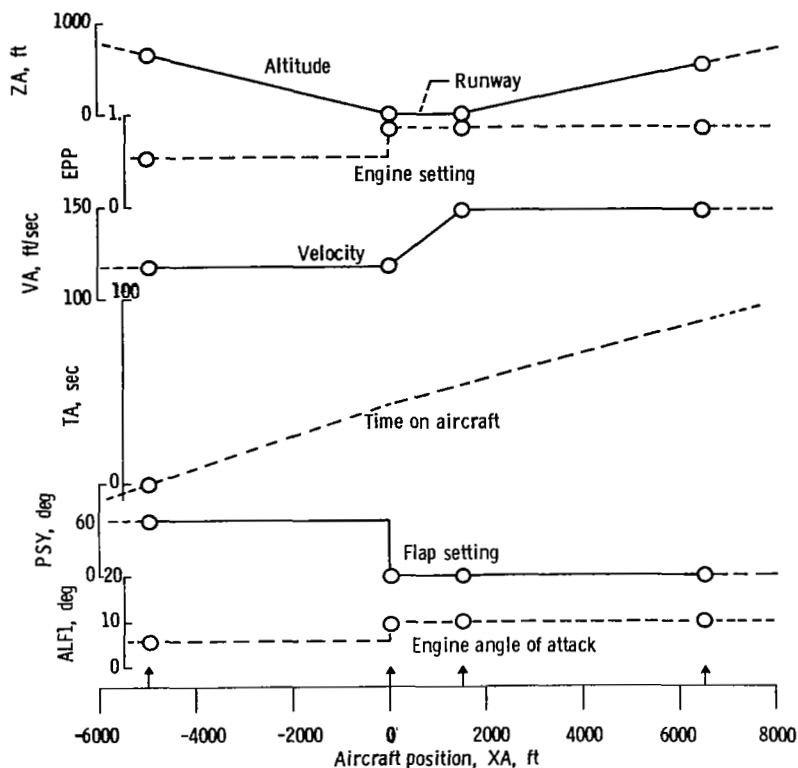

Figure 18. - Flight geometry of example three.

inlet and exhaust suppression spectra are supplied here, but are not used, since $ISUPPR = 0$. The input of $ISUPPR$ here is unnecessary since the $SOURCE$ input accepts the default value of $ISUPPR = 0$.

The jet noise input ($JETDA$) calls for a coaxial nozzle calculation ($INOZ = 1$), with values supplied for the core gas parameters $GAMMAC$ and $GASRC$. If values of the fuel flow rate ($AFUEL$) had been supplied in $PARAM$, $GAMMAC$ and $GASRC$ could have been omitted here and would have been calculated in the jet noise subroutine.

The inputs for core, turbine, and flap noise subroutines are the same as those in Example One, although the flap noise inputs ($FLAPDA$) are ignored in this example.

Example Five

In this example the aircraft noise is calculated for a single observer during an aircraft approach to the landing point. The aircraft is at 394 feet altitude as it flies over the observer at 7518 feet before touchdown. The aircraft angle of attack ($ALFL$) is 8.83° above its flight path, or 5.83° above horizontal, since the flight path represents a 3° glide slope. Slotted flaps and landing gear are deployed

throughout the approach, and engine power and aircraft velocity are constant. Noise levels will be calculated 21 times (default value) at 0.5-second intervals. The input value for $UNITS$ could have been omitted here but is included for illustration. The value is alphanumeric and is read in the Hollerith convention (as $3HENG$ or $2HSI$).

The aircraft has three engines generating fan, jet, core, and turbine noise. Airframe noise is also expected to be a contributor. Doppler frequency shift and source motion amplification will be applied as well as a simple ground reflection correction of 3 decibels. Atmospheric attenuation will be calculated by the methods of references 14 and 15. Suppression will be applied when suppression spectra are given (fan inlet and exhaust and turbine). Source spectra will be printed at each time, and $EPNL$ will be calculated for the single observer point.

Engine characteristics are given at approach and takeoff power settings. In this case no interpolation is required. Note that no values are given for the fan stream exhaust velocity or temperature. The exhaust nozzle is assumed to fully mix fan and core streams, and AVC and ATC represent the mixed values. This requires that separate values be supplied for the turbine exhaust temperatures ($ATCTUR$) for the

prediction of turbine noise. Values of AFUEL are given, although they are not used since AT4 values are included and GAMMAC and GASRC are given later.

The jet noise input accepts the default value of INOZ=0 for a simple nozzle. This is chosen to be compatible with the mixed values used for AVC and ATC. GAMMAC and GASRC are also mixed-flow values. The total mixed flow exhaust area is given for AC.

The aircraft has a total wing area of 4007.6 square feet and a wing span of 200.19 feet. The total horizontal tail area is 927.82 square feet with a total span of 68.11 feet; the vertical tail area is 577 square feet with a height (span) of 29.45 feet. There are two slotted flaps (default NF=2) with a total area of 880.5 square feet and total span of 108.4 feet (fig. 14). There is a single nose landing gear with two wheels 2.925 feet in diameter. The two main landing gear each have four wheels 4.17 feet in diameter. The ratios of strut length to wheel diameter are 3.93 for the nose gear and 3.46 for the main gear (i.e., the nose strut is 11.5 ft long and the main gear struts are 14.4 ft long). The calculation is for an aerodynamically clean aircraft; so ICLEAN=0. Setting IWING=1 causes the wing and the horizontal and vertical tail trailing-edge noise to be included, and IFL=1 adds the slotted-flap noise for flaps at the angles specified during the flight in &TRAJ. There are no leading-edge slats.

Example Six

This example shows the additional inputs required for a footprint contour calculation for the aircraft landing of Example One. A single contour of 90 EPNL is called for, in the form of Y coordinates at 11 values of XO. The extremes of these XO values were selected from preliminary calculations of EPNL at various points under the flight path (at YO=0) to find the approximate terminations of the footprint contour. To give an adequate time history for each EPNL calculation, NT was set at 21.

When the aircraft has decelerated to a stop at XA=1500 feet, the calculated EPNL will go to infinity unless the engine operating level is reduced to such a point that the PNLT is more than 10 decibels below the maximum. To enable extrapolation to such low settings, engine performance is defined artificially at EPP=0. At the XA=1500 foot point, the operating level is set to a somewhat arbitrary low level of 3 percent.

Samples of Output

The complete calculated outputs from input

Examples One through Six are given in tables V through X, respectively. Brief portions of the output derived from these same examples modified as to requested output (IOJT) are given in table XI. Detailed discussion of these output examples follows.

Example One

This output (table V) has the one-line title chosen by the user. A summary of the observer coordinates and of the aircraft trajectory points and flight conditions then follows. This summary of inputs can be turned on or off by choice of ITITLE (default ITITLE=1). The next three lines are the titling and values for the first point in response to IGEOM=1. Subsequent points only include numerical values as on the third line. The values given represent the interval number (KI), the aircraft position (XI, YI, ZI), the aircraft-observer geometry (R, THETA, THETAF, PHI), the time at the aircraft and corresponding arrival time at the observer (TI and TAU), the engine power setting (EPPI), and the aircraft velocity (VI). Although this line of information is redundant or peripheral to the noise calculations, these values can be of help in tracing the flight history, especially with a complicated geometry or in troubleshooting. The following line prepares the reader for the individual spectra at the frequencies listed on the next two lines.

At each time interval a summary of the observer location, observer time (TAU), and aircraft location in terms of radius (R) and angle (THETA) is given in a single line. Each source spectrum then follows in a two-line format corresponding to the previously listed frequencies. Values of OASPL, PNL, and PNLT for each individual source are also given. Remember that each individual spectrum is unmodified for any propagation losses specified. The total noise spectrum (on the last two lines following the source spectra) represents the sum of the individual sources, with all the appropriate corrections included—in this case, atmospheric attenuation and simple ground reflection. If shielding had been called for, the total spectrum would include the effects of shielding the fan, core, and turbine sources.

Succeeding time interval outputs include the new geometric output line for IGEOM=1, the line for the general location description at the new time, and lines for the individual and total spectra. For the first observer point the aircraft proceeds from an initial point at TAU=21.6 seconds, where R=817.0 feet and THETA=46.7°, to the closest point of approach at 26.4 seconds, where R=564.1 feet and THETA=92.8°, and ends at 31.6 seconds with R=817.0 feet and THETA=138.8°. A longer history and a greater range in THETA could be

obtained by increasing either the number (NT) or size (TD) of the time intervals. Similar time histories are generated for each position of the observer.

It is apparent for the first observer point and first time interval that fan noise is the primary contributor to the total PNL, although flap noise is predominant at the low frequencies and is the stronger contributor to OASPL. The total OASPL is 3.6 decibels above the flap noise OASPL, 3 decibels of which is due to the ground reflection. Total PNL is only 0.8 decibel above that from the fan alone, although 3 decibels are also added here by the ground reflection. Although the unattenuated high-frequency harmonics from the fan are strong, atmospheric attenuation causes the total spectrum to fall off rapidly as the frequency approaches 10 kilohertz. The user is cautioned that simply comparing individual source PNL may lead to incorrect conclusions in determining the controlling source at large distances, since the individual source levels include no atmospheric attenuation. Low-frequency sources, such as flap noise in this case, will assume increasing importance as distance and atmospheric attenuation increase.

The combined effects of source directivity and changing distance can be observed for each source as the aircraft flies past the observer points. In this particular example, changes in R with time produce changes in source levels of 3.2 decibels at the most, so that the prevailing influence on the source histories is their own directivity.

After the output of the spectra at each time and observer location, the program prints the maximum level of PNL for the total noise source at each XO,YO location of the observer points. Maximum PNL or EPNL would have been given if the input specified other values for IOU(2). Identification of the maxima is helped by also printing out the angles (THETA) and times (TAU) when the maxima occurred for each observer point. For the first two observer points at a sideline distance (YO) of 1000 feet, these maxima occur near the end of the time history, indicating that a longer time history is desirable. For the first two 500-foot sideline locations also, the last point is only 3 to 4 decibels below the maximum PNL. For calculation of a valid EPNL at these locations a longer history would be recommended.

The noise histories at the last two observer locations (XO=0 and YO=500 and 1000) show the effect of the engine power cutback at touchdown. The fan and flap noise levels drop dramatically, but the turbine noise drops only slightly. Regarding the turbine noise, it is interesting that there are no tones in the spectra and no tone corrections (PNL = PNL) before cutback; but, when the turbine speed drops, tones appear in the spectra at 3162 and 6309 hertz

that are sufficient to give a tone correction of about 3.5 decibels.

Example Two

The output from Example Two is shown in table VI. It is for an aircraft takeoff after a 1500-foot accelerating roll on the runway. The initial portion of this output is in the same form as the output from Example One, except for the summary. The engine power is constant before and after liftoff, and the aircraft velocity increases at constant acceleration until the specified VA of 148.6 feet per second at liftoff. This acceleration can be seen in the VI values listed in the geometry information.

Since IOU(1)=2 for this case, overall levels are given for the individual sources instead of spectra. Titles above the source noise levels are modified from those of the previous case. Here the observer coordinates and time (XO, YO, and TAU) are identified along with the noise level quantities. The reader is reminded that the individual levels do not include ground reflections or atmospheric attenuation. Hence the levels for fan noise alone can exceed the total levels, as in the first three time increments shown.

Because of the angle of climb and angle of attack of the aircraft, when the aircraft has passed the observer, the observer is able to "see" the upper surface of the wing and flaps (THETA>180°). Although the first part of each time history is dominated by fan noise, the last few points are dominated by the flap noise, which increases dramatically in directions above the wing for an over-the-wing configuration.

Specification of IOU(2)=2 causes the summary information with the values of maximum PNL to be given at the end. By comparing these maxima with the individual source histories, it can be seen that for this case the flap noise component is the primary noise contributor at all the maxima except at XO=3500,YO=500, where the fan noise dominates.

Even though NT was increased from 11 for Example One to 21 for this example, at some observer points the last level given in the history is only a few decibels below the maximum. Calculation of EPNL from the time histories in these cases might be quite inaccurate because of the long extrapolation involved in approximating the 10-decibel-down point.

Example Three

The output for Example Three (table VII) is for a combined landing and takeoff similar to Examples One and Two. The flight history is described in detail

in the discussion of the sample inputs. This example is included to illustrate the care that must be exercised when a large power-level change occurs at some point in the aircraft flight. By referring to figure 18, it is evident that the increase in power setting does not occur until 42.7 seconds into the flight (landing and takeoff). The resultant increase in noise level will be sensed later at the observer point, depending on the distance from the aircraft when the change occurs. The printout shows that by the 38th point in the time history the power level has changed and that the specified observer will hear it almost 2 seconds later. The total noise PNL jumps by over 17 decibels and exceeds the previous maximum PNL by 3.5 decibels. If the number of specified time increments (NT) had been 33 or less, the time history for this observer would have omitted this loudest portion, and the calculated maximum and time weighting factor (if used for EPNL) would have been in serious error.

This example also illustrates the output when IOUT(1)=3. Only the noise totals, modified by specified propagation effects, are listed at each time increment.

Example Four

The output in table VIII shows the use of RADIUS, in place of FOOTPR and NOIS, to calculate predicted noise levels at a constant radius from the source at angles chosen by the user. As can be seen from the format, this output is similar to typical printouts for the acoustic measurements from static ground tests. A page is devoted to each source component, given as free-field unattenuated values, followed by a page for the total of the sources, including any propagation corrections. This sequence of pages is repeated for each engine operating condition (EPPI) requested.

For sources that are not axisymmetric (powered-lift flap noise and airframe noise), these source levels will be calculated and printed out on separate pages for each azimuthal angle (PHI) requested.

Each page begins with four heading lines for the title, engine operating condition, source identity, and number of engines, radius, and azimuthal angle. When ITITLE=1, several lines then give the important parameters used in the prediction. These values have been either entered by the user (in &PARAM or individual source input) or are default or calculated values. For example, in the fan noise input, values of fan pressure ratio (AFPR) rather than temperature rise (ADELT) were supplied in &PARAM. From the interpolated value of FPR = 1.054 (at EPPI = 37.78) and the fan efficiency (FANEFF = 0.84), a temperature rise DELT of 9.4° R is calculated in the fan noise subroutine and is

shown in the list of input parameters. It is well for the user to check these input values to insure that no unintended omissions or defaults are entered in the calculation.

In addition to the spectrum at each THETA, the OASPL, PNL, and PNLT for each spectrum are calculated and printed near the bottom of each page. The OASPL values represent only the summation of the SPL values for the frequencies given (50 Hz to 10 kHz). Hence, in cases where the spectral energy maximizes near the high or low end of the frequency spectrum, there may be an appreciable difference between these listed OASPL values and the overall levels calculated within each source subroutine prior to generating a spectrum.

The power spectrum is calculated by assuming an axisymmetrical source and is shown in the last column of printout. The total acoustic power appears in the same column at the end of the OASPL line. The total acoustic power predicted from the fan at EPPI = 37.78 in this example is 132.9 decibels (ref. 0.1 pW).

Example Five

The output in table IX illustrates the use of FOOTPR with airframe noise included as a source. There is only one observer point; it is located under the path of the aircraft as it makes an approach. A total of 10 seconds of time history is used for calculating the EPNL. For this example, airframe noise is shown to be a minor contributor compared with the suppressed fan noise for most of the history. The total noise levels in PNL go from 91.5 decibels to a maximum of 103.9 decibels and back down to 80.1 decibels, giving adequate range for a good EPNL calculation. The summary shows an EPNL of 97.6 decibels at the observer, with the maximum levels occurring at TAU = 0.96 second (rounded to 1.0 sec in the history) and THETA = 115°.

Example Six

In table X the results of the contour calculation using the Example Six inputs are shown. For illustration of the convergence to the Y coordinate of the contour, IOUT(1) was set to 3 for those portions of the calculations when XO was -7000 and 1000 feet. Notice that at -7000 feet, two iterations were required to obtain a calculated EPNL of 90 decibels (± 0.1 dB) at a Y coordinate of about 366 feet. At XO = 1000, only one iteration was required to arrive at the contour coordinate of about 447 feet.

The normal output for IOUT = 0,3,3 is shown beginning with the repeat of the title line. The EPNL values at the two (by default) sideline distances are

then given at each XO position. Also included are the angles (THETA) and observer times (TAU) when the maximum PNLT occurred.

The 90-EPNL-contour coordinates are then listed and the approximate area in square feet, acres, and square miles. Because of the reduced power when the aircraft touches down and the near shutdown of the engines at $XA = 1500$ feet, the footprint closes just shortly beyond the end of the aircraft roll. The first and last XO points (at -7500 and 1600 ft) for this contour calculation were selected after trial calculations for the EPNL at $YO = 0$ and $XO = -8000, -7500, 1550, 1600,$ and 1700 feet. If coordinates had been requested at XO values less than about -7500 feet or greater than about 1600 feet, the program would not have been able to obtain a successful convergence.

Illustrations of Printout Options

Some of the output choices available to the user are shown in table XI; the basic inputs from Examples One and Six are used and the IOUT output controls are varied. Table III specifies the input values of IOUT, IGEOM, and ITOT to exercise various output options. For the examples discussed in this section, $IGEOM = 0$ and $ITOT = 1$.

The output resulting from $IOUT(1) = 1$ is also demonstrated in the Output from Example One (table V). Detailed spectra are given from each source and for the total at each time increment. The program equates JOUT in each noise source subroutine with $IOUT(1)$. Various selections of source outputs can be made by using $IOUT(1)$ and $ITOT$ and giving JOUT inputs to each source. For example, by setting $IOUT(1) = 0$ and then inputting $JOUT = 1$ in a particular source input, the spectrum of only that source will be given at each time increment. By setting $IOUT(1) = 1$, but $JOUT = 0$ for all individual noise source inputs, only the spectra for the total noise will be given.

The effects of setting $IGEOM = 0$ (or omitting IGEOM) and $ITITLE = 0$ are shown by comparing table XI to table V; the lines of geometric information are omitted, and there is no initial printout of the observer and trajectory coordinates. When $IOUT(1) = 2$, only the summary information of OASPL, PNL, and PNLT is shown for each source and the total at each time increment. Notice that these values are the same as those in the more detailed printout in table V. This level of output is useful when there are no problems concerning the spectra or when the user has already satisfied himself concerning the spectra in previous calculations.

When $IOUT(1) = 3$, the next sample in table XI shows just the OASPL, PNL, and PNLT histories

for the total of the noise sources, modified for the propagation losses specified. This total history may be adequate when an EPNL calculation is being made and the user wishes to check the time history being integrated into EPNL.

When $IOUT(1) = 0$, all time history information is omitted in the printout, and only the maximum levels are given for each observer, along with the angle and time when each maximum occurred.

Corresponding outputs when $IOUT(2)$ equals 1, 2, or 3 are shown next in table XI. The values of PNL-max and PNLT-max are the maxima of those shown in table V. The angles THETA and the times indicate where the maxima occurred. When $IOUT(2) = 0$, these printouts of maxima or EPNL are omitted.

To calculate PNL, PNLT, or EPNL contours, set $IOUT(3)$ equal to 1, 2, or 3, respectively. The results are shown for the inputs of Example Six. The first two values of YO are taken as the default values of 500 and 1000. To define contours for these examples, NXO is increased to 11, and XO values are added between -7500 and 1600 feet. The number of time increments (NT) is increased to 21 to improve the EPNL calculation. The contour area is that integrated between the first and last value of XO . Large errors in area can occur if the program fails to converge to a Y coordinate at some XO , or if it somehow converges to a negative value of Y. Where the user can anticipate that at some XO points the requested contour level will be very near the X axis, the solution for the Y coordinate will be expedited by setting one of the initial YO values to zero.

On the IBM 360 computer the solution for the Y coordinates for a contour level of 90 EPNdB at four XO distances required approximately 100 seconds of CPU time. The calculations are for four independent noise sources, with a 3-decibel ground reflection and atmospheric attenuation applied to the total, evaluated 21 times along the aircraft trajectory.

Program Listings

A complete listing of the main programs FOOTPR and RADIUS and all subroutines used by them are shown in appendix B. Punched cards or tapes for these listings can be obtained by suitable request from COSMIC, 112 Barrow Hall, University of Georgia, Athens, Georgia, 30602 (telephone 404-542-3265).

Concluding Remarks

Programs have been demonstrated that enable the user to make single- and multiple-point and contour

noise calculations by using the procedures recommended in the ANOP noise source documentation. Various common corrections can be made to account for propagation and shielding effects.

Each of the main programs and subroutines have been discussed to aid the user in relating the program features to the noise source predictions and to his particular problem. Sample inputs and outputs have been described at length, with tables for illustration. Generally, the programs are simple enough that the user should be able to make any modifications that might better suit his application.

There are several present limitations to this program. Some of these are listed here. However, the program will be found useful in a wide variety of noise prediction situations.

(1) No provision is made for a layered atmosphere in the calculation of atmospheric attenuation. This would require an additional subroutine to break the propagation path into several segments having distinct properties and then to apply the existing attenuation predictions to each segment.

(2) Suppression spectra can be applied to individual sources, but only as a function of frequency. Source directivity is also modified by suppression treatment, but no provision is made for this in the present version. Additional subroutines to

predict the suppression of each source, based on the physical characteristics of the suppressor, would also be highly desirable.

(3) No provision is made for the calculation of jet noise with a multiple-tube or chute type of suppressor.

(4) Provision has not yet been made for predicting the noise for inverted velocity profiles of coaxial jet nozzles.

(5) Eventually, it may be desirable to predict the propagation of each source individually to the far field. Shielding and ground reflection effects, and perhaps others, depend to some degree on the characteristics of the source. In addition, there are possible interference effects between similar noise sources on separate engines. The specific locations of the engines on the aircraft, as well as the wing and fuselage shielding will affect any interferences.

(6) Some provisions for a thrust reverser noise prediction have already been incorporated in these programs, but no subroutine for this noise source has been provided as yet. The user may wish to develop and incorporate a subroutine for reverser noise.

Lewis Research Center
National Aeronautics and Space Administration
Cleveland, Ohio, April 2, 1981

Appendix A Symbols

Symbols used in the text of this report are listed here. Other symbols for input parameters are listed in table III. Where appropriate, the noise module in which the variable appears, or is input, is identified by the module name. Variable names in capital letters correspond to the names in the Fortran coding.

A	array of variables in interpolation routine	ATIPM	array of fan blade tip relative Mach numbers, engine map
A	array of areas, AIRFR, m ² (ft ²)	ATIPM2	array of second fan stage relative Mach numbers, engine map
\hat{a}	unit direction vector on aircraft (fig. 3)	ATURTS	array of turbine rotor tip speeds, engine map, m/s (ft/s)
AC	core nozzle area, JET, m ² (ft ²)	AVC	array of core nozzle exit velocities, engine map, m/s (ft/s)
AC1	core nozzle area, FLAP, m ² (ft ²)	AVF	array of fan nozzle exit velocities, engine map, m/s (ft/s)
ADELTA	array of fan temperature rises, engine map, K (°R)	AWAFAN	array of fan total airflows, engine map, kg/s (lb/s)
AF1	fan nozzle area, FLAP, m ² (ft ²)	AWCORE	array of core total (air + fuel) flows, engine map, kg/s (lb/s)
AFPR	array of fan pressure ratios, engine map	B	array of variables in interpolation routine
AFUEL	array of fuel flow rates, engine map, kg/s (lb/s)	B	array of span lengths, AIRFR, m (ft)
AIRM	Mach number of air approaching fan face, FAN	b	aircraft position with respect to observer (fig. 4(a)), XA - XO
ALF	angle between engine axis and ground plane, ALF = ALF1 + ALF2, deg	BETA	coefficient in PHI-angle dependence, FLAP
ALF1	engine angle of attack, deg	BPD	intermediate variable in defining aircraft position
ALF2	angle of climb of aircraft, deg	BDPH	intermediate variable in defining aircraft position
ANNHT	primary nozzle annulus height JET, m (ft)	BPR	bypass ratio of engine, FLAP
ANNHTF	fan nozzle annulus height JET, m (ft)	C	array of variables in interpolation routine
AP3	array of combustor inlet pressures, engine map, N/m ² (lb/ft ²)	C	ambient speed of sound, m/s (ft/s)
APHI	array of angles to sideline (fig. 4(b)), for RADIUS, deg	CAY	coefficient in forward speed effect on source, FLAP
ARPM	array of fan speeds, engine map, rpm	CFUSE	characteristic dimension of fuselage (i.e., diam), SHLD, m (ft)
AT3	array of combustor inlet temperatures, engine map, K (°R)	CG	ratio of strut length to wheel diameter, AIRFR
AT4	array of combustor exit temperatures, engine map, K (°R)	COMMENT	array of initial title in FOOTPR or RADIUS
ATC	array of core nozzle exit temperatures, engine map, K (°R)	CS	ratio of stator chord to rotor spacing, TURB, percent
ATCTUR	array of turbine exit temperatures, engine map, K (°R)	CSUPP	suppression spectrum, CORE, dB
ATF	array of fan nozzle exit temperatures, engine map, K (°R)	CWING	characteristic dimension of wing (i.e., chord), SHLD, m (ft)
ATHETA	array of angles from engine inlet (fig. 4(b)), for RADIUS, deg	CX	speed of sound at fan face, FAN, ft/s
		d	aircraft position with respect to observer (fig. 4(a)), YA - YO

DECMPT	decrement to combination tone levels, FAN, dB	GASRC	gas constant of core exhaust, JET, j/kg/K (ft-lb/lbm/°R)
DELF	fuselage shielding factor, SHLD, dB	GEAR	gear ratio, last stage turbine to fan, TURB
DELT	fan temperature rise, FAN, °R	h	aircraft position with respect to observer (fig. 4(a)), ZA – ZO
DELW	wing shielding factor, SHLD, dB	HEAD	angle between aircraft track and X axis, deg
DHC	hydraulic diameter of core nozzle, JET, m (ft)	\hat{i}	unit vector along X axis
DHF	hydraulic diameter of fan nozzle, JET, m (ft)	IATM	key to effect atmospheric attenuation corrections
DK	array of source heights, GNDRFL, m (ft)	ICLEAN	key for clean aerodynamic configuration, AIRFR
DMB	intermediate variable in defining aircraft position	ICORR	key to correct engine parameters to ambient conditions
DTEMD	design temperature drop across turbine, CORE, K (°R)	ICPA	key to center time history or start time at first point
DW	tire diameters of nose and main gear wheels, AIRFR, m (ft)	IDOP	key for Doppler shifts and source motion corrections
EDOP	exponent on FDOP for source motion amplification	IEGA	key to effect extra ground attenuation corrections
EDOP2	same as EDOP, specific for second fan stage, FAN	IEXH	key for including inlet or exhaust noise, FAN
EPNL	effective perceived noise level, time and tone weighted, dB	IFD	key to indicate inlet flow distortion, FAN
EPP	array of engine performance parameters in FOOTPR	IFL	key to include slotted-flap noise, AIRFR
EPPI	engine performance parameter, FOOTPR, or input to RADIUS	IFLAP	key to calculate powered-lift (flap) noise, NOIS
F	array of dependent variables in interpolation routine	IFWD	key to correct sources for forward velocity, JET and FLAP
FANEFF	fan aerodynamic efficiency (<1), FAN	IGEOM	key to obtain extra geometry information in printout
FDOP	Doppler factor for frequency shift and motion amplification	IGND	key to effect ground reflection corrections
FILBW	fraction of filter bandwidth having gain of 1	IGV	key for inlet guide vanes, FAN
FLAPA	array of angles of slotted flaps, in FOOTPR, deg	IJET	key to include jet noise, NOIS
FLAPI	slotted flap angle, AIRFR, deg	ILG	key to include landing gear noise, AIRFR
FLSUPP	suppression spectrum, FLAP, dB	ILGR	array of keys for landing gear noise, in FOOTPR
FPR	fan pressure ratio, FAN	IMOD	key to use modified prediction procedure, CORE
FR	gain factor of filter, FAN and TURB	INOZ	key to indicate nozzle type, JET and FLAP
FSHIFT	array of phase shifts of reflected signal, GNDRFL, deg	INSENS	key for flap angle sensitivity, FLAP
GAM	array of banking angles of aircraft, deg	IOUT	key for various levels of detail in calculated output
GAMMA	specific heat ratio of core flow, CORE		
GAMMAC	specific heat ratio of core nozzle exhaust, JET		
GAMMAF	specific heat ratio of fan nozzle exhaust, JET		

IREVR	array of keys to calculate reverser noise, in FOOTPR	\hat{p}	unit vector along aircraft trajectory
ISKIP	key to skip unnecessary steps in NOIS and JET	PHI	angle in sideline direction (fig. 4(b)), deg
ISLAT	key to include slatted-leading-edge noise, AIRFR	PNL	perceived noise level
ISUPP	key to apply suppression spectra to all sources	PNLT	perceived noise level, tone weighted
ISUPPR	override key to ISUPP in each source module	PSY	array of powered-lift flap angles, in FOOTPR, deg
ITITLE	key for printing preliminary inputs to noise calculations	PSYI	powered-lift flap angle, in RADIUS, deg
ITONE	key to treat spectrum protrusions as tones, GNDRFL	QABS	array of ground reflectivities, GNDRFL
ITOT	key to include or reject total of source spectra in printout	R	distance from aircraft to observer, m (ft)
ITYPTB	key for turbine nozzle exhaust position, TURB	\bar{R}	radius vector from aircraft to observer
ITYPW	key for aircraft wing type, AIRFR	RPM	fan speed, FAN, rpm
IUOTW	key for engine location under or over wing, FLAP and SHLD	RSS	rotor-stator spacing, FAN, percent
IWING	key to include wing and tail noise, AIRFR	RTSM	fan rotor blade tip Mach number, FAN, ft/sec
\hat{j}	unit vector along Y axis	SFUSE	maximum fuselage shielding at THETA = 90°, SHLD, dB
JOUT	key for control of individual source outputs	SMX	angle in flyover plane of maximum wing shielding, SHLD, deg
\hat{k}	unit vector along Z axis	SPL	sound pressure level, roughly one-third octave, dB
KI	counting parameter, number of time increments, FOOTPR	SUPPEX	suppression spectrum for fan exhaust, FAN, dB
MTRD	design tip relative Mach number in ref. 1	SUPPIN	suppression spectrum for fan inlet, FAN, dB
NF	number of trailing-flap slots, AIRFR	SWIDE	angle span of fuselage shielding, SHLD, deg
NG	number of nose and main landing gear, AIRFR	SWING	maximum wing shielding, SHLD, deg
NPHI	number of values of APhi supplied, in RADIUS	T3	combustor inlet temperature, CORE, °R
NS	number of sources simulating distributed source, GNDRFL	T4	combustor exit temperature, CORE, °R
NT	number of time increments for noise calculations, in FOOTPR	TAU	retarded time at observer position, s
NTHETA	number of values of ATHETA supplied, in RADIUS	TC	core nozzle exit temperature, JET, °R
NW	number of nose and main landing gear wheels, AIRFR	TCTUR	turbine exit temperature, TURB, °R
NXO	number of XO coordinates supplied, in FOOTPR	TD	size of time increment for noise calculations, s
NYO	number of YO coordinates supplied, in FOOTPR	TF	time at end of EPNL integration (fig. 15), EPNL, s
OASPL	overall sound pressure level (broad-band), dB	THETA	angle between engine inlet and observer direction, deg
		THETA F	projection of THETA in plane of \hat{a} and \hat{u} (fig. 4(b)), deg
		THETA H	projection of THETA in plane of \hat{a} and \hat{w} (fig. 4(b)), deg
		TI	time on aircraft at noise calculation, FOOTPR, s

TIPM	relative fan tip Mach number, FAN	\hat{w}	unit direction vector on aircraft (fig. 3)
TIPM2	relative second-stage fan tip Mach number, FAN	WINGD	ratio of wing chord to nozzle diameter, FLAP
TIPMD	design relative fan tip Mach number, FAN	X	coordinate (fig. 2)
TIPMD2	second-stage design relative fan tip Mach number, FAN	XA	array of aircraft coordinates (fig. 2), m (ft)
TS	time at start of EPNL integration (fig. 15), EPNL, s	XI	aircraft coordinate at time TI, m (ft)
TSTART	reference time at first trajectory point, FOOTPR, s	XO	array of observer coordinates (fig. 2), m (ft)
TSUPP	suppression spectrum, TURB, dB	Y	coordinate (fig. 2)
TURTS	last-stage rotor relative tip speed, TURB, ft/s	YA	array of aircraft coordinates (fig. 2), m (ft)
\hat{u}	unit direction vector on aircraft (fig. 3)	YI	aircraft coordinate at time TI, m (ft)
UNITS	variable designating SI or U.S. customary units	YO	array of observer coordinates (fig. 2), m (ft)
VA	array of aircraft velocities, FOOTPR, m/s (ft/s)	Z	coordinate (fig. 2)
VI	aircraft velocity, in FOOTPR, or input to RADIUS, m/s (ft/s)	ZA	array of aircraft coordinates (fig. 2), m (ft)
VIEW	elevation angle of aircraft from observer, FOOTPR, deg	ZETA	angle between aircraft motion and observer direction, deg
		ZI	aircraft coordinate at time TI, m (ft)
		ZO	array of observer coordinates (fig. 2), m (ft)

Appendix B

Listings of Main Programs and Subroutines

Page	Program
32	FOOTPR (Main Program)
38	NOIS (Subroutine)
41	RADIUS (Main Program)
49	FAN (Subroutine)
54	JET
59	CORE
61	TURB
63	FLAP
66	AIRFR
69	AIRATT (Function Subroutine)
69	BASAT (Subroutine)
70	ATMB
71	EGAC
71	GNDRFL
72	SHLD
74	PERNOY (Function Subroutine)
74	TONE (Function Subroutine)
75	EPNL (Function Subroutine)
76	TERP (Subroutine)
77	SERCH (Subroutine)

Main Program FOOTPR

```

0000100 C      MAIN PROGRAM FOR FOOTPRINT CALCULATION
0000200 C      FROM AIRCRAFT NOISE SOURCE SUBROUTINES
0000300 C      WRITTEN AT LERC AS PART OF ANOP SUPPORT EFFORT.
0000400 C      PROGRAM CALCULATES GEOMETRY FOR FLIGHT PAST SELECTED GRID POINTS,
0000500 C      OR POINTS ON SPECIFIED NOISE CONTOUR LINES.
0000600 C
0000700 C      CALLS SUBROUTINES NOIS AND EPNL
0000800 C      OUTFLOW:  UNITS,ISKIP,IREV,ILG,FDOP,C,TAMB,PAMB,RH,
0000900 C      R,THETA,THETA,F,THETA,H,PHI,VIEW,HEAD,PSYI,FLAPI,EPPI,
0001000 C      VI,X,Y,TAU,IJ,KI,ZO,ZI
0001100 C      RETURN FLOW:  PNL,PNLT,EPNL,TIS,TIF
0001200 C
0001300 C      INPUTS ARE THROUGH NAMELIST BLOCKS "GRID", "AMB", AND "TRAJ"
0001400 C
0001500 C      DIMENSION XO(20),YO(20),XOM(20),YCON(20),YCONM(20),XA(50),YA(50),-
0001600 C      1 ZA(50),ALF(50),ALF1(50),GAM(50),EPP(50),VA(50),TA(50),PSY(50),-
0001700 C      2 FLAPA(50),ILGR(50),IREVR(50),ALFCOS(50),ALFSIN(50),FPNL(100),-
0001800 C      3 TIME(100),CONTR(5)
0001900 C      DIMENSION FPNLMX(20,20),TAUMX(20,20),THETMX(20,20),COMENT(20)
0002000 C      COMMON UNITS,ISKIP,IOUT(3),IREV,ILG,FDOP,C,TAMB,PAMB,RH,NENG
0002100 C      COMMON/GEOM/R,THETA,THETA,F,THETA,H,PHI,VIEW,HEAD,PSYI,FLAPI,EPPI,-
0002200 C      1 VI,X,Y,TAU,IJ,KI,ZO,ZI
0002300 C      DATA SI,ENG/2HSI,3HENG/,AR/.0174533/
0002400 C      NAMELIST/GRID/UNITS,NXO,NYO,XO,YO,ZO,NCONTR,CONTR
0002500 C      NAMELIST/TRAJ/NP,XA,YA,ZA,ALF1,GAM,EPP,VA,PSY,FLAPA,ILGR,IREVR,-
0002600 C      1 TSTART,TD,NT,ICPA,IGEOM,ITITLE
0002700 C      NAMELIST/AMB/TAMB,PAMB,RH
0002800 C      UNITS=ENG/SI (FOR ENGLISH/INTERNAT. UNITS FOR INPUT & OUTPUT)
0002900 C      NXO,NYO = NO. OF X AND Y COORDS. FOR OBSERVERS
0003000 C      XO,YO,ZO = X, Y, & Z COORDS. OF OBSERVERS (ALL AT ZO)
0003100 C      NCONTR = NO. OF SOUND LEVEL CONTOURS DESIRED
0003200 C      CONTR = NCONTR VALUES OF CONTOUR LEVELS (PNL,PNLT,EPNL)
0003300 C      NP = NO. OF POINTS NEEDED TO SPECIFY AIRCRAFT PATH
0003400 C      XA,YA,ZA = NP VALUES OF X, Y, & Z ON AIRCRAFT PATH
0003500 C      VA = NP VALUES OF AIRCRAFT VELOCITY
0003600 C      EPP = NP VALUES OF AIRCRAFT POWER SETTING
0003700 C      ALF1 = NP VALUES OF A/C ANGLE OF ATTACK
0003800 C      GAM = NP VALUES OF A/C BANK ANGLE
0003900 C      PSY = NP VALUES OF A/C FLAP ANGLE (FLAP NOISE)
0004000 C      FLAPA = NP VALUES OF FLAP ANGLES FOR AIRFRAME NOISE
0004100 C      ILGR = 1/0 (FOR LANDING GEAR DOWN/UP)
0004200 C      IREVR = 1/0 (Y/N FOR REVERSERS OPERATING), NP VALUES
0004300 C      TSTART=TIME ON AIRCRAFT AT FIRST PATH POINT GIVEN
0004400 C      TD = SIZE OF TIME INCREMENTS IN SEC.
0004500 C      NT = NO. OF TIME INCREMENTS (INDEP. OF NP), UP TO 100
0004600 C      ICPA = 1/0 (Y/N TO CENTER TIME HISTORY ON CLOSEST POINT OF
0004700 C      APPROACH; OTHERWISE START HISTORY AT FIRST TRAJECTORY POINT)
0004800 C      ITITLE = 1/0 (Y/N FOR TITLING OUTPUT WITH INPUT GEOMETRY)
0004900 C      IGEOM = 1/0 (Y/N FOR PRINTING EXTRA GEOMTRY INFO)
0005000 C      TAMB,PAMB,RH = AMBIENT TEMP, PRESSURE AND REL. HUM.
0005100 C      (UNIFORM ATMOSPHERE)
0005200 C      NOTE THAT THE FOLLOWING DATA ARE ASSIGNED AS DEFAULT VALUES
0005300 C      DATA ICPA,NXO,XO,TSTART,TD,NT,IGEOM/2*1,20*500.,0.,1.,21,0/
0005400 C      DATA NYO,YO,NCONTR,CONTR/2,500.,19*1000.,1,90.,95.,3*100./
0005500 C      FOR TAKEOFF WITH 6 DEG CLIMB STARTING FROM
0005600 C      XA=0., ZA=ENG HT=8 FT, TO ZA=5000., WITH VA=150., EPP=100.
0005700 C      DATA NP,XA,ZA,YA,GAM,VA/2,0.,49*47496.,8.,49*5000.,100*0.,50*150./
0005800 C      DATA EPP,PSY,FLAPA,ILGR,IREVR/50*100.,100*0.,100*0/
0005900 C      UNITS=ENG
0006000 C      ZO=4.
0006100 C      GAMMAF=1.4
0006200 C      TAMB=-1.
0006300 C      PAMB=-1.

```

```

0006400 C      THESE NEG. VALUES TO DETECT IF DATA READ IN.  FINAL DEFAULTS
0006500 C      GIVEN AT STATEMENT 6.
0006600      RH=70.
0006700      NENG=1
0006800      ITITLE=1
0006900 C
0007000      READ(5,91) (COMENT(I),I=1,20)
0007100      READ(5,GRID)
0007200      READ(5,TRAJ)
0007300      READ(5,AMB)
0007400      WRITE(6,92) (COMENT(I),I=1,20)
0007500      IF(ITITLE.EQ.0) GO TO 2
0007600      IF(UNITS.EQ.ENG) WRITE(6,97) (XO(I),I=1,NX0)
0007700      IF(UNITS.EQ.SI) WRITE(6,98) (XO(I),I=1,NX0)
0007800      WRITE(6,99) (YO(I),I=1,NYO)
0007900      WRITE(6,101) ZO
0008000      WRITE(6,102) (XA(I),I=1,NP)
0008100      WRITE(6,103) (YA(I),I=1,NP)
0008200      WRITE(6,104) (ZA(I),I=1,NP)
0008300      WRITE(6,105) (EPP(I),I=1,NP)
0008400      WRITE(6,106) (VA(I),I=1,NP)
0008500      WRITE(6,107) (ALF1(I),I=1,NP)
0008600      WRITE(6,108) (GAM(I),I=1,NP)
0008700      WRITE(6,109) (PSY(I),I=1,NP)
0008800      WRITE(6,139) (FLAPA(I),I=1,NP)
0008900      WRITE(6,140) (ILGR(I),I=1,NP)
0009000      WRITE(6,141) (IREVR(I),I=1,NP)
0009100      WRITE(6,90)
0009200      2 IF(UNITS.EQ.ENG) GO TO 6
0009300      ZO=ZO*3.28
0009400      DO 3 I=1,NP
0009500      XA(I)=XA(I)*3.28
0009600      YA(I)=YA(I)*3.28
0009700      ZA(I)=ZA(I)*3.28
0009800      3 VA(I)=VA(I)*3.28
0009900      DO 4 I=1,NX0
0010000      4 XO(I)=XO(I)*3.28
0010100      DO 5 I=1,NYO
0010200      5 YO(I)=YO(I)*3.28
0010300      TAMB=TAMB*1.8
0010400      PAMB=PAMB*.02089
0010500      6 IF(TAMB.LT.0.) TAMB=518.7
0010600      IF(PAMB.LT.0.) PAMB=2116.
0010700 C
0010800      NTI=NT/2
0010900      C=41.447*SQRT(GAMMAF*TAMB)
0011000 C      ***** CONVERT TO RADIANS, CALC TIMES AND ANGLES ALONG FLIGHT PATH
0011100      TA(1)=TSTART
0011200      DO 8 K=1,NP
0011300      ALF1(K)=ALF1(K)*AR
0011400      GAM(K)=GAM(K)*AR
0011500      ALFCOS(K)=COS(ALF1(K))
0011600      ALFSIN(K)=SIN(ALF1(K))
0011700      7 IF(K.EQ.1) GO TO 8
0011800      DG=SQRT((XA(K)-XA(K-1))**2+(YA(K)-YA(K-1))**2)
0011900      DZ=ZA(K)-ZA(K-1)
0012000      DS=SQRT(DG**2+DZ**2)
0012100      TA(K)=TA(K-1)+2.*DS/(VA(K)+VA(K-1))
0012200      ALF(K-1)=ALF1(K-1)+ATAN(DZ/DG)
0012300      8 CONTINUE
0012400      ALF(NP)=ALF(NP-1)+ALF1(NP)-ALF1(NP-1)
0012500 C
0012600      9 DO 49 M=1,NCONTR
0012700      DO 40 I=1,NX0
0012800      X=XO(I)
0012900      ICON=0
0013000      FACT=1.
0013100      DELST=1.E5
0013200      DELBST=1.E5

```

```

0013300      DO 39 J=1,NYO
0013400      Y=Y0(J)
0013500      ITER=0
0013600      IJ=I*J*M
0013700      IF(ICPA.EQ.1) GO TO 10
0013800      TI=TSTART
0013900      KST=1
0014000      GO TO 19
0014100 C    ***** FIND THE CLOSEST POINT OF APPROACH TO OBSERVER AT (I,J)
0014200 10 DO 13 K=1,NP
0014300      B=X-XA(K)
0014400      D=Y-YA(K)
0014500      H=ZA(K)-Z0
0014600      IF(K.EQ.NP) GO TO 11
0014700      DX=XA(K+1)-XA(K)
0014800      DY=YA(K+1)-YA(K)
0014900      DZ=ZA(K+1)-ZA(K)
0015000 11 TEST=B*DX+D*DY-H*DZ
0015100      IF(TEST) 15,14,12
0015200 12 TESTST=TEST
0015300      DXS=DX
0015400      DYS=DY
0015500      DZS=DZ
0015600 13 CONTINUE
0015700      DR=TEST/SQRT(DXS**2+DYS**2+DZS**2)
0015800      TCP=TA(NP)
0015900      IF(VA(NP).GT.0.) TCP=TCP+DR/VA(NP)
0016000      GO TO 17
0016100 14 TCP=TA(K)
0016200      GO TO 17
0016300 15 IF(K.GT.1) GO TO 16
0016400      DR=TEST/SQRT(DXS**2+DYS**2+DZS**2)
0016500      TCP=TA(1)
0016600      IF(VA(1).GT.0.) TCP=TCP+DR/VA(1)
0016700      GO TO 17
0016800 16 DR=TESTST/SQRT(DXS**2+DYS**2+DZS**2)
0016900      VCP=SQRT(VA(K-1)**2+2.*DR*(VA(K)-VA(K-1)))/(TA(K)-TA(K-1))
0017000      TCP=TA(K-1)+2.*DR/(VCP+VA(K-1))
0017100 17 FNTI=NTI
0017200      TI=TCP-FNTI*TD
0017300      DO 18 K=1,NP
0017400      IF(TI.GT.TA(K)) GO TO 18
0017500      KST=K-1
0017600      IF(K.EQ.1) KST=1
0017700      GO TO 19
0017800 18 CONTINUE
0017900      KST=NP
0018000 C
0018100 19 FPMAX=0.
0018200      DO 32 KI=1,NT
0018300      IF(TI.GE.TA(KST)) KST=KST+1
0018400      KT=KST
0018500      IF(KST.GT.NP) KST=NP
0018600      IF(KT.GT.NP-1) KT=NP-1
0018700      TFR=(TI-TA(KST))/(TA(KT+1)-TA(KT))
0018800      EPPST=EPPI
0018900      EPPI=EPP(KST)
0019000      IREV=IREVR(KST)
0019100      ILG=ILGR(KST)
0019200      FLAPI=FLAPA(KST)
0019300      PSYI=PSY(KST)
0019400 C    ***** VI IS INTERPOLATED VALUE WHEN VA CHANGE OCCURS
0019500      VST=VI
0019600      VI=VA(KST)+(VA(KT+1)-VA(KT))*TFR
0019700      IF(TI.LT.TA(1)) VI=VA(1)
0019800      IF(TI.GT.TA(NP)) VI=VA(NP)
0019900      VMR=(VI+VA(KST))/(VA(KT+1)+VA(KT))
0020000      DX=XA(KT+1)-XA(KT)
0020100      DY=YA(KT+1)-YA(KT)

```

```

0020200      DZ=ZA(KT+1)-ZA(KT)
0020300      DGSQ=DX**2+DY**2
0020400      DG=SQRT(DGSQ)
0020500      DS=SQRT(DGSQ+DZ**2)
0020600      20 ALFCS=(ALFCOS(KST)*DG-ALFSIN(KST)*DZ)/DS
0020700      ALFSN=(ALFSIN(KST)*DG+ALFCOS(KST)*DZ)/DS
0020800 C      ALFCS AND ALFSN BY COS & SIN OF SUM OF 2 ANGLES, ALF=ALF1+ALF2
0020900      XI=XA(KST)+DX*TFR*VMR
0021000      YI=YA(KST)+DY*TFR*VMR
0021100      ZI=ZA(KST)+DZ*TFR*VMR
0021200 C
0021300      21 B=X-XI
0021400      D=Y-YI
0021500      H=ZI-ZO
0021600      R=SQRT(B**2+D**2+H**2)
0021700      TAU=TI+R/C
0021800      22 IF(R.LT..01) GO TO 31
0021900 C      SOLVE FOR DOT PRODUCTS, AIRCRAFT UNIT VECTORS
0022000      BPD=(B*DX+D*DY)/DG
0022100      DMB=(D*DX-B*DY)/DG
0022200      BPDPH=BPD*ALFSN+H*ALFCS
0022300      RDOTA=BPD*ALFCS-H*ALFSN
0022400      IF(RDOTA.EQ.0.) RDOTA=.1E-60
0022500      GAMSN=SIN(GAM(KST))
0022600      GAMCS=COS(GAM(KST))
0022700      RDOTW=DMB*GAMCS+BPDPH*GAMSN
0022800      RDOTU=DMB*GAMSN-BPDPH*GAMCS
0022900      IF(RDOTU.EQ.0.) RDOTU=-.1E-50
0023000 C      SOLVE FOR SOURCE-RELATED ANGLES
0023100      23 COSTH=RDOTA/R
0023200      IF(COSTH.GT.1.) COSTH=1.
0023300      IF(COSTH.LT.-1.) COSTH=-1.
0023400      THETA=ARCOS(COSTH)/AR
0023500      THETAF=ATAN2(-RDOTU,RDOTA)/AR
0023600      IF(RDOTU.GT.0..AND.RDOTA.LT.0.) THETAF=THETAF+360.
0023700      THETAH=ATAN2(RDOTW,RDOTA)/AR
0023800      PHI=ATAN2(RDOTW,-RDOTU)/AR
0023900 C      DOPPLER SHIFT CORR. BASED ON COSINE OF DIRECTION OF MOTION
0024000      27 COSDOP=(B*DX+D*DY-H*DZ)/DS/R
0024100      FDOP=1.-VI*COSDOP/C
0024200      VIEW=ARSIN(H/R)/AR
0024300      HEAD=ARSIN(DY/DG)/AR
0024400      IF(IGEOM.EQ.0) GO TO 29
0024500      IF(KI.EQ.1.AND.IJ.EQ.1) WRITE(6,93)
0024600      IF(KI.EQ.NTI+1.AND.ICPA.EQ.1) WRITE(6,95)
0024700      IF(UNITS.EQ.SI) GO TO 28
0024800      WRITE(6,94) KI,XI,YI,ZI,R,THETA,THETAF,THETAH,PHI,TI,TAU,EPPI,VI
0024900      GO TO 29
0025000      28 XIM=XI/3.28
0025100      YIM=YI/3.28
0025200      ZIM=ZI/3.28
0025300      RM=R/3.28
0025400      VIM=VI/3.28
0025500      WRITE(6,94) KI,XIM,YIM,ZIM,RM,THETA,THETAF,THETAH,PHI,TI,TAU,-
0025600      1 EPPI,VIM
0025700      29 ISKIP=0
0025800      IF(KI.EQ.1) GO TO 30
0025900      IF(EPPI.EQ.EPPST.AND.VI.EQ.VST) ISKIP=1
0026000 C
0026100      30 CALL NOIS(PNL,PNLT)
0026200      IF(KI.EQ.NTI+1.AND.IGEOM.EQ.1.AND.ICPA.EQ.1) WRITE(6,96)
0026300      IF(IOUT(2).EQ.0.AND.IOUT(3).EQ.0) GO TO 32
0026400      IF(IOUT(2).EQ.1.OR.IOUT(3).EQ.1) FPNL(KI)=PNL
0026500      IF(IOUT(2).GE.2.OR.IOUT(3).GE.2) FPNL(KI)=PNLT
0026600      TIME(KI)=TAU
0026700      IF(FPNL(KI).LT.FPMAX) GO TO 32
0026800      FPMAX=FPNL(KI)
0026900      IF(ITER.GT.0) GO TO 32
0027000      FPNLMX(I,J)=FPMAX

```

```

0027100      TAUMX(I,J)=TAU
0027200      THETMX(I,J)=THETA
0027300      GO TO 32
0027400  31 WRITE(6,126) KI,TAU
0027500  32 TI=TI+TD
0027600  C      END OF LOOP IN TIME INCREMENTS WITH KI
0027700      IF(IOUT(2).NE.3.AND.IOUT(3).NE.3) GO TO 33
0027800      FPMAX=EPNL(FPNL,FPMAX,TIME,NT,TIS,TIF)
0027900      IF(ITER.EQ.0) FPNLMX(I,J)=FPMAX
0028000  33 IF(IOUT(3).EQ.0.OR.J.GT.2.OR.ICON.EQ.1) GO TO 39
0028100      DEL=ABS(CONTR(M)-FPMAX)
0028200      IF(DEL.GT..1) GO TO 34
0028300      YCON(I)=Y
0028400      ICON=1
0028500      GO TO 39
0028600  34 IF(DEL.GE.DELBST) GO TO 35
0028700  C      STORE BEST AND NEXT-BEST VALUES OF DEL,FPMAX,AND Y
0028800      DELST=DELBST
0028900      DELBST=DEL
0029000      FST=FBEST
0029100      FBEST=FPMAX
0029200      YST=YBEST
0029300      YBEST=Y
0029400      IF(FACT.LE..5) FACT=2.*FACT
0029500      IF(J.EQ.1) GO TO 39
0029600      GO TO 37
0029700  35 IF(DEL.GE.DELST) GO TO 36
0029800      DELST=DEL
0029900      FST=FPMAX
0030000      YST=Y
0030100      IF(FACT.LE..5) FACT=2.*FACT
0030200      GO TO 37
0030300  36 FACT=0.5*FACT
0030400  37 IF(ITER.LT.9) GO TO 38
0030500  C      ONE MORE TRY AT Y NEAR ZERO
0030600      Y=1.
0030700      ITER=ITER+1
0030800      IF(ITER.LE.11) GO TO 10
0030900      YCON(I)=YBEST
0031000      WRITE(6,127) CONTR(M),X,YBEST,FBEST
0031100      GO TO 39
0031200  38 IF(ITER.GT.1) Y=YBEST+FACT*(YBEST-YST)*((CONTR(M)-FBEST)/(FBEST-FST))
0031300      IF(ITER.LE.1) Y=YBEST*(YST/YBEST)**((FBEST-CONTR(M))/(FBEST-FST))
0031400      ITER=ITER+1
0031500      GO TO 10
0031600  39 CONTINUE
0031700  40 CONTINUE
0031800      IF(IOUT(2).EQ.0) GO TO 45
0031900      IF(IOUT(2).EQ.1) WRITE(6,115)
0032000      IF(IOUT(2).EQ.2) WRITE(6,116)
0032100      IF(IOUT(2).EQ.3) WRITE(6,117)
0032200      WRITE(6,110)
0032300      IF(UNITS.EQ.SI) GO TO 41
0032400      WRITE(6,111) (YO(J),J=1,NYO)
0032500      GO TO 43
0032600  41 DO 42 J=1,NYO
0032700  42 XOM(J)=YO(J)/3.28
0032800      WRITE(6,111) (XOM(J),J=1,NYO)
0032900  43 DO 44 I=1,NXO
0033000      IF(UNITS.EQ.ENG) WRITE(6,112) XO(I),(FPNLMX(I,J),J=1,NYO)
0033100      XOMM=XO(I)/3.28
0033200      IF(UNITS.EQ.SI) WRITE(6,112) XOMM,(FPNLMX(I,J),J=1,NYO)
0033300      WRITE(6,113) (THETMX(I,J),J=1,NYO)
0033400      WRITE(6,114) (TAUMX(I,J),J=1,NYO)
0033500  44 CONTINUE
0033600  45 IF(IOUT(3).EQ.0) STOP
0033700      IF(IOUT(3).EQ.1.AND.M.EQ.1) WRITE(6,118)
0033800      IF(IOUT(3).EQ.2.AND.M.EQ.1) WRITE(6,119)
0033900      IF(IOUT(3).EQ.3.AND.M.EQ.1) WRITE(6,120)

```

```

0034000 WRITE(6,121) CONTR(M)
0034100 NXM=NXO-1
0034200 AREA=0.
0034300 DO 46 I=1,NXM
0034400 46 AREA=AREA+(XO(I+1)-XO(I))*(YCON(I+1)+YCON(I))/2.
0034500 IF(UNITS.EQ.SI) GO TO 47
0034600 WRITE(6,122) (XO(I),I=1,NXO)
0034700 WRITE(6,123) (YCON(I),I=1,NXO)
0034800 AREA1=AREA/43560.
0034900 AREA2=AREA/27878400.
0035000 WRITE(6,128) AREA,AREA1,AREA2
0035100 GO TO 49
0035200 47 DO 48 I=1,NXO
0035300 XOM(I)=XO(I)/3.28
0035400 48 YCONM(I)=YCON(I)/3.28
0035500 WRITE(6,124) (XOM(I),I=1,NXO)
0035600 WRITE(6,125) (YCONM(I),I=1,NXO)
0035700 AREA=AREA/10.764
0035800 AREA1=AREA/1.E6
0035900 WRITE(6,129) AREA,AREA1
0036000 49 CONTINUE
0036100 STOP
0036200 90 FORMAT(1H4)
0036300 91 FORMAT(8X,20A4)
0036400 92 FORMAT(1H1,20X,20A4)
0036500 93 FORMAT(///,' GEOMETRIC RELATIONS OF AIRCRAFT/OBSERVER'/'-
0036600 1 8X,' KI XI YI ZI R THETA THETA F THETA H-
0036700 2 PHI TI TAU EPPI VI')
0036800 94 FORMAT(2X,6H GEOM: ,I3,4F8.1,2X,4F7.1,1X,2F8.2,2X,2F8.1)
0036900 95 FORMAT('***** CLOSEST POINT OF APPROACH')
0037000 96 FORMAT('*****')
0037100 97 FORMAT(' OBSERVER COORDINATES (IN FEET).'/8H XO: ,15F8.1/-
0037200 1 8X,5F8.1)
0037300 98 FORMAT(' OBSERVER COORDINATES (IN METERS).'/8H XO: ,15F8.1/-
0037400 1 8X,5F8.1)
0037500 99 FORMAT(8H YO: ,15F8.1/8X,5F8.1)
0037600 101 FORMAT(8H ZO: ,F8.1)
0037700 102 FORMAT(' AIRCRAFT TRAJECTORY POINTS AND OPERATING CONDITIONS.'/'-
0037800 1 8H XA: ,15F8.1/8X,15F8.1/8X,15F8.1/8X,5F8.1)
0037900 103 FORMAT(8H YA: ,15F8.1/8X,15F8.1/8X,15F8.1/8X,5F8.1)
0038000 104 FORMAT(8H ZA: ,15F8.1/8X,15F8.1/8X,15F8.1/8X,5F8.1)
0038100 105 FORMAT(8H EPP: ,15F8.1/8X,15F8.1/8X,15F8.1/8X,5F8.1)
0038200 106 FORMAT(8H VA: ,15F8.1/8X,15F8.1/8X,15F8.1/8X,5F8.1)
0038300 107 FORMAT(8H ALF1: ,15F8.1/8X,15F8.1/8X,15F8.1/8X,5F8.1)
0038400 108 FORMAT(8H GAM: ,15F8.1/8X,15F8.1/8X,15F8.1/8X,5F8.1)
0038500 109 FORMAT(8H PSY: ,15F8.1/8X,15F8.1/8X,15F8.1/8X,5F8.1)
0038600 139 FORMAT(8H FLAPA: ,15F8.1/8X,15F8.1/8X,15F8.1/8X,5F8.1)
0038700 140 FORMAT(8H ILGR: ,15I8/8X,15I8/8X,15I8/8X,5I8)
0038800 141 FORMAT(8H IREVR: ,15I8/8X,15I8/8X,15I8/8X,5I8)
0038900 110 FORMAT(7H XO ,20X,12H YO POSITION)
0039000 111 FORMAT(7H POS ,7X,16F7.0)
0039100 112 FORMAT(F7.0,7H LEVEL ,16F7.1)
0039200 113 FORMAT(8X,7H THETA ,16F7.1)
0039300 114 FORMAT(9X,7H TIME ,16F7.2)
0039400 115 FORMAT(///20X,'VALUES OF PNL-MAX')
0039500 116 FORMAT(///20X,'VALUES OF PNL-T-MAX')
0039600 117 FORMAT(///20X,'VALUES OF EPNL')
0039700 118 FORMAT(///10X,' COORDINATES FOR "PNL" CONTOUR')
0039800 119 FORMAT(///10X,' COORDINATES FOR "PNLT" CONTOUR')
0039900 120 FORMAT(///10X,' COORDINATES FOR "EPNL" CONTOUR')
0040000 121 FORMAT('/' CONTOUR LEVEL =',F8.1,' DB')
0040100 122 FORMAT(16H X - COORD (FT): ,14F8.1)
0040200 123 FORMAT(16H Y - COORD (FT): ,14F8.1)
0040300 124 FORMAT(16H X - COORD ( M): ,14F8.1)
0040400 125 FORMAT(16H Y - COORD ( M): ,14F8.1)
0040500 126 FORMAT(' R GOES TO ZERO AT KI =',I3,', TAU =',F4.1,' . POINT-
0040600 1 OMITTED IN NOISE SUMMATION')
0040700 127 FORMAT('/' Y-COORD. FOR',F6.1,' DB CONTOUR DID NOT CONVERGE IN 10-
0040800 1 ITERATIONS AT XO =',F7.1/5X,' BEST VALUE OF Y =',F7.1,', BEST-

```

```

0040900      2 LEVEL =',F6.1)
0041000 128 FORMAT(25H APPROX. CONTOUR AREA =,E11.3,7H SQ FT,,F9.2,-
0041100      1 7H ACRES,,F7.2,9H SQ MILES)
0041200 129 FORMAT(25H APPROX. CONTOUR AREA =,E11.3,6H SQ M,,F9.2,6H SQ KM)
0041300      END

```

Subroutine NOIS

```

0000100 C      NOISE SUBROUTINE FOR USE IN FOOTPRINT PROGRAM
0000200 C      INTERPOLATES FOR ENGINE MAP PARAMETERS, CALLS
0000300 C      SPECIFIED NOISE SOURCE SUBROUTINES, AND MAKES
0000400 C      PROPAGATION CORRECTIONS.  INPUTS ARE IN NAMELIST
0000500 C      BLOCKS "PARAM" AND "SOURCE".  "PARAM" CONSISTS OF
0000600 C      ARRAYS OF ENGINE VARIABLES AS A FUNCTION OF "EPP",
0000700 C      FOR EACH VARIABLE REQUIRED FOR SPECIFIED SOURCES.
0000800 C      "SOURCE" CONTAINS INDICATORS FOR NO. OF ENGINES,
0000900 C      AND NOISE SOURCES AND CORRECTIONS DESIRED, AND FOR
0001000 C      TYPE OF OUTPUT DESIRED.
0001100 C      CALLED BY FOOTPR
0001200 C      CALLS SUBROUTINES AIRATT,TERP,FAN,JET,CORE,TURB,SHLD,FLAP,AIRFR,
0001300 C      BASAT,EGAC,GNDRF,PERNOY,STONE
0001400 C      INFLOW:  R,THETA,EPPI,X,Y,TAU,IJ,KI,UNITS,ISKIP,TAMB,PAMB,FDOP
0001500 C      OUTFLOW: TP,F,IOUT,FDOP,VC,VF,TC,TF,FUEL,WAFAN,RPM,TIPM,TIPM2,
0001600 C      DELT,FPR,WCORE,P3,T3,T4,TURTS,TCTUR,F1,F2,F3,F4
0001700 C      RETURN FLOW: TP,SSPL,AIRATT,PERNOY,STONE
0001800 C
0001900 C      SUBROUTINE NOIS(PNL,PNLT)
0002000 C      DIMENSION AEPP(10),AVC(10),AVF(10),ATC(10),ATF(10),ATIPM(10),-
0002100 C      1 AWAFFAN(10),ARPM(10),ADELT(10),AFPR(10),AWCORE(10),AP3(10),-
0002200 C      2 AT3(10),AT4(10),ATURTS(10),AFUEL(10),ATIPM2(10),ATCTUR(10)
0002300 C      DIMENSION ATM(24),SSPL(24),IFREQ(24)
0002400 C      COMMON/GEOM/R,THETA,THETAFA,THETAH,PHI,VIEW,HEAD,PSYI,FLAPI,EPPI,-
0002500 C      1 VI,X,Y,TAU,IJ,KI
0002600 C      COMMON/SPECT/TP(24),SPL(24),F(24),DUMY1,DUMY2,DUMY3,F1,F2,F3,F4
0002700 C      COMMON/PARAM/VC,VF,TC,TF,FUEL,WAFAN,RPM,TIPM,TIPM2,DELT,FPR,-
0002800 C      1 WCORE,P3,T3,T4,TURTS,TCTUR
0002900 C      COMMON UNITS,ISKIP,IOUT(3),IREV,ILG,FDOP,C,TAMB,PAMB,RH,NENG,ISUPP
0003000 C      NAMELIST/SOURCE/NENG,ITOT,IFAN,IJET,IFLAP,ICORE,ITURB,IAIRF,-
0003100 C      1 IDOP,IATM,IEGA,IGND,ISUPP,ISHLD,IOUT,FILBW
0003200 C      NAMELIST/PARAM/NPARAM,AVC,AVF,ATC,ATF,AFUEL,ATIPM,ATIPM2,AWAFAN,-
0003300 C      1ARPM,ADELT,AFPR,AWCORE,AP3,AT3,AT4,ATURTS,ATCTUR,AEPP,ICORR,TCORXP
0003400 C      NOTE: PARAM VARIABLES MUST BE ENTERED IN ORDER OF INCREASING EPP
0003500 C      NENG=NUMBER OF ENGINES
0003600 C      ISUPP=1/0 (Y/N ON SUPPRESSION SPECTRA APPLIED TO EACH SOURCE
0003700 C      FOR WHICH SUPPRESSION SPECTRA ARE SUPPLIED:  MAY BE
0003800 C      OVERRIDDEN BY ISUPPR IN INDIVIDUAL SOURCE INPUT)
0003900 C      IDOP=1/0 (Y/N ON DOPPLER FREQ AND INTENSITY CORRECTION);
0004000 C      IATM=0 :  NO CORRECTION FOR ATMOSPHERIC ATTENUATION
0004100 C      1 :  CORRECT TOTAL NOISE FOR ATMOS.  ATTEN.  BY ARP 866
0004200 C      2 :  CORRECT TOTAL FOR ATMOS.  ATTEN.  BY BASS & SHIELDS
0004300 C      IEGA=1/0 (Y/N ON EXTRA GROUND ATTEN - ON TOTAL NOISE ONLY)
0004400 C      ISHLD=1/0 (Y/N FOR SHIELDING OF FAN,JET,CORE & TURBINE SOURCES)
0004500 C      IGND=0 :  NO GROUND REFLECTIONS - FREE FIELD
0004600 C      1 :  FLAT 3 DB GROUND REFLECTION CORRECTION
0004700 C      2 :  CALC GROUND REFLECTION FOR GROUND IMPEDANCE SPECIFIED
0004800 C      ICORR=1/0 (Y/N FOR ENGINE PARAMS TO BE CORR. TO AMBIENT)
0004900 C      TCORXP  ▣ EXPONENT FOR CORE TEMP. CORRECTIONS IN ENGINE PARAMS
0005000 C      FILBW  ▣ FRACTION OF FILTER BANDWIDTH WITH GAIN=1
0005100 C      IOUT( ) SELECTS LEVEL OF NOISE PRINTOUT;  I.E.,
0005200 C      IOUT(1)  ▣ 0:  NO INDIVIDUAL SOURCE PRINTOUT
0005300 C      1:  SOURCE SPECTRA, INCLUDING OASPL,PNL,PNLT
0005400 C      2:  PRINTS ONLY OASPL, PNL, PNLT OF EACH SOURCE
0005500 C      3:  PRINTS ONLY OASPL, PNL, PNLT OF TOTAL NOISE
0005600 C      IOUT(2)  ▣ 0:  NO PRINTOUT AT GRID POINTS SPECIFIED
0005700 C      1:  PRINTS PNL-MAX AT GRID POINTS
0005800 C      2:  PRINTS PNLT-MAX AT GRID POINTS
0005900 C      3:  PRINTS EPNL AT GRID POINTS
0006000 C      IOUT(3)  ▣ 0:  NO CONTOUR FOLLOWING

```



```

0006100 C          1: PRINTS COORDS. OF PNL-MAX CONTOURS
0006200 C          2: PRINTS COORDS. OF PNL-MAX CONTOURS
0006300 C          3: PRINTS COORDS. OF EPNL CONTOURS
0006400 C          NOTE THAT IOUT(1) CAN BE OVER-RIDDEN IN INDIVIDUAL SOURCE
0006500 C          PROGRAM BY SPECIFYING JOUT=1 IN INPUT DATA TO THAT SOURCE
0006600 C THIS DATA INPUT IS FOR DEFAULT VALUES
0006700 C DATA ITOT,IFAN,IJET,IFLAP,ICORE,ITURB,IAIRF,IATM,IEGA,IGND,ISHLD,-
0006800 C 1 FILBW/1,10*0,1./
0006900 C DATA SI,ENG/2HSI,3HENG/
0007000 C
0007100 C IF(IJ.NE.1.OR.KI.NE.1) GO TO 4
0007200 C ISUPP=0
0007300 C IDOP=0
0007400 C ITOT=1
0007500 C ICORR=0
0007600 C TCORXP=1.
0007700 C FUEL=0.
0007800 C
0007900 C READ(5,SOURCE)
0008000 C READ(5,PARAM)
0008100 C IF(AEPP(1).GT.AEPP(NPARAM)) WRITE(6,99)
0008200 C
0008300 C IF(UNITS.EQ.ENG) GO TO 2
0008400 C DO 1 I=1,NPARAM
0008500 C AVC(I)=AVC(I)*3.28
0008600 C AVF(I)=AVF(I)*3.28
0008700 C ATC(I)=ATC(I)*1.8
0008800 C ATF(I)=ATF(I)*1.8
0008900 C AFUEL(I)=AFUEL(I)*2.205
0009000 C AWAFFAN(I)=AWAFFAN(I)*2.205
0009100 C ADELTA(I)=ADELTA(I)*1.8
0009200 C AWCORE(I)=AWCORE(I)*2.205
0009300 C AP3(I)=AP3(I)*.02089
0009400 C AT3(I)=AT3(I)*1.8
0009500 C AT4(I)=AT4(I)*1.8
0009600 C ATCTUR(I)=ATCTUR(I)*1.8
0009700 C 1 ATURTS(I)=ATURTS(I)*3.28
0009800 C
0009900 C 2 DO 3 L=1,24
0010000 C F(L)=10.**(.1*FLOAT(L+16))
0010100 C IF(IATM.EQ.1) ATM(L)=AIRATT(TAMB,RH,F(L))
0010200 C 3 IFREQ(L)=F(L)
0010300 C F1=.78250188+.10874906*FILBW
0010400 C F2=1.-.10874906*FILBW
0010500 C F3=1.+1.2201845*FILBW
0010600 C F4=1.2440369-.12201845*FILBW
0010700 C
0010800 C IF(IOUT(1).EQ.1) WRITE(6,91) (IFREQ(L),L=1,24)
0010900 C IF(IOUT(1).EQ.2) WRITE(6,92)
0011000 C IF(IOUT(1).EQ.3) WRITE(6,93)
0011100 C IF(IOUT(1).GE.2) WRITE(6,94)
0011200 C ENTER HERE FOR SUBSEQUENT OBSERVER POINTS
0011300 C 4 TTOT=TAMB+VI*VI/12025.1
0011400 C PTOT=PAMB*(TTOT/TAMB)**3.5
0011500 C TCORR=TTOT/518.7
0011600 C TCORR1=SQRT(TCORR)
0011700 C TCORR2=TCORR**TCORXP
0011800 C PCORR=PTOT/2116.
0011900 C WCORR=PCORR/TCORR1
0012000 C IF(IDOP.EQ.0) FDOP=1.
0012100 C IF(IOUT(1).EQ.1.AND.UNITS.EQ.ENG) WRITE(6,95) X,Y,TAU,R,THETA
0012200 C XM=X/3.28
0012300 C YM=Y/3.28
0012400 C RM=R/3.28
0012500 C IF(IOUT(1).EQ.1.AND.UNITS.EQ.SI) WRITE(6,96) XM,YM,TAU,RM,THETA
0012600 C DO 5 L=1,24
0012700 C 5 TP(L)=1.E-50
0012800 C
0012900 C IF(IFAN.EQ.0) GO TO 7

```

```

0013000      IF(ISKIP.EQ.1) GO TO 6
0013100      CALL TERP(ATIPM,EPPI,1.,1.,AEPP,1.,1.,NPARAM,1,1,TIPM)
0013200      CALL TERP(AWAFAN,EPPI,1.,1.,AEPP,1.,1.,NPARAM,1,1,WAFAN)
0013300      CALL TERP(ARPM,EPPI,1.,1.,AEPP,1.,1.,NPARAM,1,1,RPM)
0013400      CALL TERP(ADELTA,EPPI,1.,1.,AEPP,1.,1.,NPARAM,1,1,DELTA)
0013500      CALL TERP(AFPR,EPPI,1.,1.,AEPP,1.,1.,NPARAM,1,1,FPR)
0013600      CALL TERP(ATIPM2,EPPI,1.,1.,AEPP,1.,1.,NPARAM,1,1,TIPM2)
0013700      IF(ICORR.EQ.0) GO TO 6
0013800      WAFAN=WAFAN*WCORR
0013900      RPM=RPM*TCORR1
0014000      DELTA=DELTA*TCORR
0014100      6 CALL FAN
0014200      7 IF(IJET.EQ.0) GO TO 9
0014300      IF(ISKIP.EQ.1) GO TO 8
0014400      CALL TERP(AVC,EPPI,1.,1.,AEPP,1.,1.,NPARAM,1,1,VC)
0014500      CALL TERP(AVF,EPPI,1.,1.,AEPP,1.,1.,NPARAM,1,1,VF)
0014600      CALL TERP(ATC,EPPI,1.,1.,AEPP,1.,1.,NPARAM,1,1,TC)
0014700      CALL TERP(ATF,EPPI,1.,1.,AEPP,1.,1.,NPARAM,1,1,TF)
0014800      CALL TERP(AFUEL,EPPI,1.,1.,AEPP,1.,1.,NPARAM,1,1,FUEL)
0014900      CALL TERP(AWCORE,EPPI,1.,1.,AEPP,1.,1.,NPARAM,1,1,WCORE)
0015000      IF(ICORR.EQ.0) GO TO 8
0015100      VC=VC*TCORR1
0015200      VF=VF*TCORR1
0015300      TC=TC*TCORR2
0015400      TF=TF*TCORR
0015500      FUEL=FUEL*PCORR*TCORR1
0015600      WCORE=WCORE*WCORR
0015700      8 CALL JET
0015800      9 IF(ICORE.EQ.0) GO TO 11
0015900      IF(ISKIP.EQ.1) GO TO 10
0016000      IF(IJET.EQ.0) CALL TERP(AWCORE,EPPI,1.,1.,AEPP,1.,1.,NPARAM,1,1,-
0016100      1 WCORE)
0016200      CALL TERP(AP3,EPPI,1.,1.,AEPP,1.,1.,NPARAM,1,1,P3)
0016300      CALL TERP(AT3,EPPI,1.,1.,AEPP,1.,1.,NPARAM,1,1,T3)
0016400      CALL TERP(AT4,EPPI,1.,1.,AEPP,1.,1.,NPARAM,1,1,T4)
0016500      IF(IJET.EQ.0) CALL TERP(AFUEL,EPPI,1.,1.,AEPP,1.,1.,NPARAM,1,1,-
0016600      1 FUEL)
0016700      IF(ICORR.EQ.0) GO TO 10
0016800      IF(IJET.EQ.0) WCORE=WCORE*WCORR
0016900      P3=P3*PCORR
0017000      T3=T3*TCORR
0017100      T4=T4*TCORR2
0017200      IF(IJET.EQ.0) FUEL=FUEL*PCORR*TCORR1
0017300      10 CALL CORE
0017400      11 IF(ITURB.EQ.0) GO TO 13
0017500      IF(ISKIP.EQ.1) GO TO 12
0017600      IF(IJET.EQ.0) CALL TERP(ATC,EPPI,1.,1.,AEPP,1.,1.,NPARAM,1,1,TC)
0017700      IF(IFAN.EQ.0) CALL TERP(ARPM,EPPI,1.,1.,AEPP,1.,1.,NPARAM,1,1,RPM)
0017800      IF(IJET.EQ.0.AND.ICORE.EQ.0) CALL TERP(AWCORE,EPPI,1.,1.,AEPP,1.,1.,-
0017900      1 1.,NPARAM,1,1,WCORE)
0018000      IF(IJET.EQ.0.AND.ICORE.EQ.0) CALL TERP(AFUEL,EPPI,1.,1.,AEPP,1.,1.,-
0018100      1 1.,NPARAM,1,1,FUEL)
0018200      CALL TERP(ATURTS,EPPI,1.,1.,AEPP,1.,1.,NPARAM,1,1,TURTS)
0018300      CALL TERP(ATCTUR,EPPI,1.,1.,AEPP,1.,1.,NPARAM,1,1,TCTUR)
0018400      IF(TCTUR.LT.1.) CALL TERP(ATC,EPPI,1.,1.,AEPP,1.,1.,NPARAM,1,1,-
0018500      1 TCTUR)
0018600      IF(ICORR.EQ.0) GO TO 12
0018700      TCTUR=TCTUR*TCORR2
0018800      IF(IFAN.EQ.0) RPM=RPM*TCORR1
0018900      IF(IJET.EQ.0.AND.ICORE.EQ.0) WCORE=WCORE*WCORR
0019000      IF(IJET.EQ.0.AND.ICORE.EQ.0) FUEL=FUEL*PCORR*TCORR1
0019100      TURTS=TURTS*TCORR1
0019200      12 CALL TURB
0019300      13 IF(ISHLD.EQ.1) CALL SHLD
0019400      C SHIELDING APPLIED TO ONLY SOURCES ABOVE THIS POINT
0019500      IF(IFLAP.EQ.0) GO TO 15
0019600      IF(ISKIP.EQ.1) GO TO 14
0019700      IF(IJET.EQ.1) GO TO 14
0019800      CALL TERP(AVC,EPPI,1.,1.,AEPP,1.,1.,NPARAM,1,1,VC)

```

```

0019900      CALL TERP(AVF,EPPI,1.,1.,AEPP,1.,1.,NPARAM,1,1,VF)
0020000      IF(ICORR.EQ.0) GO TO 14
0020100      VC=VC*TCORR1
0020200      VF=VF*TCORR1
0020300      14 CALL FLAP
0020400      15 IF(IAIRF.EQ.1) CALL AIRFR
0020500 C
0020600      DO 16 L=1,24
0020700      IF(IGND.EQ.1) TP(L)=TP(L)*2.
0020800      SSPL(L)=10.*ALOG10(TP(L))
0020900      IF(IATM.EQ.1) SSPL(L)=SSPL(L)-ATM(L)*R/1000.
0021000      16 CONTINUE
0021100      IF(IATM.EQ.2) CALL BASAT(R,TAMB,PAMB,RH,SSPL)
0021200      17 IF(IEGA.EQ.1) CALL EGAC(SSPL)
0021300      18 IF(IGND.EQ.2) CALL GNDRF(SSPL)
0021400      TSUM=0.
0021500      DO 19 L=1,24
0021600      19 TSUM=TSUM+10.**(.1*SSPL(L))
0021700      OASPL=10.*ALOG10(TSUM)
0021800      PNL=PERNOY(SSPL)
0021900      PNLT=PNL+TONE(SSPL)
0022000      IF(ITOT.EQ.0) RETURN
0022100      IF(IOUT(1).EQ.1) WRITE(6,97) (SSPL(L),L=1,24),OASPL,PNL,PNLT
0022200      IF(IOUT(1).GE.2) WRITE(6,98) X,Y,TAU,OASPL,PNL,PNLT
0022300      RETURN
0022400      91 FORMAT(//,20X,'SPECTRA FOR EACH NOISE SOURCE'/2X,6H FREQ ,17I7/-
0022500      1 8X,7I7)
0022600      92 FORMAT(20X,'NOISE CONTRIBUTIONS FOR EACH NOISE SOURCE')
0022700      93 FORMAT(20X,'TOTAL NOISE HISTORY AT EACH POINT')
0022800      94 FORMAT(57H SOURCE      XO      YO      TAU      OASPL      PNL      PN-
0022900      1LT)
0023000      95 FORMAT(10X,19H SOURCES WHEN      XO=,F7.1,9H FT, YO=,F7.1,11H FT,-
0023100      1 TAU =,F7.1,10H SEC, R =,F7.1,13H FT, THETA =,F6.1,4H DEG)
0023200      96 FORMAT(10X,19H SOURCES WHEN      XO=,F7.1,8H M, YO=,F7.1,10H M,-
0023300      1 TAU =,F7.1,10H SEC, R =,F7.1,12H M, THETA =,F6.1,4H DEG)
0023400      97 FORMAT(8H TOTALS: ,17F7.1/8X,7F7.1,21X,8H OASPL =,F7.1,6H PNL =,-
0023500      1 F7.1,7H PNLT =,F7.1/)
0023600      98 FORMAT(9H TOTAL      : ,2F8.1,F8.3,3F8.1)
0023700      99 FORMAT(2X,'WARNING: ENGINE PARAMETER INPUTS ARE NOT IN ORDER OF-
0023800      1 ASCENDING EPP')
0023900      END

```

Main Program RADIUS

```

0000100 C      MAIN PROGRAM FOR CALCULATING NOISE SOURCES AT A CONSTANT RADIUS
0000200 C      USING NOISE SOURCE PROGRAMS FROM ANOP PREDICTION REPORTS.
0000300 C      THIS VERSION CALCULATES ALL NOISE QUANTITIES FOR EACH SEPARATELY.
0000400 C
0000500 C      CALLS SUBROUTINES TERP,AIRATT,FAN,JET,CORE,TURB,SHLD,FLAP,AIRFR,
0000600 C      BASAT,EGAC,GNDRF,PERNOY,TONE
0000700 C      OUTFLOW: TP,F,UNITS,ISKIP,IOUT,ILG,FDOP,C,TAMB,PAMB,NENG,ISUPP,
0000800 C      R,THETA,THETA,PHI,PSYI,FLAPI,VI,IJ,KI,ZO,ZI,
0000900 C      VC,VF,TC,TF,FUEL,WAFAN,RPM,TIPM,TIPM2,DELT,FPR,WCORE,P3,T3,
0001000 C      T4,TURTS,TCTUR,F1,F2,F3,F4
0001100 C      RETURN FLOW: TP,SPL,OASPL,PNL,PNLT,SSPL,AIRATT,PERNOY,TONE
0001200 C
0001300      DIMENSION FSPL(24,20),TSP(24,20),TOTPWL(24),PWL(24),ATM(24),-
0001400      1 IFREQ(24),FOASPL(20),FPNL(20),FPNLT(20),-
0001500      2 SSPL(24),AREA(20),ATHETA(20),APHI(10),COMENT(20)
0001600      DIMENSION AEPP(10),AVC(10),AVF(10),ATC(10),ATF(10),ATIPM(10),-
0001700      1 ATIPM2(10),AWAFAN(10),ARPM(10),ADELT(10),AFPR(10),AWCORE(10),-
0001800      2 AP3(10),AT3(10),AT4(10),ATURTS(10),AFUEL(10),ATCTUR(10)
0001900      COMMON/GEOM/R,THETA,THETA,PHI,VIEW,HEAD,PSYI,FLAPI,EPPI,-
0002000      1 VI,X,Y,TAU,IJ,KI,ZO,ZI
0002100      COMMON/SPECT/TP(24),SPL(24),F(24),OASPL,PNL,PNLT,F1,F2,F3,F4
0002200      COMMON/PARAM/VC,VF,TC,TF,FUEL,WAFAN,RPM,TIPM,TIPM2,DELT,FPR,-
0002300      1 WCORE,P3,T3,T4,TURTS,TCTUR
0002400      COMMON UNITS,ISKIP,IOUT(3),IREV,ILG,FDOP,C,TAMB,PAMB,RH,NENG,ISUPP

```

```

0002500      DATA SI,ENG/2HSI,3HENG/,AR/.0174533/
0002600      NAMELIST/GEOMT/UNITS,R,ATHETA,APHI,NTHETA,NPHI,VIEW,HEAD,ZO,ZI
0002700 C      IF USING GROUND REFLECTION SUBROUTINE (IGND=2), ZO (OBSERVER
0002800 C      HEIGHT IN M(FT)) AND ZI (SOURCE HEIGHT IN M(FT)) ARE REQUIRED.
0002900      NAMELIST/AMB/TAMB,PAMB,RH
0003000      NAMELIST/PARAM/NPARAM,AVC,AVF,ATC,ATF,AFUEL,ATIPM,ATIPM2,AWAFAN,-
0003100      IARPM,ADELTA,AFPR,AWCORE,AP3,AT3,AT4,ATURTS,ATCTUR,AEPP,ICORR,TCORXP
0003200 C      NOTE: PARAM VARIABLES MUST BE ENTERED IN ORDER OF INCREASING EPP
0003300      NAMELIST/SOURCE/NENG,ITOT,IFAN,IJET,IPLAP,ICORE,ITURB,IAIRF,-
0003400      1 IDOP,IATM,IEGA,IGND,ISUPP,ISHLD,FILBW
0003500      NAMELIST/OPER/EPP,VI,PSYI,FLAPI,ILG
0003600 C      NOTE: IN FLAP NOISE NOISE PREDICTIONS - THETA VALUES AT VARIOUS
0003700 C      ANGLES OF PHI ARE SET EQUAL TO THE THETA VALUES SPECIFIED FOR
0003800 C      THE FLYOVER PLANE. ONLY A ROUGH APPROXIMATION OF NOISE POWER
0003900 C      IS USED - FLAP NOISE IN FLYOVER PLANE IS ASSUMED TO HAVE POLAR
0004000 C      SYMMETRY AS DO OTHER SOURCES, AND THIS "NOISE POWER" IS PRINTED
0004100 C      OUT AND ADDED TO THE TOTAL NOISE POWER.
0004200 C      NENG=NUMBER OF ENGINES
0004300 C      ISUPP=1/0 (Y/N ON SUPPRESSION SPECTRA APPLIED TO EACH SOURCE
0004400 C      FOR WHICH SUPPRESSION SPECTRA ARE SUPPLIED: MAY BE
0004500 C      OVERRIDDEN BY ISUPPR IN INDIVIDUAL SOURCE INPUT)
0004600 C      ITOT=1/0 (Y/N FOR PRINTING TOTAL OF SPECTRA)
0004700 C      IDOP=1/0 (Y/N ON DOPPLER FREQ AND INTENSITY CORRECTION);
0004800 C      IATM=0 : NO CORRECTION FOR ATMOSPHERIC ATTENUATION
0004900 C      1 : CORRECT TOTAL NOISE FOR ATMOS. ATTEN. BY ARP 866
0005000 C      2 : CORRECT TOTAL FOR ATMOS. ATTEN. BY BASS & SHIELDS
0005100 C      IEGA=1/0 (Y/N ON EXTRA GROUND ATTEN - ON TOTAL NOISE ONLY)
0005200 C      ISHLD=1/0 (Y/N FOR SHIELDING OF FAN,JET,CORE & TURBINE)
0005300 C      IGND=0 : NO GROUND REFLECTIONS - FREE FIELD
0005400 C      1 : FLAT 3 DB GROUND REFLECTION CORRECTION
0005500 C      2 : CALC GROUND REFLECTION FOR GROUND IMPEDANCE SPECIFIED
0005600 C      ICORR=1/0 (Y/N FOR ENGINE PARAMS TO BE CORR. TO AMBIENT)
0005700 C      TCORXP = EXPONENT FOR CORE TEMP. CORR. IN ENGINE PARAMETERS
0005800 C      FILBW = FRACTION OF FILTER BANDWIDTH WITH GAIN=1
0005900 C      THIS DATA INPUT IS FOR DEFAULT VALUES
0006000      DATA IFAN,IJET,IPLAP,ICORE,ITURB,IAIRF,IATM,IEGA,IGND,ICORR,-
0006100      1 ISHLD,FILBW/11*0,1./
0006200      DATA NTHETA,ATHETA/19,0.,10.,20.,30.,40.,50.,60.,70.,80.,90.,-
0006300      1 100.,110.,120.,130.,140.,150.,160.,170.,180.,190./
0006400      DATA NPHI,APHI/3,0.,45.,90.,7*0./
0006500      UNITS=ENG
0006600      GAMMAF=1.4
0006700      R=-1.
0006800      TAMB=-1.
0006900      PAMB=-1.
0007000 C      THESE NEG. VALUES TO DETECT IF DATA READ IN. FINAL DEFAULTS
0007100 C      GIVEN AT STATEMENT 4.
0007200      RH=70.
0007300      NENG=1
0007400      ISUPP=0
0007500      IDOP=0
0007600      FDOP=1.
0007700      KI=1
0007800      ISKIP=0
0007900      IOUT(1)=4
0008000      ITOT=1
0008100      FUEL=0.
0008200      TCORXP=1.
0008300 C
0008400      1 READ(5,96) (COMENT(I),I=1,20)
0008500      READ(5,GEOMT)
0008600      READ(5,AMB)
0008700      READ(5,SOURCE)
0008800      READ(5,PARAM)
0008900      IF(AEPP(1).GT.AEPP(NPARAM)) WRITE(6,95)
0009000 C
0009100      2 IF(UNITS.EQ.ENG) GO TO 4
0009200      TAMB=TAMB*1.8
0009300      PAMB=PAMB*.02089

```

```

0009400      R=R*3.28
0009500      ZO=ZO*3.28
0009600      ZI=ZI*3.28
0009700      DO 3 I=1,NPARAM
0009800      AVC(I)=AVC(I)*3.28
0009900      AVF(I)=AVF(I)*3.28
0010000      ATC(I)=ATC(I)*1.8
0010100      ATF(I)=ATF(I)*1.8
0010200      AFUEL(I)=AFUEL(I)*2.205
0010300      AWAFFAN(I)=AWAFFAN(I)*2.205
0010400      ADELTA(I)=ADELTA(I)*1.8
0010500      AWCORE(I)=AWCORE(I)*2.205
0010600      AP3(I)=AP3(I)*.02089
0010700      AT3(I)=AT3(I)*1.8
0010800      AT4(I)=AT4(I)*1.8
0010900      ATCTUR(I)=ATCTUR(I)*1.8
0011000      3 ATURTS(I)=ATURTS(I)*3.28
0011100      4 IF(R.LT.0.) R=100.
0011200      RM=R/3.28
0011300      IF(TAMB.LT.0.) TAMB=518.7
0011400      IF(PAMB.LT.0.) PAMB=2116.
0011500      C
0011600      IOUT(1)=4
0011700      C=41.447*SQRT(GAMMAF*TAMB)
0011800      DO 5 L=1,24
0011900      F(L)=10.**(.1*FLOAT(L+16))
0012000      ATM(L)=AIRATT(TAMB,RH,F(L))
0012100      5 IFREQ(L)=F(L)
0012200      F1=.78250188+.10874906*FILBW
0012300      F2=1.-.10874906*FILBW
0012400      F3=1+.12201845*FILBW
0012500      F4=1.2440369-.12201845*FILBW
0012600      C
0012700      DO 6 I=1,NTHETA
0012800      ANGF=.008727*(ATHETA(I)+ATHETA(I+1))
0012900      IF(I.EQ.NTHETA) ANGF=3.1416
0013000      AREA(I)=6.2832*R**2*(COS(ANGIN)-COS(ANGF))
0013100      6 ANGIN=ANGF
0013200      C
0013300      7 ANGIN=0.
0013400      TOTPW=0.
0013500      VSTORE=VI
0013600      DO 8 L=1,24
0013700      TP(L)=1.E-50
0013800      PWL(L)=0.
0013900      TOTPWL(L)=0.
0014000      DO 8 I=1,20
0014100      8 TSP(L,I)=0.
0014200      C
0014300      READ(5,OPER)
0014400      IF(UNITS.EQ.SI.AND.VI.NE.VSTORE) VI=VI*3.28
0014500      TTOT=TAMB+VI*VI/12025.1
0014600      PTOT=PAMB*(TTOT/TAMB)**3.5
0014700      TCORR=TTOT/518.7
0014800      TCORR1=SQRT(TCORR)
0014900      TCORR2=TCORR**TCORXP
0015000      PCORR=PTOT/2116.
0015100      WCORR=PCORR/TCORR1
0015200      C
0015300      PHI=APHI(1)
0015400      TPW=0.
0015500      VIM=VI/3.28
0015600      10 IF(IFAN.EQ.0) GO TO 20
0015700      CALL TERP(ATIPM,EPPI,1.,1.,AEPP,1.,1.,NPARAM,1,1,TIPM)
0015800      CALL TERP(AWAFFAN,EPPI,1.,1.,AEPP,1.,1.,NPARAM,1,1,WAFFAN)
0015900      CALL TERP(ARPM,EPPI,1.,1.,AEPP,1.,1.,NPARAM,1,1,RPM)
0016000      CALL TERP(ADELTA,EPPI,1.,1.,AEPP,1.,1.,NPARAM,1,1,DELTA)
0016100      CALL TERP(AFPR,EPPI,1.,1.,AEPP,1.,1.,NPARAM,1,1,FPR)
0016200      CALL TERP(ATIPM2,EPPI,1.,1.,AEPP,1.,1.,NPARAM,1,1,TIPM2)

```

```

0016300      IF(ICORR.EQ.0) GO TO 11
0016400      WAFAN=WAFAN*WCORR
0016500      RPM=RPM*TCORR1
0016600      DELT=DELT*TCORR
0016700  11 WRITE(6,97) (COMENT(I),I=1,20)
0016800      WRITE(6,106) EPPI
0016900      WRITE(6,107)
0017000      IF(UNITS.EQ.ENG) WRITE(6,99) NENG,R,PHI
0017100      IF(UNITS.EQ.SI) WRITE(6,98) NENG,RM,PHI
0017200      DO 13 I=1,NTHETA
0017300          IJ=I
0017400          THETA=ATHETA(I)
0017500          IF(IDOP.EQ.1) FDOP=1.-VI*COS(THETA*AR)/C
0017600          CALL FAN
0017700          DO 12 L=1,24
0017800              FSPL(L,I)=SPL(L)
0017900              PW=TP(L)*AREA(I)
0018000              TPW=TPW+PW
0018100              PWL(L)=PWL(L)+PW
0018200              TSP(L,I)=TSP(L,I)+TP(L)
0018300  12 TP(L)=1.E-50
0018400      FOASPL(I)=OASPL
0018500      FPNL(I)=PNL
0018600  13 FPNLT(I)=PNLT
0018700      WRITE(6,101) (ATHETA(I),I=1,NTHETA)
0018800      TPW=10.*ALOG10(TPW)
0018900      DO 14 L=1,24
0019000          PW=10.*ALOG10(PWL(L))
0019100          WRITE(6,102) IFREQ(L),(FSPL(L,I),I=1,NTHETA),PW
0019200          TOTPW(L)=TOTPW(L)+PWL(L)
0019300  14 PWL(L)=0.
0019400      WRITE(6,103) (FOASPL(I),I=1,NTHETA),TPW
0019500      WRITE(6,104) (FPNL(I),I=1,NTHETA)
0019600      WRITE(6,105) (FPNLT(I),I=1,NTHETA)
0019700 C
0019800  20 IF(IJET.EQ.0) GO TO 30
0019900      CALL TERP(AVC,EPPI,1.,1.,AEPP,1.,1.,NPARAM,1,1,VC)
0020000      CALL TERP(AVF,EPPI,1.,1.,AEPP,1.,1.,NPARAM,1,1,VF)
0020100      CALL TERP(ATC,EPPI,1.,1.,AEPP,1.,1.,NPARAM,1,1,TC)
0020200      CALL TERP(ATF,EPPI,1.,1.,AEPP,1.,1.,NPARAM,1,1,TF)
0020300      CALL TERP(AFUEL,EPPI,1.,1.,AEPP,1.,1.,NPARAM,1,1,FUEL)
0020400      CALL TERP(AWCORE,EPPI,1.,1.,AEPP,1.,1.,NPARAM,1,1,WCORE)
0020500      IF(ICORR.EQ.0) GO TO 21
0020600      VC=VC*TCORR1
0020700      VF=VF*TCORR1
0020800      TC=TC*TCORR2
0020900      TF=TF*TCORR
0021000      FUEL=FUEL*PCORR*TCORR1
0021100      WCORE=WCORE*WCORR
0021200  21 TPW=0.
0021300      WRITE(6,97) (COMENT(I),I=1,20)
0021400      WRITE(6,106) EPPI
0021500      WRITE(6,108)
0021600      IF(UNITS.EQ.ENG) WRITE(6,99) NENG,R,PHI
0021700      IF(UNITS.EQ.SI) WRITE(6,98) NENG,RM,PHI
0021800      DO 23 I=1,NTHETA
0021900          IJ=I
0022000          THETA=ATHETA(I)
0022100          IF(IDOP.EQ.1) FDOP=1.-VI*COS(THETA*AR)/C
0022200          CALL JET
0022300          DO 22 L=1,24
0022400              FSPL(L,I)=SPL(L)
0022500              PW=TP(L)*AREA(I)
0022600              TPW=TPW+PW
0022700              PWL(L)=PWL(L)+PW
0022800              TSP(L,I)=TSP(L,I)+TP(L)
0022900  22 TP(L)=1.E-50
0023000      FOASPL(I)=OASPL
0023100      FPNL(I)=PNL

```

```

0023200      23  FPNLT(I)=PNLT
0023300          WRITE(6,101) (ATHETA(I),I=1,NTHETA)
0023400          TPW=10.*ALOG10(TPW)
0023500          DO 24 L=1,24
0023600          PW=10.*ALOG10(PWL(L))
0023700          WRITE(6,102) IFREQ(L),(FSPL(L,I),I=1,NTHETA),PW
0023800          TOTPW(L)=TOTPW(L)+PWL(L)
0023900      24  PWL(L)=0.
0024000          WRITE(6,103) (FOASPL(I),I=1,NTHETA),TPW
0024100          WRITE(6,104) (FPNL(I),I=1,NTHETA)
0024200          WRITE(6,105) (FPNLT(I),I=1,NTHETA)
0024300  C
0024400      30  IF(ICORE.EQ.0) GO TO 40
0024500          IF(IJET.EQ.0) CALL TERP(AWCORE,EPPI,1.,1.,AEPP,1.,1.,NPARAM,1,1,-
0024600      1  WCORE)
0024700          CALL TERP(AP3,EPPI,1.,1.,AEPP,1.,1.,NPARAM,1,1,P3)
0024800          CALL TERP(AT3,EPPI,1.,1.,AEPP,1.,1.,NPARAM,1,1,T3)
0024900          CALL TERP(AT4,EPPI,1.,1.,AEPP,1.,1.,NPARAM,1,1,T4)
0025000          IF(IJET.EQ.0) CALL TERP(AFUEL,EPPI,1.,1.,AEPP,1.,1.,NPARAM,1,1,-
0025100      1  FUEL)
0025200          IF(ICORR.EQ.0) GO TO 31
0025300          IF(IJET.EQ.0) WCORE=WCORE*WCORR
0025400          P3=P3*PCORR
0025500          T3=T3*TCORR
0025600          T4=T4*TCORR2
0025700          IF(IJET.EQ.0) FUEL=FUEL*PCORR*TCORR1
0025800      31  TPW=0.
0025900          WRITE(6,97) (COMENT(I),I=1,20)
0026000          WRITE(6,106) EPPI
0026100          WRITE(6,109)
0026200          IF(UNITS.EQ.ENG) WRITE(6,99) NENG,R,PHI
0026300          IF(UNITS.EQ.SI) WRITE(6,98) NENG,RM,PHI
0026400          DO 33 I=1,NTHETA
0026500          IJ=I
0026600          THETA=ATHETA(I)
0026700          IF(IDOP.EQ.1) FDOP=1.-VI*COS(THETA*AR)/C
0026800          CALL CORE
0026900          DO 32 L=1,24
0027000          FSPL(L,I)=SPL(L)
0027100          PW=TP(L)*AREA(I)
0027200          TPW=TPW+PW
0027300          PWL(L)=PWL(L)+PW
0027400          TSP(L,I)=TSP(L,I)+TP(L)
0027500      32  TP(L)=1.E-50
0027600          FOASPL(I)=OASPL
0027700          FPNL(I)=PNL
0027800      33  FPNLT(I)=PNLT
0027900          WRITE(6,101) (ATHETA(I),I=1,NTHETA)
0028000          TPW=10.*ALOG10(TPW)
0028100          DO 34 L=1,24
0028200          PW=10.*ALOG10(PWL(L))
0028300          WRITE(6,102) IFREQ(L),(FSPL(L,I),I=1,NTHETA),PW
0028400          TOTPW(L)=TOTPW(L)+PWL(L)
0028500      34  PWL(L)=0.
0028600          WRITE(6,103) (FOASPL(I),I=1,NTHETA),TPW
0028700          WRITE(6,104) (FPNL(I),I=1,NTHETA)
0028800          WRITE(6,105) (FPNLT(I),I=1,NTHETA)
0028900  C
0029000      40  IF(ITURB.EQ.0) GO TO 50
0029100          IF(IJET.EQ.0) CALL TERP(ATC,EPPI,1.,1.,AEPP,1.,1.,NPARAM,1,1,TC)
0029200          IF(IFAN.EQ.0) CALL TERP(ARPM,EPPI,1.,1.,AEPP,1.,1.,NPARAM,1,1,RPM)
0029300          IF(IJET.EQ.0.AND.ICORE.EQ.0) CALL TERP(AWCORE,EPPI,1.,1.,AEPP,1.,-
0029400      1  1.,NPARAM,1,1,WCORE)
0029500          IF(IJET.EQ.0.AND.ICORE.EQ.0) CALL TERP(AFUEL,EPPI,1.,1.,AEPP,1.,-
0029600      1  1.,NPARAM,1,1,FUEL)
0029700          CALL TERP(ATURTS,EPPI,1.,1.,AEPP,1.,1.,NPARAM,1,1,TURTS)
0029800          CALL TERP(ATCTUR,EPPI,1.,1.,AEPP,1.,1.,NPARAM,1,1,TCTUR)
0029900          IF(TCTUR.LT.1.) CALL TERP(ATC,EPPI,1.,1.,AEPP,1.,1.,NPARAM,1,1,-
0030000      1  TCTUR)

```

```

0030100      IF(ICORR.EQ.0) GO TO 41
0030200      TCTUR=TCTUR*TCORR2
0030300      IF(IFAN.EQ.0) RPM=RPM*TCORR1
0030400      IF(IJET.EQ.0.AND.ICORE.EQ.0) WCORE=WCORE*WCORR
0030500      IF(IJET.EQ.0.AND.ICORE.EQ.0) FUEL=FUEL*PCORR*TCORR1
0030600      TURTS=TURTS*TCORR1
0030700      41 TPW=0.
0030800      WRITE(6,97) (COMENT(I),I=1,20)
0030900      WRITE(6,106) EPPI
0031000      WRITE(6,110)
0031100      IF(UNITS.EQ.ENG) WRITE(6,99) NENG,R,PHI
0031200      IF(UNITS.EQ.SI) WRITE(6,98) NENG,RM,PHI
0031300      DO 43 I=1,NTHETA
0031400      IJ=I
0031500      THETA=ATHETA(I)
0031600      IF(IDOP.EQ.1) FDOP=1.-VI*COS(THETA*AR)/C
0031700      CALL TURB
0031800      DO 42 L=1,24
0031900      FSPL(L,I)=SPL(L)
0032000      PW=TP(L)*AREA(I)
0032100      TPW=TPW+PW
0032200      PWL(L)=PWL(L)+PW
0032300      TSP(L,I)=TSP(L,I)+TP(L)
0032400      42 TP(L)=1.E-50
0032500      FOASPL(I)=OASPL
0032600      FPNL(I)=PNL
0032700      43 FPNLT(I)=PNLT
0032800      WRITE(6,101) (ATHETA(I),I=1,NTHETA)
0032900      TPW=10.*ALOG10(TPW)
0033000      DO 44 L=1,24
0033100      PW=10.*ALOG10(PWL(L))
0033200      WRITE(6,102) IFREQ(L),(FSPL(L,I),I=1,NTHETA),PW
0033300      TOTPW(L)=TOTPW(L)+PWL(L)
0033400      44 PWL(L)=0.
0033500      WRITE(6,103) (FOASPL(I),I=1,NTHETA),TPW
0033600      WRITE(6,104) (FPNL(I),I=1,NTHETA)
0033700      WRITE(6,105) (FPNLT(I),I=1,NTHETA)
0033800      C
0033900      50 IF(ISHLD.NE.1) GO TO 60
0034000      C      ASSUMES NO SHIELDING EFFECT ON TOTAL ACOUSTIC POWER
0034100      DO 57 J=1,NPHI
0034200      PHI=APHI(J)
0034300      COSPHI=COS(PHI*AR)
0034400      SINPHI=SIN(PHI*AR)
0034500      WRITE(6,97) (COMENT(I),I=1,20)
0034600      WRITE(6,106) EPPI
0034700      IF(UNITS.EQ.ENG) WRITE(6,99) NENG,R,PHI
0034800      IF(UNITS.EQ.SI) WRITE(6,98) NENG,RM,PHI
0034900      WRITE(6,117)
0035000      DO 55 I=1,NTHETA
0035100      IJ=I*J
0035200      ADD=0.
0035300      THETA=ATHETA(I)
0035400      IF(ABS(THETA-90.).LT.1.E-10) GO TO 51
0035500      IF(THETA.GT.90.) ADD=180.
0035600      TANTH=TAN(THETA*AR)
0035700      THETA=ATAN(COSPHI*TANTH)/AR + ADD
0035800      THETAH=ATAN(SINPHI*TANTH)/AR + ADD
0035900      GO TO 52
0036000      51 THETA=90.
0036100      THETAH=90.
0036200      52 DO 53 L=1,24
0036300      53 TP(L)=TSP(L,I)
0036400      CALL SHLD
0036500      DO 54 L=1,24
0036600      FSPL(L,I)=SPL(L)
0036700      IF(J.EQ.1) TSP(L,I)=TP(L)
0036800      54 TP(L)=1.E-50
0036900      FOASPL(I)=OASPL

```



```

0037000      FPNL(I)=PNL
0037100      55 FPNLT(I)=PNLT
0037200      WRITE(6,101) (ATHETA(I),I=1,NTHETA)
0037300      DO 56 L=1,24
0037400      56 WRITE(6,102) IFREQ(L),(FSPL(L,I),I=1,NTHETA)
0037500      WRITE(6,118)
0037600      WRITE(6,103) (FOASPL(I),I=1,NTHETA)
0037700      WRITE(6,104) (FPNL(I),I=1,NTHETA)
0037800      57 WRITE(6,105) (FPNLT(I),I=1,NTHETA)
0037900      C
0038000      60 IF(IFLAP.EQ.0) GO TO 70
0038100      IF(IJET.EQ.1) GO TO 61
0038200      CALL TERP(AVC,EPPI,1.,1.,AEPP,1.,1.,NPARAM,1,1,VC)
0038300      CALL TERP(AVF,EPPI,1.,1.,AEPP,1.,1.,NPARAM,1,1,VF)
0038400      IF(ITURB.EQ.0) CALL TERP(ATC,EPPI,1.,1.,AEPP,1.,1.,NPARAM,1,1,TC)
0038500      IF(ICORR.EQ.0) GO TO 61
0038600      IF(ITURB.EQ.0) TC=TC*TCORR2
0038700      VC=VC*TCORR1
0038800      VF=VF*TCORR1
0038900      61 DO 68 J=1,NPHI
0039000      PHI=APHI(J)
0039100      COSPHI=COS(PHI*AR)
0039200      TPW=0.
0039300      WRITE(6,97) (COMENT(I),I=1,20)
0039400      WRITE(6,106) EPPI
0039500      WRITE(6,111)
0039600      IF(UNITS.EQ.ENG) WRITE(6,99) NENG,R,PHI
0039700      IF(UNITS.EQ.SI) WRITE(6,98) NENG,RM,PHI
0039800      DO 65 I=1,NTHETA
0039900      IJ=I*J
0040000      ADD=0.
0040100      THETA=ATHETA(I)
0040200      IF(ABS(THETA-90.).LT.1.E-10) GO TO 62
0040300      IF(THETA.GT.90.) ADD=180.
0040400      TANTH=TAN(THETA*AR)
0040500      THETA=ATAN(COSPHI*TANTH)/AR + ADD
0040600      GO TO 63
0040700      62 THETA=90.
0040800      63 IF(IDOP.EQ.1) FDOP=1.-VI*COS(THETA*AR)/C
0040900      CALL FLAP
0041000      DO 64 L=1,24
0041100      FSPL(L,I)=SPL(L)
0041200      IF(J.GT.1) GO TO 64
0041300      PW=TP(L)*AREA(I)
0041400      TPW=TPW+PW
0041500      PWL(L)=PWL(L)+PW
0041600      TSP(L,I)=TSP(L,I)+TP(L)
0041700      64 TP(L)=1.E-50
0041800      FOASPL(I)=OASPL
0041900      FPNL(I)=PNL
0042000      65 FPNLT(I)=PNLT
0042100      WRITE(6,101) (ATHETA(I),I=1,NTHETA)
0042200      IF(J.EQ.1) TPW=10.*ALOG10(TPW)
0042300      DO 67 L=1,24
0042400      IF(J.GT.1) GO TO 66
0042500      PW=10.*ALOG10(PWL(L))
0042600      WRITE(6,102) IFREQ(L),(FSPL(L,I),I=1,NTHETA),PW
0042700      TOTPW(L)=TOTPW(L)+PWL(L)
0042800      GO TO 67
0042900      66 WRITE(6,102) IFREQ(L),(FSPL(L,I),I=1,NTHETA)
0043000      67 PWL(L)=0.
0043100      WRITE(6,103) (FOASPL(I),I=1,NTHETA),TPW
0043200      WRITE(6,104) (FPNL(I),I=1,NTHETA)
0043300      68 WRITE(6,105) (FPNLT(I),I=1,NTHETA)
0043400      C
0043500      70 IF(IAIRF.EQ.0) GO TO 80
0043600      DO 75 J=1,NPHI
0043700      PHI=APHI(J)
0043800      TPW=0.

```

```

0043900      WRITE(6,97) (COMENT(I),I=1,20)
0044000      IF(UNITS.EQ.ENG) WRITE(6,115) VI
0044100      IF(UNITS.EQ.SI) WRITE(6,116) VIM
0044200      WRITE(6,112)
0044300      IF(UNITS.EQ.ENG) WRITE(6,99) NENG,R,PHI
0044400      IF(UNITS.EQ.SI) WRITE(6,98) NENG,RM,PHI
0044500      DO 72 I=1,NTHETA
0044600      IJ=I*J
0044700      THETA=ATHETA(I)
0044800      IF(IDOP.EQ.1) FDOP=1.-VI*COS(THETA*AR)/C
0044900      CALL AIRFR
0045000      DO 71 L=1,24
0045100      FSPL(L,I)=SPL(L)
0045200      IF(J.GT.1) GO TO 71
0045300      PW=TP(L)*AREA(I)
0045400      TPW=TPW+PW
0045500      PWL(L)=PWL(L)+PW
0045600      TSP(L,I)=TSP(L,I)+TP(L)
0045700 71 TP(L)=1.E-50
0045800      FOASPL(I)=OASPL
0045900      FPNL(I)=PNL
0046000 72 FPNLT(I)=PNLT
0046100      WRITE(6,101) (ATHETA(I),I=1,NTHETA)
0046200      IF(J.EQ.1) TPW=10.*ALOG10(TPW)
0046300      DO 74 L=1,24
0046400      IF(J.GT.1) GO TO 73
0046500      PW=10.*ALOG10(PWL(L))
0046600      WRITE(6,102) IFREQ(L),(FSPL(L,I),I=1,NTHETA),PW
0046700      TOTPW(L)=TOTPW(L)+PWL(L)
0046800      GO TO 74
0046900 73 WRITE(6,102) IFREQ(L),(FSPL(L,I),I=1,NTHETA)
0047000 74 PWL(L)=0.
0047100      WRITE(6,103) (FOASPL(I),I=1,NTHETA),TPW
0047200      WRITE(6,104) (FPNL(I),I=1,NTHETA)
0047300 75 WRITE(6,105) (FPNLT(I),I=1,NTHETA)
0047400 C
0047500 80 KI=0
0047600      IF(ITOT.EQ.0) GO TO 7
0047700      WRITE(6,97) (COMENT(I),I=1,20)
0047800      WRITE(6,106) EPPI
0047900      WRITE(6,113)
0048000      PHI=APHI(1)
0048100      IF(UNITS.EQ.ENG) WRITE(6,99) NENG,R,PHI
0048200      IF(UNITS.EQ.SI) WRITE(6,98) NENG,RM,PHI
0048300      WRITE(6,114) IFAN,IJET,IFLAP,ICORE,ITURB,IAIRF,IREVR,IATM,IGND,-
0048400 1 IEGA,IDOP,ISHLD,ICORR
0048500      WRITE(6,101) (ATHETA(I),I=1,NTHETA)
0048600      DO 83 I=1,NTHETA
0048700      DO 81 L=1,24
0048800      SSPL(L)=10.*ALOG10(TSP(L,I))
0048900      IF(IATM.EQ.1) SSPL(L)=SSPL(L)-ATM(L)*R/1000.
0049000      IF(IGND.EQ.1) SSPL(L)=SSPL(L)+3.01
0049100 81 CONTINUE
0049200      IF(IATM.EQ.2) CALL BASAT(R,TAMB,PAMB,RH,SSPL)
0049300      IF(IEGA.EQ.1) CALL EGAC(SSPL)
0049400      IJ=I
0049500      IF(IGND.EQ.2) CALL GNDRF(SSPL)
0049600      TSUM=0.
0049700      DO 82 L=1,24
0049800      TSUM=TSUM+10.**((SSPL(L)/10.))
0049900 82 FSPL(L,I)=SSPL(L)
0050000      FPNL(I)=PERNOY(SSPL)
0050100      FPNLT(I)=FPNL(I)+TONE(SSPL)
0050200      FOASPL(I)=10.*ALOG10(TSUM)
0050300 83 CONTINUE
0050400      DO 84 L=1,24
0050500      PW=10.*ALOG10(TOTPW(L))
0050600      TOTPW=TOTPW+TOTPW(L)
0050700 84 WRITE(6,102) IFREQ(L),(FSPL(L,I),I=1,NTHETA),PW

```

```

0050800      TOTPW=10.*ALOG10(TOTPW)
0050900      WRITE(6,103) (FOASPL(I),I=1,NTHETA),TOTPW
0051000      WRITE(6,104) (FPNL(I),I=1,NTHETA)
0051100      WRITE(6,105) (FPNLT(I),I=1,NTHETA)
0051200      GO TO 7
0051300
0051400 C      95 FORMAT(2X,'WARNING: ENGINE PARAMETER INPUTS ARE NOT IN ORDER OF-
0051500      1 ASCENDING EPP')
0051600      96 FORMAT(8X,20A4)
0051700      97 FORMAT(1H1,20X,20A4)
0051800      98 FORMAT(15X,I2,' ENGINE(S) AT A CONSTANT RADIUS OF',F6.1,' METERS,-
0051900      1 IN THE PLANE OF PHI =',F5.1,' DEGREES'//)
0052000      99 FORMAT(15X,I2,' ENGINE(S) AT A CONSTANT RADIUS OF',F6.1,' FEET,-
0052100      1 IN THE PLANE OF PHI =',F5.1,' DEGREES'//)
0052200      101 FORMAT(/30X,' POLAR ANGLE, THETA, DEGREES',60X,'POWER LEVEL'/1X,-
0052300      1 4HFREQ,1X,20F6.1)
0052400      102 FORMAT(1X,I4,21F6.1)
0052500      103 FORMAT(/1X,4HOSPL,21F6.1)
0052600      104 FORMAT(/1X,3HPNL,1X,20F6.1)
0052700      105 FORMAT(/1X,4HPNLT,20F6.1)
0052800      106 FORMAT(/35X,'ENGINE PERFORMANCE PARAMETER =',F8.2)
0052900      107 FORMAT(/40X,'FAN NOISE SPECTRA')
0053000      108 FORMAT(/40X,'JET NOISE SPECTRA')
0053100      109 FORMAT(/40X,'CORE NOISE SPECTRA')
0053200      110 FORMAT(/40X,'TURBINE NOISE SPECTRA')
0053300      111 FORMAT(/40X,'FLAP NOISE SPECTRA')
0053400      112 FORMAT(/40X,'AIRFRAME NOISE SPECTRA')
0053500      113 FORMAT(/30X,'NOISE SPECTRA OF TOTAL OF ALL SOURCES')
0053600      114 FORMAT(1X,'SOURCES AND EFFECTS INCLUDED ARE DESIGNATED BY CODE-
0053700      1 > OR =1. '/1X,'SOURCES: IFAN =',I1,8H, IJET =,I1,9H, IFLAP =,-
0053800      2 I1,9H, ICORE =,I1,9H, ITURB =,I1,9H, IAIRF =,I1,9H, IREVR =,-
0053900      3 I1/1X,'PROPAGATION EFFECTS: IATM =',I1,8H, IGND =,I1,-
0054000      4 8H, IEGA =,I1,8H, IDOP =,I1,9H, ISHLD =,I1,9H, ICORR =,I1)
0054100      115 FORMAT(/35X,'AIRCRAFT VELOCITY =',F8.2,4H FPS)
0054200      116 FORMAT(/35X,'AIRCRAFT VELOCITY =',F8.2,4H M/S)
0054300      117 FORMAT(/25X,'SHIELDING FACTORS APPLIED TO THE PREVIOUS SOURCES')
0054400      118 FORMAT(/' THE FOLLOWING ARE LEVELS AFTER ABOVE SHIELDING')
0054500      END

```

Subroutine FAN

```

0000100 C      SUBROUTINE TO CALCULATE INLET AND EXHAUST FAN NOISE
0000200 C      (OR COMPRESSOR INLET NOISE)
0000300 C      BY HEIDMANN ANOP PREDICTION PROCEDURE (NASA TMX-71763)
0000400 C
0000500 C      CALLED BY NOIS OR RADIUS
0000600 C      CALLS SUBROUTINES TERP, PERNOY, TONE
0000700 C      INFLOW: TP,F,UNITS,IOUT,FDOP,C,TAMB,NENG,ISUPP,F1,F2,F3,F4
0000800 C      R,THETA,X,Y,TAU,IJ,KI,WAFAN,RPM,TIPM,TIPM2,DELT,FPR
0000900 C      RETURNS: TP,SPL,OASPL,PNL,PNLT
0001000 C
0001100 C      REQUIRES PARAM INPUT OF AWAFFAN,ARPM,ADELT OR AFPR,
0001200 C      OPTIONAL ATIPM,ATIPM2(2ND STAGE)
0001300 C
0001400      SUBROUTINE FAN
0001500      DIMENSION FIG7A(11),THET7A(11),FIG7B(14),THET7B(14),FIG13A(10),-
0001600      1  THT13A(10),FIG13B(14),FIG16(12),THT16(12),C1(3),-
0001700      2  C2(3),C3(3),C4(3),DCP(24),DP(24),DPX(24),AWREF(26),ATR(26)
0001800      DIMENSION SUPPIN(24),SUPPEX(24),SUPIN(24),SUPEX(24)
0001900      COMMON/GEOM/R,THETA,THETA,F,THETA,H,PHI,VIEW,HEAD,PSYI,FLAPI,EPPI,-
0002000      1  VI,X,Y,TAU,IJ,KI
0002100      COMMON/SPECT/TP(24),SPL(24),F(24),OASPL,PNL,PNLT,F1,F2,F3,F4
0002200      COMMON/PARAM/VC,VF,TC,TF,FUEL,WAFAN,RPM,TIPM,TIPM2,DELT,FPR
0002300      COMMON UNITS,ISKIP,IOUT(3),IREV,ILG,FDOP,C,TAMB,PAMB,RH,NENG,ISUPP
0002400      NAMELIST/FANDA/JOUT,IGV,IFD,IEXH,NH,NSTG,NBL,NVAN,FANDIA,-
0002500      1  FANHUB,TIPMD,RSS,NBL2,NVAN2,FAND2,TIPMD2,RSS2,PRAT,TRAT,GAMMAF,-
0002600      2  FANEFF,FANEF2,ISUPPR,ISUPPEX,SUPPEX,EDOP,EDOP2,DECMPT
0002700 C      IGV=1/0 (Y/N INLET GUIDE VANES);

```

```

0002800 C   IFD=1/0 (Y/N INLET FLOW DISTORTION);
0002900 C   IEXH=0/1/2 (FAN INLET ONLY/EXHAUST ONLY/OR BOTH INCLUDED);
0003000 C   NSTG=NO. OF FAN STAGES;
0003100 C   NH= NO. OF HARMONICS TO BE CONSIDERED IN TONES;
0003200 C   NBL(NBL2)=NO. OF FAN BLADES (2ND STAGE); NVAN(NVAN2)=NO. VANES;
0003300 C   FANDIA(FAND2) = FAN DIAMETER IN M(FT);
0003400 C   FANHUB=DIAMETER OF FIRST STAGE FAN HUB, IN M(FT);
0003500 C   TIPMD(TIPMD2)=DESIGN TIP RELATIVE MACH NUMBER;
0003600 C   RSS(RSS2)=ROTOR-STATOR SPACING IN PERCENT;
0003700 C   GAMMAF= GAMMA OF FAN AIR; FANEFF(FANEF2)=FAN EFFICIENCY;
0003800 C   (GAMMAF AND FANEFF REQUIRED IF USING "AFPR" IN "PARAM" INPUT
0003900 C   INSTEAD OF "ADELT")
0004000 C   DECMPT=DECREMENT TO APPLY TO COMBINATION TONES, DB
0004100 C   PRAT=RATIO OF SECOND STAGE FPR TO FIRST STAGE FPR
0004200 C   TRAT= " " " " " DELT " " " DELT
0004300 C   ISUPPR=1/0 (Y/N SUPPRESSION TO BE APPLIED TO INLET AND EXHAUST)
0004400 C   SUPPIN/SUPPEX = INLET/EXHAUST SUPPRESSION SPECTRA
0004500 C   EDOP/EDOP2 = EXP. ON SOURCE MOTION AMPLIF. (DEFAULT=4.)
0004600 C   DATA FIG7A/1.,0.,0.,0.,2.,4.5,7.5,11.,15.,19.5,25./
0004700 C   DATA THET7A/10.,20.,30.,40.,50.,60.,70.,80.,90.,100.,110./
0004800 C   DATA FIG7B/15.8,11.5,8.,5.,2.7,1.2,3,0.,2.,6.,10.,15.,20.,15./
0004900 C   DATA THET7B/60.,70.,80.,90.,100.,110.,120.,130.,140.,150.,160.,-
0005000 C   1 170.,180.,190./
0005100 C   DATA FIG13A/1.5,0.,0.,0.,1.2,3.5,6.8,10.5,14.5,19./
0005200 C   DATA THT13A/10.,20.,30.,40.,50.,60.,70.,80.,90.,100./
0005300 C   DATA FIG13B/15.,11.,8.,5.,3.,1.,0.,0.,2.,5.5,9.,13.,18.,13./
0005400 C   ABSCISSA OF FIG 7B USED FOR FIG 13B
0005500 C   DATA FIG16/9.5,8.5,7.,5.,2.,0.,0.,3.5,7.5,9.,13.5,9./
0005600 C   DATA THT16/0.,10.,20.,30.,40.,50.,60.,70.,80.,90.,180.,270./
0005700 C   DATA C1/39.28,19.59,9.96/,C2/79.5,83.6,81.5/,C3/-3.,-5.,-5./,-
0005800 C   1 C4/3.,5.,3./
0005900 C   DATA TABLES FOR USE IN CALC FAN TIP REL MACH NO.(FIRST STAGE
0006000 C   ONLY, WITH GAMMAF=1.4)
0006100 C   DATA AWREF/0.,8.495,11.9542,14.5675,16.7366,18.6179,22.515,25.67,-
0006200 C   1 30.643,34.479,37.552,38.869,40.062,41.146,42.131,43.026,43.839,-
0006300 C   1 44.576,45.245,45.849,46.393,47.317,48.044,48.995,49.386,49.41/
0006400 C   DATA ATR/1.,.998,.996,.994,.992,.99,.985,.98,.97,.96,.95,.945,-
0006500 C   1 .94,.935,.93,.925,.92,.915,.91,.905,.9,.89,.88,.86,.84,.8333333/
0006600 C   DEFAULT VALUES
0006700 C   DATA GAMMAF,IEXH,NVAN2,NBL2,NH,IGV,IFD,NSTG/1.4,2,2,1,5,0,0,1/
0006800 C   DATA SI,ENG/2HSI,3HENG/,EDOP,EDOP2/4.,4./
0006900 C   DATA AR,DISTOR,DECMPT/.0174533,2*0./
0007000 C
0007100 C   IF(IJ.NE.1.OR.KI.GT.1) GO TO 8
0007200 C   IF(KI.EQ.0) GO TO 2
0007300 C   ISUPPR=ISUPP
0007400 C   JOUT=IOUT(1)
0007500 C   READ(5,FANDA)
0007600 C   IF(UNITS.EQ.ENG) GO TO 1
0007700 C   FANDIA=FANDIA*3.28
0007800 C   FANHUB=FANHUB*3.28
0007900 C   FAND2=FAND2*3.28
0008000 C
0008100 C   1 VBRAT=1.-FLOAT(NVAN)/FLOAT(NBL)
0008200 C   IF(VBRAT.EQ.0) VBRAT=2.
0008300 C   AFAN=.7854*(FANDIA*FANDIA-FANHUB*FANHUB)
0008400 C   GAM1=GAMMAF-1.
0008500 C   GAMRAT=GAM1/GAMMAF
0008600 C   DRSS=5.*ALOG10(RSS/300.)
0008700 C   IF(RSS.GT.100..AND.IFD.EQ.1) DRSS=-2.386
0008800 C   FTIPMD=0.
0008900 C   IF(TIPMD.GT.1.) FTIPMD=20.*ALOG10(TIPMD)
0009000 C
0009100 C   2 IF(JOUT.NE.4) GO TO 6
0009200 C   IF(TIPM.GT.1) GO TO 3
0009300 C   WREF=WAFAN/AFAN
0009400 C   CALL TERP(ATR,WREF,1.,1.,AWREF,1.,1.,26,1,1,TR)
0009500 C   TIPM=SQRT((2./TR-2.)/GAM1+.0027416*(RPM*FANDIA/C)**2/TR)
0009600 C   3 IF(DELT.LT..01) DELT=TAMB*(FPR**GAMRAT-1.)/FANEFF

```

```

0009700      IF(UNITS.EQ.SI) GO TO 4
0009800      WRITE(6,95)RPM,WAFAN,FANDIA,TIPM,TIPMD,DELT,FPR,NBL,NVAN,RSS,-
0009900      1      NSTG,FANEFF,IGV,IFD,IEXH,NH,GAMMAF,FANHUB
0010000      GO TO 5
0010100      4 WAFANM=WAFAN/2.205
0010200      DELTM=DELT/1.8
0010300      FANDIM=FANDIA/3.28
0010400      FANHUM=FANHUB/3.28
0010500      WRITE(6,96)RPM,WAFANM,FANDIM,TIPM,TIPMD,DELT,FPR,NBL,NVAN,RSS,-
0010600      1      NSTG,FANEFF,IGV,IFD,IEXH,NH,GAMMAF,FANHUM
0010700      5 IF(NSTG.EQ.1) GO TO 6
0010800      IF(TIPM.LT..01) TIPM2=TIPM*TIPMD2/TIPMD
0010900      TRATX=TRAT
0011000      IF(TRAT.EQ.0.) TRATX=(TAMB/DELT+1.)*((FPR*PRAT)**GAMRAT-1.)/FANEF2
0011100      IF(UNITS.EQ.ENG) WRITE(6,97) FAND2,TIPM2,TIPMD2,TRATX,PRAT,NBL2,-
0011200      1      NVAN2,RSS2,FANEF2
0011300      FAND2M=FAND2/3.28
0011400      IF(UNITS.EQ.SI) WRITE(6,98) FAND2M,TIPM2,TIPMD2,TRATX,PRAT,NBL2,-
0011500      1      NVAN2,RSS2,FANEF2
0011600      6 IF(ISUPPR.NE.1) GO TO 8
0011700      IF(JOUT.EQ.4) WRITE(6,103) (SUPPIN(L),L=1,24),(SUPPEX(L),L=1,24)
0011800      DO 7 L=1,24
0011900      SUPIN(L)=10.*(0.1*SUPPIN(L))
0012000      7 SUPEX(L)=10.*(0.1*SUPPEX(L))
0012100 C
0012200      8 IF(DELT.LT..01) DELT=TAMB*(FPR**GAMRAT-1.)/FANEFF
0012300      RLOG=20.*ALOG10(R/3.28)
0012400      TSQEM=10.*ALOG10(DELT**2*WAFAN/FDOP**EDOP)
0012500      BPF=RPM*FLOAT(NBL)/60./FDOP
0012600      SPLPK=58.5+TSQEM-DRSS-RLOG+FTIPMD
0012700      TONLV=SPLPK+2.-DRSS
0012800      SPLPKX=SPLPK+1.5
0012900 C ***** CALCULATE FAN FACE SPEED OF SOUND, CX, ASSUMING AIR
0013000      WREF=WAFAN/AFAN
0013100      CALL TERP(ATR,WREF,1.,1.,AWREF,1.,1.,26,1,1,TR)
0013200      TX = TR*(TAMB+VI*VI/12015.1)
0013300      CX=C*SQRT(TX/TAMB)
0013400      RTSM=.05236*RPM*FANDIA/CX
0013500 C ***** TO CALC TIPM IF NOT SUPPLIED
0013600      IF(TIPM.LT..01) TIPM=SQRT((2./TR-2.)/GAM1+RTSM*RTSM)
0013700      9 DTIPM=20.*ALOG10(TIPM)
0013800      IF(TIPM.GT..9) SPLPK=SPLPK-DTIPM-.91515
0013900      IF(TIPM.GT.1.) SPLPKX=SPLPKX-DTIPM
0014000      IF(IGV.EQ.1) SPLPKX=SPLPKX+3.
0014100      IF(TIPM.LE..72) GO TO 10
0014200      DTIPM1=2.5*DTIPM+7.133
0014300      DTIPM2=3.*FTIPMD-4.*DTIPM-1.
0014400      TONLV=TONLV+AMIN1(DTIPM1,DTIPM2)
0014500      10 TONLVX=SPLPKX+3.-DRSS
0014600      IF(IGV.EQ.1) TONLVX=TONLVX+3.
0014700      CALL TERP(FIG7A,THETA,1.,1.,THET7A,1.,1.,11,1,1,FIG7AX)
0014800      SPLPK=SPLPK-FIG7AX
0014900      CALL TERP(FIG7B,THETA,1.,1.,THET7B,1.,1.,14,1,1,FIG7BX)
0015000      SPLPKX=SPLPKX-FIG7BX
0015100      CALL TERP(FIG13A,THETA,1.,1.,THT13A,1.,1.,10,1,1,F13AX)
0015200      TONLV=TONLV-F13AX
0015300      CALL TERP(FIG13B,THETA,1.,1.,THET7B,1.,1.,14,1,1,F13BX)
0015400      TONLVX=TONLVX-F13BX
0015500      CUTOF=ABS(RTSM/VBRAT)
0015600      ICUT=0
0015700      IF(CUTOF.LT.1.05.AND.RTSM.LT.1.) ICUT=1
0015800      DO 11 L=1,24
0015900      DCP(L)=0.
0016000      DP(L)=0.
0016100      11 DPX(L)=0.
0016200      IF(TIPM.LE.1.) GO TO 15
0016300 C ***** COMBINATION TONES
0016400      CALL TERP(FIG16,THETA,1.,1.,THT16,1.,1.,12,1,1,DIR)
0016500      DO 14 K=1,3

```

```

0016600      FK=2.**K
0016700      CM=30.+C1(K)*DTIPM
0016800      CN=C2(K)-2.5*DTIPM
0016900      COMBL=AMINI(CM,CN)+TSQEM-DIR-RLOG-DECMPT
0017000      IF(IGV.EQ.1) COMBL=COMBL-5.
0017100      COMB=10.**(.1*COMBL)
0017200      DO 12 L=1,24
0017300      FRAT=BPF/FK/F(L)
0017400      IF(FRAT.GT.1.12201845.OR.FRAT.LT..89125094) GO TO 12
0017500      CF=F(L)
0017600      GO TO 13
0017700      12 CONTINUE
0017800      13 DO 14 L=1,24
0017900          FREQ=F(L)/CF
0018000          IF(FREQ.LE.1.) SPEC=FREQ**C3(K)
0018100          IF(FREQ.GT.1.) SPEC=FREQ**C4(K)
0018200      14 DCP(L)=DCP(L)+COMB/SPEC
0018300 C ***** TONES AT BPF AND HARMONICS (SEE FIGURES 8 & 9)
0018400      15 DO 16 IH=1,NH
0018500          FIH=IH
0018600          HARM=3.*(FIH-1.)
0018700          IF(IGV.EQ.1.AND.IH.GT.1) HARM=HARM+6.
0018800          IF(ICUT.EQ.1.AND.IH.EQ.1) HARM=8.
0018900          IF(IFD.EQ.1) DISTR=10.**(.1*TONLV-FIH+1.)
0019000          TONPWR=10.**(.1*(TONLV-HARM))+DISTR
0019100          TONPWX=10.**(.1*(TONLVX-HARM))
0019200          DO 16 L=1,24
0019300          FRAT=BPF*FIH/F(L)
0019400          FR=1.
0019500          IF(FRAT.GT.F4.OR.FRAT.LT.F1) GO TO 16
0019600          IF(FRAT.GT.F3) FR=(F4-FRAT)/(F4-F3)
0019700          IF(FRAT.LT.F2) FR=(FRAT-F1)/(F2-F1)
0019800          DP(L)=DP(L)+TONPWR*FR
0019900          DPX(L)=DPX(L)+TONPWX*FR
0020000      16 CONTINUE
0020100          IF(NSTG.EQ.1) GO TO 20
0020200 C ***** FOR FANS OR COMPRESSORS OF TWO STAGES (REQUIRES
0020300 C          TRAT OR PRAT IN FANDA)
0020400          IF(IJ.NE.1.OR.KI.NE.1) GO TO 17
0020500          VBRAT2=1.-FLOAT(NVAN2)/FLOAT(NBL2)
0020600          IF(VBRAT2.EQ.0) VBRAT2=2.
0020700          DRSS2=5.*ALOG10(RSS2/300.)
0020800          IF(RSS2.GT.100.) DRSS2=-2.386
0020900          ETIPMD=0.
0021000          IF(TIPMD2.GT.1.) ETIPMD=20.*ALOG10(TIPMD2)
0021100      17 CX=C*SQRT((TX+DELT)/TAMB)
0021200          IF(TRAT.NE.0.) DELT2=DELT*TRAT
0021300          IF(TRAT.EQ.0.) DELT2=(TAMB+DELT)*((FPR*PRAT)**GAMRAT-1.)/FANEF2
0021400          IF(TIPM2.EQ.0.) TIPM2=TIPM*TIPMD2/TIPMD
0021500          SPLP2=58.5+10.*ALOG10(DELT2**2*WAFAN/FDOP**EDOP2)-DRSS2-RLOG+ETIPMD
0021600          BPF2=RPM*FLOAT(NBL2)/60./FDOP
0021700      18 SPLP2X=SPLP2+4.5
0021800          TONLV=SPLP2+2.-DRSS2-F13AX
0021900          DTIPM=20.*ALOG10(TIPM2)
0022000          IF(TIPM2.GT..9) SPLP2=SPLP2-DTIPM-.91515
0022100          IF(TIPM2.GT.1.) SPLP2X=SPLP2X-DTIPM
0022200          DTIPM1=2.5*DTIPM+7.133
0022300          DTIPM2=3.*ETIPMD-4.*DTIPM-1.
0022400          TONLV=TONLV+AMINI(DTIPM1,DTIPM2)
0022500          TONLVX=SPLP2X+6.-DRSS2-F13BX
0022600          SPLP2=SPLP2-FIG7AX
0022700          SPLP2X=SPLP2X-FIG7BX
0022800          RTSM2=.05236*RPM*FAND2/CX
0022900          CUTOF=ABS(RTSM2/VBRAT2)
0023000          ICUT=0
0023100          IF(CUTOF.LT.1.05.AND.RTSM2.LT.1.) ICUT=1
0023200 C ***** TONES AT BPF2 AND HARMONICS (NO COMBINATION TONES)
0023300          DO 19 IH=1,NH
0023400          FIH=IH

```

```

0023500      HARM=3.*(FIH-1.)
0023600      IF(IH.GT.1) HARM=HARM+6.
0023700      IF(ICUT.EQ.1.AND.IH.EQ.1) HARM=8.
0023800      TONPWR=10.**(.1*(TONLV-HARM))
0023900      TONPWX=10.**(.1*(TONLVX-HARM))
0024000      DO 19 L=1,24
0024100      FRAT=BPF2*FIH/F(L)
0024200      FR=1.
0024300      IF(FRAT.GT.F4.OR.FRAT.LT.F1) GO TO 19
0024400      IF(FRAT.GT.F3) FR=(F4-FRAT)/(F4-F3)
0024500      IF(FRAT.LT.F2) FR=(FRAT-F1)/(F2-F1)
0024600      DP(L)=DP(L)+TONPWR*FR
0024700      DPX(L)=DPX(L)+TONPWX*FR
0024800 19 CONTINUE
0024900 C
0025000 20 SUM=0.
0025100      DO 23 L=1,24
0025200      FLOG=3.491*(ALOG(F(L)/BPF/2.5))**2
0025300      PLEV=DP(L)+10.**(.1*(SPLPK-FLOG))
0025400      IF(TIPM.GT.1.) PLEV=PLEV+DCP(L)
0025500      PLEVEX=DPX(L)+10.**(.1*(SPLPKX-FLOG))
0025600      IF(NSTG.EQ.1) GO TO 21
0025700      FLOG2=3.491*(ALOG(F(L)/BPF2/2.5))**2
0025800      PLEV=PLEV+10.**(.1*(SPLP2-FLOG2))
0025900      PLEVEX=PLEVEX+10.**(.1*(SPLP2X-FLOG2))
0026000 21 IF(ISUPPR.NE.1) GO TO 22
0026100      PLEV=PLEV/SUPIN(L)
0026200      PLEVEX=PLEVEX/SUPEX(L)
0026300 22 IF(IEXH.EQ.1) PLEV=PLEVEX
0026400      IF(IEXH.EQ.2) PLEV=PLEV+PLEVEX
0026500      PLEV=NENG*PLEV
0026600      SUM=SUM+PLEV
0026700      SPL(L)=10.*ALOG10(PLEV)
0026800      TP(L)=TP(L)+PLEV
0026900 23 CONTINUE
0027000      IF(JOUT.EQ.0) RETURN
0027100      OASPL=10.*ALOG10(SUM)
0027200      PNL=PERNOY(SPL)
0027300      PNLT=PNL+TONE(SPL)
0027400      IF(JOUT.EQ.1) WRITE(6,93) (SPL(L),L=1,24),OASPL,PNL,PNLT
0027500      IF(JOUT.NE.2) RETURN
0027600      IF(UNITS.EQ.ENG) WRITE(6,94) X,Y,TAU,OASPL,PNL,PNLT
0027700      XM=X/3.28
0027800      YM=Y/3.28
0027900      IF(UNITS.EQ.SI) WRITE(6,94) XM,YM,TAU,OASPL,PNL,PNLT
0028000      RETURN
0028100 93 FORMAT(8H FAN      :,17F7.1/8X,7F7.1,21X,8H OASPL =,F7.1,6H PNL =,-
0028200      1   F7.1,7H PNLT =,F7.1)
0028300 94 FORMAT(9H FAN      :,2F8.1,F8.3,3F8.1)
0028400 95 FORMAT(' INPUT PARAMETERS: FAN SPEED =',F6.0,' RPM; FAN MASS-
0028500 1 FLOW (WAFAN) =',F6.1,' LB/S; FAN DIAMETER (FANDIA) =',F6.3,-
0028600 2 4H FT;,,/5X,' TIP REL MACH NO.(TIPM) =',F6.3,'; DESIGN REL TIP-
0028700 3 MACH (TIPMD) =',F6.3,'; TEMP RISE (DELT) =',F6.1,7H DEG R;,,/5X,-
0028800 4 'PRESS RATIO(1 STAGE)(FPR) =',F6.3,'; NO. BLADES(NBL) =',I3,-
0028900 5 ' ; NO. VANES(NVAN) =',I3,'; ROTOR/STATOR SPACING (RSS) =',-
0029000 6 F5.0,3H %;,,/5X,' NO. STAGES(NSTG) =',I2,'; STAGE EFF (FANEFF)-
0029100 7 =',F5.3,'; INLET GUIDE VANES (IGV) =',I1,'; INLET FLOW DISTOR-
0029200 8 (IFD) =',I1,1H;,,/5X,' EXHAUST NOISE OPTION (IEXH) =',I1,'; NO.-
0029300 9 OF TONE HARM CALC (NH) =',I2,'; AIR GAMMAF =',F5.2,'; FAN-
0029400 1 HUB DIAM(FANHUB) =',F6.3,4H FT.)
0029500 96 FORMAT(' INPUT PARAMETERS: FAN SPEED =',F6.0,' RPM; FAN MASS-
0029600 1 FLOW (WAFAN) =',F6.1,' KG/S; FAN DIAMETER (FANDIA) =',F6.3,-
0029700 2 3H M;,,/5X,' TIP REL MACH NO.(TIPM) =',F6.3,'; DESIGN REL TIP-
0029800 3 MACH (TIPMD) =',F6.3,'; TEMP RISE (DELT) =',F6.1,7H DEG K;,,/5X,-
0029900 4 'PRESS RATIO(1 STAGE)(FPR) =',F6.3,'; NO. BLADES(NBL) =',I3,-
0030000 5 ' ; NO. VANES(NVAN) =',I3,'; ROTOR/STATOR SPACING (RSS) =',-
0030100 6 F5.0,3H %;,,/5X,' NO. STAGES(NSTG) =',I2,'; STAGE EFF (FANEFF)-
0030200 7 =',F5.3,'; INLET GUIDE VANES (IGV) =',I1,'; INLET FLOW DISTOR-
0030300 8 (IFD) =',I1,1H;,,/5X,' EXHAUST NOISE OPTION (IEXH) =',I1,'; NO.-

```

```

0030400      9 OF TONE HARM CALC (NH) =',I2,'; AIR GAMMAF =',F5.2,'; FAN-
0030500      1 HUB DIAM(FANHUB) =',F6.3,3H M.)
0030600    97 FORMAT(' SECOND STAGE: DIAMETER (FAND2) =',F6.3,' FT; TIP REL-
0030700      1 MACH(TIPM2) =',F6.3,'; DES REL MACH(TIPMD2) =',F6.3,1H,/5X,-
0030800      2 'SECOND/FIRST TEMP RISE RATIO (TRAT) =',F5.3,'; SEC/FIRST PRESS-
0030900      3 RISE (PRAT) =',F5.3,1H;/,5X,'NO. BLADES(NBL2) =',I3,'; NO.-
0031000      4 VANES(NVAN2) =',I3,'; ROTOR/STATOR SPACE(RSS2) =',F5.0,' %;-
0031100      5 SECOND STAGE EFF (FANEF2) =',F5.3)
0031200    98 FORMAT(' SECOND STAGE: DIAMETER (FAND2) =',F6.3,' M; TIP REL-
0031300      1 MACH(TIPM2) =',F6.3,'; DES REL MACH(TIPMD2) =',F6.3,1H,/5X,-
0031400      2 'SECOND/FIRST TEMP RISE RATIO (TRAT) =',F5.3,'; SEC/FIRST PRESS-
0031500      3 RISE (PRAT) =',F5.3,1H;/,5X,'NO. BLADES(NBL2) =',I3,'; NO.-
0031600      4 VANES(NVAN2) =',I3,'; ROTOR/STATOR SPACE(RSS2) =',F5.0,' %;-
0031700      5 SECOND STAGE EFF (FANEF2) =',F5.3)
0031800  103 FORMAT(1X,'FAN SUPPRESSION SPECTRA -',/1X,'INLET: ',24F5.1/1X,-
0031900      1 'EXHAUST:',24F5.1)
0032000      END

```

Subroutine JET

```

0000100 C          SUBROUTINE FOR JET NOISE CALCULATION
0000200 C          BASED ON STONE'S ANOP PREDICTION (TMX-71618)
0000300 C
0000400 C          CALLED BY NOIS OR RADIUS
0000500 C          CALLS SUBROUTINES TERP, PERNOY, TONE
0000600 C          INFLOW: TP,F,UNITS,ISKIP,IOUT,FDOP,C,TAMB,PAMB,ISUPP
0000700 C                   R,THETA,VI,X,Y,TAU,IJ,KI, VC,VF,TC,TF,FUEL,WCORE
0000800 C          RETURNS: TP,SPL,OASPL,PNL,PNLT
0000900 C
0001000 C          REQUIRES PARAM INPUT OF AVC,ATC, OPTIONAL AWCORE, AFUEL FOR
0001100 C          CORE STREAM; AVF, ATF FOR FAN STREAM
0001200 C
0001300 C          SUBROUTINE JET
0001400 C          DIMENSION DSPL(27,8),SHIFT(17,5),DSHSPL(27),ASTRU(27),ATHET(8),-
0001500 C          1 VRAT(5),ARAT(17),SPLSHC(24),SPLSHF(24)
0001600 C          DIMENSION AGAM(8,3),AGASR(8,3),AFAR(3),ATEMP(8)
0001700 C          COMMON/GEOM/R,THETA,THETAH,THETAH,PHI,VIEW,HEAD,PSYI,FLAPI,EPPI,-
0001800 C          1 VI,X,Y,TAU,IJ,KI
0001900 C          COMMON/SPECT/TP(24),SPL(24),F(24),OASPL,PNL,PNLT
0002000 C          COMMON/PARAM/VC,VF,TC,TF,FUEL,WAFAN,RPM,TIPM,TIPM2,DELT,FPR,-
0002100 C          1 WCORE,P3,T3,T4
0002200 C          COMMON UNITS,ISKIP,IOUT(3),IREV,ILG,FDOP,C,TAMB,PAMB,RH,NENG,ISUPP
0002300 C          REAL MC,MF,MDC,MDF
0002400 C          NAMELIST/JETDA/JOUT,IFWD,INOZ,IPLUG,ISLOT,AC,MDC,GAMMAC,GASRC,-
0002500 C          1 DHC,ANNHT,EDOP, AF,MDF,GAMMAF,GASRF,DHF,ANNHTF
0002600 C          AC/AF = AREA OF CORE/FAN NOZZLE
0002700 C          MDC/MDF = DESIGN MACH NUMBER OF CORE/FAN NOZZLE (IF SUPERSONIC)
0002800 C          GAMMAC/GAMMAF = GAMMA OF CORE/FAN FLOW *
0002900 C          GASRC/GASRF = GAS CONSTANT OF CORE/FAN FLOW IN J/KG/DEG K ,OR
0003000 C          (FT LB/LBM/DEG R) *
0003100 C          * GAMMAC AND GASRC VALUES CAN BE CALCULATED IF FUEL AND
0003200 C          WCORE FLOW DATA IN PARAM. USES DEFAULT VALUES IF
0003300 C          NOT SUPPLIED AND FUEL=0.
0003400 C          DHC/DHF = HYDRAULIC DIAM OF CORE/FAN NOZZLE (REQD. FOR SLOT)
0003500 C          ANNHT/ANNHTF = ANNULAR HEIGHT OF CORE(PLUG)/FAN NOZZLE
0003600 C          INOZ = 1/0: (COAXIAL/SIMPLE CIRCULAR NOZZLE)
0003700 C          FOR MIXED FLOW NOZZLE, USE INOZ=0 AND ENTER
0003800 C          GASRC, GAMMAC, AVC, AND ATC FOR MIXED FLOW PROPERTIES.
0003900 C          ISLOT = 1/0: (Y/N, SLOT NOZZLE ON PRIMARY)
0004000 C          IPLUG = 1/0: (Y/N, PLUG NOZZLE ON PRIMARY)
0004100 C          IFWD = 1/0: (Y/N, FORWARD VELOCITY EFFECTS ON SOURCE)
0004200 C          EDOP = EXP. ON SOURCE MOTION (DOPPLER)AMPLIF. ON SHOCK
0004300 C          NOISE ONLY (DEFAULT=1.)
0004400 C
0004500 C          ASTRU REPRESENTS ABSCISSA VALUES FOR FIGURES 5, 7, 17, AND 19
0004600 C          DATA ASTRU/-1.8,-1.6,-1.4,-1.2,-1.1,-1.,-.9,-.8,-.7,-.6,-.5,-.4,-
0004700 C          1 -.3,-.2,-.1,0.,.1,.2,.3,.4,.5,.6,.7,.8,1.,1.2,1.8/
0004800 C          FROM FIGURE 5

```



```

0004900 DATA DSPL/38.7,34.2,29.7,25.,22.8,20.7,18.7,17.1,15.6,14.3,13.3,-
0005000 112.5,11.8,11.3,11.,2*10.8,11.,11.4,11.9,12.6,13.3,14.3,15.3,17.5,-
0005100 219.7,26.8, 43.8,38.2,32.5,26.8,24.,21.5,19.2,17.1,15.4,14.,12.8,-
0005200 311.9,11.3,10.8,10.6,10.5,10.6,11.1,11.6,12.4,13.2,14.2,15.3,16.4,-
0005300 418.8,21.1,28.2, 41.5,35.5,29.6,23.5,20.4,17.7,15.7,14.1,12.9,11.8-
0005400 5,11.,10.4,10.1,10.,10.2,10.6,11.2,11.9,13.,14.1,15.4,16.6,17.9,-
0005500 619.2,21.6,24.,31.4, 38.7,32.6,26.4,20.1,17.2,14.8,13.,11.5,10.4,-
0005600 79.7,9.3,9.4,10.,10.8,11.7,12.8,14.2,15.6,16.9,18.3,19.8,21.1,22.5-
0005700 8,23.9,26.7,29.6,37.8, 37.1,31.5,25.2,18.7,15.9,13.6,11.6,10.,8.8,-
0005800 98.,8.3,9.2,10.7,12.1,13.7,15.3,17.,18.6,20.3,21.9,23.6,25.3,26.9,-
0005900 128.7,31.9,35.3,45.1, 36.5,30.3,23.6,17.3,14.5,12.4,11.2,10.9,10.7-
0006000 2,11.2,12.6,14.3,16.,17.9,19.,21.7,23.7,25.7,27.5,29.4,31.4,33.3,-
0006100 335.2,37.2,40.9,44.7,56.2, 40.,33.6,27.4,21.2,17.9,15.7,14.2,14.,-
0006200 414.8,15.8,16.9,18.3,20.,21.8,23.9,26.2,28.3,30.4,32.5,34.5,36.7,-
0006300 538.8,40.9,42.9,47.2,51.2,63., 40.5,34.7,28.7,22.8,19.8,17.4,16.5,-
0006400 616.4,17.5,18.7,20.4,22.1,24.2,26.4,28.9,31.2,33.8,36.2,38.5,40.9,-
0006500 7 43.3,45.7,48.,50.3,55.2,60.,74./
0006600 DATA ATHET/110.,120.,130.,140.,150.,160.,170.,180./
0006700 C FROM FIGURE 7
0006800 DATA DSHSPL/36.8,32.6,28.4,24.3,22.3,20.3,18.6,17.2,15.9,14.7,-
0006900 1 13.5,12.6,11.9,11.4,11.,10.7,10.6,10.8,11.1,11.5,12.2,13.,-
0007000 2 14.1,15.2,18.1,21.1,30.7/
0007100 C FOR FIGURE 12
0007200 DATA ARAT/0.,.1,.2,.3,.4,.5,.6,.7,.8,.9,1.,1.1,1.2,1.3,1.4,-
0007300 1 1.5,1.6/
0007400 DATA SHIFT/0.,.07,.136,.19,.234,.266,.285,.291,.297,.299,7*.3,-
0007500 10.,.085,.17,.246,.315,.376,.433,.483,.53,.573,.611,.645,.676,.704-
0007600 2,.73,.753,.778,0.,.123,.23,.327,.41,.477,.534,.585,.63,.671,.708-
0007700 3,.738,.767,.794,.818,.84,.86,0.,.1,.2,.287,.365,.433,.491,.54,-
0007800 4.586,.625,.66,.689,.713,.738,.761,.783,.805,0.,.08,.157,.23,.293-
0007900 5,.35,.404,.453,.5,.542,.58,.613,.645,.674,.7,.725,.75/
0008000 DATA VRAT/.2,.4,.6,.8,1./
0008100 C TABLES FOR CALC. GAMMAC AND GASRC, BASED ON A-1 FUEL (H/C=.16,
0008200 C LHV=10335), FROM VALUES OF FUEL AND WCORE SUPPLIED TO RADIUS
0008300 C OR NOISE. IF FUEL=0., USES DEFAULTS FOR GAMMAC AND GASRC.
0008400 DATA AFAR/0.,.02,.05/
0008500 DATA ATEMP/540.,720.,1080.,1440.,1800.,2160.,2700.,3600./
0008600 DATA AGAM/1.398,1.394,1.374,1.352,1.335,1.323,1.31,1.296, 1.389,-
0008700 1 1.382,1.361,1.339,1.321,1.309,1.295,1.282, 1.377,1.367,1.343,-
0008800 2 1.321,1.303,1.29,1.277,1.263/
0008900 DATA AGASR/7*53.35,53.36,7*53.33,53.36,7*53.31,53.36/
0009000 DATA AR,CISA,RHOISA/.0174533,1116.,.0765/
0009100 C TABLE OF DEFAULT VALUES
0009200 DATA GASRC,GAMMAC,GASRF,GAMMAF/2*-1.,53.35,1.4/
0009300 DATA MDC,MDF/2*1./
0009400 DATA ISLOT,IPLUG,IFWD,IGAM,IGASR/5*0/
0009500 DATA SI,ENG/2HSI,3HENG/,EDOP/1./
0009600 C
0009700 DO 1 L=1,24
0009800 SPLSHC(L)=0.
0009900 I SPLSHF(L)=0.
0010000 C SKIP MOST CALCS IF ENGINE PARAMS AND AIRCRAFT VELOCITY CONSTANT
0010100 IF(ISKIP.EQ.1) GO TO 21
0010200 IF(IJ.NE.1.OR.KI.GT.1) GO TO 7
0010300 IF(KI.EQ.0) GO TO 3
0010400 RHOAMB=PAMB/53.3/TAMB
0010500 JOUT=IOUT(1)
0010600 ISUPPR=ISUPP
0010700 C
0010800 READ(5,JETDA)
0010900 IF(GAMMAC.GT.0.) IGAM=1
0011000 IF(GASRC.GT.0.) IGASR=1
0011100 IF(UNITS.EQ.ENG) GO TO 2
0011200 AC=AC*10.76
0011300 AF=AF*10.76
0011400 DHC=DHC*3.28
0011500 DHF=DHF*3.28
0011600 ANNHT=ANNHT*3.28
0011700 ANNHTF=ANNHTF*3.28

```

```

0011800      GASRC=GASRC*.1858
0011900      GASRF=GASRF*.1858
0012000 C ***** FOR SIMPLE JETS, OR FOR CORE FLOW OF COAXIAL JETS
0012100 C
0012200      2 ACRHO=AC*PAMB*PAMB/4478373.
0012300      DC=SQRT(AC*1.27324)
0012400      DPC=DC
0012500      DDP=0.
0012600      IF(IPLUG.NE.1) GO TO 3
0012700      DPC=ANNHT+AC/3.1416/ANNHT
0012800      DDP=DPC-2.*ANNHT
0012900      IF(DHC.EQ.0.) DHC=2.*ANNHT
0013000      3 IF(JOUT.NE.4) GO TO 7
0013100 C      FOR INPUT VALUES WHEN USING RADIUS
0013200      IF(WCORE.GT.0.) FAR=FUEL/(WCORE-FUEL)
0013300      IF(IGAM.EQ.1) GO TO 4
0013400      GAMMAC=1.4
0013500      IF(FUEL.GT.0.)CALL TERP(AGAM,TC,FAR,1.,ATEMP,AFAR,1.,8,3,1,GAMMAC)
0013600      4 IF(IGASR.EQ.1) GO TO 5
0013700      GASRC=53.35
0013800      IF(FUEL.GT.0.)CALL TERP(AGASR,TC,FAR,1.,ATEMP,AFAR,1.,8,3,1,GASRC)
0013900      5 IF(UNITS.EQ.SI) GO TO 6
0014000      WRITE(6,95) INOZ,IPLUG,ISLOT,IFWD,AC,VC,TC,GAMMAC,GASRC,MDC,-
0014100      1   DHC,ANNHT,FUEL
0014200      GO TO 7
0014300      6 ACM=AC/10.76
0014400      VCM=VC/3.28
0014500      TCM=TC/1.8
0014600      GASRCM=GASRC/.1858
0014700      DHCM=DHC/3.28
0014800      ANNHTM=ANNHT/3.28
0014900      FUELM=FUEL/2.205
0015000      WRITE(6,96) INOZ,IPLUG,ISLOT,IFWD,ACM,VCM,TCM,GAMMAC,GASRCM,-
0015100      1   MDC,DHCM,ANNHTM,FUELM
0015200      7 VMC=VC/C
0015300      IF(WCORE.GT.0.) FAR=FUEL/(WCORE-FUEL)
0015400      IF(IGAM.EQ.1) GO TO 8
0015500      GAMMAC=1.4
0015600      IF(FUEL.GT.0.)CALL TERP(AGAM,TC,FAR,1.,ATEMP,AFAR,1.,8,3,1,GAMMAC)
0015700      8 IF(IGASR.EQ.1) GO TO 9
0015800      GASRC=53.35
0015900      IF(FUEL.GT.0.)CALL TERP(AGASR,TC,FAR,1.,ATEMP,AFAR,1.,8,3,1,GASRC)
0016000      9 TEC=TC-VC*VC*(1.-1./GAMMAC)/GASRC/64.4
0016100      MC=VC/SQRT(32.2*GAMMAC*GASRC*TEC)
0016200      RHOC=PAMB/GASRC/TEC
0016300      EMMC=.62*VMC
0016400      THETAP=THETA*VMC**.1
0016500 C      USE THET FOR INTERPOLATION, WHERE 110.LE.THET.LE.180
0016600      THET=THETAP
0016700      IF(THETAP.GT.180.) THET=180.
0016800      IF(THETAP.LT.110.) THET=110.
0016900      VM=VMC
0017000      IF(IFWD.EQ.0) GO TO 10
0017100      VM=VMC*(1.-VI/VC)**.75
0017200      EMMC=EMMC*(1.-VI/VC)
0017300      10 VM35=VM**3.5
0017400      VCOR=VM**4.*VM35/(1.+01*VM*VM35)
0017500      SPLOR=141.+10.*ALOG10(ACRHO*VCOR)+(30.*VM35/(.6+VM35)-10.)*-
0017600      1   ALOG10(RHOC/RHOAMB)
0017700      CSTRUH=DC/VC*(TC/TAMB)**(.4*(1.+COS(THETAP*AR)))*FDOP
0017800 C ***** FOR PLUG OR SLOT NOZZLE
0017900      IF(IPLUG.EQ.1) SPLOR=SPLOR+3.*ALOG10(.1+2.*ANNHT/DPC)
0018000      IF(IPLUG.EQ.1.OR.ISLOT.EQ.1) CSTRUH=CSTRUH*(DHC/DC)**.4
0018100      IF(MC.LT.1..OR.ABS(MC-MDC).LT..01) GO TO 12
0018200 C ***** SHOCK NOISE OF CORE JET
0018300      FM3=(MC-1.)**3
0018400      VF8=VMC**8
0018500      F3=MC**3
0018600      DNUM=12.5*FM3*VF8

```

```

0018700      DNOM=(.04+FM3)*(1.+2.*FM3*(MC-1.))*(1.+0.05*VF8/F3)*(1.+
0018800      1 .0086*VF8/F3)
0018900      SPLOS=147.+10.*ALOG10(ACRHO*DNUM/DNOM)
0019000      SPLOSH=SPLOS-10.*ALOG10(R*R*FDOP**EDOP)
0019100      DO 11 L=1,24
0019200      STRUX=ALOG10(CSTRUH*F(L))
0019300      CALL TERP(DSHSPL,STRUX,1.,1.,ASTRU,1.,1.,27,1,1,DSPLX)
0019400      SPLSHC(L)=SPLOSH-DSPLX
0019500      11 CONTINUE
0019600      12 IF(INOZ.EQ.0) GO TO 19
0019700 C ***** FOR COAXIAL JETS
0019800      IF(IJ.NE.1.OR.KI.GT.1) GO TO 15
0019900      IF(ANNHTF.GT.0.) GO TO 13
0020000      DDF=SQRT(1.27324*(AF+AC)+DDP**2)
0020100      ANNHTF=(DDF-DPC)/2.
0020200 C      ASSUMES CIRCULAR FAN ANNULUS, THIN INNER WALL
0020300      13 IF(DHF.EQ.0.) DHF=2.*ANNHTF
0020400      IF(JOUT.NE.4) GO TO 15
0020500      IF(UNITS.EQ.SI) GO TO 14
0020600      WRITE(6,97) AF,VF,TF,GAMMAF,GASRF,MDF,DHF,ANNHTF
0020700      GO TO 15
0020800      14 AFM=AF/10.76
0020900      VFM=VF/3.28
0021000      TFM=TF/1.8
0021100      GASRFM=GASRF/.1858
0021200      DHFM=DHF/3.28
0021300      ANNHTM=ANNHTF/3.28
0021400      WRITE(6,97) AFM,VFM,TFM,GAMMAF,GASRFM,MDF,DHFM,ANNHTM
0021500      15 TEF=TF-VF*VF*(1.-1./GAMMAF)/GASRF/64.4
0021600      MF=VF/SQRT(32.2*GAMMAF*GASRF*TEF)
0021700      RHOF=PAMB/GASRF/TEF
0021800      IF(MF.LT.1..OR.ABS(MF-MDF).LT..01) GO TO 18
0021900 C ***** FOR SUPERSONIC FAN FLOW (UNDEREXPANDED) CALCULATE AS
0022000 C      SEPARATE JET PLUS SHOCK NOISE.
0022100      VMF=VF/C
0022200      DF=SQRT(AF*1.27324)
0022300      EMMC=.62*VMF
0022400      THETPF=THETA*VMF**1
0022500 C      USE THETF FOR INTERPOLATION, WHERE 110.LE.THETF.LE.180
0022600      THETF=THETPF
0022700      IF(THETPF.GT.180.) THETF=180.
0022800      IF(THETPF.LT.110.) THETF=110.
0022900      VM=VMF
0023000      IF(IFWD.EQ.0) GO TO 16
0023100      VM=VMF*(1.-VI/VF)**.75
0023200      EMMC=EMMC*(VF-VI)/VF
0023300      16 AFRHO=ACRHO*AF/AC
0023400      VM35=VM**3.5
0023500      VCOR=VM**4*VM35/(1.+0.01*VM*VM35)
0023600      SPLOF=141.+10.*ALOG10(AFRHO*VCOR)+(30.*VM35/(.6+VM35)-10.)*-
0023700      1 ALOG10(RHOF/RHOAMB)+3.*ALOG10(.1+2.*ANNHTF/DF)
0023800      FSTRUH=DF/VF*(TF/TAMB)**(.4*(1.+COS(THETPF*AR)))*(DHF/DF)**.4*FDOP
0023900      FMACH=EMMC/(1.+EMMC**5)**.2
0024000      SPLOA=SPLOF-30.*ALOG10(1.+FMACH*COS(THETA*AR))-20.*ALOG10(R)
0024100      FM3=(MF-1.)**3
0024200      VF8=VMF**8
0024300      F3=MF**3
0024400      DNUM=12.5*FM3*VF8
0024500      DNOM=(.04+FM3)*(1.+2.*FM3*(MF-1.))*(1.+0.05*VF8/F3)*(1.+
0024600      1 .0086*VF8/F3)
0024700      SPLOS=147.+10.*ALOG10(AFRHO*DNUM/DNOM)
0024800      SPLOSH=SPLOS-10.*ALOG10(R*R*FDOP**EDOP)
0024900      DO 17 L=1,24
0025000      STRUX=ALOG10(FSTRUH*F(L))
0025100      CALL TERP(DSHSPL,STRUX,1.,1.,ASTRU,1.,1.,27,1,1,DSPSHX)
0025200      CALL TERP(DSPL,STRUX,THETF,1.,ASTRU,ATHET,1.,27,8,1,DSPLX)
0025300      SPLSHF(L)=10.*ALOG10(10.**(.1*(SPLOSH-DSPSHX))+10.**(.1*-
0025400      1 (SPLOA-DSPLX)))
0025500      17 CONTINUE

```

```

0025600      GO TO 19
0025700 C ***** FOR SHOCKFREE FAN FLOW
0025800      18 ARATX=AF/AC
0025900         ARATL=ALOG10(1.+ARATX)
0026000         VRATX=VF/VC
0026100         VRATR=1.-VRATX
0026200         EM=1.1*SQRT(ARATX)
0026300         IF(ARATX.GE.29.7) EM=6.
0026400         IF(VRATR.LT.0.) VRATR=0.
0026500         SPLOR=SPLOR+5.*ALOG10(TC/TF)+10.*ALOG10(VRATR**EM+1.2*-
0026600         1 (1.+ARATX*VRATX*VRATX)**4/(1.+ARATX)**3)
0026700         CALL TERP(SHIFT,ARATL,VRATX,1.,ARAT,VRAT,1.,17,5,1,SHIFTX)
0026800         CSTRUH=CSTRUH*TC/(TC-SHIFTX*TF)
0026900      19 CMACH=EMMC/(1.+EMMC**5)**.2
0027000         GO TO 25
0027100 C *****
0027200 C      CALCULATIONS SHORTENED HERE FOR CONSTANT POWER AND AIRSPEED
0027300      21 THETAP=THETA*VMC**.1
0027400         THET=THETAP
0027500         IF(THETAP.GT.180.) THET=180.
0027600         IF(THETAP.LT.110.) THET=110.
0027700         CSTRUH=DC/VC*(TC/TAMB)**(.4*(1.+COS(THETAP*AR)))*FDOP
0027800         IF(IPLUG.EQ.1.OR.ISLOT.EQ.1) CSTRUH=CSTRUH*(DHC/DC)**.4
0027900         IF(MC.LT.1..OR.ABS(MC-MDC).LT..01) GO TO 23
0028000         SPLOSH=SPLOS-10.*ALOG10(R*R*FDOP**EDOP)
0028100         DO 22 L=1,24
0028200         STRUX=ALOG10(CSTRUH*(L))
0028300         CALL TERP(DSHSPL,STRUX,1.,1.,ASTRU,1.,1.,27,1,1,DSPLX)
0028400         SPLSHC(L)=SPLOSH-DSPLX
0028500      22 CONTINUE
0028600      23 IF(IHOZ.EQ.0) GO TO 25
0028700 C      FOR COAXIAL JETS
0028800         IF(MF.LT.1..OR.ABS(MF-MDF).LT..01) GO TO 25
0028900         THETPF=THETA*VMF**.1
0029000         THETF=THETPF
0029100         IF(THETPF.GT.180.) THETF=180.
0029200         IF(THETPF.LT.110.) THETF=110.
0029300         FSTRUH=DF/VF*(TF/TAMB)**(.4*(1.+COS(THETPF*AR)))*(DHF/DF)**.4*FDOP
0029400         SPLOA=SPLOF-30.*ALOG10(1.+FMACH*COS(THETA*AR))-20.*ALOG10(R)
0029500         SPLOSH=SPLOS-10.*ALOG10(R*R*FDOP**EDOP)
0029600         DO 24 L=1,24
0029700         STRUX=ALOG10(FSTRUH*(L))
0029800         CALL TERP(DSHSPL,STRUX,1.,1.,ASTRU,1.,1.,27,1,1,DSPSHX)
0029900         CALL TERP(DSPL,STRUX,THETF,1.,ASTRU,ATHET,1.,27,8,1,DSPLX)
0030000         SPLSHF(L)=10.*ALOG10(10.**(.1*(SPLOSH-DSPSHX))+10.**(.1*-
0030100         1 (SPLOA-DSPLX)))
0030200      24 CONTINUE
0030300 C ***** ALL CALCS RESUME HERE
0030400      25 SPLOA=SPLOF-30.*ALOG10(1.+CMACH*COS(THETA*AR))-20.*ALOG10(R)
0030500         DO 26 L=1,24
0030600         STRUX=ALOG10(CSTRUH*(L))
0030700         CALL TERP(DSPL,STRUX,THET,1.,ASTRU,ATHET,1.,27,8,1,DSPLX)
0030800      26 SPL(L)=SPLOA-DSPLX
0030900         SUM=0.
0031000         DO 28 L=1,24
0031100         PLEV=10.**(.1*SPL(L))
0031200         IF(MC.GE.1..AND.ABS(MC-MDC).GE..01) PLEV=PLEV+10.**(.1*SPLSHC(L))
0031300         IF(MF.GE.1..AND.ABS(MF-MDF).GE..01) PLEV=PLEV+10.**(.1*SPLSHF(L))
0031400         PLEV=NENG*PLEV
0031500         SUM=SUM+PLEV
0031600         SPL(L)=10.*ALOG10(PLEV)
0031700         TP(L)=TP(L)+PLEV
0031800      28 CONTINUE
0031900         IF(JOUT.EQ.0) RETURN
0032000         OASPL=10.*ALOG10(SUM)
0032100         PNL=PERNOY(SPL)
0032200         PNLT=PNL+TONE(SPL)
0032300         IF(JOUT.EQ.1) WRITE(6,93) (SPL(L),L=1,24),OASPL,PNL,PNLT
0032400         IF(JOUT.NE.2) RETURN

```

```

0032500      IF(UNITS.EQ.ENG) WRITE(6,94) X,Y,TAU,OASPL,PNL,PNLT
0032600      XM=X/3.28
0032700      YM=Y/3.28
0032800      IF(UNITS.EQ.SI) WRITE(6,94) XM,YM,TAU,OASPL,PNL,PNLT
0032900      RETURN
0033000  93 FORMAT(8H JET      :,17F7.1/8X,7F7.1,21X,8H OASPL =,F7.1,6H PNL =,-
0033100      1  F7.1,7H PNLT =,F7.1)
0033200  94 FORMAT(9H JET      :,2F8.1,F8.3,3F8.1)
0033300  95 FORMAT(' INPUT PARAMETERS: NOZZLE TYPE(SIMPLE=0,COAX=1)(INOZ) ='-
0033400      1 ,I1,'; IPLUG=' ,I1,'; ISLOT=' ,I1,'; FWD VEL EFFECTS(IFWD)=' ,I1,-
0033500      2 1H; ,/20X,'AREA(SQ FT)  VEL(FPS)-
0033600      3  TEMP(R)      GAMMA      GAS CONST  DES MACH # HYD DIA(FT) ANN-
0033700      4UL HT(FT)  FUEL (#/S)',/10X,5HCORE:,7X,F6.3,2(6X,F6.1),6(5X,F7.3))
0033800  96 FORMAT(' INPUT PARAMETERS: NOZZLE TYPE(SIMPLE=0,COAX=1)(INOZ) ='-
0033900      1 ,I1,'; IPLUG=' ,I1,'; ISLOT=' ,I1,'; FWD VEL EFFECTS(IFWD)=' ,I1,-
0034000      2 1H; ,/20X,'AREA(SQ M)  VEL(M/S)-
0034100      3  TEMP(K)      GAMMA      GAS CONST  DES MACH # HYD DIA(M) ANN-
0034200      4UL HT(M)  FUEL(KG/S)',/10X,5HCORE:,7X,F6.3,2(6X,F6.1),6(5X,F7.3))
0034300  97 FORMAT(10X,5HFAN :,7X,F6.3,2(6X,F6.1),6(5X,F7.3))
0034400      END

```

Subroutine CORE

```

0000100 C      SUBROUTINE FOR LOW-FREQ CORE NOISE CALCULATION
0000200 C      BASED ON TMX-71627 OF HUFF, OR GE-FAA EQN OF FAA-RD-77-4
0000300 C
0000400 C      CALLED BY NOIS OR RADIUS
0000500 C      CALLS SUBROUTINES TERP,PERNOY, TONE
0000600 C      INFLOW: TP,F,UNITS,IOUT,FDOP,TAMB,PAMB,NENG,ISUPP
0000700 C      R,THETA,X,Y,TAU,IJ,KI,FUEL,WCORE,P3,T3,T4
0000800 C      RETURNS: TP,SPL,OASPL,PNL,PNLT
0000900 C
0001000 C      REQUIRES PARAM INPUT OF AWCORE,AP3,AT4 (OR AFUEL)
0001100 C      OPTIONAL AT3, AT4 (IF FUEL SUPPLIED)
0001200 C
0001300 C      SUBROUTINE CORE
0001400 C      DIMENSION AFIG1(15),ATHET(15),AFIG2(12),AFREQ(12),CSUPP(24),-
0001500 C      1  ATDEL(9,4),AFAR(9),AT3R(4)
0001600 C      COMMON/GEOM/R,THETA,THETAH,PHI,VIEW,HEAD,PSYI,FLAPI,EPPI,-
0001700 C      1  VI,X,Y,TAU,IJ,KI
0001800 C      COMMON/SPECT/TP(24),SPL(24),F(24),OASPL,PNL,PNLT
0001900 C      COMMON/PARAM/VC,VF,TC,TF,FUEL,WAFAN,RPM,TIPM,TIPM2,DELT,FPR,-
0002000 C      1  WCORE,P3,T3,T4
0002100 C      COMMON UNITS,ISKIP,IOUT(3),IREV,ILG,FDOP,C,TAMB,PAMB,RH,NENG,ISUPP
0002200 C      NAMELIST/COREDA/JOUT,ISUPPR,CSUPP,GAMMA,DTEMD,IMOD,EDOP
0002300 C      VALUES OF AT3, AP3, AT4, AND AWCORE (& AFUEL) ARE ENTERED AS
0002400 C      ARRAYS IN PARAM OF CALLING PROGRAM.
0002500 C      ISUPPR = 1/0: (Y/N, SUPPRESSION TO BE APPLIED TO PREDICTION)
0002600 C      FLSUPP = SUPPRESSION SPECTRUM
0002700 C      EDOP = EXPONENT FOR SOURCE MOTION (DOPPLER) AMPLIF. (DEFAULT=2.)
0002800 C      GAMMA ASSUMED =1.4 UNLESS SUPPLIED IN COREDA - REQUIRED FOR
0002900 C      CALCULATION IF AT3 VALUES NOT SUPPLIED IN PARAM
0003000 C      ***FOR MODIFIED PREDICTION (1/18/77) (BASED ON GE-FAA
0003100 C      EQUATION), SET IMOD=1, AND SUPPLY VALUE OF
0003200 C      DESIGN TURBINE DELTA T, (DTEMD=T4(D)-TC(D)), IN COREDA
0003300 C      DATA AFIG1/32.5,29.5,26.7,25.1,24.1,23.3,22.4,19.7,18.9,18.6,-
0003400 C      1  18.6,18.7,19.,19.2,19./
0003500 C      DATA ATHET/0.,20.,40.,50.,60.,70.,80.,100.,110.,120.,130.,140.,-
0003600 C      1  160.,180.,200./
0003700 C      DATA AFIG2/33.,26.5,18.7,12.8,10.9,10.2,10.,10.5,11.3,14.2,-
0003800 C      1  19.8,30./
0003900 C      DATA AFREQ/-1.222,-1.,-.699,-.398,-.222,-.097,0.,.176,.301,-
0004000 C      1  .602,1.,1.602/
0004100 C      DATA FOR INTERPOLATING FOR T4
0004200 C      DATA AT3R/460.,1060.,1660.,2260./
0004300 C      DATA AFAR/.1,.2,.3,.4,.5,.6,.65,.7,.75/
0004400 C      DATA ATDEL/740.,1390.,1970.,2490.,2980.,3420.,3580.,3660.,3600.,-
0004500 C      1  670.,1280.,1830.,2330.,2770.,3150.,3280.,3360.,3330.,-

```

```

0004600      2  630.,1190.,1700.,2160.,2560.,2860.,2950.,3010.,3020.,-
0004700      3  570.,1110.,1570.,1990.,2320.,2530.,2600.,2640.,2660./
0004800      DATA SI,ENG/2HSI,3HENG/,AR,EDOP/.0174533,2./,IMOD/0/
0004900 C
0005000      IF(IJ.NE.1.OR.KI.GT.1) GO TO 5
0005100      IF(KI.EQ.0) GO TO 1
0005200      GAMMA=1.4
0005300      JOUT=IOUT(1)
0005400      ISUPPR=ISUPP
0005500      READ(5,COREDA)
0005600      GAMRAT=1.-1./GAMMA
0005700      IF(UNITS.EQ.SI) DTEMD=DTEMD*1.8
0005800      1 IF(JOUT.NE.4) GO TO 5
0005900      IF(IMOD.EQ.1) WRITE(6,92)
0006000      IF(T3.LT..1) T3=TAMB*(P3/PAMB)**GAMRAT
0006100      IF(T4.GT..1) GO TO 2
0006200      FAR=FUEL/(WCORE-FUEL)
0006300      CALL TERP(ATDEL,AFAR,AT3R,FAR,T3,1.,9,4,1,TDEL)
0006400      T4=T3+TDEL
0006500 C      PRECEDING FOR CALC T3 & T4 INPUT VALUES FOR RADIUS
0006600      2 IF(UNITS.EQ.SI) GO TO 3
0006700      WRITE(6,95) T3,T4,P3,WCORE,DTEMD
0006800      GO TO 4
0006900      3 T3M=T3/1.8
0007000      T4M=T4/1.8
0007100      P3M=P3/.02089
0007200      WCOREM=WCORE/2.205
0007300      DTEMDM=DTEMD/1.8
0007400      WRITE(6,96) T3M,T4M,P3M,WCOREM,DTEMDM
0007500      4 IF(ISUPPR.EQ.1) WRITE(6,99) (CSUPP(L),L=1,24)
0007600      5 CALL TERP(AFIG1,THETA,1.,1.,ATHET,1.,1.,15,1,1,FIG1)
0007700      IF(T3.LT..1) T3=TAMB*(P3/PAMB)**GAMRAT
0007800      IF(T4.GT.0.) GO TO 7
0007900 C      TO CALC T4 FROM FUEL/AIR
0008000      IF(FUEL.GT.0.) GO TO 6
0008100      WRITE(6,100)
0008200      STOP
0008300      6 FAR=FUEL/(WCORE-FUEL)
0008400      CALL TERP(ATDEL,AFAR,AT3R,FAR,T3,1.,9,4,1,TDEL)
0008500      T4=T3+TDEL
0008600      7 SPLOA=56.5-FIG1+10.*ALOG10(NENG*WCORE*((T4-T3)*P3*TAMB/PAMB/T3/-
0008700      1 R*3.28)**2/FDOP**EDOP)
0008800      IF(IMOD.EQ.1) SPLOA=SPLOA+114.5-40.*ALOG10(DTEMD)
0008900 C      (LEVELS UNCHANGED IF DTEMD=728.62 DEG R)
0009000      FREQP=740.*SQRT(P3/WCORE/2116.*SQRT(518.7/T4))
0009100      IF(FREQP.LT.300..OR.FREQP.GT.1000.) FREQP=400.
0009200      FREQP=FREQP/FDOP
0009300      8 SUM=0.
0009400      DO 9 L=1,24
0009500      FREQ=ALOG10(F(L)/FREQP)
0009600      CALL TERP(AFIG2,FREQ,1.,1.,AFREQ,1.,1.,12,1,1,FIG2)
0009700      SPL(L)=SPLOA-FIG2
0009800      IF(ISUPPR.EQ.1) SPL(L)=SPL(L)-CSUPP(L)
0009900      PLEV=10.*(1*SPL(L))
0010000      SUM=SUM+PLEV
0010100      9 TP(L)=TP(L)+PLEV
0010200      IF(JOUT.EQ.0) RETURN
0010300      OASPL=10.*ALOG10(SUM)
0010400      PNL=PERNOY(SPL)
0010500      PNLT=PNL+TONE(SPL)
0010600      IF(JOUT.EQ.1) WRITE(6,93) (SPL(L),L=1,24),OASPL,PNL,PNLT
0010700      IF(JOUT.NE.2) RETURN
0010800      IF(UNITS.EQ.ENG) WRITE(6,94) X,Y,TAU,OASPL,PNL,PNLT
0010900      XM=X/3.28
0011000      YM=Y/3.28
0011100      IF(UNITS.EQ.SI) WRITE(6,94) XM,YM,TAU,OASPL,PNL,PNLT
0011200      RETURN
0011300      92 FORMAT(22X,'MODIFIED NOISE LEVEL PREDICTION')
0011400      93 FORMAT(8H CORE  :,17F7.1/8X,7F7.1,21X,8H OASPL =,F7.1,6H PNL =,-

```

```

0011500      1 F7.1,7H PNLT =,F7.1)
0011600      94 FORMAT(9H CORE      :,2F8.1,F8.3,3F8.1)
0011700      95 FORMAT(1X,'INPUT PARAMETERS: COMBUSTOR INLET TEMP (T3) =',F6.1,-
0011800      1 ' DEG R; EXHAUST TEMP (T4) =',F6.1,' DEG R;'/10X,'INLET PRESS-
0011900      2 (P3) =',F7.1,' PSF; CORE MASS FLOW (WCORE) =',F6.1,' LB/S; -
0012000      3 DESIGN TURBINE DELTA T (DTEMD) =',F6.1,' DEG R')
0012100      96 FORMAT(1X,'INPUT PARAMETERS: COMBUSTOR INLET TEMP (T3) =',F6.1,-
0012200      1 ' DEG K; EXHAUST TEMP (T4) =',F6.1,' DEG K;'/10X,'INLET PRESS-
0012300      2 (P3) =',F9.1,' N/SQ M; CORE MASS FLOW (WCORE) =',F6.1,' KG/S; -
0012400      3 DESIGN TURBINE DELTA T (DTEMD) =',F6.1,' DEG K')
0012500      99 FORMAT(1X,'CORE SUPP:',24F5.1//)
0012600     100 FORMAT(' INADEQUATE DATA IN PARAM INPUT - SUPPLY AT4 OR AFUEL-
0012700      1 FOR COREN CALC.')
0012800      END

```

Subroutine TURB

```

0000100 C          SUBROUTINE TO CALCULATE THE TURBINE NOISE
0000200 C          BASED ON KREJSA'S (BOEING) ANOP PREDICTION (TMX-73566)
0000300 C
0000400 C          CALLED BY NOIS OR RADIUS
0000500 C          CALLS SUBROUTINES TERP, PERNOY, TONE
0000600 C          INFLOW: TP,F,UNITS,IOUT,FDOP,NENG,ISUPP,F1,F2,F3,F4
0000700 C          R,THETA,X,Y,TAU,IJ,KI,RPM,WCORE,TURTS,TCTUR
0000800 C          RETURNS: TP,SPL,OASPL,PNL,PNLT
0000900 C
0001000 C          REQUIRES INPUT OF ATCTUR (OR ATC), ARPM, AWCORE IN PARAM,
0001100 C          OPTIONAL INPUT OF ATURTS
0001200 C
0001300 C          SUBROUTINE TURB
0001400 C          DIMENSION AFIG5A(9),AFIG5B(9),ATHET(9),TSUPP(24),SUP(24),-
0001500 C          1 DP(24),ATM150(24)
0001600 C          COMMON/GEOM/R,THETA,THETA F,THETA H,PHI,VIEW,HEAD,PSYI,FLAPI,EPPI,-
0001700 C          1 VI,X,Y,TAU,IJ,KI
0001800 C          COMMON/SPECT/TP(24),SPL(24),F(24),OASPL,PNL,PNLT,F1,F2,F3,F4
0001900 C          COMMON/PARAM/VC,VF,TC,TF,FUEL,WAFAN,RPM,TIPM,TIPM2,DELT,FPR,-
0002000 C          1 WCORE,P3,T3,T4,TURTS,TCTUR
0002100 C          COMMON UNITS,ISKIP,IOUT(3),IREV,ILG,FDOP,C,TAMB,PAMB,RH,NENG,ISUPP
0002200 C          NAMELIST/TURBDA/JOUT,ISUPPR,TSUPP,TBNDIA,GEAR,CS,NBLR,ITYPTB,-
0002300 C          1 EDOP
0002400 C          NBLR: NUMBER OF ROTOR BLADES;
0002500 C          GEAR: FAN RPM/TURBINE RPM;
0002600 C          CS: STATOR CHORD TO ROTOR SPACING (USUALLY >100.%);
0002700 C          TBNDIA: DIAM OF LAST STAGE TURBINE IN M(FT);
0002800 C          ITYPTB=0: TURBOJETS, OR FANS WITH COPLANAR EXITS
0002900 C          1: TURBOFANS WITH CORE EXIT AHEAD OF FAN EXIT, IE., JT8D
0003000 C          ISUPPR = 1/0 (Y/N SUPPR. SPECTRUM SUPPLIED FOR TURBINE EXHAUST)
0003100 C          TSUPP = SUPPRESSION SPECTRUM;
0003200 C          EDOP = EXP. ON SOURCE MOTION (DOPPLER) AMPLIF. (DEFAULT=4.)
0003300 C          DATA AFIG5A/21.,13.,7.,4.,1.3,0.,1.3,8.7,19./
0003400 C          DATA AFIG5B/27.5,18.,10.,6.,2.4,0.,2.2,14.,26./
0003500 C          DATA ATHET/40.,60.,80.,90.,100.,110.,120.,140.,160./
0003600 C          DATA C1,C2/1.,-2.0176/
0003700 C          DATA ATM150/7*1.,5*1.023,2*1.047,1.072,1.096,1.122,1.148,1.202,-
0003800 C          1 1.318,1.38,1.585,1.95,2.63/
0003900 C          DATA SI,ENG/2HSI,3HENG/,AR,EDOP/.0174533,4./
0004000 C
0004100 C          IF(IJ.NE.1.OR.KI.GT.1) GO TO 5
0004200 C          IF(KI.EQ.0) GO TO 1
0004300 C          ISUPPR=ISUPP
0004400 C          JOUT=IOUT(1)
0004500 C
0004600 C          READ(5,TURBDA)
0004700 C          1 IF(JOUT.NE.4) GO TO 3
0004800 C          IF(TURTS.LT..1) TURTS=.036652*GEAR*RPM*TBNDIA
0004900 C          IF(UNITS.EQ.SI) GO TO 2
0005000 C          WRITE(6,95) TCTUR,TURTS,WCORE,RPM,GEAR,TBNDIA,NBLR,CS,ITYPTB
0005100 C          GO TO 3

```

```

0005200      2 TCTURM=TCTUR/1.8
0005300      TURTSM=TURTS/3.28
0005400      WCOREM=WCORE/2.205
0005500      TBNDIM=TBNDIA/3.28
0005600      WRITE(6,96) TCTURM,TURTSM,WCOREM,RPM,GEAR,TBNDIM,NBLR,CS,ITYPTB
0005700      3 IF(ISUPPR.NE.1) GO TO 5
0005800      IF(JOUT.EQ.4) WRITE(6,97) (TSUPP(L),L=1,24)
0005900      DO 4 L=1,24
0006000      4 SUP(L)=10.*(TSUPP(L)/10.)
0006100 C
0006200      5 RPMT=GEAR*RPM
0006300      BPF=RPMT*FLOAT(NBLR)/60./FDOP
0006400      IF(TURTS.LT..1) TURTS=.036652*RPMT*TBNDIA
0006500      6 CLR=48.5*SQR(TCTUR)/1116.
0006600      RSQ=R*R/22500.
0006700      BB=WCORE*WENG/RSQ/CLR**3/FDOP**EDOP
0006800      7 TONEL=BB*CS*TURTS**1.6*3981.07
0006900      BB=BB*TURTS**3/10.
0007000      IF(ITYPTB.EQ.1) TONEL=TONEL/10.
0007100      CALL TERP(AFIG5A,THETA,1.,1.,ATHET,1.,1.,9,1,1,FIG5A)
0007200      CALL TERP(AFIG5B,THETA,1.,1.,ATHET,1.,1.,9,1,1,FIG5B)
0007300      BB=BB/10.*(FIG5A/10.)
0007400      TONEL=TONEL/10.*(FIG5B/10.)
0007500      DO 8 L=1,24
0007600      FRAT=BPF/F(L)
0007700      IF(FRAT.GT.1.12201845.OR.FRAT.LT..89125094) GO TO 8
0007800      CF=F(L)
0007900      GO TO 9
0008000      8 CONTINUE
0008100 C      IF BPF > 10 KHZ, USE BPF FOR CF OF PEAK BROADBAND
0008200      CF=BPF
0008300      9 DO 10 L=1,24
0008400      FREQ=F(L)/CF
0008500      IF(FREQ.LE.1.) SPEC=FREQ**C1
0008600      IF(FREQ.GT.1.) SPEC=FREQ**C2
0008700      10 DP(L)=BB*SPEC
0008800 C ***** TONE SPECTRUM CALCULATION
0008900      DO 11 IH=1,4
0009000      TONEH=TONEL/10.*(IH-1)
0009100      DO 11 L=1,24
0009200      FRAT=BPF*FLOAT(IH)/F(L)
0009300      FR=1.
0009400      IF(FRAT.GT.F4.OR.FRAT.LT.F1) GO TO 11
0009500      IF(FRAT.GT.F3) FR=(F4-FRAT)/(F4-F3)
0009600      IF(FRAT.LT.F2) FR=(FRAT-F1)/(F2-F1)
0009700      DP(L)=DP(L)+TONEH*FR
0009800      11 CONTINUE
0009900      SUM=0.
0010000      DO 12 L=1,24
0010100      DP(L)=DP(L)*ATM150(L)
0010200      IF(ISUPPR.EQ.1) DP(L)=DP(L)/SUP(L)
0010300      SUM=SUM+DP(L)
0010400      SPL(L)=10.*ALOG10(DP(L))
0010500      12 TP(L)=TP(L)+DP(L)
0010600      IF(JOUT.EQ.0) RETURN
0010700      OASPL=10.*ALOG10(SUM)
0010800      PNL=PERNOY(SPL)
0010900      PNLT=PNL+TONE(SPL)
0011000      IF(JOUT.EQ.1) WRITE(6,93) (SPL(L),L=1,24),OASPL,PNL,PNLT
0011100      IF(JOUT.EQ.2) WRITE(6,94) X,Y,TAU,OASPL,PNL,PNLT
0011200      RETURN
0011300      93 FORMAT(8H TURB  :,17F7.1/8X,7F7.1,21X,8H OASPL =,F7.1,6H PNL =,-
0011400      1 F7.1,7H PNLT =,F7.1)
0011500      94 FORMAT(9H TURB  :,2F8.1,F8.3,3F8.1)
0011600      95 FORMAT(' INPUT PARAMETERS:  EXIT TEMP (TCTUR) =',F6.1,' DEG R;-
0011700      1 ROTOR TIP SPEED (TURTS) =',F6.1,' FPS;  MASS -
0011800      2 FLOW (WCORE) =',F7.3,6H LB/S; ,/5X,' FAN SPEED (RPM) =',F6.0,' RPM;-
0011900      3 TURBINE/FAN SPEED (GEAR) =',F5.2,-
0012000      4 ';  DIAMETER (TBNDIA) =',F6.3,' FT;  NO. BLADES (NBLR) =',I3,-

```



```

0012100      5 1H;/5X,'STATOR CHORD/ROTOR SPACING (CS) =',F5.1,'%'; TYPE-
0012200      6 (SHORT CORE DUCT=1,COPLANAR OR TURBOJET=0)(TYPTB) =',I1)
0012300 96 FORMAT(' INPUT PARAMETERS: EXIT TEMP (TCTUR) =',F6.1,' DEG K;-
0012400      1 ROTOR TIP SPEED (TURT5) =',F6.1,' M/S; MASS -
0012500      2FLOW (WCORE) =',F7.3,6H KG/S;,,/5X,'FAN SPEED (RPM) =',F6.0,' RPM;-
0012600      3 TURBINE/FAN SPEED (GEAR) =',F5.2,-
0012700      4 ' ; DIAMETER (TBNDIA) =',F6.3,' M; NO. BLADES (NBLR) =',I3,-
0012800      5 1H;/5X,'STATOR CHORD/ROTOR SPACING (CS) =',F5.1,'%'; TYPE-
0012900      6 (SHORT CORE DUCT=1,COPLANAR OR TURBOJET=0)(TYPTB) =',I1)
0013000 97 FORMAT(' TURB SUPP:',24F5.1//)
0013100      END

```

Subroutine FLAP

```

0000100 C          SUBROUTINE FOR FLAP NOISE CALCULATION
0000200 C          (OR JET/FLAP INTERACTION NOISE)
0000300 C          BY DORSCH ET AL ANOP PREDICTION PROCEDURE (TMX-71768)
0000400 C
0000500 C          CALLED BY NOIS OR RADIUS
0000600 C          CALLS SUBROUTINES TERP, PERNOY, TONE
0000700 C          INFLOW: TP,FP,UNITS,IOUT,FDOP,NENG,ISUPP
0000800 C          R,THETA,THETA,PHI,PSYI,VI,X,Y,TAU,IJ,KI, VC,VF
0000900 C          RETURNS: TP,SPL,OASPL,PNL,PNLT
0001000 C
0001100 C          REQUIRES PARAM INPUT OF AVC FOR CORE, AVF FOR FAN FLOW
0001200 C
0001300 C          SUBROUTINE FLAP
0001400 C          DIMENSION DSPL(29,3,2),DOSPL(29,2,2),ASTRU(29),APSY(3,2),APHI(2),-
0001500 C          1 BETA(25,3),CAY(25,2),DTHET(25,3),DOTHET(25,2),ATHET(25),-
0001600 C          2 DPHI(13),AOPHI(13),AOPSY(2,2)
0001700 C          DIMENSION C1(3),C2(3),C3(3),FLSUPP(24)
0001800 C          COMMON UNITS,ISKIP,IOUT(3),IREV,ILG,FDOP,C,TAMB,PAMB,RH,NENG,ISUPP
0001900 C          COMMON/GEOM/R,THETA,THETA,PHI,VIEW,HEAD,PSYI,FLAPI,EPPI,-
0002000 C          1 VI,X,Y,TAU,IJ,KI
0002100 C          COMMON/SPECT/TP(24),SPL(24),F(24),OASPL,PNL,PNLT
0002200 C          COMMON/PARAM/VC,VF
0002300 C          NAMELIST/FLAPDA/JOUT,IUOTW,INOZ,IFWD,INSENS,AC1,AF1,BPR,WINGD,-
0002400 C          1 ISUPPR,FLSUPP,EDOP
0002500 C          IUOTW = 1/0: OVER-THE-WING/UNDER-THE-WING CONFIGURATION
0002600 C          IFWD = 1/0: (Y/N, FORWARD VELOCITY EFFECTS ON SOURCES)
0002700 C          INSENS = 1/0: (Y/N, NOISE LEVELS REL. INSENSITIVE TO FLAP
0002800 C          ANGLE - AS 3-FLAP DATA)
0002900 C          AC1,AF1 = CORE AND FAN EXHAUST AREAS (IN SQ M(SQ FT))
0003000 C          BPR = BYPASS RATIO (FOR MIXED FLOW COAXIAL)
0003100 C          WINGD = RATIO OF WING CHORD TO TOTAL NOZZLE DIAM (USE ONLY
0003200 C          FOR LARGE BPR CORRECTION)
0003300 C          INOZ=0: SINGLE NOZZLE EXHAUST (REQUIRES ONLY AC1 INPUT IN
0003400 C          FLAPDA AND AVC IN PARAM)
0003500 C          =1: COAXIAL NOZZLE, UNMIXED (REQUIRES AC1 AND AF1 IN
0003600 C          FLAPDA AND AVC AND AVF IN PARAM)
0003700 C          =2: COAXIAL NOZZLE, MIXED (REQUIRES AC1, AF1, AND BPR IN
0003800 C          FLAPDA, AND AVC AND AVF IN PARAM)
0003900 C          ISUPPR = 1/0: (Y/N, SUPPRESSION TO BE APPLIED TO PREDICTION)
0004000 C          FLSUPP = SUPPRESSION SPECTRUM
0004100 C          EDOP = EXP. ON SOURCE MOTION (DOPPLER) AMPLIF.(DEFAULT=4.)
0004200 C          DATA DSPL/41.,34.,27.,24.,21.5,17.,14.4,12.7,11.5,10.6,10.,9.8,-
0004300 C          1 2*9.7,9.9,10.,10.1,10.2,10.6,11.,11.5,12.7,16.6,18.5,21.5,25.4,-
0004400 C          2 29.4,33.1,38.,-
0004500 C          346.,39.,32.,29.6,27.,23.,19.8,16.9,14.9,12.2,10.6,10.,9.3,9.,8.9,-
0004600 C          49.1,9.4,9.7,10.,10.5,10.9,11.9,15.7,17.9,20.7,24.5,28.4,32.,37.2,-
0004700 C          553.,47.,38.,35.,32.,28.,24.,21.2,18.,15.,12.5,11.4,10.7,10.1,9.8,-
0004800 C          6 9.2,2*9.1,9.3,9.6,9.9,11.,15.,17.1,20.,24.,27.8,31.6,36.8, -
0004900 C          742.,37.,31.7,29.6,28.,25.,22.5,20.8,19.,16.6,14.5,13.,11.3,10.,-
0005000 C          8 8.9,8.4,8.2,8.5,9.,9.4,10.,11.,14.5,16.4,19.,22.3,25.6,29.,33.5,-
0005100 C          942.,37.,31.7,29.6,28.,25.,22.5,20.8,19.,16.6,14.5,13.,11.3,10.,-
0005200 C          1 8.9,8.4,8.2,8.5,9.,9.4,10.,11.,14.5,16.4,19.,22.3,25.6,29.,33.5,-
0005300 C          242.,37.,31.7,29.6,28.,25.,22.5,20.8,19.,16.6,14.5,13.,11.3,10.,-
0005400 C          3 8.9,8.4,8.2,8.5,9.,9.4,10.,11.,14.5,16.4,19.,22.3,25.6,29.,33.5/

```

```

0005500      DATA DOSPL/23.,17.2,12.,10.5,10.2,10.5,11.4,12.,12.3,12.4,12.,-
0005600      1 11.3,10.9,2*10.3,11.,11.5,12.1,13.,13.6,14.,15.1,18.7,20.8,23.2,-
0005700      2 27.2,31.5,36.1,43.,-
0005800      321.4,16.1,11.1,10.2,10.,11.4,12.7,13.5,2*13.8,13.3,12.8,11.9,-
0005900      4 11.4,2*11.1,11.3,11.7,12.,12.5,13.,13.8,16.8,18.7,21.4,25.,29.2,-
0006000      5 34.,41.,-
0006100      633.,29.,25.,24.,23.,21.2,19.9,18.8,17.8,16.4,15.3,14.4,13.7,12.8,-
0006200      7 11.8,10.9,10.,9.7,9.2,9.1,9.3,10.,13.1,15.5,18.4,22.8,27.,31.3,-
0006300      8 37.1,-
0006400      933.,29.,25.,24.,23.,21.2,19.9,18.8,17.8,16.4,15.3,14.4,13.7,12.8,-
0006500      1 11.8,10.9,10.,9.7,9.2,9.1,9.3,10.,13.1,15.5,18.4,22.8,27.,31.3,-
0006600      2 37.1/
0006700      DATA ASTRU/-1.456,-1.301,-1.155,-1.097,-1.046,-.959,-.886,-.824,-
0006800      1 -.77,-0.699,-.638,-.585,-.538,-.481,-.42,-.347,-.301,-.252,-
0006900      2 -.194,-.143,-.097,0.,.301,.477,.699,1.,1.301,1.602,2./
0007000      DATA APHI/0.,90./
0007100      DATA APSY/0.,20.,60.,0.,20.,60./,AOPSY/20.,60.,20.,60./
0007200      DATA ATHET/0.,10.,20.,30.,40.,50.,60.,70.,80.,90.,100.,110.,120.,-
0007300      1 130.,140.,145.,150.,155.,160.,165.,170.,175.,180.,185.,190./
0007400      DATA DTJET/-4.,-3.,-2.,-1.,-.6,-.1,8*0.,.2,.6,1.2,1.8,2.6,-
0007500      1 3.,2.5,1.,0.,.6,1.,-
0007600      2 -2.6,-1.9,-1.,-.6,-.25,-.1,8*0.,.1,1.5,0.,-2.3,-5.,-5.3,-
0007700      3 -4.7,-2.4,-.7,2.,3., -
0007800      4 -.7,.2,.9,1.5,2.,2.1,2.,1.8,1.2,0.,-1.3,-3.8,-6.,-5.7,-3.2,-
0007900      5 -1.2,.5,1.,1.1,1.,.9,.6,.2,-.5,-1./
0008000      DATA DOTJET/-1.,-.5,.5,2*1.,.8,.4,0.,-.4,3*0.,-.5,-1.6,-4.2,-
0008100      1 -4.9,-5.,-4.2,-2.5,.3,3.2,5.8,9.1,9.,8.5, -
0008200      2 0.,.5,.8,1.2,1.3,1.2,1.1,1.,.6,0.,-1.,-1.8,-2.5,-.3,3.2,4.7,-
0008300      3 6.,6.8,7.5,7.6,7.7,7.5,6.9,6.375,6./
0008400      DATA BETA/0.,2.,3.,3.6,4.,6*4.1,4.05,3.8,3.3,2.65,2.3,-
0008500      1 1.93,1.55,1.05,.55,.12,3*0.,.12, -
0008600      2 0.,1.2,2.25,3.05,3.67,4.1,4.45,4.8,5.1,5.35,5.6,5.3,4.95,4.5,-
0008700      3 3.8,3.27,2.55,1.7,-1.95,-2.,-1.65,-1.,0.,-1.,-1.65,-
0008800      4 0.,.9,1.8,2.7,3.6,4.5,5.4,6.2,7.1,8.,7.1,4.5,-2.4,-2.,-1.1,-.4,-
0008900      5 .2,.8,1.2,1.4,1.1,.6,0.,.6,1.1/
0009000      DATA CAY/9*4.,3.95,3.63,3*3.5,3.7,4.1,4.6,5.3,5.9,6*6.,-
0009100      1 8*1.,1.2,1.7,2.7,5.,4*6.,5.7,5.,3.2,2.1,1.6,1.3,1.,.7,.4/
0009200      DATA DPHI/3*0.,-.5,-1.25,-2.3,-3.,-2.9,-2.1,-.75,2.,2.5,3./
0009300      DATA AOPHI/0.,10.,20.,30.,40.,50.,60.,70.,80.,90.,120.,150.,180./
0009400      DATA C1/83.6,91.4,85.1/,C2/.14,.01,.01/,C3/67.,67.,60./,WINGD/3./
0009500      DATA INOZ,IFWD,INSENS/3*0/
0009600      DATA SI,ENG/2HSI,3HENG/,AR,EDOP/.0174533,4./
0009700      C
0009800      IF(IJ.NE.1.OR.KI.GT.1) GO TO 6
0009900      IF(KI.EQ.0) GO TO 3
0010000      JOUT=IOUT(1)
0010100      ISUPPR=ISUPP
0010200      1 READ(5,FLAPDA)
0010300      IF(UNITS.EQ.ENG) GO TO 2
0010400      AC1=AC1*10.76
0010500      AF1=AF1*10.76
0010600      C
0010700      2 IF(IUOTW.EQ.0) IC=1
0010800      IF(INSENS.EQ.1) IC=2
0010900      IF(IUOTW.EQ.1) IC=3
0011000      ATOT=AC1+AF1
0011100      IF(INOZ.EQ.0) ATOT=AC1
0011200      DTOT=SQRT(4.*ATOT/3.1416)
0011300      C
0011400      3 IF(JOUT.NE.4) GO TO 6
0011500      IF(UNITS.EQ.SI) GO TO 4
0011600      WRITE(6,96) IUOTW,INOZ,INSENS,IFWD,AC1,VC,WINGD,AF1,VF,BPR
0011700      GO TO 5
0011800      4 ACM=AC1/10.76
0011900      AFM=AF1/10.76
0012000      VCM=VC/3.28
0012100      VFM=VF/3.28
0012200      WRITE(6,97) IUOTW,INOZ,INSENS,IFWD,ACM,VCM,WINGD,AFM,VFM,BPR
0012300      5 IF(ISUPPR.EQ.1) WRITE(6,98) (FLSUPP(L),L=1,24)

```

```

0012400 C ***** START HERE FOR ALL SUBSEQUENT CALCULATIONS
0012500   6 IF(INOZ.EQ.0) VAV=VC
0012600     IF(INOZ.EQ.1) VAV=((AC1*VC**6+AF1*VF**6)/ATOT)**0.1667
0012700     IF(INOZ.EQ.2) VAV=(VF*BPR+VC)/(BPR+1)
0012800   7 RSQ=R*R/1.E04
0012900     SPLOA=C1(IC)+C2(IC)*PSYI+C3(IC)*ALOG10(VAV/500.)+10.*ALOG10(NENG-
0013000     1 *ATOT/RSQ/FDOP**EDOP)
0013100     IF(WINGD.LT.3.) SPLOA=SPLOA+10.*ALOG10(WINGD/3.)
0013200     IF(IJ.EQ.1.AND.JOUT.EQ.4) WRITE(6,95) SPLOA
0013300 C       OBTAIN DIRECTIONALITY IN THETA AND PHI DIRECTIONS FROM TABLES
0013400     THET=THETA F
0013500     IF(THET.LT.-90.) THET=360.+THETA F
0013600     IF(UOTW.EQ.1) GO TO 8
0013700 C ***** UNDER-THE-WING
0013800     CALL TERP(DTHET,THET,PSYI,1.,ATHET,APSY,1.,25,3,1,DTHETX)
0013900     CALL TERP(BETA,THETA,PSYI,1.,ATHET,APSY,1.,25,3,1,BETAX)
0014000 C *** NOTE THAT FIG 14 OF ANOP TMX RE-INTERPRETED AS THETA FOR
0014100 C     ABSCISSA. THIS CHANGE MADE 2/10/77 TO AVOID ANOMOLY NEAR
0014200 C     THETA=90, PHI=90 OF RAPID LEVEL CHANGES.
0014300     DPHIX=BETAX*(COS(PHI*AR)-1.)
0014400     GO TO 9
0014500 C ***** OVER-THE-WING
0014600   8 CALL TERP(DOTHET,THET,PSYI,1.,ATHET,AOPSY,1.,25,2,1,DTHETX)
0014700     PHIAB=ABS(PHI)
0014800     CALL TERP(DPHI,PHIAB,1.,1.,AOPHI,1.,1.,13,1,1,DPHIX)
0014900     IF(PHIAB.LE.65.) PHIT=0.
0015000     IF(PHIAB.GT.65.) PHIT=3.6*(PHIAB-65.)
0015100     IF(PHIAB.GT.90.) PHIT=90.
0015200   9 SPLOA=SPLOA+DTHETX+DPHIX*ABS(SIN(THETA*AR))
0015300 C *** NOTE SINE FACTOR ADDED TO DPHIX DIRECTIONALITY SO IT ADDS
0015400 C     MAXIMUM @ THETA=90, ZERO AT THETA=0,180. 10/23/79.
0015500     IF(UOTW.EQ.1.OR.IFWD.EQ.0) GO TO 10
0015600     CALL TERP(CAY,THET,PSYI,1.,ATHET,AOPSY,1.,25,2,1,CAYX)
0015700     SPLOA=SPLOA-10.*CAYX*ALOG10(1.-VI/VAV)
0015800  10 SUM=0.
0015900     STRU=ALOG10(DTOT/VAV/FDOP)
0016000     DO 12 L=1,24
0016100     STRUH=ALOG10(F(L))+STRU
0016200     IF(UOTW.EQ.0) CALL TERP(DSPL,STRUH,PSYI,PHI,ASTRU,APSY,APHI,-
0016300     1 29,3,2,SPEC)
0016400     IF(UOTW.EQ.1) CALL TERP(DOSPL,STRUH,PSYI,PHIT,ASTRU,AOPSY,APHI,-
0016500     1 29,2,2,SPEC)
0016600     SPL(L)=SPLOA-SPEC
0016700     IF(ISUPPR.EQ.1) SPL(L)=SPL(L)-FLSUPP(L)
0016800     PLEV=10.**(.1*SPL(L))
0016900     SUM=SUM+PLEV
0017000     TP(L)=TP(L)+PLEV
0017100  12 CONTINUE
0017200     IF(JOUT.EQ.0) RETURN
0017300     OASPL=10.*ALOG10(SUM)
0017400     PNL=PERNOY(SPL)
0017500     PNLT=PNL+TONE(SPL)
0017600     IF(JOUT.EQ.1) WRITE(6,93) (SPL(L),L=1,24),OASPL,PNL,PNLT
0017700     IF(JOUT.NE.2) RETURN
0017800     IF(UNITS.EQ.ENG) WRITE(6,94) X,Y,TAU,OASPL,PNL,PNLT
0017900     XM=X/3.28
0018000     YM=Y/3.28
0018100     IF(UNITS.EQ.SI) WRITE(6,94) XM,YM,TAU,OASPL,PNL,PNLT
0018200     RETURN
0018300  93 FORMAT(8H FLAP : ,17F7.1/8X,7F7.1,21X,8H OASPL =,F7.1,6H PNL =,-
0018400  1  F7.1,7H PNLT =,F7.1)
0018500  94 FORMAT(9H FLAP : ,2F8.1,F8.3,3F8.1)
0018600  95 FORMAT(35X,'CALCULATED OASPL-REF =',F5.1,' DB')
0018700  96 FORMAT(' INPUT PARAMETERS: CONFIGURATION(UTW=0,OTW=1)(UOTW)=',-
0018800  1 I1,'; NOZZLE(SIMPLE=0,UNMIXED=1,MIXED=2)(INOZ)=' ,I1,'; FLAP-
0018900  2 ANGLE SENS(INSENS)=' ,I1,1H; ,/20X,'FWD VEL EFFECTS(IFWD)=' ,I1,-
0019000  3 1H; ,/5X,'CORE: AREA(AC1) =',-
0019100  4 F6.3,' SQ FT; VELOCITY(VC) =',F6.1,' FPS; WING-CHORD/DIAM =',-
0019200  5 F6.2/5X,'FAN : AREA(AF1) =',F6.3,' SQ FT; VELOCITY(VF) =',-

```

```

0019300      6 F6.1,' FPS;  BYPASS(BPR) =',F5.2)
0019400 97 FORMAT(' INPUT PARAMETERS:  CONFIGURATION(UTW=0,OTW=1)(IUOTW)=',-
0019500 1 I1,';  NOZZLE(SIMPLE=0,UNMIXED=1,MIXED=2)(INOZ)=' ,I1,';  FLAP-
0019600 2 ANGLE SENS(INSENS)=' ,I1,IH; ,/20X,'FWD VEL EFFECTS(IFWD)=' ,I1,-
0019700 3 IH; ,/5X,'CORE:  AREA(AC1) =',-
0019800 4 F6.3,' SQ M;  VELOCITY(VC) =',F6.1,' M/S;  WING-CHORD/DIAM =',-
0019900 5 F6.2/5X,'FAN :  AREA(AF1) =',F6.3,' SQ M;  VELOCITY(VF) =',-
0020000 6 F6.1,' M/S;  BYPASS(BPR) =',F5.2)
0020100 98 FORMAT(' FLAP SUPP:',24F5.1//)
0020200      END

```

Subroutine AIRFR

```

0000100      SUBROUTINE AIRFR
0000200 C      TO CALCULATE AIRFRAME NOISE OF AIRCRAFT DUE TO AIRFLOW
0000300 C      OVER WINGS, HORIZONTAL TAIL, VERTICAL TAIL, NOSE AND MAIN
0000400 C      LANDING GEAR, DEFLECTED SLOTTED FLAPS, AND LEADING EDGE
0000500 C      SLAT.
0000600 C      BASED ON PREDICTION BY M.R. FINK IN FAA RD 77-29,
0000700 C      AND PROGRAMMED VERSION BY ANOPP-LANGLEY.
0000800 C
0000900 C      CALLED BY NOIS OR RADIUS
0001000 C      CALLS SUBROUTINES PERNOY, TONE
0001100 C      INFLOW:  TP,F,UNITS,IOUT,ILG,FDOP,C,TAMB,PAMB,
0001200 C      R,THETA,PHI,FLAPI,VI,X,Y,TAU,IJ,KI
0001300 C      RETURNS:  TP,SPL,OASPL,PNL,PNLT
0001400 C
0001500      DIMENSION DP(24),A(4),B(4),NG(2),NW(2),C1(3),E1(3),CG(2),DW(2),-
0001600 1 C2(2),S2(2),C3(2),C4(2),E2(2),CPF(2),AM(4),BM(4),DWM(2)
0001700      COMMON/GEOM/R,THETA,THETAH,PHI,VIEW,HEAD,PSYI,FLAPI,EPPI,-
0001800 1 VI,X,Y,TAU,IJ,KI
0001900      COMMON/SPECT/TP(24),SPL(24),F(24),OASPL,PNL,PNLT
0002000      COMMON UNITS,ISKIP,IOUT(3),IREV,ILG,FDOP,C,TAMB,PAMB,RH,NENG,ISUPP
0002100      NAMELIST/AIRFDA/JOUT,A,B,ITYPW,ICLEAN,NG,NW,CG,DW,NF,IWING,IFL,-
0002200 1 ISLAT,ILG
0002300 C      IWING = 1/0 (Y/N FOR WING AND HORIZ. & VERT. TAIL NOISE)
0002400 C      IFL = 1/0 (Y/N FOR SLOTTED FLAP NOISE)
0002500 C      ISLAT = 1/0 (Y/N FOR LEADING EDGE SLAT NOISE)
0002600 C      ILG = 1/0 (Y/N FOR NOSE AND MAIN LANDING GEAR NOISE - THIS
0002700 C      CAN BE ENTERED THROUGH TRAJ INPUT TO FOOTPR)
0002800 C      A = AREAS OF WING, HORIZONTAL TAIL, VERTICAL TAIL, AND
0002900 C      SLOTTED FLAPS(AW,AH,AV,AF) - SQ M(SQ FT)
0003000 C      B = TOTAL SPANS OF WING, HORIZ. TAIL, VERT. TAIL, AND
0003100 C      FLAPS(BW,BH,BV,AF/CF) - M(FT)
0003200 C      ICLEAN=0/1 FOR AERODYN. CLEAN CONFIG (SAILPLANE)/CONVENTIONAL
0003300 C      ITYPW=1/2 FOR CONVENTIONAL/DELTA TYPE WING
0003400 C      NG = NUMBERS OF NOSE GEAR AND MAIN GEAR (NNG,NMG)
0003500 C      NW = NUMBERS OF WHEELS ON NOSE GEAR, MAIN GEAR (NNGW,NMGW)
0003600 C      DW = TIRE DIAMETERS FOR NOSE AND MAIN GEAR (TDNG,TDMG) - M(FT)
0003700 C      CG = STRUT LENGTH TO TIRE DIAM. RATIOS, NOSE & MAIN (CNG,CMG)
0003800 C      NF = NUMBER OF TRAILING FLAP SLOTS
0003900 C      (KIN. VISCOSITY OF AMBIENT AIR IS CALC FROM TAMB AND PAMB)
0004000 C
0004100      DATA C1,E1,C2,S2,C3,E2,C4,CPF/3*.613,3*1.5,.0588,.0278,20.,75.,-
0004200 1 .1722,.0579,.55,.0625,265.2,18641.,2.45E-4,6.74E-4/
0004300      DATA SI,ENG/2HSI,3HENG/,AR/.0174533/
0004400 C      FOR DEFAULTS
0004500      DATA ICLEAN,ITYPW,NG,NW,NF/3*1,4*2/
0004600      DATA A,B,DW,CG/1000.,4*100.,3*20.,4*3./
0004700 C
0004800      IF(VI.GT..1) GO TO 1
0004900      WRITE(6,92)
0005000      RETURN
0005100 1 IF(IJ.NE.1.OR.KI.GT.1) GO TO 6
0005200      IF(KI.EQ.0) GO TO 3
0005300      JOUT=IOUT(1)
0005400      RHOAMB=PAMB/53.3/TAMB/32.2
0005500      XJAI=(RHOAMB*C**2/4.1773E-7)**2

```

```

0005600      GNUAMB=TAMB**1.768/PAMB*5.241E-6
0005700      READ(5,AIRFDA)
0005800      IF(UNITS.EQ.ENG) GO TO 3
0005900      DO 2 I=1,4
0006000      A(I)=A(I)*10.76
0006100      B(I)=B(I)*3.28
0006200      2 IF(I.LE.2) DW(I)=DW(I)*3.28
0006300      3 IF(JOUT.NE.4) GO TO 6
0006400      WRITE(6,95) IWING,IFL,ILG,ISLAT
0006500      IF(UNITS.EQ.SI) GO TO 4
0006600      WRITE(6,96)
0006700      WRITE(6,98) A(1),B(1),ITYPW,ICLEAN,((A(I),B(I)),I=2,4),NF,FLAPI
0006800      WRITE(6,99)
0006900      WRITE(6,101) ((NG(I),NW(I),DW(I),CG(I)),I=1,2)
0007000      GO TO 6
0007100      4 WRITE(6,97)
0007200      DO 5 I=1,4
0007300      AM(I)=A(I)/10.76
0007400      BM(I)=B(I)/3.28
0007500      5 IF(I.LE.2) DWM(I)=DW(I)/3.28
0007600      WRITE(6,98)AM(1),BM(1),ITYPW,ICLEAN,((AM(I),BM(I)),I=2,4),NF,FLAPI
0007700      WRITE(6,100)
0007800      WRITE(6,101) ((NG(I),NW(I),DWM(I),CG(I)),I=1,2)
0007900      C
0008000      6 DO 7 L=1,24
0008100      7 DP(L)=0.
0008200      VM=VI/C
0008300      VM5R=VM**5/R/R
0008400      SINPH=SIN(PHI*AR)
0008500      COSPH=COS(PHI*AR)
0008600      SINTH=SIN(THETA*AR)
0008700      COSTH=COS(THETA*AR)
0008800      VIGNU=.37/(VI/GNUAMB)**.2
0008900      IF(IWING.EQ.0) GO TO 11
0009000      C**      FOR WING, HORIZ. TAIL, AND VERTICAL TAIL (I=1,2,3)
0009100      IF(ITYPW.LT.2) GO TO 8
0009200      C1(1)=.485
0009300      E1(1)=1.35
0009400      8 FPHI=COSPH**2
0009500      P=XJAI*VM5R*(1.+COSTH)*1.127E-6
0009600      C      CONSTANT IS 7.08E-6(LANGLEY)/2*PI
0009700      DO 10 I=1,3
0009800      CC=1.
0009900      IF(I.EQ.1.AND.ICLEAN.EQ.1) CC=6.31
0010000      BLAY=VIGNU*(A(I)/B(I))**.8
0010100      SM=10.*BLAY*FDOP/VI
0010200      IF(I.EQ.3) FPHI=SINPH**2
0010300      PW=P*CC*BLAY*B(I)*FPHI*C1(I)
0010400      DO 9 L=1,24
0010500      S=F(L)*SM
0010600      FS=(S/(S**E1(I)+.5))**4
0010700      9 DP(L)=DP(L)+FS*PW
0010800      10 CONTINUE
0010900      11 IF(I.G.EQ.0) GO TO 15
0011000      C**      FOR NOSE AND MAIN LANDING GEAR (NOSE:I=1; MAIN:I=2)
0011100      FPHI=SINPH**2
0011200      PG=.1194*XJAI*VM5R*VM*SINTH**2
0011300      DO 14 I=1,2
0011400      PGG=PG*DW(I)**2*FLOAT(NG(I))
0011500      PG1=PGG*FLOAT(NW(I))*4.3E-4
0011600      PG2=PGG*CG(I)*FPHI*5.44E-4
0011700      SM=(DW(I)*FDOP/VI)**2
0011800      DO 13 L=1,24
0011900      SS=SM*F(L)**2
0012000      IF(NW(I).GT.2) GO TO 12
0012100      F1=13.59*SS/(12.5+SS)**2.25
0012200      F2=3.244*SS/(30.+SS**4)
0012300      GO TO 13
0012400      12 F1=.3888*SS/(4.+SS)**1.5

```

```

0012500      F2=1.135*SS**1.5/(1.06+SS)**3
0012600      13 DP(L)=DP(L)+F1*PG1+F2*PG2
0012700      14 CONTINUE
0012800      15 IF(IFL.EQ.0) GO TO 19
0012900 C**      FOR SLOTTED FLAP NOISE
0013000      I=1
0013100      IF(NF.GT.2) I=2
0013200      SINFL=SIN(FLAPI*AR)
0013300      COSFL=COS(FLAPI*AR)
0013400      PF=.2387*XJAI*CPF(I)*VM5R*VM*A(4)*(SINFL*(SINFL*COSTH+-
0013500      1 COSFL*SINTH*COSPH))**2
0013600      SM=A(4)/B(4)*FDOP/VI
0013700      DO 18 L=1,24
0013800      S=F(L)*SM
0013900      IF(S.GE.2.) GO TO 16
0014000      FS=C2(I)*S
0014100      GO TO 18
0014200      16 IF(S.GT.52(I)) GO TO 17
0014300      FS=C3(I)/S**E2(I)
0014400      GO TO 18
0014500      17 FS=C4(I)/S**3
0014600      18 DP(L)=DP(L)+PF*FS
0014700      19 IF(ISLATS.EQ.0) GO TO 22
0014800 C**      FOR SLATTED LEADING EDGE OF WING
0014900      IF(ITYPW.LT.2) GO TO 20
0015000      C1(1)=.485
0015100      E1(1)=1.35
0015200      20 BLAY=VIGNU*(A(1)/B(1))**.8
0015300      PSL=XJAI*VM5R*BLAY*B(1)*(1.+COSTH)*COSPH**2*1.127E-6
0015400      SM=10.*BLAY*FDOP/VI
0015500      DO 21 L=1,24
0015600      SS1=SM*F(L)
0015700      SS2=SS1*.219
0015800      F1=C1(1)*(SS1/(SS1**E1(1)+.5))**4
0015900      F2=.613*(SS2/(SS2**1.5+.5))**4
0016000      21 DP(L)=DP(L)+PSL*(F1+F2)
0016100 C
0016200      22 SUM=0.
0016300      DO 23 L=1,24
0016400      SUM=SUM+DP(L)
0016500      TP(L)=TP(L)+DP(L)
0016600      23 SPL(L)=10.*ALOG10(DP(L))
0016700      IF(JOUT.EQ.0) RETURN
0016800      OASPL=10.*ALOG10(SUM)
0016900      PNL=PERNOY(SPL)
0017000      PNLT=PNL+TONE(SPL)
0017100      IF(JOUT.EQ.1) WRITE(6,93) (SPL(L),L=1,24),OASPL,PNL,PNLT
0017200      IF(JOUT.NE.2) RETURN
0017300      IF(UNITS.EQ.ENG) WRITE(6,94) X,Y,TAU,OASPL,PNL,PNLT
0017400      XM=X/3.28
0017500      YM=Y/3.28
0017600      IF(UNITS.EQ.SI) WRITE(6,94) XM,YM,TAU,OASPL,PNL,PNLT
0017700      RETURN
0017800      92 FORMAT(2X,'VI=0; NO AIRFRAME NOISE; RETURN')
0017900      93 FORMAT(8H AIRFR :,17F7.1/8X,7F7.1,21X,8H OASPL =,F7.1,6H PNL =,-
0018000      1 F7.1,7H PNLT =,F7.1)
0018100      94 FORMAT(9H AIRFR :,2F8.1,F8.3,3F8.1)
0018200      95 FORMAT(' INPUT PARAMETERS: OPTIONS: WING & TAIL NOISE(IWING) =',-
0018300      1 I2,', SLOTTED FLAP NOISE(IFL) =',I2,1H;,/16X,'LANDING GEAR-
0018400      2 NOISE(ILG) =',I2,', LEADING EDGE SLAT NOISE(ISLAT) =',I2)
0018500      96 FORMAT(22X,'AREA (SQ FT)          SPAN (FT)')
0018600      97 FORMAT(22X,'AREA (SQ M)           SPAN (M)')
0018700      98 FORMAT(6X,5HWING:,10X,F8.2,6X,F7.2,6X,7HITYPW =,I2,6X,8HCLEAN =,-
0018800      1 I2,/6X,12HHORIZ. TAIL:,3X,F8.2,6X,F7.2/6X,14HVERTICAL TAIL:,1X,-
0018900      2 F8.2,6X,F7.2/6X,13HSLOTTED FLAP:,2X,F8.2,6X,F7.2,6X,11HNO. FLAPS-
0019000      3 =,I2,22H; FLAP ANGLE(FLAPI) =,F5.1,5H DEG.)
0019100      99 FORMAT(22X,'NO. OF GEAR(NG)      NO. OF WHEELS(NW)   TIRE DIAM.(DW)-
0019200      1-FT  STRUT LEN/TIRE DIAM')
0019300      100 FORMAT(22X,'NO. OF GEAR(NG)      NO. OF WHEELS(NW)   TIRE DIAM.(DW)-

```

```

0019400      1-M      STRUT LEN/TIRE DIAM')
0019500 101 FORMAT(6X,18HNOSE LANDING GEAR: ,6X,I2,20X,I2,2(20X,F6.2)/-
0019600      1      6X,18HMAIN LANDING GEAR: ,6X,I2,20X,I2,2(20X,F6.2))
0019700      END

```

Function Subroutine AIRATT

```

0000100 C      FUNCTION ROUTINE FOR CALCULATION OF AIR ATTEN PER FOOT
0000200 C      BY ARP 866 (MODIFIED FROM F. MONTEGANI PROGRAM)
0000300 C
0000400 C      CALLED BY NOIS OR RADIUS
0000500 C      INFLOW: TEM,RH,FREQ; RETURNS: AIRATT
0000600 C
0000700 C      FUNCTION AIRATT(TEM,RH,FREQ)
0000800 C      DIMENSION A(22)
0000900 C      DATA A/.87,.75,.652,.57,.505,.452,.406,.369,.335,.308,.286,.268,-
0001000 C      1      .253,.24,.231,.225,.22,.215,.21,.208,.202,.2/
0001100 C      T=TEM-460.
0001200 C      AC=(.1*(FREQ/1000.))*2.05)/(1.651-.00103*T))*2.05
0001300 C      AMM=(10.*(FREQ/1000.))*1.003/10.**(.52-.00504*(T+SQRT(256.-
0001400 C      1      -(10.-T/5.))**2)))
0001500 C      HA=.25*RH/10.**(1.493-.01638*T-.02*SQRT(128.2-(10.-T/5.))**2))
0001600 C      HMM=10.**(.4973*ALOG10(FREQ)-1.4894)
0001700 C      HH=HA/HMM
0001800 C      IF(HH.GT..25) GO TO 1
0001900 C      AA=1.2*HH
0002000 C      GO TO 8
0002100 C      1 IF(HH.GT..6) GO TO 2
0002200 C      AA=1.543*HH-.086
0002300 C      GO TO 8
0002400 C      2 IF(HH.GT..95) GO TO 3
0002500 C      AA=.84+.16*SIN(3.1416/2.*(HH-.6)/.35)
0002600 C      GO TO 8
0002700 C      3 IF(HH.GT.1.25) GO TO 4
0002800 C      AA=.87+.13*COS(3.1416/2.*(HH-.95)/.3)
0002900 C      GO TO 8
0003000 C      4 IF(HH.GT.6.5) GO TO 7
0003100 C      HTEST=1.25
0003200 C      DO 5 I=2,22
0003300 C      HTEST=HTEST+.25
0003400 C      IF(HH.LE.HTEST) GO TO 6
0003500 C      5 CONTINUE
0003600 C      6 AA=A(I)+((HTEST-HH)/.25)*(A(I-1)-A(I))
0003700 C      GO TO 8
0003800 C      7 AA=.2
0003900 C      8 CONTINUE
0004000 C      AIRATT=AMM*AA+AC
0004100 C      RETURN
0004200 C      END

```

Subroutine BASAT

```

0000100 C      SUBROUTINE BASAT(R,TAMB,PAMB,RH,SSPL)
0000200 C * * * * *
0000300 C * THIS PROGRAM SUBTRACTS THE ATMOSPHERIC ATTENUATION AT DISTANCE *
0000400 C * R FROM A LOSSLESS INPUT SPECTRUM TO GIVE AN OUTPUT SPECTRUM. *
0000500 C * AIR ATTENUATION FOR EACH BAND IS DETERMINED BY NUMERICAL *
0000600 C * INTEGRATION FOLLOWING RIGOROUS FORMULATIONS THAT ACCOUNT FOR *
0000700 C * SPECTRUM AND ATTENUATION GRADIENTS AND RETAIN NON-LINEAR *
0000800 C * DEPENDENCE ON DISTANCE. IDEAL FILTER CHARACTERISTICS ARE *
0000900 C * IMPLIED, AND THE CALCULATIONS ARE BASED ON INTERNATIONALLY- *
0001000 C * PREFERRED BAND CENTER FREQUENCIES. *
0001100 C *      CALLED BY NOIS OR RADIUS *
0001200 C *
0001300 C * INFLOW: *
0001400 C * SSPL(24) INPUT FRACTIONAL-OCTAVE-BAND SOUND PRESSURE LEVEL *
0001500 C * SPECTRUM *
0001600 C * R DISTANCE FROM SOURCE, IN FEET *

```



```

0003400 ATT=ALPHA/3.28084*R
0003500 RETURN
0003600 END

```

Subroutine EGAC

```

0000100 C SUBROUTINE TO CALCULATE EXTRA GROUND ATTENUATION DUE
0000200 C TO TURBULENT SCATTERING (DOWNWIND ATTENUATION, FIG 4,
0000300 C OF SAE AIR 923) BASED ON NASA CR-114649 FROM BOEING.
0000400 C
0000500 C CALLED BY NOIS OR RADIUS
0000600 C CALLS SUBROUTINE TERP
0000700 C INFLOW: SSPL,R,VIEW,F; RETURNS: SSPL
0000800 C
0000900 SUBROUTINE EGAC(SSPL)
0001000 DIMENSION SSPL(24)
0001100 DIMENSION AFZERO(16,7),AFACT(7,6),ADIST(16),AFREQ(7),ABETA(6)
0001200 COMMON/GEOM/R,THETA,THETA F,THETA H,PHI,VIEW
0001300 COMMON/SPECT/TP(24),SPL(24),F(24)
0001400 DATA ADIST/0.,2.,2.1761,2.301,2.4771,2.6021,2.7781,2.9031,-
0001500 1 3.,3.1461,3.301,3.4771,3.6021,3.7781,3.9031,4./
0001600 DATA AFREQ/1.7245,2.0256,2.3266,2.6276,2.9287,3.2297,-
0001700 1 3.8318/
0001800 DATA ABETA/0.,2.,10.,20.,45.,90./
0001900 DATA AFZERO/0.,2.,3.,5.,7.,8.,1.1,1.5,2.,3.,4.2,5*5.,-
0002000 1 0.,.3,.5,.7,1.1,1.5,2.1,2.5,3.,4.3,6.,7.,7.1,3*7.2,-
0002100 2 0.,.5,.6,1.,1.4,1.9,2.6,3.2,4.,5.6,7.7,9.1,9.7,9.9,2*10.,-
0002200 3 0.,.6,.8,1.2,1.8,2.4,3.2,4.,5.,7.1,9.7,11.2,11.8,3*12.,-
0002300 4 0.,.7,1.,1.5,2.2,2.7,3.6,4.8,6.,8.5,11.1,13.1,14.,14.6,2*14.8,-
0002400 5 0.,.8,1.1,1.7,2.4,3.1,4.4,5.8,7.2,10.1,13.,14.7,15.4,15.9,2*16.,-
0002500 6 0.,.8,1.1,1.7,2.4,3.1,4.4,5.8,7.2,10.1,13.,14.7,15.4,15.9,2*16./
0002600 DATA AFACT/14*1.,.186,.297,.352,.406,.468,2*.534,-
0002700 1 .163,.183,.188,.198,.214,2*.235,14*0./
0002800 C
0002900 IF(R.LE.1.) RETURN
0003000 DIST=ALOG10(R)
0003100 DO 1 I=1,24
0003200 FREQ=ALOG10(F(I))
0003300 CALL TERP(AFZERO,DIST,FREQ,1.,ADIST,AFREQ,1.,16,7,1,FZERO)
0003400 CALL TERP(AFACT,FREQ,VIEW,1.,AFREQ,ABETA,1.,7,6,1,FACT)
0003500 1 SSPL(I)=SSPL(I)-FZERO*FACT
0003600 RETURN
0003700 END

```

Subroutine GNDRFL

```

1000100 C SUBROUTINE TO COMPUTE GROUND REFLECTION EFFECT ON TOTAL NOISE,
1000200 C BASED ON TMX 56033 BY T. W. PUTNAM OF DFRC, FOR ANOP USE.
1000300 C THIS PROGRAM IS BASED ON WHITE NOISE APPROXIMATION, WITH
1000400 C PROVISION FOR DISTRIBUTED SOURCE HEIGHTS AND FOR TONES.
1000500 C
1000600 C CALLED BY NOIS OR RADIUS
1000700 C INFLOW: SSPL,UNITS,IOUT,C,R,IJ,KI,ZO,ZI,F
1000800 C RETURNS: SSPL
1000900 C
1001000 SUBROUTINE GNDRFL(SSPL)
1001100 DIMENSION SSPL(24),ENN(24),QABS(24),FSHIFT(24),DK(10)
1001200 COMMON UNITS,ISKIP,IOUT(3),IREV,ILG,FDOP,C,TAMB,PAMB,RH,NENG,ISUPP
1001300 COMMON/GEOM/R,THETA,THETA F,THETA H,PHI,VIEW,HEAD,PSYI,FLAPI,EPPI,-
1001400 1 VI,X,Y,TAU,IJ,KI,ZO,ZI
1001500 COMMON/SPECT/TP(24),SPL(24),F(24)
1001600 NAMELIST/GNDDA/JOUT,QABS,FSHIFT,DK,NS,ITONE
1001700 C JOUT=1/0 (Y/N TO PRINT GROUND REFLECTION MODIFICATION

```

```

1001800 C      OVERRIDING IOUT(1).
1001900 C      QABS: ABSOLUTE VALUES OF GROUND REFLECTIVITY AS A FUNCTION
1002000 C      OF FREQUENCY (DEFAULT=24*1.)
1002100 C      FSHIFT: PHASE SHIFTS OF THE REFLECTED WAVE AS FUNCTION OF
1002200 C      FREQUENCY, IN DEGREES (DEFAULT=24*0.)
1002300 C      NS: NUMBER OF HEIGHTS TO BE ENTERED FOR A MULTIPLE SOURCE
1002400 C      MODELLING (DEFAULT=1)
1002500 C      DK: HEIGHTS OF THE MULTIPLE SOURCES FROM THE SOURCE CENTER
1002600 C      (DEFAULT=10*0.)
1002700 C      ITONE=1/0 (Y/N TO TREAT 1/3-OCTAVE BANDS 3 DB OR MORE
1002800 C      ABOVE ADJACENT BANDS AS TONES FOR REFL. CALC.
1002900 DATA QABS,FSHIFT,DK,NS,ITONE/24*1.,24*0.,10*0.,1,0/
1003000 DATA SI,ENG/2HSI,3HENG/
1003100 C
1003200 IF(IJ.NE.1.OR.KI.GT.1) GO TO 3
1003300 JOUT=IOUT(1)
1003400 1 READ(5,GNDDA)
1003500 IF(UNITS.EQ.ENG) GO TO 3
1003600 DO 2 I=1,NS
1003700 2 DK(I)=DK(I)*3.28
1003800 3 ZEE=SQRT(1.+4.*ZO*ZI/R/R)
1003900 DRC=R*(ZEE-1.)/C
1004000 PHS=.7249775*DRC
1004100 4 PHC=6.324872*DRC
1004200 DO 8 L=1,24
1004300 PS=PHS
1004400 PC=PHC
1004500 5 IF(ITONE.EQ.0) GO TO 6
1004600 SPLM=SSPL(L+1) + 3.
1004700 SPLN=SSPL(L-1) + 3.
1004800 IF(L.EQ.1) SPLN=SSPL(1)+3.
1004900 IF(L.EQ.24) SPLM=SSPL(24)+3.
1005000 IF(SSPL(L).LT.SPLM.AND.SSPL(L).LT.SPLN) GO TO 6
1005100 PS=.0000001*DRC
1005200 PC=6.2831853*DRC
1005300 6 SUM=0.
1005400 DO 7 I=1,NS
1005500 DKI=1.+DK(I)/ZI
1005600 7 SUM=SUM+SIN(PS*F(L)*DKI)*COS(PC*F(L)*DKI+.0174533*FSHIFT(L))/DKI
1005700 ENN1=1.+(QABS(L)/ZEE)**2+2.*QABS(L)/ZEE/PS/F(L)*SUM/NS
1005800 IF(ENN1.LE.0.) ENN1=1.E-20
1005900 8 ENN(L)=10.*ALOG10(ENN1)
1006000 DO 9 L=1,24
1006100 9 SSPL(L)=SSPL(L)+ENN(L)
1006200 IF(JOUT.EQ.1) WRITE(6,90) (ENN(L),L=1,24)
1006300 90 FORMAT(8H GNDRF :,17F7.1/8X,7F7.1)
1006400 RETURN
1006500 END

```

Subroutine SHLD

```

0000100 C      SHIELDING SUBROUTINE - CONSISTS OF WING AND FUSELAGE
0000200 C      SHIELDING TERMS; IN PARTICULAR,
0000300 C      FUSELAGE: FUNCTION IS HYPERBOLIC SECANT, MAXIMIZING AT
0000400 C      THETA=90 DEGREES, WITH A MAXIMUM OF "SFUSE" AND ANGULAR
0000500 C      WIDTH OF "SWIDE" DEGREES AT 1/E DOWN FROM PEAK.
0000600 C      ATTENUATION DECREASES WITH FREQUENCY FOR WAVE LENGTHS
0000700 C      LONGER THAN CHARACTERISTIC FUSELAGE DIMENSION (SUCH AS
0000800 C      DIAMETER), CFUSE
0000900 C      WING: UNDER-THE-WING: NONE
0001000 C      OVER-THE-WING: COSINE FUNCTION OF PHI FOR PHI>60 DEG,
0001100 C      WITH MAX OF 1; MULTIPLIED BY COSINE FUNCTION
0001200 C      OF THETA WITH MAX OF SWING AND MAX DIRECTION OF SMX.
0001300 C      ATTENUATION DECREASES WITH FREQUENCY FOR WAVE LENGTHS
0001400 C      LONGER THAN CHARACTERISTIC WING DIMENSION (SUCH AS CHORD),
0001500 C      CWING
0001600 C
0001700 C      CALLED BY NOIS OR RADIUS

```

```

0001800 C      INFLOW:  UNITS,TP,F,THETAF,THETAH,PHI,IJ,KI,IOUT
0001900 C      RETURNS:  TP, ATTEN. SPECTRUM (AS SPL), ATTEN. OASPL,PNL,PNLT
0002000 C
0002100      SUBROUTINE SHLD
0002200      DIMENSION SSPL(24)
0002300      COMMON/GEOM/R,THETA,THETAF,THETAH,PHI,VIEW,HEAD,PSYI,FLAPI,EPPI,-
0002400      1  VI,X,Y,TAU,IJ,KI
0002500      COMMON/SPECT/TP(24),SPL(24),F(24),OASPL,PNL,PNLT
0002600      COMMON UNITS,ISKIP,IOUT(3),IREV,ILG,FDOP,C,TAMB,PAMB,RH,NENG,ISUPP
0002700      NAMELIST/SHLDA/IUOTW,SFUSE,SWIDE,SWING,SMX,CFUSE,CWING
0002800 C      DEFAULT VALUES
0002900      DATA SFUSE,SWING,CFUSE,CWING,SWIDE,SMX/4*10.,60.,90./
0003000      DATA SI,ENG/2HSI,3HENG/,AR/.0174533/
0003100 C
0003200      IF(IJ.NE.1.OR.KI.NE.1) GO TO 4
0003300      IF(KI.EQ.0) GO TO 1
0003400      JOUT=IOUT(1)
0003500      READ(5,SHLDA)
0003600      1  IF(JOUT.NE.4) GO TO 3
0003700      IF(IUOTW.EQ.0) WRITE(6,98) SWIDE,SFUSE
0003800      IF(IUOTW.EQ.1) WRITE(6,99) SWIDE,SFUSE,SWING,SMX
0003900      IF(UNITS.EQ.SI) GO TO 2
0004000      WRITE(6,100) CFUSE,CWING
0004100      GO TO 3
0004200      2  WRITE(6,101) CFUSE,CWING
0004300      CFUSE=CFUSE*3.28
0004400      CWING=CWING*3.28
0004500      3  FWING=C/CWING
0004600      FFUSE=C/CFUSE
0004700 C      FUSELAGE SHIELDING (UTW OR OTW ENGINE) FOR PHI>70 DEG.
0004800      DELF=0.
0004900      4  IF(PHI.GT.70.) DELF=SFUSE/COSH((THETAH-90.)*3.315/SWIDE)*-
0005000      1  SIN((PHI-70.)*4.5*AR)/FFUSE
0005100      IF(DELF.LT.0.) DELF=0.
0005200      DELW=0.
0005300      IF(IUOTW.EQ.0) GO TO 8
0005400 C      WING SHIELDING FOR OTW ENGINE
0005500      6  IF(PHI.LE.60.) THDEL=SWING
0005600      IF(PHI.GT.60.) THDEL=SWING*COS(3.*(PHI-60.)*AR)
0005700      DELW=THDEL*COS((THETAF-SMX)*AR)
0005800      8  DELW=DELW/FWING
0005900      IF(DELW.LT.0.) DELW=0.
0006000      SUM=0.
0006100      DO 9 L=1,24
0006200      DEF=DELF*AMIN1(F(L),FFUSE)
0006300      DEW=DELW*AMIN1(F(L),FWING)
0006400      SPL(L)=DEF+DEW
0006500      TP(L)=TP(L)/10.**(SPL(L)/10.)
0006600      SSPL(L)=10.*ALOG10(TP(L))
0006700      9  SUM=SUM+TP(L)
0006800      IF(JOUT.EQ.0) RETURN
0006900      OASPL=10.*ALOG10(SUM)
0007000      PNL=PERNOY(SSPL)
0007100      PNLT=PNL+TONE(SSPL)
0007200      IF(JOUT.EQ.1) WRITE(6,102) (SPL(L),L=1,24),OASPL,PNL,PNLT
0007300      IF(JOUT.EQ.2) WRITE(6,103) OASPL,PNL,PNLT
0007400      RETURN
0007500      98  FORMAT(' UNDER-THE-WING SHIELDING:      SHIELDED OVER',-
0007600      1  F8.2,' DEGREES ARC BY FUSELAGE, MAXIMUM OF',F8.2,3H DB)
0007700      99  FORMAT(' OVER-THE-WING SHIELDING:      SHIELDED OVER',-
0007800      1  F8.2,' DEGREES ARC BY FUSELAGE, MAXIMUM OF',F8.2,3H DB/-
0007900      2  22X,'WING SHIELDING MAXIMUM OF',F8.2,' DB AT ANGLE OF',F8.2,-
0008000      3  8H DEGREES)
0008100      100 FORMAT(22X,'CHARACTERISTIC DIMENSIONS:  CFUSE =',F9.3,-
0008200      1  ' FEET;  CWING =',F9.3,5H FEET)
0008300      101 FORMAT(22X,'CHARACTERISTIC DIMENSIONS:  CFUSE =',F9.3,-
0008400      1  ' METERS;  CWING =',F9.3,7H METERS)
0008500      102 FORMAT(8H SHIELD: ,17F7.1/8X,7F7.1,29H (AFTER SHIELDING):-
0008600      1  OASPL =,F7.1,6H PNL =,F7.1,7H PNLT =,F7.1)

```

0008700 103 FORMAT(18H SHIELDED LEVELS:,15X,3F7.1)
0008800 END

Subroutine PERNOY

```
0000100 C      FUNCTION ROUTINE FOR CALC PERCEIVED NOISE
0000200 C
0000300 C      CALLED BY NOIS OR RADIUS AND ALL NOISE SOURCE MODULES
0000400 C      INFLOW:  SPL;          RETURNS:  PERNOY
0000500 C
0000600      FUNCTION PERNOY(SPL)
0000700      DIMENSION ELL1(24),ELL2(24),ELL3(24),ELLC(24),ELL4(24),SPL(27)
0000800      DIMENSION SLOPE1(24),SLOPE2(24),SLOPE3(24),SLOPE4(24)
0000900      DATA ELL1/49.,44.,39.,34.,30.,27.,24.,21.,18.,5*16.,15.,12.,9.,-
0001000 1 5.,4.,5.,6.,10.,17.,21./
0001100      DATA ELL2/55.,51.,46.,42.,39.,36.,33.,30.,27.,5*25.,23.,21.,18.,-
0001200 1 15.,14.,14.,15.,17.,23.,29./
0001300      DATA ELL3/64.,60.,56.,53.,51.,48.,46.,44.,42.,5*40.,38.,34.,32.,-
0001400 1 30.,2*29.,30.,31.,37.,41./
0001500      DATA ELLC/91.01,85.88,87.32,79.85,79.76,75.96,73.96,74.91,94.68,-
0001600 1 13*100.,44.29,50.72/
0001700      DATA ELL4/52.,51.,49.,47.,46.,45.,43.,42.,41.,5*40.,38.,34.,32.,-
0001800 1 30.,2*29.,30.,31.,34.,37./
0001900      DATA SLOPE1/.07952,2*.06816,.05964,10*.053013,.05964,2*.053013,-
0002000 1 2*.047712,2*.053013,.06816,.07952,.05964/
0002100      DATA SLOPE2/2*.058098,.052288,.047534,2*.043573,.040221,.037349,-
0002200 1 7*.034859,.040221,.037349,4*.034859,2*.037349,.043573/
0002300      DATA SLOPE3/.043478,.04057,2*.036831,.035336,2*.033333,.032051,-
0002400 1 .030675,6*.030103,7*.02996,2*.042285/
0002500      DATA SLOPE4/15*.030103,9*.02996/
0002600      SNOY=0.
0002700      XNOYMX=0.
0002800      DO 1 N=1,24
0002900      IF(SPL(N).GT.150.) WRITE(6,10) SPL(N)
0003000      IF(SPL(N).LT.ELL2(N)) XNOY=.1*10.**((SLOPE1(N)*(SPL(N)-ELL1(N)))
0003100      IF(SPL(N).GE.ELL2(N).AND.SPL(N).LT.ELL3(N)) XNOY=10.**((SLOPE2(N))*-
0003200 1 (SPL(N)-ELL3(N)))
0003300      IF(SPL(N).GE.ELL3(N).AND.SPL(N).LT.ELLC(N)) XNOY=10.**((SLOPE3(N))*-
0003400 1 (SPL(N)-ELL3(N)))
0003500      IF(SPL(N).GE.ELLC(N)) XNOY=10.**((SLOPE4(N)*(SPL(N)-ELL4(N)))
0003600      SNOY=SNOY+XNOY
0003700      IF(XNOY.GT.XNOYMX) XNOYMX=XNOY
0003800 1 CONTINUE
0003900      EN=XNOYMX+.15*(SNOY-XNOYMX)
0004000      PERNOY=40.+33.22*ALOG10(EN)
0004100      RETURN
0004200 10 FORMAT(25H PNDB SUBROUTINE WARNING:,F6.1,46H DB EXCEEDS RANGE-
0004300 1 (150 DB) FOR VALID PNDB CALC)
0004400      END
```

Subroutine TONE

```
0000100 C      FUNCTION SUBROUTINE TO CALCULATE TONE CORRECTION
0000200 C      FOR PNLT AS AN ADDITION TO PNL.
0000300 C
0000400 C      CALLED BY NOIS OR RADIUS AND ALL NOISE SOURCE MODULES
0000500 C      INFLOW:  SPL;          RETURNS:  TONE
0000600 C
0000700      FUNCTION TONE(SPL)
0000800      DIMENSION SPL(24),SL(25),SP(24)
0000900      LOGICAL N(24)
0001000      DO 1 I=4,24
0001100      N(I)=.FALSE.
0001200 1 SL(I)=SPL(I)-SPL(I-1)
0001300      DO 2 I=5,24
0001400      IF(ABS(SL(I)-SL(I-1)).LE.5.) GO TO 2
0001500      IF(SL(I).GT.0..AND.SL(I).GT.SL(I-1)) N(I)=.TRUE.
0001600      IF(SL(I).LE.0..AND.SL(I-1).GT.0.) N(I-1)=.TRUE.
```

```

0001700      2 CONTINUE
0001800        DO 3 I=1,23
0001900          SP(I)=SPL(I)
0002000          IF(N(I)) SP(I)=.5*(SPL(I-1)+SPL(I+1))
0002100      3 CONTINUE
0002200        SP(24)=SPL(24)
0002300        IF(N(24)) SP(24)=SPL(23)+SL(23)
0002400        DO 4 I=4,24
0002500      4 SL(I)=SP(I)-SP(I-1)
0002600        SL(3)=SL(4)
0002700        SL(25)=SP(24)
0002800        SP(3)=SPL(3)
0002900        TONE=0.
0003000        DO 5 I=4,24
0003100          FACT=2.
0003200          SP(I)=SP(I-1)+.3333*(SL(I-1)+SL(I)+SL(I+1))
0003300          FDEL=SPL(I)-SP(I)
0003400          IF(I.LE.21.AND.I.GE.11) FACT=1.
0003500          T=FDEL/3./FACT
0003600 C          FOLLOWING STATEMENT INACTIVATED, PER MARCH 1978 VERSION
0003700 C          IF(FDEL.LT.3.) T=0.
0003800          IF(FDEL.GT.20.) T=6.66667/FACT
0003900      5 IF(T.GE.TONE) TONE=T
0004000        RETURN
0004100        END

```

Subroutine EPNL

```

1000100 C          FUNCTION SUBROUTINE TO INTEGRATE EPNL FROM PNL TIME HISTORY,
1000200 C          ASSUMING PNL IS LINEAR WITH TIME BETWEEN POINTS. ROUTINE
1000300 C          DOUBLES AREA INTEGRATED AND WARNS USER IF EITHER FIRST OR
1000400 C          LAST VALUE OF PNL IS THE MAXIMUM SO THAT INTEGRAL WOULD NOT
1000500 C          BE FINITE.
1000600 C
1000700 C          CALLED BY NOIS
1000800 C          INFLOW: F,FMAX,T,N; RETURNS: EPNL,TS,TF
1000900 C
1001000          FUNCTION EPNL(F,FMAX,T,N,TS,TF)
1001100          DIMENSION F(1),T(1)
1001200          EP(F2,F1,T2,T1)=4.3429*(T2-T1)*(10.**(.1*F2)-10.**(.1*F1))/(F2-F1)
1001300          IK=0
1001400          IL=0
1001500          IWS=0
1001600          IWF=0
1001700          EPSUM=0.
1001800          F10=FMAX-10.
1001900          IF(F(1).EQ.FMAX) IWS=1
1002000          IF(F(N).EQ.FMAX) IWF=1
1002100          DO 2 J=1,N
1002200          IF(IK.EQ.1.AND.IL.EQ.1) GO TO 3
1002300          IF(IK.EQ.1) GO TO 1
1002400          IF(F(J).LT.F10) GO TO 1
1002500          I=J
1002600          IK=1
1002700      1 IF(IL.EQ.1) GO TO 2
1002800          L=N-J+1
1002900          IF(F(L).LT.F10) GO TO 2
1003000          K=L
1003100          IL=1
1003200      2 CONTINUE
1003300      3 KM=K-1
1003400          DO 5 J=I,KM
1003500          IF(ABS(F(J+1)-F(J)).GT..001) GO TO 4
1003600          EPSUM=EPSUM+(T(J+1)-T(J))*10.**(.1*F(J))
1003700          GO TO 5

```

```

1003800      4 EPSUM=EPSUM+EP(F(J+1),F(J),T(J+1),T(J))
1003900      5 CONTINUE
1004000      IJ=I
1004100      JK=K
1004200      IF(IJ.EQ.1) IJ=2
1004300      IF(JK.EQ.N) JK=N-1
1004400      IF(IWS.EQ.0) TS=T(IJ)-(F(IJ)-F10)*(T(IJ)-T(IJ-1))/(F(IJ)-F(IJ-1))
1004500      IF(TS.LE.T(I)) GO TO 6
1004600      TS=T(I)
1004700      WRITE(6,93)
1004800      6 IF(IWF.EQ.0) TF=T(JK)+(F10-F(JK))*(T(JK+1)-T(JK))/(F(JK+1)-F(JK))
1004900      IF(TF.GE.T(K)) GO TO 7
1005000      TF=T(K)
1005100      WRITE(6,94)
1005200      7 IF(F(I)-F10.LT..001) GO TO 8
1005300      IF(IWS.EQ.0) EPSUM=EPSUM+EP(F(I),F10,T(I),TS)
1005400      8 IF(F(K)-F10.LT..001) GO TO 9
1005500      IF(IWF.EQ.0) EPSUM=EPSUM+EP(F10,F(K),TF,T(K))
1005600      9 IF(IWS.EQ.1) WRITE(6,90) F(1)
1005700      IF(IWF.EQ.1) WRITE(6,91) F(N)
1005800      IF(IWS.NE.1.AND.IWF.NE.1) GO TO 10
1005900      WRITE(6,92)
1006000      EPSUM=2.*EPSUM
1006100      10 EPNL=10.*ALOG10(EPSUM/10.)
1006200      RETURN
1006300      90 FORMAT(2X,'EPNL WARNING: FIRST PNLT('F5.1,') IS MAXIMUM')
1006400      91 FORMAT(2X,'EPNL WARNING: LAST PNLT('F5.1,') IS MAXIMUM')
1006500      92 FORMAT(4X,'APPROXIMATE EPNL ASSUMING SYMMETRICAL TIME HISTORY.-
1006600      1 INCREASE TIME (TD OR NT) FOR VALID CALCULATION')
1006700      93 FORMAT(' EPNL APPROX. -LEVELS DECREASE AT START OF TIME INTERVAL')
1006800      94 FORMAT(' EPNL APPROX. -LEVELS INCREASE AT END OF TIME INTERVAL')
1006900      END

```

Subroutine TERP

```

0000100 C      INTERPOLATION SUBROUTINE FOR FINDING "FX" AS FUNCTION OF
0000200 C      ABSCISSA "AX" AND INDEPENDENT CURVES IN PARAMETERS "B" AND "C".
0000300 C      CALLED BY MANY MODULES; CALLS SERCH
0000400 C      INFLOW: F,AX,BX,CX,A,B,C,NA,NB,NC; RETURNS: FX
0000500 C      A: ARRAY OF NA ABSCISSA VALUES COMMON TO "B" AND "C"
0000600 C      B: 2-DIMEN. ARRAY OF NB CURVE VALUES FOR EACH "C" SET,
0000700 C      C: ARRAY OF NC VALUES OF C
0000800 C      F: 3-DIMEN. ARRAY AS A FUNCTION OF "A", "B", AND "C"
0000900 C      AX: INPUT VALUE OF A
0001000 C      BX: INPUT VALUE OF B
0001100 C      CX: INPUT VALUE OF C
0001200 C      FX: INTERPOLATED OUTPUT
0001300 C
0001400 C      SUBROUTINE TERP(F,AX,BX,CX,A,B,C,NA,NB,NC,FX)
0001500 C      DIMENSION FFF(2),FF(2,2),F(NA,NB,NC),A(NA),B(NB,NC),C(NC),-
0001600 C      1 B1(20),B2(20)
0001700 C
0001800 C      CALL SERCH(AX,A,NA,KA,AFR)
0001900 C      CALL SERCH(CX,C,NC,KC,CFR)
0002000 C      KC1=KC+1
0002100 C      IF(NC.EQ.1) KC1=KC
0002200 C      DO 1 KB=1,NB
0002300 C      B1(KB)=B(KB,KC)
0002400 C      B2(KB)=B(KB,KC1)
0002500 C      1 CONTINUE
0002600 C      CALL SERCH(BX,B1,NB,KB1,BFR1)
0002700 C      CALL SERCH(BX,B2,NB,KB2,BFR2)
0002800 C      BF=BFR1
0002900 C      J1=KB1
0003000 C      J1P1=J1+1
0003100 C      IF(NB.EQ.1) J1P1=J1
0003200 C      DO 3 I=KC,KC1
0003300 C      DO 2 J=J1,J1P1

```

```

0003400      FF(J,I)=F(KA,J,I)+AFR*(F(KA+1,J,I)-F(KA,J,I))
0003500      2 CONTINUE
0003600      FFF(I)=FF(J1,I)+BF*(FF(J1P1,I)-FF(J1,I))
0003700      J1=KB2
0003800      J1P1=J1+1
0003900      BF=BFR2
0004000      3 CONTINUE
0004100      FX=FFF(KC)+CFR*(FFF(KC1)-FFF(KC))
0004200      RETURN
0004300      END

```

Subroutine SERCH

```

0000100 C      SUBROUTINE TO FIND KA,KA+1 INTERVAL WHERE AX FALLS IN NA VALUES
0000200 C      OF ARRAY "A", AND TO CALCULATE FRACTION AFR WITHIN INTERVAL.
0000300 C
0000400 C      CALLED BY TERP
0000500 C      INFLOW: AX,A,NA; RETURNS: KA,AFR
0000600 C      SUBROUTINE SERCH(AX,A,NA,KA,AFR)
0000700      DIMENSION A(NA)
0000800      IF(NA.GT.1) GO TO 1
0000900      AFR=0.
0001000      KA=1
0001100      RETURN
0001200      1 IF(AX.LE.A(1)) GO TO 4
0001300      NAM1=NA-1
0001400      DO 2 I=1,NAM1
0001500      IF(AX.GE.A(I).AND.AX.LT.A(I+1)) GO TO 3
0001600      2 CONTINUE
0001700      3 KA=I
0001800      GO TO 5
0001900      4 KA=1
0002000      5 IF(A(KA+1).NE.A(KA)) GO TO 6
0002100      AFR=0.
0002200      RETURN
0002300      6 AFR=(AX-A(KA))/(A(KA+1)-A(KA))
0002400      RETURN
0002500      END

```

References

1. Heidmann, M. F.: Interim Prediction Method for Fan and Compressor Source Noise. NASA TM X-71763, 1975. (Corrected 1979 reprint available).
2. Stone, J. R.: Interim Prediction Method for Jet Noise. NASA TM X-71618, 1974. (With errata.)
3. Huff, R. G.; Clark, B. J.; and Dorsch, R. G.: Interim Prediction Method for Low Frequency Core Engine Noise. NASA TM X-71627, 1974.
4. Krejsa, E. A.; and Valerino, M. F.: Interim Prediction Method for Turbine Noise. NASA TM X-73566, 1976.
5. Dorsch, R. G.; Clark, B. J.; and Reshotko, M.: Interim Prediction Method for Externally Blown Flap Noise. NASA TM X-71768, 1975.
6. Clark, B. J.; McArdle, J. G.; and Homyak, L.: Measured and Predicted Noise of the AVCO-Lycoming YF-102 Turbofan Engine. AIAA Paper 79-0641, 1979.
7. Stone, J. R.: Flight Effects on Exhaust Noise for Turbojet and Turbofan Engines—Comparison of Experimental Data with Prediction. NASA TM X-73552, 1976.
8. Stone, J. R.: An Empirical Model for Inverted-Velocity-Profile Jet Noise Prediction. NASA TM X-73838, 1977.
9. Stone, J. R.: An Improved Method for Predicting the Effects of Flight on Jet Mixing Noise. NASA TM X-79155, 1979.
10. Matta, R. K.; Sandusky, G. T.; and Doyle, V. L.: GE Core Engine Noise Investigation—Low Emission Engines. FAA-RD-77-4, U.S. Dept. of Transportation, 1977, pp. 152-153. (Available from NTIS as AD-A048590.)
11. Fink, M. R.: Airframe Noise Prediction Method. R77-912607-11, United Technologies; FAA-RD-77-19, 1977. (Available from NTIS as AD-A039664.)
12. Standard Values of Atmospheric Absorption as a Function of Temperature and Humidity. Aerospace Recommended Practice 866, 1964, SAE.
13. Montegani, F. J.: Some Propulsion System Noise Data Handling Conventions and Computer Programs Used at the Lewis Research Center. NASA TM X-3013, 1974.
14. Bass, H. E.; and Shields, F. D.: Atmospheric Absorption of High Frequency Noise and Application to Fractional Octave Bands. NASA CR-2760, 1977.
15. Montegani, F. J.: Computation of Atmospheric Attenuation of Sound for Fractional-Octave Bands. NASA TP-1412, 1979.
16. Dunn, D. G.; and Peart, N. A.: Aircraft Noise Source and Contour Estimation. (D6-60233, Boeing Commercial Airplane Co.; NASA Contract NAS 2-6969.) NASA CR-114649, 1973.
17. Method for Calculating the Attenuation of Aircraft Ground to Ground Noise Propagation During Takeoff and Landing. Aerospace Information Report 923, Aug. 15, 1966, SAE.
18. Putnam, T. W.: Review of Aircraft Noise Propagation. NASA TM X-56033, 1975.
19. Definitions and Procedures for Computing the Perceived Noise Level of Aircraft Noise. Aerospace Recommended Practice 865A, Aug. 15, 1969, SAE.
20. Noise Standards: Aircraft Type Certification. FAA Federal Aviation Regulations Part 36, March 1978. Appendix B: Aircraft Noise Evaluation Under Section 36.103.

TABLE I. - PREDICTION SOURCE EQUATIONS AND FIGURES

Refer- ence	Source	Component	Level prediction	Directivity	Spectrum
1	Fan	Inlet broadband Inlet tones Inlet multiple pure tones Exhaust broadband Exhaust tones	Eq. (4); figs. 4(a), 6(b) Eq. (6); figs. 10(a), 12 Eq. (8); fig. 15(a) Eq. (10); figs. 4(b), 6(b) Eq. (12); figs. 10(b), 12	Fig. 7(a) Fig. 13(a) Fig. 16 Fig. 7(b) Fig. 13(b)	Eq. (2) Figs. 8, 9 Fig. 14 Eq. (2) Fig. 8
2	Jet	Subsonic (conical, slot, or plug) Shocks Coaxial	Eqs. (12), (16) Eq. (11) Eqs. (14), (16), (18), (19)	Eq. (14); fig. 5 ----- Eq. (14); fig. 5	Eq. (17); fig. 5 Eq. (13); fig. 7 Eqs. (17), (20); figs. 5, 12
3	Core	-----	Eq. (9)	Fig. 1	Eq. (12); fig. 2
4	Turbine	Broadband Tones	Eq. (1) Eq. (4)	Fig. 5(a) Fig. 5(b)	Fig. 6(a) Fig. 6(b)
5	Flap	Under the wing Over the wing	Eqs. (10), (11), (16), (22); fig. 19 Eqs. (17), (18)	Eq. (14); figs. 13, 14 Figs. 17(a) and (b)	Figs. 15(a) and (b) Figs. 18(a) and (b)
11	Air- frame ^a	Wing, tail Slotted flap Landing gear Slatted leading edge	Eq. (10) Eq. (21) Eqs. (14), (15), (19) Eq. (10)		Eq. (7) Eqs. (22) to (28) Eqs. (11) to (13), (16) to (18) Eq. (7)

^aIn form only: constants in equations modified by Langley Research Center, with consultation by M. R. Fink, United Technologies, Corp.

TABLE II - CHECKLIST OF DATA INPUT

Main program FOOTPR

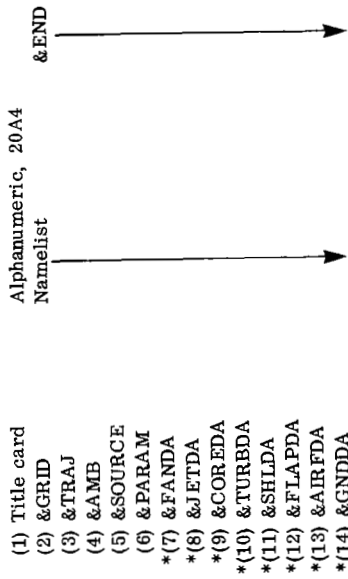

Main program RADIUS

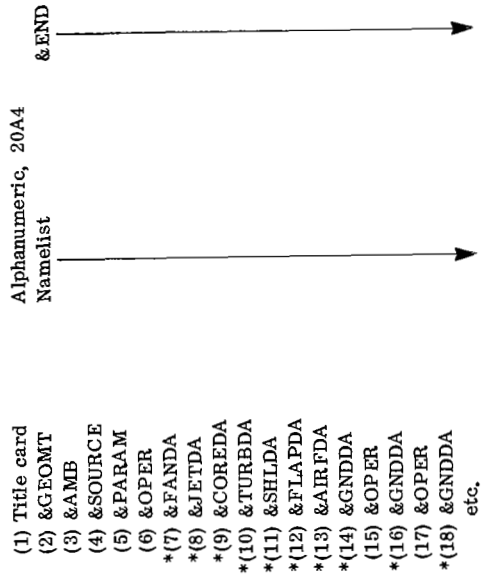

* Only required when corresponding source routines are used.

TABLE III. - INPUT VARIABLES

Program	Block	Variables	Dimension	Definition and Units, SI(English)	Default Values	Required for -
FOOTPR	EGRID	COMMENT	20	User-supplied title for output, one line		
		NYO, NYO	1	No. of YO and YO values		
		XO, YO	20	Observer coordinates m(ft)	500., 500., 1000.	1, 2
		ZO	1	Observer altitude, m(ft)		4.
		NGOYR	1	No. of sound levels desired (for IOUT(3)>0)		1.
ECONTR	CONTR	CONTR	5	Constr. levels (PML, PMLT, or EPMdB)	90., 95., 100.	ENG
		UNITS	1	For English or SI units, input and output (3HENG, 2HSI)		ENG
ETRAJ	NP	NP	1	No. of points to define aircraft path and flight conditions	2	
		XA, YA, ZA	50	Coordinates of aircraft path, m(ft)	0., 47496.; 2*0.; 8.; 5000.	
		ALF1	50	Engine angles of attack, deg		0.
		GAM	50	Banking angles of aircraft, deg		0.
		VA	50	Aircraft velocities, m/s(fps)	150.	
		FPP	50	Engine performance parameters (as % thrust or % speed)	100.	
		PSY	50	Trailing flap angles for powered lift, deg		0.
		FLAPA	50	Angles of slotted flaps for airframe noise, deg		0.
		ILGR	50	Landing gear down indicator (1/0=yes/no)		0.
		IREVR	50	Thrust reverser deployed indicator (1/0=yes/no)		0.
		TSTART	1	Time reference at first trajectory point, sec.		0.
		NT	1	No. of time increments desired (max. of 100)		21.
		TD	1	Size of time increment, sec		1.
		ICPA	1	Indicator to center time history on closest point of approach (=1), or start history at trajectory point (=0)		1.
		EAMB	IGEOM	IGEOM	1	Indicator for pinout of geometric relations at each point in time (1/0=yes/no)
ITITLE	1			Indicator to title output with input geometry (1/0=yes/no)	1	
TAMB	1			Ambient temperature, °K(°R)	518.7°R	
EAMBE	PAMB	PAMB	1	Ambient pressure, absolute, N/m² (psf)	216. psf	
		RH	1	Percent relative humidity, ambient	70.	
		REVR	1	Percent relative humidity, ambient		
ESOURCE	NENG, IFAN, IJET, ICORE, ITURB, IFLAP, IAIRF, ISUPP	NENG	1	No. of engines	1	
		IFAN, IJET, ICORE, ITURB, IFLAP, IAIRF	1	Sources to be calculated (1/0=yes/no); input must be supplied for each source	All=0	
		ISUPP	1	Suppression spectra to be applied to each source for which suppr. spectra supplied; may be over-ridden by ISUPPR in individual source inputs	0	
		IDOP	1	Doppler amplification and shift to be applied to sources (1/0=yes/no)	0	
		IGND	1	Ground reflection correction. Use IGND=0, for no reflection (free-field) 1, for simple 3dB addition 2, for reflect. calc. by Putnam's TMX 56033 (requires CGNDDA input)	0	
		IATM	1	Atmospheric absorption to be applied, as IATM=0: for no atmospheric attenuation 1: for ARP-866 attenuation prediction 2: for Bass & Shields prediction	0	
		IEGA	1	Extra ground attenuation to be applied (1/0=yes/no)	0	
		ISHLD	1	For shielding of engine sources (1/0=yes/no) (requires CSHLDA input)	0	
		ITOT	1	Set = 0, to reject output of total of all sources	1	
		FILBW	1	Fraction of filter bandwidth having gain of 1.	1.	

FLAP
AIRFR
AIRFR
REVR

TABLE III. - Continued.

Program Block	Variables	Dimension	Definition and Units, SI(English)	Default Values	Required for -
	IOUT	3	Selects level of printout desired: i.e., IOUT(1)=0: No time histories 1: Each source spectrum, OASPL,PNL,PNLTI 2: Each source OASPL,PNL,PNLTI only 3: Total OASPL,PNL,PNLTI (Note that IOUT(1) can be overridden in any individual source program by specifying JOUT in input data to that source) IOUT(2)=0: No levels at grid points 1: PNL-max at grid points 2: PNL-max at grid points 3: EpNL at grid points IOUT(3)=0: No contour calculation 1: Coordinates of PNL-max contours 2: Coordinates of PNL-max contours 3: Coordinates of EPNL contours		
EPARAM	NPARAM	1	No. of engine performance points in array file containing data on parameters affecting noise		
	APEP	10	Array of values of engine performance (in % thrust or % speed) **** (parameters listed below must be supplied according to **** individual noise sources to be calculated)		
	AWAFAN	10	Array of total engine air flows, kg/s(lb/sec)		FAN
	ARPM	10	Array of fan speeds, rpm		FAN,TURB
	ATIPM(ATIPM2)	10	Array of fan relative tip Mach numbers (These approximated by program if not supplied), first (second) stage		FAN
	ADELT	10	Array of fan temperature rises, °K(°R)		FAN
	(or) AFPR	10	Array of fan pressure ratios (if ADELT not supplied)		FAN
	AMCORE	10	Array of core and turbine air flows, kg/s(lb/sec)		JET,CORE,TURB
	AFUEL	10	Array of engine fuel flows, kg/s(lb/sec) (for core gas properties based on "A-1" fuel)		JET,CORE,TURB
	AP3	10	Array of combustor inlet pressures, M/m ² (psf)		CORE
	AT3	10	Array of combustor inlet temperatures, °K(°R)		CORE
	AT4	10	Array of combustor program if not supplied (These approximated by program if not supplied)		CORE
	ATURTS	10	Array of turbine last stage rotor relative tip speeds, m/s(fps)		TURB
	ATCTUR	10	Array of turbine exit temp., °K(°R) (assumed same as ATC if not supplied)		TURB
	AVC(AVF)	10	Array of core (fan) nozzle exhaust vel., m/s(fps)		JET,FLAP
	ATC(ATF)	10	Array of core (fan) nozzle exhaust temp., °K(°R)		JET,FLAP
	ICORR	1	Corrections to be applied to engine parameters to correct for ambient conditions (1/0=yes/no)	0	
	TCORXP	1	Exponent for core temp. corr. in engine param.	1.	
EFANDA	JOUT	1	Over-ride on IOUT(1) for printout		
	IGV	1	Inlet guide vanes? (1/0=yes/no)	0	
	IFD	1	Inlet flow distortion? (1/0=yes/no)	0	
	IEXH	1	Inlet noise only(=0); exhaust only(=1); both included(=2)	2	
	NSTG	1	No. of fan stages, first (second) stage	1	
	NBL(NBL2)	1	No. of fan blades, first (second) stage		
	NVAN(NVAN2)	1	No. of stator vanes, first (second) stage		
	FANDIA(FAND2)	1	Fan diameter first (second) stage, m(ft)		
	FANHUB	1	Diameter of fan hub, m(ft) (for fan face Mach no. calculation)		
	TIPMD(TIPMD2)	1	Design relative tip Mach number, first (second) stage		
	RSS(RSS2)	1	Rotor/stator spacing in percent, first (second) stage		
	NH	1	No. of harmonics of blade passing tone desired	5	
	GAMMAF	1	Gamma of fan air (required for DELT if AFPR in EPARAM)	1.4	
	FANEFF(FANEFF2)	1	Fan efficiency (<1.) (assumed constant at all fan speeds), first (second) stage (required for DELT if AFPR supplied rather than ADELT in EPARAM)		

TABLE III. - Continued.

Program Block	Variables	Dimension	Definition and Units, SI(English)	Default Values	Required for -
JET	DECMP	1	Decrement to combination tones, dB	0.	
	EDOP(EDOP2)	1	Exponent for source motion amplification, first (second) stage when IDOP=1	4.(4.)	
	ISUPPR	1	Over-ride on ISUPP in \$SOURCE input	0	NSTG>1
	SUPPIN	24	Fan inlet suppression spectrum, dB		NSTG>1
	SUPPEX TRAT (or) PRAT	1	Fan exhaust suppression spectrum, dB Second/first stage temperature rise ratio Second/first stage FPR ratio (requires GAMMAR and FANEF2)		
EJETDA	JOUT	1	Over-ride on IOUT(1) for printout	1.(1.)	
	INOZ	1	Coaxial (=1), core nozzle only (=0) (Coaxial requires fan stream flow properties)	0	
	ISLOT	1	Plug nozzle? (1/0=yes/no) (requires ANHNT)	0	
	ISLOT	1	Slot nozzle? (1/0=yes/no) (requires DHC)	0	
	IFWD	1	Forward velocity effects to be applied to source (1/0=yes/no)	1.	
	EDOP	1	Exponent for source motion amplification on shock noise	1.	
	AC(AF)	1	Core (fan) nozzle area, m ² (ft ²)	1.(1.)	
	MDC(MDF)	1	Design Mach number of core (fan) nozzle (if M>1)	1.4(1.4)	
	GAMMAC(GAMMAF) GASRC(GASRF)	1	Gamma of core (fan) exhaust flow Gas const. of core (fan) exhaust, J/kg*(ft-lb/lbm/°R) 53.35(53.35)ft-lb/lbm/°R	1.4(1.4)	
	DHC(DHF) ANHNT(ANHNTF)	1	(GAMMAC & GASRC are calc. from FUEL flow if not supplied) Hydraulic diam of core (fan) nozzle, m(ft) (slot nozzles only) Annular height of core (fan) nozzle, m(ft) (plug, conannular) (ANHNTF is calc. if not supplied - for circular nozzle, thin wall)		ISLOT=1 INOZ=1, IFLUG=1
CORE	JOUT	1	Over-ride on IOUT(1) for printout		
	ISUPPR	1	Over-ride on ISUPP in \$SOURCE input		
	CSUPP	24	Core suppression spectrum, dB		Calc.T3
	EDOP	1	Exponent for source motion amplification	2.	
	GAMMA	1	Required if AP3 rather than AP3 in \$PARAM	1.4	
	IMOD	1	Modified core level prediction (1/0=yes/no)	0	
	DTEND	1	Design turbine temperature drop (T4,d - TCTUR,d), °K(°R) (Required for modified level prediction)		INOD=1
	JOUT	1	Over-ride on IOUT(1) for printout		
	ISUPPR	1	Over-ride on ISUPP in \$SOURCE input		
	TSUPP	24	Turbine suppression spectrum, dB		
TURB	TBNDA	1	Diameter of last stage turbine, m(ft)		
	GEAR	1	Gear ratio for turbine rpm/fan rpm		
	GCS	1	Stator chord to rotor spacing ratio, percent (usually >100%)		
	NBR	1	No. of blades, last stage rotor		
	ITYPTB	1	Turbosans, core exit ahead of fan exit (JT8D) (=1) Turbojets, or fans with coplanar exits (=0)		
	EDOP	1	Exponent for source motion amplification	4.	
	JOUT	1	Over-ride on IOUT(1) for printout		
	ISUPPR	1	Over-ride on ISUPP in \$SOURCE input		
	TSUPP	24	Turbine suppression spectrum, dB		
	TBNDA	1	Diameter of last stage turbine, m(ft)		
SHLD	GEAR	1	Gear ratio for turbine rpm/fan rpm		
	GCS	1	Stator chord to rotor spacing ratio, percent (usually >100%)		
	NBR	1	No. of blades, last stage rotor		
	ITYPTB	1	Turbosans, core exit ahead of fan exit (JT8D) (=1) Turbojets, or fans with coplanar exits (=0)		
	EDOP	1	Exponent for source motion amplification	4.	
	IUOTW	1	Under-the-wing engine (=0), over-the-wing (=1)		IUOTW=1
	SFUSE	1	Max of fuselage shielding at THETA=90°, dB	10.	IUOTW=1
	SWIDE	1	Degrees of arc where fuselage shielding is greater than SFUSE/e (e=2.718...)	60.	
	SWING	1	Max of wing shielding for OTW engine, dB	10.	
	SNX	1	Angle in flyover plane (THETA) of max OTW shielding, deg	90.	
CFUSE	1	Characteristic fuselage dimension, such as diam, m(ft)	10.		
CWING	1	Characteristic wing dimension, such as chord, m(ft)	10.		
FLAP	JOUT	1	Over-ride on IOUT(1) for printout		
	ISUPPR	1	Over-ride on ISUPP in \$SOURCE input		
	FLSUPP	24	Flap noise suppression spectrum, dB		
	IUOTW	1	Under-the-wing (=0), over-the-wing (=1)		
	INOZ	1	Nozzle type: Single nozzle flow (=0) Mixed coaxial flow (=1) Mixed nozzle flows (-2)	0	
	IFWD	1	Forward velocity effects on source (1/0=yes/no)	0	IUOTW=0
	INSENS	1	Configuration with levels insensitive to flap angle(=1) 0	0	IUOTW=0
	EDOP	1	Exponent for source motion amplification	4.	
	AC1(CAF1)	1	Core (fan) nozzle area, m ² (ft ²)		
	VC(VF)	1	Core (fan) exhaust velocity, m/s(fps) (normally in \$PARAM)		

TABLE III. - Continued.

Program Block	Variables	Dimension	Definition and Units, SI(English)	Default Values	Required for -	
AIRFR	BPR	1	Bypass ratio, for mixed exhaust case			
	WINGD	1	Ratio of wing chord to total nozzle diam. (Use for large BPR design when WINGD<3.)	3.		
AIRFR	JOUT	1	Over-ride on IOUT(1) for printout			
	IWING	1	Include wing, horizontal and vertical tail noise (1/0=yes/no)			
	IFL	1	Include slotted flap noise (1/0=yes/no)			
	ISLAT	1	Include slatted leading-edge noise (1/0=yes/no)			
	ILG	1	Include landing gear noise (nose and main) (1/0=yes/no) (May be entered as ILGR in ETRAJ input to FOOTPR)			
	A	4	Areas of wing, horizontal tail, vertical tail, slotted flap surfaces, m ² (ft ²)	1000., 3*100.	IWING=1	
	B	4	Total spans of wing, hor. tail, vert. tail, flaps, m(ft)	100., 3*20.	IWING=1	
	ICLEAN	1	Aero clean aircraft, as sailplane (=0), conventional (=1)	1	IWING=1	
	ITYPM	1	Conventional wing (=1), delta wing (=2)	1	IWING=1	
	NF	1	No. of trailing flap slots (up to 3)	1	IFL=1	
NG	2	No. of landing gear, nose and main	1,2	IFL=1		
NM	2	No. of wheels, nose and main, m(ft)	2,2	ILG=1		
DM	2	Tire diam. of wheels, nose and main, m(ft)	3.,3	ILG=1		
CG	2	Ratio of strut length to tire diam., nose and main	3.,3	ILG=1		
GNDRFL	JOUT	1	Over-ride on IOUT(1) for Printout.			
	QABS	24	Absolute values of ground reflectivity as a function of frequency (values from 0. to 1.)	24*1.		
	FSHIFT	24	Phase shift of reflected signal, deg	24*0.		
	ITONE	1	If ITONE=1, 1/3-octave bands exceeding adjacent bands by 3 dB or more are approximated as tones	0		
	NS	1	No. of heights to be used to approximate a distributed source by multiple sources	1		
	DK	10	Heights of multiple sources from source center described by ZI, m(ft)	10*0.	NS>1	
	RADIUS	COMMENT	20	User-supplied title for output, one line		
		R	1	Radial distance to observer points, m(ft)	100. ft	
		ATHETA	20	THETA values of observer positions, deg	(0-180°, every 10°)	
		APHI	10	PHI values for non-axisymmetric sources, deg	0., 45., 90.°	
NTHETA, NPHI		1	No. of THETA, PHI values	0., 19., 3		
VIEW		1	Elevation angle of source from observer (for EGA), deg			
HEAD		1	Direction of ground track from Y-axis, deg			
ZI, ZO		1	Height of source observer, above ground plane m(ft), for ground reflection calculation		ICND=2	
UNITS		1	For English or SI units, input and output (3HENG, 2HSI)	ENG		
EAMB		TAMB, PAMB, RH	1	Ambient conditions as in FOOTPR	518.7°R, 2116. psf, 70. %	
	ESOURCE	1	Selection of sources and effects as in FOOTPR, except omit IOUT	(ALL=0)		
EPARAM	NENG, IFAN	1	To reject output of total of all sources (=0)	1		
	LJET, ICORE	1	Fraction of filter bandwidth having gain of 1.	1.		
	IFURE, IFLAP,	10	Array of engine operating parameters as in EPARAM under FOOTPR			
	LAIRF, IDOP,					
	LATM, ISHLD,					
	IEGA, ICND,					
	ISUPP					
	ITOT					
	FILBW					
	NPARAM, AEPF,					
ARPM, AWAFAN,						
ATIPM, ATIPM?						
ADFLT, AFAPR,						
AWCORE, AFUEL,						
AF3, AT3, AT4,						
ATURTS, ATCTUR,						
AVC, AVF, ATC,						
ATF						

TABLE III. - Concluded.

<u>Program Block</u>	<u>Variables</u>	<u>Dimension</u>	<u>Definition and Units, SI(English)</u>	<u>Default Values</u>	<u>Required for -</u>
ICORR, TCORXP		1	For ambient temperature corrections, as in FOOTPR	0, 1.	
EOPER	EPTI	1	Engine performance parameter (operating condition)		
	VI	1	Aircraft forward velocity, m/s (fps) (for Doppler or forward velocity corrections)		
	PSYI	1	Wing flap angle (for flap noise), deg		FLAP
	FLAPI	1	Slotted flap angle (for airframe noise), deg		AIRFR
	ILG	1	Landing gear down indicator (1/0=yes/no)		AIRFR
				As required for sources chosen	
CFANDA CJETDA CSCOREDA CTURBDA CSHLDA CFLAPDA CAIRFDA CGNDDA			(Only if IGND=2)		
EOPER EGNDDA			Changes in engine, velocity, and flap conditions are made by repeated entries of EOPER (and CGNDDA if IGND=2)		

TABLE IV. - SAMPLE INPUTS

The following are examples of input data required for particular calculations. They are discussed in detail in the text. A general list of inputs is given in table III. Computed outputs from these inputs are shown in tables V to X and discussed in the text.

SAMPLE ONE - For a landing calculation:

```

QSRA LANDING CALCULATION, ENGINE MAP FROM TEST DATA
&GRID NXO=3, XO=-2000., -1000., 0, ZO=0., &END
&TRAY NP=3, XA=-5000., 0, 1500., ZA=658.3, 2*0.,
  ALF1=6., 2*10., VA=2*118.2, 0, EPP=55.2*20.,
  PSY=60., 2*0., NT=11, TD=1., IGEOM=1, ITITLE=1, &END
&AMB TAMB=544., PAMB=2065., RH=48., &END
&SOURCE NENG=4, IFAN=1, ICORE=1, ITURB=1, IFLAP=1, IGND=1, IATM=1, IOUT=1, 1, 0, &END
&PARAM NPARAM=7, AEPF=37.2, 51.53, 61.45, 77.28, 87.88, 90.93, 96.67,
  AWAFFAN=95.82, 134.23, 162.07, 206.33, 236.78, 247.64, 261.27,
  ARPM=2753., 3813., 4547., 5719., 6503., 6729., 7154.,
  AFR=1.0523, 1.1028, 1.1526, 1.2569, 1.3517, 1.3889, 1.4427,
  AMCORE=16.14, 18.87, 22.52, 28.43, 33.11, 35.29, 37.22,
  AP3=6399., 9356., 11655., 15821., 19359., 20902., 22730.,
  AT3=779.2, 879., 939.5, 1027.9, 1090.5, 1115.7, 1147.2,
  AT4=1612., 1722., 1821., 2147., 2370., 2444., 2642.,
  AVC=351.7, 504.1, 623.7, 859.1, 1062.7, 1157.1, 1271.4,
  ATF=298.4, 414.6, 503.6, 644.7, 750.2, 784.8, 832.2,
  ATF=1212.5, 1205.3, 1293.8, 1458.3, 1603.3, 1654.8, 1742.8,
  ATF=539.8, 546.8, 554.4, 569.4, 582.6, 587.4, 595.2,
  ICORR=1, TCORXP=1.022, &END
&FANDA NBL=40, NVAN=85, FANDIA=3.392, FANHUB=1.45,
  TIPMD=1.24, RSS=275., FANEF=84, &END
&JETDA INOZ=1, GAMMAC=1.36, GASRC=53.38, AC=1.215, AF=3.951, &END
&COREDA IMOD=1, DTEMD=900., GAMMA=1.4, &END
&TURBDA TBNDIA=1.53, CS=700., GEAR=2.302, NBLR=60, ITYPB=1, &END
&SHLDA IUOTW=1, SFUSE=3., SWIDE=60., SWING=5., SMX=80., &END
&FLAPDA IUOTW=1, INOZ=2, IFWD=1, BPR=6.1, AC1=1.215, AF1=3.951 &END

```

SAMPLE TWO - For similar calculations of takeoff, without unloading FOOTPR:

```

QSRA TAKEOFF CALCULATION, ENGINE MAP FROM TEST DATA
&GRID NXO=3, XO=1500., 2500., 3500., ZO=0., &END
&TRAY NP=3, XA=0., 1500., 6500., ZA=2*0., 534.3,
  ALF1=3*10., VA=0., 2*148.6, EPP=3*85.,
  PSY=3*0., NT=21, TD=1., IGEOM=1, ITITLE=0, &END
&AMB &END
&SOURCE IOUT=2, 2, 0, &END
&PARAM &END
&FANDA &END
&JETDA &END
&COREDA &END
&TURBDA &END
&FLAPDA &END

```

TABLE IV. - Continued.

SAMPLE THREE - Combines One and Two, without unloading FOOTPR:

```

OSRA LANDING AND TAKEOFF, ENGINE MAP FROM TEST DATA
&GRID NXO=1,XO=-2000.,NYO=1,ZO=0., &END
&TRAJ NP=4,XA=-5000.,YA=1500.,ZA=658.3,2*0.,534.3,
ALF1=6.,3*10.,VA=2*118.2,2*148.6,EPP=55.,3*85.,
PSY=60.,3*0.,NT=41,TD=1.,IGEOM=1,ITITLE=0 &END
&AMB &END
&SOURCE IOUT=3,0,0 &END
&PARAM &END
&FANDA &END
&JETDA &END
&COREDA &END
&TURBDA &END
&FLAPDA &END

```

SAMPLE FOUR - FOX static test predictions on a radius:

```

OSRA (YF102) NOISE: SINGLE ENGINE, NO FLAPS, NO ATTENUATION
&GEOMT &END
&AMB &END
&SOURCE IFAN=1,IJET=1,ICORE=1,ITURB=1,IGND=1, &END
&PARAM NPARAM=7,AEPP=37.2,51.53,61.45,77.28,87.88,90.93,96.67,
ANAFAN=95.82,134.23,162.07,206.33,236.78,247.64,261.27,
ARPM=2753.,3813.,4547.,5719.,6503.,6729.,7154.,
AFPR=1.0523,1.1028,1.1526,1.2569,1.3517,1.3889,1.4427,
ANCORE=16.14,18.87,22.52,28.33,33.11,35.29,37.22,
AP3=6399.,9356.,11655.,15821.,19359.,20902.,22730.,
AT3=779.2,879.,939.5,1027.9,1090.5,1115.7,1147.2,
AT4=1612.,1722.,1821.,2147.,2370.,2444.,2642.,
AVC=351.7,504.1,623.7,859.1,1062.7,1157.1,1271.4,
AVF=298.,414.6,503.6,644.7,750.2,784.,832.2,
ATC=1212.5,1205.3,1293.8,1458.3,1603.3,1654.8,1742.8,
ATE=539.8,546.8,554.4,569.4,582.6,587.4,595.2,
ICORR=1,ICORXP=1.022 &END
&OPER EPP1=37.78,VI=200.,PSYI=0., &END
&FANDA IFD=1,NBL=40,NVAN=85,FANDIA=3.392,FANHUB=1.45,
TIPMD=1.24,RSS=275.,FANEFF=.84,
ISUPPR=0,SUPPIN=9*1.,4.,5.,8.,1.,4.,2.2,4.,8.,9.3,11.6,10.4,
8.8,7.3,4.8,0., SUPPEX=7*0.,2.,3.,4.,8.,1.,1.5,2.2,3.1,5.8,15.2,
11.,15.2,23.1,12.8,9.4,7.1,5.5, &END
&JETDA INOZ=1,GAMMAC=1.36,GASRC=53.38,AC=1.215,AF=3.951, &END
&COREDA IMOD=1,DTEMD=900.,GAMMA=1.4, &END
&TURBDA TBN DIA=1.53,CS=700.,GEAR=2.302,NBLR=60,ITYPTB=1,&END
&FLAPDA IUOTW=1,INOZ=2,IFWD=1,BPR=6.1,AC1=1.215,AF1=3.951 &END
&OPER EPP1=87.7 &END

```

TABLE IV. - Concluded.

SAMPLE FIVE - For predictions involving airframe noise:

APPROACH NOISE CALC FOR GE EEE AIRCRAFT
 XGRID UNITS=3HENG,XO=-7518.,NYO=1.,YO=0.,ZO=0.,
 XTRAJ NP=2.,XA=-7518.,ZA=394.,ALF1=2*8.83,
 FLAPA=2*42.,ILGR=2*1.,EPP=24.5,VA=2*228.,TD=.5
 XAMB XEND
 XSOURCE NENG=3,IFAN=1,IJET=1,ICORE=1,ITURB=1,IAIRF=1,IDOP=1,IGND=1,
 IAIM=2,IEGA=0,ISUPP=1,IOUT=1,3,0 XEND
 XPARAM NPARAM=2,AEPP=24.5,100.,AWAFAN=842.,1350.,ARPM=2028.,3189.,AFPR=1.133,1.469,
 ATIPM=.79,1.25,AWCORE=76.,149.,AP3=24048.,56160.,AT3=1173.,1475.,AT4=2103.,2919.,
 AFUEL=.925,3.104,ATURTS=434.,683.,ACTUR=1162.,1413.,AVC=534.,951.,ATC=604.,647.,
 XFANDA NBL=32,NVAN=36,FANDIA=7.31,FANHUB=2.47,TIPMD=1.25,RSS=360.,FANEFF=.818,
 SUPPIN=1.2,1.4,1.6,1.9,2.1,2.5,2.8,3.3,3.7,4.3,5.,5.7,6.6,7.6,
 8.7,10.1,11.5,10.3,9.2,8.1,7.3,6.5,5.8,5.1,
 SUPPEX=.5,6.8,9.1,1.1,3.1,6.1,9.2,3.2,7.3,3.3,3.9,4.8,5.7,6.8,
 8.3,7.4,6.6,5.9,5.2,4.7,4.1,3.7,3.3 XEND
 XJETDA IFWD=1,AC=23.81,GAMMAC=1.393,GASRC=53.33 XEND
 XSCOREDA IMOD=1,DTEMD=1550. XEND
 XTURBDA TBNDIA=4.092,GEAR=1.,CS=300.,NBLR=102,ITYPTB=1,
 TSUPP=.2,3.,4.,5.,6.,7.,8.,9.,1.1,1.3,1.5,1.7,2.,2.3,2.7,
 3.,2,3,7,4,2,5,4,8,4,3,3,9,3,4,3,1 XEND
 XAIRFDA A=4007.6,927.82,577.,880.5,B=200.19,68.11,29.45,108.4,
 NG=1,2,NW=2,4,CG=3.93,3.46,DW=2.925,4.17,ICLEAN=0,
 IWiNG=1,IFL=1,ISLAT=0 XEND

SAMPLE SIX - Footprint calculation of landing of Example One:

XSRA FOOTPRINT CONTOUR, LANDING AND GROUND ROLL
 XGRID NXO=11,XO=-7500.,-7000.,-6000.,-4000.,-2000.,-1000.,0.,500.,1000.,1500.,1600.,
 ZO=0.,NCONTR=1 XEND
 XTRAJ NP=3,XA=-5000.,0.,1500.,ZA=658.3,2*0.,
 ALF1=6.,2*10.,VA=2*118.2,0.,EPP=55.,20.,3.,
 PSY=60.,2*0.,NT=21,TD=1.,IGEOM=0,ITITLE=0 XEND
 XAMB TAMB=544.,PAMB=2065.,RH=48. XEND
 XSOURCE NENG=4,IFAN=1,ICORE=1,ITURB=1,IFLAP=1,IGND=1,IATM=1,IOUT=0,3,3 XEND
 XPARAM NPARAM=8,AEPP=0.,37.2,51.53,61.45,77.28,87.88,90.93,96.67,
 AWAFAN=0.,95.82,134.23,162.07,206.33,236.78,247.64,261.27,
 ARPM=0.,275.3,381.3,454.7,571.9,650.3,672.9,715.4,
 AFPR=1.,1.0523,1.1028,1.1526,1.2569,1.3517,1.3889,1.4427,
 AWCORE=0.,16.14,18.87,22.52,28.43,33.11,35.29,37.22,
 AP3=2112.,6399.,9356.,11655.,15821.,19359.,20902.,22730.,
 AT3=519.,779.2,879.,939.5,1027.9,1090.5,1115.7,1147.2,
 AT4=519.,1612.,1722.,1821.,2147.,2370.,2444.,2642.,
 AVC=0.,351.7,504.1,623.7,859.1,1062.7,1157.1,1271.4,
 AVF=0.,298.,414.6,503.6,644.7,750.2,784.,832.2,
 ATC=519.,1212.5,1205.3,1293.8,1458.3,1603.3,1654.8,1742.8,
 ATF=519.,539.8,546.8,554.4,569.4,582.6,587.4,595.2,
 ICORR=1,ICORXP=1.022 XEND
 XFANDA NBL=40,NVAN=85,FANDIA=3.392,FANHUB=1.45,
 TIPMD=1.24,RSS=275.,FANEFF=.84 XEND
 XSCOREDA IMOD=1,DTEMD=900.,GAMMA=1.4, XEND
 XTURBDA TBNDIA=1.53,CS=700.,GEAR=2.302,NBLR=60,ITYPTB=1, XEND
 XFLAPDA IUOTW=1,INOZ=2,IFWD=1,BPR=6.1,ACL=1.215,AF1=3.951 XEND

TABLE V. - OUTPUT FROM EXAMPLE ONE

QSRA LANDING CALCULATION, ENGINE MAP FROM TEST DATA
 OBSERVER COORDINATES (IN FEET).
 XO: -2000.0 -1000.0 0.0
 YO: 500.0 1000.0
 ZO: 0.0
 AIRCRAFT TRAJECTORY POINTS AND OPERATING CONDITIONS.
 XA: -5000.0 0.0 1500.0
 YA: 0.0 0.0 0.0
 ZA: 658.3 0.0 0.0
 EPP: 55.0 20.0 20.0
 VA: 118.2 118.2 0.0
 ALFL: 6.0 10.0 10.0
 GAM: 0.0 0.0 0.0
 PSY: 60.0 0.0 0.0
 FLAPA: 0.0 0.0 0.0
 ILGR: 0.0 0.0 0.0
 IREVR: 0 0 0

TABLE V. - Continued.

GEOMETRIC RELATIONS OF AIRCRAFT/OBSERVER																					
GEOM:	1	-2551.9	0.0	336.0	817.0	THETA	46.7	THETA F	29.8	41.7	PHI	57.3	TI	20.89	TAU	21.60	EPI	55.0	VI	118.2	
SPECTRA FOR EACH NOISE SOURCE																					
FREQ	50	65	79	99	125	158	199	251	316	398	501	630	794	999	1258	1584	1995				
SOURCES	3162	3981	5011	6309	7943	9999	9999	9999	9999	9999	9999	9999	9999	9999	9999	9999	9999	9999	9999	9999	
WHEN	XO=-2000.0	FT,	YO=	500.0	FT,	YO=	500.0	FT,	TAU =	21.6	SEC,	R =	817.0	FT,	THETA =	46.7	DEG				
FAN :	-19.6	-11.8	-4.5	2.6	9.2	15.4	21.3	26.9	32.0	36.8	41.2	45.2	48.9	52.2	55.2	57.7	59.9				
CORE :	64.0	63.2	64.3	68.0	65.3	67.0	65.9	55.3	55.8	56.0	OASPL =	74.5	PNL =	87.2	PNL =	88.3	50.5				
TURB :	42.1	44.7	47.3	49.3	51.2	53.2	54.3	54.3	55.3	56.0	OASPL =	55.4	54.8	53.8	52.9	51.9	45.4				
FLAP :	49.1	47.7	46.3	44.6	42.9	41.2	39.5	36.0	37.0	38.0	OASPL =	65.9	PNL =	74.7	PNL =	74.7	45.4				
TOTALS :	28.9	29.9	30.9	31.9	32.9	33.9	34.9	35.9	36.0	37.0	OASPL =	61.2	PNL =	72.6	PNL =	72.6	52.7				
GEOM:	2	-2434.7	0.0	320.5	736.0	53.0	34.9	48.5	58.3	21.89	22.53	55.0	118.2								
SOURCES	WHEN	XO=-2000.0	FT,	YO=	500.0	FT,	TAU =	22.5	SEC,	R =	736.0	FT,	THETA =	53.0	DEG						
FAN :	-20.0	-12.2	-4.9	2.1	8.8	15.0	20.9	26.4	31.6	36.4	40.8	44.8	48.5	51.8	54.7	57.3	59.5				
CORE :	63.7	62.8	63.8	67.8	64.9	66.7	65.5	57.0	57.6	57.8	OASPL =	74.1	PNL =	86.9	PNL =	88.0	52.2				
TURB :	43.8	46.4	49.0	51.0	53.0	54.9	56.0	41.2	42.9	44.6	OASPL =	67.6	PNL =	76.5	PNL =	76.5	48.8				
FLAP :	32.3	33.3	34.3	35.3	36.3	37.3	38.3	39.4	40.4	41.4	OASPL =	43.4	44.5	45.5	46.6	47.7	48.8				
TOTALS :	66.9	67.8	67.8	67.3	66.6	65.6	64.7	63.7	62.7	61.7	OASPL =	64.7	PNL =	76.1	PNL =	76.1	53.4				
GEOM:	3	-2317.5	0.0	305.1	666.3	60.8	42.4	56.9	59.3	22.89	23.47	55.0	118.2								
SOURCES	WHEN	XO=-2000.0	FT,	YO=	500.0	FT,	TAU =	23.5	SEC,	R =	666.3	FT,	THETA =	60.8	DEG						
FAN :	-20.8	-13.0	-5.6	1.4	8.0	14.3	20.1	25.7	30.8	35.6	40.0	44.1	47.7	51.0	54.0	56.5	58.7				
CORE :	63.0	62.0	63.1	67.1	64.1	66.0	64.8	58.6	59.2	59.4	OASPL =	73.4	PNL =	86.2	PNL =	87.3	53.9				
TURB :	45.5	48.0	50.6	52.6	54.6	56.5	57.7	43.3	44.3	45.3	OASPL =	69.3	PNL =	78.2	PNL =	78.2	52.7				
FLAP :	36.2	37.2	38.2	39.2	40.2	41.2	42.2	43.3	44.3	45.3	OASPL =	47.3	48.4	49.4	50.5	51.6	52.7				
TOTALS :	67.1	68.2	68.4	67.9	67.2	66.2	65.3	64.4	63.4	62.3	OASPL =	68.6	PNL =	80.0	PNL =	80.0	54.0				
GEOM:	4	-2200.3	0.0	289.7	611.6	70.1	53.8	67.4	60.4	23.89	24.43	55.0	118.2								
SOURCES	WHEN	XO=-2000.0	FT,	YO=	500.0	FT,	TAU =	24.4	SEC,	R =	611.6	FT,	THETA =	70.1	DEG						
FAN :	-21.4	-13.6	-6.2	0.8	7.4	13.7	19.6	25.1	30.2	35.0	39.4	43.5	47.1	50.4	53.4	55.9	58.1				
CORE :	62.4	61.4	62.5	66.5	63.5	65.3	64.2	60.1	60.7	60.9	OASPL =	72.8	PNL =	85.6	PNL =	86.7	55.4				
TURB :	46.9	49.5	52.1	54.1	56.1	58.0	59.1	46.9	47.9	48.9	OASPL =	70.8	PNL =	79.7	PNL =	79.7	56.3				
FLAP :	54.0	52.5	51.1	49.5	47.8	46.1	44.4	45.8	46.9	47.9	OASPL =	72.3	PNL =	83.6	PNL =	83.6	54.4				
TOTALS :	39.8	40.8	41.8	42.8	43.8	44.8	45.8	64.7	63.7	62.7	OASPL =	61.6	60.5	59.3	58.0	56.9	55.7				
GEOM:	5	51.6	68.6	68.8	68.3	67.6	66.6	65.7	64.7	63.7	62.7	61.6	60.5	59.3	58.0	56.9	55.7	54.4			
SOURCES	WHEN	XO=-2000.0	FT,	YO=	500.0	FT,	TAU =	24.4	SEC,	R =	611.6	FT,	THETA =	70.1	DEG						
FAN :	-21.4	-13.6	-6.2	0.8	7.4	13.7	19.6	25.1	30.2	35.0	39.4	43.5	47.1	50.4	53.4	55.9	58.1				
CORE :	62.4	61.4	62.5	66.5	63.5	65.3	64.2	60.1	60.7	60.9	OASPL =	72.8	PNL =	85.6	PNL =	86.7	55.4				
TURB :	46.9	49.5	52.1	54.1	56.1	58.0	59.1	46.9	47.9	48.9	OASPL =	70.8	PNL =	79.7	PNL =	79.7	56.3				
FLAP :	54.0	52.5	51.1	49.5	47.8	46.1	44.4	45.8	46.9	47.9	OASPL =	72.3	PNL =	83.6	PNL =	83.6	54.4				
TOTALS :	39.8	40.8	41.8	42.8	43.8	44.8	45.8	64.7	63.7	62.7	OASPL =	61.6	60.5	59.3	58.0	56.9	55.7	54.4			

TABLE V. - Continued.

TOTALS:	70.5	71.6	71.8	71.4	70.8	70.0	69.4	68.8	68.2	67.6	66.8	65.9	65.0	64.1	63.4	63.0	62.9
	64.3	62.9	62.7	64.1	60.4	58.9	55.6			OASPL =		81.4	PNL =	90.0	PMLT =	90.9	
GEOM: 5 -2083.1 SOURCES WHEN X0=-2000.0 FT, Y0= 576.3 FAN : -20.3 -12.6 1.8 8.4 14.7 20.6 81.0 FT, TAU = 71.6 79.8 61.5 24.89 25.39 55.0 118.2 CORE : 63.4 62.4 63.5 67.5 64.6 66.3 65.2 66.2 61.7 62.2 62.4 66.2 61.8 61.2 80.2 81.3 PMLT = 54.4 48.2 TURB : 48.5 51.1 53.7 55.6 57.6 47.6 45.9 49.3 50.6 51.6 52.6 53.6 54.6 55.7 56.7 57.8 58.9 60.0 FLAP : 61.1 62.3 63.7 64.9 66.5 68.4 72.2 64.9 64.9 63.9 62.9 61.8 60.6 59.4 58.2 57.0 55.8 54.5 TOTALS: 70.7 71.8 72.0 71.6 71.1 70.4 69.9 69.4 69.0 68.5 67.8 67.1 66.3 65.6 65.1 64.9 64.9 64.9																	
***** CLOSEST POINT OF APPROACH GEOM: 6 -1965.9 SOURCES WHEN X0=-2000.0 FT, Y0= 564.1 FAN : -17.7 -10.0 4.4 11.0 17.3 23.2 92.8 FT, TAU = 96.0 93.1 62.6 25.89 26.38 55.0 118.2 CORE : 50.3 52.9 55.4 57.4 59.4 61.3 62.5 63.6 64.0 64.2 63.9 63.6 62.9 62.0 61.0 60.1 59.5 61.7 TURB : 57.3 55.9 52.8 51.1 49.4 47.7 49.4 47.7 63.4 64.0 64.2 63.9 63.6 62.9 62.0 61.0 60.1 58.7 FLAP : 47.2 48.2 49.2 50.2 51.2 52.2 53.2 54.3 55.3 56.3 57.3 58.3 59.4 60.4 61.5 62.6 63.7 64.8 TOTALS: 69.4 70.5 70.8 70.5 70.2 69.8 69.6 69.5 69.3 69.1 68.6 68.2 67.7 67.2 67.1 67.3 67.6 67.6																	
***** GEOM: 7 -1848.7 SOURCES WHEN X0=-2000.0 FT, Y0= 576.3 FAN : -15.7 -8.0 -0.6 6.4 13.0 19.3 25.2 104.6 FT, TAU = 120.4 106.2 63.7 26.89 27.39 55.0 118.2 CORE : 51.4 54.0 56.6 58.6 60.5 62.5 63.6 64.6 65.2 65.4 65.1 64.7 64.1 63.1 62.2 61.2 60.2 59.8 TURB : 49.5 50.5 53.5 52.5 54.5 55.5 56.6 57.6 58.6 59.6 60.6 61.7 62.7 63.8 64.9 66.0 66.0 66.0 FLAP : 67.1 68.5 69.7 70.9 72.5 74.4 79.0 72.5 61.6 60.6 59.6 58.5 57.4 56.1 54.9 53.7 52.5 51.3 TOTALS: 67.7 68.8 69.3 69.1 69.1 69.2 69.3 69.6 69.7 69.6 69.4 69.1 68.8 68.6 68.7 69.0 69.5 69.5																	
***** GEOM: 8 -1731.5 SOURCES WHEN X0=-2000.0 FT, Y0= 611.6 FAN : -15.0 -7.2 0.1 7.1 13.8 20.0 25.9 115.4 FT, TAU = 138.2 117.7 64.8 27.89 28.43 55.0 118.2 CORE : 68.9 67.8 68.8 73.0 69.9 71.8 70.6 70.6 64.7 65.2 65.5 65.2 64.8 64.2 63.2 62.3 61.3 60.5 TURB : 58.5 54.1 55.7 54.0 52.3 50.6 48.9 56.1 57.1 58.1 59.1 60.1 61.2 62.2 63.3 64.4 65.5 66.5 FLAP : 69.0 70.1 70.3 69.8 69.1 68.2 67.3 66.3 65.3 64.3 64.3 62.0 62.0 60.8 59.6 58.4 57.2 55.9 TOTALS: 72.1 73.2 73.5 73.1 72.7 72.2 71.8 71.5 71.2 70.9 70.4 69.9 69.4 69.0 68.9 69.1 69.5 69.5																	
***** GEOM: 9 -1614.4 SOURCES WHEN X0=-2000.0 FT, Y0= 124.8 FAN : -15.2 -7.4 -0.1 6.9 13.6 19.8 25.7 500.0 FT, TAU = 149.6 127.2 66.0 28.89 29.47 55.0 118.2 TOTALS: 68.6 67.6 68.6 72.7 69.7 71.6 70.4 70.4 36.4 41.2 45.6 49.6 53.3 56.6 59.5 62.1 64.3 64.3																	

TABLE V. - Continued.

CORE :	50.9	53.5	56.1	58.1	60.0	62.0	63.1	64.1	64.6	64.9	64.6	64.2	63.6	62.6	61.7	60.7	59.3
TURB :	45.9	46.9	47.9	48.9	49.9	50.9	48.3	53.0	54.0	55.0	56.0	57.0	58.1	59.1	60.2	61.3	62.4
FLAP :	71.8	72.9	73.2	72.8	72.1	71.2	70.3	69.3	68.3	67.3	66.2	65.0	63.8	62.6	61.4	60.2	58.9
TOTALS:	57.5	56.1	54.6	53.0	51.5	49.8	48.1	47.9	48.1	48.1	48.1	48.1	48.1	48.1	48.1	48.1	48.1
	74.8	75.9	76.2	75.8	75.3	74.5	73.9	73.2	72.6	71.9	71.1	70.3	69.4	68.6	68.2	68.1	68.2
	70.0	68.5	68.3	69.7	65.7	64.0	60.7										
GEOM: 10 -1497.2																	
FAN :	SOURCES	WHEN	XO=-2000.0	FT,	Y0=	132.5	157.1	134.9	67.2	29.89	30.53	55.0	118.2	132.5	DEG		
	-16.4	-8.6	-1.3	5.7	12.4	18.6	24.5	30.0	35.2	40.0	44.4	48.4	52.1	55.4	58.3	60.9	63.1
CORE :	67.4	66.4	67.4	71.4	68.5	70.3	69.2	63.2	63.7	64.0	63.7	63.3	62.7	61.7	60.8	59.8	58.4
TURB :	50.0	52.6	55.2	57.2	50.8	49.1	47.4	49.3	50.3	51.3	52.3	54.4	55.4	56.5	57.6	58.7	59.6
FLAP :	42.2	43.2	44.2	45.2	46.2	47.2	48.2	49.3	50.3	51.3	52.3	54.4	55.4	56.5	57.6	58.7	59.6
TOTALS:	59.8	61.0	62.4	63.6	65.2	67.1	70.6	70.1	69.1	68.0	66.9	65.7	64.5	63.3	62.1	60.8	59.6
	72.3	73.5	73.8	73.4	72.9	71.9	71.1	70.1	69.1	68.0	66.9	65.7	64.5	63.3	62.1	60.8	59.6
	58.2	56.8	55.3	53.7	52.2	50.5	48.8	47.3	46.3	45.3	44.3	43.3	42.3	41.3	40.3	39.3	38.3
	75.3	76.4	76.7	76.4	75.9	75.1	74.3	73.6	72.8	72.0	71.0	70.0	69.0	67.9	67.2	66.7	66.5
	68.1	66.3	65.9	67.3	62.5	60.4											
GEOM: 11 -1380.0																	
FAN :	SOURCES	WHEN	XO=-2000.0	FT,	Y0=	138.8	162.2	140.9	68.4	30.89	31.60	55.0	118.2	138.8	DEG		
	-18.6	-10.8	-3.4	3.6	10.2	16.5	22.3	27.9	33.0	37.8	42.2	46.3	49.9	53.2	56.2	58.7	60.9
CORE :	65.2	64.2	65.3	69.3	66.3	68.1	67.0	62.2	62.8	63.0	62.7	62.4	61.7	60.8	59.8	58.8	57.4
TURB :	56.0	54.6	53.2	51.5	49.8	48.1	46.5	46.0	47.0	48.0	49.0	50.0	51.1	52.1	53.2	54.3	55.4
FLAP :	38.9	39.9	40.9	41.9	42.9	43.9	44.9	46.0	47.0	48.0	49.0	50.0	51.1	52.1	53.2	54.3	55.4
TOTALS:	56.5	57.7	59.1	60.3	61.9	63.8	67.1	70.0	69.0	68.0	66.9	65.7	64.4	63.2	62.0	60.7	59.5
	72.0	73.2	73.6	73.3	72.8	71.9	71.0	70.0	69.0	68.0	66.9	65.7	64.4	63.2	62.0	60.7	59.5
	58.1	56.7	55.2	53.6	52.1	50.4	48.7	47.4	46.4	45.4	44.4	43.4	42.4	41.4	40.4	39.4	38.4
	75.0	76.1	76.5	76.2	75.8	74.9	74.2	73.3	72.5	71.6	70.6	69.5	68.3	67.1	66.0	65.2	64.6
	65.7	63.7	63.0	64.2	58.9	56.3											
GEOM: 1 -2551.9																	
FAN :	SOURCES	WHEN	XO=-2000.0	FT,	Y0=	1190.6	1190.6	60.7	72.2	20.89	21.93	55.0	118.2	119.9	DEG		
	-26.0	-18.3	-10.9	-3.9	2.7	9.0	14.9	20.4	25.5	30.3	34.7	38.8	42.4	45.7	48.7	51.2	53.4
CORE :	57.7	56.7	57.8	61.8	58.8	60.7	59.5	53.7	54.2	54.5	54.2	53.8	53.2	52.2	51.3	50.3	48.9
TURB :	47.5	46.1	44.7	43.0	41.3	39.6	37.9	38.6	39.6	40.6	41.6	42.6	43.7	44.7	45.8	46.9	48.0
FLAP :	31.5	32.5	33.5	34.5	35.5	36.5	37.5	38.6	39.6	40.6	41.6	42.6	43.7	44.7	45.8	46.9	48.0
TOTALS:	49.1	50.3	51.7	52.9	54.5	56.4	59.7	60.5	59.5	58.4	57.2	56.0	54.8	53.5	52.3	51.3	49.7
	61.7	62.9	63.5	63.2	62.4	61.5	60.5	60.5	59.5	58.4	57.2	56.0	54.8	53.5	52.3	51.3	49.7
	48.3	46.9	45.4	43.9	42.3	40.8	39.1	38.8	38.8	38.8	38.8	38.8	38.8	38.8	38.8	38.8	38.8
	64.6	65.8	66.4	66.4	66.1	65.4	64.6	63.8	62.9	62.0	61.0	59.8	58.6	57.3	56.3	55.5	54.9
	56.0	53.6	52.3	52.6	45.9	41.4											
GEOM: 2 -2434.7																	
FAN :	SOURCES	WHEN	XO=-2000.0	FT,	Y0=	1136.5	1136.5	66.1	72.8	21.89	22.88	55.0	118.2	118.2	DEG		
	-26.5	-18.8	-11.4	-4.4	2.3	8.5	14.4	19.9	25.1	29.9	34.3	38.3	42.0	45.3	48.2	50.8	53.0
CORE :	57.3	56.2	57.3	61.3	58.4	60.2	59.1	54.5	55.1	55.3	55.0	54.6	54.0	53.0	52.1	51.1	49.7
TURB :	48.3	46.9	46.5	48.5	50.4	52.4	53.5	38.7	40.6	42.6	43.6	44.6	45.7	46.7	47.8	48.9	50.0
FLAP :	33.5	34.5	35.5	36.5	37.5	38.5	39.5	40.6	41.6	42.6	43.6	44.6	45.7	46.7	47.8	48.9	50.0
TOTALS:	51.1	52.3	53.7	54.9	56.5	58.4	61.8	61.0	60.0	58.9	57.7	56.5	55.3	54.0	52.7	51.5	50.1
	62.0	63.3	63.9	63.9	62.9	62.0	62.0	61.0	60.0	58.9	57.7	56.5	55.3	54.0	52.7	51.5	50.1
	48.7	47.3	45.9	44.4	42.8	41.2	39.6	38.6	37.6	36.6	35.6	34.6	33.6	32.6	31.6	30.6	29.6
	65.0	66.2	66.8	66.9	66.6	65.9	65.2	64.4	63.6	62.7	61.6	60.5	59.3	58.1	57.0	56.2	55.5
	56.3	54.1	52.9	52.1	47.1	42.8	35.0										

TABLE V. - Continued.

GEOM: 3	-2317.5	0.0	305.1	1092.7	72.7	42.4	72.0	73.5	22.89	23.85	55.0	118.2	50.7	52.9
FAN :	-26.5	-18.8	-11.4	2.2	1000.0	14.4	19.9	25.0	29.8	34.2	38.3	45.2	48.2	81.5
CORE :	57.2	56.2	47.3	58.3	8.5	59.0	55.3	55.9	56.1	55.8	54.8	53.9	52.9	51.9
TURB :	49.1	44.7	46.3	44.6	41.3	39.6	41.3	39.6	41.3	39.6	41.3	39.6	41.3	39.6
FLAP :	35.5	36.5	37.5	38.5	40.5	41.5	42.0	43.6	44.6	45.6	47.7	48.7	49.8	50.9
TOTALS:	53.1	54.3	55.7	56.9	60.4	63.9	64.4	60.4	59.3	58.1	55.7	54.4	53.1	51.9
	62.3	63.6	64.2	64.3	64.1	63.3	62.4	61.4	60.4	59.3	58.1	57.5	56.8	55.5
	49.1	47.7	46.3	44.7	43.2	41.6	40.0	38.7	37.3	36.3	35.3	34.3	33.3	32.3
	65.3	66.5	67.1	67.3	67.0	66.4	65.7	64.9	64.1	63.3	62.3	61.2	60.1	58.9
	57.0	55.0	54.0	48.6	44.5	37.7								84.1
GEOM: 4	-2200.3	0.0	289.7	1060.2	78.7	53.8	78.3	74.1	23.89	24.82	55.0	118.2	51.3	53.5
FAN :	-25.9	-18.2	-10.8	-3.8	1000.0	15.0	20.5	25.6	30.4	34.8	38.9	45.9	48.8	82.1
CORE :	57.8	56.8	47.9	61.8	58.9	59.6	56.1	56.7	56.9	56.6	55.6	54.7	53.7	52.7
TURB :	42.9	45.5	48.1	50.1	52.1	54.0	42.1	40.4	46.7	47.7	48.7	50.8	51.9	53.0
FLAP :	49.9	48.5	47.1	45.4	43.7	42.1	43.6	44.7	45.7	46.7	47.7	48.7	49.8	50.8
TOTALS:	37.6	38.6	39.6	40.6	41.6	42.6	43.6	44.7	45.7	46.7	47.7	48.7	49.8	50.8
	55.2	56.4	57.8	59.0	60.6	62.5	62.6	61.6	60.6	59.5	58.4	57.1	55.9	54.6
	62.4	63.7	64.3	64.5	64.3	63.5	62.6	61.6	60.6	59.5	58.4	57.1	55.9	54.6
	49.3	47.9	46.5	44.9	43.4	41.8	40.2	38.7	37.3	35.5	34.5	33.5	32.5	31.5
	65.4	66.6	67.3	67.5	67.3	66.7	66.0	65.3	64.6	63.8	62.8	61.8	60.8	59.7
	58.1	56.4	55.4	50.4	46.6	40.5								84.6
GEOM: 5	-2083.1	0.0	274.3	1040.3	85.0	71.6	84.8	74.8	24.89	25.80	55.0	118.2	54.7	57.5
FAN :	-24.7	-17.0	-9.6	-2.6	1000.0	16.2	21.7	26.8	31.6	36.0	40.1	47.0	50.0	85.0
CORE :	59.0	58.0	49.1	63.1	60.1	61.9	60.8	57.1	57.6	57.6	56.6	55.6	54.7	53.7
TURB :	50.9	49.5	48.1	46.4	44.7	43.0	41.3	40.4	41.3	42.3	43.3	44.3	45.3	46.3
FLAP :	39.6	40.6	41.6	42.6	43.6	44.6	45.6	46.7	47.7	48.7	49.7	50.7	51.8	52.8
TOTALS:	57.2	58.4	59.8	61.0	62.6	64.5	64.6	63.7	62.7	61.7	60.7	59.6	58.5	57.4
	62.3	63.6	64.3	64.5	64.3	63.6	62.7	61.7	60.7	59.6	58.4	57.2	55.9	54.7
	49.3	47.9	46.5	45.0	43.4	41.9	40.2	38.7	37.3	35.5	34.5	33.5	32.5	31.5
	65.3	66.6	67.3	67.5	67.4	66.9	66.2	65.6	65.0	64.3	63.4	62.5	61.5	60.5
	59.6	58.0	57.2	57.1	52.4	48.7								85.7
GEOM: 6	-1965.9	0.0	258.8	1033.5	91.5	96.0	91.6	75.4	25.89	26.79	55.0	118.2	56.2	59.3
FAN :	-23.2	-15.5	-8.1	-1.1	1000.0	17.7	23.2	28.3	33.1	37.5	41.6	48.5	51.5	86.8
CORE :	60.5	59.5	50.6	64.5	61.6	63.4	62.3	58.6	58.8	58.5	57.5	56.6	55.6	54.6
TURB :	51.8	50.4	49.0	47.3	45.6	43.9	42.3	41.3	42.3	43.3	44.3	45.3	46.3	47.3
FLAP :	41.6	42.6	43.6	44.6	45.6	46.6	47.6	48.7	49.7	50.7	51.7	52.7	53.8	54.8
TOTALS:	59.2	60.4	61.8	63.0	64.6	66.5	66.6	65.7	64.7	63.7	62.7	61.7	60.7	59.6
	60.8	62.1	62.8	63.1	63.0	62.2	61.4	60.3	59.3	58.3	57.1	55.8	54.6	53.3
	47.9	46.6	45.1	43.6	42.1	40.5	38.9	37.3	35.5	34.5	33.5	32.5	31.5	30.5
	63.9	65.2	66.0	66.3	66.3	65.9	65.5	65.0	64.6	64.1	63.4	62.7	61.9	60.4
	61.1	59.7	58.9	58.8	54.3	50.6	45.4							86.5
GEOM: 7	-1848.7	0.0	243.4	1040.3	98.0	120.4	98.2	76.1	26.89	27.80	55.0	118.2	57.5	60.3
FAN :	-22.0	-14.2	-6.8	0.2	1000.0	18.9	24.5	29.6	34.4	38.8	42.9	49.8	52.8	88.0
TOTALS:	61.7	60.8	61.9	65.7	62.9	64.6	63.5	62.5	61.5	60.5	59.5	58.5	57.5	56.5

GEOM: 7

SOURCES WHEN

XO=-2000.0 FT, YO=

6.8

18.9

24.5

29.6

34.4

38.8

42.9

46.5

50.1

53.7

57.3

60.9

64.5

TABLE V. - Continued.

CORE :	45.7	48.2	50.8	52.8	54.8	56.7	57.9	58.8	59.4	59.6	59.3	59.0	58.3	57.4	56.4	55.5	54.1
TURB :	52.7	51.3	49.8	48.2	46.5	44.8	43.1	41.9	40.4	38.8	37.1	35.4	33.7	32.0	30.3	28.6	26.9
FLAP :	60.9	62.1	63.5	64.3	64.7	65.3	65.8	66.3	66.8	67.3	67.8	68.3	68.8	69.3	69.8	70.3	70.8
TOTALS :	62.2	63.5	64.4	64.8	65.0	65.4	65.7	66.0	66.3	66.6	66.9	67.2	67.5	67.8	68.1	68.4	68.7
GEOM: 8 -1731.5																	
FAN :	0.0	228.0	1060.2	1043.3	138.2	104.7	76.8	27.89	28.82	55.0	118.2	104.3	104.3	104.3	104.3	104.3	104.3
CORE :	62.7	66.7	63.8	65.6	64.5	64.5	64.5	64.5	64.5	64.5	64.5	64.5	64.5	64.5	64.5	64.5	64.5
TURB :	53.1	51.7	50.3	48.6	46.9	45.2	43.5	41.8	40.1	38.4	36.7	35.0	33.3	31.6	29.9	28.2	26.5
FLAP :	61.8	63.0	64.4	65.6	67.2	69.1	71.3	73.7	76.6	79.9	83.7	88.0	92.8	98.1	103.9	110.2	117.0
TOTALS :	63.3	61.9	60.9	59.4	57.4	54.8	51.3	47.1	42.1	36.6	30.3	23.4	16.1	8.4	0.0	0.0	0.0
GEOM: 9 -1614.4																	
FAN :	0.0	212.5	1092.7	1103.3	149.6	110.8	77.5	28.89	29.85	55.0	118.2	110.3	110.3	110.3	110.3	110.3	110.3
CORE :	63.4	67.5	64.4	66.3	65.1	63.4	61.7	59.9	58.2	56.4	54.6	52.8	51.0	49.2	47.4	45.6	43.8
TURB :	51.5	48.8	47.1	45.4	43.7	42.0	40.3	38.6	36.9	35.2	33.5	31.8	30.1	28.4	26.7	25.0	23.3
FLAP :	67.0	68.4	69.6	71.1	72.5	74.0	75.4	76.9	78.3	79.8	81.2	82.7	84.1	85.6	87.0	88.5	89.9
TOTALS :	63.9	62.3	61.4	60.4	58.4	55.4	51.9	47.4	42.4	36.9	30.6	23.7	16.4	8.7	0.0	0.0	0.0
GEOM: 10 -1497.2																	
FAN :	0.0	197.1	1136.5	116.0	157.1	116.5	78.1	29.89	30.88	55.0	118.2	116.0	116.0	116.0	116.0	116.0	116.0
CORE :	63.5	67.7	64.6	66.5	65.3	63.6	61.9	60.1	58.4	56.6	54.8	53.0	51.2	49.4	47.6	45.8	44.0
TURB :	53.1	51.7	50.3	48.6	46.9	45.2	43.5	41.8	40.1	38.4	36.7	35.0	33.3	31.6	29.9	28.2	26.5
FLAP :	68.0	69.3	70.1	70.6	70.6	70.6	70.6	70.6	70.6	70.6	70.6	70.6	70.6	70.6	70.6	70.6	70.6
TOTALS :	63.4	61.6	60.6	59.2	57.2	54.2	50.7	46.2	41.2	35.7	29.4	22.5	15.2	7.5	0.0	0.0	0.0
GEOM: 11 -1380.0																	
FAN :	0.0	181.7	1190.6	121.1	162.2	121.6	78.8	30.89	31.93	55.0	118.2	121.1	121.1	121.1	121.1	121.1	121.1
CORE :	63.5	67.6	64.5	66.5	65.3	63.6	61.9	60.1	58.4	56.6	54.8	53.0	51.2	49.4	47.6	45.8	44.0
TURB :	52.9	51.4	50.0	48.4	46.7	45.0	43.3	41.6	39.9	38.2	36.5	34.8	33.1	31.4	29.7	28.0	26.3
FLAP :	68.1	69.5	70.3	70.8	70.9	70.9	70.9	70.9	70.9	70.9	70.9	70.9	70.9	70.9	70.9	70.9	70.9
TOTALS :	63.2	61.4	60.4	59.4	57.4	54.4	50.9	46.4	41.4	35.9	29.6	22.7	15.4	7.7	0.0	0.0	0.0

TABLE V. - Continued.

GEOM: 1 -1568.9												
SOURCES WHEN												
XO=-1000.0 FT, YO= 43.0 FT, TAU = 18.5 41.1 69.0 29.28 29.96 55.0												
R = 30.0 SEC, R = 785.1 FT, THETA = 43.0 DEG												
FAN :	-18.5	-10.8	3.6	10.2	22.4	27.9	33.1	37.9	42.3	46.3	50.0	58.2
CORE :	64.9	64.2	65.3	68.9	66.4	67.9	66.9	65.8	65.5	65.2	65.5	61.0
TURB :	41.8	44.4	47.0	49.0	51.0	52.9	54.0	55.6	55.8	55.5	54.5	50.3
FLAP :	27.8	28.8	29.8	30.8	31.8	32.8	33.8	34.9	36.9	37.9	38.9	44.3
TOTALS:	45.4	46.6	48.0	49.2	50.8	52.7	55.7	63.6	61.6	60.4	59.2	53.0
SOURCES WHEN												
XO=-1000.0 FT, YO= 43.0 FT, TAU = 18.5 41.1 69.0 29.28 29.96 55.0												
R = 30.0 SEC, R = 785.1 FT, THETA = 43.0 DEG												
FAN :	51.6	50.2	48.8	47.2	45.6	44.0	42.3	40.4	38.9	37.9	36.9	31.9
TOTALS:	68.4	69.6	70.0	69.8	69.3	68.5	67.7	66.8	65.9	65.0	64.0	61.9
GEOM: 2 -1451.7												
SOURCES WHEN												
XO=-1000.0 FT, YO= 49.3 21.4 47.6 70.3 30.28 30.89 55.0												
R = 30.9 SEC, R = 700.4 FT, THETA = 49.3 DEG												
FAN :	-18.7	-11.0	3.4	10.0	22.2	27.7	32.8	37.6	42.0	46.1	49.8	60.7
CORE :	64.9	64.0	65.1	69.0	66.1	67.9	66.8	65.0	64.3	63.6	63.0	58.5
TURB :	31.3	32.3	33.3	34.3	35.3	36.3	37.3	38.4	40.4	41.4	42.4	47.8
FLAP :	68.9	50.1	51.5	52.7	54.3	57.4	65.7	64.7	62.6	61.5	60.3	54.0
TOTALS:	52.6	51.2	49.8	48.2	46.6	45.0	43.3	41.4	39.5	37.6	35.7	31.1
GEOM: 3 -1334.5												
SOURCES WHEN												
XO=-1000.0 FT, YO= 57.3 26.2 55.9 71.5 31.28 31.83 55.0												
R = 31.8 SEC, R = 626.7 FT, THETA = 57.3 DEG												
FAN :	-19.5	-11.8	9.2	15.5	21.4	26.9	32.1	36.8	41.3	45.3	49.0	60.0
CORE :	64.2	63.2	64.3	68.3	65.4	67.2	66.0	64.8	63.6	62.4	61.2	57.8
TURB :	52.7	51.2	49.8	48.2	46.5	44.8	43.1	42.5	41.4	40.4	39.3	34.1
FLAP :	53.4	36.4	37.4	38.4	39.4	40.4	41.4	42.5	43.5	44.5	45.5	51.9
TOTALS:	67.2	68.4	69.0	68.9	68.6	68.2	67.8	67.4	66.9	66.5	66.1	62.9
GEOM: 4 -1217.3												
SOURCES WHEN												
XO=-1000.0 FT, YO= 67.1 34.9 66.1 72.8 32.28 32.78 55.0												
R = 32.8 SEC, R = 568.3 FT, THETA = 67.1 DEG												
FAN :	-20.5	-12.7	5.4	11.6	18.5	24.4	29.5	34.9	40.3	44.3	48.0	59.0
CORE :	67.3	62.3	63.3	67.4	64.4	66.2	65.1	64.0	62.9	61.8	60.7	56.8
TURB :	39.5	40.5	41.5	42.5	43.5	44.5	45.5	46.6	47.6	48.6	49.6	55.8
FLAP :	68.1	69.3	69.9	69.9	69.7	68.9	68.0	67.0	66.0	64.9	63.8	56.2
TOTALS:	54.8	53.4	51.9	50.4	48.8	47.3	45.6	43.9	42.2	40.5	38.8	33.9
GEOM: 5 -1100.2												
SOURCES WHEN												
XO=-1000.0 FT, YO= 78.7 53.8 78.3 74.1 33.28 33.74 55.0												
R = 33.7 SEC, R = 530.1 FT, THETA = 78.7 DEG												
FAN :	-19.9	-12.2	4.8	11.0	18.5	24.4	29.5	34.9	40.3	44.3	48.0	59.6
CORE :	63.8	62.8	63.9	67.9	65.0	66.7	65.6	64.5	63.4	62.3	61.2	57.4
TURB :	49.0	51.6	54.1	56.1	58.1	60.0	61.2	62.1	62.9	62.6	62.3	58.8
FLAP :	63.6	64.6	65.6	66.6	67.6	68.6	69.6	70.6	71.6	72.6	73.6	81.1
TOTALS:	61.2	62.4	63.8	65.0	66.6	68.5	72.2	76.9	82.8	89.2	96.1	118.2

TABLE V. - Continued.

GEOM: 10	-514.2	0.0	67.7	700.4	133.7	170.6	134.1	80.9	38.28	38.89	55.0	118.2	
SOURCES WHEN	X0=-1000.0	FT, Y0=	500.0	FT, TAU=	30.2	35.4	40.2	44.6	48.6	52.3	55.6	58.5	61.1
FAN :	-16.2	-8.4	17.1	5.9	12.6	18.8	24.7	30.2	35.4	40.2	44.6	48.6	52.3
CORE :	50.4	53.0	54.6	52.9	51.2	49.5	47.8	46.2	44.2	42.4	40.6	38.8	37.0
TURB :	42.2	43.2	44.2	45.2	46.2	47.2	48.2	49.3	50.3	51.3	52.3	53.3	54.4
FLAP :	59.8	61.0	62.4	63.6	65.2	67.1	70.6	73.8	72.8	71.7	70.5	69.2	67.9
TOTALS:	76.1	77.5	78.5	79.1	79.3	78.7	77.9	76.9	75.0	73.8	72.6	71.3	70.1
	68.8	67.0	66.5	67.9	63.2	61.3	56.6	56.6	55.0	53.8	52.6	51.3	50.0
GEOM: 11	-397.0	0.0	52.3	785.1	140.0	173.5	140.3	82.3	39.28	39.96	55.0	118.2	
SOURCES WHEN	X0=-1000.0	FT, Y0=	500.0	FT, TAU=	30.2	35.4	40.2	44.6	48.6	52.3	55.6	58.5	61.1
FAN :	-18.4	-10.7	3.7	10.3	16.6	22.5	28.0	33.1	37.9	42.3	46.4	50.0	53.3
CORE :	49.4	52.0	53.6	51.9	50.2	48.5	46.8	45.1	43.3	41.5	39.7	37.9	36.1
TURB :	38.9	39.9	40.9	41.9	42.9	43.9	44.9	46.0	47.0	48.0	49.0	50.0	51.1
FLAP :	72.2	73.6	74.7	75.4	75.7	75.1	74.2	73.2	72.2	71.1	69.8	68.5	67.3
TOTALS:	75.2	76.6	77.6	78.4	78.6	78.0	77.2	76.2	75.3	74.2	72.9	71.7	70.4
	66.4	64.4	63.6	64.7	59.5	57.0	51.3	51.3	50.0	48.6	47.2	45.8	44.4
GEOM: 1	-1568.9	0.0	206.6	1168.9	60.6	18.5	60.1	79.2	29.28	30.30	55.0	118.2	
SOURCES WHEN	X0=-1000.0	FT, Y0=	1000.0	FT, TAU=	20.8	26.0	30.8	35.2	39.2	42.9	46.2	49.1	51.7
FAN :	-25.6	-17.9	3.2	9.4	15.3	20.8	26.0	30.8	35.2	39.2	42.9	46.2	49.1
CORE :	48.2	47.1	45.7	44.7	43.1	41.4	39.7	38.0	36.3	34.5	32.7	30.9	29.1
TURB :	31.3	32.3	33.3	34.3	35.3	36.3	37.3	38.4	39.4	40.4	41.4	42.4	43.5
FLAP :	61.4	62.8	63.7	64.2	64.3	63.6	62.8	61.8	60.7	59.6	58.4	57.2	55.9
TOTALS:	64.4	65.7	66.6	67.1	67.2	66.6	65.8	64.9	64.0	63.0	61.8	60.6	59.3
	56.5	54.1	52.8	53.3	46.5	42.1	33.2	33.2	32.0	30.8	29.6	28.4	27.2
GEOM: 2	-1451.7	0.0	191.1	1113.8	65.8	21.4	65.5	79.8	30.28	31.25	55.0	118.2	
SOURCES WHEN	X0=-1000.0	FT, Y0=	1000.0	FT, TAU=	20.3	25.4	30.2	34.6	38.7	42.3	45.6	48.6	51.9
FAN :	-26.2	-18.4	3.2	9.4	15.3	20.8	26.0	30.8	35.2	39.2	42.9	46.2	49.1
CORE :	41.4	44.0	45.6	43.9	42.2	40.5	38.8	37.1	35.4	33.7	32.0	30.3	28.6
TURB :	33.9	34.1	35.3	36.3	37.3	38.3	39.3	40.4	41.4	42.4	43.4	44.5	45.5
FLAP :	61.9	63.2	64.2	64.8	64.9	64.2	63.4	62.3	61.3	60.2	59.0	57.7	56.5
TOTALS:	64.8	66.2	67.1	67.7	67.8	67.2	66.4	65.5	64.6	63.7	62.5	61.3	60.1
	56.7	54.5	53.3	53.6	47.5	43.4	35.6	35.6	34.4	33.2	32.0	30.8	29.6
GEOM: 3	-1334.5	0.0	175.7	1069.0	71.5	26.2	71.3	80.5	31.28	32.21	55.0	118.2	
SOURCES WHEN	X0=-1000.0	FT, Y0=	1000.0	FT, TAU=	20.1	25.3	30.1	34.5	38.5	42.2	45.5	48.4	51.0
FAN :	-26.3	-18.6	3.2	9.4	14.6	20.1	25.3	30.1	34.5	38.5	42.2	45.5	48.4
CORE :	42.2	44.8	47.4	49.4	51.3	53.3	54.4	55.4	56.0	56.2	55.9	55.5	54.9
TURB :	35.3	36.3	37.3	38.3	39.3	40.3	41.3	42.4	43.4	44.4	45.4	46.4	47.5
TOTALS:	64.8	66.2	67.1	67.7	67.8	67.2	66.4	65.5	64.6	63.7	62.5	61.3	60.1
	56.7	54.5	53.3	53.6	47.5	43.4	35.6	35.6	34.4	33.2	32.0	30.8	29.6

TABLE V. - Continued.

FLAP :	62.4	63.8	64.7	65.4	65.5	64.9	64.0	63.0	62.0	60.9	59.6	58.4	57.1	55.8	54.4	53.1	51.7
TOTALS:	50.3	48.9	47.5	46.0	44.5	43.0	41.4	66.2	65.4	64.4	63.3	62.1	60.9	59.6	58.4	57.5	56.7
	57.4	55.4	54.3	54.4	49.0	45.1	38.3							83.8	PNLT	84.8	
GEOM: 4 -1217.3																	
SOURCES WHEN	0.0	160.3	1035.8	77.7	34.9	77.5	81.2	32.28	33.18	55.0				118.2			
FAN :	-25.9	-18.1	-10.7	-3.7	2.9	9.2	15.0	20.6	25.7	30.5	34.9	39.0	42.6	45.9	48.9	51.4	53.6
CORE :	43.0	45.6	48.2	50.2	52.2	54.1	55.2	56.2	56.8	57.0	56.7	56.4	55.7	54.8	53.8	52.8	51.5
TURB :	37.4	38.4	39.4	40.4	41.4	42.4	43.4	44.5	45.5	46.5	47.5	48.5	49.6	50.6	51.8	52.8	53.9
FLAP :	62.8	64.2	65.2	65.9	66.1	63.5	64.6	63.6	62.6	61.5	60.2	59.0	57.7	56.4	55.0	53.6	52.3
TOTALS:	65.8	67.2	68.2	68.9	69.0	68.5	67.8	66.9	66.1	65.1	64.0	62.9	61.7	60.5	59.4	58.6	57.9
	58.4	56.6	55.7	55.7	50.8	47.1	41.1							84.8	PNLT	85.4	
GEOM: 5 -1100.2																	
SOURCES WHEN	0.0	144.8	1015.4	84.1	53.8	84.1	81.9	33.28	34.17	55.0				118.2			
FAN :	-24.7	-17.0	-9.6	-2.6	4.0	10.3	16.2	21.7	26.9	31.6	36.1	40.1	43.8	47.1	50.0	52.6	54.8
CORE :	44.0	46.6	49.2	51.2	53.1	55.1	56.2	57.2	57.7	57.9	57.7	57.3	56.7	55.7	54.8	53.8	52.4
TURB :	39.6	40.6	41.6	42.6	43.6	44.6	45.6	46.7	47.7	48.7	49.7	50.7	51.8	52.8	53.9	55.0	56.1
FLAP :	62.9	64.3	65.4	66.1	66.3	65.7	64.9	63.9	62.8	61.7	60.5	59.2	57.9	56.6	55.2	53.8	52.5
TOTALS:	65.9	67.3	68.4	69.1	69.3	68.8	68.1	67.3	66.5	65.6	64.6	63.5	62.4	61.3	60.4	59.7	59.2
	59.9	58.3	57.4	57.3	52.8	49.2	43.8							85.9	PNLT	86.4	
***** CLOSEST POINT OF APPROACH																	
GEOM: 6 -983.0																	
SOURCES WHEN	0.0	129.4	1008.5	90.8	96.0	90.8	82.6	34.28	35.16	55.0				118.2			
FAN :	-23.2	-15.4	-8.1	-1.1	5.6	11.8	17.7	23.3	28.4	33.2	37.6	41.6	45.3	48.6	51.5	54.1	56.3
CORE :	44.9	47.5	50.1	52.1	54.1	56.0	57.1	58.1	58.7	58.9	58.6	58.3	57.6	56.7	55.7	54.9	53.4
TURB :	52.0	50.5	49.1	47.4	45.8	44.1	42.4	48.7	49.7	50.7	51.7	52.7	53.8	54.8	55.9	57.0	58.1
FLAP :	61.5	62.7	63.8	64.5	64.8	64.2	63.4	62.3	61.3	60.2	58.9	57.7	56.4	55.1	53.7	52.3	50.9
TOTALS:	64.3	65.8	66.8	67.6	68.0	67.6	67.0	66.4	65.8	65.1	64.3	63.4	62.6	61.7	61.1	60.8	60.5
	61.4	59.9	59.2	59.1	54.7	51.2	46.1							86.6	PNLT	87.1	

GEOM: 7 -865.8																	
SOURCES WHEN	0.0	114.0	1015.4	97.4	138.2	97.5	83.3	35.28	36.17	55.0				118.2			
FAN :	-21.9	-14.1	-6.8	0.2	6.9	13.1	19.0	24.6	29.7	34.5	38.9	42.9	46.6	49.9	52.8	55.4	57.6
CORE :	45.8	48.4	51.0	52.9	54.9	56.9	58.0	59.0	59.5	59.7	59.5	59.1	58.5	57.5	56.5	55.6	54.2
TURB :	43.3	44.3	45.3	46.3	47.3	48.3	49.3	50.4	51.4	52.4	53.4	54.4	55.5	56.5	57.6	58.7	59.8
FLAP :	64.4	65.9	67.0	67.8	68.1	67.5	66.7	65.7	64.6	63.5	62.2	60.9	59.7	58.3	57.0	55.6	54.2
TOTALS:	67.4	68.9	70.0	70.8	71.1	70.5	69.9	69.1	68.4	67.5	66.5	65.5	64.5	63.6	62.9	62.4	62.1
	62.8	61.4	60.7	60.5	56.2	52.6	47.7							88.6	PNLT	89.0	
GEOM: 8 -748.6																	
SOURCES WHEN	0.0	98.6	1035.8	103.9	157.1	104.0	84.0	36.28	37.18	55.0				118.2			
FAN :	-21.9	-14.1	-6.8	0.2	6.9	13.1	19.0	24.6	29.7	34.5	38.9	42.9	46.6	49.9	52.8	55.4	57.6
CORE :	45.8	48.4	51.0	52.9	54.9	56.9	58.0	59.0	59.5	59.7	59.5	59.1	58.5	57.5	56.5	55.6	54.2
TURB :	43.3	44.3	45.3	46.3	47.3	48.3	49.3	50.4	51.4	52.4	53.4	54.4	55.5	56.5	57.6	58.7	59.8
FLAP :	64.4	65.9	67.0	67.8	68.1	67.5	66.7	65.7	64.6	63.5	62.2	60.9	59.7	58.3	57.0	55.6	54.2
TOTALS:	67.4	68.9	70.0	70.8	71.1	70.5	69.9	69.1	68.4	67.5	66.5	65.5	64.5	63.6	62.9	62.4	62.1
	62.8	61.4	60.7	60.5	56.2	52.6	47.7							88.6	PNLT	89.0	

TABLE V. - Continued.

FAN :	SOURCES WHEN	X0=-1000.0 FT,	Y0= 1000.0 FT,	TAU =	37.2 SEC,	R =	1035.8 FT,	THETA =	103.9 DEG	
	-20.9 -13.2	-5.8 1.2	7.8 14.1	25.5 30.6	35.4	39.8	43.9	47.6	50.9	53.8
CORE :	62.8 61.8	62.9 66.8	63.9 65.7	64.6 64.6	OASPL =	73.2 PNL =	73.2 PNL =	85.9 PNL =	85.9 PNL =	87.1
	51.5 48.9	53.4 48.8	55.4 47.1	58.5 43.7	60.2 60.0	60.0 59.6	59.0 59.0	59.0 57.0	58.0 57.0	56.1
TURB :	53.3 51.9	50.5 48.8	47.1 45.4	43.7 43.7	OASPL =	70.1 PNL =	70.1 PNL =	79.0 PNL =	79.0 PNL =	79.1
	44.4 45.4	46.4 47.4	48.4 49.4	50.4 50.4	52.5 53.5	54.5 55.5	56.6 56.6	57.6 58.7	57.6 58.7	58.8
FLAP :	62.0 63.2	64.6 65.8	67.4 69.3	73.8 73.8	OASPL =	77.3 PNL =	77.3 PNL =	88.4 PNL =	88.4 PNL =	88.4
	58.9 70.3	71.4 72.3	72.7 72.1	71.3 71.3	69.2 68.1	66.8 65.5	64.2 64.2	62.9 61.5	62.9 61.5	60.1
TOTALS:	71.8 73.3	74.4 75.2	75.5 75.0	74.1 74.6	73.2 72.2	71.1 69.9	68.6 67.4	66.2 65.1	64.3 64.3	63.6
	64.0 62.5	61.6 61.3	57.0 53.2	48.4 48.4	OASPL =	84.5 PNL =	84.5 PNL =	91.0 PNL =	91.0 PNL =	91.4
GEOM: 9	-631.4	0.0	83.1	1069.0	110.0	165.8	37.28	38.21	55.0	118.2
	SOURCES WHEN	X0=-1000.0 FT,	Y0= 1000.0 FT,	TAU =	38.2 SEC,	R =	1069.0 FT,	THETA =	110.0 DEG	
FAN :	-20.3 -12.6	-5.2 1.8	8.4 14.7	26.1 31.3	36.1	40.5	44.5	48.2	51.5	54.4
CORE :	46.5 49.1	51.7 53.6	55.6 47.3	45.6 43.9	60.2 60.4	OASPL =	73.9 PNL =	73.9 PNL =	86.7 PNL =	86.7
	44.9 45.9	46.9 47.9	48.9 49.9	50.9 50.9	52.0 53.0	54.0 55.0	56.0 57.1	58.1 59.2	58.2 57.3	56.3
TURB :	44.9 45.9	46.9 47.9	48.9 49.9	50.9 50.9	52.0 53.0	54.0 55.0	56.0 57.1	58.1 59.2	58.2 57.3	56.3
FLAP :	62.5 63.7	65.1 66.3	67.9 69.8	74.6 74.6	70.7 69.7	68.6 67.3	66.0 64.7	63.4 62.0	60.6 60.6	59.2
	69.2 70.7	71.8 72.8	73.1 72.6	71.8 71.8	73.6 72.6	71.5 70.3	69.0 67.8	66.5 65.5	64.6 64.6	64.0
TOTALS:	72.2 73.6	74.7 75.7	76.0 75.5	74.6 74.6	OASPL =	84.9 PNL =	84.9 PNL =	91.4 PNL =	91.4 PNL =	91.8
	64.5 62.8	61.9 61.6	57.0 53.2	48.3 48.3						
GEOM: 10	-514.2	0.0	67.7	1113.8	115.7	170.6	38.28	39.25	55.0	118.2
	SOURCES WHEN	X0=-1000.0 FT,	Y0= 1000.0 FT,	TAU =	39.3 SEC,	R =	1113.8 FT,	THETA =	115.7 DEG	
FAN :	-20.2 -12.4	-5.0 2.0	8.6 14.9	26.3 31.4	36.2	40.6	44.7	48.3	51.6	54.6
CORE :	63.7 62.6	63.7 67.8	64.7 66.6	65.5 58.5	60.0 60.3	OASPL =	74.1 PNL =	74.1 PNL =	86.8 PNL =	86.8
	48.9 48.9	51.5 48.8	55.4 47.1	45.4 43.7	59.5 60.0	60.0 59.6	59.0 59.0	58.0 57.1	58.0 57.1	56.1
TURB :	43.8 44.8	45.8 46.8	47.8 48.8	49.8 49.8	50.9 51.9	52.9 53.9	54.9 56.0	57.0 58.1	57.0 58.1	56.3
	61.4 62.6	64.0 65.2	66.8 68.7	73.3 73.3	70.7 69.7	68.5 67.2	65.9 64.6	63.3 61.9	60.5 60.5	59.1
FLAP :	69.0 70.5	71.7 72.7	73.1 72.6	71.7 71.7	73.5 72.5	71.4 70.1	68.8 67.5	66.2 65.0	64.1 64.1	63.4
	57.7 56.3	54.9 53.4	52.0 50.5	49.0 49.0	OASPL =	81.9 PNL =	81.9 PNL =	86.8 PNL =	86.8 PNL =	86.8
TOTALS:	72.0 73.4	74.6 75.5	75.9 75.4	74.5 74.5	73.5 72.5	71.4 70.1	68.8 67.5	66.2 65.0	64.1 64.1	63.4
	63.9 62.1	61.0 60.8	55.7 51.6	45.9 45.9						
GEOM: 11	-397.0	0.0	52.3	1168.9	121.0	173.5	39.28	40.30	55.0	118.2
	SOURCES WHEN	X0=-1000.0 FT,	Y0= 1000.0 FT,	TAU =	40.3 SEC,	R =	1168.9 FT,	THETA =	121.0 DEG	
FAN :	-20.2 -12.4	-5.1 1.9	8.6 14.8	26.3 31.4	36.2	40.6	44.6	48.3	51.6	54.5
CORE :	63.7 62.6	63.7 67.8	64.7 66.6	65.4 58.2	60.0 60.0	OASPL =	74.1 PNL =	74.1 PNL =	86.8 PNL =	86.8
	48.6 48.6	51.2 48.5	55.1 46.8	45.1 43.4	59.2 59.7	60.0 59.7	59.3 58.7	57.7 56.8	55.8 55.8	54.4
TURB :	42.4 43.4	44.4 45.4	46.4 47.4	48.4 48.4	49.5 50.5	51.5 52.5	53.5 54.6	55.6 56.7	57.8 57.8	58.9
	60.0 61.2	62.6 63.8	65.4 67.3	71.7 71.7	70.4 69.4	68.2 66.9	65.6 64.3	63.0 61.6	60.2 60.2	58.7
FLAP :	68.6 70.1	71.3 72.3	72.8 72.3	71.4 71.4	73.2 72.2	71.1 69.7	68.4 67.0	65.7 64.4	63.4 63.4	62.6
	57.3 56.0	54.5 53.1	51.6 50.2	48.7 48.7	OASPL =	81.5 PNL =	81.5 PNL =	86.4 PNL =	86.4 PNL =	86.5
TOTALS:	71.5 73.0	74.2 75.2	75.6 75.1	74.2 74.2	73.2 72.2	71.1 69.7	68.4 67.0	65.7 64.4	63.4 63.4	62.6
	63.2 61.1	59.9 59.8	54.1 49.8	43.1 43.1						
GEOM: 1	-585.9	0.0	77.1	774.1	40.6	6.0	40.4	83.0	37.67	38.34
	SOURCES WHEN	X0=-1000.0 FT,	Y0= 500.0 FT,	TAU =	38.3 SEC,	R =	774.1 FT,	THETA =	40.6 DEG	
FAN :	-17.9 -10.2	-2.8 4.2	10.8 17.1	23.0 28.5	33.7	38.4	42.9	46.9	50.6	56.8
CORE :	65.4 64.8	65.9 69.4	67.0 68.5	67.4 67.4	54.8 55.3	55.5 55.3	54.9 54.3	54.3 54.3	53.7 PNL =	53.7
	41.6 44.2	46.8 48.7	50.7 52.7	53.8 53.8	54.8 55.3	55.5 55.3	54.9 54.3	54.3 54.3	53.7 PNL =	53.7
TURB :	48.6 47.2	45.8 44.1	42.4 40.7	39.0 39.0	34.0 35.0	36.0 37.0	38.0 39.1	40.1 41.2	42.3 42.3	43.4
	26.9 27.9	28.9 29.9	31.9 32.9	32.9 32.9	34.0 35.0	36.0 37.0	38.0 39.1	40.1 41.2	42.3 42.3	43.4
FLAP :	65.1 66.5	67.6 68.4	68.7 68.1	67.3 67.3	66.2 65.2	64.1 62.8	61.5 60.3	58.9 57.5	56.2 56.2	54.8
	53.4 52.0	50.6 49.1	47.6 46.1	44.6 44.6	OASPL =	77.5 PNL =	77.5 PNL =	82.2 PNL =	82.2 PNL =	82.3

TABLE V. - Continued.

TOTALS:	68.0	69.5	70.5	71.3	71.6	71.0	70.2	69.2	68.2	67.1	65.8	64.6	63.4	62.0	62.2	62.6
	64.9	63.2	62.7	64.2	58.8	56.2	49.1	49.1	49.1	49.1	49.1	49.1	49.1	49.1	49.1	49.1
GEOM: 2	-468.8															
	SOURCES WHEN X0=															
FAN :	-18.1	-10.4	4.0	0.0	688.1	500.0	46.9	6.0	46.8	84.4	38.67	39.27	55.0	118.2	46.9	118.2
	FT, Y0=															
CORE :	65.4	64.6	65.7	69.5	10.6	16.9	22.8	28.3	33.5	38.2	42.7	46.7	50.4	53.7	56.6	59.2
	OASPL =															
TURB :	50.6	49.2	47.8	50.8	52.7	54.7	55.8	56.8	57.3	57.6	57.3	56.9	56.3	55.3	54.4	53.4
	OASPL =															
FLAP :	48.1	49.3	50.7	51.9	53.5	55.4	58.4	37.6	38.6	39.6	40.6	41.6	42.7	43.7	44.8	45.9
	OASPL =															
TOTALS:	64.5	63.7	63.4	65.2	60.0	58.0	51.7	70.5	69.6	68.5	67.3	66.0	64.9	63.0	63.0	63.2
	OASPL =															
GEOM: 3	-351.6															
	SOURCES WHEN X0=															
FAN :	-18.8	-11.1	-3.7	3.3	9.9	16.2	22.1	27.6	32.8	37.5	42.0	46.0	49.7	53.0	55.9	58.5
	FT, Y0=															
CORE :	64.9	63.9	65.0	69.0	66.1	67.9	66.7	58.8	59.3	59.6	59.3	58.9	58.3	57.3	56.4	55.4
	OASPL =															
TURB :	52.6	51.2	49.8	48.1	46.4	44.7	43.0	41.8	42.8	43.8	44.8	45.8	46.9	47.9	49.0	50.1
	OASPL =															
FLAP :	52.3	53.5	54.9	56.1	57.7	59.6	62.7	68.7	67.7	66.6	65.2	63.9	62.7	61.3	59.9	58.5
	OASPL =															
TOTALS:	69.9	71.4	72.6	73.6	74.0	73.6	72.8	71.9	70.9	69.9	68.7	67.5	66.3	65.2	64.2	63.7
	OASPL =															
GEOM: 4	-234.4															
	SOURCES WHEN X0=															
FAN :	-19.9	-12.2	-4.8	2.2	8.8	15.1	21.0	26.5	31.6	36.4	40.8	44.9	48.6	51.9	54.8	57.3
	FT, Y0=															
CORE :	63.8	62.8	63.9	67.9	64.9	66.8	65.6	60.6	61.1	61.4	61.1	60.7	60.1	59.1	58.2	57.2
	OASPL =															
TURB :	54.4	50.0	52.6	49.9	49.9	48.5	44.8	46.2	47.2	48.2	49.2	50.2	51.3	52.3	53.4	54.5
	OASPL =															
FLAP :	56.7	57.9	59.3	60.5	62.1	64.0	67.3	70.9	69.9	68.8	67.7	66.4	65.1	63.8	62.9	62.9
	OASPL =															
TOTALS:	70.8	72.3	73.6	74.7	75.2	74.8	74.0	73.1	72.2	71.2	70.1	68.9	67.7	66.5	65.5	64.4
	OASPL =															
GEOM: 5	-117.2															
	SOURCES WHEN X0=															
FAN :	-19.9	-12.1	-4.7	2.3	8.9	15.2	21.0	26.6	31.7	36.5	40.9	45.0	48.6	51.9	54.9	57.4
	FT, Y0=															
CORE :	49.1	51.7	54.2	56.2	58.2	60.1	61.3	62.2	62.8	63.0	62.7	62.4	61.7	60.8	59.8	58.2
	OASPL =															
TURB :	56.1	54.7	53.3	51.6	49.9	48.2	46.5	50.4	51.4	52.4	53.4	54.4	55.5	56.5	57.6	58.7
	OASPL =															
FLAP :	60.9	62.1	63.5	64.7	66.3	68.2	71.8	70.8	69.8	68.7	67.3	66.0	64.7	63.3	61.9	60.4
	OASPL =															
TOTALS:	71.5	73.0	74.4	75.6	76.2	75.8	75.1	74.2	73.3	72.4	71.3	70.2	69.1	68.0	67.0	66.1
	OASPL =															
****	CLOSEST POINT OF APPROACH															
GEOM: 6	0.0															
	SOURCES WHEN X0=															
FAN :	-13.4	-7.3	-1.6	4.0	8.8	13.5	17.7	21.6	25.2	28.3	31.1	33.5	35.6	39.4	38.5	39.5
	FT, Y0=															
TOTALS:	40.2	41.9	40.7	39.4	37.3	35.7	33.6	31.6	29.6	27.6	25.6	23.6	21.6	20.0	18.0	16.0
	OASPL =															

TABLE V. - Continued.

CORE :	60.3	42.9	45.5	47.4	49.4	51.4	52.5	53.4	54.0	54.2	54.0	53.6	53.0	52.0	51.0	50.1	48.7
TURB :	47.3	45.9	44.5	42.8	41.1	39.4	37.7	44.5	46.5	46.5	47.5	48.5	49.6	50.6	51.7	52.9	53.9
FLAP :	37.4	38.4	39.4	40.4	41.4	42.4	43.4	44.5	45.5	46.5	47.5	48.5	49.6	50.6	51.7	52.9	53.9
TOTALS:	45.1	50.3	20.3	18.8	17.3	15.9	14.4	37.3	36.0	34.6	33.1	31.6	30.2	28.8	27.5	26.0	24.6
	56.3	50.3	51.1	52.1	53.5	55.0	56.0	56.8	57.4	57.6	57.4	57.2	56.9	56.6	56.3	56.3	56.4
	64.3	64.3	54.1	51.0	52.4	43.8	40.8										

GEOM: 7	115.9	0.0	0.0	0.0	513.3	102.8	190.0	102.9	92.3	43.67	44.11	20.0	20.0	113.5			
FAN :	-11.2	-5.1	0.7	6.1	11.1	15.7	20.0	23.9	27.4	30.6	33.3	35.8	37.8	41.6	40.8	41.7	45.4
CORE :	42.5	44.1	42.9	41.6	39.6	37.9	35.9	54.8	55.4	55.6	55.3	54.9	54.3	65.6	65.6	66.7	66.7
TURB :	48.6	47.2	45.8	44.1	42.4	40.7	39.0	47.4	48.4	49.4	50.4	51.4	52.4	74.2	74.2	74.3	74.3
FLAP :	40.3	41.3	42.3	43.3	44.3	45.3	46.3	47.4	48.4	49.4	50.4	51.4	52.5	86.3	86.3	86.3	86.3
TOTALS:	57.9	68.3	57.5	55.6	52.1	49.7	48.4	47.1	45.8	44.3	42.9	41.4	40.0	38.6	37.2	35.8	34.3
	32.9	31.5	30.0	28.5	27.1	25.6	24.2	58.9	59.2	59.4	59.2	59.1	58.9	61.9	61.9	61.9	58.9
	58.2	57.7	57.3	57.1	57.3	57.8	58.3							58.7	58.7	58.7	58.9
	68.1	68.1	56.7	53.6	55.8	46.3	43.7							87.4	87.4	87.4	90.8
GEOM: 8	227.1	0.0	0.0	0.0	549.2	114.0	190.0	114.1	94.5	44.67	45.15	20.0	20.0	108.9			
FAN :	-10.6	-4.2	1.5	6.9	11.9	16.5	20.8	24.7	28.2	31.4	34.2	36.6	38.6	42.6	41.6	42.5	46.4
CORE :	43.3	45.1	43.8	42.5	40.4	38.7	36.7	54.9	55.5	55.7	55.4	55.1	54.4	66.5	66.5	67.7	67.7
TURB :	48.7	47.3	46.9	44.2	42.5	40.8	39.2	47.2	48.2	49.2	50.2	51.2	52.3	74.3	74.3	74.4	74.4
FLAP :	40.1	41.1	42.1	43.1	44.1	45.1	46.1	46.7	45.4	43.9	42.5	41.0	39.6	86.3	86.3	86.3	86.3
TOTALS:	57.5	68.5	57.3	55.5	50.7	48.0	46.7	58.9	59.2	59.4	59.2	59.1	58.8	61.4	61.4	61.5	58.7
	32.5	31.1	29.6	28.2	26.7	25.3	23.8							59.1	59.1	59.1	58.7
	57.8	57.4	57.0	56.8	57.1	57.8	58.3							87.3	87.3	87.3	90.8
	68.0	68.0	56.3	53.1	55.4	45.4	42.7							87.3	87.3	87.3	90.8
GEOM: 9	333.6	0.0	0.0	0.0	601.1	123.1	190.0	123.3	96.6	45.67	46.19	20.0	20.0	104.2			
FAN :	-10.5	-4.4	1.3	6.7	11.7	16.4	20.6	24.5	28.1	31.2	34.0	36.4	38.5	42.4	41.4	42.4	46.3
CORE :	43.1	43.7	43.6	42.3	40.2	38.2	36.5	54.3	54.9	55.1	54.8	54.4	53.8	66.4	66.4	67.5	67.5
TURB :	48.1	46.7	45.3	43.6	41.9	40.2	38.5	44.5	45.5	46.5	47.5	48.5	49.6	73.7	73.7	73.7	73.7
FLAP :	37.4	38.4	39.4	40.4	41.4	42.4	43.4	46.1	44.8	43.3	41.9	40.4	39.0	82.9	82.9	82.9	82.9
TOTALS:	53.9	53.2	52.0	51.1	50.1	48.8	47.4	58.0	58.4	58.5	58.2	57.9	57.5	60.8	60.8	60.8	56.4
	31.9	30.5	29.0	27.6	26.1	24.7	23.2							57.0	57.0	57.0	56.4
	57.2	56.7	56.3	56.1	56.3	57.0	57.4							84.2	84.2	84.2	87.2
	64.0	64.0	53.4	50.1	51.2	41.9	38.2							84.2	84.2	84.2	90.8
GEOM: 10	435.5	0.0	0.0	0.0	663.1	130.3	190.0	130.6	98.6	46.67	47.25	20.0	20.0	99.6			
FAN :	-11.2	-5.1	0.6	6.0	11.0	15.7	19.9	23.8	27.3	30.5	33.3	35.7	37.8	41.6	40.7	41.7	45.4
CORE :	42.4	44.1	42.9	41.6	39.5	37.8	35.8	53.4	54.0	54.2	54.0	53.6	53.0	65.6	65.6	66.7	66.7
TURB :	47.3	45.9	44.5	42.8	41.1	39.4	37.7	41.0	42.0	43.0	44.0	45.0	46.1	72.9	72.9	72.9	72.9
FLAP :	33.9	34.9	35.9	36.9	37.9	38.9	39.9	45.4	44.1	42.6	41.2	39.7	38.3	78.5	78.5	78.5	81.4
TOTALS:	51.5	59.9	51.1	49.2	52.2	46.7	44.5	58.0	58.4	58.5	58.2	57.9	57.5	60.8	60.8	60.8	56.4
	53.2	52.5	51.5	50.4	49.4	48.1	46.7	45.4	44.1	42.6	41.2	39.7	38.3	36.9	35.5	34.1	32.7
	64.0	64.0	53.4	50.1	51.2	41.9	38.2							84.2	84.2	84.2	90.8

TABLE V. - Continued.

TOTALS:	56.4	55.9	55.4	56.0	56.4	57.0	57.3	57.3	57.0	56.6	56.0	56.6	56.0	55.3	54.6	54.0	53.8
	52.9	58.9	50.0	37.7	32.8									80.5	PNLT =	83.0	
GEOM: 11	532.8			135.9	190.0	136.4	100.5	47.67	48.31	20.0				94.9			
FAN :	-13.2	-7.1	0.0	500.0	FT, Y0=	48.3	SEC, R =	730.7	FT, THETA =	135.9	DEG			135.9	DEG		
	40.5	42.2	40.9	37.5	18.0	21.9	25.4	28.5	31.3	33.7	35.8			39.7			
CORE :	39.4	42.0	44.6	50.5	35.9	33.9			OASPL =	50.7	PNL =	63.6	PNLT =	64.7			
	46.4	45.0	43.6	38.5	48.5	51.6	52.5	53.1	53.3	53.1	52.7	52.1	51.1	50.1	49.2	47.8	
TURB :	31.0	32.0	33.0	36.0	34.0	35.0	38.1	39.1	40.1	41.1	42.1	43.2	44.2	45.3	46.4	47.5	
	48.6	46.0	48.1	43.8	46.3	44.3	44.7	43.4	41.9	40.5	39.0	37.6	36.2	34.8	33.4	31.9	
FLAP :	52.5	51.8	50.7	47.3	46.0	44.7	43.4	41.9	40.5	39.0	37.6	36.2	34.8	33.4	31.9		
TOTALS:	55.6	55.2	54.6	55.1	55.5	56.0	56.3	56.3	55.9	55.4	54.7	53.9	52.9	52.9	52.1	51.6	
	50.4	54.8	47.0	33.9	28.0				OASPL =	67.6	PNL =	77.6	PNLT =	77.6	PNLT =		
GEOM: 1	-585.9			59.6	6.0	59.6	86.5	37.67	38.68	55.0				118.2			
FAN :	-25.3	-17.6	-10.2	1000.0	FT, Y0=	38.7	SEC, R =	1161.6	FT, THETA =	59.6	DEG			49.4			
	58.4	57.4	58.5	61.4	60.2	21.1	26.2	31.0	35.4	39.5	43.1			81.6	PNLT =	51.9	
CORE :	40.5	43.1	44.7	49.6	52.7	53.7	54.3	54.5	54.2	53.8	53.2			52.3	51.3	50.3	48.9
	47.5	46.1	44.7	41.3	39.6	37.9	38.1	40.1	41.1	42.1	43.2	44.2	45.3	46.4	47.5		
TURB :	31.0	32.0	33.0	36.0	34.0	35.0	38.1	39.1	40.1	41.1	42.1	43.2	44.2	45.3	46.4	47.5	
	48.6	49.8	51.2	54.0	55.9	59.1	63.3	62.3	61.1	59.8	58.5	57.2	55.9	54.4	53.0	51.6	
FLAP :	61.4	62.9	64.1	65.2	65.6	64.5	63.3	62.3	61.1	59.8	58.5	57.2	55.9	54.4	53.0	51.6	
TOTALS:	64.3	65.8	67.0	68.5	68.0	66.2	65.2	64.1	62.8	61.5	60.1	58.7	57.4	56.5	55.7		
	56.9	54.4	53.1	42.4	33.4				OASPL =	77.4	PNL =	83.2	PNLT =	83.2	PNLT =		
GEOM: 2	-448.8			64.8	6.0	64.8	87.2	38.67	39.63	55.0				118.2			
FAN :	-26.0	-18.2	-10.8	1000.0	FT, Y0=	39.6	SEC, R =	1106.1	FT, THETA =	64.8	DEG			48.8			
	57.8	56.8	57.9	60.7	59.6	20.5	25.6	30.4	34.8	38.9	42.5			81.0	PNLT =	51.3	
CORE :	41.4	44.0	46.6	52.5	53.6	54.6	55.1	55.3	55.1	54.7	54.1			53.1	52.1	52.1	49.8
	48.4	47.0	45.6	43.9	42.2	40.5	38.8	40.1	41.1	42.1	43.1	44.1	45.2	46.2	47.3	48.4	49.5
TURB :	33.0	34.0	35.0	38.0	39.0	40.1	41.1	42.1	43.1	44.1	45.2	46.2	47.3	48.4	49.5		
	50.6	51.8	53.2	54.4	56.0	61.3	62.8	61.7	60.4	59.0	57.8	56.4	55.0	53.5	52.1	50.6	
FLAP :	61.8	63.3	64.6	65.7	66.2	65.7	64.9	63.9	62.8	61.7	60.4	59.0	57.8	56.4	55.0	53.5	
TOTALS:	64.7	66.2	67.5	68.6	67.8	66.8	65.9	64.8	63.5	62.2	60.9	59.5	58.1	57.1	56.2		
	57.0	54.7	53.5	43.6	35.8				OASPL =	77.9	PNL =	83.7	PNLT =	83.7	PNLT =		
GEOM: 3	-351.6			70.6	6.0	70.6	87.9	39.67	40.59	55.0				118.2			
FAN :	-26.2	-18.4	-11.1	1000.0	FT, Y0=	40.6	SEC, R =	1061.0	FT, THETA =	70.6	DEG			45.6	48.5	51.1	
	57.6	56.6	57.6	60.5	59.4	20.3	25.4	30.2	34.6	38.6	42.3			80.7	PNLT =	81.9	
CORE :	42.2	44.8	47.4	53.3	54.4	55.4	55.9	56.2	55.9	55.5	54.9			53.9	53.0	52.0	50.6
	49.2	47.8	46.4	43.0	41.3	39.6	42.2	43.2	44.2	45.2	46.2	47.3	48.3	49.4	50.5	51.6	
TURB :	35.1	36.1	37.1	40.1	41.1	42.2	43.2	44.2	45.2	46.2	47.3	48.3	49.4	50.5	51.6		
	52.7	53.9	55.3	60.0	63.5	64.4	63.3	62.2	60.9	59.5	58.2	56.9	55.5	54.0	52.6	51.2	50.6
FLAP :	62.1	63.7	65.0	66.2	65.4	64.4	63.3	62.2	60.9	59.5	58.2	56.9	55.5	54.0	52.6	51.2	50.6
TOTALS:	65.1	66.6	67.9	69.1	68.4	67.4	66.5	65.4	64.2	62.9	61.6	60.3	58.9	57.9	57.0		
	57.6	55.5	54.4	45.2	38.4				OASPL =	78.5	PNL =	84.3	PNLT =	84.3	PNLT =		
GEOM: 4	-234.4			76.8	6.0	76.8	88.6	40.67	41.56	55.0				118.2			
FAN :	-25.9	-18.1	-10.8	1000.0	FT, Y0=	41.6	SEC, R =	1027.6	FT, THETA =	76.8	DEG			45.9	48.8	51.4	
	57.8	56.9	57.9	60.8	59.7	20.6	25.7	30.5	34.9	38.9	42.6			81.0	PNLT =	82.2	
CORE :	43.0	45.6	48.2	54.1	55.2	56.2	56.8	57.0	56.7	56.4	55.7			54.8	53.8	52.8	51.5
	50.0	48.6	47.2	42.2	40.5				OASPL =	66.8	PNL =	75.7	PNLT =	75.7	PNLT =		

TABLE V. - Continued.

TURB :	37.3	38.3	39.3	40.3	41.3	42.3	43.3	44.4	45.4	46.4	47.4	48.4	49.5	50.5	51.6	52.7	53.8
FLAP :	54.9	56.1	57.5	58.7	60.3	62.2	65.8	65.8	64.8	63.8	62.6	61.3	60.0	58.7	55.9	54.4	53.0
TOTALS:	65.4	66.9	68.3	69.5	70.0	69.6	68.8	67.9	67.0	66.0	64.8	63.5	62.3	61.0	59.8	58.8	58.0
<p>GEOM: 5 -117.2 1007.0 83.3 6.0 83.3 89.3 41.67 42.55 55.0 118.2 SOURCES WHEN X0= 0.0 FT, Y0= 1000.0 FT, TAU = 42.5 SEC, R = 1007.0 FT, THETA = 83.3 DEG FAN : -24.8 -17.1 -9.7 -2.7 4.0 16.1 21.6 26.8 31.6 36.0 40.0 43.7 47.0 49.9 CORE : 58.9 57.9 59.0 63.0 60.1 61.9 60.7 57.1 57.7 57.9 57.6 57.3 56.6 55.7 54.7 TURB : 51.0 46.5 49.1 51.1 53.1 44.8 43.1 41.4 46.5 47.5 48.5 50.5 51.6 52.6 53.7 54.8 55.9 FLAP : 39.4 40.4 41.4 42.4 43.4 44.4 45.4 46.5 47.5 48.5 49.5 50.5 51.6 52.6 53.7 54.8 55.9 TOTALS: 62.6 64.2 65.6 66.9 67.5 68.1 68.2 65.2 64.1 63.0 61.6 60.3 59.0 57.7 56.2 54.7 53.3 GEOM: 6 51.9 50.5 49.1 47.7 46.2 44.8 44.8 70.4 70.0 69.3 68.4 67.5 66.5 65.3 64.2 63.0 61.8 60.7 59.9 59.3 TOTALS: 59.9 58.2 57.4 57.3 52.8 49.2 43.8</p>																	
<p>***** CLOSEST POINT OF APPROACH</p>																	
GEOM: 6	0.0	0.0	1000.0	90.0	90.0	90.0	90.0	90.0	90.0	90.0	42.67	43.54	20.0	118.2	90.0	33.5	37.2
SOURCES WHEN	X0=	0.0	FT,	Y0=	1000.0	FT,	TAU =	43.5	SEC,	R =	1000.0	FT,	THETA =	90.0	DEG	32.5	37.2
FAN :	-19.4	-13.3	34.7	-7.6	33.3	31.3	11.7	15.6	19.1	22.3	25.1	27.5	29.5	33.4	32.5	58.2	58.2
CORE :	34.2	35.9	34.7	33.3	31.3	29.6	27.6	27.6	27.6	25.1	25.1	24.5	24.5	24.5	24.5	44.1	42.7
TURB :	41.3	39.9	38.4	36.8	35.1	33.4	31.7	31.7	31.7	30.5	30.5	28.5	28.5	28.5	28.5	66.6	66.6
FLAP :	49.0	58.4	48.6	46.8	45.5	44.2	42.6	42.6	42.6	40.5	40.5	38.5	38.5	38.5	38.5	79.8	79.8
TOTALS:	17.1	15.7	14.2	12.8	11.3	9.9	8.4	8.4	8.4	51.0	51.2	50.9	50.6	49.6	49.1	48.7	48.4
<p>*****</p>																	
GEOM: 7	115.9	0.0	1006.7	96.5	190.0	96.5	91.2	43.67	44.55	20.0	113.5	96.5	20.0	113.5	96.5	34.7	38.4
SOURCES WHEN	X0=	0.0	FT,	Y0=	1000.0	FT,	TAU =	44.5	SEC,	R =	1006.7	FT,	THETA =	96.5	DEG	33.8	38.4
FAN :	-18.2	-12.1	-6.3	-0.9	4.1	8.7	16.9	20.4	23.5	26.3	28.7	30.8	32.8	34.6	33.8	59.4	59.4
CORE :	35.5	37.1	35.9	34.6	32.5	30.9	28.9	28.9	28.9	26.3	26.3	25.7	25.7	25.7	25.7	66.6	66.6
TURB :	42.1	40.7	39.3	37.6	35.9	34.2	32.5	32.5	32.5	30.5	30.5	28.5	28.5	28.5	28.5	79.8	79.8
FLAP :	50.7	60.6	50.3	48.5	46.1	45.1	43.8	43.8	43.8	41.1	41.1	39.8	39.8	39.8	39.8	82.0	82.0
TOTALS:	52.1	51.6	51.1	50.7	50.8	51.3	51.6	52.1	52.4	52.4	52.1	51.8	51.4	50.9	50.4	50.1	49.9
<p>*****</p>																	
GEOM: 8	227.1	0.0	1025.5	102.6	190.0	102.6	92.3	44.67	45.56	20.0	108.9	102.6	20.0	108.9	102.6	35.7	39.4
SOURCES WHEN	X0=	0.0	FT,	Y0=	1000.0	FT,	TAU =	45.6	SEC,	R =	1025.5	FT,	THETA =	102.6	DEG	34.7	39.4
FAN :	-17.2	-11.1	-5.4	0.0	5.0	9.7	13.9	17.8	21.4	24.5	27.3	29.7	31.8	35.6	34.7	60.5	60.5
CORE :	36.4	38.1	36.8	35.5	33.5	31.9	29.8	29.8	29.8	27.3	27.3	26.7	26.7	26.7	26.7	79.8	79.8
TURB :	42.6	41.2	39.8	38.1	36.4	34.7	33.0	33.0	33.0	30.5	30.5	28.5	28.5	28.5	28.5	82.0	82.0
FLAP :	51.8	62.2	51.4	49.6	47.1	47.1	45.1	45.1	45.1	42.6	42.6	40.2	40.2	40.2	40.2	94.0	94.0
TOTALS:	26.9	25.4	24.0	22.5	21.1	19.6	18.2	18.2	18.2	52.6	52.6	52.7	52.4	51.6	51.3	51.0	50.8
<p>*****</p>																	

TABLE V. - Concluded.

GEOM: 9	333.6	0.0	0.0	1054.2	108.2	190.0	108.2	93.3	45.67	46.59	20.0	104.2	
FAN :	-16.7	-10.5	0.6	5.6	10.2	14.5	18.4	21.9	25.1	27.9	30.3	32.3	36.2 DEG
CORE :	35.0	38.8	37.5	34.1	32.4	30.4	49.0	49.5	49.8	49.5	47.3	48.5	60.0 PNLT =
TURB :	42.8	41.4	40.0	36.6	34.9	33.2	41.8	42.8	43.8	44.8	45.8	46.9	47.5 PNL =
FLAP :	52.3	63.3	51.9	47.5	47.5	40.7	40.9	39.6	38.2	36.7	35.2	33.8	68.2 PNL =
TOTALS:	48.7	48.0	47.0	46.0	44.9	42.2	40.9	39.6	38.2	36.7	35.2	33.8	81.0 PNL =
	26.8	25.3	23.9	22.4	20.9	19.5	18.0	17.0	16.0	15.0	14.0	13.0	84.7 PNL =
	52.0	51.6	51.1	51.2	51.9	52.2	52.8	53.1	53.2	52.9	52.7	52.3	82.9 PNL =
	50.6	59.5	46.6	42.2	29.9	23.3							51.9 PNL =
													82.6 PNL =
GEOM: 10	435.5	0.0	0.0	1090.7	113.2	190.0	113.2	94.3	46.67	47.62	20.0	99.6	
FAN :	-16.4	-10.3	0.8	5.8	10.5	14.8	18.6	22.2	25.3	28.1	30.5	32.6	113.2 DEG
CORE :	37.3	39.1	37.8	34.3	32.7	30.7	48.9	49.5	49.7	49.4	47.6	48.4	60.3 PNL =
TURB :	42.7	41.3	39.9	36.6	34.9	33.2	41.4	42.4	43.4	44.4	45.4	46.5	47.5 PNL =
FLAP :	51.9	62.7	51.4	49.6	47.1	42.0	40.7	39.4	38.0	36.5	35.0	33.6	48.6 PNL =
TOTALS:	26.6	25.1	23.7	22.2	20.7	19.3	17.8	17.0	16.0	15.0	14.0	13.0	80.5 PNL =
	51.8	51.4	50.9	50.8	51.0	51.6	52.1	52.6	53.0	52.8	52.5	52.1	82.2 PNL =
	50.0	58.8	45.9	41.4	28.7	21.8							54.3 PNL =
													50.9 PNL =
													81.9 PNL =
GEOM: 11	532.8	0.0	0.0	1133.1	117.6	190.0	117.7	95.3	47.67	48.66	20.0	94.9	
FAN :	-16.3	-10.2	0.9	5.9	10.5	14.8	18.7	22.2	25.4	28.2	30.6	32.6	117.6 DEG
CORE :	37.3	39.1	37.8	34.4	32.7	30.7	48.7	49.3	49.5	49.2	47.6	48.2	60.4 PNL =
TURB :	42.6	41.1	39.7	36.4	34.7	33.0	40.4	41.4	42.4	43.4	44.4	45.5	47.3 PNL =
FLAP :	50.9	61.5	50.5	48.7	46.2	41.8	40.5	39.2	37.7	36.3	34.8	33.4	48.2 PNL =
TOTALS:	26.3	24.9	23.4	22.0	20.5	19.0	17.6	17.0	16.0	15.0	14.0	13.0	79.3 PNL =
	51.5	51.1	50.7	50.5	50.7	51.3	51.8	52.3	52.6	52.7	52.4	52.0	82.9 PNL =
	49.0	57.2	44.8	40.1	27.1	19.6							29.2 PNL =
													54.0 PNL =
													50.1 PNL =
													80.6 PNL =

VALUES OF PNL-MAX
Y0 POSITION

XO ,	500.0	1000.0
POS	95.9	89.7
-2000. LEVEL	115.4	110.3
THETA	28.43	29.85
TIME	98.5	91.4
-1000. LEVEL	116.0	110.0
THETA	36.78	38.21
TIME	93.8	86.3
0. LEVEL	76.8	83.3
THETA	42.12	42.55
TIME		

TABLE VI. - OUTPUT FROM EXAMPLE TWO

This output is discussed in the text of the report.

QSR TAKEOFF CALCULATION, ENGINE MAP FROM TEST DATA														
GEOMETRIC RELATIONS OF AIRCRAFT/OBSERVER														
GEOM:	1	2	3	4	5	6	7	8	9	10	11	12	13	14
	KI	XI	YI	ZI	R	OASPL	PNI	PNL	PNLT	THETA	THETAF	THETAH	PHI	TAU
	382.0	0.0	0.0	0.0	1224.7	26.0	10.0	24.4	68.8	10.19	11.26	85.0	75.0	
NOISE CONTRIBUTIONS FOR EACH NOISE SOURCE														
SOURCE	XD	YO	TAU	PNL	PNLT	THETA	THETAF	THETAH	PHI	TAU	EPMI	VI		
FAN	1500.0	500.0	11.259	81.8	95.6	77.1	77.1	77.1	77.1	77.1	85.0	82.4		
CORE	1500.0	500.0	11.259	68.2	77.0	65.0	65.0	65.0	65.0	65.0	85.0	82.4		
TURB	1500.0	500.0	11.259	53.6	65.0	65.0	65.0	65.0	65.0	65.0	85.0	82.4		
FLAP	1500.0	500.0	11.259	84.0	88.5	88.5	88.5	88.5	88.5	88.5	85.0	82.4		
TOTAL	1500.0	500.0	11.259	86.8	94.4	97.6	97.6	97.6	97.6	97.6	85.0	82.4		
GEOM:	2	460.7	0.0	0.0	1153.3	27.4	10.0	26.0	70.2	11.19	12.20	85.0	82.4	
FAN	1500.0	500.0	12.197	82.4	96.2	99.3	99.3	99.3	99.3	99.3	85.0	82.4		
CORE	1500.0	500.0	12.197	68.9	77.8	77.8	77.8	77.8	77.8	77.8	85.0	82.4		
TURB	1500.0	500.0	12.197	54.7	66.1	66.2	66.2	66.2	66.2	66.2	85.0	82.4		
FLAP	1500.0	500.0	12.197	84.5	89.2	89.2	89.2	89.2	89.2	89.2	85.0	82.4		
TOTAL	1500.0	500.0	12.197	87.3	95.4	98.6	98.6	98.6	98.6	98.6	85.0	82.4		
GEOM:	3	546.7	0.0	0.0	1076.4	29.3	10.0	28.0	71.7	12.19	13.13	85.0	89.7	
FAN	1500.0	500.0	13.130	83.0	96.8	99.9	99.9	99.9	99.9	99.9	85.0	89.7		
CORE	1500.0	500.0	13.130	69.7	78.7	78.7	78.7	78.7	78.7	78.7	85.0	89.7		
TURB	1500.0	500.0	13.130	56.0	67.5	67.5	67.5	67.5	67.5	67.5	85.0	89.7		
FLAP	1500.0	500.0	13.130	85.1	90.1	90.1	90.1	90.1	90.1	90.1	85.0	89.7		
TOTAL	1500.0	500.0	13.130	88.0	96.5	99.7	99.7	99.7	99.7	99.7	85.0	89.7		
GEOM:	4	640.1	0.0	0.0	994.7	31.6	10.0	30.6	73.4	13.19	14.06	85.0	97.1	
FAN	1500.0	500.0	14.058	83.7	97.6	100.7	100.7	100.7	100.7	100.7	85.0	97.1		
CORE	1500.0	500.0	14.058	70.8	79.7	79.7	79.7	79.7	79.7	79.7	85.0	97.1		
TURB	1500.0	500.0	14.058	57.7	69.2	69.2	69.2	69.2	69.2	69.2	85.0	97.1		
FLAP	1500.0	500.0	14.058	85.8	91.0	91.1	91.1	91.1	91.1	91.1	85.0	97.1		
TOTAL	1500.0	500.0	14.058	88.8	97.8	100.9	100.9	100.9	100.9	100.9	85.0	97.1		
GEOM:	5	740.9	0.0	0.0	909.0	34.7	10.0	33.8	75.2	14.19	14.98	85.0	104.4	
FAN	1500.0	500.0	14.983	84.6	98.5	101.6	101.6	101.6	101.6	101.6	85.0	104.4		
CORE	1500.0	500.0	14.983	72.0	80.9	81.0	81.0	81.0	81.0	81.0	85.0	104.4		
TURB	1500.0	500.0	14.983	59.6	71.2	71.2	71.2	71.2	71.2	71.2	85.0	104.4		
FLAP	1500.0	500.0	14.983	86.6	92.1	92.2	92.2	92.2	92.2	92.2	85.0	104.4		
TOTAL	1500.0	500.0	14.983	89.7	99.2	102.3	102.3	102.3	102.3	102.3	85.0	104.4		
GEOM:	6	849.0	0.0	0.0	820.8	38.6	10.0	38.0	77.3	15.19	15.91	85.0	111.8	
FAN	1500.0	500.0	15.906	85.6	99.5	102.6	102.6	102.6	102.6	102.6	85.0	111.8		
CORE	1500.0	500.0	15.906	73.4	82.4	82.4	82.4	82.4	82.4	82.4	85.0	111.8		
TURB	1500.0	500.0	15.906	62.1	73.7	73.7	73.7	73.7	73.7	73.7	85.0	111.8		
FLAP	1500.0	500.0	15.906	87.6	93.4	93.4	93.4	93.4	93.4	93.4	85.0	111.8		
TOTAL	1500.0	500.0	15.906	90.7	100.8	103.8	103.8	103.8	103.8	103.8	85.0	111.8		
GEOM:	7	964.5	0.0	0.0	732.7	44.0	10.0	43.5	79.5	16.19	16.83	85.0	119.2	
FAN	1500.0	500.0	16.829	86.2	100.2	103.3	103.3	103.3	103.3	103.3	85.0	119.2		
CORE	1500.0	500.0	16.829	75.2	84.3	84.3	84.3	84.3	84.3	84.3	85.0	119.2		
TURB	1500.0	500.0	16.829	65.2	76.9	76.9	76.9	76.9	76.9	76.9	85.0	119.2		
FLAP	1500.0	500.0	16.829	88.7	94.7	94.8	94.8	94.8	94.8	94.8	85.0	119.2		
TOTAL	1500.0	500.0	16.829	91.9	102.2	105.1	105.1	105.1	105.1	105.1	85.0	119.2		
GEOM:	8	1087.3	0.0	0.0	648.3	51.2	10.0	50.9	81.8	17.19	17.76	85.0	126.5	
FAN	1500.0	500.0	17.755	86.5	100.7	103.7	103.7	103.7	103.7	103.7	85.0	126.5		
CORE	1500.0	500.0	17.755	77.4	86.5	86.5	86.5	86.5	86.5	86.5	85.0	126.5		
TURB	1500.0	500.0	17.755	69.2	80.8	80.9	80.9	80.9	80.9	80.9	85.0	126.5		
FLAP	1500.0	500.0	17.755	90.0	96.3	96.3	96.3	96.3	96.3	96.3	85.0	126.5		
TOTAL	1500.0	500.0	17.755	93.3	103.5	106.3	106.3	106.3	106.3	106.3	85.0	126.5		
GEOM:	9	1217.5	0.0	0.0	574.3	61.0	10.0	60.9	84.4	18.19	18.69	85.0	133.9	
FAN	1500.0	500.0	18.690	86.0	100.1	102.9	102.9	102.9	102.9	102.9	85.0	133.9		
CORE	1500.0	500.0	18.690	79.4	88.5	88.6	88.6	88.6	88.6	88.6	85.0	133.9		
TURB	1500.0	500.0	18.690	74.1	85.8	85.8	85.8	85.8	85.8	85.8	85.0	133.9		

TABLE VI. - Continued.

GEOM: 18	2534.3	0.0	110.5	1442.9	135.2	190.0	135.7	100.2	27.19	28.45	85.0	148.6
FAN	: 1500.0	1000.0	28.450	80.4	93.7	96.2						
CORE	: 1500.0	1000.0	28.450	76.7	85.8	85.9						
TURB	: 1500.0	1000.0	28.450	71.8	83.5	83.5						
FLAP	: 1500.0	1000.0	28.450	96.3	103.3	103.3						
TOTAL	: 1500.0	1000.0	28.450	98.4	103.4	104.7						
GEOM: 19	2682.1	0.0	128.3	1553.5	138.9	190.0	139.5	101.7	28.19	29.55	85.0	148.6
FAN	: 1500.0	1000.0	29.547	79.1	92.4	94.9						
CORE	: 1500.0	1000.0	29.547	76.1	85.1	85.2						
TURB	: 1500.0	1000.0	29.547	69.8	81.5	81.5						
FLAP	: 1500.0	1000.0	29.547	95.7	102.7	102.8						
TOTAL	: 1500.0	1000.0	29.547	97.7	102.6	103.4						
GEOM: 20	2859.8	0.0	162.1	1669.9	162.1	190.0	142.8	103.1	29.19	30.65	85.0	148.6
FAN	: 1500.0	1000.0	30.648	77.5	90.8	93.3						
CORE	: 1500.0	1000.0	30.648	75.4	84.4	84.5						
TURB	: 1500.0	1000.0	30.648	67.7	79.4	79.4						
FLAP	: 1500.0	1000.0	30.648	95.2	102.1	102.2						
TOTAL	: 1500.0	1000.0	30.648	97.1	101.8	102.5						
GEOM: 21	2977.6	0.0	157.9	1791.1	144.8	190.0	145.7	104.5	30.19	31.75	85.0	148.6
FAN	: 1500.0	1000.0	31.754	75.8	89.2	91.8						
CORE	: 1500.0	1000.0	31.754	74.7	83.8	83.8						
TURB	: 1500.0	1000.0	31.754	65.7	77.4	77.4						
FLAP	: 1500.0	1000.0	31.754	94.6	101.6	101.6						
TOTAL	: 1500.0	1000.0	31.754	96.5	101.0	101.7						
GEOM: 1	1048.6	0.0	0.0	1535.1	21.4	10.0	19.3	63.2	16.88	18.22	85.0	124.2
FAN	: 2500.0	500.0	18.222	79.8	93.6	96.7						
CORE	: 2500.0	500.0	18.222	65.5	74.3	74.4						
TURB	: 2500.0	500.0	18.222	49.8	60.9	61.0						
FLAP	: 2500.0	500.0	18.222	82.3	85.9	86.0						
TOTAL	: 2500.0	500.0	18.222	84.9	90.7	93.9						
GEOM: 2	1176.6	0.0	0.0	1414.7	22.9	10.0	21.0	65.3	17.88	19.12	85.0	131.6
FAN	: 2500.0	500.0	19.117	80.6	94.3	97.5						
CORE	: 2500.0	500.0	19.117	66.5	75.3	75.5						
TURB	: 2500.0	500.0	19.117	51.1	62.4	62.4						
FLAP	: 2500.0	500.0	19.117	82.9	86.7	86.7						
TOTAL	: 2500.0	500.0	19.117	85.7	92.0	95.3						
GEOM: 3	1311.8	0.0	0.0	1289.1	24.8	10.0	23.1	67.6	18.88	20.01	85.0	139.0
FAN	: 2500.0	500.0	20.007	81.4	95.1	98.3						
CORE	: 2500.0	500.0	20.007	67.5	76.4	76.4						
TURB	: 2500.0	500.0	20.007	52.7	64.0	64.0						
FLAP	: 2500.0	500.0	20.007	83.6	87.8	87.9						
TOTAL	: 2500.0	500.0	20.007	86.4	93.6	96.8						
GEOM: 4	1484.5	0.0	0.0	1158.9	27.3	10.0	25.9	70.0	19.88	20.89	85.0	146.3
FAN	: 2500.0	500.0	20.893	82.3	96.1	99.3						
CORE	: 2500.0	500.0	20.893	68.8	77.7	77.8						
TURB	: 2500.0	500.0	20.893	54.6	66.0	66.1						
FLAP	: 2500.0	500.0	20.893	84.4	89.1	89.2						
TOTAL	: 2500.0	500.0	20.893	87.3	95.3	98.5						
GEOM: 5	1602.2	0.0	10.9	1027.7	33.2	16.8	30.2	62.6	20.88	21.78	85.0	148.6
FAN	: 2500.0	500.0	21.778	83.5	97.3	100.5						
CORE	: 2500.0	500.0	21.778	70.7	79.6	79.7						
TURB	: 2500.0	500.0	21.778	58.0	69.5	69.6						
FLAP	: 2500.0	500.0	21.778	86.1	90.1	90.1						
TOTAL	: 2500.0	500.0	21.778	89.1	97.3	100.4						
GEOM: 6	1749.9	0.0	26.7	901.9	37.7	18.1	35.0	65.0	21.88	22.67	85.0	148.6
FAN	: 2500.0	500.0	22.668	84.7	98.7	101.7						
CORE	: 2500.0	500.0	22.668	72.5	81.4	81.5						
TURB	: 2500.0	500.0	22.668	60.9	72.5	72.5						
FLAP	: 2500.0	500.0	22.668	87.3	91.2	91.3						
TOTAL	: 2500.0	500.0	22.668	90.4	99.2	102.3						

TABLE VI. - Continued.

GEOM: 7	1897.7	0.0	42.5	784.0	43.7	20.1	41.4	67.4	22.88	23.57	85.0	148.6
FAN	: 2500.0	500.0	23.565	85.6	99.7	102.7						
CORE	: 2500.0	500.0	23.565	74.6	83.6	83.7						
TURB	: 2500.0	500.0	23.565	64.5	76.2	76.2						
FLAP	: 2500.0	500.0	23.565	88.5	92.9	93.0						
TOTAL	: 2500.0	500.0	23.565	91.8	101.1	104.1						
GEOM: 8	2045.4	0.0	58.3	678.3	51.7	23.4	49.9	70.0	23.88	24.47	85.0	148.6
FAN	: 2500.0	500.0	24.473	86.1	100.2	103.2						
CORE	: 2500.0	500.0	24.473	77.0	86.1	86.1						
TURB	: 2500.0	500.0	24.473	69.0	80.6	80.7						
FLAP	: 2500.0	500.0	24.473	89.7	94.6	94.6						
TOTAL	: 2500.0	500.0	24.473	93.1	102.6	105.5						
GEOM: 9	2193.2	0.0	74.1	591.3	62.4	29.7	61.3	72.6	24.88	25.40	85.0	148.6
FAN	: 2500.0	500.0	25.397	85.4	99.5	102.3						
CORE	: 2500.0	500.0	25.397	79.2	88.4	88.4						
TURB	: 2500.0	500.0	25.397	74.2	85.9	85.9						
FLAP	: 2500.0	500.0	25.397	91.2	96.5	96.5						
TOTAL	: 2500.0	500.0	25.397	94.5	103.5	106.0						
GEOM: 10	2341.0	0.0	89.9	532.3	76.1	45.6	75.7	75.4	25.88	26.35	85.0	148.6
FAN	: 2500.0	500.0	26.345	84.0	97.9	100.6						
CORE	: 2500.0	500.0	26.345	81.3	90.5	90.5						
TURB	: 2500.0	500.0	26.345	79.3	91.0	91.0						
FLAP	: 2500.0	500.0	26.345	92.0	97.7	97.7						
TOTAL	: 2500.0	500.0	26.345	95.3	103.8	105.8						
*****	CLOSEST POINT OF APPROACH											
GEOM: 11	2488.7	0.0	105.7	511.2	92.1	100.0	92.1	78.2	26.88	27.33	85.0	148.6
FAN	: 2500.0	500.0	27.327	86.3	99.8	102.3						
CORE	: 2500.0	500.0	27.327	83.6	92.8	92.9						
TURB	: 2500.0	500.0	27.327	84.3	96.1	96.1						
FLAP	: 2500.0	500.0	27.327	92.4	98.5	98.5						
TOTAL	: 2500.0	500.0	27.327	96.0	105.8	107.6						

GEOM: 12	2636.5	0.0	121.4	532.3	108.0	154.4	108.2	81.0	27.88	28.35	85.0	148.6
FAN	: 2500.0	500.0	28.345	88.7	102.1	104.6						
CORE	: 2500.0	500.0	28.345	85.0	94.2	94.3						
TURB	: 2500.0	500.0	28.345	87.2	98.9	98.9						
FLAP	: 2500.0	500.0	28.345	82.4	88.4	88.5						
TOTAL	: 2500.0	500.0	28.345	91.7	105.3	107.2						
GEOM: 13	2784.2	0.0	137.2	591.3	121.7	170.3	121.9	83.9	28.88	29.40	85.0	148.6
FAN	: 2500.0	500.0	29.397	89.1	102.4	105.0						
CORE	: 2500.0	500.0	29.397	84.5	93.8	93.8						
TURB	: 2500.0	500.0	29.397	84.6	96.3	96.3						
FLAP	: 2500.0	500.0	29.397	93.3	99.8	99.9						
TOTAL	: 2500.0	500.0	29.397	96.8	107.1	109.2						
GEOM: 14	2932.0	0.0	153.0	678.3	132.4	176.6	132.5	86.9	29.88	30.47	85.0	148.6
FAN	: 2500.0	500.0	30.473	87.6	100.8	103.3						
CORE	: 2500.0	500.0	30.473	83.3	92.5	92.6						
TURB	: 2500.0	500.0	30.473	79.4	91.1	91.2						
FLAP	: 2500.0	500.0	30.473	98.3	105.2	105.2						
TOTAL	: 2500.0	500.0	30.473	101.1	108.2	110.0						
GEOM: 15	3079.7	0.0	168.8	784.0	140.4	179.9	140.4	89.8	30.88	31.57	85.0	148.6
FAN	: 2500.0	500.0	31.565	84.7	97.9	100.5						
CORE	: 2500.0	500.0	31.565	82.0	91.2	91.2						
TURB	: 2500.0	500.0	31.565	75.2	86.9	86.9						
FLAP	: 2500.0	500.0	31.565	101.2	108.3	108.3						
TOTAL	: 2500.0	500.0	31.565	103.7	109.8	110.9						
GEOM: 16	3227.5	0.0	184.6	901.9	146.3	181.9	146.3	92.8	31.88	32.67	85.0	148.6
FAN	: 2500.0	500.0	32.668	81.2	94.6	97.2						
CORE	: 2500.0	500.0	32.668	80.7	89.8	89.9						
TURB	: 2500.0	500.0	32.668	70.9	82.6	82.6						

TABLE VI. - Continued.

GEOM: 14	3920.7	0.0	258.7	702.8	132.6	164.5	133.6	75.2	36.57	37.19	85.0	148.6
FAN	: 3500.0	500.0	37.186	87.2	100.4	103.0						
CORE	: 3500.0	500.0	37.186	83.0	92.2	92.3						
TURB	: 3500.0	500.0	37.186	79.0	90.8	90.8						
FLAP	: 3500.0	500.0	37.186	85.7	91.2	91.2						
TOTAL	: 3500.0	500.0	37.186	90.8	102.6	104.9						
GEOM: 15	4068.5	0.0	274.5	805.3	140.6	170.3	141.2	78.0	37.57	38.28	85.0	148.6
FAN	: 3500.0	500.0	38.275	84.3	97.6	100.2						
CORE	: 3500.0	500.0	38.275	81.7	90.9	91.0						
TURB	: 3500.0	500.0	38.275	74.8	86.5	86.5						
FLAP	: 3500.0	500.0	38.275	90.0	96.0	96.0						
TOTAL	: 3500.0	500.0	38.275	93.3	101.5	103.7						
GEOM: 16	4216.2	0.0	290.3	920.4	146.6	174.9	147.0	80.9	38.57	39.38	85.0	148.6
FAN	: 3500.0	500.0	39.376	80.9	94.3	97.0						
CORE	: 3500.0	500.0	39.376	80.5	89.6	89.7						
TURB	: 3500.0	500.0	39.376	70.6	82.2	82.2						
FLAP	: 3500.0	500.0	39.376	92.4	98.7	98.7						
TOTAL	: 3500.0	500.0	39.376	95.1	100.8	102.6						
GEOM: 17	4366.0	0.0	306.0	1044.1	151.2	176.6	151.3	83.8	39.57	40.48	85.0	148.6
FAN	: 3500.0	500.0	40.484	78.2	91.7	94.3						
CORE	: 3500.0	500.0	40.484	79.3	88.5	88.5						
TURB	: 3500.0	500.0	40.484	67.1	78.7	78.8						
FLAP	: 3500.0	500.0	40.484	94.3	100.9	100.9						
TOTAL	: 3500.0	500.0	40.484	96.8	102.0	103.3						
GEOM: 18	4511.7	0.0	321.8	1173.5	154.7	178.5	154.8	86.7	40.57	41.60	85.0	148.6
FAN	: 3500.0	500.0	41.597	75.9	89.4	92.1						
CORE	: 3500.0	500.0	41.597	78.3	87.4	87.4						
TURB	: 3500.0	500.0	41.597	64.3	75.9	75.9						
FLAP	: 3500.0	500.0	41.597	95.8	102.6	102.7						
TOTAL	: 3500.0	500.0	41.597	98.1	103.2	103.8						
GEOM: 19	4659.5	0.0	337.6	1307.1	157.5	179.9	157.5	89.7	41.57	42.71	85.0	148.6
FAN	: 3500.0	500.0	42.714	73.9	87.6	90.3						
CORE	: 3500.0	500.0	42.714	77.3	86.4	86.4						
TURB	: 3500.0	500.0	42.714	61.9	73.5	73.5						
FLAP	: 3500.0	500.0	42.714	97.0	104.0	104.0						
TOTAL	: 3500.0	500.0	42.714	99.1	104.1	104.5						
GEOM: 20	4807.2	0.0	353.4	1443.5	159.7	181.0	159.7	92.6	42.57	43.83	85.0	148.6
FAN	: 3500.0	500.0	43.833	72.3	86.0	88.7						
CORE	: 3500.0	500.0	43.833	76.4	85.5	85.5						
TURB	: 3500.0	500.0	43.833	59.9	71.5	71.5						
FLAP	: 3500.0	500.0	43.833	96.4	103.4	103.5						
TOTAL	: 3500.0	500.0	43.833	98.5	103.4	103.7						
GEOM: 21	4955.0	0.0	369.2	1582.2	161.5	181.9	161.6	95.6	43.57	44.95	85.0	148.6
FAN	: 3500.0	500.0	44.954	70.8	84.5	87.3						
CORE	: 3500.0	500.0	44.954	75.6	84.6	84.7						
TURB	: 3500.0	500.0	44.954	58.2	69.7	69.8						
FLAP	: 3500.0	500.0	44.954	95.8	102.8	102.8						
TOTAL	: 3500.0	500.0	44.954	97.8	102.4	102.8						
GEOM: 1	1999.8	0.0	53.4	1803.7	37.7	18.1	35.0	65.0	23.57	25.15	85.0	148.6
FAN	: 3500.0	1000.0	25.148	78.7	92.6	95.7						
CORE	: 3500.0	1000.0	25.148	66.4	75.2	75.3						
TURB	: 3500.0	1000.0	25.148	54.9	66.4	66.4						
FLAP	: 3500.0	1000.0	25.148	81.3	84.8	84.9						
TOTAL	: 3500.0	1000.0	25.148	83.9	88.5	91.6						
GEOM: 2	2147.6	0.0	69.2	1683.4	40.5	19.0	38.0	66.2	24.57	26.04	85.0	148.6
FAN	: 3500.0	1000.0	26.043	79.3	93.3	96.4						
CORE	: 3500.0	1000.0	26.043	67.4	76.3	76.3						
TURB	: 3500.0	1000.0	26.043	56.6	68.1	68.2						
FLAP	: 3500.0	1000.0	26.043	81.8	85.7	85.8						
TOTAL	: 3500.0	1000.0	26.043	84.5	89.8	92.9						

TABLE VI. - Continued.

GEOM: 3	2295.3	0.0	85.0	1567.9	43.7	20.1	41.4	67.4	25.57	26.94	85.0	148.6
FAN :	3500.0	1000.0	26.942	79.6	93.7	96.7						
CORE :	3500.0	1000.0	26.942	68.6	77.4	77.5						
TURB :	3500.0	1000.0	26.942	58.5	70.1	70.1						
FLAP :	3500.0	1000.0	26.942	82.5	86.6	86.7						
TOTAL :	3500.0	1000.0	26.942	85.2	90.9	94.0						
GEOM: 4	2443.1	0.0	100.8	1458.5	47.4	21.5	45.4	68.7	26.57	27.85	85.0	148.6
FAN :	3500.0	1000.0	27.846	79.9	94.0	97.1						
CORE :	3500.0	1000.0	27.846	69.8	78.7	78.7						
TURB :	3500.0	1000.0	27.846	60.6	72.2	72.2						
FLAP :	3500.0	1000.0	27.846	83.0	87.4	87.5						
TOTAL :	3500.0	1000.0	27.846	85.8	92.0	95.0						
GEOM: 5	2590.9	0.0	116.6	1356.5	51.7	23.4	49.9	70.0	27.57	28.76	85.0	148.6
FAN :	3500.0	1000.0	28.757	80.0	94.2	97.2						
CORE :	3500.0	1000.0	28.757	71.0	79.9	80.0						
TURB :	3500.0	1000.0	28.757	63.0	74.6	74.6						
FLAP :	3500.0	1000.0	28.757	83.7	88.3	88.4						
TOTAL :	3500.0	1000.0	28.757	86.5	93.0	95.9						
GEOM: 6	2738.6	0.0	132.4	1263.8	56.6	26.0	55.2	71.3	28.57	29.68	85.0	148.6
FAN :	3500.0	1000.0	29.676	79.9	94.0	96.9						
CORE :	3500.0	1000.0	29.676	72.1	81.1	81.1						
TURB :	3500.0	1000.0	29.676	65.6	77.2	77.2						
FLAP :	3500.0	1000.0	29.676	84.4	89.3	89.3						
TOTAL :	3500.0	1000.0	29.676	87.3	93.7	96.5						
GEOM: 7	2886.4	0.0	148.1	1182.6	62.4	29.7	61.3	72.6	29.57	30.61	85.0	148.6
FAN :	3500.0	1000.0	30.605	79.5	93.4	96.3						
CORE :	3500.0	1000.0	30.605	73.2	82.2	82.3						
TURB :	3500.0	1000.0	30.605	68.2	79.9	79.9						
FLAP :	3500.0	1000.0	30.605	85.1	90.3	90.3						
TOTAL :	3500.0	1000.0	30.605	88.0	94.3	96.9						
GEOM: 8	3034.1	0.0	163.9	1115.3	68.9	35.5	68.1	74.0	30.57	31.55	85.0	148.6
FAN :	3500.0	1000.0	31.546	78.4	92.5	95.3						
CORE :	3500.0	1000.0	31.546	74.2	83.3	83.3						
TURB :	3500.0	1000.0	31.546	70.7	82.3	82.3						
FLAP :	3500.0	1000.0	31.546	85.7	91.0	91.1						
TOTAL :	3500.0	1000.0	31.546	88.5	94.6	97.0						
GEOM: 9	3181.9	0.0	179.7	1064.7	76.1	45.6	75.7	75.4	31.57	32.50	85.0	148.6
FAN :	3500.0	1000.0	32.502	77.9	91.9	94.6						
CORE :	3500.0	1000.0	32.502	75.3	84.4	84.4						
TURB :	3500.0	1000.0	32.502	73.2	84.9	84.9						
FLAP :	3500.0	1000.0	32.502	86.0	91.5	91.6						
TOTAL :	3500.0	1000.0	32.502	88.9	95.0	97.1						
GEOM: 10	3329.7	0.0	195.5	1033.1	83.9	65.0	83.8	76.8	32.57	33.47	85.0	148.6
FAN :	3500.0	1000.0	33.474	78.7	92.4	95.0						
CORE :	3500.0	1000.0	33.474	76.4	85.5	85.5						
TURB :	3500.0	1000.0	33.474	75.8	87.5	87.5						
FLAP :	3500.0	1000.0	33.474	85.4	91.1	91.2						
TOTAL :	3500.0	1000.0	33.474	88.5	93.5	97.4						
***** CLOSEST POINT OF APPROACH												
GEOM: 11	3477.4	0.0	211.3	1022.3	92.1	100.0	92.1	78.2	33.57	34.46	85.0	148.6
FAN :	3500.0	1000.0	34.465	80.3	93.8	96.3						
CORE :	3500.0	1000.0	34.465	77.6	86.7	86.8						
TURB :	3500.0	1000.0	34.465	78.3	90.0	90.0						
FLAP :	3500.0	1000.0	34.465	86.4	92.3	92.3						
TOTAL :	3500.0	1000.0	34.465	89.5	97.0	98.8						

GEOM: 12	3625.2	0.0	227.1	1033.1	100.2	135.0	100.4	79.6	34.57	35.47	85.0	148.6
FAN :	3500.0	1000.0	35.474	81.7	95.1	97.5						
CORE :	3500.0	1000.0	35.474	78.6	87.7	87.8						
TURB :	3500.0	1000.0	35.474	80.4	92.1	92.1						

TABLE VI. - Continued.

FLAP	: 3500.0	1000.0	35.474	81.0	86.9	86.9	81.0	86.9	86.9	85.0	148.6
TOTAL	: 3500.0	1000.0	35.474	85.8	96.1	98.0	85.8	96.1	98.0	85.0	148.6
GEOM:	13	3772.9	0.0	1064.7	108.0	154.4	108.2	81.0	35.57	36.50	85.0
FAN	: 3500.0	1000.0	36.502	82.7	96.1	98.1	82.7	96.1	98.1	85.0	148.6
CORE	: 3500.0	1000.0	36.502	79.0	88.1	88.1	79.0	88.1	88.1	85.0	148.6
TURB	: 3500.0	1000.0	36.502	81.1	92.9	92.9	81.1	92.9	92.9	85.0	148.6
FLAP	: 3500.0	1000.0	36.502	76.4	82.2	82.2	76.4	82.2	82.2	85.0	148.6
TOTAL	: 3500.0	1000.0	36.502	84.1	95.8	97.8	84.1	95.8	97.8	85.0	148.6
GEOM:	14	3920.7	0.0	1115.3	115.3	164.5	115.5	82.5	36.57	37.55	85.0
FAN	: 3500.0	1000.0	37.546	83.1	96.4	99.0	83.1	96.4	99.0	85.0	148.6
CORE	: 3500.0	1000.0	37.546	78.9	88.0	88.1	78.9	88.0	88.1	85.0	148.6
TURB	: 3500.0	1000.0	37.546	80.3	92.0	92.1	80.3	92.0	92.1	85.0	148.6
FLAP	: 3500.0	1000.0	37.546	82.4	88.6	88.6	82.4	88.6	88.6	85.0	148.6
TOTAL	: 3500.0	1000.0	37.546	86.7	96.7	98.8	86.7	96.7	98.8	85.0	148.6
GEOM:	15	4068.5	0.0	1182.6	121.7	170.3	121.9	83.9	37.57	38.61	85.0
FAN	: 3500.0	1000.0	38.605	83.1	96.4	99.0	83.1	96.4	99.0	85.0	148.6
CORE	: 3500.0	1000.0	38.605	78.5	87.6	87.7	78.5	87.6	87.7	85.0	148.6
TURB	: 3500.0	1000.0	38.605	78.5	90.3	90.3	78.5	90.3	90.3	85.0	148.6
FLAP	: 3500.0	1000.0	38.605	87.3	93.7	93.8	87.3	93.7	93.8	85.0	148.6
TOTAL	: 3500.0	1000.0	38.605	90.2	97.9	100.0	90.2	97.9	100.0	85.0	148.6
GEOM:	16	4216.2	0.0	1263.8	127.5	174.0	127.5	85.4	38.57	39.68	85.0
FAN	: 3500.0	1000.0	39.676	82.6	95.8	98.4	82.6	95.8	98.4	85.0	148.6
CORE	: 3500.0	1000.0	39.676	77.9	87.0	87.1	77.9	87.0	87.1	85.0	148.6
TURB	: 3500.0	1000.0	39.676	75.9	87.6	87.6	75.9	87.6	87.6	85.0	148.6
FLAP	: 3500.0	1000.0	39.676	90.1	96.7	96.7	90.1	96.7	96.7	85.0	148.6
TOTAL	: 3500.0	1000.0	39.676	92.6	98.5	100.6	92.6	98.5	100.6	85.0	148.6
GEOM:	17	4364.0	0.0	1356.5	132.4	176.6	132.5	86.9	39.57	40.76	85.0
FAN	: 3500.0	1000.0	40.757	81.5	94.8	97.3	81.5	94.8	97.3	85.0	148.6
CORE	: 3500.0	1000.0	40.757	77.3	86.4	86.4	77.3	86.4	86.4	85.0	148.6
TURB	: 3500.0	1000.0	40.757	73.4	85.1	85.1	73.4	85.1	85.1	85.0	148.6
FLAP	: 3500.0	1000.0	40.757	92.3	99.1	99.1	92.3	99.1	99.1	85.0	148.6
TOTAL	: 3500.0	1000.0	40.757	94.6	99.9	101.8	94.6	99.9	101.8	85.0	148.6
GEOM:	18	4511.7	0.0	1458.5	136.7	178.5	136.7	88.4	40.57	41.85	85.0
FAN	: 3500.0	1000.0	41.846	80.1	93.3	95.9	80.1	93.3	95.9	85.0	148.6
CORE	: 3500.0	1000.0	41.846	76.6	85.7	85.8	76.6	85.7	85.8	85.0	148.6
TURB	: 3500.0	1000.0	41.846	71.2	82.9	82.9	71.2	82.9	82.9	85.0	148.6
FLAP	: 3500.0	1000.0	41.846	94.0	100.9	100.9	94.0	100.9	100.9	85.0	148.6
TOTAL	: 3500.0	1000.0	41.846	96.1	101.2	102.7	96.1	101.2	102.7	85.0	148.6
GEOM:	19	4659.5	0.0	1567.9	140.4	179.9	140.4	89.8	41.57	42.94	85.0
FAN	: 3500.0	1000.0	42.942	78.6	91.9	94.5	78.6	91.9	94.5	85.0	148.6
CORE	: 3500.0	1000.0	42.942	76.0	85.0	85.1	76.0	85.0	85.1	85.0	148.6
TURB	: 3500.0	1000.0	42.942	69.1	80.8	80.8	69.1	80.8	80.8	85.0	148.6
FLAP	: 3500.0	1000.0	42.942	95.2	102.2	102.3	95.2	102.2	102.3	85.0	148.6
TOTAL	: 3500.0	1000.0	42.942	97.2	102.1	102.9	97.2	102.1	102.9	85.0	148.6
GEOM:	20	4807.2	0.0	1683.4	143.5	181.0	143.6	91.3	42.57	44.04	85.0
FAN	: 3500.0	1000.0	44.043	75.3	90.2	92.8	75.3	90.2	92.8	85.0	148.6
CORE	: 3500.0	1000.0	44.043	73.8	84.3	84.4	73.8	84.3	84.4	85.0	148.6
TURB	: 3500.0	1000.0	44.043	66.9	78.5	78.6	66.9	78.5	78.6	85.0	148.6
FLAP	: 3500.0	1000.0	44.043	94.9	101.9	101.9	94.9	101.9	101.9	85.0	148.6
TOTAL	: 3500.0	1000.0	44.043	96.8	101.5	102.2	96.8	101.5	102.2	85.0	148.6
GEOM:	21	4955.0	0.0	1803.7	146.3	181.9	146.3	92.8	43.57	45.15	85.0
FAN	: 3500.0	1000.0	45.148	75.2	88.6	91.2	75.2	88.6	91.2	85.0	148.6
CORE	: 3500.0	1000.0	45.148	74.7	83.7	83.7	74.7	83.7	83.7	85.0	148.6
TURB	: 3500.0	1000.0	45.148	64.9	76.5	76.5	64.9	76.5	76.5	85.0	148.6
FLAP	: 3500.0	1000.0	45.148	94.4	101.4	101.5	94.4	101.4	101.5	85.0	148.6
TOTAL	: 3500.0	1000.0	45.148	96.3	100.8	101.5	96.3	100.8	101.5	85.0	148.6

TABLE VI. - Concluded.

		VALUES OF PNLT-MAX	
XO ,			YO POSITION
POS		500.	1000.
1500.	LEVEL	115.0	107.7
	THETA	106.3	106.3
	TIME	21.64	23.10
2500.	LEVEL	110.9	106.9
	THETA	140.4	121.1
	TIME	31.57	31.90
3500.	LEVEL	107.1	102.9
	THETA	109.0	140.4
	TIME	35.06	42.94

TABLE VII. - OUTPUT FROM EXAMPLE THREE

This output is discussed in the text. It is included to illustrate a caution to the user when large changes in engine power settings occur.

QSR4 LANDING AND TAKEOFF, ENGINE MAP FROM TEST DATA														
GEOMETRIC RELATIONS OF AIRCRAFT/OBSERVER														
GEOM:	1	-4309.7	0.0	567.4	2430.4	17.0	12.3	12.1	44.6	5.89	8.02	55.0	118.2	118.2
SOURCE	XO	YI	ZI	TAU	R	PNL	THETA	THETAF	THETAH	PHI	TI	TAU	EPTI	VI
TOTAL	NOISE	HISTORY	AT	EACH	POINT	PNL	PNLT	PNLT	PNLT	PNLT	PNLT	PNLT	PNLT	PNLT
GEOM:	2	-4192.5	0.0	552.0	2315.5	17.7	12.6	12.8	45.3	6.89	8.91	55.0	118.2	118.2
GEOM:	3	-4075.3	0.0	536.6	2201.1	18.4	13.0	13.5	46.0	7.89	9.81	55.0	118.2	118.2
GEOM:	4	-3958.1	0.0	521.1	2087.1	19.2	13.4	14.2	46.8	8.89	10.72	55.0	118.2	118.2
GEOM:	5	-3840.9	0.0	505.7	1973.5	20.1	13.9	15.1	47.6	9.89	11.62	55.0	118.2	118.2
GEOM:	6	-3723.8	0.0	490.3	1860.6	21.1	14.4	16.1	48.3	10.89	12.52	55.0	118.2	118.2
GEOM:	7	-3606.6	0.0	474.8	1748.3	22.2	15.0	17.2	49.1	11.89	13.42	55.0	118.2	118.2
GEOM:	8	-3489.4	0.0	459.4	1636.9	23.5	15.6	18.4	50.0	12.89	14.32	55.0	118.2	118.2
GEOM:	9	-3372.2	0.0	444.0	1526.4	25.0	16.4	19.9	50.8	13.89	15.23	55.0	118.2	118.2
GEOM:	10	-3255.0	0.0	428.6	1417.3	26.7	17.4	21.6	51.7	14.89	16.13	55.0	118.2	118.2
GEOM:	11	-3137.8	0.0	413.1	1309.7	28.8	18.5	23.5	52.5	15.89	17.04	55.0	118.2	118.2
GEOM:	12	-3020.6	0.0	397.7	1204.1	31.1	19.8	25.9	53.4	16.89	17.94	55.0	118.2	118.2
GEOM:	13	-2903.4	0.0	382.3	1101.1	34.0	21.4	28.7	54.4	17.89	18.85	55.0	118.2	118.2
GEOM:	14	-2786.2	0.0	366.8	1001.4	37.4	23.5	32.1	55.3	18.89	19.77	55.0	118.2	118.2
GEOM:	15	-2669.1	0.0	351.4	906.2	41.6	26.2	36.4	56.3	19.89	20.68	55.0	118.2	118.2
GEOM:	16	-2551.9	0.0	336.0	817.0	46.7	29.8	41.7	57.3	20.89	21.60	55.0	118.2	118.2
GEOM:	17	-2434.7	0.0	320.5	736.0	53.0	34.9	48.5	58.3	21.89	22.53	55.0	118.2	118.2
GEOM:	18	-2317.5	0.0	305.1	666.3	60.8	42.4	56.9	59.3	22.89	23.47	55.0	118.2	118.2
GEOM:	19	-2200.3	0.0	289.7	611.6	70.1	53.8	67.4	60.4	23.89	24.43	55.0	118.2	118.2
GEOM:	20	-2083.1	0.0	274.3	576.3	81.0	71.6	79.8	61.5	24.89	25.39	55.0	118.2	118.2
GEOM:	21	-1965.9	0.0	258.8	564.1	92.8	96.0	93.1	62.6	25.89	26.38	55.0	118.2	118.2
GEOM:	22	-1848.7	0.0	243.4	576.3	104.6	120.4	106.2	63.7	26.89	27.39	55.0	118.2	118.2
GEOM:	23	-1731.5	0.0	228.0	611.6	115.4	138.2	117.7	64.8	27.89	28.43	55.0	118.2	118.2
GEOM:	24	-1614.4	0.0	212.5	666.3	124.8	149.6	127.2	66.0	28.89	29.47	55.0	118.2	118.2
GEOM:	25	-1497.2	0.0	197.1	736.0	152.5	157.1	134.9	67.2	29.89	30.53	55.0	118.2	118.2
TOTAL	:	-2000.0	500.0	26.384	82.6	93.9	94.3							
***** CLOSEST POINT OF APPROACH														
TOTAL	:	-2000.0	500.0	26.384	82.6	93.9	94.3							

TABLE VII. - Concluded.

GEOM: 26	-1380.0	0.0	181.7	817.0	138.8	162.2	140.9	68.4	30.89	31.60	55.0	118.2
TOTAL :	-2000.0	500.0	31.605	85.6	92.3	93.3						
GEOM: 27	-1262.8	0.0	166.3	906.2	143.9	165.8	145.7	69.6	31.89	32.68	55.0	118.2
TOTAL :	-2000.0	500.0	32.683	84.9	90.4	91.5						
GEOM: 28	-1145.6	0.0	150.8	1001.4	148.1	168.5	149.5	70.9	32.89	33.77	55.0	118.2
TOTAL :	-2000.0	500.0	33.766	84.3	88.7	89.9						
GEOM: 29	-1028.4	0.0	135.4	1101.1	151.5	170.6	152.7	72.2	33.89	34.85	55.0	118.2
TOTAL :	-2000.0	500.0	34.853	83.6	87.6	88.7						
GEOM: 30	-911.2	0.0	120.0	1204.1	154.3	172.2	155.3	73.5	34.89	35.94	55.0	118.2
TOTAL :	-2000.0	500.0	35.943	83.0	86.6	87.3						
GEOM: 31	-794.0	0.0	104.5	1309.7	156.7	173.5	157.4	74.8	35.89	37.04	55.0	118.2
TOTAL :	-2000.0	500.0	37.036	82.4	85.7	86.4						
GEOM: 32	-676.8	0.0	89.1	1417.3	158.7	174.6	159.3	76.1	36.89	38.13	55.0	118.2
TOTAL :	-2000.0	500.0	38.130	81.8	84.9	85.6						
GEOM: 33	-559.7	0.0	73.7	1526.4	160.4	175.6	160.8	77.4	37.89	39.23	55.0	118.2
TOTAL :	-2000.0	500.0	39.225	81.2	84.1	84.8						
GEOM: 34	-442.5	0.0	58.3	1636.9	161.9	176.4	162.2	78.8	38.89	40.32	55.0	118.2
TOTAL :	-2000.0	500.0	40.322	80.7	83.3	84.0						
GEOM: 35	-325.3	0.0	42.8	1748.3	163.1	177.0	163.4	80.2	39.89	41.42	55.0	118.2
TOTAL :	-2000.0	500.0	41.419	80.2	82.6	83.3						
GEOM: 36	-208.1	0.0	27.4	1860.6	164.2	177.6	164.4	81.5	40.89	42.52	55.0	118.2
TOTAL :	-2000.0	500.0	42.517	79.7	82.0	82.7						
GEOM: 37	-90.9	0.0	12.0	1973.5	165.2	178.1	165.3	82.9	41.89	43.62	55.0	118.2
TOTAL :	-2000.0	500.0	43.616	79.3	81.4	82.1						
GEOM: 38	26.6	0.0	0.0	2087.3	163.0	190.0	165.9	125.1	42.89	44.72	85.0	118.8
TOTAL :	-2000.0	500.0	44.715	95.3	99.4	99.8						
GEOM: 39	146.7	0.0	0.0	2204.2	163.6	190.0	166.7	126.7	43.89	45.82	85.0	121.5
TOTAL :	-2000.0	500.0	45.818	94.7	98.8	99.2						
GEOM: 40	269.6	0.0	0.0	2324.0	164.1	190.0	167.4	128.2	44.89	46.92	85.0	124.2
TOTAL :	-2000.0	500.0	46.922	94.2	98.1	98.5						
GEOM: 41	395.2	0.0	0.0	2446.8	164.6	190.0	168.0	129.8	45.89	48.03	85.0	126.9
TOTAL :	-2000.0	500.0	48.030	93.6	97.5	97.9						

TABLE VIII. - OUTPUT FROM EXAMPLE FOUR

QSRA (YF102) NOISE: SINGLE ENGINE, NO FLAPS, NO ATTENUATION
ENGINE PERFORMANCE PARAMETER = 37.78

FAN NOISE SPECTRA
1 ENGINE(S) AT A CONSTANT RADIUS OF 100.0 FEET, IN THE PLANE OF PHI = 0.0 DEGREES

INPUT PARAMETERS: FAN SPEED = 2796. RPM; FAN MASS FLOW (WAFAN) = 97.4 LB/S; FAN DIAMETER (FANDIA) = 3.392 FT;
TIP REL MACH NO.(TIPM) = 0.473; DESIGN REL TIP MACH (TIPDM) = 1.240; TEMP RISE (DELTI) = 9.4 DEG R;
PRESS RATIO(1 STAGE)(FPR) = 1.054; NO. BLADES(NBL) = 40; NO. VANES(NVAN) = 85; ROTOR/STATOR SPACING (RSS) = 275. %;
NO. STAGES(NSTG) = 1; STAGE EFF (FAEFF) = 0.840; INLET GUIDE VANES (IGV) = 0; INLET FLOW DISTOR (IFD) = 1;
EXHAUST NOISE OPTION (IEXH) = 2; NO. OF TONE HARM CALC (NH) = 5; AIR GAMMA(F) = 1.40; FAN HUB DIAM(FANHUB) = 1.450 FT.

FREQ	POLAR ANGLE, THETA, DEGREES																	POWER LEVEL	
	0.0	10.0	20.0	30.0	40.0	50.0	60.0	70.0	80.0	90.0	100.0	110.0	120.0	130.0	140.0	150.0	160.0		170.0
50	-1.3	-0.3	0.7	0.7	0.7	-1.2	-3.4	-4.8	-4.5	-2.5	-0.4	1.0	1.9	2.2	0.2	-3.8	-7.8	-12.8	180.0
63	5.8	6.8	7.8	7.8	7.8	5.9	3.7	2.3	2.6	4.6	6.7	8.1	9.0	9.3	7.3	3.3	-0.7	-5.7	-10.7
79	12.5	13.5	14.5	14.6	14.6	12.6	10.5	9.0	9.4	11.3	13.4	14.9	15.7	16.0	14.0	10.0	6.0	1.0	-4.0
99	18.9	19.9	20.9	20.9	20.9	19.0	16.8	15.3	15.7	17.7	19.8	21.2	22.1	22.4	20.4	16.4	12.4	7.4	2.4
125	24.9	25.9	26.9	26.9	26.9	25.0	22.8	21.3	21.7	23.7	25.8	27.2	28.1	28.4	26.4	22.4	18.4	13.4	8.4
158	30.5	31.5	32.5	32.5	32.5	30.6	28.5	27.0	27.3	29.3	31.4	32.8	33.7	34.0	32.0	28.0	24.0	19.0	14.0
199	35.8	36.8	37.8	37.8	37.8	35.9	33.7	32.2	32.6	34.6	36.6	38.1	39.0	39.3	37.3	33.3	29.3	24.3	19.3
251	40.6	41.7	42.7	42.7	42.7	40.7	38.6	37.1	37.5	39.4	41.5	43.0	43.9	44.1	42.1	38.1	34.1	29.1	24.1
316	45.2	46.2	47.2	47.2	47.2	45.3	43.1	41.6	42.0	44.0	46.0	47.5	48.4	48.7	46.7	42.7	38.7	33.7	28.7
398	49.3	50.3	51.3	51.3	51.3	49.4	47.2	45.7	46.1	48.1	50.2	51.6	52.5	52.8	50.8	46.8	42.8	37.8	32.8
501	53.1	54.1	55.1	55.1	55.1	53.2	51.0	49.5	49.9	51.9	53.9	55.4	56.3	56.6	54.6	50.6	46.6	41.6	36.6
630	56.5	57.5	58.5	58.5	58.5	56.6	54.4	52.9	53.3	55.3	57.3	58.8	59.7	60.0	58.0	54.0	50.0	45.0	40.0
794	59.5	60.5	61.5	61.5	61.5	59.6	57.4	55.9	56.3	58.3	60.4	61.8	62.7	63.0	61.0	57.0	53.0	48.0	43.0
999	62.2	63.2	64.2	64.2	64.2	62.3	60.1	58.6	59.0	61.0	63.0	64.5	65.4	65.7	63.7	59.7	55.7	50.7	45.7
1258	64.4	65.4	66.4	66.4	66.4	64.5	62.4	60.9	61.3	63.2	65.2	66.8	67.6	67.9	65.9	61.9	57.9	52.9	47.9
1584	66.4	67.4	68.4	68.4	68.4	66.5	64.3	62.8	63.2	65.2	67.2	68.7	69.6	69.9	67.9	63.9	59.9	54.9	49.9
1995	68.4	69.4	70.4	70.4	70.4	68.5	66.3	64.8	65.2	67.2	69.2	70.7	71.4	71.7	69.7	65.7	61.7	56.7	51.7
2511	69.1	70.1	71.1	71.1	71.1	69.2	67.0	65.5	65.9	67.9	69.9	71.4	72.3	72.6	70.6	66.6	62.6	57.6	52.6
3162	69.9	70.9	71.9	71.9	71.9	70.0	67.8	66.3	66.7	68.7	70.8	72.2	73.1	73.4	71.4	67.4	63.4	58.4	53.4
3981	70.0	71.0	72.0	72.0	72.0	70.1	67.9	66.4	66.8	68.8	70.9	72.3	73.2	73.5	71.5	67.5	63.5	58.5	53.5
5011	70.4	71.4	72.4	72.4	72.4	70.5	68.3	66.8	67.2	69.2	71.3	72.7	73.6	73.9	71.9	67.9	63.9	58.9	53.9
6309	70.1	71.1	72.1	72.1	72.1	70.2	68.0	66.5	66.9	68.9	71.0	72.4	73.3	73.6	71.6	67.6	63.6	58.6	53.6
7943	70.7	71.7	72.7	72.7	72.7	70.8	68.6	67.1	67.5	69.5	71.6	73.0	73.9	74.2	72.2	68.2	64.2	59.2	54.2
9999	69.3	70.4	71.5	71.5	71.5	69.7	67.6	66.1	66.5	68.5	70.5	72.1	73.0	73.2	71.2	67.2	63.2	58.2	53.2
OSPL	81.3	82.5	83.7	83.7	83.8	82.2	80.1	78.2	78.1	79.8	81.7	83.3	84.2	84.4	82.4	78.6	74.8	70.2	65.2
PNL	94.4	95.6	96.8	96.8	96.9	95.3	93.2	91.5	91.6	93.5	95.4	97.0	98.0	98.1	96.1	92.4	88.6	84.1	79.1
PNLT	97.0	98.3	99.6	99.6	99.7	98.3	96.2	94.1	93.4	94.8	96.4	98.1	99.1	99.2	97.2	93.5	89.8	85.5	80.5

TABLE VIII. - Continued.

Q3RA (YF102) NOISE: SINGLE ENGINE, NO FLAPS, NO ATTENUATION
ENGINE PERFORMANCE PARAMETER = 37.78

JET NOISE SPECTRA
1 ENGINE(S) AT A CONSTANT RADIUS OF 100.0 FEET, IN THE PLANE OF PHI = 0.0 DEGREES

FREQ	POLAR ANGLE, THETA, DEGREES										FWD VEL EFFECTS(IEMD)=0;										POWER LEVEL	
	0.0	10.0	20.0	30.0	40.0	50.0	60.0	70.0	80.0	90.0	100.0	110.0	120.0	130.0	140.0	150.0	160.0	170.0	180.0	ANNUL HT(FT)	FUEL (#/S)	
50	58.2	58.2	58.3	58.5	58.7	58.8	59.1	59.3	59.6	59.8	60.1	60.3	60.7	62.1	64.1	66.0	66.8	64.4	111.6	0.000	0.000	
63	58.8	58.8	59.0	59.2	59.4	59.6	59.8	60.1	60.4	60.7	61.0	61.2	61.8	63.8	66.3	66.3	66.7	63.4	112.8	0.000	0.000	
79	59.2	59.2	59.3	59.4	59.6	59.9	60.1	60.4	60.7	61.0	61.4	61.9	62.6	63.8	65.1	65.4	65.9	61.8	112.8	0.000	0.000	
99	59.4	59.4	59.6	59.7	59.9	60.2	60.4	60.8	61.1	61.5	61.9	62.2	62.5	63.2	64.2	65.1	65.4	64.5	113.0	0.000	0.000	
125	59.6	59.6	59.7	59.9	60.1	60.4	60.7	61.0	61.4	61.8	62.2	62.6	62.9	63.6	64.5	64.9	64.5	63.0	113.2	0.000	0.000	
158	59.5	59.5	59.6	59.8	60.1	60.4	60.7	61.1	61.5	61.9	62.4	62.8	63.2	63.8	64.5	64.4	63.4	61.5	113.2	0.000	0.000	
199	59.2	59.2	59.4	59.6	59.8	60.2	60.5	60.9	61.4	61.9	62.4	62.8	63.3	63.9	64.3	63.8	62.2	59.8	113.0	0.000	0.000	
251	58.8	58.8	58.9	59.1	59.4	59.8	60.2	60.6	61.1	61.7	62.2	62.7	63.2	63.7	63.9	62.9	60.8	58.0	112.7	0.000	0.000	
316	58.2	58.2	58.4	58.6	58.9	59.3	59.7	60.2	60.7	61.2	61.8	62.4	62.9	63.3	63.3	61.9	59.3	56.3	112.2	0.000	0.000	
398	57.5	57.5	57.7	57.9	58.2	58.6	59.0	59.5	60.1	60.7	61.3	61.9	62.4	62.8	62.5	60.8	57.9	54.6	111.6	0.000	0.000	
501	56.6	56.7	56.9	57.1	57.4	57.9	58.3	58.8	59.4	60.0	60.6	61.2	61.8	62.1	61.5	59.6	56.5	53.0	110.8	0.000	0.000	
630	55.6	55.7	55.9	56.1	56.4	56.9	57.4	57.9	58.6	59.2	59.9	60.5	61.1	61.3	60.5	58.2	54.9	51.3	110.0	0.000	0.000	
794	54.6	54.7	54.8	55.1	55.4	55.9	56.4	56.9	57.6	58.2	58.9	59.6	60.3	60.4	59.4	56.9	53.5	49.5	109.0	0.000	0.000	
999	53.5	53.6	53.7	54.0	54.3	54.8	55.3	55.9	56.5	57.2	57.9	58.6	59.3	59.3	58.2	55.6	52.0	47.8	107.9	0.000	0.000	
1258	52.4	52.5	52.6	52.9	53.2	53.7	54.2	54.8	55.4	56.1	56.8	57.5	58.2	58.2	57.0	54.3	50.5	46.1	106.8	0.000	0.000	
1584	51.3	51.4	51.5	51.8	52.1	52.6	53.1	53.7	54.3	55.0	55.7	56.4	57.1	57.1	55.8	53.0	49.1	44.4	105.7	0.000	0.000	
1995	50.2	50.2	50.4	50.7	51.0	51.5	52.0	52.6	53.2	53.9	54.6	55.3	56.0	55.9	54.6	51.7	47.6	42.7	104.5	0.000	0.000	
2511	49.0	49.0	49.2	49.5	49.8	50.3	50.8	51.4	52.1	52.8	53.5	54.2	54.9	54.8	53.4	50.4	46.1	41.0	103.4	0.000	0.000	
3162	47.8	47.8	48.0	48.3	48.6	49.1	49.6	50.2	50.9	51.6	52.3	53.0	53.8	53.6	52.2	49.1	44.6	39.3	102.2	0.000	0.000	
3981	46.6	46.7	46.8	47.1	47.5	47.9	48.5	49.1	49.7	50.4	51.2	51.9	52.6	52.4	51.0	47.8	43.1	37.6	101.0	0.000	0.000	
5011	45.4	45.5	45.7	45.9	46.3	46.7	47.3	47.9	48.5	49.3	50.0	50.7	51.4	51.2	49.8	46.6	41.7	35.9	99.8	0.000	0.000	
6309	44.3	44.3	44.5	44.7	45.1	45.6	46.1	46.7	47.4	48.1	48.8	49.5	50.2	50.1	48.6	45.3	40.2	34.2	98.7	0.000	0.000	
7943	43.1	43.1	43.3	43.6	43.9	44.4	44.9	45.5	46.2	46.9	47.6	48.3	49.1	48.9	47.4	44.0	38.8	32.5	97.5	0.000	0.000	
9999	41.9	41.9	42.1	42.4	42.7	43.2	43.7	44.3	45.0	45.7	46.4	47.2	47.9	46.2	42.7	37.4	30.9	21.8	96.3	0.000	0.000	
05PL	69.9	69.9	70.0	70.2	70.5	70.8	71.2	71.6	72.0	72.5	73.0	73.5	74.0	74.4	74.7	74.5	74.3	73.5	69.7	123.7	0.000	0.000
PNL	76.2	76.3	76.4	76.7	77.0	77.4	77.9	78.5	79.1	79.8	80.4	81.1	81.7	81.8	81.0	79.0	76.1	72.9	66.7	0.000	0.000	
PNLT	76.2	76.3	76.4	76.7	77.0	77.5	78.0	78.5	79.1	79.8	80.5	81.1	81.7	81.8	81.0	79.0	76.1	72.9	66.7	0.000	0.000	

TABLE VIII. - Continued.

QSRA (YF102) NOISE: SINGLE ENGINE, NO FLAPS, NO ATTENUATION

ENGINE PERFORMANCE PARAMETER = 37.78

CORE NOISE SPECTRA

1 ENGINE(S) AT A CONSTANT RADIUS OF 100.0 FEET, IN THE PLANE OF PHI = 0.0 DEGREES

MODIFIED NOISE LEVEL PREDICTION

INPUT PARAMETERS: COMBUSTOR INLET TEMP (T3) = 783.2 DEG R; EXHAUST TEMP (T4) = 1616.5 DEG R;

INLET PRESS (P3) = 6518.7 PSF; CORE MASS FLOW (WCORE) = 16.3 LB/S; DESIGN TURBINE DELTA T (DTEND) = 900.0 DEG R

FREQ	0.0	10.0	20.0	30.0	40.0	50.0	60.0	70.0	80.0	90.0	100.0	110.0	120.0	130.0	140.0	150.0	160.0	170.0	180.0	POWER LEVEL
50	43.4	44.9	46.4	47.8	49.2	50.8	51.8	52.6	53.5	54.9	56.2	57.0	57.3	57.3	57.2	57.1	56.9	56.8	56.7	106.0
63	46.0	47.5	49.0	50.4	51.8	53.4	54.4	55.2	56.1	57.4	58.8	59.6	59.9	59.9	59.8	59.6	59.5	59.4	59.3	108.6
79	48.6	50.1	51.6	53.0	54.4	56.0	57.0	57.8	58.7	60.0	61.4	62.2	62.5	62.5	62.4	62.2	62.1	62.0	61.9	111.2
99	50.6	52.1	53.6	55.0	56.4	58.0	59.0	59.8	60.7	62.0	63.4	64.2	64.5	64.5	64.4	64.2	64.1	64.0	63.9	113.2
125	52.5	54.0	55.5	56.9	58.3	59.9	60.9	61.7	62.6	64.0	65.3	66.1	66.4	66.4	66.3	66.2	66.0	65.9	65.8	115.1
158	54.5	56.0	57.5	58.9	60.3	61.9	62.9	63.7	64.6	65.9	67.3	68.1	68.4	68.4	68.3	68.1	68.0	67.9	67.8	117.1
199	55.6	57.1	58.6	60.0	61.4	63.0	64.0	64.8	65.7	67.1	68.4	69.2	69.5	69.5	69.4	69.3	69.1	69.0	68.9	118.2
251	56.6	58.1	59.6	61.0	62.4	64.0	65.0	65.8	66.7	68.0	69.4	70.2	70.5	70.5	70.4	70.2	70.1	70.0	69.9	119.2
316	57.1	58.6	60.1	61.5	62.9	64.5	65.5	66.3	67.2	68.6	69.9	70.7	71.0	71.0	70.9	70.8	70.6	70.5	70.4	119.7
398	57.4	58.9	60.4	61.8	63.2	64.8	65.8	66.6	67.5	68.8	70.2	71.0	71.3	71.3	71.2	71.0	70.9	70.8	70.7	120.0
501	57.1	58.6	60.1	61.5	62.9	64.5	65.5	66.3	67.2	68.5	69.9	70.7	71.0	71.0	70.9	70.7	70.6	70.5	70.4	119.7
630	56.7	58.2	59.7	61.1	62.5	64.1	65.1	65.9	66.8	68.2	69.5	70.3	70.6	70.6	70.5	70.4	70.2	70.1	70.0	119.3
794	56.1	57.6	59.1	60.5	61.9	63.5	64.5	65.3	66.2	67.5	68.9	69.7	70.0	70.0	69.9	69.7	69.6	69.5	69.4	118.7
999	55.1	56.6	58.1	59.5	60.9	62.5	63.5	64.3	65.2	66.6	67.9	68.7	69.0	69.0	68.9	68.8	68.6	68.5	68.4	117.7
1258	54.2	55.7	57.2	58.6	60.0	61.6	62.6	63.4	64.3	65.6	67.0	67.8	68.1	68.1	68.0	67.8	67.7	67.6	67.5	116.8
1584	53.2	54.7	56.2	57.6	59.0	60.6	61.6	62.4	63.3	64.7	66.0	66.8	67.1	67.1	67.0	66.9	66.7	66.6	66.5	115.8
1995	51.8	53.3	54.8	56.2	57.6	59.2	60.2	61.0	61.9	63.3	64.6	65.4	65.7	65.7	65.6	65.5	65.3	65.2	65.1	114.4
2511	50.4	51.9	53.4	54.8	56.2	57.8	58.8	59.6	60.5	61.9	63.2	64.0	64.3	64.3	64.2	64.1	63.9	63.8	63.7	113.0
3162	49.0	50.5	52.0	53.4	54.8	56.4	57.4	58.2	59.1	60.5	61.8	62.6	62.9	62.9	62.8	62.7	62.5	62.4	62.3	111.6
3981	47.6	49.1	50.6	52.0	53.4	55.0	56.0	56.8	57.7	59.0	60.4	61.2	61.5	61.5	61.4	61.2	61.1	61.0	60.9	110.2
5011	45.9	47.4	48.9	50.3	51.7	53.3	54.3	55.1	56.0	57.4	58.7	59.5	59.8	59.8	59.7	59.6	59.4	59.3	59.2	108.5
6309	44.2	45.7	47.2	48.6	50.0	51.6	52.6	53.4	54.3	55.7	57.0	57.8	58.1	58.1	58.0	57.9	57.7	57.6	57.5	106.8
7943	42.5	44.0	45.5	46.9	48.3	49.9	50.9	51.7	52.6	54.0	55.3	56.1	56.4	56.4	56.3	56.2	56.0	55.9	55.8	105.1
9999	40.8	42.3	43.8	45.2	46.6	48.2	49.2	50.0	50.9	52.3	53.6	54.4	54.7	54.7	54.6	54.5	54.3	54.2	54.1	103.4
0SP1	67.2	68.7	70.2	71.6	73.0	74.6	75.6	76.4	77.3	78.7	80.0	80.8	81.1	81.1	81.0	80.9	80.7	80.6	80.5	129.8
PNL	76.0	77.6	79.1	80.6	82.0	83.6	84.7	85.5	86.4	87.8	89.2	90.0	90.3	90.3	90.2	90.0	89.9	89.8	89.7	
PNLT	76.1	77.6	79.2	80.6	82.1	83.7	84.7	85.5	86.5	87.8	89.2	90.0	90.3	90.3	90.2	90.1	89.9	89.8	89.7	

TABLE VIII. - Continued.

QSR (YF102) NOISE: SINGLE ENGINE, NO FLAPS, NO ATTENUATION

ENGINE PERFORMANCE PARAMETER = 37.78

TURBINE NOISE SPECTRA
1 ENGINE(S) AT A CONSTANT RADIUS OF 100.0 FEET, IN THE PLANE OF PHI = 0.0 DEGREES

FREQ	POLAR ANGLE, THETA, DEGREES																POWER LEVEL			
	0.0	10.0	20.0	30.0	40.0	50.0	60.0	70.0	80.0	90.0	100.0	110.0	120.0	130.0	140.0	150.0	160.0	170.0	180.0	
50	19.0	23.0	27.0	31.0	35.0	39.0	43.0	46.0	49.0	52.0	54.7	56.0	57.0	51.0	47.3	43.1	38.0	31.8	180.0	
63	20.0	24.0	28.0	32.0	36.0	40.0	44.0	47.0	50.0	53.0	55.7	57.0	58.0	52.0	48.3	44.1	39.0	32.8	27.7	
79	21.0	25.0	29.0	33.0	37.0	41.0	45.0	48.0	51.0	54.0	56.7	58.0	59.0	53.0	49.3	45.1	40.0	34.8	28.7	
99	22.0	26.0	30.0	34.0	38.0	42.0	46.0	49.0	52.0	55.0	57.7	59.0	60.0	54.0	50.3	46.1	41.0	35.8	29.7	
125	23.0	27.0	31.0	35.0	39.0	43.0	47.0	50.0	53.0	56.0	58.7	60.0	61.0	55.0	51.3	47.1	42.0	36.8	30.7	
158	24.0	28.0	32.0	36.0	40.0	44.0	48.0	51.0	54.0	57.0	59.7	61.0	62.0	56.0	52.3	48.1	43.0	37.8	31.7	
199	25.0	29.0	33.0	37.0	41.0	45.0	49.0	52.0	55.0	58.0	60.7	62.0	63.0	57.0	53.3	49.1	44.0	38.8	32.7	
251	26.1	30.1	34.1	38.1	42.1	46.1	50.1	53.1	56.1	59.1	61.8	63.0	64.0	58.0	54.3	50.1	45.0	39.9	33.8	
326	27.1	31.1	35.1	39.1	43.1	47.1	51.1	54.1	57.1	60.1	62.8	64.1	65.0	59.0	55.4	51.2	46.1	40.9	34.8	
398	28.1	32.1	36.1	40.1	44.1	48.1	52.1	55.1	58.1	61.1	63.8	65.1	66.0	60.0	56.4	52.2	47.1	41.9	35.8	
501	29.1	33.1	37.1	41.1	45.1	49.1	53.1	56.1	59.1	62.1	64.8	66.1	67.0	61.0	57.4	53.2	48.1	42.9	36.8	
630	30.1	34.1	38.1	42.1	46.1	50.1	54.1	57.1	60.1	63.1	65.8	67.1	68.0	62.0	58.4	54.3	49.2	43.9	37.8	
794	31.2	35.2	39.2	43.2	47.2	51.2	55.2	58.2	61.2	64.2	66.9	68.2	69.0	63.0	59.5	55.3	50.2	44.9	38.9	
998	32.2	36.2	40.2	44.2	48.2	52.2	56.2	59.2	62.2	65.2	67.9	69.2	70.0	64.0	60.5	56.4	51.3	46.0	39.9	
1258	33.3	37.3	41.3	45.3	49.3	53.3	57.3	60.3	63.3	66.3	69.0	70.3	71.4	65.3	61.6	57.5	52.4	47.2	41.0	
1584	34.4	38.4	42.4	46.4	50.4	54.4	58.4	61.4	64.4	67.4	70.1	71.4	72.5	66.4	62.7	58.6	53.5	48.3	42.1	
1995	35.5	39.5	43.5	47.5	51.5	55.5	59.5	62.5	65.5	68.5	71.2	72.5	73.6	67.5	63.8	59.7	54.6	49.4	43.2	
2511	36.6	40.6	44.6	48.6	52.6	56.6	60.6	63.6	66.6	69.6	72.3	73.6	74.7	68.6	64.9	60.9	55.8	50.6	44.3	
3162	37.8	41.8	45.8	49.8	53.8	57.8	61.8	64.8	67.8	70.8	73.5	74.8	75.9	69.7	66.1	62.3	57.2	52.0	45.5	
3981	39.2	43.2	47.2	51.2	55.2	59.2	63.2	66.2	69.2	72.2	74.9	76.2	77.4	71.2	67.5	63.5	58.4	53.2	46.8	
5011	40.4	44.4	48.4	52.4	56.4	60.4	64.4	67.4	70.4	73.4	76.1	77.4	78.5	72.4	68.7	64.5	59.4	54.1	48.1	
6309	42.8	47.0	51.2	55.4	59.6	63.8	68.1	71.5	75.0	78.5	81.8	83.8	84.9	77.0	73.3	69.0	63.8	58.6	50.7	
7993	40.8	44.8	48.8	52.8	56.8	60.8	64.8	67.8	70.8	73.8	76.5	77.8	78.8	72.8	69.1	64.8	59.6	54.3	48.5	
9999	40.1	44.1	48.1	52.1	56.1	60.1	64.1	67.1	70.1	73.1	75.8	77.1	78.1	72.1	68.4	64.1	58.9	53.6	47.8	
OSPL	49.4	53.4	57.5	61.5	65.6	69.6	73.7	76.8	80.0	83.2	86.0	87.6	88.1	82.0	78.0	72.8	67.5	62.3	57.1	
PNL	62.1	66.4	70.6	74.8	79.0	83.1	87.3	90.5	93.7	97.0	100.0	101.7	100.1	95.7	91.5	86.2	80.9	75.6	70.3	
PNLT	62.4	66.7	71.1	75.3	79.5	83.7	87.9	91.1	94.5	97.8	100.9	102.7	101.0	96.4	92.1	86.7	81.4	76.0	70.5	

INPUT PARAMETERS: EXIT TEMP (TCTUR) = 1212.2 DEG R; ROTOR TIP SPEED (TIURIS) = 360.9 FPS; MASS FLOW (WCORE) = 16.250 LB/S;
 FAN SPEED (RPM) = 2796 RPM; TURBINE/FAN SPEED (GEAR) = 2.30; DIAMETER (TBDIA) = 1.530 FT; NO. BLADES (NBLR) = 60;
 STATOR CHORD/ROTOR SPACING (CS) = 700.0%; TYPE (SHORT CORE DUCT=1, COPLANAR OR TURBOJET=0) (TYPTB) = 1

TABLE VIII, - Continued.

Q5RA (YF102) NOISE: SINGLE ENGINE, NO FLAPS, NO ATTENUATION

ENGINE PERFORMANCE PARAMETER = 37.78

1 ENGINE(S) AT A CONSTANT RADIUS OF 100.0 FEET, IN THE PLANE OF PHI = 0.0 DEGREES

NOISE SPECTRA OF TOTAL OF ALL SOURCES

SOURCES AND EFFECTS INCLUDED ARE DESIGNATED BY CODE > OR =1.
 SOURCES: IFAN=1, IJET=1, IFLAP=0, ICORE=1, ITURB=1, IAIRP=0, IREVR=0
 PROPAGATION EFFECTS: IATM=0, IAGND=1, IEGA=0, IDOP=0, ISHLD=0, ICORR=1

FREQ	POLAR ANGLE, THETA, DEGREES										POKER LEVEL									
	0.0	10.0	20.0	30.0	40.0	50.0	60.0	70.0	80.0	90.0	100.0	110.0	120.0	130.0	140.0	150.0	160.0	170.0	180.0	
50	61.3	61.4	61.5	61.7	62.0	62.4	62.7	63.1	63.6	64.4	65.2	65.8	65.7	66.4	67.9	69.5	70.2	70.5	68.1	
63	62.0	62.1	62.3	62.6	62.9	63.4	63.8	64.3	64.8	65.7	66.6	67.2	67.3	67.8	69.0	70.2	70.5	70.8	67.8	
79	62.6	62.7	63.0	63.3	63.8	64.4	64.9	65.5	66.1	67.0	68.1	68.7	68.8	69.2	70.0	70.6	70.4	67.9	65.4	
99	63.0	63.2	63.6	64.0	64.5	65.3	65.9	66.5	67.2	68.2	69.3	70.1	70.1	70.4	70.7	70.8	70.3	68.4	65.4	
125	63.4	63.7	64.1	64.7	65.3	66.2	66.9	67.5	68.3	69.4	70.6	71.4	71.5	71.6	71.6	71.3	70.7	69.5	66.6	
158	63.7	64.1	64.7	65.4	66.2	67.3	68.0	68.7	69.6	70.8	72.0	72.8	73.0	72.9	72.7	72.3	71.8	71.1	68.8	
199	63.8	64.3	65.0	65.8	66.7	67.9	68.7	69.5	70.3	71.6	72.9	73.7	73.9	73.7	73.4	72.9	72.5	72.1	69.6	
251	63.9	64.5	65.3	66.2	67.2	68.4	69.3	70.1	71.0	72.4	73.7	74.6	74.7	74.5	74.0	73.6	73.3	73.0	70.4	
316	63.8	64.6	65.5	66.4	67.5	68.8	69.7	70.5	71.5	72.8	74.2	75.1	75.2	74.8	74.4	74.0	73.7	73.5	70.8	
398	63.8	64.6	65.6	66.5	67.6	68.9	69.8	70.6	71.6	73.1	74.5	75.4	75.4	74.9	74.5	74.1	73.9	73.7	71.0	
501	63.7	64.6	65.6	66.5	67.6	68.7	69.6	70.4	71.5	73.0	74.5	75.4	75.4	74.6	74.2	73.8	73.6	73.4	70.9	
630	64.1	65.0	66.1	67.1	68.2	69.4	70.2	71.3	72.4	73.9	75.5	75.5	74.9	74.4	73.8	73.4	73.2	73.1	70.8	
794	65.0	66.0	67.0	67.6	68.3	68.6	69.2	69.9	71.1	72.8	74.6	75.6	75.5	74.8	73.3	72.8	72.6	72.4	70.8	
999	66.4	67.4	68.5	68.8	69.2	69.0	69.1	69.7	70.9	72.8	74.8	75.8	75.7	74.8	72.6	72.0	71.7	71.5	70.8	
1258	68.1	69.1	70.1	70.3	70.6	69.8	69.4	69.8	71.1	73.2	75.2	76.4	76.2	73.8	72.2	71.3	70.8	70.5	68.1	
1584	69.7	70.7	71.7	71.8	72.0	70.8	70.0	70.2	71.6	73.8	76.0	77.2	77.0	74.3	72.1	70.7	70.0	69.6	67.9	
1995	78.4	79.8	81.2	81.2	81.2	80.0	78.0	75.7	74.9	76.1	77.6	79.3	79.4	76.7	73.7	71.3	69.6	68.6	66.5	
2511	72.2	73.2	74.2	74.3	74.4	72.8	71.5	71.4	72.9	75.3	77.6	79.0	78.7	75.4	72.1	69.6	67.9	67.1	65.9	
3162	73.0	74.0	75.0	75.0	75.1	73.5	72.2	72.1	73.7	76.1	78.5	79.9	79.5	76.0	72.4	69.4	67.9	67.1	65.9	
3981	77.1	78.4	79.7	79.7	79.7	78.4	76.7	75.8	76.7	79.0	81.3	82.8	82.9	79.9	76.3	72.8	69.4	66.4	64.7	
5011	75.4	76.6	77.8	77.8	77.9	76.5	75.1	74.8	76.3	78.8	81.2	82.6	82.3	81.1	78.7	74.9	71.3	67.7	64.7	
6309	73.1	74.2	75.2	75.2	75.4	74.2	74.2	75.8	78.7	82.0	85.1	87.1	85.5	81.7	73.5	69.3	65.3	62.6	59.5	
7943	73.8	74.9	76.1	76.1	76.2	74.8	73.9	73.9	75.8	78.4	80.9	82.3	81.7	80.0	77.5	73.4	69.5	65.5	62.1	
9999	72.3	73.4	74.5	74.5	74.6	73.2	72.3	72.7	74.7	77.4	80.0	81.3	80.7	78.7	76.1	71.9	68.0	63.9	60.5	
05PL	84.8	85.9	87.1	87.2	87.4	86.4	85.4	85.4	86.7	89.0	91.3	92.7	92.2	90.7	89.0	86.8	85.6	84.8	84.0	
PNL	98.6	99.8	100.9	101.1	101.2	100.2	99.2	98.9	100.1	102.6	105.2	106.7	105.9	104.6	102.8	99.9	97.5	95.3	93.6	
PNLT	101.1	102.4	103.7	103.8	103.9	103.0	101.6	100.5	100.9	103.2	105.8	107.5	106.5	105.2	103.6	100.8	98.0	95.8	93.8	

TABLE VIII. - Continued

OSRA (YF102) NOISE: SINGLE ENGINE, NO FLAPS, NO ATTENUATION
ENGINE PERFORMANCE PARAMETER = 87.70

1 ENGINE(S) AT A CONSTANT RADIUS OF 100.0 FEET, IN THE PLANE OF PHI = 0.0 DEGREES

FAN NOISE SPECTRA

INPUT PARAMETERS: FAN SPEED = 6490. RPM; FAN MASS FLOW (WAFAN) = 236.3 LB/S; FAN DIAMETER (FANDIA) = 3.392 FT;
T.P. REL MACH NO. (TIPM) = 1.129; DESIGN REL TIP MACH (TIPMD) = 1.240; TEMP RISE (DELT) = 55.3 DEG R;
PRESS RATIO(I STAGE)(PR) = 1.350; NO. BLADES(NBL) = 40; NO. VANES(NVAN) = 85; ROTOR STATOR SPACING (RSS) = 275. %;
NO. STAGES(NSTG) = 1; STAGE EFF (FANEFF) = 0.840; INLET GUIDE VANES (IGV) = 0; INLET FLOW DISTOR (IFD) = 1;
EXHAUST NOISE OPTION (IEXH) = 2; NO. OF TONE HARM CALC (NH) = 5; AIR GAMMA = 1.40; FAN HUB DIAM(FANHUB) = 1.450 FT.

FREQ	0.0	10.0	20.0	30.0	40.0	50.0	60.0	70.0	80.0	90.0	100.0	110.0	120.0	130.0	140.0	150.0	160.0	170.0	180.0	POWER LEVEL
50	42.9	43.9	45.4	47.4	50.4	52.4	52.4	48.9	44.9	43.4	42.9	42.4	41.9	41.4	40.9	40.4	39.9	39.4	38.9	98.2
63	45.9	46.9	48.4	50.4	53.4	55.4	55.4	51.9	47.9	46.4	45.9	45.4	44.9	44.4	43.9	43.4	42.9	42.4	41.9	101.2
79	48.9	49.9	51.4	53.4	56.4	58.4	58.4	54.9	50.9	49.4	48.9	48.4	47.9	47.4	46.9	46.4	45.9	45.4	44.9	104.2
99	51.9	52.9	54.4	56.4	59.4	61.4	61.4	57.9	53.9	52.4	51.9	51.4	50.9	50.4	49.9	49.4	48.9	48.4	47.9	107.2
125	54.9	55.9	57.4	59.4	62.4	64.4	64.4	60.9	56.9	55.4	54.9	54.4	53.9	53.4	52.9	52.4	51.9	51.4	50.9	110.2
158	57.9	58.9	60.4	62.4	65.4	67.4	67.4	63.9	59.9	58.4	57.9	57.4	56.9	56.4	55.9	55.4	54.9	54.4	53.9	113.2
199	60.9	61.9	63.4	65.4	68.4	70.4	70.4	66.9	62.9	61.4	60.9	60.4	59.9	59.4	58.9	58.4	57.9	57.4	56.9	116.2
251	64.0	65.0	66.5	68.5	71.5	73.5	73.5	70.0	66.0	64.5	64.0	63.5	63.0	62.5	62.0	61.5	61.0	60.5	60.0	119.3
316	67.0	68.0	69.5	71.5	74.5	76.5	76.5	73.0	69.0	67.5	67.0	66.5	66.0	65.5	65.0	64.5	64.0	63.5	63.0	122.3
398	70.1	71.1	72.6	74.6	77.6	79.6	79.6	76.1	72.1	70.6	70.1	69.6	69.1	68.6	68.1	67.6	67.1	66.6	66.1	125.4
501	73.2	74.2	75.7	77.7	80.7	82.7	82.7	79.2	75.2	73.7	73.2	72.7	72.2	71.7	71.2	70.7	70.2	69.7	69.2	128.5
630	76.3	77.3	78.8	80.8	83.8	85.8	85.8	82.3	78.3	76.8	76.3	75.8	75.3	74.8	74.3	73.8	73.3	72.8	72.3	131.6
794	79.4	80.4	81.9	83.9	86.9	88.9	88.9	85.4	81.4	79.9	79.4	78.9	78.4	77.9	77.4	76.9	76.4	75.9	75.4	134.7
999	82.5	83.5	85.0	87.0	90.0	92.0	92.0	88.5	84.5	83.0	82.5	82.0	81.5	81.0	80.5	80.0	79.5	79.0	78.5	137.8
1258	85.6	86.6	88.1	90.1	93.1	95.1	95.1	91.6	87.6	86.1	85.6	85.1	84.6	84.1	83.6	83.1	82.6	82.1	81.6	140.9
1584	88.7	89.7	91.2	93.2	96.2	98.2	98.2	94.7	90.7	89.2	88.7	88.2	87.7	87.2	86.7	86.2	85.7	85.2	84.7	144.0
1995	91.8	92.8	94.3	96.3	99.3	101.3	101.3	97.8	93.8	92.3	91.8	91.3	90.8	90.3	89.8	89.3	88.8	88.3	87.8	147.1
2511	94.9	95.9	97.4	99.4	102.4	104.4	104.4	100.9	96.9	95.4	94.9	94.4	93.9	93.4	92.9	92.4	91.9	91.4	90.9	150.2
3162	98.0	99.0	100.5	102.5	105.5	107.5	107.5	104.0	100.0	98.5	98.0	97.5	97.0	96.5	96.0	95.5	95.0	94.5	94.0	153.3
3981	101.1	102.1	103.6	105.6	108.6	110.6	110.6	107.1	103.1	101.6	101.1	100.6	100.1	99.6	99.1	98.6	98.1	97.6	97.1	156.4
5011	104.2	105.2	106.7	108.7	111.7	113.7	113.7	110.2	106.2	104.7	104.2	103.7	103.2	102.7	102.2	101.7	101.2	100.7	100.2	159.5
6309	107.3	108.3	109.8	111.8	114.8	116.8	116.8	113.3	109.3	107.8	107.3	106.8	106.3	105.8	105.3	104.8	104.3	103.8	103.3	162.6
7943	110.4	111.4	112.9	114.9	117.9	119.9	119.9	116.4	112.4	110.9	110.4	109.9	109.4	108.9	108.4	107.9	107.4	106.9	106.4	165.7
9999	113.5	114.5	116.0	118.0	121.0	123.0	123.0	119.5	115.5	114.0	113.5	113.0	112.5	112.0	111.5	111.0	110.5	110.0	109.5	168.8
OSPL	100.8	102.1	103.5	104.2	105.6	106.5	106.5	102.8	99.9	99.8	100.8	101.9	102.6	102.6	100.9	98.0	95.6	93.6	92.3	153.9
PNL	115.2	116.5	117.9	118.5	119.5	119.7	118.6	115.7	113.4	113.7	114.7	115.9	116.5	116.5	114.8	111.9	109.3	106.6	104.9	
PNLT	118.6	120.1	121.6	121.8	122.4	121.9	120.4	117.6	115.6	116.1	117.3	118.7	119.5	119.4	117.6	114.6	111.7	108.5	106.1	

TABLE VIII. - Continued.

QSRA (YF102) NOISE: SINGLE ENGINE, NO FLAPS, NO ATTENUATION
ENGINE PERFORMANCE PARAMETER = 87.79

1 ENGINE(S) AT A CONSTANT RADIUS OF 100.0 FEET, IN THE PLANE OF PHI = 0.0 DEGREES

JET NOISE SPECTRA

FREQ	NOZZLE TYPE(SIMPLE=0, COAX=1)(INCH)		IPLUG=0;	GAS CONST	DES MACH	HYD DIA(FT)	ANNUAL HT(FT)	FUEL (#/S)	CORE	FAN	POLAR ANGLE,	THETA, DEGREES	FWD VEL EFFECTS(IFMD)=0;																																																																																																																																																																																																																																																																																																																																																																																																																																																																																																																																																																																																																																																																																																																																																																																																																																																																																																																																																																																																													
	AREA(SQ FT)	VEL(FPS)											TEMP(R)	ISLOT=0;	DES MACH	HYD DIA(FT)	ANNUAL HT(FT)	FUEL (#/S)	ISLOT=0;	DES MACH	HYD DIA(FT)	ANNUAL HT(FT)	FUEL (#/S)	ISLOT=0;	DES MACH	HYD DIA(FT)	ANNUAL HT(FT)	FUEL (#/S)																																																																																																																																																																																																																																																																																																																																																																																																																																																																																																																																																																																																																																																																																																																																																																																																																																																																																																																																																																																														
50	0.0	10.0	20.0	30.0	40.0	50.0	60.0	70.0	80.0	90.0	100.0	110.0	120.0	130.0	140.0	150.0	160.0	170.0	180.0	190.0	200.0	210.0	220.0	230.0	240.0	250.0	260.0	270.0	280.0	290.0	300.0	310.0	320.0	330.0	340.0	350.0	360.0	370.0	380.0	390.0	400.0	410.0	420.0	430.0	440.0	450.0	460.0	470.0	480.0	490.0	500.0	510.0	520.0	530.0	540.0	550.0	560.0	570.0	580.0	590.0	600.0	610.0	620.0	630.0	640.0	650.0	660.0	670.0	680.0	690.0	700.0	710.0	720.0	730.0	740.0	750.0	760.0	770.0	780.0	790.0	800.0	810.0	820.0	830.0	840.0	850.0	860.0	870.0	880.0	890.0	900.0	910.0	920.0	930.0	940.0	950.0	960.0	970.0	980.0	990.0	1000.0	1010.0	1020.0	1030.0	1040.0	1050.0	1060.0	1070.0	1080.0	1090.0	1100.0	1110.0	1120.0	1130.0	1140.0	1150.0	1160.0	1170.0	1180.0	1190.0	1200.0	1210.0	1220.0	1230.0	1240.0	1250.0	1260.0	1270.0	1280.0	1290.0	1300.0	1310.0	1320.0	1330.0	1340.0	1350.0	1360.0	1370.0	1380.0	1390.0	1400.0	1410.0	1420.0	1430.0	1440.0	1450.0	1460.0	1470.0	1480.0	1490.0	1500.0	1510.0	1520.0	1530.0	1540.0	1550.0	1560.0	1570.0	1580.0	1590.0	1600.0	1610.0	1620.0	1630.0	1640.0	1650.0	1660.0	1670.0	1680.0	1690.0	1700.0	1710.0	1720.0	1730.0	1740.0	1750.0	1760.0	1770.0	1780.0	1790.0	1800.0	1810.0	1820.0	1830.0	1840.0	1850.0	1860.0	1870.0	1880.0	1890.0	1900.0	1910.0	1920.0	1930.0	1940.0	1950.0	1960.0	1970.0	1980.0	1990.0	2000.0	2010.0	2020.0	2030.0	2040.0	2050.0	2060.0	2070.0	2080.0	2090.0	2100.0	2110.0	2120.0	2130.0	2140.0	2150.0	2160.0	2170.0	2180.0	2190.0	2200.0	2210.0	2220.0	2230.0	2240.0	2250.0	2260.0	2270.0	2280.0	2290.0	2300.0	2310.0	2320.0	2330.0	2340.0	2350.0	2360.0	2370.0	2380.0	2390.0	2400.0	2410.0	2420.0	2430.0	2440.0	2450.0	2460.0	2470.0	2480.0	2490.0	2500.0	2510.0	2520.0	2530.0	2540.0	2550.0	2560.0	2570.0	2580.0	2590.0	2600.0	2610.0	2620.0	2630.0	2640.0	2650.0	2660.0	2670.0	2680.0	2690.0	2700.0	2710.0	2720.0	2730.0	2740.0	2750.0	2760.0	2770.0	2780.0	2790.0	2800.0	2810.0	2820.0	2830.0	2840.0	2850.0	2860.0	2870.0	2880.0	2890.0	2900.0	2910.0	2920.0	2930.0	2940.0	2950.0	2960.0	2970.0	2980.0	2990.0	3000.0	3010.0	3020.0	3030.0	3040.0	3050.0	3060.0	3070.0	3080.0	3090.0	3100.0	3110.0	3120.0	3130.0	3140.0	3150.0	3160.0	3170.0	3180.0	3190.0	3200.0	3210.0	3220.0	3230.0	3240.0	3250.0	3260.0	3270.0	3280.0	3290.0	3300.0	3310.0	3320.0	3330.0	3340.0	3350.0	3360.0	3370.0	3380.0	3390.0	3400.0	3410.0	3420.0	3430.0	3440.0	3450.0	3460.0	3470.0	3480.0	3490.0	3500.0	3510.0	3520.0	3530.0	3540.0	3550.0	3560.0	3570.0	3580.0	3590.0	3600.0	3610.0	3620.0	3630.0	3640.0	3650.0	3660.0	3670.0	3680.0	3690.0	3700.0	3710.0	3720.0	3730.0	3740.0	3750.0	3760.0	3770.0	3780.0	3790.0	3800.0	3810.0	3820.0	3830.0	3840.0	3850.0	3860.0	3870.0	3880.0	3890.0	3900.0	3910.0	3920.0	3930.0	3940.0	3950.0	3960.0	3970.0	3980.0	3990.0	4000.0	4010.0	4020.0	4030.0	4040.0	4050.0	4060.0	4070.0	4080.0	4090.0	4100.0	4110.0	4120.0	4130.0	4140.0	4150.0	4160.0	4170.0	4180.0	4190.0	4200.0	4210.0	4220.0	4230.0	4240.0	4250.0	4260.0	4270.0	4280.0	4290.0	4300.0	4310.0	4320.0	4330.0	4340.0	4350.0	4360.0	4370.0	4380.0	4390.0	4400.0	4410.0	4420.0	4430.0	4440.0	4450.0	4460.0	4470.0	4480.0	4490.0	4500.0	4510.0	4520.0	4530.0	4540.0	4550.0	4560.0	4570.0	4580.0	4590.0	4600.0	4610.0	4620.0	4630.0	4640.0	4650.0	4660.0	4670.0	4680.0	4690.0	4700.0	4710.0	4720.0	4730.0	4740.0	4750.0	4760.0	4770.0	4780.0	4790.0	4800.0	4810.0	4820.0	4830.0	4840.0	4850.0	4860.0	4870.0	4880.0	4890.0	4900.0	4910.0	4920.0	4930.0	4940.0	4950.0	4960.0	4970.0	4980.0	4990.0	5000.0	5010.0	5020.0	5030.0	5040.0	5050.0	5060.0	5070.0	5080.0	5090.0	5100.0	5110.0	5120.0	5130.0	5140.0	5150.0	5160.0	5170.0	5180.0	5190.0	5200.0	5210.0	5220.0	5230.0	5240.0	5250.0	5260.0	5270.0	5280.0	5290.0	5300.0	5310.0	5320.0	5330.0	5340.0	5350.0	5360.0	5370.0	5380.0	5390.0	5400.0	5410.0	5420.0	5430.0	5440.0	5450.0	5460.0	5470.0	5480.0	5490.0	5500.0	5510.0	5520.0	5530.0	5540.0	5550.0	5560.0	5570.0	5580.0	5590.0	5600.0	5610.0	5620.0	5630.0	5640.0	5650.0	5660.0	5670.0	5680.0	5690.0	5700.0	5710.0	5720.0	5730.0	5740.0	5750.0	5760.0	5770.0	5780.0	5790.0	5800.0	5810.0	5820.0	5830.0	5840.0	5850.0	5860.0	5870.0	5880.0	5890.0	5900.0	5910.0	5920.0	5930.0	5940.0	5950.0	5960.0	5970.0	5980.0	5990.0	6000.0	6010.0	6020.0	6030.0	6040.0	6050.0	6060.0	6070.0	6080.0	6090.0	6100.0	6110.0	6120.0	6130.0	6140.0	6150.0	6160.0	6170.0	6180.0	6190.0	6200.0	6210.0	6220.0	6230.0	6240.0	6250.0	6260.0	6270.0	6280.0	6290.0	6300.0	6310.0	6320.0	6330.0	6340.0	6350.0	6360.0	6370.0	6380.0	6390.0	6400.0	6410.0	6420.0	6430.0	6440.0	6450.0	6460.0	6470.0	6480.0	6490.0	6500.0	6510.0	6520.0	6530.0	6540.0	6550.0	6560.0	6570.0	6580.0	6590.0	6600.0	6610.0	6620.0	6630.0	6640.0	6650.0	6660.0	6670.0	6680.0	6690.0	6700.0	6710.0	6720.0	6730.0	6740.0	6750.0	6760.0	6770.0	6780.0	6790.0	6800.0	6810.0	6820.0	6830.0	6840.0	6850.0	6860.0	6870.0	6880.0	6890.0	6900.0	6910.0	6920.0	6930.0	6940.0	6950.0	6960.0	6970.0	6980.0	6990.0	7000.0	7010.0	7020.0	7030.0	7040.0	7050.0	7060.0	7070.0	7080.0	7090.0	7100.0	7110.0	7120.0	7130.0	7140.0	7150.0	7160.0	7170.0	7180.0	7190.0	7200.0	7210.0	7220.0	7230.0	7240.0	7250.0	7260.0	7270.0	7280.0	7290.0	7300.0	7310.0	7320.0	7330.0	7340.0	7350.0	7360.0	7370.0	7380.0	7390.0	7400.0	7410.0	7420.0	7430.0	7440.0	7450.0	7460.0	7470.0	7480.0	7490.0	7500.0	7510.0	7520.0	7530.0	7540.0	7550.0	7560.0	7570.0	7580.0	7590.0	7600.0	7610.0	7620.0	7630.0	7640.0	7650.0	7660.0	7670.0	7680.0	7690.0	7700.0	7710.0	7720.0	7730.0	7740.0	7750.0	7760.0	7770.0	7780.0	7790.0	7800.0	7810.0	7820.0	7830.0	7840.0	7850.0	7860.0	7870.0	7880.0	7890.0	7900.0	7910.0	7920.0	7930.0	7940.0	7950.0	7960.0	7970.0	7980.0	7990.0	8000.0	8010.0	8020.0	8030.0	8040.0	8050.0	8060.0	8070.0	8080.0	8090.0	8100.0	8110.0	8120.0	8130.0	8140.0	8150.0	8160.0	8170.0	8180.0	8190.0	8200.0	8210.0	8220.0	8230.0	8240.0	8250.0	8260.0	8270.0	8280.0	8290.0	8300.0	8310.0	8320.0	8330.0	8340.0	8350.0	8360.0	8370.0	8380.0	8390.0	8400.0	8410.0	8420.0	8430.0	8440.0	8450.0	8460.0	8470.0	8480.0	8490.0	8500.0	8510.0	8520.0	8530.0	8540.0	8550.0	8560.0	8570.0	8580.0	8590.0	8600.0	8610.0	8620.0	8630.0	8640.0	8650.0	8660.0	8670.0	8680.0	8690.0	8700.0	8710.0	8720.0	8730.0	8740.0	8750.0	8760.0	8770.0	8780.0	8790.0	8800.0	8810.0	8820.0	8830.0	8840.0	8850.0	8860.0	8870.0	8880.0	8890.0	8900.0	8910.0	8920.0	8930.0	8940.0	8950.0	8960.0	8970.0	8980.0	8990.0	9000.0	9010.0	9020.0	9030.0	9040.0	9050.0	9060.0	9070.0	9080.0	9090.0	9100.0	9110.0	9120.0	9130.0	9140.0	9150.0	9160.0	9170.0	9180.0	9190.0	9200.0	9210.0	9220.0	9230.0	9240.0	9250.0	9260.0	9270.0	9280.0	9290.0	9300.0	9310.0	9320.0	9330.0	9340.0	9350.0	9360.0	9370.0	9380.0	9390.0	9400.0	9410.0	9420.0	9430.0	9440.0	9450.0	9460.0	9470.0	9480.0	9490.0	9500.0	9510.0	9520.0	9530.0	9540.0	9550.0	9560.0	9570.0	9580.0	9590.0	9600.0	9610.0	9620.0	9630.0	9640.0	9650.0	9660.0	9670.0	9680.0	9690.0	9700.0	9710.0	9720.0	9730.0	9740.0	9750.0	9760.0	9770.0	9780.0	9790.0	9800.0	9810.0	9820.0	9830.0	9840.0	9850

TABLE VIII. - Continued.

QSRA (YF102) NOISE: SINGLE ENGINE, NO FLAPS, NO ATTENUATION

ENGINE PERFORMANCE PARAMETER = 87.70

1 ENGINE(S) AT A CONSTANT RADIUS OF 100.0 FEET, IN THE PLANE OF PHI = 0.0 DEGREES

CORE NOISE SPECTRA

MODIFIED NOISE LEVEL PREDICTION

INPUT PARAMETERS: COMBUSTOR INLET TEMP (T3) =1089.4 DEG R; EXHAUST TEMP (T4) =2366.2 DEG R;
INLET PRESS (P3) =19298.9 PSF; CORE MASS FLOW (WCORE) = 33.0 LB/S; DESIGN TURBINE DELTA T (DTEMD) = 900.0 DEG R

FREQ.	0.0	10.0	20.0	30.0	40.0	50.0	60.0	70.0	80.0	90.0	100.0	110.0	120.0	130.0	140.0	150.0	160.0	170.0	180.0	POWER LEVEL
50	56.8	58.3	59.8	61.2	62.6	64.2	65.2	66.0	66.9	68.2	69.6	70.4	70.7	70.6	70.4	70.3	70.2	70.1	70.1	119.4
63	59.3	60.8	62.3	63.7	65.1	66.7	67.7	68.5	69.4	70.8	72.1	72.9	73.2	73.1	73.0	72.8	72.7	72.6	72.6	121.9
79	61.9	63.4	64.9	66.3	67.7	69.3	70.3	71.1	72.0	73.4	74.7	75.5	75.8	75.7	75.6	75.4	75.3	75.2	75.2	124.5
99	63.9	65.4	66.9	68.3	69.7	71.3	72.3	73.1	74.0	75.4	76.7	77.5	77.8	77.7	77.6	77.4	77.3	77.2	77.2	126.5
125	65.9	67.4	68.9	70.3	71.7	73.3	74.3	75.1	76.0	77.3	78.7	79.5	79.8	79.7	79.5	79.4	79.3	79.2	79.2	128.5
158	67.8	69.3	70.8	72.2	73.6	75.2	76.2	77.0	77.9	79.3	80.6	81.4	81.7	81.6	81.5	81.3	81.2	81.1	81.1	130.4
199	68.9	70.4	71.9	73.3	74.7	76.3	77.3	78.1	79.0	80.4	81.7	82.5	82.8	82.7	82.6	82.4	82.3	82.2	82.2	131.5
251	69.9	71.4	72.9	74.3	75.7	77.3	78.3	79.1	80.0	81.4	82.7	83.5	83.8	83.7	83.6	83.4	83.3	83.2	83.2	132.5
316	70.5	72.0	73.5	74.9	76.3	77.9	78.9	79.7	80.6	81.9	83.3	84.1	84.4	84.3	84.1	84.0	83.9	83.8	83.8	133.1
398	70.7	72.2	73.7	75.1	76.5	78.1	79.1	79.9	80.8	82.2	83.5	84.3	84.6	84.5	84.4	84.2	84.1	84.0	84.0	133.3
501	70.4	71.9	73.4	74.8	76.2	77.8	78.8	79.6	80.5	81.9	83.2	84.0	84.3	84.2	84.1	83.9	83.8	83.7	83.7	133.0
630	70.1	71.6	73.1	74.5	75.9	77.5	78.5	79.3	80.2	81.5	82.9	83.7	84.0	83.9	83.7	83.6	83.5	83.4	83.4	132.7
794	69.4	70.9	72.4	73.8	75.2	76.8	77.8	78.6	79.5	80.9	82.2	83.0	83.3	83.2	83.1	82.9	82.8	82.7	82.7	132.0
999	68.5	70.0	71.5	72.9	74.3	75.9	76.9	77.7	78.6	79.9	81.3	82.1	82.4	82.4	82.1	82.0	81.9	81.8	81.8	131.1
1258	67.5	69.0	70.5	71.9	73.3	74.9	75.9	76.7	77.6	79.0	80.3	81.1	81.4	81.4	81.3	81.2	81.0	80.9	80.8	130.1
1584	66.6	68.1	69.6	71.0	72.4	74.0	75.0	75.8	76.7	78.0	79.4	80.2	80.5	80.5	80.4	80.2	80.1	79.9	79.9	129.2
1995	65.2	66.7	68.2	69.6	71.0	72.6	73.6	74.4	75.3	76.6	78.0	78.8	79.1	79.1	79.0	78.8	78.7	78.6	78.5	127.8
2511	63.8	65.3	66.8	68.2	69.6	71.2	72.2	73.0	73.9	75.2	76.6	77.4	77.7	77.7	77.6	77.4	77.3	77.2	77.1	126.4
3162	62.3	63.8	65.3	66.7	68.1	69.7	70.7	71.5	72.4	73.8	75.1	75.9	76.2	76.2	76.1	76.0	75.8	75.7	75.6	124.9
3981	60.9	62.4	63.9	65.3	66.7	68.3	69.3	70.1	71.0	72.4	73.7	74.5	74.8	74.8	74.6	74.4	74.3	74.2	74.2	123.5
5011	59.3	60.8	62.3	63.7	65.1	66.7	67.7	68.5	69.4	70.7	72.1	72.9	73.2	73.1	72.9	72.8	72.7	72.6	72.6	121.9
6309	57.6	59.1	60.6	62.0	63.4	65.0	66.0	66.8	67.7	69.0	70.4	71.2	71.5	71.4	71.2	71.1	71.0	70.9	70.9	118.5
7943	55.9	57.4	58.9	60.3	61.7	63.3	64.3	65.1	66.0	67.3	68.7	69.5	69.8	69.8	69.7	69.5	69.4	69.3	69.2	118.5
9999	54.2	55.7	57.2	58.6	60.0	61.6	62.6	63.4	64.3	65.6	67.0	67.8	68.1	68.1	68.0	67.8	67.7	67.6	67.5	116.8
OSPL	80.6	82.1	83.6	85.0	86.4	88.0	89.0	89.8	90.7	92.0	93.4	94.2	94.5	94.5	94.4	94.2	94.1	94.0	93.9	143.2
PNL	89.7	91.2	92.8	94.2	95.6	97.2	98.2	99.0	100.0	101.3	102.7	103.5	103.8	103.8	103.7	103.5	103.4	103.3	103.2	
PNLT	89.8	91.3	92.8	94.2	95.7	97.3	98.3	99.1	100.0	101.4	102.7	103.5	103.8	103.8	103.7	103.6	103.4	103.3	103.2	

TABLE VIII. - Continued.

QSRA (YFI02) NOISE: SINGLE ENGINE, NO FLAPS, NO ATTENUATION

ENGINE PERFORMANCE PARAMETER = 87.70

1 ENGINE(S) AT A CONSTANT RADIUS OF 100.0 FEET, IN THE PLANE OF PHI = 0.0 DEGREES

TURBINE NOISE SPECTRA

INPUT PARAMETERS: EXIT TEMP (TCTUR) = 1600.8 DEG R; ROTOR TIP SPEED (TURTS) = 837.8 FPS; MASS FLOW (WCORE) = 33.031 LB/S;
 FAN SPEED (RPM) = 6490. RPM; TURBINE/FAN SPEED (GEAR) = 2.30; DIAMETER (TBDIA) = 1.530 FT; NO. BLADES (NBLR) = 60;
 STATOR CHORD/ROTOR SPACING (CS) = 700.0%; TYPE (SHORT CORE DUCT=1, COPLANAR OR TURBOJET=0)(TYPTB) = 1

FREQ	0.0	10.0	20.0	30.0	40.0	50.0	60.0	70.0	80.0	90.0	100.0	110.0	120.0	130.0	140.0	150.0	160.0	170.0	180.0	POWER LEVEL
50	27.5	31.5	35.5	39.5	43.5	47.5	51.5	54.5	57.5	60.5	63.2	64.5	63.2	59.5	55.8	50.6	45.5	40.3	35.2	110.2
63	28.5	32.5	36.5	40.5	44.5	48.5	52.5	55.5	58.5	61.5	64.2	65.5	64.2	60.5	56.8	51.6	46.5	41.3	36.2	111.2
79	29.5	33.5	37.5	41.5	45.5	49.5	53.5	56.5	59.5	62.5	65.2	66.5	65.2	61.5	57.8	52.6	47.5	42.3	37.2	112.2
99	30.5	34.5	38.5	42.5	46.5	50.5	54.5	57.5	60.5	63.5	66.2	67.5	66.2	62.5	58.8	53.6	48.5	43.3	38.2	113.2
125	31.5	35.5	39.5	43.5	47.5	51.5	55.5	58.5	61.5	64.5	67.2	68.5	67.2	63.5	59.8	54.6	49.5	44.3	39.2	114.2
158	32.5	36.5	40.5	44.5	48.5	52.5	56.5	59.5	62.5	65.5	68.2	69.5	68.2	64.5	60.8	55.6	50.5	45.3	40.2	115.2
199	33.5	37.5	41.5	45.5	49.5	53.5	57.5	60.5	63.5	66.5	69.2	70.5	69.2	65.5	61.8	56.6	51.5	46.3	41.2	116.2
251	34.6	38.6	42.6	46.6	50.6	54.6	58.6	61.6	64.6	67.6	70.3	71.6	70.3	66.6	62.9	57.7	52.6	47.4	42.3	117.3
316	35.6	39.6	43.6	47.6	51.6	55.6	59.6	62.6	65.6	68.6	71.3	72.6	71.3	67.6	63.9	58.7	53.6	48.4	43.3	118.3
398	36.6	40.6	44.6	48.6	52.6	56.6	60.6	63.6	66.6	69.6	72.3	73.6	72.3	68.6	64.9	59.7	54.6	49.4	44.3	119.3
501	37.6	41.6	45.6	49.6	53.6	57.6	61.6	64.6	67.6	70.6	73.3	74.6	73.3	69.6	65.9	60.7	55.6	50.4	45.3	120.3
630	38.6	42.6	46.6	50.6	54.6	58.6	62.6	65.6	68.6	71.6	74.3	75.6	74.3	70.6	66.9	61.7	56.6	51.4	46.3	121.3
794	39.7	43.7	47.7	51.7	55.7	59.7	63.7	66.7	69.7	72.7	75.4	76.7	75.4	71.7	68.0	62.8	57.7	52.5	47.4	122.4
999	40.7	44.7	48.7	52.7	56.7	60.7	64.7	67.7	70.7	73.7	76.4	77.7	76.4	72.7	69.0	63.8	58.7	53.5	48.4	123.4
1258	41.8	45.8	49.8	53.8	57.8	61.8	65.8	68.8	71.8	74.8	77.5	78.8	77.5	73.8	70.1	64.9	59.8	54.6	49.5	124.5
1584	42.9	46.9	50.9	54.9	58.9	62.9	66.9	69.9	72.9	75.9	78.6	79.9	78.6	74.9	71.2	66.0	60.9	55.7	50.6	125.6
1995	44.0	48.0	52.0	56.0	60.0	64.0	68.0	71.0	74.0	77.0	79.7	81.0	79.7	76.0	72.3	67.1	62.0	56.8	51.7	126.7
2511	45.1	49.1	53.1	57.1	61.1	65.1	69.1	72.1	75.1	78.1	80.8	82.1	80.8	77.1	73.4	68.2	63.1	57.9	52.8	127.8
3162	46.3	50.3	54.3	58.3	62.3	66.3	70.3	73.3	76.3	79.3	82.0	83.3	82.0	78.3	74.6	69.4	64.3	59.1	54.0	129.0
3981	47.7	51.7	55.7	59.7	63.7	67.7	71.7	74.7	77.7	80.7	83.4	84.7	83.4	79.7	76.0	70.8	65.7	60.5	55.4	130.4
5011	48.9	52.9	56.9	60.9	64.9	68.9	72.9	75.9	78.9	81.9	84.6	85.9	84.6	80.9	77.2	72.0	66.9	61.7	56.6	131.6
6309	50.5	54.5	58.5	62.5	66.5	70.5	74.5	77.5	80.5	83.5	86.2	87.5	86.2	82.5	78.8	73.6	68.5	63.3	58.2	133.2
7943	52.4	56.4	60.4	64.4	68.4	72.4	76.4	79.4	82.4	85.4	88.1	89.4	88.1	84.4	80.7	75.5	70.4	65.2	60.1	135.1
9999	54.7	58.7	62.7	66.7	70.7	74.7	78.7	81.7	84.7	87.7	90.4	91.7	90.4	86.7	83.0	77.8	72.7	67.5	62.4	137.4
OSPL	59.5	63.5	67.5	71.5	75.5	79.5	83.5	86.5	89.5	92.5	95.2	96.5	95.2	91.5	87.8	82.7	77.5	72.4	67.2	142.3
PNL	71.1	75.1	79.2	83.2	87.2	91.2	95.3	98.3	101.3	104.3	107.0	108.3	107.0	103.3	99.6	94.4	89.2	84.1	78.9	
PNLT	71.1	75.2	79.2	83.2	87.2	91.3	95.3	98.3	101.3	104.3	107.0	108.3	107.0	103.3	99.6	94.4	89.3	84.1	78.9	

TABLE VIII. - Concluded.

QSR4 (YF102) NOISE: SINGLE ENGINE, NO FLAPS, NO ATTENUATION

ENGINE PERFORMANCE PARAMETER = 87.70

1 ENGINE(S) AT A CONSTANT RADIUS OF 100.0 FEET, IN THE PLANE OF PHI = 0.0 DEGREES

SOURCES AND EFFECTS INCLUDED ARE DESIGNATED BY CODE > OR =1.
 SOURCES: IFAN =1, IFJET =1, IFAP =0, ICORE =1, ITURB =1, IAIRF =0, IREVR =0
 PROPAGATION EFFECTS: IATM =0, IGND =1, IEGA =0, IDOP =0, ISHLD =0, ICORR =1

FREQ	POLAR ANGLE, THETA, DEGREES																POWER LEVEL		
	0.0	10.0	20.0	30.0	40.0	50.0	60.0	70.0	80.0	90.0	100.0	110.0	120.0	130.0	140.0	150.0	160.0	170.0	180.0
50	78.8	78.9	79.0	79.2	79.4	79.8	80.2	80.7	81.3	81.9	82.7	83.6	83.6	87.5	91.5	93.8	96.0	170.0	180.0
63	80.2	80.3	80.4	80.7	81.0	81.4	81.8	82.3	83.0	83.8	84.7	85.6	86.0	90.0	93.9	96.2	98.3	95.9	94.2
79	81.4	81.5	81.7	81.9	82.3	82.8	83.3	83.9	84.6	85.4	86.4	87.4	88.2	91.9	95.7	98.2	99.7	97.7	95.7
99	82.3	82.4	82.6	83.0	83.4	84.0	84.6	85.2	86.0	86.9	87.9	88.9	90.0	93.4	97.2	99.9	100.4	98.3	96.2
125	83.1	83.2	83.5	83.8	84.3	85.0	85.6	86.3	87.1	88.1	89.3	90.3	91.6	94.7	98.3	101.1	100.7	98.0	95.7
158	83.8	83.9	84.2	84.6	85.2	85.9	86.6	87.3	88.2	89.2	90.4	91.5	92.9	95.8	99.0	102.0	100.5	97.2	94.7
199	84.2	84.4	84.7	85.2	85.9	86.7	87.4	88.1	89.0	90.0	91.3	92.4	94.0	96.6	99.4	101.9	99.5	96.3	93.6
251	84.5	84.7	85.1	85.7	86.4	87.3	88.0	88.7	89.6	90.7	92.0	93.2	94.7	97.1	99.4	101.1	98.1	95.2	92.4
316	84.7	85.0	85.4	86.0	86.9	87.9	88.6	89.1	90.0	91.2	92.5	93.7	95.3	97.4	98.9	99.9	96.6	94.0	91.2
398	84.8	85.1	85.6	86.3	87.4	88.6	89.2	89.5	90.3	91.5	92.8	94.0	95.6	97.5	98.2	98.6	95.1	92.7	90.1
501	84.9	85.2	85.8	86.7	88.1	89.5	90.0	89.8	90.4	91.5	92.9	94.2	95.7	97.3	97.4	97.2	94.0	91.3	89.0
630	85.1	85.5	86.3	87.4	89.2	90.8	91.2	90.3	90.4	91.5	92.9	94.2	95.7	96.9	96.5	95.8	92.3	90.0	88.1
794	85.7	86.3	87.3	88.7	91.0	92.7	92.9	91.2	90.6	91.5	92.8	94.2	95.4	96.3	95.3	94.4	90.8	88.8	87.3
999	87.1	87.9	89.1	90.7	93.3	95.2	95.3	92.8	91.2	91.7	92.8	94.1	95.2	95.7	94.3	93.2	89.4	88.1	86.9
1258	89.0	89.9	91.2	93.0	95.8	97.7	97.7	94.8	92.2	92.3	94.2	94.2	95.0	95.1	93.6	92.3	89.4	88.1	87.2
1584	91.5	92.4	93.8	95.7	98.6	100.5	100.5	97.3	94.1	93.6	94.1	94.8	95.2	95.0	93.5	92.3	90.2	89.2	88.5
1995	94.2	95.2	96.7	98.6	101.5	103.5	103.5	100.1	96.5	95.5	95.7	96.0	96.1	95.7	94.4	93.3	91.9	91.1	90.5
2511	91.8	92.8	94.2	95.9	98.7	100.5	100.5	97.2	93.9	93.4	94.0	94.6	94.8	94.4	92.8	91.1	89.4	88.5	87.8
3162	90.1	91.0	92.3	93.7	96.1	97.8	97.7	94.5	91.8	91.9	93.0	94.0	94.3	93.8	92.0	89.6	87.3	86.0	85.2
3981	99.9	101.3	102.8	102.9	103.1	102.3	100.6	98.0	96.5	97.4	98.9	100.6	101.5	101.4	99.4	96.0	92.6	89.1	85.7
5011	89.6	90.6	91.7	92.1	93.2	93.4	92.9	90.6	89.8	91.4	93.3	94.7	95.0	94.6	92.4	88.9	85.4	82.5	80.8
6309	90.1	91.1	92.2	92.4	92.9	92.3	91.5	89.8	89.9	91.9	94.1	95.4	95.7	95.2	93.0	89.2	85.4	81.7	79.2
7943	95.8	97.1	98.5	98.5	98.6	97.5	95.7	93.9	93.9	95.8	97.8	99.5	100.0	99.8	97.7	94.0	90.3	86.2	81.9
9999	90.8	91.8	92.8	92.9	93.0	91.6	90.4	89.9	91.3	93.7	96.1	97.4	97.4	96.4	94.1	90.0	85.9	81.3	77.4
OSPL	104.4	105.5	106.8	107.5	108.9	109.8	109.5	106.9	105.2	105.9	107.3	108.5	109.3	110.0	110.3	111.1	109.7	107.1	105.0
PNL	119.5	120.7	122.0	122.5	123.4	123.5	122.7	120.4	119.1	119.9	121.3	122.6	123.4	123.7	122.6	120.9	118.3	115.6	113.7
PNLT	122.8	124.2	125.5	125.8	126.2	125.7	124.4	122.2	121.0	121.8	123.2	124.7	125.7	126.1	125.0	123.2	120.3	117.2	114.6

TABLE IX. - OUTPUT FROM EXAMPLE FIVE

APPROACH NOISE CALC FOR GE EEE AIRCRAFT
OBSERVER COORDINATES (IN FEET).

XO: -7518.0
YO: 0.0
ZO: 0.0
AIRCRAFT TRAJECTORY POINTS AND OPERATING CONDITIONS.
XA: -7518.0 0.0
YA: 0.0 0.0
ZA: 394.0 0.0
EPP: 24.5 24.5
VA: 228.0 228.0
ALFL: 8.8 8.8
GAM: 0.0 0.0
PSY: 0.0 0.0
FLAPA: 42.0 42.0
ILOR: 1 1
IREVR: 0 0

FREQ	SPECTRA FOR EACH NOISE SOURCE																
	50	63	79	99	125	158	199	251	316	398	501	630	794	999	1258	1584	1995
SOURCES WHEN	2511	3162	3981	5011	6309	7943	9999										
FAN	10.9	17.3	23.3	28.8	34.0	38.7	43.2	47.0	-3.8	53.6	56.1	58.3	59.9	27.9	69.5	61.7	61.3
JET	66.6	64.5	67.6	67.1	66.6	65.3	64.5	47.1	46.5	45.8	44.9	43.9	42.8	41.7	40.6	39.5	38.4
CORE	37.2	36.0	34.8	33.6	32.5	31.3	30.1	29.1	28.3	27.5	26.7	25.9	25.1	24.3	23.5	22.7	21.9
TURB	46.9	45.5	44.1	42.6	40.9	39.2	37.5	34.6	35.4	36.2	37.0	37.8	38.6	39.3	40.0	40.5	41.2
AIRFR	41.8	42.2	44.2	42.4	41.4	41.0	40.4	65.3	64.8	64.2	63.6	63.0	61.2	58.4	55.8	53.4	51.1
TOTALS	69.6	70.6	70.7	70.3	69.8	69.3	68.8	68.2	67.7	67.2	66.8	66.5	65.6	64.6	64.0	63.1	61.7
	65.3	61.4	61.5	56.7	49.6	38.1	22.0										
SOURCES WHEN	XO=-7518.0	FT,	YO=														
FAN	24.1	29.6	34.9	39.6	44.0	47.8	47.8	-3.4	54.4	56.9	59.1	60.7	60.7	29.8	70.2	62.5	62.1
JET	67.4	65.3	67.9	67.4	66.1	65.2	48.0	47.3	46.6	45.7	44.7	43.7	42.6	41.5	40.4	39.2	38.8
CORE	38.0	38.7	38.9	38.9	38.5	38.5	30.9	30.9	30.9	30.9	30.9	30.9	30.9	30.9	30.9	30.9	30.9
TURB	47.9	46.5	45.1	43.7	42.0	40.3	38.6	36.1	36.9	37.7	38.5	39.3	40.1	40.8	41.5	42.1	42.7
AIRFR	43.3	43.7	45.7	44.0	42.9	42.5	41.9	66.3	65.7	65.2	64.6	64.0	62.1	59.4	56.8	54.4	52.2
TOTALS	67.4	68.5	68.6	68.2	67.7	67.3	66.8	66.2	65.7	65.2	64.7	64.2	63.7	62.9	62.4	61.9	61.4
	70.5	71.5	71.6	71.2	70.7	70.3	69.8	69.2	68.7	68.2	67.8	67.5	66.6	65.6	65.1	64.2	62.8
	66.5	62.8	63.0	58.7	52.1	41.5	26.6										

TABLE IX. - Continued.

	SOURCES WHEN	X0=-7518.0 FT,	Y0=	0.0 FT,	TAU □	-3.0 SEC, R =	993.3 FT,	THETA □	32.2 DEG	
FAN :	12.7	25.0	35.8	40.5	44.9	52.3	57.8	61.5	62.7	63.3
	19.0	30.5	38.2	44.9	48.7	55.3	60.0	61.5	62.7	63.3
JET :	68.2	69.1	68.2	66.9	66.0		78.1	78.1	91.0	93.7
	48.7	49.6	49.9	49.7	49.4		45.6	44.6	43.5	41.3
CORE :	38.9	37.7	35.4	33.0	31.8		60.1	60.1	65.7	65.7
	41.0	43.6	46.2	50.1	52.0		54.7	54.0	53.4	50.5
TURB :	49.1	47.6	44.8	41.4	39.7		64.6	64.6	74.1	74.1
	31.4	33.2	34.1	35.0	36.8		40.2	41.0	42.5	44.4
AIRPR :	45.0	45.4	47.5	44.7	43.7		56.1	56.1	69.7	70.1
	68.5	69.5	68.7	68.3	67.3		65.0	63.1	60.4	53.4
TOTALS :	71.5	72.5	72.2	71.8	70.3		68.9	67.7	66.7	64.0
	67.7	64.2	60.6	44.8	31.2		83.0	83.0	91.7	93.9

	SOURCES WHEN	X0=-7518.0 FT,	Y0=	0.0 FT,	TAU □	-2.6 SEC, R =	889.7 FT,	THETA =	35.1 DEG	
FAN :	13.7	26.0	36.8	41.4	45.8		58.7	62.5	63.6	63.8
	20.0	31.5	36.8	41.4	45.8		58.7	62.5	63.6	63.8
JET :	69.1	70.0	69.0	67.7	66.8		47.6	45.6	44.5	41.1
	49.7	50.2	50.8	50.7	50.4		46.6	45.6	44.5	41.1
CORE :	39.9	38.7	36.4	34.0	32.8		61.1	61.1	66.8	66.8
	39.8	42.4	47.5	51.5	53.3		56.0	55.3	54.7	51.7
TURB :	50.3	48.9	46.1	44.4	41.0		65.9	65.9	75.4	75.5
	33.5	34.4	36.2	37.1	38.0		42.3	43.1	44.6	46.5
AIRPR :	47.1	47.5	49.5	46.7	45.7		58.2	58.2	71.8	72.2
	69.6	70.6	69.8	69.4	68.9		66.1	64.2	61.5	54.7
TOTALS :	52.8	51.1	49.6	47.0	44.7		80.1	80.1	84.4	84.5
	72.6	73.3	72.9	72.4	71.9		69.8	68.8	67.9	65.2
	69.0	65.6	62.7	57.1	48.2		84.1	84.1	93.1	95.3

	SOURCES WHEN	X0=-7518.0 FT,	Y0=	0.0 FT,	TAU □	-2.2 SEC, R =	789.1 FT,	THETA □	38.7 DEG	
FAN :	14.8	27.1	32.6	42.5	46.9		59.8	61.9	64.6	65.1
	21.2	32.6	37.9	42.5	46.9		59.8	61.9	64.6	65.1
JET :	70.0	70.9	70.4	68.6	67.7		48.7	46.6	45.5	42.2
	50.8	51.4	51.9	51.8	51.5		47.7	46.6	45.5	42.2
CORE :	41.0	39.8	37.5	35.1	33.9		62.2	62.2	67.9	67.9
	41.4	46.6	49.1	51.1	53.0		57.5	56.8	56.1	53.2
TURB :	51.8	50.4	47.5	44.1	42.4		67.4	67.4	76.9	77.0
	35.8	36.7	38.5	39.4	40.3		44.6	44.6	46.9	48.2
AIRPR :	49.4	49.8	51.9	48.7	48.1		60.6	60.6	74.2	74.7
	70.8	71.8	71.4	70.6	70.1		67.9	65.3	62.8	58.1
TOTALS :	54.3	52.7	49.9	47.6	46.5		81.3	81.3	85.7	85.9
	73.8	74.8	74.5	73.6	73.2		71.4	70.1	69.1	67.7
	70.4	67.1	64.7	51.6	40.4		85.4	85.4	94.5	96.6

	SOURCES WHEN	X0=-7518.0 FT,	Y0=	0.0 FT,	TAU □	-1.8 SEC, R =	692.6 FT,	THETA =	43.4 DEG	
FAN :	15.4	27.7	33.2	43.0	47.4		60.2	63.9	64.9	65.5
	21.7	33.2	38.4	43.0	47.4		60.2	63.9	64.9	65.5
JET :	70.5	68.2	70.8	68.8	67.9		48.9	47.8	46.7	43.4
	52.1	52.6	53.2	53.1	52.2		49.9	48.9	46.7	43.4
CORE :	42.2	41.0	39.8	36.3	35.1		63.4	63.4	69.2	69.2
	43.3	45.9	48.5	54.9	56.7		59.0	58.5	57.9	54.9
TURB :	53.5	52.1	50.7	47.5	45.8		69.2	69.2	78.7	78.8
	38.7	39.6	41.4	42.3	44.1		47.5	46.3	44.9	41.7
AIRPR :	52.3	52.7	54.8	51.9	50.9		63.4	63.4	77.1	77.6
	72.1	73.1	72.7	71.9	71.4		69.2	68.6	67.1	64.7
TOTALS :	55.9	54.4	53.0	49.4	48.3		82.6	82.6	87.2	87.3
	75.1	76.1	75.7	74.9	74.5		72.7	71.2	70.1	67.4
	71.2	68.0	66.2	54.3	44.2		86.6	86.6	95.6	97.7

TABLE IX. - Continued.

SOURCES WHEN	X0=-7518.0 FT,	Y0=	0.0 FT,	TAU =	-1.4 SEC,	R =	602.3 FT,	THETA =	49.6 DEG							
FAN :	15.6	21.9	27.9	33.3	38.5	43.1	47.5	51.3	54.8	57.7	60.2	62.3	63.8	64.8	65.3	65.0
JET :	15.6	68.0	70.7	70.0	54.6	54.4	54.1	53.6	52.9	52.2	51.2	50.2	49.2	48.1	47.0	45.9
CORE :	43.5	42.3	41.1	40.0	38.8	37.6	36.4	35.9	35.0	34.3	33.6	33.0	32.4	31.8	31.2	30.6
TURB :	55.4	54.0	52.6	51.2	49.5	47.8	46.1	44.5	43.3	42.1	40.9	39.7	38.5	37.3	36.1	34.9
AIRFR :	73.4	74.4	74.4	74.0	73.6	73.2	72.8	72.3	71.8	71.2	70.6	70.0	69.4	68.8	68.2	67.6
TOTALS:	76.5	77.5	77.4	77.0	76.7	76.3	75.9	75.5	75.0	74.5	74.1	73.6	73.2	72.7	72.3	71.8
	71.9	68.6	70.0	67.2	63.1	56.4	47.4									
SOURCES WHEN	X0=-7518.0 FT,	Y0=	0.0 FT,	TAU =	-0.9 SEC,	R =	521.3 FT,	THETA =	57.8 DEG							
FAN :	15.4	21.7	27.5	33.0	38.1	42.7	47.0	50.8	54.2	57.2	59.6	61.7	63.2	64.2	64.6	64.4
JET :	69.9	67.3	70.5	69.8	69.1	67.5	66.5	65.5	64.3	63.6	62.7	61.7	60.6	59.5	58.4	57.3
CORE :	44.9	43.7	42.5	41.3	40.2	39.0	37.8	36.8	35.7	34.6	33.5	32.4	31.3	30.2	29.1	28.0
TURB :	57.2	55.8	54.4	52.9	51.2	49.5	47.8	46.1	44.5	43.3	42.1	40.9	39.7	38.5	37.3	36.1
AIRFR :	74.7	75.7	75.2	74.9	74.5	74.1	73.6	73.1	72.5	71.9	71.2	70.6	70.0	69.4	68.8	68.2
TOTALS:	77.8	78.8	78.6	78.3	78.0	77.6	77.3	76.9	76.4	75.9	75.4	74.9	74.3	73.7	73.2	72.6
	72.0	69.0	70.4	67.7	64.0	57.9	49.9									
SOURCES WHEN	X0=-7518.0 FT,	Y0=	0.0 FT,	TAU =	-0.5 SEC,	R =	456.7 FT,	THETA =	68.7 DEG							
FAN :	15.3	21.6	27.4	32.8	37.9	42.5	46.7	50.5	53.9	56.8	59.2	61.3	62.7	63.7	64.0	64.5
JET :	69.4	67.0	69.8	69.0	68.3	66.5	65.4	64.5	63.4	62.3	61.2	60.1	59.0	57.9	56.8	55.7
CORE :	46.3	45.1	43.9	42.7	41.6	40.4	39.2	38.1	37.0	35.9	34.8	33.7	32.6	31.5	30.4	29.3
TURB :	58.8	57.4	55.9	54.4	52.7	51.0	49.3	47.6	46.0	44.4	42.8	41.2	39.6	38.0	36.4	34.8
AIRFR :	75.7	76.7	76.4	76.1	75.8	75.5	75.1	74.7	74.1	73.5	72.9	72.1	71.3	70.5	69.7	68.9
TOTALS:	78.8	79.8	79.5	79.2	78.9	78.7	78.4	78.0	77.6	77.1	76.5	76.0	75.4	74.8	74.3	73.7
	72.6	70.3	71.4	68.6	65.1	59.8	52.6									
SOURCES WHEN	X0=-7518.0 FT,	Y0=	0.0 FT,	TAU =	-0.0 SEC,	R =	409.6 FT,	THETA =	82.7 DEG							
FAN :	17.8	24.0	29.8	35.2	40.2	44.8	49.0	52.8	56.1	59.0	61.4	63.4	64.8	65.7	66.2	67.2
JET :	71.4	70.9	69.6	70.6	69.8	68.0	66.6	65.4	64.2	63.0	61.8	60.6	59.4	58.2	57.0	55.8
CORE :	47.5	46.3	45.1	44.0	42.8	41.6	40.4	39.2	38.0	36.8	35.6	34.4	33.2	32.0	30.8	29.6
TURB :	60.3	58.9	57.5	55.9	54.2	52.5	50.8	49.1	47.4	45.7	44.0	42.3	40.6	38.9	37.2	35.5
AIRFR :	75.9	76.5	76.4	76.2	76.0	75.7	75.4	74.9	74.4	73.8	73.1	72.0	70.9	69.7	68.5	67.3
TOTALS:	79.0	79.7	79.5	79.2	78.9	78.7	78.4	78.0	77.6	77.2	76.7	76.3	75.8	75.4	74.9	74.5
	75.1	74.2	73.7	71.4	68.1	63.4	56.8									

TABLE IX. - Concluded.

SOURCES WHEN		XO=-7518.0 FT,	YO=	0.0 FT,	TAU □	5.0 SEC,	R =	993.3 FT,	THEIA =	165.5 DEG				
FAN :	6.1	12.0	27.1	31.4	35.2	38.6	41.6	44.1	46.2	47.8	48.8	49.4	48.7	53.7
JET :	53.0	51.2	49.7	48.3	46.5	44.1	41.6	39.5	37.7	36.5	35.2	34.0	32.3	30.4
CORE :	21.1	19.5	17.9	16.3	14.9	13.5	12.3	11.3	10.4	9.9	9.3	8.8	8.2	7.7
TURB :	52.2	50.8	49.2	47.5	45.8	44.1	42.4	40.7	39.4	38.6	37.7	36.9	36.1	35.3
AIRFR :	41.8	42.6	40.7	39.4	38.6	37.8	37.0	36.1	35.3	34.5	33.6	32.8	32.0	31.2
TOTALS :	66.7	66.3	65.9	65.7	65.7	65.7	65.7	65.7	65.7	65.6	65.6	65.6	65.6	65.6
SOURCES WHEN		XO=-7518.0 FT,	YO=	0.0 FT,	TAU =	5.6 SEC,	R =	1098.9 FT,	THEIA =	167.8 DEG				
FAN :	4.1	9.9	25.0	29.3	33.1	36.5	39.5	42.1	44.1	45.7	46.7	47.3	46.6	51.7
JET :	51.0	49.1	47.2	45.0	43.1	41.3	39.5	37.7	36.0	34.3	32.6	31.0	29.3	27.7
CORE :	18.2	16.6	15.1	13.7	12.4	11.3	10.4	9.9	9.3	8.8	8.2	7.7	7.2	6.7
TURB :	51.2	49.8	48.2	46.5	44.8	43.1	41.4	39.7	38.0	36.3	34.6	32.9	31.2	29.5
AIRFR :	39.6	40.4	38.6	37.3	36.4	35.7	35.2	34.7	34.2	33.7	33.2	32.7	32.2	31.7
TOTALS :	66.3	65.8	65.2	65.1	65.1	65.1	65.1	65.1	65.1	65.1	65.1	65.1	65.1	65.1
SOURCES WHEN		XO=-7518.0 FT,	YO=	0.0 FT,	TAU =	6.2 SEC,	R =	1206.0 FT,	THEIA =	169.8 DEG				
FAN :	2.3	8.2	23.3	27.5	31.3	34.8	37.7	40.3	42.3	43.9	44.9	45.5	44.8	50.0
JET :	49.3	47.3	45.8	44.4	42.6	40.6	38.7	36.8	35.0	33.2	31.4	29.6	27.8	26.0
CORE :	15.9	14.4	13.0	11.8	10.8	9.9	9.3	8.8	8.2	7.7	7.2	6.7	6.2	5.7
TURB :	50.4	49.0	47.4	45.7	44.0	42.3	40.6	38.9	37.2	35.5	33.8	32.1	30.4	28.7
AIRFR :	37.8	38.6	36.8	35.4	34.6	33.8	33.4	32.8	32.2	31.6	31.0	30.4	29.8	29.2
TOTALS :	65.9	65.4	65.0	64.7	64.6	64.5	64.4	64.3	64.2	64.1	64.0	63.9	63.8	63.7

VALUES OF EPNL
 POS YO POSITION
 -7518. LEVEL 97.6
 THEIA 115.0
 TIME 0.96

TABLE X. - Continued.

TOTAL	-7000.0	413.3	-15.172	73.4	87.4	87.9
TOTAL	-7000.0	413.3	-14.166	78.2	88.2	88.7
TOTAL	-7000.0	413.3	-13.148	73.7	88.5	89.0
TOTAL	-7000.0	413.3	-12.119	77.5	88.1	88.7
TOTAL	-7000.0	413.3	-11.079	77.5	87.5	88.5
TOTAL	-7000.0	413.3	-10.031	77.9	86.7	87.7
TOTAL	-7000.0	413.3	-8.975	78.3	86.0	87.1
TOTAL	-7000.0	413.3	-7.912	78.7	85.0	86.2
TOTAL	-7000.0	413.3	-6.844	79.0	84.2	85.0
TOTAL	-7000.0	413.3	-5.771	79.1	83.3	84.1
TOTAL	-7000.0	413.3	-4.693	79.1	82.5	83.3
(Second iteration begins here)						
TOTAL	-7000.0	366.5	75.0	80.0	80.9	80.9
TOTAL	-7000.0	366.5	24.704	80.7	81.6	81.6
TOTAL	-7000.0	366.5	23.781	81.3	82.6	82.6
TOTAL	-7000.0	366.5	22.655	81.3	83.1	83.1
TOTAL	-7000.0	366.5	21.924	82.4	83.6	83.6
TOTAL	-7000.0	366.5	20.988	82.9	84.0	84.0
TOTAL	-7000.0	366.5	19.094	83.6	84.6	84.6
TOTAL	-7000.0	366.5	18.134	84.4	85.2	85.2
TOTAL	-7000.0	366.5	17.164	85.5	86.0	86.0
TOTAL	-7000.0	366.5	16.182	86.7	87.1	87.1
TOTAL	-7000.0	366.5	15.182	87.7	88.2	88.2
TOTAL	-7000.0	366.5	14.164	88.6	89.0	89.0
TOTAL	-7000.0	366.5	13.164	89.5	89.3	89.3
TOTAL	-7000.0	366.5	12.134	90.0	89.9	89.9
TOTAL	-7000.0	366.5	11.094	90.0	90.4	90.4
TOTAL	-7000.0	366.5	10.045	90.0	91.1	91.1
TOTAL	-7000.0	366.5	8.924	90.0	92.2	92.2
TOTAL	-7000.0	366.5	7.825	90.0	93.1	93.1
TOTAL	-7000.0	366.5	6.781	90.0	94.2	94.2
TOTAL	-7000.0	366.5	5.704	90.0	95.4	95.4
(and at location X0=100)						
TOTAL	1000.0	500.0	44.305	57.1	68.5	69.5
TOTAL	1000.0	500.0	44.220	58.9	69.9	70.9
TOTAL	1000.0	500.0	46.142	59.6	71.3	72.5
TOTAL	1000.0	500.0	47.071	60.7	72.6	73.5
TOTAL	1000.0	500.0	48.007	61.5	73.4	74.3
TOTAL	1000.0	500.0	48.953	62.2	74.3	75.3
TOTAL	1000.0	500.0	49.908	63.0	75.4	76.6
TOTAL	1000.0	500.0	50.873	64.5	77.0	78.7
TOTAL	1000.0	500.0	51.849	65.6	79.2	81.4
TOTAL	1000.0	500.0	52.830	67.6	81.8	84.3
TOTAL	1000.0	500.0	53.834	69.8	84.7	87.3
TOTAL	1000.0	500.0	54.844	72.4	86.7	89.8
TOTAL	1000.0	500.0	55.859	73.3	87.9	91.1
TOTAL	1000.0	500.0	56.877	73.8	88.6	92.0
TOTAL	1000.0	500.0	57.896	73.0	87.5	90.7
TOTAL	1000.0	500.0	58.915	72.3	86.6	89.6
TOTAL	1000.0	500.0	59.934	71.3	85.1	87.8
TOTAL	1000.0	500.0	60.951	70.5	83.7	86.4
TOTAL	1000.0	500.0	61.967	69.8	82.7	85.3
TOTAL	1000.0	500.0	62.981	69.3	81.8	84.3
TOTAL	1000.0	1000.0	63.979	68.4	81.1	83.8
TOTAL	1000.0	1000.0	64.958	67.4	80.3	82.9
TOTAL	1000.0	1000.0	65.914	66.4	79.4	81.9
TOTAL	1000.0	1000.0	66.848	65.4	78.4	80.9
TOTAL	1000.0	1000.0	67.761	64.4	77.4	79.9
TOTAL	1000.0	1000.0	68.655	63.4	76.4	78.9
TOTAL	1000.0	1000.0	69.528	62.4	75.4	77.9
TOTAL	1000.0	1000.0	70.382	61.4	74.4	76.9
TOTAL	1000.0	1000.0	71.215	60.4	73.4	75.9
TOTAL	1000.0	1000.0	72.028	59.4	72.4	74.9
TOTAL	1000.0	1000.0	72.821	58.4	71.4	73.9
TOTAL	1000.0	1000.0	73.594	57.4	70.4	72.9
TOTAL	1000.0	1000.0	74.347	56.4	69.4	71.9
TOTAL	1000.0	1000.0	75.080	55.4	68.4	70.9
TOTAL	1000.0	1000.0	75.793	54.4	67.4	69.9
TOTAL	1000.0	1000.0	76.486	53.4	66.4	68.9
TOTAL	1000.0	1000.0	77.160	52.4	65.4	67.9
TOTAL	1000.0	1000.0	77.814	51.4	64.4	66.9
TOTAL	1000.0	1000.0	78.448	50.4	63.4	65.9
TOTAL	1000.0	1000.0	79.062	49.4	62.4	64.9
TOTAL	1000.0	1000.0	79.656	48.4	61.4	63.9
TOTAL	1000.0	1000.0	80.230	47.4	60.4	62.9
TOTAL	1000.0	1000.0	80.784	46.4	59.4	61.9
TOTAL	1000.0	1000.0	81.318	45.4	58.4	60.9
TOTAL	1000.0	1000.0	81.832	44.4	57.4	59.9
TOTAL	1000.0	1000.0	82.326	43.4	56.4	58.9
TOTAL	1000.0	1000.0	82.800	42.4	55.4	57.9
TOTAL	1000.0	1000.0	83.254	41.4	54.4	56.9
TOTAL	1000.0	1000.0	83.688	40.4	53.4	55.9
TOTAL	1000.0	1000.0	84.102	39.4	52.4	54.9
TOTAL	1000.0	1000.0	84.496	38.4	51.4	53.9
TOTAL	1000.0	1000.0	84.870	37.4	50.4	52.9
TOTAL	1000.0	1000.0	85.224	36.4	49.4	51.9
TOTAL	1000.0	1000.0	85.558	35.4	48.4	50.9
TOTAL	1000.0	1000.0	85.872	34.4	47.4	49.9
TOTAL	1000.0	1000.0	86.166	33.4	46.4	48.9
TOTAL	1000.0	1000.0	86.440	32.4	45.4	47.9
TOTAL	1000.0	1000.0	86.694	31.4	44.4	46.9
TOTAL	1000.0	1000.0	86.928	30.4	43.4	45.9
TOTAL	1000.0	1000.0	87.142	29.4	42.4	44.9
TOTAL	1000.0	1000.0	87.336	28.4	41.4	43.9
TOTAL	1000.0	1000.0	87.510	27.4	40.4	42.9
TOTAL	1000.0	1000.0	87.664	26.4	39.4	41.9
TOTAL	1000.0	1000.0	87.798	25.4	38.4	40.9
TOTAL	1000.0	1000.0	87.912	24.4	37.4	39.9
TOTAL	1000.0	1000.0	88.006	23.4	36.4	38.9
TOTAL	1000.0	1000.0	88.080	22.4	35.4	37.9
TOTAL	1000.0	1000.0	88.134	21.4	34.4	36.9
TOTAL	1000.0	1000.0	88.168	20.4	33.4	35.9
TOTAL	1000.0	1000.0	88.182	19.4	32.4	34.9
TOTAL	1000.0	1000.0	88.176	18.4	31.4	33.9
TOTAL	1000.0	1000.0	88.150	17.4	30.4	32.9
TOTAL	1000.0	1000.0	88.104	16.4	29.4	31.9
TOTAL	1000.0	1000.0	88.038	15.4	28.4	30.9
TOTAL	1000.0	1000.0	87.952	14.4	27.4	29.9
TOTAL	1000.0	1000.0	87.846	13.4	26.4	28.9
TOTAL	1000.0	1000.0	87.720	12.4	25.4	27.9
TOTAL	1000.0	1000.0	87.574	11.4	24.4	26.9
TOTAL	1000.0	1000.0	87.408	10.4	23.4	25.9
TOTAL	1000.0	1000.0	87.222	9.4	22.4	24.9
TOTAL	1000.0	1000.0	87.016	8.4	21.4	23.9
TOTAL	1000.0	1000.0	86.790	7.4	20.4	22.9
TOTAL	1000.0	1000.0	86.544	6.4	19.4	21.9
TOTAL	1000.0	1000.0	86.278	5.4	18.4	20.9
TOTAL	1000.0	1000.0	86.002	4.4	17.4	19.9
TOTAL	1000.0	1000.0	85.706	3.4	16.4	18.9
TOTAL	1000.0	1000.0	85.390	2.4	15.4	17.9
TOTAL	1000.0	1000.0	85.054	1.4	14.4	16.9
TOTAL	1000.0	1000.0	84.708	0.4	13.4	15.9
TOTAL	1000.0	1000.0	84.352	0.4	12.4	14.9
TOTAL	1000.0	1000.0	83.986	0.4	11.4	13.9
TOTAL	1000.0	1000.0	83.610	0.4	10.4	12.9
TOTAL	1000.0	1000.0	83.224	0.4	9.4	11.9
TOTAL	1000.0	1000.0	82.828	0.4	8.4	10.9
TOTAL	1000.0	1000.0	82.422	0.4	7.4	9.9
TOTAL	1000.0	1000.0	82.006	0.4	6.4	8.9
TOTAL	1000.0	1000.0	81.580	0.4	5.4	7.9
TOTAL	1000.0	1000.0	81.144	0.4	4.4	6.9
TOTAL	1000.0	1000.0	80.708	0.4	3.4	5.9
TOTAL	1000.0	1000.0	80.272	0.4	2.4	4.9
TOTAL	1000.0	1000.0	79.836	0.4	1.4	3.9
TOTAL	1000.0	1000.0	79.400	0.4	0.4	2.9
TOTAL	1000.0	1000.0	78.964	0.4	0.4	1.9
TOTAL	1000.0	1000.0	78.528	0.4	0.4	0.9
TOTAL	1000.0	1000.0	78.092	0.4	0.4	0.9
TOTAL	1000.0	1000.0	77.656	0.4	0.4	0.9
TOTAL	1000.0	1000.0	77.220	0.4	0.4	0.9
TOTAL	1000.0	1000.0	76.784	0.4	0.4	0.9
TOTAL	1000.0	1000.0	76.348	0.4	0.4	0.9
TOTAL	1000.0	1000.0	75.912	0.4	0.4	0.9
TOTAL	1000.0	1000.0	75.476	0.4	0.4	0.9
TOTAL	1000.0	1000.0	75.040	0.4	0.4	0.9
TOTAL	1000.0	1000.0	74.604	0.4	0.4	0.9
TOTAL	1000.0	1000.0	74.168	0.4	0.4	0.9
TOTAL	1000.0	1000.0	73.732	0.4	0.4	0.9
TOTAL	1000.0	1000.0	73.296	0.4	0.4	0.9
TOTAL	1000.0	1000.0	72.860	0.4	0.4	0.9
TOTAL	1000.0	1000.0	72.424	0.4	0.4	0.9
TOTAL	1000.0	1000.0	71.988	0.4	0.4	0.9
TOTAL	1000.0	1000.0	71.552	0.4	0.4	0.9
TOTAL	1000.0	1000.0	71.116	0.4	0.4	0.9
TOTAL	1000.0	1000.0	70.680	0.4	0.4	0.9
TOTAL	1000.0	1000.0	70.244	0.4	0.4	0.9
TOTAL	1000.0	1000.0	69.808	0.4	0.4</	

TABLE X. - Continued.

TOTAL	:	1000.0	1000.0	48.368	59.4	67.3	69.0
TOTAL	:	1000.0	1000.0	49.335	57.1	68.5	70.5
TOTAL	:	1000.0	1000.0	50.309	58.9	69.9	72.7
TOTAL	:	1000.0	1000.0	51.277	58.9	71.3	73.7
TOTAL	:	1000.0	1000.0	52.277	61.0	72.7	75.3
TOTAL	:	1000.0	1000.0	53.270	61.0	74.1	76.8
TOTAL	:	1000.0	1000.0	54.268	62.0	75.4	78.2
TOTAL	:	1000.0	1000.0	55.270	64.3	76.8	79.7
TOTAL	:	1000.0	1000.0	56.275	64.8	77.7	80.7
TOTAL	:	1000.0	1000.0	57.282	65.3	78.4	81.5
TOTAL	:	1000.0	1000.0	58.292	65.7	79.0	82.3
TOTAL	:	1000.0	1000.0	59.302	65.8	79.2	82.6
TOTAL	:	1000.0	1000.0	60.313	65.9	79.4	82.8
TOTAL	:	1000.0	1000.0	61.324	65.9	79.4	82.8
TOTAL	:	1000.0	1000.0	62.334	65.5	79.1	82.5
TOTAL	:	1000.0	1000.0	63.344	65.5	78.8	82.1
TOTAL	:	1000.0	1000.0	64.352	65.3	78.5	81.8
(First iteration begins here)							
TOTAL	:	1000.0	447.5	44.284	57.3	68.8	69.8
TOTAL	:	1000.0	447.5	45.197	57.6	70.3	71.2
TOTAL	:	1000.0	447.5	46.116	58.9	71.7	72.6
TOTAL	:	1000.0	447.5	47.042	61.3	73.2	74.2
TOTAL	:	1000.0	447.5	47.976	62.0	74.3	75.3
TOTAL	:	1000.0	447.5	48.918	63.0	75.3	76.3
TOTAL	:	1000.0	447.5	49.869	63.8	76.2	77.2
TOTAL	:	1000.0	447.5	50.831	64.8	77.7	79.3
TOTAL	:	1000.0	447.5	51.805	66.6	80.0	82.1
TOTAL	:	1000.0	447.5	52.789	68.0	82.8	85.3
TOTAL	:	1000.0	447.5	53.785	71.0	85.7	88.5
TOTAL	:	1000.0	447.5	54.789	73.7	88.2	91.3
TOTAL	:	1000.0	447.5	55.800	74.7	89.4	92.7
TOTAL	:	1000.0	447.5	56.816	74.7	89.5	92.8
TOTAL	:	1000.0	447.5	57.836	73.8	88.3	91.4
TOTAL	:	1000.0	447.5	58.856	73.7	86.8	89.6
TOTAL	:	1000.0	447.5	59.877	71.6	85.1	87.5
TOTAL	:	1000.0	447.5	60.897	70.8	83.8	85.9
TOTAL	:	1000.0	447.5	61.916	70.1	82.6	84.5
TOTAL	:	1000.0	447.5	62.933	69.5	81.7	83.4
TOTAL	:	1000.0	447.5	63.948	69.1	80.9	82.5

TABLE X. - Concluded.

(at this point regular output begins)
 QSRA FOOTPRINT CONTOUR, LANDING AND GROUND ROLL

VALUES OF EPNL
 YO POSITION

500.	LEVEL	1000.
88.6	THETA	86.1
107.5	TIME	108.4
-17.26	LEVEL	-15.98
89.2	THETA	86.5
108.0	TIME	108.7
-13.11	LEVEL	-11.82
90.5	THETA	87.1
109.3	TIME	109.2
-4.82	LEVEL	-3.51
92.7	THETA	88.4
112.4	TIME	115.4
11.78	LEVEL	14.18
95.0	THETA	90.6
115.4	TIME	116.0
28.43	LEVEL	30.88
96.4	THETA	90.6
116.0	TIME	110.0
36.78	LEVEL	38.21
91.6	THETA	85.9
76.8	TIME	83.3
42.12	LEVEL	42.55
89.8	THETA	85.1
109.9	TIME	61.6
49.79	LEVEL	43.32
89.4	THETA	85.4
109.9	TIME	109.7
56.86	LEVEL	61.32
84.3	THETA	77.1
89.7	TIME	89.9
67.48	LEVEL	67.92
80.7	THETA	75.1
78.6	TIME	84.2
67.49	LEVEL	67.93

COORDINATES FOR "EPNL" CONTOUR

CONTOUR LEVEL =	90.0 DB				
X - COORD (FT):	-7500.0	-7000.0	-6000.0	-4000.0	-2000.0
Y - COORD (FT):	42.1	366.5	570.0	801.0	1074.9
APPROX. CONTOUR AREA	= 0.642E 07 SQ FT, 147.48 ACRES, 0.23 SQ MILES				
	0.0	500.0	1000.0	1500.0	1600.0
	621.1	485.9	447.5	257.5	94.7

TABLE XI. - OUTPUT SAMPLES FOR VARIOUS OPTIONS OF IOU

This table is discussed in the text of this report.

For IOU = 1,0,0: (see Output from Example One (table V))

For IOU = 2,0,0:

SOURCE	XO	Y0	TAU	OASPL	PNL	PMLT
FAN	-2000.0	500.0	21.605	74.5	87.2	88.3
CORE	-2000.0	500.0	21.605	65.9	74.7	74.7
TURB	-2000.0	500.0	21.605	61.2	72.6	72.6
FLAP	-2000.0	500.0	21.605	75.6	79.6	79.6
TOTAL	-2000.0	500.0	21.605	79.2	87.9	89.1
FAN	-2000.0	500.0	22.534	74.1	86.9	88.0
CORE	-2000.0	500.0	22.534	67.6	76.5	76.5
TURB	-2000.0	500.0	22.534	64.7	76.1	76.1
FLAP	-2000.0	500.0	22.534	76.3	80.3	80.3
TOTAL	-2000.0	500.0	22.534	80.0	88.6	89.8
FAN	-2000.0	500.0	23.473	73.4	86.2	87.3
CORE	-2000.0	500.0	23.473	69.3	78.2	78.2
TURB	-2000.0	500.0	23.473	68.6	80.0	80.0
FLAP	-2000.0	500.0	23.473	77.0	81.0	81.0
TOTAL	-2000.0	500.0	23.473	80.7	89.2	90.3

(and similar output for the remaining times and observer points)

For IOU = 3,0,0:

SOURCE	XO	Y0	TAU	OASPL	PNL	PMLT
TOTAL	-2000.0	500.0	21.605	79.2	87.9	89.1
TOTAL	-2000.0	500.0	22.534	80.0	88.6	89.8
TOTAL	-2000.0	500.0	23.473	80.7	89.2	90.3
TOTAL	-2000.0	500.0	24.425	81.4	90.0	90.9
TOTAL	-2000.0	500.0	25.394	82.1	91.7	92.2
TOTAL	-2000.0	500.0	26.384	82.6	93.9	94.3
TOTAL	-2000.0	500.0	27.394	83.1	95.3	95.7
TOTAL	-2000.0	500.0	28.425	84.7	95.9	96.3
TOTAL	-2000.0	500.0	29.473	85.9	95.2	96.2
TOTAL	-2000.0	1000.0	23.846	76.7	83.1	84.1
TOTAL	-2000.0	1000.0	24.817	77.1	84.1	84.6

(continues through for each time and observer)

TABLE XI. - Continued.

FOR IOUT = 0.1,0: (compare summary of Output from Example One, table V)
 QSRA LANDING CALCULATION, ENGINE MAP FROM TEST DATA

			VALUES OF PNL-MAX
			YO POSITION
XO ,			
POS			
-2000.	LEVEL	500.	1000.
	THETA	95.9	89.7
	TIME	115.4	110.3
-1000.	LEVEL	28.43	29.85
	THETA	98.5	91.4
	TIME	116.0	110.0
0.	LEVEL	36.78	38.21
	THETA	93.8	86.3
	TIME	76.8	83.3
		42.12	42.55

FOR IOUT = 0.2,0: (compare Output from Example Two, table VI)
 QSRA LANDING CALCULATION, ENGINE MAP FROM TEST DATA

			VALUES OF PNL-MAX
			YO POSITION
XO ,			
POS			
-2000.	LEVEL	500.	1000.
	THETA	96.3	90.2
	TIME	115.4	116.0
-1000.	LEVEL	28.43	30.88
	THETA	99.0	91.8
	TIME	116.0	110.0
0.	LEVEL	36.78	38.21
	THETA	94.3	86.8
	TIME	76.8	83.3
		42.12	42.55

FOR IOUT = 0.3,0:
 QSRA LANDING CALCULATION, ENGINE MAP FROM TEST DATA

			VALUES OF EPNL
			YO POSITION
XO ,			
POS			
-2000.	LEVEL	500.	1000.
	THETA	95.0	92.4
	TIME	115.4	116.0
-1000.	LEVEL	28.43	30.88
	THETA	96.4	92.2
	TIME	116.0	110.0
0.	LEVEL	36.78	38.21
	THETA	91.9	87.0
	TIME	76.8	83.3
		42.12	42.55

1. Report No. NASA TP-1913	2. Government Accession No.	3. Recipient's Catalog No.	
4. Title and Subtitle COMPUTER PROGRAM TO PREDICT AIRCRAFT NOISE LEVELS		5. Report Date September 1981	6. Performing Organization Code 505-32-02
		8. Performing Organization Report No. E-733	10. Work Unit No.
7. Author(s) Bruce J. Clark		11. Contract or Grant No.	
9. Performing Organization Name and Address National Aeronautics and Space Administration Lewis Research Center Cleveland, Ohio 44135		13. Type of Report and Period Covered Technical Paper	
		14. Sponsoring Agency Code	
12. Sponsoring Agency Name and Address National Aeronautics and Space Administration Washington, D. C. 20546		15. Supplementary Notes	
16. Abstract <p>Methods developed at the NASA Lewis Research Center for predicting the noise contributions from various aircraft noise sources have been programmed to predict aircraft noise levels either in flight or in ground tests. The noise sources include fan inlet and exhaust, jet, flap (for powered lift), core (combustor), turbine, and airframe program obtained from the NASA Langley Research Center. Noise propagation corrections are available for atmospheric attenuation, ground reflections, extra ground attenuation, and shielding. Outputs can include spectra, overall sound pressure level, perceived noise level, tone-weighted perceived noise level, and effective perceived noise level at locations specified by the user. Footprint contour coordinates and approximate footprint areas can also be calculated. Inputs and outputs can be in either System International or U. S. customary units. The subroutines for each noise source and propagation correction are described in detail. Inputs required and some sample inputs and outputs are given in tables. A complete listing is given in an appendix. The program is available to qualified users through COSMIC, 112 Barrow Hall, University of Georgia, Athens, Georgia 30602 (telephone 404-542-3265).</p>			
17. Key Words (Suggested by Author(s)) Aircraft noise Computer program Prediction		18. Distribution Statement Unclassified - unlimited STAR Category 71	
19. Security Classif. (of this report) Unclassified	20. Security Classif. (of this page) Unclassified	21. No. of Pages 145	22. Price* A07

* For sale by the National Technical Information Service, Springfield, Virginia 22161

National Aeronautics and
Space Administration

THIRD-CLASS BULK RATE

Postage and Fees Paid
National Aeronautics and
Space Administration
NASA-451



Washington, D.C.
20546

Official Business
Penalty for Private Use, \$300

4 1 10, H, 090481 S00903DS
DEPT OF THE AIR FORCE
AF WEAPONS LABORATORY
ATTN: TECHNICAL LIBRARY (SUL)
KIRTLAND AFB NM 87117

NASA

POSTMASTER: If Undeliverable (Section 158
Postal Manual) Do Not Return
