

NATIONAL ADVISORY COMMITTEE FOR AERONAUTICS

TECHNICAL NOTE

No. 1434

A METHOD FOR CALCULATING THE HEAT REQUIRED
FOR WINDSHIELD THERMAL ICE PREVENTION
BASED ON EXTENSIVE FLIGHT TESTS IN
NATURAL ICING CONDITIONS

By Alun R. Jones, George H. Holdaway
and Charles P. Steinmetz

Ames Aeronautical Laboratory
Moffett Field, Calif.



Washington
November 1947

NATIONAL ADVISORY COMMITTEE FOR AERONAUTICS

TECHNICAL NOTE NO. 1434

A METHOD FOR CALCULATING THE HEAT REQUIRED

FOR WINDSHIELD THERMAL ICE PREVENTION

BASED ON EXTENSIVE FLIGHT TESTS IN

NATURAL ICING CONDITIONS

By Alun R. Jones, George H. Holdaway,
and Charles P. Steinmetz

SUMMARY

An equation is presented for calculating the heat flow required from the surface of an internally heated windshield in order to prevent the formation of ice accretions during flight in specified icing conditions. To ascertain the validity of the equation, comparison is made between calculated values of the heat required and measured values obtained for test windshields in actual flights in icing conditions.

The test windshields were internally heated and provided data applicable to two common types of windshield configurations; namely the V-type and the type installed flush with the fuselage contours. These windshields were installed on a twin-engine cargo airplane and the icing flights were conducted over a large area of the United States during the winters of 1945-46 and 1946-47. In addition to the internally heated windshield investigation, some test data were obtained for a windshield ice-prevention system in which heated air was discharged into the windshield boundary layer.

The general conclusions resulting from this investigation are as follows:

1. The amount of heat required for the prevention of ice accretions on both flush- and V-type windshields during flight in specified icing conditions can be calculated with a degree of accuracy suitable for design purposes.

2. A heat flow of 2000 to 2500 Btu per hour per square foot is required for complete and continuous protection of a V-type windshield in flight at speeds up to 300 miles per hour in a

moderate cumulous icing condition. For the same degree of protection and the same speed range, a value of 1000 Btu per hour per square foot suffices in a moderate stratus icing condition.

3. A heat supply of 1000 Btu per hour per square foot is adequate for a flush windshield located well aft of the fuselage stagnation region, at speeds up to 300 miles per hour, for flight in both stratus and moderate cumulous icing conditions.

4. The external air discharge system of windshield thermal ice prevention is thermally inefficient and requires a heat supply approximately 20 times that required for an internal system having the same performance.

INTRODUCTION

For several years the NACA has engaged in a broad research program on the problem of the prevention of ice formations on airplanes. Particular attention has been given to the utilization (in various thermal ice-prevention systems) of the available waste heat in the engine exhaust gases.

One part of this icing research program has been concerned with the investigation of thermal means of windshield ice-prevention. The first satisfactory solution developed was the double-panel-type system described in reference 1 and tested on the Lockheed 12-A, Consolidated B-24, and Curtiss-Wright C-46 airplanes (references 1, 2, and 3).

The tests of reference 1 resulted in the tentative specification of a heat-flow requirement of 1000 Btu per square foot per hour through the windshield outer surface. This value was based on data obtained for a V-type windshield at flight speeds up to 150 miles per hour. The flight investigation of reference 2 was also conducted with a windshield of this configuration, and the specification appeared adequate. The heated-air flush windshield installation in the C-46 airplane (reference 3) provided satisfactory protection, but did not serve as a check on the validity of the 1000 Btu per hour per square foot specification for all types of windshields, because the windshield configuration had appreciably different icing characteristics than the V-types previously tested.

Although these initial researches provided some information on windshield heat requirements, the results were empirical in nature and could not serve as a fundamental basis for the prediction of the

heating requirements for windshield configurations and flight conditions different than those investigated. Accordingly, a fundamental windshield icing research was undertaken. This research consisted of an analytical study of the heating requirements for internally heated windshields, and subsequent flight tests to determine the applicability of the design equations resulting from the analysis. In the flight tests the heat flow from the surfaces of various special test windshields of different configurations could be closely controlled and measured. Measurements were also made of the windshield surface temperatures, boundary-layer profiles, flight conditions, and meteorological factors during icing in order to provide data on all the basic factors which could be expected to affect the heating requirement.

In addition to the research directed toward the establishment of the heat-flow requirement in the case where the heating was supplied internally, a secondary investigation conducted at the same time was concerned with the practicability of ice prevention by the means of discharging a jet of heated air into the windshield boundary layer. This device was initially installed in the C-46 airplane (reference 3) as a means of augmenting the internal, double-panel windshield system with available primary air from the exhaust-gas heat exchangers. The test results with this initial installation were sufficiently promising to warrant further investigation.

An analytical approach to the external-discharge type of windshield thermal ice-prevention system was attempted, but the unknowns involved, such as the mixing of the heated jet with the boundary-layer air, precluded a reasonable prediction of the action of this system. Actual tests of external-discharge systems in icing conditions were considered necessary. It was hoped that sufficient data concerning the influence of the various pertinent factors, such as jet flow rate, size, and temperature in known icing conditions, could be obtained to provide an indication of the practicability of the system and possibly form the basis for empirical design equations. Controlled heated-air external-discharge systems, therefore, were investigated for both a V-type windshield, and a windshield which was flush with the fuselage contours.

The flight tests were conducted in clear air and in natural icing conditions with a C-46 airplane. In addition to the windshield research the flight tests included the determination of wing and propeller heating requirements and a study of the meteorological factors conducive to icing. To obtain test data in natural icing conditions, for all parts of the research program the C-46 airplane

was operated by the Ames Aeronautical Laboratory, Moffett Field, Calif., during the winters 1945-46 and 1946-47.

The appreciation of the NACA is extended to United Air Lines, Inc., the United States Weather Bureau, and to the Air Material Command of the Army Air Forces for aid and cooperation in the research. In particular, the services of Major James Murray, Army Air Forces, and Captain Carl M. Christenson and First Officer Lyle W. Reynolds, United Air Lines, who served as pilots of the research airplane, were a valuable aid to the conduct of the investigation.

SYMBOLS

The following nomenclature is used throughout this report:

a	radius of water droplet, centimeters
A	surface area, square feet
A_p	projected area, square feet
b	projected height of windshield or half of a width of ribbon, centimeters
c_p	specific heat of air, Btu per pound, degree Fahrenheit
c_{pw}	specific heat of water, Btu per pound, degree Fahrenheit
C	radius of a sphere, feet
D	a significant dimension of windshield used in determining Reynolds number, feet
e	water vapor pressure, inches of mercury
g	acceleration due to gravity, feet per second, second
h	convective heat-transfer coefficient through the windshield boundary layer, Btu per hour, square foot, degree Fahrenheit
J	mechanical equivalent of heat, foot-pounds per Btu
k	thermal conductivity, Btu per hour, square foot, degree Fahrenheit per foot

- K dimensionless quantity obtained from reference 4 and defined in the symbols of this report as $\left(\frac{2\gamma_w a^2 U_0}{9\mu g b}\right)$
- l length of a windshield panel or a flat plate in the direction of local air flow, feet
- L_S latent heat of evaporation at surface temperature, Btu per pound of water
- m liquid water content of the air, grams per cubic meter
- M weight rate of water impingement per unit area, pounds per hour, square foot
- P barometric pressure, inches of mercury
- Pr Prandtl's number $\left(\frac{c_p \mu g}{k}\right)$, nondimensional
- q unit rate of heat flow, Btu per hour, square foot
- Q rate of heat supply, Btu per hour
- r recovery factor equal to $Pr^{1/3}$ for turbulent flow
- R Reynolds number $\left(\frac{U y D}{\mu g}\right)$, nondimensional
- s distance from the region of air stagnation, feet
- t temperature, degrees Fahrenheit
- Δt_{ka} kinetic temperature rise of air, degrees Fahrenheit
- Δt_{kw} kinetic temperature rise of the water droplets, degrees Fahrenheit
- T temperature, degrees Fahrenheit absolute
- u local velocity inside boundary layer, feet per second
- U velocity, feet per second
- w weight rate of water impingement, pounds per hour

W	weight of heated air supplied, pounds per hour
x	distance along windshield in the direction of air flow, inches
X	evaporation factor, defined as $1 + \frac{0.622 L_s}{c_p P_o} \left(\frac{e_s - e_o}{t_s - t_o} \right)$
y	distance normal to the windshield surface, inches
α	angle between the plane of a windshield and a plane normal to the streamlines around the forebody of the windshield, degrees
γ	specific weight of air, pounds per cubic foot or grams per cubic centimeter
γ_w	specific weight of the water droplets, grams per cubic centimeter
ϵ	emissivity of windshield panel
η	efficiency of water impingement, percent
θ_M	half the central angle of the total area of impingement on a spherical surface, degrees
μ	viscosity of air, gram seconds per square centimeter
ϕ	dimensionless quantity obtained from reference 4 and defined in the symbols of this report as $\left(\frac{18\gamma^2 U_o b}{\gamma_w \mu g} \right)$

Subscripts

c	calculated
E	experimental
i	local conditions just outside the boundary layer
o	reference to ambient or free-stream air conditions
s	reference to windshield external surface conditions
av	average conditions

ANALYSIS

Ice formations on aircraft occur during flight through formations of supercooled droplets of water. Upon contact with an unheated surface, the water freezes and ice accumulates at a rate depending upon the efficiency with which the surface intercepts water droplets from the free air stream. With a heated surface the majority of the water evaporated is evaporated at the surface, although a few small drops may be evaporated in the boundary layer. The maximum rate of evaporation occurs when the heated surface is fully wetted, and it is for this condition that the following analysis applies.

The unit heat flow from the outer surface of a windshield during flight in icing conditions can be considered as the sum of four individual heat losses, or

$$q = q_1 + q_2 + q_3 + q_4 \quad (1)$$

where

- q_1 heat loss due to forced convection
- q_2 heat loss due to evaporation of the impinging water
- q_3 heat loss due to warming of the impinging water
- q_4 heat loss due to radiation to the surrounding atmosphere

Each of these individual heat flows will be analyzed.

Heat Loss Due to Convection

The equation for the heat loss due to convection, including the effect of kinetic heating, is written

$$q = h(t_s - t_o - \Delta t_{ka}) \quad (2)$$

where

$$\Delta t_{ka} = \frac{U_o^2 - U_1^2}{2gJc_p} + \frac{rU_1^2}{2gJc_p} \quad (3)$$

Equation (3) is obtained from references 5 or 6 which also state that the recovery factor r equals $Pr^{1/3}$ for turbulent flow.

The first term of equation (3) represents the adiabatic heating or cooling of the air just outside the boundary layer caused by the change in velocity from U_0 to U_1 . The second term of the equation represents the heating of the air which occurs as the velocity is reduced from U_1 to zero. Equation (3) can be approximated by the simpler form

$$\Delta t_{ka} = 0.832 r \left(\frac{U_0}{100} \right)^2 \quad (4)$$

Several equations for calculating the coefficient of convective heat transfer h from a flat plate have been developed, and a comparison of these equations has been made in reference 7. For a turbulent boundary layer, the general form of the coefficient was presented as

$$h = 0.0296 \times 3600 \frac{U_1 \gamma c_p}{Pr^{2/3} R^{0.2}} \quad (5)$$

Following the presentation of equation (5) in reference 7, various specific forms of the equation are derived by expressing the properties of air as a function of the average temperature of the air in the boundary layer. The coefficient at any distance s from the leading edge of a flat plate, for the region of turbulent flow, is given as,

$$h = 0.51 T_{av}^{0.3} \left(\frac{U_1 \gamma}{s^{0.25}} \right)^{0.8} \quad (6)$$

where

T_{av} average temperature in the boundary layer

U_1 velocity outside the boundary layer at distance s from the leading edge

For a turbulent boundary layer extending from $s=0$ to $s=l$ on a flat plate, the average coefficient is presented as

$$h = 0.64 T_{av}^{0.3} \left(\frac{U_1 \gamma}{l^{0.25}} \right)^{0.8} \quad (7)$$

Heat Loss Due to Evaporation

As mentioned previously, the maximum rate of evaporation occurs when the surface is fully wetted. Since this condition requires the maximum heat supply to maintain a given surface temperature, it is chosen for design. In order to establish the minimum heat requirement to prevent freezing of the water on the windshield, it is assumed that sufficient heat will be supplied to maintain the temperature of the windshield surface and the water thereon at 32° F. Since water runback from the heated-windshield area is of little consequence, no effort is made to evaporate all the water intercepted by the windshield; such a requirement would impose an exorbitant heating load in some cases.

Using the equations of reference 5 and the symbols of this report the rate of heat loss due to evaporation is

$$q_2 = 0.622 h L_s \left(\frac{e_s - e_o}{c_p P_o} \right) \quad (8)$$

Heat Loss Due to Warming the Impinging Water

Reference 5 gives the basic equation for the dissipation of heat to the water that is intercepted by the windshield, but a kinetic heating term is added in this report since the loss of energy by the water droplets assumes an appreciable value at airspeeds of 300 miles per hour or greater.

$$q_3 = M c_{p_w} (t_s - t_o - \Delta t_{k_w}) \quad (9)$$

where

$$\Delta t_{k_w} = \frac{U_o^2}{2gJc_{p_w}} = 0.198 \left(\frac{U_o}{100} \right)^2$$

and M is the average weight rate of water impingement per unit area of windshield and is given by

$$M = 0.225 \frac{\eta}{100} U_o m \frac{A_p}{A} \quad (10)$$

Since the streamlines and drop trajectories for various types of windshields are not now available to calculate the efficiency of water impingement η , data for spheres or flat ribbons can be

utilized to give approximate impingement values. Curves presenting efficiencies of water impingement for cylinders, spheres, and ribbons are given in reference 4 together with a discussion of their use.

Heat Loss Due To Radiation

The heat loss due to radiation from the windshield surface to the surrounding atmosphere is usually of small magnitude. It can be calculated from the Stefan-Boltzman equation:

$$q_A = 0.173 \epsilon \left[\left(\frac{T_S}{100} \right)^4 - \left(\frac{T_O}{100} \right)^4 \right] \quad (11)$$

Summation of Heat Losses

Combining equations (1) to (11), the complete equation for the dissipation of heat from a windshield surface in conditions of icing may be written

$$\begin{aligned} q = & h \left[t_S - t_O - 0.832 r \left(\frac{U_O}{100} \right)^2 \right] + 0.622 h L_S \left(\frac{e_S - e_O}{c_p P_O} \right) \\ & + M c_{P_W} \left[t_S - t_O - 0.198 \left(\frac{U_O}{100} \right)^2 \right] + 0.173 \epsilon \left[\left(\frac{T_S}{100} \right)^4 - \left(\frac{T_O}{100} \right)^4 \right] \end{aligned} \quad (12)$$

For flight speeds under approximately 200 miles per hour, equation (12) may be simplified by neglecting the heat loss due to radiation and the kinetic heating of the impinging water. Regrouping the terms to segregate the primary heat losses, which are due to convective heat transfer and evaporation, from the secondary effects of heating the impinging water and kinetic heating of the air, equation (12) becomes

$$q = hX(t_S - t_O) + M(t_S - t_O) - 0.832 hr \left(\frac{U_O}{100} \right)^2 \quad (13)$$

where

$$X = 1 + \frac{0.622L_s}{c_p P_o} \left(\frac{e_s - e_o}{t_s - t_o} \right) \quad (14)$$

A similar grouping was used in references 5 and 8.

DESCRIPTION OF APPARATUS

The research reported herein was conducted in flight using a C-46 cargo airplane (reference 3) modified to incorporate an NACA thermal ice-prevention system which permitted continuous operation in natural icing conditions. The airplane is shown in figure 1 as equipped for the winter of 1945-46, and in figure 2 as operated in the winter of 1946-47.

Meteorological equipment was installed to measure the free-stream air temperature and the water drop size, drop-size distribution, and liquid water content in icing clouds. A shielded thermocouple connected to a millivoltmeter was used to measure the air temperature. Rotating cylinders of different diameters, mounted coaxially on a single shaft, were used to determine the liquid water content, drop size, and drop-size distributions. The maximum drop size was determined from the area of water impingement on a single, nonrotating cylinder. A detailed description of the meteorological instruments, their use, and typical meteorological data obtained are presented in reference 9.

Internally Heated Windshields

Three general types of aircraft windshields were tested to provide fundamental heat-transfer data: flat-plate, flush, and V-type windshields. The first two types were tested during the 1945-46 operations and the third during the 1946-47 operations. Each windshield-panel test section was heated by electrical power, and the installations are shown in figures 3, 4, and 5.

Flat-plate windshield.— This installation was intended to supply heat-transfer data for two-dimensional flow over a flat plate inclined at different angles to the air stream. It was considered that the data would be applicable to the design of flat-pane windshields such as those common in fighter and transport aircraft. The test panel

was located on the right side of the fuselage of the airplane as shown in figure 3. The panel was mounted in such a manner that the angle between its surface and the relative wind direction could be varied. Provision was made to fix the panel in one of three positions: 30° , 45° , and 60° , measured from the tangent to the fuselage at the hinge line.

The over-all surface dimensions of the flat plate were 13 by 18 inches, and of this area 13 by 16.5 inches, or 1.49 square feet, were uniformly heated. The heating elements were thin metal ribbons, and were capable of dissipating 2500 Btu per hour per square foot of panel surface when connected in a 24-volt circuit. For the base of the panel, a 1/2-inch sheet of fabric-laminated plastic was used. The heating ribbons were cemented to this base and then a 1/64-inch-thick sheet of laminated plastic was cemented on top to present a smooth, electrically insulated surface to the air stream. Centrally located in the base material was a 4.5-inch-square heat meter (calibrated thermopile, reference 10), 1/64-inch-thick, to measure heat flow away from the test surface. Electrical power was supplied from an alternator through a 120/24-volt transformer, and the voltage impressed on the test section was controlled by means of a carbon-pile rheostat.

Temperatures on the surface of the flat plate were measured at 10 points by iron-constantan thermocouples which were 0.002 inch thick. The thermocouples were recessed in grooves 0.003 inch deep in the 1/64-inch-plastic outer sheet, and their junctions located as shown by figure 6. The outer surface was thinly painted to provide a smooth surface and to protect the thermocouples. Additional thermocouples were located on the back surface of the plate and at the heat meter.

All temperatures were recorded by a self-balancing automatic-recording potentiometer with an estimated over-all accuracy of $\pm 3^\circ$ F. This degree of accuracy was made possible by the provision of several calibration thermocouples, with temperatures known to $\pm 1^\circ$ F, as a check on the recording potentiometer. The potential of the heat meter was determined manually with an additional potentiometer. By measuring the temperature at the heat meter, an accuracy of measurement of heat losses to ± 10 percent was possible.

For the determination of the boundary-layer-velocity profile in clear air, conventional pressure rakes were utilized and the pressures were recorded by photographing a manometer board.

Ice formations on the panel were photographed with a 16-millimeter cinematic camera which was remotely controlled. The camera was located within the fuselage about 3 feet forward of the flat-plate panel, and was fitted with a 90° angle lens which protruded into the blister shown in figure 3.

Flush windshield.— This windshield was installed flush in the copilot's panel which, at that time (1945-46), was flush with the fuselage contours. (See figs. 3 and 4.) The test surface was almost square, though slightly curved, and covered an area of 1.16 square feet. Construction of the panel consisted of three sheets of glass bonded together with sheets of plastic. Heating elements of very fine resistance wires were imbedded between the outer glass layer and the plastic inner layer. These wires were 0.0012 inch in diameter and spaced 0.6 inch apart. The panel was a commercial product and was designed for a maximum heat dissipation of 1000 Btu per hour per square foot. Power was supplied by direct-current generators and the impressed voltage was varied with a rheostat. Thermocouples 0.002-inch-thick were cemented to the inner and outer surfaces of the test area and covered with clear spar varnish. The locations of the thermocouple junctions are shown in figure 6.

Ice formations were photographed with a box camera having flash attachments and located in the pilot's compartment. Temperatures and boundary-layer-rake pressures were recorded by the same instruments used for the flat-plate windshield.

V-type windshield.— For the 1946-47 operations the flush windshields were replaced by the V-type windshield shown in figure 5. The windshield center post was sloped at an angle of 57° (measured from the horizontal during cruising flight) and the included angle of the V was 86° measured in the horizontal plane. The fabrication of the pilot's and copilot's panels was identical and consisted of three sheets of glass bonded together with interposed sheets of plastic (fig. 7). Heating of the panels was attained through a transparent, electrically conductive surface coated on the outer sheet of glass on the surface adjacent to the plastic inner layer. The panels were a commercial product and were capable of dissipating 2000 Btu per hour per square foot. Although the panels were trapezoidal in shape, the heated area was rectangular with the bus bars applied the full length of the rectangle along the top and bottom edges to insure uniformity of heat distribution (fig. 7). The heated area of each panel was 14.5 by 25 inches or 2.52 square feet. Power was supplied by an alternator and the voltage was controlled with a variable transformer. Thermocouples 0.002-inch-thick were cemented to the inner and outer surfaces of both windshields and

covered with clear spar varnish. Locations of the thermocouple junctions are shown in figure 6.

Photographs of ice accretions on the windshields were taken with a camera having a synchronized flash attachment. Temperatures were recorded in the same manner as described for the flat-plate windshield.

External Air-Heated Windshields

Flush windshield.— The original windshield heating system installed in the C-46 airplane included both an internal double-panel heating system and an external-discharge heated-air heating system as discussed in references 3 and 11. The original system was modified as shown in figure 8 for the 1945-46 operations. The inner heating system was removed, the heated-air discharge slot for the outer system was decreased to three-sixteenths inch, and the extent of the discharge slot was reduced to a width of 1 foot at the bottom of the pilot's windshield, starting at the center post. The heated air was supplied by exhaust-gas heat exchangers, and the air flow rate was measured with a 4-inch venturi meter. A butterfly valve was installed to control the quantity of heated air flowing from the discharge slot.

Windshield surface temperatures were measured with thin iron-constantan thermocouples cemented to the glass and covered with several coats of spar varnish. Nine thermocouples were located on the outside surface and three were located on the inside surface, as shown in figure 6. Thermocouples were located at the venturi meter and just inside the discharge slot to measure the heated-air temperatures. Two temperature rakes were installed on the windshield outer surface for the determination of the temperature profile in the heated-air jet in a few clear-air flights. These rakes consisted of nine thermocouples at different heights above the windshield surface up to 1-1/2 inches. All thermocouples were connected to a recording potentiometer, and the estimated over-all accuracy was about $\pm 3^{\circ}$ F.

A pressure rake was installed for the determination of the heated-air jet-velocity profiles in clear-air flights. The rake consisted of 18 pressure probes mounted in the form of a triangular prism with its base on the windshield surface. Three of the pressure probes were static tubes and the remainder total-pressure tubes. These pressures, along with the venturi meter pressures, were recorded by photographing an alcohol manometer board.

Two methods were employed to obtain an indication of the quantity of heat flow from the external jet through the windshield into the airplane cabin. The first method consisted of the calculation of the heat flow based on the measured temperature difference between the windshield surfaces and the known thermal conductivity of the windshield materials. In addition to this calculation, a 4.5-inch-square heat meter was located on the inner surface as shown by figure 8. The potential across the heat meter was read by an indicating potentiometer. The estimated accuracy of the heat flow as determined with the heat-meter installation is approximately ± 15 percent.

V-type windshield.— For the 1946-47 operations with the V-type windshield, one $3/16$ -inch external discharge slot was located along the bottom edge of the pilot's windshield and another along the center post between the windshields with the heated air directed over the pilot's windshield. Each slot was 1 foot in length. The 4-inch venturi meter was replaced by two 3-inch venturi meters equipped with thermocouples to measure the flow rate independently to the two separate discharge slots over the pilot's windshield. The air-flow rate to each slot could be adjusted independently although a certain amount of interdependence existed, since both slots received air from the same source of supply. A booster blower was installed in the main supply duct to increase the total quantity of heated air available to the slots.

The fabrication and location of thermocouples installed on the pilot's panel were described in the preceding description of the V-type windshields. In addition to the thermocouples on the windshield surface, four thermocouples were installed just inside the center-post discharge slot, and six thermocouples were located just inside the slot at the bottom of the pilot's windshield. These thermocouples were located so as to measure the heated-air temperatures just before the air was discharged from the slots. A self-balancing potentiometer was used to record the temperatures.

The pressure differentials at the venturi meters were indicated by standard differential pressure gages and recorded by a standard NACA 60-cell recording manometer.

TEST PROCEDURE

The clear-air flights were conducted at the Ames Aeronautical Laboratory, Moffett Field, Calif. In the case of the icing flights, the Laboratory served as a main base and operations in search of

icing conditions were conducted over a considerable area of the United States. The 1945-46 operations, consisting of over 40 flights, were conducted mainly in the Pacific Northwest and North Central States. The 1946-47 operations included this same area and, in addition, some icing conditions were encountered in the Central Southern states.

The flights in clear air were made to check or modify the theoretical equations for convective heat-transfer coefficients and to measure the degree of kinetic heating experienced by the windshields.

Icing Flights

The test procedures employed were substantially the same for each test windshield. Therefore, the following discussion applies to the operations of both winters. When icing conditions were anticipated, the windshield power was turned on or, in the case of the heated-air jet, the valves were opened. Before entering the icing condition, the heat to the windshields was adjusted to a setting greater than the expected requirements. After a stabilization period of several minutes the recording instruments were started and the cloud was entered. After the completion of one run, if no ice formed, the heat supply would be decreased and the equipment allowed to stabilize for 10 minutes before the next set of data was taken. The heat input to each windshield was reduced in this manner to approximately the minimum amount required to keep the heated surface free of ice accretions. For the pilot's and copilot's windshields, the value of minimum heat required was established by visual observation of the start of ice accretions on the windshields. Since the surface of the flat-plate panel could not be observed by the windshield engineer, the outer-surface temperatures were regulated by changing the heat input so that the lowest temperature would be just above freezing.

The pilots always made an attempt to hold the altitude and airspeed constant during a specific test run, but severe turbulence sometimes made this impossible. The duration of a test run varied from a few minutes in the top of a cumulus cloud to several hours in an extensive stratus layer. For a few runs in the smaller cloud formations, the airplane was flown in a circle in order to remain in the cloud long enough to obtain a complete set of meteorological and heat-transfer data. None of this latter type of data has been presented unless the conditions were fairly stable for at least 5 minutes after an equipment-heating stabilization period of 10 minutes.

In addition to the flight and meteorological conditions, a continuous record was kept of the following windshield data: heat supplied, inner- and outer-surface temperatures, photographs of ice formations, and the heat losses inward as indicated by heat meters.

Clear-Air Tests

Clear-air flights were conducted in level flight at various altitudes and airspeeds to cover the conditions encountered during the icing operations. The test flights were made in a direction away from the sun to minimize the effects of solar radiation.

First, flight data were taken without any power supplied to the windshields. By measuring the surface-temperature rise above free-stream temperature a basis was established for comparison between the indicated recovery factor of equation (4), and the theoretical value $Pr^{1/3}$ for turbulent flow.

A check for possible significant edge losses was made by varying the heat supplied to the windshield panels while flying at a constant airspeed and altitude. Any variance in the calculated external heat-transfer coefficient after correction for inward heat losses was an indication of the edge losses, since the effect of changes of temperature in the boundary layer on the heat-transfer coefficient can be considered negligible for the temperature ranges concerned.

For several airspeeds and altitudes, heat was supplied to the windshield panels while the temperatures, heat losses, and velocities were recorded. These data were necessary for the experimental determination of the convective heat-transfer coefficient h , and the establishment of effective values of s or l (equations (6) and (7)).

During the clear-air flights after the 1945-46 operations, a survey of the boundary layer at the center of each test windshield was made with a pressure rake. The data were used to determine the boundary-layer thickness and the variance of the local velocity outside the boundary layer with changes in airplane velocity. Both pressure and temperature boundary-layer surveys were made in the heated-air jet over the flush windshield installation.

RESULTS OF TESTS

Internally Heated Windshields

Local air velocities and convective heat-transfer coefficients.-

The values of local air velocity just outside the boundary layer at the center of the flat-plate panel and the flush windshield are presented in figure 9 for various airplane speeds and altitudes. In figures 10, 11, and 12 the convective heat-transfer coefficients, based on the measured surface temperature at the center of the flat-plate and the known heat flow, are presented. The coefficients for the flush panel are not presented because of difficulties experienced with the measurement of the surface temperature. In the case of the V-type windshield only a few values of the heat-transfer coefficient obtained in clear air are available. These data were secured between the icing encounters and, since the data were recorded at different flight altitudes, they do not form a satisfactory basis for curve plotting in the same manner as figures 10, 11, and 12. This information is presented in the following table:

Test no.	Pressure altitude, (ft)	True airspeed (mph)	Free-air temperature (°F)	Windshield surface temperature (°F)	h Btu/hr, sq ft, (°F)
1	12,000	178	20	73	23.4
2	10,800	200	18	65	28.5
3	9,800	174	39	73	23.0
4	7,800	175	30	66	26.5
5	6,000	170	35	70	25.2

Meteorological and heat-transfer data during icing conditions.-

Tables I and II present the meteorological data for the two winter's operations which have been selected for discussion in this report. These data represent only a small portion of the meteorological information recorded, but have been selected as the tests which supply the most satisfactory combination of simultaneous meteorological and windshield heat-transfer data. A complete tabulation of all the meteorological data obtained in the 1945-46 operations is presented in reference 9, which also includes a detailed discussion of the procedures employed to obtain the test results.

The rotating-cylinder method utilized to measure the liquid water content and mean-effective drop-size values, presented in tables I and II, provided a 1-minute average of the icing conditions, since this was the time of exposure of the cylinders.¹ The windshield heat-transfer data required about 2 minutes to record and the rotating cylinders were exposed at some time during that interval. The meteorological data of icing conditions 4, 5, and 6 of table I were obtained prior to the installation of the rotating cylinders, hence the maximum drop-size range encountered during the heat-transfer test interval is presented.

The heat-transfer data for all three of the internally heated windshields in conditions of icing are presented in table III. All the heat flow values presented in the table do not represent the minimum requirement for the particular icing condition, since cases for which satisfactory meteorological and heat-transfer data were obtained together did not always occur at the minimum value of heat flow. The surface temperatures presented in table III are the arithmetical average of the recorded values for the several thermocouples on the surfaces. Photographs and sketches showing the ice accretions on the heated windshields and surrounding surfaces for several of the conditions encountered are presented in figure 13 to 23.

External Discharge Windshields

Temperature and velocity gradients.— The temperatures of the windshield surface at various distances from the heated-air discharge slot for the flush windshield installation are shown in figure 24. The temperature and velocity gradients in the jet for the same windshield installation are presented in figures 25, and 26.

Icing tests.— Table IV presents the windshield (flush) surface temperatures measured during operation of the external discharge jet in icing conditions. An indication of the ice-prevention action of the external discharge jet for the flush windshield installation can be seen in figure 15. The effect of the V-type windshield external jet (pilot's side of windshield) is shown in figure 20. The incomplete removal of ice accretions shown in this figure was typical

¹Mean-effective drop size for a cloud sample is defined as the diameter of a water drop for which the amount of water existing in water drops larger than that drop equals the amount of water in drops smaller than the drop.

of the operation of the external discharge system on the V-type windshield. The temperature limitations of the windshield panel precluded the use of additional heated air in an attempt to remove the residual accretions.

DISCUSSION

Prediction of Heating Requirement for Internally Heated Windshields

Since the main objective of this report is to establish fundamental design equations for the calculation of windshield heat requirements in specified icing conditions, equation (13) will be discussed in the light of the test data to establish its usefulness for this purpose. The applicability of this equation for the determination of heating requirements can best be evaluated by a comparison of calculated and measured values of heat flow from the windshield surface, for the same surface temperature, and for specified flight and icing conditions. Before such calculations can be made, however, means must be established for the determination of two components of equation (13); namely, the convective heat-transfer coefficient h and the weight-rate of water impingement M . Consequently the following discussion considers first the utilization of the flight-test data to establish means for the evaluation of h and M with a degree of accuracy suitable for design purposes. Although the methods discussed are directly applicable to the test windshields of this report, an effort was made to generalize the technique in order to provide a design procedure applicable to other configurations and icing flight conditions.

Evaluation of the convective heat-transfer coefficient.-- In the determination of the value of the convective heat-transfer coefficient h , the pertinent question is the suitability of equation (6) for the calculation of the coefficient. A comparison of measured and computed values of the convective heat-transfer coefficient h for the outer surface of the three internally heated test windshields therefore will be made.

Considering first the evaluation of h for flat-plate panels, figures 27, 28, and 29 present a comparison of the measured values of h at each panel angle and at various altitudes and airspeeds, with values calculated by equation (6). The curves representing the measured values of h have been taken from figures 10, 11, and 12.

Equation (6) is used for comparison rather than equation (7), since it has been derived for the purpose of calculating the coefficient at a given point on the surface and the test data apply to the center of each panel. The values of U_1 used in equation (6) for the calculation of the coefficients presented in figures 27, 28, and 29 were the local velocities at the center of the panel as given in figure 9. Two values of s were used in the calculations s_1 representing the distance from the panel hinge to the center of the panel, and s_2 the distance from the center of the panel to the stagnation point at the nose of the airplane fuselage.

In the case of the V-type windshield, the calculated values of h from equation (6) are compared with the test values (see table presented in Results) in the following table:

Item no.	h measured	h calculated (equation (6))	
		$s_1 = 0.67$ ft	$s_2 = 5.0$ ft
1	21.3	29.1	19.5
2	25.9	33.2	22.1
3	20.8	29.6	19.8
4	24.0	32.4	21.6
5	22.7	33.1	22.1

In the computation of h by equation (6) the value of the local velocity over the windshield was not known and hence the airplane velocity was used.

An examination of figures 27, 28, and 29 and the table just presented indicates that the use of equation (6) provides reasonably accurate values of the convective heat-transfer coefficient at the center of the test windshields. In terming the accuracy of equation (6) as "reasonable," consideration has been given to the fact that no data other than the length and location of the panel and the local velocity were employed and the agreement is considered reasonable for such an approximation. A more exact determination of the value of h would require the application of somewhat lengthy computation methods to measured values of the boundary-layer profile, or the installation of a heating plate in the windshield surface and the procurement of actual test data. The disadvantages of these means must be weighed against the inaccuracy of the general application of equation (6) in determining the method that will be employed to evaluate h in any future design computations. The agreement shown in figures 27, 28, and 29 between the measured values of h

and the values computed by equation (6) is about the same, irrespective of the value of s employed. In most instances the two computed curves bracket the experimental curve, with the lower value of s providing the larger values of h . For design purposes the use of the lower value of s should provide heat-transfer coefficients which would probably be somewhat larger than the true case, but would be conservative.

The spacing of the heating wires in the flush windshield (0.6 in. between wires) resulted in considerable nonuniformity of the surface temperature as can be observed in the ice-removal photographs (fig. 15). As a result the attempts to calculate the convective heat-transfer coefficient for the surface based on the measured heat flow and surface-temperature rise produced questionable and erratic values. Consequently a comparison of measured and computed values of h for the flush windshield has not been presented.

In an attempt to establish the accuracy of equation (13) for the prediction of the heat requirement, it is desirable to utilize the most accurate available values of the various components of the equation. Thus although the foregoing discussion indicates that equation (6) provides reasonably accurate values of h (which can be used when more precise methods are not available or are considered too complicated for the degree of accuracy desired), a more accurate determination of h would be desirable for use while checking the general equation. One possible solution would be to utilize the test values obtained in clear air, but this system has the disadvantage of inflexibility since corresponding clear-air data were not available for all the icing tests. The alternative employed was to determine the value of s in equation (6) which would provide the best average agreement between calculated and measured values of h for the test range of airspeeds and altitudes.

The determination of an average s for the case of the flat-plate panel at an angle of 45° will be used as an example of the procedure followed. In figure 11, 12 test points are plotted as measured values of h . The data corresponding to each test point (h , T , U , and γ) were inserted in equation (6) and the value of s computed for each point. The arithmetical average of the 12 values of s was calculated to be 1.68 feet. For the determination of the value of h at the center of the flat-plate panel when set at 45° for different velocities and altitudes, equation (6) becomes:

$$h = 0.51 T_{av}^{0.3} \frac{(U_{1\gamma})^{0.8}}{(1.68)^{0.2}} = 0.46 T_{av}^{0.3} (U_{1\gamma})^{0.8} \quad (15)$$

This same system was employed for the other angles of the flat-plate panel, and for the V-type windshield, with the following results:

$$\text{Panel angle} = 30^\circ, s = 0.37 \text{ foot, and } h = 0.62 T_{av}^{0.3} (U_{1\gamma})^{0.8} \quad (16)$$

$$\text{Panel angle} = 60^\circ, s = 1.93 \text{ feet, and } h = 0.45 T_{av}^{0.3} (U_{1\gamma})^{0.8} \quad (17)$$

V-type windshield:

$$s = 1.26 \text{ feet, and } h = 0.41 T_{av}^{0.3} (U_{0\gamma})^{0.8} \quad (18)$$

Evaluation of the rate of water impingement.— Assignment of a value to the factor M of equation (13) for specific design purposes is a problem regarding which very little information is available. The most recent and extensive treatment of water-drop trajectories around several generalized objects is presented in reference 4. This investigation was undertaken primarily to provide a method for estimating the rate of water impingement on an airfoil and, therefore, most of the report concerns the interception of water drops by cylinders which are assumed to represent the forward section of the various airfoils. Some trajectory calculations, however, are presented for the cases of a ribbon (flat plate normal to the direction of air flow) and a sphere. These calculations are used in this report to predict the rate of water impingement on the flat-plate panel (ribbon) and the flush windshield (sphere).

Considering first the case of the flat-plate panel, the assumption was made that the rate of water impingement on the panel would be equal to the rate of impingement on the projected area of the panel considered as one-half of a ribbon. (See fig. 30.) The efficiency of water impingement η and the weight rate of water impingement w for various drop sizes have been computed for the three panel angles at one flight condition and are presented in table V. It is of interest to note that for drop diameters greater than 30 microns, as the panel angle is reduced (panel becoming more flush with the fuselage) the impingement efficiency is increased but the weight rate of water interception is decreased. Since this latter quantity is the item of greater significance from a heat-requirement standpoint, the desirability of low panel angles is evident. Optimum benefit of this advantageous feature would be

expected to occur with flush windshield installations. The flush windshield in the C-46 airplane during the 1945-46 winter provided confirmation in this respect, since windshield icing was encountered in only 8 out of 30 actual flights in icing clouds. Figure 16 shows the lack of ice accretions on the flush windshield after a flight in a cloud which produced the accretions shown on 3/8-inch rods located just below the pilot's and copilot's windshields.

A second item of interest which can be noted in table V is the fact that the maximum calculated efficiency of water impingement is 80 percent, and this value corresponds to exceedingly large drops for an icing condition. This result is somewhat surprising, and possibly in error, since it would appear that the presence of the fuselage forward of the windshield would cause a concentration of drops near the surface and produce impingement efficiency values of large magnitude, possibly greater than 100 percent. Some attempts were made to obtain an indication of the rate of water impingement on the C-46 windshields during the operations, but nothing satisfactory resulted.

To obtain an estimation of M the rate of water impingement on the flush windshield for specific design conditions, the assumption was made that the impingement would be the same as that on a portion of a sphere having a diameter equal to the fuselage maximum diameter. (See fig. 31.) The manner in which the water-drop trajectory calculation method for a sphere presented in reference 4 was applied to the configuration shown in figure 31 is discussed in detail in Appendix A of this report. The calculated rate of water impingement on the flush test panel, based on the procedure discussed in Appendix A, is presented in table VI for various drop-size diameters. The same flight conditions employed for the flat-plate water interception calculations (table V) were again assumed to apply.

An interesting conclusion resulting from an inspection of table VI is that, for the conditions presented, drop diameters of 50 microns are required in order to achieve a value of θ_M of sufficient magnitude to reach the test panel. This conclusion is in agreement with the observations of water impingement on the C-46 flush windshield in icing conditions. The drops were observed to strike the windshield only during flights for which the meteorological data indicated the presence of mean effective drop size of 30 microns in diameter, or larger. The fact that the rate of water impingement on the flush panel as presented in table VI decreases with increased drop size is the result of the assumption (Appendix A) that the water is uniformly distributed over the area

of impingement, and means that the area of impingement increases at a more rapid rate than the weight rate of water impingement. This possible error in the value of the weight rate of water impingement is considered to be of negligible magnitude in view of the small amount of water involved for the drop-size range assumed.

Establishment of applicability of equation (13) for the prediction of windshield heating requirements.— The applicability of equation (13) will now be demonstrated by a comparison of calculated and measured values of heat flow in conditions of icing for the flat-plate, flush, and V-type windshields. The assumptions and method of calculation followed are presented in Appendix B. To illustrate the procedure employed, sample calculations are presented in detail for the flat plate and flush windshield for icing condition 6, tables I and III. An illustrative calculation for the V-type windshield is not included, since the procedure followed was identical to that presented for the flat-plate panel.

The calculated values of heat flow are compared with the measured values for the flat-plate and V-type installations in tables VII and VIII, respectively. The fact that the calculated values of q are lower than the measured values in table VII and higher in table VIII may be attributed, in part, to the different velocity basis used for the determination of h in each case. The calculated values in table VII should be more nearly correct since the velocity employed was the local velocity over the panel, while in the case of the V-type windshield (table VIII) the airplane speed was used since the local velocity over the windshield was not known.

The few instances in which icing of the flush test panel occurred provided very limited data for a comparison of the calculated and measured values of the heat flow. The one case presented as an illustration in Appendix B represents the only reliable data, and the calculated value was 23 percent greater than the experimental value.

One possible reason for the large disagreement, in some cases, between the measured and calculated values of heat flow may be traceable to the assumption, used for all of the calculations, that all the drops were of the same size. The calculation of the heat flow from the flat-plate panel for icing condition 12, table VII, will be used to illustrate the influence of drop-size distribution on the heat flow. The calculated value of 890 Btu per hour, square foot presented in table VII, icing condition 12, was based on a uniform drop size of 19 microns. The rotating-cylinder data, however, indicated a drop-size distribution defined as type E in reference 4.

Table IX presents the results of calculating the weight-rate of water impingement on the flat-plate panel, assuming the water in the free stream exists in drop sizes corresponding to distribution E. On this basis the original weight rate of water impingement (1.91 lb per hr) is increased to 8.14 pounds per hour. Although this is a sizeable increase in the amount of water intercepted, only q_3 (equation (9)) of equation (13) is affected by the increase, and the revised value of q becomes 1035 Btu per hour, square foot, which, in this case, provides better agreement with the measured value.

The assumption of uniform drop-size distribution in the calculation of q may also be the cause of the large disagreement between the measured and calculated values of q in icing conditions 1 and 7, table VII. Based on the assumption of no drops present larger than the mean effective diameter, the weight-rate of water impingement in these two cases is found to be zero. The value of q in table VII, therefore, has been derived for these two conditions on the assumption of a clear panel with no evaporation occurring on the surface. If drops of a diameter large enough to strike the panel had actually been present in sufficient quantity to wet the panel, even partially, the calculated value of q would be considerably increased and better agreement with the measured value would result. Although these discussions are by no means conclusive, they do indicate the importance of drop-size distribution and maximum drop size. This factor should be given consideration in future design calculations.

Based upon an examination of the data in tables VII and VIII, the calculation for the flush windshield heat flow in Appendix B, and a consideration of the various influencing factors which cause disagreement between the calculated and measured values of heat flow, it is concluded that equation (13) will provide predicted values of heat flow with an average accuracy of 15 percent if the entire surface is assumed or known to be completely wetted and the local velocity over the windshield panel is employed in the calculations. The accuracy of the equation is greatly dependent upon the accuracy of the values of convective heat-transfer coefficient employed. The determination of experimental values of this quantity for the particular windshield configuration proposed would be of considerable aid in the accurate prediction of the required heat flow, although in the absence of such data equations (6) and (7) will supply a reasonable approximation. The effect on the accuracy of equation (13) produced by an error in the estimation or calculation of the weight rate of water impingement is not large, provided sufficient water is intercepted by the windshield to completely wet the surface. Rates of water impingement less than the value required to wet the surface

affect the value of q_2 (equation (8)), since evaporation over the entire surface is not realized. For rates of impingement above the quantity required for completely wetting the surface, the value of q_2 remains constant and the only term of equation (13) affected is the value of q_3 (equation (9)) which is an item of secondary magnitude.

General considerations of windshield heating requirements.--

Having shown that equation (13) is applicable for the calculation of windshield heating requirements, provided the various components of the equation can be evaluated, it is of interest to utilize the equation to investigate the heat requirements for various windshield configurations in icing conditions which might be selected as design requirements. An indication of the meteorological conditions corresponding to typical, or average severity, icing and to the most probable maximum icing to be expected in all weather transport operations was obtained from a review of reference 9. For each of the two general cloud types (cumulus and stratus) a liquid water content was selected which corresponded to a moderate icing condition. In the case of the stratus cloud, the value assumed was 0.5 gram per cubic meter, while the corresponding value for the cumulus cloud was 1.0 gram per cubic meter. Based on the data in figures 6 and 9 of reference 9, values of 15° F, free-air temperature, and 15 microns, drop diameter, were selected for the stratus cloud. The corresponding values for the cumulus cloud were 0° F and 20 microns.

The heating requirement for the flat-plate, flush, and V-type windshields in the above icing conditions was calculated by the method presented in Appendix B for airplane speeds of 150 and 300 miles per hour, and the results are presented in table X. From this table the previous empirical heating requirement of 1000 Btu per hour per square foot of windshield surface (reference 1) is seen to provide adequate protection for V-type windshields in moderate stratus for flight speeds as great as 300 miles per hour. In the case of the moderate cumulus cloud, however, this quantity of heat flow would not be adequate even at a speed of 150 miles an hour. In transport aircraft operations, the most critical need for windshield ice protection occurs during flight in the congested area surrounding the air terminals. Any icing condition encountered would be of the stratus type which would tend to reduce the heating requirement. For transport operation in mountainous areas, where cumulus and stratocumulus predominate and high cruising altitudes (hence low free-air temperatures) are the rule, a heat requirement of from 2000 to 2500 Btu per hour per square foot, for speeds up to 300 miles per hour, is indicated if complete and continuous

protection is desired. Certainly complete visibility at all times is desirable for military aircraft. It is of interest to note that a heat supply of 1068° Btu per hour per square foot appears adequate for a flush windshield in all of the icing and flight conditions assumed in table X.

In considering the individual contribution of each of the various meteorological factors which constitute icing conditions to the total heat requirement, the powerful effect of changes in the value of free-air temperature is noted. This dominating effect is traceable to the fact that the surface evaporation is greatly influenced by temperature changes, and this term q_2 of the general equation is one of the major components. As an illustration of this effect, consider the increase in heating requirement (table X) for the flat-plate windshield from 540 to 1040 Btu per hour, square foot as a result of (1) increasing the drop diameter by 5 microns, (2) doubling the liquid water content, and (3) decreasing the free-air temperature by 15° F. When equation (13) is utilized, it can be shown that the 500 Btu per hour per square foot increase is composed of a 13-percent increase due to increased drop size and liquid water content, and 87 percent due to the change in the free-air temperature. This fact leads to the conclusion that once the windshield heat requirement has been established for a specified icing condition, and when the condition is assumed to be severe enough to completely wet the windshield surface, changes in drop size and liquid water content will not change the heating requirement appreciably. A change in free-air temperature, however, will have a very noticeable effect on the heating requirement. It should be noted that this conclusion is at variance with wing heating requirements because, in the case of wings, runback of the impinging water is not desirable and, therefore, sufficient heat is supplied to evaporate all of the water wherever this is practicable. An indication of the amount of heat that would be required if this design procedure were applied to windshields can be obtained with equation (13). Calculations with this equation, based on icing condition 6, table I, indicate that evaporation of all the water impinging on the flat-plate panel in this condition would require a heat supply of 19,400 Btu per hour, square foot.

External Discharge Windshields

In the introduction of this report the statement was made that measurements were taken in the jet of the heated-air external-discharge system in the hope that a basis for the establishment of empirical design equations would result. Unfortunately, a review of

the velocity and temperature profiles measured in the jet, of which figures 25 and 26 are typical examples, did not reveal any basis for a rational analysis of the mixing of the jet with the boundary-layer air, and the prediction of the resultant surface-temperature rise.

A few items of interest, however, were noted during the investigation. One of these items was the large amount of heat supply required for ice protection by the external discharge method in comparison with internal heating of the surface. For example, figure 15 illustrates a flight in which the windshield area under the discharge jet was maintained clear with a heat supply of 20,000 Btu per hour, which is an approximate unit flow of 10,000 Btu per hour per square foot of cleared surface. In the same icing condition, ice accretions were removed from the flush test panel with a heat flow of 545 Btu per hour per square foot. (See fig. 15 and table III.) Thus the external discharge system required a heat supply approximately 20 times that required for the internally heated system, for the same degree of protection in the same icing condition.

The thermal inefficiency of the external-discharge system is apparently the result of rapid mixing of the discharge jet with the cold boundary-layer air, with a resultant rapid decrease in the jet and windshield surface temperature as shown in figure 25. The surface temperature data in this figure indicate a decrease from 160° F at the discharge slot to a value of 42° F at a distance of only 6 inches from the point of discharge.

Satisfactory operation of the external-discharge system for the V-type windshield was not obtained because of failure of the jet to flow across the entire surface. Figure 20 illustrates a typical ice-removal attempt. A small area along the bottom of the pilot's windshield, and also at the center post, has been cleared by the jet but the remainder of the panel is covered by an ice formation. Attempts to raise the surface temperature by increasing the flow rate and temperature of the heated air were limited by the temperature restrictions of the vinyl plastic at the lower edge of the windshield (region of maximum temperature). The external-discharge system of windshield ice prevention appears to be a desirable installation only in those instances where (1) internal heating is not possible, (2) the discharged air will flow over the windshield without requiring the additional weight penalty of blowers, and (3) a large supply of heated air is available in the region of the windshield to be protected.

CONCLUSIONS

The following conclusions are based on the analytical studies and test data of this report and should be applicable to windshield configurations and icing conditions similar to those investigated:

1. The coefficient of convective heat transfer for the external surface of a V-type or flush windshield can be approximated with accuracy suitable for design purposes by the use of the established equations for turbulent flow on a flat plate.

2. The heat requirement for ice prevention on a flush or V-type airplane windshield during flight in specified icing conditions can be calculated to an accuracy of 20 percent.

3. The complete and continuous prevention of ice accretions on the surface of a V-type airplane windshield, for flight in moderate cumulous icing conditions at speeds up to 300 miles per hour, will require a heat flow from the surface of from 2000 to 2500 Btu per hour per square foot of surface. In the case of continuous flight for the same speed range in moderate stratus conditions, a heat flow of 1000 Btu per hour per square foot should prove adequate.

4. The complete and continuous prevention of ice accretions on the surface of a flush-type airplane windshield located well aft of the fuselage stagnation region, for a speed range up to 300 miles an hour in stratus and moderate cumulous conditions, can be obtained with a heat flow of 1000 Btu per hour per square foot of surface.

5. The tendency of ice to accrete on windshields which are installed flush with the fuselage contours is considerably less than that for V-type windshields.

6. The external discharge system of windshield thermal ice prevention is thermally inefficient and requires a heat supply approximately 20 times that required for an internal system having the same performance.

7. Windshield installations which conform to the fuselage contours are more adaptable to the use of the external discharge system than V-type installations because the heated jet will flow naturally over the windshield surface.

Ames Aeronautical Laboratory,
National Advisory Committee for Aeronautics,
Moffett Field, Calif.

APPENDIX A

Method Used for the Determination of the Rate
of Water Impingement for the Flush Test Panel

The cross sections of the C-46 airplane fuselage consisted of two circular sections separated by the floor line, the upper section being the greater. The entire flush windshield assembly was included between two stations which were located 23.5 and 50.5 inches, respectively, from the nose of the fuselage and are designated as stations A and B, respectively, (fig. 31). The flush test panel was located in the copilot's windshield as shown by figures 3 and 4.

A sphere represents the best form for which streamlines and water-drop trajectories are now known (reference 4) and which would have approximately the same rate of water impingements as the front of the fuselage. For calculations a sphere was selected with a radius equal to the maximum radius of the fuselage. The relative location of the flush test panel on this sphere is shown in figure 31.

Water intercepted by the sphere.— The projected area of the sphere is used with the impingement efficiency to determine the weight rate of water interception:

$$w = 0.225 \frac{\eta}{100} \frac{U_o \pi C^2 m}{U_o \pi C^2 m} \quad (19)$$

where

C the radius of the sphere, feet

Weight rate of water intercepted per unit of impingement area.— The weight rate of water intercepted by the sphere divided by the surface area over which the water droplets impinge gives the average rate of impingement over the area of impingement.

The equation for the impingement area is:

$$A_1 = 2\pi C^2 (1 - \cos \theta_M) \quad (20)$$

where

θ_M half the central angle of the total area of impingement on a spherical surface

Therefore, the weight rate of water intercepted per unit of impingement area may be written:

$$M = 0.225 \frac{\eta}{100} \overline{U_0 m} \frac{\pi C^2}{2\pi C^2 (1 - \cos \theta_M)}$$

which may be reduced to the form,

$$M = 0.225 \frac{\eta \overline{U_0 m}}{200 (1 - \cos \theta_M)} \quad (21)$$

Weight rate of water intercepted by the flush test panel.-

The assumption was made that, for water-drop sizes of sufficient diameter to cause the area of impingement to include the flush test panel, the water intercepted per unit area of the panel would be approximately equal to the average weight rate of water intercepted over the area of impingement. On the basis of this assumption, the following equation was written:

$$w = 0.225 \frac{\eta \overline{U_0 m} A}{200 (1 - \cos \theta_M)} \quad (22)$$

where

A the area of the flush test panel, 1.16 square feet

Calculated values of water impingement on the flush test panel for various water-drop sizes are presented in table VI.

APPENDIX B

Calculations of the Heat Requirements on the Flat-Plate
and Flush Test Windshields for Icing Condition 6I. Heat requirement for the flat-plate windshield.-

A. The following assumptions were made:

1. The water intercepted by the windshield is the same as that intercepted by a ribbon with an area equal to the projected area of the windshield. (See reference 4 and figure 30.)
2. The water that is intercepted by the windshield panel is heated to the surface temperature and then all, or in part, evaporated.
3. The windshield surface is completely wetted.
4. There is a region of air stagnation at the leading edge of the panel.
5. The air flow over the windshield is turbulent.

B. The conditions for illustration are the same as icing condition 6, table I:

1. Pressure altitude: 12,700 ft
2. Airplane true airspeed: 140 mph
3. Free-stream air temperature: -2° F
4. Liquid water content: 1.0 gram/cu meter
5. Water-drop diameter: 44 microns
6. Drop-size distribution: uniform
7. Heated area of panel: 1.49 sq ft
8. Convective heat-transfer coefficients based on test data taken at the center of the panel and the average value of $s = 1.68$ ft.

9. Panel angle with the fuselage: 45°

10. Mean surface temperature of the panel: 36° F

C. External convective heat-transfer coefficient. Since the local velocity was measured only at the center of the flat-plate panel and equation (15) (Discussion) gives the experimental convective heat-transfer coefficient at the center of the panel, a conversion factor was needed to convert the coefficient at the center of the panel to an average value for the entire heated area. By substituting $2s$ for l in equation (7) and equating the two equations, the average coefficient was found to be 1.1 times the coefficient at the center of the panel. Therefore, by using equation (15) for this case:

$$h = 1.1 \times 0.46 T_{av}^{0.3} (U_1 \gamma)^{0.8}$$

$$T_{av} = \frac{36-2}{2} + 460 = 477^\circ \text{ F absolute}$$

$$U_1 = 106 \times 1.467 = 156 \text{ ft/sec}$$

$$\gamma = 0.0525 \text{ lb/cu ft}$$

therefore

$$h = 17.3 \text{ Btu/hr, sq ft, } ^\circ \text{ F}$$

D. Rate of water impingement, equation (10):

$$M = 0.225 \frac{\eta}{100} U_o m \frac{A_p}{A}$$

The percentage of water intercepted is obtained from curves presented in reference 4 after values of K and ϕ have been calculated from the equations of that reference:

$$K = \frac{2\gamma_w a^2 U_o}{9\mu g b} = 1.21$$

$$\phi = \frac{18\gamma^2 U_o b}{\gamma_w \mu g} = 1.48 \times 10^4$$

where

- γ_w specific weight of the water drops, 1 gram/cu cm
 γ specific weight of the air, 8.22×10^{-4} grams/cu cm
 a radius of the water drop, 0.0022 cm
 b projected height of windshield or half of ribbon width,
 $1.5 \times 30.48 \times \cos 45^\circ = 32.3$ cm
 U_0 airplane speed, 6,250 cm/sec.
 g acceleration due to gravity, 980 cm/sec, sec
 μ absolute viscosity of air, 1.69×10^{-7} gram sec/sq cm

For these values of K and ϕ the impingement efficiency is equal to 43 percent, and the equation for the rate of water impingement becomes:

$$M = 0.225 \times .43 \times 205 \times \frac{1.49 \times \cos 45^\circ}{149} \times 1 = 14 \text{ lb/hr, sq ft}$$

$$w = MA = 20.9 \text{ lb/hr}$$

E. Calculation of the factor X , equation (14):

$$X = 1 + \frac{0.622L_s}{c_p P_o} \frac{(e_s - e_o)}{(t_s - t_o)}$$

For the sample conditions

$$L_s = 1074 \text{ Btu/lb at } t_s = 36^\circ \text{ F}$$

$$c_p = 0.240 \text{ Btu/lb, } ^\circ \text{F}$$

$$P_o = 18.55 \text{ in. Hg}$$

$$e_s = 0.212 \text{ in. Hg}$$

$$e_o = 0.040 \text{ in. Hg}$$

$$t_s = 36^\circ \text{ F}$$

$$t_o = -2^\circ \text{ F}$$

Therefore

$$X = 1 + 0.675 = 1.675$$

- F. Heat required at the outer surface of the flat-plate panel for ice prevention, equation (13):

$$\begin{aligned} q &= hX(t_s - t_o) + M(t_s - t_o) - 0.832 h r \left(\frac{U_o}{100} \right)^2 \\ &= 17.3 \times 1.675 \times 38 + 14 \times 38 - 0.832 \times 17.3 \times 0.89 (2.05)^2 \\ &= 1580 \text{ Btu/hr, sq ft} \end{aligned}$$

- G. Temperature of the panel surface required to evaporate all the water intercepted:

Equating the equation of mass transfer (equation (8) without the latent heat of vaporization) to the weight rate of water impingement, the difference in vapor pressures required to evaporate all the water intercepted is first determined:

$$h \left(\frac{0.622A}{c_p P_o} \right) (e_s - e_o) = 20.9 \text{ lb/hr}$$

As a first approximation, h can be taken as the previously calculated value of 17.3 Btu/hr, sq ft, $^\circ\text{F}$.

then

$$e_s - e_o = 5.8 \text{ in. Hg}$$

$$e_s = 5.84 \text{ in. Hg} = 148.3 \text{ mm Hg (saturation)}$$

therefore,

$$t_s = 139^\circ \text{ F}$$

For this value of t_s , h is recalculated to be 17.8 Btu/hr, sq ft, °F

Therefore,

$$e_s - e_o = 5.97 \text{ in. Hg}$$

$$e_s = 6.01 \text{ in. Hg} = 153 \text{ mm Hg}$$

$$t_s = 141^\circ \text{ F}$$

H. Heat required at the outer surface of the panel to evaporate all the water intercepted with no water runback or blow-off.

$$h = 17.8 \text{ Btu/hr, sq ft, } ^\circ\text{F}$$

$$M = 14.0 \text{ lb/hr, sq ft}$$

$$t_s = 141^\circ \text{ F}$$

$$X = 7.0$$

$$q = 17.8 \times 7.0 \times 141 + 14.0 \times 141 = 56 = 19,400 \text{ Btu/hr, sq ft}$$

II. Heat requirement for a flush-type windshield.— The method of calculation and the assumptions made were similar to those used for the flat-plate windshield. Icing condition 6, table I, is again selected for illustration. For the flush-type windshield the assumption was made that the water intercepted by the windshield is equal to the water intercepted by a portion of a sphere with a radius equal to the maximum radius of the upper half of the fuselage. (See Appendix A, and fig. 31.)

A. External convective heat-transfer coefficient. Since the flush windshield test panel did not deviate from the fuselage contours, the distance from the stagnation region at the nose of the fuselage to the center of the panel was utilized in equation (6), to determine the convective heat-transfer coefficient.

$$h = 0.51 T_{av}^{0.3} \left(\frac{U_1 \gamma}{s^{0.25}} \right)^{0.8}$$

$$T_{av} = 475^\circ \text{ F, absolute}$$

$$U_1 = 190 \text{ ft/sec.}$$

$$\gamma = 0.0525 \text{ lb/cu ft}$$

$$s = 5.0 \text{ ft}$$

Therefore,

$$h = 14.8 \text{ Btu/hr, sq ft, } ^\circ\text{F}$$

- B. Rate of water impingement, equation (22), Appendix A. The percentage of water intercepted was obtained from curves presented in reference 4 after the following values of K and ϕ had been calculated:

$$K = 0.242$$

$$\phi = 7.5 \times 10^4$$

then

$$\eta = 3 \text{ percent}$$

and

$$\theta_M = 16^\circ$$

The central angle $\theta_M = 16^\circ$ does not represent an impingement area extensive enough to include all the area of the flush windshield (fig. 31), yet test observations indicated that during icing condition 6 ice tended to form over the entire windshield surface. For this reason, $\theta_B = 27.5^\circ$ was substituted for θ_M in equation (22). The weight rate of water impingement was determined by the equation:

$$M = \frac{W}{A} = 0.225 \frac{\eta U_o \hat{m}}{200 (1 - \cos \theta_B)} = \overset{6.13}{\cancel{4.13}} \text{ lb/hr, sq ft}$$

- C. Calculation of the factor X , equation (14)

$$X = 1 + \frac{0.622 L_s}{c_p P_o} \left(\frac{t_s - t_o}{t_s - t_o} \right) = 1 + 0.633 = 1.633$$

$$t_s = 33^\circ \text{ F}$$

$$t_o = -2^\circ \text{ F}$$

$$L_s = 1075 \text{ Btu/lb}$$

$$P_o = 18.55 \text{ in. Hg.}$$

$$c_p = 0.24 \text{ Btu/lb, } ^\circ\text{F}$$

$$e_s = 0.1878 \text{ in. Hg}$$

$$e_o = 0.04 \text{ in. Hg}$$

D. Total heat required at the outer surface, equation (13).

$$q = 14.8 \times 1.633 \times 35 \overset{-6.13}{\cancel{= 2.3}} \times 35 - 0.832 \times 14.8 \times 0.8(2.05)^2$$

$$= \overset{1018}{\cancel{284}} \text{ Btu/hr, sq ft}$$

LIBRARY
Office of
Aeronautical Intelligence
National Advisory Committee
for Aeronautics

REFERENCES

1. Rodert, Lewis A., Clousing, Lawrence A., McAvoy, William H.: Recent Flight Research on Ice Prevention. NACA ARR, Jan. 1942.
2. Neel, Carr B., Jr. and Jones, Alun R.: Flight Tests of Thermal Ice-Prevention Equipment in the XB-24F Airplane. NACA RMR, Oct. 1943.
3. Selna, James, Neel, Carr B., Jr. and Zeiller, Lewis E.: An Investigation of a Thermal Ice-Prevention System for a C-46 Cargo Airplane. IV - Results of Flight Tests in Dry-Air and Natural-Icing Conditions. NACA ARR No. 5A03c, 1945.
4. Langmuir, Irving and Blodgett, Katherine B.: A Mathematical Investigation of Water Droplet Trajectories. General Electric Rep., 1945. (Available from Office of Technical Services, U. S. Department of Commerce as PB No. 27565.)
5. Hardy, John K.: Protection of Aircraft Against Ice. Rep. No. S.M.E. 3380, British R.A.E., July 1946.
6. Anon: Icing Report by the University of California. Fiscal Year 1946. AAF TR 5529, Nov. 1946.
7. Boelter, L. M. K., Grossman, L. M., Martinelli, R. C., and Morrin, E. H.: An Investigation of Aircraft Heaters. Part XXIX - Comparison of Several Methods of Calculating Heat Losses from Airfoils. University of California. NACA TN No. 1453, 1947.
8. Tribus, Myron and Tessman, J. R.: Report on the Development and Application of Heated Wings. AAF TR 4972, Add. I, Jan. 1946. (Available from Office of Technical Services, U. S. Department of Commerce as PB No. 18122.)
9. Lewis, William: A Flight Investigation of the Meteorological Conditions Conducive to the Formation of Ice on Airplanes. NACA TN No. 1393, 1947.
10. Martinelli, R. C., Morrin, E. H., and Boelter, L. M. K.: An Investigation of Aircraft Heaters. V - Theory and Use of Heat Meters for the Measurement of Rates of Heat Transfer which are Independent of Time. NACA ARR, Dec. 1942.
11. Jones, Alun R., and Spies, Ray J., Jr.: An Investigation of a Thermal Ice-Prevention System for a C-46 Cargo Airplane. III - Description of Thermal Ice-Prevention Equipment for Wings, Empennage, and Windshield. NACA ARR No. 5A03b, 1945.

TABLE I.-- METEOROLOGICAL AND FLIGHT DATA, C-46 AIRPLANE, WINTER 1945-46

Icing condition number	Flight number	Date	Time	Pressure altitude (ft)	True airspeed (mph)	Liquid water content (gm/m ³)	Mean-effective drop diameter (microns)	Ambient-air temperature (°F)	Remarks
1	31	3/29/46	1116	8,000	160	0.2	10	14	cumulus clouds
2	31	3/29/46	1628	11,650	180	.5	18	17	cumulonimbus clouds
3	33	3/31/46	1147	8,300	170	.9	10	18	cumulus clouds
4	23	3/2/46	1454	10,350	135	.7	^a 11 to 20	6	cumulus clouds
5	23	3/2/46	1516	11,500	145	.8	^a 20 to 30	-0.5	cumulus clouds
6	23	3/2/46	1548	12,700	140	1.0	^a 18 to 44	-2	cumulus clouds
7	39	4/8/46	1413	9,000	160	.5	11	24	stratus and strato-cumulus clouds
8	39	4/8/46	1451	8,700	160	.2	13	26	stratus and strato-cumulus clouds
9	46	4/25/46	1656	10,300	170	.2	48	20	altostratus clouds largest drop size incurred
10	49	4/29/46	1121	9,140	165	.7	23	9.5	cumulonimbus clouds
11	49	4/29/46	1132	8,930	165	.2	20	11	cumulonimbus clouds
12	49	4/29/46	1155	10,600	160	1.4	19E	5	cumulonimbus clouds largest liquid water content incurred

^aMaximum drop diameter

NATIONAL ADVISORY
COMMITTEE FOR AERONAUTICS

TABLE II.- METEOROLOGICAL AND FLIGHT DATA
C-46 AIRPLANE, WINTER 1946-47

Icing condition number	Flight number	Date	Time	Pressure altitude (feet)	True air velocity (mph)	Liquid water content (gm/m ³)	Mean effective drop diameter (microns)	Ambient air temperature (°F)	Maximum drop size (microns)	Distri- bu- tion	Remarks
13	78	2/2/47	1057	6,780	163	0.17	14	11.2	-	D	Cumulus
14	83	2/5/47	1243	19,500	150	.22	24	-12	-	C	Alto stratus
15	95	3/10/47	1630	11,500	167	.64	19.2	23	-	A	Cumulus
16	95	3/10/47	1640	11,000	165	.44	16.4	23	-	A	Cumulus
17	100	3/16/47	1155	10,840	164	.12	10.4	21.1	13	C	Stratus
18	105	3/21/47	1102	5,080	162	.39	13	18.5	14	B	Stratocumulus
19	105	3/21/47	1114	5,000	152	.34	15	19.3	19	B	Stratocumulus
20	105	3/21/47	1429	5,150	162	.57	17	21.0	27	E	Stratocumulus
21	105	3/21/47	1433	4,980	156	.37	19	21.2	19	D	Stratocumulus
22	105	3/21/47	1505	5,190	168	.41	20	20.8	18	E	Stratocumulus
23	105	3/21/47	1512	5,150	151	.30	22	19.3	23	E	Stratocumulus
24	105	3/21/47	1528	4,500	161	.26	12	22.0	16	E	Stratocumulus

TABLE III.- RESULTS OF FLIGHT TESTS OF INTERNALLY HEATED WINDSHIELDS, C-46 AIRPLANE

WINTER 1945 - 46										WINTER 1946-47				
Flat-Plate Panel					Flush Type					V-Type				
Condition number	Panel angle	Surface temperature (°F)	q (Btu/hr /sq ft)	Surface temperature (°F)	q (Btu/hr /sq ft)	Remarks	Condition number	Wind-shield	Surface temperature	q (Btu/hr /sq ft)	Remarks			
1	30	50	1520	37	274	Heat supply adequate	13	Co-pilot's	45	1740	Heat supply adequate			
2	30	39	1240	28	274	F.P.P. heat supply adequate ice previously formed removed by F.W. clearing	14	Pilot's	27	1030	Heat supply inadequate			
3	30	60	1230	31	0	F.P.P. heat supply adequate slight ice on F.W. without heat supply	15	Co-pilot's	46	935	Heat supply adequate			
4	45	37	910	23	280	Heat supply adequate	16	Co-pilot's	47	920	Heat supply adequate			
5	45	40	1630	27	565	Heat supply adequate visible runback on F.P.P.	17	Pilot's	41	430	Heat supply adequate			
6	45	36	1720	33	780	Heat supply inadequate large formations on both windshields	18	Pilot's	38	630	Heat supply slightly inadequate			
7	60	59	1220	50	218	Heat supply adequate	19	Pilot's	39	630	Heat supply slightly inadequate			
8	60	48	640	49	218	Heat supply not quite adequate to F.P.P. F.W. clear	20	Co-pilot's	39	670	Heat supply adequate			
9	60	53	1205	38	545	Heat supply adequate	21	Co-pilot's	39	670	Heat supply adequate			
10	60	47	1170	26	0	Heat supply adequate	22	Co-pilot's	39	680	Heat supply adequate			
11	60	53	1190	27	0	Heat supply not quite adequate ice being formed and removed	23	Co-pilot's	38	680	Heat supply adequate			
12	60	40	1235	21	0	Heat supply adequate ice sliding off F.P.P.	24	Co-pilot's	35	490	Heat supply slightly inadequate			

1F.P.P.- Flat-plate panel

2F.W.- Flush-type windshields

NATIONAL ADVISORY

COMMISSION FOR AERONAUTICS

TABLE IV.- RESULTS OF FLIGHT TESTS OF A HEATED-AIR EXTERNAL DISCHARGE SYSTEM FOR WINDSHIELD ICE PROTECTION. C-46 AIRPLANE, WINTER 1945-46

ICING CONDITION 4

Heat supply slightly inadequate. Windshield clear over three-quarter area of heated jet.

Air-flow rate, 390 lb/hr
Nozzle air temperature, 147° F
Nozzle air velocity, 105 mph
Heat supplied, 13,200 Btu/hr

x (in.)	t _s (°F)	t _s -t _o (°F)
0	147	141
3	75	69
6	52	46
9	41	35
12	36	30
15	32	26
18	32	26
21	31	25
24	30	24

ICING CONDITION 5

Heat supply adequate. Windshield clear in the area of the heated jet.

Air-flow rate, 460 lb/hr
Nozzle air temperature, 187° F
Nozzle air velocity, 140 mph
Heat supplied, 21,000 Btu/hr

x (in.)	t _s (°F)	t _s -t _o (°F)
0	187	187
3	96	96
6	71	71
9	54	54
12	47	47
15	40	40
18	40	40
21	39	39
24	34	34

ICING CONDITION 6

Heat supply inadequate for complete clearance of windshield.

Air-flow rate, 470 lb/hr
Nozzle air temperature, 190° F
Nozzle air velocity, 150 mph
Heat supplied, 22,000 Btu/hr

x (in.)	t _s (°F)	t _s -t _o (°F)
0	190	192
3	83	85
6	62	64
9	46	48
12	40	42
15	33	35
18	30	32
21	25	27
24	22	24

^a Conditions presented in table I.

^b Available heat in jet above ambient-air temperature

TABLE IV.-- CONCLUDED. RESULTS OF FLIGHT TESTS OF A HEATED-AIR EXTERNAL DISCHARGE SYSTEM FOR WINDSHIELD ICE PROTECTION C-46 AIRPLANE, WINTER 1945-46

ICING CONDITION 9

Heat supply adequate.
Windshield clear.

Air-flow rate, 470 lb/hr
Nozzle air temperature, 192° F
Nozzle air velocity, 138 mph
Heat supplied, 20,000 Btu/hr

x (in.)	t _g (°F)	t _g -t ₀ (°F)
0	192	172
3	62	42
6	55	35
9	43	23
12	37	17
15	-	-
18	34	14
21	33	13
24	30	10

ICING CONDITION 11

Heat supply adequate.
Windshield clear.

Air-flow rate, 330 lb/hr
Nozzle air temperature, 178° F
Nozzle air velocity, 86 mph
Heat supplied, 13,000 Btu/hr

x (in.)	t _g (°F)	t _g -t ₀ (°F)
0	178	168
3	70	60
6	53	43
9	42	32
12	38	28
15	36	26
18	28	18
21	31	21
24	35	25

ICING CONDITION 12

Heat supply adequate.
Windshield clear.

Air-flow rate, 300 lb/hr
Nozzle air temperature, 182° F
Nozzle air velocity, 86 mph
Heat supplied, 13,000 Btu/hr

x (in.)	t _g (°F)	t _g -t ₀ (°F)
0	182	180
3	79	77
6	57	55
9	32	30
12	38	36
15	34	32
18	33	31
21	30	28
24	31	29

TABLE V.- CALCULATED VALUES OF WATER INTERCEPTED BY A FLAT-PLATE PANEL
BASED ON DATA CALCULATED FOR RIBBONS, REFERENCE 4.

Drop diameter microns	$a \times 10^4$	$2 a \times 10^8$	Panel angle 60°		Panel angle 45°		Panel angle 30°	
			K	η (percent)	K	η (lb/hr)	K	η (lb/hr)
10	5	25	0.057	0	0.07	0	0.1	0
20	10	100	.185	1	.227	2	.32	5
30	15	225	.51	15	.625	20	.884	32
50	25	625	1.41	45	1.73	50	2.44	60
100	50	2500	5.65	73	6.93	75	9.8	80

Pressure altitude, 10,000 ft Area of panel, 1.49 sq ft
 True airspeed, 150 mph Half width of ribbon = panel length $\times \cos \alpha$
 Ambient-air temperature, 0° F Average value of $\phi = .2 \times 10^4$
 Liquid water content, 1.0 gm/m³

TABLE VI.- CALCULATED VALUES OF WATER IMPINGEMENT ON A FLUSH WINDSHIELD PANEL. BASED ON DATA CALCULATED FOR SPHERES, REFERENCE 4

Drop diameter (microns)	η (percent)	θ_M	Sphere w (lb/hr)	Flush test panel, M (lb/hr sq ft)	Flush test panel, w (lb/hr)
20	0	0°	0	0	0
30	<1	3°	48	8 < 1.78	8 < 2.06
50	3	16°	54 ¹⁴⁴	7.2 19.2	8.4 22.3
70	8	28°	114 ³⁸⁴	6.35 16.9	7.1 19.6
100	15	45°	270 ²⁷⁰	4.76 12.7	5.5 14.7

Pressure altitude, 10,000 ft
 True airspeed, 150 mph
 Ambient-air temperature, 0° F
 $\phi = 1.1 \times 10^5$
 θ_M = half of the central angle of the total area of impingement on a spherical surface
 Liquid water content, 1.0 gm/m³

TABLE VII.- COMPARISON OF CALCULATED AND MEASURED
HEAT FLOW FROM THE SURFACE OF THE FLAT-PLATE
PANEL. C-46 AIRPLANE, WINTER 1945-46

Icing Condi- tion Number	Panel Angle From Fuse- lage	Mean Surface Temper- ature	Calcu- lated η (%)	Calcu- lated w (lb/hr)	Calcu- lated h (Btu/hr, sq ft/°F)	Calcu- lated q_c (Btu/hr, sq ft/°F)	Experi- mental q_E (Btu/hr, sq ft/°F)	$q_c - q_E$	$\frac{q_c - q_E}{q_c} \times 100$
1	30	50	0	0	27.9	890	1520	-630	-71.0
2	30	39	9.5	2.1	30.4	1210	1240	-30	-2.5
3	30	60	0	0	30.2	1180	1230	-50	-4.0
4	45	37	3.5	1.15	17.7	730	910	-180	-24.6
5	45	40	20.5	8.26	18.3	1454	1630	-176	-12.1
6	45	36	39	19.0	17.3	1580	1720	-140	-8.9
7	60	59	0	0	16.0	500	1220	-720	-144
8	60	48	0	0	16.0	660	640	20	3.1
9	60	53	45	6.44	14.9	1250	1205	45	3.6
10	60	47	5.5	2.7	14.8	1100	1170	-70	-6.4
11	60	53	2.5	0.35	14.9	1300	1190	110	-8.5
12	60	40	2.0	1.91	15.6	890	1235	-345	-38.8

TABLE VIII.- COMPARISON OF CALCULATED AND MEASURED HEAT FLOW FROM THE SURFACE OF THE V-TYPE WINDSHIELD, C-46 AIRPLANE. WINTER 1946-47.

Icing condition number	Windshield	Mean surface temperature (°F)	Mean inside surface temperature (°F)	Calculated η (percent)	Calculated w (lb/hr)	Calculated h^* (Btu/hr. sq. ft./°F)	Calculated q_c (Btu/hr. sq. ft.)	Experimental q_E (Btu/hr. sq. ft.)	$\frac{q_c - q_E}{q_c} \times 100$	Remarks
13	Copilot's	45	73	0.1	0.04	34.5	1900	1740	8.4	Heat supply adequate
14	Pilot's	27	24	9.0	1.84	21.5	1340	1030	23.1	Heat supply inadequate
15	Copilot's	46	64	3.3	4.95	27.1	1280	935	27.0	Heat supply adequate
16	Copilot's	47	63	1.0	1.03	23.3	1120	920	17.8	Heat supply adequate
17	Pilot's	41	51	0	0	20.5	730	430	41.0	Heat supply adequate
18	Pilot's	38	50	0	0	30.0	860	630	26.8	Heat supply slightly inadequate
19	Pilot's	39	51	.1	.07	28.6	875	630	28.0	Heat supply slightly inadequate
20	Copilot's	39	53	1.1	1.43	30.1	840	670	20.0	Heat supply adequate
21	Copilot's	39	53	2.2	1.78	29.5	830	670	19.3	Heat supply adequate
22	Copilot's	39	55	3.6	3.45	30.9	885	680	23.2	Heat supply adequate
23	Copilot's	38	54	4.9	3.12	28.8	855	680	20.5	Heat supply adequate
24	Copilot's	35	50	0	0	31.4	570	490	14.0	Heat supply slightly inadequate

h^* Included the effect of edge losses calculated by the empirical equation $h^* = h + 0.005q$

NATIONAL AVIATION

COMMITTEE FOR AERONAUTICS

TABLE IX.— A CALCULATION OF THE AMOUNT OF WATER INTERCEPTED BY A FLAT-PLATE PANEL USING THE DROP-SIZE DISTRIBUTION. ICING CONDITION 12

Liquid water content (percent)	Liquid water content (gm/m ³)	Distribution E	$a \times 10^4$ (cm)	η (percent)	w (lb/hr)
5	0.07	0.23	2.19	0	0
10	.14	.44	4.18	0	0
20	.28	.65	6.18	0	0
30	.42	1.00	9.5	2	0.571
20	.28	1.48	14.08	13	2.47
10	.14	2.00	19.0	30	2.855
5	.07	2.71	25.8	47	2.24
100	1.40	--	--	--	8.136

$$\phi = 2.66 \times 10^4$$

Based on mean-effective drop diameter of 19 microns

$$a_0 = 0.00095 \text{ cm}$$

$$w = 1.91 \text{ lb/hr}$$

$$q = 890 \text{ Btu/hr, sq ft}$$

Based on drop-size distribution E

$$w = 8.14 \text{ lb/hr}$$

$$q = 1035 \text{ Btu/hr, sq ft}$$

Experimental data

$$q = 1235 \text{ Btu/hr, sq ft}$$

Water drop-size distribution and percentages of liquid water content were obtained from reference 4.

TABLE X.-- CALCULATED MINIMUM WINDSHIELD HEAT REQUIREMENTS FOR A MODERATE ICING CONDITION IN TWO TYPES OF ICING CLOUDS, BASED ON AN ASSUMED DROP-SIZE DISTRIBUTION E

Condition number	General cloud type	True air temperature ($^{\circ}$ F)	Liquid water content (gm/m^3)	Mean-effective drop size (microns)	True airspeed (mph)	Flat-plate windshield q (Btu/hr , sq ft)	Flush windshield q (Btu/hr , sq ft)	V-type windshield q (Btu/hr , sq ft)
I	Stratus	15	0.5	15	150	540	0	675
I	Stratus	15	.5	15	300	560	460	700
II	Cumulus	0	1.0	20	150	1040	880	1440
II	Cumulus	0	1.0	20	300	1630	1190	2100

Pressure altitude, 10,000 ft
 External surface temperature, 32° F
 Panel angle from the fuselage, 45°

Page intentionally left blank

Page intentionally left blank

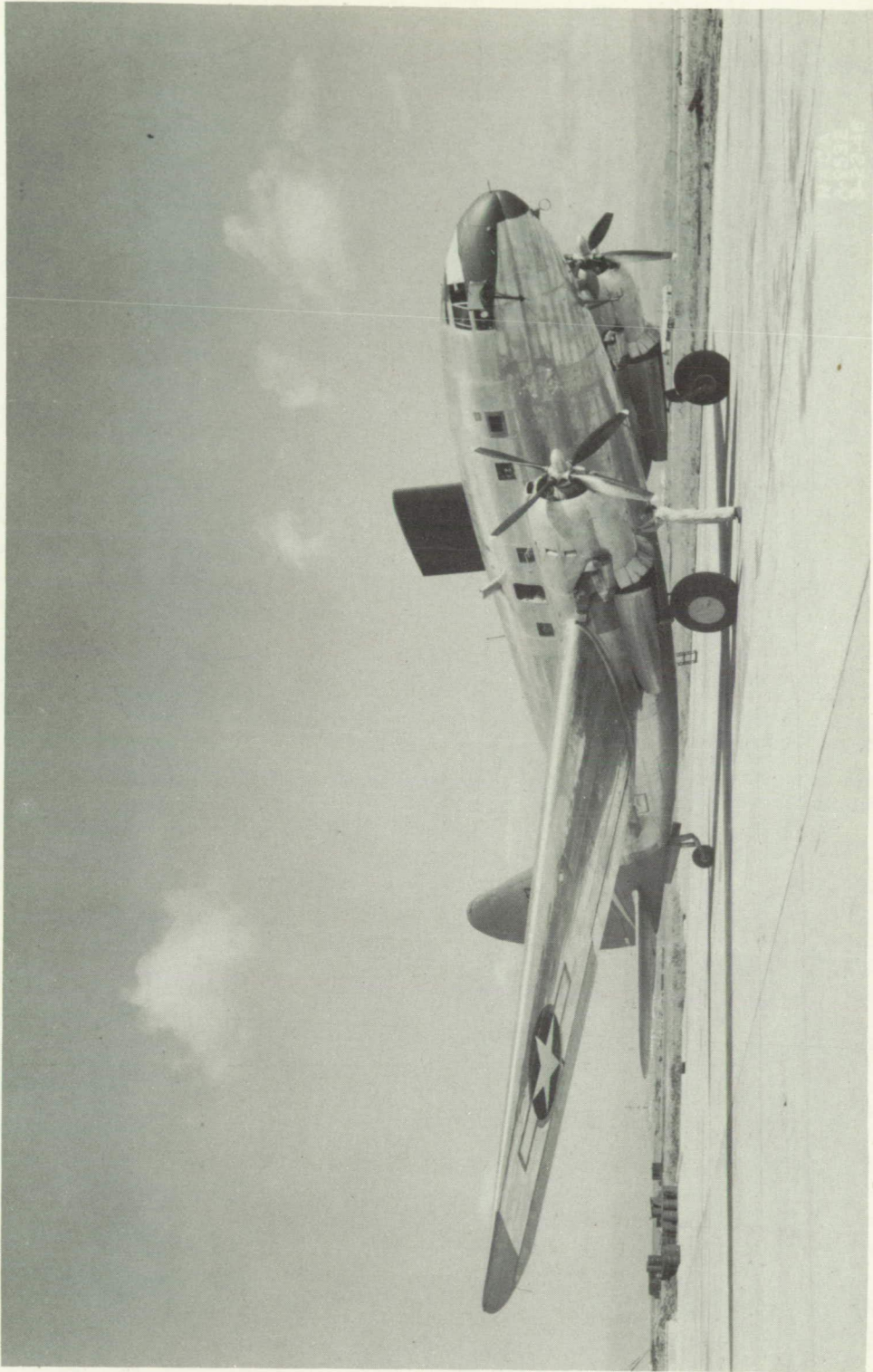

Figure 1.- The C-46 airplane as equipped for icing research flights in the winter 1945-46.

Page intentionally left blank

Page intentionally left blank



Figure 2.- The C-46 airplane as equipped for icing research flights in the winter 1946-47.

Page intentionally left blank

Page intentionally left blank

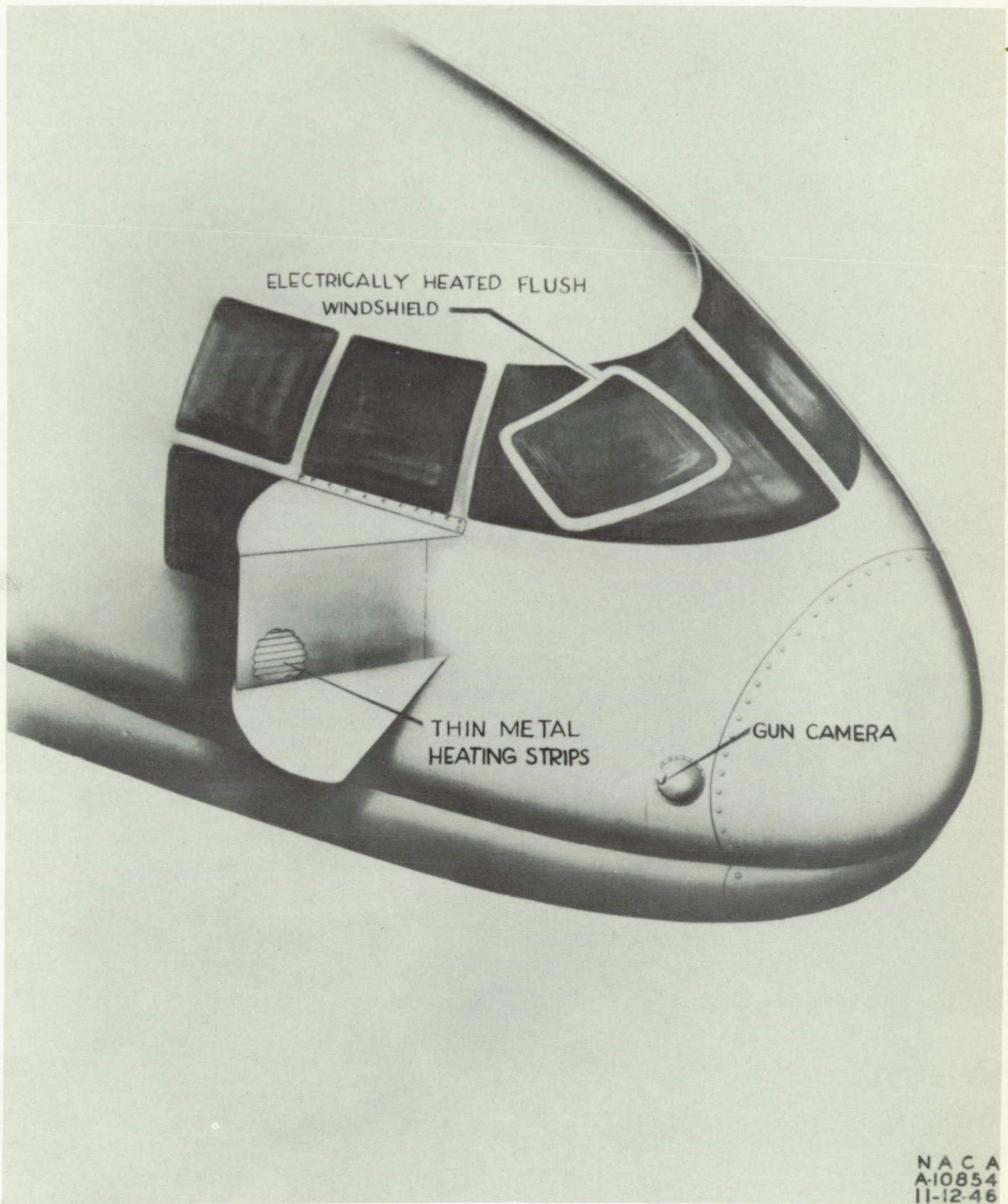

Figure 3.- Adjustable flat-plate windshield and flush windshield panel.

Page intentionally left blank

Page intentionally left blank



Figure 4.- Electrically heated flush windshield panel,
viewed from the exterior of the C-46 airplane cockpit.

Page intentionally left blank

Page intentionally left blank



(a) side view.

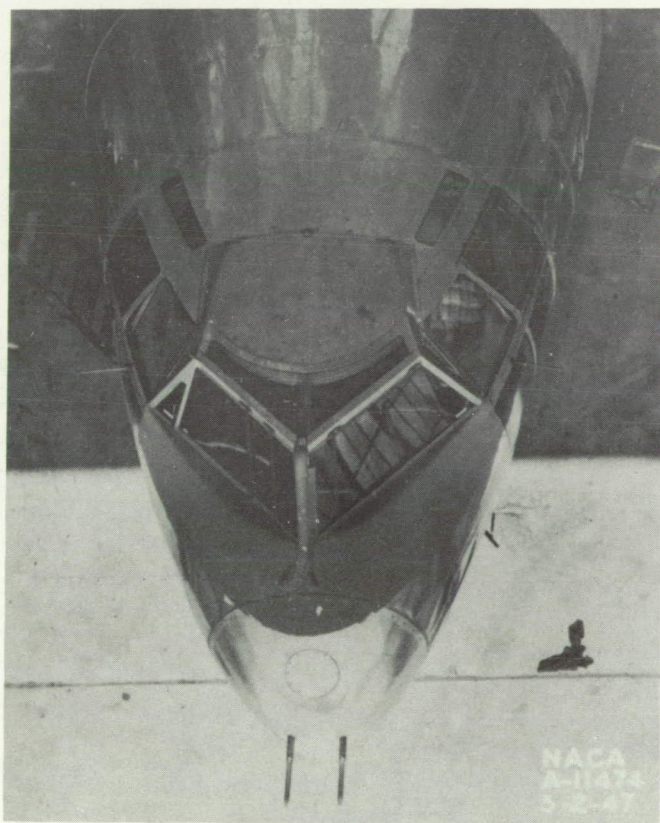

(b) Top view.

Figure 5.- V-type electrically heated windshield installed on the C-46 airplane.

Page intentionally left blank

Page intentionally left blank

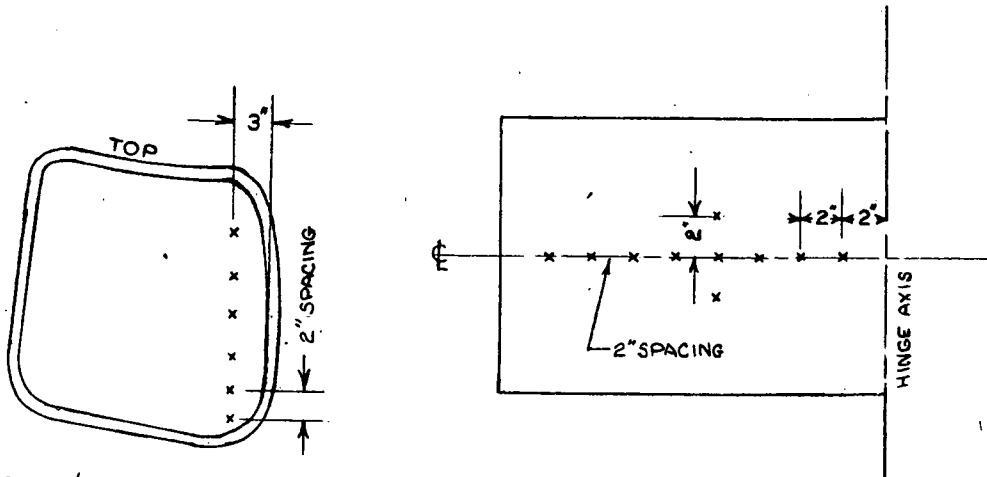

CO-PILOTS FLUSH-TYPE WINDSHIELD
WINTER 1945-46

FLAT PLATE PANEL
WINTER 1945-46

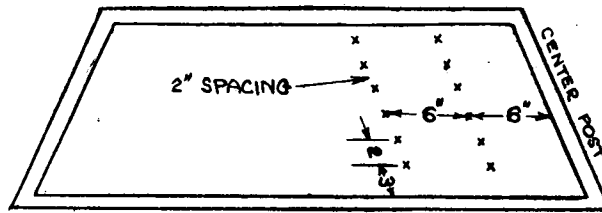

CO-PILOTS HALF V-TYPE WINDSHIELD, WINTER 1946-47

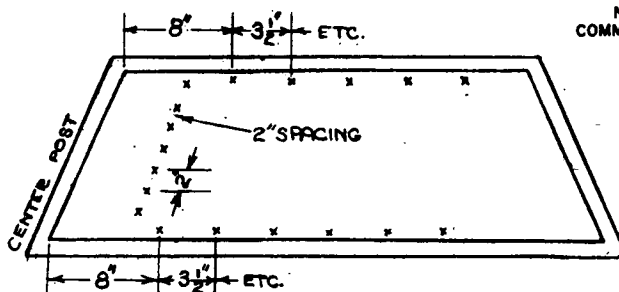

PILOTS HALF V-TYPE WINDSHIELD, WINTER 1946-47

NATIONAL ADVISORY
COMMITTEE FOR AERONAUTICS

FIGURE 6 - SKETCH SHOWING THE THERMOCOUPLE LOCATIONS ON
VARIOUS WINDSHIELD CONFIGURATIONS USED ON THE C-46 AIRPLANE

Page intentionally left blank

Page intentionally left blank

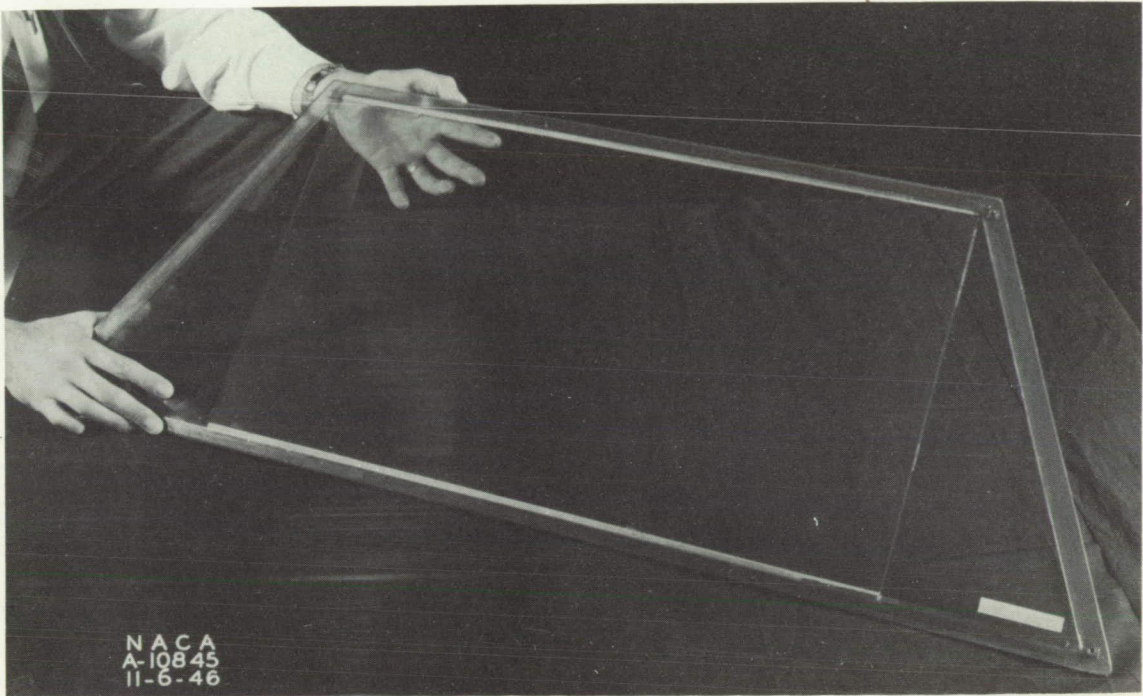

Figure 7.- Single panel from the V-type windshield installation. Heating was provided by transparent, electrical-conducting film under outer glass layer.

Page intentionally left blank

Page intentionally left blank

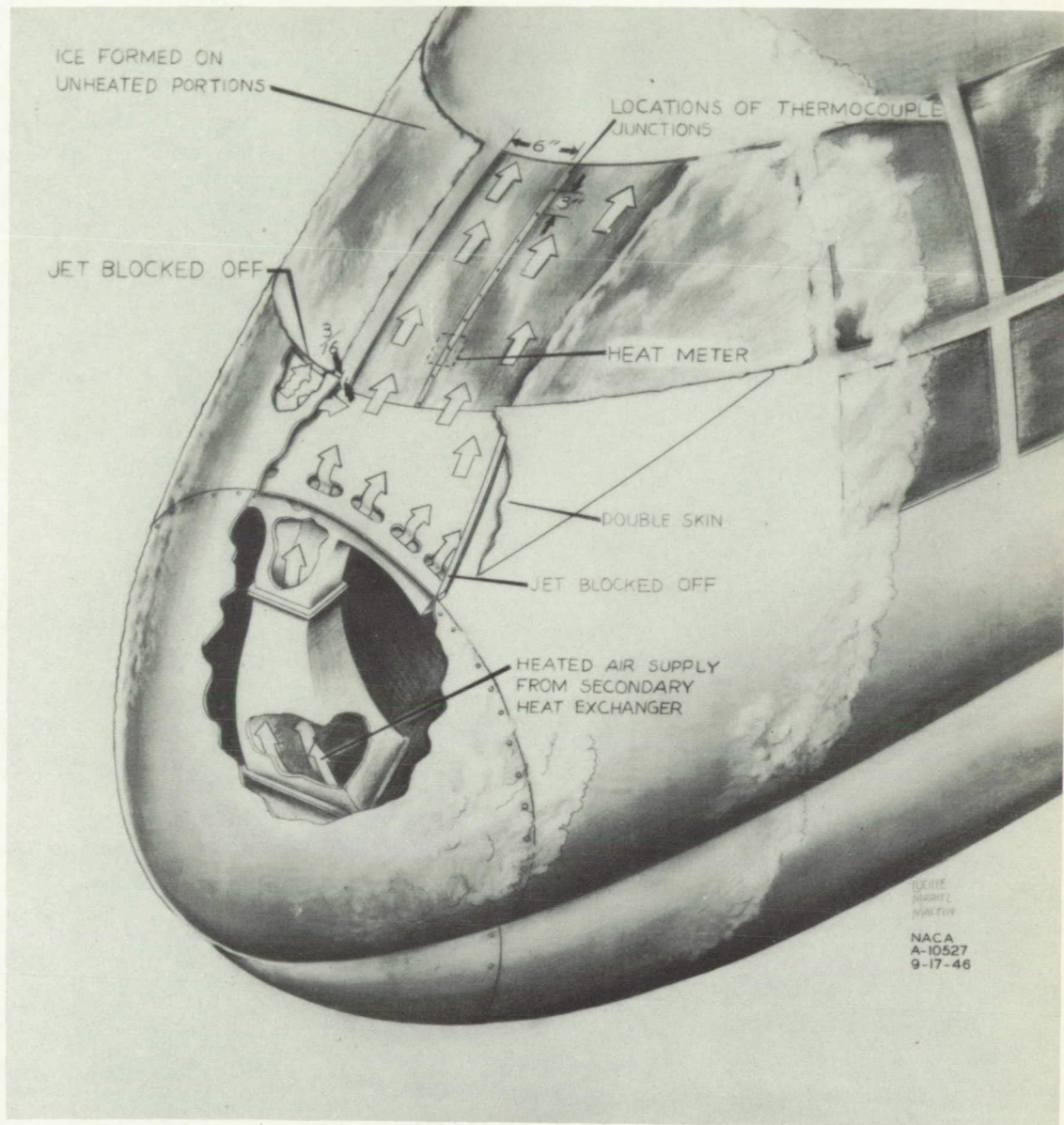
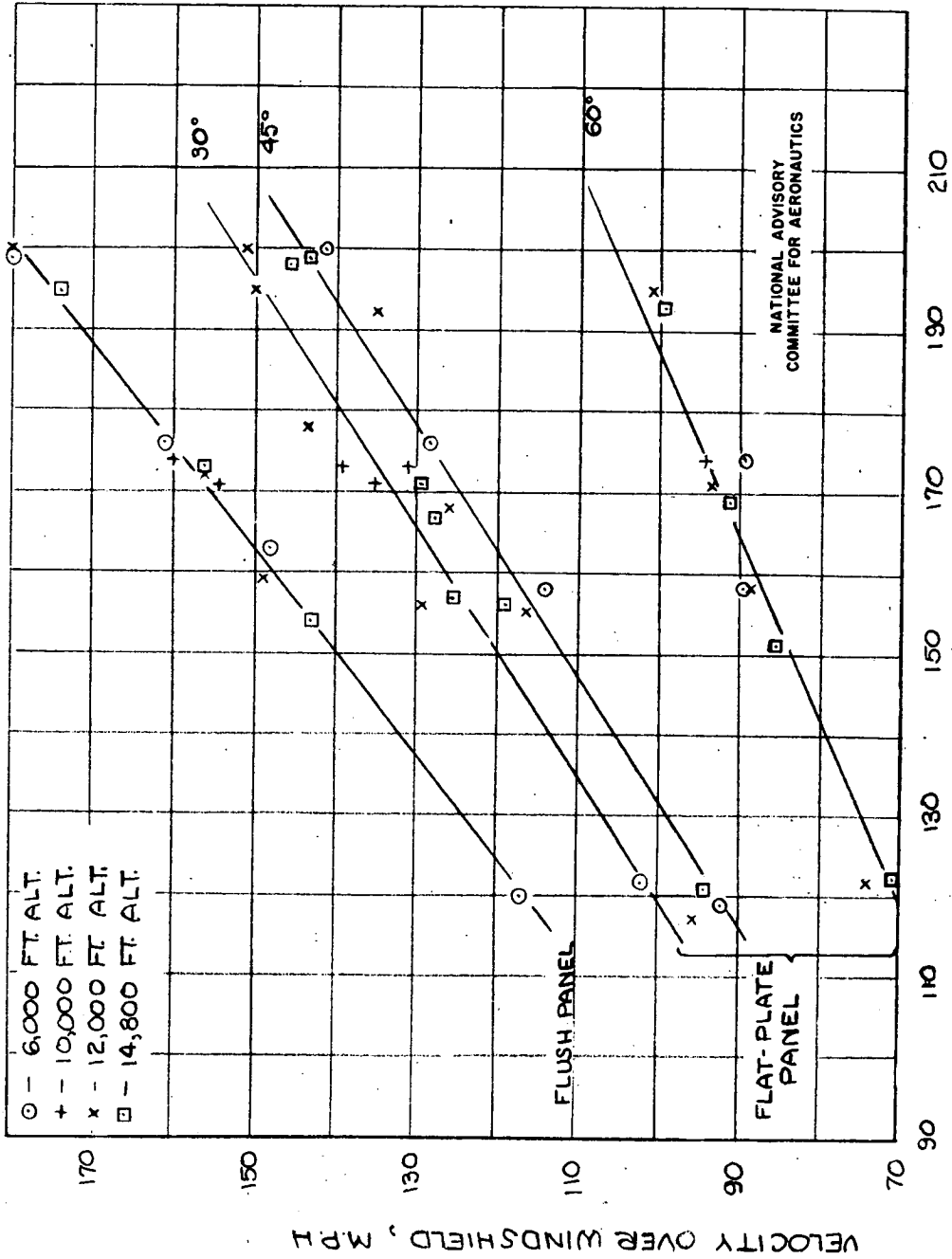

Figure 8.- Details of external discharge heated-air ice-prevention system for flush windshield of C-46 airplane.

Page intentionally left blank

Page intentionally left blank



TRUE AIR SPEED, M.P.H.

FIGURE 9.- COMPARISON OF AIRPLANE VELOCITY AND THE VELOCITY OVER FLAT-PLATE PANEL AND FLUSH-TYPE WINDSHIELD, C-46 AIRPLANE, WINTER 1945-46

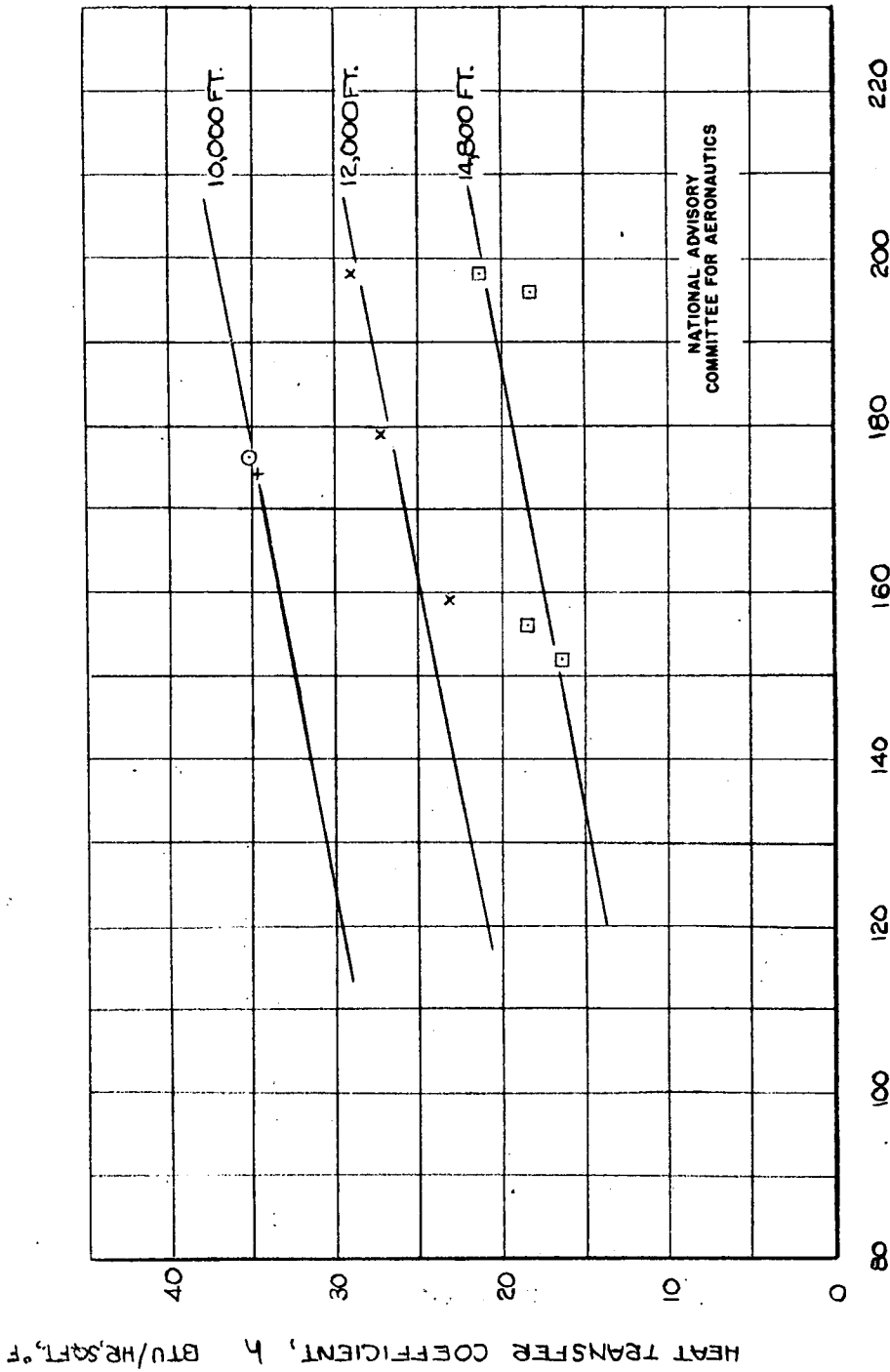

NATIONAL ADVISORY
COMMITTEE FOR AERONAUTICS

TRUE AIR SPEED MPH.
FIGURE 10.— VARIATION OF DRY AIR HEAT TRANSFER COEFFICIENT WITH AIR SPEED
AND ALTITUDE ON FLAT PLATE PANEL SET 90° FROM THE TANGENT
TO THE FUSELAGE. C-46 AIRPLANE, WINTER 1945-46

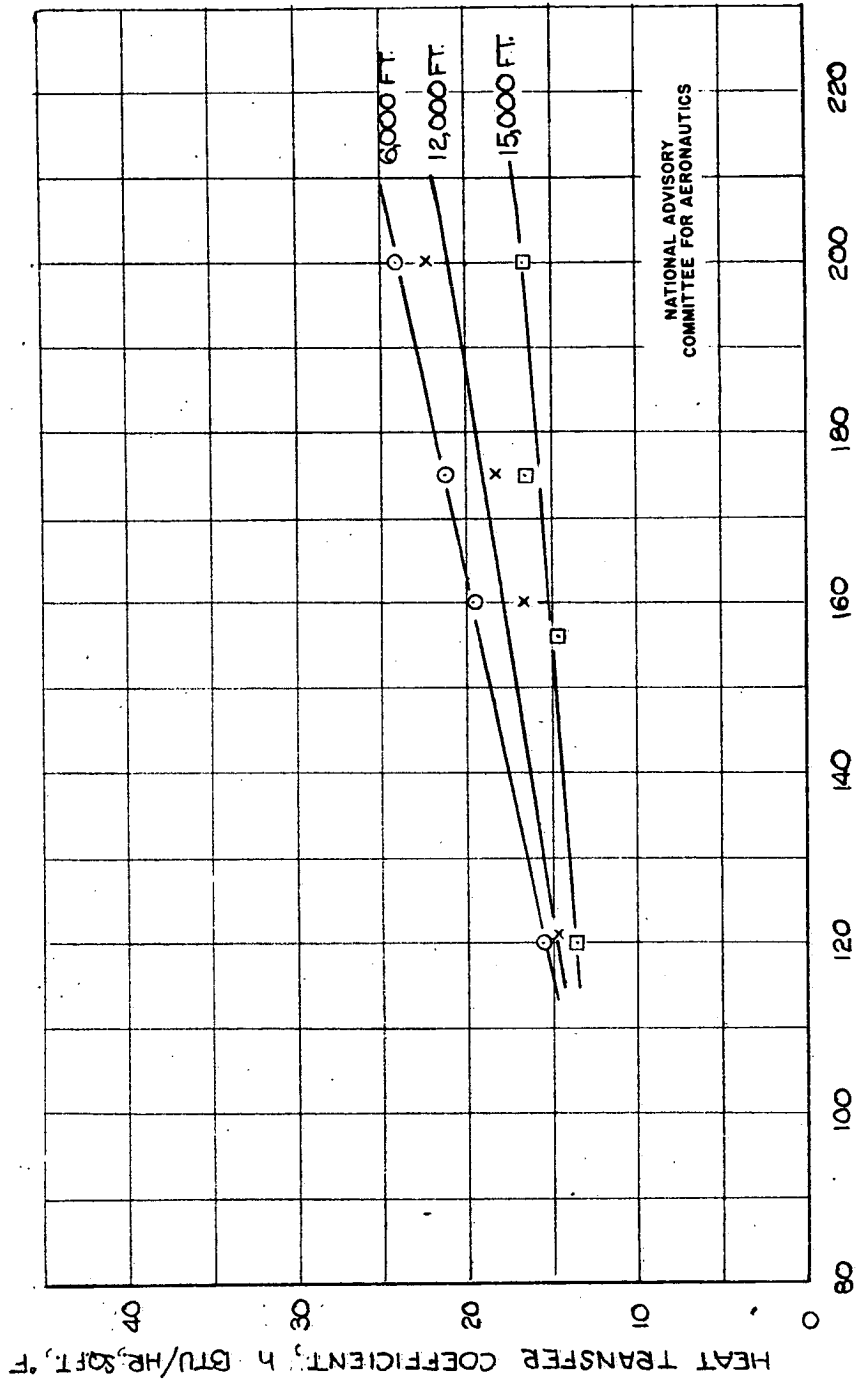

FIGURE 11.- VARIATION OF DRY AIR HEAT TRANSFER COEFFICIENT WITH AIR SPEED AND ALTITUDE ON THE FLAT-PLATE PANEL SET 45° FROM THE TANGENT TO THE FUSELAGE. C-46 AIRPLANE, WINTER 1945-46

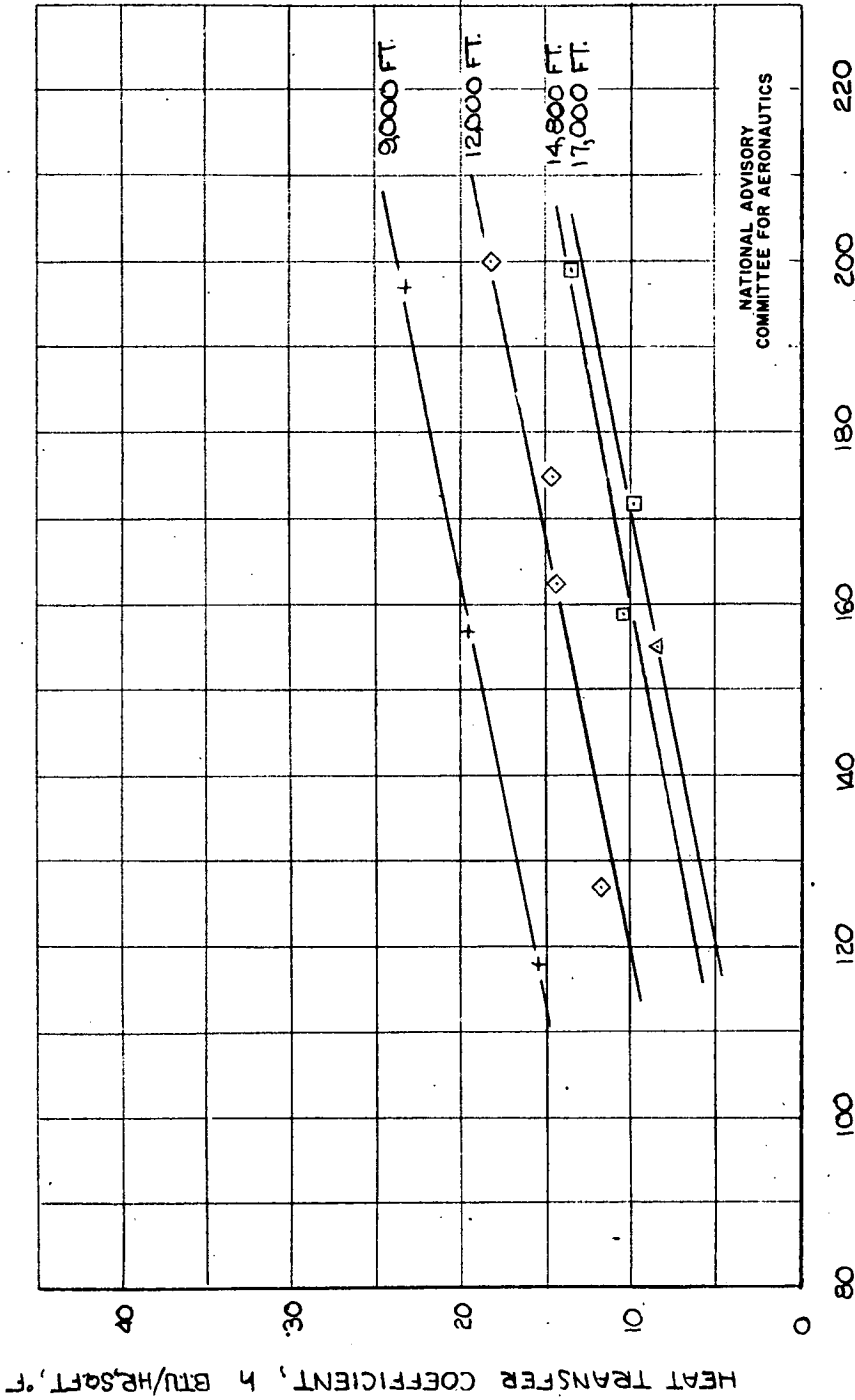
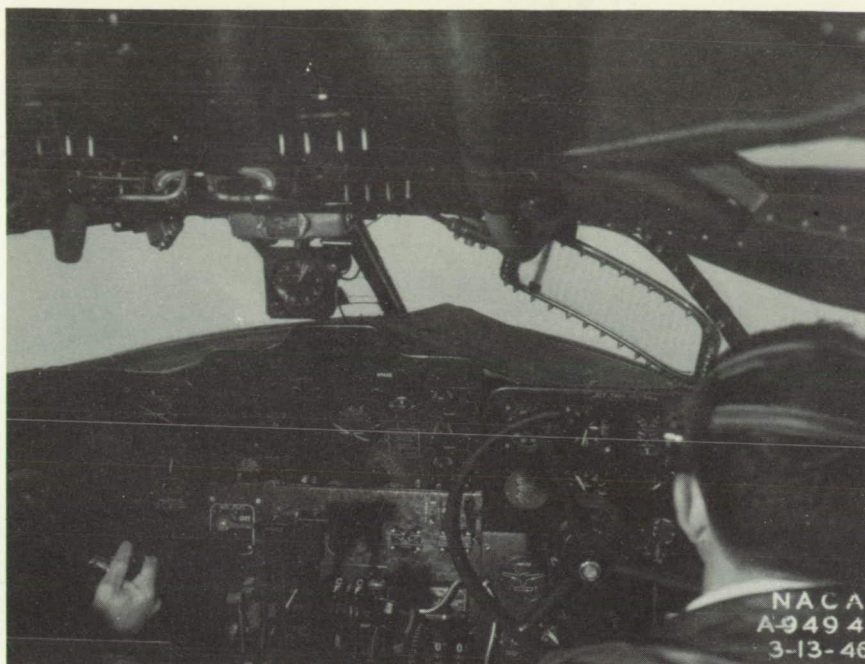

FIGURE 12.- VARIATION OF DRY AIR HEAT TRANSFER COEFFICIENT WITH AIR SPEED AND ALTITUDE ON THE FLAT-PLATE PANEL SET 60° FROM THE TANGENT TO THE FUSELAGE. C-46 AIRPLANE, WINTER 1945-46.



(a) In icing conditions. Time, 1549.



(b) Immediately after leaving icing conditions. Time, 1551.

Figure 13.- Flush windshield of C-46 airplane during icing condition 6, table I, with inadequate heat supply to the external discharge system for the pilot's panel.

Page intentionally left blank

Page intentionally left blank

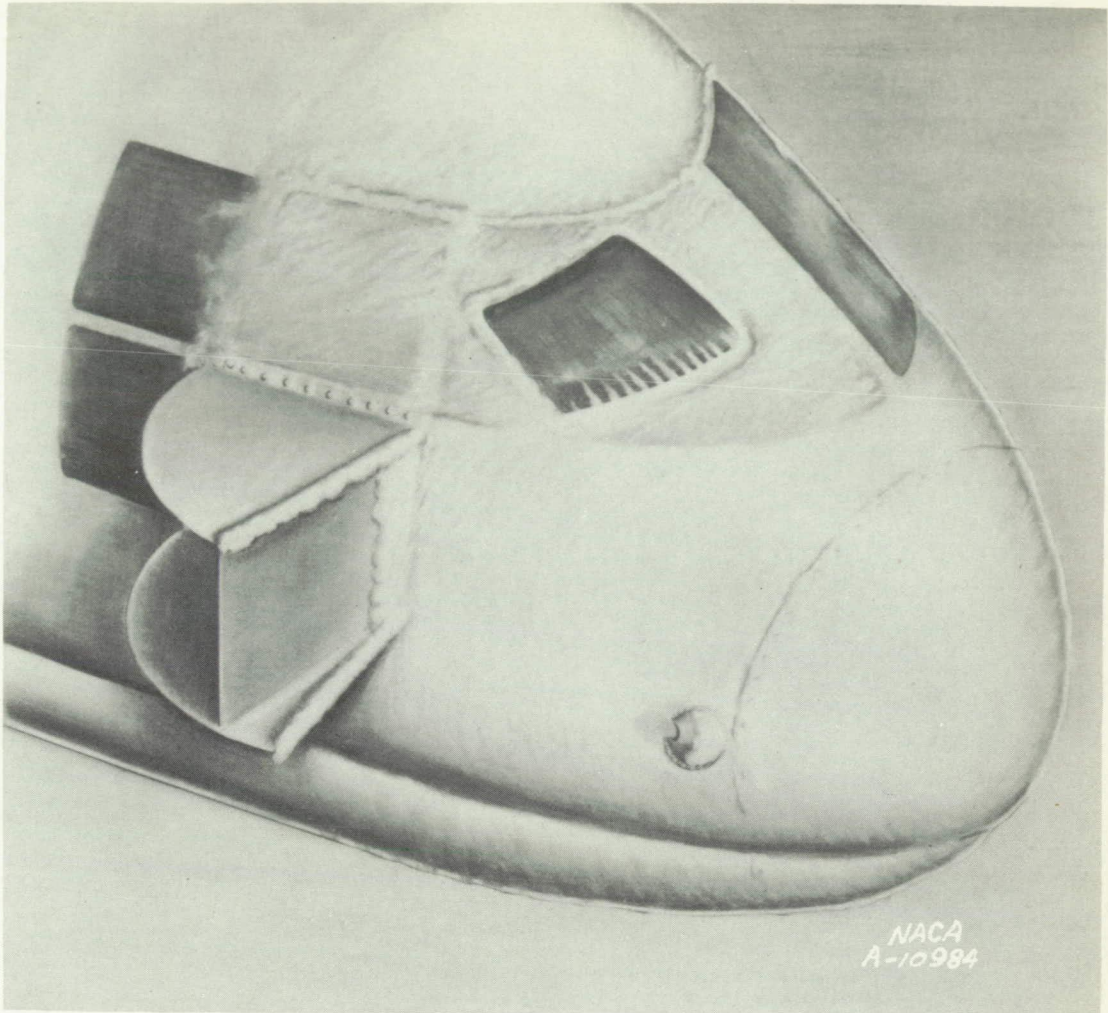

TIME	1650 TO 1720
PRESSURE ALTITUDE	10,300 TO 10,600 FEET
TRUE AIR SPEED	170 TO 150 MPH
AMBIENT AIR TEMPERATURE	20 TO 17.5°F
LIQUID WATER CONTENT	.15 TO .3 GRAM/M ³
MEAN EFFECTIVE DROP SIZE	50 TO 20 MICRONS
HEAT SUPPLIED TO PANEL	1205 BTU/HR FT ²
HEAT SUPPLIED TO WINDSHIELD	525 BTU/HR FT ²

Figure 14.- Sketch based on photographs and flight engineer's notes of ice accretions on nose and windshields of C-46 airplane after icing condition 9, table I. Panel angle 60° with the fuselage.

Page intentionally left blank

Page intentionally left blank



(a) In icing conditions, start of removal. Time, 1703.

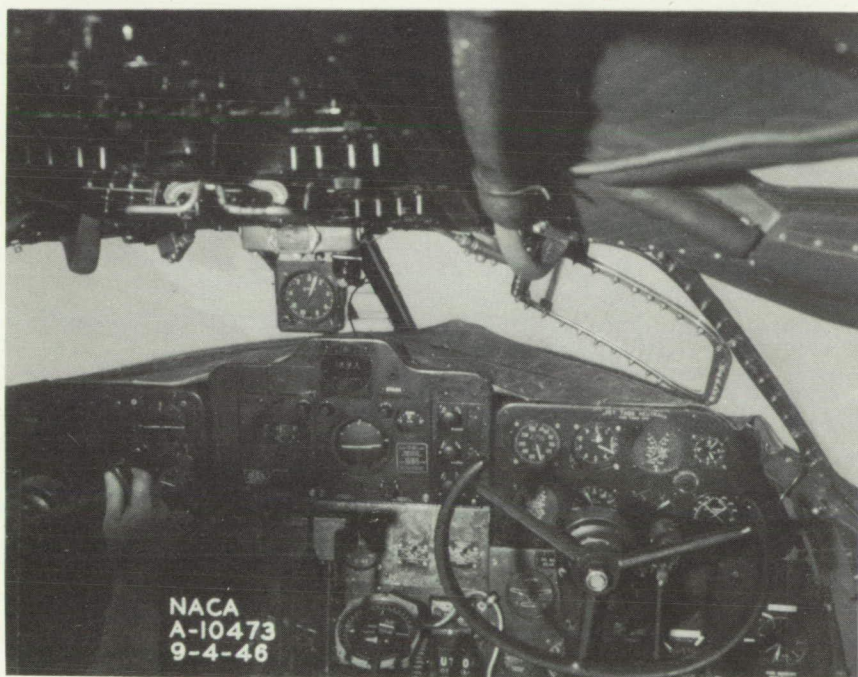

(b) In icing conditions, removal continued. Time, 1706.

Figure 15.- Windshield of C-46 airplane during icing condition 9, table I, showing removal of ice accretions from the electrically heated flush panel, right side, and the external discharge area, left side.

Page intentionally left blank

Page intentionally left blank



(c) In clear air, removal completed. Time, 1720.

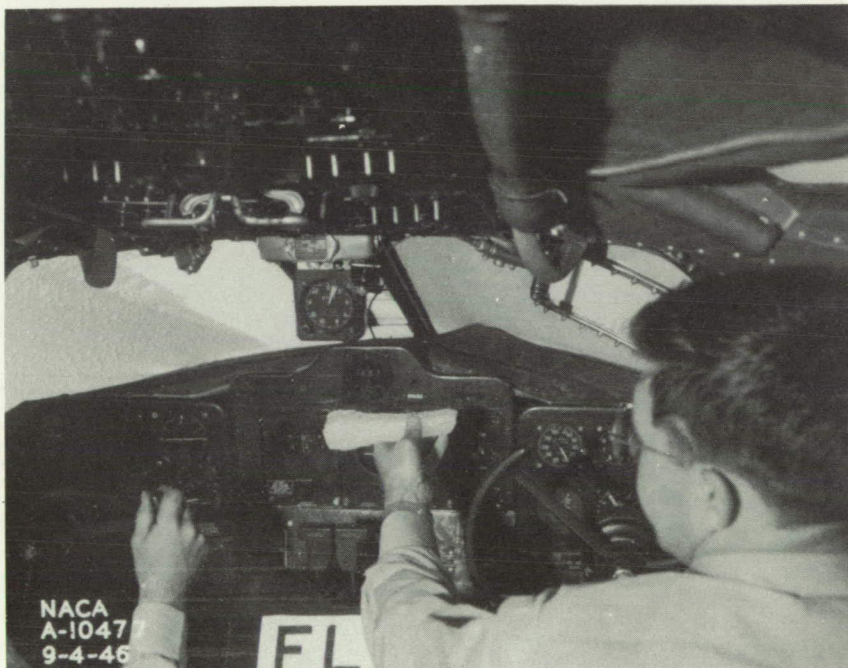

(d) Ice formation on $\frac{3}{8}$ -inch-diameter rod during the icing run.

Figure 15.- Concluded.

Page intentionally left blank

Page intentionally left blank

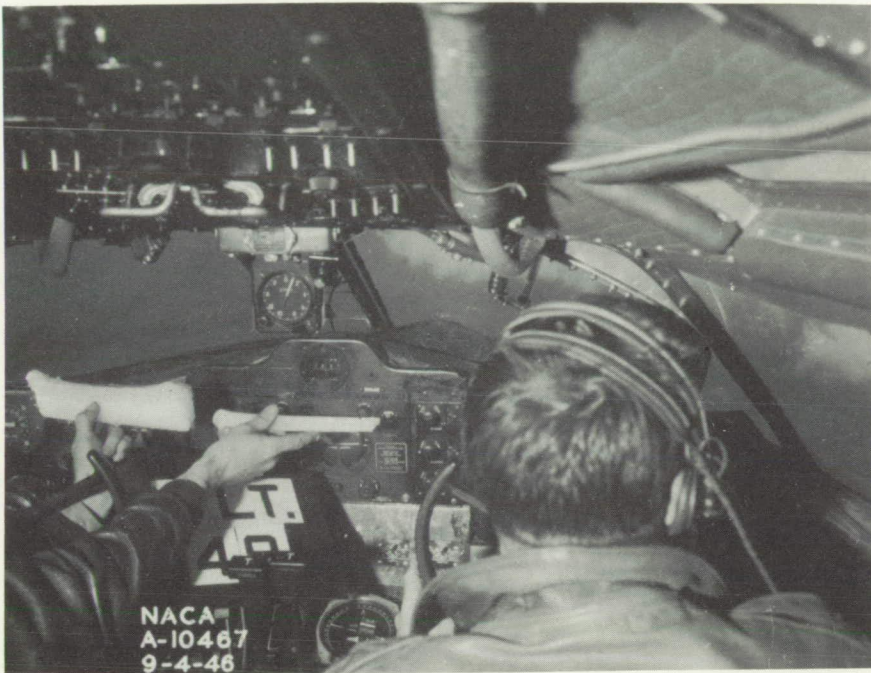
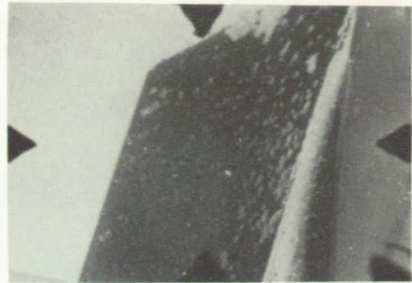
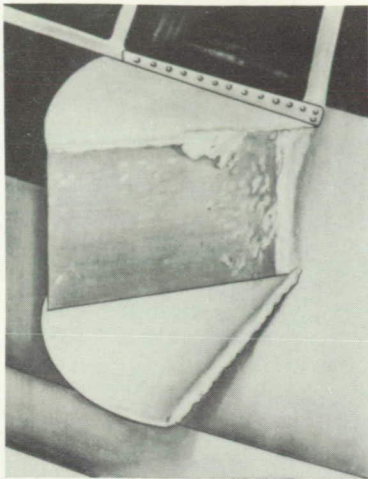

Figure 16.- Windshield of C-46 airplane after a flight in icing conditions in which there was no tendency for ice to form on the windshield. Ice accretions shown formed on $\frac{3}{8}$ -inch-diameter rods beside windshields; icing conditions 10 and 11, table I.

Page intentionally left blank

Page intentionally left blank



FLIGHT NUMBER 31	TIME 1116
PRESSURE ALTITUDE	8,000 FEET
TRUE AIR SPEED	160 MPH
AMBIENT AIR TEMPERATURE	14 °F
LIQUID WATER CONTENT	.2 GRAM/M ³
MEAN DROP SIZE	10 MICRONS
HEAT SUPPLIED TO PANEL	1520 BTU/HR FT ²
ICING CONDITION NUMBER 1	

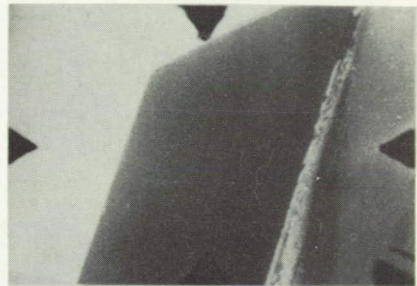
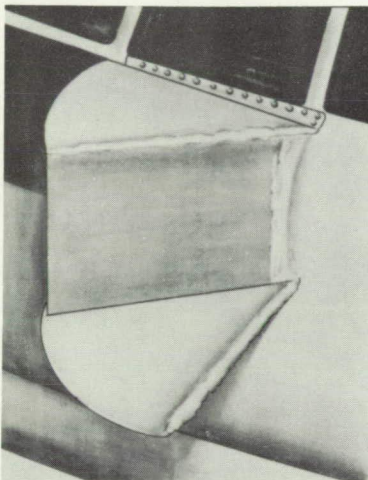

FLIGHT NUMBER 31	TIME 1628
PRESSURE ALTITUDE	11,650 FEET
TRUE AIR SPEED	180 MPH
AMBIENT AIR TEMPERATURE	17 °F
LIQUID WATER CONTENT	.5 GRAM/M ³
MEAN DROP SIZE	18 MICRONS
HEAT SUPPLIED TO PANEL	1240 BTU/HR FT ²
ICING CONDITION NUMBER 2	

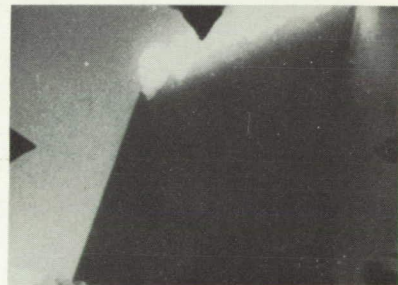
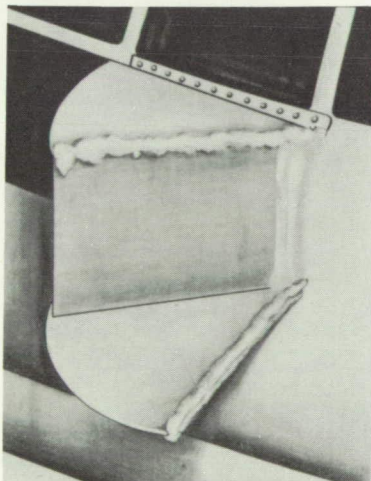

FLIGHT NUMBER 33	TIME 1147
PRESSURE ALTITUDE	8,300 FEET
TRUE AIR SPEED	170 MPH
AMBIENT AIR TEMPERATURE	18 °F
LIQUID WATER CONTENT	.9 GRAM/M ³
MEAN DROP SIZE	10 MICRONS
HEAT SUPPLIED TO PANEL	1230 BTU/HR FT ²
ICING CONDITION NUMBER 3	

NACA
A-10 981

Figure 17.- Ice accretions formed on the flat-plate windshield of the C-46 airplane during icing conditions 1, 2, and 3, table I. Panel angle 30° with the fuselage.

Page intentionally left blank

Page intentionally left blank

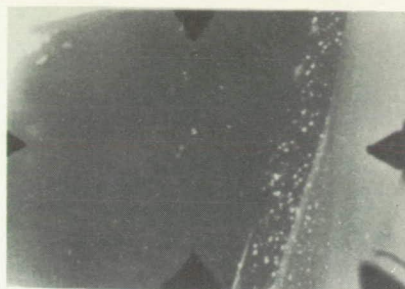
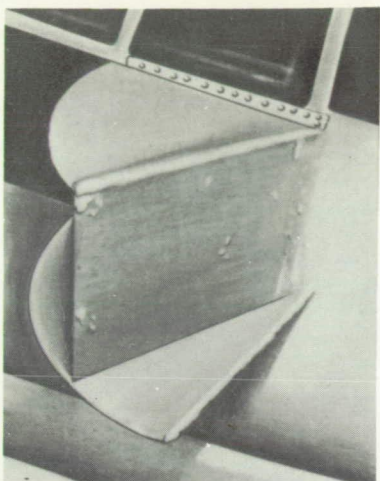

FLIGHT NUMBER 23
 PRESSURE ALTITUDE 10,350 FEET
 TRUE AIR SPEED 135 MPH
 AMBIENT AIR TEMPERATURE 6 °F
 LIQUID WATER CONTENT .6 TO .8 GRAM/M³
 MAXIMUM DROP SIZE 11 TO — MICRONS
 HEAT SUPPLIED TO PANEL 910 BTU/HR FT²
 ICING CONDITION NUMBER 4

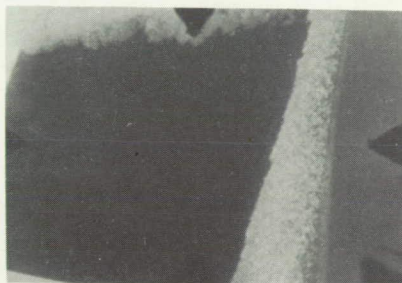
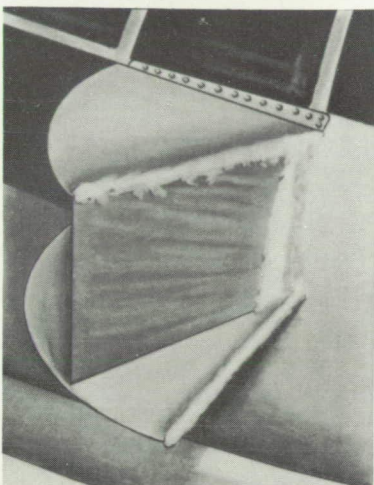

FLIGHT NUMBER 23
 PRESSURE ALTITUDE 11,500 FEET
 TRUE AIR SPEED 145 MPH
 AMBIENT AIR TEMPERATURE -0.5 °F
 LIQUID WATER CONTENT .3 TO 1.2 GRAM/M³
 MAXIMUM DROP SIZE 20 TO — MICRONS
 HEAT SUPPLIED TO PANEL 1630 BTU/HR FT²
 ICING CONDITION NUMBER 5

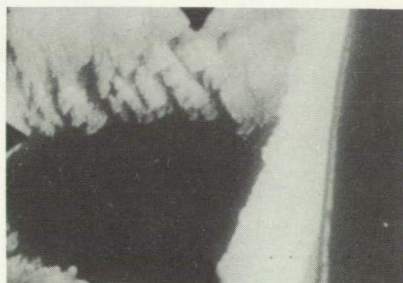
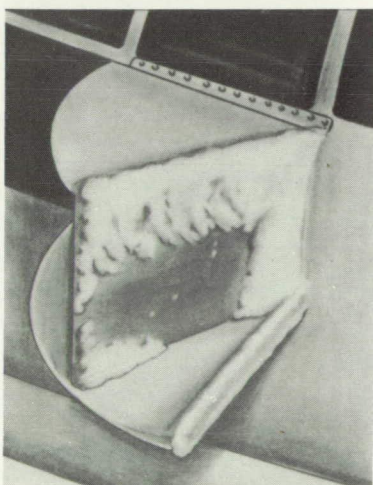

FLIGHT NUMBER 23
 PRESSURE ALTITUDE 12,700 FEET
 TRUE AIR SPEED 140 MPH
 AMBIENT AIR TEMPERATURE -2 °F
 LIQUID WATER CONTENT .6 TO 1.4 GRAM/M³
 MEAN DROP SIZE 18 TO 44 MICRONS
 HEAT SUPPLIED TO PANEL 1720 BTU/HR FT²
 ICING CONDITION NUMBER 6

NACA
 A10982
 12-11-46

Figure 18.- Ice accretions formed on the flat-plate windshield of the C-46 airplane during icing conditions 4, 5, and 6, table I. Panel angle 45° with the fuselage.

Page intentionally left blank

Page intentionally left blank

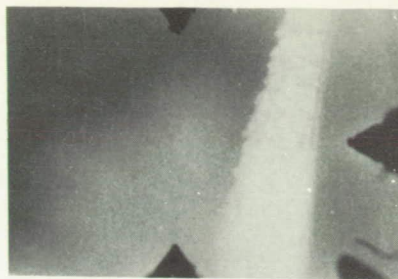
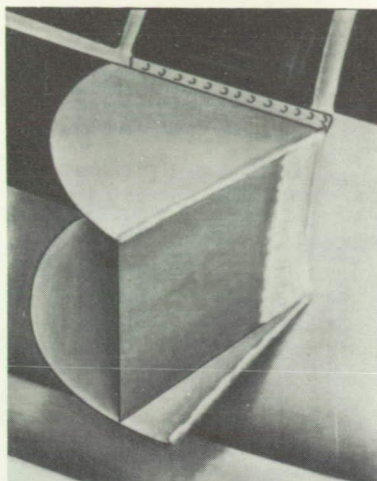

FLIGHT NUMBER 49	TIME 1121
PRESSURE ALTITUDE	9,140 FEET
TRUE AIR SPEED	165 MPH
AMBIENT AIR TEMPERATURE	9.5 °F
LIQUID WATER CONTENT	.7 GRAM/M ³
MEAN DROP SIZE	23 MICRONS
HEAT SUPPLIED TO PANEL	1170 BTU/HR FT ²
ICING CONDITION NUMBER 10	

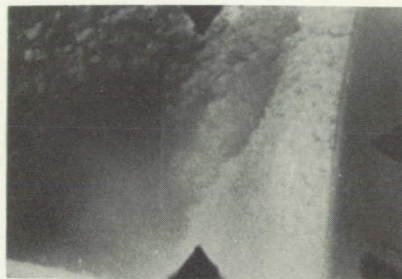
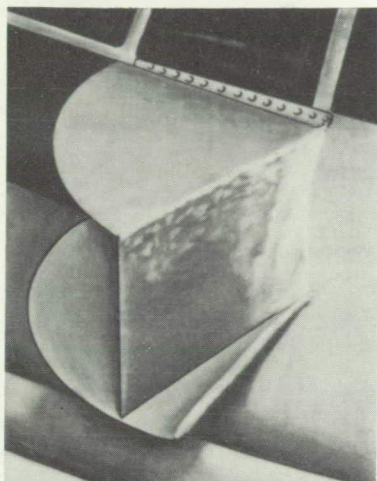

FLIGHT NUMBER 49	TIME 1132
PRESSURE ALTITUDE	8,900 FEET
TRUE AIR SPEED	165 MPH
AMBIENT AIR TEMPERATURE	11 °F
LIQUID WATER CONTENT	.2 GRAM/M ³
MEAN DROP SIZE	17 TO 44 MICRONS
HEAT SUPPLIED TO PANEL	1190 BTU/HR FT ²
ICING CONDITION NUMBER 11	

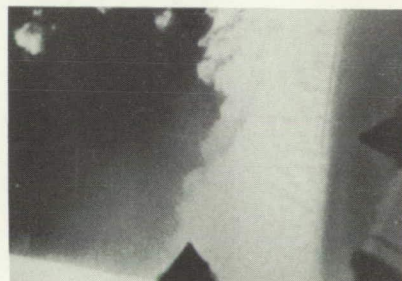
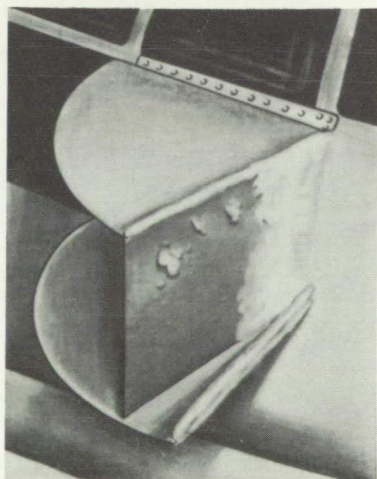

FLIGHT NUMBER 49	TIME 1155
PRESSURE ALTITUDE	10,600 FEET
TRUE AIR SPEED	160 MPH
AMBIENT AIR TEMPERATURE	5 °F
LIQUID WATER CONTENT	1.4 GRAM/M ³
MEAN DROP SIZE	19 MICRONS
HEAT SUPPLIED TO PANEL	1235 BTU/HR FT ²
ICING CONDITION NUMBER 12	

NACA
A 10983
12-11-46

Figure 19.- Ice accretions formed on the flat-plate windshield of the C-46 airplane during icing conditions 10, 11, and 12, table I. Panel angle 60° with the fuselage.

Page intentionally left blank

Page intentionally left blank

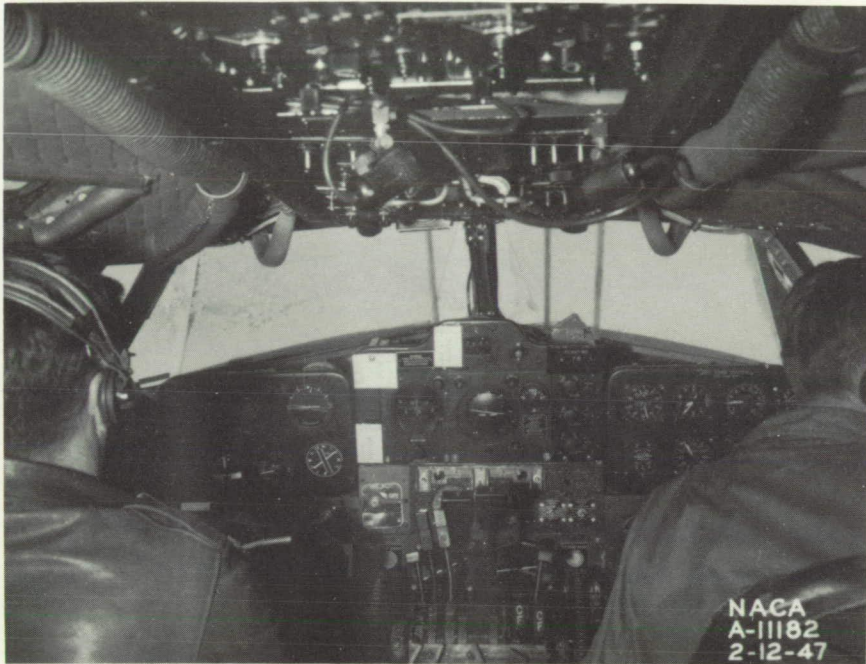

Figure 20.- V-type windshield of C-46 airplane during flight in icing conditions showing unsuccessful ice-removal operation of external discharge jets over pilot's panel, with heat supply of 18,000 Btu per hour.

Page intentionally left blank

Page intentionally left blank



Figure 21.- Typical ice accretion on V-type windshield without any heat supplied.



Figure 22.- Ice accretions formed on V-type windshield of the C-46 airplane during icing conditions 15 and 16.

Page intentionally left blank

Page intentionally left blank



(a) In icing conditions. Time, 1140.



(b) In clear air, ice removed. Time, 1215.

Figure 23.- Ice accretions formed on V-type windshield of the C-46 airplane during icing condition 17.

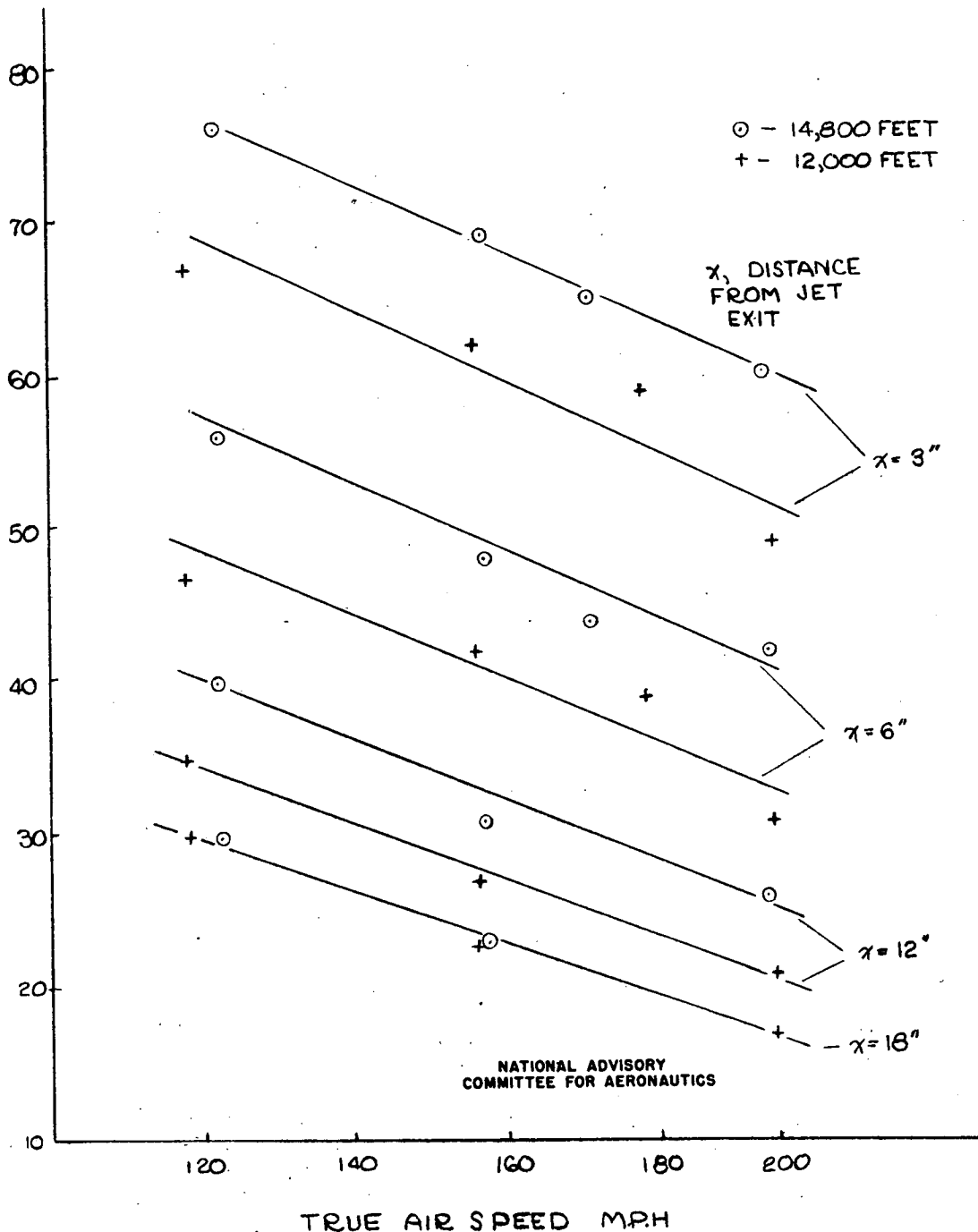

FIGURE 24.- WINDSHIELD SURFACE TEMPERATURE ABOVE AMBIENT AIR TEMPERATURES IN CLEAR AIR WITH AN AVERAGE RATE OF HEATED AIR SUPPLIED OF 13,500 Btu/hr. C-46 AIRPLANE WINTER 1945-46. FLUSH TYPE WINDSHIELD.

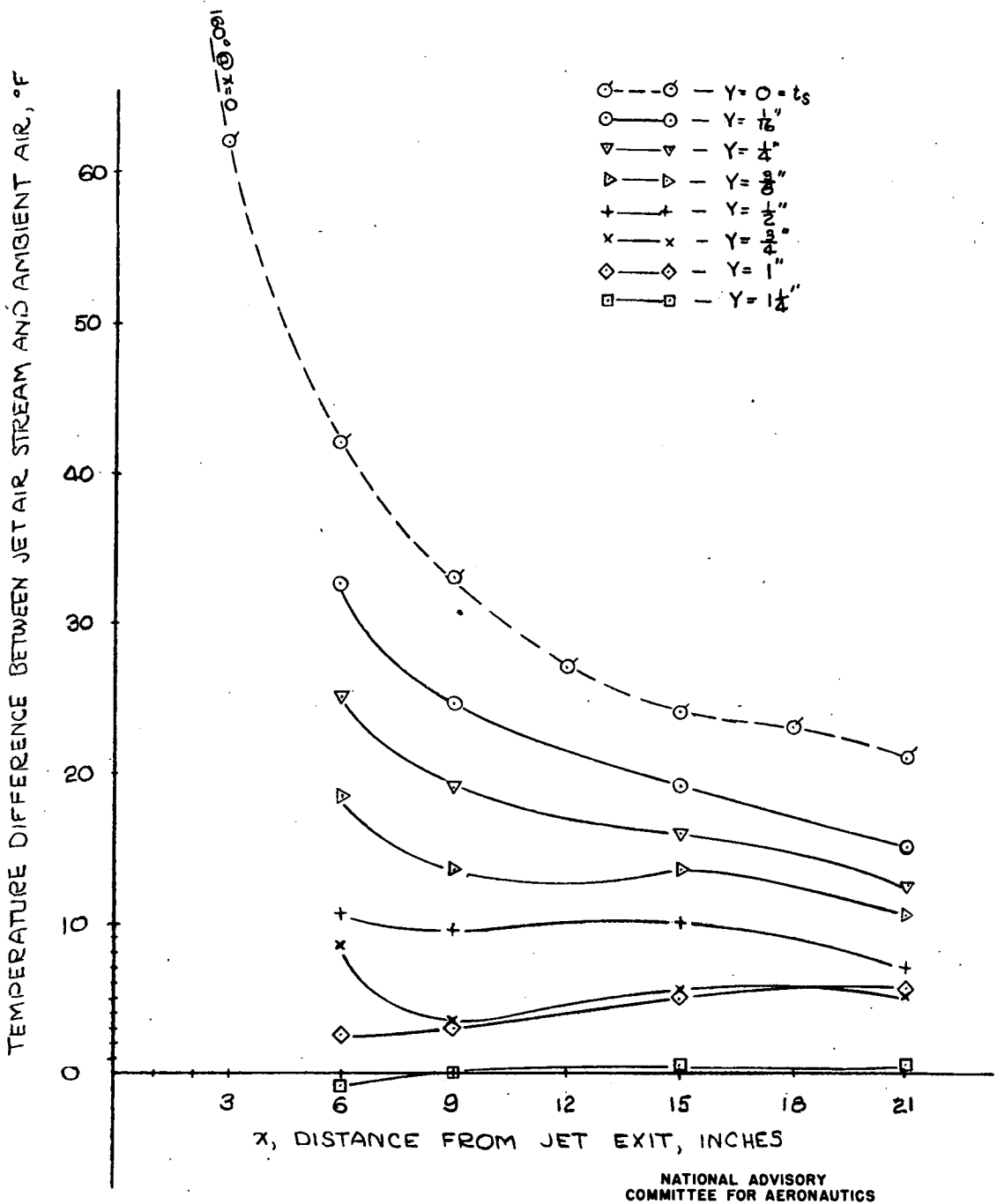

FIGURE 25.—TEMPERATURE GRADIENTS IN THE HEATED BOUNDARY LAYER OVER THE FLUSH TYPE WINDSHIELD OF THE C-46 AIRPLANE. PRESSURE ALTITUDE 12,000 FEET, TRUE AIR SPEED 155 MPH. HEATED AIR SUPPLIED 13,000 BTU/HR WINTER 1945-46

U_0	W	Q
○—○ - 252	2.25	4,000
+—+ - 250	3.15	7,500
△—△ - 255	4.70	16,000
□—□ - 250	4.70	18,000

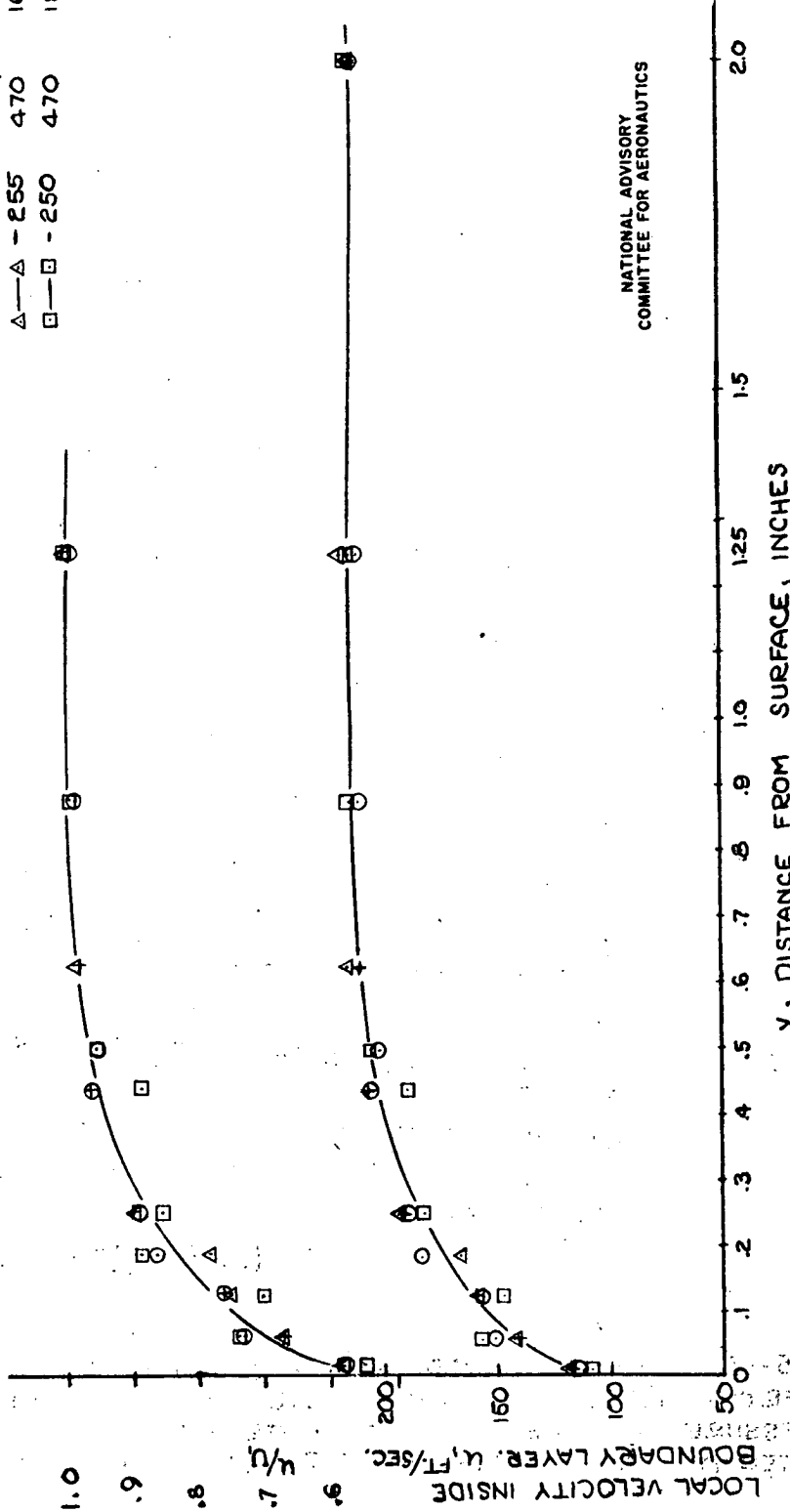

FIGURE 26.- VELOCITY PROFILES IN THE HEATED AIR JET OVER THE FLUSH TYPE WINDSHIELD OF THE C-46 AIRPLANE. PRESSURE ALTITUDE 10,600 FEET. POINT OF MEASUREMENT 9 INCHES FROM DISCHARGE SLOT. WINTER 1945-46

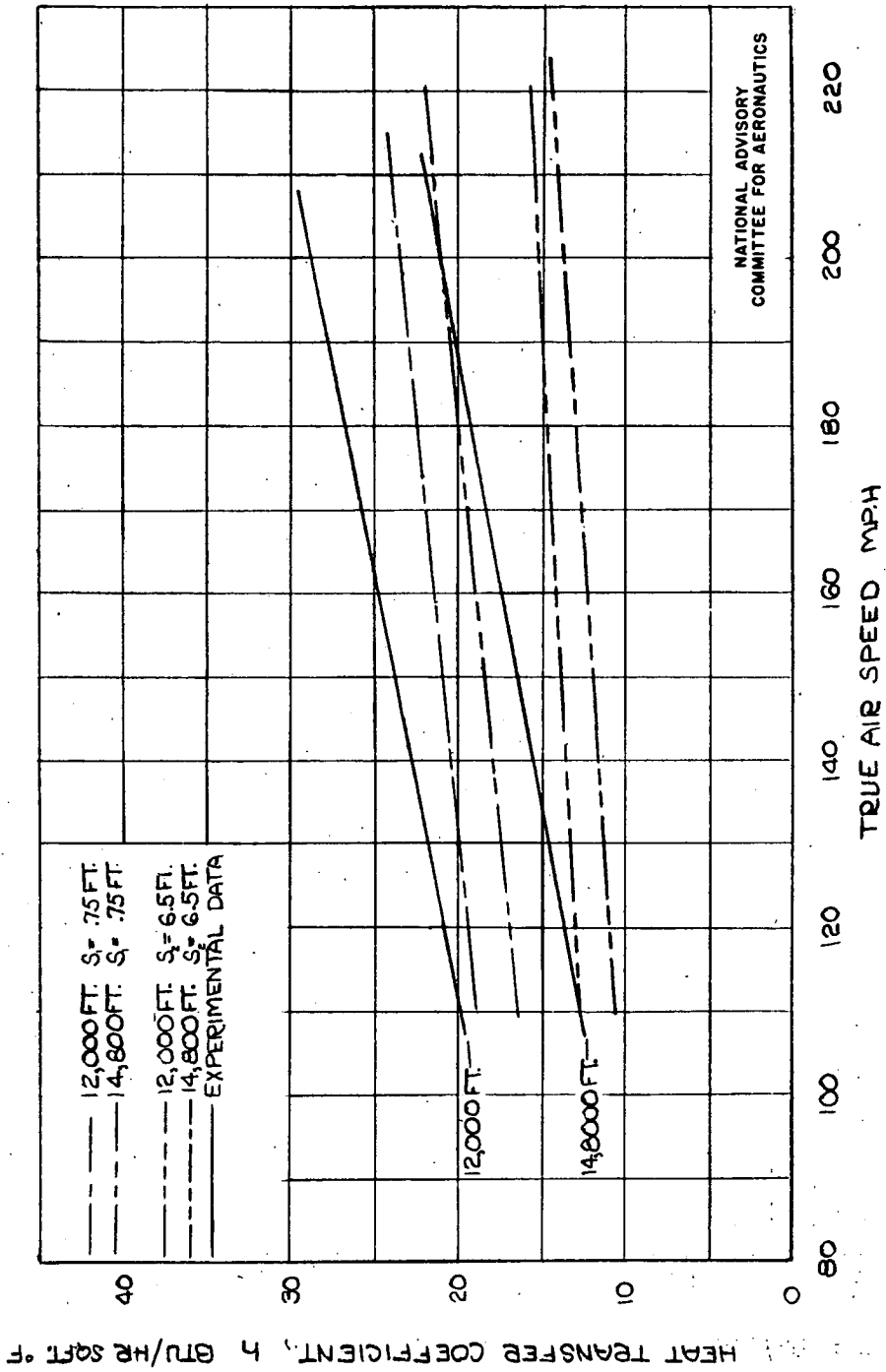

FIGURE 27.- COMPARISON OF EXPERIMENTAL AND CALCULATED VALUES OF DRY AIR HEAT TRANSFER COEFFICIENT FOR VARIOUS ALTITUDES AND STAGNATION POINTS. FLAT-PLATE PANEL SET 30° FROM THE TANGENT TO THE FUSELAGE. C-46 AIRPLANE, WINTER 1945-46.

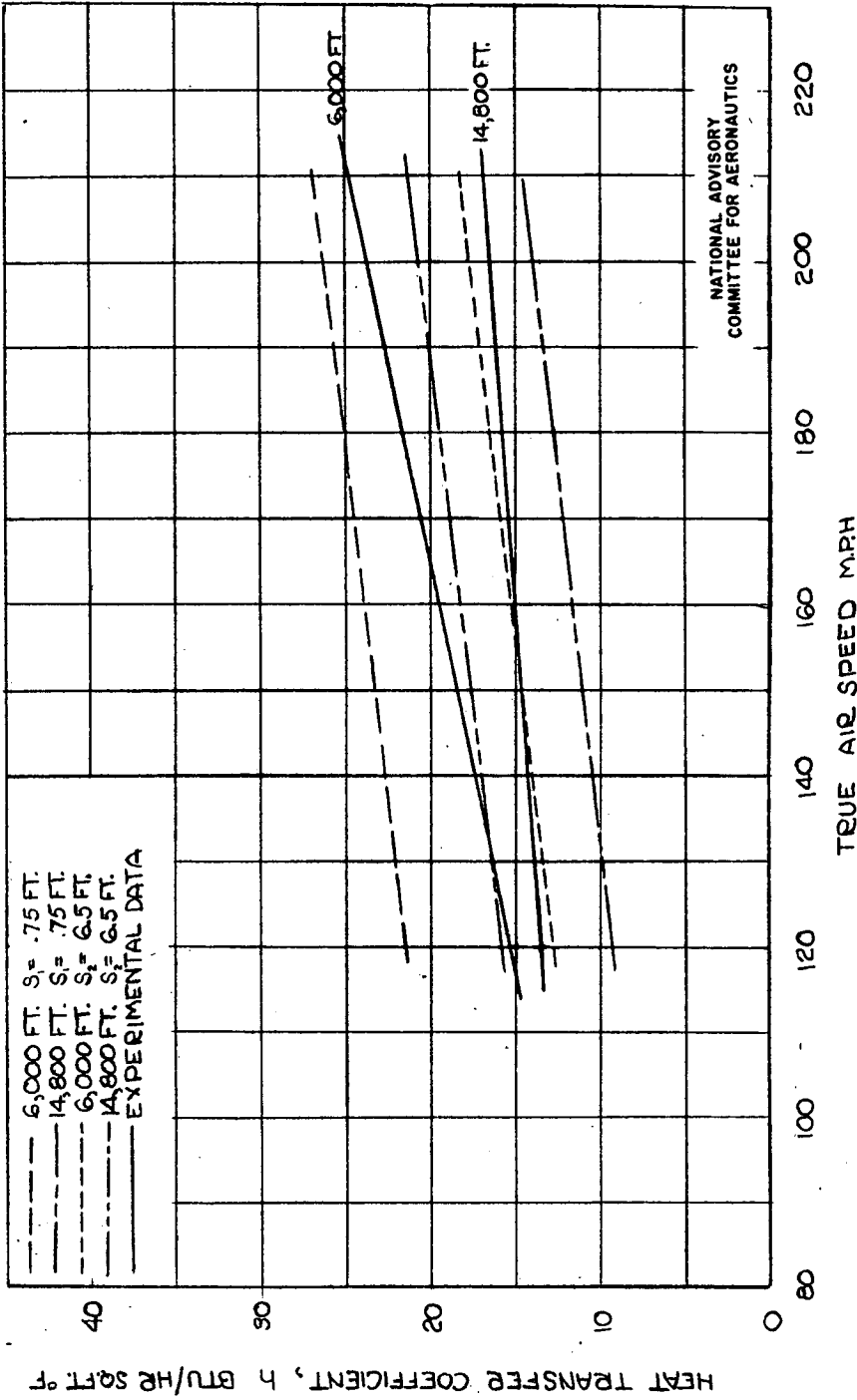

FIGURE 28— COMPARISON OF EXPERIMENTAL AND CALCULATED VALUES OF DRY AIR HEAT TRANSFER COEFFICIENT AT VARIOUS ALTITUDES AND STAGNATION POINTS. FLAT-PLATE PANEL SET 45° FROM THE TANGENT TO THE FUSELAGE. C-46 AIRPLANE, WINTER 1945-46.

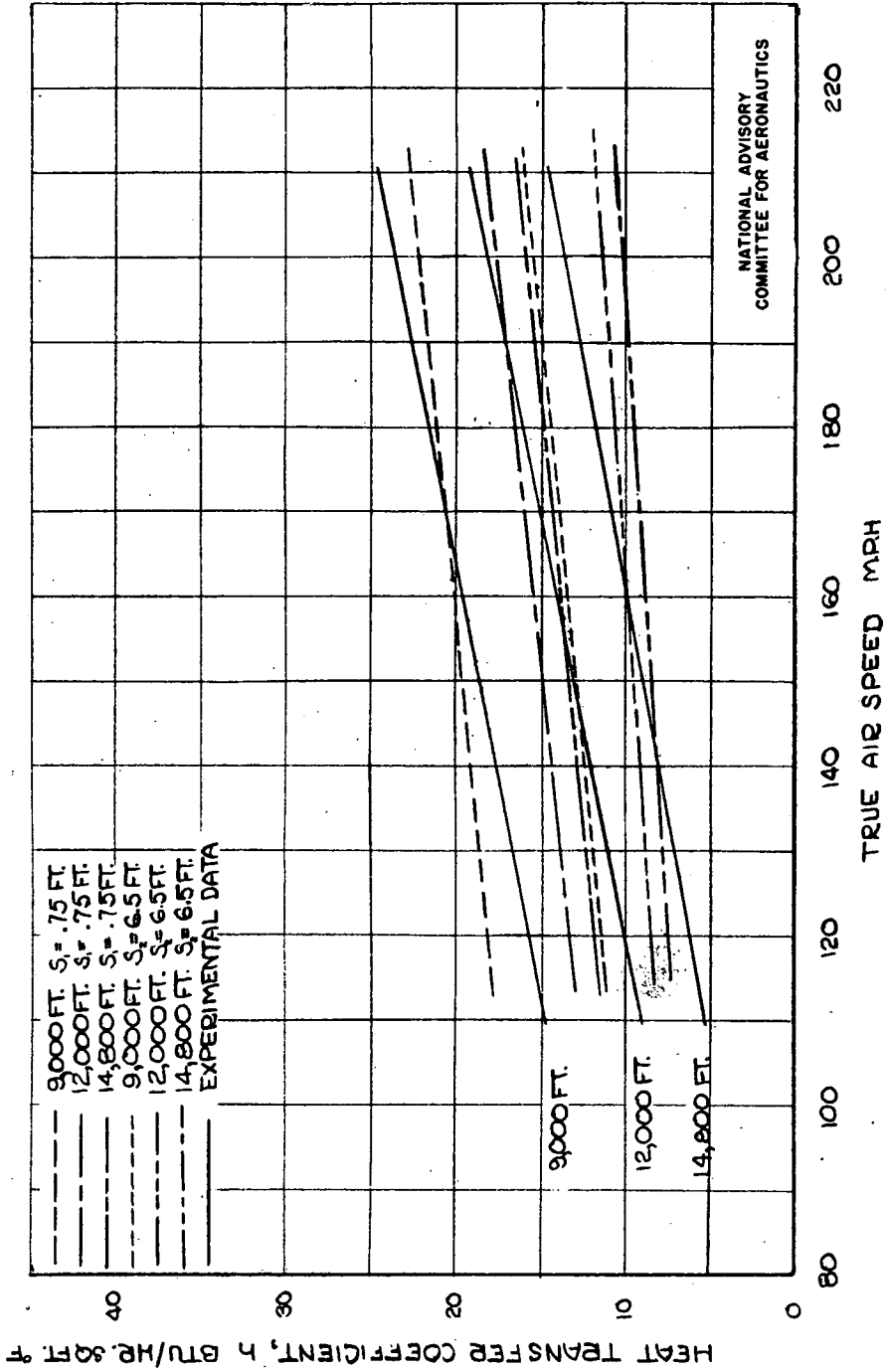

FIGURE 29.- COMPARISON OF EXPERIMENTAL AND CALCULATED VALUES OF DRY AIR HEAT TRANSFER COEFFICIENT FOR VARIOUS ALTITUDES AND STAGNATION POINTS. FLAT-PLATE PANEL SET 60° FROM THE TANGENT TO THE FUSELAGE. C-46 AIRPLANE, WINTER 1945-46

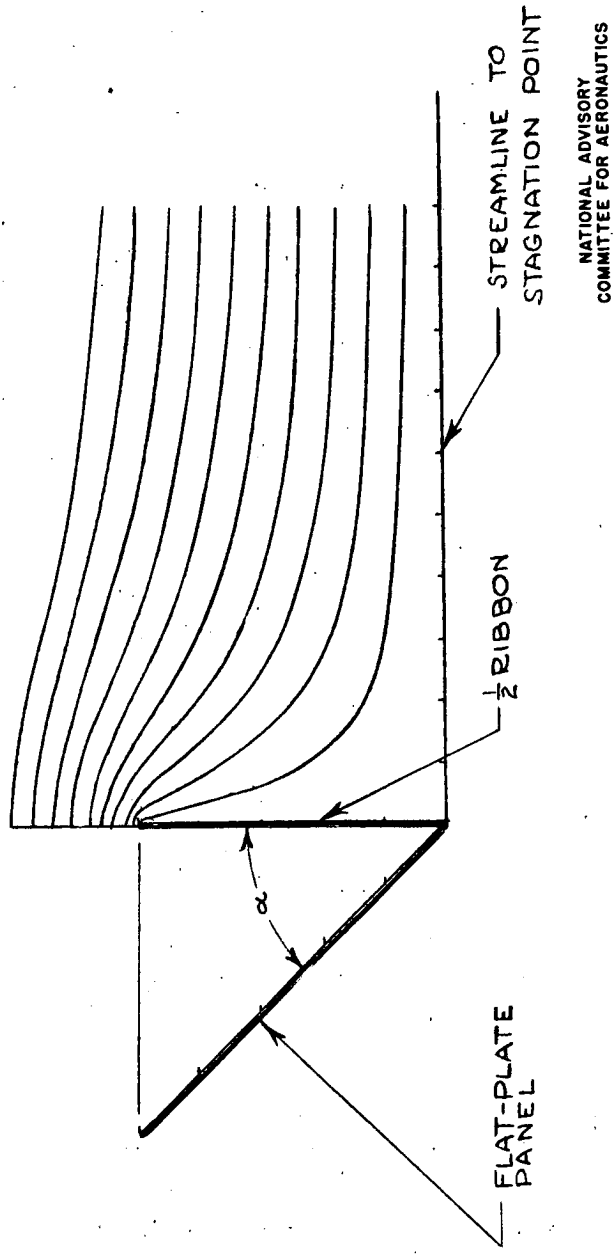
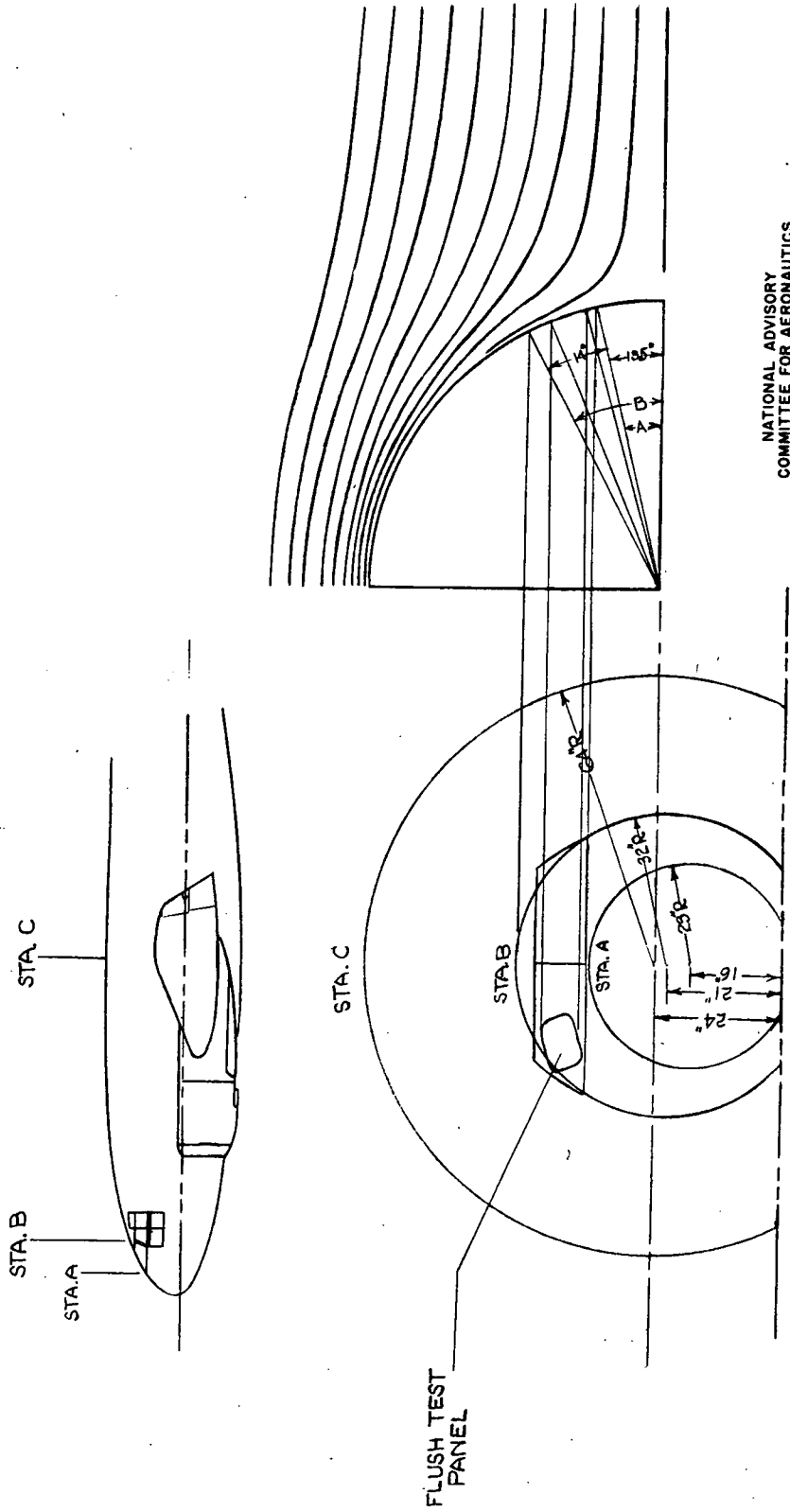

FIGURE 30 - FLOW LINES AROUND PROJECTED AREA OF FLAT-PLATE PANEL USED IN COMPUTING RATE OF IMPINGEMENT.



NATIONAL ADVISORY
COMMITTEE FOR AERONAUTICS

FIGURE 31.- FLOW LINES AROUND A SPHERE COMPARED WITH THE PROJECTED AREA OF THE C-46 AIRPLANE FUSELAGE AND WINDSHIELD, SHOWING AREA USED IN COMPUTING RATE OF IMPINGEMENT.