

N O T I C E

THIS DOCUMENT HAS BEEN REPRODUCED FROM
MICROFICHE. ALTHOUGH IT IS RECOGNIZED THAT
CERTAIN PORTIONS ARE ILLEGIBLE, IT IS BEING RELEASED
IN THE INTEREST OF MAKING AVAILABLE AS MUCH
INFORMATION AS POSSIBLE

Vehicle Test Report: Electric Vehicle Associates Electric Conversion of an AMC Pacer

Theodore W. Price
Vincent A. Wirth, Jr.
Michael F. Pompa

(NASA-CR-168425) VEHICLE TEST REPORT:
ELECTRIC VEHICLE ASSOCIATES ELECTRIC
CONVERSION OF AN AMC PACEE (Jet Propulsion
Lab.) 61 p HC A04/ A01 CSCI 13F

N82-18066

Unclas
G3/85 08909

October 15, 1981

Prepared for
U.S. Department of Energy
Through an Agreement with
National Aeronautics and Space Administration
by
Jet Propulsion Laboratory
California Institute of Technology
Pasadena, California

(JPL PUBLICATION 81-97)



5030-524
Electric & Hybrid Vehicle System
Research & Development Project

DOE/CS-54209-4
Distribution Category UC-96

Vehicle Test Report: Electric Vehicle Associates Electric Conversion of an AMC Pacer

**Theodore W. Price
Vincent A. Wirth, Jr.
Michael F. Pompa**

October 15, 1981

Prepared for
U.S. Department of Energy
Through an Agreement with
National Aeronautics and Space Administration
by
Jet Propulsion Laboratory
California Institute of Technology
Pasadena, California

(JPL PUBLICATION 81-97)

Prepared by the Jet Propulsion Laboratory, California Institute of Technology, for the U.S. Department of Energy through an agreement with the National Aeronautics and Space Administration.

This report was prepared as an account of work sponsored by the United States Government. Neither the United States nor the United States Department of Energy, nor any of their employees, nor any of their contractors, subcontractors, or their employees, makes any warranty, express or implied, or assumes any legal liability or responsibility for the accuracy, completeness or usefulness of any information, apparatus, product or process disclosed, or represents that its use would not infringe privately owned rights.

Reference herein to any specific commercial product, process, or service by trade name, trademark, manufacturer, or otherwise, does not necessarily constitute or imply its endorsement, recommendation, or favoring by the United States Government or any agency thereof. The views and opinions of authors expressed herein do not necessarily state or reflect those of the United States Government or any agency thereof.

ABSTRACT

The EVA Change of Pace, an electric vehicle assembled by Electric Vehicle Associates of Cleveland, Ohio was tested at the Jet Propulsion Laboratory's (JPL) dynamometer facility in Pasadena and at JPL's Edwards Test Station, located near Lancaster, California. The tests were conducted between 28 August and 7 December 1979. These tests were performed to characterize certain parameters of the EVA Pacer and to provide baseline data that can be used for the comparison of improved batteries that may be incorporated into the vehicle at a later time.

The vehicle tests were concentrated on the electrical drive subsystem; i.e., the batteries, controller and motor. The tests included coastdowns to characterize the road load, and range evaluations for both cyclic and constant speed conditions. A qualitative evaluation of the vehicle's performance was made by comparing its constant speed range performance with those vehicles described in the document titled "State of the Art Assessment of Electric and Hybrid Vehicles." The Pacer performance was approximately equal to the majority of the vehicles tested in that 1977 assessment.

GLOSSARY

ABBREVIATIONS AND ACRONYMS

AMC	American Motors Corporation
DOE	Department of Energy
EHV	Electric and Hybrid Vehicle
EPA	Environmental Protection Agency
ESB	Electric Storage Battery Company
ETS	Edwards Test Station
EVA	Electric Vehicle Associates
GVW	gross vehicle weight
ICE	internal combustion engine
IDAC	Integrated Data Acquisition and Control
JPL	Jet Propulsion Laboratory
MERADCOM	Mobility Equipment Research and Development Command
PWM	pulse width modulation
SAE	Society of Automotive Engineers
SCR	silicon-controlled rectifier

ACKNOWLEDGMENT

This work was sponsored by the U.S. Department of Energy through an interagency agreement, DE-AI01-78CS 54209, with the National Aeronautics and Space Administration (Task RD 152, Amendment 66).

CONTENTS

I.	SUMMARY	1-1
II.	INTRODUCTION	2-1
III.	TEST OBJECTIVE AND SCOPE	3-1
IV.	VEHICLE DESCRIPTION AND OPERATION	4-1
V.	TEST METHODOLOGY	5-1
	A. ROAD LOAD DETERMINATION AND DYNAMOMETER LOAD ADJUSTMENT . . .	5-1
	B. CHASSIS DYNAMOMETER INSTRUMENTATION	5-2
	1. Power Measurements (Voltage, Current, Energy)	5-4
	2. Motor and Drive Shaft Rotational Speed	5-4
	3. Vehicle Velocity and Distance Traveled	5-4
	4. Torque and Aerodynamic Horsepower	5-4
	5. Miscellaneous Measurements	5-5
	C. VEHICLE CONDITIONING AND WARM-UP	5-5
	D. DYNAMOMETER TEST PREPARATIONS	5-5
	E. TEST TERMINATION CRITERIA	5-5
VI.	TEST HISTORY	6-1
	A. PRE-TEST ACTIVITIES	6-1
	B. BATTERY CHARGING	6-2
	C. EDWARDS TEST STATION (ETS) ACTIVITIES	6-2
	D. DYNAMOMETER ACTIVITIES	6-3
VII.	TEST RESULTS	7-1
	A. RANGE AT CONSTANT SPEED TESTS	7-1
	B. DRIVING CYCLE RANGE TESTS	7-5

C.	REGENERATION DURING CYCLE TESTS	7-8
D.	ROAD ENERGY CONSUMPTION	7-8
VIII.	DISCUSSION AND PROBLEMS	8-1
A.	GENERAL OBSERVATION	8-1
B.	DRIVING CHARACTERISTICS OF EVA PACER	8-1
C.	VEHICLE RELIABILITY	8-3
D.	ENERGY USAGE	8-3
E.	COMPARISON TO OTHER ELECTRIFIED VEHICLES AT STEADY SPEED	8-4
REFERENCES	9-1

APPENDIXES

A.	THEORY OF OPERATION OF PULSOMATIC MARK 10 CONTROLLER	A-1
B.	EVA TEST DATA SUMMARY	B-1

Figures

4-1.	EVA Change of Pace--Left Front View	4-3
4-2.	EVA Change of Pace--Left Rear View	4-4
4-3.	Cutaway Showing Major Components	4-5
4-4.	Battery Front Location	4-8
4-5.	Battery Rear Location	4-9
4-6.	EVA Pacer Propulsion System Block Diagram	4-10
4-7.	Schematic of EVA Pacer System	4-11
4-8.	Oscilloscope Trace at 25 mph	4-12
4-9.	Oscilloscope Trace at 35 mph	4-13
4-10.	Oscilloscope Trace at 45 mph	4-14
5-1	Typical Data Recording Format	5-3
7-1.	Average Speed vs Time Increment	7-11
7-2.	Average Speed vs Road Energy	7-12

7-3.	Average Speed vs Road Power	7-13
8-1.	Controller Efficiency vs Vehicle Speed	8-2
8-2.	Energy Usage for Driving Schedule "B" at 40% Depth of Discharge	8-5
8-3.	Energy Usage for Driving Schedule "C" at 40% Depth of Discharge	8-5
8-4.	Comparison of Driving Schedules "B" and "C" Energy Usage at 40% Depth of Discharge	8-6
8-5.	Schedule "B" Energy Usage as a Function of Battery Depth of Discharge	8-7
8-6.	Schedule "C" Energy Usage as a Function of Battery Depth of Discharge	8-8
8-7.	Vehicle Range as a Function of Speed	8-9

Tables

1-1.	Summary of Range Tests of the EVA Pacer	1-1
4-1.	Vehicle Specifications	4-6
7-1.	Change of Pace--72 km/h (45 mph) Constant Speed	7-2
7-2.	Change of Pace--56 km/h (35 mph) Constant Speed	7-3
7-3.	Change of Pace--40 km/h (25 mph) Constant Speed	7-4
7-4.	Change of Pace--J227a Schedule "B"	7-6
7-5.	Change of Pace--J227a Schedule "C"	7-7
7-6.	Track Coastdown Data	7-9
7-7.	Road Energy Power	7-10

SECTION I

SUMMARY

The Change of Pace is an electric vehicle resulting from a conversion of an American Motors Corporation (AMC) Pacer. The conversion was done by Electric Vehicle Associates (EVA) located in Cleveland, Ohio. The vehicle was tested by NASA's Jet Propulsion Laboratory (JPL) and those tests are the subject of this report. Tests were performed using the JPL dynamometer facility in Pasadena, and an Air Force runway at JPL's Edwards Test Station (ETS) located near Lancaster, California. The purpose of these tests, conducted between August 28 and December 7, 1979, was to characterize certain parameters of the EVA Pacer and to provide baseline data to be used for the comparison of near-term batteries, later to be used with the vehicle. This report presents the results obtained during baseline testing of this vehicle with the lead-acid batteries that were supplied by the vehicle manufacturer.

The EVA Pacer is a converted four passenger American Motors Pacer Station Wagon. It is powered by twenty 6-V Varta traction batteries through a silicon-controlled rectifier (SCR) controller manufactured by the Cableform Company. Vehicle speed control is achieved through a conventional foot pedal. The foot pedal controls the voltage applied to both the field and armature of a 30 hp, separately excited dc motor manufactured by Reliance Electric. The motor is connected to the stock Pacer three speed automatic transmission. Regenerative braking is used in conjunction with the standard hydraulic brake system which utilizes front wheel discs and rear drums.

U.S. customary units were used in the collection and reduction of data reported here. The units were converted to the International System of Units for presentation in this report. U.S. customary units are included in parentheses. A summary of the test results is shown in Table 1-1.

Table 1-1. Summary of Range Tests of the EVA Pacer

Speed		Range		Battery Energy Consumption	
(km/h)	(mph)	(km)	(mi)	(MJ/km)	(Wh/mi)
40	25	60.07	37.33	751	336
56	35	56.53	35.13	738	330
56	35	61.95	38.50	734	328
72	45	52.04	32.34	720	322
72	45	56.00	34.80	718	321
"B" CYCLE		36.04	22.40	1304	583
"B" CYCLE		38.62	24.00	1298	580
"C" CYCLE		22.42	20.15	1222	546
"C" CYCLE		31.42	19.53	1215	543

SECTION II

INTRODUCTION

The vehicle tests and the data presented in this report are in support of Public Law 94-413 enacted by Congress on September 17, 1976. A section of this law requires the U.S. Department of Energy (DOE) to promote increased research and development of electric and hybrid vehicles. In consonance with this act of Congress, the DOE awarded contracts for two each of four different vehicles to small business concerns in June 1978. This has become known as the "2 x 4" program. Four of these vehicles, including the EVA "Change of Pace," have been delivered to JPL for use in the assessment of near-term¹ batteries.

The vehicle tests and data presented in this report are part of JPL's Vehicle Test and Evaluation Task in support of the Electric and Hybrid Vehicle (EHV) System Research and Development Project objectives. Both road and dynamometer tests were conducted using JPL procedures based on the Society of Automotive Engineers' "Electric Vehicle Test Procedure," SAE J227a (Reference 2-1). Results include vehicle driving range at steady speeds and cyclic driving schedules.

The primary purpose of the near-term battery assessment task was to determine "in vehicle" performance of various near-term batteries (i.e., nickle-iron, nickle-zinc). Because the emphasis was on batteries, the test activities were structured to determine the battery performance as measured by vehicle range, the energy consumed per mile driven, and the energy gained from regeneration. The bulk of the vehicle test effort was devoted to the vehicle-to-battery interface and to the battery performance itself. Other vehicle characteristics, unrelated to energy usage, such as steering, braking, passenger accommodations, etc., were not characterized.

¹For the purposes of this report near-term means batteries which could be available in the next ~5 years, and which also have the potential for greater capability than batteries currently available.

SECTION III

TEST OBJECTIVE AND SCOPE

The work described in this report is a subset of a larger effort. The primary purpose of this larger effort was to evaluate several types of near-term batteries within the system environment. The method selected for the evaluation was to compare the performance of several vehicles equipped with lead-acid batteries (of the vehicle manufacturer's choice) with the performance of the same vehicle when equipped with a set of near-term batteries. One obvious requirement for this comparison method is to maintain the test conditions and vehicle state constant over the course of all tests of any single vehicle.

With the above background in mind, the objective for the baseline tests described in this report was to obtain a set of reference data using lead-acid batteries which can be used as a basis for comparison with other battery types.

To aid in accomplishing this objective, a set of test requirements was formulated. The emphasis of the test requirements was directed at the performance of the batteries under a variety of operating conditions. A necessary adjunct to determining the battery performance was a need to monitor the vehicle "state of tune" over the course of the test program. The performance of the vehicle itself was also of interest, but secondary to the battery needs. Nearly all the measurements were directly related to the propulsion subsystem.

The test requirements were specific in defining the configurations and conditions of the tests. This was necessary so that test repeatability could be accomplished. All the performance tests were conducted on a chassis dynamometer, again for the purpose of achieving repeatability and stability. The only tests performed in the field were those necessary to establish the vehicle's "road load" and, hence, the dynamometer settings.

SECTION IV

VEHICLE DESCRIPTION AND OPERATION

The EVA "Change of Pace" Electric Vehicle is a converted American Motors Pacer station wagon powered by twenty 6-V lead-acid batteries. The Pacer modification was performed by Electric Vehicle Associates Incorporated, Cleveland, Ohio. Overall views of the vehicle are shown in Figures 4-1 and 4-2. The EVA Pacer has a total curb weight of 1996 kg (4400 lb) and a maximum gross vehicle weight of 2268 kg (5000 lb). The total battery weight is 571 kg (1260 lb), which excludes 18 kg (40 lb) of battery cables and clamps. Therefore, the battery weight fraction of the EVA Pacer is 29.5% based on curb weight and 26% relative to the gross weight. The gross vehicle weight (GVW) was used for all testing; therefore, all road load horsepower data are based on the GW.

Placement of the major components is shown in Figure 4-3, and the Vehicle Specifications are summarized in Table 4-1. The traction batteries are located in both the front and rear of the vehicle; eight in the front and twelve in the rear (see Figures 4-4 and 4-5). A conventional 12 V battery is also installed in the front compartment and is used to power the controller and accessories. Several modifications were made by EVA to the body and chassis to accommodate the storage batteries. Structural members have been added to the frame to restrain the polyethylene battery boxes. The battery boxes protect the vehicle occupants from electric shock, acid vapors and odors, and allow complete battery wash-down for maintenance. The boxes also protect the batteries from the environment and contain any hydrogen generated. A forced air ventilation system is provided to purge gases from battery boxes. In addition, the rear suspension was modified by adding an extra leaf to each spring to accept the increased battery weight. A dc to dc power converter provides continuous charge current to the 12 V dc auxiliary battery (i.e., even with the ignition "switch" off the converter is operational). The only time the converter is off is when the main battery pack is disconnected.

Limited information was available concerning the operation of the controller and the associated control strategy. Although the test program was not designed to determine the control strategy, some understanding resulted from observations of vehicle operation and analysis of the recorded electrical data. This limited understanding is included here as an aid to interpretation of the test data.

A block diagram of the Pacer propulsion system is shown in Figure 4-6.² The dual mode SCR controller is activated by the accelerator pedal. The controller varies the motor speed and torque in response to the driver's demands via the accelerator pedal. The motor speed control is through either current modulation (chopping) of the armature or field, depending on whether the motor speed is below or above its base speed.

²A schematic of the Pacer power system, including instrumentation sense points is illustrated in Figure 4-7.

Motor base speed appears to be 1800 rev/min at a battery voltage of 108 V, and it varies directly with the battery voltage. The apparent control strategy employed is to coordinate the transmission shifts with the transition through the motor base speed (i.e., transmission upshifts occur whenever motor base speed is reached). The result is that motor control is by armature chopping until the transmission is in third gear and vehicle speed is above 57.9 km/h (36 mph).³ When the transmission and speed criteria are met, then the control mode switches to field weakening.

Figures 4-8, 4-9, and 4-10 are photographs of oscilloscope traces of current and voltage as measured at three locations: the battery pack, the motor armature, and the motor field. The three figures correspond to vehicle speeds of 25 mph, 35 mph, and 45 mph, is labeled, and illustrate the change from armature chopping to field weakening.

The vehicle is propelled by a separately excited dc traction motor manufactured expressly for the vehicle by the Reliance Electric Co. The rated continuous power of the motor is 13.42 kW (18 hp) with a peak rating of 22.37 kW (30 hp). The motor is directly coupled to the existing 3-speed automatic transmission normally used in the internal combustion engine (ICE) version of the Pacer. The only change to the stock drive train was to change the differential ratio to 3.58 to 1.

This drive train configuration has one minor drawback in that during idle periods the electric motor is shut off. Because the motor does not turn, the automatic transmission pump does not function and the fluid coupling is lost. This idiosyncrasy is most pronounced when accelerating the vehicle from a stop. There is a one or two second delay between movement of the accelerator pedal and vehicle motion.

It should be noted that the deactivation of the motor during idle periods also has a positive benefit. The electrical energy consumed during idle is minimized. However, about 1 kW of power is required for fans.

A gasoline-fired hot air heater and defroster has been incorporated in the vehicle to replace the hot water system normally used. A 3.8 liter (1 gal) fuel tank is located under the right rear wheel well.

³57.9 km/h (36 mph) corresponds to a motor speed of 1800 rev/min in third gear. The speed criteria is really one of motor base speed and varies with battery voltage.

ORIGINAL DE
BLACK AND WHITE PHOTOGRAPH

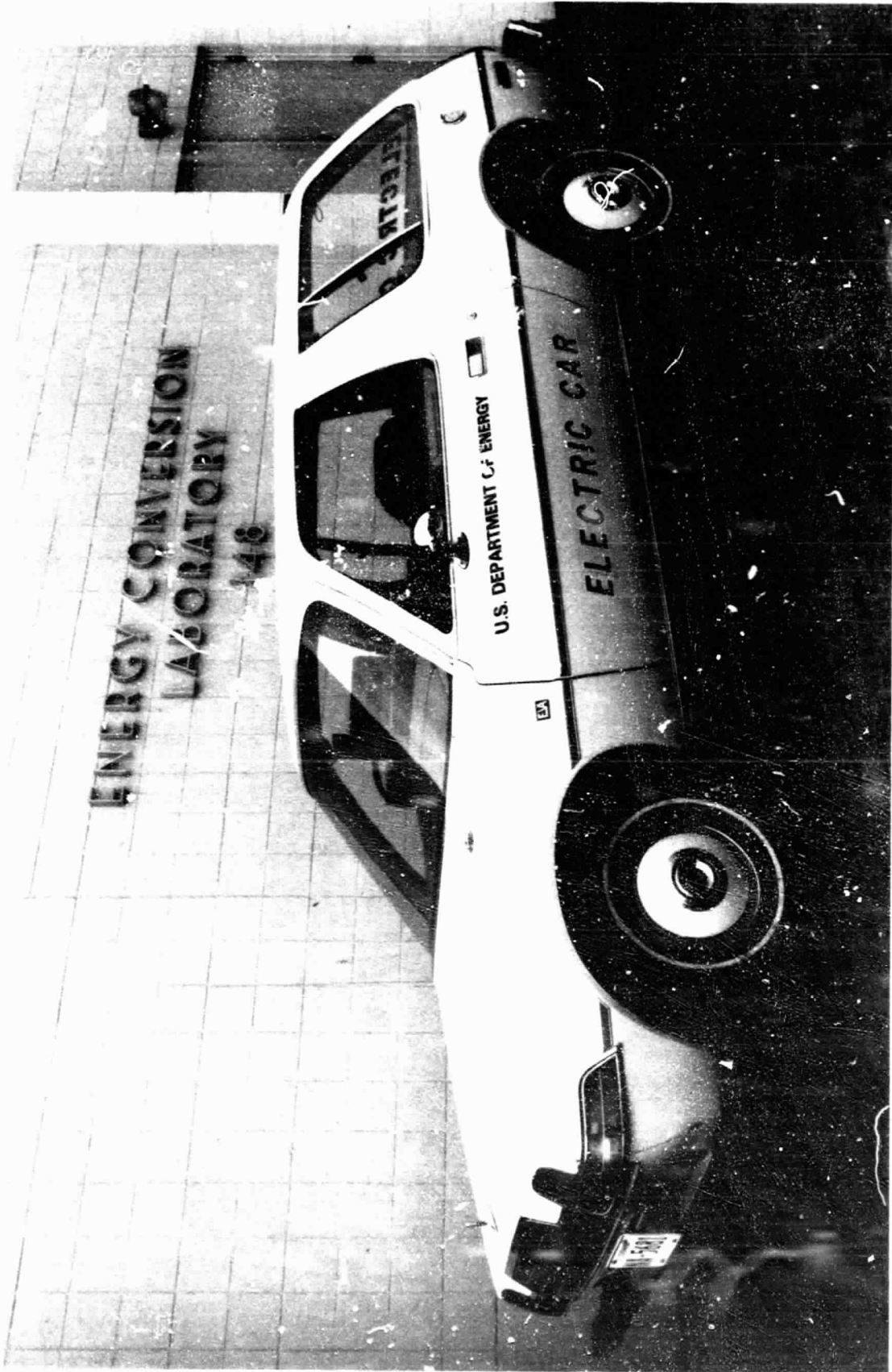

Figure 4-1. EVA Change of Pace--Left Front View

ORIGINAL PAGE
BLACK AND WHITE PHOTOGRAPH



Figure 4-2. EVA Change of Pace--Left Rear View

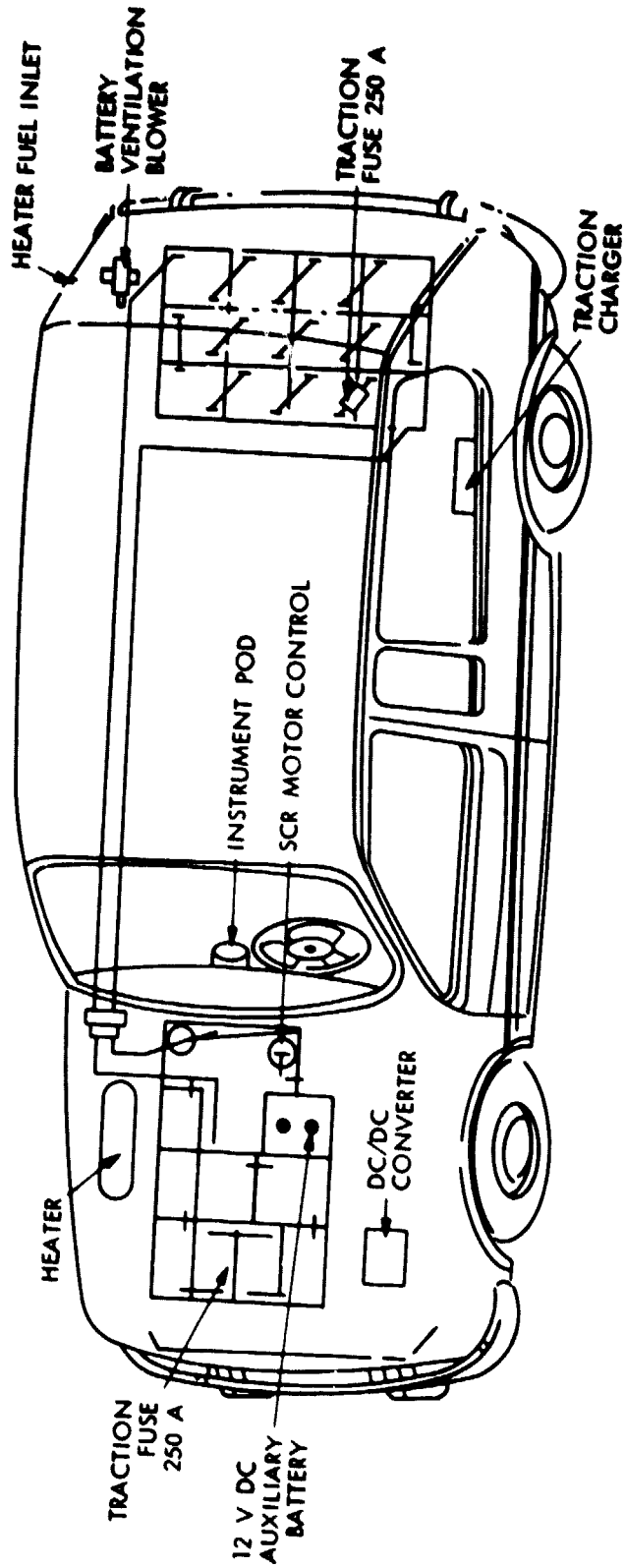

Figure 4-3. Cutaway Showing Major Components

Table 4-1. Vehicle Specifications

Vehicle Weight, kg (lb)		
Gross Weight	2268	(5000)
Curb Weight	1996	(4400)
Driver Weight	68	(150)
Payload Weight	204	(450) (without passengers)
Vehicle Size, cm (in.)		
Wheelbase	254	(100)
Length	449	(177)
Width	195	(77)
Headroom	98	(38.5)
Legroom	103	(40.7)
Transmission Type	3-speed automatic with lock-up torque converter	
Propulsion Batteries (Lead-Acid)		
Number	20	
Manufacturer	Varta	
Voltage	120	
Ampere-Hour Capacity	160 Ah @c/3 or 156 Ah @75 A	
Battery Weight, kg (lb) (excluding 18 kg of connectors and cable)	571	(1260)
Controller		
Type	Dual Chopper	
Manufacturer	Cableform	
Voltage Rating	144	
Current Rating (amp)	340 ^a	
Size, cm (in.)	2.54 x 48 x 18.41	
Weight, kg (lb)	22.7 (10 x 19 x 7 1/4) (50)	
Propulsion Motor		
Type	Separately Excited	
Manufacturer	Reliance	
Insulation Class	H	
Voltage Rating	120	
Current Rating (amp)	112 continuous, 186 peak	
Power Rating, kW (hp)	19.4 (26) continuous; 22.4 (30) peak	
Size diameter, cm (in.)	35.5	(14)
Weight, kg (lb)	145.6	(321)
Rated Speed, rpm	1800	
Maximum Speed, rpm	4000	

^aController manufacturer's rating. During tests at JPL, currents as high as 450 A were observed.

Table 4-1. Vehicle Specifications (Cont'd)

Body	
Type	Station Wagon
Manufacturer	American Motors Corp.
Number of Doors (type)	3 (hinged)
Number of Windows (type)	4 (fixed) + 2 (roll down) + 2 (flip-out)
Number of Seats (type)	4 (bucket/bench)
Cargo Volume, m ³ (ft ³)	1.42 (50.4)
Dimensions, cm (in.)	167 x 117 x 79 (66 x 46 x 31)
Brake Type	
Front	Disc
Rear	Drum
Tire Type	Steel-Belted Radial
Manufacturer	Firestone
Size	P-195/75/R14
Pressure, kilo pascal (psig)	241.3 (35)
Rolling Radius, cm (in.)	31.534 (12.415)

ORIGINAL PAGE
BLACK AND WHITE PHOTOGRAPH

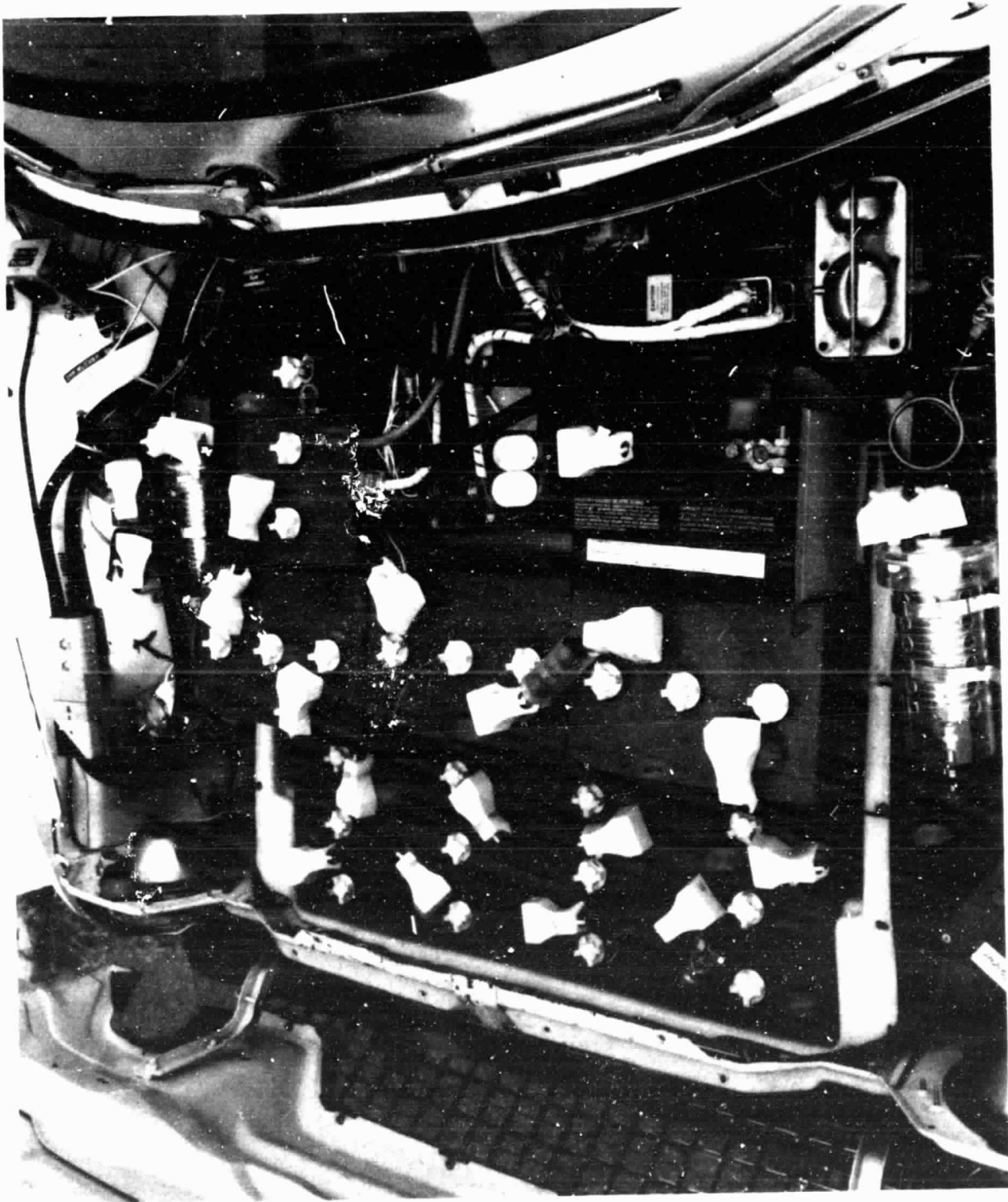

Figure 4-4. Battery Front Location

ORIGINAL PAGE
BLACK AND WHITE PHOTOGRAPH

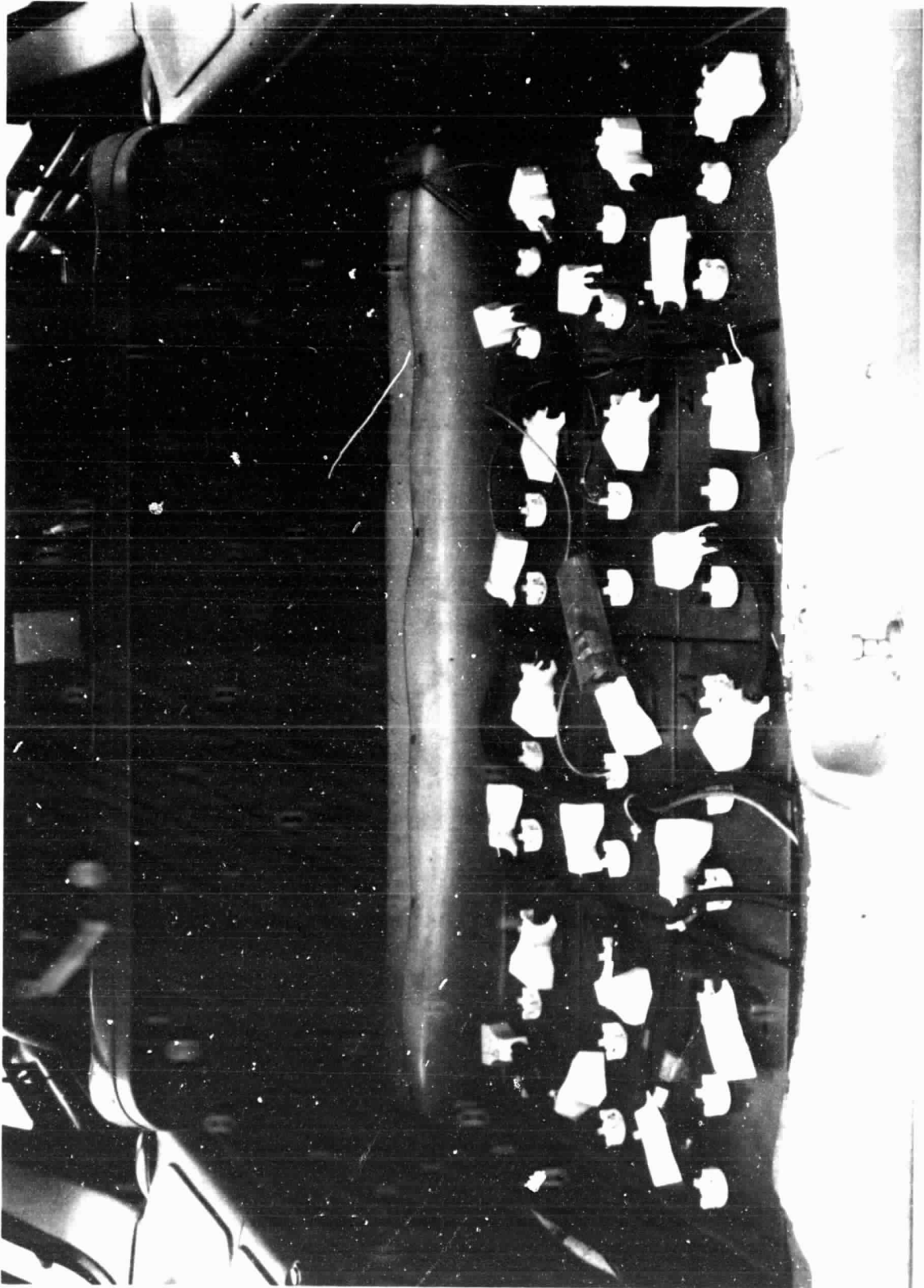

Figure 4-5. Battery Rear Location

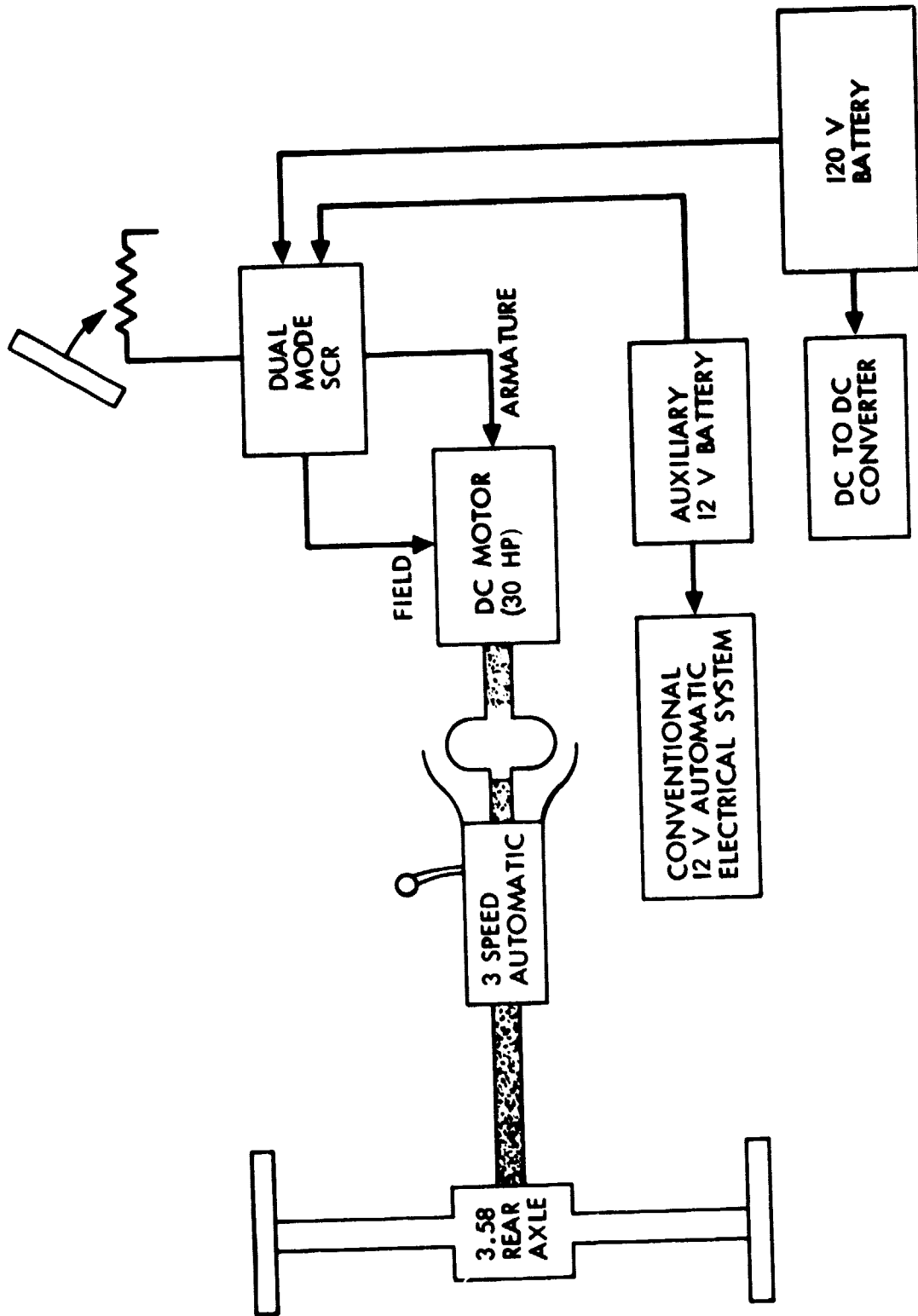

Figure 4-6. EVA Pacer Propulsion System Block Diagram

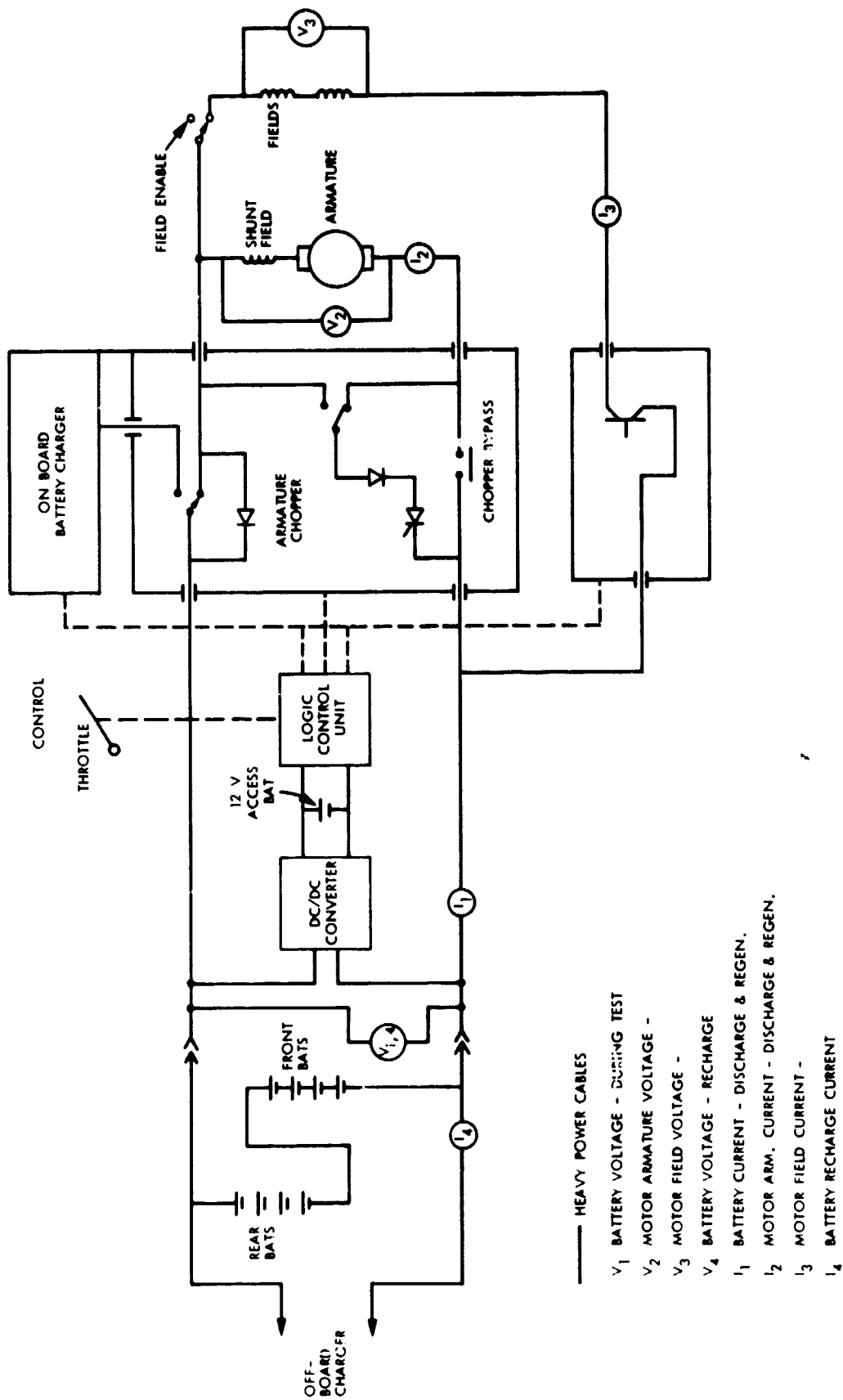

Figure 4-7. Schematic of EVA Pacer System

25 mph

EVA PACER

10-2-79

BATTERY

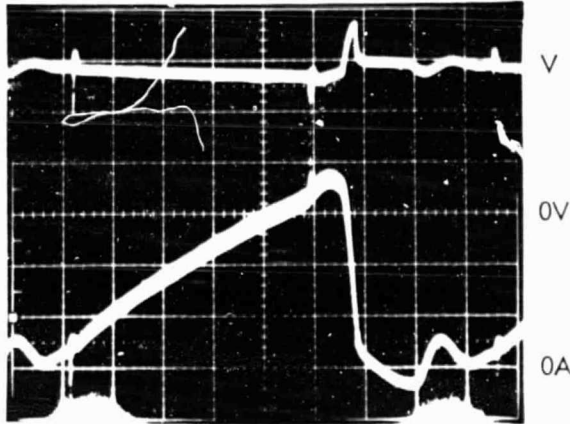

V = 40 V/cm
A = 50 A/cm

MOTOR
ARMATURE

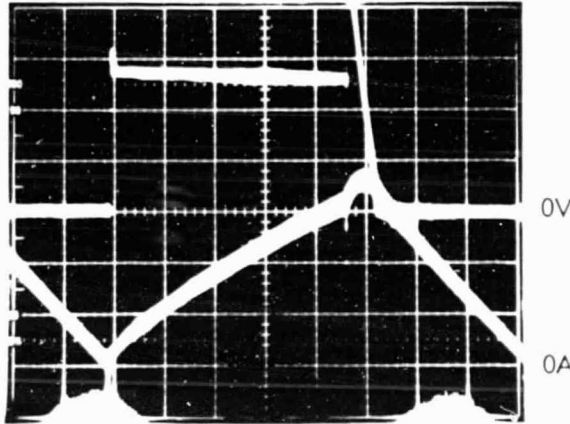

V = 40 V/cm
A = 50 A/cm

MOTOR
FIELD

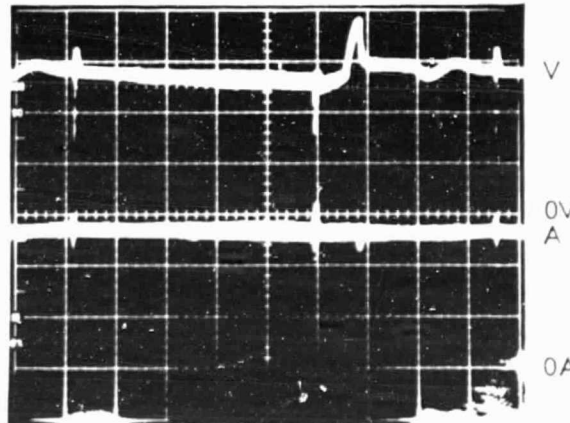

V = 40 V/cm
A = 2.5 A/cm

t = 0.2 ms/cm

Figure 4-8. Oscilloscope Trace at 25 mph

ORIGINAL PAGE
BLACK AND WHITE PHOTOGRAPH

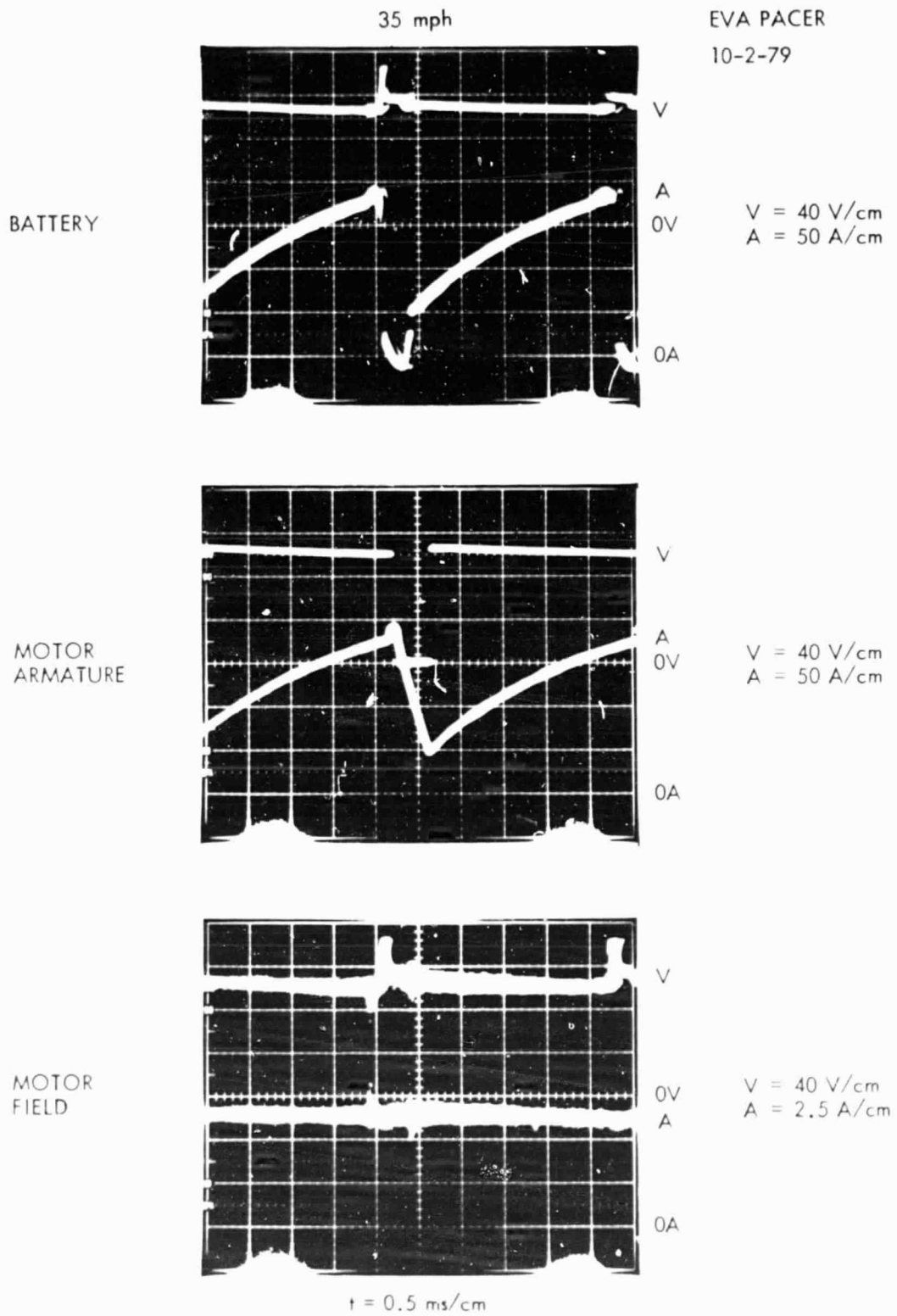

Figure 4-9. Oscilloscope Trace at 35 mph

ORIGINAL PAGE
BLACK AND WHITE PHOTOGRAPH

45 mph

EVA PACER
10-2-79

BATTERY

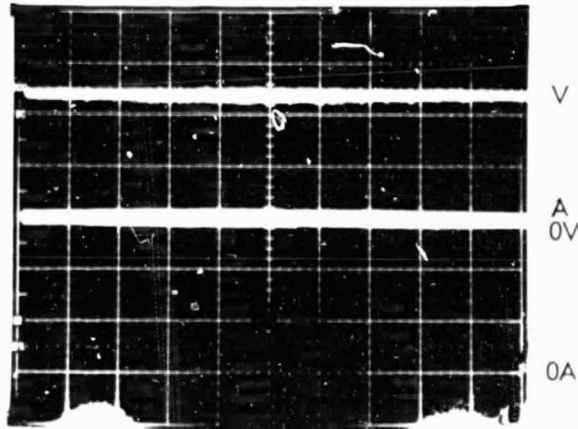

V = 40 V/cm
A = 50 A/cm

MOTOR
ARMATURE

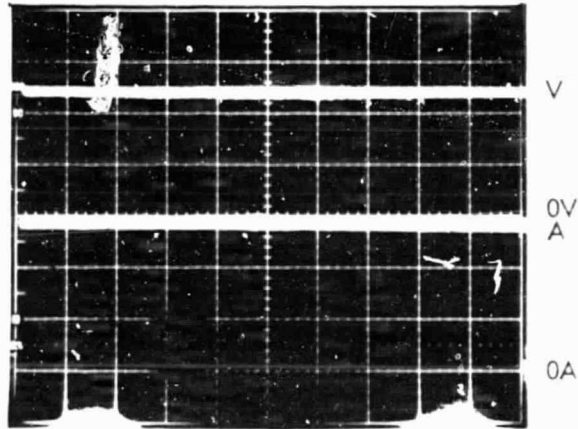

V = 40 V/cm
A = 50 A/cm

MOTOR
FIELD

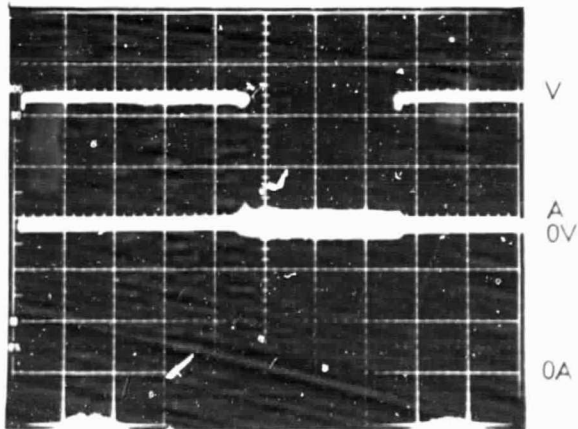

V = 40 V/cm
A = 1.25 A/cm

t = 0.5 ms/cm

Figure 4-10. Oscilloscope Trace at 45 mph

SECTION V

TEST METHODOLOGY

Testing was divided into two general categories; track and chassis dynamometer. Limited track tests were performed which consisted of coastdowns for road load determination. The road load determination tests were conducted solely for the purpose of establishing dynamometer settings. The chassis dynamometer tests consisted of range at constant speeds of 56 km/h (35 mph) and 72 km/h (45 mph) and driving the J227a schedules "B" and "C". These are discussed in more detail below.

A more detailed discussion of the test methodology used for the 2 x 4 Program may be found in a companion report, Reference 5-1. The discussion included here is, in general, limited to those items unique to the EVA Pacer.

JPL operates a Test Facility at the Edwards Air Force Base which is located near Lancaster, California. At this facility, known as Edwards Test Station (ETS) JPL has access to a semi-active Air Force Runway 1829 m (6000 ft) in length. This facility was utilized for roadload determination testing.

The steady speed range and cyclic range tests were conducted in the chassis dynamometer portion of the JPL Automotive Test Facility. A twin-roll Clayton dynamometer with 218 mm (8.6 in.) diameter rollers and direct-drive inertia weights available in 57 kg (125 lb) increments was used in the dynamometer tests. This dynamometer is of the type used by the Environmental Protection Agency (EPA) for Exhaust Emission Certification testing.

The Clayton twin-roll type of dynamometer used at JPL has only a single adjustment for the simulation of aerodynamic load. That is, the load can be set at only one value of vehicle speed. The loads at other speeds are fixed by the cubic variation of load as a function of vehicle velocity that is built into the dynamometer. In addition, the tire pressure and/or the tire loading (vehicle weight on the drive wheels) can be manipulated, within limits, so as to vary the tire/roller losses.

A. ROAD LOAD DETERMINATION AND DYNAMOMETER LOAD ADJUSTMENT

Determination of road load power requirements is a standard test specified in the SAE Test Procedure J227a. However, the intent of the procedure is to define road load for reporting purposes, while in the context of this report road load is established primarily for defining dynamometer adjustments.

After the road load determination is completed at ETS the vehicle is next moved to the dynamometer and the coastdown process is repeated. First, the time required to coast from 32 to 16 km/h (20 to 10 mph) is matched to the track time by adjusting the tire pressure and/or tire loading. Over this velocity increment the aerodynamic portion of the total road load is small and the necessary tire adjustments are not masked by the aerodynamic variable.

Once the 32 to 16 km/h (20 to 10 mph) coastdown time is matched, the aerodynamic load is adjusted by means of the water brake absorber portion of the dynamometer. This is generally done by matching the coast time between 88 and 72 km/h (55 to 45 mph), but can in principle be done at any velocity. As high a speed as practical is used so that the aerodynamic load is as large a part of the total as possible. Again, the time to coast between two speeds is matched to that obtained during the track test. The 32 to 16 km/hr (20 to 10 mph) coastdown is repeated and the tire pressure/loading is adjusted if necessary. The two coastdowns are alternately performed until the two road times are matched as closely as possible.

After the "road" coastdown times have been duplicated on the dynamometer, the resultant aerodynamic horsepower at 80 km/h (50 mph) is measured. Note that this is the first time that a power value has been quantified and, further, that quantification is not necessary to the process. The dynamometer is then adjusted to this specific horsepower value before each subsequent test of the vehicle. A more detailed description of the coastdown and dynamometer processes may be found in Reference 5-1.

B. CHASSIS DYNAMOMETER INSTRUMENTATION

A relatively large, general purpose Integrated Data Acquisition and Control (IDAC) data system is an integral part of the JPL Automotive Test Facility (see References 5-1 and 5-2). The digital recording system is used to record data for all tests conducted on the chassis dynamometer. Approximately 40 data channels are routinely recorded. The energy data (in digital format) and each analog channel are sampled 10 times per second for a minimum of one second.

Data recording is accomplished in two ways: real time high-speed printer and magnetic tape. The bulk of the recording is done with the magnetic tape while the direct printing is used for a "quick look" immediately after test completion. Subsequent data reduction of the magnetic tapes provides a detailed tabular printout of the data as well as plots of pertinent parameters.

Slices of data are acquired at various time intervals. The exact time within the test depends on the type of test. For instance, during constant-speed tests, a 1 s interval of data is recorded once every 60 s. During the driving schedule tests the 60 s interval data are supplemented by several longer recordings. Continuous recordings of two complete repetitions of the driving cycle (Figure 5-1) are made at several levels of battery depth of discharge. This strategy allows characterization of the vehicle transient performance. These continuous recordings are intended to occur at 0%, 40%, 80%, and 100% levels of battery depth of discharge. However, the time at which these levels of depth of discharge occur must be estimated in advance of the test. Therefore the designations 0%, 40%, 80% and 100% depth of discharge are only approximate. During some tests, the continuous recording at 100% depth of discharge was missed altogether because of the estimating process and the very rapid decay in battery voltage as 100% depth of discharge is approached.

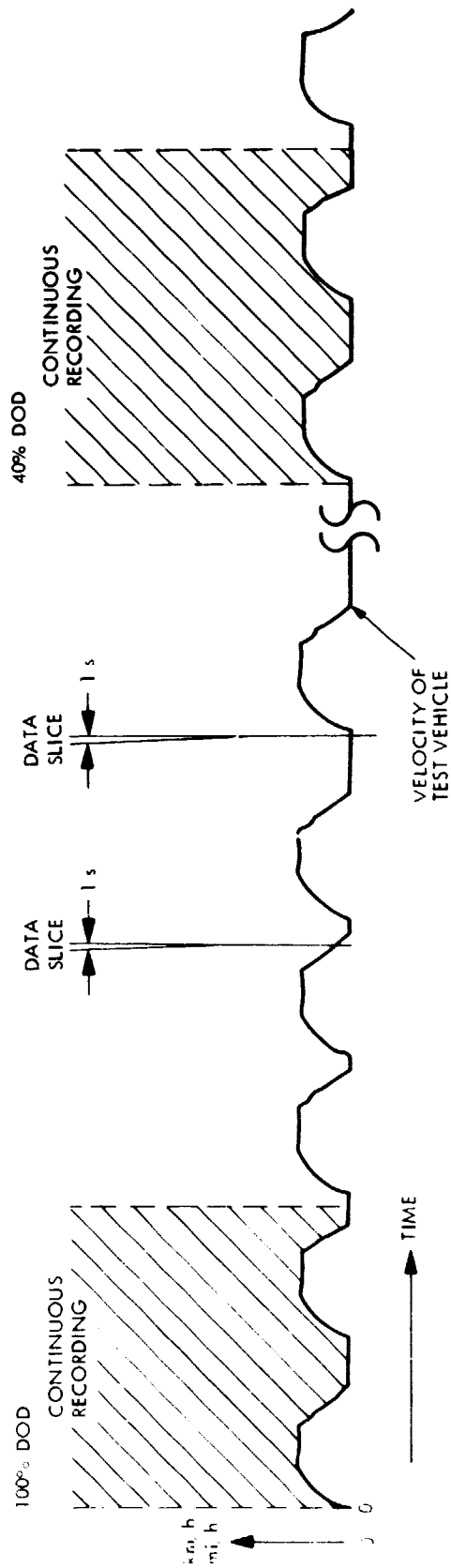

Figure 5-1. Typical Data Recording Format

The key measurements were those of voltage, current, energy and power for the battery, motor armature, and the motor field, motor and drive shaft rotational speed, vehicle velocity, total distance traveled, and battery electrolyte temperature. Each of these is discussed in more detail in Reference 5-1: a brief discussion is included below.

1. Power Measurements (Voltage, Current, Energy)

The power measurement system uses signals proportional to voltage and current, multiplies the current and voltage signals, and provides digital output signals proportional to bipolar power. Analog signals of the input current and voltages are also available. These analog signals are isolated from common-mode voltages and include both wideband (approximately 50 kHz) and filtered (approximately 10 Hz) output signals. The 50 kHz response outputs are primarily used for checkout, investigation of waveforms, and related activities. The low frequency signals are connected to the test facility's data system to provide recorded data of both voltage and current. The output signals proportional to power are recorded by the digital data system.⁴ A more detailed description of the power measurements is included in Reference 5-2.

2. Motor and Drive Shaft Rotational Speed

During dyno testing, the rotational speed of the electric motor and drive shaft were recorded. The motor speed signal was acquired using a magnetic sensor in conjunction with the starter ring gear. (The ring gear, which is mounted within the transmission bell housing, was left in place when the electric conversion was done.) Alternating strips of reflective and black tape were placed on the drive shaft. A photo optical sensor was used to monitor the black-to-reflective tape transitions and thus provide a signal proportional to the drive shaft rotational speed.

3. Vehicle Velocity and Distance Traveled

Each of the two dynamometer rolls is equipped with a digital transducer which produces a pulse proportional to each centimeter of distance traveled. These pulses are recorded as a rate (miles per hour) and integrated with a counter (miles). Although the pulse signals from both dynamometer rolls are recorded, only the data on the idle roll are used for reporting purposes. Data from the other dynamometer roll (absorption roll) are used for engineering information and to adjust the dynamometer aerodynamic horsepower.

4. Torque and Aerodynamic Horsepower

The reactive torque which results from energy being dissipated in the dynamometer absorption unit is measured by a precision load cell. The

⁴The power signal is also integrated to give energy and is recorded both by the digital data system and by mechanical counters.

torque measurement and dynamometer rotational speed are combined by the IDAC data system to calculate horsepower in near real time (within 0.1 s). This permits accurate adjustments of the dynamometer aerodynamic horsepower.

5. Miscellaneous Measurements

Additional recorded measurements include battery temperature, motor case temperature, atmospheric pressure, calibration voltages and several other parameters.

C. VEHICLE CONDITIONING AND WARM-UP

No vehicle warm-up was performed before the dynamometer range and acceleration tests. However, a warm-up was performed prior to all road load determination (coastdown) testing at ETS and before the companion chassis dynamometer coastdowns. The warm-up at ETS was accomplished by towing the vehicle up and down the length of the runway at 40-56 km/h (25-35 mph) for approximately 20 km (12 mi). The purpose of this warm-up period was to bring the vehicle lubricants, wheel bearings, and tires to their normal operating temperatures.

Before each dynamometer range test, the vehicle was temperature conditioned. The primary purpose for this temperature soak was to ensure that the battery electrolyte temperature was $21 \pm 2.8^{\circ}\text{C}$ ($70 \pm 5^{\circ}\text{F}$); a requirement JPL imposes on all EV tests to enhance battery comparisons.

D. DYNAMOMETER TEST PREPARATIONS

A dynamometer warm-up is conducted prior to vehicle testing in the following manner. The 2268 kg (5000 lb) inertia weight setting corresponding to the Pacer GVW is coupled to the dynamometer rollers. An IC engine powered vehicle is operated on the dynamometer for 5 min at 80 km/h (50 mph) and an additional 5 min at 56 km/h (35 mph). The warm-up vehicle is then operated at a constant speed of 80 km/h (50 mph) and the dynamometer is adjusted to the specific horsepower value required by the Pacer (see page 5-2). Immediately following the warm-up, the test vehicle is winched onto the dynamometer. No test vehicle warm-up was performed prior to dynamometer testing.

Range at steady speed was performed as specified in the SAE Test Procedure J227a. Driving schedule tests were performed using the SAE J227a with additional JPL definition. The details of the additional JPL definition may be found in Reference 5-1.

E. TEST TERMINATION CRITERIA

Three test termination criteria were used depending on the nature of the test; i.e., constant speed or cyclic. Constant speed tests were ended when; (1) the pack battery voltage decayed to an average of 1.3 V/cell for more than 5 s (78 V for the total battery pack), (2) the batteries or motor

temperature exceeded the limit specified by the manufacturer, or (3) the vehicle speed could not be maintained within 95% of the specified velocity. Criteria (1) and (2) were also employed for the cyclic tests. A different velocity criteria was used for the cyclic tests. Those tests were terminated when the acceleration portion of any cycle could not be completed within 2 s of the time specified by the procedure. In practice, the constant speed tests were terminated by the battery voltage criteria, while the cyclic tests were ended when the vehicle could no longer complete the acceleration ramp in the allotted time.

SECTION VI

TEST HISTORY

A. PRE-TEST ACTIVITIES

The EVA Pacer was received by JPL on 14 August 1979 from Electric Vehicle Associates. The vehicle weight at the time of receipt was 2018 kg (4450 lb). There was one outstanding lien against the vehicle in that the traction batteries that were installed in the vehicle as delivered (early Varta P125) were known to be unacceptable for use in testing. Others had noted that the batteries were not capable of sustained loads of over 400 A. In particular, the cell inter-connect straps in the battery were of insufficient size to accommodate sustained high current, and melted open. Both EVA and Varta were aware of this condition and were in the process of rectifying the problem. New batteries with larger interconnect straps were manufactured and delivered to JPL.

Upon receipt of the vehicle at JPL, a safety inspection was performed. A self-imposed requirement calls for this inspection prior to the instrumenting and testing of the vehicle. The primary purpose of the inspection was to insure that the vehicle was safe for testing purposes. For example, it was verified that the battery terminals were covered, all points of high voltage were shielded from accidental human contact, the propulsion system was electrically isolated from the vehicle chassis, the batteries were adequately constrained, the conventional safety equipment (horn, lights, turn indicators, etc.) operated properly, and the battery compartment ventilation system functioned properly.

Prior to start of the test phase the wheel bearings and suspension system were inspected and lubricated. All wheels were balanced and aligned according to the manufacturer's specifications. The vehicle was weighed and the load distribution between the front and rear axles defined. From this the additional weight required to bring the vehicle to the manufacturers' recommended gross vehicle weight of 2268 kg (5000 lb) was determined and distributed evenly.

Minor modifications were made to the vehicle by JPL in preparation for testing. The existing front bumper was replaced with one of special design for the EVA Pacer. This heavy-duty bumper allows for the safe towing of the vehicle at high speeds. Quick disconnect connectors were installed between the battery pack and the motor/controller. This provides a safe, convenient way to isolate the batteries from the motor and controller during maintenance and repair, and also allows a convenient place to connect facility batteries for non-test operation of the vehicle on the chassis dynamometer. Current sensors (shunts) were installed on the negative side of the battery pack, the motor armature, and the motor field. In addition, a shunt was installed within the vehicle for use with the external battery charger used during the test program.

B. BATTERY CHARGING

Vehicle range is dependent on several factors. Battery energy capacity is one of the major factors. In turn, battery capacity is directly dependent on, among other things, the particular charging procedure which is used. The procedure used for the tests of the EVA Pacer (described below) was designed to provide a consistent, 100% charge at the start of each range test. Secondly, the procedure was also designed to be as efficient as possible and still meet the consistency requirements. The efficiency aspect also leads to minimum heating of the battery electrolyte and thus reduces the time for subsequent temperature stabilization (see below). Note that battery life was not a primary consideration in the design of the charge procedure. In fact, since the procedure is very nearly an equalization charge (albeit more efficient than the usual equalization), long-term battery life could well be shortened by use of the procedure. No tests were performed to evaluate the effect of the charging procedure on battery life.

The battery charging procedure employed for all range tests consisted of the following steps:

- (1) Charge the batteries at a constant 25 A rate until the average cell voltage is 2.46 V/cell [corrected to an electrolyte temperature of 26°C (80°F)].
- (2) When the average cell voltage is 2.46 V/cell, switch from current control to voltage control. Maintain the temperature compensated cell voltage at 2.46 V/cell and allow the charge current to taper (i.e., decrease) for 6 h.
- (3) Allow the battery electrolyte to cool to 21±2°C (70±5°F) before a test is begun.

The purpose of the third step of the charging procedure was to eliminate battery electrolyte temperature as a source of range variation. All else being equal, a "hot" battery will deliver more energy than a "cold" one. Typical electrolyte temperatures at the end of step (2) above were above 38°C (100°F). In order to start a test with an electrolyte temperature of 21±2°C (70±5°F) the vehicle was placed in a temperature controlled room for 24 h. The cool air of the room was circulated over the batteries by means of a fan. Because of the large thermal mass of the battery pack and the packaging of the batteries, these steps were just adequate to achieve the desired battery temperature within 24 h after completion of the charge.

C. EDWARDS TEST STATION (ETS) ACTIVITIES

The EVA Pacer was towed from JPL to ETS, a distance of 144 mi, with the drive shaft disconnected. The rationale for towing was to acquire service time on the vehicle running gear, specifically the steel belted radial tires. A requirement that the tires have a minimum of 640 km (400 mi) road wear before testing was adopted. Before the JPL test activities, a total of 710 km (441 mi) were acquired on the running gear prior to start of the coastdown testing. A total of 29 high-speed and 24 low-speed coastdown tests were accomplished.

D. DYNAMOMETER ACTIVITIES

After returning the EVA Pacer to JPL, the vehicle was prepared for operation on the JPL dynamometer. During this period it was noted that the traction batteries were not performing as expected, and that four modules had extremely low terminal voltage under load. The four individual voltages ranged from 1.27 V to 3.08 V during a 75 A constant current discharge, while the average module voltage was 5.0 V.

Since new Varta modules were to be delivered shortly from EVA, a decision was made to postpone further testing until they arrived. After the new modules were installed, battery conditioning began. A total of eighteen charge-discharge (conditioning) cycles were performed before formal testing was started.

The original test requirements for the "2 x 4" vehicles specified that the following tests would be performed:

- (1) Range at steady speeds of 56 km/h (35 mph) and 88 km/h (55 mph).
- (2) Driving cycle range for the J227a "B" and either "C" or "D" schedules.

The requirement for range at a steady speed of 88 km/h (55 mph) was reduced to a velocity of 72 km/h (45 mph) due to the fact that the maximum velocity attainable during dyno/vehicle operation was 80 km/h (50 mph). For the driving cycles, the "C" schedule was chosen because the EVA Pacer could not perform the schedule "D" acceleration profile.

SECTION VII

TEST RESULTS

This section presents the results of both the track (ETS) and dynamometer testing. These tests were of three major types: range at constant speed, range under the SAE J227a driving schedule B and C, and road load determination tests. The results reported here pertain only to tests of the EVA Pacer which were accomplished with the Varta P-125 lead acid batteries; the results of additional tests using advanced nickel-zinc batteries will be published in a separate report. All test data were recorded in customary U.S. units, but are reported in this section in both S.I. (metric) and U.S. units. Appendix B is a summary of the test data.

A. RANGE AT CONSTANT SPEED TESTS

Due to the limited length of the runway, no constant speed tests were performed at the ETS facility. Two each 72 km/h (45 mph), 56 km/h (35 mph) and 40 km/h (25 mph) constant speed tests were conducted on the dynamometer at the JPL Automotive Test Facility. Speed was held constant to within +5% of the nominal value and the tests were terminated when either the battery pack voltage fell below 70 V dc (1.3 V/cell) or the vehicle speed could not be held to within 5% of the nominal value. The highlights of the test data are shown in Tables 7-1, 7-2, and 7-3.

Tables 7-1, 7-2, and 7-3 illustrate a unique feature of the combined motor control strategy and torque converter characteristics. The vehicle battery energy consumption (wh/km) is nearly constant from 40.2 km/h (25 mph) to 72.4 km/h (45 mph). In other words, although the tractive power requirements (road-load) increase with velocity, the battery power needed to travel a given unit of distance stays the same. This is in contrast to the typical behavior exhibited by most EVs (see References 7-1 and 7-2). For the typical referenced EVs, battery energy consumption varies directly with speed. For the EVA vehicle three factors contributed to this atypical characteristic;

- (1) Controller efficiency increases with increasing speed. The losses internal to the controller are a relatively constant 1.2 kw during the armature chopping mode. Therefore, as controller throughput power increases with increasing speeds (due to higher road-load), the relative efficiency of the controller improves (see Figure 8-1). Once the vehicle is at sufficient speed to enter the field weakening mode, the armature chopper is bypassed and controller efficiency increases as a one time step function.
- (2) During the armature chopping mode, the motor's efficiency becomes sensitive to pulsed dc supplied by the controller. At low speeds, the crest factor of the pulsed dc was high, resulting in relatively high motor heating losses (eddy current and I^2R). With increasing speeds, these losses were reduced by the lower crest-factor (see Figures 4-8 to 4-10) which effectively permitted the motor to operate more efficiently at higher vehicle speeds.

Table 7-1. Change of Pace--72 km/h (45 mph) Constant Speed

U. S. Customary Units												
Test No.	Range mi	Cycles Driven	Battery Energy (kWh)		Battery Energy Consumption Wh/mi	Battery Energy Recharge Wh	Battery A-h		Discharge	Recharge	Battery Temperature/°C	
			Out	In (Regen)			Pre-Test	Post-Test			Pre-Test	Post-Test
2	33.0	--	10.63	0.0	322	17.88	96.53	127.1	69.6	--	--	
8	35.0	--	11.21	0.0	320	18.44	101.5	131.7	73.2	--	--	

SI Units												
Test No.	Range km	Cycles Driven	Battery Energy (MJ)		Battery Energy Consumption MJ/km	Battery Energy Recharge MJ	Battery A-h		Discharge	Recharge	Battery Temperature/°C	
			Out	In			Pre-Test	Post-Test			Pre-Test	Post-Test
2	53.1	--	38.27	0.0	720	64.37	96.53	127.1	20.9	--	--	
8	56.3	--	40.36	0.0	716	66.38	101.15	131.7	22.9	--	--	

Table 7-2. Change of Pace--56 km/h (35 mph) Constant Speed

U. S. Customary Units												
Test No.	Range mi	Cycles Driven	Battery Energy (kWh)		Battery Energy Consumption Wh/mi	Battery Energy Recharge Wh	Battery A-h		Discharge	Recharge	Battery Temperature, °F	
			Out	In (Regen)			Discharge	Recharge			Pre-Test	Post-Test
1	35.3	--	11.66	0.0	330	19.12	105.4	137.0	71.0	--		
6	38.7	--	12.67	0.0	327	20.7	114.3	144.5	73.2	--		

SI Units												
Test No.	Range km	Cycles Driven	Battery Energy (MJ)		Battery Energy Consumption MJ/km	Battery Energy Recharge MJ	Battery A-h		Discharge	Recharge	Battery Temperature/°C	
			Out	In			Discharge	Recharge			Pre-Test	Post-Test
1	56.8	--	41.98	0.0	738	68.83	105.4	137.0	21.7	--		
6	62.3	--	45.61	0.0	732	72.25	114.3	144.5	22.9	--		

Table 7-3. Change of Pace--40km/h (25 mph) Constant Speed

U. S. Customary Units												
Test No.	Range mi	Cycles Driven	Battery Energy (kWh)		Battery Energy Consumption Wh/mi	Battery Energy Recharge Wh	Battery A-h		Battery Temperature/°F			
			Out	In (Regen)			Discharge	Recharge		Pre-Test	Post-Test	
3	37.4	--	12.66	0.0	338	20.79	113.7	149.0	69.0	--		
13	44.2	--	14.19 ^a	0.0	321 ^a	21.68	126.7	157.3	73.4	--		
17	46.7	--	14.36	0.0	307	23.14	128.2	165.5	69.0	--		

SI Units												
Test No.	Range km	Cycles Driven	Battery Energy (MJ)		Battery Energy Consumption MJ/km	Battery Energy Recharge MJ	Battery A-h		Battery Temperature/°C			
			Out	In			Discharge	Recharge		Pre-Test	Post-Test	
3	60.2	--	45.58	0	756	74.84	113.7	149.0	20.6	--		
13	71.1	--	51.08 ^a	0	718	78.05	126.7	157.3	23.0	--		
17	75.1	--	51.70	0	687	83.30	128.2	165.5	20.6	--		

^aEnergy measurement failed during test. This value calculated using the energy A-R values from test 17.

- (3) The typical torque converter efficiency increases with increasing speed and load, and this is presumed to have occurred during testing of the EVA Pacer. Since only electrical power losses were measured internal to the vehicle, the mechanical losses in the transmission are not quantified here.

Although only the first of the above three items were characterized (see Figure 8-1) during JPL testing, it is postulated that the combination of these three factors account for the atypical energy consumption characteristic of this vehicle.

The effect of this increasing controller and motor efficiency as a function of velocity is that little if any, additional battery power is required to supply the additional tractive power at the wheels. At 72 km/h (45 mph) control is just into the field weakening mode. At velocities above 72 km/h (45 mph) one would expect to see a decrease in energy economy because of the rapidly increasing aerodynamic drag losses and the relatively flat controller efficiency (see Section VIII).

It can also be noticed that the range increased somewhat for like tests, i.e., test 8 range vs test 2 range - 7% better; test 6 range vs test 1 range - 9% better. This can be attributed to two factors. First, the vehicle breakin was still occurring and second, battery conditioning was still not complete. (See Section VIII, Discussion and Problems, for more on conditioning.) These same two factors are also evident in the SAE J227a cycle tests that were performed.

B. DRIVING CYCLE RANGE TESTS

To simulate "normal" operation of an electric vehicle, i.e., stop-and-go driving, the SAE has established four driving cycles for electric vehicles. The driving cycles exercise the vehicle in a somewhat "normal" manner, but, more importantly, are intended to lead to test repeatability and standardization. The exact requirements of these cycles are presented in Reference 2-1. For the purposes of the JPL tests, additional definition has been added to these driving schedules. The added definition consists of specifying the velocity of the acceleration, coast, and brake segments at one second intervals. The basic J227a procedure defines only the end points of each segment. The form of the cycles used at JPL are described in detail in Reference 5-1. Two each of the schedule "B" and "C" tests were completed at the JPL dynamometer facility. Each of the cyclic tests were terminated when the vehicle was unable to complete the acceleration ramp in the allotted time. Tables 7-4 and 7-5 summarize the results of those tests.

Very good agreement was achieved in the range data from each of two tests from the "B" cycle testing, and the two tests at the "C" cycle. The average range from the "B" cycle tests was 37.33 km (23.2 mi) with a $\pm 3.5\%$ variation; whereas the "C" cycle range mean at 31.92 km (19.8 mi) has only a $\pm 1.66\%$ variation.

The approximately 7% difference in range and battery energy for the "B" cycles cannot be totally attributed to the difference in battery temperature levels. Ordinarily, a 1% range variation can be expected for each 1°C (1.8°F) change on battery temperature. Using this rule of thumb, less than 3% of the

Table 7-4. Change of Pace-J227a Schedule "B"

U. S. Customary Units											
Test No.	Range mi	Cycles Driven	Battery Energy (kWh)		Battery Consumption Wh/mi	Battery Energy Recharge Wh	Battery A-h		Battery Temperature/°C		
			Out	In (Regen)			Discharge	Recharge	Pre-Test	Post-Test	
5	22.4	109	13.07	0.001	583	22.12	119.0	159.8	66.0	84	
9	24.1	117	13.96	0.002	579	21.96	125.9	159.5	70.2	88	

SI Units											
Test No.	Range km	Cycles Driven	Battery Energy (MJ)		Battery Energy Consumption MJ/km	Battery Energy Recharge MJ	Battery A-h		Battery Temperature/°C		
			Out	In			Discharge	Recharge	Pre-Test	Post-Test	
5	36.0	109	47.05	0.004	1.304	79.63	119.0	159.8	18.9	28.9	
9	38.8	117	50.26	0.007	1.295	79.06	125.9	159.5	21.2	31.1	

Table 7-5. Change of Pace--J227a Schedule "C"

Test No.	Range mi	Cycles Driven	Battery Energy (kWh)		U. S. Customary Units		Battery A-h	Battery Temperature/°F		
			Out	In	Battery Energy Consumption Wh/mi	Battery Energy Recharge Wh			Discharge	Recharge
4	20.15	57	11.02	0.002	547	18.56	104.0	132.8	72.9	88
11	19.53	55	10.61	0.001	543	17.82	99.4	128.3	73.2	91

Test no.	Range km	Cycles Driven	Battery Energy (MJ)		SI Units		Battery A-h	Battery Temperature/°C		
			Out	In	Battery Energy Consumption MJ/km	Battery Energy Recharge MJ			Discharge	Recharge
4	32.4	57	39.67	0.007	1.224	66.81	104.0	132.8	22.2	31.1
11	31.4	55	38.20	0.004	1.215	64.15	99.4	128.3	22.9	32.8

range variation can be attributed to the difference in temperature between these two runs. A portion of the performance variation may be related to additional battery conditioning that occurred during actual testing. (See Section VIII, Discussion and Problems).

For the schedule "C" tests the range variation is only 1.5%. There appears to be no affect of battery temperature, and indeed there was less than 1°C difference in the two tests. Therefore, the range variations shown in Table 7-5 reflect general precision of the data.

C. REGENERATION DURING CYCLE TESTS

As can be seen on Tables 7-4 and 7-5, the energy returned to the batteries by regeneration was nil. This occurs because of the automatic transmission. There is no direct mechanical coupling between the wheels and the motor and the reverse coupling of the torque converter is insufficient to transfer stored kinetic energy back to the motor. Even if the reverse coupling were adequate, the transmission does not downshift at a significantly high velocity so as to keep the motor output voltage above the battery voltage. For these reasons, it would appear that the increased controller complexity and cost for including regeneration are not a worthwhile investment in a vehicle which uses this type of automatic transmission.

D. ROAD ENERGY CONSUMPTION

Energy consumption and road power requirements were determined using methods similar to those given in SAE Test Procedure J227a, Section 10, Vehicle Road Energy Consumption (Reference 2-1). For the SAE procedure, three pairs of the coastdown tests are averaged for the full velocity profile. The data from Table 7-6 are an average of 24 separate coastdown tests (i.e., 12 pairs) which were conducted on the separate days. The results of the calculations represent the energy required by the vehicle to overcome aerodynamic and rolling, including part of the transmission energy losses. This is not the energy needed from the vehicle batteries to propel the vehicle at various speeds. The battery, controller, motor, and a majority of the transmission energy losses are excluded from the energy consumption values reported here.

Table 7-6 is a tabulation of the time increment required to coast between each of the velocity increments listed. Figure 7-1 shows the same data graphically. After plotting the data from Table 7-6 the curve of Figure 7-1 was fitted to provide some smoothing. "Smoothed" values of time were read from this curve and are included in Table 7-6. The smoothed values were used in the subsequent calculations of road energy and power. The road power and energy consumption were calculated using the appropriate equation from SAE Procedure J227a. The results of these calculations are given in Table 7-7 and are plotted in Figures 7-2 and 7-3.

Table 7-6. Track Coastdown Data

Velocity Increment		Average Velocity		Time Increment	'Smoothed' Time Increment
km/h	mph	km/h	mph	s	s
96.5-80.5	60-50	88.5	55	17.1	16.7
88.5-72.4	55-45	80.5	50	18.3	18.7
80.5-64.4	50-40	72.4	45	20.4	20.9
72.4-56.3	45-35	64.4	40	24.9	23.2
64.4-48.3	40-30	56.3	35	25.6	25.6
56.3-40.2	35-25	48.3	30	28.8	28.2
48.3-32.2	30-20	40.2	25	32.1	31.2
40.2-24.1	25-15	32.2	20	34.0	34.3
32.2-16.1	20-10	24.1	15	37.5	37.8

Table 7-7. Road Energy and Power

Velocity Increment		Average Velocity		Road Energy		Road Power	
km/h	mph	km/h	mph	$\frac{\text{kW-h}}{\text{km}}$	$\frac{\text{kW-h}}{\text{mi}}$	kW	hp
96.5-80.3	60-50	88.5	55	0.168	0.271	14.9	20.00
88.5-72.4	55-45	80.5	50	0.150	0.242	12.1	16.3
80.5-64.4	50-40	72.4	45	0.134	0.217	9.8	13.1
72.4-56.3	45-35	64.4	40	0.121	0.195	7.8	10.5
64.4-48.3	40-30	56.3	35	0.110	0.177	6.2	8.3
56.3-40.2	35-25	48.3	30	0.100	0.161	4.8	6.5
48.3-32.2	30-20	40.2	25	0.090	0.145	3.6	4.9
40.2-24.1	25-15	32.2	20	0.082	0.132	2.6	3.5
32.2-16.1	20-10	24.1	15	0.075	0.120	1.8	2.4

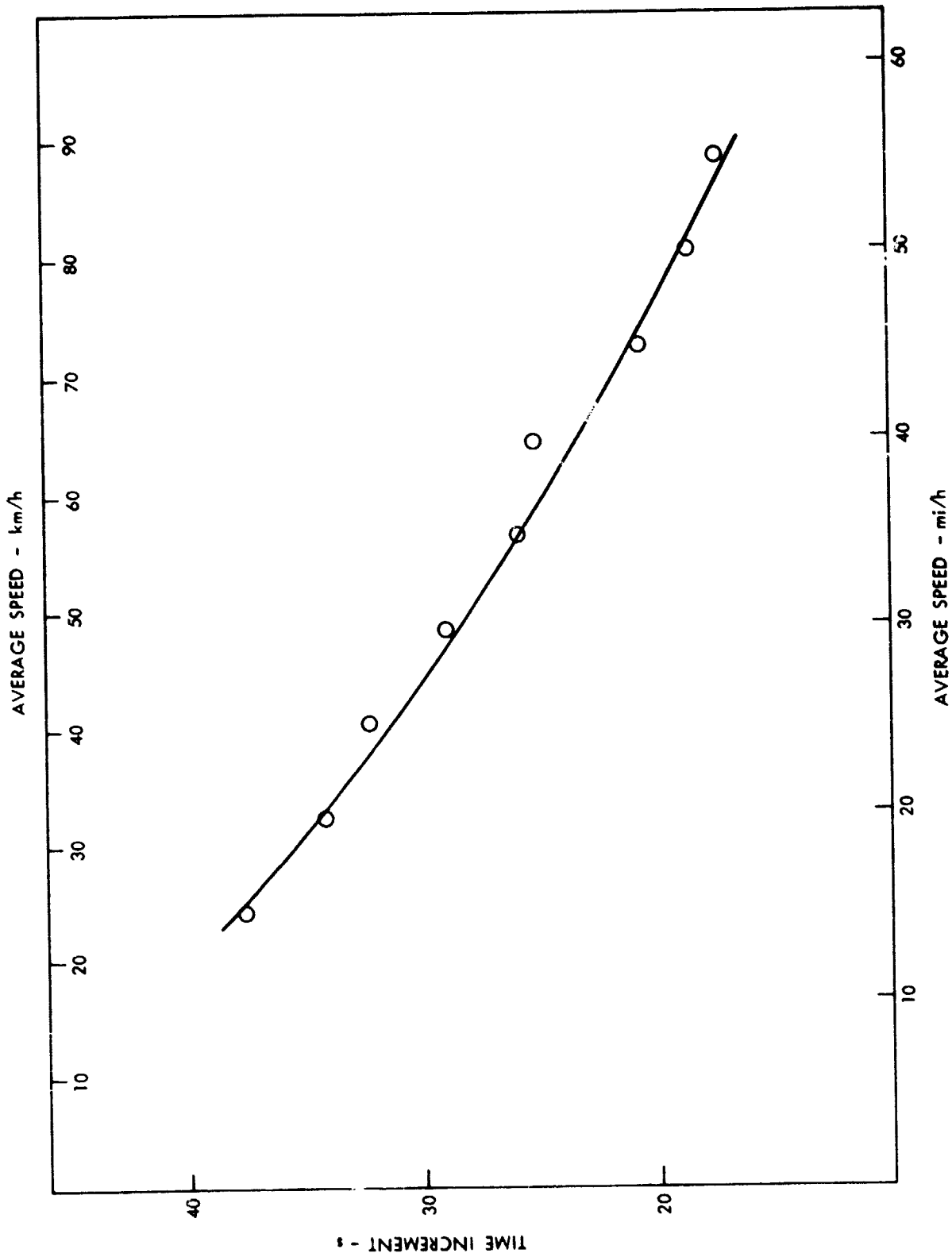

Figure 7-1. Average Speed vs Time Increment

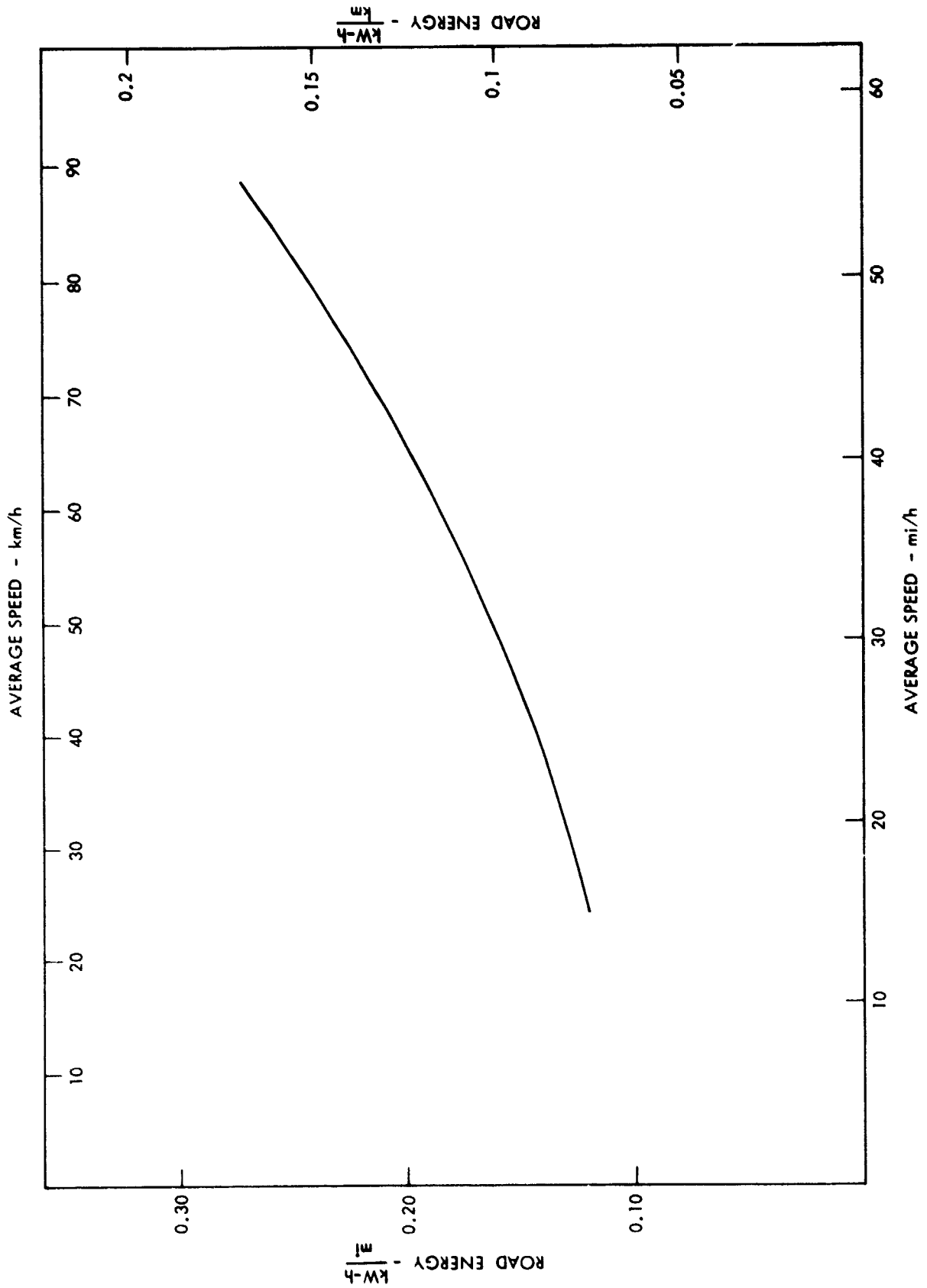

Figure 7-2. Average Speed vs Road Energy

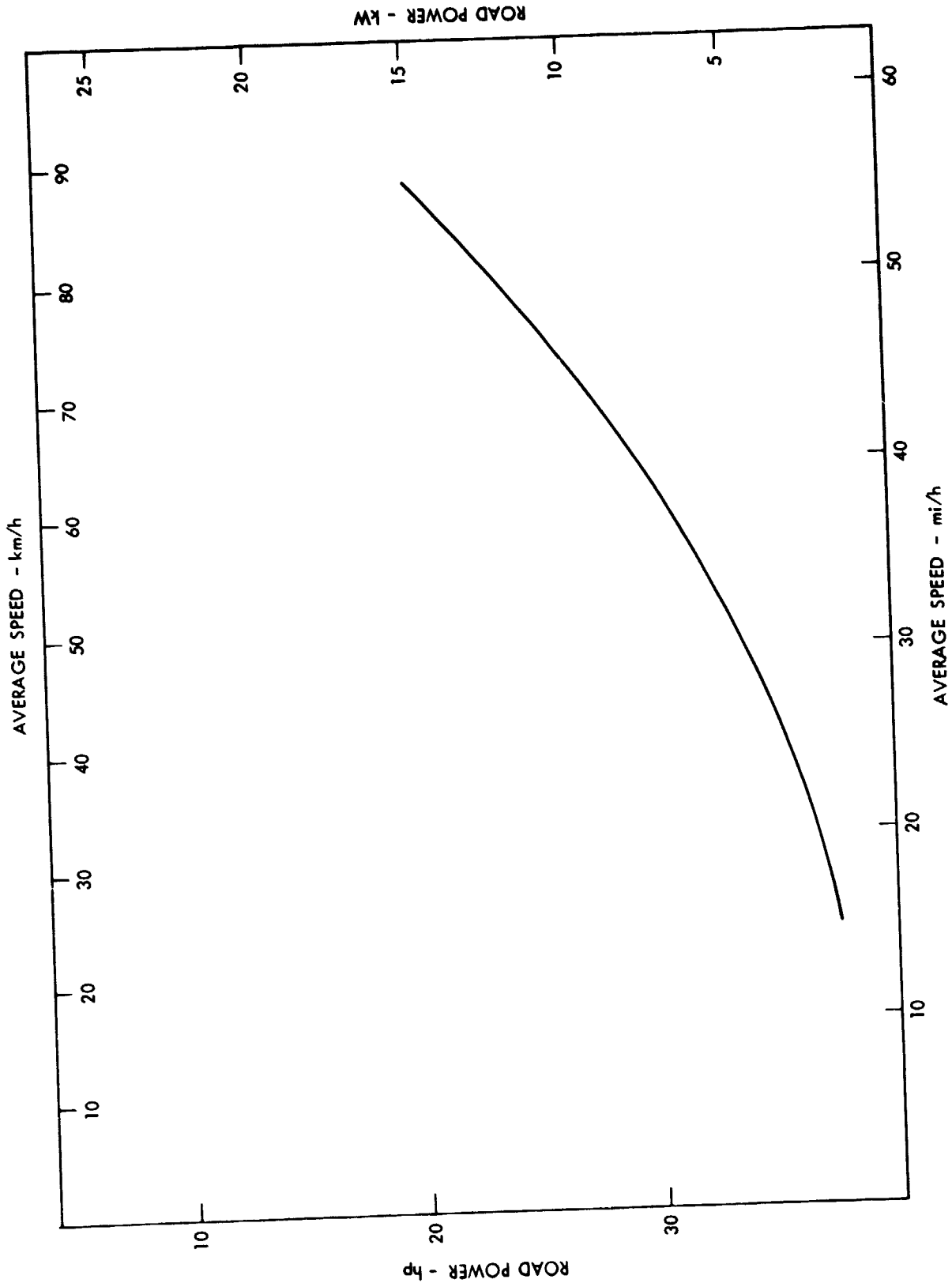

Figure 7-3. Average Speed vs Road Power

SECTION VIII

DISCUSSION AND PROBLEMS

This section presents observations regarding the performance characteristics, advantages and disadvantages of the EVA Pacer. Problems encountered during the JPL tests are also discussed.

A. GENERAL OBSERVATION

The EVA Pacer displayed several system level shortcomings. Two of these, the hesitation at the beginning of an acceleration from rest and the ineffective regeneration, have been noted earlier. In addition, the vehicle was very heavy. At a curb weight of 1996 kg (4400 lb) and a test weight of 2268 kg (5000 lb), the acceleration capability of the vehicle was poor. The EVA Pacer was not capable of performing the J227a "D" schedule acceleration ramp. All of these are the direct result of electrifying a conventional vehicle, and highlight the advantages and need for a system level design.

B. DRIVING CHARACTERISTICS OF EVA PACER

A dual mode controller is certainly a viable approach and is used in at least one other electric vehicle; the DOE ETV-1, which was designed and built by General Electric. The principal objective of combining armature and field current modulation is to improve driveability. Use of field weakening alone, while more efficient than armature control alone, presents some driveability problems because the motor operation below base speed is not feasible. The base speed of the electric motor chosen for the EVA Pacer is ~1800 rev/min. Not only does this base speed preclude the use of most automatic transmissions for single mode field weakening control strategies, but when combined with a standard transmission, requires a change in driving technique. Speed control by means of armature current modulation eases the driveability problems, but at the cost of increased controller losses. The effect is shown in Figure 8-1 where controller efficiency is plotted as a function of vehicle speed. The controller efficiency of Figure 8-1 is defined as

$$\text{cont eff} = \frac{E_{MI} + E_F}{E_{BO}} \times (100) \%$$

where

E_{MI} = energy consumed by the motor armature, kWh

E_F = energy consumed by the motor field, kWh

E_{BO} = energy discharged by the battery, kWh

As Figure 8-1 indicates, the controller efficiency increases with vehicle speed while in the armature control mode. The efficiency in the field control mode is significantly greater than for armature control.

The hesitation between application of pressure to the accelerator pedal and response of the vehicle was noted in Section IV. This is counter to the the expectations of drivers of ICE-equipped vehicles. Since the delay could be anticipated, there was no effect on the test results, but the JPL drivers still found the effect disconcerting. Further, such a hesitation could pose a safety problem under real-world traffic conditions.

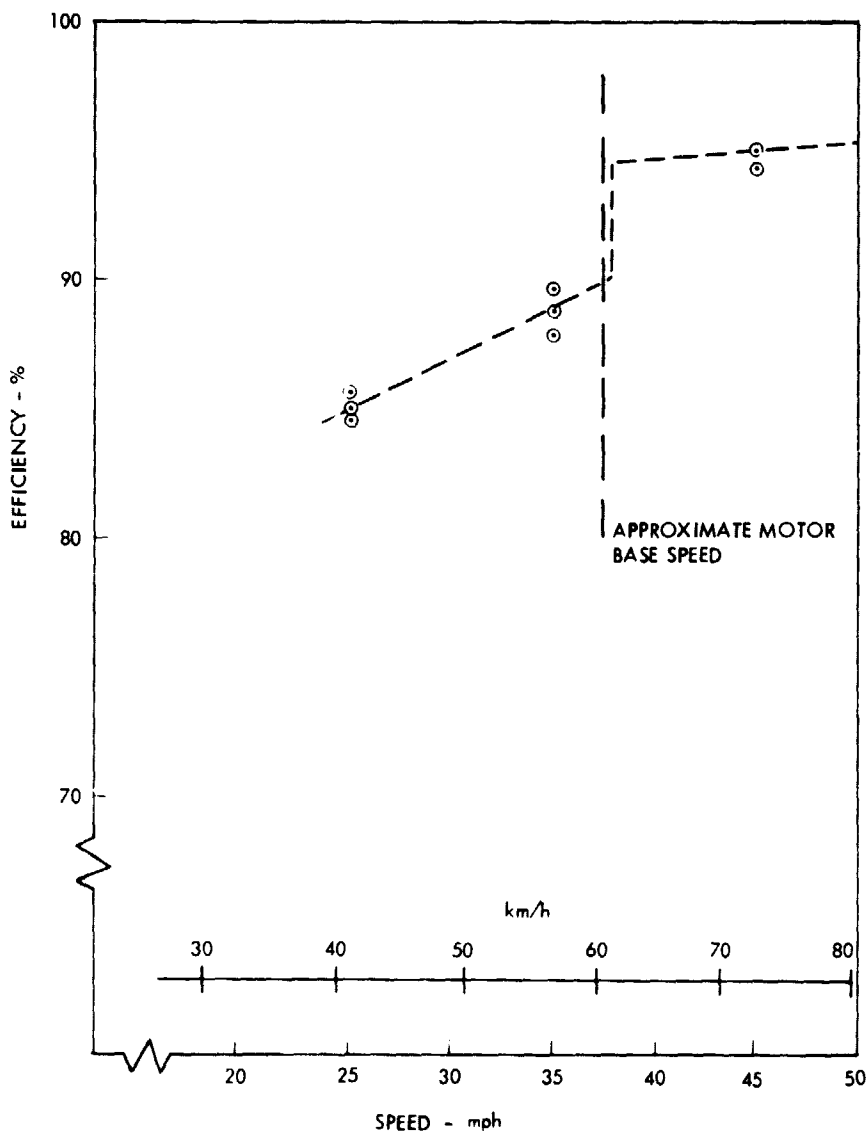

Figure 8-1. Controller Efficiency vs Vehicle Speed

C. VEHICLE RELIABILITY

Several component/subsystem failures occurred that resulted in the vehicle being inoperative; consequently, delays were caused in the test program. These failures were associated with the propulsion batteries, the controller, and the on-board battery charger.

As noted earlier, the batteries delivered with the vehicle contained a design flaw and were incapable of continuous high current. The vehicle performance testing could not begin until the batteries were replaced and conditioned. The conditioning consisted of 18 charge-discharge cycles. The discharges were done in two ways; either using a bank of ordinary light bulbs as a constant load, or by driving the vehicle (on the dyno) at a constant 35 mph speed until the batteries were discharged. Hindsight has shown that this conditioning was deficient in two ways. First, the nature of the Varta P-125 batteries is such that they require more than 18 cycles before conditioning is complete. This is believed to be an effect on the order of 4% in energy capacity and hence has a small effect on the results report here. Second, and more importantly, it appears that the nearly constant power and constant current conditioning discharges were not adequate. After the first 25 mph range test, during which motor control is well within the armature chopping mode (see Figure 4-7), there was a significant increase in battery capacity. This was not detected until the next 25 mph test (see Table 7-3). The increase in capacity is attributed to the pulsed current imposed on the battery. The conclusion we draw from this experience is that battery conditioning should include some pulsed operation if subsequent use of the batteries also includes pulsed current.

The controller represented a new design by Cable-Form and only three copies incorporating the dual mode control were fabricated. Since the controllers were in essence prototypes they included many of the problems commonly associated with prototypes; parts were not readily available, documentation was somewhat sketchy and not always accurate, and "fixes" had been added to the basic circuits. In addition, some difficulties were experienced with cold solder joints. There were several controller failures during the course of the test program. The subsequent repairs resulted in delays in the tests.

The on-board battery charger failed shortly after the vehicle arrived at JPL. The cause was traced to an inadequate heat sink. The original design utilized a solid iron block, 2 in. x 5 in. long, bolted to the rear wheel well. EVA redesigned the unit using a finned heat sink and fan. This redesigned unit was installed in the Pacer but was never completely checked out. All battery charging was done using a facility charger.

D. ENERGY USAGE

As an aid to understanding the characteristics of the EVA Pacer, energy usage was analyzed as a function of the five phases of the SAE Procedure J227a Driving Schedules (acceleration, cruise, coast, brake and idle). Figures 8-2 and 8-3 depict the energy division for a single SAE J227a B and C driving cycle respectively. The two cycles are compared directly in Figure 8-4 and

the effect of battery depth of discharge is shown in Figures 8-5 and 8-6. As expected, over half of the total energy drawn from the batteries was expended during acceleration and another large part was used during cruise. The relatively high energy usage during "idle" is a result of high housekeeping power requirements during non-motive conditions and the need to run the motor up to about 500 rev/min for approximately two seconds prior to each acceleration to avoid the hesitation previously discussed.

As noted earlier, only a small amount of energy was recovered through regeneration. This is the direct result of using an automatic transmission. There is no mechanical path by which the vehicle's inertial energy can be transformed into electrical energy. However, even without the automatic transmission effects, the amount of regeneration would probably have been small. There were no provisions for boosting the voltage during regeneration, and, consequently, whenever the motor speed was below the base speed, no energy could be returned to the batteries.

E. COMPARISON TO OTHER ELECTRIFIED VEHICLES AT STEADY SPEED

A qualitative evaluation of the EVA Pacer has been made by comparing the performance described in this report with the results reported in Reference 7-1. That report contains test results for 22 electric vehicles that were tested specifically for the purpose of assessing the state-of-the-art of electric vehicles in 1977. Figure 8-7 has data from this report superimposed on a figure taken from the referenced report.

Figure 8-7 is a plot of vehicle range for constant-speed operation versus vehicle speed. The vehicles in Reference 7.1 fell into two broad categories. The average of each of these two categories is shown by light dashed lines. As can be seen by the dotted line representing the Pacer, the Pacer range is approximately that of the majority of the vehicles tested in 1977. It should be emphasized that the type of comparison shown in Figure 8-7 is qualitative, but at the same time it seems obvious that the power train efficiency of the Pacer is about the same as for the 1977 state-of-the-art vehicle. Also, it should be noted that vehicle safety and driveability were not evaluated for this report.

TOTAL ENERGY USAGE
FOR ONE CYCLE = 119.0 Wh

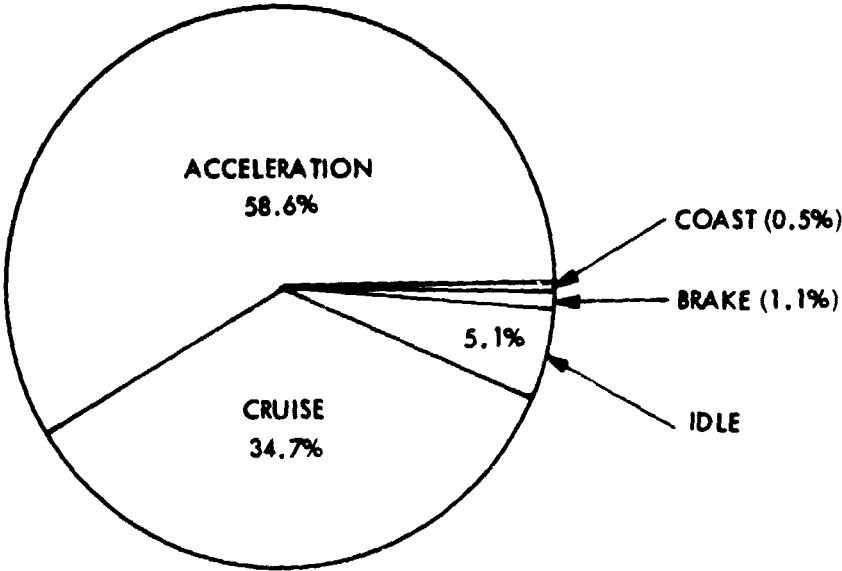

Figure 8-2. Energy Usage for Driving Schedule "B" at 40% Depth of Discharge

TOTAL ENERGY USAGE
FOR ONE CYCLE = 188.6 Wh

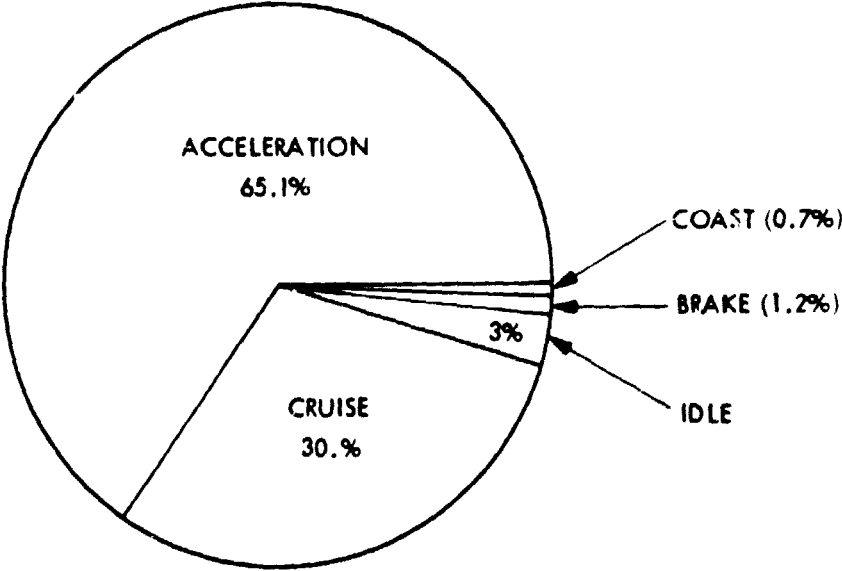

Figure 8-3. Energy Usage for Driving Schedule "C" at 40% Depth of Discharge

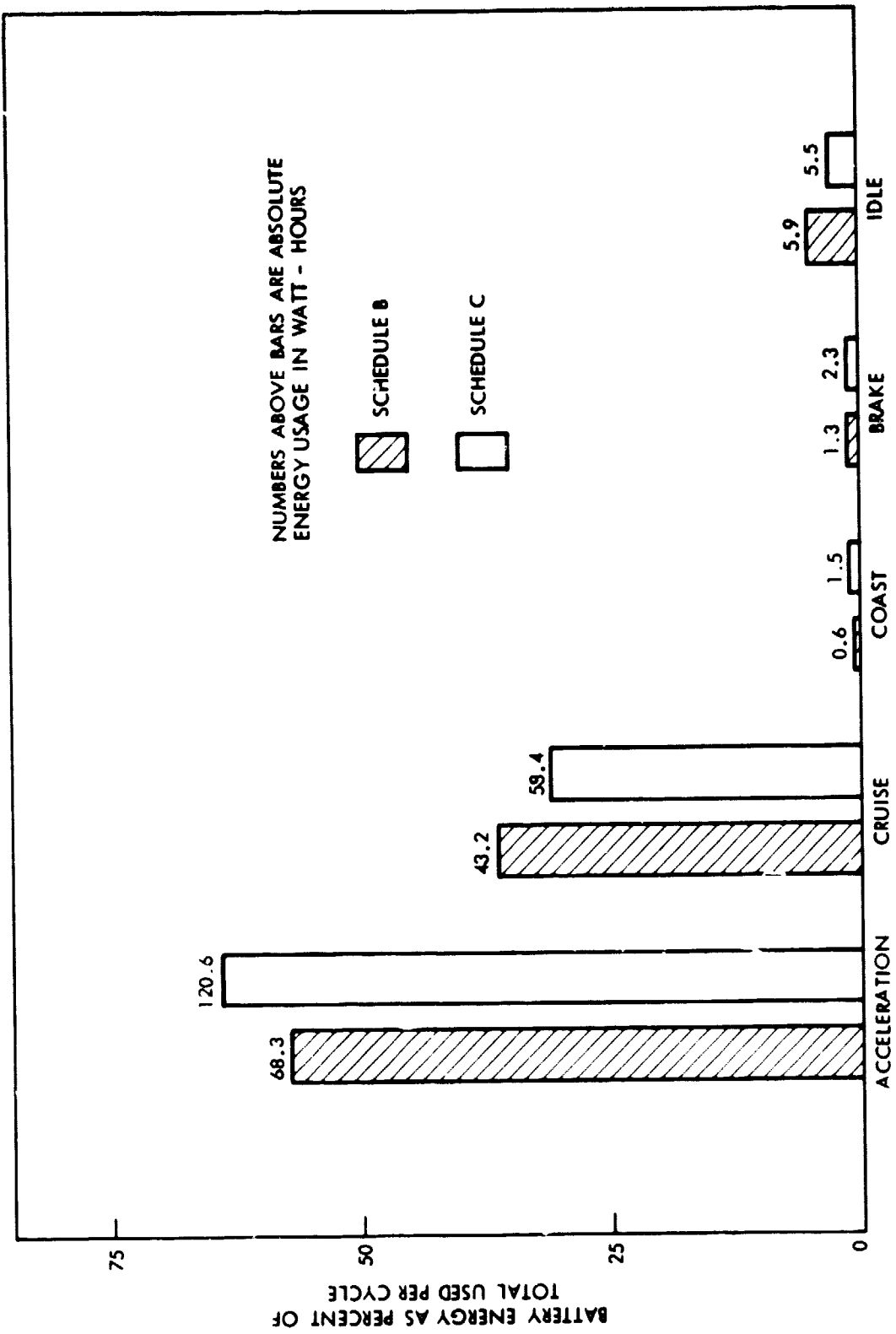

Figure 8-4. Comparison of Driving Schedules "B" and "C" Energy at 40% Depth of Discharge

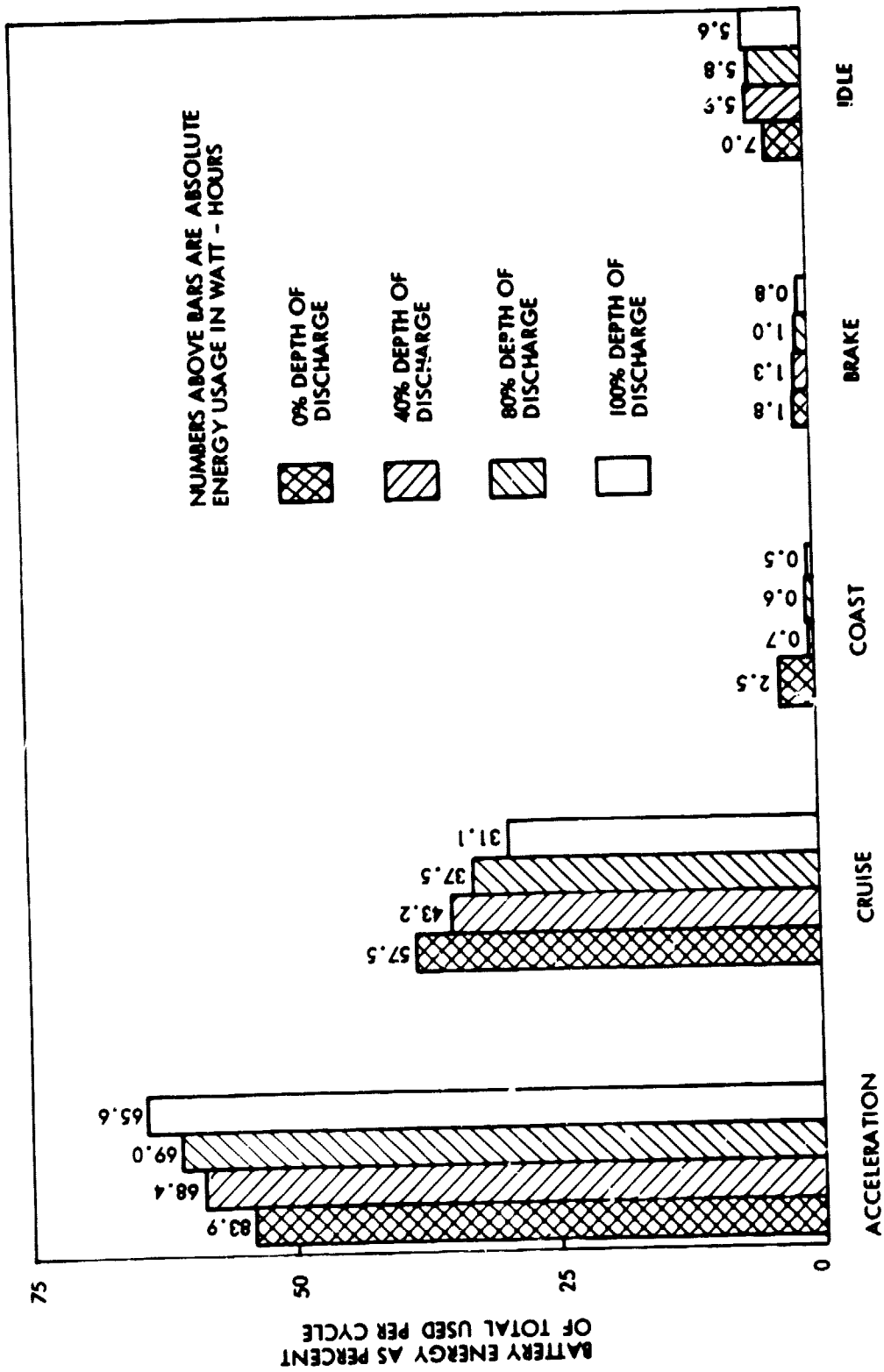

Figure 8-5. Schedule "B" Energy Usage as a Function of Battery Depth of Discharge

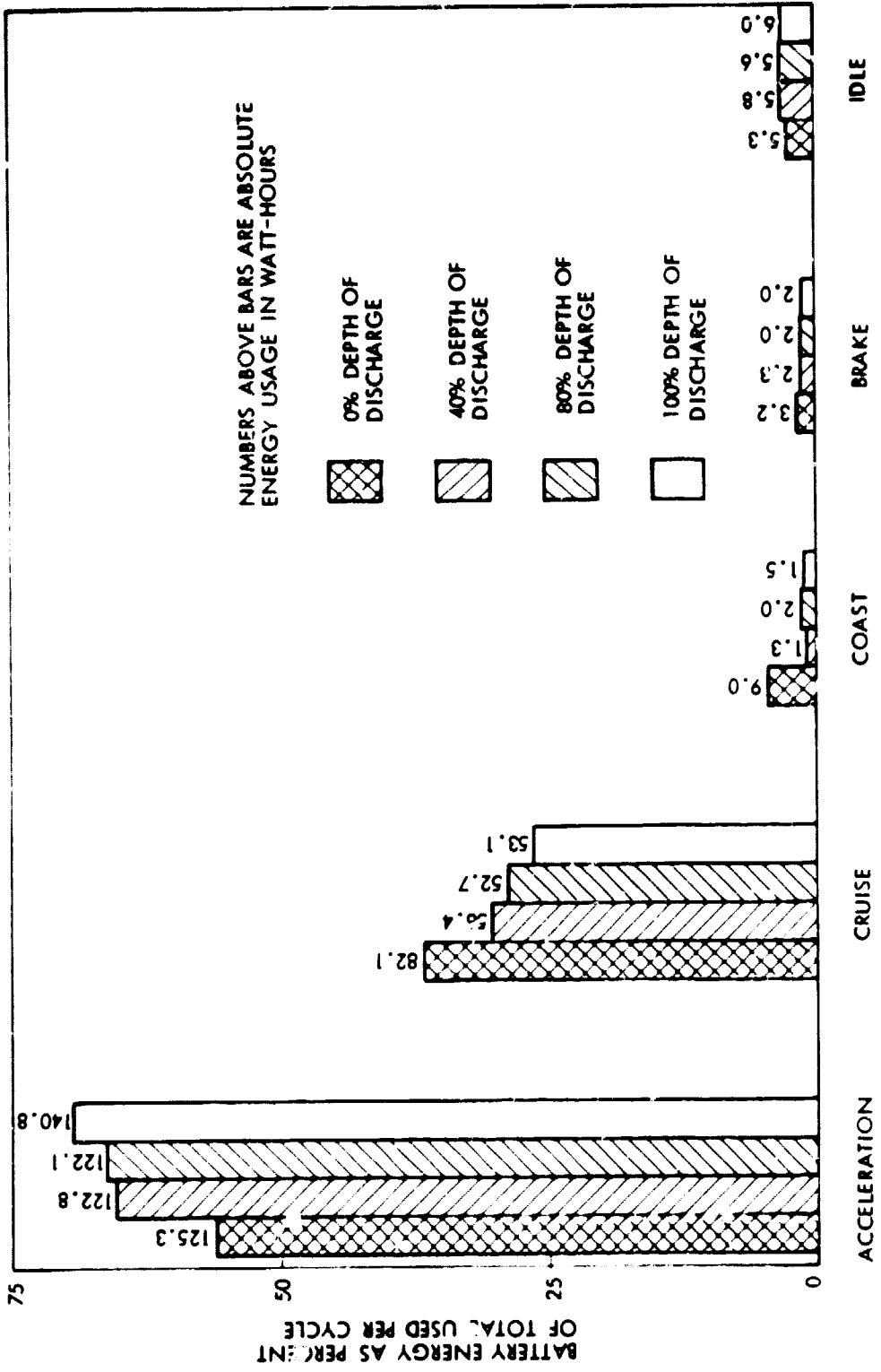

Figure 8-6. Schedule "C" Energy Usage as a Function of Battery Depth of Discharge

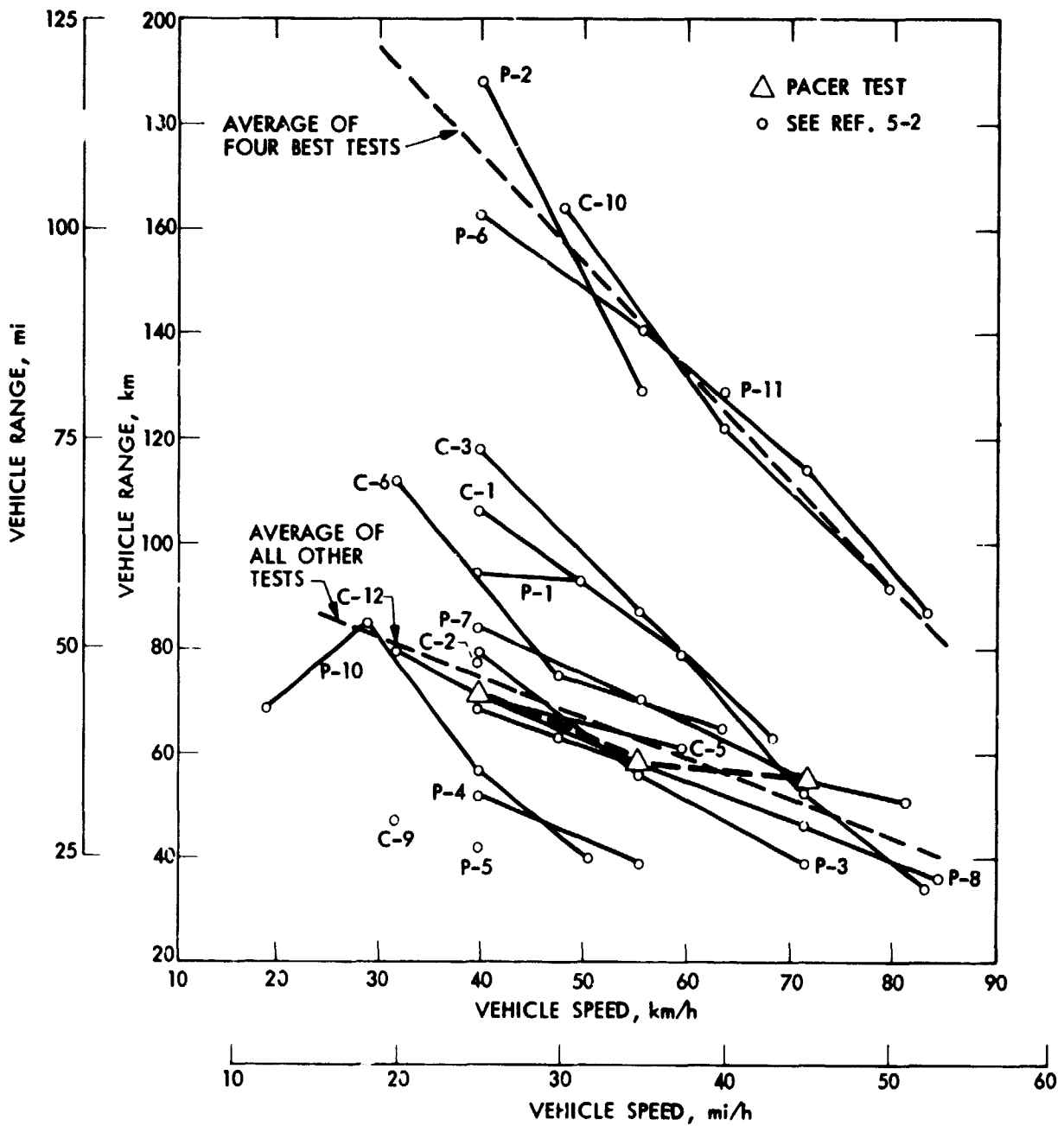

Figure 8-7. Vehicle Range as a Function of Speed

REFERENCES

- 2-1. Electric Vehicle Test Procedure - SAE J2272, Society of Automotive Engineers - Recommended Practice, February 1976.
- 5-1. Bryant, J. A., et al., Test Methodology for Electric Vehicles at JPL, (to be published).
- 5-2. Griffin, D. C., and Bryant, J. A., "Data Acquisition System for Electric Vehicle Tests," Proceedings of the IAS Annual Meeting, IEEE Industry Applications Society, September 1980.
- 7-1. State of the Art Assessment of Electric and Hybrid Vehicles, NASA TM-73756, Lewis Research Center, September 1977.
- 7-2. Price, T. W., Shain, T. W., and Bryant, J. A., Vehicle Test Report: South Coast Technology Electric Conversion of a Volkswagen Rabbit, JPL Publication 81-28, Jet Propulsion Laboratory, Pasadena, California, February 1981.

APPENDIX A

THEORY OF OPERATION OF PULSOMATIC MARK 10 CONTROLLER

The simplified schematic for this chopper, shown in Figure A-1, contains a thyristor switch (TH1) which is triggered at the gate at a repetition rate of ω_c , and force commutated by an external commutating circuit. At the instance of gate triggering TH1, precharged commutation capacitor (C4) discharges through TH1 and diode (D4), such that the positive charge at its upper terminal is transferred to the lower terminal. Charge reversal accomplished, it is then possible to commutate thyristor (TH1) either by gate or anode triggering of thyristor (TH2). Capacitor (C4) discharges again, in the process displacing the forward current in TH1 with a larger current amplitude in the reverse direction, yielding the commutation of TH1. As the lower terminal of C4 continues to be depleted, its upper terminal is recharged by the now decreasing motor current amplitude until its terminal voltage exceeds the battery supply voltage (EBAT). At this point the upper terminal of C4 is clamped to EBAT by the inverse by-pass diode (D2), and excess charge is circulated through the battery and thyristor (TH2) in its reverse direction until this device is commutated. The stored energy in the motor continues to be expended, meanwhile, locally through freewheeling diode (D2) until TH1 is retriggered.

It is noteworthy that the elapsed minimum conduction period of thyristor (TH1) prior to its earlier possible commutation is relatively constant at $T \approx \pi \cdot L \cdot C4$, is independent of load and current amplitude variations, and solely a function of resonant recharge interaction between capacitor (C4) and inductor (L). Control of power transfer from the source to the motor through manipulation of the conduction duty cycle of TH1, hence, is primarily accomplished by a variable gate trigger control frequency between typically zero and 400 Hertz, and only to a lesser degree through variation of the conduction period in this application.

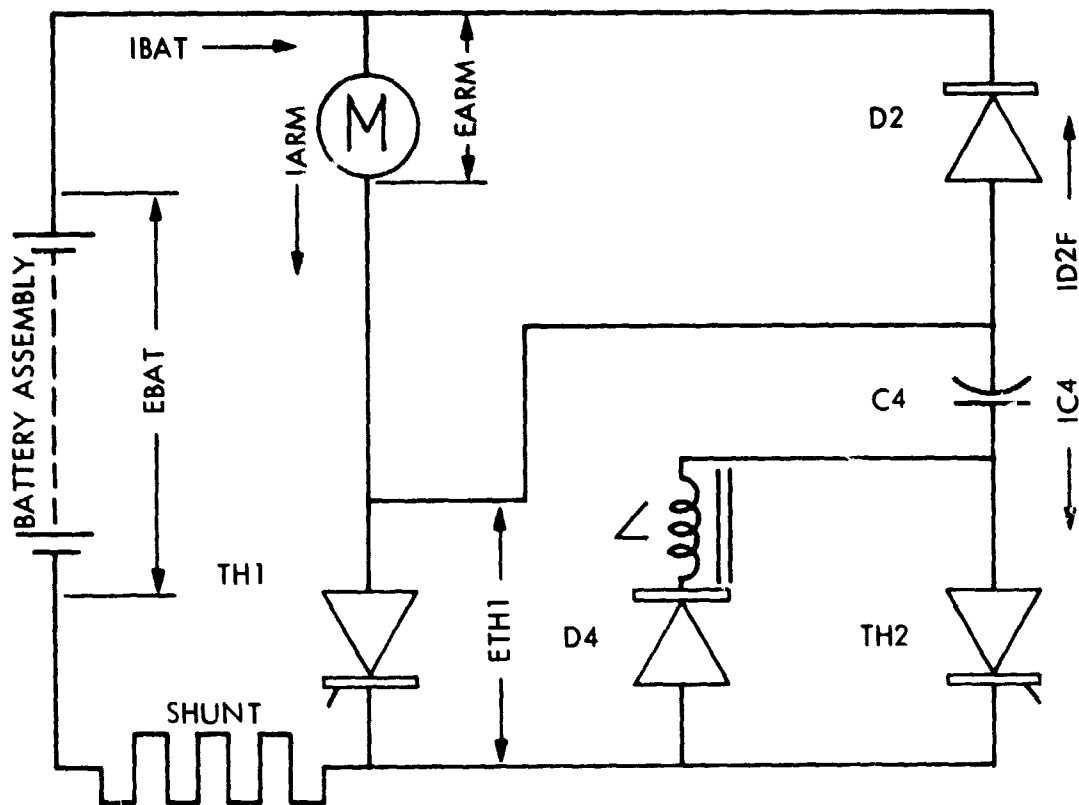

Figure A-1. Simplified Circuit Schematic for CABLEFORM Pulsomatic Mark 10 Controller

APPENDIX B

EVA TEST DATA SUMMARY

TEST NUMBERS	1	2	3	4	5	6	8
TEST DATE	11/14/79	11/16/79	11/19/79	11/21/79	11/26/79	11/28/79	11/30/79
TEST TYPE	35MPH	45MPH	25MPH	C	U	35MPH	45MPH
BATTERY TYPE	PN=A	PB=A	PD=A	PE=A	PF=A	PG=A	PH=A
BATTERY	VARTA	VARTA	VARTA	VARTA	VARTA	VARTA	VARTA
BATTERY ENERGY ECONOMY (MI/KWH)	3.03	3.10	2.96	1.83	1.71	3.05	3.12
RANGE (MILES)	15.3	33.0	37.4	20.2	22.4	38.7	39.0
ELAPSED TIME (MINUTES)	41.6	45.2	40.7	76.8	131.2	67.3	47.5
BATTERY DISCHARGE ENERGY (KWH)	1.7	10.6	12.7	11.0	13.1	12.7	11.3
BATTERY REGEN. ENERGY (KWH)	0.00	0.00	0.00	0.00	0.00	0.00	0.00
BATTERY REGEN. ENERGY (%)	0.0	0.0	0.0	0.0	0.0	0.0	0.0
BATTERY DISCHARGE (AMP - HOURS)	105.4	96.5	113.7	104.0	119.0	114.3	101.6
BATTERY REGEN. (AMP - HOURS)	0.0	0.0	0.0	0.3	0.0	0.0	0.0
BATTERY REGEN. AMPERAGE (%)	0.0	0.0	0.0	0.3	0.0	0.0	0.0
ARMATURE INPUT ENERGY (KWH)	9.76	9.78	9.67	9.23	9.91	10.51	10.23
ARMATURE REGEN. OUTPUT (KWH)	0.00	0.01	0.16	0.11	0.19	0.00	0.00
ARMATURE REGEN. OUTPUT (%)	0.0	0.1	1.7	1.2	2.0	0.0	0.0
FIELD ENERGY (KWH)	0.690	0.308	1.022	0.553	0.948	0.742	0.330
CONTROLLER EFFICIENCY (%)	49.6	94.9	84.5	88.8	43.1	88.4	94.2
ODOMETER READING (MILES)	2778.4	2819.7	2857.5	2912.2	2935.4	2961.2	3077.2
BATTERY RECHARGE ENERGY EFFICIENCY (%)	60.96	59.46	60.88	59.37	59.09	63.19	60.80
BATTERY RECHARGE AMPERAGE EFFICIENCY (%)	76.9	75.9	76.3	78.4	74.5	79.1	77.1
BATTERY TEMP. BEFORE (DEG F)	71.4	69.6	67.7	72.0	67.3	73.2	73.2
BATTERY TEMP. AFTER (DEG F)	44.0	62.1	81.9	69.1	84.4	69.0	66.0

• COMMENTS

EVA TEST DATA SUMMARY

TEST NUMBERS	9	11	13	15	17
TEST DATE	12/03/79	12/05/79	12/07/79	02/13/80	02/20/80
TEST TYPE	U	C	25MPH	25MPH	25MPH
BATTERY TYPE	PB-A	PB-A	PB-A	PB-A	PB-A

BATTERY	VARTA	VARTA	VARTA	VARTA	VARTA
BATTERY ENERGY ECONOMY (MI/KWH)	1.72	1.84	0.0	0.00	3.25
RANGE (MILES)	24.1	19.5	44.2	0.0	46.7
ELAPSED TIME (MINUTES)	140.6	73.8	106.7	119.8	113.2

BATTERY DISCHARGE ENERGY (KWH)	14.0	10.6	0.0	0.0	14.4
BATTERY REGEN. ENERGY (KWH)	0.00	0.00	0.00	0.00	0.00
BATTERY REGEN. ENERGY (%)	0.0	0.0	0.0	0.0	0.0

BATTERY DISCHARGE (AMP - HOURS)	125.9	99.4	126.7	0.0	128.2
BATTERY REGEN. (AMP - HOURS)	0.0	0.0	0.0	0.0	0.0
BATTERY REGEN. AMPERAGE (%)	0.0	0.0	0.0	0.0	0.0

ARMATURE INPI ENERGY (KWH)	10.47	8.78	10.54	0.00	10.97
ARMATURE REGEN. OUTPUT (KWH)	0.16	0.10	0.00	0.00	0.00
ARMATURE REGEN. OUTPUT (%)	1.5	1.2	0.0	0.0	0.0

FIELD ENERGY (KWH)	1.007	0.520	1.173	0.000	1.318
CONTROLLER EFFICIENCY (%)	86.2	87.7	89.9	0.0	85.4

ODOMETER READING (MILES)	3117.3	3219.2	3285.8	0.0	3559.4

BATTERY RECHARGE ENERGY EFFICIENCY (%)	63.56	59.48	N.A.	N.A.	62.06
BATTERY RECHARGE AMPERAGE EFFICIENCY (%)	76.9	77.5	80.6	N.A.	77.5

BATTERY TEMP. BEFORE (DEG F)	70.2	73.2	73.4	N.A.	69.0
BATTERY TEMP. AFTER (DEG F)	86.0	91.5	87.4	N.A.	85.2

COMMENTS
 TEST NO. 131 ERU & ERI MEASUREMENT FAILED DURING TEST
 TEST NO. 151 INVALID RANGE TEST (WRONG DRY-D SETTING)