

NZ

NASA Technical Memorandum 82729

(NASA-TM-82729) PERFORMANCE AND OPERATIONAL
ECONOMICS ESTIMATES FOR A COAL GASIFICATION
COMBINED-CYCLE COGENERATION POWERPLANT
(NASA) 32 p HC A03/HF A01 CSCI 10B

M82-19072

Unclass

33/44 09257

Performance and Operational Economics Estimates for a Coal Gasification Combined- Cycle Cogeneration Powerplant

Joseph J. Nainiger, Raymond K. Burns, and Annie J. Easley
Lewis Research Center
Cleveland, Ohio

March 1982



PERFORMANCE AND OPERATIONAL ECONOMICS ESTIMATES FOR A COAL

GASIFICATION COMBINED-CYCLE COGENERATION POWERPLANT

Joseph J. Mainiger, Raymond K. Burns, and Annie J. Easley

National Aeronautics and Space Administration
Lewis Research Center
Cleveland, Ohio

SUMMARY

Performance and operating cost estimates were made for an integrated-gasifier, combined-cycle (IGCC) system assumed to be applied at the NASA Lewis Research Center to meet the steam and baseload electrical requirements. Because of the type of advanced-technology work being done at Lewis, such an IGCC cogeneration system could serve as a test bed for advanced-technology components in addition to meeting a large part of the Lewis energy requirements. Lewis electrical loads vary significantly during a typical week. The loads range from a minimum of approximately 5 MW during weekends or non-workdays to a maximum of over 200 MW during the week when major facilities are in operation. The steam heating requirements vary from a summer base of 2.27 kg/sec (18 000 lb/hr) to over 12.6 kg/sec (100 000 lb/hr) during the winter. IGCC systems with maximum electric power outputs of 20, 25, and 30 MW were analyzed. These systems could supply the baseload electrical requirement of about 10 MW and, by extraction of steam from the bottoming steam turbine, could supply all or most of the steam requirements throughout the year. The amounts and timing of additional electricity purchases from the utility and sales of excess electricity to the utility were determined. The resulting expenses for electricity purchases and revenue from electricity sales were then estimated by using an assumed electric utility rate structure model based on electricity rates approved by the Public Utilities Commission of Ohio (PUCO). The cogeneration system performance and operational economic results for these IGCC systems were compared with the fuel consumption and annual costs of purchased electricity and natural gas at Lewis without cogeneration. The sensitivity of the results to cogeneration system availability was examined. Also the assumed prices for fuel and electricity were parametrically varied to determine the sensitivity of the results to these variables.

Results indicate that, for Lewis' electric load profiles during a typical year, the IGCC systems studied would have excess electric generating capacity more than 75 percent of the year. Thirty to forty percent of this excess generation would occur during the utility's peak load periods, thereby indicating the potential to generate excess cogenerated power economically during these periods for sale to the utility. An IGCC system in the 20- to 30-MW size range operating 80 percent of the year could save about 2.1×10^8 MJ/yr (0.2×10^6 MBtu/yr) of fuel energy, which is about 10 percent of the total fuel energy required to meet Lewis' steam and electrical requirements without

cogeneration. Maximum fuel savings at peak steam demands could reach 17 percent with an overall IGCC energy utilization of 62 percent.

The use of an on-site IGCC cogeneration system would significantly reduce the annual expenditure for purchased electricity and natural gas. Although the operation of an IGCC system would increase the site operation and maintenance (O&M) costs and introduce on-site expenditures for coal, an overall annual operating cost savings of \$1.9 million to \$2.4 million (1985 costs expressed in 1980 dollars) was estimated for such a system operating 80 percent of the year. This is 21 to 26 percent of the estimated 1985 costs to purchase the total electrical requirement and to purchase natural gas to generate the required steam without cogeneration. The analysis indicates that an operating cost savings could be obtained even at relatively low IGCC system assumed availabilities. The potential cost savings also remained significant at low assumed values of the selling price for excess electricity generated by the IGCC. If such an IGCC cogeneration system were constructed at Lewis and used for testing advanced-technology components, this analysis indicates that there is a good potential that it could yield an operating cost savings.

INTRODUCTION

A conceptual design of an integrated coal gasification combined-cycle (IGCC) powerplant to supply the steam and baseload electrical requirements of the NASA Lewis Research Center was presented in reference 1. In that study a reference system was established to assess the technical feasibility, the environmental characteristics, and the capital cost of such a powerplant located at Lewis. Presently natural-gas-fired boilers provide the steam used at Lewis and electricity is purchased from a utility company. An on-site IGCC powerplant with the ability to meet Lewis' steam requirements by extracting low-pressure steam from the steam turbine would allow a significant reduction in natural gas use, substituting the use of Ohio high-sulfur coal in an environmentally attractive manner. Operation of the IGCC as a cogeneration system (i.e., the extracted steam represents relatively low-temperature heat rejected from the power system) would significantly improve the overall energy efficiency associated with supplying Lewis' steam and electrical requirements.

In addition to meeting a large part of Lewis' energy requirements, the powerplant could be of significant benefit (1) by providing a Lewis on-site test bed for advanced-technology components, (2) by providing a major step toward acceptance of IGCC powerplants in utility service, and (3) by providing another option for industrial cogeneration using coal.

This report summarizes the results of an analysis that was done at Lewis in parallel with the contracted study of reference 1. This analysis evaluated the performance and operational economics of such an on-site IGCC powerplant and compared these results with the fuel consumption and annual purchased electricity and natural gas costs at Lewis without cogeneration.

Because of the research activities at Lewis the electric load requirements vary considerably with time. Peak power demand levels exceeding 200 MW are reached during intervals of several hours when major research facilities

are in operation. The load is generally reduced to 4 to 5 MW during non-workdays. The steam requirement is mainly for space heating and varies directly with the ambient temperature. An IGCC power system sized to meet the range of steam loads would not be able to meet the high peak electrical demands that frequently occur for several hours during a workday and would have electric generating capacity in excess of demand during other hours of a typical day. Because the peak power demands are of short duration, it would not be economical to size an on-site powerplant to meet these peak demands. Therefore the powerplants considered in this analysis, which were sized more to meet the required range of steam loads, require the purchase of additional electricity from a utility during periods of peak demand and result in excess on-site electric generating capacity during other periods. An analysis of the operational economics for these powerplants must therefore include the effects of purchasing additional electricity during some time intervals and either operating at part power or selling excess electricity during other time intervals. This was not included in the study of reference 1.

In this analysis, operation of the IGCC powerplant is considered on an hour-by-hour basis for a typical year. It is assumed that the powerplant is operated with constant coal input and that the steam turbine extraction rate is varied to meet the Lewis steam requirements. If the resulting electric power output of the IGCC powerplant is less than the electric power requirement, the difference between the required power and that generated by the powerplant is purchased from the utility. If the powerplant electric power output exceeds the requirement, the excess electrical generation is sold to the utility. The amounts of electricity that are purchased and sold are determined, and the time of the day and the day of the week during which this would occur are identified. This information is necessary to realistically estimate the costs associated with the purchase and sale of the electric power since, in general, the rate for electricity purchased from a utility by an industrial customer depends on such things as the amount used, the amount used relative to the peak demand, and the timing of the usage. These influences have been included in this analysis by using published electricity rates and rate structures as a model for the assumptions made for the prices of electricity purchased or sold. Furthermore these assumed prices, and those assumed for coal and natural gas, were parametrically varied to determine the sensitivity of the results to these assumptions. Also the IGCC powerplant size was parametrically varied since this would have a significant effect on the amounts and timing of electricity purchases and sales and hence on the operational economics.

DESCRIPTION OF LEWIS STEAM AND ELECTRICAL REQUIREMENTS

The Lewis steam requirements are mainly for space heating and generally vary directly with ambient temperature. Saturated steam is required at a pressure of 0.87 MPa (125 psia). In figure 1 a steam load duration curve for a typical year at the Lewis site is shown. The steam requirement is shown as a function of the number of hours at that load or higher. A peak steam load of about 12.6 kg/sec (100 000 lb/hr) is typically reached on the coldest winter day and the steam generation and distribution system is generally operated at a minimum output of about 2.27 kg/sec (18 000 lb/hr) independent of ambient

temperature. Steam loads above 7.56 kg/sec (60 000 lb/hr) occur only about 700 hours (or 8 percent) of a typical year. The annual average steam load for this example year was about 4.66 kg/sec (37 000 lb/hr).

The Lewis electric load is dependent on the scheduling of major test facilities and varies considerably with time. The actual electric load variations for one week in 1979 are shown in figure 2. As indicated, facilities are generally scheduled so that the highest electric loads occur at night during the local utility's off-peak hours, when the capacity is available and the cost of electricity is lowest. The utility's peak hours are defined as 7:00 a.m. to 10:00 p.m. on weekdays and 7:00 a.m. to 10:00 a.m. on Saturday and are indicated in the figure. During 1979, electric loads typically ranged up to 40 MW during the utility's peak hours. Because the major facilities require so much power and are not operated continuously, the Lewis average load is relatively small as compared with the peak load (i.e., the load factor is low).

The electric load duration curves for 1979 and 1980 are shown in figure 3(a). The electric load duration curves for these two years are very similar. Therefore the electrical data for 1979 were taken as being typical of the Lewis requirements and used in this analysis. The average load for both years was about 18 MW. The maximum load exceeded 200 MW so that the load factor was less than 0.09. The load exceeded 50 MW about 600 hours per year (or 7 percent of the time) and exceeded 25 MW about 1500 hours per year (or 17 percent of the time). Half of the time the load was below 10 MW.

These characteristics of the Lewis load are the result of the specific nature of the electrical requirements for the test facilities and the availability and cost of electricity from the local utility. The total cost of generating and distributing electricity depends on the capacity of the equipment that must be made available as well as on the amount of electricity generated. Thus utility rates for industrial customers include a demand charge that is proportional to the customer's peak power demand and an energy charge that is proportional to the amount of energy used. Furthermore these rates are structured to encourage customers to manage their loads to keep the load factor (average load relative to peak load) as high as possible. But, as just discussed, Lewis' load factor is unavoidably low because of the electrical requirement characteristics of the research facilities (i.e., large electrical requirements for relatively short time periods). Therefore, during the example years 1979 and 1980, the Lewis contract with the local utility required prior approval from the utility for power levels used above a specified value. This value, which was 24 MW, satisfied the baseload and a relatively modest amount of power for smaller test facilities. Generally, the larger power-consuming facilities were scheduled during the utility's off-peak hours when more generating capacity was available and the rate charged for electricity was lower. This is more clearly illustrated in figures 3(b) and (c), where electric load duration curves are shown for the utility's peak and off-peak hours, respectively. During peak hours (fig. 3(b)) the maximum electrical demand was only 57 MW and exceeded 25 MW only about 550 hours out of 4100 hours (about 13 percent of the time). During off-peak hours (fig. 3(c)) the maximum electrical demand was more than 200 MW and exceeded 25 MW about 1050 hours out of 4700 hours (about 22 percent). Also note that the electric load during off-peak hours was less than 10 MW for about two-thirds of the

time since many off-peak hours correspond to weekends and holidays when electrical requirements are low. A further description of the utility rate structure used in this analysis is presented later in this report.

DESCRIPTION OF COGENERATION SYSTEM

A schematic of the integrated-gasifier, combined-cycle (IGCC) system is shown in figure 4. Gasifier air is extracted from the gas turbine compressor and further pressurized in a motor-driven boost compressor. The hot, raw low-Btu gas from the gasifier passes through a cyclone separator and is cooled before further cleanup. The cooled gas passes through additional cyclone separators and a venturi scrubber to remove particulates and then to a Holmes-Stretford desulfurization system, where H_2S in the fuel gas is removed and converted into elemental sulfur for disposal. The clean fuel gas is then reheated in the raw-gas cooler before injection into the gas turbine combustor. Electricity is produced by the gas turbine-generator, and heat from the gas turbine exhaust is recovered in a heat-recovery steam generator (HRSG), where steam turbine throttle steam is raised. Gasifier steam and additional throttle steam are raised in the raw-gas cooler. This throttle steam is combined with that produced in the HRSG, and the total is expanded in the steam turbine-generator, where additional electricity is produced. Steam required for heating at Lewis is extracted from the steam turbine at 0.87 MPa (125 psia). For this analysis it has been assumed that the gasifier-cleanup system and the gas turbine always operate at full design capacity. The rate of steam extraction from the steam turbine is varied with the steam demand, leading to variations in the system total electric power output as a result of the steam turbine power variations. When the system is down for maintenance, or when the steam demand exceeds the steam turbine maximum extraction rate, a natural-gas-fired supplementary boiler is used to supply the total steam requirement or to make up the difference between the required amount and that produced by the power system. An alternative to using natural gas would be to size the gasifier slightly larger and produce extra fuel gas for use in the supplementary boiler. However, an alternative fuel like natural gas would still be needed when the gasifier was not operating.

The IGCC system parameters for this analysis are shown in table I. The gas turbine parameters reflect state-of-the-art conditions. The relatively low steam turbine throttle conditions were selected because of the relatively low gas turbine exhaust temperature and small steam turbine size. The gasifier is the air-blown Westinghouse fluid bed selected for study in reference 1. The gasifier operating pressure is sufficiently above the gas turbine combustor pressure to overcome gasifier and cleanup pressure losses and the pressure loss that results when the fuel gas is injected into the combustor. The heating value of the clean fuel gas is as shown. Particulate emissions are kept low through efficient removal of particulates from the fuel gas by the combination of cyclones and a venturi scrubber. The low SO_x emissions are a result of H_2S removal from the fuel gas in a Holmes-Stretford unit, where elemental sulfur is recovered for disposal in a solid cake form. The low NO_x emissions are due to the low-flame temperature from the combustion of the low-Btu fuel gas.

Based on the IGCC system schematic shown in figure 4 and the IGCC system parameters listed in table I, a heat and mass balance for the IGCC cogeneration powerplant was calculated for a range of steam extraction rates. The IGCC system power output as a function of the steam extraction rate is shown in figure 5 for the three system capacities that were analyzed. The 20-, 25-, and 30-MW system capacities refer to the design power output of the system when no steam is extracted from the steam turbine. These system capacities cover a range from the size considered in reference 1, which is near the annual average electrical requirement (20 MW), to an IGCC capacity of 30 MW, which satisfies the maximum steam requirement. For this size range the IGCC system efficiency at any given extraction rate is assumed to be the same. The extraction rate is expressed in terms of the percent of steam turbine throttle flow, with the maximum extraction rate assumed to be 88 percent. The electric power output decreases with an increasing amount of steam extraction as the steam turbine electric power output decreases. The power output at the maximum steam extraction is 25 percent lower than the maximum output at zero steam extraction. The range of Lewis steam requirements is indicated on the abscissa. As shown, the 30-MW IGCC system can satisfy the maximum Lewis steam requirement. The 20- and 25-MW systems cannot and require the use of a supplementary boiler.

GROUND RULES AND ASSUMPTIONS

The technical assumptions used in this analysis are as follows:

- (1) The gasifier-cleanup system and the gas turbine operate at constant power.
- (2) Steam is extracted from the steam turbine to match Lewis' steam requirement.
- (3) Electricity is purchased and sold as required.
- (4) A supplementary boiler is used when the steam requirement exceeds maximum cogeneration system steam extraction.
- (5) A supplementary boiler is used for the entire steam requirement when the cogeneration system is down.
- (6) Ambient temperature variations are not included in performance calculations.
- (7) Cogeneration system downtime is equally probable at all loads.

As mentioned previously, the gasifier-cleanup system and the gas turbine are assumed to operate at constant, full-design-point conditions, while the steam turbine extraction rate follows the steam demand. If the Lewis electrical demand is greater than the amount of electricity produced by the power system, additional electricity is assumed to be purchased from the utility company. If electrical demand is less than the amount of electricity produced on-site, excess electricity is assumed to be sold to the utility company. An obvious alternative assumption would be to turn down the on-site system so that excess

power is not generated. This was not considered in this preliminary analysis. When the steam requirements exceed the maximum amount of steam that can be extracted from the steam turbine, a supplementary boiler firing natural gas makes up the difference. Also, when the IGCC system is down for maintenance or repair, the supplementary boiler supplies the entire steam requirement. The supplementary boiler is therefore sized to meet the maximum Lewis steam load (12.6 kg/sec, 100 000 lb/hr). Ambient temperature variations were not considered in the power system performance (15° C (59° F) ambient temperature was assumed for all calculations). For calculation purposes the time that the IGCC system is assumed to be down is equally distributed throughout the year (i.e., is equally probable at all loads).

The price for electricity assumed in this analysis is based on utility rates for large industrial users approved by the Public Utilities Commission of Ohio (PUCO). The values for various charges in effect as of June 1980 corresponding to this rate structure were escalated to 1985 (assumed to be the date of plant startup) by using Department of Energy projections (ref. 2). These assumed 1985 costs are expressed in 1980 dollars.

It was further assumed that a contract with the utility company would be of the same form as previous contracts. This would allow for a contractually fixed demand charge. All purchased power requirements above the power level that corresponds to the fixed demand charge would require utility company approval. The assumed rates are shown in table II. The power level for the fixed contract demand (FCD) charge was assumed to be 24 MW in the situation without cogeneration. In the 30-MW IGCC cogeneration case the FCD power level was assumed to be 5 MW, which is the minimum peak demand level to qualify for the large industrial customer rate. In the other cogeneration cases the FCD power level was taken as the difference between 24 MW and the minimum power output of the on-site IGCC system. (The FCD power level in these cases is then greater than 5 MW.) The FCD charge covers the utility's costs for making available the generating capacity to provide power up to the FCD power level at any time during the billing period. In addition to this charge, an energy charge is made as a function of the amount used. The energy charge for electricity used at power levels below the FCD power is based on a declining block structure. The size of the energy consumption blocks is expressed in terms of the FCD power as shown in table II. The first energy consumption block extends up to 115 kW-hr per FCD power. The FCD charge is applied to this block and no additional energy charge is made. The energy charges for the succeeding two consumption blocks are also shown in table II.

As previously shown in figure 3, the Lewis electrical requirement often exceeds the FCD power level. For energy used at power levels above the FCD power, energy charges are assumed to depend on whether energy is purchased during the utility's peak or off-peak hours. During utility peak hours the charge corresponds to the overall effective cost of the electricity purchased during that billing period at power levels below the FCD power. During utility off-peak hours the energy charge equals the charge applied to the third energy consumption block (>420 kW-hr per FCD power).

In addition to the demand and energy charges, a fuel charge is uniformly applied to all electricity purchases. The fuel charge shown in table II is

based on the fuel charge for June 1980 escalated to 1985 costs and expressed in 1980 dollars.

In the cogeneration cases it was anticipated that there would be a cost to the utility company associated with the capability to supply additional power when the cogeneration system is down for maintenance or repair. In this analysis this standby charge shown in table II is assumed to be applied to the difference between the FCD power levels for the noncogeneration and the cogeneration cases. The assumed charge for this standby capacity is also based on utility rates approved by the PUCO for large industrial users and is shown in the table. Finally, discounts typical of those given to large industrial customers who use high-voltage power and supply transforming and switching equipment were assumed. These amount to slightly over 3 percent of the total electricity bill. Using the assumptions in table II, the effective cost of electricity used at power levels less than the FCD power is shown in figure 6 as a function of the amount purchased during a monthly billing period. The amount purchased is shown on the abscissa per unit of FCD power. As shown, the effective cost of electricity decreases with increased amounts of electricity purchased under the FCD power level, with the effective COE approaching \$0.04/kW-hr for large amounts of purchased electricity.

The prices assumed for coal and natural gas, taken from reference 2, are shown in table III. Also shown in table III is the overall average cost of electricity for the noncogeneration case and for each cogeneration case. These average costs of electricity are presented here to show the effects of the assumed rate structure (as described in table II) when combined with the steam and electric load data displayed in figures 1 and 3, respectively, and the IGCC performance shown in figure 5. These calculations are described later in the report. The average electricity prices shown in table III are higher for the cogeneration cases than for the noncogeneration case because of the decreased amount of purchased electricity and the additional standby charge. The price for electricity sold to the utility was assumed to be the sum of the fuel charge and the energy charge for the third energy consumption block (>420 kW-hr per FCD power) shown in table II for electricity purchased below the FCD power level. Also shown in table III are ranges over which each price was parametrically varied.

METHOD OF ANALYSIS

As shown in figure 5, the performance of the IGCC system varies with the amount of steam extracted to meet the Lewis steam load. The IGCC performance data as a function of steam extraction rate were combined with the steam and electric load demand curves shown in figures 1 and 3 to calculate the annual consumption of coal for the IGCC system and the annual natural gas consumption for the supplementary boiler. The amounts of electricity purchased and sold annually, along with the corresponding amounts of fuel used or displaced at the utility site, were also calculated.

The Lewis electrical and steam demands are independent of each other. Therefore it was assumed that all combinations of electric and steam loads are encountered during a year. At each value of electric load the corresponding

steam loads were determined from the steam load duration curve expressed as a percentage of the year spent at that load or higher. These calculations were made by approximating each of the load curves by a series of discrete time steps. A computer code was used to calculate the values of fuel consumption and of electricity purchases and/or sales in each discrete time interval and to sum these values over a year. The timing of the electricity purchases and sales with respect to the utility's peak and off-peak hours and workdays or nonworkdays was determined by using load duration curves for those particular time periods.

From the calculated fuel energy usages and the assumed fuel prices previously shown in table III, the annual expenditures for fuel for both the noncogeneration and cogeneration cases were calculated. Also, by using the amounts and timing of electricity purchases and sales with the assumed electricity rate structure previously described, the respective expenditures for electricity purchases in the noncogeneration and cogeneration cases and revenues for electricity sales to the utility in the cogeneration cases were determined. Operation and maintenance (O&M) costs for the noncogeneration case were based on actual Lewis boiler operation data; O&M costs for the cogeneration cases were calculated from estimates in reference 1. From these calculations the total annual operating costs for the noncogeneration and cogeneration cases were calculated.

The relative capital costs of the cogeneration systems were estimated by assuming that capital costs are proportional to the ratio of cogeneration system maximum electric power output capacities raised to the 0.7 power. By using these relative capital costs and the operating cost savings, first-year relative payback periods (defined as capital cost relative to first year operating cost savings) were calculated for the three cogeneration cases. These payback periods are relative to a base payback period. The base was assumed to be the 20-MW cogeneration case using the fuel and electricity price assumptions shown in table III.

COGENERATION PERFORMANCE

As previously shown in figure 5, the electric power output from the IGCC cogeneration system varies as the amount of steam extracted from the steam turbine is changed to meet Lewis' steam demand. Likewise, Lewis' electrical demand varies over a wide range, as shown in figure 3. This results in situations when the electrical requirement exceeds the amount of electricity produced by the IGCC system, and additional electricity must be purchased. At different times, the electrical requirements are less than the amount of electricity that can be produced by the cogeneration system, and the excess electrical production is sold to the utility. This is illustrated in figure 7, where the average power output of the 25-MW IGCC system is superimposed on the Lewis electric load duration curve. Also shown are the amounts of electricity sold and purchased. The range of cogeneration system power outputs indicated in the figure represents the variation in electric power output that corresponds to the variation in the steam turbine extraction rates that would be encountered. The figure illustrates that, if the cogeneration system operated 100 percent of the time, the sale of excess electricity to the

utility could occur more than 75 percent of the year, with up to 19 MW available for sale. The purchase of electricity would occur about 20 percent of the time when higher power levels are required.

The amounts of electricity purchased and sold annually are shown as a function of cogeneration system size in figure 8. In addition to the total amount of electricity sold, the amounts sold during the utility's peak and off-peak hours are also displayed. The results were obtained by assuming that the cogeneration system operates 80 percent of the year and is down 20 percent of the time for maintenance and/or repair. At 80 percent availability, an equal amount of electricity is annually purchased and sold for an IGCC system size of 25.6 MW. The amount of electricity sold increases and the amount of electricity purchased decreases with increasing cogeneration system size. This implies higher revenue from the sale of electricity and lower costs for the purchase of electricity with increasing cogeneration system size. An important point illustrated in figure 8 is that for the 1979 and 1980 electric load requirements a significant fraction of the excess power generating capacity would occur during the utility's peak hours. This would increase the chances that the excess generating capacity could be economically used. The generation of this excess electricity would be more fuel efficient than the generation of electricity at the utility because of the waste heat recovery from the IGCC cogeneration system. Much of the excess generating capacity during utility off-peak hours would occur during weekends and holidays. If the revenue from electricity sales is relatively low during these periods, an option would be to operate the IGCC system at lower capacities.

Cogeneration performance can be expressed in terms of the fuel savings, both at the site being cogenerated and at the utility company site as a result of on-site electrical production with waste heat recovery from the cogeneration system. An example of this is shown in figure 9, where the fuel savings are shown for the 25-MW IGCC system at the Lewis site as a function of the site steam and electrical requirements. The fuel savings are shown as a percentage of the total fuel that would be used at the Lewis and utility sites to produce the same amount of electricity and steam in a noncogeneration situation. This is the fuel savings parameter used in reference 3. The fuel energy savings obtained at any time during the year would fall within this cogeneration performance envelope for this particular IGCC system. The top line of this envelope corresponds to the fuel savings achieved when the power output of the IGCC system is greater than or equal to the site electrical requirements. Whenever the site electrical requirements exceed the output of the IGCC and additional power must be purchased from the utility, the fuel savings are lower and fall within the envelope. For a given site steam requirement the fuel energy savings decrease as the site electrical requirement increases. The lowest value of fuel energy savings is given by the lower boundary of the performance envelope, corresponding to the periods of maximum Lewis electric power requirement. The fuel energy savings are highest when the steam requirements are highest because of the greater opportunity for waste heat recovery from the IGCC system. The maximum value of fuel energy savings occur at a site steam requirement slightly above 10.08 kg/sec (80 000 lb/hr), which corresponds to the maximum amount of steam extraction from the 25-MW IGCC system. The fuel energy savings do not increase with steam demands greater than this since a supplementary boiler is required to

raise the additional steam. Thus the largest instantaneous fuel energy savings would be realized at high site steam requirements with simultaneously low power requirements, corresponding to a cold winter nonworkday or a cold winter workday when research and testing power requirements are relatively low. The fuel energy savings could reach almost 17 percent with an overall energy utilization, defined as the useful power plus heat divided by the fuel input, of about 62 percent. Conversely, the smallest instantaneous fuel energy savings would be achieved at low site steam requirements with high power requirements, corresponding to the running of large electricity-consuming facilities in the summer. Note that the difference in fuel energy savings between these two extremes is substantial.

The annual fuel use rates and cogeneration fuel savings are shown in table IV. These were calculated by combining the instantaneous performance, as indicated in figure 5, with the load profiles of figures 1 and 3. The cogeneration results assume an IGCC system availability of 80 percent and an overall utility electrical efficiency (including transmission losses) of 32 percent. In the noncogeneration system, natural gas is used in the on-site boiler to meet the steam requirements and all the electricity required is purchased from the utility company. The utility fuel, which is dominantly coal, is assumed to be all coal in table IV. As shown, the natural gas use is substantially reduced in the cogeneration cases. In the 30-MW IGCC cogeneration case the amount of natural gas use shown is required for a supplementary boiler to meet the steam requirements only when the IGCC system is down for maintenance or repair. For the 20- and 25-MW IGCC cogeneration cases, an additional amount of natural gas is needed to meet the peak steam requirements, which exceed the steam turbine extraction limit. As discussed earlier, at times the cogeneration cases require the purchase of electricity from the utility (when the power demands are high or when the IGCC is not operating), and at other times the cogeneration cases involve the generation and sale of excess electricity to the utility. The coal required at the utility site for the purchased power and the coal that could be displaced at the utility site because of the excess power generated at the Lewis site are shown in table IV. When this is combined with the coal input to the IGCC system, it is evident that the total coal use in the cogeneration cases slightly exceeds the coal use in the noncogeneration case. However, the reduction in natural gas consumption exceeds the increase in coal use, and there results a net fuel savings as shown in the last column. As the IGCC size increases, the amount of total coal use (including coal used at the utility) and natural gas use decreases, resulting in a greater fuel energy savings.

The data in table IV are sensitive to the assumed IGCC system availability, as illustrated in figure 10. As stated earlier, it has been assumed that the IGCC system is operated at full design coal input whenever it is available for operation, so that the capacity factor equals the assumed availability. Also it has been assumed that the probability of the cogeneration system being down is equally likely throughout the year. In figure 10(a) the annual fuel energy savings are expressed in dimensional terms. As expected, the annual savings increase with increasing cogeneration system availability. As shown in figure 10(a) the 2.41×10^8 MJ/yr (2.29×10^5 MBtu/yr) fuel savings shown in table IV for the 30-MW IGCC cogeneration case would increase to 3.02×10^8 MJ/yr (2.86×10^5 MBtu/yr) if the IGCC operated continuously at

full capability for the entire year. In figure 10(b) the fuel savings are shown as a percentage of the amount of fuel that would have been required without cogeneration to produce the same amount of power and heat as produced with cogeneration. The CTAS definition of fuel energy savings has been used (ref. 3). Thus the noncogeneration fuel use in this definition includes, in addition to the boiler fuel, the utility system fuel that would be needed to generate power equal to the Lewis site requirements plus the excess generation of the cogeneration case. At a cogeneration system availability of 80 percent, the total fuel energy savings for the three IGCC system sizes amount to approximately 7.5 percent of the noncogeneration fuel energy use. If the fuel savings were expressed only as a percentage of the sum of the 4.45×10^8 MJ/yr (4.22×10^5 M³tu/yr) of natural gas used and the 18.02×10^8 MJ/yr (17.08×10^5 MBtu/yr) of utility fuel needed to meet only the Lewis site needs, the fuel savings at 80 percent system availability would range from 9.2 to 10.7 percent.

OPERATING COST

In table V the amount of electricity purchased or sold per year is shown for the noncogeneration case and the three cogeneration cases. These values assume a cogeneration power system availability of 80 percent. The amount of electricity purchased is categorized according to whether it was purchased at power levels below or above the FCD power level, whether it was purchased when the cogeneration system was operating, and whether it was purchased during the utility's peak or off-peak hours. Electricity that is sold is categorized according to whether it is sold during the utility's peak or off-peak hours or sold during Lewis workdays or nonworkdays. As shown, most of the electricity purchased in the noncogeneration case is purchased below the assumed 24-MW FCD power level. Most of the electricity purchased at higher power levels is purchased during utility off-peak hours. This was previously illustrated in figures 2 and 3. For the cogeneration cases about half of the purchased electricity is required at power levels below the FCD power level. Most of the electricity purchased below the FCD power level is purchased when the IGCC cogeneration system is down for maintenance or repair. For the cogeneration cases most of the electricity purchased at power levels above the FCD power level is purchased during off-peak hours. Significantly 30 to 40 percent of the electricity sold to the utility is sold during their peak hours.

In table VI the annual costs and revenues for the purchased and sold electricity of table V are shown for the noncogeneration and cogeneration cases. The costs for purchased electricity are categorized as in table V. The revenues for electricity sold to the utility are not categorized as in table V because only one price was assumed for electricity sold to the utility regardless of when it is sold. In practice, it would be expected that the price paid by the utility for electricity sold to them during peak hours would be higher than that paid for electricity sold to them during off-peak hours. The standby charges represent a large portion of the total cost for purchased electricity for the cogeneration cases. As shown previously in table III, the price charged for electricity purchased from the utility in the cogeneration cases was assumed to be greater than that paid for electricity sold back to the utility. Thus for the 30-MW cogeneration case the revenue from the electricity

sold to the utility is less than the cost for purchased electricity even though, as shown in table V, the amount of electricity sold is considerably more than that purchased. The total expense for purchased electricity decreases and the revenue from sold electricity increases with increasing IGCC system size.

The operating cost summary for the noncogeneration and cogeneration cases is shown in table VII. The costs are expressed as 1985 costs in 1980 dollars. The two largest operating expenses in the noncogeneration case, the costs for natural gas and purchased electricity, are substantially reduced in the cogeneration cases. As shown, the bigger the IGCC cogeneration system, the lower is the expense for purchased electricity, and the higher is the revenue from excess power generation. But on-site cogeneration systems will have higher O&M expenses and will incur an additional expense for coal. The O&M cost estimates shown for the IGCC cogeneration cases were based on estimates from reference 1. Because of the greater amounts of coal used, the on-site coal expenses are higher than the expense for natural gas in the noncogeneration case. But as shown, the net effect is a reduction in total operating expenses for the cogeneration cases as compared with the noncogeneration case. Also the total operating costs for the cogeneration cases decrease as the cogeneration system size increases. The operating costs shown for the cogeneration cases correspond to cost savings of 21 to 26 percent relative to the operating cost for the noncogeneration case.

The results shown in table VII assume an on-site cogeneration system availability of 80 percent. The variation in first-year operating cost savings as a function of cogeneration system availability is shown in figure 11. As expected, the first-year operating costs are sensitive to cogeneration system availability, with operating cost savings increasing as availability increases. Another potentially key assumption made to calculate the results shown in tables VI and VII concerns the standby charge paid to the utility for the purchase of electricity when the on-site cogeneration system is down. In figure 11(a), operating cost savings are shown with the assumption that the sum of the FCD power level in the cogeneration case and the standby power level equals the FCD power level in the noncogeneration case. The resulting 24 MW would allow "business as usual" operation when the cogeneration system is down for maintenance. In figure 11(b), the first-year operating cost savings are shown with the assumption that the sum of the FCD power level and the standby power level equals 12 MW. This assumption implies a curtailment of research facility operation when the cogeneration system is down and yields a decrease in the standby charge paid to the utility, with a resulting substantial increase in the operating cost savings relative to those shown in figure 11(a). The operating cost savings shown in both figures 11(a) and (b) are a significant percentage of the total operating costs of the noncogeneration case.

Another key assumption made in tables VI and VII and figure 11 is the price obtained for excess electricity sold to the utility. The operating cost savings shown in figure 11 were calculated by using an assumed electricity selling price of \$0.0311/kW-hr. The effect of variations in the selling price on the operating cost savings for the three cogeneration cases is shown in figure 12. The selling price is varied from a minimum of \$0.022/kW-hr,

corresponding to only the fuel charge in the assumed electrical rate structure, to a maximum of \$0.042/kW-hr, which is the average price for purchased electricity in the noncogeneration case. As shown, the 30-MW IGCC is the most sensitive to changes in the selling price because it produces the largest amount of excess electricity. The 30-MW IGCC has the largest first-year operating cost savings over the range of selling prices considered.

RELATIVE ECONOMICS

Cost comparisons presented to this point have included only the first-year operating cost savings of the different-size cogeneration systems. The relative economic attractiveness of the different-size systems depends on the comparison of the operating cost savings and the required capital investment. To examine this in a simplified manner, relative payback periods were calculated. These relative payback periods would be expected to be very sensitive to the values assumed for electricity, natural gas, and coal prices. Therefore the sensitivity of the relative payback periods to changes in each of these assumptions was examined.

The relative payback periods for the three cogeneration cases are shown in figure 13 as a function of electricity price. The electricity prices for the noncogeneration and cogeneration cases and the excess electricity selling price were varied by the same percentage simultaneously. At the base electricity price, the 20-MW cogeneration system has the best payback period. For electricity prices of about 16 percent or more above the base price, the 30-MW cogeneration system achieves the most attractive payback.

The relative payback period as a function of variations only in the selling price of excess electricity is shown in figure 14. For a selling price less than \$0.0338/kW-hr, the lowest payback period is achieved with the 20-MW system. At selling prices greater than \$0.0338/kW-hr, the 30-MW system achieves the lowest payback period.

Figure 15 shows the relative payback period as a function of the natural gas price. The payback periods decrease with increasing natural gas price since, in cogeneration, the operating cost savings are largely a result of avoiding the purchase of natural gas for steam generation. At natural gas prices less than \$4.00/MBtu, the 30-MW system has the best payback. At natural gas prices greater than \$4.00/MBtu, the 20-MW system has the best payback.

The relative payback period as a function of coal price is shown in figure 16. At coal prices less than \$1.26/MBtu, the 30-MW system has the lowest payback. At coal prices greater than \$1.26/MBtu, the 20-MW system has the lowest payback.

The data presented in figures 13 to 16 indicate that the 20-MW cogeneration system has the lowest payback period at the base fuel and electricity prices. At higher electricity prices and lower coal and natural gas prices, the 30-MW system has the lowest payback period. A more detailed analysis, including the effects of escalating electricity and fuel prices and using more

detailed capital cost estimates, is required to determine the best system size on an economic basis.

SUMMARY OF RESULTS

Lewis' electric loads vary from a minimum of about 5 MW to a maximum of over 200 MW, with an annual average of about 18 MW. The steam heating requirement varies from a base of about 2.27 kg/sec (18 000 lb/hr) to over 12.6 kg/sec (100 000 lb/hr). Integrated-gasifier, combined-cycle (IGCC) cogeneration systems with maximum electric outputs of 20, 25, and 30 MW were analyzed for potential application at the Lewis site. These systems could supply the baseload electric requirement and, by extraction of steam from the bottoming steam turbine, could supply all or most of the heating requirement. The 20-MW-capacity system could supply the steam for all but the peak requirements above 8.82 kg/sec (70 000 lb/hr), which occur during 3 percent of the year. The 30-MW-capacity system is just big enough to meet the maximum steam requirement. Because the power output of these systems at the point of maximum steam extraction is about 25 percent lower than the maximum output at zero steam extraction, the electric generating capability is a function of the steam heating load. The electricity needed to meet the very high power requirements of the major research facilities would have to be purchased, while at other periods of a typical day the on-site IGCC system would have excess generating capacity. For load profiles typical of 1979 and 1980, the IGCC system could have excess generating capacity during more than 75 percent of the year. It is significant that from 30 to 40 percent of the excess electricity would be generated during the utility's peak load period (between 7:00 a.m. and 10:00 p.m.). Thus there is potential for economical use of this generating capacity. Generating this excess electricity in a cogeneration system is more fuel efficient than generating electricity at the utility because of the waste heat recovery from the cogeneration system. Of the excess electricity generated during the utility's off-peak hours, more than 60 percent occurs during weekends, when a practical option might be to turn down the powerplant to meet only site requirements.

For loads that were typical in 1979 and 1980, a 20- to 30-MW IGCC cogeneration system, operating for 80 percent of the year, could save about 2.1×10^8 MJ/yr (0.2×10^6 MBtu/yr) of energy. This is about 10 percent of the total fuel energy required to meet the steam and electrical requirement without cogeneration in 1979 or 1980. Because both the electric and steam loads vary so much during the year, the fuel savings achieved at any time also vary considerably. Because of the higher degree of IGCC system waste heat utilization, the highest instantaneous fuel savings percentages are achieved during the time of peak heating needs in the winter. At the peak steam demand the fuel savings could reach about 17 percent with an overall IGCC energy utilization (i.e., useful power plus heat divided by the fuel input) of about 62 percent.

Since an on-site IGCC cogeneration system could supply the baseload electrical requirement and most of the steam requirement, the annual expenditure for purchased electricity and natural gas could be significantly reduced. Even when this is weighed against the increased site O&M costs and the coal

costs to operate the IGCC system, a net overall annual operating cost savings could be achieved. Assuming that the IGCC cogeneration system operated 80 percent of the year, the annual savings estimated for the 20- to 30-MW IGCC systems analyzed range from \$1.9 million to \$2.4 million, expressed in terms of 1980 dollars for 1985 operation. This is 21 to 26 percent of the estimated cost to provide the total steam and electrical requirements in 1985 without cogeneration. The estimated savings were found to be significant for wide ranges of assumed prices for fuels and purchased electricity, prices of excess electricity sold to the utility, and the IGCC powerplant availability. The estimates for the purchase and selling prices of electricity were based on a typical rate structure for industrial customers. In using such a model, the resulting estimates for the overall average unit price for purchased electricity were always higher for the cogeneration cases than for the non-cogeneration case. The reason is that less electricity is purchased in the cogeneration cases and the demand charges relative to energy charges are more significant. Also in the cogeneration cases it was assumed that a standby charge would be paid to the utility so that, when the IGCC system is down, enough power could be purchased to maintain business as usual. The estimate for this charge alone exceeds \$1 million per year. Another assumption that has a significant effect on the results is the selling price for excess electricity. This was varied over a wide range extending down to relatively low values, and the potential cost savings remained significant.

If an IGCC cogeneration system were constructed at the NASA Lewis Research Center and used for testing advanced-technology components, this analysis indicates that there is a good potential that its operation could be economical, in spite of the relatively unfavorable characteristics of the electric and steam loads as compared with potential industrial applications. In addition, the estimates of operating cost savings remain positive down to relatively low assumed IGCC system availabilities. Although the IGCC system has not been considered in detail from the perspective of investment, simple relative payback periods for the 20-, 25-, and 30-MW IGCC systems were compared in this analysis. Although the estimated operating cost savings for the 30-MW system are higher, the 20-MW system has a better relative payback period for the base price assumptions. The relative payback periods were estimated on the basis of a simple scaling assumption for the capital cost variation with system capacity.

REFERENCES

1. Bloomfield, Harvey S.; et al: Conceptual Design Study of a Coal Gasification Combined-Cycle Powerplant for Industrial Cogeneration. NASA TM-81687, 1981.
2. Borg, Steve; and Moden, Robert: Historic and Forecasted Energy Prices by U.S. Department of Energy Region and Fuel Type for Three Macroeconomic Scenarios and One Imported Oil Price Escalation Scenario. DOE/EIA-0102/27, Department of Energy, 1978.
3. Barna, Gerald J.; Burns, Raymond K.; and Sagerman, Gary D.: Cogeneration Technology Alternatives Study (CTAS), Volume I - Summary. NASA TM-81400, 1980. (DOE/NASA/1062-80/4.)

TABLE I. - MAJOR SYSTEM PARAMETERS

Gas turbine:	
Turbine inlet temperature, °C (°F)	1094 (2000)
Compressor pressure ratio	12
Steam cycle:	
Throttle conditions, MPa/°C (psia/°F)	4.29/399 (615/750)
Condenser pressure, MPa (in. Hg abs)	0.013 (4.0)
Process steam extraction pressure, MPa (psia)	0.87 (125)
Gasifier:	
Type	Westinghouse fluid bed (air blown)
Operating pressure, MPa (psia)	1.98 (284)
Low-Btu-gas higher heating value, MJ/kg (Btu/lb)	5.151 (2216)
Cleanup system:	
Particulate removal	Cyclones and venturi scrubber
Desulfurization	Holmes-Stretford unit
Specific emissions, kg/MJ (lb/MBtu):	
SO _x	4.30x10 ⁻⁵ (0.1)
NO _x	4.30x10 ⁻⁵ (0.1)
Particulates	7.31x10 ⁻⁷ (0.0017)

TABLE II. - ASSUMED ELECTRIC UTILITY RATE STRUCTURE

[1985 prices in 1980 dollars.]

Fixed-contract-demand (FCD) power level, MW:	
Noncogeneration case	24.0
Cogeneration cases	
20-MW IGCC	9.0
25-MW IGCC	5.3
30-MW IGCC	5.0
FCD charge per demand power, \$/kW-month:	
Up to 5-MW demand	6.64
5 MW to FCD power	6.17
Energy charge, \$/kW-hr:	
Energy purchased at power ≤ FCD power	
<115 kW-hr per FCD power	Covered by FCD charge
115 to 420 kW-hr per FCD power	0.0146
>420 kW-hr per FCD power	0.0098
Energy purchased at power > FCD power:	
During utility peak hours	Cost of electricity purchased in above category
During utility off-peak hours	0.0098
Fuel charge, \$/kW-hr	0.0223
Standby power, MW:	
20-MW IGCC	15.0
25-MW IGCC	18.7
30-MW IGCC	19.0
Standby charge per standby power, \$/kW-month	5.92
Discounts, \$/month per kW FCD power	0.30

TABLE III. - FUEL AND AVERAGE ELECTRICITY PRICES

[1985 prices in 1980 dollars.]

	Base price	Parametric variations
Coal, \$/MBtu	2.04	1.00 - 2.50
Natural gas, \$/MBtu	5.00	3.00 - 7.00
Average price for purchased electricity, \$/kW-hr:		
Noncogeneration case	0.0424	} -20 to +60 percent
Cogeneration cases		
20-MW IGCC	0.0521	
25-MW IGCC	0.0576	
30-MW IGCC	0.0592	
Price for electricity sold to utility (selling price), \$/kW-hr	0.0311	0.0223 - 0.0424

TABLE IV. - ANNUAL FUEL ENERGY USE
 [Cogeneration system availability, 80 percent.]

Case	Utility power system coal			IGCC cogeneration system coal			Total coal		Lewis boiler natural gas		Cogeneration fuel savings	
	To generate Lewis purchased electricity	Displaced by Lewis excess generation										
	MJ/yr	Mbtu/yr	MJ/yr	Mbtu/yr	MJ/yr	Mbtu/yr	MJ/yr	Mbtu/yr	MJ/yr	Mbtu/yr	MJ/yr	Mbtu/yr
Noncogeneration	18.020x10 ⁸	17.080x10 ⁵	0	0	0	0	18.020x10 ⁸	17.080x10 ⁵	4.450x10 ⁸	4.218x10 ⁵	0	0
Cogeneration:												
20-MW IGCC	8.902	8.438	4.532x10 ⁸	4.296x10 ⁵	15.116x10 ⁸	14.328x10 ⁵	19.486	18.470	.919	.871	2.065x10 ⁸	1.957x10 ⁵
25-MW IGCC	7.915	7.502	7.469	7.080	18.889	17.904	19.334	18.326	.897	.850	2.239	2.122
30-MW IGCC	7.163	6.790	10.560	10.104	22.661	21.480	19.165	18.166	.890	.844	2.414	2.288

Bitility fuel is assumed to be coal.

TABLE V. - AMOUNT OF ELECTRICITY PURCHASED AND SOLD PER YEAR FOR NONCOGENERATION AND COGENERATION CASES

	Noncogeneration case	Electricity, MW-hr	Cogeneration cases ^a			
				20 MW	25 MW	30 MW
				Electricity, MW-hr		
Electricity purchased	Below FCD power level	1.15x10 ⁵	Below FCD power level System on	0.14x10 ⁵ .24	0.07x10 ⁵ .24	0.05x10 ⁵ .25
			System off			
	Over FCD power level	.04 .41	Over FCD power level Peak hours	.02	.02	.01
			Off-peak hours	.41	.37	.33
Subtotal			0.81x10 ⁵	0.70x10 ⁵	0.64x10 ⁵	
Electricity sold			Peakhours:			
			Workday	-0.11x10 ⁵	-0.22x10 ⁵	-0.35x10 ⁵
			Nonworkday	-.02	-.04	-.05
			Off-peak hours:			
			Workday	-.08	-.13	-.19
Nonworkday	-.18	-.27	-.36			
Subtotal			-0.39x10 ⁵	-0.66x10 ⁵	-0.95x10 ⁵	
Total		1.60x10 ⁵	Total net	0.42x10 ⁵	0.04x10 ⁵	-0.31x10 ⁵

^aBased on cogeneration system availability of 80 percent.

TABLE VI. - ELECTRICITY COSTS AND REVENUES PER YEAR FOR NONCOGENERATION AND COGENERATION CASES

	Noncogeneration case	Electricity cost, dollars	Cogeneration cases ^a			
				20 MW	25 MW	30 MW
				Electricity cost, dollars		
Costs for purchased electricity	Below FCD power level	5.37x10 ⁶	Below FCD power level System on	0.94x10 ⁶ .83	0.51x10 ⁶ .86	0.42x10 ⁶ .50
			System off			
	Over FCD power level	.18 1.28	Standby charge	^b 1.06x10 ⁶	^c 1.33x10 ⁶	^d 1.35x10 ⁶
			Over FCD power level Peak hours	0.16x10 ⁶	0.14x10 ⁶	0.07x10 ⁶
	Off-peak hours	1.23	1.19	1.05		
	Subtotal			4.22x10 ⁶	4.03x10 ⁶	3.79x10 ⁶
Revenues for sold electricity			-1.25x10 ⁶	-2.08x10 ⁶	-2.96x10 ⁶	
Total		6.78x10 ⁶	Total net cost	2.97x10 ⁶	1.95x10 ⁶	0.83x10 ⁶

^aBased on cogeneration system availability of 80 percent.

^bBased on 14.98-MW standby power requirement.

^cBased on 18.71-MW standby power requirement.

^dBased on 19.00-MW standby power requirement.

TABLE VII. - FIRST-YEAR OPERATING COST SUMMARY FOR NONCOGENERATION AND COGENERATION CASES

[1985 costs in 1980 dollars.]

	Noncogeneration case	Cogeneration cases ^a		
		20 MW	25 MW	30 MW
Natural gas costs, dollars	2.11x10 ⁶	0.43x10 ⁶	0.42x10 ⁶	0.42x10 ⁶
Operation and maintenance costs, dollars	0.40x10 ⁶	1.05x10 ⁶	1.15x10 ⁶	1.24x10 ⁶
Coal cost, dollars	0	2.92x10 ⁶	3.65x10 ⁶	4.38x10 ⁶
Cost of purchased electricity, dollars	6.78x10 ⁶	4.22x10 ⁶	4.03x10 ⁶	3.79x10 ⁶
Revenue from electricity	-----	-1.25x10 ⁶	-2.08x10 ⁶	-2.96x10 ⁶
Total	9.29x10 ⁶	7.37x10 ⁶	7.17x10 ⁶	6.87x10 ⁶

^aBased on cogeneration system availability of 80 percent.

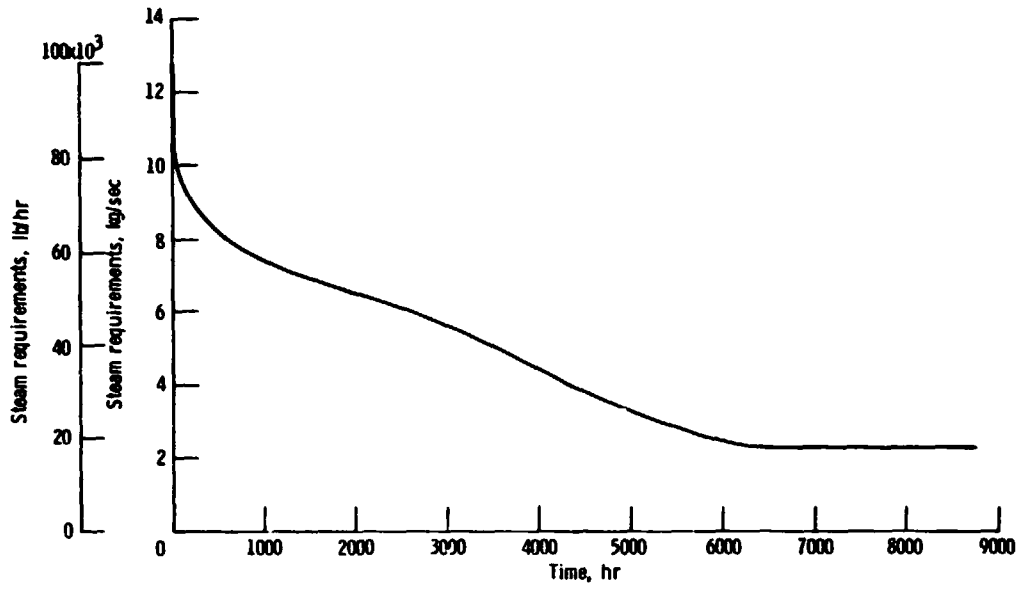

Figure 1. - Steam load duration curve at Lewis site for typical year.

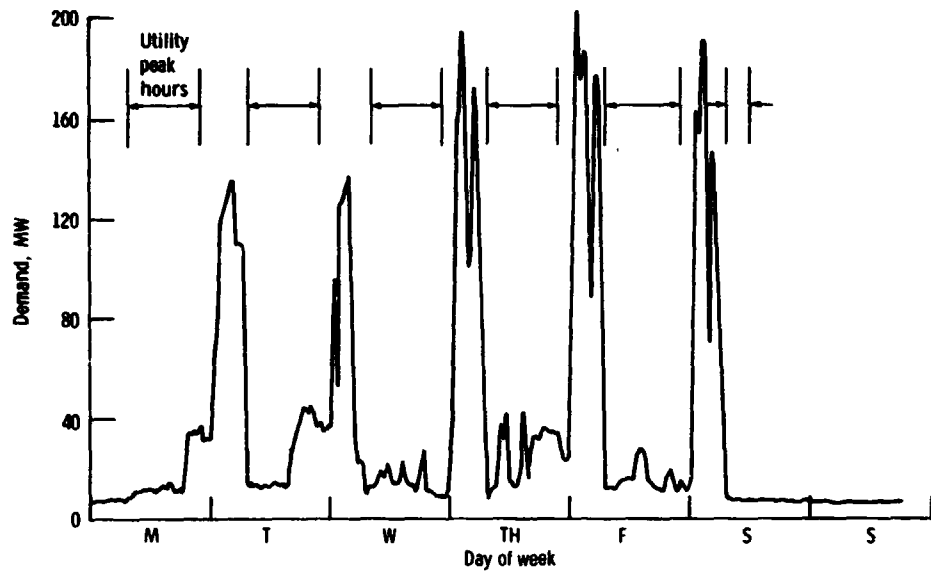

Figure 2. - Actual Lewis electric load time variation for example week (August 1979).

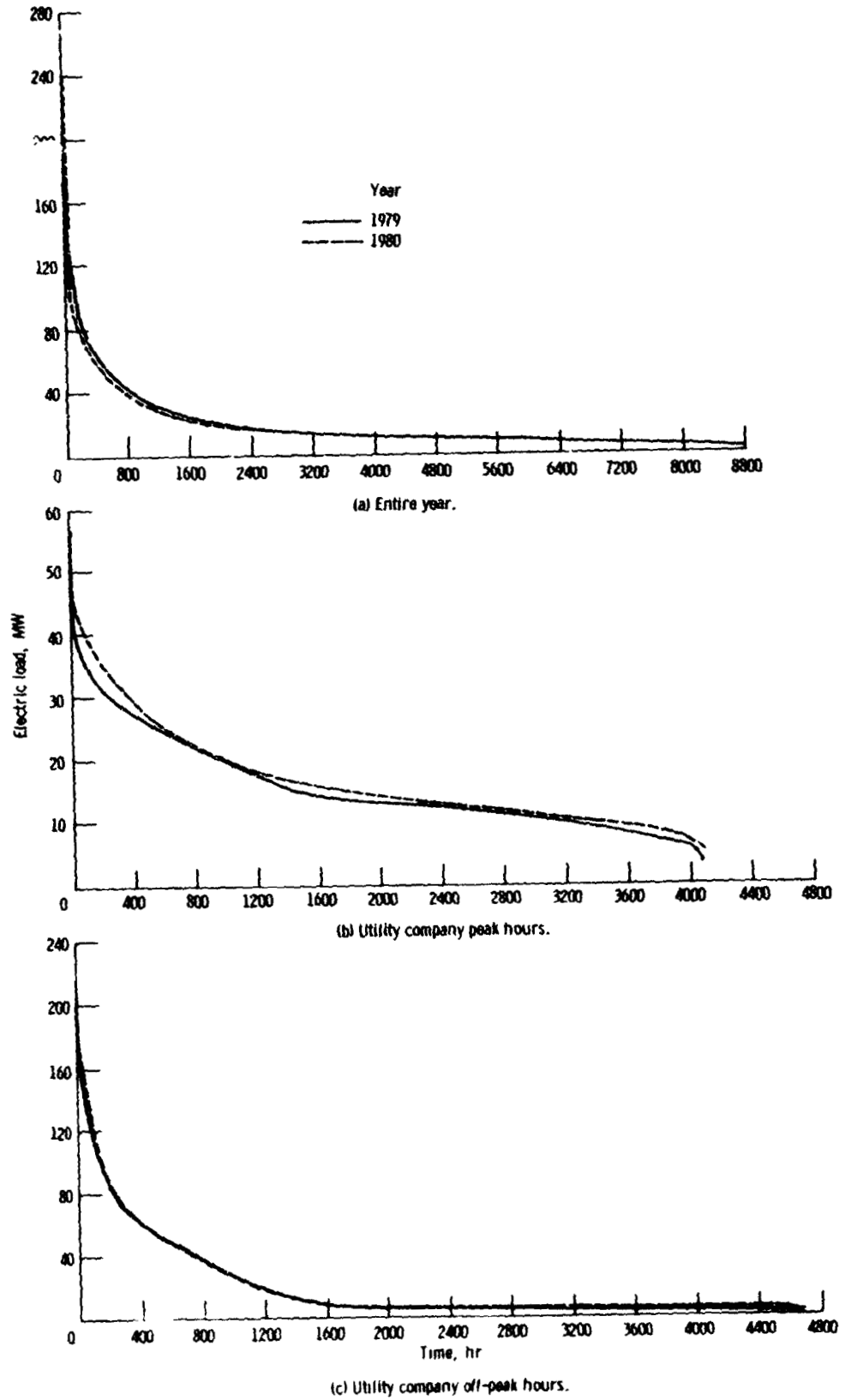

Figure 3. - Lewis electric load duration curves.

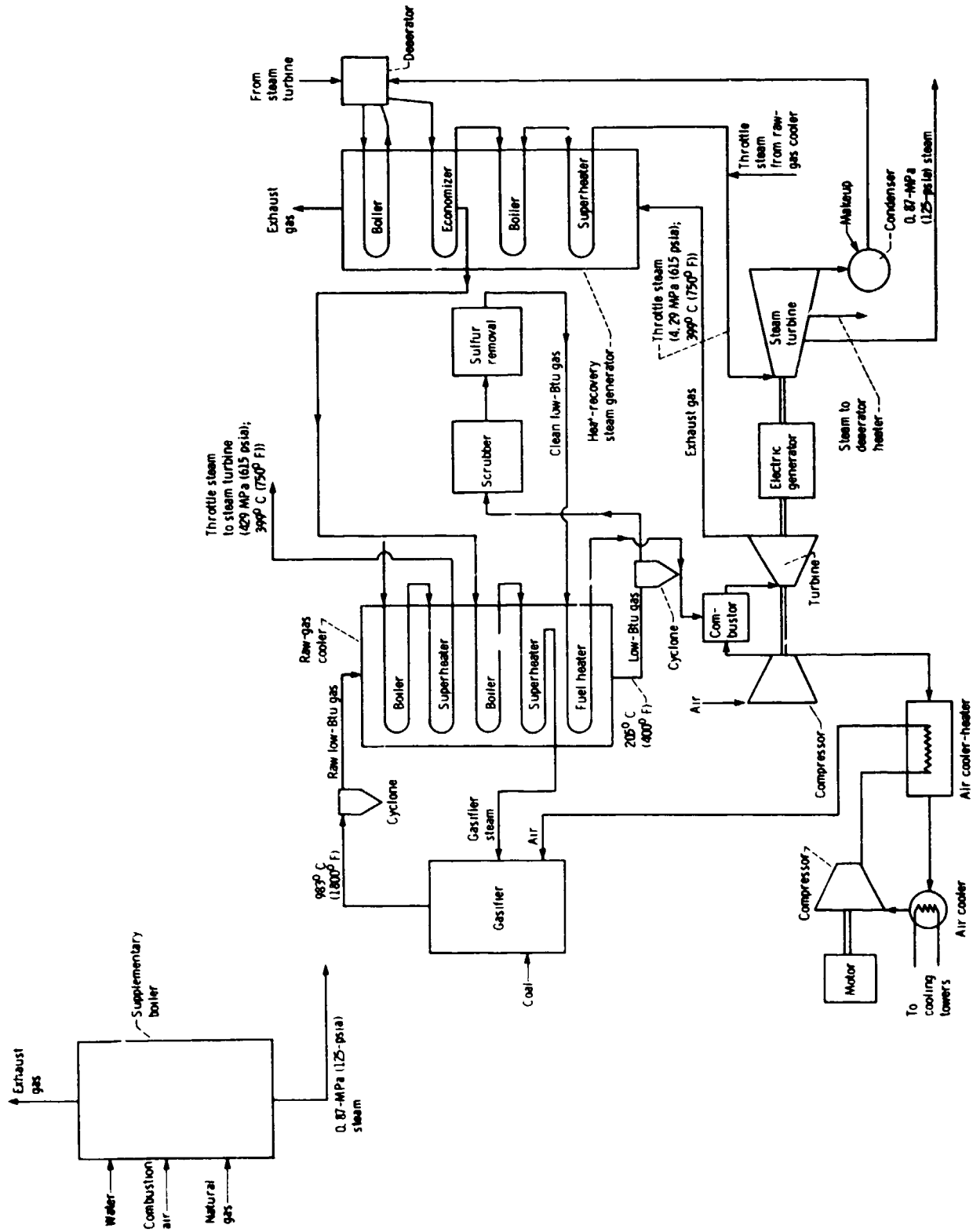

Figure 4. - Schematic of integrated-gasifier combined-cycle (IGCC) cogeneration system, including supplementary boiler.

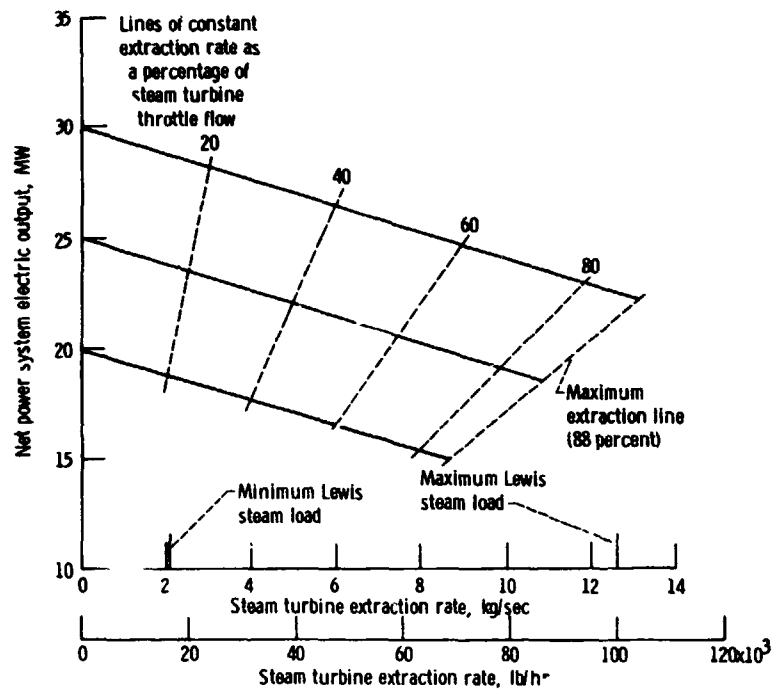

Figure 5. - Power output as a function of steam turbine extraction rates for different IGCC cogeneration system sizes.

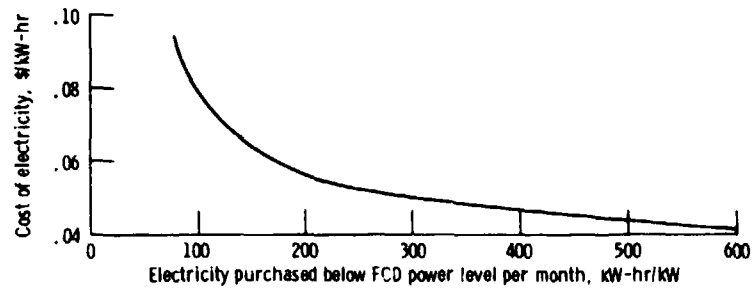

Figure 6. - Cost of electricity purchased at power levels below fixed contract demand (FCD) power as a function of electricity purchased (1985 costs expressed in 1980 dollars).

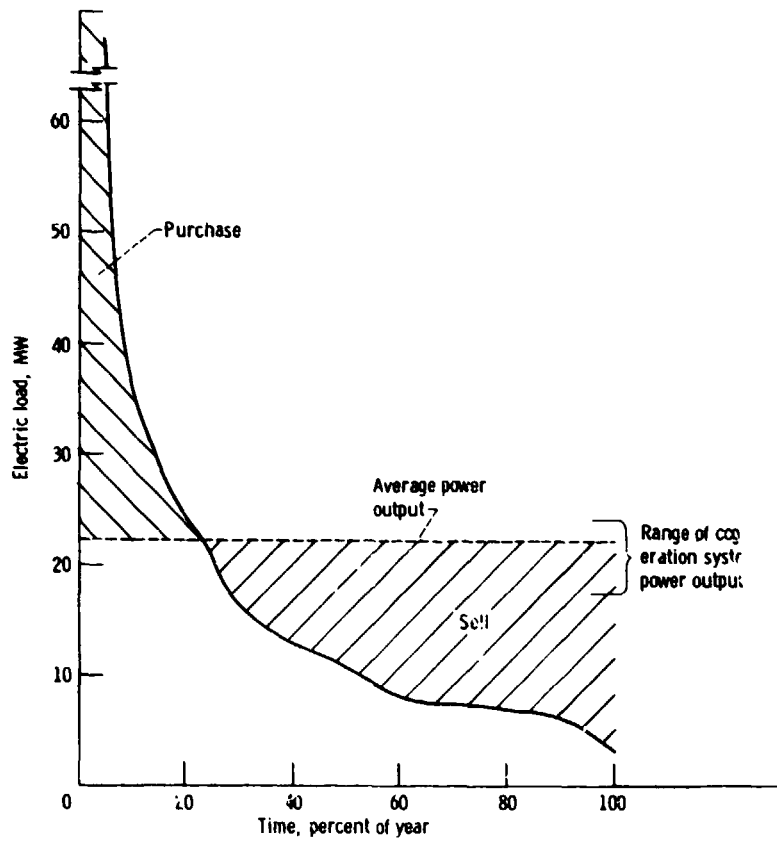

Figure 7. - Lewis annual electric load duration curve showing amounts of electricity purchased and sold with 25-MW IGCC cogeneration system.

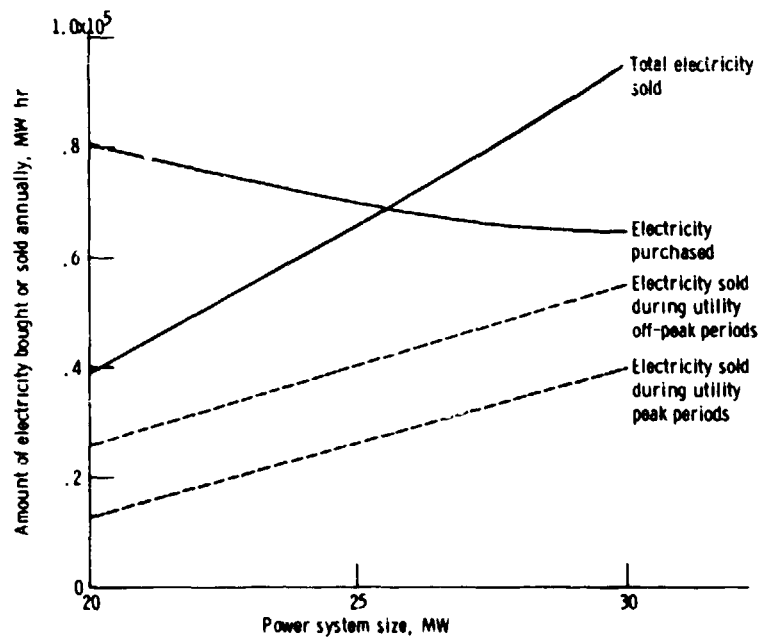

Figure 8. - Electricity purchased or sold per year as a function of IGCC cogeneration system size (80 percent power system availability).

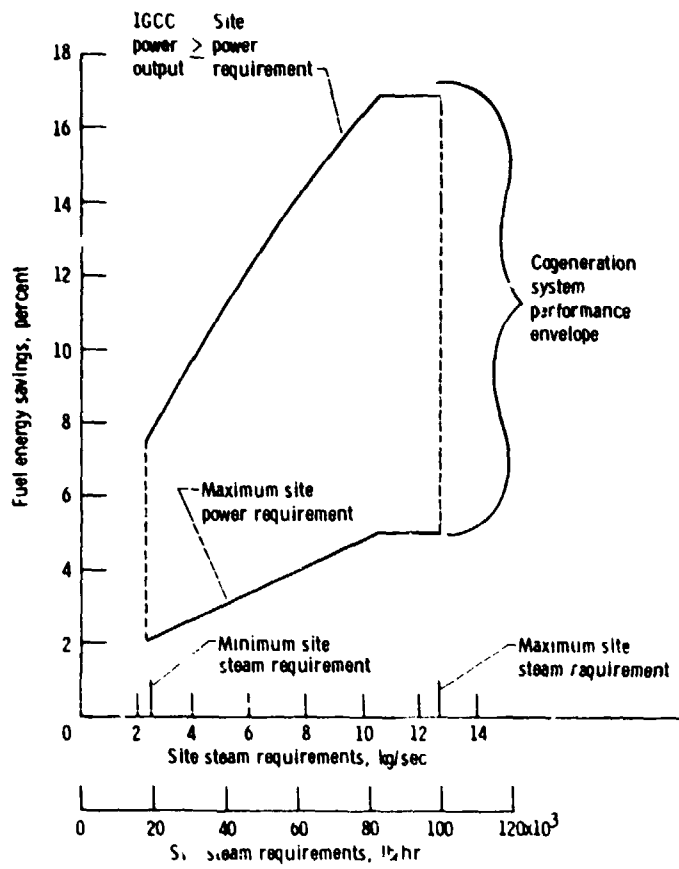
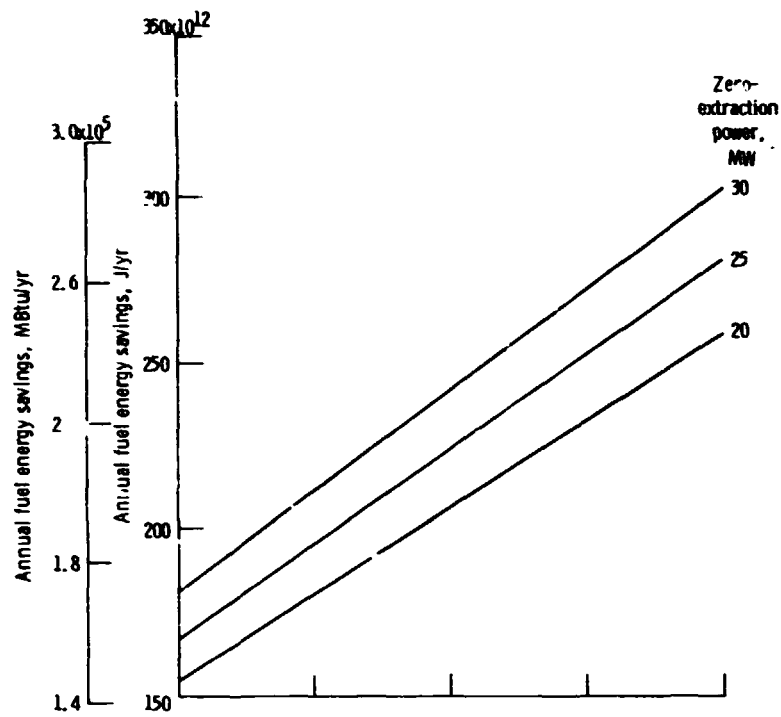
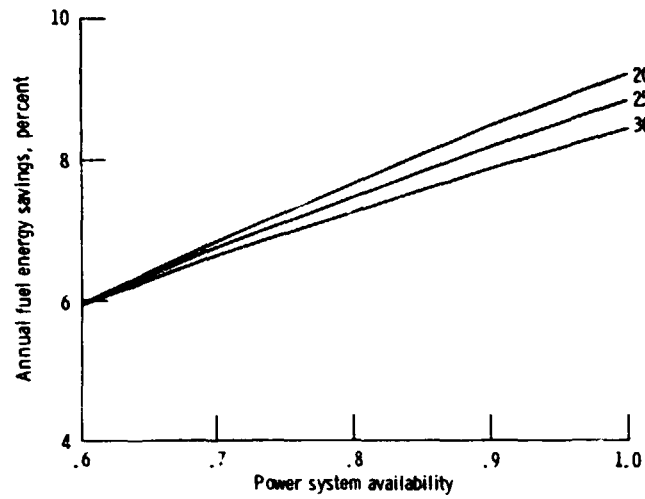

Figure 9. - Instantaneous fuel savings as a function of site steam and electrical requirements for 25-MW IGCC cogeneration system at Lewis site.



(a) Annual energy savings in joules (MBtu).



(b) Annual fuel savings in percent of nongeneration fuel use.

Figure 10. - Annual fuel energy savings as a function of IGCC cogeneration system availability for various cogeneration system sizes at Lewis site.

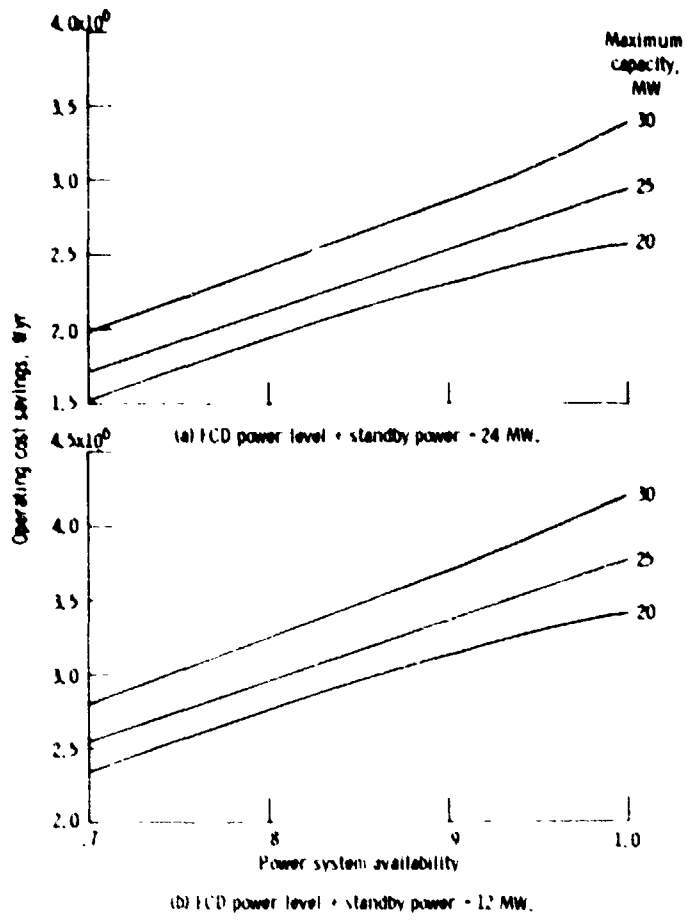

Figure 11 First year operating cost savings as a function of IGCC cogeneration system availability for various cogeneration system sizes.

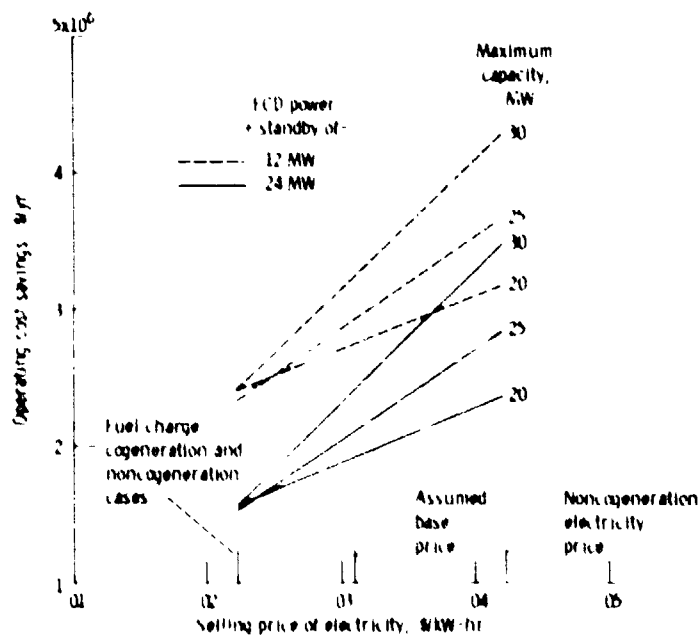

Figure 12 First year operating cost savings as a function of selling price of electricity (IGCC cogeneration system availability, 80 percent).

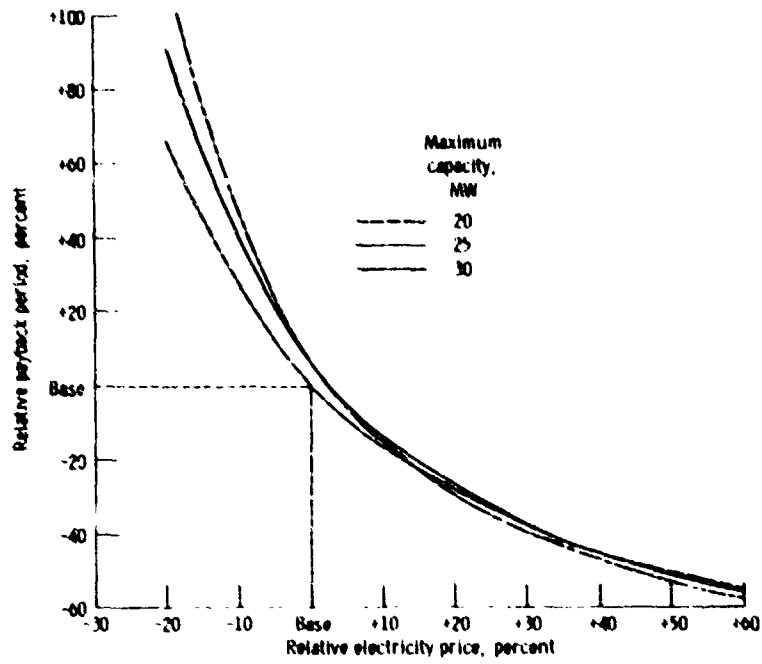

Figure 13 - Relative payback as a function of relative electricity price for IGCC cogeneration system.

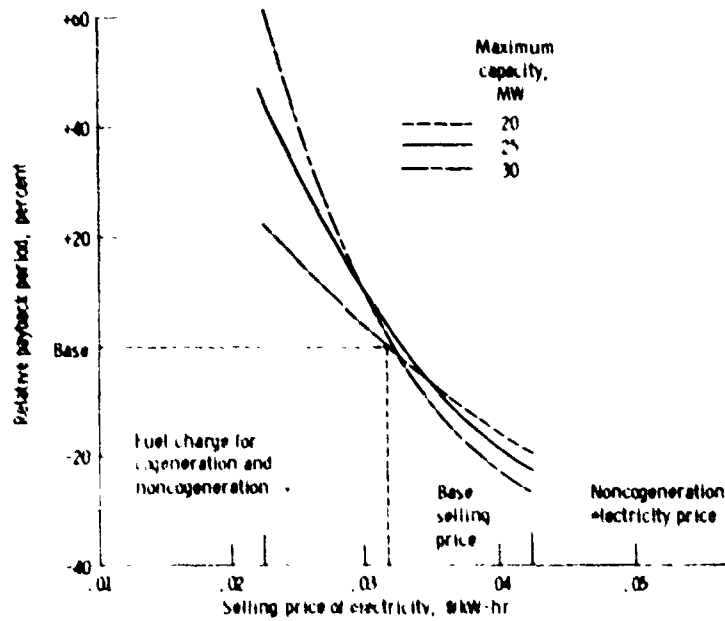

Figure 14. Relative payback as a function of electricity selling price for IGCC cogeneration system.

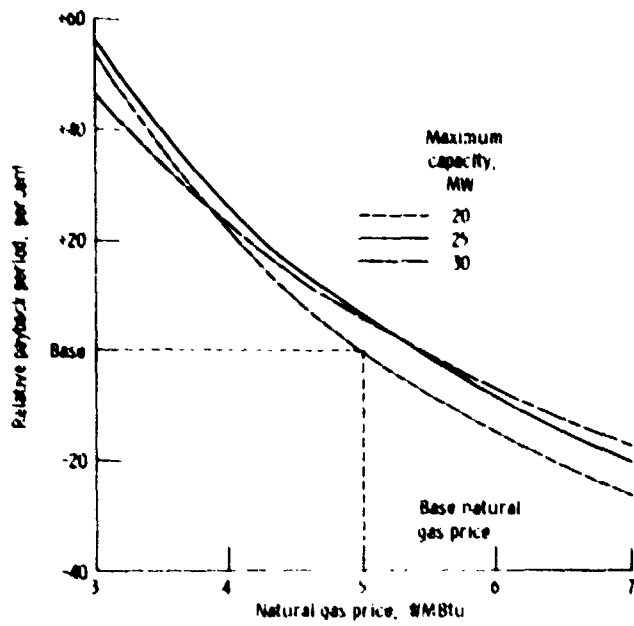

Figure 15 Relative payback as a function of natural gas price for IGCC cogeneration system

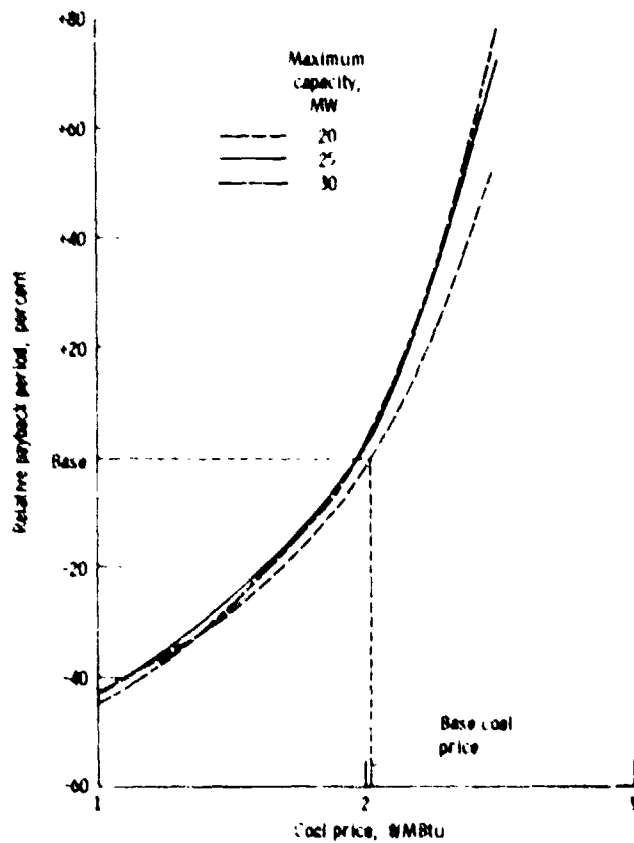

Figure 16. Relative payback as a function of coal price for IGCC cogeneration system