

NASA  
CP  
2217  
c.1

NASA Conference Publication 2217

# The 1981 Goddard Space Flight Center Battery Workshop

TECH LIBRARY KAFB, NM  
0099356

LOAN COPY: RETURN TO  
AFWL TECHNICAL LIBRARY  
KIRTLAND AFB, N. M.

*A workshop held at  
Goddard Space Flight Center  
Greenbelt, Maryland  
November 17-19, 1981*



**NASA**



*NASA Conference Publication 2217*

# The 1981 Goddard Space Flight Center Battery Workshop

*G. Halpert, Editor  
Goddard Space Flight Center  
Greenbelt, Maryland*

A workshop held at  
Goddard Space Flight Center  
Greenbelt, Maryland  
November 17-19, 1981

**NASA**

National Aeronautics  
and Space Administration

**Scientific and Technical  
Information Branch**

**Page intentionally left blank**

## Preface

This, the 14th Annual Battery Workshop, was attended by manufacturers, users, and government representatives interested in the latest results of testing, analysis, and development of lithium, nickel-cadmium, and nickel-hydrogen batteries. The purpose of the Workshop was to share flight and test experience, to stimulate discussion on problem areas, and to review latest technology improvements.

The papers presented were derived from transcripts taken at the Workshop held at the Goddard Space Flight Center on November 17 to 19, 1981. The transcripts were lightly edited by the speakers with their vugraphs assembled at the end of each presentation for uniformity.



**Page intentionally left blank**

## INTRODUCTION

G. Halpert  
Goddard Space Flight Center

Welcome to Goddard Space Flight Center and the 1981 NASA/GSFC Battery Workshop. We are pleased that Goddard management has continued to support this activity through the last thirteen years. We appreciate the NASA Headquarters support we have had.

Each year as we review the accomplishments that have been made, it is clear that we continue to improve the technology and continue to gain further experience and have taken steps to better understand and improve the reliability of secondary systems used in space. However, the more we advance, the more we realize that there is still much to be learned. Furthermore, the interest in these systems continues to be high.

We anticipate that this will be another informative workshop. We hope that you will participate by asking questions and by offering stimulating comments.

For your information, we have included a list of the acquisition numbers for all workshop proceedings dating back to 1970.

### BATTERY WORKSHOP PROCEEDINGS

<u>Year</u>		<u>Doc. No.</u>
1980	Workshop	81N21493
1979	Workshop	80N20820
1978	Workshop	79N28669
1977	Workshop	79N21565
1976	Workshop	77N21550
1975	Workshop	76N24704
1974	Workshop	75N16976
1973	Workshop (1st Day)	75N15152
	Workshop (2nd Day)	75N17808
1972	Workshop (1st Day)	73N21956
	Workshop (2nd Day)	73N21957
1971	Workshop (Vol. 1)	72N27061
	Workshop (Vol. 2)	72N27062
1970	Workshop (1st Day)	71N28659
	Workshop (2nd Day)	71N28672

NASA or NASA contractors, contact:

NASA Scientific and Technical  
Information Facility (STIF)  
P.O. Box 8757  
BWI Airport  
Baltimore, MD 21240  
(301) 796-5300

All others, contact:

National Technical Information  
Service (NTIS)  
U.S. Department of Commerce  
Springfield, VA 22161  
(703) 557-4600

CONTENTS

	<u>Page</u>
Preface . . . . .	iii
Introduction	v
G. Halpert, GSFC . . . . .	
Session I	
Overview of NASA Programs	
The NASA/QAST Energy Storage Program	
J. Ambrus, NASA Headquarters . . . . .	1
Session II	
Lithium Cell Technology	
High Rate, High Reliability Li/SO <sub>2</sub> Cells	
R. Chireau, PCI . . . . .	15
Accelerating Rate Calorimetry: A New Technique for Safety Studies in Lithium Systems	
W. Ebner, Honeywell . . . . .	31
Alternate Seal Configuration for Lithium Primary Cells	
J. Kelley, Honeywell . . . . .	45
Recent Test Results on Lithium BCX Cells	
B. Bragg, JSC . . . . .	55
Case-Positive Vs Case-Negative Designs for Low-Rate Lithium Thionyl Chloride Cells	
T. Mahy, CIA . . . . .	77
Heat Generation Rates in Lithium Thionyl Chloride Cells	
H. Frank, JPL . . . . .	91
Discharge of 1400 AH Lithium Thionyl Chloride Cells into Voltage Reversal	
A. Zolla, Altus . . . . .	101
High-Rate Lithium Thionyl Chloride Cells	
F. Goebel, GTE . . . . .	113
Factors Affecting Cycle Life in Ambient Temperature of Secondary Lithium Batteries	
R. Somoano, JPL . . . . .	123

CONTENTS (continued)

	<u>Page</u>
Progress in Secondary Lithium Batteries	
G. L. Holleck . . . . .	141
Army Position on Lithium Battery Safety	
E. Reiss, U.S. Army, ERDC . . . . .	149
Navy Position on Lithium Safety	
F. Bis, NSWC . . . . .	157
Session III	
Prediction and Modeling	
Destruct/Non-Destruct Evaluation of Cycled NiCd Cells	
S. DiStefano, JPL . . . . .	165
Electrochemical Models for the Discharge Characteristics of the NiCd Cell	
M. Spritzer, Villanova University . . . . .	177
NiCd Battery Failure Analysis	
K. Sense, Rockwell . . . . .	189
Life Prediction Model Comparisons	
I. Schulman, JPL . . . . .	201
NiCd Battery Cycle Life Prediction Equation for Low Earth Orbit	
D. Hafen, Lockheed . . . . .	213
Time-to-Failure Analysis for NiCd Batteries in a GPS Orbit	
K. Sense, Rockwell . . . . .	223
Galileo Battery	
L. Marcoux, Hughes . . . . .	237
An Improved Equation for Discharge Voltage	
P. McDermott, Coppin State . . . . .	257
Session IV	
Orbit Testing and Results	
NiCd Cell Reversals During Reconditioning	
W. Hwang, Aerospace Corp. . . . .	271



CONTENTS (continued)

	<u>Page</u>
OAO-C End-of-Mission Power Subsystem Engineering Evaluation	
M. Tasevoli, GSFC . . . . .	285
DSCS III Life Test Progress Report	
H. Thierfelder, GE . . . . .	293
SMM Parallel Battery Operation in Orbit	
R. Broderick, GSFC . . . . .	305
RCA Satcom In-Orbit Experience: An Update	
D. Stewart, RCA . . . . .	317
Update: Viking Lander NiCd Batteries - Year Six	
A. Britting, Martin Marietta . . . . .	327
GPS On-Orbit Battery Performance	
J. Kasten, Rockwell . . . . .	341
New NiCd Battery Standard and Guide	
M. Milden, Aerospace Corporation . . . . .	353
Session V	
Electrode Technology	
Effects of the Mode of Storage on the Capacity Fading of the Sintered Nickel Electrodes	
B. Vyas and M. P. Bernhardt, Bell Labs. . . . .	367
Sintered Plaque Characteristics	
H. Vaidyanathan, Comsat . . . . .	397
Recent Developments in the NSWC Composite Electrode	
W. Ferrando, NSWC . . . . .	403
Corrosion in NiCd Cells	
C. Badcock and J. Galligan, Aerospace Corp. . . . .	415
Tribute to Lou Belove	
I. Schulman, JPL . . . . .	421
A Method for Battery Activation	
G. Halpert and M. Tasevoli, GSFC . . . . .	423

CONTENTS (continued)

	<u>Page</u>
Comparisons of Different Plate Treatment and Designs: An Update	
D. Baer, GSFC . . . . .	435
Comparisons of Different Plate Treatments and Designs: Analysis	
V. Kunigahalli, Bowie State College . . . . .	443
Chargeability of Nickel Electrodes Studies by Optical Microscopy	
C. Dyer, Bell Labs . . . . .	459
Positive Electrode Processing for Hughes NiH <sub>2</sub> Cells	
C. Bleser, Hughes Aircraft . . . . .	471
Session VI Nickel Hydrogen	
Comsat Labs Life Test Data for NiH <sub>2</sub> Cells	
J. Stockel, Comsat . . . . .	481
Life Test of 50 Ah NiH <sub>2</sub> Battery	
D. Warnock, USAF . . . . .	487
Cycling Characteristics of NiH <sub>2</sub> Cells in Standard and Daily Energy Balance Leo Orbits	
P. Ritterman, TRW . . . . .	501
Some Properties of NiH <sub>2</sub> Cells	
H. H. Rogers, Hughes Aircraft . . . . .	513
Nickel-Hydrogen Flight Relay and Cell Shorting Test	
S. Stadnick, Hughes Aircraft . . . . .	525
NiH <sub>2</sub> Cell Test Update	
V. Mueller, McDonnell Douglas . . . . .	533
Nickel System Manufacturing Update	
L. Miller, Eagle Picher . . . . .	547
List of Attendees . . . . .	551

## OVERVIEW OF NASA PROGRAMS

### The NASA/DASI Energy Storage Program

J. Ambrus

NASA Headquarters

AMBRUS: Good morning. I am very pleased to be here again as part of this eagerly awaited annual event, the battery workshop, where I meet old friends and make new ones every year.

This event has become more and more important as the years went by, not just to me but, judging from the size of the audience, to just about everybody else in the community. I'm really very pleased to be part of it and now part of the NASA team that organizes it.

I am often asked by my colleagues what it is that we do here every year, how can we go on year after year having a battery workshop and talking about batteries, of all things, for three whole days, and anyway, batteries still don't work. And to top it off, we have been hoping that by now some new energy source would come along that works much better than batteries.

Well, to this I usually reply that what we do here is talk to each other without having to figure out cute answers to the other questions, and anyway, batteries work a great deal better than they used to. And no other practical energy storage device has come along that is as good as batteries to this day. So there are going to be many years when we are still going to be talking to each other.

This particular program, the three-day program, has got many interesting aspects. One very interesting one, and to me a particularly gratifying one, is that I perceive a subtle change in the approach to the technology improvement. When you look at the list of speakers and the topics, I am finding that the researcher and the applications technologist who, when I first started out in this field, sort of suspiciously eyed each other when they passed in the hall, are actually sitting down in the same auditorium together. They are also talking to each other, and, God forbid, maybe one day they're going to learn from

each other. So with that I would like to add my little part to this.

This conference is always about the latest happenings in applications technology, and I am here to learn, and I'm also trying to tell you about what we do at NASA Headquarters in the Research and Technology Department to underpin this kind of activity in research and technology improvement.

(Figure 1-1)

First of all, what is the mission of the NASA Research and Technology Program? Well, to provide the technology base that will adequately support, enhance and enable current and future activities in the exploitation of space. This of course is the mission of the Space Research and Technology Program, part of which is the Space Power Research and Technology Program which I am part of here.

(Slide.)

Now what are these missions that they support? This is an artist's conception of some future mission, and, whatever it is, we know that it's going to be big, it's going to require a lot of power, and it's also going to be shuttle-launched. So these are the kind of restraints that are upon us and with which we are working to get the technology to.

(Figure 1-2)

In summary, we know that the major technology drivers are going to be advanced planetary spacecraft, advanced spacecraft in geostationary orbit, and large space systems in low earth orbit. We are addressing all three of these in our basic research program.

Of course at the heart of each one of these is the power system.

So what is it that we're working for? Well, high capacity, of course: we're going to need more and more power. High energy density: we're going to have to package it into less and less. And of course we're going to be

looking for long life, both cycle life and storage life.

(Figure 1-3)

Now I'm sure that you are interested in what it is we are looking at on the whole in space power. We are looking at the power sub-system.

Photovoltaics is still the primary power source in space today, and we still primarily store the energy in batteries, in secondary batteries, and sometimes we carry energy in chemical form to be converted as a one-time application to electrical energy in primary batteries.

Thermal-to-electric energy conversion is particularly important in planetary exploration. The heat source is usually a radioisotope or possibly a reactor, and thereby you can have missions where you are independent of the sun.

And of course power system management and distribution. This is a new one for us. We have found that as the large power systems come about, it is not random any more, how we put together eight cells. I mean it's not going to be eight cells or 20 cells any more; it's going to be many, many, many cells, and large cells.

So now it really matters ahead of time to know how you're going to manage and distribute the power. Twenty-eight volts are just not going to hack it any more. We are going to have to go to high voltage systems. We are going to have switches, transistors. We are going to see how we have got to manage the heat distribution of the batteries. So this is an important part of the entire power system.

And then there is what we call "advanced energetics" which seeks to explore the evolution of new concepts. In the back of our minds we are still looking for the perfect energy storage system that is not a battery.

(Figure 1-4)

Now I'm sure that you're interested in how the money is distributed. Here is our Space Power Research and Technology Program fund distribution by what we call Specific Objectives in '81 and '82.



You can see photovoltaics is a large part. So is chemical energy conversion and storage, power system management and distribution. Thermal-to-electric conversion is still a little bit, because, after all, it only applies right now to one kind of mission, which is the planetary mission.

In advanced energetics we're looking for new ideas of power conversion. It's a reasonable part.

When you look from '81 to '82 there's a small increase in chemical energy conversion and storage, and a decrease in photovoltaics and an increase in power systems management and distribution, which means that this is becoming more and more important as time goes by.

(Figure 1-5)

When we now look at just chemical energy conversion and storage, how are we distributing the funds by task area?

Fuel cell/water electrolysis is nearly half of it, and there is a little bit that can be identified as just primary fuel cell work, but really this whole chunk is primarily fuel cell work. Maybe it should be more.

Nickel-hydrogen, which is the new energy storage device, is taking up 13 percent. New, advanced high energy density is .11 percent, and this is the new high energy density secondary batteries. Then fundamental investigations, which are really very basic investigations. And, of course, we have new high energy density primary battery work, too.

by Center, Lewis Research Center is the largest center that does electrochemical research and technology; JPL and, of course, the Johnson Space Center, which has the responsibility for fuel cell/electrolysis.

(Figure 1-6)

We manage by setting certain goals, and those of you who work at NASA Centers know these as paso targets. We

set certain targets up for the different centers to work toward.

For instance, you can see that the Lewis Research Center now is responsible for the nickel-hydrogen component selection by the end of '83. And a fuel cell/electrolysis breadboard will be delivered to Johnson Space Center at the end of '82, and so on and so forth.

Now let me start describing to you the program in detail. I'm not going to talk very much, primarily because I don't know all that much about the details, and there are many experts in the audience here who work in these programs, and I'm going to try to introduce them to you as I go through the program.

(Slide.)

Primary fuel cells. Well, I figured I would show you what a shuttle fuel cell looks like. This is one of the three. This isn't the one that failed. And what we are going is primarily done in the Lewis Research Center, and this is component technology.

(Slide.)

We are working on advanced components. For instance this particular fuel cell has got an advanced calcium-leached asbestos matrix, and a new polysulfone frame which will reduce its weight considerably in future fuel cells. So this is the kind of thing that we are doing in our Primary Fuel Cell Program.

Now the fuel cell is considered to be a reasonably mature technology, and we've been using them successfully in just about all the manned space flights by now, and will continue to use them. The idea has come up that why don't we use fuel cells in conjunction with water electrolysis as an energy storage device for large, future space systems in low-earth orbit.

(Figure 1-7)

Thus, this program was born.

Now I'd like to point out the following things:

we are only thinking at this point in time about hydrogen-oxygen fuel cells. There are two kinds that we are working on. One is the alkaline fuel cell that is right now flying in the Shuttle. The other one is the acid or solid polymer electrolyte fuel cell which is being brought along at the same time on a development basis.

both systems have agreed that the fuel cell and the electrolysis cell should be dedicated systems; that is, it is not cost-effective or system-effective to make one cell that switches back and forth from fuel cell to electrolysis. It's better to have dedicated systems.

It is an awfully good concept in the way that you can integrate it into the spacecraft. You can integrate it into a large space platform. There's hydrogen and oxygen; you can use it in the fuel system, you can integrate it into the life support system; so it is overall a very good idea.

It is also very competitive with nickel-hydrogen as far as energy density is concerned. As a matter of fact, we had several studies done and, depending on who does the study, the fuel cell electrolysis and the nickel-hydrogen in large, 25 to 100 kilowatt applications, come out neck and neck. Sometimes one is a little bit ahead and sometimes the other one is.

So we decided to develop both and then, let's see what happens.

The development work has been going on mainly on the electrolysis side and on the systems side. We are using the mature technologies, the shuttle technology, on the fuel cell side. Most of the work, the improvement work has been done on the electrolysis side (both alkaline and SPE).

I took these two charts out from two entirely different reports. And they show nearly the same performance. So right now, again depending on who you talk to, one or the other comes out ahead by about 10 percent.

Let me tell you that the plans are to have the acid, the SPE fuel cell that's being developed by GE up in Wilmington, the breadboard delivered to JSC by the end of this fiscal year, and testing is going to start. The alkaline breadboard is supposed to be delivered at the end

of '83. And of course the testing is going to show which one is preferable. Chances are that both are going to be very good, and that they are both going to have given applications.

(Figure 1-8)

Now the next large area that we're working on is, of course, nickel-hydrogen. Now you have all seen this before. This is state of the art, a 25 ampere-hour nickel-hydrogen cell that has been developed by COMSAT, by the Air Force, by Hughes. We are looking for high capacity in low-earth orbit, which means that we have got to have many, many cycles at deep depths of discharge.

We are working against a plan. We have put together a five-year plan with Lewis Research Center leadership, and we have involved all of the Centers and the Air Force. The Lewis Research Center has the leadership but it's a collaborative program with all the Centers and the Air Force.

We have so little money we have got to use every cent.

We are trying coordination with the user Centers and if you are from a user Center and you are not being coordinated with, please squawk.

The technology program is aimed at improved components and improved cells.

This is what we are after. We are trying to double the energy density of the nickel-cadmium. The prototype high capacity cells are supposed to be ready by '82, and let me tell you, they are not necessarily going to look like this.

(Slide.)

The Lewis Research Center is working on some advanced designs, bipolar designs, that may look something like this. Some of you may be familiar with this idea already.

In geostationary orbit we are going to need

very high energy densities. This is what is right now in geostationary orbit, and this is what we are looking for. This is not necessarily going to be lithium but it's going to be some advanced system that has got very high energy density.

(Figure 1-9)

Our high energy density program consists of two parts, the ambient temperature lithium systems which is being performed at JPL, and the sodium anode/molten salt/beta alumina systems which is performed by the Lewis Research Center at EIC.

The ambient temperature lithium system. The emphasis right now is on the material performance and degradation mechanisms. We're looking for a 200-watt per kilogram prototype for a five-year geosynchronous orbit by the end of '87, and in the meantime we're looking at the basic understanding of performance characteristics and failure mechanisms by the end of '85.

I'm not going to tell you more about this. It's a very successful program and Dr. Somoano, who is going to be a session chairman here, can tell you more about it because he's the leader of that particular task.

The sodium anode/molten salt/beta aluminum systems, where the emphasis is on low temperature molten salts (about 165 degrees) and high capacity cathode materials. I understand that the best one found to date is nickel sulfide. It's sort of fortuitous, because they were looking at niobium sulfides and such things, and they found out it was the nickel screen that actually gave the best performance. So it's nickel sulfide now. And they are going to start making prototype cells during this year, I understand.

(Figure 1-10)

NASA always had a certain amount of use for primary batteries and of course the primary battery used by NASA until now has been the silver-zinc battery. We are looking for high rates.

Now we have a program in place at JPL which looks



at primary lithium batteries. The emphasis is on safety and life. The goal is to demonstrate a safe, high energy density, long-life prototype cell by the end of '85.

We are approaching this a little bit differently now. There's enough practical experience in the community so that we can go back and develop a prototype cell, but first understand what's going on in it.

Again I'm not going to give you any details of this program because Harvey Frank from JPL is the leader of that task and he is also sitting in the audience, and I'm certainly not qualified to take his place. If there are any questions you have, please direct them to him.

Now all this sounds pretty research and technology-ish, and it is. There is also something that is just unabashedly basic research, and we call that fundamentals, and it helps along in most of the programs.

(Figure 1-11)

We want to understand basic mechanisms, and we want to understand the basic mechanism even in the nickel-cadmium system in which nobody understands the basic mechanisms yet, even though the battery works very well.

Irwin Schulman, who is the leader of the task of the nickel-cadmium failure model, is also in the audience; so I'm not going to elaborate on the failure model which is a very good one and which is now in the process of being validated successfully.

There is also some basic, supportive work going on at the Lewis Research Center such as electrolyte volume management in metal-gas batteries and in fuel cells, and a very interesting interactive graphics program in synthetic batteries which really graphically tells you when you do not balance cells in a battery what can happen just after a very few cycles. Larry Thaller gave a paper on that in Atlanta. I'm sure that you can get a reprint of that.

Well, this is the extent of the NASA Office of Aeronautics and Space Technology, Battery Research and Technology Program. Now I am going to learn in the next three days how to change it.

Thank you very much.

#### DISCUSSION

BIERMAN (Honeywell): You showed your pie charts there with the various percentages of where you're spending your funds. Would you care to comment on the overall budget dollars themselves?

AMBRUS: Yes. The overall budget for fiscal '82 is about \$15 million, 15.5. Of that, chemical energy conversion and storage is 3.7-some. I don't remember the '81 figure exactly but it comes out about the same. Up until a couple of months ago it was much larger.

SENSE (Rockwell): The overall system analysis for the fuel cell system shows that its efficiency is quite a bit less than that of, say, a nickel-hydrogen system, and I'm just wondering: I'd like to have your comments as to the justification for the use of a fuel cell system in view of such a great difference in the overall efficiency.

The implications here are that when you have such low efficiency, you need much larger solar arrays, and for low earth orbit this also implies that you have an extra load because you have to keep the bird in orbit.

AMBRUS: Yes, I agree with you, and there are some studies that agree with you. And there are some studies that say that no, it's nickel-hydrogen that is going to be heavier.

This is why I commented that we are having several studies done on the use of fuel cell electrolysis versus nickel-hydrogen, and, depending on who does the study, depending upon the assumptions that people make, they come out neck and neck. Now since we are committed to improve fuel cell technology, we figure we had better go on with both, and then let the practical experience decide.

MISSION OF THE NASA SPACE RESEARCH AND TECHNOLOGY PROGRAM

TO PROVIDE A TECHNOLOGY BASE THAT WILL ADEQUATELY  
SUPPORT  
ENHANCE, AND  
ENABLE  
CURRENT AND FUTURE ACTIVITIES IN THE EXPLOITATION OF SPACE

Figure 1-1

MAJOR TECHNOLOGY DRIVERS

- O ADVANCED PLANETARY SPACECRAFT
- O ADVANCED SPACECRAFT IN GEOSTATIONARY ORBIT
- O LARGE SPACE SYSTEMS IN LOW-EARTH ORBIT

POWER SYSTEM REQUIREMENTS

- O HIGH CAPACITY
- O HIGH ENERGY DENSITY
- O LONG LIFE
  - CYCLE LIFE
  - STORAGE LIFE

Figure 1-2

MAJOR THRUSTS OF THE SPACE POWER RESEARCH AND TECHNOLOGY PROGRAM

- O PHOTOVOLTAIC ENERGY CONVERSION
  - CHEMICAL ENERGY CONVERSION AND STORAGE
  - THERMAL TO ELECTRIC ENERGY CONVERSION
  - POWER SYSTEMS MANAGEMENT AND DISTRIBUTION

- O ADVANCED ENERGETICS

SEEKS TO EXPLORE REVOLUTIONARY NEW CONCEPTS

Figure 1-3

SPACE POWER RESEARCH AND TECHNOLOGY  
 FUND DISTRIBUTION BY SPECIFIC OBJECTIVE

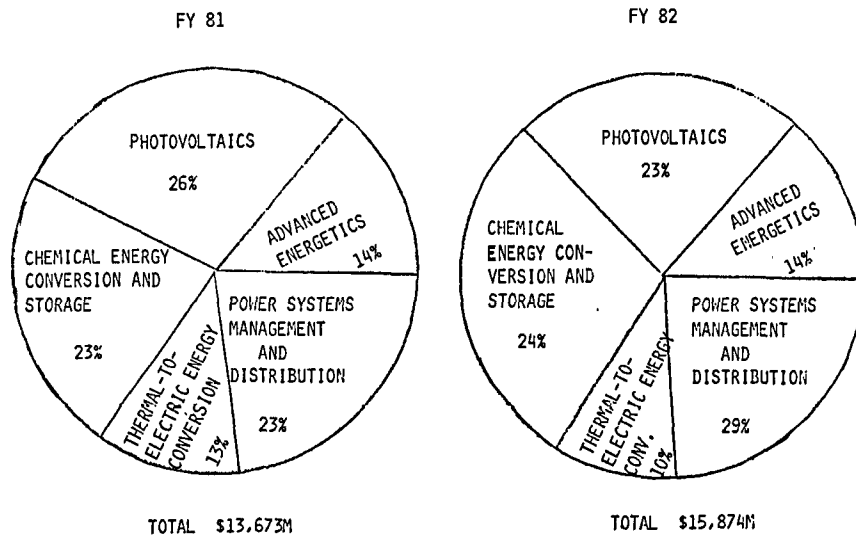

Figure 1-4

CHEMICAL ENERGY CONVERSION AND STORAGE  
 FY 82 FUND DISTRIBUTION

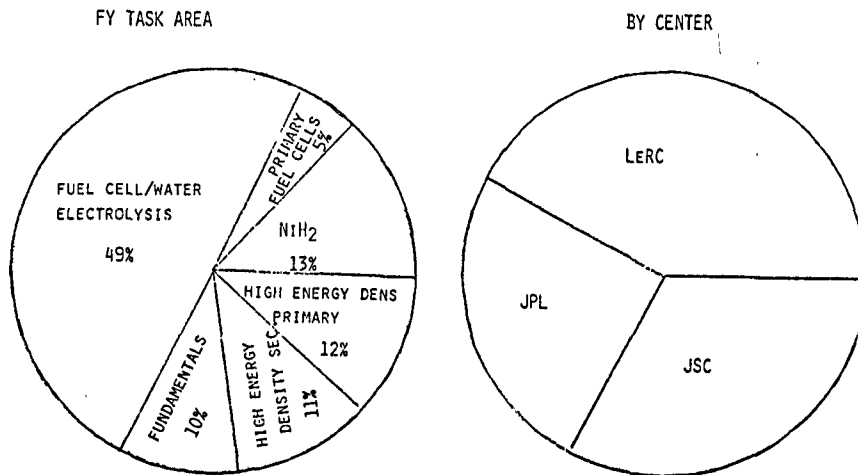

Figure 1-5

# CHEMICAL ENERGY CONVERSION AND STORAGE

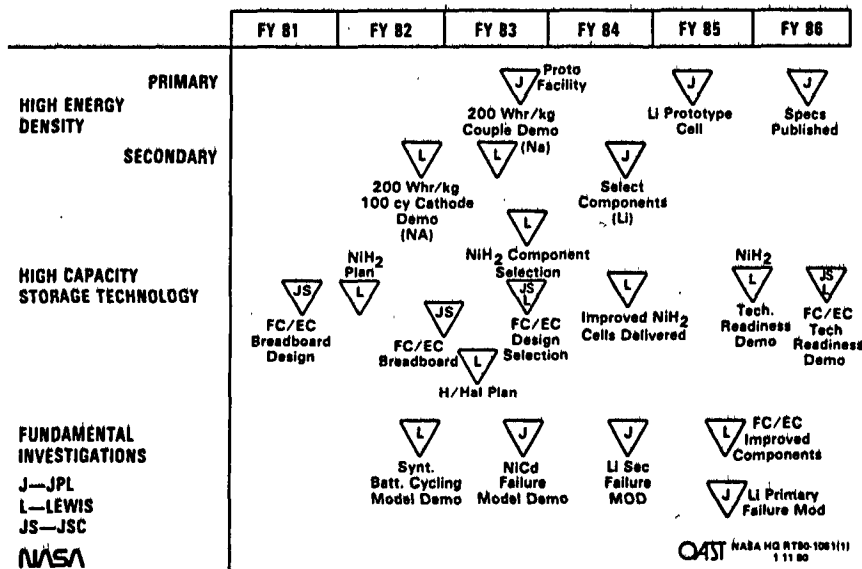

Figure 1-6

### FUEL CELL - WATER ELECTROLYSIS

- o ADVANCED ENERGY STORAGE
- o COUPLING OF TWO MATURE TECHNOLOGIES
- o TWO COMPETING SYSTEMS
  - ALKALINE H<sub>2</sub>-O<sub>2</sub>
  - SPE H<sub>2</sub>-O<sub>2</sub>
- o SPE BREADBOARD BY END FY 82
- o ALKALINE BREADBOARD BY END FY 83
  - o HIGH CAPACITY
  - o INTEGRATION WITH CREW LIFE SUPPORT PROPULSION
  - o HIGH ENERGY DENSITY

Figure 1-7

### NiH<sub>2</sub> BATTERY SYSTEM

- o EMPHASIS
  - LONG RANGE PLAN DEVELOPED (FY 81-86)
  - CONTINUOUS COORDINATION WITH NASA CENTERS AND AIR FORCE
  - IMPROVED COMPONENTS
  - IMPROVED SYSTEMS
- o GOAL
  - DEVELOP A NICKEL-HYDROGEN ENERGY STORAGE SYSTEM WITH TWICE THE USABLE ENERGY DENSITY AS THE EQUIVALENT NiCd SYSTEM AT EQUIVALENT SYSTEM LIFE (LOW-EARTH ORBIT)

Figure 1-8



HIGH ENERGY DENSITY SECONDARY BATTERIES

0 AMBIENT TEMPERATURE LITHIUM SYSTEMS

EMPHASIS

MATERIALS PERFORMANCE  
DEGRADING MECHANISMS

GOAL

200 WHR/KG PROTOTYPE (5YR GEO) BY END OF FY 87  
BASIC UNDERSTANDING OF PERFORMANCE CHARACTERISTICS AND FAILURE  
MECHANISM BY END OF FY 85

0 SODIUM ANODE, MOLTEN SALT/BETA ALUMINA SYSTEMS

EMPHASIS

LOW TEMPERATURE MOLTEN SALTS  
HIGH CAPACITY CATHODE MATERIALS

GOAL

200 WHR/KG COUPLE DEMONSTRATION BY END OF FY 83

Figure 1-9

PRIMARY LITHIUM BATTERIES

0 EMPHASIS

SAFETY  
LIFE

0 APPROACH

IN SITU ANALYSES  
INVESTIGATION OF  $ClO_2$   
THERMAL ANALYSIS  
MICROCALORIMETRY  
DSC  
VOLTAGE DELAY  
HIGH RATE CATHODES  
SOA MONITORING

0 GOAL

DEMONSTRATE SAFE, HIGH ENERGY  
DENSITY (300 WHR/KD), LONG LIFE  
PROTOTYPE CELLS BY END OF FY 85

Figure 1-10

FUNDAMENTAL INVESTIGATIONS

SUPPORTS ONGOING EFFORTS BY UNDERSTANDING BASIC MECHANISMS

0 NiCd FAILURE MODEL  
MODEL VALIDATION

CYCLING PROGRAM - DESTRUCT ANALYSIS  
NONDESTRUCT ANALYSIS  
STATISTICAL ANALYSIS

0 ELECTROLYTE VOLUME MANAGEMENT  
SEPARATOR PORE SIZE ENGINEERING

0 SYNTHETIC BATTERY CYCLING

Figure 1-11

## HIGH RATE, HIGH RELIABILITY Li/SO<sub>2</sub> CELLS

R. Chireau, PCI

We're going to discuss today the use of the lithium/sulfur dioxide system specifically for some high rates, high reliability aerospace applications.

The lithium/sulfur dioxide electrochemical system is well known, extensively used. It's probably the most advanced of the primary lithium systems that are in use today but we think primarily of it as a low rate system. In fact most of the applications to which it has been devoted have been restricted to low rate applications.

Our work here will endeavor to show some of the applications, some of the changes which can be made to the system to make it work in the realm of high rate applications.

(Figure 2-1)

Our first slide simply indicates the comparison of the high rate density in the system, the sulfur dioxide system, in comparison to some common primary systems: mercury zinc, silver zinc, magnesium oxide. We have applied some conservative estimates here on the storage life, shelf life of the system so far as the lithium/sulfur dioxide is concerned.

We have documented values for more than five years although it is here indicated as five years. All the rest of the characteristics which are enumerated here are pretty well known to the audience I'm sure and what else we found I think speaks for itself.

(Figure 2-2)

In the next slide in this maze of numbers we have tried to come out with a standard -- well, not pretty much standard but a line of lithium/sulfur dioxide cells, and I think the last two columns are pretty well indicative of the values of energy density which have been achieved. These actual numbers have actually been achieved. And you can see we are pretty well in the ballpark of what we had put in the previous slide.

We're talking of numbers which range from roughly 100 watt-hours per pound to about 150 watt-hours per pound, and these are actual finished cells. The various model numbers change only insofar as the capacity is concerned, and the diameter, height, etc.

(Figure 2-3)

Here we have indicated the cross section of a typical cell. All of the cell models which we previously put on the board followed this same design construction. We're talking of the commonly known jellyroll construction, a cathode wound as a laminate separated from the anode which is lithium, of course, by means of a separator.

The cathode is a carbon compound laminated onto a cric, separating microporous propylene material, an anode lithium sheet of course. The can, steel. Hermetically sealed construction. And you can see immediately the contribution of the can and the weight of the various materials which of course do not directly contribute to the energy density.

However, I show this picture to indicate that in our work on the high rate system we use this as a basic model, and no changes have been made basically to the structural construction of the cell.

(Figure 2-4)

Now then, in a high rate system what are we looking for? What are the characteristics of the typical high rate system for an aerospace application? What would we consider as being desirable goals?

Here we have two types of batteries which we will look into in a little more detail. And we have what many of you will recognize as being some rather stringent missile/aerospace requirements. We have a high rate, high voltage, 35 volts overall. We have two conditions under low profile. One is a pulsing type regime which rates to 18 amps. The other, no pulses but a steady state requirement.

The environmental requirements are almost standard so far as qualification, acceptance and storage, ranging from minus 65 to as high as 125 to 140 degrees.

Our energy density requirements are not that strict in terms of what we require, 47 watt-hours per pound in one case and 50 watt-hours per pound in another case, and neither are the watt-hours per cubic inch.

We bring your attention to the power density requirements, however, of 14.1 watt-hours per cubic inch in this Type A battery under maximum load which is considered unusually high for a lithium application.

(Figure 2-5)

Now in the design of the cell, what are some considerations that we have to examine in order to make the system work as a high rate system? We've listed here some of the most important requirements which had to be examined and actually solved to make this system a reality.

"A" is fairly obvious. You have to have the maximum surface area that you can possibly put into the system. Remember again we're talking about general construction so you're kind of limited there.

Then we go on to a series of other requirements such as balanced electrode configuration. Here we're talking about stoichiometrically balancing reactants in the cell for safety reasons. This system we consider must be lithium-limited.

High cathode efficiency, again an obvious design requirement. To minimize the voltage drop within the cell very heavy current collectors are required, multiple tabbing, etc.

The hermetic seal design which we put under the design considerations is a must; obviously, for the long shelf life requirements we must have a hermetic seal.

The "C" we consider again a must, venting, because of the safety aspects. We mustn't forget that we're talking of high rates and therefore we're going to see large thermal gradients, and so the venting of the cell becomes a requirement.

In subsequent slides we hope to show you some data on what happens at the high current densities that we're

talking about. Low resistance separator, again to keep down the IR losses and of course the temperature which ensues from the high rate discharges. I think most of these things that we listed here are fairly obvious.

(Figure 2-6)

From battery design consideration, the power and energy densities must be maximized; that is to say, we work with the lightest materials in the operation of the cell. There's not too much we can do within the cell itself to maximize the material except to try to thin out our materials such as grids and can to the limit, but there is not too much we can do there.

A battery consists of not just the cells plus all of the auxiliary equipment which are the intercell connectors or pads and the can and potting, and of course those are the reasons you have to look in order to maximize energy and power density within the system.

Item 3, the susceptibility to mechanical, chemical, electrochemical degradation, we've lumped under the term "Reliability." Actually we've had a reliability goal that we set for ourselves in doing this work, and the reliability of each one of the components of the battery has to be examined in the light of achieving this reliability goal.

Battery design. In the design of the primary battery, Item 4, the voltage regulation, the voltage on load is extremely important in view of the fact that the well-known initial voltage drop or voltage transient which is commonly observed in the lithium/sulfur dioxide system must be taken into account.

Here there are several design approaches which are available to us to minimize these transients. But the chemistry of the cell mitigates against the complete solution, the complete elimination of what we call transients. At least we can minimize them to get them into the millisecond range, under a millisecond, but so far it has not been possible to completely eliminate that which we call a transient and therefore its effect on voltage degradation.

Continuing down the list, we have, again obvious, design criteria storage life. The storage life of the system I think is pretty well documented over a period of five years. We have shelf life data which indicate 95 percent of capacity retention at normal temperature ambience.

As we go up the temperature, temperatures of 130 to 160 degrees, that capacity retention figure drops off a bit but it is still fairly acceptable. What has proven to be a bit of a roadblock is the effect of the temperature and storage time on again the voltage transient. That is something which remains to be worked on and for which right now the solution is not readily seen.

We have enumerated various other criteria in the primary battery design which for the sake of continuing we will just pass over.

(Figure 2-7)

Now, having enumerated all the good things that we would like to do, that we see should be done, how did we fare in a typical design of a high energy density and high power or let's say high rate battery?

Well, going back again to our two type A and Type B batteries, we have two systems which we consider come pretty close to meeting our original goals and under envelope dimensions we give you some figures as to the length, width, weight dimensions.

As to the configuration of the cells, we have two different configurations since there are two different requirements. One uses a cell which is a little smaller than the other. Most of the work on these data that we'll present will center around the type B battery where we're using our model 550 which reduces down to the size of a D cell. This would be a D-sized cell, so therefore we're talking of a modified D-type cell capable of high rate.

And the cell of course is packaged within a canister of stainless steel with all the rest of the fruit salad that goes along with any aerospace application.

A heater blanket is required because of the

operational requirement down to minus 65.

(Figure 2-8)

Before we go into the actual data I'd like to show a terrible picture. This would be our type A battery.

(Figure 2-9)

This is our Type B battery.

(Figure 2-10)

In the cell design, to show the range of current density and the voltage response obtained you see we're a little beyond the normally accepted range of current densities for lithium/sulfur dioxide systems.

(Figure 2-11)

Here we show what happens at a fairly high rate. The current density is equivalent to about 20 milliamps per square centimeter and the system is carried all the way to zero discharge, into reversal. The cell vents after the reversal condition.

(Figure 2-12)

This slide shows again a typical cell and its temperature profile limited to discharge. Notice that we do not carry the cell into reversal, therefore there was no venting. The temperature is only 110 degrees Fahrenheit.

(Figure 2-13)

Finally, we have a battery voltage. This would be the Type A battery. The temperature is plus 40 and therefore doesn't use heater power. But notice that this is a complete battery, 12 cells. Notice the temperature profile.

(Figure 2-14)

And, finally, the Type B battery. This is constant current at 9.2 amperes, and again the temperature goes to almost 200° F.

(Figure 2-15)

The last slide shows an actual testing of batteries with heater, minus 65, under pulsing loads which one can calculate. You have the actual ohms. You're talking very high current. The voltage response is on the right.

The battery on the right-hand side -- the Type A battery -- was tested at 125 degrees Fahrenheit and again we get good voltage. Notice that none of these batteries have vented during the course of the discharge.

In conclusion I'd like to say that our work, although limited so far, indicates that the system, the lithium/sulfur dioxide system, appears to have come of age, is coming of age, and that a low rate system looks like it's about to enter into the high rate application category.

Thank you.

#### DISCUSSION

MARCOUX (Hughes): Have you attempted any environmental testing in mechanically severe environments with either cells or batteries?

CHIREAU: Yes, we have.

MARCOUX: Could you tell us about that, please, vibration environments in particular?

CHIREAU: We have tested both cells and batteries under conditions of very severe random vibration and have found that there is no effect, provided certain precautions are taken in the design of the cell.

The main area that one has to watch out for is the breakage of the tabs during random vibration should one reach a harmonic, but that problem has been solved.

MARCOUX: Thank you.

RAMAN (Duracell): Would you explain to me the short circuit current of the cell used in Type A and Type B batteries?



CHIREAU: In the Type A battery which uses our Model 660, the short circuit current would be estimated at approximately 22 or 25 amps. In the 550 that current would probably be somewhere in the range of about 30 amps.

RAMAN: And you were able to get with a 9 amp discharge about 2.2 volts with that 22 amp?

CHIREAU: Yes.

RAMAN: Thank you.

OTZINGER (Rockwell): What are the capacities of these two units?

CHIREAU: In the first unit the capacity is approximately 4.5 ampere-hours, and in the second about 8 ampere-hours. I will modify that to state that those are the capacities at a rated nominal, say four-hour rate. As the current or the current density goes up you will get a correspondingly lower capacity which we have established empirically, but I'd have to get it.

OTZINGER: These are basically B cell types?

CHIREAU: Yes.

BIS (NSWC): I have one question. You mentioned you balanced the cell stoichiometrically and in the same vugraph, if I recall correctly, you also mentioned that you basically are limited, lithium-limited, which means if you're going to pick the ratio you're going to be -- lithium to SO<sub>2</sub>, you're going to be excess SO<sub>2</sub>. Is that correct?

CHIREAU: No. No, that's not what was meant by projecting that vugraph. What we are trying to say is that these are desirable characteristics that we would like to see in the system. Obviously it is not possible; we can't be all things to all men. We would like to be balanced for safety, obviously, but we also know that for the sake of maximizing energy density in certain cases we would also like to be lithium-limited.

So the two statements do not compete against each other, and the designer of this system, the designer of the high rate cell, must take these things into account. What

I'm really saying is that every application must be examined on its own. We're not going to be able to pick a common garden variety cell for all applications.

WATSON (SAFT): You mentioned in your presentation reliability goals. What were your high reliability goals and did you achieve them?

CHIREAU: We have achieved the reliability goals. I believe that we had on the two battery types a requirement or goal of a mean time before failure in a non-operational mode of 420,000 hours, and under mission -- operational conditions -- a mean time between failures of 330,000 hours under some specified environmental conditions.

We achieved an equivalent of 440,337 hours, which is about, oh, 20 percent higher than what we expected. This is under the reliability assessment work that we did on this program.

SCHUILLA (CIA): I have a three-part question. I would like to know if you deliberately vented cells in a battery configuration. That's one part.

The second part is if you did, what's the case deflection in the vent area?

And the third question is if you get any deflection with the close packing arrangement in your cells -- I believe you have two vents at 90 degree angles -- what prevents it from shorting out to the cell? What would prevent one cell from shorting into another cell and bypassing the protection you have provided?

CHIREAU: Well, I'll answer your questions in turn. The answer to the first question, which was do we provide for venting in the cell, and the answer is yes.

The second question, the case deflection. You will have noted in the vignette that the battery is provided with a pressure relief valve. The pressure relief valve faces directly into the center of the battery pack.

SCHUILLA: I'm not talking about the battery case deflection; I'm talking about the cell vent area deflection.

CHIREAU: Okay. The vents are oriented in the assembly of the battery. They are oriented towards the central longitudinal space where they can deflect or move and it is not restrained. Actually when the cells vent and there is movement of the vent, of the side vent, the metal just merely moves in the center space which we allow for such deflection of the metal.

There is no problem insofar as preventing the motion of the cells, or the motion of the wall in some case, the wall from moving. We have not had that problem.

And what was the third part?

SCHUILLA: I'm looking at the two cells. They're situated butted up against each other. If you have a vent portion facing another cell--

CHIREAU: They do not face another cell. They face a void which is located, as I say, in the longitudinal aspect. The cells are cylindrical and when they're formed into the configuration we have shown there's a center void space which is allowed, and the cells vent into that space. And there's a conduit which allows the gases to escape from that space into the vent.

SCHUILLA: Thank you.

HELLFRITZSCH (Self-employed): When I hear 400,000 hours mean time between failure, that's like over 40 years or 50 years. I think I need to know what "failure" is defined as, and how in the devil you ever were able to determine something like 50 years.

CHIREAU: We did what I guess the statistician would call a failure mode effects and criticality analysis, and basically every component in the system is assessed a certain mean time to failure. And the addition of the time to failure of every one of these components amounts to this nebulous number of 400,000. I'm not much of a statistician myself but apparently the numbers come out.

HELLFRITZSCH: I'd be interested in if a hundred batteries or cells are put to the test, or a thousand for the old reliability figure on what percent will have failed and what percent will not have failed.

CHIREAU: In effect in the program the same approach is taken. In fact, as part of this program, some -- what? -- upward of 3500 cells were actually put through their paces through various tests, of course.

HELLFRITZSCH: And how many failed?

CHIREAU: I don't have those figures.

HELLFRITZSCH: Did any fail?

CHIREAU: Yes. There are various criteria for failing.

HELLFRITZSCH: I recommend that they develop a way of conveying reliability in numbers that make some technical sense. This method doesn't make any sense at all.

PRIMARY CELL COMPARATIVE PERFORMANCE

CHARACTERISTIC	CARBON	MnO <sub>2</sub>	LITHIUM	MERCURY	SILVER
	ZINC	ALKALINE	-SO <sub>2</sub>	ZINC	ZINC
OPERATING VOLTAGE	1.55	1.55	3.0	1.25	1.50
SHELF LIFE :					
STORAGE TEMP.					
70°F	1-2 yrs	1-2 yrs	5 yrs	2-3 yrs	1 yr
130°F	1-5 mos	2 mos	5 yrs	3 mos	3 mos
LOW TEMPERATURE: (PERCENT OF 70 F) CAPACITY					
+20°F	5%	15%	96%	0%	50%
-20°F	0%	3%	85%	0%	10%
-40°F	0%	0%	60%	0%	0%
WATT-HRS PER LB	19.5	26	125	40	45
WATT-HRS PER CU. IN	1.6	2.3	7.1	4.8	3.5

Figure 2-1

PROPERTIES OF PCI LITHIUM SULFUR DIOXIDE PRIMARY CELLS

MODEL NO.	EQUIV. SIZE	CAPACITY AH	RATED LOAD MA	OZ.	GM.	IN.	DIA. MM	IN.	HEIGHT MM	IN. <sup>3</sup>	VOLUME CC	WATT-HRS PER POUND	WATT-HRS PER IN. <sup>3</sup>
400-5S	½ AA	.525	20	.28	8.0	.562	14.27	.98	24.89	.24	3.98	90	6.5
440S		1.0	40	.42	12	.637	18.18	1.31	33.27	.42	6.83	115	7.2
400S	AA	1.2	50	.46	13	.562	14.27	2.0	50.80	.49	8.13	125	7.2
440-1S		1.3	60	.63	18	.637	16.18	1.687	42.85	.54	8.82	99	7.2
660-2S	¾C	3.0	160	1.34	38	1.012	25.70	1.63	41.40	1.31	21.48	107	6.9
660S	C	4.0	180	1.62	46	1.012	25.70	2.000	50.80	1.61	26.35	119	7.5
660-3S	1½C	5.0	200	1.97	56	1.012	25.70	2.4	60.96	1.93	31.64	122	7.8
550S	D	8.0	250	2.96	84	1.310	33.27	2.4	60.96	3.25	53.23	130	7.3
660-AS		10.0	400	3.56	101	1.637	41.58	2.000	50.80	4.21	68.97	135	7.1
660-50S		10.0	400	4.05	115	1.012	25.70	5.0	127.00	4.02	65.91	119	7.5
1500-20S		10	400	3.17	90	1.512	38.40	2.00	50.80	3.59	58.84	151	8.4
660-5S		25.0	750	7.82	222	1.637	41.58	4.5	114.30	9.47	155.20	154	7.9
1500-50S		25	750	7.75	220	1.512	38.40	5.00	127.00	8.98	147.12	156	8.4
660-5AS		30.0	1000	10.1	287	1.637	45.58	5.5	139.70	11.57	189.70	143	7.8

Figure 2-2

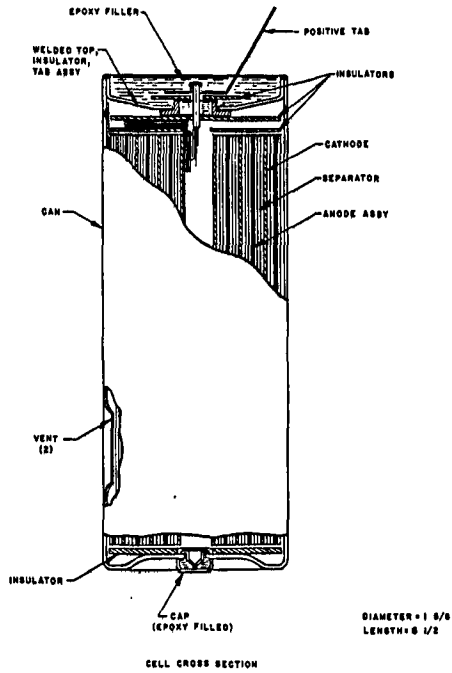

Figure 2-3

BATTERY FUNCTIONAL USE AND ELECTRICAL CHARACTERISTICS.

	TYPE A	TYPE B
1. OPEN CIRCUIT VOLTAGE	35.4	35.4
2. LOAD PROFILE (MAX CURRENT)	4A Steady State load	9.2 aa load
	18A 10 ms pulse	No pulses
	10A 10 ms pulse	
	9.6A 200 ms pulse	
	5.4A 50 ms pulse	
3. NOMINAL OUTPUT VOLTAGE		
@ Steady State	4 amps	9.2 amps
+ 70°F	31.8 volts	31.2
+125°F	32.4 volts	31.8
- 65°F (with heater)	26.4 volts	30.0
4. CUT-OFF VOLTAGE	24.0 volts	24.0
5. SERVICE LIFE	11.5 minutes min.	11.5 minutes min.
6. INSULATION RESISTANCE	100 megohms	100 megohms
	@ 500 vdc	@ 500 vdc
7. TEMPERATURE RANGE		
QUALIFICATION LEVEL	-65 to + 125°F	+40 to + 120°F
ACCEPTANCE LEVEL	-47 to 107°F	+58 to + 102°F
STORAGE	-40 to 140°F	-40 to + 140°F
8. ENERGY DENSITY		
Whrs/lb	47	50
Whrs/cu. in.	2.4	2.6
9. POWER DENSITY, W/cu. in.	14.1	4.8

Figure 2-4

CELL DESIGN CONSIDERATIONS FOR HIGH RATE APPLICATIONS.

- (a) ELECTRODE DESIGN
  - HIGH POWER CONFIGURATION
  - BALANCED ELECTRODE CONFIGURATION
  - LITHIUM LIMITED
  - HIGH CATHODE EFFICIENCY
  - ANODE CURRENT COLLECTOR
  - MULTIPLE TABS
  - PARALLEL ELECTRODES
- (b) HERMETIC SEAL DESIGN .
- (c) EVALUATION OF VENTING FEATURES AND CONDITIONS OF VENTING.
- (d) EFFECTS OF UNUSUAL CONDITIONS OF USE SUCH AS HIGH TEMPERATURE DISCHARGE.
- (e) LOW RESISTANCE SEPARATOR TO MINIMIZE OHMIC LOSSES.
- (f) PERFORMANCE/SAFETY CONSIDERATIONS.

Figure 2-5

PRIMARY BATTERY DESIGN CRITERIA

- 1. ENERGY AND POWER DENSITIES (Wh/kg, Wh/dm<sup>3</sup>, W/kg, W/dm<sup>3</sup>).
- 2. CHANGE OF THE ABOVE WITH STORAGE.
- 3. SUSCEPTIBILITY TO MECHANICAL, CHEMICAL OR ELECTROCHEMICAL DEGRADATION (I.E. RELIABILITY).
- 4. VOLTAGE REGULATION (LOAD ON DISCHARGE).
- 5. STORAGE LIFE.
- 6. EFFECT OF TEMPERATURE ON (1) (3) (4) (5).
- 7. SPECIAL CRITERIA (I.E. RESISTANCE TO SPECIFIC ENVIRONMENTS).
- 8. DIODE PROTECTION
- 9. BATTERY ENCAPSULATION
  - NON-FLAMMABLE
  - SAFETY VENT ACTIVATION
- 10. TEMPERATURE CONTROL AND LIMITATION ON DISCHARGE.

Figure 2-6

BATTERY DESCRIPTION AND CHARACTERISTICS.

TYPE A

TYPE B

ENVELOPE DIMENSIONS:

Length : 5.00 inch (max)  
 Width : 3.91 " "  
 Height : 2.44 " "  
 Weight : 2.5 lbs "

5.90 in. (max)  
 4.50 " "  
 2.80 " "  
 3.35 lbs "

CONFIGURATION :

- |   |  |
|---|--|
| <ol style="list-style-type: none"> <li>1. BATTERY CONSISTS OF 12 SERIES CONNECTED, SEALED LI/SO<sub>2</sub> CELLS MODEL 660-3-S- HRS PACKAGED WITHIN A SEALED S.S. CANISTER .</li> <li>2. CONNECTOR : MATES WITH MS 274-84E 10F 35P.</li> <li>3. DIODE PROTECTION : INDIVIDUAL CELLS ARE DIODE PROTECTED.</li> <li>4. A SAFETY CENT MECHANISM ON THE COVER OF THE BATTERY CASE IS DESIGNED TO RELIEVE INTERNAL CANISTER PRESSURE.</li> <li>5. A HEATER BLANKET SURROUNDS THE INTERNAL CELL STACK STRUCTURE TO PERMIT BATTERY OPERATION AT TEMPERATURE OF -65 F .</li> </ol> | <ol style="list-style-type: none"> <li>BATTERY CONSISTS OF 12 SERIES CONNECTED SEALED LI/SO<sub>2</sub> CELLS MODEL 550-S - HRS PACKAGED WITHIN A SEALED S.S. CANISTER .</li> <li>CONNECTOR : MATES WITH MS 27484E 14F 18P.</li> </ol> |
|---|--|

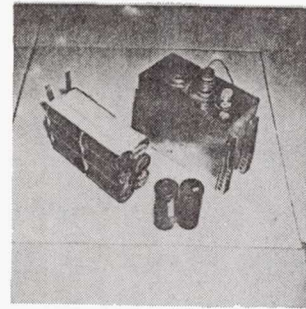

Type 'A' Li/SO<sub>2</sub> Battery  
 12 x 660-3-SHR-S (5.3AHnom)

Figure 2-7

Figure 2-8

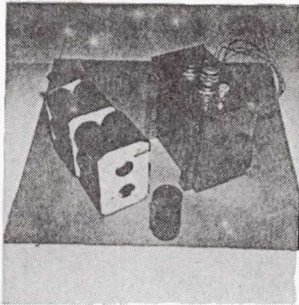

Type 'B' Li/SO<sub>2</sub> Battery  
 12 x 550-SHR-S (8.0AHnom)

Figure 2-9

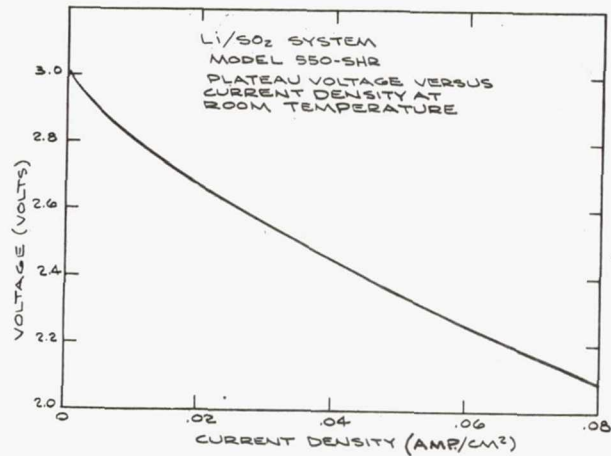

Figure 2-10

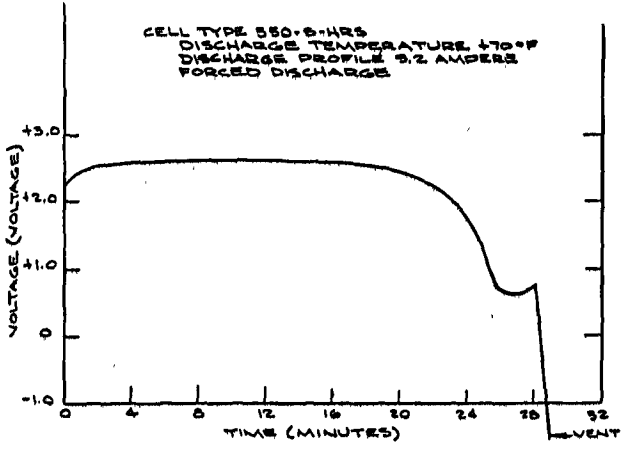

Figure 2-11

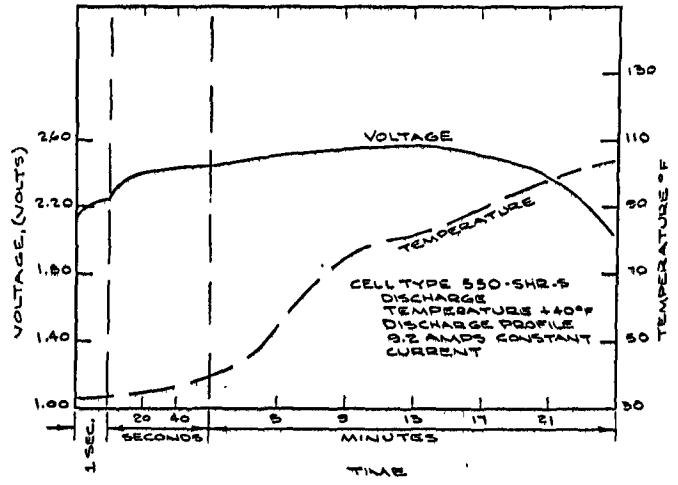

Figure 2-12

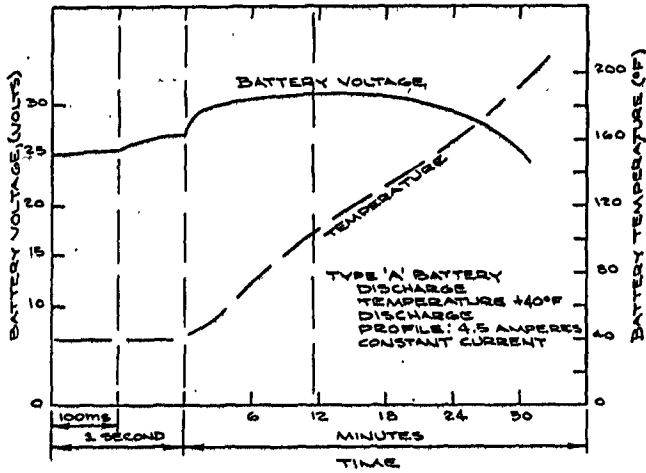

Figure 2-13

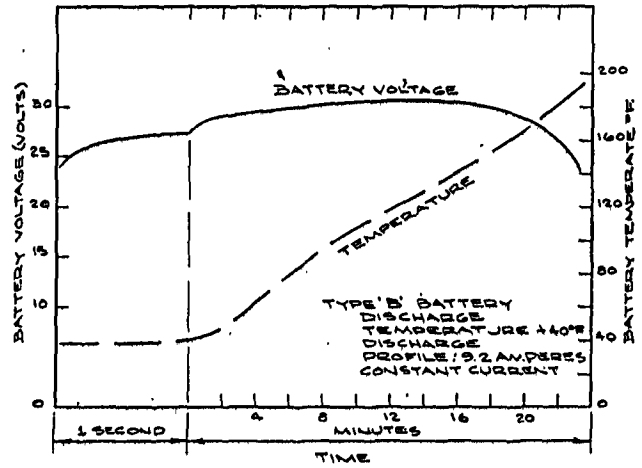

Figure 2-14



BATTERY DEVELOPMENT TESTING RESULTS.

I- BATTERY TYPE A ( TESTED @ TWO (2) TEMPERATURES)  
(PULSING PROFILE)

DISCHARGE TIME ( SEC)	PULSING LOAD		BATTERY VOLTAGE	
	AMPS	OHMS	<u>S/N 001</u> -65°F (W/HEATER)	(VOLTS) <u>S/N 002</u> +125°F
0	-	-	35.07	35.04
36	4.0	-	30.89	31.09
37	-	0.5	23.43	22.20
37.5	4.0	-	30.89	31.09
38	-	1.0	24.66	22.20
38.5	4.0	-	30.89	31.09
39	-	0.5	23.43	23.69
39.5	4.0	-	30.89	27.22
40	-	1.0	24.66	29.08
40.3	-	2.9	26.71	23.69
41	5.4	-	29.45	29.70
44	-	1.0	24.66	25.20
290	5.4	-	29.45	30.13
300	-	1.0	24.66	25.20
314	5.4	-	30.14	30.13
527	-	1.0	26.99	25.20
690	4.0	-	31.91	31.63

II. - BATTERY TYPE B ( TESTED @ TWO (2) TEMPERATURES)  
( 9.2 AMPERE CONSTANT CURRENT)

	<u>+ 40°F</u>	<u>+ 120°F</u>
DISCHARGE TEMPERATURE		
BATTERY OCV	35.15	35.05
BATTERY VOLTAGE	-	-
@ 20 MS	23.64	29.04
@ 11.5 minutes	30.44	31.20
@ END OF DISCHARGE	24.75	30.46
DISCHARGE TIME (MINUTES)	23	18
BATTERY TEMPERATURE°F	-	-
@ 11.5 minutes	118	181
@ END OF DISCHARGE	167	213

Figure 2-15

ACCELERATING RATE CALORIMETRY: A NEW TECHNIQUE  
FOR SAFETY STUDIES IN LITHIUM SYSTEMS

W. Ebner, Honeywell

Thank you, Dr. Bis.

Solving the safety problems associated with lithium electrochemical systems is currently a major priority for the battery industry. This morning I would like to discuss a new technique we're using at Honeywell to study these safety problems, and present some of the initial results we've attained with the lithium-sulphur dioxide system in a contract with the Naval Surface Weapons Center.

The technique is accelerating rate calorimetry and was developed by Dow Chemical Company specifically for the purpose of studying thermal runaway reactions. Columbia Scientific Industries, Incorporated, commercially markets the instrument we are using.

Lithium cells are sometimes known to undergo thermal runaway reactions following certain abuse modes such as forced discharge into reversal and charging. Safety studies therefore should quantitatively determine the hazards associated with these thermal runaway reactions independent of any heating effects. This is what we are presently trying to do with the lithium-sulphur dioxide system under conditions of forced discharge into reversal, resistive overdischarge, and charging.

Generally a thermal hazard is characterized by the rate of temperature rise and the overall magnitude of temperature and pressure increase. Therefore, in conducting a thermal hazards investigation it's important to acquire information dealing with the kinetics of the reaction; that is, its time and temperature behavior, the thermodynamics of the reaction; that is, its total energy release, along with its pressure behavior.

In our studies with the lithium-sulphur dioxide system, our objectives are first to determine whether or not exothermic reactions play a significant role in a particular test mode.

Secondly, we want to characterize any observed exothermic reactions with respect to their time-temperature and time-pressure behavior.

Finally, for any major exotherms, we want to identify the reactions occurring so that we may find a way to eliminate or inhibit them.

because the accelerating rate calorimeter was designed specifically for the purpose of thermal hazard investigations, it has certain advantages over conventional techniques such as differential thermal analysis and differential scanning calorimetry. These advantages are summarized in the first slide.

(Figure 3-1)

First, the effects of self-heating are taken into consideration, which allows an accurate assessment of the hazard to be made both with respect to the degree to which the reaction is accelerated by temperature, and also with respect to obtaining the minimum initiation temperature.

When the effects of self-heating are taken into account, the initiation temperature would be much lower than that obtained in DTA studies.

Secondly, the instrument is designed to be rugged enough to withstand explosions.

Third, pressure data are obtained directly thus allowing the magnitude of the hazard to be directly obtained.

Fourth, large sample sizes can be employed. This allows us to conduct analyses on actual cells rather than being limited to microquantities of reagents such as is the case in DTA and DSC studies. This feature also makes it much easier to collect samples at the end of the experiment in order to identify the products formed.

Finally, gas samples can be collected during the course of an experiment which are very useful for identifying the reactions taking place.

The accelerating rate calorimeter is essentially a

microprocessor-controlled adiabatic calorimeter. During the course of an exothermic reaction the instrument maintains a sample under adiabatic conditions and monitors the temperature and pressure as a function of time. This particular instrument has the capability of studying reactions up to temperatures as high as 500 degrees Centigrade, and pressures up to 2500 pounds per square inch.

(Figure 3-2)

This slide shows the time-temperature behavior of a typical thermal runaway reaction, in this case the decomposition of di-tertiary butyl peroxide. It is this exponential behavior that characterizes a thermal runaway reaction.

Data obtained from the experiment can be used to kinetically model the behavior of a system over the temperature range of interest. Without mechanistic information, however, on the reactions taking place, the kinetic parameters cannot be given fundamental significance, but they are very useful in predicting the behavior of the system.

The key feature here is that this type of information can be obtained without having any knowledge of the reactions taking place. This is extremely important when evaluating complex samples such as are involved in lithium cell evaluations.

The kinetic parameters of the reaction are extracted through a mathematical analysis of the data. First the data are plotted as the log of temperature rate versus the reciprocal of the absolute temperature which is shown in the next slide.

(Figure 3-3)

Again this is the data for the di-tertiary butyl peroxide which is used as a standard for the instrument. This is essentially an Arrhenius plot of the data, and the activation energy of the reaction is given by the slope of the curve at the starting point of the reaction, while the overall temperature rise (the adiabatic temperature rise) gives the energy released by the reaction.

In those systems where consecutive or multiple reactions take place, each reaction will give a curve similar to this which then can be individually analyzed.

In the studies we are conducting with the lithium/sulphur dioxide system, our work has focused mainly on forced discharge into reversal, at least to date. I would now like to present some of those results.

(Figure 3-4)

This slide shows the general characteristics of the cell we're using in our evaluation. We're incorporating a reverse wrap. The cell has a surface area of approximately 70 square centimeters and a capacity of 1.4 amp-hours. Our electrolyte solution incorporates 68 weight percent sulphur dioxide and 6.4 weight percent lithium bromide. Also our anode incorporates a nickel-expanded metal current collector.

(Figure 3-5)

This slide shows the test vehicle we are using. The cell wrap is contained in a stainless steel housing which has an internal O-ring seal. The case acts as the negative terminal and the positive terminal is brought out through a teflon compression seal. The cell is then connected to the calorimeter through a Swagelok fitting.

Our investigations also consider the effects of cell design on safety. Four different cell designs are being employed, each incorporating different ratios of active components.

(Figure 3-6)

This slide summarizes the four designs that we're using. The first design is lithium-limited. The second design is coulombically balanced. The third design incorporates excess carbon, while the fourth design incorporates excess lithium.

In reverse discharge testing, each of these designs was tested and evaluated at current densities of 1 and 5 milliamps per square centimeter for a minimum of 200 percent overdischarge based on the initial sulphur dioxide

capacity.

Our results showed that all cells were thermally stable following discharge to the 2 volt cutoff. We found, however, that those cells having excess lithium at end of life, either by design or because of rate-induced inefficiencies, demonstrated an exothermic reaction shortly after the cell went into voltage reversal. We attribute this exotherm to the lithium-acetonitrile reaction although we have performed no confirmational analyses to date.

(Figure 3-7)

This slide shows some of the component ratios present at the cells at the 2 volt cutoff level. Of the eight cells that we tested, four demonstrated this exothermic reaction during voltage reversal. At the 1 milliamp per square centimeter discharge rate, we found that only the cell containing excess lithium by design gave the reaction.

At 5 milliamps per square centimeter, however, all cells except the one that was lithium-limited by design gave the reaction.

We wanted to look at some indicators to see if we could predict whether or not this reaction would occur in future cells. And using the weight of sulfur dioxide per unit area of lithium as an indicator, we found that this reaction can occur at values as high as 25 milligrams of sulfur dioxide per square centimeter of lithium.

Another indicator we looked at was the sulfur dioxide/lithium ratio. From these results this appears to be a more reliable indicator as to whether or not this reaction will occur in a particular cell. A value between 1.7 and 2.0 is indicated to be the threshold for stability.

(Figure 3-8)

Now this slide shows the time/temperature profile for this reaction. Here the experimental data being presented is for the cell containing excess lithium by design. It was tested at the 1 milliamp per square centimeter rate.

The bottom curve represents the actual experimental data, and in contrast to a typical thermal runaway reaction, this reaction doesn't show the exponential time/temperature behavior at the end of the reaction. The type of behavior observed in this cell is indicative of a low activation energy reaction and in fact, our results indicate an activation energy of approximately 8 kilocalories per mole for this reaction.

One of the key features of the accelerating rate calorimetry is the ability to use the experimental data to make predictions about the chemical system in different types of hardware and equipment. Now using this data, we were able to easily make predictions about how this reaction would behave in different cell configurations. Here is the predicted behavior of a lithium/SO<sub>2</sub> D cell.

Although this reaction doesn't constitute a thermal runaway hazard in itself, these results show that insulated cells can reach temperatures in excess of 130 degrees Centigrade.

(Figure 3-9)

This slide shows the pressure/time behavior for this reaction. Again, the shape is very similar to that of the time/temperature profile. This particular cell obtained a maximum pressure value of approximately 115 pounds per square inch.

No additional exothermic reactions were detected during continued reverse discharging of any of the cells. However, at the completion of the reverse discharge, the cells were heated and the stability evaluated at elevated temperatures. We found that in most instances the cells exhibit a series of exothermic reactions initiated in the 120 to 140 degrees C. range.

(Figure 3-10)

Now this slide shows the time/temperature profile for one of the cells. Again, this is the cell containing excess lithium by the design, tested at 1 milliamp per square centimeter.

Here we see that we obtain an exponential

time/temperature behavior indicating that these reactions constitute a thermal runaway hazard. The lower curve represents the actual experimental data. Again, the upper curve represents the predicted behavior for the lithium/sulfur dioxide D cell.

We see here that these reactions can cause an insulated cell to exceed temperatures of 300 degrees Centigrade.

(Figure 3-11)

Now this slide shows the Arrhenius type plot for these data. These data demonstrate that this exotherm is caused by multiple reactions, and specifically two major reactions are indicated, one represented by this peak, and one represented by this peak.

There is also indication that this second exotherm is actually composed of two separate reactions, one here and one here.

We are still in the process of analyzing the data, but I would like to present some of our preliminary results.

(Figure 3-12)

We found that the first exotherm has an initiation temperature of 138 degrees Centigrade and the second exotherm starts at 163 degrees Centigrade. For this preliminary analysis we're treating the second exotherm as a single reaction.

Now the adiabatic temperature rise shown in this column is proportional to the energy released by these reactions, and our preliminary analysis shows that both exotherms are represented by first order reactions with apparent activation energies of 54 and 36 kilocalories per mole respectively.

(Figure 3-13)

This slide shows the pressure/time behavior for this reaction. Again we see exponential behavior and the high values obtained demonstrate that these exotherms indeed represent a serious safety hazard.



Also, the fact that the lithium-acetonitrile reaction can cause cells to reach the initiation temperatures of these exothermic reactions is important. This means that a significant thermal runaway hazard can exist for reverse discharge cells containing excess lithium even at temperatures near ambient.

We are now in the process of conducting similar investigations involving resistive overdischarge and charging of lithium/sulfur dioxide cells. Following this we plan to conduct analytical work to attempt to identify the reactions responsible for the exotherms we've detected.

In conclusion, we believe that the accelerating rate calorimeter is a powerful tool for studying the safety problems associated with lithium electrochemical systems and hopefully this technique can lead to a solution to some of these problems.

We also wish to thank the Naval Surface Weapons Center for support of this work.

Thank you.

BIS: Any questions on this paper?

RAMAN (Duracell): Can you explain to me about the SO<sub>2</sub> to cathode ratio? You showed that. How did you arrive at the capacity of the cathode?

EBNER: For this purpose we used a nominal value of 1.44 amp/hours per gram of carbon as a baseline value. That's approximately the limiting value obtained at low current densities.

RAMAN: Okay. I asked because it could vary with the kind of process you use.

EBNER: Yes, it could. But this is based on our technology at the present time, and essentially that's the limiting value for our present cathode.

RAMAN: Thank you.

CHODUSH (Power Conversion): On one table you indicated the ratios of SO<sub>2</sub> to lithium and described them

as safe limits. If my notes are correct it was 25 milligrams of SO<sub>2</sub> to 1 milligram of lithium, and in another column there was a ratio of 1.7 to 2 for stability. If you could expound on those areas I'd appreciate it.

EBNER: The first value that I referred to was the milligrams of sulfur dioxide per square centimeter of lithium and the second was the SO<sub>2</sub>/Li ratio. These are both intended to represent the balance between sulfur dioxide and the lithium metal present.

There's a certain threshold of sulfur dioxide concentration that's required to inhibit or prevent the lithium-acetonitril reaction. And what we're trying to do here is take this information and see if we could identify a parameter that would indicate whether or not this reaction would occur, to see if we could identify a threshold concentration level.

Intuitively, the weight of sulfur dioxide per unit area would be the more reliable indicator. And there's been some references in the literature that a minimum value of 10 milligrams of sulfur dioxide per square centimeter of lithium is required to prevent the lithium-acetonitrile reaction.

Our results indicate that this indicator is somewhat rate-dependent, however, and that values as high as 25 milligrams of SO<sub>2</sub> per square centimeter of lithium were not sufficient to prevent the reaction.

Now the other indicator that we used was the sulfur dioxide/lithium ratio, and this is the equivalent of sulfur dioxide per equivalent of lithium. This compares the actual quantities or concentrations of the two components.

ADVANTAGES OF THE ACCELERATING RATE CALORIMETER

- TESTS CONDUCTED UNDER ADIABATIC CONDITIONS SO THAT THE RATE OF SELF-HEATING CAN BE DETERMINED.
- INSTRUMENT RUGGED ENOUGH TO WITHSTAND EXPLOSIONS.
- PRESSURE DATA CAN BE OBTAINED.
- LARGE SAMPLE SIZES CAN BE EMPLOYED.
- GAS SAMPLES CAN BE COLLECTED DURING EXPERIMENT

Figure 3-1

BEHAVIOR OF A TYPICAL THERMAL RUNAWAY REACTION

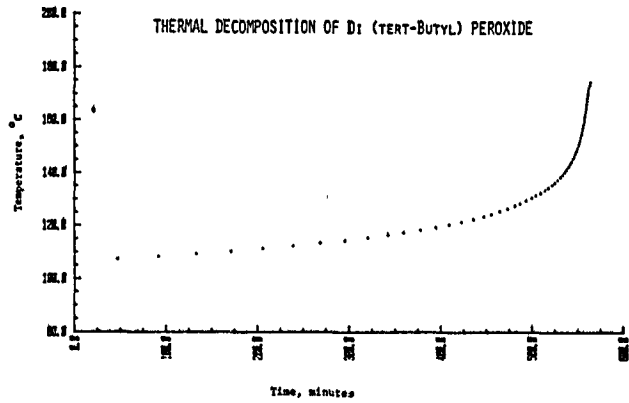

Figure 3-2

BEHAVIOR OF A TYPICAL THERMAL RUNAWAY REACTION

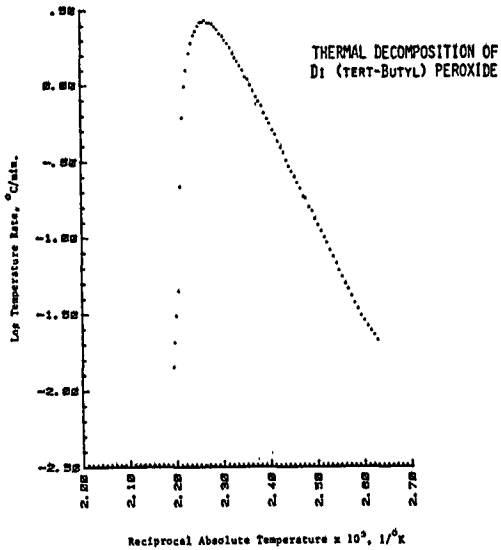
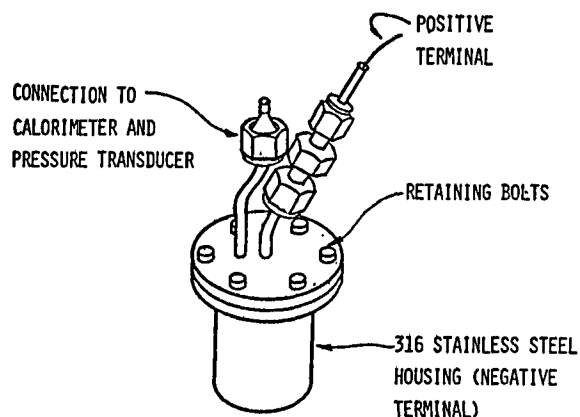

Figure 3-3

ARC Li/SO<sub>2</sub> CELL DESCRIPTION

- ELECTRODE CONFIGURATION: REVERSE WRAP
- ELECTRODE AREA: APPROX. 70 cm<sup>2</sup>
- CAPACITY: APPROX. 1.4 AH
- ELECTROLYTE SOLUTION: 6.40 WEIGHT PERCENT LiBr  
25.6 WEIGHT PERCENT AN  
68.0 WEIGHT PERCENT SO<sub>2</sub>
- ANODE COLLECTOR: NICKEL EXPANDED METAL GRID

Figure 3-4



ARC Li/SO<sub>2</sub> CELL HARDWARE

Figure 3-5

ARC Li/SO<sub>2</sub> CELL DESIGNS

DESIGN No.	Li/SO <sub>2</sub> RATIO	SO <sub>2</sub> /C RATIO	Li/C RATIO	DESIGN DESCRIPTION
I	0.5	1.25	0.625	LITHIUM LIMITED
II	1.0	1.25	1.25	COULOMBICALLY BALANCED (BASELINE)
III	1.0	0.5	0.5	EXCESS CARBON
IV	1.5	1.25	1.875	EXCESS LITHIUM

Figure 3-6

CELL STATUS AT END OF DISCHARGE VS DETECTED EXOTHERMS DURING VOLTAGE REVERSAL

CELL No.	CELL DESIGN	CURRENT DENSITY, mA/cm <sup>2</sup>	SO <sub>2</sub> /Li	SO <sub>2</sub> /Li AREA, mg/cm <sup>2</sup>	REVERSE EXOTHERMS	INITIAL TEMP, °C
I-1	LITHIUM LIMITED	1.0	11.3	31.3	No	-
II-1	COULOMBICALLY BALANCED	1.0	3.0	13.8	No	-
III-1	EXCESS CARBON	1.0	2.0	17.4	No	-
IV-1	EXCESS LITHIUM	1.0	0.19	6.44	Yes	40.5
I-2	LITHIUM LIMITED	5.0	7.0	41.5	No	-
II-2	COULOMBICALLY BALANCED	5.0	1.1	23.0	Yes	45.7
III-2	EXCESS CARBON	5.0	1.7	25.5	Yes	77.3
IV-2	EXCESS LITHIUM	5.0	0.44	25.2	Yes	44.0

Figure 3-7

THERMAL BEHAVIOR OF REVERSE EXOTHERM

CELL NO. IV-1

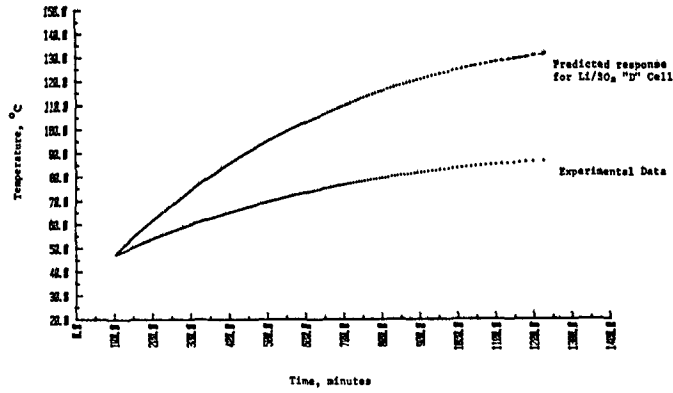

Figure 3-8

PRESSURE BEHAVIOR OF REVERSE EXOTHERM

CELL NO. IV-1

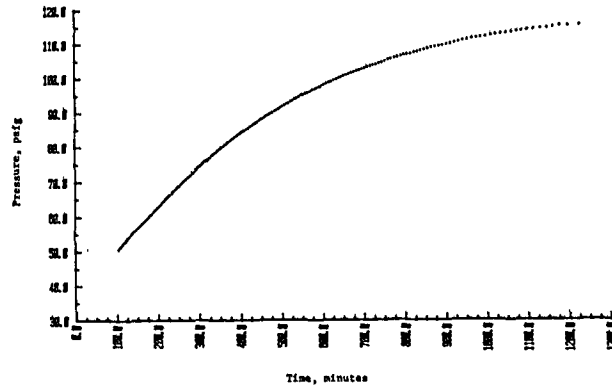

Figure 3-9

THERMAL BEHAVIOR OF ELEVATED TEMPERATURE EXOTHERMS

CELL NO. IV-1

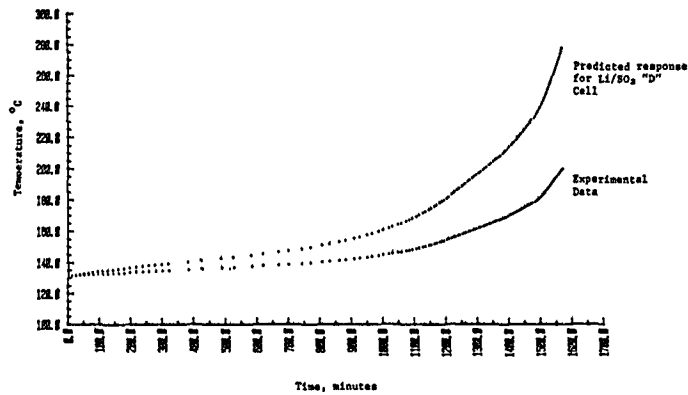

Figure 3-10

THERMAL BEHAVIOR OF ELEVATED TEMPERATURE EXOTHERMS

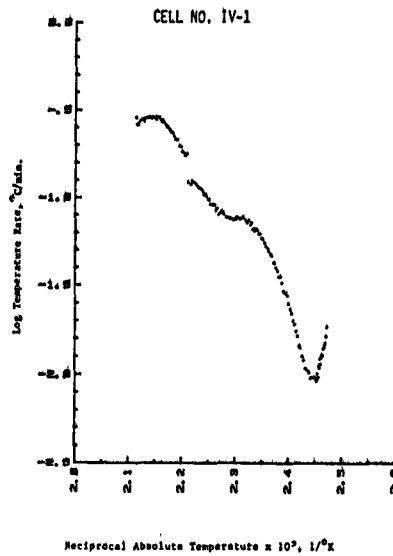

Figure 3-11

SUMMARY OF MAJOR ELEVATED TEMPERATURE EXOTHERMS

EXOTHERM NO.	INITIAL TEMPERATURE, °C	FINAL TEMPERATURE, °C	ADIABATIC TEMPERATURE RISE, °C	REACTION ORDER	ACTIVATION ENERGY KCAL/MOLE
1	138	163	25	1	54
2*	163	200	37	1	36

\* THE DATA INDICATE THAT THIS MAY ACTUALLY BE TWO REACTIONS.

Figure 3-12

PRESSURE BEHAVIOR OF ELEVATED TEMPERATURE EXOTHERMS

CELL NO IV-1

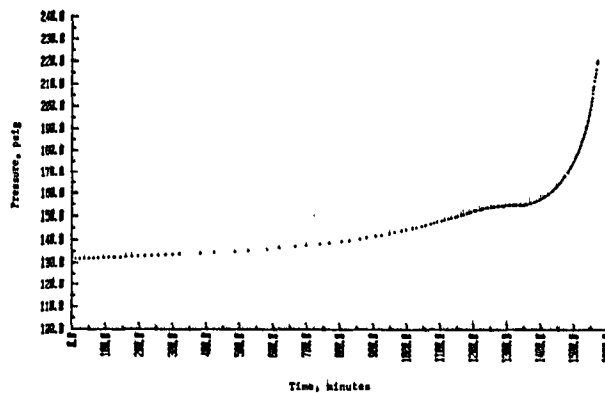

Figure 3-13

**Page intentionally left blank**

## ALTERNATE SEAL CONFIGURATION FOR LITHIUM PRIMARY CELLS

J. Kelley

Honeywell

At this time I would like to acknowledge that the work done to prepare for this paper was done under contract to Sandia Laboratories and express our appreciation for their continued support of the lithium sulfur dioxide system.

(Figure 4-1)

A problem was found in hermetically sealed lithium/sulfur dioxide cells in relationship to the glass-to-metal seals that are commonly used. This problem consisted of a degradation of the glass when it was exposed to 160 degrees Fahrenheit storage for any length of time.

The glass degradation mechanism was attributed to lithium reacting with glass which was a result of deposition of lithium at the glass/metal/electrolyte interface.

The worst degradation was observed when cells were stored in the inverted position. This degradation had two inherent failure modes; one being the deposition of lithium on the glass which made the glass conductive and applied a parasitic load between the positive terminal pin and the negative case which eventually led to self-discharge.

The second failure mode was weakened glass due to chemical reaction which led to embrittlement and stress cracking. Where this happened the seal integrity was lost and you had leakage of electrolyte.

(Figure 4-2)

In defining the problem, alternate sealing methods were looked into and one that seemed to have good possibilities was a modified Ziegler seal. This consists of a crimp type soft seal using a plastic annulus and a metal tube. This seal could be effected with a variety of materials which meant, through careful selection, that all the seal materials could be picked in such a way as to be chemically and electrochemically stable in the system.



Other advantages of the Ziegler seal were the ability to use an entire aluminum positive connection and eliminate tantalum from the design. Tantalum was used due to the diverse coefficients of thermal expansion between aluminum and most glasses. Tantalum had experienced corrosion problems in high temperature storage, which were usually linked with electrolyte degradation or decomposition.

The literature had shown that Ziegler seals were made that had comparable leak rates to standard glass to metal seals and were potentially able to survive harsher environments such as shock and vibration and temperature cycling. And combined with the mechanical simplicity of the seal and the environmental survivability, these seals could be made cost effective.

(Figure 4-3)

This is a simplified cross section of a Ziegler seal. It illustrates the basic principle of the seal as a long leakage path with a very small cross sectional area that is crimped using multiple crimps.

In our particular design we had a 304 stainless header and a standard 304 stainless tube which is laser welded at this point to the header. And we had aluminum wire with a plastic coating. Our plastic coating was a continuous coating on the length.

In our design we had used five individual crimps with a quarter of an inch separation between crimps, and the reduction in diameter due to the crimping was about ten-thousandths of an inch. These seals, when they were tested using a leak tester, showed leakage rates that met the requirements commonly used for glass metal seals.

Having established the feasibility of the seal itself, incorporation into the lithium/sulfur dioxide system was begun, the first task being to find plastic materials that were compatible electrochemically and chemically to the system. The two that were chosen were Halar, which is a copolymer of ethylene, trifluoroethylene, and Tefzel, which is ethylene-tetrafluoroethylene.

To establish electrochemical compatibility the

method of Jantz was used, and this method involves a .04 percent lithium amalgam and the sample is 50 percent immersed for seven days at room temperature.

Prior to actually building cells with these seals, dummy Ziegler Halar D cells were built. These contained electrolyte and some scavenger lithium. They were thermally cycled at 15 degrees Fahrenheit to 130 degrees Fahrenheit for four hours at each extreme.

These tests proved that there was hermeticity in the design and to date there has been no weight loss or visual evidence of leakage, and they've been on test for five months. We felt at this time there is justification to build 140 Ziegler Halar sealed cells, and they were basically of a D configuration.

(Figure 4-4)

The basic design for the cell was a D diameter jellyroll wrap with a shortened length. The Ziegler seal was inserted down the center of the wrap and a positive connection was made to the aluminum wire at the bottom of the wrap, the negative connection to the case.

(Figure 4-5)

These cells were then filled and were put through a text matrix.

(Figure 4-6)

This was the feasibility text matrix for the Ziegler Halar seals. This was to determine the effect of storage on cells.

The storage plan consisted of taking baseline cells and discharging them at 6.25 ohms at room temperature, taking two other sets of cells, putting them on storage at thermal cycling each for four hours - 15 degrees Fahrenheit and 130 degrees Fahrenheit, and taking these cells off test at one and three months to determine the effects on capacity.

The second set of tests run were to determine the effects of mechanical and electrical abuse. These tests

consisted of a short circuit test, a forced discharge to 200 percent of initial capacity, a drop test which is a 1,000g shock in the horizontal and vertical axis, and a vibration test which was defined by DDT-E-7052, which is the standard transportation shock and vibration requirement for lithium/sulfur dioxide cells.

(Figure 4-7)

This shows the results of the storage test. The baseline cell delivered approximately 7.9 ampere-hours and after three months cyclic storage the capacity loss was approximately .3 ampere-hours.

(Figure 4-8)

This slide and the next one show typical discharge curves, voltage versus time. This is for a fresh cell.

(Figure 4-9)

And this is for a cell that has been stored for three months, or 93 days. As you can see, the curves are quite similar, the only difference being a slight decrease in capacity on the stored cells.

(Figure 4-10)

During abuse testing, there were actually no unexpected problems from short-circuiting the cells. Cell peak currents were approximately 50 amperes, and the safety mechanism, which is a coined slot vent at the bottom of the cell case, functioned as it normally does in our glass-to-metal seal cells.

In cell reversal, cells were driven into reversal up to 200 percent of their initial capacity, and there were no problems. There was no venting of the cells, and no evidence of leakage, either from visual inspection or weight loss.

The drop test and vibration test had no effect on seal integrity. It also had no effect on the performance of the cells.

(Figure 4-11)

In conclusion, we feel that the feasibility of a Ziegler seal in the lithium/sulfur dioxide system has been demonstrated. The hermeticity was maintained under both thermal cycling conditions and continuous exposure to 160 degrees F. The cell is easily adapted to using only chemically and electrochemically inert materials such as Halar and Tefzel.

The abuse testing showed that even in the unoptimized configuration, these cells were able to withstand standard abuse for lithium/sulfur dioxide cells and the key advantage of the Ziegler seal is that it can be optimized and it can be adapted to other lithium systems

The areas where this can be done are component materials. These materials can be picked to be compatible with other electrochemistries, and the mechanical properties of the materials can be optimized to make cells that have better seal integrity.

The structural integrity can be optimized by doing more analytical work on the natural crimping patterns and the size of crimp.

Reproducibility of the Ziegler seal is quite good. It's a very simple design. The integration into the cell is easy. Such things as using the Ziegler seal as a mandrel for the jellyroll wrap and other things will be investigated.

And the cell, since it uses standard components, will be very cost-effective while still being rugged and reliable. Continued development of these seals should yield an effective alternative to the glass-metal seals.

#### DISCUSSION

HENNIGAN (Bedford Engineering): When do you make that laser weld in there? Is the plastic assembled in a tube or do you--

KELLEY: No, it's previous to that.

HENNIGAN: Okay.

KELLEY: The sleeve and header are welded

together, then the wire is inserted.

HENNIGAN: Okay. Thanks a lot.

WATSON (SAFT): Would you care to project on the estimated cost of producing this seal as compared to the glass seal in a large quantity purchase?

KELLEY: I really couldn't give you exact numbers.

WATSON: Do you think it would be more expensive or less?

KELLEY: No, it would be less expensive.

WATSON: Thank you.

ALLVEY (SAFT): On your temperature cycling, can you give an indication of the period over which the temperature changed? You went from, say, 15 to 130 in what sort of time?

KELLEY: It's approximately 20 minutes.

THOMAS (RAY-O-VAC): You have used the term "crimp" but I'm not sure. Do you mean a crimp in the sense that you nip the tube between two counterposed jaws, or did you --

KELLEY: Yes, we actually--

THOMAS: -- reduce the diameter of the tube?

KELLEY: You reduce the diameter of the tube.

THOMAS: I see. In other words it is more of a swaging inward of the material.

KELLEY: Yes.

THOMAS: Thank you.

DTZINGER (Rockwell): I notice you are using an aluminum lead then up through that --

KELLEY: Yes, an aluminum wire.

OTZINGER: That's kind of nasty to connect to that. Are you going to continue doing it that way or are there other metals that might be a little easier for us to attach to? You know, we can't solder to aluminum.

KELLEY: Yes, I know.

OTZINGER: We're going to have to come up with some kind of a special crimp.

VOICE: It's not worse than tantalum.

KELLEY: That's not good, either.

FELDHAKA (RAY-O-VAC): You showed a D sized cell there.

KELLEY: Yes.

FELDHAKA: How long was the Ziegler seal? How far did it go into the cell?

KELLEY: It's approximately two inches.

FELDHAKA: Really.

JAGID (Power Conversion): You mentioned hermeticity but you said it was approaching some value. Could you tell us what that value is?

KELLEY: The standard for glass-metal seals is  $2 \times 10^{-8}$  cc per second of helium and we test all our glass-metal seals at this, and we tested these seals. And unless it has a better leakage rate than that, they are not acceptable.

JAGID: I see. How does that compare with sulfur dioxide instead of helium at elevated temperatures?

KELLEY: Sulfur dioxide would be a larger molecule and would be less permeable in the plastic material so it would be a lower leakage rate.

#### STATEMENT OF PROBLEM

- GLASS SEAL USED IN STD.  $\text{Li}/\text{SO}_2$  CELLS DEGRADED DURING HIGH TEMPERATURE STORAGE ( $160^\circ\text{F}$ )
  - GLASS DEGRADATION MECHANISM ATTRIBUTED TO  $\text{Li}$  REACTION WITH GLASS RESULTING FROM DEPOSITION OF  $\text{Li}$  AT GLASS/METAL/ELECTROLYTE INTERFACE.
  - WORST DEGRADATION WAS OBSERVED WHEN CELLS WERE IN INVERTED POSITION.
  - FAILURE MODES:
    - RENDERED GLASS CONDUCTIVE, LEADING TO SELF-DISCHARGE OF CELLS.
- OR
- WEAKENED GLASS, LEADING TO STRESS CRACKING AND SUBSEQUENT LEAKAGE OF  $\text{SO}_2$

Figure 4-1

#### DESIGN APPROACH

- PRIOR WORK IN SEAL DESIGN SUGGESTED A MODIFIED ZIEGLER SEAL AS AN ALTERNATIVE TO GLASS-TO-METAL SEALS.
  - SEAL COULD BE EFFECTED UTILIZING MATERIALS CHEMICALLY AND ELECTROCHEMICALLY COMPATIBLE WITH THE  $\text{Li}/\text{SO}_2$  SYSTEM.
  - ELIMINATION OF TANTALUM/ALUMINUM CONNECTION AND THUS THE POTENTIAL TANTALUM CORROSION OCCASIONALLY IN EVIDENCE IN CELLS STORED AT ELEVATED TEMPERATURES.
  - HERMETICITY COMPARABLE TO STD. GLASS-TO-METAL SEALS.
  - OPTIMIZATION POTENTIAL IN THE AREAS OF ENVIRONMENTAL SURVIVABILITY AND PRODUCTIBILITY WHICH WOULD YIELD A RELIABLE, COST EFFECTIVE SEAL CAPABLE OF MEETING DEMANDING REQUIREMENTS.
- MCHENRY E. J. AND HUBBAUER, HERMETIC COMPRESSION SEALS FOR ALKALINE BATTERIES, J. ELECTROCHEM. SOC.: ELECTROCHEMICAL SCIENCE AND TECHNOLOGY, VOL. 119, No. 5, 567-568, MAY 1972.

Figure 4-2

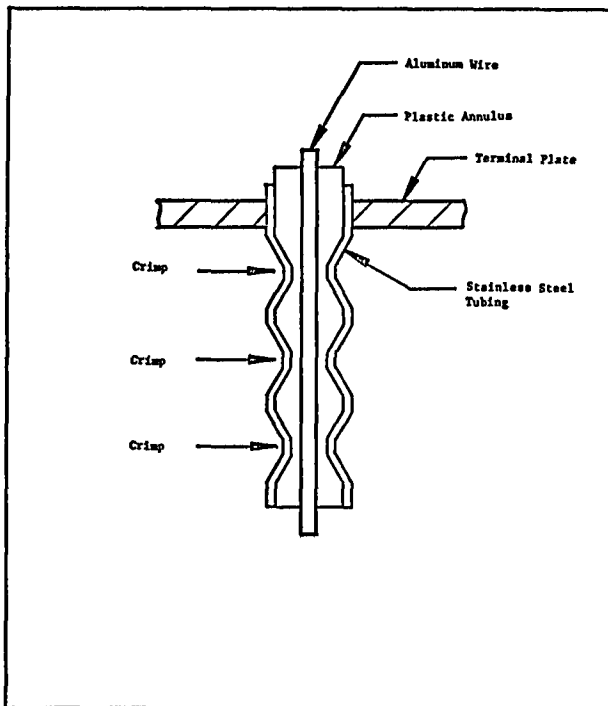

Cross Sectional View of Crimp Seal

Figure 4-3

#### ZIEGLER SEAL CELLS

- INVESTIGATED CHEMICAL AND ELECTROCHEMICAL COMPATIBILITY OF TWO HALOCARBON PLASTICS, BOTH DEMONSTRATED COMPATIBILITY.
  - HALAR (ECTFE)
  - TEFZEL (ETFE)
- METHOD OF JANTZ\* WAS USED TO TEST THE RESISTANCE OF BOTH PLASTICS TO ELECTROCHEMICAL REDUCTION.
  - PLASTICS WERE 50% IMMERSED IN 0.04%  $\text{Li}$  AMALGAM FOR 7 DAYS AT ROOM TEMP.
- PRIOR TO ACTUAL CELL BUILDS, "DUMMY" ZIEGLER/HALAR "D" CELLS (CONTAINED ONLY ELECTROLYTE AND LITHIUM) WERE THERMALLY CYCLED -  $+15^\circ\text{F}$  (4 HOURS) AND  $+130^\circ\text{F}$  (4 HOURS) - FOR HERMETICITY. TO DATE, NO WEIGHT LOSS WAS OBSERVED AFTER 5 MONTHS OF THERMAL CYCLING.
- A TOTAL OF 140 ZIEGLER/HALAR CELLS WERE BUILT FOR PERFORMANCE EVALUATIONS INCLUDING STORAGE AND ABUSE TESTS.

\*JANTZ, J. ET AL., QUANTITATIVE EXPLANATION OF THE MECHANISM OF CORROSION OF POLY (TETRAFLUOROETHYLENE) CAUSED BY ACTIVE ALKALI METALS, JOURNAL OF APPLIED POLYMER SCIENCE, 19, 3201-3210, 1975.

Figure 4-4

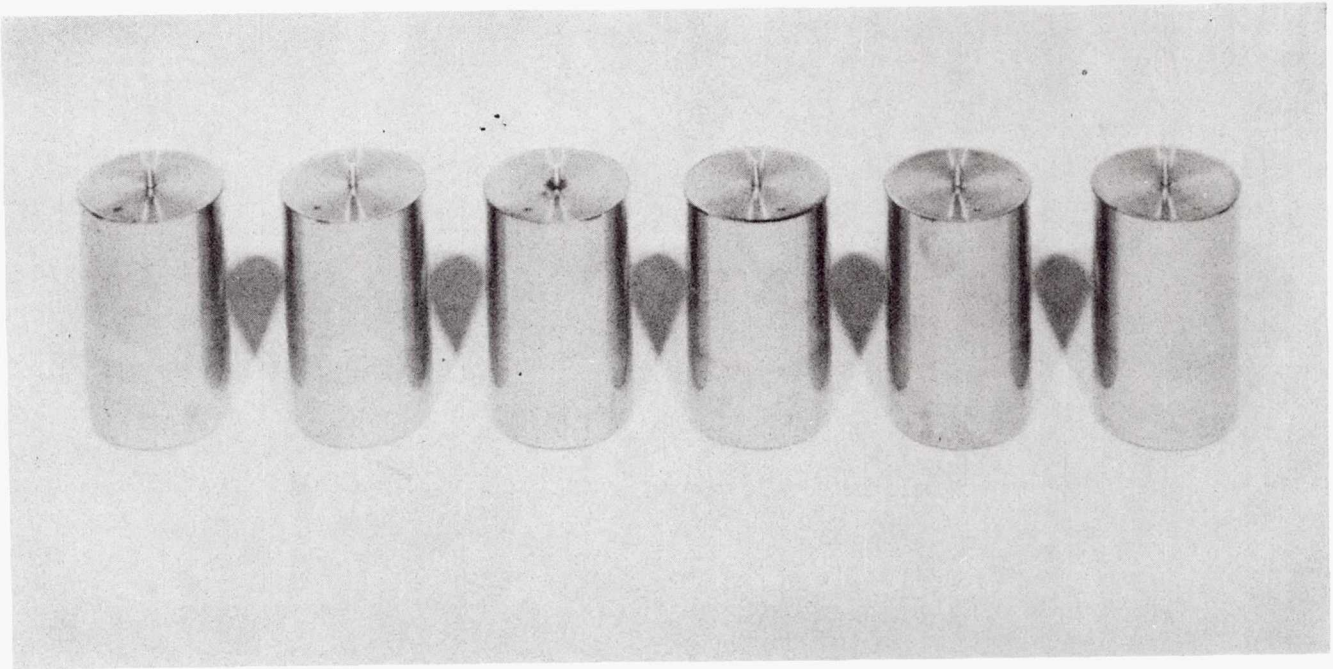

Figure 4-5

TEST PLAN FOR ZIEGLER/HALAR CELLS

- To determine the effect of storage on Ziegler/Halar Li/SO<sub>2</sub> "D" cells

	STORAGE TIME, MONTHS*		
	0	ONE	THREE
CELLS STORED ON OPEN CIRCUIT	5	5**	10**

\*ALL CELLS DISCHARGED AT ROOM TEMP WITH 6.25 OHM LOADS

\*\*CYCLE 4 HRS AT 15°F; 4 HRS AT +130°F

- To determine the effects of mechanical and electrical abuse on Ziegler/Halar Li/SO<sub>2</sub> "D" cells.

- SHORT CIRCUIT (5 CELLS)
- FORCE OVERDISCHARGE (5 CELLS) UP TO 200% OF INITIAL CAPACITY
- DROP TEST (5 CELLS)  
SHOCK AT 1000 G'S ON BOTH HORIZONTAL AND VERTICAL AXES.
- VIBRATION TEST (5 CELLS)  
DOT-E7052,8,E,111

Figure 4-6

DISCHARGE RESULTS OF ZIEGLER/HALAR Li/SO<sub>2</sub> "D" CELLS

FRESH AND AFTER VARIED STORAGE CONDITIONS

CELL #	STORAGE CONDITIONS	TIME, DAYS	Avg. E	DISCHARGE TIME, HOURS	CAPACITY, AHR
123	BASELINE ↓	0 ↓	2.79	17.7	7.9
131			2.79	17.8	7.9
134			2.78	17.5	7.8
138			2.79	17.6	7.9
151			2.78	17.7	7.9
Avg.			2.79		7.9
86	CYCLIC/OCV ↓	33 ↓	2.79	17.3	7.7
88			2.78	17.4	7.8
90			2.79	17.5	7.8
91			2.79	17.3	7.7
99			2.79	18.0	8.0
Avg.			2.79		7.8
H-74	CYCLIC/OCV ↓	93 ↓	2.76	16.86	7.45
H-78			2.75	16.85	7.41
H-80			2.78	17.57	7.82
H-33			2.78	17.37	7.73
Avg.			2.77		7.60

Figure 4-7



Baseline Ziegler/Haler Li/SO<sub>2</sub>  
"D" Cell Discharged at Room  
Temperature

TR NUMBER: 9481  
CELL NUMBER: 129  
CHANNEL NUMBER: 19  
LOAD: 0.25 Ohms

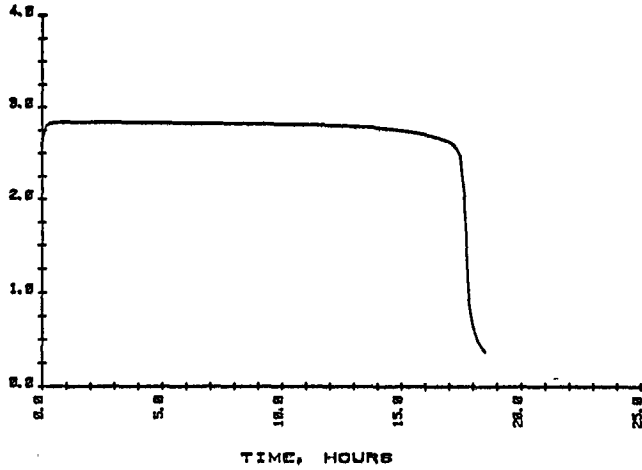

Figure 4-8

C/Cyclic  
Ziegler/Haler Li/SO<sub>2</sub> "D" Cell  
Stored 15 days on open circuit  
at temp. cycle of 4 hours at 150°F/  
4 hrs. at 130°F  
Discharged at room temperature

TR NUMBER: 9481  
CELL NUMBER: 99  
CHANNEL NUMBER: 1  
LOAD: 0.25 Ohms

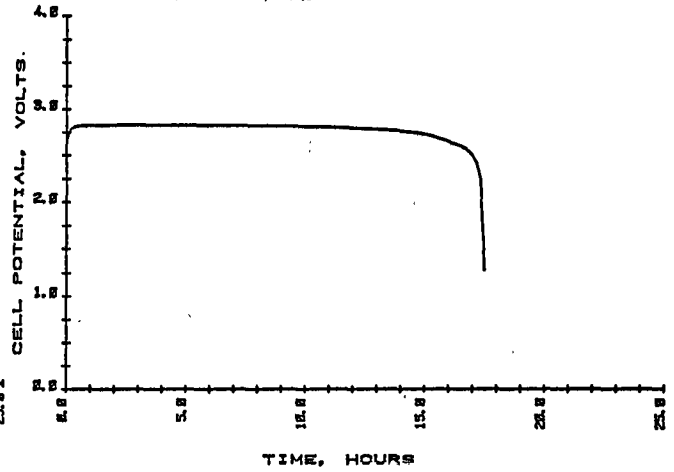

Figure 4-9

#### ABUSE TEST RESULTS

- SHORT CIRCUIT - CELL VENTING MECHANISM FUNCTIONED AS IN CONVENTIONAL CELL WITH GLASS-TO-METAL SEAL.
- CELL REVERSAL - RESULTS COMPARABLE TO CONVENTIONAL CELL WITH GLASS-TO-METAL SEAL.
- DROP TEST - NO DEGRADATION OF SEAL INTEGRITY
- VIBRATION - NO DEGRADATION OF SEAL INTEGRITY.

Figure 4-10

#### CONCLUSION

- FEASIBILITY OF ZIEGLER SEALS IN THE Li/SO<sub>2</sub> SYSTEM HAS BEEN DEMONSTRATED - A VIABLE ALTERNATE SEAL FOR THE Li/SO<sub>2</sub> SYSTEM.
- CELL HERMETICITY IS MAINTAINED UNDER BOTH THERMAL CYCLING CONDITIONS AND CONTINUOUS EXPOSURE TO +160°F.
- CELL IS EASILY ADAPTED TO USING ONLY CHEMICALLY AND ELECTROCHEMICALLY INERT MATERIALS.
- ABUSE TEST RESULTS SHOW COMPARABLE RESULTS TO CELLS UTILIZING GLASS-TO-METAL SEALS.
- THE MECHANICAL SIMPLICITY OF THE ZIEGLER SEAL LENDS ITSELF TO OPTIMIZATION AND ADAPTATION TO OTHER LITHIUM SYSTEMS.
  - COMPONENT MATERIALS
  - STRUCTURAL INTEGRITY
  - PRODUCIBILITY
  - INTEGRATION INTO CELL
  - COST EFFECTIVITY
- CONTINUED DEVELOPMENT SHOULD YIELD A RELIABLE, COST EFFECTIVE ALTERNATIVE FOR GLASS-TO-METAL SEALS.

Figure 4-11

## RECENT TEST RESULTS ON LITHIUM BCX CELLS

B. Bragg

JSC

At JSC we've been testing some Electrochem lithium BCX cells lately. We tested both the AA and D cell configurations. I'd like to describe the kind of tests we ran, consisting of hazards, off-limits type tests. We did some performance tests; we also did some assembly qualification tests with the cells or batteries installed in equipment.

(Figure 5-1)

The purpose we are pushing in the work we're doing now is to attempt to take essentially available cells from various manufacturers and attempt to certify those cells to an envelope of requirements--hopefully a rather parametric set of requirements--trying to stay ahead of some of the users we have at JSC.

We've been simply bombarded with applications of various instrumentation, primarily for small cell applications: instrumentation, crew equipment, radios, flashlights, you name it. And our intent here is to generate a family of cell sizes that we can certify to a set of requirements that future users will be able to adapt to with very minimal delta testing required.

The problem in staying ahead of these users is that we're trying to uphold the various requirements that come to light and make sure our parameters are selected such that we meet the majority of those people's needs.

What has been happening to us on these particular cells is that the users are coming up with the hard requirements before we can give them this very nice generalized cell to meet all future requirements. So we're training our users right now is what it amounts to. And our intent is to prove to ourself or disprove to ourself that we can or cannot use existing cell technology.

(Figure 5-2)

The kinds of tests that we're doing include hazards/off-limits tests. Each of these tests we run, we do an acceptance test that I've described here on each cell. We do a visual; we're looking for anything you can see with visual examination -- sort of a receipt-and-inspection type test. We measure dimensions, we measure the weight on both the AA's and the D cell. These X's indicate a repeat of a requirement that is on the left there.

We perform a temperature screen; that's simply taking a cell to various temperature levels and looking for leakage. We also look for bulging under these conditions.

On the AA's, you see, we have tested to 125° F for two hours for the cells that we would intend to fly eventually. We take the D cells to 200 degrees for two hours, looking for leakage, looking for bulging.

The length measurements I made both before and after the temperature screen.

We look for an OCV, as indicated here on the cells. We look for a load voltage check. Both these tests are six-minute maximum duration tests. The AA, we're looking at a 30-ohm load and the D, a three-ohm load; both cells should give us at least three volts at that six-minute point.

On reversal, we're looking at voltage reversal. This is the overdischarge condition. For our AA test, we tested at 65 and 125 milliamps. Under the D, we tested at those three rates: one, 1.5 and three amps under room temperature, minus 20 degree F environments, 120 degree F environments in both Argon and in a vacuum environment.

We exposed the AA's to a maximum of 300 degrees F to see if they would vent at that point. The D's, we went ahead and heated until they did vent and recorded those temperatures. We did that on both fresh and discharged cells.

In load sharing, what we were looking for there was to see if there's any chance at all of getting by without diodes under parallel load configurations.

My feeling is that we would not fly cells without

that diode protection. But we were primarily looking for the amount of charging or reverse current that we might get through the cell when you hooked up a discharged cell and a fresh cell in parallel.

On the AA's, what we actually did was hook up four-cell packs: one discharged four-cell pack and one fresh four-cell pack in parallel on a 10 $\Omega$ -ohm load. The D's were run with three cells in parallel.

And essentially all of these conditions were pretty well prescribed by several applications that were in-hand at the time and that we were trying to spread our data to meet the requirements.

(Figure 5-3)

Under performance, we did capacity tests. On the AA, we looked at a couple of rates: 25 ma and 65 ma at those three temperatures we indicated. On the D's, we had three rates and four temperatures.

The room temperature indication should be 25 degrees F under the D. 25 degrees F, minus 40, 90 and 160.

Those rates pretty well correspond to a range of rates we were looking for: that is, about a half an amp, one amp, one and a half amps.

We subjected the cells at the cell level, hard-mounted cells, to shock and vibration tests: 20 g peak for 11 millisecond rise on both.

We also conducted a random vibration test. Only the maximum level do I give you here, and that is the 0.1 g squared per hertz: I guess the integrated energy is 9.625 G(RMS).

On assembly tests, a couple of the applications have run through their qualification testing, and those rates on D's, at least, consisted of approximately one amp and one and a half amps at a number of temperature extremes.

(Figure 5-4)

Some results on the D cells under short-circuit

conditions. We tested a total of about 36 cells in various configurations. I guess I should point out first that all of our tests, in order to establish some sort of a worst-case base position, attempted to insulate the cells and run them under the short-circuit conditions.

Once we established what our thinking was, once we established the maximum temperature you could get to with no heat rejection or no heat conduction out of the cell, we could back off from there in our designs to accommodate whatever heat rejection was required.

It turns out that a ceramic holder -- it's a ceramic foam holder, it's a fairly lightweight ceramic -- does have heat capacity. And the heat capacity that that holder did have was sufficient in all those tests to keep the cells down below this 300-degree maximum in the range that I indicate there: 163 to 290 degrees F. I indicate that we did not get any venting under those conditions.

I have a footnote that we did get some venting; however, what we found is that in order to try to get as low an impedance as we could on that particular test, we wound up with a clamped sort of an arrangement and, in doing so, as the temperature went up in the cell and the cell attempted to bulge or move, we were imposing some axial stresses on the pin that's in the glass seal. And subsequently, we repeated those tests without that feature in our holder, by going to this Fiberfrax insulation material--and subsequently got no vents at those lower temperatures.

Let me comment on the current very briefly. The current at approximately the minimum resistance we could put on the circuit, which was about 15 milliohms, turned out to give us upward of 20 amps. At greater than 20 amps, we wound up just opening up the cell internally.

We would fail a tab-to-pin connection is what it amounted to and the short went away and, thus, we didn't maximize our potential hazard. We thus had to cut back on the current, i.e., increase the resistance, cut back on the rate at which the cells were discharging so as to maintain that current for as long as the cell would deliver it to maximize the temperature effect that we were seeing.

The Fibrefax insulation and the increased resistance did that; almost too successfully, I might add.

In Fibrefax, it turned out to be a very good insulator. We essentially let no heat escape from the cell. The cell definitely has sufficient energy, if you don't let any heat out of it, to vent -- I call it vent, it vents, all the way to explodes. Okay?

We did a test in vacuum on some eight cells: the first five were mounted directly on a piece of angle iron connected to the cover of the chamber. Just that two-line conduction to that piece of angle iron was sufficient heat removal, apparently, so that that cell didn't get above 300 degrees. 203 to 286 degrees was the maximum temperature we saw in that condition.

We subsequently repeated those tests with a piece of insulating material underneath the cell to isolate it conductively from the angle iron and exceeded 300 degrees and thus vented.

I might mention those last two lines: Those eight cells were conducted in a temperature environment of 120 and 160 degrees F.

(Figure 5-5)

The reversal test, the overdischarge test. We used 47 cells in the course of these tests. For the most part, they were performed in various holders as indicated here. They were performed on three cells in series. We connected a power supply to the cells in series. We found we had to start out with a purely resistive load and then switch over to a power supply controlling current: else we weren't seeing the effect of the voltage delivery, the initial voltage delivery capability of the cell if we just connected it immediately to the power supply.

In the ceramic holder, again we had to take the cells all the way up to a three amp reversal test before we got over 300 degrees, again due to the heat capacity of that ceramic holder.

But in Fibrefax, we got venting in every case. The bulk of that heat, however, we were generating

apparently during the course of the discharge, which you would expect. These are relatively high rates for a D cell.

And the last line indicates to you the point at which the cell went to zero volts. So those temperatures we were achieving were getting pretty close to the 300-degree level, just on the basis of the discharge.

(Figure 5-6)

We exposed 12 cells to heat-to-vent testing. All of them achieved approximately 300 degree or greater before they did vent. We did this test on both discharged cells and fresh cells to observe the effect.

(Figure 5-7)

We took some 75 D cells through capacity tests: four temperatures, three rates. We were testing about five cells per rate, that comes out to about 60 cells. We threw in an extra 15 cells on a constant current to ascertain what kind of resistances to use.

Again the rates are high enough such that we were getting a fairly wide spread in our capacity, particularly at the lower temperatures. It indicates that we could not expect to use the cell at these rates in conjunction with that very low temperature; we don't get a usable capacity that's worthwhile.

I don't have specific data to indicate it but I feel that at lower rates we would get fairly good performance, even at these lower temperatures. The parallel load sharing gave us the results we pretty much expected.

Only in the case of two fresh cells with one discharged cell, all those in parallel on a two-ohm load, did we get any reversal at all, and it was like two milliamp reversal current. When I'm saying reversal here, I mean charging current.

The fresh cells, of course, supplied the load. The discharged cell had been discharged down to about a two-volt end voltage, so it wasn't a totally dead cell. It would put out a very low level current in parallel on a sharing basis with the fresh cells.

And we saw no abnormal temperature rise nor venting in the course of that test.

(Figure 5-8)

Going to our AA's, we tested approximately 50 cells. We were aiming this particular test -- In fact, it was a qual. test per se: we didn't have time to do a nice batch of engineering evaluation tests and to turn around and set forth a qual. criteria; I had to make those up ahead of time. I thought I put in plenty of margin.

We had a much smaller cell; we had all the D cell experience in the background. Much less energy. We had some data from our vendor that indicated that he could insulate cells, short-circuit them and not get venting. And in that case, the energy content of the cell was not sufficient to give you venting under total dissipation of its energy inside an insulated package.

However, we didn't have any problem with the short-circuit tests. We didn't insulate the cells for our short-circuit tests, we put them in a non-convective atmosphere. Basically, we peaked up to about five amps on a 36-milliohm short. Now that's with four cells in series. We reached a maximum temperature of about 205 degrees in that condition.

On reversal, however, we ran into problems. We tested three four-cell packs. Two of those packs were tested at 125 milliamps, we discharged the cell at some lower rate and then, upon reaching zero, pushed the cells into reversal at this 125 ma with power supply. We also did that same kind of test at 65 ma.

The 125-ma test gave us two ventings: one of those occurred by a hole being burned in the cell can.

The problem we have with that, the concern it causes us is that the cell was chugging along at about 100 degrees F or so and it was in reversal; it was approximately minus-0.4 volts in reversal and had only been in reversal for two or three hours or so. It experienced a thermal event of some sort with resulting venting.

In other words, unlike the D cells where we think



we have pretty well established a venting incident temperature, namely 300 degrees F on the D cell in that configuration, this cell was only at 100 degrees and experienced a very high temperature event at which the cell opened, a hole was burned in it.

We also experienced -- on removal of that one cell out of that pack and continuing on with three cells left in the pack, we experienced a vent through the glass seal. However, we had to push the power supply up to, like, minus 20 volts per cell to get that particular venting, which is not at all the realistic condition under a four-cell series battery kind of situation.

Under high temperature exposure, we have taken them to 300 degrees max. We got no venting.

Under parallel load sharing with two four-cell packs as I described earlier, we saw no abnormal temperature rise nor any venting.

We got very minimal load sharing as the fresh pack ran down and the discharged pack was able to pick up some amount of current.

(Figure 5-9)

The capacity results on the AA's -- a fairly minimal number of cells were tested here.

Under room temperature, 160 degree F and minus 40° F, three environments (we tested two rates at room temperature) for cells in a series string to approximate end voltage of two volts per cell is what the test involved.

By projecting those out, we got an average of about two ampere-hours, which is the manufacturer's spec essentially at 20 ma at room temperature. However, the range of capacities was greater than what we would have liked to have seen: they ranged from one and three-quarters to two and a quarter.

At higher rates, where we expected to see 1.6 to 1.75 ampere-hours, again only 12 cells were tested in that mode. We ranged from one ampere-hour to almost two ampere-hours, with an average of about 1.53 averaging the

entire 12 cells. This is a little more variation than, as I say, we would have liked to have seen.

Very few cells were tested on either the 160 or minus 40 degree F modes, and also not very much differences in these capacities. The results you see there.

(Figure 5-10)

To summarize, we have taken D cells through a series of tests, both in terms of performance and off-limits tests. We've described those tests with what becomes, I guess, a specification and have an approved certification of the D cells. That is for a given envelope of conditions. Okay?

That envelope is described by the report I have listed here. That certification is at a cell level and a user at JSC who wants to use this particular cell can use that data base then to put the cell into an application, making sure that its application falls within the envelope that we've established and take his package, then, as an assembly with the battery installed and perform a qual test on it and receive approval for flight. This approval for flight extends to manned applications, in-cabin use.

On the AA cells, we're a little bit further away yet. We are presently in the process of signing off a certification, a limited certification for AA cells for one particular application: a SUMS application; that's Shuttle Upper Atmosphere Spectrometer. It's located in the front wheelwell and is not in the cabin. It's approximately a 20 ma rate.

In our qual testing, we had to back off of our criteria to the extent that we got this thing under the wire. We hope to go ahead and continue to work on this particular cell configuration, possibly modifying it, and achieve a general certification of it, much as we have with the D.

The applications that I've just listed there, to give you a sampling of the kinds of things we're looking at: The WCCU is a Wireless Crew Communication Unit. You may have heard the crewmen complaining -- not the most recent mission, but on STS-1 about all the extension cords they had

to drag around through the vehicle.

On this mission they used a wireless communication unit strapped to the leg. Only it had alkaline cells in it, the old penlight cell. We were not able to get the lithium AA in time to use that. It's a ten cell alkaline battery; about a 15-volt battery.

What we do for the lithium configuration is to use the same battery case: we use two four-cell strings. That's the reason for all the four-cell testing you saw earlier.

We do hope by STS-4 to have the AA's in a certification status with additional testing such that we can fly that on STS-4.

We have various other equipment that would use the AA, also the D's. On STS-3 there is a data recorder that is going to fly using two D cells, a two D-cell battery.

In all these packages, we pay great attention to protective circuitry and diodes, fuses, heat sinking, such that we feel we can fly these batteries with confidence that we can keep those temperatures down, well under the limits that we found at which they will vent.

That concludes the presentation.

#### DISCUSSION

KORNEY (Fairchild): You indicated the D cells, as you call it, vented. Do I understand correctly these are not design-vented cells and, if not, where did they vent? And also, where did you measure the temperature on these cells; as you indicated the 300 degree, especially on the D cell, temperature at which they seemed to vent?

BRAGG: My word "venting" describes the minimal, the minimal release of the insides of the cell possible, and that will range from a simple vent which is a leakage up to an explosion. Okay?

When we get cells above the lithium melting temperature -- and particularly the D cells; we haven't taken a great number of the AA's into that kind of a test. But on the D's, we've taken a goodly number of them past

the lithium melting temperatures, and we get explosions.

The temperatures are measured on the cell case, on the metallic case of the cell; both on the end of the cell and on the cylindrical surface.

KORNEY: When the venting occurred, did it occur at the glass-to-metal seal?

BRAGG: For instance, in the ceramic foam holders where it was meant to be an insulated holder, it turned out that it had enough heat capacity, enough heat sinking, that it was removing heat at some rate from the cell.

None of those cells vented, or the ones that did, we feel were because they were compressed and we got that axial force on that pin.

But if we take the cell up in temperature at a low enough rate such that the header, with the glass seal in it, starts to bulge, that glass will then break or crack and we will leak the gaseous products or liquid product out of the cell. That is the minimum sort of vent that I talk about; it will leak, in other words.

Now if you have a thermal situation such that your heating rate just accelerates you on up into the lithium melting temperature -- and I don't know how to tell you what this heating rate would be to get there -- but you can get the cell, it will hang in long enough that this thermal event or exothermic event takes place and you get the rupture, the detonation, you get high temperatures, you get melting of the stainless steel, you get holes in that through melting.

What it appears to do is go first through the seal, it'll blow the seal out. But the subsequent high temperature goes ahead and either ruptures the can or burns holes in the can. So if you can get it hot enough, you can get into those modes, that's right.

HELLFRITZSCH: I don't know what a BCX cell is. I gather it's a cell that will fit in your envelope; you described your envelope.

You obviously tested some cells. What can you

tell us about what type they were and what sorts? The only clue that I saw in all of these things was there was a 3.9 open circuit voltage. It would seem to be rather unduly high. So what can you tell us, so we know what these test results referred to?

BRAGG: I'm sorry. I meant to do that at the beginning of the presentation and I got carried away on my certification lecture.

The cell is a bromine complex. It's built by Electrochem Industries. It's a mixture of bromine chloride and thionyl chloride. That's what the bromine complex is.

All of the cells that we tested in this program, both the AA's and the D's, were this particular configuration. The D cells were a cell with lithium on the outside and, as I understand, it has lithium excess. The AA's were more of a balanced cell with lithium on the inside of the wrap, with the carbon on the outside. Thus, the can on the AA is positive, the can on the D is negative.

HELLFRITZSCH: And who made them?

BRAGG: Electrochem Industries.

HELLFRITZSCH: I see.

BRAGG: Clarence, New York.

HELLFRITZSCH: Thank you.

KORNEY (Fairchild): On the D cells that you tested, these all had the fusible link within the case of the battery for the testing?

BRAGG: This fusible link wasn't a designed fusible link, it just turned out that the current carrying capability of the spot weld of the tab to the pin -- there's a tab coming up from both electrodes, one going to the carbon on the lithium-- on the D cell, the tab coming from the carbon goes to the pin at the top; on the lithium, the tab goes to the actual can, it's welded to the can.

What we feel is that the spot weld to the pin fails at about 25 amps, 20-25 amps those spot welds fail.

They don't necessarily totally open up, but we think that enough of them fail such that you can't carry a short-circuit current any longer, all you can carry is milliamps. So it becomes a high-impedance connection is what it amounts to.

On future cells built by Electrochem, they are looking, in their termination assembly -- not inside the can structure, but on the outside where they make their connection; they are currently putting in a nicked-down version of a tab that, in effect, is a fuse; it will open up. Seven amps, I think, is what they're currently using. Future procurements will probably be made with that fuse incorporated in the cell.

OLBERT (Bell Aerospace): In the present STS/GAS applications lithium cells are forbidden. Does this mean that this certification now means that lithium cells can be used for GAS applications?

BRAGG: I think your word is maybe a little strong, "forbidden." Probably discouraged, I think, is probably closer to the word --

OLBERT: No, it says they are forbidden.

BRAGG: Gerry, help me out on this: Am I correct in GAS are Goddard -- Is that limited to Goddard, the GAS packages?

HALPERT: I think it's correct that they are being managed by Goddard and at the present time they're all silver zinc. But as far as I know, we would do the same thing for silver zinc; that we would have to submit our requests for changing that power source to Johnson for their approval.

So if you had ideas on using other kinds of power sources other than silver zinc, you're certainly welcome to try that to see if our people there will approve them.

BRAGG: They are not forbidden by Johnson. If they are -- quote -- forbidden but, as I say, the story I got -- the only interaction I've had with that issue is somebody says that we're strongly recommending that they not look at lithium.

BIS (NSWC): Bob, on your STS-2 I notice you have a survival radio. Is that the PRC-96?

BRAGG: Yes.

BIS: And what supply are you using in that?

BRAGG: That would be two of the lithium BCX cells, D cells.

BIS: You've never flown the SO2 in it?

BRAGG: No, that radio has not flown yet. And I think it's not going to fly until 5, I believe, STS-5.

METHLIE (Arlington, Va.): Bob, two questions: One, with the cell that burned the hole through the case, would you comment on the location of the hole and what you think might have induced that hole? And secondly, what were the ages of the cells at the start of the test?

BRAGG: Essentially any cell that went past lithium melting temperatures exhibited some of this high temperature on the case.

The one cell that vented on AA -- that may be what you're specifically referring to, the one I mentioned on the AA -- I don't know what caused that. I think that what may have caused it is enough sulfur was formed that, when lithium got in contact with the sulfur, we got the exothermic event that normally accompanies that reaction. We were not able to tell what happened.

What we are looking at on that particular cell is a potential reconfiguration of the internal configuration of the AA cell.

At least within the temperature regime that we're talking about we have not seen this on the D's below a certain temperature. Okay?

And that's what really concerned us, the level at which we did see it. I wouldn't have been so surprised to see it if we had been pushing the cell up into the lithium melting temperatures. When we saw it at a cell temperature or can temperature at least of, like, 100 degrees r that

concerns me.

So the difference in configuration between that and the D we think may be a gross answer to that question. We are going to look at putting the lithium on the outside of the wrap for the AA's and redo some of our tests and see what happens.

But we've also seen that high temperature event effect on the cans on the D's when we get into these very high temperature levels.

METHLIE: Where was the hole?

BRAGG: On this particular cell, on the AA cell; it was near the bottom, around the end from the bottom. On AA cells that we'd gotten in, we had seen some leakages from holes.

We feel like what we were seeing there is a problem -- they try to make the cell in a commercial configuration with the little button, positive button. And since the can is positive, that button had to be swaged into the can itself. There's thinning at the corners of that little swaged button.

Out of 500 cells, we got six in that leaked, and we think that it resulted in very thin cracks that allowed access of moisture and the reaction, and we got little holes right in those corners of that button on six cells.

However, this venting situation was a hole that was not down at the button per se, it was around the end from the button, in the side of the cell case.

MARSH (Air Force): Are you planning on certifying chemistry?

BRAGG: No, we're locked in on AA cells -- whatever it is we have our test experience in, you know, a configuration --

MARSH: The lithium SO2 cell from a particular company?

BRAGG: Right now we're just getting into this, we



intend to look at other cell chemistries, yes. Our current plans, though, for this coming year at least don't extend much beyond the BCX configuration in, say, a C cell and possibly a DD.

As the need arises and as applications arise that look like if they don't have this particular high energy density system they can or cannot make a flight or make an application, we will certainly consider attacking those and attempting to certify them.

MARSH: My other question is if you're certifying a particular chemistry, are you given complete disclosure of the chemistry, and then how do you track whether it's the same cell a year from now?

BRAGG: We're going to have to depend primarily on the goodwill of a vendor, for one thing.

(Laughter.)

The other aspect we hope will work for us, and maybe it's a naive approach, but our acceptance tests, we hope, will uncover any changes that have been made in cell design that we're not aware of and will hopefully highlight those, in which case we will attack those specifically.

If we can't get the cell that we certified, we'll stop buying the cell. We'll uncertify that cell is what it amounts to.

HARRISMAN (Eagle-Picher): Are you limited to certification of payload batteries? This is not a launch vehicle or external tank, is it?

BRAGG: What you may be referring to is, on SRB and ET you have batteries that you-all have certified.

The classification isn't payload bay, it's JSC government furnished at this point in time, is what it amounts to. These are particular applications that JSC specifically has that we're trying to meet and, hopefully, we will be able to meet -- once certified, we will be able to meet other applications outside JSC, if they so desire.

RECENT TEST RESULTS ON L1-BCX CELLS	PROPULSION AND POWER DIVISION	
	E. J. BRAGG	11/17/81
<ul style="list-style-type: none"> <li>o INTRODUCTION                             <ul style="list-style-type: none"> <li>o L1-BCX AA AND D CELLS</li> <li>o TEST DESCRIPTION                                     <ul style="list-style-type: none"> <li>o HAZARDS/OFF-LIMITS</li> <li>o PERFORMANCE</li> <li>o ASSEMBLY QUALIFICATION</li> </ul> </li> <li>o TEST RESULTS</li> </ul> </li> <li>o PURPOSE                             <ul style="list-style-type: none"> <li>o CERTIFICATION OF CELLS</li> <li>o MANNED APPLICATIONS</li> </ul> </li> </ul>		

Figure 5-1

RECENT TEST RESULTS ON L1-BCX CELLS	PROPULSION AND POWER DIVISION																																		
	E. J. BRAGG	11/17/81																																	
<ul style="list-style-type: none"> <li>o TEST DESCRIPTION                             <table border="0" style="width: 100%; margin-left: 20px;"> <thead> <tr> <th style="text-align: left;">o HAZARDS/OFF-LIMITS:</th> <th style="text-align: center;">AA</th> <th style="text-align: center;">D</th> </tr> </thead> <tbody> <tr> <td colspan="3">o ACCEPTANCE TESTS</td> </tr> <tr> <td>o VISUAL</td> <td style="text-align: center;">X</td> <td style="text-align: center;">X</td> </tr> <tr> <td>o DIMENSIONAL</td> <td style="text-align: center;">L, DIA, WT</td> <td style="text-align: center;">X</td> </tr> <tr> <td>o TEMPERATURE SCREEN</td> <td style="text-align: center;">125°F FOR 2 HRS</td> <td style="text-align: center;">200°F FOR 2 HRS</td> </tr> <tr> <td>o OCV</td> <td style="text-align: center;">3.90 <sup>+ .03</sup> - .05 V</td> <td style="text-align: center;">X</td> </tr> <tr> <td>o LOAD VOLTAGE</td> <td style="text-align: center;">3 V MIN ON 30 Ω</td> <td style="text-align: center;">3 V MIN ON 3 Ω</td> </tr> <tr> <td>o SHORT CIRCUIT</td> <td style="text-align: center;">25 m Ω @ RT</td> <td style="text-align: center;">≥ 15 m Ω AT RT, 120°F, 160°F, ARGON AND VAC</td> </tr> <tr> <td>o REVERSAL (VOLTAGE)</td> <td style="text-align: center;">@ 65 AND 125 ma</td> <td style="text-align: center;">@ 1.0, 1.5, 3.0 @ RT, -20°F, 120°F IN ARGON AND VAC</td> </tr> <tr> <td>o HIGH TEMPERATURE EXPOSURE</td> <td style="text-align: center;">300°F MAX</td> <td style="text-align: center;">HEAT UNTIL VENT ON FRESH AND DISCHARGED CELLS</td> </tr> <tr> <td>o PARALLEL LOAD SHARING</td> <td style="text-align: center;">FRESH AND DISCHARGED 4-CELL PACKS ON 100 Ω LOAD</td> <td style="text-align: center;">FRESH AND DISCHARGED SINGLE CELLS</td> </tr> </tbody> </table> </li> </ul>			o HAZARDS/OFF-LIMITS:	AA	D	o ACCEPTANCE TESTS			o VISUAL	X	X	o DIMENSIONAL	L, DIA, WT	X	o TEMPERATURE SCREEN	125°F FOR 2 HRS	200°F FOR 2 HRS	o OCV	3.90 <sup>+ .03</sup> - .05 V	X	o LOAD VOLTAGE	3 V MIN ON 30 Ω	3 V MIN ON 3 Ω	o SHORT CIRCUIT	25 m Ω @ RT	≥ 15 m Ω AT RT, 120°F, 160°F, ARGON AND VAC	o REVERSAL (VOLTAGE)	@ 65 AND 125 ma	@ 1.0, 1.5, 3.0 @ RT, -20°F, 120°F IN ARGON AND VAC	o HIGH TEMPERATURE EXPOSURE	300°F MAX	HEAT UNTIL VENT ON FRESH AND DISCHARGED CELLS	o PARALLEL LOAD SHARING	FRESH AND DISCHARGED 4-CELL PACKS ON 100 Ω LOAD	FRESH AND DISCHARGED SINGLE CELLS
o HAZARDS/OFF-LIMITS:	AA	D																																	
o ACCEPTANCE TESTS																																			
o VISUAL	X	X																																	
o DIMENSIONAL	L, DIA, WT	X																																	
o TEMPERATURE SCREEN	125°F FOR 2 HRS	200°F FOR 2 HRS																																	
o OCV	3.90 <sup>+ .03</sup> - .05 V	X																																	
o LOAD VOLTAGE	3 V MIN ON 30 Ω	3 V MIN ON 3 Ω																																	
o SHORT CIRCUIT	25 m Ω @ RT	≥ 15 m Ω AT RT, 120°F, 160°F, ARGON AND VAC																																	
o REVERSAL (VOLTAGE)	@ 65 AND 125 ma	@ 1.0, 1.5, 3.0 @ RT, -20°F, 120°F IN ARGON AND VAC																																	
o HIGH TEMPERATURE EXPOSURE	300°F MAX	HEAT UNTIL VENT ON FRESH AND DISCHARGED CELLS																																	
o PARALLEL LOAD SHARING	FRESH AND DISCHARGED 4-CELL PACKS ON 100 Ω LOAD	FRESH AND DISCHARGED SINGLE CELLS																																	

Figure 5-2

RECENT TEST RESULTS ON L1-BCX CELLS		PROPULSION AND POWER DIVISION	
		E. J. BRAGG	11/17/81
Page 2			
o TEST DESCRIPTION (Continued)	AA	D	
o PERFORMANCE			
o CAPACITY	20 MA AND 65 MA TO 2.0 V AT -40, RT, AND 160°F	6.2, 3, AND 2 @ 25°F, -40°F, 90°F, AND 160°F	
o SHOCK	20g PEAK FOR 11 MS RISE	X	
o VIBRATION	0.1 g <sup>2</sup> /HZ, 9.625 GRMS	X	
o ASSEMBLY TESTS	-	1.0 + 1.5a AT NOM. + HIGH TEMPERATURES	

Figure 5-3

RECENT TEST RESULTS ON L1-BCX CELLS		PROPULSION AND POWER DIVISION		
		E. J. BRAGG	11/17/81	
SHORT CIRCUIT TEST RESULTS - D CELLS				
TEST CONFIGURATION	CELLS TESTED	PEAK CURRENT RANGE	MAX. TEMP. RANGE	VENT?
o CERAMIC HOLDER IN ARGON	23	8.2-26.8 AMPS	163-290°F	NO*
o FIBERFRAX INSULATION IN ARGON	5	9.3-14.9 AMPS	379-534°F	YES
o CONDUCTIVE HOLDER IN VAC	5	11-18 AMPS	203-286°F	NO
o NON-CONDUCTIVE HOLDER IN VAC	3	14.5-17.5 AMPS	305-332°F	YES
o TOTAL CELLS	36			

\* ALL CELLS ACHIEVING > 300°F VENTED. CERTAIN CELLS IN CERAMIC HOLDER SUFFERED VENTING AT < 300°F DUE TO HOLDER-INDUCED, AXIAL FORCES ON PIN IN GLASS SEAL.

Figure 5-4

RECENT TEST RESULTS ON L1-BCX CELLS		PROPULSION AND POWER DIVISION	
		B. J. BRAGG	11/17/81
<u>HIGH RATE DISCHARGE WITH REVERSAL TEST (47 CELLS TOTAL) - D CELLS</u>			
DISCHARGE RATE	1 A	1.5 A	3 A
CAPACITY (A-H TO OV) (INTERVAL)	6.92-11.12	5.63-9.25	3.5-6.25
MAX. CELL TEMP.			
o CERAMIC HOLDER	190 <sup>0</sup>	250 <sup>0</sup> F	350 <sup>0</sup> F*
o FIBERFRAX BLANKET	395 <sup>0</sup> F*	380 <sup>0</sup> F*	400 <sup>0</sup> F*
o NON-CONDUCTIVE HOLDER IN VAC	201 <sup>0</sup> F	-	-
MAX. CELL TEMP. AT REVERSAL ( <sup>0</sup> F) (ALL IN FIBERFRAX BLANKET)	300 <sup>0</sup> F	275 <sup>0</sup> F	320 <sup>0</sup> F
* VENTED			

Figure 5-5

RECENT TEST RESULTS ON L1-BCX CELLS		PROPULSION AND POWER DIVISION	
		B. J. BRAGG	11/17/81
<u>HIGH TEMPERATURE EXPOSURE TEST (12 CELLS) - D CELLS</u>			
CELL NO.	ELAPSED TIME TO VENT (MIN.)	VENT TEMP. ( <sup>0</sup> F)	REMARKS
1	70	330	VENT SAMPLE TAKEN, FRESH CELL
2	45	305	DISCHARGED CELL, VENT SAMPLE TAKEN
3	20	300	DISCHARGED CELL, VENT SAMPLE TAKEN
4	10	300	DISCHARGED CELL, VENT SAMPLE TAKEN
5	17	300	DISCHARGED CELL, VENT SAMPLE TAKEN
6	20	360	FRESH CELL
7	20	306	VENT SAMPLE TAKEN, FRESH CELL
8	22	325	DISCHARGED CELL
9	25	300	FRESH CELL
10	60	452 <sup>0</sup> F	DISCHARGED
11	140	465 <sup>0</sup> F	FRESH CELL
12	81	441 <sup>0</sup> F	DISCHARGED

Figure 5-6

RECENT TEST RESULTS ON L1-BCX CELLS					PROPULSION AND POWER DIVISION	
					B. J. BRAGG	11/17/81
<u>CAPACITY RESULTS - "D" CELLS (75 CELLS)</u>						
A-H						
TEMP	END VOLT	2 $\Omega$	3 $\Omega$	6.2 $\Omega$	NO. OF CELLS	
90°F	2.5 V	5.8 - 8.5	8 - 10.5	11.3 - 13.1	30	
160°F	2.5 V	5.4 - 7.3	6.7 - 7.6	7.6 - 9.0	15	
25°F	2.5 V	3.5 - 4.4	5.0 - 6.0	6.0 - 8.7	15	
-40°F	1.5 V	0 - 2.5	2.1 - 4.1	4.9 - 6.0	15	
<u>PARALLEL LOAD SHARING RESULTS "D" CELLS (6 CELLS)</u>						
<ul style="list-style-type: none"> <li>o EXPECTED LOAD SHARING WITH LITTLE OR NO CHARGING (*2 ma MAX.)                             <ul style="list-style-type: none"> <li>o 3 FRESH CELLS IN PARALLEL ON 2 <math>\Omega</math> LOAD</li> <li>o 2 FRESH CELLS PLUS *1 DISCHARGED CELL ON 2 <math>\Omega</math> LOAD</li> <li>o 1 FRESH CELL PLUS 2 DISCHARGED CELL ON 2 <math>\Omega</math> LOAD</li> </ul> </li> <li>o NO ABNORMAL TEMPERATURE RISE NOR VENTING</li> </ul>						

Figure 5-7

RECENT TEST RESULTS ON L1-BCX CELLS					PROPULSION AND POWER DIVISION	
					B. J. BRAGG	11/17/81
<u>AA CELL TEST RESULTS (APPROX. 50 CELLS)</u>						
<ul style="list-style-type: none"> <li>o SHORT CIRCUIT                             <ul style="list-style-type: none"> <li>o 4 CELLS IN SERIES IN NON-CONVECTIVE ATM</li> <li>o 5 AMPS PEAK CURRENT ON 36 m <math>\Omega</math> SHORT</li> <li>o 205°F MAX. CELL CASE TEMP.</li> </ul> </li> <li>o REVERSAL                             <ul style="list-style-type: none"> <li>o 8 CELLS @ 125 ma (TWO 4-CELL PACKS)</li> <li>o 4 CELLS @ 65 ma (ONE 4-CELL PACK)</li> <li>o 2 CELLS VENTED ON 125 ma WITH HIGH TEMP.                                     <ul style="list-style-type: none"> <li>o 1 VENTED THROUGH HOLE BURNED IN CAN</li> <li>o 1 VENTED THROUGH GLASS SEAL</li> </ul> </li> </ul> </li> <li>o HIGH TEMPERATURE EXPOSURE (300°F MAX)                             <ul style="list-style-type: none"> <li>o NO VENTING</li> </ul> </li> <li>o PARALLEL LOAD SHARING (FRESH AND DISCHARGED 4-CELL PACKS ON 108 <math>\Omega</math> LOAD)                             <ul style="list-style-type: none"> <li>o APPROXIMATELY 6 ma CHARGING CURRENT MAX.</li> <li>o NO TEMPERATURE RISE NOR VENTING</li> <li>o MINIMAL LOAD SHARING AS FRESH PACK DISCHARGED DOWN</li> </ul> </li> </ul>						

Figure 5-8

RECENT TEST RESULTS ON LI-BCX CELLS		PROPULSION AND POWER DIVISION	
		B. J. BRAGG	11/17/81
<u>CAPACITY RESULTS - AA CELLS</u>			
<u>TEMP</u>	<u>END VOLT.</u>	<u>182 <math>\Omega</math> (20 ma)</u>	<u>A-H<sub>0</sub></u> <u>54 <math>\Omega</math> (65 ma)</u>
RT	2.0 V	1.76 - 2.27 (AVG 2.01) (4 CELLS)	0.96 - 1.98 (AVG 1.53) (12 CELLS)
160°F	2.0 V	1.39 - 1.76 (AVG 1.63) (4 CELLS)	-
-40°F	2.0 V	.73 - .78 (AVG .77) (4 CELLS)	-

Figure 5-9

RECENT TEST RESULTS ON LITHIUM LI-BCX CELLS		PROPULSION AND POWER DIVISION	
		B. J. BRAGG	11/17/81
<u>CERTIFICATION STATUS</u>			
o D-CELLS - VENDOR PART NUMBER 3B21 FOR NASA JSC			
o CELL CERTIFICATION ENVELOPE DESCRIBED BY LITHIUM-BCX "D" CELLS CERTIFICATION REPORT - EP5-81-008			
o AA-CELLS - VENDOR PART NUMBER 3B39 FOR NASA JSC			
o CERTIFICATION FOR SPECIFIC APPLICATION ONLY STILL IN WORK (SUMS)			
o EFFORT CONTINUING TO ACHIEVE GENERAL CERTIFICATION			
<u>APPLICATIONS</u>			
o WCCU - WIRELESS CREW COMMUNICATION UNIT - STS-2 - AA			
o AIR SAMPLER - SPACE LAB - AA			
o LSLE DATA RECORDER - STS-3 - D			
o SURVIVAL RADIO - STS-5 - D			
o EMU TV/LIGHTS - STS-5 - D			
o MINI-O-SCOPE - SPACE LAB - D			

Figure 5-10

**Page intentionally left blank**

CASE-POSITIVE VS. CASE-NEGATIVE DESIGNS FOR LOW-RATE  
LITHIUM THIONYL CHLORIDE CELLS

T. Mahy

CIA

My topic is what I will mostly talk about, but it's not all that I'll talk about. And I'll tell you in advance, though, my slides will have too many numbers on them for you to read. Concentrate on the numbers that I point at. The rest of the numbers are there for you to have later. I'm using this talk not only to discuss the topic, but also to make public some very interesting data that I do not believe has shown up in any other medium.

(Figure 6-1)

I'm going to talk about three rather different designs here. It's really apples, oranges and grapefruit, but it's about all you can get hold of, if you think you have a problem with the case polarity choice.

This is an outline of the design data for the AA cells that I'll talk about. The dimensions are conventional. They are bobbin cathode; the electrolyte is 1.8 molar lithium tetrachloroaluminate; glass-to-metal seals with 7052 glass; Kovar, or 52 alloy for the terminal pins. The interelectrode area is, crudely, 14 square centimeters.

One design is thionyl chloride limited. Now that means that you run out of thionyl chloride before you run out of anything else. These cells were made in 1976, and that's how I'll refer to them from here on: thionyl chloride limited AA's made in 1976.

The other set of AA's was made in 1977. They are lithium-limited. And they are truly lithium-limited: at the end of a complete discharge the lithium is completely consumed.

(Figure 6-1 cont.)

This is my case-positive example. There's only one. It's a D-size cell, conventional dimensions. The



electrodes are spiral wound, however, not bobbin. And the electrolyte solution is .5 molar. In the first two cases, the cells are made low rate because it's a bobbin type cathode structure. In this design we have essentially a high rate electrode grouping, but the cells are made low rate by using a low concentration electrolyte.

Now there's a spin-off advantage to the low concentration electrolyte, in that it contains more thionyl chloride per cubic centimeter than the more concentrated ones do. For low rate applications this is not as crazy as it might seem.

The glass-to-metal seals: I do not know what the glass is -- I got the usual deal that it's the standard glass that's put into these seals. The pins are moly.

The cathode-to-case attachment -- now remember, these are case-positive cells, so this matters -- it's nickel welded to 304 stainless steel.

The lithium electrode current collector is a full interior nickel exmet grid. The interelectrode area is about 215 square centimeters. And they are thionyl chloride limited. Made in 1978.

Those are the three designs I'm going to talk about. Now I'm going to tell you what my results are, and then I'll show you the data that lets me derive those results.

First of all, case-positive/case-negative does not seem to have much bearing on storage. They all store very well. If the technology is advanced to modern state of the art, if the cells are made cleanly, with control of the things that you normally have to control, storage is not affected by whether they're case-positive or case-negative.

Low rate discharge is quite another matter, however. During low rate discharge, the case-negative cells show a steadily decreasing capacity as you go to lower and lower rates.

Now I should say that the correlation coefficient associated with this decrease is .997. Never in my career as an engineer have I had a correlation coefficient like

that from engineering data. So I'm inclined to believe that the trend is real and it's unavoidable. If you know what it is, you can use the cell. But bear that in mind. That's the main conclusion about case-negative designs: at low rates the capacity is much, much less than you think it's going to be.

For case-positive cells, that's not the way it is at all. The rate doesn't seem to have a whole lot of bearing on the capacity you get in the low-rate regime. I'm sure if I had five-year rate data or ten-year rate data on this design, I'd have to revise that conclusion. I only have out through two-year rate data on the case-positive design, but I do have five-year rate data on the case-negative design.

Now the final conclusion, naturally, has to be, there's something wrong with the case-positive designs, too. You have to be very, very careful exactly what you do on that positive case. This weld here (cathode collector to case) can frequently be a major cause of problem.

Take a completely discharged cell, a cell in which the thionyl chloride is all gone: basically it's a sulfur dioxide cell now. And many people in the audience know very well that you cannot make case-positive lithium/sulfur-dioxide cells. Well, apparently you can't have case-positive sulfur dioxide cells that are created during the discharging of a thionyl chloride cell, either because many of these cells will breach their cases after they have been through a complete discharge.

I'll have to add that these cells have always still been on the resistive load to the time that they breached their cases. But the case breach is always at the cathode tab-to-case weld.

You've seen the designs, you've heard the conclusions. Now let me present the data.

(Figure 6-2)

I have a lot of problems in my mind with dealing with small sample statistics. And I've wrestled with these problems for the better part of my 20-year professional

career. I've never been able to come up with an answer that really works. But for this kind of talk, what I'm going to do is the following:

I will talk about median values, not average values. When you're talking about experimental cells, there's always the inevitable turkey, and the inevitable turkey is very, very often in the test that you don't want it to be in. So I tend not to talk about mean values or averages: I talk about median values.

And I have a hard time believing in normal distribution statistics when you're talking about cells because you never have a cell that's 3-sigma above the mean, but you damn sure have cells that are 20-sigma below the mean. So I will not use normal distribution statistics in this talk.

Now that really nails me to the wall. Now how do I talk about my numbers? I don't have a reliability model, I don't have any kind of a probability model. We've spent good money trying to get one, and the statisticians always come back and say "There ain't one." So I will resort to distribution-free statistics, which means I'm making the most pessimistic conclusions that it's possible to make -- unless I'm willing to assume that there was no control over the cell manufacturing process at all. If there's any control at all, then distribution-free statistics will give me valid pessimistic statements.

I have never been burned by sticking to that kind of a presentation. My final hardware always does better than I said it would, and therefore people are happy, including me.

But this (the slide) is here for reference. If you're talking about a 5-cell sample, and you've got a median value, and you want to know what confidence you can have that that median value is where you think it is, unfortunately all you can have is 93.7 percent confidence that the real median lies between your poorest and your best. So you don't want to test with five samples very often, unless your results can be extremely qualitative.

This (15 cells) is the number that I like. That says that you can have 96 percent confidence that the true

median lies between your fourth cell and your twelfth cell, if the data are rank-ordered on the capacity.

(Figure 6-3)

By the way, there was a footnote at the bottom of the previous slide that tells you one source where you can read about distribution-free statistics.

This is my test plan for the case-negative 1976 design. This is the storage data. If I had this to do over again, I'd never do what I did here. But I was young and foolish when I set this up.

What we have here is the age of the cell in months; and this is age after closing the cell (sealing the cell) it's not age after receipt or anything else, it's age after closing. The nominal current and the nominal run times are here. Now the nominal currents assume a 3.5 volt operating voltage. The tests are really constant in resistance. And the nominal run time assumed 1.8 ampere-hours from the cell.

And then over here you have the replication level that I used.

The room temperature tests are split into two groups. There's the 10 mA and the .6 mA. And the .6 mA at -10 and at 120. The storage, however, is all room temperature. It's the discharges that are at the various temperatures.

(Figure 6-4)

Now I switched gears. I told you what I expected to get for currents on the first page and what I expected to get for run times. Now I tell you what I really got for currents and what I really got for run times for the median cell, and where there's more than one temperature, it's the median cell in the room temperature test. So these are kind of ballpark currents for all of the cells except the median at room temperature.

If you want to know what kind of resistor value I used, you have the current that really applies to the median cell. On the next page I'll give you the time

averaged voltage that really applies to the median cell, and you can calculate the resistors. But most people at talks like this don't respond to resistors. I don't.

Let's take a look at the data. This is brand new, so to speak. This, six months old, this, twelve months old and this, twenty-four months old.

If you look at the 93 percent confidence values on these medians, you might be able to say that there has been a change from there (1 month old, 10mA, 75°F) to there (24 months old, 10mA, 75°F). But I don't think you could really statistically justify it. And if you looked at all the data, you'd be certain that you couldn't statistically justify it.

There has been very little capacity change in the 10 mA tests across two years of storage. Now, 10 mA is a high rate for this particular cell: 180 hour rate on a bobbin AA -- that's a comparatively high rate.

At the lower currents, we start out here (6 months old, 0.6 mA, 75°F). And that looks like, Gee, maybe there's a difference. But you've got to remember, those are four significant numbers, and the fourth figure is not justified. I included it so you could tell the difference between the median and the confidence limits quickly.

If you look at these numbers (6 months old) and those numbers (24 months old), again your conclusion is: no change. If you look at the 120°F temperature, your conclusion is: probably no change. And over here, your conclusion is: Oh, my God, those tests were non-reproducible, but probably no change with the storage, -- minus ten is just not an acceptable operating condition, even at the 3000-hour rate, for this particular design.

Now that last doesn't matter, that doesn't have anything to do with this talk, it's part of the interesting data that's also here.

(Figure 6-5)

The voltage data I show you just so you can see them. They're there for your reference.

The only numbers I want you to form in your mind are crudely what these (the 75°F results) are. Now, remember that these are thionyl chloride limited cells.

(Figure 6-6)

Case-negative, 1977. Test plan: formatted the same way as the previous one. You'll note the 15-cell replication level and the longer run times. That's one year, three years and five years, nominal. These cells, the assumption is 1.7 ampere-hours per cell.

(Figure 6-7)

Here's the results. 96 percent confidence on the location of the median. I would ask you to immediately note this (the room temperature result for 10 mA), and this (the room temperature result for the five-year rate), and all the numbers in between. The trend is monotonic. In the early stages you would have to say it isn't statistically significant. But, of course, if you were me, you were trying to make predictions even though it wasn't statistically significant. And in this case all the predictions were high. Any estimate that you make based on what you think you've got in the earlier tests leads you to predict higher capacities than you ultimately get in the one, the three, and the five-year tests. And that's even true if you use all of this data (all the room temperature results except the five-year test) and then try to predict the five-year test. You still fall above what you get by more than you would appreciate.

(Figure 6-8)

Here's the voltage data again. These are time averaged voltages to a 2-volt cutoff. Notice that these cells performed better on a voltage basis than did the thionyl chloride limited cells. This fact has been published in the Journal of the Electrochemical Society for larger cells. The whole point is that these cells discharge essentially flat, and then they fall off the end of the world. And you spend very, very little time at voltages much below the plateau voltage. Whereas with thionyl chloride limited cells, the cells kind of taper into their failure mode, and you end up spending perhaps 15 to 20 percent of the time below the plateau voltage.

I want you to take particular note of this value right here (the five-year rate result). That's a pretty reproducible number. This is a 15-cell test element, and if you took all of the time-averaged voltages and averaged them and took the standard deviation of that 15-cell sample, you'd find that the standard deviation affects the fourth significant figure only, and it doesn't affect it very much.

So that is a nice, realistic load voltage number for quite a low current. Now remember, this is the 5-year rate nominal, even though they only really ran three and a half years.

The reason why I want to stomp on this point is, at the recent Electrochemical Society meeting I heard two papers in which the authors used lower numbers (3.55 and 3.60 volts) than my 3.650 volts for their assumed, thermodynamic, open circuit voltages. I can find no justification for their values -- but using them did make their cell designs look better than they probably were. I don't know what the thermodynamic open circuit voltage should be (and I have tried to unambiguously determine it), but it must be greater than or equal to my 3.650 volts -- time-averaged voltage for complete discharge at the 5-year nominal rate -- at 75°F.

Unfortunately I'm running out of time, so I'll have to cover the remaining data even more briefly than I have been doing up to now.

(Figure 6-9)

Here I present one interpretation of the room temperature capacity results for the case-negative approach. First I define my symbol usage. Then I give in mathematical symbols the equation that I shall fit, and I interpret these mathematical symbols with their empirical equivalents.

Now the equation is this, in empirical symbols. And it rearranges into this, which could be interpreted as saying that the total current reducing the cell's capacity is equal to the load current plus the corrosion current. Well, if that's the case, this is the corrosion current. And then I can derive the corrosion current expression as actually being this. I get that by taking the definition of  $C$  from here, substituting it in there.

Now, what this equation says is, for large  $I$  the corrosion current is a constant. But as the actual discharge current approaches the corrosion current, this value slowly increases until eventually they both become equal to the value of  $2b$ .

(Figure 6-9 cont.)

I will not go beyond the value  $2b$ , as you'll see in the next data.

This is the actual data: the average currents, the apparent run times, the actual capacities, the calculated capacities, and the differences. And these capacities are all in milliampere-hours.

You'll note that the differences are small for four significant figure numbers. That's the actual equation: it says my corrosion current is about 12 microamps. The lowest current I tested at was 41 microamps.

Now if you use (the note on the slide) this more straightforward model which says that the corrosion current is constant, you get a correlation coefficient of  $-0.989$ . I don't know that you can really choose between the two models on the basis of this data, in spite of the "large" difference in the correlation coefficients.

(Figure 6-10)

This is the case-positive storage results, spanning from 6 to 31 months, with a 42-month one planned. The sample sizes varied, mainly because I had to cancel some of the tests, and I plowed the cells in here.

You'll note that until you get here (31 months old), there really hasn't been a capacity change at all. And even this one is not statistically significant.

So this design also stores well.

(Figure 6-11)

This is the test plan for my capacity testing. It assumes 18 amp-hours. It also assumes 3.5 volts. These are



the nominal run times. That's two years. And there's the room temperature replication level.

(Figure 6-12)

This design, spiral wound or not, is rate limited at the 180-hour rate. It's actually a lower rate cell than the AA bobbin. The cell is not rate limited at the 600-hour rate, however, and you can see that there is no capacity change that's meaningful as you go to lower and lower rates. If anything, they might be a little bigger, but certainly the difference is not significant.

(Figure 6-13)

That's the load voltage table. It's there for reference.

I gave you the conclusions first, and I really don't think I need to repeat them. But I want to make one further conclusion. This might have seemed like a nit-picking topic: case-positive versus case-negative. I want to stress that I do not believe that it was. In fact, I'm sorry to say, I think almost everything is important; and you'd better check almost everything out.

Thank you.

Slide 1: Overview Comparison of the Cell Designs Considered

Case Material: 304 Stainless Steel  
 Cathode Matrix: Thionin/Carbon Black

I. Case-Negative:

"AA" Size -- L = 4.375 cm (1.720 in )  
 D = 1.395 cm (0.545 in )  
 V = 7.35 cm<sup>3</sup> (0.450 in<sup>3</sup>)

Pebbin Cathode

Electrolyte Solution -- 1.2M Li(AlCl<sub>4</sub>) in SOCl<sub>2</sub>

Glass-to-Metal Seals -- 7052 Glass

KOVAR or 52-11 Alloy Pins

Interelectrode Area = 14 cm<sup>2</sup>

A. Thionyl Chloride Limited

Weight = 16.9 g

Made in 1976

B. Lithium Limited

Weight = 17.2 g

Made in 1977

Slide 1 Continued

II. Case-Positive:

"D" Size -- L = 6.045 cm (2.380 in )

D = 3.325 cm (1.310 in )

V = 52.5 cm<sup>3</sup> (3.20 in<sup>3</sup>)

Spiral-Wound Electrodes

Electrolyte Solution -- 0.5M Li(AlCl<sub>4</sub>) in SOCl<sub>2</sub>

Glass-to-Metal Seals -- Glass Type Not Known

Molybdenum Pins

Cathode-to-Case Attachment -- Nickel Welded to 304 SS

Lithium Electrode Current Collector --

Full, Interior Nickel Emnet Grid

Interelectrode Area = 215 cm<sup>2</sup>

Thionyl Chloride Limited

Weight = 124 g

Made in 1978

Figure 6-1 (cont)

Figure 6-1

Slide 2: Confidence Intervals for Median Values Using a Distribution-Free Sign Test (Fisher)

Rank order the data; assign the ranks; then:

Number in the Sample	Rank Interval for 95% Confidence	Confidence Possible (%)
5	(1, 5)	93.7
6	(1, 6)	96.9
7	(1, 7)	98.4
8	(2, 7)	93.0
9	(2, 8)	96.1
10	(2, 9)	97.9
11	(3, 9)	93.5
12	(3, 10)	96.1
13	(3, 11)	97.7
14	(4, 11)	94.2
15	(4, 12)	96.4

Slide 3: Test Plan; Storage, Case-Negative (1976).

Cell Age (months)	Nominal Current (mA)	Nominal Run Time (h)	Number of Cells used at the following Temperatures (°F)		
			-10	75	120
1	10	180		10	
6	10	180		8	
6	0.6	3000	8	8	8
12	10	180		8	
12	0.6	3000	8	8	8
24	10	180		7	
24	0.6	3000	8	7	8

Reference: Nonparametric Statistical Methods (esp. Chap. 3) by N. Hollander and D. Wolfe; Copyright 1973, by John Wiley and Sons, Inc.

Notes: Assumed capacity = 1.8Ah, Assumed load voltage = 3.5v. Cutoff voltage = 2.000v.

Figure 6-2

Figure 6-3

Slide 4: Median Cell Capacity and its 95% Confidence Interval; Storage, Case-Negative (1976).

Cell Age (months)	Approx. Current (mA)	Approx. Run Time (h)	Capacities (Ah) at the following Temperatures (°F)		
			-10	75	120
1	9.32	209.9		2.05 1.956 1.87	
6	9.16	212.2		1.99 1.944 1.91	
6	0.617	3080	1.94 1.329 1.21	1.93 1.901 1.89	1.61 1.566 1.48
12	9.19	208.5		2.00 1.916 1.83	
12	0.617	3053	1.71 1.428 1.32	1.90 1.883 1.86	1.58 1.507 1.45
24	9.10	210.9		1.95 1.920 1.83	
24	0.609	3120	1.42 1.356 1.25	2.07 1.899 1.70	1.54 1.503 1.40

Notes: The current and run time are correct for the 75°F test; the resistor values are what were actually controlled.

Figure 6-4

Slide 5: Time-averaged Discharge Voltage for the Median Cells; Storage, Case-Negative (1976).

Cell Age (months)	Approx. Current (mA)	Approx. Run Time (h)	Load Voltages at the following Temperatures (°F)		
			-10	75	120
1	9.32	209.9		3.393	
6	9.16	212.2		3.359	
6	0.617	3080	3.325	3.589	3.647
12	9.19	208.5		3.377	
12	0.617	3053	3.312	3.562	3.620
24	9.10	210.9		3.327	
24	0.609	3120	3.256	3.560	3.611

Notes: See Slides 3 and 4, as appropriate.

Figure 6-5

Slide 6: Test Plan; Case-Negative (1977).

Nominal Current (mA)	Nominal Run Time (h)	Number of Cells Used at the following Temperatures (°F)		
		32	75	120
10	170	9	15	9
3	567	9	9	9
1	1700	9	9	9
0.1941	8760		15	
0.0647	26280		15	
0.0388	43800		15	

Notes: Assumed capacity = 1.7 Ah. Assumed load voltage = 3.5v. Cutoff voltage = 2.000v.

Figure 6-6

Slide 7: Median Cell Capacity and Its 95% Confidence Interval; Case-Negative (1977).

Approximate Current (mA)	Approximate Run Time (h)	Capacities (Ah) at the following Temperatures (°F)		
		32	75	120
9.40	185.7	1.74 1.716 1.46	1.78 1.744 1.72	1.73 1.699 1.66
3.034	566	1.78 1.745 1.72	1.75 1.719 1.70	1.65 1.604 1.53
1.026	1661	1.76 1.727 1.70	1.73 1.705 1.68	1.42 1.404 1.34
0.2018	8236		1.68 1.662 1.64	
0.0683	21090		1.49 1.440 1.41	
0.0409	30174		1.27 1.235 1.17	

Notes: The current and run time are correct for the 75°F tests; the resistor values are what were actually controlled.

Figure 6-7

Slide 8: Time-Averaged Discharge Voltage for the Median Cell;  
Case-Negative (1977).

Approximate Current (mA)	Approximate Run Time (h)	Load Voltages at the following Temperatures (°F)		
		32	75	120
9.40	185.7	3.267	3.452	3.528
3.034	566.4	3.412	3.526	3.596
1.026	1661	3.494	3.579	3.607
0.2018	8236		3.624	
0.0683	21090		3.638	
0.0409	30174		3.650	

Notes: See Notes on Slides 6 and 7, as appropriate.

Figure 6-8

Slide 9: continued

The Data:

$\bar{I}$	X	Y	Y(calc)	Y - Y(calc)
9.40	185.0	1744	1737	+ 7
3.034	573.2	1719	1732	- 13
1.026	1659	1705	1719	- 14
0.2018	8620	1662	1638	+ 24
0.0683	25460	1440	1440	0
0.0409	42520	1235	1239	- 4

$$Y(\text{calc}) = 1739.0 - (0.011751)X$$

Correlation Coefficient = - 0.997

Note: A physically more straightforward model,

$$Q = Q_0 - I_c t$$

where t = run time and the corrosion current,

$I_c$  is assumed constant, yields a

correlation coefficient = - 0.989.

Figure 6-9 (cont)

Slide 9

One Interpretation of the Capacity Data at 75 °F for the Case-Negative (1977) Design

$\bar{I}$  = Average Current (mA)

$Q_0$  = Apparent Theoretical Capacity = 1739.0 mAh

$Y = Q =$  Delivered Capacity (mAh)

$Y =$  Apparent Run Time (h) to Deliver 1739.0 mAh

$$= Q_0 / \bar{I}$$

Using Linear Regression Analysis, Fit the Equation

$Y = a - bX$  -- which means

$Q = Q_0 - b(Q_0 / \bar{I})$ , which rearranges to

$(Q_0 / Q) \bar{I} = \bar{I} + b(Q_0 / Q)$  -- which could mean

Total "Current" = Load Current plus

Corrosion "Current".

If  $b(Q_0 / Q) =$  Average Corrosion "Current" =  $\bar{I}_c$ , then

$\bar{I}_c = b\bar{I} / (\bar{I} - b)$  -- which says

$\bar{I}_c = b$ , for large  $\bar{I}$ , and

$\bar{I}_c$  increases slowly with decreasing  $\bar{I}$ , until

$$\bar{I} = 2b = \bar{I}_c.$$

Figure 6-9

Slide 10: Storage Results at 75°F; Case-Positive (1978).

Cell Age (months)	Approx. Current (mA)	Approx. Run Time (h)	Number of Cells	Average Load Voltage	Median Capacity and Its 95% Confidence Limits (Ah)
					18.5 18.23 18.0
6	22.23	623.7	14	3.450	
12	22.21	622.0	5	3.458	18.4 18.21 18.1
18	22.30	621.8	12	3.457	18.4 18.22 18.1
31	22.42	614.7	12	3.440	18.3 18.08 18.0
42			5		

Notes: Cutoff voltage = 2.000 V.

The Approx. Current, Approx. Run Time, and

Average Load Voltage are all correct for the

appropriate median cell.

Figure 6-10

Slide 11: Test Plan; Case-Positive (1978).

Nominal Current (mA)	Nominal Run Time (h)	Number of Cells Used at the following Temperatures (°F)				
		-40	-10	32	75	122
100	180	5	5	5	14	5
30	600	5	5	5	14	5
10	1800	5	5	5	14	5
3	6000	5		5	14	
1	18000				5	

Notes: Assumed capacity = 18.0Ah. See last two Notes on Slide 6.

Figure 6-11

Slide 12: Median Cell Capacity and Its 95% Confidence Interval; Case-Positive (1978).

Approximate Current (mA)	Approximate Run Time (h)	Capacities (Ah) at the following Temperatures (°F)				
		-40	-10	32	75	122
96.2	139.1	5.2	6.6	10.1	13.6	16.9
		4.97	6.34	9.59	13.39	16.58
		4.2	6.0	9.1	13.0	16.0
29.23	623.7	7.3	9.1	14.7	18.5	17.8
		6.95	8.57	14.26	18.23	17.72
		6.7	8.2	13.2	18.0	17.1
9.91	1836	8.9	15.2	18.9	18.4	17.7
		8.81	14.48	18.26	18.19	17.44
		8.3	13.7	16.3	17.8	15.3
3.032	6000	12.1		19.1	18.2	
		11.71		18.61	18.21	
		11.0		18.0	17.9	
1.018	18050				18.5	
					18.36	
					18.2	

Notes: See Notes on Slide 7.

Figure 6-12

Slide 13: Time-Averaged Discharge Voltage for the Median Cell; Case-Positive (1978).

Approx. Current (mA)	Approx. Run Time (h)	Number of Cells Used at the following Temperatures (°F)				
		-40	-10	32	75	122
96.2	139.1	2.750	2.919	3.126	3.379	3.376
29.23	623.7	2.898	3.070	3.371	3.450	3.453
9.91	1836	3.032	3.322	3.462	3.467	3.501
3.032	6000	3.212		3.511	3.536	
1.018	18050				3.570	

Notes: See Notes on Slides 11 and 6, 12 and 7, as appropriate.

Figure 6-13

## HEAT GENERATION RATES IN LITHIUM THIONYL CHLORIDE CELLS

Harvey Frank

JPL

I would like to mention at the beginning that this work is sponsored by the DAST Office of NASA. It's part of the high energy primary battery program that Dr. Ambrus mentioned this morning.

The work that I'll be describing here deals with thermal characteristics of thionyl-chloride batteries, and, in particular, the heat generation rate in these batteries.

Heat generation rate data can be used for several applications. We'll be describing some of the results that we've obtained and how these have been applied.

(Figure 7-1)

The particular cells of interest that we've been examining are experimental types. They are of the D size with spiral wound configuration and are instrumented with a thermocouple. Here is a photograph of one. We've listed the components here. These comprise what one might call the conventional thionyl-chloride system without any additives. Also listed are the specific heats of the various components, from which, with the weights, we have computed the thermal mass of the system, which is used in subsequent calculations, and the electrode areas in case anyone desires to compute the current densities that we've been running at.

(Figure 7-2)

The calorimetric data has been obtained on the assembly shown here. This is fast response calorimeter. A cell is installed here, as we'll see in the next Vu-graph. Its response time is within about a few seconds to a minute depending on the load. We typically run at constant current. The heat generation rate is measured directly in watts. It's an isothermal device and can be operated over a range from -40 to 70 degrees Centigrade. It's not a micro, but we'll call it a macro calorimeter, up to 50 watts of heat generation rate.

(Figure 7-3)

This shows the particular cell installed in the calorimeter. The cell is on a baseplate which communicates with a copper rod and then to liquid nitrogen underneath. It's shielded for negligible heat losses. So all of the heat that's generated by this cell goes down a copper rod into liquid nitrogen underneath here, and the heat generation rate is measured by probes along the copper rod to give a direct reading, thermal reading, and convert it to a heat generation rate in terms of watts.

(Figure 7-4)

Before we present the results we will first mention this equation here. It has been discussed in the ECS Journal and at the Electrochem Society meeting. This equation gives the heat generation rate in an electrochemical system in terms of the polarization heat and the entropy heat. This is for the general case in terms of the open circuit voltage, the operating voltage, and the "dE/dT" term, which is the measure of entropy which has been determined experimentally. For the case of thionyl-chloride, the values of the constants have been computed, and we arrive at the equation at the bottom here, giving the heat generation rate in watts as a function of operating current and voltage. I might mention that this equation applies only to electrochemical heat, not other types of heat that may be generated in an electrochemical device. It's only electrochemical in nature; not including, for example, chemical heat effects which can arise, and which are speculated to occur in these batteries.

(Figure 7-5)

We have two typical results that were obtained on the calorimeter. We've plotted here the operating voltage for a constant current discharge at 1 amp, and two sets of heat generation data: first of all, the experimentally measured value by this line here from the calorimeter and, underneath, the lower dashed line giving the theoretical heat generation rate as per the equation which we've just shown.

There are two points to be made here. First, as per the electrochemical equation, the heat generation rate

rises with a fall in voltage, as predicted by the equation, and at this particular current, up to 3 watts. The second point is that there is a delta, one notices, between the experimental value and the theoretically predicted value. Now this signifies another type of heating effect. It can be, most likely, a chemical heat effect, whether it's corrosion of the lithium as we just had reference to, or other types of chemical reactions. We don't know exactly what they are.

We are investigating the reactions that occur in the thionyl-chloride and the sulfury-chloride cells to explain these reactions by in situ electrochemical techniques. But for the sake of this presentation, I'll just say that it is a chemical heat effect.

(Figure 7-6)

This gives another set of data: this particular one at a higher current, 3 amps, which is relatively high for this type of cell considering the electrode area.

In this case we observe a similar trend: i.e., a decline in voltage at the end of discharge, with a rise in heat generation rate as the voltage falls.

These are two sets of typical calorimetric data we obtained with the thionyl-chloride system along with the theoretically predicted values.

(Figure 7-7)

Now, we mentioned we're studying the mechanism of the reactions. Well, this is not related to the mechanism but is for someone who wants a first cut approximation for predicting heat. By taking the experimental data, the experimental heat generation data, one can make an empirical fit; which has been done here; and arrive at the simplest of all equations. This gives an empirical prediction of the heat generation rate simply as a function of operating voltage and current.

(Figure 7-8)

Bob Bragg mentioned this morning about adiabatic type tests. We have done similar work, with two purposes in



mind; one was reach the melting point of lithium and observe it; the cell exploded at this point. The other was to test the empirical equation which we have just described. These, again, were constant current discharge runs on cells under near-adiabatic conditions with measurement of internal temperature. We also measured external temperature, which is not shown on this graph.

Here we have the operating voltage down to a zero volt cutoff. The actual internal temperature is measured by the thermocouple, and the predicted temperature as per the simplified equation.

For someone who would like to make a first cut approximation at the heat generation rate, the equation apparently gives a fairly reasonable prediction.

In this particular case the cell opened near the end of discharge. (Loss of internal contact.) And the current dropped, and, correspondingly, the heat generator dropped. And we were not quite able to reach the melting point of lithium.

(Figure 7-9)

This is another adiabatic run at a higher current. Again, the intent was to reach the melting point of lithium, also to check accuracy of the model.

Again we see in this particular case, at 4 amps, we get a fairly good correspondence between the actual and predicted temperature from the equation. In this particular case the cell did not again quite reach the melting point of lithium; it did, however, go slightly into reversal. We carried it shortly beyond this point. The temperature rose to 250 degrees F., and then slowly declined. It did not explode. But apparently there was internal chemical reaction after it reached the melting point of lithium.

(Figure 7-10)

Now, one additional run on this particular type of cell was carried out for the purpose of obtaining some additional thermal data. This is for the condition of forced overdischarged on a cell which had been previously

discharged to zero cutoff voltage, and had been on stand for a few weeks to this point.

The purpose of the test was to examine the problem of thermal behavior on reversal and, in particular, the subject of lithium plating during the condition of reversal.

Well, first of all, to explain the experimental results: At the onset of discharge, the cell voltage indicated a small residual capacity. Shortly thereafter the cell went into reversal, and voltage stabilized at the indicated value, at 1 amp discharge. The temperature was moderate, near 30 degrees Centigrade at this time.

The idea, then, was to raise the temperature for the condition of reversal. We did this by increasing the current, stepping the current up to 5 amps, and observed a rise in internal temperature. At approximately 60 degrees Centigrade, the cell was noted to explode.

There has been a great deal of discussion about the danger of lithium being plated on the carbon electrode for the condition of reversal. From DSC work and by the Naval Surface Weapons Center, and also work done at JPL, it has been shown that the combination of lithium, thionyl-chloride and carbon can exhibit an exotherm at a moderately low temperature; experimentally, on the DSC work, near 50 degrees Centigrade. The observed phenomena gives support to the belief that lithium is plated on the carbon during reversal and this can cause an explosion.

One point I forgot to mention was that these were cathode-limited cells. By that we mean carbon-limited, not thionyl-chloride-limited. And so there was excess lithium available to plate on the carbon. And when the temperature reached a moderate level, much below those which we heard this morning, in this particular case near 50 to 60 degrees Centigrade, the cathode-limited cell did explode on reversal.

(Figure 7-11)

Just a few concluding remarks here. We have some indication of chemical heat effects in the thionyl-chloride system. We do have a measure, a quantitative measure, of

the magnitude of these heat effects. When the reactions are understood, we can obtain a measure of their rates from the thermal data. And this work is going on both at JPL and at other locations.

For engineering purposes we have developed a simple equation for thermal analyses, not only for the adiabatic case but for any environment. By applying suitable heat transfer equations one can use the heat generation rate and establish fairly accurate internal temperature under any operating condition.

Finally, the cathode-limited cell can explode on reversal, and this gives support to the conviction of the reactivity of lithium, carbon and thionyl chloride.

Thank you.

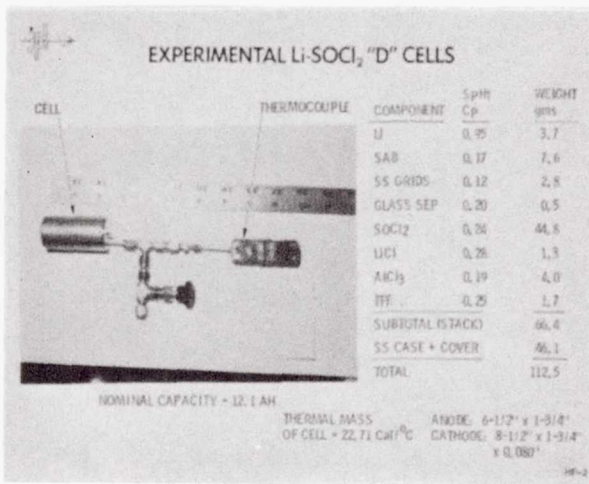

Figure 7-1

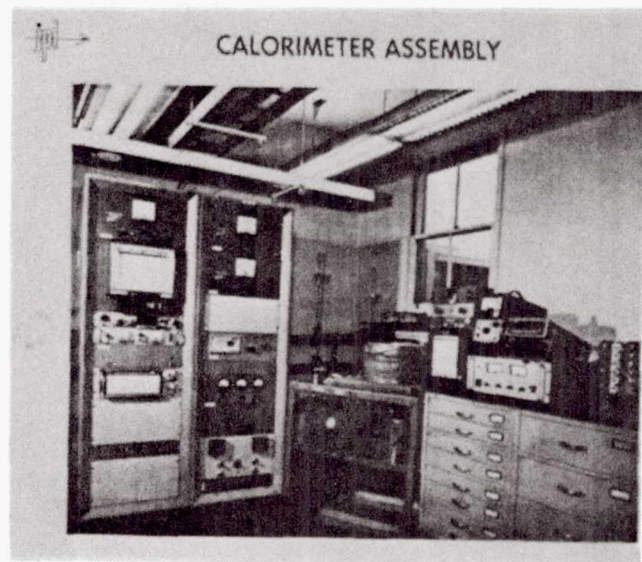

Figure 7-2

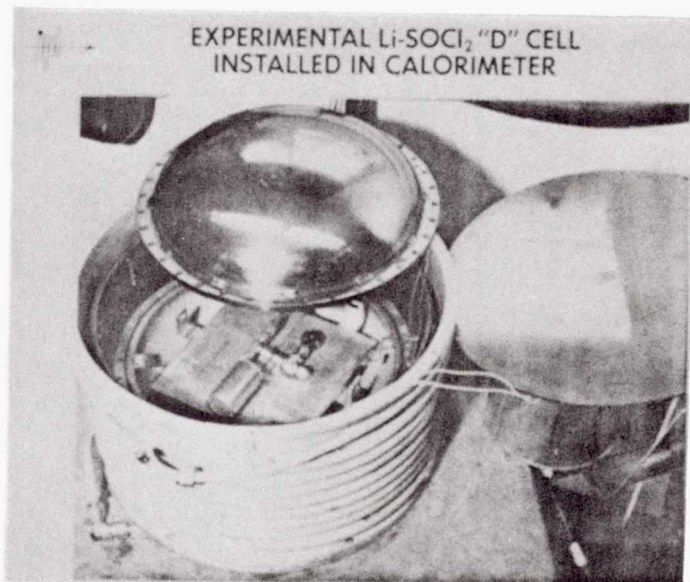

Figure 7-3

#### THEORETICAL HEAT GENERATION RATES

- GENERAL CASE

$$Q = I (E_{oc} - E_{op}) - I T \frac{dE_{oc}}{dT}$$

WHERE: Q = HEAT, WATTS

E<sub>oc</sub> = OPEN CIRCUIT VOLTAGE, VOLTS

E<sub>op</sub> = OPERATING VOLTAGE, VOLTS

I = CURRENT, AMPS

T = ABSOLUTE TEMP, °K

$\frac{dE_{oc}}{dT}$  = CHANGE IN E<sub>oc</sub> WITH T, VOLTS/°K

- FOR Li-SOCl<sub>2</sub> CELLS AT 20°C

$$Q = I (3.65 - E_{op}) - I (0.316)$$

Figure 7-4



HEAT GENERATION DURING CONSTANT CURRENT DISCHARGE OF "D" SIZE Li-SOCl<sub>2</sub> CELL

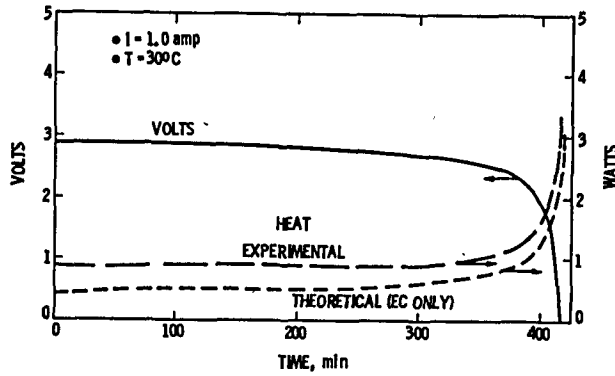

Figure 7-5



HEAT GENERATION DURING CONSTANT CURRENT DISCHARGE OF "D" SIZE Li-SOCl<sub>2</sub> CELL

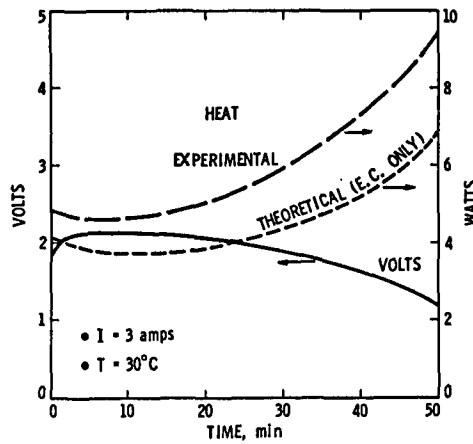

Figure 7-6



SIMPLIFIED EMPIRICAL EQUATION FOR PREDICTING HEAT GENERATION RATES IN Li-SOCl<sub>2</sub> CELLS

$$Q = (3.7 - E_{op})I$$

WHERE:

- Q = HEAT, WATTS
- E<sub>op</sub> = OPERATING VOLTAGE, VOLTS
- I = CURRENT, AMPS

Figure 7-7

→ **CONSTANT CURRENT DISCHARGE OF  $\text{Li-SOCl}_2$  "D" CELL UNDER NEAR ADIABATIC CONDITIONS**

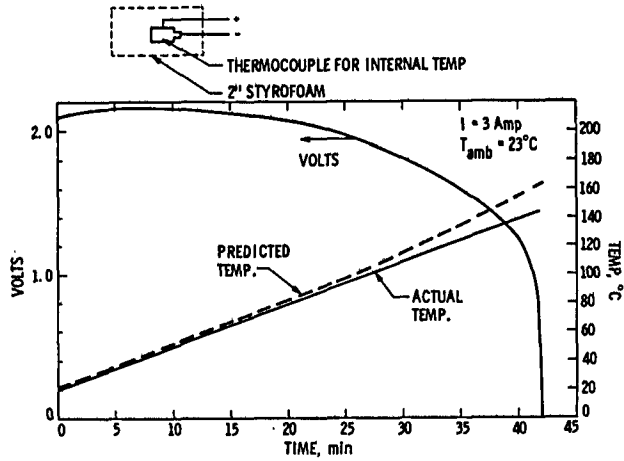

Figure 7-8

→ **CONSTANT CURRENT DISCHARGE OF  $\text{Li-SOCl}_2$  "D" CELL UNDER NEAR ADIABATIC CONDITIONS**

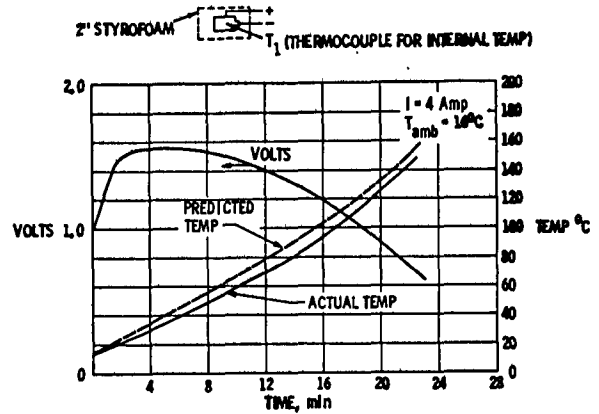

Figure 7-9

→ **FORCED OVERDISCHARGE OF  $\text{Li-SOCl}_2$  "D" CELL**

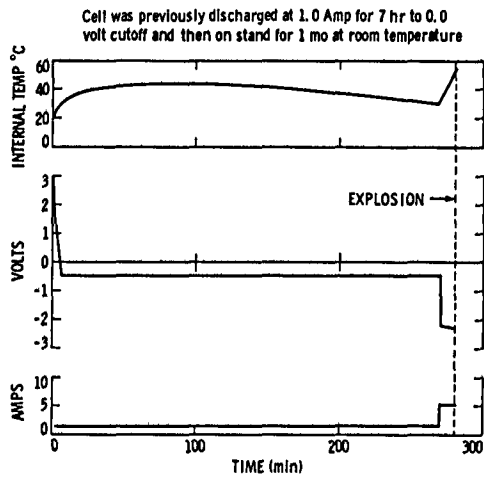

Figure 7-10

→ **CONCLUDING REMARKS**

- SOME INDICATION AND MEASURE OF CHEMICAL IN ADDITION TO ELECTROCHEMICAL HEAT EFFECTS - REACTIONS UNDER INVESTIGATION
- EMPIRICAL EQUATION USEFUL FOR GOOD FIRST APPROXIMATION IN THERMAL MODELING
- CATHODE LIMITED CELL CAN EXPLODE ON REVERSAL AT MODERATE TEMPS. - HELPS SUPPORT PRIOR DSC STUDIES

Figure 7-11

**Page intentionally left blank**

DISCHARGE OF 1400 AH LITHIUM THIONYL CHLORIDE CELLS  
INTO VOLTAGE REVERSAL

Adrian Zolla

ALTUS

I'd like to thank NAVALEX and NOSC for supporting the work which I'm going to talk about today. Over a three-year period, the Navy, through NOSC, has funded ALTUS to develop and characterize a thionyl-chloride active cell with capacity in the range of 1000 to 2000 ampere-hours and a 10-year active shelf life.

This cell will be incorporated, hopefully, into a high energy density battery, HEDB, with configurations up to 150 to 200 kilowatt hours of energy for use in underwater instrumentation packages, surface buoys and undersea vehicles, where safety and operation in any orientation, structural strength and hermeticity are key factors.

The HEDB battery concept is shown in the first Vu-graph.

(Figure 8-1)

Forty cells of 1400 ampere-hour capacity are connected in series within a pressure housing.

(Figure 8-2)

The 1400 ampere-hour cell is disc shaped and has a diameter of 17 inches, a thickness of 1-3/8 inches, and with a center hole of 2-5/8 inches diameter, which houses the electrode terminals. The 1400 ampere-hour is depicted in the top left of the photograph.

The cell weighs 29 pounds for 4.8 kilowatt hours output, and is optimized for currents up to 15 amperes.

The cell at the lower left is very similar. It's two inches thick and weighs 39 pounds, for a capacity of 2000 ampere-hours and 7.3 kilowatt hours of energy. The technology is easily scaled, and also shown is a similar



17-inch diameter cell, height 7 inches, weighing 25 pounds, for 8000 ampere-hours and 26 kilowatt hours of capacity. All three cells are optimized for discharge rates of 100 hours or longer and a long, 10-year shelf life.

ALTUS has built 200 cells of 1400 ampere-hours capacity and about 50 cells of 2000 ampere-hours capacity, and one prototype 8000 amp-hour cell.

We have characterized this technology extensively for performance under a variety of operating rates and temperatures and for safety under a broad range of abusive conditions for various states of cell discharge.

The cells are filled with high purity thionyl-chloride electrolyte at the factory, hermetically sealed, and shipped in an active sealed state.

I'll give you a brief synopsis of the test program prior to the reverse voltage data which I recently acquired.

(Figure 8-3)

The next two photographs are representative of the abuse tests, namely, drop testing in this picture,

(Figure 8-4) and crush testing of 1400 ampere-hour cells in fresh, partial and fully discharged conditions.

(Figure 8-5)

This table provides a brief overview of the tests which have been conducted on the numerous cells without ever a single incident at either ALTUS or at NOSC with regard to overheating or venting of the cells.

In many cases permutations of these tests have been performed on the same cell, and the cell later delivered full capacity upon discharge.

(Figure 8-6)

This is representative of some twenty tests in which a fresh cell has been penetrated by a conductive object, such as a nail or a 1/4-inch diameter ram device, and in all but a couple of cases there has been no venting

or exothermic reaction resulting. The high degree of resilience to this type of extreme abuse test is due to the method of construction which avoids the exothermic reaction of molten lithium thionyl chloride in the presence of carbon.

For single cell applications like the space shuttle experiment package power source, a reverse voltage condition cannot occur. However, this condition can result when a cell of poor capacity delivery is force discharged by other normal cells in a series connected battery stack, a problem that has continued to plague lithium thionyl chloride multi-cell batteries of large capacity.

The final phase of the ALTUS-NQSC program, just completed, addressed this reverse voltage condition. The objective of this work was to extend the capability of the 1400 ampere-hour cell to reliably withstand a force discharge into voltage reversal for a total of ampere-hours equal to 100 percent of the normal capacity rating, to simulate a case where a dead cell had accidentally been included in a fresh battery system.

The Naval Surface Weapons Center suggested safety standard was to test several cells to voltage reversal for 150 percent of the capacity rating: that's 2100 ampere-hours beyond zero volt output: in order to demonstrate a margin of safety of 50 percent above the worst case conditions. The test conditions were to investigate the forced discharge of 6 amps at 21 degrees Centigrade: that's .45 milliamps per square centimeter: and 12 amps at zero degrees Centigrade, or .9 milliamps per square centimeter of lithium.

In order to achieve this result, the following criteria were invoked in the cell design:

(Figure 8-7)

(1) The cell is limited to 1400 ampere-hours capacity by the weight of carbon in the cathode, operating at about 3 ampere-hours per gram.

(2) The situation of lithium limitation is avoided by building in 30 percent excess material into the anodes, which theoretically allows for 1800 ampere-hours

lithium capacity.

(3) The void volume between the separator and cathode structures is designed to accommodate 2000 ampere-hours of thionyl chloride catholyte.

(4) Each lithium anode is firmly attached to a nickel exmet current collector to eliminate the problem of hot spots developing as the lithium is utilized and when the anodes become extremely thin; this effect being assumed responsible for cell venting in extended force discharge in some cases.

(5) The cathode current collector is of stainless steel, rather than nickel, to minimize the lithium plating to the cathode grid structure.

(6) Most important: a chemical switch mechanism is incorporated which operates when the cell output voltage is zero. This low ohmic shunt both diverts 70 percent of the forced discharge current from lithium plating reactions and further limits the negative voltage excursion to less than 150 millivolts negative, where electrolysis reactions occurring at higher potentials are circumvented.

Note the energy density is maintained at 150 watt-hours per pound with the above criteria invoked.

The details of the switch mechanism are still considered proprietary at this time. But I should point out that two patents have been allowed, and public disclosure will be forthcoming by the turn of the year. Full disclosure of all construction details has been made to the program sponsor.

Each cell in this experiment was built with four feed-through terminals for experiment monitoring purposes: two for normal anode and cathode terminals, one for the lithium/lithium ion reference electrode incorporated into the cell, and the fourth feed-through to bring out one end of the internal switch in order that the shunted current could be monitored. These modifications to the cell to achieve a four-terminal output caused some loss in capacity for the cells compared to previous production units tested.

The constant current discharge of each cell was

accomplished using a power supply as shown in the next Vu-graph.

(Figure 8-8)

This is a very simple circuit diagram. The discharge current and internal switch current were monitored across 1-milliohm shunts incorporated into the circuit. The cell is equipped with a sensimetric pressure transducer, permitting the cell's internal pressure to be followed. Thermocouples in the test chamber and affixed to the cell's surface gave temperature data, and the EMF between lithium reference and both anode and cathode terminals gave data on internal polarization effects.

All parameters were recorded using a Fluke 2240A data logger. A strip chart recording was made, in addition, as the cell went into voltage reversal.

(Figure 8-9)

This slide is for one of the cells discharged, and typifies the results obtained at 12 amps discharge current and zero degrees Centigrade. The cell voltage commences at 3.25 volts, holds a plateau, and then, reaching about 2.8 volts, rapidly declines to a negative voltage of 120 millivolts negative.

At zero volts output, the internal switch operates. The shunted current, through this internal switch, rises rapidly from zero and reaches a plateau of 8.4 amps, which is approximately 74 percent of the force discharge current, which was 12 amps. The cell voltage remains clamped because of this, at a low negative potential, and is only 132 millivolts negative at the end of test, after 189 hours beyond zero volts when the test was terminated, for 2262 ampere-hours of reverse voltage. That's greater than 150 percent of the cell's 1400 ampere-hour capacity rating.

(Figure 8-10)

This next slide shows the information gained from the lithium/lithium ion reference electrode and demonstrates a carbon cathode limited system. Anode polarization was about 50 millivolts during normal discharge, and about

90 millivolts during the reverse voltage force discharge. The cathode displayed, meanwhile, a 40 millivolt negative voltage with respect to the lithium reference electrode during reverse voltage.

These voltages were held till the end of test.

(Figure 8-11)

The temperature data are shown in this Vu-graph. One sees the ambient refrigerated temperature of zero degrees plus or minus 2, with the cell remaining at zero except for a brief excursion to plus 4 degrees Centigrade during voltage decline, due, undoubtedly, to the heating effects of the heavy, polarized carbon surface.

It's worthy to note that the internal cell pressure commences at -2 psi gage and at the end of test only rose to plus 5 psi, after 289 hours at 12 amps.

(Figure 8-12)

The data from the 6 amp discharge at 27 degrees Centigrade ambient are similar, as shown in this Vu-graph. The cell voltage holds 3.47 volts, a little higher, of course, than for zero degrees, for a period. It's reasonably constant until 3.2 volts is obtained, when there's a rapid drop; in this case to -80 millivolts. Again, as the cell voltage crosses zero volts, the internal switch closes, and the shunted current rises to 4 amps in this case, thereby shunting, again, two-thirds of the force discharge current. The cell voltage remains clamped at a mere 60 millivolts negative for the duration of the 275 hours or 2183 ampere-hours in voltage reversal.

(Figure 8-13)

This is the reference voltage data.

The reference voltage data, again, shows a cathode limited design, with a 50 millivolt anode polarization with respect to lithium/lithium ions, and a 20 millivolt negative potential for the cathode with respect to the reference at the end of test.

(Figure 8-14)

The temperature and pressure data are shown here. They show no internal heating or unique pressure rise. Cell temperature remained flat at 27 degrees, plus or minus 3 degrees, with only diurnal effects evidence. The cell internal pressure rose from 2 psi gage to 16 psig at the completion of the 150 percent voltage reversal. In this case you cannot see any temperature rise as the cell went through zero volts, and maybe a very slight hump on the pressure, a psi or so.

(Figure 8-15)

This final vu-graph summarizes the reverse voltage data for the series of 1400 ampere-hour cells tested.

During this test program, not one cell vented or showed any significant temperature or pressure excursion, and the Navy requirement for 2100 ampere-hours of discharge in voltage reversal was easily obtained without incident.

The internal switch mechanism consistently shunted two-thirds of the force discharge current, and held the negative potential to 65 millivolts plus or minus 5 for the 6 amp discharge at 21° C and 125 millivolts plus or minus 5 millivolts negative for the 12 amp discharge at zero degrees Centigrade.

The effects of the switch in shunting the majority of the current allows for a prolonged cathode limited system, where the lithium anodes are not consumed for the duration of the extensive reverse voltage condition. Without a shunting mechanism I have found that the anode limited situation is reached very quickly in voltage reversal, and dangerously high negative potentials are attained once electrolysis reactions are forced to take place.

The reliability of dendritic shunting between anode and carbon by lithium plating reaction is not, in itself, reliable for thick cathodes in cells. Cathode limited cells can frequently revert to anode limited cells during reverse voltage unless the current is otherwise diverted, as in the cells described.

This reverse voltage testing of a series of active cells of improved grid design completes the HEDB development

for the Navy. The summation of the data from the testing of 200 cells over a three-year period has demonstrated unique safety features early on. Now with the completion of the reverse voltage work, the technology is ready for application in battery systems.

The cell design offers the advantage of ease of scale ability to cells of different capacity and aspect ratios. The location of electrode terminals is optional. The cell case is hermetically sealed, has high vacuum integrity, and no discharge products can escape to the exterior environment. There is no technical barrier to the immediate and safe application of this cell to a variety of battery configurations in rugged environments.

Thank you.

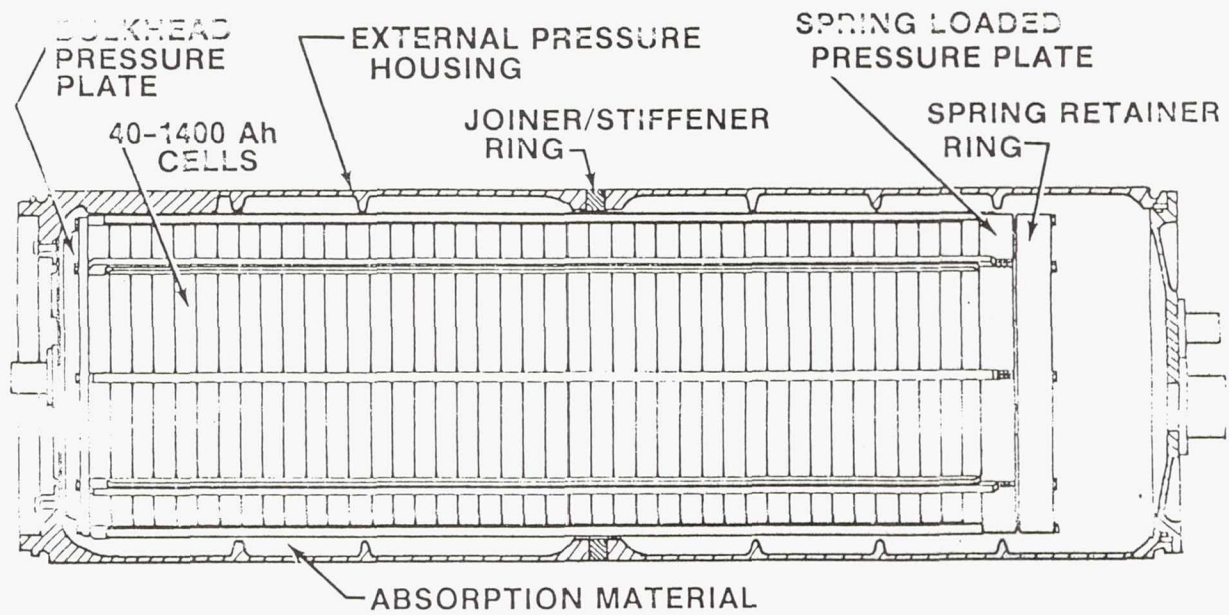

HEDB CONTAINMENT STRUCTURE

Figure 8-1

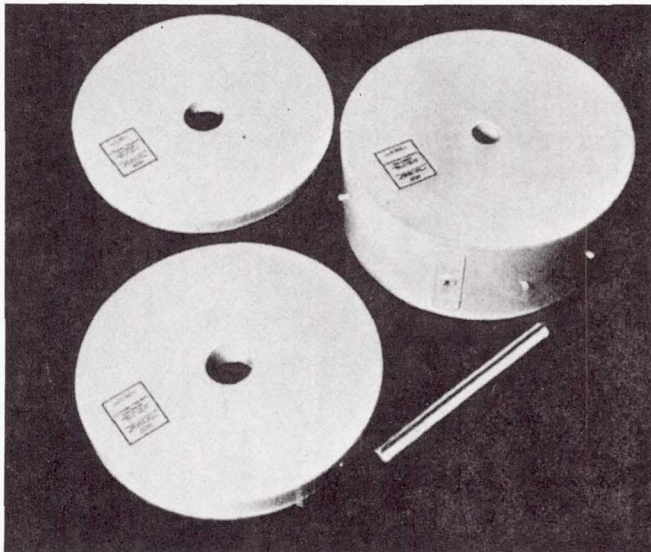

Figure 8-2

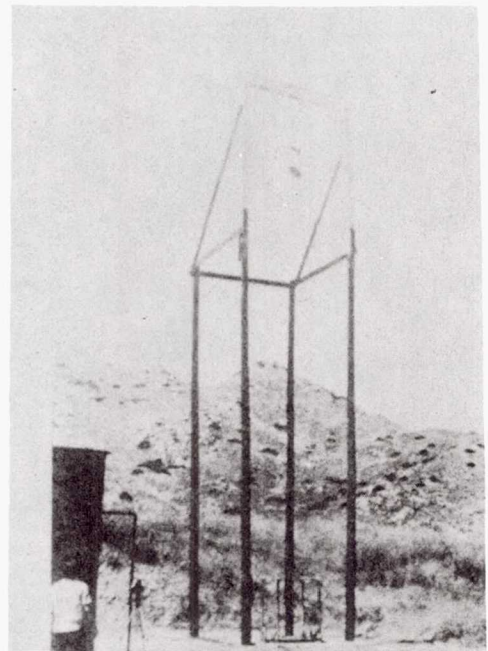

Figure 8-3



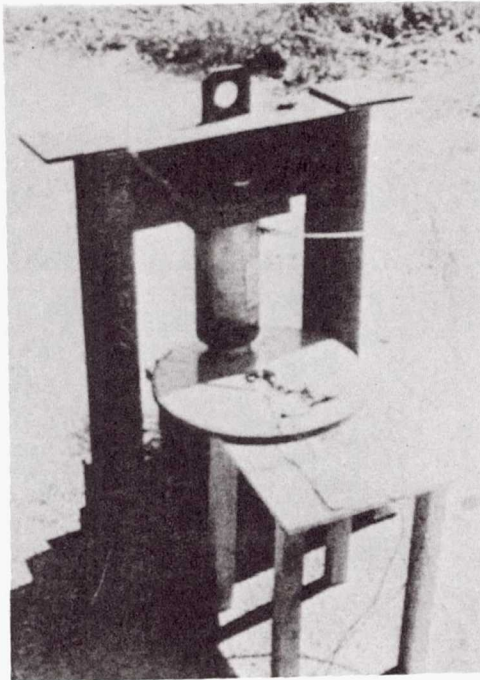

Figure 8-4

1400 AH CELL TESTS

WHICH HAVE NEVER LED TO A VENTING OR EXPLOSION

1. DROP: - 3 FT TO 12 FT
2. CRUSH: - 1000 LBS OVER 10 SQ. INS
3. VIBRATION: - 0-60Hz, 0.06 INS AMPLITUDE
4. SHOCK: - 300 G, 15 MILLISECONDS
5. HYDROSTATIC PRESSURE: - 500 PSI
6. CHARGE CURRENT: - TO 100% CAPACITY RATING
7. SHORT CIRCUIT OF TERMINALS
8. DISCHARGE: - 0° TO 110°C  
6A TO 16 AMPS  
INTERMITTENT/PULSE LOADS  
1 YEAR STORAGE

Figure 8-5



Figure 8-6

CRITERIA FOR EXTENDED RV SAFETY OF 1400 CELL

1. CAPACITY OF CELL CARBON LIMITED
2. 30% EXCESS LITHIUM ABOVE THEORETICAL OF 1400 AH
3. 45% EXCESS SOC<sub>1/2</sub> ABOVE THEORETICAL OF 1400 AH
4. ALL LITHIUM DISC ANODES FIRMLY BONDED TO NICKEL EXMET CURRENT COLLECTOR
5. CATHODE CURRENT COLLECTOR GRIDS STAINLESS STEEL
6. A CHEMICAL SWITCH MECHANISM INCLUDED IN THE INTERNAL DESIGN TO
  - (A) SHUNT > 70% OF FORCED DISCHARGE CURRENT IN REVERSE VOLTAGE
  - (B) CLAMP CELL NEGATIVE VOLTAGE TO LOW VALUES THROUGH THE LOW SWITCH IMPEDANCE OF 15 MILLIOHMS

NOTE: CELL WEIGHT OF 31 POUNDS IS MAINTAINED EVEN WITH RV SAFETY FEATURES ABOVE.

Figure 8-7

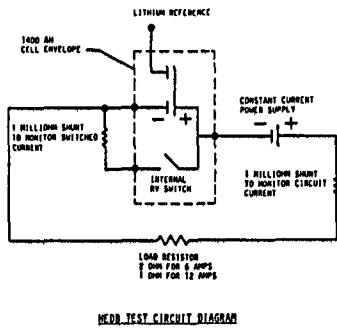

Figure 8-8

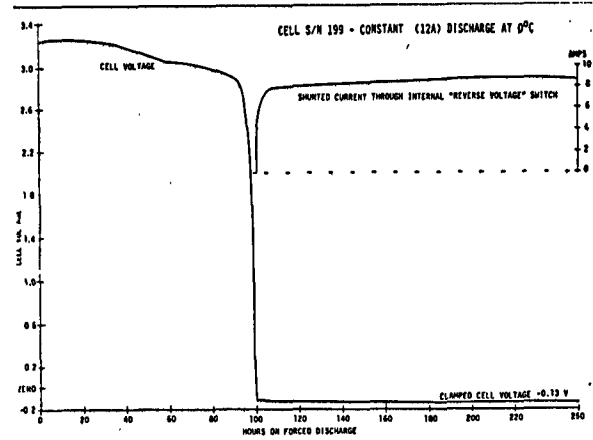

Figure 8-9

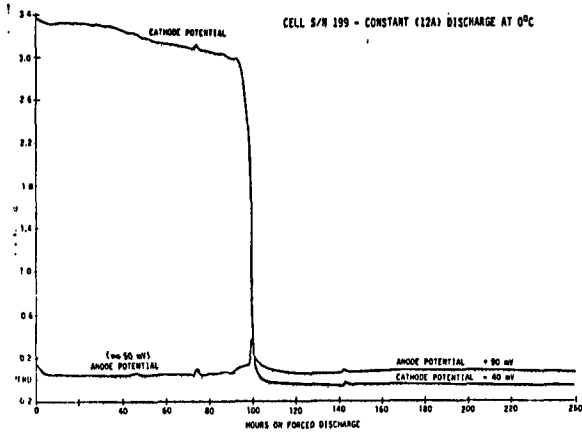

Figure 8-10

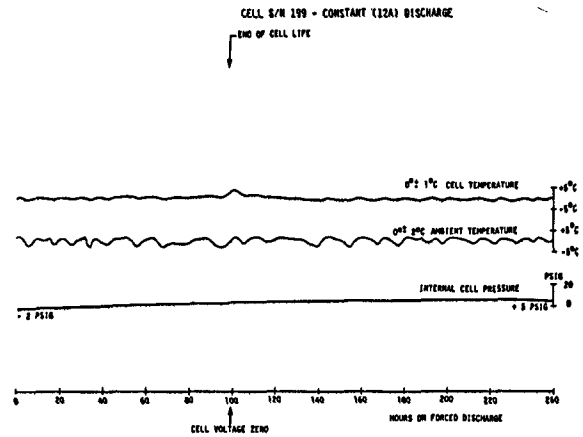

Figure 8-11

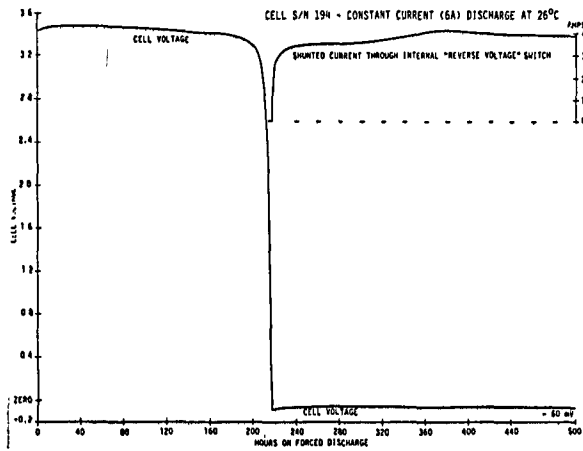

Figure 8-12

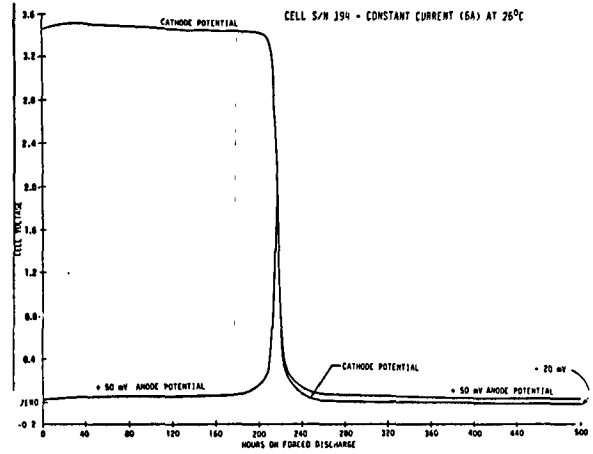

Figure 8-13

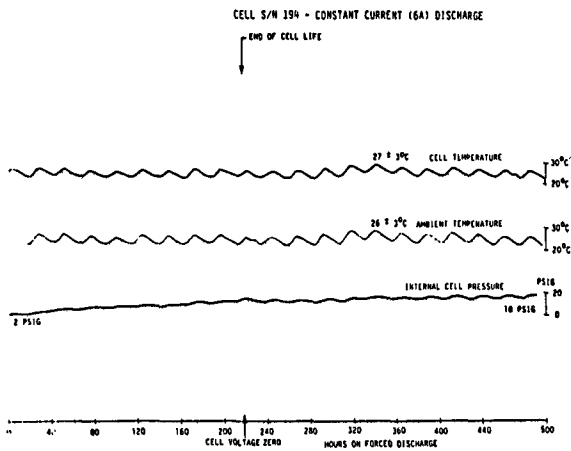

Figure 8-14

REVERSE VOLTAGE DATA

CELL S/N	192	194	196	198	193	195	199
CONSTANT FORCE DISCHARGE CURRENT	5.84 A	5.83 A	5.87 A	5.97	12.05 A	12.04 A	11.97
AMP HOURS ENDURED IN REVERSE-VOLTAGE BEFORE TEST TERMINATED	2105 AH	2183 AH	2302 AH	2185 AH	2127 AH	2137 AH	2262 AH
HOURS IN REVERSAL	355 H	375 H	393 H	366 H	177 H	178 H	189 H
CLAMPED NEGATIVE VOLTAGE	-0.074 V	-0.056 V	-0.068 V	-0.070 V	-0.132 V	-0.120 V	-0.132 V
6 SHUNTED CURRENT THROUGH SWITCH	700	688	686	700	688	676	746
ENVIRONMENTAL TEMPERATURE	27 ± 3°C	26 ± 3°C	26 ± 3°C	26 ± 3°C	26 ± 3°C	26 ± 3°C	26 ± 3°C
CELL TEMPERATURE	27 ± 3°C	27 ± 3°C	26 ± 3°C	26 ± 3°C	26 ± 3°C	26 ± 3°C	26 ± 3°C
FINAL CELL PRESSURE	20 PSIG	18 PSIG	22 PSIG	17 PSIG	1 PSIG	MEASURED	6 PSIG

Figure 8-15

## HIGH-RATE LITHIUM THIONYL CHLORIDE CELLS

F. Goebel

GTE

The conductivity of non-aqueous electrolytes is considerably lower than measured in aqueous electrolytic solutions. These differences have an effect on the discharge rate capability of the battery. Current densities of 100 milliamperes per square centimeter in cells with alkaline electrolyte, for instance, are standard. To obtain high current rates from lithium  $\text{SOCl}_2$  cells, special electrode designs in conjunction with optimizing the electrolyte conductivity are required.

For low rate discharge, less than 1 milliampere per square centimeter, the bobbin type cell with very thick and low surface area electrodes was designed. The geometrical electrode surface area density of these cells does not exceed one square centimeter per cubic centimeter electrode volume. For higher current densities than 1 milliampere per square centimeter, these type of cells become less efficient due to diffusion problems within the thick carbon cathodes.

In order to achieve high current rates from identical cell volumes, it is necessary to reduce diffusion paths within the cell, and to increase the electrode surface area density.

This basic information resulted in the development of the so-called jellyroll electrode structure and disc electrode configuration for cylindrical cells.

The jellyroll configuration uses thin strips of anode and cathode material which are rolled up in a spiral, wound together, with a separator insulating the active materials.

(Figure 9-1)

The ends of the individual electrodes are connected by welding metal strips to the corresponding terminals of the cell. In a case where round disc electrodes are used, a large number of electrodes are

stacked on top of each other, alternating anodes and cathodes, with separators in between.

(Figure 9-2)

Each electrode disc has direct contact to the terminal, which, in this configuration, is a center rod for all the lithium anodes, and the cell case serves as a common terminal for all the cathodes.

The disc cell design has some advantages over the jellyroll configuration, since each electrode disc has its own contact to the current collector, whose maximum length never exceeds the radius of the cell; which results in a minimal IR loss for all the electrodes within the stack.

This arrangement has demonstrated uniform and maximum material utilization as well as high current drain capability.

The specially designed cathode substrate is making contact over its entire periphery to the steel case as the current collector, which establishes a gradient in discharge profile, being slightly higher on the outside than toward the center. This discharge profile allows an anode limited design, which is one of the major safety features within this type of cell.

Both systems, the jellyroll and the disc electrode design, can be constructed with an electrode surface area density of 10 square centimeters per 1 cubic centimeter electrode volume, which is one order of magnitude larger than within the typical bobbin-type configuration.

The increase in surface area by one order of magnitude effects in the same proportion the discharge rate capability of the cell.

The high rate C cell has been discharged at constant loads to establish the capacity at different current densities, ranging from 1 milliamperere per square centimeter to 10 milliamperes per square centimeter.

(Figure 9-3)

At the nominal rate of 210 milliamperes, which is

equivalent to the 25-hour rate, 90 percent of the anodic capacity can be obtained at a 3-volt cutoff. The cell is able to discharge at much higher currents, as the other curves on this slide indicate. At 1 ampere, for instance, the same cell delivers approximately 4 ampere-hours, at a 2.1 ampere discharge, 3 ampere-hours, respectively, without any hazardous condition resulting.

Low temperature testing was performed at -40 degrees C at a nominal rate of 210 milliamperes. The obtained capacity to the 3-volt cutoff was 2.1 ampere-hours or 37 percent of the room temperature capacity. After the -40 degrees C discharge, the cell was allowed to recover to room temperature without any load applied, and then discharged again to a 3-volt cutoff.

(Figure 9-4)

The additional capacity of 2.94 ampere-hours added to the capacity obtained at -40 degrees C results in a total of about 5.04 ampere-hours, which is 90 percent of the maximum capacity which was achieved at a discharge of 22 degrees C.

The cell was not optimized in electrolyte concentration for low temperature performance. In the meantime, however, it has been demonstrated at GT&E that lower concentrations than 1.8 molar are more efficient in cathode utilization than higher concentrations.

Abuse testing: An abuse test program has been conducted in the operational and non-operational modes.

(Figure 9-5)

This test flow diagram identifies the abuse tests performed and the respective sequence of testing. Each test within the flow sequence is identified by a unique reference number. All test samples were high-rate C cells of identical design, and were all lithium-limited. In this report, however, only these test results are discussed which are significant for the characterization of the high-rate C cell.

Non-operational abuse: Sequence Nos. 1, 4 and 5 identify the tests performed on the high-rate C cells, which are characterized as non-operational tests. Test conditions

and the results are seen in the next slides.

(Figures 9-6 and 9-7)

There was no hazardous condition at any time, and the electrical and mechanical integrity was maintained throughout the entire test sequence. The discharge of the cells involved in Test Sequence Nos. 1 and 4 resulted in 3.8 and 3.6 ampere-hours respectively. There was no capacity loss on cells which were subjected to a drop test.

Operational abuse: Tests performed under operational abuse included charging, overdischarge, external short circuit, cell penetration and cell crush.

Cell charging was performed with a constant current of 210 milliamperes, and these conditions were maintained until all parameters had stabilized.

(Figure 9-8)

The maximum voltage during the tests was 4.38 volts, with a maximum temperature increase of approximately 13 degrees Centigrade over a 4-hour and 20-minute test period. There was no visible or apparent evidence of damage or deterioration as a result of the test.

On overdischarge, the test sample was discharged at 210 milliamperes constant current, and driven into reversal at the same rate.

(Figure 9-9)

The cell was overdischarged for 24 hours without any apparent evidence of damage or abnormal behavior. The maximum temperature on overdischarge was 5 to 6 degrees above ambient shortly after voltage reversal. At the end of the test there was only a small temperature difference between the test sample and the test chamber.

Short circuit testing was performed on a fresh high-rate C cell and on an identical cell which was charged and then discharged to the 3-volt cutoff according to Test Sequence No. 2 in the test flow diagram. In both cases, a 10-milliohm load resulted in a surge current of 45 amperes.

(Figure 9-10)

At that point the internal contact between the current collector and the feedthrough acted like a fuse and burned, as confirmed by post mortem analysis. The temperature after the short test was still rising to about 29 degrees, and then dropped back to room temperature, and no other abnormal behavior was realized during this test.

The crush was performed by reducing the cell diameter to 50 percent of the original size between two quarter-inch diameter anvils. The cell exploded seven seconds after the cell voltage dropped to zero volts, indicating a short circuit between the metallic hardware of the cathode and the lithium.

The skin temperature of the cell reached a maximum of 70.2 degrees Centigrade. A visual examination indicated that the cell top was missing from the can, and about one-third of the upper electrode stack was ejected from the can by force of the explosion. There was no fire after the explosion had occurred.

Cell puncture test was performed with a quarter-inch diameter drill at mid-height of the cell perpendicular to the longitudinal axis. A drop in cell voltage to about the 50-millivolt level indicated a direct short between the anode and cathode. No explosion occurred. There were sparks visible for about two and a half minutes before a continuous flame was evident, and the cell case temperature rose to over 500 degrees Centigrade. The fire ceased after four minutes after initiation of the internal short.

Conclusions: A high-rate C cell with disc electrodes was developed to demonstrate current rates which are comparable to other primary systems. The development of this cell has progressed to the point that a certain amount of risk must be accepted that, under some conditions like crush and puncture, they may ignite or explode.

The tests performed in this study established the limits of abuse beyond which the cell became hazardous. Work is continuing, however, to minimize these safety limitations.



Finally, we would like to thank Wright-Pat Air Force Base for their support of this program in its initial part.

Thank you very much.

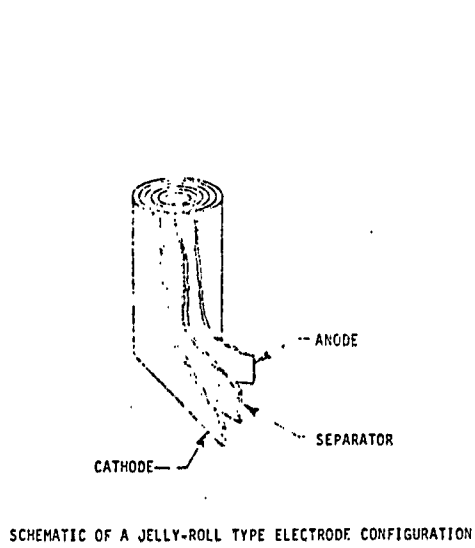

Figure 9-1

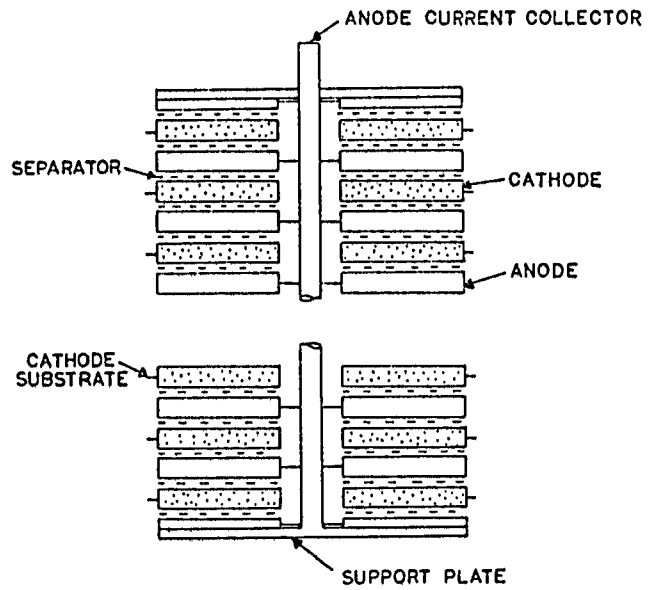
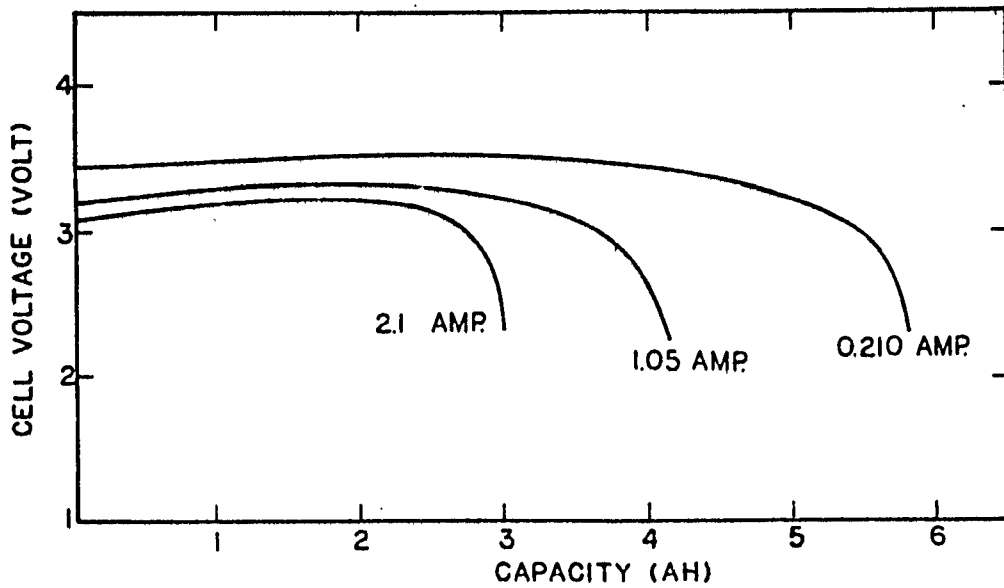

Figure 9-2



DISCHARGE CURVES OF A C-CELL WITH DISC ELECTRODES AT R.T.

Figure 9-3

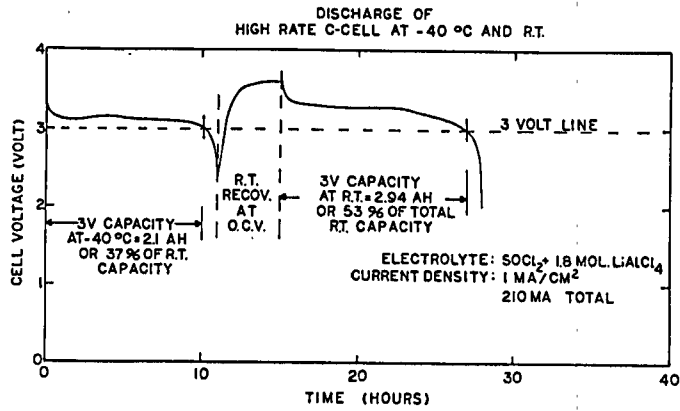

Figure 9-4



## HIGH RATE 'C' CELL TEST FLOW DIAGRAM

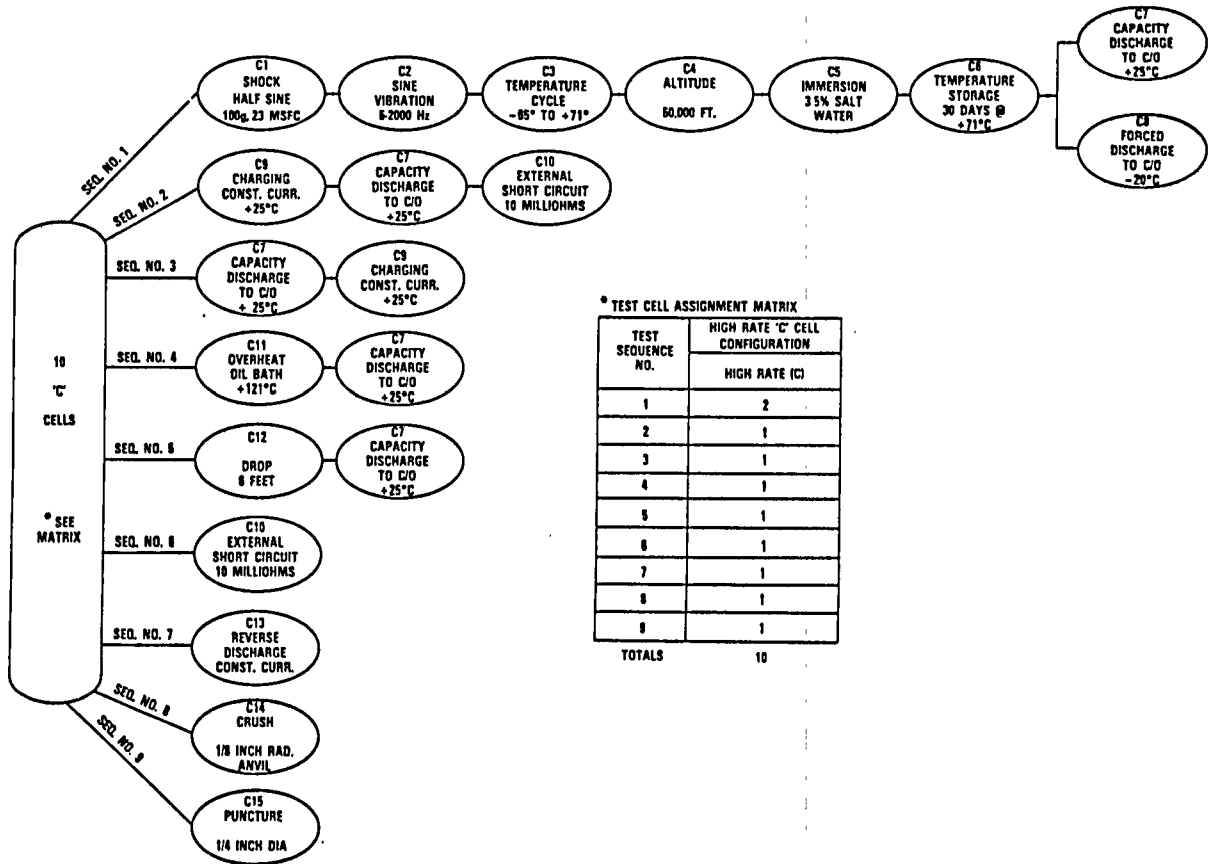

Figure 9-5

"C" CELL EVALUATION TEST SUMMARY

NON-OPERATING ENVIRONMENT

<u>TEST</u>	<u>CONDITIONS</u>	<u>RESULTS</u>
SALT WATER IMMERSION (FRESH CELLS)	3.5% SALT SOLUTION @ ROOM AMB. TEMP. 15 HOURS	● ELECTRICAL/MECHANICAL INTEGRITY MAINTAINED
TEMPERATURE STORAGE, HIGH (FRESH CELLS)	30 DAYS @ +71°C O.C.V. CONFIGURATION	● OCV STABLE, NO VARIATION

Figure 9-6

"C" CELL EVALUATION TEST SUMMARY

NON-OPERATING ENVIRONMENTS

<u>TEST</u>	<u>CONDITIONS</u>	<u>RESULTS</u>
SHOCK, IMPACT (FRESH CELLS)	100 g's, 23 MSEC's HALF-SINE PULSE (3 AXES)	● ELECTRICAL/MECHANICAL INTEGRITY MAINTAINED
VIBRATION, SINE (FRESH CELLS)	0.1 INCH (D.A.) 5-37 Hz 7 g's (PEAK) 37-2000 Hz (3 AXES)	● ELECTRICAL/MECHANICAL INTEGRITY MAINTAINED
TEMPERATURE CYCLING (FRESH CELLS)	-65°C to +71°C (5) 24 HOUR CYCLES	● ELECTRICAL/MECHANICAL INTEGRITY MAINTAINED ● NO CELL DEFORMATION RESULTING FROM TEMP. CYCLING
ALTITUDE (FRESH CELLS)	50,000 FT. @ +25°C (6) SIX-HOUR STORAGE	● ELECTRICAL/MECHANICAL INTEGRITY MAINTAINED ● NO CELL DEFORMATION RESULTING FROM REDUCED PRESSURE.

Figure 9-7

GTE

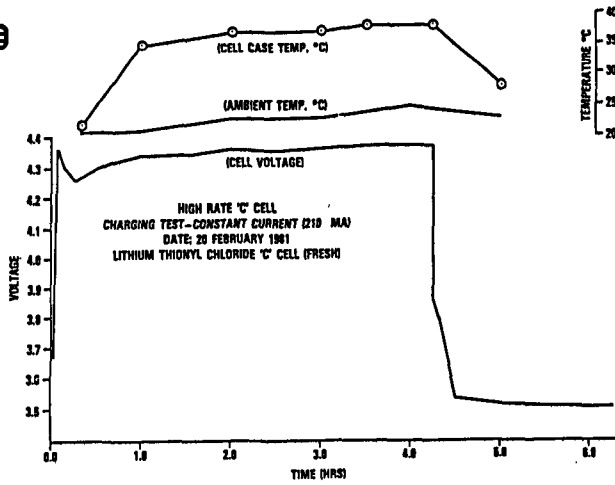

Figure 9-8

GTE

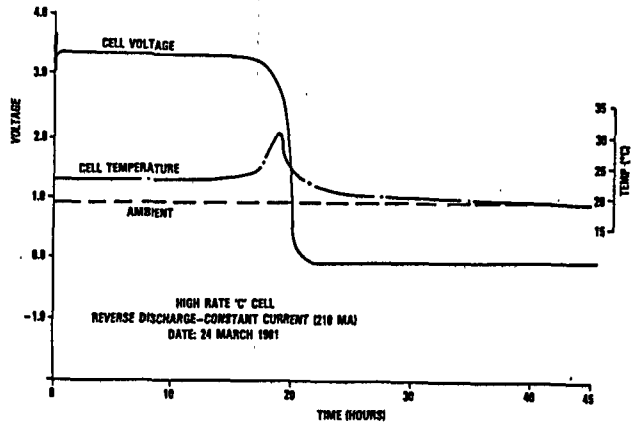

Figure 9-9

GTE

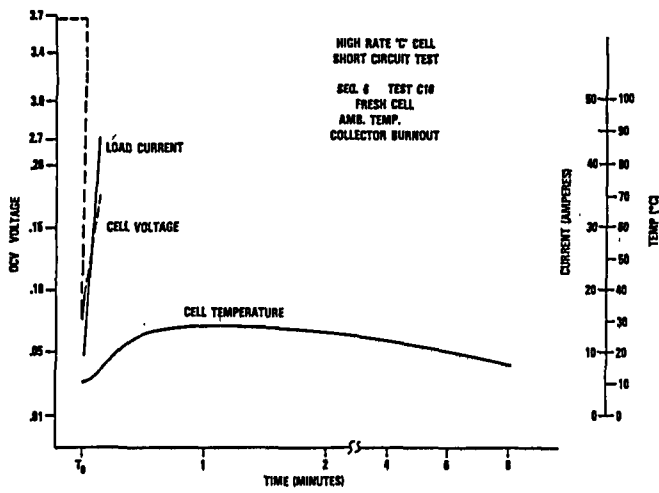

Figure 9-10

FACTORS AFFECTING CYCLE LIFE IN AMBIENT TEMPERATURE OF  
SECONDARY LITHIUM BATTERIES

R. Somoano

JPL

I will be giving a talk in place of one by Burt Otzinger. The talk will concern factors which affect the cycle life of ambient temperature secondary lithium batteries. This work is sponsored by NASA's Office of Aeronautics and Space Technology, by Judy Ambrus.

The technology for secondary lithium batteries is somewhat behind that of primary lithium batteries. A lot of the work that we are presently doing at JPL is more research oriented in nature. Nevertheless, it's really quite clear that one of the principal factors which inhibits current use of secondary lithium systems, especially on spacecraft, is the very limited rechargeability, or cycle life, of lithium systems.

In particular, we're interested in cycle life of the order of 500 to 1000 cycles. The fact that we can get 100 cycles is good, but not enough, and we feel we have to understand and optimize all the dominant factors which control cycle life in order to obtain the desired performance and meet this very demanding cycle life goal.

So during this talk I'd like to describe some of our thoughts, some of our results, concerning this very complex problem of cycle life. There are quite a few factors that contribute to cycle life. I've listed three of these that are of interest to us.

(Figure 10-1)

The first one: electrode integrity. This stems from the fact that the type of system we are using utilizes a lithium anode and a titanium disulfide intercalatable cathode. And the problem is, simply, that upon intercalation or de-intercalation -- that is, upon discharge and charge -- the  $TiS_2$  lattice expands and contracts plus or minus 10 percent. This leads to a breakup, or loss of particle contact, intergrain contact, and disruption of the

electrode morphology and geometry. So the actual mechanical integrity of the electrode upon cycling is a very real problem and a potential failure mode.

As I will show, the conventional way of making cathodes is really quite time-consuming, and I will describe some alternative approaches which we've taken, in which we use, for example, polymeric elastomers to improve cathodes integrity. The lithium anode also has its problems if you try to alloy it, for example, with aluminum. But I won't be talking about the lithium electrode; but rather the  $TiS_2$  cathode.

The second problem, which is really quite important and quite fundamental, is the electrolyte stability. The problem here is that we are interested in ambient temperature operation, and, therefore, our focus has been mostly on organic electrolyte. I will be particularly talking about lithium arsenic hexafluoride dissolved in 2-methyl tetrahydrofuran (2-meTHF). The problem is very simple; upon charging the highly reactive electro-deposited lithium reacts with this organic electrolyte. It degrades the electrolyte, it degrades the cycle life, it gives rise to a very important passivation chemistry which can dominate, or control the cell performance. So we're very interested in understanding what the limits of this electrolyte are, so that maybe we can come about and develop better electrolytes, because, indeed, we think we need something better than what we now have.

Finally, and related to it, I'd like to discuss some of our thoughts on dendrite formation. Most of the ambient temperature secondary lithium cells have failed because of dendritic shorts. The usual approach has been to try to put more wraps of separator, and to develop better separators. And our feeling at this time is that we'd like to see if there's something we could do to control the morphology of the lithium anode during plating and inhibit dendritic growth in the first place. I want to now discuss this idea about the cathode. Again, the problem with the cathode upon cycling is that it really isn't elastic enough, it doesn't contract and expand the  $TiS_2$  particles as well as you'd like.

(Figure 10-2)

This is the common procedure for making the  $TiS_2$  cathode used by many people in the field. The binder for this material is Teflon. It has a melting point of around  $327^\circ C$ .

Normally you take Teflon and  $TiS_2$  and you ball mill it for, let's say, two days. The idea is to break up the particles, get smaller and smaller particle size. You may or may not want to use carbon black as a conductive dilutant or expander.  $TiS_2$  itself, is semi-metallic. One then takes this mixture and you put it into a mold and you heat it to, say, 350 degrees Centigrade, under pressure. And, from that, we get our final electrode, which is in a flat planar geometry.

This electrode is very brittle, and incapable of yielding cylindrical or spiral geometries. And the main problem is, after you cycle it quite a few times, you can look at it visually and see that the electrode is starting to lose its mechanical integrity, it's starting to break up.

There are several things about this. First of all, you can see that a lot of these things here are just arbitrary. It's also quite labor- and time-consuming. Our approach was really to try to come up with some alternate way where we could make these cathodes simpler, so they'd be a little more flexible, a little more elastic, and maybe let us get them in another type of geometry.

The approach was to go to, instead of Teflon, to go to a polymeric material, an elastomer. Polymeric material you must think of like rubber. And if you're above the glass transition temperature it has rubbery characteristics, if you're below the glass transition temperature it's a glass, like a bowling ball. Teflon is like a bowling ball.

So, as I'll show you, for each different electrolyte solvent that you're interested in you might need a different type of polymer.

(Figure 10-3)

I'll show you the particular polymer we've been



using for the 2-methyl THF system, and then I'll describe to you how one can go about selecting these types of systems.

This one right here is called ethylene/propylene/diene-terpolymer (EPDM). It's really a very common co-polymer. It has a molecular weight of about 100,000 to 200,000, and it's a very elastomeric material. It's commercially available, you can buy it from Exxon, you can buy it from Uniroyal. Its glass transition temperature is around  $-60^{\circ}\text{C}$ .

(Figure 10-4)

This slide compares cathode fabrication using a polymeric binder with what I showed you in the earlier slide.

The polymer is dissolved in a very common solvent, cyclohexane, for example, and then you take  $\text{IIS}_2$ , in a powder form, and you add it to this mixture to yield approximately 5 percent binder for the cathode; compared to 8 to 15 percent Teflon and carbon black in cathodes made by the common procedure.

Well, because of the molecular weight of the polymer, what you get is a very nice paste, and you can paint it on nickel exmet and get a very nice, uniform cathode. This cathode can be rolled, it can be processed into cylinders, spirals and what-not.

In our cycle tests of these materials they've always, as soon as we compare them with the Teflon-based cathode, we always get greater cathode utilization using polymers, as compared to the cathode. If you cycle them 'x' cycles, like 50 or 80 cycles, the polymer-based cathodes always look much better, they look almost as good as they did with you started. The Teflon-bonded polymers tend to show some disruption, some cracks; you know, flaws.

(Figure 10-5)

This is really just some photos of this. This is what one looks like after 120 cycles. You can see you can make spirals very easily, very tightly-wound spirals. This has 5 percent polymer, but you can use as little as 2 percent and not influence the performance. The picture doesn't show it very well, but after 120 cycles it's still

quite flexible. It's a little darker, but it still looks very smooth.

(Figure 10-6)

This merely shows that you don't need nickel exmet. This is just the  $TiS_2$  without nickel exmet.

(Figure 10-7)

This shows what I would say are some of the desirable features that you would like to use in a polymer binder. Incidentally, there is nothing magic to lithium. It can apply to any battery system if one is interested, and has this problem.

When I say "soluble in common solvents," that means a solvent that's inert to your cathode and active material, like  $TiS_2$ : in this case we're talking about soluble in, say, hydrocarbons.

The low  $T_g$ , that really is determined by what load temperature operation you seek. If you want to work at -40 degrees C and your battery system is capable of doing it, you'd like to have a polymeric binder that has a  $T_g$  of, say, -60 degrees C. So this temperature right here can sort of limit your low temperature operation.

As I mentioned, high molecular weight merely gives you a more viscous solution out of it.

Finally, one doesn't really have to guess at what kind of polymer to use for a particular electrolyte, one can use the concept of solubility parameter, which is fairly well known in solution theory, to actually compare a given binder, polymeric binder, with a potential solvent.

(Figure 10-8)

I'll go through this somewhat quickly. Basically this just defines the solubility parameter. It comes from the free energy of mixing. This was all done by Hildebrand, and I think he's still doing it. But the solubility parameter is proportional to the energy density and to the surface tension.

All these factors are readily found in the literature for almost any material you're interested in. If you look down here at the calculated values, for example, here's the solubility parameter of 2-meTHF and EPDM. And you see they're really quite close. If you compare the solubility parameter of 2-meTHF with Teflon, that's a significant difference, and, indeed, it's this closeness that allows the electrolyte solvent to wet the cathode. And there's a problem with wetting, right here, with the Teflon and 2-meTHF.

So the whole idea is that you're trying to pick a solvent, calculate the solubility parameter, and then start looking for the polymers you're interested in, and calculate those solubility parameters. And if they're close, it tells you they're compatible and they'll wet one another and they'll maybe get in there and swell some.

If we wanted to work with propylene carbonate, our EPDM elastomer would not be suitable. We'd have to find some kind of polymer that would have a solubility parameter near 11.

(Figure 10-9)

So as far as our studies about trying to improve the cathode integrity, we think the elastomers are a very nice development; they've helped us quite a bit. We routinely now use spiral-wound and cylindrical-wound cathodes where, in the past, we were stuck with planar geometries. We seem to get much better cycle life and cycle capacity.

The other interesting thing is that a lot of our work has involved electrochemistry, in which we need micro electrodes of, say,  $\text{TiS}_2$ . We've never been able to get suitable micro electrodes using conventional Teflon type binders. With these polymeric binders you can get these types of micro electrodes and allow you to do these studies.

And, finally, as I mentioned earlier, the solubility parameter takes some of the black magic out of it; you can actually use a little logic to help you choose a system of interest to you.

I'd like now to discuss the second topic in which

we're interested as far as cycle life, and this, again, is the electrolyte stability. This is really one of a lot of interest and importance to us, since this is a very significant problem.

With the 2-meTHF system, we're really primarily interested in the oxidation potentials and the reduction potentials of this system.

(Figure 10-10)

This shows a typical lithium  $TiS_2$  charging cycle, and this is with the electrolyte lithium/arsenic/hexafluoride, 2-meTHF. And one of the problems we're interested in is right here when we're charging. In a lot of these secondary lithium systems you find that you get solvent polymerization, and all types of chemical reactions occur right up here near this end point. And the question that we asked ourselves is, How forgiving is the system? If we have a battery with stacks of cells and we accidentally overshoot, what will happen? And also we're interested in trying to find out what happens anyway, so that we can maybe try to improve upon it.

Well, what we have done is carried out quite a bit of electrochemical studies-- And I'm not going to go into the actual measurements, they're very standard cyclic voltametry studies. --in which we've used various electrodes, such as platinum, nickel,  $TiS_2$ , and various salts and solvents that help us deconvolute the data.

We've asked ourselves: When we get near this region, what is happening at both the electrodes, both the oxidation region and the reduction region.

(Figure 10-11)

This shows where we're at right now. We've elucidated some of the oxidation properties of this system. This is the same slide, the same graph, you just saw. And then there's a break right here. And then we see the other voltages.

The point of this is that 2-meTHF indeed has a very high oxidation potential; you know, it's really quite forgiving. And I think this is one of the excellent

characteristics about it; in fact, the TiS<sub>2</sub> oxidation, if there's any exposed nickel, in fact, you can have problems with those being oxidized first.

What this really tells us is that we know from some earlier surface studies we've done that there is a degradation problem occurring with this electrolyte. We can't really know how severe it is. But if it's occurring, it's more likely due to solvent reduction by the lithium metal, the highly reactive electro-deposited lithium metal, it's more likely due to solvent reduction by the lithium metal, the highly reactive electro-deposited lithium metal.

And so to try to improve this system, what you might like to do, for example, is to try to make it more so that it's not so easily reduced; you'd like to maybe raise the energy to the lowest unoccupied molecular orbit level a little higher, so that lithium has to pay more of a price to donate that electron to the 2-meTHF molecule and cleave the ring.

In the time we were doing this work we started to realize that reduction potential is, indeed, the dominant problem. Again, our concern is that we haven't been able to measure reduction potential: I neglected to mention that; primarily, because of the time, lithium plating is masking it. By using some other salts and solvents we hope to finally get the actual number of volts for it.

Our concern is that this solvent, 2-meTHF may be reduced right near where lithium plates. And then it's not too forgiving. On the other hand, it may be a long ways up, just like we saw over here. So that's why we're continuing our studies. But in the process of doing this, we decided to look for other systems which we felt might have improved reduction capability compared to 2-meTHF.

(Figure 10-12)

One such system is heterocyclics. These are based on the sulfolane system. In place of the oxygen in 2-meTHF we now have sulfur. And there are several of these things here.

Several points to mention. You might notice the low melting points here. That means it's fairly difficult to use some of these at room temperature: you might need to

heat them up to 40 or 50 degrees Centigrade in order to get enough viscosity and some good motion of the liquid.

The literature shows that this system has quite a wider electrochemical domain, you might say, than 2-meTHF and also the literature suggests that it has better plating characteristics; that is, dendrites are not that severe a problem.

We've just started doing some work on this system, and one of the interesting facts is if you take lithium/arsenic/hexafluoride and dissolve it in any of these solvents, the conductivity at about, say, 40 or 50 degrees Centigrade, is similar to what we had earlier with the 2-meTHF. And if you go to 80 or 90 degrees Centigrade you can double that conductivity.

The point associated with this is that it has a very low vapor pressure, 2-meTHF has a very high vapor pressure, and one constantly has a problem in sealing cells, making them tight. The problem is not nearly so critical here. So if you wish to work at 90 degrees Centigrade, you can do it, although then you have a little problem with the salts.

One, incidentally, can also use mixtures of this and 2-meTHF, and you get a little lower temperature operation. Obviously you're going to compromise and sacrifice something when you do it. But there are quite a few alternatives available.

(Figure 10-13)

This shows some cycle life data. Lithium/arsenic/hexafluoride, 2-meTHF, with a lithium electrode and a TiS<sub>2</sub> cathode. This is the percent of theoretical capacity versus the number of cycles. And there are two cells here: these are what has been termed "practical laboratory cells," they're about 400 milliamp hours. And this is the data I'll be talking about.

The discharge data is about 2 milliamps per square centimeter. These are both cylindrical and spiral wound cathodes, using this polymeric binder that I mentioned. We're talking about 62 degrees Centigrade operation at about 100 percent depth of discharge. And in the cycle we used

about 1 milliamp; that is half the discharge current, 1 milliamp per square centimeter to charge.

As you can see, this right here shows really some older data that Gerhard Holleck presented here, oh, two years ago. This is on some lithium/arsenic/hexafluoride 2-methoxy cells, and I think they probably have some data that moves further out here now.

But you see, the sulfolane system does get some very nice cycle life. Here at 30 percent capacity we just arbitrarily cut the current in half, the discharge current, and let it continue. This one (Cell No. 2) we stopped for post mortem studies. This one right here (Cell No. 1) is now running up to 350 to 400 cycles.

There are some other interesting features here. The thing we don't like is, the capacity is dropping with cycle life. We would all like to see that. But we have a ways to go.

This is around half a percent per cycle in here, and you can tell there's actually a plateau. This is about .2 percent per cycle. This right here is about the same as you have over here, a half a percent per cycle.

So this shows that just having some understanding, or some indication of how your electrolyte is degrading can give you some insight on what better electrolyte to choose. We're still working with this, and we hope to improve upon it. But, indeed, it does give us some nice cycle life. And one of the ways that we feel that we're able to use it quite well was because of the polymeric binders which wetted the cathode quite well. This sulfolane would not wet the TiS<sub>2</sub> cathode. And, in fact, either Allied Chemical or Union Carbide has a patent on this as a primary lithium cell electrolyte. And you can tell from the electrolyte they tried, or listed in the patent, they tried to make it a recyclable one. But, again, it's the wetting problem.

So this is where a polymeric binder might give you a little more flexibility and allow you to look at some systems that you might not be able to otherwise.

(Figure 10-14)

Finally, I'd like to discuss this idea of the dendritic formation. Now this is some very preliminary data that we're doing with Burt Otzinger at Rockwell International.

Essentially what we've been doing is looking at some batteries made by EIC: They're cells, 5 amp-hour cells. And we had tested some of these at JPL, a very few of them, using constant current charging, which is a typical technique here. And these cells had failed, and the current voltage characteristics showed very clearly that it was due to dendritic shorts. So our feeling was that, if you remember that lithium TiS<sub>2</sub> curve I showed you, as we get up near 3 volts, the voltage is just climbing straight up there, and here we are forcing, in our case, 300 milliamps back onto the lithium electrode at a very high voltage. And what this does, with a high electric field, if there's any type of morphological perturbations on that lithium electrode, you're just going to enhance, or exacerbate the dendritic formation.

So what we're interested in trying is seeing, well, can we try to plate back a little more gently using something like constant voltage and a tapered current or pulse tapered current mode. And that's what some of this is: this is just tapered current charging.

We got 25 cycles, and this stopped at one of these batteries, mainly because we accidentally overcharged it. The only other cell we've looked at has gotten 53 cycles. This is shown right here. This may not look like a lot of cycles, but really this is a fairly large cell. And you have to realize, this cell was made in early 1979 in a set. So this is not too bad.

We've used current densities that are really fairly high here. This is of the order of 4 to 5 milliamps per square centimeter. And this is normally where we used to work. And working in here, going back up, when we reduce the current density, the discharge density, we recover most of the capacity. We got quite a bit of capacity very early in the cycles. Normally it takes 4, 5, 6, 7 cycles before it levels off.

So it's really too early to say just how effective



this may be. But at least the very limited data we have looks quite promising.

So, in summary, we feel that the cycle life problem is really very important, and it's really quite complex, and one is not going to solve it by staying in a lab and dreaming up new electrolytes. One is going to have to look into electrode engineering, to other modes of charging and handling these materials, as well as packaging them. Certainly the electrolyte is a very critical problem that has to be solved together with them.

Thank you.

#### DISCUSSION

VENKATESAN (ECD): I have two questions.

What is the compatibility of EPDM for aqueous solutions?

And, I think in one of your graphs the axes must have gotten mixed up. The charging curve, I think it is Graph No. RS-11. I think the labeling of the X and Y axes got mixed up.

SOMOANO: I don't know the compatibility in aqueous solutions. We've not worked with them, so I don't know anything about it. I can find out for you, though.

VENKATESAN: Can you use the same criterion you use to evaluate it to see whether it is soluble?

SOMOANO: Yes, I think so. The solubility parameter is really quite simple. However, when one goes to use it, one should read a little bit of the literature, because there's a little more complexity to than what I showed. There are some polarization factors that come in. But it is really quite straightforward to use. But we've never tried applying it to aqueous systems.

HALPERT (Goddard): Those were 100 percent depth of discharge cycles, I take it?

SOMOANO: Yes.

HALPERT: And which is the limiting electrode?

SOMOANO: The cathode. Lithium is never taken out or removed or replaced; it's the same lithium. But it is cathode limited.



FACTORS AFFECTING CYCLE-LIFE IN AMBIENT TEMPERATURE SECONDARY LITHIUM CELLS

- ELECTRODE INTEGRITY
- ELECTROLYTE STABILITY
- DENDRITE FORMATION

Figure 10-1



A COMMON PROCEDURE FOR TiS<sub>2</sub> CATHODE PREPARATION

**BINDER:** TEFLON (T<sub>m</sub> = 327°C)

**PREPARATION:** TiS<sub>2</sub>, FINE TEFLON POWDER WITH OR WITHOUT CARBON BLACK, BALL MILLED FOR ~ 2 DAYS.

**PROCESSING:** POWDERED MIXTURE PRESSED IN A MOLD AT 350°C AT 2000 PSI FOR 5 MINUTES. COOL TO ROOM TEMPERATURE BEFORE REMOVED FROM MOLD.

**FINISHED PROPERTIES:** BRITTLE, NON-FLEXIBLE PLATE. MINIMUM THICKNESS ABOUT 20 MIL.

Figure 10-2



CATHODE POLYMERIC BINDER  
ETHYLENE PROPYLENE DIENE TERPOLYMER (EPDM)

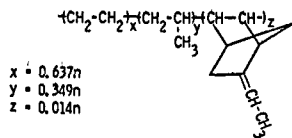

\*POLYMERIZATION CONDITION:

MONOMERS:



DICYCLOPENTADIENE

OR

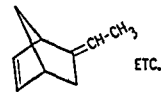

5-ETHYLIDENE-2-NORBORNENE ETC.

INITIATOR = (C<sub>2</sub>H<sub>5</sub>)<sub>3</sub>AL<sub>2</sub>Cl<sub>3</sub>, VCl<sub>4</sub>

SOLVENT = n-HEPTANE

TEMPERATURE = 50°C

\* W. R. SORENSON AND T. W. CAMPBELL "PREPARATIVE METHODS OF POLYMER CHEMISTRY" INTERSCIENCE PUBLISHERS, JOHN WILEY AND SONS P299 © (1968)

Figure 10-3



COMPARISON OF EPDM AND TEFLON AS BINDERS FOR CATHODE FABRICATION

<b>BINDER:</b>	TEFLON (T <sub>m</sub> = 327°C)	EPDM (T <sub>g</sub> = -60°C)
<b>PREPARATION:</b>	BALL-MILL THE TEFLON AND TiS <sub>2</sub> POWDER FOR 1 TO 2 DAYS	DISSOLVE EPDM IN CYCLOHEXANE, ADD THE SOLUTION TO TiS <sub>2</sub> POWDER
<b>PROCESSING:</b>	PRESS THE BALL MILLED TiS <sub>2</sub> - TEFLON MIXTURE IN A PREHEATED MOLD AT 350°C, 2000 PSI, HOLD FOR ~ 5 MINUTES AND COOL TO ROOM TEMPERATURE BEFORE REMOVING FROM MOLD	BRUSH THE VISCOUS TiS <sub>2</sub> - EPDM MIXTURE ONTO Ni-EXHET AT ROOM TEMPERATURE
<b>FINISHED PROPERTIES:</b>	NON-FLEXIBLE, BRITTLE PLATE SHAPE ONLY, MINIMUM THICKNESS ~20 MIL	CAN BE PROCESSED IN PLATE, FLEXIBLE CYLINDER OR SPIRAL SHAPES, MINIMUM THICKNESS ~ 8 MIL.

Figure 10-4

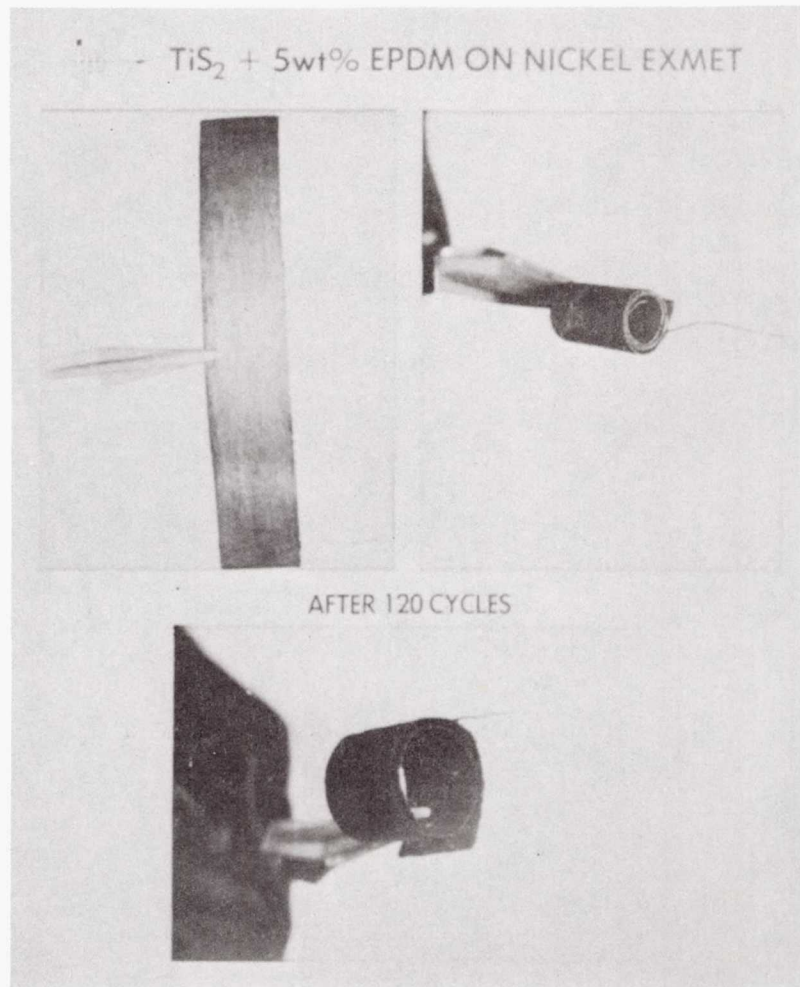

Figure 10-5

TiS<sub>2</sub> + 5wt% EPDM

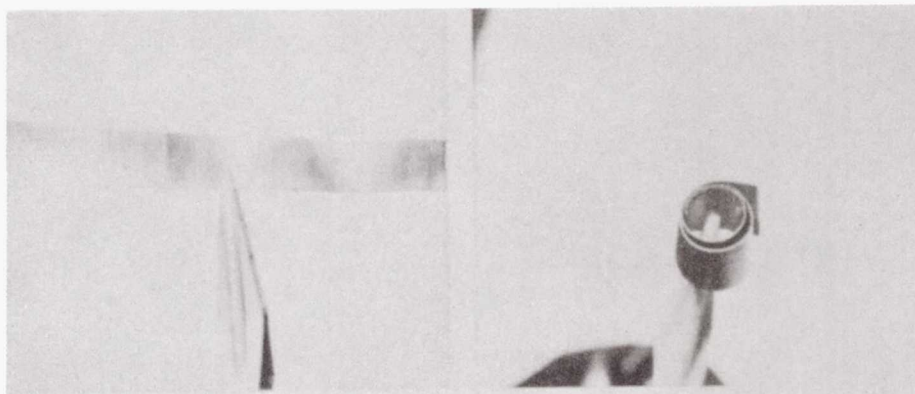

Figure 10-6



SELECTION SCHEME FOR SOLVENT SOLUBLE ELASTOMERIC BINDERS

- SOLUBLE IN COMMON SOLVENTS.
- LOW  $T_g$  (BELOW  $-20^\circ\text{C}$  IF POSSIBLE).
- HIGH MOLECULAR WEIGHT.
- CHEMICALLY AND ELECTROCHEMICALLY STABLE WITH ALL CELL COMPONENTS.
- SOLUBILITY PARAMETER ( $\delta$ ) OF THE ELASTOMERIC BINDER MUST BE COMPATIBLE WITH  $\delta$  OF ELECTROLYTE SOLVENT IN ORDER TO ACHIEVE LOW SURFACE TENSION BETWEEN CATHODE AND ELECTROLYTE.

Figure 10-7



SOLUBILITY PARAMETER  
DEFINITION AND EXAMPLE

\*  $\Delta F_{MIX} \sim (\delta_1 - \delta_2)^2 V_1 V_2$  (FOR BINARY SYSTEM)  $(\delta_1 - \delta_2) + 0$ ; TWO COMPONENTS MOST COMPATIBLE

$$\delta = \left( \frac{\Delta E_v}{V} \right)^{1/2} = \gamma = 0.43$$

$\Delta F_{MIX}$  = FREE ENERGY OF MIXING

$\Delta E_v$  = MOLAR ENERGY OF VAPORIZATION

$V$  = MOLAR VOLUME

$\frac{\Delta E_v}{V}$  = COHESIVE ENERGY DENSITY

$\delta$  = SOLUBILITY PARAMETER

$\gamma$  = SURFACE TENSION

\*\* CALCULATION OF SOLUBILITY PARAMETER OF LIQUIDS AND POLYMERS BY GROUP ADDITIVITY METHOD.

$$\Delta E_v = \sum_1 \Delta e_1 \quad V = \sum_1 \Delta v_1$$

$e_1$  = ATOM OR GROUP MOLAR CONTRIBUTION TO THE ENERGY VAPORIZATION

$v_1$  = ATOM OR GROUP MOLAR CONTRIBUTION TO THE VOLUME.

EXAMPLE:

	PROPYLENE CARBONATE	CYCLOHEXANE	2-METH	EPDM	TEFLON
$\delta_{CALC}$ (CAL-CM <sup>3</sup> ) <sup>1/2</sup>	11.1	8.07	8.06	8.42	6.66
$\delta_{MEASURED}$ (CAL-CM <sup>3</sup> ) <sup>1/2</sup>				8.16	6.2

\* J.H. HILDEBRAND AND R.L. SCOTT "THE SOLUBILITY OF NONELECTROLYTES" 4.C.S. MONOGRAPH SERIES NO. 17 (1950).

\*\* R.F. FEDORS, POLYMER ENGINEERING AND SCIENCE 14 NO. 2 P. 147 (1974) AND 14 NO. 5 P. 472 (1974).

Figure 10-8

CONCLUSIONS

- ELASTOMERS CAN FUNCTION AS IMPROVED BINDERS FOR RECHARGEABLE CATHODES.
- **FLEXIBILITY:** CAN BE PROCESSED INTO DIFFERENT GEOMETRIC SHAPES, e.g., CYLINDER, SPIRAL, PLATE - ALL WITH VARIABLE THICKNESS.
- **MECHANICAL PROPERTIES:** CATHODES RETAIN INTEGRITY UNDER LONG CYCLE LIFE WITH NO VISUAL DETERIORATIONS.
- MICROELECTRODES CAN BE MADE FROM POWDERY CATHODE MATERIALS FOR VOLTAMMETRY STUDIES.
- SOLUBILITY PARAMETER IS A USEFUL TOOL IN SELECTION OF AN ELASTOMER WHICH IS BOTH COMPATIBLE WITH THE ELECTROLYTE SOLVENT

Figure 10-9

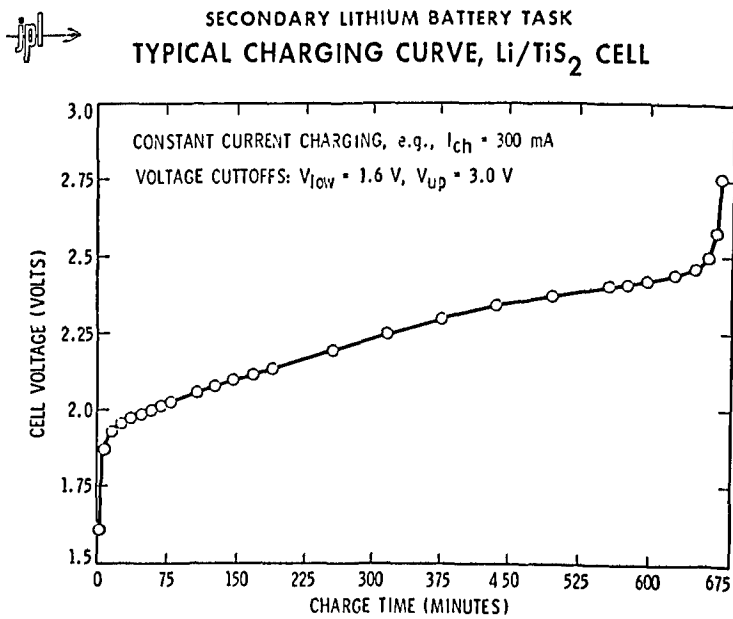

Figure 10-10

OXIDATION POTENTIALS  
IN A Li/LiAsF<sub>6</sub>-2-Me-THF/TiS<sub>2</sub> CELL

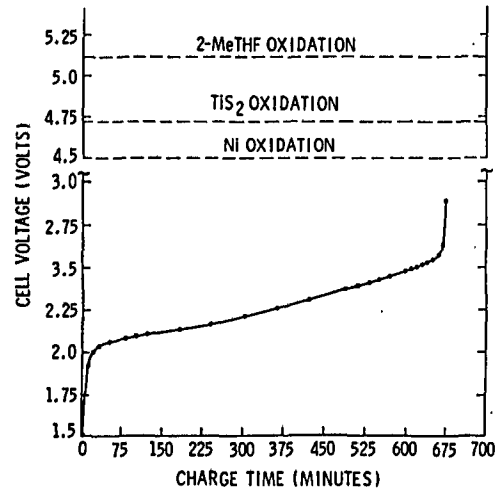

Figure 10-11

SECONDARY LITHIUM BATTERY TASK  
CONDUCTIVITY OF LiAsF<sub>6</sub>/SULFOLANE ELECTROLYTE

SECONDARY LITHIUM BATTERY TASK  
NEW ELECTROLYTE SOLVENTS  
SULFOLANE SYSTEM

- HETEROCYCLICS



SULFOLANE

M.P. = 27°C  
B.P. = 285°C

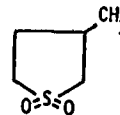

3-METHYL SULFOLANE

M.P. = 0°C  
B.P. = 276°C

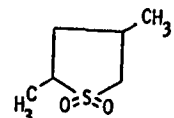

M.P. = -3°C  
B.P. = 281°C

M.P. = MELTING POINT  
B.P. = BOILING POINT

Figure 10-12

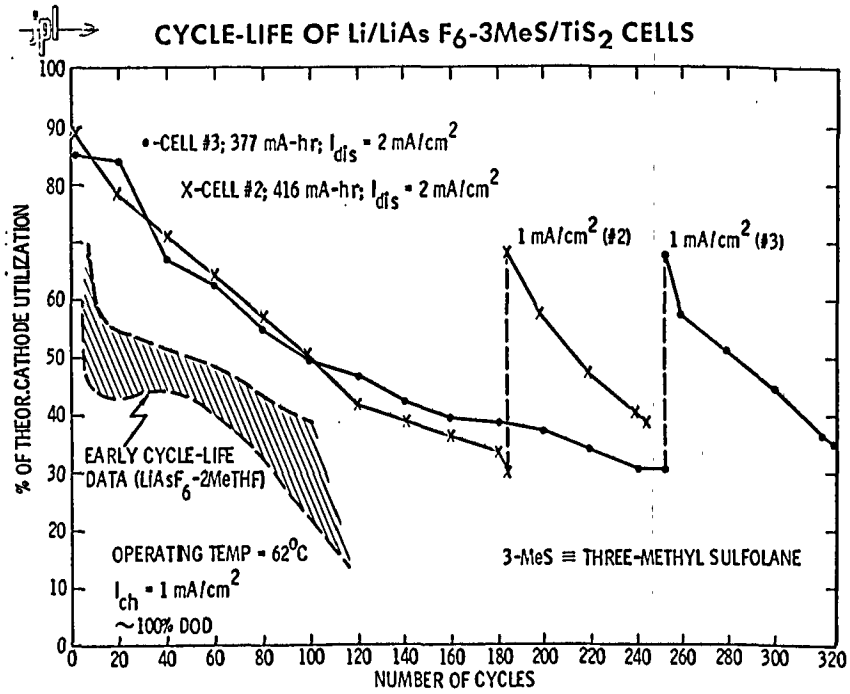

Figure 10-13



**EFFECTS OF CHARGING MODE**  
**EIC BATTERY EVALUATION/5 A-HR CELLS**  
 (W/ROCKWELL INTERNATIONAL)

- CONSTANT CURRENT CHARGING
  - 18 CYCLES TILL FAILURE (DENDRITIC SHORTING)
- CONSTANT VOLTAGE/TAPERED CURRENT CHARGING
  - 25 CYCLES
  - 53 CYCLES (GREATEST CYCLE-LIFE FOR A SECONDARY LI CELL OF THIS SIZE)

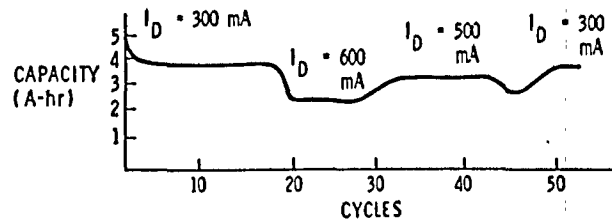

Figure 10-14

## PROGRESS IN SECONDARY LITHIUM BATTERIES

G. L. Holleck

EIC

I'd like to give today a brief update on some of our activities in secondary lithium batteries. In particular I'll be reporting on test results obtained with 20 ampere-hour lithium/molybdenum trisulfide cells. And let me mention that this work was supported by NOSC with DOE funds, and the contract monitor was Joe MacCartney, and it was funded through our ONR contract which is monitored by Dr. Jerry Smith.

Over the years we have developed a rechargeable lithium electrode, and we have reported repeatedly on various occasions about many aspects of this development, and we have demonstrated the performance in hermetically sealed laboratory cells. These cells use flat plate electrodes of typically .6 ampere-hours which are enclosed in D-size hardware.

We have literally built hundreds of such cells and they are generally designed to deliver 100 cycles.

(Figure 11-1)

There are some of them.

To demonstrate cell performance in practical packages, we have manufactured prismatic lithium/titanium disulfide and lithium vanadium oxide ( $V_6O_{13}$ ) cells of about 5 ampere-hours.

(Figure 11-2)

These are the types of cell that Dr. Somoano mentioned.

Most recently we have also built 20-hour prismatic lithium/molybdenum trisulfide cells and they are shown in the next slide.

(Figure 11-3)



It's turned around, but it doesn't matter.

Those are the cells that I will be talking about, the mirror image of those cells.

Why are we interested in the lithium/molybdenum trisulfide system?

(Figure 11-4)

It had a potential energy density which is higher than that of lithium/titanium disulfide. Some possible energy densities and performance values for cells, projected from preliminary data obtained on small cells, are summarized in this figure here.

If you look at, say, a D cell in a primary mode, you can expect about 91 watt-hours per pound and over seven watt-hours per cubic inch.

Now when you go to a rechargeable system you naturally have lower energy densities. Typically you might look at something of 75 watt-hours per pound at the beginning, and about 50 watt-hours per pound after 50 cycles.

In larger packages than this, depending on rate, it's in the area of 100 watt-hours per pound, and that is considerably more than you can get from practical lithium/titanium disulfide cells.

(Figure 11-5)

This is some of the data obtained in small laboratory cells that was used for those calculations, and here's a family of discharge and charge curves. The discharge voltage is about 1.9 volts and as you see, we get three electrons per molybdenum trisulfide initially, and after 50 cycles we are still above two electrons per molybdenum trisulfide. And if we reduce the current density, we recover most of this lost capacity again, which is an indication that we haven't really changed the active material but rather it is electrode structure that causes this decrease.

(Figure 11-6)

As I mentioned, electrode structure is an important parameter. This includes the formulations, the binder and conductive material like carbon that you might add to the electrode.

Here you see a family of curves which have different amounts of carbon and, again, at the lower current density and the higher carbon contents, you realize three electrons per molybdenum trisulfide.

(Figure 11-7)

On the basis of such data we have designed 20-ampere-hour breadboard modules, and we chose a prismatic cell design with a side opening. This allows us to adjust the capacity, to use various capacity cells with the same hardware and the same components.

The electrodes are approximately four by four inches to give you an idea of the size. And the cells that I'm talking about here have 11 cathodes and 21 anodes, and they use a Celgard separator.

We have built five such cells.

(Figure 11-8)

This shows you a discharge-charge curve, a typical one, of such a cell, and you see it delivers somewhat above 20 ampere-hours. The voltage is 1.9 volts, and it looks exactly the same as the small cell curve that I have shown you before.

(Figure 11-9)

This slide shows you a variation in the discharge rate. Here at the lower rate we obtained almost 25 ampere-hours, which is equivalent for this cell to 2.5 electrons per molybdenum trisulfide. At 2 ampere the capacity was 20 Ah.

Three cells were used for cycle testing. The test regime is shown here.

(Figure 11-10)

Initially all cells were subjected to full depth capacity cycles between preset voltage limits. Then cycle testing was carried out to 70% DOD. The cells were charged at constant current to 2.8V.

(Figure 11-M)

This table summarizes the cycle test results. After 20 cycles cell 2 developed a soft short probably due to Li dendrites and testing was discontinued. Cell 3 showed a similar problem after 35 cycles. Then in subsequent cycles the soft short disappeared and the cell cycled normally until in cycle 50 a soft short reappeared again. This soft shorting manifests itself by a higher charge input without reaching the upper voltage limit. Occasionally we observed also voltage fluctuations during charge. Cell 5 has completed over 50 cycles without shorting. After 35 cycles the cell reached the cutoff voltage on discharge and subsequently you see a decreasing capacity upon cycling. In cycle 52 we reduced the current density and we recovered the initial capacity. So again it is not a material change but rather an electrode structural change.

This cell is still on test.

So in summarizing, we are quite pleased with the performance of these first-order cells. The failure mode has been as you have seen, shorting by lithium dendrites. And what we'll be doing now is to take these cells apart and carry out a detailed analysis in an effort to identify the location and the reasons for the shorting. Then we will proceed to develop solutions to this problem.

Thank you.

#### DISCUSSION

MALACHESKY (Exxon): One of the big problems that we see which will be a major technical difficulty to overcome in secondary ambient temperature to lithium cells is of course the problem of series cell operation.

Do you know what the behavior is of these cells on reversal, on discharge, and on overcharge?

HOLLECK: You cannot overcharge these cells without taking special precautions or you degrade, irreversibly degrade the electrolyte.

Now we have done some experimentation with introducing a chemical shuttle, for example, which can carry an overcharge current, but clearly that needs further work and it has to be addressed because in some way you have to cut off and prevent overcharge unless you introduce a special mechanism to take care of it.

With large systems I think it can be done without much penalty also electronically. But with small systems this is not feasible.

MALACHESKY: My next question is what is the ratio of lithium in these molybdenum trisulfide cells to the capacity of the cathode material?

HOLLECK: A factor of five. If they would not have shorted these cells would have gone much longer.

HIMY (Navy Department): Have you tried to prevent dendrites by transfer membrane? Are you using Cellgard?

HOLLECK: Yes, this is Cellgard.

HIMY: Are you trying to change it?

HOLLECK: We would like to have a better separator, yes.

HIMY: Are you trying to work on it?

HOLLECK: We are trying to work on it but we do not at the moment have sufficient funds for that work.

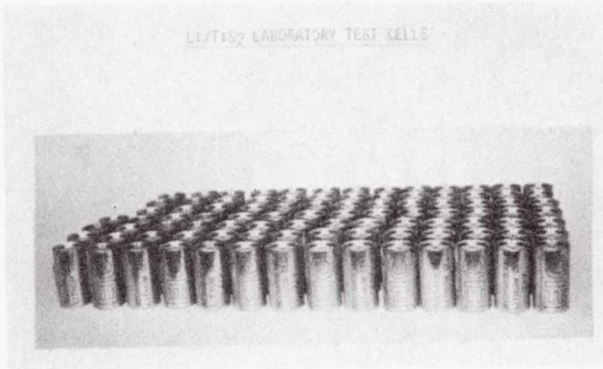

Figure 11-1

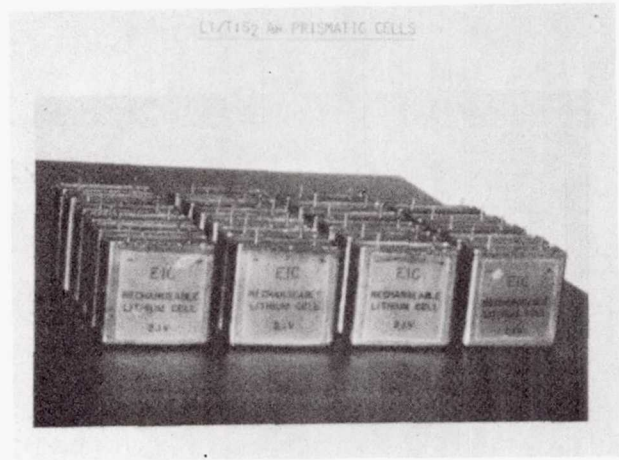

Figure 11-2



Figure 11-3

Li/MoS<sub>3</sub>. SOME POSSIBILITIES BASED ON SCALE-UP  
OF PRELIMINARY DATA

		RATE	AH	WH	WH/LB	WH/CU IN.
D-CELL - PRIMARY		300 MA	~13	22	~91	>7
D-CELL - RECHARGEABLE	1ST CYCLE	300 MA	>10	>18	70-75	>6
	50TH CYCLE	300 MA	>6.8	>12	45-50	>4
100 AH SIZE-	1ST CYCLE	C/20			127	>7
	50TH CYCLE	C/20			>85	>5
	1ST CYCLE	C/10			100	>6
	50TH CYCLE	C/10			65-70	>4

Figure 11-4

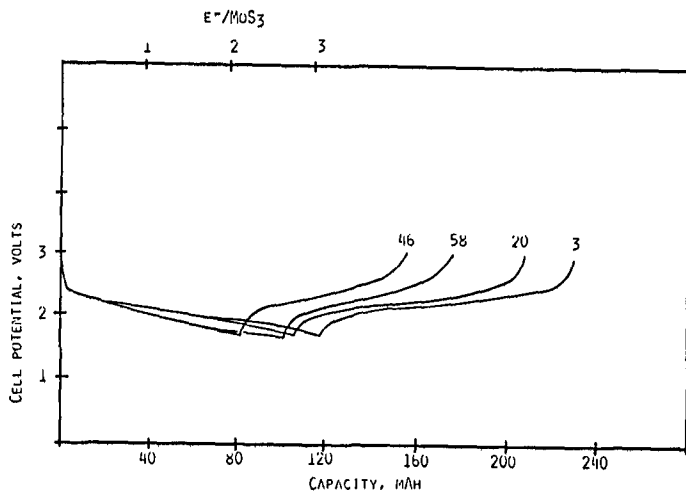
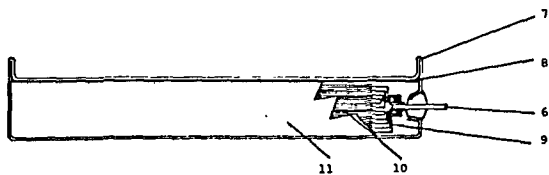
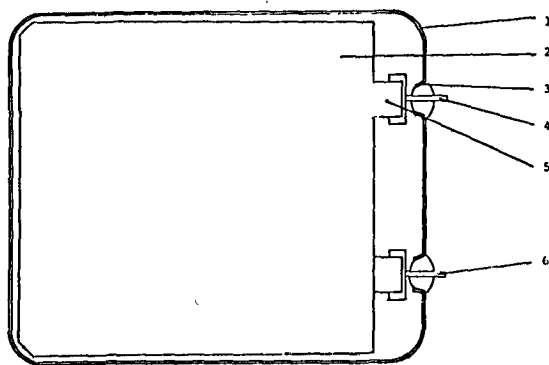

Figure 11-5



- |                              |   |
|------------------------------|---|
| 1. Hudson can #7640          | 7. Can-cover weld   |
| 2. Negative electrode        | 8. PTFE sheet   |
| 3. Glass to metal seal       | 9. Leads to positive terminal   |
| 4. Negative terminal         | 10. Alternating electrodes with 2 layers Celgard 2400 between each pair |
| 5. Lead to negative terminal | 11. Celgard 2400  |
| 6. Positive terminal         |   |

DESIGN FOR 20 Ah SECONDARY LI BATTERY

Figure 11-7

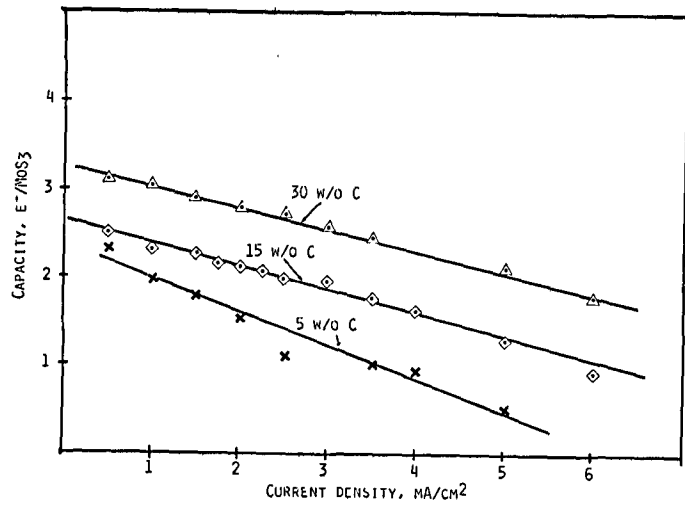
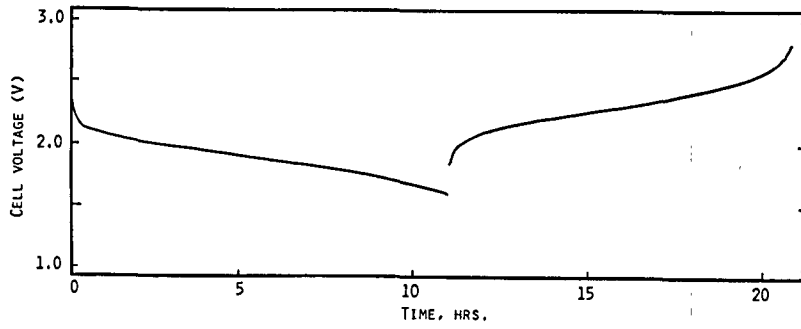
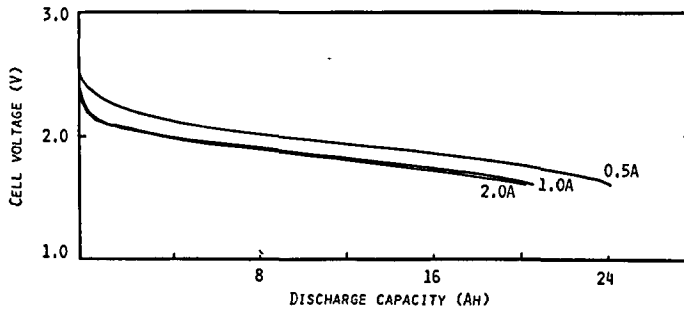

Figure 11-6



Li/MoS<sub>3</sub> CELL DISCHARGE-CHARGE CYCLE AT 2A

Figure 11-8



Li/MoS<sub>3</sub> CELL DISCHARGE

Figure 11-9

20 AH Li/MoS<sub>3</sub> CELL CYCLE TEST

CYCLE NO.	CELL 2		CELL 3		CELL 5		COMMENTS
	C <sub>d</sub> AH	MDV <sub>d</sub> V	C <sub>d</sub> AH	MDV <sub>d</sub> V	C <sub>d</sub> AH	MDV <sub>d</sub> V	
1	20.3	1.86	18.1	1.90	18.2	1.90	
3	19.8	1.90	18.8	1.90	16.3	1.93	
5	12.0	2.05	12.0	1.98	12.0	2.00	
10	14.0	2.05	12.0	1.99	12.0	1.95	
15	14.0	2.04	12.0	1.93	12.0	1.93	
20	14.0	1.88	12.0	1.97	12.0	1.93	CELL 2 SOFT SHORT
30			12.0	1.90	12.0	1.92	
35			8.6	1.83	11.5	1.90	CELL 3 SOFT SHORT
45			12.0	1.90	7.7	1.91	CELL 3 RECOVERED
50			9.8	1.85	6.0	1.92	CELL 3 SOFT SHORT
52					18.7	1.97	I REDUCED, 0.25A

Figure 11-11

TEST REGIME

CAPACITY CYCLES (4)

DISCHARGE: 2A TO 1.6V

CHARGE: 2A TO 2.8V

CYCLE TEST

DISCHARGE: 2A TO 70% DOD

CHARGE: 1A TO 2.8V

Figure 11-10

## ARMY POSITION ON LITHIUM BATTERY SAFETY

E. Reiss

U.S. Army  
Electronics Research and Development Command

This afternoon Gerry Halpert asked me if I would speak with you for a few minutes, substituting for several of the speakers that were unable to give you their formal presentations today.

The first thing he asked me was what is the Army's position on safety, and then he made a comment about there aren't enough questions this afternoon, see if you can get people to respond. Let me see if I can do both things for you in a brief period of time.

First off, when I'm asked what's the Army's position on safety, it brings up one question, and that is whose definition of safety do you want to use? Are we going to use the soldier's definition, whether he be the truck driver, the aviator, or are we going to go back into the laboratory and dig out the most scientific definitions?

We at Fort Monmouth, as the primary center for battery applications in the Army, have come to a conclusion in the last few years that safety is the most important factor in the design of lithium batteries. And to that end, in the last six to nine months we have been addressing very specifically the lithium/sulfur dioxide battery.

Following that up, we have come up with a specification that describes what we hope to see as a safe product that can be used by the Army.

Now how safe do we want it? We want it to be as safe as possible. We would like to be able to take a battery and subject it to any conditions that any of you here can think of and have no harm to yourself or to someone near you. And we know that can be done.

We have tried to be a little realistic. We know that there are certainly limitations to what you, the



manufacturers, can put into a battery, and certainly you expect there are certain limitations on what the users will do with your products.

Several of you I'm sure have seen our previous specifications. Several of you have delivered batteries and cells to us for evaluation and presently we have probably half a dozen different production contracts for batteries. Again I'm talking about lithium/sulfur dioxide only. These batteries will be used by our soldiers.

In order to try to tell you what we consider to be a safe design, I thought I would briefly run through the new specification that we have put together-- It's Mil B-49377. It has a date on it right now of 9 September 1961. It will be updated, probably within the month, due to several portions of that document that we feel have to be updated. The new spec number is MIL-B-49430.

In that particular document we thought the best way of addressing safety was to start with the cell. We're not telling any of the manufacturers how large they have to make the cell; we're only really talking about the dimensions of a battery.

but in the cell area, we have agreed that the first thing that we need is an hermetically sealed cell, and a cell that must have a balanced or lithium-limited chemistry. We have seen hundreds, probably thousands, of cells and many more batteries that we've been testing in the last several years to document the limitations that we feel are acceptable to the Army.

From these batteries, these cells, we've come up with what we feel is the proper background material to document and support the specification.

But I don't want to bore you with the specification. The first part is the cells.

We're going to be looking for hermetically sealed, we're going to be looking for lithium-limited or a balance of lithium to sulfur dioxide with a ratio of one, based on stoichiometry. We're going to be performing some tests on these cells prior to testing batteries to insure that they do meet our requirements.

We are also looking for low moisture content in the cells. We feel that this contributes a high degree of quality to the cells in the areas of rapid startup voltages under heavy currents.

We have also had some experience where high moisture content, we feel, is directly related to degradation in shelf life.

From the cell, we're going to go to the battery. The batteries certainly are going to have to give us acceptable capacity.

The specification that I mentioned presently defines five different batteries. Three of them are at 6.9 amp-hours under a 2 amp load at 70 degrees Fahrenheit. Another battery has slightly higher capacity. And the last battery is a .85 amp-hour battery under I believe a 50 milliamp load. There are corresponding capacities at high temperature and low temperature that go along with these capacities.

One of the things that we are planning to do is to insure that we are getting the product that we have defined, and to do that we have a series of tests spelled out. They cover shock, vibration, altitude, high temperature storage, low temperature discharges, high temperature discharges, and combinations of all of these things.

What we're looking for is good capacity and safety. The whole reason for doing it again is the safety that's inherent in the design. We know that it can be met and that the soldiers that we're dealing with need.

The spec itself is based on real data. We are trying to get the best product possible. If you'll take a look at some of these numbers you'll say, "Why do you want 7 amp-hours from a D cell type battery?" And the answer is we really don't want 7 amp-hours, we want 7-1/2.

When you take a look at it and you see some of the reversed current discharge tests, we are asking for 1-1/2 amps in reversal. We really want 2 amps but the state of the art really isn't there that we can document it that rigidly in a spec and expect anyone to bid on it or give us that type of a product.

But we really want it. We really would like to see 3 amps in reversal but the technology is not there.

The driving force that we've been operating under in the last nine months is essentially a dictate from our command saying that the battery must be safe for the soldiers. And when we were given that edict, it essentially said, "The soldier doesn't know what the product is. He doesn't know what tests you've done on it. He doesn't know what limitations it has. In fact, he probably thinks it's a big flashlight battery."

And if we take a look at the incidence of leakage of alkaline cells or possibly some explosions in mercury cells, and if you go to the users in the military and civilian market, you will hear that there are incidents weekly, maybe monthly. It's not unheard of that you have these types of incidents.

We have been tasked with trying to come up with a lithium/sulfur dioxide battery that surpasses all of the standards for previous batteries.

Now we feel that it certainly can be made. We have purchased it and we're going to continue purchasing it.

But I would like to emphasize today that we're definitely looking for a product that's superior to the product of yesterday.

The next real area that we've addressed is related to the quality assurance. How do we verify that we're getting a good product? Very quickly I'd like to sum it up.

We're doing two things, and these are in relation to the production contracts that have been awarded and will be awarded in the near future.

What we're proposing to do and have done is to require an increased number of samples in the first-article phase of our program. In the past, the first article of lithium-sulfur dioxide batteries for the Army required a sample size of 56 batteries that were subjected to the various environmental capacity tests. And based on a hundred percent acceptance of those tests, the contractor was permitted to go on with production.

At the production level he would do similar tests and providing he met the acceptance rate -- I believe the number was around a 10 percent, maybe 6 percent acceptable quality level, -- the manufacturer would continue to deliver the product.

To enhance that, to give us the safety that we're now asking for, the government at Fort Monmouth is going to have an additional quantity of batteries delivered at the beginning of the first article. These 30 batteries are going to be subjected to similar tests that the contractor is doing.

We will be analyzing for the ratio; we'll be analyzing for the moisture content; we'll be discharging the batteries at the high, low and room-temperature conditions. These batteries carry the same acceptance/failure rate as the tests done by the contractor; that is, no failures are permitted.

Once we get to the production phase of these batteries, a new clause is being inserted in the contracts which will require 2 percent of the production batteries to be delivered to the Army for evaluation. This is something that has not been done on other battery contracts in recent years. However, it is one of the methods that we feel is mandatory to insure that we're getting the product that we need.

This is the only way that we can go out to the soldiers and say, "We have the documentation to show that the batteries met the conditions imposed by the specification and the same level of performance should be exhibited by the products that they see."

The last item that we're doing in the quality assurance area to again enhance safety is that we're going to be requiring a quality control plan or quality assurance plan by the manufacturers essentially on how they build and control the product. It should start from the introduction of the raw materials into their plant, through the manufacturing processes to the finished product.

This will be a document that will be required in all of our contracts. Approval must be obtained prior to fabrication of the batteries. Again it's an attempt to

insure that high quality has gone into the manufacturing of these particular products.

So with that, I would like to stop. It's a quick summary of where we are at this point in time.

I'd like to ask for any questions that you have.

ALLVEY (SAFT): You described the specification. I can't quite see the need to specify a composition. It seems to me that if you had arrived at a black box type specification you wouldn't have excluded many other couples.

REISS: You're correct. If we had written the spec in a general nature it would have permitted many electrochemistries to meet the requirements. We realize that certainly some of them could not meet some of the technical requirements of high rates and low temperatures for a given volume.

However, we felt that we must have a complete understanding of what's going into these products.

Over the years you've all heard of many safety incidents related to lithium batteries in general. Some of the comments that you've heard were true and some of them were simply rumors.

The specification that we put together is based on very specific data that we have generated and have confidence in. We are presently in the position where we have received phone calls and inquiries on the use of various new electrochemistries in applications.

I'm in a very awkward position sometimes because I don't have the background to fully qualify one of these other electrochemistries. And to that end we have specified a lithium sulfur dioxide chemistry that's based on real data that we have generated, so that we have a complete understanding of what the product is.

ALLVEY: Does that mean then that you'll follow up with another specification for each and every couple?

REISS: At this point in time I would say Yes. As we build confidence in thionyl chloride or sulfural chloride

or whatever the particular need is that is required by the Army, we will address it singularly for that electrochemistry, and we will address it with a specific specification.

ALLVEY: So does that really mean that you're excluding thionyl chloride for the next three or four years?

REISS: I would say at this point in time, for the next two years we will not have a specification on thionyl chloride. But we will be working on generating the data to support such a specification. We presently have several programs doing just that.

HARRIMAN (Cargocaire): You mentioned that you're going to specify the amount of moisture in the cell. What level of moisture do you intend to specify, and how do you propose to measure that?

REISS: We are presently specifying 1,000 parts per million or less. The particular method is by titration, the Carl Fisher method. I don't have all the specifics of it, but I can obtain them for you.

MAHY (CIA): No failure acceptance testing is good. but I'm a little curious as to how you're going to define failure such that you can actually do it. Good quality batteries generally have some turkeys, and that's a fact of being in the primary battery business.

How are you going to define failure such that you're going to be able to really get contracts and really, then, get hardware into the warehouse?

REISS: Under the first article phase of it, I said that the contract will require no failures in the first article.

Failure in capacity would be a battery that exhibits capacity below the specified number in the contract. These numbers are set on the low side. For instance, I said 6.9 amp-hours at 2 amps for the D cell batteries, and we expect 7-1/2. We feel that that margin is sufficient to give the manufacturer the confidence that he can meet the 6.9 amp-hours.

When it comes to the safety portion, we're considering venting fires or explosions. A single venting is considered a failure by us at this point in time. In years past venting was considered to be one of the safety mechanisms in a battery. We're requiring that a vent be in the batteries.

But, on the other hand, we consider that if a battery vents under the conditions imposed by the specifications, which are conditions that are likely to occur in the field, that that would be unacceptable to some of the users.

Now it depends whether it's an aviator in a closed cockpit, or a soldier sitting out in the middle of a desert. There are different conditions. But venting is now considered by definition a failure.

When we get to the production level, there is either a 6 or 10 percent failure rate that we will permit on capacity for the contractor's testing, and 9 percent failure on capacity on the government testing. That's of the 2 percent sample.

When it comes to the safety portion of the two phases, venting, fire, explosion are considered very critical to us and a single failure is considered grounds for lot rejection or first article rejection.

JAMES (Naval Surface Weapons Center): Do you have any published information that I could obtain on the effect of water content on the degradation of these lithium SO<sub>2</sub> cells?

REISS: I believe there is a paper put out by one of the people at Fort Monmouth, Gabe DiMasi. If you let me get your name and address I'll see that the two of you get together.

Thank you.

## NAVY POSITION ON LITHIUM SAFETY

F. Bis

Naval Surface Weapons Center

I'm not going to talk about the DOD Safety Committee because that is for official use only, but what I would like to do is to address the Navy's position on lithium safety because it is quite different from that of the Army.

The Army has fewer platforms to work with than the Navy. For example, the Navy has land, sea, air and subsurface platforms to be concerned with, so we have to evaluate the lithium batteries and the system under all of those various platforms.

Now the way the Navy is tasked -- and many of you have heard of the document which I'm going to refer to is NAVSEA INST. 9310.1. NAVSEA O4H is the primary center for lithium safety in the Navy and they're tasked by the Naval Material Command. That appears in NAVSEA INST. 9310.1. In 9310.1, NSWC is named as the focal point for lithium battery safety, reporting directly to NAVSEA O4H.

Now there's an update coming out in February on NAVSEA Instruction 9310.1. It will be called 9310.1A, and it's much more detailed than the previous instruction in that it goes into what the pass/fail criteria are and what tests will actually be performed.

Now first of all, the Navy does not certify batteries. We certify a system for the end item. In other words the tests which I will describe are safety tests on the whole system.

The safety tests which we run are principally: (1), short circuit with all fuses bypassed; (2), forced discharge at the fuse value. Whatever fuse value goes into that circuit the battery will be discharged at that value into reversal for 150 percent of the advertised battery capacity.

The last test is the one that you are all going to love. It's called the modified incineration test or the



heat tape test. Many of you have heard of it. You don't like it. But the idea is we take the battery, fresh, and discharged, and heat it up at 20 degrees C. per minute to 500 degrees C. inside the unit.

Now there are some units within the Navy we can't get a heat tape inside because they're so closely packed. So on those, we run what is called Wk-50, which is a full-up fuel fire. In other words you heave it in the fire and see what happens.

Now you say is this the real world? I mean can you really subject batteries to this? And the answer is Yes.

For example, I have become familiar with the Sonobuoy business lately and I've found that the way they take Sonobuoys apart is they send a White Hat out with an ax. Using the ax and he takes the Sonobuoy apart. These systems can be abused. In other words, if there is any way to abuse them they'll be abused.

So we're really looking at what happens to the system under these very severe battery abuse conditions. The philosophy is as follows:

What we're trying to do is to create the worse hazard. One of the above three tests will lead to a hazardous situation and we want to see how the system reacts to that hazard.

Now hopefully, through the aid of safety devices such as diodes, fuses, and thermal devices, to shut adverse reactions down, we can eliminate or severely drop back from the most hazardous situation. However, we still want to know how the system is going to react under these severe conditions.

Now just recently we completed a test program on three manufacturers of the Q-62 Sonobuoy. These are full-up tests asking for certification for service use, so the above three tests were run. There were three different manufacturers. I won't name the manufacturers.

One of them worked well with no problems

during the tests. In other words the unit vented. They were SO<sub>2</sub> batteries. The unit vented quite nicely because they had provided for pressure relief within the housing. Temperatures upon venting reached 1500 degrees Celsius. In other words we had a fire inside but the fire never got outside the shell of the Sonobuoy. That was Manufacturer A.

Manufacturer B: The pressure built up; it cracked the transducer, swelled the clamshells and we might have had problems getting that out of the aircraft.

Manufacturer C: Under all three tests, the Sonobuoy came apart, and suffered from fire and flame. Pressures varied from 20 in Case C to 200 psig. When it reached 200 psig we had a missile going down range when it let go.

Now let's get back to the pass-fail criteria. Suppose we're sitting on land in a warehouse. (1), one can tolerate a venting and also a minor fire. There will be a sprinkler system in the warehouse to try to keep the combustibles from catching on fire.

Now let's put it on an aircraft. In an aircraft one can tolerate venting, but one cannot tolerate an external fire from the unit, or swelling of the unit so you can't get rid of it.

And the same thing occurs on board surface ships. We can tolerate a minor fire and expulsion of the gas.

Now we get to the worst case, the submarines.

The submarine is a complete containment problem. In other words, if the battery gets into a hazardous situation it cannot expel its contents outside the unit.

Now we are recently working on a system called the GPS system. That's the Global Positioning System. It's a tri-service positioning system. It has a small lithium battery for backup memory. It is not contained.

Now we're taking a different approach on the GPS battery. We're asking what would be the quantity and types of gases which could come out of that battery if it were to vent. The same three tests described above are going to be run on the GPS system.

Now how did all this come about?

Well, every one of you has heard of the Bermuda Incident, and that's where it all started. The Sonobuoys weren't being tested before Bermuda as far as lithium batteries. But, after Bermuda, all these systems are now coming in for testing. We've tried to standardize what the test plan is going to be so that the manufacturers of the battery and the equipment know exactly what they're facing.

And I repeat: The three tests are short circuit, forced discharge at the fuse value, and modified or full-up incineration. And the approach is what happens to the system?

Sometimes even though the system reacts in an adverse way,-- for example, we had an air deployable expendable store "Photo Finish", and the whole nose cap ejected upon venting. That one we got around by modifying the stockpile-to-target scenario, and we encased it in a gray overpack like you would a Sonobuoy. So there are always ways to work your way around a problem.

And I repeat, we're not certifying batteries, we're certifying a system with a battery in it. It's the end item that gets certified.

Any questions on this point?

(No response.)

You're all happy with the incineration test?

HELLFRITZSCH: How are we going to keep track of the origin of the first batches that pass all this to make sure that you continue to get a similar product?

BIS: Well, you notice I said the end item. If there's a change in the battery of any type, or the battery compartment or the circuit, that becomes a Class 1 ECP and is brought in for review and may be subjected to retest depending on the safety review.

HELLFRITZSCH: What I'm thinking about is the internal construction.

BIS: The internal construction of the battery?

HELLFRITZSCH: Of the battery.

BIS: Okay, I see the point you're making.

It's impossible to tell if there is anything changed internally. But, periodically, for example, in the Sonobuoy business there are recertifications which are done, and those are all done at Crane. And part of that recertification involves recertification of the safety tests. So they are periodically done.

If there are any adverse effects which happen at that point, then we go back in and take another look at it.

There are two types of reviews also, which I failed to mention. There's a preliminary review and there's a final review. The final one is a full-up test program, whereas the preliminary is a paper study where we look at the circuit, the interaction of the battery, the coupling of the battery to the load, et cetera, and we make recommendations at that point for improved safety.

GROSS (Gulf and Western): NAVSEA Instruction 9310.1 specifically requires a hermetic seal for lithium batteries.

BIS: That's correct.

GROSS: That is to be assumed that that's gospel; there will be no departure from that?

BIS: Not at the present time. That's included also in 9310.1A. In other words, basically 9310.1A is almost identical to 9310.1, except at the back end of it there is a full-up test plan for certification for service use with few changes in the words at the front.

HARRIMAN (Cargocaire): Do you, as with the Army, specify the moisture level in the battery?

BIS: No. I think I'm going to get myself in trouble, but you notice I haven't addressed any chemistry. I don't care what chemistry you come in with; I don't care if you put dynamite inside the unit. We're going to test it the same way. I don't care what moisture content; I don't

care what you put in there. That's the test that you're going to be judged against.

Now you'll notice I never mentioned anything about performance. This is strictly safety. We're not specifying performance. That's up to the original equipment manufacturer, to see that the performance is adequate. And we have programs within the Navy, obviously, to look at that, particularly in the Sonobuoy area or in other areas.

but the safety tests are actually run on whatever is inside. You're really looking at a black box, in essence.

ALLVEY: Just out of interest, how do you define a hermetic seal? You say it's quoted in 9310.1. How do you define it?

BIS: How do I define a hermetic seal?

ALLVEY: Yes.

BIS: I don't have 9310.1 with me, but normally a hermetic seal is defined as the leak rate of the seal to gaseous helium, and I believe the number quoted here is  $1 \times 10^{-8}$  cc's per second. So that would be defined as the hermeticity of the seal.

SCUILLA (CIA): The new NAVSEA Instruction that is going to be coming out, will that be exclusive to lithium systems or are you looking at others; zinc anodes?

BIS: No, that's exclusively addressing lithium systems. We're not specifying just SO<sub>2</sub> or thionyl chloride or NMO<sub>2</sub>.

SCUILLA: Are there any intentions to do comparative tests with other systems like you're doing to the lithium system? You're talking about safety aboard vessels and in submarines. There are other types of battery chemistry couples. Are you going to expose them to the same types of rigid testing regimes that you're exposing the lithium systems to?

BIS: No, because we're charged and tasked under 9310.1A and we're limited to lithium systems.

To answer your question, if we did the same tests on an alkaline cell, we'd get into serious trouble. Alkaline cells will explode under an incineration.

WR50 really is a weapons specification that pertains to explosives, and the question that is normally asked, is how long before the explosive lets go. And the only parts of WR50 which are really applicable to lithium batteries are that you set the systems three feet above a JP5 fuel fire.

But we're not trying to imply that lithium batteries are explosives in any way, shape or form. but we do use WR50 for the fuel fire specification.

**Page intentionally left blank**

## DESTRUCT/NON-DESTRUCT EVALUATION OF CYCLED NiCd CELLS

S. DiStefano

Good morning. This work is part of the effort that was described to you by Dr. Ambrus yesterday, and it is funded by NASA's DAST office.

(Figure 14-1)

Figure 1 is a brief description of our JPL nickel-cadmium battery task. And I'll just briefly describe to you some of the elements.

Statistical analysis -- is a topic which Irv will be talking about a little bit later on, and I won't touch upon that. The basis for this task is our cycling program which was in part designed from results from statistical analysis, and it consists of 40 12-ampere-hour General Electric cells which have chemically impregnated plates. We have a test matrix consisting of temperature and depth of discharges, as shown on figure 1.

Destruct analysis. I will speak very briefly about destruct analysis because the results of most of our tests were presented at the Denver electrochemical society meeting, and there will be a symposium published which will contain the results that I presented there. So I won't dwell on that.

What I'll be talking about today in the most part will be our non-destruct analysis, and in particular the application of AC impedance techniques, as a non-destruct evaluation means.

(Figure 14-2)

Figure 2 is a brief description of the engineering goals of this program. In particular we want to provide a non-destructive method to analyze and study the degradation processes occurring in nickel-cadmium cells to provide a test for -- an in situ test -- for general energy availability -- state of charge, if you will and to provide a technique for determining the quality of cells or failure signatures, and ultimately provide a technique for determining battery cycle life.



(Figure 14-3)

Figure 3 is a brief description of the experimental technique. Briefly, we measured cells at several states of charge, although I'll mainly be speaking of cells measured at zero state of charge.

Impedance is measured as a function of frequency over a range from about .1 millihertz to ten kilohertz. And as you can see from the brief schematic diagram, the spectra are measured as a response to an rms voltage applied at a stabilized potential state of the cell. Most of the data manipulation is done by a computer.

(Figure 14-4)

Figure 4 is a brief description of circuit analysis. As you can see, the definition of impedance as a vector in the complex plane. And as you look at these different schematics, there's a response -- for example, the response of a pure resistive element in the impedance plane, and similarly here's a response of a pure capacitive element in the impedance plane. Here's a response that one would expect from a series connection of a resistor and a capacitor. And, similarly, here is the response one would expect from a parallel connection of a capacitor and a resistor.

It's these type of elements that we're looking at.

(Figure 14-5)

Figure 5 is a brief generalization of how one can consider an electrochemical interface as a set of resistive and capacitive elements, and how one might determine electrochemical information from studying the frequency response of an equivalent circuit. The thing that I'm trying to point out on this chart is that basically there are two processes which can be described as fast and slow, namely electron transfer processes as depicted here are relatively fast processes, whereas mass transfer processes, which are generally limited by diffusion, are relatively slow processes. And the equivalent circuit shown here is the one commonly used. It takes into account the major processes that occur at electrochemical interfaces.

(Figure 14-6)

Figure 6 is the expected response of circuits such as I've shown on the previous slide. Analytically one can show that at very fast frequencies the frequency response of the impedance obeys this equation, which is the equation of a circle. Similarly, at relatively low frequencies the impedance obeys the equation of a straight line.

This is the type of response that one would expect from an electrochemical interface. And this method has been used for many other applications, particularly corrosion and just general electrochemical studies.

As you can see, the parameters such as the double layer capacitance and charge transfer resistance and the ohmic resistance, which are indicative of electrochemical processes, can be obtained directly from such a diagram.

(Figure 14-7)

On this slide I have some actual spectra of sealed cells which we obtained using this technique, a couple of things I want to point out. Firstly, they appear very much like they are predicted. This is a control cell, it just had undergone several -- or conditioning cycles. And this is a cell which had been cycled according to the conditions shown here, in particular 40 degrees Centigrade and 35 percent DOD. Secondly, I want to point out the inductive-type effect, which, as far as I know, no one has really been able to understand why it happens. There is some speculation that this could be due to some kind of inductive effect of the stacking of plates inside the cell, but that has not been verified.

(Figure 14-8)

This slide is meant to show some of the work we've done on the properties of the porosity of the sinter inside these nickel-cadmium cells. In particular what we did is we went back and looked at some of the data obtained by Tracey and Williams on the different types of sinter and developed from this literature data, an equation, an empirical equation which fits this data. This equation, fits the data for the obtained porosities. In other words, this equation which is schematically depicted here describes the porosity

as a function of resistivity. The reason I'm putting this here is because we think that this is one of the things which will be more evident in some of the AC impedance spectra.

(Figure 14-9)

I show here a literature correlation between the different kinds of pores of different geometry and their predicted AC impedance spectra. And as you can see, as the pore geometry changes the spectra is predicted to change also.

If one assumes circular pores, cylindrical pores and transmission line theory, one predicts that the slope of the line when you plot the imaginary part of the impedance as a function of frequency should be to the order of .75 or minus three-quarters. And for planar electrodes it's shown that the slope should be proportional to the minus one-half power. Figure 10 shows that for some cells this is verified.

(Figure 14-10) As you can see, at a given frequency range what's happening here, the electrodes appear to be behaving as planar, and at the higher frequency range they appear to be behaving as the porous electrodes. And we think that this transition here where the behavior changes from porous to planar could be an indication as to what is happening inside the cell. And that's what we're monitoring. The numbers at the bottom of Figure 10 show that there are different ways of plotting these parameters, and they are all consistent with each other. If one plots the log of omega versus the real part of the impedance, one obtains the same parameters as you would from just plotting Z versus Z', or Z-imaginary versus the real part.

(Figure 14-11)

Figure 11 is some of the data that we've obtained so far. There are very slight trends being observed. In particular we see that the double-layer capacitance -- which is a measure of surface area available for electrochemical reactions -- usually decreases with cycling in almost all conditions that we've looked at. The ohmic resistance is pretty much constant, but you would expect that since that

really reflects the external circuit. Charge transfer resistance appears to be increasing also as a function of cycling. We have no hard core explanations for the data. I'm just showing this to show what kind of experiments we're monitoring.

(Figure 14-12)

One of the things that we have observed is signature for cell failure. This AC impedance spectrum again is characteristic to some extent. It was taken approximately 300 cycles before the cell failed. And at the time we really could not explain why this spectra was somewhat anomalous. In particular we were monitoring the Warburg slope, and it tended to show just a pure capacitive element. And we think that perhaps in this case it was due to some kind of pore blocking or something where the cell was acting as a capacitor. And if you'll recall, in the schematic for response of electrical elements the capacity shows basically an up-and-down spectrum when monitored.

This is the spectrum after the cell failed; just a short basically.

In conclusion, we think that the AC impedance technique can be used to monitor many of these degradation processes occurring in the cell, and we are right now in the process of doing some boiler cell type experiments. That is to say, we are monitoring individual components of the cell to see what is particularly causing these changes in the spectra.

Thank you.

#### DISCUSSION

LACKNER (Defense Research Board, Canada): In the slide you had showing the double layer decreasing with cycling it seems as if there's a temperature dependence. At 40 degrees C and 35 DOD there doesn't seem to be any change with cycling, whereas at 30 degrees C and 35 DOD, as well as at 20 DOD there's quite a change. Do you have any comment on that?

DI STEFANO: I won't comment at this time since this is only a two point set of data. I'll look at it more

closely when I get back. But I think before I could make any comments I'd have to look at a lot more data, and that's what we're doing.

Irv might have a comment.

SCHULMAN: What we have noticed in this cycling program is that the depth of discharge seems at least to have a much greater effect on the quality of the cells than the temperature over this particular range.

BARDRUM (Hughes Research Labs): What sort of separator were you using in these studies, and what period of time were these? What sort of cycle rates were you using?

DI STEFANO: The separator was a Pellon separator, usually used in the GE cells. And I don't understand what you mean by "period of time."

BARDRUM: For the LEO cycle.

DI STEFANO: Yes, these cells are in simulate LEO program.

OLBERT (Bell Aerospace): Are you doing these measurements at any other temperature other than this? Are you going down like --

DI STEFANO: These are the highest temperatures we're using; 40 degrees Centigrade is the highest.

OLBERT: How about low?

DI STEFANO: 20 degrees is our lower limit. We're going from 20 to 40 degrees.

OLBERT: It's my understanding that most people are running batteries in spacecraft now closer to zero. Why are you not doing your testing in this area?

DI STEFANO: Like I said in the beginning of the talk, the program was designed in conjunction with the JPL failure model that we developed previously, and in order to get parameters for the failure model it appeared better that we use these temperatures.

We claim that we can extrapolate from the failure model to low temperatures, but we haven't verified it. But that was the reason why we haven't used lower temperatures.

BRODERICK (Goddard): There's a little confusion in my mind whether this is a separate test from the accelerated program. Do you actually run these tests at JPL or is this completely isolated from the accelerated test program?

DI STEFANO: If you mean by that the Crane accelerated test program, yes, these are run at JPL.

MALDY (Seton Hall University): It's my understanding that the theory for this is developed for single electrodes. That is, you're measuring a single electrode double layer capacitance and so on, and then you apply this to the cells.

Would you care to comment as to which electrode you feel has contributed the most to the total double layer capacitants?

DI STEFANO: We've done some preliminary tests using reference electrodes, and other people have done this also. And we're fairly sure that we're looking at the positive electrode. This is the nickel electrode that we're looking at.

ROGERS (Hughes Aircraft): I'm a little confused about something. You say you're looking at the positive electrode. Actually the double layers look like two capacitors in series, which means the one with the least capacitance would show up in your test.

Do I have that right?

DI STEFANO: That's correct.

ROGERS: Is that what you're trying to say?

DI STEFANO: What happens is in this two electrode mode that we're doing these tests the contribution from the cadmium negative electrode does not appear to show in this spectra.



## JPL NICKEL-CADMIUM BATTERIES TASK

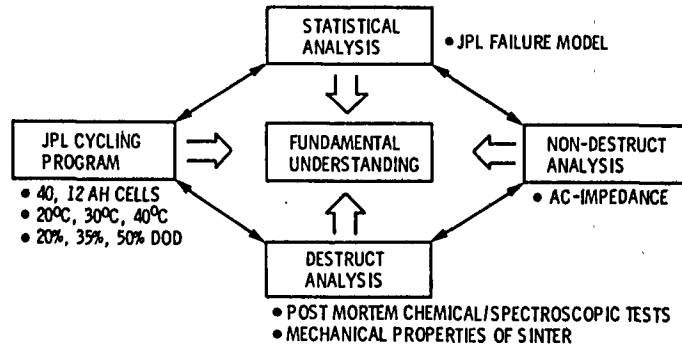

Figure 14-1

### PURPOSE

- PROVIDE A NON-DESTRUCTIVE METHOD TO ANALYZE AND STUDY DEGRADATION PROCESSES
- TO PROVIDE AN IN SITU TEST OF ENERGY AVAILABILITY
- TO PROVIDE A TECHNIQUE FOR THE DETERMINATION OF FAILURE "SIGNATURES"
- TO PROVIDE A NON-DESTRUCTIVE MEANS OF PREDICTING BATTERY CYCLE LIFE

Figure 14-2



### A.C. IMPEDANCE TESTING - EXPERIMENTAL TECHNIQUE

- CELLS CAN BE MEASURED AT SEVERAL STATES OF CHARGE
- IMPEDANCE IS MEASURED OVER FREQUENCY RANGE 0.1 mHz TO 10 KHz
- SPECTRA ARE MEASURED FROM CURRENT RESPONSE TO A 10 mV RMS ALTERNATING VOLTAGE APPLIED TO THE EQUILIBRATED STATE OF CHARGE OF A GIVEN CELL
- FREQUENCY RESPONSE ANALYZER MEASURES IMPEDANCE AS A FUNCTION OF FREQUENCY

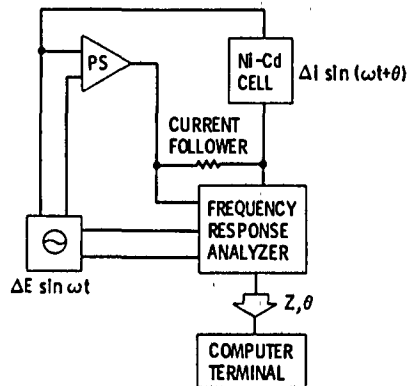
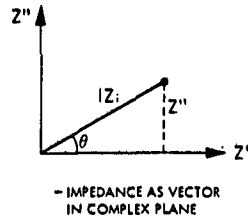

Figure 14-3



## A.C. IMPEDANCE TESTING SIMPLE CIRCUIT THEORY



- $\Delta E \sin \omega t \Rightarrow \Delta i \sin (\omega t + \theta)$
- $Z = \Delta E / \Delta i$

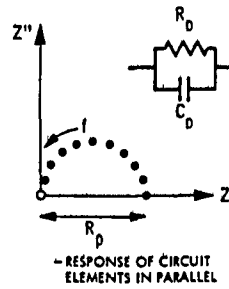
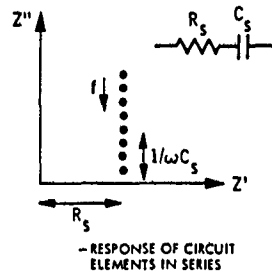
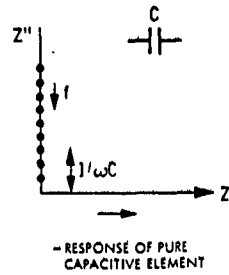
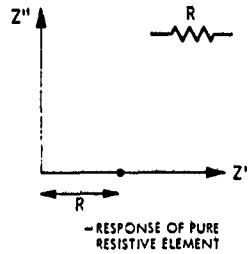
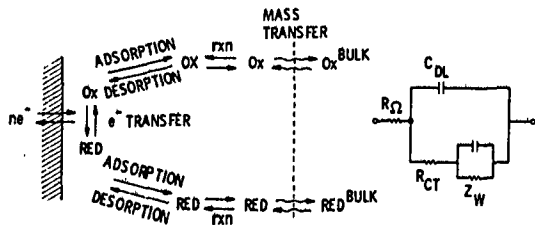

Figure 14-4



## A.C. IMPEDANCE TESTING - EQUIVALENT CIRCUIT



- $C_{DL}$  - DOUBLE LAYER CAPACITANCE - REFLECTS THE ELECTRODE SURFACE AREA AND CONCENTRATIONS OF IONS, ADIONS, AND ADSORBED SPECIES
- $R_{CT}$  - CHARGE TRANSFER RESISTANCE - DETERMINING FACTOR IN THE RATE OF ELECTRODE REACTIONS, HIGH VALUES MAY INDICATE IRREVERSIBLE REACTIONS
- $Z_W$  - 'WARBURG' DIFFUSION IMPEDANCE - MEASURE OF SURFACE CONCENTRATIONS
- $R_{\Omega}$  - SOLUTION AND SEPARATOR RESISTANCES

Figure 14-5



## A.C. IMPEDANCE TESTING - EQUIVALENT CIRCUIT RESPONSE

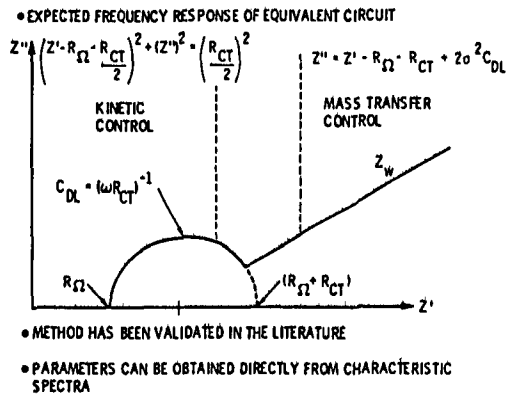

Figure 14-6





## A.C. IMPEDANCE TESTING - TYPICAL SPECTRA

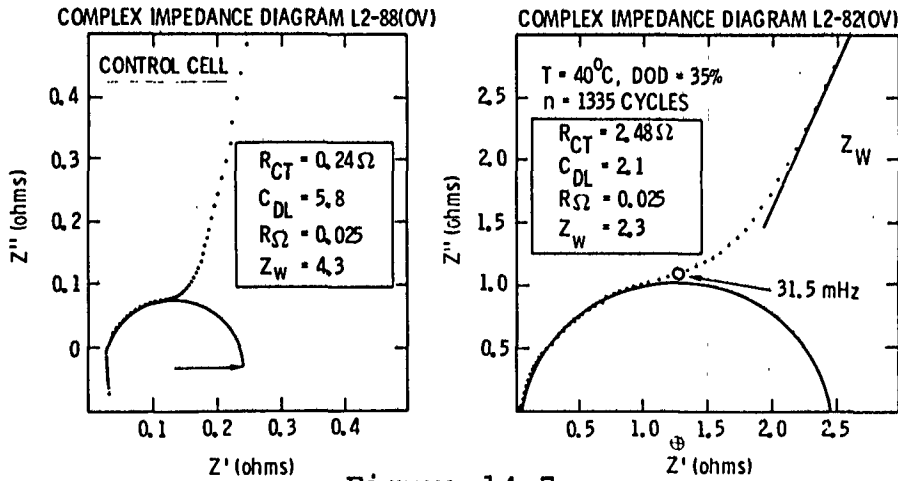

Figure 14-7



## POROSITY VS. RESISTIVITY

- DEVELOPED A CORRELATION BETWEEN ELECTRICAL RESISTIVITY AND SINTERED PLAQUE POROSITY
  - AS  $\phi$  APPROACHES  $\phi_{MAX}$  RESISTIVITY INCREASES WITHOUT LIMIT
- $\Omega_0$  = RESISTIVITY OF BULK NICKEL  
 $\approx 7 \mu\text{-ohm-cm}$  (LIT. VALUE)
- $\phi_{MAX}$  = MAXIMUM POROSITY CONSISTENT WITH STABLE PACKING

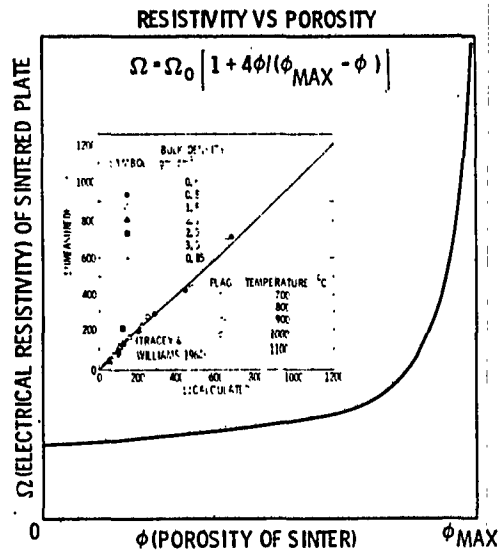
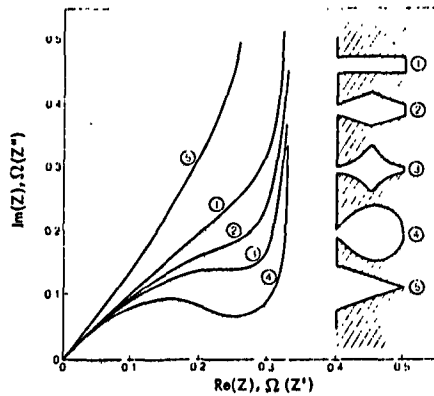

Figure 14-8



## A.C. IMPEDANCE TESTING - POROUS ELECTRODES



• DEPENDENCE OF IMPEDANCE WITH FREQUENCY AS A FUNCTION OF PORE GEOMETRY HAS BEEN DETERMINED,

- H. KEISER, ELECTROCHIM ACTA., 21, 539 (1976)

- USING CYLINDRICAL PORES AND TRANSMISSION LINE THEORY  $Z''$  IS PROPORTIONAL TO  $\omega^{-3/4}$
- FOR PLANAR ELECTRODES  $Z''$  IS PROPORTIONAL TO  $\omega^{-1/2}$

Figure 14-9



## CELL L2-59 IMPEDANCE PARAMETERS

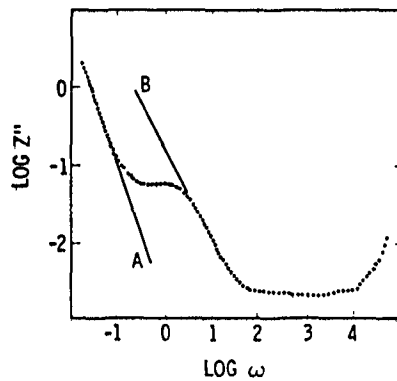

SLOPE OF A  $\approx -0.769$   
SLOPE OF B  $\approx -0.526$

FREQUENCY RANGE  $Z'$  VS  $\omega$   
<100 mHz  $Z' \propto \omega^{-3/4}$   
>1 Hz  $Z' \propto \omega^{-1/2}$

### RESULTS

#### • IMPEDANCE PARAMETERS MEASURED

METHOD	$R_{\Omega}$	$R_{CT}$	$C_{dl}$
$Z' \text{ VS } Z''$	0.0475	0.175-0.225Ω	1.36-1.74F
$\text{LOG } \omega \text{ VS } Z'$	0.0475	0.1325Ω	1.51F
$\omega Z'' \text{ VS } Z'$	0.0475	0.1325Ω	1.98F

- IN ONE FREQUENCY RANGE (<100 mHz) THE CELL BEHAVIOR CORRESPONDS TO POROUS PLATES AND IN ANOTHER (>1 Hz) IT CORRESPONDS TO PLANAR PLATES

Figure 14-10



## A.C. IMPEDANCE TESTING

### • ELECTROCHEMICAL PARAMETERS FOR CYCLED CELLS

	<u>CELL NUMBER</u>	<u>CYCLES</u>	<u>Z<sub>W</sub></u>	<u>R<sub>Ω</sub></u>	<u>R<sub>CT</sub></u>	<u>C<sub>DL</sub></u>
30°C, 35% DOD	59	0	4.0	0.04	0.14	3.6 F
	59	1116	3.0	0.07	0.33	1.7 F
30°C, 20% DOD	68	1957	1.3	0.03	0.6	15.2 F
	68	3119	3.4	0.04	2.9	2.2 F
40°C, 35% DOD	82	1332	2.3	0.04	2.1	2.1 F
	82	2448	1.8	0.03	2.1	2.2 F

Figure 14-11



## A.C. IMPEDANCE TESTING

### "SIGNATURE" FOR CELL FAILURE OBSERVED

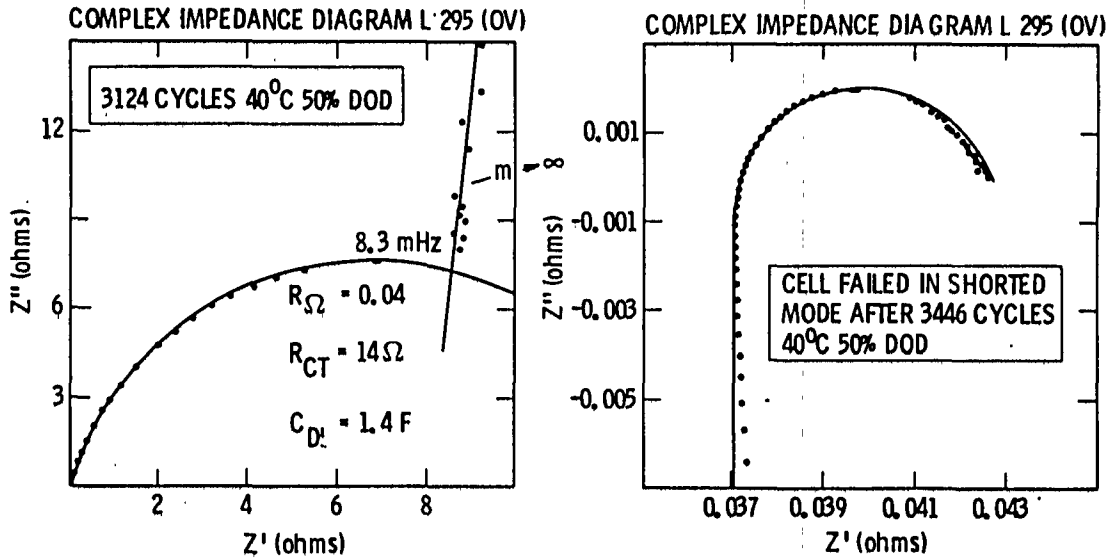

Figure 14-12

## ELECTROCHEMICAL MODELS FOR THE DISCHARGE

### CHARACTERISTICS OF THE NiCd CELL

M. Spritzer

Villanova University

I'd like to talk today about a brief study that was done here at Goddard this summer. The idea was to see if by using basic electrochemical principles, without trying to get too empirical, we could evaluate several, or come up with several, different models and compare them with some experimental data that had been taken previously. We didn't take the experimental data.

(Figure 15-1)

If we start with a very simple-minded thermodynamic model of the nickel-cadmium cell and we use the usual reaction equation proposed for the reaction at the positive, we get a standard Nernst equation for the potential which can be rearranged slightly; you'll see in a moment why.

Similarly, for the reaction preceding at the negative we come up with a similar Nernst type equation; it's broken up in this form as you'll see in a moment.

(Figure 15-2)

On this vucraph, by combining the two equations we come up with a Nernst type equation for the potential of the cell. Now at this point we make some assumptions: the assumptions being that the solids at the negative—that is, the cadmium hydroxide—are in fact separate phases, and we can take each of their activities to be one, which is going to serve to drop out this term from the equation.

(Indicating.)

But there is some evidence in the literature that at the positive, in fact if these are the two species we're dealing with, the oxyhydroxide and the hydroxide are not two separate phases with activity one, but, rather, at least for

most of the cycle, are in a single phase, in other words, a solid solution.

If this is true the activities of neither of these are truly one and can be represented in fact by their mole fraction in this solid solution. If we make a further simplifying assumption that these are the only two components in this solid solution -- which is probably not true -- then of course these mole fractions must add up to one. Which means, then, that if we then represent -- to simplify the equations -- the mole fraction of the nickel hydroxide by X -- then, of course, the oxyhydroxide becomes one minus X -- and a Nernst equation representation for the cell becomes this.

(Indicating.)

Also, we can represent the fraction of discharge by this X since if the cell was completely discharged, the nickel would all be in the hydroxide form and the mole fraction of the nickel would be one. And if it was completely charged—whatever that really means—then this mole fraction would be zero and this would be one, which fits into this equation.

(Indicating.)

Actually those two extremes would not fit into this equation since you can't have either one of the terms in the log term be zero. So it doesn't really mathematically fit on either end, at least 100 percent or zero percent discharge.

Since there is current flow conditions under most of the tests, or the tests that we used -- of course, in actual operation the potential must be corrected for resistance of the cell and the current flow.

What we did then was, using some literature values for formal potentials, incorporate a formal cell potential, which then has this form.

(Figure 15-3)

On this vugraph the previous equation is repeated.

As you can see, this is a rather poor fit. The solid curve is a plot of the equation and the broken curve is a plot of an experimental discharge curve, and, as you probably expected, doesn't fit very well.

The next approach was to look at a modified thermodynamic model. This is also based on some literature precedent.

(Figure 15-4)

What's added in this particular equation -- this one doesn't include the resistive term yet for purely potentiometric thermodynamics. This term takes into account either an entropy of interaction or of solution formation or non-ideality of solid solution formation. Introducing this term and the value of  $A/RT$ , if it is zero, then that is basically an ideal solid solution and it brings us back to the simplified thermodynamic model.

If this parameter here, (indicating) this term, is either a positive or a negative one, that's positive or negative deviation from ideality. If this term is two, that's a special case: basically it's the borderline between a one-phase and a two-phase system. If the value of this term goes beyond two, then there has been a phase separation into two phases, two solid solutions.

To simplify the equation we replaced this term by  $K$  (indicating), and then in fact fit this equation, which now has a resistive term, to a set of experimental discharge curves and got a least squares best fit for the parameter  $K$ , evaluating the resistance -- which I don't have indicated here -- basically by fitting it at 50 percent discharge.

So these curves were made to fit. And the fit is much better. I'll comment a little further on the fit.

At least from 50 percent on the fit is fairly good. And there's a problem here with the initial portion, which I'll come back to in a moment.

(Figure 15-5)

Another model, almost as an afterthought:

since it's well known that the oxyhydroxide and hydroxide have different resistivities we tried one approach with a varying resistance. And this is without really very good reason, just trying an equation where the resistance varies, and it varies in an exponential,  $e$  to the minus one minus  $X$  where  $X$  is again the fraction discharge or the mole fraction of the hydroxide. We get a similar fit. I'll compare these fits in just a moment.

Then we decided to try a totally different approach.

(Figure 15-6)

I'm not sure how many of you are familiar with the technique known as chronopotentiometry, which basically involves constant current electrolysis, monitoring the potential, which is essentially the way all these tests were run. And the curves -- This is a typical type of a chronopotentiogram where the potential is monitored as a function of time and under diffusion controlled conditions. When the diffusion layer is essentially depleted there's a rapid drop or change in the potential, and the time to achieve this is called the transition time. And the potential corresponding to one-quarter of the transition time is in fact comparable to related to the formal potential for the system.

The standard equation for this type of curve involves (indicating) -- Here's the transition time and this is the time at any point along the curve.

Now if we rearrange it slightly, the term within the log term, we can get an equation in this form.

(Indicating.)

Now at constant current the charge at any instant is equal to the constant current times the time at that instant. And the total capacity for this particular cell represents the transition time multiplied by the current.

(Figure 15-7)

This type of an equation now where  $X$  again is the fraction of discharge, which is simply the time divided by

the transition time since the two respective charges are those times multiplied by the same current, we can get an equation like this (indicating).

From this diagram it doesn't seem -- and in fact it's true it -- doesn't fit quite as well as some of the others, but basically it has the same form.

Let me very quickly move on to another model. There really isn't time to go through all the details.

(Figure 15-8)

This assumes there's a double layer charging contribution which tends to distort the current -- or, rather, the potential time curve. And the net effect there, in the literature there are some studies done evaluating that problem. And it turns out there's an adjustable parameter that has been introduced, and this term here (indicating) enters into it modifying the equation. The value of this K was fit by the least squares method using the test data. And this was the number we ended up with.

(Indicating.)

Which is this particular curve. And, again, the broken one, which is hard to see on here, is the experimental data.

Let me compare the different models on the next graph.

(Figure 15-9)

Basically for the different models this is the error curve. Now each of these is done by comparing the calculated or the equation with the same test curve. As you can see, this is the simple-minded thermodynamic one. It only agrees on the one point and a few other points that we made fit. The others agree from about 50 percent on, more or less.

This is the chronopotentiometric model, and this is the modified one.

(Figure 15-10)



On this vugraph there is a better comparison. These are equations for the five different models that we considered. Obviously this one was just put in there, knowing beforehand it wouldn't really fit. But basically by now doing a data analysis, the standard deviation for all of the curves with each of these equations, these are the standard deviations in millivolts for the whole curve.

I broke it up into three different sets, the full curve, which is this column here (indicating) of the different standard deviations, the first half, zero to 50 percent, and then the last half over here. And so far it seems the best fit in all regions is with the modified thermodynamic approach. The changing resistance one is not far behind it. The chronopotentiometric one actually is fairly off. And this one, of course, we expected to be off, although on the whole it's really not bad, less than 15 millivolts standard deviation for the entire curve.

Now why the initial portion does not agree is something that we have to work on. Either it's an artifact of the way the tests were carried out or there is actually a change in mechanism or some phenomenological problem in that region of the discharge characteristic curve that we're not introducing into the model. Hopefully, further work will try to pinpoint down what other parameters have to be fit into here in order to get this to better fit the region which in fact turns out to be the most important region, the first 50 percent of discharge rather than the last 50 percent of discharge.

Thank you.

#### DISCUSSION

SCHULMAN: Are there any questions for Dr. Spritzer?

SPERBER (GTE): What does the five percent cobalt that people typically mix in with the metal do to your equations? I'm talking of the nickel here.

SPRITZER: Yes.

At this point I'm not really sure, but if -- in a very simple minded approach if you simply take the five

percent and adjust the mole fractions, for instance, they no longer add up to one. But that's a relatively minor adjustment to the equation.

What it does mechanistically I can't really say. In terms of how it could fit in this model with five percent cobalt, for instance, if you assume that's in the solid solution that would decrease the mole fraction of both forms of the nickel. They simply don't add up to one then. They add up to .95, if you take five mole percent; the figure would be different if you actually go in at five weight percent.

RITTERMAN (TRW): All your mechanisms assume that you have a solid solution of nickel hydroxide and beta-nickel hydroxide. I was wondering if you checked various percentages of this solution on open circuit. That is to say, when you have ten percent you should have a 59 millivolt drop or rise, what have you. And that would probably be an easy way to determine whether you do indeed have a solid solution or not.

SPRITZER: The data we were using was data that was determined a number of years ago, and so it wasn't really possible to go back experimentally. That's another thing.

RITTERMAN: Well, yes, it is. You simply take a positive electrode and you have it 100 percent charged and put an open circuit and then discharge it and leave ten percent or any value in between and see how that affects the open circuit voltage.

SPRITZER: Yes, I understand that. Unfortunately I wasn't in the laboratory for this particular project, so I couldn't really do that.

MARGERUM (HUGHES RESEARCH LABS): Apparently there are some recent studies where people were not able to find nickel oxyhydroxide in the nickel electrode. How would you modify your model if that happens to be the case?

SPRITZER: The same thing would basically apply, for example, to the nickel two and four hydroxides. You could use a similar model. Obviously the exact model is different. There has been other evidence that the

oxyhydroxide has been indicated.

There is a paper, I guess around February of this year, where they're proposing essentially solid solution with proton and electron separated, and essentially it is a proton on oxyhydroxide or on the hydroxide that is free to migrate.

Thermodynamically it could fit any model that you pick. Whether it will fit as well, I don't know.

STOCKEL (COMSAT): You fixed a temperature here, is that correct?

SPRITZER: There were several different temperatures that the data was taken at.

STOCKEL: But did you consider that the temperature can change during the discharge?

SPRITZER: No, this didn't take that into account.

STOCKEL: You don't feel that that would affect your model?

SPRITZER: In terms of the test data the temperature was maintained constant.

Now since there's a temperature term in fact varying the temperature could be plugged into this.

DYER (Bell Labs): A question of clarification:

Do I understand that these curves, voltage as a percent of discharge, were on during discharge or were they open circuit measurements?

SPRITZER: During discharge.

DYER: Okay.

Are you aware of the work of Bernard? I think he did some open circuit measurements and he seems to have some very similar ideas to yours of mixed oxides, non-ideality, and he got a very good fit, I think, with open circuit measurements using the thermodynamics modified models.

SPRITZER: Yes, I'm aware of that.

REICHMAN (ECD): What's your conclusion from such a model? What would you prefer? Would you prefer it to be two separate phases or to be a solid solution from a practical point of view?

SPRITZER: What I would prefer or what I have to conclude from the data?

It would be much simpler if it was two separate phases.

REICHMAN: Simpler to make the model.

SPRITZER: Yes.

REICHMAN: But from a practical point of view?

SPRITZER: I like the single phase model.

Now the Bernard group has proposed a phase separation into two phases with complementary compositions so that they remain essentially constant for a good portion of the cycle.

MODEL I. SIMPLE THERMODYNAMIC MODEL



$$E_{\text{pos}} = E_{\text{pos}}^0 + \frac{RT}{nF} \ln \frac{a_{\text{NiOOH}} a_{\text{H}_2\text{O}}}{a_{\text{Ni(OH)}_2} a_{\text{OH}^-}} \quad (2a)$$

$$E_{\text{pos}} = E_{\text{pos}}^0 + \frac{RT}{F} \ln \frac{a_{\text{NiOOH}}}{a_{\text{Ni(OH)}_2}} + \frac{RT}{F} \ln a_{\text{H}_2\text{O}} - \frac{RT}{F} \ln a_{\text{OH}^-} \quad (2b)$$



$$E_{\text{neg}} = E_{\text{neg}}^0 + \frac{RT}{2F} \ln \frac{a_{\text{Cd(OH)}_2}}{a_{\text{Cd}} a_{\text{OH}^-}^2} \quad (4a)$$

$$E_{\text{neg}} = E_{\text{neg}}^0 + \frac{RT}{2F} \ln \frac{a_{\text{Cd(OH)}_2}}{a_{\text{Cd}}} - \frac{RT}{F} \ln a_{\text{OH}^-} \quad (4b)$$

Figure 15-1

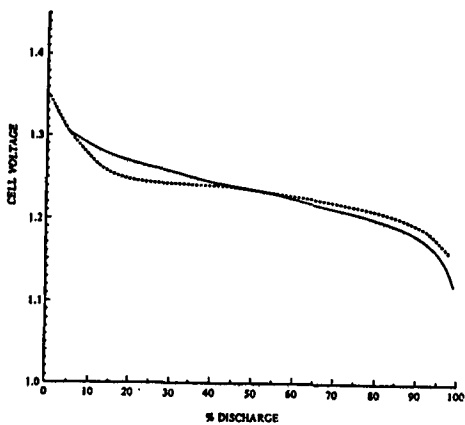

Figure 1. Calculated discharge curve based on the simple thermodynamic model, equation (7). The broken curve is experimental data.

$$E = 1.294 + \frac{RT}{F} \ln \left( \frac{1-X}{X} \right) - 1R_0 \quad (7)$$

Figure 15-3

MODEL I. SIMPLE THERMODYNAMIC MODEL

$$E_{\text{cell}} = E_{\text{pos}}^0 - E_{\text{neg}}^0 + \frac{RT}{F} \ln \frac{a_{\text{NiOOH}}}{a_{\text{Ni(OH)}_2}} - \frac{RT}{2F} \ln \frac{a_{\text{Cd(OH)}_2}}{a_{\text{Cd}}} + \frac{RT}{F} \ln a_{\text{H}_2\text{O}} \quad (5)$$

assumptions:

- (a) The Cd and the Cd(OH)<sub>2</sub> at the negative electrode appear as separate solid phases so that  $a_{\text{Cd}} = a_{\text{Cd(OH)}_2} = 1$
- (b) The NiOOH and Ni(OH)<sub>2</sub> at the positive electrode are present in a single phase, i.e., a solid solution.

$$a_{\text{NiOOH}} = X_{\text{NiOOH}} \text{ and } a_{\text{Ni(OH)}_2} = X_{\text{Ni(OH)}_2}$$

$$X_{\text{NiOOH}} + X_{\text{Ni(OH)}_2} = 1$$

$$E_{\text{cell}} = E_{\text{cell}}^0 + \frac{RT}{F} \ln \left( \frac{1-X}{X} \right) \quad (6a)$$

$$E = E^0 + \frac{RT}{F} \ln \left( \frac{1-X}{X} \right) - 1R_0 \quad (6b)$$

$$E = 1.294 + \frac{RT}{F} \ln \left( \frac{1-X}{X} \right) - 1R_0 \quad (7)$$

Figure 15-2

MODEL II. MODIFIED THERMODYNAMIC MODEL

$$E_{\text{Ni}} = E_{\text{Ni}}^0 + \frac{RT}{nF} \ln \left( \frac{1-X}{X} \right) + \frac{RT}{nF} \left( \frac{A}{RT} \right) (2X-1) \quad (8a)$$

$$E = 1.294 + \frac{RT}{F} \ln \left( \frac{1-X}{X} \right) + \frac{RT}{F} K (2X-1) - 1R_0 \quad (8b)$$

$$E = 1.294 + \frac{RT}{F} \ln \left( \frac{1-X}{X} \right) + 0.789 \frac{RT}{F} (2X-1) - 1R_0 \quad (9)$$

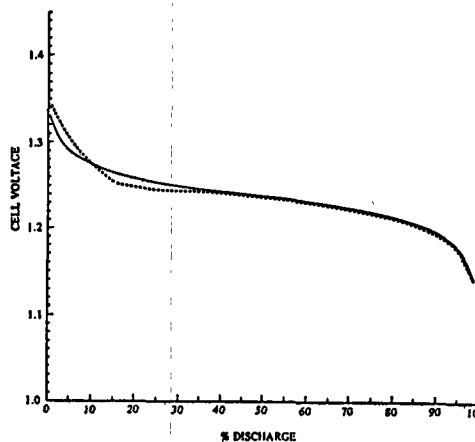

Figure 2. Calculated discharge curve based on the modified thermodynamic model, equation (9). The broken curve is experimental data.

Figure 15-4

MODEL III. MODIFIED THERMODYNAMIC MODEL WITH VARYING RESISTANCE

$$E = 1.294 + \frac{RT}{F} \ln \left( \frac{1-X}{X} \right) + \frac{RT}{F} K (2X-1) - IR_0 \text{Exp}[-(1-X)] \quad (10)$$

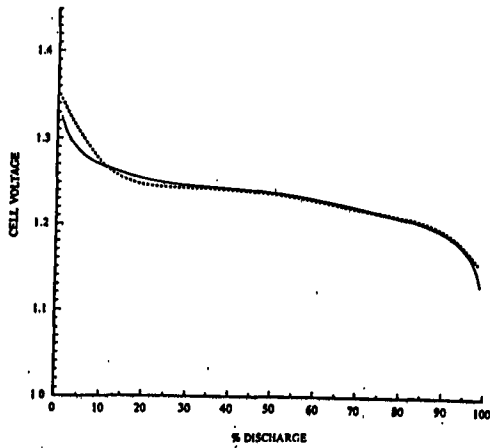

Figure 4. Calculated discharge curve based on Model III, equation (10). The broken curve is experimental data.

Figure 15-5

MODEL IV. CHRONOPOTENTIOMETRIC MODEL

$$E = 1.294 + \frac{RT}{F} \ln \left( \frac{1-X^{1/2}}{X^{1/2}} \right) - IR_0 \quad (12)$$

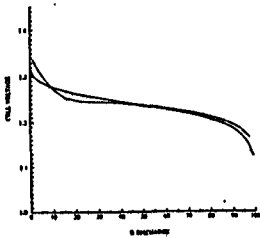

Figure 6. Calculated discharge curve based on Model IV, equation (12). The broken curve is experimental data.

Figure 15-7

MODEL IV. CHRONOPOTENTIOMETRIC MODEL

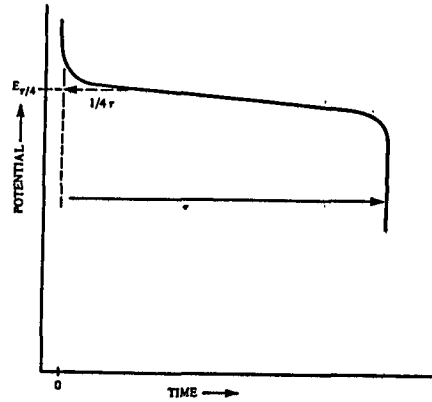

Figure 5. A typical chronopotentiogram. The quarter-wave potential,  $E_{7/4}$ , corresponds to the potential at a time  $t = 1/4 \tau$ .

$$E = E_{7/4} + \frac{RT}{nF} \ln \left( \frac{t^{3/2} - t^{1/2}}{t^{1/2}} \right) \quad (11a)$$

$$E = E_{7/4} + \frac{RT}{nF} \ln \left[ \frac{1 - \left( \frac{t}{\tau} \right)^{1/2}}{\left( \frac{t}{\tau} \right)^{1/2}} \right] \quad (11b)$$

Figure 15-6

MODEL V. MODIFIED CHRONOPOTENTIOMETRIC MODEL

$$E = 1.294 + \frac{RT}{F} \ln \left[ \frac{1 - \left( \frac{2nF}{RT} K X \right)^{1/2}}{\left( \frac{2nF}{RT} K X \right)^{1/2}} \right] - IR_0 \quad (16)$$

$$E = 1.294 + \frac{RT}{F} \ln \left[ \frac{1 - \left( 0.02416 \frac{F}{RT} X \right)^{1/2}}{\left( 0.02416 \frac{F}{RT} X \right)^{1/2}} \right] - IR_0 \quad (17)$$

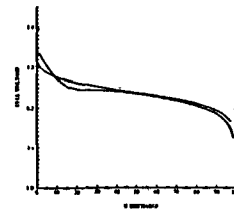

Figure 7. Calculated discharge curve based on Model V, equation (17). The broken curve is experimental data.

Figure 15-8

COMPARISON OF THE MODELS

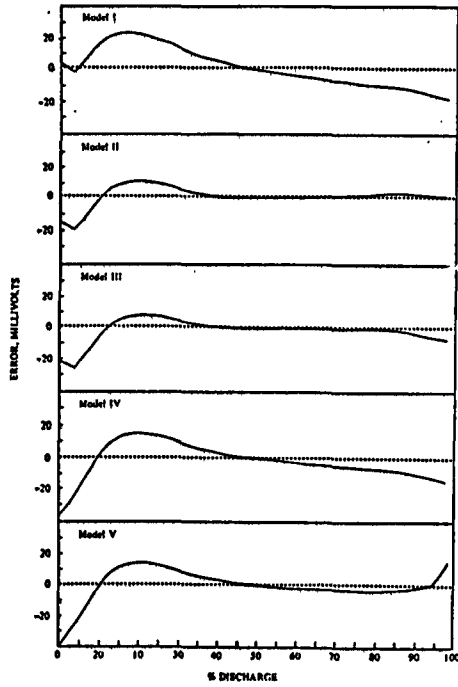

Figure 8. Typical error curves for the five models.  
The curves shown are all with respect to the same experimental discharge.

Figure 15-9

COMPARISON OF THE MODELS

Model	Equation <sup>a</sup>	Standard Deviation <sup>b</sup> , millivolts		
		0-100%	0-50%	50-100%
I Simple Thermodynamic	$E = 1.294 + \frac{RT}{nF} \ln \left( \frac{1-X}{X} \right) - i R_0$	14.4	13.9	14.8
II Modified Thermodynamic	$E = 1.294 + \frac{RT}{nF} \ln \left( \frac{1-X}{X} \right) + 0.789 \frac{RT}{nF} (2X-1)^2 - i R_0$	8.1	9.5	5.7
III Modified Thermodynamic with Varying Resistance	$E = 1.294 + \frac{RT}{nF} \ln \left( \frac{1-X}{X} \right) + 1.973 \frac{RT}{nF} (2X-1) - i R_0 e^{-(1-X)}$	9.7	11.1	7.6
IV Chronopotentiometric	$E = 1.294 + \frac{RT}{nF} \ln \left( \frac{1-X^{1/2}}{X^{1/2}} \right) - i R_0$	13.2	14.0	12.0
V Modified Chronopotentiometric	$E = 1.294 + \frac{RT}{nF} \ln \left[ \frac{1 - \left( .01208 \frac{2nF}{RT} X \right)^{1/2}}{\left( .01208 \frac{2nF}{RT} X \right)^{1/2}} \right] - i R_0$	10.8	14.0	6.4

<sup>a</sup>X is the fraction of discharge, R<sub>0</sub> is the cell resistance

<sup>b</sup>Each standard deviation is the mean for the four experimental-discharge curves

Figure 15-10

## NiCd BATTERY FAILURE ANALYSIS

K. Sense

Rockwell

We're dealing with the nickel-cadmium battery failure analysis.

(Figure 16-1)

The test plan in this figure is as follows:

We had a 22 cell nickel-cadmium battery that had successfully passed functional and random vibration tests and was being readied for qualification level thermal-vacuum tests in a vacuum chamber, according to the test plan as shown in Figure 1.

The intent was to trickle charge the already fully charged battery SNO01, charged at 29.742 volts or 1.352 volts per cell, at a .5 amp rate, hold the battery mounting surface at 22 degrees C and maintain a chamber pressure of less than 1 times 10 to the minus 5 torr over the weekend of January 16 through 19 of this year. Since this was considered a benign environment complete functional monitoring was not activated.

Thermal vacuum testing was to begin Monday, January 19 -- that is over the weekend, of course.

(Figure 16-2)

This slide shows the test configuration.

As shown in Figure 2, the battery was fastened by means of a thin layer of thermally-conductive adhesive to a copper cold plate, wrapped in MLI thermal insulation, and mounted on a micarta shelf in the vacuum chamber. A Haake temperature bath with an N2 controller pumped coolant fluid through tubing soldered to the copper cold plate. Strip heaters on the cold plate were not energized. A Perkin Electronics power supply provided the trickle charge via an inoperative battery test console and vacuum penetration cabling.



(Figure 16-3)

This gives the condition of the battery test on 1/19/61.

At about 8:10 a.m. on January 19 the conditions described in Figure 3 were observed. The battery was completely destroyed. Some cells were blown apart. The rest were bulged so that all were unsealed. Parts were scattered throughout the vacuum chamber. Debris fouled the vacuum system. The vacuum chamber was subsequently backfilled with nitrogen, opened, and the contents carefully removed. Representative photos of specimens are shown in Figures 4 through 6.

(Figure 16-4)

We weren't very hilarious at the time we saw this, as you can imagine, because we had a 22-cell battery which was fairly expensive and it had gone through all of the test procedures and passed them.

This is one of the constraining plates that holds the battery together, in other words the 22 cells.

(Figure 16-5)

This shows a layout of the way the individual cells were arranged. You can see that some of them were completely exploded; all of them were opened. But this is the order in which they were arranged in the battery.

(Figure 16-6)

The next slide shows the same thing, except from the other end.

The cause of the disaster, human error, caused both the heater and the circulating pump for the coolant to shut down when the battery was warmed to ten degrees Celsius. It had been at one degree Celsius. Hence the battery and the coolant were effectively isolated from each other, the battery being heated continuously by the trickle-charge input while the coolant attained very low temperatures.

(Figure 16-7)

The specimen analysis conclusions. The final cell temperatures were bracketed by the fact that the nylon separators melted at 216 degrees Celsius and the nickel hydroxide decomposes at 230 degrees Celsius. The nylon separators melted and the nickel hydroxide did not decompose.

Potassium carbonate is an end product when nylon is degraded chemically in a nickel-cadmium cell. Hence the presence of potassium carbonate indicates chemical attack on nylon.

The cell liner, Kynar, was not chemically attacked but was found to have been melted. The melting point of Kynar is 162 to 164 degrees Celsius.

The complete and partial discharge of the electrolytic plates indicates that large amounts of energy were discharged into the cells.

(Figure 16-8)

Our first course of action after the explosion was to see whether trickle charging the battery by itself was sufficient to have caused the high battery temperatures called for by the analysis of the specimens. A thermal response test, SNOO2, was undertaken to determine the rate at which the temperature of the battery rises.

Use of this information enabled determination of the heat capacity of a cell, and that was determined to be 253.6 calories per degree Celsius.

(Figure 16-9)

We'll go through this elementary analysis here for purposes of seeing that we would not get up to the high temperatures called for by analysis if we considered only the energy input resulting from trickle charging the battery.

The time from the start of trickle charge to discovery of the accident was 64.7 hours. The initial battery temperature was one degree Celsius. Therefore the maximum possible battery temperature due to trickle charge alone is 152 degrees Celsius. However the attained battery temperature, as determined from analysis, was 216 to 229

degrees Celsius.

Obviously, then, an additional mechanism is responsible for the battery temperature attained.

(Figure 16-10)

We have here a figure on the discharge capacity of a cell, and the figure shows that there is a dramatic decrease in cell capacity with increase in temperature.

(Figure 16-11)

This is from the GE manual, a figure on the self-discharge characteristics of the nickel-cadmium cell. The figure shows how rapidly a cell discharges as a function of temperature. It is evident that an increase in temperature from 20 degrees to 40 degrees Celsius shows a much greater discharge rate than when the temperature is increased from zero degrees to 20 degrees Celsius.

(Figure 16-12)

The scenario for the battery temperature rising to 216 to 229 degrees Celsius is as follows:

Since the cells were fully charged to start with, any trickle-charge input turned to heat. Since the battery was in a nearly adiabatic state, the battery temperature kept rising steadily. The capacity of a nickel-cadmium cell decreases with temperature. As the temperature is increased the excess capacity must be dumped into the cell itself, further increasing its temperature, causing further dumping of energy into the cell, thus establishing a thermal runaway condition.

As the temperature rises these processes take place at an increasingly faster rate.

(Figure 16-13)

The suggested mechanism responsible for self-discharge of nickel-cadmium cells is as shown. The charged nickel electrode is not thermodynamically stable, but decomposes with the evolution of oxygen. This implies a decrease in the state of oxidation and, hence, a lowered

energy state. Though slow at room temperature, this process is accelerated at elevated temperatures.

This increased amount of oxygen may also lead to a lowered energy state for the cadmium electrode because of the reaction of oxygen with cadmium and water to form cadmium-hydroxide. Both processes release energy into the cell.

Secondly, processes involved in forming the electrodes usually use nitrates of cadmium and nickel as source materials. Though efforts are generally made to reduce the nitrate content of the electrodes as much as possible, even a very small amount of nitrate will generate a so-called nitrogen shuttle cycle of self-discharge. The cycle will continue until the cell is totally discharged with the probable reaction of ammonia with NiOOH to form nitrogen and nickel hydroxide.

(Figure 16-14)

There are other temperature increasing factors. Separator puncture results from several causes. For one, degradation of nylon occurs. When the cell temperature reaches the melting-point region of the separator, which is about 260 degrees Celsius, the combination of nylon degradation, nylon melting, and buckling of plates is likely to lower the impedance between the plates.

In some areas all the nylon may be squeezed out between the plates, causing short-circuiting and high local temperatures.

The interaction of nylon separators with KOH solution has been extensively investigated by Lim of Hughes. He has shown that nylon-6 is degraded in two steps, hydrolysis, the slow step, followed by oxidation, which is the fast step.

We note from the equation that besides nitrogen, potassium carbonate and large amounts of water are formed. The liberation of nitrogen will increase pressure within the cell. Furthermore, the overcharge protection at the cadmium electrode is lost when the reaction goes to completion. When this occurs hydrogen is produced under overcharge conditions, resulting in a potentially explosive situation.

This will occur when ten percent of the nylon is completely oxidized according to the equation shown, and will completely ruin the cell.

An Arrhenius-type equation, shown at 2b, was used to determine length of time required for ten percent degradation of nylon-6 in KOH as a function of temperature. The constant, A, was determined from Lim's work. The equation is plotted in the next figure.

(Figure 16-15)

This figure is a plot of the time it takes for the cell to be ruined as a function of temperature under overcharge conditions. We note that at the cell temperature attained, according to the specimens analysis, namely 216 to 229 degrees Celsius, the cells are completely ruined in about five to six minutes.

You see, this scale here is in minutes. And, for convenience, I have put down the hours, days, months and years. But the thing that we're interested in is that we have attained temperatures in this region that cause the cell to be ruined in a very, very short time. It's a matter of minutes.

This, then, explains that we would have the condition that did exist.

I was going to show a couple of more slides, but I'm not going to because it's a kind of exercise in futility. What I was going to do is give a lower bound at which the temperature rises over the time interval in which we're interested.

I think it's quite obvious from the talk that I've given so far that the kinetics of the situation increase very, very rapidly. As you well know, the rate of the reaction is increased by one and a half to three times for every ten degrees Celsius's rise. And so it doesn't really take much imagination to realize that once the self-discharge gets started it increases at a rapidly increasing rate and gets to the temperature that we've indicated.

Now the other thing that I ought to mention is

that as the cell discharges itself, enough heat is liberated within the cell to take it to a little over 200 degrees Celsius. Now this, added to the trickle charge input, which takes it to a little over 150 degrees Celsius, would take the temperature to over 350 degrees Celsius. So there is no problem as far as the attainment of temperatures in the range of 220 degrees Celsius is concerned.

This concludes my talk.

#### DISCUSSION

CONSTANTINEAU (Pellon Corp.): What type of separator was used in this battery?

SENSE: Nylon.

CONSTANTINEAU: What manufacturer? Do you know offhand?

SENSE: Whatever General Electric uses. These were General Electric cells.

CONSTANTINEAU: Okay.

In our separators, nylon separators, we do contain quite a bit of heterofill fibers or nylon-66, which have a much lower melting temperature. Could this affect your results?

SENSE: I'm sorry, could you repeat the question?

CONSTANTINEAU: Okay.

In our materials we do put in more than ten percent of heterofill fiber, nylon fiber, namely nylon-66, and it has a much lower melting temperature. Would this have any effects on your test results?

SENSE: Well, the main thing is that there's enough nylon-6. Whatever else may be added I don't really think would really have that much of an impact on the overall situation.

CONSTANTINEAU: Okay. Thank you.

MARGERUM (Hughes Research Labs): Nylon-66 hydrolyzes sooner than nylon-6; not quite as fast, but you'd have the same sort of effect as you observed if you had both present.

FORD (NASA Goddard): I'm looking at your picture of that explosion. It looked like it was quite an avalanche or catastrophic.

Did you take into consideration the possibility of a mixture of gas in the cell with an arch that could cause the initial explosion and the penetration of the impact to other cells, you know, as an avalanche type of effect?

You know, there are records where cells have exploded spontaneously on cycling; very few, fortunately for the NiCd business, but that has happened before. So there's no reason to believe that, you know, this could not happen again one day.

SENSE: Well, I'm not saying that it couldn't happen. I don't think it happened in this particular instance because we had the exploded cells in more or less isolated areas. In other words, the exploded cells weren't all adjacent to each other. We had non-exploded cells adjacent to exploded cells.

So in answer to your comment, I'd say it might happen, but it certainly did not happen in this case.

## Test Plan

- 1/19-24/81 Perform Thermal-Vacuum part of Qualification Test on Battery SNOO1
- 1/16-19/81 Maintain Readiness Configuration on fully-charged battery by subjecting it to the following conditions:
- $10^{-5}$  Torr
  - $22 \pm 0.5^\circ\text{C}$
  - Trickle-charging battery at 0.5amp (C/70) starting on 1/16/81 at 1530 hrs. with initial battery temp of  $1^\circ\text{C}$

Figure 16-1

## Condition of Battery Test at 0810 Hrs. on 1/19/81

- Individual cells of battery scattered throughout the vacuum chamber
- All cells were unsealed
- Some cells were blown apart
- Particles on wall adjacent to chamber cover
- Battery charger delivered 0.5amp at 0 volt
- Coolant temperature in bath at  $-59^\circ\text{C}$
- Vacuum chamber at 0.5 torr

Figure 16-3

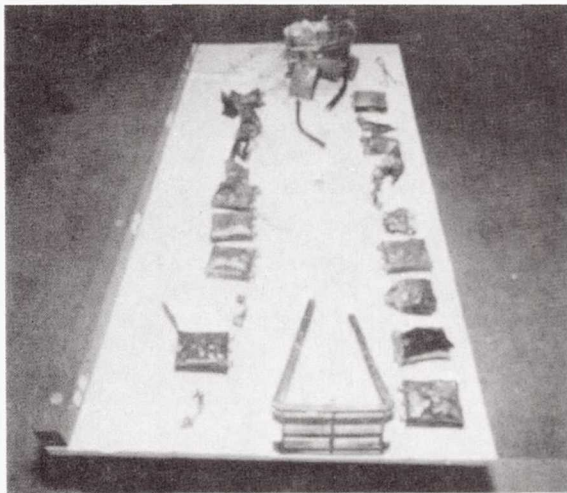

Figure 16-5

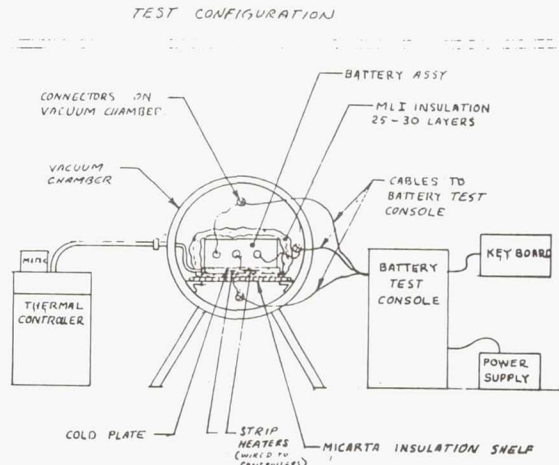

Figure 16-2

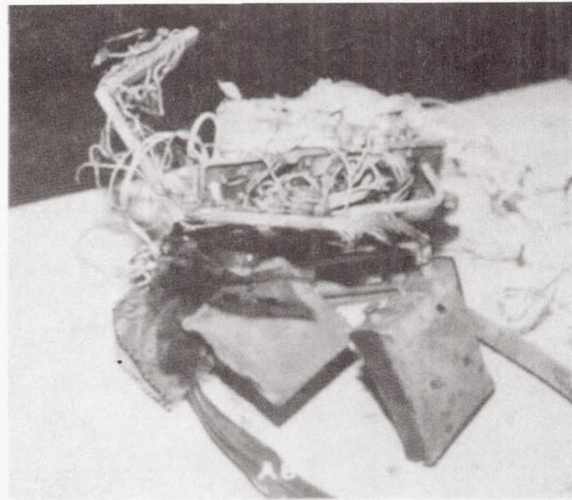

Figure 16-4

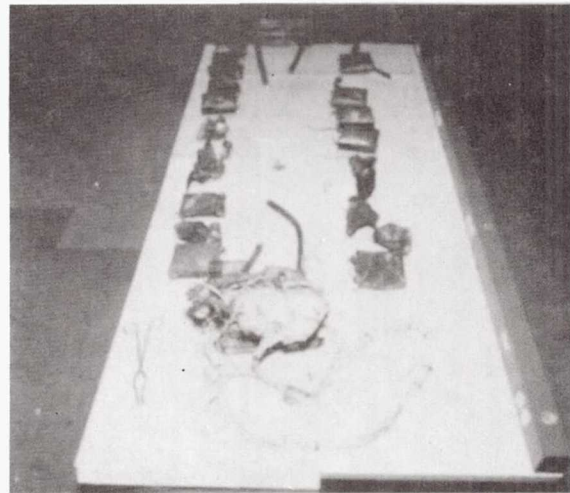

Figure 16-6



Specimen Analysis Conclusions

1. Final cell temperatures: 216°-229°C
  - Nylon separators melted
  - No Ni(OH)<sub>2</sub> decomposition
2. Nylon separators chemically degraded
  - K<sub>2</sub>CO<sub>3</sub> evident in unexploded cells
3. Cell liner (Kynar) not chemically attacked, but melted
4. All Cd plates discharged
5. All Ni plates of exploded cells discharged.
6. All Ni plates of unexploded cells partially discharged

Figure 16-7

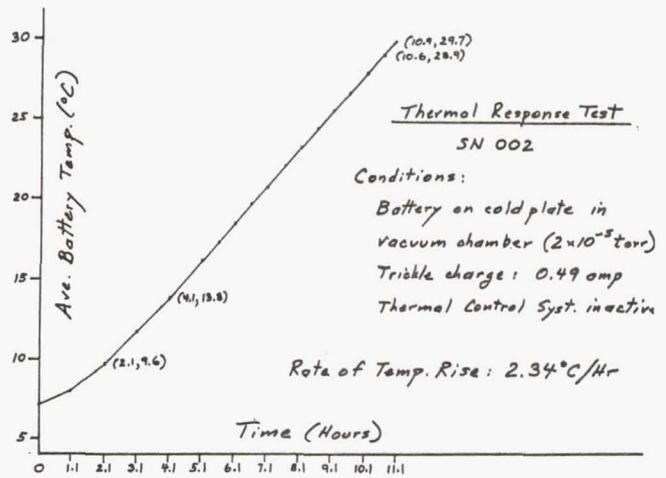

Figure 16-8

Battery Temperature due to Trickle-Charge

Time from start of trickle-charge to discovery of accident: 64.7 hours

Initial battery temperature: 1°C

The maximum possible battery temperature due to trickle-charge alone is:

$$(64.7 \text{ hrs.}) (2.34 \text{ °C/hr}) + 1 \text{ °C} = 152 \text{ °C}$$

Attained battery temperature as determined from analysis: 216°-229°C

Deduction: An additional mechanism responsible for battery temp. attained

Figure 16-9

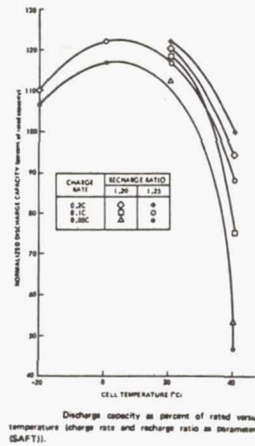

Figure 16-10

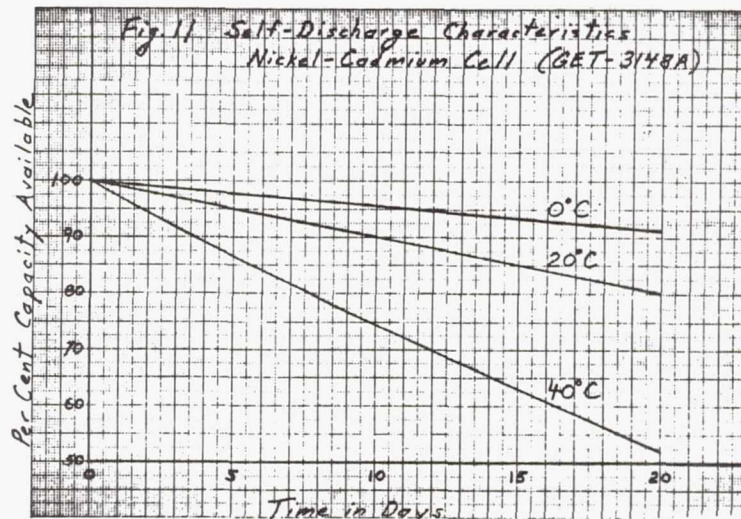

Figure 16-11

### Scenario for High Battery Temperature

- Ni-Cd cells fully charged at start
- Trickle-charging heats cells because of nearly adiabatic conditions
- Capacity of Ni-Cd cells decreases with temperature rise.
- Energy exceeding cell capacity is dumped into cell increasing temperature even more.
- Kinetics of reactions increase with temperature causing thermal runaway and ultimately cell rupture.

Space Operations and Satellite Systems Division  Rockwell International

Figure 16-12

### Suggested Mechanisms Responsible for Self-Discharge of Ni-Cd Cells

- Thermodynamic instability of the charged Ni electrode resulting in its decomposition with the evolution of oxygen. This implies a lower oxidation state for the Ni electrode and release of energy into the cell.
- Discharge of the Cd and Ni electrodes by the nitrogen shuttle process:

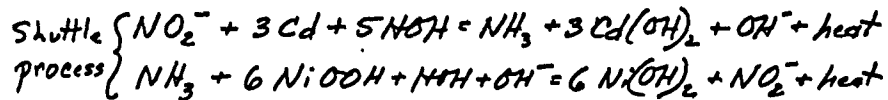

Reaction rate increases  $1\frac{1}{2}$  - 3 times/ $10^\circ\text{C}$

Space Operations and Satellite Systems Division  Rockwell International

Figure 16-13

## Other Temperature-Increasing Factors

1. Separator puncture
2. Separator (nylon 6) degradation according to Lim (Hughes)

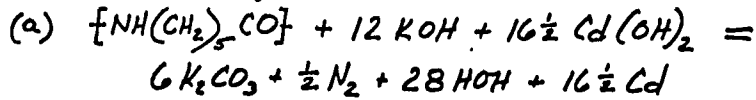

(b) 
$$\ln K = -\frac{E}{RT} + A$$

where  $\frac{1}{K}$  = time required for 10% degradation of nylon 6 in 34% KOH (in years)

$E$  = activation energy, 19.8 kcal/mole

$R$  = gas constant/mole, 1.9864 cal/°K

$T$  = °K

$A = 31.405$

Figure 16-14

Figure 16-15

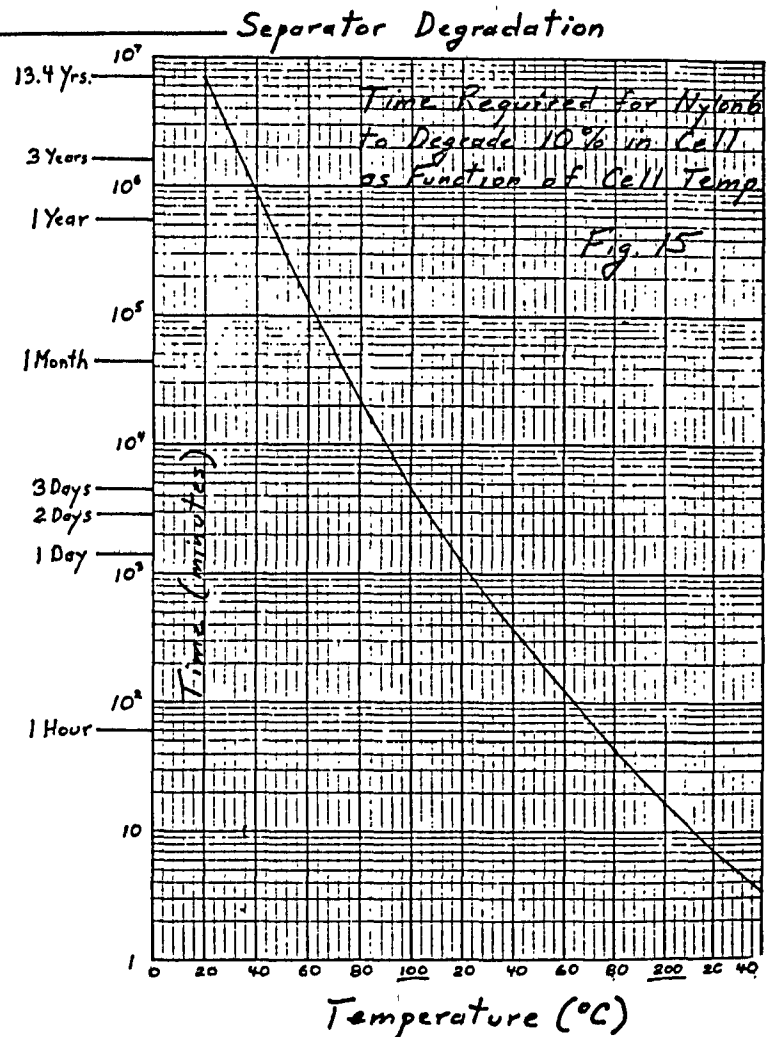

## LIFE PREDICTION MODEL COMPARISONS

### I. Schulman

#### JPL

It looks to me like nickel-cadmium just doesn't want to be outdone by lithium.

The work I'm going to describe has been sponsored by the OAST office of NASA under a general effort described by Dr. Ambrus, your first speaker yesterday in the morning.

During the past few years there have been published a number of predictive failure models from nickel-cadmium aerospace cells. In fact, some of these have had their first disclosure at this workshop. This report is a discussion and comparison of three such models, and they are best entitled the McDermott model, the Lander model and the JPL Failure Model.

(Figure 17-1)

The McDermott model, of course, as you know, has been derived by Dr. Patrick McDermott, who is on the teaching staff of Coppin State, and who is a consultant here at Goddard.

Dr. John Lander, who is very well known in the battery community and who is a member of the technical staff of the aerospace power division and Wright-Pat, of course, authored the Lander Model; and the JPL Failure Model is principally authored by Dr. Bob Fadis, who is a member of the technical staff at JPL in Pasadena.

The purpose of this report is really to discuss and compare these various models, and in no way is intended as a criticism of any of them.

Now each of these predictive models is based on data obtained from the NASA accelerated test program, and so, of course, a few comments should be made about that program.

This test program was an extremely adventurous endeavor and it made attempts to solve many, many

uncertainties. The overall program was well planned and considering its size was also extremely well conducted.

As most of you know, the simplest cycling program often has many difficulties, mostly associated with power outages, failures of equipment, etc. Therefore a cycling program as large as the NASA accelerated test program -- and, by the way, there were approximately 545-odd cells in that program in 87-cell packs -- such a program must be considered a unique undertaking, and the Weapons Support Center should be commended for their effort.

In addition, their interim report is an excellent report and contains information which may stand for a considerable time as probably the most complete data package concerning nickel-cadmium aerospace cells.

The first slide merely shows the various models and the constants associated with them. Both the McDermott and Lander models use the more classical regression techniques to achieve their predictive models. There are certainly implied boundary conditions in each of these two models. If not, using the McDermott model, you could discharge to 150 percent and get about 250 cycles. Of course, this is an impossibility. So there must be an implied boundary condition on the model itself.

It's also interesting to note that he has an upper temperature limit of 70 degrees, which is a reasonable limit for cycling programs.

In the Lander model there is obviously 100 percent DOD boundary conditions. It's right there. You can't go beyond that. However as far as temperature is concerned, he also has not described a temperature boundary condition, and it would be possible, just utilizing the mathematics of this model, to cycle at 100 degrees Centigrade and obtain something like 6400 cycles at a 20 percent DOD. And there again, this is an impossibility. So again there must be an implied boundary condition as far as temperature is concerned.

The JPL failure model differs from both the Lander and the McDermott models in two important areas: the JPL model has not been developed using the regression techniques used on the aforementioned models. It was

developed from intuitive arguments applied to floor theory. However it was applied to the same exact data package used for the other two models.

The predicted cycle life in the JPL model can only be determined in the context of the probability of success or reliability of that number of cycles being obtained.

(Figure 17-2)

I apologize for what I might call the dizziness of this particular table, but this table does list the number of cycles as predicted by both McDermott and Lander models for temperatures ranging from zero to 40 degrees and at depths of discharge from 10 to 40 percent.

The same predictions are made by the JPL failure model. However in that case we must choose a reliability. The arbitrary reliability of 0.9 has been chosen, and you can see the predictions made for the similar conditions to the other two models.

both the similarities and differences between the McDermott and Lander models are quite obvious. The largest differences occur in regions where extrapolation is used. These regions are both in the zero degree Centigrade and ten degrees Centigrade temperatures, and also at all temperatures at ten percent DOD.

When you attempt to compare either the McDermott or Lander models with the JPL model, we are immediately faced with two difficulties: first and foremost, the JPL model predicts cycle life as a function of reliability, and the other models don't do this.

Secondly, on examination of both the McDermott and Lander models we find that the meaning of the term "cycles to failure" is not entirely clear. For example, does this expression denote the number of cycles until the first failure occurs or is it associated with some average number of cycles before failure occurs, or what have you.

(Figure 17-3)

Now in order to circumvent these problems I've made certain assumptions. The first assumption is that

nickel-cadmium cells wear out at a constant rate and therefore the exponential distribution which describes constant failure rate can be used to obtain reliabilities. The equation (1) shown is the reliability in terms of the exponential distribution.

Lambda is the failure rate and T is the operating time, and they're both, of course, in the same units of time. Now if we take the mean time between failures as being one over lambda we obtain equation (2). Again it's most important that the units of time always be in the same units. Otherwise nothing works.

Now T being the operating time, if we express this as a mission requirement in terms of low earth orbit cycles and mean time between failure, also in terms of LEU cycles, it can be assumed that the predictions made by both the McDermott and Lander models can be thought of being mean time between failures for particular conditions. And it is then possible to compare both the McDermott and Lander models with the JPL model in the following way:

(Figure 17-4)

For any specific operating condition a depth of discharge and time -- in this case we've taken 20 degrees and 30 percent DOD -- we take the JPL prediction for a particular reliability number as the mission requirement.

For the same specific conditions we take the model which we wish to compare to -- for instance the Lander model -- we take their prediction as the mean time between failures.

Here we have the case of, therefore, taking a case where stating 4000 cycles as the mission requirement and 22600 cycles as predicted by the Lander model as the mean time between failure, and for this situation we have a reliability for this mission requirement of 0.84.

But, as you remember, the JPL prediction for 4000 cycles was 0.9, and now we find ourselves at least comparing reliability against reliability.

(Figure 17-5)

The second table describes the reliability factors obtained from these types of calculations.

Using the reliability predictions of the JPL model and a 0.9 factor as a mission requirement, we have plugged these numbers in again using an exponential distribution, and we come up with these reliability factors for both the McDermott and the Lander models. All of these have to be compared with 0.9 on the JPL predictions.

Now this type of calculation is not being advanced as a rigorous statistical argument by any means, but, rather, as a reasonable attempt to compare models in equivalent terms.

This type of analysis emphasizes at least two important considerations: the first, that it is extremely difficult to compare different models, even though they are based on the same data, especially if they use extremely different techniques to deduce their final formulation. And if models assume different types of frequency distributions the comparisons become more difficult.

This technique that I've just described suffers greatly from the fact that the JPL model which is based on a Weibel distribution attempts to compare itself to, say, the Lander model which we base on an exponential distribution.

If in turn the data were assumed to reflect failures due to true wear-out conditions, and further, that the frequency of failure could be represented by a normal Gaussian distribution with a standard deviation -- and this is arbitrary -- of 20 percent of the mean value, then much higher comparative values of reliability could be determined for both the Lander and the McDermott models than shown in that paper.

If we use the Lander and the McDermott predictions as mean values -- and again, the JPL prediction at a reliability of 0.9 as the mission goal -- then both the Lander and the McDermott predictions give comparative reliabilities of 0.999 for all the test conditions.

Thus, assuming one type of distribution as in Table 2, we obtain reliabilities of 0.56.



(Figure 17-6)

You can see under one condition you get a Lander model reliability from .79 to .84, and you assume just a different type of distribution. You're right down to 0.999 under all conditions. The temperatures should be 20 degrees Centigrade, not 20 percent.

This implies that the actual type, of course, of failure of frequency distribution must be fully understood before any statistical manipulation is applied. This leads to another consideration, and that is the importance of reliability factors as applied to battery cycling.

Many aerospace programs have strictly interpreted reliability requirements, and in many cases these requirements have been satisfied by what I call statistical ledger domain. This has been necessary because of insufficient data to obtain the required reliability factors rather than because of unreliable components.

In other aerospace programs the term "reliability" is used in the sense of high quality rather than having any statistical significance.

Thus one use is quantitative and the other is qualitative. If reliability with statistical significance is going to be a requirement, then further evaluation of data such as the train data package must be accomplished. In all probability these data should be augmented with flight data to provide sufficient information for this statistical analysis which can provide usable reliability factors.

This was done to some extent a few years ago by TRW in their reliability evaluations of NiCd batteries for the Helio program; they augmented their data package with actual flight information.

What do we conclude from this? The present predictive models are extremely difficult to compare because of the absence of information concerning the frequency of failure distribution. The JPL model is a bit pessimistic, and though statistically accurate, it's based on a limited sample size. It would be extremely difficult to use the factors derived from the JPL model in actual aerospace programs.

For instance, the JPL model predicts for a cell 7300 cycles at a reliability of 0.9 at 20 percent DOD and 20 degrees Centigrade. 0.9 is a very low reliability factor for a component. A battery with 22 cells would have a reliability of 0.1. You don't fly with such reliability numbers.

This in no way impugns the derivation of the JPL model. In fact, the concept used and its derivation are unique and they are creative, and the true value of this model has probably not as yet been fully realized.

Since the JPL model fits the NASA accelerated test program extremely well, this would imply that these accelerated test data do not really represent real time data and that further correlation is needed between accelerated test and real time data.

both the Lander and the McDermott models also represent considerable effort and probably represent within the interpolated data the popular concepts, at least, of life expectancy of nickel-cadmium cells. They both suffer from the fact that they do not determine the type of frequency of failure with which they are working, and thus it's very difficult to interpret their predictions in terms of reliability. However they both make rather reasonably close-like predictions when they are within their interpolated data range; once they get outside into the extrapolated data range they're wide apart. And they will produce usable reliability factors only if we assume Gaussian type distributions.

The importance of the reliability requirements is a complex topic and very sprightly between aerospace programs. If a reliability requirement is to have statistical significance, then test programs must produce data which can be utilized to obtain reliability information. This has not been done in the past. These test programs must produce data for which frequency of failure distributions can be either obtained directly or from which reasonable assumptions can be made, leading to these reliability factors.

Are there any questions?

DISCUSSION

THIERFELDER (GE): As you pointed out, at 20 degrees Centigrade and 20 percent depth of discharge, the prediction is only 7300 cycles with a reliability of .9. Well, couldn't we work this backward, then, and plug in-- orbital experience indicates we can get about 30,000 cycles--plug in 30,000 cycles and see what the reliability number would come out?

Have you done that? It would be interesting to see what the reliability would be if you worked the equation backwards.

SCHULMAN: Which equation are you referring to? The JPL prediction?

THIERFELDER: Well, where they determined that 7300 cycles.

SCHULMAN: That doesn't come from the equation. There is more than merely the equation. There was a series of curves which go along with the equation.

THIERFELDER: well, if you still worked it backwards, couldn't you solve for the reliability number?

SCHULMAN: No, you can't do that; I'm sorry.

SULLIVAN (Bell Labs): Just a couple of quick comments. We've been studying the real time Crane data rather than the accelerated for the Telstar program. And it appears from the low-earth orbit and the geosynchronous orbits at Crane that the distribution, the failure distribution for GE cells: those are the only ones we've studied, the prismatic GE cells: is a log-normal distribution. It is neither normal nor random failures, but log-normal. The Weibull would be an added distribution to log-normal, in that you have another adjustable parameter. We find we don't need this.

This distribution is simpler to use to go from cell data to the probability of your battery survival in whatever mission you have.

So I would think that if anyone is going to do this type of calculation, they might start with a log-normal

distribution. It's a little simpler than a Weible and appears to handle the data far better than normal or random failures.

SCHULMAN: Have you published the work on that as yet?

SULLIVAN: No, I'm sorry we haven't. It's just about finished, and it will be out fairly soon.

SCHULMAN: But at least you recognize the fact that you must be aware that the term "distribution" is important.

SULLIVAN: Oh, yes; without that you're lost.

SCHULMAN: That's right. That's the point I was trying to make.

SULLIVAN: In a log-normal distribution you only have two parameters, the median life and the standard deviation. There do appear to be standard deviations for the two failure modes: the self-shorting and cell degradation. And they appear to be separable, and transfer from low-earth to geosynchronous orbit.

Once you have the parameters in the distribution, you can calculate what cell performance you need to insure a, let's say, 90 percent probability of battery survival over your mission life.

SCHULMAN: We don't have trouble with the transfer of cell data to battery data. The point is, we don't like what we see. You can't work with reliability factors of .9. You must be up above the .99 level to get a reasonable battery.

SULLIVAN: Oh, yes; your cells had better be very, very good. Otherwise you'll never get 90 percent.

SCHULMAN: That's right.

RITTERMAN (TRW): I presume that all of these models are for low-earth orbit, although, from some questions, you could use them for geo.

SCHULMAN: All of these were low-earth orbit type cycles.

RITTERMAN: Then the recharge ratio and the rates would essentially be the same. That was my question.

None of these models address recharge ratio or charge return, nor do they address charge and discharge rates.

SCHULMAN: The actual NASA accelerated test program did address those problems; however, if you study the data, you'll find that the major effects on cycle life are DOD and temperature. And so we've addressed those.

RITTERMAN: Provided that you're talking about similar cycles.

SCHULMAN: That's right.



## LIFE PREDICTION MODELS

### McDERMOTT MODEL

$$N_F = A (B - \text{TEMP}) e^{-C(\text{DOD})}$$

$N_F$  = NUMBER OF CYCLES TO FAILURE

A = 1500, B = 70, C = 0.038

TEMP = °C, DOD = %

### LANDER MODEL

$$\text{CYCLE LIFE} = \left[ \frac{1}{2} (3^{-(T-50)/10} - 1) X + A \right] \left( \frac{100 - \% \text{ DOD}}{\% \text{ DOD}} \right)$$

X = 600, A = 1900

T = °C

### JPL FAILURE MODEL

$$N_{F, \text{NORM}} = n_f (\text{DOD})^{1.5} e^{\Delta E/R (1/303 - 1/T)}$$

$N_{F, \text{NORM}}$  = LIFETIME OF CELL NORMALIZED WITH RESPECT TO TEMP AND DOD

DOD = DECIMAL VALUE

T = °K,  $\Delta E$  = 5.5 K CAL/MOLE

Figure 17-1



**TABLE I**  
**LIFE PREDICTIONS OF AEROSPACE NI-CD CELLS**  
**McDERMOTT, LANDER, AND JPL MODELS**

TEMP	%DOD	P. McDERMOTT	J. LANDER	JPL FAILURE MODEL RELIABILITY = 0.9
		$N = 1500(70 - T)e^{-0.038(\text{DOD})}$	$N = \left[ \frac{1}{2} (3^{-(T-50)/10} - 1) 600 + 1900 \right] \left( \frac{100 - \% \text{ DOD}}{\% \text{ DOD}} \right)$	
0°C	10	71,800	670,500	41,100
	20	49,100	298,000	14,500
	30	33,600	173,800	7,900
	40	23,000	111,800	5,100
10°C	10	61,500	233,100	28,800
	20	42,000	103,600	10,200
	30	28,800	60,400	5,500
	40	19,700	38,900	3,600
20°C	10	51,300	87,300	20,700
	20	35,100	38,800	7,300
	30	24,000	22,600	4,000
	40	16,400	14,600	2,600
30°C	10	41,000	38,700	15,200
	20	28,100	17,200	5,400
	30	19,200	10,000	2,900
	40	13,100	6,500	1,900
40°C	10	30,800	22,500	11,400
	20	21,000	10,000	4,000
	30	14,400	5,800	2,200
	40	9,800	3,800	1,400

Figure 17-2



### RELIABILITY (EXPONENTIAL DISTRIBUTION)

$$R = e^{-\lambda t} \quad (1)$$

- R = RELIABILITY
- $\lambda$  = FAILURE RATE, RECIPROCAL TIME
- t = OPERATING TIME, UNITS OF TIME
- MTBF = MEAN TIME BETWEEN FAILURE
- $MTBF = \frac{1}{\lambda}$

$$R = e^{-t/MTBF} \quad (2)$$

Figure 17-3



### APPLICATION

- USE JPL PREDICTION AT 20°C AND 30 % DOD OF 4,000 CYCLES AT RELIABILITY OF 0.9 AS MISSION REQUIREMENT 1
- USE LANDER MODEL PREDICTION AT 20°C AND 30 % DOD OF 22,600 CYCLES AS MTBF

$$R = e^{-t/MTBF} = e^{-4000/22,600}$$

$$R = 0.84$$

COMPARE R = 0.84 AND JPL PREDICTION OF R = 0.9

Figure 17-4



TABLE II  
RELIABILITY COMPARISON  
MCDERMOTT, LANDER, AND JPL MODELS

TEMP	%DOD	P. McDERMOTT MODEL JPL - R = 0.9	J. LANDER MODEL JPL - R = 0.9
0°C	10	0.56	0.94
	20	0.74	0.95
	30	0.79	0.96
	40	0.80	0.96
10°C	10	0.63	0.88
	20	0.78	0.91
	30	0.83	0.91
	40	0.83	0.91
20°C	10	0.67	0.79
	20	0.81	0.83
	30	0.85	0.84
	40	0.85	0.84
30°C	10	0.69	0.68
	20	0.83	0.73
	30	0.86	0.75
	40	0.86	0.75
40°C	10	0.69	0.60
	20	0.83	0.67
	30	0.86	0.68
	40	0.87	0.69

Figure 17-5



TABLE III  
RELIABILITY COMPARISON  
LANDER AND JPL MODELS

TEMP	% DOD	J. LANDER PREDICTION CYCLES	JPL PREDICTION (R = 0.9) CYCLES	LANDER MODEL EXPONENTIAL DISTRIBUTION RELIABILITY	LANDER MODEL GAUSSIAN DISTRIBUTION RELIABILITY
20°C	10	87,300	20,700	0.79	0.999 +
	20	38,800	7,300	0.83	0.999 +
	30	22,600	4,000	0.84	0.999 +
	40	14,600	2,600	0.84	0.999 +

Figure 17-6

NiCd BATTERY CYCLE LIFE PREDICTION EQUATION  
FOR LOW EARTH ORBIT

D. Hafen

Lockheed

This audience needs little motivation to perform some type of cycle life analysis, and the equation and the method I'm going to present is going to concentrate on low earth orbit.

(Figure 18-1)

In any engineering design of a spacecraft there are some things that are predetermined and some that basically the engineer has control over. The orbit would be one of the things that is basically given. And the method of heat transfer, for example, would be something that the engineer has some control over.

By performing a cycle life analysis it has some bearing on the values or parameters that are going to be used to fly the spacecraft.

(Figure 18-2)

This paper is going to basically concentrate on these first two boxes of this flow chart.

A data base is selected, and then a life prediction method is created. And this goes on to be used for any number of life predictions for different spacecrafts. And this is kind of a decision process.

(Figure 18-3)

The data base that Lockheed has selected for this particular analysis is Naval Weapons Support Center Crane real time NiCd test data. And a lot of this has been eliminated based on three criteria, basically.

One is the way the test is run, and that would include no geosynchronous tests, only low earth orbit.



Another is the type of hardware. For example, there are no polypropylene separator cells included. There are no Pellon 2503 cells included.

And the other is the way the actual test turned out. And that is characterized by the fifth bullet here, which says no packs that were subsequent to power supply failures or that type of thing were included because it was actually premature.

Now subsequent to listing all the NiCd cells that fit these various criteria some were eliminated on the basis of a plot. Some of them looked like they would bias the data too far in the conservative direction, and those were mainly things like the old Gulton cells that were received at Crane in 1963. And it ended up that there were only a couple of packs of Eagle-Picher and SAFT cells. So those were eliminated.

And we were left with a large data base that was only General Electric cells.

(Figure 18-4)

This chart summarizes all of the data base. This can be divided into two parts. The first is prior to 1970, which is basically only one design of a GE 12 ampere-hour cell. And the others are past the line, the demarcation line of 1970. And there are several other differences that come out in this.

One of these is that the original cells were under a test matrix of 12 conditions. There are six shown here, but that's for 1.5 or 3 hour charge times. The others are not a test matrix. But you might notice that most of them are either 25 percent 20 degrees C or 40 percent zero degrees C. So it's not nearly as nice a range of data as for the original test.

(Figure 18-5)

Now concentrating on the original test, if you look at what the cycles to failure are you can derive a very nice equation and it really doesn't matter a whole lot what the form of the equation is. If it goes through a couple of these points it's liable to go through all of them.

This was the basis of an equation that was developed by Lockheed in 1977, which was a predecessor to the one I'm going to present.

(Figure 18-6)

This is the basic equation that we're presenting, and it's based on a distribution of failures within a battery.  $N$  is the number of cells in the battery and represents a failure number. And you're most likely to be interested in  $M$  equals one. And there's an Arrhenius temperature term out here. This assumes that there's only one degradation mode, and that probably isn't true either.

One other thing I ought to mention here is what the definition of failure is, and that's the definition that Crane uses, which is a cell reaching .75 volts or experiencing a short.

So we went through this. And for the post-1970 cells we developed these coefficients. It didn't have a large correlation coefficient. It was something like .8, whereas for the test matrix before, the 1964 matrix let's call it, that had a correlation coefficient of .97.

However, as you'll see, it parallels the other equation nicely in a lot of respects.

(Figure 18-7)

This is a comparison of a bunch of equations and some others taken from other references, and I will try to go through these in a meaningful fashion.

$A$  represents the original test matrix from 1964.  $BC$  and  $BC^*$  are both basically the same equation from post-1970. And it is the same as  $A$  except we're shifted by a multiplicative factor for this reason: that it only differs by a multiplicative factor, and the fact that this data base  $A$  had a .97 correlation coefficient, it puts a fair amount of confidence in these equations.

There are several others shown here.  $H$  is an optimistic estimate of cycle life. It only used about three packs. This  $BC$  number 17 is from the latest Crane report,

whereas these used the 16th annual Crane report. And there's one down here that was derived from reliability predictions that Etheridge Paschal made in 1974 by convoluting his reliability predictions into a cycle life prediction.

This doesn't look too good. But if you look at his figures, he has the highest reliability at 10 and 12 degrees. It's just a dropping off from ten degrees C to zero degrees C to minus 20 that causes this to be low. I don't think it really disagrees substantially from this.

This TRW curve which is here was taken directly out of the NASA manual that Scott and Rusta worked on just recently, and it refers back to some work that TRW had done before that.

L is using the post-1970 data base except that it was constructed so as to make this linear on this type of paper.

(Figure 18-8)

This is just this data base L shown parametrically, and there are several things about this equation that make it more reasonable which is outside the range of where the data were anyhow. And that is that you don't get infinite cycle life at zero DOD, and also you don't get 500 cycles at 100 percent DOD, which also would be unreasonable.

So this is a different equation which I guess has a higher correlation coefficient than that curve that I showed. I've only been working with this recently on advice of some people as a result of the LECEC.

(Figure 18-9)

Now moving on from what the cycle life prediction equation is to how that would be used in an actual regime where you don't have a single DOD and you don't have a single temperature but you're working at various DODs and temperatures, and the way that is done is to essentially calculate a fraction life for each part of the cell's life. But before you do that you construct a histogram of where it's going to be operating so that it will be integrated

easier.

I guess this is better explained in the next Vu-graph.

(Figure 18-10)

This is just an example, just to make it simple. It has six compartments and each one of them has a height. This is the fractional life that it will spend at 30 percent and 15 degrees C, for example. Once you get those the life expended due to that is given by a term like this. If you add up all those fractions and divide it into one you come out with a cycle life prediction.

This seems like a complicated process and it actually turns out if you do this and you also take the averages of all the DODs and temperatures before you do it, this cycle life prediction is only three percent higher. So you might say, well, three percent might be even more than the data justifies, which may be true.

(Figure 18-11)

This is a more complicated example, and it's basically constructed so that it gives a pretty picture of what's going on.

It shows that for these types of histograms also you can shake down each side and you can get a histogram of the temperature and the DOD, basically showing the same type of calculation.

(Figure 18-12)

This just shows what each compartment predicted cycle life is, and comparing what it is for this type of analysis that I'm using and also just using the average. And this is about three percent higher, like I said.

I'd also like to say most of this material appeared in the IECEC in August of this year.

And I will entertain questions now.

GASTON (RCA): We've been talking quite a bit

about percent DOD this morning. How do you define DOD, with respect to weighted capacity or actual capacity obtained? I'd just like you to clarify that point.

HAFEN: In this case this was the same DOD in the Crane test data which is based on the nominal DOD.

GASTON: All right. Thank you.

CONSTANTINEAU (Pellon Corporation): You stated that in your data base you excluded the use of Pellon 2503. Is that because it works so well?

HAFEN: Well, I believe from the data that I saw at the time that those were working about the same. However I was trying to eliminate all designs that by any imagination were different.

Now I know that 2503 is closer to 2505 than Pellon is -- I mean than polypropylene is.

CONSTANTINEAU: Okay.

The difference between the 2503 and the 2505 and -6 are just the orientation of the fibers. The 2503 is uni-directional whereas the older 2505 and 2506 were cross-laid materials. But essentially they are chemically the same.

TO DETERMINE ONE OR MORE OF THE FOLLOWING:

- DEPTH OF DISCHARGE
- NUMBER OF BATTERIES
- SIZE (CAPACITY) OF BATTERIES
- OPERATING TEMPERATURE

TO DETERMINE THERMAL CONTROL NEEDED

- METHOD OF HEAT TRANSFER
- PLACEMENT OF BATTERIES

Figure 18-1

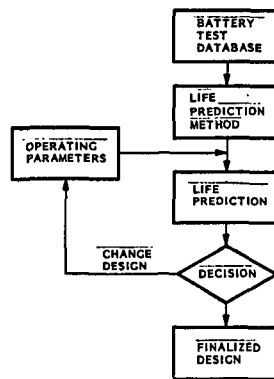

Figure 18-2

- NO GEOSYNCHRONOUS OR 24-HOUR ORBITS INCLUDED
- ONLY NYLON SEPARATOR INCLUDED; PELLON STYLE 2503 EXCLUDED
- NO PACKS INCLUDED WITH PREMATURE PRESSURE FAILURES
- NO CYLINDRICAL CELLS INCLUDED
- NO PACKS WITH FAILURES SUBSEQUENT TO REVERSAL OR EQUIPMENT ANOMALIES INCLUDED
- NO CELLS HAVING GAS RECOMBINATION ELECTRODES INCLUDED
- NO PACKS FAILURES INCLUDED, SINCE IT IS NOT INDICATED HOW MANY CELLS FAILED
- NO PACKS USING "SOPHISTICATED" CHARGE METHODS, SUCH AS AUXILIARY ELECTRODE CONTROLS, INCLUDED
- NO PACKS SUBJECTED TO MULTIPLE TEMPERATURE REGIMENS INCLUDED
- NO DESIGN VARIABLES CELLS INCLUDED (SUCH AS THOSE INCORPORATING VARIABLE PRECHARGE OR VARIABLE ELECTROLYTE AMOUNT)
- NO CELLS INCORPORATING "INTERNAL PRESSURE DEVICES" INCLUDED

Figure 18-3



# CELL HARDWARE INCLUDED IN CYCLE LIFE PREDICTION EQUATIONS

START DATE	VENDOR CAPACITY	TEST NAME	DESIGN	OPERATING CONDITIONS	CYCLE LIFE* (CYCLES)
1-4-64	GE 12 Ah	ORIG	NO PQ, NO TFE	DOD 0 25 40 FOR 1.5, 3.0 HR CHARGE TIME % 15 X X X 25 X X X 40 X	NEXT SLIDE
3-14-71	GE 6 Ah	NICKEL BRAZE	PQ, NO TFE	#92B 25% DOD, 0°C #95B 25% DOD, 20°C #106B 25% DOD, 40°C	2 PREMATURE FAILURES AT 5844, DISC AT 39446 CELL FAILURES AT 38804, 40294, 40571, DISC AT 40790 PACK FAIL AT 7538
12-11-73	GE 12 Ah	OSO-I	PQ, SILVER	#7C 16% DOD, 10°C	NF, DISC 24890
3-6-74	GE 8 Ah	SAS-C	PQ, NO TFE	#18E 25% DOD, 20°C	NF, DISC 23748
3-6-74	GE 8 Ah	SAS-C	PQ, TFE	#18F 25% DOD, 20°C	NF, DISC 23772
9-17-74	GE 20 Ah	STANDARD VS TEFLON	PQ, AB29TFE	#1C 25% DOD, 20°C	CELL FAILURE AT 20686, 21237, PACK FAIL AT 24088
9-17-74	GE 20 Ah	STANDARD VS TEFLON	PQ, AB30 NO TFE	#1H 40% DOD, 0°C #1I 25% DOD, 20°C #1J 40% DOD, 0°C	NF, ON TEST 26895 NF, ON TEST 27128 NF, ON TEST 26664
5-5-75	GE 6 Ah	ITOS	PQ, NO TFE	#7D + 29% DOD, 20°C	NF, DISC 8275
3-7-76	GE 12 Ah	IUE	PQ, TFE	#8F 25% DOD, 20°C #8G 40% DOD, 0°C	NF, ON TEST 24200 NF, ON TEST 23561
6-24-77	GE 20 Ah	STANDARD CELL	PQ, TFE	#12F 40% DOD, 10°C #12C 25% DOD, 20°C #12I 40% DOD, 30°C	NF, ON TEST 13247 NF, ON TEST 13386 4/4 CELLS FAILED
1-22-78	GE 26.5 Ah	TIROS-N AND NOAA-A	PQ, TFE	#26G 20% DOD, 10°C #26H 25% DOD, 10°C	NF, ON TEST 9065 NF, ON TEST 9083

\*AS REPORTED IN 1980 "NWS/CRANE REPORT" NO. WQEC/C 80-34

Figure 18-4

## GE 12 Ah ORIGINAL CRANE TEST CYCLE DATA

		CYCLE LIFE (CYCLES)		
		0°C	25°C	40°C
1.5-HR CYCLE TIME	15% DOD	54972 62680 75278 75868	NOT TESTED	8832 8896 9710
	25% DOD	13218 25786 34343	7536 10608 10878	3792 3792 4853
	40% DOD	NOT TESTED	3792 4020 4020	NOT TESTED
3-HR CYCLE TIME	15% DOD	28312	NOT TESTED	8988 10575 10661
	25% DOD	19654	12316 12822 13897	4080 4368 4424
	40% DOD	NOT TESTED	3864 3936 5002	NOT TESTED

Figure 18-5

## DEVELOPMENT OF PREDICTION EQUATION

$$(\text{CYCLE OF Mth FAILURE}) = a \left(\frac{M}{N}\right)^b (\text{DOD})^c \exp\left\{\frac{d}{T (\text{deg K})}\right\}$$

FAILURE FRACTION
DEPTH OF DISCHARGE
ARRHENIUS TEMPERATURE TERM

COEFFICIENTS FROM POST-1970 CELL TESTS (DATABASE 8C\*)

- a = 9.71
- b = 0.229
- c = -1.545
- d = 3.843

Figure 18-6

**COMPARISON OF CYCLE LIFE PREDICTIONS AT 0°C**

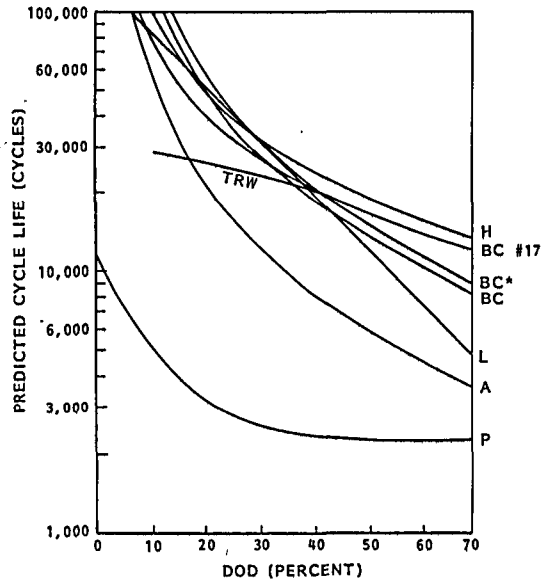

Figure 18-7

**PREDICTION EQUATION "L" (LINEAR WITH DOD)**

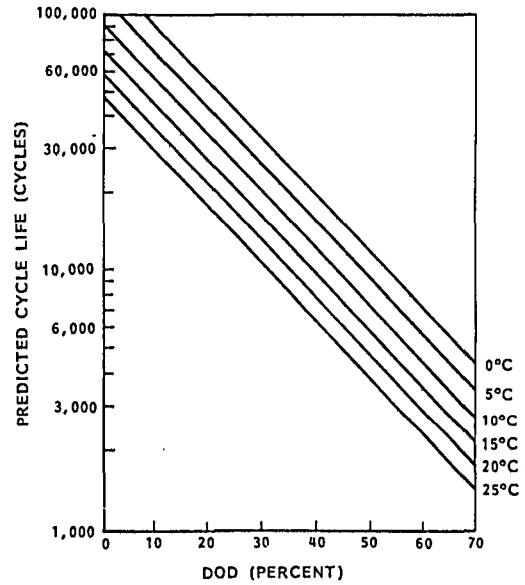

Figure 18-8



**CYCLE LIFE PREDICTIONS FOR MULTI-DOD, MULTI-TEMP**

- CONSTRUCT TWO-DIMENSIONAL HISTOGRAM (T VS DOD)
- CALCULATE CYCLE LIFE FOR EACH COMPARTMENT OF HISTOGRAM ( $W_i$ )
- CALCULATE FRACTION LIFE EXPENDED, FOR EACH COMPARTMENT:

$$\frac{\text{COMPARTMENT HEIGHT, } W_i}{\text{PREDICTED CYCLE LIFE FOR COMPARTMENT}}$$

- ADD LIFE FRACTIONS AND DIVIDE INTO TOTAL COMPARTMENT HEIGHT

$$\left( \frac{\text{PREDICTED}}{\text{CYCLE LIFE}} \right) = \frac{\sum W_i}{\sum (W_i / (\text{CYCLE LIFE}_i))}$$

Figure 18-9



EXAMPLE OPERATING REGIMEN I

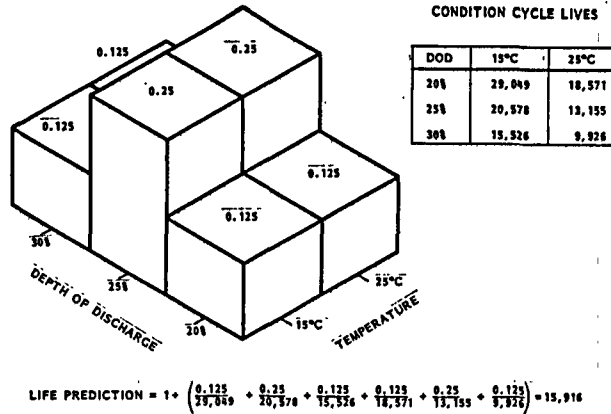

Figure 18-10

EXAMPLE OPERATING REGIMEN II

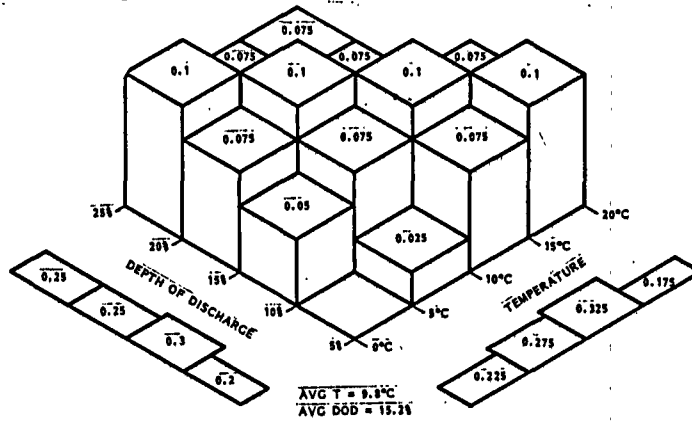

Figure 18-11

EXAMPLE OPERATING REGIMEN II ANALYSIS

DOD	TEMPERATURE			
	2.5°C	7.5°C	12.5°C	17.5°C
7.5%	---	188,829	106,878	117,876
12.5%	109,952	85,768	67,888	53,539
17.5%	65,379	50,997	40,127	---
22.5%	44,341	34,587	27,215	---

- PREDICTION FOR FIRST FAILURE OF 22 CELLS
- PREDICTION USING "FRACTION LIFE" EXPENDED = 56,016 CYCLES
- LIFE PREDICTION USING AVERAGE DOD (15.24) AND AVERAGE TEMPERATURE (9.8°C) = 54,721

Figure 18-12

TIME-TO-FAILURE ANALYSIS  
FOR NiCd BATTERIES IN A GPS ORBIT

K. Sense

Rockwell

(Figure 19-1)

For its Block II Global Positioning System, the GPS program, Rockwell International will use 35 amp-hour nickel-cadmium cells instead of the 18 amp-hour nickel-cadmium cells used for its Block I program. To achieve greater utilization of energy stored in nickel-cadmium cells, Rockwell is considering operating these cells at five degrees Celsius or less, and going to a 60 to 65 percent depth of discharge.

I undertook an analysis to determine whether nickel-cadmium cells operating under these conditions would have a useful working life of 7.5 years in a GPS orbit.

The GPS orbit is circular, of 12 hours duration and undergoes 220 eclipses a year. Table 1 compares the characteristics of various orbits. We note that the GPS orbit experiences only 220 cycles a year and must be treated as a geosynchronous rather than a low-earth orbit. This becomes more obvious from the fact that the GPS orbit undergoes two eclipse seasons per year, each season lasting about 55 days. The eclipse seasons are therefore separated by approximately 128 days, about the same interval as for the geosynchronous orbit, 138.5 days.

Since the eclipse season undergoes about 55 days and the solstice period about 128 days, GPS orbit cell degradation may be considered to be divided into an eclipse degradation mode and a solstice degradation mode.

Cell degradation may be considered to be the result of both trickle-charge degradation and degradation due to cycling. Time-to-failure due to trickle-charge degradation is designated as  $F(t)$ , while time-to-failure due to cycling is designated as  $F'(c)$ .

As a first approximation, these failure modes are

considered to be independent of each other for the following reasons:

Degradation due to cycling is principally the result of thickening of the positive electrode. This occurs during the discharge-charge cycle, thus causing a narrowing of the interelectrode space. Ultimately the interelectrode space becomes so narrow that the nylon separator has little or no porosity; thus causing separator dryout which leads to cell failure.

This undesirable action is abetted by a large increase in the micropore structure of the positive plate with time. The enlarged pores of the positive plate compete with the separator for the electrolyte by capillary action, thus promoting interelectrode dryout.

Cell degradation due to trickle charge is of a somewhat different nature. When overcharge rates are relatively high during trickle charge the internal cell temperature is increased. This leads to increased nylon degradation, extensively investigated by Lim of Hughes, resulting in the production of carbonate.

The presence of carbonate in turn causes cadmium to go into solution and increases cadmium migration leading to shorts within the cell.

Other products of the degradation of nylon are nitrogen and water. The nitrogen formed increases the pressure within the cell and the water dilutes the KOH solution and thus decreases cell performance.

Also loss of overcharge protection occurs if overcharge rates are relatively high thus causing hydrogen generation.

(Figure 19-2)

Taking both failure modes into consideration the resulting time-to-failure value for the cell is designated as  $11F$ . Since as a first approximation these failure modes are taken to be independent of each other, I have formulated the equation designated as 1-A in Figure 1.

This equation relates TTF,  $F(t)$ , and  $F'(c)$ .  $11F$  is

solved for explicitly in equation 1-B. This equation is valid for any selected functions of  $F(t)$  and  $F'(c)$ .

I have chosen modified versions of P. McDermott's expressions of these functions as the principal functions for this study, although other expressions may be used with equal validity, such as one relating the  $F'(c)$  expressions given by Hafen and Corbett of Lockheed at this year's IECEC meeting. And, incidentally, Mr. Hafen showed you the expression that I have used, namely the BC\* expression.

(Figure 19-3)

In a recent publication McDermott investigated cell degradation in a synchronous orbit. From a study of Crane real-time synchronous orbit data, as well as from data obtained by simulated synchronous orbits with accelerated test packs, he came to the conclusion that the trickle-charge period may be the prime cause of cell degradation in synchronous orbits for depths of discharges equal to or less than 40 percent.

Since under synchronous conditions he considered cell degradation due to cycling insignificant, he did not include a factor for depth of discharge degradation in his time to failure equation.

Equation 2-A, shown in Figure 2, may therefore be considered to reflect only trickle-charge degradation.

Now McDermott was largely correct in making this assumption, particularly in view of the fact that in the geosynchronous orbit the battery undergoes only 88 cycles per year. In fact, for a C/30 charge rate in the synchronous orbit and a cell temperature of zero degrees Celsius the time-to-failure value is decreased only a small amount, namely from 16.9 years to 16.4 years, when degradation due to cycling to 40 percent DOD, depth of discharge, is taken into account.

However we're considering cell degradation in a GPS orbit. Since the cells in this orbit undergo 220 eclipses a year and since we wish to go to deeper depths of discharge, degradation due to cycling becomes a major factor. As indicated, Equation 2-A was formulated by McDermott for 6 amp-hour cells used in the accelerated test

program carried out at NWSC/Crane. Since block II GPS program uses 35 amp-hour cells, Equation 2-A is modified to the more general form 2-B, where the rated cell capacity C can take any value.

(Figure 19-4)

It is clear that during the solstice period only trickle-charge degradation takes place. However, it must be noted that during the cycling period in a GPS orbit the maximum eclipse is only of 55 minute duration. Since there are only two eclipses a day during the eclipse season, cells have a minimum of 11 hours and five minutes to recharge.

In a LED orbit, on the other hand, the satellite undergoes 14 to 16 cycles a day, and therefore has correspondingly shorter recharge periods. Because of these considerations I have assigned half the time spent in the cycling mode to trickle-charge degradation. The resulting expression for  $F(t)$  is given in Figure 3, namely equation 3.

(Figure 19-5)

Degradation due to cycling is generally reported in the literature as cycles-to-failure, CtF. The relationship between cycles-to-failure and time-to-failure due to cycling degradation,  $F'(c)$ , is given in Figure 4.

(Figure 19-6)

Equations for the determination of CtF have, among others, been developed by Hafen and Corbett of Lockheed and by McDermott. As stated previously, I will use a modified version of McDermott's equation in this analysis. However, in addition I will compare TTF results obtained in this manner with those obtained using Hafen and Corbett's equation for selected values of temperature and depth of discharge.

Figure 5 shows McDermott's equation for cycles-to-failure. The coefficients in this equation are the results of nonlinear regression analysis. In the modified version used by me the last two terms relating to discharge and charge are left off, as shown in the next figure.

(Figure 19-7)

The reason for leaving off the last two terms is that for deep depths of discharge, say 70 percent or 80 percent, the last two terms exert a disproportionate influence, making the calculated cell cycle life appear longer since the values of the last two terms remain constant or increase while that of the first term decreases. Hence truncating Equation 5 in this manner eliminates this problem.

The effect of this action on less severe operational modes is as follows:

For depths of discharges less than about 60 percent and temperatures less than about 20 percent Celsius, the calculated cycle life is less than about 3.5 percent than it otherwise would be. The change is therefore minor, and the cycle-life values calculated by leaving out the last two terms are slightly on the pessimistic side.

With the aid of Equation 4,  $F'(c)$  for the GPS orbit is therefore evaluated from Equation 6 in Figure 6.

(Figure 19-8)

We are now in a position to determine whether 35 amp-hour nickel-cadmium cells operating at five degrees Celsius or less and 65 percent depth of discharge have a useful working life of 7.5 years in a GPS orbit. For an overcharge rate of 175 milliamps -- and this is a C/200 rate -- 140 percent recharge and 60 percent DOD,  $F'(c)$  is calculated to be 28.57 years, and  $F(t)$ , 25 years.

Using these values in Equation 1-B we note from Figure 7 that TTF under these conditions is 13.3 years.

A similar calculation shows that TTF for a NiCd battery going to 65 percent depth of discharge is 11.9 years.

It is concluded that a 35 amp-hour nickel-cadmium battery operating at five degrees Celsius or less and 65 percent DOD will last for at least seven and a half years in a GPS orbit.

(Figure 19-9)

It was considered useful to plot TTF as a function of temperature for various depths of discharges. Figure 8 shows such a plot.

At 57 degrees Celsius the battery has essentially no lifetime in terms of years. This must be so because of the 57 minus T -- T being temperature -- factor in Equation 3, which is the F(t) equation.

(Figure 19-10)

Figure 9 gives TTF as a function of depth of discharge for various temperatures. We note that for temperatures less than 10 degrees Celsius the nickel-cadmium cells experience a rather long lifetime before failure, even at 80 percent DOD. On the other hand, time-to-failure is quite sensitive to temperature.

(Figure 19-11)

Finally, table 2 compares TTF values obtained with the aid of the modified McDermott  $F'(c)$  expression, and the values obtained using Hafen and Corbett's expression, and that is the BC\* expression that he talked about just previously. And they gave that also in a paper at the 1981 IECEC. With one exception the results are in reasonable agreement. In general, however, shorter lifetimes were obtained when the modified McDermott expression was used, particularly at low temperatures.

You can see that in the last column the only one that's really radically different is the third one, which is at a depth of discharge of 70 percent and a temperature of zero degrees Celsius. The rest of them are in reasonable agreement.

That concludes my talk.

HELLFRITZSCH: A very simple question. Maybe I can't understand everything, didn't follow everything. These years to failure, are those averages?

SENSE: No.

HELLFRITZSCH: Or, if not, what --

SENSE: In the case -- and Mr. Hafen talked about this in his equation -- I took the first failure to be the failure.

HELLFRITZSCH: Yes, the first failure. But this is time to first failure, in other words. But is that on the average or ten percent or what?

SENSE: Well, this has been worked out. I've taken the conditions that McDermott gave and they are the short, if you have a short in any cell, or if the pressure goes to let's say 250 psi or if the cell doesn't hold the voltage, if it goes below one volt, and, as was mentioned, say, .75 or thereabouts.

The conditions for failure are very nearly the same for both the McDermott case and also for the Hafen and Corbett case.

MILDEN (Aerospace): Have you considered any derating factor to the various equations for the fact that Crane data is presented to .75 volts per cell whereas most working satellite systems operate down to somewhere around to 1.1 volts per cell?

SENSE: Well, I have tied myself strictly to the Crane mold of taking data.

MAURER (Bell Labs): When I first proposed I guess about two years ago that you could separate the cyclic part from the solstice part of the geosynchronous orbit you could use that as a first order approximation. Last year I think I pointed out that that was only a first order approximation, and the reason is that during the solstice aging you get degradation products which then accelerate the degradation in the cyclic mode.

For example, if you take a set of new cells and cycle them to death you get a certain cycle life that might be predicted by the cycling equation up here. But if you take those same cells and do a trickle charge age for some fraction of what their trickle charge life would be and then put them on cycling you get an entirely different number for the cycle life. It's much, much shorter because of these accelerating factors, especially the corrosion on the positive electrode that occurs due to the carbonate that's



formed in the solstice age. The carbonate accelerates the growth rate and so the cycle life becomes less.

SENSE: Yes.

MAURER: And finally, I think if you plug in the values for the COMSTAR satellites or the INTELSAT-IV satellites where you have about 45 percent depth of discharge and something like 15 degrees, your equations were predicting 12 to 13 years of life and the satellites in fact failed before seven years.

SENSE: I emphasize the fact that this is a first approximation. And what I have done is I have developed an equation which allows you to put whatever equations you prefer to put in for either the cycle life or for the trickle charge.

Now I agree -- I'm not sure, I think there's a difference whether you fly it or whether you do it on the ground, and just why there is a difference I don't know.

In trickle charge, of course, what happens is that you do have shorting taking place because the standard free energy of formation of cadmium hydroxide is only minus-112.5 kilocalories per mole, whereas that for cadmium carbonate is minus-160 kilocalories per mole. And therefore the cadmium does want to leave the hydroxide and go and join up with the carbonate. Of course you'll have growth because the cadmium carbonate is insoluble in water, and so you do have shorting of the cells taking place.

KASTEN (Rockwell): I think one key thing that you mentioned was your prediction was based on a C/200 trickle charge rate and a less than five degrees C temp, and I think that's a significant difference than the two satellite programs you mentioned.

SENSE: Yes.

Well, the equations for the other two satellite programs did not limit themselves to the kind of trickle charge that you have. It turns out that C/200 is a fairly low trickle charge. McDermott in his paper has considered trickle charges much greater than that, and so there might be some discrepancy there. I don't know.

The point I do want to make is that we can modify the equation and put a different kind of equation in the general equation which I developed at the beginning of my talk.

FORD (Goddard): I'd like to ask you to comment on a statement you made earlier. If I understood it correctly, you implied that cadmium migration was associated with trickle charge. Was that what you said earlier in your presentation?

SENSE: Okay. This is kind of a tricky question. Equation 3 in Figure 3 gives the time-to-failure due to trickle charge. We note the overcharge rate is a factor in the negative exponent. Hence, for large values of  $F(t)$  we would want the trickle charge to be as small as possible. In my presentation I stated that as a first approximation degradation due to cycling is primarily the result of thickening of the positive electrode, and that cell degradation due to trickle charging leads to increased nylon degradation if the trickle-charge rate is sufficiently high such that the internal cell temperature is increased. This leads to an increased rate of nylon degradation resulting in the production of carbonate. This, in turn, causes cadmium to go into solution and increases cadmium migration leading to shorts in the cell. However, if the cell temperature is kept low enough in spite of higher overcharge rates the degradation of nylon, and hence the rate of carbonate production, would be low. The net result would be a low rate of cadmium migration.

FORD: Well, I'm not sure I still understand. But the implication I got earlier was that trickle charge does produce cadmium migration. And I pointed out to you several years ago there was a test run to look at that where trickle charge was the dominant mode for about three years, and cadmium migration did not show up as an important parameter in terms of the cell degradation mechanism. And I think that was about C/30 at room temperature.

MAURER (Bell Labs): Two more comments:

back in about 1970 or '71 I presented a paper here that first proposed this nylon degradation mechanism, the high temperature overcharge, the nylon degradation products migrating to the positive electrode, decomposing and taking

away the oxygen evolution that would normally have kept the negative discharged or at its constant state of charge, and developed a set of equations which predicted this as a function of temperature and the overcharge current. So if you want to make a modification to your solstice aging equation to take into account the trickle charge current you can refer back to that paper.

SENSE: I appreciate it. And I'd like to get together with you afterwards and you can tell me just exactly where I can find that. I'd appreciate that.

MAURER: It's about the 1971 workshop.

The other comment is that this mechanism predicts that the nylon degradation reaction continues to dominate all the way down to zero degrees or so, and that's not true. The 15 kilocalorie or so activation energy that it has is perfectly valid above room temperature. But when you drop below room temperature another mechanism takes over and gives you shorter lives than you would predict from the 15 kilocalorie lives, down around six to eight kilocalories.

SENSE: Yes.

MAURER: And the Crane data reflects that.

SENSE: I'm not saying that the nylon degradation is a dominant factor at all down near zero degrees.

As far as the activation energy of 15 kilocalories is concerned, I'm well aware of the fact that you've worked on that and I think the implication there is that you go from 19.8 kilocalories to 15 at around 26 degrees Celsius or thereabouts. So there would be a slight change, yes.

MARGERUM (Hughes): What do you envision as the source of carbonate at the low temperatures? If you have your solid at five degrees, what do you envision your source of carbonate?

SENSE: Well, there will always be some nylon degradation going on. And I think most of the time these birds are flown at -- what? -- ten degrees C or thereabouts.

In other words, the generation of carbonate doesn't come to

an abrupt halt; it just means that the kinetics are such that they are very, very slow, and there is not really that much carbonate generated.

I'm not saying that there isn't any. I think it will be small; it will be in very minute quantities. And, of course, if it is present in very minute quantities then of course you don't have much cadmium migration. And this is the advantage of flying at very low temperatures, like zero degrees.

Table 1

Some Parameters for Various Orbits		
Orbit	Cycles/Year	Interval Between Eclipse Seasons (Days)
GEO	88	138±
GPS	220	128
LEO	5300-5800	0

Figure 19-1

TTF Determination

$$\frac{TTF}{F(t)} + \frac{TTF}{F(c)} = 1 \quad (1a)$$

Equation (1a) relates TTF, F(t), and F(c)

$$TTF(\text{yrs}) = \frac{F(t) \cdot F'(c)}{F(t) + F'(c)} \quad (1b)$$

Explicit solution for TTF

Legend: TTF = time-to-failure with both failure modes F(t) and F'(c) taken into consideration

F(t) = time-to-failure mode due to trickle-charge degradation

F'(c) = time-to-failure mode due to cycling degradation

Figure 19-2

$$\text{Time-to-Failure (yrs)} = (0.5)(57.0 - T) \exp(-1.17 \sqrt{OCR}) \quad (2a) \text{ (after P. McDermott)}$$

where T = °C  
OCR = overcharge rate in amps for a 6 Ah cell

$$\text{Time-to-Failure (yrs)} = (0.5)(57.0 - T) \exp(-2.866 \sqrt{OCR/C}) \quad (2b)$$

where T = °C  
OCR = overcharge rate in amps  
C = rated cell capacity

Figure 19-3

F(t) Determination

GPS cycle period/year: 110 days

GPS solstice period/year: 255 days

Trickle-charge days/year:

$$255 + \frac{1}{2}(110) = 310$$

Therefore:

$$F(t)(\text{yrs}) = \frac{365}{310} (0.5)(57.0 - T) \exp(-2.866 \sqrt{OCR/C}) \quad (3)$$

Figure 19-4

$$F'(c)(\text{years}) = \frac{CtF}{\text{cycles/year}} \quad (4)$$

where

CtF = cycles-to-failure

Figure 19-5

Cycles-to-Failure (after P. McDermott)

$$CtF = (3083 - 10.8 RC)(62.0 - T) \exp(-0.045 \text{ DOD}) + 30.6 \text{ DCR} + 34.6 \text{ CR} \quad (5)$$

where

CtF = cycles to failure

RC = % recharge

T = °C

DOD = depth of discharge

DCR = discharge rate in amps for a 6 Ah cell

CR = charge rate in amps for a 6 Ah cell

Figure 19-6

F'(c) Determination

$$F'(c)(\text{yrs.}) = (220)^{(3083 - 10.3RC)(62.0 - T)} \times \exp(-0.045 \text{ DOD}) \quad (6)$$

where

RC = % recharge  
 T = °C  
 DOD = depth of discharge

Figure 19-7

Time-To-Failure in GPS Orbit

OCR = 175 mA  
 C = 85 Ah  
 RC = 140 %  
 T = 5 °C

For DOD = 60 %

$$TTF = \frac{F(t) \cdot F'(c)}{F(t) + F'(c)} = \frac{(25.00)(28.57)}{25.00 + 28.57} = 13.3 \text{ yrs.}$$

For DOD = 65 %

$$TTF = 11.9 \text{ yrs.}$$

Figure 19-8

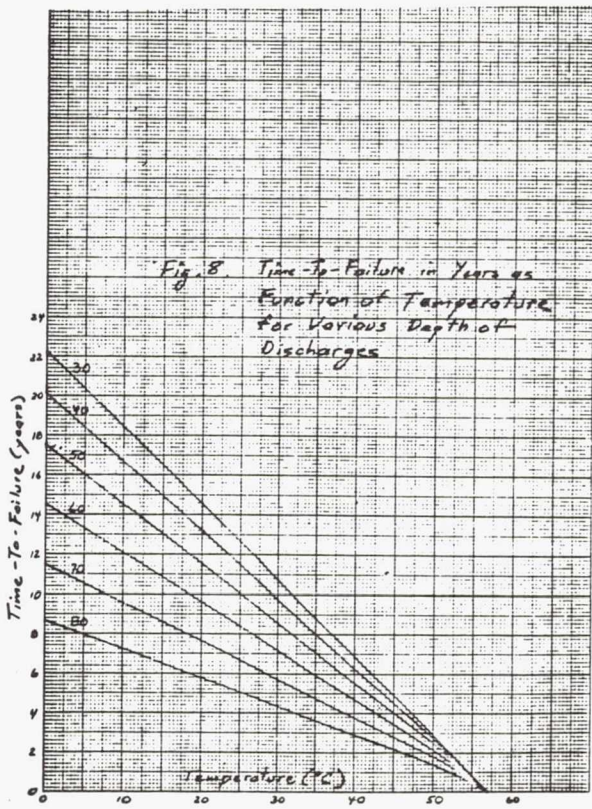

Figure 19-9

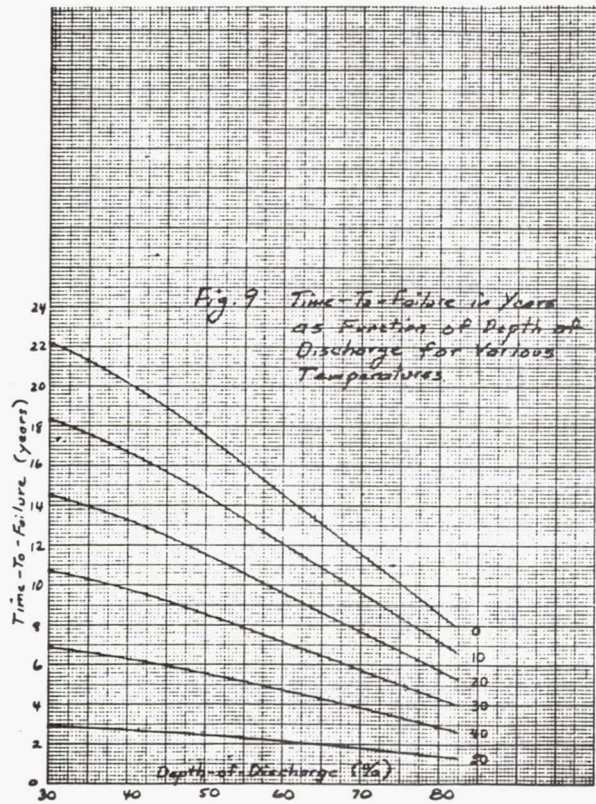

Figure 19-10

Table 2. Comparison of Time-To-Failure Values for Selected Temperatures and Depth of Discharges

Temp (°C)	DOD	Time-To-Failure (years)		$\left(\frac{\text{Time-To-Failure Meth. 2}}{\text{Time-To-Failure Meth. 1}} - 1\right) \times 100$
		Method 1*	Method 2**	
0	30	22.2	23.3	+5
0	50	17.5	19.8	+13
0	70	11.5	16.6	+44
15	30	16.5	15.9	-4
15	50	13.5	12.7	-2
15	70	8.6	10.1	+17
35	30	8.8	7.9	-10
35	50	7.0	6.1	-13
35	70	4.7	4.7	0

\* Modified version of McDermott's expression for Cycles-to-Failure used in calculations

\*\* Hafen and Corbett's Cycle-Life expression used in calculations

Space Operations and  
Satellite Systems Division



Rockwell  
International

Figure 19-11

## GALILEO BATTERY

L. Marcoux

Hughes

Today I had to make a choice between the two papers I planned to present. Because I knew that the nickel-cadmium community probably couldn't tolerate two battery tirades from Marcoux in the same day, I elected the one that I think is probably going to be of most interest to this group, and that is reporting on another episode in that interplanetary soap opera that we call the Galileo probe mission.

We've been doing this for some four years and it has been interesting because it's a brand-new technology which we're seeing, really stretched to its limits in terms of mission time and performance requirements. The last year has been a fairly exciting one, as a matter of fact. We began by celebrating the winter solstice with a major vibration failure during the qualification sequence of the second five modules that we had built.

We emphasize on that chart the word "recovery." In a very short time we were able to analyze the problem and come up with what appears to be a totally unbreakable cell and battery now, and have been able to move on.

As part of the rubber mission nature of Galileo, we had a series of mission changes which in turn generated a change in what we felt was the best cell for the mission, and also forced us to repeat our electrical simulation of the 150-day coast and descent. We spoke about that to some extent last year on two tests. This will be the fourth test in that series, and it is interesting because it is a real time simulation of the electrical mission for the last 150 days.

(Figure 20-1)

The history of vibration testing in Galileo is spotty. You'll notice this chart indicates it's a modern history. There is also a Galileo vibration history testing chart which is the ancient history, and that involved something like three levels of embedded subcontractors. Not



surprisingly, by the time the test was actually performed, it was performed at something like three times the qualification level, and obviously everything broke.

Those modules were replaced. To convince ourselves there wasn't a problem we did some cell testing. I think 10 cells is quite a bit of cell testing. It turns out it really wasn't enough.

We took our five prototype modules through the acceptance level test with no difficulty, as you can see. We roared on through the sine sequence with no difficulties, but when we reached the Y axis random, all hell broke loose and we actually broke a cell, or it was clear that a cell had opened and that it was going to be necessary to tear the whole thing down and really see what the problem was and start from scratch.

In so doing we—I shouldn't say "we," Honeywell. This work was performed by Honeywell. The design is their work. I'm talking about it today because what we're talking about is more mission-oriented rather than cell technology-oriented.

But Honeywell, in the course of the module dissection, discovered that their module design was all right but they thought they could make it a lot better. So we also took advantage of this chance to redesign, also to redesign the module. We came up with I think what is a vastly superior module design to the one we were operating with.

We then carried cells through heavy overvibration and passed the module through standard qual. vibration and passed.

(Figure 20-2)

Not surprisingly, the place that the failure occurred was on the anode tab at the dotted line. It turns out that we were apparently way out on the wings on the distribution when that happened because prior to this test we had probably tested 30 or 40 cells in the same vibration regime and not encountered a failure.

What it appears is if that operator crimps that tab just a little bit when they insert it in the cell, which happens now and then, you introduce a stress point and in vibration of the Y axis, which is the long axis of the cell, you will encounter failure. That's exactly what happened.

(Figure 20-3)

To understand which cell it was, it was Cell Number 5, which is in the middle of the module. Of course we are seeing a greater amplification factor there. That's not an excuse because the vibration levels we're testing to are those calculated for the bracket input to the modules. So indeed, the levels that it saw in the tests are the same levels that it would see in a mission.

The cross-section of the module that we were using at that time is fairly interesting. You can see it's extremely complex. The major features are, the cells fit in on a series of offsets; those offsets are necessary to permit the cell vents to operate in the event of a short circuit.

You can see the next layer above, a rubber pad. And the offset is epoxy foam and then finally a hard potting material cast on top.

Our dissection of the module wasn't conclusive that the cells had been mobile, but there was some indication that the cells were slightly mobile in that configuration. We decided we would be much happier with a fully rigid configuration, so we changed the module design and beefed up that cell tab.

(Figure 20-4)

As you can see, we went from .2 inch to tab to .6 inch, and from a 3-mil nickel strip to a 5-mil nickel strip. The increase in width you see allowed us to get a little bit of radiusing in it, which gave us some additional strength.

We also anticipated the next failure mode, which would be the tearing away of the tab from the nickel, and we included in the new design a nickel grid. We wanted to do that anyway. There are certain advantages to that from the

standpoint of capacity because one of the modules-- The battery consists of three batteries. Two modules are dedicated to the final 48 minutes of the mission. One module has to operate a timer at a fairly low pulse current for 150 days prior to the actual entry.

The coast timer module is badly depleted by the time it enters the Jovian environment. If we didn't have the grid we wouldn't be able to take advantage of all of its capacity because we would have used up enough lithium that we'd have a lithium lacework anode.

Consequently, that was something we wanted to do anyway and something we felt also strengthened the cell.

(Figure 20-5)

The module change that Honeywell recommended was a vast simplification of the existing design. We didn't change the case configuration or anything like that but we changed the potting arrangement.

The clever thing that they did was they eliminated all of the small offset pieces that required bonding to the module case and opted instead to cast a 13-cell block.

Now that line halfway up indicates the level to which the cells are potted. That cell block is then dropped into the module case. The electrical connections to the flexible printed circuit board can then be made with captured cells instead of cells that are sitting up wobbling on these offsets, so it gave us a great deal more control in the fabrication of the modules.

Under ordinary circumstances that wouldn't be too terribly important because in a conventional battery you'll perhaps build six packs, nine packs, something like that. but because this is a primary we have to build something like a hundred modules to see us through systems tests and all those other test sequences.

So we need a degree of confidence in our fabricability here, and this change allowed us to accomplish that. I think you can probably see it much more rapidly in these pictures.

(Slide. Not available)

This is a photograph of the mold that's used to form the cell block.

(Slide. Not available)

Here is a picture of the cell block, indicating what it looks like before it's dropped into the module. You can see the vent areas are open, allowing the cells to vent.

(Slide. Not available)

We can then drop the module block into the case itself, bring the flexible PC boards over, do a final potting with the same rigid die-cast material, and then button the module up and it's finished.

We've built five of those modules now. In fact, we're embarking on a build of some 40 or 50 of them, but we've completed five and carried them through the qualification level vibration with no difficulties whatsoever.

(Figure 20-6)

We have also taken one module and carried it through the entry deceleration loading which in this particular mission is appreciable. The qualification level is ramped up to 425g's and then backed off and sustained at 300g's for something like two or three minutes, so it's a fairly stiff environment as a matter of fact.

We also felt that we needed to define, at least on the cell level, the level at which failure occurred, so we went into severe overvibration. That's one five-cell group we carried through 12 G(RMS) for 40 minutes which is ten times the qualification time period.

On the same cell group we then moved on up to 18 G(RMS), and finally to 27 G(RMS), and at no time in those 120 minutes did we encounter any open circuit anomalies or anything like that. The cells are virtually unbreakable.

We repeated at the 27 G(RMS) just to give us another degree of confidence.

So based on those results we think the vibration failure is behind us. We also think that anyone using lithium-SO<sub>2</sub> cells in the aerospace environment has probably learned something because shortly after our difficulties, problems were encountered with the battery for the instrumented test vehicle and the same fixes were used and are apparently going to be equally effective.

(Figure 20-7)

The most exciting thing that happened was the decision early in the year not to have the probe carried on its own individual spacecraft but, rather, to return it as the original configuration, add it to the orbiter that was being built by JPL, and the ramifications of that change from a dual launch to a single launch were as follows:

The launch was delayed from '84 to '85;

The coast period which had been dropped back to 100 days, which had given us a great deal of confidence and a great deal of extra capacity -- I think you'll remember me standing here with a silly grin on my face last year because we'd done electrical simulations and shown we had something like 30, 35, 40 minutes of margin in our design. That stole all of that away from us.

Finally, the interface temperature between the orbiter and the probe was some 20 degrees higher than originally anticipated for the probe/probe carrier configuration, and now all of a sudden this corrosion business, which I'd always been able to laugh off and say Aha, we're flying at zero degrees C., we don't have a problem, is not yet a problem but it's moving us into a dangerously iffy region.

We fly now somewhere between 20 and 25 C. and we have to do that for a period of from three to five years. Our trajectory is still slightly uncertain, so we're starting to worry more about corrosion, shelf-life-type effects than we had in the past.

(Figure 20-8)

We had, very wisely I think, a year and a half ago built 400 cells which we called the alternate cells, which

were a compromise between Sam Levy's state-of-the-art cells and what we thought we could conservatively incorporate into a spacecraft battery and not raise too many eyebrows at NASA/Ames.

You can see the top line indicates our original baseline cell which was 1978 state-of-the-art lithium-SO<sub>2</sub> technology. Sandia, and Sandia in conjunction with Honeywell, and Mallory carried out several studies on increasing shelf life and increasing low rate performance, and the upshot of that were several component changes.

As well as those component changes, people got much smarter about how to assemble cells, and there were many process changes. So our present cell that we believe is the cell we'll fly, in that final cell you can see the major changes in terms of components are:

We have now added an anode grid which we think is extremely important;

We have changed from the glass seal company blue glass, which has some number that is only used during formal occasions, and I don't think this is formal enough to drag it out, to the Fusite 108 which is a much more thermodynamically stable glass.

Finally, we've changed the electrolyte concentration. We reduced the lithium bromide concentration and that has serious ramifications in terms of shelf life. So I'd like to talk in a little more detail about the glass seal change, and about the electrolyte change.

(Figure 20-9)

The cell degradation has really two sorts of effects. One is the glass seal effect and the other is the combination of those last three shown on the chart, namely electrolyte degradation generates products that undoubtedly facilitate tantalum corrosion and also facilitate self-discharge. So if we cover the glass seal we cover the electrolyte change, and I think we've covered the major shelf life effects.

(Figure 20-10)

I think the conference was the first place this business was openly discussed. Chuck Bennett from GE started talking about glass seal corrosion and everyone became concerned with it.

That's a horror picture of what a corroded old blue glass seal looks like. The only reason I keep that around is when interest starts to wane on funding for corrosion testing, I bring that picture out and NASA becomes much more interested in corrosion testing.

(Figure 20-11)

The probable cause of that, Sam Levy feels, and I think most of the community agrees with him, is an underpotential deposition of lithium on the glass that leads to reactions with the glass to either cause the glass to change volume and deteriorate because it's in compression or form a conductive film across the surface of the glass, so we either have self-discharge or rupture. In either case, neither is too desirable.

There are three approaches to solving this. The first would have been to use a polymeric coating, and that was a popular approach two or three years ago. In the Galileo program that approach was rejected because we felt coming up with material compatibility for four to five years using polymers was going to be something that we'd have to do too much real time testing to get meaningful results.

We felt a more straightforward approach was a band-aid approach that used a mechanical coverup. In the past year's testing we found out that the band-aid was not that effective and as a matter of fact, we would be better off using a more thermodynamically stable glass.

(Figure 20-12)

The configuration that you've probably seen in connection with the Galileo program is that configuration in which the tantalum pin is surrounded by a polypropylene washer and then a tantalum washer is forced down on top of that. It's not truly a hermetic seal. In fact, you can measure glass seal degradation by the amount of hydrogen evolved by a standard seal sample saying, you know, whatever happens, a reductant is formed and the amount of that

reductant reflects the extent of corrosion. And if you do that you get a fairly interesting result.

(Figure 20-13)

You can see the top line indicates the volume of hydrogen evolved versus storage time, at a very high temperature, by the way.

You can see the second line reflects the results that you obtained with the tantalum washer coverup, and you can see that initially the tantalum precludes the electrolyte solution from coming into contact with the glass. But ultimately it is not a hermetic seal; it leaks.

Once sufficient material has leaked in, the decomposition rate is essentially the same as that of the unprotected glass. And every cell that we opened up in the course of this work that was more than six months old and had this glass coverup had decomposition products on the surface of the glass.

You can see the more thermodynamically stable glass had much, much better performance even at that elevated temperature. And it is based on those results that we elected to change to Fusite 108.

(Figure 20-14)

The lithium bromide concentration question is an interesting one. Early cells, when placed on high temperature storage, would initially indicate an increase in open circuit voltage from 3, up to 3.5, 3.6, and ultimately then they would open circuit.

Fairly clearly what's happening, based on two or three other sources of evidence, is that SO<sub>2</sub> is reacting with the bromide forming bromine. The bromine is attacking the tantalum weld. This is work that Sam Levy has presented here and other places that I think has borne out experimentally pretty clearly and pretty carefully that that's the case.

Furthermore, that bromine can also increase the self-discharge rate by reacting with lithium. What you see then is at 3.5, 3.6 open circuit voltage. is the



lithium-bromine couple. When the corrosion finally completes, the cell opens up and you see that behavior.

(Figure 20-15)

If you compare three different lithium-bromide concentrations, the results are fairly interesting. If you look at a ratio of 2.5, which is an extremely high ratio, you can see that the open circuit voltage increases very rapidly, and then the cell opens in something like 25 or 30 days.

The 8 percent lithium-bromide was the baseline Galileo electrolyte concentration. You can see there was a touch of a chemical reaction early but obviously that was just a trace-impurity sort of thing. And then ultimately at 150 days the reaction takes off.

Finally, you can see in the case of the 6.4 as you'll note the error on the chart, the 6.4 percent lithium-bromide. The open circuit voltage is essentially invariant even at prolonged times at rather high temperatures.

(Figure 20-16)

You can see the same effect on capacity. There's the 8 percent capacity dropping off, again at 160 degrees F., whereas at 6.4 percent capacity, the decline is much less rapid.

So based on those cell changes we thought it was necessary to repeat our simulated battery tests.

The simulated battery test doesn't use battery modules; it uses 13-cell groups taped together, wired exactly as they would be in the battery with the protective diodes and all of that, and configured and loaded as you would with the battery.

We've done several of these tests. The mission has changed. We've also gotten progressively cleverer, and our last test is probably the best simulation that we've carried out of the 150-day coast timer load.

(Figure 20-17)

We were originally simulating simply a steady state. It's a pulse load. We ultimately went to an artificial pulse. In our last test we actually built up a breadboard of the coast timer and carried out the test for the 150 days with a breadboard simulating the flight instrumentation.

We also have grown increasingly wiser about what the load of our G-switch bus is, and what that amounts to is that the redundancy to the coast timer is an inertial switch and that inertial switch requires some 28 microamps at its bus during the 150 days of coast. So that's an additional parasitic load that goes on the two descent modules because earlier testing indicated that microamp level loads didn't introduce any problem in terms of high rate capacity later on in the mission.

So you can see we have matured in our testing.

We have also had to go back to 150 days because that is once again our mission.

(Figure 20-18)

The results that we got are quite encouraging. This is the voltage time curve for the simulated battery test. Those initial events are some conditioning pulses that we use. We found it necessary to drop the battery across heater resistors for something like ten seconds in order to remove the passivation layer. That will permit us then the rate capability for the very critical relay events early in the mission.

You can see then there's some pre-entry science for something like seven hours. A little bit of more intense science begins just before entry, and then when you see it drop down at entry, that's the transmitter turning on and it's drawing something like a 9-amp load from the battery and that amounts to 3-1/2 to 4 amps from the two dedicated descent modules, and whatever the other module can provide, which it turns out in this last test was appreciable.

The blips, their voltage is critical. Those are pyrotechnic events.

The specified mission from the entry point of 0.1-bar pressure is 48 minutes past that point that's indicated there at E plus 51 on the chart. And you can see our final cutoff voltage is that voltage at which the transmitter no longer functions, 27 volts, and you can see that happens at E plus 68 minutes.

(Figure 20-19)

We are contractually required to provide no more than 90 percent depth of discharge at end of mission, and this is difficult to calculate because our current profile is erratic and our temperature profile goes from zero to 60 degrees in the course of the 48 minutes.

I think the best definition of depth of discharge is really the capacity that is required divided by the capacity that you observe at the cutoff voltage of 27 volts, and if you do the calculation that way you'll see we're well under that 90 percent depth of discharge and have quite a bit of encouragement that we have a significant margin.

(Figure 20-20)

You can also look at that margin in terms of time, and you can see in our most recent tests that margin is 14.3 minutes. The reason we compare it with Test Number 1 is two-fold. Test Number 1 is a comparable test because it was performed with a 150-day coast. It also allows us to sit back and see how clever we were in changing our cell design because those ten minutes of additional margin are clearly due entirely to the changes in cell design that we carried out. And you can see our present position is that we're back to the sorts of margin we were talking about last year, which is very pleasant.

(Figure 20-21)

The voltage performance for those pulses isn't too terribly exciting. We have a 16-volt requirement. You can see throughout the 48 minutes we were well above the 16 volts.

So the situation now is our only real concern is life testing. We are about to embark on a major life test matrix, some 600 cells and seven years with five temperatures. And I think with that done we'll be able to

proceed with the sort of confidence that you want to when you know that this battery is the sole power supply for the entire scientific package.

In closing I think we should point out that this afternoon we're going to hear the Sixth Annual Report on Viking. I don't think Viking really has a chance in terms of Annual Reports because our earliest possible planetary encounter is 1988, so I think you should bear with us and be assured that this isn't the last you're going to hear about the Galileo battery.

## VIBRATION TESTING HISTORY MODERN



- EARLY 1980 - FIVE PROTOTYPE MODULES REPLACED
- JUL 1980 - TEN CELLS TESTED TO 12.1 G (RMS) RANDOM; NO FAILURES
- DEC 1980 - PROTOTYPE MODULE VIBRATION TESTS RESUME
  - ACCEPTANCE LEVEL TESTS
    - X-AXIS RANDOM - ALL PASSED
    - Y-AXIS RANDOM - ALL PASSED
    - Z-AXIS RANDOM - ALL PASSED
  - QUALIFICATION LEVEL TESTS
    - X-AXIS SINE - ALL PASSED
    - Y-AXIS SINE - ALL PASSED
    - Z-AXIS SINE - ALL PASSED
    - X-AXIS RANDOM - ALL PASSED
    - Y-AXIS RANDOM - ONE ANOMALY (MODULE 012), ONE FAILURE (MODULE 008) - TESTING TERMINATED
- JAN 1981 - CELL AND MODULE REDESIGNED
- MAR 1981 - PREPROTOTYPE MODULE PASSED QUALIFICATION LEVEL TESTS
- MAY 1981 - REINFORCED ANODE CELLS SURVIVE MASSIVE OVERVIBRATION TESTS
- JUN 1981 - FIVE PROTOTYPE MODULES PASS QUALIFICATION LEVEL TESTS

Figure 20-1

## CELL FAILURE POINT

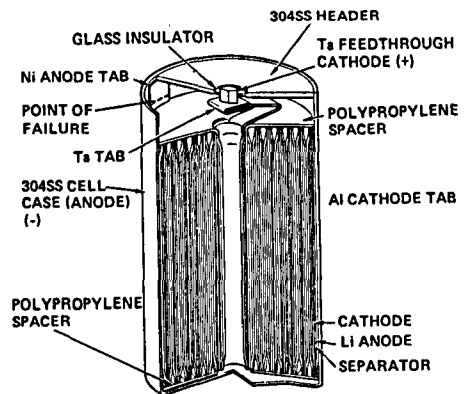

Figure 20-2

## GALILEO Li/SO<sub>2</sub> BATTERY MODULE DESIGN DETAILS

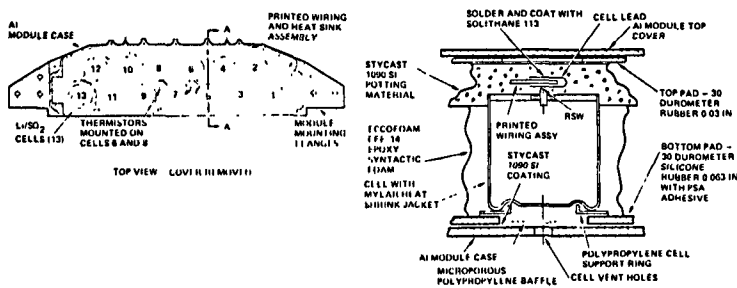
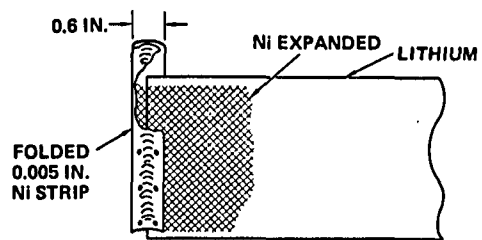
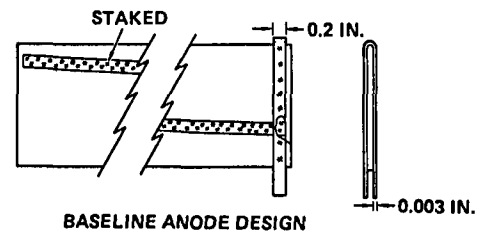

Figure 20-3

## ADOPTED CELL REDESIGN



REVISED ANODE DESIGN

Figure 20-4

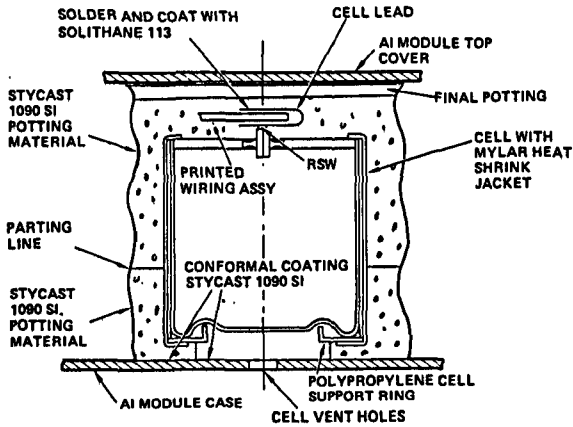

Figure 20-5

**CELL VIBRATION TEST RESULTS**

**LOT 2 CELLS**

- Y-AXIS RANDOM SPECTRUM, 5-CELL FIXTURE
- ALL SURVIVED 12 G(RMS) FOR 40 MIN
- TWO CELLS FAILED (20.55 MIN AND 33.4 MIN) AT 18 G (RMS)

**REINFORCED ANODE CELLS**

- ONE 5-CELL GROUP CARRIED THROUGH SUCCESSIVE 40 MIN EXPOSURES
  - 12 G (RMS) - NO FAILURES
  - 18 G (RMS) - NO FAILURES
  - 27 G (RMS) - NO FAILURES
- CONTINUOUS MONITORING OF OCV NOT POSSIBLE AT 27 G (RMS)
- FIVE PREVIOUSLY UNVIBRATED CELLS EXPOSED TO 3 SUCCESSIVE 4 MINUTE 27 G (RMS) SEQUENCES - NO FAILURES
- POSTMORTEM EXAMINATION REVEALED ONE CELL FROM SUCCESSIVE VIBRATION GROUP HAD EXPERIENCED PERIODIC SHORTING - NO OTHER ADVERSE EFFECTS NOTED

Figure 20-6



- PROBE RETURNED TO ORBITER
- LAUNCH DELAYED FROM 1984 UNTIL 1985
- COAST PERIOD EXTENDED FROM 100 TO 150 DAYS
- VEHICLE TEMPERATURE INCREASED FROM 0°C TO ~20°C

Figure 20-7

## GALILEO Li/SO<sub>2</sub> CELL EVOLUTION



DESIGNATION	CATHODE DRYING	TA WELD	ANODE		FEEDTHRU		ELECTROLYTE	
			GRID	TAB. IN.	GLASS	COVERUP	PROCESS	CONCENTRATION, %
LOT 1	NO	AIR	NO	0.2	BLUE	YES	METAL NO PREMIX	8
LOT 2	NO	AIR	NO	0.2	BLUE	YES	METAL NO PREMIX	8
SERIES I (NEVER BUILT)	YES	INERT GAS	NO	(OLD BASELINE) 0.2	BLUE	YES	METAL NO PREMIX	8
SERIES IA (PREPROTOTYPE MODULE)	YES	INERT GAS	YES	0.6	BLUE	YES	METAL NO PREMIX	8
SERIES II (400 ALTERNATE CELLS)	YES	INERT GAS	YES	0.2	FUSITE 108	NO	GLASS PREMIX	6.4
SERIES IIA	YES	INERT GAS	YES	(NEW BASELINE) 0.6	FUSITE 108	NO	GLASS PREMIX	6.4

Figure 20-8

## Li/SO<sub>2</sub> CELL DEGRADATION DURING STORAGE RELEVANCE TO GALILEO MISSION



Figure 20-9

- ALTHOUGH DEGRADATIVE EFFECTS MOST NOTICEABLE AT HIGHER TEMPERATURES, THEY UNDOUBTEDLY TAKE PLACE AT LOWER TEMPERATURES AS WELL
- DATA BEING DEVELOPED WHICH INDICATES THAT BELOW 25°C THESE EFFECTS WOULD NOT BE MISSION LIMITING
- APPROACH HAS BEEN TO UTILIZE HIGH TEMPERATURE ACCELERATED TESTING TO ESTABLISH MOST STABLE COMPONENTS
- SOURCES OF CELL DEGRADATION:
  - GLASS SEAL DEGRADATION
  - ELECTROLYTE DEGRADATION
  - Ta CORROSION
  - SELF-DISCHARGE CAPACITY LOSSES

## GLASS SEAL DEGRADATION



15X APPEARANCE OF SEAL DEGRADED AT 160°F (71.1°C)

Figure 20-10

## GLASS SEAL DEGRADATION



### PROBABLE CAUSE

- UNDERPOTENTIAL DEPOSITION OF LI METAL AT GLASS/METAL/ELECTROLYTE INTERFACE, FOLLOWED BY LI METAL REACTION WITH GLASS

### EFFECTS

- CONDUCTIVE FILM GROWS ACROSS SEAL FROM OUTSIDE TO INSIDE, LEADING TO SELF-DISCHARGE PATHWAY
- LI REACTIONS WITH GLASS WEAKEN COMPRESSION SEAL, LEADING TO RUPTURE

### REMEDIES

- POLYMERIC COATING OF GLASS – REJECTED FOR GALILEO
- MECHANICAL COVER-UP – INITIALLY USED FOR GALILEO
- MORE THERMODYNAMICALLY STABLE GLASS – PRESENTLY USED FOR GALILEO

Figure 20-11

## GLASS SEAL COVER-UP

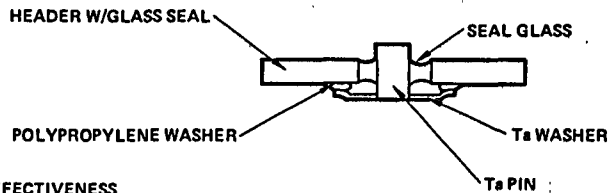

### EFFECTIVENESS

- INITIALLY REDUCED SEAL DEGRADATION
- MOST DISASSEMBLED CELLS REVEALED ELECTROLYTE PENETRATION TO SEAL
- AFTER PENETRATION, DEGRADATION APPARENTLY SAME AS FOR UNPROTECTED SEAL

### REMEDY

- USE MORE STABLE GLASS (FUSITE 108)

Figure 20-12

## GLASS SEAL DEGRADATION COMPARISON OF APPROACHES

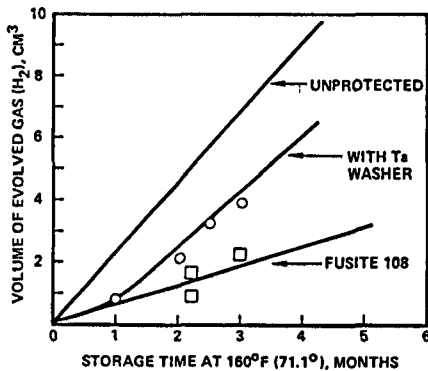

Figure 20-13

## ELECTROLYTE STABILITY AND Ta CORROSION



### OBSERVATION – OCV

- BEGINS TO INCREASE WITH STORAGE
- ULTIMATELY FALLS TO ZERO

### PROBABLE CAUSE

- INITIAL REACTION BETWEEN  $SO_2$  AND  $Br^-$ , GENERATING  $Br_2$
- OCV CHARACTERISTIC OF  $Li/Br_2$  CELL
- ELECTROLYTE DEGRADATION AND CAPACITY LOSS DUE TO SELF-DISCHARGE
- CORROSION OF Ta WELDS WHICH LEADS TO WELD FAILURE
- REDUCED CAPACITY DUE TO INCREASED CONTACT RESISTANCE

### REMEDY

- REDUCE  $LiBr$  CONCENTRATION
- REVISE ELECTROLYTE PROCESSING TO AVOID OVERCONCENTRATIONS OF  $SO_2$  WITH  $LiBr$

Figure 20-14



**ELECTROLYTE STABILITY VS COMPOSITION**

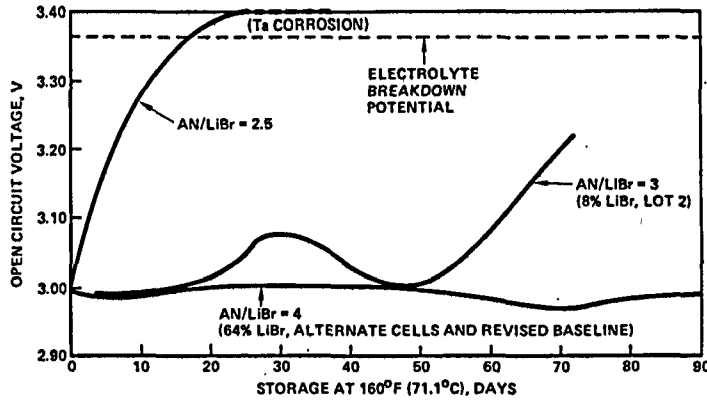

Figure 20-15

**CAPACITY RETENTION VS ELECTROLYTE COMPOSITION**

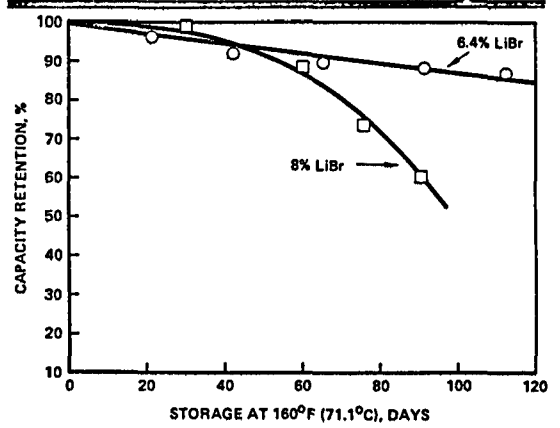

Figure 20-16

**SIMULATED BATTERY TESTS TEST SUMMARY**



TEST NO.	COAST PERIOD LOAD SIMULATION			FIRST RELAY Ω	PYRO PULSE T-SATT/ NMS, A	TOTAL CELLS	CELL TYPE	DESCENT CAPACITY BUDGET, A-HR	PROCEDURAL CAPACITY BUDGET, A-HR
	DURATION DAYS	COAST TIMER	G-SWITCH BUS-A						
1	150	STEADY STATE ONLY (RESISTIVE)	0	138	7.35/4.2	39	LOT 1	15.137	16.297
2	100	STEADY STATE PLUS PULSE (RESISTIVE)	2	89	7.35/4.2	38	LOT 1	14.500	13.78
3	100	STEADY STATE PLUS PULSE (RESISTIVE)	2	89	7.35/4.2	39	LOT 1	14.500	13.78
4	150	COAST TIMER BREADBOARD	28	75	6.3/2.5	39	ALTER-NATE	16.370	15.83

Figure 20-17

**SIMULATED BATTERY TEST NO. 4 VOLTAGE PROFILE MAIN BUS**

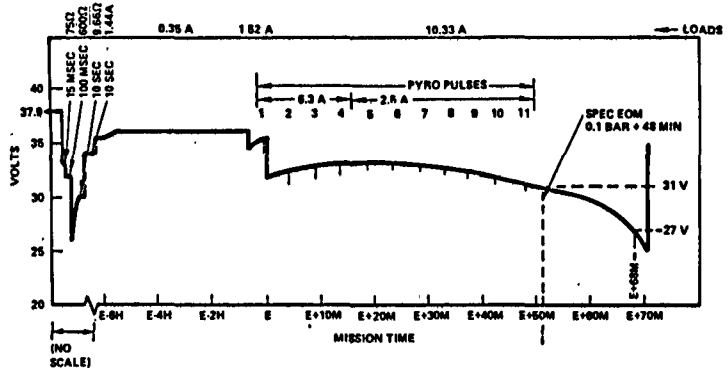
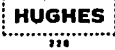

Figure 20-18

**SIMULATED BATTERY TEST NO. 4**  
CAPACITIES

HUGHES

MODULE NO.	CAPACITY, A-HR	
	AT 0.1 BAR + 48 MIN	AT 27.0 V
1	5.80	6.97
2	5.88	7.03
3	8.14	8.68
TOTAL	19.80	22.68

DEPTH OF DISCHARGE =  $\frac{\text{REQUIRED CAPACITY}}{\text{CUTOFF CAPACITY}} = \frac{19.80}{22.68} = 87.3\%$

Figure 20-19

**SIMULATED BATTERY TEST**  
NO. 1 AND 4 COMPARED

HUGHES

TEST NO.	BATTERY CAPACITY, A-HR	TIME TO CUTOFF, MIN	MISSION MARGIN, MIN
1	21.33	55.3	4.0
4	22.68	68.0	14.3

Figure 20-20

**SIMULATED BATTERY TEST NO. 4**  
PULSE RESPONSE

HUGHES

PULSE NO.	PULSE AMP, A	PYRO BUS REQ, V	MEASURED PULSE MIN, V
1	6.3	16.0	18.7
2	6.3	16.0	17.3
3	6.3	16.0	17.6
4	6.3	16.0	17.9
5	2.5	16.0	18.8
6	2.5	16.0	18.5
7	2.5	16.0	18.3
8	2.5	16.0	18.2
9	2.5	16.0	18.0
10	4.5	—	17.3
11	2.5	16.0	17.5

Figure 20-21

**Page intentionally left blank**

## AN IMPROVED EQUATION FOR DISCHARGE VOLTAGE

P. McDermott

Coppin State

Let me give you a little background information.

About four years ago we had tried to develop some fit equations for discharge curves in order to provide some parameters for the Crane accelerated test regression equation. We had initially tried a sort of standard fourth and fifth degree polynomial fit, and we got very good fits with the voltage data. But when we took those parameters and tried to put them into the large regression equation which was being developed for the Crane data, we could not get real high correlations.

So a colleague of mine, Dr. Edward Sommerfeldt, about four years ago began to develop other equations which might represent more the physical and the chemical nature of the battery, and therefore try to map the coefficients, the fifth coefficients better with the degradation of the cell. We were looking for coefficients which would be correlated either linearly or non-linearly somehow with cycles to failure so that we could get a prediction out of it. In other words, we'd look at the voltage discharge curves and we would try to predict how long the cell would last.

This equation that we developed was a double-exponential type equation which I'll show you today.

More recently I've tried to refine that and to get a better equation, because that equation didn't fit certain voltage curves as well as I would like. So I've gone back to -- I sort of dropped the project for a couple of years and now I'm back on to it, both for using this for predicting failure but also to use it for a larger model, a larger power systems model so that the battery equation would be one of other equations to model the whole power system.

And the utility of it I think is clear, that if you can get an equation to define voltage that is temperature-dependent, rate-dependent, DOD-dependent and so on, you can then use it in an operational sense if you are

going to change the current on a battery and you wanted to find out what the voltage was going to look like after the current changed, or if you're in a spacecraft and you had a temperature change and you wanted to sort of map that it would give you a good way of doing that without having to load a large table of voltage versus temperature values into a computer.

(Figure 21-1)

Let me start out by showing the equations that we have worked on.

The first is the previous version which shows a double exponential function. This term is a decreasing exponential term which takes care of the first drop in the voltage, the initial drop before it flattens out. This term is really sort of the terminal droboff of the voltage. You can see as  $X$  in this equation,  $X$  is amp-hours or charge out during the discharge. That is supposed to be an  $X/F$  or  $X-1$  to be really the capacity of the cell. As  $X$  approaches  $X-1$ , this term becomes very large. And since it's a negative term then the voltage value drops off rather quickly.

But this didn't fit all situations as well as I would like. So I developed really in an empirical sense a new term for this middle term in here. The third term remained the same and the first was just a constant. And this term had a  $B/C-X$  where  $C$  now is a capacity term. That is as  $X$ , which is amp-hours out, approaches the capacity of the cell, then the denominator begins to increase rapidly. And since that's a negative term then it drops the voltage off.

So the non-linear regression that we're going to do today is with this five parameter fit equation. And I might add that after I found this equation I found that Shepherd at NRL had a similar equation I think published in '65 where in his coefficients up here,  $B$  had a current term in it and  $E$  up here also had a capacity term.

But what I was doing was, although this I think maps the physics and the chemistry of the cell better than this equation, I have not attributed at this point any variable-like temperature or charge or current to any of these coefficients. But what I'll attempt to do once I have

fit a number of voltage curves is to then take A, B, C, D and E and try to correlate those with environmental factors such as temperature, depth of discharge, rates of discharge, and so on.

(Figure 21-2)

This is the fit of a curve, just to indicate what that parameter C does. By the way, these cells are 12 ampere-hour GE cells which are being tested out at JPL, and I think Irv Schulman has talked about these or will talk about these during the conference.

The dropoff here shows a dropoff down to between six and eight ampere-hours. Now this is a 12 ampere-hour cell, but it has in a sense memorized a falloff to the 50 percent DOD level. So 50 percent DOD would be six ampere-hours nominal. So this is tending to drop off a little after six.

The C factor, which is what I'm calling the capacity factor, turns out to be 7.1 here, which is fairly reasonable since cells after cycling for many thousands of hours -- this is 3200 cycles -- tend to drop off even before their nominal capacity.

(Figure 21-3)

Now this shows a fit at 1000 cycles. What I'm going to show you is fits at 1000 cycles and 2000 cycles and 3200 cycles to show you the progression or the change in characteristics of the curve and then the change of the fit parameters with those changes.

This, of course, is the voltage curve in here. This dotted line corresponds to the curve if you only had A, B and C of my fit equations. Let me put those on the other vugraph because I'm going to be referring to them throughout the talk.

In other words, after the fit if you had only plotted A, B and C and left off the DE/-EX term, you would get the dotted line. And so the DE exponential term would correspond to just this area up here. And the ABC would correspond to all this area under here.

(Indicating.)

The D coefficient is essentially this distance in here at X equals zero.

So this is the 1000 cycles 20 degrees Centigrade.

(Figure 21-4)

Here's one at 30 degrees Centigrade; a little more curvature here, a rounding off toward the higher state of charge -- or state of discharge.

(Figure 21-5)

And here is 40 degrees; a little more curvature out here. Now to fit the equation it helps to have a little bit of curvature down in this area to indicate that we are starting to drop off, because that C coefficient is fairly much dependent on this curvature right in that region.

(Figure 21-6)

Here is 1000 cycles later at 2000 cycles. We can see a little more dropoff here than we had at the previous 20-degree slide.

(Figure 21-7)

As we get higher temperatures we have higher dropoff, and finally at 40 degrees a pretty severe dropoff.

(Figure 21-8)

Also this tends to flatten out a little bit as you get this severe dropoff toward the upper region.

(Figure 21-9)

I would like to now show a table of the coefficients versus different temperatures and different cycles. These are all 50 percent DOD cells. So we have three temperature levels, 20, 30, 40. at different cycles, 100, 500, 1000, 1500, 2000 and 3200. Here are the fit parameters, A, B, C, D and E.

Now we notice some general trends here, that as you increase the cycles, A tends to drop a little bit; not much, the 1.4, 1.5 region down to 1.2. You see I'm trying to get some sort of a feel for how the coefficients are changing as the cell is degrading.

Now B is probably the most unstable of the coefficients. You'll notice it starts .113 here. All the way down the page it seems to have a high variability although it's tending to drop rather rapidly; .26, .06, and so on.

C, which corresponds to what we're talking about, the capacity of the cell, starts out at 100 cycles being pretty close to -- except for this one -- being pretty close to the nominal capacity of the cell, and then drops.

Now I think what's happening here is that as time goes on the cell isn't losing that much capacity, but you are starting to lose that apparent capacity as the cell "memorizes" in the 50 percent DOD. In other words, it's tending to tail off as it hits 6 ampere-hours, which would be the end of discharge.

D is fairly stable throughout. In other words, throughout temperature and cycles it remains around .1, .12.

Now E, which is really the curvature of the early part of the cell, stays somewhere around 1.

(Figure 21-10)

I did a correlation, but unfortunately I don't have one on the slide. A student did this and handed it to me this morning, so I wasn't able to get a slide made of it. But it shows that there is some correlation in the coefficients with cycles. For example, A correlated to cycles is .7, actually -.7. C is .7; D also. And E is .5, which is not a real high correlation.

In terms of other, however, correlations within the coefficients there are some very high correlations. For example, A correlated against C is .99, and B correlated against C is also .99.

So I think what this indicates is that if there



are internal correlations within the coefficients themselves we may be able to lower the number of fit parameters which would help in terms of the fit itself. That is, if A is very highly correlated with one of the other parameters we could eliminate A and then incorporate that into the other parameter.

(Figure 21-11)

Now the question arose as to whether we could fit not 50 percent DOD discharges, but 30 percent, 20 percent. In other words, can we actually get a fit when you don't get the rounding off of that last portion of the curve? When Shepherd did all of his work he needed complete total discharges of the cell in order to fit his parameters. But in an operational sense you want to be able to fit a curve. If you're in low earth orbit and you've only got 25 percent DOD, you want to be able to try to fit that curve. So I did a study in which I took a curve which had a well rounded knee and backed off. I dropped off data points so that....

(Figures 21-12 and 21-13)

This is a 1600 cycle cell at 20 percent. We have the well rounded knee down here. And what I'm going to do is crop off data points, so that I'm essentially approaching equivalently less depth of discharge. So I'm going to try to fit this curve which has just a slight rounding off there.

(Figure 21-14)

So this shows the effect of fit parameters of varying the number of data points entering the regression. This is 50 percent DOD, 20 percent, 30 and 40.

Parameter A tends to remain fairly stable. This is as you get really effectively lower depth of discharge. B, however, jumps around a bit. C increases here, not so much down here at 40 degrees. C actually stays pretty much the same. C in here rises a little bit.

(Indicating.)

You can understand that; as you're losing sort of a data point toward the end and have less rounding off it's

harder to define that area where C is dropping off. D again is fairly stable throughout, 1.1, .12, .10.

So I think what it tells me, at least, is some of the coefficients are fairly stable independent of depth of discharge. So we might attempt to lock those in at that level and then attempt the fit again. The less variables you have in the fit the more control you have over it.

(Figure 21-15)

Now I took one more iteration of this thing. I backed off two more points so that I had barely any curvature. This is a computer printout so I have to explain it a little bit. Parameter A are these values, every other value. Parameter E here are the values with the little triangles next to them. And BC and D are shown listed.

Now notice the residuals over here for the various iterations of the regression. We drop off rather rapidly; by the third iteration or fourth we're stabilizing out and just dropping really very slightly. But notice there are still some fairly large changes in some of the parameters. C, for example, creeps from eight up to nine. Parameter D stays fairly stable. B, however, is the renegade; that one keeps moving quite a bit. It almost doubles here, and you have very little change in the residuals out there.

So in order to try to find a way of becoming independent of the latter part of the curve and try to fit just the beginning part where you're initially dropping the voltage off, I tried to devise another equation that would be a good approximation, if not the same equation, and I came up with the four-parameter fit.

Now this is only for fitting the beginning part of the curve, not the latter part of the curve, to get a good estimate of DOD. If we can get a good estimate of DOD from the initial points, then we can lock them in and rerun the regression to get a better fit for A, B and C.

(Figure 21-16)

This underlying portion is fairly linear during the early part. And so what we're going to be doing is

fitting just a line equation,  $A-MX$ , against this declining exponential, which is the  $DE-EX$ . So the four-parameter fit is really -- you're fitting a line plus that initial dropoff factor.

This is what the fit looks like. Now here we're getting extremely close fits to the data points. You've noticed on some of the previous curves they were good fits, but the data points were missing a little bit on various places.

Here we've got an extremely close fit to the first five points.

(Figure 21-17)

When I do this at different temperatures parameter  $a$ , which is the intercept really of zero,  $m$  is the slope of the straight line and  $D$  and  $E$  are the parameters in the equation, as always, we find  $a$  and  $m$  are fairly stable -- This is 2000 cycles and 3000 cycles -- 1.3, 1.3, .02, .0196, and so on.

I think we have some pretty good confidence that the fit of  $D$  and  $E$  here is very close to what we want for the final value.

This is the point that we are at now in the program. The next phase is to actually run through and get a fit of  $D$  and  $E$  and then go lock those in and fit  $A$ ,  $b$  and  $C$ , and I think we'll have much higher correlations. The ultimate end, of course, is to be able to find temperature dependence, current dependence of these coefficients and then go back and have a generalized equation which has temperature and depth of discharge and current and be able to predict voltage versus cycles.

Thank you.

# EQUATIONS

## Previous Version

$$\text{DISCHARGE VOLTAGE} = A - Be^{C(x_f - x)} + De^{-Ex}$$

## Five Parameter Fit (this study)

$$\text{DISCHARGE VOLTAGE} = A - \frac{B}{C-x} + De^{-Ex}$$

## Four Parameter Fit (this study)

$$\text{DISCHARGE VOLTAGE} = a - mx + De^{-Ex}$$

Figure 21-1

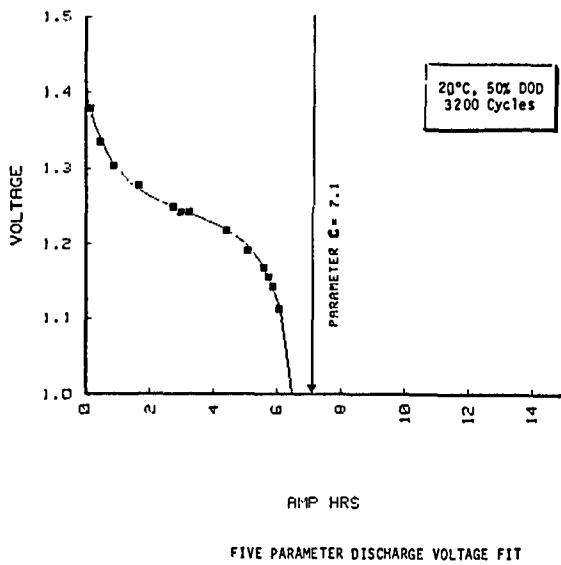

Figure 21-2

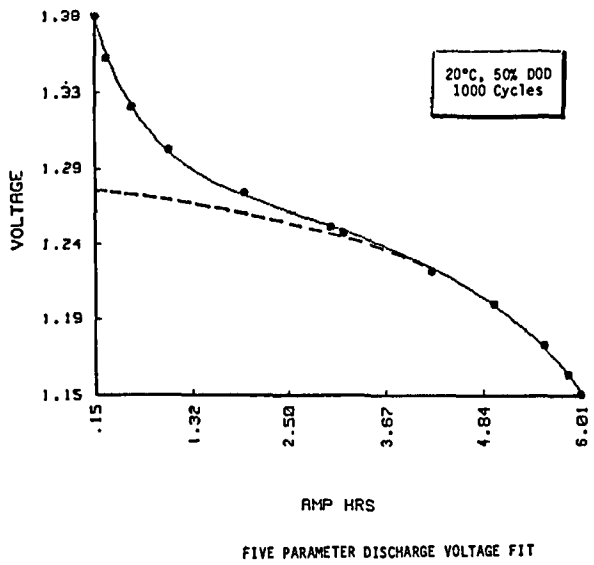
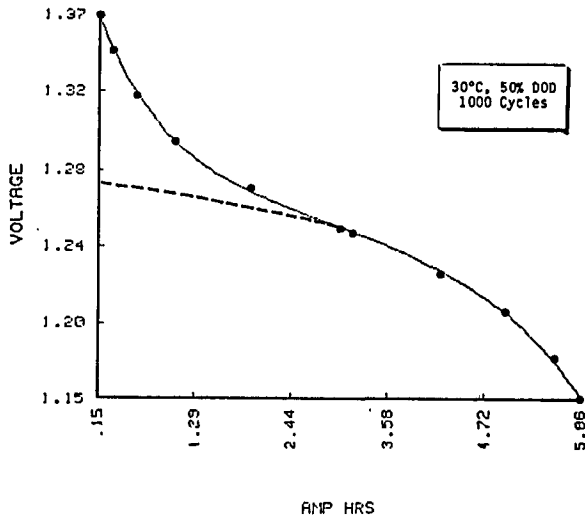
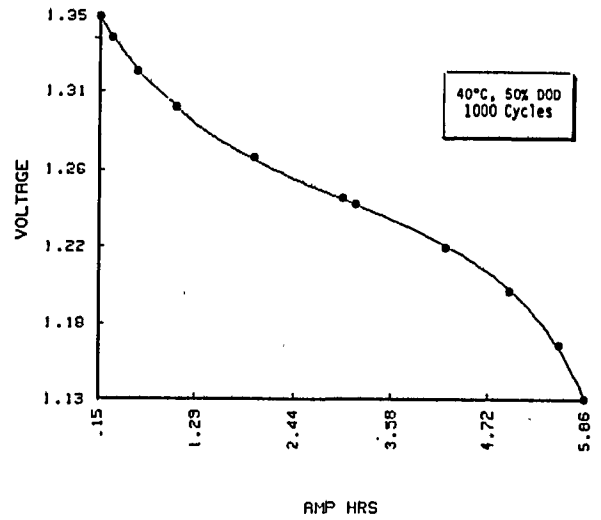

Figure 21-3



FIVE PARAMETER DISCHARGE VOLTAGE FIT

Figure 21-4



FIVE PARAMETER DISCHARGE VOLTAGE FIT

Figure 21-5

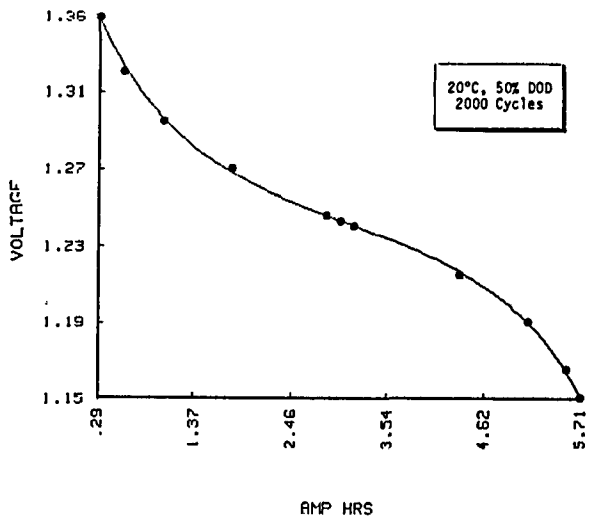

FIVE PARAMETER DISCHARGE VOLTAGE FIT

Figure 21-6

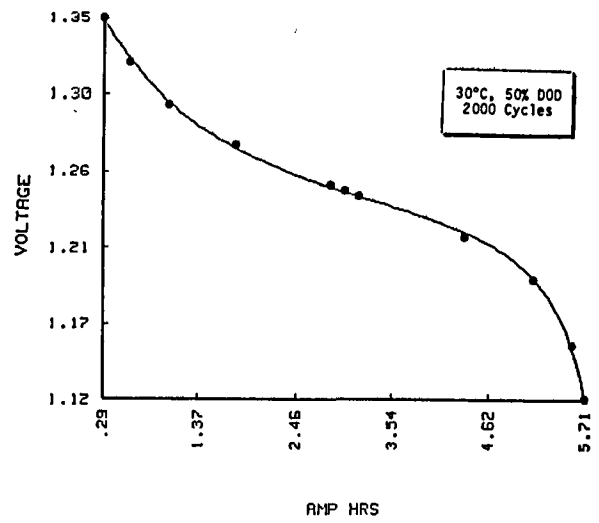

FIVE PARAMETER DISCHARGE VOLTAGE FIT

Figure 21-7

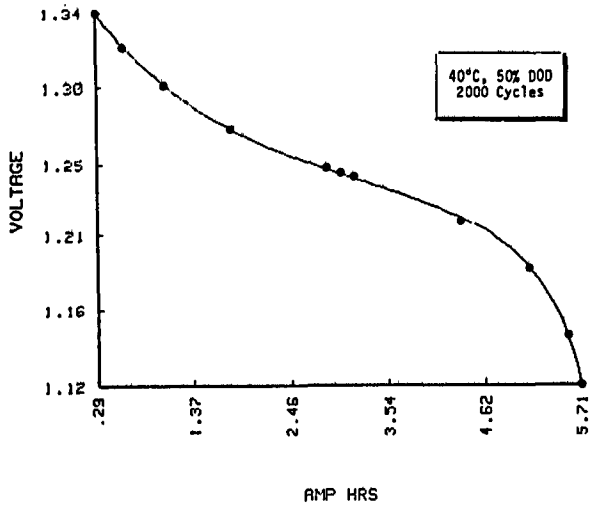

FIVE PARAMETER DISCHARGE VOLTAGE FIT

Figure 21-8

TABLE 1  
FIT PARAMETERS FOR 50% DOD CELLS AT  
THREE TEMP LEVELS: CYCLES 100-3200

DOD	TEMP	CYCLES	A	B	C	D	E
50	20	100	1.406	1.393	12.150	.1071	1.745
50	30	100	1.446	1.957	13.133	.0918	1.821
50	40	100	1.544	3.701	15.711	.0542	1.795
50	20	500	1.401	1.198	10.978	.1181	1.828
50	30	500	1.370	.8391	9.915	.0995	1.502
50	40	500	1.282	.1509	6.647	.1013	.756
50	20	1000	1.344	.5546	8.826	.1239	1.592
50	30	1000	1.317	.3611	8.079	.1113	1.227
50	40	1000	1.286	.2095	7.213	.1059	.769
50	20	1500	1.287	.1891	7.148	.1403	1.188
50	30	1500	1.295	.1868	6.806	.1159	1.214
50	40	1500	1.269	.1341	6.826	.1168	.737
50	20	2000	1.302	.2627	7.445	.1328	1.252
50	30	2000	1.252	.0665	6.223	.1287	.760
50	40	2000	1.260	.0937	6.361	.1193	.726
50	20	3200	1.281	.1736	7.100	.1414	1.134
50	30	3200	1.263	.0937	6.388	.1313	.968

Figure 21-9

TABLE 1a  
CORRELATION MATRIX

Temp.	Cycles	A	B	C	D	E	Temp.
1	1	1	1	1	1	1	1
	1	-.709	-.623	-.712	.724	-.559	Cycles
		1	.971	.992	-.790	.866	A
			1	.965	-.831	.749	B
				1	-.770	.858	C
					1	-.429	D
						1	E

Figure 21-10

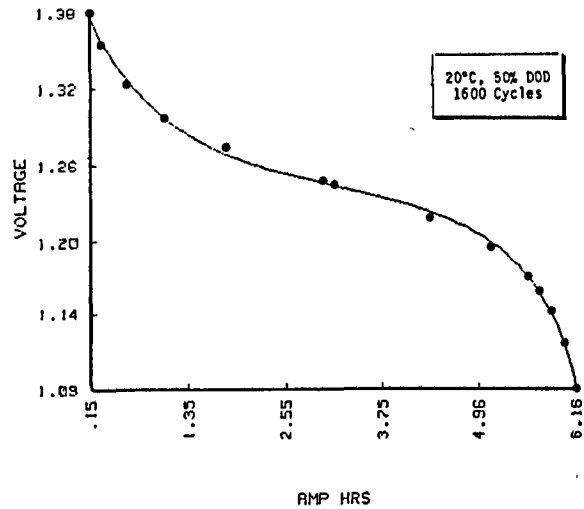

FIVE PARAMETER DISCHARGE VOLTAGE FIT  
(All 14 data points included)

Figure 21-11

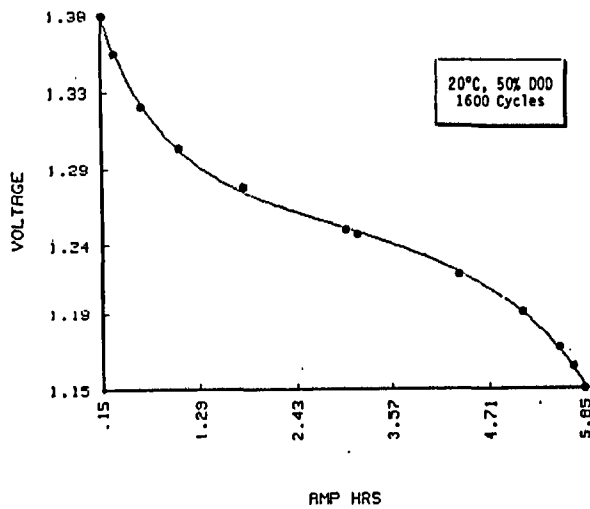

FIVE PARAMETER DISCHARGE VOLTAGE FIT  
(Final 2 of 14 data points omitted)

Figure 21-12

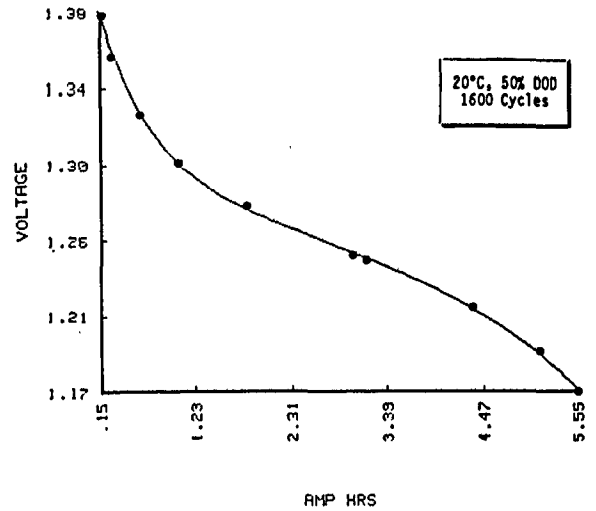

FIVE PARAMETER DISCHARGE VOLTAGE FIT  
(Final 4 of 14 data points omitted)

Figure 21-13

TABLE 2

EFFECT ON FIT PARAMETERS OF VARYING THE NUMBER  
OF DATA POINTS ENTERING THE REGRESSION  
(50% DOD; 20°C, 30°C, 40°C; 1600 CYCLES)

TEMP °	NUMBER OF DATA POINTS ENTERED →	14 POINTS	12 POINTS	10 POINTS
20°C	PARAMETER A	1.27	1.31	1.36
	PARAMETER B	.14	.33	.74
	PARAMETER C	6.90	7.84	9.48
	PARAMETER D	.14	.13	.12
	PARAMETER E	1.06	1.35	1.59
30°C	PARAMETER A	1.28	1.26	1.31
	PARAMETER B	.14	.09	.37
	PARAMETER C	6.79	6.50	8.11
	PARAMETER D	.11	.12	.10
	PARAMETER E	1.05	.86	1.24
40°C	PARAMETER A	1.30		1.28
	PARAMETER B	.22		.16
	PARAMETER C	6.92		6.79
	PARAMETER D	.10		.11
	PARAMETER E	1.09		.84

Figure 21-14

TABLE 3

FIVE PARAMETER DISCHARGE VOLTAGE FIT  
(Final 6 of 14 data points omitted)

20°C, 50% DOD  
1600 Cycles

ITERATION	ESTIMATED PARAMETER VALUES				S.S. RESIDUALS
	PARAMETER A	PARAMETER B	PARAMETER C	PARAMETER D	
0	1.26000	.09000	6.50000	.12000	.0013435
1	1.26524	.16245	7.00472	.13559	.0002760
2	1.29892	.24364	7.52820	.13420	.0001055
3	1.30906	.30644	7.60104	.13190	.0000444
4	1.31656	.35581	8.01536	.13024	.0000321
5	1.32234	.39650	8.10994	.12903	.0000276
6	1.32697	.43009	8.33208	.12810	.0000252
7	1.33079	.46042	8.45214	.12735	.0000236
8	1.33401	.48612	8.55438	.12674	.0000226
9	1.33677	.50870	8.64258	.12623	.0000219
10	1.33915	.52870	8.71948	.12580	.0000213
11	1.34124	.54654	8.78710	.12544	.0000209
12	1.34308	.56255	8.84701	.12512	.0000206
13	1.34471	.57697	8.90041	.12484	.0000203
14	1.34793	.63899	9.13021	.12363	.0000203
15	1.35854	.70562	9.36091	.12258	.0000199
16	1.36120	.73435	9.45217	.12223	.0000192
17	1.36209	.74278	9.47901	.12213	.0000191

PARAMETER E

Figure 21-15

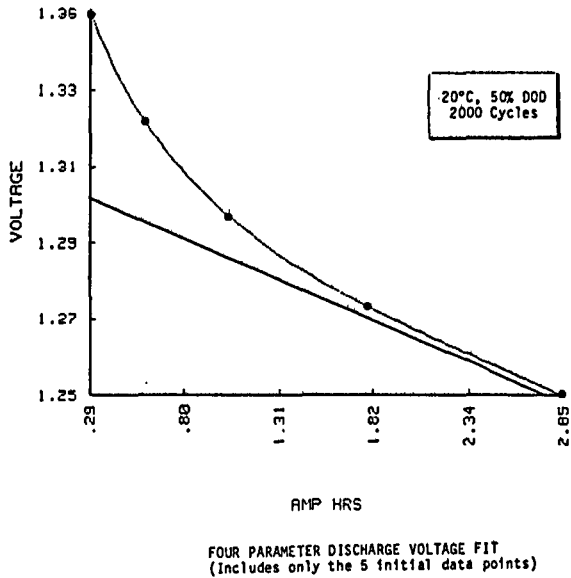

Figure 21-16

TABLE 4

FOUR PARAMETER FIT OF VOLTAGE DISCHARGE  
CURVES AT 2000 and 3200 CYCLES (50% DOD)

TEMP	TIME ON TEST	2000 CYCLES	3200 CYCLES
20°C	PARAMETER a	1.310	1.310
	PARAMETER m	.0215	.0226
	PARAMETER D	.0936	.0994
	PARAMETER E	1.990	2.239
30°C	PARAMETER a	1.306	1.300
	PARAMETER m	.0206	.0198
	PARAMETER D	.0787	.0852
	PARAMETER E	1.883	1.732
40°C	PARAMETER a	1.282	1.293
	PARAMETER m	.0134	.0154
	PARAMETER D	.0850	.0836
	PARAMETER E	1.025	1.334

Figure 21-17



**Page intentionally left blank**

## NiCd CELL REVERSALS DURING RECONDITIONING

W. Hwang

Aerospace Corp.

I'd like to describe to you today the results of some ground tests that we've been doing where we have had 15 reconditioning cycles on a battery. Some of you have heard partial results from this at the last IECEC. We'll give you a look at some of the rest of the data today.

The battery that we're using is a 15 amp-hour rated G.E. battery used in the GPS program. At the beginning of our 20-month test it had an activation life of 54 months.

(Figure 22-1)

Deep discharge reconditioning is being considered, so one of the questions that came up was, well, what happens if you're going to reverse some of the cells and what happens to hydrogen production. So we're interested in taking a look to see if you produce hydrogen, how much of it is produced and what happens to it later. What about hydrogen removal; and we wanted to take a look to see if we can see any differences in performances due to these reversals during reconditioning.

(Figure 22-2)

We selected four of the 16 cells out of this battery. We fitted them with pressure transducers and those were the four cells that we've reversed. We also took some pains to try to prepare the cells and the battery in a standard state before and after each one of these reversal reconditioning cycles. The next vugraph will tell you a little bit more about that.

After we prepared the standard state we charged it back up. Then we removed capacity out of the four selected cells. Then we start reversing them, either at C/100 or the C/300 rate. We take a look at the pressure and watch the hydrogen buildup. Also after the reversal period we open circuit the battery and take a look at the hydrogen disappearance upon open circuit.

On two of the reversal periods we also took a look at the impedance of the four cells that go into reversal. We're interested in impedance at low frequencies. We're looking at the range of one hertz to about 10 to the 4th hertz, and this is the region where we've noticed changes in impedance due to electrochemical processes actually in the cell. We used a little different technique than what was described this morning. We have a small perturbation technique. We have essentially a constant current discharge over short periods of time. You have a small step function in that constant current and you watch the voltage response to that perturbation.

(Figure 22-3)

This is the standard procedure that I just mentioned. We go through the cycling procedure which includes individual cell reconditioning. This lasts at least 24 hours and sometimes longer. We repeat these cycles until we get the capacities to agree fairly well.

On our reversal procedure, after we get the standard state we charge it back up. We'll remove anywhere from one to seven amp-hours capacities from those four cells, and then we start the reconditioning discharge. In order to speed the tests up we do a power discharge first until the lowest cell, which happens to be one of the four we took the capacity out of, reaches .9 volt. Then at that point we switch over to our C/100 or C/300 rate, just put in a resistor across the whole battery, and we continue to monitor until one of the other 12 cells reaches .9 volt.

A quick comment on why we used .9 volt here. We found, during this period anyway, that when our lowest cell reached .9 volt the average cell voltage was about 1.1 volt and we wanted to stop the test under this criterion.

(Figure 22-4)

This is the typical result we get. This is a C/300 discharge. This was for cell number one. This was our third reversal cycle.

Let me apologize for the units on the hydrogen pressure here. That's kilopascals. If you divide these numbers here by seven you'll get the pressure in psi. In

other words, this hydrogen peak right around here is around 22 psi.

If you take a look at this curve there are about three regions that you can discern in this pressure curve. Right toward the beginning here there is an induction period where there is very little hydrogen production. Then there is a hydrogen production region where the hydrogen pressure is almost linear. Then there is a third region which we call the shorting region, in this case, where you peak in hydrogen pressure and actually you start decreasing hydrogen pressure here slightly.

You take a look at the cell voltages at this time; typically during the induction period you see a very rapid decrease in voltage. It's sort of a spike a great deal of the time. You go to about 70 to 90 millivolts negative. In your hydrogen production region your voltages are more stable. You usually have a gradual decline in this region. Then in the shorting region where the pressure tails off and actually peaks you have voltage that's consistent with formation of internal shorts inside the cell. This is this slow short formation. What you see is that the voltage rises toward zero gradually.

(Figure 22-5)

This is the very recent data that we just completed, our 15th reversal. So this is fresh out of the lab. This is again cell one at the C/300 rate for the 15th reversal. This is the impedance data that we have. This is the resistive component. Let me make a correction here. This is the negative of the reactive component on this axis. So we're actually taking a look at the capacitive plane here.

The solid line is the spectra that we get at two-tenths amp-hours of reversal. And you really don't have much of a chance to form a great deal of this internal short yet. After four and a half amp-hours you form a relatively decent short, and you'll notice the large qualitative difference there.

(Figure 22-6)

These are the peak pressures that we've reached in cell one. In our first reversal cycle we actually didn't

get a peak pressure. At that time we only took one amp-hour capacity out before starting the test. That wasn't sufficient, and so the pressure was still rising at that time. There was no shorting behavior on the first one.

We got a little bit wiser after that and we took anywhere from three to seven amp-hours out afterwards on the rest of these tests. And on the second reversal cycle here we did see a peaking in hydrogen pressure. We did see what we considered to be the internal shorting behavior. This corresponds to 140 psi.

A couple of things to note here is that at your lower rates, if you take a look at tests two, three and four, -- the lower rates give you lower peak pressures. Again down here 13, 14 and 15, the lower rates are the ones that give you lower peak pressures.

Another thing to note is that your pressures are much higher during your first reversal. This is the first reversal. It's much higher here. If you take a look at a comparable rate -- this is actually the third, fourth and fifth reversal -- these are lower pressures. And, again, way down here on the 14th reversal, again a comparable rate, low pressures.

You can see this trend if you take a look at the second reversal. This is C/300. Here it's 156. And then these are the rest. So the two phenomena we have noticed here are the lower peak pressure with lower rates and also that as you have more reversals, or at least after the first few, lower peak pressures as well.

This is consistent with the picture that what happens is when you form these internal shorts you have a network that bridges from the positive to the negative electrode. Fortunately we've been able to reverse that process, and upon recharge all the shorts have been broken each time.

Now when you break these shorts you don't necessarily destroy the whole network. You've just broken the network in certain parts so that the next time you come around into reversal you've already got a head start in the short formation. So what you're liable to have is lower pressures here.

This brings up one of the questions about this picture, however, that if you do have a partial network remaining will that contribute to the formation of hard shorts. And that's a question that we really don't have an answer to.

We also took a look at the hydrogen pressures after the reversal in open circuit conditions. We found that the hydrogen removal was first order in hydrogen concentration. Half-lives are on the order of 4 to 14 days. There's a reasonable range there.

These were run at -- all this data and most of the data that are not shown -- these tests were run at ten degrees. At 25 degrees the hydrogen removal rate was about a factor of two higher roughly. You could calculate an activation energy on the order of ten cal. That activation energy can differ from one type of cell to another, by the way.

(Figure 22-7)

This is the peak pressure. It's for the other three cells that went into reversal. The same type phenomena on test number one, none of these shorted, so that none of these actually are peak pressures.

On test number two we actually peaked out on our pressure transducer here, so we're not sure what that final pressure was. It's in excess of 100 psi.

We note the same type behavior on the first reversal. The peak pressure is fairly high. We went back to the C/100 rate on the 14th reconditioning, which was the 13th reversal, and the pressures are much lower here.

Again the C/300 rates give you lower peak pressures.

One thing to note here as well is test number six.

It has an anomaly here. We actually have higher peak pressures than the ones before and afterwards. We had a computer malfunction right after test number five and just before test number six. And because of that malfunction we feel that we didn't really get back to the

standard state that we talked about toward the beginning.

This is one of the things that I would like to point out here, that if you actually just have these cells or batteries in a somewhat different condition these numbers can turn out to be different. I think the major trends and features that we've seen we don't expect to change. But the immediate history of the cell can influence the actual pressures that you'll have here.

(Figure 22-8)

These are the capacities. We started out with about 21. That's sort of what we wound up with. This was over a 20-month duration, so that we haven't seen any loss in capacities. This is where we missed the data from the computer.

The other thing to note here that's not in the vugraph is that on each one of these -- except for this one where we don't have the data -- after about three or four of our standard cycles, which included individual cell reconditioning, that the lowest cell was not one of the ones that was reversed, so that, you know, we really can't tell a difference even from that point of view.

(Figure 22-9)

What we've seen is that at rates such as C/300 for these cells that we do have a limit to the hydrogen production because of the short formation, and we've had no problems in reversing these shorts. Upon recharge the shorts break. In fact they'll even break if you just open circuit it.

For instance, after the 15th reversal, the latest one we just finished, we open circuited it for 24 hours, and at the end of 24 hours the lowest cell reading was 1.14 volts.

Our tests by no means can substitute for a real time life test. But during these 20 months we have seen no degradation in performance of these cells.

Thank you. /

## DISCUSSION

SEIGER (Seiger Associates): When you have a pressure rise rate can you compare that pressure rise to the theoretical current, to the theoretical rise?

HWANG: It's about 70 or 80 percent.

SEIGER: Does it change any as you keep going along, as you age these and go to each cycle, each reversal cycle?

HWANG: We can't tell that from the first few reversals. What happens is toward the end there the pressure rise was so small that it was really hard to come up with a slope on that. But if you try to come up with the linear portion of the curve it gets to be less.

PICKETT (Hughes Aircraft): Have you tried any other currents other than the C/100 and C/300 that you've indicated there?

HWANG: No, we haven't. The C/300 is what was being considered, and we did the C/100 to see what would happen so we could be a little bit on the conservative side.

PICKETT: You indicated that all the shorts were reversible. You never saw a case where you had a short that become permanent, is that right?

HWANG: That's correct.

HALL (NOAA): You mentioned removing capacity. Exactly how was this done? I'm not familiar with the term.

HWANG: Actually there were some sense leads from each one of the cells. So what we did was just put a resistor across the sense leads related to each one of the four selected cells.

HALL: Thank you.

BADCOCK (Aerospace): Just a comment on your question, Dave. We also did a standard short test where we shorted cells for I think 72 hours and then allowed them to stand open circuit. And within 24 hours the voltages were



all above 1.15 volts.

HWANG: They were actually above 1.16.

LURIE (TRW): Did you ever take any of these cells and reverse them for longer periods of time than indicated to watch the pressure profile?

HWANG: No, not these. This was in a battery configuration. We didn't really want to do that. We have done things like that with individual cells, but not this type.

LURIE: Would you comment on the fact that we have seen curves where the pressure peaked but then came down and the slope down approximated the slope coming up? And if in fact we're looking at a mechanism wherein the hydrogen generation stops or is reduced because of shunting of the current, how do you explain the down slope?

HWANG: Well, I think that one of the things is that if you take a look at different cells I think you'll have different slopes. I don't know if I can come up with an explanation for why those particular results were that way. I'm not that familiar with those results.

BADCOCK (Aerospace): We didn't see that, Chuck. They were always pretty slow coming back down. Faster with a short circuit or -- I don't even know whether it's short circuited or with current flow than open circuit, but they were considerably slower than the rate with which they rose at all times.

RITTERMAN (TRW): I brought a vugraph that I'd like to show which is part of a presentation I gave in 1977 regarding the effect of hydrogen drop, hydrogen pressure drop while a cell is being -- while a battery is being reconditioned. So, if I may, I'd like to show it.

BAER: Okay.

(Figure 22-10)

RITTERMAN: This was described in 1977. We used a 13 cell battery and we had one of the cells predischarged, so when we put a shorting resistor on the one cell went into

reverse and we monitored pressure and we monitored the overdischarge current.

And as you can see, the hydrogen pressure hit a maximum and then as the overdischarge current went down the pressure started to drop. And there was nothing but hydrogen in the cell. And this demonstrated that the hydrogen recombination obviously, as Chuck pointed out, pressure drop cannot occur due to a short. So there was hydrogen recombination going on. And I calculated the hydrogen recombination current, the dotted line that's shown over there.

And this occurred for something like 10 or 15 seasons that we repeated this phenomenon. And I have other examples, but this is the only one I have here.

HWANG: Just a reiteration: We haven't really seen that phenomenon. We've also done some tests with other cells, not necessarily these, where we have reasonably good evidence that in the cells that we've tested there is really internal shorting occurring.

HARKNESS (Crane): One question:

We have reversed cells where our criteria was to discharge at the discharge rate and they were 20 ampere-hour cells and had two years' life on them, and the discharge rate was 16 amps, and we would want to discharge to -1.5 volts.

Now on the curves you've shown and the one that Paul just showed we have seen both types of curves. But in each case when we would stop the discharge whenever we would reach our criteria we would never have a short and the cell would come back and charge again. We would never have a hard short.

HWANG: Well, we've never seen hard shorts either.

HARKNESS: But we have seen both types of curves, the one Paul showed and the one you showed.

HWANG: I think that just shows that you have to be a little careful about applying these data to different type cells.

LURIE (TRW): Would you describe the negative electrode in the cells you're testing?

HWANG: I'm not sure I understand.

LURIE: Are they teflonated?

HWANG: They're not teflonated, they're silver.

## Objectives

- PERFORM ACCELERATED BATTERY TEST WITH 15 PERIODS OF CELL REVERSALS DURING RECONDITIONING
- EXAMINE NATURE AND EXTENT OF HYDROGEN GENERATION
- DETERMINE EFFECTS OF REVERSALS ON BATTERY PERFORMANCE

Figure 22-1

## Reversal Tests

- FOUR OUT OF 16 CELLS SELECTED FOR REVERSAL AND FITTED WITH PRESSURE TRANSDUCERS
- BATTERY PREPARED BY STANDARD PROCEDURE BEFORE AND AFTER EACH REVERSAL PERIOD
- PARTIAL REMOVAL OF CAPACITY FROM 4 SELECTED CELLS
- FOUR CELLS REVERSED AT C/100 OR C/300 RATE
- HYDROGEN RECOMBINATION DURING OPEN CIRCUIT PERIOD
- IMPEDANCE MEASUREMENTS ON 4 SELECTED CELLS DURING TWO REVERSAL PERIODS

Figure 22-2

## Test Procedures

- STANDARD PREPARATION PROCEDURE
  - CYCLE: C/10 CHARGE FOR 16 HOURS  
C/700 TRICKLE CHARGE FOR 5 HOURS  
C/2 DISCHARGE UNTIL LOWEST CELL REACHED 0.9V  
CELL RECONDITIONING (1.3Ω) UNTIL ALL CELLS  $\leq 25$  mV
  - REPEAT CYCLES UNTIL C/2 CAPACITIES AGREE TO  $\leq 0.3$  Ah
- REVERSAL PROCEDURE:
  - C/10 CHARGE FOR 16 HOURS
  - C/700 TRICKLE CHARGE FOR 5 HOURS
  - REMOVE 1-7 Ah CAPACITY FROM 4 SELECTED CELLS ONLY
  - C/2 BATTERY DISCHARGE UNTIL LOWEST CELL REACHED 0.9V
  - BATTERY RECONDITIONING AT C/100 OR C/300 RATE UNTIL LOWEST OF 12 UNSELECTED CELLS REACHED 0.9V

Figure 22-3

# Impedance of Cell 1, Reversal Cycle 15 at C / 300 Rate

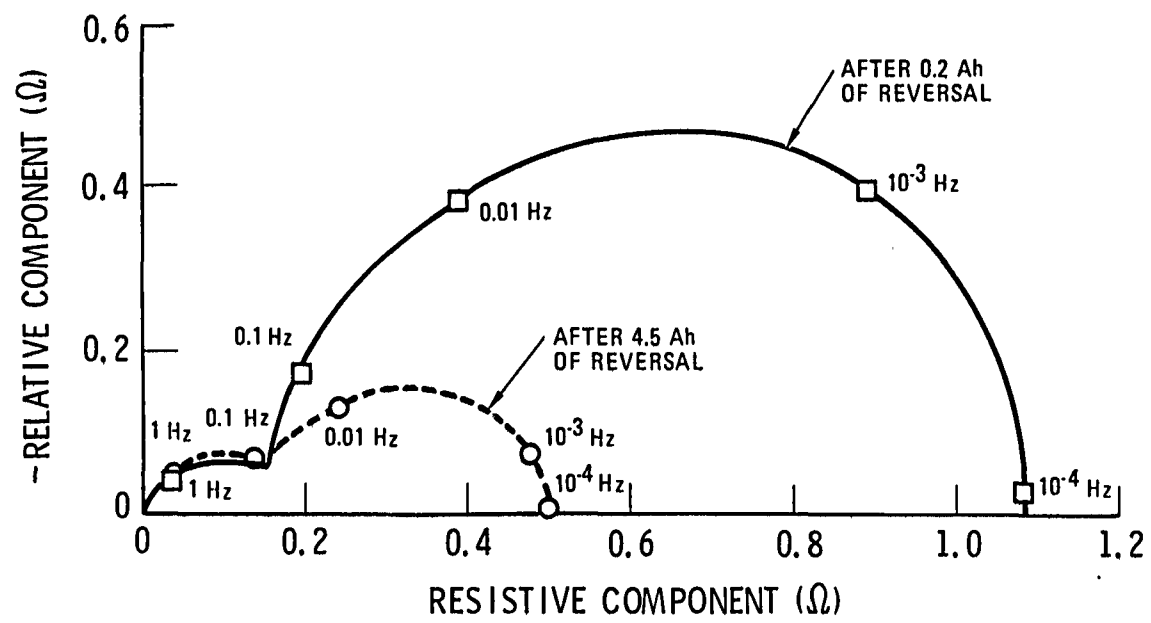

Figure 22-4

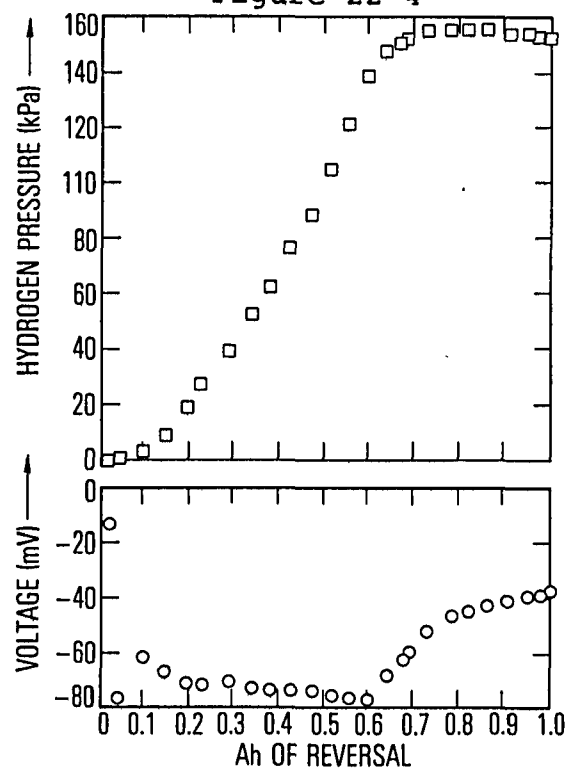

Figure 22-5

**Peak Hydrogen Pressures, Cell 1**

<u>TEST No.</u>	<u>CURRENT</u>	<u>PRESSURE (kPa)</u>
1	C/100	>430
2	C/100	1010
3	C/300	156
4	C/100	263
5	C/100	203
6	C/100	231
7	C/300	34
8	C/300	22
9	C/300	42
10	C/300	21
11	C/300	23
12	C/300	48
13	C/300	19
14	C/100	89
15	C/300	22

Figure 22-6

**Peak Hydrogen Pressures, Cells 5, 12, 14**

<u>TEST No.</u>	<u>CELL 5 PRESSURE (kPa)</u>	<u>CELL 12 PRESSURE (kPa)</u>	<u>CELL 14 PRESSURE (kPa)</u>
1 <sup>o</sup>	>430	>140	>140
2 <sup>o</sup>	762	1140	>710
3	178	84	114
4	45	35	42
5	25	19	58
6	160	110	147
7	65	66	86
8	24	19	29
9	46	26	38
10	27	26	25
11	23	26	24
12	41	39	30
13	12	25	20
14 <sup>o</sup>	27	77	49
15	23	39	22

<sup>o</sup>C/100 rate, all others at C/300 rate

Figure 22-7

**Capacities After Reversals**

<u>REVERSAL No.</u>	<u>CHARGE (Ah)</u>	<u>DISCHARGE (Ah)</u>
BEFORE 1	25.2	21.0
1	25.2	21.1
2	24.4	20.7
3	24.8	20.8
4	25.5	21.2
5	N.R.	N.R.
6	24.8	21.1
7	26.1	21.1
8	25.4	21.2
9	24.9	21.3
10	25.4	21.3
11	25.6	21.4
12	25.6	21.2
13	25.3	21.2
14	25.2	21.2
15	25.2	21.3

Figure 22-8

**Conclusions**

- H<sub>2</sub> PRESSURE DURING LOW RATE RECONDITIONING LIMITED BY INTERNAL SHORTS
- SHORTS WERE REVERSIBLE UPON RECHARGE
- NO SHORT TERM DEGRADATION IN BATTERY PERFORMANCE

Figure 22-9

**TRW**

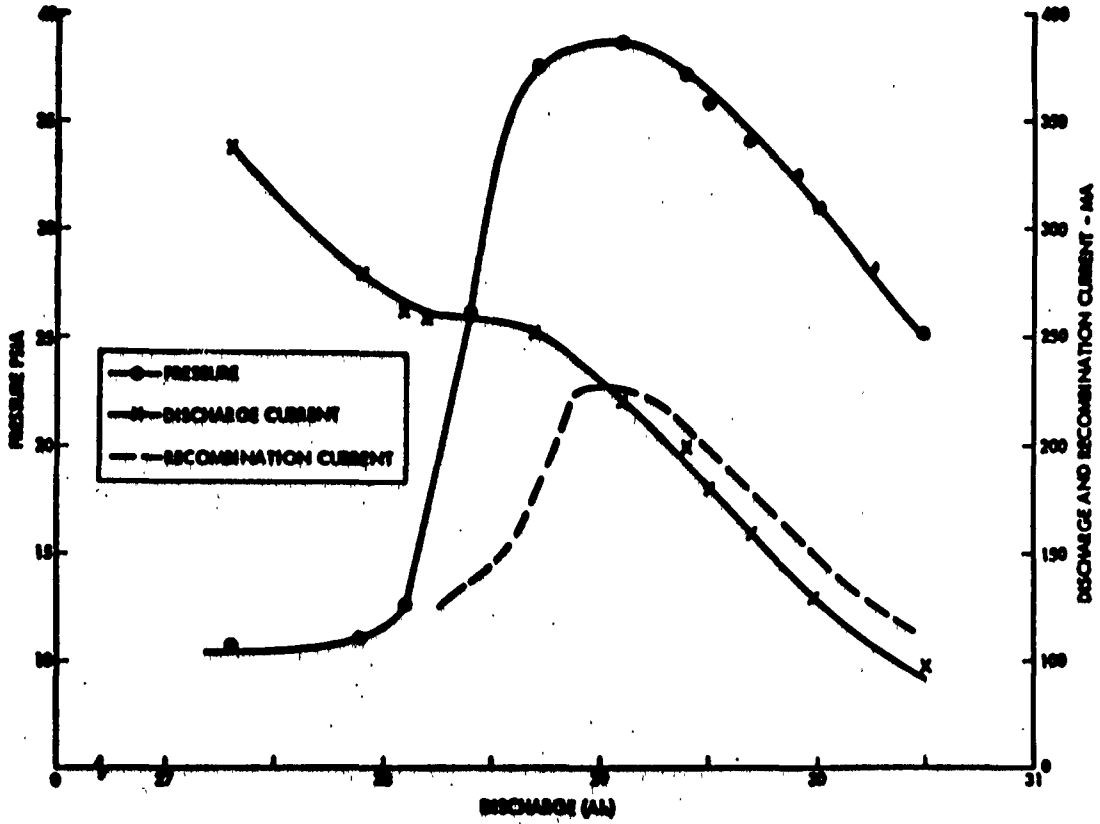

Figure 22-10

# DAO-C END-OF-MISSION POWER SUBSYSTEM ENGINEERING EVALUATION

M. Tasevoli

GSFC

(Figure 23-1 )

The DAO missions starting in the late '60s and spanning over a ten-year mission life were highly successful. The power systems for DAO-B and DAO-C performed flawlessly, and were deactivated after more than five and eight years of mission life.

The end-of-mission power subsystem tests on the battery and the solar array provided a real-time degradation analysis for those two components.

In addition to the array and the battery, analysis of the power regulator unit as a maximum power tracker was also performed in order to gain some understanding of a peak power tracker operation in a degraded power system.

because of the time limitation, I'd like to limit my discussion to the battery tests that were performed.

(Figure 23-2 )

This is a simplified block diagram of the DAO power system. It consists of a main array feeding power to a power regulator unit which conditions the array power to limit both the recharge and the overcharge in the batteries. An auxiliary array feeds power directly to the loads through the unregulated bus.

In addition there are three nickel-cadmium batteries, 20 amp-hours, which are operated in parallel.

(Figure 23-3 )

In one word, the battery performance on both these missions was excellent.

For DAO-C, which was recently deactivated after approximately 100 months of orbit and 44-some-odd-thousand orbits, the battery voltage levels were varied between 1 to



2 during normal operation, and 3 and 4 for the case of low solar power.

The depth of discharge was typically 15 to 17 percent, with a peak of approximately 20 percent depth of discharge per battery.

The average temperature over the entire life was approximately 10 degrees C.

The percent recharge was normally between 103 and 105 percent.

The resolution for both the current and the voltage sharing was well within the telemetry limits. The currents during the mission really varied no more than .1 amp per battery, and battery divergence was between 10 and 15 millivolts.

The DAD power system did have an undervoltage trip. For the first six months it was set at 26.4 volts and was reduced in steps down to 23.3, and for a time the power system operated without any undervoltage limits.

(Figure 23-4 )

This table details the design summary for the DAD-C batteries. The cells were 20 amp-hour cells manufactured by Gulton. Each battery was 22 series cells, three batteries per spacecraft.

The batteries were assembled essentially in two packs and installed in separate thermal bays. The design operating life of the battery was one year in low earth orbit and somewhere between 15 and 20 percent DOD.

The temperatures remained between 5 and 10 degrees with an overprotection cutoff of 35 degrees.

The charge control utilized in both missions was an eight commandable voltage compensated -- commandable levels, and as I mentioned before, the charging was in parallel.

(Figure 23-5 )

This is a quick summary of the cell features for this mission. Again, the cell manufacturer was Gulton. The nominal cell capacity was 20 amp-hours. A Pellon separator 2505 was used. Electrolyte, 31 percent KOH to an amount of 66 c.c.'s.

The precharge was established using the oxygen vent method and a typical value for precharge was 4.6 ampere-hours.

The following is a list of plate design features, and I would just highlight the fact that the plate thickness for this cell is thicker than the thickness that we're presently using on a standard GE cell.

(Figure 23-6 )

The battery tests were the last tests to be performed of all the subsystem tests that were done. The purpose of the test was to determine the end of mission capacity on all three batteries.

The method used was to orientate the spacecraft in such a manner as to discharge the battery through the entire sunlight portion.

We started off here with a fully charged battery. The first 35 minutes is the discharge profile during a normal eclipse period.

Following the eclipse, the batteries were discharging at approximately 1.5 amps for the entire sunlit portion.

Coming out of the sunlight, the batteries discharged at the normal spacecraft loads at eclipse.

(Figure 23-7 )

The batteries were allowed to charge up for approximately 48 hours, and the same test was performed, this time with additional loads and with a different spacecraft orientation.

You can see the profile is quite similar. The voltage profile shows the voltages for all three batteries.

are well within telemetry resolution.

The current is peaking close to about seven amps during the eclipse period, and approximately two amps during the sunlight period.

Of particular note here, toward the end of this test, even with relatively steady battery discharge current, there seems to be a small plateau here approximately less than 23 volts where the voltage seems to have flattened off.

(Figure 23-8 )

What I attempted to do here was to compare the two profiles as a function of the discharge ampere-hours. And, in comparison, I've used some test results that were performed on some flight cells from the OAO program.

There were two such packs. Pack 4-C, which I'm showing here, were cells from a preproduction lot. Pack 4-D, not shown here, are cells from the actual flight lot. Pack 4-D cycled for over 22,000 cycles with no cell failures. Here Pack 4-C went in excess of 33,000 with no cell failures prior to discontinuing.

You'll notice the first test results plotted as a function of discharge ampere-hours here, and the results of the second discharge test.

These were the only tests that were scheduled on the battery.

(Figure 23-9 )

One of the main conclusions that came out of these two missions was the feasibility of operating high capacity nickel-cadmium batteries in parallel. In addition, some confirmation as to a second voltage plateau at approximately 1.03 volts per cell.

The degradation that was seen on this mission was in close agreement with the life cycle simulations -- the life cycle simulations forming an accurate data base for mathematical modeling of cell lifetime.

The last point which is still argued is that limited

preflight testing of flight batteries during spacecraft integration contributed to the trouble-free performance of the OAO batteries.

Thank you.

ORBITING ASTRONOMICAL OBSERVATORY (OAO-C)  
 END-OF-MISSION  
 POWER SUBSYSTEM EVALUATION

OBJECTIVES

- o DETERMINE SOLAR ARRAY AND BATTERY DEGRADATION
- o DETERMINE THE PERFORMANCE CHARACTERISTICS OF THE MAXIMUM ARRAY POWER TRACKER

Figure 23-1

OAO-C POWER SUBSYSTEM BLOCK DIAGRAM

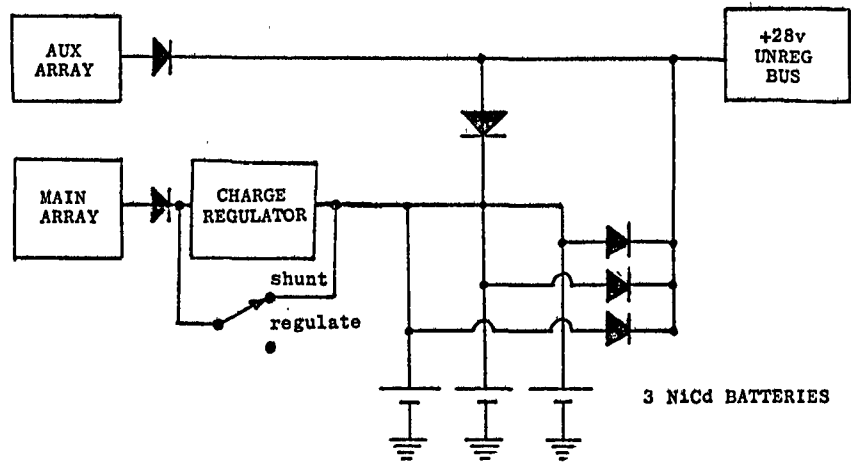

Figure 23-2

SUMMARY OF OAO-C BATTERY PERFORMANCE

OPERATING LIFE FEBRUARY 1981	100 MONTHS, 44,890 ORBITS
BVLS LEVELS USED	NORMAL OPERATION - 1 OR 2 LOW ARRAY POWER - 3 OR 4
TYPICAL DISCHARGE CAPACITY	2.8 TO 3.2 AH PER BATTERY 4.0 AH PEAK PER BATTERY
BATTERY TEMPERATURE	AVERAGE OF 10 C
RECHARGE RATIO	TYPICALLY - 105% MINIMUM - 103%
BATTERY CURRENT SHARING	WITHIN RESOLUTION OF TELEMETRY
BUS UNDERVOLTAGE SETTING	FIRST SIX MONTHS - 26.4 VOLTS INCREMENTALLY REDUCED TO 23.3 VOLTS

Figure 23-3

DAO-C BATTERY DESIGN SUMMARY

- 20 AH NICKEL-CADMIUM CELLS (GULTON)
- 22 SERIES CONNECTED CELLS PER BATTERY
- THREE BATTERIES PER SPACECRAFT
  - TWO MECHANICAL ASSEMBLIES
  - EACH ASSEMBLY CONTAINS 11 CELLS OF EACH BATTERY
  - BOTH ASSEMBLIES LOCATED IN ISOLATED THERMAL BAY
- OPERATING DESIGN LIFE 1 YEAR (NEAR EARTH)  
15 TO 20 PERCENT DOD
- TEMPERATURE 5 TO 10 C RANGE  
35 C THERMOSTATS
- CHARGE CONTROL 8 COMMANDABLE LEVELS  
TEMPERATURE COMPENSATED  
PARALLEL CHARGING
- UNDERVOLTAGE 26.4 VOLTS 1.2 VOLTS/CELL
- SPACECRAFT LAUNCHED AUGUST 1972

DAO-C NICKEL-CADMIUM CELL DESIGN FEATURES

CELL MANUFACTURER:	GULTON	
CELL CAPACITY:	20AH NOMINAL	
SEPARATOR:	PELLON 2505	
ELECTROLYTE:	31% KOH 66CC	
PRE-CHARGE:	O <sub>2</sub> VENT, 4.6AH	
	<u>POSITIVE</u>	<u>NEGATIVE</u>
NUMBER	9	10
AREA	0.91 DM <sup>2</sup>	0.91 DM <sup>2</sup>
THICKNESS	0.0345 IN	0.0309 IN
POROSITY	46.7%	66.5%
PLATE LOADING	16.1 GR/DM	16.95 GR/DM <sup>2</sup>
CAPACITY/AREA	4.12 AH/DM <sup>2</sup>	4.20 AH/DM <sup>2</sup>
FLOODED CAPACITY	27.7 AH	39.8 AH*
	*CAPACITY MEASURED TO -1.0V	

Figure 23-4

Figure 23-5

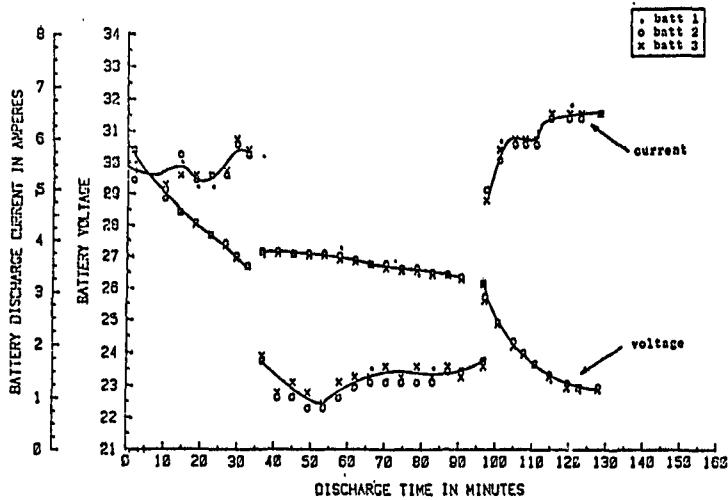

DAO-3 Battery Capacity Discharge Test 1.

Figure 23-6

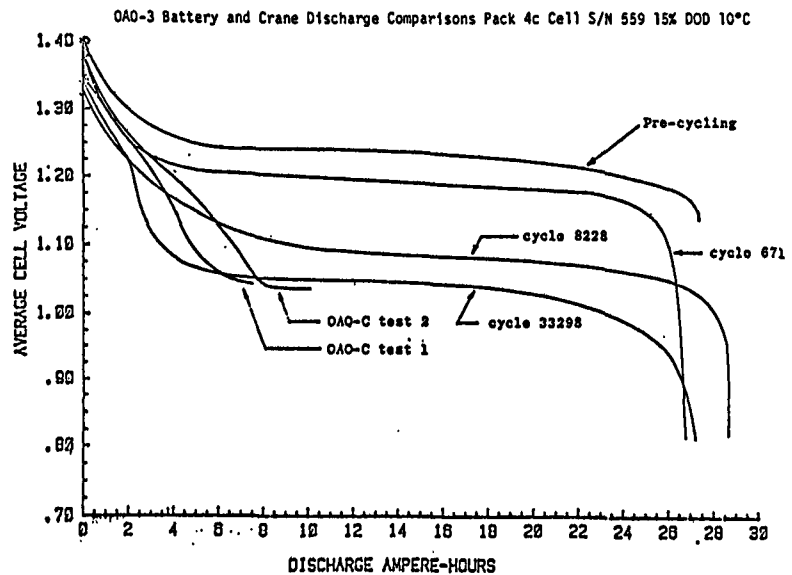
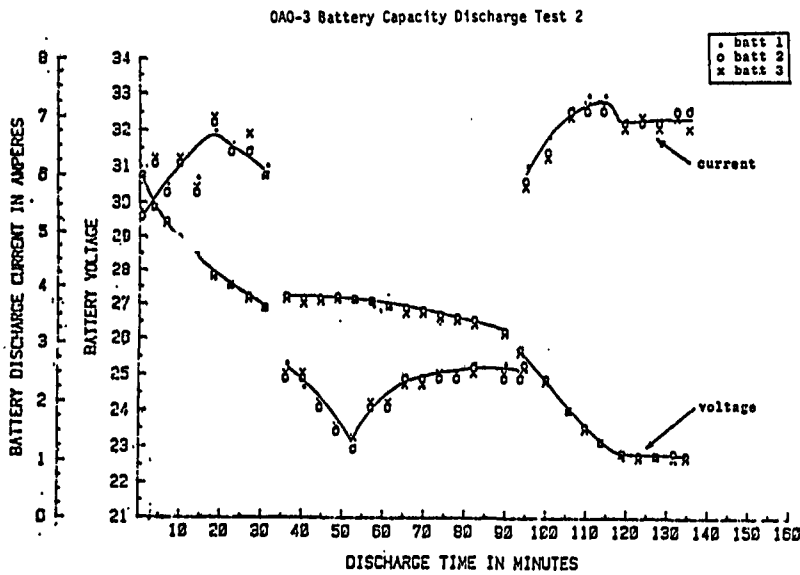

CONCLUSIONS OF OAO-C EOM BATTERY DISCHARGE TEST

- o CONFIRMED EXISTENCE OF SECOND VOLTAGE PLATEAU AT APPROXIMATELY 1.03 VOLTS PER CELL.
- o DEGRADED VOLTAGE CHARACTERISTICS ARE IN CLOSE AGREEMENT WITH LIFE CYCLE SIMULATIONS.
- o LIFE CYCLE SIMULATIONS FORM AN ACCURATE DATA BASE FOR MATHEMATICAL MODELING OF CELL LIFETIME.
- o LIMITED PRE-FLIGHT TESTING OF FLIGHT BATTERIES DURING SPACECRAFT INTEGRATION CONTRIBUTED TO TROUBLE-FREE BATTERY PERFORMANCE.

Figure 23-9

## DSCS III LIFE TEST PROGRESS REPORT

H. Thierfelder

GE

The General Electric Space Systems Division of Valley Forge is the prime contractor for the Defense Satellite Communication System, and we have designed and built the power system for this, and we have a life test going.

The DSCS III power system is an approximately 1,000 watt system. It's a direct energy transfer system with a regulated bus. The bus is 28 volts, plus or minus one percent.

The battery system is three batteries that are charged independently off the 28 volt bus and discharged through diodes, through redundant boost regulators back into the 28 volt bus.

The power system is very, very similar to the power system which we designed and built for the Japanese broadcast satellite which has been in orbit for over three years, and also it is very, very similar to the GPS Block 1 power system, and also to the GPS Block 2 power subsystem.

The program started in 1976, and in 1977 we presented a little report on the lightweight cell which we used in the batteries, 35 ampere-hour, nickel-cadmium cells, GE-designed.

Last year I presented a little report on the life test. Last year we had accomplished two eclipse periods. This year we have accomplished six eclipse periods, so I just want to give you an update.

One of the other things that you'll find probably of interest is that we do reconditioning until the cells reverse, and you'll see this as I go along.

(Figure 24-1 )

This is a photograph of a DSCS III flight battery. It is not the battery that is on the flight test.



but electrically it's identical. On the life test we do not have the heaters and we do not have the fancy side plates and end plates.

One point of interest here may be that the large holes that you might notice in the mounting lugs are due to the fact that the battery in the spacecraft is thermally isolated. The battery is thermally isolated from the spacecraft and thermal bushings are put in there to accomplish this.

(Figure 24-2 )

I showed this in 1977. This is one of the cells, a 35-ampere-hour cell, and the cell is encased in an aluminum retainer. This cell is being used not only now for DSCS but for the GPS Block 2 program.

(Figure 24-3 )

Just a little more detail on the cell itself. We have the stainless steel case, the aluminum retainer, and then the combination of aluminum retainer and the stainless steel cell case into which the cell itself was put.

(Figure 24-4 )

Now getting down to the life test itself, as I mentioned we've accomplished six eclipse periods, and this is a summary chart just made up of the overall results. The temperature that we're maintaining is 10 degrees Centigrade, and on charge, the battery temperature will go down to about 7 degrees. In fact, in the spacecraft, it will maintain about 7 degrees with the heaters, and on discharge it will peak up to about 13 degrees or thereabouts.

The minimum discharge voltage which occurs at Day Number 29 of the eclipse period is plotted here, and you see it going up and down because the odd-number eclipse periods are a little different than the even-number eclipse periods. The odd numbers have a deeper depth of discharge, and you'll see that on the next slide.

But the main point here of course is that there is no degradation at least in the six eclipse periods of three years in the end of discharge voltage.

In this power system we have a voltage-limited charge control; that is, the batteries will charge up to an average cell voltage which, at 10 degrees, I believe is 1.43 volts per cell, and then the current will taper down. And these are the end-of-charge currents. And the currents are quite low. At 300 millivolts we're down below a C/100 rate. So we're in that range where you're actually below 300 millivolts on the end-of-charge current.

Now if the charge current would become too low we can select a higher voltage limit. This is now on what we call Voltage Limit Number 2 in our system, which is the normal charge voltage for the battery.

(Figure 24-5 )

What I have done, I've brought the data for the last two eclipse periods, Eclipse Periods 5 and 6, and I thought maybe I could show them at the same time.

(Figure 24-6 )

The data is pretty much the same and I think I'll just run over it on one of them.

At the top we have the temperature and again, the low temperatures are the temperatures at end of charge, or during charge, and the higher temperatures are during discharge, and they are above and below the 10 degrees Centigrade.

The voltage limit, as I mentioned, is fixed by the test equipment at about 1.43 volts per cell. This is the average cell voltage at which we limit.

Now the current of course jumps around somewhat but is in that region between the 200 and 400 mils, the same as we see on the other chart.

Now maybe of greatest interest is the end of discharge average cell voltage at the bottom. Now I'll have to explain a little bit that we break up the 45-day eclipse periods into five different programs. Each eclipse is a 24-hour period. This is a synchronous orbit system, so for the first eight days of the 45 days, we have a 40-minute discharge, a 40 minute eclipse, and we're removing in the

odd-number eclipse periods 34 percent depth of discharge.

The depth of discharge is based on the 35 ampere-hour, the rated capacity.

During the next eight days we discharged for 60 minutes, or 54 percent, and then for 13 days it was at the maximum, a 72-minute eclipse at 62 percent depth of discharge. And then of course it goes back down again.

Now the end of discharge voltage is at its lowest when you get to that 29th day. This is Eclipse Period 5, and if you look at the other, you get exactly the same profile on each of these measured parameters.

(Figure 24-7 )

One of the things that I think is of greatest interest is the reconditioning after each eclipse period.

(Figure 24-8 )

The two discharge rates that Warren Hwang mentioned on his studies at Aerospace I think probably come from our program; that is, when we recondition the battery and there's a resistor across the entire battery, the 16-cell battery, this resistor is sized so that when the battery is fully charged, the battery will discharge at about the 100-hour rate. And the current here is about that. It's about 340 mils, so it's approximately the 100-hour rate, and the current is here.

Of course the battery voltage is up here.  
(Indicating.)

We also have pressure being recorded. Actually four of the 16 cells in the battery are equipped with both pressure gauges, which we have to read manually, and also pressure transducers. Pressure transducers are read out on the test equipment.

What we have plotted here is the highest of the pressure transducer readings, so there's not very much change in the pressures. They are in pounds per square inch, absolute. They're starting here at 30-some-odd pounds, and actually are going down during the discharge

because just previous to this the battery had been charged up. And then levels off.

The automatic safety feature that we have built into the system, which is in the spacecraft as well as in our test program, is that when the battery voltage drops to 18 volts during this reconditioning discharge, an additional resistor is switched into the line and there's a step function here where the discharge current will then drop from this approximately C/100 rate to approximately a C/300 rate.

So this is this big drop down on the current.

We have annotated on here where the first cell has reversed out here, and the first cell has reversed after we dropped to the C/300 rate.

Now the current of course continues to drop down as the battery voltage drops down.

The criterion that we've used for the end of reconditioning is when the battery voltage reaches one volt. You see of course that the current has pretty well stabilized in that area. The voltage has stabilized. The pressure has stabilized.

Now this is approximately a ten-day period.

The other graph over here is very, very similar. This was on Eclipse Period 6. By the way, it's Eclipse Period 6 but this is the ninth reconditioning cycle on this battery. The other was the eighth. They have done it 15 times at Aerospace. We have only done it so far nine times, but this test of course is scheduled to run for 20 eclipse periods. So I hope in 1964 I will report that the 20 eclipse periods are finished.

The capacity we found on discharge out to 18 volts on the sixth eclipse period was 38 ampere-hours, not very much difference on the fifth. It was 37 ampere-hours. There is no significant difference there.

(Figure 24-9 )

One other set of curves that I have here is the

data from Day 29, or in this case it was Day 20. Something happened to the computer data from Day 29 of the fifth, and I have it for the sixth eclipse period.

These are 72-minute eclipse periods but we've broken the 72 minutes down into a 60-minute period and a 12-minute period. On the odd number, like Eclipse Period 5, which is more severe than the even numbers, we first have a 12-minute discharge at 16.1 amps, and then we follow that continuously right up with a 60-minute discharge at the worst-case conditions when all the loads are on, and the current is 16.4 amps.

And we have here of course the voltage, temperature, current, and pressure.

One point of interest I guess is that in this charge control system we have we have a very low overcharge or C-to-D ratio. In this case we've taken out a total of 21.52 ampere-hours.

Then on the recharge we've put in 25.31 ampere-hours, or a C-to-D ratio of only 1.20. This is a very low C-to-D ratio for any batteries that are in synchronous orbit. And of course the reason for that is the taper charge of the current where they first have the constant current period of charge, and then it tapers off and we're winding up down at a charge current below the 100-hour rate.

(Figure 24-10 )

Again, Eclipse Period 6 is very similar where we have less depth of discharge. Both periods are 16.1 ampere-hours. Still it was run in two separate segments, and the final current again is below the 100-hour rate, and the C-to-D ratio was 1.26.

That's the status of where we are.

I have one other Vugraph here, which simply shows the data. All the data is put on magnetic tape and then we can put it into a computer program and have the curves plotted out. At the same time we have digital data summarized in a form such as this.

(Figure 24-11 )

This is a 60-minute discharge and each one of the cells is read out, the average cell voltage, and the current and the accumulated ampere-hours, and the temperatures, and the average pressure. Here we have two pressure transducers readings, and the average of the two. What we plotted out in the plots was the highest pressure reading.

GASTON (RCA): How do these data compare with the real flight data?

THIERFELDER: We do not have any DSCS batteries in flight. Some year now we hope we will.

GASTON: I wasn't aware of that.

THIERFELDER: The program has been slightly delayed as far as the flights go.

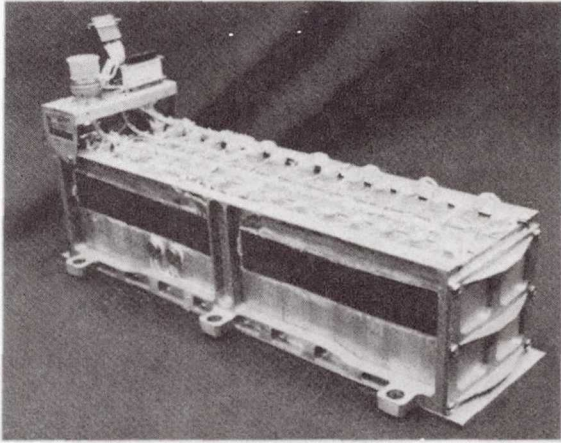

Figure 24-1

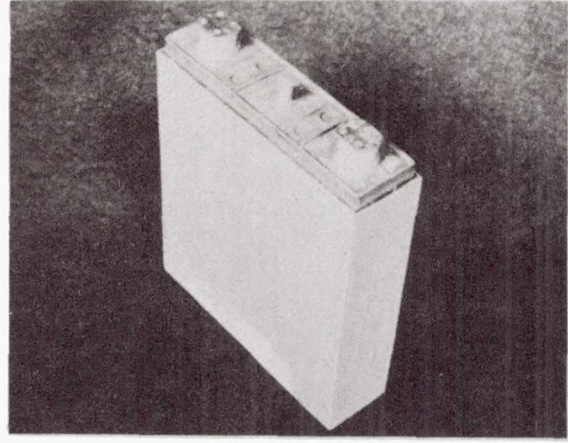

Figure 24-2

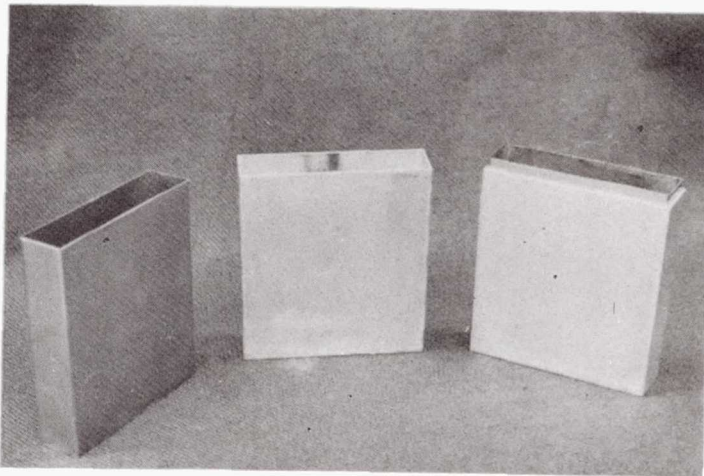

Figure 24-3

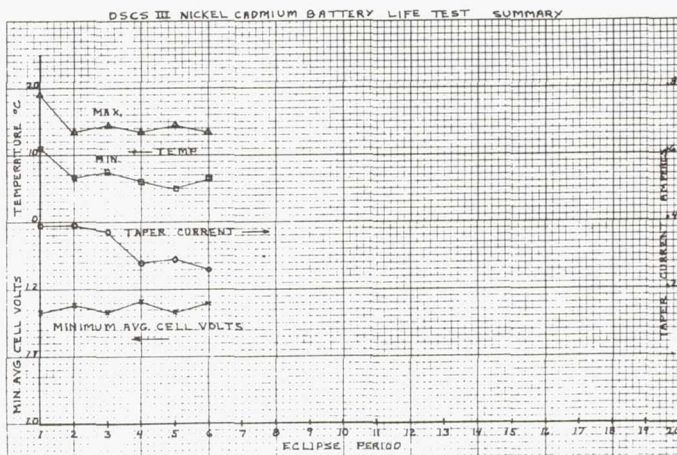

Figure 24-4

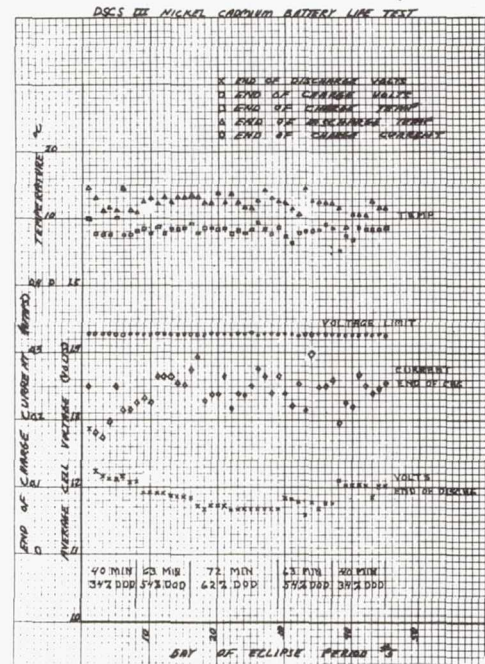

Figure 24-5



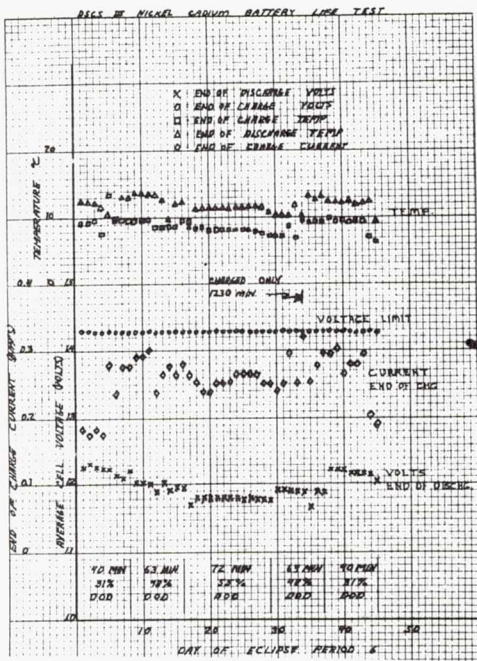

Figure 24-6

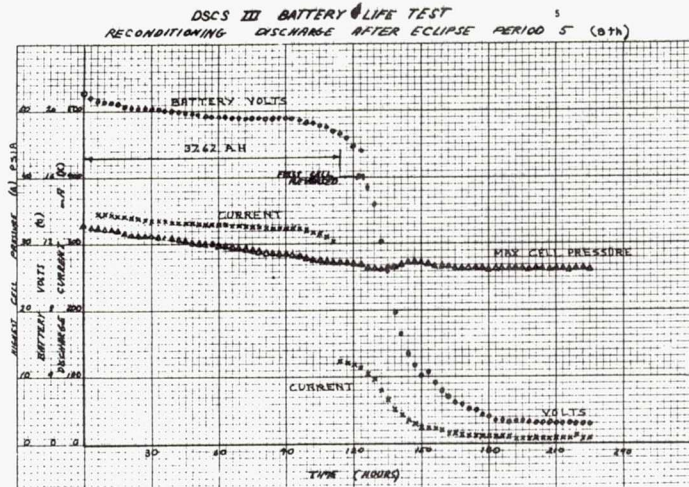

Figure 24-7

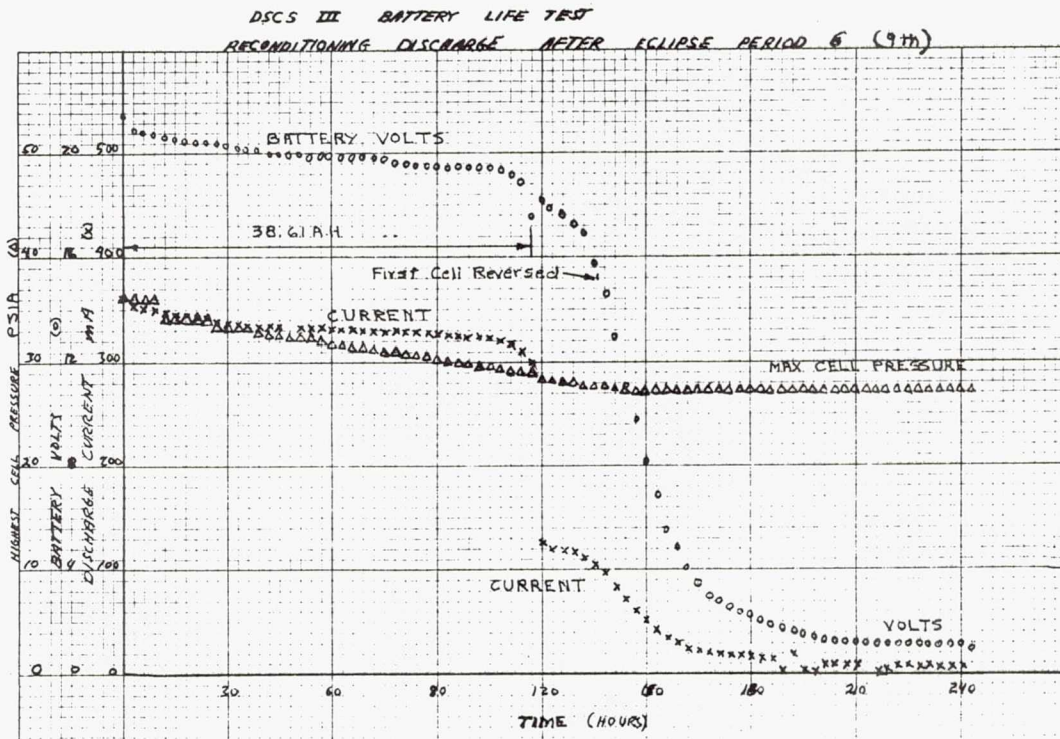

Figure 24-8



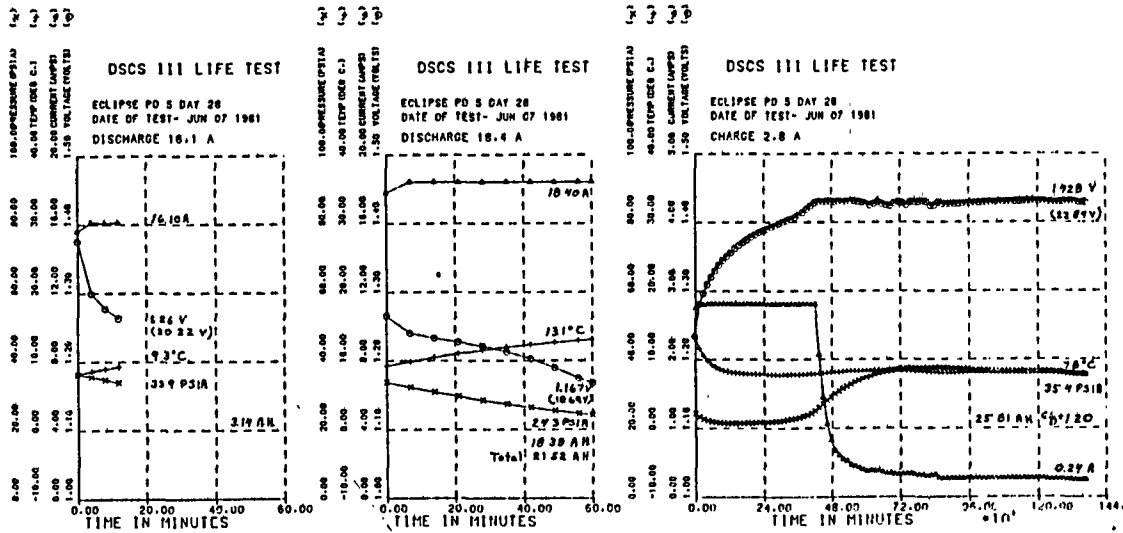

Figure 24-9

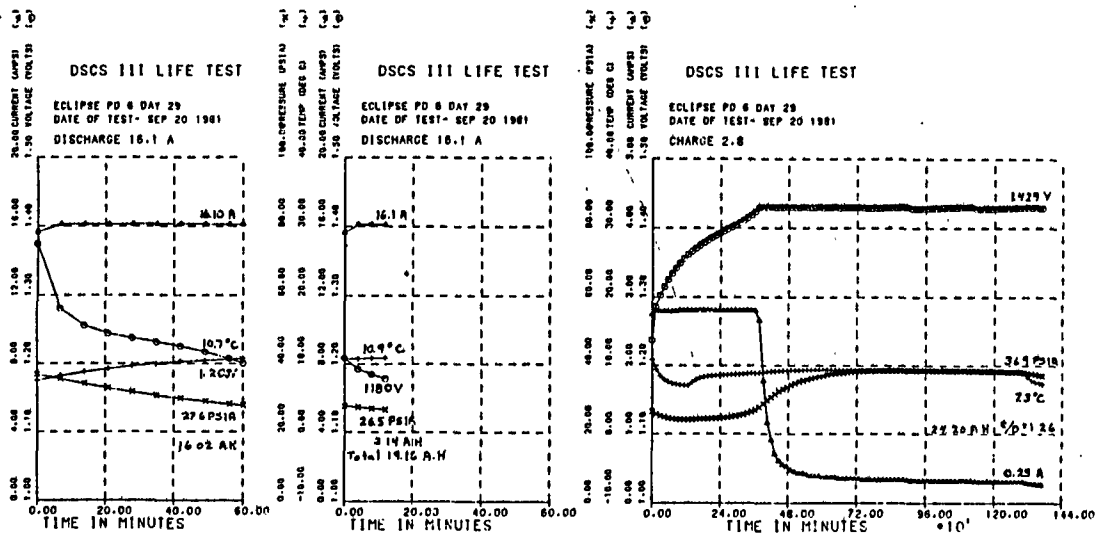

Figure 24-10

PROGRAM- DSCS III LIFE TEST											
TEST-ECLIPSE PD @ DAY 29											
RACK NO- 1											
CONTROLLER NO- 3											
DATE OF TEST- SEP 20 1991											
TIME	10:17	10:25	10:32	10:39	10:46	10:53	11: 0	11: 7	11:14	11:17	
MIN	0	7	14	21	28	35	42	49	56	60	
CELL POSITION											
1	1.3938	1.2841	1.2591	1.2472	1.2404	1.2349	1.2283	1.2204	1.2101	1.2040	
2	1.3899	1.2794	1.2545	1.2428	1.2362	1.2309	1.2248	1.2189	1.2070	1.2010	
3	1.3830	1.2779	1.2528	1.2414	1.2349	1.2297	1.2238	1.2188	1.2059	1.1993	
4	1.3820	1.2784	1.2534	1.2417	1.2352	1.2298	1.2236	1.2199	1.2059	1.1993	
5	1.3709	1.2684	1.2617	1.2497	1.2428	1.2384	1.2324	1.2208	1.2097	1.2023	
6	1.3565	1.2654	1.2401	1.2283	1.2214	1.2158	1.2091	1.2010	1.1906	1.1840	
7	1.3797	1.2841	1.2594	1.2478	1.2412	1.2357	1.2294	1.2213	1.2110	1.2045	
8	1.3751	1.2818	1.2570	1.2454	1.2387	1.2327	1.2263	1.2179	1.2077	1.2007	
9	1.3732	1.2795	1.2547	1.2433	1.2367	1.2310	1.2249	1.2167	1.2068	1.2001	
10	1.3700	1.2778	1.2532	1.2413	1.2346	1.2289	1.2225	1.2144	1.2039	1.1970	
11	1.3745	1.2845	1.2598	1.2482	1.2416	1.2359	1.2296	1.2212	1.2108	1.2042	
12	1.3725	1.2801	1.2552	1.2442	1.2378	1.2324	1.2261	1.2180	1.2080	1.2014	
13	1.3689	1.2789	1.2548	1.2434	1.2367	1.2310	1.2247	1.2164	1.2062	1.1994	
14	1.3646	1.2778	1.2529	1.2409	1.2343	1.2283	1.2218	1.2134	1.2029	1.1959	
15	1.3702	1.2853	1.2608	1.2483	1.2425	1.2365	1.2300	1.2215	1.2110	1.2043	
16	1.3666	1.2883	1.2631	1.2514	1.2447	1.2388	1.2323	1.2240	1.2134	1.2069	
AVG CELL VOLTS	1.3745	1.2806	1.2558	1.2441	1.2375	1.2318	1.2254	1.2172	1.2069	1.2003	
CURR	15.6500	16.0900	16.1100	16.1000	16.1000	16.1100	16.1100	16.1100	16.1000	16.1000	
ACCUMULATED											
AHRS	0.	1.5090	3.7880	6.6660	9.8460	9.4250	11.3040	13.1840	15.0630	16.2230	
TEMP 1	7.8900	8.3300	8.8000	9.2700	9.6600	9.9600	10.2200	10.4100	10.5700	10.6400	
TEMP 2	7.4100	8.1600	8.7600	9.2600	9.6700	10.0100	10.3000	10.5200	10.6900	10.7700	
AVG TEMP	7.8000	8.1900	8.7800	9.2600	9.6600	9.9900	10.2600	10.4700	10.6300	10.7100	
PRES 1	45.3700	44.0200	42.5200	41.1800	40.0300	39.0200	38.1300	37.3200	36.6000	36.2300	
PRES 2	28.2800	27.0400	25.9700	24.4700	23.2900	22.2400	21.2700	20.3800	19.5300	19.0800	
AVG PRES	36.8100	35.5300	34.1000	32.8000	31.6600	30.6300	29.7000	28.8400	28.0600	27.6600	
BATTERY											
VOLTS	22.2540	20.9010	20.1040	19.9160	19.8100	19.7180	19.6150	19.4850	19.3210	19.2130	

Figure 24-11

**Page intentionally left blank**

## SMM PARALLEL BATTERY OPERATION IN ORBIT

R. Broderick

GSFC

I'd like to talk to you this afternoon about the SMM parallel battery operation.

We are presently just about to complete our second year in orbit, operating around the 9600 orbit.

(Figure 25-1 )

Some preliminary information on the mission: As I said, the batteries were integrated—well, maybe I didn't say that, but the batteries were integrated about two years ago. We actually launched in February of 1980.

We are in a near-earth orbit and we're seeing sun times between 61 and 68 minutes. We initially had a two-year design with a four-year requirement or rather "desirement." Since that time there has been some consideration given to a refurbishment of the SMM spacecraft in the last quarter of FY 83, in which case we could extend out to about a five-year requirement.

(Slide. Not available)

This is a picture during the integration, showing the modular power spacecraft. This is the modular power system here. (Indicating.)

(Slide. Not available)

This is an artist's conception in space.

(Figure 25-2 )

It is a parallel battery charge configuration very similar to the OAO configuration you just saw, a parallel battery charging through a peak power tracking series regulator.

There are three GE batteries, 20 ampere-hours, 22 cells per battery. The modular power system makes up the majority of this system, which was manufactured by McDonnell-Douglas.

(Figure 25-3 )

I'd like to describe to you some of the battery system performance as a function of lifetime over the orbit.

This is times 10 K. We're up to about 9600 orbits.

This top one shows the end of charge voltage which is just our voltage limit. Presently we're at standard voltage level 4, which is about 1.436 volts per cell.

We made a couple of voltage level changes throughout the mission. We recently went back to a voltage level 4, and I'll get into that a little more. We're presently at about an average 1.2 volts per cell. Initially we were at about 1.24, so we have seen about 40 millivolts degradation over the two-year mission so far, in end of discharge voltage.

(Figure 25-4 )

This shows the depth of discharge again as a function of orbit time out to about 9600 orbits. Initially we were running about 16 to 18 percent DOD.

We suffered a loss in our attitude control system where we essentially lost our momentum wheel control and we are into a magnetic control at this time. Because of that fact around orbit 4,000 we had to turn off about four of the seven instruments because pointing accuracy was no longer accurate for useful science. So our depth of discharge is decreased down to the 12 to 14 percent range.

(Figure 25-5 )

This shows an average C-to-D ratio of the three batteries over the mission lifetime. Initially we were at voltage level 4. We didn't feel that we were adequately recharging. We went to voltage level 5. Because of the problem I just described and other reasons which I'll talk about, we've gone back to voltage level 4 to try to improve

the C-to-D to get us down more in-- It looks like we're in an average of about 113 percent where we were upwards of 120 percent and during peak sun time seeing charges of upwards of 130 percent.

(Figure 25-6 )

We do have a battery differential voltage comparator on the spacecraft which looks at the voltage between the top 11 cells and the bottom 11 cells, and gives us a telemetry point on that. Essentially we have two curves here. This is the difference which you see during the charge period and the difference during the discharge period. What we're looking for here are abnormal deviations -- We hope that's not one -- which will show cell divergence and possibly result in cell failure.

One little line here looks like our last telemetry point took a little dive. We'll keep an eye on that, but so far we haven't seen anything which we interpret at this point as a cell divergence. We're in the range of about 50 millivolts between the top pack, the top 11 cells and the bottom 11 cells.

(Figure 25-7 )

Now I'll describe to you a typical orbit performance. We're presently out around 9600 orbits. This particular orbit is 9255. We're looking at bus voltage through a discharge cycle, charge and voltage limit.

The battery current, during discharge, is seeing a little current divergence between the three packs. I'll talk a little bit more about that. An inrush through the peak power tracker of upwards of C rate, 20 amps per battery.

We reach voltage limit very quickly because of the low DOD here and the essentially oversized array. In about three minutes we begin our taper. We taper down to about .4 amp, a slight divergence in the charge current. This is all three batteries plotted on top of each other. And then back into the discharge.

This curve is the total load current variance.

(Figure 25-8 )

A typical orbit battery temperature variation over an orbit period. Battery Number 3 is the center battery. Presently it appears to be running between about two to four degrees C.

Similarly we're seeing about a two-degree swing on Batteries 1 and 2, Battery 2 being the coldest, down around minus one degree C.

This is the end of discharge point in the orbit. (Indicating.)

I'm going to go back a little on one orbit to show a comparison between a one-year, third electrode over an orbit period, and then the next slide will show the present one.

(Figure 25-9 )

From this curve this is the first minute of sun. It's not really an overcharge, it's just the generation is exceeding the recombination at this point. We kind of reach an equilibrium toward the end of the orbit.

But on Battery Number 3 it appeared that we were starting generation, oxygen generation to exceed recombination about mid-orbit, which we tended to think that we were reaching a full state of charge, at least on Battery 3, fairly early in orbit. It's one of the reasons that we did change. The difference between the charge period is about 30 millivolts at this time.

(Figure 25-10 )

Since we've made the change and are now out around 9200 orbits, we've brought that in. It's a lot closer. We're only about 12 millivolts across Battery 1 to 2, and we're no longer seeing that oxygen generation mid-orbit.

(Figure 25-11 )

This chart summarizes essentially what I've been saying, where we're looking at an orbit before we made a voltage level change, and then the current orbit.

You see the beginning of eclipse current, the en

of eclipse current, the end of charge current, and the beginning of eclipse temperature, and the end of eclipse temperature. Really, this end of eclipse current is the one that we were beginning to become concerned about in that we were seeing about a 1.2 amp divergence between the three batteries.

After making the change we did improve that somewhat, .4 amp, which turns out to be one LSB on the telemetry, but it still looks like we did improve it. The negative indicates that we did improve all of them except the beginning of eclipse divergence which again is 1 LSB, possibly not large enough to be significant. But this improvement we were happy with.

It appears that the end of eclipse current divergence is down in the .8 amp range.

(Figure 25-12 )

This curve compares a couple of discharge curves, one, the conditioning cycle prior to integration, an in-module conditioning which we did right at the launch site, and a couple of in-flight conditionings which we didn't really plan on when we lost our attitude control and discharged the batteries down to about 50 percent of their capacity.

There are a couple of orbits in here. They are kind of hard to pick off of here, but this one here is actually that C/3, Orbit 400. And this one here is the C/4, 9255. So it appears that somehow we've actually got a little bit of voltage recovery due to our lower depth of discharge and the cycling regime that we're now in.

Essentially that's what I wanted to present. It appears that after 21 months the parallel charging method has been effective. There are no indications of any abnormal performance that we've been able to detect.

OLBERT (Ball Aerospace): All your data indicated that the performance was superior with your Charge Level 4 and yet someplace in the mission you did make the decision to go to 5. Apparently you were concerned that you weren't fully charging the batteries.



but at a low level of discharge, why would you care? Why not normally run them at 95 percent discharge, for example?

BRODERICK: Run them at less than full recharge?

OLBERT: That's correct.

BRODERICK: I guess because we would continue to run down over a period of time.

We were concerned early in the mission when we still had a full complement of instruments that we weren't getting recharged. Our C-to-D ratio is-- We essentially have a software routine in the OBC for sending down ampere-hours out and ampere-hours in.

Our current sensors are plus or minus one percent over a hundred amp range, and the method we chose to implement was using the coarse current sensor as what we would monitor.

As a result, when we get down into our taper range when we're down .4 amp we're sensing it with this plus or minus one percent sensor, and our accuracy, we feel, was not that great. We felt that we were six to eight percent high on the C-to-D reading.

At Voltage Level 4 we're not getting any third electrode indication that we are kind of reaching that full state of charge at the end of the orbit, and we weren't seeing any temperature effect at the end of charge.

So that's what made us go to the Voltage Level 5. After looking at it for a year and a half, we decided that the 130 percent was definitely too high, and because our DOD had gone down, that's why we went back.

It appears that ideally we would either have a Level 4-1/2 or we would routinely, once a week, make voltage level changes to optimize it. It doesn't appear that one level is going to be ideal over a mission.

HALPERT (Goddard): I do want to add one thing to your talk.

The NASA standard 20 ampere-hour cells and the NASA standard 20 ampere-hour batteries which were selected, 66 cells, three 22-cell batteries were selected from 75 for this particular operation, and they have worked very, very well, and are one of the reasons why the power system is working very well.

HALL (NOAA): If you have a problem with the resolution of your current census, frequently an indication that you're fully charging your batteries each cycle, is to monitor the end-of-discharge battery terminal voltage, and if it stays at the level or increases, then you're doing the job.

If it starts decreasing monotonically with successive discharge cycles, then you've got a problem with C-to-D.

BRODERICK: We were looking at that. It appeared we would get a 200 millivolt drop which was our telemetry resolution, so we were uncertain whether that was an indication of the voltage level change or a result of a C-to-D type change.

FORD (Goddard): I'd just like to respond to that comment.

In my experience, one of the poorest indicators of the state of charge of the battery is the discharge voltage. It doesn't tell you a hell of a lot about the health and welfare simply because the double plateau effect comes in very early during the cycle life.

MISSION PROFILE

INTEGRATION DATE- 11-79

LAUNCH DATE- 2-14-80

ORBIT- 574 KM CIRCULAR  
3 AXIS STABILIZED  
SUN POINTING

ORBIT PERIOD- 96 MINUTES  
61-68 M SUNLIGHT PERIOD  
35- 28 M ECLIPSE PERIOD

MISSION LIFETIME- 2 YEAR DESIGN  
4 YEAR REQUIREMENT

Figure 25-1

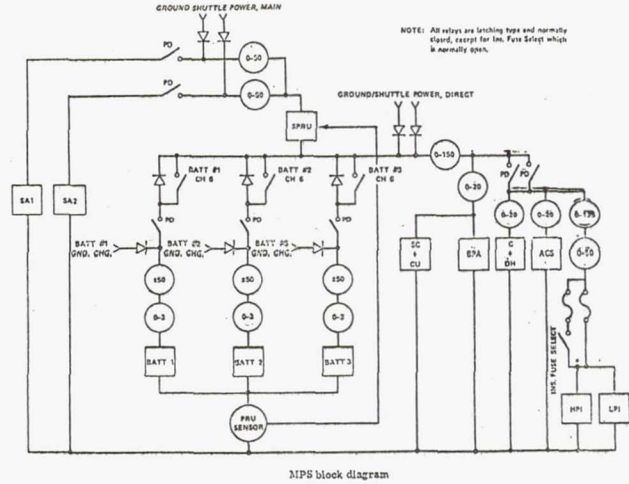

Figure 25-2

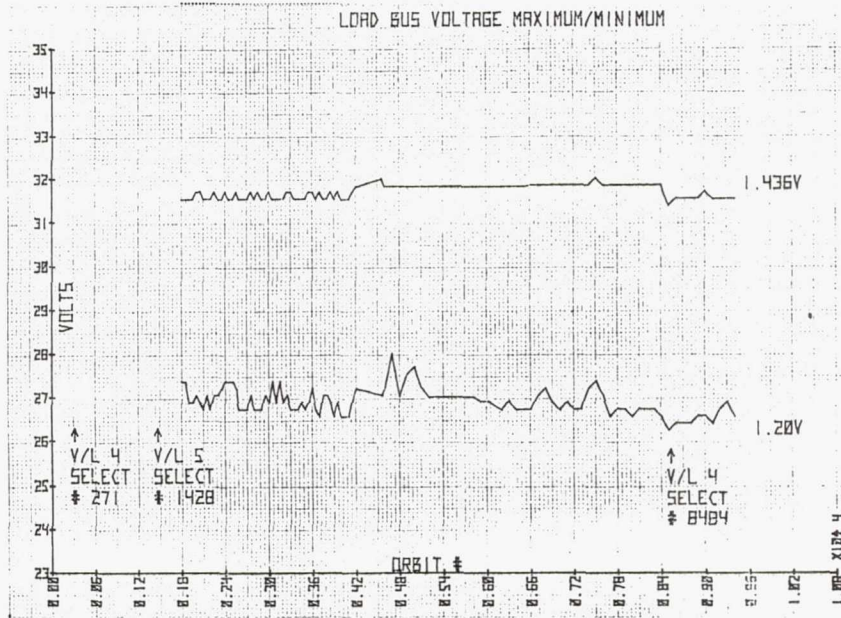

Figure 25-3

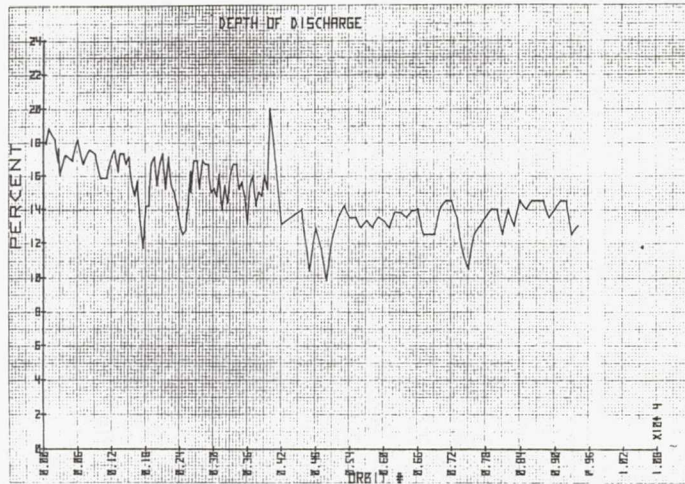

Figure 25-4

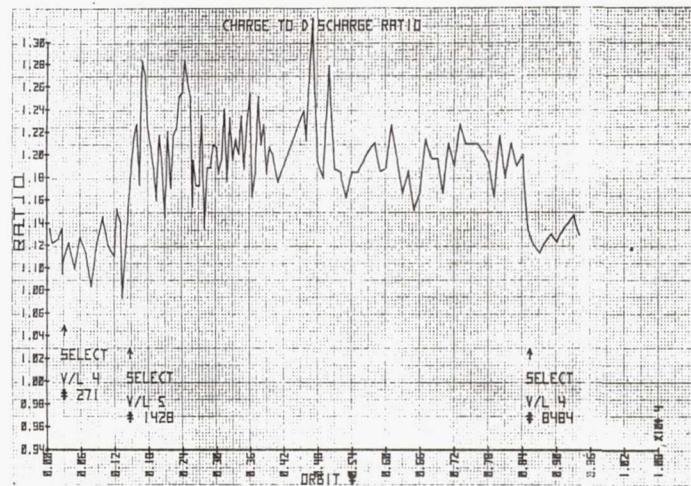

Figure 25-5

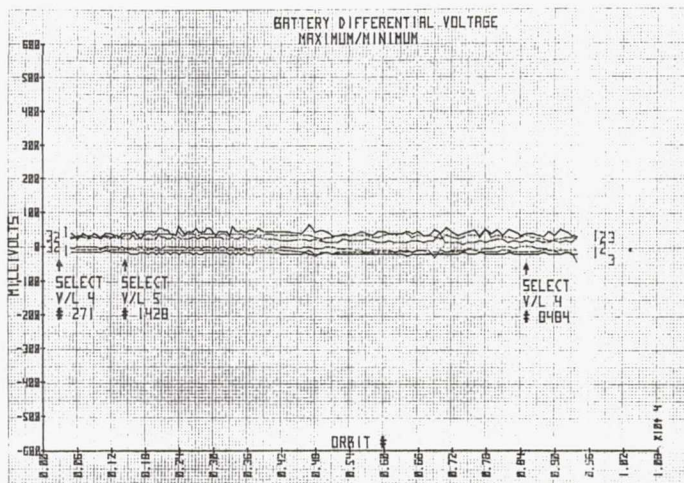

Figure 25-6



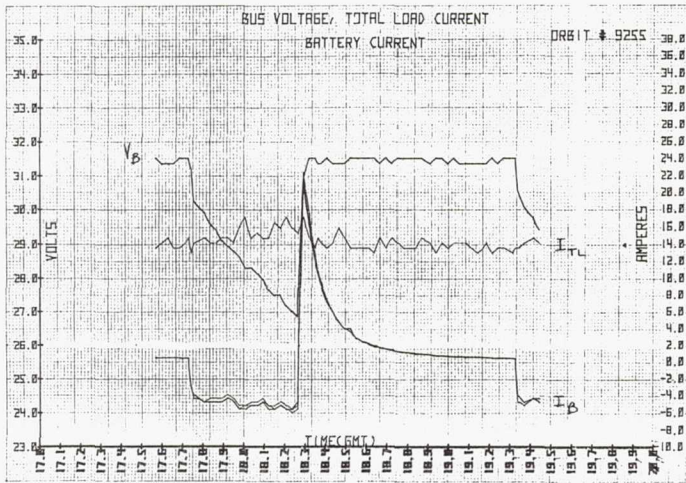

Figure 25-7

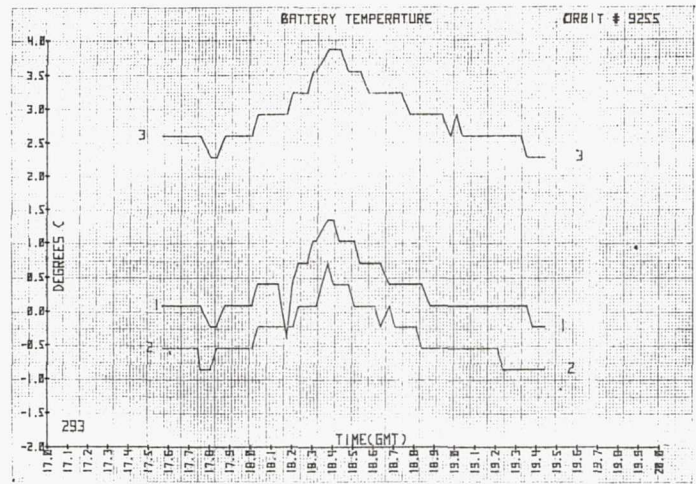

Figure 25-8

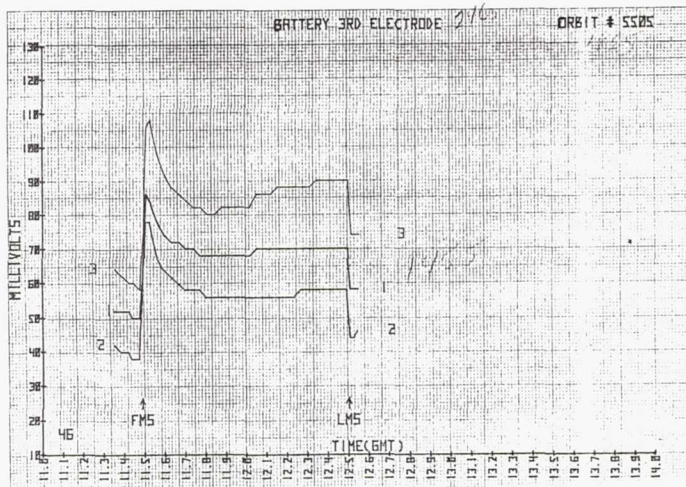

Figure 25-9

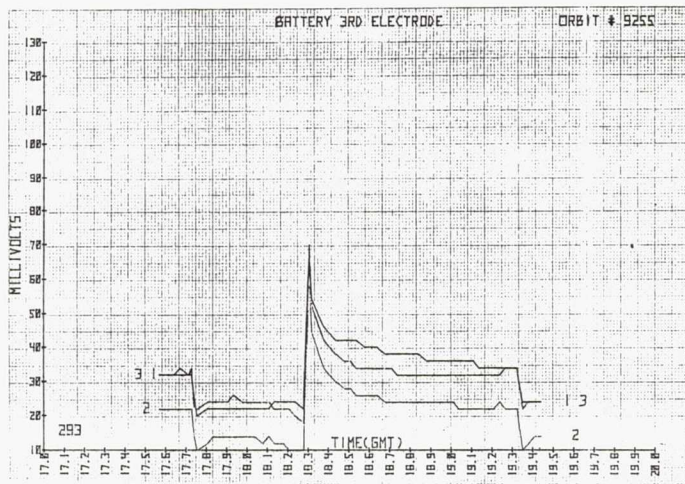

Figure 25-10

EFFECT OF CHANGE V/L 5 TO V/L 4

ORBIT 7775

BTRY	lboe	leoe	leoc	Tboe	Teoe
1	-4.0	-5.6	0.50	3.0	3.5
2	-4.0	-5.6	0.52	2.2	2.9
3	-4.4	-4.4	0.59	6.0	6.4
DIFF	0.4	1.2	.09	3.8	3.5

ORBIT 9254

1	-4.0	-6.0	0.38	0.8	0.7
2	-4.0	-6.0	0.38	-0.8	0.1
3	-4.4	-5.2	0.39	2.6	3.2
DIFF	0.4	0.8	0.01	3.5	3.1

DELTA --- -0.4 -0.08 -0.4 -0.4

Figure 25-11

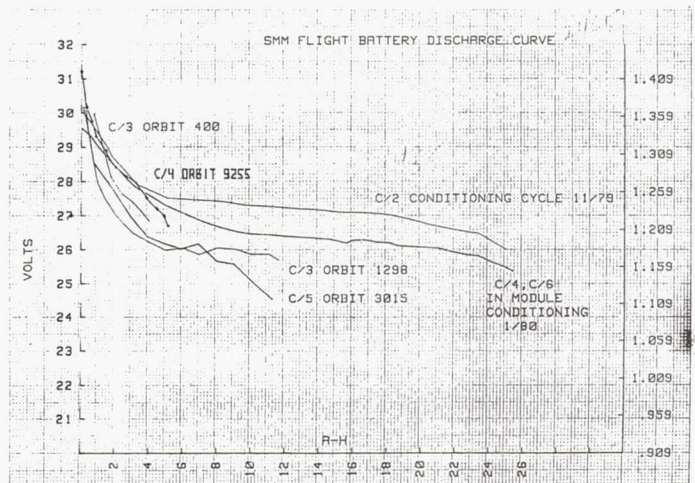

Figure 25-12

**Page intentionally left blank**

## RCA SATCOM IN-ORBIT EXPERIENCE: AN UPDATE

D. Stewart

RCA

Good afternoon. I'd like to present a brief update on RCA SATCOM battery performance. We've been in orbit for about six years, and I feel it's important to present data at this time because the fifth and sixth years have been critical for other geosynchronous space programs. Some people even told us a couple of years ago that we'd be lucky to get five or six years out of our batteries.

Before I go into the data, however, I'd like to briefly describe the SATCOM history and some of the design details.

(Figure 26-1 )

SATCOMs I and II are domestic communications satellites in geosynchronous orbit. They are identical except that SATCOM II was launched three months later than SATCOM I. SATCOM I was launched in December of 1975, which means that it has seen 12 eclipse seasons or almost six years in orbit.

SATCOM II was launched in March of '76 and has seen eleven eclipse seasons and is about five and three-quarters years old.

There are three batteries on each spacecraft. Each of these is required to support the mission. They're connected to an unregulated bus with redundant diodes. There are 22 cells per battery; they are 12 ampere-hour NiCds. They are GE cells rated, at 12 ampere-hours. They had an initial measured capacity of 14 ampere-hours and they're contained in 10 ampere-hour cases.

There are three constant current charge rates that we have. We have what we call our normal charge rate, which is C over 20 charge rate, C being rated capacity. We use this for recharge following eclipses or any other time that we have battery discharge, such as after spacecraft maneuvers. We have a high charge rate of C over 10, which we use primarily for reconditioning recharge. But we also use



it occasionally in the eclipse seasons.

The third rate is the C over 60 trickle charge rate which we use any other time we're not using those other two charge rates, such as between eclipse seasons and following the completion of recharge during the eclipse season.

For the C over ten charge rate we have overcharge protection. We have a voltage/temperature taper charge curve. Temperatures are typically between zero and 15 degrees during the eclipse season. Occasionally due to power management problems we let the batteries get down to minus five. In a trickle charge mode we will turn the heaters off and cycle the heaters.

We also see temperatures at the other extremes. We get daily peak temperatures in the summer of over 30 degrees.

The only other item here to cover is reconditioning. About two weeks prior to each eclipse season we sequentially discharge and recharge each of the batteries down to about two volts, and this works out to about .1 volt per cell. And we do this with individual cell bypass resistors.

(Figure 26-2)

This slide shows a typical eclipse discharge profile. We have three things plotted here: the current, voltage and temperature. The day shown here is the Autumnal Equinox, which is the longest eclipse, at 72 minutes. There are two indications of battery performance that we have. One of these is the current sharing. Here we see that Battery 2 is putting out a little less than its share of the current. But at the end of discharge it's within about three percent of the mean.

Another indication of performance we have is the sharing of capacity or ampere-hours out of the battery. This too is three percent over the discharge, and we judge this to be acceptable for the age of the batteries.

Also plotted here are the battery temperatures. They are all within the two to eight degree temperature

range. And shown here is a single curve, an average of the battery voltages.

The depth of discharge here based on rated is 55.9 percent.

(Figure 26-3 )

We have a similar graph for SATCOM II. Here the temperatures are between zero and four degrees. Current sharing is a little better. The capacity out is within two percent of the mean. We think this is very good for the age of the batteries.

Those two parameters, the current sharing and the capacity sharing, help us to determine the relative health of the batteries to each other.

Another thing we monitor, and what we look at the most, is the end of discharge voltage during eclipse. And this is our key performance parameter to tell us how we're going throughout the life of the mission.

What we've done is we have kept track of this voltage. It doesn't always happen on the longest eclipse. We have some cycling loads which during some eclipses come on and in some eclipses they don't. So the minimum voltage doesn't always happen on the equinoxes.

As you can see here, we had a battery heater which was switched off at about ten minutes. The temperature was high enough that we didn't need it.

(Figure 26-4 )

Here we have tabulated the minimum average battery voltages that I pointed out on the last slide. We have the individual battery voltages here. We average these to come up with an average battery voltage, and then we have an average cell voltage which is the average battery voltage divided by 22.

These individual battery voltages are themselves averages. We have two telemetry units, and we average these.

In the past we used to take the battery voltages from one telemetry unit or the other and we had a lot of scatter in the data. So we went back through all the eclipse seasons' worth of data and averaged the two telemetry values.

The most important thing to note here is that between the first eclipse season and the last eclipse season we've dropped about .55 volts on F-1, and on F-2, SATCOM II, we've dropped about .46 volts. And we think this is a very small drop.

(Figure 26-5 )

This slide shows a little more dramatically the small drop in voltage. We have plotted the minimum average cell voltage versus the number of eclipses here.

Now I should do some explaining about the F-2 data here.

In the first three years of operation of F-2 we had a blockage which prevented our solar arrays from making a complete revolution each day. Up at the top of this slide here is a little picture of our spacecraft. We have sun tracking arrays with one degree of freedom. And, as I mentioned, there was a blockage. So what we would have to do is put the array drive motor into reverse and rewind the array. And because of this we would lose our solar array power and go on to the batteries, and we would have about a 27 percent depth of discharge daily. So we had about 1000 cycles of this up to the sixth eclipse season, where we discovered that the blockage was no longer there so we terminated the daily rewind maneuver.

The way that was affecting the data here, or the voltages, was we weren't fully charging the batteries before each eclipse. At least that's what we think was happening. Once we stopped that procedure you see that our voltage jumped right up here.

There were also several other things that might have contributed to the increase in voltage. We had a load reduction of about five percent and we had double reconditioning performed between the sixth and seventh eclipse seasons.

We also had a load reduction after the tenth eclipse season, so we see another jump here. That was about three percent.

Plotted along with the in-orbit data here is the predicted voltage degradation curve. Now this degradation curve is based on Crane data from the 207-A and 209-A packs. The 207-A pack was held at zero degrees and was discharged to 60 percent of rated. And the 209 pack was held at 20 degrees and also discharged to 60 percent depth of discharge.

This curve was a best-fit curve to these data.

I'd also like to point out our minimum voltage required for full payload operation. As you see, we're quite a ways from that. Barring any shorts or events like that we should meet our goal of 16 eclipse seasons or eight years in orbit. We're pretty optimistic at this point.

(Figure 26-6 )

Since I used Crane data I thought I had better provide a comparison here. I'd like to thank Steve Gaston for the data. He came up with these numbers.

Both the SATCOM and Crane cells are GE cells. They're both rated at 12 ampere-hours. The measured capacities are different, the SATCOM batteries are at 14 and the Crane packs at 16. Average discharge currents are about 5.4 to 5.9 for the SATCOM cells and 6.0 amperes for the Crane cells.

If you take into account the total positive electrode surface areas here it works out to an equivalent discharge current density, 37 to 40 for the SATCOM and 33 for the Crane cells.

I guess the only other thing I'd like to point out here are the depths of discharge based on rated. We're seeing 53 to 58 percent depth of discharge whereas the Crane cells are seeing 60 percent. And based on measured, our depths of discharge are 46 to 50 percent versus 45.

I'd also like to point out that we have teflonated negative electrodes whereas the Crane cells do not.

I'd just like to summarize. We think our batteries are performing very well here. We're optimistic about getting our mission objective of eight years of operation. We attribute the good performance so far to four things: The method of reconditioning, which is down to about .1 volts per cell; the trickle charge storage during the non-eclipse seasons; the low average battery temperatures -- the yearly average is about 12 degrees -- and the teflonated negative plates.

We think RCA Astroelectronics has given us a good battery system.

Any questions?

#### DISCUSSION

THIERFELDER (General Electric): Dave, is it right to conclude that while all of the TWTs were operating there was no payload reduction?

STEWART: Well, as I noted on the SATCOM II curves, we had some load reduction. We had a five percent and three percent. They were TWTA loads that we turned off. We have 21 operating on SATCOM II and 23 on SATCOM I.

HENDEE (Telesat, Canada): You indicated you normally returned following eclipse at C over 20 but that you occasionally used the C over 10. What were the indicators for going to the C over 10?

STEWART: Whenever we needed to have a fast recharge. There are certain times when we're power limited and we're pressed for time, so to get fully charged before the next eclipse we used the C over 10.

HENDEE: You don't sequence-charge, do you?

STEWART: When we use the C over 10 we do sequence.

HENDEE: You do sequence?

STEWART: Yes.

HENDEE: Why don't you use that all the while? We have the same bird, but we use the C over 10 sequence, which I find extremely nice.

STEWART: Okay.

I believe you have an automatic sequencer, whereas ours would be a manual.

HENDEE: Lazy.

STEWART: That's it, we're lazy.

Any more questions?

FORD (Goddard): Ed Hendee, by sequence you mean you charge one battery for a while and then charge another battery for a while? Is that what you mean? Or bi-level charging, C over 10 to C over 20?

HENDEE: No, we actually charge for five minutes at C over 10, literally open circuits for the ten minutes. We just commutate around through the batteries.

I know other people have called me up and inquired, are you not worried about hydrogen generation and a few other things. In my lab I have a fairly rigorous test going, as you can well imagine, and I am seeing no significant pressure buildup. I think that we're running -- I think our maximum pressures are about 22 psia, probably a total minimum to maximum of about five pounds.

FORD: But in recent work -- well, in previous workshops there's been quite a controversy about that matter of sequential charging, as you know.

HENDEE: I know that.

RCA



### BATTERY DESIGN/HISTORY

**IN ORBIT:** Satcom I-December 1975 (12 Eclipse Seasons)  
Satcom II-March 1976 (11 Eclipse Seasons)

**BATTERY:** Three, 22 Cell, 12AH NiCd

**CHARGING:** Normal C/20 -Eclipse Seasons  
High C/10 -Reconditioning  
Trickle C/60 -in-Orbit Storage

**OVERCHARGE PROTECTION:** V/T-Single Curve (C/10 Rate Only)

**TEMPERATURE:** 0 To 15°C During Eclipse Season

**RECONDITIONING:** Individual Cell Bypass, To 0.1 V/Cell

Figure 26-1

RCA



SATCOM I ECLIPSE BATTERY DISCHARGE - 9/22/81

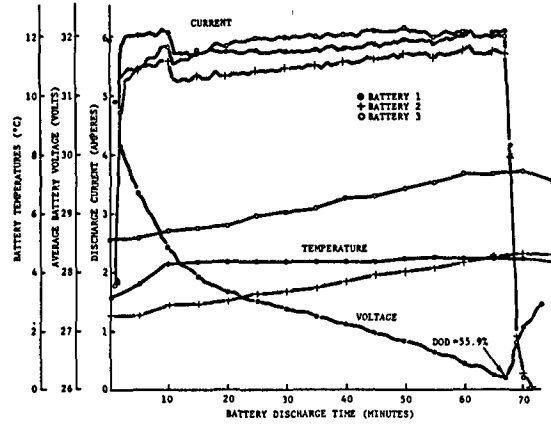

Figure 26-2

RCA



SATCOM II ECLIPSE BATTERY DISCHARGE - 9/22/81

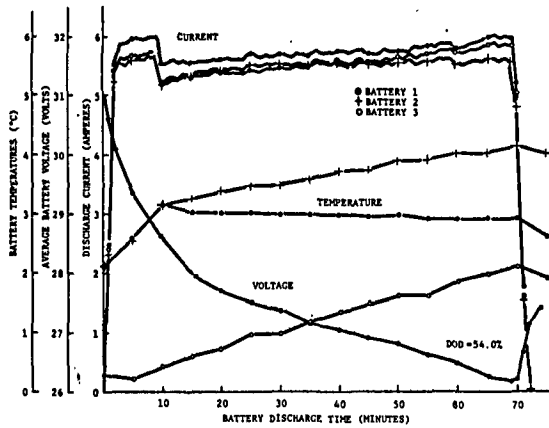

Figure 26-3

RCA

RCA SATCOM MINIMUM AVERAGE BATTERY VOLTAGE DURING ECLIPSE

ECLIPSE SEASON	SATCOM F1					SATCOM F2				
	V <sub>a1</sub>	V <sub>a2</sub>	V <sub>a3</sub>	V <sub>AVG</sub>	V <sub>AVG/CELL</sub>	V <sub>a1</sub>	V <sub>a2</sub>	V <sub>a3</sub>	V <sub>AVG</sub>	V <sub>AVG/CELL</sub>
1	26.56	26.71	26.45	26.57	1.208	26.61	26.48	26.42	26.50	1.205
2	26.27	26.35	26.47	26.36	1.199	26.36	26.18	26.11	26.22	1.192
3	26.26	26.42	26.27	26.32	1.196	25.97	25.99	25.90	25.95	1.180
4	26.26	26.42	26.27	26.31	1.196	25.97	25.93	25.90	25.93	1.179
5	26.20	26.40	26.25	26.29	1.195	25.81	25.78	25.75	25.78	1.172
6	26.13	26.29	26.11	26.18	1.190	25.81	25.75	25.75	25.77	1.171
7	26.05	26.23	26.18	26.16	1.189	26.46	25.38	26.31	26.38	1.199
8	26.04	26.23	26.08	26.12	1.187	26.36	26.22	26.11	26.23	1.192
9	26.09	26.29	26.17	26.19	1.191	26.24	25.99	26.10	26.11	1.187
10	25.92	26.13	26.13	26.06	1.184	26.14	25.96	25.93	26.01	1.182
11	25.99	26.16	26.08	26.08	1.185	26.32	26.15	25.96	26.14	1.188
12	25.92	26.12	26.03	26.02	1.183					

ALL VALUES ARE IN VOLTS

Figure 26-4

RCA

MINIMUM AVERAGE CELL VOLTAGE DURING ECLIPSE VS NUMBER OF ECLIPSE SEASONS

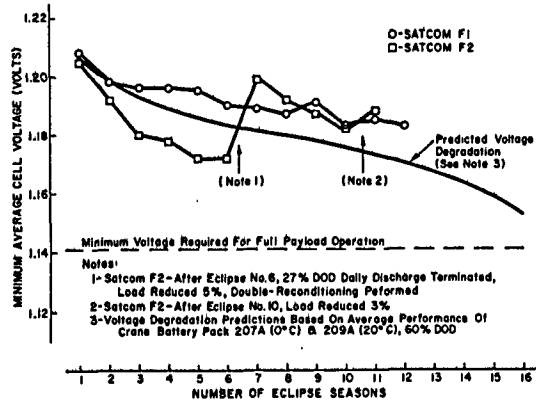

Notes:  
 1- Satcom F2-After Eclipse No.6, 27% DOD Daily Discharge Terminated, Load Reduced 5%, Double-Reconditioning Performed  
 2- Satcom F2-After Eclipse No.10, Load Reduced 3%  
 3- Voltage Degradation Predictions Based On Average Performance Of Crane Battery Pack 207A (0°C) & 209A (20°C), 60% DOD

Figure 26-5

RCA

DESIGN COMPARISONS

DESCRIPTION	SATCOM F1 & F2		CRANE TEST PACK 207A & 209A*
	GE (GENERAL ELECTRIC)		
CELL MANUFACTURER	GE (GENERAL ELECTRIC)		G.E.
RATED CAPACITY (A.H.)	12		12
MEASURED CAPACITY (A.H.)	14		16
AVG DISCHARGE CURRENT DURING ECLIPSE (AMP.)	5.4-5.9		6.0
CAPACITY REMOVED AT MAX. ECLIPSE (A.H.)	6.4-7.0		7.2
APPROXIMATE PERCENT D.O.D. AT MAX. ECLIPSE			
● BASED ON RATED CAPACITY	53-58		60
● BASED ON MEASURED CAPACITY	46-50		45
TOTAL POSITIVE ELECTRODE SURFACE AREA (IN <sup>2</sup> )	149		182
DISCHARGE CURRENT DENSITY (MA/IN <sup>2</sup> )	37-40		33
NEGATIVE ELECTRODE TREATMENT	TEFLON		NONE
QUANTITY OF ELECTROLYTE (CC)	35		45
CC ELECTRO/AM MEASURED CAP.	2.50		2.81
CC ELECTRO/AM POSITIVE ELECTROCHEM CAP	2.34		2.37

NOTE: \*REFERENCE: J.D. HARKNESS, RESULTS OF CONTINUOUS SYNCHRONOUS ORBIT TESTING ON SEALED Ni-CD CELLS, NAVAL WEAPON SUPPORT CENTER, WOE/C 77-134, JUNE 9, 1977 AND PRIVATE COMMUNICATION WITH S. GASTON

Figure 26-6



**Page intentionally left blank**

UPDATE: VIKING LANDER NiCd BATTERIES - YEAR SIX

A. Britting

Martin Marietta

(Figure 27-1 )

I would like to discuss, as Dave Baer introduced, the performance of the NiCd batteries on the Viking Mars landers that were built by Martin Marietta at Denver. They were both launched in 1975. They cruised for 11 months. Three of the four batteries on each lander were maintained in the discharged state, with a 19.3 K ohm resistor tied across each battery for telemetry purposes. The Landers touched down on the Martian surface in July and September of 1976 for a planned 90-day mission.

We are currently in the 1900th day of that 90-day mission on Viking Lander 1. The Viking Lander 2 mission terminated two years ago.

(Figure 27-2 )

On board each lander were four 24-cell, eight ampere-hour NiCd batteries. For weight savings we used two batteries per battery assembly, and then two assemblies per spacecraft.

Each battery weight was 50-1/2 pounds. Because of a planetary quarantine requirement we were forced to sterilize the batteries, the entire spacecraft, as a matter of fact, for 54 hours at 233 degrees Fahrenheit. This caused us to select Pellon FT2140 nonwoven polypropylene separator material.

The cells were manufactured by GE. Prior to launch we did have individual cell monitoring for all the prelaunch testing we did, and the conditioning we did on the batteries. However, after launch, all we had was battery terminal voltage and battery temperature for monitoring purposes.

Following the landing the batteries experienced 500 discharge/recharge cycles in the range of 10 to 40 percent depth of discharge. The remainder of the cycles to

date, which are in excess of 10,000 now, have been less than five percent depth of discharge.

The battery charge regime entails charging a battery for one hour while the other three batteries are maintained on the equipment bus supplying the lander loads, switching that battery off the charge bus, connecting another battery to the charge bus, and repeating the cycle in one hour charge increments six times a day on each battery.

(Figure 27-3 )

I'll place on the right-hand screen the cell characteristics without discussing them.

(Figure 27-4 )

At the August 1981 IECEC conference, I reported two batteries degraded only about 15 to 20 percent and the remaining two batteries degraded 67 percent. I had identified the fact that we had been doing a once per 37 days reconditioning cycle on each of the batteries. One month we would recondition Battery A, the next month we'd recondition Battery C, the next month Battery B, and the following month Battery D, and begin five months later on Battery A again.

At that time it appeared that we had arrested, or at least had significantly reduced, the degradation of batteries C and D by going through this regime.

The batteries are, as I said, 24 cells, and discharging with this charge regime does not discharge the battery cells below 1 volt per cell. In fact we discharge at a C/5 rate to 27.3 volts, total battery voltage. Allowing for some imbalance, some of the cells might get below 1 volt per cell, but on the average you would say 1.1 volt per cell.

We recharge at C/8 until such time as we either reach a voltage temperature charge cutoff, or 21 hours, depending on the equipment bus load.

(Figure 27-5 )

This is a typical discharge-recharge conditioning cycle that we use. We connect a 19.3 ohm resistor across the battery terminals, discharge the battery to the 27.3 volts cutoff level. We allow a seven-hour period for this to occur. But once the low voltage cutoff does occur, we just wait for the remainder of the seven-hour period to elapse and then begin recharge. In this case it was cutoff, charge, cutoff; do nothing then for the remainder of the 21-hour period that began with charge, and then begin the regular one-hour charge sequence all over again.

(Figure 27-6 )

Performance-wise, the batteries on Viking Lander 1 have been subjected to one ampere discharges for one hour about once per week. Three of the four batteries would experience this, the three that are normally on the equipment bus while one is being charged.

In the past the peak discharges have been to as much as 15 percent, depending on the amount of voltage imbalance between the three batteries and how they are sharing. The recharge rate was C/8. This is in addition to the once per month reconditioning charges that we're doing.

The results, as I reported at the IECEC, were a little degradation on two batteries, two other batteries being degraded by 67 percent, and I identified unequal load sharing between the battery pairs. Batteries C and D did not supply as much of the equipment bus load as the two less degraded batteries, and there existed a significantly higher operating temperature on the weaker batteries.

(Figure 27-7 )

Early in November we obtained a new data point for battery D, and the important points are right over there: 1.1 ampere-hours, 1.12, to be exact, compared to over 3 ampere-hours measured in the five-month prior conditioning cycle. Batteries A and B are still staying on track. I did neglect to put a data point at the end of the A curve that showed the last A data point that I had is 7.1 ampere-hours, which is still very high.

Part of what has happened is that because Batteries C and D are typically on the equipment bus with

either a Battery A or a Battery B that are in excellent condition, A or B, if I may use the word, hog the load. They supply the majority of the equipment bus load, and these two batteries don't even get the little bit of benefit of any discharging that might occur if they were at least equal voltage and they could share the load. They're not doing any sharing, and Batteries A and B are getting themselves in better condition at this time; Batteries C and D are dragging themselves down.

Coupled with this, at this time at about 1700 days after launch, the equipment mounting plate was at about 40 to 50 degrees Fahrenheit on a diurnal cycle. We are now in a 55- to 65-degree Fahrenheit diurnal cycle here, so we're seeing the effect of increased temperature lowering the battery terminal voltage and giving us a lower starting point. For our reconditioning cycles, we're obviously going to get fewer ampere-hours out of the battery.

(Figure 27-8 )

During the time that we do a conditioning cycle as I showed in the previous graph like this one, I showed Battery A being reconditioned. This is a plot of Battery B, and the next two will be Batteries C and D of their open circuit performance for the 28 hours that they're not being charged or discharged but just sitting idle, attached to the equipment bus.

You'll see that battery B, which is the other good battery, drops approximately one-half volt in the 28-hour period.

(Figure 27-9 )

This graph shows Battery C, the first of the weaker batteries, dropping approximately 2-1/2 volts in that same period, which appears to be implying perhaps parasitic shorting is occurring.

(Figure 27-10 )

Battery D actually drops exactly three volts over that same 28-hour period. So Batteries C and D seem to be possibly suffering a cadmium-migration problem, — I'm

guessing -- ultimately resulting in parasitic shorts.

(Figure 27-11 )

I proposed to JPL, and it is now being proposed to NASA Headquarters, that I be allowed to go in and, at the suggestion of Dr. Williard Scott of TRW, among others, perform some very close-together, deep-discharge reconditioning cycles on the Batteries C and D, designing the cycles such that they can be performed on Batteries A and B if I ever need to, but mainly to perform the deep-discharge reconditioning cycles on Batteries C and D as a minimum.

The spacecraft can operate with only two batteries. The two batteries, C and D, being significantly overgraded -- and we're approaching Martian summer at this time -- lead us to the point where we're going to be unable to get any energy from Batteries C and D to do any reconditioning to 27.3 volts. I honestly believe we're going to drift down to that point.

About the first time we connect a 19.3 ohm resistor across one of those batteries we'll sense undervoltage and each battery will be automatically disconnected from the reconditioning cycle.

Rather than read through all of this, as I say we're rapidly approaching Martian summer, which is going to elevate the equipment mounting plate temperature. That's about a hundred days away right now. When that happens Batteries A and B will be operating at about 50 to 60 degrees. Batteries C and D will probably be in a 70- or 75- or maybe as high as 90-degree environment. So I'm concerned about this, and I have requested permission to get these batteries reconditioned.

What I plan to do is this, and when I finish, I would appreciate any comments, constructive or whatever.

Let me take Battery D first, because I have a known weakened condition on that. I would like to discharge it for at least four hours with a 19.3 ohm resistor across its terminals, and then terminate that discharge, recharge it at C/8, get the data back from the lander which will take about a week -- it gets recorded on a tape recorder, and the

next time I get information is a week later through the Deep Space Net -- analyze the data for a week, and then, everything looking good, uplink the next command to repeat that same sequence, and do that for a total of three times.

I understand in talking with some of our experts at previous conferences here, that doing several of those reconditioning discharge-recharge cycles can possibly bring back these batteries significantly.

In addition to that I do have some experience with reconditioning the Viking Lander 2 batteries. All four batteries on Viking Lander 2 saw excessively high temperatures for a 137-day period late in the Viking Lander 2 extended mission. I did experiment with deep discharges, seven-hour timed discharges, with a 19.3-ohm resistor.

And with doing two, seven-hour timed discharges within a 90-day period on one battery I was able to recover almost three-quarters of the capacity that I had lost. So the batteries seemed to respond to this type of reconditioning scheme.

However, I'm starting the reconditioning at a lower remaining energy condition on these batteries than I did with Viking Lander 2. When I started on the program on Viking Lander 2, I had 3 ampere-hours minimum in any of the batteries and as high as 4-1/2 ampere-hours.

Here I'm starting with 1.1 ampere-hours. I don't know how far I dare push the battery before I permanently reverse the cell. I recognize in four hours of discharge I will in all probability reverse some cells. But with the battery terminal voltage going down, and with a fixed resistance across the battery, I don't think -- and again I'm saying "think" purposely -- I'm discharging a battery at a high enough rate to permanently reverse the cell.

HENDEE (Telesat, Canada): Tell you what, even when you can see the battery voltages and know what's happening, you're probably going to reverse the cell. I tell you, I've got two satellites up there, and I'm doing it two or three times every week, conditioning per battery. And I'm lucky. I've lucked out that we've been able to bring

them back. You'll probably luck out. Try it.

(Figure 27-12 )

BRITLING: For your information I happen to have brought the Lander 2 curve that I presented at the IECEC. The longest curve here that's flat, going all the way out to this point, is the energy that remained in the battery at the Earth-Mars cruise time period. It turns out to be 9.13 ampere-hours.

We discharged that battery for 6.3 hours, to the 27.3-volt cutoff level and got 9.13 ampere-hours out of it.

SOL-547 -- SOL is the Martian solar day. It's 24.7 earth hours long. SOL-547, or 547 Martian days later, we obtained 8.15 ampere-hours to 27.3 volts. On SOL-777 -- this was after we had seen this 137-day period at elevated temperatures -- we got only 2.12 ampere-hours out of this battery.

Ninety days later, just to see what was happening, I think we did experience some recovery. There's an indication we had done some recovery from SOL-777 to SOL-853 because you see almost one additional ampere-hour out. But you must keep in mind the battery temperature in the earlier cycle was 57 degrees. Here it's 40 degrees so there may not have been any gain other than the fact that the battery being colder, the terminal voltage on the battery was higher and the colder temperature was responsible for obtaining a fractional additional ampere-hour out of the battery.

One week later we performed our first seven-hour timed discharge to 27.3 volts. We obtained 5.11 ampere-hours out of the battery. At the end of seven hours we were at 9.88 volts.

Ninety days later we repeated that seven-hour test and we got 6-1/2 ampere-hours to 27.3 volt discharge cutoff. We recovered another 1-1/2 ampere-hours. The temperatures there are fairly comparable, and the battery discharged only to 18.04 volts in that seven hours. Notice possible evidence of a second plateau on the last discharge cycle.

This was the experience on Viking Lander 2, but



that mission did terminate early because of loss of the Viking Orbiter that I needed to relay my data back to Earth.

One thing I might point out, as you see the voltage decaying in the first seven-hour timed discharge, we might be seeing evidence of cell reversals there, there, and maybe there, maybe one right there. (Indicating inflection points in the discharge curve.)

HENDEE: That's what I was going to point out. You have one, two, three, four, five reversals in there probably.

BRITTING: And we did come back.

HENDEE: You got them back. Our satellites are approaching their tenth anniversary here in another month, I think, the first one. Every reconditioning period we drop out a cell. You can see it. You can see a discontinuity just like you see it there. You can see the cell drop out, and our capacity was just going to hell in a hand bucket again, just like yours.

We had to make a decision, were we going to give up a cell to recover the capacity, the voltage on the other cells, and we said, "Yes, we'd try it." So we went and we at least said "We're going to go into our second reversal without any qualms." And we've been recovering.

BRITTING: Do you have the capability of shorting across a cell that's going negative?

HENDEE: No, I wish we did.

BRITTING: I wish we did, too.

HENDEE: We have no protection whatsoever.

BRITTING: Hindsight.

HENDEE: No, we knew about it when we did it.

BRITTING: We probably did, too. I wasn't around at that time.

KUNIGAHALLI (Bowie State College): Could you

kindly comment on the second plateau that I see on the curve there? What is the rate of charge and discharge of that curve?

BRITTING: Let's see. About that time the average discharge rate is identified right here, 1-1/2 amps. We start out at roughly 1.6 amps. By this period in here we're discharging at about 1.4. We're probably discharging at about a 1.25 to 1.4 ampere rate by that point.

KUNIGAHALLI: I see. Do you observe this second plateau in all the cells that are SATCOM?

BRITTING: As I say, the mission ended before I was able to get sufficient information from the other batteries so I can't honestly say that. I'm banking a lot on this being typical of all the batteries.

KUNIGAHALLI: Can you comment on why the second plateau appears? Do you have any suggestion why it's happening there?

BRITTING: I'm not a battery expert. Somebody else might feel free to comment on that.

Viking 75 Mars Lander

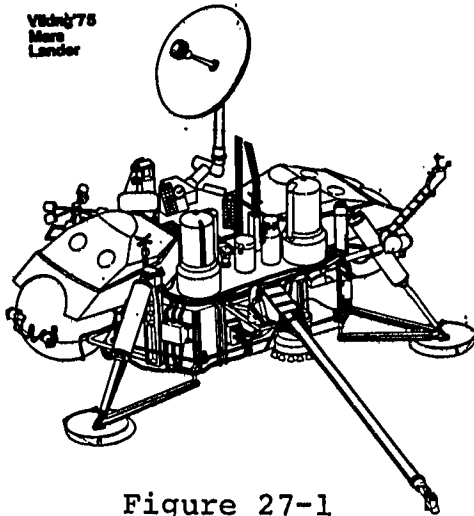

Figure 27-1

**BATTERY CHARACTERISTICS**

2 - 24-8AH BATTERIES/ASSEMBLY  
 2 - BATTERY ASSEMBLIES/SPACECRAFT  
**BATTERY WEIGHT** 50.5 LBS  
**HEAT STERILIZATION** 54 HOURS @ 233°F  
**CHARGE CONDITIONS**  
 VOLTAGE/TEMPERATURE CONTROL  
 C/15 - IN CRUISE FROM VO 75  
 C/160 - TRICKLE  
 C/8 - TYPICAL LANDED OPERATION  
**MONITORING**  
 TEMPERATURE } FLIGHT  
 BATTERY VOLTAGE }  
 CELL VOLTAGE - GROUND ONLY

Figure 27-2

Table I Cell Characteristics

Cell Capacity	8 A-h (Rated)
Cell Weight	273 gm - Lot Average
Cell Size	7.589 cm x 2.27 cm x 8.651 cm (including terminals)
Case Material	304L Stainless Steel
Case Wall Thickness	0.48 ± 0.05 mm
Insulated Terminals	Positive & Negative
Terminal Type	Nickel Post with Ceramic Insulator Ce - all Nickel - Bronze
Auxiliary Electrode	None
Separator Material	Pellon FT2140 Nonwoven Polypropylene
Separator Thickness	0.216 mm
Plate Pack Wrap	Pellon FT2140 Nonwoven Polypropylene
Case Liner	0.127 mm Solid Polypropylene Sheet
Electrolyte	KOH
Electrolyte Concentration	34%
Electrolyte Quantity	21.5 to 23.5 cc
Plate Substrate	0.101 mm Perforated Steel Sheet
Sinter Porosity	80% Nominal
Number of Plates	POS 11 NEC 12
Plate Size	7.0 ± 0.03 x 4.9 ± 0.03cm
Plate Thickness	POS 0.066 to 0.071 cm NEC 0.078 to 0.081 cm

Figure 27-3

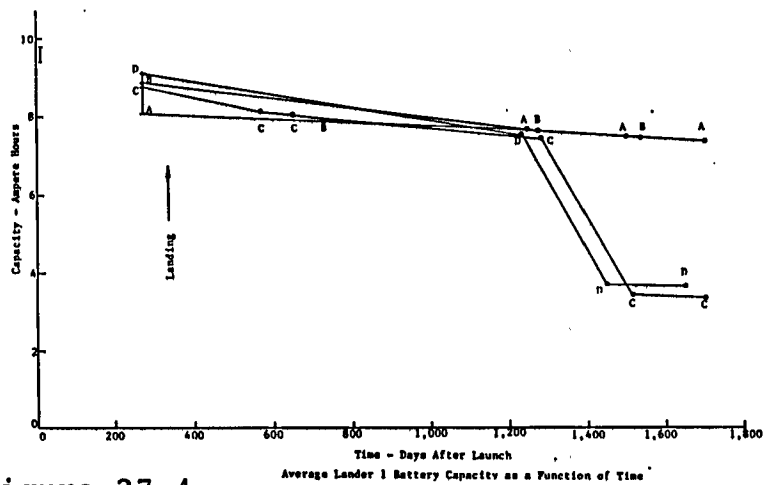

Figure 27-4

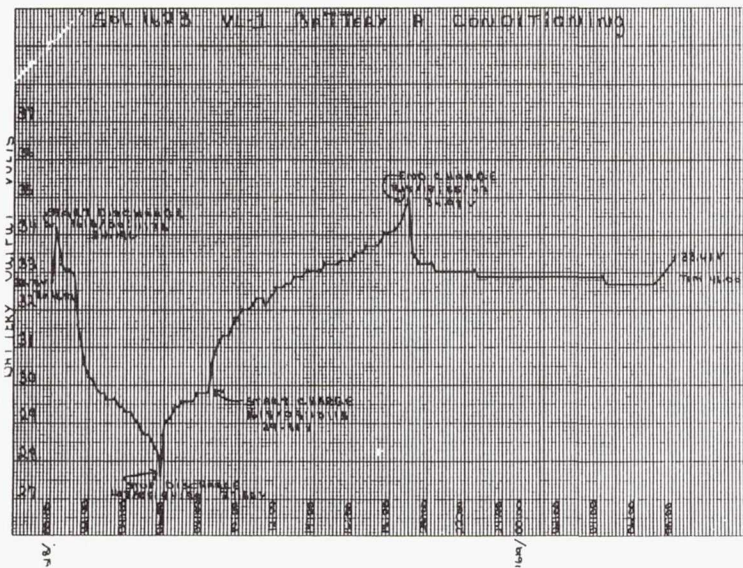

Figure 27-5

PERFORMANCE

VIKING LANDER 1

- o DISCHARGE/RECHARGE
  - 1 AMPERE DISCHARGE (C/8) FOR 1 HOUR ONCE/WEEK (12% DOD)
  - PEAK DISCHARGES TO 15%
  - RECHARGE @ C/8 RATE
  - ONCE/5 MONTH DISCHARGE @ C/5 TO 27.3 VDC, RECHARGE @ C/8
- o RESULTS
  - LITTLE DEGRADATION TWO BATTERIES - OCV @ 32-33 VDC
  - TWO BATTERIES GREATER DEGRADATION - OCV @ 30-31 VDC
  - UNEQUAL LOAD SHARING BETWEEN BATTERY PAIRS
  - 10-15°F HIGHER OPERATING TEMPERATURE ON WEAK BATTERIES

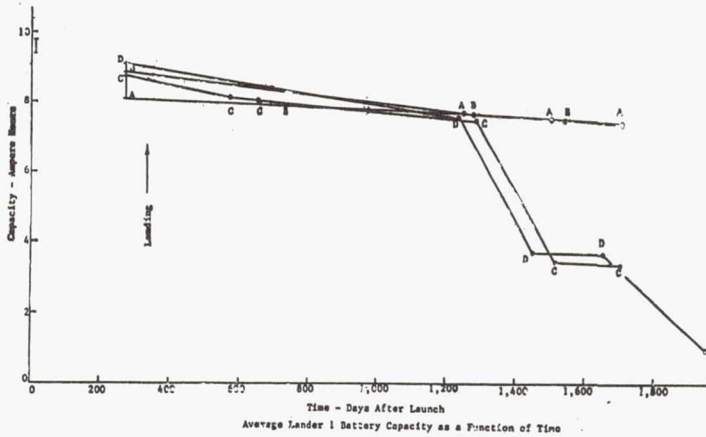

Figure 27-6

Figure 27-7

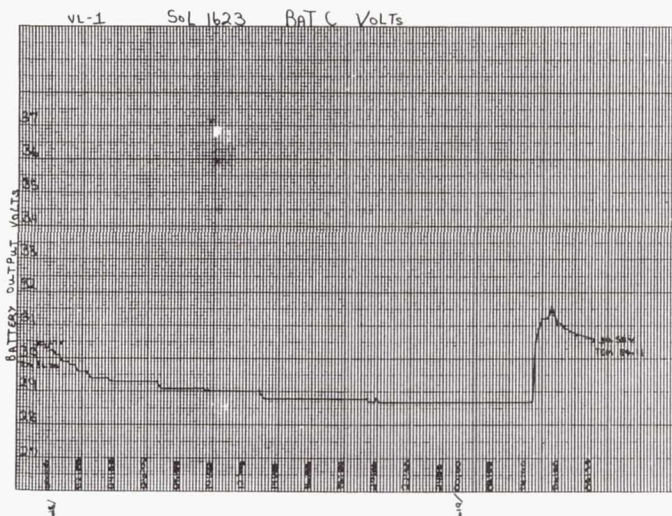

Figure 27-8

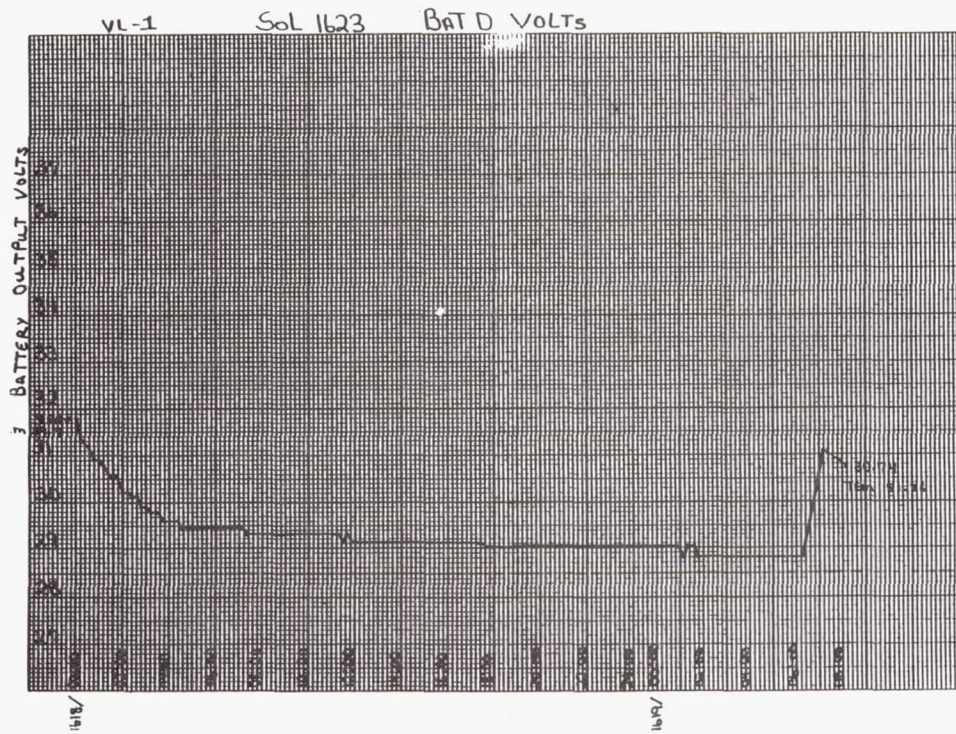

Figure 27-9

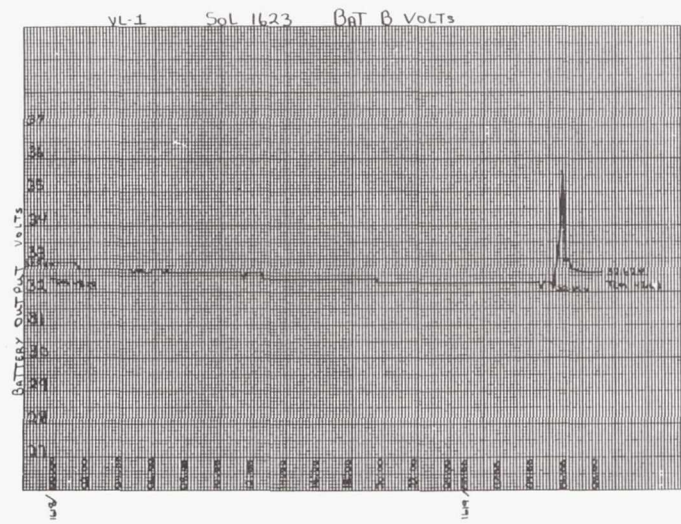

Figure 27-10





RECOMMENDED TASKS - BATTERY RECONDITIONING

PROBLEM

- SPACECRAFT CAN OPERATE WITH ONLY TWO BATTERIES
- TWO BATTERIES (C & D) SIGNIFICANTLY DEGRADED (60%)
- EACH BATTERY IS RECONDITIONED EVERY FIVE MONTHS (DIFFERENT BATTERY EVERY 37 SOLS)
- PRESENT ONBOARD RECONDITIONING SCHEME ONLY RETARDS RATE OF DEGRADATION
- ELEVATED S/C TEMPERATURES DURING MARTIAN SUMMER (SOL 1994) AGGRAVATE PROBLEM

PROPOSAL

- DESIGN UPLINK TO ALLOW MORE FREQUENT, GREATER DEPTH OF DISCHARGE RECONDITIONING CYCLES
- PERFORM RECONDITIONING SEVERAL TIMES ON ONE OF WEAKER BATTERIES, ANALYZE RESULTS
- PERFORM RECONDITIONING ON REMAINING WEAKER BATTERY
- FLIGHT SOFTWARE CHANGE TO REMAIN IN FLIGHT COMPUTER FOR FUTURE USE ON ANY BATTERY
- REPORT RESULTS

Figure 27-11

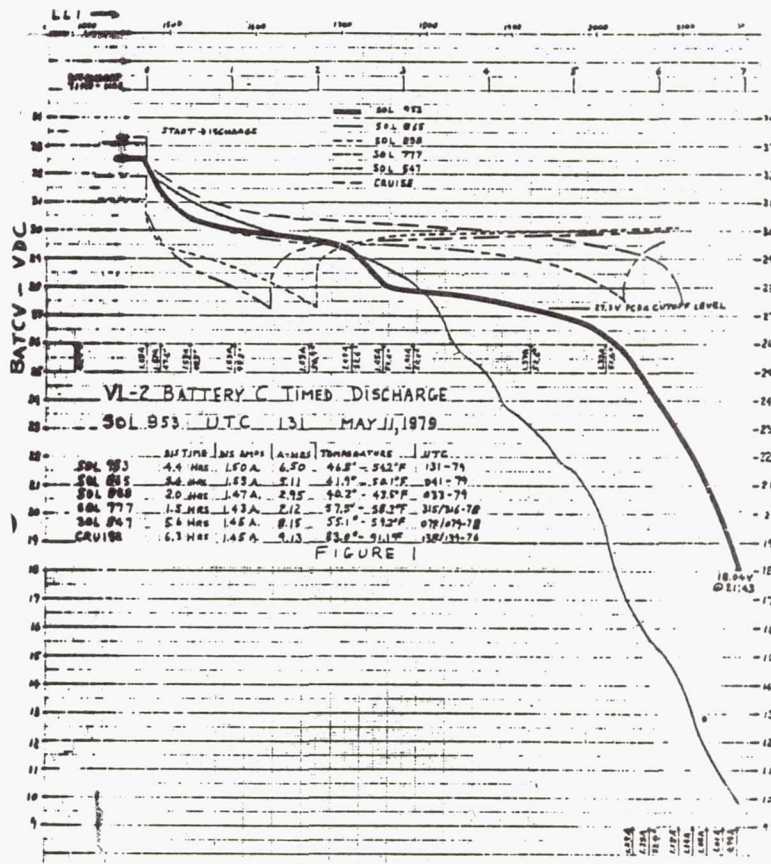

Figure 27-12

**Page intentionally left blank**

## GPS ON-ORBIT BATTERY PERFORMANCE

J. Kasten

Rockwell

(Figure 28-1 )

The GPS system has three General Electric batteries. There are 16 cells in series, and at 25 degrees the rated capacity is around 18 amp-hours. These three batteries are wired together, and during the eclipse period they are discharged through parallel diodes into a boost converter which then boosts the battery voltage up to the totally regulated bus voltage (27.4 V). Each battery has its individual charger, and the system life is supposedly good for about five years.

To just give a little pre-flight history on these batteries, the age of all of the batteries varied around 20 to 38 months at launch, and this consisted of around 20 months of cell test (time from activation) battery fab time, and space vehicle test time. The balance of the time was in cold storage. The cell test and battery fab was what I classified as time at GE. That's from the fill time at Gainesville. There was approximately eleven months on these batteries. The space vehicle test on these vehicles that I'm showing is around nine months. We store them at five degrees C in a discharged state, open circuited.

The vehicles that I'm showing here, all of these batteries, when they were stored in cold storage they were open circuited.

The battery during space vehicle test was in use or maintained on a trickle charge. The approximate temperature range was around 20 plus or minus 5 degrees. Sometimes it would be a couple of degrees cooler, sometimes a couple of degrees warmer. When they were on trickle charge they were either charged to a VT curve -- that's a clamped voltage/temperature (the next chart will show what I mean by that) or else it was a constant current charge of around 150 milliamps.

We have a hard and fast requirement that we limit



the open circuit time. It has to be less than 14 days. In reality we usually end up with one or two days. Most of this open circuit time is accumulated during vehicle transportation from one test facility to another.

A deep reconditioning is performed on the batteries every four months. Just prior to shipping our vehicle up to Vandenberg we do a deep reconditioning which is within six weeks of launch. At this point the batteries are taken down to first cell voltage of 1.1 at a fast rate and then there are individual resistors placed across each cell until the cell voltage is less than 20 mv.

Our battery flight history. The GPS orbit is a 12 hour orbit. It has a 30 day eclipse season twice each year. Max eclipse is 55 minutes, and the eclipse time roughly follows the sine curve.

The flight battery temperature except on one battery on each vehicle is maintained within zero to five degrees C. That was our goal with the exception of one of the three batteries which operates at zero to 30 degrees, or a little bit more, actually, zero to about 35 now. The batteries are charged to a V/T curve, and this equates to around 100 milliamps at two degrees C. We perform a shallow reconditioning -- that's taking the battery voltage down to 17.6 volts -- prior to each eclipse season.

(Figure 2b-2 )

This is a picture of our battery. The battery is mounted to the vehicle with these mounting attach points here, and it's thermally isolated from the vehicle.

It's not shown in this picture, but there's a radiator on the bottom of each battery -- a heat rejection plate. The idea is that the heat flow out of the battery is through the radiator, which looks at deep space. We control the temperature of the battery with thermal heaters, controlled by thermostats, and that maintains them over the zero to five degree range.

(Figure 2b-3 )

This is basically our V/T curves. Nominally on V/T curve number two -- this one right here -- and if the

battery temperature is around zero degrees or two degrees then the voltage is around 23 volts, and the battery coming out of an eclipse period is charged. When the voltage reaches 23 volts the current is clamped back, it rapidly drops off and enters into a taper charge region which ends up to be about 100 milliamps after about 24 hours of charging.

(Figure 28-4 )

This is kind of a gross summary of the data that we have on our first satellite that was launched on Washington's birthday back in '78. So we're approaching four years of life on this vehicle.

The data I plotted here was the battery capacity during the reconditioning. Basically we just put a constant resistive load across the entire battery and we end up with about a 150 milliamp discharge rate at 18.5 volts. This load is removed when the battery voltage reaches 17.6 V.

As you can see, on all of these batteries we have a relatively constant capacity over the flight history. We have shown they indicated basically no degradation at all. We're really level. There is some noise level back and forth because the people up at Sunnyvale who watch the vehicle don't always catch it right at the point in time where the load is tripped off.

I should mention the reconditioning load. When the battery voltage reaches 17.6 volts, as I mentioned earlier, it is automatically removed. And so they always don't catch it at that time. So we usually back off to the last time they find it -- they saw that it was still discharging. And this can vary eight hours or so.

The battery number three which sees the run on the first four vehicles that were launched, as I mentioned earlier, does vary in temperature range of 0 to 30 degrees C, and, is the battery that our thermal people blew it on. And the radiator surface, which is coated with silver teflon tape, degraded at a lot faster rate. The alpha on it degraded at a lot faster rate than was anticipated predicted back in '77 when the design basically was done.

And so within about six months after launch we

were approaching 20 degrees C and now it's up to 35. I think it has pretty much leveled off. I think it's degraded about as far as it's going to degrade. The battery is swinging through a temperature cycle of zero to about 30, 35 degrees every 12 hours. But on these batteries -- and I'll have another vehicle where you can see some degradation, quite a bit of degradation -- but on this one we have seen none.

The lower part of this chart is a summary of the end of eclipse voltage that we see during our longest eclipse period, our 55-minute eclipse period. I plotted the battery voltage along here, which refers back to this chart here. You can see it's right around 19.5 volts.

These numbers down here are the currents that were being drawn out of the battery at the end of the eclipse when the voltage was recorded.

(Indicating.)

At the last eclipse period, which took place in April, the last eclipse period I have plotted, which was April of '81, our battery one was about six amps, two were 6.1 amps, and battery number three was about 5.3 amps. So you can see the thermal effect there.

Also on battery three, since it is getting up into the high temperatures, they are managing the charging circuit now. We have an automatic cutoff at about 32 degrees. However a customer is a little reluctant to rely on that, so whenever the battery gets up to 25 degrees they cut off the charger. So battery number three is seeing significant open circuit time now.

At this point I will identify the period of time (through the eclipse period) they had our payload in what is called the high power mode, so we had larger currents which are identified here, and that's the reason for the lower voltage.

(Figure 28-5 )

This is kind of a busy chart of the raw data showing each eclipse period. Basically these are the numbers used in calculating the capacity plotted on the previous chart. The other reason I'm showing it is we also calculate

the average discharge voltage for each battery. And, as you can see, on this particular vehicle we have seen little drop in the discharge voltage. This is the reconditioning discharge voltage.

Over here you can see a drop right around in here.

(Indicating.)

And that is a point in time where we went to a lower charge curve, charge curve one, if you'll recall the V/T curve figure.

(Figure 28-6 )

Vehicle two is pretty much the same as vehicle one. We have seen very little or no degradation of any of the batteries.

On our vehicle number three, which was launched in October, October 7 of '75, we have seen some degradation. Battery two looks real good. It's pretty much flat, still staying at an amp-hour calculated capacity of around 23 amp-hours through this area.

Battery one has shown a gradual decline, but not a whole lot.

Battery three, though -- this is the one, again, that's being thermal cycled -- we have seen a significant drop after about the third reconditioning period. We saw a significant drop. And the ground rules that we have set up when we see more than a six percent degradation, they automatically go and perform the second reconditioning cycle. These reconditioning cycles are performed within about a week or a week and a half of each other. So due to the temperature cycling and everything it appears that we do not really gain that much in capacity.

Now I just received data Friday, and it has now taken another six percent drop. So the next plot shown will be right about in here. It appears we are getting some degradation on battery number three, which is probably being caused by the temperature cycling.

Again the eclipse performance, though, this is the

plot of the end of eclipse voltage, with the currents. We're getting fairly good current sharing.

What will happen is at the beginning of the elipse we'll get very little sharing with battery number three due to the temperature. It's basically off-line. But as the eclipse gets into, say, five or ten minutes it will slowly start picking up. And by the time we're into 15 to 20 minutes the discharge current is near the final value recorded.

So batteries one and two, as the man from Martin mentioned, tend to hog the load.

(Figure 28-7 )

This is just, again, detail numbers from which the capacities were plotted. Voltages on this battery again appear to be holding out very, very well.

Battery number three, the voltage showed a drop when we went to charge curve one, which is right about in this period, and it's dropped a little bit more here.

(Indicating.)

Another thing I'll point out, this is the reconditioning load, the resistive load that the battery voltage or the battery is reconditioned across.

We ended up with a mix on age of batteries on our first six vehicles. This battery number one happens to be one of the older batteries in our system that we launched. It was approximately 38 months old at launch in real life. And one could assume that may be some of the reasons why we're seeing some of this degradation here, even though it is minor. It doesn't show up on some of the other vehicles. The reason for the age mix was because we had, again, a design change after we had received another number of batteries. So in trying to shuffle things around we mixed them up. We don't intentionally assign batteries to vehicles this way.

(Figure 28-8 )

This is the reconditioning discharge curve from the third vehicle, battery number three. The dashed line is basically what we predicted it should be based on previous test data. Our first reconditioning (solid line), which was held May '79, followed that line down fairly close and carried right out. We're coming off with a fairly sharp dropoff. Where this ends here, that's the last data point that we got from the vehicle monitoring. It should not have dropped off until we got down to about 17 volts down in this area.

Then in November of '80 we did the reconditioning and had a significant decrease in capacity, as I pointed out in the earlier charts. And the voltage discharge curve was somewhat depressed from what we had seen earlier. And also the slope at the end had a very soft knee to it, which could indicate that we were getting some cell divergence. So a second reconditioning was performed. And, as it came out, the first part of the curve looked good up to here. We saw all the things you would expect to see with reconditioning. The voltage plateau had increased. But the discharge voltage still dropped off early to a second plateau. And on this we just happened to luck out; they were watching the vehicle and waiting for it to trip, and we had a little extension here which could indicate that we're seeing a cell drop off right about here. That's the weakest cell.

The latest data from this battery that was just received shows the same thing. We had an extended period of time, around nine to ten hours, where we had dropped down and then it just kind of held its own for about another ten hours and then dropped off. And, of course, we were sitting right on the cutoff point.

(Figure 28-9 )

Our fourth vehicle, which was also launched back in '78, December 11th, again battery number three capacity is dropping. I don't know if there's anything you could say here or not, but it seems like when we did the two reconditioning cycles the next time up seems to hold its own. It's a sample of two, I guess, on these two vehicles. But we're kind of looking forward and watching that later on.

Again the discharge voltage at the end of the

eclipse periods are fairly level.

(Figure 28-10 )

This is, the detailed capacity information for our fourth vehicle. The voltages basically have remained unchanged for these two. We've seen some drop here again because, I don't have it noted here, but we are on charge curve one.

We have two other vehicles in orbit that were launched in 1980, and we have seen no capacity degradation on those batteries. And we resolved our battery three problem of temperature cycling by redesigning the battery radiator system. Now on our vehicles all the batteries are maintained over a zero to five degrees temperature range.

Any questions?



## GPS BATTERY DATA

- BATTERY DESCRIPTION
  - MANUFACTURER - GE
  - 16 18AH CELLS
- BATTERY PRE FLIGHT HISTORY
  - AGE AT LAUNCH RANGED FROM 20 TO 38 MONTHS
    - 20 MONTHS OF CELL TEST/BATT FAB/SV TEST TIME
    - CELL TEST/BATT FAB - 11 MONTHS
    - SV TEST - 9 MONTHS
  - REMAINING TIME (IF ANY) WAS IN COLD STORAGE
    - DISCHARGED
    - 5°C
  - BATTERY SV TEST TIME
    - IN USE OR MAINTAINED ON TRICKLE CHARGE
      - ≈ 20°C
    - CHARGED TO V/T CURVE (CLAMPED VOLTAGE/TEMPERATURE) OR CONSTANT CURRENT OF 150 MA
    - OPEN CIRCUIT TIME MINIMIZED TO LESS THAN 14 DAYS
    - RECONDITIONED APPROXIMATELY EVERY 4 MONTHS AND WITHIN 6 WEEKS OF LAUNCH
- BATTERY FLIGHT HISTORY
  - 12 HOUR ORBIT, 30 DAY ECLIPSE SEASON, 55 MIN MAX ECLIPSE
  - TEMPERATURE MAINTAINED OVER 0 TO 5°C RANGE (EXCEPT WHERE NOTED)
  - CHARGE TO V/T CURVE (≈ 100 MA AT 2°C)
  - SHALLOW RECONDITIONED (BATTERY VOLTAGE OF 17.6V) PRIOR TO EACH ECLIPSE SEASON

Satellite Systems Division  
Space Systems Group



Figure 28-1

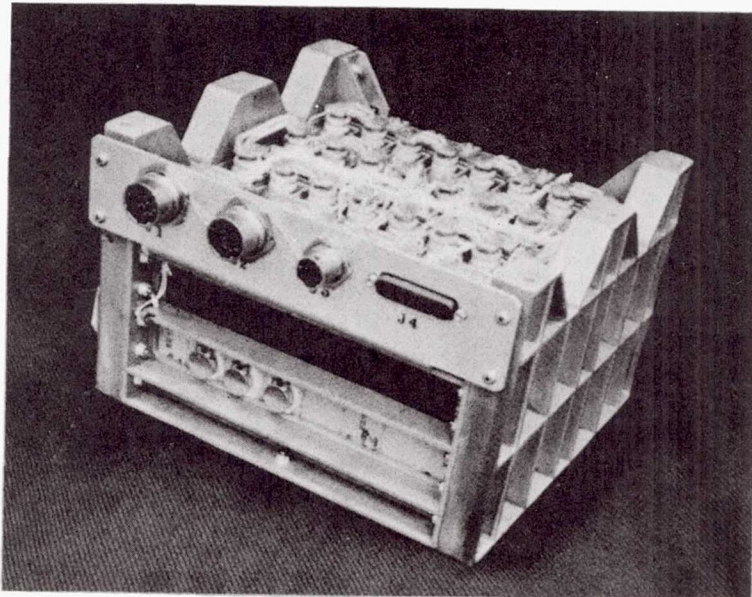
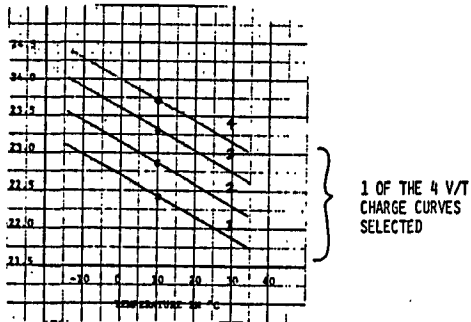

Figure 28-2



V/T CURVES FOR BATTERY CHARGING



- NOMINALLY V/T CURVE 2 IS SELECTED
- BATTERY VOLTAGE IS CLAMPED AT TEMPERATURE (CHARGE CURRENT TAPERS)

Satellite Systems Division  
Space Systems Group



Figure 28-3

NAVSTAR I BATTERY RECONDITIONING DATA

DATE	BATT #1 S/N 018 (32.074)			BATT #2 S/N 017 (32.072)			BATT #3 S/N 020 (32.071)		
	CAP (AH)	VOLT (AVG) (VOLTS)	TIME (HOURS)	CAP (AH)	VOLT (AVG) (VOLTS)	TIME (HOURS)	CAP (AH)	VOLT (AVG) (VOLTS)	TIME (HOURS)
SEPT 79	22.4	19.88	143.04	22.6	19.94	142.80	22.7	19.89	142.80
MAR 79	22.1	19.89	140.64	22.7	19.81	144.24	22.6	19.86	142.36
SEPT 79	22.5	19.87	143.52	22.74	19.87	144.24	22.8	19.81	144.00
MAR 80	22.6	19.83	144.36	22.52	19.85	142.76	22.76	19.75	144.48 <sup>#</sup> (TEMP RANGE = 0.0-35.0°C)
SEPT 80	22.63	19.87	144.57	22.34	19.87	141.72	22.75	19.78	144.16 <sup>#</sup> (TEMP RANGE = 0.0-35.0°C)
FEB 81	22.29	19.86	142.35	22.61	19.85	143.56	22.54	19.70	143.40 <sup>#</sup> (TEMP RANGE = 3.1-35.0°C)
AUG 81	22.55	19.82	144.05	22.49	19.82	145.00	22.16	19.68	142.50 <sup>#</sup> (TEMP RANGE = 3.1-35.0°C)

# CHG CURVE # 1

Figure 28-5



NAVSTAR I BATTERY DATA

LAUNCH DATE 2/22/78

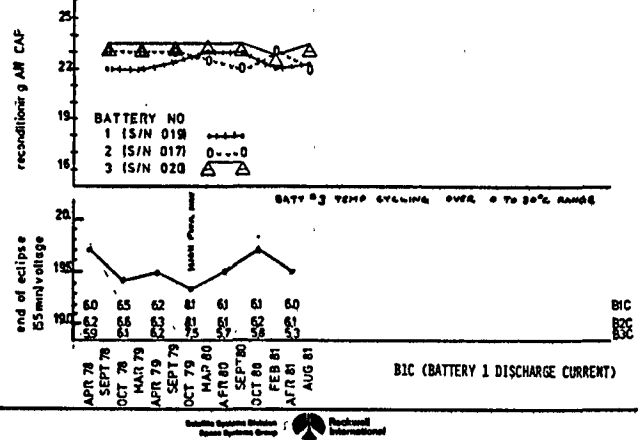

Figure 28-4



NAVSTAR III BATTERY DATA

LAUNCH DATE 10/7/78

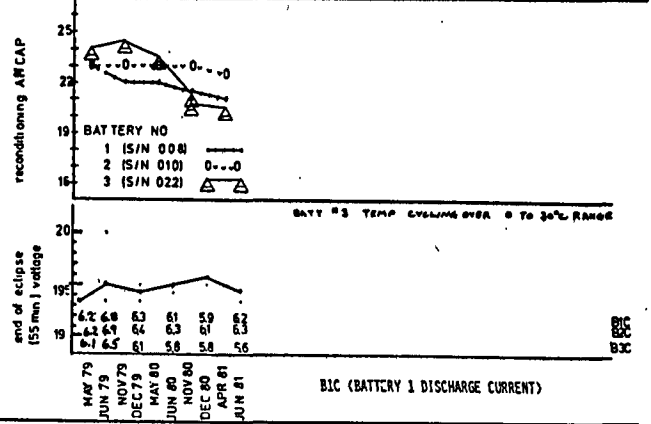

Figure 28-6

NAVSTAR III BATTERY RECONDITIONING DATA

DATE	BATT #1 (S/N008) RECOND LOAD 126.69 Ω			BATT #2 (S/N010) RECOND LOAD 125.89 Ω			BATT #3 (S/N022) RECOND LOAD 124.54 Ω		
	CAP (AH)	VOLT DISCHG (AVE)	TIME (HOURS)	CAP (AH)	VOLT DISCHG (AVE)	TIME (HOURS)	CAP (AH)	VOLT DISCHG (AVE)	TIME (HOURS)
MAY 79	22.80	19.83	145.62	23.26	19.80	147.85	23.56	19.86 (0°C TO 14°C TEMP RANGE)	147.75
NOV 79	22.22	19.84	141.90	22.85	19.79	145.38	23.64	19.75 (2°C TO 20°C TEMP RANGE)	149.02
MAY 80	21.92	19.82	140.07	22.65	19.79	144.07	23.07	19.66 (2°C TO 20°C TEMP)	146.14
NOV 80	21.51	19.82	137.54	22.64	19.75	144.32	20.95 CURVE #1 (2°C TO 29°C TEMP)	19.68	132.55
							20.53 CURVE #1 (2°C TO 29°C TEMP)	19.84	128.88
APR 81	20.99	19.85	134.10	22.42	19.76	142.81	19.80 CURVE #1 (1.8°C TO 24°C TEMP)	19.70	125.12



Figure 28-7

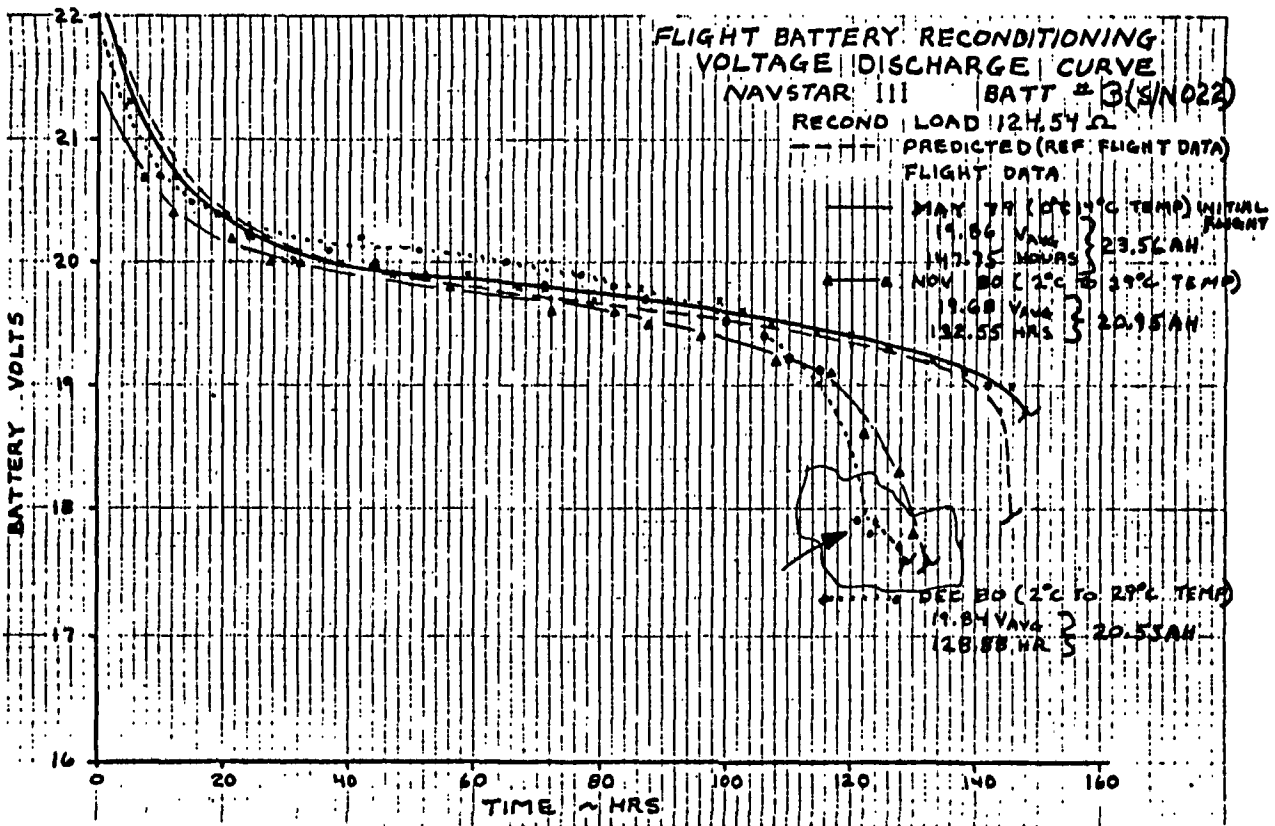
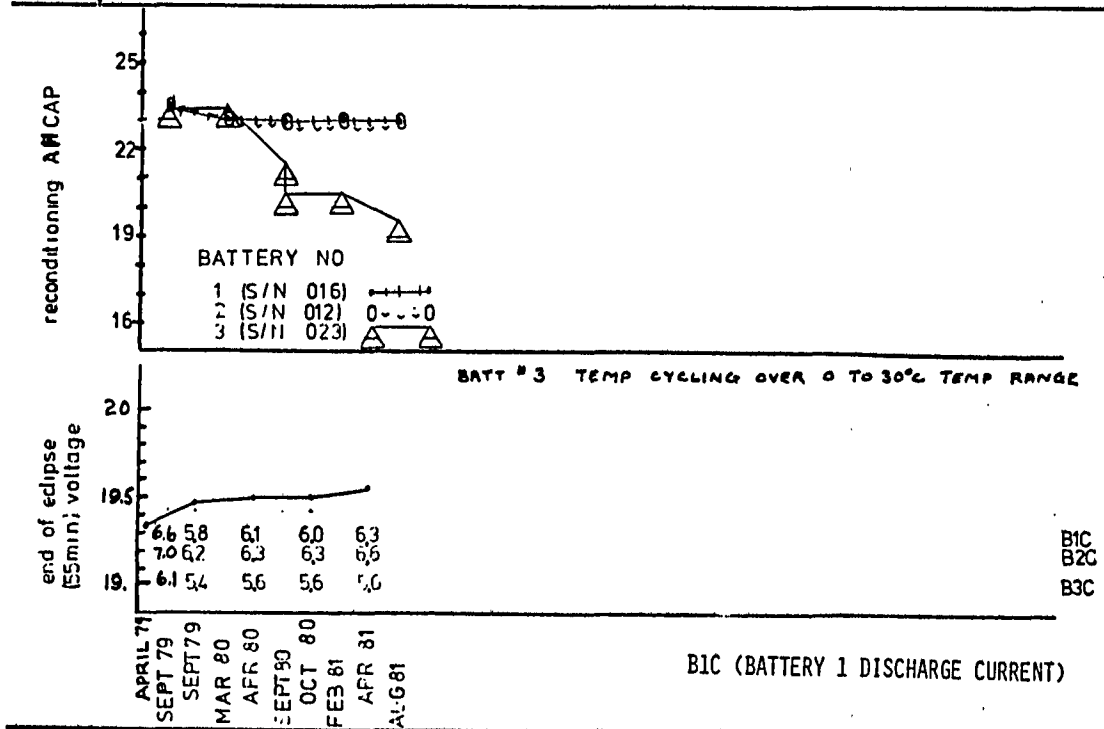

Figure 28-8



NAVSTAR IV BATTERY DATA

LAUNCH DATE 12/11/78



Satellite Systems Division  
Space Systems Group



Rockwell  
International

Figure 28-9

NAVSTAR IV BATTERY RECONDITIONING DATA

DATE	BATT #1 (S/N 016) (126.53Ω)			BATT #2 (S/N 012) (125.93Ω)			BATT #3 (S/N 023) (125.11Ω)		
	CAP (AH)	VOLT DISCHG (AVE)	TIME (HRS)	CAP (AH)	VOLT DISCHG (AVE)	TIME (HRS)	CAP (AH)	VOLT DISCHG (AVE)	TIME (HRS)
SEPT 79	23.50	19.86	149.71	23.52	19.88	148.96	23.37	19.82	147.62
MAR 80	23.35	19.90	148.46	23.19	19.89	146.83	22.65	19.73	143.64 (TEMP RANGE 0.8 → 20.0°C)
SEPT 80	22.65	19.90	144.05	23.22	19.87	147.11	21.38 1 <sup>ST</sup>	19.74	135.51 (TEMP RANGE 1.2 → 23.3°C)
FEB 81	22.66	19.88	144.20	23.12	19.89	146.36	20.16 2 <sup>ND</sup>	19.96	126.33 (TEMP RANGE 0.6 → 21.6°C)
AUG 81	23.10	19.84	147.35	22.66	19.89	143.46	20.25	19.82	127.87 (TEMP RANGE 3.4 → 20.3°C)
							19.44	19.70	123.50 (TEMP RANGE 1.2 → 21.6°C)

Figure 28-10

## NEW NiCd BATTERY STANDARD AND GUIDE

M. Milden

Aerospace Corporation

I think this is a fitting paper to end up today's session on NiCd cells and NiCd battery performance data.

One of the functions that Aerospace Corporation has is to examine the entire industry and examine what's been going on and interface with the various industry organizations and try and distill out of it some general practices, and this is what we have attempted to do.

(Figure 29-1 )

We're basically working with two kinds of documents. The first one is military standards and specifications. These provide a formal listing of good practices through an iterative process dealing with people in the industry.

Another purpose is to provide a compliance document for imposing requirements in procurements. Normally these documents do not contain design data. It's usually not the place of a military standard or spec to contain design data. This is usually left for handbooks.

It also provides a technical basis for procurement. It provides a nominal requirement. It's a basis for discussion and negotiations. Any of these documents is always open for negotiation.

(Figure 29-2 )

Internal to the Space Division, which is part of the Air Force, there is a new series of documents which are going to be called Program Engineering Technical Guides. These will be used by the various program office individuals and Air Force individuals to gain some general background of the industry practices and various tradeoffs on what might be controversial areas.

The basic difference between a guide and mil spec is a specification is a mandatory document whereas the guide

will be informational and primarily a tutorial document. These are strictly going to be in-house documents. They are presented as part of a series. The initial group consists of five documents. And what I have done is I have solicited about 30 inputs from various people throughout the industry on three drafts of this document.

I'm sorry I couldn't get around to all of you, but I just took a selected list of various different government agencies and suppliers.

The Program Engineering Technical Guide is less formal. It's a more dynamic document. It doesn't go through a formal release cycle. It will also allow for divergence of opinions. There will be controversy presented in the documents. It will document engineering or technical data that exists in the industry, and it can also act as a design handbook.

Hopefully it will provide a consistent technical approach. And it will be useful for evaluating diversity of opinions. As some of you are well aware, there are lots of opinions on things like reconditioning, what temperature to operate a battery, different voltage curves, different techniques.

At present there are five guides being prepared. One deals with propulsion system pressurants. Another one deals with vehicle instrumentation during acoustic tests. Another one deals with retest requirements. Another one deals with verifying redundant capabilities in space. And the fifth one deals with use of NiCd batteries during systems tests.

(Figure 29-3 )

First I'd like to go over -- incidentally, Gerry Halpert leaned on me. I had 22 viewgraphs, and he twisted my arm to cut out about two-thirds of them. So hopefully we'll finish right on time. The remaining 16 viewgraphs will be contained in the proceedings for completeness.

First I'd like to go over the main points of the nickel-cadmium battery usage practices for space vehicles. This will be published as Mil Standard 1578; the nominal release date is 27 July '82. It's currently in the release

cycle being published somewhere or other in the vast bureaucracy. Eventually it will be available to the public.

It will establish requirements, and these are based on experience and successful practices, much of the material we've seen here today.

Compliance with the document will help assure proper performance for NiCd's during space missions. The compliance with handling procedures should go quite a ways to minimizing degradation. And one thing that it will hopefully do, it will define terminology to be used.

As most of you are aware, there are a lot of confusing and ambiguous terms, like capacity, and this will just provide a definition. It may help eliminate some ambiguities.

(Figure 29-4 )

The Program Engineering Technical Guides title is "Use of Rechargeable NiCd Flight Batteries During Space Vehicle Testing." It has three major sections. The first one is a survey of practices that are current in the industry, a discussion of current usage, and it makes recommendations.

(Figure 29-5 )

These are the results of a survey of a total of 28 spacecraft systems use broken down in terms of no use, thermal vacuum only, and all systems testing. The majority of people do not use the flight batteries for other than flight. They acceptance test the batteries, they acceptance test the cells first, and then they put the batteries in storage, reconditioning them periodically and reconditioning them just before putting them on the flight vehicle.

Generally the older programs used flight batteries for all systems testing. The trend in most of the newer programs is to minimize use of the designated flight batteries.

(Figure 29-6 )

In going through this survey there were a number of reasons which were presented by enough people to give

some repetition. The reasons given for the use of flight batteries in systems testing were the collection of base line data; in actual vehicle environment where you've got the actual leads, you've got the actual connections, it gives you a chance to do a full up test.

In many vehicles the battery is an intimate part of the thermal subsystem, and if the battery is a part of it this is the one chance you really have for checking out that thermal interface.

A number of people said it gave them an opportunity to discover early failures by actually using the flight batteries. I'd like to point out, though, that there's a clear tradeoff between life and testing.

And a couple of people -- particularly on commercial programs -- said that the use of the flight batteries or a single set of flight batteries is a low cost option. In commercial systems this is a major consideration. However in many military systems this is really not a consideration. Life and performance are the critical parameters.

(Figure 29-7 )

The reasons given against the use of flight batteries in system tests were that secondary batteries do have a limited life, and what we would like to do is maximize the on-orbit life. Jim Dunlop said he thinks that if you use the batteries on the ground you're going to lose as much as a year in orbit. Probably a good number.

Of course another very important point is the only environment where there is a simulation of space is during a thermal vacuum test, and in the survey a large number of people said the only test they did use the actual flight batteries, the designated flight batteries, was during thermal vacuum.

Of course the other reason, or major reason, against is the batteries could be damaged in test. Most of you are familiar with the horror stories of the test area and junction boxes and the various holds and whatever that go on during vehicle testing, particularly on the first vehicle in a series. So you've got to trade off the

handling and the installation problems with the data that you're going to gain.

Finally, perhaps one of the strongest reasons is battery related data can be collected in subsystem testing where you actually do have access to the battery with hard wired connectors as opposed to, on a spacecraft, where you're counting on telemetry through some kind of a data acquisition system. This is much, much safer from a battery standpoint. And in most cases use of the engineering test models will give you all the test data that you need. There's really no need to use flight batteries.

(Figure 29-8 )

The Program Engineering Technical Guide ends up with three basic recommendations:

The first one is not to use batteries designated for flight during vehicle systems testing except to provide absolutely necessary data.

The second is using space quality batteries for vehicle systems testing. This could be engineering models, it could be qual. models, it could be any other battery but not the actual designated flight batteries. They could be flight type, flight quality or flight configuration. Each different organization uses different words for the same thing.

And the final recommendation is install flight batteries at the last practicable time prior to launch. If possible install them at the launch pad, if you have the facilities. If not, install them just before shipping.

Any questions?

#### DISCUSSION

HENDEE (Telesat Canada): The result of all these wise comments is Floyd's comment to me in the hall that I wasn't giving everybody enough static again this year.

I'd like to make two comments:

First of all, it's my old one, that once again I'd



like to say that limiting cost is rather selfish. Let's give Jim Dunlop 100 percent error in his calculations. Let's say it's only six months that you will degrade -- you will lose six months of performance at a cost of around -- what? -- let's say 80 million projected over an eight year period. That's amortizing it off at about ten million a year; in half a year it's worth five million dollars. I'm quite sure GE would like to sell us a five million dollar battery for test purposes. It's stupid.

MILDEN: Well, the funny thing is in some of the older programs when you're dealing with program office people get very adamant when you talk about -- you know, my God, you could extend the thing so many months if you'd only give us \$100,000. You've been there.

HENDEE: Oh, I know I've been there. We're flying a couple of them too.

MILDEN: Yes.

HENDEE: The other thing is you made a comment there -- and validly so -- install flight batteries at the last practical time prior to launch. In my rather disorganized paper of a couple of years ago I showed that also activation date had a large effect on my end result. And I can quite readily envision people buying a lot of cells, or several lots of cells, for the systems testing and flight, putting the flight aside. I say you're also probably going to be giving up something doing it that way.

My recommendation is that you probably at least activate your batteries at the latest possible time so that you can verify that they're good batteries, have a fall-back, et cetera, and then install them on the satellite.

MILDEN: Among the 15 or so viewgraphs that Gerry twisted my arm over, one of them says there's a three year maximum activation time at time of launch, preferably two years.

HENDEE: Yes, preferably as little as possible.

Gerry, you shouldn't have done that. You see, I took up the time anyway.

MILDEN: Also, in terms of the activation, what a lot of programs where you've got several vehicles will do is they'll give the cell vendor the order and they'll release the procurement in staged fashion so that you get them activated at the latest possible point.

FORD (Goddard): I guess I have a little bit different perspective on that activation date than you do. I think I heard somebody talk about this afternoon batteries had been activated 38 months or something before launch. I think once you get over the hurdle of this problem we're talking about in terms of use in integration, certainly that becomes another factor. But until we get program managers off their adamant positions, as you mentioned, and get them to recognize that they are taking -- and I think Jim is being conservative at one year -- I think for every hour they're on the spacecraft before launch it's at least two hours you're going to lose in orbit. That's our experience.

There's things that go on during this integration period that are not common to NiCd cells in a space environment. And I think if you go back to the OAO life test that was run and reported over a period of five years here, we saw degradation mechanisms in what we refer to as intermittent years that don't show up under cycling. So, you know, I don't think there's any question. And your program manager, your old program is very right -- people, the older they get the harder they are to change. Just remember that.

STEINHAUER (Hughes): My recommendation is that the customer, the end user, if he wants to system test batteries, bring money. I think they can go on at the Cape or the launch site. There's one thing -- And I think all portions of the test programs at the system level can be accommodated with test batteries with one possible exception: The availability of dynamic balancing facilities at the launch site and the utilization of those facilities at the Cape. It may be difficult. Those batteries may be needed just before it leaves the manufacturer to get proper balancing.

MILDEN: That's an interesting point. Hopefully these documents will be used by -- Well, Floyd's comment is really to the wrong group. I mean we're all convinced here

that you've got to minimize battery use and you've got to do all these good things.

By providing some kind of a standard document hopefully you can go back to your management and say, 'Hey, guys, here's a document we can argue from.'

HENDEE (Telesat Canada): I'd like to back up Floyd just -- I'm close, I'm in between the two of you guys. I saw about a one-to-one degradation; if you got them two years in advance, knock two years off the end.

DUNLOP (COMSAT): Other people responded to that question here besides me, I'm sure.

One comment: One thing you might want to add, if you're going to have batteries around for two years or three years, you might also add how you're going to store those batteries if you're not going to put them in the spacecraft. And I'm sure that's something that a lot of people are working on right now.

MILDEN: Minus ten to plus five degrees C.

DUNLOP: That's in your --

MILDEN: Yes.

DUNLOP: Okay.

KASTEN: Since I was the one that presented the 38 month battery that we launched, we went through an exercise, I guess it was about a year ago, where we were coming up and launching a vehicle that our batteries were really getting old. They were all 38 months and older on most of them. And we did go through quite an exercise with our customer and we did finally make some program changes. We ended up ordering five new batteries from GE -- we gave Helmut some more business -- for replacement batteries for our vehicles that -- we're scheduled to launch one in December '81 and that's going to have newer batteries on.

We've also compromised in our test flow. We are now putting the batteries on just prior to thermal vac,

which should cut down the test time to about five months. But we're also finding out that when we're producing -- If you'll recall, one year in '78 we launched four vehicles. During that time our test people were very busy. Things were going through the test flow very rapidly. When they don't get very busy this test time tends to stretch out, especially at the beginning. You're always waiting for that one last box. And so what you plan on nine months ends up to be 18 months; plus either the launch vehicle isn't ready or something else.

So usually after thermal vac in our experience things are flowing fairly fast. So we have compromised in installing our batteries just prior to thermal vac, mainly, again, because of some of the reasons you mentioned: our thermal people like to see those batteries on the vehicle and balancing and all of that stuff.

The other thing, when we store our batteries now we kind of caved in to people on the other side of town, and we are shorting them.

One thing I guess you have to watch out for when you store the batteries, though, is to make sure you don't end up storing them at the temperature that your thermal switches are closed at because then you can end up damaging -- or ending up with a permanent set in your thermal switches if you do have thermal switches on the batteries. That's something to consider.

DUNLOP (COMSAT): I really can't resist this. There was one other comment I made to you in that letter regarding nickel hydrogen batteries, and I think the comment was that in the nickel-cadmium battery the major problem is temperature - or one of the problems was temperature and an uncontrolled temperature and a degradation of separator material. The nickel hydrogen battery, the types of separator materials that are typically used are really rather insensitive to temperature and there's a good likelihood that with the nickel hydrogen battery you wouldn't have - you could go back to the original old program office idea of using that battery through all the spacecraft integration testing.

MILDEN: Well, Jim, what I did as a result of your letter and about three others, all of whom are nickel hydrogen users, was to add the words "nickel-cadmium" to the title of the program guide. We've got to make room for new technology.

## Program Engineering Technical Guide

### Mil Stds/Specs

- FORMAL LISTING OF GOOD PRACTICES
- COMPLIANCE DOCUMENT FOR IMPOSING REQUIREMENTS
- NORMALLY DOES NOT CONTAIN DESIGN DATA
- PROVIDES TECHNICAL BASIS FOR PROCUREMENT

Figure 29-1

- IN-HOUSE DOCUMENTS
- LESS FORMAL - MORE DYNAMIC
- DOCUMENTS ENGINEERING OR TECHNICAL DATA
- CAN INCLUDE DESIGN HANDBOOK INFORMATION
- PROVIDES A CONSISTENT TECHNICAL APPROACH

Figure 29-2

### Nickel-Cadmium Battery Usage Practices for Space Vehicles

- ESTABLISHES REQUIREMENTS
- COMPLIANCE HELPS ASSURE PROPER PERFORMANCE FOR NiCds DURING SPACE MISSIONS
- COMPLIANCE WITH HANDLING PROCEDURES WILL MINIMIZE DEGRADATION
- DEFINES TERMINOLOGY TO BE USED

Figure 29-3

### Use of Rechargeable Flight Batteries During Space Vehicle Testing

- SURVEY OF PRACTICES
- DISCUSSION OF USAGE
- RECOMMENDATIONS

Figure 29-4

**Survey of Practices**  
**USE OF FLIGHT BATTERIES DURING SYSTEMS TESTS**

**USE OF FLIGHT BATTERIES DURING SYSTEMS TESTS**

	<u>ALL PROGRAMS</u>	<u>MILITARY</u>
NO USE	13	5
THERMAL VACUUM ONLY	7	5
ALL SYSTEMS TESTING	<u>8</u>	<u>3</u>
	28	13

- OLDER PROGRAMS USED FLIGHT BATTERIES FOR ALL SYSTEMS TESTS
- TREND IS TO MINIMIZE USE OF FLIGHT BATTERIES

Figure 29-5

**Survey of Practices**

**REASONS GIVEN AGAINST USE OF FLIGHT BATTERIES IN SYSTEMS TESTS:**

- SECONDARY BATTERIES HAVE A LIMITED LIFE
- ONLY THERMAL VACUUM TEST ENVIRONMENT IS SIMILAR TO SPACE
- BATTERIES MAY BE DAMAGED IN TEST
- BATTERY RELATED DATA CAN BE COLLECTED IN SUBSYSTEM TESTING

Figure 29-7

**Survey of Practices**

**REASONS GIVEN FOR USE OF FLIGHT BATTERIES IN SYSTEMS TESTS:**

- COLLECTION OF BASELINE DATA IN ACTUAL VEHICLE ENVIRONMENT
- VALIDATION OF THERMAL INTERFACE
- DISCOVERY OF EARLY FAILURES BY USING FLIGHT BATTERIES
- USE OF SAME BATTERIES IS A LOW COST OPTION

Figure 29-6

**Recommendations**

- DO NOT USE BATTERIES DESIGNATED FOR FLIGHT DURING VEHICLE SYSTEMS TESTING EXCEPT TO PROVIDE NECESSARY DATA
- USE SPACE QUALITY BATTERIES FOR VEHICLE SYSTEMS TESTING
- INSTALL FLIGHT BATTERIES AT LAST PRACTICABLE TIME PRIOR TO LAUNCH

Figure 29-8

## Battery Storage and Handling

- >45 DAYS, STORE
  - DISCHARGED
  - SHORTED
  - $-10^{\circ}$  TO  $+5^{\circ}\text{C}$
- CONDITIONING AFTER STORAGE
  - C/20 FOR  $40 \pm 4$  HRS AT  $22^{\circ} \pm 3^{\circ}\text{C}$
  - C/2 TO 1.0V/CELL, AVERAGE
  - $1\Omega$  RESISTOR ACROSS EACH CELL FOR  $\geq 16$  HRS

Figure 29-9

## Battery Storage and Handling

- CONTINUOUS TRICKLE CHARGE
  - BATTERY TO BE AT  $\leq 27^{\circ}\text{C}$
- OPEN CIRCUIT PERIODS
  - MINIMIZE NUMBER
  - MINIMAL DURATION,  $\leq 96$  HRS
- RECONDITIONING
  - EVERY  $45 \pm 3$  DAYS IN USE
  - WITHIN 30 DAYS OF LAUNCH

Figure 29-11

## Battery Storage and Handling

- SHIPPING
  - DISCHARGED AND SHORTED, EACH CELL OR AT BATTERY CONNECTOR
  - ON OR OFF S/C;  $-15^{\circ}$  TO  $+30^{\circ}\text{C}$
  - $30^{\circ}\text{C}$  EXPOSURE MINIMAL  $\leq 10$  DAYS,  $\leq 4$  HRS PER DAY

Figure 29-10

## Battery Storage and Handling

- TRACEABILITY FROM ASSEMBLY TO LAUNCH
- CELLS ACTIVATED > THREE YEARS ARE NONFLIGHT

Figure 29-12

## On Orbit Operations

- CHARGE CONTROL BASED UPON DEVELOPMENT TESTING
- MINIMAL HIGH RATE OVERCHARGING
- TRICKLE CHARGE TO AVOID STAND LOSSES

Figure 29-13

## On Orbit Operations

- RECONDITIONING
  - GEO, PRIOR TO EACH ECLIPSE SEASON
  - MEO, VARIABLE PERIODIC BASIS
  - LEO, MAY NOT BE POSSIBLE
- DoD AND CYCLE LIMITS
  - TO BE BASED UPON GERMANE DATA
  - $5^{\circ} \pm 5^{\circ}\text{C}$ ; MINIMAL EXCURSIONS

Figure 29-14

## On Orbit Operations

- DATA
  - BATTERY AND INDIVIDUAL CELL VOLTAGE
  - BATTERY CURRENT
  - BATTERY TEMPERATURE

Figure 29-16

## On Orbit Operations

- OVERTEMPERATURE BACK-UP PROTECTION
  - $\leq 32^{\circ}\text{C}$
  - SWITCHING TO REDUCE OR TERMINATE CHARGING
- BATTERY ISOLATION
  - CHARGE CIRCUITS
  - LOAD

Figure 29-15

## Development Testing

- NOMINAL AND FAILURE MODE CASES
  - FOR EACH APPLICATION OF A NEW BATTERY DESIGN
  - FOR EACH NEW APPLICATION OF AN EXISTING DESIGN
  - FOR EACH NEW SUPPLIER OF AN EXISTING DESIGN

Figure 29-17

## Development Testing/Charge Control

- MINIMUM CHARGE RATE AND RECHARGE RATIO TO MAINTAIN RATED CAPACITY THROUGHOUT THE MISSION
- PARAMETER CHARACTERIZATION
  - $\Delta V$
  - $\Delta I$
  - $\Delta T$
- DESIGN MUST ADDRESS CONTINGENCIES

Figure 29-18



## **Development Testing/Charge Control**

- EXCLUDED AS PRIMARY METHOD
  - THIRD ELECTRODE CELLS
  - COULOMBMETER CELLS
  - SINGLE TEMPERATURE SET POINT

Figure 29-19

## **Development Testing/Life**

- ACCEPTANCE TESTED FLIGHT-TYPE BATTERIES
- ELECTRICAL AND ENVIRONMENTAL CONDITIONS EXPECTED DURING S/C OPERATION
- THERMAL PROFILE CHARACTERIZATION
- REAL TIME (no acceleration)

## **Development Testing/Thermal Vacuum**

Figure 29-20

- FLIGHT-TYPE BATTERIES
- THERMAL CYCLE TEMPERATURE MONITORING
- BATTERY HEAT TRANSFER VALIDATION

Figure 29-21

## EFFECTS OF THE MODE OF STORAGE ON THE CAPACITY

### FADING OF THE SINTERED NICKEL ELECTRODES

B. Vyas and M. P. Bernhardt

Bell Laboratories

I guess my talk is a continuation of the last talk yesterday where we tried to set up guidelines as to how a battery should be used and not misused. And one of the topics we ended on is how should we store these batteries?

I'm going to talk about the storage problem.

In the guidelines, one of the recommendations being made is that the battery should be stored before launch onto the satellite in a discharged mode at a low temperature of minus 5 to 10 degrees Centigrade, and in the shorted condition. This is rather early in the morning to try to tell you to put this up.

This work will show that it should be stored at a low temperature, but we should probably store the batteries in the open circuit condition rather than the shorted condition.

This work is a systematic investigation of the effect of temperature and the two conditions of storage, shorted and open circuit.

The impetus for this work was that cells from the manufacturer and the capacity which we measured on the cells before testing were lower than what were measured by the fabricator at their location. The understanding is that there was in some manner a loss during storage and shipping from the manufacturer to our lab.

Other investigators have also observed such a loss and so we wanted to understand what is happening during the shipping and storage.

Getting back to this business of shorted and open circuit, if you look at the literature, the open literature at least, there is no systematic work, or very little of the effects of storage, although there is a lot of work on

capacity fading due to cycling.

In talking to the people who have been in the business for years I gather the impression that cells are stored in the shorted mode partly for safety reasons, partly out of folklore, and partly what I call scientific judgment, which is really just good guesswork.

However, in this first attempt at looking at the systematic study of this sort, we found that maybe that is not the best way of storage.

Now a simple thought experiment on the cell, what could go wrong during storage, is that there are three main components in there, the positive nickel electrode, the negative cadmium, and the electrolyte, and either of these three may not be where they should be, and that would cause a loss.

The cadmium electrode—normally you have a lot more cadmium, so a loss cannot be at least found due to that electrode during the shipping and storage period. These are positive limited electrodes so the loss would be due to a loss in these positive electrodes rather than the negative electrodes.

There is a possibility that the electrolyte is not where it is supposed to be, but if we assume for a moment that does not happen, then the main culprit would be the positive electrode. Therefore, we decided to study the sintered nickel electrode alone and the effect of storage on it.

All these tests were done on sintered electrodes in flooded cells, so we do not have the complication of a shifting or loss of electrolyte or the complication of changes in the negative electrode.

(Figure 30-1)

This is just a slide of the experimental condition. We used a sintered nickel electrode. All the work I'm going to report today is on electrochemically deposited by the aqueous process. And I have recently done some on chemically deposited plates obtained from GE and they show a similar phenomenon. In fact the rate of

degradation is faster in them, which probably will be clearer as I get to why this loss occurs.

It is then stored flooded in 30 percent KDH during the discharge condition, and at three different temperatures, 22, -- that's room temperature -- 60 degrees Centigrade and 80 degrees Centigrade. We have not done any lower temperatures. However, we do have a program of doing real cells at lower temperatures, of the order of 10 degrees.

And they were stored in two modes, shorted or open circuit.

After storage they were taken out, cooled down to room temperature, and all cycling to measure the capacity was then at room temperature.

These were done at two rates, C/10 and C rate.

When you take the electrode out after storage and cycle it, the first cycle always gives you a very low capacity but the capacity comes back to a nominal value in about three cycles, and we normally give it five cycles. What I'm going to show as a capacity loss is the initial capacity minus the capacity of the fifth cycle.

This loss or this recovery in the five cycles is of the order of 10 percent of the loss, just to give you an order of magnitude. But at all stages you do get a much lower capacity in the first cycle, and it flattens out in about the fourth or the fifth cycle.

Another important point listed here is that the capacity measured here is the capacity out to one volt. That is the useful capacity as far as the satellite application is concerned, and that's all the capacity that's being measured.

So this is a very simple test, nothing very complicated.

(Figure 30-2)

Here is shown a loss of capacity as a function of

time of storage. Starting at zero, all these plots are normalized and we stored them for one day, then three or four days, over the weekend, and subsequent stages of seven days and they were given five cycles in each stage.

One thing to note which we don't have a very good understanding of, after one day I didn't plot the point but after three days, the first two point, the capacity is the same or slightly higher than what they started with. I don't have a good explanation for that, but that's an observation I guess that should be kept in mind, after which you see a loss in capacity.

As we look here, you have the first one which is open circuit at room temperature, the next open triangles are open circuit, 60 degrees, and the circles here are open circuit, 80 degrees.

The function of temperature in the open circuit condition, the loss of capacity, increases with the increase in temperature. The same thing happens with the shorted electrodes. The first one is room temperature shorted, then 60 degrees shorted, then 80 degrees shorted.

So two things: The shorted electrode showed a higher rate of loss than the open circuit electrodes. And second of all, there's an increase in both modes with the increase in temperature.

Another point to be pointed out:

These lines are just drawn to show an indication that the rate of loss is changing. It really does not mean that the rate of loss is linear. It was just shown to make it clear, and I'm not sure if that's an important implication. It could be.

(Figure 30-3)

This is now showing the same effect, a loss of capacity again, with time of storage at a C rate of charge and discharge which is 340 milliamps. Most of these are around three to four hundred milliamps capacity electrodes.

Again you see that the first three are for an open circuit condition, room temperature, 60 degrees, 80 degrees

Centigrade, and the next three are for the shorted condition, room temperature, 60 degrees and 80 degrees.

Two things: Again here you see a higher capacity initially, and then you see a general degradation as a function of time. Again there's an increase with an increase in temperature, and under all conditions, the shorted electrodes show a much higher rate of loss than the samples stored in the open circuit condition.

Comparing the C/10 charge to the C/2 discharge, which is the nominal rate used in most satellite type of work, and the C rate, which was really done to accelerate the process, this is a very simple but boring and mundane experiment, and we thought probably we could accelerate it by this.

But we see that the rate does have an effect on the loss of capacity. I don't have an absolute understanding of this. However, it could be rationalized in terms of the polarization. There's a change in the structure and the electrode sees the polarization effect and therefore at higher rates, it cannot give back the capacity that it can at the lower rates of charging and discharging.

All this can be quickly summarized in a table form.

(Figure 30-4)

Here again you have open circuit and shorted at the two rates. This is the initial capacity and this is the loss after 25 days, and again you see an increase in temperature in all three cases, and also the shorted condition shows a much higher loss than the open circuit condition.

This one here should be 18.4 and not 14.8.  
(Indicating.)

So the next obvious question which all bosses tend to ask their people is, is this real? Is this an artifact of the experiment? And second of all, can we revive this electrode?

And so we tried to do two quick experiments to see

if we could.

After the 25 days, these electrodes were further cycled with 400 percent overcharge. Three to five more cycles were given, with 400 percent overcharge. And you see in the two electrodes which were under the open circuit conditions, this is the resultant loss from the initial. It's only 1.7, which is within the error bar, really. So most of the capacity which was lost in these 25 days has been recovered for these two electrodes in the open circuit condition.

However, in the ones which were stored in the shorted mode, this has only gone from 14.8 to 12, and 42.3 to 37.8. So the ones which were shorted, it seems that they do not recover very easily while the open circuit one comes back.

Another way of trying to recover this is to just continue cycling under the same mode for a longer time, and after 25 cycles, again you see the ones which were open circuit, most of it comes back, while the ones that were shorted, there is no change.

So I think we have a reasonable amount of data to say with a reasonable amount of confidence that electrodes which are stored -- at least the sintered positive electrode stored in the open circuit mode does not lose much capacity, or at least they can be recovered, while the one which is shorted is dead for you.

So the next question arises: Why is that? And we find out what changes are operating in the electrode to lead to such losses.

(Figure 30-5)

The first clue comes in this voltage charge/discharge curve. This was taken after 18 days. I tried to plot this as close to as it comes off from the graph paper, but this is kind of normalized, so don't take the absolute value but just to show the general trends.

The dark line here is the voltage curve of the initial electrode before storage. This is room temperature open circuit; this one here is 60 degrees open circuit. This

one is room temperature and 60 degrees shorted.

Two things come clear, the same thing here. There's a lower loss in the open circuit one than in the shorted one.....

Two things to note here is that the shorted ones, both of them, show a higher end-of-charge voltage than the open circuit one, which may be one indication that one is degrading worse than the other.

But in either case what we did is after we discharged this, we had a cutoff at about .4, and all of these came back to open circuit. We decided to discharge this at the C/10 rate at 30 milliamps, and you see that most of the capacity is recovered at the lower voltage.

In this table is shown the two capacities. When you add the two, 400 or 415 compared to 408 initially, what that plot shows you, and the table, is that all the capacity isn't dead, it's just that it cannot be realized up to one volt.

So one thing can be easily concluded. The material is not lost physically. It is not out of the electrode. It is also not just loosely held in the pores. It's all there. You just cannot get it out due to some polarization effect.

So the immediate conclusion is that there's a change in the structure of the active material which is causing this loss. And how can we study that?

We have initiated a program to look at the structure of the active material by X-rays, and do some systematic, electrochemistry-like pulses and polarization curves, in an attempt to understand what's happening to the active material during storage.

This work is rather preliminary. All the results are not here.

In the short time left to me I would just like to give you a few polarization curves which, to me, look like a landscape view of what may be happening to these electrodes as a function of time, and speculate with you what may be



the mechanism of this loss.

(Figure 30-6)

I guess all of you are quite familiar with this. This is the current-versus-voltage curve of the electrode. The same experiment is done. The electrode is taken, stored, taken out. Instead of doing the charge/discharge at constant time we now run polarization curves.

This is the charge. We see the double peak. This is oxygen and this is the discharge peak. This is a typical curve obtained from most electrochemically deposited electrodes. And the scan rate is .05 millivolts per second so it's reasonably slow. This is on sintered electrodes.

(Figure 30-7)

Now as we store it and then take them out and run polarization curves, this is what you see in ten days. You see a shift, both in the charge and the discharge. What is really important, what this tells you, by the potential you can get an indication of the structure of the materials, so you see that peak maximum here shifts slightly, on the order of 5 millivolts.

Second of all, the second peak, which is a sharp, clear peak, has now become rather vague. Also on the discharge curve, this one has shifted and you now have a new peak.

(Figure 30-8)

If you do it further for 25 days, the second peak now starts growing while the first one is decreasing on discharge. And again here you see a slight blip, and the second peak is totally lost to you.

(Figure 30-9)

You carry on this further, and this I guess was after 65 days, you could see that the original peak is totally lost to you. You just have the secondary peak.

And also on top if you watch you have a double peak of this sort. This is the curve on the charge.

So if you have a totally distinct peak like that, that means there's a new phase, and so we said, Okay, the material is probably going through a phase transformation from this alpha to beta and gamma and all that kind of stuff, and if you look at the literature, it is known that the beta-nickel-hydroxide to beta-nickel-oxi-hydroxide, the potential for that is higher than the gamma-to-beta or alpha-to-gamma reaction. So this shift in the positive direction could be due to a structure going to the beta form.

If that is true we could check that by now overcharging this electrode for a very long time because we know if we overcharge a beta-nickel-hydroxide at a high rate for a very long time, we can convert the beta to gamma. That could be a quick check for that, and we did do this after 65 days.

After 65 days you started here. You only listed this one peak and then this complex peak here.

Then we overcharged it at the 4 C. rate for 16 hours, an overnight charge, and then ran a discharge curve. This was the original discharge curve, and now you get a curve, this one, out over it. So this potential has shifted over to the original position and you get a much higher capacity, too. So that was the first indication, yes, maybe this is beta, and by overcharging it you can convert it back to gamma which would shift the potential back down.

On the subsequent charge you get this curve here and again, the double peak here is your discharge curve. So it shows that this heavy overcharging can convert it to a gamma phase, but this is not a stable phase, and on a subsequent regular kind of charge and discharge you're going to see a double peak.

So what I'm leading to is that whatever structure you start with, you're now faced with a change in the phase of that active material from maybe an alpha to a beta form, and a beta form which is really what I have called a beta-prime, which cannot be overcharged any more.

That case is for what was stored in the shorted mode. I forgot to mention that. Here is a case, what happens along a similar time sequence.

Many more polarization curves, by the way, were built up. I've just shown a few for clarity here.

This is the case of a similar experiment done but the sample is stored in the open circuit condition. Again here, this is after 20 days compared to the first 10 days.

You see the same thing happening, a second peak, a shift here, and a loss in this second peak.

You go to 65 days. Again you see the second peak is growing at the expense of the first one. But if you compared the shorted one for 65 days, this lower potential peak was totally lost. Only the second one existed.

So what this is saying is that the same phenomenon is occurring in both these electrodes. However, the rate at which it's occurring in the shorted electrode is much faster.

Now if the second peak is really a beta, and this is unstable material, if you do not go into overcharge, then you should only get a second peak. That's a second check of whether this kind of transformation is taking place.

And that is what we have here, where we took the electrode as soon as it comes down to its minimum, we started discharging it and not letting it go into overcharge. And there you see just a higher 314 potential discharge, again showing that that material is beta.

If you don't take it to overcharge you don't see the gamma transformation.

So this kind of gives you a first-order indication of the kind of changes in the active material.

(Figure 30-10)

This I took from, I think -- I'm not sure -- Toumy's old work where he shows all the possible reactions in a nickel positive electrode. And you have the alpha-to-gamma electrochemically deposited, the chemical beta-to-beta during overcharge. We have gamma and it can discharge straight to beta.

What all this is now telling us is that the electrode now forms a beta form. If it's initially the beta form it can go to beta-nickel-oxy-hydroxide when the old charge goes to gamma. That's what gives you higher capacity. Now you have a material which will only go to this reaction, not to this reaction.

I think I forgot to mention one thing here.

If you now measure the capacities under here, this capacity, after 65 days, is about 30 percent less than what you had initially. If you now overcharge it and measure the capacity over here, it's about 5 percent more than what you started with, which again tells you that the literature says that not only is there a phase change but there's an electron change. You normally just have about a .9 to a 1 electron volt change from the beta-nickel-hydroxide to oxy-hydroxide. However, the gamma form is probably a nickel 4 plus. You normally have about 130 to 160 percent increase in charge. These changes in capacities are of the same order of magnitude.

(Figure 30-11)

So we have now a total picture showing here that an electrochemical plate which, when you deposit it -- it's probably alpha -- goes to a beta, but still works. It can go into the gamma form during overcharge, but on aging it becomes into an inactive beta' which cannot be easily overcharged, and that is what leads to a loss in capacity.

That the first form. That should give you automatically about a 30 percent loss in capacity.

Beyond that, the beta' probably just grows in size and it becomes more difficult to polarize.

This period, which will only be checked thoroughly once some extra analysis is done on these other materials in there, although the electrochemistry does seem to indicate what is happening.

So now to summarize, I think we've shown clearly that there is a capacity loss; it increases with increasing temperature of storage, and the rate of capacity loss is larger for the shorted electrodes than the electrodes stored

at open circuit.

This I think is the most important result of this. I would appreciate comments as to why people do store them under shorted conditions.

This is a proposed mechanism of what may be happening to the active material which is leading to this loss.

This is just a word of caution, that the results from these flooded cells should not be directly translated to a starved cell. However, the same kind of trend is going to occur in a cell, and we've done a similar systematic storage test on cells and a similar loss does occur. The numbers are not the same but the same type of rate does occur. So that's something that has to be kept in mind.

And finally, it just says as a result of this we can recommend that nickel-cadmium or nickel-hydrogen cells should be stored at low temperature, maybe minus 5 to 10 degrees is the right range, and also as far as possible, in the open circuit condition rather than the shorted condition.

ROGERS (Hughes Aircraft): What is inactive beta'? Is that something you've seen, or is it just an explanation?

VYAS: It's just a term I've used. It is what I define as the beta form which cannot be easily over-charged to the gamma state. You need a tremendous high overcharge for it. That's all. I define that as the inactive beta' form.

If you take a chemical plate which is beta known -- and we've done this experiment -- and go through a polarization, show where a charge/discharge is transformed to the gamma form, if you now stored the chemical plate, you cannot overcharge it into the gamma form. So that's what I have called as an inactive or a beta'.

Now what the structure is, I think X-ray will probably tell us.

KUNIGAHALLI (Bowie State College): Can you tell me the size of the electrode that you use, and what is the size of the electrode that you use, and what is the number

of cycles maximum number of cycles it underwent?

VYAS: The first charge/discharge, the loss in capacity, they were 1-1/2 by 1-1/2 inches by I think 28 mils thick, having a capacity of about 300 to 400 milliamps. And initially they were given ten cycles, then go through the storage stages at various times and at each storage it was given five cycles.

If I understand your question correctly, we had the same problem. When you're doing a test like that, the time of cycling should be shorter than the time of storage; otherwise, the test has no meaning. And the time of cycling was much smaller than the time of storage. That's an important criterion in such a type of a test.

KUNIGAHALLI: My second question is did these nickel electrodes contain any cadmium,--

VYAS: No.

KUNIGAHALLI: -- what is usually referred to as PQ treatment?

VYAS: All these electrodes are nickel containing, most of them-- I think all the results I've shown today are 5 percent cobalt. I've done some work with 10 percent cobalt but no cadmium or any other additive.

KUNIGAHALLI: One more question:

During the discharge you used a C/10 rate for discharge?

VYAS: No, that was the second step. We did a C rate discharge, then followed by a C/10 rate discharge.

KUNIGAHALLI: Have you tried any higher rates of discharge in these experiments?

VYAS: The other electrodes were done C/10 charge and C/2 discharge.

KUNIGAHALLI: Did you observe any reaction to the

loss of capacity? Did you observe any voltage drop?

VYAS: Well, if you look at that plot, I tried to get data on what is called the mid-discharge voltage as a function of cycling. However, that data does not come out very systematic. You have changes in the cadmium electrode and things of that sort, and the result is not very good.

But I want to point out on those polarization curves where you see a double peak, if you now do a charge/discharge with respect to a mercury-mercury oxide reference electrode, you can see in the case where you have only a gamma peak, discharge at the lower potential and almost flat; however, in the case having a double peak, you see a more sloping discharge curve --if that's what you're trying to ask.

You have to do the test carefully in a flooded cell. With a cadmium electrode, it's difficult to distinguish the change in this mid-voltage.

KUNIGAHALLI: I think why I asked this, you may be aware of the recent paper of Craig Moore and Bernard, et al.

They have studied the nickel-hydroxide electrode, and after a large number of cycles it has shown a voltage drop in the plateau.

And I was wondering whether you did observe any such plateau during the discharge of these-

VYAS: Yes, every now and then since we have a cutoff at point 4 you'll see a secondary discharge plateau at about .8, .7, depending on the rate of discharge. Those results are similar to Bernard's work, and it's quite possible that the changes occurring may be similar, although not the same, during cycling and storage.

This work not only deals with the immediate problem of how to store cells but may lead to a better understanding of what's happening in this mysterious nickel electrode. But there is no contradiction between the two works.

KUNIGAHALLI: Thank you.

REICHMAN (ECD): I would like to know the charge that you measure under the voltogram? Is it the same charge that you measure during the discharge and charge experiment?

VYAS: The voltogram samples were smaller. They were 2 centimeters by 2-1/2 centimeters since my potentiostat would only give off one amp. But a quick calculation of measuring the area under the curve is of the same order. But they have not done a charge/discharge on the same electrode as such, and these experiments are still continuing.

At the end we hope to match that with a chemical analysis--

REICHMAN: And what was the scan rate that you were--

VYAS: .05 millivolts per second.

REICHMAN: Thank you.

SCHULMAN (JPL): Would your work have any implications as far as deep reconditioning is concerned? Do you have any thoughts on that matter?

VYAS: I'd just like to abstain from answering that. It's a touchy business, and the work is still in progress. I guess I'll just wait until it's complete and I understand everything about it.

But yes, absolutely, it does have important implications.

HENDEE (Telesat, Canada): I'm sure I missed it, but the state of charge of your open circuit cells was what?

VYAS: State of charge?

HENDEE: 100 percent, 0 percent?

VYAS: They were discharged-- All the electrodes were discharged, and we have a diode cutoff at .4, and the electrodes do show a sharp knee, so that's the condition.

HENDEE: Okay. So your open circuit is



effectively discharged then for the storage.

VYAS: Yes.

HENDEE: Thank you.

VYAS: If you're trying to imply, the material probably does have some capacity in there.

HENDEE: Yes.

GASTON (RCA): I think you are aware that most of our experience has been somewhat different. For the last decade or so we stored them discharged and shorted.

My question is how come I haven't seen any capacity loss on my cells? And I think a lot of other people might not have seen a capacity loss either by storing them shorted. In other words I'm not quite convinced by your work. Now whether it's unique or something special, I'm not convinced that I will see the capacity loss in my cells because I haven't seen it.

VYAS: As I said, I think I tried to emphasize that temperature plays a very important role in this, room temperature. If you'll look at the shorted and the open circuit, the difference in about a month of storage is of the order of only 4 percent.

So if you are at the lower temperature as far as a practical application is concerned, you may not see a loss, but the results do seem to suggest that there is a difference when you go through a whole random matrix.

We have seen losses in cells which are shipped to us. Others have done that, and they are mostly shipped shorted. So there is a loss.

There is also a loss if you store them in open circuit for a very long time. I think there was a paper in the late '70s suggesting that, too. So there is a loss. But temperature is a very important factor.

GASTON: Well, it's pretty well standard procedure at Aerospace to store them at 0 degrees C, so that's the

range where you store them.

Now are your results based on cylindrical cells, prismatic cells? Are they commercial type cells?

VYAS: Prismatic Aerospace.

GASTON: Your results are somewhat unique and also different from what NASA had observed several years ago.

VYAS: We have a program now to try to study this on real cells. That's why I pointed out we have to be careful in translating the electrode work to a cell. But I feel quite reasonably confident that you'll see similar stuff if a systematic kind of work is done.

I'm not aware of a systematic work on the cell where they tried to really study it. If there is any I'd like to know.

GASTON: I just wanted to caution people somewhat on the recommendation not to switch over immediately. This may be just--

VYAS: I absolutely agree, and that's why it was underlined out there.

Electrode: Sintered NiCe Electrode  
 Electrochemically Deposited  
 $1.5'' \times 1.5'' \times 0.028''$

Electrolyte: 30% KOH, Flooded Cell

Storage: Discharged Condition  
 22°C (RT), 60°C and 80°C  
 Shorted and Open Circuit

Cycling: At Room Temperature  
 Rate - (i) Ch - C/10 for 16h, Disch - C/2  
 (ii) Ch - C for 1.2h, Disch - C  
 Five Cycles

Capacity Loss = Capacity of 5<sup>th</sup> Cycle - Initial Capacity

Figure 30-1

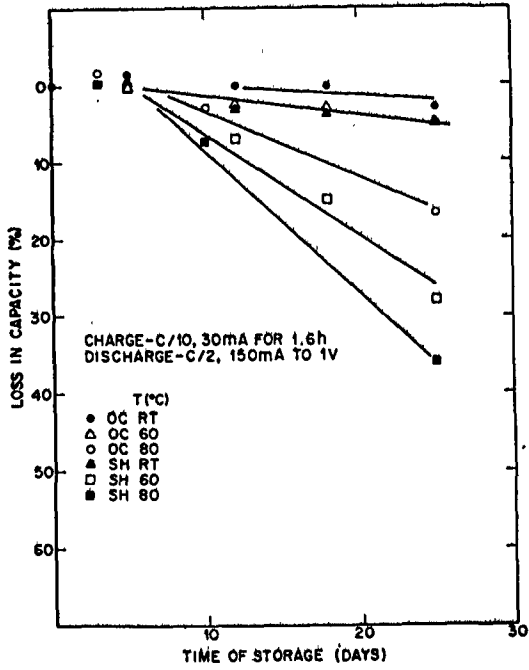

Figure 30-2

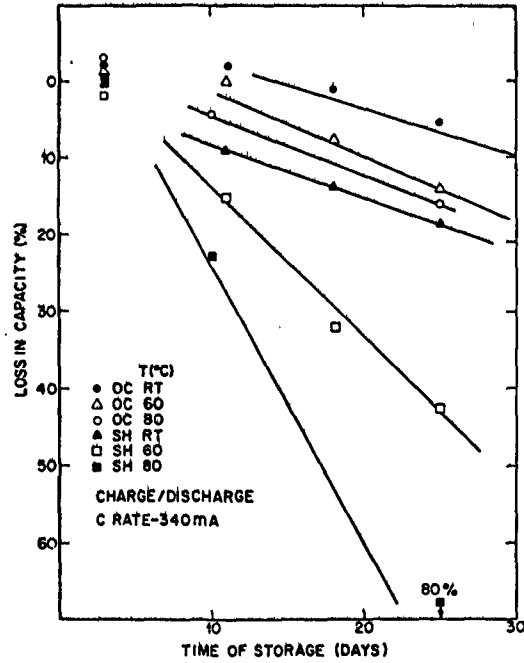

Figure 30-3

EFFECT OF STORAGE ON CAPACITY FADING IN SINTERED NICKEL ELECTRODE

Sample #	Condition of Storage	Temp. C°	Initial Capacity mAh	Loss After 25 Days %	Resultant Loss After 400X Overcharge %	After 25 Cycles
CHARGE/DISCHARGE - CRATE - 340mA FOR 1.2H.						
11-521-1	OC	RT	408	6.6	1.7	
11-521-4	OC	60	408	14.9	1.7	
T05C3-5	OC	80	391	15.9		4.1
11-521-2	SH	RT	383	14.8	12.0	
11-521-3	SH	60	383	42.3	37.8	
T05C3-6	SH	80	391	80.0		80.8
CHARGE C/10 - 30mA FOR 16h. DISCHARGE C/2 - 150mA						
T010C1-1	OC	RT	374	2.6		
T010C1-4	OC	60	376	4.8		
T05C3-8	OC	80	368	16.8		
T010C1-2	SH	RT	374	4.3		
T010C1-3	SH	60	381	28.1		
T05C3-7	SH	80	368	35.6		

OC - OPEN CIRCUIT  
SH - SHORTED

Figure 30-4

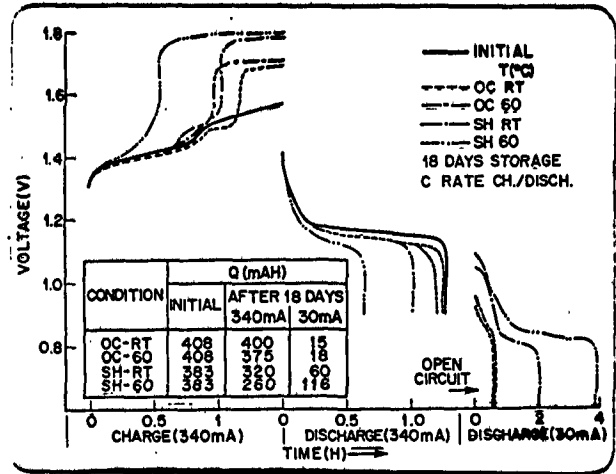

Figure 30-5

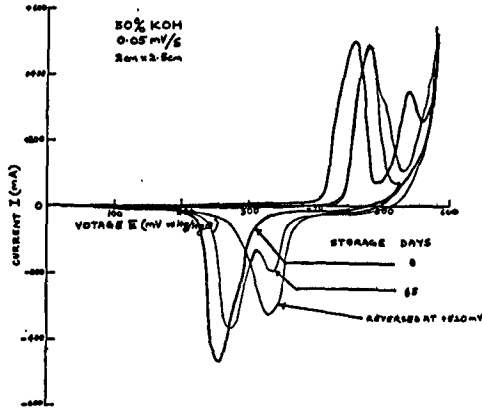

Figure 30-6

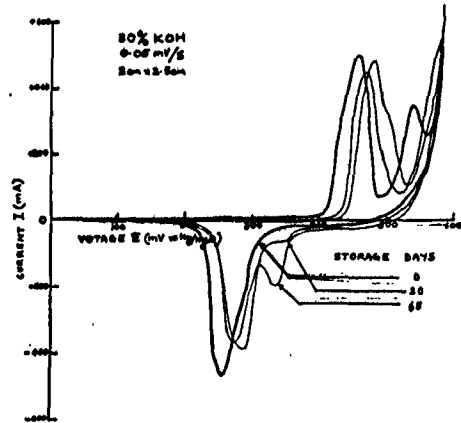

Figure 30-7

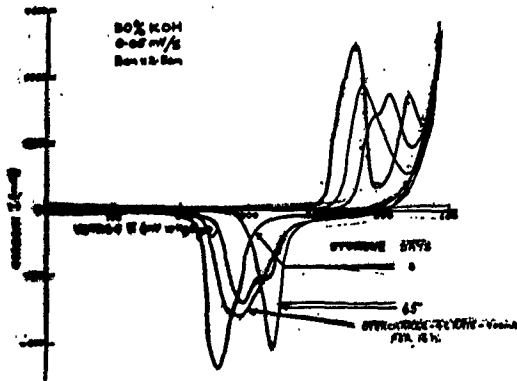

Figure 30-8

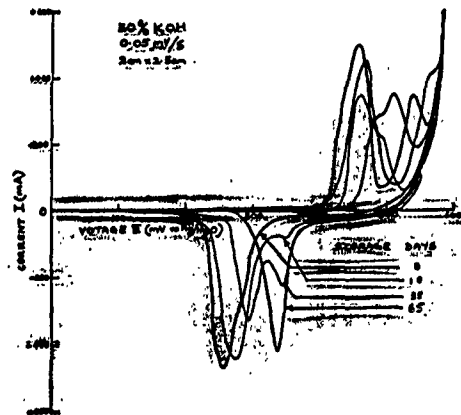

Figure 30-9

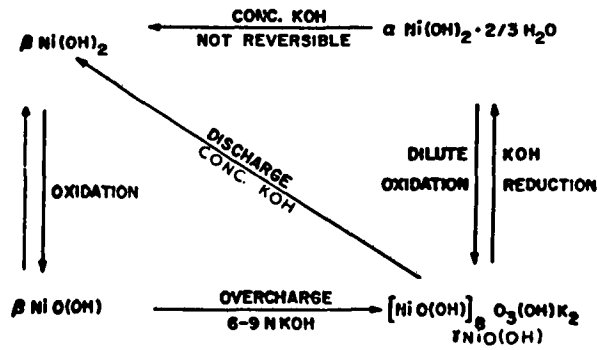
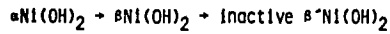

Figure 30-10

SUMMARY

1. Capacity loss increases with increase in temperature of storage.
2. The rate of capacity loss is larger for shorted electrodes than electrodes stored in the open circuit condition.
3. Capacity loss related to structural changes in the active material.



4. Results from flooded cells may not directly translate to starved condition in sealed cells.

RECOMMENDATION

Store and ship Ni/Cd and Ni/H<sub>2</sub> cells at low temperatures and in the open circuit condition.

Figure 30-11

## SINTERED PLAQUE CHARACTERISTICS

H. Vaidyanathan

COMSAT

The positive electrode degrades in performance with cycling in a nickel-hydrogen battery, and this limits the battery cycle life. This degradation can be traced to several structural and operating parameters in the battery, and, most importantly, the quality of the sintered plaque. Therefore, COMSAT Laboratories have initiated a positive electrode R&D program which encompasses all aspects of fabrication and characterization.

As a first step, we are focusing on the sintered plaque. Our objective here is to identify a manufacturing procedure in which we can have the maximum control of the process parameters. We are also exploring several ways to characterize the sintered plaque so that improvements can be compared.

By way of background, the structural transformations occurring during sintering is illustrated in the first slide.

(Figure 31-1)

Now, as you know, the starting material is the Inco nickel powder. And there are two kinds of powders; the type 255 and the type 287. The Inco nickel powder has a very characteristic spikey structure, and it has an irregular crystal structure, too. And these powders have a size, in terms of diameter, of about 2-1/2 micrometers and a density that ranges from half a gram per cubic centimeter to one gram per cubic centimeter.

When this nickel powder is roasted under a reducing atmosphere, at about 600 to 800 degrees C. the rounding of the particles by surface diffusion takes place. The second step is consolidation of these rounded particles, which occurs at 800 to 900 degrees C.

If the sintering is continued and the temperature is raised, these rounded particles form clusters. If a

properly sintered plaque is viewed under a scanning electron microscope it will present the appearance of clusters of spherical particles.

Now, if the sintered plaque is oversintered, and then it is cooled, then there is some plastic flow, and this plastic flow results in a shrinkage. Not only that, the plastic flow creates some necks in the sintered matrix. It has been shown in the literature that the necks are very brittle. So predominant necking in a sintered plaque is an indication that the plaque has lower strength.

There are some empirical relations regarding the parameters during sintering, and they are illustrated in the next slide.

(Figure 31-2)

These empirical relationships should be considered in addition to what has been published by Falk and Salkind in their battery review.

The important parameter we have considered is the density of the compacted powder before sintering. There is a relationship in the sense that the ratio of the volume of the pores after sintering to the volume of the pores before sintering is a constant. And it is a constant for a certain range of values for the density of the compacted powder.

Now the second relationship is, there is a deviation from this constancy, and that begins with increase in closed porosity.

The third is that, if the density of the compact is increased, then the strength of the sintered plaque increases. And as the density increases, the porosity decreases.

In addition to all this, if you introduce additives to the nickel powder, as you do in the slurry process, such as carboxy-methyl-cellulose or polyor, then that disrupts the normal densification. Or, in other words, it disrupts the shrinkage during sintering.

Now, if you consider the other parameters like temperature and time, increasing the sintering temperature

increases densification, or it decreases porosity.

Now, expansion of the pores occurs if the isothermal sintering time is increased. This normally doesn't happen in the battery plaque, because the sintering time is about twenty minutes. And you can actually observe expansion only if the time exceeds one hour.

Now, in order to illustrate the first point, I will show you a graphical relationship.

(Figure 31-3)

Here is a literature plot of the ratio of the pore after sintering to before sintering, plotted against the density of the compact. The dependence of the porosity and strength on temperature and time also is dependent on where we are looking at in this curve. Most of the relationships apply only if you are in this plateau region.

Now, I should say that these empirical relationships will help in selecting a set of process parameters to produce the sintered plaque. However, there is no physical theory to explain the phenomena of densification.

On the basis of these relationships, we evolved a procedure to make the sintered plaque, and, as you know, we had a choice between the loose powder procedure and the slurry procedure. We selected the loose powder procedure for reasons which will be obvious during the course of my presentation.

The loose powder procedure consists of using a sintering furnace, which has zonal heating. And this is a conveyor-type furnace, which we acquired.

(Figure 31-4)

This slide shows the scanning electron microgram of the 255 powder at a magnification of 15,000. As I mentioned, this nickel powder has a characteristic spikey surface. The driving force for the sintering is the excess surface energy of this powder.



First we produced an experimental plaque to see the effect of temperature on the microstructural characteristics.

(Figure 31-5)

This is a sintered plaque produced by the loose powder procedure in which we purposely reduced the temperature to 800 degrees C. And, as I said, a properly sintered plaque exhibits rounded particles, whereas this sintered plaque still retains some of the angular features particles. And this an example of incomplete sintering.

(Figure 31-6)

This is the scanning electron microscope picture of an optimized sintered plaque, which was produced by the Comsat procedure. And this consists of rounded particles, several of them. And the particle diameter when measured is about 3 micrometers. And sometimes some of the particles join together. And, even here, the diameter does not exceed more than 7 micrometers.

This micrograph does not show any long necks, and it does not have the so-called "clumping" which you observe in an improperly sintered plaque.

(Figure 31-7)

We compared the microstructural characteristics of the Comsat sinter with those we purchased from a vendor. And this plaque is produced by the slurry procedure. As you can see, this shows predominant necking. There are several necks in the sintered plaque, and we have observed such kind of necking in all the plaques produced by the slurry procedure.

Now, as I said before, necking is a source of weaker strength in the plaque. In order to prove our point, we studied the fracture mechanics of a sintered plaque. For this, we examined the slurry process plaque, and then we fractured it by pulling it in a direction perpendicular to the surface. And we modified our scanning electron microscopic procedure and used the stereo scan in the SEM.

(Figure 31-8)

Now, when you use the stereo scan, you necessarily take a stereo pair. And that stereo pair is examined, which gives a three-dimensional view of the fracture. This is one of the pairs in that stereo pair. And here is the fracture. And this is part of the neck. And this particle is actually below this one. And here, also, the neck broke.

Now this proves that necking decreases the strength in a sintered plaque.

Now another microstructural characteristic we considered was the occurrence of macro voids in the sintered plaque.

When the sintered plaque is examined, or the cross section of it is examined under an optical microscope, sometimes you observe large voids.

(Figure 31-9)

This is the cross section of a slurry-produced sintered plaque. We took a sample of the slurry plaque, and then mounted it, potted, ground, polished, and viewed it under a microscope. And this at a magnification of about 60.

Now you can see several large voids in this. And the largest dimension of some of these voids actually exceeds a tenth of the thickness of the sample. And there are several of them. And, in addition to that, the slurry process plaques have got clumping; the particles are agglomerated, which gives a non-uniform porosity.

Now, this can be compared to the loose powder plaque.

(Figure 31-10)

This is the cross section of the Comsat loose powder sinter. There are no large voids, and the porosity is uniform. This is actually the substrate, which is 20 X 20 mesh.

Now another structural characteristic of the sintered plaque is the compaction at the edges. Sometimes

when the slurry plaque is examined under a microscope you will see some compaction.

(Figure 31-11)

This is the microscope picture of a slurry process plaque which is showing compaction at the edges. Both the edges show compaction. Compaction is not desirable, since during electrochemical impregnation the active materials do not penetrate fully if there is compaction.

(Figure 31-12)

This slide shows the cross section of the loose powder plaque. There is no compaction, and the distribution of the particles is uniform.

Now, our objective in this detailed microstructural characterization is to relate the microstructural characteristic to the mechanical strength of the sintered plaque, which, in turn, can be correlated to other failure mechanism on the positive electrode, such as blistering and swelling.

The next characteristic we examined was the microgeometrical characteristic, and a geometrical analysis of the sintered plaque can be made using a mercury porosimeter.

(Slide, not available)

The mercury porosimeter gives a relationship between the volume of the mercury in cc's per gram with respect to absolute pressure.

(Figure 31-13)

This is the graphical result of the mercury porosimeter experiment. And here the penetration volume is plotted against, actually, the absolute pressure, from which we calculate the pore diameter.

This is the conventional way of describing the pore size distribution in a sintered plaque. However, if you view it-- this is actually an integral curve, and the analysis of the data can be simplified further by taking the

derivative of the penetration volume with respect to logarithm of the pressure. Now, such a plot is shown in the next slide.

(Figure 31-14)

This curve shows the distribution of the pores, or the population of the pores in a given range of diameters. Or we can also view the derivative as the volume distribution function and the figure becomes pore spectrum. In the Comasat sinter, most of the pores have size which is 9 micrometers.

Now the height of the peak is proportional to the population of the pores with that diameter. In actual practice the median volume pore diameter is slightly different from the pore diameter at which most of the pores occur.

Now, even here the analysis of the data is incomplete, since we really don't know what is happening in this range of pore diameter, at the higher and the lower end.

Therefore we replotted the first curve in the following manner:

(Figure 31-15)

This shows the percentage pore volume with respect to pore diameter, and from which you can calculate several data, and those are shown in this figure. And this shows that, for example, the 90 percent volume pore diameter and the 10 percent volume pore diameter, as well as the median volume pore diameter and porosity.

These data can be compared to the data obtained when you use a slurry process plaque.

(Figure 31-16)

Here is the porosimeter first curve which gives the relationship between penetration volume and pore diameter.

(Figure 31-17)

This gives the derivative curve. Here we can see the difference between the loose powder procedure and the slurry procedure. Here the peak is not only truncated, but has a wider range. The distribution of the pores is inferior in the slurry process plaque.

(Figure 31-18)

Here I have compared the percent volume per diameter, the 10 percent/90 percent median, and porosity.

The next slide summarizes all the data.

(Figure 31-19)

Here is a slurry plaque, which has a porosity of 70.6, and we get a median volume pore diameter of 11.7. Ten percent of the pores had a diameter in excess of 17.5. And 90 percent of the pores had volume in excess of 4.5.

The next characteristic we examined was the mechanical strength of the sintered plaque.

(Slide, not available)

For this, we used a pull test procedure to determine the tensile strength. And in this procedure the sintered plaque is pulled in a direction perpendicular to the surface. The sample is pulled in an Instron machine, and the deflection versus load is recorded.

(Figure 31-20)

This slide shows the results of the tensile strength data. "Commercial" stands for slurry process plaques. They had a lower strength than the loose powder plaque.

The last characteristic we examined was the corrosion of the sintered plaque. As you know, the sintered plaque is normally passivated before it is impregnated in the electrochemical procedure. The passivation is done to reduce corrosion during impregnation.

Sometimes the plaques do not passivate easily. And this has been attributed to the impurities in the sintered plaque, particularly those produced using the slurry process.

(Figure 31-21)

We determined the corrosion of the passivated plaque using a procedure evolved at Bell Laboratories. The procedure consists of immersing the passivated plaque in cadmium nitrate solution, and if the plaque has a weight gain it shows that it is corroding. And if there is no weight gain it is not corroding.

We didn't have any problem with the loose powder plaque. As I told you, this is actually related to the ease with which you can passivate the sintered plaque. Where as the slurry process plaque gives a wide spectrum of results. If you do not clean the plaque, they corrode. And sometimes it corrodes more. And if the plaque is washed thoroughly the corrosion is practically nothing.

Now to conclude.

(Figure 31-22)

We have obtained some experimental results that show that the loose powder plaque has properties somewhat superior to that produced by the slurry process. And this slight edge over the slurry process is not in our fabrication procedure, but it is actually inherent in the loose powder technique itself.

So I have summarized the advantages of the loose powder technique, in the sense that the densification is normal or the shrinkage mechanism is normal, and it is a function of only three variables: time, temperature and density of the compact. Now, since we are going to deal only with three variables, it is very easy to evolve sintering parameters to suit a particular application. We can produce a sintered plaque with a lower strength and higher porosity or a higher strength and lower porosity. The properties of the plaque, such as porosity and strength, are predictable.

Thank you.

## DISCUSSION

SCHULMAN (JPL): What sort of powder did you use on these experiments?

VAIDYANATHAN: 255.

SCHULMAN: Just the Carbonel-nickel?

VAIDYANATHAN: Yes.

SCHULMAN: Did you try any of the reduce nickel powders at all?

VAIDYANATHAN: No.

LACKNER (Defense Research, Canada): On your porosity analysis you used a mercury porosimeter. Did you try any correlation with a gas analysis, like a BET, which is perhaps a little bit more sensitive?

VAIDYANATHAN: BET will provide you the overall surface area. But what we are looking for is the porosity and the distribution of the pores.

LACKNER: Well, we've sort of found that the mercury is a little bit of a sledge-hammer approach: it could break up the pores, and it either gives a reading or it doesn't give a reading. The slope you have there is very sharp. It doesn't show any spread of porosity.

VAIDYANATHAN: That is the advantage of our procedure. With the loose powder technique one can produce a plaque with a pore distribution which is very uniform.

LACKNER: Well, even on the slurry which you showed in your electron microscope that had clumping and voids, the mercury porosimeter still did have a fairly sharp--

VAIDYANATHAN: Yes, it has, if you consider the first curve, which merely shows the relationship between the penetration volume and the diameter of the pores.

Most of the curves look the same. That is why we went and took the derivative of this penetration volume and

replotted it. There you can see some difference.

PUGLISI (Yardney): You mentioned that you were using screen; is that correct?

VAIDYANATHAN: Yes.

PUGLISI: Also I notice in a cross-section of the plaque you're producing, that the screen is off to one side.

VAIDYANATHAN: Yes, it is.

PUGLISI: Do you foresee any problems in the impregnation as far as uniformity across the cross-section?

VAIDYANATHAN: No, we don't.

PUGLISI: And do you foresee any problems with potential warpage of the plaque because of the grid being off to one side, when you start getting to larger electrodes?

VAIDYANATHAN: You mean when the thickness exceeds a certain value? We may see that.

PUGLISI: Well, what thickness do you anticipate?

VAIDYANATHAN: We're talking about 30 mills.

PUGLISI: I suspect that you're going to start seeing some warpage of plates, especially if you stay with the grid off to one side. I know the loose powder tends to kind of force you to that sort of geometry.

DUNLOP (Comsat): The screen was purposely put on one-sided. It can be put in the middle.



## SINTERING MECHANISM OF NICKEL POWDER

600 - 800°C	ROUNDING OF PARTICLES BY SURFACE DIFFUSION
800 - 900°C	CONSOLIDATION OF ROUNDED PARTICLES
900 - 1000°C	FORMATION AND GROWTH OF CLUSTERS
1000 - 1100°C	PLASTIC FLOW DURING SHRINKAGE WHICH RESULTS IN NECKS

Figure 31-1

### EMPIRICAL RELATIONSHIPS

1. THE RATIO OF THE VOLUME OF THE PORES AFTER SINTERING ( $v_s$ ) TO THE VOLUME OF THE PORES BEFORE SINTERING ( $v_p$ ) IS A CONSTANT FOR VARIOUS VALUES OF THE DENSITY ( $D_p$ ) OF THE COMPACTED POWDER.
2. THE DEVIATION FROM  $v_s/v_p = \text{CONSTANT}$  BEGINS WITH AN INCREASE OF CLOSED POROSITY.
3. STRENGTH OF THE PLAQUE INCREASES AND POROSITY DECREASES WITH AN INCREASE IN  $D_p$ .
4. ADDITION OF PORE FORMERS DISRUPTS THE NORMAL DENSIFICATION.
5. INCREASE IN SINTERING TEMPERATURE INCREASES DENSIFICATION.
6. EXPANSION OF THE PORES OCCURS IF THE ISOTHERMAL SINTERING TIME IS INCREASED.

Figure 31-2

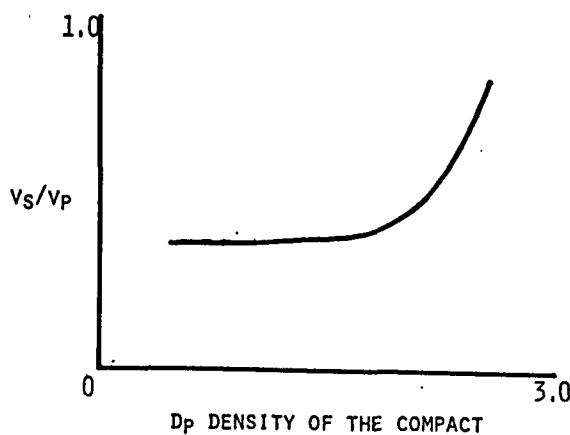

VARIATION OF  $v_s/v_p$  WHEN THE DENSIFICATION IS NORMAL.

Figure 31-3

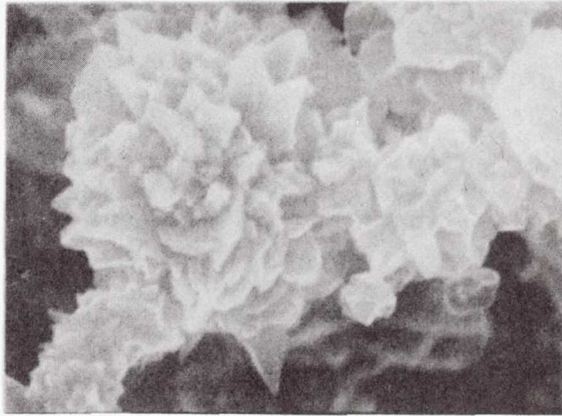

Figure 31-4

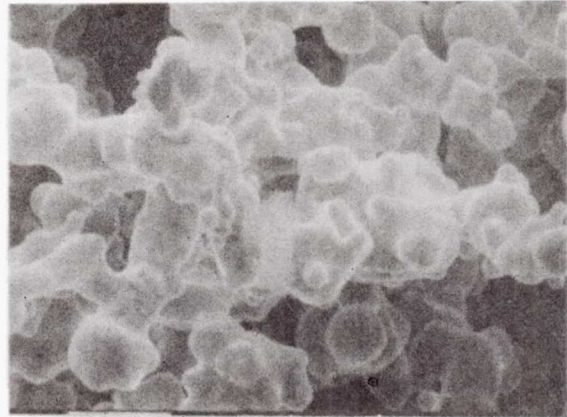

Figure 31-5

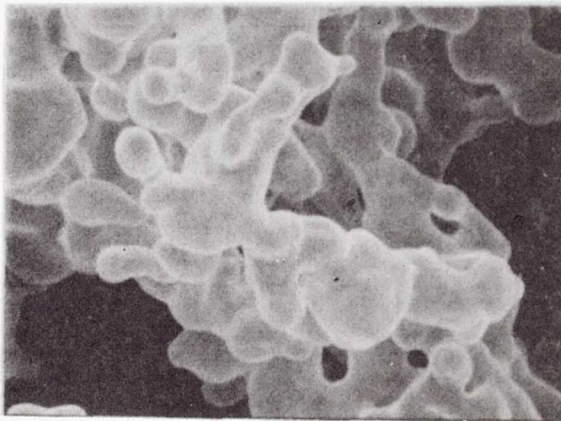
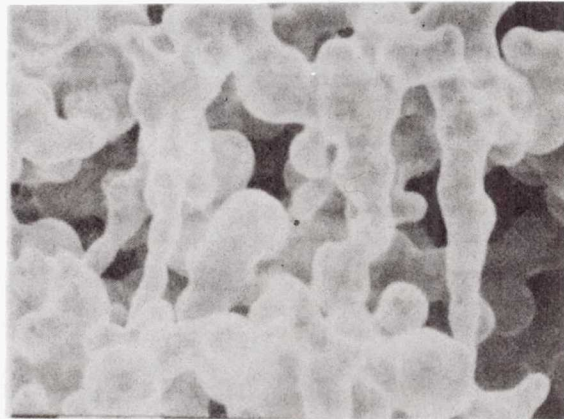

Figure 31-6



SEM of Sintered plaque at a magnification of 5000X. Sample Lot 9/10 sintering procedure = slurry coating.

Figure 31-7

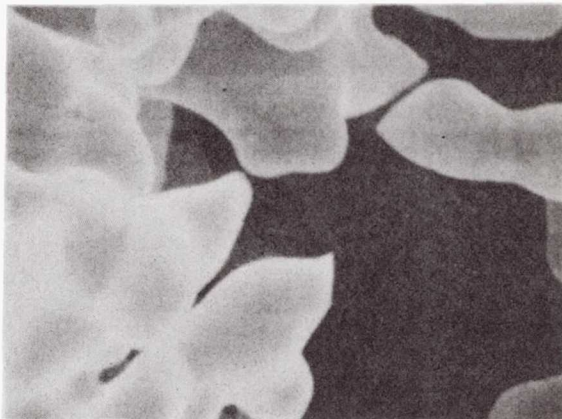
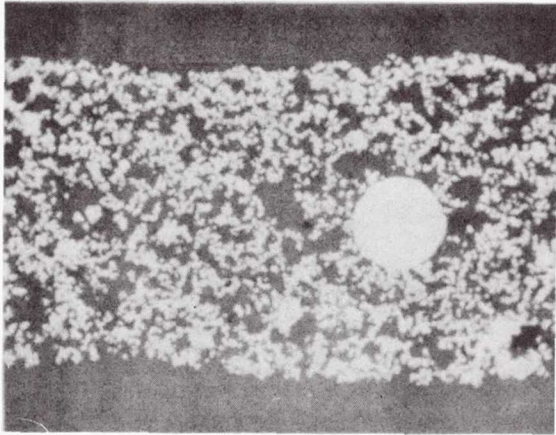

Figure 31-8



Cross section of a slurry prepared sintered plaque which shows macrovoids.

Figure 31-9

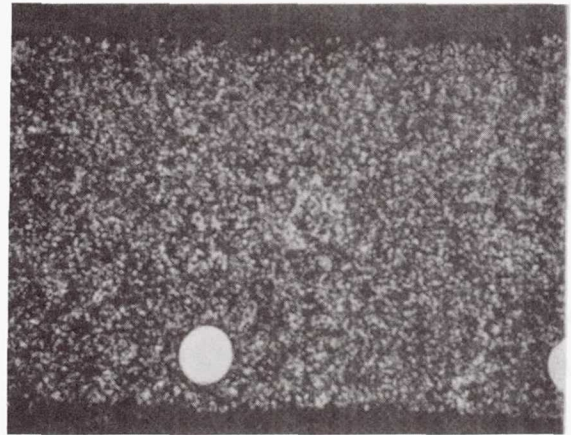

Figure 31-10

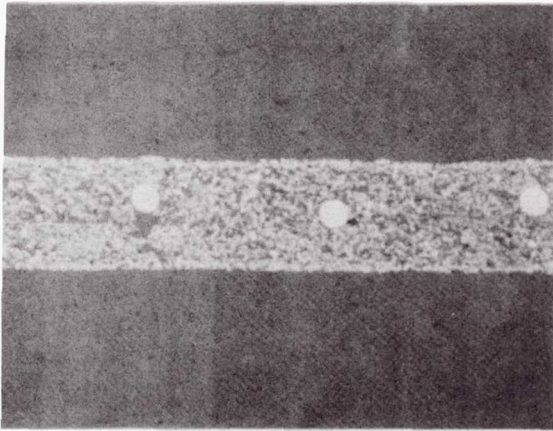

Figure 31-11

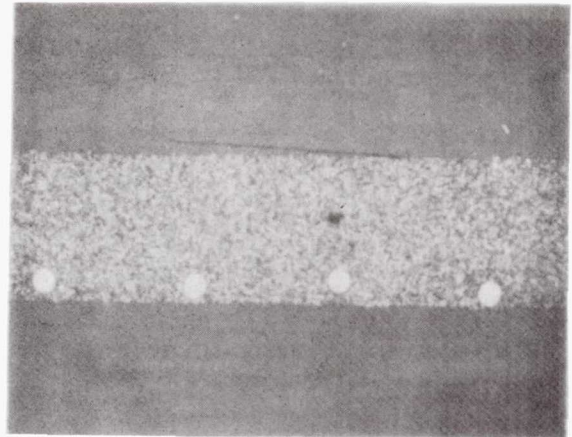

Figure 31-12

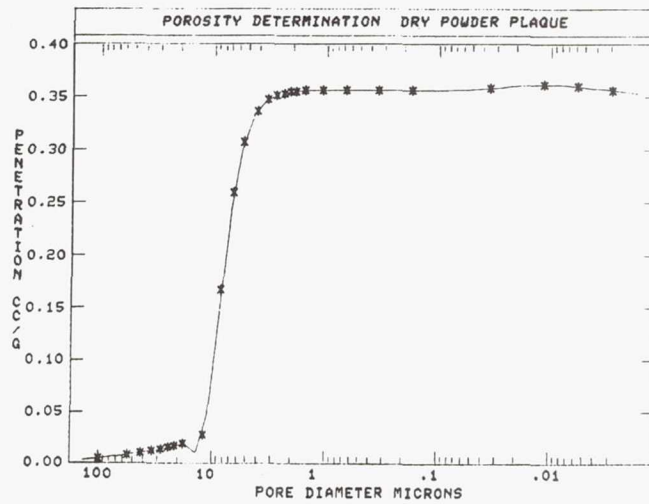

Figure 31-13

STDEV PANGOLD  
 0.361883 0.776777

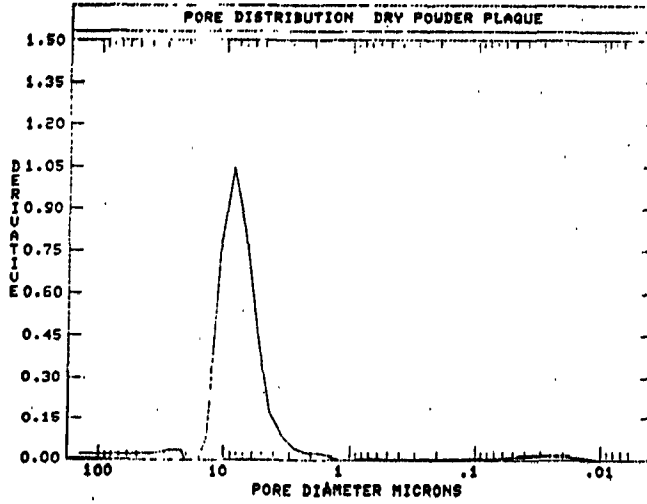

Figure 31-14

DENSITY PANGOLD  
 0.000000 0.000000  
 0.000000 0.000000

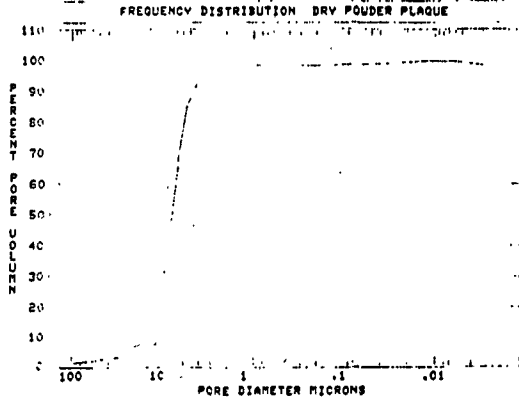

Figure 31-15

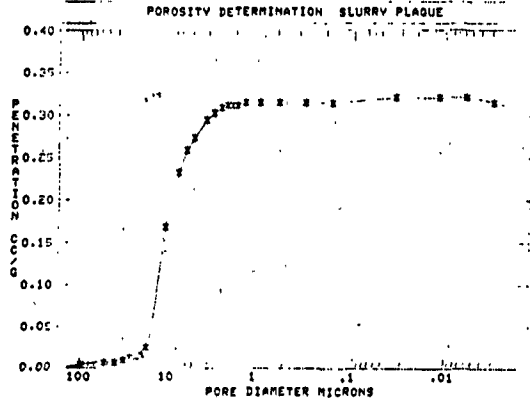

Figure 31-16

STDEV PANGOLD  
 0.361883 0.776777

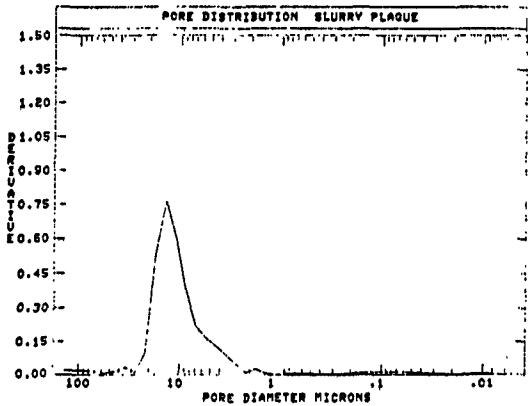

Figure 31-17

DENSITY PANGOLD  
 0.000000 0.000000  
 0.000000 0.000000

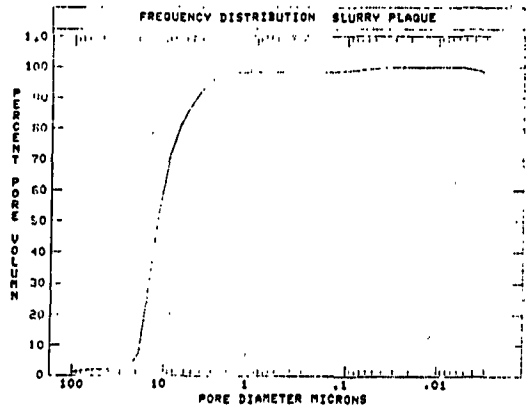

Figure 31-18

TABLE 1  
TYPICAL MICROGEOMETRICAL DATA

SAMPLE I.D.	SINTERING PROCEDURE	POROSITY %	MEDIAN VOL. PORE DIAMETER $\mu$ M	10% VOL. DIAMETER $\mu$ M	90% VOL. DIAMETER $\mu$ M
A	SLURRY	70.6	11.7	17.5	4.5
59-2	SLURRY	74.8	9.9	16.8	4.4
SPIRAL 1	SLURRY	76.4	7.1	13.0	2.3
COMSAT 58,8	LOOSE POWDER	76.7	8.0	11.3	4.7

Figure 31-19

TABLE 3  
TYPICAL TENSILE STRENGTH OF SINTERED PLAQUE

SAMPLE I.D.	TENSILE STRENGTH PSI
COMMERCIAL - A	514
COMMERCIAL - 9/10	261
COMMERCIAL - 59-S-4	583
COMSAT - 58-8	636
COMSAT - 59	726
AF	286

Figure 31-20

CORROSION OF PASSIVATED PLAQUE

SAMPLE I.D.	% WEIGHT GAIN
A	14
B	19.9
59-S-7	0
COMSAT 59	0

Figure 31-21

ADVANTAGES OF LOOSE POWDER TECHNIQUE

1. THE DENSIFICATION IS NORMAL AND IT IS A FUNCTION OF ONLY THREE VARIABLES: TEMPERATURE, TIME, AND DENSITY OF THE COMPACT.
2. EASY TO EVOLVE SINTERING PARAMETERS TO SUIT A PARTICULAR APPLICATION.
3. PROPERTIES OF THE PLAQUE SUCH AS POROSITY AND STRENGTH ARE PREDICTABLE.

Figure 31-22

## RECENT DEVELOPMENTS IN THE NSWC COMPOSITE ELECTRODE

W. Ferrando

NSWC

Before I start I'd like to credit not only Dr. Sutula and Dr. Lee but also U.S.N. Ensign Fred Flight and Anne Lee, a coop chemical engineering student, who are also working with us.

There have been a number of attempts in recent years to improve the nickel hydroxide electrode, with respect to what we call the three L's; longevity, light-weight, low cost. And this is the continuing story of our attempt to do so.

The objective of this talk is to characterize the physical parameters and life cycle data on the nickel composite electrodes, which we've abbreviated as Ni.C.E. electrodes.

(Figure 32-1)

This is a picture of one of our sintered composite electrodes fabricated from a pitch-mat carbon fiber. The nominal uncoated fiber diameter range is 7 to 17 microns. It's a highly graphitized pyrolytic graphite. About .6 to .8 micron coating of nickel is deposited on the fibers using an electrolysis process. The mats are then pressed between two plates and sintered in hydrogen atmosphere for two hours, which may be an overkill.

Concerning the pore size, we haven't done too much work on this as far as distribution, shape, etc, but we have estimated the pore size to be on the order of the fiber diameter, 7 to 17 microns. This, of course, depends on the compaction.

As far as the modeling of the pore shape profile, there could be one completely open pore through the whole plaque, or it could be a bunch of tetrahedral or trapazoidal shapes with maybe cycloidal walls. But this remains to be seen in the future.

(Figure 32-2)

The next slide shows how we actually make the plaque and subsequently the plate itself. The graphite mat fiber is coated with nickel and then pressed around a grid and sintered, producing the plate in the fourth quadrant. Shown is the rough comparison of weight.

We've gone over to an expanded metal, pure nickel metal grid. It's easier to fabricate than the homemade one.

After these plaques are characterized, they are impregnated by the Pickett method. We've been using ten percent cobalt and closely following his method in "Fabrication and Investigation of Nickel-Alkaline Cells", AFAPL-TR-75-34 (1975). The composite electrodes are put into test cells versus commercial cadmium negatives. We put enough negatives around them to make sure the cells are positive-limiting. The plate size is six inches by two and three-quarters.

We've been testing the single plate cells. I'll say a little bit about multi-plate cells at the end, but we're still in the single plate test phase. Cells are cycled in the flooded condition, 31 percent KOH, no additives to the KOH, no compression on the cell stack. So the electrodes are essentially free-standing. We have a bubble around it to prevent the contamination from the air, carbon, etc.

(Figure 32-3)

I'm going to present about four sets of data, cycles versus utilization. There are important parameters indicated.

First a word about cycling. The cycling machine we used is continuous cycling, constant charge followed by about a ten minute rest, then discharge continuously to .05V cutoff. The dropped points there are the cyclers malfunction. So that's a problem with the cycler. We have since corrected that in the rest of the data.

Using the new cyclers, we estimate fluctuation error at about plus or minus two percent, to three percent. So the fluctuations in capacity noted as cycling progresses are real.

A couple of features on this: You'll notice the long time, the long number of cycles to get up to the plateau utilization. This is a thin electrode, relatively thin, 24 mils. This first cell was discharged at two C to the 0.5 cutoff, about a 95 percent DOD.

For about 80 cycles or so it's rising up and then it reaches about 100 percent utilization. This is a fairly lightly loaded plate. By our standard it's moderately loaded. The amp-hours per kilogram are given on the right side, so it goes up to about 125.

(Figure 32-4)

This is another thin plate, 20 mils. What we did on this one to try to get maximum information is to vary the rate, the cycling rate. The charge rate was set at C, 125 percent charge. Out to 400 cycles the discharge rate was C/2. Then we began to cycle it with the same charge. We ran the cycle at the C rate to essentially the failure to see how far the thing would go.

So again it went up for about 100 cycles up to a plateau at 100 percent.

Now, on the thin plates we achieved around 100 percent utilization. At 400 cycles, the C rate discharge was employed out to about 750 cycles; I dropped it back to C/2 and cycled it at 800 cycles. A partial recovery was noted during the latter 50 cycles.

Here I drew two curves through the data, a rough chart of electrode life at those two different rates. In other words, approximating the respective electrode lifetime profiles. I realize this is not completely valid, but we're trying to get the maximum information to put on the shortest time.

I have two more sets of data.

(Figure 32-5)

These two are of thicker plates (40 mil). You can see the capacity there, 4.9 amp-hours. The cell was charged at C/2 rate, 120 percent. Two rates of discharge were employed on this cell: C/2 (dark points) and C/5 (open points).



You can see this is a higher loaded plate (1.98 g/cc void. And you can see the utilization is between about 70 and, say, 85, 87 percent. At the C/5 discharge rate it reached 175 amp-hours per kilogram. And it stayed pretty much of a plateau out to 500 cycles.

(Figure 32-6)

It's another electrode, 40 mils, C rate. And this one I altered. I altered between three different rates. The C/5 points are around 200 cycles (the diamond) and then there's one C/5 at 750 cycles. It rises up to more or less flat (200-500 cycles) then begins to tail off at a larger number of cycles. Similarly for C/2 (dark) and C (open) points. You can see the amp-hours per kilogram bare electrode energy densities: 165 or so for the C/5, and then the C/2 around 160, and then the C rate about 130.

We learned from this that it takes 100 cycles or so to reach maximum utilization, then it goes along, then it starts to tail off.

(Figure 32-7)

This is some of Dr. Lee's data on our thick and thin electrodes and a recently obtained commercial one. This versus the mercuric oxide counterelectrode shows the effects of the cadmium are eliminated in this case. We're just looking at the potential of the nickel.

This is very preliminary data. This is at the 2C rate on these. On discharge, the potential is lower than the commercial; but on the thin one, the potential remains quite good, as a matter of fact. The thin one is ten mils and the thick one is 40 mils.

At first we thought we might be able to explain this by some morphology changes in the active material or structural changes, but possibly it's due to the differences here as a proton diffusion limitation. And we're going to do more work on this. But you can see, though, that we do get the range as far as performance. We can vary the range around the commercial electrode.

(Figure 32-8)

These are the physical characteristics of a group of electrodes, including the ones that I showed. Table I gives the thickness. And these are thicknesses after impregnation. Here are the loadings and the grams per cc void and then the amp-hours per kilogram and amp-hours per pound loading, and then there's the amp-hours per cubic inch, and the C rating and porosities.

The porosity of these plaques can be varied anywhere from 55 to over 90 percent with good integrity, I mean a plaque that's usable, because of the fibrous nature of the structure. It's an interesting system. We can get a very wide range of porosities. We haven't really tapped all of these yet.

The commercial electrode has a thickness 33 mils.

I want to point out number 97. That's not a fluke, amp-hours per kilogram loadings of 200 without exceeding 2 grams per cc void are readily achievable. The reason is the very light weight of the plaque. You can really load to very high levels. To reach a 200 amp-hour per kilogram loading, the final plaque weight must be 3.25 times the initial weight. This is virtually impossible with a conventional plaque.

Now the high loadings, of course, aren't the whole story. You've got to be able to get it out, and that has to do with the utilization. And we're working on that now (Table II).

(Figure 32-9)

This is the actual performance, again a whole set of electrodes at the different rates around the given cycle numbers. This is the utilization to .9 volt. The first one is to .5 volt; I wanted to record it both ways.

You can see that the Ni.C.E. electrode does very well in the category of amp-hours per kilogram versus the commercial, which was tested along side the rest of them under the same conditions. We didn't put as many cycles on the commercial one though. Its capacity was slowly

decreasing.

In the case of the commercial one I couldn't get the porosity from the last table. This is nominal capacity, the capacity given on the cell divided by the number of plates.

You can see that the Ni.C.E. electrodes are very good on the amp-hours per kilogram and still pretty good on the amp-hours per cubic centimeter versus the commercial in most of the cases. And, of course, the loadings were given in Table I. Number 97 has a very high loading.

Some conclusions on the Ni.C.E. electrodes: they exhibit good cycle life characteristics, 500 to 600 cycles at C rate, greater than 1000 cycles at C/5 rate at 95 percent DOD, and usable energy densities under these conditions of 120 to 170 amp-hours per kilogram.

The swelling is minimal for carefully made electrodes. After about 150 cycles of the well performing ones, swelling from zero to about six percent was observed. More careful studies must be done here, however.

The utilizations are around 100 percent for lightly loaded plates. What we mean by lightly loaded in our case is less than 1.5 grams per cc void. About 70 to 90 percent, with the heavier loadings: 1.5 to 2.0 grams per cc void. An initial region of 150 cycles of increasing utilization is followed by slow decay after 600 cycles.

The initial increasing region might be due to a change in morphology in the active material, sort of a long formation period or redistribution in the pores so that smaller pores become useful in the plaque. This is just speculation. The slow decay may be conversion to a non-active form of active material, or probably more likely due to loss of contact with the grid.

We observe no detectable electrolyte contamination due to the presence of graphite. We did do a chemical analysis on this and found after 200 or 300 hard cycles, including even reversals, no detectable carbonate. So that's encouraging.

Our final conclusion is that the Ni.C.E. approach would seem to present real possibilities for the future as a method of making electrodes durable and lightweight and low cost.

I might make one comment about the multiplate cell. We'll be reporting on these in the future. We have done very preliminary work on an eight plate cell. Indications are that we're getting an improvement of about 38 to 40 percent over the commercial cell under the same conditions. And that's just with our composite plate in place of the nickel hydroxide plate against commercial negative. So if we assume the same improvement in the negative plate, we produce our negative plate this way, we possibly could get a 75 to 80 percent improvement. But, as I say, we're just beginning to work on this now.

Thank you.

#### DISCUSSION

RITTERMAN (TRW): A few comments.

One: The theoretical utilization of nickel hydroxide is about 289 grams per kilogram, and usually in the flooded state you get more than 100 percent because of the two electron change, or what have you. So we're talking about 300 ampere-hours per kilogram.

The best number that you had was I think about 204. I guess that was a measured number.

Now back a few years ago TRW had a lightweight cell program and we got comparable numbers using sintered nickel plaque, about 83, 84 percent porous, and loaded to about 1.8, 1.9 grams per centimeter cube void. So I don't understand your comparison to the standard. I don't think the standard is that far off from our lightweight. The standard would be about 50 percent of the weight of the standard sintered plaque is active material with a utilization of better than 100 percent in flooded conditions.

And, two -- this is a completely different comment. Two is that you say you found no CO<sub>2</sub> in your electrolyte. But you also stated that you were bubbling gas

through the electrolyte, I believe, to protect it against CO<sub>2</sub> formation from the air.

FERRANDO: From the air, yes.

RITTERMAN: Okay.

I don't quite understand your system. Isn't it possible the very fact that you bubble gas through caused any formation of CO<sub>2</sub> to also be dissipated?

FERRANDO: What we did was we just allowed the gas products to come off through a bubbler. It was like a one-way valve, so that the air wouldn't go back into the electrolyte. That's what I meant by bubbler. We're not bubbling any gas through the cell.

RITTERMAN: I see.

FERRANDO: It's just on charge. It's just to prevent -- it's like a one-way valve, essentially.

RITTERMAN: Okay.

Because you will be forming CO<sub>2</sub>. Obviously I would think you would be when you go to an overcharge situation and you're putting back 125 percent of what you put out. So you are gassing oxygen off that graphite electrode.

RAMPEL (General Electric): I think all your characterizations and utilizations were based on C/2 charge?

FERRANDO: Some C rate charge and some C/2.

RAMPEL: Okay.

FERRANDO: Most C/2.

RAMPEL: What would it look like at ten hour rate charging, C/10?

FERRANDO: The lowest I've ever charged it at is C/5. Usually I understand that these types of cells don't do very well at C/10. I think there's an optimum charge rate on these. I don't know what it is exactly.

RAMPEL: Okay. Thank you.

THIERFELDER (General Electric): You listed 120 ampere-hours per kilogram. I was wondering how you arrived at that number. Did that include hardware and you just projected that, or how did you arrive at 120 ampere-hours per kilogram?

FERRANDO: Okay. That's the bare plate with just its own tab, and based on dry weights, based on initial dry weights, excluding any kind of shedding or anything. We saw on the well performing electrodes very little shedding, I'll say half a gram, maybe half a gram.

KUNIGAHALLI (Bowie State College): I have one comment to make.

In our experience of analyzing design variable cells made by GE nearly after one year of cycling about 5800 cycles we haven't seen any swelling in the positive plate. So I would say it is too early to speculate that there is no swelling just after 100 cycles.

FERRANDO: I agree.

KUNIGAHALLI: The second observation is that carbonate contamination also, it's too early to say because we have only tried at about 100 cycles -- or 800 cycles, I mean. So the temperature and rate of charge also could contribute.

FERRANDO: Your cycles were 95 percent DOD and at the C rate or --

KUNIGAHALLI: No.

FERRANDO: --- or at C/2?

Yes, because it makes a difference.

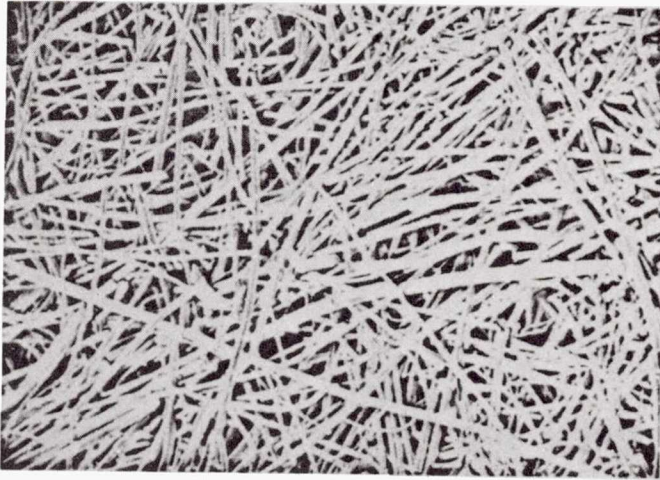

Figure 32-1

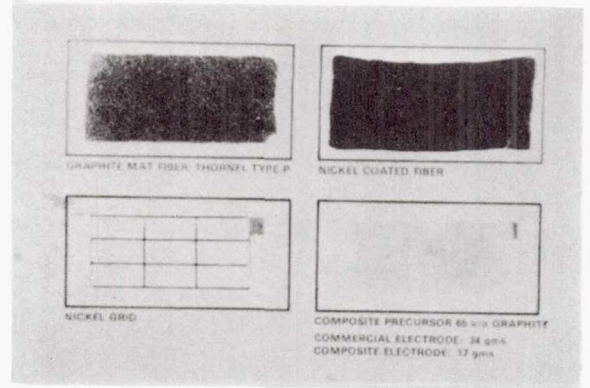

Figure 32-2

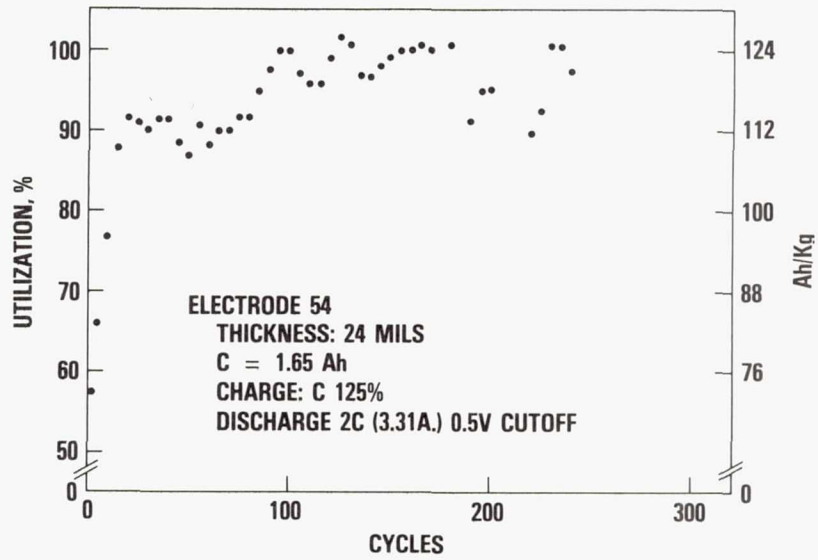

Figure 32-3

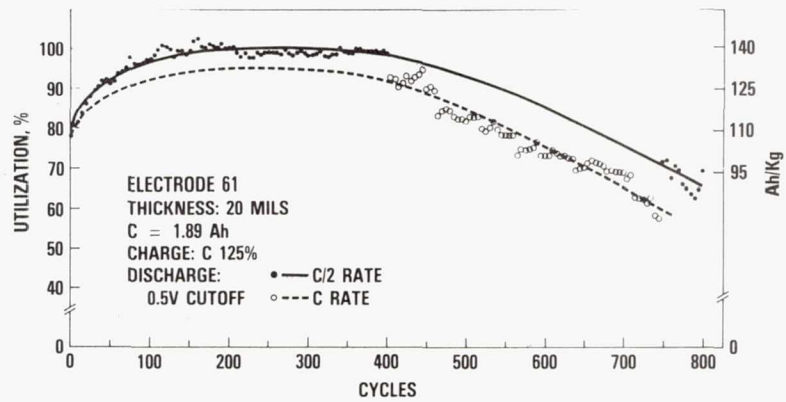

Figure 32-4

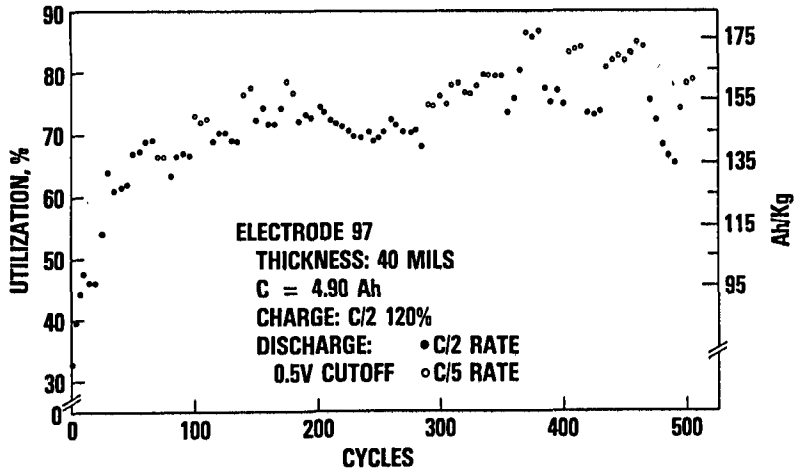

Figure 32-5

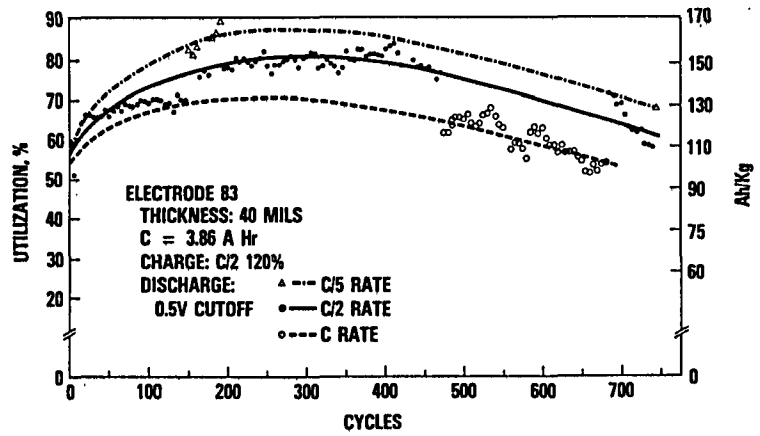

Figure 32-6



**CHARGE-DISCHARGE CURVE**

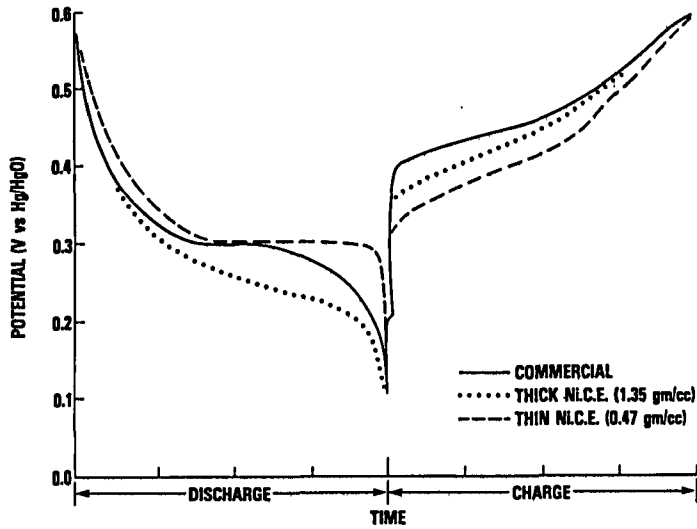

Figure 32-7





## "Ni. C. E." PHYSICAL CHARACTERISTICS

ELECTRODE	THICKNESS MILS	LOADING g/cc VOID	LOADING A.h/Kg. A.h/LB	LOADING Ah/cc Ah/IN <sup>3</sup>	C RATING Ah	POROSITY %
54	24.0	1.49	123.9 56.3	0.252 4.13	1.65	71
59	19.7	1.66	132.6 60.3	0.349 5.71	1.9	75
61	19.0	1.62	139 63.2	0.355 5.82	1.9	71
83	42.4	1.49	189.8 86.3	.383 6.27	3.9	89
85	42.0	1.66	191.4 87.0	.408 6.68	4.3	85
97	43.5	1.98	204.6 93.0	0.41 6.72	4.9	82
101	44.0	1.88	168.6 76.6	0.375 6.15	4.8	71
COMMERCIAL MANUFACTURED 8/81	33.0	-	83.7 38.1	0.328 5.34	2.846	-

Figure 32-8



## "Ni. C. E." CYCLING PERFORMANCE

ELECTRODE	DISCHARGE RATE	CYCLE NUMBER	UTILIZATION %	Ah/Kg.	Ah/cc
54	2C	235	97	120.2	.244
			86.4	107.0	.218
57	3C	100	94	112.4	.199
			64	76.5	.135
83	C/2	400	80.4	152.6	0.308
			71.8	136.3	0.275
	C/5	190	89.0	168.9	0.341
			86.6	164.4	0.332
C	540	87.8	128.7	0.260	
		43.0	81.6	0.165	
97	C/5	460	82	170.0	0.340
			76	156.5	0.312
	C/2	470	75.5	154.5	0.310
57.9			118.5	0.237	
101	C/2	785	73.8	124.4	0.277
			68.9	112.8	0.251
	C/5	750	81.5	137.4	0.308
77.4			130.5	0.290	
COMMERCIAL MANUFACTURED 8/81	C/2	17	89.7	75.1	0.292
			87.8	73.5	0.288
	C	5	90.8	76.0	0.296
			77.8	65.1	0.254

Figure 32-9

## CORROSION IN NiCd CELLS

C. Badcock and J. Galligan

Aerospace Corp.

The first thing I want to point out is this really should be corrosion in the terminals of nickel-cadmium cells; that's what I'm going to talk about.

Prof. Jim Galligan from the University of Connecticut was working at Aerospace this summer, and I asked him to examine the terminals in the cells. My understanding is when we had problems in the past with terminals it was in the '60s and this problem was corrected. Now we're doing fine for missions up to seven years or so. But our time scale for using nickel-cadmium cells is going out to ten years.

The question is are we going to have a problem with corrosion associated with the longer lives or longer application times for present day nickel-cadmium cells. To that end we examined two cells.

(Figure 33-1)

We took a GE cell. This cell was approximately eight years old. It had about 500 cycles on it. We examined the welded areas and the brazed areas on the terminals. I pictured here the areas that I'll be talking about.

(Figure 33-2)

Then, not wanting to be prejudiced in any way, we looked at an Eagle-Picher cell also. And we're looking in this area.

(Indicating)

In the welds, we saw no problem at all. There was no corrosion evident in any way. So what I'll be talking about are just the brazed areas associated with the terminals.

(Figure 33-3)

What we observed when we expanded this area, as you'll see, is corrosion down in the crevice or along the line of the braze. This is on the inside of the cell, it's not on the outside. And in the GE cell you can see that we're having corrosion forming here and here, the little black line.

(Indicating.)

You'll notice it has a long way to go.

(Figure 33-4)

This is the Eagle-Picher cell. The Eagle-Picher cell had an unknown number of cycles on it, but it was approximately five years old. And accordingly it shows somewhat less, but still the same type of corrosion, crevice type corrosion at the interface between the stainless steel material, the nickel material and the braze.

So we conclude that there is some corrosion taking place in these areas. The next thing we tried to do is we looked at a higher magnification.

(Figure 33-5)

You'll notice here we have some pits and voids, indicating some pit corrosion, again not extensive but it's occurring in the range of five to seven years.

(Figure 33-6)

What we really concluded from this work is that with the welds, there's absolutely no problem. They were clean, no interaction at all. There was corrosion of crevice type in the brazed areas and some pitting was evident between the braze and the base material.

Finally I guess the most important thing is I don't think we see any problem that this is going to give us up to ten years or more in a nickel-cadmium cell. The corrosion is going too slow.

But I guess the other thing I would like to point out and suggest is let's not forget about the problem.

Thank you.

#### DISCUSSION

VYAS (Bell Labs): Do you see a difference between the rate of corrosion or the amount of discoloration between the positive and the negative terminals?

BADCOCK: We looked at this, obviously we had some other pictures too. No, we really didn't see much of anything that would suggest that. It's just corroding at that interface. The strongest correlation was that the Eagle-Picher cell was not as old as the GE cell; nothing else.

STOCKEL (COMSAT): Chuck, was the braze nickel gold?

BADCOCK: You know, I thought so because I knew the specs on these cells and it called out nickel braze. But when we did ion microprobe on these -- I should mention we did ion microprobe on the interface too, mostly we wanted to see if there were any contaminants. And other than a trace of magnesium which got into one of them we saw nothing, except that I didn't see a peak for gold either. What I saw was silver and palladium. I'm not so sure I understand this. I expected to see nickel gold braze because they were built, you know, '73 and on and I thought we were using only nickel gold braze at that time.

Maybe Guy Rampel could comment on that. Is that what we are using?

(Laughter.)

I was sure surprised when I looked there and I didn't see a gold peak in the ion microprobe, but I saw a lot of palladium and silver.

RAMPEL (General Electric): We're using nickel gold. We had used other brazes, maybe at the time of the cell you were examining, I'm not sure. But we've been using nickel gold now for quite some time.

BADCOCK: Yes.

I went running down to look at the color of the braze right after this that we had on some brand new cells that we got, and the color looks the same. The braze is gold colored. But I didn't see a gold peak, so that's why I didn't mention what I thought the gold from the braze was.

RAMPEL: We're getting charged for gold.

(Laughter.)

BADCOCK: The corrosion is there but it's not very fast.

DYER (Bell Labs): One of your micrographs seemed to show a two-phase system in the braze. Is there some galvanic attack involved here perhaps?

BADCOCK: I really can't answer your question. I don't know. I would suggest that there is a slight amount of it.

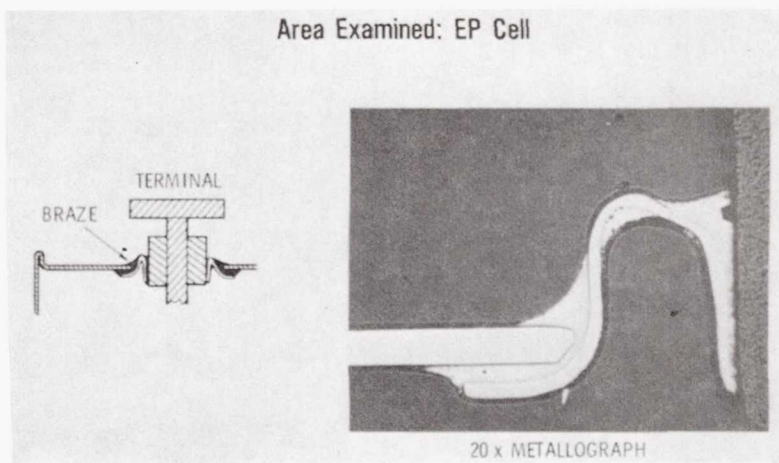
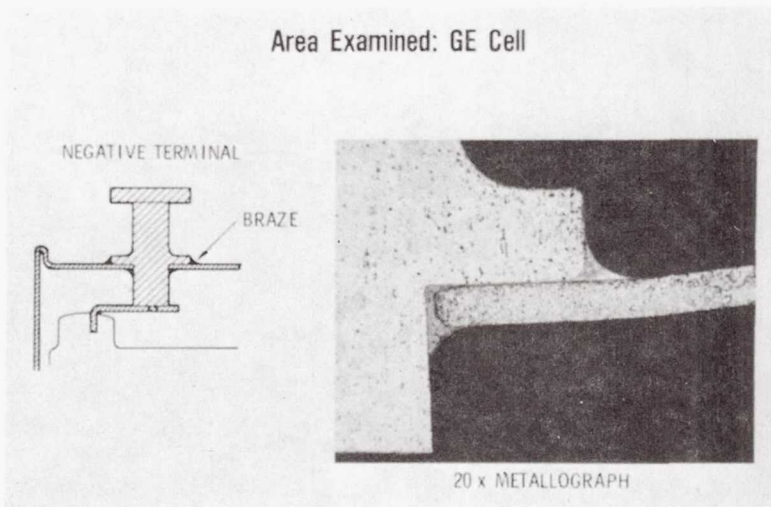

Figure 33-2

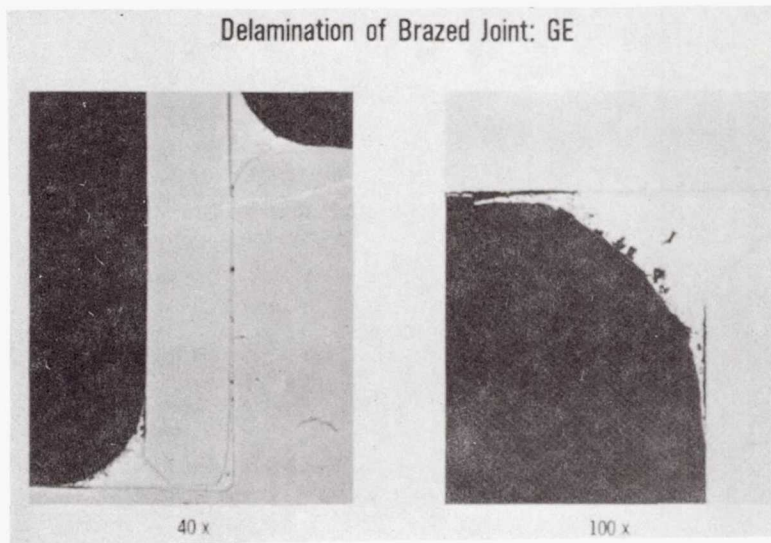

Figure 33-3



Figure 33-4

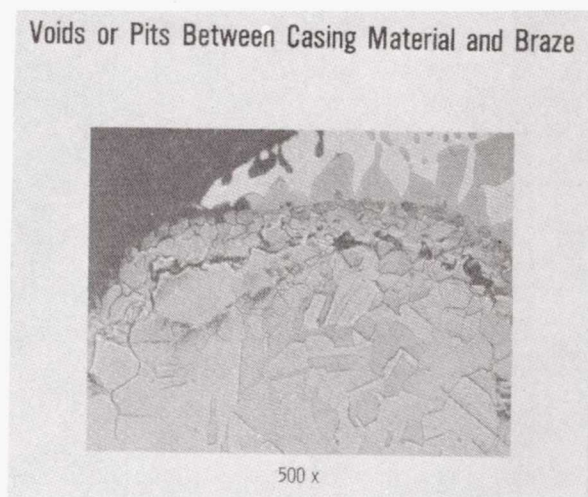

Figure 33-5

### Conclusions

- WELDED JOINTS SHOW NO CORROSION
- CREVICE TYPE CORROSION WAS FOUND AT BRAZED JOINT AREAS
- SOME PITTING WAS EVIDENT BETWEEN BRAZE AND BASE MATERIAL
- CORROSION IS VERY SLOW AND APPEARS UNIMPORTANT BELOW 20°C FOR CURRENT MISSION DURATIONS

Figure 33-6

## TRIBUTE TO LOU BELOVE

I. Schulman

JPL

This will be really unrehearsed. There are no vugraphs. And this is certainly nontechnical.

I would like to ask this forum to join with me in paying our respects to one of the giants of the industry, Lou Belove, who died since the last Battery Conference. Lou holds a unique, a very special position in this industry, and I felt that it is only correct to have this recorded in the proceedings.

Many of us, Harvey Seiger, Ritterman, Frank Alliegro, Guy Rampel, who certainly have worked very closely with Lou, know of his contributions. But there are many, many new faces, and I always feel that they may know him only as possibly some reference that they saw way, way back in the mid-'50s when he did publish many of his papers. But he was more than that. And for their benefit let me just review to a certain extent some of his accomplishments.

Lou developed the sealed nickel-cadmium cell. That in itself is a tremendous accomplishment. He did it because Lou wouldn't listen to people who said it couldn't be done. He didn't understand that statement, that it can't be done. Lou would try anything. And so the first cylindrical sealed cell he rolled up on a pencil.

He developed the first cylindrical cell that flew, and I'd say probably the next four or five types of cylindrical cells that flew.

He worked on the first commercial sealed cell which was made on a Sears-Roebuck lathe in Port Chester, New York.

He also worked on the first rectangular sealed cell. He was the innovator. He's the man who started it all. He recognized the importance of the seal. He was the first one to use a ceramic-to-metal seal. They leaked like taps, but he started it; he started the whole thing.



He defined the first separator to be used, which worked. And, by the way, the first separator was Wattman's #40 filter paper. That's what it was.

I might add that he made what we used to call the one by one cell, which was one inch diameter, one inch high, using Wattman's #40 filter paper, and that cell was cycled at the signal core in a vacuum desiccator because they were afraid that it would go the way that many of them did at that time, and so they protected it with a vacuum desiccator. The cell was cycled at about a 20 percent DOD and it went for five years in a LEO cycle. It went over 25,000 cycles, and these people couldn't kill it.

So Lou contributed so much. He started the industry which we're talking about today. And I felt that this man who was a mentor to so many of us, who treated us as his colleague all the time, and certainly was a friend to all people, should be remembered at this time because we have lost a very fine human being. And I think it's proper that we should acknowledge it at this forum.

I thank you.

## A METHOD FOR BATTERY ACTIVATION

G. Halpert and M. Tasevoli

GSFC

My paper this morning will describe something that we assumed to be fact for a long time. It is the matter of activating a battery after it has been stored for long periods of time.

The technique that everyone has used has come down through the ages; I'm not exactly sure who to give credit to for that, but it has worked up until now. The method involves removal of the short, let it come to room temperature, and charge it at C/20 rate for 48 hours. It's a time-consuming process, and it involves some heating. Until now, we really haven't had too much of a problem dealing with that particular technique.

As a matter of fact, when it came to the Solar Max Mission program, the approach was to use the flight batteries in the thermal vacuum test for the two-week period only, remove them, put back on the test batteries, short the flight batteries, send the flight batteries to the Cape with the spacecraft, install them in the spacecraft at the Cape and activate them (I'm calling this technique activation, some people call it conditioning) in the usual way, C/20 rate for 48 hours.

This procedure does involve a bit of heat, and with the heat in the spacecraft there's a problem of getting rid of same. So we had to blow some cold air in. If you consider that we're running a 22-cell battery, roughly 30 volts, and 20-ampere-hour cells which we were using at 1 amp, we have roughly 90 watts being generated by the three batteries running at the same time. Getting rid of the 90 watts isn't really a terribly difficult problem.

In the next mission for the multi-mission modular spacecraft, the Landsat-D mission, we had planned to do the same thing; except now we're dealing with 50 amp-hour batteries, three of them. In this case we have 2 1/2 times as much heat (225 watts) to try and dissipate in the spacecraft which cannot be done. So it was incumbent upon us to come up with a new procedure for activating the

batteries and getting them into the proper condition, without going through this long time-consuming, costly, high temperature, or high heating overcharge.

A technique was conceived and Mike Tasevoli from our office took two 5-cell packs and ran them through their paces. This different scheme works for this particular mission and for this particular sequence. And I'd like to tell you about it now.

(Figure 35-1)

First, I'll show you a figure of a typical profile of C/20 charge for 48 hours. You see voltage goes up to the oxygen gassing and continues for a while, and you see the pressure continue to increase until it levels off. And the turning point here, with the pressure and the temperature increasing, is about 36 hours. The remaining twelve hours between 36 hours and the 48-hour charge is really just heat generation and overcharge; which, as I say, was causing us the problem.

(Figure 35-2)

We felt that we could use our NASA standard voltage limits to be able to help in this regard. You've seen these before, and I'm just putting them in for the record. These are the typical temperature-compensated voltage levels that are in the MMS spacecraft in the modular power subsystem built by McDonnell Douglas. We felt we could use these voltage limits in a similar way for this activation procedure.

(Figure 35-3)

One of the techniques we thought we could try was first starting off at a low rate to remove some of the impedance problems, a C/20 rate for roughly eight hours. Again, this is not a very scientific test, and we just chose some parameters and went through the test procedure.

We then raised the current level to C/10 for six hours. And then we put it on a constant voltage charge at our voltage level 6 shown on the previous slide, until the current dropped off, to the C/20 rate.

(Figure 35-4)

When you do that, you can see the difference. The voltage rises to the voltage limit, which we of course maintain. You don't see the current listed here, but the current did drop off until we hit the C/20 rate. We see the signal electrode picking up to show that we have some oxygen in the cell indicating that the pressure was picking up a little bit. The temperature is fairly minimal at this particular point.

(Figure 35-5)

Now the technique was to take two packs and first make sure that they were similar. And this data shows the similarity between the packs: the normal standard conditioning charge, C/20 for 48 hours, and the capacity. These are 50 amp-hour cells. We follow that with a one-ohm letdown, and then what we call a capacity -- and what most people call capacity -- charge, C/10 for 24 hours. Again, the same type of a charge, where you get a lot of heat at the end. But normally we measure only capacity. The capacity is listed; 58 and 60.9 amperes.

We did the letdown and open circuit recovery, and then ran a voltage level charge to C/20 taper current, which would be consistent with what we would try and do for putting a battery in a full state of charge. And you can see that we put in a lot less energy and a lot less ampere-hours, and we have still the capacity maintained. So the two packs were very consistent.

Then we went through the procedure of trying the different ways of "activation". One pack we "activated" in the same way each time, with C/20 and 48 hours. And with the other pack we tried various methods of "activation". First the C/20 for eight hours, followed by C/10 for twelve, then the C/20 for eight hours, C/10 for eight hours, then C/5 to voltage limit. Then C/20 for eight hours, C/10 for six, and then C/5 to a voltage limit 6.

In all three cases you can see the capacity delivered, 60.6, 60.2 and 60.2 ampere-hours using those particular techniques. So we were able to get out the full charge.

Just to make sure we hadn't done anything to the cells, we put it back on the standard reconditioning charge again, (C/20 for 48 hours) and again we got the 60 ampere-hours. So it seems we're at least going to get the capacity out.

Now, what does it do in terms of the voltage on the discharge?

(Figure 35-6)

Here's the voltage on discharge for the different sequences that we tried. This one happens to be one that I had not listed, but it's C/5. You can see that the capacity is down. These were discharged at the C/2 rate, and therefore two hours is the normal capacity.

The charge to the voltage limit 5 gave us too low a capacity. The other ones were voltage level 6. You can see that they all maintained a fairly good voltage level.

But I wanted to compare the one that is a plus, which is on the lower level here, with the one that's the circle, the circle that's on the upper level. And you can actually see a significant voltage improvement; indicating, without a lot of proof, that the battery, or the cells are being not only activated to get their capacity up but their voltages actually increased when compared with the C/20, 48-hour charge.

(Figure 35-7)

Another example. This is a comparison of both packs, the control pack and the test pack, both done at the 48-hour C/20 rate. And we get the voltage at the bottom. When done in the manner I suggested: C/20 for eight hours, C/10 for eight hours, and then charge at C/5 to the voltage limit 6, and then drop off. The discharge gives us the higher voltage.

(Figure 35-8)

Just to show you a comparison with the actual control pack, we did the standard reconditioning of the control pack and repeated the same activation technique with that control pack that had had the same ordinary activation

procedure. And, again, you see the voltage level is higher for the new method.

So what we've seen previously is a technique that has been used for many years, and I'm not sure who knows why it was started in the first place. But certainly a method has been described that does three things: it shortens the time, especially at the Cape where we need the time, and it is very costly time; it eliminates the temperature rise in the batteries, which we're very concerned about in terms of heating the equipment, and it turns out that the voltage on discharge is better than when we ran the C/20 for 48 hours.

Thank you very much.

#### DISCUSSION

LURIE (TRW): Gerry, I believe that most, perhaps a large fraction of sealed nickel-cadmium cells can be reactivated after storage, at rates considerably greater than C/20.

I think historically the reason that C/20 was chosen is that virtually all of them can be reactivated safely at C/20. What happens, you can take a bunch of cells, reactivate them at C/10, and occasionally some will show anomalous voltage and pressure characteristics. I'm not sure anyone really understands it. But I believe that's the genesis of the C/20 for 48 hours; just uncertainty.

HALPERT: Thank you.

OLBERT (Bell Aerospace): Will you elaborate on the one short curve, the C/5, that you observed?

HALPERT: The charge was to the voltage limit 5 and not voltage limit 6. If you go back to our standard voltage curves, there's about a 20-millivolt difference in the curves. We're running at 20 degrees.

When we charge it to the voltage level 6 we're able to get everything in and have the right capacity and the right voltage. When we did it to voltage level 5 we didn't get the capacity.

THIERFELDER (GE): Gerry, I just want to ask about the resistor letdown. You say one ohm, and it says one-tenth ohm.

My other question is: Do you do it for a fixed time period, or do you let down with the resistors to a given cell voltage or battery voltage?

HALPERT: We do it for a fixed period: I think it's overnight, sixteen hours.

THIERFELDER: And is it one ohm or one-tenth ohm?

HALPERT: Mike Tasevoli, is it one ohm or one-tenth ohm?

TASEVOLI (Goddard): We did it both. We did a .1 ohm letdown and a 1 ohm letdown. The difference between the two letdowns is insignificant as far as open circuit voltage recovery in any additional tests that we did.

We did let the packs down, resistive letdown, for a minimum of 16 hours, after which time the packs were shorted for a period of one week prior to any additional testing.

HALPERT: There was a week in between each one of these tests, in the direct shorted condition.

RAMPEL (GE): I agree with your reasons to avoid heat at the Cape, and elsewhere perhaps. But I would urge other people to stick with C/20 reconditioning, so that some older cells do not develop voltages over 1.50 at room temperature and hydrogen evolution. So I would continue that practice.

I feel that the charge cutoff could be less than 48 hours, or even 40. But I recommend that you stick with C/20 in the field. C/5 can be dangerous on some old cells: you'll definitely go over 1.50 on some cells and some batteries.

HALPERT: As you know, Guy, we did have a voltage limit control on this, so we couldn't go to 1.50V. And that voltage limit was very low.

These cells did have a significant amount of electrolyte. We're on the higher side on the electrolyte, as we've suggested in the past.

GASTON (RCA): Were those negative electrodes Teflonated?

HALPERT: Yes, they were. NASA Goddard uses only Teflonated negatives.

FORD (Goddard): I'd like to make a comment to Rampel's comment.

I'm glad you qualified that statement to "all cells," because I'm under the impression we don't have hydrogen generation in NiCd cells any more, based on the technology.

The second point: I think it may be overlooked here, and I think Gerry alluded to it, but I think there is such a thing as activation energy, that nickel electrode that we may be looking at, that you're getting by going to a higher rate and a higher voltage to enhance the discharge voltage on the cell.

Now, you know, one of the things we're concerned with, with long life, is maintaining a good discharge voltage. And it's probably the subject we know least about in the NiCd. And this is a case where I've seen where the actual charge regime actually shows some improvement in the discharge voltage prior to launch. Now the question we don't know, and I think it's worth looking into, is: will this enhance the discharge voltage performance with the life of the battery? I don't know that.

BETZ (NRL): On occasions when we've taken non-flight batteries out of storage, I've started them almost as high as C/2. I bring the voltage up first to get the initial peak off, and run them at C/2 for 100 percent, and then cut back, just to prevent the voltage from going up in overcharge. I haven't really caused a problem, but they haven't been flight batteries, either.

RITTERMAN (TRW): I want to comment on Floyd's comment on Guy's comment. Guy beat me to it, he asked the question I originally intended to ask.



But I still think you should be leery in today's cells as well, because what happens when a cell stands around for a long time, there is a redistribution of electrolyte. And at low temperature especially, if you charge above C/20, you're going to have a possible dry spot at the negative electrode and you have hydrogen gassing and dispersed voltages.

BETZ: If you are monitoring cell voltage would you observe that?

HALPERT: Yes. You'd be up at 1.5 volts at a very low state of charge.

BAER: So as long as you're monitoring cell voltage you can avoid hydrogen evolution?

FORD: Just one response to that. Yes, I know what you're talking about in terms of the initial peak and voltage on charge, and the electrolyte problem, yes. But with a lighter load plates, more electrolyte, that problem should have gone away about five years ago.

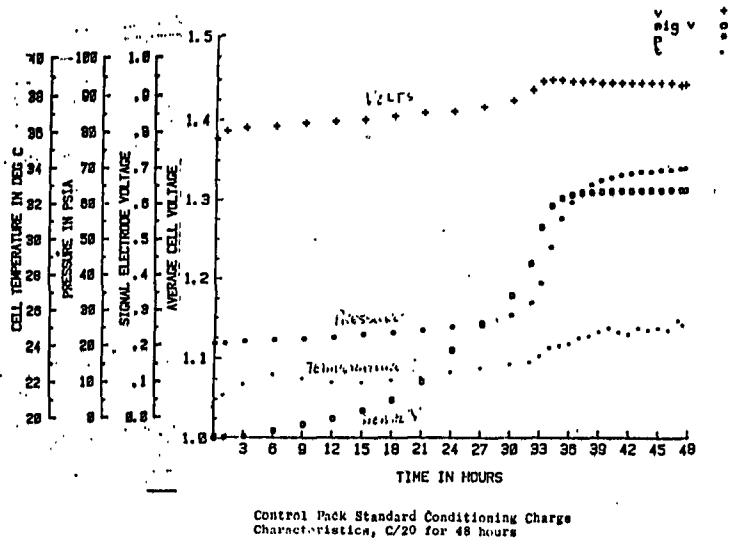

Control Pack Standard Conditioning Charge Characteristics, C/20 for 48 hours

Figure 35-1

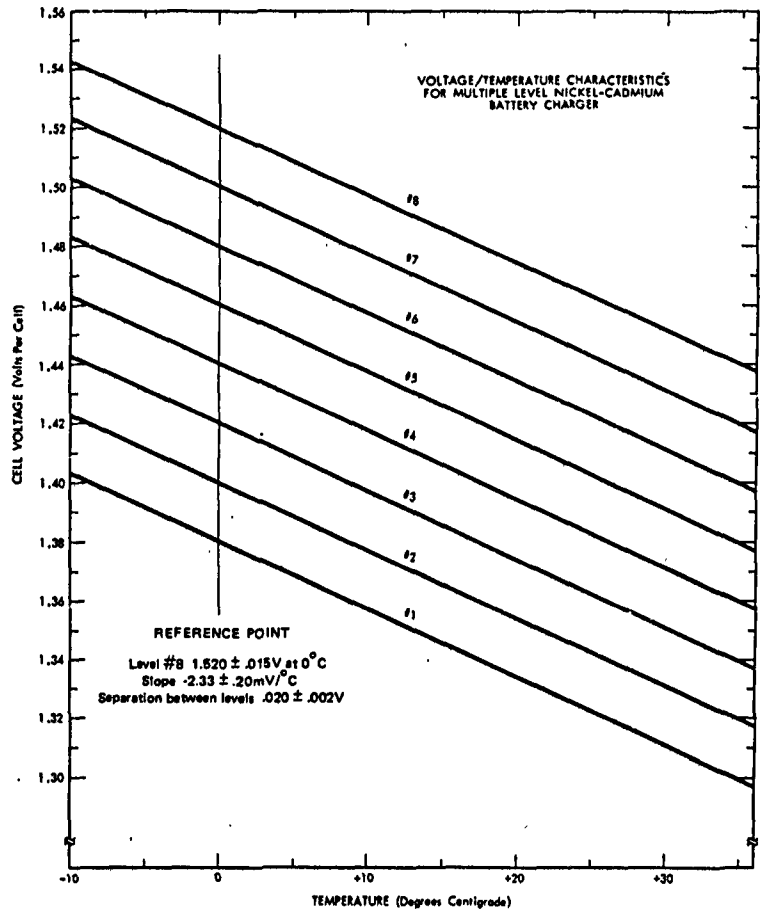

Cell Voltage Limit versus Temperature

Figure 35-2

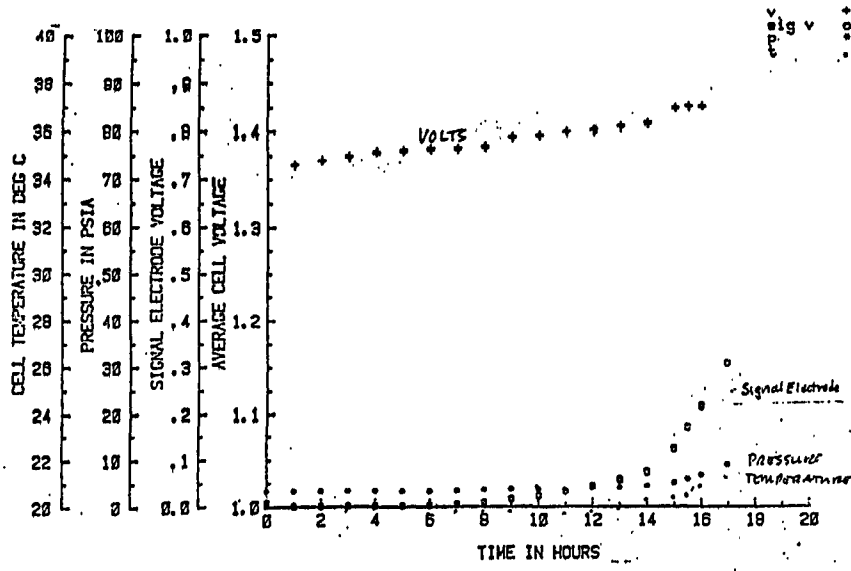

Control Pack Conditioning Charge Characteristics for C/20 for 8 hours, C/10 for 6 hours and C/5 to Voltage Limit Level 6 and C/20 ROCI

Figure 35-3

BASELINE TESTS		
	PACK 1 (CONTROL)	PACK 2 (TEST)
STD COND CHRG	119.3	119.2
C/2 COND DISCHRG	60.5	61.7
		0.1 Ω LETDOWN
C/10 RECHARGE	88.6	93.6
C/2 DISCHARGE	58.3	60.9
		0.1 Ω LETDOWN
		OCV RECOVERY
VL6 CHRG C/20 EOCI	71.7	72.1
C/2 DISCHARGE	60.3	60.2
		0.1 Ω LETDOWN

Figure 35-4

RESULTS OF ALTERNATE CONDITIONING CHARGE SCHEMES			
	PACK 1	PACK 2	
STD COND CHARGE	120	C/20 8 HRS, C/10 12 HRS	80.6
DISCH	62.3	DISCH	62.3
VL6 CHRG	72.0	VL6 CHRG	70.1
DISCH	60.3	DISCH	60.6
STD COND CHARGE	119	C/20 8 HRS, C/10 8 HRS, C/5 TO VL6	72.9
DISCH	61.6	DISCH	61.9
VL6 CHRG	71.6	VL6 CHRG	69.1
DISCH	59.7	DISCH	60.2
STD COND CHARGE	121.3	C/20 8 HRS, C/10 6 HRS, C/6 TO VL6	72.2
DISCH	62	DISCH	61.2
VL6 CHRG	70	VL6 CHRG	69.1
DISCH	58.6	DISCH	60.2
		STD COND CHRG	119
		DISCH	62.8
		VL6 CHRG	70.8
		DISCH	60.3

Figure 35-5

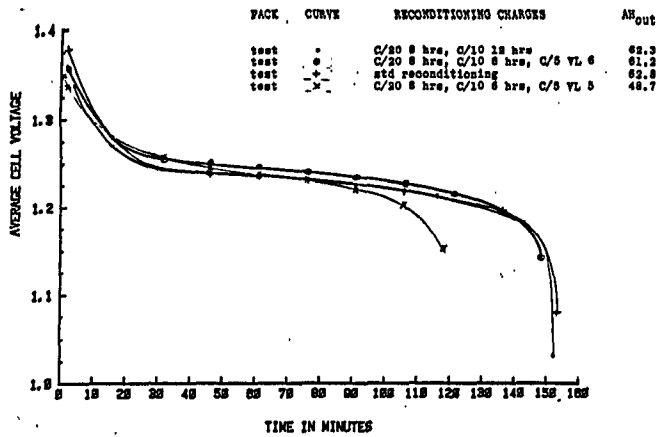

Test Pack Conditioning Discharge Comparison

Figure 35-6

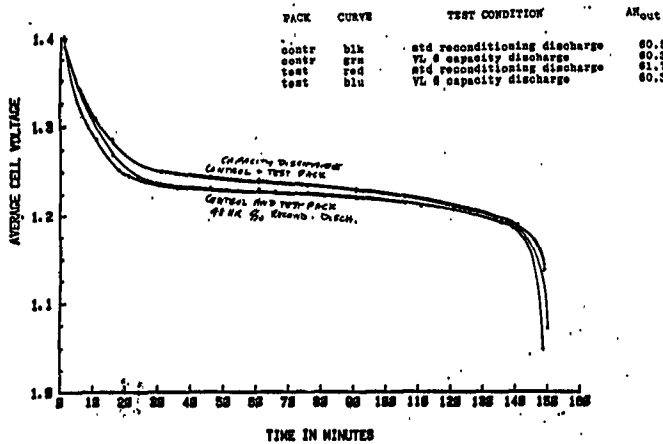

Baseline Conditioning and VL Capacity Tests for Control and Test Packs

Figure 35-7

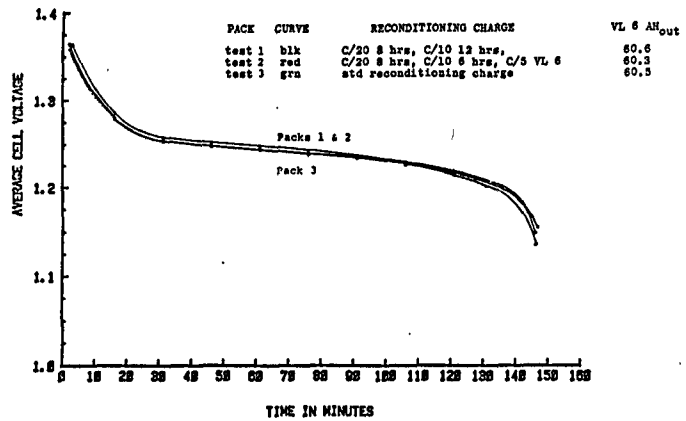

Test Pack Voltage Limit Capacity Comparison

Figure 35-8

**Page intentionally left blank**

## COMPARISONS OF DIFFERENT PLATE TREATMENT AND DESIGNS:

### AN UPDATE

D. Baer

GSFC

This presentation is an update of previous presentations I've given at the workshop, and it's on the continuation of testing of cells with different plate treatments and different plate designs.

The first vugraph is a little reminder of what the variables are.

(Figure 36-1)

The group number one cells are the control, and the basic design is positive treatment is PQ, which is cadmium in the positive plate, and no negative treatment. The plate loading level was the IUE. The separator was pellen. And we used the present ECT precharge processes present as of 1978. I don't know if they have made any changes since then. And the cell was decarbed.

These boxes show the variables for the other groups, such as; teflon for group two, silver for group three and so on. If you're interested in any more details of the design, it was presented in the 1978 workshop by myself, and also in a paper presented by Floyd and coauthored by myself and presented in the fall 1978 electrochemical society meeting in Pittsburgh.

I'll put this over on the other vugraph machine so you can refer to it, if you so desire, during the rest of my presentation.

The test regime for these cells was a 90 minute cycle with 40 percent depth of discharge and a temperature of 20 degrees C. The charge rate was 9.6 amps to a voltage limit, and we tried to keep 110 to 115 percent return, although that wasn't always possible all through the testing. The discharge rate was 9.6 amps.

(Figure 36-2)

The next vugraph you've all seen the data last year, although it might be a little easier to understand now since it was professionally done rather than my hen-scratching. It's the 20 degrees C capacity tests, at six month intervals, to 1 volt.

The Y axis is a percent of initial capacity. The first capacity check was done until the first cell reached 0.75 volts. Now at that point either cell number one was limiting or it was very near depletion, except for the 1968 plate old processes. And that's probably the reason why the capacity increases in that pack and the rest are going down, at least part of the reason.

The numbers listed are the cell that was discharged for that six month capacity test. Now if you'll notice, at the one year point there are two points in most cases, cell number one and cell number two. That's where cell number one was pulled for analysis, which Dr. Vasandt will address later.

As I said, part of this was shown last year. The trends seem to be the same, except now pack 3H seems to be the high capacity cells to this 1.0 volt point. Also, the ED plate pack there seems to have had a slight increase or a little recovery. I might add that they were rather low in capacity to start with. It was one of GE's earlier attempts at the electrochemical process, although they still are doing quite well.

If you'll notice, we're down around 30 percent of initial capacity for several of these packs. So if the depth of discharge is based on rated, they'd be about finished.

(Figure 36-3)

The next vugraph is similar, except these are the capacities to 0.75 volts. Here most of the packs are doing quite a bit better except the 1968 plate with the present processes and the polypropylene pack are rather low. Here again pack 3H, which is the pack with no PQ treatment, is the highest capacity. The control pack capacity is also pretty good, and so is the ED plate pack. And the rest of the group's capacities have degraded further.

(Figure 36-4)

The next vugraph shows the discharge voltage profile during the two year capacity check. It's an average of four cells to get each curve. I just selected four packs to give you an idea of the profile. I picked the high capacity group and one that was about the lowest -- capacity packs, and then a couple in the middle just for comparison. I think one of the important things is that the cell without the PQ treatment has a higher discharge plateau, especially when you get down to the second plateau, and that's the primary reason for having a better capacity to one volt, although it does have a better capacity to depletion.

These others pretty well follow the same trend. It's just a matter of how much total capacity you have in the cells.

(Figure 36-5)

This vugraph is to show you a little bit about what kind of divergence we're getting at the end of charge and the end of discharge. Most of them are around 14,000 cycles except for the ED plate, which is around 11,000. That pack got started a little later than the other ones.

If you look at the first four groups on charge there is very little difference in the charge voltage as far as divergence. There's four cells in the packs now.

Group five has a little bit of divergence.

Group six, which is the poly, has quite a bit of divergence.

Group seven again has only a little bit.

Group eight has very little; however that's only two cells, there are only two cells left in that pack.

And group nine has a lot of divergence and there's only three cells left in that pack.

At this point most of the packs are starting to look a little ragged and we're starting to get some failures which I'll address on the next vugraph.



In the discharge we either have quite a bit of divergence or else the voltages are very low, except for group five where the divergence isn't too bad and the voltages are holding up good as they are on your group seven. You have divergence there but the voltages are still up above 1.1 volts.

The last column is percent return during the particular cycle that I pulled the end points off. And it's because of some of the voltage divergence that we're having trouble with the percent return on some of these packs.

(Figure 36-6)

The last vugraph shows cells that have been removed or failed. In group seven, which is a 1968 plate with the old process, the cell was removed very early at cycle 248 because of high voltage. Likewise, in group eight two cells were removed relatively early because of high voltage.

This one in group seven, it was so early in the cycling life I just replaced it with another cell. The high voltage cell, I think, we probably should have picked up in the screening but we didn't.

We have to remember, though, that these are the old style, old design plate, and very little ratio, only about 1.25 to 1 and very little overcharge protection. The group eight in particular, where we used present precharge procedures and criteria. So I feel these cells are negative limited on charge, and that's why we're having so much trouble with this pack in particular.

Now at cycle 10,200 another cell in group 8 failed with low end of discharge voltage. We didn't remove it, and it eventually shorted on cycle 10,268.

I might add that before we remove a cell we try to increase the percent return to see if we can't get the cell to recover. And this one didn't and eventually shorted.

Group nine, which is the ED plate, one cell was removed for low end of discharge voltage. It went negative. I might add here, though, when we removed this cell it didn't really appear shorted. So we recharged it and ran a

seven day open circuit stand test. At that point, at the end of the seven days, the voltage was 1.304 and we got almost nine and a half ampere-hours out to three-quarters of a volt. So the cell was not shorted or if it had a parasitic short someplace along the line it obviously cleared itself.

The last cell that failed but wasn't removed yet was in group two, at 14,517 cycles the cell hit the Crane failure criteria of .75 volt. We didn't remove it, we let it continue to cycle, and it appeared to recover somewhat and it's now around .9 volt.

Since this vugraph was made pack 3I also has had a cell that hit the .75 volt limit, but we're letting that cycle since it's probably not hurting anything. We've also had some trouble with that pack as far as high pressures, where pressures have gone as high as 100 psia with only 1.11 percent return.

So I guess to kind of sum it up, the thing to do is pick what I consider as the cell that's giving the best performance, and it looks like it's the group five, although the control pack isn't doing too bad. But the group five seems to be the best pack of this program at this point.

That's all. Thank you.

**G.E. 12Ah CELLS — COMPARISON OF PLATE  
DESIGNS AND TREATMENTS**

GROUP#	CRANE PACK#	POS. TREATMENT	NEG. TREATMENT	PLATE DESIGN/ LOADING LEVEL	SEPARATOR	ECT/ PRECHG. PROCESSES	DECARB PROCESS
1	3D	PQ	NONE	IUE	PELLON	PRESENT	YES
2	3E	PQ	TEFLON	IUE	PELLON	PRESENT	YES
3	3F	PQ	SILVER	IUE	PELLON	PRESENT	YES
4	3G	PQ	NONE	LIGHT	PELLON	PRESENT	YES
5	3H	NONE	NONE	IUE	PELLON	PRESENT	YES
6	3I	PQ	NONE	IUE	GAF POLY- PROPYLENE	PRESENT	YES
7	3J	NONE	NONE	1968	PELLON	1968	NO
8	3K	NONE	NONE	1968	PELLON	PRESENT	YES
9	3L	NONE	NONE	E.D.	PELLON	PRESENT	YES

NOTE: BOXES SIGNIFY VARIATIONS FROM GROUP #1 DESIGN

Figure 36-1

**Comparison of Plate Designs and Treatments  
20 °C Capacity Tests at  
9.6 AMP Discharge to 1.0 Volt  
Initial Discharge Until 1st Cell 0.75 Volt**

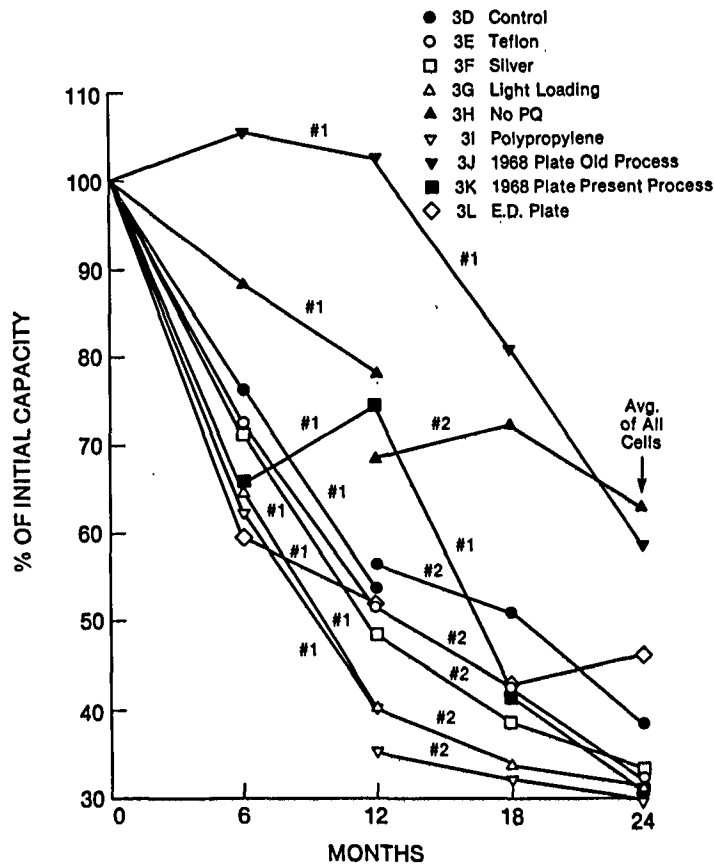

Figure 36-2

**Comparison of Plate Designs and Treatments**  
**20 °C Capacity Tests at**  
**9.6 AMP Discharge to 0.75 V/Cell**

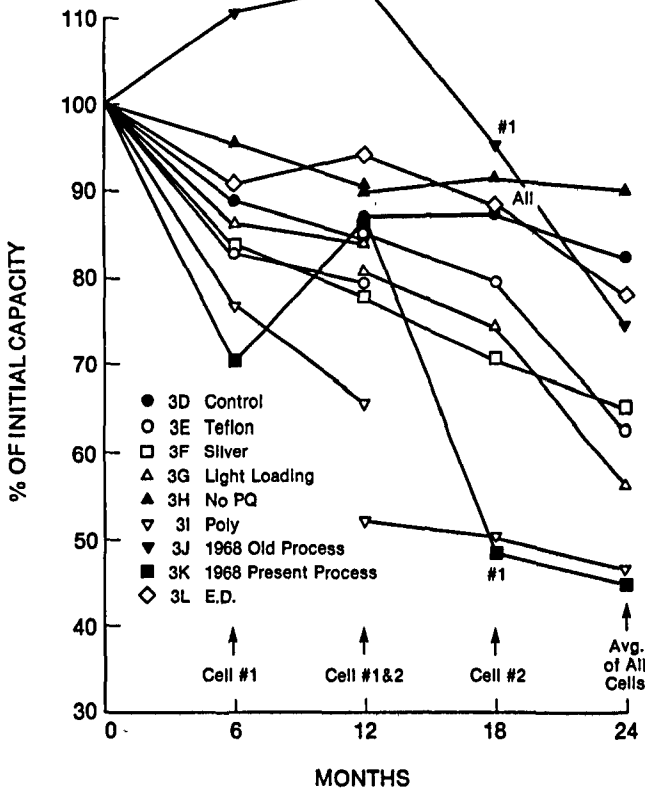

Figure 36-3

**Comparison of Plate Designs and Treatments**  
**2 Year Capacity Check at 9.6 AMP and 20 °C**  
**Average of Four Cells**

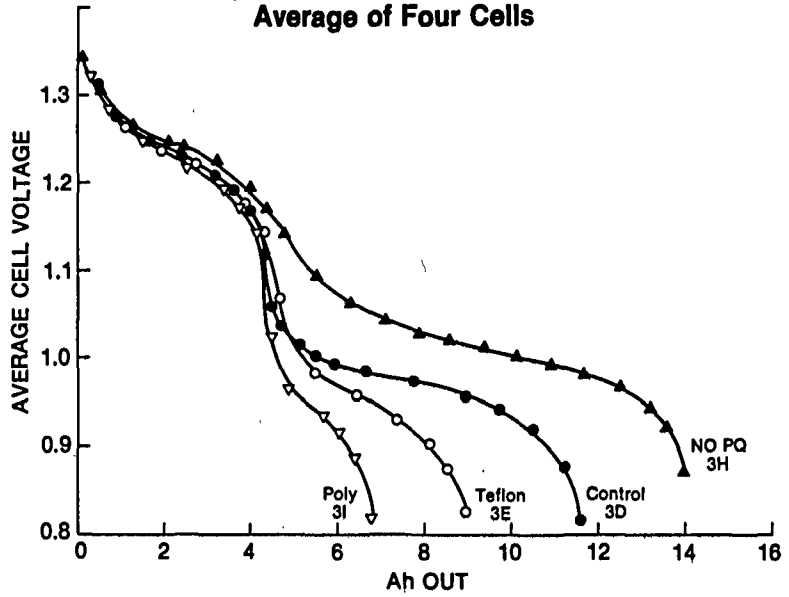

Figure 36-4

GROUP#	CRANE PACK#	VARIABLE	CYCLE#	EOC VOLTAGE		EOD VOLTAGE		% RECHARGE
				HIGH	LOW	HIGH	LOW	
1	3D	CONTROL	14286	1.475	1.474	1.096	1.066	109.0
2	3E	TEFLON	14252	1.452	1.440	1.086	0.965	111.5
3	3F	SILVER	14247	1.475	1.471	1.055	1.011	112.2
4	3G	LIGHT LOADING	14322	1.474	1.472	.965	.954	110.7
5	3H	NO PQ	14152	1.473	1.455	1.153	1.145	107.2
6	3I	POLY	14169	1.471	1.425	1.012	.975	108.5
7	3J	1968 PLATE OLD PROCESS	14172	1.459	1.448	1.166	1.115	108.6
8	3K	1968 PLATE PRESENT PROCESS	13788	1.443	1.440	1.049	1.012	103.4
9	3L	E.D. PLATE	11365	1.489	1.419	1.11	1.088	102.1

Figure 36-5

## CELL FAILURE/REMOVAL

GROUP#	CRANE PACK#	CYCLE# FAILED/ REMOVED	FAILURE MODE/REASON FOR REMOVAL
7	3J	248	CELL REMOVED — HIGH EOC VOLTAGE (1.525V) TYP (1.434V)
8	3K	2008 2459 10200	REMOVED BECAUSE OF HIGH EOC VOLTAGE $\geq 1.52V$ FAILED LOW EOD VOLTAGE $\leq 0.75V$ ; CELL SHORTED CYCLE 10268
9	3L	9022	REMOVED FOR LOW EOD VOLTAGE (-0.17)
2	3E	14,517	CELL HIT 0.75V EOD, NOT REMOVED

Figure 36-6

## COMPARISONS OF DIFFERENT PLATE TREATMENTS AND DESIGNS:

### ANALYSIS

V. Kunigahalli

Bowie State College

For the sake of completeness I would like to give some background information about the cells that we have analyzed. All the cells have completed acceptance testing by the manufacturer, GE, and some cells underwent cycling at the NWSA Crane, Indiana.

The results of the acceptance tests have been discussed by Ford and David Baer in a paper which appeared in the ECS meeting in Pittsburgh in 1978.

52 cells were sent to NWSA for evaluation of the various design variables incorporated in these GE cells on a near-earth orbit test regime. The test procedure and the results of the evaluation have been given by Jim Harkness in the report WQEC/C 79-114 in December 1979. It was recommended that these cells be placed on a near-earth orbit life test regime.

(Figure 37-1)

In February 1979 eight five-cell packs, pack 3D through pack 3K, corresponding to group one to eight, as you can see on that vugraph, began life test in 1.48 hour orbit regime, one hour charge with a voltage limit control at 20 degrees C, and a depth of discharge of 40 percent.

Group nine cells, pack 3L, began life test in August 1979 with the same test regime.

Test parameters: temperature 20 degrees C, cycle period 90 minutes, DOD 40 percent, discharge rate 9.6 amps, charge rate 9.6 amps to voltage limit. The voltage limit was set at 1.453 per cell to maintain a percent recharge of 110 to 115.

After one year of cycling one cell from each pack was removed and the initial evaluation tests were repeated. An update of the results of the evaluation test and the

performance of these cells was presented by David Baer in the 1980 Battery Workshop, and you have just now heard the latest update about these cells.

It was shown that among these cells, the cells without the PQ treatment performed the best — just now you heard that -- losing about 5.6 percent of the capacity in one year. The cells with the greatest decrease in percent capacity in one year were those containing polypropylene separators. These cells had the highest internal resistance, about 4.2 milliohms after one hour of discharge. The other cells ranged from 3 to 3.7 milliohms.

(Figure 37-2)

The objective of this test program and analysis is to understand the influence of the design and process changes on cell performance and life, and thereby help to evaluate the merit or the demerit of each design by performing physical, chemical and electrochemical analysis of these cells.

(Figure 37-3)

The experimental techniques that have been followed are visual inspection, physical measurements, chemical analysis, and, finally, electrochemical analysis.

A teardown analysis of each cell was carried out according to the analysis procedure given in the X document, X-7.11-74-279, Revision A. Visual inspection; there were no leaks as found by the phenolphthalein test, and the external appearance of all the cells was found good.

On opening the cell it was found that the cell pack was moist with the electrolyte, the extent varying from one cell to another.

The cell components, the positives, the negatives and the separators, could be separated easily from a cell pack of an uncycled cell. The separators from the uncycled cell were clean and white; in the case of cycled cells the separators were stuck to the surface of the negative plates.

During the removal of these separators from the

negative plates invariably a thin layer of the separator material was strongly adhering to the surface of the negative plates and could not be removed as easily as in the case of the uncycled cells.

The separators had dark patches due to cadmium migration.

Physical measurements:

(Figure 37-4)

The thickness and the weight of each negative plate and positive plate was recorded after carrying out the electrolyte extraction and further drying it in an oven at 45 degrees C. overnight. These are the results recorded in Table One.

These thickness results agree very well with the thickness results given in Table I on the other vugraph, which are the results of the acceptance test. This first column is the positive plate thickness and the second column contains negative plate thickness. The first value is for the uncycled cell and the second one for the cycled cell of group one, two and three and so on.

So you can see the positive plate thickness is almost the same compared to the positive thickness given there, .069 and .072 cm. Very little swelling is there, about which I am going to discuss.

There is a very small increase, of about 1.5 mil, in the thickness of the positive plate and the gain in weight of the positive plate is in the range of .15 to .349 for a cycled cell. The weights are given in these two columns. You can see from the uncycled cell to the cycled cell there is a slight increase in weight in the case of the positive plate.

McDermott observed a gain in weight of about .352 grams per positive plate in the accelerated test program of six ampere-hour cells. And he has explained this weight increase in terms of corrosion model, meaning that the nickel from the sinter is turned into nickel hydroxide, thus accounting for the increase in weight.



There seems to be negligible change in the thickness of the negative plate, if you'll compare these numbers with the acceptance test results for the negative plate. In some cases you will find the thickness is slightly more than the results given in the other vugraph. That's because after one year of cycling when we removed the cells there was invariably a thin layer of the separator material sticking to the negative plate. So the slight increase in thickness is due to the separator material.

In some cases of cycled cells slightly higher values of thickness is recorded, maybe because the negative plates had a thin layer of the separator material sticking onto the surface. There is, however, a definite decrease in the weight of the negative plate. The last column indicates the negative plate weight from the uncycled cell to the cycled cell in each group. The range is about .5 to one gram per plate, and this weight varies from one group to another for the cycled cell.

(Figure 37-5)

Summarizing, we can say with regard to physical changes only, due to cycling that the positive plate weight increased and the range is from .15 to .34 grams, and the plate thickness increased from 1 to 1.5 mils.

For the negative plate, there's a decrease in the plate weight in the range of .5 to one gram, and there is no change in the plate thickness.

(Figure 37-6)

Electrolyte analysis. The electrolyte analysis and the chemical analysis of the negative plate and the positive plates were carried out according to the paragraphs five, seven and eight of the earlier mentioned X document. The results of the electrolyte analysis for the cycled and uncycled cells of these different groups are given here in Table 2.

First column is the weight of the electrolyte associated with the negative plate, second column the weight of the electrolyte associated with the positive plate, third column the same with reference to the separator, and fourth column gives the total grams of electrolyte in the cell.

The first line refers to the uncycled cell and the second line values refer to the cycled cell which has undergone 5833 cycles.

The next column indicates the percentage of KOH, the percentage of potassium carbonate, and the last two columns indicate the milliliter of KOH found after one year cycling and the milliliter of KOH which was added at the time of manufacture. You can see that these numbers appear even on the other vugraph indicating the milliliter of KOH that went in.

Well, within permissible error of handling and analysis the amount of electrolyte determined agreed with that amount which went into the cell at the time of manufacture. This supports the observation made that there were no leaks in any of these design variable cells.

In most of the cases the carbonate content increased for the cycled cells. However there are some exceptions, group one and group four. You'll find the carbonate even in the uncycled cell is slightly higher compared to the cycled cell. It's difficult to generalize based on these exceptions.

Cells from group seven and group eight contain large quantities of potassium carbonate. You can see compared to the other numbers these numbers are higher. The reason is the cells of group seven used the design of the middle '60s wherein the plates were not decarbonated. That could be the reason why they have higher carbonate content. However, the cells of Group eight contain the same plate lot as group seven but were processed using the present day Aerospace cell process which includes decarbonization.

In addition, both of these groups of cells, seven and eight, have positive plates which were thicker compared to the rest of the groups.

From the weight of the electrolyte, we can see that the amount of potassium hydroxide varies from one group to another. This was done to maximize the amount of KOH in each cell group and still maintain a reasonable overcharge pressure. The design goal was to have all the cells in a pressure range of 30 to 75 psia during overcharge.

Talking of electrolyte distribution, I remember year before last in the Battery Workshop there was a doubt expressed regarding how the electrolyte is distributed: is it more toward the negative or the positive or the separator? Last year we did analyze a couple of six ampere-hour cells and eight ampère-hcur cells, and I pesented a paper on the electrolyte distribution wherein the order of distribution was that the negative contains most of the electrolyte, and next comes the positive, and the least amount of electrolyte is associated with the separator.

(Figure 37-7)

Some of the conclusions we can draw from the earlier table of electrolyte analysis are: carbonate content increases due to cycling, which we all know, and cells of groups seven and eight contain the largest content of carbonate. And the possible reasons could be group seven cells were not decarbonated and group eight cells -- I mean cells of group eight have thicker positives. I do not know whether with this limited data we can say that thicker the plates larger the carbonate. With this limited data it's very difficult to generalize.

Finally, the electrolyte distribution follows the general order. That is, negative has the largest quantity and the separator has the least quantity of electrolyte associated with them.

(Figure 37-8)

The chemical and electrochemical capacities for negatives and positives for each group of cells along with the percent utilization is given in this table. Following are some of the observations that can be made.

Number one, the electrochemical capacity for both the negatives and the positives is generally lower than the corresponding chemical capacity. That you can see here. The base line capacity is what we refer to as the electrochemical capacity, and this is the chemical capacity. In each case the chemical capacity is larger than the electrochemical capacity, both in the positive and in the negative, irrespective of the design group. This is not unusual since some part of the active material in the

negative and the positive plate might have become inactive, possibly due to cycling, and hence do not contribute to the electrochemical capacity.

The second point that we can see is within the design variable group going from the uncycled cell to the cycled cell both the chemical and the electrochemical capacity of the negative plate decreases. You can see that the chemical capacity decreases from 34 to 30 for group 1. And here the electrochemical capacity of the negative also decreases from 25 to 18. And the trend is similar in all the cases generally.

This should be due to the loss of active material, as I said, from the negative plates due to cycling, which is often deposited as loose particles on the separator material, which is commonly referred to as cadmium migration. In fact we did verify these in these cycled cells; when we opened the cells there were a lot of dark patches on the separator material which we observed.

Similar behavior, in fact, has been observed by McDermott. He pointed out that the loss in weight of negative plate and loss in the total negative capacity has been recorded in the analysis of six ampere-hour nickel-cadmium cells that underwent an accelerated test program.

(Figures 37-9 and 37-10)

One other point that I wanted to bring about, this table contains the results of the percentage of cadmium hydroxide in the positive plate. In each group we analyzed, for example, the first one, the control group, has about 10.74 in the uncycled cell and it increases to 12.17 in the cycled cell.

Similarly if you come the no PQ treatment group, group five, although according to the statement no PQ treatment should not contain any cadmium in the positive plate, it still has 6.46% in the uncycled and it increases to 7.3%.

Similarly you see the AK plate old process and the AK plate new process, group seven and group eight, also do not have PQ treatment but still contain a small quantity of

cadmium, 2.75 in this case and 4.71 respectively, which increases on cycling. So this indicates clearly that on cycling cadmium is going out of the negative plate due to cadmium migration. And when we opened the cell some of the cadmium was deposited along the positive.

(Figure 37-11)

Well, this is a summary of the last-but-one table about the capacity. Negative chemical capacity decreases and the range is from 2.01 to 5.51, and the minimum decrease -- this is with reference to group five cells, which, incidentally, as Dave Baer pointed out, are the cells which have no PQ treatment. And the maximum change is for group two cells in this case. Those are with the teflonated negatives.

Positive chemical capacity increases slightly, .84 to 2.2 ampere-hours. Negatives from the cells without PQ treatment have the highest utilization, about 73 percent.

Thank you.

#### DISCUSSION

RITTERMAN (TRW): What's interesting about your data is not that the CO<sub>3</sub> content decreases. In some cases it would seem strange, but in the non-exceptional cases the CO<sub>3</sub> content increases to such a small extent. And I wonder if you would comment on how you did the DPA.

Did you take the individual positive, negative and separator and leach out the electrolyte?

KUNIGAHALLI: Exactly.

RITTERMAN: How many samples of each did you take per cell?

KUNIGAHALLI: When we opened the cells we collected all the positives together, all the negatives together and the separator, so these three packs were extracted separately in different Soxhlet extractors.

RITTERMAN: Okay.

Could you comment on what the relative carbonate formation was in the separator, the positive and the negative, or don't you have that figure?

KUNIGAHALLI: I have got it in analysis summary.

RITTERMAN: Oh, you have.

KUNIGAHALLI: But I don't have it right now here.

RITTERMAN: Okay. Fine.

THIERFELDER (General Electric): You gave the expansion of the positive plates, 1 to 1.5 mils. And over the last several years there's been a lot of discussion about the expansion of the positive plates.

Have you compared this? Is this compared to other reports on expansion; 1 to 1.5, is that normal?

KUNIGAHALLI: It's very small, compared to -- In fact, that's what I referred to as McDermott's work. In six ampere-hour cells it has been shown to have more weight increase and swelling.

THIERFELDER: All of these at about 5000 cycles?

KUNIGAHALLI: Yes, roughly about 5800 cycles.

THIERFELDER: So this is a comparatively low expansion.

KUNIGAHALLI: Very low, I agree with you.

HELLFRITZSCH: I have a question about how many cells there were in each group. The only thing I heard is that in groups seven and eight there were two cells in one and three cells in the other.

KUNIGAHALLI: I think Dave Baer should answer that.

HELLFRITZSCH: How many were there in the other groups?

BAER: There were six cells purchased from each

group and we set one aside and we just ran it through some initial evaluation tests of Crane. We started the cycling with five cells in each group.

At the one year point we removed one cell for analysis, so that left four. And then several were removed, if you remember from my last slide, where cells were removed from group eight; two were removed at 2000-some-odd cycles, and then one, I think it was around 10,000, where it shorted. And group nine had one cell removed around 9000 cycles because of what we thought was a short.

HELLFRITZSCH: The reason I ask, on the second paper I noticed there were serial numbers of the cells, cell number one and cell number four. So I assumed that the data from that line was based on that one cell.

Now when you compare then the weight of one cell to that of a different cell before and after, because these are destructive tests -- and that's of course what you have to do -- you really need to know how uniform were the weights of all cells initially.

Do you see what I'm getting at?

BAER: We have that information. I mean, I don't have it right here.

HELLFRITZSCH: If these differences in gain or loss are large compared to how uniform the cells initially were it's significant. If it's of the same order of magnitude, of course, it doesn't mean anything.

I looked through some of them. In a case like this often you look down the line for the different groups and you just do a plus or a minus. If they're all consistently higher or consistently lower then it can mean something. But they jump back and forth. Of course they were different designs, so it could be the design. But I just wanted to caution because the sample size was as small as it could be, a single specimen each time. And of course there's a lot of work in this. I know that. But we have to be cautious in interpreting whether these are real differences or not.

BAER: Right. Well, I think that's one of the

problems with why you see them jump back and forth in some cases such as the carbonate. And these were control manufactured, the best that's being done today.

HELLFRITZSCH: Especially if we report the data for significant figures.

HALPERT (Goddard): In reference to Helm's question, Dave, weren't these using the IUE type loading on the first groups of cells, and so the loading was lighter than what we've seen in the past?

BAER: Yes, it's probably a little lighter than what they were generally making at that point. GE has since lightened up on their loading a little bit, but I don't think it's quite as light as what the IUE is. The loading number was given in grams per decimeter cube.

KUNIGAHALLI: In the last vugraph we have the loading. Here is the loading.

(Indicating.)

BAER: Helm, it would be probably about 12.5 grams per decimeter squared -- That's a number you're used to hearing -- for the positives.

RAMPEL (General Electric): I'd like to clarify the cadmium content in the positive electrodes for so called uncycled cells. I take it that they're uncycled at Crane but you have to keep in mind they were cycled at GE, and that's enough to introduce the cadmium into those positive plates that have had no PQ treatment per se.

BAER: That's right, Guy. And they also went through initial evaluation tests at Crane, which are essentially acceptance tests. But they did have some cycles on them, that's right.



## CELL DESIGN VARIABLES - GE 12 AH CELL

VARIABLE	GROUP #	TYPICAL POSITIVE THICKNESS cm	TYPICAL NEGATIVE THICKNESS cm	POSITIVE LOADING gm/dm <sup>2</sup> OF SINTER	NEGATIVE LOADING gm/dm <sup>2</sup> OF SINTER	FINAL KOH QUANTITY cc N/V <sup>3</sup> d <sup>3</sup> **	RECHARGE ADJUST*** Ah
CONTROL*	1	0.069	0.073	2095	2180	40/40	4.6
TEFLON TREATMENT	2	0.069	0.071	2095	2180	48/49	4.6
SILVER TREATMENT	3	0.069	0.079	2095	2180	43/44	4.6
LIGHT LOADING	4	0.069	0.079	1840	1833	45/46	4.6
NO P.O. TREATMENT	5	0.069	0.079	2113	2180	40.3/41.5	4.6
POLYPROPYLENE SEPARATOR	6	0.069	0.073	2095	2180	39/40	4.6
A.K. PLATE-1968 DESIGN, NO PQ OLD ECT PROCESS, NO DECARB PROCESS	7	0.081 (UNSIZE)	0.068	2130	2542	38/39	0
A.K. PLATE-1968 DESIGN, NO PQ PRESENT AEROSPACE CELL PROCESSES	8	0.081 (UNSIZE)	0.066	2130	2542	39/40	1.8

\*CONTROL CELL REPRESENTS PRESENT AEROSPACE DESIGN AND PROCESSES WITH NO EXTRA TREATMENTS: NONWOVEN NYLON SEPARATOR, P.O. TREATED POSITIVES, DECARBONATION PROCESS, IUE LOADING LEVELS, 31% KOH.

\*\*TWO CELLS IN EACH GROUP CONTAINED SIGNAL ELECTRODES.

\*\*\*BASED ON 228 cc O<sup>2</sup>/Ah.

Figure 37-1

### OBJECTIVE

TO EXAMINE THE INFLUENCE OF  
DESIGN VARIABLES  
ON  
CELL PERFORMANCE AND LIFE  
BY  
PHYSICAL, CHEMICAL AND ELECTROCHEMICAL  
ANALYSIS

Figure 37-2

### EXPERIMENTAL TECHNIQUES:

1. VISUAL INSPECTION
2. PHYSICAL MEASUREMENTS
3. CHEMICAL ANALYSIS
4. ELECTROCHEMICAL ANALYSIS

Figure 37-3

Table 1.

## PHYSICAL CHARACTERISTICS OF DESIGN VARIABLE CELLS

GROUP #	S.N. OF CELL	PACK #	NO. OF CYCLES	PLATE THICKNESS (cm)		PLATE WEIGHT WITH TAB (Gms.)	
				POSITIVE	NEGATIVE	POSITIVE	NEGATIVE
1	04	3D	UNCYCL	0.072	0.079	13.69	15.46
1	01		5833	0.074	0.080	13.97	14.83
2	04	3E	UNCYCL	0.072	0.080	13.85	15.87
2	01		5841	0.074	0.079	14.00	14.87
3	01	3F	5844	0.074	0.083	14.03	14.82
4	01	3G	UNCYCL	0.068	0.079	13.02	14.71
4	02		5844	0.072	0.079	13.31	13.83
5	01	3H	UNCYCL	0.074	0.079	13.32	15.43
5	02		5840	0.077	0.080	13.65	14.92
6	02	3I	UNCYCL	0.072	0.079	13.65	15.59
6	01		5833	0.074	0.083	13.88	15.38
7	05	3J	UNCYCL	0.091	0.074	15.34	14.13
7	06		5834	0.094	0.073	15.68	13.68
8	02	3K	UNCYCL	0.090	0.071	15.35	14.02
8	06		2008	0.093	0.072	15.56	13.66
8	05		2459	0.094	0.073	15.57	13.62

Figure 37-4

## PHYSICAL CHANGES DUE TO CYCLING

	PLATE WEIGHT	PLATE THICKNESS
POS	INCREASE 0.15 — 0.34 g	INCREASE 1.0 — 1.5 MILS
NEG	DECREASE 0.5 — 1.0 g	NO CHANGE

Figure 37-5

Table 2.

## RESULTS OF ELECTROLYTE ANALYSIS OF DESIGN VARIABLE CELLS

GROUP #	NO. OF CYCLES	GMS OF ELECTROLYTE				TOTAL	% KOH	% K <sub>2</sub> CO <sub>3</sub>	ML KOH	
		NEG	POS	SEP	FOUND				ADDED	
1	—	22.55	15.69	13.56	51.80	21.64	9.21	39.15	40/40	
	5833	29.32	16.14	9.09	54.55	23.94	6.76	41.42		
2	—	20.91	15.99	24.63	61.53	26.82	6.49	46.75	48/49	
	5841	26.68	16.16	22.42	65.26	25.26	6.91	49.54		
3	5844	31.03	15.86	9.95	56.84	25.69	6.87	43.15	43/44	
4	—	24.14	16.49	18.17	58.80	25.25	6.45	44.58	45/46	
	5844	31.51	16.36	14.70	62.57	19.65	4.71	47.70		
5	—	23.38	17.77	9.84	50.99	25.40	8.97	40.86	40.3/41.5	
	5840	28.15	18.12	4.64	50.91	23.53	10.45	38.39		
6	—	21.8	15.41	8.16	45.37	29.41	7.36	34.41	39/40	
	5833	29.84	16.73	3.42	49.99	26.20	9.63	37.75		
7	—	22.78	20.11	7.63	50.52	22.01	13.35	37.87	38/39	
	5834	25.54	21.47	3.70	50.71	20.47	16.08	37.82		
8	—	21.42	20.10	9.25	50.77	22.50	14.94	37.95	29/40	
	2008	27.92	15.47	6.46	49.85	23.43	15.47	37.22		
	2459	22.69	20.58	7.40	50.67	22.15	16.08	37.79		

Figure 37-6

## CONCLUSIONS FROM ELECTROLYTE ANALYSIS

- CO<sub>3</sub><sup>=</sup> INCREASES DUE TO CYCLING
- CELLS OF GROUPS 7 AND 8 CONTAIN THE LARGEST CONTENT OF CO<sub>3</sub><sup>=</sup>
  - GROUP 7 CELLS NOT DECARBONATED
  - GROUP 8 CELLS HAVE THICKER POSITIVES
- THICKER THE PLATES LARGER THE CO<sub>3</sub><sup>=</sup>
- ELECTROLYTE DISTRIBUTION FOLLOWS THE GENERAL ORDER NEG > POS > SEP

Figure 37-7

Table 3.

## COMPARISON OF CAPACITIES FOR DESIGN VARIABLE CELLS

NAME	GROUP #	S.N. OF CELL	PACK #	NO. OF CYCLES	CHEM. CAPACITY		BASELINE CAPACITY		% UTILIZATION	
					(AH ON CELL BASIS)					
					POS	NEG	POS	NEG	POS	NEG
CONTROL	1	04	3D	UNCYCL 5833	22.64	34.02	15.54	25.60	68.87	75.25
		01			21.22	30.30	14.63	18.52	58.92	61.30
TEFLON	2	04	3E	UNCYCL 5841	21.74	36.28	16.39	25.56	75.39	70.45
		01			22.90	30.77	15.99	18.67	69.82	60.69
SILVER	3	01	3F	5844	20.86	32.80	15.55	20.14	77.63	61.05
LIGHT LOADING	4	01	3G	UNCYCL 5844	20.02	30.48	14.43	23.83	72.07	78.17
		02			21.44	26.17	13.98	14.47	65.21	55.30
NO PQ	5	01	3H	UNCYCL 5840	22.69	34.65	16.91	28.11	74.55	81.11
		02			22.44	32.11	17.02	23.54	75.85	73.31
POLYPROPYLENE SEPARATOR	6	02	3I	UNCYCL 5833	22.36	36.62	15.89	28.14	71.06	76.83
		01			23.20	31.35	16.66	19.07	71.81	60.83
A.K. PLATE OLD PROCESS	7	05	3J	UNCYCL 5834	25.23	32.54	19.61	24.99	77.70	76.81
		06			26.85	28.83	18.85	23.0	70.20	79.78
A.K. PLATE NEW PROCESS	8	02	3K	UNCYCL 2008	25.63	32.93	16.52	24.86	64.46	75.52
		06			26.97	31.69	19.02	23.47	70.50	74.06
		05			27.90	30.92	18.78	22.96	67.30	74.26

Figure 37-8

Table 4.

NAME	GROUP	S.N. OF CELL	PACK #	NO. OF CYCLES	% Cd (OH) <sub>2</sub> IN POS	AH CHARGED Cd IN NEG
CONTROL	1	04	3D	UNCYCL 5833	10.74	0.59
		01			12.17	0.75
TEFLON	2	04	3F	UNCYCL 5841	9.49	1.17
		01			11.48	1.20
SILVER	3	01	3F	5844	12.38	1.84
LIGHT LOADING	4	01	3G	UNCYCL 5844	11.52	0.71
		02			13.27	0.35
NO PQ TREATMENT	5	01	3H	UNCYCL 5840	6.46	0.71
		02			7.31	1.16
POLYPROPYLENE SEPARATOR	6	02	3I	UNCYCL 5833	8.39	1.12
		01			9.63	0.03
AK PLATE OLD PROCESS NO DECARB	7	05	3J	UNCYCL 5834	2.75	0.87
		06			4.92	0.65
AK PLATE NEW PROCESS	8	02	3K	UNCYCL 2008	4.71	0.91
		06			5.36	0.89
		05			4.55	0.78

Figure 37-9

## RESULTS OF ALTERNATE CONDITIONING CHARGE SCHEMES

		PACK 1	PACK 2	
STD COND CHARGE	120		C/20 8 HRS, C/10 12 HRS	80.6
	DISCH	62.3	DISCH	62.3
VL6 CHRГ	72.0		VL6 CHRГ	70.1
	DISCH	60.3	DISCH	60.6
STD COND CHARGE	119		C/20 8 HRS, C/10 8 HRS, C/5 TO VL6	72.9
	DISCH	61.6	DISCH	61.9
VL6 CHRГ	71.6		VL6 CHRГ	69.1
	DISCH	59.7	DISCH	60.2
STD COND CHARGE	121.3		C/20 8 HRS, C/10 6 HRS, C/6 TO VL6	72.2
	DISCH	62	DISCH	61.2
VL6 CHRГ	70		VL6 CHRГ	69.1
	DISCH	58.6	DISCH	60.2
			STD COND CHRГ	119
			DISCH	62.8
			VL6 CHRГ	70.8
			DISCH	60.3

Figure 37-10

## EFFECTS OF CYCLING ON CAPACITY

- **NEGATIVE CHEM. CAPACITY DECREASES** 2.01 TO 5.51 AH
  - MINIMUM CHANGE FOR GROUP 5 CELLS
  - MAXIMUM CHANGE FOR GROUP 2 CELLS
- **POSITIVE CHEM. CAPACITY INCREASES** 0.84 TO 2.2 AH
- **NEGATIVES WITHOUT PQ TREATMENT** > 73%  
**HAVE HIGH UTILIZATION**

Figure 37-11

CHARGEABILITY OF NICKEL ELECTRODES STUDIED  
BY OPTICAL MICROSCOPY

C. Dyer

Bell Labs

Just a change of system here to nickel hydrogen. This is an attempt to explain some of the operational characteristics of some nickel-hydrogen cells that we received at Bell Labs and put on cycling, and saw some strange capacity excursions with cycling. A summary of that is shown on this Vugraph.

(Figure 38-1)

You will see there is a dropoff in capacity over the first few cycles. Actually to this point there's a rapid decrease and then a further drop while the cells were shipped to us in a shorted state. And I represent that by no change in the cycle number. For both of the two cells shown here, the numbers just refer to the serial numbers of the cell.

I haven't got much time so I just want to draw your attention to the main characteristics of this recovery.

You'll see that basically on continued cycling there is a slow but gradual increase in capacity back up to theoretical values which are shown by the broken lines up there, calculated on the basis of weight gain of the positive electrode on electrochemical impregnation. The positive plates were electrochemically impregnated by the Bell aqueous system. I think that's the important point here, that these were electrochemically impregnated plates.

(Figure 38-2)

Now the companion Vugraph to this is this one which shows the state of charge, and some pressures. Let's look at the pressures first here.

This is with cycling as shown on the previous Vugraph. You observe an increase in the end-of-charge pressure with cycling up to 400 cycles. It increases from

about a hundred and something up to 490.

The other characteristic which is very useful in the case of the nickel-hydrogen cell is that you can also follow the end of discharge pressure. And you know really what the state of charge of the negative electrode is of course since you're always monitoring it by the pressure. You'll see that the end-of-discharge pressure also rises but at a slower rate so we have both rising end-of-charge and end-of-discharge pressure.

Incidentally you'll notice that this represents that capacity loss. It's about 65 percent of what you would expect. This represents the starting point at the bottom of the trough in this capacity cycle in curves shown previously.

So these are the facts of what is going on here.

You heard this morning that nickel-cadmium cells also seem to lose capacity on standing open and shorted. Brij Vyas from our lab gave you a discussion of this, so it doesn't seem to be isolated to the nickel-hydrogen case.

Now if you take a positive electrode and fill it with epoxy resin and then section it across the electrode we then have a microsection, which is what I did, essentially, which I then oxidized in this way.

(Figure 38-3)

Essentially this is a very simplified model of the experimental concept.

This represents the nickel substrate, of course. This represents the nickel sinter connected. And on the outside of the nickel is electrodeposited the active material in a profile something like this. (Indicating.) I haven't drawn it in, but there will be a space over here where the electrolyte comes in.

So there's a path through here in the normal electrode now which then goes through the active material to the nickel.

Now this is a different geometry. We filled up

all the porosity in the electrode and we're simply looking at the electrochemistry in an orthogonal sense. In other words if you put a drop of KOH on top of this combination of nickel and nickel hydroxide and then oxidize it, you see some strange and wonderful things happening when you look under a microscope, and let me go quickly to that.

(Figure 38-4)

You can't see too much here except really the bright spots which are the polished sections of nickel (F-4a). Somewhere in here in this gray area is the active material which you can't see very well. Also, there is epoxy in here which is between the active material deposits, and actually there also is epoxy here.

Now when you oxidize it with a drop of KOH on the surface you get a rather nice contrast effect (4b) and you can see the demarcation now very clearly between the epoxy resins in the same field, except that this is oxidized, anodized, and this is not. You can now see very clearly the boundary between the epoxy resin here and the active material here, and the nickel particles of sinter here. So you have three rather nicely resolved components of the electrode.

Now let's have a look to see how this process of oxidation progresses.

I should just say that this is quite a normal physical phenomenon. That is, as you increase the conductivity of the active material which occurs when you form the oxy-hydroxide, not only do you get absorption of the transmitted light but you get an increase in reflectivity. And the calculations tell us that this increase in reflectance of the active material is entirely in agreement with the optical parameters due to two parts of the optical refractive index, the real and the imaginary part which both increase as you oxidize.

(Figure 38-5)

This shows the progress now of oxidation of a section. Keep your eyes on the central grain here, which is this one here, and you'll see that there's a particle of nickel right there, and you'll see a brightening here (F-5a).



Now in this region here, the first oxidation step has brightened quite a large area of this active material. It has not managed to completely oxidize the whole of that grain there, and you'll notice that it's quite a thick grain. There's quite a large distance between the nickel and the edge of that material there which, incidentally, is separated from this one, insulated from that one by epoxy resin, so you wouldn't expect the oxidation to proceed from that part of your nickel.

This shows the progress as you put on more charge. You see that the grain gradually fills up and becomes totally oxidized (F-5b, 5c). At the bottom left there you can see it when it's fully charged.

You then discharge it, and you look at this under a microscope. The magnification is about 800 times. A reduction step reduces the contrast quite significantly from the lower left, but you never quite get rid of it. (F-5d)

In fact the picture on the top right there is after two pulses of reduction, quite heavy reduction, even to gas evolution.

If you leave the thing standing overnight you lose the contrast completely.

Here we are. We're back to that first picture I showed where you really can't determine the difference between the epoxy and the active material. I'm going to refer to this particular picture later on as an attempt to explain some of the strange phenomena we've been seeing.

(Slide not available)

Here's a chemical electrode. It's a little hard to see exactly what's going on here, but let me explain it. This is not an electrochemical, this is a chemically impregnated electrode, with very thick films now. It's fully loaded. I don't know how much voidage. I couldn't see any voidage at all in this material before I filled it with epoxy.

And indeed, this area here is all active material.

Now a series of pulses reduces the size of this nickel-hydroxide as the reaction front towards nickel-oxy-hydroxide progresses away from the electron sinks here which are the nickel particles, but you are still left with a region which does not want to charge up.

Now this was heavily overcharged, I should point out, several pulses, and a few minutes later, after this third oxidation, some rather horrifying things took place.

You can see this change in contrast. It becomes cracked. And if you look at it under the scanning electron microscope, what has happened is that the heavily overcharged region has started to spall. It has cracked and pieces have come off, and that's the origin of this rather strange reflectance here. It's just a broken up surface.

So there's a caution: don't overcharge these surfaces too much, particularly the chemical plates, because they seem to disintegrate.

(Figure 38-6)

I'm just going to show this very simple reaction here. What seems to be going on here is that the positive electrode which is largely comprised initially of nickel-hydroxide is initially a poor conductor, and as you form the better conducting nickel-oxy-hydroxide you get an improvement in the chargeability.

Now the reaction progresses interestingly from the metal particle away from it.

(Figure 38-3)

I just want to make this point. This Vugraph here shows the direction of the reaction. The reaction progresses. The region of light contrast, that is, the high conducting nickel-oxy-hydroxide, the reaction moves away from the nickel.

Now this says something important about the reaction kinetics that it's not controlled by the proton but by the electron mobility. Because of course the proton path

length is the same all the way across here, and it's a nice visual display of the importance of the conductivity of the nickel-hydroxide.

Now what are the implications of this for operational characteristics? Well, let's go back and see if we can now explain some of the things we've been seeing. I think this is the most useful one to look at.

(Figure 38-2)

Looking at this and just for a minute pretending we don't know anything about that model. At 400 cycles, the measurements indicate that we have a cyclable capacity shown here by the cross-hatched area of approximately 22.7 ampere-hours. Now that's pretty close to theoretical, and you might rest your case there and say Okay, the cell is working near theoretical, why should we bother to think any more about it, it's fine.

But we have a residual pressure here. Now the only way you can have a residual pressure at the end of charge is if charged active material remains undischarged. This incidentally is discharged to one volt at the C/2 rate. The only reason you can have an end-of-discharge pressure is if you have some active material that is already charged and the corresponding amount of hydrogen remains and will remain until you can discharge that portion of the active material which has been charged.

In other words, this pressure really corresponds to uncyclable capacity already built into the active material which subsequently is unable to be discharged.

Now have we got any evidence that indeed there were regions in this electrode which are still charged to account for these measurements? Are there regions fully charged but still remaining in the electrode?

(Figure 38-7)

This electrode here has been cycled about 3,000 times and this has not been oxidized in the method I showed before. This is simply a sectioned electrode, and this is as received, sectioned, after filling with epoxy. It has not been charged.

If you look up here you'll see ghost regions up in this region here which do not appear on an uncharged or uncycled electrode. Normally they are all totally gray, but you can see patches of light contrast regions, in other words, regions of high conductivity, because that's what the difference in contrast means in optical terms, regions of higher contrast separated from the nickel electron sinks by a region of low contrast, which again in optical terms means low conductivity. In other words it's electrical isolation that we're looking at here. This electrode has been totally discharged after 3,000 cycles and shorted, and yet there is still residual capacity in there.

That's the last of the Vugraphs.

Let's go back to the some of the models here.

(Figure 38-2)

So yes indeed, we do have residual capacity which you can see by this optical microscopy technique to explain that. All right, what's the next thing?

How do we explain the rising capacity, both rising capacities and the rising EOD and the EOC pressures?

What it says is that each time you cycle the electrode you charge a little more of the available capacity, but when you discharge it you don't get all of that additional delta of capacity back. You leave a little bit of it behind, so you're topping up the reservoir of uncyclable material but you're also adding to the reservoir of cyclable material.

That would seem to explain some of that.

Now can we explain some of the other observations we've made, that is, of the declining capacity on open circuit or, indeed, after shorting, what caused this drop here?

(Figure 38-1)

I've seen this not only with these particular cells but with another set of cells made by a different contractor, again with electrochemical positives in them, so

it's not unique to these two cells. It seems to be a general phenomenon.

And just discussing nickel hydrogen now, it's possible that this is also a conductivity effect. Don't forget these cells have been shorted, and you can imagine on shorting that indeed the conductivity will be continuously drained as the nickel-oxy-hydroxide is completely reduced.

Now the question remains, why do we see this with chemical plates and not with electrochemical plates? And the only reason I can think of why there should be a difference is that in the electrochemical plates, you have a very high surface-to-volume ratio. There's a lot of electrolyte inside. You have much thinner films generally because of the lighter loading levels.

Obviously this will help with the discharge process but it will also help even on open circuit. The self-discharge of the nickel-oxy-hydroxide will generally be faster than on more fully loaded electrodes, and this may explain why one does not see the same effect on the chemical plates.

I have never seen the same kinds of problems on those plates; that is, I have never seen regions of hungup charge after long periods on open circuit. They don't seem to show that. They seem to be self-discharging in that way.

That self-discharge reaction, according to comments earlier, is quite a fast reaction. Apparently it can take place in nickel-cadmium cells very rapidly, so that you can lose a hundred percent of the charge in six months, but it's very much more rapid to begin with.

But these are qualitative ideas. More experiments will need to be done. It does seem to form a general picture.

There are some other things I should add.

The effects of shorting may be exacerbated by electro-wetting effects. Recently some people at Bell Labs, Beni and Hackwood, were trying to develop a new type of opto-display device, and the method by which that works is by an electro-wetting type mechanism. It's like an electric

capillary but you have metallic capillaries, and by applying a potential you can change the surface energy so much that you actually get a movement of electrolyte down the capillary.

Now it turns out that if you take a positive electrode and polarize it to near the shorting potential, that is, the negative potential, there is a net loss of electrolyte out of that electrode. We've done these measurements and we can show that. So this may also contribute to the capacity loss which is worse in the shorted case than in the unshorted case.

I'm sure there will be a lot of questions about why one gets the low voltage plateaus. Below one volt there are several plateaus, and these again tend to be highly polarizable plateaus, as shown by Bernard, and this is generally known that they are rate-dependent. They're not thermodynamic potentials. They are sensitive to the rate at which you discharge them. They are not really thermodynamic arrests. And so again that would support the model of isolation and conductivity within the active material.

ROGERS (Hughes Aircraft): On this undischageable capacity, we've done experiments, not on these particular cells but on other cells where we've shown that if you leave a cell shorted, say, after it builds up this pressure, say for a month or two, you can pick up all that capacity and measure it as current on a shorted cell, or measure the current through the short. You will pick up a capacity roughly corresponding to the pressure drop.

DYER: That's more or less what I'm saying except that you can recover it at very low rates. If you try to take that capacity out at a very high rate you are not going to get it out because it's polarized.

ROGERS: That's true. After you test the cell after all that, the capacity at normal rates hasn't really changed but the pressure is down.

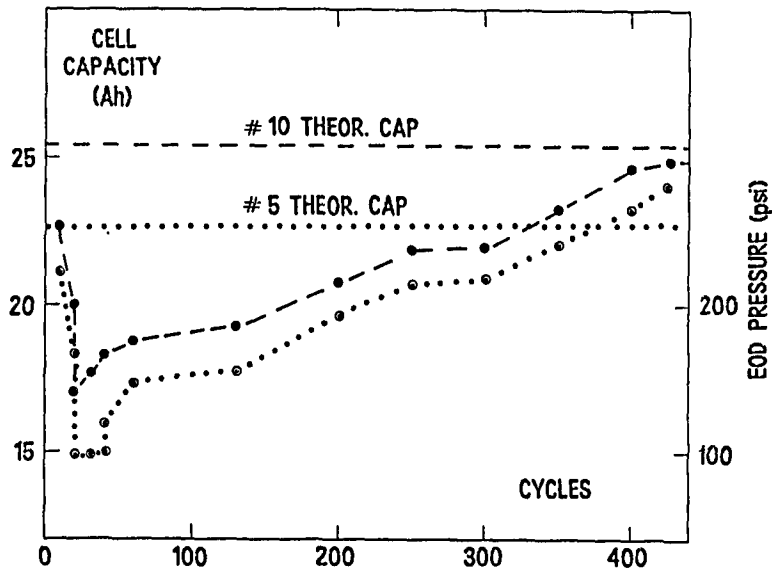

Figure 38-1

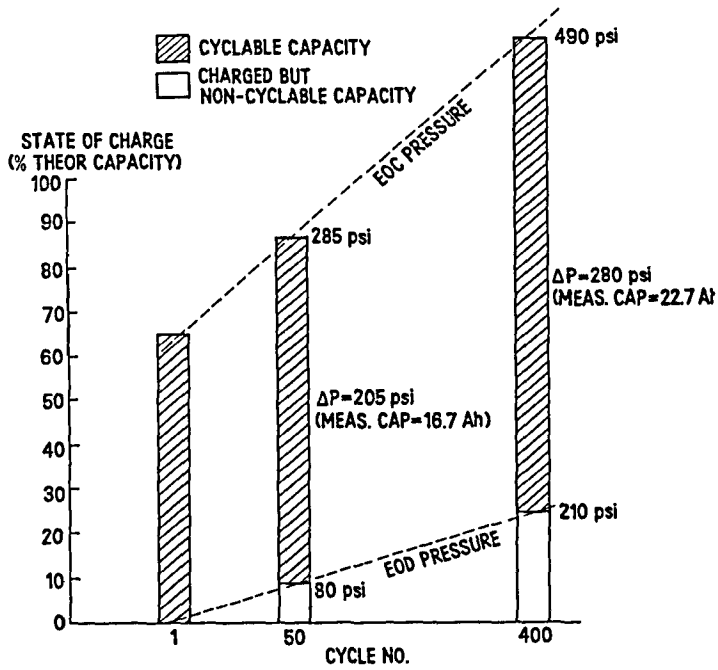

Figure 38-2

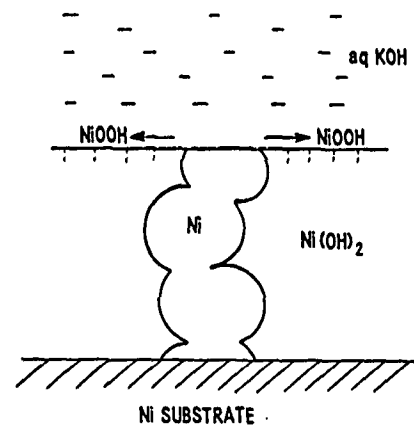

Figure 38-3

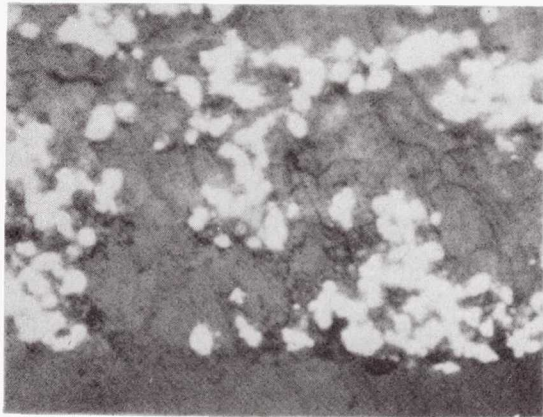

Figure 38-4a

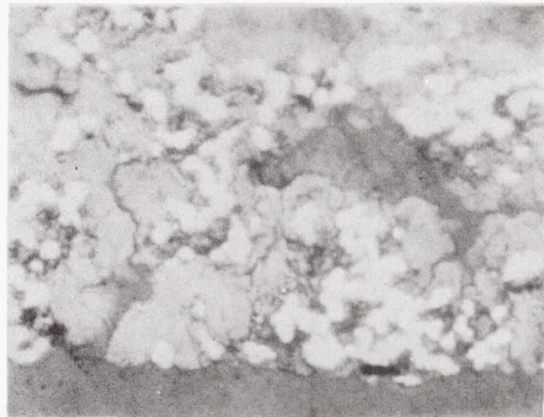

Figure 38-4b



Figure 38-5a

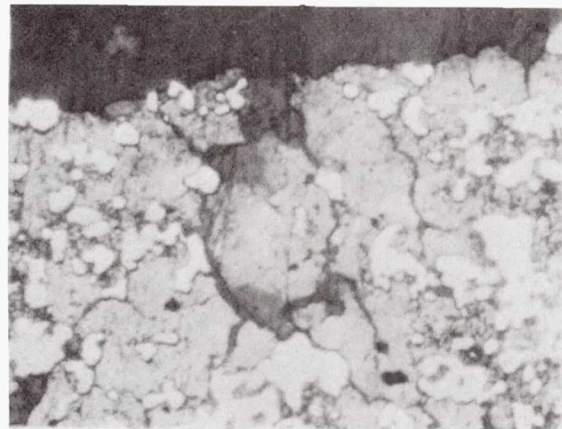

Figure 38-5b



Figure 38-5c

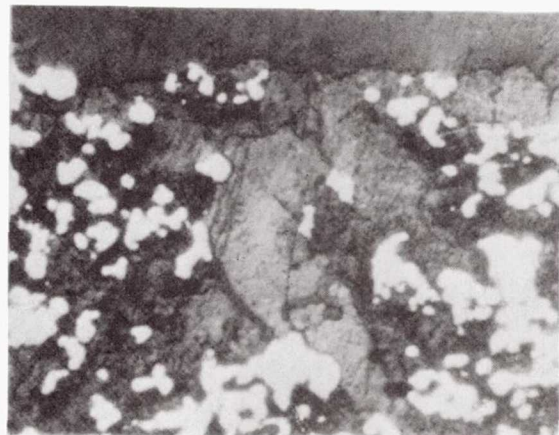

Figure 38-5d





## POSITIVE ELECTRODE PROCESSING FOR HUGHES NiH2 CELLS

C. Bleser

Hughes Aircraft

Positive electrodes manufactured at Eagle-Picher, Colorado Springs, have been used by Hughes in conjunction with the Air Force for flight program cells and advanced development program cells. They've also been used by NASA Lewis in technology programs, and by Hughes for an internal development program.

(Figure 39-1)

The basic procedures were developed for the Air Force under a contract for the manufacture of nickel-cadmium batteries. An electrochemical impregnation in an aqueous ethanol solution is used in this process.

Several additional controls were instituted by Hughes for production of flight electrodes, including a Hughes controlled MCD, a solution reserved exclusively for the impregnation of Hughes positive electrodes; a system of complete traceability for individual electrodes; an electrical characterization test to provide information on weight and capacity at the plaque level, and a stress test to provide data on capacity, weight and physical parameters at the electrode level. There's also a 100 percent inspection for dimensional conformance and physical appearance.

(Figure 39-2)

The flow chart shows the major steps in the manufacturing process. There are twenty-four steps indicated there, and Hughes approval is required in eleven of those twenty-four steps.

(Figure 39-3)

The raw plaque is made using the dry sinter process. We use Inco powder Type 287 of a selected density; thickness, .029 plus or minus .002. The porosity is 82 to 87 percent excluding the grid, and 78 to 82 percent with the grid included. The bend strength is 550 plus or minus 50 psi, and the plaque are given a 100 percent inspection for

visible flaws.

(Figure 39-4)

The impregnation solution is 1.6 to 1.8 molar nickel nitrate, .12 to .18 molar cobalt nitrate, 45 plus or minus 2 percent alcohol. The pH is controlled between 2.8 and 3.2. Temperature, 70 to 80 degrees C. The current used is .35 amps per square inch. And the loading level desired is 1.45 to 1.75 grams per cubic centimeter void volume, including the cobalt hydroxide.

The solution is analyzed just prior to each impregnation run. The cobalt and nickel are determined by atomic absorption analysis and also by EDTA titration. The alcohol percentage is determined by distillation. pH, temperature and current are controlled at the impregnation area.

(Figure 39-5)

This is a typical graph of the voltage change with time during an impregnation run.

(Figure 39-6)

Formation is done in 20 percent potassium hydroxide. It is a 3-1/2 cycle process, beginning and ending with discharge. There's an error, in that the average is per square inch, not square centimeter.

Each cycle is 40 minutes long. The first 2 cycles at .45 amps per square inch. At Cycle 3 the current is reduced to .1 amps per square inch, and at the last the current is again reduced to .07 amps per square inch. The formation is done at room temperature. I forgot to mention that.

(Figure 39-7)

This graph shows the voltages that we see during the formation procedure.

(Figure 39-8)

This is a photograph of the positive impregnation area. The impregnation tanks are on the left, and the

formation tanks are on the right.

(Figure 39-9)

This shows the formation tanks, which are now on the left, the two rinse tanks, which are in the center, and the control panels, which are in the foreground of the picture. The two control panels on the left control the impregnation process, and the panel on the right controls the formation process.

pH is monitored there in the batch tank which houses the solution, and also in each of the impregnation tanks. Temperature is also monitored at the batch tank and in each of the three impregnation tanks. Current and voltage are on digital read-outs in the center panel.

The pH and the temperature are controlled in the batch itself, and not in the impregnation tanks. That information, on pH, temperature, voltage and current, is taken every ten minutes during an impregnation.

The formation panel also has digital current and voltage displays. The panel is set up to automatically step through the 3-1/2 formation cycles. Information is recorded every twenty minutes.

We also get formation and ECT information from the Fluke data logger which is in another room.

(Figure 39-10)

After formation, plaque are scrubbed, rinsed, dried and weighed. Then they go back to the formation tanks for an electrical characterization test. The test has 20 cycles of a 72-minute charge at C rate, followed by a C rate discharge to minus .2 volts. The plaque are then charged for sixteen hours at a C/10 rate, and discharged at C/2 rate to minus .2 volts. The measured capacity at this point must be the equivalent of 1.25 ampere-hours per electrode.

The plaque are again scrubbed, rinsed and dried, and ECT weight loss is determined.

(Figure 39-11)

This graph shows the increase in capacity seen during that 20-cycle test.

(Figure 39-12)

This is some weight loss data from the 1200 series electrodes. You can see that there is a low of minus .6 grams, up to a high of minus 3.8 grams lost during that test.

(Slide not available)

This is a photograph of a plaque that has gone through ECT. I was hoping you could see how clean the surface of the plaque was. The ECT cycling seems to do a lot for cleaning the surface of the plaque.

(Figure 39-13)

A one percent random sample of electrodes is subjected to stress testing. The first part of that procedure is a hot formation in 20 percent potassium hydroxide at 70 degrees C. The formation procedure is an 18-minute charge, followed by an 18-minute discharge, both at the 5 C rate.

The electrodes are scrubbed, rinsed and dried. They are weighed and measured for thickness at three designated points. The test is conducted in 31 percent potassium hydroxide, and begins with an initial capacity which consists of a 12-minute charge at the 5 C rate, followed by a 1-hour charge at C/2 rate; discharge is a C rate to minus 1 volt. The C rate is designated as 1.4 ampere-hours.

The stress test itself is 200 cycles, consisting of a 12-minute charge and an 8-minute discharge, both at the 10 C rate. After 200 cycles there are five more capacity cycles, exactly the same as the initial capacity.

The electrodes here must also have a minimum capacity of 1.25 ampere-hours based on the average of the fourth and fifth capacities of the stress test.

The electrodes are again scrubbed, rinsed, dried, weighed and measured at the same three points, as they were

before the test. They are inspected for blisters, cracks and other visible defects.

(Figure 39-14)

Here's some information from the 1000 series stress test, showing the initial weight, capacity, the capacities after the stress, final weight, and the weight loss for those electrodes.

(Figure 39-15)

This is the picture of an electrode that has been through stress testing. It's not as clear as I would like; you can't see too well; but the electrode looks pretty good for the cycling it has been through.

(Figure 39-16)

We are beginning to work on a technology program with Hughes and NASA Lewis to make positive electrodes with the variables shown on this chart. The electrodes we now produce generally fit in the center category, in bend strength, pore size and loading. And now we're going to be able to try and make electrodes on either side of what we now make, and compare those to the current electrodes.

(Figure 39-17)

Eagle-Picher, Colorado Springs, has demonstrated the capability for the production of flight quality nickel-hydrogen electrodes. We've built over 12,000 electrodes to this point. These electrodes pass severe acceptance tests without loss in capacity and without physical deterioration. Quality and performance are further being upgraded by both government-funded program and Hughes internally funded technology programs.

Thank you.

#### DISCUSSION

MAURER (Bell Labs): Would you say a word about thickness increase on the stress test, and the blister count requirements?

BLESER: I don't have any data with me right now. We do see some swelling. We have a swelling requirement.

PICKETT (Hughes Aircraft): Let me answer the question.

Our restriction is no more than 3 percent of the total area will contain blisters, and it's usually much lower than that. The last lot we processed was the 1200 series, which she showed you some data on. It had less than 1 percent blisters. And the thickness increase requirement is 2 mills maximum, and it's usually well below a mill.

STOCKEL (Comsat): Dave, looking at that stress test with the C rate you had listed there, it looked like you'd get an overdischarge for about two minutes.

PICKETT: In formation we do, yes. But during the stress test the electrodes are not overdischarged beyond minus 1.9 volts. There are two diodes protecting each cell, so they don't go further into reversal.

TASEVOLI (Goddard): What are the advantages of the aqueous alcohol impregnation when compared to the Bell process? Are any of those advantages increased cycle life?

PICKETT: Well, we haven't made a one-to-one comparison with this process run here. The process originally formulated, the alcohol was to lower the boiling point, or lower the temperature of the process, is what it initially intended for.

I think it has some other advantages, like decreasing the amount of hydration of the hydroxide as it goes into the pores. And the solution can be buffered to some extent by the alcohol, because the ionization constant is decreased quite substantially by the alcohol.

## USAF POSITIVE ELECTRODE PROCESS

- BASIC PROCEDURE DEVELOPED FOR USAF/WPAFB UNDER CONTRACT F33615-76-C-5407, MANUFACTURING METHODS FOR NICKEL-CADMIUM BATTERIES
- ELECTROCHEMICAL PROCESS UTILIZING AQUEOUS ETHANOL SOLVENT SYSTEM
- SEVERAL ADDITIONAL CONTROLS INSTITUTED BY HUGHES FOR FLIGHT ELECTRODES
  - HUGHES CONTROLLED MCD
  - DEDICATED SOLUTION ANALYZED PRIOR TO EACH RUN
  - COMPLETE TRACEABILITY FOR EACH ELECTRODE
  - ELECTRICAL CHARACTERIZATION TEST (CAPACITY AND WEIGHT AT PLAQUE LEVEL)
  - STRESS TEST (CAPACITY, WEIGHT, AND APPEARANCE AT ELECTRODE LEVEL)
  - 100% INSPECTION (DIMENSIONS AND APPEARANCE)

Figure 39-1

### FLOW CHART FOR EPI/USAF POSITIVE ELECTRODE PROCESS

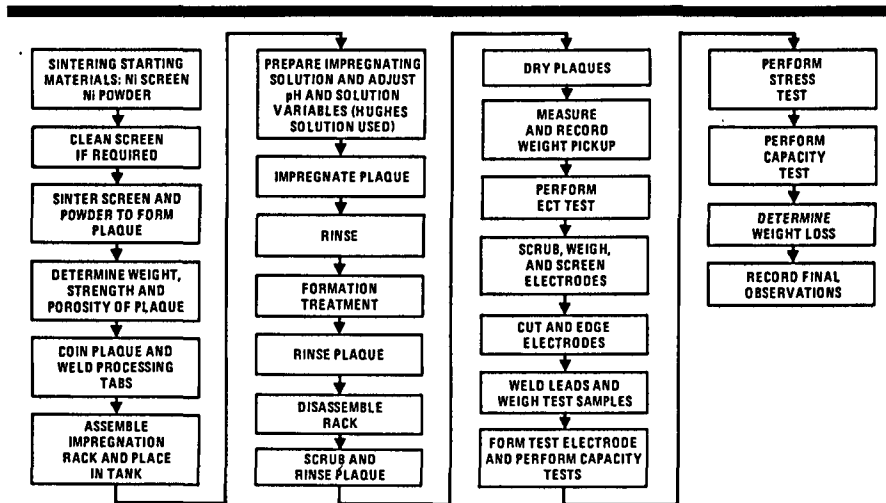

Figure 39-2

### PLAQUE PROCESSING

- DRY SINTER PROCESS
- SELECTED DENSITY: INCO 287 POWDER
- THICKNESS            0.029 ± 0.002 IN.
- SINTER POROSITY    82 < 87%, OVERALL POROSITY 78 TO 82%
- BEND STRENGTH    550 ± 50 PSI
- PHYSICAL APPEARANCE

Figure 39-3



## ELECTROCHEMICAL IMPREGNATION

- 1.6 TO 1.8 M  $\text{Ni}(\text{NO}_3)_2$
- 0.12 TO 0.18 M  $\text{C}^0(\text{NO}_3)_2$
- $45 \pm 2\%$  ETHANOL
- pH 2.8 TO 3.2
- 70 TO 80°C
- 0.35 AMP/IN.<sup>2</sup>
- LOADING 1.45 TO 1.75 Gm/CM<sup>3</sup> VOID VOLUME, INCLUDES  $\text{C}^0(\text{OH})_2$

Figure 39-4

## FORMATION

- 20% KOH
- 3 1/2 CYCLE
- INITIAL DISCHARGE

CYCLE	C/D	I, AMP/CM <sup>2</sup>	TIME, MIN
1	D	0.45	20
	C	0.45	20
2	D	0.45	20
	C	0.45	20
3	D	0.10	20
	C	0.10	20
4	D	0.07	20

Figure 39-6

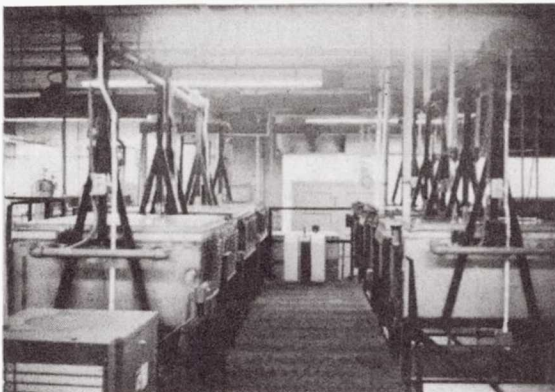

Figure 39-8

## LOT 1211 IMPREGNATION CURRENT TIME BEHAVIOR

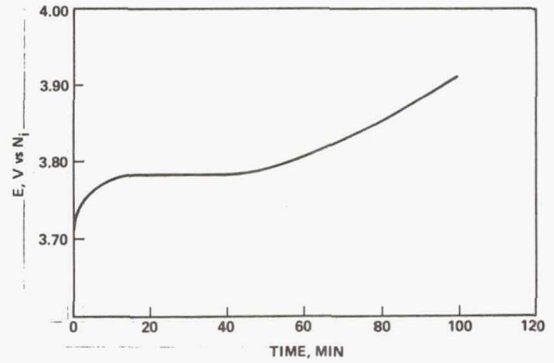

Figure 39-5

## LOT 1211 FORMATION

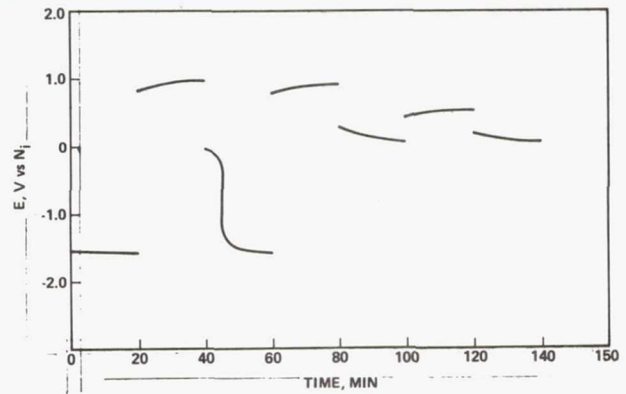

Figure 39-7

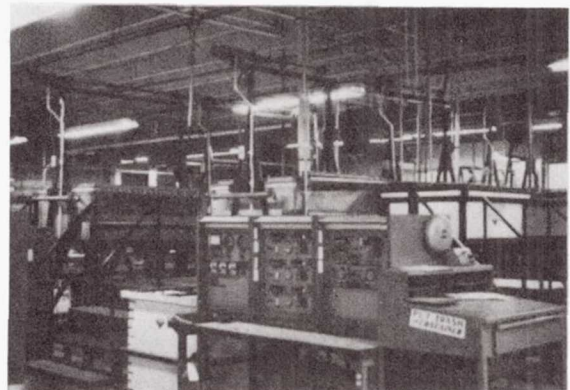

Figure 39-9

### ELECTRICAL CHARACTERIZATION TEST (ECT)

- 20 CYCLES AT C RATE
- 16 HOUR CHARGE C/10
- C/2 DISCHARGE TO -0.2 V VS HG/HG0
- FINAL CAPACITY MEASURED
- RINSE TO CLEAR PHENOLPHTHALEIN AND DRY
- FINAL WEIGHT

Figure 39-10

### ECT CAPACITY INCREASE WITH CYCLING

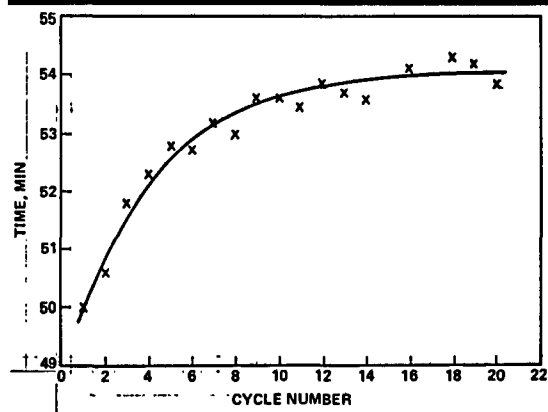

Figure 39-11

### LOT 1200 ECT WEIGHT LOSS DATA

LOT NUMBER	PICK-UP WT, GM	WT AFTER ECT, GM	ΔWT, GM
1208	90.9	90.3	-0.6
1209	93.3	89.5	-3.8
1210	92.6	90.0	-2.6
1211	92.8	90.4	-2.4
1212	95.8	93.4	-2.4
1213	96.8	93.1	-3.7
1214	94.2	91.9	-2.3
1215	94.7	93.3	-1.4
1216	92.7	91.2	-1.5
1217	92.7	92.1	-0.6
1219	93.2	92.4	-0.8

Figure 39-12

### POSITIVE ELECTRODE STRESS TEST

- HOT FORMATION
  - 2 CYCLE
  - 20% KOH
  - 70°C
  - 5C RATE
- INITIAL WEIGHT
- INITIAL CAPACITY
  - 12 MIN 5C CHARGE
  - 1 HOUR C/2 CHARGE
  - C DISCHARGE TO -1.0V
- 200 CYCLES
  - 12 MIN 10C CHARGE
  - 8 MIN 10C DISCHARGE
- 5 CYCLES IDENTICAL TO INITIAL CAPACITY
- CAPACITY
- WEIGHT LOSS
- APPEARANCE

Figure 39-13

### LOT 1000 STRESS TEST RESULTS

ELECTRODE DESIGNATION	INITIAL WT, GM	INITIAL CAPACITY, AH	CAPACITIES AFTER STRESS, AH					FINAL WT, GM	WEIGHT LOSS, GM
			1	2	3	4	5		
1005 18-04	15.045	1.24	1.47	1.47	1.49	1.52	1.52	14.826	0.219
1008 16-01	14.651	1.24	1.38	1.40	1.42	1.45	1.45	14.424	0.227
1006 24-03	14.510	1.24	1.45	1.45	1.47	1.49	1.49	14.328	0.152
1008 15-08	14.856	1.19	1.28	1.31	1.35	1.38	1.38	14.604	0.252
1005 15-05	14.441	1.19	1.31	1.28	1.31	1.33	1.33	14.299	0.142
1003 12-09	14.657	1.19	1.40	1.42	1.45	1.45	1.45	14.490	0.167
1001 28-03	14.865	1.31	1.45	1.47	1.49	1.53	1.52	14.594	0.271
1002 06-04	14.483	1.26	1.42	1.45	1.47	1.49	1.49	14.262	0.221

Figure 39-14

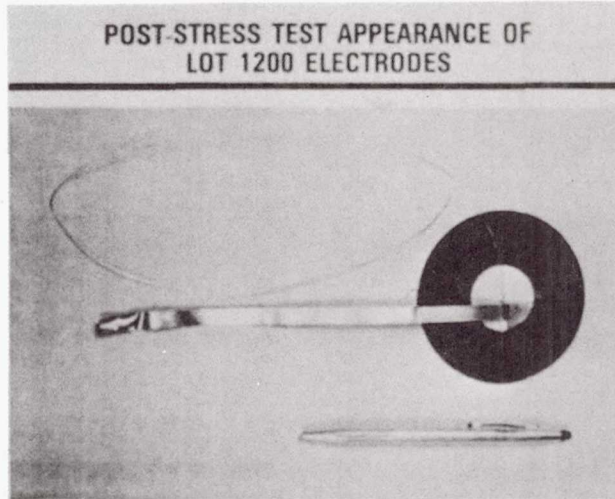

Figure 39-15

**NASA-LeRC TECHNOLOGY PROGRAM**

LEVELS	1	2	3
FACTORS			
PLAQUE MECHANICAL STRENGTH, PSI	350	500	650
PLAQUE PORE SIZE, $\mu$ IN DIAMETER	8	15	25
ACTIVE MATERIAL LOADING LEVEL GM/CM <sup>3</sup> VOID	1.3	1.45	1.6

Figure 39-16

*Summary*



- Capability Demonstrated at EPI Colorado Springs for production of flight quality Ni- $\text{H}_2$  pos. Electrodes - 5 lots, (2000-3000/lot) built.
- Electrodes pass severe acceptance tests without loss in capacity and without physical deterioration
- Quality and performance being further upgraded with both Govt. funded and Hughes internally funded technology programs.

Figure 39-17

## COMSAT LABS LIFE TEST DATA FOR N1 H2 CELLS

J. Stockel

COMSAT

This afternoon I'm going to give a very short presentation on the data that we've been taking in our lab over the last six and a half years. This is a nickel hydrogen battery that was made for Intelsat by TRW back in 1975. It was a ten cell battery and the cells are the NPS-2 type cell. The identical cells are flying in orbit in a Navy satellite.

It's a 35 ampere-hour rated cell that delivers about 37.5 to 40 measured capacity. The plates are electrochemically impregnated using slurry plaque. And, like I said, it's been on test now for about six, six and a half years, and we just completed or we just went through two days ago the 14th eclipse season.

(Figure 40-1)

On this axis is plotted the eclipse season, and on the Y axis is the average end of discharge voltage for the cells.

Back in '75 we decided we would start the battery testing simulating the 12 hour NPS-2 type orbit. Then after the fourth eclipse season we shifted over to the geosynchronous type orbit.

In between I guess five and seven we did have daily discharges to 60 percent depth of discharge during the solstice period. Then we stopped that. On the ninth eclipse season we did do a zero volt reconditioning of all the cells. From then on we're just doing zero volt reconditioning of half the cells.

The cells that we picked to recondition were the worst cells in the battery. But the depth of discharge for the longest eclipse is 60 percent. As you can see, the rest of the rather low recharge ratio, only 1.06, 600 milliamps trickle rate discharged at approximately C/2, which is 17.5, and we charged at approximately zero to ten, which is 3.5 amps.

So it's been fairly steady throughout the 14 eclipse seasons, six and a half, seven years of lifetime. And this is real time, by the way.

(Figure 40-2)

I did take out just a few weeks ago one of the cell from the battery to analyze, and I'll present for information purposes the physical and chemical analyses I did on one plate from the cell that I removed from the battery.

We have a thickness of about .081 centimeters. We do the chemical analysis for the nickel hydroxide, the cobalt; we break out the sinter, the substrate; total them all up, and the difference of that weight subtracted from what the plate weight started at the beginning, we give the catch-all term of water.

The loading is 1.37. And what I mean here is that's just loading considering nickel, nickel hydroxide only, 1.37. But I was interested in nickel plus cobalt and that's also given, and then this would be the total loading or the loading that you would be based on if you took the typical weight gain of a plate during impregnation.

I do utilizations at two temperatures. This is flooded. The utilization is just a ratio of the flooding capacity to the theoretical capacity. The flooded capacity, this is free standing electrolyte, we do a 20 degrees C; it's 1.33. We get a vast increase when we go down to zero degrees, we go down to 1.76 on this plate. And the utilization at room temperature is 1 and 1.32 at the lower temperature.

This is porosity that of course we'd get from just measuring the thickness and the area and the volume of the plate. Just for the plaque it's about 82 and for the sinter it's a little higher. Plaque, of course, contains the substrate.

(Figure 40-3)

Just to give a little comparison, what I call new plate, very limited data. I really had only one plate to compare that to. This was back five years ago. I went back

through some of my old archive data and found that we had about .79 centimeters on one of the plates that we analyzed. We did do a flooded capacity at room temperature. It was 1.34.

Now this used plate was the one I removed from the cell after six and a half years. And that, once again, is only one plate. This is very preliminary and I will get a better number for these actually when I measure all the plates. And it was 1.33. But what was more interesting I thought, the cell that I took the plate out of, I reached into the battery, pulled out the cell that had been on trickle charge for the solstice period, took it back to the laboratory and discharged it, just as it was. And it was able to produce 40 ampere-hours out to one volt. If anyone remembers when I gave my paper in Atlanta at the ICEC, the capacity we were able to measure in orbit on the NPS-2 battery was 40 ampere-hours.

(Slide not available)

Also I did a high rate cycling on this plate after six and a half years. What we do for our high rate cycling is an 18-minute cycle where we charge at 12 amps for 12 minutes and then discharge at 12 amps for six minutes. That's with 100 percent overcharge. There is no overdischarge.

We did it overnight for about 58 cycles, and we did not see any blistering on these six and a half year old plates.

(Slide not available)

I have a picture here of what happens when a plate blisters. It's very obvious. This is a plate that went through that high rate cycle test. A lot of times it will happen in the first or second cycle; this one I believe was overnight. This is what happened to this plate after 58 cycles.

Thank you.

STADNICK (Hughes Aircraft): What was the temperature during the orbital average?

STOCKEL: Ten degrees, Steve. In this battery the cells are captured in sleeves, similar to your design. It's captured in sleeves and the cell actually sits through a honeycomb base plate. The base plate is bolted to a temperature control plate, and we maintain that at ten degrees.

STADNICK: And your capacity tests were for what temperature?

STOCKEL: The capacity tests were all done at ten. The average temperature of the NPS-2 spacecraft in orbit when it discharged was about 14.5 to 15 degrees.

MILLER (Eagle-Picher): Joe, those were real good looking cells there. Who made those, Joe?

(Laughter.)

STOCKEL: I can't remember, Lee. Have you got any idea?

(Laughter.)

Didn't I say? I thought I did. I slipped up there.

BETZ (NRL): Joe, on the discharge after six and a half seasons did you see a second plateau or was it the same type of curve? Did you see any evidence of second plateau on that discharge?

STOCKEL: No. At the high rate I didn't.

**NI-H BATTERY**  
 REAL TIME LIFE TEST  
 R.O.D. AVERAGE CELL VOLTAGE VS. ECLIPSE SEASON

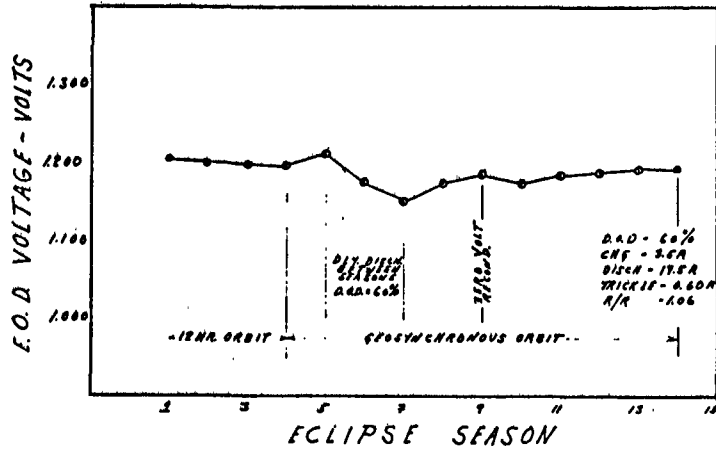

Figure 40-1

**POSITIVE PLATE ANALYSIS**

NTS-2 USED

**PHYSICAL ANALYSIS**

PLATE WT. 12.2862 g  
 THICKNESS 0.081 cm  
 AREA 5.222 cm<sup>2</sup>

**CHEMICAL ANALYSIS**

	g/PLATE	WT%
NI	4.60	38.93
CO	0.23	1.91
SINTER	2.76	22.63
SUBSTRATE	1.91	15.73
TOTAL	10.51	86.15
WATER	0.22	1.82

**LOADING**

NI 133 g/cm<sup>2</sup>  
 NI+CO 1.64  
 NI+CO+WATER 1.58

**UTILIZATION**

FLOODED CAP. @ 20°C 133 AH  
 FLOODED CAP. @ 0°C 126 AH  
 UTIL. @ 20°C 1.00  
 UTIL. @ 0°C 0.88  
 THEOR. CAP 133 AH

**POROSITY**

PLAQUE 21.01 %  
 SINTER 22.20 %

**NTS-2 NICKEL PLATES**

VINTAGE - 1982

	THK. (MM)	PL. CAR (u)	REAL COIL CAP (u)
NEW PLATE	1.77	134	-
USED PLATE 6.5 YR. OF REAL TIME TESTING	0.51	133	40.0
ORBITING BATTERY 3.0 YR.	-	-	40.0

**HIGH RATE CYCLING OF USED PLATE**

18 MIN CYCLE, 12A CHG, 12A DISCH, 10% OVERCHG  
 - NO BUBBLERS AFTER 59 CYCLES

Figure 40-3

Figure 40-2



**Page intentionally left blank**

## LIFE TEST OF 50 AH NiH<sub>2</sub> BATTERY

D. Warnock

USAF

I have two topics and one time slot, so I have abbreviated both of the presentations to make them fit.

(Figure 41-1)

I have two Vu-graphs on some life cycle testing that we have been doing on a battery whose age is very similar to Joe Stockel's battery: the cells were built in 1975, they were put into a battery in 1976, flown in 1977 in low earth orbit. These cells were made by Eagle-Picher.

(Figure 41-2)

I'm just going to give you the two most important charts. The test is being run in a rather unusual fashion. We cycle for a 1000 cycles or so, and then we short it, let it sit around the lab at room temperature for several months -- nine months, a year, whatever, cycle it for another 1000 cycles or so, and then let it rest.

One of the things that we're looking for is to see if we are getting degradation in performance during the periods when the battery is not being cycled, and comparing that to degradation of performance that we get when the battery is being cycled. We have about 6000 cycles on it now.

For those of you who are familiar with presentations that Marty Gandel has made on a similar battery, this is the same kind of battery that Marty has reported on. Marty eventually got to 13,000 cycles on his. There were three batteries built for that space experiment, 50 ampere-hour cells, 21-cell batteries, asbestos separators, slurry process plaque, Eagle-Picher/Bell process type electrochemical impregnation.

We had one cell failure when we tried to restart after 3000 cycles. And although I have other data and charts that will not be shown today, I assume those will appear in the proceedings.

The most interesting data is when you take the average cell voltage of the cells that are operating. And what we see here is that, well, initially they were cycled—you can hardly see: there's a little point here and a little point here, and that indicates some cycling that was done at Eagle-Picher under the same conditions in 1976, I believe.

This represents the first phase of testing at the Propulsion Lab. So there's a gap between here and the start of this testing of, oh, a couple or three years.

The axis down here is cycles, not time.

There's a gap over here of about nine months, and a gap over here of, I think on the order of nine months to a year or so.

We've done a least squares linear fit to the data in each of the cycling phases. And, as you can see, the slope of that fit is almost exactly parallel for each of those phases. So it looks like the same process is taking place at the same rate.

There does not appear to be any degradation in the periods when the battery is not being cycled; in fact, it's rather obvious that there is a recovery of performance.

It could be that there's a component of degradation which is being masked by a larger component of recovery. I really don't know the answer to that. But it certainly appears that on these cells, which are about six years old, that shelf life is not a problem for them. There does not appear to be any degradation of the battery that can be related to the period of time when it's sitting on the shelf.

(Figure 41-3)

The only other graph on this topic is to show a similar plot for the end of charge voltage. It shows about the same performance.

The slopes of the degradation curves are about the same, and you can see that the performance at the end of the last period is about the same as the performance at the end of this period (indicating), and about the same as the

performance bracketed out here by the very early testing done by Eagle-Picher in 1976.

There will be more about this. This is a continuing test. And I hope to be able to present more data on that in the future.

My second topic is that, about once a year I like to come here and give some indication of where the Air Force is and where we're going, and why. So I have about a half a dozen charts that will give you some idea of where we are going and why.

(Figure 41-4)

Many of you may have seen this chart before. It covers the Air Force program since the beginning: the exploratory development, the advanced development leading to a 3-1/2 inch individual pressure vessel, or IPV, cell. That has now gone into manufacturing technology. Yardney Electric has the manufacturing technology program. Hughes has the advanced development program here.

We've taken these components, and, in 1979, we went into exploratory development of common pressure vessel modules. That work is being done by EIC Corporation. The main advantage of common pressure vessels is that it simply increases your packaging efficiency. It gives you better weight energy density, better volume energy density. But basically it's a packaging program.

I think the last time I presented this chart here I probably indicated that the next step we hoped to take was to go to a large capacity IPV. That would be a 4-1/2 inch diameter, which would enable us to go to capacities as high as 150 ampere-hours. We ran into approval problems on that, because that doesn't improve your volume energy density and it doesn't improve your weight energy density, and the Air Force wasn't really too happy about that.

The only thing that we could tell them that it would do was extend cell capacity and reduce cost, and that wasn't sufficient to get approval for the program.

We were, however, successful in getting approval to go to a 4-1/2 inch diameter CPV program, and that enables

us to do an end-run and develop the components we need here, and, if necessary, come back and do that later on. And that's what we'll be doing.

(Figure 41-5)

The benefits of the CPV program are the subject of the next few charts.

What I've plotted here-- It will take a minute to get oriented to it; it's obviously a three-dimensional plot.

We have cell capacity out to 150 ampere-hours versus cell diameter up to 6-1/2 inches, and the Y axis is cell energy density in watt-hours per pound.

So we have a surface -- actually we have two surfaces. The lower surface is for 1PV cell technology, and the upper surface is for common pressure vessel technology, where there are six cells in each module.

The advantage of this kind of a graph is not for picking off data points, obviously, but it does give you a good idea in a very concise form of what the trends are when you change various parameters, what it does to you in terms of weight and volume and energy density.

A couple of points of interest here. It's sort of hard to see, but at 3-1/2 inches, this line coming up through here stops at this point. And what that means is that the packaging of the leads in the hole that runs down the middle of the electrode stack starts to get very crowded, and in the Air Force design you cannot go beyond around 50 to 60 ampere-hours with the 3-1/2 inch diameter because of the lead crowding. So this surface ends here.

You go to 4 inches and you can go out to a larger capacity. You go to 4-1/2 inches and you can now go all the way out to 150 ampere-hours, which is our interface with NASA. The Air Force will be doing cells up to 150 ampere-hours, NASA will be doing above 150 ampere-hours. 4-1/2 inches enables us to get to the limit of the capacity that the Air Force is interested in.

The red line indicates the present capability; that is, the 3-1/2 inch diameter cell running out to 50 to

60 ampere-hours.

The upper red line indicates the capacity, or, rather, the energy density that we will get with the 4-1/2 inch 6-cell CPV. And, as you can see, there's a substantial increase in weight energy density or watt-hours per pound.

Since you can't pick the numbers off this graph very well, I've done it for you, and put it on another chart.

(Figure 41-6)

This now shows, in terms of cell capacity out to 150 ampere-hours, the advantage in percent that a 6-cell, 4-1/2 inch CPV has compared to a 3-1/2 inch IPV, and to a 4-1/2 inch IPV.

You can see that at capacities below around 50 ampere-hours, the advantage of the CPV runs up to a very high percent, 50 percent or more. Beyond about 50 to 60 ampere-hours, the advantage plateaus at about 22 to 23 percent increase in weight energy density. That isn't dramatic, but it's worthwhile.

(Figure 41-7)

We'll take a quick look at the same thing for volume energy density. The axes are the same, the lower surface is IPV and the upper surface is CPV. Now you can see an even more dramatic improvement in volume energy density. Instead of a gain on the order of 20 to 50 percent, we're getting a volume energy density increase closer to about 100 percent. And when you get that kind of an increase in volume energy density with nickel-hydrogen, you're getting very close -- not quite to, but you're getting very close to the energy density, volume-wise, of nickel-cadmium; not quite, but you're within about 10 or 15 percent.

Again, the lower red line indicates the present capability, a 50-ampere-hour cell, 3-1/2 inch diameter, out to about 60 ampere-hours. The upper, the CPV running all the way out to 150 ampere-hours. And, again, I've done the arithmetic for you and put it on another chart so that you can see directly, or more quantitatively, what the advantage is.

(Figure 41-8)

Now we're looking at the percentage improvement in watt-hours per cubic inch of the 6-cell, 4-1/2 inch CPV, in this case compared to a 3-1/2 inch IPV. You can see you're running from 150 percent improvement, 100 percent improvement, to, oh, about 70 percent improvement here. And if you were comparing to a 4-1/2 inch IPV, this kind of improvement out here (indicating).

Beyond the capability of the 3-1/2 inch diameter cell, the improvement, again, would be a maximum of about 175 percent down to a minimum of 100 percent improvement in volume energy density.

So this is what the Air Force is looking for.

There's one set of charts missing, and maybe one day I'll have them. I'd like to be able to show the improvement in cost. I think it's going to be very substantial. A lot of the cost of our cells is in the pressure vessel and the labor and the welding. And it certainly will be less expensive to make one large pressure vessel than it would be to make, say, five or six small ones. But in order to come up with those cost numbers, I need information that we don't have right now. I do expect a very substantial cost improvement.

Thank you.

#### DISCUSSION

RAMPEL (General Electric): What was the nature of that cell failure you mentioned in Topic No. 1?

WARNOCK: The cell shorted. And we don't know what happened internally, but it was a short failure. We did not wire around it. The cell is still wired in, just as if it were an active cell in the battery. And there is a voltage drop across the cell, both on charge and discharge.

The data that you saw, we took that voltage out so that when we normalized it to average we would get the true average of the cells that were operating.

But it's a short failure. The cell is still wired into the battery, and it's having a voltage drop across it.

DYER (Bell Labs): On the charging after your period of stand on the low earth orbit cycles, what were the conditions on the recharge? Did you use the C rate or thereabouts, on recharge?

WARNOCK: I honestly don't know. I'll have to ask my laboratory engineer. But I think that the first charge after a rest period is a rather gentle charge over a period of like 12 hours. And it's done at a current that would not give us significant overcharge.

So it's that sort of a thing. But within one or two cycles it goes right back into a regular 90-minute orbit.

DYER: And what temperature would that have been at; do you remember?

WARNOCK: Our battery is operating at the laboratory room temperature; which is nominally 20 degrees C. And it is stored also at that temperature.

DYER: And it's stored shorted, too, I assume, during the intervals?

WARNOCK: Yes.

DYER: One other question. The common pressure vessel design. Are we getting close to any of those limits you showed on those theoretical surfaces?

WARNOCK: Not in the work that has been done so far, because the exploratory program is using only boilerplate pressure vessels; there have been no lightweight cells built. However, the surfaces that are shown are not based on any improvement in technology. In other words, those are computer generated numbers based on the kind of technology that we use now in the IPV cells; the same strength for the pressure vessel material, the same capacity for the electrodes, and that sort of thing. There is no improvement in the technology. Those surfaces show purely changes in packaging factors.



HARKNESS (Crane): Along the same lines, on the reconditioning, you said you ran a couple of cycles after the initial charge. Were those 100 percent DOD cycles? And did you see a slow buildup in the capacity, or did you have almost maximum capacity after the first couple of cycles?

WARNOCK: Those are not 100 percent depth. Again, I'm not sure about this, but I think that-- The battery has been stored shorted. He charges it up rather slowly for about a 12-hour period to essentially full charge, then does a 50 percent depth, back up to full charge, and, if everything looks good, immediately goes into 90-minute cycling at 50 percent depth.

OTZINGER (Rockwell): When you showed your surfaces there, one parameter that you didn't spell out was the maximum design pressure. And that pressure, of course, would influence drastically the results. I think right now you're designed for -- what? -- around 500?

WARNOCK: About 800 is the max operating design.

OTZINGER: So if you went up to, say, 1000 or so, then it would change your.... Is there any plan to look into doing that?

WARNOCK: The pressure increase that you get in doing these various packaging exercises manifests itself in a thickening of the pressure vessel, which is included in the calculation, in the computer program. So the surfaces accurately represent what happens to the weight of the pressure vessel as the pressure changes when you change the packaging factors. It turns out that at 4-1/2 inch diameter you will have pressures of around 1500 psi.

One of the reasons that the 3-1/2 inch CPV has a poor energy density-- If I may, I'll go back just momentarily to that Vu-graph.

(Figure 41-8)

On this upper blue surface which represents CPV, I hope you can see that as you go to lower diameters this surface is starting to curve over here rather dramatically. And the reason why that surface is turning down, and it actually drops below the IPV surface at 3-1/2 inches, is

because of the increase in thickness of the pressure vessel as the pressure gets very high in a 3-1/2 diameter CPV. Because you're really cramming the cell down into the minimum pressure vessel size that you can get. And the pressure starts to skyrocket below around 4-1/2 inches.

I have plots -- I don't have them with me, but I have plots that show what happens to the pressure. And you have a buildup in pressure coming in this direction, and at about 4-1/2 inches that pressure starts to shoot up off the top of the graph. It's shooting up to like 3000, 4500 psi. And that's another reason why the CPV optimizes much better at about 4-1/2 inches than at 3-1/2.

HARKNESS: At the end of each cycling period I know you must run a capacity check before you go into your rest period. We can see the voltage degradation. Are you also getting a degradation in capacity?

WARNOCK: Again, I don't have the numbers at my fingertips, but we have not experienced any significant degradation in capacity, other than the fact that the end-of-discharge voltage is a little bit lower. The capacity of the battery still is essentially what it was five or six years ago.

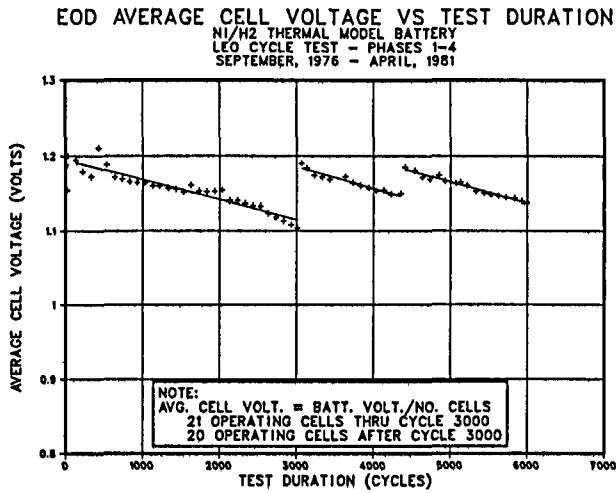

Figure 41-1

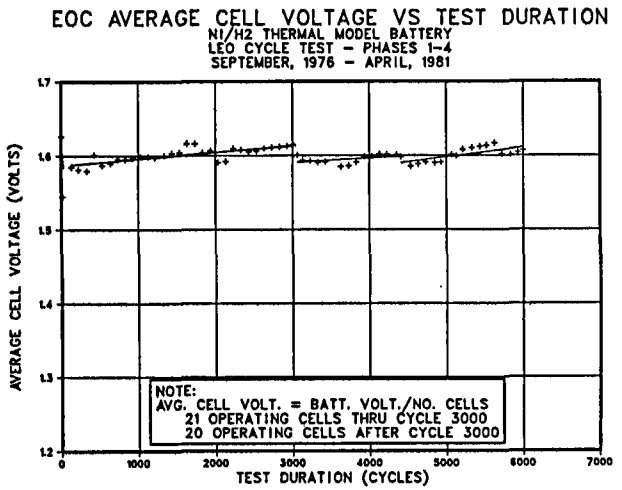

Figure 41-2

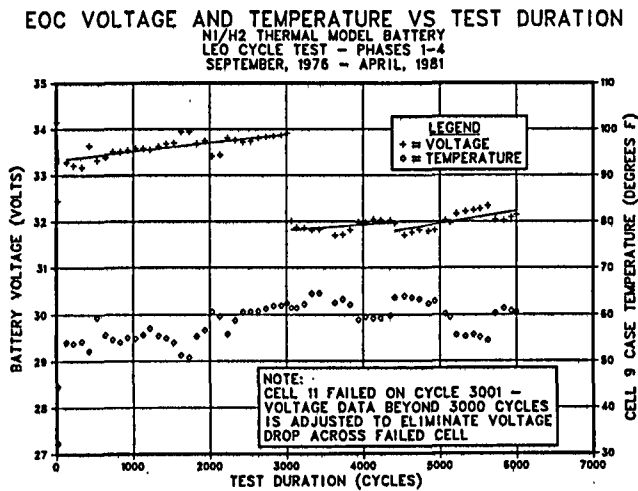

Figure 41-3

# NI/H2 BATTERY STANDARD COMPONENTS SYSTEM

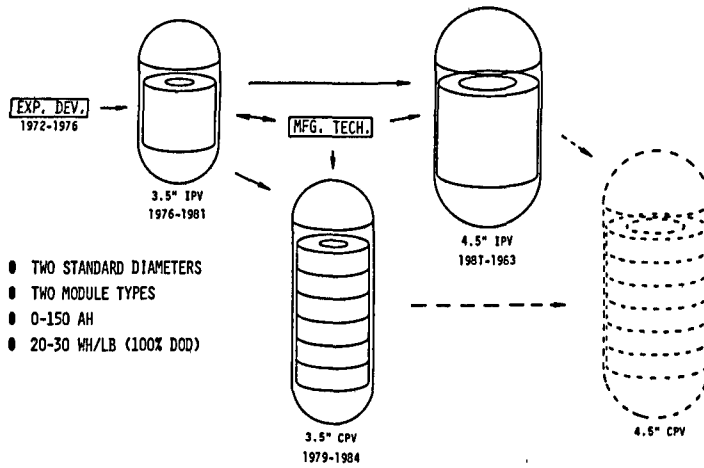

Figure 41-4

## NI/H2 CELL ENERGY DENSITY

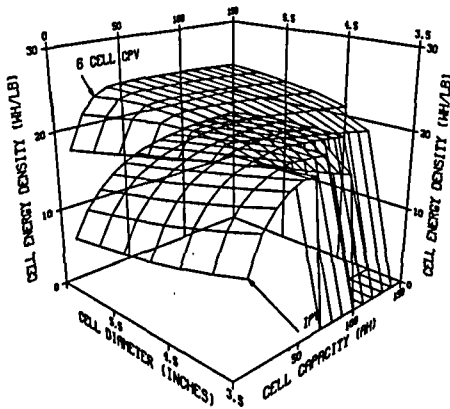

Figure 41-5

## CPV WH/LB ADVANTAGE OVER IPV 6 CELL - 4.5 INCH DIAMETER CPV

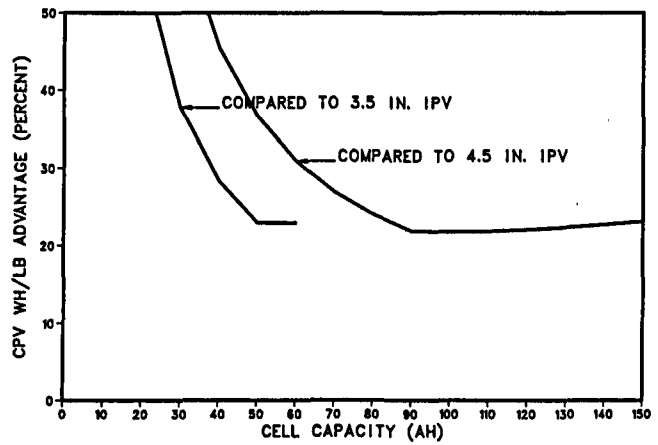

Figure 41-6

NI/H2 CELL ENERGY DENSITY

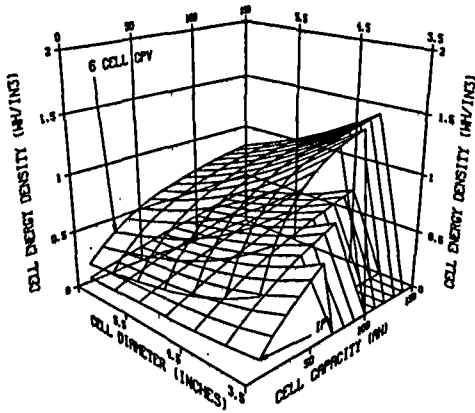

Figure 41-7

CPV WH/IN3 ADVANTAGE OVER IPV  
6 CELL - 4.5 INCH DIAMETER CPV

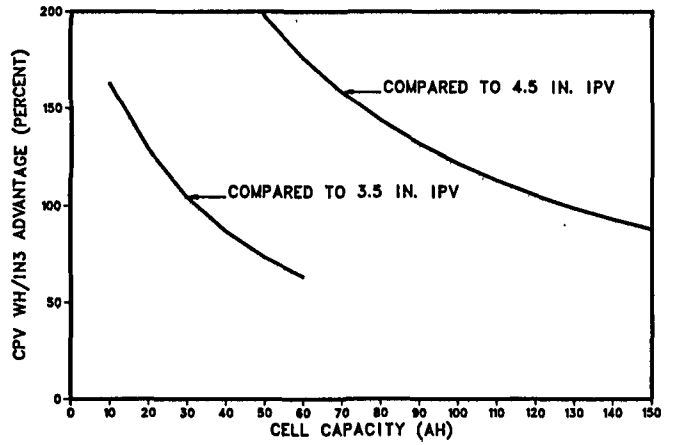

Figure 41-8

EOC VOLTAGE AND CURRENT VS TEST DURATION  
NI/H2 THERMAL MODEL BATTERY  
LEO CYCLE TEST - PHASES 1-4  
SEPTEMBER, 1976 - APRIL, 1981

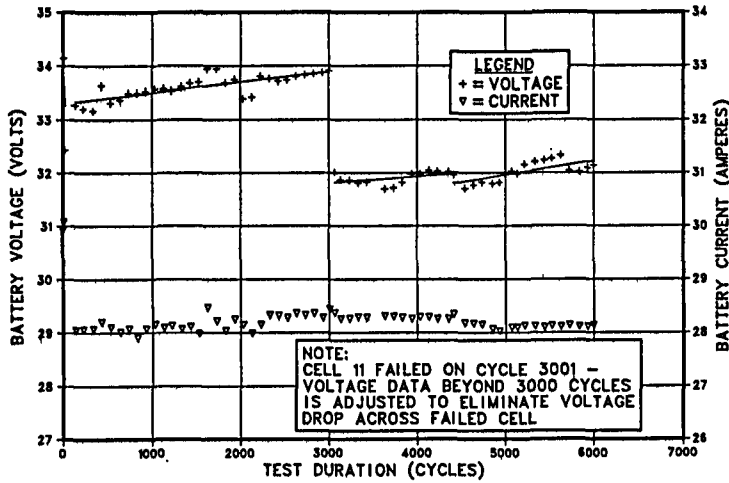

Figure 41-9

EOD VOLTAGE AND CURRENT VS TEST DURATION  
 NI/H<sub>2</sub> THERMAL MODEL BATTERY  
 LEO CYCLE TEST - PHASES 1-4  
 SEPTEMBER, 1976 - APRIL, 1981

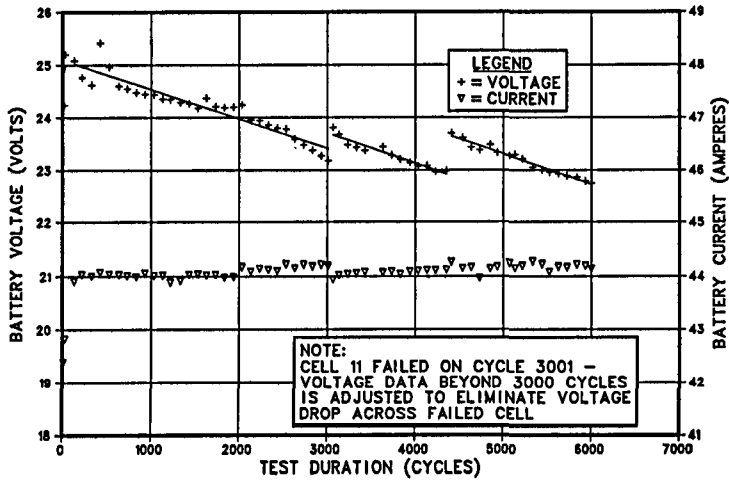

Figure 41-10

NI/H<sub>2</sub> CELL ENERGY DENSITY

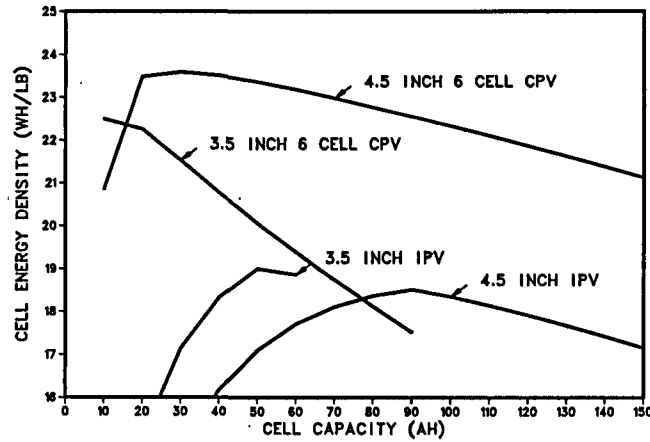

Figure 41-11

NI/H<sub>2</sub> CELL ENERGY DENSITY

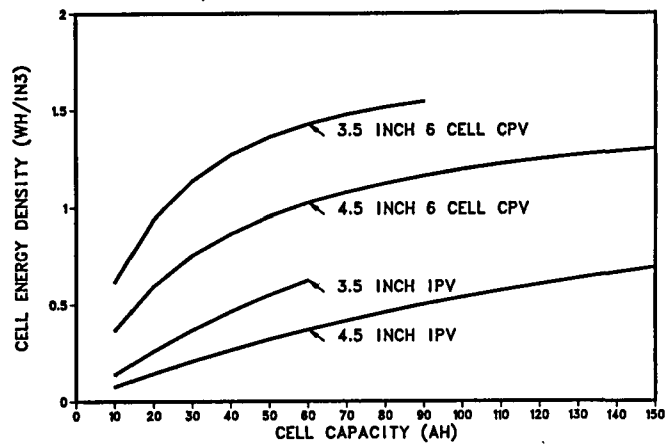

Figure 41-12

**Page intentionally left blank**

CYCLING CHARACTERISTICS OF NiH<sub>2</sub> CELLS IN STANDARD  
AND DAILY ENERGY BALANCE LEO ORBITS

P. Ritterman

TRW

About three years ago Don Warnock was kind enough to arrange for Hughes to lend or give TRW three cells from their Advanced Development Program. I'm going to talk about some tests that we've done on the first generation cells of the Air Force-sponsored Advanced Development Program.

These results involve a conventional low-earth orbit and a daily energy balance peak power low earth orbit.

(Figure 42-1)

As most of you know, various spacecraft houses received three cells from the Air Force via Hughes and the cells were of the Air Force design. They were 50 ampere-hours rated capacity. The electrodes were the pineapple-slice shaped electrodes with a recirculating stack design.

The separator extended beyond the stack to the cell wall, touching the zirconium oxide-coated cell wall for electrolyte recapture which was lost through entrainment.

The positive electrodes were made by an aqueous solution electrochemically impregnated method, and two cells had an asbestos separator, one cell had the Zircar separator.

(Figure 42-2)

First let's talk about the conventional low earth orbit.

Two asbestos-separator cells were used. I have the same base plate but by selecting the mass of the thermal jacket I got the one cell to operate from 5 to 10 degrees C., and the other cell to operate from 10 to 15 degrees C.

The two cells were subjected to a 90-minute orbit.



50 amps, the C rate was the discharge rate lasting half an hour, the initial recharge ratio was 1.08.

The data I'm going to show is a plot of end-of-charge and end-of-discharge voltage versus the number of cycles completed, and end-of-charge and end-of-discharge pressure versus cycles completed.

(Figure 42-3)

Let's look at the end of charge initially.

We get a slight rise in voltage, a tapering off, and then, due to a power failure in the power supply that we ran the tests with, we were forced to do a reconditioning. The reconditioning caused a slight drop in the end-of-charge voltage.

Let's go down and see what happens at the end of discharge at the same time.

At the end of discharge the results of the reconditioning caused a voltage rise but as you can see from the end-of-discharge data, the voltage was beginning to decline before the reconditioning and continued to decline at a more rapid rate afterwards than prior to the reconditioning.

In essence if we had not done the reconditioning this would have been a smooth curve descending down to an end-of-discharge voltage slightly below 1.10.

We then did a deliberate reconditioning. And it seemed that the two cells just went along on the same predetermined path, so that if we drew a solid line it would essentially follow this except for it would not have the slight rise in voltage which was the result of reconditioning.

We then turned to increasing the recharge ratio to 1.16, and this didn't help matters significantly. Perhaps it helped initially but at the end of 6,000 cycles, both cells failed due to low voltage and low capacity.

(Figure 42-4)

During that same time we traced the pressure and the pressure seemed to indicate -- and this is a tentative conclusion -- that the chargeability of the cell was being reduced; that is to say, the end-of-charge pressure was gradually going down. And naturally the end-of-discharge pressure is going to follow that. In fact, the difference between the end-of-charge pressure and the end-of-discharge essentially remained a constant throughout.

(Figure 42-5)

Now let's discuss the daily energy balance-peak power load. That was done with the Zircar separator cell. We used 15 different cycles of peak different duration, repeated on a daily basis, so that every day was like every other day but you had 15 different cycles during that day. Each cycle used two discharge rates.

"Initial peak pulse" is really an incorrect term because sometimes that rate is as long as 18 minutes, an initial peak rate of approximately 1.4 C., and then a basic rate following that initial rate of about .2 C.

We had the same ampere-hour input for each charge, and that was about 16.9 ampere-hours, or 17 amps for a duration of 58 minutes. The daily recharge ratio was 1.05. That means if you added up all the charges in one day and all the discharges, you'd have 105 percent of the discharge equal to the recharge.

And the operating temperature -- this is cell top, and the previous operating temperatures I was talking about were also cell top -- ranged from 10 degrees C. to 20 degrees C.

(Figure 42-6)

This slide describes in greater detail the 15 different cycles. For the first three cycles, the peak pulse lasted for 18 minutes. Since we had a 36-minute total discharge time, the low basic rate also lasted for 18 minutes. And then we go on to slightly different times.

We hit the minimum, the greatest depth of discharge at the end of the third discharge of the day; that

is, 18 minutes of peak pulse rate and 18 minutes of just basic rate.

(Figure 42-7)

Using the charge and discharge ampere hours numbers I made a theoretical plot of the state of charge at the end of charge, the state of charge being this ordinate and the depth of discharge at the end of discharge at the high rate and the end of discharge at the subsequent lower rate the other ordinate.

What this shows is that we are only fully charged initially; that is, after the first charge I don't indicate anything above 100 percent. We're at 100 percent when we begin, and we're back to 100 percent when we end, and we are at 100 percent after the 14th charge.

So that means in the 15 cycles each day, there are only two cycles where the cell is actually subjected to an overcharge.

The depth of the discharge, according to the calculation, reaches a maximum 66 percent DOD at the high rate and then when we follow up with 18 minutes of low rate, we hit a maximum DOD of 74 percent. And we follow this all the way up and it essentially goes back to its initial condition.

I don't show a 15 over here. I should also show a 1 over here, but it does go back to what it did the previous day, of the first charge and the first discharge.

Let me put this Vu-graph over here.

Now let's look at the voltage, actual measured voltage during the 100th day, which is the 1500th cycle to the 1515 cycle.

(Figure 42-8)

As I mentioned before, the voltages indicate that we are in overcharge only after the first charge, and after the 15th, you can see the voltage is essentially below 1.5 during all the other end-of-charge points.

The minimum end-of-discharge voltage at the end of the basic rate is about 1.26 V on the hundredth day; the minimum end-of-discharge voltage at the end of the 18-minute high rate discharge is about 1.17 V.

(Figure 42-9)

Now this is the same data at the end of the 700th day, or about 9,000 cycles later. Essentially the results have not changed. There's a slight drop in voltage as we go from the 100th day to the 700th day, but there's essentially no change and I would say no significant degradation.

Let's look at the plot a different way.

(Figure 42-10)

Plotting the minimum end of discharge voltage at the two rates, we see that we now have completed more than above 10,000 cycles. This is a semilog plot. Deterioration is very slight, relative to the amount of voltage deterioration we saw on the conventional low earth orbit cycle.

Let's look at pressure.

(Figure 42-11)

Pressure is an indicator of nickel-hydrogen state of charge, and if you look at that Vu-graph over there and this pressure data here you essentially have the same curve.

So there is a theoretical curve and here is an actual curve of pressure, so the pressure accurately tracks the state of charge.

This time I went back to the first cycle after the 15th, and we essentially go back to the same state of charge that we started with on the first cycle. That's the end of charge. And the same end-of-discharge pressure as we began initially, so we're returning the cells to the same state of charge at the end of each day, at the end of each 15-cycle day.

(Figure 42-12)

Now here's the same data. This was at the end of 1,500 cycles. This is the end of 10,500 cycles, 9,000 cycles later, and the cell pressure essentially behaving the same way. The cell has not increased the state of charge or has not gained any hydrogen pressure nor has it lost any.

I will superimpose the 100th day pressure data over the 700th day pressure data.

As you can see, except for minor differences because we don't have absolute control of the current and there are slight variations, it coincides very well.

(Figure 42-13)

Some tentative conclusions:

Let me say I had other cells on these tests. I'm not ready to discuss this yet. I just reduced this data about a week ago in this particular fashion, but the conclusion I want to discuss now is tentative and based only on what I described here today.

Based on these results I would have to say that under routine, conventional LEO application, the first generation Hughes cells indicate a life of just a little bit more than one year at temperatures of 5 to 10 degrees and temperatures of 15 to 20. Howard (Rogers of Hughes) is looking at me, but I'm saying based on these results.

The daily energy balance treatment has significantly prolonged the cell life and has resulted in significant improvement in performance.

The daily energy balance-peak power load application for nickel-hydrogen cells of this type has been shown feasible for two years and beyond. I have some cells that have gone as long as four years and are still running.

#### DISCUSSION

MILDEN (Aerospace): Have you taken the two apart that have failed?

RITTERMAN: No, I have not, but I intend to.

MUELLER (McDonnell-Douglas): I notice that you don't see any pressure buildup whatsoever on your daily energy balance test. Do you feel that's a function of the Zircar separator, or is it a function of the charge regime, or what do you attribute that to?

RITTERMAN: It's probably a function of the charge regime. I haven't shown all the data. I have some asbestos cells made by another manufacturer that underwent this test and they behaved essentially the same way.

MUELLER: Thank you.

ROGERS (Hughes Aircraft): For what it may be worth, we've cycled cells with different positive electrodes, in this case Air Force process, and I've seen pressure build up over many, many cycles at 80 percent depth of discharge, as many as 6,000-plus cycles.

RITTERMAN: I don't deny that there is pressure buildup on your ordinary low-earth-orbit cycling. In fact I've shown it. Where I say there is no pressure buildup and no deterioration is on the daily energy balance type of cycling where we limit the number of overcharges.

DYER (Bell Labs): Could you show us your daily charging regime, please, again?

(Slide.)

RITTERMAN: This is one. I think you're talking about the little picture.

DYER: Yes. There were 15 cycles I believe.

RITTERMAN: Yes.

DYER: I can't read the currents on the right hand very well.

RITTERMAN: That's why I wanted to show the other one.

The currents are 69.2 for the pulse rate, 9.2 for the basic rate, 17.2 amperes for the charge.

DYER: Okay.

What's the sequence? Can you remind me of the sequence in which these occur?

RITTERMAN: Okay. Beginning with charging, we charge the cells for-- Well, actually we begin with discharge so we start out with Cycle 1 with a fully-charged cell, so we discharge at 69.2 amps for X minutes. Then we discharge for 9.2 amps for 36 minus X minutes. And then we charge for 17.2 amperes for 58 minutes. That's the same throughout the entire test.

DYER: Thank you.

THREE NICKEL HYDROGEN CELLS MANUFACTURED BY HUGHES WERE FURNISHED TO TRW FOR EVALUATION BY THE U.S. AIR FORCE AS PART OF THEIR NICKEL HYDROGEN CELL DEVELOPMENT PROGRAM

- 50 AH RATED CAPACITY
- PINEAPPLE SLICE SHAPED ELECTRODES
- RECIRCULATING STACK DESIGN
- SEPARATOR EXTENDING BEYOND STACK TO CELL WALL
- AQUEOUS SOLUTION ELECTROCHEMICALLY IMPREGNATED POSITIVES
- 2 CELLS - ASBESTOS SEPARATOR; 1 CELL ZIRCAR SEPARATOR

Figure 42-1

CONVENTIONAL LOW EARTH ORBIT TEST

- TWO ASBESTOS SEPARATOR CELLS
    - 5 TO 10°C
    - 10 TO 15°C
  - 90 MINUTE ORBIT
    - 50 A DISCHARGE RATE
    - 50% DOD
    - 1.08 RECHARGE RATIO
  - DATA
    - END OF CHARGE/DISCHARGE VOLTAGE
    - END OF CHARGE/DISCHARGE PRESSURE
- VS NUMBER OF CYCLES

Figure 42-2

STANDARD LEO - END OF CHARGE/DISCHARGE VOLTAGE VS CYCLE NUMBER

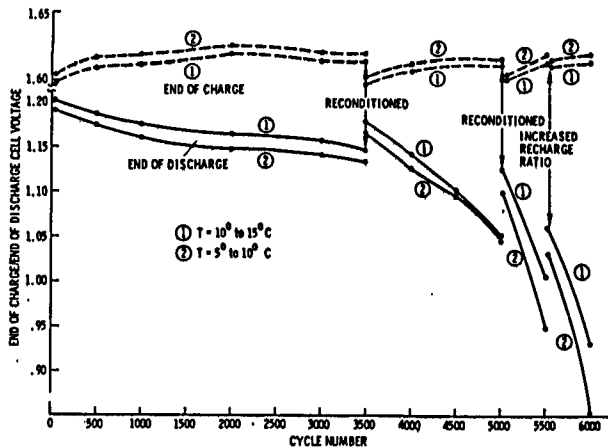

Figure 42-3



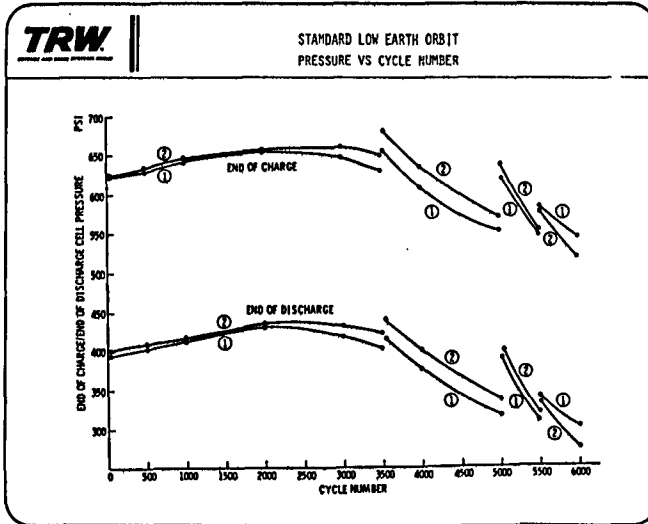

Figure 42-4

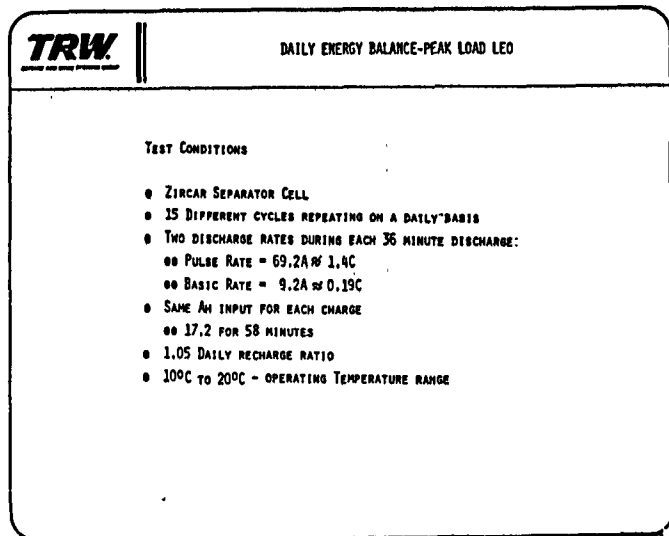
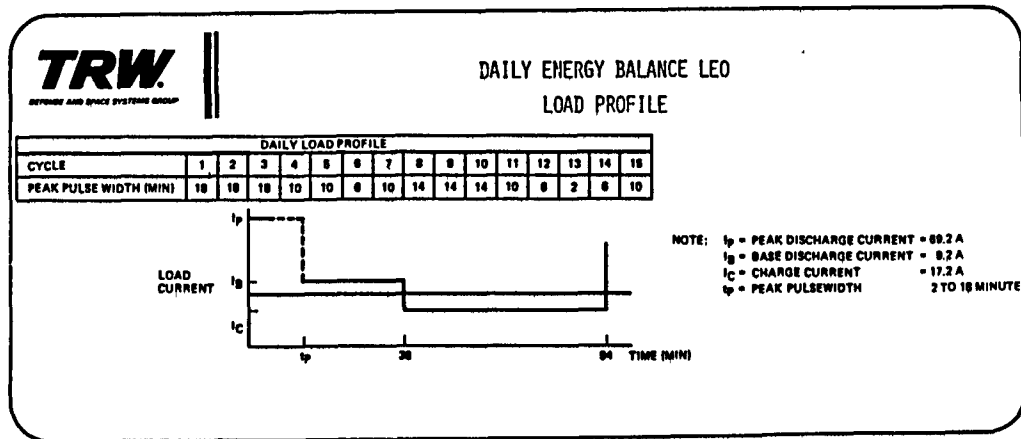

Figure 42-5



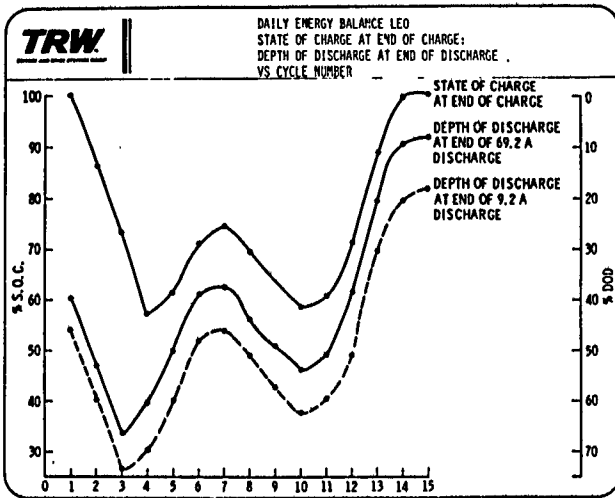

Figure 42-7

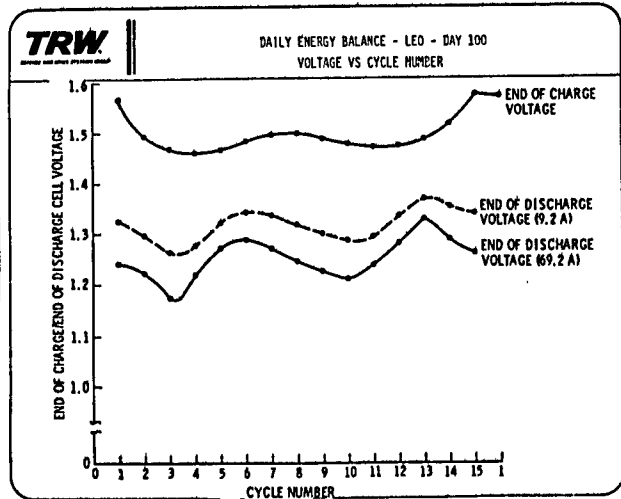

Figure 42-8

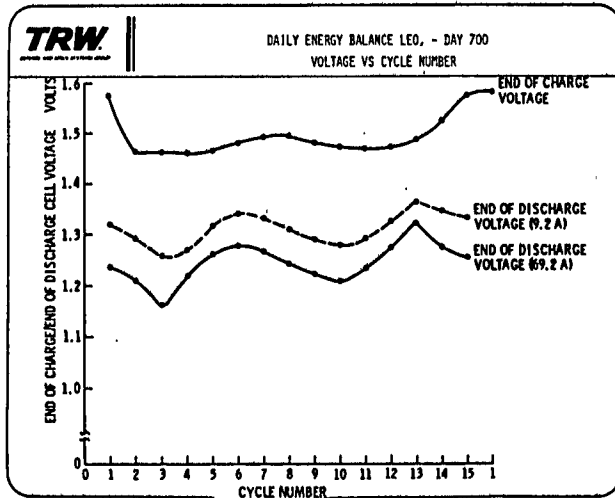

Figure 42-9

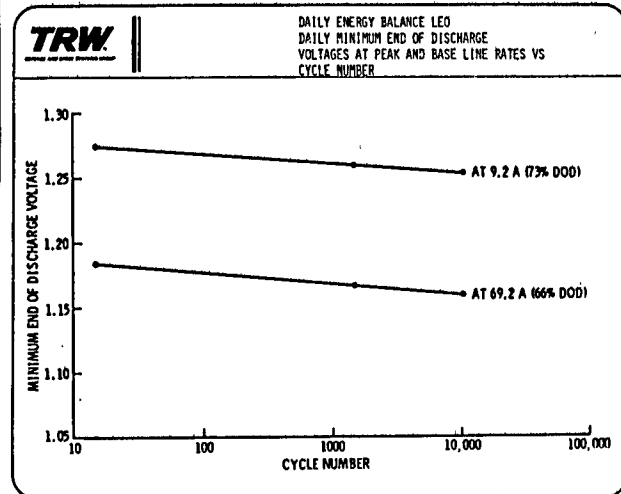

Figure 42-10

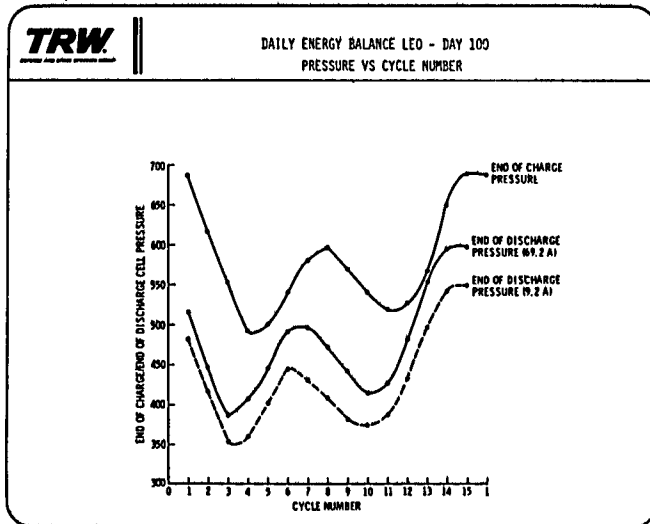

Figure 42-11

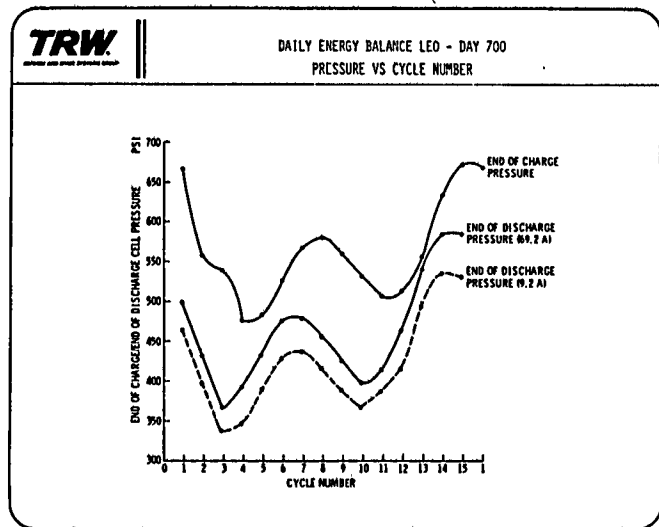

Figure 42-12



### CONCLUSIONS

BASED ON THE RESULTS OF THE CONVENTIONAL AND DAILY ENERGY BALANCE WITH THESE THREE AIR FORCE DESIGN CELLS IT MAY BE CONCLUDED THAT:

- THE LIFE OF THE FIRST GENERATION OF HUGHES ADVANCED DEVELOPMENT CELLS IN CONVENTIONAL LEO APPLICATION AT 50% DEPTH APPEARS TO BE A LITTLE MORE THAN 1 YEAR.
- DAILY ENERGY BALANCE TREATMENT SIGNIFICANTLY PROLONGS CELL LIFE AND IMPROVES PERFORMANCE
- DAILY ENERGY BALANCE-PEAK POWER LOAD APPLICATION HAS BEEN SHOWN FEASIBLE FOR 2 YEARS AND BEYOND

Figure 42-13

## SOME PROPERTIES OF N1 H2 CELLS

H. H. Rogers

Hughes Aircraft

The title is a little misleading. What I'm really going to be reporting on is a number of different tests on a flight type cell.

(Figure 43-1)

The cell which I'll be talking about is essentially a 25 ampere-hour lightweight cell, and I'll be describing it in a little more detail later.

The temperature was measured at the cell flange, and in this test we charged the cell to rollover at .75 C rate at 40 degrees Centigrade for the first temperature. Then it was trickle charged at C/80 for the next 40 minutes. At that point we took a voltage reading. Then we charged at .75 C for ten seconds. The ten seconds was simply arbitrary to get a stable -- momentarily, at least, stable -- voltage. We recorded the voltage and then went ahead and did the same thing at 30 degrees, 20 degrees, ten degrees and zero degrees.

(Figure 43-2.)

This vu-graph shows the plot of the results.

The C/80 work gave an absolutely straight line from 40 to zero degrees. And interestingly enough, that slope -- and I noticed on the vu-graph that was shown previously, which I think was for nickel-cadmium, gave, if I remember correctly, -2.33 millivolts per degree C. This one for nickel hydrogen gives a value that would almost be within the experimental error.

At a higher rate you get a somewhat different slope which changes, and I think what we're doing is seeing the effects of resistance and polarization generally in the cell.

(Figure 43-3)

The next thing we did was to look, again with the same cell, at cell voltage as a function of charge rate at full charge. I'm basically defining full charge here as that charge which is accepted at C/10 at around room temperature. So to start this work we charged at C/10 until we get a stable voltage, and then went at C/10 to the next level, to the next level and to the next level.

The cell flange temperature in this test ranged up to as high as 28 degrees initially due to the C/10 overcharge. But the voltages which you'll be seeing were corrected using the previous curve to 22 degrees Centigrade.

(Figure 43-4)

The C/10 plot as you may notice, looks like the usual end of a C/10 charge. We then dropped to a C/20 rate and got the somewhat peculiar looking curve you see. Then the next one went to C/40.

(Figure 43-5)

In this vu-graph you see the result at C/80. We're actually able to hold a charge at those trickle charge rates. But at C/160 we could not maintain a full charge. Now I'm sure that the cell voltage would stabilize at a lower state of charge, but we didn't continue the charge.

(Figure 43-6)

Next we looked at the recombination of oxygen at a low temperature where naturally there is a concern in nickel hydrogen. At a cold temperature you might get an oxygen bulloop that could be a cause for concern. So we did the actual experiment using the same cell again, charging at C/2 for 15 minutes past voltage rollover. That is what we at Hughes do as a standard oxygen test to determine the performance of the cell under high rate overcharge conditions.

We found at -25 degrees C an oxygen concentration of 0.19 percent. Now normally at near room temperature we get between .10 and .15 percent. But I think all you're seeing is a small change due to a change in the diffusion

rate of oxygen probably through an electrolyte layer on the negative electrode. In any case it's well below any limit that would give us any kind of concern. So we obviously can conclude that the hydrogen electrode works extremely well at temperatures as low as -25 degrees C, and probably lower.

(Figure 43-7)

I will try to be as clear as I can on this one. It's a rather confusing test. The cell, which I'll describe now, since it becomes of major significance in this test, is a flight type cell except it was equipped with a valve and a gauge because we did have to change the gas in it. The positives were Eagle-Picher -- Dave Pickett's Air Force process. The separator was our usual Zircar (knit type). The negatives were also our etched nickel-platinum-teflon negative, originally developed at EIC. The gas screen was polypropylene. This is a recirculating-design cell using the plasma-sprayed zirconia wallwick.

The procedure was to do 16 conditioning cycles at a 1.1 to 1 in a low earth orbit, and then to do a capacity test at a C/10 charge. A C-rate discharge was done to one volt and C/2 rate following that to one volt.

(Figure 43-8)

We then did a series of capacity tests. The first one was to establish the performance of the cell, in this case giving 20 ampere-hours. We then put in eight psi of nitrogen, a little more hydrogen, and then ran a capacity test again and found no significant difference. We then put in 50 psi of nitrogen and still no effect.

At that point we charged the cell at C/2 to ten ampere-hours, evacuated all the gas out of the cell, and then put in the 65 pounds of nitrogen and no precharge of hydrogen, just letting the cell discharge the hydrogen normally. At that point our capacity dropped to 12.2 ampere-hours, so we were seeing an effect.

(Figure 43-9)

We concluded from this test that a very large amount of nitrogen is needed to affect the performance, in

this case 40 percent at C rate. Probably the most important observation is that if you had a cell which had a leak in manufacture originally and you filled it completely with air at one atmosphere you wouldn't see the effect in performance.

(Figure 43-10)

The next thing we looked at was cell reversal under negative-limited conditions, which, of course, is not the usual way of operating a nickel-hydrogen cell.

We used a boiler plate cell in this case with six positives, the same type of electrodes as I previously described. We did a capacity test with a C rate charge, 1.4 C discharge, and ran 12 cycles of what we call a cycling capacity test at a C/D ratio 1.1 to 1, which will build up the capacity. A final discharge to one volt resulted in a capacity of seven ampere-hours.

The initial test was done under positive-limited conditions. We discharged the cell at .73 C for 30 minutes past zero volts, to a negative 190 millivolts. And that's very much the normal performance for a nickel-hydrogen cell.

(Figure 43-11)

Now to get what we refer to as negative-limited reversal, we charge the cell to rollover, bleed off 30 percent of the hydrogen in the cell and then discharge at the same rate for five minutes past reversal, an end of discharge voltage of a -.36 volt.

We then refilled the cell with hydrogen, did the cycling capacity test and got 7.3 ampere-hours.

We then repeated the same sequence with 60 percent of the hydrogen removed, and again came out with a very similar result with no effect whatsoever on capacity.

On disassembly of the cell we found no observable damage to the components.

One comment on that voltage: What you're seeing here in these cases is basically an oxygen cell as opposed to the hydrogen cell in normal reversal.

Thank you.

RITTERMAN (TRW): It's much, much easier to ask questions than to answer them.

I don't think you are seeing an oxygen-oxygen cell. What you're seeing is an oxygen evolution off your hydrogen electrode and you're seeing discharge of nickel hydroxide, whereas if you have a normal reversal you get a hydrogen-hydrogen cell.

ROGERS: Let's see. That will be hard to see, Paul, because I believe that potential is about the same.

RITTERMAN: Yes. The thing is you have stated that you bled off some hydrogen. You made the cell negative-limited. So therefore you have some positive capacity left when you're gassing oxygen off the hydrogen electrode.

ROGERS: You're right. All I'm saying is if you didn't have that situation where you're generating oxygen it should be about the same, if it's catalytic.

RITTERMAN: Right.

GASTON (RCA): Howard, you mentioned a lightweight 25 amp-hour cell. What makes it lightweight and how does it differ from the standard 25 amp-hour cell?

ROGERS: Well, our standard boiler plate weighs 22 pounds, roughly. And this one is -- actually it's an Inconel 718 case, normal construction for the lightweight cell as opposed to a boiler plate design. The only thing different was we put a valve and a pressure gauge on it so that we could tell what was going on, and then we're capable of refilling with gas if we wanted to. Otherwise it was exactly the same as our normal flight cell.

DYER (Bell Labs): When you introduced nitrogen into a cell and you saw low capacities, what was happening in fact? Were you getting a softening of the knee? Was it, in other words, indicating some kind of diffusion limitation? Is that what gave you the low capacity? Can you remember the voltage time charge on discharge when you had a lot of nitrogen there?



ROGERS: I really don't.

Do you, Steve?

STADNICK (Hughes): It was very steep at high rates, as you would expect, and as you became rate-limited you just couldn't find enough hydrogen to discharge.

DYER: You just ran out of hydrogen? Is that what it was? I thought I saw an end of discharge pressure of hydrogen there.

ROGERS: You did. But what we probably did -- I would say Steve is undoubtedly correct in what he said -- it was that probably we ran out of hydrogen in the vicinity of the electrode because some other experiments which I didn't show indicated that there was a time factor. If you let the cell stand you can pick up I think as much -- if I remember right -- as much as a half to an ampere-hour, which would indicate a diffusion mechanism.

DYER: One other question.

You seem to indicate I think that state of charge could be indicated by the potential of the cell. You showed C/80 maintaining the state of charge while C/160 did not. Were you trying to imply that by stabilization of the voltage you can maintain full capacity?

ROGERS: I want to make sure I understand the question. I think we're maintaining full capacity of the cell at those trickle charge rates. I don't mean that you can use the voltage to determine the state of charge.

DYER: Okay. But you're not changing the state of charge; you're saying if you don't have any change in the potential of the cell it's....

ROGERS: Yes. And while I didn't show it, the pressure gauge said the same thing.

DYER: Oh. Okay. The pressure gauge was steady.

ROGERS: I should have mentioned that.

DYER: Okay. That's important.

RITTERMAN (TRW): Just to clear up a few loose ends on that oxygen, nickel-oxygen-hydrogen situation, you start out with a nickel-oxygen cell. Now when the nickel electrode fails you've got an oxygen-hydrogen cell. So that at .36 you must have a nickel-oxygen cell. You've never going to have an oxygen-oxygen cell. You're discharging -- when the nickel electrode discharges it gasses hydrogen when it's completely discharged. When it's completely charged it gasses oxygen.

ROGERS: Yes.

RITTERMAN: So that you would get -1.4 after the nickel electrode exhausted. So when you're at -.36 you've got to have a nickel-oxygen in the system going.

ROGERS: That sounds correct. I haven't really thought about it that much, but that sounds right.

MAURER (Bell Labs): Two things:

On the nickel-oxygen question, if you really had a nickel-oxygen cell you would see a pressure rise due to the oxygen increase. Did you see that?

ROGERS: I don't recall.

MAURER: The other thing is that you showed that in a negative-limited cell you got no damage to the components. But that was negative-limiting because the hydrogen pressure had gone away by some means or another. You could have negative-limiting by other methods and still maintain hydrogen pressure in the cell; for example, the negative gets flooded or the electrode connection gets disturbed and then you could have a dangerous situation.

ROGERS: Let's see, could you have a dangerous situation?

MAURER: Now you could build up oxygen in the cell and in the presence of hydrogen which wasn't being recombined.

ROGERS: If you had a negative electrode that didn't recombine oxygen, yes, you could tend to build up oxygen.

MAURER: If it was flooded, for example, so that it couldn't recombine.

ROGERS: No, more than if it was flooded. If all the negatives were flooded and almost completely, because it doesn't take, I think as you noticed, a lot of negative electrode surface to recombine oxygen. And you have free diffusion of oxygen through a cell, especially with a zircar separator where there's just nothing stopping it. So that it would imply you had to have negative electrodes with no real amount of surface activity, and that's a little difficult to imagine because you can get to the negative from both directions. You'd have to flood not just the backing but also the active side of the electrode, and that's a hard thing to imagine short of somebody pouring a box of Tide in there.

DUNLOP (COMSAT): Two comments:

Back on that business about the trickle charge rate, if I took what you now said, or -- what I think you said is that at C/80 you were able to maintain the cell in the fully charged condition, and at C/120 you were not.

ROGERS: 160.

DUNLOP: C/160.

The other thing that has been discussed here a little bit in a slightly different way: we did have some cells on test a long time ago that were running on a continuous cycle basis, and I believe that one of the cells leaked over a three-day weekend gradually. We had a transducer on there that was recording pressure as well as currents and so forth. And we did tend to get into that situation where the hydrogen leaked down, so that it became negative-limited. So it went down, you consumed the hydrogen, and you made oxygen, pressure went back up. When you generated oxygen the limit went back down and you consumed the oxygen first and then you generated hydrogen, and it cycled back and forth in that mode for about -- we were running a three-hour cycle, and I think over that

weekend we put on 40 or 50 cycles that way.

ROGERS: It's an interesting test. I don't know if I would want to plan one like that.

DUNLOP: We didn't plan it either.

**TEMPERATURE COEFFICIENT OF CHARGE VOLTAGE**

HUGHES

- 25 A-HR LIGHTWEIGHT NICKEL-HYDROGEN CELL
- TEMPERATURE AT CELL FLANGE
- CHARGE TO ROLLOVER AT 0.75 C RATE AT 40°C
- TRICKLE CHARGE C/80 FOR 40 MIN
- CHARGE 0.75 C FOR 10 SEC; RECORD VOLTAGE
- REPEAT PROCEDURE AT 30°, 20°, 10°, AND 0°C

Figure 43-1

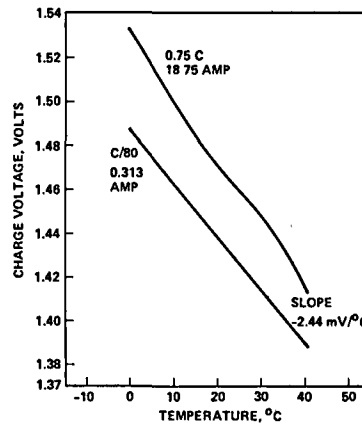

HUGHES

**TEMPERATURE COEFFICIENT OF VOLTAGE**

Figure 43-2

**STEADY STATE CHARGE VOLTAGE**

HUGHES

- 25 A-HR LIGHTWEIGHT CELL
- CELL VOLTAGE AS A FUNCTION OF CHARGE RATE AT FULL CHARGE
- CHARGE C/10 UNTIL VOLTAGE STABILIZES
- REPEAT AT C/40, C/80, AND C/160
- CELL FLANGE TEMPERATURE RANGE FROM 22° TO 28°C (AT C/10)
- ALL VOLTAGES CORRECTED TO 22°C (COEFFICIENT - 2.44 mV/°C)

Figure 43-3

**STEADY STATE CHARGE VOLTAGE AT 22°C**

HUGHES

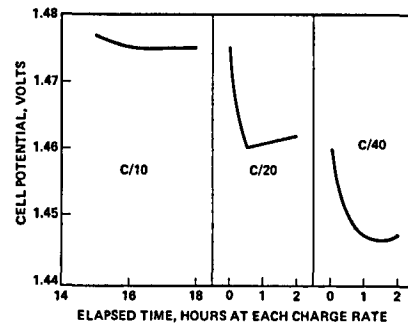

Figure 43-4

**STEADY STATE CHARGE VOLTAGE  
AT 22°C (CONT)**

HUGHES

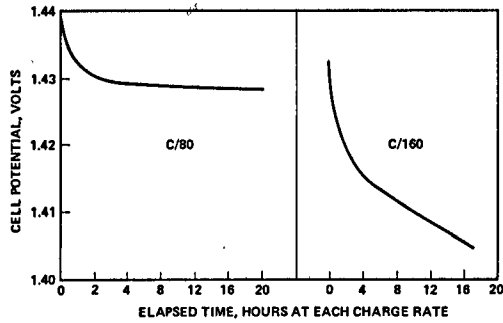

Figure 43-5

**LOW TEMPERATURE OXYGEN  
RECOMBINATION**

HUGHES

STANDARD OXYGEN RECOMBINATION TEST  
 25 A-HR LIGHTWEIGHT CELL  
 CHARGE C/2 15 MIN PAST VOLTAGE ROLLOVER  
 OXYGEN CONCENTRATION 0.19% AT -25°C  
 0.10 TO 0.15% AT 20°C  
 ABILITY OF O<sub>2</sub> ELECTRODE TO RECOMBINE OXYGEN  
 UNIMPAIRED AT -25°C

Figure 43-6

**TOLERANCE OF A NICKEL-HYDROGEN  
CELL TO INERT GAS**

HUGHES

**CELL**

- FLIGHT TYPE WITH VALVE AND GAGE
- POSITIVES – EAGLE-PICHER – AF PROCESS
- SEPARATOR – ZIRCAR ZYK-15
- NEGATIVES – HUGHES ETCHED Ni + Pt/TFE
- GAS SCREEN – POLYPROPYLENE
- RECIRCULATING DESIGN WITH ZIRCONIA WALL WICK

**PROCEDURE**

- 16 CONDITIONING CYCLES C/D = 1.1:1, 18 A-HR DISCHARGE LEO
- CAPACITY TEST
  - C/10 CHARGE
  - C/1 TO 1.0 VOLT
  - C/2 TO 1.0 VOLT

Figure 43-7

**CAPACITY TEST DATA**

HUGHES

TEST NO.	EOCP PSIA	C/1 A-HR	EODP A-HR	C/2 A-HR	EODP PSIA	PRECHARGE	
						H <sub>2</sub> PSIA	N <sub>2</sub> PSIA
1	435	20.2	190	0.78	185	65	0
2	465	19.6	205	0.42	185	75	8
3	475	19.7	215	0.46	210	65	50
CHARGE C/2 – 10 A-HR AND EVACUATE GAS							
4	295	12.2	165	1.35	115	0	65

Figure 43-8

## **SUMMARY AND CONCLUSIONS**

HUGHES

ONLY LARGE AMOUNT OF N<sub>2</sub> AFFECTS PERFORMANCE

40% N<sub>2</sub> REQUIRED AT "C" RATE

NO OBSERVABLE EFFECT AT 23% N<sub>2</sub>, EQUIVALENT TO  
AIR PRECHARGE AT 1 ATM

Figure 43-9

## **CELL REVERSAL UNDER NEGATIVE-LIMITED CONDITIONS**

HUGHES

DETERMINE EFFECTS OF OXYGEN GENERATION AT HYDROGEN  
ELECTRODE ON STACK COMPONENTS

BOILERPLATE CELL, 6 POSITIVES

CAPACITY, "C" RATE CHARGE, 1.4 C DISCHARGE, 12 CYCLES,  
1.10:1 RATIO, FINAL DISCHARGE TO 1.0 VOLTS, 7.00 A-HR

INITIAL TEST UNDER POSITIVE-LIMITED CONDITIONS

CHARGE "C" RATE TO ROLLOVER

DISCHARGE 0.73 C FOR 30 MINUTES PAST REVERSAL,  
EODV = 0.19 VOLTS

Figure 43-10

## **NEGATIVE-LIMITED REVERSAL**

HUGHES

CHARGE "C" RATE TO ROLLOVER

BLEED OFF 30% OF HYDROGEN

DISCHARGE 0.73 C FOR 5 MINUTES PAST REVERSAL.  
EODV = -0.36 VOLTS

CYCLING CAPACITY TEST, 7.27 A-HR

REPEAT, 60% OF HYDROGEN REMOVED

EODV = -0.33 VOLTS, CAPACITY 7.33 A-HR

DISASSEMBLY - NO OBSERVABLE DAMAGE TO COMPONENTS

Figure 43-11

NICKEL-HYDROGEN FLIGHT RELAY  
AND CELL SHORTING TEST

S. Stadnick

Hughes Aircraft

(Figure 44-1)

Basically what I'm going to talk about is the relay that we used on a standard flight configuration of Hughes' nickel-hydrogen cells. This relay is used in the event of an open circuit cell.

Now we've hypothesized but never seen that you can have a nickel-hydrogen cell which, in the flight configuration of a spacecraft, will develop a leak in the case. The cell would evaporate its electrolyte. The hydrogen would disappear and the cell would become open-circuited. At that point we would close the relay, and short-circuit around the cell.

We designed very carefully our electronic activation system, and tested our relays so that under no possible circumstances could the relay close on a fully-charged cell.

The immediate question that everyone asks is, "Well, what if it did, even though we have designed it so that it cannot possibly happen."

We ran the test, and basically took a fully charged nickel-hydrogen cell, put in our flight configuration wiring, our flight configuration relay, and then closed the relay. We measured cell voltage, current, pressure, and recorded all of the data.

We also had four thermocouples on the terminal where we have a screw type attachment threaded onto silver-plated copper lugs. We put a thermocouple on the dome of the cell, another thermocouple on the thermal flange.

(Figure 44-2)



Just discussing the test conditions, we basically use three sets of contacts on the relay and wire them in parallel. Each set of contacts is rated at 25 amps. And we used wiring which approximated our flight wiring. We measured the current with a DC amp meter.

Immediately prior to the test we measured the capacity of the cell since we also wanted to find out what happened to the cell, not only to the wiring and the relays. We did a standard capacity test for the nickel-hydrogen cell.

Immediately prior to the short test we charged the cell with a 25 amp-hour charge to full charge, and turned on the relay.

(Figure 44-3)

I'm not going to tell you what happened yet because we have one more Vu-graph which shows us our relay contact resistance as we measured it prior to the test, including the wire resistance. This is typical intercell wiring through the relay, and our total current path resistance is as it exists on the spacecraft.

(Figure 44-4)

Now here are the results.

Basically it's a little hard to see on here, but the important point, and the first one that everyone asks is what happens to the pressure in the nickel-hydrogen cell when you are discharging it at an 8 C. rate, which is what happened? The pressure decreased linearly as we would have expected. There was no maintenance or increase in pressure whatsoever. The cell terminal voltage remained approximately constant at a little more than one volt, which was fairly phenomenal for an 8 C. discharge.

Our current maintained itself at approximately a 7 to 8 C rate until we had exhausted some 80 percent of the total capacity within the cell. And then the voltage dropped down to complete the discharge. We discharged the cell all the way to zero volts.

(Figure 44-5)

In terms of the temperatures that were reached in the various components, the relay case temperature as you can see went up to 160 or so degrees Centigrade. The cell delivered approximately three times as much current through it as it was rated for.

(Figure 44-6)

We did a capacity test on the nickel-hydrogen cell and it had the same capacity after the test as before the test, and apparently suffered no ill effects whatsoever from its high rate discharge.

#### DISCUSSION

KUNIGAHALLI (Bowie State College): In the discharge curve I see a plateau. Could you please put on that Vu-graph?

(Figure 44-4)

On the right-hand side you see the voltage, and the discharge curve is not-- There's a knee and a plateau. Can you account for that?

STADNICK: Usually we account for that by calling it trapped or chemi-absorbed oxygen. The sharpness of this knee in here is artistic license from our graphics department. The real curve didn't look sharp like that.

KUNIGAHALLI: You mean to say the oxygen absorbed on the positive electrode?

STADNICK: It absorbed on the positive electrode. At a cell voltage below 1 volt, somewhere around .8, .7 volts it will be recombined and will be usable but inefficient capacity. And you'll see that on any nickel-hydrogen cell discharged through the approximate .8 volt range.

KUNIGAHALLI: Thank you.

STEINHAEUER (Hughes): I assume that wasn't a GEO 5

relay. Are you really proposing the use of relays for flight as opposed to diodes, and could you comment?

STADNICK: We are using relays for flight as opposed to diodes. The diode has a temperature delta which typically has been high. Just due to its resistive loss it generates too much heat in one particular area of our spacecraft. In the event that we would have to run current through it, we chose to use a relay instead of a diode.

MAURER (Bell Labs): Would you expect temperatures to be any different if you had done this in a vacuum?

STADNICK: Not very greatly different. There might be some minor differences but the thermal sinking that we did, we tried to make it as close as could be to normal spacecraft conditions, and the convection and conduction to the air I feel is fairly small during the five-minute discharge. I don't think it would be much different.

DYER (Bell Labs): Clearly the secondary plateau there is because your current is not constant during this discharge. You show indeed a plateau in the current as well. Isn't that simply reflecting the discharge rate, the plateau on the cell terminal voltage?

STADNICK: I think it's the other way around. The current is reflecting the drop in the voltage of the cell. This is through a constant approximate resistance.

ROGERS (Hughes): Perhaps maybe I can explain that a little more.

This is not, as is typical with most of the test work in nickel-hydrogen or nickel-cadmium for that matter, a constant current discharge. We're discharging into a gradually increasing resistance because of temperature effects increasing the temperature coefficient of copper.

So it's a little difficult to kind of define. If you start to try to analyze the curve it's a little difficult because the conditions are not as we normally see them.

BETZ (Naval Research Lab): A couple of questions.

If a relay were to go like that in orbit would you be able to unlatch it the other way?

STADNICK: The relay would not do this in orbit, shorting across a fully charged cell.

BETZ: Thank you.

STADNICK: The relays are commandable either in the open or closed conditions at our request.

BETZ: The other question is have you considered the possibility of fusing, rather than taking that kind of risk, just fusing the relay? Wouldn't you rather lose the protection circuitry due to an inadvertent relay latch that could conceivably happen, like an act of God maybe?

STADNICK: We did a tradeoff, debating whether that was likely or not, and of course if you had a fused cell and that cell did indeed become inoperative, you now have an open circuit.

BETZ: If you fuse the relay?

STADNICK: If you fuse the relay and your cell became an open circuit, you would have an inoperative circuit.

BETZ: Okay.

Could you mention what kind of relay that was? Do you remember what that was by any chance?

I'll ask you later.

## RELAY SHORTING TEST SCHEMATIC

HUGHES

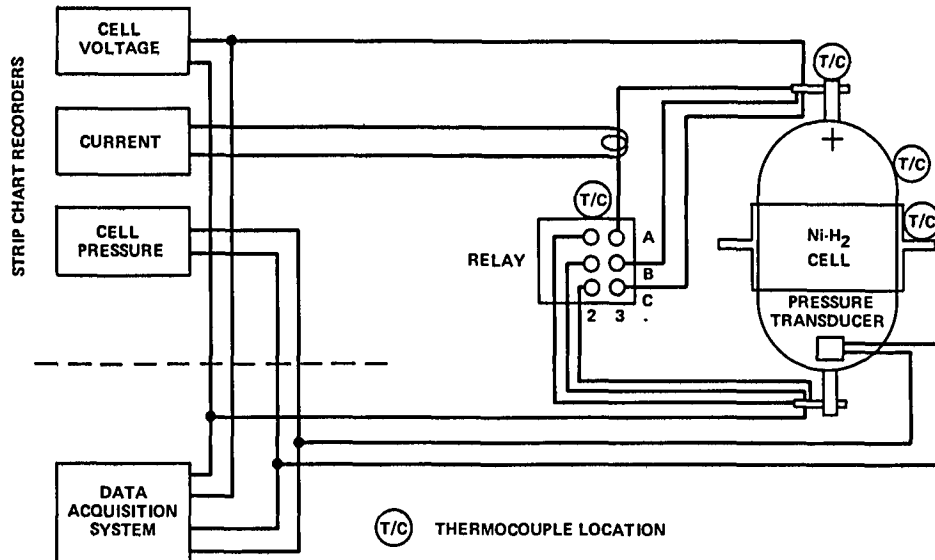

Figure 44-1

## TEST CONDITIONS

HUGHES

LIGHTWEIGHT 25 A-HR NICKEL-HYDROGEN CELL

MAGNETIC LATCH TYPE RELAY

- 3 CONTACTS, 25 AMP AT 28 VDC EACH, CONTINUOUS WIRING – NO. 16 TFE, 7 INCH PER LENGTH

CLIP ON DC AMMETER

- MODEL CG100A, F.W. BELL CO.

CALIBRATION WITH SHUNT – NOT USED FOR TEST

CAPACITY TEST

- 2.5 AMP CHARGE – 16 HOURS
- 12.5 AMP DISCHARGE TO 1.0 VOLTS
- AT ROOM TEMPERATURE

SHORT TEST

- 25 AMP CHARGE TO ROLLOVER
- TURN ON RELAY

Figure 44-2

# ELECTRICAL TEST RESULTS

HUGHES

RELAY CONTACT RESISTANCE  $2.9 \times 10^{-3}$  OHMS EACH

WIRE RESISTANCE – EACH LENGTH  $2.5 \times 10^{-3}$  OHMS

TOTAL CURRENT PATH RESISTANCE  $2.6 \times 10^{-3}$  OHMS  
AT ROOM TEMPERATURE

Figure 44-3

# RELAY SHORTING TEST ELECTRICAL AND PRESSURE DATA

HUGHES

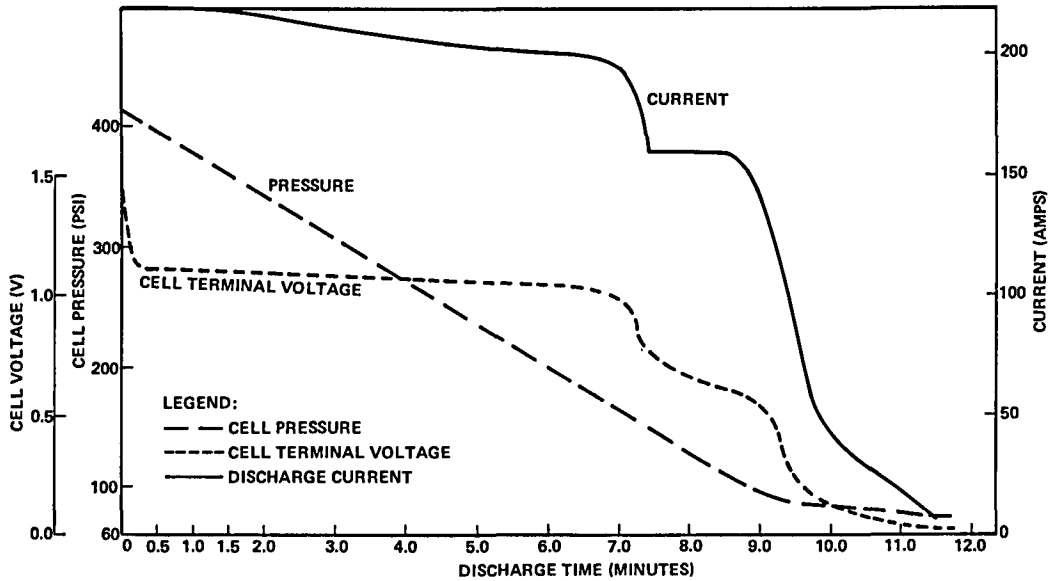

Figure 44-4

## RELAY SHORTING TEST TEMPERATURE DATA

HUGHES

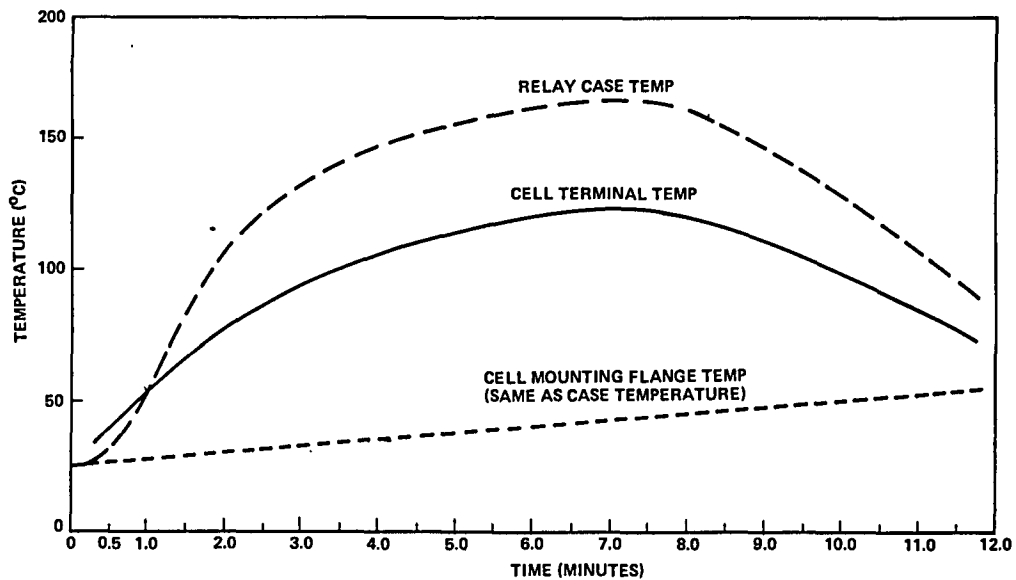

Figure 44-5

## TEST RESULTS

HUGHES

SOLDER ON RELAY TERMINALS FUSED

TFE INSULATION ON POSITIVE LEADS DECOMPOSED AFTER 30 SECONDS

RELAY STILL FUNCTIONAL AFTER TEST

NO EVIDENCE OF ANY CELL DAMAGE

NO LOSS IN CAPACITY

Figure 44-6

## NIH2 CELL TEST UPDATE

V. MUELLER

McDonnell Douglas

As the title implies, this is an update of some material I presented last year, where we talked about our testing through approximately 3000 cycles. We're now at about 9500 cycles on one cell, 7500 on the second cell; the third cell has failed.

These are the three cells that we have. They are three that were in a group provided to us by Don Warnock of the Air Force and were contained in the test. We intend to continue until we either run out of money or the cells fail, whichever occurs first.

(Figure 45-1)

Our testing is done in simulated low earth orbit, 90-minute cycles, 35 minutes of discharge, 55 minutes of charge. And ours is a conventional monotonous discharge characteristic, not with a programmed system.

The cells are mounted on a fixture which, in turn, is cooled by a temperature controlled coolant pad, which removes the heat from the cells.

As I said, one cell failed.

We had two cells with Zircar separators, one with asbestoes. One of the cells with the Zircar separator failed after 2500 cycles, roughly. And we have done a failure analysis on that cell.

We had a second problem where we developed a leak in our external plumbing. These cells were provided with AN fittings and valves, and we had those connected into pressure transducers. We developed a leak in the external manifold, and lost pressure on a second cell. We have since repressurized that, and we have returned it to cycling.

(Figure 45-2)



This is simply a plan diagram showing the three cells in the test fixture. The baseplate is 1-inch aluminum, and we circulate coolant around that baseplate. The standoffs are 60 mills thick aluminum alloy. And the numbers refer to thermocouples. We have thermocouples mounted on the three cells, coolant inlet at the top end and outlet at the bottom.

I might mention, also, those cells are wrapped with fiberglass insulation, so we have no convective cooling.

(Figure 45-3)

One of our interests was to see if we could charge these cells in the same manner that we now use in the Modular Power Subsystem for a nickel-cadmium cell. And so we have reconstructed here Levels 5 through 8 of the standard power regulator unit in the MPS. Because you need slightly higher charge voltages for a nickel-hydrogen cell, we have constructed three more levels: they're simply our own invention, and they're just offset from the three lower levels at 20 millivolt separation between levels.

These VT levels are set manually by the test engineer; in other words, he reads the temperature and sets the voltage accordingly.

(Figure 45-4)

Now this is a typical performance cycle on our Cell No. 1. This has been cycled practically since the beginning, at 50 percent DOD. We did do 500 cycles at 25 percent DOD. And this is a typical cycle after we have done the repressurization. We did have a pressure buildup prior to the pressure loss, and after we repressurized we returned to the initial pressure, roughly. As you can see, at 50 percent DOD we charge at roughly 50 ampere constant current until we hit the voltage limit, and then we go into a taper charge.

(Figure 45-5)

This is the same type of information for Cell No. 3. This is the one with a Zircar separator. And on this one we have seen a pressure creep-up. We're now over

1000 psi. I believe we started around 750 or 800. We're currently operating at 50 percent depth of discharge; that's what this cycle is. And the initial charge here is 60 amperes to voltage limit, and then taper off.

(Figure 45-6)

I've plotted the end-of-discharge voltage versus the cyclic history for Cell No. 1, and we're currently at 7500 cycles, and my last data point is at about 7000 cycles. I didn't present any data below 2000 cycles. You can refer to our presentation last year.

All of these cycles are done at a nominal temperature of 23 degrees Centigrade.

We started with Level 8, 50 percent depth of discharge. That seemed to be a little too low, due to voltage problems, and we went to Level 9, then, to 3000 cycles. Our return factor, the ratio of ampere-hours in to ampere-hours out, was rather high, and we wanted to back that off somewhat. So we lowered it to Level 8-1/2, an artificial 8-1/2. And at a later time we found, again, that our return factors levels had dropped to 1.04, so we went back to Level 9, and we're continuing at that level.

(Figure 45-7)

This is a plot of the ampere-hour return factor corresponding to the previous plot. And, as you can see, we're now operating at around 1.04.

(Figure 45-8)

The same information for Cell No. 3. Cell No. 3 we operated initially at 80 percent depth of discharge based on 50 ampere-hours. And we had two cells in series, to begin with. One of the cells has failed. And we had a problem with the second cell reaching one volt cutoff voltage during cycling. We had to back off on the depth of discharge. We had backed off to 70 percent depth of discharge right around 2000 cycles, and we had to back off further to 60 in order to keep Cell 2 from dropping out at the low voltage.

After the one cell failed, we didn't change the

depth of discharge, but we did later: at slightly over 3000 cycles we went back to 70 percent depth of discharge. We continued that way for a while, and we got into a problem again with voltage level, end-of-discharge voltage, and we went to 60 percent. And we're now at 50 percent depth of discharge.

Our cycling system has an automatic cutoff: if you get below one volt during discharge, it will turn itself off.

(Figure 45-9)

Here is the ampere-hour return factor as a function of cycles. We're now running around 1.06. We were trying to get around 1.08 to 1.12, which seemed to be about the best level.

(Figure 45-10)

Here I've just plotted the capacity for all three cells since we've started. Cell No. 2, the cell that failed, is represented by the little squares, and at Cycle 2470 it failed. This was the last capacity check before failure.

The cell performed normally during our capacity discharge, but when we tried to recharge after we had completed that cycle it would not accept a charge, and it was shorted, exhibited a shorting characteristic.

Cell No. 1, which is the one with the asbestoes separator, held the capacity rather well at the beginning. Then we had a rather severe dropoff: I don't really know why: and at Cycle 6200 is where we had the loss of pressure. And we did two intermediate capacity discharges between Cycles 6000 and 7000, and I didn't plot them because they did appear to be anomalous, but I'll talk about those later when we talk about the loss of pressure.

Cell No. 3, which is the Zircar separator, seems to fairly monotonously decrease. We have a capacity now of roughly 30 ampere-hours.

(Figure 45-11)

I'm talking here about the failure analysis we did on Cell S/N 133, or Cell No. 2. As I said, it failed after 2473 cycles, we were doing capacity discharge, everything seemed fine until we tried to recharge, and it was shorted at that time.

This has a single-layer Zircar separator. When we took it apart, it looked very well; there was no obvious evidence of mechanical short by looking externally at the stack, and we did some voltage measurements. The short disappeared as soon as we loosened the nut which compresses the stack. So it was not a very hard short at all.

When we took the stack apart, we did find two areas that seemed to be shorted. We found a little mound of positive material, and we think that caused the short.

We understand that Hughes has done some tests where they have looked at positive material, and it appears to be non-conductive for at least 1500 cycles. So we're postulating that possibly this anomaly formed early and in the process of cycling was reduced to nickel.

A third area showed some damage, but it didn't appear to be shorted. And we saw evidence of the rapid recombination of oxygen. We found pits and burn holes in the gas screens and negatives.

(Figure 45-12)

This is just a diagram showing one of the areas, and I guess this is the most severely damaged area. There was a hole burned completely through the gas screen, the negative and the separator. The mound shown on the positive plate appeared to extend from the positive to the negative. And there was a small amount of positive material deposited on the Positive No. 13. And, as I said, a hole completely through the gas screen, the negative and the separator.

(Figure 45-13)

This is another area where there was a mound on the positive, and there did appear to be shorting, a complete bridge between the Positive No. 19 to the Negative No. 20, with a hole burned in the gas screen.

(Figure 45-14)

This is a third area that showed some evidence of damage. However, there didn't appear to be a complete bridge here; evidently some heat. There's a hole in the separator and in one of the positives.

(Figure 45-15)

As I mentioned earlier, we lost pressure in one of the cells due to a leak in the external plumbing. It developed rather quickly; I don't really understand why. We looked at the pressure-versus-time plot for this particular cycle, and we completely lost pressure in a space of about thirty minutes. And on the next cycle it caused an undervoltage shutdown when we discharged.

We left the cell in the test set-up with the internal pressure near zero for about ten weeks. Initially it was open circuited, and then we shorted it for another three weeks. And I guess after this short we tried an initial attempt at repressurization by pressurizing to 50 psi. The pressure dropped very rapidly. When we put in 50 psi it almost immediately fell to zero. And the cell appeared hot to the touch. We didn't really know what was happening. We looked around for a hydrogen leak, but we didn't find any. We did some additional leakage tests to confirm that we did have gas integrity in the cell and in the external plumbing. Over a period of a number of weeks; in fact we went from early July to about the end of August; periodically putting in 50 psi of hydrogen, and watching it bleed off, until finally we reached roughly a steady condition.

At that time we recharged the cell by charging at 5 amps for 24 hours. Immediately after that recharge we did a capacity check at C/2 to 1 volt per cell, and we measured 57-1/2 ampere-hours; which was considerably more than we had ever seen. And we can't account for that.

We then thought we would work a little easier for at least the first portion of cycling, so we went to 20 percent depth, and we did 93 cycles at 20 percent depth, after which we measured the capacity again. At that time we measured 38 ampere-hours. At that time we went to our normal 50 percent depth of discharge cycling in low earth.

orbit, and after we had completed an additional 681 cycles, or at 7000 cycles, we measured 29 ampere-hours.

As I mentioned, we intend to keep on cycling these cells, and we're now at about 9500 cycles on one of the cells and 7500 cycles on the second.

Thank you very much.

#### DISCUSSION

ROGERS (Hughes Aircraft): I'll answer the most obvious point that you just made about that cell that had hydrogen bugs in it that ate it, apparently. If all you had was a shorted cell with a fully-charged, or somewhere near fully-charged positive, without any hydrogen in it there was no way to discharge. As soon as you put the hydrogen in it's like a shorted cell. You know, with hydrogen it is almost like that experiment that Steve talked about.

And so of course it got hot, and by adding it incrementally it prevented overheating and got the positive electrode discharge.

MUELLER: I don't quite understand, Dr. Rogers. The cell was shorted, you say?

ROGERS: I'm only judging from what I saw. Apparently you had a shorted cell, at least at that time. By putting hydrogen into a cell which had no hydrogen in it but had a positive electrode which was charged, you immediately discharge it through that short.

MUELLER: I see.

ROGERS: So that would continue until you had the positives completely discharged.

In other words, you had to add the normal amount of hydrogen back in, in effect. That's what it appears from what data I see there.

MUELLER: It seems to be cycling normally now.

PICKETT (Hughes Aircraft): Did you do an analysis of the material between the plates which apparently caused

the short?

MUELLER: No, we did not.

STOCKEL (COMSAT): Did you analyze the electrolyte in the cell?

MUELLER: No. It was strictly a mechanical dissection and visual examination.

## NI H<sub>2</sub> CELL CYCLIC TEST PROGRAM

- o THREE CELLS AUTOMATICALLY CYCLED IN SIMULATED LOW EARTH ORBIT (35 MINUTE DISCHARGE, 55 MINUTE CHARGE)
- o CHARGING IN VOLTAGE-LIMITED, TEMPERATURE-COMPENSATED MODE
- o TEMPERATURE CONTROLLED COOLANT BATH REMOVES HEAT FROM CELL MOUNTING FIXTURE
- o ONE CELL WITH ZIRCAR SEPARATOR FAILED (SHORTED) AFTER 2473 CYCLES
- o FAILURE ANALYSIS PERFORMED ON SHORTED CELL
- o LEAK IN EXTERNAL PLUMBING CAUSED SHUT DOWN OF SECOND CELL AT CYCLE 6229
- o CELL REPRESSURIZED AND RETURNED TO CYCLING
- o TWO CELLS (ONE WITH ZIRCAR AND ONE WITH ASBESTOS SEPARATOR) CONTINUE TO CYCLE

Figure 45-1

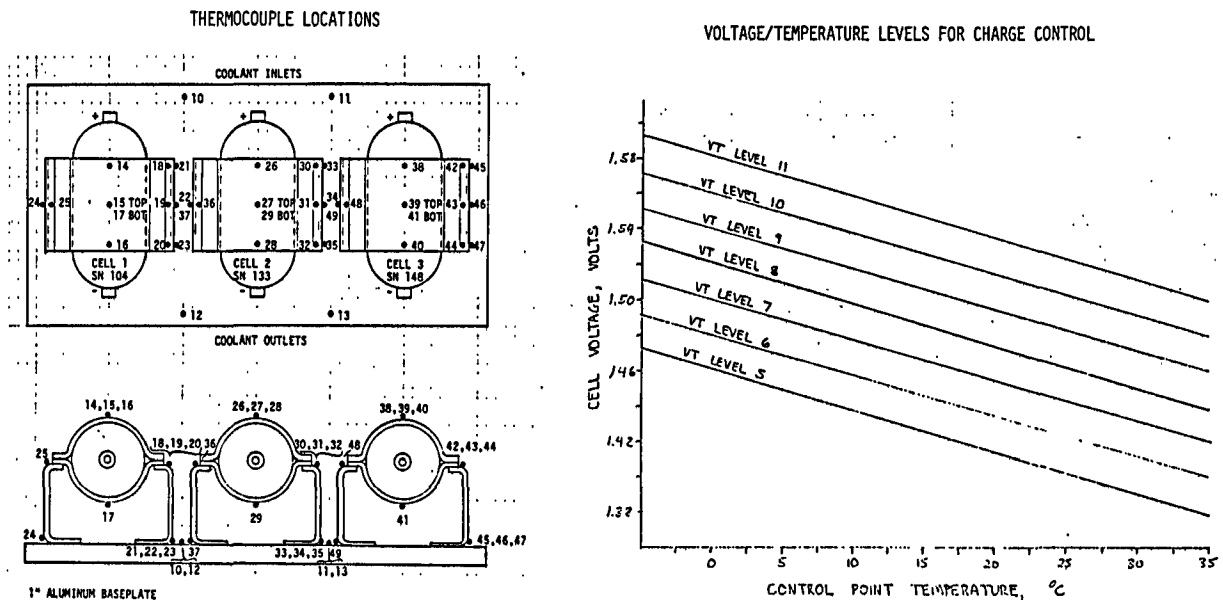

Figure 45-3



TYPICAL PERFORMANCE DATA - CELL 1

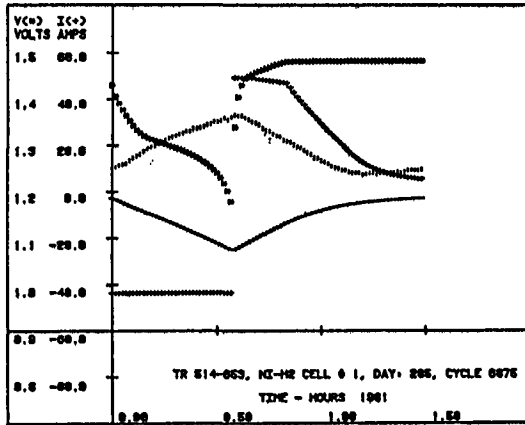

Figure 45-4

TYPICAL PERFORMANCE DATA - CELL 3

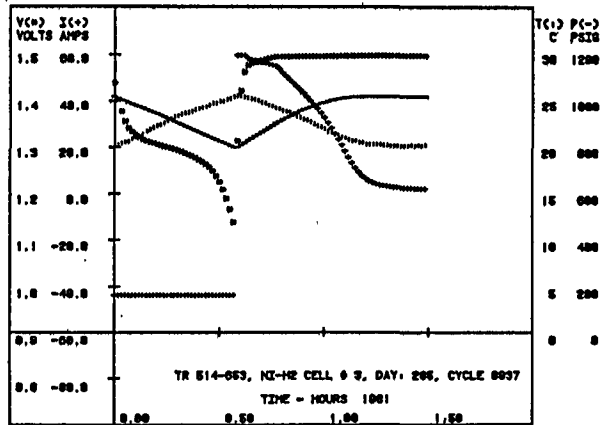

Figure 45-5

END OF DISCHARGE VOLTAGE VS CYCLES - CELL 1

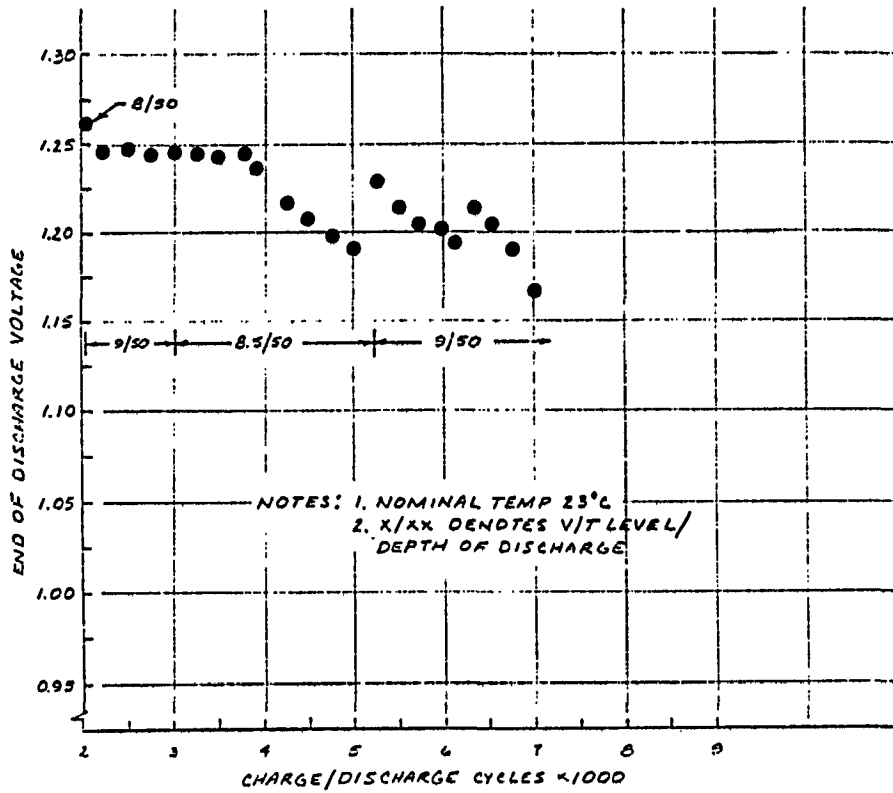

Figure 45-6

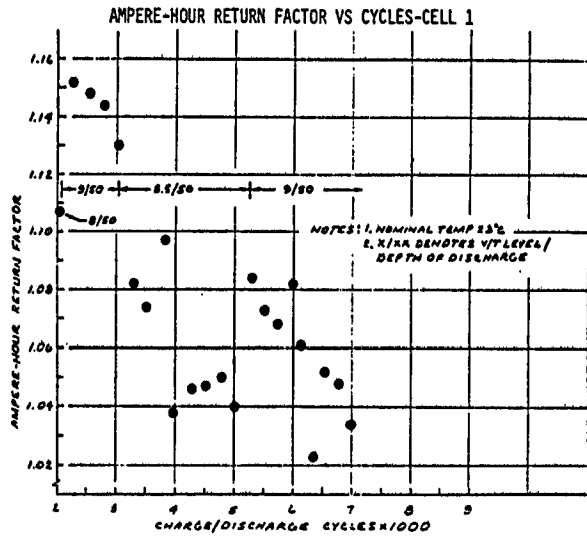

Figure 45-7

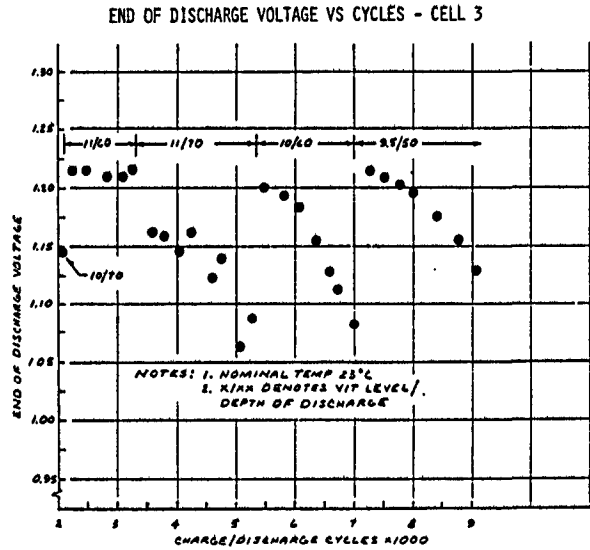

Figure 45-8

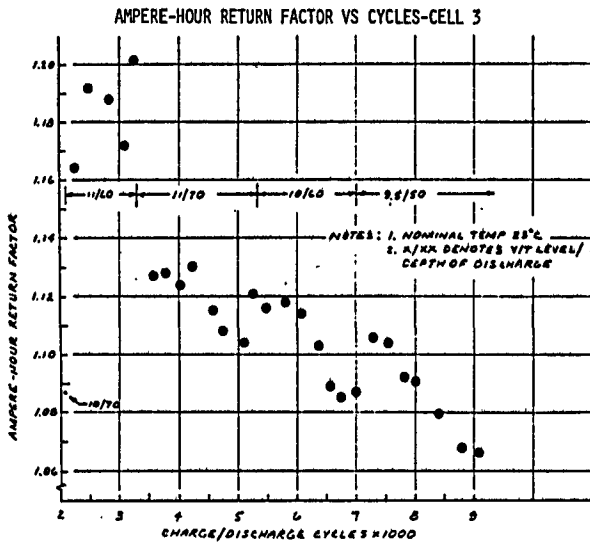

Figure 45-9

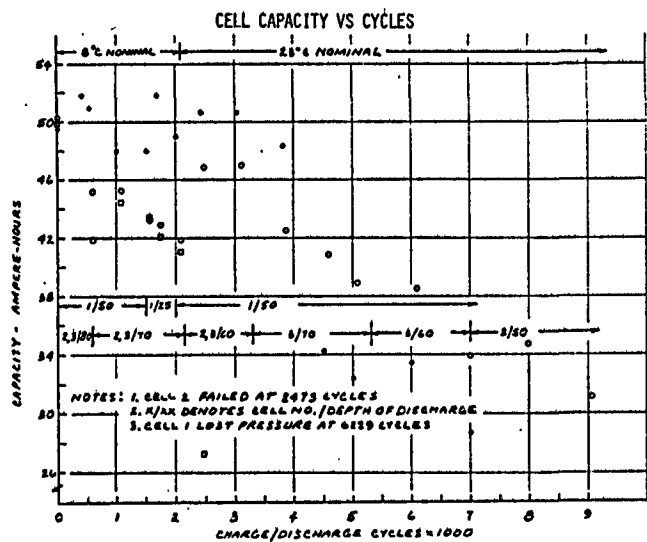

Figure 45-10

FAILURE ANALYSIS OF NICKEL-HYDROGEN CELL S/N 133

**BACKGROUND:**

- o CELL FAILED AFTER 2473, 90-MINUTE CHARGE/DISCHARGE CYCLES
- o PRIOR TO FAILURE, CELL EXHIBITED LOW END-OF-DISCHARGE VOLTAGE AND SIGNIFICANT CAPACITY LOSS
- o DEVELOPED INTERNAL SHORT FOLLOWING OTHERWISE NORMAL CAPACITY CHECK
- o SINGLE-LAYER ZIRCAR SEPARATOR

**OBSERVATIONS:**

- o NO OBVIOUS EVIDENCE OF MECHANICAL SHORTS FROM EXAMINATION OF STACK ASSEMBLY
- o SHORT DISAPPEARED WHEN STACK COMPRESSION WAS RELIEVED
- o DISASSEMBLY OF STACK REVEALED TWO AREAS WHICH MAY HAVE SHORTED IF MOUND OF POSITIVE MATERIAL FOUND IS CONDUCTIVE
- o A THIRD AREA SHOWED SOME DAMAGE, BUT DID NOT APPEAR TO BE SHORTED
- o GAS SCREENS AND NEGATIVES SHOW TINY BURN HOLES FROM RAPID OXYGEN RECOMBINATION
- o TINY PITS SEEN ON BOTH SIDES OF SOME POSITIVES

Figure 45-11

SIGNIFICANT ANOMALY - CELL 2 FAILURE ANALYSIS

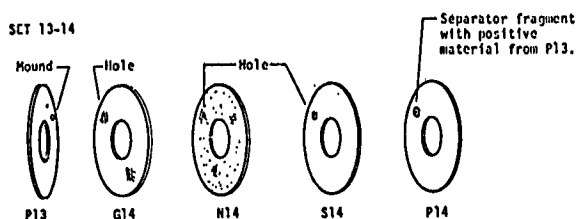

- NOTES: 1. STACK ELEMENTS NUMBERED CONSECUTIVELY BEGINNING AT WELD RING END.  
 2. P-POSITIVE ELECTRODE, G-GAS SCREEN, N-NEGATIVE ELECTRODE, S-SEPARATOR.  
 3. P13 DENOTES POSITIVE ELECTRODE NO. 13.

Figure 45-12

SIGNIFICANT ANOMALY - CELL 2 FAILURE ANALYSIS

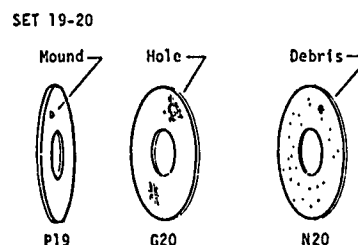
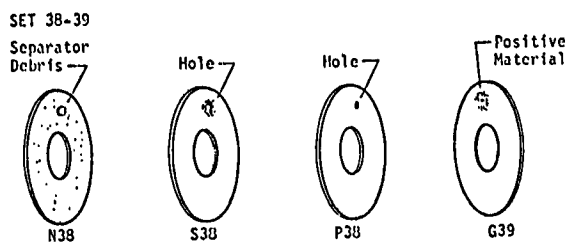

Figure 45-13

SIGNIFICANT ANOMALY - CELL 2 FAILURE ANALYSIS



- NOTE: POSITIVE MATERIAL DID NOT APPEAR TO EXTEND TO NEGATIVE ELECTRODE.

Figure 45-14

#### CELL PRESSURE LOSS AND RETURN TO CYCLING

- o LEAK OCCURRED IN EXTERNAL PLUMBING DURING CYCLE 6229 WHICH SUBSEQUENTLY CAUSED UNDERVOLTAGE SHUTDOWN
- o CELL LEFT IN TEST SETUP WITH INTERNAL PRESSURE NEAR ZERO FOR APPROXIMATELY 10 WEEKS; OPEN CIRCUITED INITIALLY, SHORTED FINAL 3 WEEKS
- o DURING INITIAL ATTEMPT AT REPRESSURIZATION, PRESSURE DROPPED RAPIDLY AND CELL WAS HOT TO TOUCH
- o ADDITIONAL LEAKAGE TESTS PERFORMED TO CONFIRM CELL AND EXTERNAL PLUMBING INTEGRITY
- o SUBSEQUENTLY INTRODUCED HYDROGEN INCREMENTALLY UNTIL STABLE PRESSURE RESULTED
- o REMOVED SHORT AND RECHARGED AT 5 AMPERES FOR 24 HOURS
- o CAPACITY CHECK RESULTED IN ABNORMALLY HIGH CAPACITY OF 57.5 AMPERE-HOURS
- o PERFORMED 93, 90-MINUTE CYCLES AT 20% DEPTH OF DISCHARGE
- o CAPACITY THEN MEASURED 38.7 AMPERE-HOURS
- o RETURNED TO CYCLING AT 50% DEPTH OF DISCHARGE
- o AFTER 681 ADDED CYCLES (7003 TOTAL), CAPACITY MEASURED 28.8 AMPERE-HOURS

Figure 45-15

**Page intentionally left blank**

NICKEL SYSTEM MANUFACTURING UPDATE

L. Miller

Eagle Picher

I called Gerry Halpert several weeks ago and I said, "Gerry, I want to speak at the upcoming B Workshop."

And he said, "Okay, but under two conditions. First," he said, "I want you to tell us something, not try to sell us something. And second, I want you to be very brief."

Well, we're going to have a brief presentation.

(Laughter.)

To be consistent with a number of other papers that have been presented here this afternoon, the title of my paper also has little to do with what I'm going to talk about.

(Laughter.)

I'd like to show you some trend data as it relates to electrochem-impregnated positive electrodes used in various battery systems. What I'd like to get back from this is for someone else to say, "Yes, we see this," or "No, we have not seen this."

To give you a little background, we've been using the electrochem positive electrode in nickel-hydrogen probably for six or seven years with very good results, primarily because of the dimensional stability and the high electrical utilization of the active material.

It would seem reasonable that you could take the same electrode, put them in nickel-cad and achieve the same advantages. Let me show what we've seen when we've done this.

(Figure 46-1)

Again this is just basic trend data. We haven't been into the nickel-cad portion of it long enough to really

be definitive. But what we see is that in the nickel-hydrogen you get very good utilization in the final sealed state versus nickel-cadmium.

I probably need to clarify this point. When we design a LEO cell, we put more electrolyte into it than a GEO cell design. The utilization of the electrode is going down as you go into these lower electrolyte systems.

I could have drawn another curve on there. If you run flooded electric capacity tests for all three of these cells, you would have a curve that would start right here (nickel-hydrogen data point) and come flat across like this.

So apparently what we're looking at is an electrolyte sensitivity associated with this electrode.

The X axis is not really correct. It's correct with respect to the GEO and the LEO ni-cad cell but then when you get up to the nickel-hydrogen (in terms of absolute volume of electrolyte in the cell), it's not correct. It actually reverses direction.

But what I think it's saying is we should really be interested in the true distribution of electrolyte in the cell.

There definitely seems to be a correlation between electrolyte, electrical utilization and the system.

Like I said, I'm trying to be very brief, so thank you.

ELECTROCHEMICAL DEPOSITION  
POSITIVE ELECTRODE  
PERFORMANCE TREND

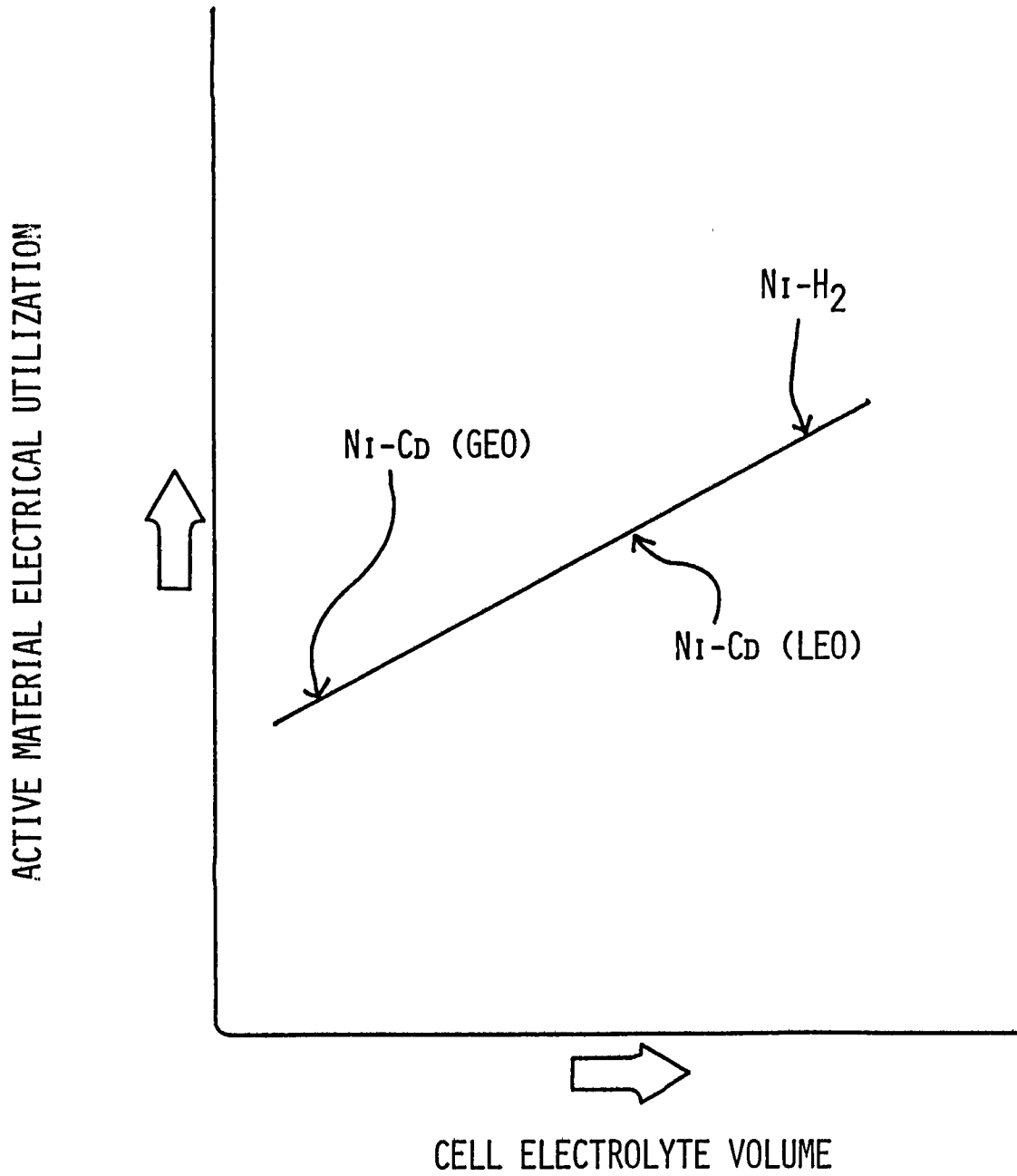

EAGLE EP Picher



**Page intentionally left blank**

1981 GSFC BATTERY WORKSHOP  
LIST OF ATTENDEES

Dr. Kathleen M. Abbey  
NASA/Lewis Research Center  
Brookpark Road  
Cleveland, OH 44135  
(216) 433-4000, Ext. 313

Ervin Adler  
Hughes Aircraft  
P.O. Box 92919  
Los Angeles, CA 90009  
(213) 647-8190

Frank Alliegro  
RCA Astro-Electronics  
P.O. Box 800  
Princeton, NJ 08540  
(609) 448-3400

George Allvey  
SAFT Corporation  
107 Beaver Court  
Cockeysville, MD 21030  
(301) 667-0693

Walter Alsbach  
International Telecommunications  
Satellites  
490 L'Enfant Plaza, S.W.  
Washington, DC 20024  
(202) 488-2638

Dr. Judith H. Ambrus  
NASA RTS-6  
600 Independence Ave.  
Washington, DC 20546  
(202) 755-3278

W. Andruk  
Power Conversion, Inc.  
70 MacQuesten Parkway, S.  
Mt. Vernon, NY 10550

Isaac A. Angres  
Department of Defense  
Washington, DC  
(202) 965-3517

Philippe Antoine  
SAFT-Division Aerospatiale  
156 Avenue de Metz  
Romainville, France 93230  
1-843-9361

Jon D. Armantrout  
Lockheed Missiles & Space Co.  
1111 Lockheed Way 0/62-16 B/151  
Sunnyvale, CA 94086  
(408) 743-2614

Dr. J.J. Auburn  
Bell Laboratories  
Rm. 1A-317  
Murray Hill, NJ 07974  
(201) 582-4263

Charles Badcock  
Aerospace Corporation  
P.O. Box 92957  
Los Angeles, CA 90009  
(213) 648-5180

David Baer  
NASA/GSFC  
Code 711.2  
Greenbelt, MD 20771  
(301) 344-6691

Arien Baldwin  
Sandia National Labs  
Div. 2523, P.O. Box 5800  
Albuquerque, NM 87185  
(505) 844-5341

Wilbert L. Barnes  
Naval Research Lab.  
Code 7048  
Washington, DC 20375  
(202) 767-2635

Philip W. Barnhart  
JHU/APL  
Johns Hopkins Road  
Laurel, MD 20707  
(301) 953-7100

M.P. Bernhardt  
Bell Labs  
Mountain Ave.  
Murray Hill, NJ 07974  
(201) 582-3749

E.R. Berry  
Aerospace Corp.  
P.O. Box 92957  
Los Angeles, CA 90009  
(213) 648-6273

Frederick E. Betz  
Naval Research Laboratory  
Code 7710  
Overlook Ave., S.W.  
Washington, DC 20375  
(202) 767-2635

Tom Bierman  
Honeywell Inc.  
104 Rock Road  
Horsham, PA 19044  
(215) 674-3800

Samuel Birken  
Aerospace Corporation  
P.O. Box 92958, Bldg. D8  
Los Angeles, CA 90009  
(213) 648-6080

Frank Bis  
NSWC  
Code R-33, White Oak  
Silver Spring, MD 20910  
(301) 394-1299

Larry Blagdon  
Honeywell  
104 Rock Road  
Horsham, PA 19044  
(215) 674-3800

Ernest Blase  
R&D Assoc.  
1401 Wilson Blvd.  
Arlington, VA 22209  
(703) 522-5400

Carole A. Bleser  
Eagle-Picher Ind.  
3820 South Hancock Exp.  
Colorado Springs, CO 80931  
(303) 392-4266

R. Sam Bogner  
Hughes Aircraft  
P.O. Box 92919  
Los Angeles, CA 90009  
(213) 648-3755

Frederic M. Bowers  
11817 Indigo Rd.  
Silver Spring, MD 20906  
(301) 946-9361

Gerard H. Boyle  
GTE Products Corp.  
520 Winter St.  
Waltham, MA 02254

B.J. Bragg  
Mail Code EP5  
NASA-Johnson Space Center  
NASA Rd. 1  
Houston, TX 77058  
(713) 483-6491

A.O. Britting, Jr.  
Martin Marietta Aerospace  
Jet Propulsion Laboratory  
MS 230-114  
4800 Oak Grove Drive  
Pasadena, CA 91103  
(213) 354-7826

Richard Broderick  
NASA/GSFC  
Code 711.1  
Goddard Space Flight Center  
Greenbelt, MD 20771  
(301) 344-5964

Mrs. Irina Brodksy  
Bowie State College  
Bldg. 11, Room 208, GSFC  
Greenbelt, MD 20771  
(301) 344-5751

Robert B. Byrnes  
U.S. Army  
4316 San Carlos Dr.  
Fairfax, VA 22030  
(703) 273-9583

Gabriel Castro  
SAFT SCURE  
200 Wight Ave.  
Cockeysville, MD 21300  
(301) 666-3200

Larry Chine  
Gates Energy Products  
P.O. Box 5887  
Denver, CO 80210  
(303) 744-5018

R. Chireau  
Power Conversion, Inc.  
70 MacQuesten Parkway, S.  
Mt. Vernon, NY 10550  
(914) 699-7333

S.M. Chodosh  
Power Conversion, Inc.  
70 MacQuesten Parkway, S.  
Mt. Vernon, NY 10550  
(914) 699-7333

D. Chua  
Honeywell Power Sources Center  
104 Rock Road  
Horsham, PA 19044

Lee Coleman  
Utah Research & Development  
Co., Inc.  
P.O. Box 26297  
1820 S. Industrial Road  
Salt Lake City, UT 84126-0297  
(801) 972-5444

John A. Constantineau  
Pellon Corp., Ind. Prod. Div.  
20 Industrial Ave.  
Chelmsford, MA 01824  
(617) 256-6588

Dennis B. Cooper  
INTELSAT  
Room 8076  
490 L'Enfant Plaza, S.W.  
Washington, DC 20024  
(202) 488-0176

Glenn F. Cruze  
Duracell International, Inc.  
South Broadway  
Tarrytown, NY 10591  
(914) 591-7000

F.S. Cushing  
Exide Corporation  
19 West College Ave.  
Yardley, PA 19067  
(215) 493-7189

Chester Dacres  
Naval Surface Weapons Center  
Silver Spring, MD 20910  
(301) 394-1109

Dr. James F. Dalby  
SBS  
8283 Greensboro Dr.  
McLean, VA 22102

Ivan F. Danzig  
U.S. Army Scientific Liaison and  
Advisory Group  
The Pentagon  
Washington, DC 20310  
(202) 695-3516

Robert A. DePaul  
INCO Research & Development  
Center  
Sterling Forest  
Suffern, NY 10901  
(914) 753-2761, Ext. 257

Salvador DiStefano  
Jet Propulsion Laboratory  
4800 Oak Grove Dr.  
Pasadena, CA 91109  
(213) 354-6320

James Dunlop  
COMSAT Labs  
22300 Comsat Dr.  
Clarksburg, MD 20871  
(301) 428-4545

C.K. Dyer  
Bell Laboratories  
600 Mountain Ave.  
Murray Hill, NJ 07974  
(201) 582-3265

Mr. Martin Earl  
COMSAT Labs  
22300 Comsat Dr.  
Clarksburg, MD 20871  
(301) 428-4503

Walter B. Ebner  
Honeywell Power Sources Center  
104 Rock Road  
Horsham, PA 19044  
(215) 674-3800

Robert R. Eliason  
Lockheed  
Bldg. 153, P.O. Box 504  
Sunnyvale, CA 94086  
(408) 742-4470

Rex Erisman  
Eagle-Picher Industries, Inc.  
"C" & Porter, P.O. Box 47  
Joplin, MO 64802  
(417) 623-8000

Ralph A. Feldhake  
Ray-O-Vac  
630 Forward Drive  
Madison, WI 53711  
(608) 271-5454

W.A. Ferrando  
Naval Surface Weapons Center  
Bldg. 24-9  
New Hampshire Avenue  
Silver Spring, MD 20910  
(301) 394-2730

Ensign Frederic P. Flight  
NSWC  
Qts. 6, Porter Rd.  
Annapolis, MD 21413  
(301) 268-5208

John A. Flyzik  
RCA Service Company  
P.O. Box 666  
Bellevue, NB 68005  
(402) 291-3745

Pierre G. Fougere  
SAFT-Division Aerospatiale  
156 Avenue de Metz  
Romainville, France 93230  
(1) 843-9361

Harvey Frank  
Jet Propulsion Laboratory  
4800 Oak Grove Dr.  
Pasadena, CA 91103  
(213) 354-4157

David Frankel  
TADIRAN, Box 75, Rehovot  
Rehoveth, Israel  
(054) 5005

C.A. Freeman  
NSWC  
Code R-33, White Oak  
Silver Spring, MD 20910  
(301) 394-1146

J.A. Fynes  
Foote Mineral Co.  
Route 100  
Exton, PA 19341  
(215) 363-6500

Ed Gaddy  
NASA/GSFC  
Code 711.2  
Greenbelt, MD 20771  
(301) 344-6202

Anthony K. Galassi  
Hughes Aircraft Company  
P.O. Box 339  
Springfield, VA 22150  
(703) 664-9602

Stephen J. Gaston  
RCA Astro-Electronics  
P.O. Box 800  
Princeton, NJ 08540  
(609) 448-3400, Ext. 2559

Franz Goebel  
GTE  
520 Winter St.  
Waltham, MA 02154  
(617) 890-9200

H.R. Grady  
Foote Mineral Co.  
Route 100  
Exton, PA 19341  
(215) 363-6500

Donald Green  
C&D Battery Co.  
Washington & Cherry Sts.  
Conshohocken, PA 19428  
(215) 825-2150

H. Gerald Gross  
G&W/H.Koch & Sons  
5410 E. LaPalma Ave.  
Anaheim, CA 92807  
(714) 779-2003

Sid Gross  
Boeing Aerospace Co.  
P.O. Box 3999  
Seattle, WA 98124  
(206) 773-1381

G. Gutmann  
Mercedes Benz  
1 Mercedes Dr.  
Montville, NJ 07645  
(201) 573-2722

Kenneth M. Haag  
Martin Marietta  
P.O. Box 179  
Denver, CO 80261  
(303) 977-4977

Douglas Hafen  
Lockheed MSC  
D/62-15, B/151, P.O. Box 504  
Sunnyvale, CA 94086  
(408) 742-4371

Orrington R. Hall  
NOAA/NESS  
Rm. 0251, FOB-4  
Suitland Fed. Ctr.  
Washington, DC 20233  
(301) 763-1980

Gerald Halpert  
NASA/GSFC  
Code 711.2,  
Greenbelt, MD 20771  
(301) 344-5752

Alan Harkness  
Ballard Research  
1164 15th St. West  
N. Vancouver, B.C.  
Canada V-7-P-IM9  
(604) 986-4104

James D. Harkness  
Naval Weapons Support Center  
Bldg. 2919, Code 3053  
Crane, IN 47522  
(812) 854-1593

Lewis G. Harriman III  
Cargocaire Engineering Corp.  
79 Monroe St.  
Amesbury, MA 01913  
(617) 388-0600

Albert F. Heller  
The Aerospace Corporation  
Bldg. D8, Rm. 1102F,  
P.O. Box 92957  
Los Angeles, CA 90009  
(213) 648-6858

A.G. Hellfritsch  
608 Winona Court  
Silver Spring, MD 20902  
(301) 649-2664

E.A. Hendee  
Telesat Canada  
333 River Rd.  
Ottawa, Ontario  
Canada K1L8B9  
(613) 746-5920

Thomas J. Hennigan  
T.J. Hennigan, Associates  
900 Fairoak Ave.  
W. Hyattsville, MD 20783  
(301) 559-0613

Robert Higgins  
Eagle-Picher Industries, Inc.  
"C" & Porter, P.O. Box 47  
Joplin, MO 64802  
(417) 623-8000

Jim Hill  
Eagle-Picher  
3820 S. Hancock  
Colorado Springs, CO 80911  
(303) 392-4266

Albert Himy  
Navy Dept. (NAVSEA)  
Code 5433  
Washington, DC 20362  
(202) 692-6794

H. Peter Hirschler  
Vitro Laboratories  
Bldg. 127  
Naval Underwater Systems Ctr.  
Newport, RI 02840  
(401) 841-3987

Dr. Gerhard L. Holleck  
EIC Laboratories, Inc.  
67 Chapel St.  
Newton, MA 02158  
(617) 965-2710

Harry T. Holter  
Naval Sea Systems Command  
Washington, DC 20362  
(202) 692-2080

Warren Hwang  
Aerospace Corp.  
P.O. Box 92957  
MSA6/2657  
Los Angeles, CA 90009  
(213) 648-6962

Linda Jackson  
NASA/JSC EP5  
NASA Rd. 1  
Houston, TX 77058  
(713) 483-4027

B. Jagid  
Power Conversion, Inc.  
70 MacQuesten Parkway, So.  
Mt. Vernon, NY 10550  
(914) 699-7333

S.D. James  
Naval Surface Weapons Center  
Code R-33  
Silver Spring, MD 20910  
(301) 394-2730

James D. Jensen  
Naval Surface Weapons Center  
Code R-33  
Silver Spring, MD 20910  
(301) 394-1208

Dr. David Johnson  
Spring Arbor College/Chem. Dept.  
Spring Arbor, MI 49283  
(517) 750-1200, Ext. 301

L.J. Johnson  
Naval Ocean Systems Center  
Code 6343, 271 Catalina  
San Diego, CA 92152  
(714) 225-2670

John L. Kasten  
Rockwell International  
Mail Code SN65  
12214 Lakewood Blvd.  
Downey, CA 90241  
(213) 594-3985

John A. Kelley  
Honeywell Power Sources Center  
104 Rock Road  
Horsham, PA 19044  
(215) 674-3800

John J. Kelley  
Exide Management & Technology Co.  
19 W. College Ave.  
Yardley, PA 19067  
(215) 493-7033

Randy Kientz  
General Electric Co.  
P.O. Box 114  
Gainesville, FL 32601  
(904) 462-3557

E.W. Kipp  
TRW-Spacecraft Engineering Div.  
M2/2132, One Space Pk.  
Redondo Beach, CA 90278  
(213) 535-0776

Martin Klein  
Energy Research Corp.  
3 Great Pasture Rd.  
Danbury, CT 06810  
(203) 792-1460

Chip Koehler  
Ford Aerospace  
3939 Fabian Way  
Palo Alto, CA 94303  
(415) 494-7400

Paul W. Krehl  
Electrochem Industries, Inc.  
9990 Wehrle Dr.  
Clarence, NY 14031  
(716) 759-2828

Dr. Vasanth Kunigahalli  
Bowie State College  
Bldg. 11, Room 208E, GSFC  
Code 711.2  
Greenbelt, MD 20771  
(301) 344-5751

Joseph Lackner  
DND/DREO/ECD  
Shirley Bay  
Ottawa, Ontario,  
Canada K1A0Z4  
(613) 596-9419

M. Lamnin  
G.E. Space Systems Div.  
Box 8555  
Philadelphia, PA 19101  
(215) 962-2173

John W. Lear  
Martin Marietta Aerospace  
6819 N. Ridgeway Cr.  
Parker, CO 80134  
(303) 977-5457

Ann Lee  
NSWC/WO  
R32  
Silver Spring, MD 20910  
(301) 394-1422

W.W. Lee  
U.S. Naval Surface Weapons Center  
Bldg. 24-9  
New Hampshire Avenue  
Silver Spring, MD 20910  
(301) 394-2730

David Linden  
Duracell International  
78 Lovett Ave.  
Little Silver, NJ 07739  
(201) 741-2271

Rodney Liu  
Defense Meteorological Sat.  
Proj.-USAF  
SD/YDE, HQ SD, P.O. Box 92960  
World Way  
Los Angeles, CA 90009  
(213) 643-1328



Charles Lurie  
TRW Spacecraft Engineering Div.  
M2/2132, One Space Pk.  
Redondo Beach, CA 90278  
(213) 535-0777

John S. Lynch  
Vought Corp.  
P.O. Box 225907  
Dallas, TX 75265  
(214) 266-5838

Gary Lyons  
Howard Textile Mills, Inc.  
20 Roosevelt Ave.  
Roslyn, NY 11576  
(516) 621-4414

Dr. Tyler X. Mahy  
Central Intelligence Agency  
130 Duvall Lane, Apt. T-1  
Gaithersburg, MD 20877  
(703) 351-2908

C.E. Maiden  
Hughes  
5325 Surfrider Way  
Oxnard, CA 93030  
(213) 648-3242

D.E. Mains  
NWSC  
Code 3053, Bldg. 2949  
Crane, IN 47522  
(812) 854-1593

Paul Malachesky  
Exxon Enterprises  
P.O. Box 45, Bldg. 28/A130  
Linden, NJ 07922  
(201) 474-6369

Joseph Maloy  
Dept. Chem., Seton Hall Univ.  
South Orange, NJ 07079  
(201) 761-9031

Michelle Manzo  
NASA Lewis  
309-1 21000 Brookpark Rd.  
Cleveland, OH 44111  
(216) 433-4000, Ext. 764

Lynn Marcoux  
Hughes Aircraft Co.  
Bldg. S.12, MS/V330  
P.O. Box 92919  
Los Angeles, CA 90009  
(213) 615-7220

J. David Margerum  
Hughes Research Laboratories  
3011 Malibu Canyon Rd.  
Malibu, CA 90265  
(213) 456-6411

Richard A. Marsh  
U.S. Air Force  
AFWAL/POOC  
W-PAFB, OH 45433  
(513) 255-6235

D.W. Maurer  
Bell Labs  
Rm. 1E243  
Murray Hill, NJ 07974  
(201) 582-3237

George Methlie  
CIA  
2705 N. Jefferson St.  
Arlington, VA 22207  
(703) 533-1499

Ronald P. Mikkelsen  
General Dynamics/Convair  
MZ41-6390, P.O. Box 80847  
San Diego, CA 92138  
(714) 277-8900, Ext. 1486

M.J. Milden  
The Aerospace Corp.  
P.O. Box 92957 (D8-1102)  
Los Angeles, CA 90009  
(213) 648-6273

Lee Miller  
Eagle-Picher Industries, Inc.  
"C" & Porter, P.O. Box 47  
Joplin, MO 64802  
(417) 623-8000

Anthony J. Miserendino  
GTE Systems - Power Operation  
520 Winter St.  
Waltham, MA 02254  
(617) 890-9200

Georgina More  
Motorola, Inc.  
8000 W. Sunrise Blvd.  
Fort Lauderdale, FL 33322  
(305) 475-6102

Walter Moroz  
Defense Res. Establishm. Ottawa  
Shirley Bay Na. Defense HQ DREO  
Ottawa, Ontario,  
Canada K1A 0Z4  
(613) 596-9203

Dr. Carl E. Mueller  
Naval Surface Weapons  
Center/White Oak  
Code R-33  
Silver Spring, MD 20910  
(301) 394-2495

V.C. Mueller  
McDonnell Douglas Astronautics  
Co.  
P.O. Box 516, E454/106/4/C7  
St. Louis, MO 63166  
(314) 233-8068

William S. Muney  
NASA/GSFC  
Code 683.1  
Greenbelt, MD 20771  
(301) 344-8711

Robert M. Murphy  
Electrochem Industries, Inc.  
9990 Wehrle Drive  
Clarence, NY 14031  
(716) 759-2828

J.H. McCann  
RCA  
9012 Stevens Lane  
Lanham/Seabrook, MD 20706  
(301) 459-0791

Dr. Patrick McDermott  
Coppin State College  
2500 W. North Ave.  
Baltimore, MD 21216  
(301) 383-4553

Bruce McDonald  
Duracell International  
175 Clearbrook Rd.  
Elmsford, NY 10523  
(914) 592-3556

Donald W. Nelson  
RCA  
Building 17A3  
Camden, NJ 08102  
(609) 338-3580

Tom Noble  
COMSAT Labs  
22300 Comsat Dr.  
Clarksburg, MD 20871  
(301) 428-4048

Lewis S. Norman  
COMSAT Labs  
22300 Comsat Dr.  
Clarksburg, MD 20871  
(301) 428-4142

Philip Olbert  
Ball Aerospace Div.  
P.O. Box 1062  
Boulder, CO 80306  
(303) 441-4000

Thomas O'Sullivan  
Bell Labs  
600 Mountain Ave.  
Murray Hill, NJ 07974  
(201) 582-2899

Burton Otzinger  
Rockwell International  
M/C S-L-10  
12214 Lakewood Blvd.  
Downey, CA 90241  
(213) 594-3783

Charles F. Palandati  
GSFC  
4915 56th Avenue  
Hyattsville, MD 20781  
(301) 344-5379

John M. Parry  
Arthur D. Little, Inc.  
Acorn Park  
Cambridge, MA 02140  
(617) 864-5770

Florido S. Pe  
Bedford Engineering Corp.  
3805 Mt. Vernon Ave.  
Alexandria, VA 22305  
(703) 549-3930

David F. Pickett  
Hughes Aircraft Co., S&CG  
MS-S12/V330, Box 92919  
Airport Station  
Los Angeles, CA 90009  
(213) 648-2128

Philip R. Pierce  
MS 113, RCA  
Box 800  
Princeton, NJ  
(609) 448-3400, Ext. 3131

Arthur J. Pokorny  
Fairchild Industries  
E-2, Century Blvd.  
Germantown, MD 20874  
(301) 428-6202

Michael J. Pollack  
Three E Laboratories, Inc.  
P.O. Box 375  
Montgomeryville, PA 18936  
(215) 362-7072

Dr. A.J. Prasad  
Hyderabad Batteries, Ltd.  
D-31 Ind. Dev. Area  
Jeedimetia, Hyderabad  
India 500854  
225278

Dr. Vincent J. Puglisi  
Yardney's Electric Corp.  
82 Mechanic St.  
Pawcatuck, CN 06379  
(203) 599-1102

Rod Quinn  
Sandia National Labs  
Div. 2523, P.O. Box 5800  
Albuquerque, NM 87185  
(505) 844-1933

Nachiappan S. Raman  
Duracell International  
60 Elm Street  
N. Tarrytown, NY 10591  
(914) 631-4014

Guy G. Rampel  
General Electric  
Box 114  
Gainesville, FL 32602  
(904) 462-3521

Plaridel H. Recato  
Bedford Engineering Corp.  
3805 Mt. Vernon Ave.  
Alexandria, VA 22305  
(703) 549-3930

Ben Reichman  
Energy Conversion Devices, Inc.  
1896 Barrett St.  
Troy, MI 48084  
(313) 280-1900, Ext. 313

Edward Reiss  
U.S. Army ERADCOM  
DELET-PB  
Ft. Monmouth, NJ 07703  
(201) 544-4211

Paul Ritterman  
TRW  
One-Space Park  
Redondo Beach, CA 90278  
(213) 535-0777

Dr. Michael Rock  
Bowie St. College/Dept. Math and  
Natural Sciences  
Bowie, MD 20715  
(301) 464-3396

Dr. Howard H. Rogers  
Hughes Aircraft Co.  
S12/V330, P.O. Box 92919  
Los Angeles, CA 90009  
(213) 648-0480

Richard J. Rugg  
SBS Sat. Business Systems  
7902 Hope Valley Ct.  
Adamstown, MD  
(301) 428-3464

Douglas Rusta  
TRW/STG  
M2/2120  
Redondo Beach, CA 90278  
(213) 535-1711

Albert C. Sadilek  
Johns Hopkins University  
Applied Physics Lab  
Johns Hopkins Road  
Laurel, MD 20707  
(301) 953-7100

David F. Schmidt  
General Electric Co.  
P.O. Box 801  
Gainesville, FL 32602  
(904) 462-4752

Irwin M. Schulman  
Jet Propulsion Laboratory  
4800 Oak Grove Drive  
Pasadena, CA 91103  
(213) 354-6094

Charles Scuilla  
CIA  
Washington, DC 20505  
(703) 351-2908

Dr. H. N. Seiger  
Harvey N. Seiger Associates  
8 Beacon Hill Drive  
Waterford, CT 06385  
(203) 443-5886

Karl A. Sense  
Rockwell Intern. Space Opns. &  
Sat. Sys. Division  
SL-10, 2201 Seal Beach Blvd.  
Seal Beach, CA 90740  
(213) 594-3676

Eddie T. Seo  
The Gates Rubber Company  
P.O. Box 5887  
Denver, CO 80217  
(303) 744-4614

Pinakin Shah  
GE - Battery Business Dept.  
P.O. Box 114  
Gainesville, FL 32602  
(904) 462-3689

F. Shelton  
NASA  
Code 862  
Goddard Space Flight Center  
Greenbelt, MD 20771  
(301) 344-7513

David E. Simm  
G.E./GSFC  
Bldg. 23, Code 514  
Greenbelt, MD 20771  
(301) 344-7785

John Sindorf  
Johnson Controls, Inc.  
P.O. Box 591  
Milwaukee, WI 53201  
(414) 228-2719

Luther W. Slifer, Jr.  
NASA/Goddard Space Flight Center  
Code 711  
Greenbelt, MD 20771  
(301) 344-8841

Jerry J. Smith  
Office of Naval Research  
Chemistry Division  
Arlington, VA 22217  
(202) 696-4410

Pat Smith  
NSWC Code R-33  
White Oak, MD 20910  
(202) 394-1519

Robert Somoano  
Jet Propulsion Laboratory  
122/123 4800 Oak Grove Drive  
Pasadena, CA 91109  
(213) 354-2213

Dennis Sorenson  
Gould, Inc.  
931 N. Vandalia  
St. Paul, MN 55114  
(612) 645-8531

Ray Sperber  
GTE-Satellite  
1 Stamford Forum  
Stamford, CT 06904  
(203) 965-3626

Michael S. Spritzer  
Chemistry Department  
Villanova University  
Villanova, PA 19085  
(215) 645-4878

Dr. Steven J. Stadnick  
Hughes Aircraft Co.  
S12/V330, P.O. Box 92919  
El Segundo, CA 90009  
(213) 648-9322

C. Stanley  
TRW  
One Space Park  
Redondo Beach, CA 90278

R. Stearns  
GE Space Systems Div.  
Box 8555  
Philadelphia, PA 19101  
(215) 962-2240

Jay Stedman  
United Tech. Power System Div.  
P.O. Box 109, SMS21  
S. Windsor, CT 06074  
(203) 727-2211

Irv Stein  
JPL  
4800 Oak Grove Dr. M.S. 198-220  
Pasadena, CA 91109  
(213) 354-6048

R.A. Steinhauer  
Hughes Aircraft Co.  
Space and Communications Group  
Building S1, M/S D319  
Los Angeles, CA 90009  
(213) 648-1404

David Stewart  
RCA American Communications  
400 College Road East  
Princeton, NJ 08540  
(609) 734-4122

Joseph Stockel  
COMSAT Labs  
22300 Comsat Drive  
Clarksburg, MD 20871  
(301) 428-4502

Martin Sulkes  
USAERADCOM  
DELET-PC  
Fort Monmouth, NJ 07703  
(201) 544-2458

Dr. R.A. Sutula  
U.S. Naval Surface Weapons Ctr.  
Bldg. 24-9  
New Hampshire Avenue  
Silver Spring, MD 20910  
(301) 394-2730

Larry Swette  
GINER, Inc.  
14 Spring Street  
Waltham, MA 02154  
(617) 899-7270

Lam Tang  
SPC Spacenet  
1700 Old Meadow Rd.  
5th Floor, Spacenet  
McLean, VA

Michael Tasevoli  
NASA/GSFC  
Code 711.1  
Greenbelt, MD 20771  
(301) 344-6691

H.E. Thierfelder  
General Electric Space Systems  
Division  
Box 8555  
Philadelphia, PA 19101  
(215) 962-2027

John R. Thomas  
Ray-O-Vac Corporation  
6416 Schroeder Road  
Madison, WI 53711  
(608) 271-5454

Stephen Thornell  
Exide Corp.  
19 West College Ave.  
Yardley, PA 19067  
(215) 493-7188

Smith Tiller  
NASA/GSFC  
Code 711.2  
Greenbelt, MD 20771  
(301) 344-5379

H. Vaidyanathan  
COMSAT Labs  
22300 Comsat Drive  
Clarksburg, MD 20871  
(301) 428-4507

Dr. Sriniv Venkatesan  
Energy Conversion Devices, Inc.  
1896 Barrett St.  
Troy, MI 48084  
(313) 280-1900

Donald C. Verrier  
Yardney Electric Corp.  
82 Mechanic St.  
Pawcatuck, CT 06379  
(203) 599-1100

Scott Verzwylvelt  
Hughes Res. Lab.  
3011 Malibu Canyon Rd.  
Malibu, CA 90265  
(213) 456-6411

B. Vyas  
Bell Labs.  
Murray Hill, NJ 07974  
(201) 582-6757

Fred Wagner  
Utah Research & Dev. Co., Inc.  
P.O. Box 26297  
1820 S. Industrial Rd.  
Salt Lake City, UT 84126-0297  
(801) 972-5444

Charles Walk  
Bedford Engineering Corp.  
3805 Mt. Vernon Ave.  
Alexandria, VA 22305  
(703) 549-3932

Willie Walters  
COMSAT 52-165  
950 L'Enfant Plaza, S.W.  
Washington, DC 20024  
(202) 863-6348

Don R. Warnock  
U.S. Air Force  
AFWAL/POOC  
WPAFB, OH 45433  
(513) 255-6235

Rpobert A. Warriner  
Hughes Aircraft Co.  
10181 Firwood Dr.  
Cupertino, CA 95014  
(408) 745-3149

Thomas Watson  
SAFT Corporation  
107 Beaver Ct.  
Cockeysville, MD 21030  
(301) 667-0769

Thomas E. Watterson  
SCORE, Inc.  
200 Wight Ave.  
Cockeysville, MD 21030  
(301) 666-3200

D.A. Webb  
McDonnell Douglas Astronautics  
Co.  
P.O. Box 516, E454/106/4/C7  
St. Louis, MO 63166  
(314) 232-4471

Douglas White  
U.S. Army Countermeasures  
Research Lab  
P.O. Box 115  
Ft. Belvoir, VA 22060  
(703) 664-2243

Eileen Whitlock  
SLAG (Sci. Liaison Advis. Grp.)  
5925 Quantrell Ave.  
Alexandria, VA 22312  
(202) 347-4342

Mr. Alvin H. Willis  
Boeing Aerospace Company  
P.O. Box 3999, M/S 45-31  
Seattle, WA 98124  
(206) 773-2994

Thomas H. Willis  
Bell Labs  
600 Mountain Ave.  
Murray Hill, NJ 07974  
(201) 582-3545

Patrick Willmann  
ESA/ESTEC  
Postbus 299  
Noordwijk,  
The Netherlands 2200AG  
(1) 719-82071

Thomas Wylie  
RCA - AE  
Box 800  
Princeton, NJ 08540  
(609) 448-3400, Ext. 2581

I. David Yalom  
Catalyst Research Corp.  
10813 E. Nolcrest Drive  
Silver Spring, MD 20903  
(301) 593-1973

David Yedwab  
ARRADCOM  
Bldg. 61-S  
Dover, NJ 07801  
(201) 328-3058

Dr. Adrian E. Zolla  
Altus Corporation  
1610 Crane Court  
San Jose, CA 95112  
(408) 295-1300

## BIBLIOGRAPHIC DATA SHEET

1. Report No. NASA CP-2217	2. Government Accession No.	3. Recipient's Catalog No.	
4. Title and Subtitle The 1981 Goddard Space Flight Center Battery Workshop		5. Report Date March 1982	
		6. Performing Organization Code 711	
7. Author(s) G. Halpert, Editor		8. Performing Organization Report No.	
9. Performing Organization Name and Address  Goddard Space Flight Center Greenbelt, MD 20770		10. Work Unit No.	
		11. Contract or Grant No.	
		13. Type of Report and Period Covered	
12. Sponsoring Agency Name and Address  National Aeronautics and Space Administration Washington, D.C. 20546		14. Sponsoring Agency Code	
		15. Supplementary Notes	
16. Abstract  <p style="text-align: justify;">This, the 14th Annual Battery Workshop, was attended by manufacturers, users, and government representatives interested in the latest results of testing, analysis, and development of lithium, nickel-cadmium, and nickel-hydrogen batteries. The purpose of the Workshop was to share flight and test experience, to stimulate discussion on problem areas, and to review latest technology improvements.</p> <p style="text-align: justify;">The papers presented were derived from transcripts taken at the Workshop held at the Goddard Space Flight Center on November 17 to 19, 1981. The transcripts were lightly edited by the speakers with their vugraphs assembled at the end of each presentation for uniformity.</p>			
17. Key Words (Selected by Author(s))  Batteries, electrochemical		18. Distribution Statement  STAR Category 33 Unclassified-Unlimited	
19. Security Classif. (of this report)  Unclassified	20. Security Classif. (of this page)  Unclassified	21. No. of Pages  564	22. Price*  A24

\*For sale by the National Technical Information Service, Springfield, Virginia 22151.

GSFC 25-44 (10/77)