

INTRODUCTION TO SOME FUNDAMENTAL CONCEPTS OF GENERAL RELATIVITY
AND TO THEIR REQUIRED USE IN SOME MODERN TIMEKEEPING SYSTEMS*

by

C. O. Alley

Department of Physics and Astronomy
University of Maryland
College Park, Maryland

ABSTRACT

This is a largely tutorial lecture on the basic ideas of General Relativity - Einstein's theory of gravity as curved space-time - emphasizing the physical concepts and using only elementary mathematics. For the slow motions and weak gravitational fields which we experience on the earth, the main curvature is that of time, not space. Recent experiments demonstrating this property (Alley, Cutler, Reisse, Williams, et al, 1975 and Vessot and Levine, 1976) will be briefly reviewed.

The extraordinary stability of modern atomic clocks makes it necessary to understand and to include the fundamental effects of motion and gravitational potential on clocks in many practical situations. These include the NAVSTAR/Global Positioning System and time synchronization using ultra stable clocks transported by aircraft.

In future system such as global time synchronization using clocks in low earth orbit, the accuracy may be limited by uncertainties in the calculated proper time of the travelling clock, rather than by intrinsic clock performance.

INTRODUCTION

This talk will be in the same general vein as one I gave at the time of the Einstein Centennial two and half years ago at the 33rd Annual Frequency Control Symposium¹, so I apologize to those of you who

* This paper is an edited version of a tape recording of the invited tutorial talk.

¹ C. O. Alley, "Relativity and Clocks", Proceedings, 33rd Annual Symposium on Frequency Control, U.S. Army Electronics Research and Development Command, Fort Monmouth, N.J., pp 4 - 39A (1979). Copies available from Electronic Industries Association, 2001 Eye Street, N.W., Washington, D.C. 20006.

Reference should be made to this paper for details of some results given here and for further references.

may have heard that talk. But for a tutorial talk, perhaps it is excusable, or even desirable, to repeat important things. The emphasis here is somewhat different from Reference 1, however.

The concept of proper time in relativity is really central to the whole subject. The proper time is the ordinary time actually kept by a clock, its own time, or, in German, eigenzeit. The high stability that has been achieved by the time keeping community with modern atomic clocks allows the effects of motion and gravity to be actually measured, with results in agreement with Einstein's predictions. Einstein's ideas are no longer just a matter of great scientific interest, actually forming the basis of the view of the universe that we now have from modern astronomy, but also a matter of practical engineering concern. These timekeeping applications are the first practical applications of General Relativity which go beyond Newtonian gravity.

The subject can be understood. In the past, the subject was largely taken over by mathematicians, from about 1920 until the 1950's. The central physical ideas were rarely brought to the fore. The ideas were obscured by the Tensor Calculus with all of its bristling indices and the higher mathematics associated with differential geometry. The actual way in which Einstein got to these concepts was generally ignored in the teaching of the subject (at the few places where it was taught) and those of us in the academic community have to take some responsibility for not having understood these things properly and for not having taught them to many generations of engineering and physics students. But that situation has now changed.

In addition to these practical applications, many modern discoveries in astrophysics require the use of General Relativity in order to comprehend them. There's the whole notion of compact objects with the extreme being the black holes which probably exist. They may be the power sources of quasars. The energy conversion resulting from matter falling down the deep potential well of a black hole is something like 30% of the rest energy compared with only 0.7% for thermo-nuclear fusion. The expanding universe could have been predicted by Einstein, except that it was uncongenial to the world view in the teens of our century, and he modified his equations to avoid it. It was probably his greatest mistake (in his own evaluation) but General Relativity does describe its growth from the "Big Bang". The changes in the orbit of the Binary Pulsar², revealed by precise timing of its periodic radio pulses with atomic clocks, seems to show the emission of the gravity waves predicted by General Relativity. We will hear more this afternoon about attempts to detect low frequency gravity waves left from the early

² J. M. Weisberg, J. H. Taylor, and L. H. Fowler, "Gravitational Waves from an Orbiting Pulsar", Scientific American, Vol. 245, No. 4, pp. 74-82 (October, 1981).

universe, using the atomic clock controlled tracking of interplanetary probes, opening a new window on the universe, if successful.

Now, let me give you some good introductory references. I like to approach the subject from an historical point of view, the way I think Einstein actually developed it. There's a great book by Banesh Hoffmann called Albert Einstein: Creator and Rebel (Plume Books, 1973). I recommend this to all of my students and I recommend it to you to read both for Einstein's physics and for his life. Nigel Calder has recently written a popular book called Einstein's Universe (Penguin Books, 1979) which was made into a two-hour BBC television film of the same name, which is highly recommended. I'm going to use an approach to relativity called the k-calculus by its developer, Hermann Bondi. It is described in a book called Relativity and Common Sense (Dover Books, 1980) and in another, Assumption and Myth in Physical Theory (Cambridge University Press, 1967). On the astrophysics, there are excellent books by Robert Wall, Space Time and Gravity: Theory of the "Big Bang" and Black Holes (University of Chicago Press, 1977), and by Roman and Hannelore Sexl, White Dwarfs and Black Holes (Academic Press, 1979).

The plan of the talk is the following. I will give you an introduction to General Relativity by adding gravity to special relativity through Einstein's Principle of Equivalence. This is the historical approach I mentioned. Then I will discuss some recent experiments which have measured the relativistic effects on clocks. This include experiments with aircraft and lasers in which Len Cutler and I collaborated with some of the students and staff at Maryland, with the support of the Navy and Air Force, and, very briefly, the rocket probe experiment with a hydrogen maser and microwave frequency detection, which Bob Vessot and Marty Levine have done with the support of NASA. Finally, I will talk about the influence of these effects in some actual systems: the NAVSTAR/Global Positioning System, the LASSO (Laser Synchronization from Stationary Orbit) experiment, and a technique called the Shuttle Time and Frequency Transfer (STIFT), which some of us are planning and hoping to persuade NASA to develop. The relativistic effects on clocks transported by air craft will also be discussed.

REVIEW OF SPECIAL RELATIVITY

Figure 1 shows Einstein in his study at the age of about 40, several years after he completed General Relativity. (Some of us take great solace from the disorderliness of his shelves.) Einstein began to think about relativity when he was 16 years old. Figure 2 shows him at age 16 in a classroom in Aarau, Switzerland (he is on the far right). He began to think along the lines of: "What would happen if I could catch up with a beam of light? Suppose I were looking at a mirror and could run with the speed of light, what would I see?" At his last lecture in Princeton in 1954, before he died in 1955, I was privileged

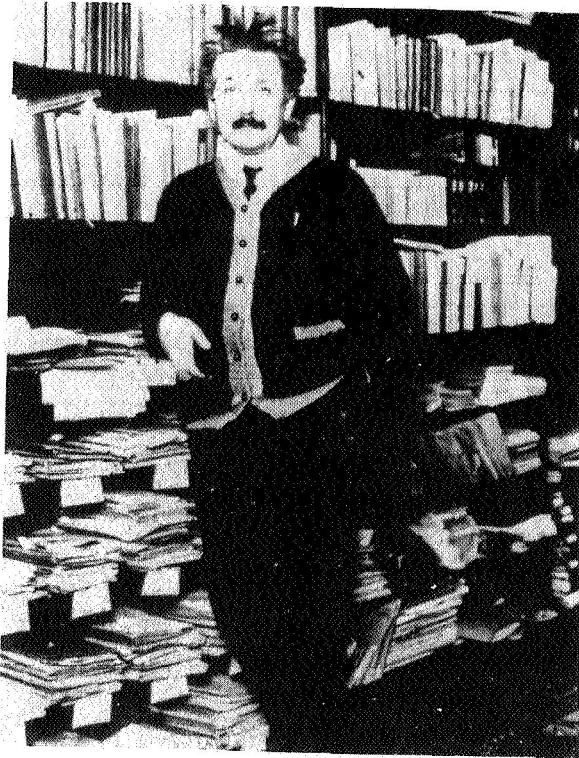

Figure 1



Figure 2

to be present when he reminisced about some of these things. He mentioned that his independent study of Maxwell's Electro-magnetic Theory as an undergraduate gave him the answer: that if you could catch up with a beam of light, you would see a static electric field and a static magnetic field at right angles to each other, with no charges and no currents

present. But Maxwell's theory doesn't allow that. Therefore, you can never catch up with light. No matter how fast you move, it recedes with the speed $c \approx 3 \times 10^8$ m/sec. This was one of the real clues to his realization at the age of 26, at the Patent Office in Bern, Switzerland (Figure 3), that time is not absolute, and that this is the key to the question: How do you reconcile the classical Principle of Relativity, that any inertial observer should formulate in the same way the laws of physics, with the notion that the speed of light should be the same for all inertial observers?

Einstein wanted to have this restricted Principle of Relativity (restricted, that is, to inertial observers) include all of physics, not just mechanical physics: electro-magnetism and everything else. He also wanted to say that the velocity of light should be the same for all observers independent of the speed of the source. Now these requirements seem incompatible, because, if you imagine two space shuttles going by each other (Figure 4), each with a light source in the center of its bay, which emits beams of light, forward and backward, A would want to see the two waves spreading out with the velocity c in each direction. But then A would observe, from his point of view, that



Figure 3

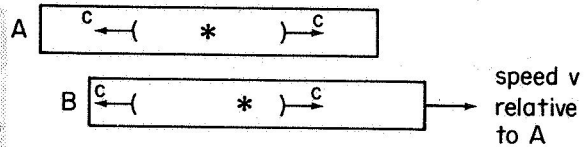

Figure 4

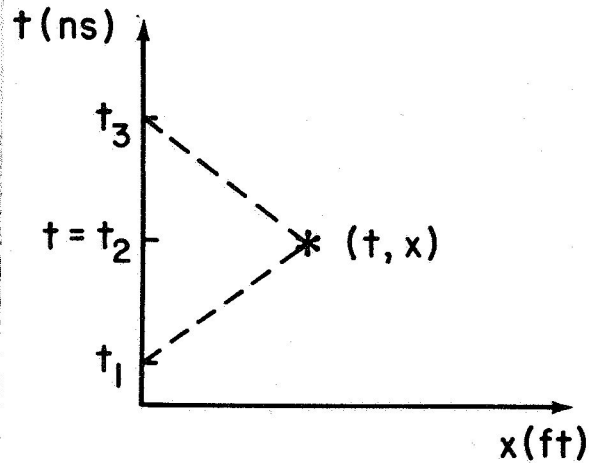

Figure 5

in B's system the light going forward would be travelling, with respect to B, with a smaller velocity than the light going backward. But B ought to be able to maintain the same point of view as A! How do you reconcile these things? Well, in 1905, at the age of 26, according to Hoffman, Einstein sat bolt upright in bed one morning, after having pondered these matters for ten years, with the realization that time is not absolute; that the simultaneity of separated events is relative to the inertial observer. This was the key to reconciling this whole thing. It has had profound consequences for all of physics. Let's formulate these ideas in terms of Minkowski space-time diagrams, and the so-called k-calculus.

In Figure 5 time is plotted vertically in units of nanoseconds, and distance horizontally in units of 30 centimeters, so that a light pulse has a slope of 45° . The dashed line is the worldline of a light pulse that would be sent out and reflected back from some event. Events are the raw materials of relativity: the time and place where something happens. If you send the light pulse out at a certain time, t_1 , and get the pulse back at a time, t_3 , then you would say you'd be sending out at $t_1 = t - x/c$, and getting it back at $t_3 = t + x/c$, where x is the position coordinate and t is the time coordinate of the reflection event. The time of reflection for you is naturally taken as midway between the emission and reception events,

$$t = t_1 + \frac{1}{2} (t_3 - t_1) = t_1 + \frac{1}{2} t_3 - \frac{1}{2} t_1 = \frac{1}{2} (t_1 + t_3) .$$

This is Einstein's original prescription for defining time at a distance when comparing clocks which are not adjacent to one another, which he gave in 1905 in his paper on restricted relativity. You get the distance of an event by taking the difference between the emission and reception times and multiplying by the speed of light and dividing by 2:

$$x = (t_3 - t_1) c/2 .$$

This is the basis for all the laser ranging measurements, including the ranging to corner reflectors on the moon³, whose motion has been monitored since 1969 with an accuracy of ten centimeters or so. It turns out that this method of comparing time between distant clocks is not only conceptually very clear, but it's practically the best way, the most accurate way, of comparing distant clocks which we know at the present time.

Modern observers now would be equipped with atomic clocks, short pulse lasers, fast photo detectors, and event timers to measure the epoch of arrival of light pulses. Let's consider two such observers, A and B, B moving with some relative velocity with respect to A, as shown in Figure 6. A sends out pulses with the separation T between them, and it's clear that they will be received by B with the separation kT, because of his motion. It is very easy (See Ref. 1) to show that k, this relativistic Doppler factor, is

$$k = \left[\frac{1 + v/c}{1 - v/c} \right]^{1/2}$$

Now, how would A define his axis of simultaneity? (Refer to Figure 6) He would send out a pulse and get it reflected back. If it is sent out at the same time before his origin event as the time he

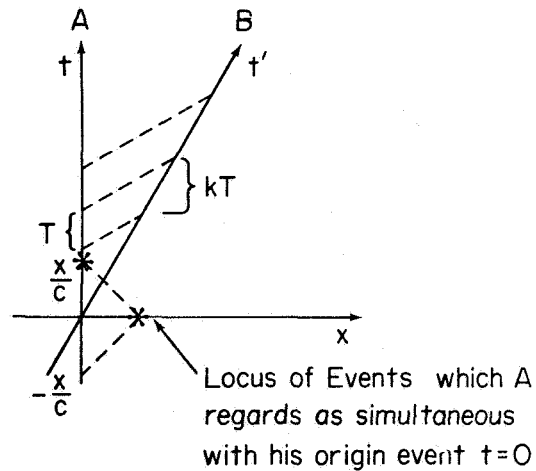

Figure 6

³ C. O. Alley, "Apollo 11 Laser Ranging Retro-Reflector (LR³) Experiment: One Researcher's Personal Account", in Adventures in Experimental Physics, edited by B. Maglich, α 1972.

gets it back after his origin event, he would say that the event is simultaneous with his origin event. This procedure defines his X axis, the locus of events which he regards as simultaneous with his origin event. B can do the same thing. But both A and B measure the same speed of light, represented by the dashed lines in Figure 7, so that when B sends out his pulse and gets it back the same time before his origin event (taken to be the same as A's) as afterward, the reflection must occur as shown in Figure 7. This procedure defines a tilted space axis, which is B's locus of events which are simultaneous with respect to his origin event. So, B's time axis is tilted with respect to A's time axis, and his space axis is tilted with respect to A's space axis. This is the famous Minkowski diagram. Hermann Minkowski was one of Einstein's teachers at the technical university in Zurich, who was very negatively impressed with Einstein as a student, but later came to recognize his great accomplishments. It was Minkowski who contributed the space-time geometry to the physics of relativity that Einstein had developed.

We've had observers A and B, now suppose we have C. If C is moving to the left then his axis of simultaneity is tilted down, as shown in Figure 8. The several observers will register different relative times for two events. Consider the events, labelled 1 and 2 in Figure 9. Then it's clear that A would regard these as occurring at the same time since they're on his axis of simultaneity. But for B, he has to project over parallel to his axis of

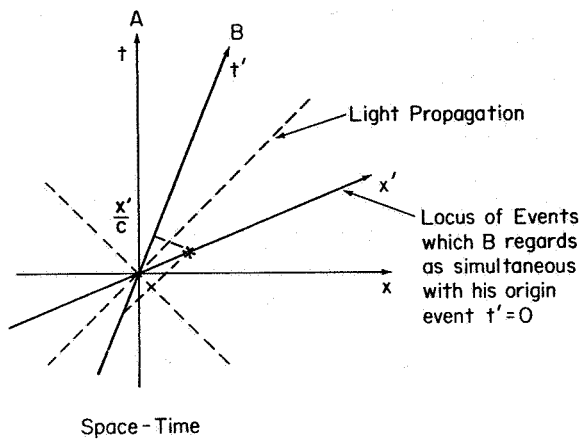

Figure 7

Minkowski's Absolute Space-Time (1907)

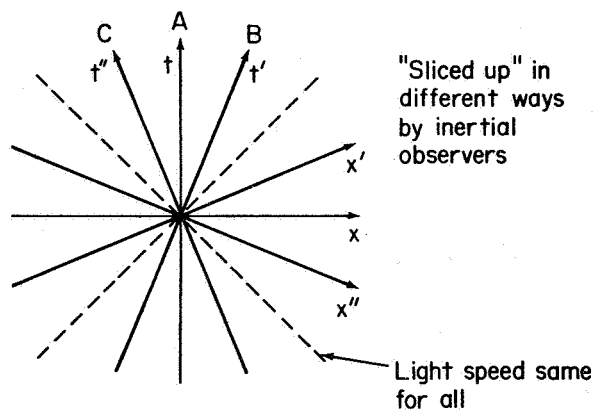

Figure 8

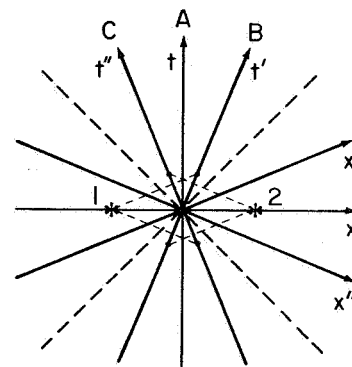

Figure 9

simultaneity and it is clear that Event 2 occurs before Event 1, according to B's time. C must project parallel to his axis of simultaneity and he will conclude that Event 1 occurs before Event 2. So they don't agree on which occurs first. They also don't agree on the magnitude of the time interval between two events. They won't agree either on the distance interval between two events. But Minkowski showed that they do agree on something! What they agree on is the so-called invariant interval, Δs , which is given by:

$$(\Delta s)^2 = c^2(\Delta t)^2 - (\Delta x)^2 \quad (A)$$

$$= c^2(\Delta t')^2 - (\Delta x')^2 \quad (B)$$

$$= c^2(\Delta t'')^2 - (\Delta x'')^2 \quad (C)$$

where unprimed, primed, and double-primed refer to A, B, and C respectively. They all get the same value when they make this combination of time and space intervals. The quantity Δs is invariant with respect to a change of inertial observers with their respective time and space coordinates. It's a very important result. It forms the basis for Einstein's whole development of gravity as curved space-time.

Einstein was often tempted to change the name of the theory of relativity to the theory of invariance because it wasn't so much, in his view, the way different observers see things in relative fashion, but what is unchanged for the various observers. But that suggested change of name never caught on. It is not hard to demonstrate the invariance of the interval. Because of limited time, I'm not going to do it. It can be done in only a few algebraic steps using the k -calculus and space-time diagrams (See Ref. 1). You don't have to introduce Lorentz transformations, and other complications to prove it.

Here's how Minkowski described his result in a talk in 1908:

"The views of space and time which I wish to lay before you have sprung from the soil of experimental physics and therein lies their strength. Henceforth, space by itself and time by itself are doomed to fade away into mere shadows and only a kind of union of the two will preserve an independent reality."

He's talking about his slicing up of space-time with the tilted axes in Figure 8. I think of the axes tilting for different observers like the blades of a pair of scissors pivoted at the origin.

Now we have all we need in order to deduce the effect of motion on clocks. Consider Figure 10, which shows the worldline of a moving clock with the events corresponding to a couple of ticks on the clock in the

space-time diagram for some inertial observer. Between the two ticks, the inertial observer will say there's a certain interval of time, Δt , which we will call the coordinate time interval. The moving observer, of course, will record the interval between his own ticks and we will call that the interval of proper time, $\Delta \tau$. For the coordinate observer there's also a space interval between these two ticks: the clock is moving. But for the clock itself there is no spacial difference because the clock is always at the origin of its own instantaneous coordinates. So, in terms of this notion of proper time, we can deduce the difference between it and coordinate time by appealing to the invariance of the interval.

The Effect of Motion on Clocks

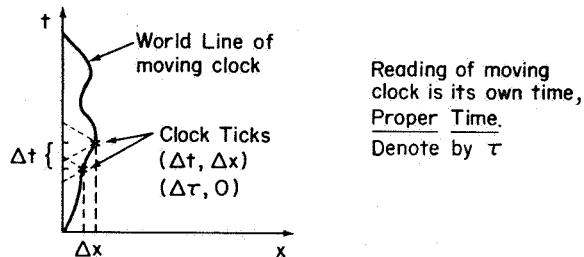

Figure 10

$$\Delta s^2 = c^2(\Delta t)^2 - (\Delta x)^2 = c^2(\Delta t')^2 - (\Delta x')^2$$

where the prime now refers to the moving clock. But we've agreed to identify $\Delta t'$ with $\Delta \tau$, the proper time interval, and we've agreed that $\Delta x' = 0$, so if we substitute that into the equation, and further note that $\Delta x = v \Delta t$ where v is the instantaneous velocity, we have

$$(\Delta s)^2 = c^2(\Delta t')^2 - (\Delta x')^2 = (c^2 \Delta t)^2 - (\Delta x)^2 = c^2(\Delta t)^2 - (v \Delta t)^2$$

$$(\Delta \tau)^2 = (1 - v^2 / c^2) (\Delta t)^2$$

$$\Delta \tau = [1 - v^2 / c^2]^{1/2} \Delta t$$

proper time interval	coordinate time interval
----------------------------	--------------------------------

This famous equation, of course, is one of the basic equations that we will be dealing with. If we consider two clocks, A and B, which are moving along different paths in space-time, as shown in Figure 11, the elapsed proper time for each will be different. "Your time is not my time." If we synchronize the clocks when they are together and they then go on different paths and rejoin, one must evaluate an integral to get the elapsed proper time for each clock with respect to the coordinate time for some inertial observer.

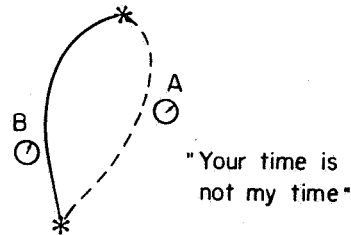

Figure 11

$$\tau_A(\text{final}) - \tau_A(\text{initial}) = \int (1 - v_A^2 / c^2)^{1/2} dt$$

$$\tau_B(\text{final}) - \tau_B(\text{initial}) = \int (1 - v_B^2 / c^2)^{1/2} dt$$

And since v_A^2 will be different from v_B^2 over the paths, these are not equal. There's a route dependence for proper time.

Einstein recognized these implications for clocks in 1905, and he actually made a prediction and suggested an experiment. He said that a clock (excluding one whose rate depends on the local value of the apparent acceleration of gravity, like a pendulum clock) at the Equator will run slow with respect to a similar clock at the Pole, because of the surface velocity produced by the earth's rotation, as shown in Figure 12.

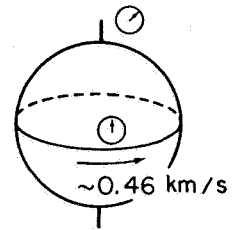

Figure 12

If you put in the value 0.46 kilometer per second for the equatorial surface velocity, you get 102 nanoseconds per day, according to the time dilation equation for the difference in rate between an equatorial clock and a polar clock. If one could have done that experiment in 1905 -- if sufficiently stable clocks had existed then -- a different result would have been obtained than he predicted: a null result! His 1905 prediction ignores the effect of gravity. It was to be two years before he discovered the effect of gravity on time as a consequence of his famous Principle of Equivalence. I will come back to this question and describe an experiment we've done recently transporting clocks from Washington, D.C. to Thule, Greenland and back.

I'd like to quote from the Presidential Address at the American Association for the Advancement of Science in 1911 by Professor W. F. Magie of Princeton University.

"I do not believe that there is any man now living, who can assert, with truth, that he can conceive of time, which is a function of velocity."

That was six years after Einstein's paper of 1905 by which time most of the leading physicists had accepted his ideas. But to this day, there are people who do not believe that clocks behave in this fashion.

INCLUSION OF GRAVITY: THE PRINCIPLE OF EQUIVALENCE

Let me now turn to gravity. How does gravity get into the relativity picture? This is an excerpt from an essay that Einstein wrote in 1919 that was published in the New York Times when his papers began to be edited in 1972 (he was recalling what he was doing in 1907);

"At that point there came to me the happiest thought of my life in the following form: Just as in the case where an electric field is induced by electromagnetic induction, the gravitational field similarly has only a relative existence. Thus, for an observer in free fall from the roof of a house, there exists, during his fall, no gravitational field, at least not in his immediate vicinity. If the observer releases any objects, they will remain relative to him in a state of rest or in a state of uniform motion independent of their particular chemical and physical nature. The observer is therefore justified in considering his state as one of rest."

This is Einstein's own statement of the Principle of Equivalence between an accelerated system and a system in a gravitational field.

There is a story, probably apocryphal, that while Einstein was at the Patent Office in Bern, a workman fell off of the roof of a house and reported that his tools fell along with him. They all landed in bushes, and so he survived to tell the tale, thereby influencing Einstein. But I think that's really not true.

In a system falling freely under the influence of gravity, there is no local gravitational field. Of course, we're very familiar with this now, from the space flights of the Apollo Program, the Skylab, Space Shuttle and the Soviet Soyuz spacecraft, and so on. Objects that are put out in front of an astronaut will stay there, as shown in the upper left part of Figure 13. I'm told that on the Skylab, some of the astronauts made a basketball-size drop of water, which would just stay there, held together by surface tension (and of course oscillating just a bit). Consider now, in a region where gravity is not present, an accelerated lab, an "Aclab", which is pushed by a rocket engine. Then, if you release objects of whatever composition they would seem to approach the floor in the same way, equivalent to what you would see in a gravitational lab, "Gravlab", in the presence of a gravitational field, for example, on the surface of the earth. There have been many experiments showing that all objects, whatever their composition, fall (in a vacuum) with the same

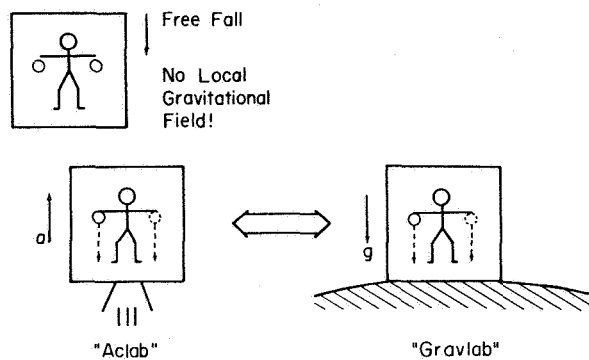

Figure 13

acceleration. In technical language, one says that the inertial mass is the same as the gravitational mass. In recent years, this has been shown by R. H. Dicke⁴ and by V. Braginsky⁵ to be valid to parts in 10^{11} to 10^{12} . Lunar laser ranging has shown this also to be true for the earth and moon falling to the sun, with the same precision⁶. Einstein's idea was not to stick with the mechanical properties only but to ask what are the consequences of the Principle of Equivalence for other parts of physics, in particular for electromagnetic phenomena, which includes light. Suppose you had light sent across this "Aclab", as shown in Figure 14. Think of it as rows of marching soldiers corresponding to the wavefronts. The lab is accelerated, so it would appear inside it as though the light beam were being bent. If the equivalence idea is true then in a gravitational field, you would see this bending of light, and the marching soldier analogy tells you that the soldiers at the top would have to move faster than those at the bottom in order to make the curve. So you predict that light paths should be bent by a gravitational field, and that the speed of light increases with the height. There's no mathematics in this deduction at all, just physical ideas.

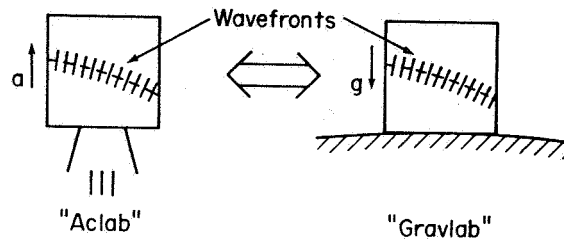

Figure 14

There's a little mathematics needed to deduce the properties of clocks in a gravitational field. Suppose you have this "Aclab" with a low clock on the floor and a high clock on the ceiling and you are exchanging laser pulses between them, as displayed in Figure 15. We can calculate what would happen in this situation, and I'll do it in just a moment. If the "Gravlab" is equivalent to the "Aclab", then what we

⁴ P. G. Roll, R. Krotkov, and R. H. Dicke, "The Equivalence of Inertial and Passive Gravitational Mass," Ann. Phys. (U.S.A.), Vol. 26, pp. 442-517 (1964).

⁵ V. B. Braginsky and V. I. Panov, "Verification of the Equivalence of Inertial and Gravitational Mass," Zh. Eksp. & Teor. Fiz., Vol. 61, pp. 873 - 879 (1971). English translation in Sov. Physics - JETP Lett., Vol. 10, pp 80 - 283 (1972).

⁶ J. G. Williams, R. H. Dicke, P. L. Bender, C. O. Alley, W. E. Carter, D. G. Currie, D. H. Eckhardt, J. E. Faller, W. M. Kaula, J. D. Mullholland, H. H. Plotkin, S. K. Poultney, P. J. Shelus, E. C. Silverberg, W. S. Sinclair, M. A. Slade, and D. T. Wilkinson, "A New Test of the Equivalence Principle from Lunar Laser Ranging", Physical Review Letters, Vol. 36, pp 551 - 554, (1976).

calculate in the "Aclab" should apply for the "Gravlab", and we will see that the high clocks are predicted to run fast with respect to the low clocks. One can deduce this result easily by using the ideas of the k-calculus which we introduced earlier.

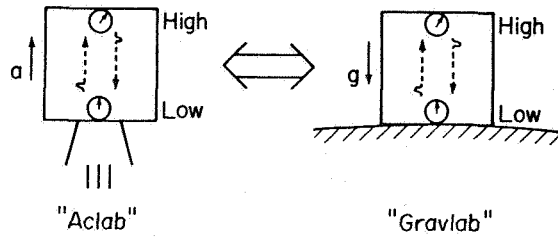

Figure 15

It is not true that you cannot consider accelerated motions in special relativity. Let us consider them. The left of Figure 16 shows the curved worldlines plotted in an inertial system Minkowski diagram of the low and high clocks of Figure 15 in the "Aclab". Let us send light pulses from the low clock to the high clock, as shown on the right of Figure 16. There will be a stretching factor kT just as we have discussed

Comparison of Clocks in "Aclab"

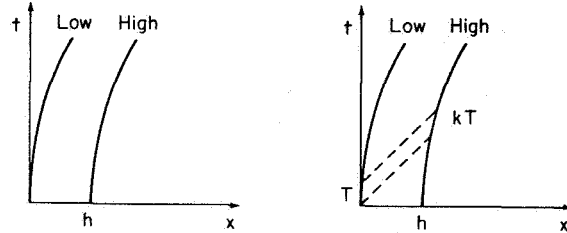

Figure 16

earlier, because there is some velocity of the high clock at the time of reception. Even though the high clock started off with zero velocity with respect to the inertial system, the acceleration produces some velocity according to $v = at$. If we substitute for v in the equation, and make a few manipulations, we find for k

$$k = [(1 + v/c) / (1 - v/c)]^{1/2} = [(1 + at/c) / (1 - at/c)]^{1/2}$$

$$\approx (1 + 2at/c)^{1/2}$$

But $t = h/c$ where h is the separation of the clocks. Therefore,

$$k = (1 + 2ah/c^2)^{1/2}$$

But by the Principle of Equivalence, the acceleration of gravity g is equivalent to a , so we substitute g for a and get

$$k = (1 + 2gh/c^2)^{1/2}$$

Then we remember that, according to Newtonian physics, the gravitational potential difference ϕ is gh , so we have

$$k = (1 + 2\phi/c^2)^{1/2}$$

In the "Gravlab", as shown in Figure 17, the worldlines of the low and the high clocks will be straight, since they are not moving. However, if we send light pulses from the low clock to the high clock, we would still get a stretching factor given by the above equation because of the Principle of Equivalence. This straightened space-time diagram exhibits the curvature of space-time, in this case, the curvature of time, that is at the heart of Einstein's theory of gravity, General Relativity. Let's look a little more at that.

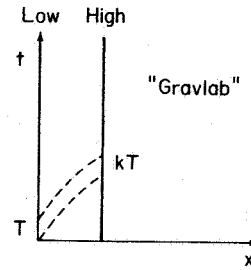

Figure 17

To compare a low clock with a high clock in a gravitational field, we can use the same Einstein prescription we discussed earlier: send out a light pulse, get it reflected back, and identify the mid-point between sending and receiving with the time of reflection, as shown in Figure 18. These two events are simultaneous for the low observer. A little bit later, the low observer could do the same thing and identify the mid-point time with the reflection time as being simultaneous. But what we've just seen is that the elapsed time for the high clock, $\Delta\tau$, is going to be different from the elapsed time for the low clock, Δt , defined this way: $\Delta\tau \neq \Delta t$.

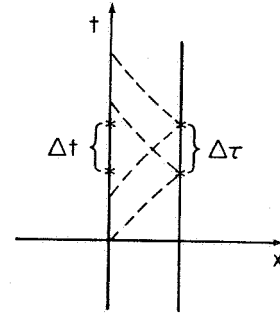

Figure 18

Now, how to incorporate this gravitational effect into the metric structure that Minkowski had proposed, the invariant interval? Einstein's idea was to retain the identification of $(\Delta s)^2 \equiv c^2(\Delta\tau)^2$, $\Delta\tau$ being the proper time interval, and to insert a metric coefficient in the invariant interval expression in order to make things come out the way we have just calculated for a static situation. So here is the presence of a metric coefficient in this invariant interval which is a manifestation of time curvature.

$$(\Delta s)^2 = (1 + 2\phi/c^2) c^2(\Delta t)^2 - (\Delta x)^2 = c^2(\Delta\tau)^2$$

metric
coefficient

For the stationary high clock, we have then that

$$\Delta\tau = (1 + 2\phi/c^2)^{1/2} \Delta t$$

We can get the speed of light by noting that for light pulses, the two events lying along a light line, $(\Delta s)^2$ is going to be 0, so if you put this equal to 0, we can solve for $\Delta x/\Delta t$, the coordinate speed of light,

and we get

$$\frac{\Delta x}{\Delta t} = (1 + 2\phi/c^2)^{1/2} c$$

This shows that the higher you go, the faster the light must move, as we had concluded already. We can now ask what happens to a moving clock. Let's bring in three dimensions, and include Δx , Δy and Δz in the metric,

$$(\Delta s)^2 = c^2(\Delta\tau)^2 = (1 + 2\phi/c^2) c^2(\Delta t)^2 - (\Delta x)^2 - (\Delta y)^2 - (\Delta z)^2$$

The sum of the squares of these is just $v^2(\Delta t)^2$. Making that substitution, and carrying out a few lines of algebra,

$$c^2(\Delta\tau)^2 = (1 + 2\phi/c^2) c^2(\Delta t)^2 - v^2(\Delta t)^2$$

$$(\Delta\tau)^2 = (1 + 2\phi/c^2 - v^2/c^2) (\Delta t)^2$$

we get that in this gravitational case the relationship between the proper time interval and the coordinate time interval is given by

$$\begin{array}{l} \Delta\tau \\ \text{proper} \\ \text{time} \\ \text{interval} \end{array} = (1 + 2\phi/c^2 - v^2/c^2)^{1/2} \begin{array}{l} \Delta t \\ \text{coordinate} \\ \text{time} \\ \text{interval} \end{array}$$

We can expand this when ϕ/c^2 and v^2/c^2 are small, which is certainly the case on the surface of the earth, and we get

$$\Delta\tau = (1 + \phi/c^2 - v^2/2c^2) \Delta t$$

One can synchronize clocks to the coordinate time (which we are taking as the time kept by clocks on the surface of the earth) by using the laser pulse technique illustrated in Figure 18. The light line is drawn slightly curved in Figure 18 to illustrate the speed of light changing with altitude. To make the high clock run at the same rate as the low clock, one must physically adjust it (See the later discussion on the GPS).

The above equation is the basic one needed in order to understand these effects of General Relativity on proper time. I'd like to give an analogy to the curved surface of the earth in Figure 19. Here we have a coordinate increment of longitude, call it $\Delta\alpha$, with $\Delta\alpha$ being one degree. You know that at the equator the actual proper distance on the earth is about 112 kilometers, whereas, if we go to a latitude of 45° and consider the same longitude interval, it's only about 79 kilometers. There is a proper

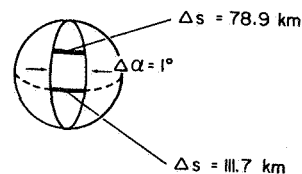

Figure 19

distance interval Δs which is related to the coordinate distance interval $\Delta \alpha$ by the following equation

$$\Delta s = R \cos \beta \Delta \alpha$$

Proper	Coordinate
Distance	Distance
Interval	Interval

and there is a coefficient, called the metric coefficient, $R \cos \beta$, where β is the latitude and R is the radius of the earth. This is an excellent analogy to the situation in curved space-time. There, we have, when the clock is not moving

$$(\Delta s)^2 = c^2 \Delta \tau^2 = (1 + 2\phi/c^2) c^2 (\Delta t)^2 = g_{00} c^2 (\Delta t)^2$$

or
$$\Delta s = g_{00}^{1/2} c \Delta t$$

where g_{00} is the name given by relativists to the metric coefficient $(1 + 2\phi/c^2)$. The proper time interval $\Delta \tau$ is related to the coordinate time interval Δt in this way for stationary clocks:

$$\Delta \tau = (1 + 2\phi/c^2)^{1/2} \Delta t = g_{00}^{1/2} \Delta t$$

One can often establish on two-dimensional curved surfaces a metric formula. In the case of the sphere when we consider both latitude and longitude we get

$$(\Delta s)^2 = R^2 \cos^2 \beta (\Delta \alpha)^2 + R^2 (\Delta \beta)^2$$

For a different choice of coordinates on a two-dimensional surface, as shown in Figure 20, there can be cross-product terms

$$(\Delta s)^2 = g_{11} (\Delta x_1)^2 + g_{12} \Delta x_1 \Delta x_2 + g_{21} \Delta x_2 \Delta x_1 + g_{22} (\Delta x_2)^2$$

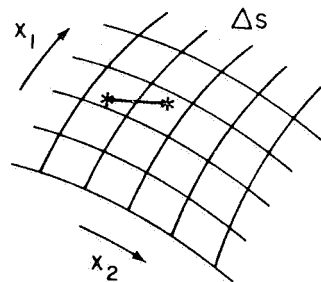

Figure 20

The great mathematician Gauss and his successors Riemann and Levi-Civita and many other differential geometers, have extended this to any number of dimensions and have written the proper interval of distance as a quadratic form with metric coefficients, which are always called g now, because of their application to gravity by Einstein in his curved space-time.

$$\begin{aligned}
 (\Delta s)^2 &= g_{11}(\Delta x_1)^2 + g_{12}\Delta x_1\Delta x_2 + \dots \\
 &= g_{21}\Delta x_2\Delta x_1 + g_{22}(\Delta x_2)^2 + \dots \\
 &= g_{31}\Delta x_3\Delta x_1 + \dots \\
 &\vdots
 \end{aligned}$$

Unfortunately, we cannot go into the mathematics of differential geometry for lack of time. It is highly interesting and enlightening and very powerful for calculations, but in many ways it has obscured the physics of General Relativity.

Einstein got these ideas about including metric coefficients in the expression for $(\Delta s)^2$ to describe gravity around about 1911/1912. During the years 1912-1914, he worked with his long-time friend, the mathematician Marcel Grossmann, to develop the General Theory of Relativity. They wanted to allow curvature of space as well as curvature of time, and they proposed field equations to describe how matter will curve space and time. That is, how the metric coefficients will be determined by the distribution of matter. Matter curves space-time. Einstein proposed that objects would move in this curved space-time along geodesics: the shortest path or the extremal path. A geodesic between two points on the surface of the earth is the shortest path -- the arc of a great circle. In the case of curved space-time, if you imagine a clock attached to a particle which is moving, the motion will be such that the elapsed proper time will be a maximum. Bertrand Russell wittily called this the "Principle of Cosmic Laziness".

There is the prescription: "Curved space-time tells objects how to move; matter tells space-time how to curve." This is the way Professor John Wheeler likes to summarize General Relativity. There is no more Newtonian force. Objects move under the influence of gravity because of the way clocks behave. A clock will run faster the higher it is, and it will run slower the faster it moves. The primary curvature for slow speeds and weak gravitational fields is the curvature of time, not the curvature of space, as you read in so many of the popular books. How can you represent this curvature of time? We can do it in terms of the diagram in Figure 21. Imagine the sun on the left, and plot the gravitational potential ϕ of the sun, as a function of the distance r from its center (or, better, plot ϕ/c^2 since this combination occurs in the relation between proper time and coordinate time).

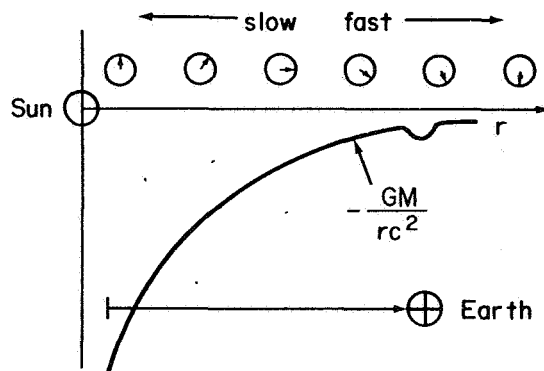

Figure 21

Imagine the sun on the left, and plot the gravitational potential ϕ of the sun, as a function of the distance r from its center (or, better, plot ϕ/c^2 since this combination occurs in the relation between proper time and coordinate time).

$$\frac{\phi}{c^2} = \frac{-GM_{\odot}}{R_{\odot} c^2} \left(\frac{R_{\odot}}{r} \right)$$

where G = Newtonian Gravitational Constant

M_{\odot} = Mass of the Sun

R_{\odot} = Radius of the sun

This plot is often called the "potential well" of the sun. Its "depth" is $\frac{GM_{\odot}}{R_{\odot} c^2} \approx 2 \times 10^{-6}$. The much smaller potential well of the earth is shown superimposed (in exaggerated form) on the curve for the sun. Its depth is $\frac{GM_{\oplus}}{R_{\oplus} c^2} \approx 7 \times 10^{-10}$ (M_{\oplus} = mass of the earth; R_{\oplus} = radius of the earth). With respect to a clock at a great distance (at the "top" of the potential well), a clock will run slower as it is placed deeper in the potential well.

To dramatize this effect, consider Figure 22 which is a drawing made by Herblock, the great cartoonist of the Washington Post, at the time of Einstein's death in 1955. Imagine that an observer at a great distance from the sun is observing events on earth. One hundred years on earth (for example, the time between Einstein's birth and his centennial celebration on March 14, 1979) would appear to this observer as 100 years plus 41 seconds: 29 seconds from the ascent from the earth up the potential well of the sun; two seconds from the potential well of the earth; and 15 seconds from the $-\frac{v^2}{2c^2}$ effect of the earth's velocity around the sun.



Figure 22

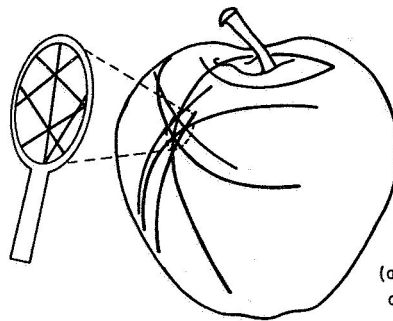

(after Misner, Thorne, and Wheeler)

Figure 23

Wheeler likes to demonstrate the motion along geodesics in space-time by considering ants on an apple. Figure 23 is a sketch from the cover of the great book, Gravitation, by Misner, Thorne and Wheeler. Suppose you imagine ants that try to move as straight as they can locally (this is one way to define a geodesic). Since the surface of the apple is curved, they tend to move in curved paths, and this is analogous to the motion of objects in curved space-time. Locally, they try to go as straight as possible and they end up going in curves, which manifests itself in an acceleration, the acceleration of gravity. So his Principle of Equivalence gave the clue to Einstein: gravity is to be described by the metric coefficients in curved space-time, including not only the g_{00} coefficient, but all the other coefficients that could come in from the different products of Δt , Δx , Δy , and Δz .

$$\begin{aligned}
 (\Delta s)^2 = & g_{00} c^2 (\Delta t)^2 + g_{01} c \Delta t \Delta x + g_{02} c \Delta t \Delta y + g_{03} c \Delta t \Delta z \\
 & + g_{10} c \Delta t \Delta x + g_{11} (\Delta x)^2 + g_{12} \Delta x \Delta y + g_{13} \Delta x \Delta z \\
 & + g_{20} c \Delta t \Delta y + g_{21} \Delta y \Delta x + g_{22} (\Delta y)^2 + g_{23} \Delta y \Delta z \\
 & + g_{30} c \Delta t \Delta z + g_{31} \Delta z \Delta x + g_{32} \Delta z \Delta y + g_{33} (\Delta z)^2
 \end{aligned}$$

A certain symmetry is imposed

$$\begin{aligned}
 g_{10} = g_{01} ; g_{20} = g_{02} ; g_{30} = g_{03} ; \\
 g_{12} = g_{21} ; g_{13} = g_{31} ; g_{23} = g_{32}
 \end{aligned}$$

so that you end up with only ten metric coefficients which can be arrayed in this fashion.

$$g_{\mu\nu} = \begin{array}{cccc}
 g_{00} & g_{01} & g_{02} & g_{03} \\
 g_{10} & g_{11} & g_{12} & g_{13} \\
 g_{20} & g_{21} & g_{22} & g_{23} \\
 g_{30} & g_{31} & g_{32} & g_{33}
 \end{array}$$

This is the famous metric tensor; these $g_{\mu\nu}$ are functions of space and time in general. Einstein wanted to allow any coordinates, not just inertial coordinates (inertial observers), but for an inertial observer (realizable locally by a freely falling laboratory), this array of metric coefficients reduces to a simple form

$$g_{\mu\nu} = \begin{array}{cccc}
 1 & 0 & 0 & 0 \\
 0 & -1 & 0 & 0 \\
 0 & 0 & -1 & 0 \\
 0 & 0 & 0 & -1
 \end{array}$$

This represents the Minkowski metric that we have seen earlier:

$$(\Delta s)^2 = c^2 (\Delta t)^2 - (\Delta x)^2 - (\Delta y)^2 - (\Delta z)^2 .$$

When you make a change of coordinates, the metric coefficients are going to have to change also in order to keep Δs^2 invariant. The metric coefficients play the role of generalized gravitational potentials. I wish there were more time to elaborate on these things.

SUMMARY OF GENERAL RELATIVITY

Einstein wrote the quadratic form that implies summation on repeated indices: μ and ν run from 0 to 3,

$$(\Delta s)^2 = g_{\mu\nu} \Delta x_\mu \Delta x_\nu .$$

invariant metric
interval coefficients

The coefficients $g_{\mu\nu}$ are to be obtained by solving the famous field equations which are shown here in symbolic form.

$$R_{\mu\nu} - \frac{1}{2} R g_{\mu\nu} = \frac{8 \pi G}{c^4} T_{\mu\nu}$$

Contracted Riemann Curvature Tensor	- 1/2 Rg _{μν} Curvature Scalar	= 8 π G / c ⁴ T _{μν} Stress Energy Tensor
-------------------------------------	---	---

These are ten second order partial differential equations. They are non-linear in that they involve products of the first derivatives of the metric coefficients. The source term on the right-hand side $T_{\mu\nu}$, is the general stress energy tensor of matter; it includes the effects of matter, energy, and pressure, all of which produce gravitational fields. On the left-hand side are various curvatures from differential geometry involving first and second order partial derivatives with respect to time and space of the metric coefficients $g_{\mu\nu}$. $R_{\mu\nu}$ is the contracted Riemann Curvature Tensor and R is the Curvature Scalar. In 1917, Karl Schwarzschild solved these equations and got the famous Schwarzschild metric, which I display here.

$$(\Delta s)^2 = \left(1 - \frac{2GM}{rc^2}\right) c^2 (\Delta t)^2 - \frac{(\Delta r)^2}{(1 - 2GM/rc^2)} - r^2 \cos^2 \beta (\Delta \alpha)^2 - r^2 (\Delta \beta)^2$$

$c^2 (\Delta t)^2$	Curvature of Time	Curvature of Space	
for moving objects	of Time	of Space	

This is the metric that is to exist outside of an isolated spherical body of mass M. The coefficient g_{00} of the $c^2 (\Delta t)^2$ term involves $-GM/r$, which is the Newtonian potential ϕ . It describes the curvature of time as we have seen earlier. There's also a similar expression in the denominator of the $(\Delta r)^2$ term, when one uses spherical coordinates as here. This describes the curvature of space. But, for

ordinary motion (that is, in weak gravitational fields, like on the earth, and for velocities much less than the speed of light), you can neglect the curvature of space. All of Newtonian physics follows from the curvature of time alone.

It is the Schwarzschild metric that leads to the famous concept of the black hole. This is a phrase coined by John Wheeler. Suppose you ask, can the coefficient of the $c^2(\Delta t)^2$ term, the g_{00} coefficient, go to 0? Well, it can:

$$g_{00} = 1 - \frac{2GM}{rc^2} = 0$$

$$\text{for } r = \frac{2GM}{c^2}$$

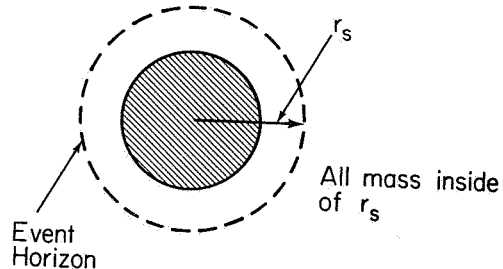

Figure 24

One calls this value of r the Schwarzschild Radius and often denotes it by r_s . You can calculate its value for various masses. In the case of the earth, it's about nine millimeters. In the case of the sun, it's three kilometers. Now suppose you could compress all of the mass of the sun into a sphere with a radius of less than three kilometers? Then you would have a very singular surface outside the mass, which is shown as a dashed line in Figure 24. The surface, often called the event horizon, has remarkable properties, because the coefficient g_{00} vanishes there. If you imagine watching a clock moving in towards the event horizon from a great distance, its time and motion would slow down and you would never see it get there. For this reason, the Russians call an object of this sort a frozen star, just because of the property that matter would fall in and seem to never get beyond the event horizon. You cannot get any information out from inside this event horizon. However, if you are riding in with some of the falling matter, and recording things in your proper time, it takes a finite proper time to get in and through the event horizon. If there is a supernova explosion and subsequent collapse of the central material to form a black hole, this can happen in a few milliseconds. Such collapses are, perhaps, potent sources of gravity waves, about which we will hear in the next talk.

I want to correct a widespread misconception about black holes: that they are all very, very dense. This is certainly the case for the examples of black holes with a solar mass or an earth mass as discussed above. Note, however, that the Schwarzschild radius r_s is proportional to the mass M , and that the density varies as M/r_s^3 . Therefore, the density depends on mass as $1/M^2$. For a black hole with very large mass, the density can be very small. Figure 25 shows the galaxy M87 in the Virgo cluster. This is a weak exposure so that you can see this bright

jet coming out of the center unobscured by outer parts of the galaxy. There is some evidence, for example the high velocities of stars near the center of this galaxy, that suggests that there is a black hole of several billions of solar masses present there. The jet is probably associated with the rotation of that black hole; matter being converted into energy as it falls into the black hole, and somehow propelling the jet along the axes of rotation. There are many jets of this sort in galaxies. There may be a black hole in the center of our own galaxy. There's some evidence for it, but no time to discuss it here.

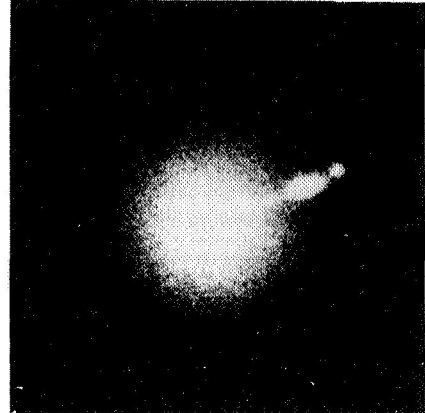

Figure 25

EXPERIMENTAL MEASUREMENTS OF RELATIVISTIC CLOCK EFFECTS

Let me now talk some about experiments very quickly. We have done experiments with aircraft and lasers to illustrate, measure and demonstrate these effects. My chief collaborator was Len Cutler who was the designer of the Hewlett-Packard 5061 Cesium atomic beam standards which we used. Bob Reisse⁷ and Ralph Williams⁸ did their theses as part of these experiments. There were many other participants at the University of Maryland and the Naval Observatory. Dr. Gernot Winkler, Director of the Time Services Division, very kindly lent the clocks and gave much, much support to these activities.

We were able to fly clocks in an airplane, suitably packaged so that they didn't suffer from environmental degradation of their performance. Figure 26 shows a schematic diagram of the flights. We could send light pulses up and get them reflected back from a lunar-type corner reflector on the plane, also registering the time of their arrival with the airplane clocks in just the way Einstein prescribed. We tracked the aircraft with radar beams in order to have an independent knowledge of the position and velocity from which to calculate the proper time differences. We used minicomputers and event timers both on the ground and on the plane. There's no time to go into details; these have been discussed in other places¹. The plane would fly for about 15 hours over the Chesapeake Bay from the Patuxent Naval Air Test Center in a racetrack pattern, taking about 20 minutes to go around a path shown

⁷ R. A. Reisse, "The Effects of Gravitational Potential on Atomic Clocks as Observed with a Laser Pulse Time Transfer System," University of Maryland Ph.D. dissertation (May, 1976).

⁸ R. E. Williams, "A Direct Measurement of the Relativistic Effects of Gravitational Potential on the Rates of Atomic Clocks Flown in an Aircraft," University of Maryland Ph.D. dissertation (May, 1976).

in Figure 27. We would accumulate, during one of these flights, a typical time difference of about 50 nanoseconds. These measurements were in good agreement with the proper time integral. The time difference between the airborne and ground clocks would be given by integrals of this sort.

$$\tau_A = \int_0^T \left(1 + \frac{\phi_A}{c^2} - \frac{v_A^2}{2c^2} \right) dt$$

$$\tau_G = \int_0^T \left(1 + \frac{\phi_G}{c^2} - \frac{v_G^2}{2c^2} \right) dt$$

$$\tau_A - \tau_G = \int_0^T \left(\frac{\phi_A - \phi_G}{c^2} - \frac{v_A^2 - v_G^2}{2c^2} \right) dt$$

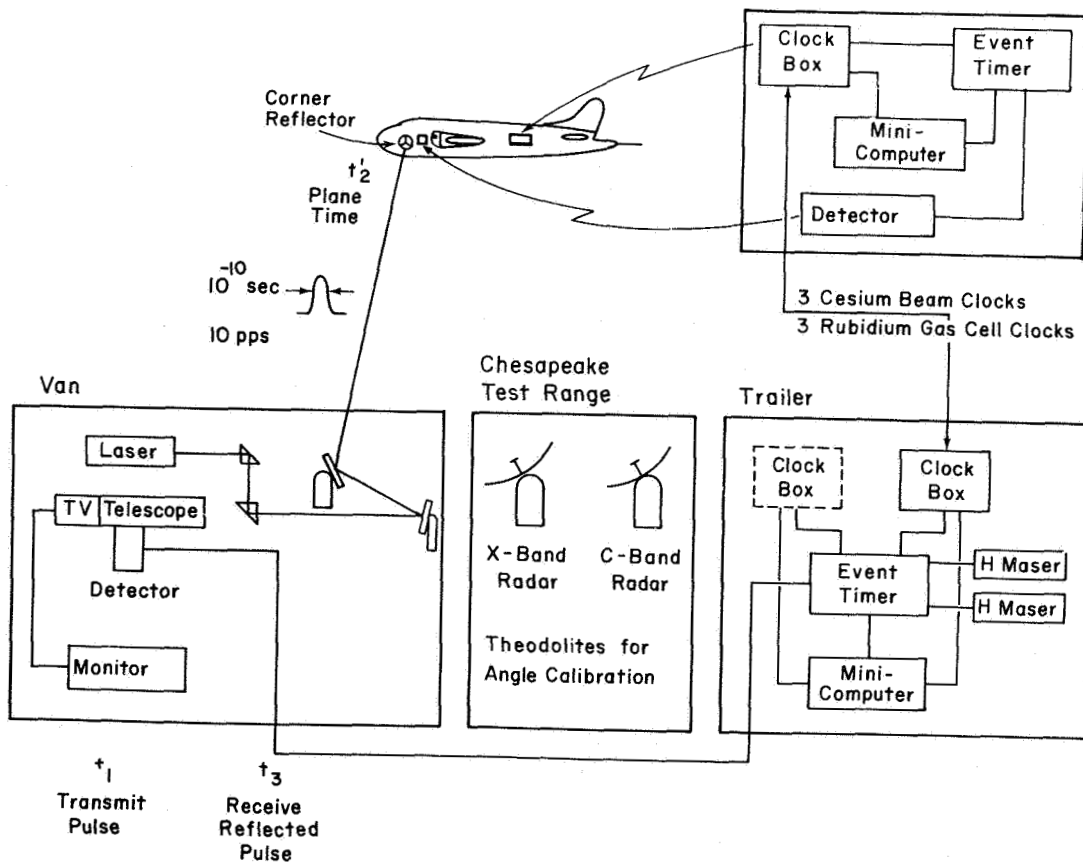

Figure 26

We allowed for higher terms in the earth's gravitational potential due to its oblate shape, and for the rotational effects of the earth. We evaluated the proper time integral in a reference frame centered on the earth which is non-rotating with respect to distant matter, as shown in Figure 28.

The clocks were modified in order to give the performance needed. Following suggestions by Len Cutler and others at Hewlett-Packard, we increased the beam current by a factor of 2, we added an integrating loop in the crystal control, and there was a proprietary modification of the beam tube (now standard on all high performance tubes). All in all, we could achieve stabilities over the 15 hours at a couple of parts in 10^{14} with standard commercial clocks, as shown in Figure 29. We paid much attention to providing a stable environment for the clocks. Let us look at some pictures to show you the equipment and give you some feeling for the experiment.

Figure 30 is the plane which we used. Figure 31 shows it on the ground; the clocks were in the trailer, and the laser equipment was in the bus. Figure 32 is the detector on the plane behind one of the observation windows. Figure 33 shows the corner reflector outside the observation window. Figure 34 is the beam directing optics. Figure 35 shows the laser, below which is the 7.5 inch telescope which receives the reflected laser pulses. Both the detector and a closed circuit TV camera for guiding are coupled to it with a beam splitter. Figure 36 shows Len Cutler adjusting some of the six Cesium beam clocks. Figure 37 is the clock box that protected them from environmental changes. It contained magnetic shields, vibration isolators with near critical damping at a resonant frequency of several

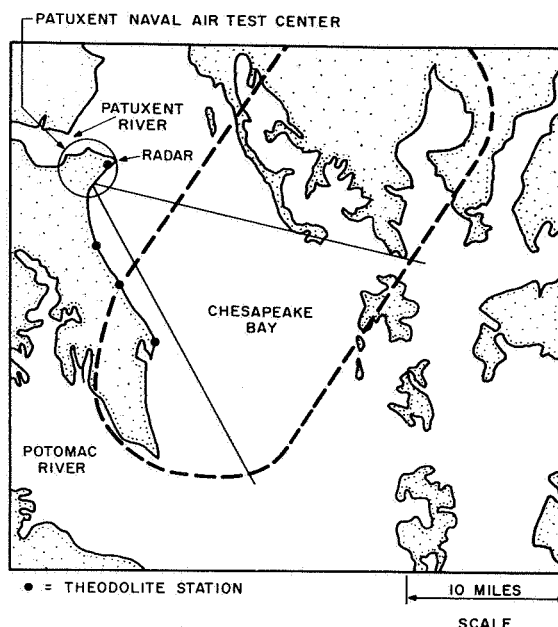

Figure 27

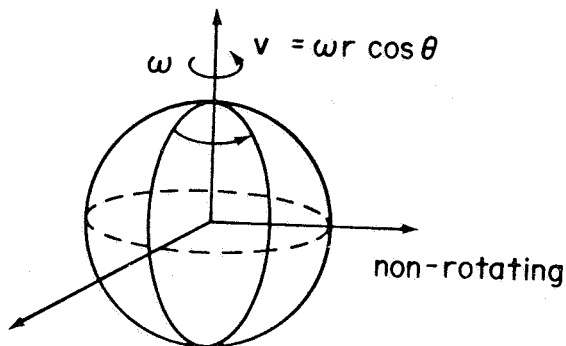

Figure 28



Figure 30

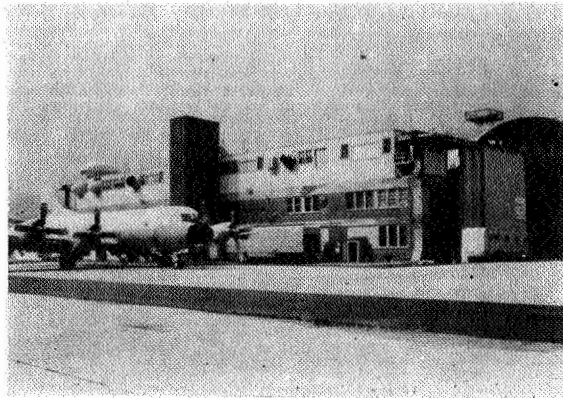

Figure 31

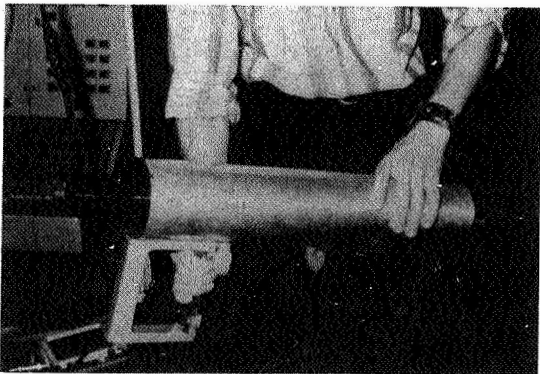

Figure 32

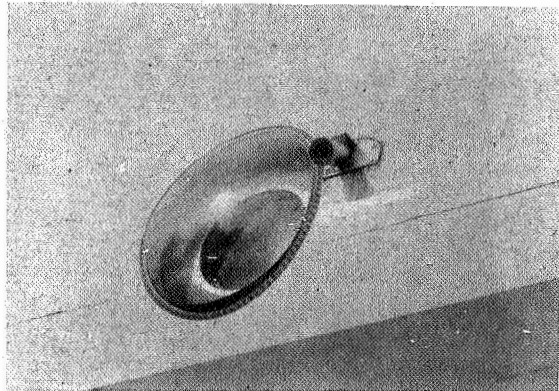

Figure 33

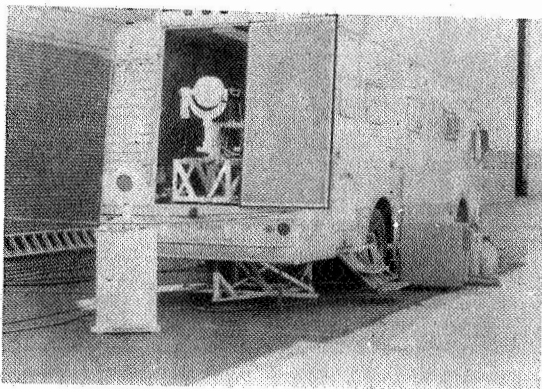

Figure 34

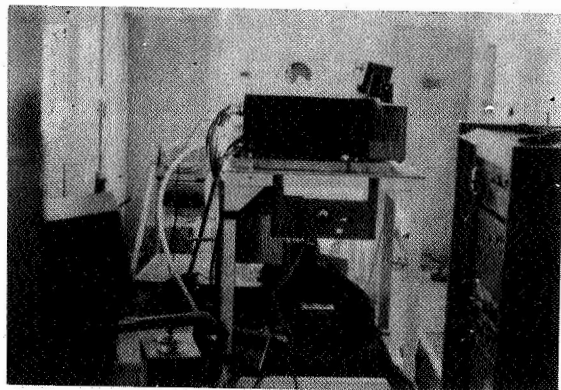

Figure 35

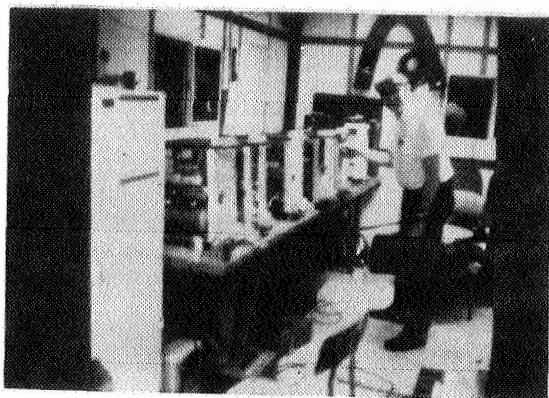

Figure 36

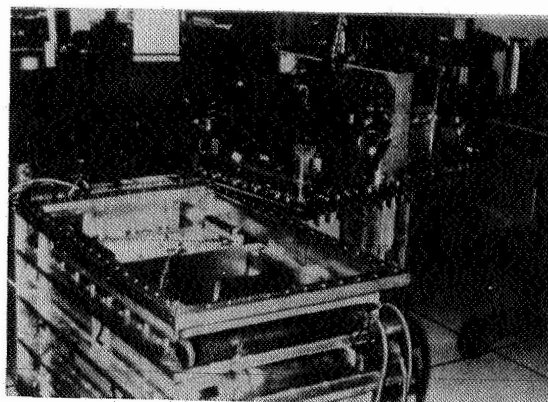

Figure 37

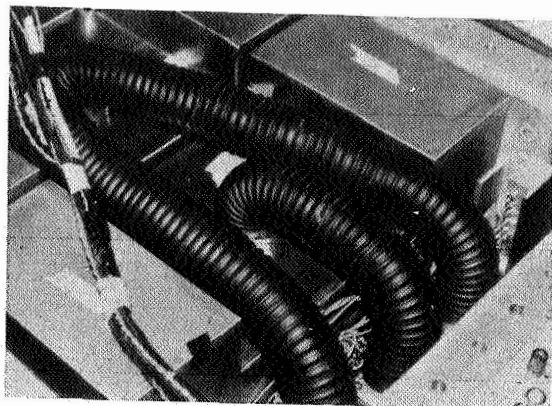

Figure 38

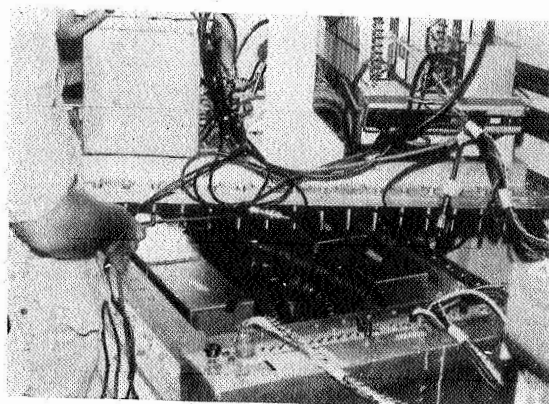

Figure 39

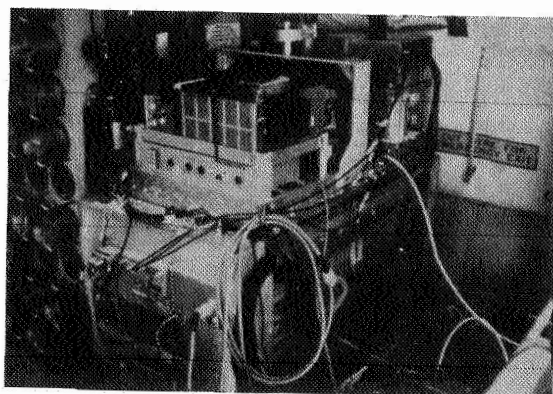

Figure 40

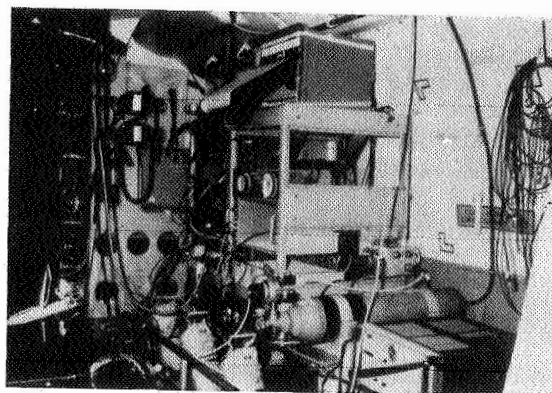

Figure 41

Hertz, and constant pressure and constant temperature controls. Air was circulated through the boxes to get the heat out and to keep the temperature constant, as shown in Figure 38. Figure 39 shows the lid which supported voltage and pressure regulators. Figure 40 shows the clock box mounted in the P3C airplane. Figure 41 is the electronic equipment to measure and record the relative performance of clocks on board and to record the epoch of the arrival of the laser pulse. On the right of Figure 41 is a travelling clock, whose environment was not controlled.

The kinds of data that one could get are shown in Figure 42 for a flight on November 22, 1975. We flew for five hours at 25,000 feet, and for another five hours at 30,000 feet to burn off fuel, concluding with another five hours at 35,000 feet. So there were steps in the potential

difference. The vertical scale is parts in 10^{12} . There were changes of velocity due to wind as the aircraft circled, shown in the lower part of Figure 42 (the v^2/c^2 effect). The integral of these curves is shown in Figure 43. The potential effect integrates out to about 53 nanoseconds, the velocity effect to about -6 nanoseconds, with the net effect being about 47 nanoseconds. The error bar points are the laser pulse time comparisons. The actual data before flight and after flight can be seen in Figure 44 with the direct side-by-side clock comparison represented by the solid line, the laser comparison shown again by error bar points. The agreement between the prediction and the measurements is quite good. The relative rate of the airborne and ground clocks ensembles is represented by the slope and is seen to be the same both before and after flight. There was a similar effect for each of the individual clocks. Figure 45 illustrates the effects of the steps in altitude. They produced changes in relative clock rates which were measured by the laser pulse time comparison. The technique can serve as a crude altimeter! Figure 46 shows the time of an on-board clock with respect to the average of all on-board clocks. You can't even tell where the flight occurred! If that same clock is compared with the ground ensemble as shown in Figure 47, there is a step of some 47

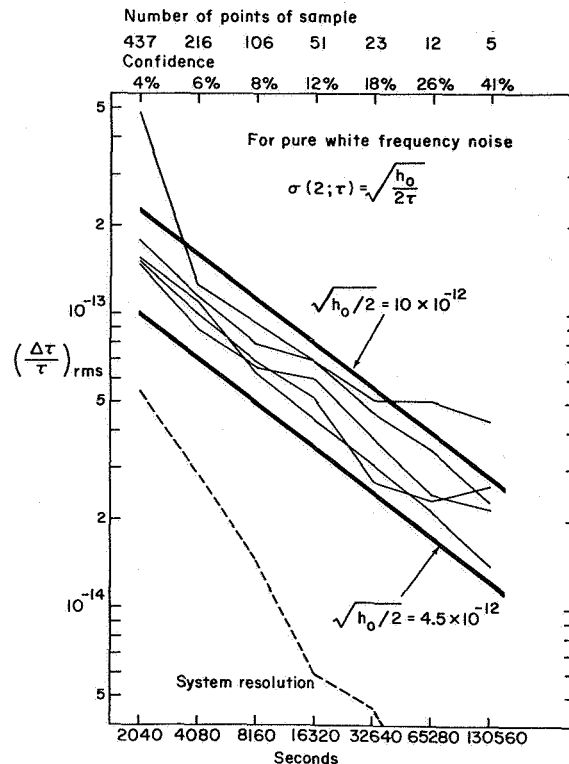

Figure 29

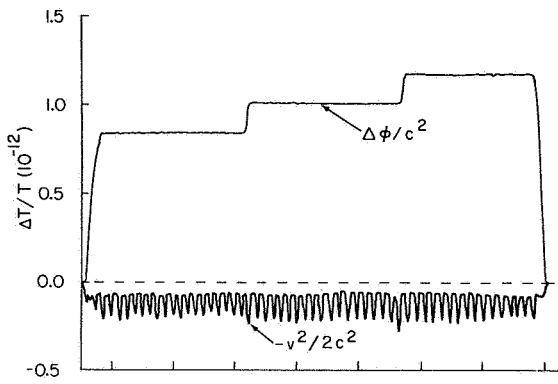

Figure 42

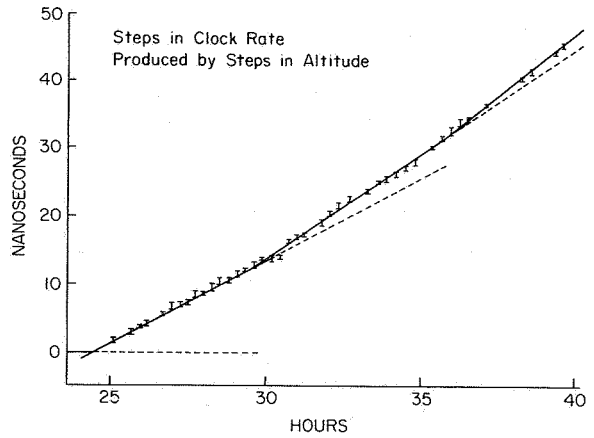

Figure 45

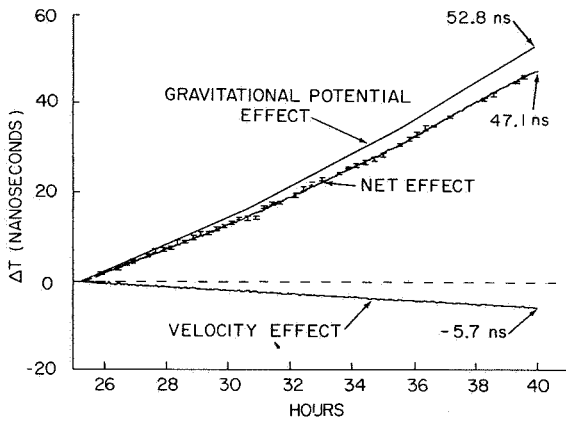

Figure 43

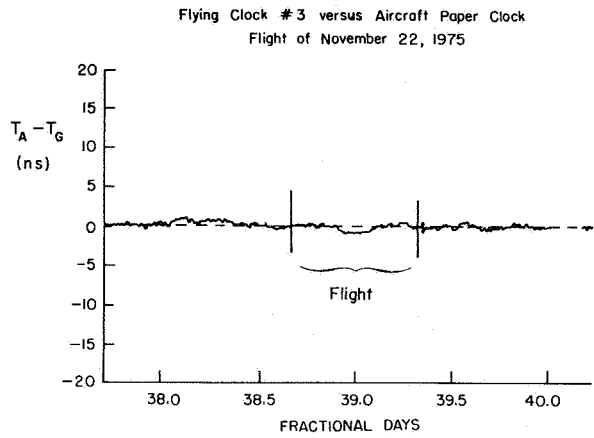

Figure 46

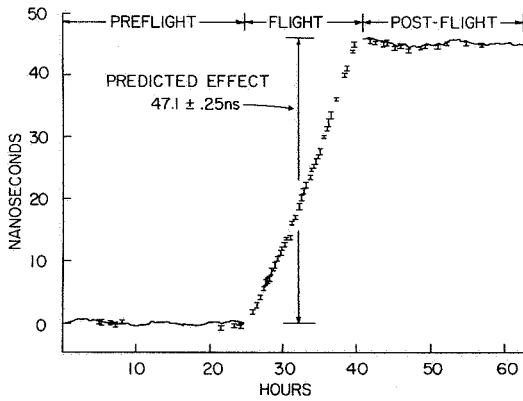

Figure 44

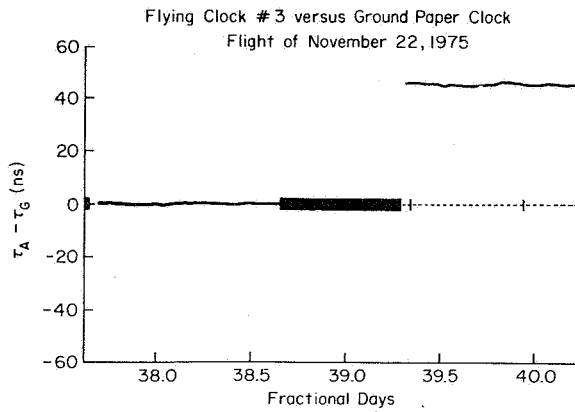

Figure 47

nanoseconds or so, as expected. Five separate 15-hour flights of this type were carried out, each yielding similar results.

We have done other aircraft clock experiments on a global scale. You will recall Einstein's "error" that we referred to earlier, the equator to the pole clock comparison. The surface velocity, if we consider only that, gives a prediction of 102 nanoseconds a day for the relative clock rates. But this is wrong, because you must also consider the gravitational potential difference. In going from the equator to the pole on an oblate earth there is a change in potential, as shown in Figure 48. The earth is an oblate spheroid and the mean ocean surface is an equipotential of $\phi - v^2/2$, the so-called geopotential. You remember that's exactly what comes into the relation between proper time and coordinate time:

$$d\tau = \left[1 + \frac{1}{c^2} \left(\phi - \frac{v^2}{2} \right) \right] dt$$

$\phi - v^2/2$ is constant along the mean ocean surface on the oblate earth. So the proper time is going to be constant along the mean ocean surface. Thus, one would expect a time difference to be produced only by flight conditions, the altitude above the ocean surface and the velocity contributing to the proper time integral, as we have discussed. We flew clocks to Thule, Greenland, left them four days, and brought them back. We measured a time difference of 38 ± 5 nanoseconds, and we calculated 35 ± 2 nanoseconds from inertial navigation and air to ground data. There is no anomalous latitude effect. The "Einstein error", if that prediction were calculated for Washington to Thule, would have been 224 nanoseconds over four days from a predicted rate of 56ns/day. The experiment provides another demonstration, from this point of view, of the effect of the gravitational potential difference which just compensates the velocity effect.

We have also done experiments with Einstein's freely falling laboratory in which we've used the earth itself as the falling laboratory. The earth is always falling freely towards the sun, but it moves in orbit around the sun and never falls in. Its spin axis is tilted 23.5 degrees with respect

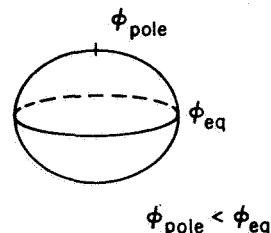

Figure 48

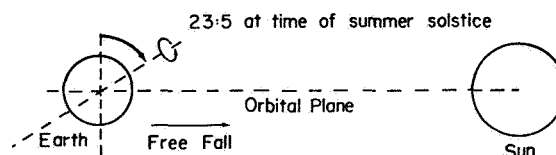

Figure 49

to the plane of its orbit, so that at the time of the summer solstice, clocks in the Northern Hemisphere are closer to the sun than clocks in the Southern Hemisphere, as shown, with an exaggerated tilt, in Figure 49. There's been a long-standing puzzle, or confusion, on the part of some people: on the earth, should the high clocks in the sun's potential run fast with respect to the low clocks in the sun's potential?^{9,10,11}

The answer is no, by the Principle of Equivalence. You will remember that gravity is cancelled locally in a freely falling laboratory. We actually did the experiment by flying clocks from Washington to Christchurch, New Zealand and back again. The disagreement and the confusion in the literature, results from people wanting to retain the linear term in the expansion of the potential about the center of the earth, as sketched in Figure 50. There is

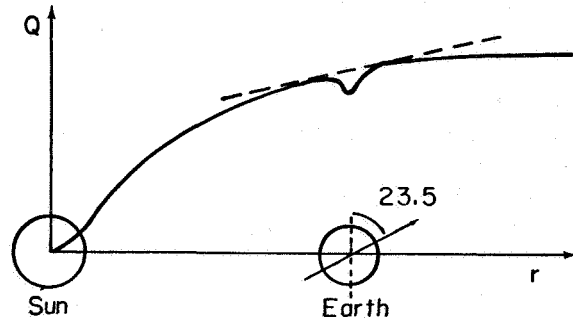

Figure 50

an excellent paper by J.B. Thomas from JPL¹², which does this calculation correctly. There are remaining second order terms in the expression of the potential which cause tidal effects, but these can be neglected in their effects on currently available clocks. In our experiments we found agreement between the calculated proper time difference and the measured proper time difference. The results are shown in the following Table.

⁹ B. Hoffmann, "Noon-Midnight Red Shift," Physical Review, Vol. 121, pp 337ff (1961).

¹⁰ R. U. Sexl, "Seasonal Differences Between Clock Rates," Physics Letters, Vol. 61B, pp 65ff (1976).

¹¹ W. H. Cannon and O. G. Jensen, "Terrestrial Timekeeping and General Relativity: A New Discovery," Science, Vol. 188, pp 317ff (1975). The errors in this paper have been pointed out in many letters in "Acceleration and Clocks," Science, Vol. 191, pp 489-491 (1976). The authors have retracted their claims.

¹² J. B. Thomas, "Reformulation of the Relativistic Conversion Between Coordinate Time and Atomic Time," Astronomical Journal, Vol. 80, No. 5, pp 405ff (1975).

		FLIGHT 1 (10 - 17 July 1977)	FLIGHT 2 (23 - 30 July 1977)
$(\tau_A - \tau_G)$ measured	(ns)	115 ± 10	131 ± 10
$(\tau_A - \tau_B)$ calculated	(ns)	129 ± 2	122 ± 2
(Measured - Calculated)	(ns)	-14 ± 12	11 ± 12
Calculated Effect of Linear Term	(ns)	80 ± 2	70 ± 2

Note that there is no evidence for the alleged effect of the linear term.

These flights also point up the effect on proper time of clock transport by aircraft. The following table displays the calculated proper times using data from the on-board inertial navigation units and plane-to-ground radar for the different legs of the trips.

EFFECT OF EARTH'S ROTATION

	FLIGHT 1 (ns)	FLIGHT 2 (ns)
Andrews AFB to Travis AFB (E - W)	35	31
Travis AFB to Hickam AFB (E - W)	35	31
Hickam AFB to Christchurch (E - W)	47	52
Christchurch to Hickam AFB (W - E)	16	16
Hickam AFB to Andrews AFB (W - E)	-1	-4
Dwell Time on Ground	-3	-3

Note the large difference between East-West and West-East legs caused by the earth's rotation: In the West-East direction the surface velocity of the earth adds to the surface velocity of the aircraft, giving a large velocity in the inertial frame attached to the center of the earth where the calculations are best made. The large $v^2/2c^2$ very nearly cancels the ϕ/c^2 in the proper time integral. The entries in the table are typical of the effects to be expected for an air speed of 500 knots and an altitude of 35,000 feet, characteristic of jet aircraft.

Let me show you a few pictures of our global flights. Figure 51 is a polar view of a National Geographic globe on which is marked the path of the flight from Washington to Thule and back. You can see there is a large change in distance from the earth's spin axis, producing a large

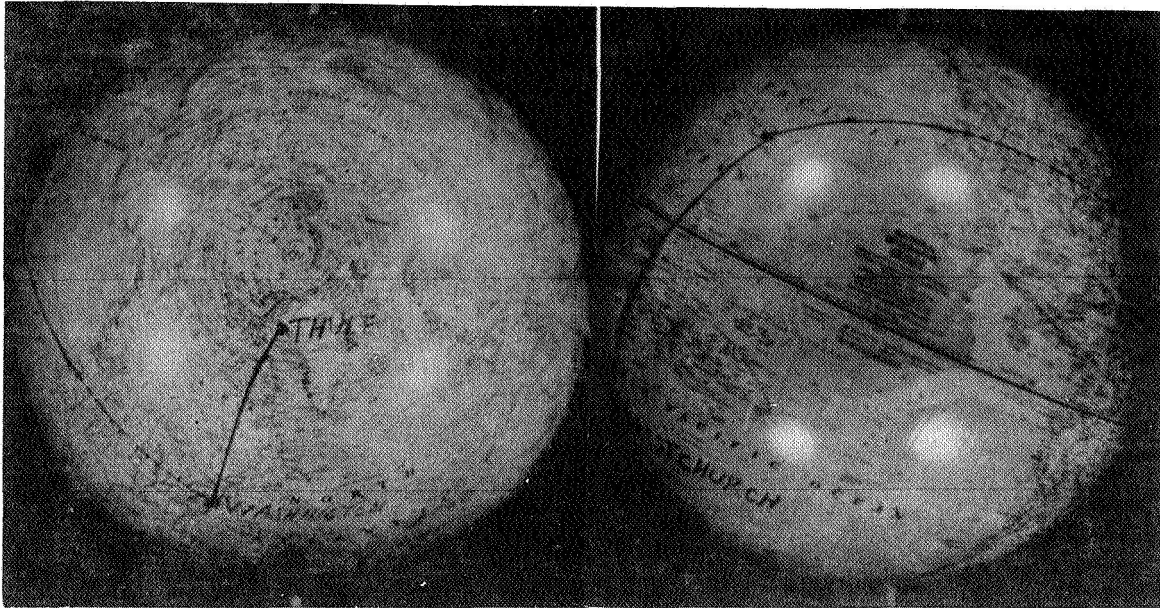

Figure 51

Figure 52

change in surface velocity. Figure 52 shows the tilted earth, the sun being off to the right at the time of the summer solstice. The path from Andrews AFB in Washington to the Travis AFB in California to Hickam Field in Hawaii, and down to Christ Church is marked. Figure 53 shows the repackaged equipment for flying on an Air Force C141 transport plane. Figure 54 shows the equipment mounted on a cargo pallet with the surrounding thermal protection enclosure. Figure 55 shows the pallet carrying the equipment being loaded into the C141. Figure 56 shows a later step in the loading process. Figure 57 is a picture taken during one of the flights. The equipment for recording the inertial navigation systems and air-to-ground radar information from which to calculate the proper time integral is on the table on the left.

Other experiments were done recently by Bob Vessot and Marty Levine¹³, with a hydrogen maser in a rocket probe, in which the ratio of the measured to predicted value was $1 + (2.5 \pm 70) \times 10^{-6}$. This is better than a hundredth of a percent confirmation. They measured frequency rather than time directly, but the same basic equation that we've been working with had to be used. The great thing about their experiment was the ability to essentially cancel out the Doppler effect, and ionospheric, which is two parts in 10^5 , sufficiently well to measure

13 R. F. C. Vessot and M. W. Levine, "A Test of the Equivalence Principle Using a Spaceborne Clock," General Relativity and Gravitation, Vol. 10, No. 3, pp 181 -204 (179).

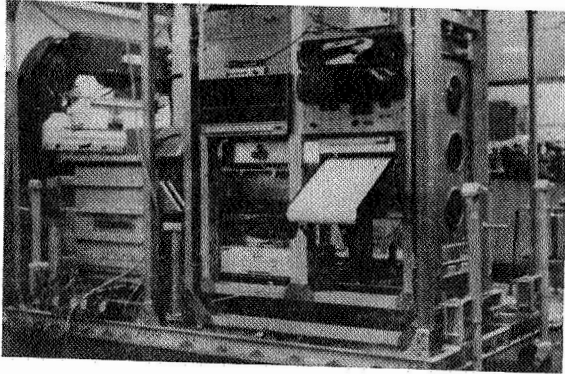

Figure 53

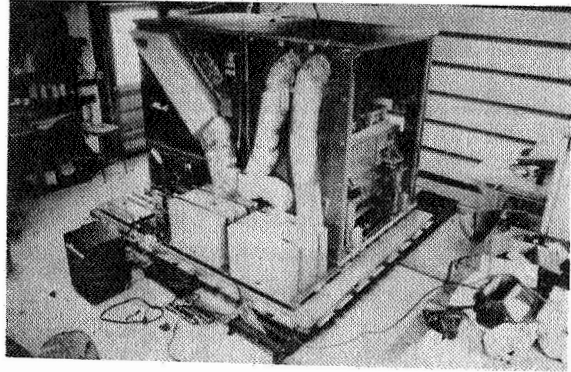

Figure 54

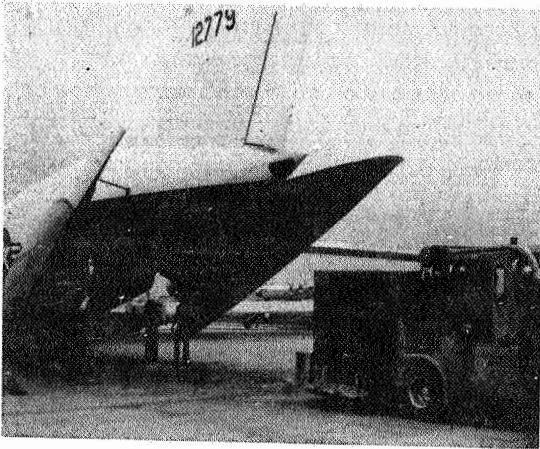

Figure 55

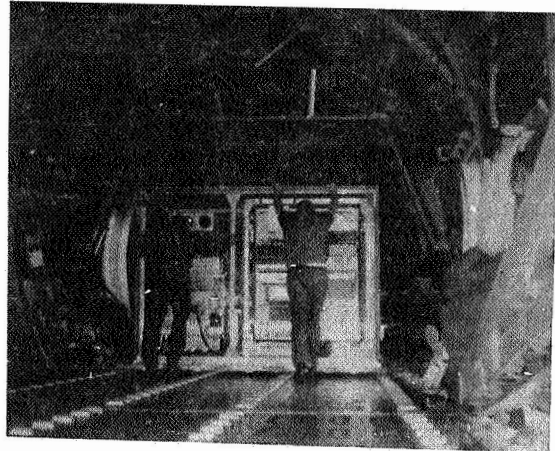

Figure 56

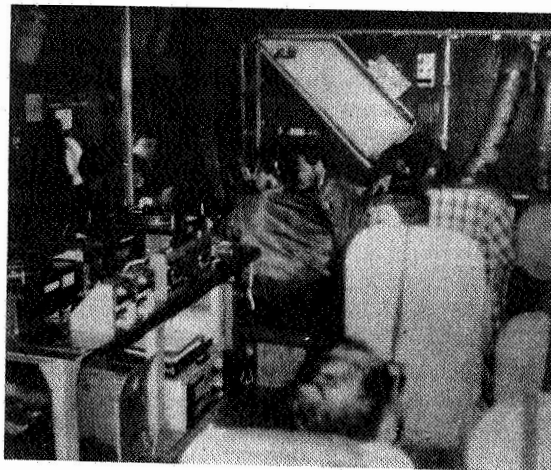
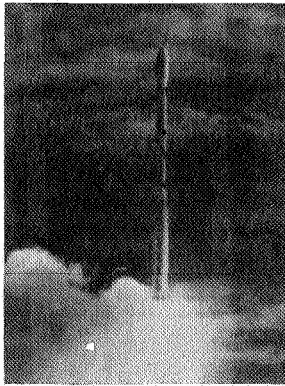
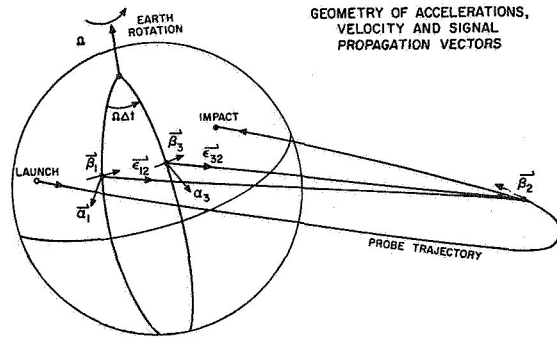

Figure 57



Left:
Figure 58



Right:
Figure 59

to 10^{-4} the effect of the potential, which is only four $\gamma 10^{10}$, by a very clever three-frequency cancellation scheme. Figure 58 shows the Scout rocket that was used in that experiment, and Figure 59 shows its trajectory rising to several earth radii and falling back into the Atlantic Ocean. Unfortunately, there's no time to go into more details.

SOME APPLICATIONS

Let us now consider some practical engineering applications. Figure 60 is an artist's view of the GPS/NAVSTAR system, which I think now has only 18 satellites planned rather than the 24 shown here. They are in 12 hour period orbits, and they carry very good atomic clocks. The circular orbits are about 14,000 kilometers above the earth's surface. Figure 61 illustrates the way in which the system works. A

Right:
Figure 61

Below: Figure 60

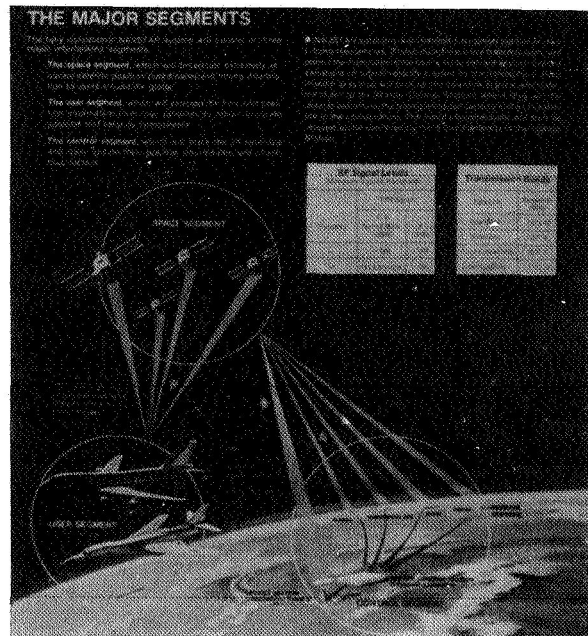
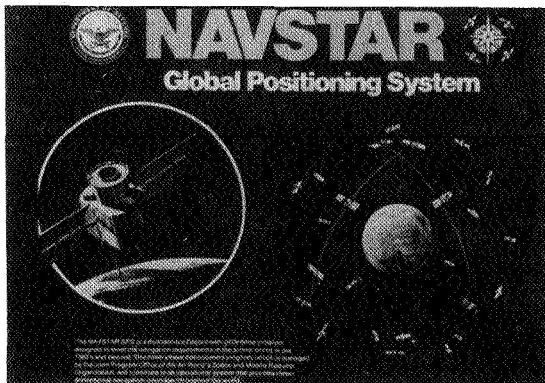

user receives L-band signals from each of several satellites, consisting of a coded bit stream whose rate is set by the onboard atomic clock at 10.23 MHz. The user's receiver is equipped with the same code, which is shifted in time to lock on to the satellite bit stream. By doing microprocessor calculations from four satellites, the user's equipment finds out where he is and also what the time is. But for all of this to work, the satellite clocks must be synchronized with the GPS master station. You have to allow for the gravitational potential and motional effects of General Relativity, which we have been discussing.

In the Global Positioning System, the calculations can be made in the way we have demonstrated.

$$\begin{aligned} d\tau_{\text{sat}} &= \left(1 + \frac{\phi_{\text{sat}}}{c^2} - \frac{v_{\text{sat}}^2}{2c^2} \right) dt \\ d\tau_{\text{ground}} &= \left(1 + \frac{\phi_{\text{ground}}}{c^2} - \frac{v_{\text{ground}}^2}{2c^2} \right) dt \end{aligned}$$

Dividing the equations, and retaining only the constant and first order terms,

$$\frac{d\tau_{\text{sat}}}{d\tau_{\text{ground}}} = 1 + \frac{\phi_{\text{sat}} - \phi_{\text{ground}}}{c^2} - \frac{v_{\text{sat}}^2 - v_{\text{ground}}^2}{2c^2}$$

Evaluating this expression for the NAVSTAR circular orbit, one finds,

$$\frac{d\tau_{\text{NAVSTAR}}}{d\tau_{\text{ground}}} = 5.1 \times 10^{-10} = 44,000 \text{ ns/day}$$

This result means that if a NAVSTAR atomic clock has a certain relative rate to the GPS master clock when they are side by side at an elevation corresponding to the mean ocean surface (the surface used for reference in the GPS system as well as for UTC) -- say 20 ns/day -- this rate will be increased by 44,000 ns/day when the clock is placed in orbit. This was observed in 1977 by the Naval Research Laboratory with the NTS-2 satellite.¹⁴ But before that, there had been some doubt on the part of some people associated with the GPS program whether these effects were actually there. I remember well a meeting at the GPS offices in the Spring of 1976, when Gernot Winkler, Len Cutler and I presented the

¹⁴ T. McCaskill, J. White, S. Stebbins, and J. Buisson, "NTS-2 Frequency Stability Results," Proceedings of the 32nd Frequency Control Symposium (1978).

results of our P3C aircraft clock experiments when such questions were raised.

If there is some eccentricity to the orbit, there will be a periodic change in the distance of the satellite from the center of the earth. For an eccentricity 5×10^{-3} , the change in gravitational potential is enough to produce an amplitude of 12 nanoseconds (peak to peak of 24ns) with a 12 hour periodic in the onboard clock reading. This would produce an error in position of 24 feet, if not allowed for.

One must understand and include these effects correctly, as the GPS now does. For the large relativistic offset in clock rate in orbit of +44,000 ns/day, one adjusts the clock so that on the ground it would have a rate of -44,000 ns/day with respect to the reference GPS clock. This compensates for the relativistic effect when it is put into orbit. Once this is done, there is no longer a "gravitational red (blue) shift" on transmitted frequencies from the satellite to the ground, even though the radiation passes through a difference of gravitational potential $\Delta\phi$. This mistake was made by one of the GPS contractors during the development of the system. It is a natural mistake following from an often presented derivation of the blue shift in terms of the energy of a photon, $E = h\nu$, at the satellite; the mass equivalent of the photon, $m = h\nu/c^2$; and the gravitational energy change $m\Delta\phi$. If $h\nu'$ is the energy of the photon at the ground, energy conservation gives the equation

$$h\nu' = h\nu + (h\nu/c^2)\Delta\phi$$
$$\text{or } \frac{\nu' - \nu}{\nu} = \Delta\phi/c^2$$

This argument does not hold if the clocks have been adjusted as described above.

There is an upcoming experiment called LASSO, Laser Synchronization from Stationary Orbit, being done by the European Space Agency¹⁵ with the first operational launch of the ARIANE rockets, currently scheduled for April 1982. The experiment is on the Sirio 2 satellite, as shown in Figure 62. There will be corner reflectors, an avalanche photodiode detector, an event timer and a crystal clock on the satellite. Laser pulses will be fired at this synchronous satellite from the 1.2m telescope at the Goddard Optical Research Facility in a cooperative undertaking by the U. S. Naval Observatory, the University of Maryland, and NASA; and from several laser stations in Europe. The technique is

¹⁵ B. E. H. Serene, "Progress of the LASSO Experiment," Proceedings of the Twelfth Annual Precise Time and Time Interval (PTTI) Applications and Planning Meeting; NASA Conference Publication 2175, pp 307 - 327, December 2 - 4, 1980.



Figure 62

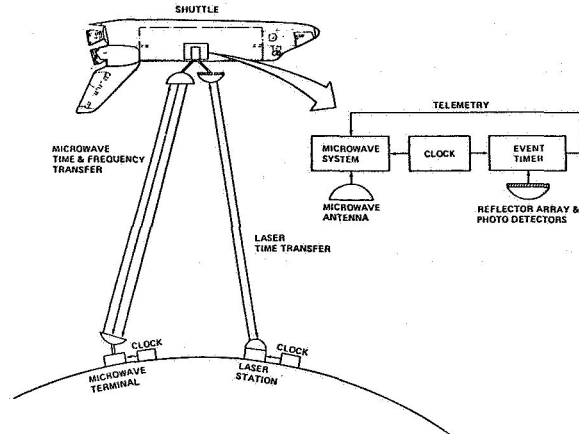

Figure 63

essentially the same as that used in the P3C aircraft experiments. The goal for the first experiments is one nanosecond synchronization between the United States and Europe. It is hoped that this will be the first of a series of satellite experiments with the goal of one tenth of a nanosecond synchronization later on. Since the comparisons on the satellite will be made rather close in time, we don't have to worry too much about the relativistic effect, but we just note that it is on the order of 50,000 nanoseconds per day, or about 6/10ths of a nanosecond per second. So if one has a goal of one nanosecond and one lets the reception between pulses spread over a few seconds, you may have to worry a bit about this effect.

There is a third space experiment which I wish to discuss this afternoon. This is the proposed Shuttle Time and Frequency Transfer experiment which we call STIFT. The plan has been developed by D. W. Allan of the National Bureau of Standards, Rudolf Decher of the Marshall Space Flight Center, Gernot Winkler of the U.S. Naval Observatory, and the speaker.¹⁶ The idea is shown in Figure 63. There would be a hydrogen maser and other clocks on the shuttle, along with microwave frequency comparison equipment of the type developed by Vessot, et al., for the rocket probe relativity experiment, and laser pulse time comparison equipment of the type developed by Alley, et al., for the P3C

¹⁶ R. Decher, D. W. Allan, C. O. Alley, R. F. C. Vessot, and G. M. R. Winkler, "A Space System for High-Accuracy Global Time and Frequency Comparison of Clocks," Proceedings of the Twelfth Annual Precise Time and Time Interval (PTTI) Applications and Planning Meeting; NASA Conference Publication 2175, pp 99 - 111, December 2 - 4, 1980.

aircraft relativity experiments. It now appears that the principal uncertainty in the STIFT technique will be that imposed on the calculation of the proper time integral by lack of knowledge of the velocity of the space shuttle.

$$\tau_S - \tau_G = \int \left[\frac{\phi_S - \phi_G}{c^2} - \frac{(v_S^2 - v_G^2)}{2c^2} \right] dt$$

For a several hundred kilometer orbit,

$$\frac{v_S^2}{2c^2} = 3 \times 10^{-10}$$

If we wish to maintain a fractional time uncertainty $\Delta\tau/\tau = 10^{-14}$ which the hydrogen maser is capable of, one must have

$$\frac{\Delta(v_S^2/2c^2)}{(v_S^2/2c^2)} = \frac{2 \Delta v}{v} = 3 \times 10^{-5}$$

This requires that $\Delta v = 10\text{cm/sec}$. This may be very difficult to know without special instrumentation such as high quality inertial navigation systems. For this technique, the limiting performance for time transfer may be set by relativity rather than by clock performance!