

INTEGRATED COCKPIT FOR A-129

Dott. Ing. Filippo Reina
Director, Helicopter Systems Engineering
Costruzioni Aeronautiche Giovanni Agusta S.p.A
Cascina Costa, Samarate, Italy

James A. Gracia
Systems Operations Engineer
and
Bryce W. Koth
Human Factors Engineer
Harris Government Information Systems Division
Melbourne, Florida

Abstract

The Agusta A-129 is a compact and lightweight tandem cockpit combat helicopter under development for multimission usage with a full complement of electronic aircraft control and ASE equipment. Weight, size, and mission requirements for the A-129 mandated an integrated system approach for the crew/cockpit interface design. Instead of the usual multitude of cockpit controls, indicators, gauges, and lights, the primary crew interface is a single multifunction keyboard and one or more multifunction CRT display units. This cockpit design approach imposed unusual constraints upon the system architecture to overcome the inherent information access limitations of a data input/output window that was restricted by the available space. This paper describes the conceptual approach and resulting design of the A-129 cockpit with the intent to enhance the development of cockpit standardization.

Introduction

The A-129 integrated cockpit is the crew's interface with a sophisticated weapon system. Its particularly small size and mission scenario flexibility make the A-129 man-machine interface a challenge to optimize. Its crew compartments must accommodate pilot and gunner comfortably, provide excellent forward quadrant visibility for the pilot to safely fly in the Nap-of-the-Earth (NOE) environment, and provide command and control capability for aircraft and mission equipment. A highly integrated helicopter system and a highly integrated cockpit are demanded to satisfy the A-129 requirements.

Integrated systems are presently emerging but the design technique has not. There are isolated examples of integrated cockpit design techniques, but a validated design practice that is fully accepted by the industry and the government-user community does not exist. The A-129 demanded a highly integrated cockpit, therefore a conceptual system design approach had to be evolved. This paper addresses the approach followed in the definition and development of this innovative highly integrated cockpit. However further refinements are planned during 1) the ground simulator test phase (October 1982 - August 1983), 2) the early flight test of the A-129 (late 1983),

and 3) the prototype field trials. The ground simulator will validate the system for the most effective flyable configuration. The first flight will initiate fine tuning of this concept to the flight environment. Throughout the flight test of the four prototype helicopters, a large amount of experimental data will be amassed and used for the final definition of the operational cockpit system. The incorporation of these experimental test results will confirm the operational flexibility of the software intensive man-machine interface.

A-129 Definition*

The Agusta A-129 (Fig. 1) is a light, twin turboshaft powered, combat helicopter under development for the Italian Army to serve primarily in an anti-tank role. It has a single four-blade articulated main rotor and a two-blade semirigid tail rotor. The helicopter design, presently completed and frozen, reflects the results of extensive trade-offs down to the component level in order to satisfy the Italian Army's requirement for an agile, small size, limited cost aircraft, which retains the advantages of state-of-the-art technology.

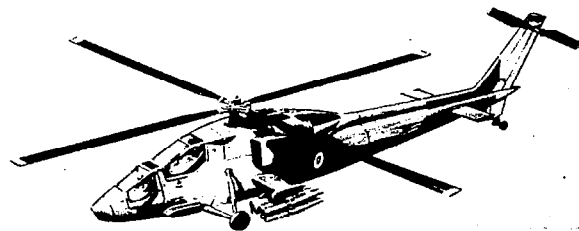

Fig. 1. A-129 Helicopter

* Lovera, Bruno, "The Agusta A-129", Vertifite, 26 (6), November/December, 1980, pp 6-9.

The crew of two is seated in tandem with the aircraft commander/pilot located aft and above the copilot/gunner. Primary armament in the present plan is the TOW system with 8 missiles carried on 4 pylons mounted to the stub wings. Rockets, machine gun pods, and external fuel tanks can be interchanged in any combination with the TOW missiles.

The A-129 has some unique design features which give it unprecedented capability and flexibility as a combat air vehicle. The cockpit configuration provides both crew members with identical and unequalled flight visibility. The main transmission, main rotor shaft, rotor head, and primary flight controls are designed to provide protection against icing and ballistic and/or wire line damage as well as a stable mounting platform for a mast-mounted sight (MMS). Finally, the A-129 incorporates a modular, expandable, multiprocessor-based data bus system which is presently unequalled in comprehensiveness and flexibility in a rotary winged aircraft.

Extensive Italian Army and Agusta study and experimentation, including the use of full-scale cockpit mockups, were used to arrive at the A-129 cockpit configuration. The "camel" configuration, as shown in Fig. 2, was selected to maximize visibility for both crew members in NOE mission environments.

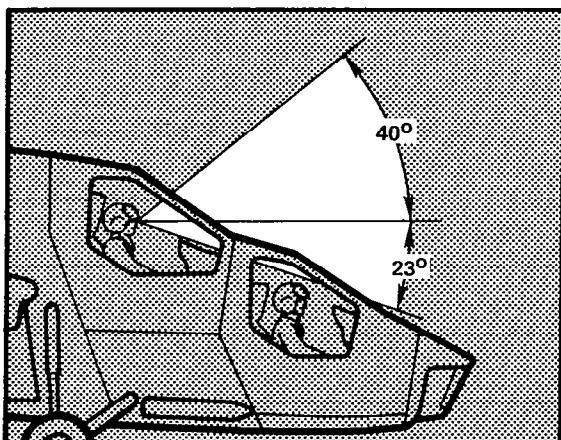

Fig. 2. A-129 Cockpit configuration

Baseline Configuration

The A-129 is equipped to fly and attack in day and night under instrument and visual flight conditions. In addition to full instrumentation, stability augmentation, and auto-pilot capability, the Integrated Multiplex System (IMS), the heart of the integrated system, incorporates a navigation computer capability. Inputs to this system come from the installed Doppler radar system, the radar altimeter, and standard navigational radios. For night visual flight, a Pilot's Night Vision System (PNVS) will be incorporated.

UHF-AM, VHF-AM, VHF-FM and HF communications radios with standard NATO encrypting devices are integrated and controlled through the A-129 IMS. Primary armament consists of the TOW M-65 missile system, but space, weight, and power provisions have been incorporated into the A-129 design for FLIR Augmented Cobra Tow System (FACTS), Laser Augmented Aerial Tow (LAAT), and second generation missile systems.

The A-129 will also be fully provisioned with a full suite of Aircraft Survivability Equipment (ASE). Candidates for inclusion are Radar and Laser Warning Receivers, Radar and Infrared Jammers, and Flare and Chaff Dispensers.

The A-129 baseline system capabilities are listed in Table 1.

Configuration Flexibility

Due to its size and performance, the A-129 is an attractive candidate for a variety of weapons options as well as other combat helicopter roles and missions. The possible armament options range from the heavier more potent HELLFIRE to the ultra-lightweight air-to-air Multi-Launch Missile System (MLMS). With respect to differing roles and missions, there is strong interest in several NATO countries in a capable, survivable, multi-role attack/scout helicopter. Consequently, the A-129 design had to be versatile and flexible. And the design of the integrated cockpit had to be sufficiently flexible to accommodate conversion to either HOT or HELLFIRE and for MLMS or other air-to-air missile systems.

In the visionics arena, the initial A-129 prototypes will incorporate the nose mounted, day only, M-65 TOW Sight Unit (TSU), with provisions for LAAT and FACTS. However, several other visionics options are either in production or R&D which will enhance the capabilities of the A-129 as a survivable attack or scout helicopter. In particular, provisions have been incorporated into the A-129 cockpit design for conversion to a Mast-Mounted Sight/Target Acquisition and Designation System (MMS/TADS). This equipment, presently under development, will retain commonality with the TADS developed by the U.S. Army. The visionics package will be completed with PNVS and IHADSS (Integrated Helmet and Display Sight System).

Integrated System

The Integrated Multiplex System (IMS) provides this small helicopter with unprecedented flexibility, and extends its basic capability via integration and automation. The heart of the IMS is a redundant MIL-STD-1553B data bus communication and centralized data processing system. The multitude of functions performed by the IMS fall into four major categories:

Mission Electronics - Optimized integration of all mission equipment, including radios and navigation equipment, which provides for change and growth as well as efficiency. Performs navigation,

weapons delivery, and provides performance monitor capabilities.

Basic Aircraft Systems - Handling of electrical power distribution, power plant monitoring, caution and warning presentations, and integration of other general airframe related electronics. Provides checklists and status of integrated equipment.

Flight Control and Stability - Including motion sensors, digital stability augmentation systems, and flight director functions, plus a complete redundant backup fly-by-wire control system which can be engaged and disengaged at will.

Cockpit Control and Display - Including integrated flight management, equipment control, instrumentation, and workload reducing automation.

The cockpit is where the benefits of the IMS are most apparent. The need for a multitude of controls, switches, indicators, displays, and lights is eliminated. In their places are a single multifunction keyboard (MFK) unit and one or more video-type multifunction display (MFD) units for each crew position.

Schedule and Cost Objective

Agusta's objective is to enter production in the mid-1980's with a modern, versatile combat helicopter which is (1) capable of performing effectively and surviving in a NATO threat environment; (2) capable of being adapted to a variety of attack, scouting/reconnaissance, and battlefield management roles; and (3) reliable, maintainable and affordable.

Requirements Summary

In essence the basic requirements for the A-129 integrated cockpit design can be distilled as follows:

- 1) Control a comprehensive complement of aircraft/mission equipment
- 2) Flexibility to modify mission requirements with ease of fleet retrofit
- 3) Commonality of tandem cockpits
- 4) Limited cockpit real estate
- 5) Acceptability of crew workload
- 6) Integrated system approach to meet mission/weight requirements
- 7) Program cost and schedule objectives

Table 1. A-129 Baseline system capability

EQUIPMENT	INTEGRATED FUNCTIONS
<p>COMMUNICATION/IDENTIFICATION UHF/VHF TRANSCEIVERS HF TRANSCEIVER IFF TRANSPONDER</p>	<p>COMMUNICATIONS CONTROL AND DISPLAYS PRESET SELECTION</p>
<p>NAVIGATION AIR DATA SYSTEM DOPPLER RADAR DIRECTIONAL GYRO RADAR ALTIMETER AUTO DIRECTION FINDER</p>	<p>NAVIGATION/FLIGHT CONTROLS FLY-BY-WIRE DOPPLER/AIR DATA NAVIGATION STABILITY/CONTROL AUGMENTATION ATTITUDE HOLD HEADING HOLD ALTITUDE HOLD GROUND SPEED/AIR SPEED HOLD VERTICAL SPEED HOLD HOVER COURSE HOLD WAYPOINT ENTRY COUPLED FLIGHT PLAN</p>
<p>FLIGHT CONTROLS VERTICAL GYROS (THREE) ACCELEROMETER TRIAD STANDBY INSTRUMENTS AFCS ACTIVATORS</p>	<p>WEAPONS STORES MANAGEMENT WEAPONS DELIVERY FLIGHT CONTROLS</p>
<p>SURVIVABILITY EQUIPMENT RADAR AND LASER WARNING RECEIVERS FLARE AND CHAFF DISPENSERS</p>	<p>POWER TRAIN ENGINE MONITOR SYSTEM ROTOR TRANSMISSION MONITOR HYDRAULICS MONITOR AND CONTROL VIBRATION MONITOR FUEL CONTROL FUEL MONITOR</p>
<p>WEAPONS M-65 TOW TOW SIGHT UNIT 2.75 ROCKETS</p> <p>ENGINE ROLLS ROYCE GEM-2 ENGINES (TWO) ENGINE MONITOR SENSORS</p>	<p>COCKPIT INTERFACE ELECTRICAL POWER CONTROL SUBSYSTEM CONTROL PERFORMANCE MONITOR STATUS CHECKLISTS</p>
<p>FUEL ROTOR TRANSMISSION HYDRAULICS ELECTRICAL POWER DISTRIBUTION INTEGRATED COMPUTER/MULTIPLEX BUS SYSTEM</p>	

Cockpit System Design

The A-129 cockpit system design was constrained by requirements for duplicate capability in each cockpit and the limited real estate in each cockpit. A perspective view of the pilot's cockpit is shown in Fig. 3. Since all A-129 subsystems are not incorporated within the integrated system, some space was allocated to conventional controls and displays for these subsystems. The remainder of the cockpit was dedicated to the integrated cockpit system which functions as the crew/IMS interface. Programmable displays and controls for the integrated cockpit system were located to optimize visibility and accessibility. The balance of the cockpit real estate was budgeted by priority — criticality of information and control and/or frequency of usage.

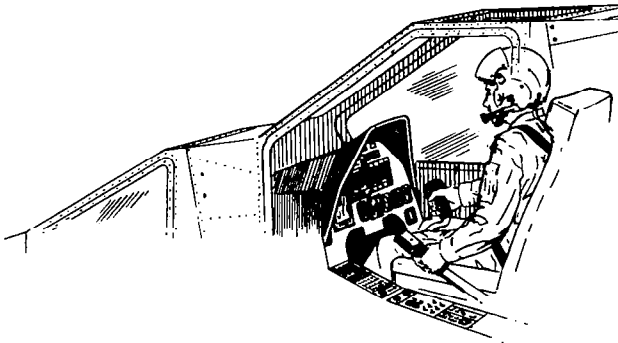

Fig. 3. Pilot cockpit perspective

The crew interface aspects of the A-129 IMS modular subsystems can be grouped into seven general categories:

1) Automatic Flight Control System (AFCS) is a high priority module that demands dedicated controls and displays.

2) Basic Equipment Controls and Displays are represented by callable display pages that have been translated from conventional control/display devices. Communications, Weapons Stores Management, Engine Monitor, Fuel, Rotor/Transmission, Hydraulics, Vibration, Electrical Power Control, and Utility (e.g., IMS test and configuration control) are subsystems that fall within this category.

3) Caution/Warning Subsystem consists primarily of dedicated programmable display space for instant presentation of alerts and a means of storing alerts for later retrieval.

4) Status Monitor Subsystem is a branching structure which collects and reports on-line BIT fault indications from throughout the IMS. Starting with a top level display, the crew can access lower level status summaries to isolate faults.

5) Performance Monitor Subsystem computes information required by the crew for mission planning.

6) Navigation Subsystem provides graphic and interrelated alphanumeric displays which allow the crew to use, control, or update the aircraft navigation.

7) Checklist Subsystem provides a semi-automated sequence for crew execution of procedures normally listed in flight manuals.

These seven subsystem categories are interfaced by the crew through a common basic dialogue design.

Basic Design

The cockpit system consists of two interface devices — a multifunction display unit (MFD), which is basically an interactive video display terminal, and a multifunction keyboard (MFK), which provides the control interface for the crew to select displays, create IMS entries, and manage the Automatic Flight Control System (AFCS). Cockpit panel space restricted the CRT for the MFD to a usable viewing area of only 4.80 inches square. Accounting for U.S. DOD and other recognized requirements on minimum character size, and the expected viewing distance, a maximum MFD data window (page size) of 15 lines and 28 characters per line was provided. A summary of character requirements and design parameters of the A-129 alphabet is shown in Table 2. The MFK was similarly constrained by the limited space in the upper left cockpit console area: the baseline A-129 allocation was 5.75 in. wide by 7.50 in. long, of which only about 50 percent could be utilized each for the AFCS controls and indicators area and the MFK keypad area. Despite the use of a maximum density U.S. DOD compliant keypad configuration, the requirement for full alphanumeric pilot entry capability limited the number of special function display call keys to 15. Access to all alphanumeric MFD data and controls representative of all subsystems integrated within the A-129 IMS therefore had to be prioritized under a 15 key hierarchy. The graphic displays are called by three dedicated MFD keys.

The A-129 control/display access hierarchy is shown in Fig. 4. At the far left are listed all dedicated control and display devices: these devices are available at all times for the A-129 crew usage. The second column lists all IMS subsystem displays and controls which are directly accessed by depressing one MFK or one MFD button. The third column lists all secondary subsystems and functions accessed through menus called by single button pressings, while the fourth column lists displays accessed only from the secondary menu displays or from other secondary display pages. The directly callable subsystem displays were selected with a sensitivity to pilot needs in the presently defined Augusta mission scenarios. Appropriate priority was given to basic aircraft

Table 2. A-129 Alphanumeric character font requirements and design (3)

PARAMETER	REQUIREMENT(1)	DESIGN
Vertical Height	20'(2)	0.192 in. (20' @ 33 in.)
Width to Height Ratio	60-100%	62.5%
Stroke Width to Character Height Ratio	12.5-14%	12.5%
Vertical Spacing (Between Characters)	≥1 Stroke Width	2 Stroke Widths
Horizontal Spacing (Between Lines, Relative to Character Height)	50%	62.5%

NOTES:

- (1) Applicable requirements from "Human Engineering Design Criteria for Military Systems, Equipment, and Facilities," MIL-STD-14728, Note 1, 10 May 1976; Woodson, W.E., Human Factors Design Handbook, 1981; and Shurtleff, D.A., How to Make Displays Legible, 1980.
- (2) Symbol size must additionally be corrected for off-axis viewing angles per Reinwald (as published in Shurtleff, 1980).
- (3) The font is 10x16 pixels with 2 pixel stroke width.

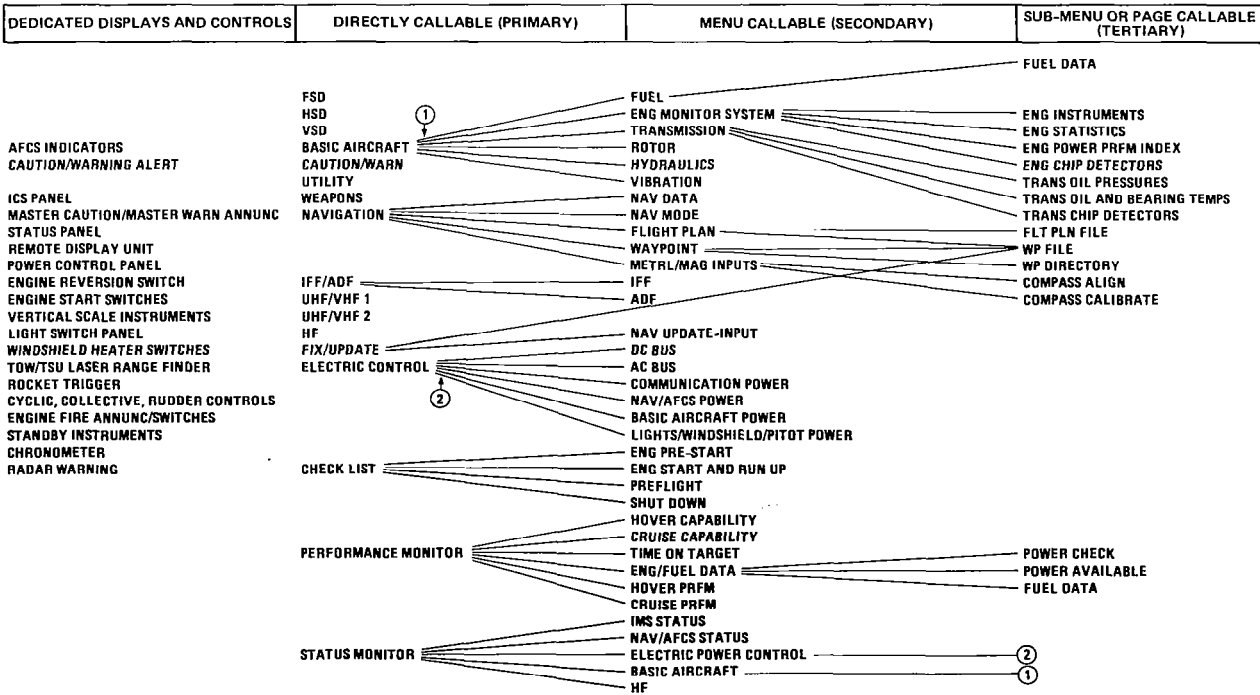

Fig. 4. Agusta A-129 control/display system hierarchy

subsystems (such as the Basic Aircraft subsystem, which accesses the Engine, Transmission, and Fuel subsystems, etc., as well as Electric Power Control that provides access to all remote control circuit breakers throughout the aircraft), the special graphics displays (which when coupled to the AFCS provide flight guidance cues), emergency and fault condition monitoring (Status, Caution/Warning), Navigation, and mission critical Weapons. Priority was also given to special requirements (such as the full complement of readily-accessed communications units) and automated pilot information aids (Performance Monitor and Checklists).

Enhancement of the pilot/IMS cockpit system interface was addressed through automation, systematic standardization of visual coding for control options and display types, and a friendly dialogue style requiring simple keyboard entries from the pilot and providing fixed visual prompts. Further automation is a subject for future growth. It has been implemented in the present IMS where tradeoffs with system complexity were acceptable. Automation is most apparent in the caution/warning alert generation and recording, in the collection of all on-line BIT type status information for easily accessed pilot viewing, in the coupled aircraft control and weapons delivery subsystem, in the aircraft performance monitor calculus, and in the manner in which sequences of displays were automated to follow a logical mission task orientation. A standardized method of information coding was implemented to help the pilot differentiate between data, control requests, and control status information displayed simultaneously on the same page. Some of these coding techniques included the use of character attributes: control status positions are designated by boxes, special timely or cautionary information is displayed in inverse video, and keypad entry control prompts are underlined. Coding conveys contextual information to the operator; standardization reduces training and learning requirements; and both simplify the task.

AFCS Design

The Automatic Flight Control System is managed by the pilot using the upper portion of the MFK. The AFCS interface includes IMS redundancy control, Fly-By-Wire (FBW) control, Stabilization functions (attitude hold, heading hold, vertical speed hold, altitude hold, airspeed and groundspeed hold, autotrim, and wings level) and Flight Director modes (hover, attack, course hold, and flight plan). The interface was implemented using 0.75 in square lighted legend pushbuttons for an integrated control/indicator design. Switches have visible legends (backlighted at night) and dead face indicators; legends are visible in full 10,000 footcandles ambient sunlight; indicators are color coded for daytime cue enhancement; legend lighting is compatible with present (second generation) Night Vision Goggle systems (NVGs).

IMS redundancy control switches allow the pilot to manually select one of two redundant processors or to engage the automated self-selection mode.

Status indicators present operational status and passage of self-tests. The FBW switches control main rotor and tail rotor electronic control systems and arm the automatic sensing of control linkage severances. The Stabilization section of AFCS provides pilot control over A-129 augmentation systems in pitch, roll, yaw and collective, provides automatic hold in altitude, attitude, heading, and speed (vertical, ground, and air) and provides automatic trim and command to wing level attitude. All Stabilization modes have fly-through capability.

The Flight Director functions, in the display mode, provide flight cues to the pilot on the graphic situation displays. In the engage mode, the Flight Director operates as a full autopilot with fly-through capability. The Flight Director indicators, supplemented by aural alarms, are used for visual command cues while in the Flight Plan mode. The Flight Plan indicator flashes as waypoints are attained: this button must be depressed to commit to the next flight plan leg, otherwise the flight plan mode disengages.

Basic Equipment Control/Display Design

A generic example of pilot usage of the A-129 cockpit system for basic aircraft equipment control and monitoring is shown in Fig. 5. The hydraulics subsystem is first accessed by depressing the MFK "BSC ACFT" key. The MFD displays the basic aircraft menu list and the line address key adjacent to "HYD" is pressed to call the HYDRAULIC display page. This page contains switches for the three hydraulic power supplies and presents status information on the position of each switch, and present values from three pressure sensors and three temperature sensors. The HPS switches are controlled as shown. Pushing the line address keys shown operates the switches in rotating fashion with the present switch position always indicated by a box.

Pressure and temperature data is conveyed in digital format and in an analog gauge format. The gauge displays are analogous to dedicated cockpit instruments and provide dynamic range information as well as a "quick look" capability. Gauges may contain up to one "green", two "red", and two "yellow" zones as indicated by the steps shown. The boxed double arrow in the lower left hand corner of the display indicates paging options to the pilot. In this case, the pilot can slew the display "up" (allowing a return to the basic aircraft menu) or "down" (to the second page of hydraulics information). The box indicates that these options are enabled and available to the pilot via the MFD rocker switch.

Caution/Warning Subsystem Design

Caution and warning alerts to the pilot are critical to success of the mission and the safe operation of the A-129 aircraft. Accordingly, the caution/warning subsystem has a dedicated display: the 15th (bottom) line of all MFD graphic and alphanumeric displays. Other dedicated cockpit

interface devices for this subsystem include the MASTER WARN and MASTER CAUTION annunciators and switches. Some critical warning alerts are accompanied by an audible alarm from the ICS.

The caution and warning subsystem for A-129 continuously compares data from various sensors and other subsystems to predetermined thresholds and failure criteria. When a caution or warning condition occurs, the alert name is presented on the MFD (in a priority queue with all warnings presented first) and the MASTER WARN or MASTER CAUTION annunciator is lighted. When the pilot acknowledges the alert by depressing the appropriate annunciator, the alert name and other information are entered into a quasi-LIFO list which is retained in nonvolatile memory for retrieval by the pilot or by ground support personnel. The list is accessed by depressing the MFK "CAUT" key and a sample display as shown in Fig. 6 is presented to the pilot. In addition to the alert name, information is also presented to indicate whether the alert was a caution or warning, whether it is a historical alert or is presently active, and whether the alert sensing device is inhibited or active. Line address keys adjacent to each caution/warning alert provide the capability of inhibiting (or re-activating) a sensor which may be faulty or to suppress repetitive presentations of the same alert. For switch type alerts, the number of occurrences is also reported. For analog sensor alerts, the value reported is always the highest value attained.

Status Monitor Subsystem Design

The status monitor subsystem continuously monitors and collates the status of on-line BIT results throughout the A-129 IMS system and presents this information to the pilot when the "STAT" key on the MFK is depressed. Two of the unique status monitor displays presently implemented on the A-129 IMS are shown in Fig. 7. Three information display conventions are used. A subsystem fault is indicated as a "NO GO" in inverse video. Absence of a fault indication for any subsystem is indicated simply by a blank field. Where it is possible to track down a fault condition from a subsystem to a lower equipment level, the inverse video NO GO is supplemented by a downward arrow symbol. Depressing the adjacent line address key calls up a lower-level display which may contain the fault. In the example shown, the IMS status is NO GO because of a failed Master Unit (MU 2) and a failed Data Bus (D/B) Test A. Lower level access to status information is available for the IMS equipment, the Navigation and AFCS equipment, the Electrical Power Control subsystem (e.g., remote circuit breaker trips), the Basic Aircraft subsystems, and the radios.

Performance Monitor Subsystem

The A-129 performance monitor subsystem provides information to the pilot for making preflight and inflight plans and decisions based on aircraft performance predictions. By viewing

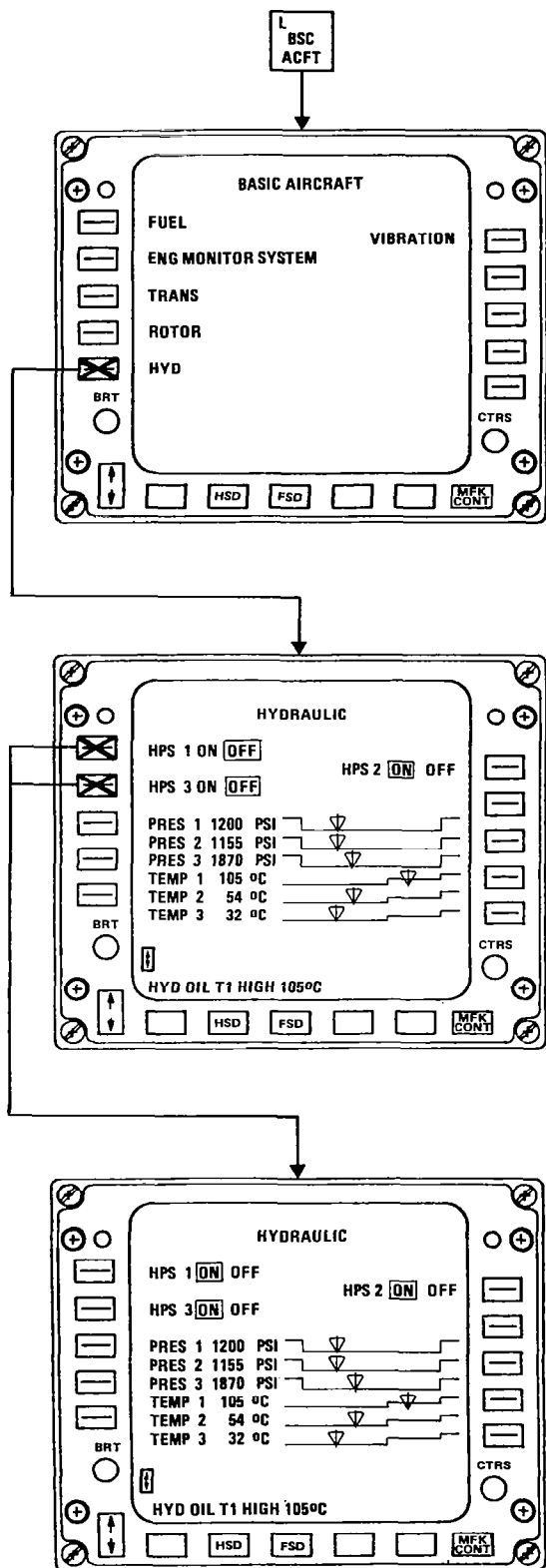

Fig. 5. Basic aircraft function

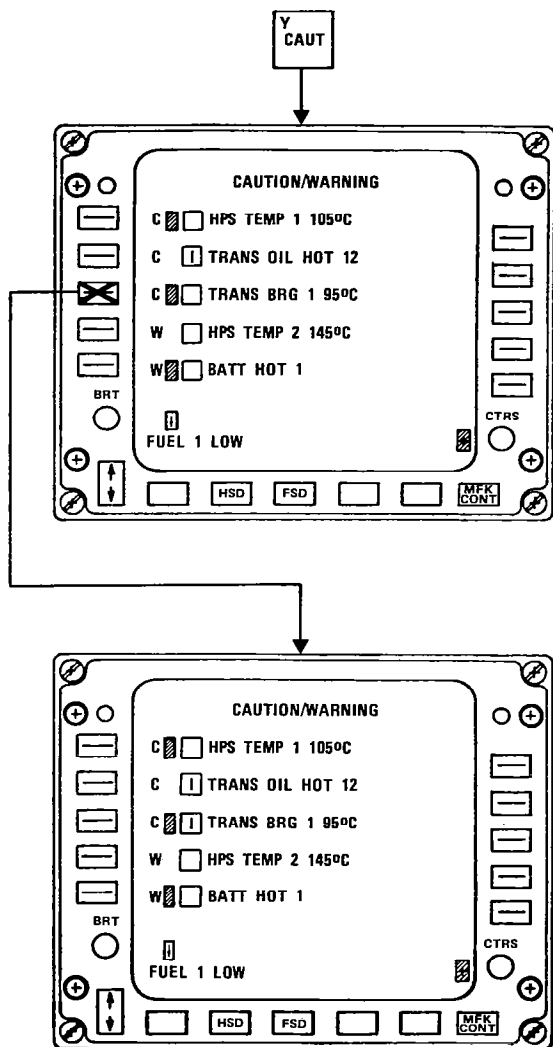

Fig. 6. Caution/Warning inhibit function

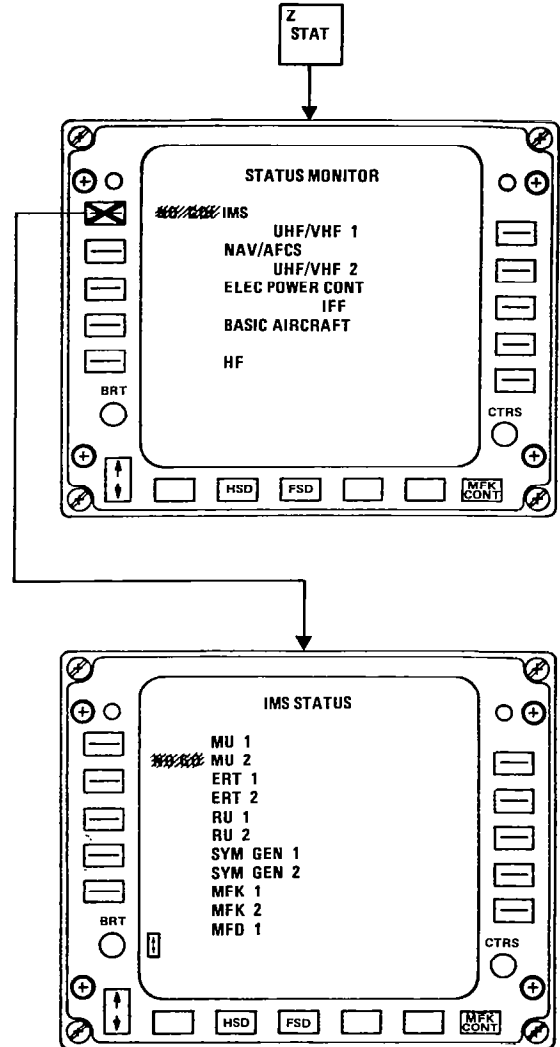

Fig. 7. Status function operation

the MFD, the pilot has available all information normally accessed in the typical pilot's flight manual. Data such as flight range, flight time, autorotation envelope, etc. are presented using either actual environmental conditions (e.g., OAT, ALT, etc.) from aircraft sensors or pilot input values for either preflight or inflight calculations. One of the most critical variables to these calculations, aircraft weight, is derived in real time by interaction with the weapons and fuel subsystems. Engine performance data calculated in the Engine Monitor Subsystem is utilized to provide actual aircraft performance characteristics. Predictions and calculations obtained through usage of the performance monitor subsystem are thus greatly improved over results formerly obtained through conventional pilot usage of manuals or nonintegrated standalone performance systems.

Navigation Subsystem

The navigation subsystem integrated within the A-129 IMS provides a highly complex, highly pilot-interactive, and highly automated capability that combines on-board sensors to calculate current aircraft position and progress against a prestored flight plan. When coupled with the AFCS in the flight director mode, a prestored flight plan can be executed automatically.

The principal sensors providing inputs to the A-129 navigation subsystem include three orthogonal accelerometers, Doppler velocity sensor, vertical gyros, TSU range and bearing data, magnetic heading, air data (air speed, barometric altitude, rate of climb), and radar altimeter. Interfaces with directional gyros and DF radios are also integrated within the navigation subsystem, allowing automatic tuning, compass/gyro synchronization, and compass calibration. Other

navigation subsystem functions include computation of track, cross track, and track angle errors; position update over a known waypoint, and target position acquisition by pilot input or TSU; computations of corrected heading considering magnetic heading variations and wind speed and direction.

The highly pilot interactive navigation subsystem accepts manual keyboard entry of up to 100 waypoints (specified by latitude/longitude or UTM coordinates, elevation and altitude, and a target/enemy/friendly designation) which may be arranged into as many as ten different flight plans. Full editing capability of flight plans and waypoints is provided. Flight plans can be created prior to flight or while in flight and allow a fly-to-waypoint capability. Other pilot interactive capabilities include the selection of navigation mode, input of meteorological and magnetic data, waypoint fix in offset or flyover modes, and navigation update in flyover or manual position input modes.

Besides an alphanumeric navigation data page, the primary display outputs of the navigation subsystem are the graphic situation displays — the Horizontal Situation Display (HSD), Forward Situation Display (FSD), and Vertical Situation Display (VSD). The A-129 HSD is shown in Fig. 8. The HSD is a graphic map display with compass rose, a variety of aircraft control and guidance cues, several aircraft performance indications, and flight plan related data. Aircraft control cues include aircraft heading, aircraft track, a track-offset based steering cue, a digital aircraft course readout, and a crosstrack error scale. Aircraft flight performance indicators present digital values for air speed, ground speed, and vertical speed and direction. Flight plan related data that are presented on the HSD include a connected waypoint sequence with leg distances, interest and avoidance area waypoints, waypoint type, number, and alpha identifiers, selected flight plan number, next waypoint, time and distance to next waypoint, and time remaining on target.

Other display related information included on the HSD are the display scale and map orientation, both of which are pilot-controllable using the MFD line address keys and rocker switch. As in all MFD display formats, the HSD has dedicated fields for a pilot entry scratch pad and for presentation of caution/warning alerts.

The FSD is a subset of the HSD with the aircraft in the lower center of the screen. A linear course prediction line is also provided. The VSD is similar in concept but it displays a perspective ground plan pictorial relative to aircraft position, aircraft to ground and aircraft to tree top distance cues, and aircraft velocity vectors in all dimensions.

Checklist Subsystem

The A-129 checklists subsystem provides a semi-automated mechanism for interactive control and prompting of pilot procedures normally performed with flight manuals. Engine Pre-Start, Engine Start and Run-Up, Preflight, and Shut Down procedures are implemented as sequences of alphanumeric checklist pages with quick access to other subsystem status pages where required (e.g., to monitor aircraft oil pressures and temperatures during run up).

Future Activities

The definition and design phases of the A-129 integrated cockpit system are complete. The implementation phase is currently under way. The next steps in the system evolution are the integration of the many IMS subsystems, checkout of the A-129 prototype, field trials, and eventually production.

Parallel with the cockpit system implementation phase a simulation is being constructed which mechanizes the display hierarchy. This computerized simulator will serve a dual function: 1) to familiarize the test pilots with the integrated system and gain their acceptance, and 2) to provide pilot feedback for system fine tuning.

The system integration and checkout phases of the A-129 IMS will provide the first real measure of pilot workload. The overall goal of the IMS cockpit design is obviously to enhance pilot mission performance through reduction of the workload associated with normal aircraft control and mission operations. The pilot acceptability of the workload reduction afforded by the IMS cockpit system is ultimately the final measure of success.

Integration and checkout phase activities will be followed by the A-129 operation and field trial phase. This will be the final test of the IMS cockpit design concept, and the outcome of this

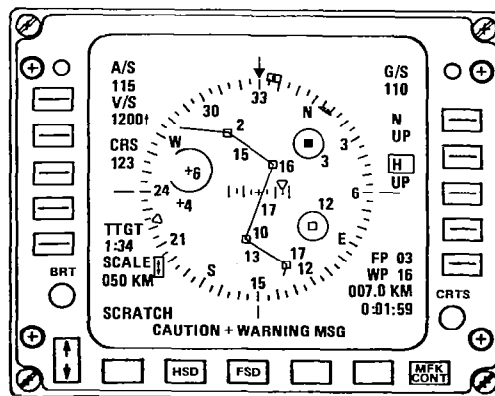

Fig. 8. Horizontal situation display

phase will be the production IMS system baseline. The test trials will provide an environment for further evaluation of the design in meeting multi-mission sortie requirements, another opportunity to evaluate the pilot acceptability of the workload. To improve system orientation to a particular mission, field trial results may indicate the need to retrofit the A-129 cockpit design. Any subsequent redesign activity will be easily accommodated by the overall flexibility and modularity of the cockpit system design.

During the production phase and remainder of the life cycle of the A-129 IMS, many opportunities to enhance the cockpit system design and aircraft mission capability will occur. The new emerging technologies in pilot interactive devices (e.g., visionics, supplemental helmet mounted displays, voice recognition command and synthesized voice alerts, color CRTs for additional information coding and workload reduction, digital moving maps and perspective terrain presentations, etc.) are all software-driven. At the center of the A-129 integrated cockpit system is a separate operator interface software subsystem. This system architecture isolates and thereby simplifies the process of updating the cockpit interface design to accommodate emerging technologies.

There are of course many different approaches to pilot interaction in an integrated cockpit design. The approach we have followed incorporates a set of concepts which represent a quantum advance to integrated cockpit technology. We anticipate that this design evolution will provide information to foster further development of standards for cockpit interface systems, thereby freeing future creative effort to concentrate on other technology aspects of the operator interface.

Concluding Remarks

The A-129 integrated cockpit design is driven by a stringent requirement for handling a sophisticated system within a small cockpit area. This has resulted in a highly integrated system.

Its conceptual design has been completed and it is in the implementation stage. In a short time the prototype models will be integrated with the A-129 helicopter systems and then they will be field tested. At this point the design will have matured to a state that it will be ready for production and deployment.

The modularity of the integrated system's software has separated the subsystems to permit easy retrofitting of new or other subsystems required to support new mission requirements. This modular design was carried into the integrated cockpit design so that the controls/displays of additional subsystems can be easily incorporated. This modular approach was also planned to permit the incorporation of new developments in the design of cockpit interface equipments. Hopefully this degree of technology independence will permit cost-effective optimization of the A-129 during its fielded life while maximizing operational capability.

Flight tests of the A-129 prototypes will provide data to verify the integrated cockpit design approach, which will then be useful in establishing pilot accepted standards that may become as popular as round dials have been in the past.