

NASA-CR-165,891



NASA Contractor Report 165891

NASA-CR-165891
19820024089

**Coupled Rotor/Airframe Vibration
Analysis Program Manual - Volume I
User's and Programmer's Instructions**

S. Cassarino and R. Sopher

**Sikorsky Aircraft
Stratford, Connecticut, 06602**

**Prepared for the U.S. Army Research and
Technology Laboratories (AVRADCOM)
Langley Research Center
under Contract NAS1 - 16058
June, 1982**

LIBRARY COPY

AUG 31 1982

LANGLEY RESEARCH CENTER
LIBRARY, NASA
HAMPTON, VIRGINIA

NASA

National Aeronautics and
Space Administration

Langley Research Center
Hampton, Virginia 23665



NF01941



1. Report No. NASA CR-165891	2. Government Accession No.	3. Recipient's Catalog No.	
4. Title and Subtitle COUPLED ROTOR/AIRFRAME VIBRATION ANALYSIS PROGRAM MANUAL-VOLUME I USER'S AND PROGRAMMER'S INSTRUCTIONS		5. Report Date June 1982	
		6. Performing Organization Code	
7. Author(s) S. Cassarino and R. Sopher		8. Performing Organization Report No.	
		10. Work Unit No.	
9. Performing Organization Name and Address Sikorsky Aircraft Main Street Stratford, Conn. 06602		11. Contract or Grant No. NAS1-16058	
		13. Type of Report and Period Covered	
12. Sponsoring Agency Name and Address National Aeronautics and Space Administration Langley Research Center Hampton, Virginia 23665		14. Sponsoring Agency Code	
		15. Supplementary Notes Langley Technical Monitor: R. L. Tomaine The contract research effort which has led to the results in this report was financially supported by the Structures Laboratory of the U.S. Army Research and Technology Laboratories (AVRADCOM). Final Report.	
16. Abstract <p>This report provides user instruction and software descriptions for the Base Program of the Coupled Rotor/Airframe Vibration Analysis. The program (SIMVIB) was developed to simulate the dynamics of a coupled helicopter rotor and airframe. It can be used as a design tool for predicting helicopter vibrations and perform parametric studies. Various dynamic configurations can be represented, including vibration isolation devices and absorbers.</p> <p>The functional capabilities and procedures for running the program are provided. Interfaces with external programs are discussed. The procedure of synthesizing a dynamic system and the various solution methods are described. Input data and output results are presented. Detailed information is provided on the program structure.</p> <p>Sample test case results for five representative dynamic configurations are provided and discussed. System responses are plotted to demonstrate the plots capabilities available. Instructions to install and execute SIMVIB on the CDC computer system complete this report.</p>			
17. Key Words (Suggested by Author(s)) Vibration Analysis Rotor/Airframe Program Manual		18. Distribution Statement Unclassified-Unlimited	
19. Security Classif. (of this report) Unclassified	20. Security Classif. (of this page) Unclassified	21. No. of Pages 205	22. Price



COUPLED ROTOR/AIRFRAME VIBRATION ANALYSIS
PROGRAM MANUAL

VOLUME I

USER'S AND PROGRAMMER'S INSTRUCTIONS

S. CASSARINO and R. SOPHER



TABLE OF CONTENTS

Volume I - User's and Programmer's Instructions

<u>SECTION</u>		<u>PAGE</u>
	List of Figures	v
	List of Tables	vii
1	SUMMARY	1
2	INTRODUCTION	2
3	COMPUTER PROGRAM FUNCTIONAL CAPABILITIES	2
4	COMPUTER PROGRAM EXECUTION	3
5	BASE PROGRAM INTERFACING WITH EXTERNAL PROGRAMS	3
	5.1 G400 Rotor Aeroelastic Analysis	3
	5.2 E927 Rotor Aeroelastic Stability Analysis	4
	5.3 RIEVA Empennage Excitation Analysis	4
	5.4 Base Program Plot Package	5
	5.5 Refinement of External Rotor Model	5
	5.5.1 F389 Rotor Induced Flow Program	5
	5.5.2 WABAT (Wing and Body Aerodynamic Technique) Program	5
	5.6 Execution of the G400/F389 Coupled Program	6
6	OVERVIEW OF BASE PROGRAM COMPONENTS	6
	6.1 Substructures Attributes	7
	6.2 Solution and Operational Modes Attributes	7
	6.3 Summary of Component Attributes	7
7	BASE PROGRAM COMPONENT USER INFORMATION	7
	7.1 Input Data Format	9
	7.2 Component Descriptions, Input Data Specification and Output Coordinate Labels	11
8	BASE PROGRAM OUTPUT DESCRIPTION	39
	8.1 Component Output	39
	8.2 Debugging Output	39
	8.3 Solution Methods Output	40

TABLE OF CONTENTS - (continued)

<u>SECTION</u>	<u>PAGE</u>	
9	OVERALL PROGRAM STRUCTURE	43
9.1	Segmentation Structure	44
9.2	Flow Diagrams	44
9.3	Fortran Subroutines Descriptions	44
9.4	Fortran Subroutines Revisions for CDC Operation	45
9.5	Common Blocks	45
9.6	Input/Output Data Transmission	45
9.7	Control of Base Program Size	45
9.8	Addition of New Substructures and Modifi- cation of Existing Substructures	47
10	TEST CASES DESCRIPTIONS AND RESULTS	48
11	IBM JOB CONTROL LANGUAGE (JCL)	49
12	CDC PROGRAM INSTALLATION AND OPERATION	50
	REFERENCES	51
	FIGURES	52
	TABLES	151
APPENDIX A:	G400/F389 Coupled Program	188
	A.1. Program Structure and Usage	188
	A.2. Program Execution	189
	A.3. CDC Program Installation and Operation	189
APPENDIX B:	E927 Program	202
	B.1. Program Execution	202
	B.2. CDC Program Installation and Operation	202

LIST OF FIGURES

<u>FIGURE</u>		<u>PAGE</u>
1	Coupled Rotor/Airframe Vibration Analysis Data Flows	52
2	Coupled Rotor/Airframe Vibration Analysis Input/Output File Functions	53
3	Local and Global Axes	54
4	Base Program Input Card Format and Examples	55
5	Input Data Sample 1	56
6	Input Data Sample 2	57
7	E927 Aeroelastic Rotor Matrices	58
8	Sample User Input of Rotor Impedance Matrix and Force Vector	60
9	Sample Output of Rotor Impedance Matrix and Force Vector	61
10	Horizontal Linear Bifilar BF1	62
11	Vertical Linear Bifilar BF2	63
12	Uniform Beam Segment BM1	64
13	Displacements and Forces Acting on a Connection Node of a Substructure	65
14	Fixed Absorber FA1	66
15	Generalized Force GF1	67
16	Two Degree-of-Freedom Vibration Isolator IS1	68
17	Base Program Output Samples	69
18	Base Program Debugging Output Samples	89
19	Base Program Coordinate Responses	94
20	Base Program Segmentation Structure	102
21	Flow Chart for the Main Program	103
22	Flow Chart for Subroutine INPCDC	104
23	Flow Chart for Subroutine INPUT	105
24	Flow Chart for Subroutine PINPUT	106
25	Flow Chart for Subroutine LINK	107
26	Flow Chart for Subroutine RECOVR	108
27	Flow Chart for Subroutine TRNSFM	109
28	Flow Chart for Subroutine COORD	110
29	Flow Chart for Subroutine LABEL	111
30	Flow Chart for Subroutine COMPUT	112
31	Flow Chart for Subroutine UPDATE	113
32	Flow Chart for Subroutine ASSMBL	114
33	Flow Chart for Subroutine SOLVE	115
34	Flow Chart for Subroutine SOLEGN	116
35	Flow Chart for Subroutine EIGZF	117
36	Flow Chart for Subroutine SOLFRT	118
37	Flow Chart for Subroutine MATD1	119
38	Flow Chart for Subroutine RESTOR	120
39	Flow Chart for Subroutine RESFR1	121
40	Flow Chart for Subroutine RESTH1	122
41	Flow Chart for Subroutine SAVE	123

LIST OF FIGURES - (continued)

<u>FIGURE</u>		<u>PAGE</u>
42	Variation of Working Storage with CPU Time	124
43	Fortran Subroutines for Component BF1	125
44	Vibration Isolator Models	133
45	Base Program Results for Test Case 5	134
46	Base Program Results for Test Case 7	135
47	Base Program Results for Test Case 11	136
48	Base Program Results for Test Case 13	144
49	Base Program IBM JCL	146
50	CDC JCL for Installation of the Base Program Batch Mode	147
51	CDC JCL for Installation of the Base Program Batch Interactive Mode	148
52	CDC JCL for Execution of the Base Program Batch Mode	149
53	CDC JCL for Execution of the Base Program Batch Interactive Mode	150
A1	G400/F389 Segmentation Structure	190
A2	G400/F389 Logic Flow Diagram	191
A3	G400/F389 Input/Output Files	192
A4	G400/F389 IBM Job Control Language	193
A5	CDC JCL for Installation of the G400/F389 Program	195
A6	CDC JCL for Execution of the G400/F389 Program	197
B1	E927 Program IBM JCL	203
B2	CDC JCL for Installation of the E927 Program	204
B3	CDC JCL for Execution of the E927 Program	205

LIST OF TABLES

<u>TABLE</u>		<u>PAGE</u>
1	Base Program Substructures	151
2	Base Program Solution and Operational Modes	152
3	Summary of Attributes of Base Program Components	153
4	Summary of Base Program Debug Output Options	154
5	Description of High Level Routines	155
6	Segmentation Structure and Common Blocks	156
7	Alphabetical List of Base Program Fortran Routines	159
8	Functions of Fortran Routines in Base Program	161
9	Base Program Common Blocks/Subroutines Cross- Reference List	172
10	Base Program Input/Output Data Files	179
11	New Subroutines Required for Addition of a Substructure	180
12	Revisions to Subroutines Required for Addition of a Substructure	181
13	Base Program Test Cases Summary	183
14	Base Program Test Cases Tektronix Plots Summary	186
A.1	G400/F389 Segmentation Structure Description	198
A.2	G400/F389 Input/Output Files	199
A.3	G400/F389 Input Outline for Two Cycles	201



Section 1

SUMMARY*

This report provides user instructions and software descriptions for the Base Program of the Coupled Rotor/Airframe Vibration Analysis of Reference 1. The Base Program, SIMVIB, was developed to simulate the dynamics of a coupled helicopter rotor and airframe. The program can be used as a design tool for predicting helicopter vibrations. Parametric studies can be performed during the preliminary design phase of an aircraft. The analysis is capable of representing various dynamic configurations, including fixed system and rotating system vibration absorbers and vibration isolation devices.

Information is provided on the functional capabilities and procedures for running the SIMVIB program. Interfaces with external programs are discussed. The method of synthesizing a dynamic system and the various solution and operational modes are described. A detailed description of the program input data and output results is presented.

The section "Overall Program Structure" provides detailed information on the overlay segmentation structure, flow diagrams, Fortran subroutines descriptions, Common blocks, data transfer files, storage size of the computer program, and necessary additions and revisions for incorporating a new component.

Sample test case results are provided and discussed. The complete input data and output results are included in this manual for five representative cases. System responses are plotted to demonstrate the plot capability of the SIMVIB computer program. The Job Control Language (JCL) required to execute the computer program on the IBM 370/168 is included. Program installation instructions for the CDC system complete this user's manual.

Sample test case listings are provided for key test cases in their entirety in Volume II of the Program Manual.

*The research effort which led to the results of this report was financially supported by the Structures Laboratory, USARTL, (AVRADCOM).

Section 2

INTRODUCTION

The purpose of computer program SIMVIB is to simulate the coupled dynamics of a helicopter rotor and airframe. The program can be used as a design tool for predicting helicopter vibrations. The analysis can predict vibrations for parametric studies conducted in preliminary design. User features provided in the program include minimum core storage, cost effective operation, and interactive input/output options. The SIMVIB program has a flexible capability for representing various dynamic configurations, including fixed system and rotating system vibration absorbers and vibration isolation devices. It is an advanced design tool for coupled helicopter rotor/airframe vibrations, which overcomes the deficiencies of other current programs. The basis of the analysis is described in Reference 1.

This manual provides user's and programmer's instructions. The instructions enable a user to prepare input to synthesize configurations for vibration analysis. Sample outputs are interpreted. Program structure and subroutine functions are defined to aid the development of modifications.

Section 3

COMPUTER PROGRAM FUNCTIONAL CAPABILITIES

The Coupled Rotor/Fuselage Vibration Analysis is a package of programs consisting of a Base Program, called SIMVIB, communicating with a set of External Programs to achieve a vibration modeling capability for helicopters. A substructure assembly method is used in the Base Program to assemble a dynamic model of the helicopter from physical helicopter components contained in the Base Program and External Program models of the rotor system. The Base Program solution modes enable the user to obtain steady state forced responses, eigensolutions, time history solutions, and parameter variations yielding the effects of variations in system properties. After the rotor data are transferred to the Base Program, the Base Program functions in a stand-alone mode to yield rapidly the effects of parameter variations on vibrations. Stand-alone operation is achieved with a small core requirement. The data flows between the Base Program and the External Programs provide the user with wide latitude to select applications tailored to user interest, aptitude, and convenience. Applications range from simple use of the Base Program to obtain the effects of parameter variations to more advanced configurations involving External Programs. Input to the Base Program is designed to provide an economical format requiring input only for components selected by the user. Results are displayed for only those components comprising the final system configuration.

Section 4

COMPUTER PROGRAM EXECUTION

The Base Program SIMVIB employs a substructure method for assembling a dynamic configuration. The substructure assembly method is discussed in detail in Reference 1. The user specifies the number and kinds of components or substructures making up the dynamic system and the manner in which the separate components interact with each other through connection nodes. The computer program reads the input data for the system components, converts parameters to the internal units (foot, pound, second, and radian), and prints out the component input data. The user may elect to read data for the rotor model from external sources such as the "Rotor Aeroelastic Stability Analysis" (E927 program) described in Reference 5 or the "Rotor Aeroelastic Analysis" (G400 program) described in Reference 3. The transformation matrix which relates the set of dependent coordinates for the component assembly to the final set of independent coordinates used to obtain the solution to the equations of motion is developed. After forming the labels needed to identify the output system coordinates, the computer program proceeds to calculate the mass, damping, and stiffness matrices of the individual components and assembles the various matrices together. The system generalized forces are specified by the user. The final dynamic system equations can now be solved by one of several methods selected by the user: eigensolutions (real or complex), steady state forced response, or time history. The final component responses are printed out and saved in a data file for execution of the "Plot Package Program". Time history solution results can be stored in a separate data file for restart conditions.

Section 5

BASE PROGRAM INTERFACING WITH EXTERNAL PROGRAMS

The Base Program SIMVIB communicates with four external programs, as illustrated by the block diagram in Figure 1: G400 (Reference 3), E927 (Reference 5), RIEVA (Reference 6), and the Plot Package (Reference 7). The transfer of data is done through file units which are identified in Figure 2.

5.1 G400 Rotor Aeroelastic Analysis

The G400 Rotor Aeroelastic Analysis calculates the time history response of conventional articulated, non-articulated, teetering and composite bearingless rotors. The theoretical development is presented in Reference 2. Instructions to execute the program are found in Reference 3 and in this report in Appendix A, "G400/F389 Coupled Program". The options available are uniform or variable inflow, steady or unsteady aerodynamic airfoil data, radial flow, blade mounted pendulum absorbers, higher harmonic control (HHC) of

blade pitch, and coupling with the F389 Rotor Induced Inflow Program. The program calculates the hub excitation vector for a fixed hub and the rotor impedance matrix relating 6 hub forces and moments to harmonic perturbations of the hub. The data are written to unit 11 and then loaded into the Base Program. The rotor hub excitation vector and impedance matrix are assembled with the mass, damping, and stiffness matrices of the internal components by activating component RE3. The steady state forced response mode, which is invoked through component FR1, is used to calculate the coupled system responses. The parametric variation option, PV1, can be executed if changes in design characteristics need to be investigated.

5.2 E927 Rotor Aeroelastic Stability Analysis

The E927 Rotor Aeroelastic Stability Analysis prior to modifications made for the contract provided a description of the stability of coupled helicopter main or tail rotor/airframe systems. The analysis obtained linear stability characteristics for axial flow or hover conditions from calculations of the eigenvalues and eigenvectors of the coupled system. The analysis allows a maximum of 24 blade degrees of freedom: up to four blade coupled flatwise/edgewise bending modes and two torsional modes plus blade rigid flapping and lead lag motion. Each blade has a collective and two cyclic rotor mode coordinates associated with it. The rotor hub is represented by five displacements: longitudinal, lateral, vertical, pitch, and roll. The trim rotor conditions may derive from G400 or a similar analysis. The theoretical development of the analysis is presented in Reference 4. The instructions for executing the E927 program are available from Reference 5, and Appendix B of the present report.

For this contract the E927 program was modified to calculate only mass, damping, and stiffness matrices associated with rotor and hub coordinates. This specialization enabled the E927 model to be represented as a substructure and to be coupled to other substructures by means of the assembly method contained in the Base Program. The mass, damping, and stiffness matrices are transmitted to the Base Program through unit 10. The rotor matrices are then assembled with the matrices from the other system components by activating the RE2 component and the eigensolution EG2 for systems with damping. The system stability is then determined from an inspection of the calculated eigenvalues. Steady state forced response can also be calculated if a rotor hub force and moment excitation vector is input to the Base Program by activating components FR1 and GF1. The excitation data would be provided by the G400 program or by any other suitable analysis.

5.3 RIEVA - Empennage Excitation Analysis

The RIEVA Empennage Excitation Analysis from Reference 6 calculates the N/Rev (N is the number of blades) unsteady aerodynamic

loads induced by a rotor wake at an empennage which may be a vertical or a horizontal surface. The RIEVA utilizes rotor induced velocities from the F389 program through unit 15. Lifts and moments which affect the empennage are evaluated and then are input to the Base Program as harmonic coefficients through the substructure component GF1. The steady state forced response mode (FR1) is used to provide a solution for the final coupled system.

5.4 Base Program Plot Package

Results from the Base Program are stored in unit 2 for processing by the Base Program Plot Package. Execution of the plot program is discussed in detail in Reference 7. The program can display results for the different solution methods (eigensolutions, forced response, and time history). Examples of output plots are available in this report in section 10, "Test Cases Descriptions and Results".

5.5 Refinement of External Rotor Model

The rotor model provided to the Base Program from the G400 program can be refined by executing the F389 Rotor Induced Flow Program and the WABAT (Wing and Body Aerodynamic Technique) Program.

5.5.1 F389 Rotor Induced Flow Program

This program calculates the velocities induced by the rotor at the rotor disc or an empennage. It can be executed in an iterative manner with the G400 analysis to obtain the variable inflow field. Convergence is obtained when the blade circulations and induced velocities are consistent from the two programs. Wake models which can be utilized are classical (skewed helix) or distorted wakes. The G400 and F389 programs communicate with each other by transfer of data through units 13, 16 and 23 (G400 to F389) and unit 14 (F389 to G400). More details are in section 5.6, "Execution of the G400/F389 Coupled Program". The F389 program is described in Reference 8. The F389 Program may also be used to calculate the rotor induced velocities at an empennage as input to the RIEVA Program. The data transfer is accomplished through unit 7. No iteration between the F389 and RIEVA programs is performed.

5.5.2 WABAT (Wing And Body Aerodynamic Technique) Program

This program provides the fuselage induced velocities at the rotor disc to the F389 program through unit 15. No iteration between the two programs is performed. The WABAT geometry module is run before the potential flow program to define the fuselage geometry, as indicated in Figure 1. The WABAT plot package is executed to verify

that the fuselage geometry input is correct. Additional information on the WABAT program is available in References 9 and 10.

5.6 Execution of the G400/F389 Coupled Program

The G400 and F389 programs have been coupled to allow the user three execution options:

1. G400 only
2. F389 only
3. G400/F389/G400 cycling operation

The options are controlled through an additional input quantity specified on the first input card. A value of -2 specifies execution of the F389 program alone, -1 or zero are used to run G400 alone, while a positive number indicates the number of cycles of G400/F389 to perform. Appropriate input for the G400 or the F389 program (if run alone) is then loaded. In the uncoupled mode, the G400 program calculates the time history response with uniform or variable inflow (calculated from a previous F389 run). Input needed to run the F389 program by itself can be punched out; this includes blade physical data, airfoil section characteristics, and non-induced axial velocities. If the coupled mode is exercised, the above input is passed through automatically from G400 to F389 using units 13, 16, and 23 as shown in Figure 2.

The F389 program calculates the rotor induced velocities which are passed to the G400 program through unit 14 in the coupled mode or can be punched out in cards for input to G400 when run alone. When the coupled version is activated, a number of cycles can be specified; one cycle consists of execution of G400, F389, and G400. The accuracy of the rotor induced flow increases as more iterations are performed, however, the computer time also increases. One cycle normally requires 2 minutes of CPU (central processing unit) time, while two cycles require about 3 and one-half minutes of execution time on the IBM 370/168 system. A trade-off between variable inflow accuracy and computer time usage and cost must be considered. For additional information on the execution of the G400/F389 Coupled Program refer to Appendix A, "G400/F389 Coupled Program".

Section 6

OVERVIEW OF BASE PROGRAM COMPONENTS

This section provides an overview of the ten substructures presently available in the Base Program: BF1, BF2, BM1, CN1, FA1, GF1, IS1, MS1, RE2, and RE3. The four solution methods (EG1, EG2, FR1, and TH1) and the two operational modes (GEN and PV1) are also outlined. A summary of the attributes of the SIMVIB program components is provided in the last part.

6.1 Substructures Attributes

The substructures available with the Base Program are discussed in detail in Reference 1. A summary of the substructures and a brief description is presented in Table 1. Each substructure or component is identified by a three-character name and is assigned by the user a unique element number. The Base Program requires input data for only those components identified by the three-character name and element number. Several components may be present in the synthesis of a dynamic system. One component may be connected to another component by assigning the same connection node number among the two components. When components are connected, the displacements of the components at the point of connection are equal. The specification of connections enables a system to be synthesized from components. A component may be repeated several times. For example, a dynamic structure may be represented by five normal mode shapes (MS1). However, each MS1 component must have a unique element number. The user should refer to section 7 entitled "Base Program Component User Information" for examples of input data.

6.2 Solution and Operational Modes Attributes

The Base Program can employ four methods of solution to calculate the dynamic system responses. The methods are eigensolutions (real and complex), forced response, and time history. Two operational modes are available also. These are parametric variation and general control mode. The solution and operational modes are summarized in Table 2 which includes a brief description of each mode. If additional information is desired by the user, Reference 1 should be consulted.

6.3 Summary of Component Attributes

A summary of the attributes of the Base Program components (10 substructures, 4 solution modes, and 2 operational modes) is shown in Table 3. This table provides the three-character name, the number (NDLOAD) of component-dedicated input locations (see sections 9.7 and 9.8), the number (NWORK) of component-dedicated work locations (see sections 9.7 and 9.8), the number of connection nodes which may be used with each substructure, the total number of coordinates, and the Fortran names associated with each substructure output coordinates.

Section 7

BASE PROGRAM INPUT DESCRIPTION

This section contains information on the input data required to execute the SIMVIB program. A description of the input case may be provided through the use of up to four title cards. The input data for the individual components then follow. Each component is

at first identified by a three-character name and a unique element number. Component names and element numbers may be located in any order; the computer program reads the data, checks for duplication of element numbers, and processes the data to calculate the system response. The individual components are coupled to each other through the connection nodes.

Each connection node has associated with it three Euler angles defining the angular orientation of a substructure relative to a global axis system. When these angles are defined, one substructure may be connected to another with an arbitrary angular orientation. All connection node displacements are resolved to global axes and the system solution is obtained in terms of coordinates resolved to global axes (see Reference 1). Figure 3 illustrates the angular disposition of any local axis system relative to the global system. For small Euler angle displacements, the Euler angles may be identified with pitch, roll, and yaw displacements. For large angles these names are not conventional. However, for the sake of convenience the Euler angles θ , ϕ , and ψ are referred to as pitch, roll, and yaw angles, respectively. After the system response has been obtained, substructure responses referred to substructure local axes are recovered and are displayed as line printer output or plot output. Coordinates which are not connected - e.g. absorber mass displacement - are invariant to rotations and have the same values in all axis systems. These properties of the coordinates are discussed in Reference 1 (see Substructure Assembly Method).

The component data are loaded three items per card. The additional space on the input cards is reserved for comments to provide a brief description of the input data. The input data for the various substructures, solution modes and operational modes employ the same format.

Any solution mode may be invoked for a dynamic configuration. The only exception occurs when the rotor model component, RE3, from the G400 analysis is used. In this case, the only solution method applicable is the forced response solution (FR1). The operational mode, GEN, can be used for all cases. The parametric variation mode, PV1, cannot be activated when a time history response solution (TH1) is performed.

Several cases may be executed in succession (this is discussed in greater detail in the following section). Only revised or additional input data for the present components need to be loaded. New components may not be introduced after the first case since computer storage for components data is allocated for the first case only. The final case must have the word STOP on the last card.

7.1 Input Data Format

The card input format for the Base Program components is illustrated in Figure 4. Three different loader formats are used for describing titles, component specification/multiple cases control/end of run, and component characteristics as described below.

1. Titles (card 1)

- a. Up to four titles can be specified.
- b. Each title is coded in columns 1 through 40.
- c. Read format is 4A10 for CDC and 10A4 for IBM.
- d. Titles are only read once for a complete run.
- e. If results are to be plotted, then the first 3 titles will comprise the heading for each plot while the fourth title will describe the abscissa. For plotting purposes, 4 titles must be coded (the second and third title may be blank cards). Column 1 must be blank for all 4 titles when the Tektronix plot package is used. The fourth title is limited to 15 characters (columns 2 - 16).
- f. The exact image of the input titles is printed out before the component input data images are printed.

2. Component Specification (card 2)

- a. The component name, NAM1, is coded in columns 1 through 4, left adjusted. Format is A4.
- b. Each component is assigned a unique element number, NB1. It is coded in columns 10 through 12, right adjusted. Format is I3.
- c. If input data are to be repeated for a component, then COPY is coded in columns 18 through 21 and the previous element number, NB2, is specified in columns 25 through 27 (right adjusted - I3 format). If no data are to be copied from a previous component, COPY and NB2 are not coded.
- d. Comments may be added in columns 40 through 79. Format is 4A10 for CDC and 10A4 for IBM.

3. Component Characteristics (card 3)

- a. The input location of the first data item on the card, LOC, is located in columns 1 through 3, right adjusted. Format is I3. The last input data card for a given component has a minus sign in columns 1 or 2.
- b. A delimiter comment, DEL, may be coded in columns 4 through 6 to separate the location number and the input data. Format is A3.

- c. Up to 3 input values may be loaded per card. The format field is 3G10.3.
- d. Comments may be added in columns 40 through 79.

4. Multiple Cards Control (card 4)

- a. Card loader format is similar to that described in section "Component Specification" above.
- b. To run multiple cases, the control flags END and CASE are coded exactly as shown on card 4 in Figure 4 after the last input data card for the case.
- c. The case number, NCS, is optional.

5. End of Run (card 5)

The last input data card contains the control flag STOP coded in columns 1 through 4.

The loader is designed to allow the user to supersede data in a card by inserting an additional card which contains new data. This card must be placed further down in the input stream than the card whose data are to be replaced, and it must be placed in a data region applicable to the component whose data are to be modified. One or more cards may be modified. More than one card may be used to provide a succession of modifications in the input stream. This modification capability is designed to provide flexibility in input preparation. A restriction is that if a new value is zero, this new value must always be placed in columns 7 through 16 (first data field, Figure 4). Two examples of loader data are presented in Figures 5 and 6.

The first run in Figure 5, represents a forced response study (FR1) of a system including a fixed system absorber (FA1), and a single normal mode (MS1) being excited by a longitudinal (x) force (GF1) at a frequency range from 1.59 to 9.55 hz (PV1). The output printout is not suppressed and the variable stored for three-dimensional plotting is the damping ratio of the fixed system absorber (GEN). For plots, the abscissa is labelled "FREQUENCY (HZ)", as indicated by the fourth title card. Only one case is executed in this example.

The running of a second case with a new value of damping ratio in FA1 location 3 and GEN location 10 would cause new results to be stored for the second damping ratio. The specification of a damping value in GEN location 10 causes this value to be stored for plotting. Successive cases similar to those described may be run to store results corresponding to additional damping ratios. A three-dimensional plot generated by the plot program consists of two axes of abscissas and one axis of ordinates. In the sample problem, the first axis of abscissas is the axis of frequencies. The second axis of abscissas is the axis of dampings. The axis of

ordinates is the axis of system responses. A curve of variation of system responses with frequency is displayed for each value of damping. These curves are disposed on the second axis of abscissas at points defined in GEN location 10. If the value in GEN location 10 is not loaded (blank string), the plot package defaults to displaying points on the second axis of abscissas equidistantly.

The second run in Figure 6 calculates the time history response (TH1) for the system described above employing a second normal mode (MS1) introduced by the COPY command. Three cases are executed using the END CASE commands. In the second case, the fixed system absorber mass has been changed from 10 to 15 slugs; the mass is increased to 20 slugs for the third case. The print-out of the output results is eliminated by the control switch in GEN. For plots, the abscissa is labelled "TIME (SEC)".

Additional inputs are needed if elastic rotor representations (component RE2 from the E927 program and component RE3 from the G400 program) are utilized in a computer run. The E927 rotor mass, damping, and stiffness matrices are written to unit 10 from an independent execution of the E927 program. The Base Program reads the rotor data from unit 10 in subroutine LK2RE2 and, after conversion to the proper internal units, they are printed out in subroutine ASMMCK, if the debug switch is activated. A sample output of the E927 matrices appears in Figure 7 for a rotor/fuselage system with 17 degrees of freedom. The rotor impedance, higher harmonic control (HHC), and blade stress matrices, and the force vector from the G400 program are input to the Base Program through unit 11. Unit 12 may be used to transmit user input data defining the impedance properties and force vector of a general substructure. A sample input from unit 12 is shown in Figure 8. The data are read in subroutine LK2RE3 and printed in PRTRE3 and PRTSTR. A sample output is shown in Figure 9. No controls are provided to suppress the input force excitation vector and rotor impedance matrix display.

7.2 Component Descriptions, Input Data Specifications, and Output Coordinate Labels

Detailed descriptions are given in this section of the functions, assumptions, and coordinates employed by components available in the Base Program. Components comprise substructures, solution modes, and operational modes. Input specifications are provided for each component. Appendix B in Reference 1 defines the equations of motion for each substructure. Reference 1 also describes the mathematical basis of the solution modes (see section Solution Modes).

7.2.1 Horizontal Linear Bifilar BF1

Horizontal linear bifilar BF1 is a bifilar vibration absorber designed to reduce N per rev vibrations in the plane of rotation of a helicopter rotor. The bifilar absorber is assumed to consist of N arms equal in number to the rotor blades. Each arm holds a pendular mass free to lead or lag. The arms are assumed to be equally disposed and each holds an equal absorber mass. The bifilar absorber rotates at the helicopter rotor speed. Figure 10 is a schematic of one arm of the bifilar. Each bifilar mass lead-lag displacement may be expressed as the sum of bifilar lead-lag collective and cyclic displacements.

The BF1 substructure employs 8 coordinates consisting of bifilar mass sine (y_s) and cosine (y_c) cyclic amplitudes and 6 hub displacements. The reduced equation set has constant coefficients. Restrictions on the configurations that may be treated are that they must have three or more equally disposed and equal masses. Pendulum perturbations are assumed to be small enough to permit linearization of the equations of motion. Solutions are obtained in terms of the cyclic amplitudes y_c and y_s . Solution modes that may be used with BF1 are FR1, EG1, EG2, and TH1. Initial values of bifilar mass cyclic mode amplitudes may be specified for transient analysis.

HORIZONTAL LINEAR BIFILAR BF1
INPUT DATA

Location No.	Fortran Name	Input Item Description	Units
1	NCN1	Connection node number	nd
2	N	Total number of bifilar masses	nd
3	MB	Bifilar mass	slugs
4	RR	Distance from center of bifilar tracking hole to center of rotation	in
5	R	Equivalent pendulum arm	in
6	ZETGAM	Bifilar damping ratio	nd
7	OMEGA	Bifilar rotational speed	rad/sec
8	THETA	Euler pitch angle at node (θ_y)	deg
9	PHI	Euler roll angle at node (θ_x)	deg
10	XSI	Euler yaw angle at node (θ_z)	deg
11	GAMMAC	Bifilar mass cosine cyclic ² initial amplitude	deg
12	DGAMMC	Bifilar mass cosine cyclic initial velocity	deg/sec
13	GAMMAS	Bifilar mass sine cyclic initial amplitude velocity	deg/sec
14	DGAMMS	Bifilar mass sine cyclic initial velocity	deg/sec

HORIZONTAL LINEAR BIFILAR BF1
COORDINATE LABELS

Symbol	Coordinate Code	Output	Description
γ_C	GAMMAC	GAMC	Bifilar mass cosine cyclic lead amplitude
γ_S	GAMMAS	GAMS	Bifilar mass sine cyclic lead amplitude
u	X	X	Hub x linear displacement
v	Y	Y	Hub y linear displacement
w	Z	Z	Hub z linear displacement
θ_1	THTX	THTX	Hub roll displacement
θ_2	THTY	THTY	Hub pitch displacement
θ_3	THTZ	THTZ	Hub yaw displacement

7.2.2 Vertical Linear Bifilar BF2

Vertical linear bifilar BF2 is a bifilar vibration absorber designed to reduce N per rev vibrations perpendicular to the plane of rotation of a helicopter rotor. The bifilar absorber is assumed to consist of N arms equal in number to the rotor blades. Each arm holds a pendular mass free to flap up or down. The arms are assumed to be equally disposed and each holds an equal absorber mass. The bifilar absorber rotates at the helicopter rotor speed. Figure 11 is a schematic of one arm of the bifilar. Substructure BF2 employs 9 coordinates consisting of bifilar mass collective (β_o), sine cyclic (β_s), and cosine cyclic (β_c) amplitudes, and 6 hub displacements. Restrictions on the configurations that may be treated are that they must have three or more equally disposed and equal masses. Solution modes that may be used with BF2 are FR1, EG1, EG2, and TH1. Initial values of bifilar mass collective and cyclic amplitudes may be specified for transient analysis.

VERTICAL LINEAR BIFILAR BF2
INPUT DATA

Location No.	Fortran Name	Input Item Description	Units
1	NCN1	Connection node number	nd
2	N	Total number of bifilar masses	nd
3	MB	Bifilar mass	slugs
4	RR	Distance from center of bifilar tracking hole to center of rotation	in
5	R	Equivalent pendulum arm	in
6	ZETBET	Bifilar damping ratio	nd
7	OMEGA	Bifilar rotational speed	rad/sec
8	THETA	Euler pitch angle at node (θ_y)	deg
9	PHI	Euler roll angle at node (θ_x)	deg
10	XSI	Euler yaw angle at node (θ_z)	deg
11	BETAO	Bifilar mass collective initial amplitude	deg
12	DBETAO	Bifilar mass collective initial velocity	deg/sec
13	BETAC	Bifilar mass cosine initial amplitude	deg
14	DBETAC	Bifilar mass cosine initial velocity	deg/sec
15	BETAS	Bifilar mass sine initial amplitude	deg
16	DBETAS	Bifilar mass sine initial velocity	deg/sec

VERTICAL LINEAR BIFILAR BF2
COORDINATE LABELS

Figure	Coordinate Code	Output	Description
β_o	BETAO	BETO	Bifilar mass collective flapping amplitude
β_s	BETAC	BETC	Bifilar mass cosine cyclic flapping amplitude
β_c	BETAS	BETS	Bifilar mass sine cyclic flapping amplitude
X	X	X	Hub x linear displacement
Y	Y	Y	Hub y linear displacement
Z	Z	Z	Hub z linear displacement
θ_1	THTX	THTX	Hub roll displacement
θ_2	THTY	THTY	Hub pitch displacement
θ_3	THTZ	THTZ	Hub yaw displacement

7.2.3

Substructure BM1

Beam Model 1, BM1, is a uniform elastic beam. The substructure has 12 coordinates consisting of 6 linear and angular displacements at each of the two ends of the beam. The beam may be connected to other substructures at its ends. The uniform mass of the beam, m_0 , is approximated by two concentrated masses equal to $m_0/2$ at its ends. The beam is assumed to have zero mass moment of inertia associated with bending and torsion rotational displacements. Structural damping is assumed to be zero. Figure 12 illustrates BM1 properties.

BEAM MODEL BM1
INPUT DATA

Location No.	Fortran Name	Input Item Description	Units
1	NCN1	Connection mode number at end 1	nd
2	NCN2	Connection mode number at end 2	nd
3	E	Young's modulus	psi
4	A	Cross sectional area	ft ²
5	IYA	Second area moment about y-axis	ft ⁴
6	IZA	Second area moment about z-axis	ft ⁴
7	GJ	Torsional stiffness	slug-ft/sec
8	MO	Beam mass	slugs
9	IXX	Second mass moment about x-axis	slug-ft ²
<p>There is no provision in this program version for representation of rotary inertias in the BM1 equations of motion.</p>			
10	IYY	Second mass moment about y-axis	slug-ft ²
11	IZZ	Second mass moment about z-axis	slug-ft ²
<p>There is no provision in this program version for representation of c.g. offset terms in the BM1 equations of motion.</p>			
12	UCG	Offset of beam c.g. from elastic axis in the x-direction	ft
13	VCG	Offset of c.g. in the y-direction	ft
14	WCG	Offset of c.g. in the z-direction	ft
15	LENGTH	Beam length	ft
16	THETA1	Euler pitch angle at node 1 (y1)	deg
17	PHI1	Euler roll angle at node 1 (x1)	deg
18	XS11	Euler yaw angle at node 1 (z1)	deg

Input values of Euler angles at node 2 must be equal to the values at node 1.

19	THETA2	Euler pitch angle at node 2 (y2)	deg
20	PHI2	Euler roll angle at node 2 (x2)	deg
21	XSI2	Euler yaw angle at node 2 (z2)	deg

BEAM MODEL BM1
COORDINATE LABELS

Symbol	Coordinate Code	Output	Description
u ₁	X1	X1	Node 1 x displacement
v ₁	Y1	Y1	Node 1 y displacement
w ₁	Z1	Z1	Node 1 z displacement
(θ_1) ₁	THTX1	THX1	Node 1 roll displacement
(θ_2) ₁	THTY1	THY1	Node 1 pitch displacement
(θ_3) ₁	THTZ1	THZ1	Node 1 yaw displacement
u ₂	X2	X2	Node 2 x displacement
v ₂	Y2	Y2	Node 2 y displacement
w ₂	Z2	Z2	Node 2 z displacement
(θ_1) ₂	THTX2	THX2	Node 2 roll displacement
(θ_2) ₂	THTY2	THY2	Node 2 pitch displacement
(θ_3) ₂	THTZ2	THZ2	Node 2 yaw displacement

7.2.4 Constraint Substructure CN1

Constraint substructure CN1 may be used to eliminate or constrain coordinates at a connection node. There are six coordinates at each connection node (see Figure 13). The coordinates consist of three linear displacements and three angular displacements. The user may constrain any five of the six coordinates at a connection node. At least one coordinate among the six must be retained.

Constraint substructure CN1 may not be used in conjunction with modal substructure MS1 at the same connection node. CN1 may be used to eliminate physical coordinates at a node. Retained physical coordinates cannot then be replaced by modal coordinates. Simultaneous elimination of physical connection node coordinates and replacement of retained coordinates by modal coordinates is accomplished by using zero mode shapes in an MS1 substructure.

Non-zero Euler angles (locations 8 to 10) are used to constrain local coordinates; zero values constrain global coordinates.

CONSTRAINT SUBSTRUCTURE CN1
INPUT DATA

Location No.	Fortran Name	Input Item Description	Units
1	NCN	Connection node number	nd
2-7	CONSTR	Constraint control switch If = 0, then degree of freedom (d.o.f.) is constrained at connection node If = 1, then d.o.f. is not restrained Loc 2 controls x d.o.f. at node Loc 3 controls y d.o.f. at node Loc 4 controls z d.o.f. at node Loc 5 controls θ_x d.o.f. at node Loc 6 controls θ_y d.o.f. at node Loc 7 controls θ_z d.o.f. at node	nd
8	THETA	Euler pitch angle (θ_y) at node	deg
9	PHI	Euler roll angle (θ_x) at node	deg
10	XSI	Euler yaw angle (θ_z) at node)	deg

Constraint substructure CN1 coordinate output labels are the same as the coordinate labels obtained from the component constrained by CN1. If constraint coordinate CN1 is used to constrain 5 BM1 connection coordinates at a connection node, and the remaining coordinate is w at node 1, the output label of this coordinate will be Z_1 .

7.2.5 Eigensolution for Systems Without Damping EGI

This eigensolution mode yields the frequencies and mode shapes of structures without damping. Matrices must be constant w.r.t. time. The effects of changes in physical properties on mode shapes and frequencies may be determined. These effects may be used to aid the interpretation of the effects of design variables on normal modes and vibratory response. Section 8.3 describes the line printer output displayed by EGI.

COMPONENT EGI INPUT DATA

Location No.	Fortran Name	Input Item Description	Units
1	IDEBUG	Set = 0 for no debug printout - default value Set = 1 display M and K matrices in substructure and system equations of motion	nd

7.2.6 Eigensolution for Systems with Damping EG2

The eigensolution mode for systems with damping is used to provide information on the stability of coupled systems. These systems may include rotor representations which embody dynamic and aerodynamic matrices derived from rotor aeroelastic analysis E927. Stability information may be used to supplement the steady state vibratory response data for a system to provide more data on system attributes. Section 8.3 describes the line printer output displayed by EG2.

COMPONENT EG2 INPUT DATA

Location No.	Fortran Name	Input Item Description	Units
1	IDEBUG	Set = 0 for no debug printout - default value Set = 1 display M, C, and K matrices in substructure and system equations of motion.	nd

7.2.7 Substructure FA1

The function of substructure FA1 is to simulate a vibration absorber which may be attached to any other substructure in the fixed (non-rotating) system. Substructure FA1 has seven coordinates. These are absorber mass displacement and six displacements of the base consisting of three linear displacements and three angular displacements. The mass of the absorber is free to move perpendicular to the base. The mass of the absorber is not free to move parallel to the base. Viscous damping is assumed. Figure 14 illustrates substructure FA1 properties. Initial mass displacement and velocity may be specified for transient response analysis.

FIXED ABSORBER FA1 INPUT DATA

Location No.	Fortran Name	Input Item Description	Units
1	NCN	Connection node number	nd
2	MO	Absorber mass	slugs
3	ZETA	Absorber damping ratio	nd
4	KO	Absorber stiffness	lb/ft
5	IXX	Second mass moment about x-axis	slug-ft ²
6	IYY	Second mass moment about y-axis	slug-ft ²
7	IZZ	Second mass moment about z-axis	slug-ft ²
8	THETA	Euler pitch angle (θ_y) at node	deg
9	PHI	Euler roll angle (θ_x) at node	deg
10	XSI	Euler yaw angle (θ_z) at node	deg
11	DELTA	Initial displacement of absorber mass	ft
12	DDELTA	Initial velocity of absorber mass	ft/sec

FIXED ABSORBER FA1 COORDINATE LABELS

Coordinate Symbol	Code	Output	Description
	DELTA	DELT	Absorber mass displacement
u	X	X	Base x linear displacement
v	Y	Y	Base y linear displacement
w	Z	Z	Base z linear displacement
θ_1	THT1	THTX	Base roll displacement
θ_2	THT2	THTY	Base pitch displacement
θ_3	THT3	THTZ	Base yaw displacement

7.2.8 Steady State Forced Response FR1

The harmonic steady state forced response mode of calculation FR1 yields the harmonic coefficients of response to a steady harmonic excitation. The system equation reduces to an algebraic equation which is solved to obtain the harmonic coefficients of response. Speed of calculation in the FR1 mode is high and the method is suitable for parametric design studies with component PV1. Section 8.3 describes the line-printer output displayed by FR1.

COMPONENT FRI INPUT DATA

<u>Location No.</u>	<u>Fortran Name</u>	<u>Input Item Description</u>	<u>Units</u>
1	OMEGA	Forcing frequency	hz
2	IDEBUG	Debug control switch Set = 0 for no debug printout - default value Set = 1 to display M, C, and K matrices and force vectors for sub- structures and assembly, and solution vector for assembly at solution step.	nd
3	ICONVG	If = 0, results are displayed as displacements (ft) If = 1, results are displayed as accelerations (g's)	nd

7.2.9 General Control Mode, GEN

The general control mode, GEN, is designed to provide a basis for the application of general controls to a case. In the present version of the Base Program, GEN provides input which may be used to suppress line printer output. When line printer output is suppressed, only the input echo, and coordinate solution list for one iteration (parameter variation or time step) are displayed. Solution data are stored on the plot file. The coordinate list is then used to identify variables to be plotted. Suppression of line printer output minimizes hard copy line printer output. A further control now present in GEN permits a numerical value to be specified for an independent variable on the first axis of abscissas. The second axis of abscissas may contain the value of the mass of a vibration absorber varied in a design study. The axis of ordinates would contain vibratory response of the system. If the variable occurring on the second axis of abscissas is not specified, the plot package displays curves corresponding to points on the second axis equidistantly. If the GEN string is not loaded, the GEN mode is not invoked and its input is not required.

COMPONENT GEN INPUT DATA

Location No.	Fortran Name	Input Item Description	Units
1	CNTL1	Final results control switch If = 0, suppress full line printer output-default value If = 1, get line printer output When output is suppressed a coordinate list of coordinate numbers and names is displayed for the first solution step. Coordinate numbers are tabulated against element number and coordinate name. The values of coordinate responses are stored for plotting at each solution step and are printed only at the first step. When coordinates are substructure connection node displacements, these displacements are referred to substructure local axes. Unconnected coordinates - e.g. vibration absorber mass displacement - and modal coordinates are in-variant to axis rotations. The first solution step may yield the response vector obtained for the first value of a parameter in a parameter variation mode or for the first time instant in a time history solution. When the plot package is invoked, the user uses the first step coordinate list to identify and key in the coordinate numbers of the coordinates that are to be plotted.	nd
2	CNTL2	Input narrative control switch If = 0, suppress printout - default value If = 1, display input narrative	
3-9	---	Open locations for future use	
10	XINDEP	Independent variable for 3-dimensional plots.	

A three-dimensional plot generated by the plot program is based on two axes of abscissas and one axis of ordinates. The axis of ordinates contains the values of the responses of a coordinate of the system (referred to substructure local axes in the case of connection node displacements). A curve of variation of response with values along the first axis of abscissas is placed on the second axis at a position corresponding to the value in location 10. If a blank string is loaded in location 10 the plot package defaults to displaying curves equidistantly on the second axis of abscissas.

7.2.10

Substructure GF1

Generalized Force 1, GF1, permits the specification of a harmonic force and moment excitation acting at a point on a structure. The GF1 substructure has six coordinates, comprising three linear and three angular displacements at a connection node. Forces and moments are resolved to a non-rotating axis system. The user specifies the cosine and sine coefficients of these forces and moments to define a harmonic excitation of known magnitude. The mass, damping, and stiffness matrices for substructure GF1 are null matrices. Substructure GF1 may be used to represent an excitation for forced response (FR1) and time history (TH1) solution modes. Substructure GF1 may be included in eigen-solution (EG1 and EG2) input streams without affecting the final eigensolution. Figure 15 illustrates GF1 properties. Substructure GF1 may be used to define a point at which vibrations are to be minimized by application of higher harmonic control inputs. The HHC mode is invoked by setting IHRESP = 1. In this mode, a weighted sum of the six responses at the connection node to which GF1 is attached is minimized. Weighting factors are placed in GF1 loader locations following the HHC flag IHRESP. The performance index to be minimized and the basis of the minimization method is described in Reference 1. When the HHC mode is invoked, it is necessary to employ substructure RE3 to read HHC matrices transmitted to the Base Program (SIMVIB). Rotor aeroelastic analysis G400 must be run in a stand alone mode to place rotor impedance and HHC data on files. Cases 14 to 16 in Table 13 illustrate the use of GF1 without and with HHC.

GENERALIZED FORCE GF1 INPUT DATA

Location No.	Fortran Name	Input Item Description	Units
1	NCN	Connection node number	nd
2	THETA	Euler pitch angle (θ_y)	deg
3	PHI	Euler roll angle (θ_x)	deg
4	XSI	Euler yaw angle (θ_z)	deg
5	FXCOS	Coefficient of cosine term in harmonic force excitation in x direction	lb
6	FXSIN	Coefficient of sine term in harmonic force excitation in x direction	lb
7	FYCOS	Coefficient of cosine term in harmonic force excitation in y direction	lb
8	FYSIN	Coefficient of sine term in harmonic force excitation in y direction	lb
9	FZCOS	Coefficient of cosine term in harmonic force excitation in z direction	lb
10	FZSIN	Coefficient of sine term in harmonic force excitation in z direction	lb
11	FT1COS	Coefficient of cosine term in harmonic moment excitation in x direction	ft-lb
12	FT1SIN	Coefficient of sine term in harmonic moment excitation in x direction	ft-lb
13	FT2COS	Coefficient of cosine term in harmonic moment excitation in y direction	ft-lb
14	FT2SIN	Coefficient of sine term in harmonic moment excitation in y direction	ft-lb
15	FT3COS	Coefficient of cosine term in harmonic moment excitation in z direction	ft-lb
16	FT3SIN	Coefficient of sine term in harmonic moment excitation in z direction	ft-lb
17	IHRESP	Control switch for HHC option = 0 do not activate option = 1 activate option to minimize a weighted sum of responses at the HHC connection node by application of HHC control inputs	nd
18	WZX	Weighting factor for X response in HHC mode	nd
19	WZY	Weighting factor for Y response in HHC mode	nd
20	WZZ	Weighting factor for Z response in HHC mode	nd
21	WZWX	Weighting factor for θ_x response in HHC mode	nd
22	WZWY	Weighting factor for θ_y response in HHC mode	nd
23	WZWZ	Weighting factor for θ_z response in HHC mode	nd

GENERALIZED FORCE GF1 COORDINATE LABELS

Symbol	Coordinate Code	Output	Description
u	X	X	Node x linear displacement
v	Y	Y	Node y linear displacement
w	Z	Z	Node z linear displacement
θ_1	THT1	THTX	Node roll displacement
θ_2	THT2	THTY	Node pitch displacement
θ_3	THT3	THTZ	Node yaw displacement

7.2.11 Vibration Isolator IS1

Vibration isolator IS1 is a nodal isolator which may be placed between an excitation source, like the rotor/transmission system, and a fuselage to minimize vibrations at the fuselage. In its essential form, the isolator employs a pivoted bar weight to balance spring and inertia forces to create a node or point of zero vibration motion at the fuselage attachment. When damping is present, vibrations are minimized at the fuselage attachment at the excitation frequency (N per rev for an N bladed rotor). Nodal isolator IS1 employs 18 coordinates. Figure 16a illustrates a physical isolator and Figure 16b is a schematic corresponding to the physical isolator. The schematic shows two antiresonant bar weights. The lower bar weight is a mathematical bar weight permitting additional design flexibility. It has no counterpart in Figure 16a. There are two attachment (connection) nodes. Each connection node is allowed to have three translational and three rotational displacements. The upper connection node A would be attached to a rotor/transmission system. The lower connection node B would be attached to a fuselage; this is the point where vibrations are to be minimized. Each antiresonant bar weight has three translational degrees of freedom. Antiresonant bar flexibilities and bar dampings may be introduced by modifying the effective mass of the antiresonant bar weight with factors employing the bar natural frequencies and dampings (locations 50 to 55).

COMPONENT IS1 INPUT DATA

Location No.	Fortran Name	Input Item Description	Units
1	NCN1	Connection node number 1	nd
2	NCN2	Connection node number 2	nd
3	AL	Distance between node 1 & pivot 2	in
4	BL	Distance between pivot 2 & Y-Z isolator	in
5	CL	Distance between pivot 2 & node 2	in
6	DL	Distance between pivot 2 & X isolator	in
7	W1	Anti-resonant bar weight of Y-Z isolator (mass 1)	lb
8	XI1Y	Y-Z isolator mass moment about y-axis	in-lb-sec ²
9	XI1Z	Y-Z isolator mass moment about z-axis	in-lb-sec ²
10	W2	Anti-resonant bar weight of X isolator (mass 2)	lb
11	XI2Y	X isolator mass moment about y-axis	in-lb-sec ²
12	TKTX	Stiffness between pivot 1 & node 1 in x direction	lb/in
13	TKTY	Stiffness between pivot 1 & node 1 in y direction	lb/in
14	TKTZ	Stiffness between pivot 1 & node 1 in z direction	lb/in
15	TKEX	Stiffness between pivot 1 & node 2 in x direction	lb/in
16	TKEY	Stiffness between pivot 1 & node 2 in y direction	lb/in
17	TKEZ	Stiffness between pivot 1 & node 2 in z direction	lb/in
18	TKAX	Stiffness between pivot 2 & node 2 in x direction	lb/in
19	TKAY	Stiffness between pivot 2 & node 2 in y direction	lb/in
20	TKAZ	Stiffness between pivot 2 & node 2 in z direction	lb/in
21	RKTHB	Rotational stiffness of node 2 about y-axis	in-lb/rad
22	RKHTT	Rotational stiffness of pivot 2 about y-axis	in-lb/rad
23	RKPHT	Rotational stiffness of pivot 2 about z-axis	in-lb/rad
24	TCTX	Damping ratio of damper in parallel with spring TKTX	nd
25	TCTY	Damping ratio of damper in parallel with spring TKTY	nd
26	TCTZ	Damping ratio of damper in parallel with spring TKTZ	nd

27	TCEX	Damping ratio of damper in parallel with spring TKEX	nd
28	TCEY	Damping ratio of damper in parallel with spring TKEY	nd
29	TCEZ	Damping ratio of damper in parallel with spring TKEZ	nd
30	TCAX	Damping ratio of damper in parallel with spring TKAX	nd
31	TCAY	Damping ratio of damper in parallel with spring TKAY	nd
32	TCAZ	Damping ratio of damper in parallel with spring TKAZ	nd
33	RCTHB	Damping ratio of spring in parallel with RKT HB	nd
34	RCTHT	Damping ratio of spring in parallel with RKT HT	nd
35	RCPHT	Damping ratio of spring in parallel with RKP HT	nd

NOTE: Damping is calculated from $TCTX1=2 * TCTX * TKTX/WTX$, lb sec/in
If $WTX=0$, then $TCTX1=0$.

Locations 36 to 47 permit the user to input values of frequencies required in the formulas for dampings contributed by damper elements.

36	WTX	Frequency required to define value of damper in parallel with TKTX	hz
37	WTY	Frequency required to define value of damper in parallel with TKTY	hz
38	WTZ	Frequency required to define value of damper in parallel with TKTZ	hz
39	WEX	Frequency required to define value of damper in parallel with TKEX	hz
40	WEY	Frequency required to define value of damper in parallel with TKEY	hz
41	WEZ	Frequency required to define value of damper in parallel with TKEZ	hz
42	WAX	Frequency required to define value of damper in parallel with TKAX	hz
43	WAY	Frequency required to define value of damper in parallel with TKAY	hz
44	WAZ	Frequency required to define value of damper in parallel with TKAZ	hz
45	WTHB	Frequency required to define value of damper in parallel with RKT HB	hz
46	WTHT	Frequency required to define value of damper in parallel with RKT HT	hz

47	WPHT	Frequency required to define value of damper in parallel with RKPHT	hz
48	I3D2D	Isolator type flag. Set = 2 for 2-D or Y-Z isolator type. Set = 3 for 3-D or Y-Z and X isolator type. When the flag is set to 2, the terms contributed by the second (lower) anti-resonant bar weight are removed from the isolator equations of motion. When the flag is set to 3, both anti-resonant bar weights are represented.	
49	IFLEX	Isolator bar flexibility effects option. If = 0, no flexibility effects. If = 1, include flexibility effects. <u>Note:</u> isolator bar flexibility effects are applied to the isolator weights and mass moments of inertia using the amplification factor calculated from the frequency ratio (forcing/natural) and critical damping values input in the following locations.	nd
50	RXYM1	Y-Z isolator bar frequency ratio in X-Y plane	nd
51	RXZM1	Y-Z isolator bar frequency ratio in X-Z plane	nd
52	RXZM2	X isolator bar frequency ratio in X-Z plane	nd
53	DXYM1	Y-Z isolator bar critical damping in X-Y plane	nd
54	DXZM1	Y-Z isolator bar critical damping in X-Z plane	nd
55	DXZM2	X isolator bar critical damping in X-Z plane	nd
56	THETA1	Euler pitch angle at connection node 1 (θ_{y1})	deg
57	PHI1	Euler roll angle at connection node 1 (θ_{x1})	deg
58	XSI1	Euler yaw angle at connection node 1 (θ_{z1})	deg
59	THETA2	Euler pitch angle at connection node 2 (θ_{y2}).	deg

The Euler angles at connection node 2 must be equal to the Euler angles at connection node 1.

60	PHI2	Euler roll angle at connection node 2 (θ_{x2})	deg
61	XSI2	Euler yaw angle at connection node 2 (θ_{z2})	deg
62	XT	Initial X displacement of anti-resonant bar weight 1	in
63	DXT	Initial X velocity of anti-resonant bar weight 1	in/sec
64	YT	Initial Y displacement of anti-resonant bar weight 1	in
65	DYT	Initial Y velocity of anti-resonant bar weight 1	in/sec
66	ZT	Initial Z displacement of anti-resonant bar weight 1	in
67	DZT	Initial Z velocity of anti-resonant bar weight 1	in/sec
68	XB	Initial X displacement of anti-resonant bar weight 2	in
69	DXB	Initial X velocity of anti-resonant bar weight 2	in/sec
70	YB	Initial Y displacement of anti-resonant bar weight 2	in
71	DYB	Initial Y velocity of anti-resonant bar weight 2	in/sec
72	ZB	Initial Z displacement of anti-resonant bar weight 2	in
73	DZB	Initial Z velocity of anti-resonant bar weight 2	in/sec

7.2.12 Modal Substructure MS1

Modal Substructure MS1 represents a dynamical system employing normal modes of a substructure. Each substructure of type MS1 is limited to the use of one normal mode. The user must supply input defining the modal generalized mass, damping ratio, and frequency of the normal mode. These properties may derive from analysis or from test data. Processing in the program forms damping and stiffness of the mode from the input data. Each substructure of type MS1 is allowed to have up to five nodes. At each node, structure orientation angles and elements of the modal matrix for the normal mode are defined. At each such node, the elements of the modal matrix are three linear and three angular displacements for a unit value of the normal mode amplitude. The directions of the displacements at a node must be the same as the directions in Figure 13. The specification of the same node number among two substructures of any type leads to the connecting of the two substructures at the node. More than one modal substructure of type MS1 is connected to the same node when it is desired to represent the effects on a node of several normal modes. Nodes on MS1 substructures may be used to define fuselage modes at up to five points. If a physical substructure is not connected to a node at which responses are desired, these responses may be displayed by connecting a GF1 substructure to the node of interest, with zero forcing coefficients. The GF1 substructure contributes no matrices or forces to the system. It introduces physical displacements at the node which become members of the set of dependent system coordinates which are used to monitor the node response. Initial modal amplitudes and velocities may be specified to analyze transient system response.

COMPONENT MS1 INPUT DATA

Location No.	Fortran Name	Input Item Description	Units
1	ZETA	Modal Damping ratio	nd
2	MO	Modal Generalized mass	lb-sec ² /in
3	OMEGA	Modal Frequency	hz
4	NNODE	Number of connection nodes allowing the substructure to be connected to other substructures (maximum of 5)	nd

5-9 NODE

Connection node numbers

nd

A representation of a normal mode structure with M (greater than one) normal modes is achieved by connecting M substructures of type MS1 to the same connection node. The value of M can be any number which does not cause the system to be solved to exceed the working storage allocation in the Base Program (see section 9.7 for control of working storage size).

10-39 GAMMA

Mode shapes at connection nodes.

in/in &
rad/in

For each node specified in locations 5-9, define elements of the modal matrix at the node contributed by the normal mode. The 6 modal matrix elements are: U (longitudinal), V (lateral), W (vertical), THETAX (roll), THETAY (pitch), THETAZ (yaw).

Ex. loc. 5-9 contain 2, 5, 6, 8, 9.

Then, loc 10-15 has mode shape for node 2,

loc 16-21 has mode shape for node 5,

loc 22-27 has mode shape for node 6,

loc 28-33 has mode shape for node 8,

loc 34-39 has mode shape for node 9.

The monitoring of the response at a point on a normal mode structure which is not connected to another physical structure may be achieved by connecting a GF1 substructure to the point of interest. The forces in the GF1 substructure input are equated to zero. The GF1 substructure has null mass damping, and stiffness elements and six displacements at the connection node. The GF1 substructure does not affect the system response. The values of the displacements at the connection node are calculated from the assembled system solution coordinates and are displayed as line printer output or are saved for plotting. The user may constrain one or more of these displacements from being displayed by nulling the mode shape elements

at the node in the senses which are not of interest-e.g., the rotational elements of the mode shape at the node would be equated to zero.

40-54	EULER	Euler angles input. For each node specified in loc 5-9, input in sequence THETA (pitch), PHI (roll), XSI (yaw). Ex. for modes specified above, then loc 40-42 has Euler angles for mode 2, loc 43-45 has Euler angles for mode 5, loc 46-48 has Euler angles for mode 6, loc 49-51 has Euler angles for mode 8, loc 52-54 has Euler angles for mode 9.	deg
55	---	Not presently used	
56	Q	Initial modal amplitude	in/in
57	DQ	Initial modal velocity	sec ⁻¹

7.2.13 Parameter Variation Mode (PV1)

The parameter variation mode, PV1, is used to identify a parameter which is to be changed in design studies and the range of values to be assumed by the parameter. This operational mode provides a convenient and general mode of selection of parameters to be varied among the substructures available in the Base Program and flagged in the input. Up to 10 parameters from any of the substructures may be varied simultaneously. The user specifies in the input to PV1 the element number and loader input location number of a component to identify the parameter to be varied. The three character string PV1 triggers the input for PV1. If the PV1 string is not loaded, the parameter variation mode is not invoked, and its input is not required.

COMPONENT PV1 INPUT DATA

Location No.	Fortran Name	Input Item Description	Units
1	FIRSTV	Starting value of parameter to be changed in design study	(as appropriate)
2	FINALV	Final value of parameter to be changed in design study	(as appropriate)

3	NPTS	Number of points of parameter variation	nd
4-23	NEL	Element number and corresponding location of parameter to be varied (up to 10 pairs can be loaded). Ex., conduct parametric studies of variations in fixed absorber weight (FA1) and forcing frequency in the range of 5 to 20 (slugs or Hz) in steps of 5.	nd

If FA1 is element No. 3 and FR1 is element No. 6, then PV1 input is:

Loc 1	5.	(Starting Value)
Loc 2	20.	(End Value)
Loc 3	4.	(No. of Cases)
Loc 4	3.	(FA1 Element No.)
Loc 5	2.	(Location of Weight)
Loc 6	6.	(FR1 Element No.)
Loc 7	1.	(Location of Frequency)

7.2.14 Rotor Aeroelastic Substructure RE2

Rotor aeroelastic substructure RE2 is used to represent a multi-blade aeroelastic rotor in hover. The function of this component is to read rotor matrices transmitted to a file by rotor aeroelastic analysis E927 and to prepare the rotor data for assembly with other components. Standard application of RE2 is in conjunction with eigensolution mode EG2.

The use of component RE2 is preceded by stand-alone application of E927. Rotor aeroelastic analysis E927 is an external program in the program package yielding the mass, damping, and stiffness matrices of a multi-blade elastic rotor in hover. The analysis is based on the assumption of linear perturbations about a given rotor trim state. Blade coordinates comprise flapping, leading, pitching, coupled flatwise/edgewise bending modes, and uncoupled torsion modes. Five hub displacements are represented. These are shown in Figure 13, except that the hub is restrained from yawing. Blade coordinates are transformed to rotor modes. Rotor modes consist of collective and first cyclic sine and cosine functions of rotor speed. Use of rotor coordinates in the rotor equations, and the assumption of equal blades, equally disposed on the rotor disc, enables a constant coefficient equation set to be derived. Rotor coordinate selection is made in the input specification to

E927. Rotor aeroelastic analysis E927 transmits to a file the number of coordinates, flags defining coordinates selected, and corresponding mass, damping, and stiffness matrices. Matrices embody dynamic and aerodynamic contributions. The three character string RE2 in the Base Program input stream triggers reading of data and Base Program processing required to represent the aeroelastic rotor. File data are read by the Base Program. Numerical input data following the RE2 flag consist of hub connection node number and hub orientation angles. Processing by the Base Program includes the addition of a dummy yaw coordinate. Zero mass, damping, and stiffness matrices are created for this coordinate. This yields a six coordinate hub consistent with coordinate representations for other substructures. Six hub coordinates enable the rotor component to be coupled to other components without changing Base Program assembly logic. A valid physical model of rotor yaw motion is not achieved. Null rotor matrices are associated with this displacement. The user must eliminate the hub yaw coordinate from the system model. This may be accomplished with constraint component CN1. A valid model would occur also if fuselage normal modes in component MS1 have no hub yaw displacement. In the present program version, only one rotor of type RE2 may be requested.

AEROELASTIC ROTOR RE2 INPUT DATA

Location No.	Fortran Name	Input Item Description	Units
1	IEXEC	E927 program execution control = 0. Read matrices from unit 10. = 1. Execute E927 and read matrices from unit 10. This option is not available on CDC system.	nd
2	NCN	Rotor hub connection node number.	nd
3	THETA	Hub connection node Euler pitch angle (θ_y)	deg
4	PHI	Hub connection node Euler roll angle (θ_x)	deg
5	XSI	Hub connection node Euler yaw angle (θ_z)	deg

AEROELASTIC ROTOR RE2 COORDINATE LABELS

Coordinate	Description
Output Label	
QFT1-QFT4	Blade bending collective modal amplitude ^(a)
THTR	Blade pitching ^(b)
THTE	Blade torsion ^(b)
BETA	Flapping collective mode ^(c)
GAMA	Leading collective mode ^(d)
QT1S, QT1C QT2S, QT2C QT3S, QT3C QT4S, QT4C THRS, THRC	Blade bending cyclic sine and cosine modal amplitudes ^(a) Blade pitching sine and cosine cyclic amplitudes ^(b)
THES, THEC	Blade torsion sine and cosine cyclic amplitudes ^(b)
BETS, BETC	Blade flapping sine and cosine cyclic amplitudes ^(c)
GAMS, GAMC	Blade leading sine and cosine amplitudes ^(d)
X, Y, Z, THTX, THTY, THTZ	Hub displacements. See Figure 13 for positive directions
<u>NOTES:</u>	
a)	Positive flatwise bending up and edgewise bending forward.
b)	Positive control nose down.
c)	Positive up.
d)	Positive forward.

7.2.15. Rotor Aeroelastic Substructure RE3

Rotor aeroelastic substructure RE3 is used to represent a multi-blade aeroelastic rotor in forward flight or hover. The function of this component is to read the rotor hub excitation force and moment vector and the rotor impedance matrix transmitted to a file by rotor aeroelastic analysis G400. Component RE3 triggers the calculations required to assemble the G400 rotor force vector and rotor impedance with impedance elements contributed by other dynamical components. The use of RE3 is preceded by stand-alone application of G400. The coordinates represented in the RE3 substructure are six hub displacements shown in Figure 13. The RE3 rotor impedance substructure is consistent only with a steady state forced response solution mode, FR1. The frequency of force excitation specified in the input to FR1 must be the same as that specified in the input to G400 to derive the rotor impedance matrix. This frequency will be an integer multiple of rotor speed and blade number ($wf = nb$). Component RE3 may be flagged to calculate Higher Harmonic Control (HHC) angles to minimize vibrations. Optimal control angles, blade stresses resulting from hub displacements, and HHC control inputs may be calculated. This is achieved by reading from a file the matrices transmitted from G400, deriving the effects on hub loads and blade stresses of HHC angle perturbations and hub displacements. When the HHC mode is invoked, it is necessary to employ a GF1 substructure to define the node at which a weighted sum of response is to be minimized. Weight factors applied to the 6 nodal displacements are defined in GF1 input. Weight factors applied to the HHC control angles to limit control excursions are defined in RE3 input. The basis of the HHC minimization method is described in Reference 1.

Component RE3 may be used to introduce the impedance and load excitation of a substructure which is not a rotor. A sample application would be the representation of an empennage. Substructure RE3 has an option to permit a user to load in unit 12 a load excitation vector and impedance matrix. The data may derive from any suitable source. Flag IRDFIL (see below) would be set equal to one. When a rotor is not represented, the use of RE3 is not preceded by stand-alone application of G400. The HHC and stress flags (see below) must be turned off. Only one substructure of type RE3 may be requested.

AEROELASTIC ROTOR RE3 INPUT DATA

Location No.	Fortran Name	Input Item Description	Units
1	IRDFIL	Read option for rotor impedance matrix and force vector = 0, read input from save file 11 = 1, read input from user file 12	nd
2	ISTFOR	Rotor hub forces option = 0, leave force vector unchanged = 1, null force vector in the code.	nd
3	IDPFOR	Display hub force option = 0, display hub displacements = 1, display hub forces and moments Six hub translational and rotational displacements which are solutions to the assembled system equations are displayed if IDPFOR = 0. If this flag is 1.0, the interface reaction forces and moments between the hub and connected substructures - e.g., fuselage - consistent with the motion of the assembled system are displayed (see Reference 1, Assembly of Rotor Impedance Matrix) There is an override instruction in the code which sets IDPFOR to zero if the user selects a display of system response in fractions of the acceleration of gravity (g's) (location 3 in FR1 is equal to 1). In other words, the selection of a display of results in g's in FR1 supersedes IDPFOR = 1 selection in RE3 and causes hub displacements to be displayed, even if hub forces and moments are requested.	nd
4	NCN	Rotor hub connection node	nd
5	THETA	Hub connection node Euler pitch angle (θ_y)	deg
6	PHI	Hub connection node Euler roll angle (θ_x)	deg

7	XSI	Hub connection node Euler yaw angle (θ_z)	deg
8	IHHC	HHC control switches = 0, do not activate option - default value = 1, activate option This option is set to zero internally if IRDFIL = 1 (loc. 1).	nd
9	ITHHC	Control input option for HHC applications = 0, compute optimal theta by quadratic minimization - no user input required - default value = 1, read HHC input angles as loaded in locations 11 through 16 below	nd
10	ISTRSS	Calculate blade stresses option = 0, do not calculate blade stresses. G400 location 933 is zero. This option is set to zero internally if IRDFIL = 1 (loc. 1). Default value is zero. = 1, calculate blade stresses. G400 location 933 is greater than zero. In the following, N refers to the number of blades in locations 11 to 19.	nd
11	THNM1C	HHC input angle - (N-1)th cosine component	deg
12	THNM1S	HHC input angle - (N-1)th sine component	deg
13	THNC	HHC input angle - Nth cosine component	deg
14	THNS	HHC input angle - Nth sine component	deg
15	THNP1C	HHC input angle - (N+1)th cosine component	deg

16	THNP1S	HHC input angle - (N+1)th sine component	deg
17	WTHNM1	Weighting factor for (N-1)th HHC angle	nd
18	WTHN	Weighting factor for Nth HHC angle	nd
19	WTHNP1	Weighting factor for (N+1)th HHC angle	nd

7.2.16. Time History Solution Mode (TH1)

The time history solution mode TH1 yields the response of a system as a function of time. Transient responses, steady responses, and the stability of systems may be determined from the time history behavior of a system. The solution algorithm yielding the time history response is the Newmark Beta method described in Reference 1. Section 8.3 describes the line printer output descriptors displayed by TH1.

COMPONENT TH1 INPUT DATA

Location No.	Fortran Name	Input Item Description	Units
1	BETN	Newmark Beta factor. Range permitted is 0. to 0.25	nd
2	DELT	Time increment	sec
3	TMAX	Time limit for integration of the equations of motion.	sec
4	OMEGA	Forcing frequency	hz
5	IDEBUG	Debug printout switch = 0, for no printout - default value = 1 to display matrices for substructures and assembled system	nd
6	IRSTRT	Restart option = 0 for no restart case - default value = 1 for restart case.	nd

NOTE: Restart data are written to and read from file 8.

Section 8

BASE PROGRAM OUTPUT DESCRIPTION

Typical outputs from the Base Program are shown in Figures 17 through 19. The outputs are presented in the same order as outputs obtained from program execution.

Figure 17(a) is printed out as shown at the beginning of each run. It is the same for all runs; it is coded in subroutine INPUT (segment 3). Figures 17(b) and 17(c) are card image listings of the run titles and input data for the first case. If multiple cases are run, the new input data cards are printed at the beginning of each case. This sample run consists of one case only. It has 4 title cards with W (HZ) as the abscissa label to be used for plotting. Figure 17(c) shows that this case uses 5 components: FA1, GF1, TH1, MS1, and GEN.

8.1 Component Output

Figures 17(d) through 17(w) provide a narrative description of the input locations and the loader input values for each Base Program component. Component input narrative descriptions are listed in alphabetical order of the three character component names, starting with component BF1 and ending with component TH1. Figures 17(d) through 17(w) may be used to aid the preparation of component inputs.

8.2 Debugging Output

After the component inputs are printed, a variety of debugging printouts are available to show the assembly of the substructure matrices, and intermediate calculations obtained for the different methods of solution. These printouts are obtained if the debug switch is set to 1.0 in any one of the components EG1, EG2, FR1, and TH1. For all solution modes, subroutine DSUB is called to identify the name of the subroutine providing the debug printout. Subroutine DMTRX is called to provide the debug output. Only non-zero quantities are displayed. A summary of the debugging printouts available for the four solution methods is presented in Table 5. Sample outputs are illustrated in Figures 18(a) through 18(e). Figure 18(a) shows part of the assembly of the system mass, damping, and stiffness matrices as performed in subroutine ASMMCK before the real eigensolution EG2 is executed. Matrices M0, C0, and K0 are substructure matrices referred to substructure local coordinates. Matrices M, C, and K are matrices for the assembled system obtained after mapping to independent coordinates. Figure 18(b) provides a sample output of the real eigensolution EG1 results obtained from subroutine SO2EG1. In Figure 18(c) results from the real eigensolution EG2 are shown. These are obtained in subroutine SO2EG2. Typical results obtained for the forced response solution FR1 are illustrated in Figure 18(d)

in subroutine SO2FR1. Finally, time history solution results are shown in Figure 18(e) in subroutine SO2TH1.

8.3 Solution Methods Output

Figures 19(a) to 19(d) are samples of standard outputs obtained with the four solution methods EG1, EG2, FR1, and TH1. For all solution modes, the display consists of seven fields of data containing alphanumeric name strings and numeric data keyed to the alphanumeric strings. These fields are listed by number below and contain the following data:

- 1) Item counter for variables listed in each output row.
- 2) The word ELEMENT.
- 3) Element number of a substructure, listed in ascending order.
- 4) Substructure three-character name or a blank string, or strings `FREQ`, `DAMP`, or `TIME`.
- 5) Character name of a variable. Up to four characters may be used. If field 4 (above) is blank, the variable listed in each row is not a coordinate. The variable may be an eigenvalue or time. If field 4 contains a substructure name, the variable in the row is a coordinate.
- 6) Solution mode description.
 - a) For EG1, the descriptor is EIGV. This string is followed by the eigenvalue number, where the eigenvalue number is an integer ranging from one to the number of independent coordinates for the assembled system. (See Figure 19(a)).
 - b) For EG2, the descriptor is EIGV when the string `FREQ` or `DAMP` occurs in field 5. The string `FREQ` is the descriptor for frequency of the eigenvalue in hz and the string `DAMP` is the descriptor for damping of the eigenvalue expressed as a fraction of critical damping (see equations (40) and (41) in Reference 1). When the string in field 5 is the name of a coordinate, the string in field 6 is either `REAL` or `IMAG`, denoting the real and imaginary values of an element in the eigenvector. These strings are followed by the eigenvalue number (integer ranging from one to number of independent coordinates for the assembled system). The output displays are repeated until results for all eigenvalues are displayed. (See Figure 19(b)).

- c) For FR1, the descriptors are AMPLITUD and PHASE denoting amplitude and phase of a coordinate response. If the display conversion factor ICONVG in FR1 is equal to 0, amplitude measures are feet for translations, radians for rotations, and non-dimensional for modal amplitudes. Phase responses are expressed in degree measure. If a hub interface force and moment display is requested in component RE3 (IDPFOR = 1), forces are in lb units, and moments are in ft-lb units. Phase responses are in degree measure. If the display conversion factor ICONVG in FR1 is equal to 1, displacement responses (translational, rotational, and modal) are converted to accelerations, divided by the acceleration of gravity, and displayed (see equations (28) and (29), Reference 1) as shown in Figure 19(c).

The notation used in the calculations of the coordinate amplitude and phase angle is:

$$X = \text{AMPLITUD} * \cos(\omega_F t - \text{PHASE})$$

- d) For TH1, the descriptors are SEC and DISPMENT denoting time and displacement. Time is expressed in seconds and displacements are feet for translations, radians for rotations, and non-dimensional for modal amplitudes. (See Figure 19(d)).
- 7) The numerical value of the variable.
The appropriate units are as follows:
- | | | | |
|----|---------------|---|-----------------------------------|
| a) | eigenvalue | - | frequency is in hz; |
| | | - | damping is non-dimensional |
| b) | eigenvector | - | translation is non-dimensional |
| | | - | rotation is 1/rad |
| c) | translation | - | ft, non-dimensional, or g's |
| d) | rotation | - | rad, or (rad/sec ²)/g |
| e) | hub reactions | - | forces are in lbs |
| | | - | moments are in ft-lbs |
| f) | phase | - | degrees |
| g) | time | - | sec |

After the solution results are printed, the computer program working storage requirement for the run is displayed in terms of the maximum number of working storage words needed for the run as shown in Figure 19(e). The significance of this value is discussed in the section 9.7, "Base Program Size". The solution results are sent to unit 2 to save data for the Tektronix plot package. The data are formatted to facilitate checking of the Base Program. Figure 19(f) was obtained by transmitting the plot file data to the line printer. These data are not displayed in

the course of a normal run performed to obtain plot results. The output data in Figure 19(f) are discussed below to aid the interpretation of the program by users.

A sample output is presented in Figure 19(f) for a time history solution up to 0.05 seconds. The format is typical of all data to be plotted. The title cards, up to 4, are shown first. The first three title cards comprise the plot heading while the fourth title card defines the abscissa, which, for this example, is TIME (SEC). The next line provides 3 pieces of information: the total number of steps (or cases), (6.1), the total number of system coordinates, (15.1), and the parameter value for 3-dimensional plots (0.1200). Next, the variables are listed in order of increasing element number; in this case, element 1 is component FA1, element 2 is component GF1, and element 4 is MS1. Element 3 is TH1 which is represented by the first variable, which is time in seconds. The data to be plotted follow the list of variables. The first card contains the step (or case) number (1.1 through 6.1) and the abscissa value (this is the parametric value if PV1 component is activated or time if the time history solution is exercised). In this example, it is seen that the variable time has values from zero to 0.05 in steps of 0.01 second. The numerical values of the final system coordinates are then displayed. For this example, it is seen that the following plots could be generated versus time:

1. variable 2, FA1 DELT (fixed absorber mass translation).
2. variable 3, FA1 X (fixed absorber base translation).
3. variable 9, GF1 X (generalized force connection node displacement).
4. variable 15, MS1 MODE (normal mode amplitude).

A plot of these four variables versus time is illustrated in Figure 19(g). Up to 5 curves can be shown on the same plot.

When the time history solution is used, the final results are written to unit 8 in subroutine SV3TH1 for restart conditions. A sample output is presented in Figure 19(h) for time increments of 0.01 up to 0.05 seconds. As shown, the displacement, velocity, acceleration, and force vectors are provided at each time step of the run. To restart a time history solution, only the data at an initial time are needed as input. These data are acquired from the last time step of a prior run. The results from Figures 19(f) and 19(h) originate from the same computer run. At a time of 0.05 second, the displacements are the same, as indicated by the underlined quantities.

Section 9

OVERALL PROGRAM STRUCTURE

This section provides information on the overall program structure to enable users and programmers to understand the program logic and the overlay segmentation structure. Flow diagrams for the different overlay segments are presented. Brief descriptions are provided for all the Fortran subroutines. The routines which require modification for CDC computer operation and the IMSL routines which must be replaced by the contractor are identified. The COMMON Blocks and input/output data files employed by the Base Program are described. Also, the determination of the computer storage requirements and of the program size are discussed as well as the method employed to change the computer program size. Finally, revisions to the computer program subroutines necessary to add a new substructure or to modify an existing substructure are presented in detail.

9.1 Segmentation Structure

The Base Program SIMVIB was overlaid to minimize the CDC computer storage requirements. The overlaid program size comprising a 23.6K₁₀ (decimal) word instruction bank and a 8.4K₁₀ (decimal) data bank is 32K₁₀ (decimal) words. This is equivalent to 100 K₈ (octal) words. This limit complies with the requirement specified by the NASA Technical Monitor for interactive operation on the Langley Research Center CDC computer. The program size can be increased by specifying the size of the IA vector in the MAIN routine to enable the program to be applied to large problems (see section 9.7).

The 18 overlay segments are shown in Figure 20. A brief description of the function performed by each segment is provided in Table 5. The Fortran subroutines needed in the execution of the overlay segments are listed in Table 6. This table also includes a list of COMMON blocks. All COMMON blocks are stored in the main segment (number 1). IMSL routines which must be replaced by the contractor with equivalent routines are marked with an asterisk (*) while the routines which must be modified or replaced for CDC operation are indicated by a plus sign (+).

9.2 Flow Diagrams

Computer logic flow diagrams are presented in Figures 21 through 41 for the high level subroutines. The flow chart in Figure 21 illustrating the main program logic flow shows the parametric variation and the multiple cases loops.

9.3 Fortran Subroutines Descriptions

To aid the understanding of the Base Program, an alphabetical list of Fortran subroutines is provided in Table 7; the appropriate segment number containing the routine is also provided in this table. The functions of the subroutines are given in Table 8. In addition, source code in the Base Program listing supplied to the NASA Structures Laboratory is commented to facilitate an understanding of the program. An asterisk (*) denotes IMSL subroutines which have to be replaced by equivalent IMSL subroutines available at the Langley Research Center CDC facility. A plus sign (+) denotes system dependent subroutines. These routines contain CDC dedicated lines of code which are commented in column 1. These comments must be removed and IBM dependent code corresponding to these lines in their immediate vicinity must be commented out.

9.4 Fortran Subroutines Revisions for CDC Operation

The revisions to the IBM Fortran subroutines which must be performed in order for the Base Program to execute on the CDC computer system fall into the three categories listed below:

1. 3 routines must be replaced: ACONDP, ACON, and CORE.
2. 8 routines must be revised: FFLOAD, GVPLOT, INPUT, LBLEG1, LBLEG2, LOAD, MAINSV, and NAMES.

The revisions are discussed in Table 8 and are also explained in the program Fortran code.

3. 18 IMSL routines must be replaced with equivalent IMSL routines by the contractor: EIGZF, EQZQF, EQZTF, EQZVF, LEQT2F, LINV2F, LINV3F, LUDATF, LUELMF, LUREFF, UERTST, UGETIO, VHSH2C, VHSH2R, VHSH3R, VXADD, VXMUL, and VXSTO.

9.5 COMMON Blocks

The Base Program utilizes a total of 18 COMMON blocks in its Fortran code. The Fortran subroutines in which the different COMMON blocks appear are presented in Table 9. Both the Fortran subroutines and the COMMON blocks are listed alphabetically for easy reference. The word size of a specific COMMON block is the same in all of the subroutines which reference it.

9.6 Input/Output Data Transmission

Input/output data transmission is accomplished in the Base Program through the use of nine files which are described in Table 10. The data files are assigned Fortran names in subroutine BLOCK, which is the first subroutine called in the main program. A description of the type of data transfer and the subroutines which

use a specific file are provided in the table. The input/output files are used to read input data (1, 5, 8, 10, 11 and 12), write output results (6), store solution results (2), and punch results on cards (7). The punch file is not presently used in the Base Program but can be readily activated.

9.7 Control of Base Program Size

The user of the Coupled Rotor/Fuselage Vibration Analysis may employ a convenient means of controlling the size of the Base Program. Size control may be achieved by changing two statements in the main routine. These statements as presently configured on the CDC system are:

<u>INTERACTIVE MODE</u>	<u>BATCH MODE</u>
1. DIMENSION IA (8400)	1. DIMENSION IA (40000)
2. MAXA = 8400	2. MAXA = 40000

The first statement describes the size of the working storage vector (defined below) in terms of decimal words. The allocation of the working storage can be varied by changing the above statements. For example, 30000 decimal words may be allocated by modifying these statements to

1. DIMENSION IA (30000)
2. MAXA = 30000

The program is recompiled and a new executable version created and stored for use. The new version will employ 30000 words of working storage. A user desiring to control the program size does not need to know any programming details beyond these statements.

As a guide to programmers wishing to make other modifications, an introduction is given here of the space management capability contained in the Base Program. The working storage vector is a region of storage which is separate from regions used to store COMMON block data. It is a region of storage where arrays (literal strings, vectors of integers and real variables, matrices) may be placed or removed during program execution. Data are placed in the working vector IA or removed from IA by invoking in the program code two space management Fortran function subroutines. Function subroutine ISETSP allocates storage in IA for any array whose literal name, dimensions, and character (real, complex) are placed in the argument list of ISETSP. Function subroutine IRMVSP may be used to remove the catalog entries (name, dimensions) applicable to the array referred to in ISETSP. Subroutine IRMVSP may be thought of as removing the space allocated in IA to that array. These procedures may be used to allocate or remove storage spaces allocated to arrays during the

execution of the program. In other words, they have the effect of controlling dynamically the amount of storage occupied in IA. The time history of variation of storage in IA with CPU time is shown schematically in Figure 42 for a hypothetical problem. The largest amount of storage taken up by arrays occupying IA is designated MAXSIZ. The current storage in IA at any instant of time is ISIZE. The magnitude of ISIZE is always less than or equal to MAXSIZ. The program calculates ISIZE during execution and equates MAXSIZ to ISIZE if ISIZE exceeds a prior value of MAXSIZ. The program compares the value of MAXSIZ with MAXA. The parameter MAXA is equal to the size of IA. If MAXSIZ is less than MAXA, processing continues to completion. The program displays the value of MAXSIZ at the termination of the calculations for each case (see Figure 19(e)). If at any time in the calculations MAXSIZ is calculated to exceed MAXA, the processing terminates with a message informing the user to allocate more storage.

If two or more cases are run successively, it is found that the value of MAXSIZ is larger for the second case as compared to the first case since computer storage allocated for the input components cannot be freed at the end of the calculations. As shown in the sample output in Figure 19(e), MAXSIZ is 1887 words after the first case and 2161 words after the second case - an increase of 274 words. Subsequent cases will have the same value of MAXSIZ as for the second case.

Convenient size control provides a user with latitude to treat a wide range of problems. The version of the program used interactively on the CDC system employs 8400 decimal loads. A larger version of the program employs 40000 decimal words. This version can be used to solve large problems in a batch mode. For MAXA = 0, the program size is composed of storage required for instructions and common blocks, and is equal to 23600 decimal words on the CDC system. Thus, the version of the program with MAXA = 8400 would have a size equal to $23600 + 8400 = 32000$ decimal words. The larger program would have a size of $23600 + 40000 = 63600$ decimal words.

Programmers must exercise care in the employment of function subroutines ISETSP and IRMVSP. A safe procedure for invoking these subroutines is to follow the applications in the program.

A third space management routine is IASKSP which must be used by the programmer to return information on arrays which have already been allocated. Function subroutine IASKSP returns a pointer defining the position in the IA vector of an array named in its argument list.

Programmers intending to add a new substructure to the code are not required to employ or understand the space management subroutines ISETSP, IRMVSP, and IASKSP. Section 9.8 describes the procedure for introducing code for a new substructure except a

substructure adding a forcing function such as GF1, or substructures similar to RE2 or RE3. The programmer must define in subroutine NSPACE the size (NDLOAD) of the input loader vector for the new substructure, and the size of a component dedicated work vector (NWORK). The value of NWORK is equal to 0 for all substructures (see Table 3) except RE2, RE3, and TH1. Substructures RE2 and RE3 involve the LINK subroutine (the RE3 substructure also includes logic to process impedance data) and the procedure for adding substructures of these types is different from the procedure for other substructures and is not described. The procedure for the addition of solution modes and operational modes capabilities is also not described. Modifications made to the program in these areas can be developed by following the code.

The IA vector is equivalenced to a vector of real variables A. The programmer may recover integer variables by referring to the IA vector and real variables by referring to the A vector. The size of a word in the IA vector is the same as the size of a word in the A vector. Each subroutine called by the main routine MAINSV has an argument list containing IA and A as its first two members. The equivalence of IA and A is achieved by naming the first two arguments IA in the calls made to the subroutines in MAINSV.

9.8 Addition of New Substructures and Modification of Existing Substructures

The addition of a hypothetical substructure to the Base Program, referred to as BF4 for this example, requires two main steps:

1. provide 7 new subroutines, as shown in Table 11.
2. revise 18 existing subroutines, as shown in Table 12.

The new subroutines to be developed for the BF4 component are listed in Table 11. They would be similar to those illustrated in Figures 43(a) through 43(g) for component BF1. The BF1 routines are provided as a guideline only and therefore must be revised appropriately for each new substructure being added.

The revisions to existing Base Program subroutines required to incorporate a new substructure are summarized in Table 12. All the subroutines contain labelled COMMON CNames which is modified to include the new element BF4. In this illustration, assume that BF4 is the 21st element to be added to the Base Program.

The procedure described above for adding code for a new substructure applies to any substructure except substructures introducing a forcing function, like GF1 or substructures introducing rotor effects, like RE2 and RE3. The procedure described does not apply to solution or operational modes.

Modifications made to existing substructures involve the same set of routines listed in Tables 11 and 12. Many modifications would be limited to a subset of the routines listed in these two tables.

Section 10

TEST CASES DESCRIPTION AND RESULTS

The Base Program has been exercised with all program components. Check cases have been run to check out significant combinations of substructures and solution modes. A list of 16 test cases is provided in Table 13. The test cases include application of inplane and vertical bifilar, fixed system absorber, several isolator models (Cases 7 to 11 - see Figure 44), rotor contributions from two different rotor models, and elastic beam representation. The four methods of solution, which are eigensolutions with and without system damping, forced response, and time history, are invoked and checked. Parametric variations are conducted for several design conditions.

Restrictions affecting program applications are:

1. to obtain non-zero responses, the GF1 substructure must be used with the time history (TH1) solution mode.
2. when the time history (TH1) solution is used, the parametric variation option (PV1) is not applicable.
3. the only method of solution consistent with the rotor impedance representation (RE3) is the forced response solution (FR1).
4. the GF1 component must be connected to modal substructure MS1 at a point where it is desired to monitor responses and which is not connected to another structure.
5. only one substructure of type RE2 or RE3 may be requested at one time. However, the input may include both of these types.

The program working storage requirement for each case is shown under the column heading "Size of Work Vector" in Table 13. Most cases require less than 8000 words. Cases 11 and 12 have the largest storage requirement nearing 15000 words due to the utilization of four isolator units for case 11 and the complex eigensolution application for case 12. Thus, all but cases 11 and 12 can be run in the interactive mode.

From Table 13, the IBM central processing unit (CPU) time needed to execute a typical run is under 3 seconds. A time history solution of one second real time (case 5) requires 4.5 seconds of CPU time. This run also takes the longest to execute.

The input and output for five representative cases (5, 7, 11, 12, and 13) are provided in Reference 11, Appendices A through E, respectively. They show results for different dynamic systems and methods of solution.

Plots were developed for these cases except for case 12 using the Tektronix Plot Package described in Reference 7. The plots are presented in Figures 45 through 47 for cases 5, 7, 11, and 13 respectively. A summary of the plots generated and a brief description of each plot is presented in Table 14. Results for case 12 could be plotted if additional runs are made and all the results stored on unit 2. For example, the rotor blade collective pitch could be varied when executing the E927 program. The resulting matrices are then read from unit 10 by the Base Program. Finally, the final system eigenvalues and eigenvectors could be plotted against blade collective pitch.

Up to 5 variables from one case may be plotted at the same time. Also, one variable from as many as 5 cases may be displayed on the same plot.

Section 11

IBM JOB CONTROL LANGUAGE (JCL)

The IBM Job Control Language (JCL) needed to execute the Base Program on the IBM 370/168 computer system is shown in Figure 49. This setup reads basic input from unit 1, E927 matrices from unit 10 if component RE2 is invoked, and G400 impedance matrix and force vector from unit 11 (or 12 if input by the user) if component RE3 is invoked. Time history restart conditions are either read from or written to unit 8. Output results are sent to unit 6. If plots are desired, the output results are stored on unit 2. Different options are presented in the JCL setup for writing of the output results to files on unit 2 for plotting or unit 8 for time history restart conditions. It should be noted that any JCL card starting with 3 or more asterisks is a comment card. Any card starting with // is a control card. The counter on the left hand side of Figure 49 shows that there are 13 control cards in the standard JCL setup required to execute the Base Program on the IBM system.

Section 12

CDC PROGRAM INSTALLATION AND OPERATION

This section provides the Job Control Language (JCL) for the installation and operation of the SIMVIB program on the NASA-Langley CDC NOS computer facility. The installation and operation procedures are based on protocol and system library facilities associated with the NASA-Langley CDC NOS computer facility.

The JCL for installation of the SIMVIB program is presented in Figure 50 for the batch mode version (IA vector dimensioned 40000) and in Figure 51 for the interactive mode version (IA vector dimensioned 8400).

The JCL for execution of the SIMVIB program batch and interactive versions is shown in Figures 52 and 53 respectively.

The JCL instructions apply to remote job entry operation (such as a telephone linkup). Revisions needed to run with card images are indicated in Figures 50 through 53.

REFERENCES

1. Sopher, R.; Studwell, R. E.; Cassarino, S. J.; and Kottapalli, S. B. R.: Coupled Rotor/Airframe Vibration Analysis. NASA CR-3582, June 1982.
2. Bielawa, R. L.: Aeroelastic Analysis for Helicopter Rotor Blades with Time-Variable, Nonlinear Structural Twist and Multiple Structural Redundancy - Mathematical Derivation and Program User's Manual. NASA CR-2638, 1976.
3. Bielawa, R. L.: Aeroelastic Analysis for Helicopter Rotors with Blade Appended Pendulum Vibration Absorbers - Mathematical Derivations and Program User's Manual. NASA CR-165896, June 1982.
4. Johnston, Robert A.; and Cassarino, S. J.: Aeroelastic Rotor Stability Analysis. USAAMRDL-TR-75-40, January 1976.
5. Cassarino, S. J.; and Mouzakis, T.: Bifilar Analysis User's Manual - Volume II. NASA CR-159228, August 1980.
6. Gangwani, Santu T.: A Doublet Lattice Method for the Determination of Rotor Induced Empennage Vibration Airloads - Analysis Description and Program Documentation. NASA CR-165893, June 1982.
7. Studwell, R. E.: User's Manual for the Coupled Rotor/Airframe Vibration Analysis Graphics Package. NASA CR-165897, June 1982.
8. Egolf, T. A.; and Landgrebe, Anton J.: A Prescribed Wake Rotor Inflow and Flow Field Prediction Analysis. NASA CR-165894, June 1982.
9. Studwell, R. E.: User's Manual for the Automated Paneling Technique (APT) and the Wing Body Aerodynamic Technique (WABAT) Programs. NASA CR-165895, June 1982.
10. Sheehy, T. W.: A Method for Predicting Helicopter Hub Drag (USSAMRDL Contract DAAJ02-74-C-0050) USAAMRDL-TR-75-48, 1975.
11. Cassarino, S.; and Sopher, R: Coupled Rotor/Airframe Vibration Analysis Program Manual - Volume II - Sample Input and Output Listings. NASA CR-165892, June 1982.

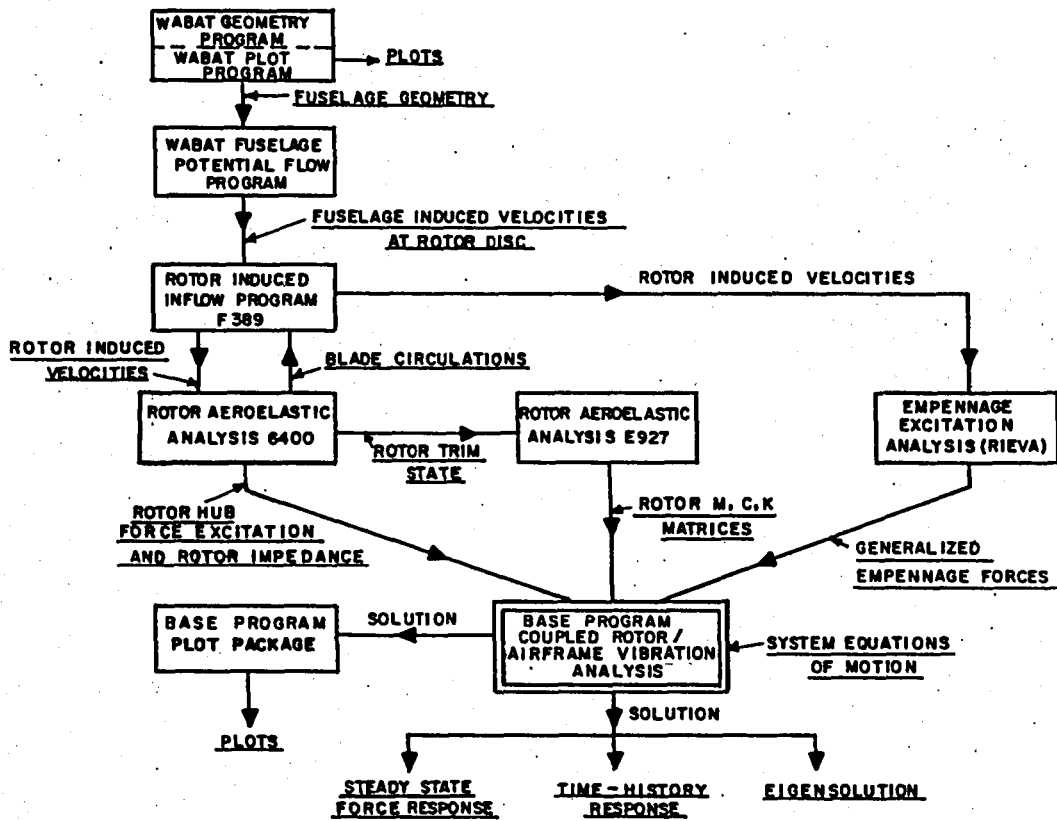

Figure 1. Coupled Rotor/Airframe Vibration Analysis Data Flows.

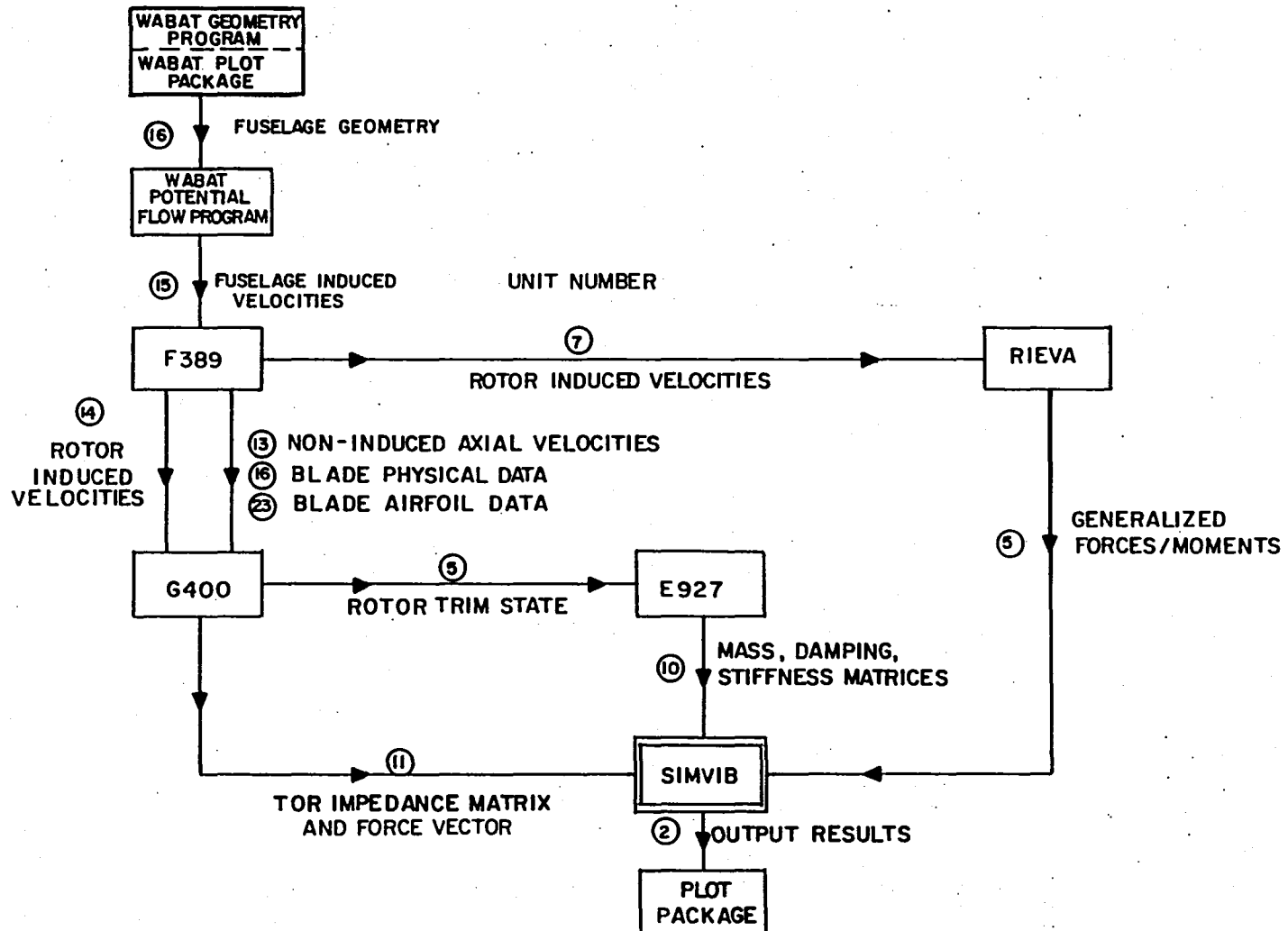

Figure 2. Coupled Rotor/Airframe Vibration Analysis Input/Output File Functions.

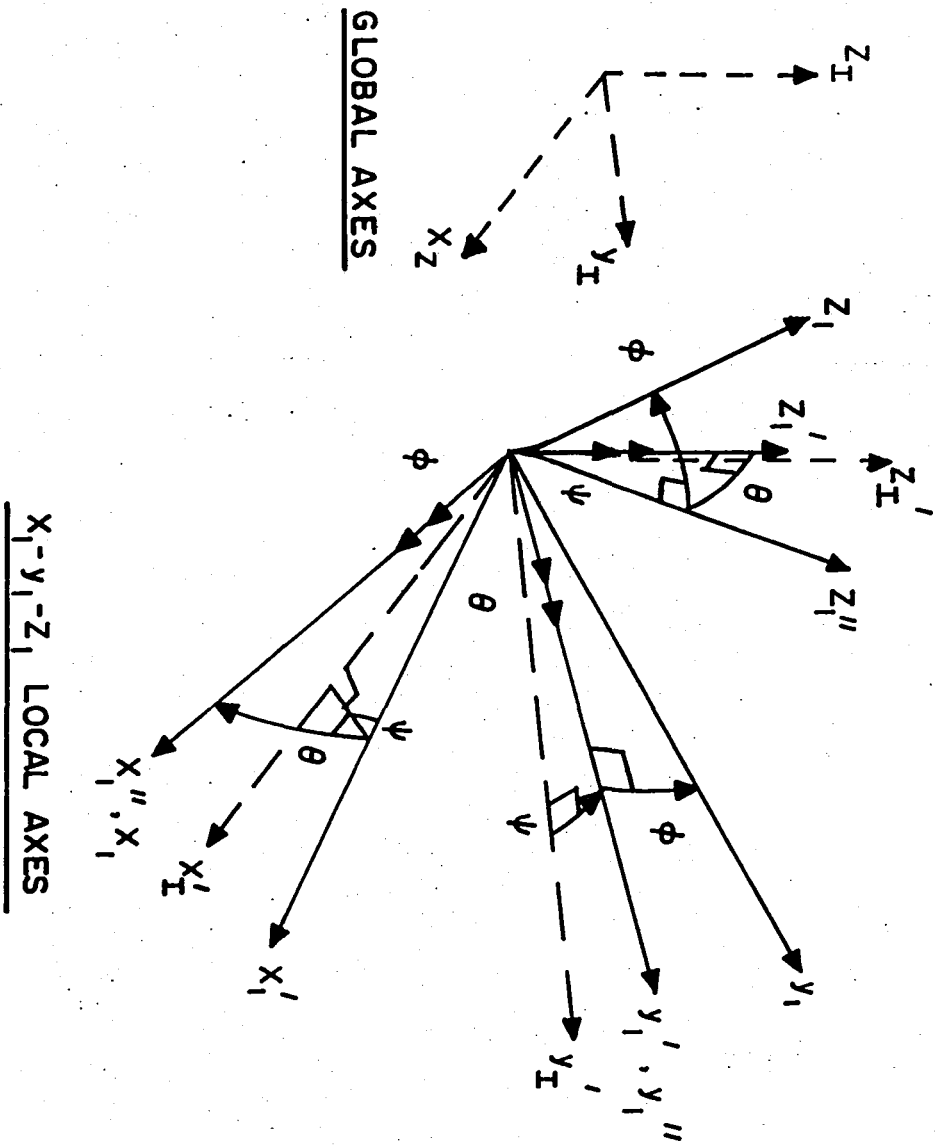

Figure 3. Local and Global Axes.

CARD NO. COLUMN NUMBER

	1	2	3	4	5	6	7	8	9	10	11	12	13	14	15	16	17	18	19	20	21	22	23	24	25	26	27	28	29	30	31	32	33	34	35	36	37	38	39	40	41	42	43	44	45	46	47	48	49	50	51	52	53	54	55	56	57	58	59	60															
1															T	I	T	L	E																	I	-	4	D																																				
2	N	A	M	I											N	B	I						C	O	P	Y											N	B	2															C	O	M	M	E	N	T	S														
3	L	O	C	D	E	L						D	A	T	I						D	A	T	2						D	A	T	3															"																											
4	E	N	D											N	C	S						C	A	S	E											N	C	S															"																						
5	S	T	O	P																																																																							

(a) GENERAL INPUT CARD FORMAT

	1	2	3	4	5	6	7	8	9	10	11	12	13	14	15	16	17	18	19	20	21	22	23	24	25	26	27	28	29	30	31	32	33	34	35	36	37	38	39	40	41	42	43	44	45	46	47	48	49	50	51	52	53	54	55	56	57	58	59	60																																					
1															V	I	B	R	A	T	I	O	N						S	T	U	D	Y						O	F											S	A	M	P	L	E															A	I	R	C	R	A	F	T																			
2	B	F	I											I	3						C	O	P	Y											2															*	/															B	I	F	I	L	A	R						T	Y	P	E						I	*	/								
3	-	3	/											0	.	1	2	0						2	.	5	E	4						1	.	0															*	/															D	A	M	P	,						S	T	I	F	F	,						M	O	M						*	/
4	E	N	D											I	I						C	A	S	E											I	I															*	/															E	N	D	O	F						C	A	S	E						I	I						*	/			
5	S	T	O	P																																																																																													

(b) SAMPLE INPUT CARDS FOR COMPONENT BFI

Figure 4. Base Program Input Card Format and Examples.

START	COL	1	2	3	4	5	6	7
1		BASE PROGRAM - INPUT SAMPLE 1 - 1 CASE						0001
1		FIXED SYSTEM ABSORBER - 1 MODE SHAPE						0002
1		FREQUENCY PARAMETRIC VARIATION						0003
1		FREQUENCY (HZ)						0004
								0005
1	FA1	1						/* FIXED ABSORBER 1 */ 0006
3	1 /	1.						/* CONNECTION NODE NUMBER */ 0007
3	2 /	10.0						/* MASS (SLUGS) */ 0008
3	3 /	0.12						/* DAMPING RATIO (RD) */ 0009
3	4 /	25000.						/* SPRING STIFFNESS (LB/FT) */ 0010
3	5 /	1.0	1.0	1.0				/* INERTIAS (SLUG-FT**2) */ 0011
3	8 /	0.0	0.0	0.0				/* EULER ANGLES (DEG) */ 0012
1	-11 /	0.0	0.0	0.0				/* INITIAL VALUES */ 0013
								0014
1	GF1	2						/* GENERALIZED FORCE 1 */ 0015
3	1 /	1.						/* CONNECTION NODE NUMBER */ 0016
3	2 /	0.0	0.0					/* EULER ANGLES (DEG) */ 0017
3	5 /	1500.	400.0					/* X FORCE (LB) - COS , SINE */ 0018
3	7 /	0.0	0.0					/* Y FORCE - COS , SINE */ 0019
3	9 /	0.0	0.0					/* Z FORCE - COS , SINE */ 0020
2	11 /	0.0	0.0					/* THETA1 FORCE - COS , SINE */ 0021
2	13 /	0.0	0.0					/* THETA2 FORCE - COS , SINE */ 0022
1	-15 /	0.0	0.0					/* THETA3 FORCE - COS , SINE */ 0023
								0024
1	FRI	3						/* FORCED RESPONSE 1 */ 0025
3	1 /	1.591549						/* FORCING FREQUENCY (HZ) */ 0026
1	- 2 /	1.						/* GET DEBUG PRINTOUT */ 0027
								0028
1	MS1	4						/* MODAL STRUCTURE TYPE 1 */ 0029
3	1 /	0.0						/* DAMPING RATIO (RD) */ 0030
3	2 /	1.0						/* GENER. MASS (LB-SEC**2/IN) */ 0031
3	3 /	0.0						/* MODAL FREQUENCY (HZ) */ 0032
3	4 /	1.						/* NUMBER OF NODES */ 0033
3	5 /	1.						/* NODE NUMBERS */ 0034
2	10 /	1.0	0.	0.				/* MODE SHAPE */ 0035
2	13 /	0.	0.	0.				/* MODE SHAPE */ 0036
2	40 /	0.	0.	0.				/* EULER ANGLES (DEG) */ 0037
1	-56 /	0.	0.	0.				/* INITIAL VALUES */ 0038
								0039
1	PV1	5						/* PARAMETRIC VARIATION 1 */ 0040
3	1 /	1.591549						/* STARTING VALUE (HZ) */ 0041
3	2 /	9.549297						/* FINAL VALUE (HZ) */ 0042
3	3 /	6.						/* NUMBER OF POINTS */ 0043
3	4 /	3.						/* ELEMENT NUMBER */ 0044
1	- 5 /	1.						/* LOADER LOCATION */ 0045
								0046
1	GEN	6						/* GENERAL ELEMENT */ 0047
3	1 /	0.						/* =0 NO PRINTOUT OF RESULTS */ 0048
1	-10 /	0.12						/* VALUE FOR 3-D PLOTS - CAMP */ 0049
								0050
1	STOP							0051

Figure 5. Input Data Sample 1.

```

START
COL  -----1-----2-----3-----4-----5-----6-----7-----+
1  BASE PROGRAM - INPUT SAMPLE 2 - 3 CASES                                0001
1  FIXED SYSTEM ABSORBER - 2 MODE SHAPES                                0002
1  TIME HISTORY SOLUTION                                               0003
1  TIME (SEC)                                                            0004
1  TIME (SEC)                                                            0005
1  FA1      1                                                            /* FIXED ABSORBER 1          */ 0006
3  1 / 1.0      /* CONNECTION NODE NUMBER          */ 0007
3  2 / 10.0     /* MASS (SLUGS)                */ 0008
3  3 / 0.12     /* DAMPING RATIO (ND)          */ 0009
3  4 / 25000.   /* SPRING STIFFNESS (LB/FT)    */ 0010
3  5 / 1.0      1.0      1.0     /* INERTIAS (SLUG-FT**2)      */ 0011
3  3 / 0.0      0.0      0.0     /* EULER ANGLES (DEG)         */ 0012
1  -11 / 0.0    0.0      0.0     /* INITIAL VALUES            */ 0013
1  GF1      2                                                            /* GENERALIZED FORCE 1        */ 0014
3  1 / 1.0      /* CONNECTION NODE NUMBER      */ 0015
3  2 / 0.0      0.0             /* EULER ANGLES (DEG)         */ 0016
3  5 / 1500.    400.0          /* X FORCE (LB) - COS , SINE  */ 0017
3  7 / 0.0      0.0             /* Y FORCE - COS , SINE        */ 0018
3  9 / 0.0      0.0             /* Z FORCE - COS , SINE        */ 0019
2  11 / 0.0     0.0             /* THETA1 FORCE - COS , SINE   */ 0020
2  13 / 0.0     0.0             /* THETA2 FORCE - COS , SINE   */ 0021
1  -15 / 0.0    0.0             /* THETA3 FORCE - COS , SINE   */ 0022
1  TH1      3                                                            /* TIME HISTORY 1            */ 0023
3  1 / 0.25     /* NEWMARK BETA FACTOR         */ 0024
3  2 / 0.01     /* TIME INCREMENT (SEC)       */ 0025
3  3 / .05      /* MAX TIME (SEC)              */ 0026
3  4 / 6.0      /* FORCING FREQUENCY (HZ)     */ 0027
3  5 / 0.0      /* DEBUG SELECTOR              */ 0028
1  - 6 / 0.0    /* RESTART FLAG                */ 0029
1  MS1      4                                                            /* MODAL STRUCTURE TYPE 1    */ 0030
3  1 / 0.0      /* DAMPING RATIO (ND)          */ 0031
3  2 / 1.0      /* GENER. MASS (LB-SEC**2/IN) */ 0032
3  3 / 0.0      /* MODAL FREQUENCY (HZ)       */ 0033
3  4 / 1.0      /* NUMBER OF NODES             */ 0034
3  5 / 1.0      /* NODE NUMBERS                */ 0035
2  10 / 1.0     0.0      0.0    /* MODE SHAPE                   */ 0036
2  13 / 0.0     0.0      0.0    /* MODE SHAPE                   */ 0037
2  40 / 0.0     0.0      0.0    /* EULER ANGLES (DEG)          */ 0038
1  -56 / 0.0    0.0      0.0    /* INITIAL VALUES            */ 0039
1  MS1      5  COPY  4          /* MODAL STRUCTURE TYPE 1    */ 0040
1  -10 / 0.0    1.0      0.0    /* MODE SHAPE                   */ 0041
1  GEN      6                                                            /* GENERAL ELEMENT           */ 0042
3  1 / 0.0      /* =0 NO PRINTOUT OF RESULTS  */ 0043
1  -10 / 0.12   /* VALUE FOR 3-D PLOTS - DAMP */ 0044
1  END      1  CASE  1          /* END OF INPUT FOR CASE 1   */ 0045
1  FA1      1                                                            /* FIXED ABSORBER 1          */ 0046
1  - 2 / 15.0   /* MASS (SLUGS)                */ 0047
1  END      2  CASE  2          /* END OF INPUT FOR CASE 2   */ 0048
1  FA1      1                                                            /* FIXED ABSORBER 1          */ 0049
1  - 2 / 20.0   /* MASS (SLUGS)                */ 0050
1  STOP                                               0051

```

Figure 6. Input Data Sample 2.

MO (1, 1) = 1.040490-02	MO (1, 2) = -2.098830-05	MO (1, 3) = 5.238290-02	MO (1, 4) = -8.007410-03
MO (1, 15) = -3.769500-01	MO (2, 1) = -2.098830-05	MO (2, 2) = 1.746330-02	MO (2, 3) = -3.279930-01
MO (2, 4) = 6.314840-02	MO (2, 15) = 1.543060-02	MO (3, 1) = 5.238290-02	MO (3, 2) = -3.279930-01
MO (3, 3) = 1.512540+03	MO (3, 4) = -2.045230-01	MO (3, 15) = 3.445870+02	MO (4, 1) = -8.007410-03
MO (4, 2) = 6.314840-02	MO (4, 3) = -2.045230-01	MO (4, 4) = 1.516990+03	MO (5, 5) = 1.040490-02
MO (5, 7) = -2.098830-05	MO (5, 9) = 5.238290-02	MO (5, 11) = -8.007410-03	MO (5, 13) = -3.898620-02
MO (5, 14) = 8.004910-03	MO (5, 16) = -1.336760-01	MO (5, 17) = -3.023950-03	MO (6, 6) = 1.040490-02
MO (6, 8) = -2.098830-05	MO (6, 10) = 5.238290-02	MO (6, 12) = -8.007410-03	MO (6, 13) = 8.004910-03
MO (6, 14) = 3.898620-02	MO (6, 16) = -3.023950-03	MO (6, 17) = 1.336760-01	MO (7, 5) = -2.090830-05
MO (7, 7) = 1.746330-02	MO (7, 9) = -3.279930-01	MO (7, 11) = 6.314840-02	MO (7, 13) = 2.323360-01
MO (7, 14) = -9.104380-03	MO (7, 16) = -6.482050-01	MO (7, 17) = 6.051640-02	MO (8, 8) = -2.098830-05
MO (8, 8) = 1.746330-02	MO (8, 10) = -3.279930-01	MO (8, 12) = 6.314840-02	MO (8, 13) = -9.104380-03
MO (8, 14) = -2.323360-01	MO (8, 16) = 6.051640-02	MO (8, 17) = 6.482050-01	MO (9, 5) = 5.238290-02
MO (9, 7) = -3.279930-01	MO (9, 9) = 1.512540+03	MO (9, 11) = -2.045230-01	MO (9, 14) = -1.055300+01
MO (9, 16) = 3.243510+03	MO (9, 17) = -3.113950+02	MO (10, 6) = 5.238290-02	MO (10, 8) = -3.279930-01
MO (10, 10) = 1.512540+03	MO (10, 12) = -2.045230-01	MO (10, 13) = -1.055300+01	MO (10, 16) = -3.113950+02
MO (10, 17) = -3.243510+03	MO (11, 5) = -8.007410-03	MO (11, 7) = 6.314840-02	MO (11, 9) = -2.045230-01
MO (11, 11) = 1.516990+03	MO (11, 13) = -1.720990+02	MO (11, 14) = 1.772650+01	MO (11, 16) = -5.124120-01
MO (11, 17) = -1.059160+02	MO (12, 6) = -8.007410-03	MO (12, 8) = 6.314840-02	MO (12, 10) = -2.045230-01
MO (12, 12) = 1.516990+03	MO (12, 13) = 1.772650+01	MO (12, 14) = 1.720990+02	MO (12, 16) = -1.059160+02
MO (12, 17) = 5.124120-01	MO (13, 5) = -1.949310-02	MO (13, 6) = 4.002460-03	MO (13, 7) = 1.161690-01
MO (13, 8) = -4.552190-03	MO (13, 10) = -5.276900+00	MO (13, 11) = -8.604940+01	MO (13, 12) = 8.663240+00
MO (13, 13) = 3.169840+01	MO (13, 17) = 2.110760+01	MO (14, 5) = 4.7002460-03	MO (14, 6) = 1.049310-02
MO (14, 7) = -4.552190-03	MO (14, 8) = -1.161690-01	MO (14, 9) = -5.276900+00	MO (14, 11) = 8.663240+00
MO (14, 12) = 8.604940+01	MO (14, 14) = 3.169840+01	MO (14, 16) = -2.110760+01	MO (15, 1) = -9.423750-02
MO (15, 2) = 3.857650-03	MO (15, 3) = 8.614670+01	MO (15, 15) = 3.169840+01	MO (16, 5) = -6.683820-02
MO (16, 6) = -1.511950-03	MO (16, 7) = -3.241030-01	MO (16, 8) = 3.025820-02	MO (16, 9) = 1.621760+03
MO (16, 10) = -1.556970+02	MO (16, 11) = -2.562060-01	MO (16, 12) = -9.295790+01	MO (16, 14) = -2.110760+01
MO (16, 16) = 3.535790+03	MO (17, 5) = -1.511950-03	MO (17, 6) = 6.683820-02	MO (17, 7) = 3.025820-02
MO (17, 8) = 3.241030-01	MO (17, 9) = -1.556970+02	MO (17, 10) = -1.621760+03	MO (17, 11) = -9.295790+01
MO (17, 12) = 2.562060-01	MO (17, 13) = 2.110760+01	MO (17, 17) = 3.535790+03	

17X17
MASS
MATRIX

CO (1, 1) = 2.871030-01	CO (1, 2) = 1.351140-01	CO (1, 3) = 2.337830+01	CO (1, 4) = 3.056850+00
CO (1, 15) = -2.058530+00	CO (2, 1) = 1.167550-01	CO (2, 2) = 2.009790-01	CO (2, 3) = -1.013460+01
CO (2, 4) = 4.058040+00	CO (2, 15) = -3.502750+00	CO (3, 1) = 2.236980+01	CO (3, 2) = -5.929410+00
CO (3, 3) = 5.025860+04	CO (3, 4) = -4.165200+03	CO (3, 15) = 1.033750+04	CO (4, 1) = -2.650440+00
CO (4, 2) = -1.206700+03	CO (4, 3) = -6.720900+03	CO (4, 4) = 8.417180+03	CO (4, 15) = -3.390190+02
CO (5, 5) = 2.871030-01	CO (5, 6) = -5.622330-01	CO (5, 7) = 1.351140-01	CO (5, 8) = 1.134120-03
CO (5, 9) = 2.337830+01	CO (5, 10) = -2.830540+00	CO (5, 11) = 3.056850+00	CO (5, 12) = 4.326850-01
CO (5, 13) = -1.637330+00	CO (5, 14) = 2.128160-01	CO (5, 16) = 4.563060+01	CO (5, 17) = -1.161480+01
CO (6, 5) = 5.622330-01	CO (6, 6) = 2.871030-01	CO (6, 7) = -1.134120-03	CO (6, 8) = 1.351140-01
CO (6, 9) = 2.830540+00	CO (6, 10) = 2.337830+01	CO (6, 11) = -4.326850-01	CO (6, 12) = 3.056850+00
CO (6, 13) = 2.128160-01	CO (6, 14) = 1.637330+00	CO (6, 16) = -1.161480+01	CO (6, 17) = -4.563060+01
CO (7, 5) = 1.167550-01	CO (7, 6) = 1.134120-03	CO (7, 7) = 2.009790-01	CO (7, 8) = -9.436320-01
CO (7, 9) = -1.013460+01	CO (7, 10) = 1.772330+01	CO (7, 11) = 4.050040+00	CO (7, 12) = -3.412260+00
CO (7, 13) = -4.230670-01	CO (7, 14) = 1.543620-01	CO (7, 16) = -2.571590+01	CO (7, 17) = -3.205070+01
CO (8, 5) = -1.134120-03	CO (8, 6) = 1.167550-01	CO (8, 7) = 9.436380-01	CO (8, 8) = 2.009790-01
CO (8, 9) = -1.772330+01	CO (8, 10) = -1.013460+01	CO (8, 11) = 3.412260+00	CO (8, 12) = 4.050040+00
CO (8, 13) = 1.543620-01	CO (8, 14) = 4.236670-01	CO (8, 16) = -3.205070+01	CO (8, 17) = 2.571590+01
CO (9, 5) = 2.236980+01	CO (9, 6) = -2.830540+00	CO (9, 7) = -5.929410+00	CO (9, 8) = 1.772330+01
CO (9, 9) = 5.025860+04	CO (9, 10) = -8.173100+04	CO (9, 11) = -4.165200+03	CO (9, 12) = 1.165150+01
CO (9, 13) = 1.588630+03	CO (9, 14) = -3.997860+02	CO (9, 16) = 1.238040+05	CO (9, 17) = 1.614010+05
CO (10, 5) = 2.830540+00	CO (10, 6) = 2.236980+01	CO (10, 7) = -1.772330+01	CO (10, 8) = -5.929410+00
CO (10, 9) = 8.173100+04	CO (10, 10) = 5.025860+04	CO (10, 11) = -1.165150+01	CO (10, 12) = -4.165200+03
CO (10, 13) = -3.997860+02	CO (10, 14) = -1.588630+03	CO (10, 16) = 1.614010+05	CO (10, 17) = -1.238040+05
CO (11, 5) = -2.650440+00	CO (11, 6) = 4.326850-01	CO (11, 7) = -1.206700+00	CO (11, 8) = -3.412260+00

17X17
DAMPING
MATRIX

Figure 7. E927 Aeroelastic Rotor Matrices.

CO (11, 9)=-6.720900+03	CO (11, 10)= 1.105150+01	CO (11, 11)= 8.417180+03	CO (11, 12)=-8.197150+04
CO (11, 13)=-8.851440+01	CO (11, 14)= 1.903410+01	CO (11, 16)=-3.604880+03	CO (11, 17)= 1.480930+03
CO (12, 5)=-4.326850-01	CO (12, 6)=-2.650440+00	CO (12, 7)=-3.412240+00	CO (12, 8)=-1.206700+00
CO (12, 9)=-1.195150+01	CO (12, 10)=-6.720900+03	CO (12, 11)= 8.197150+04	CO (12, 12)= 6.417180+03
CO (12, 13)= 1.903410+01	CO (12, 14)= 8.651440+01	CO (12, 16)= 1.480930+03	CO (12, 17)= 3.604880+03
CO (13, 5)= 2.213370-02	CO (13, 6)= 5.479690-02	CO (13, 7)= 1.959060-01	CO (13, 8)= 1.470670-02
CO (13, 9)= 8.472490+01	CO (13, 10)=-1.548450+02	CO (13, 11)=-4.459140+01	CO (13, 12)= 3.391770+01
CO (13, 13)= 6.378210+00	CO (13, 14)= 3.206070+00	CO (13, 16)= 1.837200+02	CO (13, 17)= 3.101910+02
CO (14, 5)= 5.479690-02	CO (14, 6)=-2.213370-02	CO (14, 7)= 1.470670-02	CO (14, 8)=-1.959060-01
CO (14, 9)=-1.548450+02	CO (14, 10)=-8.472490+01	CO (14, 11)= 3.391770+01	CO (14, 12)= 4.459140+01
CO (14, 13)=-3.206070+00	CO (14, 14)= 6.378210+00	CO (14, 16)=-3.101910+02	CO (14, 17)= 1.837200+02
CO (15, 1)=-6.194990-01	CO (15, 2)=-3.868130-01	CO (15, 3)= 2.584080+03	CO (15, 4)=-5.189570+02
CO (15, 15)= 5.930160+02	CO (16, 5)= 2.180380+01	CO (16, 6)= 6.800660-01	CO (16, 7)=-6.130420+00
CO (16, 8)= 1.785540+01	CO (16, 9)= 4.507560+04	CO (16, 10)=-9.284750+04	CO (16, 11)= 9.825440+03
CO (16, 12)= 8.462160+02	CO (16, 13)= 1.100990+03	CO (16, 14)=-3.280020+02	CO (16, 16)= 1.139020+05
CO (16, 17)= 1.909420+05	CO (17, 5)= 6.800660-01	CO (17, 6)=-2.180380+01	CO (17, 7)= 1.765540+01
CO (17, 8)= 6.130420+00	CO (17, 9)=-9.284750+04	CO (17, 10)=-4.507560+04	CO (17, 11)= 8.462160+02
CO (17, 12)= 9.825440+03	CO (17, 13)= 3.280020+02	CO (17, 14)=-1.100990+03	CO (17, 16)=-1.909420+05
CO (17, 17)= 1.139020+05			

KO (1, 1)=-5.951420+01	KO (1, 2)=-6.193370+00	KO (1, 3)=-1.043510+02	KO (1, 4)= 6.336540+01
KO (2, 1)=-1.176240-01	KO (2, 2)= 2.775160+02	KO (2, 3)=-1.920130+02	KO (2, 4)=-1.220020+02
KO (3, 1)=-1.115850+02	KO (3, 2)=-1.496630+02	KO (3, 3)= 9.872660+05	KO (3, 4)= 9.008480+04
KO (4, 1)= 2.650720+01	KO (4, 2)=-1.023690+02	KO (4, 3)= 2.004780+04	KO (4, 4)= 7.583910+04
KO (5, 5)= 5.191900+01	KO (5, 6)=-7.756880+00	KO (5, 7)=-6.178050+00	KO (5, 8)=-3.680400+00
KO (5, 9)=-1.425880+02	KO (5, 10)=-6.316290+02	KO (5, 11)= 6.921050+01	KO (5, 12)=-8.258930+01
KO (5, 16)= 8.465060+00	KO (5, 17)= 4.450040+01	KO (6, 5)= 7.756880+00	KO (6, 6)= 5.191900+01
KO (6, 7)= 3.650460+00	KO (6, 8)=-6.178050+02	KO (6, 9)=-6.316290+02	KO (6, 10)=-1.425880+02
KO (6, 11)=-8.258930+01	KO (6, 12)=-6.921050+01	KO (6, 16)=-4.450040+01	KO (6, 17)=-8.465060+00
KO (7, 5)=-1.023040-01	KO (7, 6)=-3.154460+00	KO (7, 7)= 2.647690+02	KO (7, 8)=-5.430010+00
KO (7, 9)= 4.740880+01	KO (7, 10)= 2.738150+02	KO (7, 11)=-1.688980+02	KO (7, 12)=-1.096390+02
KO (7, 16)= 2.365070+00	KO (7, 17)= 3.617160+01	KO (8, 5)= 3.154460+00	KO (8, 6)=-1.023040-01
KO (8, 7)= 5.430010+00	KO (8, 8)=-2.647690+02	KO (8, 9)=-2.738150+02	KO (8, 10)= 4.740880+01
KO (8, 11)= 1.096390+02	KO (8, 12)=-1.688980+02	KO (8, 16)= 3.617160+01	KO (8, 17)=-2.365070+00
KO (9, 5)=-1.498220+02	KO (9, 6)=-6.043330+02	KO (9, 7)= 8.975900+01	KO (9, 8)=-1.601990+02
KO (9, 9)=-1.168280+05	KO (9, 10)=-1.357870+06	KO (9, 11)= 9.023410+04	KO (9, 12)= 1.125340+05
KO (9, 16)=-1.559240+04	KO (9, 17)=-4.001410+04	KO (10, 5)= 6.043830+02	KO (10, 6)=-1.498220+02
KO (10, 7)=-1.601990+02	KO (10, 8)= 8.975900+01	KO (10, 9)=-1.357870+06	KO (10, 10)=-1.168280+05
KO (10, 11)=-1.125340+05	KO (10, 12)= 9.023410+04	KO (10, 16)=-4.001410+04	KO (10, 17)= 1.559240+04
KO (11, 5)= 3.243230+01	KO (11, 6)= 7.160890+01	KO (11, 7)=-1.484650+02	KO (11, 8)= 3.260230+01
KO (11, 9)=-2.019710+04	KO (11, 10)=-1.815840+05	KO (11, 11)=-1.031510+06	KO (11, 12)=-2.274130+05
KO (11, 16)=-1.346540+05	KO (11, 17)= 1.738660+04	KO (12, 5)=-7.160890+01	KO (12, 6)= 3.243230+01
KO (12, 7)=-3.260230+01	KO (12, 8)=-1.484650+02	KO (12, 9)=-1.815840+05	KO (12, 10)=-2.019710+04
KO (12, 11)=-2.274130+05	KO (12, 12)=-1.031510+06	KO (12, 16)= 1.738660+04	KO (12, 17)= 1.346540+05
KO (13, 5)= 1.711560+00	KO (13, 6)=-3.308940+01	KO (13, 7)=-5.123570+00	KO (13, 8)= 8.496050+00
KO (13, 9)=-4.083650+03	KO (13, 10)= 1.732550+03	KO (13, 11)= 7.532960+02	KO (13, 12)=-7.563590+02
KO (13, 16)=-1.250430+02	KO (13, 17)=-1.633530+04	KO (14, 5)= 3.308940+01	KO (14, 6)=-1.711560+00
KO (14, 7)= 8.496050+00	KO (14, 8)= 5.123570+00	KO (14, 9)= 1.732550+03	KO (14, 10)= 4.083650+03
KO (14, 11)=-7.563590+02	KO (14, 12)=-7.532960+02	KO (14, 16)=-1.633530+04	KO (14, 17)=-1.250430+02
KO (15, 1)=-1.123280+02	KO (15, 2)=-1.128080+02	KO (15, 3)=-1.012970+04	KO (15, 4)= 3.811790+03
KO (16, 5)=-2.717240+03	KO (16, 6)=-5.953080+02	KO (16, 7)=-2.973540+03	KO (16, 8)= 2.585750+02
KO (16, 9)=-3.463990+05	KO (16, 10)=-1.452590+06	KO (16, 11)= 9.857040+04	KO (16, 12)= 1.965680+05
KO (16, 16)=-1.279270+04	KO (16, 17)=-1.085400+04	KO (17, 5)=-5.953080+02	KO (17, 6)= 2.717240+03
KO (17, 7)=-2.585750+02	KO (17, 8)=-2.973540+03	KO (17, 9)=-1.452590+06	KO (17, 10)= 3.463990+05
KO (17, 11)=-1.965680+05	KO (17, 12)=-9.857040+04	KO (17, 16)= 4.294090+04	KO (17, 17)=-1.279270+04

17x17
STIFFNESS
MATRIX

Figure 7. Concluded.

START COL	1	2	3	4	5	6	7	8
4	4.000							
3	-.7388D+05	.4761D+05	-1159.	-.3640D+05	-7113.	-7990.		← number of blades
4	.5097D+05	5162.	-1280.	-.3145D+05	-.2262D+05	-7872.		
3	-.4872D+05	-.6406D+05	-2092.	.2115D+05	-9757.	.4468D+05		12X12 IMPEDANCE MATRIX
4	5685.	.3954D+05	-1485.	.2074D+05	-.1862D+05	8142.		
3	-.1814D+05	.1331D+05	-.2183D+05	.1192D+05	-3774.	2450.		
4	.1098D+05	9765.	.2395D+05	-1068.	-.3433.	-.2186D+05		
3	-5297.	-7481.	3837.	.2389D+05	-2835.	-.2319D+05		
3	-.1678D+05	4603.	4839.	-3193.	.1415D+05	-7586.		
4	1798.	4008.	3211.	-.1189D+05	.2830D+05	.2380D+05		
3	-3666.	1584.	-1096.	-.1393D+05	-4855.	.2248D+05		
3	-.7323D+05	-.1612D+06	-564.8	5860.	-.3953D+05	-.2719D+05		
3	-.1856D+06	.4305D+05	-.2533D+05	-.3573D+05	-.2671D+06	.7577D+06		
3	-.5267D+05	.1200D+05	1974.	.3427D+05	6160.	.2895D+05		
3	-.6480D+05	.4575D+05	1763.	-1854.	.3050D+05	.1918D+05		
3	-730.9	-.4500D+05	2332.	7754.	.1210D+05	-6484.		
3	-.4656D+05	-.7567D+05	-2801.	7650.	-.1028D+05	.5211D+05		
3	-.1041D+05	-.1353D+05	-.2413D+05	2607.	3170.	.1954D+05		
3	-.2001D+05	8220.	-.2211D+05	.1141D+05	-4310.	1508.		
4	.2072D+05	-.2277D+05	-5340.	-4584.	-.1504D+05	.1843D+05		
3	-5064.	-.2089D+05	2782.	.2403D+05	-2737.	-.3928D+05		
3	-2842.	.1185D+05	1050.	.1240D+05	-5042.	-2697.		
4	5394.	313.0	4402.	-656.5	.3929D+05	.3820D+05		
4	.1537D+06	-.4981D+05	.3551D+05	9127.	.1980D+06	-.6794D+06		
3	-.7980D+05	-.1122D+06	5994.	.1600D+06	.1735D+06	.1215D+06		
4	200.2	2.373	1.144	36.69	247.9	123.6	← 12X1 FORCE VECTOR	
3	-90.68	10.26	-76.03	-174.6	112.3	-17.10		

Figure 8. Sample User Input of Rotor Impedance Matrix and Force Vector.

SUMMARY OF ROTOR HUB 4/REV LOADS AND HUB IMPEDANCE MATRIX CALCULATIONS FOR 4/REV VIBRATORY HUB ACCELERATIONS
 UNITS... U(SHEAR) = LBS, U(MOMENT) = FT-LBS, U(LINEAR ACCELERATION) = FT/SEC2, U(ROTATIONAL ACCELERATION) = RAD/SEC2
 CONVENTIONAL FOURIER SERIES REPRESENTATIONS

			HUB LOADS	VXPC	VYPC	VZPC	WXPC	WYPC	WZPC
LONG.	SHR (+, AFT)	COS	200.2	-.7388D+05	.4761D+05	-1159.	-.3640D+05	-7113.	-7990.
LAT.	SHR (+, STRBD)	COS	2.373	-.4672D+05	-.6406D+05	-2092.	.2115D+05	-9757.	.4468D+05
VERT.	SHR (+, UP)	COS	1.144	-.1814D+05	.1331D+05	-.2183D+05	.1192D+05	-3774.	2450.
ROLL	MOHT (+, STRBD UP)	COS	36.69	-5297.	-7481.	3837.	.2389D+05	-2835.	-.2319D+05
PITCH	MOHT (+, NOSE UP)	COS	247.9	1798.	4008.	3211.	-.1189D+05	.2830D+05	.2380D+05
YAW	MOHT (+, OMEGA DIR.)	COS	123.6	-.7323D+05	-.1612D+06	-564.8	5860.	-.3953D+05	-.2719D+05
LONG.	SHR (+, AFT)	SIN	-90.68	-.5267D+05	.1200D+05	1974.	.3427D+05	6160.	.2895D+05
LAT.	SHR (+, STRBD)	SIN	10.26	-730.9	-.4500D+05	2332.	7754.	.1210D+05	-6484.
VERT.	SHR (+, UP)	SIN	-76.03	-.1041D+05	-.1353D+05	-.2413D+05	2607.	3170.	.1954D+05
ROLL	MOHT (+, STRBD UP)	SIN	-174.6	.2072D+05	-.2277D+05	-5340.	-4584.	-.1504D+05	.1843D+05
PITCH	MOHT (+, NOSE UP)	SIN	112.3	-2842.	.1165D+05	1050.	.1240D+05	-5042.	-2697.
YAW	MOHT (+, OMEGA DIR.)	SIN	-17.10	.1537D+06	-.4981D+05	.3551D+05	9127.	.1980D+06	-.6794D+06
				VXPS	VYPS	VZPS	WXPS	WYPS	WZPS
LONG.	SHR (+, AFT)	COS		.5097D+05	5162.	-1280.	-.3145D+05	-.2262D+05	-7872.
LAT.	SHR (+, STRBD)	COS		5685.	.3954D+05	-1485.	.2074D+05	-.1862D+05	8142.
VERT.	SHR (+, UP)	COS		.1098D+05	9765.	.2395D+05	-1068.	-3433.	-.2186D+05
ROLL	MOHT (+, STRBD UP)	COS		-.1678D+05	4603.	4839.	-3193.	.1415D+05	-7586.
PITCH	MOHT (+, NOSE UP)	COS		-3666.	1584.	-1096.	-.1393D+05	-4855.	.2248D+05
YAW	MOHT (+, OMEGA DIR.)	COS		-.1856D+06	.4305D+05	-.2533D+05	-.3573D+05	-.2671D+06	.7577D+06
LONG.	SHR (+, AFT)	SIN		-.6480D+05	.4575D+05	1763.	-1854.	.3050D+05	.1918D+05
LAT.	SHR (+, STRBD)	SIN		-.4658D+05	-.7567D+05	-2801.	7650.	-.1028D+05	.5211D+05
VERT.	SHR (+, UP)	SIN		-.2001D+05	8220.	-.2211D+05	.1141D+05	-4310.	1508.
ROLL	MOHT (+, STRBD UP)	SIN		-5064.	-.2089D+05	2782.	.2403D+05	-2737.	-.3928D+05
PITCH	MOHT (+, NOSE UP)	SIN		5394.	313.0	4402.	-656.5	.3929D+05	.3820D+05
YAW	MOHT (+, OMEGA DIR.)	SIN		-.7980D+05	-.1122D+06	5994.	.1600D+06	.1735D+06	.1215D+06

Figure 9. Sample Output of Rotor Impedance Matrix and Force Vector.

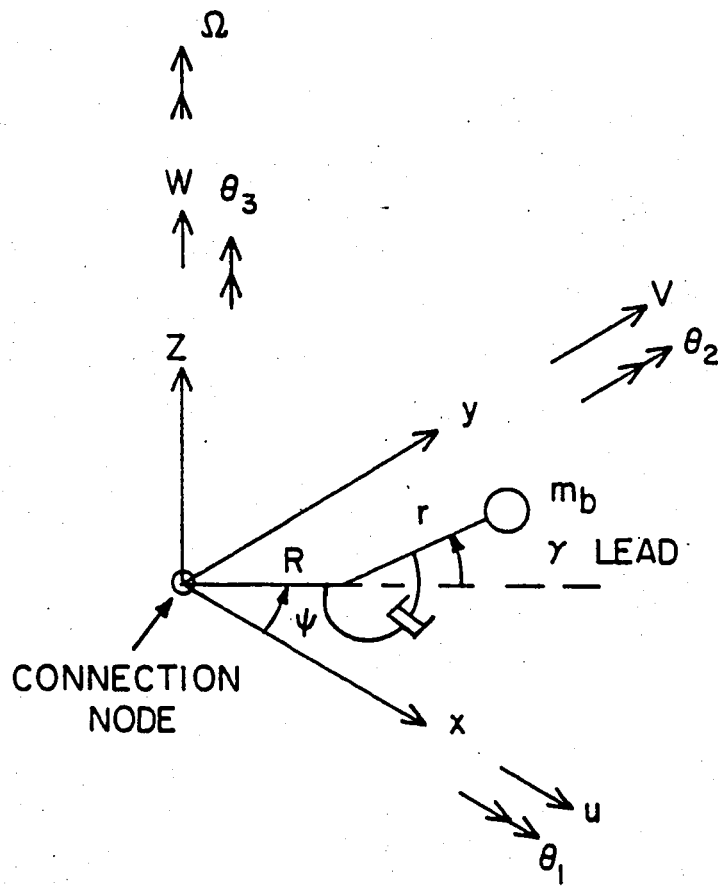

N MASSES, ONLY ONE MASS SHOWN

$$\underline{\gamma = (\gamma_c \cos \psi + \gamma_s \sin \psi) (2/N)}$$

Figure 10. Horizontal Linear Bifilar BF1.

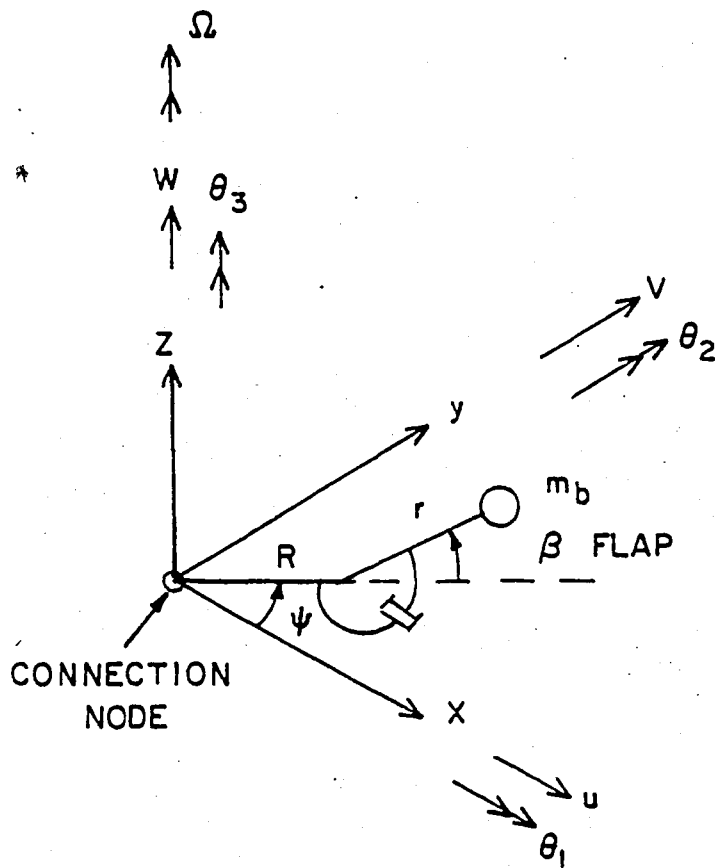

N MASSES, ONLY ONE MASS SHOWN

$$\underline{\beta = \beta_0 / N + (\beta_c \cos \psi + \beta_s \sin \psi)(2 / N)}$$

Figure 11. Vertical Linear Bifilar BF2.

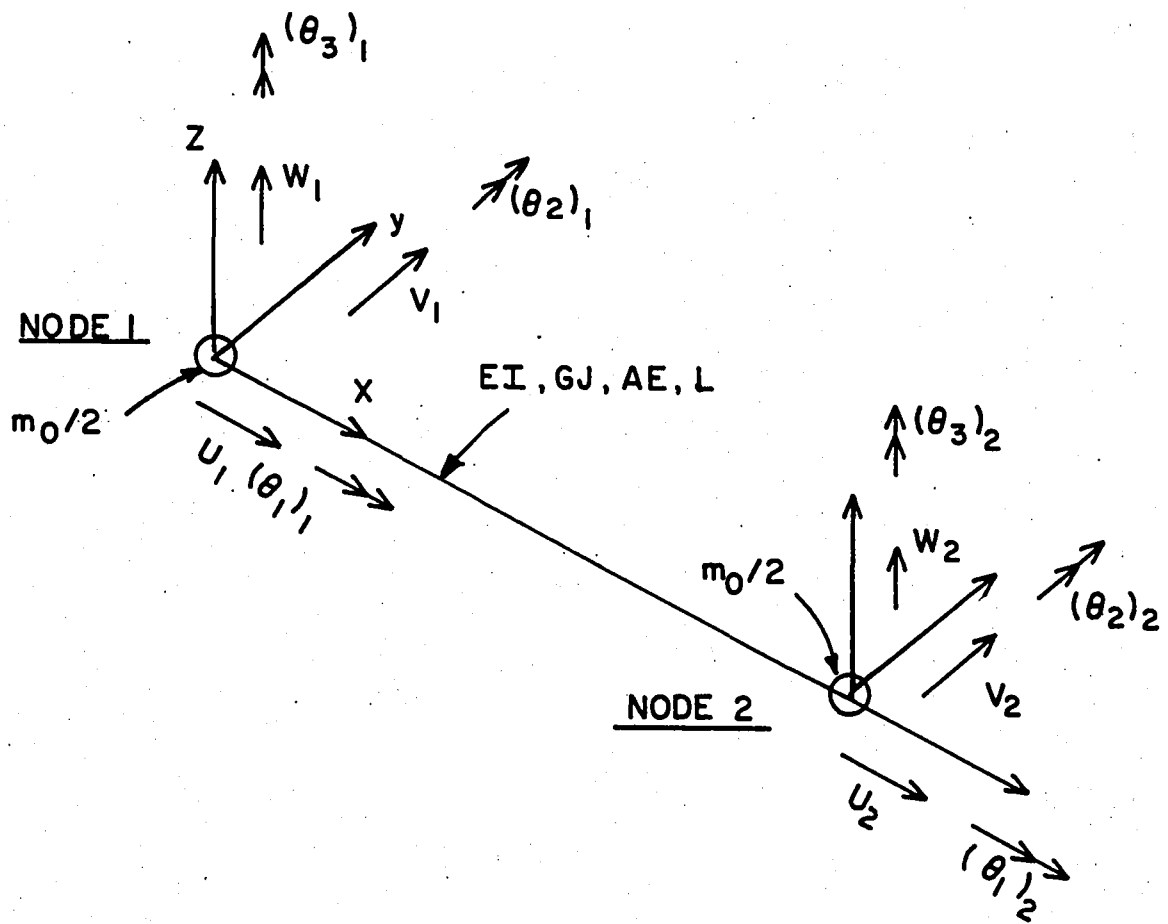

Figure 12. Uniform Beam Segment BM1.

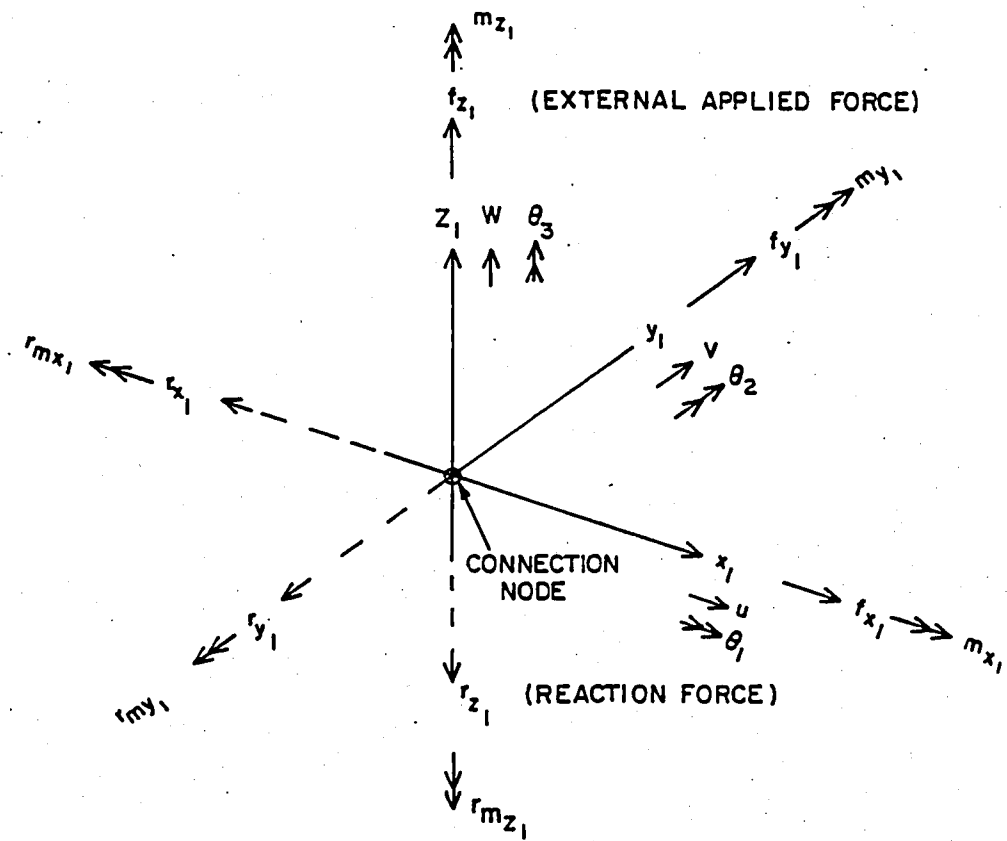

Figure 13. Displacements and Forces Acting on a Connection Node of a Substructure.

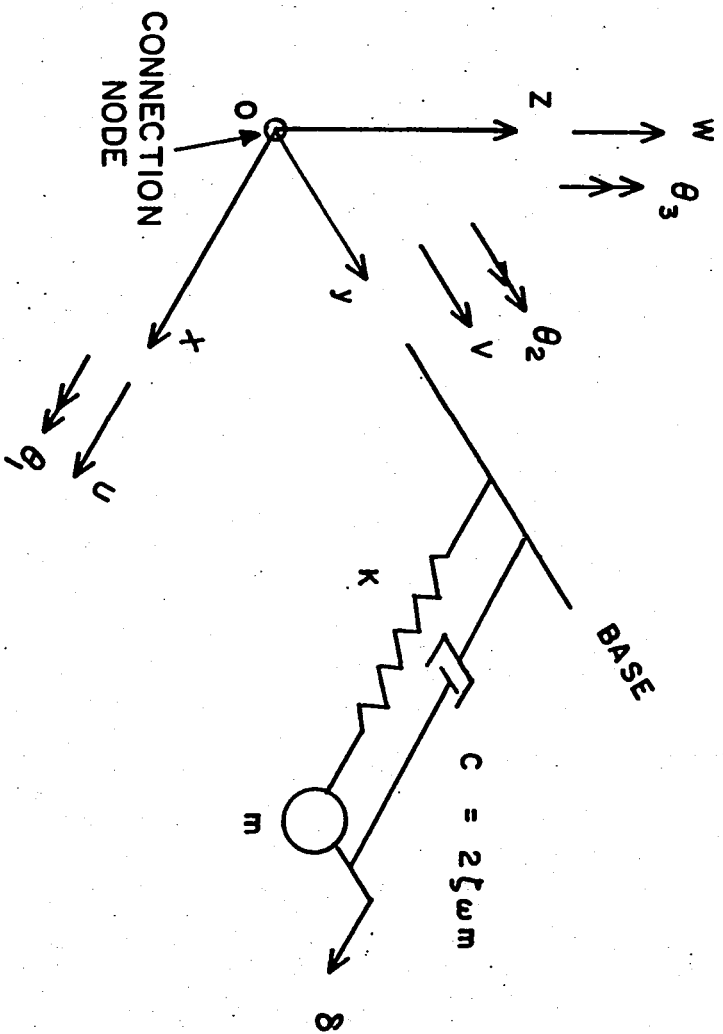

Figure 14. Fixed Absorber FA1.

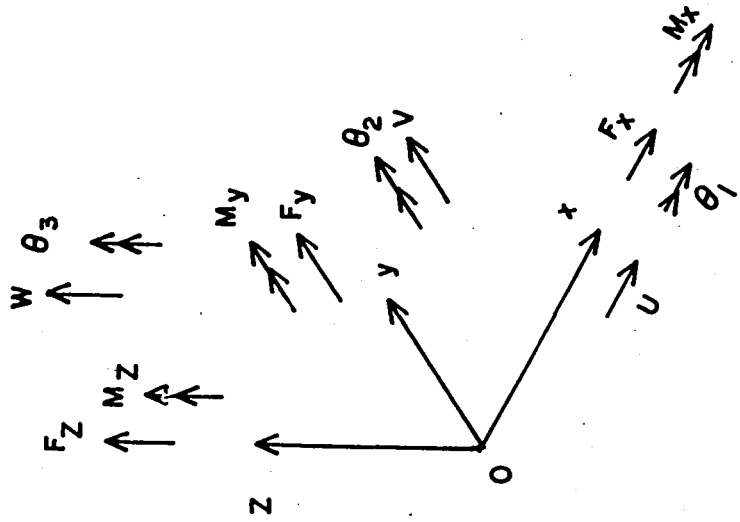

Figure 15. Generalized Force GF1.

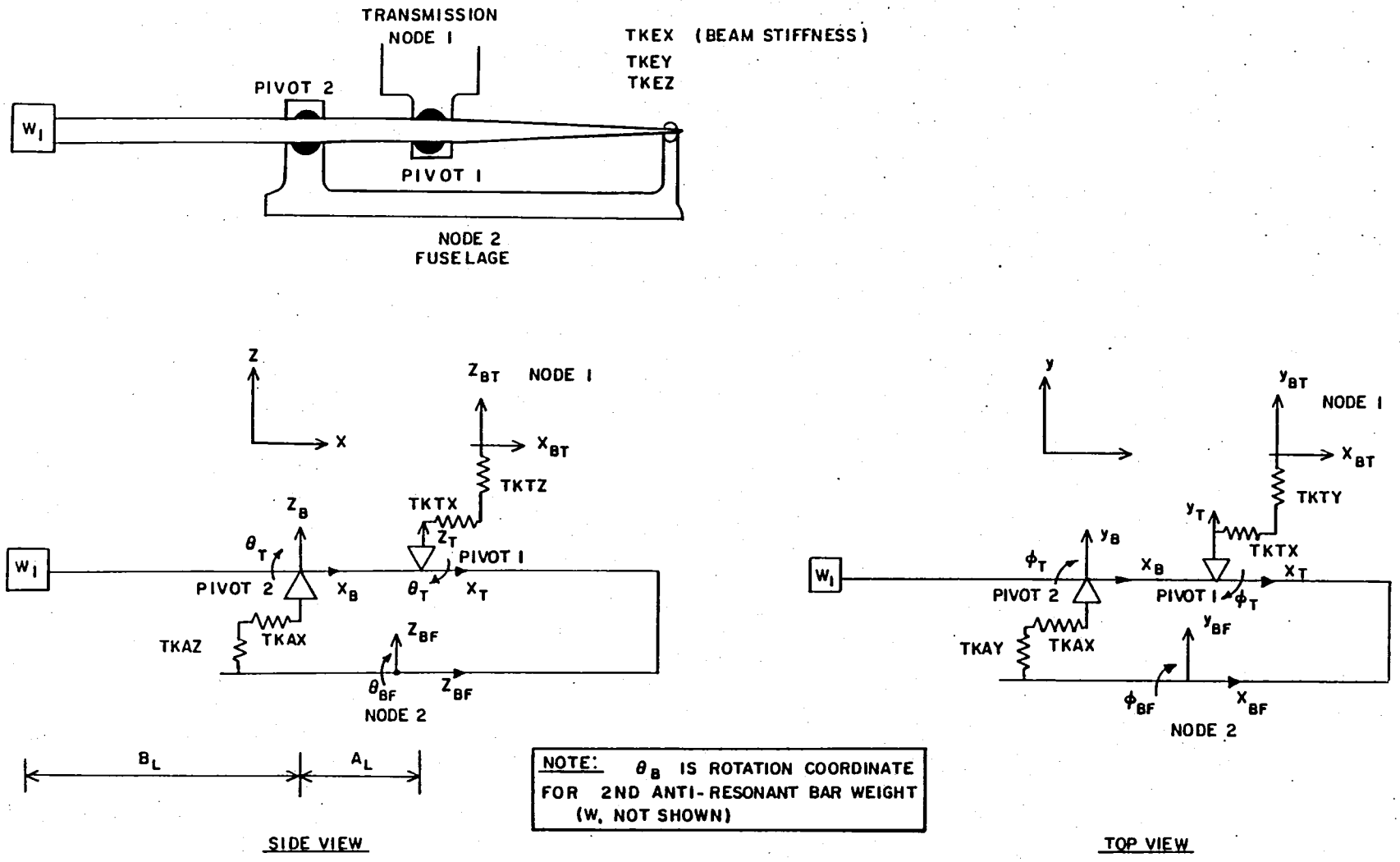

Figure 16. Two Degree-of-Freedom Vibration Isolator IS1.

```
*****
*                               *
*   S I M V I B   P R O G R A M   *
*                               *
* INPUT AND INTERNAL CALCULATIONS *
*   EMPLOY STANDARD UNITS         *
*   (FOOT, POUND, SECOND)       *
*                               *
*****
```

(a) Program Name and Units

```
TITLE 1 - SIMVIB PROGRAM TEST RUN
TITLE 2 - INPLANE BIFILARS WITH 5 MODES
TITLE 3 - FORCED RESPONSE SOLUTION
TITLE 4 - W (HZ)
```

(b) Run Title Cards

Figure 17. Base Program Output Samples.

INPUT DECK CARD IMAGE LISTING

FA1	1	0	0005000
1 /	1.000D+00	0.0	0.0 /* CONNECTION NODE NUMBER */ 0007000
2 /	1.000D+01	0.0	0.0 /* MASS */ 0008000
3 /	1.200D-01	0.0	0.0 /* DAMPING RATIO */ 0009000
4 /	2.500D+04	0.0	0.0 /* SPRING STIFFNESS */ 0010000
5 /	1.000D+00	1.000D+00	1.000D+00 /* MOMENTS OF INERTIA */ 0011000
8 /	0.0	0.0	0.0 /* EULER ANGLES */ 0012000
-11 /	1.000D-02	2.000D-02	0.0 /* INITIAL VALUES */ 0013000
GF1	2	0	0015000
1 /	1.000D+00	0.0	0.0 /* CONNECTION NODE NUMBER */ 0016000
2 /	0.0	0.0	0.0 /* EULER ANGLES */ 0017000
5 /	1.500D+03	4.000D+02	0.0 /* X FORCE - COS , SINE */ 0018000
7 /	0.0	0.0	0.0 /* Y FORCE - COS , SINE */ 0019000
9 /	0.0	0.0	0.0 /* Z FORCE - COS , SINE */ 0020000
11 /	0.0	0.0	0.0 /* THETA1 FORCE - COS , SINE */ 0021000
13 /	0.0	0.0	0.0 /* THETA2 FORCE - COS , SINE */ 0022000
-15 /	0.0	0.0	0.0 /* THETA3 FORCE - COS , SINE */ 0023000
TH1	3	0	0025000
1 /	2.500D-01	0.0	0.0 /* NEWMARK BETA FACTOR */ 0026000
2 /	1.000D-02	0.0	0.0 /* TIME INCREMENT SEC */ 0027000
3 /	1.000D+00	0.0	0.0 /* MAX TIME SEC */ 0028000
4 /	6.000D+00	0.0	0.0 /* FORCING FREQUENCY HZ */ 0029000
5 /	0.0	0.0	0.0 /* DEBUG SELECTOR */ 0030000
-6 /	0.0	0.0	0.0 /* RESTART FLAG */ 0031000
MS1	4	0	/* MODAL STRUCTURE TYPE1 */ 0033000
1 /	0.0	0.0	0.0 /* DAMPING RATIO */ 0034000
2 /	1.000D+00	0.0	0.0 /* GENER. MASS LB-SEC**2/IN */ 0035000
3 /	0.0	0.0	0.0 /* MODAL FREQUENCY HZ */ 0036000
4 /	1.000D+00	0.0	0.0 /* NUMBER OF NODES */ 0037000
5 /	1.000D+00	0.0	0.0 /* NODE NUMBERS */ 0038000
10 /	1.000D+00	0.0	0.0 /* MODE SHAPE */ 0039000
13 /	0.0	0.0	0.0 /* MODE SHAPE */ 0040000
40 /	0.0	0.0	0.0 /* EULER ANGLES */ 0041000
-56 /	2.000D-02	0.0	0.0 /* INITIAL VALUES */ 0042000
GEN	5	0	/* GENERAL ELEMENT */ 0044000
1 /	0.000D+00	0.0	0.0 /* =0 NO PRINTOUT OF RESULTS */ 0045000
-10 /	1.200D-01	0.0	0.0 /* VALUE FOR 3-D PLOTS- DAMP. */ 0046000

STOP

(c). Input Data Listing

Figure 17. Continued.

COMPONENT: BIFILAR

***** HORIZONTAL LINEAR BIFILAR ***

ELEMENT: 2

1	NCN1	CONNECTION NODE NUMBER END 1 (ND)	1
2	N	TOTAL NUMBER OF BIFILARS (ND)	4
3	MB	BIFILAR MASS (SLUGS)	9.316800-01
4	RR	DISTANCE FROM CENTER OF BIFILAR TRACKING HOLE TO CENTER OF ROTATION (INCH)	1.842000+01
5	R	EQUIVALENT PENDULUM ARM (INCH)	1.960800+00
6	ZETGAM	INPLANE BIFILAR DAMPING RATIO C/CCRIT (NTD)	2.500000-03
7	OMEGA	BIFILAR ROTATION SPEED (RAD/SEC)	2.701770+01
8	THETA	EULER PITCH ANGLE AT NODE - ROTATE SECOND ABOUT THE Y-AXIS (DEGREES)	0.0
9	PHI	EULER ROLL ANGLE AT NODE - ROTATE THIRD ABOUT THE X-AXIS (DEGREES)	0.0
10	XSI	EULER YAW ANGLE AT NODE - ROTATE FIRST ABOUT THE Z-AXIS (DEGREES)	0.0
11	GAMMAC	COSINE COEFFICIENT OF INITIAL PENDULUM CYCLIC DISPLACEMENT (DEGREES)	0.0
12	DGAMMC	COSINE COEFFICIENT OF INITIAL PENDULUM CYCLIC VELOCITY (DEGREES/SEC)	0.0
13	GAMMAS	SINE COEFFICIENT OF INITIAL PENDULUM CYCLIC DISPLACEMENT (DEGREES)	0.0
14	DGAMMS	SINE COEFFICIENT OF INITIAL PENDULUM CYCLIC VELOCITY (DEGREES/SEC)	0.0

(d) Component BF1 Data

Figure 17. Continued.

COMPONENT: BIFILAR		*****	VERTICAL LINEAR BIFILAR ***	ELEMENT:	2
1	NCNI	CONNECTION NODE NUMBER END 1 (ND)		1	
2	N	TOTAL NUMBER OF BIFILARS (ND)		4	
3	MB	BIFILAR MASS (SLUGS)		9.31680D-01	
4	RR	DISTANCE FROM CENTER OF BIFILAR TRACKING HOLE TO CENTER OF ROTATION (INCH)		1.84200D+01	
5	R	EQUIVALENT PENDULUM ARM (INCH)		1.22800D+00	
6	ZETBET	VERTICAL BIFILAR DAMPING RATIO C/CCRIT (NTD)		2.50000D-03	
7	OMEGA	BIFILAR ROTATION SPEED (RAD/SEC)		2.70177D+01	
8	THETA	EULER PITCH ANGLE AT NODE - ROTATE SECOND ABOUT THE Y-AXIS (DEGREES)		0.0	
9	PHI	EULER ROLL ANGLE AT NODE - ROTATE THIRD ABOUT THE X-AXIS (DEGREES)		0.0	
10	XSI	EULER YAW ANGLE AT NODE - ROTATE FIRST ABOUT THE Z-AXIS (DEGREES)		0.0	
11	BETA0	BIFILAR MASS COLLECTIVE INITIAL FLAPPING ANGLE (DEGREES)		0.0	
12	DBETA0	BIFILAR MASS COLLECTIVE INITIAL FLAPPING VELOCITY (DEG/SEC)		0.0	
13	BETAC	BIFILAR MASS COSINE COEFFICIENT OF INITIAL FLAPPING ANGLE (DEGREES)		0.0	
14	DBETAC	BIFILAR MASS COSINE COEFFICIENT OF INITIAL FLAPPING VELOCITY (DEG/SEC)		0.0	
15	BETAS	BIFILAR MASS SINE COEFFICIENT OF INITIAL FLAPPING ANGLE (DEGREES)		0.0	
16	DBETAS	BIFILAR MASS SINE COEFFICIENT OF INITIAL FLAPPING VELOCITY (DEG/SEC)		0.0	

(e) Component BF2 Data

Figure 17. Continued.

COMPONENT:BEAM1		***** BEAM ELEMENT TYPE 1 *****	ELEMENT: 2
1	NCN1	CONNECTION NODE NUMBER END 1 (ND)	1
2	NCN2	CONNECTION NODE NUMBER END 2 (ND)	2
3	E	BEAM ELASTIC MODULUS (PSI)	3.00000D+07
4	A	BEAM CROSS-SECTIONAL AREA (FT**2)	1.66700D-01
5	IYA	BEAM SECOND AREA MOMENT OF INERTIA ABOUT THE Y-AXIS (FT**4)	8.03760D-06
6	IZA	BEAM SECOND AREA MOMENT OF INERTIA ABOUT THE Z-AXIS (FT**4)	3.21500D-05
7	GJ	BEAM TORSIONAL STIFFNESS (SLUG-FT/RAD)	2.00000D+08
8	M0	MASS OF BEAM (SLUGS)	8.00000D-02
9	IXX	BEAM SECOND MASS MOMENT OF INERTIA ABOUT THE X-AXIS (SLUG-FT**2)	0.0
10	IYY	BEAM SECOND MASS MOMENT OF INERTIA ABOUT THE Y-AXIS (SLUG-FT**2)	0.0
11	IZZ	BEAM SECOND MASS MOMENT OF INERTIA ABOUT THE Z-AXIS (SLUG-FT**2)	0.0
12	UCG	OFFSET OF BEAM CENTER OF GRAVITY FROM ELASTIC AXIS IN X-DIRECTION (FT)	0.0
13	VCG	OFFSET OF BEAM CENTER OF GRAVITY FROM ELASTIC AXIS IN Y-DIRECTION (FT)	0.0
14	WCG	OFFSET OF BEAM CENTER OF GRAVITY FROM ELASTIC AXIS IN Z-DIRECTION (FT)	0.0
15	LENGTH	LENGTH OF BEAM (FEET)	4.00000D-01
16	THETA1	EULER PITCH ANGLE AT END 1 - ROTATE SECOND ABOUT THE Y-AXIS (DEGREES)	0.0
17	PHI1	EULER ROLL ANGLE AT END 1 - ROTATE THIRD ABOUT THE X-AXIS (DEGREES)	0.0
18	XSI1	EULER YAW ANGLE AT END 1 - ROTATE FIRST ABOUT THE Z-AXIS (DEGREES)	0.0
19	THETA2	EULER PITCH ANGLE AT END 2 - ROTATE SECOND ABOUT THE Y-AXIS (DEGREES)	0.0
20	PHI2	EULER ROLL ANGLE AT END 2 - ROTATE THIRD ABOUT THE X-AXIS (DEGREES)	0.0
21	XSI2	EULER YAW ANGLE AT END 2 - ROTATE FIRST ABOUT THE Z-AXIS (DEGREES)	0.0

(f) Component BM1 Data

Figure 17. Continued.

```

COMPONENT:CONSTR1 ***** CONSTRAINT COMPONENT 1 ***** ELEMENT: 7
1 NCN CONNECTION NODE NUMBER (ND) 1
2 CONSTR DEGREE OF FREEDOM SELECTOR
  = 0 DEGREE OF FREEDOM CONSTRAINED
  = 1 DEGREE OF FREEDOM FREE
      X   Y   Z   THTX THTY THTZ
      0   0   0   0    0    1
8 THETA EULER PITCH ANGLE (DEGREES) - ROTATE SECOND ABOUT THE Y-AXIS 0.0
9 PHI   EULER ROLL ANGLE (DEGREES) - ROTATE THIRD ABOUT THE X-AXIS 0.0
10 XSI  EULER YAW ANGLE (DEGREES) - ROTATE FIRST ABOUT THE Z-AXIS 0.0

```

(g) Component CN1 Data

```

COMPONENT:EIGEN1 ***** REAL EIGENSOLUTION ***** ELEMENT: 1
1 IDEBUG DEBUG SELECTOR 1
  = 0 ==> NO DEBUG PRINTOUT
  = 1 ==> TRACE MATRIX ASSEMBLY AND SOLUTION

```

(h) Component EG1 Data

```

COMPONENT:EIGEN2 ***** COMPLEX EIGENSOLUTION ***** ELEMENT: 7
1 IDEBUG DEBUG SELECTOR 1
  = 0 ==> NO DEBUG PRINTOUT
  = 1 ==> TRACE MATRIX ASSEMBLY AND SOLUTION

```

(i) Component EG2 Data

COMPONENT:FIXABS1 ***** FIXED SYSTEM ABSORBER TYPE 1 ***** ELEMENT: 1

1	NCN	CONNECTION NODE NUMBER (NO)	1
2	M0	ABSORBER MASS (SLUGS)	1.00000D+01
3	ZETA	ABSORBER DAMPING RATIO (ND)	1.20000D-01
4	K0	ABSORBER STIFFNESS (LB/FT)	2.50000D+04
5	IXX	ABSORBER SECOND MASS MOMENT OF INERTIA ABOUT THE X AXIS (SLUG-FT**2)	1.00000D+00
6	IYY	ABSORBER SECOND MASS MOMENT OF INERTIA ABOUT THE Y AXIS (SLUG-FT**2)	1.00000D+00
7	IZZ	ABSORBER SECOND MASS MOMENT OF INERTIA ABOUT THE Z AXIS (SLUG-FT**2)	1.00000D+00
8	THETA	EULER PITCH ANGLE (DEGREES) - ROTATE SECOND ABOUT THE Y-AXIS	0.0
9	PHI	EULER ROLL ANGLE (DEGREES) - ROTATE THIRD ABOUT THE X-AXIS	0.0
10	XSI	EULER YAW ANGLE (DEGREES) - ROTATE FIRST ABOUT THE Z-AXIS	0.0
11	DELTA	ABSORBER MASS INITIAL DISPLACEMENT (FT)	1.00000D-02
12	DOELTA	ABSORBER MASS INITIAL VELOCITY (FT/SEC)	2.00000D-02

(j) Component FA1 Data

COMPONENT:FORCER1 ***** FORCED RESPONSE SOLUTION TYPE 1 ***** ELEMENT: 8

1	OMEGA	FORCING FREQUENCY (HERTZ)	1.95200D+01
2	IDEBUG	DEBUG SELECTOR = 0 ==> NO DEBUG PRINTOUT = 1 ==> TRACE MATRIX ASSEMBLY AND SOLUTION	0
3	ICONVG	OUTPUT DISPLAY SELECTOR = 0 ==> DISPLACEMENTS (FEET) = 1 ==> ACCELERATIONS (G'S)	0

(k) Component FR1 Data

Figure 17. Continued.

```
COMPONENT:GENINPUT ***** GENERAL INPUT FOR PROGRAM CONTROL ***** ELEMENT: 9
1 ICNTL1 PRINT_SELECTOR_FOR_FINAL_RESULTS ..... 0
  = 0 ==> SUPPRESS LINE PRINTER OUTPUT
  = 1 ==> FULL LINE PRINTER OUTPUT
2 ICNTL2 PRINT_SELECTOR_FOR_COMPONENT_INPUTS ..... 1
  = 0 ==> SUPPRESS LINE PRINTER OUTPUT
  = 1 ==> FULL LINE PRINTER OUTPUT
3-9 ----- OPEN_LOCATIONS_FOR_FUTURE_USE .....
10 XINDEP INDEPENDENT VARIABLE FOR 3-D PLOTS ..... 0.0
```

(1) Component Gen Data

Figure 17. Continued.

COMPONENT: GENFOR1 ***** GENERALIZED FORCE TYPE 1 (USED WITH FORCER1) ***** ELEMENT: 1

1	NCN	CONNECTION NODE NUMBER (ND)	1
2	THETA	EULER PITCH ANGLE (DEGREES) - ROTATE SECOND ABOUT THE Y-AXIS	0.0
3	PHI	EULER ROLL ANGLE (DEGREES) - ROTATE THIRD ABOUT THE X-AXIS	0.0
4	XSI	EULER YAW ANGLE (DEGREES) - ROTATE FIRST ABOUT THE Z-AXIS	0.0
5	FXCOS	COSINE COMPONENT OF X DIRECTION FORCE (LB)	-1.70000D+03
6	FXSIN	SINE COMPONENT OF X DIRECTION FORCE (LB)	0.0
7	FYCOS	COSINE COMPONENT OF Y DIRECTION FORCE (LB)	0.0
8	FYSIN	SINE COMPONENT OF Y DIRECTION FORCE (LB)	1.10000D+03
9	FZCOS	COSINE COMPONENT OF Z DIRECTION FORCE (LB)	0.0
10	FZSIN	SINE COMPONENT OF Z DIRECTION FORCE (LB)	0.0
11	FT1COS	COSINE COMPONENT OF THETA 1 MOMENT (LB)	0.0
12	FT1SIN	SINE COMPONENT OF THETA 1 MOMENT (IN-LB)	0.0
13	FT2COS	COSINE COMPONENT OF THETA 2 MOMENT (IN-LB)	0.0
14	FT2SIN	SINE COMPONENT OF THETA 2 MOMENT (IN-LB)	0.0
15	FT3COS	COSINE COMPONENT OF THETA 3 MOMENT (IN-LB)	0.0
16	FT3SIN	SINE COMPONENT OF THETA 3 MOMENT (IN-LB)	0.0
17	IHRESP	HHC FLAG = 0 HHC NOT ACTIVE = 1 HHC ACTIVE	0
18	WZX	WEIGHT FOR X RESPONSE	0.0
19	WZY	WEIGHT FOR Y RESPONSE	0.0
20	WZZ	WEIGHT FOR Z RESPONSE	0.0
21	WZX	WEIGHT FOR THETA1 RESPONSE	0.0
22	WZY	WEIGHT FOR THETA2 RESPONSE	0.0
23	WZW	WEIGHT FOR THETA3 RESPONSE	0.0

(m) Component GF1 Data
Figure 17. Continued.

COMPONENT: ISOLATE1		***** ISOLATOR TYPE 1 *****	ELEMENT:	1
1	NCN1	CONNECTION NODE NUMBER 1	(NO)	1
2	NCN2	CONNECTION NODE NUMBER 2	(NO)	5
3	AL	DISTANCE BETWEEN NODE 1 & PIVOT 2	(IN)	1.250000+00
4	BL	DISTANCE BETWEEN PIVOT 2 & Y-Z ISOLATOR	(IN)	1.000000+01
5	CL	DISTANCE BETWEEN PIVOT 2 & NODE 2	(IN)	0.0
6	DL	DISTANCE BETWEEN PIVOT 2 & X ISOLATOR	(IN)	0.0
7	W1	WEIGHT OF Y-Z ISOLATOR	(LBS)	4.400000+01
8	XI1Y	INERTIA OF Y-Z ISOLATOR ABOUT THE Y-AXIS	(IN-LB-SEC**2)	0.0
9	XI1Z	INERTIA OF Y-Z ISOLATOR ABOUT THE Z-AXIS	(IN-LB-SEC**2)	0.0
10	W2	WEIGHT OF X ISOLATOR	(LBS)	0.0
11	XI2Y	INERTIA OF X ISOLATOR ABOUT THE Y-AXIS	(IN-LB-SEC**2)	0.0
12	TKTX	X STIFFNESS BETWEEN NODE 1 & PIVOT 1	(LBS/IN)	1.000000+01
13	TKTY	Y STIFFNESS BETWEEN NODE 1 & PIVOT 1	(LBS/IN)	1.000000+09
14	TKTZ	Z STIFFNESS BETWEEN NODE 1 & PIVOT 1	(LBS/IN)	1.000000+09
15	TKEX	X STIFFNESS BETWEEN PIVOT 1 & NODE 2	(LBS/IN)	1.000000+05
16	TKEY	Y STIFFNESS BETWEEN PIVOT 1 & NODE 2	(LBS/IN)	1.000000+05
17	TKEZ	Z STIFFNESS BETWEEN PIVOT 1 & NODE 2	(LBS/IN)	1.000000+05
18	TKAX	X STIFFNESS BETWEEN NODE 2 & PIVOT 2	(LBS/IN)	1.000000+09
19	TKAY	Y STIFFNESS BETWEEN NODE 2 & PIVOT 2	(LBS/IN)	1.000000+09
20	TKAZ	Z STIFFNESS BETWEEN NODE 2 & PIVOT 2	(LBS/IN)	1.500000+04
21	RKTHB	ROTATIONAL STIFFNESS OF NODE 2 ABOUT THE Y-AXIS	(IN-LB/RAD)	0.0
22	RKTHT	ROTATIONAL STIFFNESS OF PIVOT 2 ABOUT THE Y-AXIS	(IN-LB/RAD)	0.0
23	RKPHT	ROTATIONAL STIFFNESS OF PIVOT 2 ABOUT THE Z-AXIS	(IN-LB/RAD)	0.0
24	TCTX	X DAMPING BETWEEN NODE 1 & PIVOT 1	(NO)	5.000000-02
25	TCTY	Y DAMPING BETWEEN NODE 1 & PIVOT 1	(NO)	5.000000-02
26	TCTZ	Z DAMPING BETWEEN NODE 1 & PIVOT 1	(NO)	5.000000-02
27	TCEX	X DAMPING BETWEEN PIVOT 1 & NODE 2	(NO)	5.000000-02
28	TCEY	Y DAMPING BETWEEN PIVOT 1 & NODE 2	(NO)	5.000000-02

(n) Component IS1

Figure 17. Continued.

29	TCEZ	Z DAMPING BETWEEN PIVOT 1 & NODE 2	(ND)	5.000000-02
30	TCAX	X DAMPING BETWEEN NODE 2 & PIVOT 2	(ND)	5.000000-02
31	TCAY	Y DAMPING BETWEEN NODE 2 & PIVOT 2	(ND)	5.000000-02
32	TCAZ	Z DAMPING BETWEEN NODE 2 & PIVOT 2	(ND)	5.000000-02
33	RCTHB	ROTATIONAL DAMPING OF NODE 2 ABOUT THE Y-AXIS	(ND)	5.000000-02
34	RCTHT	ROTATIONAL DAMPING OF PIVOT 2 ABOUT TH Y-AXIS	(ND)	5.000000-02
35	RCPHI	ROTATIONAL DAMPING OF PIVOT 2 ABOUT TH Z-AXIS	(ND)	5.000000-02
36	HTX	X FREQUENCY BETWEEN NODE 1 & PIVOT 1	(HZ)	2.480000+01
37	HTY	Y FREQUENCY BETWEEN NODE 1 & PIVOT 1	(HZ)	2.480000+01
38	HTZ	Z FREQUENCY BETWEEN NODE 1 & PIVOT 1	(HZ)	2.480000+01
39	HGX	X FREQUENCY BETWEEN PIVOT 1 & NODE 2	(HZ)	2.480000+01
40	HGY	Y FREQUENCY BETWEEN PIVOT 1 & NODE 2	(HZ)	2.480000+01
41	HGZ	Z FREQUENCY BETWEEN PIVOT 1 & NODE 2	(HZ)	2.480000+01
42	HAX	X FREQUENCY BETWEEN NODE 2 & PIVOT 2	(HZ)	2.480000+01
43	HAY	Y FREQUENCY BETWEEN NODE 2 & PIVOT 2	(HZ)	2.480000+01
44	HAZ	Z FREQUENCY BETWEEN NODE 2 & PIVOT 2	(HZ)	2.480000+01
45	WYHB	ROTATIONAL FREQUENCY OF NODE 2 ABOUT THE Y-AXIS	(HZ)	0.0
46	WYHT	ROTATIONAL FREQUENCY OF PIVOT 2 ABOUT TH Y-AXIS	(HZ)	0.0
47	WPHT	ROTATIONAL FREQUENCY OF PIVOT 2 ABOUT TH Z-AXIS	(HZ)	0.0
48	I3D2D	CONTROL SWITCH ==> 2 FOR 2-D DAVI & ==> 3 FOR 3-D DAVI ISOLATOR	(ND)	2
49	IFLEX	ACCOUNT FOR FLEXIBILITY OF ISOLATOR BARS ==>0 - NO & ==>1 - YES	(ND)	0
50	RXYM1	FREQUENCY RATIO OF Y-Z ISOLATOR IN X-Y PLANE	(ND)	0.0
51	RXZM1	FREQUENCY RATIO OF Y-Z ISOLATOR IN X-Z PLANE	(ND)	0.0
52	RXZM2	FREQUENCY RATIO OF X ISOLATOR IN X-Z PLANE	(ND)	0.0
53	DXYM1	CRITICAL DAMPING OF Y-Z ISOLATOR IN X-Y PLANE	(ND)	0.0
54	DXZM1	CRITICAL DAMPING OF Y-Z ISOLATOR IN X-Z PLANE	(ND)	0.0
55	DXZM2	CRITICAL DAMPING OF X ISOLATOR IN X-Z PLANE	(ND)	0.0
56	THETA1	EULER PITCH ANGLE AT END 1 - ROTATE SECOND ABOUT THE Y-AXIS	(DEG)	0.0
57	PHI1	EULER ROLL ANGLE AT END 1 - ROTATE THIRD ABOUT THE X-AXIS	(DEG)	0.0
58	XSI1	EULER YAW ANGLE AT END 1 - ROTATE FIRST ABOUT THE Z-AXIS	(DEG)	0.0

(n) Component IS1 Data

Figure 17. Continued.

59	THETA2	EULER PITCH ANGLE AT END 2 - ROTATE SECOND ABOUT THE Y-AXIS	(DEG)	0.0
60	PHI2	EULER ROLL ANGLE AT END 2 - ROTATE THIRD ABOUT THE X-AXIS	(DEG)	0.0
61	XSI2	EULER YAW ANGLE AT END 2 - ROTATE FIRST ABOUT THE Z-AXIS	(DEG)	0.0
62	XT	PIVOT 1 INITIAL X DISPLACEMENT	(INCH)	0.0
63	DXT	PIVOT 1 INITIAL X VELOCITY	(IN/SEC)	0.0
64	YT	PIVOT 1 INITIAL Y DISPLACEMENT	(INCH)	0.0
65	DYT	PIVOT 1 INITIAL Y VELOCITY	(IN/SEC)	0.0
66	ZT	PIVOT 1 INITIAL Z DISPLACEMENT	(INCH)	0.0
67	DZT	PIVOT 1 INITIAL Z VELOCITY	(IN/SEC)	0.0
68	XB	PIVOT 2 INITIAL X DISPLACEMENT	(INCH)	0.0
69	DXB	PIVOT 2 INITIAL X VELOCITY	(IN/SEC)	0.0
70	YB	PIVOT 2 INITIAL Y DISPLACEMENT	(INCH)	0.0
71	DYB	PIVOT 2 INITIAL Y VELOCITY	(IN/SEC)	0.0
72	ZB	PIVOT 2 INITIAL Z DISPLACEMENT	(INCH)	0.0
73	DZB	PIVOT 2 INITIAL Z VELOCITY	(IN/SEC)	0.0

(n) Component IS1

Figure 17. Continued.

COMPONENT:MODSTR1

***** MODAL STRUCTURE TYPE 1 *****

ELEMENT: 1

1 ZETA DAMPING RATIO (RD) 3.40000D-02

2 M0 GENERALIZED MASS (LB-SEC**2/IN) 1.80000D+00

3 OMEGA MODE FREQUENCY (HERTZ) 1.61000D+01

4 NNODE NUMBER OF NODES DESCRIBED BY THIS MODE 1

5 NODE CONNECTION NODE NUMBERS OF NODES DESCRIBED BY THIS MODE
 1 0 0 0 0

10 GAMMA MODE SHAPE. ENTER U, V, W, THETAX, THETAY, THETAZ FOR EACH NODE:

		U	V	W	THETAX	THETAY	THETAZ
10 - 15	NODE 1	1.0000D+00	1.0000D-02	-2.4000D-01	0.0	0.0	0.0
16 - 21	NODE 2	0.0	0.0	0.0	0.0	0.0	0.0
22 - 27	NODE 3	0.0	0.0	0.0	0.0	0.0	0.0
28 - 33	NODE 4	0.0	0.0	0.0	0.0	0.0	0.0
34 - 39	NODE 5	0.0	0.0	0.0	0.0	0.0	0.0

40 EULER EULER ANGLES AT CONNECTION NODES. ENTER:

THETA - EULER PITCH ANGLE. ROTATE SECOND ABOUT THE Y-AXIS (DEGREES)

PHI - EULER ROLL ANGLE. ROTATE THIRD ABOUT THE X-AXIS (DEGREES)

XSI - EULER YAW ANGLE. ROTATE FIRST ABOUT THE Z-AXIS (DEGREES)

		THETA	PHI	XSI
40 - 42	NODE 1	0.0	0.0	0.0
43 - 45	NODE 2	0.0	0.0	0.0
46 - 48	NODE 3	0.0	0.0	0.0
49 - 51	NODE 4	0.0	0.0	0.0
52 - 54	NODE 5	0.0	0.0	0.0

55 --- EMPTY LOCATION

56 Q INITIAL MODAL AMPLITUDE (IN/IN) 0.0

57 DQ INITIAL MODAL VELOCITY (1/SEC) 0.0

(o) Component MS1 Data.

Figure 17. Continued.

```

COMPONENT:PARMV1          ***** PARAMETRIC VARIATION TYPE 1 *****          ELEMENT:      10

1  FIRSTV  STARTING VALUE FOR PARAMETRIC VARIATION ..... 1.00000D+01
2  FINALV  FINAL VALUE FOR PARAMETRIC VARIATION ..... 3.00000D+01
3  NPTS    NUMBER OF POINTS IN PARAMETRIC VARIATION ..... 10
4  NEL     GLOBAL ELEMENT NUMBER AND CORRESPONDING LOADER LOCATION FOR INDEPENDENT VARIABLE
           TO BE PARAMETRICALLY VARIED (UP TO 10 PAIRS)
           3           3
           0           0
           0           0
           0           0
           0           0
           0           0
           0           0
           0           0
           0           0
           0           0

```

(p) Component PV1 Data

```

COMPONENT:ROTOREL2      ***** ELASTIC ROTOR TYPE 2 *****      ELEMENT:      1

1  IEXEC   E927 EXECUTION CONTROL FLAG ..... 0
           = 0 READ ROTOR MATRICES FROM INPUT FILE. DO NOT RUN E927.
           = 1 RUN E927 TO CALCULATE ROTOR MATRICES --NOT AVAILABLE--
2  NCN     ROTOR CONNECTION NODE NUMBER ..... 4
3  THETA   EULER PITCH ANGLE - ROTATE SECOND ABOUT THE Y-AXIS (DEGREES) ..... 0.0
4  PHI     EULER ROLL ANGLE - ROTATE THIRD ABOUT THE X-AXIS (DEGREES) ..... 0.0
5  XSI     EULER YAW ANGLE - ROTATE FIRST ABOUT THE Z-AXIS (DEGREES) ..... 0.0

```

(q) Component RE2 Data

Figure 17. Continued.

COMPONENT:ROTOREL3	***** ELASTIC ROTOR TYPE 3 *****	ELEMENT: 7
1	IROFIL READ FILE FLAG = 0 READ ROTOR IMPEDANCE AND HUB FORCE VECTOR FROM SAVE FILE 11 (6400 PROGRAM) = 1 READ ROTOR IMPEDANCE AND HUB FORCE VECTOR FROM UNIT 12 (USER INPUT) NOTE 1 - INPUT DATA FORMAT IS 6612.4. NOTE 2 - IF IROFIL=1, IHHC (LOC. 8) AND ISTRSS (LOC. 10) ARE SET TO ZERO INTERNALLY.	1
2	ISTFOR SET ROTOR HUB FORCE FLAG = 0 LEAVE HUB FORCE VECTOR UNCHANGED = 1 NULL THE HUB FORCE VECTOR IN THE CODE	0
3	IDPFOR DISPLAY HUB FORCE FLAG = 0 DISPLAY HUB DISPLACEMENTS AND SAVE DISPLACEMENTS FOR PLOTTING = 1 DISPLAY HUB INTERFACE FORCES AND MOMENTS AND SAVE FOR PLOT ROUTINE (ABOVE FLAG IS SET TO ZERO INTERNALLY FOR ACCELERATIONS OUTPUT)	1
4	NCN ROTOR HUB CONNECTION NODE NUMBER	1
5	THETA EULER PITCH ANGLE - ROTATE SECOND ABOUT THE Y-AXIS (DEGREES)	0.0
6	PHI EULER ROLL ANGLE - ROTATE THIRD ABOUT THE X-AXIS (DEGREES)	0.0
7	XSI EULER YAW ANGLE - ROTATE FIRST ABOUT THE Z-AXIS (DEGREES)	0.0
8	IHHC HHC FLAG = 0 HHC NOT ACTIVE = 1 HHC ACTIVE	0
9	ITHHC READ THETA FOR HHC FLAG = 0 COMPUTE OPTIMAL THETA BY QUADRATIC MINIMIZATION = 1 READ HHC INPUT ANGLES - LOCATIONS 11 TO 16 BELOW	0
10	ISTRSS DISPLAY BLADE STRESSES FLAG - SET INTERNALLY FROM 6400 INPUT LOCATION 993 = 0 DO NOT DISPLAY STRESSES - 6400 LOCATION 993 IS ZERO = 1 DISPLAY STRESSES - 6400 LOCATION 993 IS GREATER THAN ZERO	0
11	THM1C HHC INPUT ANGLE - (N-1)TH COSINE COMPONENT (DEGREES). N = NUMBER OF BLADES	0.0
12	THM1S HHC INPUT ANGLE - (N-1)TH SINE COMPONENT (DEGREES). N = NUMBER OF BLADES	0.0
13	THM2C HHC INPUT ANGLE - (N)TH COSINE COMPONENT (DEGREES). N = NUMBER OF BLADES	0.0
14	THM2S HHC INPUT ANGLE - (N)TH SINE COMPONENT (DEGREES). N = NUMBER OF BLADES	0.0
15	THM3C HHC INPUT ANGLE - (N+1)TH COSINE COMPONENT (DEGREES). N = NUMBER OF BLADES	0.0
16	THM3S HHC INPUT ANGLE - (N+1)TH SINE COMPONENT (DEGREES). N = NUMBER OF BLADES	0.0
17	WTHM1 WEIGHT FOR (N-1)TH COMPONENT OF HHC INPUT ANGLES. N = NUMBER OF BLADES	0.0
18	WTHM2 WEIGHT FOR (N)TH COMPONENT OF HHC INPUT ANGLES. N = NUMBER OF BLADES	0.0
19	WTHM3 WEIGHT FOR (N+1)TH COMPONENT OF HHC INPUT ANGLES. N = NUMBER OF BLADES	0.0

(r) Component RE3 Data Input

Figure 17. Continued.

HUB IMPEDANCE MATRIX FOR HHC PITCH ANGLES (UNITS = DEG)

			A3S	A4S	A5S	B3S	B4S	B5S
LONG.	SHR (+, AFT)	COS	-6.122	-2.269	-10.49	6.087	.3472	6.623
LAT.	SHR (+, STRBD)	COS	5.983	-6.202	-7.944	2.679	1.216	-9.454
VERT.	SHR (+, UP)	COS	-.9781	-12.70	.1284	-4.017	3.210	-3.038
ROLL	MOMT (+, STRBD UP)	COS	-3.113	.6585	-1.804	1.172	-2.287	1.968
PITCH	MOMT (+, NOSE UP)	COS	1.450	-.2336	-2.126	3.585	.2067	-1.958
YAW	MOMT (+, OMEGA DIR.)	COS	-.5519	6.095	-3.664	.1123	1.048	.7380
LONG.	SHR (+, AFT)	SIN	-6.731	.1032	-6.567	-6.156	-1.600	-9.874
LAT.	SHR (+, STRBD)	SIN	-4.019	-1.996	8.844	5.674	-6.713	-8.297
VERT.	SHR (+, UP)	SIN	4.041	-2.930	3.490	-.7051	-12.99	.1188
ROLL	MOMT (+, STRBD UP)	SIN	-1.292	2.294	-1.932	-3.076	.5805	-1.843
PITCH	MOMT (+, NOSE UP)	SIN	-3.460	-.3038	1.856	1.376	-.1772	-2.101
YAW	MOMT (+, OMEGA DIR.)	SIN	-.2991	-1.254	-.9614	-.6519	6.058	-3.819

(s) Hub Impedance Matrix for HHC Pitch Angles for RE3 Component

Figure 17. Continued.

***** SUMMARY OF HHC RESULTS *****

WZX	WEIGHT FOR X RESPONSE		2.00000D+04
WZY	WEIGHT FOR Y RESPONSE		2.00000D+04
WZZ	WEIGHT FOR Z RESPONSE		1.50000D+05
WZX	WEIGHT FOR THETA1 RESPONSE		0.0
WZY	WEIGHT FOR THETA2 RESPONSE		0.0
WZZ	WEIGHT FOR THETA3 RESPONSE		0.0
WTHN1	WEIGHT FOR (N-1)TH COMPONENT OF HHC INPUT ANGLES.	N = NUMBER OF BLADES	1.00000D-02
WTHN	WEIGHT FOR (N)TH COMPONENT OF HHC INPUT ANGLES.	N = NUMBER OF BLADES	1.00000D-02
WTHN1	WEIGHT FOR (N+1)TH COMPONENT OF HHC INPUT ANGLES.	N = NUMBER OF BLADES	1.00000D-02
THSTR(1)	OPTIMAL ANGLE - (N-1)TH COSINE COMPONENT (DEGREES).	N = NUMBER OF BLADES	3.50881D-01
THSTR(2)	OPTIMAL ANGLE - (N)TH COSINE COMPONENT (DEGREES).	N = NUMBER OF BLADES	6.12618D-02
THSTR(3)	OPTIMAL ANGLE - (N+1)TH COSINE COMPONENT (DEGREES).	N = NUMBER OF BLADES	2.52027D-02
THSTR(4)	OPTIMAL ANGLE - (N-1)TH SINE COMPONENT (DEGREES).	N = NUMBER OF BLADES	-4.28786D-01
THSTR(5)	OPTIMAL ANGLE - (N)TH SINE COMPONENT (DEGREES).	N = NUMBER OF BLADES	2.16384D-01
THSTR(6)	OPTIMAL ANGLE - (N+1)TH SINE COMPONENT (DEGREES).	N = NUMBER OF BLADES	-1.41675D-01
	QUADRATIC PERFORMANCE INDEX		1.16575D-06

(t) Summary of HHC Results for RE3 Component.

Figure 17. Continued.

***** BLADE STRESS HARMONICS FOR AEROELASTIC ROTOR RE3 *****

HARMONIC =		1	2	3	4	5	6	7	8
FLAT	STN 1 COS	-0.2805D+01	0.1196D+01	-0.8949D+00	0.4774D-01	-0.1358D+00	0.9099D+00	-0.6089D+00	-0.3231D+00
FLAT	STN 1 SIN	0.3630D+01	-0.1223D+00	0.9215D-01	0.1009D+01	-0.1150D+01	-0.7573D+00	-0.2579D+00	0.1581D+00
FLAT	STN 2 COS	0.9062D+00	0.3200D+01	-0.5344D+00	0.2869D+00	-0.4980D+00	-0.3868D-01	-0.1197D+00	0.2462D+00
FLAT	STN 2 SIN	0.1044D+02	-0.7417D+00	0.1393D+01	-0.3987D+00	0.8898D+00	-0.4513D+00	-0.1603D+00	0.2780D+00
FLAT	STN 3 COS	-0.7916D+01	0.5688D+01	0.1961D+01	-0.1411D+01	-0.3843D+00	0.5195D-01	-0.2162D+00	-0.8053D-01
FLAT	STN 3 SIN	0.9469D+01	0.2203D+00	-0.9511D+00	-0.7705D+00	0.3952D+00	0.8310D+00	-0.1351D+00	-0.1255D+00
EDGE	STN 1 COS	-0.9156D+01	0.1475D+01	0.9441D+00	-0.3598D+01	-0.4350D+01	0.1169D+00	0.8728D+00	0.5897D-01
EDGE	STN 1 SIN	0.1423D+02	-0.1978D+01	-0.8554D+00	0.4341D+01	-0.2531D+01	-0.1864D+01	0.1225D+01	-0.2851D+00
EDGE	STN 2 COS	-0.5431D+01	0.3368D+01	0.1046D+01	-0.2970D+01	-0.4291D+01	0.6123D+00	0.1020D+01	-0.3676D-01
EDGE	STN 2 SIN	0.9388D+01	-0.2493D+01	-0.1822D+01	0.5529D+01	-0.1883D+01	-0.2768D+01	0.1428D+01	-0.2631D+00
EDGE	STN 3 COS	-0.1615D+01	0.1276D+01	0.6461D+00	-0.1104D+01	-0.1265D+01	0.4383D+00	0.3791D+00	-0.1088D+00
EDGE	STN 3 SIN	0.1733D+01	-0.8403D+00	-0.9749D+00	0.1833D+01	-0.6376D+00	-0.1073D+01	0.4516D+00	-0.9677D-01
TORS	STN 1 COS	0.7988D+00	-0.9671D+00	0.1491D+01	-0.8112D+00	0.1304D+01	-0.4445D-01	-0.8184D-01	-0.6112D-01
TORS	STN 1 SIN	0.3015D+01	-0.6199D+00	0.8295D+00	0.7809D+00	0.6988D-01	-0.2477D+00	0.5282D-01	0.8631D-01
TORS	STN 2 COS	0.1167D+01	-0.9259D+00	0.1099D+01	-0.6698D+00	0.1040D+01	-0.7366D-01	-0.7655D-01	-0.2594D-01
TORS	STN 2 SIN	0.2962D+01	-0.4462D+00	0.7905D+00	0.4705D+00	0.2795D+00	-0.1776D+00	0.3732D-02	0.7829D-01
TORS	STN 3 COS	0.2448D+01	-0.6684D+00	0.3423D+00	-0.2679D+00	0.5765D+00	-0.5966D-01	-0.4577D-01	0.9755D-02
TORS	STN 3 SIN	0.2956D+00	-0.2771D+00	0.6564D+00	-0.7465D-01	0.3980D+00	-0.9404D-01	-0.2267D-01	0.2992D-01
PUSH	STN 1 COS	0.2908D+00	-0.3477D+00	0.6327D+00	-0.2486D+00	0.5006D+00	-0.8971D-02	-0.2919D-01	-0.2211D-01
PUSH	STN 1 SIN	0.9146D+00	-0.2247D+00	0.1541D+00	0.4007D+00	-0.1067D+00	-0.9806D-01	0.2346D-01	0.3399D-01

(u) Blade Stress Harmonics for RE3 Component.

Figure 17. Continued.

HALF PEAK TO PEAK VALUES

FLAT	STN 1	0.6387D+01
FLAT	STN 2	0.1112D+02
FLAT	STN 3	0.1787D+02
EDGE	STN 1	0.2477D+02
EDGE	STN 2	0.2103D+02
EDGE	STN 3	0.6307D+01
TORS	STN 1	0.5506D+01
TORS	STN 2	0.4730D+01
TORS	STN 3	0.3728D+01
PUSH	STN 1	0.2018D+01

(v) Half Peak-To-Peak Values of Stresses and Pushrod Load
for RE3 Component

Figure 17. Continued.

COMPONENT: TIMEHIS1	***** NEWMARK INTEGRATION METHOD *****	ELEMENT: 3
1 BETN	NEWMARK BETA FACTOR, RANGE PERMITTED = 0.0 TO 0.25	2.50000D-01
2 DELT	TIME INCREMENT (SECONDS)	1.00000D-02
3 TMAX	TIME LIMIT FOR INTEGRATION OF EQUATIONS OF MOTION (SEC)	1.00000D+00
4 OMEGA	FORCING FREQUENCY (HERTZ)	6.00000D+00
5 IDEBUG	DEBUG SELECTOR = 0 ==> NO DEBUG PRINTOUT = 1 ==> TRACE MATRIX ASSEMBLY AND SOLUTION	0
6 IRSTRT	RESTART FLAG = 0 ==> NO RESTART = 1 ==> RESTART	0

(w) Component TH1 Data

Figure 17. Concluded.

```

***** DEBUG PRINT SUBROUTINE ASPTCK *****
MO ( 1, 1)= 1.00000D+01    MO ( 3, 3)= 1.00000D+01    MO ( 4, 4)= 1.00000D+01    MO ( 5, 5)= 1.00000D+00
MO ( 6, 6)= 1.00000D+00    MO ( 7, 7)= 1.00000D+00
-----
CO ( 1, 1)= 1.20000D+02    CO ( 1, 2)=-1.20000D+02    CO ( 2, 1)=-1.20000D+02    CO ( 2, 2)= 1.20000D+02
-----
KO ( 1, 1)= 2.50000D+04    KO ( 1, 2)=-2.50000D+04    KO ( 2, 1)=-2.50000D+04    KO ( 2, 2)= 2.50000D+04
-----
-----
M ( 1, 1)= 1.00000D+01
-----
C ( 1, 1)= 1.20000D+02    C ( 1, 2)=-1.20000D+02    C ( 2, 1)=-1.20000D+02    C ( 2, 2)= 1.20000D+02
-----
K ( 1, 1)= 2.50000D+04    K ( 1, 2)=-2.50000D+04    K ( 2, 1)=-2.50000D+04    K ( 2, 2)= 2.50000D+04
-----
-----
MO ( 1, 1)= 1.20000D+01
-----
-----
-----
M ( 1, 1)= 1.00000D+01    M ( 2, 2)= 1.20000D+01
-----
C ( 1, 1)= 1.20000D+02    C ( 1, 2)=-1.20000D+02    C ( 2, 1)=-1.20000D+02    C ( 2, 2)= 1.20000D+02
-----
K ( 1, 1)= 2.50000D+04    K ( 1, 2)=-2.50000D+04    K ( 2, 1)=-2.50000D+04    K ( 2, 2)= 2.50000D+04
-----
-----
M ( 1, 1)= 1.00000D+01    M ( 2, 2)= 1.20000D+01
-----
C ( 1, 1)= 1.20000D+02    C ( 1, 2)=-1.20000D+02    C ( 2, 1)=-1.20000D+02    C ( 2, 2)= 1.20000D+02
-----
K ( 1, 1)= 2.50000D+04    K ( 1, 2)=-2.50000D+04    K ( 2, 1)=-2.50000D+04    K ( 2, 2)= 2.50000D+04
-----

```

(a) Matrix Assembly

Figure 18. Base Program Debugging Output Samples.

***** DEBUG PRINT SUBROUTINE S02EG1 *****

***** WKAREA(1) = 1.82403D-01

***** IER = 0

EIGENVALUE 1 A = 1.60330D+05 0.0 B = 3.79318D-02 FREQUENCY (HZ) = 3.27209D+02

COORDINATE = 1 EIGENVECTOR = -1.00000D+00 Z (REAL/IMAG) = -1.00000D+00 0.0

COORDINATE = 2 EIGENVECTOR = -3.74536D-01 Z (REAL/IMAG) = -3.74536D-01 0.0

COORDINATE = 3 EIGENVECTOR = -8.09017D-01 Z (REAL/IMAG) = -8.09017D-01 0.0

COORDINATE = 4 EIGENVECTOR = -6.06011D-01 Z (REAL/IMAG) = -6.06011D-01 0.0

COORDINATE = 5 EIGENVECTOR = -3.09017D-01 Z (REAL/IMAG) = -3.09017D-01 0.0

COORDINATE = 6 EIGENVECTOR = -6.06011D-01 Z (REAL/IMAG) = -6.06011D-01 0.0

COORDINATE = 7 EIGENVECTOR = 3.09017D-01 Z (REAL/IMAG) = 3.09017D-01 0.0

COORDINATE = 8 EIGENVECTOR = -3.74536D-01 Z (REAL/IMAG) = -3.74536D-01 0.0

COORDINATE = 9 EIGENVECTOR = 8.09017D-01 Z (REAL/IMAG) = 8.09017D-01 0.0

COORDINATE = 10 EIGENVECTOR = 1.00000D+00 Z (REAL/IMAG) = 1.00000D+00 0.0

(b) Real Eigensolution EG1

Figure 18. Continued.

***** DEBUG PRINT SUBROUTINE S02EG2 *****

EIGENVALUE 1 EIGENVALUE = -3.1671D+00 6.4399D+00

COORDINATE = 1 EIGENVECTOR = 1.0000D+00 0.0

COORDINATE = 2 EIGENVECTOR = -4.1269D-01 -2.5038D-03

COORDINATE = 3 EIGENVECTOR = 1.1382D-01 -5.1199D-02

COORDINATE = 4 EIGENVECTOR = -9.4922D-01 -1.5154D-01

COORDINATE = 5 EIGENVECTOR = -4.8726D-04 -2.6827D-04

COORDINATE = 6 EIGENVECTOR = 1.8634D-04 -1.4924D-04

COORDINATE = 7 EIGENVECTOR = 2.4610D-04 9.4295D-05

COORDINATE = 8 EIGENVECTOR = -2.0848D-05 1.1720D-05

COORDINATE = 9 EIGENVECTOR = -4.8672D-05 -8.8094D-05

COORDINATE = 10 EIGENVECTOR = -4.6813D-06 -7.0757D-05

COORDINATE = 11 EIGENVECTOR = 4.5676D-05 4.5992D-06

COORDINATE = 12 EIGENVECTOR = -1.5660D-05 3.8861D-05

COORDINATE = 13 EIGENVECTOR = -6.2627D-08 -7.1447D-07

COORDINATE = 14 EIGENVECTOR = 1.7651D-06 1.2017D-06

COORDINATE = 15 EIGENVECTOR = 3.5542D-03 -2.3583D-03

COORDINATE = 16 EIGENVECTOR = -5.7497D-08 -9.0936D-07

COORDINATE = 17 EIGENVECTOR = 1.6267D-03 -1.0776D-03

(c) Complex Eigensolution EG2

Figure 18. Continued.

***** DEBUG PRINT SUBROUTINE SQ2FR1 *****

FSIN (3, 1)= 6.25000D+01

FMPDN (16, 1)= 6.25000D+01

XMPDN (1, 1)= 1.20000D+10	XMPDN (1, 4)=-1.20000D+10	XMPDN (1, 9)= 4.83871D+07	XMPDN (1, 12)=-4.83871D+07
XMPDN (2, 2)= 1.20002D+10	XMPDN (2, 5)=-2.31026D+05	XMPDN (2, 10)= 4.83881D+07	XMPDN (2, 13)=-9.67742D+02
XMPDN (3, 3)= 1.20002D+10	XMPDN (3, 6)=-2.31026D+05	XMPDN (3, 7)=-1.20000D+10	XMPDN (3, 11)= 4.83881D+07
XMPDN (3, 14)=-9.67742D+02	XMPDN (3, 15)=-4.83871D+07	XMPDN (4, 1)=-1.20000D+10	XMPDN (4, 4)= 2.40000D+10
XMPDN (4, 9)=-4.83871D+07	XMPDN (4, 12)= 9.67742D+07	XMPDN (5, 2)=-2.31026D+05	XMPDN (5, 5)= 1.20002D+10
XMPDN (5, 10)=-9.67742D+02	XMPDN (5, 13)= 4.83881D+07	XMPDN (6, 3)=-2.31026D+05	XMPDN (6, 6)= 4.10158D+05
XMPDN (6, 8)=-1.80000D+05	XMPDN (6, 11)=-9.67742D+02	XMPDN (6, 14)= 1.69355D+03	XMPDN (6, 16)=-7.25806D+02
XMPDN (7, 3)=-1.20000D+10	XMPDN (7, 7)= 1.19999D+10	XMPDN (7, 11)=-4.83871D+07	XMPDN (7, 15)= 4.83871D+07
XMPDN (8, 6)=-1.80000D+05	XMPDN (8, 8)= 1.70407D+05	XMPDN (8, 14)=-7.25806D+02	XMPDN (8, 16)= 7.25806D+02
XMPDN (9, 1)=-4.83871D+07	XMPDN (9, 4)= 4.83871D+07	XMPDN (9, 9)= 1.20000D+10	XMPDN (9, 12)=-1.20000D+10
XMPDN (10, 2)=-4.83881D+07	XMPDN (10, 5)= 9.67742D+02	XMPDN (10, 10)= 1.20002D+10	XMPDN (10, 13)=-2.31026D+05
XMPDN (11, 3)=-4.83881D+07	XMPDN (11, 6)= 9.67742D+02	XMPDN (11, 7)= 4.83871D+07	XMPDN (11, 11)= 1.20002D+10
XMPDN (11, 14)=-2.31026D+05	XMPDN (11, 15)=-1.20000D+10	XMPDN (12, 1)= 4.83871D+07	XMPDN (12, 4)=-9.67742D+07
XMPDN (12, 9)=-1.20000D+10	XMPDN (12, 12)= 2.40000D+10	XMPDN (13, 2)= 9.67742D+02	XMPDN (13, 5)=-4.83881D+07
XMPDN (13, 10)=-2.31026D+05	XMPDN (13, 13)= 1.20002D+10	XMPDN (14, 3)= 9.67742D+02	XMPDN (14, 6)=-1.69355D+03
XMPDN (14, 8)= 7.25806D+02	XMPDN (14, 11)=-2.31026D+05	XMPDN (14, 14)= 4.10158D+05	XMPDN (14, 16)=-1.80000D+05
XMPDN (15, 3)= 4.83871D+07	XMPDN (15, 7)=-4.83871D+07	XMPDN (15, 11)=-1.20000D+10	XMPDN (15, 15)= 1.19999D+10
XMPDN (16, 6)= 7.25806D+02	XMPDN (16, 8)=-7.25806D+02	XMPDN (16, 14)=-1.80000D+05	XMPDN (16, 16)= 1.70407D+05

XINDC (3, 1)= 3.75625D-07 XINDC (6, 1)=-7.65464D-07 XINDC (7, 1)= 3.75647D-07 XINDC (8, 1)=-2.19068D-06

XINDS (3, 1)=-1.00075D-03 XINDS (6, 1)=-7.50747D-04 XINDS (7, 1)=-1.00076D-03 XINDS (8, 1)=-4.26248D-04

(d) Forced Response Solution FR1

Figure 18. Continued.

***** DEBUG PRINT SUBROUTINE S02TH1 *****

FCOS (1, 1)= 1.50000D+03

FSIN (1, 1)= 4.00000D+02

X (1, 1)= 1.18260D-02 X (2, 1)= 2.48950D-02

DX (1, 1)= 1.82596D-01 DX (2, 1)= 4.89503D-01

X1 (1, 1)= 1.00000D-02 X1 (2, 1)= 2.00000D-02

DX1 (1, 1)= 2.00000D-02

F1 (2, 1)= 1.50000D+03

X2 (1, 1)= 1.18260D-02 X2 (2, 1)= 2.48950D-02

DX2 (1, 1)= 1.82596D-01 DX2 (2, 1)= 4.89503D-01

F2 (2, 1)= 1.54191D+03

X3 (1, 1)= 1.79061D-02 X3 (2, 1)= 3.90942D-02

DX3 (1, 1)= 6.08014D-01 DX3 (2, 1)= 1.41992D+00

F3 (2, 1)= 1.58383D+03

(e) Time History Solution TH1

Figure 18. Concluded.

NUMBER	②	OUTPUT COORDINATES				⑥	⑦	FIELD
①		③	④	⑤				EIGENVALUE 1
1	ELEMENT				EIGV	1	3.2721D+02	
2	ELEMENT	2	BH1	X1	EIGV	1	0.0	
3	ELEMENT	2	BH1	Y1	EIGV	1	0.0	
4	ELEMENT	2	BH1	Z1	EIGV	1	0.0	
5	ELEMENT	2	BH1	THX1	EIGV	1	0.0	
6	ELEMENT	2	BH1	THY1	EIGV	1	0.0	
7	ELEMENT	2	BH1	THZ1	EIGV	1	-1.0000D+00	
8	ELEMENT	2	BH1	X2	EIGV	1	0.0	
9	ELEMENT	2	BH1	Y2	EIGV	1	-3.7454D-01	
10	ELEMENT	2	BH1	Z2	EIGV	1	0.0	
11	ELEMENT	2	BH1	THX2	EIGV	1	0.0	
12	ELEMENT	2	BH1	THY2	EIGV	1	0.0	
13	ELEMENT	2	BH1	THZ2	EIGV	1	-8.0902D-01	
14	ELEMENT	3	BH1	X1	EIGV	1	0.0	
15	ELEMENT	3	BH1	Y1	EIGV	1	-3.7454D-01	
16	ELEMENT	3	BH1	Z1	EIGV	1	0.0	
17	ELEMENT	3	BH1	THX1	EIGV	1	0.0	
18	ELEMENT	3	BH1	THY1	EIGV	1	0.0	
19	ELEMENT	3	BH1	THZ1	EIGV	1	-8.0902D-01	
20	ELEMENT	3	BH1	X2	EIGV	1	0.0	
21	ELEMENT	3	BH1	Y2	EIGV	1	-6.0601D-01	
22	ELEMENT	3	BH1	Z2	EIGV	1	0.0	
23	ELEMENT	3	BH1	THX2	EIGV	1	0.0	
24	ELEMENT	3	BH1	THY2	EIGV	1	0.0	
25	ELEMENT	3	BH1	THZ2	EIGV	1	-3.0902D-01	
26	ELEMENT	4	BH1	X1	EIGV	1	0.0	
27	ELEMENT	4	BH1	Y1	EIGV	1	-6.0601D-01	
28	ELEMENT	4	BH1	Z1	EIGV	1	0.0	
29	ELEMENT	4	BH1	THX1	EIGV	1	0.0	
30	ELEMENT	4	BH1	THY1	EIGV	1	0.0	
31	ELEMENT	4	BH1	THZ1	EIGV	1	-3.0902D-01	
32	ELEMENT	4	BH1	X2	EIGV	1	0.0	
33	ELEMENT	4	BH1	Y2	EIGV	1	-6.0601D-01	
34	ELEMENT	4	BH1	Z2	EIGV	1	0.0	
35	ELEMENT	4	BH1	THX2	EIGV	1	0.0	
36	ELEMENT	4	BH1	THY2	EIGV	1	0.0	
37	ELEMENT	4	BH1	THZ2	EIGV	1	3.0902D-01	
38	ELEMENT	5	BH1	X1	EIGV	1	0.0	
39	ELEMENT	5	BH1	Y1	EIGV	1	-6.0601D-01	
40	ELEMENT	5	BH1	Z1	EIGV	1	0.0	
41	ELEMENT	5	BH1	THX1	EIGV	1	0.0	
42	ELEMENT	5	BH1	THY1	EIGV	1	0.0	
43	ELEMENT	5	BH1	THZ1	EIGV	1	3.0902D-01	
44	ELEMENT	5	BH1	X2	EIGV	1	0.0	
45	ELEMENT	5	BH1	Y2	EIGV	1	-3.7454D-01	
46	ELEMENT	5	BH1	Z2	EIGV	1	0.0	
47	ELEMENT	5	BH1	THX2	EIGV	1	0.0	
48	ELEMENT	5	BH1	THY2	EIGV	1	0.0	
49	ELEMENT	5	BH1	THZ2	EIGV	1	8.0902D-01	
50	ELEMENT	6	BH1	X1	EIGV	1	0.0	
51	ELEMENT	6	BH1	Y1	EIGV	1	-3.7454D-01	
52	ELEMENT	6	BH1	Z1	EIGV	1	0.0	
53	ELEMENT	6	BH1	THX1	EIGV	1	0.0	
54	ELEMENT	6	BH1	THY1	EIGV	1	0.0	
55	ELEMENT	6	BH1	THZ1	EIGV	1	8.0902D-01	

FIELD
EIGENVALUE 1

PART OF
EIGENVECTOR 1

(a) Real Eigensolution EG1

Figure 19. Base Program Coordinate Responses.

NUMBER	②	OUTPUT COORDINATES				VALUE	FIELD
①		③	④	⑤	⑥	⑦	
1	ELEMENT			FREQ	EIGV	1	1.02490+00
2	ELEMENT			DAMP	EIGV	1	4.41310-01
3	ELEMENT	1	RE2	QFT1	REAL	1	1.00000+00
4	ELEMENT	1	RE2	QFT1	IMAG	1	0.0
5	ELEMENT	1	RE2	QFT2	REAL	1	-4.12690-01
6	ELEMENT	1	RE2	QFT2	IMAG	1	-2.50380-03
7	ELEMENT	1	RE2	BETA	REAL	1	1.13820-01
8	ELEMENT	1	RE2	BETA	IMAG	1	-5.11990-02
9	ELEMENT	1	RE2	GAHA	REAL	1	-9.74920-01
10	ELEMENT	1	RE2	GAHA	IMAG	1	-1.51540-01
11	ELEMENT	1	RE2	QT19	REAL	1	-4.87260-04
12	ELEMENT	1	RE2	QT19	IMAG	1	-2.68270-04
13	ELEMENT	1	RE2	QT1C	REAL	1	1.86340-04
14	ELEMENT	1	RE2	QT1C	IMAG	1	-1.49240-04
15	ELEMENT	1	RE2	QT23	REAL	1	2.46100-04
16	ELEMENT	1	RE2	QT23	IMAG	1	9.42950-05
17	ELEMENT	1	RE2	QT2C	REAL	1	-2.00480-05
18	ELEMENT	1	RE2	QT2C	IMAG	1	1.17200-05
19	ELEMENT	1	RE2	BETS	REAL	1	-4.86720-05
20	ELEMENT	1	RE2	BETS	IMAG	1	-8.80940-05
21	ELEMENT	1	RE2	BETC	REAL	1	-4.88130-06
22	ELEMENT	1	RE2	BETC	IMAG	1	-7.07570-05
23	ELEMENT	1	RE2	GAHS	REAL	1	4.56760-05
24	ELEMENT	1	RE2	GAHS	IMAG	1	4.59920-06
25	ELEMENT	1	RE2	GAHC	REAL	1	-1.56600-05
26	ELEMENT	1	RE2	GAHC	IMAG	1	3.88610-05
27	ELEMENT	1	RE2	X	REAL	1	4.06030-03
28	ELEMENT	1	RE2	X	IMAG	1	-2.69110-03
29	ELEMENT	1	RE2	Y	REAL	1	1.70120-07
30	ELEMENT	1	RE2	Y	IMAG	1	1.62380-06
31	ELEMENT	1	RE2	Z	REAL	1	2.33760-03
32	ELEMENT	1	RE2	Z	IMAG	1	-1.54920-03
33	ELEMENT	1	RE2	THTX	REAL	1	-1.04870-09
34	ELEMENT	1	RE2	THTX	IMAG	1	-1.65870-08
35	ELEMENT	1	RE2	THTY	REAL	1	-1.09740-04
36	ELEMENT	1	RE2	THTY	IMAG	1	7.26180-05
37	ELEMENT	1	RE2	THTZ	REAL	1	0.0
38	ELEMENT	1	RE2	THTZ	IMAG	1	0.0
39	ELEMENT	2	MS1	MODE	REAL	1	-6.26270-08
40	ELEMENT	2	MS1	MODE	IMAG	1	-7.14470-07
41	ELEMENT	3	MS1	MODE	REAL	1	-1.76510-06
42	ELEMENT	3	MS1	MODE	IMAG	1	1.20170-06
43	ELEMENT	4	MS1	MODE	REAL	1	3.55420-03
44	ELEMENT	4	MS1	MODE	IMAG	1	-2.35830-03
45	ELEMENT	5	MS1	MODE	REAL	1	-5.74970-08
46	ELEMENT	5	MS1	MODE	IMAG	1	-9.09360-07
47	ELEMENT	6	MS1	MODE	REAL	1	1.62670-03
48	ELEMENT	6	MS1	MODE	IMAG	1	-1.07760-03
49	ELEMENT			FREQ	EIGV	2	1.31240+00
50	ELEMENT			DAMP	EIGV	2	8.92760-01
51	ELEMENT	1	RE2	QFT1	REAL	2	1.09510-03
52	ELEMENT	1	RE2	QFT1	IMAG	2	-1.10530-03
53	ELEMENT	1	RE2	QFT2	REAL	2	-7.22660-05
54	ELEMENT	1	RE2	QFT2	IMAG	2	4.23460-05
55	ELEMENT	1	RE2	BETA	REAL	2	1.11240-04

EIGENVALUE 1

EIGENVECTOR 1

EIGENVALUE 2

EIGENVECTOR 2

(b) Complex Eigensolution EG2

Figure 19. Continued.

NUMBER		OUTPUT COORDINATES				VALUE	
①	②	③	④	⑤	⑥	⑦	← FIELD
1	ELEMENT	1	MS1	MODE	AMPLITUD	5.3449D-01	
2	ELEMENT	1	MS1	MODE	PHASE	1.3677D+02	
3	ELEMENT	2	MS1	MODE	AMPLITUD	3.1676D-03	
4	ELEMENT	2	MS1	MODE	PHASE	-5.4071D+01	
5	ELEMENT	3	MS1	MODE	AMPLITUD	2.1233D-02	
6	ELEMENT	3	MS1	MODE	PHASE	-4.9433D+01	
7	ELEMENT	4	MS1	MODE	AMPLITUD	5.1216D-03	
8	ELEMENT	4	MS1	MODE	PHASE	1.3604D+02	
9	ELEMENT	7	RE3	X	AMPLITUD	5.3430D-01	
10	ELEMENT	7	RE3	X	PHASE	1.3677D+02	
11	ELEMENT	7	RE3	Y	AMPLITUD	1.4041D-02	
12	ELEMENT	7	RE3	Y	PHASE	-5.4834D+01	
13	ELEMENT	7	RE3	Z	AMPLITUD	1.2847D-01	
14	ELEMENT	7	RE3	Z	PHASE	-4.3244D+01	
15	ELEMENT	7	RE3	WX	AMPLITUD	0.0	
16	ELEMENT	7	RE3	WX	PHASE	0.0	
17	ELEMENT	7	RE3	WY	AMPLITUD	0.0	
18	ELEMENT	7	RE3	WY	PHASE	0.0	
19	ELEMENT	7	RE3	WZ	AMPLITUD	0.0	
20	ELEMENT	7	RE3	WZ	PHASE	0.0	
21	ELEMENT	9	GF1	X	AMPLITUD	5.3430D-01	
22	ELEMENT	9	GF1	X	PHASE	1.3677D+02	
23	ELEMENT	9	GF1	Y	AMPLITUD	1.4041D-02	
24	ELEMENT	9	GF1	Y	PHASE	-5.4834D+01	
25	ELEMENT	9	GF1	Z	AMPLITUD	1.2847D-01	
26	ELEMENT	9	GF1	Z	PHASE	-4.3244D+01	
27	ELEMENT	9	GF1	THTX	AMPLITUD	0.0	
28	ELEMENT	9	GF1	THTX	PHASE	0.0	
29	ELEMENT	9	GF1	THTY	AMPLITUD	0.0	
30	ELEMENT	9	GF1	THTY	PHASE	0.0	
31	ELEMENT	9	GF1	THTZ	AMPLITUD	0.0	
32	ELEMENT	9	GF1	THTZ	PHASE	0.0	

(c) Forced Response Solution FR1

Figure 19. Continued.

NUMBER		OUTPUT COORDINATES				VALUE	
①	②	③	④	⑤	⑥	⑦	← FIELD
1	ELEMENT			TIME	SEC	0.0	
2	ELEMENT	1	FA1	DELT	DISPMENT	1.0000D-02	
3	ELEMENT	1	FA1	X	DISPMENT	2.0000D-02	
4	ELEMENT	1	FA1	Y	DISPMENT	0.0	
5	ELEMENT	1	FA1	Z	DISPMENT	0.0	
6	ELEMENT	1	FA1	THTX	DISPMENT	0.0	
7	ELEMENT	1	FA1	THTY	DISPMENT	0.0	
8	ELEMENT	1	FA1	THTZ	DISPMENT	0.0	
9	ELEMENT	2	GF1	X	DISPMENT	2.0000D-02	
10	ELEMENT	2	GF1	Y	DISPMENT	0.0	
11	ELEMENT	2	GF1	Z	DISPMENT	0.0	
12	ELEMENT	2	GF1	THTX	DISPMENT	0.0	
13	ELEMENT	2	GF1	THTY	DISPMENT	0.0	
14	ELEMENT	2	GF1	THTZ	DISPMENT	0.0	
15	ELEMENT	4	MS1	MODE	DISPMENT	2.0000D-02	

(d) Time History Solution TH1

***** STATISTICS *****

PRESENT SIZE OF WORKING STORAGE (MAXSIZ) IS 1887 WORDS.

} INTERMEDIATE CASE

***** STATISTICS *****

FINAL SIZE OF WORKING STORAGE (MAXSIZ) IS 2161 WORDS.

} FINAL CASE

(e) Present and Final Size of Computer Storage

Figure 19. Continued.

SIMVIB TEST RUN
FIXED ABSORBER TIME HISTORY RESPONSE
1 MODE SHAPE - FX FORCE (COS & SIN)

TIME (SEC)	0.1200				
6.1	15.1	0.1200			
-1.1	TIMESEC				
-2.1	1FA1 DELTDISPMT				
-3.1	1FA1 X DISPMT				
4.1	1FA1 Y DISPMT				
5.1	1FA1 Z DISPMT				
6.1	1FA1 THYDISPMT				
7.1	1FA1 THYDISPMT				
8.1	1FA1 THYDISPMT				
-9.1	2GF1 X DISPMT				
10.1	2GF1 Y DISPMT				
11.1	2GF1 Z DISPMT				
12.1	2GF1 THYDISPMT				
13.1	2GF1 THYDISPMT				
14.1	2GF1 THYDISPMT				
-15.1	4MS1 MODEDISPMT				
1.1	0.0				
0.0	1.0000D-02	2.0000D-02	0.0	0.0	
0.0	0.0	0.0	2.0000D-02	0.0	
0.0	0.0	0.0	0.0	2.0000D-02	
2.1	1.0000D-02				
1.0000D-02	1.1826D-02	2.4895D-02	0.0	0.0	
0.0	0.0	0.0	2.4895D-02	0.0	
0.0	0.0	0.0	0.0	2.4895D-02	
3.1	2.0000D-02				
2.0000D-02	1.7906D-02	3.9094D-02	0.0	0.0	
0.0	0.0	0.0	3.9094D-02	0.0	
0.0	0.0	0.0	0.0	3.9094D-02	
4.1	3.0000D-02				
3.0000D-02	3.0247D-02	5.9470D-02	0.0	0.0	
0.0	0.0	0.0	5.9470D-02	0.0	
0.0	0.0	0.0	0.0	5.9470D-02	
5.1	4.0000D-02				
4.0000D-02	5.0176D-02	8.1861D-02	0.0	0.0	
0.0	0.0	0.0	8.1861D-02	0.0	
0.0	0.0	0.0	0.0	8.1861D-02	
6.1	5.0000D-02				
5.0000D-02	7.7225D-02	1.0243D-01	0.0	0.0	
0.0	0.0	0.0	1.0243D-01	0.0	
0.0	0.0	0.0	0.0	1.0243D-01	

TIME	DELT	FA1 X	GF1 X	MS1	← OUTPUT COORDINATE	NAME
(1)	(2)	(3)	(9)	(15)	← " "	NUMBER

(f) Sample Output for Plotting

Figure 19. Continued.

SIMUIB TEST RUN
 FIXED ABSORBER TIME HISTORY RESPONSE
 1 MODE SHAPE - FX FORCE (COS & SIN)

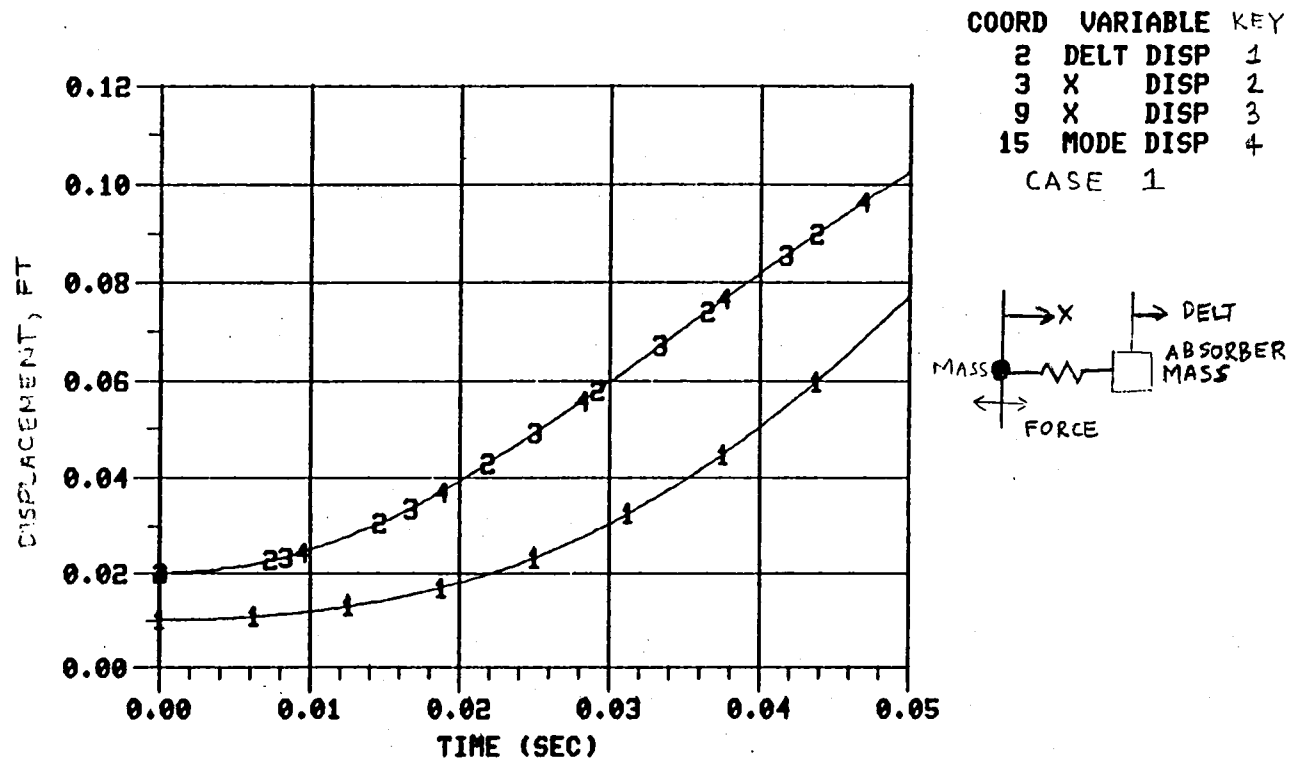

(g) Sample Tektronix Plot.

2	14			
0.0				
1.0000D-02	2.0000D-02	0.0	0.0	
2.0000D-02	0.0	0.0	1.5000D+03	
1.1826D-02	1.8260D-01	1.6260D+01	0.0	
2.4895D-02	4.8950D-01	4.8950D+01	1.5000D+03	
1.0000D-02	2.0000D-02	0.0		
2.0000D-02	0.0	0.0		
0.0	0.0	0.0		
0.0	0.0	0.0		
0.0	0.0	0.0		
0.0	0.0	0.0		
0.0	0.0	0.0		
0.0	0.0	0.0		
0.0	0.0	0.0		
0.0	0.0	0.0		
0.0	0.0	0.0		
0.0	0.0	0.0		
0.0	0.0	0.0		
0.0	0.0	0.0		
2.0000D-02	0.0	0.0		
0.0	0.0	0.0		
0.0	0.0	0.0		
0.0	0.0	0.0		
0.0	0.0	0.0		
0.0	0.0	0.0		
0.0	0.0	0.0		
0.0	0.0	0.0		
2.0000D-02	0.0	0.0		
2	14			
1.0000D-02				
1.0000D-02	2.0000D-02	0.0	0.0	
2.0000D-02	0.0	0.0	1.5000D+03	
1.1826D-02	1.8260D-01	1.6260D+01	0.0	
2.4895D-02	4.8950D-01	4.8950D+01	1.5419D+03	
1.1826D-02	1.8260D-01	1.6260D+01		
2.4895D-02	4.8950D-01	4.8950D+01		
0.0	0.0	0.0		
0.0	0.0	0.0		
0.0	0.0	0.0		
0.0	0.0	0.0		
0.0	0.0	0.0		
0.0	0.0	0.0		
0.0	0.0	0.0		
0.0	0.0	0.0		
0.0	0.0	0.0		
2.4895D-02	4.8950D-01	4.8950D+01		
0.0	0.0	0.0		
0.0	0.0	0.0		
0.0	0.0	0.0		
0.0	0.0	0.0		
0.0	0.0	0.0		
0.0	0.0	0.0		
0.0	0.0	0.0		
2.4895D-02	4.8950D-01	4.8950D+01		
2	14			
2.0000D-02				
1.1826D-02	1.8260D-01	1.6260D+01	0.0	
2.4895D-02	4.8950D-01	4.8950D+01	1.5419D+03	
1.7906D-02	6.0801D-01	4.2542D+01	0.0	
3.9094D-02	1.4199D+00	9.3041D+01	1.3673D+03	
1.7906D-02	6.0801D-01	4.2542D+01		
3.9094D-02	1.4199D+00	9.3041D+01		
0.0	0.0	0.0		
0.0	0.0	0.0		
0.0	0.0	0.0		
0.0	0.0	0.0		
0.0	0.0	0.0		
0.0	0.0	0.0		
0.0	0.0	0.0		
0.0	0.0	0.0		
3.9094D-02	1.4199D+00	9.3041D+01		
0.0	0.0	0.0		
0.0	0.0	0.0		
0.0	0.0	0.0		
0.0	0.0	0.0		
0.0	0.0	0.0		
0.0	0.0	0.0		
0.0	0.0	0.0		
0.0	0.0	0.0		
3.9094D-02	1.4199D+00	9.3041D+01		

(h) Sample Time History Output for Restart.

Figure 19. Continued.

2	14				
3.0000D-02					
1.7906D-02	6.0801D-01	4.2542D+01	0.0		
3.9094D-02	1.4199D+00	9.3041D+01	1.3673D+03		
3.0247D-02	1.2341D+00	6.2610D+01	0.0		
5.9470D-02	2.0376D+00	6.1765D+01	1.0006D+03		
3.0247D-02	1.2341D+00	6.2610D+01			
5.9470D-02	2.0376D+00	6.1765D+01			
0.0	0.0	0.0			
0.0	0.0	0.0			
0.0	0.0	0.0			
0.0	0.0	0.0			
0.0	0.0	0.0			
5.9470D-02	2.0376D+00	6.1765D+01			
0.0	0.0	0.0			
0.0	0.0	0.0			
0.0	0.0	0.0			
0.0	0.0	0.0			
0.0	0.0	0.0			
5.9470D-02	2.0376D+00	6.1765D+01			
2	14				
4.0000D-02					
3.0247D-02	1.2341D+00	6.2610D+01	0.0		
5.9470D-02	2.0376D+00	6.1765D+01	1.0006D+03		
5.0176D-02	1.9928D+00	7.5873D+01	0.0		
8.1861D-02	2.2391D+00	2.0156D+01	4.9340D+02		
5.0176D-02	1.9928D+00	7.5873D+01			
8.1861D-02	2.2391D+00	2.0156D+01			
0.0	0.0	0.0			
0.0	0.0	0.0			
0.0	0.0	0.0			
0.0	0.0	0.0			
0.0	0.0	0.0			
8.1861D-02	2.2391D+00	2.0156D+01			
0.0	0.0	0.0			
0.0	0.0	0.0			
0.0	0.0	0.0			
0.0	0.0	0.0			
0.0	0.0	0.0			
8.1861D-02	2.2391D+00	2.0156D+01			
0.0	0.0	0.0			
0.0	0.0	0.0			
0.0	0.0	0.0			
0.0	0.0	0.0			
0.0	0.0	0.0			
8.1861D-02	2.2391D+00	2.0156D+01			
2	14				
TIME → 5.0000D-02					
5.0176D-02	1.9928D+00	7.5873D+01	0.0	← 1	} NGIND
8.1861D-02	2.2391D+00	2.0156D+01	4.9340D+02	← 2	
7.7225D-02	2.7050D+00	7.1213D+01	0.0		
1.0243D-01	2.0568D+00	-1.8228D+01	-8.3103D+01		
DELTA → 7.7225D-02	2.7050D+00	7.1213D+01			
FAIX → 1.0243D-01	2.0568D+00	-1.8228D+01			
0.0	0.0	0.0			} NG
0.0	0.0	0.0			
0.0	0.0	0.0			
0.0	0.0	0.0			
0.0	0.0	0.0			
0.0	0.0	0.0			
0.0	0.0	0.0			
GFIX → 1.0243D-01	2.0568D+00	-1.8228D+01			
0.0	0.0	0.0			
0.0	0.0	0.0			
0.0	0.0	0.0			
0.0	0.0	0.0			
0.0	0.0	0.0			
0.0	0.0	0.0			
MS1 → 1.0243D-01	2.0568D+00	-1.8228D+01			

(h) Concluded.

Figure 19. Concluded.

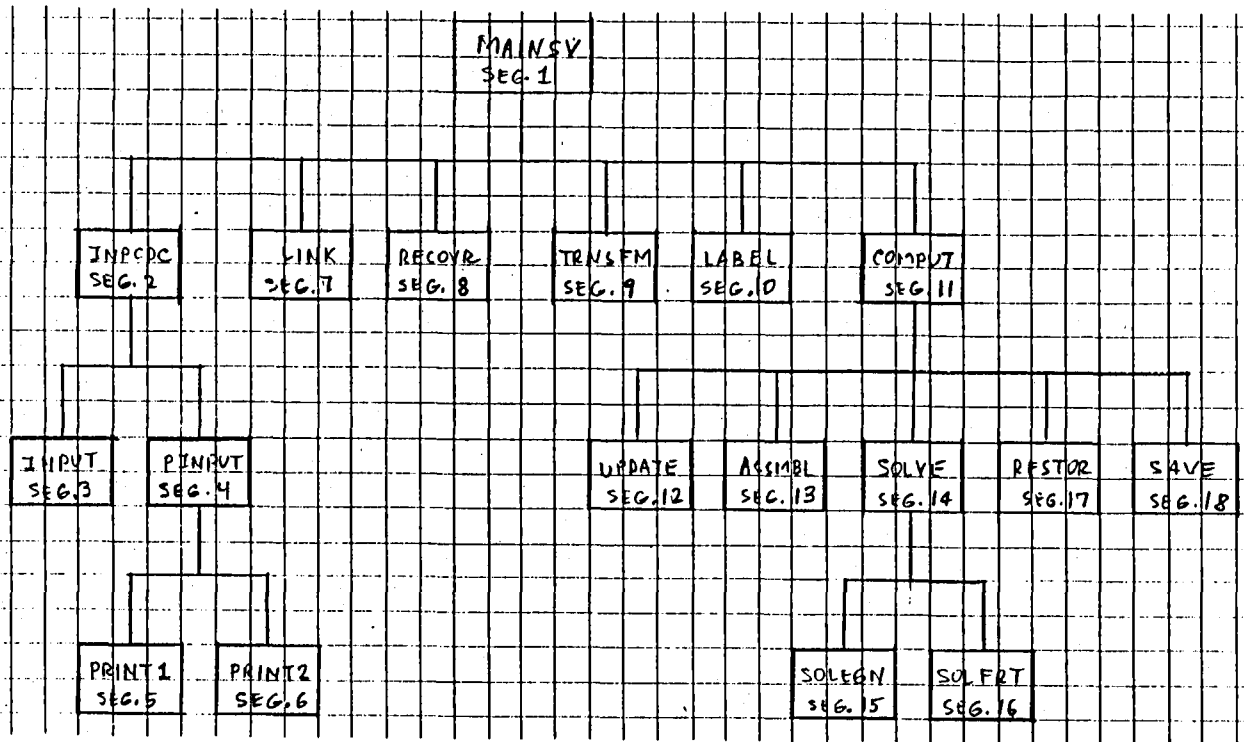

Figure 20. Base Program Segmentation Structure.

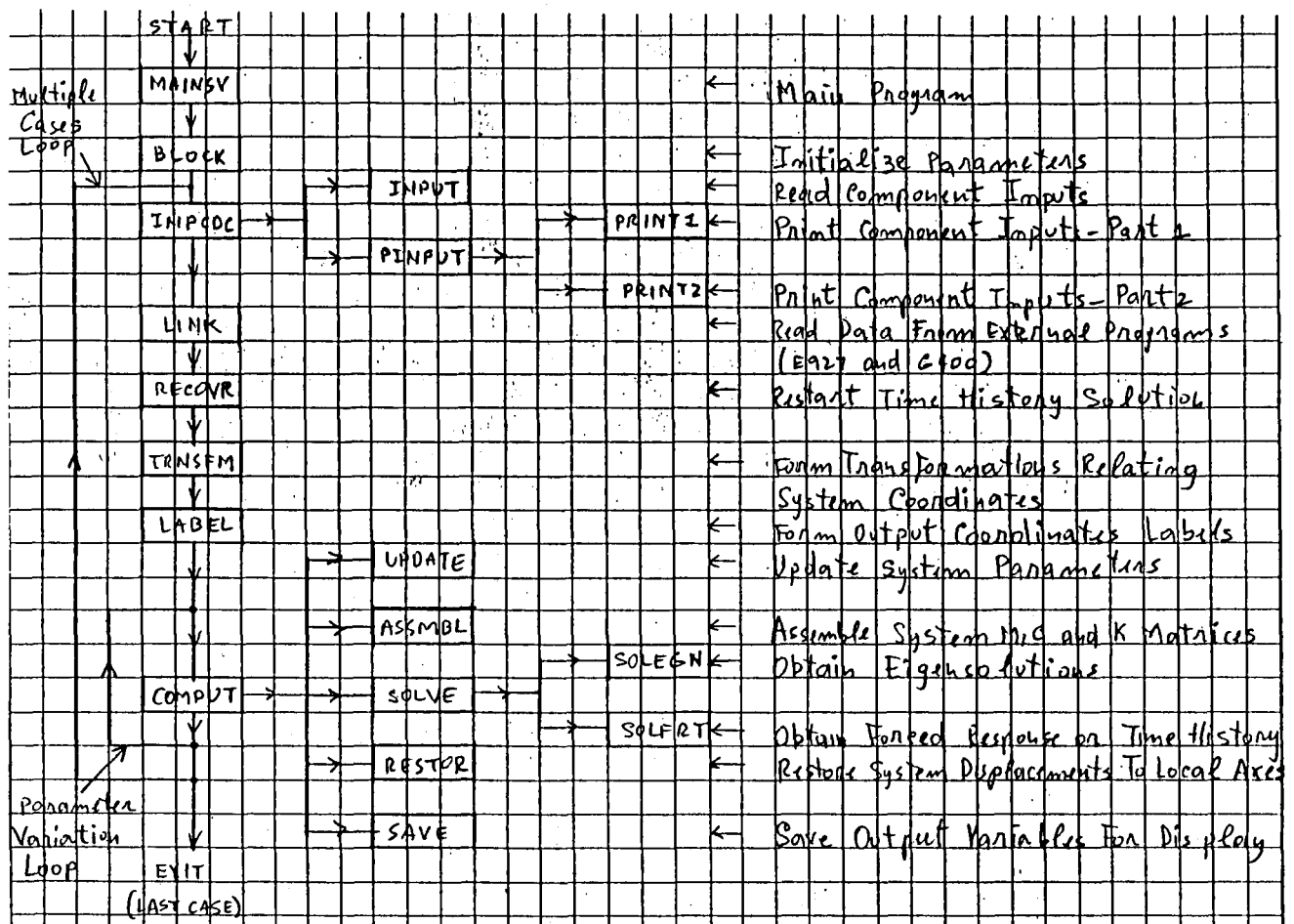

Figure 21. Flow Chart for the Main Program.

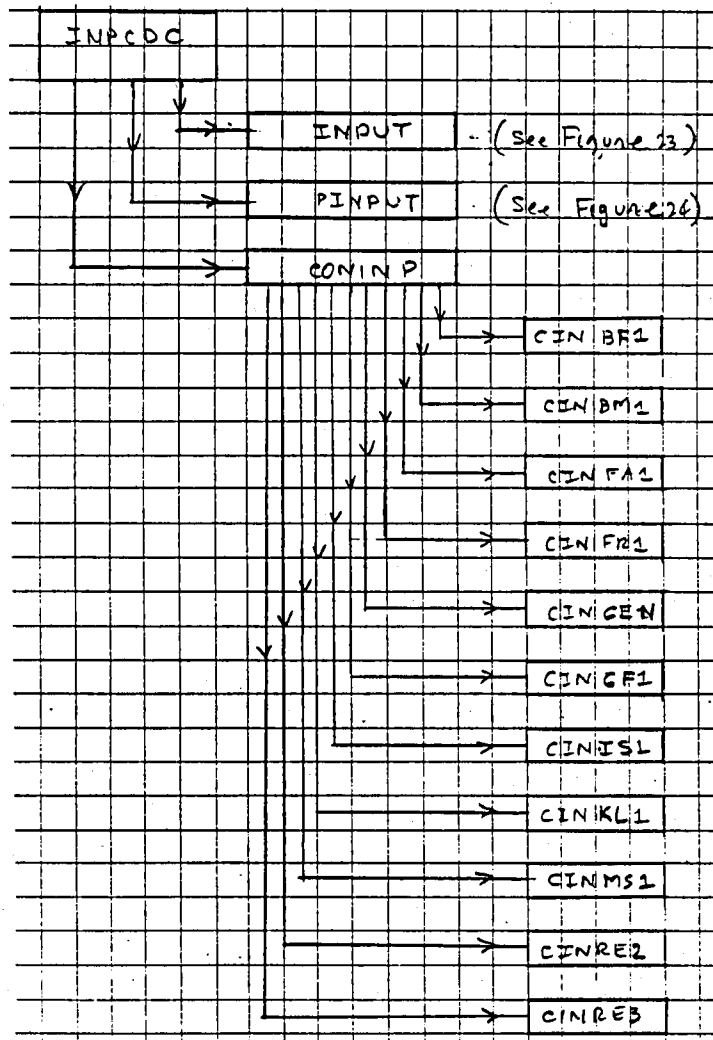

Figure 22. Flow Chart for Subroutine INPCDC.

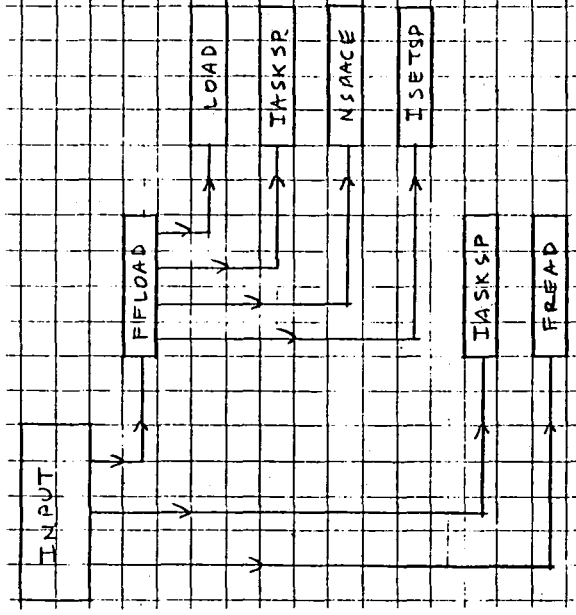

Figure 23. Flow Chart for Subroutine INPUT.

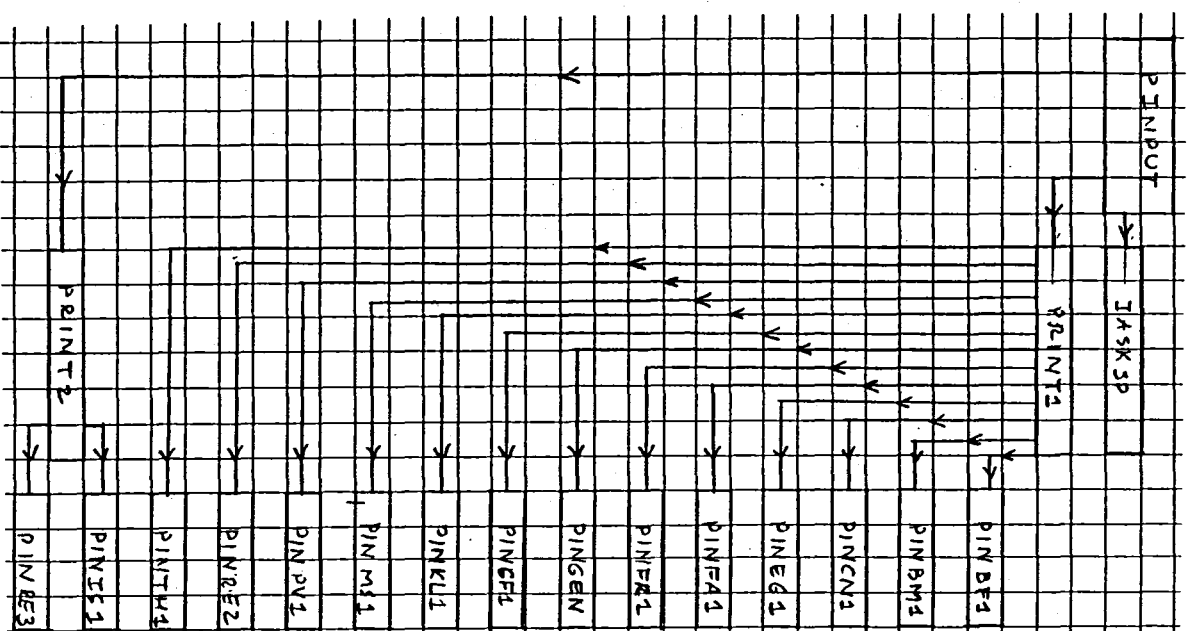

Figure 24. Flow Chart for Subroutine PINPUT.

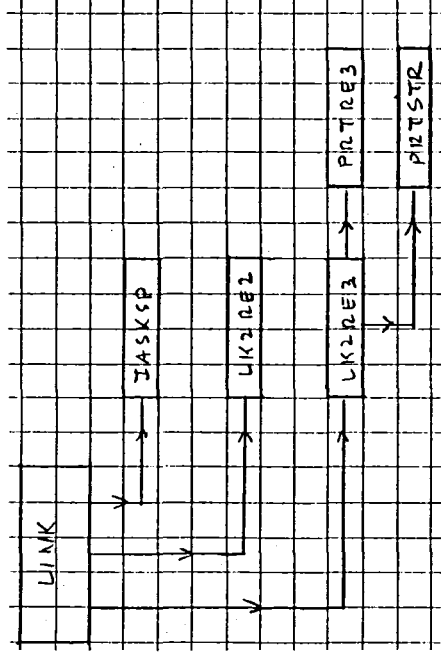

Figure 25. Flow Chart for Subroutine LINK.

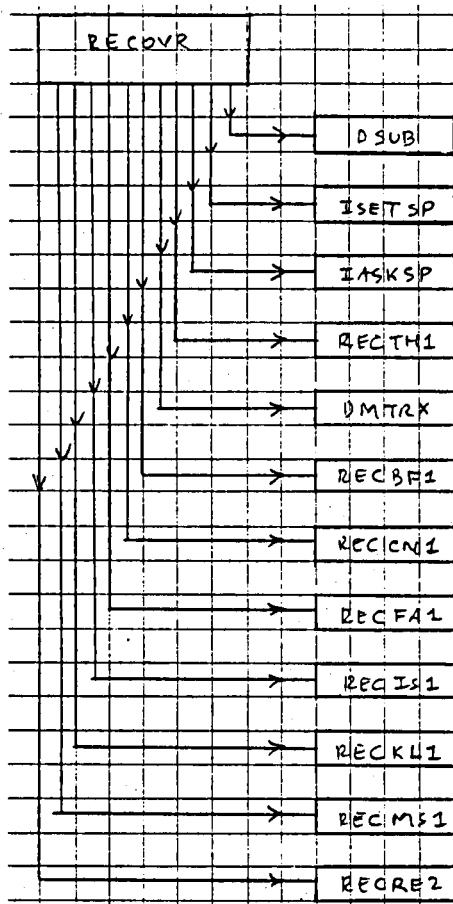

Figure 26. Flow Chart for Subroutine RECOVR.

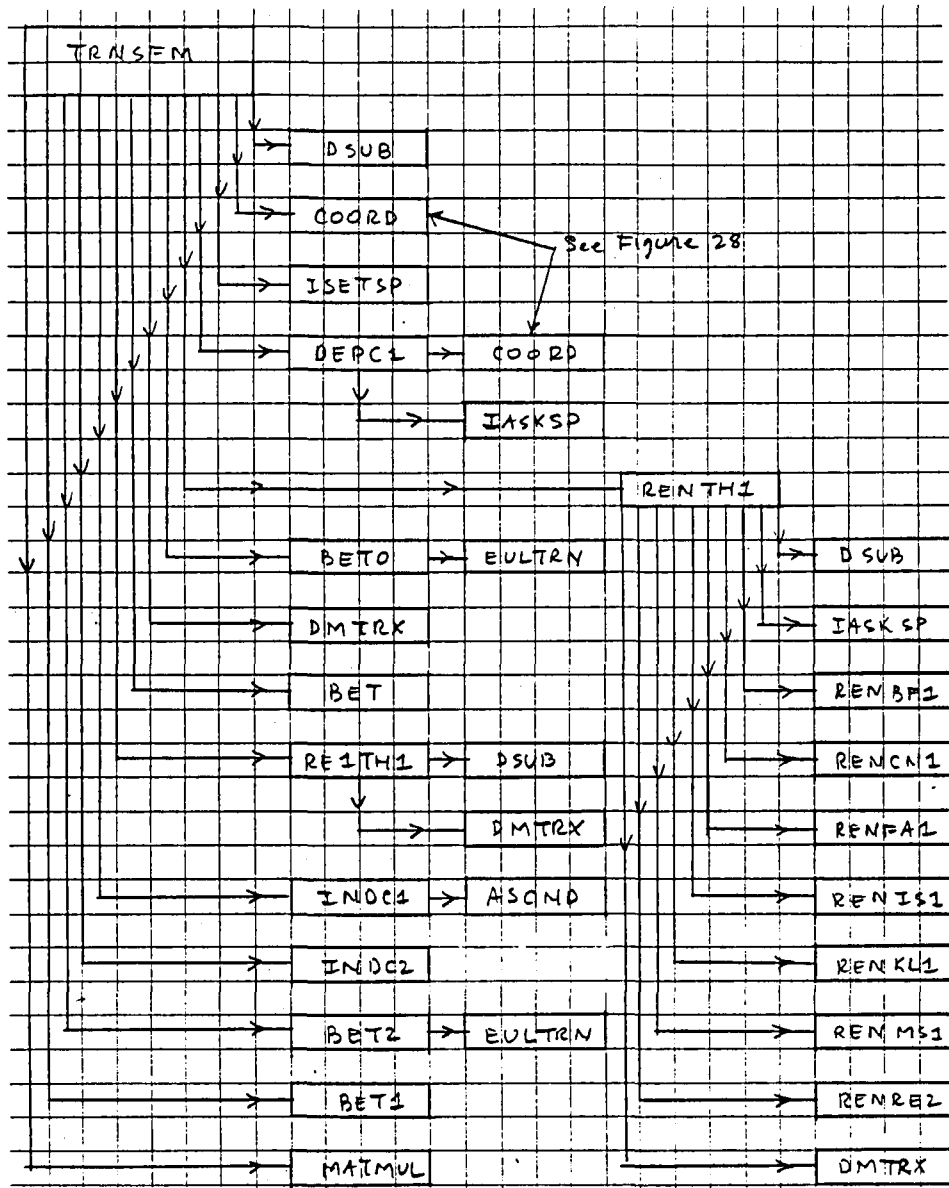

Figure 27. Flow Chart for Subroutine TRNSFM.

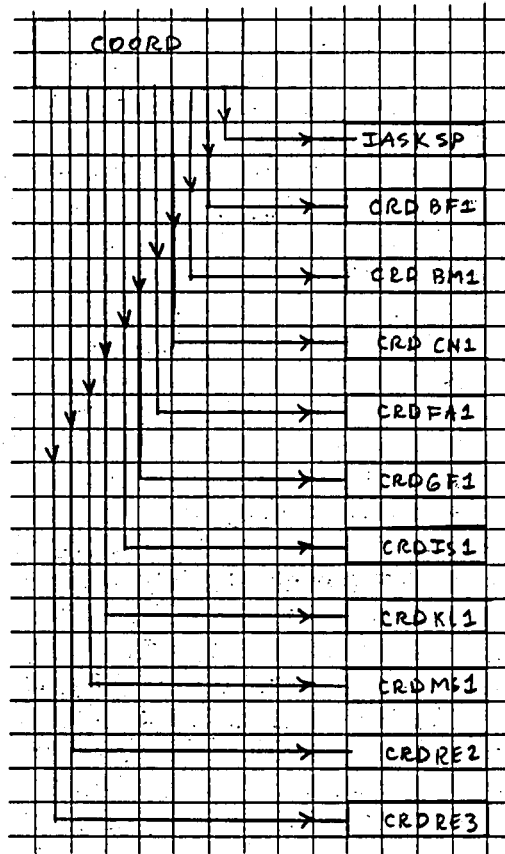

Figure 28. Flow Chart for Subroutine COORD.

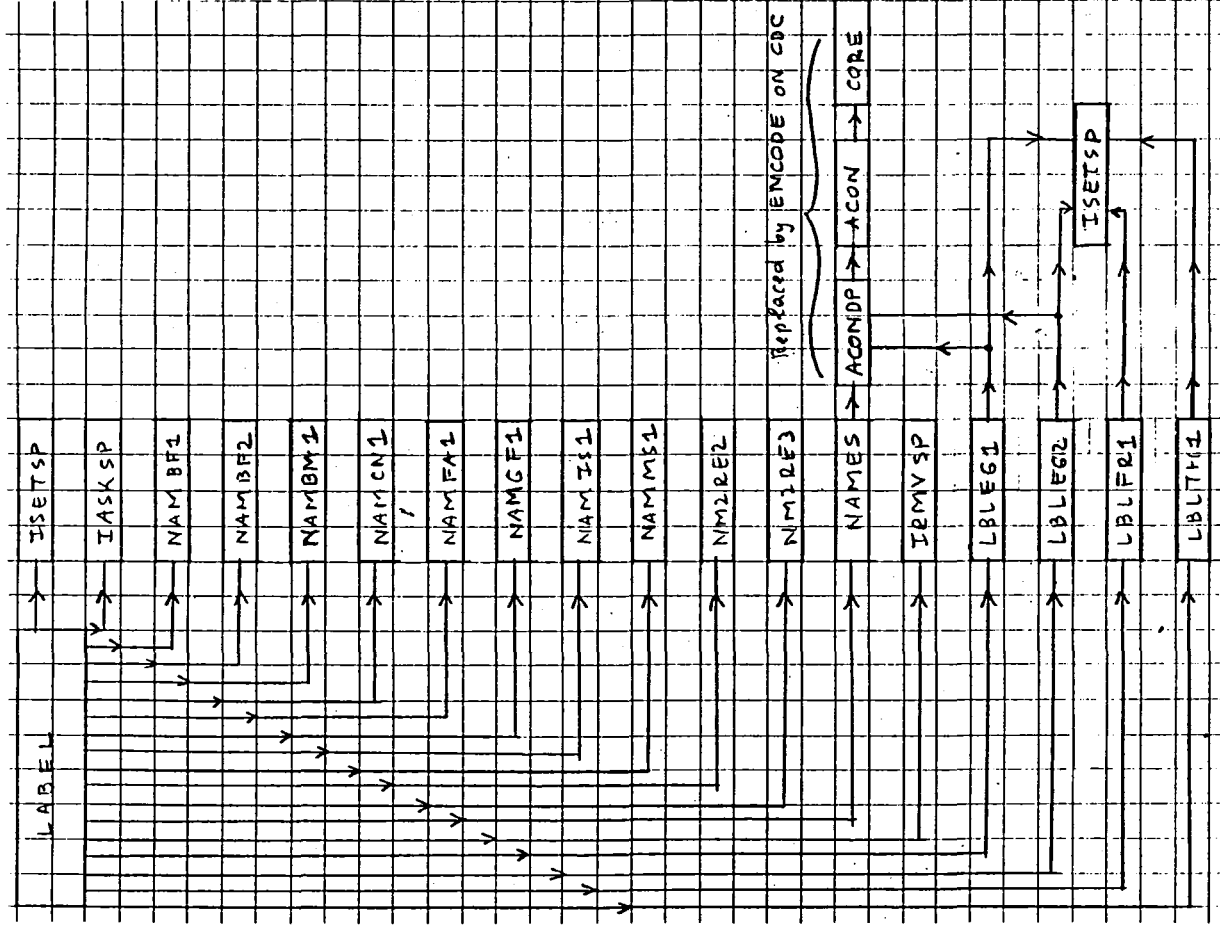

Figure 29. Flow Chart for Subroutine LABEL.

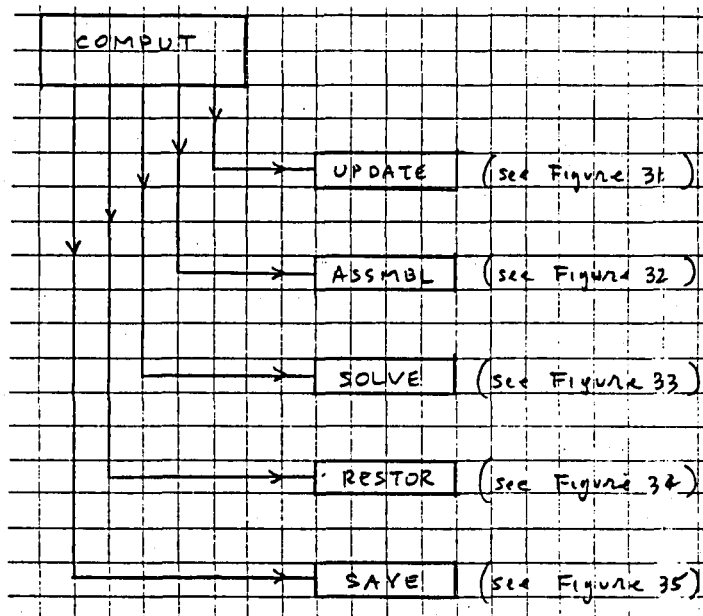

Figure 30. Flow Chart for Subroutine COMPUT.

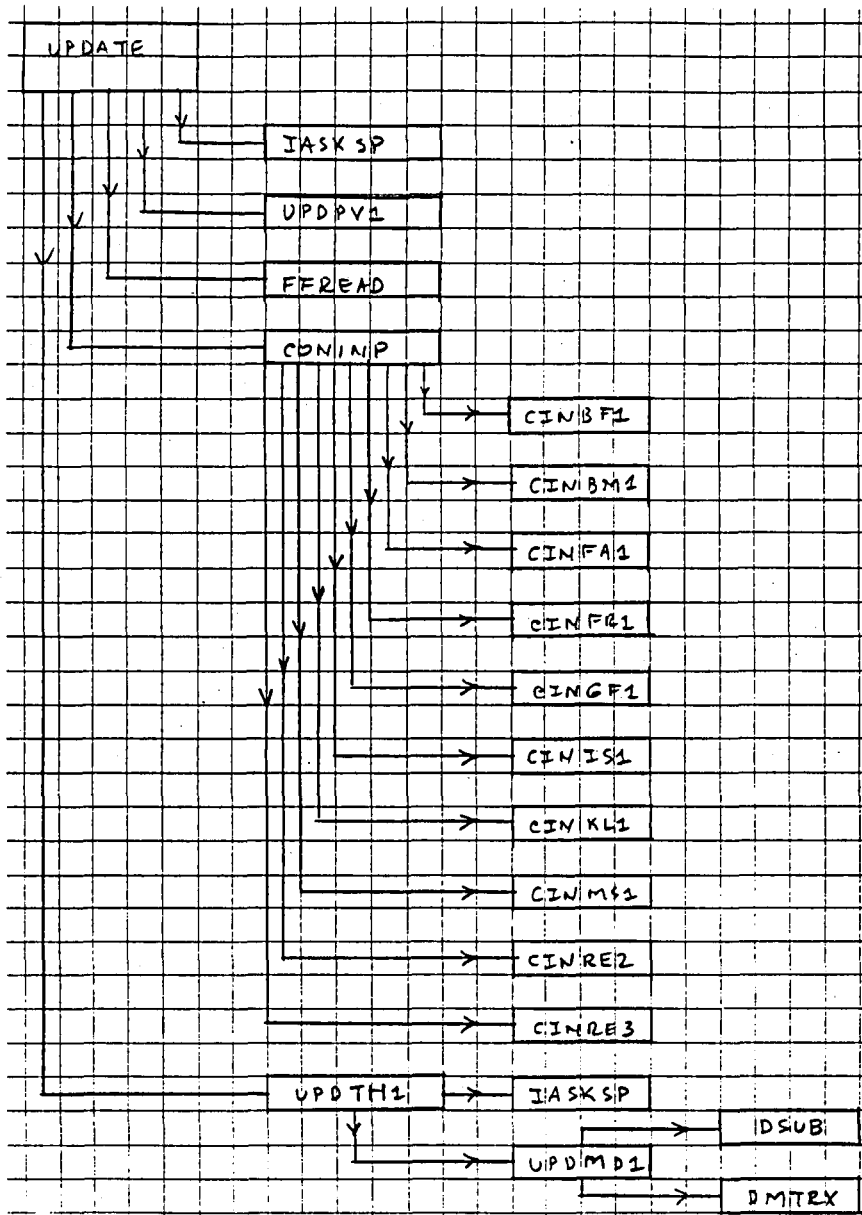

Figure 31. Flow Chart for Subroutine UPDATE.

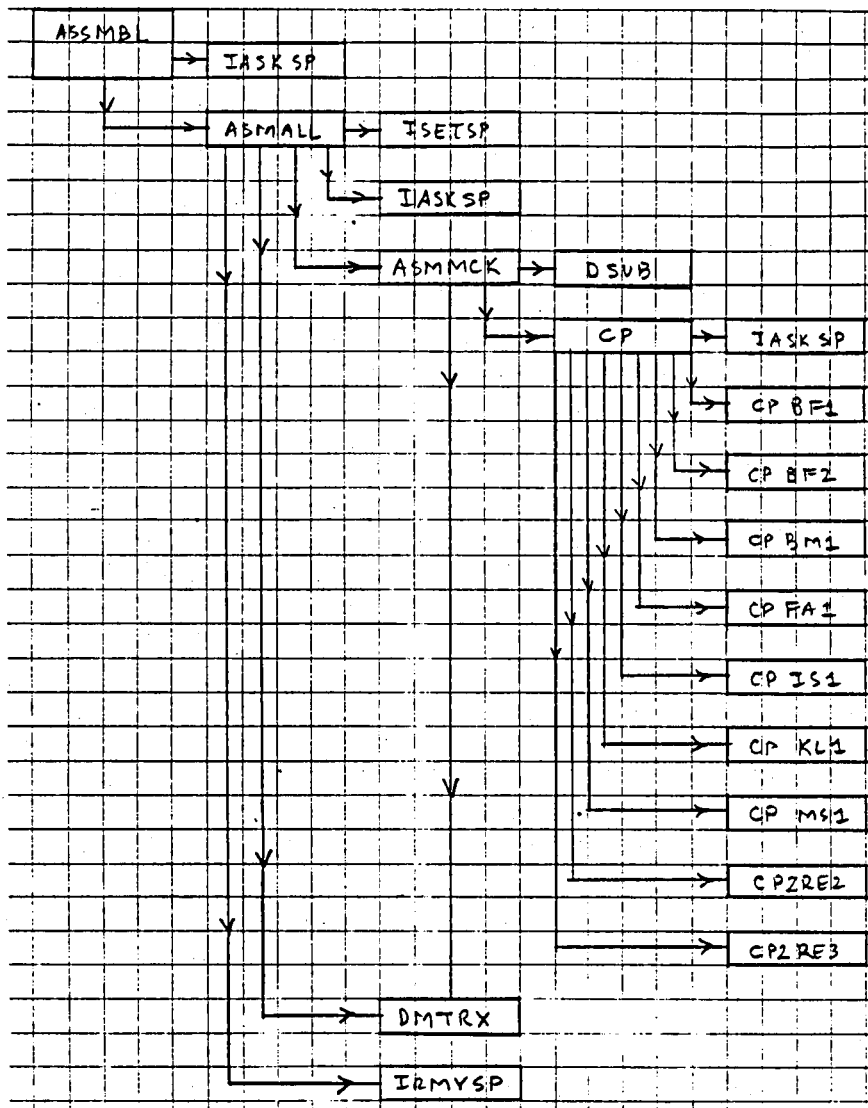

Figure 32. Flow Chart for Subroutine ASSMBL.

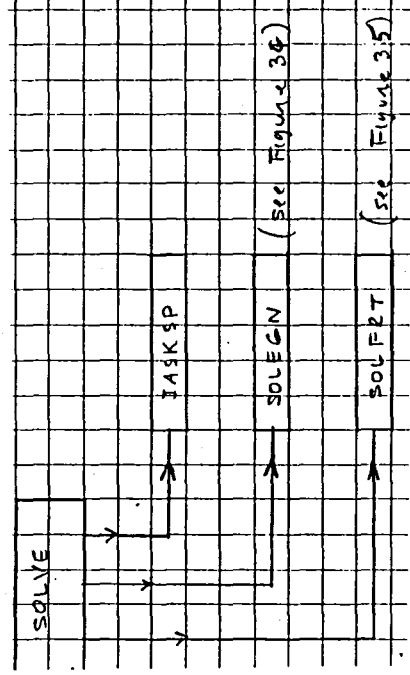

Figure 33. Flow Chart for Subroutine SOLVE.

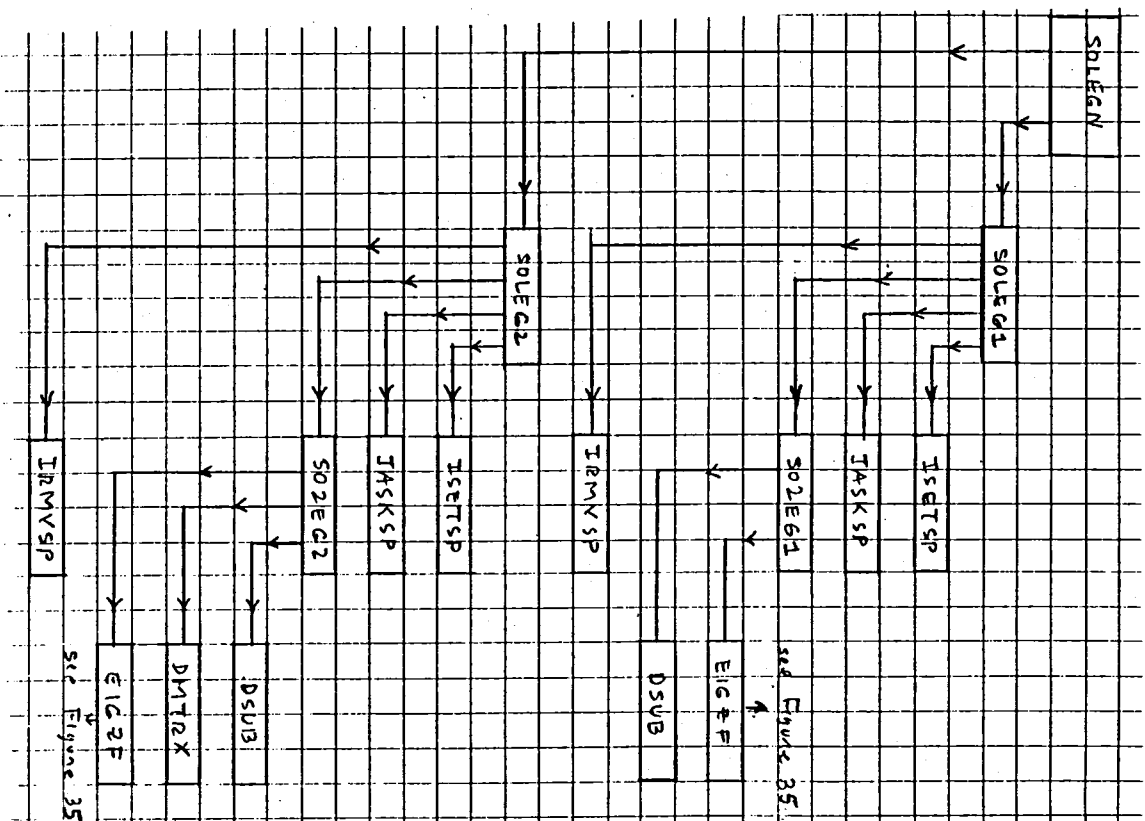

Figure 34. Flow Chart for Subroutine SOLEGN.

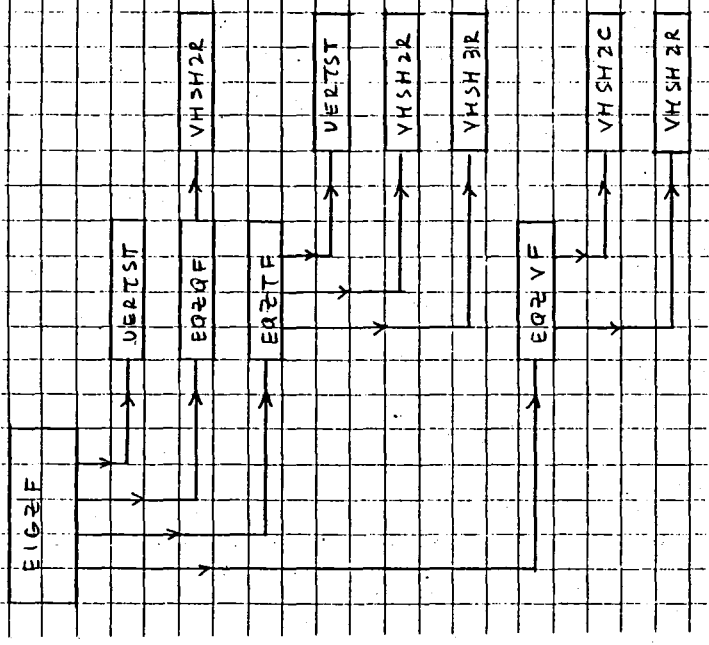

Figure 35. Flow Chart for Subroutine EIGZF.

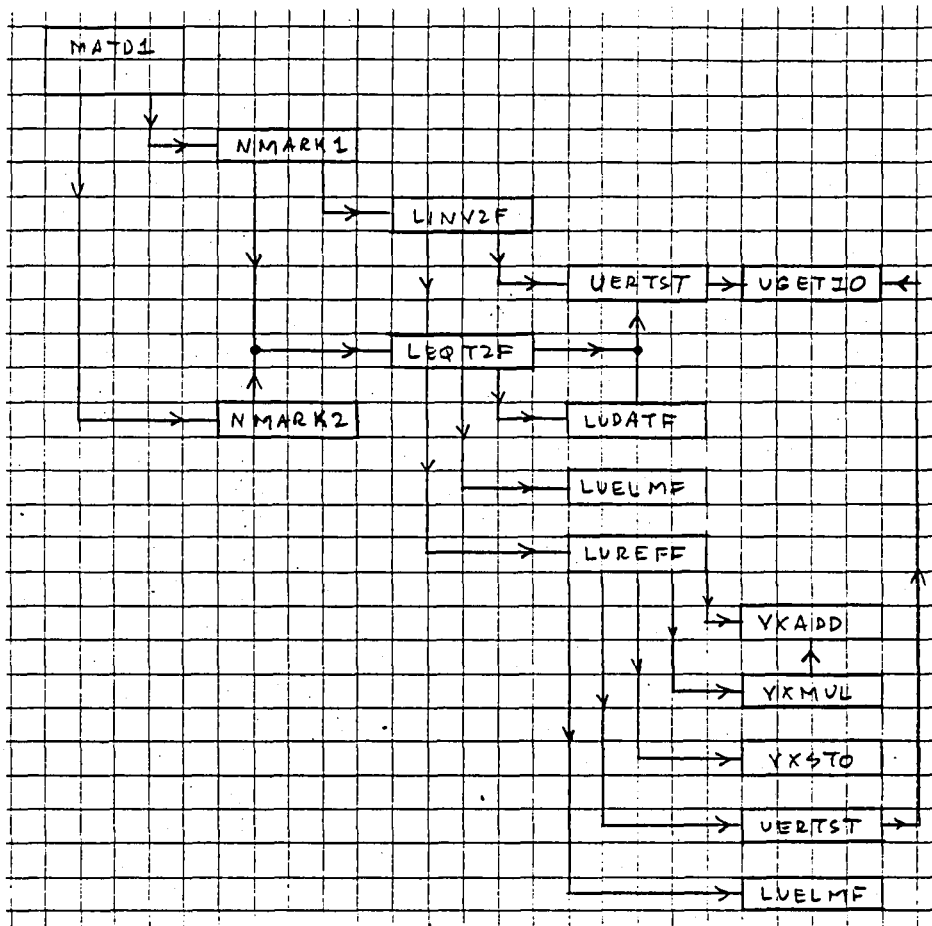

Figure 37. Flow Chart for Subroutine MATD1.

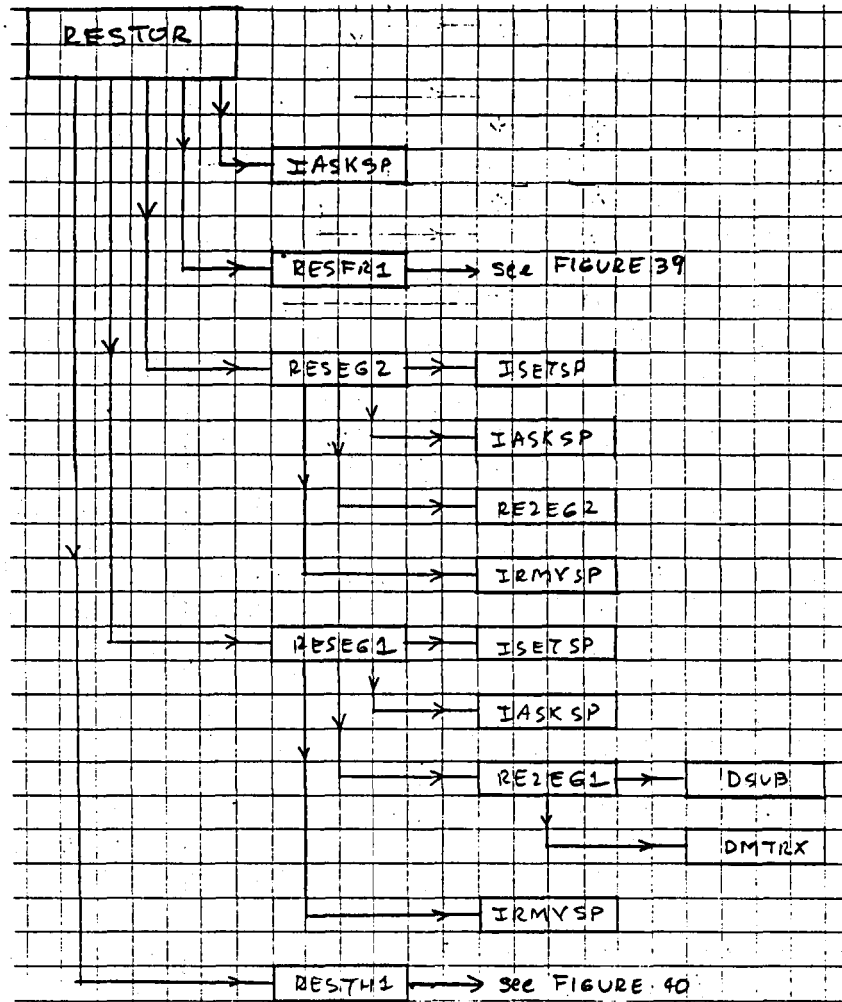

Figure 38. Flow Chart for Subroutine RESTOR.

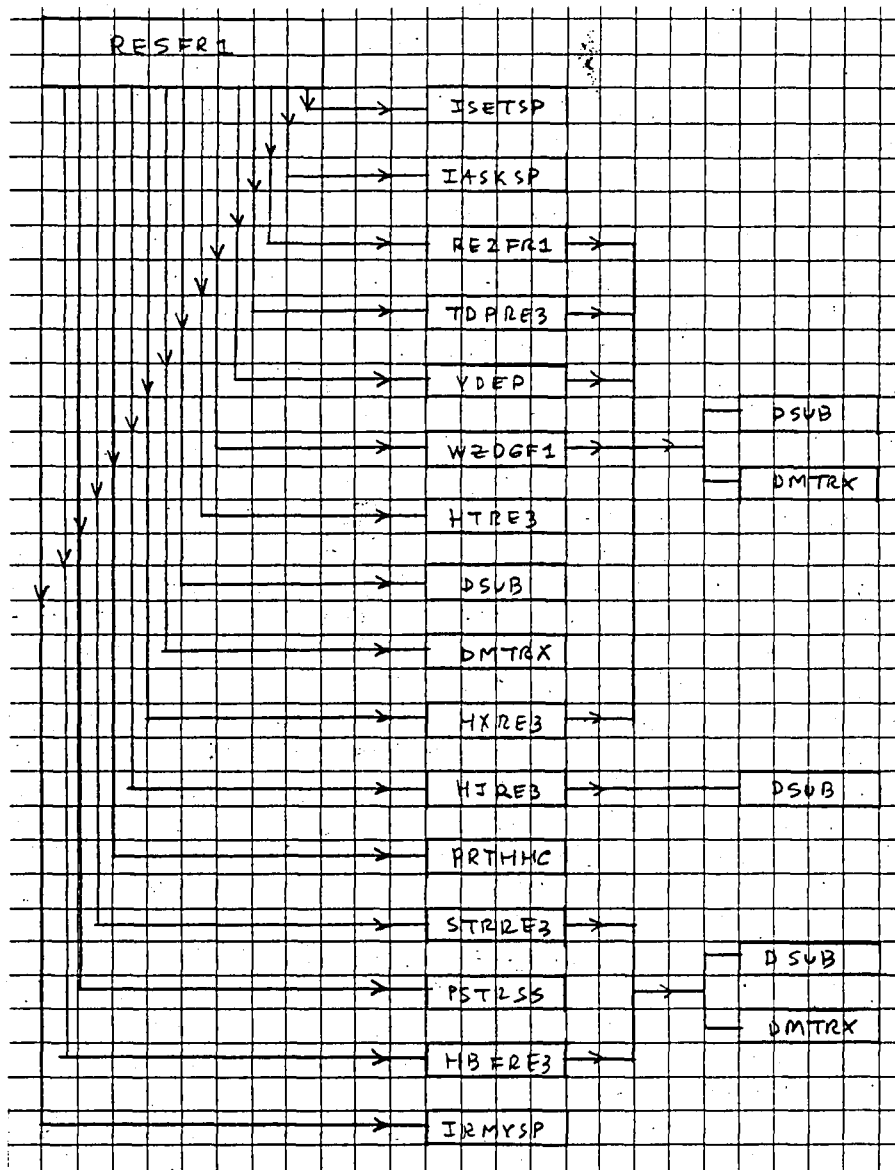

Figure 39. Flow Chart for Subroutine RESFR1.

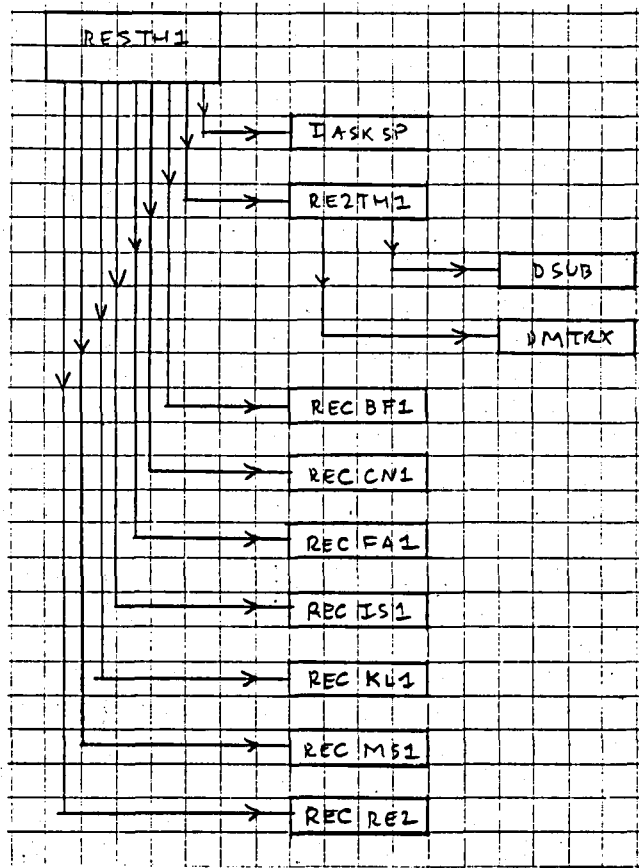

Figure 40. Flow Chart for Subroutine RESTH1.

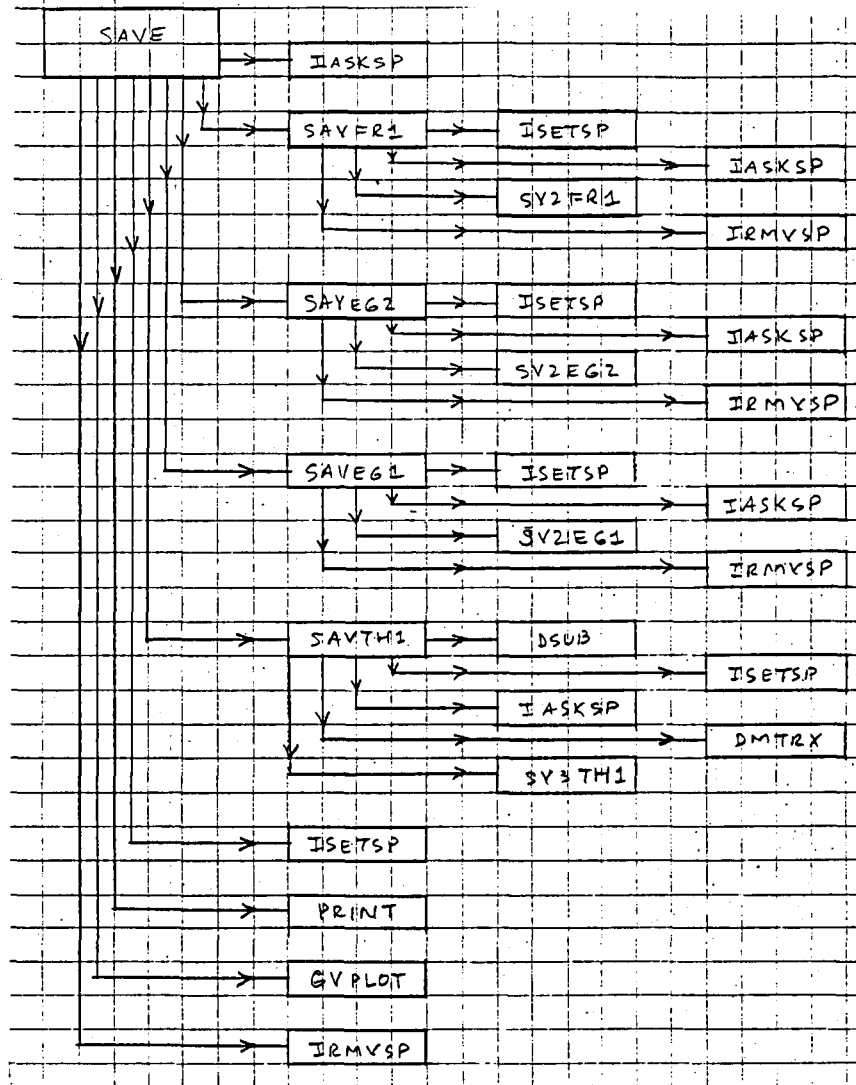

Figure 41. Flow Chart for Subroutine SAVE.

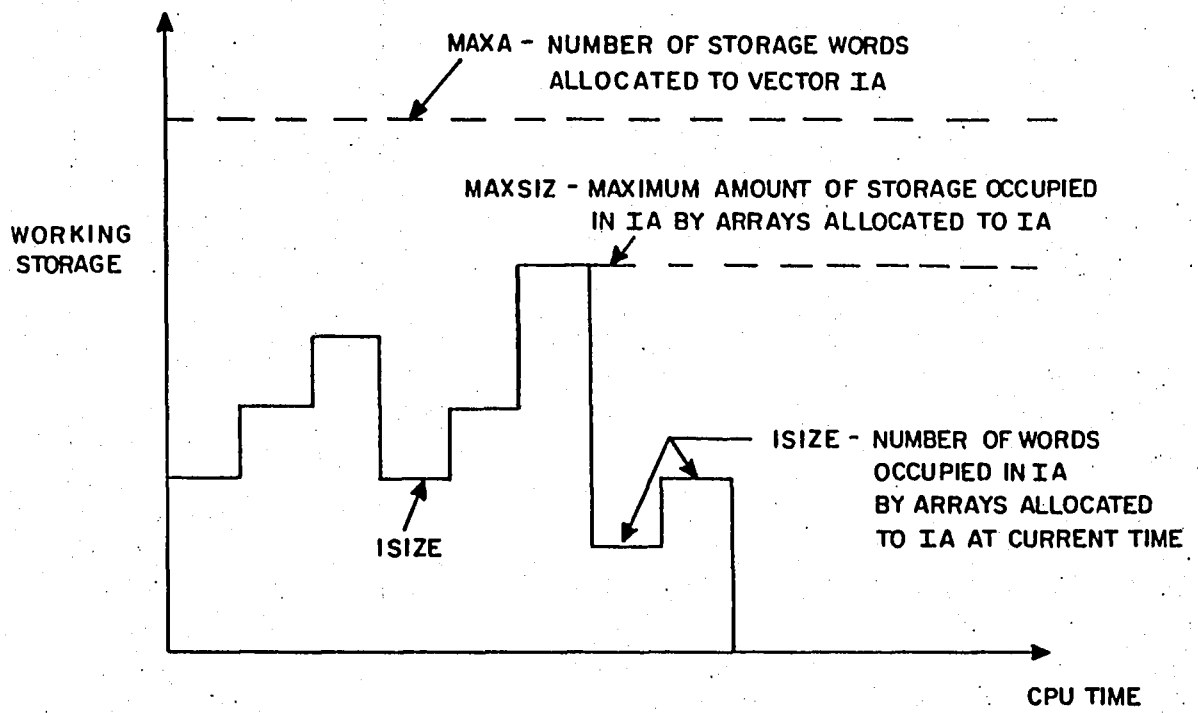

Figure 42. Variation of Working Storage with CPU Time.

START	COL	1	2	3	4	5	6	7	
7		SUBROUTINE CINBF1(V,N)							0001
1	C*	*****0002							0002
1	C*								0003
1	C*	SUBROUTINE NAME : CINBF1							0004
1	C*								0005
1	C*	FUNCTION :							0006
1	C*	CONVERT INPUT							0007
1	C*	FOR INPLANE BIFILARS IF N=1,							0008
1	C*	FOR VERTICAL BIFILARS IF N=2							0009
1	C*								0010
1	C*	*****0011							0011
1	C								0012
7		DIMENSION V(1)							0013
7		DATA RC /57.295780/							0014
1	C								0015
1	C	* INPLANE *	(V(1),XNCN)	(V(2),XN)	(V(3),MB)			0016	
1	C		(V(4),RR)	(V(5),R)	(V(6),ZETGAM)			0017	
1	C		(V(7),OMEGA)	(V(8),THETA)	(V(9),PHI)			0018	
1	C		(V(10),XSI)					0019	
1	C		(V(11),GAMMAC)	(V(12),DGAMMC)				0020	
1	C		(V(13),GAMMAS)	(V(14),DGAMMS)				0021	
1	C	* VERTICAL *	(V(1),XNCN)	(V(2),XN)	(V(3),MB)			0022	
1	C		(V(4),RR)	(V(5),R)	(V(6),ZETBET)			0023	
1	C		(V(7),OMEGA)	(V(8),THETA)	(V(9),PHI)			0024	
1	C		(V(10),XSI)					0025	
1	C		(V(11),BETA0)	(V(12),DBETA0)				0026	
1	C		(V(13),BETAC)	(V(14),DBETAC)				0027	
1	C		(V(15),BETAS)	(V(16),DBETAS)				0028	
1	C								0029
7		V(4) = V(4) / 12.0							0030
7		V(5) = V(5) / 12.0							0031
7		II=14							0032
7		IF(N.GT.1) II=16							0033
7		DO 10 I=8,II							0034
7		V(I)=V(I)/RC							0035
4		10 CONTINUE							0036
1	C								0037
7		RETURN							0038
7		END							0039

(A) ROUTINE CINBF1

Figure 43. Fortran Subroutines for Component BF1.

START	COL	1	2	3	4	5	6	7	
7		SUBROUTINE RECBF1(V,NG,XDEP,DXDEP,KN)							0001
1	C	*****							0002
1	C*								0003
1	C*	SUBROUTINE NAME : RECBF1							0004
1	C*								0005
1	C*	FUNCTION :							0006
1	C*	RECOVER BIFILAR DISPLACEMENTS AND VELOCITIES							0007
1	C*	FOR RESTART WITH TIME HISTORY SOLUTION							0008
1	C*	FOR INPLANE BIFILARS IF KN=1,							0009
1	C*	FOR VERTICAL BIFILARS IF KN=2							0010
1	C*								0011
1	C	*****							0012
1	C								0013
7		DIMENSION V(1),XDEP(1),DXDEP(1)							0014
1	C								0015
1	C	INITIALIZE THE COORDINATE INDEX FOR THIS ELEMENT							0016
1	C								0017
7		NN = NG + 1							0018
1	C								0019
1	C	INITIALIZE THE BIFILAR DISPLACEMENTS AND VELOCITIES							0020
1	C								0021
7		V(11) = XDEP(NN)							0022
7		V(12) = DXDEP(NN)							0023
7		NN = NN + 1							0024
7		V(13) = XDEP(NN)							0025
7		V(14) = DXDEP(NN)							0026
7		IF(KN.LT.2) GO TO 10							0027
7		NN = NN + 1							0028
7		V(15) = XDEP(NN)							0029
7		V(16) = DXDEP(NN)							0030
1	C								0031
1	C	INCREASE THE COORDINATE INDEX TO ACCOUNT FOR THE HUB COORDINATES							0032
1	C								0033
4		10 CONTINUE							0034
7		NG = NN + 6							0035
1	C								0036
7		RETURN							0037
7		END							0038

(B) ROUTINE RECBF1

Figure 43. Continued.

```

START
COL  -----1-----2-----3-----4-----5-----6-----7-----
7      SUBROUTINE PINBFI(V,IELEM,KPRINT,KN)                                0001
1 C*****0002
1 C*                                                                            *0003
1 C*          SUBROUTINE NAME : PINBFI                                     *0004
1 C*                                                                            *0005
1 C* F U N C T I O N :                                                    *0006
1 C* PRINT THE INPUT                                                       *0007
1 C*   FOR INPLANE BIFILARS IF KN=1,                                       *0008
1 C*   FOR VERTICAL BIFILARS IF KN=2                                       *0009
1 C*                                                                            *0010
1 C*****0011
1 C                                                                            0012
7      DIMENSION V(1)                                                       0013
1 C                                                                            0014
7      IF (KN.EQ.1) WRITE(KPRINT,1000) IELEM                               0015
7      IF (KN.EQ.2) WRITE(KPRINT,2000) IELEM                               0016
7      NCN1 = V(1) + .001                                                    0017
7      WRITE(KPRINT,1001) NCN1                                              0018
7      N     = V(2) + .001                                                    0019
7      WRITE(KPRINT,1002) N                                                 0020
7      WRITE(KPRINT,1003) V(3)                                              0021
7      WRITE(KPRINT,1004) V(4)                                              0022
7      WRITE(KPRINT,1005) V(5)                                              0023
7      IF (KN.EQ.1) WRITE(KPRINT,1006) V(6)                                  0024
7      IF (KN.EQ.2) WRITE(KPRINT,2006) V(6)                                  0025
7      WRITE(KPRINT,1007) V(7)                                              0026
7      WRITE(KPRINT,1008) V(8)                                              0027
7      WRITE(KPRINT,1009) V(9)                                              0028
7      WRITE(KPRINT,1010) V(10)                                             0029
1 C                                                                            0030
7      IF(KN.GT.1) GO TO 10                                                 0031
7      WRITE(KPRINT,1011) V(11)                                             0032
7      WRITE(KPRINT,1012) V(12)                                             0033
7      WRITE(KPRINT,1013) V(13)                                             0034
7      WRITE(KPRINT,1014) V(14)                                             0035
7      GO TO 20                                                             0036
4      10 CONTINUE                                                         0037
7      WRITE(KPRINT,2011) V(11)                                             0038
7      WRITE(KPRINT,2012) V(12)                                             0039
7      WRITE(KPRINT,2013) V(13)                                             0040
7      WRITE(KPRINT,2014) V(14)                                             0041
7      WRITE(KPRINT,2015) V(15)                                             0042
7      WRITE(KPRINT,2016) V(16)                                             0043
4      20 CONTINUE                                                         0044
1 C                                                                            0045
1 C          FORMAT STATEMENTS                                             0046
1 C                                                                            0047
2      1000 FORMAT(55H1COMPONENT:BIFILAR ***** HORIZONT 0048
6          1      , 55HAL LINEAR BIFILAR *** ELEMENT: 0049
6          2      ,I10,/) 0050
2      2000 FORMAT(55H1COMPONENT:BIFILAR ***** VERTIC 0051
6          1      , 55HAL LINEAR BIFILAR *** ELEMENT: 0052
6          2      ,I10,/) 0053
2      1001 FORMAT(55H0 1 NCN1 CONNECTION NODE NUMBER END 1 (ND) 0054

```

Figure 43. Continued.

START	COL	1	2	3	4	5	6	7
6	1				,40X,I15)			0055
2	1002	FORMAT(55H0	2	N	TOTAL NUMBER OF BIFILARS	(ND)		0056
6	1				,40X,I15)			0057
2	1003	FORMAT(55H0	3	MB	BIFILAR MASS (SLUGS)			0058
6	1				,40X,1PE15.5)			0059
2	1004	FORMAT(55H0	4	RR	DISTANCE FROM CENTER OF BIFILAR TRACKING			0060
6	1				,35H HOLE TO CENTER OF ROTATION (INCH)	,5X,1PE15.5)		0061
2	1005	FORMAT(55H0	5	R	EQUIVALENT PENDULUM ARM (INCH)			0062
6	1				,40X,1PE15.5)			0063
2	1006	FORMAT(55H0	6	ZETGAM	INPLANE BIFILAR DAMPING RATIO C/CCRIT (N			0064
6	1				,3HTD),T96,1PE15.5)			0065
2	1006	FORMAT(55H0	6	ZETBET	VERTICAL BIFILAR DAMPING RATIO C/CCRIT (N			0066
6	1				,3HTD),T96,1PE15.5)			0067
2	1007	FORMAT(55H0	7	OMEGA	BIFILAR ROTATION SPEED (RAD/SEC)			0068
6	1				,40X,1PE15.5)			0069
2	1008	FORMAT(55H0	8	THETA	EULER PITCH ANGLE AT NODE - ROTATE SECO			0070
6	1				,30HND ABOUT THE Y-AXIS (DEGREES)	,10X,1PE15.5)		0071
2	1009	FORMAT(55H0	9	PHI	EULER ROLL ANGLE AT NODE - ROTATE THIRD			0072
6	1				,30H ABOUT THE X-AXIS (DEGREES)	,10X,1PE15.5)		0073
2	1010	FORMAT(55H0	10	XST	EULER YAW ANGLE AT NODE - ROTATE FIRST			0074
6	1				,30HABOUT THE Z-AXIS (DEGREES)	,10X,1PE15.5)		0075
2	1011	FORMAT(55H0	11	GAMMAC	COSINE COEFFICIENT OF INITIAL PENDULUM C			0076
6	1				,30HYCLIC DISPLACEMENT (DEGREES)	,10X,1PE15.5)		0077
2	1012	FORMAT(55H0	12	DGAMMC	COSINE COEFFICIENT OF INITIAL PENDULUM C			0078
6	1				,30HYCLIC VELOCITY (DEGREES/SEC)	,10X,1PE15.5)		0079
2	1013	FORMAT(55H0	13	GAMMAS	SINE COEFFICIENT OF INITIAL PENDULUM CYC			0080
6	1				,30PCLIC DISPLACEMENT (DEGREES)	,10X,1PE15.5)		0081
2	1014	FORMAT(55H0	14	DGAMMS	SINE COEFFICIENT OF INITIAL PENDULUM CYC			0082
6	1				,30HLIC VELOCITY (DEGREES/SEC)	,10X,1PE15.5)		0083
2	2011	FORMAT(55H0	11	BETA0	BIFILAR MASS COLLECTIVE INITIAL FLAPPING			0084
6	1				,30H ANGLE (DEGREES)	,10X,1PE15.5)		0085
2	2012	FORMAT(55H0	12	DBETA0	BIFILAR MASS COLLECTIVE INITIAL FLAPPING			0086
6	1				,30H VELOCITY (DEG/SEC)	,10X,1PE15.5)		0087
2	2013	FORMAT(55H0	13	BETAC	BIFILAR MASS COSINE COEFFICIENT OF INITI			0088
6	1				,30HAL FLAPPING ANGLE (DEGREES)	,10X,-1PE15.5)		0089
2	2014	FORMAT(55H0	14	DBETAC	BIFILAR MASS COSINE COEFFICIENT OF INITI			0090
6	1				,30HAL FLAPPING VELOCITY (DEG/SEC)	,10X,1PE15.5)		0091
2	2015	FORMAT(55H0	15	BETAS	BIFILAR MASS SINE COEFFICIENT OF INITI			0092
6	1				,30HAL FLAPPING ANGLE (DEGREES)	,10X,1PE15.5)		0093
2	2016	FORMAT(55H0	16	DBETAS	BIFILAR MASS SINE COEFFICIENT OF INITI			0094
6	1				,30HAL FLAPPING VELOCITY (DEG/SEC)	,10X,1PE15.5)		0095
1	C							0096
7		RETURN						0097
7		END						0098
								0099
								0100

(C) ROUTINE PINBF1

Figure 43. Continued.

```

START
COL  -----1-----2-----3-----4-----5-----6-----7-----
7      SUBROUTINE CRDBF1(DATA,NLOCAL,NNODEL,NCNL,EULER,KN)          0001
1 C*****0002
1 C*          SUBROUTINE NAME : CRDBF1          *0003
1 C*          *0004
1 C*          *0005
1 C* F U N C T I O N :          *0006
1 C*   INFORM THE MAIN PROGRAM OF THE REQUIRED NUMBER OF COORDINATES *0007
1 C*   FOR INPLANE BIFILARS IF KN=1,          *0008
1 C*   FOR VERTICAL BIFILARS IF KN=2          *0009
1 C*          *0010
1 C*****0011
1 C          *0012
7      REAL MB          *0013
7      DIMENSION DATA(1),V(10)          *0014
7      DIMENSION NCNL(1),EULER(3,1)          *0015
7      EQUIVALENCE(V( 1),XNCN1 ),(V( 2),XN      ),(V( 3),MB      ),          *0016
6      1      (V( 4),RR      ),(V( 5),R      ),(V( 6),ZETGAM),          *0017
6      2      (V( 7),OMEGA ),(V( 8),THETA ),(V( 9),PHI      ),          *0018
6      3      (V(10),XSI      )          *0019
1 C          *0020
1 C RETRIEVE INPUT DATA          *0021
1 C          *0022
7      DO 20 I=1,10          *0023
7      V(I) = DATA(I)          *0024
4      20 CONTINUE          *0025
1 C          *0026
1 C SPECIFY NUMBER OF COORDINATES, CONNECTION NODE NUMBERS & EULER ANGLES *0027
1 C          *0028
7      NLOCAL = KN          *0029
7      NNODEL = 1          *0030
1 C          *0031
7      NCNL = XNCN1 + .001          *0032
7      NCNL(1) = 0          *0033
7      NCNL(2) = 0          *0034
7      NCNL(3) = 0          *0035
7      KNMS = KN - 5          *0036
7      DO 10 I = KNMS,KN          *0037
7      NCNL(I) = NCNL          *0038
4      10 CONTINUE          *0039
1 C          *0040
7      EULER(1,1) = THETA          *0041
7      EULER(2,1) = PHI          *0042
7      EULER(3,1) = XSI          *0043
1 C          *0044
7      RETURN          *0045
7      END          *0046

```

(D) ROUTINE CRDBF1

Figure 43. Continued.

START	COL	1	2	3	4	5	6	7	
7		SUBROUTINE RENBF1(V,NG,XDEP,DXDEP,KN)							0001
1		C*****							0002
1		C*							0003
1		SUBROUTINE NAME : RENBF1							0004
1		C*							0005
1		FUNCTION :							0006
1		INITIALIZE DISPLACEMENTS AND VELOCITIES							0007
1		FOR RESTART WITH TIME HISTORY SOLUTIONS							0008
1		FOR INPLANE BIFILARS IF KN=1,							0009
1		FOR VERTICAL BIFILARS IF KN=2							0010
1		C*							0011
1		C*****							0012
1		C							0013
7		DIMENSION V(1),XDEP(1),DXDEP(1)							0014
1		C							0015
1		INITIALIZE THE COORDINATE INDEX FOR THIS ELEMENT							0016
1		C							0017
7		NN = NG + 1							0018
1		C							0019
1		INITIALIZE THE BIFILAR DISPLACEMENTS AND VELOCITIES							0020
1		C							0021
7		XDEP(NN) = V(11)							0022
7		DXDEP(NN)= V(12)							0023
7		NN = NN + 1							0024
7		XDEP(NN) = V(13)							0025
7		DXDEP(NN)= V(14)							0026
7		IF(KN.LT.2) GO TO 10							0027
7		NN = NN + 1							0028
7		XDEP(NN) = V(15)							0029
7		DXDEP(NN)= V(16)							0030
1		C							0031
1		INCREASE THE COORDINATE INDEX TO ACCOUNT FOR THE HUB COORDINATES							0032
1		C							0033
4		10 CONTINUE							0034
7		NG = NN + 6							0035
1		C							0036
7		RETURN							0037
7		END							0038

(E) ROUTINE RENBF1

Figure 43. Continued.

```

START
COL  -----1-----2-----3-----4-----5-----6-----7-----
7      SUBROUTINE NAMBF1(ALPHA,NLOCAL)                                0001
1 C*****0002
1 C*                                SUBROUTINE NAME : NAMBF1          *0003
1 C*                                SUBROUTINE NAME : NAMBF1          *0004
1 C*                                SUBROUTINE NAME : NAMBF1          *0005
1 C* F U N C T I O N :                                             *0006
1 C* NAME VARIABLES FOR INPLANE BIFILARS.                          *0007
1 C*                                SUBROUTINE NAME : NAMBF1          *0008
1 C*****0009
1 C                                SUBROUTINE NAME : NAMBF1          *0010
7      DIMENSION ALPHA(5,1),GAMMAC(2),GAMMAS(2),                    0011
6      1      X(2),Y(2),Z(2),THTX(2),THTY(2),THTZ(2)                0012
7      DATA GAMMAC/4HBF1 ,4HGAMC/,                                0013
6      1      GAMMAS/4HBF1 ,4HGAMS/,                                0014
6      2      X      /4HBF1 ,4HX  /,                                0015
6      3      Y      /4HBF1 ,4HY  /,                                0016
6      4      Z      /4HBF1 ,4HZ  /,                                0017
6      5      THTX   /4HBF1 ,4HTHTX/,                               0018
6      6      THTY   /4HBF1 ,4HTHTY/,                               0019
6      7      THTZ   /4HBF1 ,4HTHTZ/                                0020
1 C                                SUBROUTINE NAME : NAMBF1          0021
1 C RETURN THE COORDINATE NAMES                                     0022
1 C                                SUBROUTINE NAME : NAMBF1          0023
7      NLOCAL = 8                                                  0024
1 C                                SUBROUTINE NAME : NAMBF1          0025
7      DO 10 I=1,2                                                  0026
7      I1 = I + 1                                                  0027
7      ALPHA(I1, 1) = GAMMAC(I)                                     0028
7      ALPHA(I1, 2) = GAMMAS(I)                                    0029
7      ALPHA(I1, 3) = X(I)                                         0030
7      ALPHA(I1, 4) = Y(I)                                         0031
7      ALPHA(I1, 5) = Z(I)                                         0032
7      ALPHA(I1, 6) = THTX(I)                                      0033
7      ALPHA(I1, 7) = THTY(I)                                      0034
7      ALPHA(I1, 8) = THTZ(I)                                      0035
4      10 CONTINUE                                                0036
1 C                                SUBROUTINE NAME : NAMBF1          0037
7      RETURN                                                       0038
7      END                                                           0039

```

(F) ROUTINE NAMBF1

Figure 43. Continued.

```

START
COL  -----1-----2-----3-----4-----5-----6-----7-----
7      SUBROUTINE CPBF1(DATA,NC,M,C,K,F,IDIM)                                0001
1 C*****0002
1 C*                                                                              *0003
1 C*          SUBROUTINE NAME : CPBF1                                        *0004
1 C*                                                                              *0005
1 C*  F U N C T I O N :                                                    *0006
1 C*  ----- CALCULATE THE MASS, STIFFNESS, AND DAMPING MATRICES ----- *0007
1 C*          AND THE FORCE VECTOR FOR INPLANE BIFILARS                      *0008
1 C*                                                                              *0009
1 C*****0010
1 C                                                                              0011
7      REAL K,M,MB                                                         0012
7      DIMENSION V(10),DATA(1)                                             0013
7      DIMENSION M(IDIM,1),C(IDIM,1),K(IDIM,1),F(1)                       0014
7      EQUIVALENCE(V( 1),XNCN1 ),(V( 2),XN      ),(V( 3),MB      ),      0015
6      1      (V( 4),RR      ),(V( 5),R      ),(V( 6),ZETGAM),      0016
6      2      (V( 7),OMEGA ),(V( 8),THETA ),(V( 9),PHI  ),      0017
6      3      (V(10),XSI  )                                             0018
1 C                                                                              0019
1 C  RETRIEVE INPUT DATA                                                  0020
1 C                                                                              0021
7      DO 20 I=1,10                                                         0022
7      V(I) = DATA(I)                                                     0023
4      20 CONTINUE                                                         0024
1 C                                                                              0025
1 C  INITIALIZE MATRICES TO ZERO                                           0026
1 C                                                                              0027
7      DO 10 I=1,8                                                           0028
7      F(I) = 0.0                                                            0029
7      DO 30 J=1,8                                                           0030
7      M(I,J) = 0.0                                                         0031
7      C(I,J) = 0.0                                                         0032
7      K(I,J) = 0.0                                                         0033
4      30 CONTINUE                                                         0034
4      10 CONTINUE                                                         0035
1 C                                                                              0036
1 C  CALCULATE THE MATRICES                                                0037
1 C                                                                              0038
7      NC = 8                                                                0039
7      N      = XN                                                            0040
7      OMEGAM = OMEGA * SQRT(RR/R)                                          0041
1 C                                                                              0042
7      C(1,1) = 2.0*ZETGAM*OMEGAM                                          0043
7      C(1,2) = 2.0*OMEGA                                                    0044
7      C(2,1) = -2.0*OMEGA                                                   0045
7      C(2,2) = 2.0*ZETGAM*OMEGAM                                          0046
1 C                                                                              0047
7      K( 1, 1) = OMEGA**2*(RR/R-1.0)                                       0048
7      K( 1, 2) = 2.0*ZETGAM*OMEGAM*OMEGA                                  0049
7      K( 2, 1) = -2.0*ZETGAM*OMEGAM*OMEGA                                 0050
7      K( 2, 2) = OMEGA**2*(RR/R-1.0)                                       0051
1 C                                                                              0052
7      M(1,1) = 1.0                                                           0053
7      M(1,4) = N/(2.0*R)                                                     0054
7      M(2,2) = 1.0                                                           0055
7      M(2,3) = -N/(2.0*R)                                                   0056
7      M(3,2) = -MB*R                                                         0057
7      M(3,3) = N*MB                                                         0058
7      M(4,1) = MB*R                                                         0059
7      M(4,4) = N*MB                                                         0060
1 C                                                                              0061
7      RETURN                                                                0062
7      END                                                                    0063
(G) ROUTINE CPBF1

```

Figure 43. Concluded.

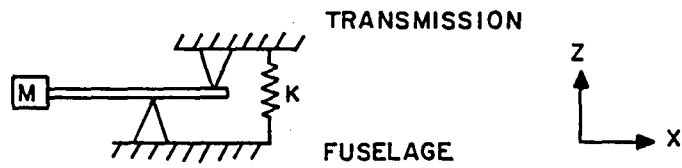

(a) ONE D.O.F. ISOLATOR MODEL FOR CASE 7 (Z VIBRATION ISOLATION)

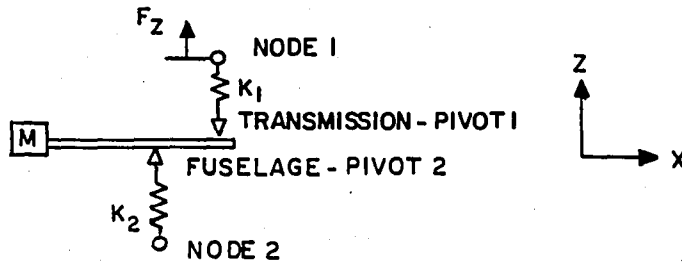

(b) TWO D.O.F. ISOLATOR MODEL FOR CASE 8 (Y AND Z VIBRATION ISOLATION)

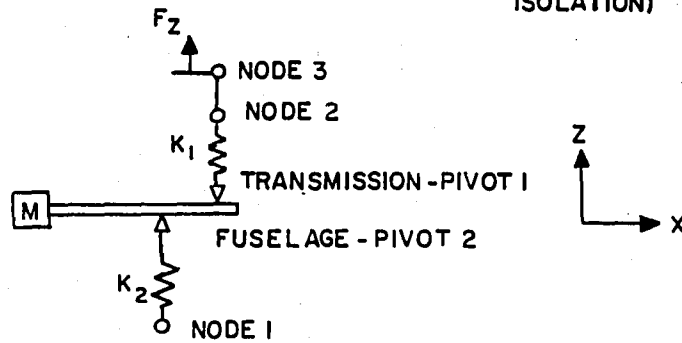

(c) TWO D.O.F. ISOLATOR MODEL FOR CASE 9 (Y AND Z VIBRATION ISOLATION)

Figure 44. Vibration Isolator Models.

BASE PROGRAM CASE 5
 FIXED ABSORBER TIME HISTORY RESPONSE
 1 MODE SHAPE - FX FORCE (COS & SIN)

COORD VARIABLE KEY
 2 DELT DISP 1
 3 X DISP 2
 CASE 1

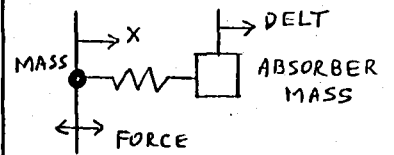
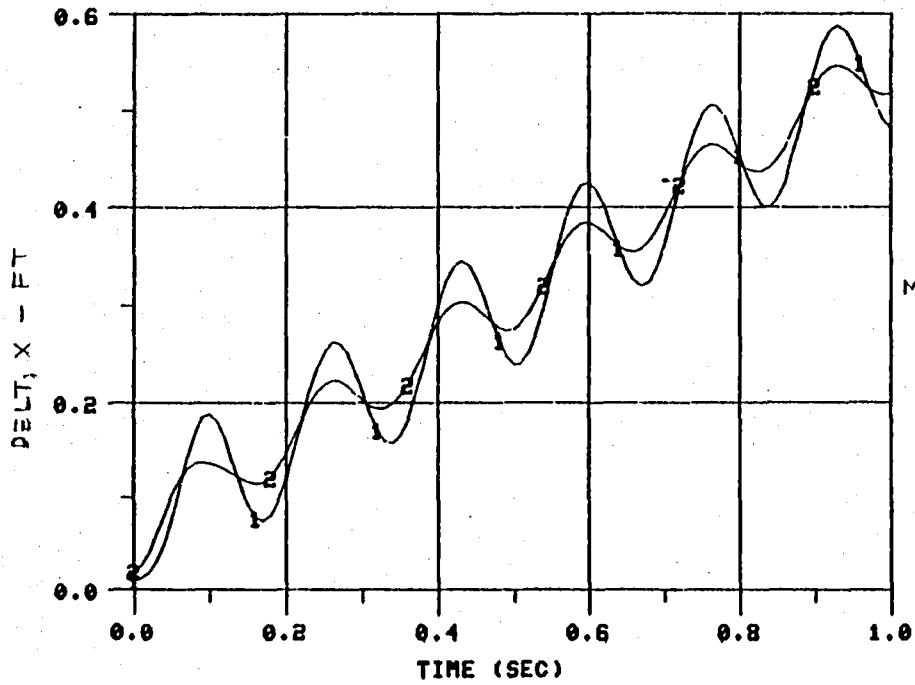

Figure 45. Base Program Results for Test Case 5.

BASE PROGRAM CASE 7
 1-D SINGLE ISOLATOR - OUTPUT IN G'S
 1 TRANS. & 2 FUS. MODES - FZ FORCE

COORD VARIABLE KEY
 5 ZT AMPL. 1
 11 ZB AMPL. 2
 CASE 1

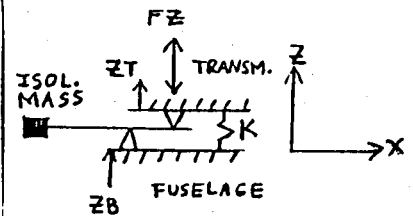
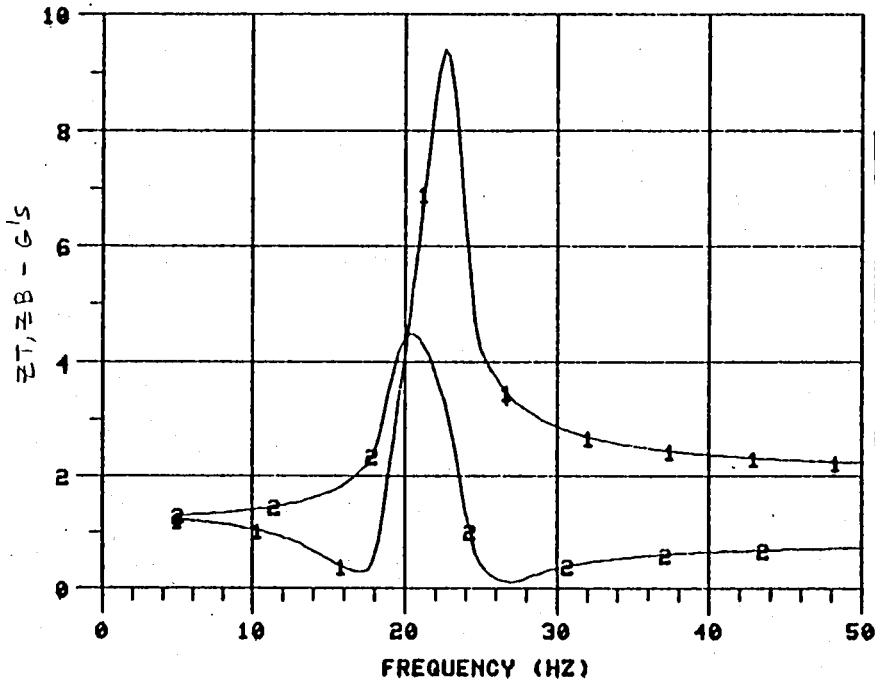

Figure 46. Base Program Results for Test Case 7.

BASE PROGRAM CASE 11
 4 2-D ISOLATORS - 3 FORCES & 3 MOMENTS
 6 TRANSMISSION & 6 FUSELAGE MODES

ISOLATOR 1

COORD VARIABLE KEY

25 XBF AMPL. 1
 27 YBF AMPL. 2
 29 ZBF AMPL. 3

CASE 1

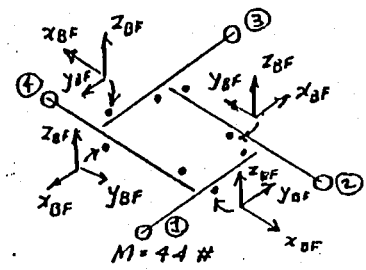
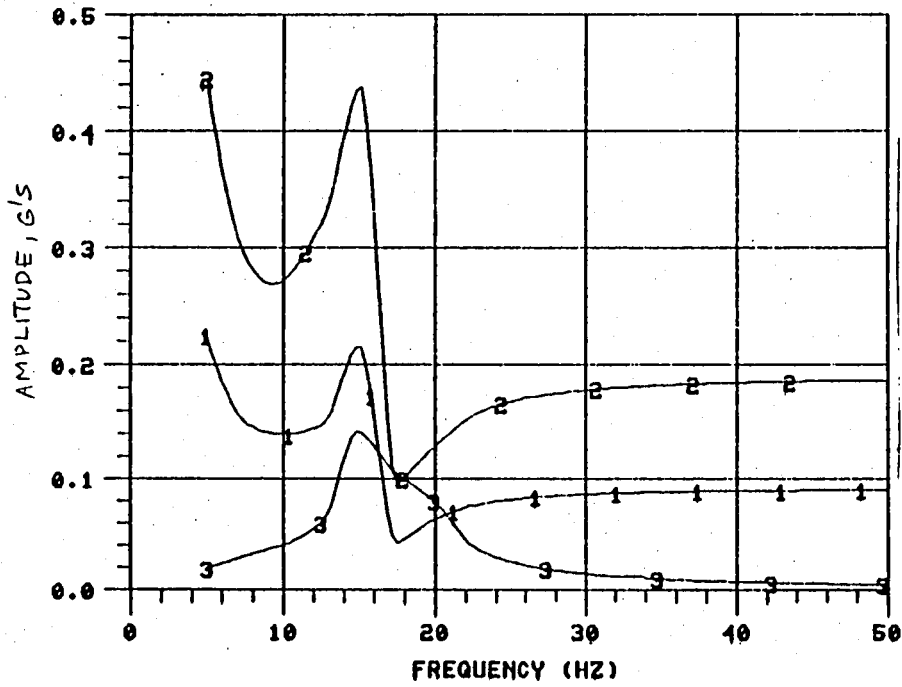

(a) Isolator 1 Response

Figure 47. Base Program Results for Test Case 11.

BASE PROGRAM CASE 11
 4 2-D ISOLATORS - 3 FORCES & 3 MOMENTS
 6 TRANSMISSION & 6 FUSELAGE NODES

COORD	VARIABLE	ISOLATOR
29	ZBF AMPL.	1
65	ZBF AMPL.	2
101	ZBF AMPL.	3
137	ZBF AMPL.	4

CASE 1

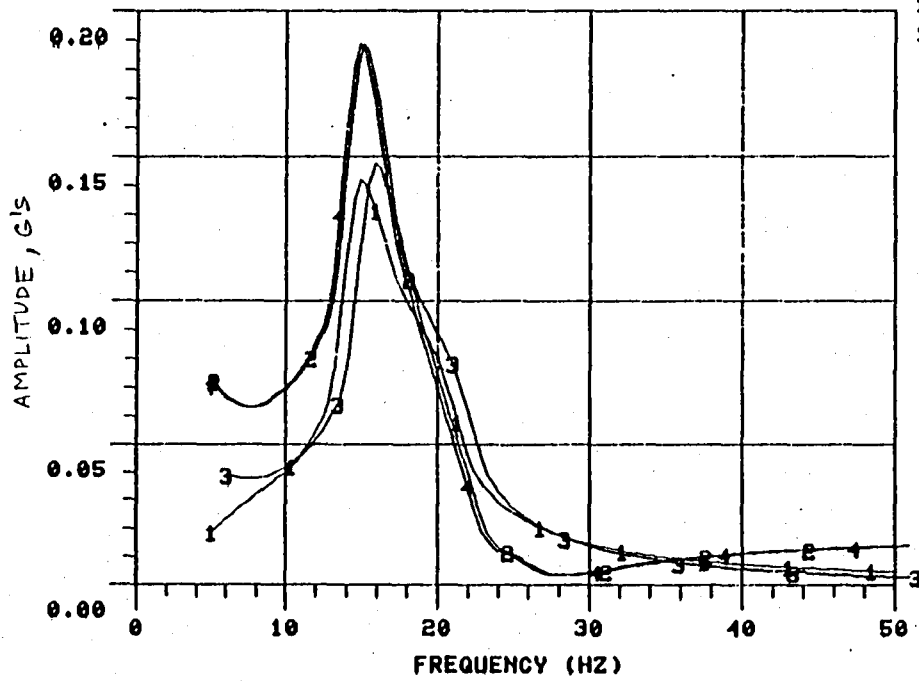

(b) Vertical Response at Four Isolator Locations

Figure 47. Continued.

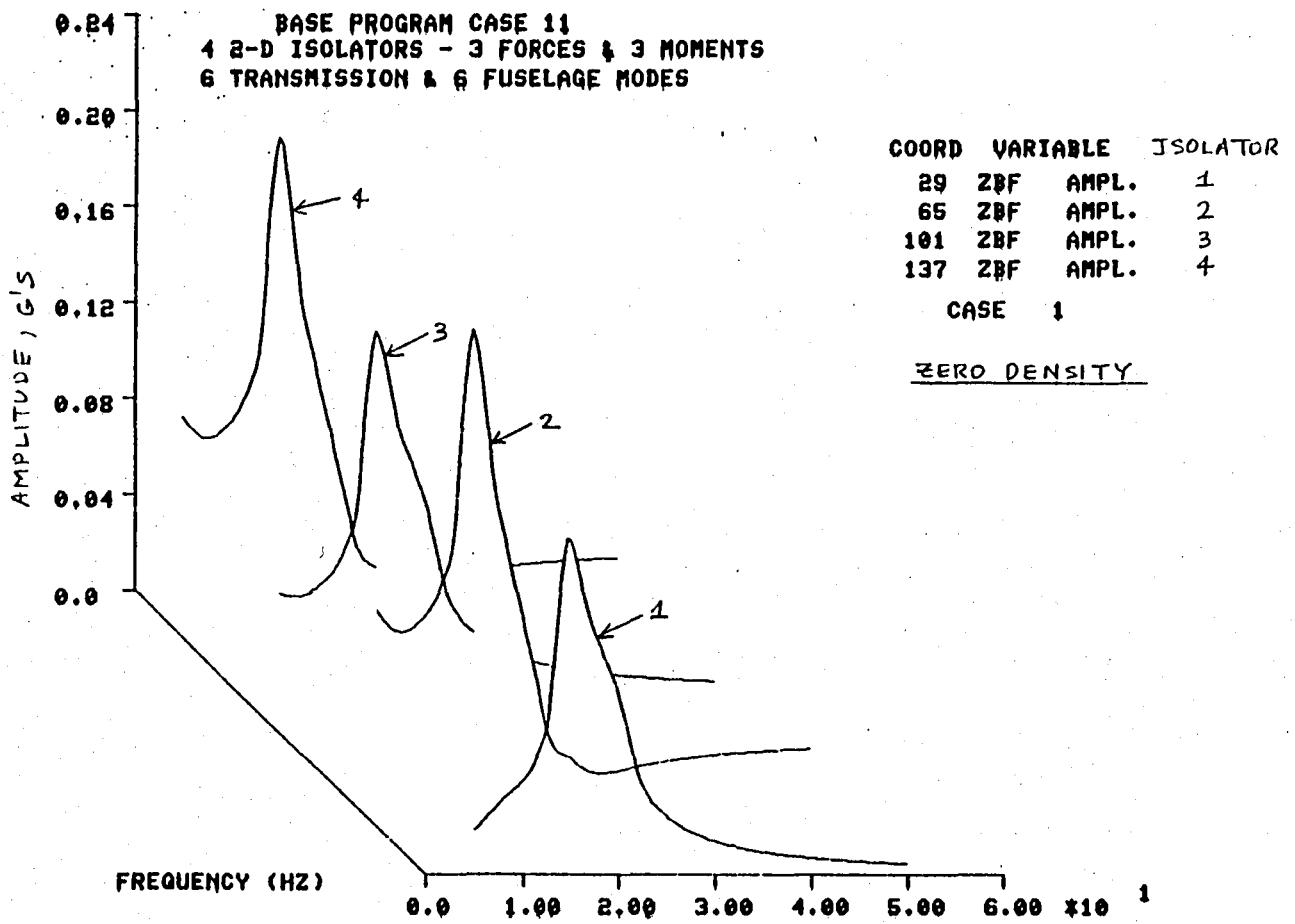

(c) Vertical Response at Four Isolator Positions

Figure 47. Continued.

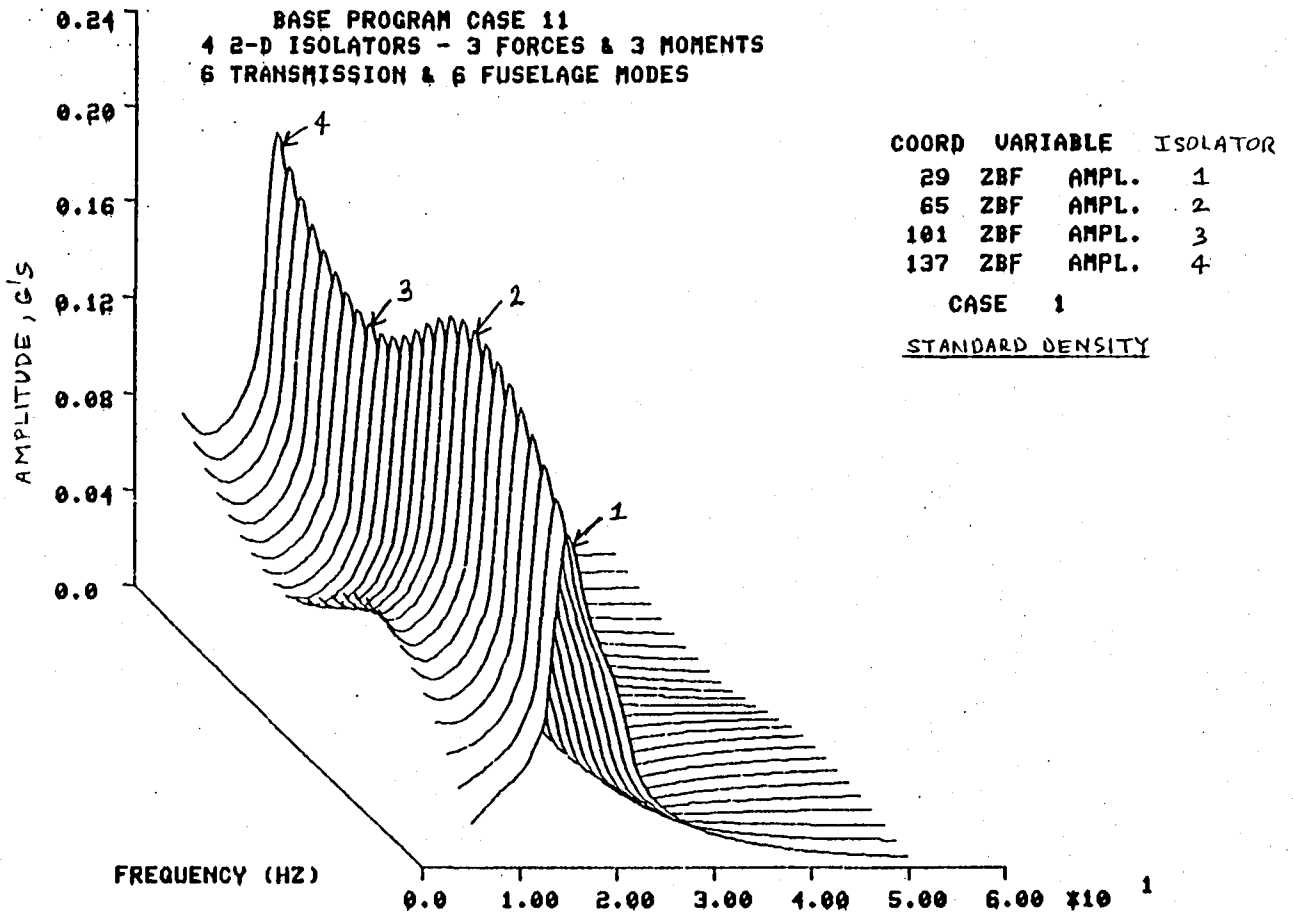

(d) Vertical Response at Four Isolator Positions

Figure 47. Continued.

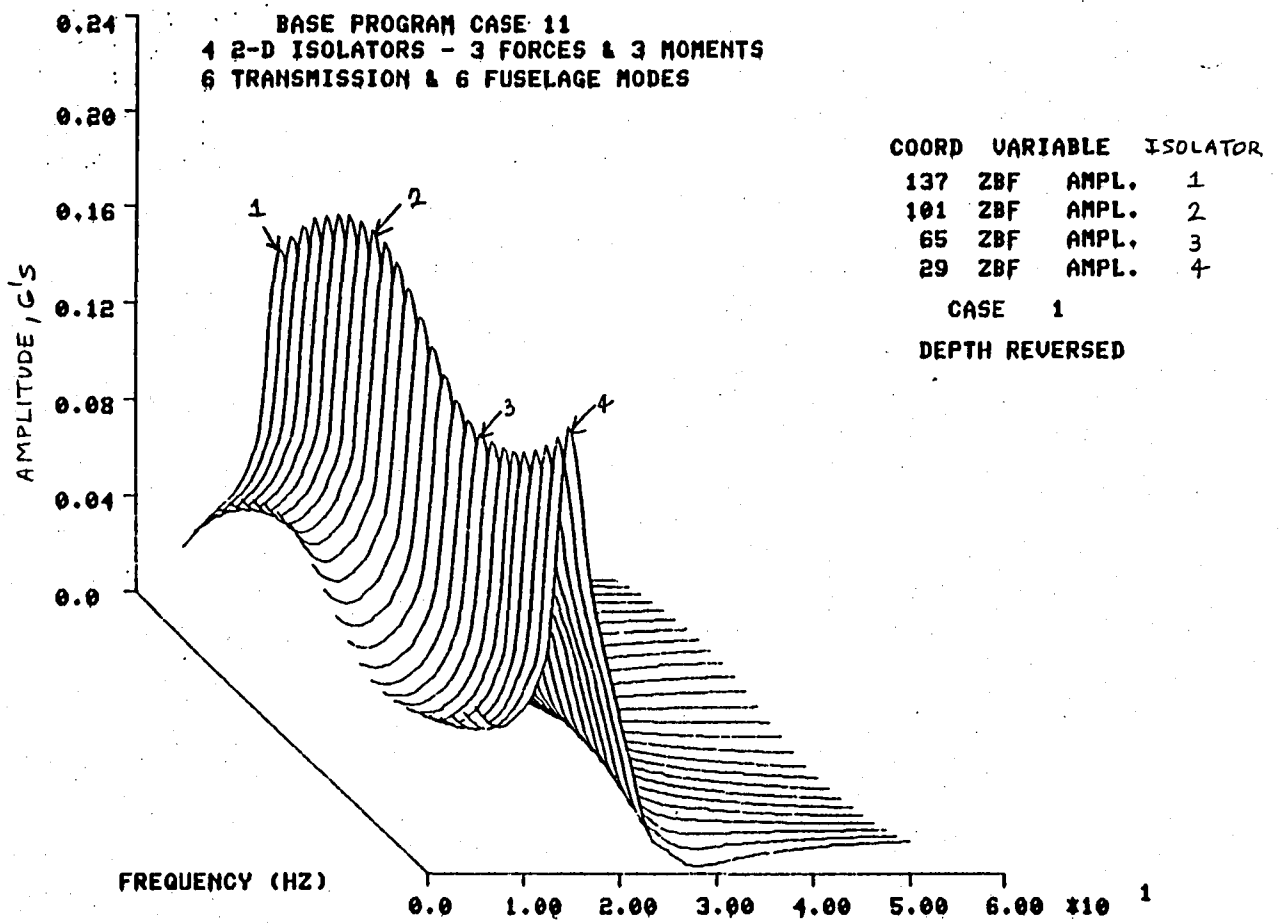

(e) Vertical Response at Four Isolator Positions

Figure 47. Continued.

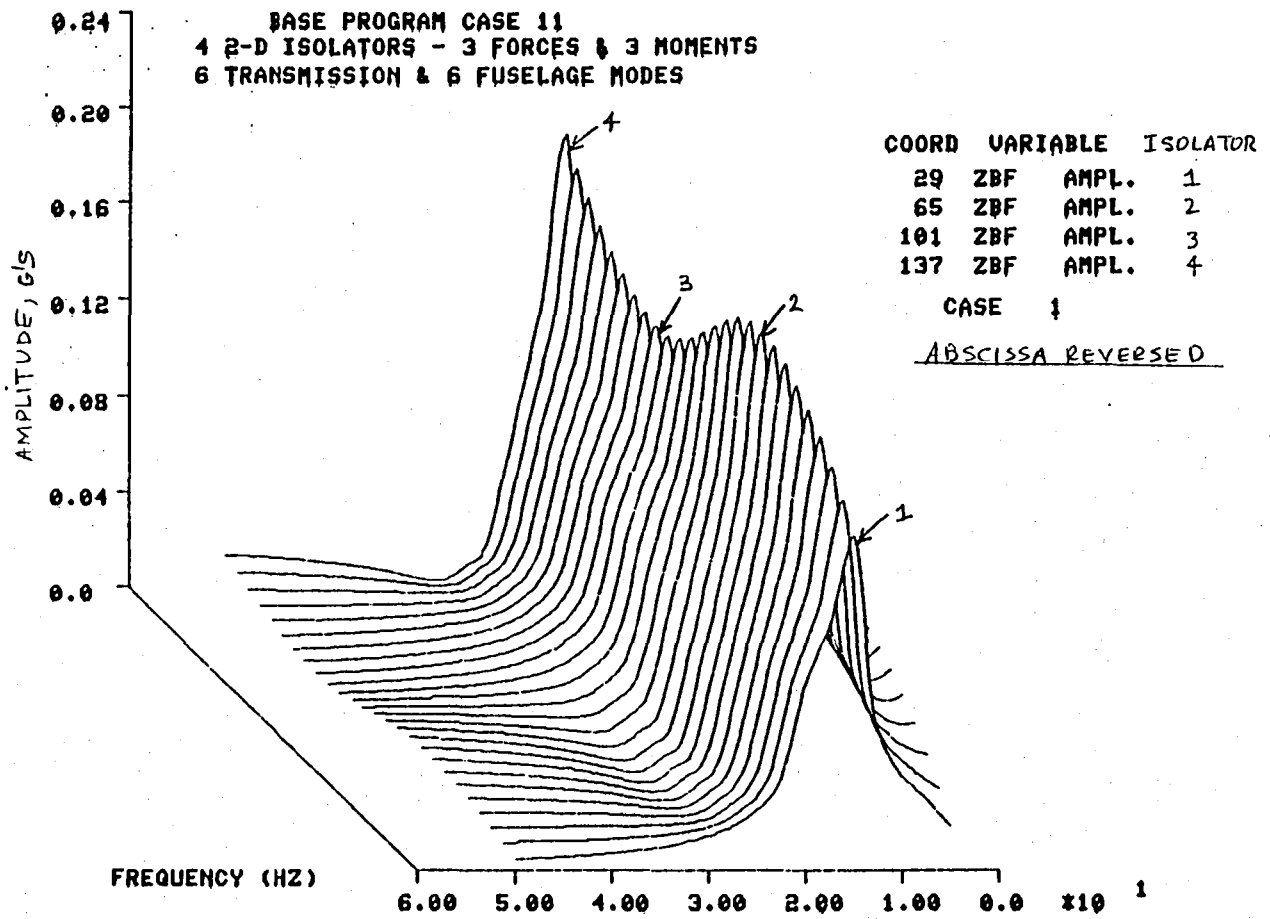

(f) Vertical Response at Four Isolator Positions

Figure 47. Continued.

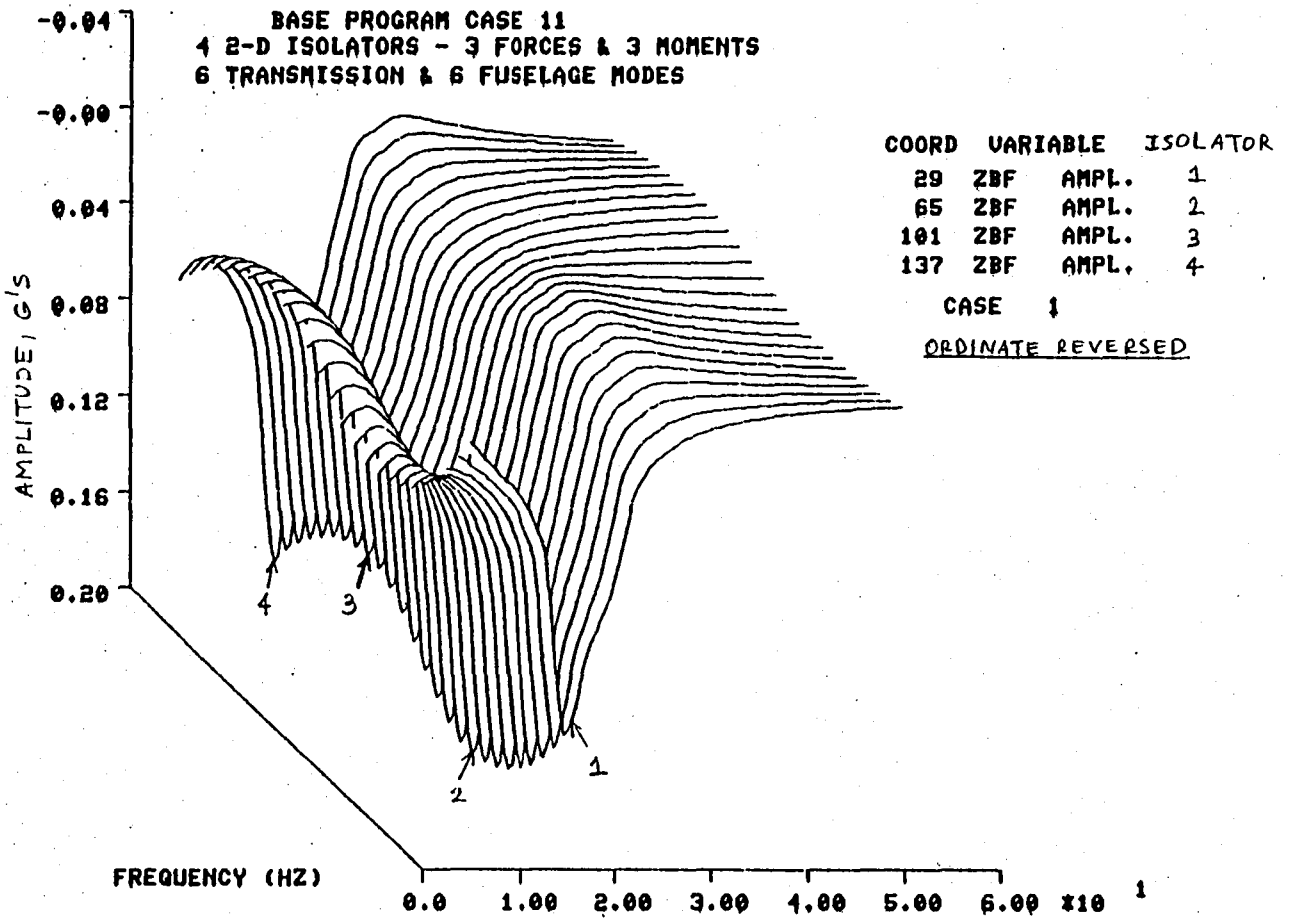

(g) Vertical Response at Four Isolator Positions

Figure 47. Continued.

BASE PROGRAM CASE 11 - M=24 TO 64 LBS
 4 2-D ISOLATORS - 3 FORCES & 3 MOMENTS
 6 TRANSMISSION & 6 FUSELAGE MODES

COORD VARIABLE ISOLATOR
 29 ZBF AMPL. 1
 CASES
 1 3 5

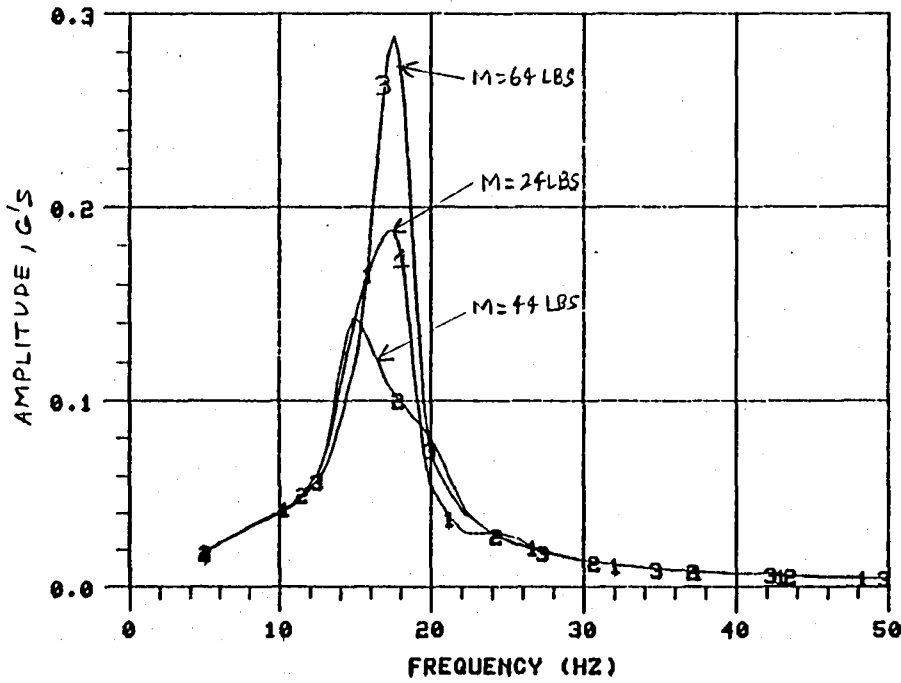

KEY	MASS (LBS)	CASE
1	24	1
2	44	3
3	64	5

(h) Vertical Response for Different Isolator Masses

Figure 47. Concluded.

BASE PROGRAM CASE 13
 Q400 IMPEDANCE - RESULTS IN LBS
 4 FUSELAGE MODES AND 6 ROTOR D.O.F.

COORD VARIABLE KEY
 9 RX AMPL. 1
 11 RY AMPL. 2
 13 RZ AMPL. 3
 CASE 1

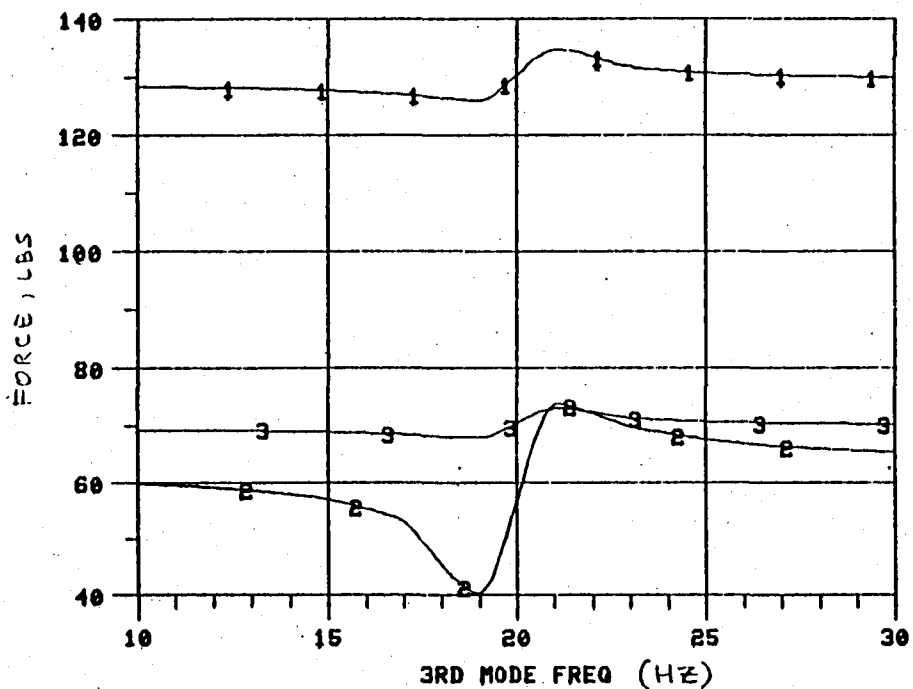

(a) Force Results

Figure 48. Base Program Results for Test Case 13.

BASE PROGRAM CASE 13
 G400 IMPEDANCE - RESULTS IN G'S
 4 FUSELAGE MODES AND 6 ROTOR D.O.F.

COORD	VARIABLE	KEY
9	X	AMPL. 1
11	Y	AMPL. 2
13	Z	AMPL. 3

CASE 2

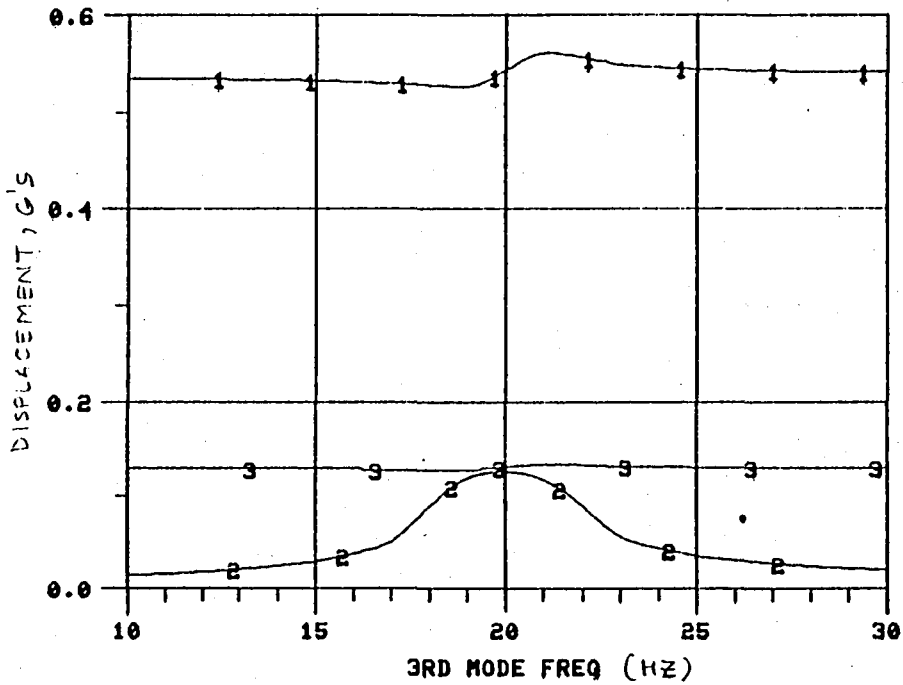

(b) Displacement Results

Figure 48. Concluded.

```

1 //ET473RUN JCB (4045,STAL,19,15), 'CASSAMPINO - X735A',
// CLASS=D,TIME=01,MSOLEVEL=(1,0),REGION=3000K,
// MSGCLASS=T,NOTIFY=ET473
*****
*** ROTORCRAFT DYNAMIC SYSTEMS ANALYSIS PROGRAM
*** EXECUTES SIMVIB PROGRAM WITH OVERLAY STRUCTURE FOR CDC COMPUTER
*****
2 //STEP01 EXEC PGM=FIHALD1
3 //STEPLIB DD DSN=ET473.SIMVIB.LOAD,DISP=SHR
*****
4 //FT05F001 DD DUMMY
***
*** READ INPUT DATA FROM UNIT 1 FOR NORMAL RUN
*****
5 //FT01F001 DD DSN=ET473.SIMVIB.DATA(SVID01),DISP=SHR
***
*** READ G-400 INPUT DATA FROM UNIT 11 (PROGRAM) OR UNIT 12 (USER)
*****
6 //FT11F001 DD DUMMY <== ALL CASES EXCEPT 14,15,16
***FT11F001 DD DSN=ET473.SIMVIB.DATA(G400IMMS),DISP=SHR <== CASE 14
***FT11F001 DD DSN=ET473.SIMVIB.DATA(G400IMMS),DISP=SHR <== CASES 15,16
***
*** USE UNIT 12 FOR ALL CASES EXCEPT FOR CASES 14,15,16
*****
7 //FT12F001 DD DSN=ET473.SIMVIB.DATA(SVID13X),DISP=SHR
***
*** READ INPUT DATA FROM UNIT 10 FOR COUPLING WITH E-927
*****
8 //FT10F001 DD DSN=ET473.SIMVIB.DATA(SVID12X),DISP=SHR
***
*** NORMAL OUTPUT IS WRITTEN ON FILE 6
*****
9 //FT06F001 DD SYSOUT=T
***
*** PUNCHED OUTPUT GOES TO FILE 7
*****
10 //FT07F001 DD DUMMY
***
*** OUTPUT USED FOR PLOTTING IS WRITTEN TO FILE 2
*****
11 //FT02F001 DD SYSOUT=T
***
*** OUTPUT USED FOR TIME HISTORY RESTART IS WRITTEN TO FILE 3
*****
12 //FT08F001 DD SYSOUT=T <== FOR ALL CASES EXCEPT CASE 6
***FT08F001 DD DSN=ET473.SVID04X.DATA,DISP=(MOD,KEEP) <== CASE 6
*****
***** OPTIONS FOR OUTPUT RESULTS *****
***** UNIT 2 TO PLOT RESULTS IS USED AS AN EXAMPLE *****
***
*** OPTION 1. WRITE OUTPUT TO PAPER
***FT02F001 DD SYSOUT=T
*****
*** OPTION 2. WRITE OUTPUT TO A NEW FILE
***FT02F001 DD DSN=ET473.PLOTSV01.DATA,DISP=(NEW,CATLG),
*** UNIT=TSO,SPACE=(TRK,(5,5)),
*** DCB=(RECFM=FB,LRECL=80,BLKSIZE=3120)
*****
*** OPTION 3. WRITE OUTPUT OVER AN OLD FILE
***FT02F001 DD DSN=ET473.PLOTSV01.DATA,DISP=(OLD,KEEP)
*****
*** OPTION 4. WRITE OUTPUT IN BACK OF AN OLD FILE
***FT02F001 DD DSN=ET473.PLOTSV01.DATA,DISP=(MOD,KEEP)
*****
*** OPTION 5. DO NOT WRITE ANY OUTPUT
***FT02F001 DD DUMMY
*****
13 // <== LAST JCL INPUT CARD

```

Figure 49. Base Program IBM JCL.

```

* /JOB
* /NOSEQ
SVLINKB,T1400,CM300000.
USER,-----.
CHARGE,-----,LRC.
RFL(300000)
GET,SVB1B.
GET,SVB2.
FTN(I=SVB1B,R=0,L=TAPE1,B=NSVB1GO,A)
FTN(I=SVB2,R=0,L=TAPE2,B=NSV2GO,A)
REPLACE(NSVB1GO)
REPLACE(NSV2GO)
ATTACH(ALTMLIB/UN=LIBRARY)
SEGLOAD(B=SVBABS)
LDSET(LIB=ALTMLIB,PRESET=ZERO,MAP=SBEX/LMAP)
LOAD(NSV21GO)
LOAD(NSV2GO)
NOGO.
REPLACE(SVBABS)
DAYFILE,JCLOUT.
REPLACE,JCLOUT.
REPLACE(TAPE1=FORTB1)
REPLACE(TAPE2=FORTB2)
REPLACE,LMAP.
EXIT.
DAYFILE,JCLOUT.
REPLACE,JCLOUT.
REPLACE(TAPE1=FORTB1)
REPLACE(TAPE2=FORTB2)
REPLACE,LMAP.
* /EOR
SIMVIB GLOBAL ACONVR,CBETA,CDATA,CDEBUG,CFR1,CGEN,CGF1,CINOUT
SIMVIB GLOBAL CITER,CLABEL,CMAXA,CNAMES,CPLOT,CRE2,CRE3
SIMVIB GLOBAL CRE3H1,CRE3H2,CRSTR
SUB2 TREE COMPUT-(UPDATE,ASSMBL,SOLVE-(SOLEGN,SOLFRT),RESTOR,SAVE)
SUB1 TREE INPCDC-(INPUT,PINPUT-(PRINT1,PRINT2))
TREE SIMVIB-(SUB1,LINK,RECOVR,TRNSFM,LABEL,SUB2)
END SIMVIB
* /EOF

* For card images operation:
1. delete /JOB and /NOSEQ instructions (first 2 cards).
2. replace /EOR with a 6/7/8 multiple punch card.
3. replace /EOF with a 6/7/8/9 multiple punch card.

```

FIGURE 50. CDC JCL FOR INSTALLATION OF THE BASE PROGRAM BATCH MODE.

```

* /JOB
* /NOSEQ
SVLINKI, T1400, CM300000.
USER, -----.
CHARGE, -----, LRC.
RFL(300000)
GET, SVB1T.
GET, SVB2.
FTN(I=SVB1T, R=0, OPT=2, L=TAPE1, B=NSVT1GO, A)
FTN(I=SVB2, R=0, OPT=2, L=TAPE2, B=NSVT2GO, A)
REPLACE(NSVT1GO)
REPLACE(NSVT2GO)
ATTACH(ALTMLIB/UN=LIBRARY)
SEGLOAD(B=SVOABS)
LDSET(LIB=ALTMLIB, PRESET=ZERO, MAP=SBEX/LMAP)
LOAD(NSVT1GO)
LOAD(NSVT2GO)
NOGO.
REPLACE(SVOABS)
DAYFILE, JCLOUT.
REPLACE, JCLOUT.
REPLACE(TAPE1=FORTT1)
REPLACE(TAPE2=FORTT2)
REPLACE, LMAP.
EXIT.
DAYFILE, JCLOUT.
REPLACE, JCLOUT.
REPLACE(TAPE1=FORTT1)
REPLACE(TAPE2=FORTT2)
REPLACE, LMAP.
* /EOR
SIMVIB GLOBAL ACONVR, CBETA, CDATA, CDEBUG, CFR1, CGEN, CGF1, CINDOUT
SIMVIB GLOBAL CITER, CLABEL, CMAXA, CNAME, CPLOT, CRE2, CRE3
SIMVIB GLOBAL CRE3H1, CRE3H2, CRSTR
SUB2 TREE COMPUT-(UPDATE, ASSMBL, SOLVE-(SOLEGN, SOLFRT), RESTOR, SAVE)
SUB1 TREE INPCDC-(INPUT, PINPUT-(PRINT1, PRINT2))
TREE SIMVIB-(SUB1, LINK, RECOVR, TRNSFM, LABEL, SUB2)
END SIMVIB
* /EOF

* For card images operation:

1. delete /JOB and /NOSEQ instructions (first 2 cards).
2. replace /EOR with a 6/7/8 multiple punch card.
3. replace /EOF with a 6/7/8/9 multiple punch card.

```

FIGURE 51. CDC JCL FOR INSTALLATION OF THE BASE PROGRAM INTERACTIVE MODE.

```

* /JOB
* /NOSEQ
SIMVIB,T1400,CM300000.
USER,-----
CHARGE,-----,LRC.
RFL(300000)
GET,SVBABS.
GET,TAPE1=SVB12.
GET,TAPE10=E927MAT.

```

NOTE - REPLACE CARD ABOVE WITH FOLLOWING CARD(S):

```

GET,TAPE8=SVB06X. <=== FOR TIME HISTORY RESTART - SEE TABLE 13, CASE 6
GET,TAPE11=SVB14X. <=== FOR G400 IMPEDANCES - SEE TABLE 13, CASE 14
GET,TAPE11=SVB15X. <=== FOR G400 IMPEDANCES - SEE TABLE 13, CASES 15&16
GET,TAPE12=SVB13X. <=== FOR USER INPUT IMPEDANCES - SEE TABLE 13, CASE 13

```

```

SVBABS.
DAYFILE,JCLOUT.
REPLACE,JCLOUT.
REPLACE(OUTPUT=OUTRUN1)
REPLACE(TAPE2=SVBP12)
EXIT.
DAYFILE,JCLOUT.
REPLACE,JCLOUT.
REPLACE(OUTPUT=OUTRUN1)
REPLACE(TAPE2=SVBP12)
DMD(200)

```

```

* /EOF

```

* For card images operation:

1. delete /JOB and /NOSEQ instructions (first 2 cards).
2. replace /EOF with a 6/7/8/9 multiple punch card.

FIGURE 52. CDC JCL FOR EXECUTION OF THE BASE PROGRAM BATCH MODE.

. . . FOLLOW NORMAL LOGON PROCEDURE

```
GET,SVOABS.  
GET,TAPE1=DATA1.          <=== SEE NOTE 1 BELOW  
GET,TAPE8=DATA8.          <=== "  
GET,TAPE10=DATA10.        <=== "  
GET,TAPE11=DATA11.        <=== "  
GET,TAPE12=DATA12.        <=== "  
SVOABS.
```

NOTE 1: DATA FILES BELOW ARE USED AS NEEDED FOR EACH RUN.

```
DATA1 = INPUT DATA FILE.  
DATA8 = TIME HISTORY RESTART DATA FILE.  
DATA10 = E927 MATRICES FILE.  
DATA11 = G400 ROTOR IMPEDANCES FILE.  
DATA12 = USER INPUT OF ROTOR IMPEDANCES FILE.
```

. . . AFTER "?" APPEARS, KEY IN THE LETTER "T" AND CLEAR THE SCREEN.
. . . OUTPUT RESULTS WILL BE PRINTED OUT IN BLOCKS OF 30 LINES.
. . . A PAUSE ALLOWS THE USER TO MAKE A COPY IF DESIRED.
. . . TO CONTINUE, CLEAR THE SCREEN AND KEY IN A "." (PERIOD).
. . . AT THE END OF THE CALCULATIONS, KEY IN A "." TO END EXECUTION.
. . . PLOT FILE RESULTS ARE ON TAPE2.
. . . OUTPUT PRINTOUT IS ON TAPE3.

```
REPLACE,TAPE2=DATA2.      <=== SEE NOTE 2 BELOW  
REPLACE,TAPE3=DATA3.      <=== "
```

NOTE 2:

```
DATA2 = PLOT DATA FILE.  
DATA3 = OUTPUT DATA FILE.
```

. . . TO OBTAIN A HARD COPY OF THE OUTPUT, REPLACE CARD ABOVE WITH:

```
REWIND,TAPE3.  
COPYSBF,TAPE3,LIST.  
DELIVER.BLDG_____ JOHN DOE  
ROUTE,LIST,DC=LP.
```

. . . TO STACK UP PLOT FILES, REPLACE TAPE2 CARD ABOVE WITH:

```
APPEND,DATA2,TAPE2.  
GET,DATA2.  
PACK,DATA2.              <=== THIS PROCEDURE TAKES OUT THE  
REPLACE,DATA2.           -EOR- MARK AT THE END OF THE  
                          PLOT DATA FILE "DATA2".
```

. . . NOW THE PLOT DATA FOR 2 RUNS IS ON ONE FILE!

FIGURE 53. CDC JCL FOR EXECUTION OF THE BASE PROGRAM INTERACTIVE MODE.

TABLE 1. BASE PROGRAM SUBSTRUCTURES

Component Flag	Descriptive Name	Component Description
BF1	BIFILAR 1	Inplane linear bifilar vibration absorber for reduction of inplane rotor vibrations
BF2	BIFILAR 2	Vertical linear bifilar vibration absorber for reduction of out-of-plane rotor vibrations
BM1	BEAM MODEL 1	Uniform elastic beam segment
CN1	CONSTRAINT 1	Component allowing elimination of various degrees of freedom at a connection node
FA1	FIXED ABSORBER 1	Single mass, spring and damper vibration absorber for reduction of aircraft vibrations at specific locations
GF1	GENERALIZED FORCE 1	Force component allowing specification of harmonic force and moment input excitations
IS1	ISOLATOR 1	Modal isolator employing two anti-resonant bar weights
MS1	MODAL SUBSTRUCTURE 1	Normal mode representation of a dynamic structure
RE2	ROTOR ELASTIC 2	Aeroelastic rotor model represented by mass, damping and stiffness matrices derived from program E927 (hover only)
RE3	ROTOR ELASTIC 3	Aeroelastic rotor model represented by an impedance matrix derived from program G400 (hover and forward flight). Higher Harmonic Control (HHC) option available with RE3.

TABLE 2. BASE PROGRAM SOLUTION AND OPERATIONAL MODES

Mode Flag	Descriptive Name	Component Description
EG1	EIGENSOLUTION 1	Eigensolution mode for systems without damping (real)
EG2	EIGENSOLUTION 2	Eigensolution mode for systems with damping (complex)
FR1	FORCED RESPONSE 1	Forced response solution mode yielding harmonics of steady state response
TH1	TIME HISTORY 1	Time history solution mode using Newmark Beta Method (Reference 1)
GEN	GENERAL	General control operational mode providing general control for a computer run
PV1	PARAMETER VARIATION 1	Parametric variation operational mode facilitating variation of parameters for design studies

TABLE 3. SUMMARY OF ATTRIBUTES OF BASE PROGRAM COMPONENTS

Number	Name	Number of Input Locations (NDLOAD)	Number of Work Locations (NWORK)	Number of Connection Nodes	Number of Coordinates	Output Coordinates Fortran Names
1	BF1	14	0	1	8	GAMMAC, GAMMAS, X, Y, Z, THTX, THTY, THTZ
2	BF2	16	0	1	9	BETAO, BETAC, BETAS, X, Y, Z, THTX, THTY, THTZ
3	BM1	21	0	2	12	X1, Y1, Z1, THTX1, THTY1, THTZ1 (at end 1), X2, Y2, Z2, THTX2, THTY2, THTZ2 (at end 2) X, Y, Z, THTX, THTY, THTZ
4	CN1	10	0	1	6	X, Y, Z, THTX, THTY, THTZ
5	*EG1	1	0	-	-	-
6	*EG2	1	0	-	-	-
7	FA1	12	0	1	7	DELTA, X, Y, Z, THT1, THT2, THT3
8	*FR1	3	0	-	-	-
9	+GEN	10	0	-	-	-
10	GF1	23	0	1	6	X, Y, Z, THT1, THT2, THT3
11	IS1	73	0	2	18	XT, YT, ZT, XB, YB, ZB, XBT, YBT, ZBT, TXBT, TYBT, TZBT, XBF, YBF, ZBF, TXBF, TYBF, TZBF
12	MS1	57	0	1 to 5	1	MODE
13	+PV1	23	0	-	-	-
14	RE2	5	30+3*NC*NC	1	1+NC	E927 names (see section 7) - NC=29 max.
15	RE3	19	232 (ISTRSS=0) 3269 (ISTRSS=1)	1	6	Displacements are X, Y, Z, WX, WY, WZ. Forces/moments are RX, RY, RZ, RMX, RMY, RMZ
16	*TH1	6	2	-	-	-

*Indicates solution mode.
+Indicates operational mode.

TABLE 4. SUMMARY OF BASE PROGRAM DEBUG OUTPUT OPTIONS

Segment No.	Subroutine Name	Solution Methods				Description of Debug Printout
		EG1	EG2	FR1	TH1	
8	RECOVR				X	Time history restart input data
9	TRNSFM	X	X	X	X	Matrix coordinate transformations
9	RENTH1				X	Initial displacements and velocities
9	RE1TH1				X	As above
12	UPDMD1				X	Displacements and velocities at each time step
13*	ASMMCK	X	X	X	X	Assembly of M, C, and K matrices
15*	SO2EG1	X				Eigenvalues and eigenvectors - real
15*	SO2EG2		X			Eigenvalues and eigenvectors - complex
16*	SO2FR1			X		Forced response solution intermediate results
16*	SO2TH1				X	Time history solution intermediate results
16	ASMZ2			X		G400 impedance matrix and force vector assembly
16	ASMH2			X		G400 H matrix relating hub reaction loads to HHC inputs
17	RESFR1			X		HHC angle inputs used in the calculations of responses
17	HTRE3			X		Intermediate matrix P and optimal HHC angles
17	HXRE3			X		Dependent coordinate response - cosine and sine components
17	TDPRE3			X		T matrices in independent and dependent domains for HHC application
17	VDEP			X		Baseline vector in dependent domain without HHC
17	WZDGF1			X		Weighting factors for responses with HHC application
17	STRRE3			X		Baseline vector, HHC angles, stress vector and and one-half peak-to-peak stresses
17	RE2EG1	X				Displacements as referred to a local axis system
17	RE2FR1			X		As above
17	RE2TH1				X	As above
18	SAVTH1				X	Time history data saved for restart

* Indicates that sample outputs are included in this report.
X Indicates which solution method is applicable.

TABLE 5. DESCRIPTION OF HIGH LEVEL ROUTINES

Segment Number	Leading Routine	Segment Description
1	MAINSV	Main program
2	INPCDC	Controls subroutines reading, printing, and converting to internal program units of component input data
3	INPUT	Reads the component input data
4	PINPUT	Controls component dedicated routines reading component input data
5	PRINT1	Prints out input for all components except IS1 and RE3
6	PRINT2	Prints out input for components IS1 and RE3
7	LINK	Controls the reading of input data transmitted by external programs E927 and G400
8	RECOVR	Recovers component initial displacements and velocities for a time history restart condition
9	TRNSFM	Forms matrix transformations relating to system coordinates
10	LABEL	Forms labels for output coordinates and solution methods
11	COMPUT	Controls routines processing the data and solves the system equations
12	UPDATE	Updates system parameters or value of time
13	ASSMBL	Assembles system mass, damping, and stiffness matrices
14	SOLVE	Controls choice of solution methods (eigen-solutions or forced response/time history)
15	SOLEGN	Calculates eigensolutions (real or complex)
16	SOLFRT	Calculates forced response or time history solution
17	RESTOR	Restores system coordinate displacements from a global to a local axis system
18	SAVE	Saves final results for printing, plotting, and for time history solution restart conditions.

TABLE 6. SEGMENTATION STRUCTURE AND COMMON BLOCKS

Segment Number	Fortran Subroutine Name	COMMON Block Name
1	MAINSV	
	BLOCK	DMTRX
	CINBF1	DSUB
	CINBM1	IASKSP
	CINFR1	IRMVSP
	CINGEN	ISSETP
	CINGF1	MATMUL
	CINIS1	RECFB1
	CINKL1	RECCN1
	CINMS1	RECFA1
	CINRE2	RECIS1
	CINRE3	RECKL1
	CONINP	RECMS1
		RECRE2
		ACONVR
		CBETA
		CDEBUG
	CFR1	
	CGEN	
	CGF1	
	CINOUT	
	CITER	
	CLABEL	
	CMAXA	
	CNAMES	
	CPLLOT	
	CRE2	
	CRE3	
	CRE3H1	
	CRE3H2	
	CRSTRT	
2	INPCDC	
3	+INPUT	
	+FFLOAD FREAD	+LOAD NSPACE
4	PINPUT	
5	PRINT1	
	PINBF1	PINKL1
	PINBM1	PINMS1
	PINCN1	PINPV1
	PINEG1	PINRE2
	PINF A1	PINTH1
	PINFR1	
	PINGEN	
	PINGF1	
6	PRINT2	
	PINIS1	PINRE3
7	LINK	
	LK2RE2	PRTRE3
	LK2RE3	PRTSTR
8	RECOVR	
	RECTH1	-

TABLE 6. CONTINUED.

Segment Number	FORTRAN Subroutine Name	COMMON Block Name
9	TRNSFM	
	ASCND	CRDRE3
	BET	DEPC1
	BETO	EULTRN
	BET1	INDC1
	BET2	INDC2
	COORD	RENBF1
	CRDBF1	RENCN1
	CRDBM1	RENFA1
	CRDCN1	RENIS1
	CRDFA1	RENKL1
	CRDGF1	RENMS1
	CRDIS1	RENRE2
	CRDKL1	RENTL1
	CRDMS1	RE1TH1
CRDRE2		
10	LABEL	
	+ACON	NAMBM1
	+ACONDP	NAMCN1
	+CORE	+NAMES
	+LBLEG1	NAMFA1
	+LBLEG2	NAMGF1
	LBLFR1	NAMIS1
	LBLTH1	NAMMS1
	NAMBF1	NM2RE2
	NAMBF2	NM2RE3
11	COMPUT	
	*LINV3F	*UERTST
	*LUDATF	*UGETIO
12	UPDATE	
	FFREAD	UPDPV1
	UPDMD1	UPDTH1
13	ASSMBL	
	ASMALL	CPFA1
	ASMMCK	CPIS1
	CP	CPKL1
	CPBF1	CPMS1
	CPBF2	CP2RE2
	CPBM1	CP2RE3
14	SOLVE	

TABLE 6. CONCLUDED.

Segment Number	FORTRAN Subroutine Name	COMMON Block Name	
15	SOLEGN	-	
	*EIGZF		SO2EG1
	*EQZQF		SO2EG2
	*EQZTF		*VHSH2C
	*EQZYF		*VHSH2R
	SOLEG1		*VHSH3R
SOLEG2			
16	SOLFRT	-	
	ASMH2		NMARK2
	ASMZ2		SOLFR1
	FORGF1		SOLTH1
	*LEQT2F		SO2FR1
	*LINV2F		SO2TH1
	LUREFF		*VXADD
	MATD1		*VXMUL
	NMARK1		*VXSTO
17	RESTOR	-	
	HBFRE3		RE2EG1
	HJRE3		RE2EG2
	HTRE3		RE2FR1
	HXRE3		RE2TH1
	PRTHHC		STRRE3
	PSTRSS		TDPRE3
	RESEG1		VDEP
	RESEG2		WZDGF1
	RESFR1		
	RESTH1		
18	SAVE	-	
	+GVPLT		SAVTH1
	PRINT		SV2EG1
	SAVEG1		SV2EG2
	SAVEG2		SV2FR1
	SAVFR1		SV3TH1

*IMSL routines to be replaced by the contractor.

+Fortran routines to be revised or replaced for CDC system operation.

TABLE 7 ALPHABETICAL LIST OF BASE PROGRAM FORTRAN ROUTINES

No.	Routine Name	Seg. No.	No.	Routine Name	Seg. No.	No.	Routine Name	Seg. No.
1	+ACON	10	33	CPFAL	13	65	HXRE3	17
2	+ACONDP	10	34	CPIS1	13	66	IASKSP	1
3	ASCND	9	35	CPKL1	13	67	INDC1	9
4	ASMALL	13	36	CPMS1	13	68	INDC2	9
5	ASMH2	16	37	CP2RE2	13	69	INPCDC	2
6	ASMMCK	13	38	CP2RE3	13	70	+INPUT	3
7	ASMZ2	16	39	CRDBF1	9	71	IRMVSP	1
8	ASSMBL	13	40	CRDBM1	9	72	ISSETSP	1
9	BET	9	41	CRDCN1	9	73	LABEL	10
10	BET0	9	42	CRDFAL	9	74	+LBLEG1	10
11	BET1	9	43	CRDGF1	9	75	+LBLEG2	10
12	BET2	9	44	CRDIS1	9	76	LBLFR1	10
13	BLOCK	1	45	CRDKL1	9	77	LBLTH1	10
14	CINBF1	1	46	CRDMS1	9	78	*LEQT2F	16
15	CINBM1	1	47	CRDRE2	9	79	LINK	7
16	CINFAL	1	48	CRDRE3	9	80	*LINV2F	16
17	CINFRL	1	49	DEPC1	9	81	*LINV3F	11
18	CINGEN	1	50	DMTRX	1	82	LK2RE2	7
19	CINGF1	1	51	DSUB	1	83	LK2RE3	7
20	CINIS1	1	52	*EIGZF	15	84	+LOAD	3
21	CINKL1	1	53	*EQZQF	15	85	*LUDATF	16
22	CINMS1	1	54	*EQZTF	15	86	*LUELMF	16
23	CINRE2	1	55	*EQZVF	15	87	*LUREFF	16
24	CINRE3	1	56	EULTRN	9	88	MAINSV	1
25	COMPUT	11	57	+FFLOAD	3	89	MATD1	16
26	CONINP	1	58	FFREAD	12	90	MATMUL	1
27	COORD	9	59	FORGF1	16	91	NAMBF1	10
28	+CORE	10	60	FREAD	3	92	NAMBF2	10
29	CP	13	61	+GVPL0T	18	93	NAMBM1	10
30	CPBF1	13	62	HBFRE3	17	94	NAMCN1	10
31	CPBF2	13	63	HJRE3	17	95	+NAMES	10
32	CPBM1	13	64	HTRE3	17	96	NAMFAL	10

*IMSL routines to be replaced by the contractor.

+Fortran routines to be revised or replaced for CDC system operation.

TABLE 7 CONCLUDED.

No.	Routine Name	Seg. No.	No.	Routine Name	Seg. No.	No.	Routine Name	Seg. No.
97	NAMGF1	10	129	RECCN1	1	161	SOLEG1	15
98	NAMIS1	10	130	RECF1	1	162	SOLEG2	15
99	NAMMS1	10	131	RECIS1	1	163	SOLFRT	16
100	NMARK1	16	132	RECKL1	1	164	SOLFR1	16
101	NMARK2	16	133	RECMS1	1	165	SOLTH1	16
102	NM2RE2	10	134	RECOVR	8	166	SOLVE	14
103	NM2RE3	10	135	RECRE2	1	167	SO2EG1	15
104	NSPACE	3	136	RECTH1	8	168	SO2EG2	15
105	PINBF1	4	137	RENB1	9	169	SO2FR1	16
106	PINBM1	4	138	RENCN1	9	170	SO2TH1	16
107	PINC1	4	139	RENFA1	9	171	STRRE3	17
108	PINEG1	4	140	RENIS1	9	172	SV2EG1	18
109	PINF1	4	141	RENKL1	9	173	SV2EG2	18
110	PINFR1	4	142	RENMS1	9	174	SV2FR1	18
111	PINGEN	4	143	RENRE2	9	175	SV3TH1	18
112	PINGF1	4	144	RETH1	9	176	TDPRE3	17
113	PINIS1	4	145	RESEG1	17	177	TRNSFM	9
114	PINKL1	4	146	RESEG2	17	178	*UERTST	14
115	PINMS1	4	147	RESFR1	17	179	*UGETIO	14
116	PINP1	4	148	RETH1	17	180	UPDATE	12
117	PINPV1	4	149	RESTOR	17	181	UPDMD1	12
118	PINRE2	4	150	RE1TH1	9	182	UPDPV1	12
119	PINRE3	4	151	RE2EG1	17	183	UPDTH1	12
120	PINTH1	4	152	RE2EG2	17	184	VDEP	17
121	PRINT	18	153	RE2FR1	17	185	*VHSH2C	15
122	PRINT1	5	154	RE2TH1	17	186	*VHSH2R	15
123	PRINT2	6	155	SAVE	18	187	*VHSH3R	15
124	PRTHHC	17	156	SAVEG1	18	188	*VXADD	16
125	PRTRE3	7	157	SAVEG2	18	189	*VXMUL	16
126	PRTSTR	17	158	SAVFR1	18	190	*VXSTO	16
127	PSTRSS	17	159	SAVTH1	18	191	WZDGF1	17
128	RECBF1	1	160	SOLEGN	15			

*ISML routines to be replaced by the contractor.

+Fortran routines to be revised or replaced for CDC system operation.

TABLE 8. FUNCTIONS OF FORTRAN ROUTINES IN BASE PROGRAM

No.	Routine Name	Brief Description
+ 1	ACON	IBM routine, called by ACONDP, which converts floating point or integer numbers to alpha numeric characters. Not used for CDC applications.
+ 2	ACONDP	IBM routine to be replaced by equivalent CDC routine ENCODE. It is called by subroutines NAMES, LBLEG1, and LBLEG2. It provides interface between a global double precision program module and single precision system routines.
3	ASCND	Sorts a vector of integers into ascending order. Ex: 3,3,3,2,1,1,4,4, to 1,1,2,3,3,3,4,4.
4	ASMALL	Sets computer storage needed for assembling mass (M), damping (C), and stiffness (K) matrices and force vector.
5	ASMMCK	Assembles the global M,C, and K matrices from the local matrices and forms the global force vector.
6	ASMH2	Assembles the rotor impedance matrix H.
7	ASMZ2	Assembles the rotor impedance matrix (Z) and the force vector (F) for component RE3 and forced response solution FR1.
8	ASSMBL	Controls assembly of M,C, and K matrices for the different solution methods.
9	BET	Saves non-zero elements of the BETA matrix (product of BETA), BETA1, and BETA2 below) in vector form for fast assembly.
10	BET0	Forms BETA0 transformation matrix relating local element coordinates to the global element coordinates.
11	BET1	Forms BETA1 transformation matrix relating dependent and independent coordinates in the global system.
12	BET2	Forms BETA2 transformatin matrix relating coordinates defined by routines INDC1 and INDC2.
13	BLOCK	Initializes data in COMMON blocks.
<p><u>NOTE:</u> Subroutines CINBF1 (no. 13) through CINRE3 (no. 23) perform the same function, which is to convert component input data to internal program units (slug, foot, sec, and radian). The component name is identified by the last 3 characters in the routine's Fortran name.</p>		
14	CINBF1	See note above (this routine handles both in-plane and vertical bifilars).
15	CINBM1	See note above.

TABLE 8. CONTINUED.

No.	Routine Name	Brief Description
16	CINFAL	See note above.
17	CINFR1	See note above.
18	CINGEN	See note above.
19	CINGF1	See note above.
20	CINIS1	See note above.
21	CINKL1	See note above.
22	CINMS1	See note above.
23	CINRE2	See note above.
24	CINRE3	See note above.
25	COMPUT	Controls lower level routines processing the data and solving system equations of motion at each step (parametric variation or time step).
26	CONINP	Controls routines converting input units to internal units.
27	COORD	Defines the number of coordinates to be used for each component.
+28	CORE	IBM routine, called by ACON, which provides computer storage. Not used or CDC applications.
29	CP	Controls component dedicated routines forming local M,C, and K matrices and local force vector.
<p><u>NOTE:</u> Subroutines CPBF1 (no. 29) through CP2RE3 (no. 37) perform the same function, which is to calculate the local M,C, and K matrices and local force vector for a system component. The component name is identified by the last 3 characters in the routine name.</p>		
30	CPBF1	See note above.
31	CPBF2	See note above.
32	CPBM1	See note above.
33	CPFAL	See note above.
34	CPIS1	See note above.
35	CPKL1	See note above.
36	CPMS1	See note above.
37	CP2RE2	See note above.
38	CP2RE3	See note above.

TABLE 8. CONTINUED.

No.	Routine Name	Brief Description
		<u>NOTE:</u> Subroutines CRDBF1 (no. 38) through CRDRE3 (no. 47) perform the same function, which is to specify the number of coordinates, connection node numbers, and Euler angles for each component. The component name is identified by the last 3 characters in the routine name.
39	CRDBF1	See note above (this routine handles both in-plane and vertical bifilar).
40	CRDBM1	See note above.
41	CRDCN1	See note above.
42	CRDFA1	See note above.
43	CRDGF1	See note above.
44	CRDIS1	See note above.
45	CRDKL1	See note above.
46	CRDMS1	See note above.
47	CRDRE2	See note above.
48	CRDRE3	See note above.
49	DEPC1	Forms attributes of the dependent coordinates of the assembly.
50	DMTRX	Displays non-zero elements of a matrix or a vector.
51	DSUB	Writes out the name of the subroutine being called for debug printout
* 52	EIGZF	IMSL routine called by SO2EG1 and SO2EG2 for eigensolutions. It calculates eigenvalues and eigenvectors (optionally) of the system $A * X = * B * X$ where A and B are real matrices.
* 53	EQZQF	IMSL routine called by EIGZF for eigensolutions. It reduces two input matrices A and B, simultaneously, A to upper Hessenberg and B to upper triangular form.
* 54	EQZTF	IMSL routine callee by EIGZF for eigensolutions. It reduces an upper Hessenberg matrix A to quasi-upper triangular form while keeping matrix B triangular.

TABLE 8. CONTINUED.

No.	Routine Name	Brief Description
* 55	EQZVF	IMSL routine called by EIGZF for eigensolutions. It calculates the eigenvalues and eigenvectors (optionally) of the system $A * Z = * B * Z$ where A is quasi-upper triangular and B is upper triangular.
56	EULTRN	Forms 3 x 3 rotation transformation matrix of direction cosines from input Euler angles (THETA, PHI, XSI).
+ 57	FFLOAD	Reads component name and element number, prints out run heading and image of input data, controls reading of input data for successive cases and stores input data into 2 vectors, ILOAD for integer values and DLOAD for real values. The WRITE statements are computer dependent (CDC or IBM).
58	FFREAD	Updates input data; called by UPDATE in the execution of a parametric variation study.
59	FORGF1	Forms the force vector from the input excitation forces for component GF1.
60	FREAD	Updates input data called by INPUT at the start of the run. This routine is identical to FFREAD; a duplicate routine is used to reduce the size of the first overlay segment.
+ 61	GVPLOT	Writes titles, output results and labels to a file on unit 2 for plotting purposes. The WRITE statements are computer dependent (CDC or IBM).
62	HBFRE3	Restores hub interface forces and moments resolved to the hub local axis from a solution for rotor type RE3.
63	HJRE3	Computes performance index J for HHC application.
64	HTRE3	Computes HHC optimum control angles.
65	HXRE3	Computes dependent coordinate response with HHC.
66	IASKSP	FUNCTION IASKSP returns information defining computer storage allocations for a specific variable. EX: LOCEXP=IASKSP (IA,A,4HEXPL,KIND,KLASS,NROWS,NCOLS). The function subroutine IASKSP provides the storage location, LOCEXP, for variable EXPL in the IA vector which contains integer values (the A vector contains real values) and the storage locations for the attributes KIND, KLASS, NROWS, NCOLS, where KIND = 1 for real, 2 for complex values KLASS = 1 for all cases NROWS = number of rows in EXPL NCOLS = number of columns in EXPL

TABLE 8. CONTINUED.

No.	Routine Name	Brief Description
		If the variable name EXPL is not found in the catalog entry list of the IA vector, a message is printed to that effect and program execution is terminated. The programmer should then use the function ISETSP to reserve storage for the variable EXPL (see writeup for ISETSP, no. 68).
67	INDC1	Stores the element number, connection node number, displacements and velocities of the independent coordinates of the assembled system.
68	INDC2	Calculates the size of the independent coordinates vector and assigns global element numbers and node numbers to the set of independent coordinates by removing those coordinates expressible in terms of modal coordinates for elastic structures.
69	INPCDC	Controls reading, printing, and converting to internal units of the component input data.
+ 70	INPUT	Reads the component input data. It also reads and writes up to 4 title cards. CDC format is 4A10, IBM format is 10A4.
71	IRMVSP	Frees computer storage allocations no longer needed for the variable specified. EX: CALL IRMVSP (IA,A,4HEXPL). The catalog entry list is first searched to find the variable name EXPL. If found, then storage is freed and the variable EXPL does not exist any longer. If the name EXPL is not found, than space was not previously allocated and therefore none can be freed; program yields a message to that effect and proceeds with execution.
72	ISETSP	FUNCTION ISETSP reserves computer storage for the variable specified. EX: LOCEXP=ISETSP (IA,A,4H EXPL,KIND, KCLASS, NROWS, NCOLS). The routine first checks to see if storage has already been reserved for variable EXPL. If it has, it returns the value LOCEXP (location in the IA vector) and program execution continues. If it hasn't, it reserves storage locations in the IA and A vectors if enough space is available. If the space requested is not available, a message is printed to that effect and program execution is stopped. The programmer should then either reduce the storage requested for EXP or increase the size of the IA and A allocation vectors.

TABLE 8. CONTINUED.

No.	Routine Name	Brief Description
73	LABEL	Forms labels for output system coordinates and methods of solution.
+ 74	LBLEG1	Forms the labels for eigenvalue solution EG1 with no system damping. CDC uses ENCODE, IBM uses ACONDP.
+ 75	LBLEG2	Forms the labels for eigenvalue solution EG2 with system damping. CDC uses ENCODE, IBM uses ACONDP.
76	LBLFR1	Forms the labels for the forced response solution FR1.
77	LBLTH1	Forms the labels for the time history solution TH1.
* 78	LEQT2F	IMSL routine called by IMSL routine LINV2F and by the Base Program subroutines NMARK1 and NMARK2. It solves a set of linear equations (highly accurate).
79	LINK	Controls the reading of input data transmitted by external programs E927 and G400.
* 80	LINV2F	IMSL routine called by subroutine NMARK1. It calculates the inverse of a matrix (highly accurate - uses full storage).
* 81	LINV3F	IMSL routine called by SO2FR1 and HTRE3. It calculates the inverse of a matrix (not as accurate as LINV2F but requires less storage).
82	LK2RE2	Reads rotor matrices (M,C, and K) from program E927 stored in unit 10.
83	LK2RE3	Reads rotor impedance matrix and force vector from program G400 stored in unit 11 or as specified by the user on unit 5 (standard read unit).
+ 84	LOAD	Reads input data. The READ statements are computer dependent (CDC or IBM).
* 85	LUDATF	IMSL routine called by IMSL routine LEQT2F. It performs L-U decomposition by the CROUT algorithm with optional accuracy test.
* 86	LUELMF	IMSL routine called by IMSL routines LEQT2F and LUREFF. It eliminates part of the solution of $AX = B$.
* 87	LUREFF	IMSL routine called by IMSL routine LEQT2F. It refines the solution of a set of linear equations.
+ 88	MAINSV	Controls the Base Program logic flow, sets size of the IA and A vectors, initializes both vectors to zero, and sets the first 5 locations of the integer vector IA. At the end of the computer run, MAINSV prints out the maximum size of the working storage.
89	MATD1	For CDC code, add PROGRAM SIMVIB (...) card. Solves for the displacement response of the system using the Newmark Beta method to find the time history solution.

TABLE 8. CONTINUED.

No.	Routine Name	Brief Description
90	MATMUL	Multiplies two matrices together.
		<u>NOTE:</u> Subroutines NAMBF1 (no. 86) through NAMCN1 (no. 89) all perform the same function, which is to assign names to the different degrees of freedom of each system component.
91	NAMBF1	See note above.
92	NAMBF2	See note above.
93	NAMBM1	See note above.
94	NAMCN1	See note above.
+ 95	NAMES	Stores element number for each component in its coordinate labels. CDC uses ENCODE, IBM. uses ACONDP.
96	NAMFA1	See note above before NAMBF1.
97	NAMGF1	See note above before NAMBF1.
98	NAMISL	See note above before NAMBF1.
99	NAMMS1	See note above before NAMBF1.
100	NMARK1	Calculates parameters required to solve the time history equations of motion by the Newmark Beta Method for initial points.
101	NMARK2	As above but for intermediate points.
102	NM2RE2	See note above before NAMBF1.
103	NM2RE3	See note above before NAMBF1.
104	NSPACE	Defines number of input loader locations required for system components.
		<u>NOTE:</u> Subroutines PINBF1 (no. 100) through PINMS1 (no. 110) perform the same functions, which is to print the input for the specified component.
105	PINBF1	See note above (this routine handles both in-plane and vertical bifilar).
106	PINBM1	See note above.
107	PINCNI	See note above.
108	PINEG1	See note above.
109	PINFAL	See note above.
110	PINFRI	See note above.
111	PINGEN	See note above.
112	PINGF1	See note above.
113	PINIS1	See note above.
114	PINKL1	See note above.

TABLE 8. CONTINUED.

No.	Routine Name	Brief Description
115	PINMS1	See note above.
116	PINPUT	Controls the routines which print the component input data.
117	PINPV1	See note above before PINBF1.
118	PINRE2	See note above before PINBF1.
119	PINRE3	See note above before PINBF1.
120	PINTH1	See note above before PINBF1.
121	PRINT	Prints output results.
122	PRINT1	Controls the printing of component input data except for IS1 and RE2.
123	PRINT2	Controls the printing of component input data for IS1 and RE3.
124	PRTHHC	Prints summary of HHC results.
125	PRTRE3	Prints rotor impedance matrix and force vector from G400 program as stored on unit 11 or from user input on unit 12.
126	PRTSTR	Prints stress matrices from G400 program.
127	PSTRSS	Prints summary of stresses.
		<u>NOTE:</u> Subroutine RECBF1 (no. 118) through RECMS1 (no. 123) perform the same function, which is to recover initial values of displacements and velocities for time history restart conditions.
128	RECBF1	See note above (this routine handles both in-plane and vertical bifilars).
129	RECNI	See note above.
130	RECF1	See note above.
131	RECIS1	See note above.
132	RECKL1	See note above.
133	RECMS1	See note above.
134	RECOVR	Controls the recover of initial values of component displacements and velocities for a time history restart condition.
135	RECRE2	See note above before RECBF1.
136	RECTH1	See note above before RECBF1.

TABLE 8. CONTINUED.

No.	Routine Name	Brief Description
		NOTE: Subroutine RENBF1 (no. 127) through RENRE2 (no. 133) perform the same function, which is to initialize the values of displacements and velocities in the globaldependent coordinate system and/or recover the component coordinates number.
137	RENBF1	See note above.
138	RENCN1	See note above.
139	RENFA1	See note above.
140	RENIS1	See note above.
141	RENKL1	See note above.
142	RENMS1	See note above.
143	RENRE2	See note above.
144	RENTH1	Controls the recovery of the initial displacements and velocities for the various components.
145	RESEG1	Controls restoring of component displacements from the global to the local axis system for eigensolution EG1.
146	RESEG2	As above but for eigensolution EG2.
147	RESFR1	As above but for forced response solution FR1. In addition, it controls the restoring of the hub interface forces for component RE3.
148	RESTH1	As above for RESEG1 but for the time history solution TH1.
149	RESTOR	Controls the restoring of component displacements from the global to the local axis system for the four methods of solution (EG1, EG2, FR1, and TH1).
150	RE1TH1	Resolves component displacements, velocities, and accelerations from local to global axis system.
151	RE2EG1	Restores component displacements from the global to the local axis system for eigensolution EG1.
152	RE2EG2	As above but for eigensolution EG2.
153	RE2FR1	As above but for forced response solution FR1.
154	RE2TH1	As above but for time history solution TH1.
155	SAVE	Controls the saving of output results for printing and/or plotting.
156	SAVEG1	Controls saving of output results for eigensolution EG1.
157	SAVEG2	As above but for eigensolution EG2.

TABLE 8. CONTINUED.

No.	Routine Name	Brief Description
158	SAVFR1	As above but for forced response solution FR1.
159	SAVTH1	Saves output results for time history solution TH1.
160	SOLEGN	Controls choice of eigensolution EG1 for systems without damping or eigensolution EG2 for systems with damping.
161	SOLEG1	Controls eigenvalue solution EG1.
162	SOLEG2	Controls eigenvalue solution EG2.
163	SOLFRT	Controls choice of forced response solution FR1 or time history solution TH1.
164	SOLFR1	Controls forced response solution FR1.
165	SOLTH1	Controls time history solution TH1.
166	SOLVE	Controls type of solution requested: eigensolution (EG1 or EG2) or forced response/time history (FR1 or TH1).
167	SO2EG1	Calculates the eigenvalues and eigenvectors for the system defined by the mass and stiffness matrices.
168	SO2EG2	Calculates the eigenvalues and eigenvectors for the system defined by the mass, damping, and stiffness matrices.
169	SO2FR1	Calculates the forced response solution. Assembles rotor impedance matrix for component RE3 with impedances from other components.
170	SO2TH1	Controls the calculations of the time history response of the system using the Newmark Beta method to find the solution.
171	STRRE3	Calculates harmonics of stresses and pushrod loads and one-half peak-to-peak stresses and loads.
172	SV2EG1	Saves output results for eigensolution EG1.
173	SV2EG2	Saves output results for eigensolution EG2.
174	SV2FR1	Saves output for forced response solution FR1.
175	SV3TH1	Saves output results for time history restart cases on unit 8.
176	TDPRE3	Assembles T matrix in the dependent coordinates domain.
177	TRNSFM	Forms the matrix transformations relating the system coordinates.
*178	UERTST	IMSL routine called by IMSL routines EIGZF, EQ2TF, LINV2F, LEQT2F, LUDATF, and LUREFF. It generates error messages.

TABLE 8. CONCLUDED.

No.	Routine Name	Brief Description
*179	UGETIO	IMSL routine called by IMSL routine UERTST.
180	UPDATE	Updates time or parameter dependent coordinates.
181	UPDMD1	Defines displacements, velocities, and accelerations for the independent coordinates at the next time increment.
182	UPDPV1	Updates the independent parameter requested by component PV1.
183	UPDTH1	Updates the time for a time history solution.
184	VDEP	Calculates dependent coordinates for HHC and/or stress options for the RE3 component.
*185	VHSH2C	IMSL routine called by IMSL routine EQZVF. Zeroes out a single complex element of a matrix.
*186	VHSH2R	IMSL routine called by IMSL routines EQZQF, EQZTF, and EQZVF.
*187	VHSH3R	IMSL routine called by IMSL routine EQZTF. Zeroes out 2 elements of a matrix.
*188	VXADD	IMSL routine called by IMSL routines LUREFF and VXMUL. It adds a double precision floating point number to the extended precision accumulator.
*189	VXMUL	IMSL routine called by IMSL routine LUREFF. It multiplies two double precision floating point numbers and adds the extended precision result to the extended precision accumulator.
*190	VXSTO	IMSL routine called by IMSL routine LUREFF. It moves a double precision floating point number contained in the most significant half of the extended precision accumulator into the location specified in the VXSTO argument list.
191	WZDGF1	Recovers weighting factors for HHC option from the A storage vector.

*IMSL routines to be replaced by the contractor.

+Fortran routines to be revised or replaced for CDC system operation.

TABLE 9. BASE PROGRAM COMMON BLOCKS/SUBROUTINES CROSS-REFERENCE LIST

Subroutine Name/ Common Block																																Subroutine Name/ Common Block	
	1	2	3	4	5	6	7	8	9	10	11	12	13	14	15	16	17	18	19	20	21	22	23	24	25	26	27	28	29	30	31		
	ACON	ACONDP	ASCND	ASMLL	ASMH2	ASMLK	ASMLZ	ASSMBL	BET	BETO	BET1	BET2	BLOCK	CINBEI	CINBYI	CINFAI	CINFR1	CINGEN	CINGFI	CINIS1	CINKLI	CINMS1	CINRE2	CINRE3	COMPT	CONINP	COORD	CORE	CP	CPBF1	CPBF2		
1 ACONVR																																ACONVR	1
2 CEFTA			X										X																			CBETA	2
3 CDATA			X					X					X													X						CDATA	3
4 CDEBUD			X	X	X	X						X				X									X							CDEBUD	4
5 CFR1												X					X															CFR1	5
6 CGEN												X					X															CGEN	6
7 CGF1												X																				CGF1	7
8 CINOUT												X																X				CINOUT	8
9 CITER																									X							CITER	9
10 CLABEL																																CLABEL	10
11 CMAXA												X																				CMAXA	11
12 CNAMES								X				X														X	X			X		CNAMES	12
13 CPLOT												X																				CPLOT	13
14 CRE2												X																				CRE2	14
15 CRE3				X	X							X												X						X		CRE3	15
16 CRE3H1												X																				CRE3H1	16
17 CRE3H2												X																				CRE3H2	17
18 CRSTRT												X														X						CRSTRT	18

NOTE: + Denotes computer dependent subroutines (IBM or CDC).
 * Denotes INSL routines which must be replaced by the Contractor.

TABLE 9. CONTINUED.

	32	33	34	35	36	37	38	39	40	41	42	43	44	45	46	47	48	49	50	51	52	53	54	55	56	57	58	59	60	61			
Subroutine Name/ Common Block	CPBM1	CPFA1	CPIS1	CPKL1	CPMS1	CPRE2	CPRE3	CRDBF1	CRDBM1	CRDCN1	CROFAL	CRGGF1	CRDLS1	CRONL1	CRONF1	CRDRE2	CRDRE3	DEPAC	DMTRY	DSUC	EIGZF	EQZGF	EQZTF	EQZYF	EULTRN	FFLOAD	FFREAD	FORGF1	FREAD	HGPLOT	Subroutine Name/ Common Block		
1 ACONVR																										X				ACONVR 1			
2 CBETA																															CBETA 2		
3 CDATA																										X	X	X			CDATA 3		
4 CDEBUG																			X												CDEBUG 4		
5 CFR1																																CFR1 5	
6 CGEN																														X		CGEN 6	
7 CGF1																																CGF1 7	
8 CINOUT																			X	X						X				X		CINOUT 8	
9 CITER																																CITER 9	
10 CLABEL																													X			CLABEL 10	
11 CMAXA																										X	X	X				CMAXA 11	
12 CNAMES																																	CNAMES 12
13 CPLOT																														X			CPLOT 13
14 CRE2						X																											CRE2 14
15 CRE3																																	CRE3 15
16 CRE3H1																																	CRE3H1 16
17 CRE3H2																																	CRE3H2 17
18 CRSTRT																										X			X				CRSTRT 18

TABLE 9. CONTINUED.

Subroutine Name/ Common Block	96	97	98	99	100	101	102	103	104	105	106	107	108	109	110	111	112	113	114	115	116	117	118	119	120	121	122	123	124	Subroutine Name/ Common Block
1 ACONVR																														ACONVR 1
2 CBETA																														CBETA 2
3 CDATA																														CDATA 3
4 CDEBUG																														CDEBUG 4
5 CFR1																														CFR1 5
6 CGEN																														CGEN 6
7 CGF1																														CGF1 7
8 CINOUT																														CINOUT 8
9 CITER																														CITER 9
10 CLABEL																														CLABEL 10
11 CMAXA																														CMAXA 11
12 CNAME																														CNAME 12
13 CPLOT																														CPLOT 13
14 CRE2																														CRE2 14
15 CRE3																														CRE3 15
16 CRE3H1																														CRE3H1 16
17 CRE3H2																														CRE3H2 17
18 CRSTR																														CRSTR 18

TABLE 9. CONTINUED.

Subroutine Name/ Common Block	152	153	154	155	156	157	158	159	160	161	162	163	164	165	166	167	168	169	170	171	172	173	174	175	176	177	178	Subroutine Name/ Common Block	
1 ACONVR	RE2GG2	REFR1	RE2TH1	SAVE	SAVEG1	SAVEG2	SAVER1	SAVTH1	SOLEG1	SOLEG2	SOLFRT	SOLFRI	SOLTH1	SOLVE	SOREG1	SOREG2	SORFR1	SORTH1	STRER	SVREG1	SVREG2	SVFR1	SV3TH1	TDRER	TRUSM	VERTST	ACONVR	1	
2 CBETA					X	X	X	X		X	X	X	X															CBETA	2
3 CDATA			X									X		X														CDATA	3
4 CDEBUG	X	X						X							X	X	X	X	X									CDEBUG	4
5 CFR1																	X											CFR1	5
6 CGEN				X																								CGEN	6
7 CGF1																												CGF1	7
8 CINOUT								X								X	X	X										CINOUT	8
9 CITER																			X									CITER	9
10 CLABEL																												CLABEL	10
11 CMAXA									X	X		X																CMAXA	11
12 CNAMES			X											X			X	X										CNAMES	12
13 CPLOT																												CPLOT	13
14 CRE2																												CRE2	14
15 CRE3																												CRE3	15
16 CRE3H1																	X											CRE3H1	16
17 CRE3H2																	X											CRE3H2	17
18 CRSTRT																			X						X			CRSTRT	18

TABLE 9. CONCLUDED.

Subroutine Name/ Common Block	179 180 181 182 183 184 185 186 187 188 189 190 191												Subroutine Name/ Common Block		
	UGETID	UPDATE	UPDMO1	UPDEV4	VERTH1	VDEP	VHSH2C	VHSH2R	VHSH3R	VXADD	VXKVL	VXSTD		WZDSF1	
1 ACONVR					X									ACONVR	1
2 CBETA														CBETA	2
3 CDATA	X													CDATA	3
4 CDEBUG		X											X	CDEBUG	4
5 CFR1								X						CFR1	5
6 CGEN				X	X									CGEN	6
7 CGF1														CGF1	7
8 CINOUT				X	X									CINOUT	8
9 CITER														CITER	9
10 CLABEL														CLAEEL	10
11 CMAXA	X													CMAXA	11
12 CNAMES	X													CNAMES	12
13 CPLOT				X	X									CPLOT	13
14 CRE2														CRE2	14
15 CRE3														CRE3	15
16 CRE3H1														CRE3H1	16
17 CRE3H2														CRE3H2	17
18 CRSTRT		X												CRSTRT	18

TABLE 10. BASE PROGRAM INPUT/OUTPUT DATA FILES

File Number	Fortran Name*	Subroutine(s) for Referencing File & (Segment No. of Subroutine)	Input/Output Function of File and Character of Data
1	KINPUT	1. INPUT (3) 2. LOAD (3)	Read title cards (up to 4). Read component input data (standard read file).
2	KSAVE	GVPL0T (18)	Store titles, number of parametric variations, total number of output coordinates, coordinate labels and final results for plotting.
5	IOUNIT	LK2RE3 (7)	Read G400 rotor impedance matrix and force vector as specified by the user.
6	KPRINT	(As Needed)	Write titles, input data image, input for each component intermediate calculations for debugging and final results (standard write unit).
7	KPUNCH	(As Needed)	Standard punch unit.
8	KRSTR	1. RECOVR (8) 2. RECTH1 (8) 3. SV3TH1 (18)	Read coordinate dimensions for time history restart case. Read data (displacements and derivatives) for restart case. Write coordinate dimensions and data (displacements and derivatives) for restart case.
10	IOXRE2	LK2RE2 (7)	Read E927 stiffness, damping, and mass matrices.
11	IOXRE3	LK2RE3 (7)	Read G400 rotor impedance matrix and force vector from program.
12	IOXRE3	LK2RE3 (7)	Read user input of rotor impedance matrix and force vector.

*Specified in subroutine BLOCK

TABLE 11. NEW SUBROUTINES REQUIRED FOR ADDITION OF A SUBSTRUCTURE

Number	Routine Name	Segment Number	Called by Subroutine (in Segment Number)	Description of New Routine
1	CINBF4	1	CONINP (1)	Converts input to internal units.
2	RECBF4	1	RECOVR (8) and RESTH1 (17)	Recovers displacements and velocities for restart cases.
3	PINBF4	4	PINPUT (4)	Prints component input data.
4	CRDBF4	9	COORD (9)	Forms coordinate attributes.
5	RENB4	9	RENTH1 (9)	Initializes displacements and velocities for restart cases.
6	NAMBF4	10	LABEL (10)	Assigns names to the output coordinates.
7	CPBF4	13	CP (13)	Forms component mass, damping and stiffness matrices.

TABLE 12. REVISIONS TO SUBROUTINES REQUIRED FOR ADDITION OF A SUBSTRUCTURE

Number	Subroutine Name	Segment Number	Description of Revisions
1	BLOCK	1	<ol style="list-style-type: none"> 1. COMMON/CNAMES/IY(21) 2. DIMENSION IX(21) 3. DATA IX/4HFA1, , 4HBF4 / 4. DO 10 I = 1, 21
2	CONINP	1	<ol style="list-style-type: none"> 1. COMMON/CNAMES/XFA1, , XBF4 2. INTEGER XBF4 3. IF(ANAME.EQ.XBF4) CALL CINBF4(A(LOC DAT))
3	NSPACE	3	<ol style="list-style-type: none"> 1. COMMON/CNAMES/IX(21) 2. DIMENSION IY(21) 3. DATA IY/12, , NDLOAD/ where NDLOAD = number of input items needed to specify new element BF4 4. DO 10 I = 1, 21 5. Define NWORK = number of work variables needed for BF4(0) 6. Revise NTOTAL = NDLOAD + NWORK as appropriate for BF4
4	PINPUT	4	<ol style="list-style-type: none"> 1. COMMON/CNAMES/XFA1, , XBF4 2. INTEGER XBF4 3. IF(ANAME.EQ.XBF4) CALL PINBF4 (A(LOC DAT), IELEM, KPRINT)
5	LINK	7	Same as revisions 1 and 2 for PINPUT (seg. 4)
6	RECOVR	8	<ol style="list-style-type: none"> 1. Same as revisions 1 and 2 for PINPUT (seg. 4) 2. IF(ANAME.EQ.XBF4) CALL RECBF4 (A(LOC DAT), NNG, A(IXDEP), A(IDXDEP)) 3. If no initial displacements and velocities are to be recovered for BF4, then code IF(ANAME.EQ.XBF4) NNG = NNG + NCBF4 . where NCBF4 = number of coordinates associated with BF4.

TABLE 12. CONCLUDED.

Number	Subroutine Name	Segment Number	Description of Revisions
7	COORD	9	1. Same as revisions 1 and 2 for PINPUT (seg. 4) 2. IF (ANAME.EQ.XBF4) CALL CRDBF4(A(LOC DAT),NLOCAL, NNODEL,NCNL,EULERL)
8	RENTH1	9	1. Same as revisions 1 and 2 for PINPUT (seg. 4) 2. IF (ANAME.EQ.XBF4) CALL RENBF4(A(LOC DAT),NNG,XDEP, DXDEP) 3. If no displacements and velocities are to be initialized for BF4, then code IF (ANAME.EQ.XBF4) NNG = NNG + NCBF4 (same as RECOVER above)
9	LABEL	10	1. Same as revisions 1 and 2 for PINPUT (seg. 4) 2. IF (ANAME.EQ.XBF4) CALL NAMBF4(A(LNAME),NLOCAL)
10	UPDATE	12	Same as revisions 1 and 2 for PINPUT (seg. 4)
11	ASSMBL	13	Same as revisions 1 and 2 for PINPUT (seg. 4)
12	CP	13	1. Same as revisions 1 and 2 for PINPUT (seg. 4) 2. IF (ANAME.EQ.XBF4) CALL CPBF4(A(LOC DAT),NLOCAL,MO, CO, KO, FO, IDIM)
13	SOLVE	14	Same as revisions 1 and 2 for PINPUT (seg. 4)
14	SOIFR1	16	Same as above
15	SO2TH1	16	Same as above
16	RESTOR	17	Same as above
17	RESTH1	17	Same as revisions for RECOVER (seg. 8)
18	SAVE	18	Same as revisions 1 and 2 for PINPUT (seg. 4)

TABLE 13. BASE PROGRAM TEST CASES SUMMARY

Case No.	Case Description	BASE PROGRAM SUBSTRUCTURES											OPERATIONAL AND SOLUTION MODES				Size of Work Vector	CPU Time (Sec)	
		BF1	BF2	BM1	FA1	IS1	RE2	RE3	CN1	CF1	MS1	GEN	PV1	EG1	EG2	FR1			TH1
1	Inplane bifilars with 5 fuselage normal modes using a forced response solution with longitudinal and lateral excitation forces.	V								V	V	V				V		2161	0.5
2	Vertical bifilars with 5 fuselage normal modes using a forced response solution with a vertical excitation force.		V							V	V	V				V		2307	0.4
3	Elastic beam model comprising 5 segments constrained to vertical displacement using eigensolution 1.			V					V			V		V				7865	0.8
4	Fixed system absorber with mass added to base using a forced response solution with a longitudinal force at various frequencies.				V				V	V	V	V				V		1065	0.4
*5	As Case 4 above using a time history solution calculated up to 1 second-line printer output suppressed.				V				V	V	V	X				V		1032	4.5
6	As Case 5 above using the time history restart option from 0.05 to 0.10 second-line printer output suppressed.				V				V	V	V	X				V		1131	0.5

NOTES: 1) V indicates substructures and solution method used.
2) X indicates operational modes and solution methods which cannot be used.
3) * input and output are provided in this manual. Plots are provided except for Case 12.

TABLE 13. CONTINUED.

Case No.	Case Description	BASE PROGRAM SUBSTRUCTURES											OPERATIONAL AND SOLUTION MODES					Size of Work Vector	CPU Time (Sec)
		BF1	BF2	BM1	FA1	IS1	RE2	RE3	CN1	GF1	MS1	GEN	PV1	EG1	EG2	FR1	TH1		
*7	One d.o.f. (Vertical Motion) nodal isolator with 2 fuselage and one transmission normal mode using a forced response solution with a vertical excitation force at various frequencies (see Figure 44a).					V				V	V	V	V			V		3055	1.0
8	Two d.o.f. (Vertical and Lateral Motion) nodal isolator with one transmission normal mode with the vertical force acting on node 1 (see Figure 44b).					V				V	V	V	V			V		2794	0.4
9	Two d.o.f. (Vertical and Lateral Motion) nodal fuselage and one transmission normal mode with the vertical force acting on node 3 (see Figure 44c).					V				V	V	V	V			V		3090	0.4
10	As Case 9 above but with 6 normal modes for the fuselage and six normal modes for the transmission.					V				V	V	V	V			V		5915	0.7
*11	Six d.o.f. nodal isolator assembled from 4 isolator bars, positioned 90° to each other.					V				V	V	V	V			V		+14831	2.30

NOTES: 1) V indicates substructures and solution method used.
2) X indicates operational modes and solution methods which cannot be used.
3) * input and output are provided in this manual. Plots are provided except for Case 12.
4) + case cannot be run in an interactive mode since size is greater than 8400 words.

TABLE 13. CONCLUDED.

Case No.	Case Description	BASE PROGRAM SUBSTRUCTURES											OPERATIONAL AND SOLUTION MODES					Size of Work Vector	CPU Time (Sec)
		BF1	BF2	BM1	FA1	IS1	RE2	RE3	CN1	GF1	MS1	GEN	PV1	EG1	EG2	FR1	TH1		
*12	E927 elastic rotor with 12 rotor coordinates and 5 fuselage modes using eigensolution 2.						V			V	V			V				+14529	2.2
*13	User input of rotor impedance matrix with 6 hub displacements and 4 fuselage normal modes using forced response solution.							V		V	V	V	V	X	X	V	X	1985	1.0
14	G400 program rotor impedance matrix with 6 hub displacements and 3 ARES model normal modes. No HHC and no stress options used.						V		V	V	V		X	X	V	X	2190	0.8	
15	As Case 14 with the stress option invoked.						V		V	V	V		X	X	V	X	5397	1.4	
16	As Case 14 with both HHC and stress options invoked.						V		V	V	V		X	X	V	X	5538	1.5	

NOTES: 1) V indicates substructures and solution method used.
2) X indicates operational modes and solution methods which cannot be used.
3) * input and output are provided in this manual. Plots are provided except for Case 12.
4) + case cannot be run in an interactive mode since size is greater than 8400 words.

TABLE 14. BASE PROGRAM TEST CASES TEKTRONIX PLOTS SUMMARY

Test Case	Figure No.	Abcissa		Ordinates		Plot Description
		Name	Units	Name	Units	
5	45	TIME	Sec	1. DELT 2. X	Ft "	Time history response of fixed system absorber and modal structure longitudinal displacements. Response increases with time because system is not restrained.
7	46	FREQUENCY	Hz	1. ZT 2. ZB	G's "	Forced response of transmission and fuselage vertical displacements with one 1-D isolator system for a forcing frequency range up to 50 Hz. Fuselage motion is a minimum near frequencies of 17 and 27 Hz and a maximum near 21 Hz.
11	47a	FREQUENCY	Hz	1. XBF 2. YBF 3. ZBF	G's " "	Forced response of fuselage displacements at the location of the first 2-D isolator for a system made up by four 2-D isolators. Frequency range is up to 50 Hz.
	47b	FREQUENCY	Hz	1-4 ZBF	G's	Forced response of fuselage vertical motion at the four isolator locations. Positions 1 and 3 show almost the same response; similarly for positions 2 and 4.
	47c	FREQUENCY	Hz	1-4 ZBF	G's	Figure 45c is a perspective plot of the results of Figure 45b with zero density value.
	47d	FREQUENCY	Hz	1-4 ZBF	G's	Same as Figure 45c with the default density value.
	47e	FREQUENCY	Hz	1-4 ZBF	G's	Same as Figure 45d with depth reversed.
	47f	FREQUENCY	Hz	1-4 ZBF	G's	Same as Figure 45d with abscissa reversed.
	47g	FREQUENCY	Hz	1-4 ZBF	G's	Same as Figure 45d with ordinate reversed.
	47h	FREQUENCY	Hz	1. ZBF	G's	Forced response of fuselage vertical motion at the location of the first 2-D isolator as a function of isolator mass and frequency. Test case 11 was run for 5 values of isolator mass: 24 to 64 pounds in increments of 10 pounds. The response is plotted for cases 1, 3 and 5 to show the plot package capability of plotting data from different cases (up to 5 cases can be used).

TABLE 14. CONCLUDED.

Test Case	Figure No.	Abscissa		Ordinates		Plot Description
		Name	Units	Name	Units	
13	48a	3RD MODE FREQ	Hz	1. RX 2. RY 3. RZ	Lbs " "	Forced response results of hub forces using user input of rotor impedance matrix and force vector for a frequency up to 30 hz.
	48b	3RD MODE FREQ	Hz	1. X 2. Y 3. Z	G's " "	As Figure 48a but with display of hub accelerations.

APPENDIX A: G400/F389 COUPLED PROGRAM

A.1 PROGRAM STRUCTURE AND USAGE

The computer programs G400 and F389 were coupled by means of a Fortran driver program to allow blade circulations and rotor induced velocity fields to be calculated iteratively to achieve a consistent rotor aeroelastic response and variable inflow state among the programs. The G400 program analysis and user's manual are presented in References 2 and 3. The F389 program analysis and user's manual are described in References 8.

The driver program is called VIBIT. The coupled program segmentation structure is illustrated in Figure A.1. From this figure, it is seen that the G400 program is made up of 3 segments: G400PG, NIAM and MOTION, while the F389 program consists of 6 segments: F389PG, SECCONE, SECTWO, SECTRE, SECFOR and SECFIV. A description of the 10 segments making up the G400/F389 program appears in Table A.1. CDC dependent routines are: RESETQ (segment 2), NIAM (segment 3), SREC and SKPFIL (both in segment 9).

The logic of the coupled program allows 3 modes of operation: G400 alone, F389 alone, and G400/F389 coupled operation. These options are illustrated in the logic flow sketch from Figure A.2. The control parameter, N, is the first item of input loaded in the program. It controls the different modes of operation as shown in the table attached to Figure A.2.

The data transfer files required for the execution of the G400 and F389 programs in both the uncoupled and coupled modes are shown in Figure A.3. A summary and a description of the various input/output data files is presented in Table A.2.

A sample input runstream is presented in Table A.3 for a 2-cycle operation. To run G400 alone, data blocks 1 and 2 only are needed. To run F389 alone, data blocks 1 and 3 are needed; however, in this case, the user must also provide the linearized airfoil characteristics and the axial velocities (if desired) as part of input block 3. To run one complete cycle, then data blocks 1 through 4 are needed. Four input locations for the G400 data block 2 must be given the values listed below:

- location 48 = 1.0 - calculate harmonics of blade responses.
- location 76 = 1.0 - write initial conditions to unit 24.
- location 998 - DELTA PSI - azimuthal increment for F389 data.
- location 999 = 1.0 - transfer of data to F389 through units 13, 16 and 23.

The F389 input locations 88 and 206 in data block 3 must be set to 1.0 for coupling with the G400 program. Data block 4 contains only new or revised input locations as compared to the G400 data already provided in data block 2 which were stored in unit 24 for later use. Examples of revised input parameters are: tip loss factor should be set to 1.0 (location 7), variable inflow option is activated (locations 53 and 54 are set to 1.0), new initial conditions should be read from unit 26 (location 76 equals 2.0). Other parameters may be changed as desired by the user. To execute more than one cycle, the input data blocks 5 and 6 are repeated. The F389 data in block 5 contain only new or revised locations because the previous loader data from block 3 have been stored in unit 25 for use in subsequent F389 runs. The new character of block 5 data for F389 is analogous to the block 4 data for G400. A precautionary observation is that new or revised input data provided in data blocks 4 and 5 are not written to units 24 and 25 respectively. Thus, when more than one G400/F389 cycle is requested, the new or revised input parameters must be relocated. For example, in Table A.3, G400 data block 6 must duplicate the revisions provided in data block 4 if they are still required.

A.2 PROGRAM EXECUTION

The execution of the G400/F389 coupled program for one cycle is presented in Figure A.4 and Appendices H and I. Figure A.4 shows the Job Control Language (JCL) used to run the program on the IBM 370/68 computer system. The input data are contained in the file specified under unit 5. A listing of the complete input data is provided in Appendix H. Referring to Table A.3, the input data contain the cycle control option (data block 1), G400 data for the first pass (data block 2), F389 data for the first pass (data block 3), and G400 data for the second and final (for this example) pass (data block 4). The output for the coupled run is shown in Appendix I. Additional results can be printed out for both programs but are not shown for this sample run to minimize the size of this report.

A.3 CDC PROGRAM INSTALLATION AND OPERATION

This section provides the Job Control Language (JCL) for the installation and operation of the G400/F389 program on the NASA-Langley CDC NOS computer facility. The installation and operation procedures are based on protocol and system library facilities associated with the NASA-Langley CDC NOS computer facility.

The JCL for installation of the G400/F389 program is presented in Figure A5.

The JCL for execution of the G400/F389 program is presented in Figure A6.

The JCL instructions apply to remote job entry operation (such as a telephone linkup). Revisions needed to run with card images are indicated in Figures A5 and A6.

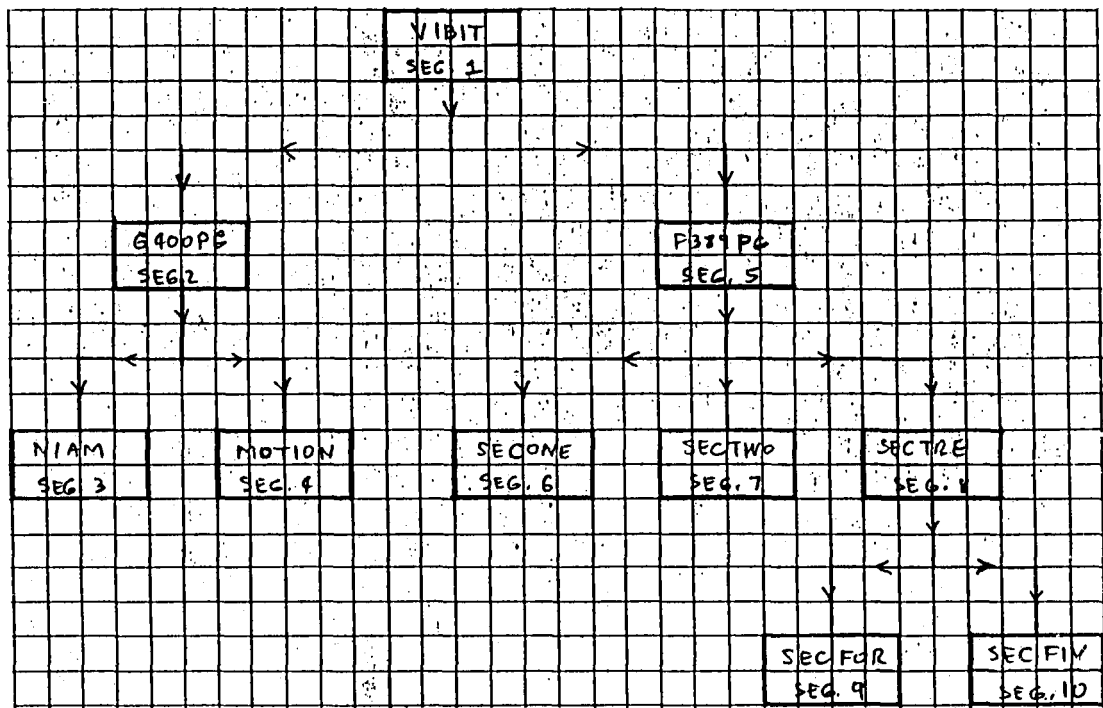

Figure A1. G400/F389 Segmentation Structure.

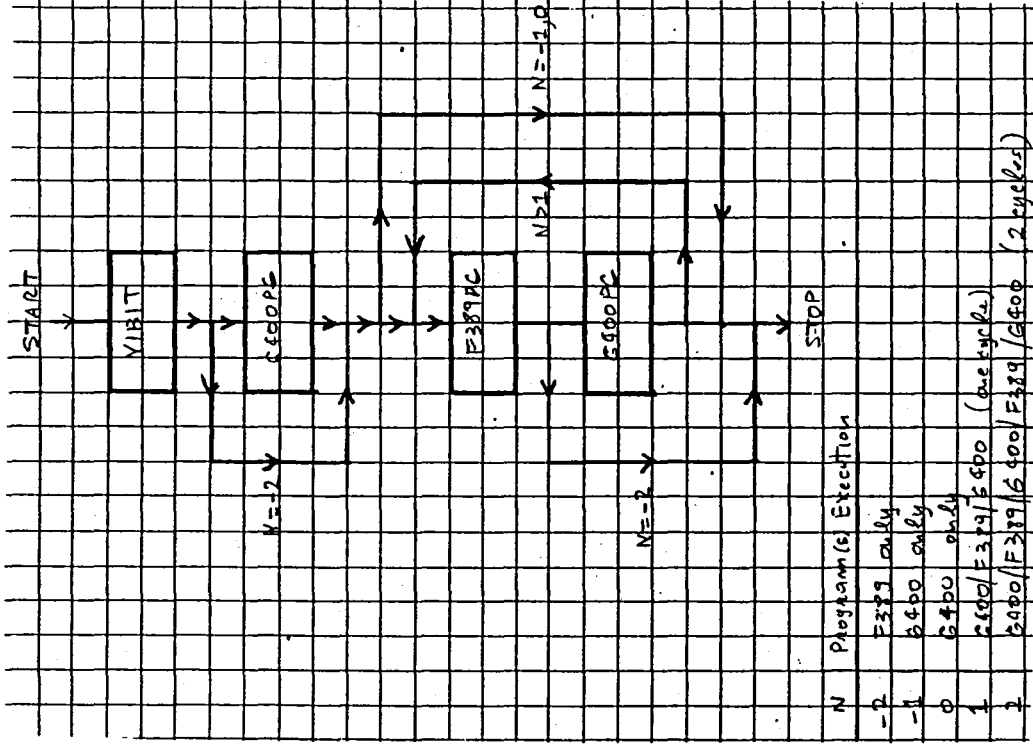

Figure A2. G400/F389 Logic Flow Diagram.

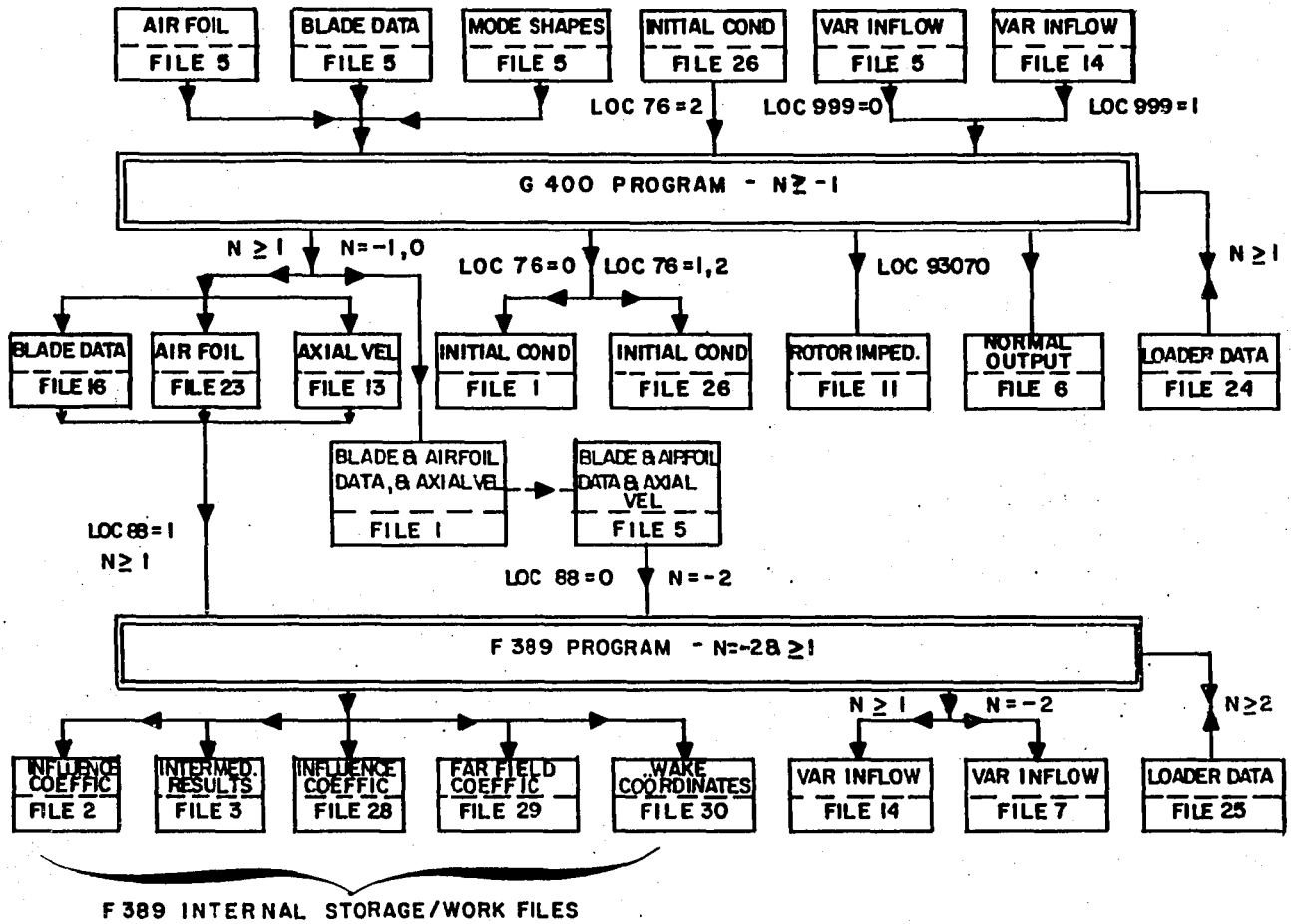

Figure A3. G400/F389 Input/Output Files.

```

START
COL 1-----2-----3-----4-----5-----6-----7-----
1 1 //ET473RUN JOB (4045,STAL,15,15),'CASSARINO - X7358',          0001
1 // CLASS=0,TIME=01,REGION=3000K,                              0002
1 // MSGCLASS=T,MSGLEVEL=1,NOTIFY=ET473                        0003
1 /*JOBPARM S=CPOD                                           0004
1 /******                                           0005
1 /*          G400/F389 COUPLED PROGRAM                          0006
1 /*          JCL FROM 'ET473.G400F389.CNTL(REPORT)'           0007
1 /*          EXECUTES N CYCLE(S) - G-400/F-389/G-400         0008
1 /******                                           0009
2 1 //STEP01 EXEC PGM=COUPLEDX,TIME=10                            0010
3 1 //STEPLIB DD DSN=ET473.G400F389.LOAD,DISP=SHR              0011
1 //*****                                           0012
1 /*          STANDARD READ UNIT                                 0020
1 //*****                                           0021
4 1 //FT05F001 DD DSN=ET473.G400F389.DATA(CYCLES1),DISP=SHR    0022
1 //*****                                           0023
1 /*          STANDARD WRITE UNIT                               0024
1 //*****                                           0025
5 1 //FT06F001 DD SYSOUT=T                                     0026
1 //*****                                           0027
1 /*          STANDARD PUNCH UNIT                               0028
1 //*****                                           0029
6 1 //FT07F001 DD SYSOUT=T                                     0030
1 //*****                                           0031
1 /****** G-400 PROGRAM USES FILES 11,24,25 *****           0032
1 //***** UNIT 11- G-400 DATA ONLY - IMPEDANCE FOR RODYNE - FORMATTED 0033
1 //*****                                           0034
1 //*****                                           0035
7 1 //FT11F001 DD DSN=FILE11,UNIT=VWORK,SPACE=(TRK,(20,10)),    0036
1 // DCB=(RECFM=FB,LRECL=80,BLKSIZE=19040),DISP=(NEW,DELETE) 0037
1 //*****                                           0038
1 //***** UNIT 24- G-400 DATA ONLY - LOADER DATA - FORMATTED 0039
1 //*****                                           0040
8 1 //FT24F001 DD DSN=FILE24,UNIT=VWORK,SPACE=(TRK,(20,10)),    0041
1 // DCB=(RECFM=FB,LRECL=120,BLKSIZE=18960),DISP=(NEW,DELETE) 0042
1 //*****                                           0043
1 //***** UNIT 26- G-400 DATA ONLY - INITIAL CONDITIONS - FORMATTED 0044
1 //*****                                           0045
9 1 //FT26F001 DD DSN=FILE26,UNIT=VWORK,SPACE=(TRK,(20,10)),    0046
1 // DCB=(RECFM=FB,LRECL=80,BLKSIZE=19040),DISP=(NEW,DELETE) 0047
1 //*****                                           0048
1 /****** F-389 PROGRAM USES FILES 2,3,15,25,28,29,30 ***** 0049
1 //*****                                           0050
1 //***** UNIT 15- F-389 DATA ONLY - WABAT HARMONICS - FORMATTED 0051
1 //*****                                           0052
10 1 //FT15F001 DD DSN=ET473.F389.DATA(WABAT2),DISP=SHR        0053
1 //*****                                           0054

```

Figure A4. G400/F389 IBM Job Control Language.

START COL	1	2	3	4	5	6	7
	1	/*-----	UNIT 25- F-389 LOADER DATA	-	FORMATTED	0055	
	1	/*-----				0056	
11	1	/*FT25F001 DD DSN=	&&FILE25,UNIT=VWORK,SPACE=(TRK,(20,10)),			0057	
	1	/*	DCB=(RECFM=FB,LRECL=120,BLKSIZE=18960),DISP=(NEW,DELETE)			0058	
	1	/*-----				0059	
	1	/*-----	F-389 PROGRAM USES FILES 2,3,28,29,30 FOR TEMPORARY STORAGE			0060	
	1	/*-----				0061	
12	1	/*FT02F001 DD DSN=	&&FILE02,UNIT=VWORK,SPACE=(TRK,(20,10)),			0062	
	1	/*	DCB=(RECFM=VBS,LRECL=19060,BLKSIZE=19069),			0063	
	1	/*	DISP=(NEW,DELETE)			0064	
13	1	/*FT03F001 DD DSN=	&&FILE03,UNIT=VWORK,SPACE=(TRK,(20,10)),			0065	
	1	/*	DCB=(RECFM=VBS,LRECL=19060,BLKSIZE=19069),			0066	
	1	/*	DISP=(NEW,DELETE)			0067	
14	1	/*FT28F001 DD DSN=	&&FILE28,UNIT=VWORK,SPACE=(TRK,(20,10)),			0068	
	1	/*	DCB=(RECFM=VBS,LRECL=19060,BLKSIZE=19069),			0069	
	1	/*	DISP=(NEW,DELETE)			0070	
15	1	/*FT29F001 DD DSN=	&&FILE29,UNIT=VWORK,SPACE=(TRK,(20,10)),			0071	
	1	/*	DCB=(RECFM=VBS,LRECL=19060,BLKSIZE=19069),			0072	
	1	/*	DISP=(NEW,DELETE)			0073	
16	1	/*FT30F001 DD DSN=	&&FILE30,UNIT=VWORK,SPACE=(TRK,(20,10)),			0074	
	1	/*	DCB=(RECFM=VBS,LRECL=19060,BLKSIZE=19069),			0075	
	1	/*	DISP=(NEW,DELETE)			0076	
	1	/*-----				0077	
	1	/*-----	G-400/F-389 COUPLED PROGRAM ALSO USES FILES 15,16,23			0078	
	1	/*-----				0079	
	1	/*-----	G-400 DATA FOR THE F-389 PROGRAM - FILES 13,16,23			0080	
	1	/*-----				0081	
	1	/*-----	UNIT 13- G-400 DATA FOR F-389 - TWI'S	-	FORMATTED	0082	
	1	/*-----				0083	
17	1	/*FT13F001 DD DSN=	&&FILE13,UNIT=VWORK,SPACE=(TRK,(20,10)),			0084	
	1	/*	DCB=(RECFM=FB,LRECL=80,BLKSIZE=19040),DISP=(NEW,DELETE)			0085	
	1	/*-----				0086	
	1	/*-----	UNIT 16- G-400 DATA FOR F-389 - BLADE INPUT	-	FORMATTED	0087	
	1	/*-----				0088	
18	1	/*FT16F001 DD DSN=	&&FILE16,UNIT=VWORK,SPACE=(TRK,(20,10)),			0089	
	1	/*	DCB=(RECFM=FB,LRECL=120,BLKSIZE=18960),			0090	
	1	/*	DISP=(NEW,DELETE)			0091	
	1	/*-----				0092	
	1	/*-----	UNIT 23- G-400 DATA FOR F-389 - AIRFOIL DATA	-	FORMATTED	0093	
	1	/*-----				0094	
19	1	/*FT23F001 DD DSN=	&&FILE23,UNIT=VWORK,SPACE=(TRK,(20,10)),			0095	
	1	/*	DCB=(RECFM=FB,LRECL=120,BLKSIZE=18960),			0096	
	1	/*	DISP=(NEW,DELETE)			0097	
	1	/*-----				0098	
	1	/*-----	F-389 DATA FOR THE G-400 - FILE 14			0099	
	1	/*-----				0100	
	1	/*-----	UNIT 14- F-389 DATA FOR G-400 - HARMONICS V.I.	-	FORMATTED	0101	
	1	/*-----				0102	
20	1	/*FT14F001 DD DSN=	&&FILE14,UNIT=VWORK,SPACE=(TRK,(20,10)),			0103	
	1	/*	DCB=(RECFM=FB,LRECL=80,BLKSIZE=19040),			0104	
	1	/*	DISP=(NEW,DELETE)			0105	
	1	/*-----				0106	
	1	/*	<=== END OF JCL CONTROL CARDS			0107	
	1	/*-----				0108	
21	1	/*				0109	

Figure A4. Concluded.

```

* /JOB
* /NOSEQ
VIBITL, T1400, CM300000.
USER, -----.
CHARGE, -----, LRC.
RFL(300000)
GET, FILE3.
GET, FILE4.
GET, FILE5X.
GET, FILE6.
GET, FILE7.
FTN(I=FILE3, R=0, L=TAPE10, B=VIBGO, A)
FTN(I=FILE4, R=0, L=TAPE11, B=VIB1GO, A)
FTN(I=FILE5X, R=0, L=TAPE12, B=VIB2GO, A)
FTN(I=FILE6, R=0, L=TAPE13, B=VIB3GO, A)
FTN(I=FILE7, R=0, L=TAPE14, B=VIB4GO, A)
REPLACE(VIBGO)
REPLACE(VIB1GO)
REPLACE(VIB2GO)
REPLACE(VIB3GO)
REPLACE(VIB4GO)
ATTACH(ALTMLIB/UN=LIBRARY)
SEGLOAD(B=VIBABS)
LDSET(LIB=ALTMLIB, PRESET=ZERO, MAP=SBEX/LMAP)
LOAD(VIBGO)
LOAD(VIB1GO)
LOAD(VIB2GO)
LOAD(VIB3GO)
LOAD(VIB4GO)
NOGO.
REPLACE(VIBABS)
DAYFILE, JCLOUT.
REPLACE, JCLOUT.
REPLACE(TAPE10=FORT3)
REPLACE(TAPE11=FORT4)
REPLACE(TAPE12=FORT5X)
REPLACE(TAPE13=FORT6)
REPLACE(TAPE14=FORT7)
REPLACE, LMAP.
EXIT.
DAYFILE, JCLOUT.
REPLACE, JCLOUT.
REPLACE(TAPE10=FORT3)
REPLACE(TAPE11=FORT4)
REPLACE(TAPE12=FORT5X)
REPLACE(TAPE13=FORT6)
REPLACE(TAPE14=FORT7)
REPLACE, LMAP.
* /EOR

```

FIGURE A5. CDC JCL FOR INSTALLATION OF THE G400/F389 PROGRAM.

```

F389PG GLOBAL BETDAT, BLKDAT, BLOCK1, CONST1, CONST2, CONST3, CONTRL-SAVE
F389PG GLOBAL CWAKES, GRPL, LAFDAT, PSIVAR, STOP IT, TEMPST, XAFDAT-SAVE
G400PG GLOBAL ADERIV, BLDDOF, BLOCK, BLSTRS, CBRVAR, CLDMTB, DATALV-SAVE
G400PG GLOBAL DATEET, DOFVAR, DSINTS, FLXBTC, GLAURT, HARRAY, HRMINF-SAVE
G400PG GLOBAL IMISC1, IMPDAT, INRTHB, IOF389, LINEAR, MISC1, MISC2-SAVE
G400PG GLOBAL MISC3, MISC4, MISC5, NVDAMP, PNDULM, PNDVAR, SINTS-SAVE
G400PG GLOBAL SPNVAR, TRIM, TRNSNT, TTBNDG-SAVE
SUB TREE F389PG-(SEONE, SECTWO, SECTRE-(SECFOR, SECFIV))
TREE VIBIT-(G400PG-(NIAM, MOTION), SUB)
END VIBIT
* /EOF

```

* For card images operation:

1. delete /JOB and /HOSEQ instructions (first 2 cards).
2. replace /EOR with a 6/7/8 multiple punch card.
3. replace /EOF with a 6/7/8/9 multiple punch card.

FIGURE A5. CONCLUDED.

```

* /JOB.
* /NOSEQ
VIBRUN, T1400, CM300000.
USER, -----.
CHARGE, -----, LRC.
RFL(300000)
GET, VIBABS.
GET, TAPE5=G400R3.
GET, TAPE15=F2 9WAB2 <==== HARMONICS OF FUSELAGE INDUCED
VIBABS, TAPE5. VELOCITIES FROM WABAT PROGRAM
DAYFILE, JCLOUT.
REPLACE, JCLOUT.
REPLACE(OUTPUT=OUTVIB)
REPLACE(TAPE11=G400M3) <==== IMPEDANCE MATRICES STORED IN UNIT 11
EXIT.
DAYFILE, JCLOUT.
REPLACE, JCLOUT.
REPLACE(OUTPUT=OUTVIB)
REPLACE(TAPE11=G400M3)
DMD(200)
* /EOF

```

* For card images operation:

1. delete /JOB and /NOSEQ instructions (first 2 cards).
2. replace /EOF with a 6/7/8/9 multiple punch card.

FIGURE A6. CDC JCL FOR EXECUTION OF THE G400/F389 PROGRAM.

TABLE A.1. G400/F389 SEGMENTATION STRUCTURE DESCRIPTION

Segment Number	Leading Routine	Segment Description
1	VIBIT	Controls execution of the uncoupled and coupled program versions.
2	G400PG	Controls execution of the G400 program. Reads and writes airfoil data and initializes variables.
3	NIAM	Reads and prints input data for blade characteristics, mode shapes, and variable inflow, forms various parameters, sets up deflection arrays, and calculates pitch coupling terms.
4	MOTION	Initializes variables, sets up data for hub motion and pendulum absorbers, calculates trim required quantities, solves for the time history response, calculates rotor performance, blade stresses, and hub loads, and performs harmonic analysis of final results.
5	F389PG	Controls execution of the F389 program. Initializes the loader vector.
6	SECONE	Reads and prints input loader data.
7	SECTWO	Reads airfoil data, calculates rotor attitude, blade flapping, and blade coordinates, sets up wake model, calculates aerodynamic parameters, reads axial velocities, and prints out intermediate results.
8	SECTRE	Controls input of the wake geometry and solution of the rotor induced velocity field.
9	SECFOR	Sets up the rotor wake geometry.
10	SECFIV	Solves for the rotor induced velocity field and provides output of the circulations and the variable inflow velocities and harmonics.

TABLE A.2. G400/F389 INPUT/OUTPUT FILES

File No.	F389 Mode	G400 Mode	G400/F389 Mode	Description of Input/Output Files
1		X		1. G400 output of initial conditions if loc 76 = 0 2. G400 output of blade and airfoil data and axial velocities for F389
2	X		X	Temporary storage of circulation solution geometric influence coefficients in block form
3	X		X	Temporary storage of intermediate solution quantities
5	X	X	X	Standard read file
6	X	X	X	Standard write file
7	X			Standard punch file - F389 output of variable inflow
11		X	X	G400 save unit for rotor impedance matrix and force vector
13			X	G400 save unit for axial velocities transmitted to F389 program
14			X	F389 save unit for variable inflow transmitted to 6400 program
15	X			F389 input of induced velocities from the WABAT program
16			X	G400 save unit for blade data transmitted to F389 program
23			X	G400 save unit for linearized airfoil data transmitted to F389 program
24			X	G400 loader data storage for coupled operation
25			X	F389 loader data storage for coupled operation
26		X	X	G400 output of initial conditions if loc 76 = 1 or 2. Initial conditions are read from unit 26 only if loc 76 = 2

TABLE A.2. CONCLUDED.

File No.	F389 Mode	G400 Mode	G400/F389 Mode	Description of Input/Output Files
28	X		X	Temporary storage of circulation solution geometric influence coefficients
29	X		X	Temporary storage of far field geometric influence coefficients
30	X		X	Storage of wake coordinates

TABLE A.3. G400/F389 INPUT OUTLINE FOR TWO CYCLES

Data Block	Program G400 or F389	Input Description
1	G400 and F389	Load N in I2 format for all runs: N = -2. - run F389 alone N = -1,0. - run G400 alone N 1. - run N cycles of G400/F389
2	G400	G400 program input data for: a) airfoil characteristics b) blade data c) mode shapes d) variable inflow (if desired) Data stored in unit 24.
3	F389	F389 program input data. Data stored in unit 25.
4	G400	For the 2nd pass on the G400 program, only new or revised locations need to be loaded. The G400 data of block 2 above are stored in unit 24 and read in subsequent calls to G400.
5	F389	If more than one cycle is requested, then only new or revised locations need to be loaded for the 2nd pass on the F389 program. The F389 data of block 3 above are stored in unit 25.
6	G400	This is the 3rd pass on the G400 program for 2 or more cycles. These data could be the same as that of block 4 above. Repeat data blocks 5 and 6 for more cycles.

APPENDIX B: E927 PROGRAM

B.1 PROGRAM EXECUTION

A brief description of the Rotor Aeroelastic Stability Analysis (Program E927) is provided in section 5.2 of this report. The instructions for executing the E927 program are provided in Reference 5. For this contract, location 110, which controls the coupling of the rotor matrices with the bifilar analysis, is not applicable. The input value is ignored in the revised program logic.

The IBM job control language (JCL) needed to execute the E927 program is presented in Figure B1. Unit 10 is used to store the rotor matrices (mass, damping, and stiffness), as indicated by the control card no. 8.

A typical input case is shown in Appendix J. The generated output is presented in Appendix K. The rotor matrices printed out at the end of the case are stored in unit 10 and are used subsequently in the execution of the Base Program (SIMVIB). Case 12 from Table 13 employs the rotor matrices from this sample run.

B.2 CDC PROGRAM INSTALLATION AND OPERATION

This section provides the Job Control Language (JCL) for the installation and operation of the G400/F389 program on the NASA-Langley CDC NOS computer facility. The installation and operation procedures are based on protocol and system library facilities associated with the NASA-Langley CDC NOS computer facility.

The JCL for installation of the E927 program is presented in Figure B2.

The JCL for execution of the E927 program is presented in Figure B3.

The JCL instructions apply to remote job entry operation (such as a telephone linkup). Revisions needed to run with card images are indicated in Figures B2 and B3.

```

1 //ET473RUN JOB (4045,STAL,19,15),'CASSARINO - X7358',
// CLASS=D,TIME=01,MSGLEVEL=(1,0),REGION=3000K,
// MSGCLASS=T,NOTIFY=ET473
*****
*** EXECUTION OF E-927 PROGRAM REVISED FOR SIMVIB PROGRAM
*****
2 //STEP01 EXEC PGM=E90BCSV1
3 //STEPLIB DD DSN=ET473.E90BCNAS.LOAD,DISP=SHR
***
*** READ INPUT DATA FROM UNIT 5
***
4 //FT05F001 DD DSN=ET473.SIMVIB.DATA(E927RUN),DISP=SHR
***
*** WRITE OUTPUT TO UNIT 6
***
5 //FT06F001 DD SYSCUT=T
***
*** PROGRAM USES WORK FILES 8 AND 11
***
6 //FT08F001 DD UNIT=WORK,DISP=(NEW,DELETE),SPACE=(TRK,(5,1)),
// DCB=(RECFM=VSB,LRECL=680,BLKSIZE=2050)
7 //FT11F001 DD UNIT=WORK,DISP=(NEW,DELETE),SPACE=(TRK,(13,1)),
// DCB=(RECFM=VSB,LRECL=404,BLKSIZE=2050)
***
*** OUTPUT MATRICES ARE WRITTEN TO UNIT 10 FOR SIMVIB PROGRAM
***
8 //FT10F001 DD DSN=ET473.E927CUT.DATA,DISP=(NEW,CATLG),
// UNIT=TSO,SPACE=(TRK,(5,5)),
// DCB=(RECFM=FB,LRECL=80,BLKSIZE=3120)
***
*** END OF JCL SETUP
***
9 //

```

Figure B1. E927 Program IBM JCL.

```

* /JOB
* /NOSEQ
E927LNK,T1400,CM300000.
USER,-----.
CHARGE,-----,LRC.
RFL(300000)
GET,E927BF.
GET,E927SV.
FTN(I=E927BF,R=0,L=TAPE1,B=E9BFGO,A)
FTN(I=E927SV,R=0,L=TAPE2,B=E9SVGO,A)
REPLACE(E9BFGO)
REPLACE(E9SVGO)
ATTACH(ALTMLIB/UN=LIBRARY)
SEGLOAD(B=ESVABS)
LDSET(LIB=ALTMLIB,PRESET=ZERO,MAP=SBEX/LMAP)
LOAD(E9BFGO)
LOAD(E9SVGO)
NOGO.
REPLACE(ESVABS)
DAYFILE,JCLOUT.
REPLACE,JCLOUT.
REPLACE(TAPE1=FORTBF)
REPLACE(TAPE2=FORTSV)
REPLACE,LMAP.
EXIT.
DAYFILE,JCLOUT.
REPLACE,JCLOUT.
REPLACE(TAPE1=FORTBF)
REPLACE(TAPE2=FORTSV)
REPLACE,LMAP.
* /EOR
SHAKIT GLOBAL DYNINP,INEIGN,INEIG,EOF6,PRNTSW,TMDS,NIMIC,LAGDAM
TREE SHAKIT-(PRELIM,DYHMAT,AERMAT,EIGER)
END SHAKIT
* /EOF

* For card images operation:

```

1. delete /JOB and /NOSEQ instructions (first 2 cards).
2. replace /EOR with a 6/7/8 multiple punch card.
3. replace /EOF with a 6/7/8/9 multiple punch card.

FIGURE B2. CDC JCL FOR INSTALLATION OF THE E927 PROGRAM.

```

* /JOB
* /NOSEQ
E927RUN, T1400, CM300000.
USER, -----.
CHARGE, -----, LRC.
RFL(300000)
GET, ESVABS.
GET, TAPE5=E927R1.
ESVABS, TAPE5.
DAYFILE, JCLOUT.
REPLACE, JCLOUT.
REPLACE(TAPE6=E927OUT)
REPLACE(TAPE10=E927MAT) <=== ROTOR & HUB MATRICES STORED IN UNIT 10
EXIT.
DAYFILE, JCLOUT.
REPLACE, JCLOUT.
REPLACE(TAPE6=E927OUT)
REPLACE(TAPE10=E927MAT)
DMD(200)
* /EOF

```

* For card images operation:

1. delete /JOB and /NOSEQ instructions (first 2 cards).
2. replace /EOF with a 6/7/8/9 multiple punch card.

FIGURE B3. CDC JCL FOR EXECUTION OF THE E927 PROGRAM.

End of Document