

General Disclaimer

One or more of the Following Statements may affect this Document

- This document has been reproduced from the best copy furnished by the organizational source. It is being released in the interest of making available as much information as possible.
- This document may contain data, which exceeds the sheet parameters. It was furnished in this condition by the organizational source and is the best copy available.
- This document may contain tone-on-tone or color graphs, charts and/or pictures, which have been reproduced in black and white.
- This document is paginated as submitted by the original source.
- Portions of this document are not fully legible due to the historical nature of some of the material. However, it is the best reproduction available from the original submission.

Low- and Medium-Heating-Value Coal Gas Catalytic Combustor Characterization

(NASA-CR-165560) LOW AND MEDIUM HEATING
VALUE COAL GAS CATALYTIC COMBUSTOR
CHARACTERIZATION (Westinghouse Electric
Corp.) 137 p HC A07/MF A01 CSCL 10B

N82-32856

Unclas
28946
G3/44

John A. Schwab
Westinghouse Electric Corporation
Synthetic Fuels Division

November 1981



Prepared for
NATIONAL AERONAUTICS AND SPACE ADMINISTRATION
Lewis Research Center
Under Contract DEN 3-277

for
U.S. DEPARTMENT OF ENERGY
Fossil Energy
Office of Coal Utilization

DOE/NASA/0277-1
NASA CR-165560

Low- and Medium-Heating-Value Coal Gas Catalytic Combustor Characterization

John A. Schwab
Westinghouse Electric Corporation
Synthetic Fuels Division
Madison, Pennsylvania 15663

November 1981

Prepared for
National Aeronautics and Space Administration
Lewis Research Center
Cleveland, Ohio 44135
Under Contract DEN 3-277

for
U.S. DEPARTMENT OF ENERGY
Fossil Energy
Office of Coal Utilization
Washington, D.C. 20545
Under Interagency Agreement DE-AI01-77ET10350

FOREWORD

Funding for this program was provided by the United States Department of Energy, Fossil Energy, Office of Coal Utilization, Interagency Agreement DE-AI01-77ET-10350. Technical program management is provided by the Lewis Research Center of the National Aeronautics and Space Administration, Cleveland, Ohio. Mr. D. Bulzan is the Technical Program Manager.

The work was conducted by Westinghouse Electric Corporation, Synthetic Fuels Division, Madison, Pennsylvania. Mr. A. B. Turner is the Project Manager. Test work was conducted under the direction of Mr. J. A. Schwab, Project Engineer.

The project was also supported by the Westinghouse Combustion Turbine Systems Division, Concordville, Pennsylvania (Mr. D. R. Carl).

Permission to use coal gas produced by the DOE/Westinghouse Process Development Unit (PDU) for this program was granted by Messrs. D. C. Cicero, DOE Project Manager, and P. Cherish, Westinghouse Technical Program Manager. DOE funding of the PDU is via contract DE-AC21-80ET14752.

PRECEDING PAGE BLANK NOT FILMED

TABLE OF CONTENTS

<u>Section</u>	<u>Title</u>	<u>Page</u>
	SUMMARY	1
1.0	INTRODUCTION	3
2.0	TEST RIG	4
3.0	TEST FACILITY	18
4.0	FUEL CHARACTERISTICS	27
5.0	COMBUSTION TEST RESULTS	35
6.0	SUMMARY OF RESULTS	82
7.0	DEFINITIONS AND CALCULATIONS	85
8.0	REFERENCES	93
	APPENDIX	

PRECEDING PAGE BLANK NOT FILMED

SUMMARY

The work described in this report is part of the DOE/NASA LeRC Critical Research and Advanced Technology Support Project. The Low- and Medium-Heating-Value Coal Gas Catalytic Combustor Characterization is a two-contract effort, with funding provided by the Department of Energy and technical program management provided by NASA LeRC. Successful catalytic combustor operation was obtained with both low- and medium-heating-value gasifier-produced coal gas. The DOE/Westinghouse gasifier was operated with Indiana #7 coal and operated in both an enriched-air and oxygen-blown mode to produce both low- and medium-heating-value gas.

Data obtained from a distillate fuel, ERBS, were similar to that reported by previous investigators^(1,2,3). At an inlet air temperature of 600 K, pressures of 5×10^5 Pa and 10×10^5 Pa, and reference velocities of 10 and 20 m/s, combustion efficiencies greater than 99.5% were obtained.

Efficient operation of the catalyst was obtained with low-heating-value coal-derived gas. Combustor efficiencies of 99.5% and above were measured. Axial temperature rise through the catalyst was much more rapid than for liquid fuel, with 70 to 80% of the catalyst temperature rise occurring across the first catalyst element.

Trends observed include increased combustion efficiency at increasing inlet temperatures and decreasing reference velocity or pressure. Flashback/autoignition occurred only twice for low-heating-value tests. Catalyst performance degraded with test time. After testing the catalytic reactor on low-heating-value gas, a coating of iron and nickel oxides was present on the catalytic reactor surfaces. This coating was probably responsible for the performance degradation with test time. Some evidence exists to suggest that iron and nickel carbonyls, formed either in the gasifier or carbon steel combustor supply pipeline, are oxidized and deposited in the catalytic reactor.

Efficient operation was also obtained with medium-heating-value gas. Combustion efficiencies of 99.5% and above were obtained with medium-heating

value gas. A degradation in catalyst performance was again observed with increasing run time. A few flashbacks were observed, but none at inlet temperatures above 700 K (800°F). Trends observed for medium-heating-value tests were similar to those previously obtained during low-heating-value tests. An inspection of the test rig after the medium-heating-value tests revealed some local overheating had occurred in the first three catalytic elements, indicating a non-uniform fuel-air distribution. Six of the nineteen fuel injector tubes were significantly plugged with a solid material, which probably caused the non-uniform fuel-air distribution.

NO_x results obtained from burning ERBS, a petroleum-derived liquid fuel, were quite typical of those achieved by previous investigators (1, 2, 3). Measured NO_x was generally less than 2 ppmv, corrected to 15% oxygen. Both low- and medium-heating-value coal-gas-fired tests produced NO_x levels ranging from 10 to 19 ppmv at 15% O_2 . A slight upward trend of NO_x with increased equivalence ratio was observed for medium-heating-value gas. This observation may be due to thermal NO_x production as a result of localized hot spots from fuel-air non-uniformities. The 14 ppmv baseline NO_x readings probably result from conversion of trace levels of ammonia and cyanide compounds in the product gas to NO_x . In addition, as much as 1 to 2 ppm NO could be the result of gasifier-produced NO_x .

The loss of catalyst reactivity previously discussed above is not quantitative. If no damage had occurred during medium-heating-value tests, a retest of the liquid fuel test matrix would be very interesting. It is recommended that subsequent coal gas catalytic testing include a rerun of the baseline liquid fuel to provide a more quantitative measure of catalytic reactor degradation.

1.0 INTRODUCTION

This report contains the results of Westinghouse Synthetic Fuels Division work performed for NASA LeRC on the Low- and Medium-Heating-Value Coal Gas Catalytic Combustor Characterization Program, contract DEN3-277.

The program objective was to demonstrate catalytic combustion with both low- and medium-heating-value coal gases obtained from an operating gasifier. The goal was to determine a practical operating range for efficient operation and also to identify potential problem areas for consideration during future stationary gas turbine engine design. NASA provided the test rig consisting of fuel injectors, a fuel-air premixing section, a catalytic reactor with thermocouple instrumentation and a single-point, water-cooled sample probe. The test rig included inlet and outlet transition pieces and was designed for installation into an existing test loop at the Westinghouse facility in Madison, Pennsylvania. Westinghouse integrated the test section into the operating loop and the DOE/Westinghouse 25-ton-per-day fluidized bed gasifier.

The catalytic combustor was tested at pressures of 5×10^5 and 10×10^5 Pa, combustor exit temperatures up to 1480 K (2200°F), inlet temperatures from 530 to 720 K, and reference velocities from 10 to 20 m/s. Baseline tests were performed using petroleum-derived ERBS distillate fuel. A comparison was made of the data generated from the low- and medium-heating-value gas tests and then evaluated against the liquid reference fuel results. Temperatures, catalytic reactor pressure drop, and emissions of NO_x , CO, CO_2 , unburned hydrocarbons, and O_2 were measured to evaluate catalytic combustor performance.

2.0 TEST RIG

The test rig utilized in this program consisted of a NASA-supplied catalytic combustor test section and the Westinghouse air distribution/straightening inlet and quench/pressure control exhaust sections. A test rig schematic is shown in Figure 2-1. Pressure boundary is formed by flanged sections of 22-cm (8-inch) and 17-cm (6-inch), Schedule 40, 304 stainless steel pipe. The rig was designed to ANSI B31.3 for a 998 K (1000°F) skin temperature at 21.7×10^5 Pa (315 psia). The rig was oriented horizontally and extended a distance of 5.03 m (16.5 feet). The length of the NASA-supplied test section was 2.03 m (6.7 feet). Rig pressure was controlled by a rear-mounted reduced-port butterfly valve. Test rig instrumentation is summarized in Table 2-1.

The inlet section consists of the valve and piping arrangements that direct preheated non-vitiated combustion air to the flanged tee. The inlet tee houses sheetmetal components, consisting of a 25-cm (10-inch) long tube bundle in a 13-cm (5-inch) flow duct which distribute and subsequently straighten the air flow. Figure 2-2 details the inlet tee internals. A NASA-LeRC-supplied reducer section, 73 cm (28.75 inches) long, accomplishes the transition between the 22-cm (8-inch) inlet tee to the 17-cm (6-inch) combustion section. The reducer section contains a 12.1-cm (4.75-inch) inside diameter stainless steel liner backed by Fiberfrax tube insulation. Fiberfrax insulation properties are given in Table 2-2. No attempt was made to smooth the transition between the 13-cm (5-inch) tee internals and the 12.1-cm (4.75-inch) reducer internal inside diameter. The nominal combustor section inside diameter is 12.1 cm (4.75-inches) throughout.

The NASA-LeRC-supplied combustor section consists of four subsections. These include an inlet instrumentation, a fuel injection/premixing, a catalytic reactor and an exit instrumentation section.

The inlet instrumentation section is a 15.2-cm (6-inch) long spool piece which houses a stainless steel liner backed by Fiberfrax tube insulation. This

section contains the inlet air temperature thermocouples and a static pressure tap upstream of the fuel injector. Figure 2-3 details the instrumentation of this section.

The fuel injector consisted of two separate components, a flange-mounted fuel injector base and a second flange which contained the fuel injection tubes. A schematic diagram of the fuel injector base is shown in Figure 2-4. The fuel injector base contained nineteen diffuser passages, each with a half angle of 7.5 degrees. Fuel was injected into the center of each passage approximately 0.3 cm (0.12 inch) downstream of the inlet to provide good atomization of the liquid fuel and good mixing of both the liquid and gaseous fuels. Fuel was injected 21 cm (8.25 inches) upstream of the catalytic reactor. A liquid fuel injector tube is detailed in Figure 2-5. A gaseous injector tube is shown in Figure 2-6. Liquid fuel supply to the nineteen 0.5-mm (0.020-inch) inside diameter tubes was via a 19-mm (0.75-inch) fuel manifold ring. Low- and medium-heating-value gas was supplied to the 4.6-mm (0.18-inch) inside diameter tubes via a 51-mm (2-inch) fuel manifold ring.

Premixing and vaporization of liquid fuel droplets occurs in the premixing section spool piece, immediately upstream of the catalyst. This spool piece also contains a 12.1-cm (4.75-inch) inside diameter stainless steel liner backed by Fiberfrax tube insulation to minimize heat losses. As previously mentioned, total premixing length is \sim 21 cm (\sim 8.25 inches). This section also contains a flashback/autoignition thermocouple inserted \sim 3.2 mm (\sim 0.125 inch) into the gas stream and the catalyst inlet pressure tap. Figure 2-7 details the premixing zone instrumentation.

The catalytic reactor section consists of a 25-cm (9.8-inch) long spool piece (see Figure 2-1) with a 12.1-cm (4.75-inch) inside diameter Hastelloy X liner. The liner is surrounded by a 15.2-cm (6.0-inch) outside diameter insulation tube. Six 2.54-cm (1-inch) long, 11.8-cm (4.65-inch) outside diameter catalyst elements are slid into the metal liner. Each of the 2.5-cm (1-inch) thick elements are separated by a 3.2-mm (0.125-inch) outside diameter, chromel alumel thermocouple located at the centerline. The six-element catalyst assembly is supported by an array of twelve thermocouples

at the exit of the last element. A description of each catalyst element is provided in Table 2-3. The overall length of the reactor is 16.8 cm (6.6 inches).

Catalytic reactor thermocouple instrumentation is presented in Figures 2-8 through 2-10. Figure 2-8 shows the thermocouple orientation for measuring exit temperatures from elements 1 through 5. Figure 2-9 is a sketch of the exit thermocouple for element 6. This thermocouple array also served to support the reactor. For the final test series (medium-heating-value coal gas), two additional thermocouples were installed in the exit plane of elements 2 and 4. Figure 2-10 provides the details of the modified instrumentation.

The exit instrumentation spool piece is ~23-cm (~ 9 inches) long and houses the same liner and insulation previously described for the reactor section. The exit spool piece contains four instrumentation planes, which are described in Figures 2-11 and 2-12. Exit planes 1, 2 and 3 contain a centerline chromel alumel thermocouple. Exit plane 1 also is the location of the reactor outlet static pressure tap. Exit instrumentation planes 1, 2 and 3 are 7.1 cm (2.8 inches), 11.9 cm (4.7 inches) and 17.0 cm (6.7 inches), respectively, downstream of the reactor outlet. Finally, exit plane 4 is 22.1 cm (8.7 inches) downstream and is described in Figure 2-12. Plane 4 contained eleven thermocouples along with the centerline-mounted 0.95-cm (0.375-inch) outside diameter water-cooled gas sample probe. The gas sample probe is described in Figure 2-13.

A NASA-supplied, 37.6-cm (14.8-inch) long, reducer spool piece accomplishes the transition from the 17-cm (6-inch) combustion section pipe to the 22-cm (8-inch) quench/pressure control exhaust section. The high-pressure portion of the exhaust section contains sheetmetal and ceramic* parts. The section is ceramic lined for approximately 33 cm (13 inches) at a 12.7-cm (5-inch) inside diameter. Immediately following the ceramic liner, a nominal 0.68 kg/sec (1.5 lbs/sec) of dilution air is admitted to the reactor combustion products through sixteen 2.54-cm (1-inch) holes. High-pressure water is then injected

*High-alumina, phosphate-bonded ramming mixture.

to further cool the air stream to about 700 K (800°F) due to backpressure valve temperature limitations. The high-pressure water injection point is approximately 120 cm (47 inches) downstream of the catalytic reactor outlet.

The quenched combustion products flow through two 90-degree elbows to the reduced-port butterfly backpressure valve. Figure 2-14 is a schematic of a portion of the quench/pressure control section showing the rear-mounted viewport used to observe catalyst operation.

Following pressure control, hot gases are again water quenched before release to the atmosphere through a muffle chamber/stack that is an integral part of the laboratory building rear-wall structure.

**ORIGINAL PAGE IS
OF POOR QUALITY**

TABLE 2-1

LOW- AND MEDIUM-HEATING-VALUE COAL GAS CATALYTIC COMBUSTOR CHARACTERIZATION INSTRUMENTATION

Tag Name	Units	Log Description	Range	Tag Name	Units	Log Description	Range
TI-300	DEGF	Compressed Air Temp	0-1200	TR-309-21	DEGF	'S' Skin Temperature	0-2500
TI-301	DEGF	Combustor Exit Temp	0-2500	TR-309-22	DEGF	Fuel Injector Temp	0-2500
TI-302	DEGF	Muffler House Temp	0-1200	TR-309-23	DEGF	Fuel Injector Temp	0-2500
TI-305	DEGF	Backpressure Valve Temp	0-1200	TR-309-24	DEGF	Dilution Air Temp	0-2500
TI-306	DEGF	Rich burner Inlet Temp	0-1200	PDT-321	"H2O	Comp Air to Trans Mixer	0.00-420.00
TI-315	DEGF	Pyridine Temperature	0-600	PDT-322	"H2O	Cooling Air Flow	0.00-420.00
TI-316A	DEGF	#2 Fuel Temperature	0-600	FT-315	GPM	Pyridine Flow	0.00-10.00
TI-316B	DEGF	#6 Fuel Temperature	0-600	FT-316A	GPM	#2 Fuel Flow	0.00-2.00
TI-316C	DEGF	Fuel C Temperature	0-600	FT-316B	GPM	#6 Fuel Flow	0.00-2.00
TI-321	DEGF	Comp Air T, to Trans Mix	0-1200	FT-316C	GPM	Fuel C Flow	0.00-2.00
TI-322	DEGF	Cooling Air Temperature	0-1200	FT-319	GPM	Secondary Fuel Flow	0.00-1.00
TR-308-1	DEGF	Premix Zone Temp 1/4 In	0-2500	PT-300	PSIG	Compressed Air Pressure	0.00-350.00
TR-308-2	DEGF	Cat Plane 1 Temp C.L.	0-2500	PT-303A	PSIG	Hi-Press Air to Pri Fuel	0.00-600.00
TR-308-3	DEGF	Cat Plane 2 Temp C.L.	0-2500	PT-304	PSIG	Passage Pressure	0.00-400.00
TR-308-4	DEGF	Cat Plane 3 Temp C.L.	0-2500	PT-307	PSIG	Fuel Manifold Pressure	0.00-600.00
TR-308-5	DEGF	Cat Plane 4 Temp C.L.	0-2500	PT-310	PSIG	Passage Inlet Pressure	0.00-600.00
TR-308-6	DEGF	Cat Plane 5 Temp C.L.	0-2500	PT-316B	PSIG	#6 Fuel Feed Pressure	0.00-600.00
TR-308-7	DEGF	Cat Outlet 12, 1-3/4 In	0-2500	PDT-300	"H2O	Comp Air Flow to Rich Bn	0.00-100.00
TR-308-8	DEGF	Cat Outlet 1, 3/4 In	0-2500	PT-303B	PSIG	Hi-Press Air to Sec Fuel	0.00-600.00
TR-308-9	DEGF	Cat Outlet 2, 1/4 In	0-2500	PT-315	PSIG	Pyridine Feed Pressure	0.00-600.00
TR-308-10	DEGF	Cat Outlet 3, 1-3/4 In	0-2500	PT-316A	PSIG	#2 Fuel Feed Pressure	0.00-600.00
TR-308-11	DEGF	Cat Outlet 4, 3/4 In	0-2500	PT-316C	PSIG	Fuel C Feed Pressure	0.00-600.00
TR-308-12	DEGF	Cat Outlet 5, 1/4 In	0-2500	PT-319	PSIG	Primary Fuel Inject Pres	0.00-600.00
TR-308-13	DEGF	Cat Outlet 6, 1-3/4 In	0-2500	PT-320	PSIG	Catalytic Reactor Inlet	0.00-400.00
TR-308-14	DEGF	Cat Outlet 7, 3/4 In	0-2500	PT-329	PSIG	Transition Mixer Outlet	0.00-400.00
TR-308-15	DEGF	Cat Outlet 8, 1/4 In	0-2500	PDT-303A	"H2O	Hi-P Air to Pri Fuel Inj	0.00-600.00
TR-308-16	DEGF	Cat Outlet 9, 1-3/4 In	0-2500	PDT-303B	"H2O	Hi-P Air to Pri Fuel Inj	0.00-600.00
TR-308-17	DEGF	Cat Outlet 10, 3/4 In	0-2500	BE-332	VOLT	IR Flame Detector (RB)	0.00-10.00
TR-308-18	DEGF	Cat Outlet 11, 1/4 In	0-2500	BE-331	VOLT	UV Flame Detector	1.00-5.00
TR-308-19	DEGF	Cat Exit Plane 1 C.L.	0-2500	PU-110	PSID	Reactor & Injector DP	0.00-20.00
TR-308-20	DEGF	Reactor Outlet Skin Temp	0-2500	PT-56	PSIG	PDU Gas Pressure	0.00-300.00
TR-308-21	DEGF	Inlet Air Temp 1-3/4 In	0-2500	PDT-56	"H2O	PDU Gas Flow DP (H)	0.00-250.00
TR-308-22	DEGF	Inlet Air Temp 1-3/4 In	0-2500	PCT-57	"H2O	PDU Gas Flow Low	0.00-250.00
TR-308-23	DEGF	Inlet Air Temp 1-3/4 In	0-2500	PDT-341	PSID	Catalytic Reactor DP	0.00-10.00
TR-308-24	DEGF	Inlet Air Temp 1-3/4 In	0-2500	PT-54	PSIG	NH3 Loop Pressure	0.00-300.00
TR-309-1	DEGF	Cat Exit Plane 2 C.L.	0-2500	PDT-54	"H2O	NH3 Loop Flow	0.00-150.00
TR-309-2	DEGF	Cat Exit Plane 3 C.L.	0-2500	CO-B-R	PCNT	Gas Analysis	0.00-100.00
TR-309-3	DEGF	Exit 12, 1-3/4 In	0-2500	CO2-B-R	PCNT	Gas Analysis	0.00-100.00
TR-309-4	DEGF	Exit 1, 3/4 In	0-2500	H2O-B-R	PCNT	Gas Analysis	0.00-100.00
TR-309-5	DEGF	Exit 2, 1/4 In	0-2500	O2-B-R	PCNT	Gas Analysis	0.00-100.00
TR-309-6	DEGF	Exit 3, 1-3/4 In	0-2500	UHC-B-R	PCNT	Gas Analysis	0.00-100.00
TR-309-7	DEGF	Exit 4, 3/4 In	0-2500	NOX-D-R	PCNT	Gas Analysis	0.00-100.00
TR-309-8	DEGF	Exit 5, 1/4 In	0-2500	NO-B-R	PCNT	Gas Analysis	0.00-100.00
TR-309-9	DEGF	Exit 6, 1-3/4 In	0-2500	CO-PCNT	PCNT	using CO % Cell on GA	5.-0.-1.
TR-309-10	DEGF	Exit 7, 3/4 In	0-2500	EVENT	DMUF	Event Flag	1.
TR-309-11	DEGF	Exit 8, 1/4 In	0-2500	NO-B	PPM	DIB#2/Gas Analysis (NO)	10000.-10.
TR-309-12	DEGF	Exit 9, 1-3/4 In	0-2500	NOX-B	PPM	DIB#2/Gas Analysis (NOX)	10000.-10.
TR-309-13	DEGF	Exit 10, 3/4 In	0-500	NOX-D	PPM	DIB#2/Gas Analysis (NOX)	500.-50.
TR-309-14	DEGF	Cat Plane 2, 1-3/4 Inch	0-2500	O2-B	PCNT	DIB#2/Gas Analysis (O2)	25.-5.
TR-309-15	DEGF	Cat Plane 2, 1-3/4 Inch	0-2500	UHC-B	PPM	DIB#3/Gas Analysis (UHC)	0.-50000.-50.
TR-309-16	DEGF	Cat Plane 4, 1-3/4 Inch	0-2500	H2O-B	%	DIB#3/Gas Analysis (H2O)	5.
TR-309-17	DEGF	Cat Plane 4, 1-3/4 Inch	0-2500	CO-B	PPM	DIB#3/Gas Analysis (CO)	100.-1000.
TR-309-18	DEGF	Rig Outlet Gas Temp	0-2500	CO2-B	PCNT	DIB#3/Gas Analysis (CO2)	5.-20.
TR-309-19	DEGF	Rig Outlet Gas Temp	0-2500				
TR-309-20	DEGF	Rig Outlet Gas Temp	0-2500				

TABLE 2-2
 FIBERFRAX-LAMINATED TUBE
 (TYPICAL PHYSICAL PROPERTIES)

Basic Composition	Alumina-Silica
Temperature Limit (Continuous)	1530 K (2300°F)
Melting Point	2060 K (3260°F)
Density	800 kg/m ³ (50 lb/ft ³)

TABLE 2-3
 LOW- AND MEDIUM-HEATING-VALUE COAL GAS
 CATALYTIC REACTOR ELEMENTS

<u>Element*</u>	<u>Catalyst</u>	<u>Loading</u> (kg/m ³)	<u>Substrate</u>
1	Pt	5.3	Corning ** Cordierite
2	Pd	5.3	"
3	Pd	5.3	"
4	Pd	3.6	"
5	2Pd/Pt	3.6	"
6	2Pd/Pt	3.6	"

*Elements are numbered from inlet.

**Substrate has 63% open area with a cell density of 46.5/cm² (300/in²).

ORIGINAL PAGE IS
OF POOR QUALITY

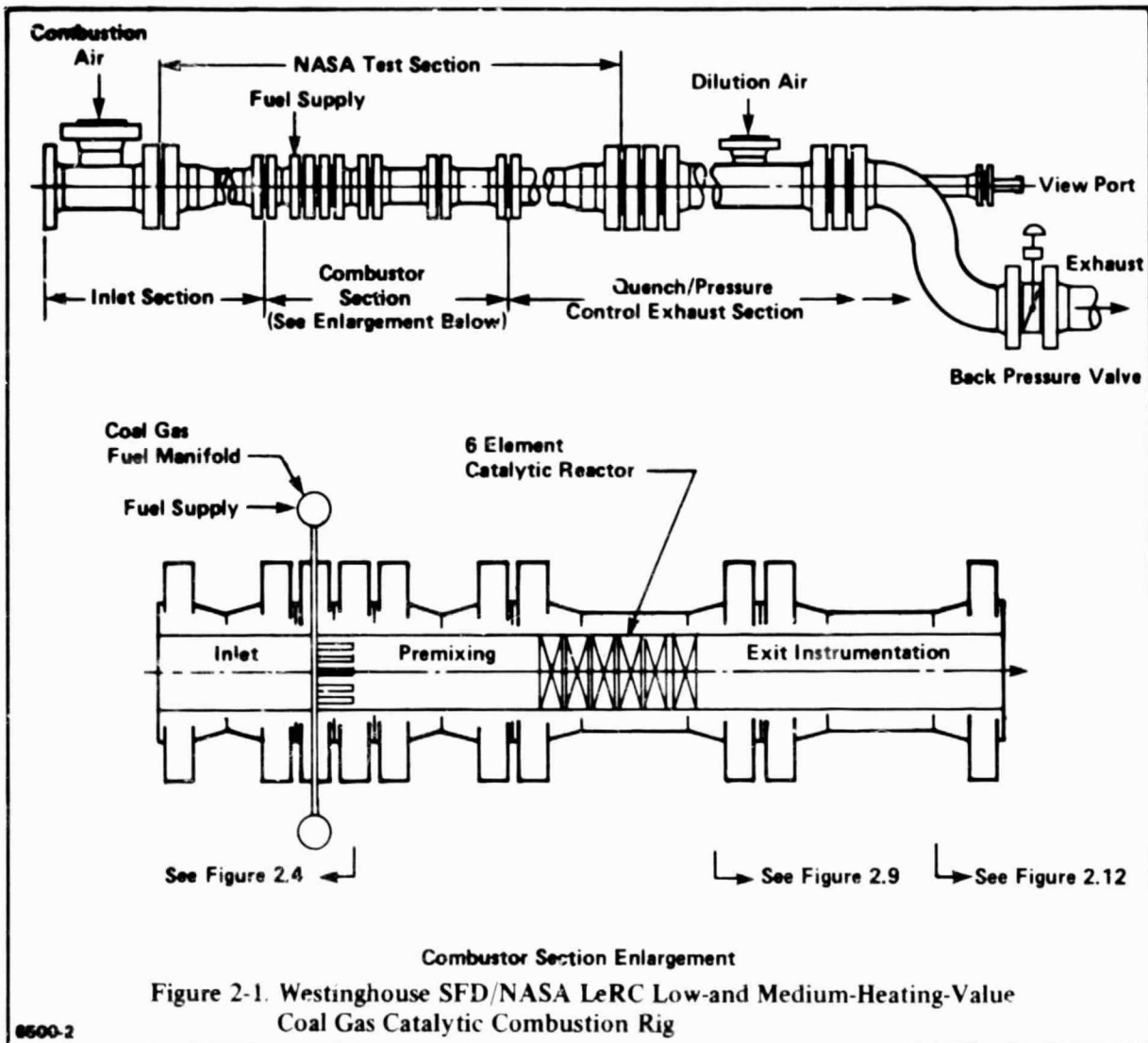

ORIGINAL PAGE IS
OF POOR QUALITY

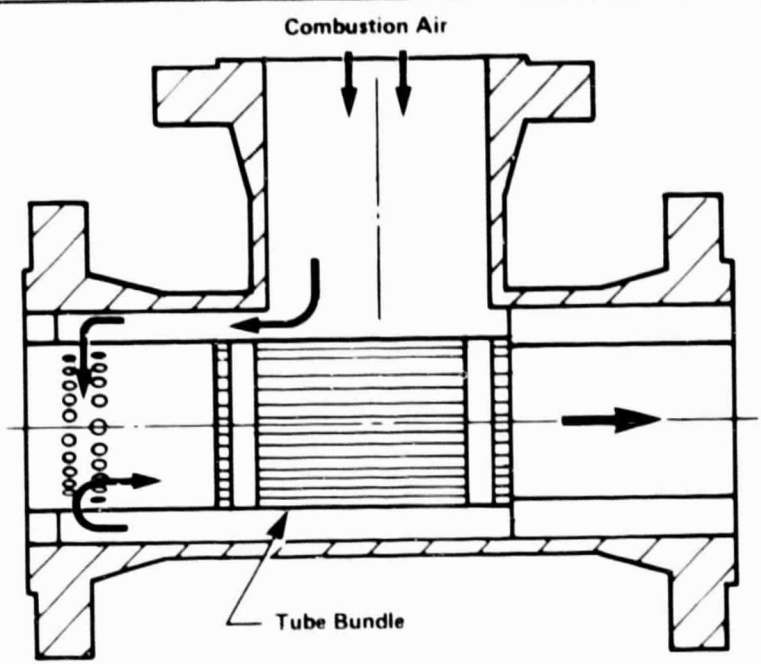
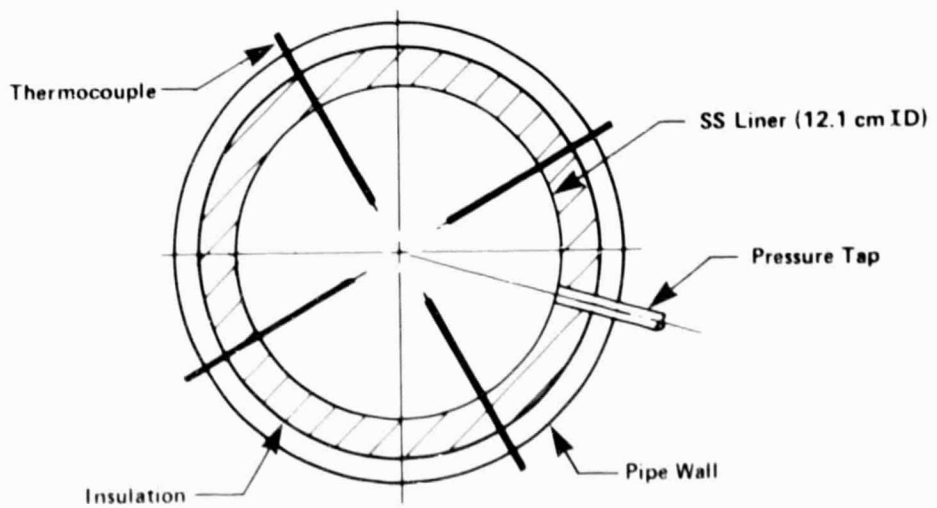

Figure 2-2. Inlet Tee Internals

6500-1



Note: Thermocouple insertion from liner wall - 4.4 cm

Figure 2-3. Inlet Instrumentation Plane ~5 cm (~2") Upstream of Fuel Injection Plane

6500-3

ORIGINAL PAGE IS
OF POOR QUALITY

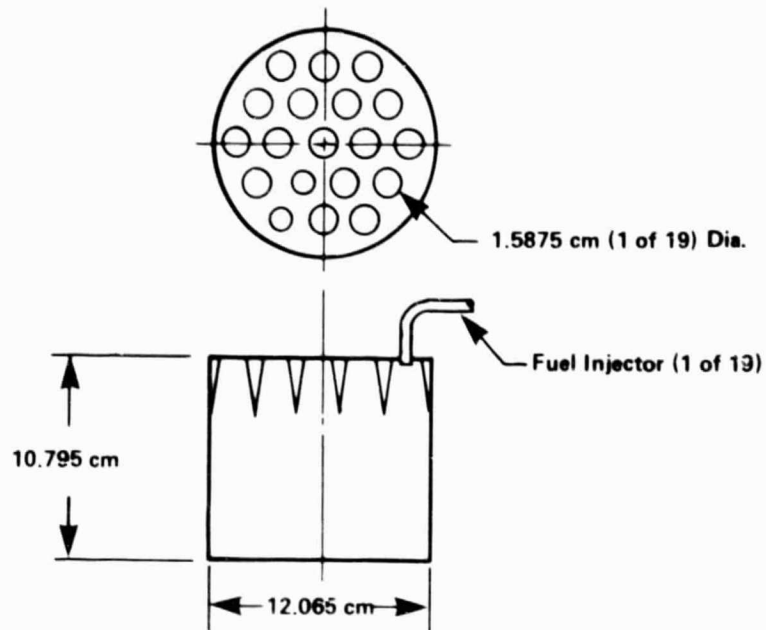

Figure 2-4. Fuel Injector Base

6500-4

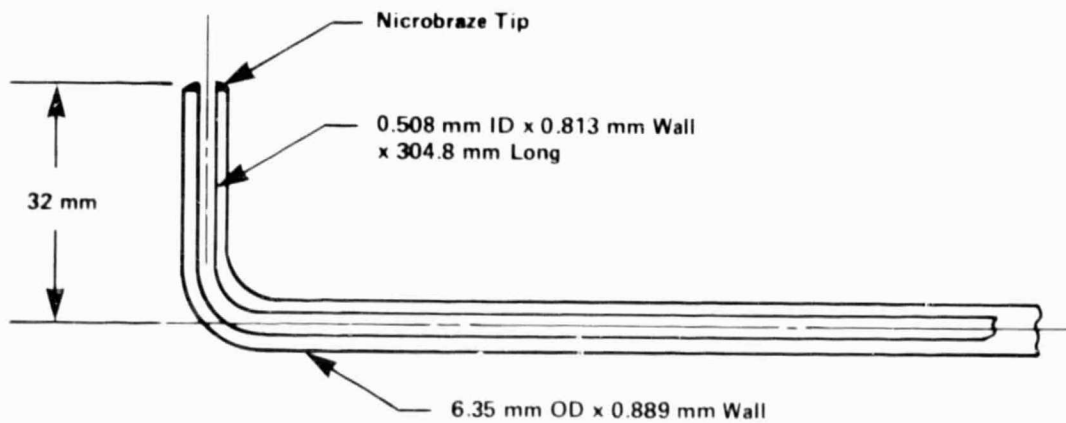

Figure 2-5. Liquid Fuel Injector Tube Details

6500-5

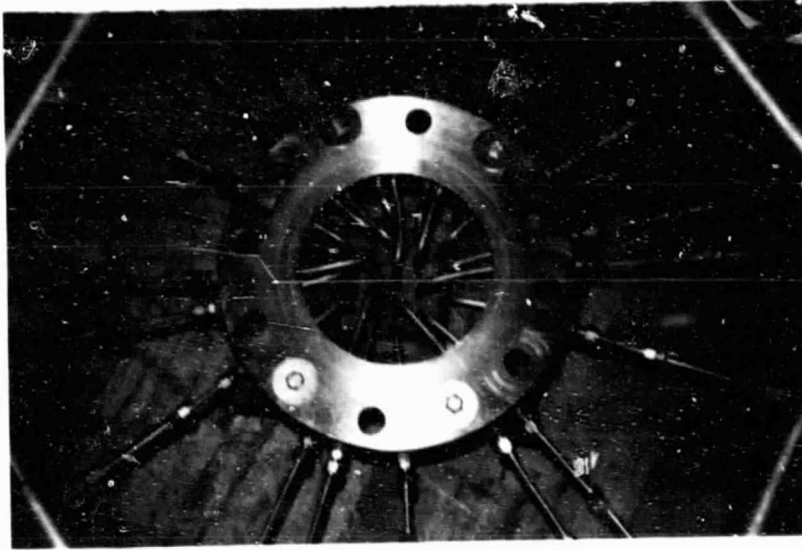
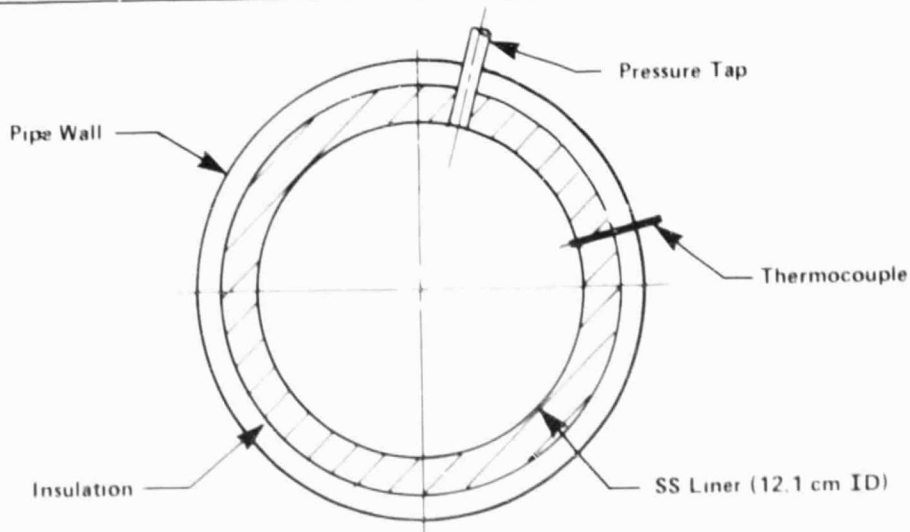

Figure 2-6. Gaseous Fuel Injector Tube Details

6500 6



Note: Thermocouple insertion from liner wall 0.64 cm

Figure 2-7. Premixing Zone Instrumentation 5 cm (2") Upstream of
Catalytic Reactor Inlet

6500 7

ORIGINAL PAGE IS
OF POOR QUALITY

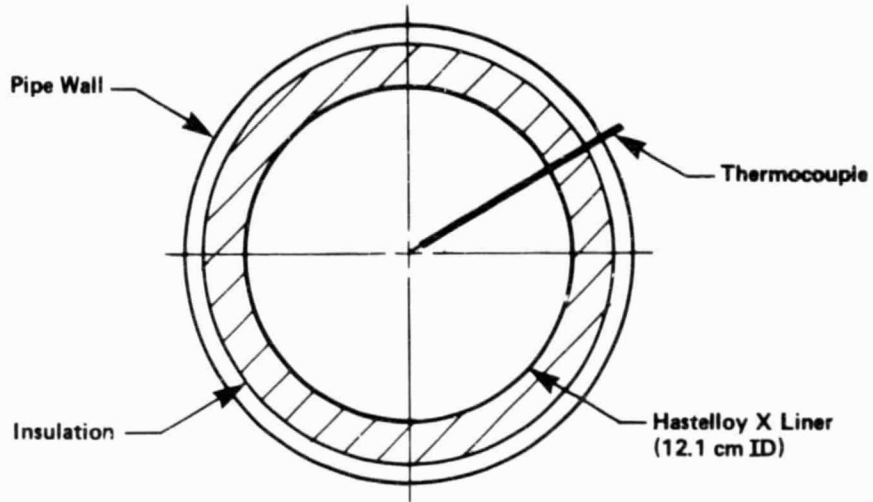
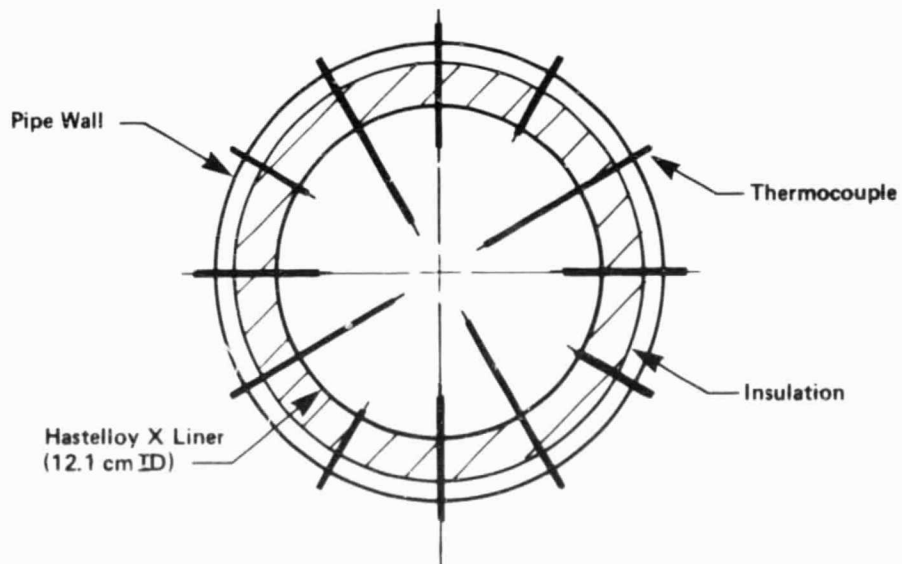

Figure 2-8. Catalyst Elements 1 Through 5 Exit Plane Thermocouple Arrangement

6500-8



Note: Thermocouple insertion from liner wall 4.4 cm, 1.9 cm, & .64 cm

Figure 2-9. Catalyst Element 6 Exit Plane Thermocouple Arrangement

6500-9

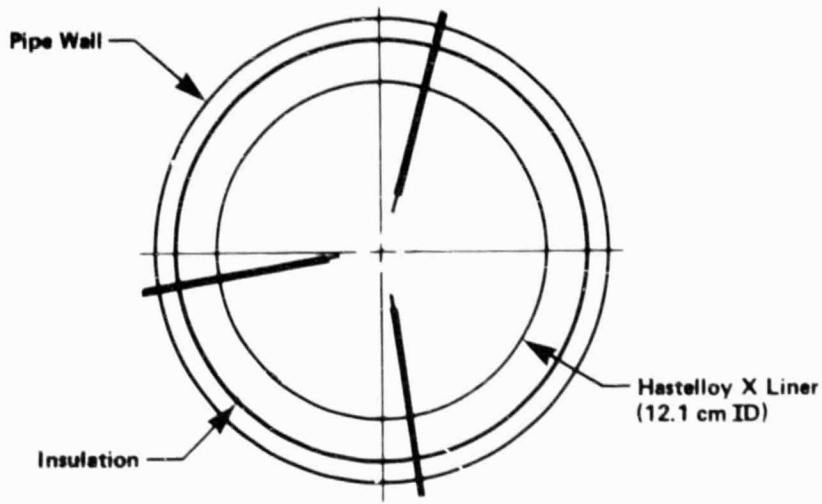

Note: Thermocouple insertion from liner wall - 4.4 cm

Figure 2-10. Catalyst Elements 2 and 4 Exit Plane Thermocouple Arrangement -
Medium-Heating-Value Gas Only

6500-10

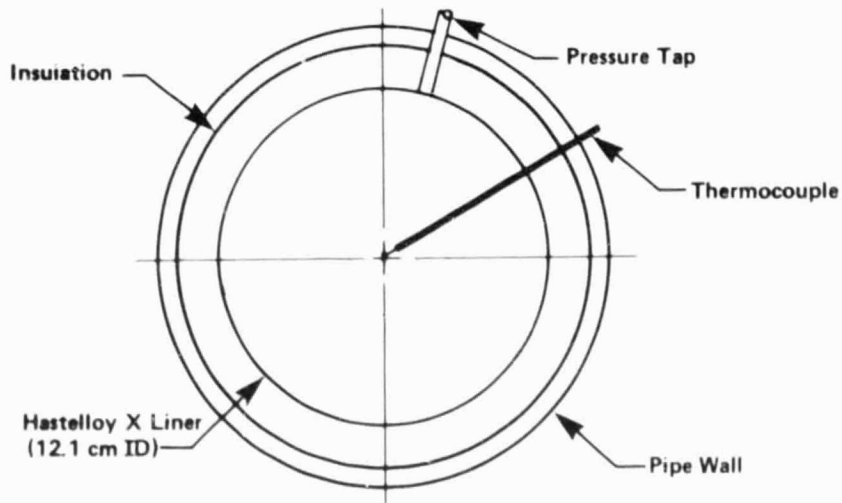
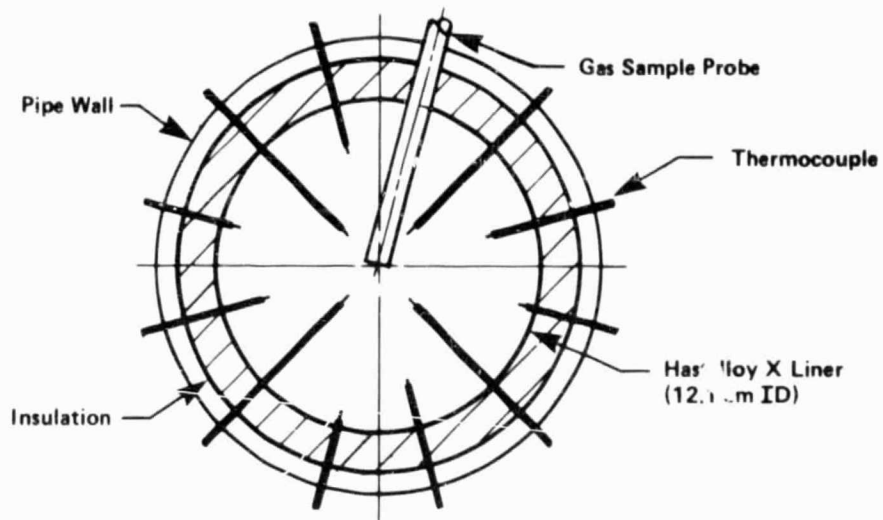

Figure 2-11. Downstream Exit Planes 1, 2 and 3 Instrumentation Arrangement

6500-11

ORIGINAL PAGE IS
OF POOR QUALITY



Note: Thermocouple insertion from liner wall - 4.4 cm, 1.9 cm and .64 cm

Figure 2-12. Downstream Exit Plane 4 Instrumentation Arrangement

6500-12

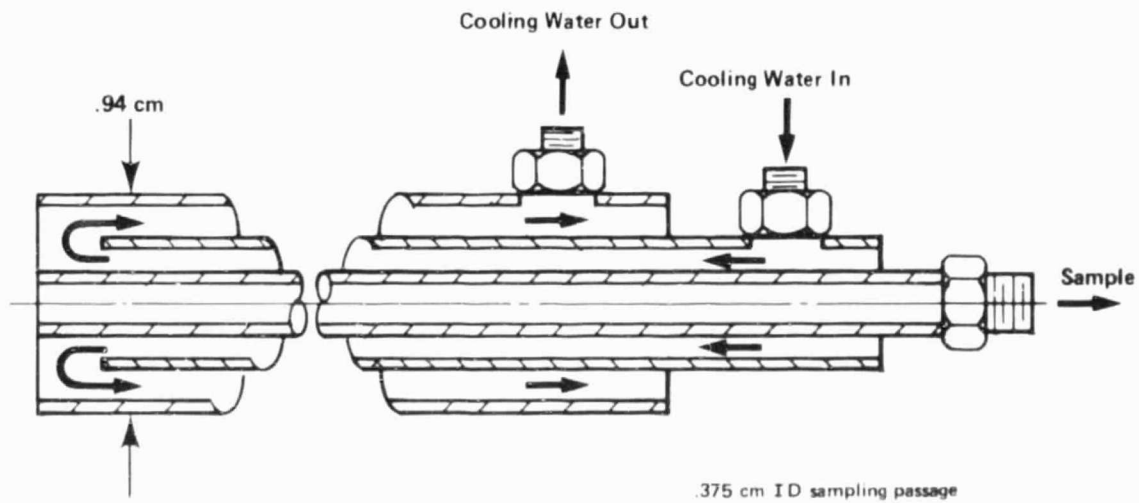

Figure 2-13. Water-Cooled Emission Sample Probe

6500-13

ORIGINAL PAGE IS
OF POOR QUALITY

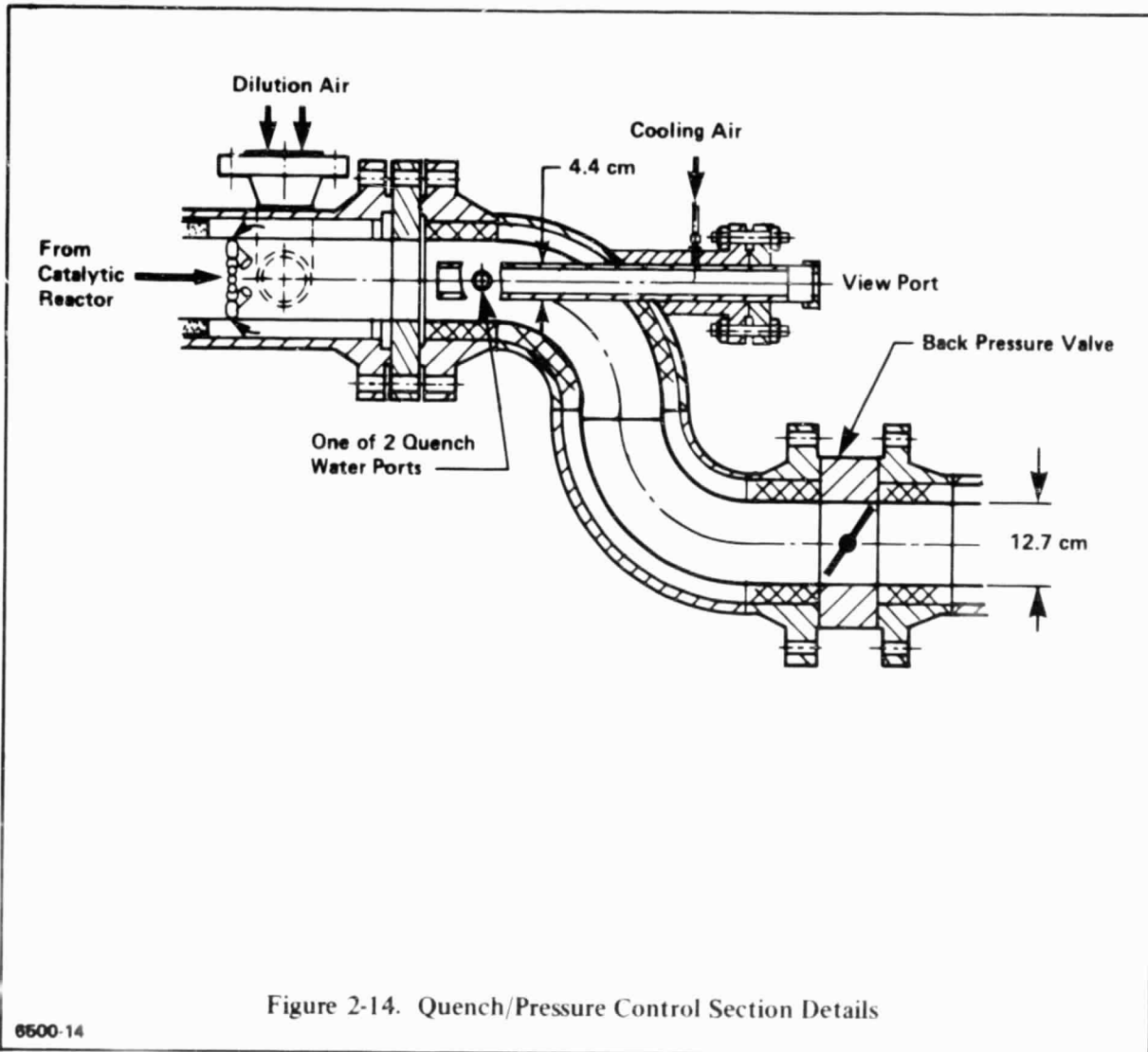

Figure 2-14. Quench/Pressure Control Section Details

6500-14

3.0 TEST FACILITY

All test facilities used to complete the requirements of this program are located at the Westinghouse Synthetic Fuels Division, Madison, Pennsylvania. The test rig, previously described in Section 2, was installed in the Test and Development Center (TDC). Coal gas was produced by the Westinghouse/Department of Energy Process Development Unit (PDU).

A schematic drawing of the PDU is shown in Figure 3-1. Components shown are for the single-stage gasification process utilized during catalytic combustion tests. Only a brief description and operation summary is provided. A complete description of the PDU is given in Reference 4. The PDU is a pressurized, fluidized bed gasifier.

Pulverized, dried coal is pneumatically fed into the gasifier through lockhoppers and rotary feeders. Recycled product gas is used to transport the feed coal as well as recycled char fines from two downstream cyclones into the gasifier. Untreated coal is injected into the gasifier along its centerline.

Combustion occurs when oxygen, fed through a central feed tube, combines with the coal. Steam, fed with oxygen in other parts of the gasifier, reacts with coal and char to form hydrogen and carbon monoxide. As the bed of char recirculates, carbon in the char is consumed by combustion and gasification, leaving particles rich in ash. The ash particles contain mineral compounds that melt between 810 K (1000°F) and 1370 K (2000°F). The liquid in the char extrudes through pores to the surface and sticks to other liquid droplets on adjacent char particles. The ash agglomerates that form are larger and more dense than the char and coal in the bed. Agglomerates settle from the fluidized bed and are continuously removed by a rotary feeder to lockhoppers. Recycled product gas partially fluidizes and cools the ash as it is withdrawn.

Raw product gas containing methane, hydrogen, carbon monoxide, carbon dioxide and gaseous impurities exits the reactor at ~ 1260 K ($\sim 1800^\circ\text{F}$). Refractory-lined cyclones remove char particles for reinjection into the gasifier. The gas is then quenched and cooled in a water scrubber to remove remaining

particulate matter. The scrubber also removes all but a few ppm of the ammonia and cyanide compounds contained in the product gas. Sulfur compounds in the product gas are not removed by the scrubber. A portion of the product gas flow enters a carbon steel pipeline to the TDC combustion rig. Operating conditions for each gasifier set point are summarized in Table 3-1. Coal feedstock for both set points was Indiana #7. Analysis for Indiana #7 is given in Table 3-2.

The TDC was the site of combustion testing. This combustion laboratory has numerous common facilities available for tests on four operating test passages. Figure 3-2 is a photograph of the installed test rig for catalytic combustion of low- and medium-heating-value coal gas.

Figure 3-3 is a simplified schematic of the TDC. Combustion and dilution air was supplied by a five-stage centrifugal compressor driven by a 2000-hp electric motor. The compressor is rated at 23.4×10^5 Pa (7.5 lbs/s at 340 psia). Maximum air flow to the test rig for this program was only 4.75 lbs/s. Air from the compressor discharge was then heated with a natural-gas-fired, non-vitiating heat exchanger to inlet temperatures ranging from 560 K to 780 K (550°F to 950°F). Combustion air flow is metered with an ASME venturi tube prior to flow control. Dilution air* flow (typically 1.5 lbs/s) is metered with an ASME orifice meter prior to flow control. Both air flow rates are temperature and pressure compensated.

Baseline characterization tests were performed using a petroleum distillate, ERBS, fuel stored in a 38,000-liter (10,000-gallon) underground tank. Following transfer to a 1900-liter (500-gallon) run tank, fuel is delivered to the test rig with a 5-hp screw-type pump. The combustor fuel flow is passed through a 3-micron nominal filter and a positive displacement meter prior to flow control.

*Dilution air required for rig cooling in the quench/pressure control exhaust section (see Figure 2-1).

Coal-derived gaseous fuel characterization of the catalyst used gasifier product gas following particulate scrubbing. The gas pipeline connecting the PDU to the TDC combustion facility is an underground 90-m (300-foot) long, Schedule 80, 15-cm (6-inch) carbon steel pipe. Metering of the gas flow is via a temperature- and pressure-compensated ASME orifice meter prior to flow control.

The gas analysis system consists of the instruments listed in Table 3-3. Continuous gas samples were routed to the gas analysis instruments through a 0.64-cm outside diameter (0.25-inch) stainless steel sample line which was heated to a temperature of 470 K.

The gas analysis system includes continuous recording of all parameters. Sample flow to any instrument can be interrupted for on-line calibration checks. General operating practices include calibration prior to and following each test period. All data recorded were also fed to the data acquisition system described below.

A secondary system utilized during this program includes the cooling water system. Cooling water was utilized by the process air compressor. The closed system consists of three centrifugal pumps and two fan-driven cooling towers. High-pressure water was injected prior to the backpressure control valve (see Figure 2-14) in order to limit the valve temperature to 760 K (900°F). A second water quench was used to further cool the rig exhaust following pressure reduction. The city water supply was used to reduce the temperature to 480 K (400°F). Finally, quenched exhaust gas enters the multiple baffle muffler chamber with accompanying stack.

Primary data acquisition for this program was by way of a Digital PDP-II computer. The operating system provided real-time data acquisition with time-sharing capability. A schematic of the system is shown in Figure 3-4.

In the data acquisition mode, approximately 110 analog and digital signals were periodically scanned by the multi-speed SCAN routine. The typical scan

rate utilized was once every 10 s. SCAN also performed approximately 25 simple calculations of flow rate, multi-point averages and determination of both maximum and minimum values from a group of points.

In the time-sharing mode, the PDP-11 performed on-line calculations, including combustor reference velocity, theoretical flame temperature, fuel-to-air ratios and others, totaling approximately 25 separate calculations. A more complicated on-line calculation is that of fuel flow. The PDU FLO program performs this task according to the requirements of ASME Fluid Meters, 6th ed., 1971, using input coal gas composition. This is necessary since the equations are dependent on density and viscosity, which are composition dependent.

All data channels, from instruments or calculated, were periodically written, unformatted, on magnetic tapes for future reference. The PLAYBACK program provided post-test analysis (historical trend and graphic trend) of these tapes. Finally, large-scale report data generation is handled by the program CGREDU. CGREDU is capable of an unlimited number of calculations, with up to 50 variables, using input from magnetic tape.

TABLE 3-1
PDU OPERATING SUMMARY

<u>Operating Parameters</u>	<u>Test Dates</u>	
	<u>7/17/81</u>	<u>7/31/81-8/1/81</u>
Coal Feed Rate, lb/hr (kg/hr)	1406 (640)	1613 (730)
Oxygen/Coal Ratio, MAF ⁽¹⁾	0.95	1.03
Steam/Coal Ratio, MAF ⁽¹⁾	0.35	0.35
Recycle Gas/Coal Ratio, MAF ⁽¹⁾	2.42	1.89
System Pressure, psia (Pa)	245 (15.9 x 10 ⁵)	245 (15.9 x 10 ⁵)
Freeboard Temperature, °F (K)	1784 (1247)	1794 (1252)
LHV, Btu/scf (MJ/m ³ @ STP)	159 (5.9)	252 (9.4)
Average Gas Composition, volume % (dry)		
CO	28.31	44.06
H ₂	17.23	25.22
CH ₄	2.29	4.47
CO ₂	22.13	25.55
N ₂	29.59	0.50
H ₂ S	0.14	0.20
Gas Make/Coal Ratio, scf/lb (m ³ @ STP/kg)	34.5 (2.17)	33.41 (2.09)
Net Gas Rate, lb/hr (kg/hr)	5104 (2590)	5716 (2590)
Ash Rate, lb/hr (kg/hr)	80 (36)	111 (50)

⁽¹⁾MAF - Based on Moisture and Ash Free Coal

TABLE 3-2
COAL FEEDSTOCK ANALYSIS - INDIANA #7

<u>Proximate, Wt%</u> <u>(as rec'd)</u>		<u>Ultimate, Wt%</u> <u>(as rec'd)</u>		<u>Ultimate, Wt%</u> <u>Dry Basis</u>
Volatile Matter	29.97	Carbon	64.03	71.62
Fixed Carbon	49.19	Hydrogen	5.49	4.81
Moisture	10.60	Oxygen	18.04	9.66
Ash*	10.24	Nitrogen	1.54	1.72
		Sulfur	0.66	0.74

*Ash contains 59% SiO₂, 24% Al₂O₃, 6% Fe₂O₃ and 2% K₂O.

TABLE 3-3
TDC EMISSIONS MONITORING EQUIPMENT

<u>Analyzer</u>	<u>Method</u>
NO/NO _x	Chemiluminescence
CO	Infrared
CO ₂	Infrared
H ₂ O	Infrared
O ₂	Magnetic Susceptibility
Hydrocarbons	Flame Ionization

ORIGINAL PAGE
BLACK AND WHITE PHOTOGRAPH

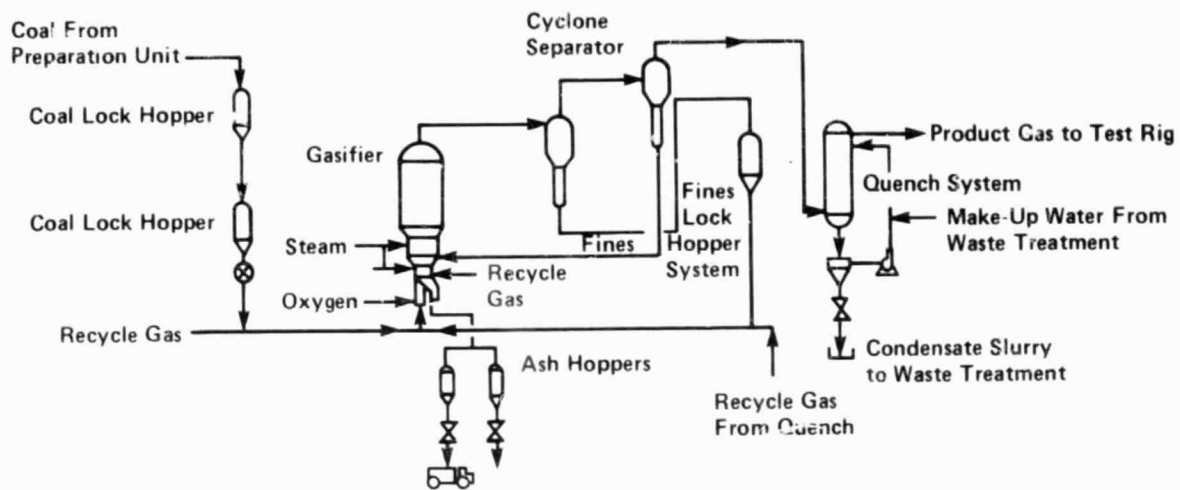

Figure 3-1. Process Development Unit (PDU) Schematic

6500-15

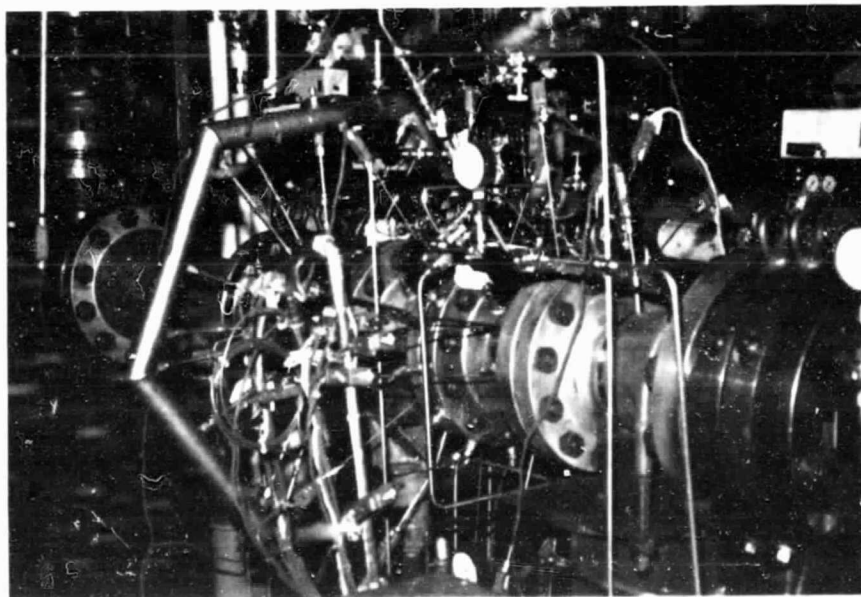

Figure 3-2. Test Rig Installed in Passage 3

6500-16

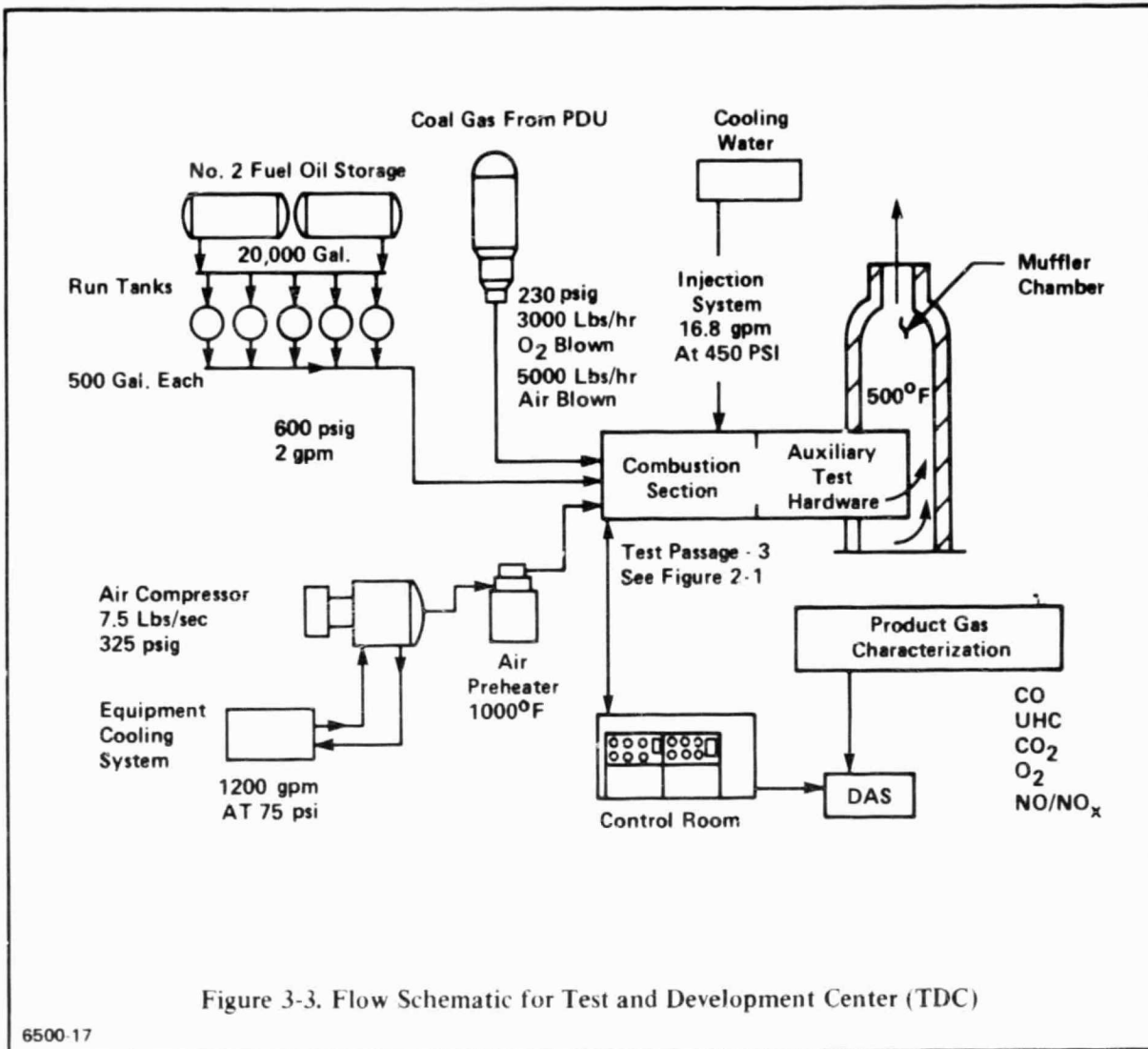

Figure 3-3. Flow Schematic for Test and Development Center (TDC)

6500-17

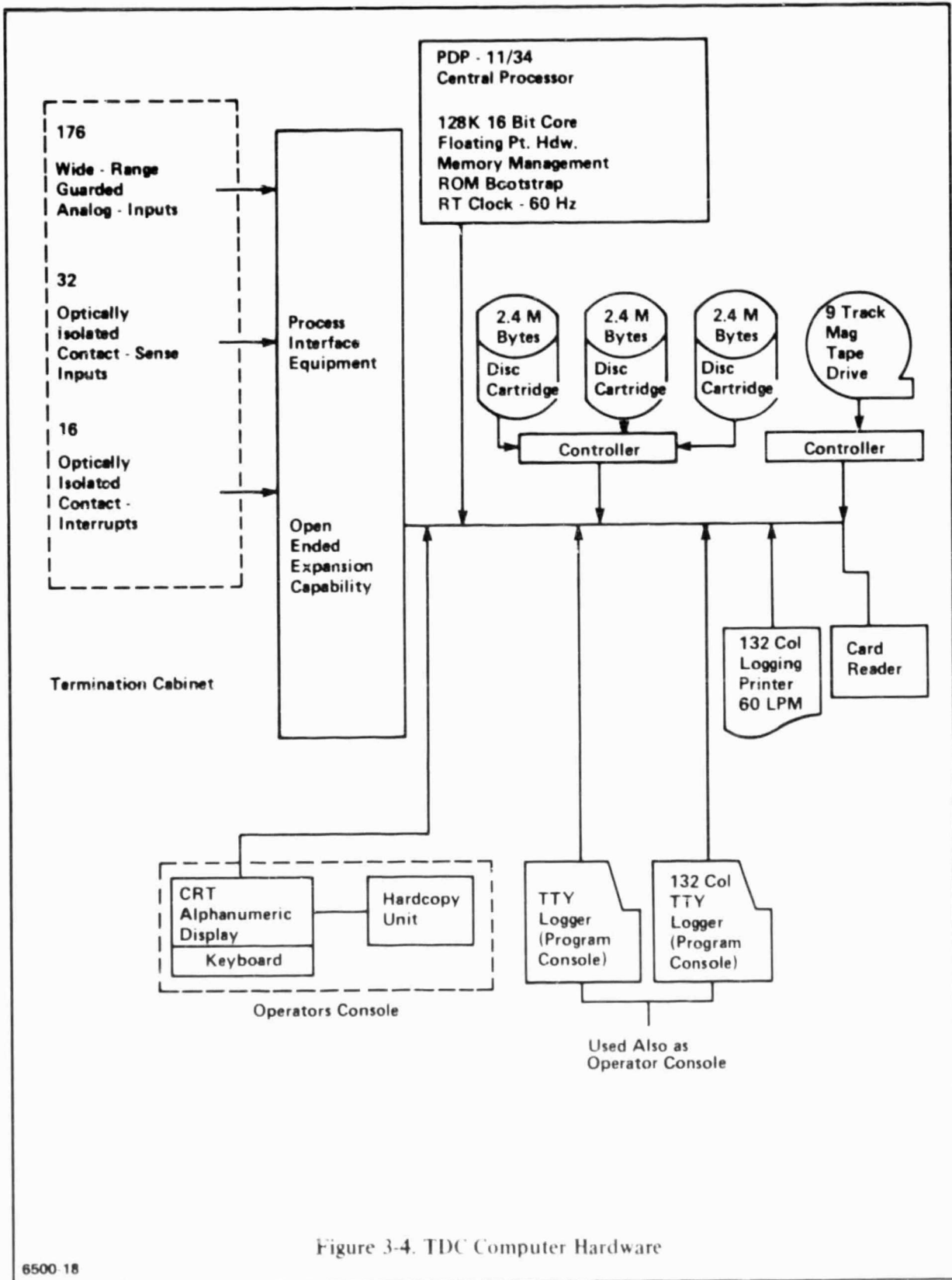

Figure 3-4. TDC Computer Hardware

4.0 FUEL CHARACTERISTICS

ERBS, a petroleum distillate fuel, was used to initially characterize the rig and catalytic combustor. Fuel properties are provided in Table 4-1 and Figures 4-1 and 4-5. Figure 4-5 is a plot of adiabatic flame temperature vs equivalence ratio.

Gaseous fuels used in this program were obtained from the DOE/Westinghouse gasifier (PDU) at the Synthetic Fuels Division, Waltz Mill Site, Madison, Pennsylvania. A low-heating-value gas was produced while the gasifier operated in an oxygen-enriched air-blown mode. Medium-heating-value gas was produced by an oxygen-blown operation.

Average gas compositions are provided in Table 3-1. Significant variations in gas composition occurred during test operations due to gasifier system upsets (loss of O₂ system). Tables 4-2 and 4-3 contain more comprehensive gas composition data obtained from gas chromatographs at the PDU. Figures 4-2, 4-3 and 4-4 present the carbon monoxide concentration as a function of gasifier operating time. Similar curves could be made for each gas component. Note that during the major gasifier upset between 1530 and 1730 on July 17, 1981, no combustor data were taken. The relationship between flame temperature and equivalence ratio is defined for various inlet temperatures in Figures 4-6 and 4-7 for both the low- and medium-heating-value coal gas using the average values of gas composition from Table 3-1.

Periodic analysis of some trace components (nitrogen compounds) were also made during gasifier operation. Results of these analyses are summarized in Tables 4-2 and 4-3. Generally, nitrogen compounds are present in low concentrations in the PDU-produced fuel gas. As a result of sampling and measurement techniques currently being developed, data obtained on NO_x and cyanide compounds are quite limited and must be considered preliminary. A chemiluminescence meter was used to determine the NO_x concentration in a grab sample of product gas. Both ammonia and cyanide compound levels are determined with a distilled-water scrubber and an ion-specific electrode. Limited experience with cyanide compound measurements indicates that maximum values given for cyanide compounds and ammonia do not occur simultaneously.

TABLE 4-1
 PETROLEUM DISTILLATE FUEL CHARACTERISTICS

<u>Analysis/Test</u>	<u>Method</u>	<u>Result</u>
Composition		
Carbon, wt.%		87.39
Hydrogen, wt.%		12.55
Oxygen, wt.%		<0.5
Sulfur, wt.%		0.09
Nitrogen, wt.%	Kjeldahl(2)	0.008
Hydrocarbon Compositional Analysis	GC/MS	
Proton Type, % of Total	NMR	
Aromatic		10
Olefinic		10.5
Saturates		79.5
Water, vol.%	ASTM D1796	None
Sediment, vol.%	ASTM D1796	Trace
Halogens, ppm	Combustion Titration	<4
Cl, Br, I (as Cl)	Ion Electrode	<0.2
F		
Volatility	ASTM D2887	See Figure 4-1
Distillation Range	(Gas Chromatographic)	
Initial B.P., °C		124
10%, °C		180
50%, °C		224
Final B.P., °C		400
Specific Gravity, API at 15.6°C	ASTM D1298	38.2
Fluidity		
Pour Point, °C (°F)	37.8°C ASTM D97	-45.6 (-50)
Viscosity Kinematic @ 37°C (100°F), Centistokes	ASTM D445	1.87
Combustion	ASTM D240	
Net Heat, Btu/lb		18,343
Net Heat, cal/g		10,826

TABLE 4-1 (Continued)

<u>Analysis/Test</u>	<u>Method</u>	<u>Result</u>
Trace Metals	Emission	ppm
V	Spectrographic	<0.1
Ni	Accuracy +50%	<0.1
Na		<1
K		<1
Mg		0.4
Ca		<0.4
Pb		2.5
Cu		<0.1
Fe		1.2
Si		1
Zn		<0.6
Ba		<1
Mn		<0.1
Mo		<0.1
Ti		<0.1

TABLE 4-2
PDU PRODUCT GAS COMPOSITIONS
LOW-HEATING-VALUE TEST
VOLUME %

<u>Component</u>	<u>Mean Value</u>	<u>Variance</u>	<u>Standard Deviation</u>
CO	28.31	2.82	1.73
H ₂	17.23	2.27	1.55
CH ₄	2.29	0.16	0.41
CO ₂	22.13	0.92	0.99
N ₂	29.59	1.53	1.27
H ₂ S	0.14	0.0005	0.023
NO _x *	10 ppm	---	---
CN*	70-200 ppm	---	---
NH ₃ *	20-250 ppm	---	---

TABLE 4-3
PDU PRODUCT GAS COMPOSITIONS
MEDIUM-HEATING-VALUE TEST
VOLUME %

<u>Component</u>	<u>Mean Value</u>	<u>Variance</u>	<u>Standard Deviation</u>
CO	44.06	0.62	0.79
H ₂	25.22	1.51	1.24
CH ₄	4.47	0.18	0.43
CO ₂	25.55	3.50	1.89
N ₂	0.50	0.0008	0.028
H ₂ S	0.20	0.0002	0.016
NO _x *	2-15 ppm	---	---
CN*	140-420 ppm	---	---
NH ₃ *	23-260 ppm	---	---

*Values presented based on limited data including subsequent gasifier operation; subject to change.

ORIGINAL PAGE IS
OF POOR QUALITY

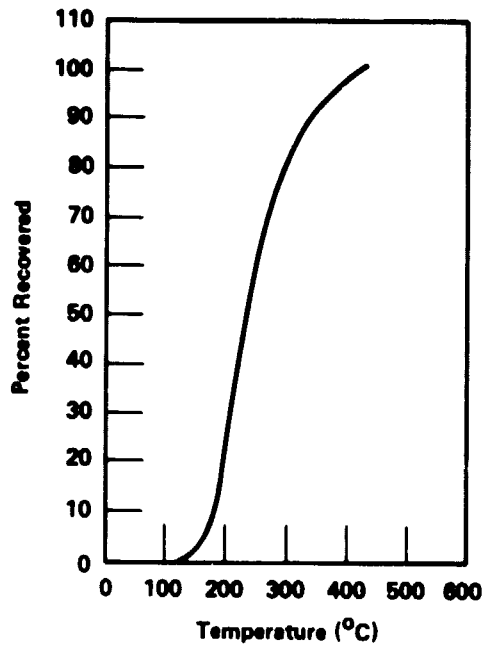

Figure 4-1. Distillation Curve for ERBS Distillate Fuel

6500-19

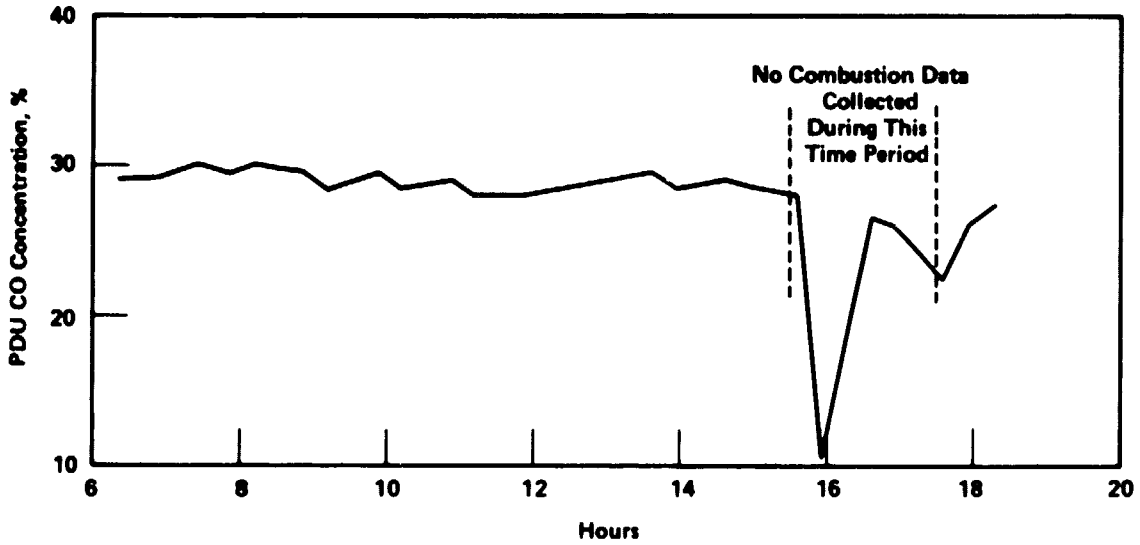

Figure 4-2. CO vs PDU Run Time 7/17/81-
Low-Heating-Value Coal Gas

6600-20

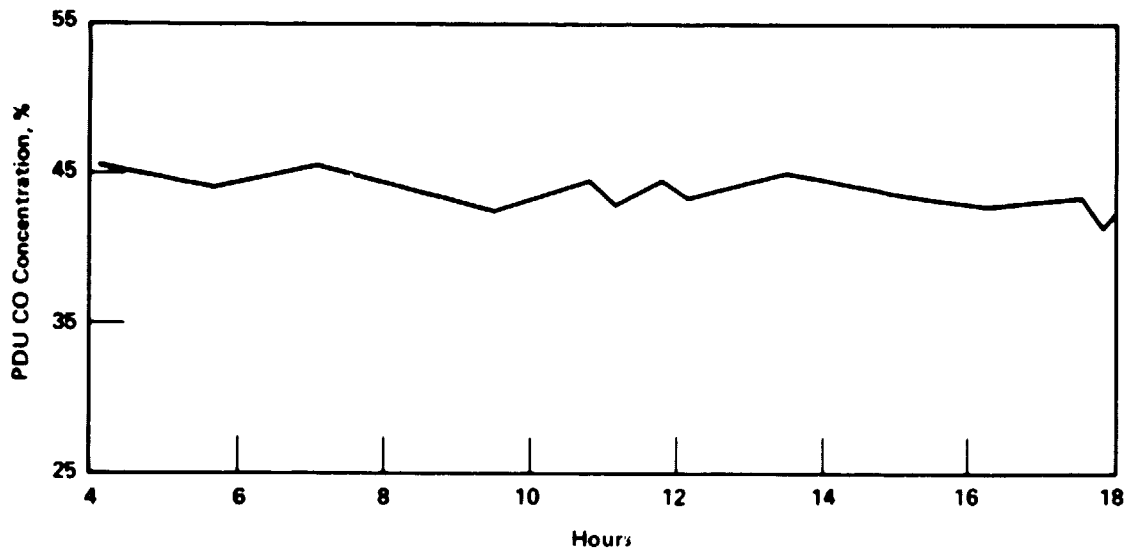

Figure 4-3. CO vs PDU Run Time 7/31/81 and 8/1/81-
Medium-Heating-Value Coal Gas

6600-21

ORIGINAL PAGE IS
OF POOR QUALITY

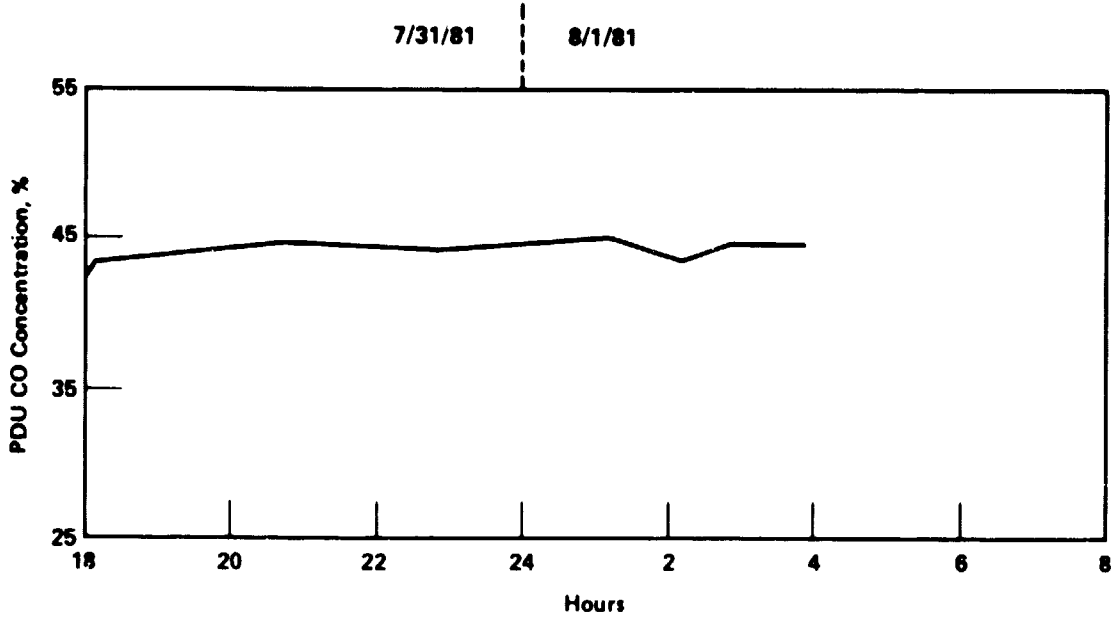

Figure 4-4. CO vs PDU Run Time-Medium-Heating-Value Coal Gas

6500-22

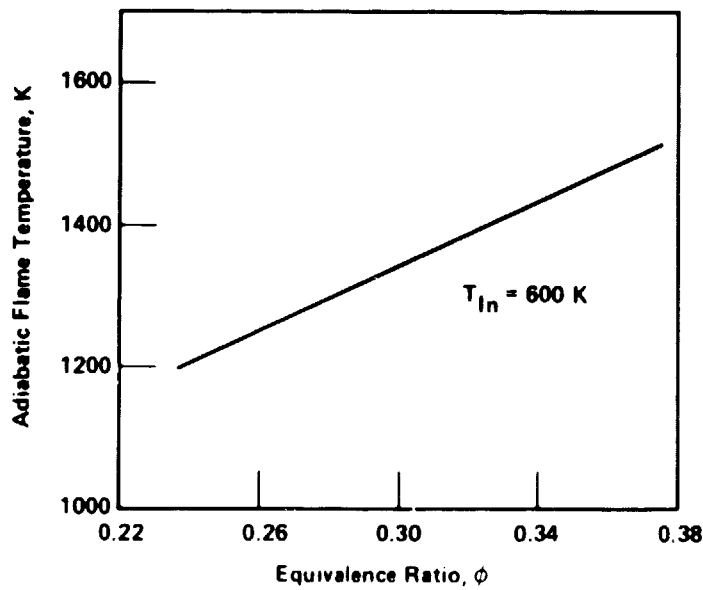

Figure 4-5. Adiabatic Flame Temperature vs Equivalence Ratio - ERBS Distillate Fuel

6500-75

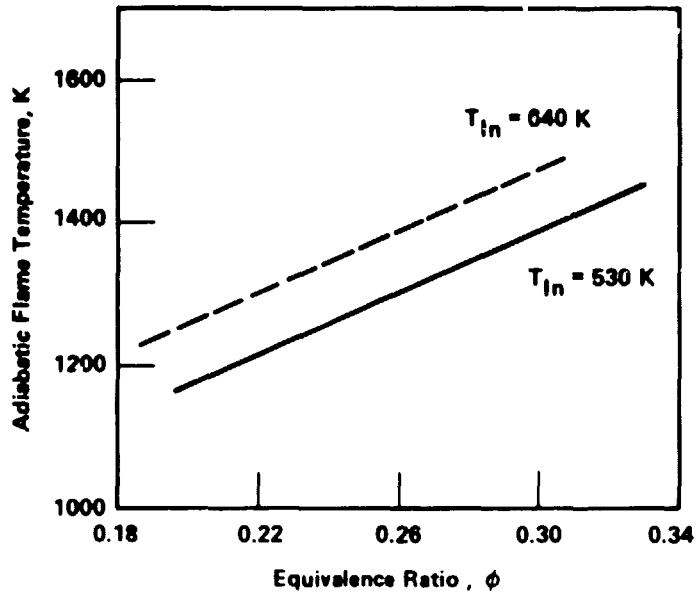

Figure 4-6. Adiabatic Flame Temperature vs Equivalence Ratio –
Low-Heating-Value Coal Gas

6500-76

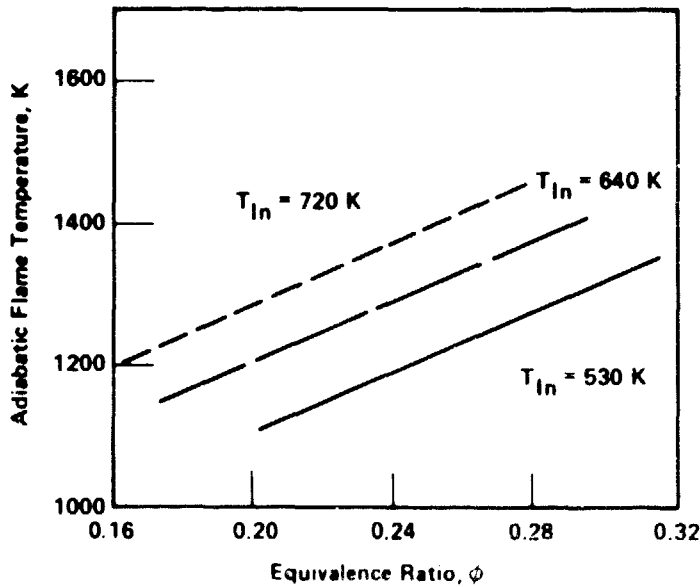

Figure 4-7. Adiabatic Flame Temperature vs Equivalence Ratio
Medium-Heating-Value Coal Gas

6500-77

5.0 COMBUSTION TEST RESULTS

In this section, test operations and data summaries are presented for each test to enable interpretation of data. Test operations were initiated with liquid fuel characterization of the test rig and the catalytic combustor using ERBS. Following a fuel injector change, a test was conducted using low-heating-value gas. Some difficulties were encountered during this test due to pipe wall overheating. Prior to the final test with medium-heating-value gas, modifications were made to reduce wall overheating problems and improve catalyst support. A brief summary of each test day will be made. All data tables are contained in Appendix A, where 173 steady-state data points are summarized.

5.1 LIQUID FUEL CATALYST CHARACTERIZATION

Tests were initially conducted with ERBS. The purpose of these tests was to characterize the catalytic combustor and to shakedown the test rig. The test matrix completed for ERBS is provided in Table 5-1. Seven data points at a pressure of 5×10^5 Pa and ten at a pressure of 10×10^5 Pa were obtained at an inlet temperature of ~ 600 K, a reference velocity of ~ 20 m/s and a range of exit temperatures (1270 to 1460 K). Detailed tabular results are contained in Appendix A, Tables A-1 and A-2.

The data obtained from the ERBS fuel testing are presented in Figures 5-1 through 5-9. Figures 5-1 and 5-2 are plots of combustor centerline temperature as a function of distance from the catalyst inlet. Figure 5-1 has both high- (10×10^5 Pa) and low-pressure (5×10^5 Pa) curves for a nominal 1450 K adiabatic flame temperature. Similar curves for a 1315 K adiabatic flame temperature are provided in Figure 5-2. Temperature rise seems to occur more rapidly for low-pressure operation.

Radial temperature distributions and pattern factors are shown in Figures 5-3 and 5-4 for the same conditions as in Figures 5-1 and 5-2.

Figure 5-5 is a plot of thermocouple efficiency vs equivalence ratio. The adiabatic flame temperature for a given equivalence ratio can be found in Figure 4-5. The measured thermocouple efficiency is based on the average of twelve thermocouples at the catalyst exit (catalyst element plane 6, Figure 2-9). Figure 5-6 presents combustion efficiency as a function of equivalence ratio and is based on emission measurements. Compared to Figure 5-5, the results are substantially higher. This is not unexpected, since heat losses are not a factor, and it also includes the gas-phase reaction zone downstream of the catalytic reactor. Combustion efficiencies approaching 100% were obtained at equivalence ratios above 0.34. Figure 5-7 is a plot of measured CO in ppm by volume vs measured equivalence ratio. The CO emission index is shown in Figure 5-8 as a function of equivalence ratio. Finally, the NO_x emissions as a function of equivalence ratio are presented in Figure 5-9.

Comparing the results obtained in this program with Anderson⁽⁵⁾ and others^(1,2,3), ERBS distillate fuel characterization of the catalytic combustor is quite typical. Efficient operation is obtained only over a narrow operating range, and NO_x emission levels are extremely low. Figures 5-1, 5-2, and 5-5 through 5-8 all suggest that operation at a pressure of 5×10^5 Pa is more efficient than a pressure of 10×10^5 Pa for equivalence ratios below 0.34.

5.2 LOW-HEATING-VALUE FUEL GAS EVALUATION

After the baseline diesel ERBS tests, the rig was inspected and found to be undamaged by the diesel fuel testing. The liquid fuel injector was replaced by the gaseous fuel injector. During this test series, the PDU was operated in an enriched air-blown mode to produce a product gas with a nominal lower heating value of 5.9 MJ/m^3 (158 Btu/scf). The completed test matrix is provided in Table 5-2. Only a few high-pressure data points were obtained as test rig wall overheating occurred, limiting high-pressure, high-temperature operation. Nominal 10, 20 and 30 m/s reference velocities were investigated. Three inlet temperatures were also studied: 530, 590 and 640 K. Thirty-eight data points are detailed in Tables A-3 through A-7 in Appendix A. Eight of the 38 are high-pressure set points.

Figures 5-10 and 5-11 are plots of combustor centerline temperature as a function of distance from catalyst inlet. Figure 5-10 presents data for pressures of 5×10^5 and 10×10^5 Pa at a reference velocity of 20 m/s, and an adiabatic flame temperature of 1425 K. Figure 5-11 does the same for a 1270 K adiabatic flame temperature. As previously observed with diesel fuel, it appears that a pressure of 5×10^5 Pa is more efficient than a pressure of 10×10^5 Pa. No temperature rise for the first catalyst element in run 38 (Figure 5-11) seems to indicate a loss of reactivity for the first element.

Radial temperature distributions and pattern factors are shown in Figures 5-12 and 5-13 for the data described in Figures 5-10 and 5-11. Pattern factors reported are quite high, compared to those reported by Anderson (5).

Additional axial temperature profiles are provided in Figures 5-14 through 5-17. Figures 5-14, 5-15 and 5-16 show the reference velocity influence on axial temperature profile for inlet temperatures of 530, 570 and 635 K, respectively. When comparing runs closely related in time, increased reference velocity reduces combustor efficiency. Figure 5-17 shows the effect of inlet temperature on the axial temperature profile. When comparing runs 18 and 25, it is seen that increasing inlet temperature improves performance, particularly across the first element. A comparison of early and late runs indicates a decline in performance with run time. In Figure 5-15, data for a reference velocity of 10 m/s for run 23 show poorer performance than a reference velocity of 20 m/s in run 5. Figure 5-17 shows that increasing the inlet temperature to 637 K for run 25 does not bring the level of performance up to that obtained for run 4 at an inlet temperature of 579 K.

Figure 5-18 presents the effect of equivalence ratio on thermal efficiency. The two low-pressure (5×10^5 Pa) curves indicate an increase in inlet temperature improves efficiency. The high-pressure (10×10^5 Pa) curve indicates a decrease of efficiency might be expected with increased pressure, but the high-pressure data were obtained at the end of the low-heating-value test series and degradation of the catalytic reactor could have occurred. Combustion efficiency based on measured emissions is given in Figure 5-19. As previously described for the ERBS fuel tests, the combustion efficiency

measurement based on measured emissions includes the gas-phase reaction length downstream of the catalytic reactor. Heat losses are also not a factor. Combustion efficiency at a reference velocity of 20 m/s is shown for inlet temperatures of 530 to 640 K. The adiabatic flame temperature corresponding to each equivalence ratio for each inlet temperature can be found from Figure 4-6.

Figures 5-20 through 5-22 contain CO emission rate data. CO emissions decrease rapidly at equivalence ratios between 0.3 and 0.34. CO emissions also decrease at a leaner equivalence ratio for a pressure of 5×10^5 Pa when compared to a pressure of 10×10^5 Pa. Little effect of inlet temperature is shown for inlet temperatures ranging from 530 to 640 K.

Unburned hydrocarbons emissions are presented in Figures 5-23 and 5-24. Unburned hydrocarbons emissions, expressed as g/MJ fuel, are presented as a function of equivalence ratio. The trends shown are similar to those previously shown for CO emissions. Little effect of inlet temperature for the range of 530 to 640 K is shown.

Finally, NO_x curves are provided in Figures 5-25 and 5-26. NO_x emissions, corrected to 15% O_2 in the exhaust, were very low and ranged from 10 to 15 ppm by volume for equivalence ratios ranging from 0.18 to 0.34. A slight decrease in NO_x emissions with increasing equivalence ratio is shown. Fairly wide data scatter is also shown, which could have resulted from variations in the fuel gas composition. A level of 14 ppm by volume would result for complete conversion of the average levels of cyanide compound and ammonia to NO_x found in the fuel gas. In addition, 1 to 2 ppm of NO_x by volume is produced in the gasifier itself. Therefore, the measured NO_x levels are probably the result of conversion of fuel-bound nitrogen to NO_x .

To summarize the low-heating-value test results, it can be stated that efficient operation of the combustor was obtained. Axial temperature rise through the catalyst was much more rapid than for liquid fuel, with 70 to 80% of the catalyst temperature rise occurring across the first element. Exit

pattern factors were comparable to ERBS fuel results. Trends observed include increasing combustion efficiency with increasing inlet temperature and decreasing reference velocity. Catalyst performance degraded with test time.

Post-test inspection revealed the cause of the test rig wall overheating at higher pressures and exit temperatures, as previously described. Significant bypassing of both inlet air and combustion products had occurred between the fiberfrax-laminated insulating tube and the pressure vessel wall. This problem was compounded by a misalignment of the catalyst elements, which resulted when the plane 6 thermocouples (Figure 2-9) bent, causing element 6 to shift downstream. Since all subsequent elements were supported by only one thermocouple, they pivoted about the thermocouple anchor point. Combustion products exit flow was directed against the upper portion of the Hastelloy X liner, causing localized burnout.

Elements 5 and 6 developed severe cracks at the thermocouple anchor points and were subsequently replaced with identical elements for the medium-heating-value fuel gas test runs. New liners and insulation were installed with a cast ceramic seal at the inlet to both the combustor and exit instrumentation pieces to prevent bypassing of the gases. Cooling water coils were also soldered onto the outside pipe wall as an additional precaution. Finally, two additional thermocouples were installed at the exits of elements 2 and 4 for added support (see Figure 2-10).

While catalyst elements 1 through 4 were not physically damaged during the low-heating-value tests, they were all coated with a film of iron oxide. The fuel injector and inside walls of the test rig were also coated. This coating was probably responsible for the catalyst performance degradation with operating time.

5.3 MEDIUM-HEATING-VALUE FUEL GAS EVALUATION

Following the rig modifications described above, medium-heating-value coal gas tests were conducted. The PDU was operated in an oxygen-blown mode, producing a nominal 9.4 MJ/m^3 @ STP (252 Btu/scf) medium-heating-value product gas.

The completed test matrix is provided in Table 5-3. Each data point is detailed in Appendix A, Tables A-8 through A-19. Data points marked with an asterisk contain incorrect carbon monoxide readings and, as a result, incorrect exhaust gas analysis efficiency calculations. Erroneous data points are 10, 11, 13, 14 through 37, 39 through 43, 49, 50, 51, 55, 56, 57, 60, 61 and 62. NO_x , UHC, O_2 and CO_2 readings, as well as all physical readings listed, are accurate.

The modifications made successfully eliminated the test rig wall overheating problems encountered during previous low-heating-value coal gas tests. Data points were obtained at reference velocities of 10 and 20 m/s, pressures of 5×10^5 and 10×10^5 Pa, and inlet temperatures from 520 to 750 K.

Figures 5-27 and 5-28 are plots of combustor centerline temperature as a function of distance from catalyst inlet. Comparing runs made at the start of the test series, only a minor pressure effect is observed for a reference velocity of 20 m/s, an inlet temperature of 560 K, and adiabatic flame temperatures of 1295 and 1390 K. It is interesting to note that the temperature rise through the catalyst is more gradual than low-heating-value runs. Axial temperature profile for medium-heating-value runs resembled the profiles obtained for ERBS fuel. Figures 5-27 and 5-28 also show that no temperature rise is taking place across the first element.

Radial temperature distributions and pattern factors are shown in Figures 5-29 and 5-30 for the same data points described in the previous two figures. Pattern factors for medium-heating-value fuel were approximately the same as previously obtained for ERBS and low-heating-value fuel. Additional axial temperature profiles are provided in Figures 5-31 through 5-35. The expected reference velocity effect is observed in Figure 5-31. For a pressure of 5×10^5 Pa, summarized in Figure 5-33, inlet temperature influences the rate of temperature rise through the catalyst. Figure 5-34 indicates that, at high inlet temperature and pressure, residence time (reference velocity) has little effect. A comparison of a relatively early and a late run, shown in Figure 5-35, indicates that some degradation in performance has occurred between runs 32 and 73.

Combustion efficiency performance is summarized in Figures 5-36 through 5-48. Figures 5-36, 5-37 and 5-38 are plots of catalyst-exit-thermocouple efficiency-versus-equivalence ratio. Results are quite similar to those previously discussed for ERBS and low-heating-value fuels. Efficiency is improved by increased inlet temperature and decreased pressure at a reference velocity of 10 m/s, as shown in Figure 5-36. Figures 5-37 and 5-38 show inlet temperature and run time dependence for a reference velocity of 20 m/s. As previously discussed, catalyst performance degraded with run time but increased with increasing inlet temperature.

Combustion efficiency based on gas analysis is provided in Figures 5-39, 5-40, and 5-41. These include the gas-phase reaction zone downstream of the catalytic reactor and should not be sensitive to heat losses. Figure 5-39 indicates that at a reference velocity of 10 m/s, the combustion efficiency was 99.5% for equivalence ratios from 0.22 to 0.28. Little effect of inlet temperature was shown. Figure 5-40 presents data at a reference velocity of 20 m/s at a pressure of 5×10^5 Pa and 10×10^5 Pa. It appears that inlet temperature has a strong influence; however, when plotted against the adiabatic flame temperature, the inflection point of both "S"-shaped curves occurs at an adiabatic flame temperature of approximately 1300 K.

Combustion efficiency at a pressure of 10×10^5 Pa and a reference velocity of 20 m/s is presented in Figure 5-41. A loss of catalyst reactivity seems to be indicated by the data at an inlet temperature of 560 K being quite close to the 720 K inlet temperature data. The data at an inlet temperature of 720 K were obtained at the end of the test series. Combustion efficiencies of 99.5% could still be obtained at the end of the test series.

The CO emission rate, in g/MJ and lb/MBtu, is presented as a function of equivalence ratio for the medium-heating-value fuel in Figures 5-42 through 5-44. All three figures show a sharp decrease in CO emissions as the equivalence ratio is increased. As previously shown for the low-heating-value and ERBS fuels, an increase in inlet temperature generally decreased the CO emissions. An increase in reference velocity generally increased CO

emissions. CO emission rate results are presented for inlet temperatures between 530 and 730 K, reference velocities of 10 and 20 m/s, and pressures of 5×10^5 and 10×10^5 Pa.

Since unburned hydrocarbon data were obtained for all medium-heating-value data points, more comprehensive plots have been made for the UHC emission. Figures 5-45 through 5-48 contain UHC data. Figures 5-45 and 5-46 contain data obtained at a reference velocity of 20 m/s. The data indicate a decrease in UHC with increasing inlet temperature. Figure 5-46 indicates that some degradation in catalyst performance with test time has occurred. Emission rates for UHC at a reference velocity of 10 m/s is given in Figures 5-47 and 5-48. Increasing inlet temperature decreases UHC emissions at pressures of 5×10^5 and 10×10^5 Pa, as shown in figures 5-47 and 5-48.

NO_x emissions in ppm by volume corrected to 15% O_2 are presented in Figures 5-49 and 5-50. NO_x emissions were very low and ranged from 11 to 18 ppmv. No effect of inlet temperature on NO_x emissions is shown. A slight increase in NO_x with increasing equivalence ratio is shown in Figure 5-49.

Figures 5-49 and 5-50 both indicate a nominal 14 ppmv NO_x over a wide range of equivalence ratios. The same concentration of 14 ppmv was previously observed for low-heating-value gas tests (Figures 5-25 and 5-26). Using the average cyanide compound and ammonia concentrations of Table 4-3 for run 75, a conversion rate of fuel-bound nitrogen (FBN) to NO_x of $\sim 27\%$ was calculated. In light of extensive liquid fuel test data^(6,7) indicating FBN conversion rates in catalytic combustors to be 50 to 75% for lean equivalence ratios, average concentrations of cyanide compounds and ammonia given in Tables 4-2 and 4-3 may be high. A large range of values is given in Table 4-3, however, so actual values are probably in the lower range.

To summarize the medium-heating-value test results, it can be stated that efficient operation was obtained. Flashback or autoignition problems, anticipated at very high inlet temperatures, were essentially non-existent. Medium-heating-value trends were the same as those previously observed for other fuels. Some catalyst performance degradation with test time was observed.

Catalytic reactor and fuel injector static pressure drop data are presented in Figure 5-51. The ratio of static pressure drop to inlet static pressure is plotted as a function of the inlet Mach number. An isothermal curve, along with curves for two combustor loadings (T_{OUT}/T_{IN}), are presented. Data shown for all three fuels. Combustor pressure loss is a function of inlet Mach number. As combustor-temperature ratio increases, the pressure drop increases, as would be expected.

Post-medium-heating-value-test inspection revealed significant catalyst damage caused by local overheating. Photographs are provided in Figures 5-52 and 5-53. Figures 5-54 through 5-56 are sketches of damaged elements 1, 2 and 3 with comments and dimensions. Some of the fuel injector tubes were almost completely plugged by a solid, cream-colored material. Figure 5-57 is a sketch of the fuel injector tubes after the medium-heating-value tests showing the blocked tubes. Six of the nineteen fuel injector tubes showed substantial blockage. It is expected that this blockage would result in a non-uniform fuel-air distribution and produced the local hot areas which damaged the inlet of the catalytic reactor. This plugging may have been prevented by increasing the fuel gas velocity through the tubes. No temperature rise in the premixing zone was detected by the single thermocouple located in the premixing zone.

TABLE 5-1

LIQUID FUEL TEST MATRIX

Data Point	Inlet Air Temp (K)	Pressure (10 ⁵ Pa)	Reference Velocity (m/s)	Ad. Flame Temp (K)	Table No.	NO _x EI g NO _x /kg Fuel	CO EI g CO/kg Fuel	UHC EI g Hc/kg Fuel	Combustion Effic. %
15	598	5.47	18.0	1263	A-1	0	41.1	0.5	98.9
16	598	5.54	17.8	1303	A-1	0	4.4	0	99.9
1	606	5.25	19.1	1314	A-1	0	3.2	0.5	99.9
2	607	5.16	19.6	1361	A-1	0	1.4	0.2	99.9
19	597	4.99	19.7	1378	A-1	0	1.0	0	100.0
3	607	5.14	19.6	1450	A-1	0	0.7	0.1	100.0
20	598	5.05	19.5	1459	A-1	0	0.8	0	100.0
9	602	9.82	19.5	1325	A-2	0	29	0	99.45
13	602	9.85	19.4	1337	A-2	0	45.5	0	98.98
12	602	9.84	19.5	1347	A-2	0	28	0	99.36
14	602	9.80	19.6	1355	A-2	0	15.1	0	99.66
11	602	9.84	19.5	1359	A-2	0	11.9	0	99.73
10	602	9.84	19.5	1368	A-2	0	3.6	0	99.92
7	602	9.85	19.5	1404	A-2	0	1.2	0	99.97
15	602	9.87	19.5	1409	A-2	0	1.1	0	99.99
8	602	9.85	19.4	1428	A-2	0	0.9	0	99.98
9	602	9.87	19.4	1430	A-2	0	0.6	0	100.0

ORIGINAL PAGE IS
OF POOR QUALITY

TABLE 5-2
LOW-HEATING-VALUE COAL GAS TEST MATRIX

Data Point	Inlet Temp (K)	Pressure (10 ⁵ Pa)	Reference Velocity (m/s)	Ad. Flame Temp (K)	Table No.	NO _x ER (lb/MBtu)	CO ER (lb/MBtu)	UHC ER (lb/MBtu)	Combustion Effic., % ETAT (%)
20	532.22	4.96	10.99	1295.00	A-3	0.1	0.5	2.6	99.56
22	524.44	5.05	10.67	1394.44	A-3	0.1	0.1	0	99.81
21	524.44	5.03	10.68	1398.89	A-3	0.2	0.3	0	99.75
16	536.67	5.13	18.06	1206.11	A-3	0.1	0.5	9.5	97.34
19	535.00	5.07	18.21	1242.22	A-3	0.1	0.5	9.6	96.62
18	532.78	5.11	18.02	1270.56	A-3	0.1	0.5	9.8	96.31
17	530.56	4.87	18.77	1295.56	A-3	0.1	0.5	5.9	98.40
13	538.72	5.09	30.48	1222.22	A-4	0	0.5	7.6	97.97
14	533.61	5.09	30.15	1280.00	A-4	0	0.4	8.1	97.25
15	532.33	5.10	30.05	1286.11	A-4	0.1	0.4	7.9	97.35
23	575.00	5.05	10.90	1346.67	A-4	0.1	0	0	99.93
24	596.67	4.90	19.10	1192.78	A-4	0.1	0.5	11.6	95.53
2	582.78	5.17	18.61	1255.56	A-4	0.1	3.0	2.8	99.42
41	573.33	4.90	18.87	1311.11	A-4	0.1	0.4	4.8	98.72
4	579.44	5.17	18.50	1315.56	A-4	0.1	0.4	2.7	99.47
5	569.44	5.26	17.79	1452.22	A-4	0.1	0	0	99.75
37	581.11	10.22	18.43	1260.00	A-5	0	0.3	15.3	92.22
38	577.22	10.14	18.46	1305.00	A-5	0.1	0.3	11.5	92.92
40	573.33	10.30	18.01	1347.22	A-5	0.1	0.3	2.3	99.28
39	568.89	10.27	18.53	1393.89	A-5	0.1	0.2	0.3	99.53
9	577.78	5.89	30.10	1310.56	A-5	0	0.4	4.4	98.71
7	573.33	6.07	30.33	1344.44	A-5	0	0.3	5.0	98.56
8	570.56	6.16	30.78	1369.44	A-5	0	0.3	2.8	99.10
10	568.33	6.25	30.25	1416.11	A-5	0.1	0.2	0	99.61
11	564.44	6.29	29.81	1470.00	A-5	0.1	0	0	99.45
12	563.89	6.29	29.82	1479.44	A-5	0.1	0.1	0	99.52

ORIGINAL PAGE IS
OF POOR QUALITY

TABLE 5-2 (Continued)

Data Point	Inlet Temp (K)	Pressure (10 ⁵ Pa)	Reference Velocity (m/s)	Ad. Flame Temp (K)	Table No.	NO _x ER (1b/MBtu)	CO ER (1b/MBtu)	UHC ER (1b/MBtu)	Combustion Effic., % ETAT (%)
28	642.78	5.02	19.03	1231.11	A-6	0.1	0.5	12.0	95.66
27	639.44	5.10	18.70	1253.89	A-6	0.1	0.4	11.3	95.66
25	635.56	5.04	18.76	1270.00	A-6	0.1	0.4	9.0	96.59
26	632.22	5.01	18.80	1313.89	A-6	0.1	0.4	2.8	99.43
29	642.78	5.09	30.69	1226.67	A-6	0.1	0.5	9.5	96.86
30	637.22	5.12	30.20	1283.33	A-6	0.1	0.4	8.3	96.99
31	635.00	5.14	30.00	1306.11	A-6	0.1	0.4	7.3	97.35
32	631.11	5.21	29.47	1343.89	A-6	0	0.4	7.0	97.35
33	642.78	9.85	18.50	1231.11	A-7	0.1	0.4	8.0	97.83
34	640.00	9.67	18.73	1250.56	A-7	0.1	0.4	7.0	97.85
36	636.67	9.82	18.35	1292.78	A-7	0.1	0.4	5.7	98.31
35	632.78	9.80	18.23	1332.22	A-7	0.1	0.4	2.4	99.21

**ORIGINAL PAGE IS
OF POOR QUALITY**

TABLE 5-3
MEDIUM-HEATING-VALUE COAL GAS TEST MATRIX

Data Point	Inlet Temp (K)	Pressure (10 ⁵ Pa)	Reference Velocity (m/s)	Ad. Flame Temp (K)	Table No.	NO _x ER (1b/MBtu)	CO ER (1b/MBtu)	UHC ER (1b/MBtu)	ETAT (%)
71	531.06	4.98	19.36	1153.89	A-8	0	118.7	13.4	78.04
70	530.33	4.98	19.14	1152.78	A-8	0	123.8	0	93.13
69	529.00	4.98	19.13	1210.00	A-8	0	112.8	0	93.69
72	526.67	4.98	19.08	1249.44	A-8	0.1	104.0	11.2	79.73
68	526.33	5.05	18.91	1263.89	A-8	0	104.0	0	94.08
77	525.22	4.98	19.13	1272.78	A-8	0	103.0	8.6	82.63
73	525.11	5.05	18.89	1279.44	A-8	0.1	102.5	7.2	84.36
76	524.11	5.05	18.70	1302.22	A-8	0.1	43.2	1.7	95.79
65	524.61	5.05	18.70	1317.22	A-8	0.1	62.7	5.0	89.44
75	522.28	5.05	18.62	1334.44	A-8	0.1	1.3	0	99.35
40*	538.06	5.05	10.15	1129.44	A-9	0.2	-	12.2	-
41*	528.56	5.05	9.94	1210.00	A-9	0.2	-	8.1	-
42*	523.56	5.12	9.91	1255.56	A-9	0.3	-	0.1	-
43*	521.61	5.12	9.87	1337.22	A-9	0.3	-	0	-
34*	538.39	5.05	20.49	1181.67	A-9	0.1	-	10.8	-
32*	529.11	4.98	20.33	1273.33	A-9	0.1	-	0	-
33*	529.28	5.05	20.16	1310.00	A-9	0.1	-	0	-
67	523.00	5.12	18.57	1337.78	A-9	0.1	0.6	0	99.34
74	521.56	5.12	18.53	1358.89	A-9	0.2	0.5	0	99.37
66	521.22	5.12	18.44	1382.78	A-9	0.2	17.0	0	99.03
63	526.72	10.08	9.76	1292.22	A-10	0.2	1.3	0	99.45
64	524.22	10.15	9.62	1318.33	A-10	0.2	0.4	0	99.35
60*	531.61	10.01	9.91	1196.67	A-10	0.1	-	7.3	-
61*	531.67	10.08	9.83	1217.78	A-10	0.1	-	1.6	-

ORIGINAL PAGE IS
OF POOR QUALITY

*Data points marked with an asterisk contain erroneous CO data.

TABLE 5-3 (Continued)

Data Point	Inlet Temp (K)	Pressure (10 ⁵ Pa)	Reference Velocity (m/s)	Ad. Flame Temp (K)	Table No.	NO _x ER (lb/MBtu)	CO ER (lb/MBtu)	UHC ER (lb/MBtu)	ETAT (%)
62*	529.39	10.01	9.85	1250.56	A-10	0.1	-	0	-
28*	539.72	9.87	18.57	1175.00	A-10	0	-	9.6	-
30*	531.50	10.01	19.53	1235.00	A-10	0	-	7.7	-
31*	529.78	10.08	19.33	1260.56	A-10	0	-	5.5	-
2	567.89	4.98	19.58	1278.33	A-11	0	4.7	3.6	98.19
78	566.72	4.98	18.80	1315.56	A-11	0.1	2.2	2.6	96.73
4	566.11	4.91	19.92	1316.11	A-11	0.1	4.4	1.5	99.01
79	566.78	4.98	18.84	1341.67	A-11	0.1	10.1	0.2	99.19
7	564.06	4.98	19.44	1355.56	A-11	0.1	3.0	0	99.44
80	566.61	4.98	18.52	1368.33	A-11	0.1	0.4	0	99.35
6	562.44	4.91	19.49	1382.78	A-11	0.1	0.4	0	99.40
3	561.50	4.98	19.63	1390.56	A-11	0.1	0.5	0	99.63
5	561.78	4.98	19.48	1394.44	A-11	0.1	0.2	0	99.41
8	567.67	10.01	19.09	1248.33	A-12	0	0	9	96.13
9	558.89	10.01	18.97	1307.22	A-12	0	0	6.2	97.62
12	555.78	10.08	19.02	1350.56	A-12	0.1	0.7	0	99.46
10*	558.89	10.08	18.65	1307.22	A-12	0	-	3.3	-
11*	555.78	9.87	18.94	1350.56	A-12	0	-	0	-
44	598.06	5.12	10.83	1250.00	A-12	0.2	1.5	0	99.62
45	597.33	5.12	10.78	1302.78	A-12	0.2	0.8	0	99.51
81	572.89	4.84	19.25	1272.22	A-12	0	87.3	8.0	83.29
58	581.61	10.01	10.19	1287.78	A-13	0.2	0.7	0	99.51
59	579.50	10.01	10.12	1321.67	A-13	0.2	0.1	0	99.41
55*	585.89	9.94	10.31	1191.67	A-13	0.1	-	5.3	-

*Data points marked with an asterisk contain erroneous CO data.

TABLE 5-3 (Continued)

Data Point	Inlet Temp (K)	Pressure (10 ⁵ Pa)	Reference Velocity (m/s)	Ad. Flame Temp (K)	Table No.	NO _x ER (1b/MBtu)	CO ER (1b/MBtu)	UHC ER (1b/MBtu)	ETAT (%)
57*	583.33	10.01	10.25	1257.78	A-13	0.1	-	0.5	-
54	529.11	5.05	18.84	1247.22	A-13	0.1	61.0	9.6	83.74
52	516.39	4.91	19.17	1336.67	A-13	0.1	20.5	1.4	97.82
53	518.28	4.93	18.91	1362.78	A-13	0.1	0.2	0	99.36
13*	619.89	10.01	18.71	1242.78	A-14	0	-	6.9	-
17*	615.28	10.15	19.00	1347.22	A-14	0.1	-	0.8	-
16*	612.78	10.01	19.31	1384.44	A-14	0	-	0	-
19*	610.56	10.08	19.07	1415.00	A-14	0.1	-	0	-
20*	608.94	10.08	18.80	1446.11	A-14	0.1	-	0	-
46	643.06	5.05	11.66	1256.11	A-15	0.2	0.6	0	99.60
48	643.56	5.12	11.09	1283.33	A-15	0.2	0.3	0	99.53
47	638.61	4.91	9.96	1328.33	A-15	0.3	0.3	0	99.43
85	633.00	5.05	19.23	1204.44	A-15	0.1	61.0	11.8	82.57
35*	652.33	5.12	20.42	1221.67	A-15	0.1	-	9.1	-
36*	651.33	4.91	19.17	1249.44	A-15	0.1	-	2.3	-
37*	649.78	5.05	18.88	1272.78	A-15	0.1	-	0	-
38	645.61	4.91	18.79	1343.33	A-15	0.2	0.7	0	99.62
52	638.00	9.94	9.88	1290.56	A-16	0.2	0.4	0	99.63
53	637.11	10.01	10.26	1309.44	A-16	0.2	0.2	0	99.56
54	634.78	10.01	10.23	1340.00	A-16	0.2	0.1	0	99.45
51*	640.22	9.94	9.88	1260.00	A-16	0.1	-	0	-
21*	656.22	9.94	19.05	1256.11	A-16	0	-	7.1	-
22*	654.83	9.87	19.15	1285.00	A-16	0	-	4.0	-
24*	651.56	10.08	18.98	1341.11	A-16	0.1	-	0.3	-

ORIGINAL PAGE IS
OF POOR QUALITY

*Data points marked with an asterisk contain erroneous CO data.

TABLE 5-3 (Continued)

Data Point	Inlet Temp (K)	Pressure (10 ⁵ Pa)	Reference Velocity (m/s)	Ad. Flame Temp (K)	Table No.	MCX ER (1b/MBtu)	CO ER (1b/MBtu)	UHC ER (1b/MBtu)	ETAT (%)
26*	647.67	10.01	19.45	1402.22	A-15	0.1	-	0	-
27*	646.00	10.08	19.27	1428.89	A-16	0.1	-	0	-
107	684.50	10.36	3.28	1193.89	A-17	0	42.8	13.4	84.34
104	681.44	9.87	9.57	1255.56	A-17	0	42.8	1.5	96.48
105	675.44	9.80	9.48	1316.67	A-17	0	4.0	0	99.52
106	671.44	9.67	9.78	1357.22	A-17	0.1	0.6	0	99.57
103	683.83	9.94	18.62	1373.89	A-17	0	0.4	0	99.43
37	672.06	5.05	19.38	1250.56	A-17	0	53.5	13.1	80.55
86	664.56	5.05	19.10	1260.00	A-17	0	53.2	10.8	83.26
83	670.22	5.05	19.14	1308.33	A-17	0	55.2	2.5	93.55
90	667.22	5.05	18.93	1362.78	A-17	0.1	2.7	0	99.51
108	718.33	10.22	9.49	1203.89	A-18	0	38.2	9.5	89.81
109	720.94	10.29	9.59	1266.67	A-18	0	37.6	4.3	94.48
110	718.28	9.87	9.88	1314.44	A-18	0	9.9	0.7	99.33
111	714.33	9.80	9.79	1374.44	A-18	0.1	0	0	99.56
100	696.00	9.87	19.14	1245.00	A-18	0	59.2	8.4	86.58
101	690.00	9.87	19.15	1307.78	A-18	0	54.0	1.3	95.46
102	686.78	9.87	18.90	1341.67	A-18	0	2.5	0	99.55
92	725.50	4.98	19.29	1243.89	A-19	0	51.0	10.0	85.85
91	713.44	4.98	18.96	1294.44	A-19	0	55.0	3.4	92.52
93	722.44	4.98	19.25	1302.22	A-19	0	50.7	2.4	94.42
94	716.56	4.98	18.76	1373.89	A-19	0.1	0.9	0	99.56
99	747.33	9.60	19.07	1223.33	A-19	0	57.2	7.3	89.37
95	742.06	9.74	18.99	1241.11	A-19	0	58.1	7.1	89.05
96	736.61	9.87	18.70	1319.44	A-19	0	23.2	0.2	99.08
98	731.61	9.87	18.85	1384.44	A-19	0.1	0.6	0	99.52
97	727.22	9.87	18.47	1424.44	A-19	0.1	0.3	0	99.43

ORIGINAL PAGE IS OF POOR QUALITY

*Data points marked with an asterisk contain erroneous CO data.

ORIGINAL PAGE IS
OF POOR QUALITY

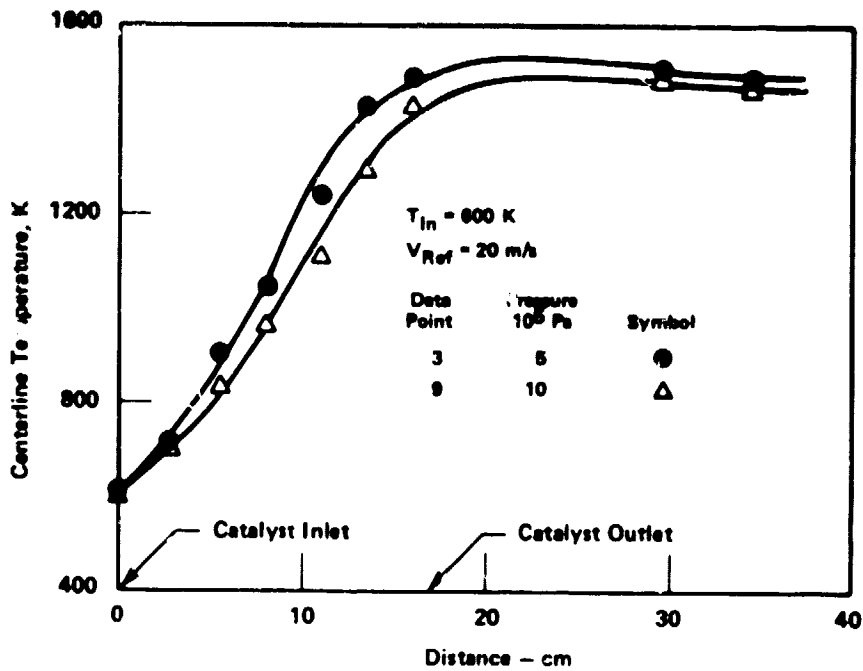

Figure 5-1. Axial Temperature Profile - ERBS Distillate Fuel, Adiabatic Flame Temperature 1450 K

6500-23

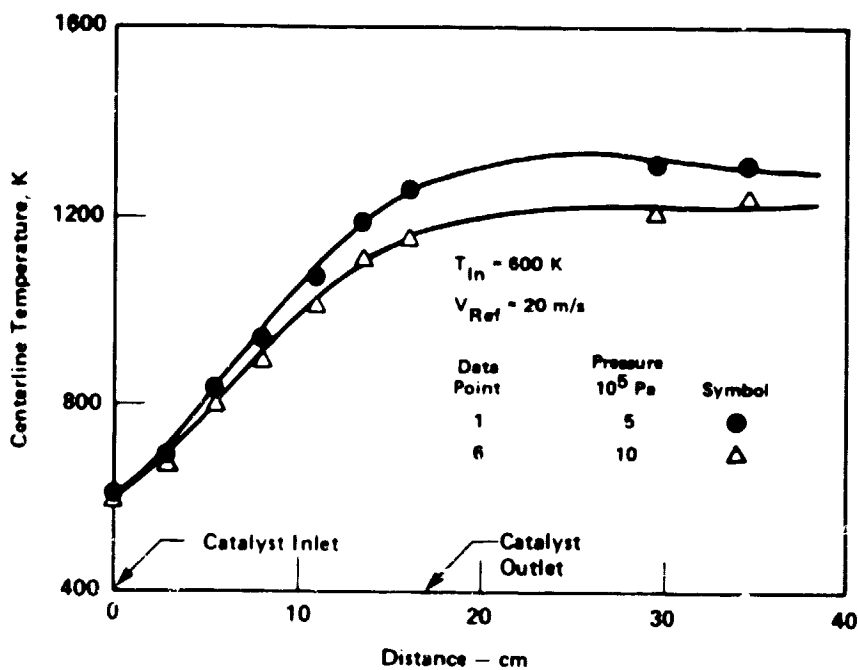

Figure 5-2. Axial Temperature Profile - ERBS Distillate Fuel, Adiabatic Flame Temperature 1315 K

6500-24

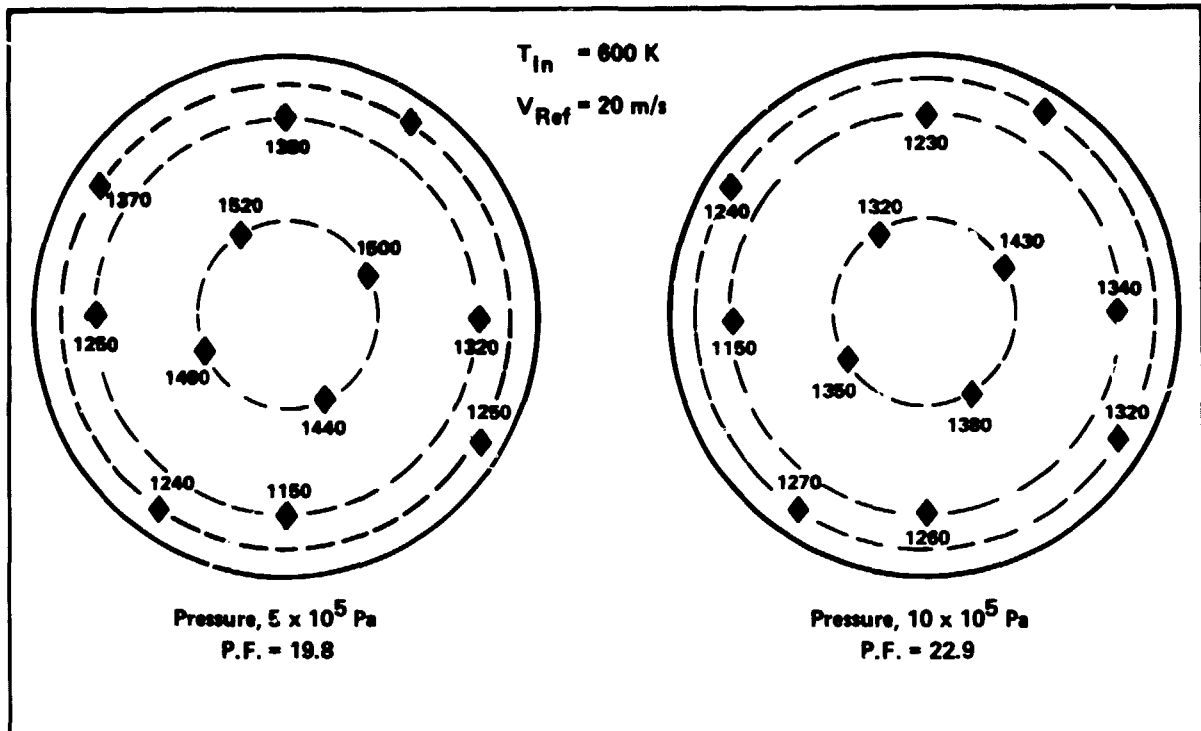

Figure 5-3. Catalyst Exit, Plane 6 Radial Temperature Profile, ERBS Distillate Fuel, Adiabatic Flame Temperature 1450 K

6500-26

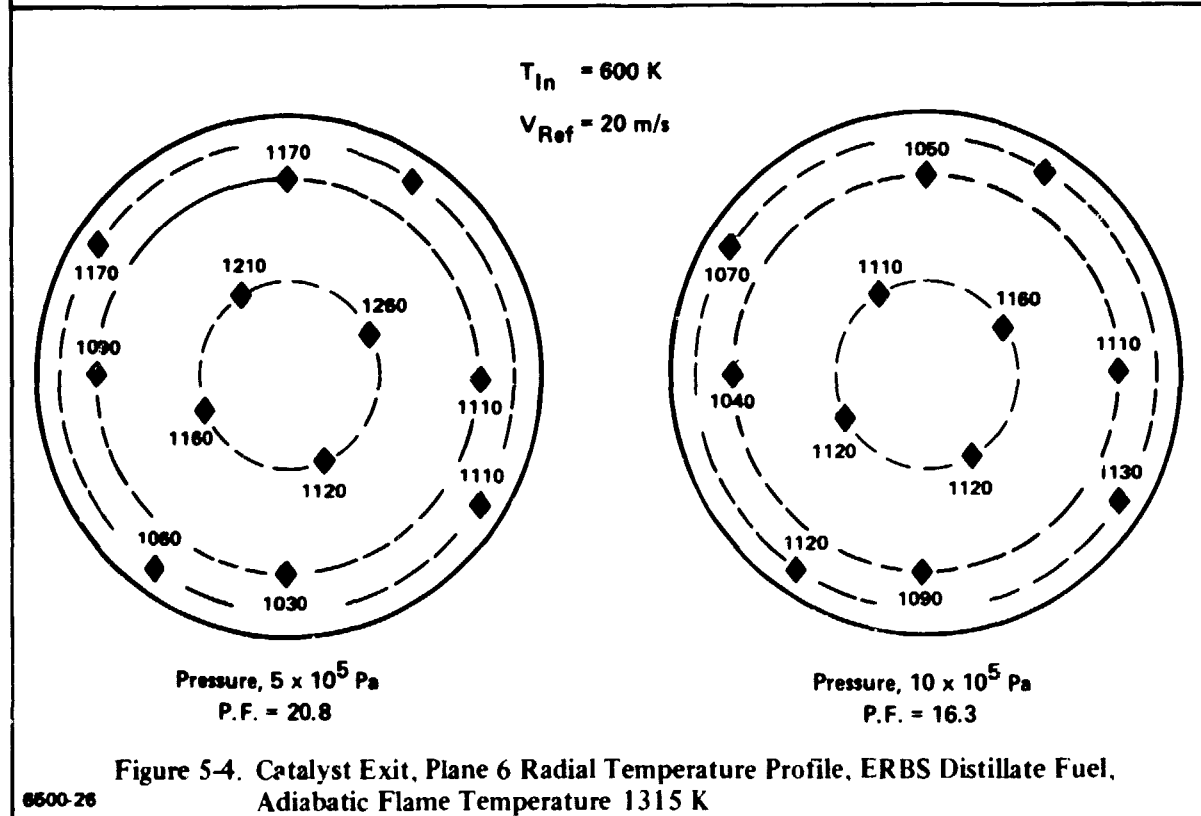

Figure 5-4. Catalyst Exit, Plane 6 Radial Temperature Profile, ERBS Distillate Fuel, Adiabatic Flame Temperature 1315 K

6500-26

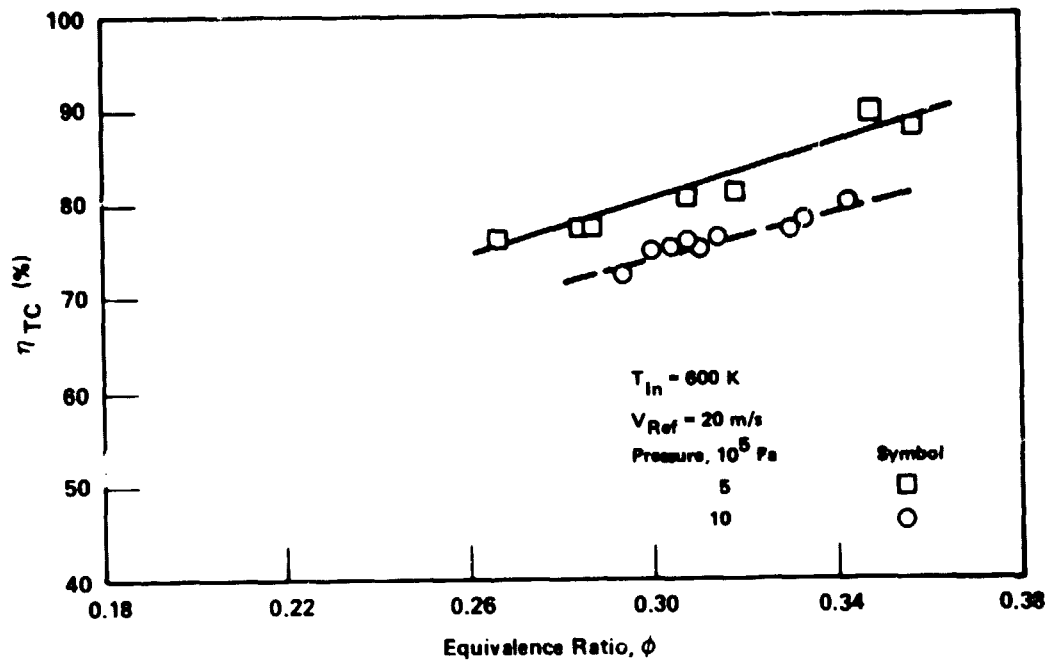
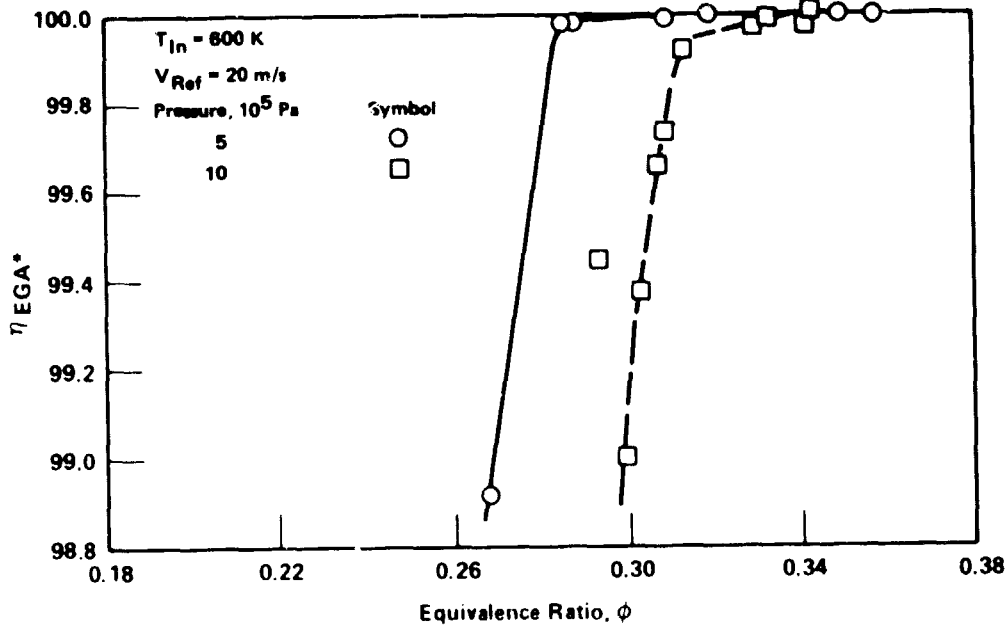

Figure 5-5. Catalyst Outlet Thermocouple Efficiency vs Equivalence Ratio – ERBS Distillate Fuel

6500-27



* EGA - Exhaust Gas Analysis

Figure 5-6. Combustion Efficiency vs Equivalence Ratio – ERBS Distillate Fuel - Based on Measured Emissions

6500-78

ORIGINAL PAGE IS
OF POOR QUALITY

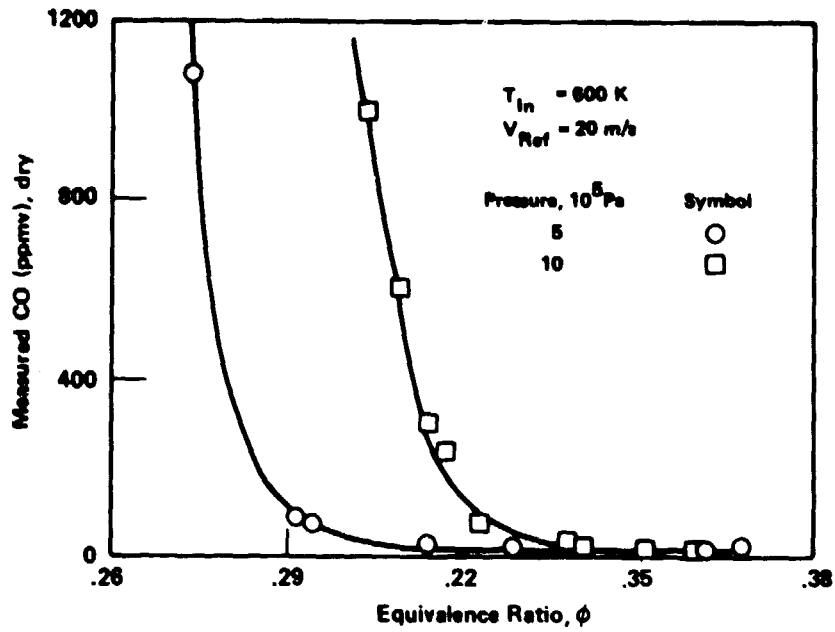

Figure 5-7. Measured CO vs Equivalence Ratio – ERBS Fuel

8500-28

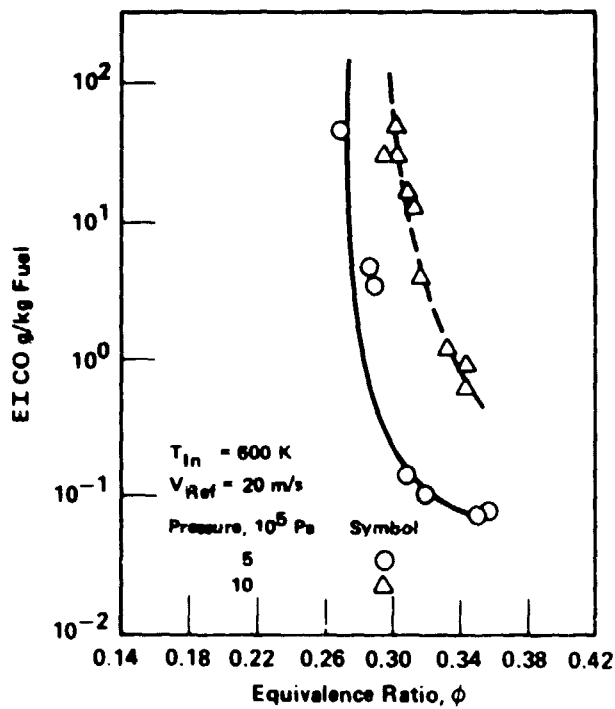
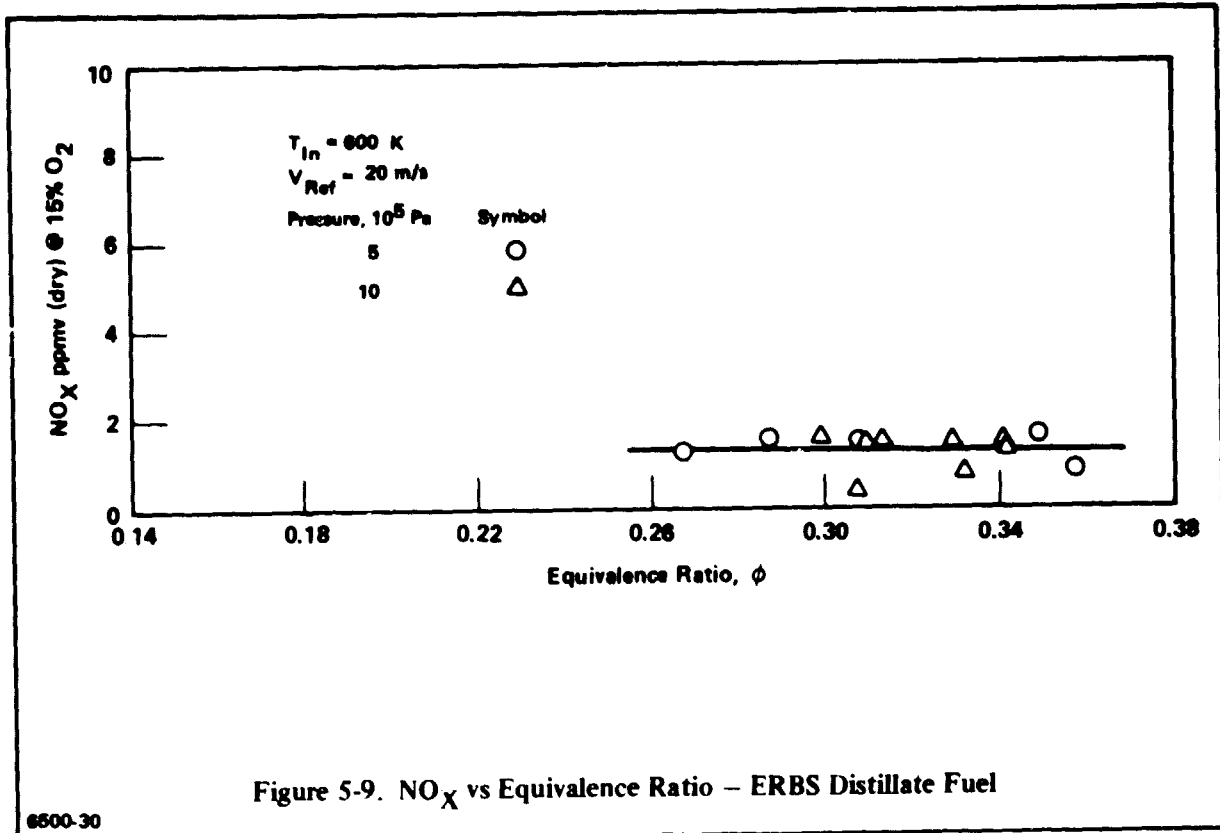

Figure 5-8. Emission Index (EI) for CO vs Equivalence Ratio – ERBS Fuel

8500-29



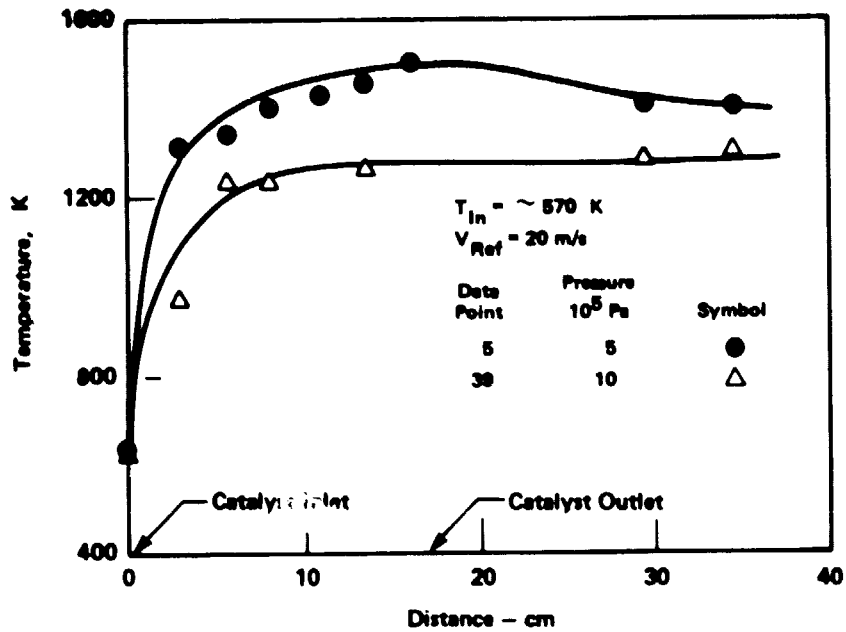

Figure 5-10. Axial Temperature Profile - Low-Heating-Value Coal Gas,
Adiabatic Flame Temperature 1425 K

8500-31

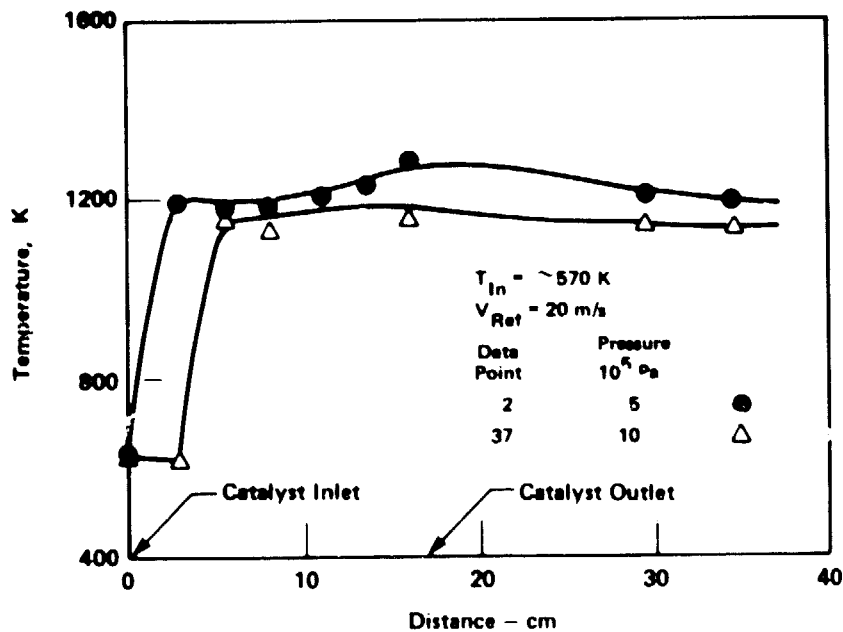

Figure 5-11. Axial Temperature Profile - Low Heating Value Coal Gas,
Adiabatic Flame Temperature 1270 K

8500-32

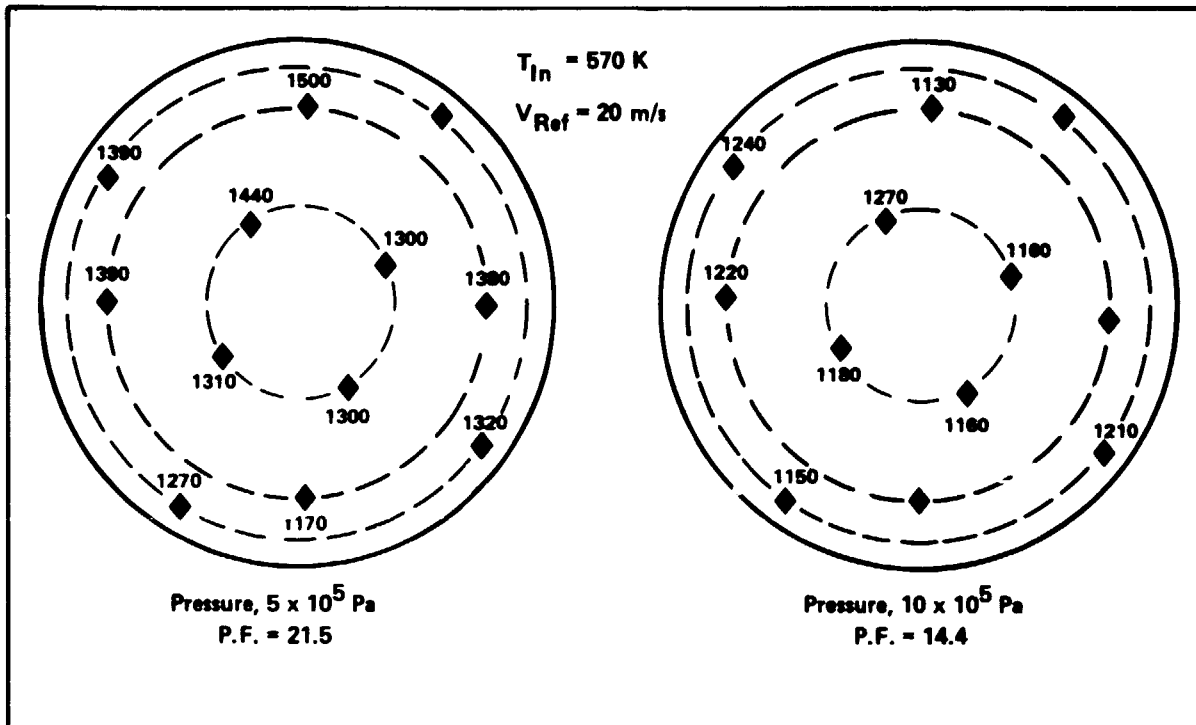

Figure 5-12. Radial Temperature Profile – Low-Heating-Value Coal Gas, Adiabatic
Flame Temperature 1375 K

6500-33

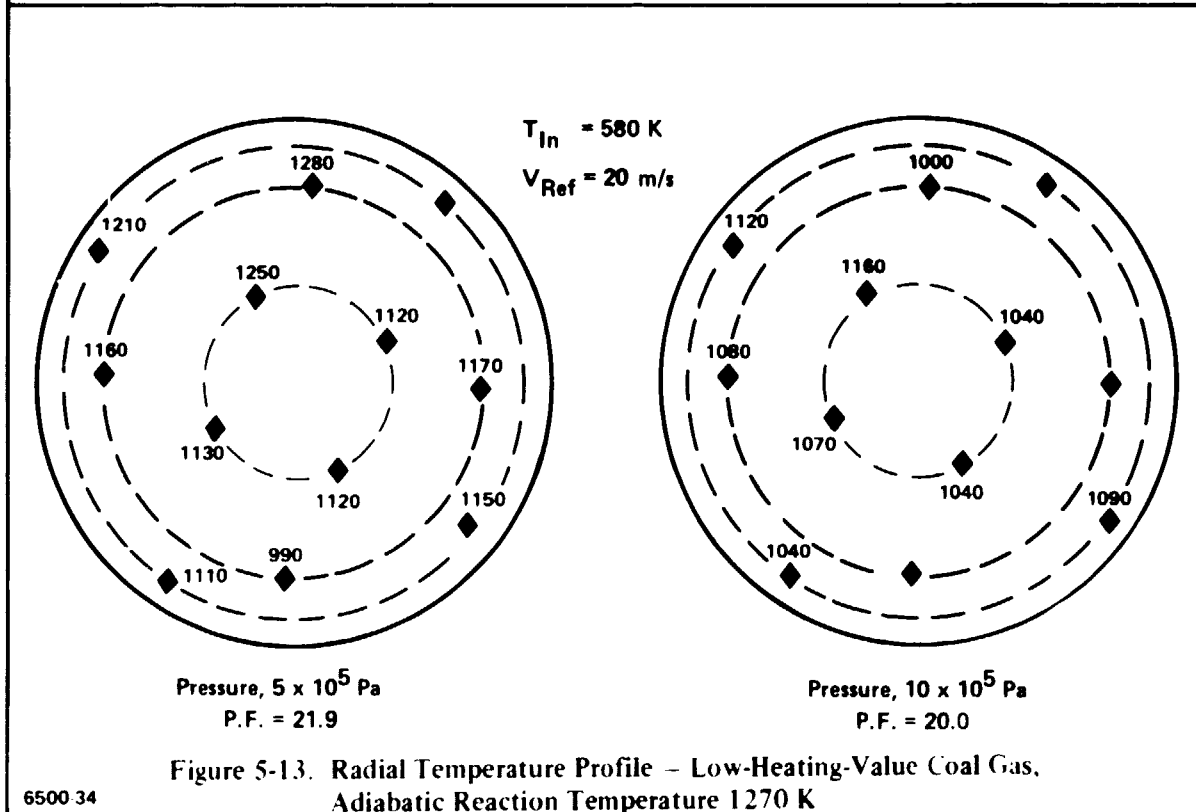

Figure 5-13. Radial Temperature Profile – Low-Heating-Value Coal Gas,
Adiabatic Reaction Temperature 1270 K

6500-34

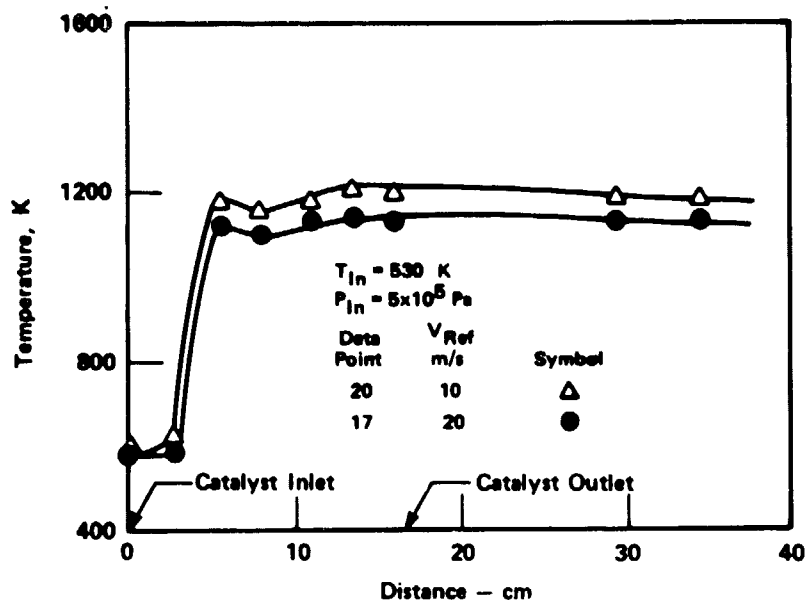

Figure 5-14. Effect of Reference Velocity on Axial Temperature Profile –
Low-Heating-Value Coal Gas, Adiabatic Flame Temperature 1300 K

6500-36

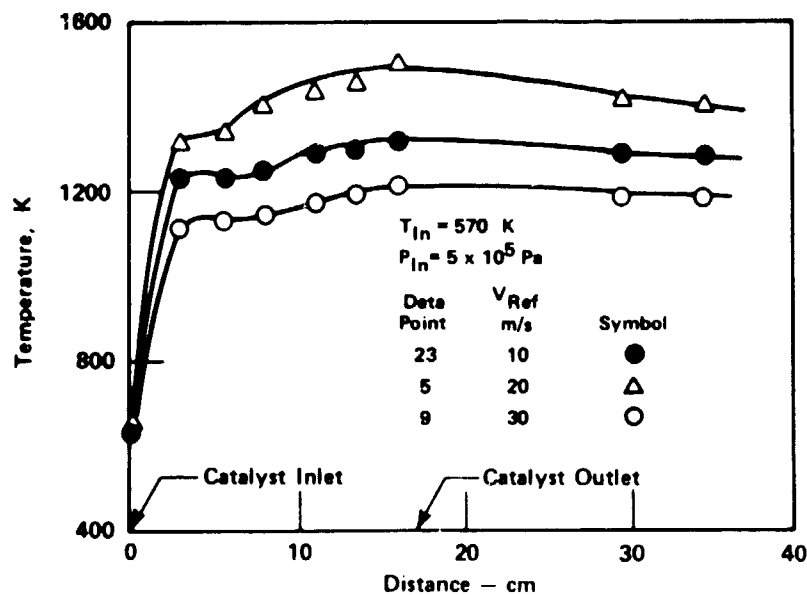

Figure 5-15. Effect of Reference Velocity on Axial Temperature Profile –
Low-Heating-Value Coal Gas, Adiabatic Flame Temperature 1400 K

6500-36

ORIGINAL PAGE IS
OF POOR QUALITY

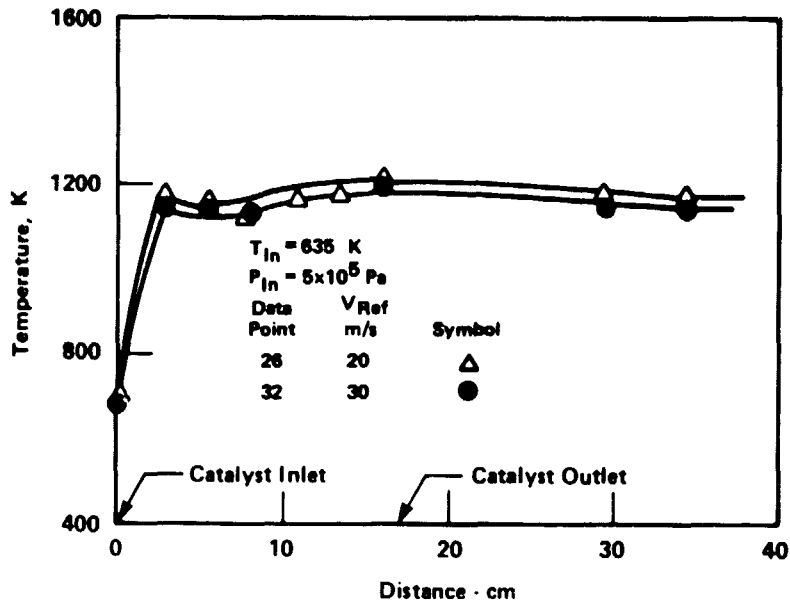

Figure 5-16. Effect of Reference Velocity on Axial Temperature Profile –
Low-Heating-Value Coal Gas, Adiabatic Flame Temperature 1330 K

6500-37

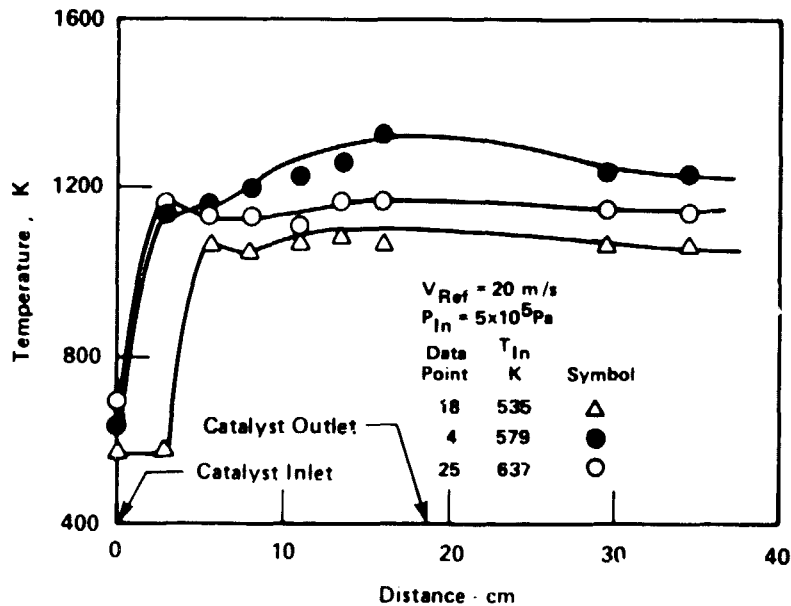

Figure 5-17. Effect of Inlet Temperature on Axial Temperature Profile –
Low-Heating-Value Coal Gas, Adiabatic Flame Temperature 1300 K

6500-38

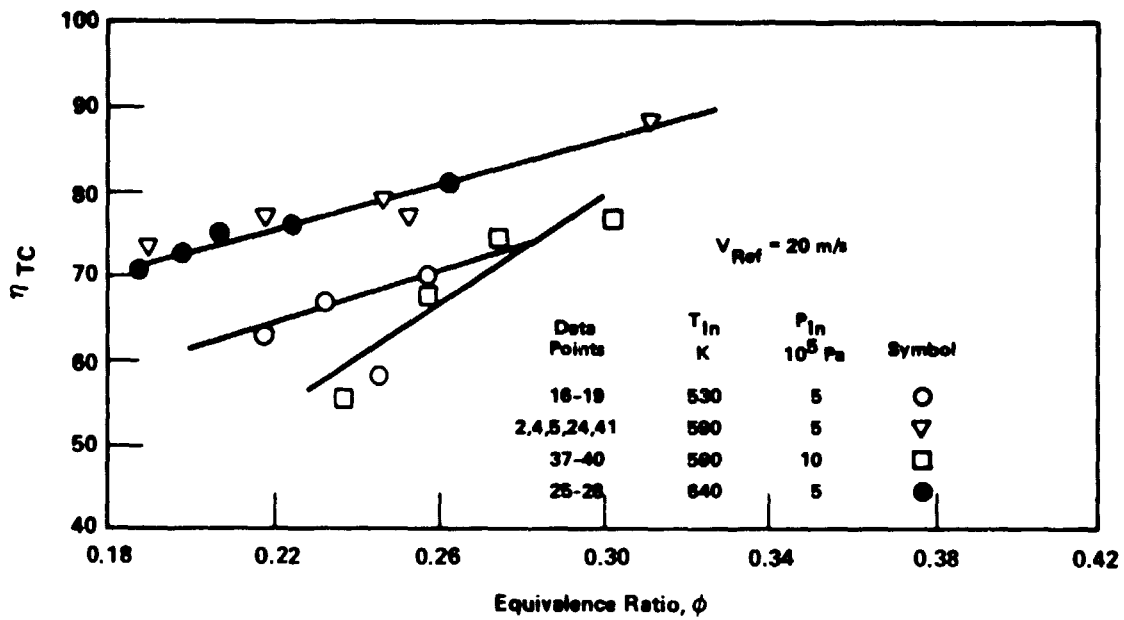

Figure 5-18. Catalyst Outlet Thermocouple Efficiency vs Equivalence Ratio - Low-Heating-Value Coal Gas

6500-40

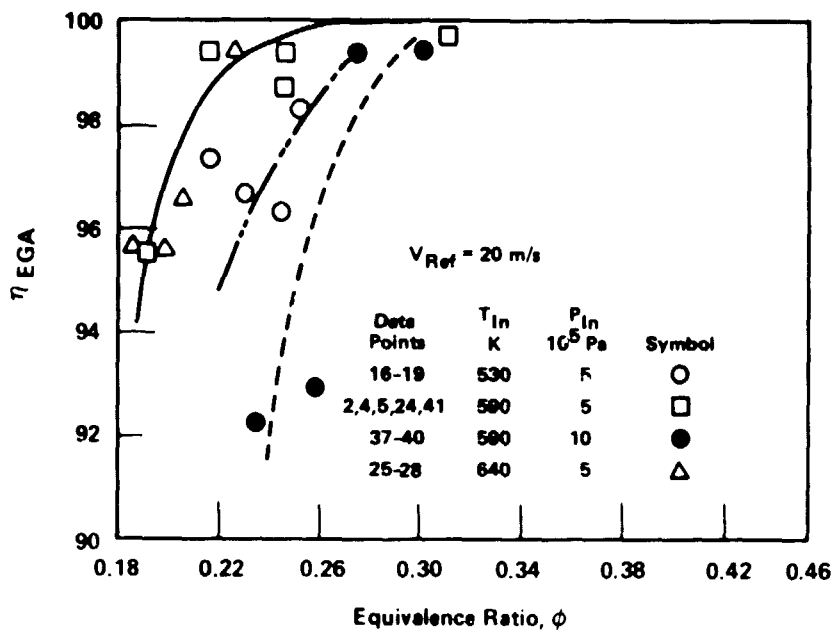

Figure 5-19. Combustion Efficiency vs Equivalence Ratio - Low-Heating-Value Coal Gas - Based on Measured Emissions

6500-79

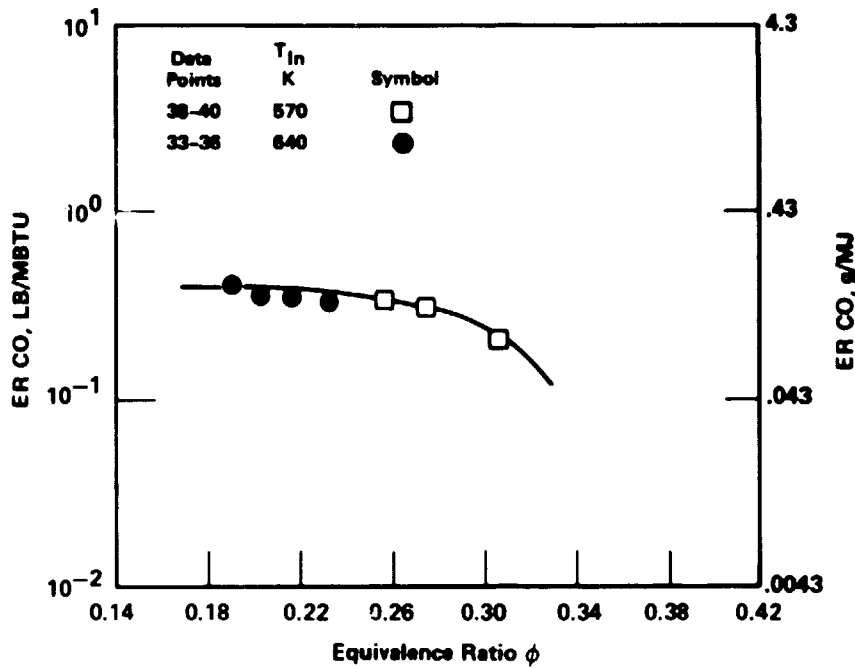

Figure 5-20. Emission Rate (ER) for CO vs Equivalence Ratio - Low-Heating-Value Coal Gas, Reference Velocity 20 m/s, Pressure 10×10^5 Pa

6500-39

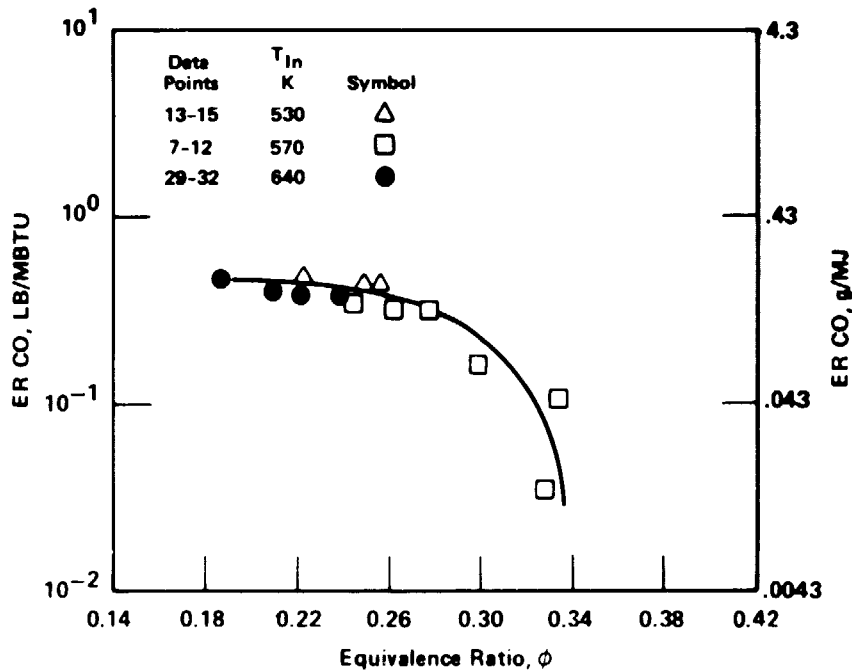

Figure 5-21. Emission Rate (ER) for CO vs Equivalence Ratio - Low-Heating-Value Coal Gas, Reference Velocity 30 m/s, Pressure 5×10^5 Pa

6500-41

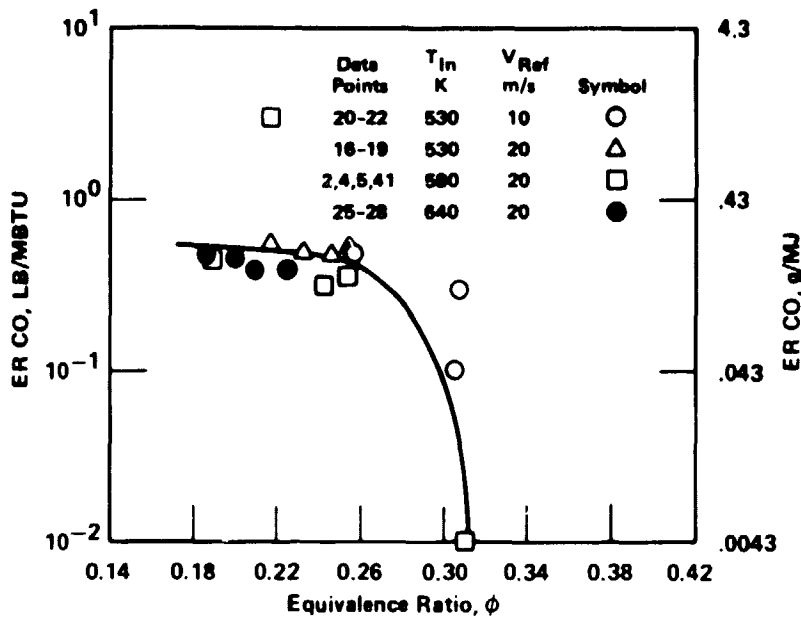

Figure 5-22. Emission Rate (ER) for CO vs Equivalence Ratio - Low-Heating-Value Coal Gas - Reference Velocity, 10 & 20 m/s, Pressure, 5×10^5 Pa

6500-42

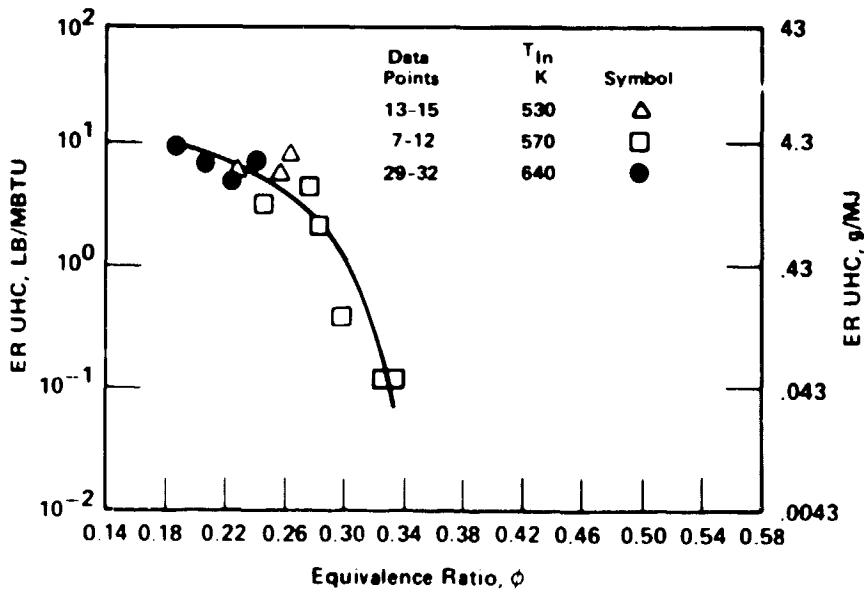

Figure 5-23. Emission Rate (ER) for UHC vs Equivalence Ratio - Low-Heating-Value Coal Gas, Reference Velocity 30 m/s, Pressure 5×10^5 Pa

6500-43

ORIGINAL PAGE IS
OF POOR QUALITY

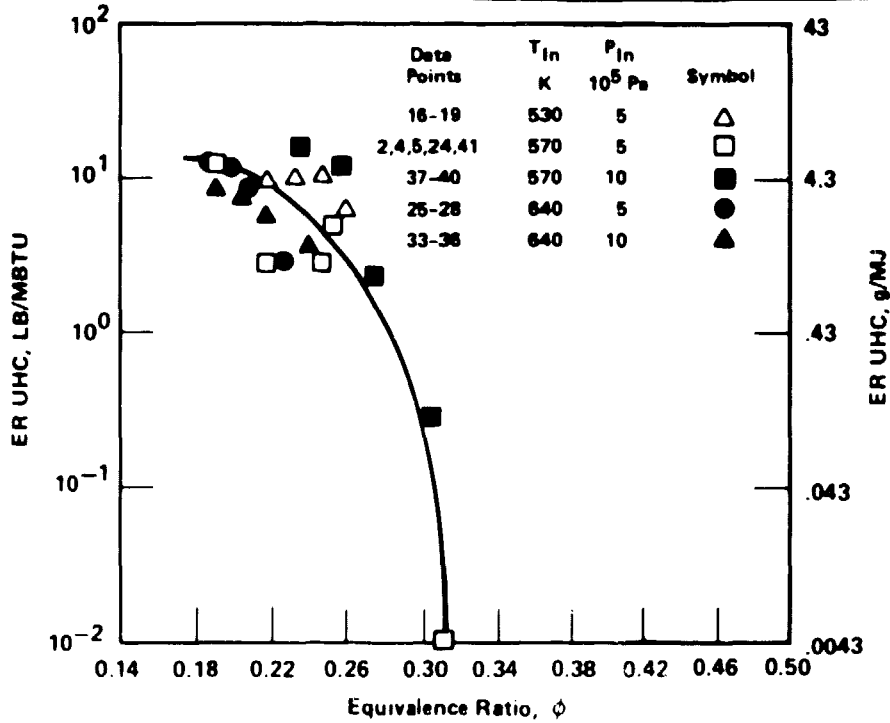

Figure 5-24. Emission Rate (ER) for UHC vs Equivalence Ratio - Low-Heating-Value Coal Gas, Reference Velocity 20 m/s

6500-44

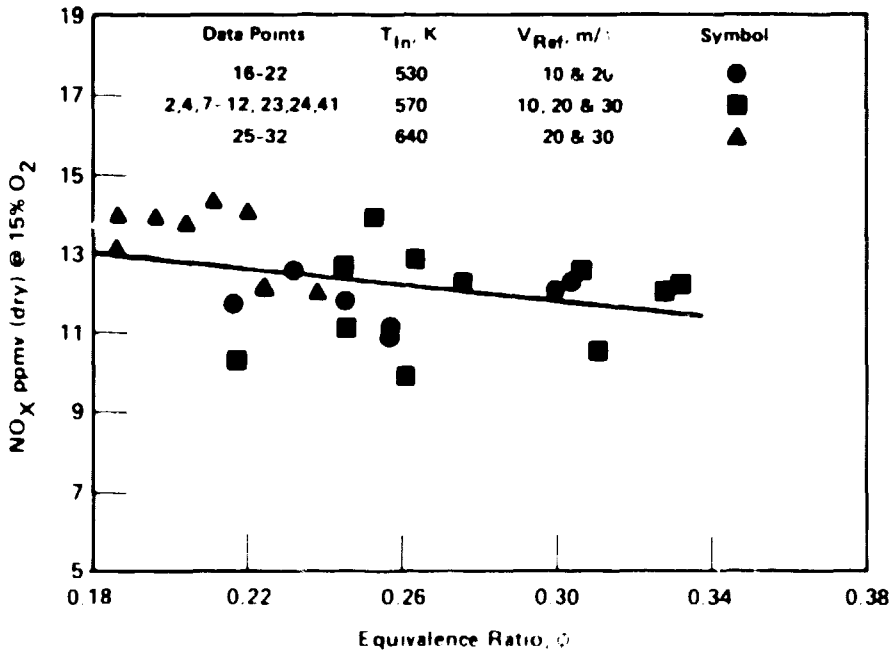

Figure 5-25. NO_x vs Equivalence Ratio - Low-Heating-Value Coal Gas, Pressure 5×10^5 Pa

6500-46

ORIGINAL PAGE IS
OF POOR QUALITY

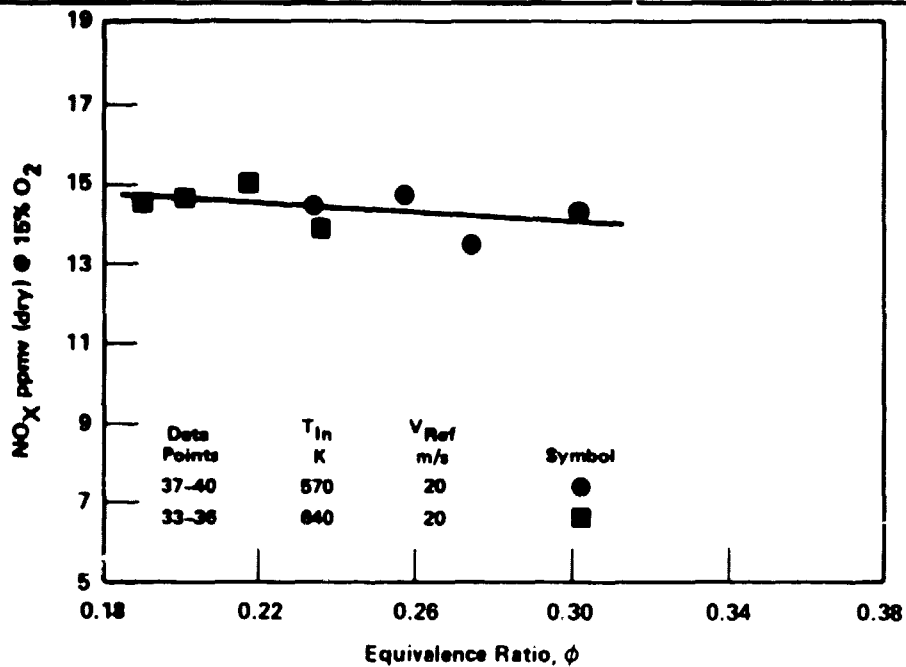

Figure 5-26. NO_x vs Equivalence Ratio - Low-Heating-Value Coal Gas, Pressure 10×10^5 Pa

6500-46

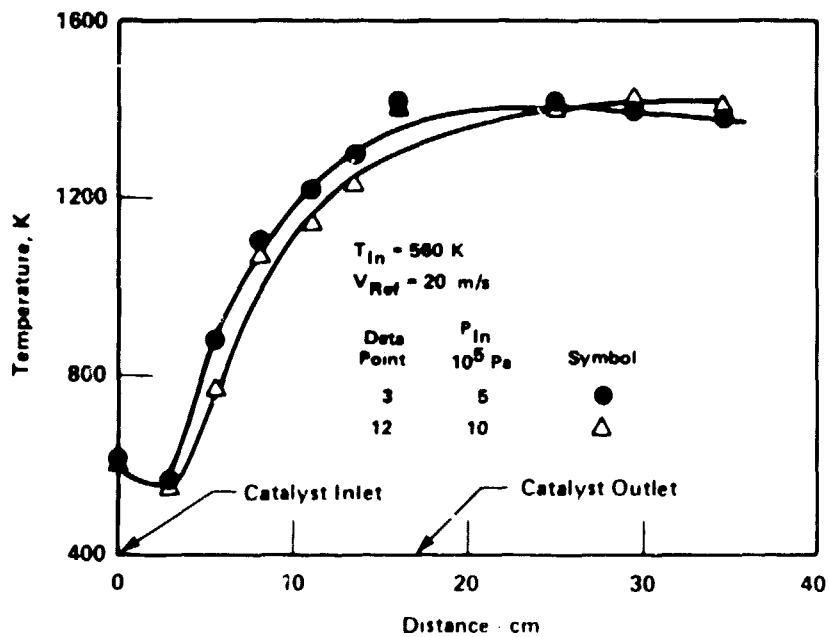

Figure 5-27. Axial Temperature Profile - Medium-Heating-Value Coal Gas
Adiabatic Flame Temperature 1375 K

6500-47

ORIGINAL PAGE IS
OF POOR QUALITY

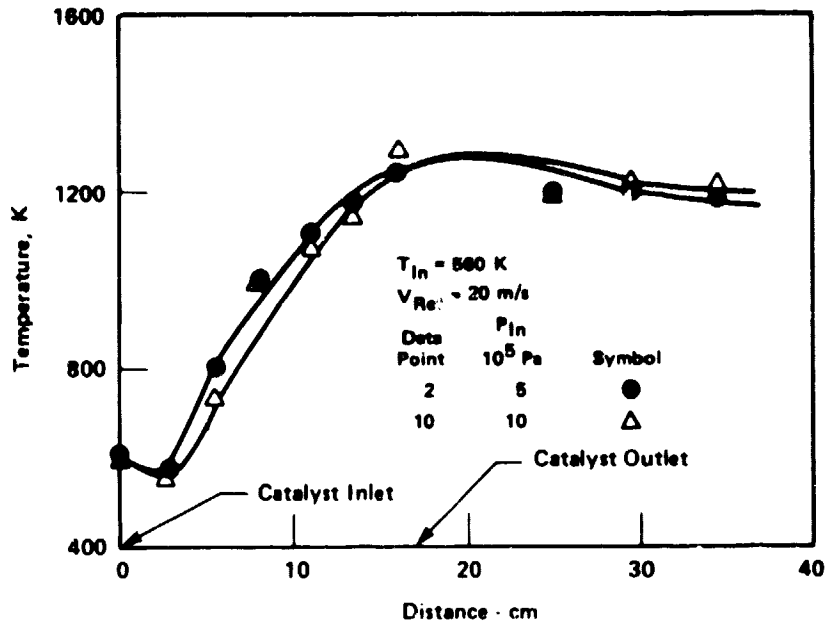

Figure 5-28. Axial Temperature Profile - Medium-Heating-Value Coal Gas,
Adiabatic Flame Temperature 1295 K

6500-48

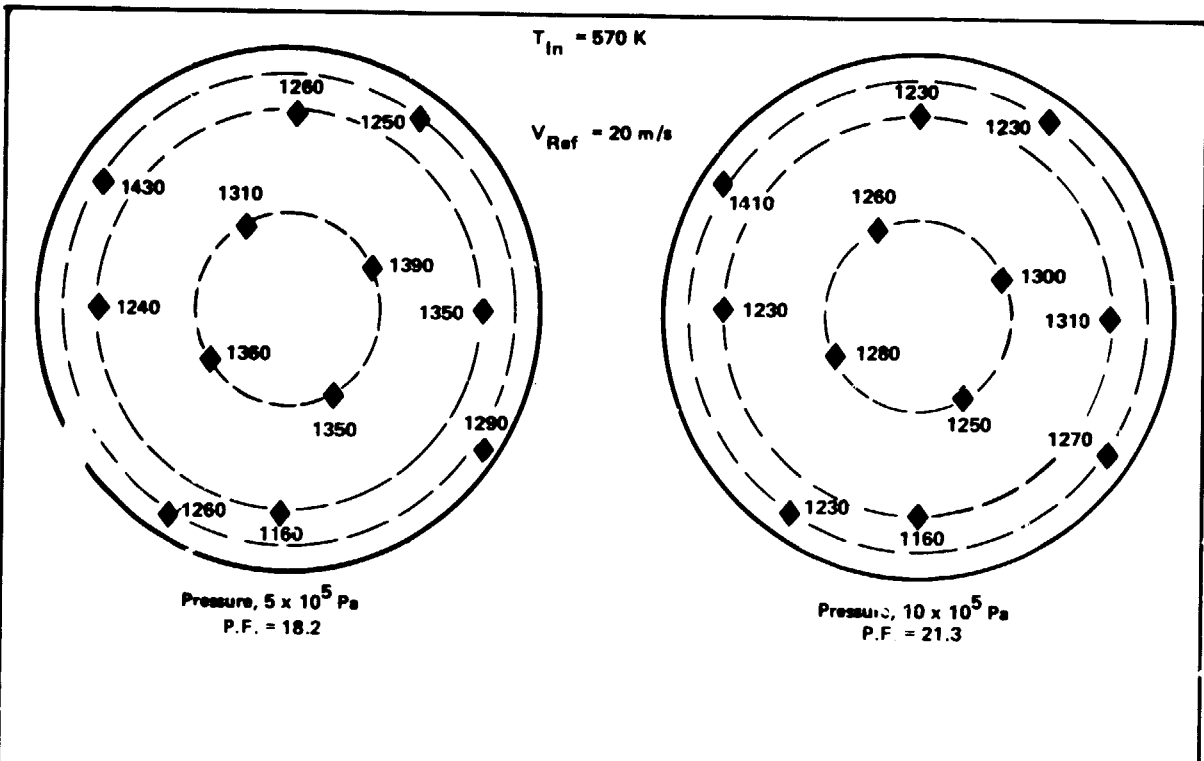

Figure 5-29. Radial Temperature Profile - Medium-Heating-Value Coal Gas, Adiabatic Flame Temperature 1375 K

6500-49

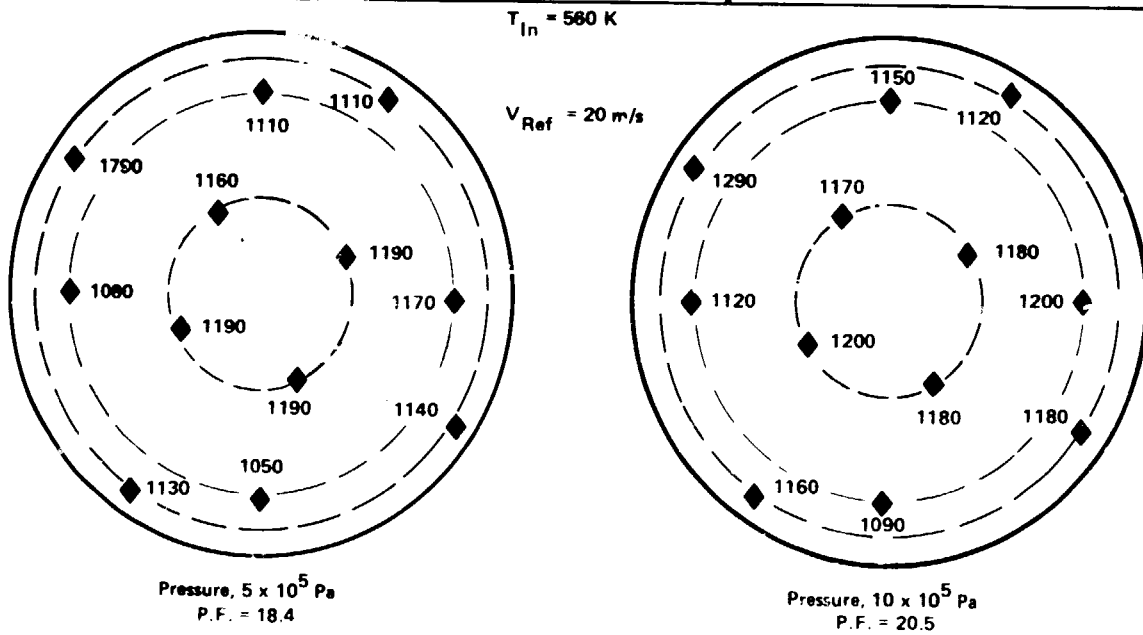

Figure 5-30. Radial Temperature Profile - Medium-Heating-Value Coal Gas, Adiabatic Flame Temperature 1295 K

6500-50

ORIGINAL PAGE IS
OF POOR QUALITY

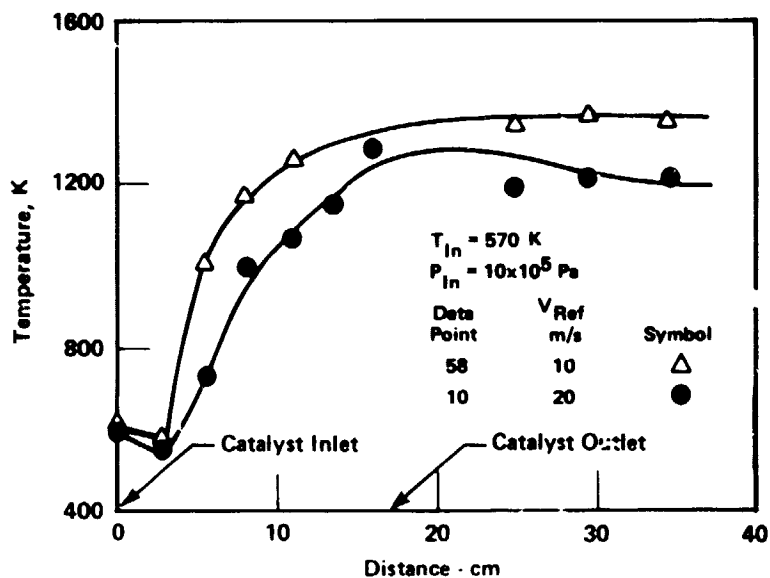

Figure 5-31. Effect of Reference Velocity on Axial Temperature Profile - Medium-Heating-Value Coal Gas, Adiabatic Flame Temperature 1300 K
6500-51

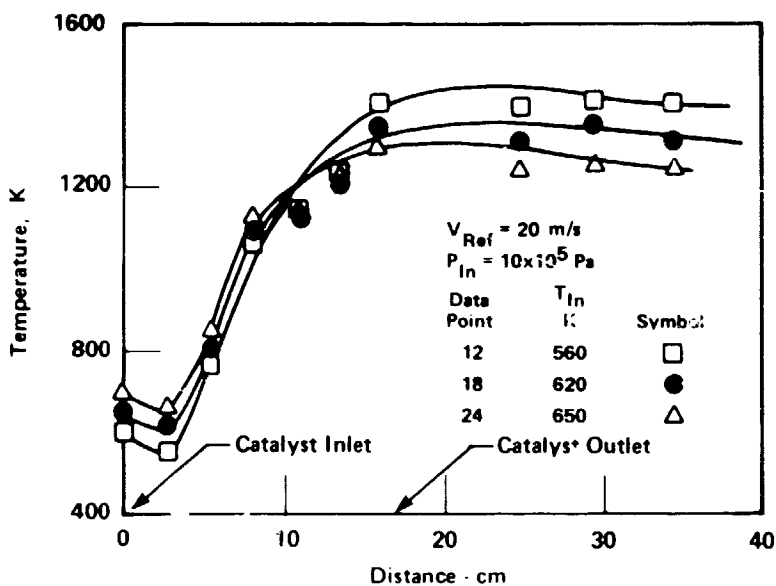

Figure 5-32. Effect of Inlet Temperature on Axial Temperature Profile - Medium-Heating-Value Coal Gas, Adiabatic Flame Temperature 1370 K
6500-52

ORIGINAL PAGE IS
OF POOR QUALITY

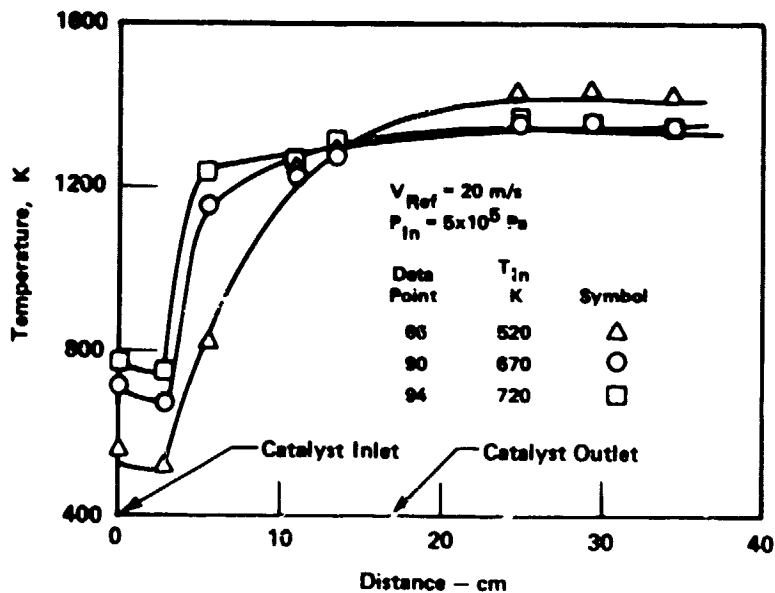

Figure 5-33. Effect of Inlet Temperature on Axial Temperature Profile - Medium-Heating-Value Coal Gas, Adiabatic Flame Temperature 1370 K

8600-83

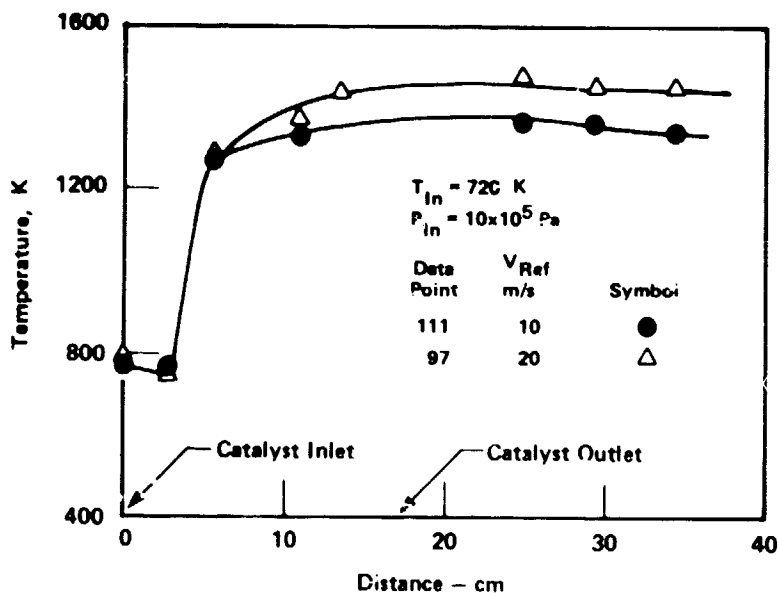

Figure 5-34. Effect of Reference Velocity on Axial Temperature Profile - Medium-Heating-Value Coal Gas, Adiabatic Flame Temperature 1400 K

8600-84

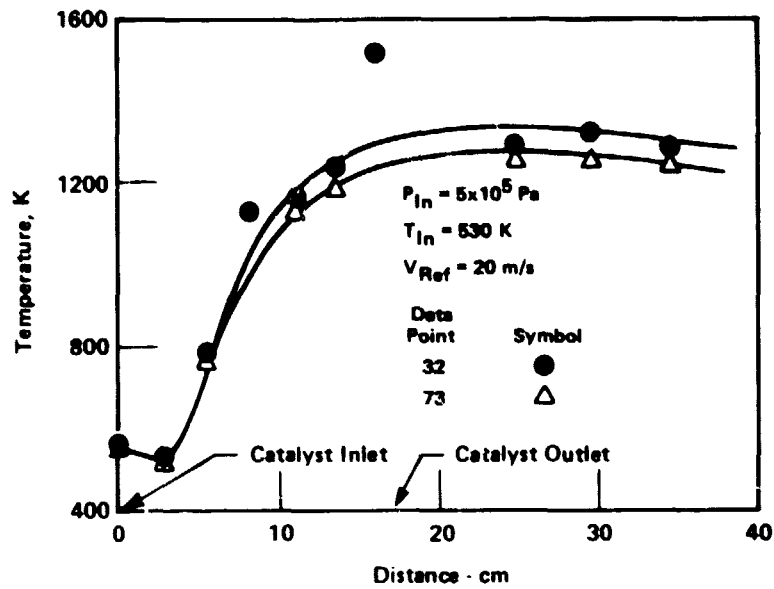

Figure 5-35. Effect of Run Time on Axial Temperature Profile – Medium-Heating-Value Coal Gas, Adiabatic Flame Temperature 1275 K

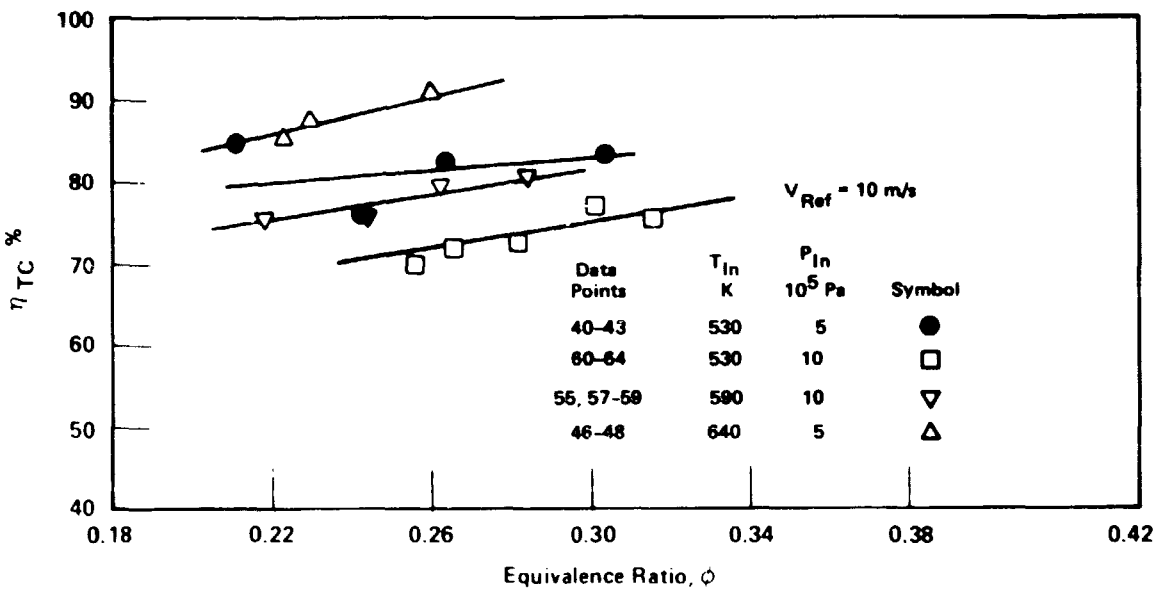

Figure 5-36. Catalyst Outlet Thermocouple Efficiency - Medium-Heating-Value Coal Gas, Reference Velocity 10 m/s

6500 56

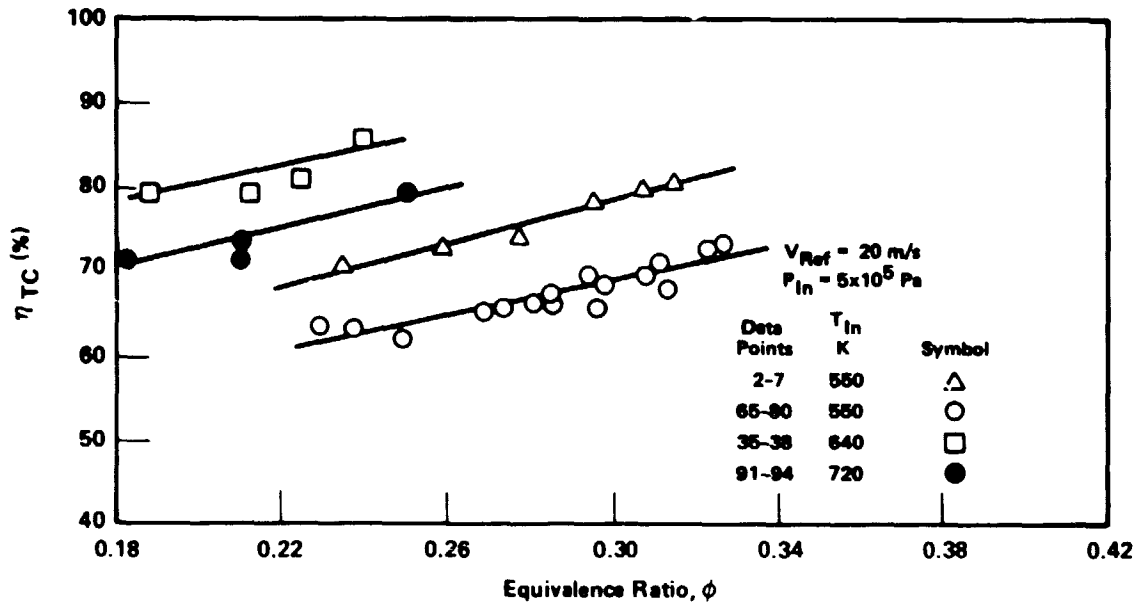

Figure 5-37. Catalyst Outlet Thermocouple Efficiency - Medium-Heating-Value Coal Gas, Reference Velocity 20 m/s, Pressure 5×10^5 Pa

6500-57

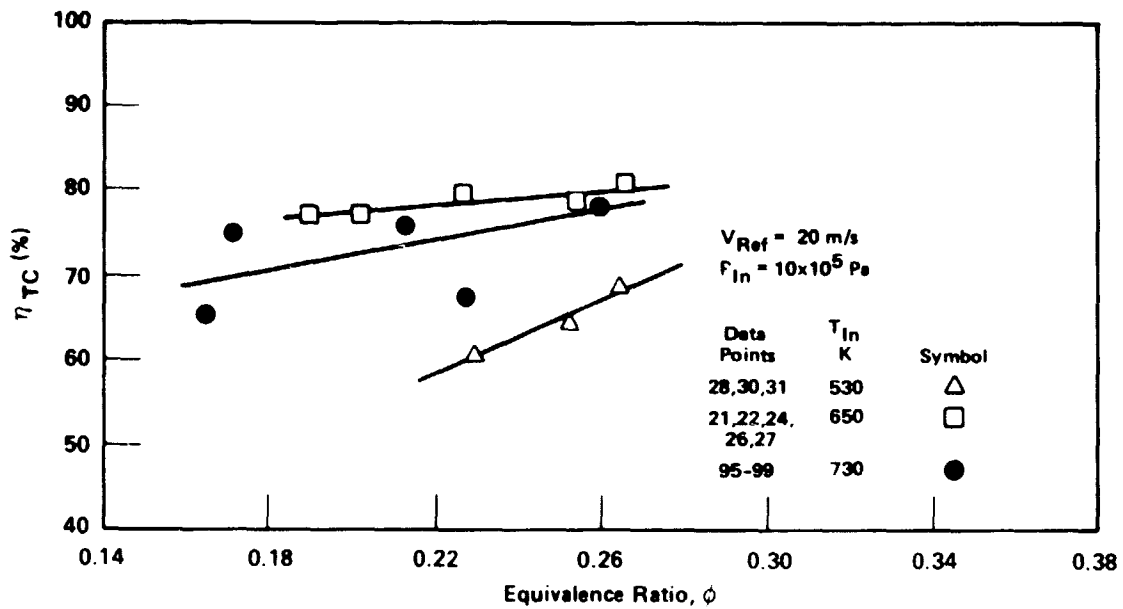

Figure 5-38. Catalyst Outlet Thermocouple Efficiency - Medium-Heating-Value Coal Gas, Reference Velocity 20 m/s, Pressure 10×10^5 Pa

6500-58

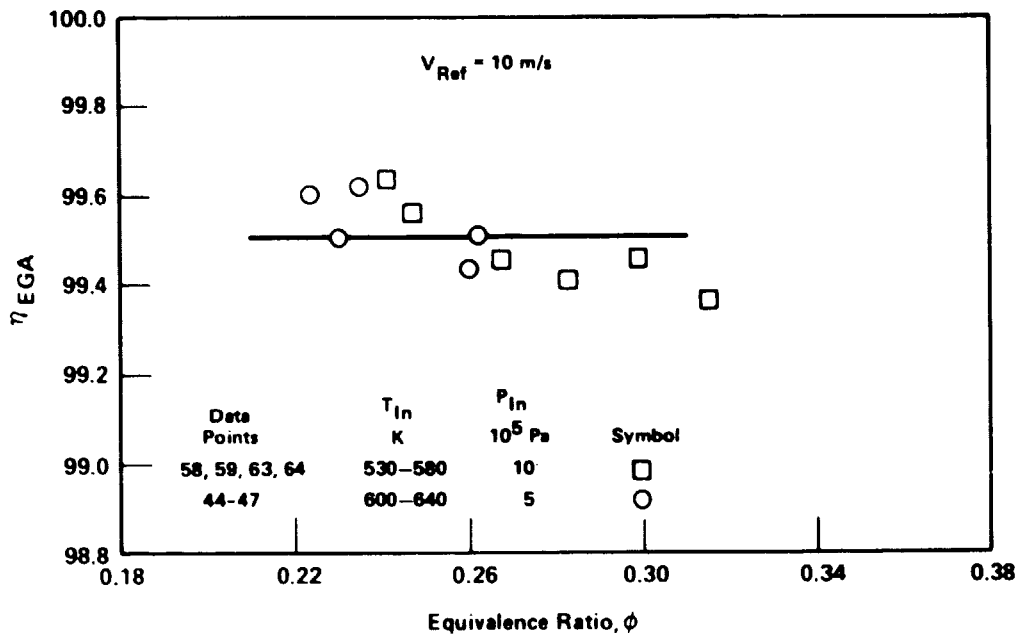

Figure 5-39. Rig Outlet Combustion Efficiency vs Equivalence Ratio - Medium-Heating-Value Coal Gas - Based on Measured Emissions - Early Data

6500-80

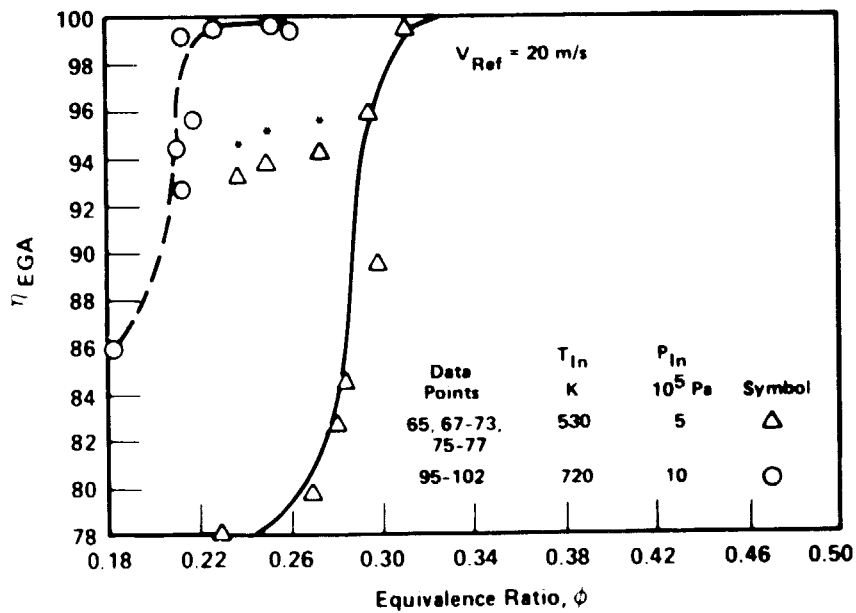

Figure 5-40. Rig Outlet Combustion Efficiency vs Equivalence Ratio - Medium-Heating-Value Coal Gas - Based on Measured Emissions - Later Data

6500 81

ORIGINAL PAGE IS
OF POOR QUALITY

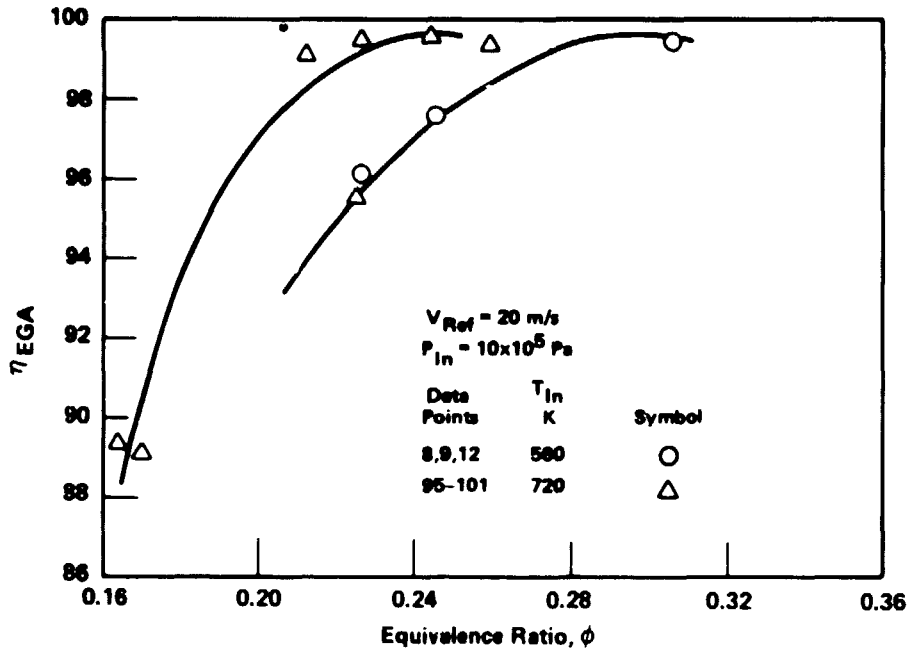

Figure 5-41. Combustion Efficiency vs Equivalence Ratio –
Medium-Heating-Value Coal Gas – Based on Measured Emissions

6500-82

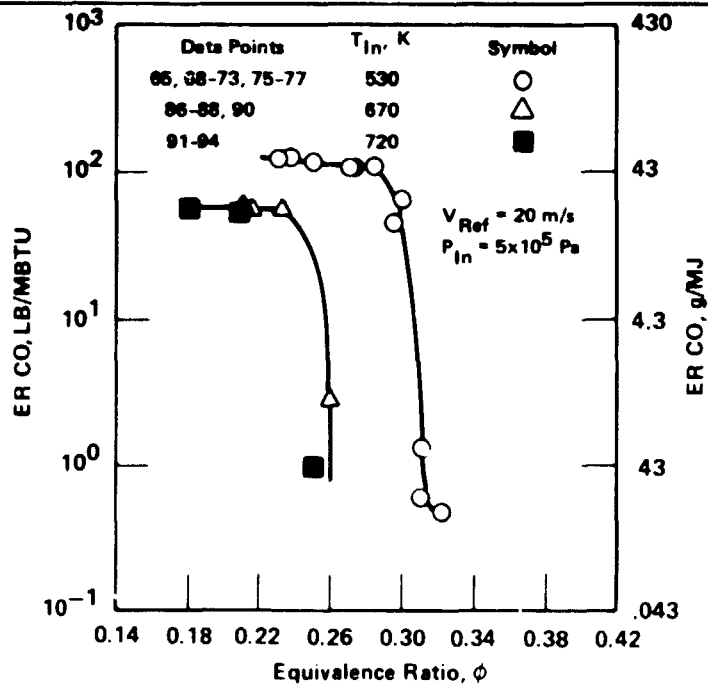

Figure 5-42. Emission Rate (ER) for CO vs Equivalence Ratio – Medium-Heating-Value
Coal Gas, Reference Velocity 20 m/s, Pressure $5 \times 10^5 \text{ Pa}$

6500-59

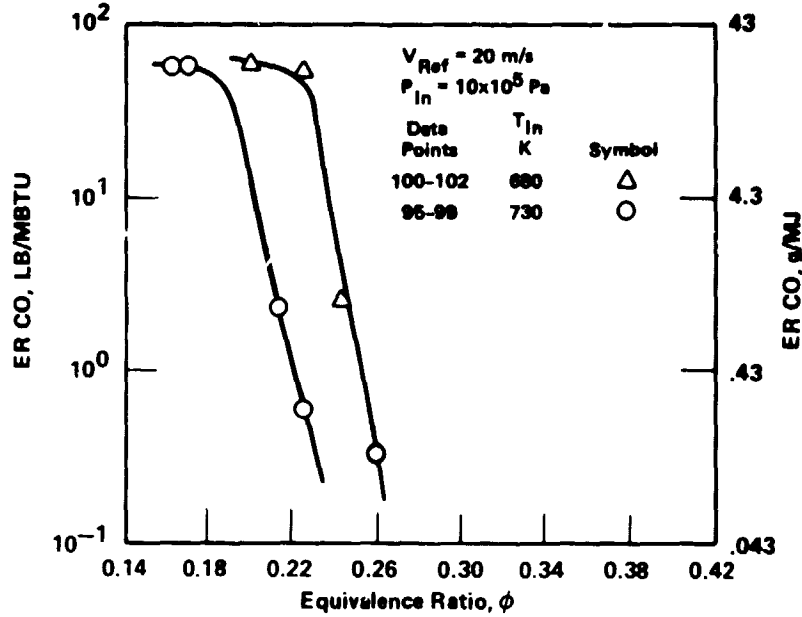

Figure 5-43. Emission Rate (ER) for CO vs Equivalence Ratio – Medium-Heating-Value Coal Gas, Reference Velocity 20 m/s, Pressure $10 \times 10^5 \text{ Pa}$
6500-60

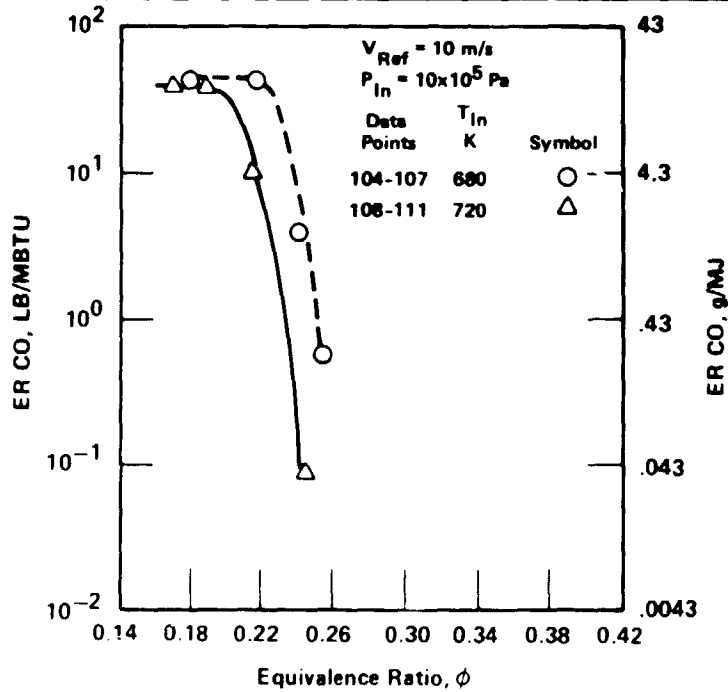

Figure 5-44. Emission Rate (ER) for CO vs Equivalence Ratio – Medium-Heating-Value Coal Gas, Reference Velocity 10 m/s, Pressure $10 \times 10^5 \text{ Pa}$
6500-61

ORIGINAL PAGE IS
OF POOR QUALITY

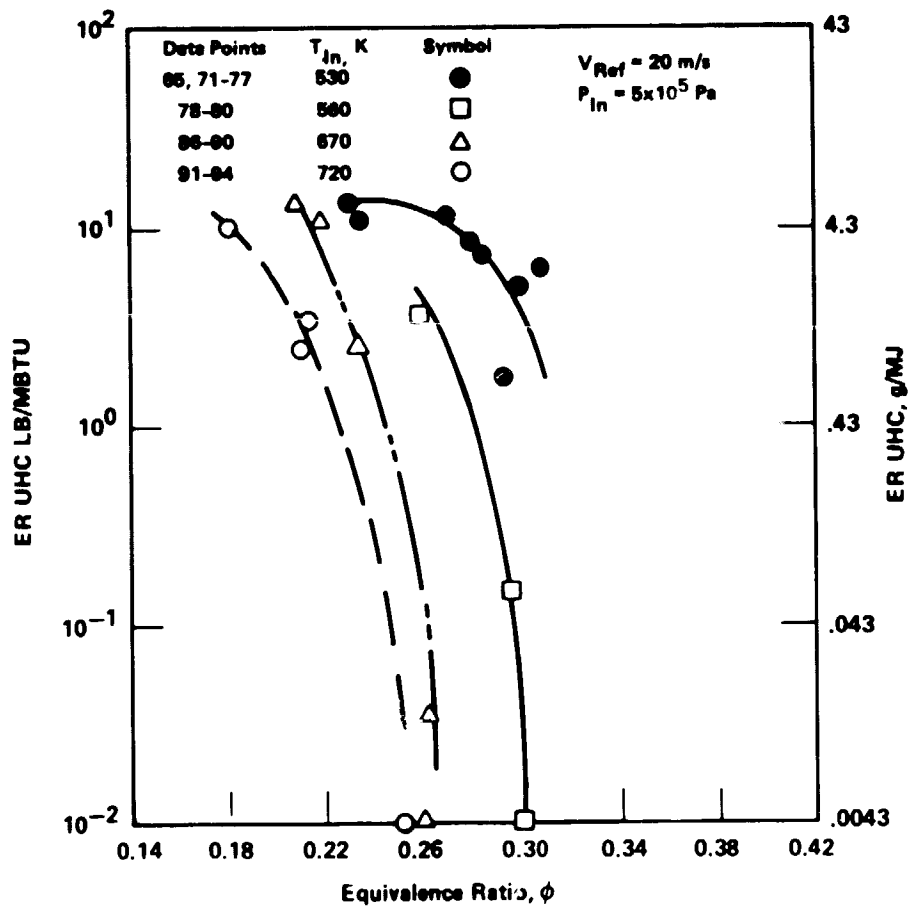

Figure 5-45. Emission Rate (ER) for UHC vs Equivalence Ratio – Medium-Heating-Value Coal Gas, Reference Velocity 20 m/s, Pressure 5×10^5 Pa

6500-62

ORIGINAL PAGE IS
OF POOR QUALITY

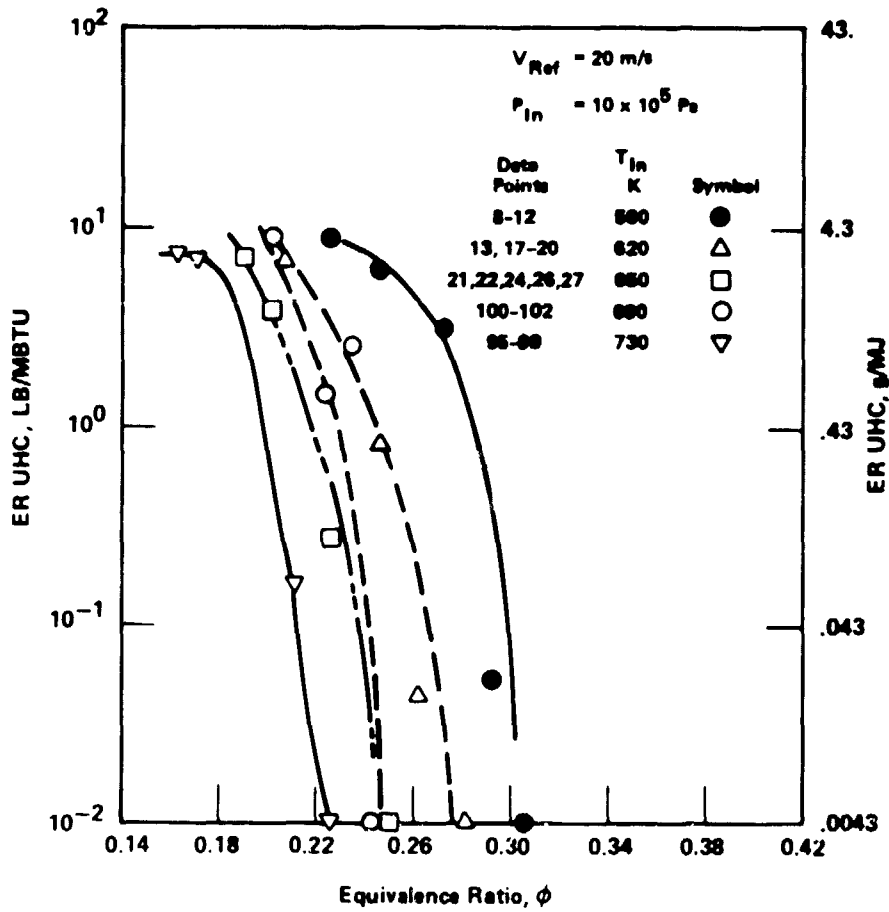

Figure 5-46. Emission Rate (ER) for UHC vs Equivalence Ratio - Medium-Heating-Value Coal Gas, Reference Velocity 20 m/s, Pressure $10 \times 10^5 \text{ Pa}$

6500-63

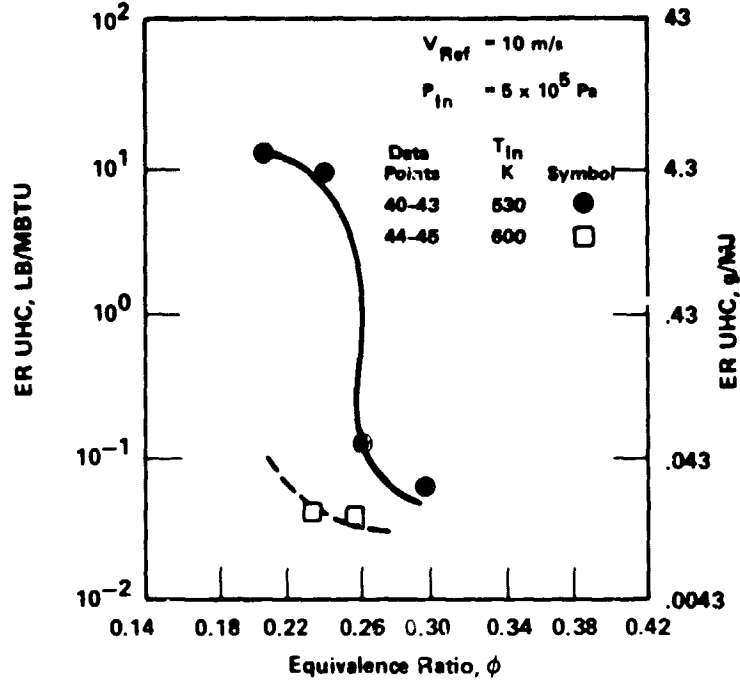

Figure 5-47. Emission Rate (ER) for UHC vs Equivalence Ratio – Medium-Heating-Value Coal Gas, Reference Velocity 10 m/s, Pressure 5×10^5 Pa

6500-64

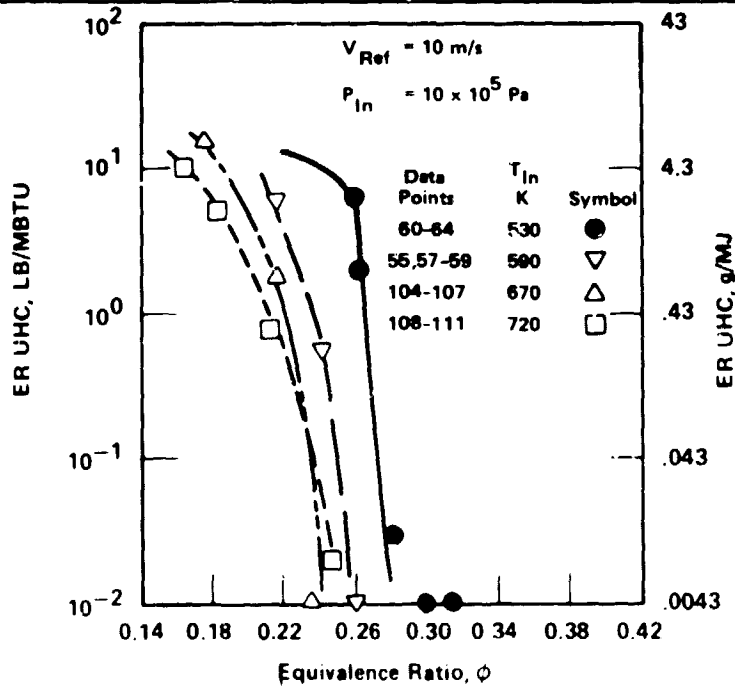

Figure 5-48. Emission Rate (ER) for UHC vs Equivalence Ratio – Medium-Heating-Value Coal Gas, Reference Velocity 10 m/s, Pressure 10×10^5 Pa

6500-65

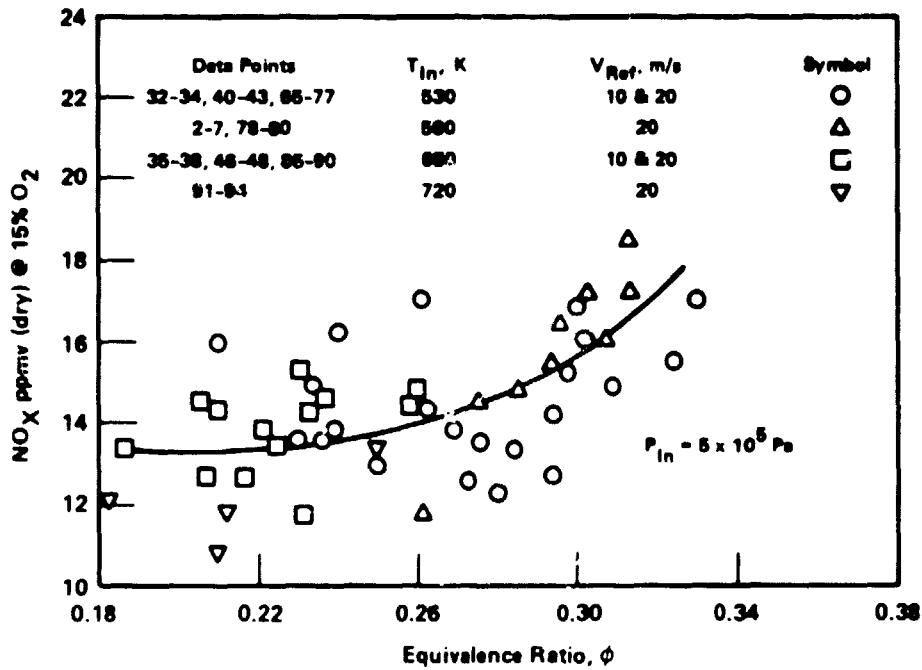

Figure 5-49. NO_x vs Equivalence Ratio – Medium-Heating-Value Coal Gas, Pressure $5 \times 10^5 \text{ Pa}$

6500-66

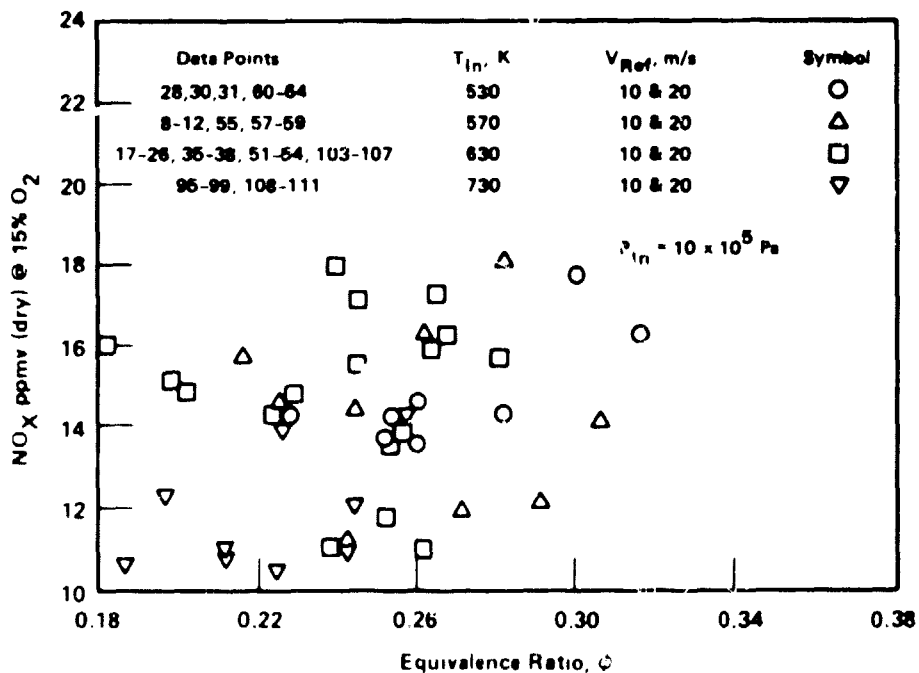

Figure 5-50. NO_x vs Equivalence Ratio – Medium-Heating-Value Coal Gas, Pressure $10 \times 10^5 \text{ Pa}$

6500-67

ORIGINAL PAGE IS
OF POOR QUALITY

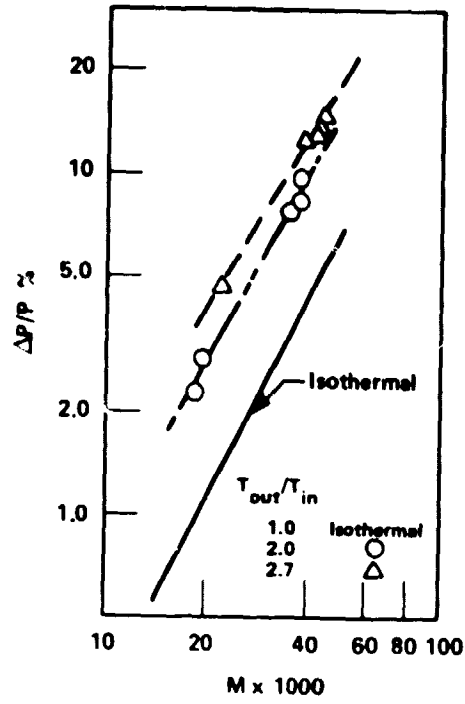

Figure 5-51. Pressure Drop vs Mach Number

ORIGINAL PAGE
BLACK AND WHITE PHOTOGRAPH

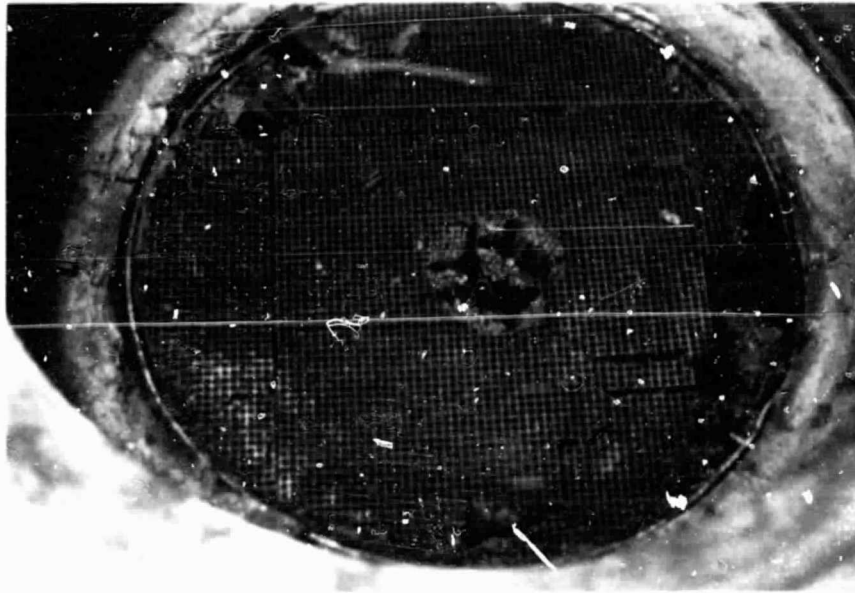

Figure 5-52. Damaged Element 3 - Photograph - Post-Medium-Heating-
Value Coal Gas Tests

6500-69

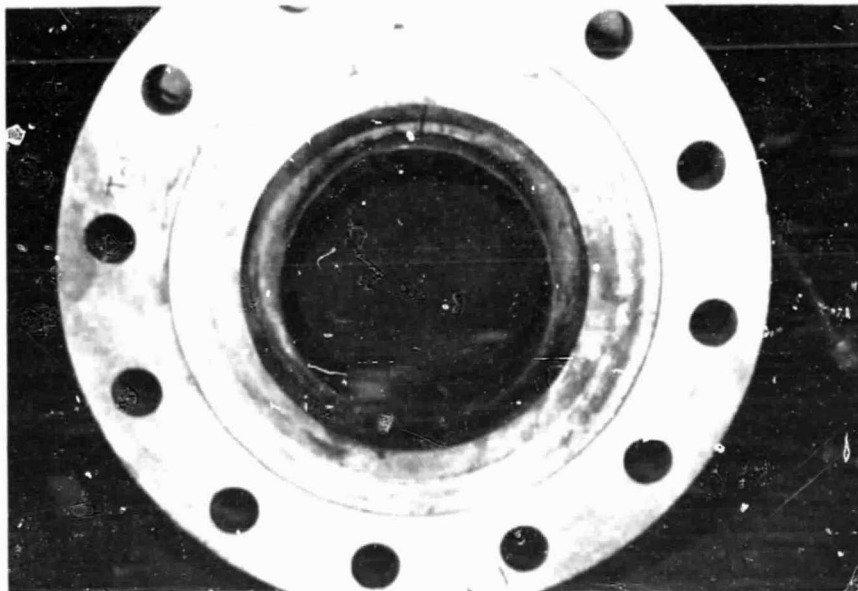

Figure 5-53. Damaged Element 3 - Photograph - Post-Medium-Heating-
Value Coal Gas Tests

6500-70

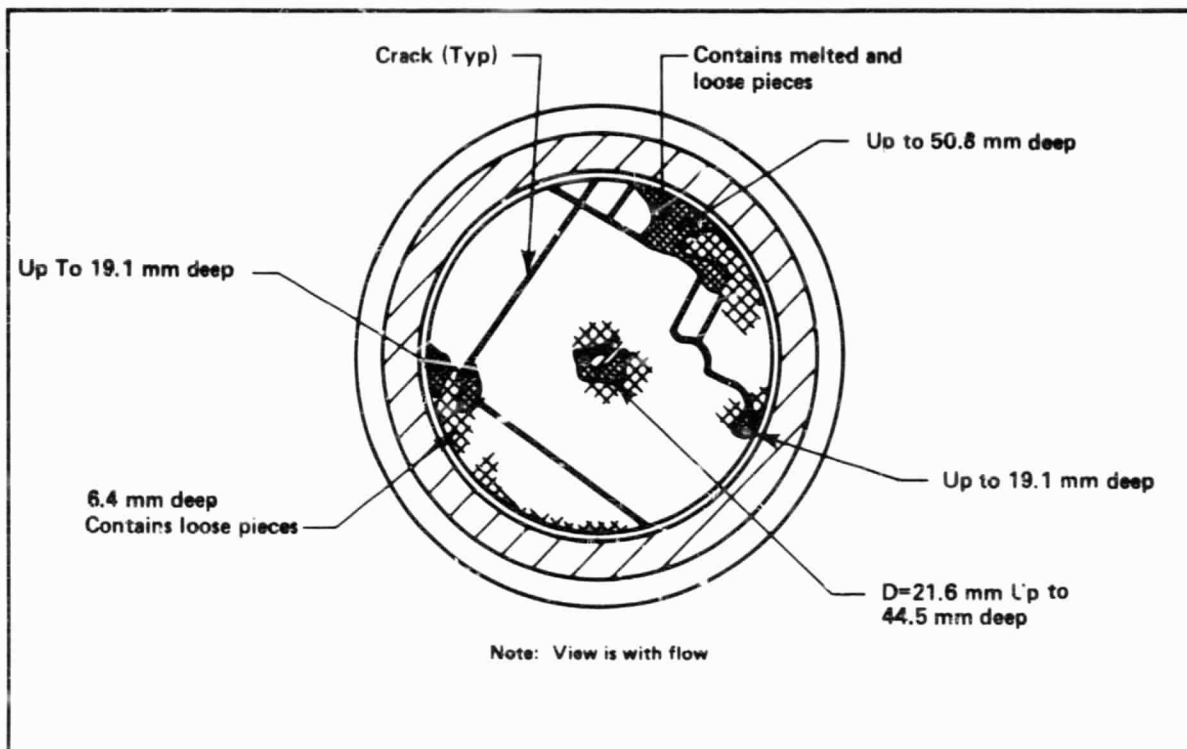

Figure 5-54. Damaged Element 1 – Post-Medium-Heating-Value Coal Gas Tests

6500-71

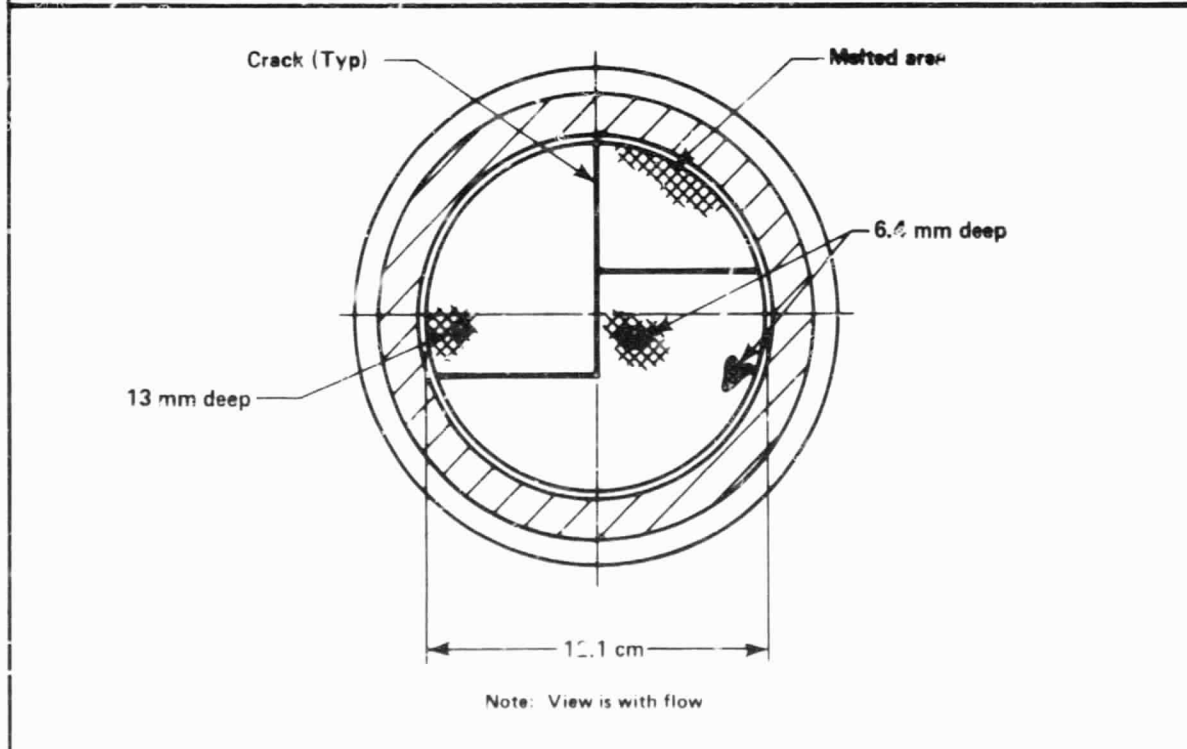

Figure 5-55. Damaged Element 2 – Post-Medium-Heating-Value Coal Gas Tests

6500-72

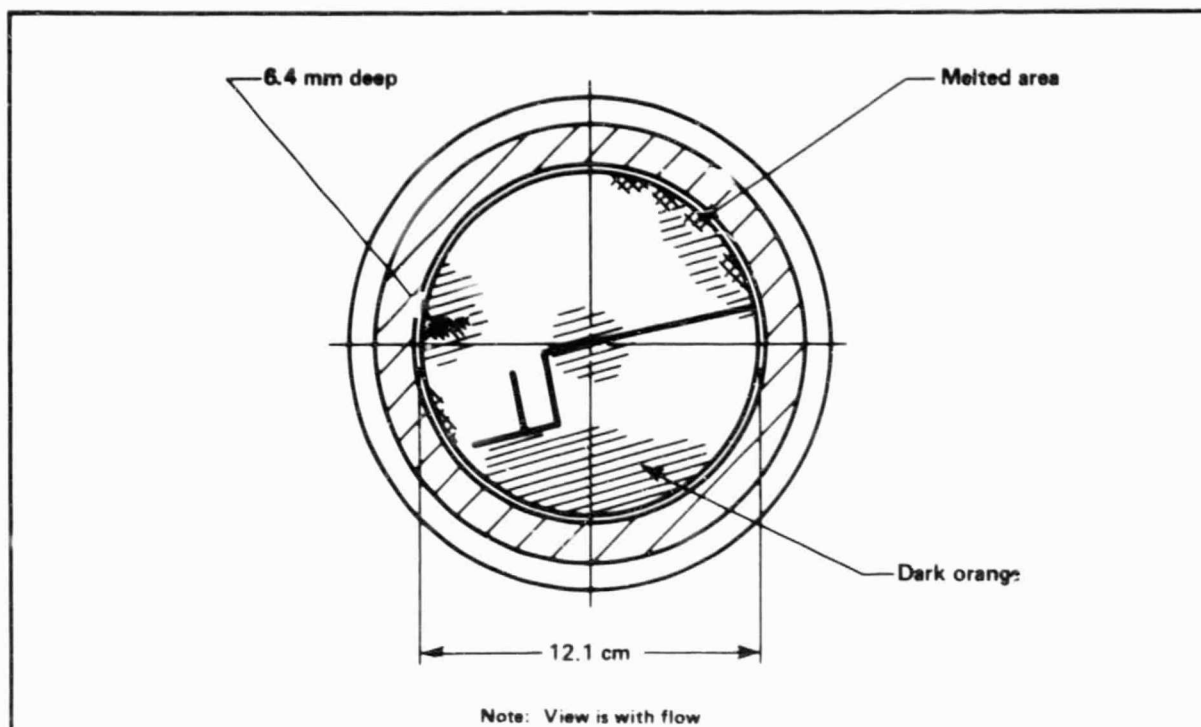

Figure 5-56. Damaged Element 3 – Post-Medium-Heating-Value Coal Gas Tests

6500-73

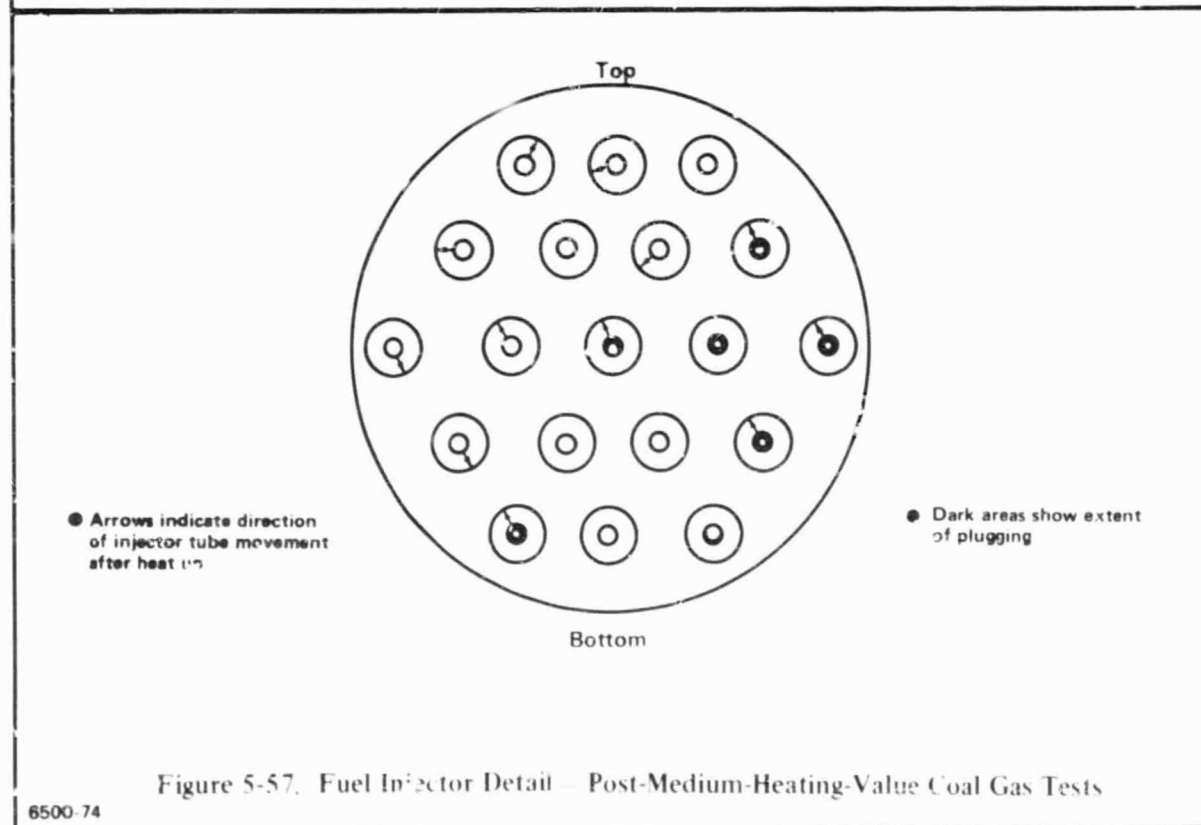

Figure 5-57. Fuel Injector Detail – Post-Medium-Heating-Value Coal Gas Tests

6500-74

6.0 SUMMARY OF RESULTS

Catalytic combustion of both low- and medium-heating value coal gas obtained from an operating coal gasifier has been demonstrated. Baseline ERBS fuel test results were consistent with a significant data base reported by many experimentors. Catalytic combustion of ERBS fuel oil resulted in NO_x emissions less than 2 ppmv and combustion efficiencies of 99.5% and above. At a reference velocity of 20 m/s and an inlet temperature of 600 K, operation at a pressure of 5×10^5 Pa gave higher combustion efficiencies than a pressure of 10×10^5 Pa.

Catalytic combustion of low-heating-value coal gas, 5.9 MJ/m^3 (158 Btu/scf), was demonstrated at inlet temperatures from 530 to 640 K, pressures of 5×10^5 and 10×10^5 Pa, and reference velocities of 10 and 20 m/s. Combustion efficiencies of 99.5% and above were obtained. NO_x emissions ranged from 10 to 14 ppm by volume at 15% O_2 . Unburned hydrocarbons were the major contributor to combustion inefficiency. Major trends observed include increasing combustion efficiency with increasing inlet temperature and also decreasing reference velocity. Some loss of catalytic activity with run time was observed which was probably caused partly by a coating of iron and nickel oxides that were deposited on the surfaces of the catalytic reactor. This reddish coating has been found on all combustors that have been tested in coal gas at the Test and Development Center. It is suspected that the coating may have resulted from the oxidation of trace amounts of iron and nickel carbonyls in the product gas.

The precise source of the carbonyls is not known. It is known that iron and nickel carbonyls exist in coal gas with high partial pressure of carbon monoxide in the presence of carbon steel at about $420 \text{ K}^{(10)}$. Kinetic data indicate that small amounts of oxygen strongly repress iron carbonyl formation, whereas hydrogen, ammonia and hydrogen sulfide enhance the reaction. All three of the compounds which enhance the formation are present in the PDU product gas. The most likely locations for carbonyl formation are the cool, lower portion of the gasifier and the coal gas supply line between the PDU and TDC. In the lower portion of the gasifier, recycled product gas comes in contact with ash fines. Ash contains both iron and nickel.

Catalytic combustion of medium-heating-value coal gas, 9.4 MJ/m^3 (252 Btu/scf), was demonstrated at inlet temperatures from 520 to 730 K, pressures of 5×10^5 and 10×10^5 Pa, and reference velocities of 10 and 20 m/s. Combustion efficiencies of 99.5% and above were obtained. NO_x emissions ranged from 11 to 19 ppm by volume at 15% O_2 . Higher exit temperatures were required to reduce CO emissions for the medium-heating-value gas compared to the low-heating-value gas. A loss in catalyst activity with run time on the medium-heating-value coal gas was observed, which was probably caused by the deposition of iron oxide on the surfaces of the catalytic reactor, as previously discussed.

Flashback/autoignition problems were anticipated before the testing began but did not occur to any significant extent. Two flashbacks were detected for each of the low- and medium-heating value tests. At the high inlet temperatures (730 K) run during the later part of the medium-heating-value test, no flashbacks were detected. Some damage to the first three elements did occur during the medium-heating-value gas testing due to a non-uniform fuel-air mixture which caused localized overheating. The centerline-mounted thermocouple at element 1 exit plane did not indicate temperatures high enough to melt the catalyst substrate.

The fuel maldistribution problem mentioned above was the result of injector plugging. Four of the nineteen fuel tubes were more than 75% blocked by a cream-colored solid material. Since no deposit was observed during low-heating-value tests, the deposition of this material might be eliminated by decreasing the fuel tube diameter for medium-heating-value gas. Both gas velocity and nozzle pressure drop would be increased and, as a result, fuel-air distribution would be improved. Perhaps the increased gas velocity would prohibit solid deposition. It is of some importance to note that during pressure checks, prior to low-heating-value tests, an internal recirculation of air was established in the fuel injector. Air from the compressors was flowing into some injector tubes and out of others. This is most likely the result of air flow maldistribution causing static pressure differences in

wakes of the injector tubes. At the low injector pressure drops encountered during medium-heating-value tests, the gas jet velocity may be inadequate in completely overcoming these static pressure differences, resulting in fuel-air mixing problems.

The production of oxides of nitrogen for liquid fuel tests was the expected 2 ppmv (@ 15% O₂). As previously discussed, both low- and medium-heating-value coal gas tests produced NO_x levels of approximately 14 ppmv (@ 15% O₂). The 14 ppmv baseline NO_x level from coal gas tests suggests that the small amounts of ammonia and cyanide compounds found in the gas (up to 15 and 18 ppmv, respectively) are being efficiently converted to NO_x. Up to 1 to 2 ppmv NO_x could also be the result of gasifier-produced NO_x.

7.0 DEFINITIONS AND CALCULATIONS

This section summarizes the definitions and equations used in analyzing the measured data points summarized in Table 2-1. The analysis was implemented by a computer program, CGREDU. This program is a modified version (CG = coal gas) of the program developed by Westinghouse for NASA under contract DEN 3-146.(Reference 8)*. ERBS fuel test results were run on the unmodified version, i.e., REDUCE. Since the general arrangement and calculational philosophy are unchanged, only a brief summary of pertinent equations and definitions are presented.

7.1 DISTILLATE DATA DEFINITIONS

	Tables A-1 and A-2	<u>Equation</u>
TIN	Inlet air temperature, °F	7.2.1
PIN	Inlet pressure, psia	
WFE	Distillate fuel flow, lb/s	
TEMPFE	Distillate fuel temperature, °F	
FBN	Fuel nitrogen concentration, weight %	
ASH	Fuel ash concentration, weight %	
STOICHF	Stoichiometric fuel/air ratio	
HCR	Hydrogen to carbon molar ratio	
WAP	Air flow through catalyst, lb/s	
WAD	Dilution air flow, lb/s	
WAT	Total air flow, lb/s	
PERCAP	Catalyst air split, %	
REFVEL	Reference velocity, ft/sec	7.2.2
MACH	Mach number at inlet conditions	
SPHUM	Specific humidity of combustion air	
FARS	Catalyst average fuel-to-air ratio	
PHIS	Catalyst equivalence ratio	
ADFTS	Adiabatic flame temperature, °R	7.2.3
TAUS	Residence time from catalyst inlet to sample probe, msec	
BOT	Average measured catalyst outlet temperature, °F	7.2.4
ETATC	Catalyst thermal efficiency, %	7.2.5

* Low NO_x Heavy Fuel Combustor Concept Program - Phase I - Combustion Technology Generation.

Tables A.1 and A.2

Equation

PF	Temperature pattern factor, %	7.2.6
POUT	Measured rig outlet pressure, psia	
NOZDEP	Fuel nozzle pressure drop, psi	
NOXPPMW	Measured NOX concentration, ppmv (wet)	
COPPMW	Measured CO concentration, ppmv (dry)	
UHCPPMW	Measured UHC concentration, ppmv (wet) as methane	
CO2PERD	Measured CO ₂ concentration, % dry	
O2PERD	Measured O ₂ concentration, % dry	
CORNOXD	Corrected emission levels, ppmv (dry)	7.2.7
CORCOD	} @ 15% O ₂	7.2.8
CORUHCD		7.2.9
EINOX		7.2.11
EICO	} Emission indices, lb emission/1000 lb exhaust	7.2.12
EIUHC		7.2.13
FARCO2	Calculated fuel-to-air ratio based on measured CO ₂	7.2.14
FARO2	Calculated fuel-to-air ratio based on measured O ₂	7.2.15
ETAEGA1	Combustion efficiency based on measured emissions, %	7.2.16
ETAEGA2	Thermal efficiency based on exhaust measurements, %	7.2.17
FARR	Fuel-to-air ratio-ratio	7.2.18
TOUT	Measured catalyst outlet temperature, 12 thermocouples as per Figure 2-9, °F	

7.2 DISTILLATE DATA - DATA REDUCTION EQUATIONS/BASIS

7.2.1 TIN INLET TEMPERATURE, °F

Average inlet air temperature, based on average of four thermocouples shown in Figure 2-3.

7.2.2 REFVEL Reference velocity, ft/sec

$$\text{REFVEL} = \text{WAP}/(\rho A)$$

$$\rho = 2.7026 \left(\frac{\text{PIN}}{\text{TIN} + 460} \right), \frac{\text{lbm}}{\text{ft}^3}$$

$$A = 0.12306 \text{ ft}^2 \text{ (I.D. = 4.75 inches)}$$

7.2.3 ADFTS - Adiabatic flame temperature, °R

ADFTS is the calculated exit temperature assuming adiabatic conditions and based on measured fuel-air ratio (FARS) assuming equilibrium is attained.

7.2.4 BOT - Measured catalyst outlet temperature, °F

BOT is the average of 12 thermocouples positioned at the catalyst outlet, catalyst exit plane 6, as per Figure 2-9.

7.2.5 ETATC - Catalyst thermal efficiency, %

$$ETATC = \left(\frac{BOT - TIN}{ADFTS - TIN} \right) 100$$

7.2.6 PF - Pattern factor

$$PF = \left(\frac{TOUT(MAX) - BOT}{BOT - TIN} \right) 100$$

where

TOUT(MAX) is the maximum measured outlet temperature from catalyst exit plane 6 (Figure 2-9).

7.2.7 CORNOXD - NO_x, corrected to ppmv (dry) @ 15% O₂

$$CORNOXD = \left(\frac{NOXPPMW}{k} \right) \left(\frac{5.9}{20.9 - O2PERD} \right)$$

where

k is a constant to account for the difference between wet and dry measurement.

7.2.8 CORCOD - CO, corrected to ppmv (dry) @ 15% O₂

$$\text{CORCOD} = \text{COPPMW} \left(\frac{5.9}{20.9 - 02\text{PERD}} \right)$$

7.2.9 CORUHCD - UHC, corrected to ppmv (dry) @ 15% - as methane

$$\text{CORUHCD} = \left(\frac{\text{UHCPPMW}}{K} \right) \left(\frac{5.9}{20.9 - 02\text{PERD}} \right)$$

7.2.10 EMISSIONS INDEX - calculated from the equations in Reference 9

7.2.11 EINOX - Emission index for NO_x 1b NO_x/1000 1b fuel

$$\text{EINOX} = \frac{(46,007)(\text{NOXPPMW})}{10^6(12 + \alpha) (\text{CO}_2)_{\text{eff}}}$$

where,

α is the hydrogen to carbon molar ratio in fuel

(CO₂) eff is the effective carbon concentration in the exhaust.

$$(\text{CO}_2)_{\text{eff}} = \frac{(k)(\text{CO2PERD})}{100} + \frac{(k)(\text{COPPMW})}{10^6} + \frac{\text{UHCPPMW}}{10^6}$$

7.2.12 EICO - Emission index for CO, 1b CO/1000 1b fuel

$$\text{EICO} = \frac{(28,011)(k)(\text{COPPMW})}{10^6(12 + \alpha) (\text{CO}_2)_{\text{eff}}}$$

7.2.13 EIUHC - Emission index for UHC, 1b UHC/1000 lbs fuel

$$\text{EIUHC} = \frac{\text{UHCPPMW}}{10^3 (\text{CO}_2)_{\text{eff}}}$$

7.2.14 FARCO₂ - Calculated fuel-to-air ratio based on measured CO₂ and chemical balance. See DEN3-146 comprehensive data report for equations.

7.2.15 FAR02 - Calculated fuel-to-air ratio based on measured O₂ and chemical balance. See DEN 3-146 comprehensive data report for equations.

7.2.16 ETAEGA1 - Combustion efficiency based on measured emissions, %.

$$\text{ETAEGA1} = \left\{ 1 - \frac{\text{UHCPPMW} + [0.468(k)(\text{COPPM D})]}{10^6 (\text{CO}_2)_{\text{eff}}} \right\} 100$$

7.2.17 ETAEGA2 - Thermal efficiency based on exhaust measurements, %.

$$\text{ETAEGA2} = \left\{ \left[1 - \left(\frac{\Delta T_{\text{CO}} + \Delta T_{\text{UHC}} - \Delta T_{\text{NOX}}}{\text{ADFTS} - \text{TIN}} \right) \right] \right\} 100$$

where,

ΔT_{CO} , ΔT_{UHC} , ΔT_{NOX} are temperature deviations from the calculated outlet temperature due to species concentration which are not included in the equilibrium calculation.

$$\Delta T_{\text{CO}} = 14,124 \text{ K} \frac{\text{COPPM D}}{10^6} \quad (\text{JANAF Tables})$$

$$\Delta T_{\text{UHC}} = \left[\frac{28.954}{12.011 + 1.008 \alpha} \right] (\text{ADFTS} - \text{TIN}) \left[\frac{\text{UHCPPMW}}{10^6 (f/a)_o} \right]$$

$$\Delta T_{\text{NOX}} = 4,551 \frac{\text{NOXPPMW}}{10^6} \quad (\text{JANAF Tables})$$

7.2.18 FARR = Fuel air ratio ratio

$$\text{FARR} = \frac{\text{FARCO}_2}{\text{FARS}}$$

7.3 COAL GAS DATA - DEFINITIONS

	Tables A-3 through A-19	<u>Equation</u>
TIN	Inlet temperature, °F	7.4.1
CO	Carbon monoxide concentration, % (wet)	
CO2	Carbon dioxide concentration, % (wet)	
H2	Hydrogen concentration, % (wet)	
CH4	Methane concentration, % (wet)	
N2	Nitrogen concentration, % (wet)	
H2S	Hydrogen sulfide concentration, % (wet)	
H2O	Water concentration, %	7.4.2
LHV	Low heating value of coal gas, Btu/scf	7.4.3
TMMS	Inlet temperature, °F	7.4.4
ADFTS	Adiabatic flame temperature at catalyst outlet, °F	7.4.5
ETAT	Combustion efficiency based on enthalpy balance using measured emissions, %	7.4.7
CNOXE	Corrected NOX @ 15% O ₂ , dry basis normalized to 26% CO ₂ in fuel gas, ppmv	7.4.8
ERNOX		7.4.9
ERCO	Emission rates, lb emission/MBtu input	7.4.10
ERUHC		7.4.11
IPCDP	Fuel injector plus catalyst pressure drop, psi	
CATDP	Catalyst pressure drop, psi	

7.4 COAL GAS DATA - DATA REDUCTION EQUATIONS/BASES

7.4.1 TIN - Inlet temperature, °F

Calculated catalyst inlet fuel-air mixture temperature based on energy balance using measured air and fuel temperature.

7.4.2 H2O - Water concentration, %

Based on saturated conditions at measured fuel gas temperature and pressure

7.4.3 LHV - Lower heating value of coal gas Btu/scf

$$LHV = \frac{[(H_2)(275) + (CO)(322) + (CH_4)(913)]}{100}$$

7.4.4 TMMS - Catalyst inlet temperature, °F

$$TMMS = TIN$$

7.4.5 ADFTS - Adiabatic flame temperature at catalyst outlet, °F

ADFTS is the calculated catalyst exit temperature assuming adiabatic, equilibrium conditions. Computational approach is that of an enthalpy balance.*

7.4.6 ETAT - Combustion thermal efficiency based on enthalpy balance using measured emissions, %

$$ETAT = \left[\frac{(INEFFT - TIN)}{(ADFTS - TIN)} \right] 100$$

where,

INEFFT is the calculated catalyst exit temperature assuming adiabatic conditions using an enthalpy balance with measured CO₂, UHC and CO to incorporate combustion inefficiency.

7.4.7 CNOXE - NO_x, corrected to 15% O₂, dry basis normalized to 26% CO₂ in fuel gas, ppmv

$$CNOXE = CORNOX / \{0.00178 + [(0.41069)(CO_2)] + [(-0.2265)(CO_2)^2] + [(0.0003203)(CO_2)^3]\}$$

* Species enthalpy based on correlation provided in API Technical Data Book.

The correlation given above is based on a proprietary computer program that predicts NO_x production from conventional combustion systems. The program

treats CO₂ concentration in the fuel gas much as it treats water concentration in liquid fuel. The normalized NO_x permits comparison of data obtained over a wide range of gas heating values.

$$7.4.8 \text{ ERNOX} = (4.42 \times 10^{-3}) (\text{NOXPPMW} \times 10^{-6}) (K_2)$$

where

$$K_2 = \frac{(WAT + WFT) (MWF)}{(WFT) (HHV)}$$

where

WFT = total fuel flow

MWF = molecular weight of fuel

HHV = higher heating value of fuel

$$7.4.9 \text{ ERCO} = (2.69 \times 10^{-3}) (\text{COPPMD} \times 10^{-6}) (K_2)$$

$$7.4.10 \text{ ERUHC} = (1.54 \times 10^{-3}) (\text{UHCPPMW} \times 10^{-6}) (K_2)$$

8.0 REFERENCES

1. Lew, H. G., et al., "Experimentally Determined Catalytic Reactor Behavior and Analysis for Gas Turbine Combustors," ASME Paper 79-GT-150.
2. Kesselring, J. P., et al., "Recent Advances in Catalytic Combustion System Development," ASME Paper 79-WA/Fu-8.
3. Anderson, D. N., "Performance and Emissions of a Catalytic Reactor with Propane, Diesel and Jet A Fuels," NASA TM-73786, September 1977.
4. Salvador, L., et al., "The Westinghouse Coal Gasification Process," presented at the International Gas Research Conference, June, 1980.
5. Anderson, D. N., "Emissions and Performance of Catalysts for Gas Turbine Catalytic Combustors," ASME Paper 77-GT-65.
6. Lew, H. G., et al., "Low NO_x and Fuel Flexible Gas Turbine Combustors," ASME 81-GT-99.
7. Bulzan, D. L. and Tacina, R. R., "Catalytic Combustion of Coal Derived Liquids," NASA TM-81594, March, 1981.
8. Lew, H. G., et al., "Low NO_x Heavy Fuel Combustor Concept Program, Phase I, Combustion Technology Generation," NASA CR-165482, October, 1981.
9. "Procedure for the Continuous Sampling and Measurement of Gaseous Emissions from Aircraft Turbine Engines," Aerospace Recommended Practice 1256, October 1, 1971, SAE.
10. Brynstad, J., "Iron and Nickel Carbonyl Formation in Steel Pipes and Its Prevention," Oakridge Nat. Lab., ORNL/TM-5499, Contract No. W-7405, Eng.-26.

APPENDIX A

Tables A-1 to A-2 - ERBS Distillate Fuel Steady-State Data

Tables A-3 to A-7 - Low-Heating-Value Steady-State Data

Tables A-8 to A-19 - Medium-Heating-Value Steady-State Data

ORIGINAL PAGE IS
OF POOR QUALITY

TABLE A-1
ERBS DISTILLATE FUEL--STEADY STATE DATA

DATA POINT		18	16	1	2	19	3	20
TIME		14:30:57	14:21:57	12:11:57	12:23:57	14:35:57	12:29:57	14:38:57
OPERATING CONDITIONS								
FUEL								
TIN	DEGF	615.977	616.638	631.308	632.408	615.580	632.989	615.404
FIN	PSIA	78.546	79.889	75.982	74.343	72.645	74.721	72.726
WFE	#/SEC	0.027	0.029	0.029	0.032	0.032	0.036	0.036
WFR	#/SEC	0.000	0.000	0.000	0.000	0.000	0.000	0.000
LFC	#/SEC	0.000	0.000	0.000	0.000	0.000	0.000	0.000
WFFY	#/SEC	0.000	0.000	-0.000	-0.000	0.000	-0.000	0.000
PERCFR	PCNT	0.000	0.000	0.000	0.000	0.000	0.000	0.000
PERCFC	PCNT	0.000	0.000	0.000	0.000	0.000	0.000	0.000
WFF	#/SEC	0.027	0.029	0.029	0.032	0.032	0.036	0.036
WFS	#/SEC	0.000	0.000	0.000	0.000	0.000	0.000	0.000
WFT	#/SEC	0.027	0.029	0.029	0.032	0.032	0.036	0.036
PERCFS	PCNT	0.000	0.000	0.000	0.000	0.000	0.000	0.000
TEMPFE	DEGF	81.118	80.765	78.298	79.355	80.589	79.531	80.589
TEMPFR	DEGF	79.355	79.179	75.129	75.129	79.355	75.129	79.355
TEMPFC	DEGF	83.587	83.587	77.241	78.298	83.587	78.298	83.587
WAAP	#/SEC	0.000	0.000	0.000	0.000	0.000	0.000	0.000
WAAS	#/SEC	0.000	0.000	0.000	0.000	0.000	0.000	0.000
PN0ZAFR	#A/#F	0.000	0.000	0.000	0.000	0.000	0.000	0.000
SNOZAFR	#A/#F	0.000	0.000	0.000	0.000	0.000	0.000	0.000
FEN	PCNT N	0.008	0.008	0.008	0.008	0.008	0.008	0.008
ASH	WT FCNT	0.000	0.000	0.000	0.000	0.000	0.000	0.000
STGICHF	#F/#A	0.070	0.070	0.070	0.070	0.070	0.070	0.070
HCR		1.711	1.711	1.711	1.711	1.711	1.711	1.711
AIR								
WAF	#/SEC	1.440	1.444	1.460	1.456	1.443	1.458	1.438
WAG	#/SEC	0.000	0.000	0.000	0.000	0.000	0.000	0.000
WAB	#/SEC	1.454	1.454	1.405	1.400	1.457	1.397	1.455
WAT	#/SEC	2.892	2.896	2.861	2.873	2.898	2.851	2.891
PERCAP	PCNT	49.793	49.862	51.031	50.679	49.793	50.961	49.741
PERCAD	PCNT	-0.069	-0.069	-0.140	-0.069	-0.069	0.210	-0.069
PERVEL	FT/SEC	53.598	52.876	56.976	57.743	58.051	57.947	57.776
MACH	FT/SEC #1000	33.628	33.167	35.508	35.968	36.428	36.086	36.211
SPHUP	#H2O/#A	0.001	0.001	0.001	0.001	0.001	0.001	0.001
LEAN BURNER								
FARS	#F/#A	0.019	0.020	0.020	0.021	0.022	0.024	0.025
PHIS		0.267	0.285	0.287	0.308	0.319	0.349	0.357
PL	PSIA	71.635	73.626	68.592	67.536	65.536	67.481	65.474
ADFTS	DEGR	2262.609	2339.030	2351.090	2431.351	2457.108	2586.340	2598.430
TAUS	MSEC	9.106	9.056	8.276	7.779	7.628	7.330	7.213

TABLE A-1 (Continued)
ERBS DISTILLATE FUEL-STEADY STATE DATA

	18	16	1	2	19	3	20
PERFORMANCE							
BOY	1536.563	1603.968	1628.949	1733.987	1766.170	2007.965	2000.815
ETAC	76.697	77.868	78.321	81.144	81.903	90.596	89.323
PF	16.249	20.772	21.659	24.454	24.495	19.834	24.653
FOU	71.872	73.058	68.784	67.482	65.203	66.994	64.999
DELPER	8.489	8.551	9.473	9.835	10.244	10.341	10.625
DELFRAY	0.068	0.070	0.080	0.091	0.099	0.115	0.119
NOZDEP	24.299	26.252	26.496	29.955	30.871	35.450	36.224
MEASURED EMISSIONS							
NOZPPM	1.272	0.161	1.701	1.640	0.439	2.260	1.201
COPPM	866.420	101.158	72.414	32.055	25.381	19.064	21.473
UHCPPM	21.433	-3.244	23.334	11.042	4.339	7.640	1.217
CO2PER	4.215	4.650	4.604	4.730	5.131	5.602	5.692
O2FER	14.609	14.070	14.318	14.166	13.258	12.649	12.308
SAE SMOKE							
EMISSIONS AT 15% O2*							
CORNOXD	1.239	0.145	1.587	1.497	0.355	1.696	0.866
CORCO	812.602	87.384	64.913	28.084	19.595	13.633	14.745
CORUNCD	20.871	-2.918	21.771	10.080	3.501	5.733	0.878
CORNOXDE	1.260	0.148	1.614	1.522	0.360	1.724	0.881
EMISSIONS INDEX*							
EI NOX	0.000	0.000	0.000	0.000	0.000	0.000	0.000
EI CO	41.130	4.435	3.207	1.383	1.010	0.495	0.770
EI UHC	0.587	-0.072	0.526	0.243	0.088	0.143	0.022
EMISSIONS FOR FAR*							
FARCO2	0.020	0.021	0.021	0.022	0.024	0.026	0.026
FAR02	0.022	0.024	0.023	0.023	0.026	0.028	0.030
ETAREG1	99.006	99.874	99.874	99.944	99.968	99.970	99.980
ETAREG2	58.902	99.907	99.814	99.920	99.957	99.954	99.977
FARR	1.064	1.080	1.062	1.015	1.060	1.057	1.050
MISCELLANEOUS							
SCOMBUSTOR OUTLET TEMPERATURES							
TOUTX1	1574.418	1638.722	1741.663	1862.293	1908.687	2229.886	2160.999
TOUTX2	1659.009	1726.135	1787.750	1927.247	1984.674	2280.684	2326.578
TOUTX3	1482.958	1538.342	1493.139	1598.249	1663.767	1799.882	1859.365
TOUTX4	1384.311	1450.348	1481.347	1571.786	1549.146	1773.781	1682.834
TOUTX5	1592.888	1650.593	1660.100	1736.557	1810.556	2012.735	2072.770
TOUTX6	1680.094	1774.364	1780.668	1932.253	2024.431	2279.250	2342.776
SCOMBUSTOR OUTLET TEMPERATURES							
TOUT1	1464.387	1549.327	1493.497	1592.639	1700.498	1906.466	1997.882
TOUT2	1347.892	1393.307	1387.659	1459.322	1482.955	1620.130	1615.743
TOUT3	1456.932	1509.611	1559.962	1588.980	1610.313	1796.335	1745.926
TOUT4	1587.087	1647.123	1663.213	1774.474	1816.762	2034.800	2035.965
TOUT5	1686.152	1809.059	1845.429	2003.371	2048.011	2233.317	2243.637
TOUT6	1502.626	1560.687	1652.965	1760.656	1694.237	2128.309	1925.291

ORIGINAL PAGE IS
OF POOR QUALITY

TABLE A-2
ERBS DISTILLATE FUEL--STEADY STATE DATA

		61	13	12	14	11	10	7	15	8	9	
		12:54:57	13:43:57	13:37:57	14: 2:57	13:32:57	13:23:57	13: 8:57	14: 7:57	13:11:57	13:17:57	
**OPERATING CONDITIONS:												
TIN	DEGF	624.307	624.086	624.263	624.307	623.998	624.086	624.086	624.219	624.042	623.954	
PIN	PSIA	142.364	142.812	142.730	142.323	142.527	142.649	142.608	142.893	142.934	142.649	
FUEL												
WFE	\$/SEC	0.058	0.058	0.059	0.060	0.060	0.061	0.064	0.065	0.066	0.067	
WFR	\$/SEC	0.000	0.000	0.000	0.000	0.000	0.000	0.000	0.000	0.000	0.000	
WFC	\$/SEC	0.000	0.000	0.000	0.000	0.000	0.000	0.000	0.000	0.000	0.000	
WFPY	\$/SEC	-0.000	0.000	0.000	0.000	0.000	0.000	0.000	0.000	0.000	0.000	
PERCFR	PCNT	0.000	0.000	0.000	0.000	0.000	0.000	0.000	0.000	0.000	0.000	
PERCFC	PCNT	0.000	0.000	0.000	0.000	0.000	0.000	0.000	0.000	0.000	0.000	
WFF	\$/SEC	0.058	0.058	0.059	0.060	0.060	0.061	0.064	0.065	0.066	0.067	
WFS	\$/SEC	0.000	0.000	0.000	0.000	0.000	0.000	0.000	0.000	0.000	0.000	
WFT	\$/SEC	0.058	0.058	0.059	0.060	0.060	0.061	0.064	0.065	0.066	0.067	
PERCFS	PCNT	0.000	0.000	0.000	0.000	0.000	0.000	0.000	0.000	0.000	0.000	
TEMPFE	DEGF	79.531	80.413	80.413	80.413	80.589	80.413	80.236	80.413	80.413	80.413	
TEMPFR	DEGF	76.185	78.298	77.418	78.298	77.241	77.241	76.185	78.298	76.889	77.241	
TEMPFC	DEGF	80.413	82.581	82.528	83.587	82.528	81.470	81.118	83.587	81.470	81.470	
WAP	\$/SEC	0.000	0.000	0.000	0.000	0.000	0.000	0.000	0.000	0.000	0.000	
WAS	\$/SEC	0.000	0.000	0.000	0.000	0.000	0.000	0.000	0.000	0.000	0.000	
PNOZAFR	\$/#	0.000	0.000	0.000	0.000	0.000	0.000	0.000	0.000	0.000	0.000	
SNOZAFR	\$/#	0.000	0.000	0.000	0.000	0.000	0.000	0.000	0.000	0.000	0.000	
FBN	PCNT N	0.008	0.008	0.008	0.008	0.008	0.008	0.008	0.008	0.008	0.008	
ASH	WT PCNT	0.000	0.000	0.000	0.000	0.000	0.000	0.000	0.000	0.000	0.000	
STOICHF	\$/#	0.070	0.070	0.070	0.070	0.070	0.070	0.070	0.070	0.070	0.070	
HCR		1.711	1.711	1.711	1.711	1.711	1.711	1.711	1.711	1.711	1.711	
AIR												
MAP	\$/SEC	2.791	2.796	2.794	2.794	2.796	2.791	2.793	2.799	2.794	2.797	
WAG	\$/SEC	0.000	0.000	0.000	0.000	0.000	0.000	0.000	0.000	0.000	0.000	
WAD	\$/SEC	1.668	1.660	1.657	1.665	1.654	1.661	1.666	1.664	1.657	1.659	
WAT	\$/SEC	4.486	4.452	4.447	4.455	4.446	4.478	4.455	4.469	4.447	4.482	
PERCAP	PCNT	62.216	62.803	62.829	62.716	62.888	62.327	62.694	62.631	62.829	62.405	
PERCAD	PCNT	0.602	-0.090	-0.090	-0.090	-0.090	0.581	-0.090	0.134	-0.090	0.580	
PERCAD	PCNT	37.102	37.287	37.261	37.374	37.202	37.092	37.396	37.234	37.015	37.015	
REFUEL	FT/SEC	57.759	57.669	57.670	57.837	57.780	57.632	57.689	57.705	57.576	57.718	
MACH FT/SEC	#1000	36.105	36.053	36.051	36.155	36.173	36.029	36.066	36.073	35.995	36.105	
SPHUM	#M20/#A	0.001	0.001	0.001	0.001	0.001	0.001	0.001	0.001	0.001	0.001	
LEAN BURNER												
FARS	\$/F/#A	0.020	0.021	0.021	0.021	0.022	0.022	0.023	0.023	0.024	0.024	
PHIS		0.293	0.299	0.303	0.307	0.309	0.313	0.329	0.332	0.341	0.342	
PL	PSIA	132.324	132.317	132.313	132.303	132.304	132.282	132.267	132.249	132.242	132.219	
ADFTS	DEGR	2368.872	2389.524	2405.949	2419.268	2426.870	2440.835	2503.539	2511.905	2544.924	2549.560	
TAUS	MSEC	3.184	8.185	8.132	8.035	8.053	7.932	7.802	7.729	7.665	7.356	

ORIGINAL PAGE IS
OF POOR QUALITY

TABLE A-3
LOW HEATING VALUE--STEADY STATE DATA

DATA POINT	20	22	21	16	19	18	17
TIME	11:13:47	11:25:47	11:22:47	10:33:47	10:55:47	10:48:47	10:40:47
OPERATING CONDITIONS							
TIN	497.694	484.280	483.991	506.041	502.934	498.845	494.760
FIN	72.035	73.174	73.012	74.436	73.459	74.110	70.732
#FUEL GAS COMPOSITION#							
CO	27.963	27.982	27.978	28.543	28.541	28.614	28.576
CO2	21.609	22.092	21.972	22.178	21.743	21.859	22.029
H2	18.572	18.071	18.197	17.384	18.049	17.832	17.593
CH4	2.613	2.456	2.495	2.221	2.440	2.369	2.290
N2	28.849	28.997	28.961	29.299	28.843	28.943	29.133
H2S	0.150	0.153	0.152	0.140	0.150	0.148	0.144
H2O	0.245	0.250	0.246	0.228	0.231	0.231	0.230
NH3	0.000	0.000	0.000	0.000	0.000	0.000	0.000
LHV	164.972	162.250	162.911	155.994	163.813	162.803	161.304
* FUEL *							
W/F	0.154	0.188	0.188	0.232	0.239	0.256	0.272
J/S	0.000	0.000	0.000	0.000	0.000	0.000	0.000
W/T	0.154	0.188	0.188	0.232	0.239	0.256	0.272
PERCFS	0.000	0.000	0.000	0.000	0.000	0.000	0.000
TEMPF	82.528	82.881	82.528	79.884	80.589	80.413	80.236
* AIR *							
WAF	0.902	0.902	0.901	1.518	1.515	1.519	1.517
WAF	0.000	0.000	0.000	0.000	0.000	0.000	0.000
WAD	1.404	1.406	1.404	1.841	1.689	1.714	1.846
WAT	2.306	2.308	2.305	3.359	3.204	3.233	3.363
PERCAP	39.115	39.081	39.089	45.192	47.285	46.984	45.109
PERCAQ	0.000	0.000	0.000	0.000	0.000	0.000	0.000
PERCAD	60.885	60.919	60.911	54.808	52.715	53.016	54.891
RFAIRV	36.070	35.012	35.040	59.258	59.734	59.114	61.592
MACH FT/SEC*1000	23.924	23.379	23.401	39.140	39.516	39.185	40.911
MUMID	0.001	0.001	0.001	0.001	0.001	0.001	0.001
* LEAN BURNER *							
FARS	0.170	0.209	0.209	0.153	0.158	0.168	0.179
PHIS	0.255	0.303	0.306	0.217	0.232	0.245	0.257
TNHS	497.694	484.280	483.991	506.041	502.934	498.845	494.760
ADTS	1871.468	2049.525	2058.652	1710.998	1775.766	1826.744	1871.875
TAUS	12.448	11.429	11.388	7.879	7.561	7.428	6.837
PERFORMANCE							
ROT	1564.629	1708.431	1675.493	1259.847	1360.646	1270.907	1460.813
ETATC	0.777	0.782	0.757	0.626	0.674	0.581	0.701
ETAT	99.563	99.808	99.746	97.344	96.622	96.310	98.402
PF	11.192	11.544	12.729	32.487	18.544	31.395	13.939
FOUT	66.459	66.988	66.866	65.604	64.546	65.401	61.290
DELPPR	7.741	8.454	8.418	11.865	12.133	11.751	13.349
DPPRAY	0.043	0.049	0.048	0.084	0.097	0.086	0.118
NOZDEP	2.971	4.213	4.192	4.599	5.210	6.146	7.082
MEASURED EMISSIONS							
NOXPMW	13.260	18.223	17.774	11.093	12.503	12.562	12.696
COFPMW	77.791	19.695	59.305	86.199	86.769	85.279	88.389
COFMD	0.000	0.000	0.000	0.000	0.000	0.000	0.000
UHCPMW	719.600	12.364	16.300	2536.450	2851.450	3064.300	1854.300
CO2PD	7.923	9.874	9.594	6.597	6.852	7.148	7.628
O2PD	13.769	12.108	12.517	15.327	14.967	14.593	14.129

OLDOUT FRAME

ORIGINAL PAGE IS
OF POOR QUALITY

**TABLE A-3
LOW HEATING VALUE—STEADY STATE DATA**

DATA POINT	20	21	16	19	18	17
TIME	11:13:47	11:22:47	10:33:47	10:55:47	10:48:47	10:40:47
OPERATING CONDITIONS						
TIN	497.694	483.991	506.041	502.934	498.845	494.760
FIN	72.035	73.012	74.436	73.459	74.110	70.732
FUEL GAS COMPOSITION						
CO	27.963	27.978	28.543	28.541	28.614	28.576
H2	21.609	21.972	22.178	21.743	21.859	22.029
CH4	18.572	18.197	17.384	18.049	17.832	17.593
N2	2.613	2.495	2.321	2.440	2.369	2.290
H2S	28.849	28.997	29.299	28.843	28.943	29.133
H2O	0.150	0.152	0.140	0.150	0.148	0.144
NH3	0.245	0.250	0.246	0.231	0.231	0.230
LHV	164.972	162.911	159.994	163.813	162.803	161.304
* FUEL *						
WFF	0.154	0.188	0.232	0.239	0.256	0.272
WFS	0.000	0.000	0.000	0.000	0.000	0.000
WFT	0.154	0.188	0.232	0.239	0.256	0.272
WFKCFS	0.000	0.000	0.000	0.000	0.000	0.000
WTFPF	82.528	82.528	79.884	80.589	80.413	80.236
* AIR *						
WAF	0.902	0.901	1.518	1.515	1.519	1.517
WAO	0.000	0.000	0.000	0.000	0.000	0.000
WAD	1.404	1.404	1.841	1.689	1.714	1.846
WAT	2.306	2.305	3.359	3.204	3.233	3.363
WERCAP	39.115	39.089	45.192	47.285	46.984	45.109
WERCAB	0.000	0.000	0.000	0.000	0.000	0.000
WERCAD	60.885	60.911	54.808	52.715	53.016	54.891
WFAIRV	36.070	35.012	59.258	59.734	59.114	61.592
WMACH	23.924	23.379	39.140	39.516	39.185	40.911
WUMID	0.001	0.001	0.001	0.001	0.001	0.001
* LEAN BURNER *						
WAFS	0.170	0.209	0.153	0.158	0.168	0.179
WFLS	0.255	0.303	0.217	0.232	0.245	0.257
WTHMS	497.694	483.991	506.041	502.934	498.845	494.760
WADPTS	1871.468	2058.672	1710.998	1775.766	1826.766	1871.875
WTAUS	12.448	11.429	7.879	7.561	7.428	6.937
PERFORMANCE						
WROT	1764.629	1675.493	1259.847	1360.646	1270.907	1460.813
WETATC	0.777	0.757	0.626	0.674	0.581	0.701
WETAT	99.563	99.746	97.344	96.622	96.310	98.402
WFF	11.192	12.729	32.487	18.544	31.395	13.939
WFOUT	66.459	66.988	63.604	64.546	65.401	61.290
WDELFPK	7.741	8.418	11.865	12.133	11.751	13.349
WDFPRAY	0.043	0.048	0.084	0.097	0.086	0.118
WNOZDEF	2.971	4.192	4.599	5.210	6.146	7.082
MEASURED EMISSIONS						
WNOXPHW	13.260	17.774	11.093	12.503	12.562	12.696
WCOFPMO	77.791	59.305	86.199	86.769	85.009	88.389
WCOFO	0.000	0.000	0.000	0.000	0.000	0.000
WUHCPMW	719.600	16.364	2536.450	2851.450	3064.300	1854.300
WCO2FO	7.923	9.874	6.597	6.852	7.148	7.628
WCO2FO	13.769	12.108	15.327	14.967	14.593	14.129

FOLDOUT FRAME

* SAE SMOKE
EMISSIONS AT 15% CO

ORIGINAL PAGE IS
OF POOR QUALITY

ETAT 0.777 0.782 0.757 0.626 0.757 0.753 0.753 0.753
 ERNDX 99.563 99.808 99.746 97.344 99.746 99.570 99.570 99.570
 ERNDX 11.192 12.729 12.729 32.487 12.729 18.544 18.544 18.544
 ERNDX 66.459 66.988 66.866 65.604 66.866 65.604 65.604 65.604
 ERNDX 7.741 8.454 8.418 11.865 8.418 11.865 11.865 11.865
 ERNDX 0.043 0.049 0.048 0.084 0.048 0.086 0.086 0.086
 ERNDX 2.971 4.213 4.192 4.599 4.192 5.210 5.210 5.210

*SAE SMOKE
 EMISSIONS AT 15% O2*
 CORNOX PPMV 11.093 12.503 12.503 12.562 12.503 12.562 12.562 12.562
 CORNOX PPMV 86.199 86.769 86.769 85.279 86.769 85.279 85.279 85.279
 CORNOX PPMV 0.000 0.000 0.000 0.000 0.000 0.000 0.000 0.000
 CORNOX PPMV 2536.450 2851.450 2851.450 3064.300 2851.450 3064.300 3064.300 3064.300
 CORNOX PPMV 6.597 6.852 6.852 7.148 6.852 7.148 7.148 7.148
 CORNOX PPMV 15.327 14.967 14.967 14.593 14.967 14.593 14.593 14.593

*EMISSIONS#RATE *
 ERNDX \$/MRTU 0.119 0.120 0.120 0.116 0.120 0.116 0.116 0.116
 ERNDX \$/MRTU 0.544 0.491 0.491 0.461 0.491 0.461 0.461 0.461
 ERNDX \$/MRTU 9.452 9.562 9.562 9.827 9.562 9.827 9.827 9.827

*EMISSIONS FOR FAR *
 FARCO2 #F/#A 0.138 0.145 0.145 0.152 0.145 0.152 0.152 0.152
 FARCO2 #F/#A 0.170 0.180 0.180 0.193 0.180 0.193 0.193 0.193
 FARCO2 PCNT 96.132 95.820 95.820 95.701 95.820 95.701 95.701 95.701
 FARCO2 PCNT 99.953 99.953 99.953 99.953 99.953 99.953 99.953 99.953
 FARCO2 PCNT 99.955 99.955 99.955 99.955 99.955 99.955 99.955 99.955
 FARCO2 PCNT 0.962 0.962 0.962 0.903 0.962 0.903 0.903 0.903
 FARCO2 PCNT 1689.704 1689.704 1689.704 1689.704 1689.704 1689.704 1689.704 1689.704

MISCELLANEOUS
 COMBUSTOR OUTLET TEMPERATURE
 TOUTX1 DEGF 1673.112 1655.570 1655.570 1387.660 1655.570 1412.571 1412.571 1412.571
 TOUTX2 DEGF 1838.488 1814.727 1814.727 1480.276 1814.727 1505.313 1505.313 1505.313
 TOUTX3 DEGF 1754.594 1728.034 1728.034 1403.903 1728.034 1426.207 1426.207 1426.207
 TOUTX4 DEGF 1464.584 1550.443 1550.443 1335.436 1550.443 1361.422 1361.422 1361.422
 TOUTX5 DEGF 1662.846 1808.535 1808.535 1437.556 1808.535 1467.795 1467.795 1467.795
 TOUTX6 DEGF 1631.422 1789.304 1789.304 1434.540 1789.304 1448.929 1448.929 1448.929

COMBUSTOR OUTLET TEMPERATURE
 TOUT1 DEGF 1743.719 1689.704 1689.704 1347.540 1689.704 1374.268 1374.268 1374.268
 TOUT2 DEGF 1574.052 1524.128 1524.128 639.050 1524.128 1119.268 1119.268 1119.268
 TOUT3 DEGF 1743.719 1689.704 1689.704 1347.540 1689.704 1374.268 1374.268 1374.268
 TOUT4 DEGF 1574.052 1524.128 1524.128 639.050 1524.128 1119.268 1119.268 1119.268
 TOUT5 DEGF 1522.703 1665.820 1665.820 1332.806 1665.820 1359.136 1359.136 1359.136
 TOUT6 DEGF 1691.308 1691.308 1691.308 1332.806 1691.308 1359.136 1359.136 1359.136

MEASURED PRESSURE DROP
 IFCDDP PSI 2.399 2.898 2.898 5.083 2.898 5.285 5.285 5.285
 CATDP PSI 1.527 1.830 1.830 3.008 1.830 3.162 3.162 3.162

2 FOLDOUT FRAME

TABLE A-4 LOW HEATING VALUE--STEADY STATE DATA

	13	14	15	23	24	2	21	41	4
	9:52:47	9:59:47	10: 6:47	12:16:47	12:30:47	7:22:22	18: 6:34	7:52:22	8: 6:22
OPERATING CONDITIONS									
TIN	509.679	500.513	498.245	575.186	613.633	589.343	571.984	583.313	564.569
PIN	73.785	73.826	73.826	73.256	71.139	75.006	70.977	74.965	76.064
FUEL GAS COMPOSITION									
C0	29.246	28.980	28.700	28.329	28.506	29.829	25.991	29.529	29.907
C02	21.617	21.558	22.310	22.560	22.188	21.628	23.018	22.144	21.468
H2	17.328	17.135	16.939	17.539	17.894	16.727	16.982	16.424	16.850
CH4	2.010	2.010	2.014	2.218	2.288	2.031	2.916	2.087	2.044
N2	29.470	29.582	29.697	28.959	28.736	29.470	30.691	29.501	29.414
H2S	0.125	0.126	0.128	0.157	0.155	0.123	0.175	0.120	0.114
H2O	0.201	0.202	0.204	0.239	0.234	0.188	0.226	0.197	0.202
NH3	0.000	0.000	0.000	0.000	0.000	0.000	0.000	0.000	0.000
LHV	160.173	158.793	157.384	159.705	161.887	160.596	157.018	159.301	161.299
* FUEL *									
WFF	0.398	0.451	0.464	0.156	0.182	0.225	0.255	0.257	0.317
WFS	0.000	0.000	0.000	0.000	0.000	0.000	0.000	0.000	0.000
WFT	0.398	0.451	0.464	0.156	0.182	0.225	0.255	0.257	0.317
PERCFS	0.000	0.000	0.000	0.000	0.000	0.000	0.000	0.000	0.000
TEMPF	76.185	76.185	76.361	81.294	80.765	74.074	79.355	75.305	76.185
* AIR *									
MAP	2.530	2.528	2.525	0.841	1.380	1.451	1.414	1.450	1.445
MAP	0.000	0.000	0.000	0.000	0.000	0.000	0.000	0.000	0.000
WAD	1.811	1.811	1.830	1.331	1.325	1.561	1.569	1.558	1.554
WAT	4.341	4.339	4.355	2.172	2.705	3.012	2.983	3.008	2.999
PERCAP	58.281	58.262	57.979	38.720	51.017	48.174	47.402	48.205	48.183
PERCAG	0.000	0.000	0.000	0.000	0.000	0.000	0.000	0.000	0.000
PERCAD	41.718	41.738	42.021	61.280	48.983	51.826	52.598	51.795	51.817
RAIRU	100.009	98.931	98.580	35.746	62.645	61.059	61.839	60.699	58.545
NACH FT/SEC*1000	65.938	65.524	65.366	22.844	39.345	38.769	39.578	38.646	37.598
HUMID	0.001	0.001	0.001	0.001	0.001	0.001	0.001	0.001	0.001
* LEAN BURNER *									
FARS	0.157	0.179	0.184	0.185	0.132	0.155	0.181	0.178	0.219
PHIS	0.222	0.249	0.253	0.261	0.190	0.218	0.253	0.246	0.310
THMS	509.679	500.513	498.245	575.186	613.633	589.343	571.984	583.313	564.569
ADFTS	1739.929	1844.125	1854.945	1964.090	1687.138	1799.897	1900.998	1909.276	2147.880
PERFORMANCE									
BOT	1194.044	1269.356	1245.967	1802.564	1403.339	1521.487	1603.874	1636.247	1838.261
ETAC	0.558	0.572	0.551	0.884	0.776	0.776	0.776	0.795	0.804
ETAT	97.968	97.246	97.346	99.928	95.529	99.422	98.721	99.472	99.747
PF	35.193	33.751	34.513	14.226	16.320	18.569	14.307	21.687	23.775
POUT	55.551	54.574	54.859	67.110	62.307	65.604	61.453	64.627	64.994
DELPR	24.712	26.078	25.691	8.390	12.415	12.535	13.418	13.790	14.554
DPRAY	0.216	0.242	0.234	0.043	0.080	0.093	0.110	0.106	0.123
NOZDEP	12.027	17.114	18.213	3.154	2.890	4.395	7.326	5.992	9.504
MEASURED EMISSIONS									
NOXPPM	11.648	12.833	14.615	13.469	10.332	10.448	17.460	12.592	16.223
COFPPM	93.297	95.235	95.096	11.010	74.404	524.526	74.160	68.137	6.045
COPD	0.000	0.000	0.000	0.000	0.000	0.000	0.000	0.000	0.000
UHCPPM	2643.850	3134.700	3047.550	5.063	3094.400	796.700	1530.525	877.410	4.245
C02PD	6.421	7.137	7.328	9.078	6.004	7.293	8.110	8.137	9.756
O2PD	15.407	14.566	14.499	12.883	15.824	14.931	13.630	13.624	12.354
* SAE SMOKE EMISSIONS AT 15% O2*									
CORNOX	12.511	11.954	13.472	9.713	12.009	10.326	14.170	11.022	11.201
CORCOD	100.210	88.717	87.656	8.103	56.482	518.441	60.187	55.253	4.174

ORIGINAL PAGE IS
OF POOR QUALITY

FOLDOUT FRAME

EVAC	PCNT	0.558	0.572	0.551	0.554	0.736	0.770	0.776	0.775	0.804
ETAT	PCNT	97.948	97.246	97.346	99.928	93.229	99.422	98.721	99.472	99.747
PF	PCNT	35.193	33.751	34.513	14.226	16.310	18.569	14.307	21.687	23.775
POUT	PSIG	55.551	54.574	54.859	67.110	52.307	55.604	61.453	64.627	64.994
DELPPR	PCN	24.712	26.078	25.691	8.390	12.515	12.535	12.418	13.790	14.554
INPRAY	PCNT	0.216	0.242	0.234	0.043	0.013	0.093	0.110	0.106	0.123
NOZDEP	PSI	12.027	17.114	18.213	3.154	2.100	3.353	7.326	5.902	9.504
MEASURED EMISSIONS										
NOXPHM	PPHV	11.648	12.833	14.615	13.469	10.021	10.448	17.460	13.592	16.223
COFPHD	PPHV	93.297	95.235	95.096	11.010	74.494	524.526	4.160	68.137	51.540
COPD	PCNT	0.000	0.000	0.000	0.000	0.000	0.000	0.000	0.000	0.000
UHCPHM	PPHV	2643.850	3134.700	3067.550	5.063	3094.400	794.700	430.525	877.410	4.245
CO2PD	PPHV	6.421	7.137	7.328	9.078	6.004	7.293	0.110	6.137	9.756
O2PD	PPHV	15.407	14.566	14.499	12.883	15.824	14.931	13.670	17.524	12.354
* SAE SMOKE										
EMISSIONS AT 15X 02*										
CORNOX	PPHV	12.511	11.954	13.472	9.913	12.009	10.326	14.170	11.022	11.201
CORCOD	PPHV	100.210	88.717	87.656	8.103	86.482	518.441	60.187	55.253	4.174
CORCUP	PCNT	0.000	0.000	0.000	0.000	0.000	0.000	0.000	0.000	0.000
CORUHC	PPHV	2839.744	2920.144	2827.566	3.726	3596.722	787.457	1242.147	711.503	2.931
CNOXE	PPHV	8.180	8.031	9.318	7.004	8.221	6.757	10.425	7.518	7.239
* EMISSIONS RATE *										
ERNOX	\$/MBTU	0.096	0.095	0.108	0.140	0.112	0.104	0.156	0.121	0.117
ERUCO	\$/MBTU	0.454	0.417	0.412	0.067	0.475	3.086	0.389	0.358	0.025
ERUCO	\$/MBTU	7.587	8.112	7.871	0.018	11.643	2.769	4.777	2.731	0.011
* EMISSIONS FOR FAR *										
FARCO2	\$/#A	0.135	0.152	0.156	0.187	0.126	0.149	0.173	0.166	0.201
FAR02	\$/#A	0.168	0.198	0.201	0.230	0.157	0.172	0.216	0.212	0.247
EAG1	PCNT	95.871	95.606	95.801	99.989	94.910	98.563	98.035	98.859	99.993
EAG2	PCNT	90.767	89.992	90.300	99.978	87.659	96.614	95.036	97.120	99.988
FARR	-	0.859	0.849	0.847	1.009	0.960	0.960	0.958	0.935	0.918
MISCELLANEOUS										
COMBUSTOR OUTLET TEMPERATURE										
TOUTX1	DEGF	1332.280	1410.109	1384.498	1801.200	1442.352	1490.636	1600.682	1587.811	1773.798
TOUTX2	DEGF	1409.915	1499.422	1473.334	1962.169	1518.936	1654.977	1736.850	1788.502	2001.190
TOUTX3	DEGF	1347.364	1435.801	1413.998	1825.721	1419.296	1508.354	1618.857	1606.132	1784.790
TOUTX4	DEGF	1291.366	1368.819	1331.942	1714.320	1355.268	1448.214	1524.498	1551.489	1702.524
TOUTX5	DEGF	1386.218	1492.805	1469.057	1903.441	1470.467	1607.945	1695.701	1721.325	1888.480
TOUTX6	DEGF	1354.038	1433.140	1406.390	1914.295	1469.397	1619.219	1700.302	1743.521	1983.303
COMBUSTOR OUTLET TEMPERATURE										
TOUT1	DEGF	1305.334	1396.676	1377.626	1800.099	1346.839	1548.422	1611.217	1647.851	1854.684
TOUT2	DEGF	543.699	542.810	533.195	1690.019	1358.256	1257.751	1518.037	1329.654	1534.025
TOUT3	DEGF	1305.334	1396.676	1377.626	1800.099	1346.839	1507.279	1611.217	1680.268	1897.773
TOUT4	DEGF	543.699	542.810	533.195	1690.019	1358.256	1677.510	1518.037	1842.236	2111.792
TOUT5	DEGF	1266.449	1356.692	1325.460	1764.695	1377.259	1468.860	1555.453	1568.090	1743.365
TOUT6	DEGF	1266.797	1356.516	1325.284	1764.695	1376.907	1468.682	1555.633	1568.090	1763.385
MEASURED PRESSURE DROPS										
IPCOP	PSI	13.368	14.166	13.919	2.790	5.405	5.940	5.936	6.412	6.941
CATDP	PSI	7.603	8.375	8.225	1.777	3.129	2.403	3.766	2.732	2.893

ORIGINAL PAGE IS
OF POOR QUALITY

2 FOLDOUT FRAME

TABLE A-5
LOW HEATING VALUE--STEADY STATE DATA

	37	38	40	39	9	7	8	10	11	12
	17:36:34	17:40:34	17:51:34	17:44:34	8:40:12	8:44:12	8:50:12	9: 2:57	9: 5:57	9: 8:57
OPERATING CONDITIONS										
TIN	586.116	578.463	571.920	563.477	579.724	572.280	567.127	563.413	555.516	554.884
PIN	148.307	146.597	149.121	148.958	85.384	88.111	89.414	90.675	91.164	91.204
FUEL GAS COMPOSITION										
C0	22.217	22.858	24.957	23.622	29.517	29.432	29.305	28.808	28.676	28.545
C02	23.928	23.738	23.258	23.564	22.180	22.336	22.569	22.171	22.018	21.866
H2	16.534	16.620	16.863	16.709	16.530	16.454	16.334	17.064	17.300	17.537
CH4	4.399	4.153	3.326	3.852	1.920	1.905	1.882	2.181	2.274	2.367
N2	32.537	32.246	31.208	31.870	29.528	29.552	29.588	29.440	29.342	29.342
H2S	0.151	0.155	0.168	0.160	0.125	0.129	0.129	0.140	0.142	0.145
H2O	0.237	0.233	0.219	0.223	0.196	0.193	0.190	0.189	0.188	0.186
NH3	0.000	0.000	0.000	0.000	0.000	0.000	0.000	0.000	0.000	0.000
LHV	157.174	157.225	157.100	157.187	158.029	157.404	156.462	159.597	160.676	161.757
***FUEL**										
WFF	0.467	0.512	0.551	0.603	0.482	0.544	0.596	0.622	0.673	0.675
WFS	0.000	0.000	0.000	0.000	0.000	0.000	0.000	0.000	0.000	0.000
WFT	0.467	0.512	0.551	0.603	0.482	0.544	0.596	0.622	0.673	0.675
PERFCS	0.000	0.000	0.000	0.000	0.000	0.000	0.000	0.000	0.000	0.000
TEMPF	80.765	80.236	78.474	79.003	75.129	74.602	74.074	74.250	74.250	74.074
***AIR**										
WAF	2.847	2.851	2.846	2.848	2.696	2.824	2.923	2.923	2.919	2.923
WAG	0.000	0.000	0.000	0.000	0.000	0.000	0.000	0.000	0.000	0.000
WAD	1.581	1.580	1.561	1.580	1.399	1.371	1.334	1.705	1.702	1.704
WAT	4.428	4.431	4.407	4.428	4.095	4.195	4.257	4.628	4.621	4.627
PERCAP	64.295	64.342	64.579	64.318	65.836	67.318	68.663	63.159	63.168	63.173
PERCAD	0.000	0.000	0.000	0.000	0.000	0.000	0.000	0.000	0.000	0.000
PERCAD	35.705	35.658	35.421	35.682	34.164	32.682	31.337	36.841	36.832	36.827
FFAIRV	60.404	60.747	59.238	58.859	98.747	99.516	100.997	99.232	97.804	97.834
MACH FT/SEC*1000	38.409	38.762	37.914	37.819	42.974	43.682	44.784	43.742	43.077	43.116
HUMID	0.001	0.001	0.001	0.001	0.001	0.001	0.001	0.001	0.001	0.001
***LEAN BURNER**										
FARS	0.164	0.180	0.194	0.212	0.179	0.192	0.204	0.213	0.230	0.231
PHIS	0.236	0.258	0.274	0.302	0.245	0.263	0.276	0.299	0.327	0.332
TWMS	506.116	578.463	571.920	563.477	579.724	572.280	567.127	563.413	555.516	554.884
ADFTS	1807.732	1891.179	1964.732	2050.094	1899.129	1960.480	2005.227	2068.659	2186.332	2203.139
***PERFORMANCE**										
ROT	1261.234	1458.827	1605.812	1702.663	1408.626	1470.401	1539.435	1715.903	1830.033	1764.207
ETAIC	0.553	0.671	0.742	0.766	0.628	0.647	0.676	0.754	0.782	0.734
ETAT	92.223	92.915	99.282	99.529	98.712	98.559	99.096	99.607	99.448	99.515
FF	30.615	19.870	15.348	14.026	24.314	23.586	21.806	15.158	16.071	16.071
FOUT	135.975	133.451	134.916	134.713	64.790	65.848	65.319	65.401	65.238	64.790
DEPPR	8.315	8.967	9.526	9.563	24.119	25.267	26.948	27.873	28.439	28.961
DLPFRAY	0.067	0.090	0.101	0.111	0.222	0.248	0.279	0.322	0.352	0.334
NOZDEP	10.337	12.841	15.018	18.295	16.301	21.022	25.152	28.226	34.025	34.046
***MEASURED EMISSIONS**										
NOXPHU	12.993	15.574	17.169	19.261	13.380	14.251	15.156	18.465	20.061	19.715
COFPHD	79.622	83.594	83.529	81.608	89.325	91.319	93.574	47.607	11.010	33.061
COFD	0.000	0.000	0.000	0.000	0.000	0.000	0.000	0.000	0.000	0.000
UHCPHU	5805.750	5593.317	1024.825	40.700	1880.750	2097.700	1385.450	18.901	6.247	6.607
CO2FD	6.479	7.205	8.261	9.092	7.369	7.866	8.348	9.947	10.839	10.489
O2FD	15.441	14.558	13.374	12.686	14.670	14.371	13.582	11.837	11.078	11.373
***SAE SMOKE EMISSIONS AT 15% O2**										
CORNOX	14.044	14.489	13.460	13.835	12.672	12.878	12.219	12.022	12.051	12.210
CORCOX	86.062	77.771	65.482	58.618	84.597	82.521	75.437	30.994	6.614	20.476
CORCOX	0.000	0.000	0.000	0.000	0.000	0.000	0.000	0.000	0.000	0.000

ETATC	PCNT	0.553	0.671	0.742	0.766	0.628	0.647	0.676	0.756	0.782	0.734
ETAT	PCNT	92.223	92.915	99.282	99.529	98.712	98.559	99.096	99.607	99.448	99.515
FF	PCNT	30.615	19.870	15.348	14.046	24.314	23.586	21.804	15.158	16.123	16.071
FOUT	PSIG	135.975	133.451	134.916	134.713	64.790	65.848	65.319	65.401	65.238	64.790
HELPR	PCNT	8.315	8.967	9.526	9.563	24.119	25.267	26.948	27.873	28.439	28.961
DPRAY	PCNT	0.067	0.090	0.101	0.111	0.222	0.248	0.279	0.322	0.352	0.334
NOZDEP	PSI	10.337	12.841	15.018	18.295	16.301	21.022	25.152	28.226	34.025	34.046
MEASURED EMISSIONS											
NOXPHW	PPMV	12.993	15.574	17.169	19.261	13.380	14.251	15.156	18.465	20.061	19.715
COFFPH	PPMV	79.622	83.594	83.529	81.608	89.325	91.319	93.574	47.607	11.010	33.061
COFD	PCNT	0.000	0.000	0.000	0.000	0.000	0.000	0.000	0.000	0.000	0.000
UHCPHW	PPMV	5805.750	5593.317	1024.825	40.700	1880.750	2097.700	1385.450	18.901	6.247	6.607
CO2FD	PPMV	6.479	7.205	8.261	9.092	7.369	7.866	8.348	9.947	10.839	10.489
CO2FD	PPMV	15.441	14.558	13.374	12.686	14.670	14.371	13.582	11.837	11.078	11.373
* SAE SMOKE											
CORNIX	PPMV	14.044	14.489	13.460	13.835	12.672	12.878	12.219	12.022	12.051	12.210
CORCOD	PPMV	86.062	77.771	65.482	58.618	84.597	82.521	75.437	30.994	6.614	20.476
CORCOP	PCNT	0.000	0.000	0.000	0.000	0.000	0.000	0.000	0.000	0.000	0.000
CORUHC	PPMV	6275.336	5203.701	803.410	29.234	1781.199	1895.609	1116.917	12.305	3.753	4.092
CNOXE	PPMV	11.260	11.402	10.122	10.708	8.670	8.926	8.639	8.218	8.136	8.142
* EMISSIONSRATE *											
ERNOX	\$/MBTU	0.096	0.106	0.109	0.113	0.090	0.089	0.089	0.109	0.109	0.105
ERCO	\$/MBTU	0.344	0.331	0.310	0.278	0.355	0.335	0.323	0.163	0.035	0.103
ERUHC	\$/MBTU	14.902	13.215	2.265	0.083	4.418	4.551	2.832	0.039	0.012	0.012
* EMISSIONS FOR FAR *											
FARCO2	\$/FA	0.150	0.166	0.177	0.196	0.152	0.163	0.172	0.207	0.228	0.221
FAR02	\$/FA	0.183	0.209	0.220	0.234	0.188	0.199	0.220	0.265	0.289	0.278
EAG1	PCNT	91.441	92.476	98.679	99.911	97.382	97.268	98.262	99.958	99.989	99.979
EAG2	PCNT	79.718	81.810	96.797	99.815	93.854	93.493	95.822	99.911	99.980	99.961
FARR	-	0.917	0.924	0.913	0.925	0.850	0.849	0.845	0.972	0.991	0.956

MISCELLANEOUS

COMBUSTOR OUTLET TEMPERATURES											
TOUTX1	DEGF	1320.205	1467.260	1609.219	1684.152	1489.037	1543.905	1598.870	1706.590	1795.597	1768.764
TOUTX2	DEGF	1438.637	1613.230	1747.597	1846.060	1585.101	1656.448	1726.499	1872.430	2014.880	1937.876
TOUTX3	DEGF	1332.115	1490.823	1612.493	1712.128	1516.073	1591.073	1646.023	1763.949	1844.871	1823.275
TOUTX4	DEGF	1289.977	1416.287	1555.456	1616.331	1480.821	1536.544	1578.578	1691.490	1773.040	1725.229
TOUTX5	DEGF	1370.228	1547.709	1691.288	1787.434	1554.742	1637.265	1719.848	1862.417	1987.709	1933.106
TOUTX6	DEGF	1381.150	1546.086	1678.248	1775.506	1492.073	1559.244	1633.432	1749.852	1858.243	1802.314
COMBUSTOR OUTLET TEMPERATURES											
TOUT1	DEGF	1287.535	1473.856	1610.674	1753.588	1463.702	1549.867	1649.862	1841.416	2000.932	1841.775
TOUT2	DEGF	942.908	1331.763	1535.829	1629.603	1241.768	1278.465	1291.191	1392.079	1530.970	1554.645
TOUT3	DEGF	1287.535	1473.856	1610.674	1753.588	1463.702	1549.867	1649.862	1841.416	2000.932	1841.775
TOUT4	DEGF	942.908	1331.763	1535.829	1629.603	731.777	735.954	840.208	1531.000	1638.358	1497.773
TOUT5	DEGF	1270.807	1406.733	1541.221	1621.980	1442.358	1502.088	1559.422	1668.913	1757.432	1721.877
TOUT6	DEGF	1270.807	1406.556	1541.221	1621.980	1442.358	1502.088	1559.422	1469.280	1757.432	1721.877
MEASURED PRESSURE DROPS											
IPCDP	PSI	8.476	9.107	9.874	9.704	14.988	16.361	17.613	17.605	17.794	19.011
CATDP	PSI	4.877	5.448	6.102	6.071	6.449	7.167	7.930	8.388	8.992	9.843

ORIGINAL PAGE IS
OF POOR QUALITY

TABLE A-6
LOW HEATING VALUE—STEADY STATE DATA

	28	27	25	26	29	30	31	32
	13:20:47	13:13:47	13: 1:47	13: 6:47	13:58:47	14: 5:57	14:12:57	14:23:57
**OPERATING CONDITIONS:								
TIN	697.158	691.334	683.945	678.225	697.011	687.245	683.376	676.086
FIN	72.849	73.948	73.134	72.727	73.785	71.273	74.640	75.535
#FUEL GAS COMPOSITION:								
C0	29.131	29.043	28.891	28.956	28.589	28.674	28.757	28.895
C02	20.856	21.042	21.361	21.229	20.472	20.686	20.581	20.686
H2	19.156	18.979	18.675	18.803	19.555	19.506	19.457	19.380
CH4	2.539	2.504	2.443	2.469	2.891	2.837	2.783	2.699
N2	27.937	28.049	28.239	28.161	28.107	28.019	27.932	27.794
H2S	0.150	0.150	0.151	0.150	0.153	0.156	0.159	0.164
H2O	0.226	0.228	0.236	0.227	0.217	0.212	0.214	0.214
NH3	0.000	0.000	0.000	0.000	0.000	0.000	0.000	0.000
LHV	169.663	168.373	166.696	167.487	172.228	171.870	171.514	170.946
* FUEL *								
WFP	0.158	0.169	0.178	0.194	0.250	0.284	0.299	0.325
WFS	0.000	0.000	0.000	0.000	0.000	0.000	0.000	0.000
WFT	0.158	0.169	0.178	0.194	0.250	0.284	0.299	0.325
PERCFS	0.000	0.000	0.000	0.000	0.000	0.000	0.000	0.000
TEMPF	80.413	80.589	81.470	80.413	79.355	78.650	78.474	78.827
* AIR *								
MAP	1.310	1.310	1.308	1.310	2.135	2.134	2.135	2.136
MAD	0.000	0.000	0.000	0.000	0.000	0.000	0.000	0.000
MAD	1.520	1.507	1.277	1.272	1.516	1.509	1.514	1.512
MAT	2.830	2.817	2.585	2.582	3.651	3.643	3.649	3.648
PERCAP	46.290	46.503	50.600	50.736	58.477	58.509	58.509	58.553
PERCAD	0.000	0.000	0.000	0.000	0.000	0.000	0.000	0.000
PERCAD	53.710	53.497	49.400	49.264	41.523	41.422	41.491	41.447
RFAIRV	62.589	61.349	61.540	61.669	100.700	99.147	98.373	96.633
NACH FT/SEC*1000	37.936	37.273	37.503	37.671	61.038	60.339	59.964	59.082
HUMID	0.000	0.001	0.001	0.001	0.001	0.001	0.001	0.001
* LEAN BURNER *								
FARS	0.121	0.129	0.136	0.148	0.117	0.133	0.140	0.152
PHIS	0.187	0.197	0.206	0.225	0.187	0.211	0.221	0.239
TMMS	697.158	691.334	683.945	678.225	697.011	687.245	683.376	676.086
ADFTS	1797.042	1797.042	1826.367	1904.790	1747.907	1849.402	1869.437	1958.878
PERFORMANCE								
ROT	1449.085	1500.911	1543.570	1610.231	1396.451	1455.926	1515.865	1589.381
ETATC	0.710	0.732	0.752	0.760	0.666	0.661	0.690	0.712
ETAT	95.656	95.659	96.586	99.429	96.988	96.988	97.347	97.350
PF	17.983	16.554	15.917	14.736	18.979	17.433	16.385	15.965
POUT	63.773	64.831	64.139	63.366	56.650	56.732	56.691	56.976
DELFFR	12.459	12.329	12.299	12.871	23.223	23.617	24.047	24.570
DFFRAY	0.065	0.068	0.074	0.081	0.158	0.171	0.184	0.197
NOZDEP	1.791	2.279	2.727	3.256	2.686	4.762	5.799	7.468
#MEASURED EMISSIONS#								
NOXPMU	11.087	12.071	12.904	12.766	10.360	11.897	12.364	11.955
COFFMD	70.456	71.596	74.014	77.530	80.574	82.137	84.180	86.036
COFD	0.000	0.000	0.000	0.000	0.000	0.000	0.000	0.000
UMCPMU	2859.200	2873.850	2523.800	868.150	2824.600	2777.800	2629.200	2635.350
CO2FD	5.731	6.016	4.328	6.899	5.156	5.767	6.167	6.586
CO2FD	15.918	15.696	11.370	14.686	16.476	15.934	15.651	15.038
* SAE SMOKE								
EMISSIONS AT 15% C28	13.129	13.685	13.768	12.121	13.878	11.134	13.898	12.034
CORNOX	83.434	81.168	78.970	73.618	107.932	97.585	94.620	86.601
CORCOD	0.000	0.000	0.000	0.000	0.000	0.000	0.000	0.000
CORCOP	0.000	0.000	2692.784	824.348	3783.643	3300.246	2955.283	2652.640
CORCNC	3385.876	3258.052	2692.784	7.694	8.743	8.561	8.480	8.480

BOLDOUT FRAME

ORIGINAL PAGE IS
OF POOR QUALITY

CORCOP PCNT 824.348 3783.663 0.000 2692.784 0.121 0.129 0.134 0.148 0.117 0.133 0.140 0.152
 CORUMC PPMV 3385.874 3258.052 8.554 8.554 0.187 0.197 0.206 0.225 0.187 0.211 0.221 0.239
 FARS #F/EA 0.121 0.129 0.134 0.148 0.117 0.133 0.140 0.152
 FHS DEG 0.187 0.197 0.206 0.225 0.187 0.211 0.221 0.239
 THMS DEG 697.011 691.334 683.945 678.225 697.011 687.245 683.376 676.086
 ADFTS DEG 1797.042 1797.042 1826.367 1904.790 1747.907 1849.402 1889.437 1958.878

***PERFORMANCE**
 BOT DEG 1500.911 1500.911 1543.570 1610.231 1396.451 1455.926 1515.865 1589.391
 ETATC PCNT 0.732 0.732 0.752 0.760 0.666 0.661 0.690 0.712
 ETAT PCNT 95.659 95.659 96.586 99.429 96.860 96.988 97.347 97.350
 FF PCNT 17.983 16.554 15.917 14.736 18.979 17.433 16.385 15.965
 POUT PCNT 63.773 64.831 63.366 63.366 56.650 56.732 56.691 56.976
 DELPFR PCNT 12.459 12.329 12.299 12.871 23.223 23.617 24.047 24.570
 INFRAY PCNT 0.065 0.068 0.074 0.081 0.158 0.171 0.184 0.197
 NOZDEP PSI 1.791 2.279 2.727 3.256 2.686 4.762 5.799 7.468

MEASURED EMISSIONS*
 NOXFHM PPMV 11.087 12.071 12.904 12.766 16.360 11.897 12.364 11.955
 COFFMD PPMV 70.456 71.596 74.014 77.530 80.574 82.137 84.180 86.036
 COFD PCNT 0.000 0.000 0.000 0.000 0.000 0.000 0.000 0.000
 UMCFNM PPMV 2859.200 2873.850 2523.800 868.150 2824.600 2777.800 2629.200 2635.350
 CO2FD PPMV 5.731 6.016 6.328 6.899 5.156 5.767 6.167 6.586
 O2FD PPMV 15.918 15.696 15.370 14.686 16.496 15.934 15.651 15.038

SAE SMOKE
 EMISSIONS AT 15% O2*
 CORNOX PPMV 13.129 13.685 13.768 12.121 13.878 11.134 13.898 12.034
 CORCOD PPMV 83.434 81.168 78.970 73.618 107.932 97.585 94.620 86.601
 CORCOP PCNT 0.000 0.000 0.000 0.000 0.000 0.000 0.000 0.000
 CORUMC PPMV 3385.874 3258.052 2692.784 824.348 3783.663 3300.246 2955.283 2652.660
 CHDXE PPMV 8.108 8.567 8.826 7.694 8.343 8.561 8.480 7.429

EMISSIONS RATE *
 ERNOX #/MBTU 0.132 0.137 0.130 0.118 0.100 0.102 0.102 0.092
 ERCO #/MBTU 0.497 0.478 0.439 0.422 0.458 0.415 0.407 0.387
 ERUHC #/MBTU 11.906 11.337 8.858 2.798 9.480 8.305 7.537 7.032
 EMISSIONS FOR FAR *
 FARCO2 #F/EA 0.121 0.127 0.132 0.141 0.110 0.122 0.130 0.139
 FARO2 #F/EA 0.149 0.156 0.164 0.174 0.131 0.147 0.154 0.172
 EAG1 PCNT 95.056 95.251 95.994 98.663 94.594 95.201 95.717 95.963
 EAG2 PCNT 88.437 88.870 90.528 96.910 88.476 89.750 90.644 91.182
 FARR PCNT 0.998 0.984 0.971 0.954 0.935 0.919 0.931 0.912

MISCELLANEOUS**
 COMBUSTOR OUTLET TEMP
 TOUTX1 DEG 1498.867 1549.683 1590.345 1648.411 1449.282 1503.518 1562.308 1634.704
 TOUTX2 DEG 1568.452 1419.583 1665.046 1732.247 1512.837 1573.148 1635.798 1717.998
 TOUTX3 DEG 1458.532 1512.037 1561.406 1629.433 1420.713 1489.922 1551.485 1627.777
 TOUTX4 DEG 1402.137 1446.949 1487.420 1559.975 1378.669 1439.864 1499.937 1578.936
 TOUTX5 DEG 1531.508 1562.554 1622.859 1685.608 1485.277 1540.858 1602.860 1679.713
 TOUTX6 DEG 1523.783 1582.556 1623.224 1691.123 1459.244 1518.396 1578.574 1646.934
 COMBUSTOR OUTLET TEMP
 TOUT1 DEG 1389.073 1441.462 1487.241 1553.297 1333.508 1389.600 1448.925 1518.396
 TOUT2 DEG 1384.839 1430.814 1480.812 1553.297 1318.098 1381.312 1438.444 1515.346
 TOUT3 DEG 1389.073 1441.462 1487.241 1553.297 1318.098 1381.312 1438.444 1515.346
 TOUT4 DEG 1384.839 1430.814 1480.812 1553.297 1318.098 1381.312 1438.444 1515.346
 TOUT5 DEG 1429.225 1483.496 1518.220 1581.300 1374.089 1431.879 1492.429 1559.420
 TOUT6 DEG 1428.693 1483.497 1518.219 1581.480 1374.089 1431.702 1492.250 1559.601
 MEASURED PRESSURE DRG
 IPCDP PSI 5.104 5.151 5.315 5.543 12.133 12.495 12.780 13.083
 CATDP PSI 2.893 2.934 3.023 3.237 6.810 7.177 7.460 7.829

2 FOLDOUT FRAME

**TABLE A-7
LOW HEATING VALUE--STEADY STATE DATA**

ORIGINAL PAGE IS
OF POOR QUALITY

	33	34	36	35
	15:15:57	15:19:57	15:31:57	15:23:57
OPERATING CONDITIONS				
TIN				
DEGF				
PIN	697.046	691.814	685.036	678.600
PSIA	142.812	140.329	142.568	141.957
FUEL GAS COMPOSITION				
CO				
PCNT	28.316	28.250	28.052	28.185
H2	21.760	21.810	21.959	21.860
PCNT	18.273	18.263	18.233	18.253
CH4	2.656	2.675	2.733	2.695
PCNT	28.617	28.621	28.633	28.625
H2S	0.161	0.171	0.166	0.166
PCNT	0.215	0.216	0.216	0.215
NH3	0.000	0.000	0.000	0.000
LHV	165.676	165.612	165.426	165.552
BTU/SCF				
* FUEL *				
WFP	0.316	0.337	0.362	0.391
WFS	0.000	0.000	0.000	0.000
WFT	0.316	0.337	0.362	0.391
PERCFS	0.000	0.000	0.000	0.000
TEMPF	78.474	78.650	78.650	78.474
DEGF				
* AIR *				
WAP	2.487	2.486	2.488	2.482
WAG	0.000	0.000	0.000	0.000
WAD	1.729	1.551	1.528	1.532
WAT	4.216	4.037	4.016	4.014
PERCAP	58.990	61.580	61.952	61.834
PERCAD	0.000	0.000	0.000	0.000
RFAIRU	41.010	38.420	38.048	38.166
FT/SEC	60.607	61.376	60.147	59.879
MACH FT/SEC*1000	36.736	37.282	36.626	36.572
HUMID	0.001	0.001	0.001	0.001
PCNT				
* LEAN BURNER *				
FARS	0.127	0.136	0.145	0.158
PHIS	0.190	0.203	0.217	0.235
TMMS	697.046	691.814	685.836	678.600
ADFTS	1758.094	1808.913	1865.732	1937.370
DEGF				
PERFORMANCE				

ROT	1462.117	1474.219	1526.224	1594.615
DEGF				
ETATC	0.721	0.700	0.712	0.728
ETAT	97.832	97.852	98.305	99.206
PF	17.837	17.819	16.669	15.202
PCNT	131.375	128.811	130.928	130.154
PSIG	8.008	8.208	8.165	8.314
DELFFR	0.063	0.067	0.069	0.075
DFFRAY	4.172	5.129	6.186	7.591
NOZDEP				
PSI				
* MEASURED EMISSIONS*				
NOXPMW	11.815	12.639	14.161	14.908
PPHV	73.957	74.364	79.117	80.070
COFFMD	0.000	0.000	0.000	0.000
COPD	2446.500	2441.600	2037.850	1178.250
UHCPMW	3.660	5.968	6.458	6.952
CO2PD	16.123	15.875	15.342	14.705
O2PD				
PPHV				
* SAE SMOKE				
EMISSIONS AT 15% O2*				
CORNOX	14.593	14.840	15.032	14.198
PPHV	91.348	87.313	83.982	76.254
CORCOD	0.000	0.000	0.000	0.000
CORCOP	3021.794	2866.755	2163.147	1122.098
CORUHC	9.649	9.851	10.100	9.463
CNDXE				

FOLDOUT FRAME

ORIGINAL PAGE IS
OF POOR QUALITY

ROD	1462.117	1474.219	1526.224	1594.615
DEGF	0.721	0.700	0.712	0.728
ETATC	5.832	97.852	98.305	99.206
ETAT	17.837	17.819	16.669	15.202
PF	131.375	128.811	130.928	130.154
POUT	8.008	8.208	8.165	8.314
DELFFR	0.063	0.067	0.069	0.075
DFFRAY	4.172	5.129	6.186	7.591
NOZDEP				

MEASURED EMISSIONS

NOXPMW	11.815	12.639	14.161	14.908
PPHV	73.957	74.364	79.117	80.070
COFFMD	0.000	0.000	0.000	0.000
COFD	2446.500	2441.600	2037.850	1178.250
UHCPMW	5.660	5.968	6.458	6.952
CO2FD	16.123	15.875	15.342	14.705
O2FD				

* SAE SMOKE

EMISSIONS AT 15% O2*

CORNOX	14.593	14.840	15.032	14.198
PPHV	91.348	87.313	83.982	76.254
CORCOD	0.000	0.000	0.000	0.000
CORCOP	3021.794	2866.755	2163.147	1122.098
CORUHC	9.649	9.851	10.100	9.463
CNOXE				

* EMISSIONS RATE *

ERNOX	0.111	0.108	0.113	0.111
ERC0	0.412	0.375	0.372	0.349
ERUHC	8.041	7.270	5.667	3.046

* EMISSIONS FOR FAR *

FARCO2	0.118	0.125	0.134	0.143
FF/FA	0.142	0.149	0.162	0.176
FAR02	95.685	95.901	96.790	98.224
EAG1	90.110	90.625	92.573	95.940
EAG2	0.929	0.919	0.923	0.908
FARR				

MISCELLANEOUS

COMBUSTOR OUTLET TEMPERATURE

TOUTX1	1480.813	1493.498	1555.632	1608.855
DEGF	1582.196	1576.330	1649.127	1717.070
TOUTX2	1476.352	1493.856	1552.386	1613.036
DEGF	1432.589	1444.306	1502.444	1555.453
TOUTX4	1528.453	1541.041	1600.138	1658.088
DEGF	1542.481	1556.537	1603.405	1668.892
TOUTX6	1406.026	1417.880	1476.707	1552.027
DEGF	1423.725	1431.171	1459.420	1559.242
TOUT2	1406.026	1417.880	1476.707	1552.027
DEGF	1423.725	1431.171	1459.420	1559.242
TOUT3	1421.422	1433.477	1489.743	1545.901
DEGF	1421.599	1433.477	1489.564	1545.541
TOUT5	7.499	7.741	7.875	8.112
DEGF	4.159	4.341	4.494	4.696
TOUT6				
DEGF				

COMBUSTOR OUTLET TEMPERATURE

TOUT1	1406.026	1417.880	1476.707	1552.027
DEGF	1423.725	1431.171	1459.420	1559.242
TOUT2	1406.026	1417.880	1476.707	1552.027
DEGF	1423.725	1431.171	1459.420	1559.242
TOUT3	1421.422	1433.477	1489.743	1545.901
DEGF	1421.599	1433.477	1489.564	1545.541
TOUT4				
DEGF				
TOUT5				
DEGF				
TOUT6				
DEGF				

MEASURED PRESSURE DROP

IFCDP	7.499	7.741	7.875	8.112
PSI	4.159	4.341	4.494	4.696
CATDP				

2 FOLDOUT FRAME

TABLE A-8
MEDIUM HEATING VALUE - STEADY STATE DATA

DATA POINT	71	70	69	72	68	77	73	76	65	75
TIME	20:59:55	20:51:55	20:45:55	21: 6:55	20:37:55	21:12:55	21:34:55	19:56:55	21:28:55	
OPERATING CONDITIONS										
TIN	495.598	494.272	492.186	488.003	487.752	486.040	485.346	483.526	484.198	480.336
PIN	71.872	72.564	72.320	72.157	72.808	71.994	72.849	73.419	73.459	73.581
FUEL GAS COMPOSITION										
CO	44.635	44.670	44.643	44.608	44.572	44.455	44.582	44.490	44.214	44.514
CO2	23.526	23.559	23.622	23.498	23.731	23.350	23.473	23.383	24.287	23.407
H2	26.413	26.418	26.383	26.467	26.326	26.582	26.486	26.557	26.036	26.537
CH4	4.505	4.461	4.459	4.543	4.476	4.740	4.576	4.697	4.560	4.664
N2	0.500	0.501	0.500	0.499	0.499	0.496	0.499	0.497	0.493	0.497
H2S	0.199	0.199	0.199	0.200	0.199	0.202	0.200	0.202	0.202	0.201
H2O	0.183	0.183	0.183	0.177	0.187	0.170	0.176	0.170	0.199	0.173
NH3	0.000	0.000	0.000	0.000	0.000	0.000	0.000	0.000	0.000	0.000
LHV	257.573	257.216	257.015	257.902	256.781	259.526	258.170	259.159	255.596	258.893
* FUEL *										
WFP	0.144	0.149	0.157	0.169	0.173	0.173	0.177	0.183	0.190	0.194
WFS	0.000	0.000	0.000	0.000	0.000	0.000	0.000	0.000	0.000	0.000
WFT	0.144	0.149	0.157	0.169	0.173	0.173	0.177	0.183	0.190	0.194
PERCFS	0.000	0.000	0.000	0.000	0.000	0.000	0.000	0.000	0.000	0.000
TEMPF	76.185	76.185	76.185	75.129	76.713	74.074	75.129	74.074	78.298	74.602
* AIR *										
WAP	1.588	1.587	1.585	1.584	1.588	1.588	1.587	1.587	1.587	1.589
WAS	0.000	0.000	0.000	0.000	0.000	0.000	0.000	0.000	0.000	0.000
WAD	1.750	1.764	1.761	1.765	1.762	1.770	1.761	1.771	1.756	1.766
WAT	3.348	3.351	3.346	3.349	3.350	3.358	3.349	3.358	3.343	3.355
PERCAP	47.431	47.359	47.370	47.298	47.403	47.290	47.417	47.260	47.472	47.362
PERCAD	0.000	0.000	0.000	0.000	0.000	0.000	0.000	0.000	0.000	0.000
PERCAV	52.569	52.641	52.630	52.702	52.597	52.710	52.583	52.740	52.528	52.638
RFAIRV	63.508	62.775	62.770	62.596	62.177	62.766	61.984	61.346	61.306	61.080
MACH	42.166	41.708	41.748	41.720	41.446	41.875	41.367	40.979	40.972	40.868
HUMID	0.002	0.002	0.002	0.002	0.002	0.002	0.002	0.002	0.002	0.002
* LEAN BURNER *										
FAPS	0.091	0.094	0.099	0.106	0.109	0.107	0.112	0.115	0.120	0.122
PHIS	0.229	0.237	0.249	0.269	0.273	0.280	0.284	0.294	0.298	0.311
TMMS	495.598	494.272	492.186	488.003	487.752	486.040	485.346	483.526	484.198	480.336
ADFS	1811.453	1848.095	1901.990	1992.453	2003.811	2034.632	2052.274	2097.274	2112.527	2168.453

TABLE A-8 (Continued)
MEDIUM HEATING VALUE - STEADY STATE DATA

***PERFORMANCE**		71	70	69	72	68	77	73	76	65	75
ROT	DEGF	1333.370	1353.399	1364.303	1477.324	1489.522	1515.969	1542.163	1602.268	1595.977	1675.163
ETATC	PCNT	63.667	63.459	61.661	65.901	65.860	66.507	67.495	69.327	68.277	70.779
ETAT	PCNT	78.037	93.131	93.687	94.791	94.083	82.629	84.324	95.786	99.437	99.348
FF	PCNT	14.622	16.104	17.248	13.791	18.154	12.246	13.083	12.296	11.024	14.470
FSIG	PCNT	59.135	59.499	58.970	58.723	58.889	53.441	58.929	59.296	59.011	59.133
DELFFR	PCNT	17.725	18.005	18.660	18.311	19.117	18.825	19.108	19.236	19.668	19.636
DELFRAY	PCNT	0.109	0.110	0.112	0.111	0.127	0.134	0.134	0.139	0.138	0.149
NOZIEP	PSI	1.669	1.709	1.953	2.151	3.297	3.378	3.895	3.052	3.745	3.256
MEASURED EMISSIONS											
NOXFMW	PPMV	9.915	10.200	10.273	12.405	11.901	11.600	12.448	16.676	16.651	22.052
COFMD	PPMV	0.000	0.000	0.000	0.000	0.000	0.000	0.000	0.000	0.000	0.000
COFD	PPMV	2.149	2.313	2.212	2.208	2.241	2.267	2.298	0.999	1.472	0.032
UHC FMW	PPMV	4056.200	0.322	0.322	3972.400	0.322	3132.350	2651.650	656.134	1911.750	-0.996
CO2FD	PPMV	5.327	5.524	5.803	6.395	6.634	6.634	6.959	8.264	7.695	9.545
CO2FE	PPMV	16.602	16.470	16.222	15.623	15.304	15.350	14.972	13.959	14.423	12.778
* SAE SMOKE											
EMISSIONS AT 15% O2											
COKNOX	PPMV	13.611	13.584	12.955	13.871	12.547	12.333	13.384	14.191	15.167	16.020
COFCOD	PPMV	0.000	0.000	0.000	0.000	0.000	0.000	0.000	0.000	0.000	0.000
COFCOF	PPMV	2.950	3.030	2.790	2.469	2.362	2.410	2.287	0.849	1.341	0.023
COXUHC	PPMV	5568.376	0.429	0.406	4441.590	0.339	3330.186	2639.125	557.708	1741.376	-0.724
COXDE	PPMV	10.492	10.508	10.083	10.668	9.867	9.354	10.270	10.797	12.606	12.116
* EMISSIONS RATE *											
ERNOX	\$/MBTU	0.094	0.094	0.090	0.101	0.095	0.091	0.104	0.125	0.123	0.156
ERCO	\$/MBTU	118.713	123.837	112.823	103.923	104.000	102.874	102.506	43.185	62.716	1.311
ERUHC	\$/MBTU	13.426	0.001	0.001	11.271	0.001	8.589	7.152	1.714	4.914	-0.002
* EMISSIONS FOR FAR											
FARCO2	\$/FAR	0.111	0.110	0.112	0.127	0.125	0.130	0.134	0.131	0.131	0.135
FAR02	\$/FAR	0.128	0.116	0.120	0.149	0.139	0.151	0.158	0.156	0.153	0.167
EAG1	PCNT	81.696	86.187	87.081	83.907	88.184	84.928	85.786	94.248	90.497	99.844
EAG2	PCNT	64.861	76.932	78.830	69.094	80.218	71.816	73.198	89.994	82.898	99.754
FARR	-	1.223	1.168	1.135	1.193	1.145	1.191	1.203	1.141	1.095	1.106
***MISCELLANEOUS**											
*COMBUSTOR OUTLET TEMI											
TOUTX1	DEGF	1380.783	1410.976	1430.992	1525.398	1598.531	1578.212	1602.860	1669.441	1646.751	1718.921
TOUTX2	DEGF	1380.078	1409.561	1432.233	1543.201	1579.130	1557.617	1619.037	1659.368	1634.886	1724.092
TOUTX3	DEGF	1387.659	1418.233	1433.830	1519.474	1570.465	1544.819	1587.445	1654.794	1633.609	1716.707
TOUTX4	DEGF	1307.483	1418.587	1431.159	1525.039	1561.410	1554.731	1657.083	1640.360	1581.831	1681.182
TOUTX5	DEGF	1450.347	1483.669	1505.667	1602.863	1661.026	1615.581	1672.741	1732.410	1711.725	1810.540
TOUTX6	DEGF	1450.347	1483.669	1505.667	1602.863	1661.026	1615.581	1672.741	1732.410	1711.725	1810.540
*COMBUSTOR OUTLET TEMI											
TOUT1	DEGF	1309.717	1420.181	1427.445	1532.945	1578.228	1553.108	1605.584	1664.678	1656.257	1744.072
TOUT2	DEGF	1238.641	1272.193	1285.765	1357.376	1394.722	1388.189	1405.317	1459.776	1415.400	1497.790
TOUT3	DEGF	1238.641	1272.193	1285.765	1357.376	1394.722	1388.189	1405.317	1459.776	1415.400	1497.790
TOUT4	DEGF	973.459	871.746	801.516	1053.255	741.509	1316.173	1136.999	1252.710	1461.046	1337.371
TOUT5	DEGF	1344.205	1370.215	1399.310	1518.218	1554.374	1521.806	1591.794	1642.368	1648.213	1838.857
TOUT6	DEGF	1380.078	1409.561	1432.233	1543.201	1579.130	1557.617	1619.037	1659.368	1634.886	1724.092
*MEASURED PRESSURE DRI											
IFCDP	PSI	6.800	6.864	8.954	9.381	9.565	9.579	9.654	9.768	9.746	10.039
CATDP	PSI	6.800	7.045	7.045	7.515	7.704	7.739	7.813	8.004	7.891	8.309

TEMPERATURE*

OP*

ORIGINAL PAGE IS
OF POOR QUALITY

TABLE A-9
MEDIUM HEATING VALUE—STEADY STATE DATA

	40	41	42	43	34	32	33	67	74	66
	14:56:57	15: 5:57	15:11:57	15:17:57	13:14:57	12:46:47	12:59:47	20:26:55	21:18:55	20: 5:55
OPERATING CONDITIONS										
TIN	505.150	490.987	482.733	479.860	509.139	493.659	493.044	481.556	478.395	478.767
PIN	73.907	74.029	73.988	74.029	73.215	72.605	73.134	73.785	73.785	74.029
FUEL GAS COMPOSITION										
CO	43.485	43.377	43.300	43.236	44.584	44.021	44.280	44.476	44.557	44.293
CO2	28.352	28.558	28.590	28.472	26.155	27.058	26.641	23.880	23.449	24.165
H2	23.104	22.984	22.981	23.080	24.474	24.125	24.286	26.248	26.505	26.100
CH4	4.094	4.108	4.156	4.240	3.914	3.920	3.917	4.498	4.609	4.541
N2	0.497	0.500	0.500	0.498	0.466	0.474	0.470	0.498	0.498	0.495
H2S	0.211	0.213	0.214	0.215	0.191	0.189	0.190	0.200	0.201	0.201
H2O	0.248	0.251	0.251	0.251	0.214	0.216	0.215	0.191	0.174	0.194
NH3	0.000	0.000	0.000	0.000	0.000	0.000	0.000	0.000	0.000	0.000
LHV	240.938	240.391	240.565	241.399	246.595	243.881	245.133	256.461	258.444	255.862
** FUEL **										
WFP	0.081	0.093	0.102	0.117	0.171	0.206	0.217	0.196	0.202	0.208
WFS	0.000	0.000	0.000	0.000	0.000	0.000	0.000	0.000	0.000	0.000
WFT	0.081	0.093	0.102	0.117	0.171	0.206	0.217	0.196	0.202	0.208
PERCFS	0.000	0.000	0.000	0.000	0.000	0.000	0.000	0.000	0.000	0.000
TEMPF	83.234	83.587	83.587	83.587	79.531	79.531	79.531	77.241	74.778	77.594
** AIR **										
WAF	0.848	0.844	0.848	0.848	1.688	1.688	1.687	1.587	1.589	1.586
WAO	0.000	0.000	0.000	0.000	0.000	0.000	0.000	0.000	0.000	0.000
WAD	1.738	1.747	1.743	1.738	1.535	1.545	1.545	1.755	1.763	1.761
WAT	2.586	2.591	2.591	2.586	3.223	3.233	3.232	3.342	3.352	3.347
PERCAP	32.792	32.574	32.729	32.792	52.374	52.212	52.197	47.487	47.405	47.386
PERCAQ	0.000	0.000	0.000	0.000	0.000	0.000	0.000	0.000	0.000	0.000
PERCAO	67.208	67.426	67.271	67.208	47.626	47.788	47.803	52.513	52.595	52.614
PERCAV	33.309	32.612	32.500	32.383	67.208	66.690	66.126	60.914	60.736	60.495
MACH FT/SEC#1000	22.011	21.703	21.719	21.672	44.323	44.322	43.961	40.732	40.711	40.509
HUMID	0.002	0.002	0.002	0.002	0.002	0.001	0.001	0.002	0.002	0.002
** LEAN BURNER **										
FARS	0.096	0.110	0.120	0.137	0.101	0.122	0.129	0.123	0.127	0.131
PHIS	0.211	0.242	0.263	0.303	0.234	0.276	0.294	0.309	0.323	0.326
TRMS	505.150	490.987	482.733	479.860	509.139	493.659	493.044	481.556	478.395	478.767
AUFTS	1724.885	1857.064	1943.243	2114.064	1846.990	2019.990	2097.990	2156.990	2215.632	2225.990

TABLE A-9 (Continued)
MEDIUM HEATING VALUE—STEADY STATE DATA

**PERFORMANCE#	40	41	42	43	34	32	33	67	74	66
ROT	1545.566	1527.637	1688.308	1847.760	1452.212	1780.125	1870.141	1647.091	1746.820	1762.414
IEGF	85.399	75.885	82.545	83.704	70.492	84.285	85.803	69.566	73.014	73.468
ETAT	95.509	96.413	99.509	99.449	90.432	99.541	99.190	99.343	99.367	99.027
FCNT	11.592	11.438	17.239	15.514	18.352	49.098	38.973	23.088	25.640	25.213
FF	65.744	65.907	66.459	66.459	59.825	57.464	57.546	59.092	59.133	59.133
FSIG	9.692	9.621	10.176	10.226	18.289	20.854	21.314	19.913	19.858	20.122
DELFFR	0.037	0.034	0.041	0.047	0.134	0.186	0.196	0.144	0.157	0.157
DIFFRAY	1.282	1.282	2.849	2.442	3.012	4.232	4.436	3.785	4.151	5.372
NOZDEF										
**MEASURED EMISSIONS*										
NJXPMU	14.978	14.819	21.594	23.606	12.988	17.416	17.841	20.839	22.207	24.136
FFMU	16.860	653.245	25.051	21.015	0.000	1.901	0.000	0.000	0.000	0.000
COFPMU	0.000	0.000	0.000	0.000	0.340	0.000	0.404	0.015	0.012	0.438
CGFD	2382.650	1791.250	27.750	15.100	3680.150	3.055	-0.405	0.054	15.950	-3.655
UHCPMU	6.968	7.161	9.595	10.512	6.477	9.214	9.800	9.681	9.911	10.261
CO2FR	15.395	15.487	13.446	12.674	15.760	13.309	12.709	12.648	12.487	12.530
O2FD										
** SAE SMOKE										
EMISSIONS AT 15% O2*										
CORNDX	16.024	16.152	17.091	16.932	14.907	13.537	12.851	14.899	15.574	17.013
FFMU	18.038	712.017	19.828	15.073	0.000	1.478	0.000	0.000	0.000	0.000
CORCOD	0.000	0.000	0.000	0.000	0.391	0.000	0.291	0.010	0.008	0.309
CORCOF	2549.097	1952.406	21.964	10.831	4224.091	2.375	-0.292	0.038	11.186	-2.576
CORUHC	21.729	22.533	23.949	23.344	15.235	15.464	13.933	11.889	11.922	13.967
CNOXE										
** EMISSIONS/RATE *										
ERNDX	0.221	0.192	0.258	0.245	0.110	0.126	0.122	0.149	0.152	0.164
ERCO	0.146	4.987	0.174	0.127	16.892	0.008	16.037	0.602	0.477	17.079
ERUHC	12.224	8.102	0.115	0.055	10.840	0.008	-0.001	0.000	0.038	-0.009
** EMISSIONS FOR FAR *										
FARCO2	0.097	0.100	0.131	0.144	0.098	0.127	0.141	0.136	0.140	0.151
FAR02	0.127	0.123	0.160	0.177	0.127	0.162	0.180	0.171	0.174	0.179
EAG1	96.574	97.086	99.958	99.976	92.488	99.996	98.146	99.929	99.926	98.086
EAG2	91.685	93.780	99.903	99.950	84.847	99.995	96.619	99.889	99.874	96.675
FARR	1.014	0.904	1.090	1.047	0.970	1.038	1.096	1.108	1.103	1.153
** MISCELLANEOUS**										
COMBUSTOR OUTLET TEMPE										
TOUTX1	1591.635	1574.097	1732.779	1860.117	1535.283	1743.331	1813.722	1733.704	1787.005	1789.243
IEGF	1555.111	1540.184	1729.082	1971.167	1469.220	1771.362	1866.716	1737.776	1820.274	1819.712
TOUTX2	1524.880	1511.524	1686.324	1835.093	1487.065	1697.909	1796.521	1754.641	1803.432	1821.398
IEGF	1472.441	1463.198	1601.953	1682.100	1472.606	1647.674	1709.332	1674.942	1725.570	1706.748
TOUTX4	1660.501	1634.585	1829.462	1994.024	1615.401	1865.395	1988.639	1878.236	1954.687	1979.600
IEGF	1660.501	1634.585	1829.462	1994.024	1615.401	1865.395	1988.639	1878.236	1954.687	1979.600
TOUTX6	1594.022	1547.023	1755.198	1950.089	1503.699	1757.610	1894.137	1785.888	1850.509	1933.859
IEGF	1304.812	1297.133	1407.616	1481.883	1326.150	1480.098	1534.022	1510.325	1539.059	1546.080
TOUT2	1304.812	1297.133	1407.616	1481.883	1326.150	1480.098	1534.022	1510.325	1539.059	1546.080
IEGF	1653.705	1639.996	1644.386	1937.320	932.945	1713.203	1812.038	661.708	1112.085	1137.703
TOUT3	1640.567	1614.310	1886.179	2049.753	1539.241	1897.545	2046.259	1901.532	2055.198	2069.231
IEGF	1593.809	1578.077	1749.632	1935.769	1546.983	1762.253	1848.820	1737.776	1820.274	1819.712
TOUT6	2.898	2.884	3.162	3.366	8.860	10.210	10.570	10.153	10.427	10.391
IPCDP	2.322	2.296	2.595	2.821	6.747	8.147	8.585	8.423	8.728	8.721
CATDP										

ORIGINAL PAGE IS
OF POOR QUALITY

ORIGINAL PAGE IS
OF POOR QUALITY

TABLE A-10
MEDIUM HEATING VALUE—STEADY STATE DATA

	63	64	60	61	62	28	30	31
	18:47:27	18:53:27	18:26:27	9:31:27	18:32:27	11:53:47	12: 7:47	12:14:47
OPERATING CONDITIONS								
TIN	486.908	483.457	496.855	496.363	494.793	509.143	497.088	493.657
FIN	145.743	147.493	145.091	146.353	146.475	143.301	145.458	146.434
FUEL GAS COMPOSITION								
CO	43.610	43.662	43.426	43.470	43.478	44.058	43.329	43.331
CO2	25.231	25.150	25.516	25.448	25.434	26.531	28.130	28.083
H2	25.546	25.588	25.397	25.433	25.439	24.419	23.719	23.730
CH4	4.703	4.690	4.746	4.735	4.733	4.109	3.943	3.927
N2	0.483	0.484	0.480	0.481	0.481	0.492	0.485	0.482
H2S	0.205	0.205	0.207	0.206	0.206	0.184	0.185	0.186
H2O	0.211	0.209	0.217	0.216	0.217	0.212	0.217	0.218
NH3	0.000	0.000	0.000	0.000	0.000	0.000	0.000	0.000
LHV	253.610	253.782	253.001	253.145	253.170	246.537	240.747	240.798
* FUEL *								
WFP	0.202	0.212	0.172	0.179	0.184	0.297	0.369	0.387
WFS	0.000	0.000	0.000	0.000	0.000	0.000	0.000	0.000
WFT	0.202	0.212	0.172	0.179	0.184	0.297	0.369	0.387
PERCFS	0.000	0.000	0.000	0.000	0.000	0.000	0.000	0.000
TEMPF	79.708	79.531	80.589	80.413	80.589	79.179	79.355	79.531
* AIR *								
WAP	1.638	1.641	1.639	1.641	1.641	2.994	3.238	3.238
WAS	0.000	0.000	0.000	0.000	0.000	0.000	0.000	0.000
WAD	1.718	1.721	1.721	1.715	1.715	0.000	0.000	0.000
WAT	3.356	3.362	3.360	3.356	3.356	1.645	1.610	1.609
PERCAP	48.808	48.810	48.780	48.897	48.897	4.848	4.848	4.847
PERCAR	0.000	0.000	0.000	0.000	0.000	64.540	66.790	66.804
PERCAD	51.192	51.190	51.250	51.103	51.103	0.000	0.000	0.000
KFAIRU	32.011	31.573	32.512	32.255	32.175	35.460	33.210	33.196
MACH FT/SEC*1000	21.347	21.092	21.573	21.407	21.371	60.905	64.084	63.429
HUMID	0.002	0.002	0.002	0.002	0.002	40.166	42.517	42.155
* LEAN BURNER *								
FARS	0.123	0.129	0.105	0.109	0.112	0.099	0.114	0.120
PHIS	0.301	0.316	0.255	0.265	0.273	0.229	0.252	0.264
TMMS	486.908	483.457	496.855	496.363	494.793	509.143	497.088	493.657
ADFTS	2121.064	2181.064	1926.064	1971.064	2005.064	1818.990	1909.990	1963.990

ORIGINAL PAGE IS
OF POOR QUALITY

TABLE A-10 (Continued)
MEDIUM HEATING VALUE--STEADY STATE DATA

PERFORMANCE		63	64	60	61	62	28	30	31
RO1	DEGF	1742.464	1764.890	1498.729	1557.780	1616.100	1302.754	1399.387	1501.074
ETAIC	FCNT	76.893	75.485	70.100	71.975	72.598	60.588	63.861	68.516
ETA1	FCNT	99.449	99.352	96.921	99.622	99.483	96.030	96.886	97.960
PF	FCNT	19.085	20.654	22.531	22.653	23.699	30.048	25.045	19.239
POUT	PSIG	135.893	137.480	135.608	136.666	135.649	126.451	126.044	126.410
DELFFR	FCNT	6.758	6.789	6.536	6.619	6.537	11.758	13.347	13.674
DFFRAY	FCNT	0.043	0.043	0.033	0.036	0.040	0.093	0.119	0.132
NOZDEP	PSI	3.805	3.325	3.358	3.195	3.398	3.988	5.677	6.960
MEASURED EMISSIONS									
NOXFMW	PPMV	23.724	22.469	13.938	15.149	17.949	10.922	11.801	14.210
COFFMD	PPMV	299.836	89.446	34.587	256.893	14.864	25.867	9.099	2.593
COFD	FCNT	0.000	0.000	0.000	0.000	0.000	0.000	0.000	0.000
UNCFMW	PPMV	0.043	0.513	2519.000	555.709	9.200	3866.950	3520.200	2627.650
CO2FD	PPMV	9.525	10.014	6.851	7.845	8.938	5.998	6.725	7.387
O2FD	PPMV	13.029	12.774	15.151	14.404	13.515	16.413	15.882	15.180
* SAE SMOKE EMISSIONS AT 15% O2*									
CORNOX	PPMV	17.783	16.314	14.305	13.759	14.340	14.361	13.875	14.657
CORCOF	PPMV	224.776	64.946	35.497	233.333	11.875	34.011	10.697	2.664
CORCOP	FCNT	0.000	0.000	0.000	0.000	0.000	0.000	0.000	0.000
CORUHC	PPMV	0.032	0.372	2585.275	504.743	7.350	5084.408	4138.729	2710.220
CNOXE	PPMV	16.341	14.858	13.571	12.954	13.377	15.360	18.252	19.159
* EMISSIONS RATE *									
ERNOX	\$/MBTU	0.169	0.153	9.117	0.122	0.137	0.078	0.074	0.086
ERCO	\$/MBTU	1.237	0.352	0.169	1.204	0.066	0.108	0.034	0.009
ERUHC	\$/MBTU	0.000	0.001	7.341	1.558	0.024	9.571	7.729	5.512
* EMISSIONS FOR FAR *									
FARCO2	\$/FA	0.133	0.140	0.098	0.110	0.124	0.087	0.096	0.104
FAR02	\$/FA	0.164	0.169	0.128	0.136	0.153	0.110	0.122	0.133
EAG1	FCNT	99.853	99.958	96.296	99.116	99.981	93.741	94.859	96.442
EAG2	FCNT	99.761	99.934	92.481	98.168	99.967	87.430	89.406	92.407
FARR	-	1.083	1.087	0.936	1.009	1.078	0.878	0.844	0.871
MISCELLANEOUS									
*COMBUSTOR OUTLET									
TOUTX1	DEGF	1730.391	1771.361	1557.797	1610.490	1661.016	1383.255	1453.548	1593.789
TOUTX2	DEGF	1750.569	1807.919	1559.782	1630.511	1669.808	1374.798	1462.268	1564.114
TOUTX3	DEGF	1767.841	1816.903	1548.061	1613.944	1674.025	1375.149	1458.886	1535.821
TOUTX4	DEGF	1670.545	1691.103	1497.790	1540.139	1605.041	1351.407	1415.223	1484.383
TOUTX5	DEGF	1948.413	2009.064	1712.094	1785.327	1868.226	1525.404	1610.853	1683.568
TOUTX6	DEGF	1948.413	2009.064	1712.094	1785.327	1868.226	1525.404	1610.853	1683.568
*COMBUSTOR OUTLET									
TOUT1	DEGF	1866.917	1933.669	1566.823	1607.403	1703.985	1421.251	1507.280	1589.982
TOUT2	DEGF	1517.319	1538.159	1362.122	1381.488	1444.127	1229.100	1312.850	1373.736
TOUT3	DEGF	1517.319	1538.159	1362.122	1381.488	1444.127	1229.100	1312.850	1373.736
TOUT4	DEGF	1482.056	1214.936	990.102	1037.462	1069.574	1102.223	1161.991	1456.411
TOUT5	DEGF	1971.222	2040.426	1556.175	1689.267	1715.231	1428.513	1499.579	1603.586
TOUT6	DEGF	1750.569	1807.919	1559.782	1630.511	1669.808	1416.466	1479.384	1570.075
*MEASURED PRESSURE DROP									
IPCDP	PSI	5.625	5.726	5.216	5.358	5.503	12.029	14.308	14.691
CATDP	PSI	4.613	4.745	4.147	4.298	4.469	8.685	9.994	9.994

ORIGINAL PAGE IS
OF POOR QUALITY

TABLE A-11
MEDIUM HEATING VALUE--STEADY STATE DATA

	2	78	4	79	7	80	6	3	5
	5: 7:52	22: 9:55	5:43:52	22:22:55	6:12:52	22:28:55	6: 3:52	5:33:52	5:57:52
* OPERATING CONDITIONS*									
TIN	562.056	560.841	559.035	551.435	555.101	559.541	552.625	553.675	551.027
PIA	72.198	71.587	70.977	71.343	72.279	72.482	71.994	71.506	71.913
* FUEL GAS COMPOSITIONS*									
CO	44.391	44.340	44.047	44.285	44.570	44.259	44.407	44.001	44.300
CO2	24.912	23.238	25.048	23.185	24.761	23.150	24.850	25.079	24.910
H2	25.302	26.669	25.351	26.710	25.372	26.730	25.365	25.339	25.361
CH4	4.549	4.888	4.707	4.959	4.446	4.972	4.527	4.731	4.581
H2	0.539	0.493	0.534	0.492	0.542	0.491	0.539	0.533	0.538
H2S	0.176	0.204	0.168	0.205	0.166	0.205	0.166	0.170	0.167
H2O	0.122	0.166	0.134	0.164	0.138	0.163	0.138	0.136	0.135
NH3	0.000	0.000	0.000	0.000	0.000	0.000	0.000	0.000	0.000
LHV	254.051	260.735	254.520	261.324	253.877	261.595	254.073	254.557	254.213
* FUEL *									
WFP	0.160	0.159	0.171	0.164	0.183	0.173	0.190	0.186	0.194
WFS	0.000	0.000	0.000	0.000	0.000	0.000	0.000	0.000	0.000
WFT	0.160	0.159	0.171	0.164	0.183	0.173	0.190	0.186	0.194
PERCFS	0.000	0.000	0.000	0.000	0.000	0.000	0.000	0.000	0.000
TEMPF	64.417	73.546	66.872	73.195	67.749	73.019	67.749	67.223	67.047
* AIR *									
MAP	1.509	1.438	1.513	1.435	1.510	1.436	1.511	1.510	1.511
MAD	0.000	0.000	0.000	0.000	0.000	0.000	0.000	0.000	0.000
MAU	1.508	1.706	1.508	1.705	1.502	1.701	1.505	1.503	1.507
MAT	3.017	3.144	3.021	3.140	3.012	3.137	3.016	3.013	3.018
PERCAP	50.017	45.738	50.083	45.701	50.133	45.776	50.099	50.116	50.066
PERCAD	0.000	0.000	0.000	0.000	0.000	0.000	0.000	0.000	0.000
PERFAIRV	49.983	54.262	49.917	54.299	49.867	54.224	49.901	49.884	49.934
MACH FT/SEC*1000	64.254	61.680	65.339	61.798	63.787	60.756	63.926	64.386	63.897
HUMID	41.313	39.680	42.070	39.745	41.147	39.110	41.284	41.561	41.297
FCNT	0.001	0.002	0.001	0.002	0.001	0.002	0.001	0.001	0.001
* LEAN BURNER *									
FARS	0.106	0.110	0.113	0.114	0.121	0.120	0.126	0.123	0.129
PHIS	0.258	0.285	0.277	0.296	0.295	0.313	0.307	0.302	0.314
TMMS	562.054	560.841	559.035	561.435	555.101	559.541	552.625	553.675	551.027
ALFYS	2000.770	2119.917	2078.949	2167.917	2158.949	2237.738	2205.307	2180.949	2233.307

TABLE A-11 (Continued)
MEDIUM HEATING VALUE—STEADY STATE DATA

	2	78	4	79	7	80	6	3	5
PERFORMANCE									
ROT	1608.898	1597.073	1685.093	1612.855	1807.098	1704.807	1871.730	1830.796	1906.550
DEGF	72.762	66.466	74.087	65.449	78.062	68.244	79.816	78.482	80.577
ETATC	98.193	94.729	99.013	99.191	99.439	99.345	99.631	99.631	99.406
ETAT	18.355	13.379	16.539	14.757	17.986	21.604	16.605	18.193	15.776
PF	61.046	58.089	59.092	58.644	59.865	59.540	59.418	59.214	59.296
FOUT	15.446	17.738	14.745	17.800	17.175	17.855	17.190	17.190	17.545
DELFFR	0.122	0.112	0.137	0.114	0.147	0.121	0.156	0.153	0.160
DIFFRAY	1.343	1.954	2.197	2.930	1.628	2.341	1.913	2.401	2.360
NOZIEP									
MEASURED EMISSIONS									
NOXPH	9.131	14.775	14.552	16.501	15.476	18.479	16.032	17.351	17.161
COFFM	996.931	0.000	996.931	0.000	742.228	0.000	111.328	109.767	46.776
COF	0.000	0.475	0.000	0.218	0.000	0.009	0.000	0.000	0.000
UHCFFM	1271.900	931.408	588.900	57.125	-0.443	-3.092	-0.464	1.600	-0.345
CO2FD	6.910	8.135	7.868	8.614	8.839	9.256	9.189	4.978	9.537
O2FD	15.192	13.336	14.451	13.700	13.582	13.342	13.334	13.153	13.061
* SAE SMOKE									
EMISSIONS AT 15% O2*									
CORNOX	9.438	12.341	13.314	13.522	12.478	14.425	12.502	13.213	12.917
CORCO	1030.420	0.000	912.098	0.000	598.428	0.000	86.814	83.595	35.207
CORCOP	0.000	0.397	0.000	0.187	0.000	0.007	0.000	0.000	0.000
CORUHC	1314.625	777.987	538.788	46.812	-0.357	-2.414	-0.361	1.218	-0.260
CNOXE	8.376	9.264	11.991	10.100	10.896	10.751	11.021	11.940	11.460
* EMISSIONS RATE *									
ERNOX	0.074	0.118	0.110	0.127	0.110	0.135	0.110	0.121	0.115
ERCO	4.706	21.930	4.380	10.135	3.050	0.377	0.441	0.452	0.181
ERUHC	3.573	2.593	1.548	0.154	-0.001	-0.008	-0.001	0.004	-0.001
* EMISSIONS FOR FAR *									
FARCO2	0.098	0.122	0.111	0.125	0.124	0.131	0.128	0.068	0.133
FAR02	0.123	0.152	0.136	0.149	0.152	0.154	0.157	0.154	0.163
EAG1	97.496	96.321	98.653	98.728	99.611	99.958	99.944	99.894	99.977
EAG2	95.304	93.379	97.471	97.955	99.382	99.942	99.915	99.908	99.968
FARR	0.930	1.111	0.983	1.092	1.023	1.085	1.018	0.553	1.034
MISCELLANEOUS									
#COMBUSTOR OUTLET TEMPE									
TOUTX1	1685.599	1672.927	1769.136	1698.645	1891.869	1773.783	1963.296	1926.852	2003.333
TOUTX2	1629.059	1673.295	1690.556	1697.908	1800.634	1785.518	1869.739	1837.193	1908.968
TOUTX3	1593.978	1651.141	1671.280	1676.410	1797.085	1747.598	1849.757	1804.956	1873.723
TOUTX4	1582.565	1663.763	1647.303	1686.508	1765.044	1755.572	1797.455	1770.448	1812.416
TOUTX5	1788.803	1726.680	1859.748	1757.424	2018.927	1848.069	2049.414	2049.414	2108.043
TOUTX6	1545.547	1726.680	1611.585	1757.424	1708.045	1799.891	1744.302	1744.302	1856.397
#COMBUSTOR OUTLET TEMPE									
TOUT1	1656.082	1645.640	1750.009	1685.774	1891.488	1810.353	1961.955	1908.784	2005.070
TOUT2	1429.931	1489.029	1496.003	1511.222	1596.512	1579.118	1635.798	1599.786	1652.605
TOUT3	1479.569	1489.029	1573.335	1511.222	1703.258	1579.118	1758.357	1716.195	1792.260
TOUT4	1549.512	1104.123	1466.207	982.896	1738.154	1006.917	1797.641	1752.813	1823.475
TOUT5	1686.884	1649.316	1755.761	1690.922	1906.862	1939.056	2009.265	1954.769	2059.965
TOUT6	1679.172	1673.295	1750.195	1697.908	1867.291	1785.518	1939.586	1904.037	1982.346
*MEASURED PRESSURE DROP									
IPCDDP	7.782	8.541	8.386	8.696	8.795	8.873	8.991	8.753	9.078
CATDP	6.014	6.928	6.617	7.156	7.142	7.443	7.314	7.067	7.411

ORIGINAL PAGE IS
OF POOR QUALITY

ORIGINAL PAGE IS
OF POOR QUALITY

TABLE A-12
MEDIUM HEATING VALUE--STEADY STATE DATA

	8	9	12	10	11	44	45	81
	6:49:52	6:54:52	7:26:52	7: 3:52	7:11:52	15:49:57	15:53:57	22:40:55
* OPERATING CONDITIONS*								
TIN	579.276	559.337	554.279	545.888	540.504	618.537	615.112	598.752
FIN	144.481	145.498	144.399	146.027	143.056	73.948	74.029	72.686
* FUEL GAS COMPOSITION*								
CO	45.238	45.327	45.159	45.490	45.482	42.899	42.855	44.209
CO2	24.395	24.345	25.042	24.256	24.385	27.847	27.768	23.111
H2	25.400	25.403	24.969	25.410	25.323	23.608	23.674	26.768
CH4	4.113	4.068	3.970	3.987	3.954	4.688	4.744	5.057
N2	0.551	0.553	0.548	0.555	0.555	0.490	0.489	0.490
H2S	0.162	0.162	0.164	0.161	0.161	0.220	0.221	0.206
H2O	0.141	0.143	0.150	0.143	0.144	0.242	0.245	0.160
NH3	0.000	0.000	0.000	0.000	0.000	0.000	0.000	0.000
LHV	253.064	252.949	250.329	252.753	252.187	245.862	246.411	262.138
* FUEL *								
WFP	0.270	0.298	0.381	0.332	0.359	0.073	0.092	0.144
WFS	0.000	0.000	0.000	0.000	0.000	0.000	0.000	0.000
WFT	0.270	0.298	0.381	0.332	0.359	0.083	0.092	0.144
PERCFS	0.000	0.000	0.000	0.000	0.000	0.000	0.000	0.000
TEMPF	68.276	68.802	69.856	68.802	68.802	82.881	83.234	72.491
* AIR *								
WAF	2.895	2.953	2.954	2.953	2.954	0.810	0.810	1.441
WAD	0.000	0.000	0.000	0.000	0.000	0.000	0.000	0.000
WAD	1.464	1.476	1.463	1.478	1.477	1.615	1.615	1.659
WAT	4.359	4.429	4.417	4.431	4.431	2.425	2.425	3.100
PERCAP	66.414	66.674	66.878	66.644	66.667	33.402	33.402	46.484
PERCAD	0.000	0.000	0.000	0.000	0.000	0.000	0.000	0.000
PERCAD	33.586	33.326	33.122	33.356	33.333	66.598	66.598	53.516
RFAIRV	62.637	62.228	62.411	61.184	62.142	35.535	35.383	63.135
MACH FT/SEC	39.953	40.061	40.275	39.640	40.363	22.270	22.208	39.916
HUMID	0.001	0.001	0.001	0.001	0.001	0.002	0.002	0.002
* LEAN BURNER *								
FAPS	3.093	0.101	0.101	0.112	0.121	0.103	0.114	0.100
FHIS	0.226	0.245	0.245	0.272	0.292	0.235	0.262	0.262
THMS	579.276	559.337	554.279	545.888	540.504	618.537	615.112	598.752
ADFTS	1871.485	1943.843	2205.664	2055.307	2140.843	1932.064	2049.064	2046.917

TABLE A-12 (Continued)
MEDIUM HEATING VALUE - STEADY STATE DATA

	8	9	12	10	11	44	45	81
***PERFORMANCE**								
ROT	1462.059	1543.565	1848.825	1643.320	1757.220	1774.694	1905.636	1527.607
ETATC	68.316	71.089	78.392	72.706	76.029	88.019	89.998	64.140
ETAT	96.131	97.616	99.455	98.675	99.500	99.619	99.512	83.209
PF	21.201	19.864	21.271	20.518	20.203	13.324	12.762	12.315
FSIG	128.323	128.119	124.538	127.957	124.049	66.581	66.459	60.476
DELFFR	11.183	11.944	13.754	12.374	13.286	9.962	10.226	16.798
DFFRAY	0.095	0.109	0.145	0.120	0.139	0.037	0.042	0.098
NOZDEP	0.855	1.303	5.515	3.765	4.233	1.790	1.709	0.794
MEASURED EMISSIONS								
NOXPMW	10.879	12.102	19.038	11.915	14.467	16.095	17.978	10.029
COFPMW	13.368	17.464	216.537	505.802	3.634	192.309	118.415	0.000
COFD	0.000	0.000	0.000	0.000	0.000	0.000	0.000	1.755
UHCPMW	3664.700	2768.900	-1.713	1602.800	27.958	8.775	8.775	2674.450
CO2FD	5.554	6.179	9.657	6.738	8.623	8.692	9.317	6.257
CO2D	16.559	15.985	12.943	15.068	13.889	14.056	13.460	15.922
* SAE SMOKE								
EMISSIONS AT 152 02:								
CORNOX	14.788	14.529	14.117	12.054	12.175	13.876	14.256	11.888
CORCOD	18.172	20.966	160.564	511.677	3.058	165.790	93.904	0.000
CORCOP	0.000	0.000	0.000	0.000	0.000	0.000	0.000	2.093
CORUHC	4981.392	3324.145	-1.270	1621.419	23.529	7.565	6.959	3170.117
CNOXE	12.428	12.147	12.705	9.987	10.221	17.571	17.864	8.820
* EMISSIONS RATE *								
ERNOX	0.076	0.078	0.100	0.070	0.079	0.210	0.212	0.086
ERCO	0.055	0.064	0.656	1.733	0.012	1.465	0.810	87.285
ERUHC	8.911	6.213	-0.003	3.261	0.053	0.040	0.036	7.959
* EMISSIONS FOR FAR								
FARCO2	0.082	0.089	0.134	0.096	0.120	0.119	0.128	0.117
FAR02	0.104	0.113	0.133	0.128	0.147	0.144	0.156	0.130
EAG1	93.615	95.556	99.897	97.269	99.964	99.886	99.931	86.663
EAG2	87.937	91.487	99.833	95.034	99.927	99.779	99.868	75.777
FARR	0.876	0.881	1.044	0.854	0.986	1.154	1.117	1.164
***MISCELLANEOUS**								
*COMBUSTOR OUTLET TEM								
TOUTX1	1538.519	1606.129	1872.756	1692.760	1798.203	1802.497	1970.774	1602.679
TOUTX2	1426.736	1541.759	1838.285	1646.936	1758.725	1813.157	2014.089	1595.602
TOUTX3	1496.539	1573.871	1861.812	1669.810	1772.853	1745.925	1867.849	1563.211
TOUTX4	1464.050	1527.372	1777.503	1619.221	1709.884	1698.276	1758.014	1582.737
TOUTX5	1436.527	1726.679	2107.620	1854.656	1989.417	1919.194	2070.846	1633.610
TOUTX6	1356.322	1456.750	1791.481	1563.213	1702.331	1919.194	2060.846	1633.610
TOUT1	1497.969	1583.823	1946.649	1694.766	1825.527	1860.492	2029.760	1581.831
TOUT2	1355.092	1422.837	1663.029	1501.730	1588.715	1511.222	1620.675	1439.331
TOUT3	1437.160	1491.009	1777.750	1554.553	1694.785	1511.222	1620.675	1439.331
TOUT4	1403.563	1491.009	1777.334	1601.051	1706.416	1771.364	1763.571	1099.991
TOUT5	1502.981	1584.728	1936.338	1664.130	1784.401	1919.765	2046.446	1563.753
TOUT6	1497.254	1570.798	1825.335	1656.991	1755.385	1824.022	2014.088	1595.602
*MEASURED PRESSURE DR								
IPCDP	12.348	13.089	14.829	13.470	14.365	3.193	3.407	8.276
CATDP	9.033	9.840	9.994	9.994	9.994	2.630	2.838	6.684

ORIGINAL PAGE IS
OF POOR QUALITY

TABLE A-13 MEDIUM HEATING VALUE--STEADY STATE DATA

	58	59	55	57	84	82	83
17:55:27	18: 2:27	17:37:27	17:46:27	23:16:45	22:58:45	23: 4:45	
OPERATING CONDITIONS							
IN	586.783	582.800	594.781	589.532	670.867	649.124	651.707
FIN	145.743	145.743	145.051	145.132	73.581	70.854	72.075
FUEL GAS COMPOSITIONS							
CO	42.075	42.695	42.620	41.750	44.348	44.227	44.268
CO2	28.185	26.929	27.871	29.017	23.144	23.096	23.113
H2	23.995	24.656	23.990	23.519	26.689	26.761	26.738
CH4	4.833	4.807	4.619	4.805	4.966	5.061	5.029
N2	0.480	0.479	0.474	0.479	0.489	0.489	0.489
H2S	0.199	0.204	0.192	0.195	0.209	0.207	0.208
H2O	0.228	0.222	0.236	0.233	0.158	0.161	0.158
NH3	0.000	0.000	0.000	0.000	0.000	0.000	0.000
LHV	245.592	249.125	245.378	242.981	261.536	262.210	261.991
FUEL *							
WFP	0.177	0.185	0.147	0.168	0.120	0.143	0.148
WFS	0.000	0.000	0.000	0.000	0.000	0.000	0.000
WFT	0.177	0.185	0.147	0.168	0.120	0.143	0.148
PERCFS	0.000	0.000	0.000	0.000	0.000	0.000	0.000
TEMP	81.118	80.765	82.176	81.470	72.140	72.667	72.140
AIR *							
MAP	1.547	1.543	1.546	1.546	1.337	1.336	1.337
MAD	0.000	0.000	0.000	0.000	0.000	0.000	0.000
MAD	1.637	1.633	1.635	1.632	1.623	1.632	1.629
MAT	3.184	3.176	3.181	3.178	2.960	2.968	2.966
PERCAP	48.587	48.583	48.601	48.647	45.169	45.013	45.078
PERCAD	0.000	0.000	0.000	0.000	0.000	0.000	0.000
PERCAD	51.413	51.417	51.399	51.353	54.831	54.987	54.922
PERAIR	33.421	33.208	33.815	33.628	61.807	62.905	62.029
MACH FT/SLC1000	21.245	21.148	21.418	21.350	37.872	38.902	38.318
HUMID	0.002	0.002	0.002	0.002	0.001	0.001	0.001
LEAN BURNER *							
FARS	0.114	0.120	0.095	0.105	0.090	0.107	0.111
PHIS	0.262	0.283	0.218	0.244	0.233	0.279	0.289
THMS	586.783	582.800	594.781	589.532	670.867	649.124	651.707
ADFTS	2022.064	2116.064	1830.064	1942.706	1981.096	2155.917	2214.917

ORIGINAL PAGE IS
OF POOR QUALITY

TABLE A-13 (Continued)
MEDIUM HEATING VALUE - STEADY STATE DATA

	58	59	55	57	84	82	83
***PERFORMANCE**							
FOI	1727.752	1811.482	1525.718	1610.992	1568.925	1656.142	1748.808
DEGF	75.454	80.135	75.362	75.485	68.542	66.391	70.183
FCNT	99.512	99.413	99.452	99.485	83.743	97.824	99.360
ETA1C	18.965	19.589	15.450	17.529	15.709	13.264	19.246
ETA1	136.219	135.893	135.893	135.812	62.348	59.092	59.784
FF	6.535	6.758	6.314	6.422	15.266	16.600	17.053
FOU1	0.033	0.037	0.028	0.030	0.080	0.076	0.101
DELFFR	2.523	2.889	1.933	3.683	-0.040	1.221	1.059
NOZIEF							
MEASURED EMISSIONS*							
NOXFMV	19.705	22.986	13.378	12.868	10.520	13.635	17.860
COXFMV	140.513	32.784	13.662	557.901	0.000	0.000	0.050
COXFD	0.000	0.000	0.000	0.000	1.067	0.426	0.004
UHCXFMV	1.920	1.715	1547.050	154.135	2823.850	493.941	-2.921
COXFD	8.932	9.351	6.422	8.237	5.667	7.796	8.437
OXFD	13.727	13.407	15.910	14.144	16.574	14.482	13.993
* SAE SMOKE							
EMISSIONS AT 15% O2†							
CORNOX	16.207	18.099	15.819	11.237	14.355	12.534	15.257
FCMV	122.152	25.815	16.155	487.196	0.000	0.000	0.000
CORCOF	6.000	0.000	0.000	0.000	1.455	0.392	0.004
CORUHC	1.579	1.350	1829.269	134.601	3851.075	454.057	-2.496
COXVE	21.480	20.341	20.098	16.714	10.683	9.267	11.321
* EMISSIONSRATE *							
ERNOX	0.162	0.175	0.131	0.113	0.103	0.113	0.143
ERCO	6.711	0.145	0.079	2.869	60.912	20.453	0.196
ERUHC	0.006	0.005	5.285	0.473	9.629	1.427	-0.008
* EMISSIONS FOR FAR †							
FARCO2	0.123	0.129	0.089	0.113	0.098	0.116	0.119
FARCO2	0.151	0.157	0.110	0.143	0.110	0.136	0.140
EAG1	99.921	99.982	97.560	99.493	88.707	96.963	99.980
EAG2	99.861	99.973	94.667	99.961	79.819	94.845	99.977
FARR	1.079	1.077	0.938	1.039	1.093	1.089	1.069
MISCELLANEOUS							
*COMBUSTOR OUTLET TEMP							
TOUTX1	1787.939	1900.012	1597.433	1663.394	1586.539	1710.251	1838.474
DEGF	1780.483	1908.554	1560.700	1651.140	1562.907	1716.338	1809.606
DEGF	1782.997	1858.232	1565.395	1642.186	2038.878	1656.624	1724.646
DEGF	1708.960	1780.858	1509.082	1583.790	1508.175	1697.174	1774.711
DEGF	1930.047	2037.515	1660.307	1778.249	1613.398	1779.180	1931.382
DEGF	1930.047	2037.515	1660.307	1778.249	1613.398	1779.180	1931.382
DEGF	1811.101	2002.894	1581.304	1668.526	1654.235	1747.409	1937.347
DEGF	1537.800	1622.861	1390.839	1443.061	1399.132	1555.813	1622.495
DEGF	1537.800	1622.861	1390.839	1443.061	1399.132	1555.813	1622.495
DEGF	1304.119	1033.009	1251.668	1345.259	1001.749	1193.605	1139.580
DEGF	1861.249	2024.918	1580.039	1673.845	1876.630	1765.974	1943.975
DEGF	1780.483	1908.554	1560.700	1651.140	1567.907	1716.338	1809.606
MEASURED PRESSURE DRI							
IPCDF	5.285	5.566	4.906	5.061	7.458	8.036	8.360
PCDF	4.306	4.603	3.853	4.038	6.046	6.667	7.024

ORIGINAL PAGE IS
OF POOR QUALITY

ORIGINAL PAGE IS
OF POOR QUALITY

TABLE A-14
MEDIUM HEATING VALUE—STEADY STATE DATA

	13	17	18	19	20
	8:18:52	8:48:52	8:56:52	9: 7:52	9:14:52
OPERATING CONDITIONS					
TIN	656.355	648.437	643.933	640.843	638.018
FIN	145.865	147.371	144.410	145.865	147.778
FUEL GAS COMPOSITION					
CO	44.041	43.399	43.227	42.991	42.841
CO2	27.319	28.634	28.984	29.466	29.772
H2	23.745	23.041	22.852	22.594	22.429
C44	4.028	4.062	4.071	4.083	4.091
N2	0.525	0.512	0.509	0.504	0.501
H2S	0.173	0.178	0.179	0.181	0.182
H2O	0.172	0.179	0.183	0.185	0.188
NH3	0.000	0.000	0.000	0.000	0.000
LHV	243.893	240.194	239.203	237.848	236.982
* FUEL *					
WFP	0.245	0.310	0.332	0.349	0.365
WFS	0.000	0.000	0.000	0.000	0.000
WFT	0.245	0.310	0.332	0.349	0.365
PERCFS	0.000	0.000	0.000	0.000	0.000
TEMPF	72.843	73.546	74.074	74.250	74.502
* AIR *					
WAP	2.666	2.755	2.756	2.756	2.760
WAO	0.000	0.000	0.000	0.000	0.000
WAD	1.410	1.406	1.406	1.404	1.404
WAT	4.076	4.161	4.162	4.160	4.164
PERCAP	65.407	66.210	66.218	66.250	66.282
PERCAD	0.000	0.000	0.000	0.000	0.000
PERCAU	34.593	33.790	33.782	33.750	33.718
RFAIRV	61.372	62.328	63.357	62.563	61.684
MACH	37.837	38.556	39.269	38.828	38.329
HUMID	0.001	0.001	0.001	0.001	0.001
* LEAN BURNER *					
FARS	0.092	0.113	0.120	0.126	0.132
PHIS	0.207	0.246	0.261	0.271	0.282
TMMS	656.355	648.437	643.933	640.843	638.018
ADFTS	1844.022	2011.380	2072.917	2111.917	2151.917

ORIGINAL PAGE IS
OF POOR QUALITY

TABLE A-14 (Continued)
MEDIUM HEATING VALUE - STEADY STATE DATA

	13	17	18	19	20
PERFORMANCE					
BT	1528.641	1685.285	1736.467	1755.403	1835.393
ETATC	73.445	76.074	76.455	75.765	79.092
ETAT	97.558	99.560	99.580	99.524	99.472
PF	16.093	19.694	19.057	18.909	19.343
POUT	130.684	130.114	126.532	127.794	129.259
DELFFR	10.408	11.710	12.398	12.389	12.532
DPFKAY	0.078	0.098	0.107	0.107	0.112
NOZDEP	0.569	2.726	4.009	4.660	4.822
MEASURED EMISSIONS:					
NOXPMW	11.229	15.804	12.845	19.422	19.357
COFFMD	15.589	11.817	16.555	12.533	10.399
COPD	0.000	0.000	0.000	0.000	0.000
UHCPMW	2557.650	360.240	20.618	3.665	-2.440
CO2FD	5.707	7.393	8.692	9.233	9.675
O2FD	16.458	14.866	14.013	13.826	13.706
*SAE SMOKE					
EMISSIONS AT 15% O2*					
CORNOX	14.914	15.454	11.005	16.200	15.876
CORCOD	20.705	11.555	14.183	10.454	8.529
CORCOF	0.000	0.000	0.000	0.000	0.000
CORLHC	3396.958	352.255	17.664	3.057	-2.001
CNOXE	17.618	21.787	16.293	25.678	26.288
EMISSIONSRATE					
ERNDX	0.087	0.103	0.079	0.116	0.111
ERCO	0.071	0.045	0.060	0.044	0.035
ERUHC	6.867	0.817	0.044	0.008	-0.005
EMISSIONS FOR FAR					
FARCO2	0.080	0.100	0.118	0.125	0.131
FAR02	0.104	0.129	0.148	0.152	0.156
EAG1	95.579	99.491	99.966	99.990	99.998
EAG2	90.834	98.870	99.927	99.984	100.003
FARR	0.875	0.889	0.977	0.988	0.990
MISCELLANEOUS					
*COMBUSTOR OUTLET TEMP					
TOUTX1	1550.404	1672.376	1713.202	1726.679	1788.871
TOUTX2	1532.764	1688.531	1735.556	1755.012	1826.460
TOUTX3	1510.863	1683.938	1733.707	1758.724	1831.526
TOUTX4	1488.135	1653.516	1697.726	1710.987	1766.342
TOUTX5	1658.453	1874.083	1928.908	1949.898	2049.759
TOUTX6	1482.062	1656.259	1712.095	1731.671	1810.351
*COMBUSTOR OUTLET TEMP					
TOUT1	1554.550	1738.148	1790.924	1818.401	1919.768
TOUT2	1429.750	1555.092	1597.598	1613.398	1663.212
TOUT3	1460.311	1599.050	1671.643	1701.406	1768.386
TOUT4	1547.887	1655.354	1705.832	1718.562	1796.149
TOUT5	1591.250	1757.614	1815.970	1835.657	1974.805
TOUT6	1537.260	1689.451	1734.446	1744.444	1829.090
*MEASURED PRESSURE DROP					
IPCDDP	10.499	12.354	13.014	13.069	13.282
CATDP	7.598	9.467	9.994	9.994	9.994

ORIGINAL PAGE IS
OF POOR QUALITY

TABLE A-15
MEDIUM HEATING VALUE - STEADY STATE DATA

	46	48	47	85	35	36	37	38
	16:17:57	16:25:57	16:20:57	23:22:45	13:57:47	14: 3:47	14: 9:47	14:15:47
* OPERATING CONDITIONS								
TIN DEG	698.262	701.166	687.834	679.135	718.914	712.741	709.796	706.109
PIN PSIA	74.110	74.070	73.948	72.605	74.477	71.628	72.442	72.767
* FUEL GAS COMPOSITION								
C0	42.778	42.851	42.806	44.388	44.424	44.329	44.238	44.147
C02	27.397	27.329	27.371	23.160	26.553	26.728	26.905	27.082
H2	23.979	24.029	23.997	26.665	24.154	24.050	23.947	23.845
CH4	4.898	4.847	4.877	4.935	3.969	3.981	3.994	4.006
N2	0.483	0.481	0.482	0.489	0.473	0.475	0.478	0.480
H2S	0.220	0.216	0.218	0.209	0.199	0.200	0.201	0.202
H2O	0.243	0.246	0.244	0.157	0.221	0.230	0.230	0.230
NH3	0.000	0.000	0.000	0.000	0.000	0.000	0.000	0.000
LHV BTU/SCF	248.405	248.310	248.368	261.312	245.711	245.229	244.765	244.302
* FUEL *								
WFP #/SEC	0.078	0.076	0.078	0.107	0.116	0.119	0.126	0.135
WFS #/SEC	0.000	0.000	0.000	0.000	0.000	0.000	0.000	0.000
WFT #/SEC	0.078	0.076	0.078	0.107	0.116	0.119	0.126	0.135
PERCFS	0.000	0.000	0.000	0.000	0.000	0.000	0.000	0.000
TEMPF DEGF	83.234	83.587	83.410	71.964	80.413	81.470	81.470	81.470
* AIR *								
MAP #/SEC	0.814	0.772	0.700	1.337	1.407	1.277	1.275	1.279
MAQ #/SEC	0.000	0.000	0.000	0.000	0.000	0.000	0.000	0.000
MAO #/SEC	1.557	1.553	1.554	1.621	1.552	1.548	1.549	1.547
MAT #/SEC	2.371	2.325	2.254	2.958	2.959	2.825	2.824	2.826
PERCAP	34.332	33.204	31.056	45.199	47.550	45.204	45.149	45.258
PERCAD	0.000	0.000	0.000	0.000	0.000	0.000	0.000	0.000
PERCAD	65.668	66.796	68.944	54.801	52.450	54.796	54.851	54.742
RFAIRU FT/SEC	38.266	36.402	32.682	63.096	66.991	62.888	61.928	61.650
MACH FT/SEC	23.183	22.028	19.885	38.528	40.247	37.876	37.343	37.231
HUMID FCNT	0.002	0.002	0.002	0.001	0.002	0.002	0.002	0.002
* LEAN BURNER *								
FARS #F/#A	0.096	0.099	0.111	0.080	0.082	0.093	0.099	0.106
PHIS -	0.223	0.230	0.260	0.206	0.188	0.212	0.224	0.239
THMS DEGF	698.262	701.166	687.834	679.135	718.914	712.741	709.796	706.109
ADFTS DEGF	1946.243	1981.064	2101.064	1860.917	1807.064	1919.064	1969.885	2034.885

TABLE A-15 (Continued)
MEDIUM HEATING VALUE - STEADY STATE DATA

PERFORMANCE		46	48	47	85	35	36	37	38
ROT	DEGF	1765.431	1826.027	1971.839	1524.227	1582.633	1671.135	1728.827	1848.670
ETATC	FCNT	85.512	87.887	90.856	71.510	79.375	79.447	80.870	85.986
ETAT	FCNT	99.599	95.531	99.434	82.569	87.869	99.420	89.842	99.624
PF	FCNT	18.163	18.614	16.313	67.160	35.759	10.011	14.161	19.250
POUT	PSIG	66.377	66.500	66.622	61.860	62.592	60.354	60.842	60.883
DELFFR	FCNT	10.434	10.220	9.907	14.799	15.958	15.740	16.013	16.332
DFFRAY	FCNT	0.035	0.032	0.030	0.077	0.083	0.081	0.085	0.095
NOZNEP	FSI	1.628	2.035	1.180	0.203	0.712	0.936	1.831	1.506
MEASURED EMISSIONS									
NOXPHM	PPMV	15.623	17.249	19.783	9.370	11.398	12.637	13.635	16.195
COPFMD	PPMV	82.103	36.081	34.721	0.000	0.000	0.000	0.000	134.248
COPU	FCNT	0.000	0.000	0.000	0.947	0.763	0.010	2.976	0.000
UHCPMH	PPMV	1.715	1.595	1.715	3078.600	2292.700	619.500	1.630	-0.587
CO2FD	PPMV	8.338	8.685	9.658	5.032	6.415	6.808	7.802	8.402
O2FD	PPMV	14.270	13.991	13.169	17.115	15.873	15.690	14.821	14.292
* SAE SMOKE									
EMISSIONS AT 15% O2*									
CORNIX	PPMV	13.903	14.730	15.097	14.606	13.379	14.313	13.234	14.461
CORCOD	PPMV	73.063	30.813	26.498	0.000	0.000	0.000	0.000	119.873
CORCOP	FCNT	0.000	0.000	0.000	0.896	0.011	0.011	2.889	0.000
CORUHC	PPMV	1.326	1.309	1.477	4798.875	2691.123	701.612	1.532	-0.525
CNOXE	PPMV	16.591	17.423	17.956	10.885	14.348	15.685	14.829	16.570
* EMISSIONSRATE *									
ERNOX	\$/MBTU	0.209	0.231	0.252	0.103	0.131	0.135	0.139	0.155
ERUC	\$/MBTU	0.641	0.292	0.256	61.087	51.282	0.633	175.164	0.749
ERUHC	\$/MBTU	0.008	0.007	0.008	11.801	9.146	2.307	0.006	-0.002
* EMISSIONS FOR FAR *									
FARCO2	\$/#A	0.114	0.119	0.133	0.088	0.101	0.093	0.149	0.115
FARO2	\$/#A	0.138	0.144	0.162	0.099	0.124	0.112	0.153	0.140
EAG1	FCNT	99.952	99.979	99.981	87.884	91.977	99.000	87.075	99.926
EAG2	FCNT	99.911	99.963	99.968	78.028	81.497	97.708	68.304	99.870
FARR	-	1.190	1.204	1.193	1.102	1.231	1.003	1.509	1.087
MISCELLANEOUS									
COMBUSTOR OUTLET TEMPERATURE									
TOUTX1	DEGF	1845.258	1949.913	2167.787	1477.064	1561.952	1661.198	1770.245	1811.663
TOUTX2	DEGF	1841.874	1962.734	2158.231	1464.050	1559.606	1686.140	1770.431	1850.508
TOUTX3	DEGF	1781.423	1864.648	2014.124	1682.969	1545.903	1644.559	1711.909	1776.758
TOUTX4	DEGF	1726.686	1792.790	1904.577	1409.031	1493.681	1602.134	1682.650	1753.713
TOUTX5	DEGF	1946.090	2021.439	2159.814	1509.788	1621.591	1741.108	1862.377	1964.633
TOUTX6	DEGF	1946.090	2021.439	2159.814	1509.788	1621.591	1741.108	1862.377	1964.633
COMBUSTOR OUTLET TEMPERATURE									
TOUT1	DEGF	1882.599	1983.449	2120.034	1778.251	1596.151	1708.038	1792.414	1876.157
TOUT2	DEGF	1562.131	1639.448	1732.232	1311.626	1411.689	1488.492	1552.386	1612.671
TOUT3	DEGF	1562.131	1639.448	1732.232	1311.626	1510.687	1594.695	1666.875	1729.081
TOUT4	DEGF	1311.106	1030.255	1209.606	1122.525	1868.420	1759.845	1471.365	2053.059
TOUT5	DEGF	1926.250	2007.135	2136.038	2049.953	1617.401	1737.220	1832.088	1948.558
TOUT6	DEGF	1853.539	1999.629	2167.581	1464.050	1582.923	1689.080	1770.803	1842.609
MEASURED PRESSURE DROP									
IPCDD	PSI	3.527	3.366	3.132	7.165	7.397	6.939	7.169	7.401
CATDF	PSI	2.914	2.799	2.650	5.696	5.747	5.521	5.800	6.037

ORIGINAL PAGE IS
OF POOR QUALITY

ORIGINAL PAGE IS
OF POOR QUALITY

TABLE A-16
MEDIUM HEATING VALUE--STEADY STATE DATA

	52	53	54	51	21	22	24	26	27
	16:57:27	17: 4:27	17:10:07	16:50:27	9:59:52	10: 4:52	10:23:52	10:41:52	10:47:52
* OPERATING CONDITIONS*									
TIN	688.244	687.026	681.827	692.377	723.059	720.008	714.152	707.174	704.015
PIN	144.074	145.539	145.091	144.562	144.684	143.626	146.475	145.254	146.231
* FUEL GAS COMPOSITIONS*									
CO	43.142	43.210	43.256	43.077	43.260	43.375	43.820	44.245	44.386
C02	27.062	27.005	26.954	27.121	29.378	29.213	28.591	28.002	27.806
H2	24.229	24.276	24.314	24.184	22.533	22.603	22.872	23.128	23.213
CH4	4.646	4.601	4.563	4.690	3.934	3.906	3.800	3.700	3.666
N2	0.475	0.474	0.473	0.477	0.508	0.510	0.518	0.526	0.528
H2S	0.202	0.199	0.197	0.205	0.184	0.184	0.184	0.184	0.184
H2O	0.245	0.237	0.237	0.247	0.207	0.212	0.218	0.218	0.218
NH3	0.000	0.000	0.000	0.000	0.000	0.000	0.000	0.000	0.000
LMV	247.962	247.905	247.839	248.036	237.182	237.492	238.695	239.849	240.234
* FUEL *									
W/F	0.140	0.151	0.163	0.131	0.225	0.238	0.270	0.307	0.320
W/S	0.000	0.000	0.000	0.000	0.000	0.000	0.000	0.000	0.000
W/T	0.140	0.151	0.163	0.131	0.225	0.238	0.270	0.307	0.320
FERCFS	0.000	0.000	0.000	0.000	0.000	0.000	0.000	0.000	0.000
TEMPF	83.587	82.528	82.528	83.763	77.418	78.122	79.179	79.355	79.355
* AIR *									
MAP	1.353	1.420	1.418	1.352	2.541	2.543	2.582	2.640	2.640
WAD	0.000	0.000	0.000	0.000	0.000	0.000	0.000	0.000	0.000
WAD	1.556	1.553	1.553	1.559	1.370	1.369	1.542	1.592	1.590
WAT	2.909	2.973	2.971	2.911	3.911	3.912	4.124	4.232	4.230
PERCAP	46.511	47.763	47.728	46.445	64.771	65.005	62.609	62.382	62.411
PERCAD	0.000	0.000	0.000	0.000	0.000	0.000	0.000	0.000	0.000
PERCAD	53.489	52.237	52.272	53.555	35.029	34.995	37.391	37.618	37.589
K/AIRU	32.434	33.662	33.566	32.417	62.454	62.843	62.255	63.808	63.210
MACH FT/SEC*1000	19.731	20.488	20.473	19.687	37.467	37.739	37.474	38.517	38.205
HU*1/D	0.002	0.002	0.002	0.002	0.001	0.001	0.001	0.001	0.001
* LEAN BURNER *									
FARS	0.104	0.106	0.115	0.097	0.060	0.094	0.104	0.116	0.121
PHIS	0.241	0.247	0.267	0.226	0.187	0.201	0.226	0.253	0.265
THMS	688.244	687.026	681.827	692.377	723.059	720.008	714.152	707.174	704.015
ADFTS	2023.243	2049.243	2132.780	1958.064	1809.090	1862.917	1977.453	2099.990	2151.811

TABLE A-16 (Continued)
MEDIUM HEATING VALUE—STEADY STATE DATA

	52	53	54	51	21	22	24	26	27
PERFORMANCE									
FOI	1736.403	1794.271	1903.675	1639.699	1556.189	1601.749	1718.518	1793.710	1870.521
ETATC	78.514	81.283	84.216	74.846	76.713	77.149	79.503	78.369	80.571
EIAT	99.625	99.580	99.446	99.609	97.330	99.038	99.763	99.569	99.517
FF	20.575	18.103	16.332	16.421	17.330	16.414	17.542	17.455	17.565
FOUT	135.690	136.666	136.056	136.504	128.608	127.265	129.015	126.654	127.468
DELFFR	5.819	6.097	6.227	5.574	11.111	11.391	11.920	12.805	12.831
DEFRAY	0.023	0.028	0.032	0.021	0.069	0.074	0.084	0.077	0.102
NOZUEP	1.872	1.994	2.931	2.544	0.591	1.160	2.524	3.745	5.026
MEASURED EMISSIONS									
NOXFMW	19.937	19.140	20.851	14.713	11.229	11.681	14.443	15.379	17.571
COPIHD	75.190	44.211	30.928	727.397	463.003	11.227	7.878	2.807	5.499
COFD	0.000	7.000	0.000	0.000	0.000	0.000	0.000	0.000	0.000
UHCFMW	0.185	-0.283	-0.322	8.733	2403.000	1428.200	105.460	0.820	-1.117
CO2FD	8.374	8.450	8.992	7.653	5.505	6.024	7.333	8.716	9.098
CO2FD	14.408	14.290	13.788	14.943	16.763	16.331	15.112	14.286	13.957
** SAE SMOKE									
EMISSIONS AT 15% O2*									
CORN0X	18.120	17.084	17.297	14.574	16.015	15.085	14.723	13.719	14.930
CORCOD	68.338	39.464	25.656	720.418	660.314	14.499	8.031	2.504	4.673
CORCOP	0.000	0.000	0.000	0.000	0.000	0.000	0.000	0.000	0.000
COFUHC	0.168	-0.252	-0.268	8.450	3427.049	1844.452	107.510	0.732	-0.950
CNOXE	20.710	19.384	19.500	16.782	25.069	23.070	20.633	17.739	18.804
** EMISSIONS RATE *									
ERNOX	0.184	0.169	0.171	0.145	0.095	0.094	0.107	0.103	0.112
ERCO	0.406	0.227	0.147	4.193	2.333	0.053	0.034	0.011	0.021
ERUHC	0.001	-0.001	-0.001	0.030	7.115	3.990	0.273	0.002	-0.002
** EMISSIONS FOR FAR *									
FARCO2	0.115	0.116	0.124	0.105	0.077	0.082	0.099	0.118	0.124
FAR02	0.136	0.138	0.149	0.125	0.098	0.103	0.124	0.142	0.150
EAG1	99.958	99.976	99.584	99.548	95.372	97.613	99.847	99.998	99.998
EAG2	99.930	99.963	99.979	99.196	90.014	94.680	99.642	100.000	100.004
FARR	1.107	1.091	1.078	1.085	0.871	0.877	0.946	1.019	1.021
** MISCELLANEOUS **									
** COMBUSTOR OUTLET TEMP									
TOUTX1	1825.147	1861.623	1981.911	1700.485	1593.064	1637.805	1739.998	1817.277	1888.451
TOUTX2	1836.031	1877.868	2011.965	1705.089	1565.559	1612.125	1721.136	1808.480	1880.504
TOUTX3	1785.327	1821.213	1903.805	1679.346	1542.839	1579.988	1700.854	1774.152	1842.421
TOUTX4	1736.294	1767.037	1837.910	1630.510	1506.025	1553.107	1674.392	1748.705	1803.245
TOUTX5	1936.148	1990.369	2089.371	1783.277	1688.714	1734.629	1880.694	1973.840	2059.288
TOUTX6	1936.148	1990.369	2089.371	1783.277	1688.714	1734.629	1880.694	1973.840	2059.288
** COMBUSTOR OUTLET TEMP									
TOUT1	1887.694	1929.103	2048.782	1760.767	1580.383	1629.234	1769.874	1871.435	1974.224
TOUT2	1603.405	1627.600	1693.861	1504.234	1440.574	1481.169	1582.736	1641.638	1690.919
TOUT3	1603.405	1627.600	1693.861	1504.234	1440.574	1481.169	1582.736	1641.638	1690.919
TOUT4	936.382	1214.375	1422.234	1149.917	1563.753	1604.859	1694.971	1755.755	1808.295
TOUT5	1914.820	1966.182	2059.094	1770.059	1584.366	1631.422	1788.684	1909.120	2013.700
TOUT6	1836.031	1877.868	2011.965	1705.089	1564.114	1607.219	1715.046	1787.564	1857.665
** MEASURED PRESSURE DRG									
IPCUP	4.227	4.636	4.815	4.023	11.007	11.335	12.143	13.348	13.598
CATOP	3.403	3.783	3.966	3.182	8.166	8.552	9.491	9.994	9.994

ORIGINAL PAGE IS
OF POOR QUALITY

ORIGINAL PAGE IS
OF POOR QUALITY

TABLE A-17
MEDIUM HEATING VALUE - STEADY STATE DATA

	107	104	105	106	103	87	86	88	90
3:13:55	2:52:55	2:58:55	3: 5:55	2:33:55	23:48: 5	23:36:45	23:59: 5	0: 7: 5	
TIN	771.676	762.824	754.238	749.130	770.774	750.298	736.489	746.917	741.690
PIN	149.283	143.708	143.708	139.108	145.091	72.482	72.523	72.971	73.622
OPERATING CONDITIONS									
FUEL GAS COMPOSITION									
CO	44.591	44.638	44.624	44.608	44.165	44.556	44.480	44.629	44.252
H2	23.160	23.228	23.208	23.185	23.329	23.227	23.197	23.256	23.106
CH4	26.617	26.354	26.429	26.517	26.624	26.562	26.608	26.517	26.748
N2	4.781	4.917	4.873	4.833	5.018	4.802	4.861	4.744	5.042
H2S	0.485	0.490	0.488	0.487	0.491	0.488	0.489	0.488	0.489
H2O	0.218	0.223	0.222	0.220	0.218	0.211	0.210	0.212	0.208
NH3	0.146	0.157	0.151	0.150	0.157	0.157	0.158	0.157	0.157
LHV	0.000	0.000	0.000	0.000	0.000	0.000	0.000	0.000	0.000
BTU/SCF	260.432	261.100	260.906	260.681	261.242	260.353	260.760	259.937	262.086
*FUEL *									
WFE	0.085	0.103	0.114	0.121	0.239	0.103	0.107	0.115	0.126
WFS	0.000	0.000	0.000	0.000	0.000	0.000	0.000	0.000	0.000
WFT	0.085	0.103	0.114	0.121	0.239	0.103	0.107	0.115	0.126
PERCFS	0.000	0.000	0.000	0.000	0.000	0.000	0.000	0.000	0.000
TEMPF	70.031	70.910	70.910	70.734	71.964	71.964	72.140	71.964	71.964
*AIR *									
MAP	1.227	1.227	1.224	1.227	2.394	1.266	1.263	1.262	1.265
WAG	0.000	0.000	0.000	0.000	0.000	0.000	0.000	0.000	0.000
WAD	1.554	1.555	1.550	1.555	1.571	1.569	1.576	1.564	1.569
WAT	2.781	2.782	2.774	2.782	3.915	2.835	2.839	2.826	2.834
PERCAP	44.121	44.105	44.124	44.105	61.149	44.656	44.487	44.657	44.637
PERCAD	0.000	0.000	0.000	0.000	0.000	0.000	0.000	0.000	0.000
PERCAU	55.879	55.895	55.876	55.895	38.851	55.344	55.513	55.343	55.363
RFAIRV	30.450	31.404	31.107	32.079	61.083	63.585	62.675	62.784	62.106
MACH FT/SEC*1000	17.919	18.544	18.430	19.043	35.959	37.729	37.392	37.303	36.976
HUMID	0.001	0.001	0.001	0.001	0.001	0.001	0.001	0.001	0.001
*LEAN BURNER *									
FARG	0.069	0.084	0.093	0.098	0.100	0.081	0.084	0.091	0.100
FHIS	0.178	0.217	0.240	0.253	0.259	0.209	0.218	0.233	0.261
IMHS	771.676	762.824	754.228	749.130	770.774	750.298	736.489	746.917	741.690
ADFTS	1805.917	1983.559	2083.559	2140.559	2193.201	1937.917	1966.917	2050.095	2164.917

TABLE A-17 (Continued)
MEDIUM HEATING VALUE - STEADY STATE DATA

	107	104	105	106	103	87	86	88	90
PERFORMANCE									
EOT	1374.643	1559.663	1670.174	1734.602	1776.588	1593.374	1641.507	1648.787	1776.266
ETATC	50.300	65.292	68.903	70.824	71.212	70.989	73.553	69.205	72.692
ETAT	84.336	95.478	99.624	99.569	99.434	80.549	83.258	93.554	99.508
PF	14.798	17.277	18.689	22.442	13.828	100.646	75.344	11.173	11.714
FOUT	143.260	137.358	137.033	132.230	128.852	62.063	61.941	62.023	62.267
DELFR	4.035	4.419	4.645	4.944	11.192	14.375	14.591	15.003	15.423
IFFRAY	0.010	0.015	0.016	0.026	0.075	0.070	0.074	0.073	0.083
NOZDEP	0.692	0.773	1.322	1.262	1.038	0.387	0.651	0.203	0.224
MEASURED EMISSIONS									
NOXFMU	5.569	7.066	9.980	11.787	14.693	8.100	8.743	9.769	14.303
COXFMU	0.000	0.000	0.000	0.000	0.000	0.000	0.000	0.000	0.000
COFU	0.558	0.678	0.068	0.010	0.011	0.831	0.858	0.958	0.051
URCFMU	2768.300	395.625	-8.100	-96.025	-21.280	3432.700	2924.750	736.433	11.225
CO2FD	4.116	5.464	6.693	7.191	7.775	5.101	5.352	6.072	7.365
CO2F	17.908	16.541	15.548	15.053	14.752	17.107	16.793	16.045	15.031
* SAC SMOKE									
EMISSIONS AT 15Z 02*									
CORNOX	10.983	9.564	11.002	11.895	14.101	12.599	12.561	11.870	14.379
CORCOU	0.000	0.000	0.000	0.000	0.000	0.000	0.000	0.000	0.000
CORCOF	1.101	0.917	0.076	0.010	0.011	1.293	1.232	1.164	0.051
CORUHC	5854.242	535.487	-8.929	-96.904	-20.422	5339.204	4202.124	894.853	11.284
CHOXE	8.185	7.173	8.236	8.885	10.674	9.447	9.393	8.925	10.663
* EMISSIONS*RATE *									
ERNOX	0.072	0.076	0.097	0.109	0.098	0.089	0.093	0.096	0.127
ERCO	42.777	42.783	3.906	0.560	0.431	53.547	53.235	55.221	2.656
ERUHC	13.412	1.483	-0.028	-0.310	-0.049	13.141	10.806	2.534	0.035
* EMISSIONS FOR FAR *									
FARCO2	0.069	0.086	0.094	0.100	0.109	0.088	0.091	0.099	0.104
FARCO	0.078	0.097	0.109	0.118	0.125	0.100	0.104	0.112	0.119
EAG1	88.610	94.206	99.538	100.072	99.962	88.148	89.171	92.612	99.661
EAG2	80.403	91.065	99.330	100.196	99.962	78.195	80.431	87.644	99.485
FARR	0.998	1.022	1.013	1.023	1.091	1.078	1.076	1.090	1.040
MISCELLANEOUS									
*COMBUSTOR OUTLET TEMP									
TOUTX1	1406.915	1625.784	1755.226	1683.948	1824.023	1544.640	1592.521	1691.840	1805.317
TOUTX2	1406.385	1628.677	1752.252	1873.162	1809.230	1539.239	1583.462	1680.633	1799.339
TOUTX3	1406.915	1625.784	1755.226	1883.948	1824.023	1646.026	1706.939	1511.224	1816.918
TOUTX4	1324.577	1511.047	1617.961	1713.582	1753.713	1471.535	1513.194	1612.310	1729.829
TOUTX5	1444.134	1684.681	1826.108	1936.951	1903.237	1588.714	1635.252	1740.741	1887.344
TOUTX6	1444.134	1684.681	1826.108	1936.951	1903.237	1588.714	1635.252	1740.741	1887.344
*COMBUSTOR OUTLET TEMP									
TOUT1	1252.023	1484.218	1634.187	1672.009	1777.787	2370.595	2000.016	1728.176	1843.003
TOUT2	1247.498	1410.801	1497.077	1580.750	1658.453	1372.328	1406.555	1497.612	1599.779
TOUT3	1454.626	1511.582	1564.309	1440.403	1698.636	1543.561	1365.832	1701.961	1773.598
TOUT4	1454.626	1511.582	1564.309	1440.403	1698.636	1543.561	1365.832	1701.961	1773.598
TOUT5	1406.385	1628.677	1752.252	1873.162	1809.230	1539.239	1583.462	1680.633	1799.339
*MEASURED PRESSURE DRC									
IPCDF	2.859	3.278	3.433	3.712	12.452	3.880	7.019	7.277	7.593
CATDF	2.222	2.667	2.841	3.107	9.994	5.574	5.717	6.014	6.341

ORIGINAL PAGE IS
OF POOR QUALITY

TABLE A-18
MEDIUM HEATING VALUE--STEADY STATE DATA

	108	109	110	111	100	101	102
OPERATING CONDITIONS							
TIN	3:23:55	3:33:25	3:38:25	3:46:25	2:10:55	2:17:55	2:24:55
DEGF							
FSIA							
PIN	833.741	840.412	833.587	825.359	792.183	782.332	775.801
PCNT	148.185	148.022	143.219	143.341	143.626	142.649	143.585
\$FUEL GAS COMPOSITIONS							
CO	44.568	44.545	44.535	44.516	43.528	43.724	43.916
CO2	23.175	23.095	23.078	23.052	23.458	23.420	23.380
H2	26.742	26.861	26.924	27.023	27.022	26.902	26.780
CH4	4.715	4.655	4.622	4.570	5.137	5.101	5.065
N2	0.483	0.480	0.479	0.477	0.493	0.493	0.492
H2S	0.216	0.214	0.213	0.211	0.210	0.212	0.215
H2O	0.146	0.145	0.145	0.145	0.155	0.151	0.156
NH3	0.000	0.000	0.000	0.000	0.000	0.000	0.000
LHV	260.168	259.803	259.641	259.382	261.373	261.347	261.295
\$ FUEL \$							
WFP	0.077	0.086	0.099	0.114	0.182	0.208	0.225
WFS	0.000	0.000	0.000	0.000	0.000	0.000	0.000
WFT	0.077	0.086	0.099	0.114	0.182	0.208	0.225
PERCFS	0.000	0.000	0.000	0.000	0.000	0.000	0.000
TEMPF	70.031	69.856	69.856	69.856	71.782	70.910	71.788
\$ AIR \$							
MAP	1.186	1.191	1.193	1.191	2.394	2.398	2.395
MAO	0.000	0.000	0.000	0.000	0.000	0.000	0.000
MAD	1.507	1.507	1.504	1.509	1.517	1.520	1.520
MAT	2.693	2.698	2.697	2.700	3.911	3.918	3.915
PERCAP	44.040	44.144	44.234	44.111	61.212	61.205	61.175
PERCAD	0.000	0.000	0.000	0.000	0.000	0.000	0.000
PERCAF	55.960	55.856	55.766	55.889	38.788	38.795	38.825
RFAIRV	31.145	31.472	32.411	32.124	62.780	62.817	62.002
MACH FT/SEC*1000	17.908	18.053	18.637	18.528	36.658	36.817	36.429
HUMID	0.001	0.001	0.001	0.001	0.001	0.001	0.001
\$ LEAN BURNER \$							
FARS	0.065	0.073	0.083	0.095	0.076	0.087	0.094
PHIS	0.167	0.187	0.213	0.245	0.198	0.225	0.244
TMS	833.741	840.412	833.587	825.359	792.183	782.332	775.801
ADFTS	1805.201	1910.022	2033.559	2173.559	1917.380	2037.738	2119.559

ORIGINAL PAGE IS
OF POOR QUALITY

TABLE A-18 (Continued)
MEDIUM HEATING VALUE—STEADY STATE DATA

SUPPLEMENTAL	108	109	110	111	100	101	102
PERFORMANCE							
BOI	1408.976	1514.134	1651.943	1732.338	1634.935	1728.691	1710.992
ETATC	59.213	62.992	68.198	71.027	74.898	75.383	69.595
ETAT	89.809	94.484	99.333	99.555	84.520	95.460	99.553
PF	32.626	24.706	17.197	23.378	26.683	75.285	12.507
POUT	142.324	141.998	136.789	136.870	128.689	127.021	127.672
DELPPR	3.955	4.070	4.490	4.514	10.400	10.956	11.083
DPPRAY	0.011	0.012	0.016	0.018	0.063	0.072	0.070
NOZDEP	0.691	0.854	0.957	1.201	-0.549	0.855	1.873
MEASURED EMISSIONS							
NOXPM	5.316	6.415	8.816	11.437	7.913	9.069	11.413
COPPM	0.000	0.000	0.000	0.000	0.000	0.000	0.000
COPPD	0.466	0.515	0.155	0.002	1.180	1.223	0.060
UNCPHM	1967.100	990.500	172.391	5.125	2802.900	507.879	2.895
CO2PB	3.829	4.551	5.914	6.897	4.786	5.840	7.301
O2PB	18.163	17.347	16.112	15.298	17.142	15.890	14.836
8 SAE SMOKE EMISSIONS AT 15% O2							
COHMX	11.459	10.653	10.863	12.045	12.422	10.680	11.104
COHCOB	0.000	0.000	0.000	0.000	0.000	0.000	0.000
COHCOF	1.005	0.856	0.191	0.002	1.852	1.441	0.059
COHMC	4240.370	1444.461	212.417	5.377	4401.494	598.101	2.817
CMOXE	8.514	7.892	8.036	8.888	9.518	8.154	8.445
8 EMISSIONS RATE 8							
ERNOX	0.074	0.079	0.096	0.109	0.068	0.069	0.080
ERCO	38.228	37.641	9.876	0.088	59.182	54.047	2.473
ERMC	9.490	4.271	0.652	0.017	8.369	1.341	0.007
8 EMISSIONS FOR FAR 8							
FARCO2	0.062	0.072	0.085	0.097	0.088	0.100	0.103
FAR02	0.068	0.081	0.100	0.114	0.100	0.116	0.123
EAG1	90.653	93.356	98.514	99.982	86.517	91.210	99.611
EAG2	84.800	89.470	97.633	99.972	75.163	85.103	99.387
FARR	0.961	0.991	1.026	1.016	1.153	1.153	1.098
8 MISCELLANEOUSES							
SCOMBUSTOR OUTLET TEMP							
TOUTX1	1426.561	1539.245	1712.100	1946.305	1561.406	1677.694	1748.334
TOUTX2	1423.548	1541.046	1719.665	1947.253	1546.981	1659.368	1728.341
TOUTX3	1426.561	1539.245	1712.100	1946.305	1561.406	1677.694	1748.334
TOUTX4	1330.354	1422.665	1574.056	1747.976	1502.264	1605.584	1685.222
TOUTX5	1455.686	1591.622	1778.625	1985.003	1616.672	1731.854	1817.277
TOUTX6	1455.686	1591.622	1778.625	1985.003	1616.672	1731.854	1817.277
SCOMBUSTOR OUTLET TEMP							
TOUT1	1299.931	1390.316	1491.005	1446.456	2381.298	2381.298	1511.122
TOUT2	1257.055	1343.855	1470.823	1620.317	1439.154	1530.966	1596.872
TOUT3	1257.055	1343.855	1470.823	1620.317	1439.154	1530.966	1596.872
TOUT4	1575.861	1662.848	1697.912	1601.233	1703.617	1778.821	1776.956
TOUT5	1575.861	1662.848	1697.912	1601.233	1703.617	1778.821	1776.956
TOUT6	1423.548	1541.046	1719.665	1947.253	1546.981	1659.368	1728.341
MEASURED PRESSURE DROP							
IPCBP	2.776	2.959	3.315	3.581	11.333	12.027	12.304
CATBP	2.175	2.396	2.736	3.004	8.896	9.666	9.994

ORIGINAL PAGE IS
OF POOR QUALITY

ORIGINAL PAGE IS
OF POOR QUALITY

TABLE A-19
MEDIUM HEATING VALUE - STEADY STATE DATA

		92	91	93	94	95	96	98	97
		0:36: 5	0:26: 5	0:44: 5	0:50: 5	1: 7:55	1:16:55	1:30:55	1:24:55
OPERATING CONDITIONS									
TIN	L/GF								
PIN	PSIA	845.814	826.927	838.983	826.145	876.906	864.082	861.158	848.518
		71.506	71.791	71.587	72.767	142.039	142.975	141.713	143.016
FUEL GAS COMPOSITIONS									
CO	FCNT	44.645	44.508	44.752	44.833	45.072	44.914	44.542	44.702
CO2	FCNT	23.263	23.208	23.305	23.337	23.432	23.445	23.450	23.448
H2	FCNT	26.510	26.591	26.444	26.394	26.246	26.322	26.511	26.430
CH4	FCNT	4.733	4.840	4.648	4.584	4.393	4.640	4.640	4.563
N2	FCNT	0.438	0.489	0.488	0.487	0.487	0.488	0.489	0.489
H2S	FCNT	0.212	0.211	0.214	0.214	0.217	0.217	0.215	0.216
H2O	FCNT	0.152	0.156	0.153	0.153	0.155	0.158	0.158	0.158
NH3	FCNT	0.000	0.000	0.000	0.000	0.000	0.000	0.000	0.000
LHV	BTU/SCF	259.873	260.639	259.256	258.796	257.421	257.72J	258.690	258.278
* FUEL *									
WFP	\$/SEC	0.082	0.095	0.095	0.115	0.149	0.185	0.196	0.225
WFS	\$/SEC	0.000	0.000	0.000	0.000	0.000	0.000	0.000	0.000
WFT	\$/SEC	0.082	0.095	0.095	0.115	0.149	0.185	0.196	0.225
PERCFS	PCNT	0.000	0.000	0.000	0.000	0.000	0.000	0.000	0.000
TEMPF	DEGF	70.910	71.788	71.065	71.085	71.437	71.964	71.964	71.964
* AIR *									
MAP	\$/SEC	1.152	1.154	1.157	1.158	2.201	2.202	2.205	2.202
MAG	\$/SEC	0.000	0.000	0.000	0.000	0.000	0.000	0.000	0.000
MAD	\$/SEC	1.509	1.513	1.509	1.506	1.475	1.472	1.472	1.473
MAT	\$/SEC	2.661	2.667	2.666	2.664	3.676	3.674	3.677	3.675
PERCAP	PCNT	43.292	43.270	43.398	43.468	59.875	59.935	59.967	59.918
PERCAG	PCNT	0.000	0.000	0.000	0.000	0.000	0.000	0.000	0.000
PERCAD	PCNT	56.708	56.730	56.602	56.532	40.125	40.065	40.033	40.082
RFAIRV	FT/SEC	63.278	62.223	63.149	61.564	62.312	61.832	61.832	60.600
MACH FT/SEC@1000		36.226	35.867	36.241	35.497	35.281	34.887	35.205	34.659
HUMID	PCNT	0.001	0.001	0.001	0.001	0.001	0.001	0.001	0.001
* LEAN BURNER *									
FARS	\$/F/HA	0.071	0.082	0.082	0.099	0.068	0.084	0.089	0.102
FHIS		0.182	0.212	0.210	0.251	0.170	0.212	0.226	0.259
TMS	DEGF	845.814	826.927	838.983	826.145	876.906	864.082	861.158	848.518
ADFTS	DEGF	1891.917	2018.917	2020.917	2201.917	1863.096	2055.095	2115.917	2254.917

ORIGINAL PAGE IS
OF POOR QUALITY

TABLE A-19 (Continued)
MEDIUM HEATING VALUE—STEADY STATE DATA

PERFORMANCE**	92	91	93	94	99	95	98	97
BOI	1597.308	1682.066	1714.395	1927.717	1505.709	1623.604	1777.663	1709.400
ETATC	71.837	71.740	74.064	80.069	65.345	75.715	76.706	67.602
ETAT	85.852	92.617	94.416	99.568	89.049	99.076	99.527	99.431
PF	48.955	28.555	34.256	27.242	55.742	59.520	32.000	26.641
PSIG	62.063	61.900	61.597	62.307	129.259	128.893	127.224	23.895
DELPPR	13.206	13.777	13.815	14.375	9.231	9.456	10.224	10.558
DIFFRAY	0.053	0.060	0.062	0.076	0.041	0.048	0.056	0.071
NOZIEP	-0.407	0.284	0.488	0.102	-0.732	-0.794	6.712	2.197
MEASURED EMISSIONS*								
NGXFMW	6.659	8.458	8.190	12.545	8.556	5.943	8.833	16.362
COFFHD	0.000	0.000	0.000	0.000	0.000	0.000	0.000	0.000
COFD	0.668	0.839	0.769	0.017	0.927	0.978	0.486	0.008
UMCFMW	2211.300	872.650	614.600	1.661	2005.350	2037.900	57.323	2.810
CO2FD	4.414	5.329	5.520	7.056	4.108	4.319	6.115	7.059
CO2FD	17.650	16.712	16.433	15.342	17.815	17.632	16.116	14.471
SAE SMOKE								
EMISSIONS AT 15% O2*								
CORNOX	12.090	11.916	10.818	13.318	16.363	10.729	10.893	15.017
CORCOD	0.000	0.000	0.000	0.000	0.000	0.000	0.000	0.000
CORCOF	1.213	1.183	1.015	0.018	1.773	1.766	0.600	0.014
CORUMC	4014.629	1229.378	811.807	1.763	3635.193	3678.915	70.691	2.579
CHOXE	9.096	8.919	8.171	10.090	12.533	8.200	8.336	11.495
EMISSIONS RATE *								
ERNOX	0.086	0.094	0.092	0.118	0.090	0.060	0.072	0.110
ERCO	50.992	54.984	50.659	0.921	57.210	58.126	23.238	0.334
ERUHC	9.970	3.397	2.407	0.005	7.312	7.157	0.163	0.607
EMISSIONS FJR FAR								
FAC02	0.074	0.087	0.080	0.099	0.073	0.076	0.092	0.110
FAR02	0.082	0.097	0.101	0.114	0.080	0.085	0.103	0.132
EAG1	59.813	92.276	93.334	99.887	87.774	87.869	96.465	99.913
EAG2	82.277	87.308	88.943	99.834	77.676	77.649	94.244	99.915
FARR	1.037	1.060	1.074	0.997	1.140	1.127	1.093	1.077
MISCELLANEOUS**								
COMBUSTOR OUTLET TEM								
TOUTX1	1531.149	1658.271	1672.194	1899.638	1513.014	1539.960	1707.854	2083.504
TOUTX2	1530.790	1657.539	1671.460	1894.142	1501.727	1531.147	1701.590	2119.240
TOUTX3	1879.620	1903.432	1856.725	2201.753	1513.014	1539.960	1793.773	2083.506
TOUTX4	1450.883	1580.384	1592.884	1785.144	1454.615	1481.883	1656.990	1913.490
TOUTX5	1584.371	1717.445	1730.564	1989.607	1560.684	1611.581	1813.159	2192.499
TOUTX6	1584.371	1717.445	1730.564	1989.607	1560.684	1611.581	1813.159	2192.499
COMBUSTOR OUTLET TEM								
TOUT1	1492.286	1618.153	1710.074	2157.621	1814.496	1731.670	1769.354	1550.590
TOUT2	1361.596	1468.682	1481.883	1656.811	1402.136	1425.496	1584.366	1809.229
TOUT3	1361.596	1468.682	1481.883	1656.811	1402.136	1425.496	1584.366	1809.229
TOUT4	1930.619	1868.604	1986.526	2003.666	1422.137	2026.661	2042.763	1790.556
TOUT5	1930.619	1868.604	1986.526	2003.666	1422.137	2026.661	2042.763	1790.556
TOUT6	1530.790	1657.539	1671.460	1894.142	1501.727	1531.147	1701.590	2119.240
MEASURED PRESSURE DI								
IPCDP	5.956	6.347	6.447	6.923	9.595	9.764	10.446	11.504
CATDP	4.788	5.201	5.294	5.781	7.339	7.561	8.362	9.440