

NASA-TM-84521 19820025274

NASA Technical Memorandum 84521

# Measurements of Mean Static Pressure and Far-Field Acoustics of Shock-Containing Supersonic Jets

Thomas D. Norum and John M. Seiner

FOR INFORMATION

NOT TO BE TAKEN FROM THIS ROOM

SEPTEMBER 1982

**NASA**

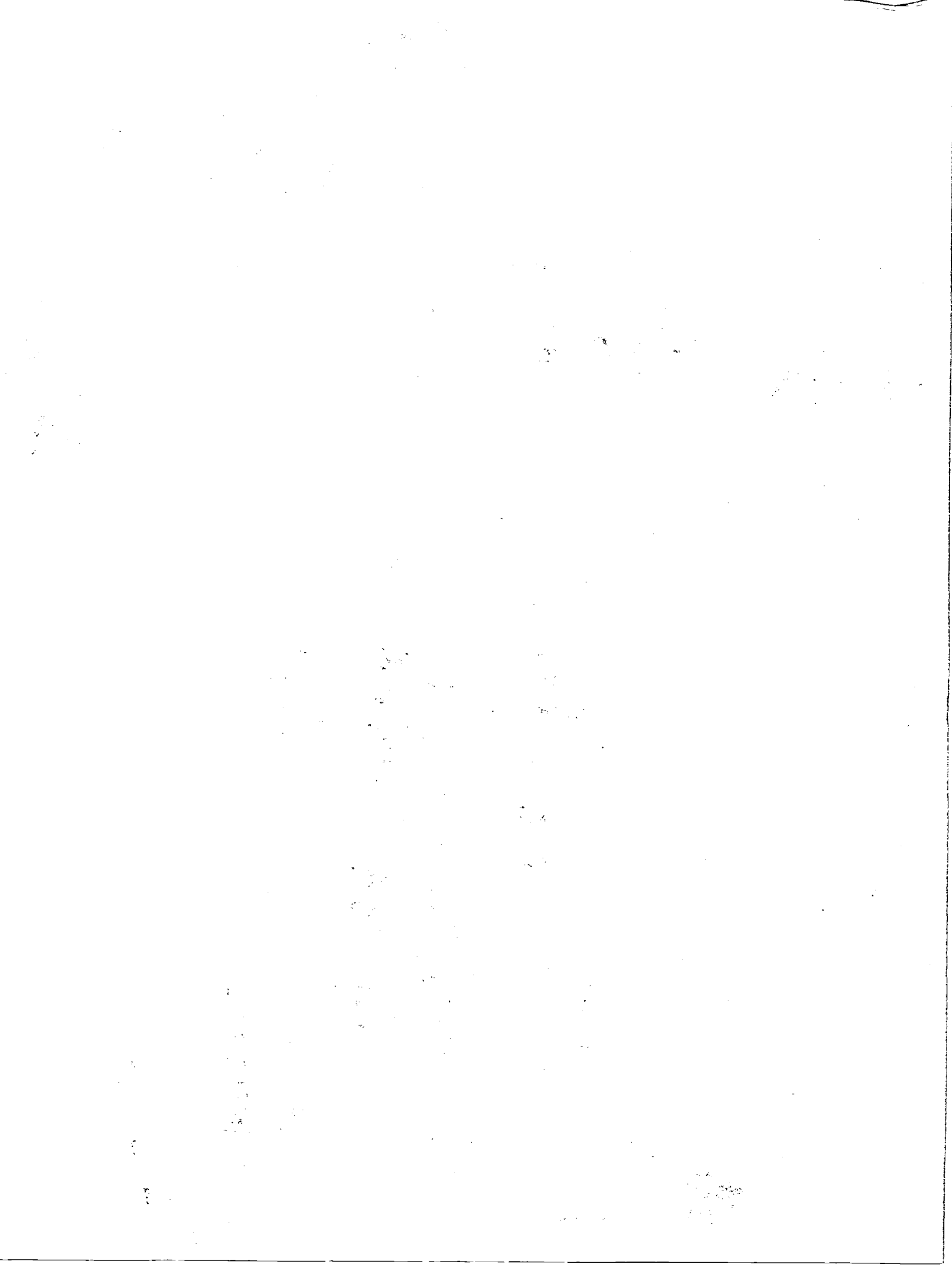

NASA Technical Memorandum 84521

# Measurements of Mean Static Pressure and Far-Field Acoustics of Shock-Containing Supersonic Jets

Thomas D. Norum and John M. Seiner  
*Langley Research Center  
Hampton, Virginia*



National Aeronautics  
and Space Administration

**Scientific and Technical  
Information Branch**

1982



## SUMMARY

The far-field acoustic data base generated in studies of broadband shock noise from supersonic jets is presented. Both conical and contoured nozzles of exit Mach numbers 1.0, 1.5, and 2.0 were tested using unheated air at pressure ratios ranging from 1.9 to 14. Tests were performed both with and without screech suppression tabs. Results include overall sound pressure variations and representative 1/3-octave and narrowband spectra. This data report also presents surveys of the mean static pressure measured within these jets.

## INTRODUCTION

A program to investigate the aeroacoustics of shock-containing supersonic jets was undertaken at NASA Langley Research Center beginning in 1978. A primary goal of this research was to aid the development of a supersonic cruise commercial aircraft by generating a data base for supersonic jet noise. Particular attention was paid to the noise associated with the shock structure within the jet. The program was designed to enhance and supplement work performed by the Lockheed-Georgia Company (refs. 1 and 2) and the General Electric Company (refs. 3 and 4) that had been supported by the Air Force and the Department of Transportation a few years earlier.

Shock-associated noise from supersonic jets can contain two components. The first consists of high-amplitude discrete tones, called screech, which was first studied by Powell (ref. 5). He inferred that the mechanism of screech generation was a resonant loop consisting of acoustic feedback of noise generated by the passage of disturbances through a shock. This process results in the creation of additional disturbances at the nozzle exit. The second component is the broadband component. Its spectrum rises rapidly with frequency to a well-defined peak and then decreases at higher frequencies. Harper-Bourne and Fisher (ref. 6) were the first to investigate the broadband component in detail. They proposed an array of noise sources formed through turbulence-shock interaction. To aid in their study of the broadband noise, a small projection, or tab, was inserted into the jet at the nozzle exit to suppress the screech.

The desire to better understand the noise generation process in supersonic jets led to several related studies at NASA. These studies incorporated extensive measurements of near- and far-field acoustic pressures, mean static and total pressures using inflow probes, and turbulence fluctuations within the jet utilizing hot-film probes. Analyses of the data, highlighting the relationship between the jet shock structure and the radiated broadband noise, have been presented in references 7 through 11.

The primary purpose of this report is to document the far-field acoustic data base generated during the NASA experiments. Results from both conical and contoured convergent and convergent-divergent (C-D) nozzles were obtained. Tests were performed with and without screech suppression tabs at nozzle pressure ratios ranging from the sonic condition to a fully expanded Mach number of about 2.4. Overall sound pressure levels and 1/3-octave and narrowband spectra were generated and are presented herein.

To aid in the interpretation of these supersonic-jet noise measurements, the detailed mean static pressures obtained within these jets are also presented. These measurements have proven useful in evaluating jet-plume prediction schemes and in determining the strength and spacing of the shocks. (See refs. 7 through 9.)

#### SYMBOLS

C-D	convergent-divergent
d	nozzle exit diameter
$d_t$	nozzle throat diameter
$M_j$	fully expanded Mach number
OASPL	overall sound pressure level
p	static pressure in jet plume
$p_a$	ambient static pressure
$p_t$	jet total pressure
SPL	sound pressure level
$T_a$	ambient temperature
$T_j$	fully expanded jet static temperature
$V_j$	fully expanded jet velocity
x	distance from nozzle exit to probe tip
$x_s$	nozzle inlet-to-exit distance
$x_t$	nozzle throat-to-exit distance
y	distance from nozzle centerline to probe tip
$\beta$	$= \sqrt{M_j^2 - 1}$
$\beta_d$	$\beta$ for perfect expansion based on one-dimensional isentropic flow
$\rho_j$	fully expanded jet static density
$\phi$	relative humidity
$\psi$	microphone far-field angle measured from inlet axis

## EXPERIMENTAL DETAILS

The mean static pressure measurements were performed in the Langley Jet-Noise Laboratory (LJNL). This facility is supplied with a continuous flow of dry, unheated air at a maximum flow rate of 4.1 kg/s and is controlled electronically to maintain nozzle pressure ratios within 0.3 percent of the desired set point. The pressure probe was housed in a minimum-drag supersonic wing and positioned within the flow with a spatial accuracy of 0.03 mm via a computer-controlled, three-dimensional drive mechanism. The output of the static-pressure transducer was recorded by a minicomputer through a digital multimeter. The data averaging time of the multimeter was chosen to limit data scatter to 0.2 percent, the accuracy of the transducer. Figure 1 is a photograph of the drive mechanism installed adjacent to a test nozzle in the LJNL.

The static-pressure probe used was designed by Pinckney (ref. 12). Its dual conical sections (fig. 2) permit a faster recovery than a conventional supersonic probe, which allows the pressure ports to be located much closer to the probe tip. This is a distinct advantage in shock-containing flow, since it permits static pressure to be measured in the neighborhood of the shocks. As seen in figure 2, the pressure ports are less than 5 mm from the probe tip. This distance corresponds to about a tenth of a diameter of the nozzles tested. The static-pressure error due to incomplete recovery was calculated for this geometry probe at zero angle of attack and was found to be less than 1 percent for free-stream Mach numbers from 2.5 down to at least 1.45. No corrections are applied to the data given in this report.

The far-field acoustic measurements were performed in the Langley Anechoic Noise Facility. This facility has interior dimensions of 6.7 m  $\times$  8.4 m  $\times$  7.2 m and utilizes the same air supply as the LJNL. Free-field, 1/4-inch condenser microphones were positioned on an arc in 7.5° increments from 30° to 157.5° from the nozzle inlet axis. The microphone arc was initially 3.66 m from the jet exit. During a second phase of acoustic testing, the radius of the arc was reduced to 3.05 m. For both phases, the test nozzles were covered with fiberglass as shown in figure 3.

Five nozzles were tested, two of which were convergent nozzles. One convergent nozzle was contoured for exit flow parallel to the jet axis, and the other had a conical internal contour, and hence, a convergent exit flow. The remaining nozzles were convergent-divergent; two were designed for an exit Mach number of 1.5 and the other for 2.0. One Mach 1.5 nozzle consisted of two conical sections, and hence, a divergent exit flow. The other two C-D nozzles were designed for parallel flow at the exit. Their contraction section was developed using the method of Hopkins and Hill (ref. 13), which permits optimization of the sonic surface for a given contraction area ratio. The contour generated by this method was matched with a method-of-characteristics solution for the supersonic section (ref. 14). Actual dimensions of the five nozzles are given in figure 4.

Tabs, in the form of a small protrusion into each jet at the nozzle exit, were designed to suppress screech. The tab data reported herein were derived from a single rectangular-shaped tab for each nozzle. Their design was based on that used in reference 2, 0.125d wide and extending 0.063d into the jet. Figure 5 is a schematic of a nozzle with a tab installed.

Several nozzle pressure ratios were investigated and are reported in terms of the shock parameter  $\beta$ . A summary of jet parameters for most of the conditions tested is given in table 1. Additional pressure ratios near the perfectly expanded

condition of the contoured C-D nozzles were attained during the second phase of acoustic tests.

#### PRESENTATION OF RESULTS

The static-pressure surveys were obtained by traversing the probe downstream in increments of 1 to 2 mm. The size of the increment was dependent upon the region of the jet being investigated. Only the three contoured nozzles were investigated, and the results are given in appendix A. The jet static pressure nondimensionalized by the ambient pressure is plotted against the distance to the probe tip from the nozzle exit normalized by the diameter. The value of  $\beta$  and the nondimensional distance from the jet centerline, at which the axial survey was made, is given on each plot.

The acoustic data are presented in appendixes B through E. For the acoustic tests, the data were recorded on a 14-channel FM magnetic tape recorder with a flat frequency response to above 80 kHz. Because 18 microphones were used, two runs were necessary at each test condition. Hence, two data segments were obtained for angles between 67.5° and 120°. Overall sound pressure levels (OASPL) were obtained for each data segment and results for the same test condition and angle agreed generally to within 1.0 dB.

Values of OASPL plotted against  $\beta$  are presented in appendix B for each of the five nozzles with and without tab. The far-field measurement angle and maximum OASPL attained for each curve are given at the right of the figures. Data from the second phase of acoustic testing are given as solid symbols. Because exact far-field conditions were not met, no data corrections were applied to account for the different microphone positions during the two acoustic test phases.

The variations of sound pressure level with far-field angle are given in appendix C for each value of  $\beta$  tested during the first phase. Again, the maximum OASPL for each curve is given at the far right along with the  $\beta$  value.

Measured 1/3-octave levels for each of the three contoured nozzles and most operating conditions are shown in appendix D. The values of ambient temperature and relative humidity are listed for each condition to allow for atmospheric absorption corrections. The dB level listed to the right of each curve represents the maximum 1/3-octave level of that curve.

Power spectra for each of the contoured nozzles without tab and the contoured convergent nozzle with tab are given in appendix E. The analysis bandwidth of all the spectra was 40 Hz. Angles from 30° to 120° are given to highlight the broadband, shock-associated noise component. The maximum level of each curve is given at its right in the figures along with the far-field measurement angle.

#### CONCLUDING REMARKS

A NASA Langley Research Center program to investigate the noise associated with the shock structure in supersonic jets has produced a data base for the radiated noise from both convergent and convergent-divergent nozzles. Far-field acoustic results of overall sound pressure level and 1/3-octave and narrowband spectra were



obtained with and without screech suppression at nozzle pressure ratios from 1.9 to 14. Detailed mean static-pressure surveys, depicting the shock structure within the jet plume, have also been generated. These as-measured, far-field acoustic pressures and inflow static pressures are presented in this data report.

Langley Research Center  
National Aeronautics and Space Administration  
Hampton, VA 23665  
August 2, 1982

APPENDIX A

LONGITUDINAL STATIC-PRESSURE SURVEYS

<u>Nozzle configuration</u>	<u><math>\beta</math></u>	<u>y/d</u>	<u>Page</u>
Mach 1.0 contoured nozzle without tab	0.40	0	8
	0.60	0	8
	0.70	0	8
	0.80	0	9
	0.80	0.45	9
	0.94	0	10
	0.94	0.45	10
	1.00	0	11
	1.00	0.45	11
	1.10	0.45	12
	1.34	0.45	12
	1.50	0.45	13
	1.72	0.55	13
Mach 1.5 contoured nozzle without tab	0.40	0	14
	0.60	0.25	14
	0.70	0	15
	0.70	0.23	15
	0.70	0.45	15
	0.80	0	16
	0.80	0.25	16
	0.94	0	17
	0.94	0.30	17
	0.94	0.45	17
	1.34	0	18
	1.34	0.45	18
	1.50	0	19
	1.50	0.45	19
	1.72	0	20
	1.72	0.42	20
1.85	0.45	21	
2.00	0.51	21	

APPENDIX A

<u>Nozzle configuration</u>	<u><math>\beta</math></u>	<u><math>y/d</math></u>	<u>Page</u>
Mach 2.0 contoured nozzle without tab	0.70	0.25	22
	0.80	0.25	22
	0.94	0.25	22
	1.10	0	23
	1.10	0.25	23
	1.34	0	24
	1.34	0.25	24
	1.50	0	25
	1.50	0.38	25
	1.60	0	26
	1.60	0.38	26
	1.72	0	26
	1.85	0	27
	1.85	0.38	27
	1.85	0.45	27
	2.00	0	28
	2.00	0.25	29
	2.00	0.45	29

Mach 1.0 contoured nozzle without tab

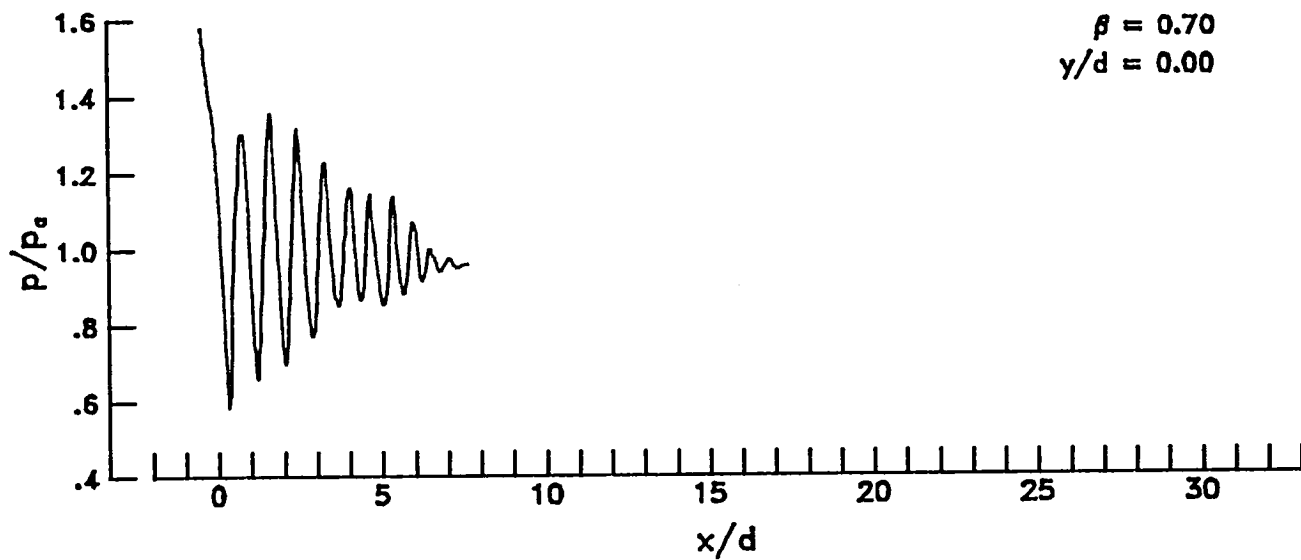
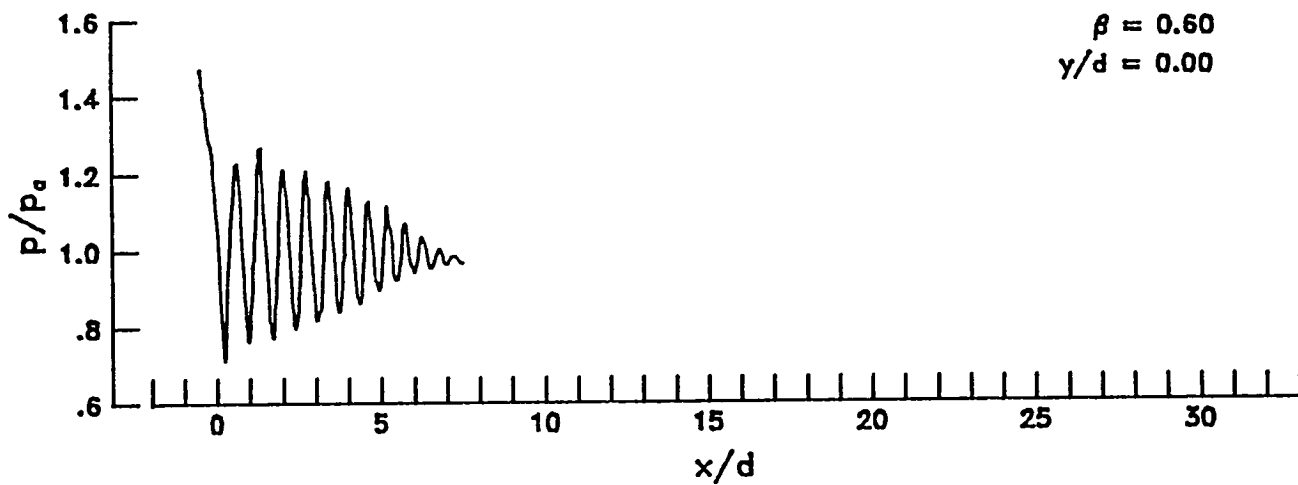
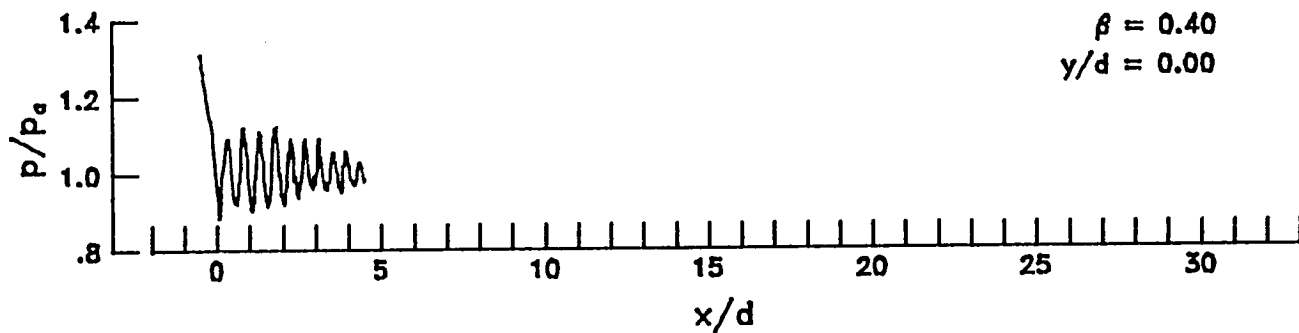

Mach 1.0 contoured nozzle without tab

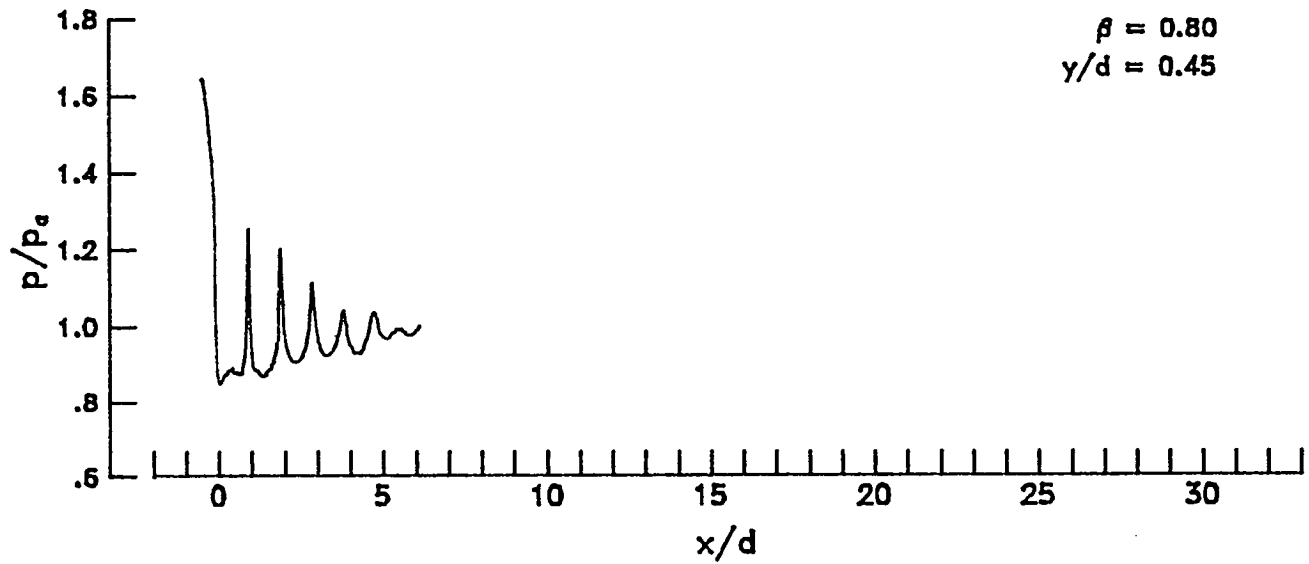
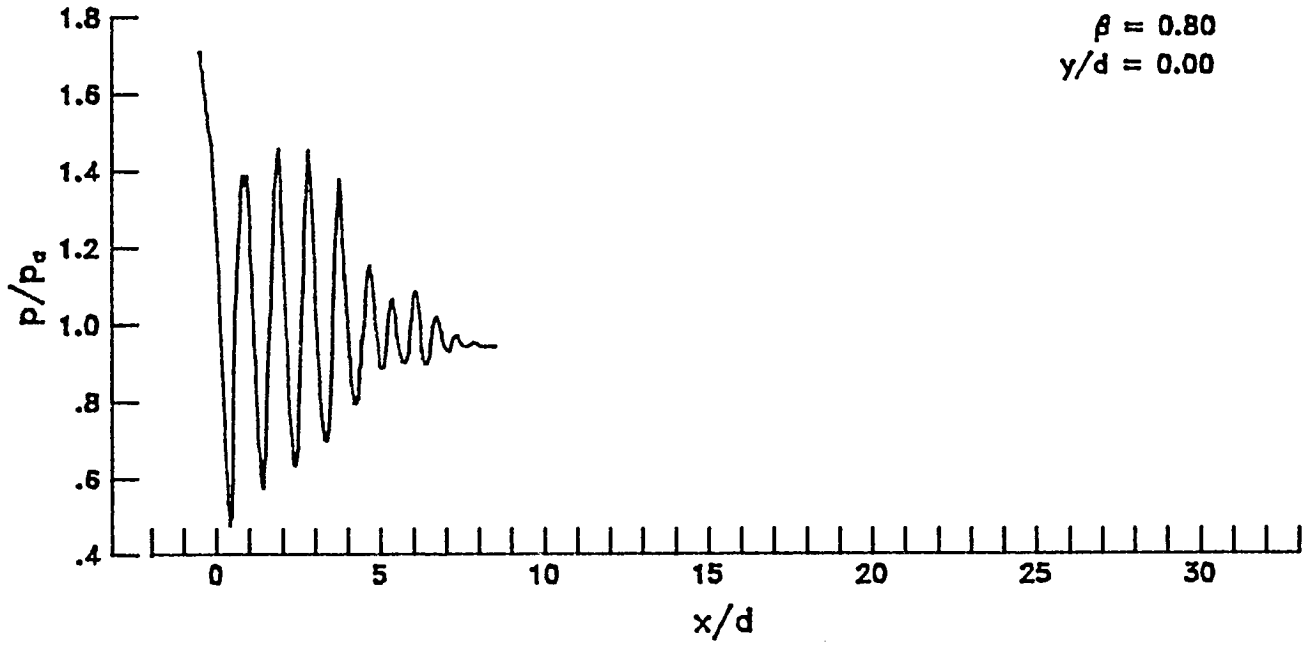

Mach 1.0 contoured nozzle without tab

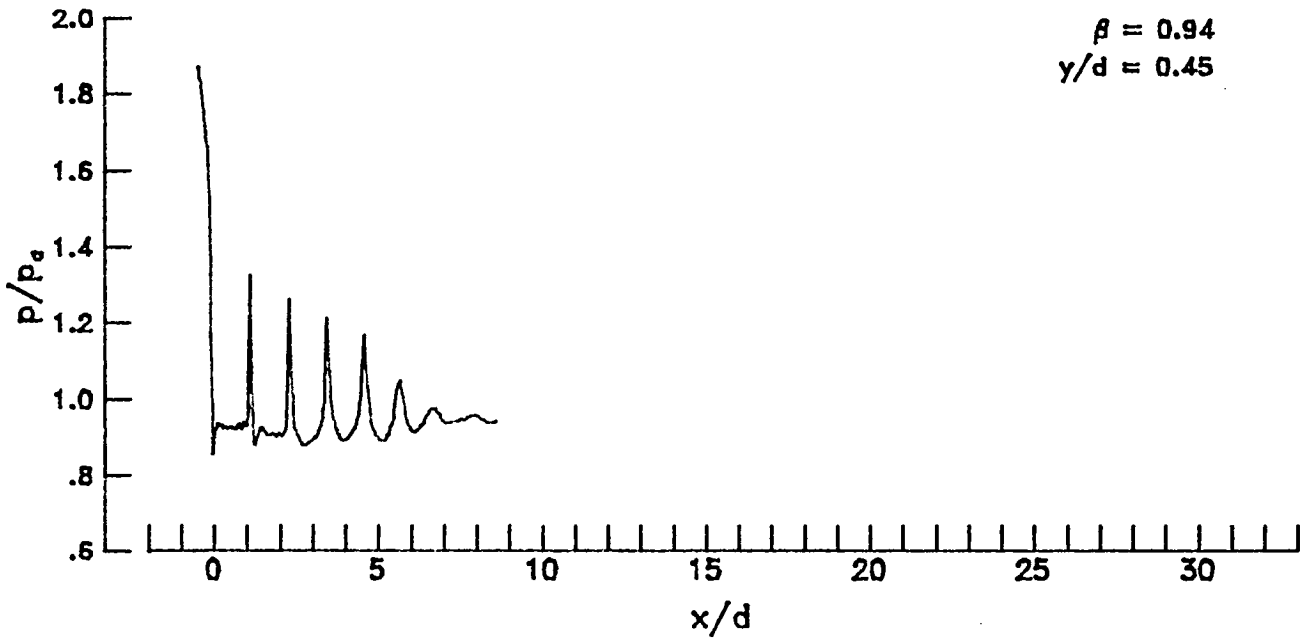
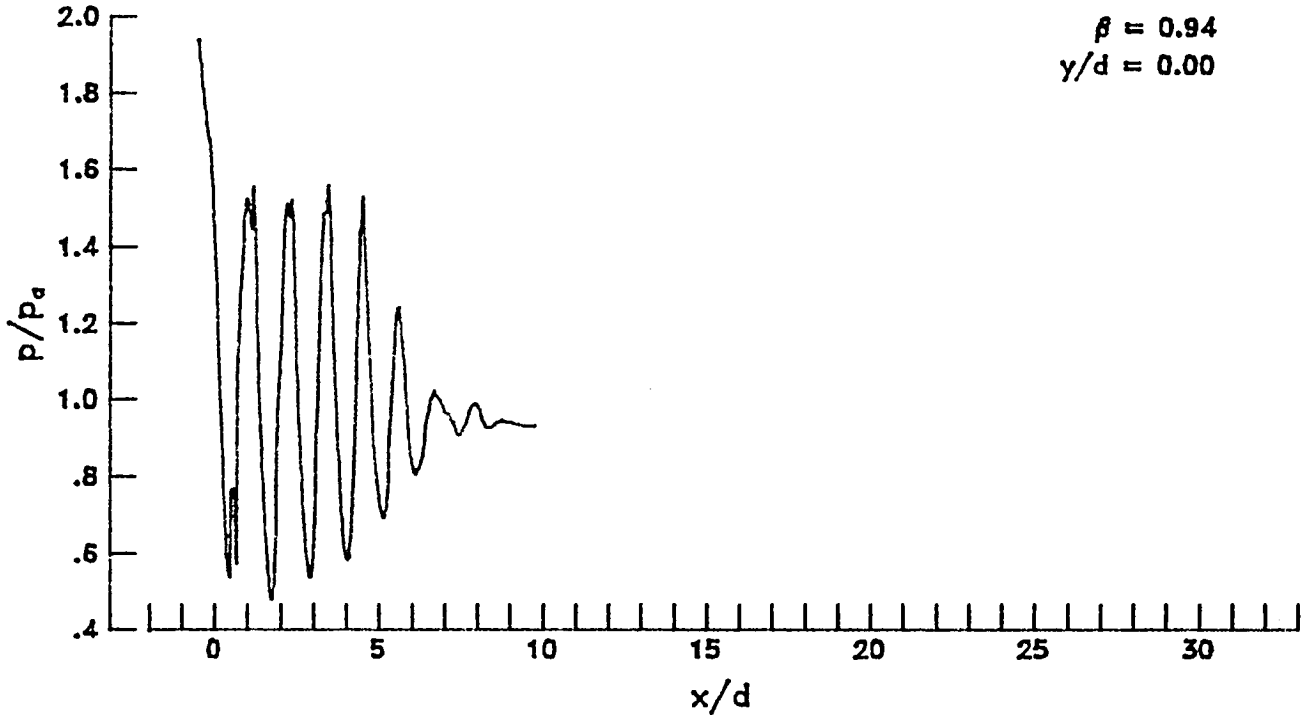

Mach 1.0 contoured nozzle without tab

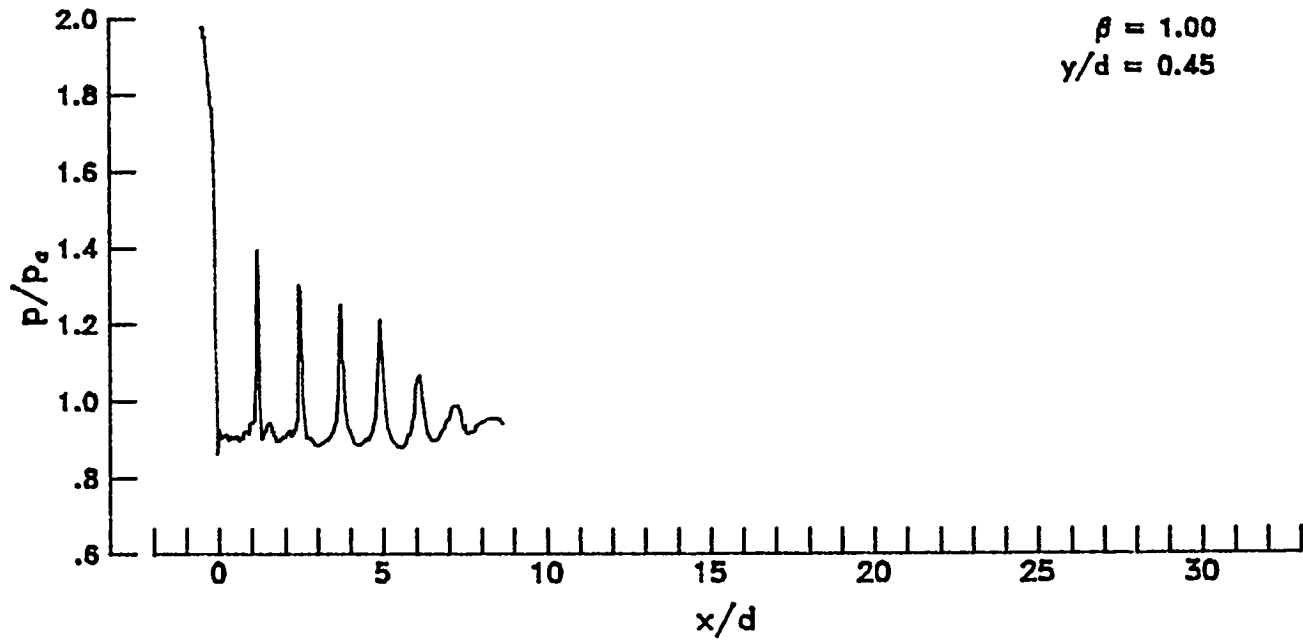
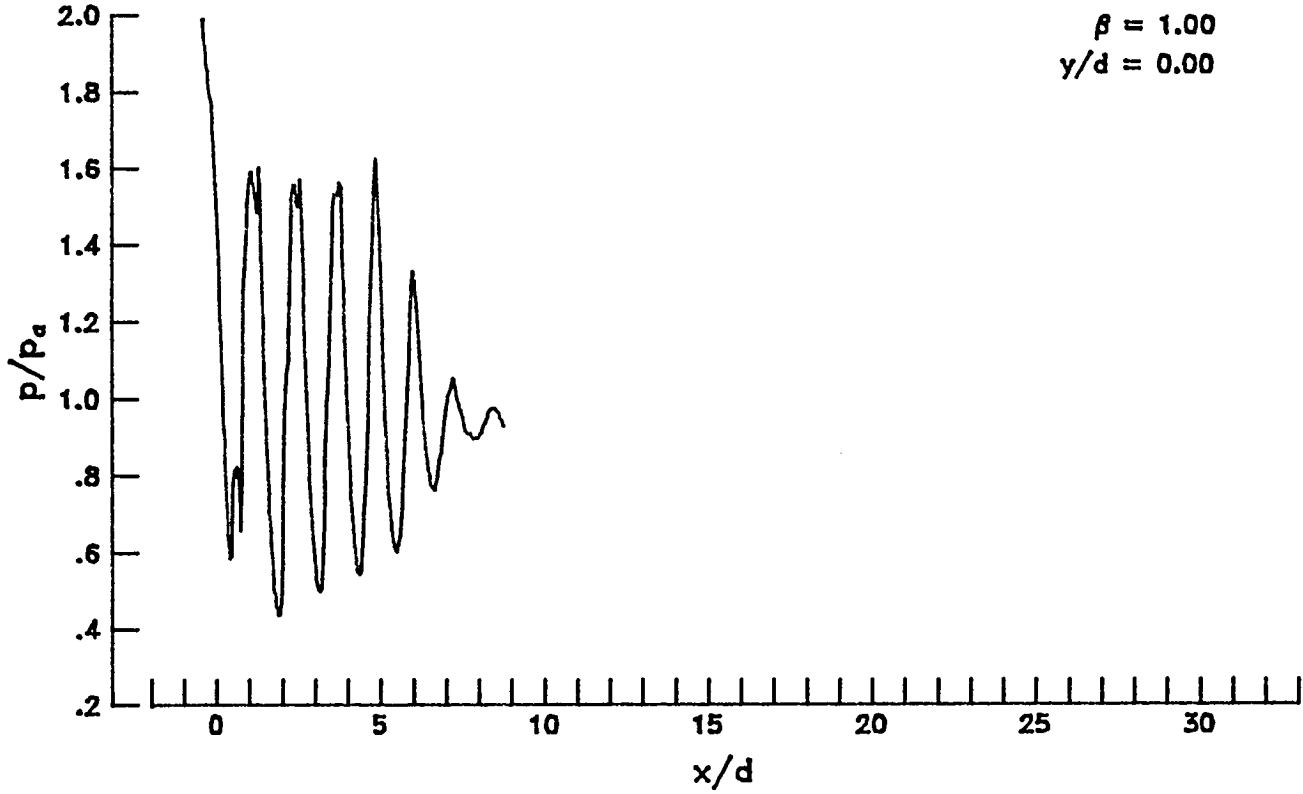

Mach 1.0 contoured nozzle without tab

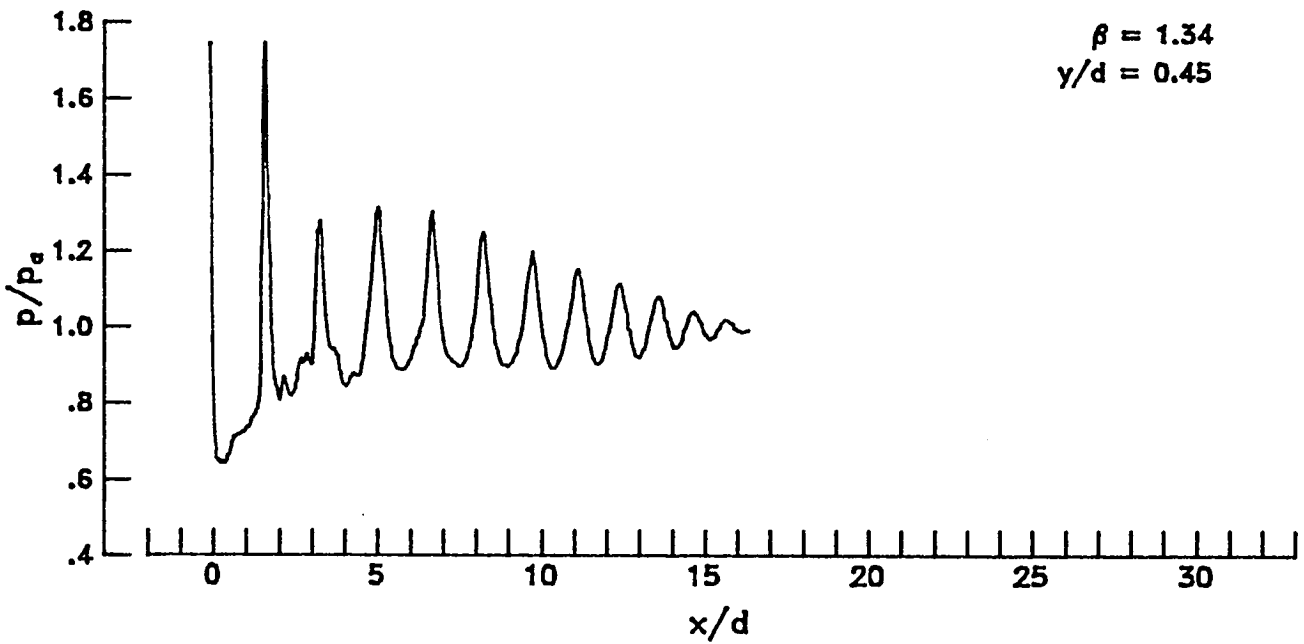
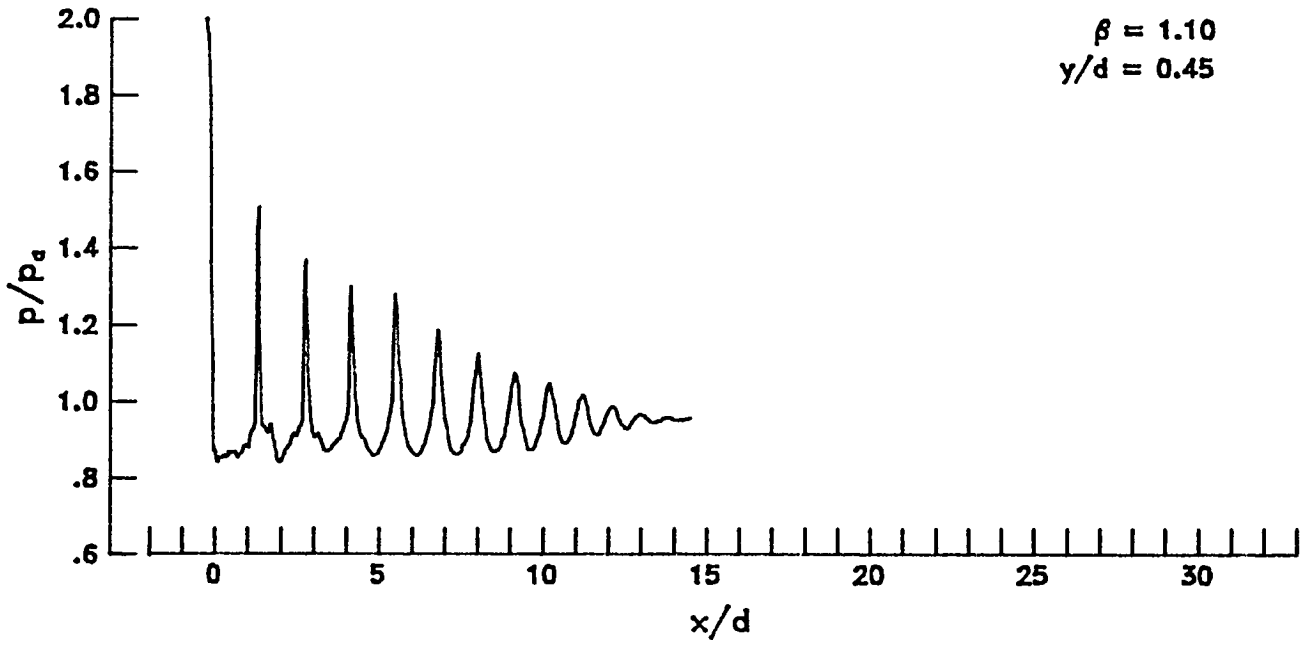



## Mach 1.0 contoured nozzle without tab

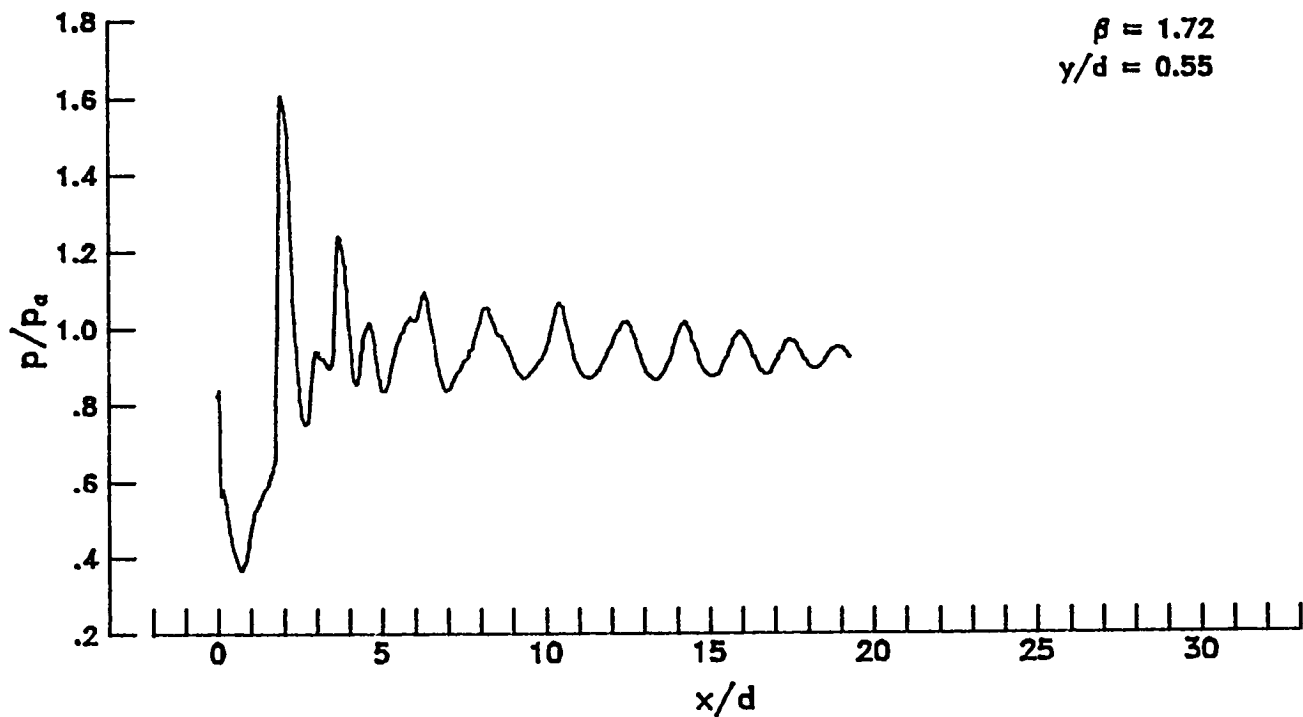
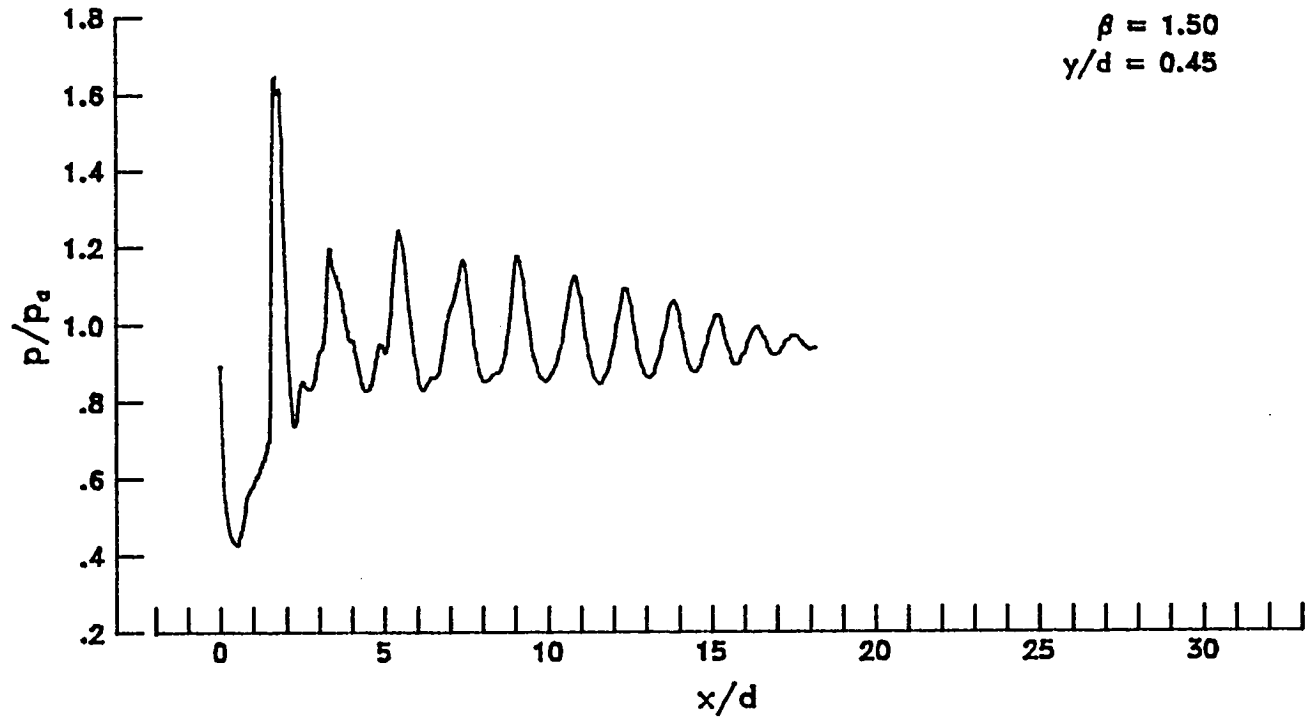

APPENDIX A

Mach 1.5 contoured nozzle without tab

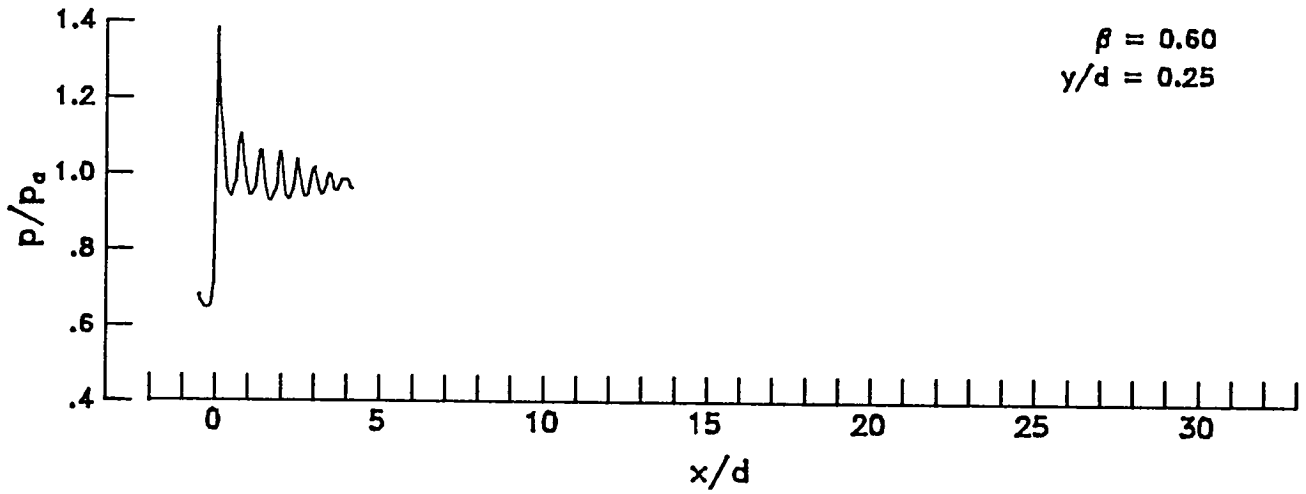
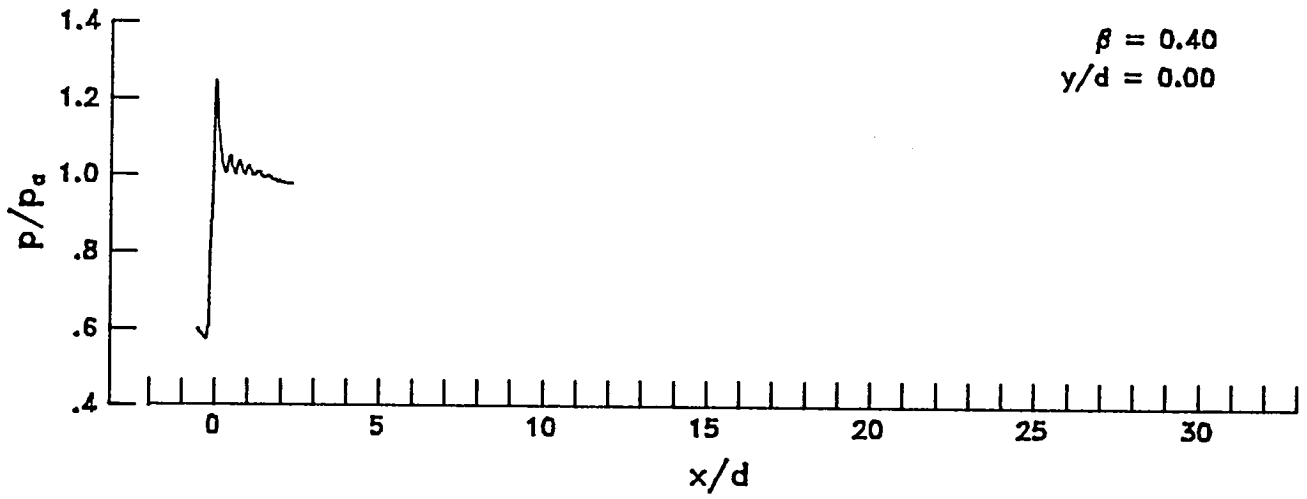

APPENDIX A

Mach 1.5 contoured nozzle without tab

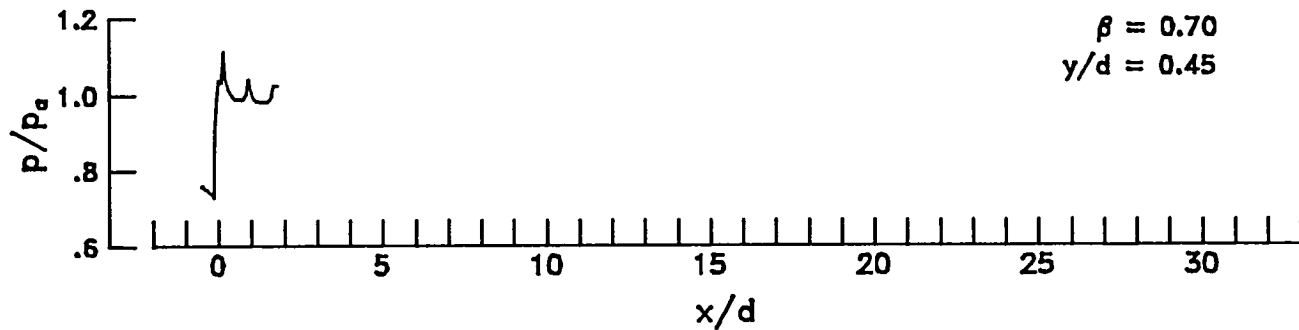
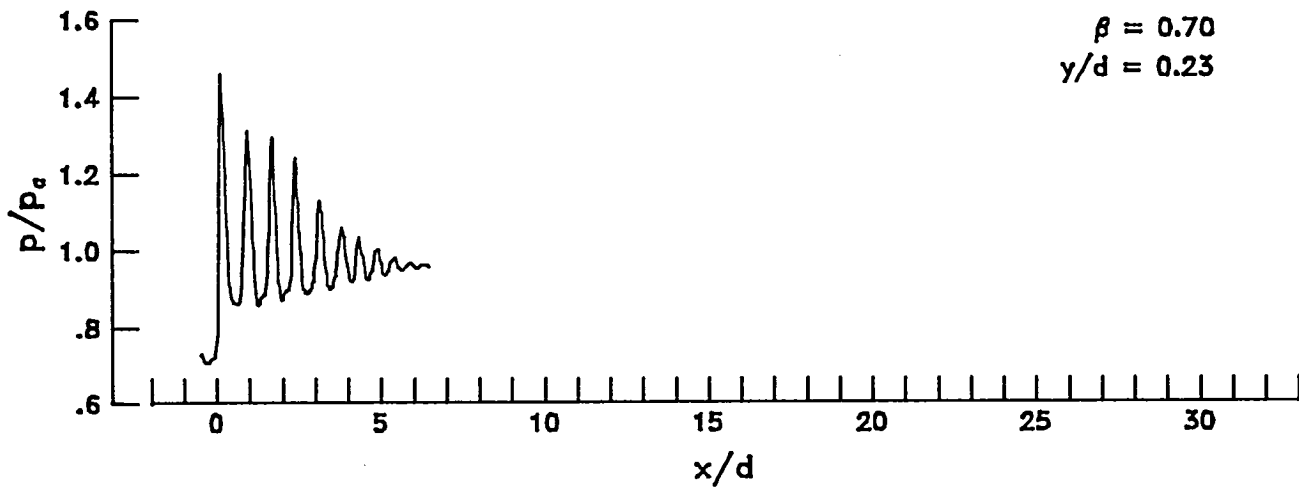
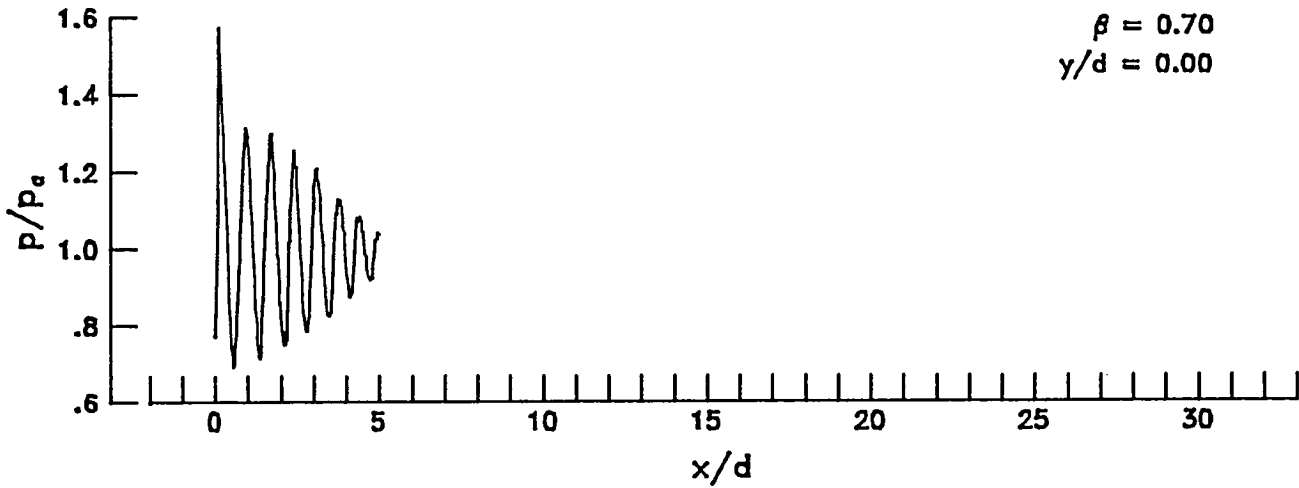

Mach 1.5 contoured nozzle without tab

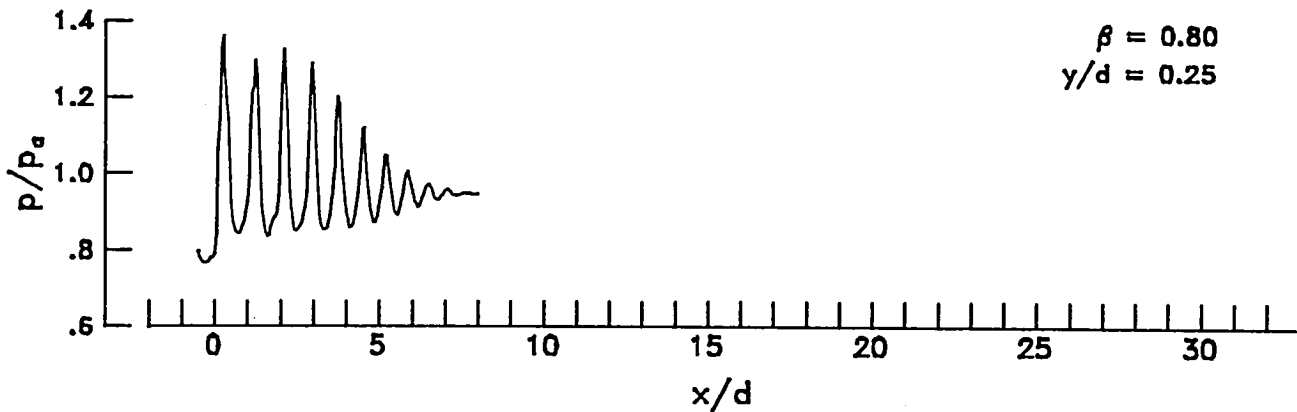
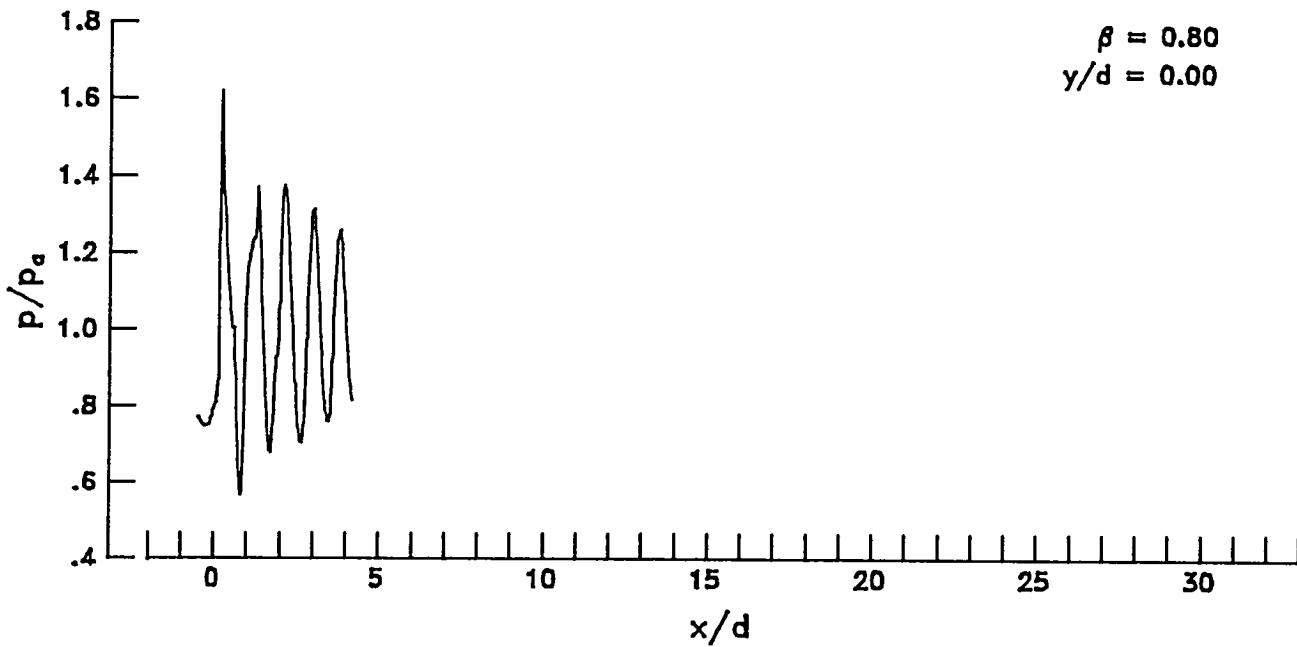

APPENDIX A

Mach 1.5 contoured nozzle without tab

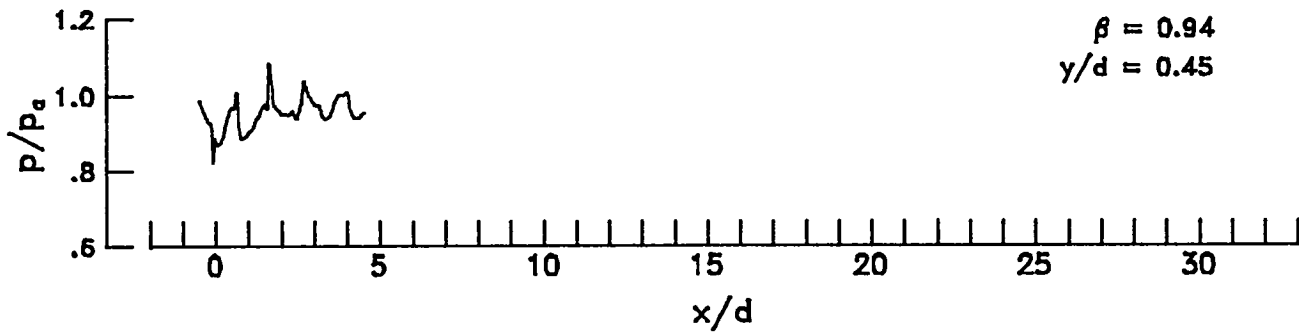
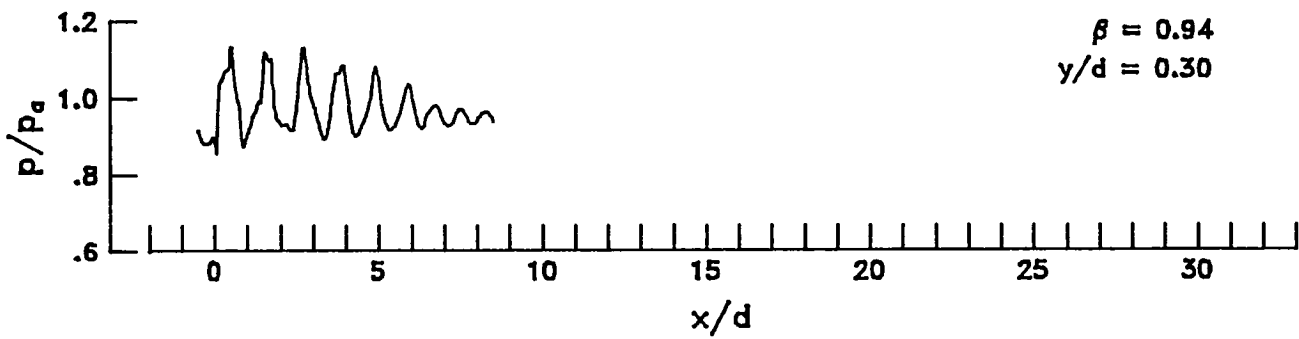
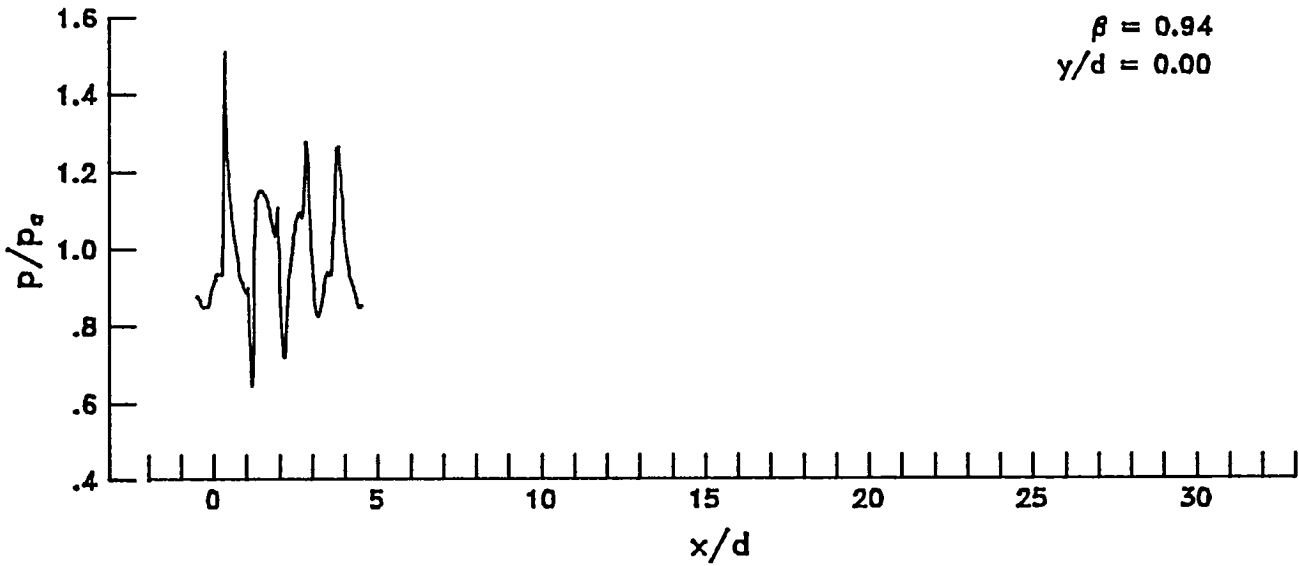

Mach 1.5 contoured nozzle without tab

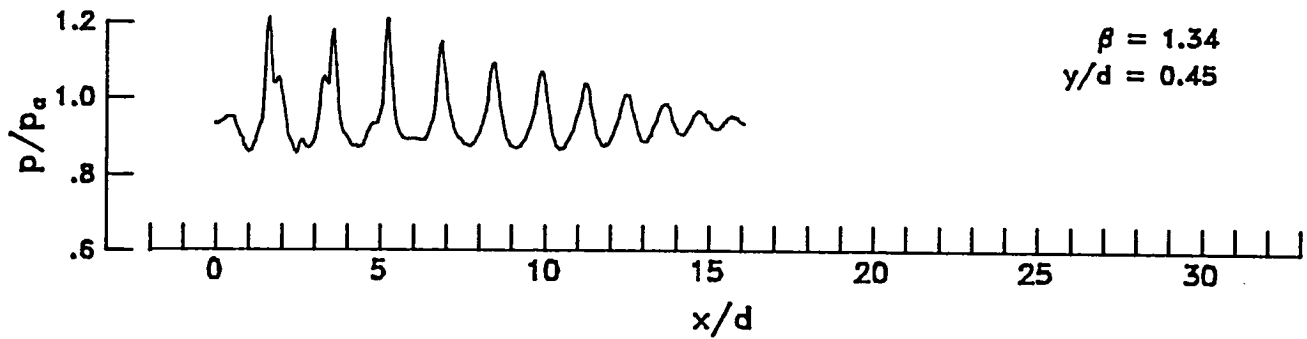
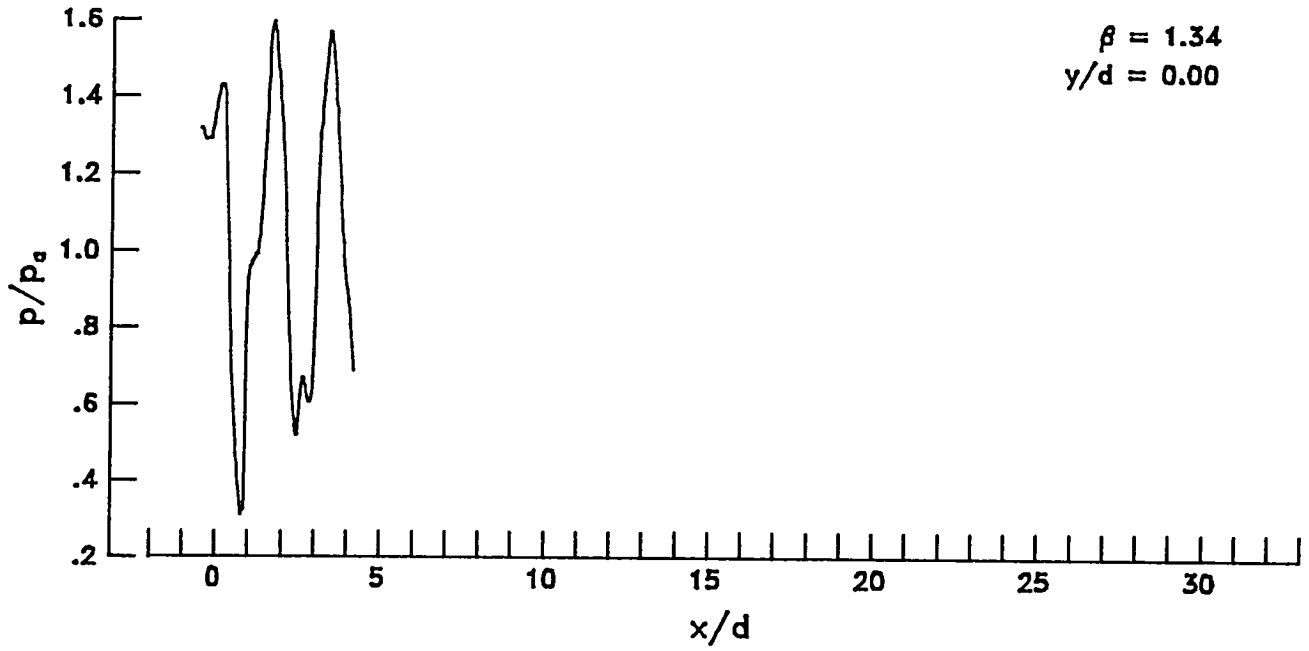

Mach 1.5 contoured nozzle without tab

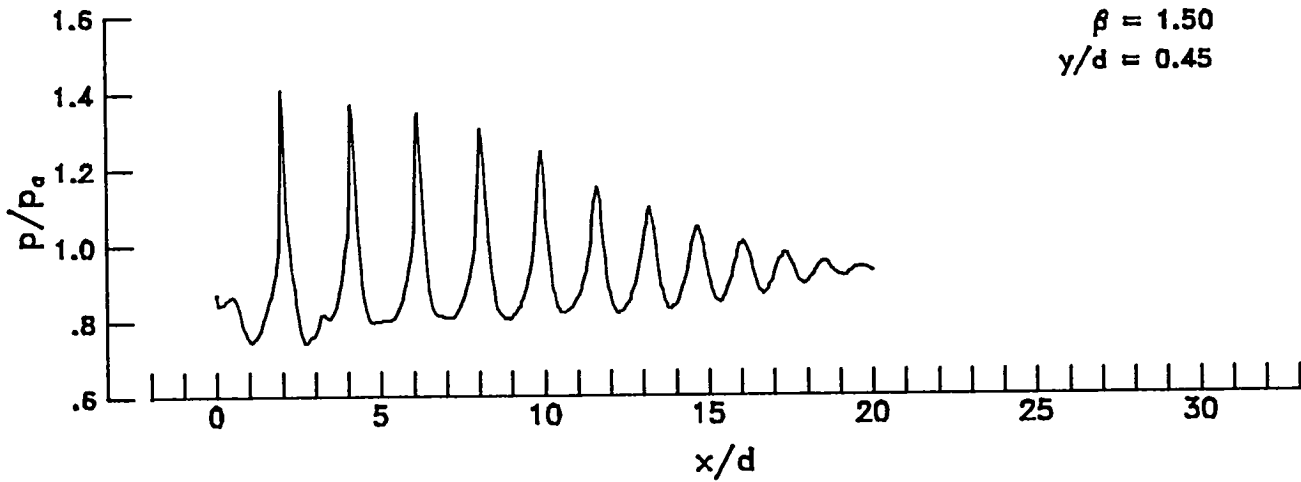
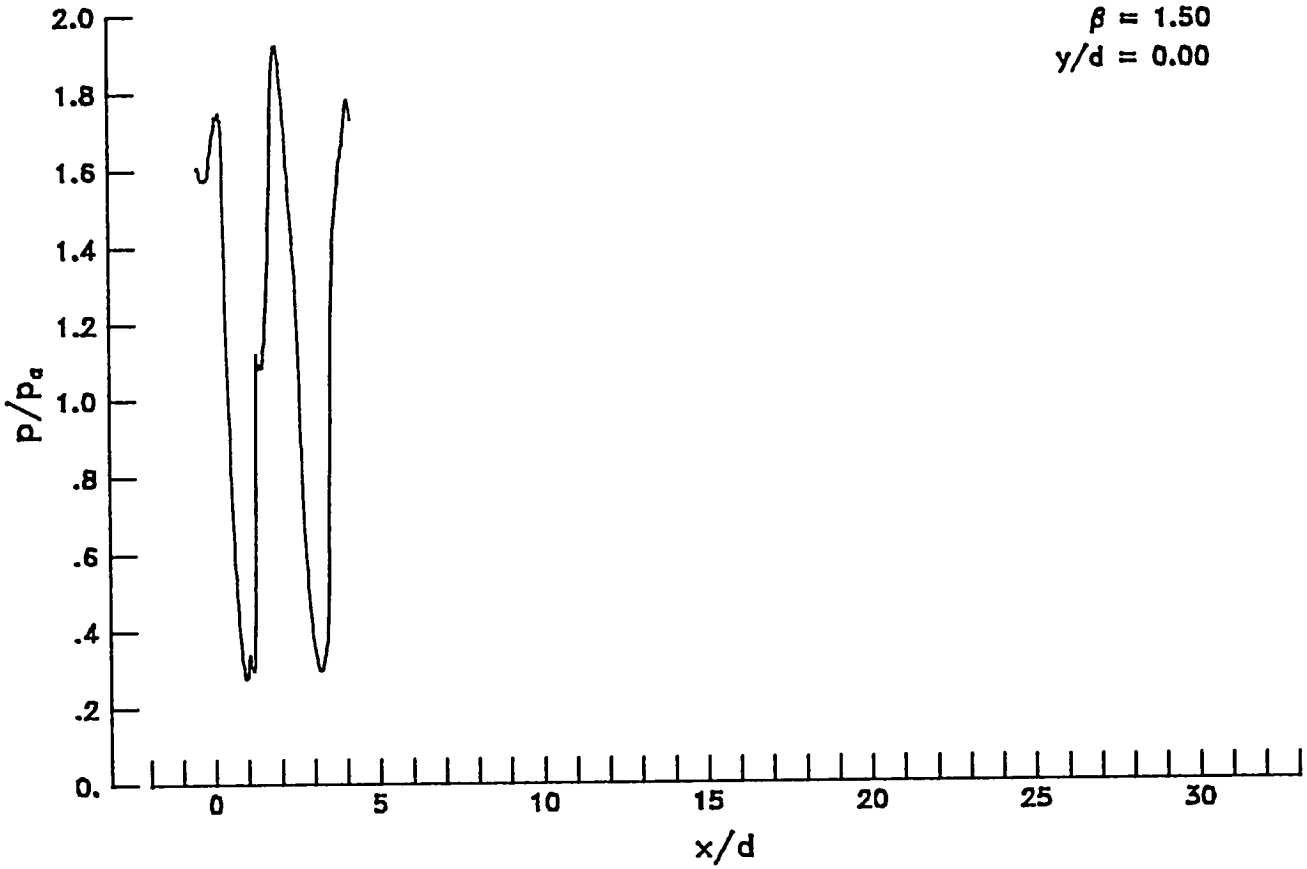

Mach 1.5 contoured nozzle without tab

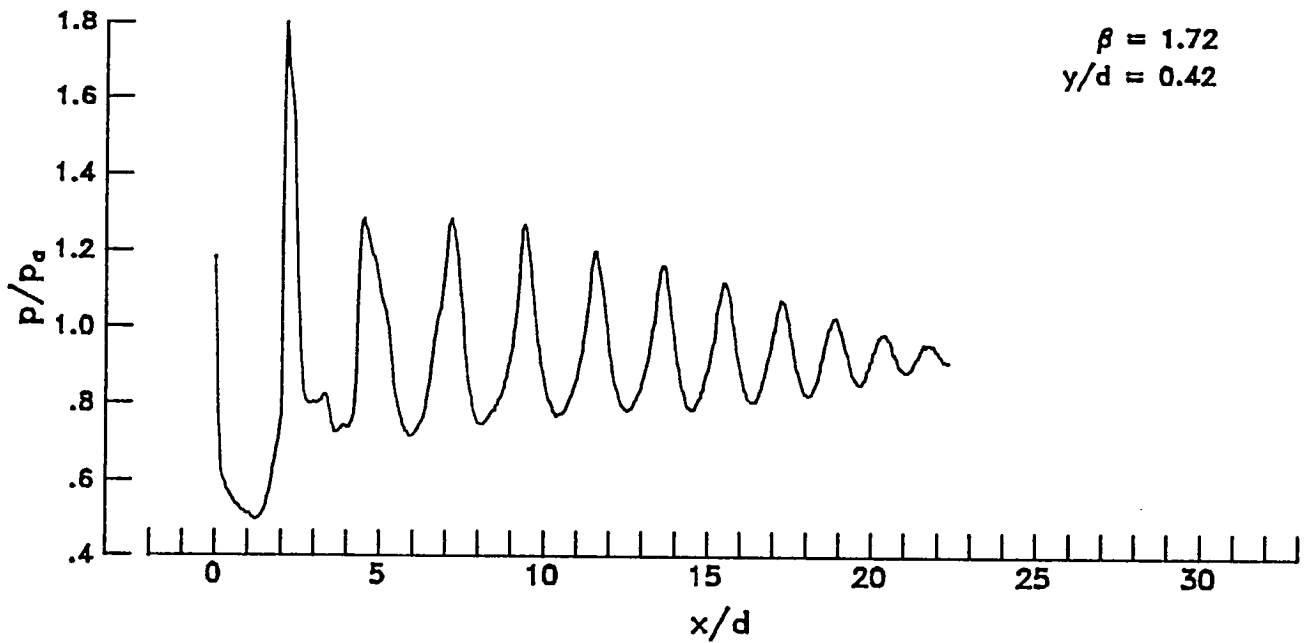
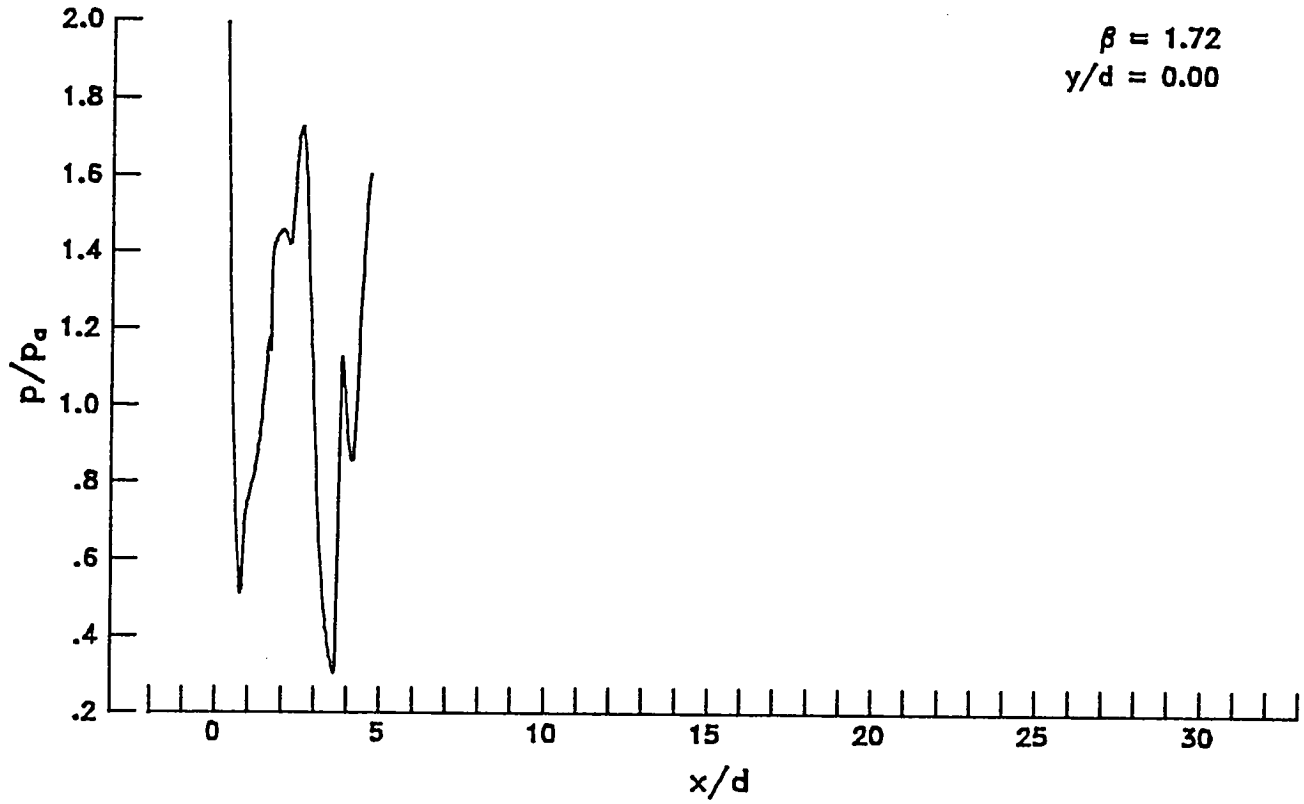



Mach 1.5 contoured nozzle without tab

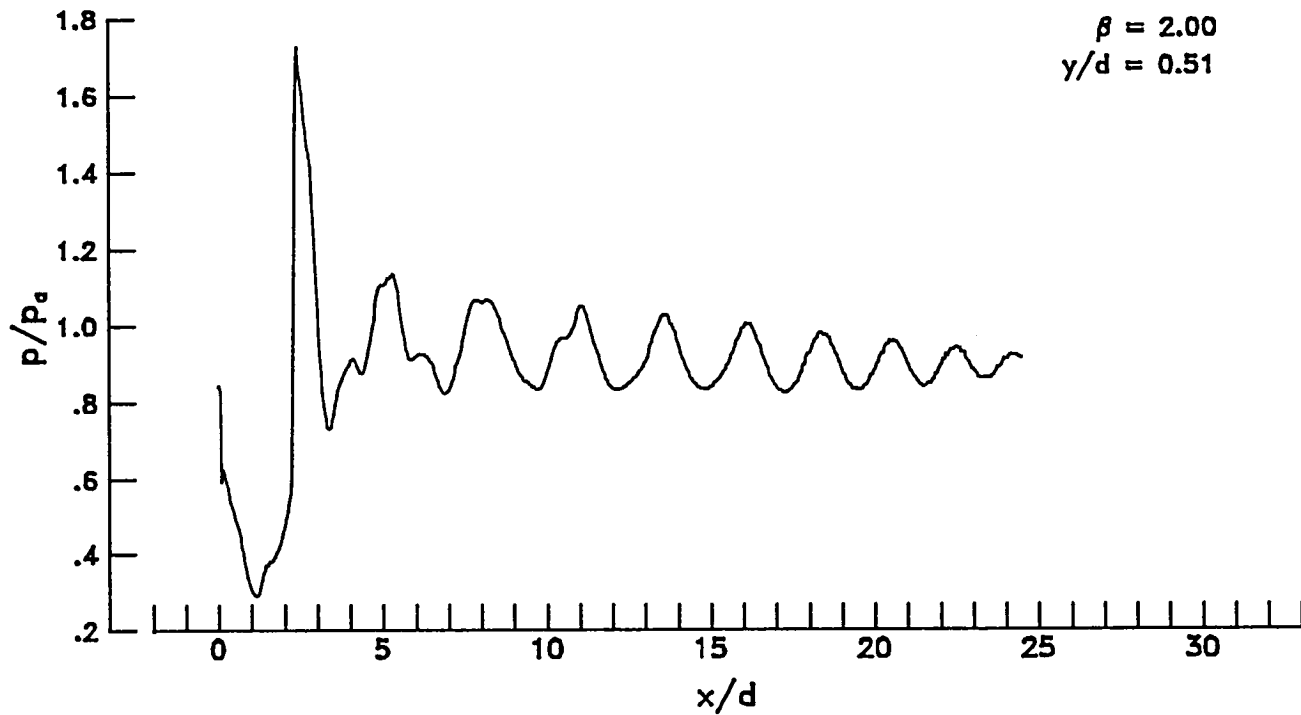
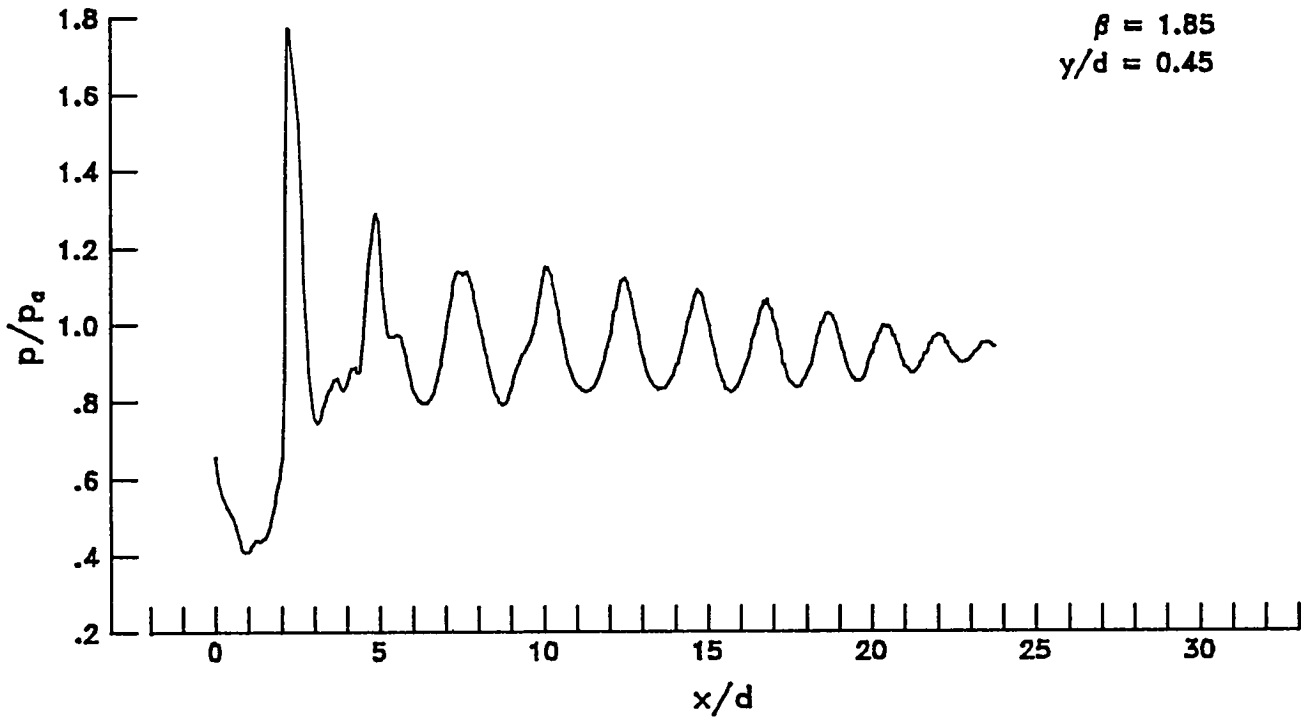

## Mach 2.0 contoured nozzle without tab

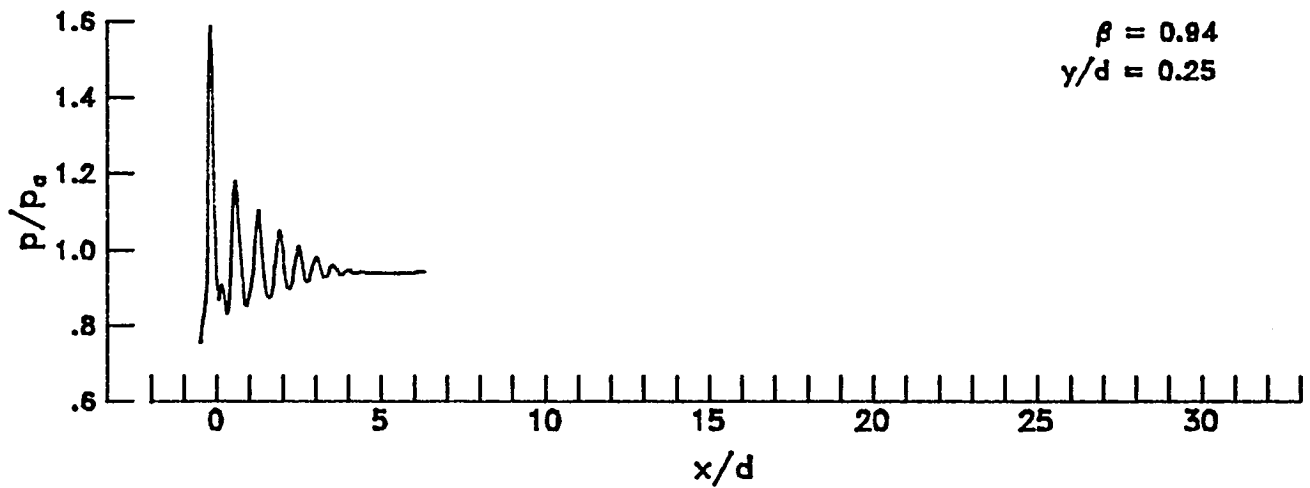
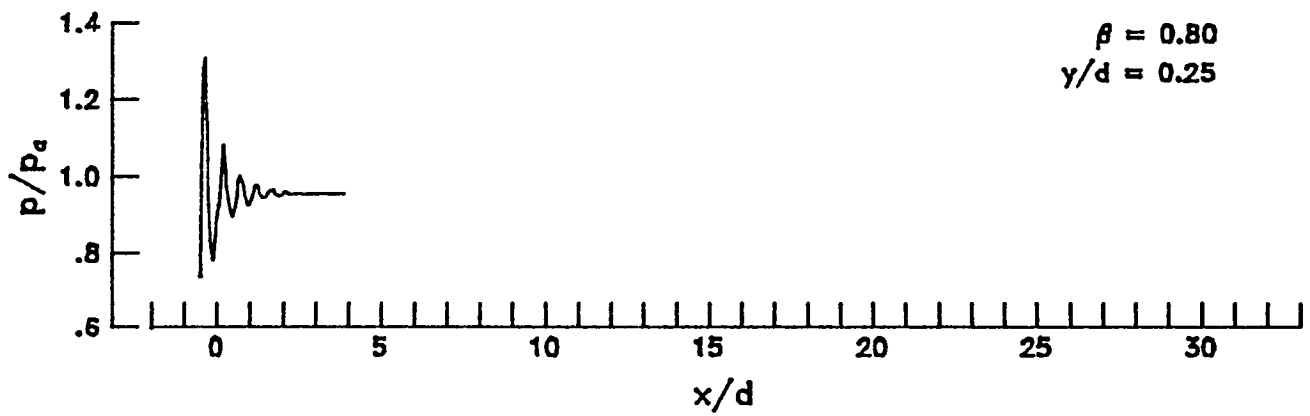
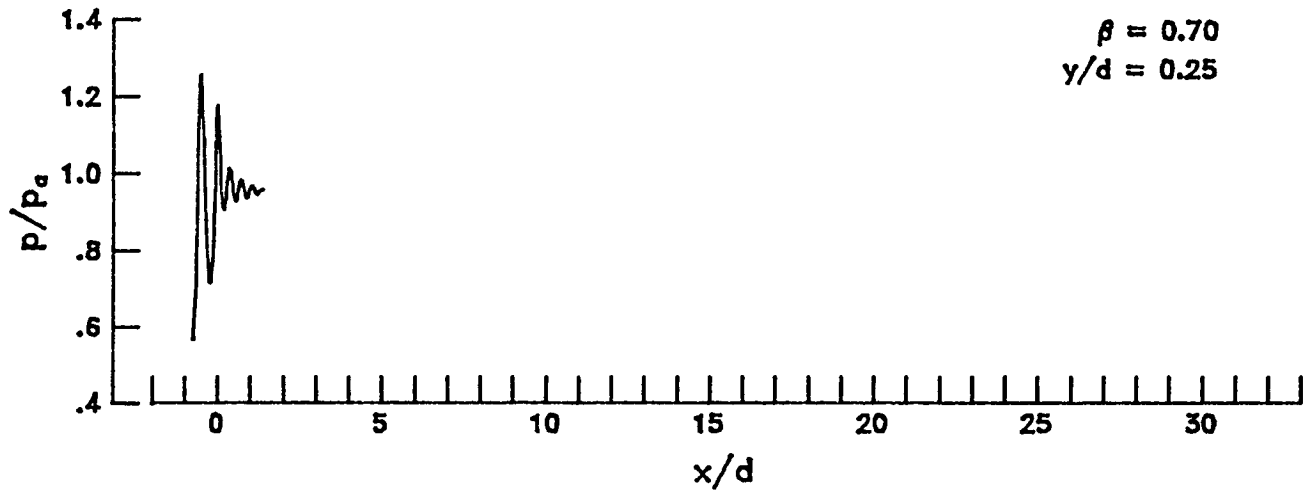

## Mach 2.0 contoured nozzle without tab

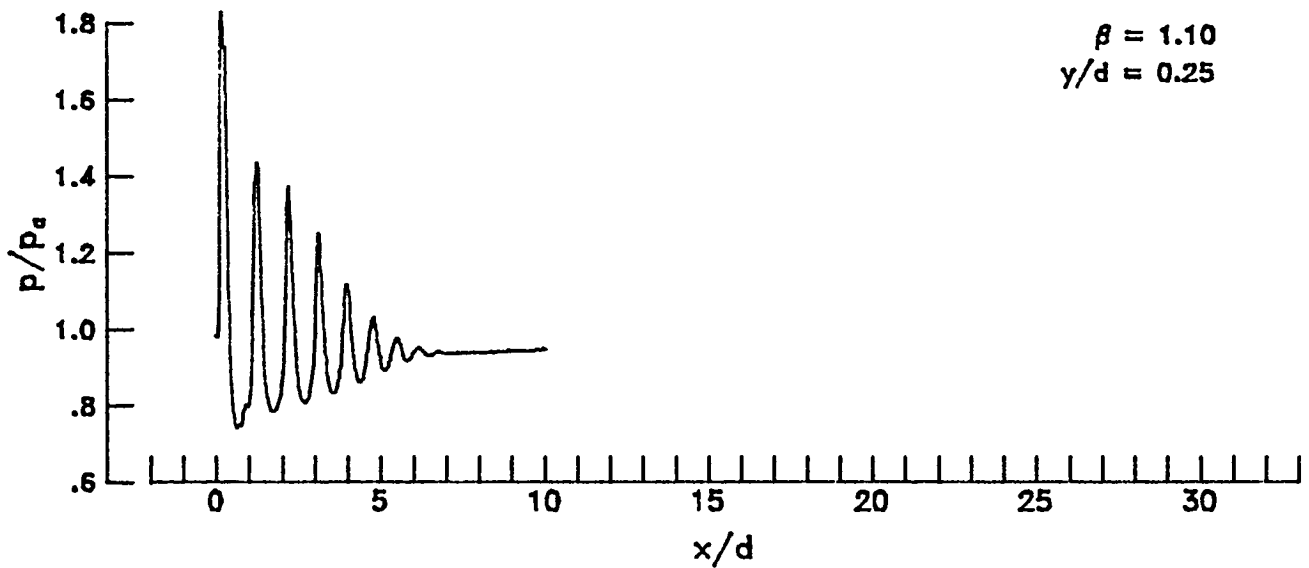
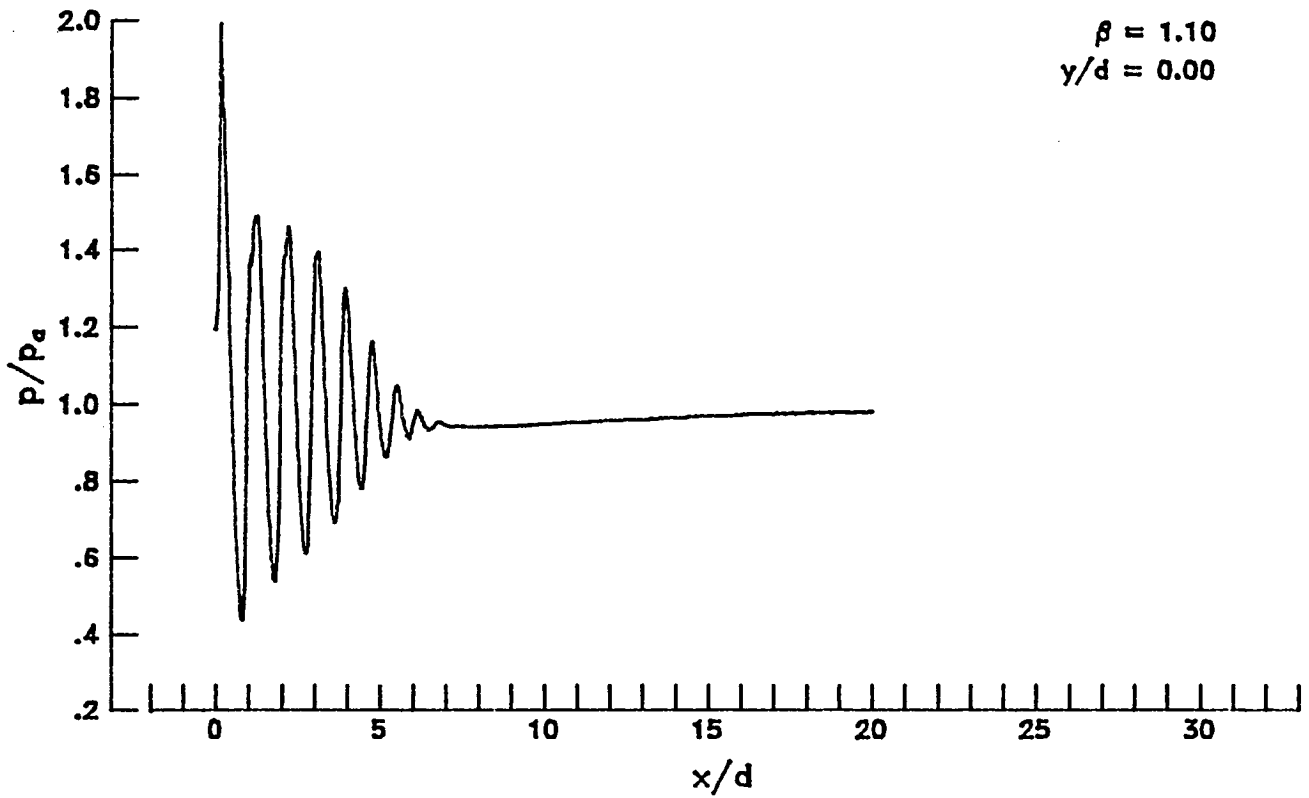

## Mach 2.0 contoured nozzle without tab

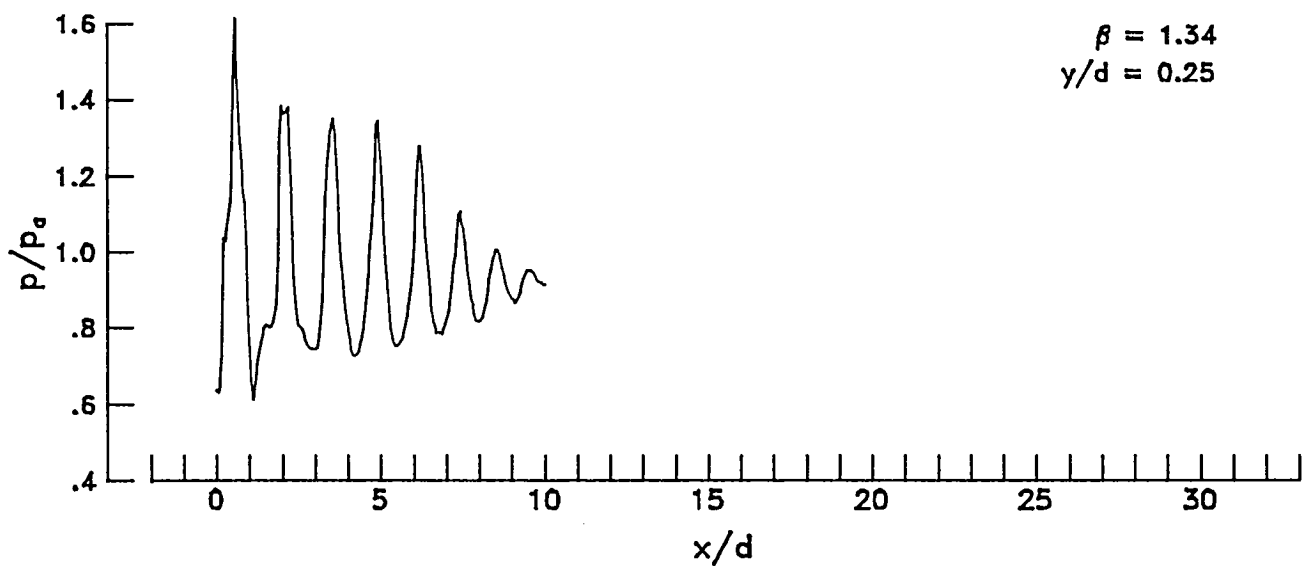
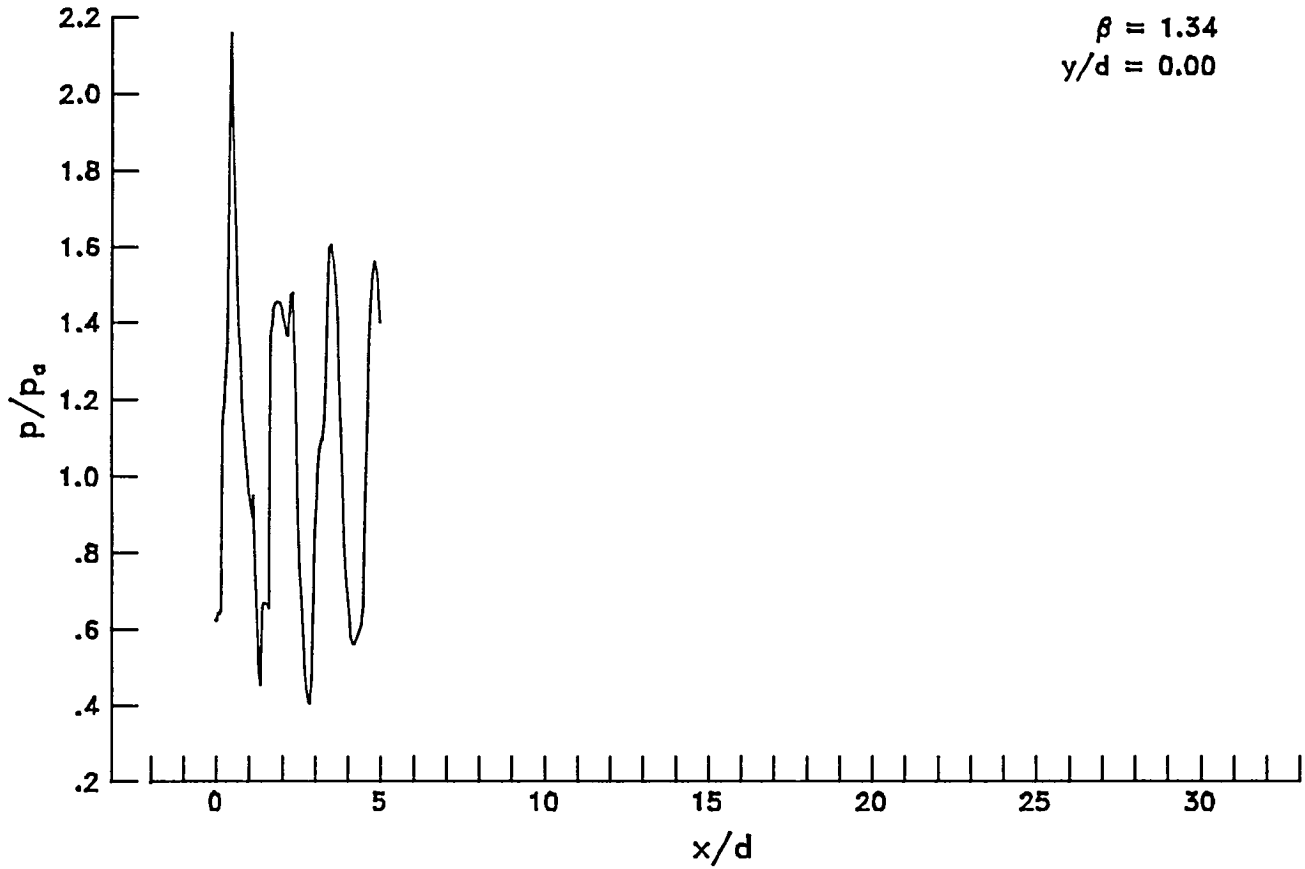

Mach 2.0 contoured nozzle without tab

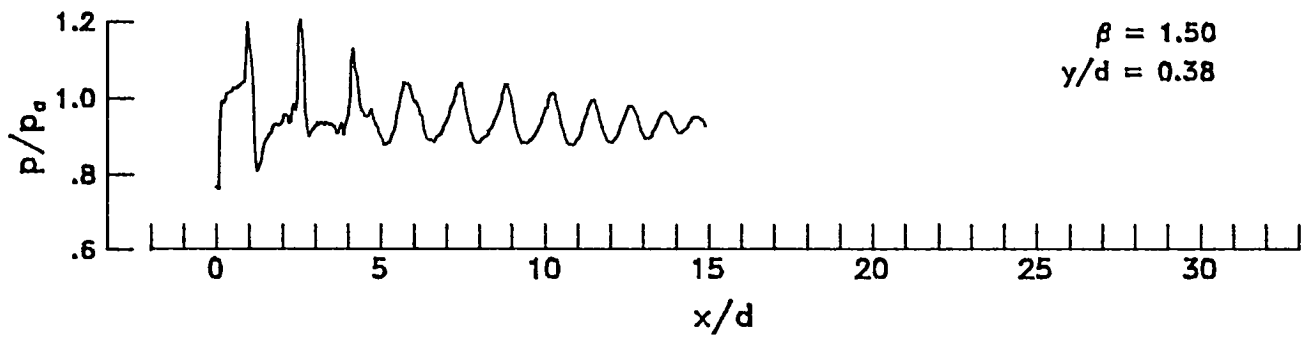
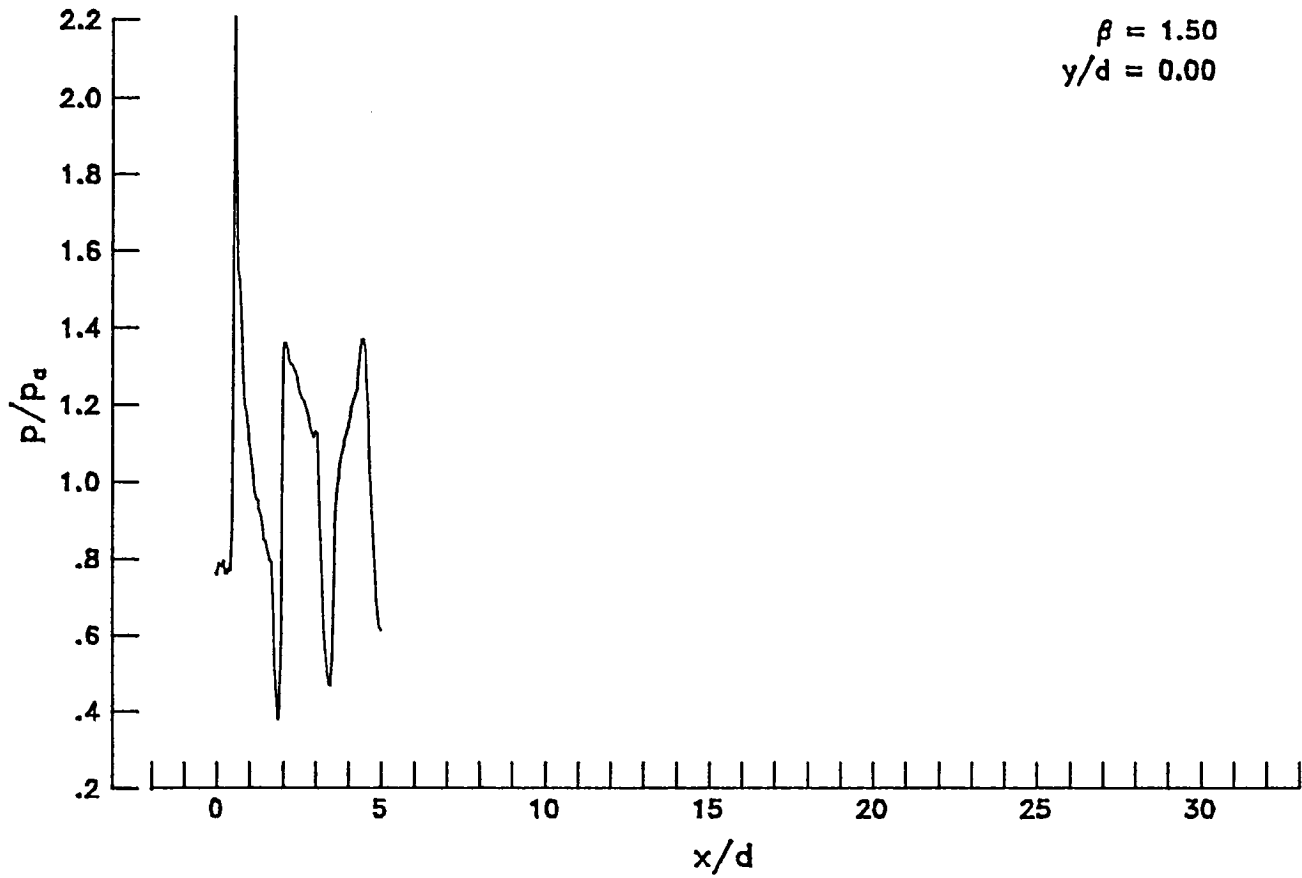

Mach 2.0 contoured nozzle without tab

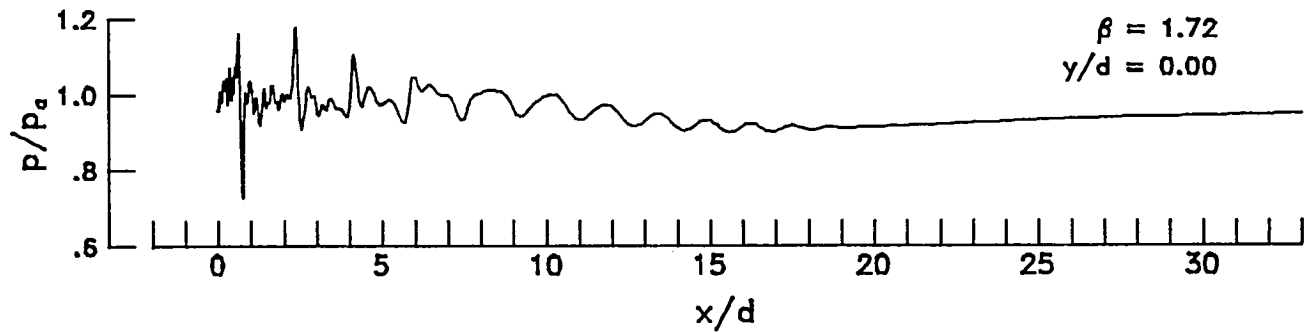
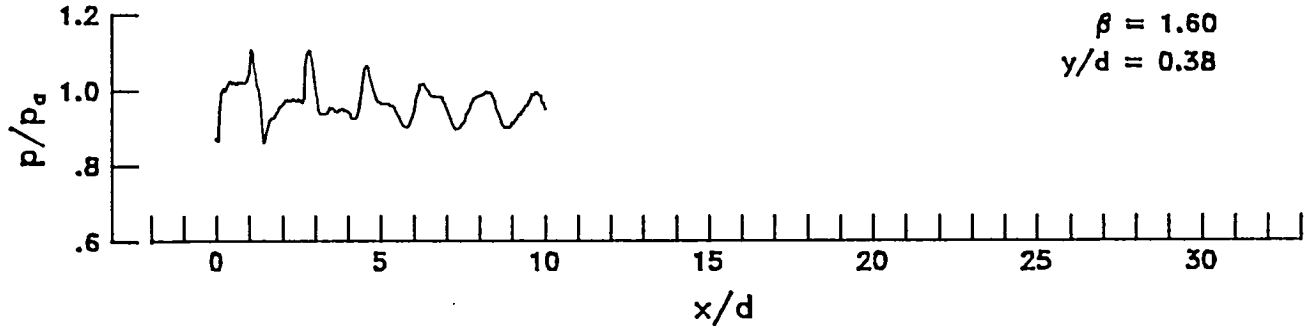
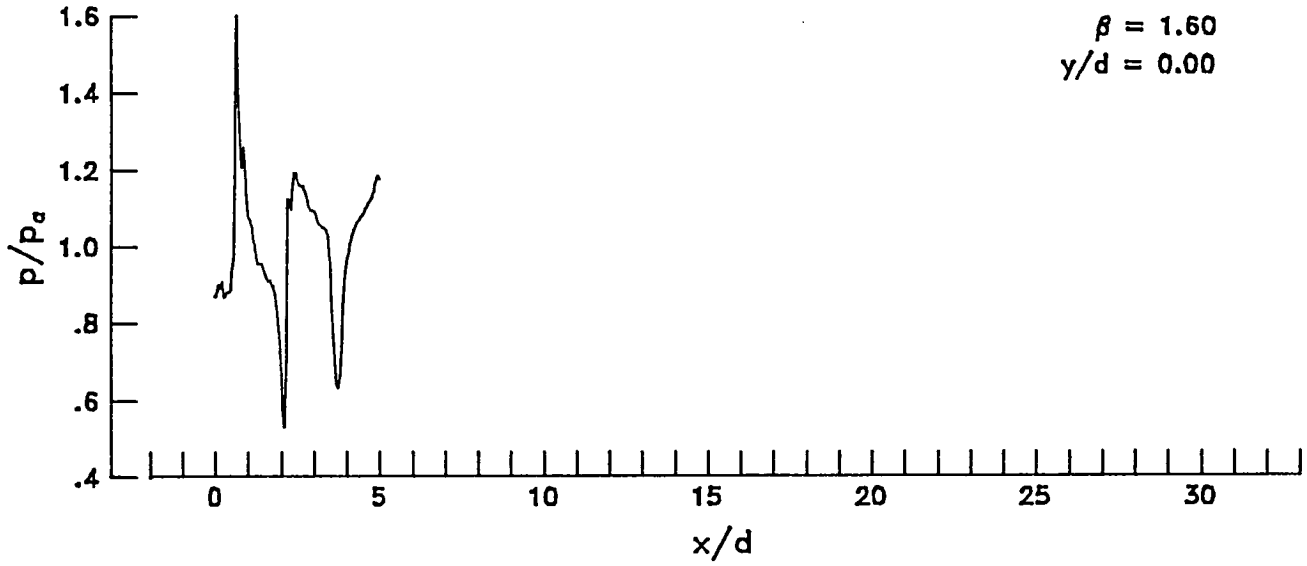

Mach 2.0 contoured nozzle without tab

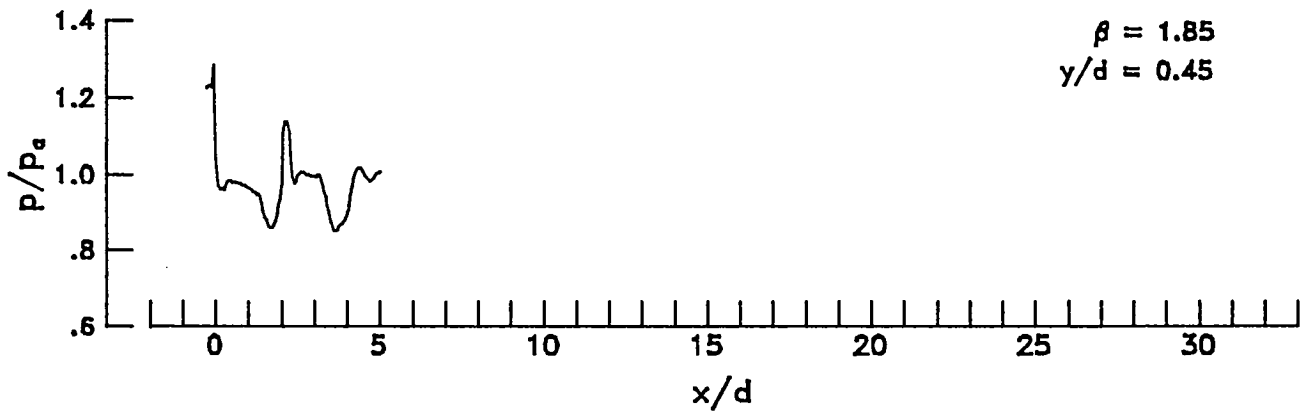
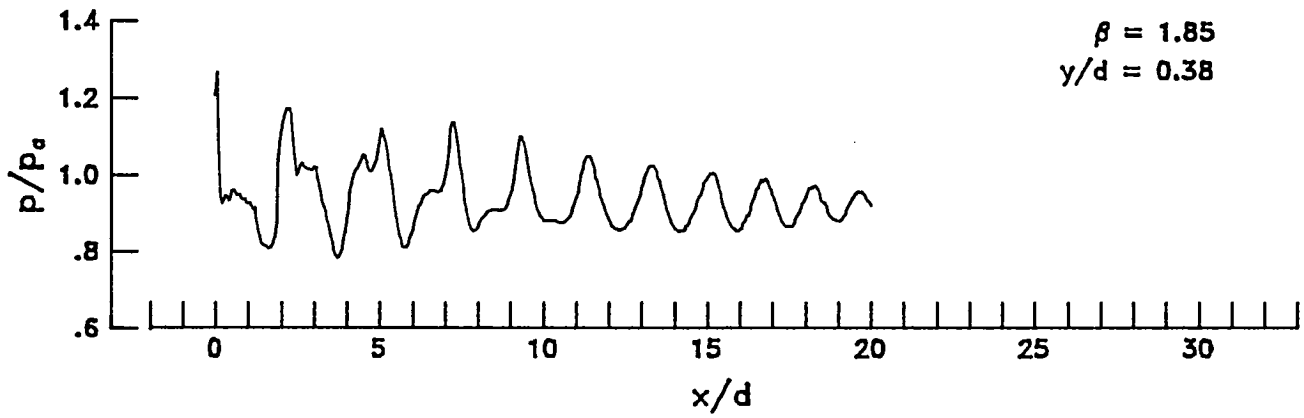
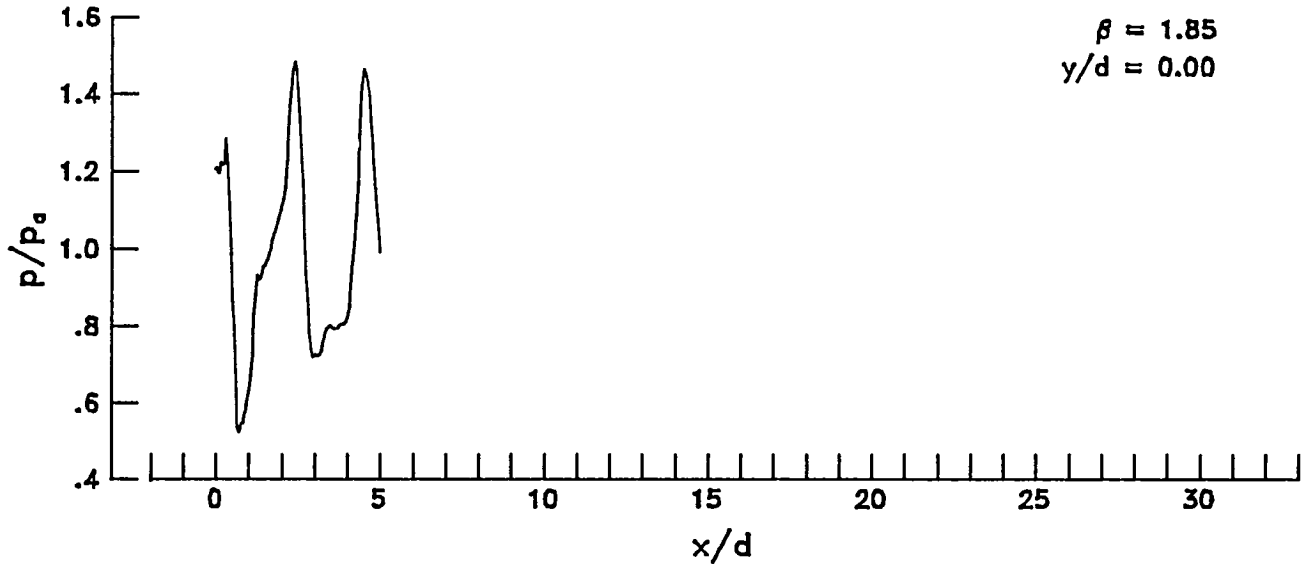

APPENDIX A

Mach 2.0 contoured nozzle without tab

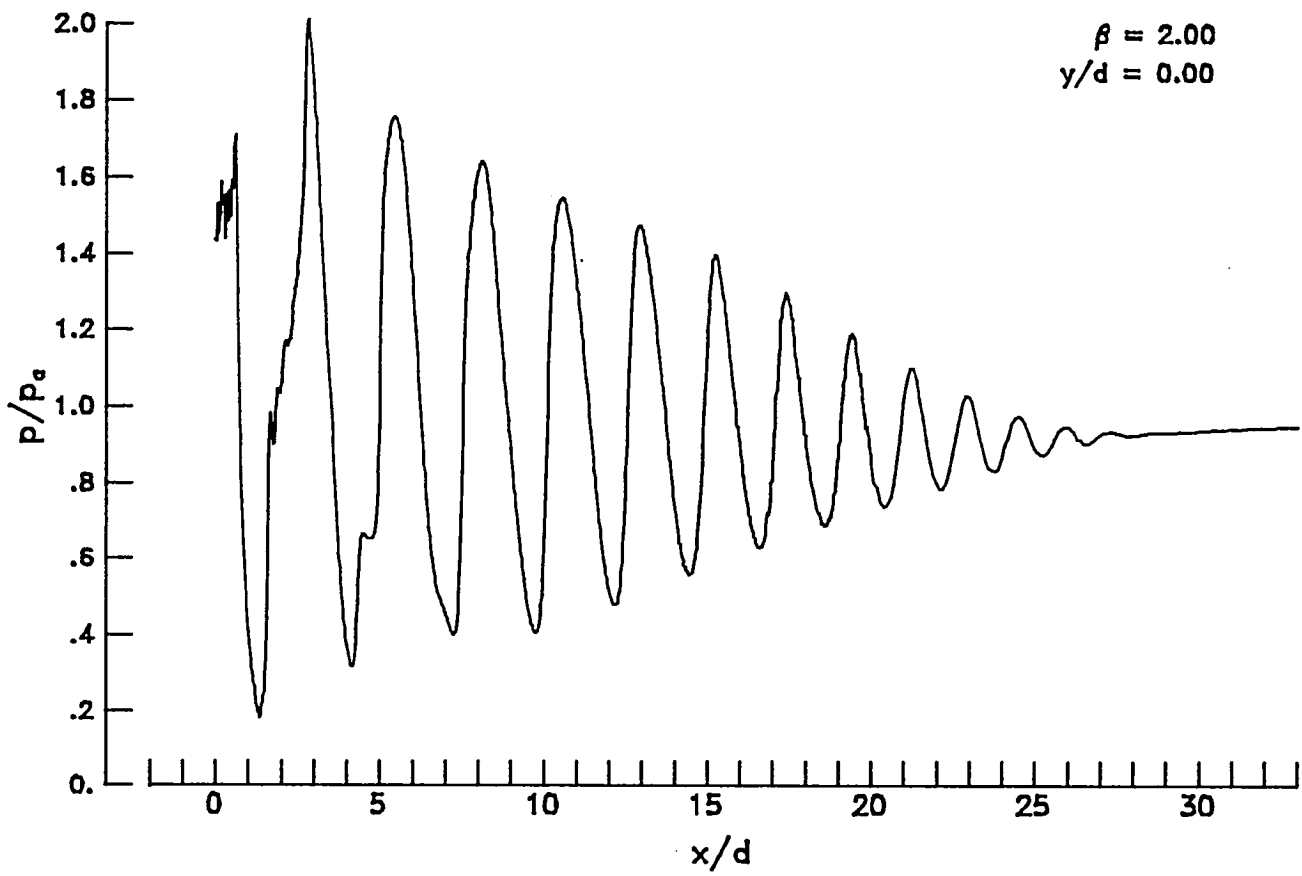



### Mach 2.0 contoured nozzle without tab

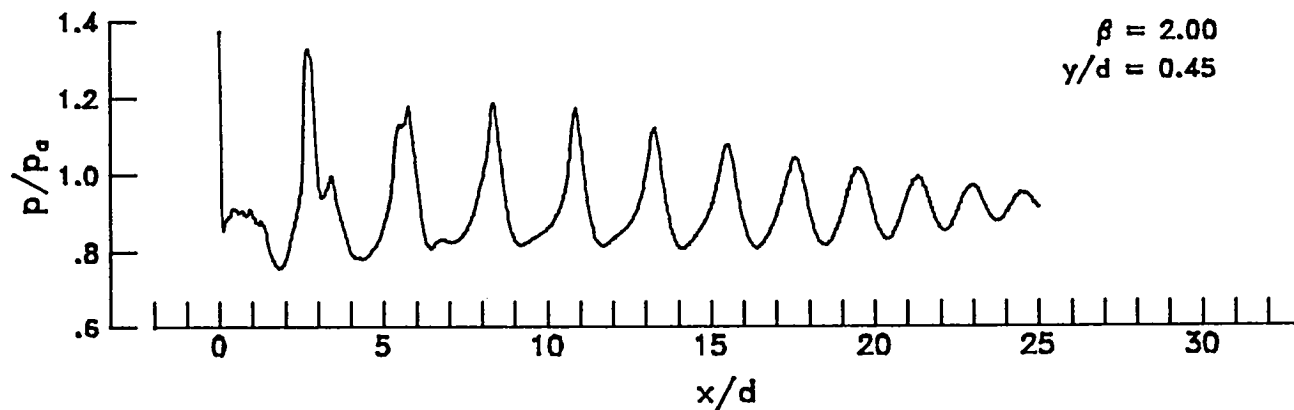
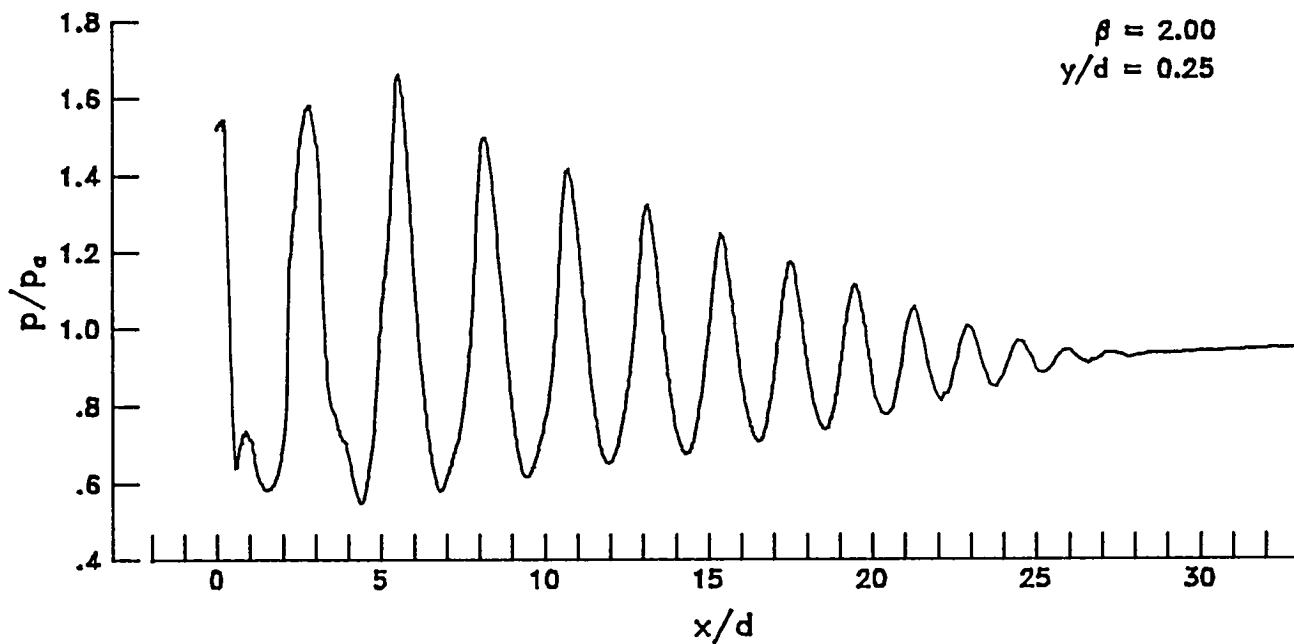

APPENDIX B

VARIATION OF OVERALL SOUND PRESSURE LEVEL WITH  $\beta$  FOR DIFFERENT  
VALUES OF  $\phi$

<u>Nozzle configuration</u>	<u>Page</u>
Mach 1.0 contoured nozzle without tab	31
Mach 1.0 contoured nozzle with tab	32
Mach 1.5 contoured nozzle without tab	33
Mach 1.5 contoured nozzle with tab	34
Mach 2.0 contoured nozzle without tab	35
Mach 2.0 contoured nozzle with tab	36
Mach 1.0 conical nozzle without tab	37
Mach 1.0 conical nozzle with tab	38
Mach 1.5 conical nozzle without tab	39
Mach 1.5 conical nozzle with tab	40

Mach 1.0 contoured nozzle without tab

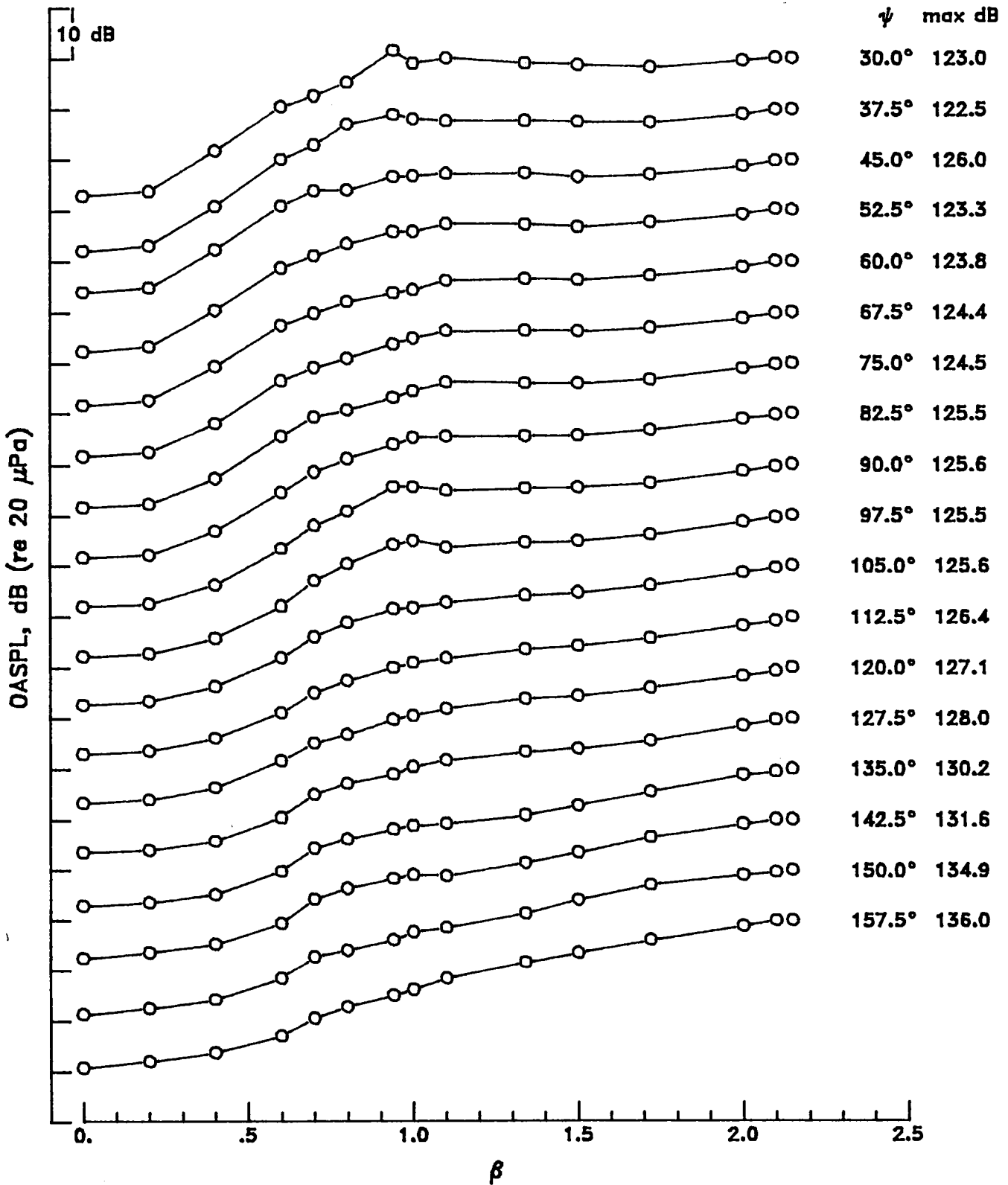

Mach 1.0 contoured nozzle with tab

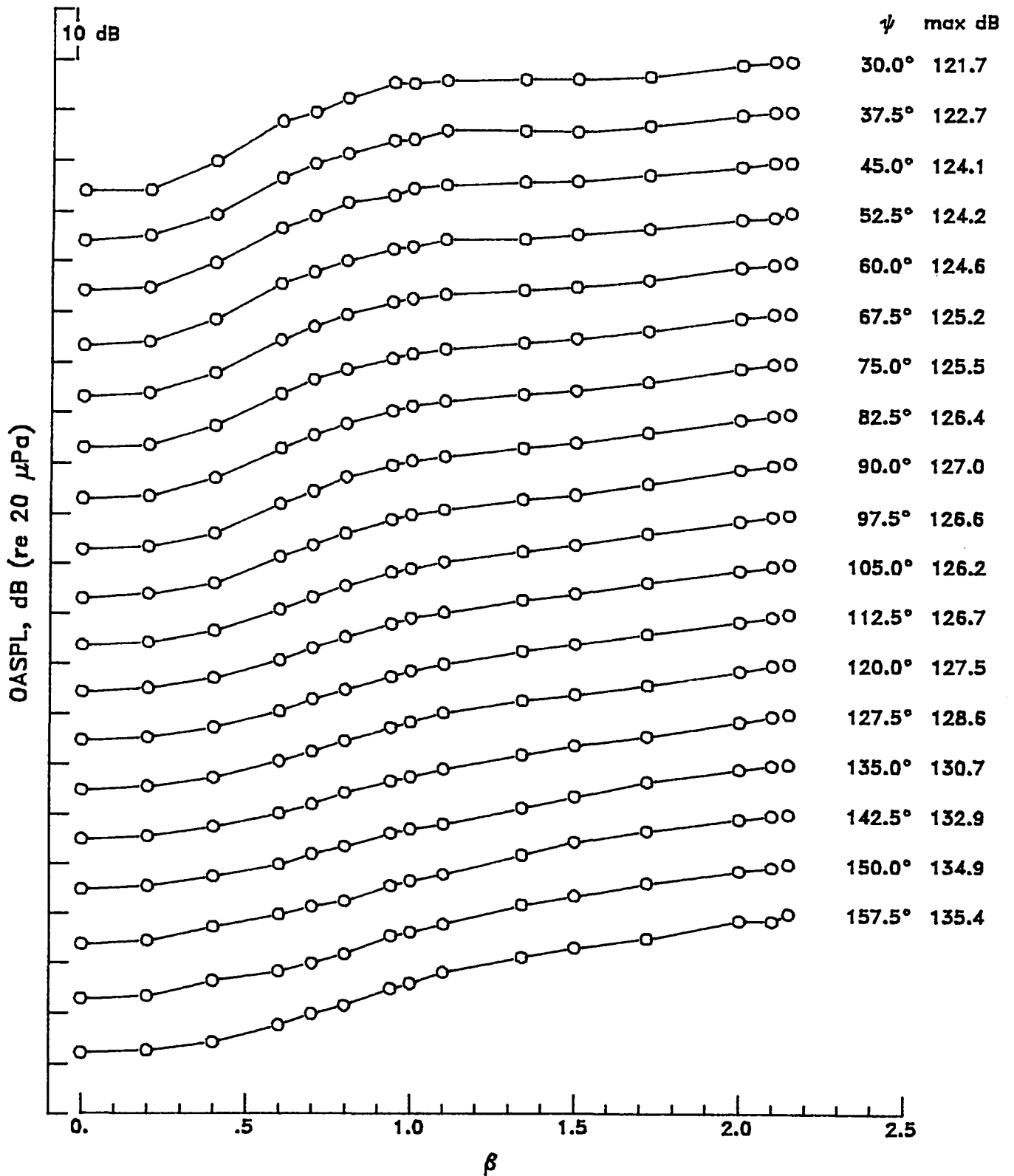

Mach 1.5 contoured nozzle without tab

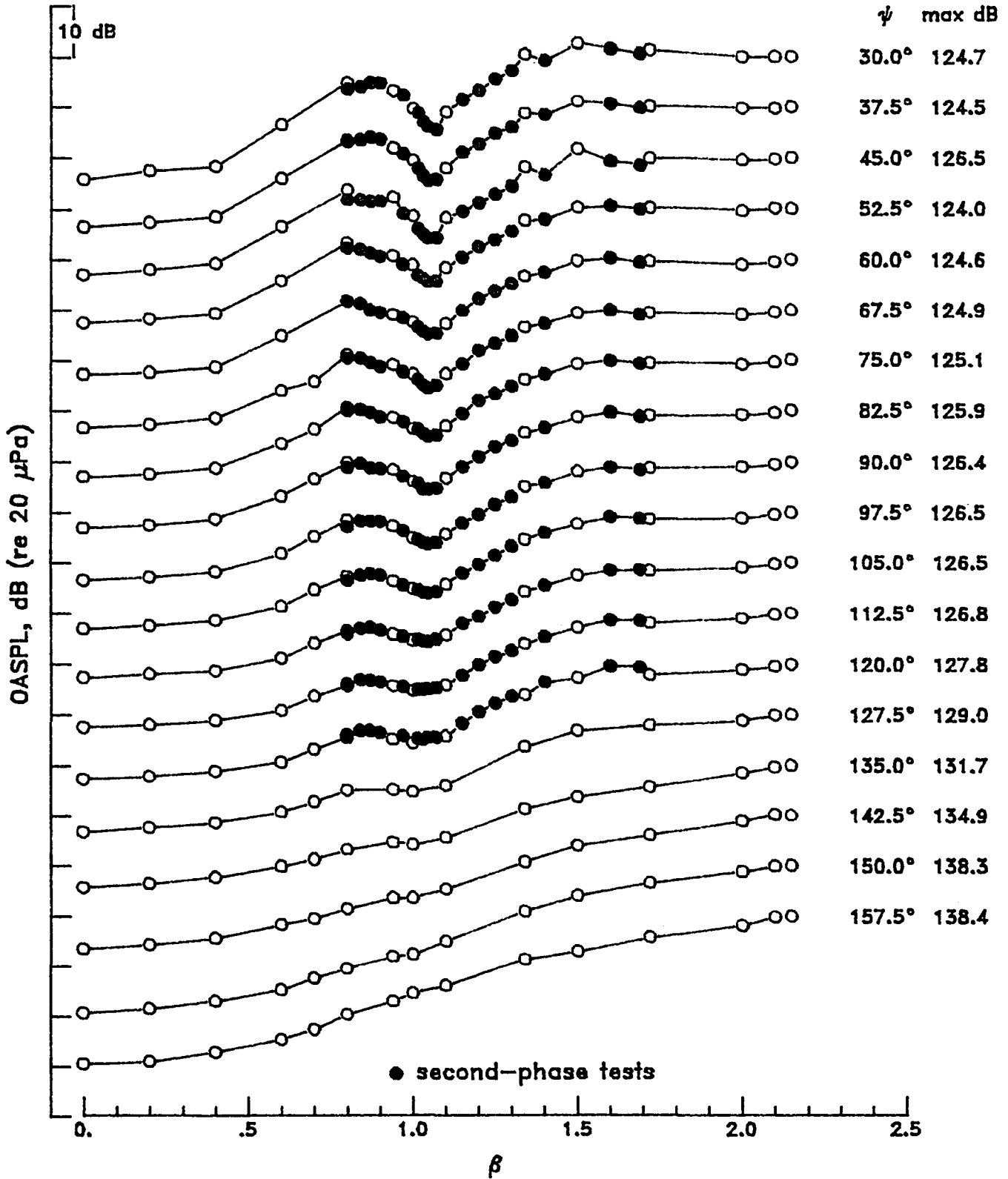

APPENDIX B

Mach 1.5 contoured nozzle with tab

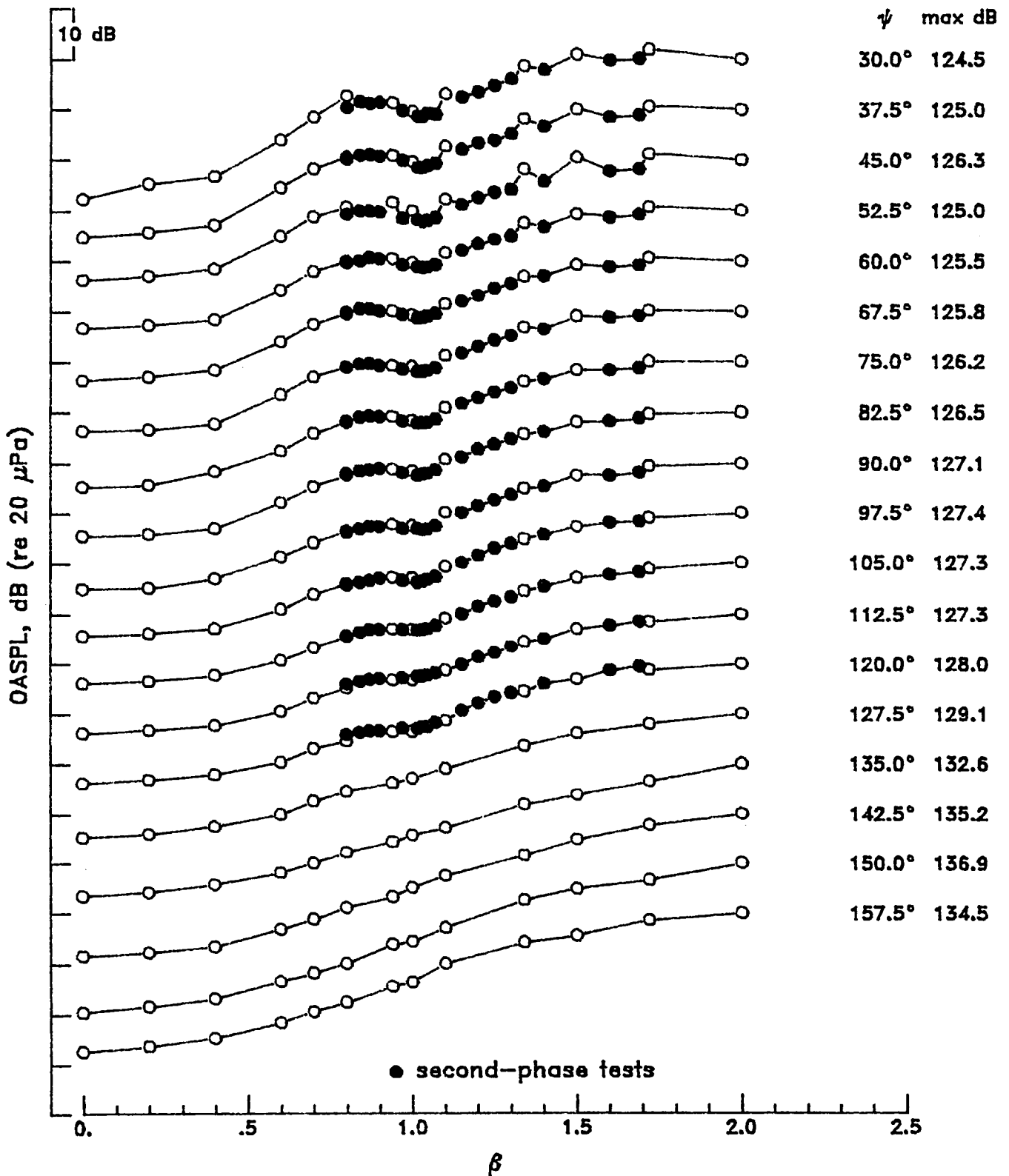

Mach 2.0 contoured nozzle without tab

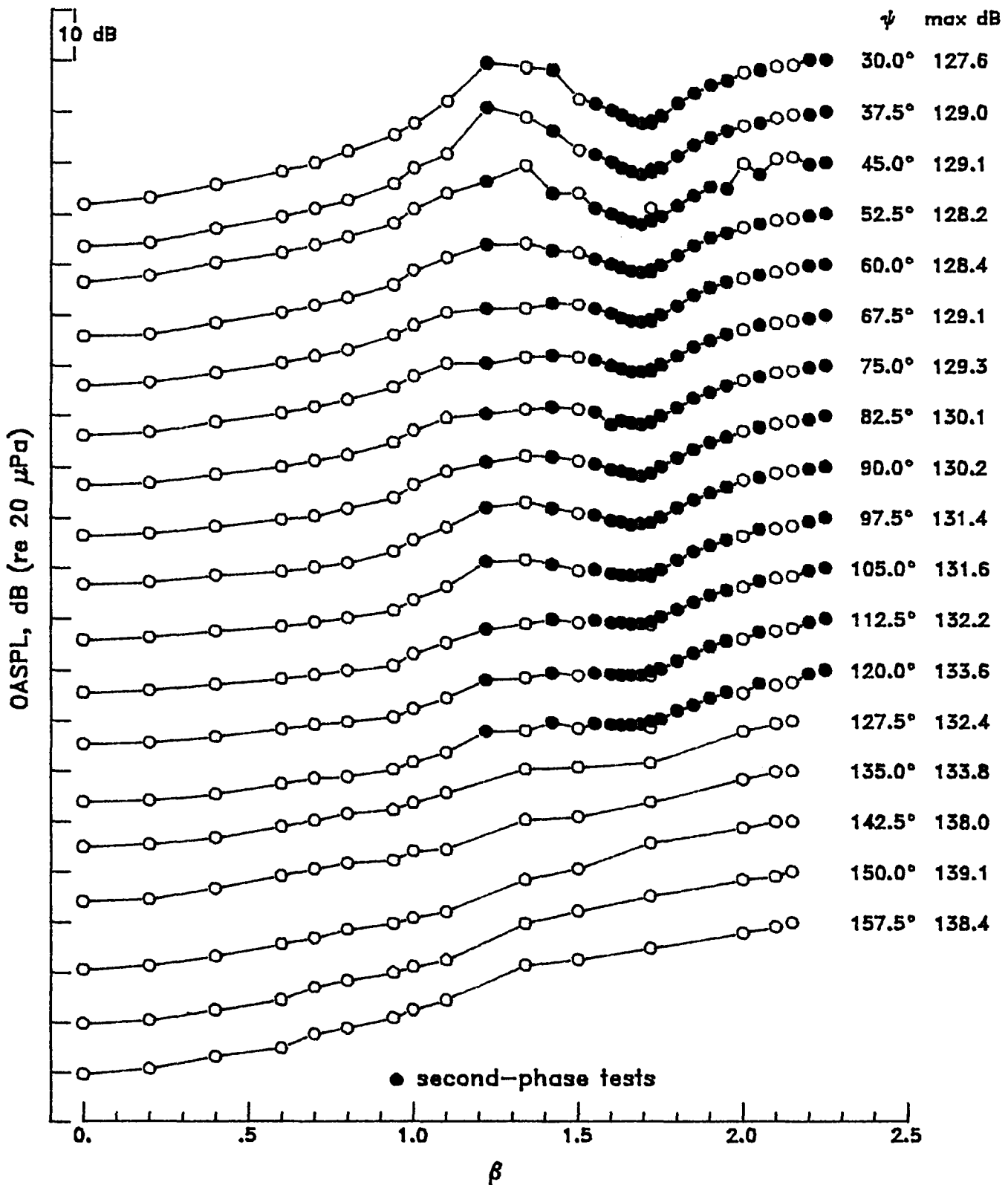

### Mach 2.0 contoured nozzle with tab

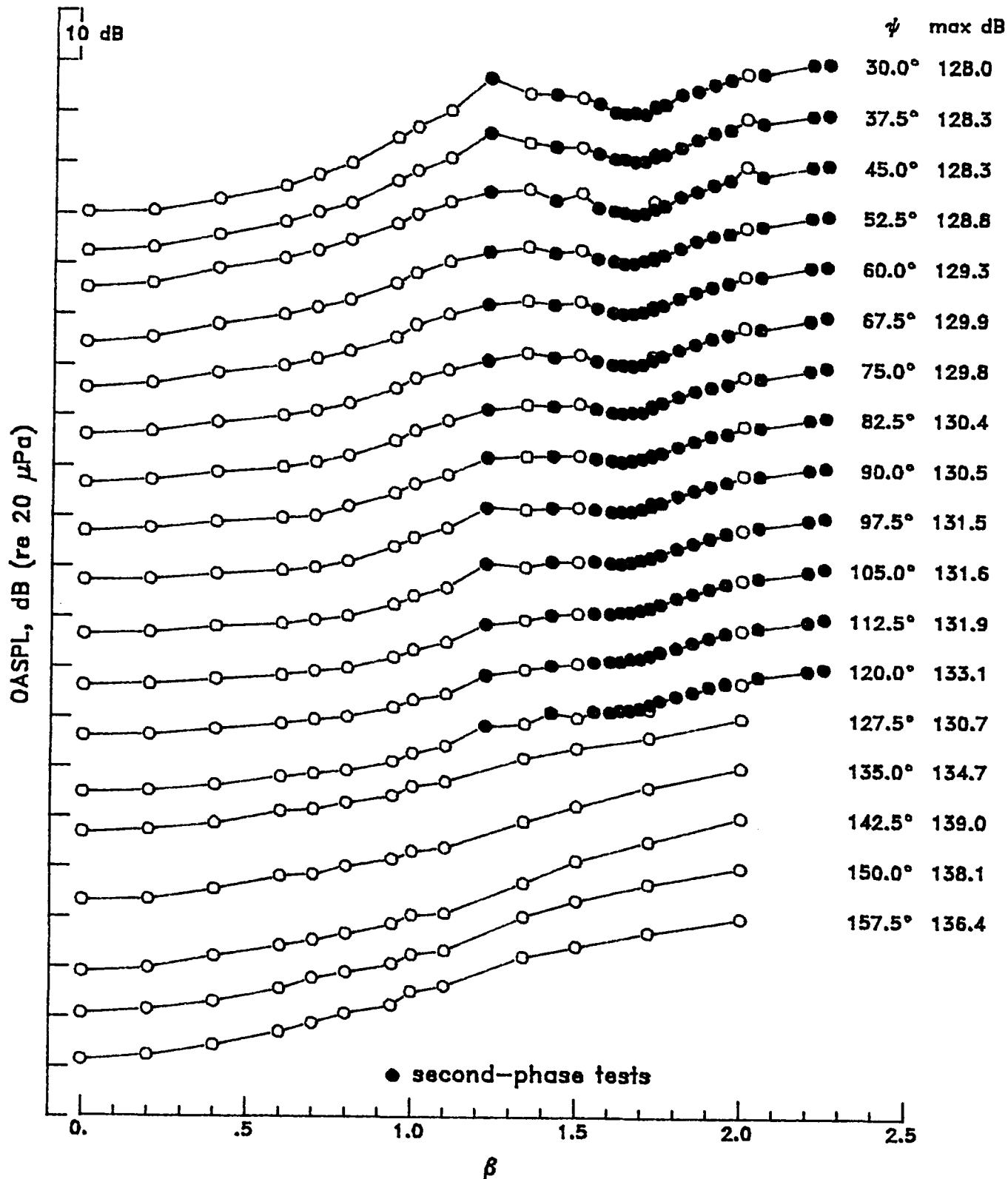



Mach 1.0 conical nozzle without tab

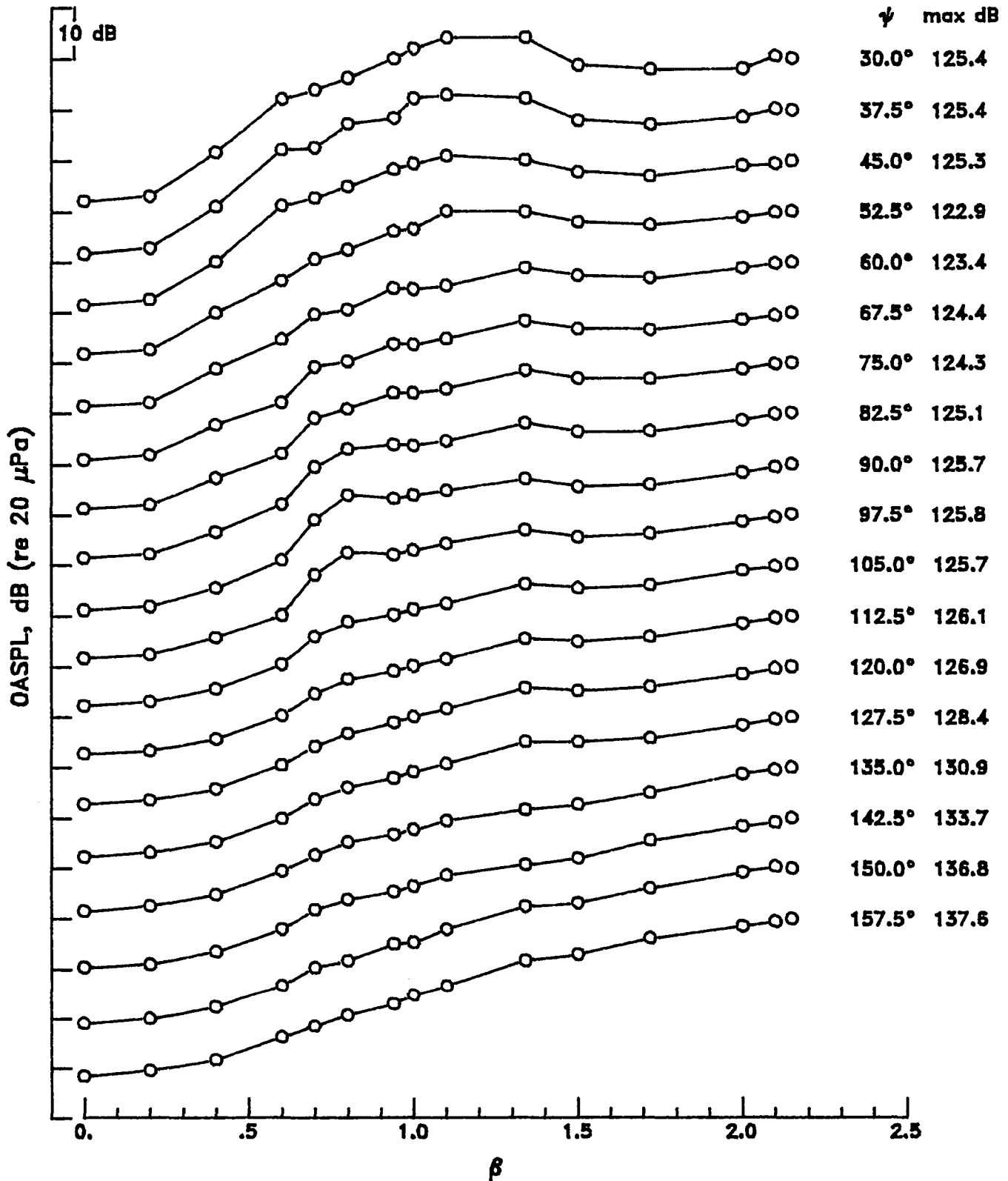

Mach 1.0 conical nozzle with tab

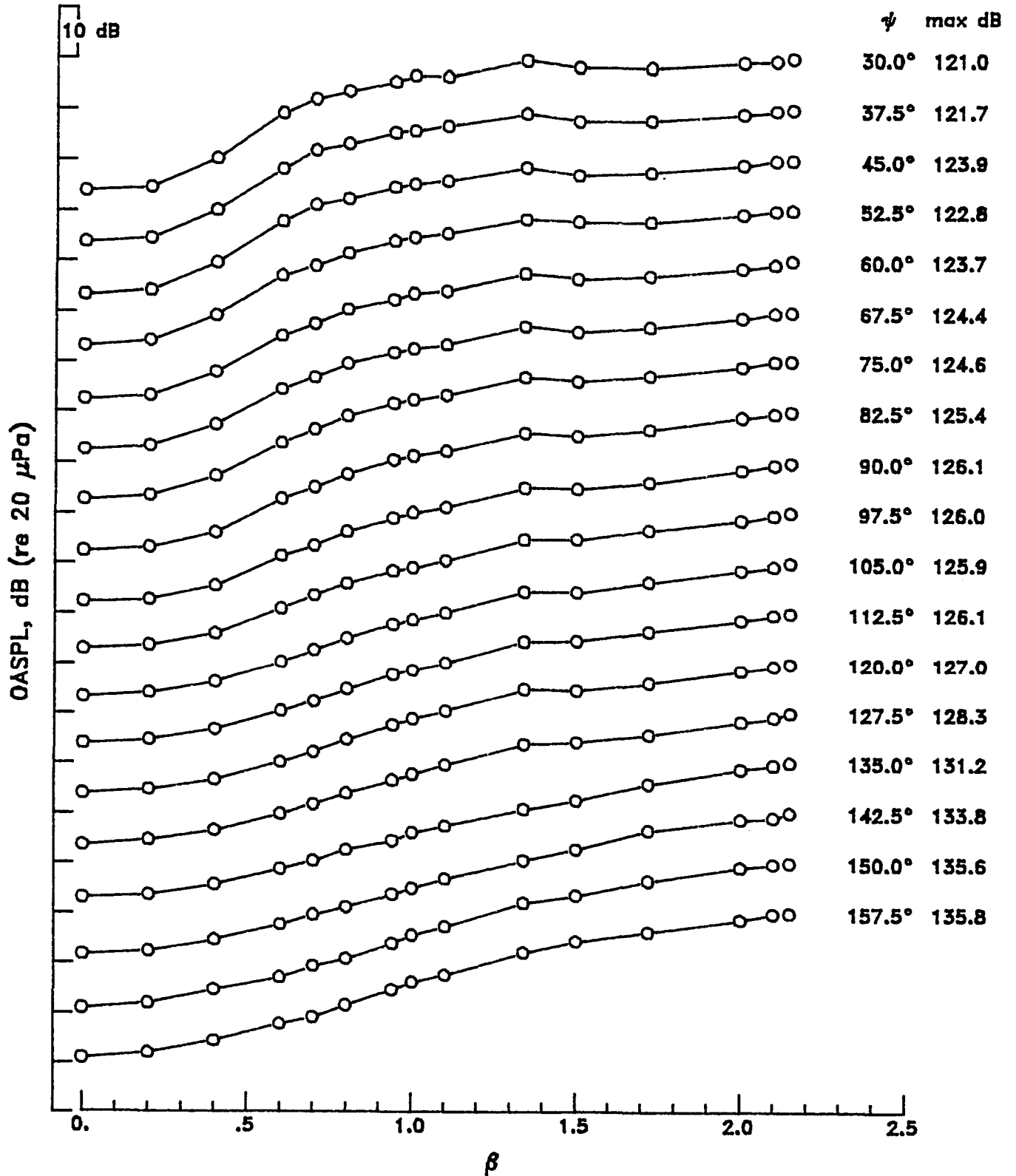

Mach 1.5 conical nozzle without tab

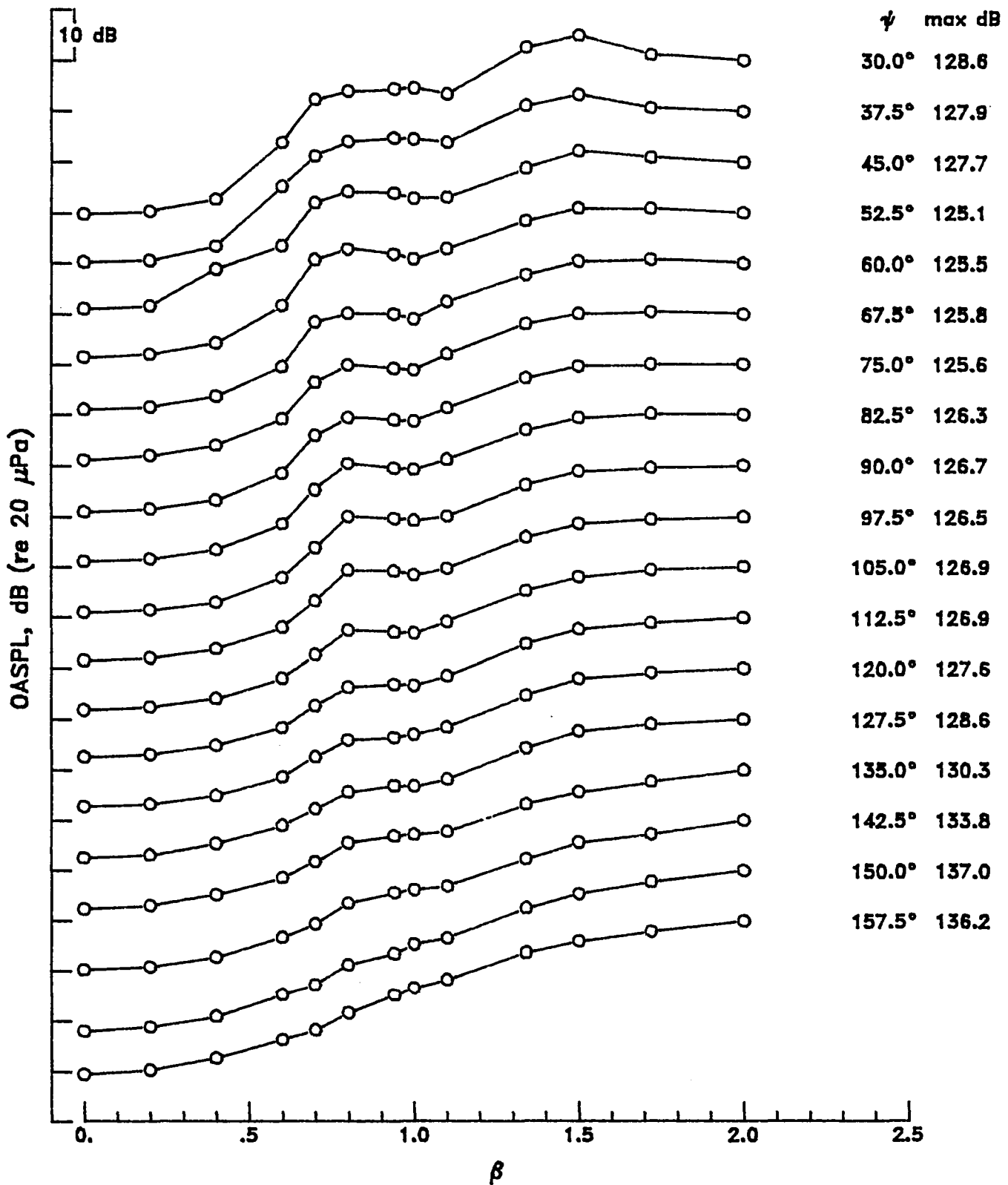

Mach 1.5 conical nozzle with tab

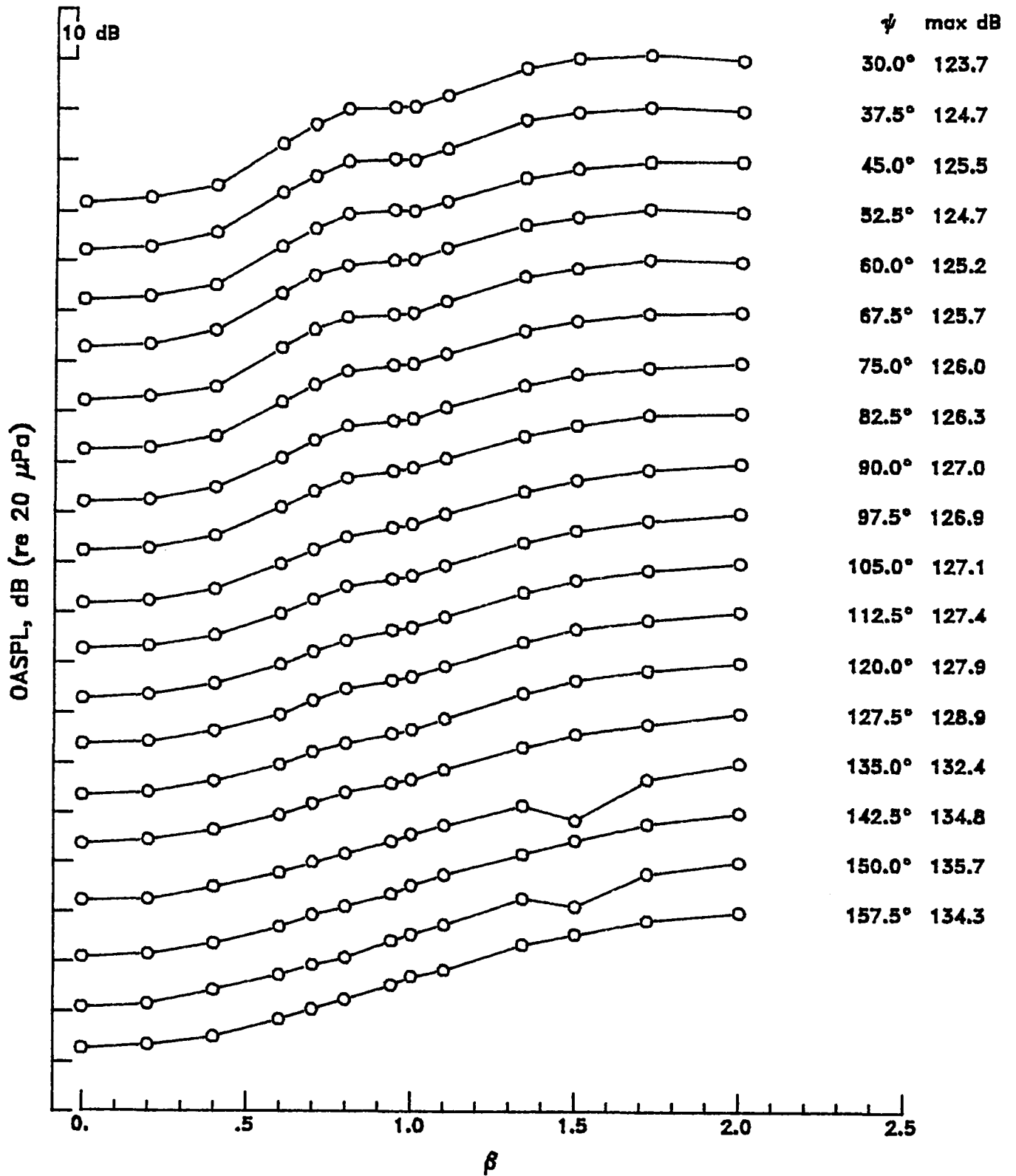

APPENDIX C

VARIATION OF OVERALL SOUND PRESSURE LEVEL WITH  $\phi$  FOR DIFFERENT  
VALUES OF  $\beta$

<u>Nozzle configuration</u>	<u>Page</u>
Mach 1.0 contoured nozzle without tab	42
Mach 1.0 contoured nozzle with tab	43
Mach 1.5 contoured nozzle without tab	44
Mach 1.5 contoured nozzle with tab	45
Mach 2.0 contoured nozzle without tab	46
Mach 2.0 contoured nozzle with tab	47
Mach 1.0 conical nozzle without tab	48
Mach 1.0 conical nozzle with tab	49
Mach 1.5 conical nozzle without tab	50
Mach 1.5 conical nozzle with tab	51

Mach 1.0 contoured nozzle without tab

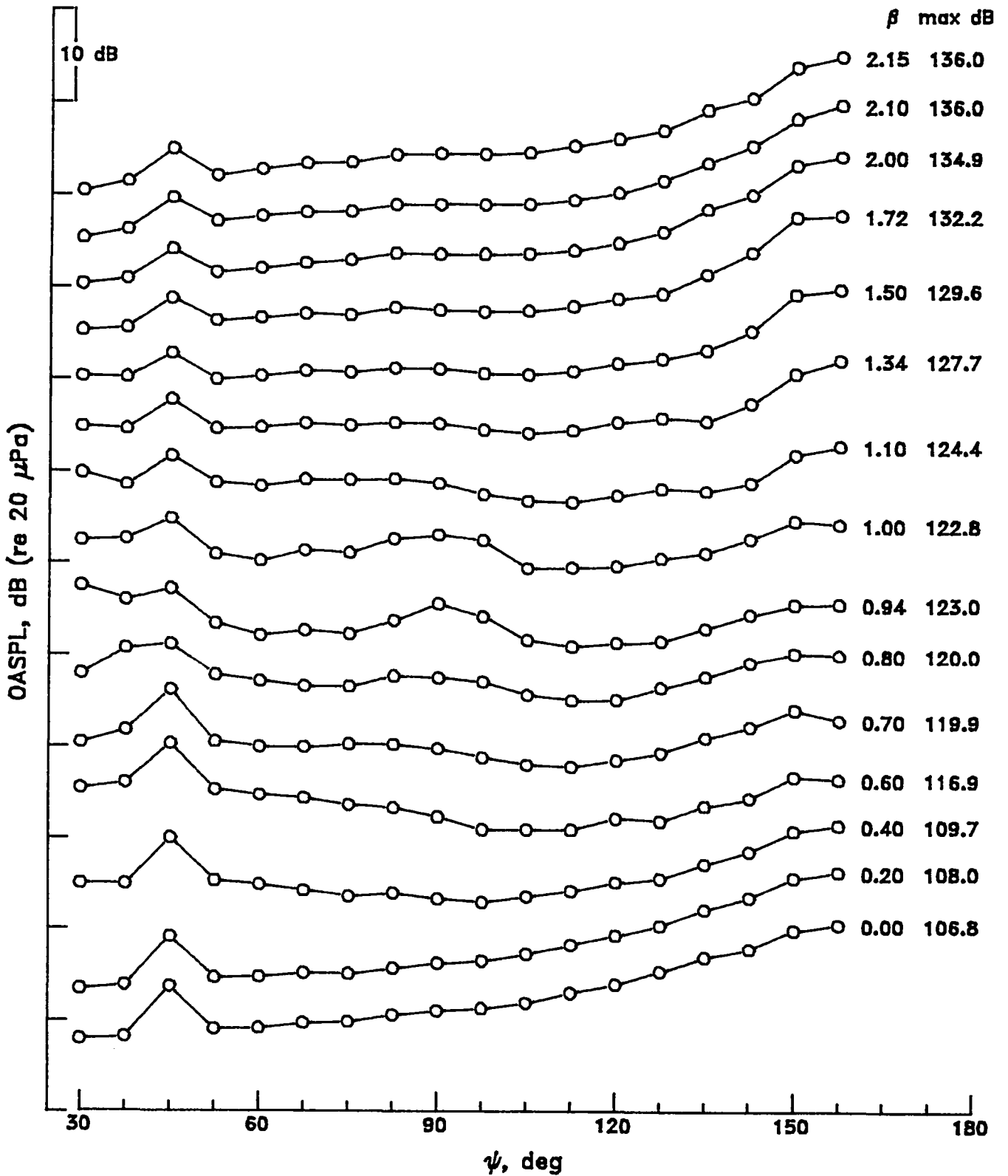

APPENDIX C

Mach 1.0 contoured nozzle with tab

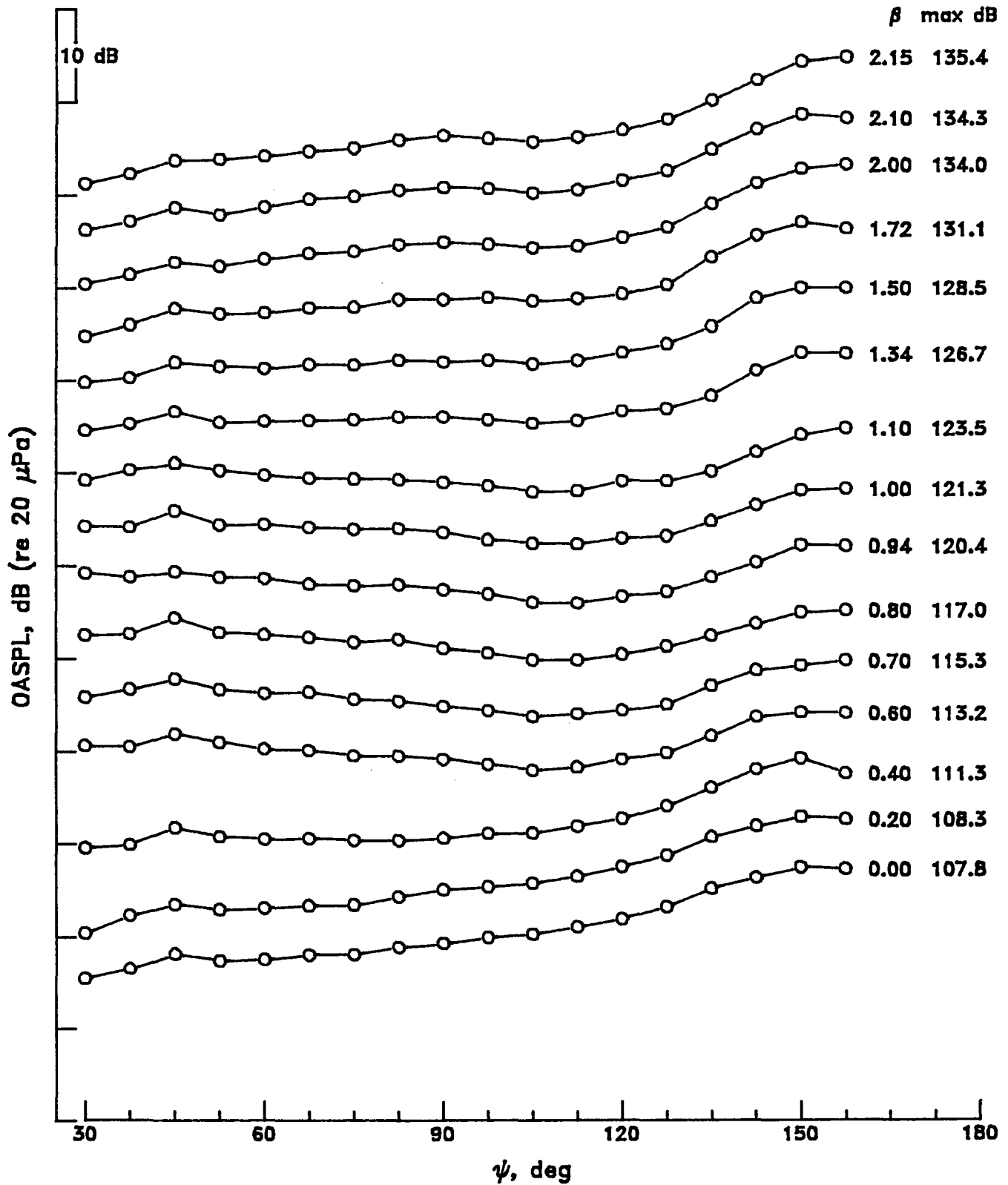

Mach 1.5 contoured nozzle without tab

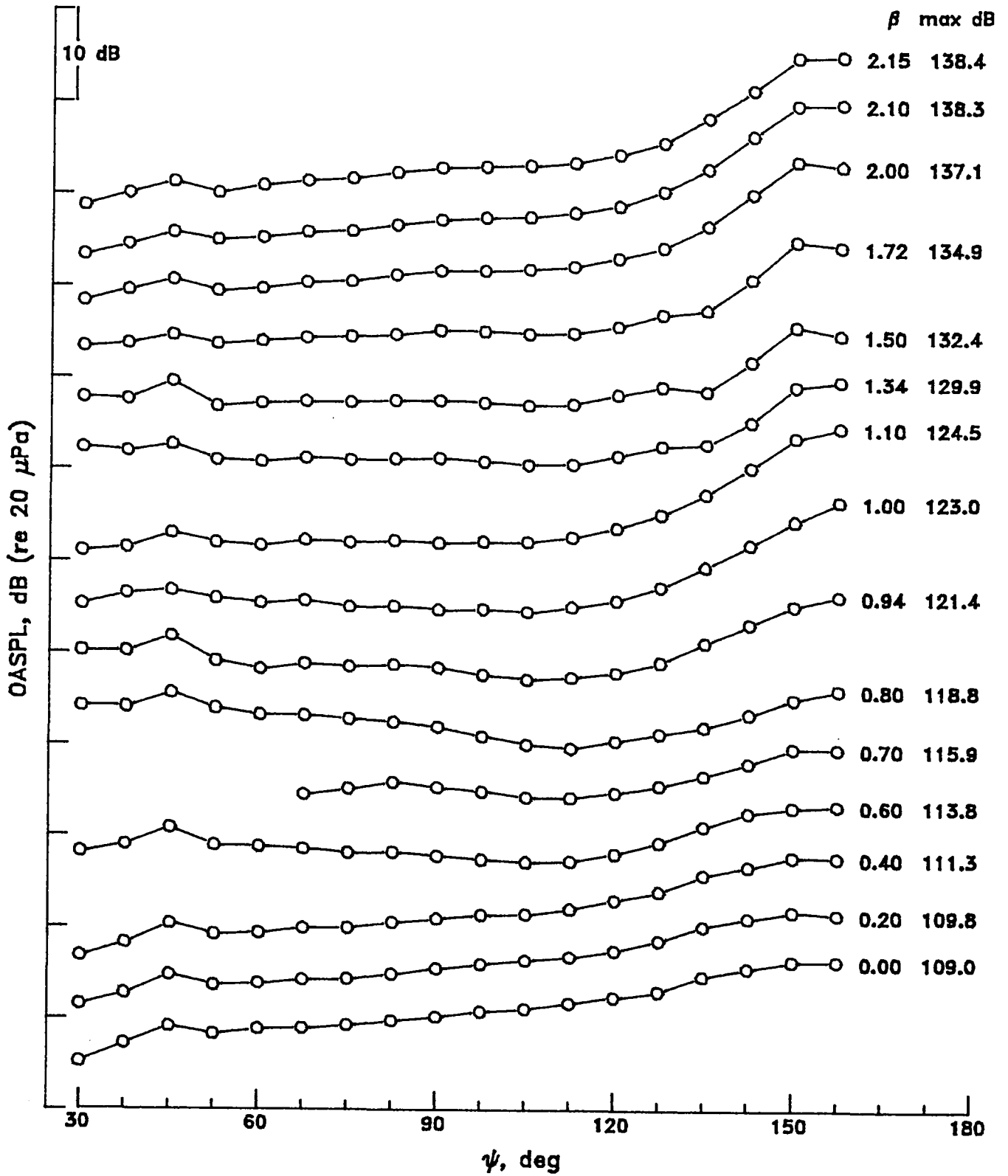



APPENDIX C

Mach 1.5 contoured nozzle with tab

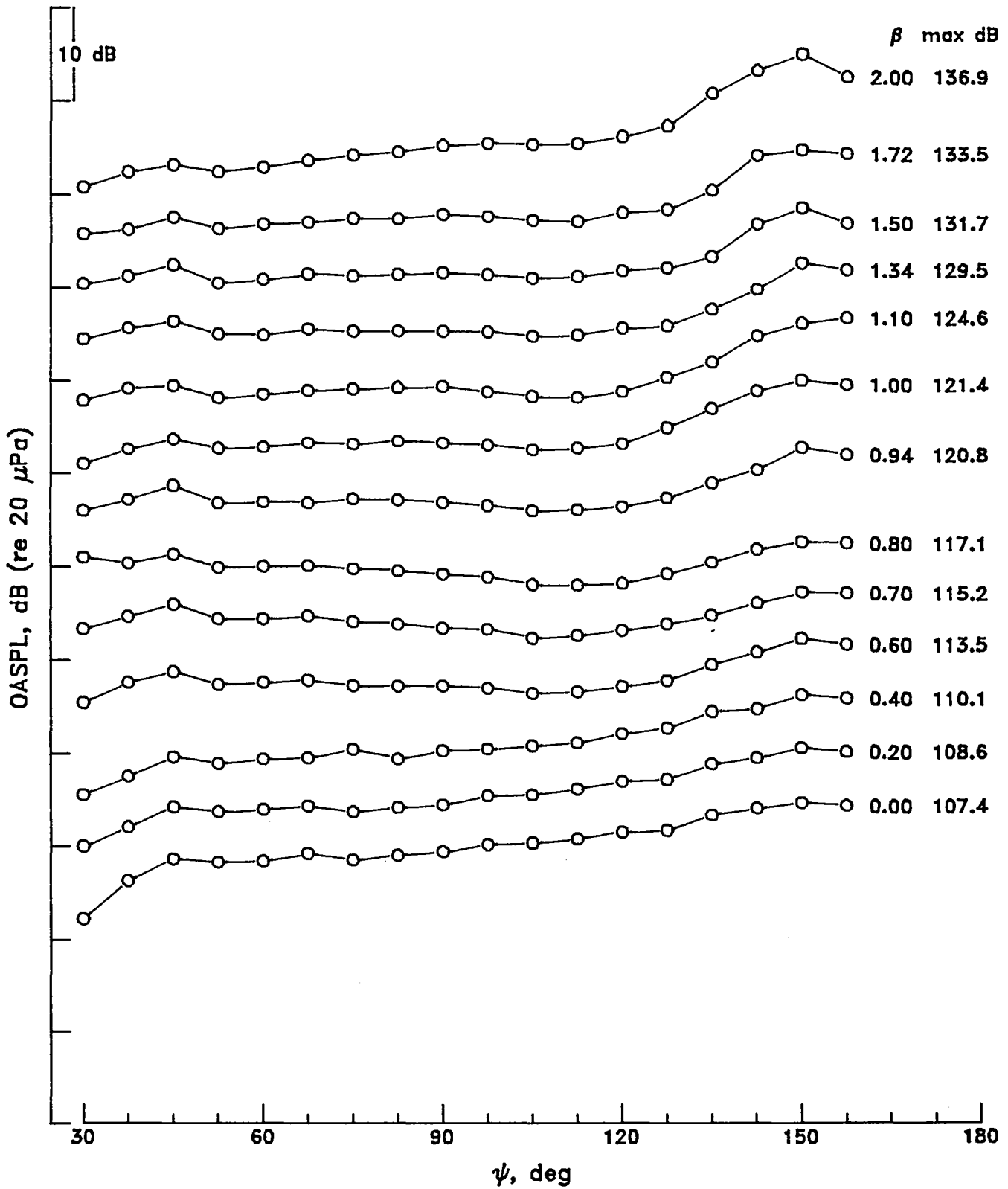

Mach 2.0 contoured nozzle without tab

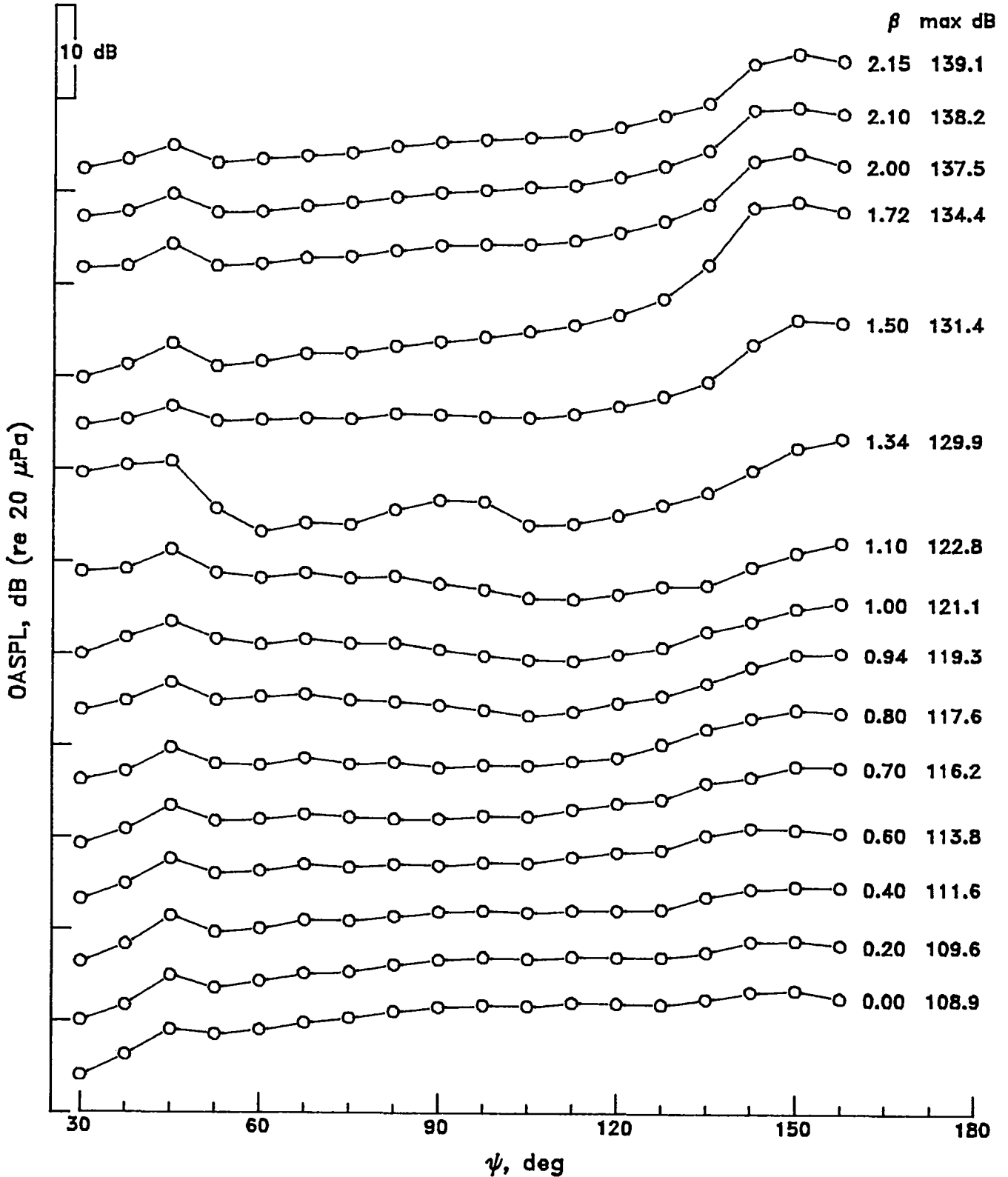

APPENDIX C

Mach 2.0 contoured nozzle with tab

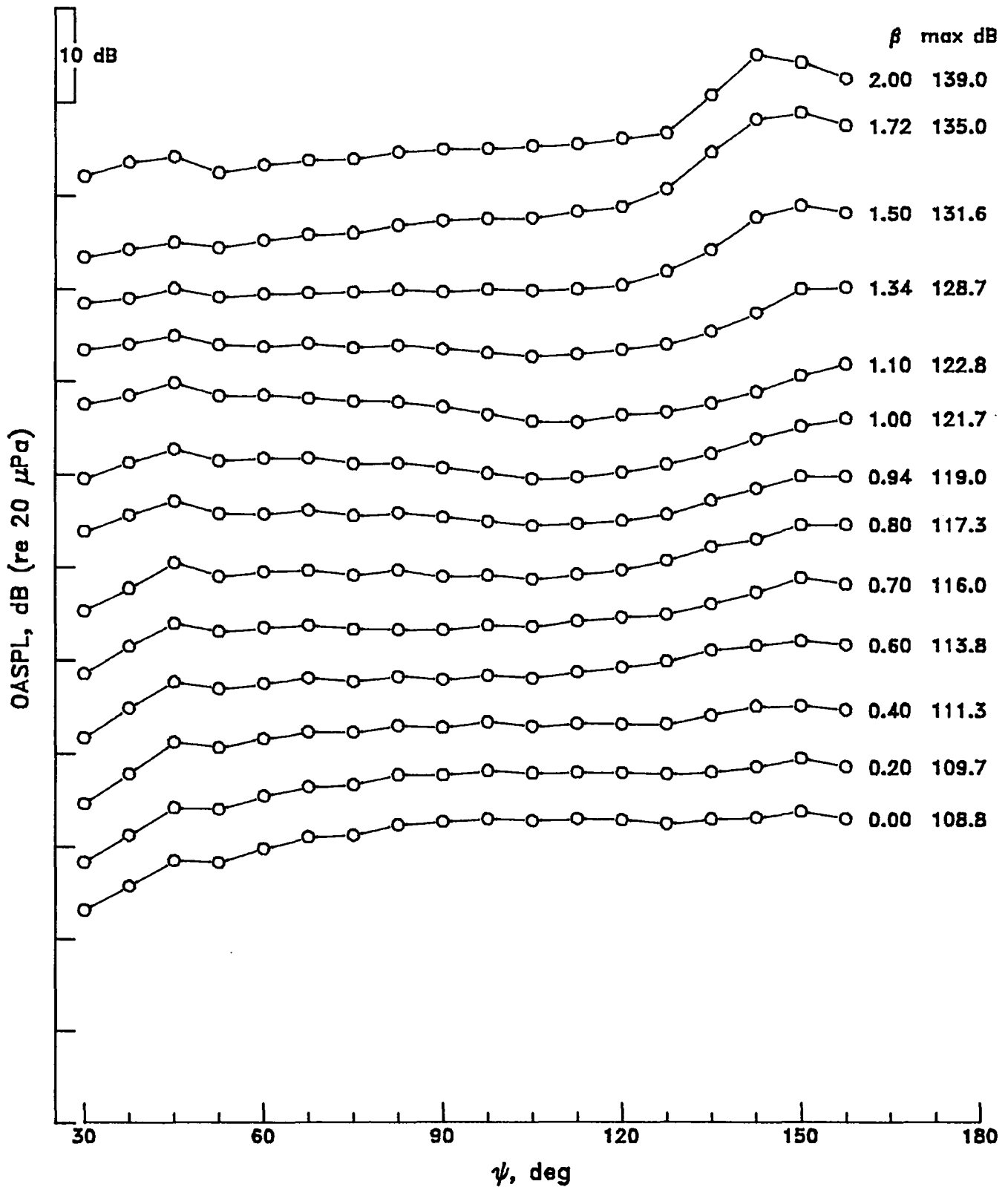

APPENDIX C

Mach 1.0 conical nozzle without tab

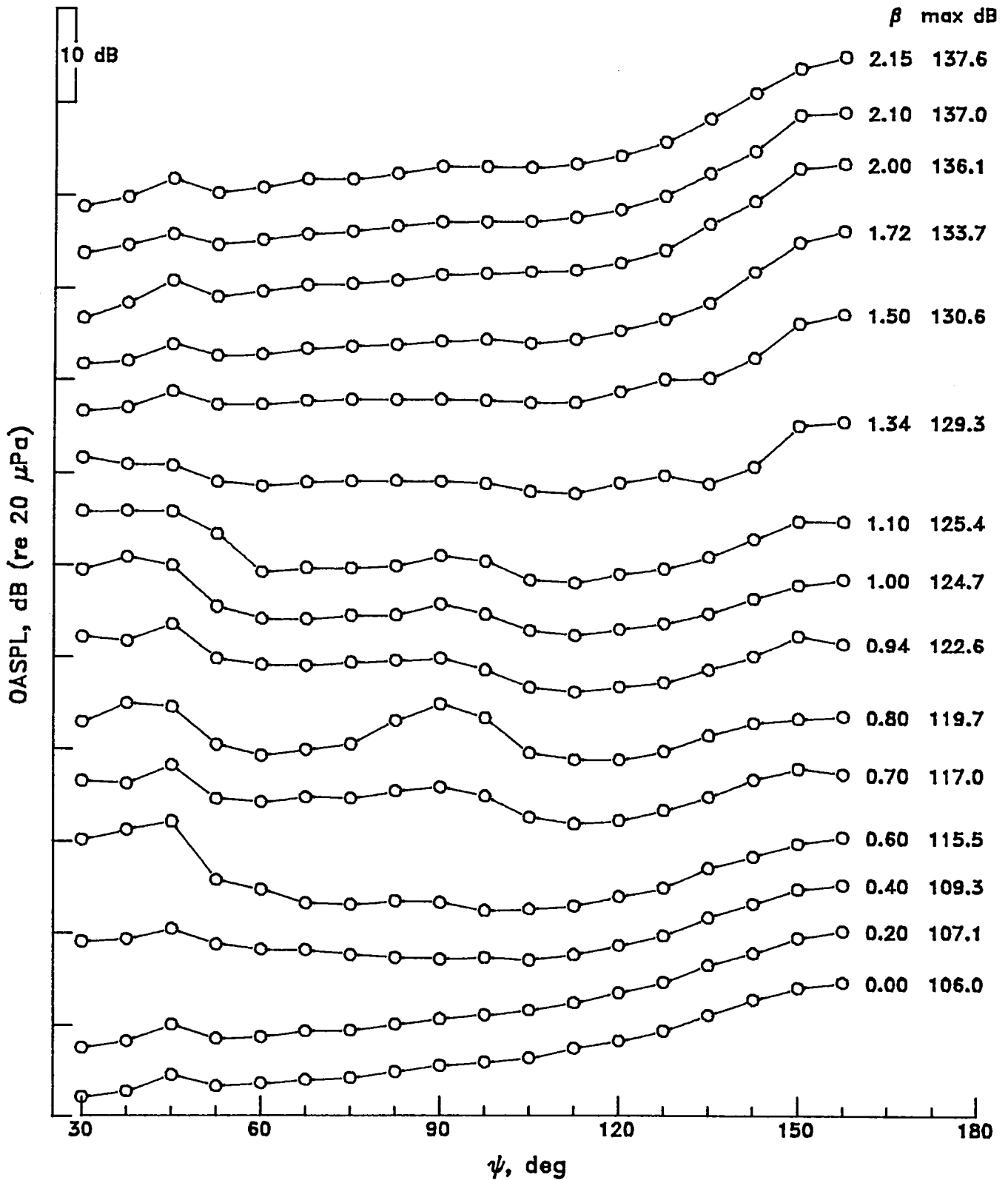

APPENDIX C

Mach 1.0 conical nozzle with tab

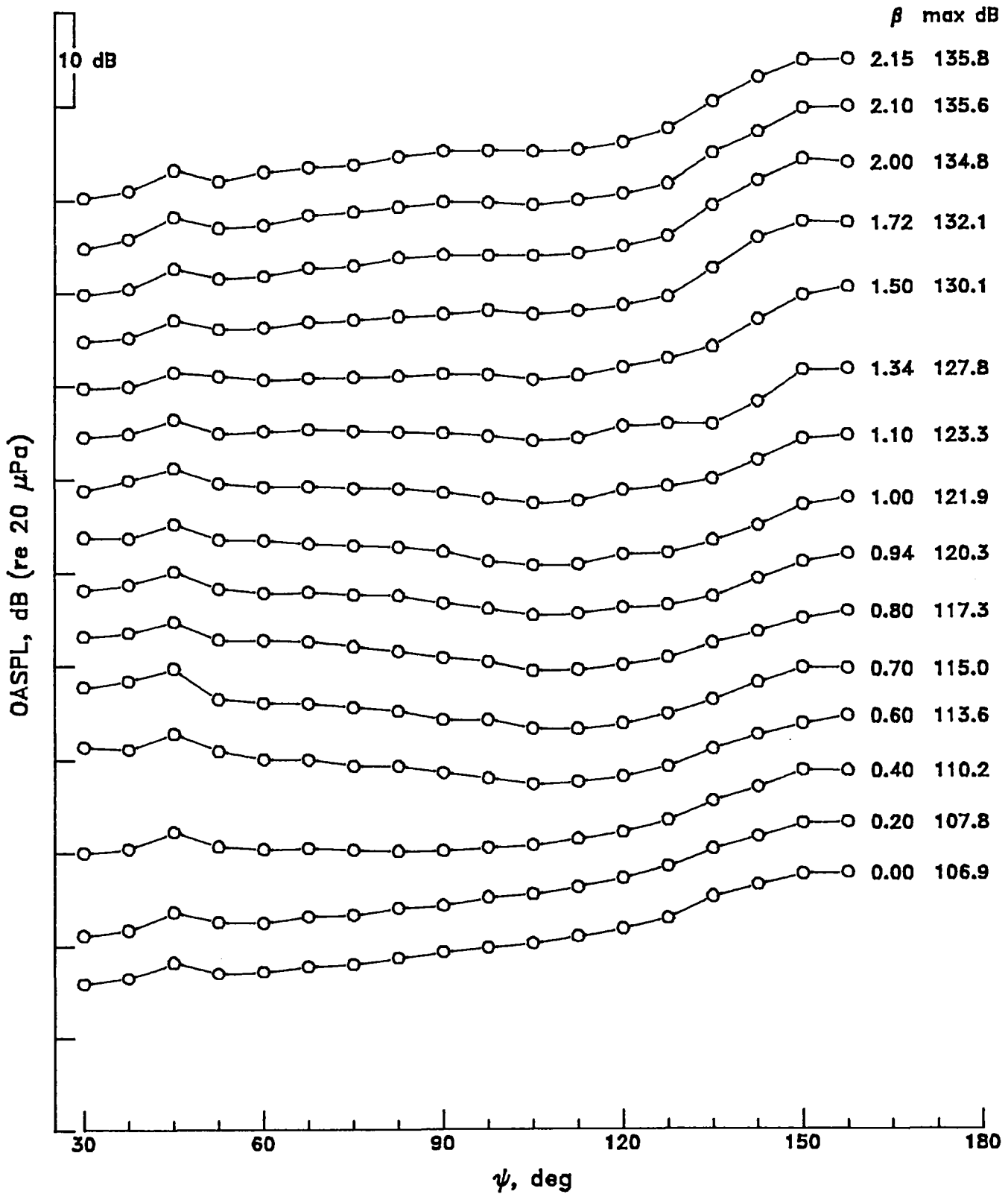

Mach 1.5 conical nozzle without tab

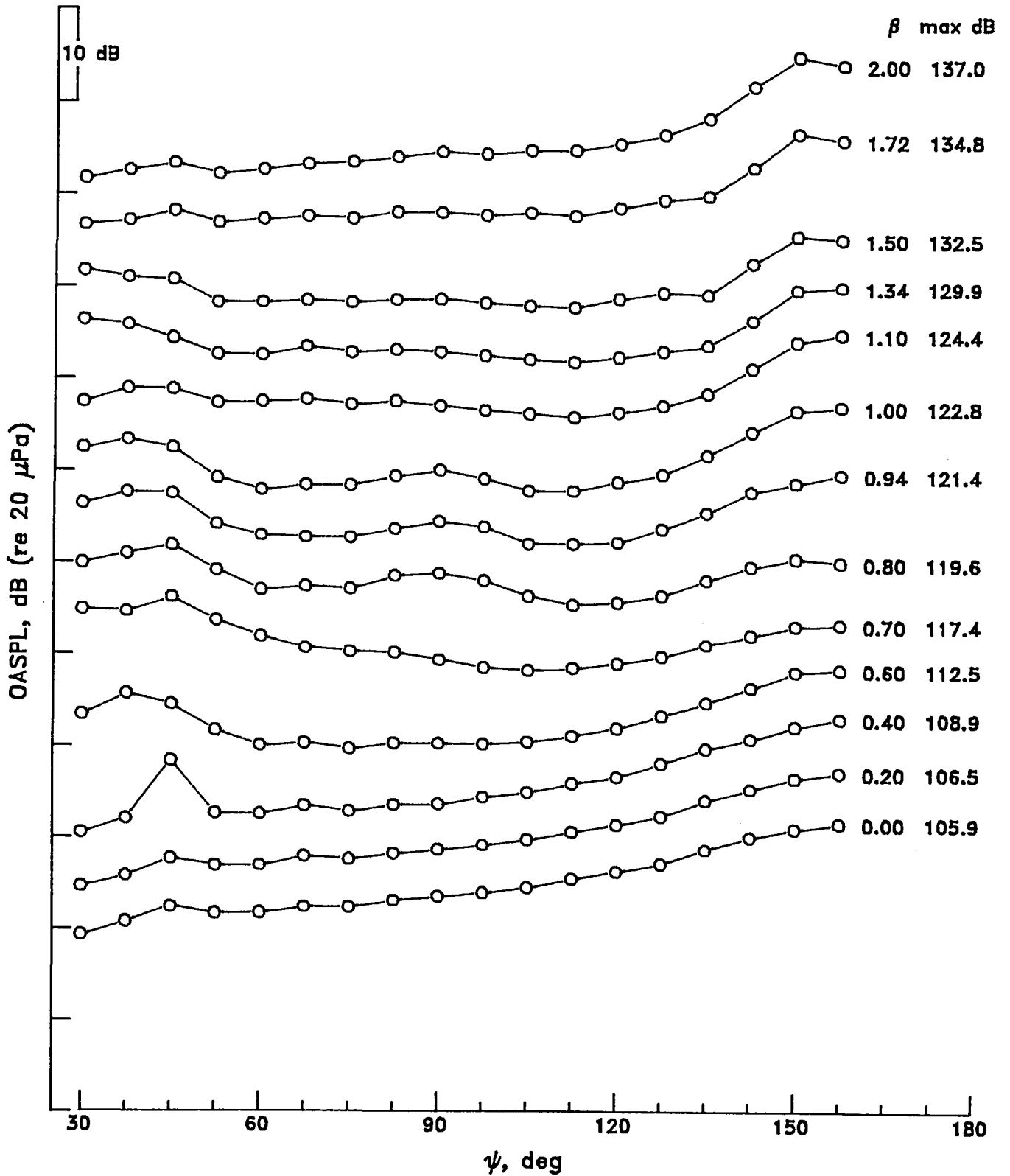

### Mach 1.5 conical nozzle with tab

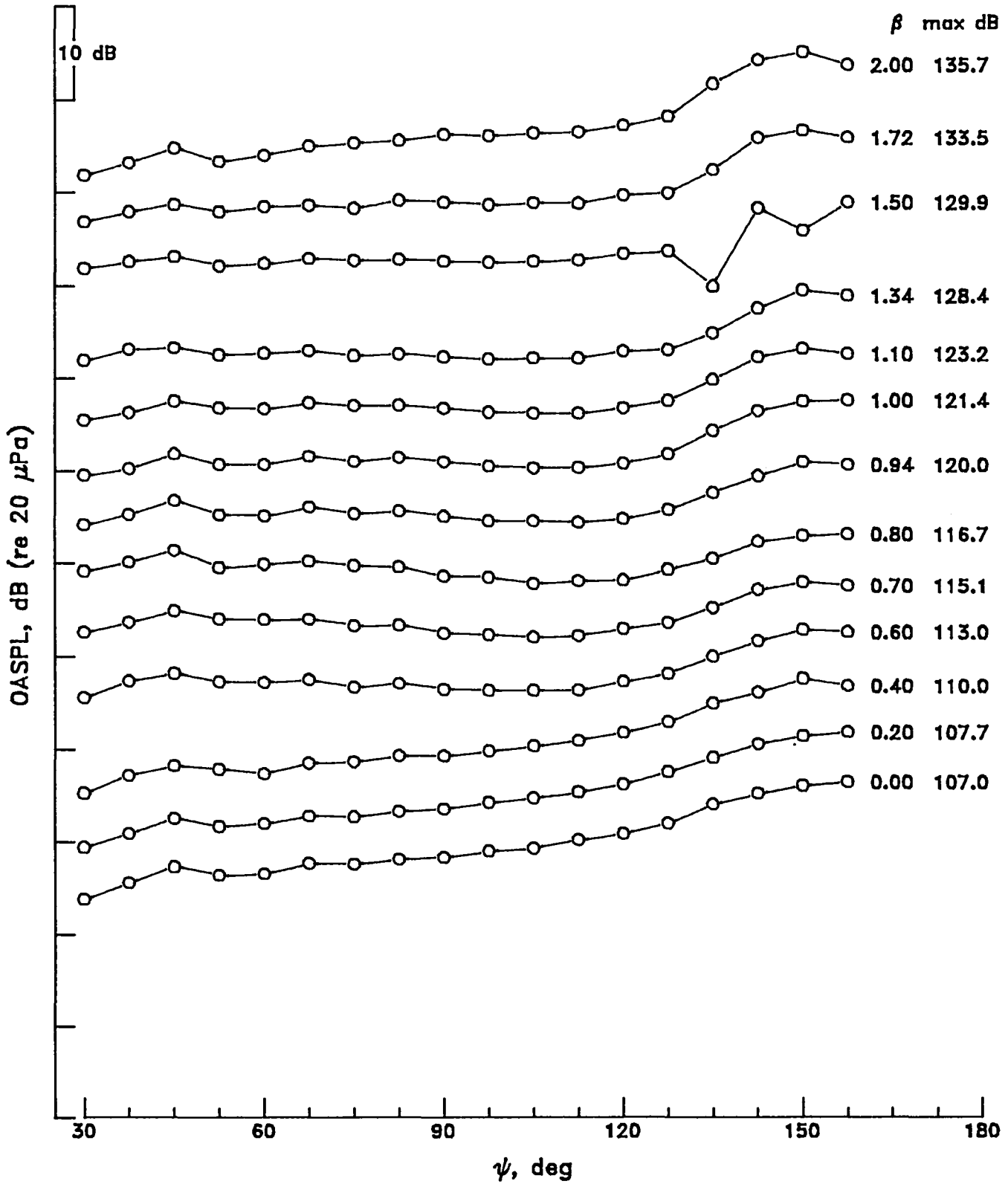

APPENDIX D

1/3-OCTAVE SOUND PRESSURE LEVELS FOR DIFFERENT VALUES OF  $\phi$

<u>Nozzle configuration</u>	<u>Pages</u>
Mach 1.0 contoured nozzle without tab	53-67
Mach 1.0 contoured nozzle with tab	68-82
Mach 1.5 contoured nozzle without tab	83-97
Mach 1.5 contoured nozzle with tab	98-110
Mach 2.0 contoured nozzle without tab	111-125
Mach 2.0 contoured nozzle with tab	126-138



Mach 1.0 contoured nozzle without tab,  $\beta = 0.00$

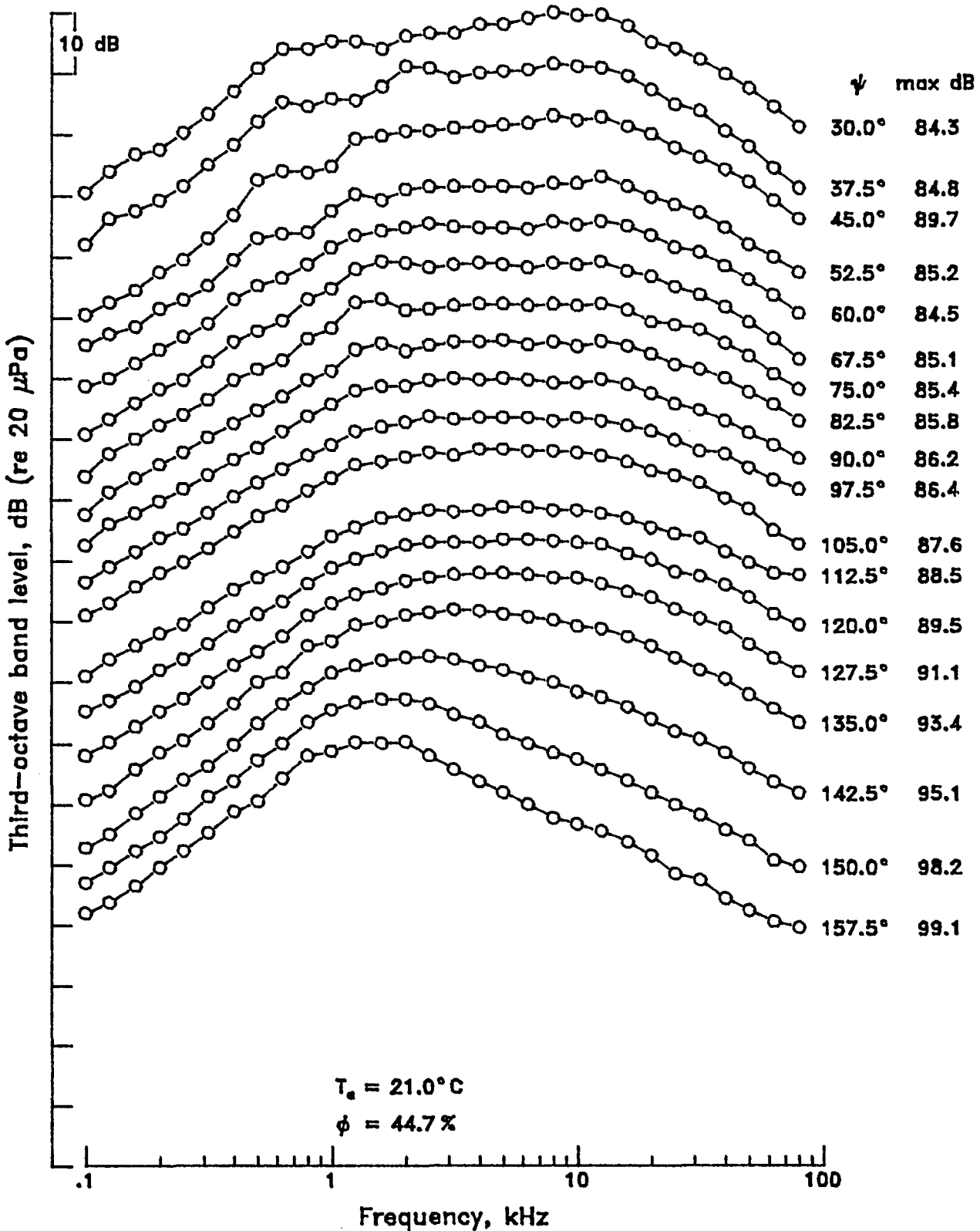

Mach 1.0 contoured nozzle without tab,  $\beta = 0.20$

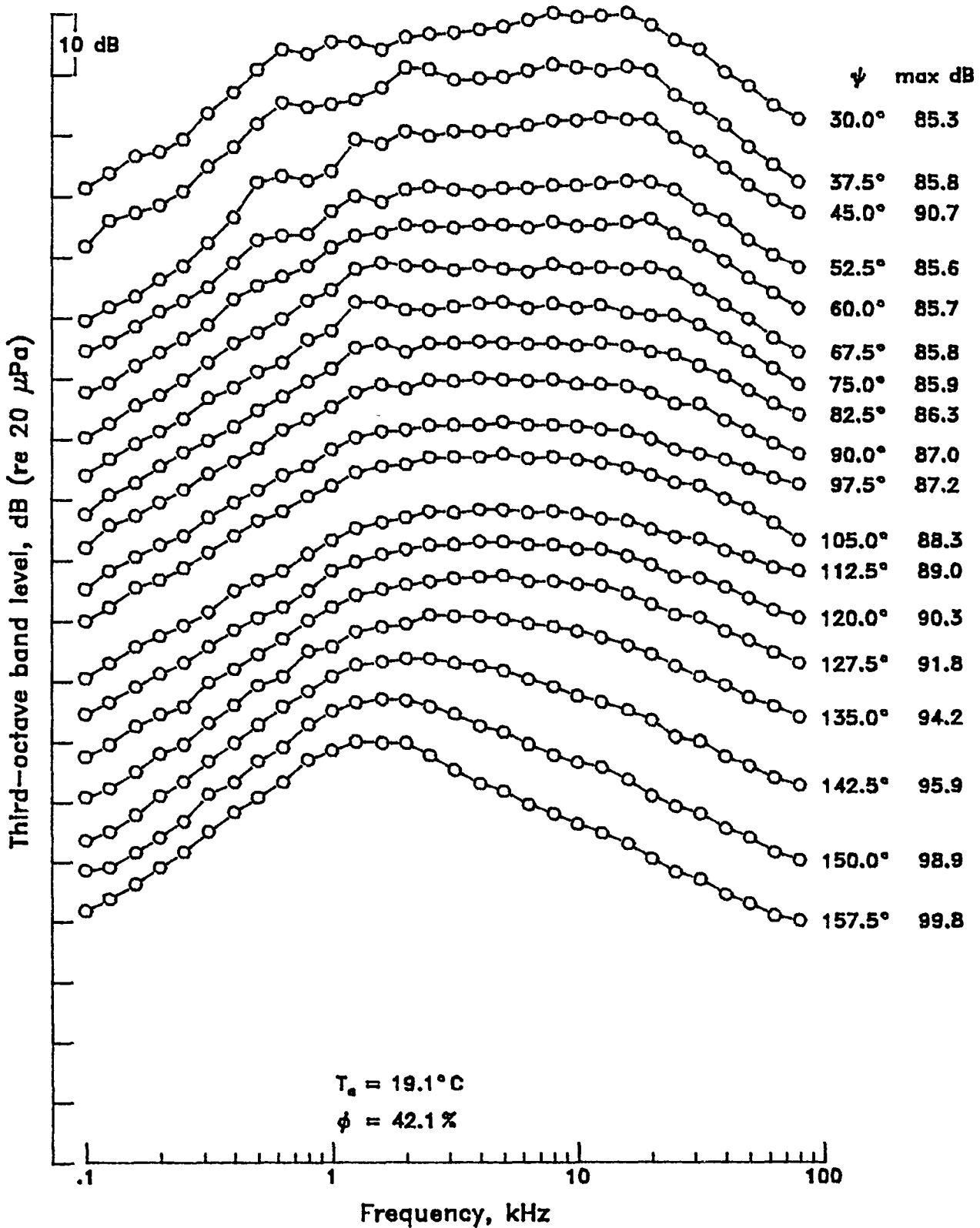

Mach 1.0 contoured nozzle without tab,  $\beta = 0.40$

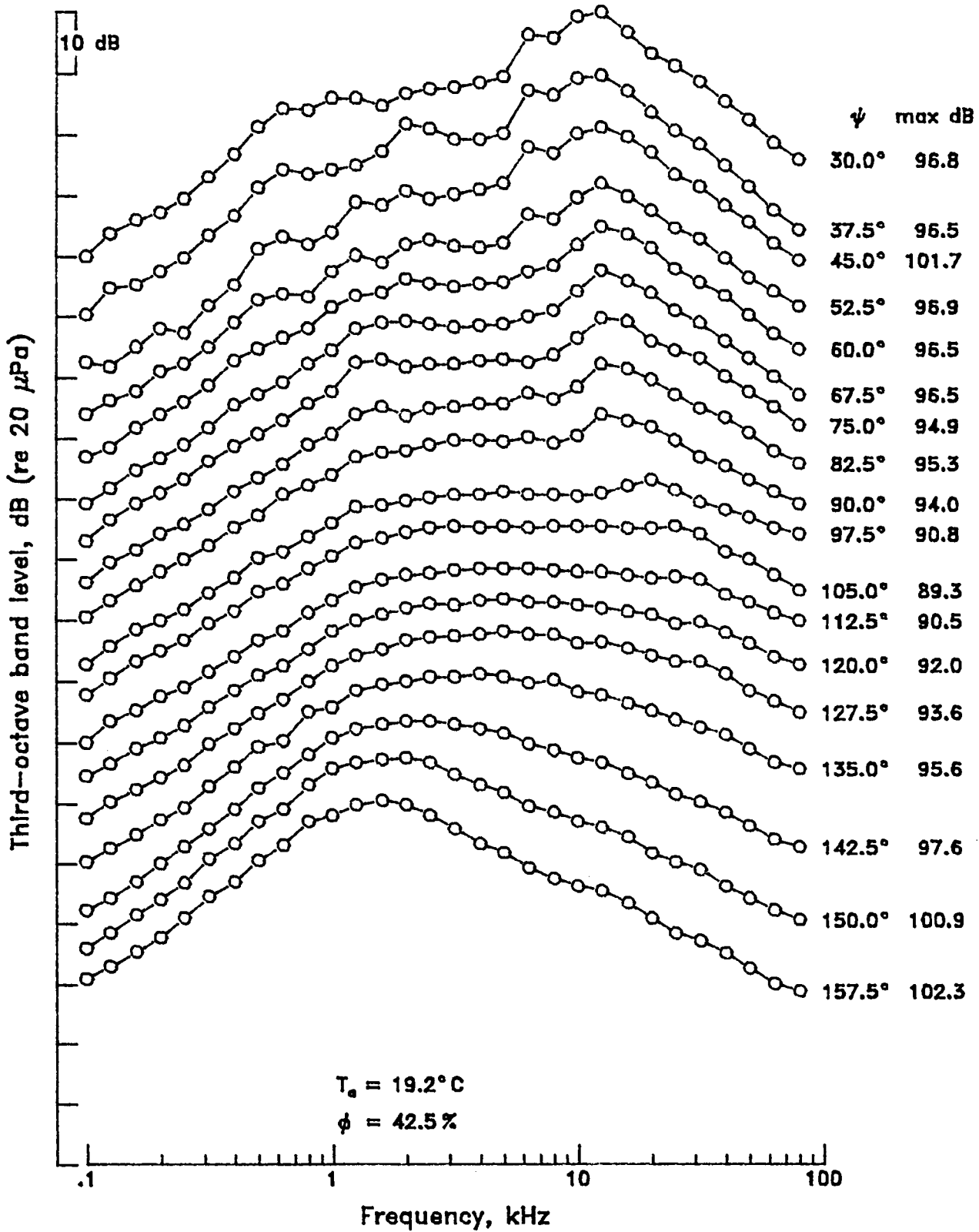

APPENDIX D

Mach 1.0 contoured nozzle without tab,  $\beta = 0.60$

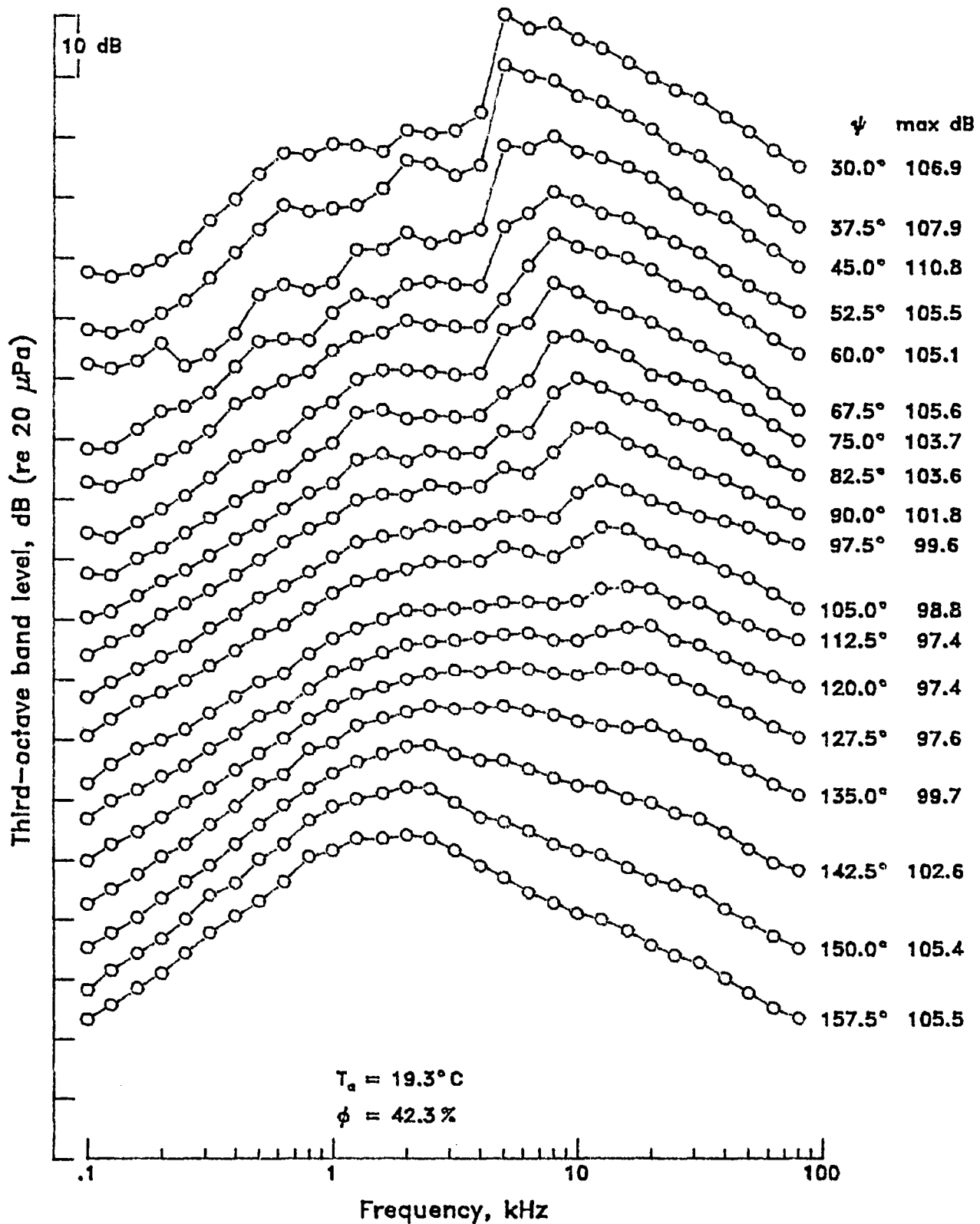

Mach 1.0 contoured nozzle without tab,  $\beta = 0.70$

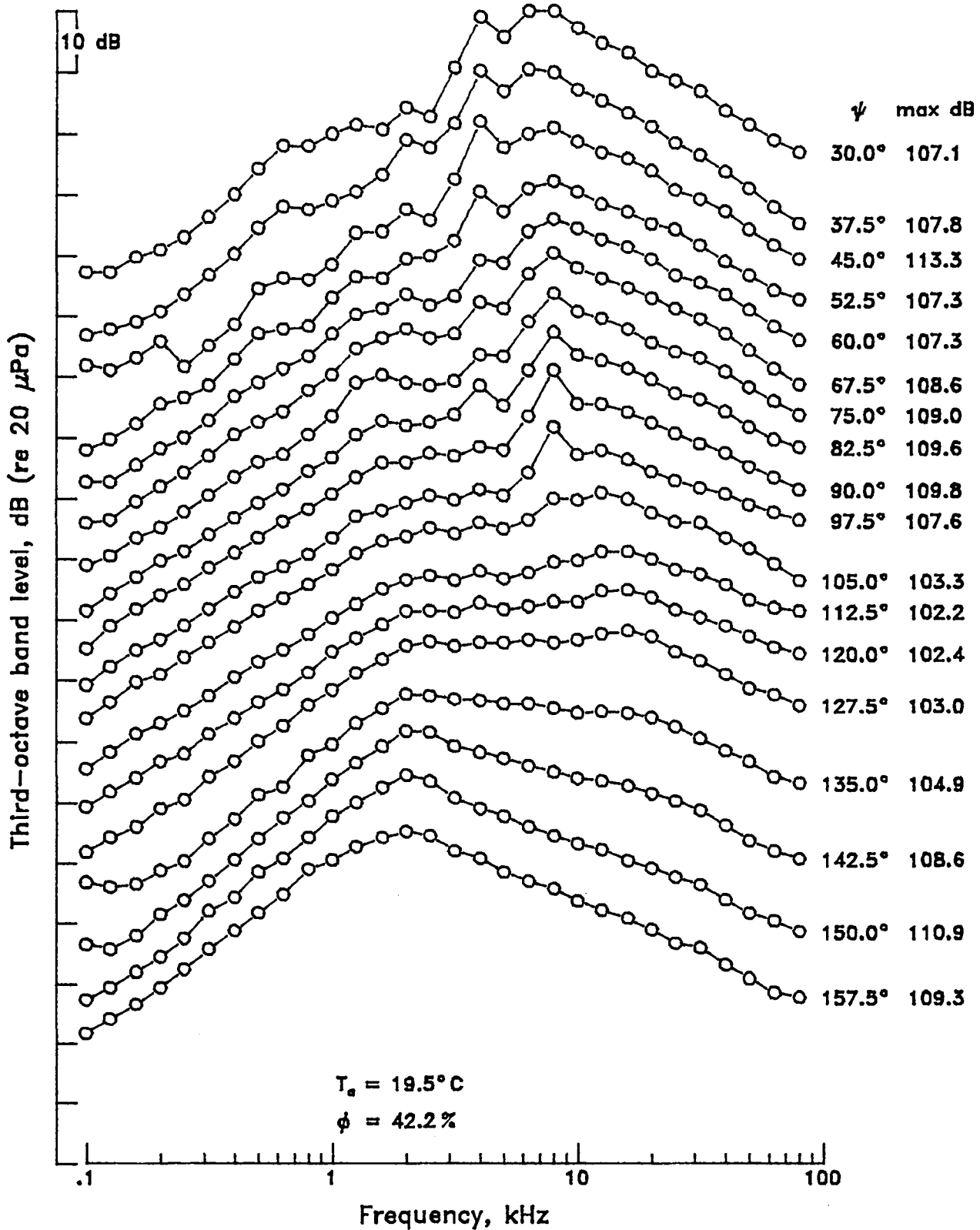

Mach 1.0 contoured nozzle without tab,  $\beta = 0.80$

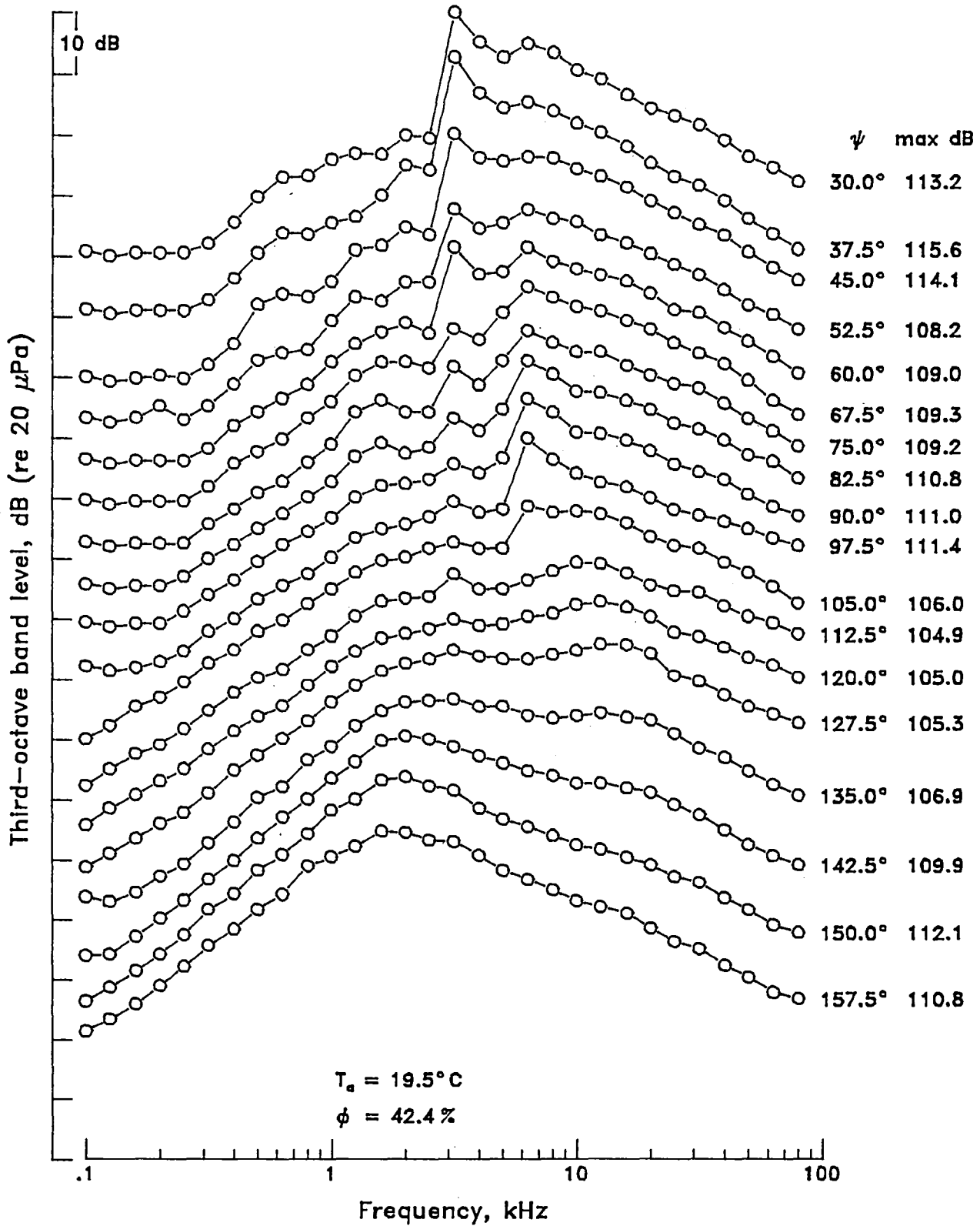

APPENDIX D

Mach 1.0 contoured nozzle without tab,  $\beta = 0.94$

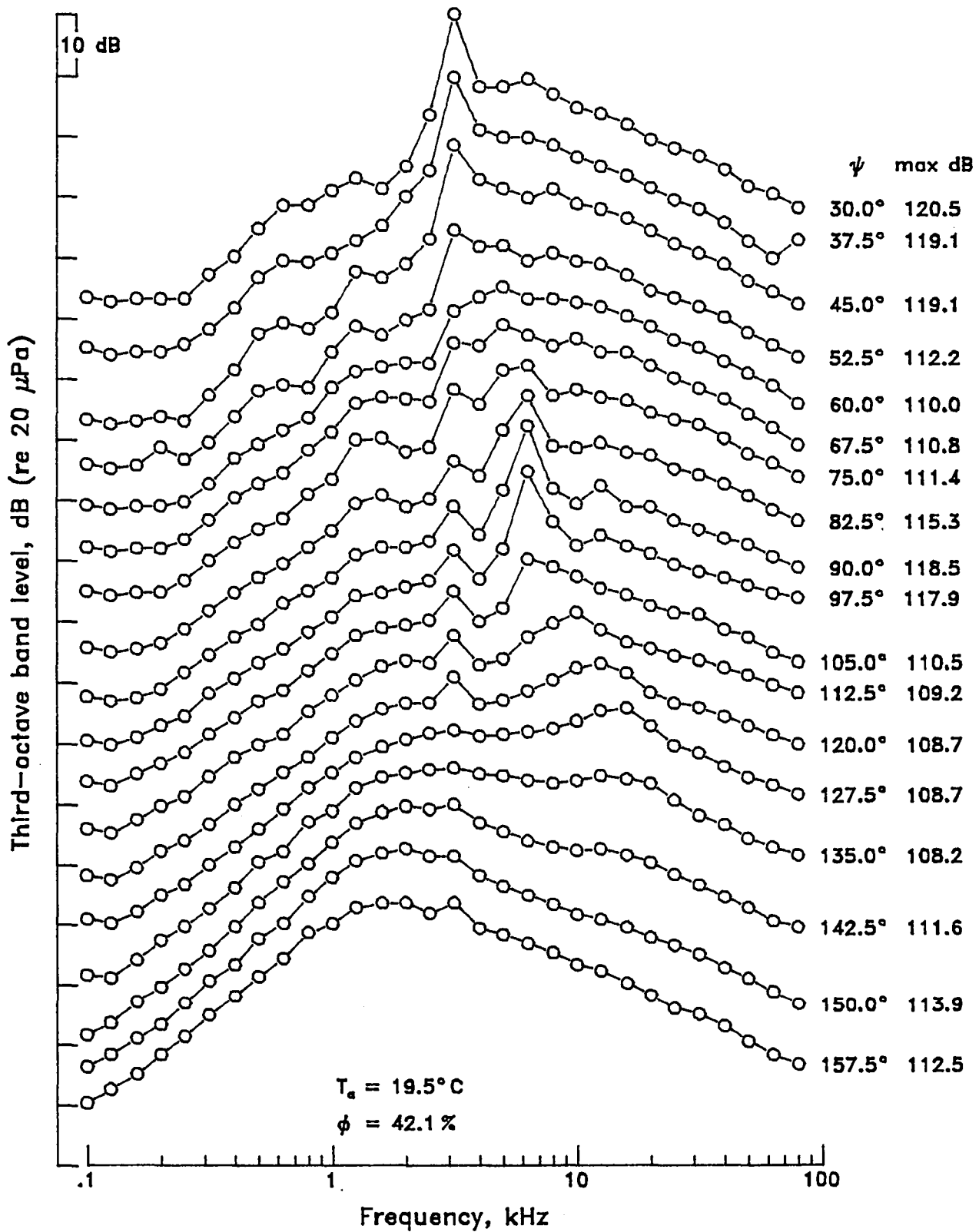

APPENDIX D

Mach 1.0 contoured nozzle without tab,  $\beta = 1.00$

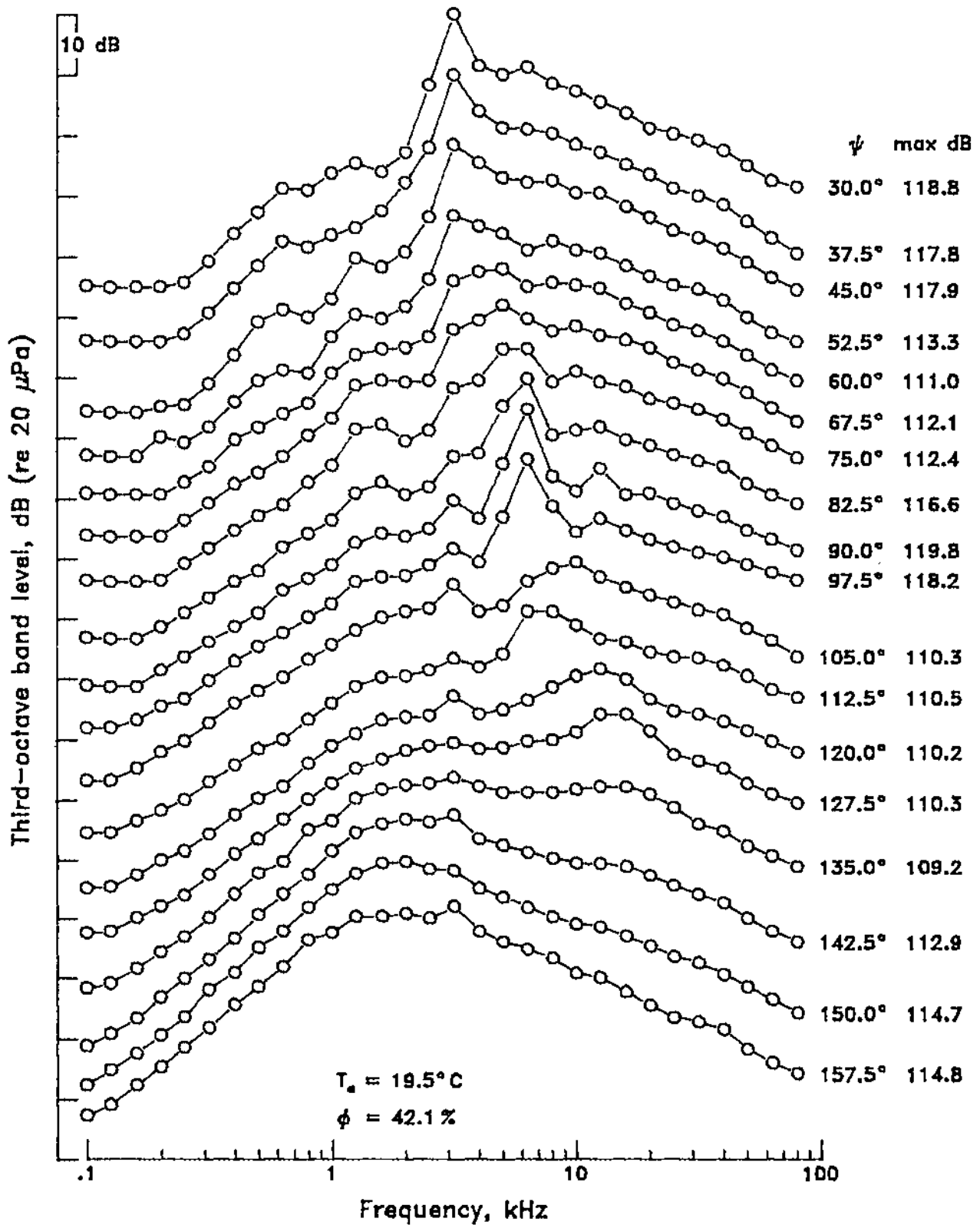



APPENDIX D

Mach 1.0 contoured nozzle without tab,  $\beta = 1.10$

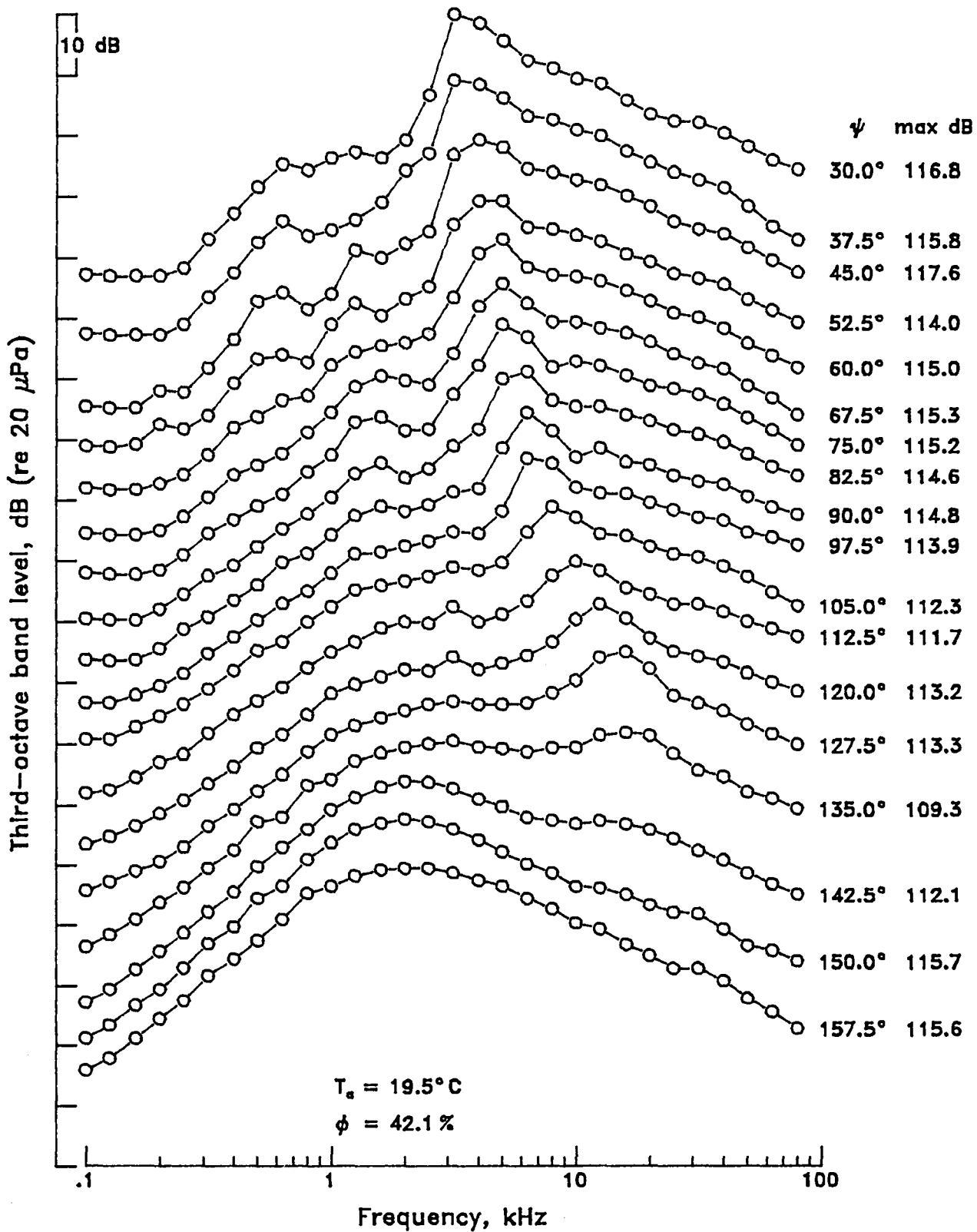

Mach 1.0 contoured nozzle without tab,  $\beta = 1.34$

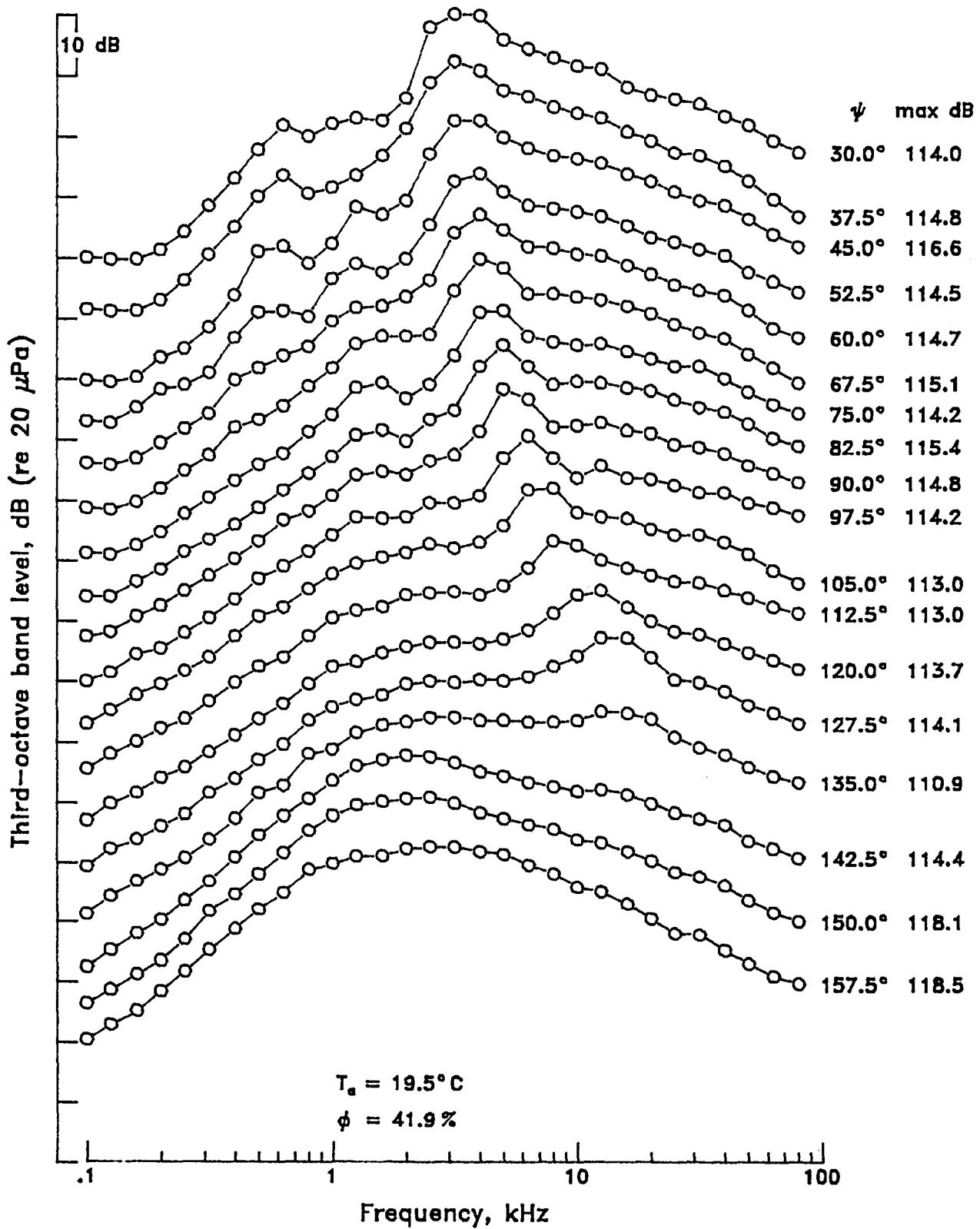

APPENDIX D

Mach 1.0 contoured nozzle without tab,  $\beta = 1.50$

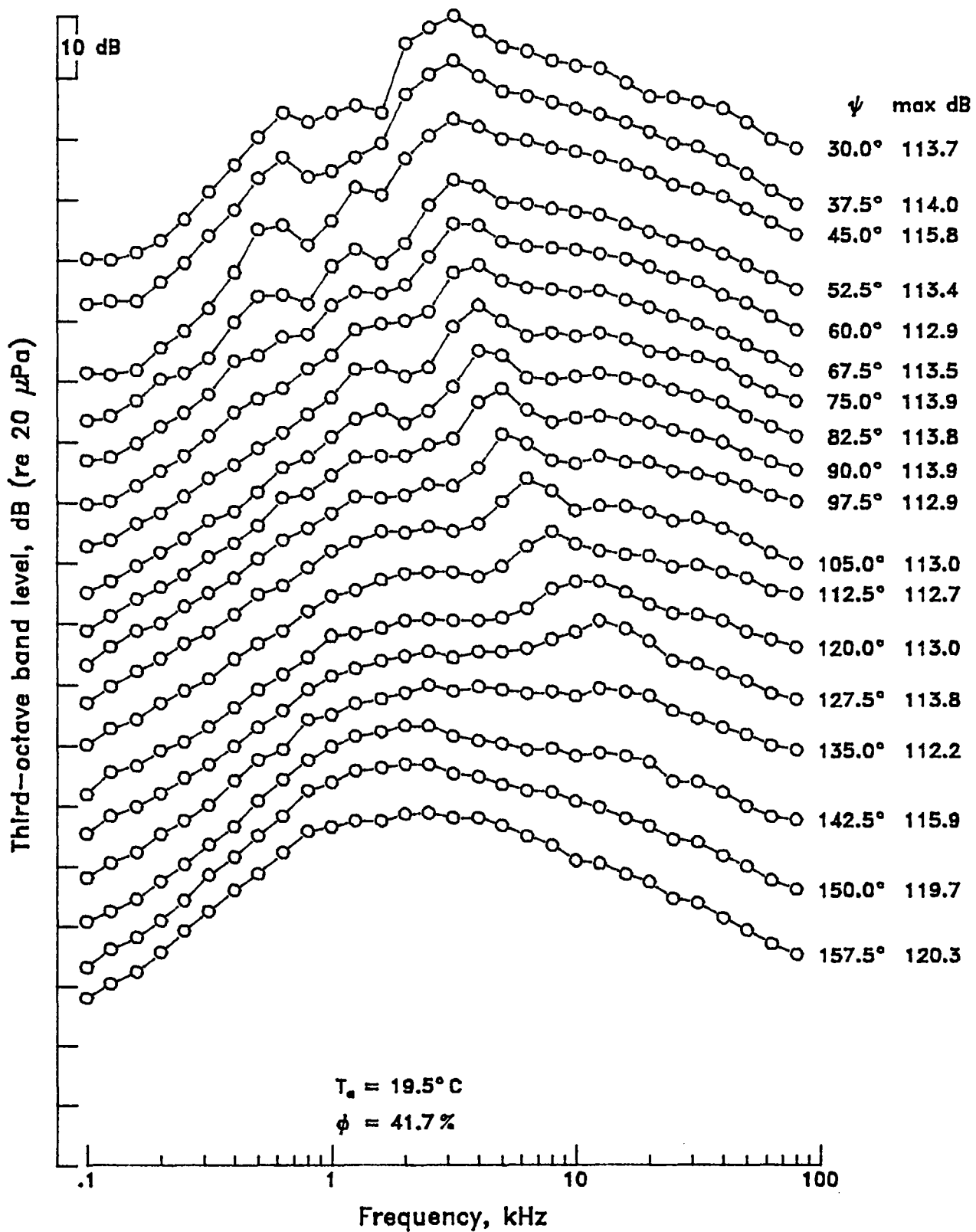

Mach 1.0 contoured nozzle without tab,  $\beta = 1.72$

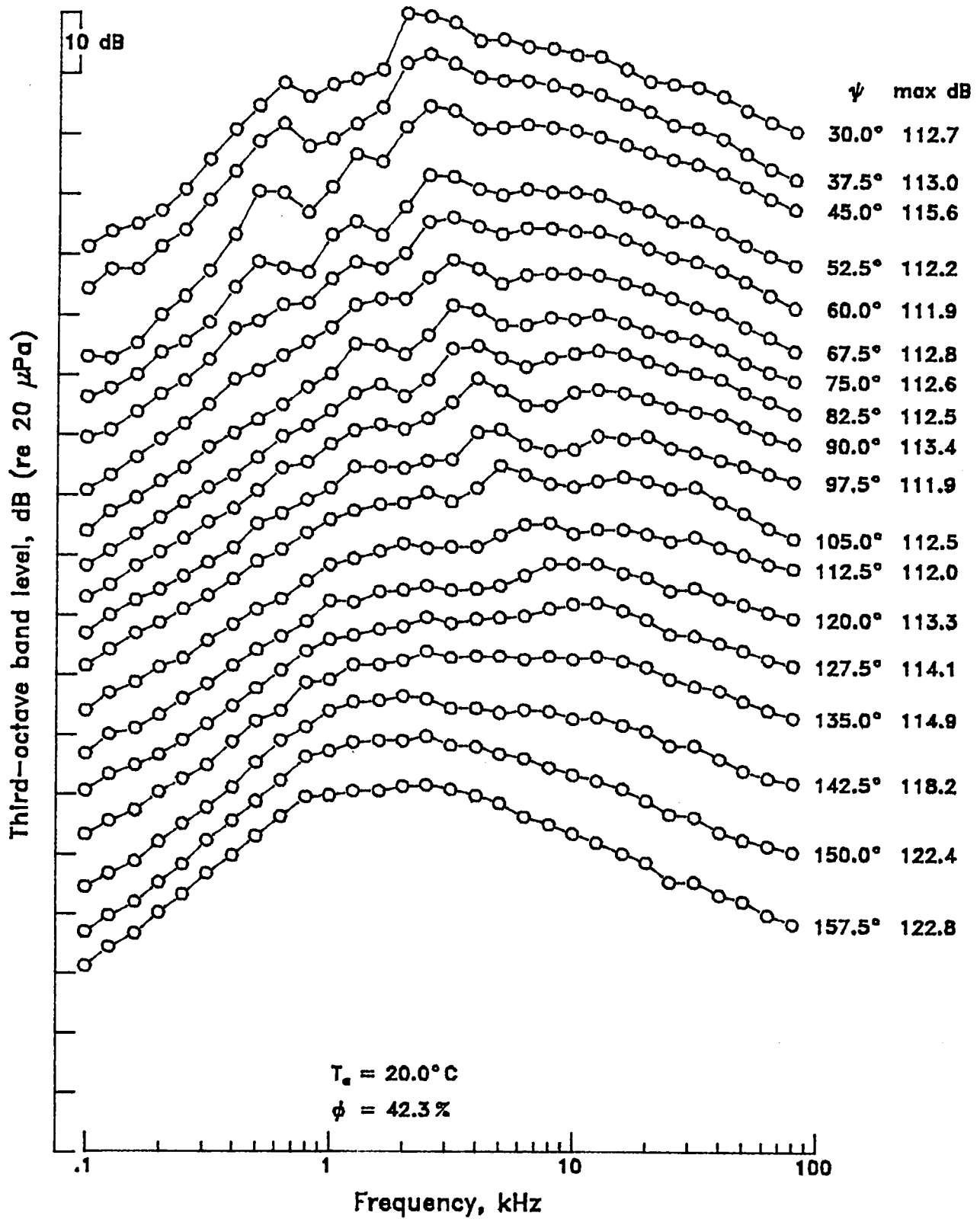

APPENDIX D

Mach 1.0 contoured nozzle without tab,  $\beta = 2.00$

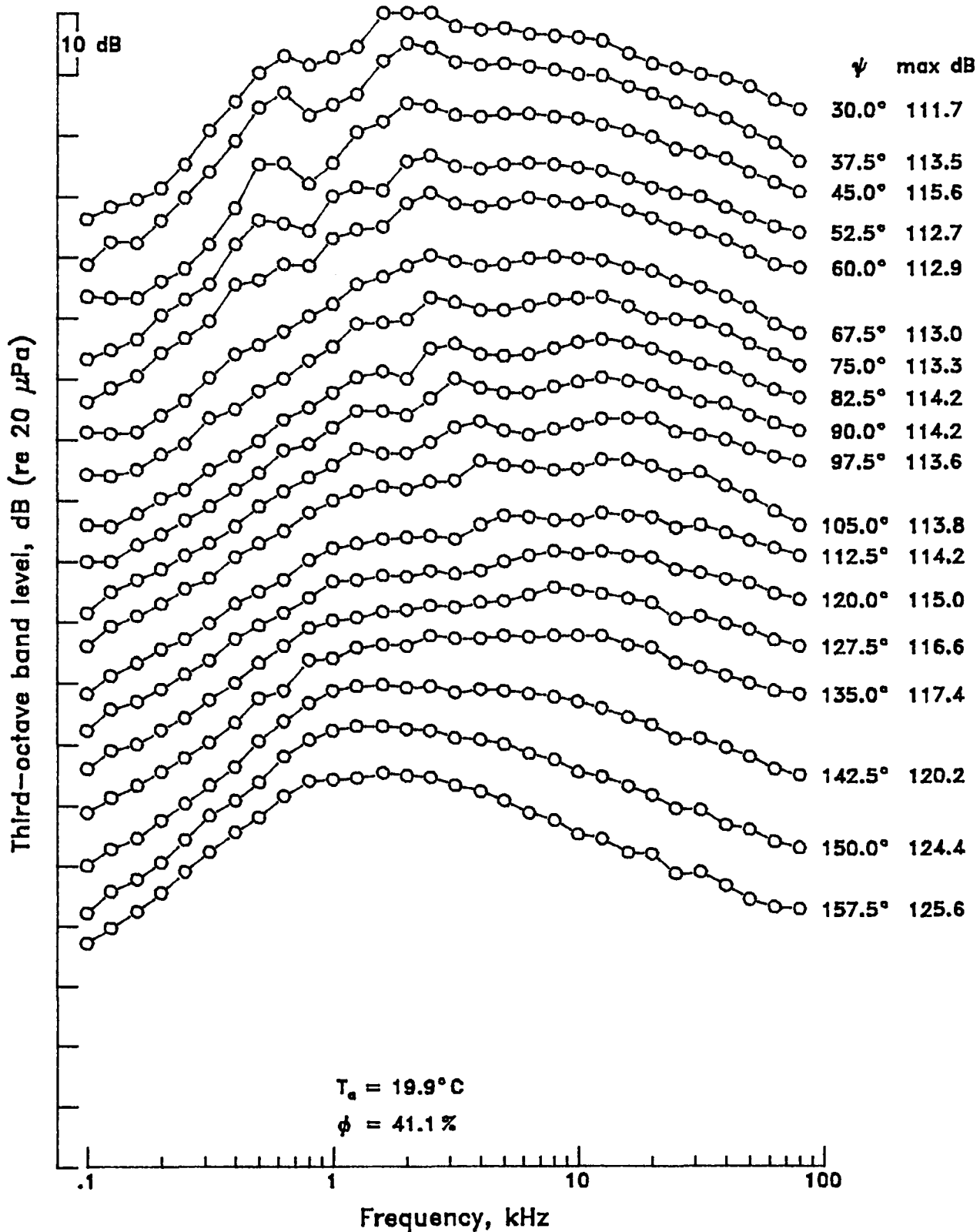

Mach 1.0 contoured nozzle without tab,  $\beta = 2.10$

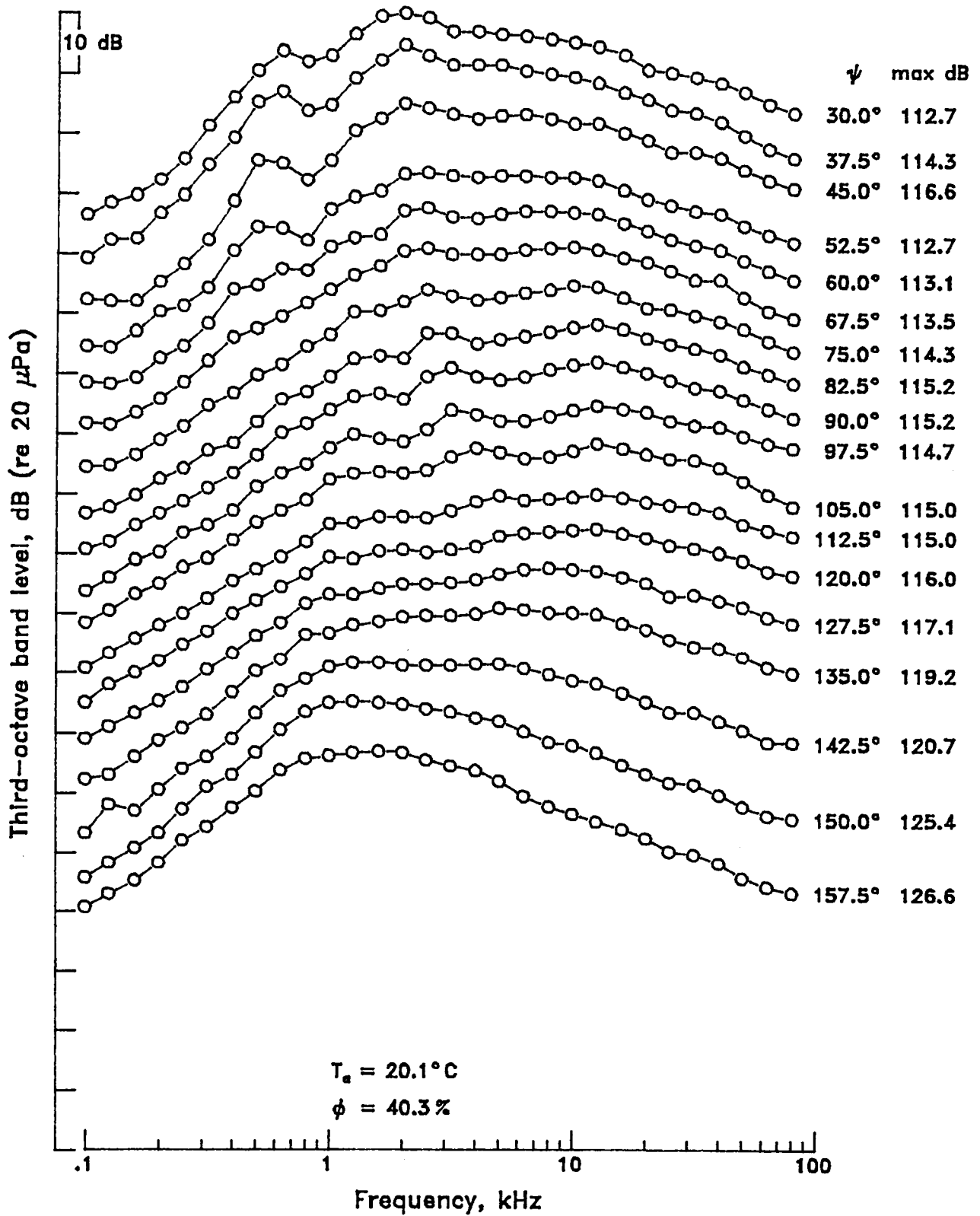

Mach 1.0 contoured nozzle without tab,  $\beta = 2.15$

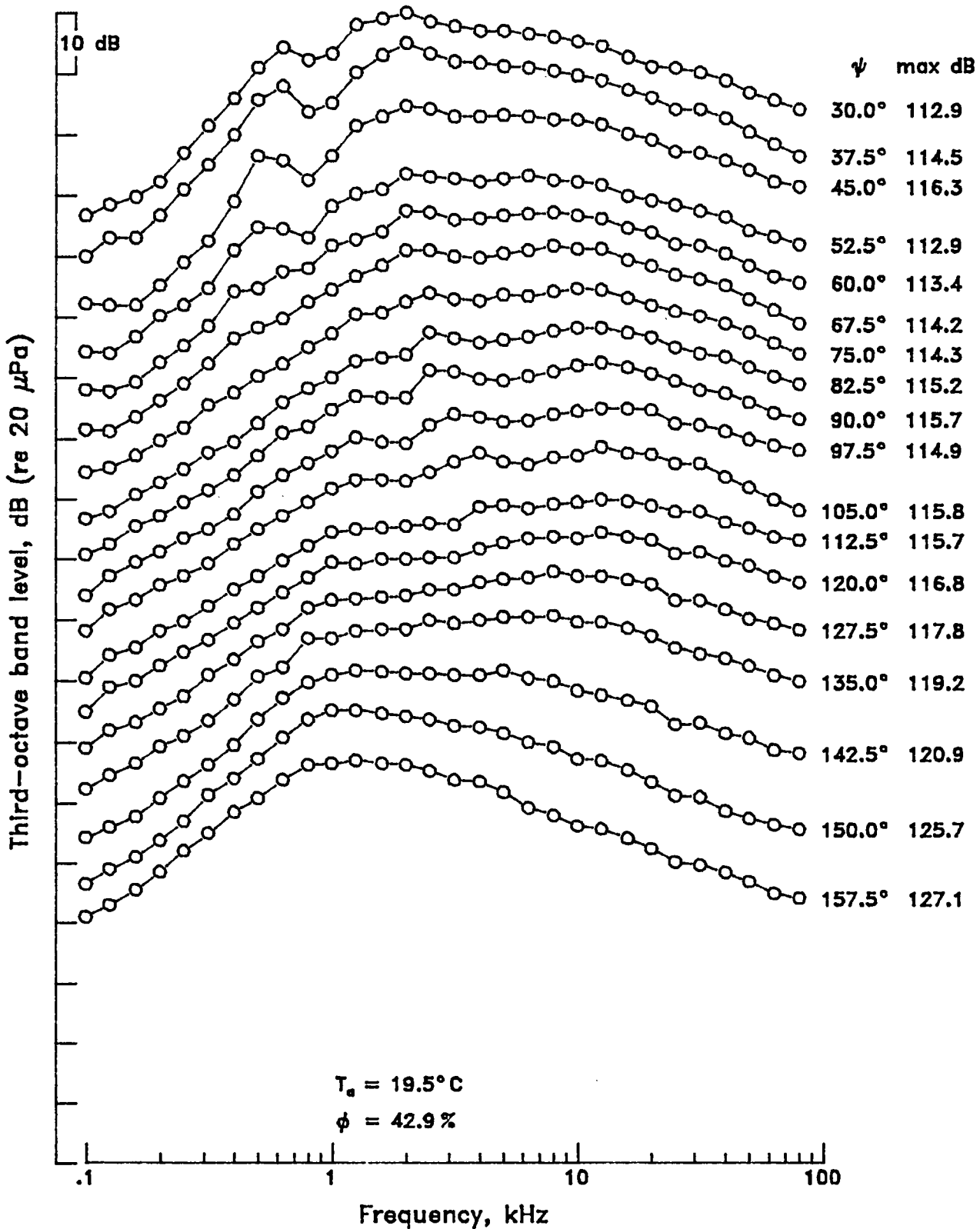

Mach 1.0 contoured nozzle with tab,  $\beta = 0.00$

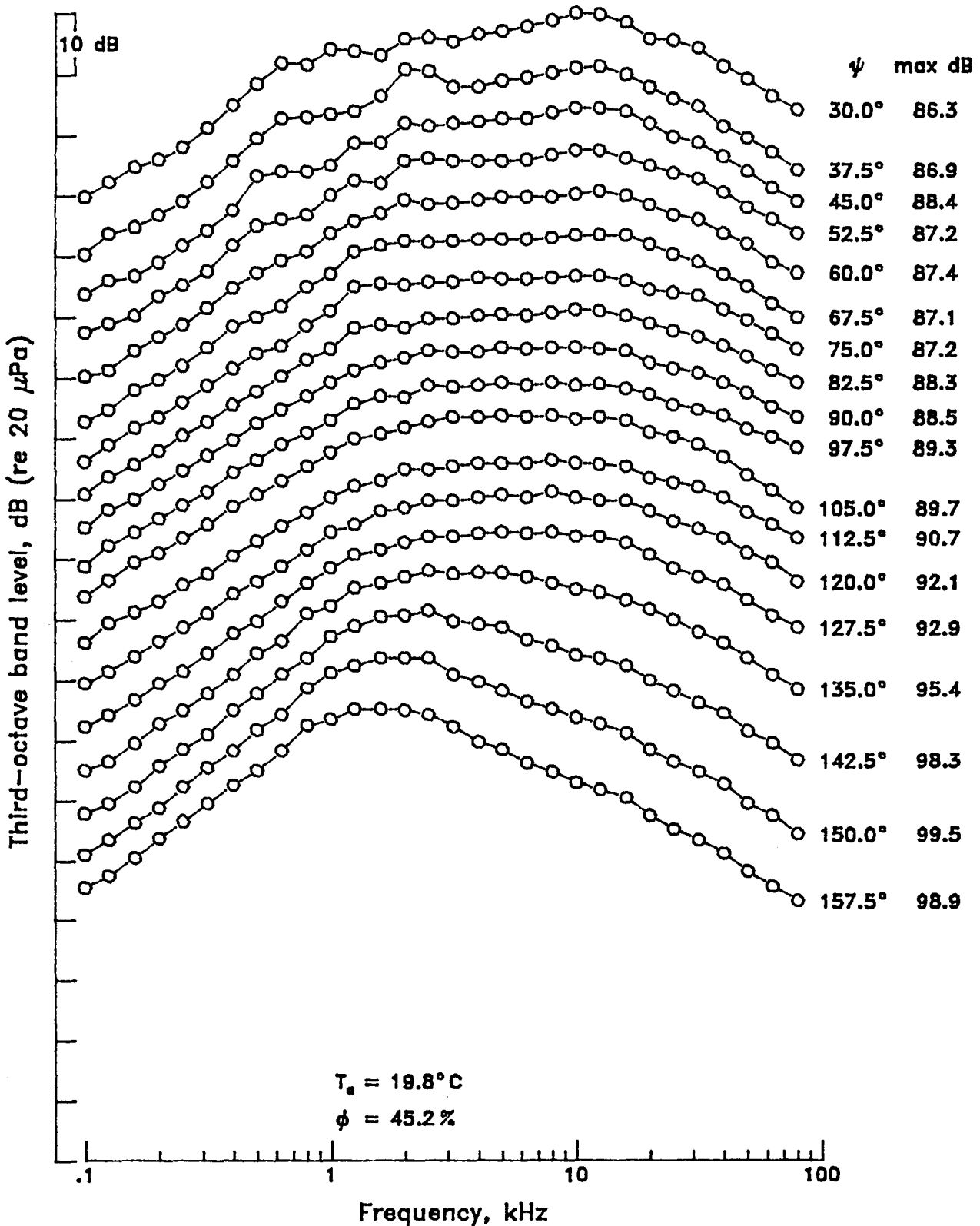



Mach 1.0 contoured nozzle with tab,  $\beta = 0.20$

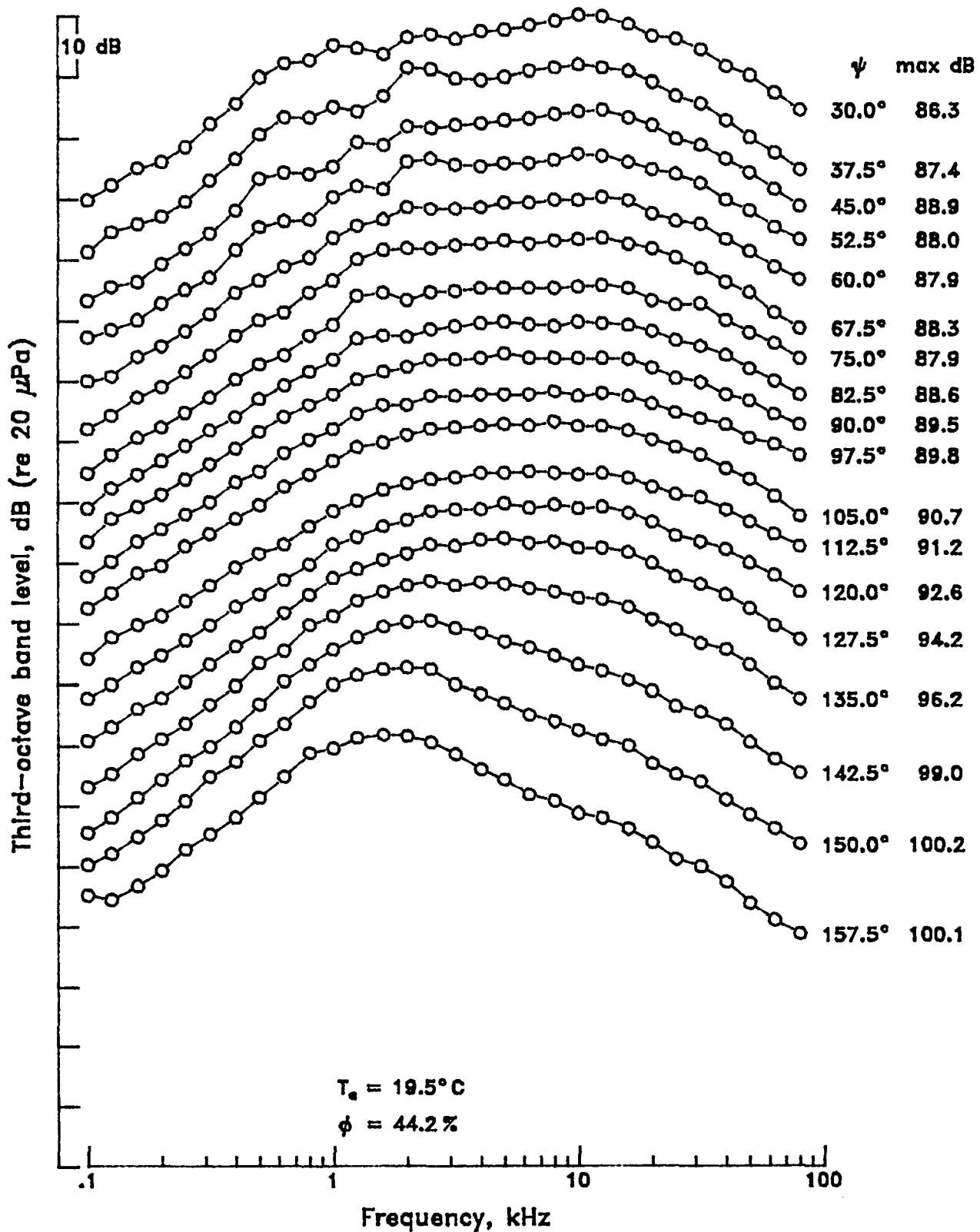

Mach 1.0 contoured nozzle with tab,  $\beta = 0.40$

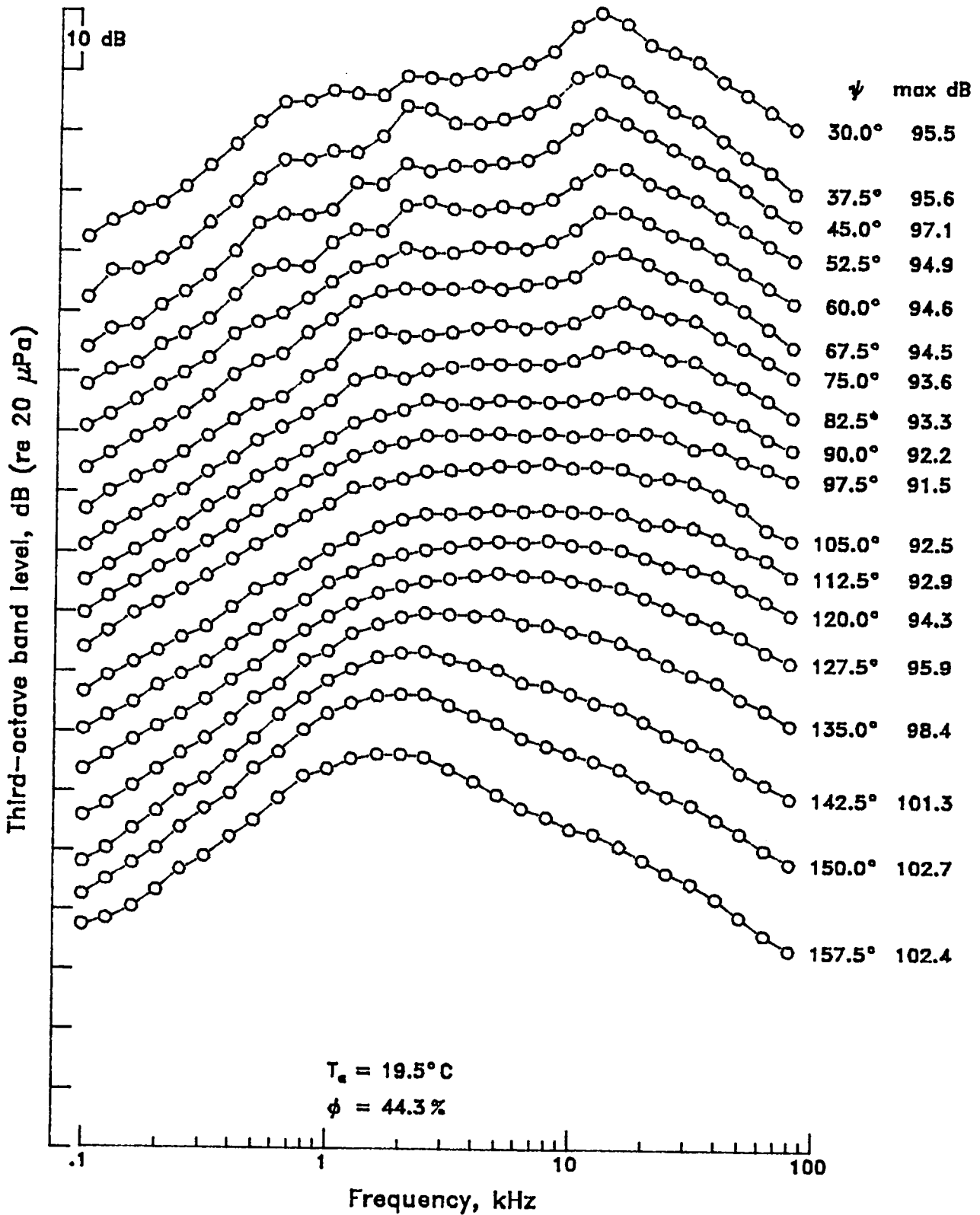

Mach 1.0 contoured nozzle with tab,  $\beta = 0.60$

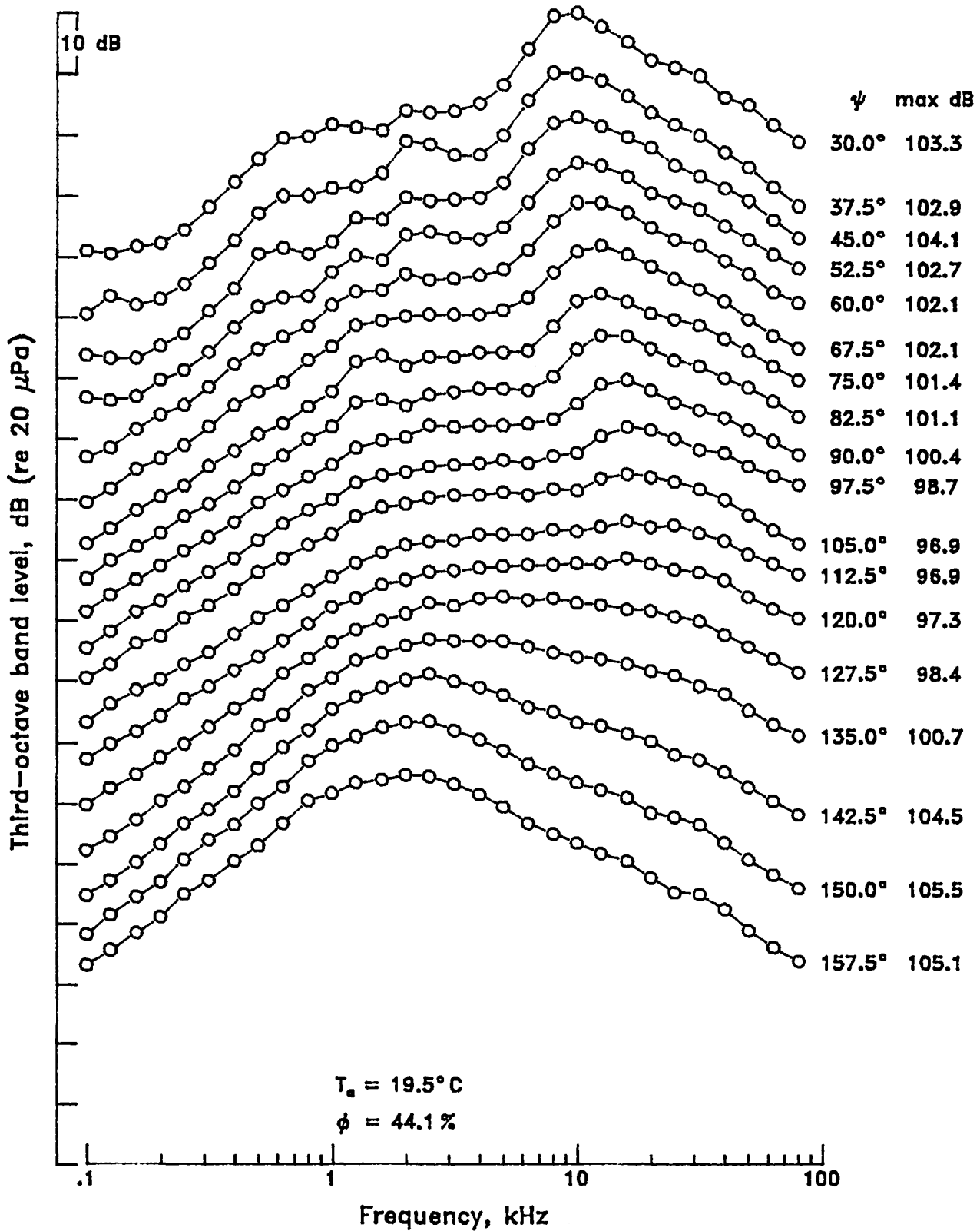

Mach 1.0 contoured nozzle with tab,  $\beta = 0.70$

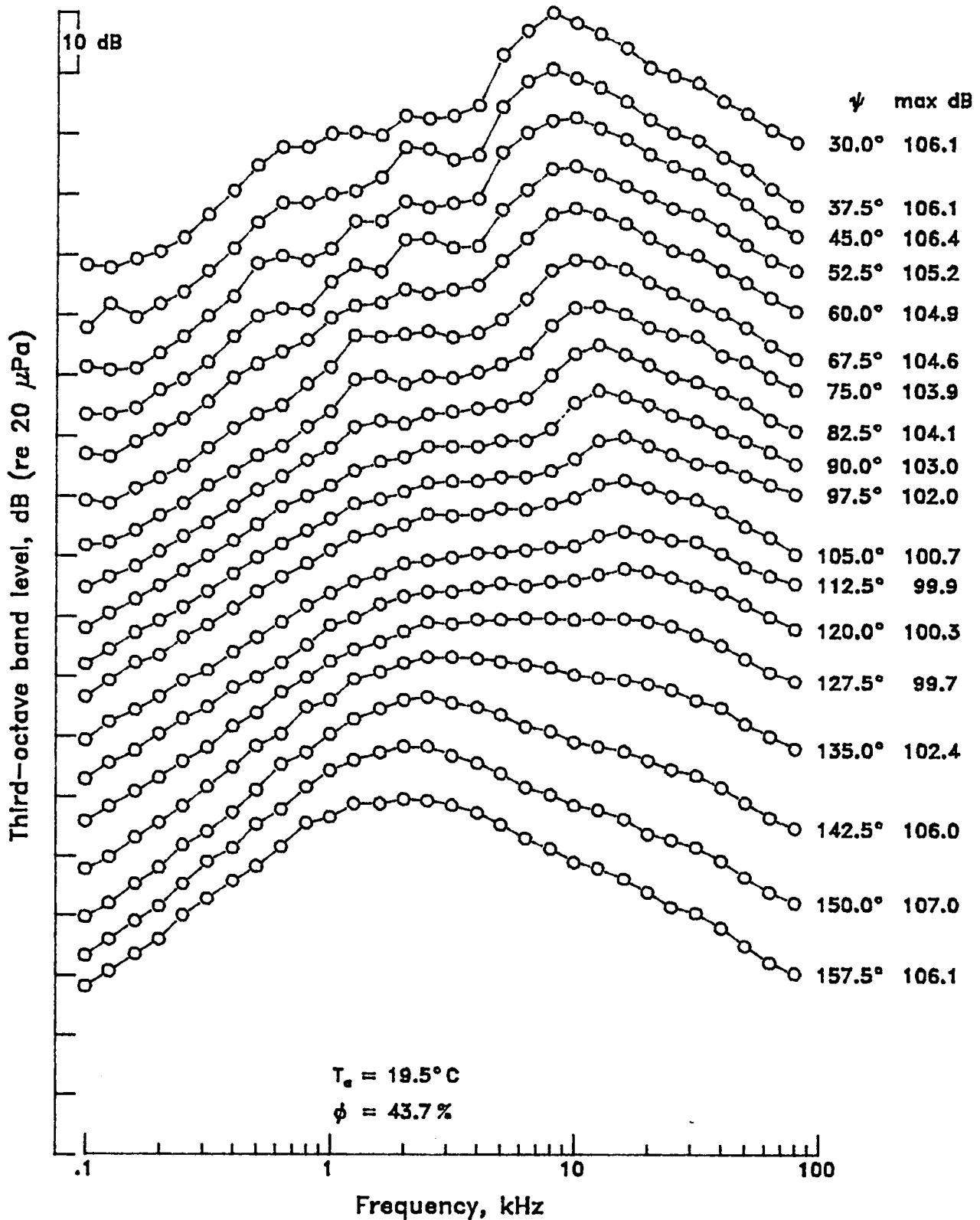

Mach 1.0 contoured nozzle with tab,  $\beta = 0.80$

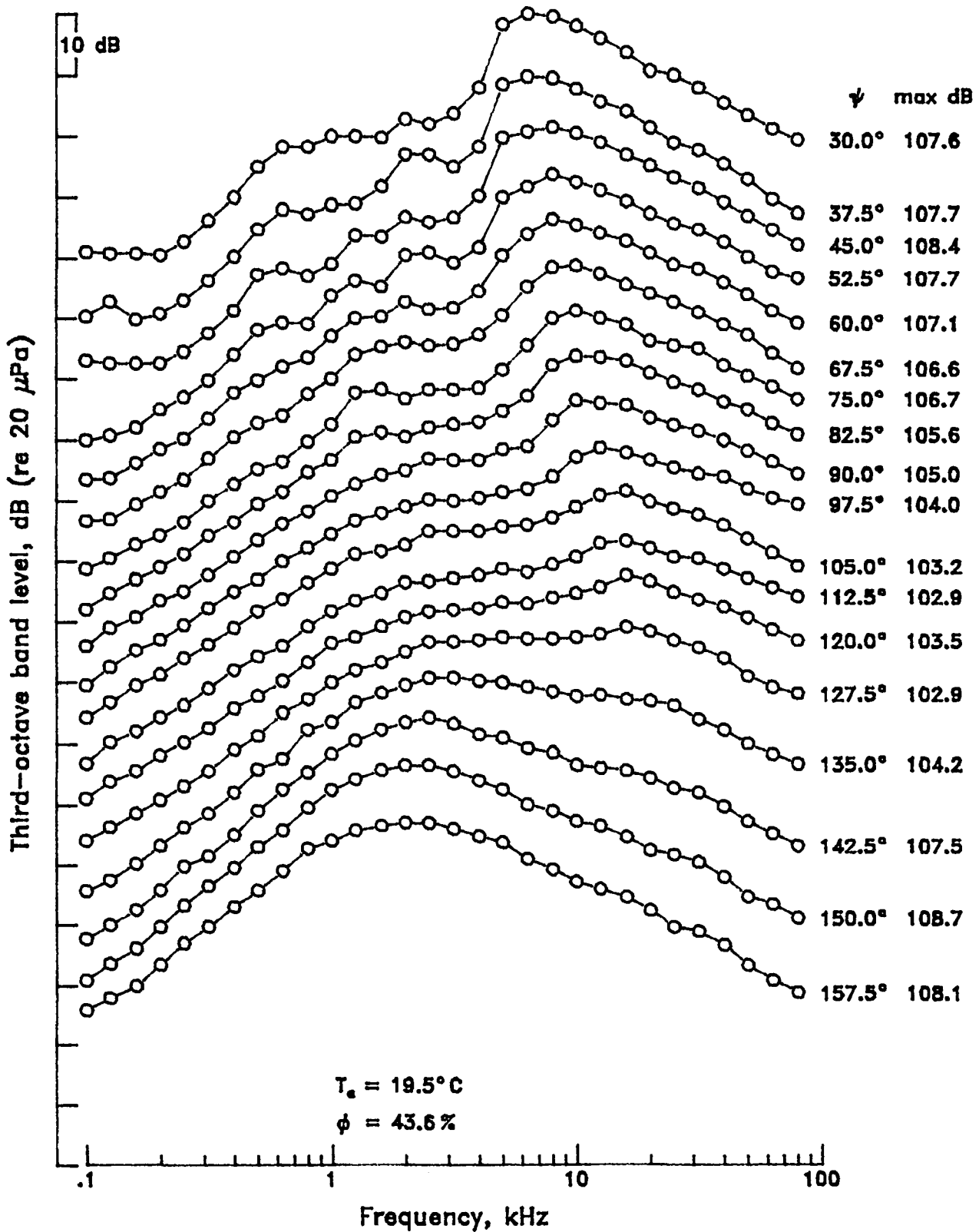

Mach 1.0 contoured nozzle with tab,  $\beta = 0.94$

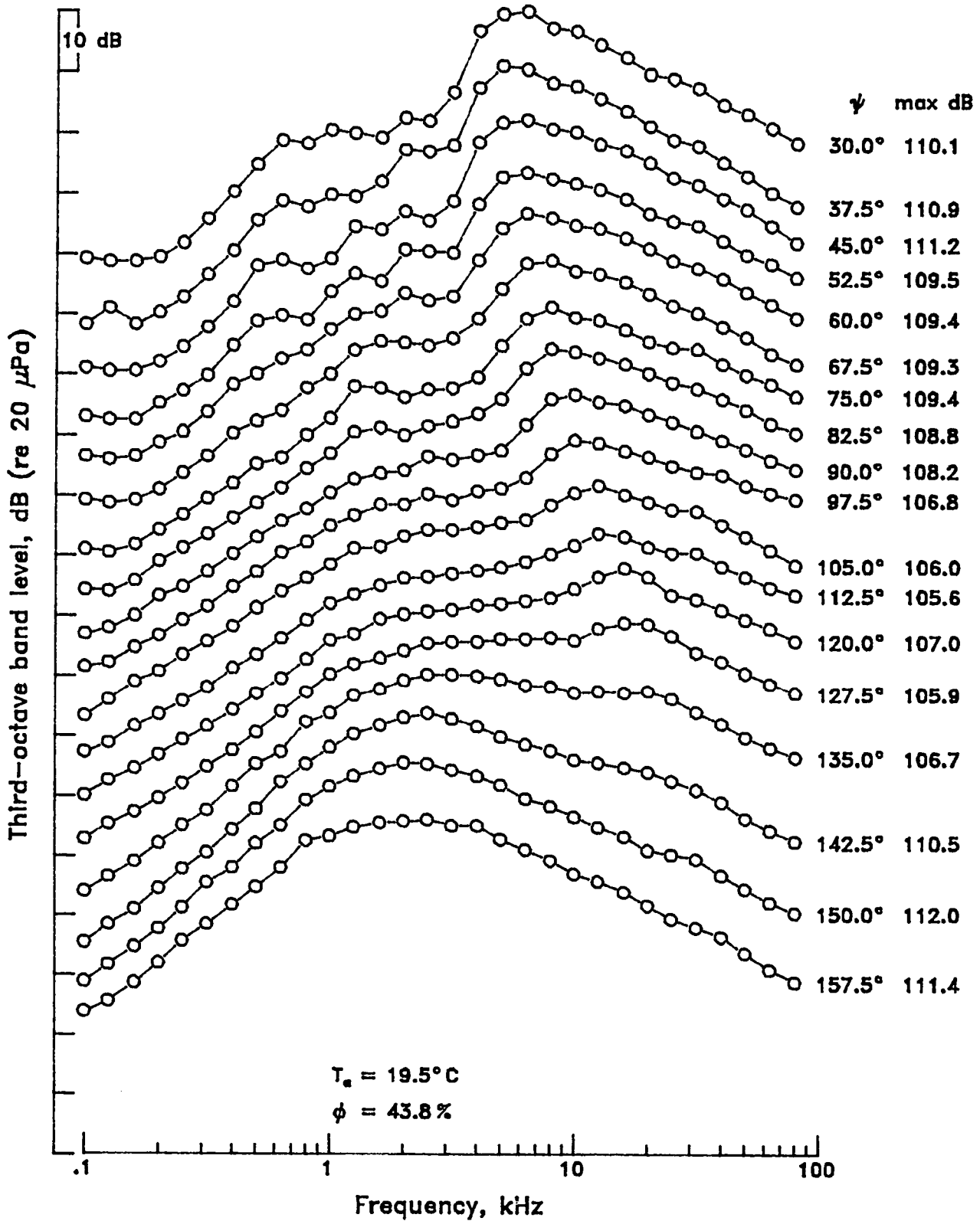

Mach 1.0 contoured nozzle with tab,  $\beta = 1.00$

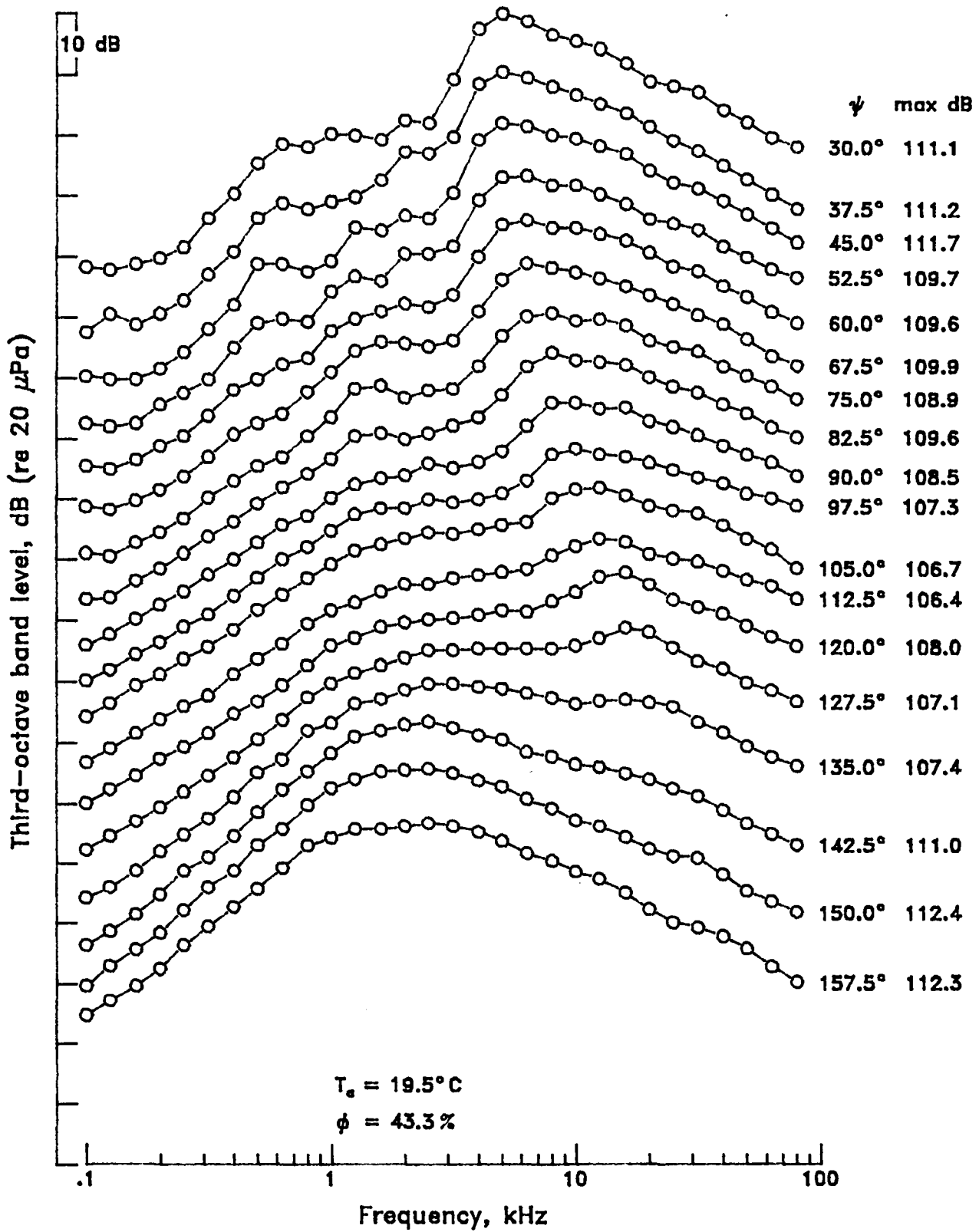

APPENDIX D

Mach 1.0 contoured nozzle with tab,  $\beta = 1.10$

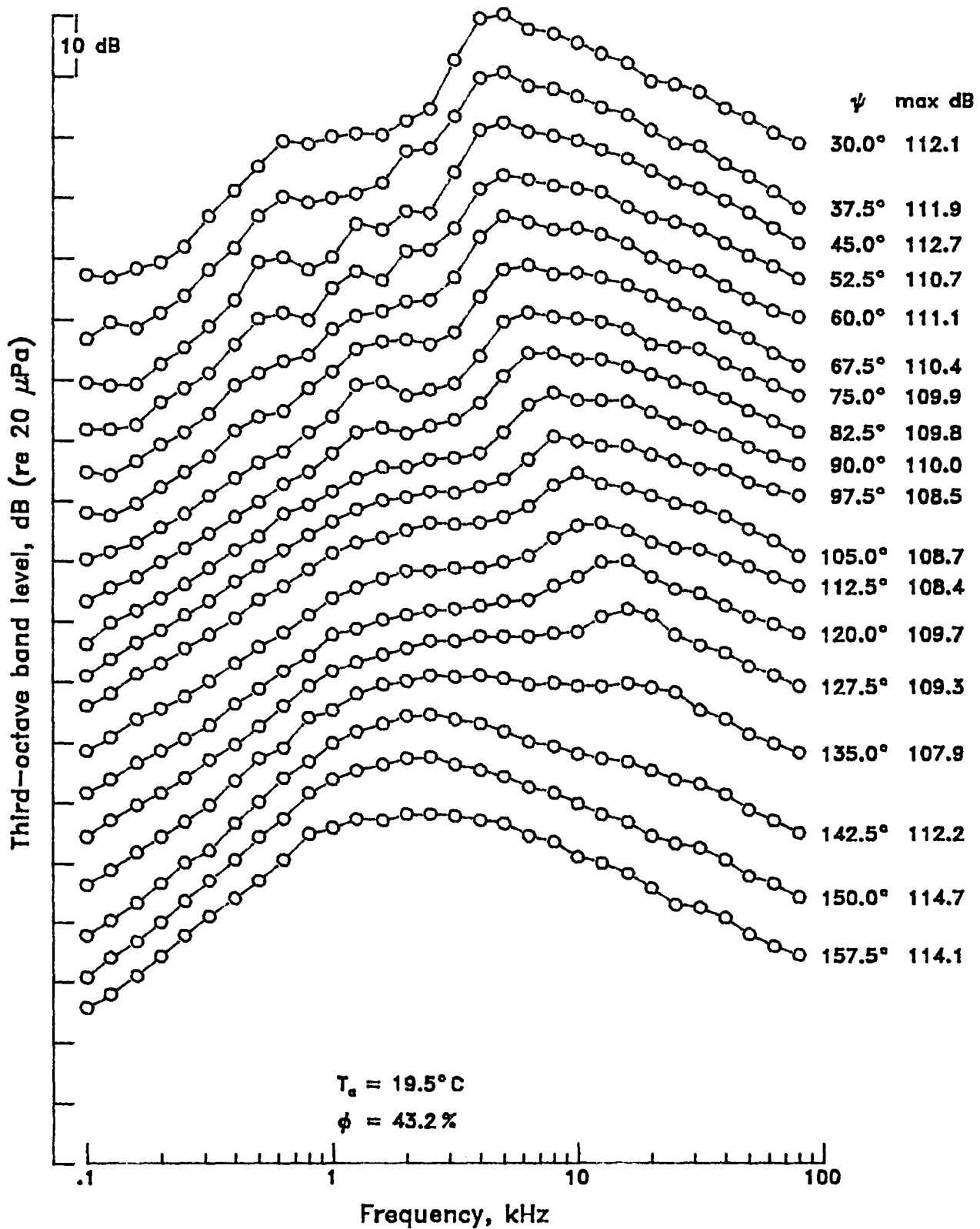



APPENDIX D

Mach 1.0 contoured nozzle with tab,  $\beta = 1.34$

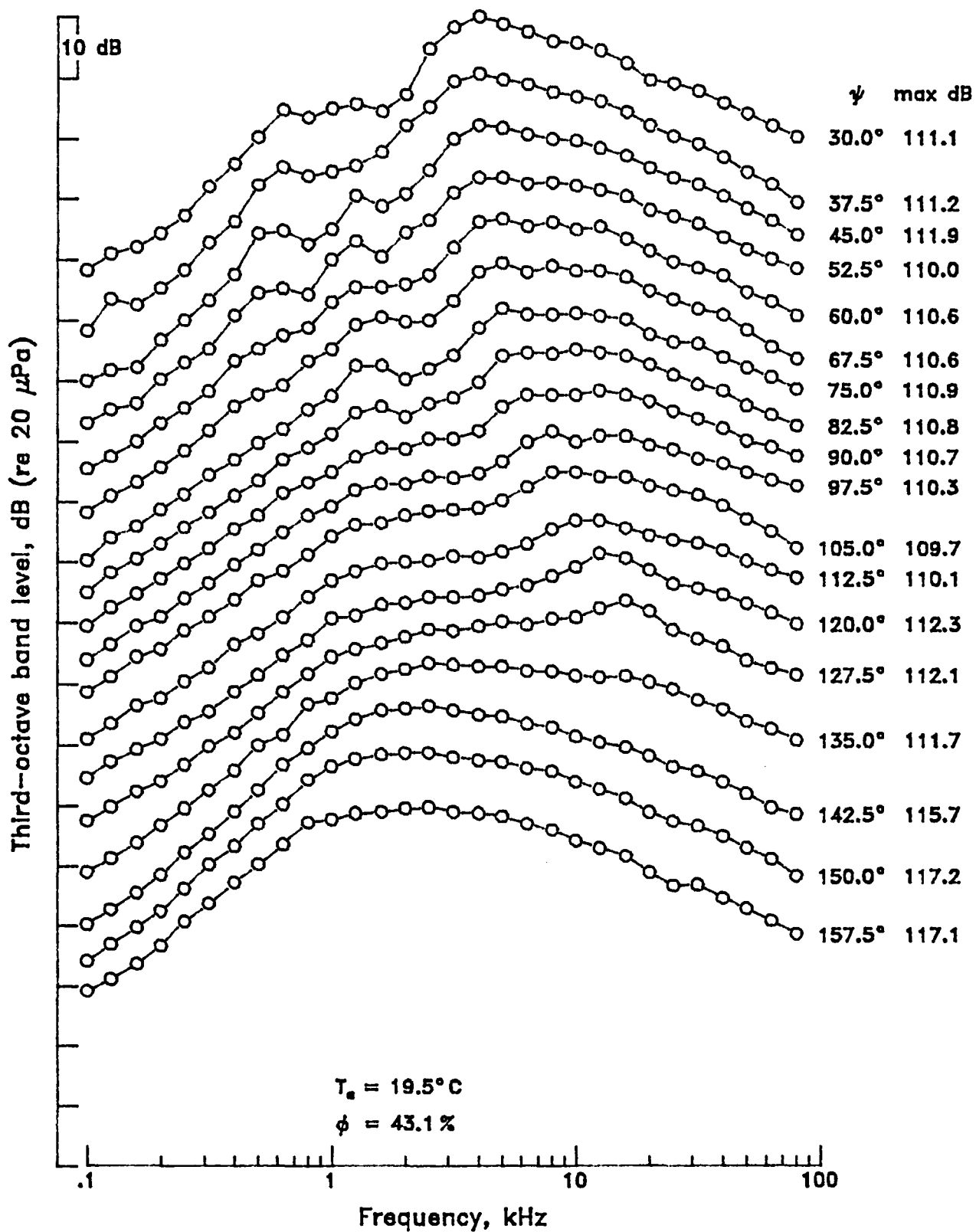

Mach 1.0 contoured nozzle with tab,  $\beta = 1.50$

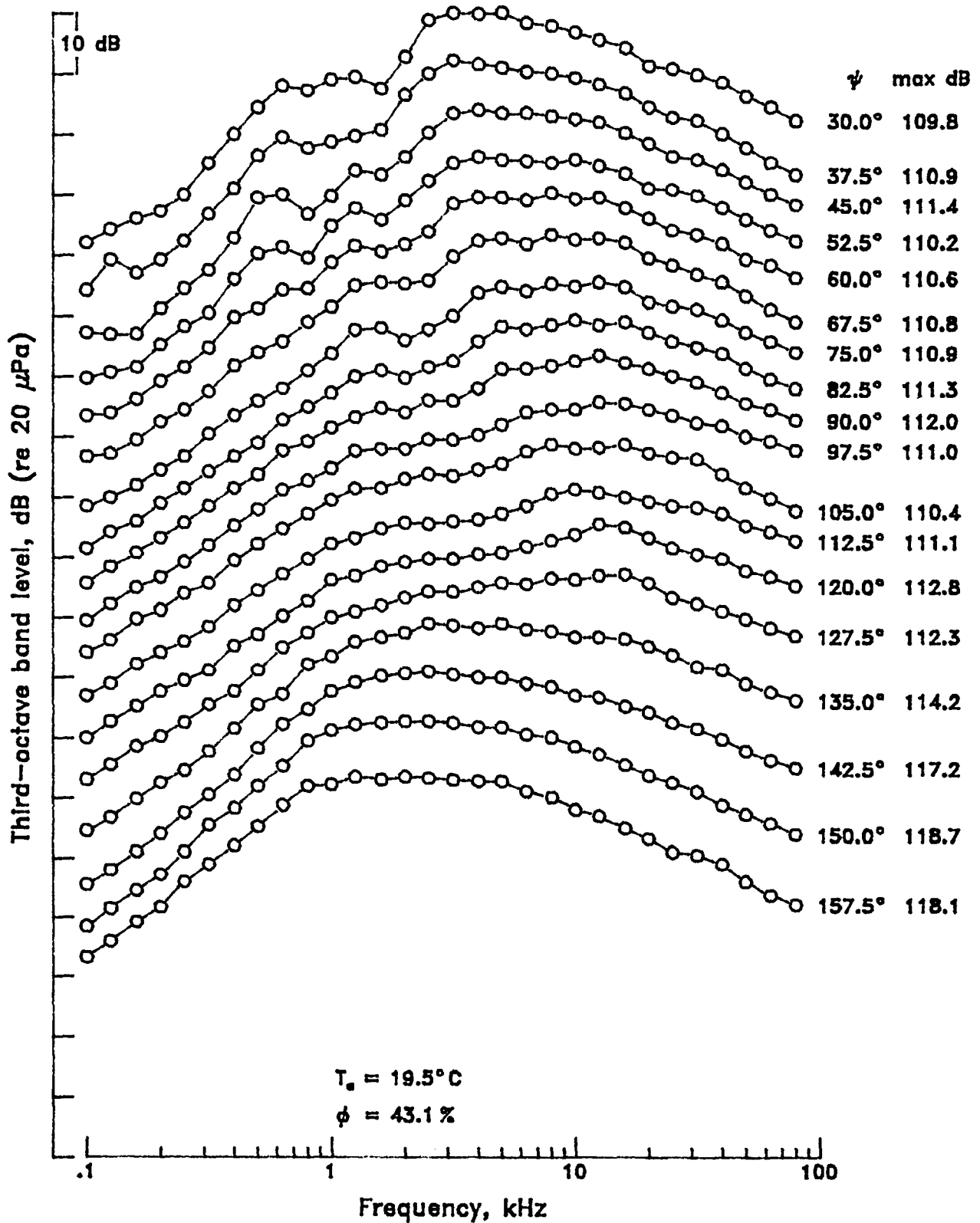

Mach 1.0 contoured nozzle with tab,  $\beta = 1.72$

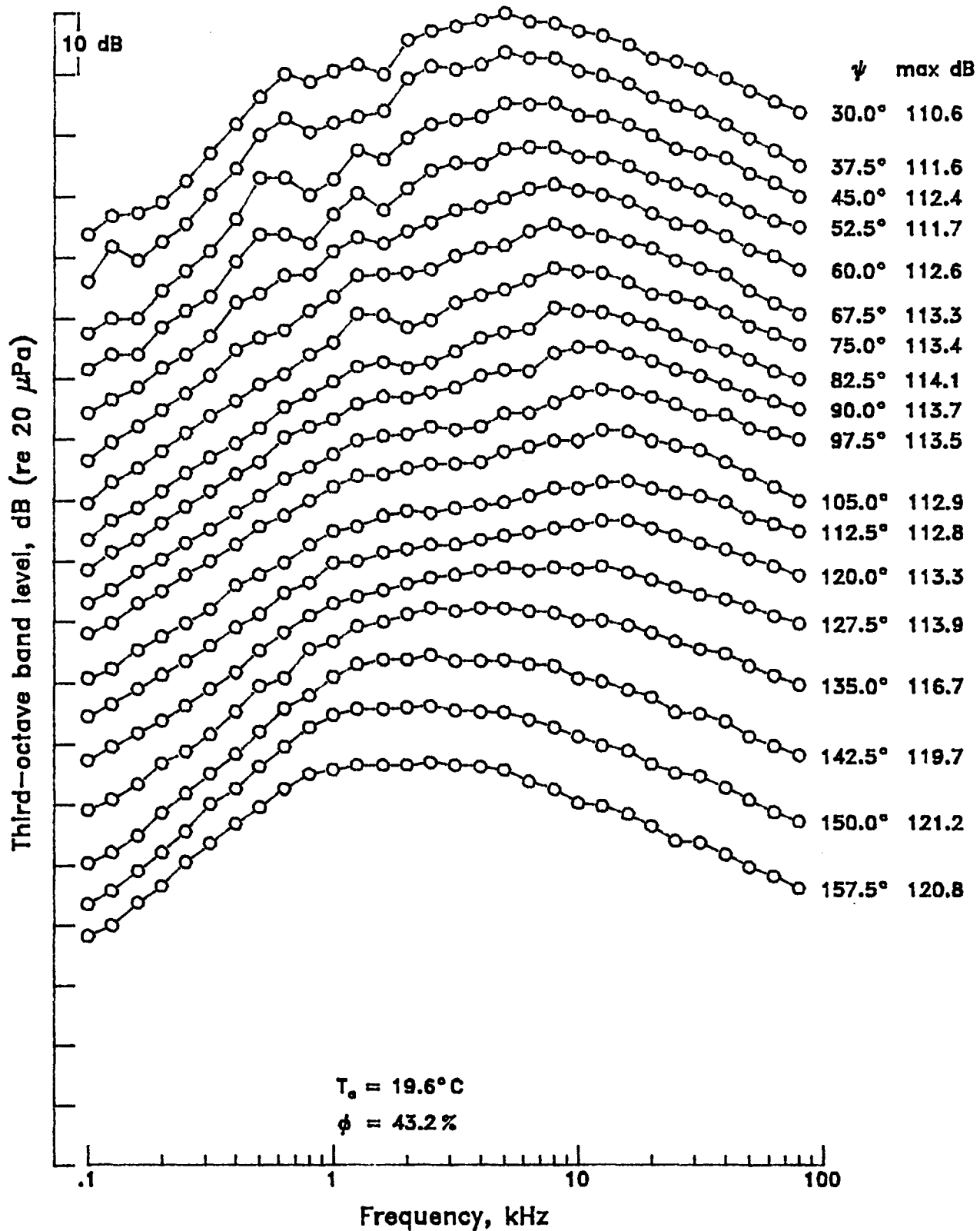

Mach 1.0 contoured nozzle with tab,  $\beta = 2.00$

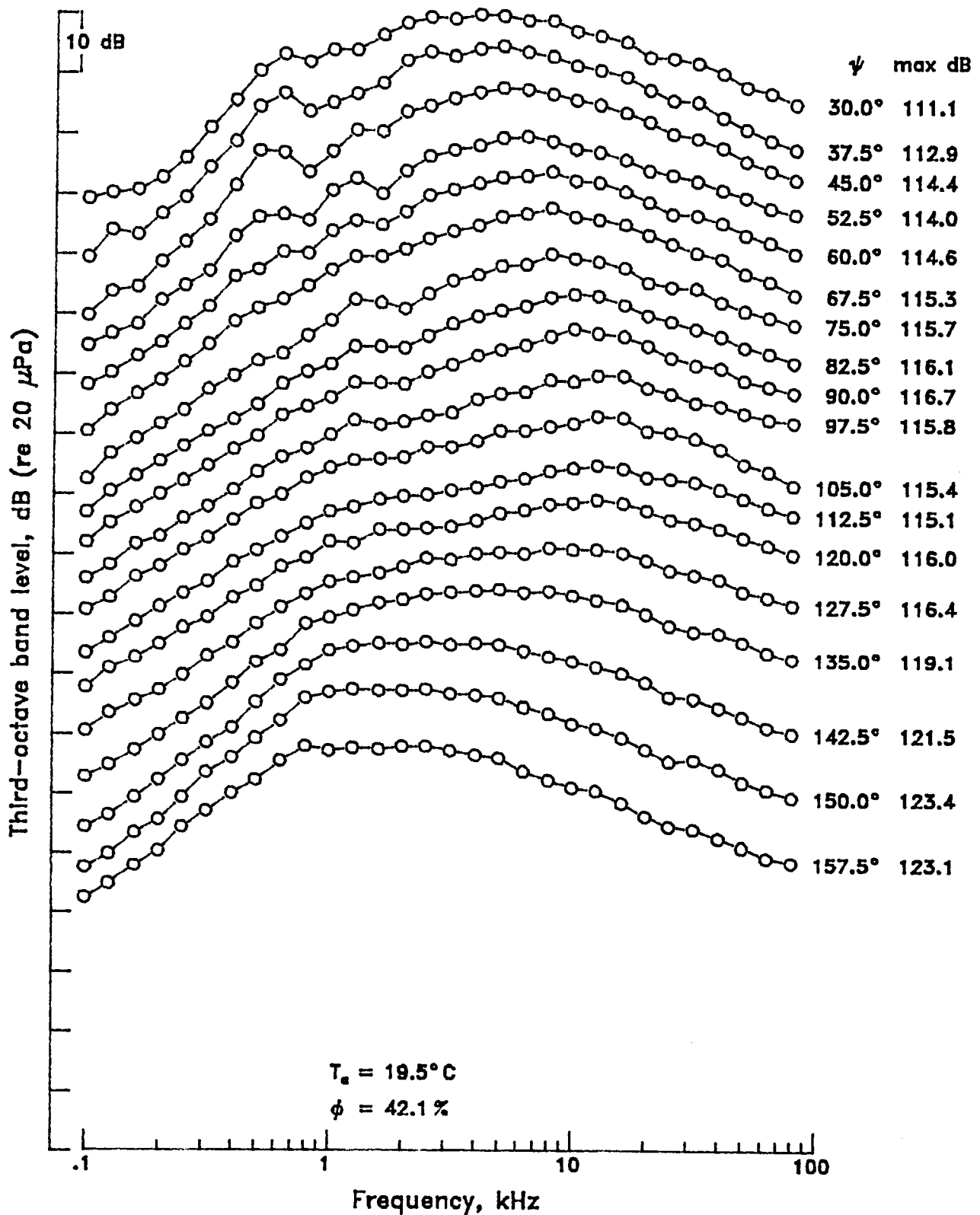

Mach 1.0 contoured nozzle with tab,  $\beta = 2.10$

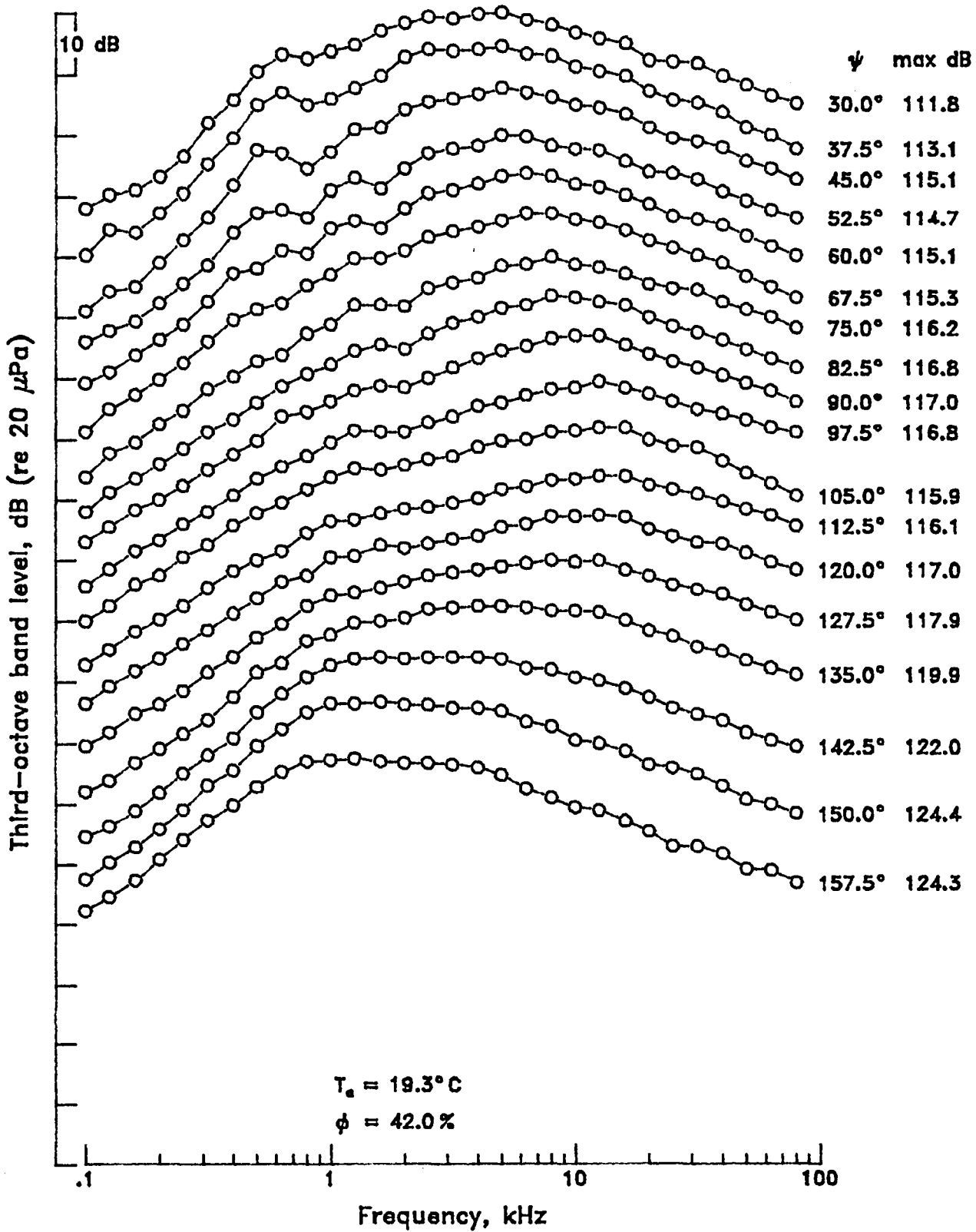

Mach 1.0 contoured nozzle with tab,  $\beta = 2.15$

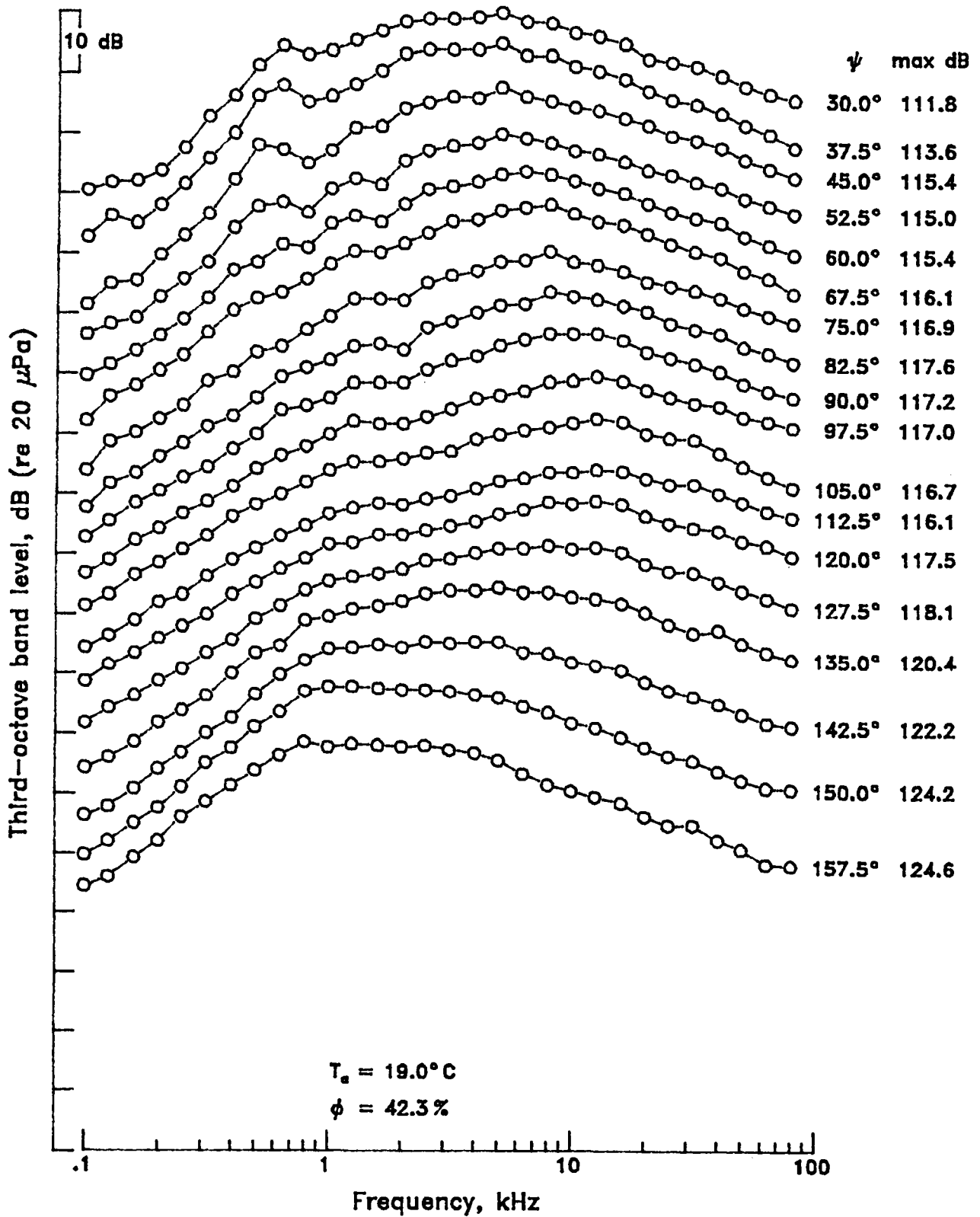

Mach 1.5 contoured nozzle without tab,  $\beta = 0.00$

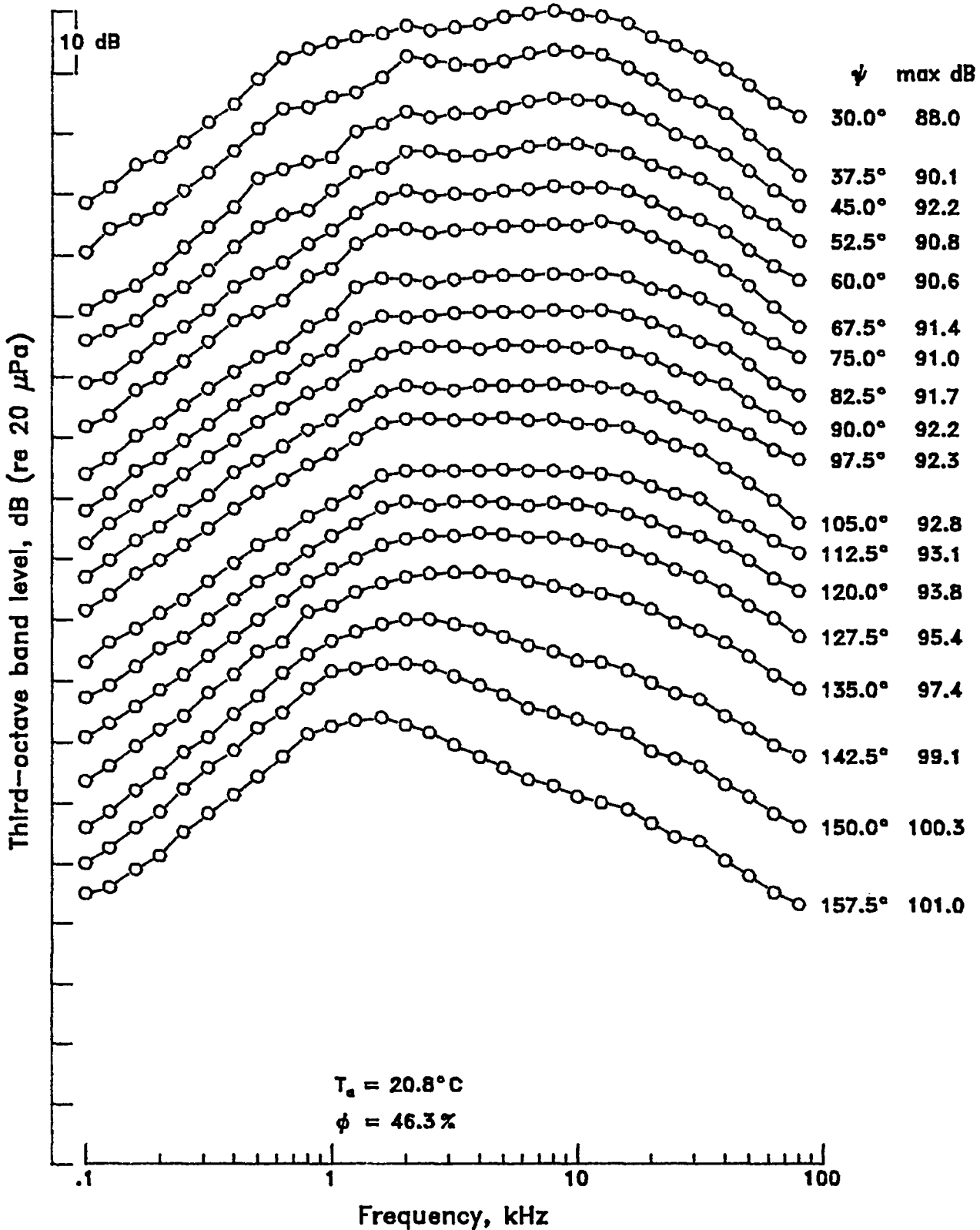

Mach 1.5 contoured nozzle without tab,  $\beta = 0.20$

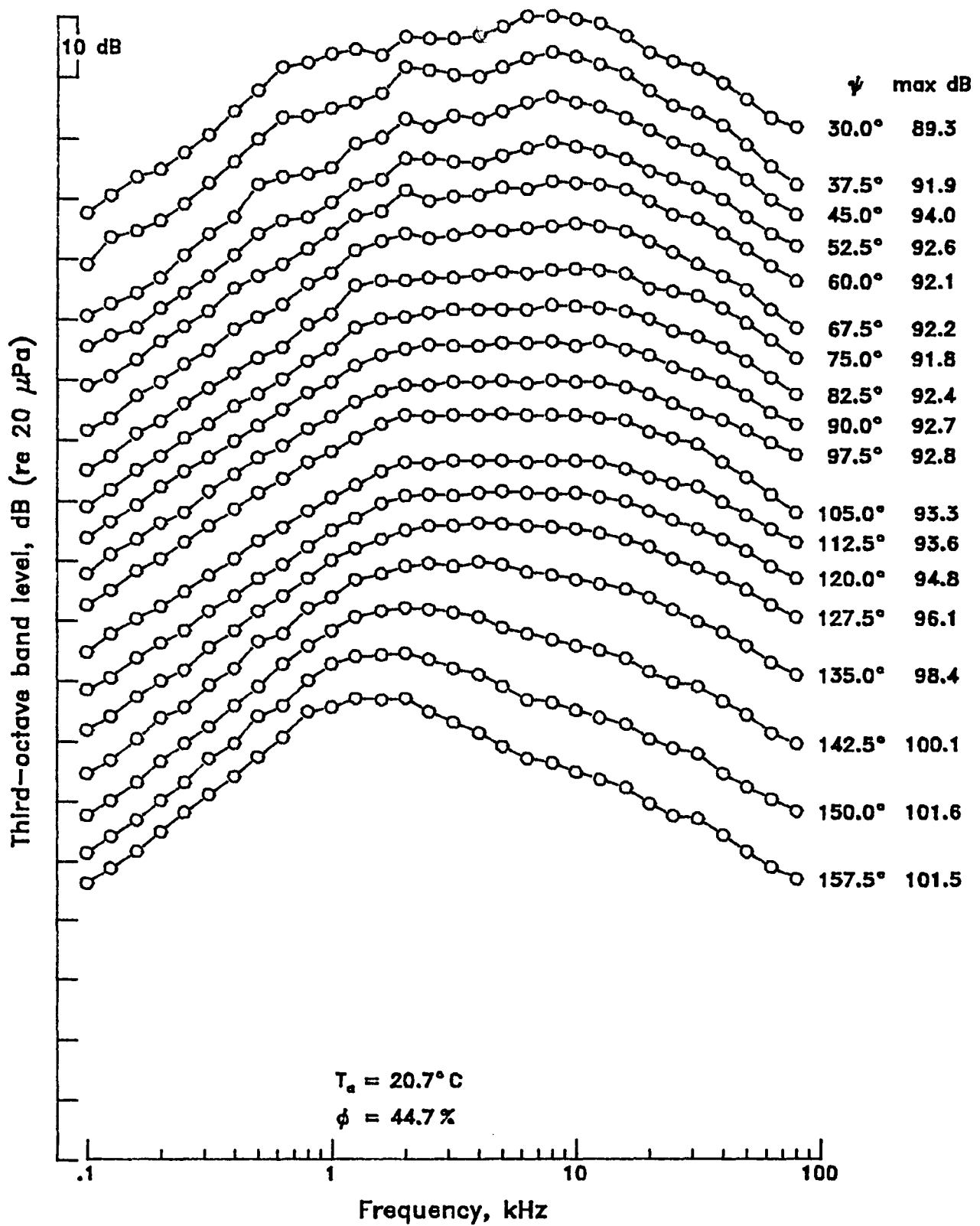



Mach 1.5 contoured nozzle without tab,  $\beta = 0.40$

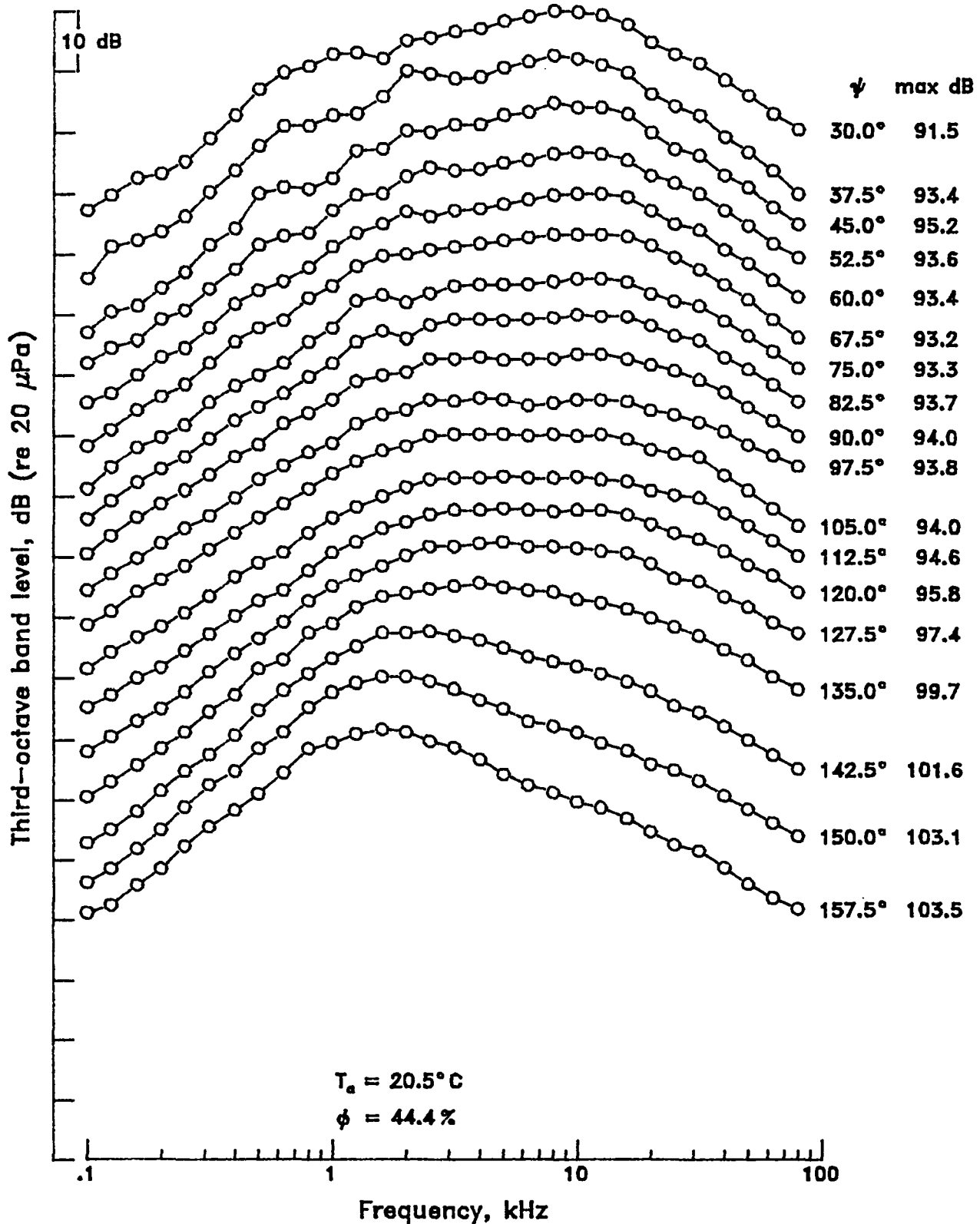

Mach 1.5 contoured nozzle without tab,  $\beta = 0.60$

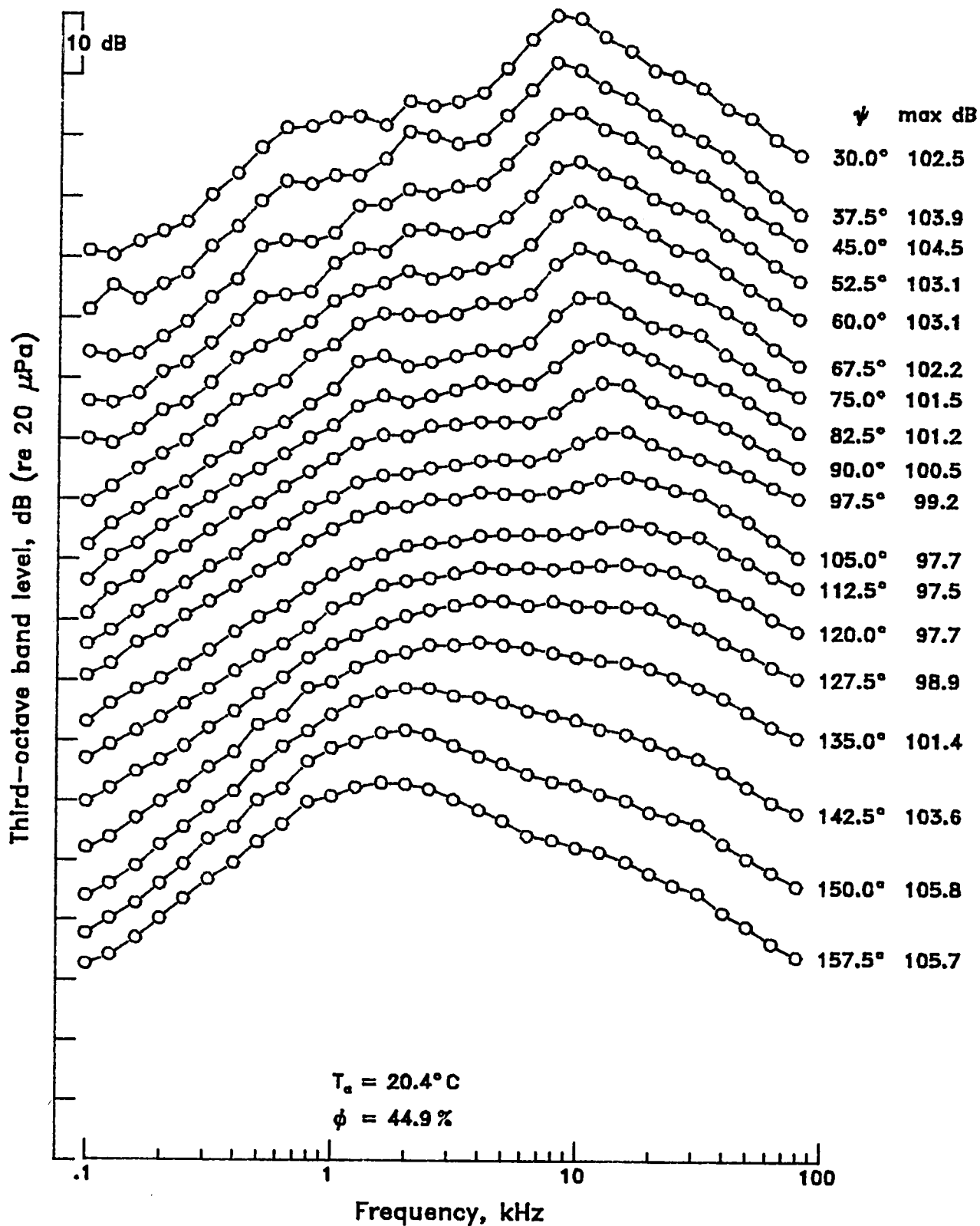

Mach 1.5 contoured nozzle without tab,  $\beta = 0.70$

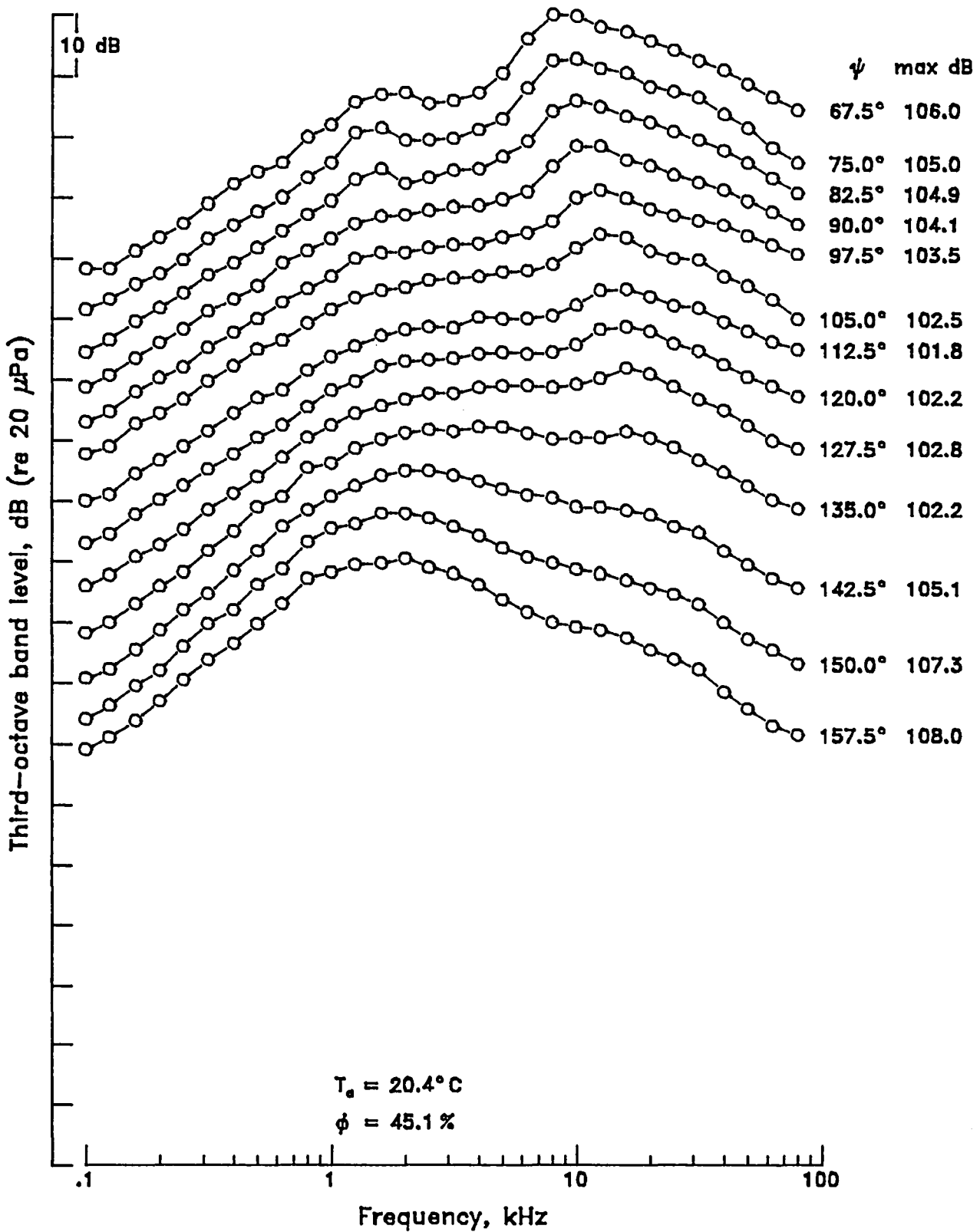

Mach 1.5 contoured nozzle without tab,  $\beta = 0.80$

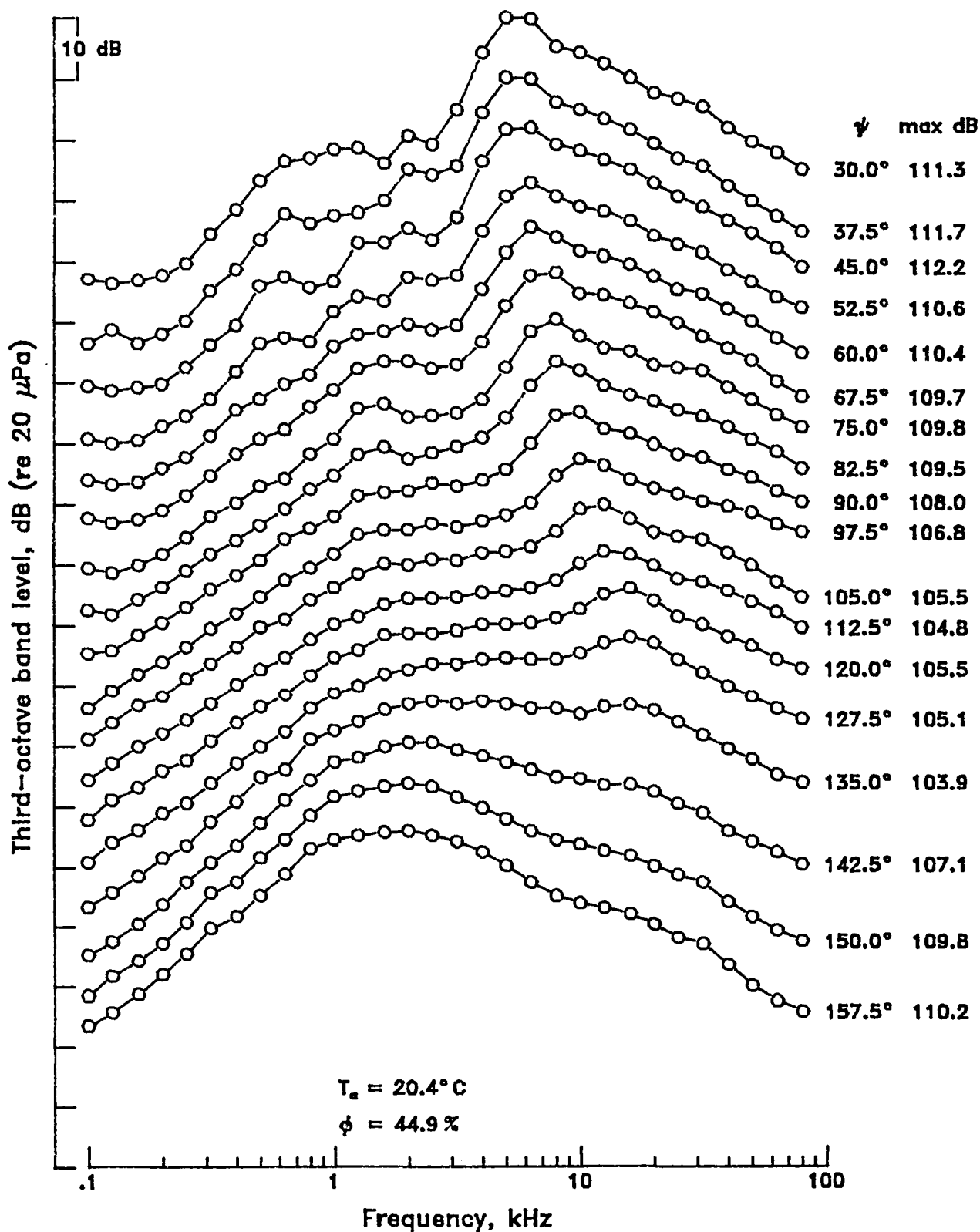

Mach 1.5 contoured nozzle without tab,  $\beta = 0.94$

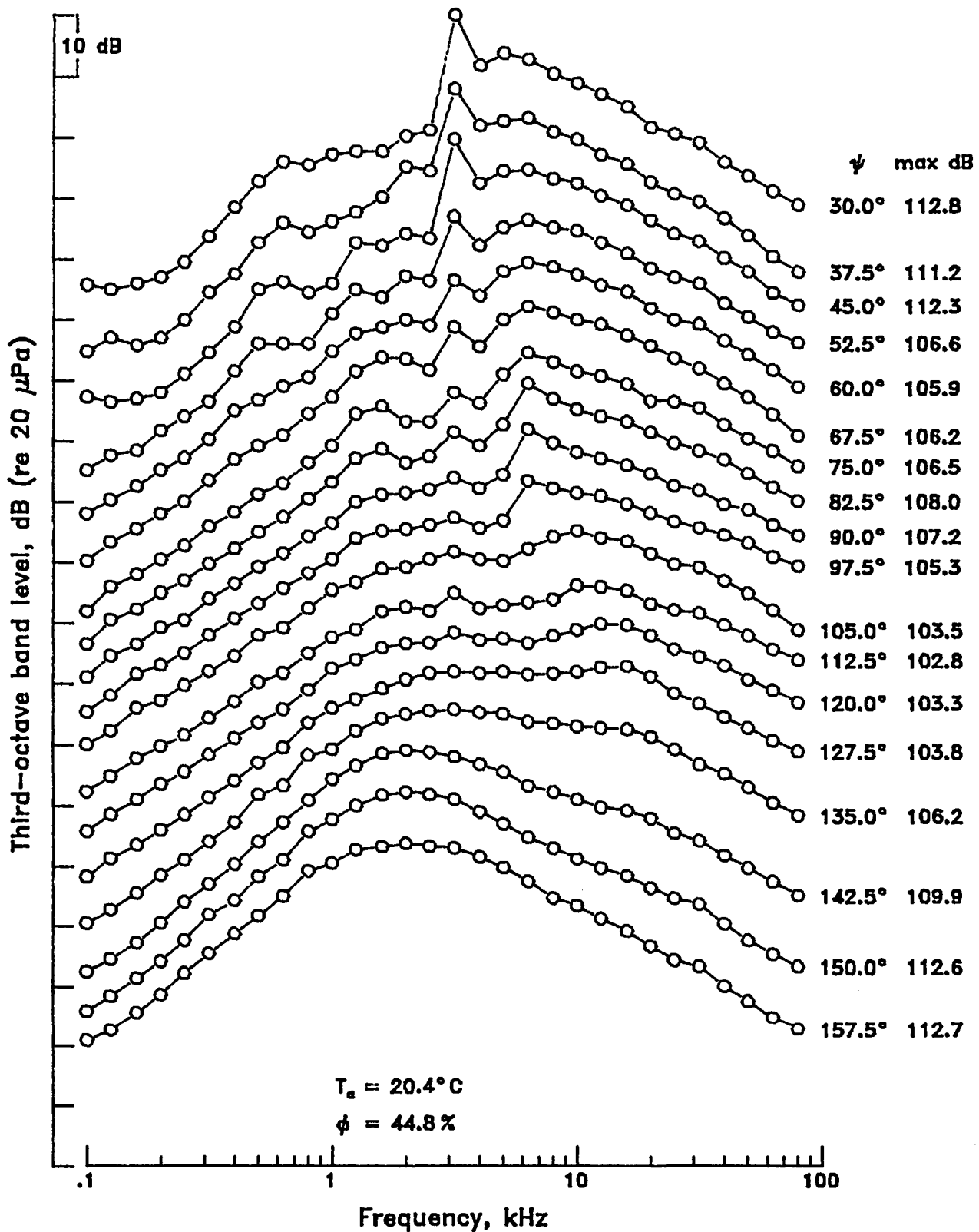

Mach 1.5 contoured nozzle without tab,  $\beta = 1.00$

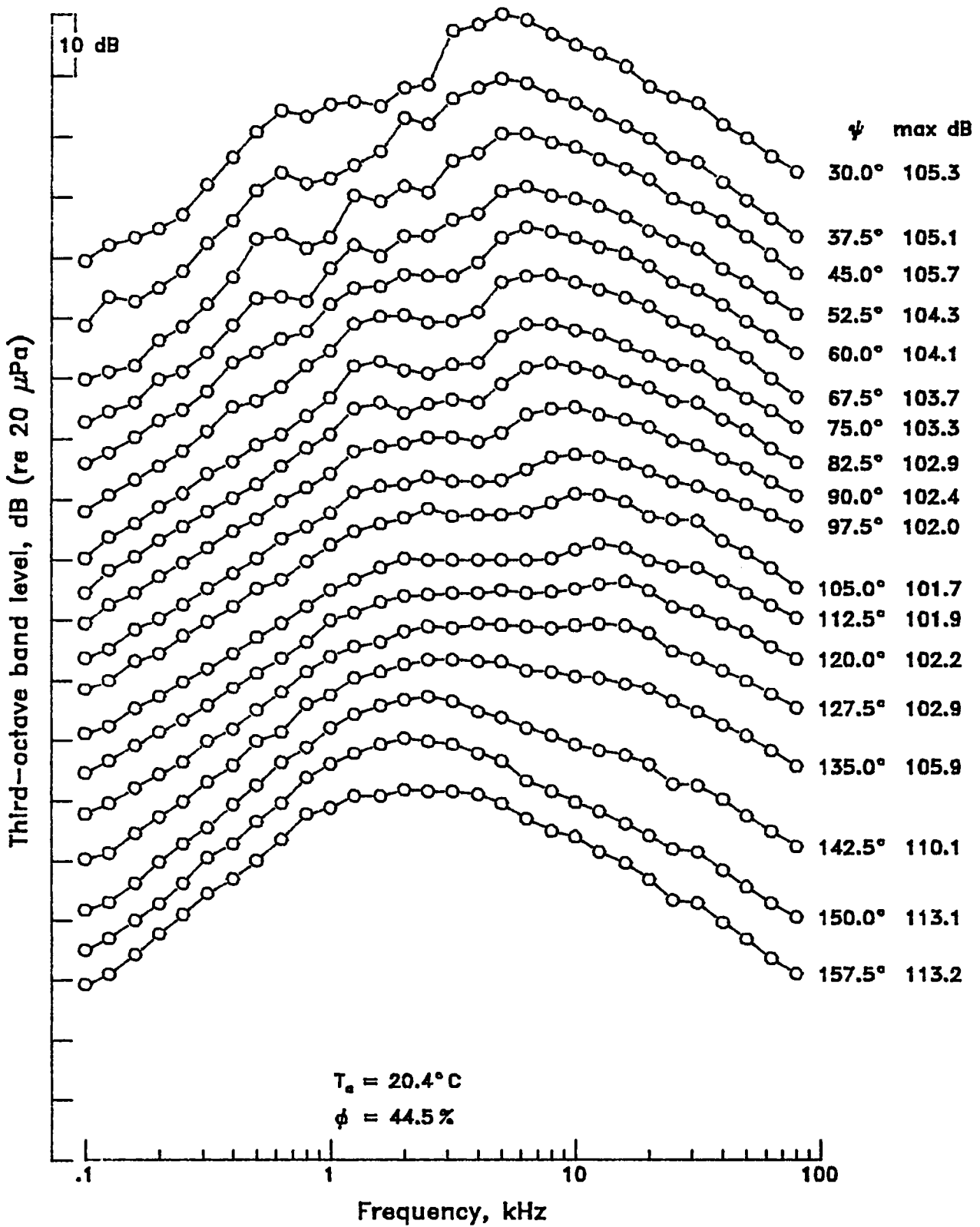

Mach 1.5 contoured nozzle without tab,  $\beta = 1.10$

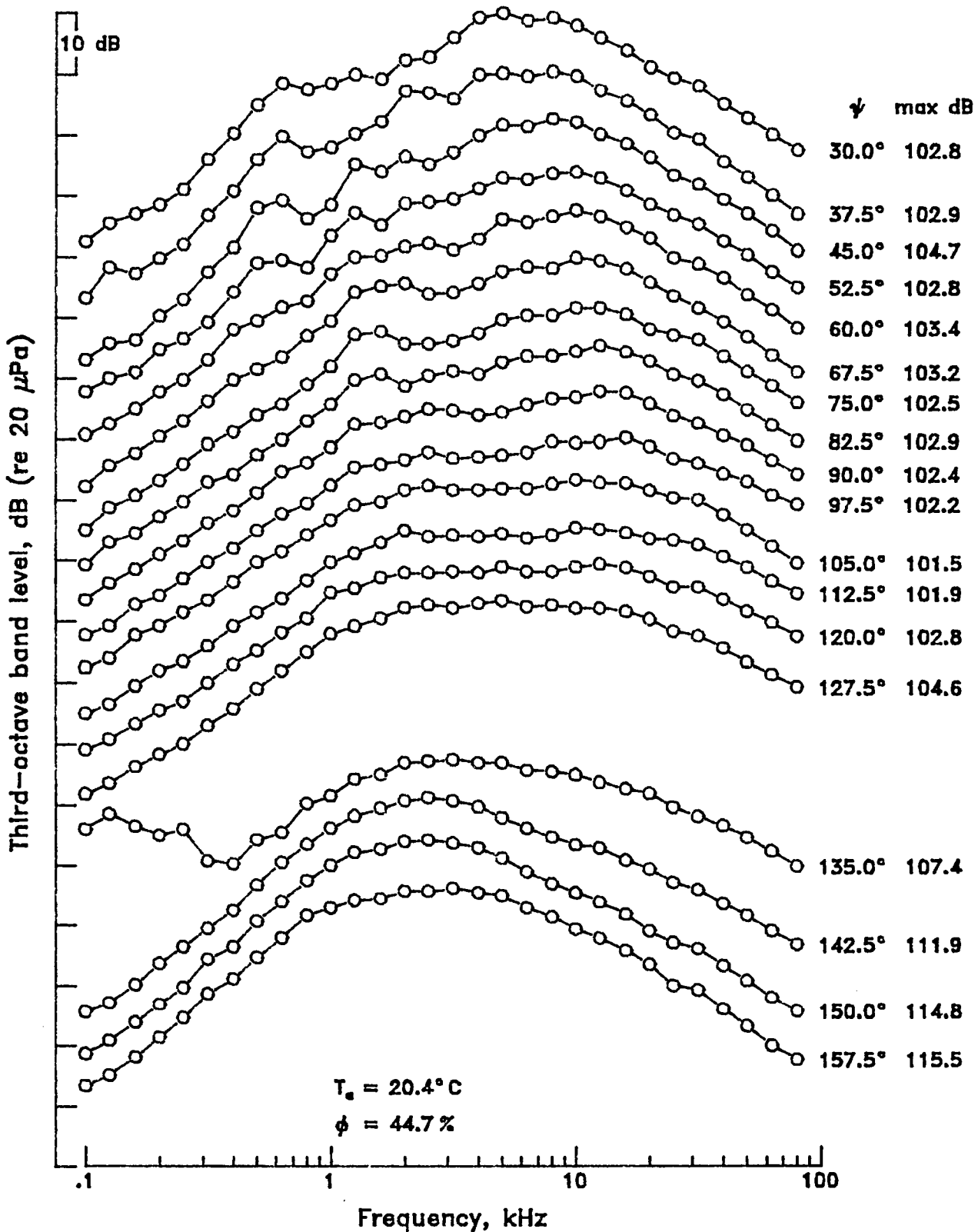

Mach 1.5 contoured nozzle without tab,  $\beta = 1.34$

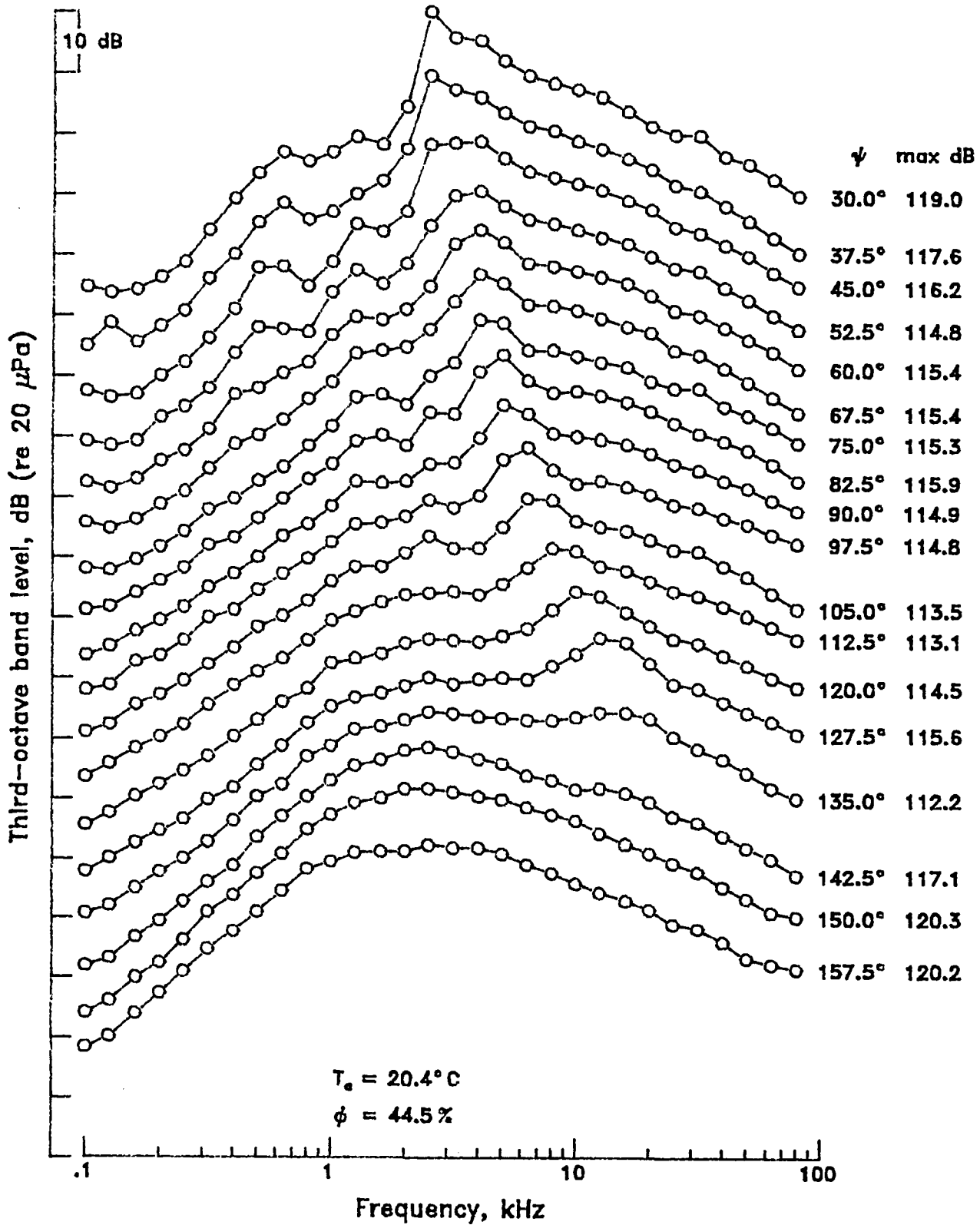



Mach 1.5 contoured nozzle without tab,  $\beta = 1.50$

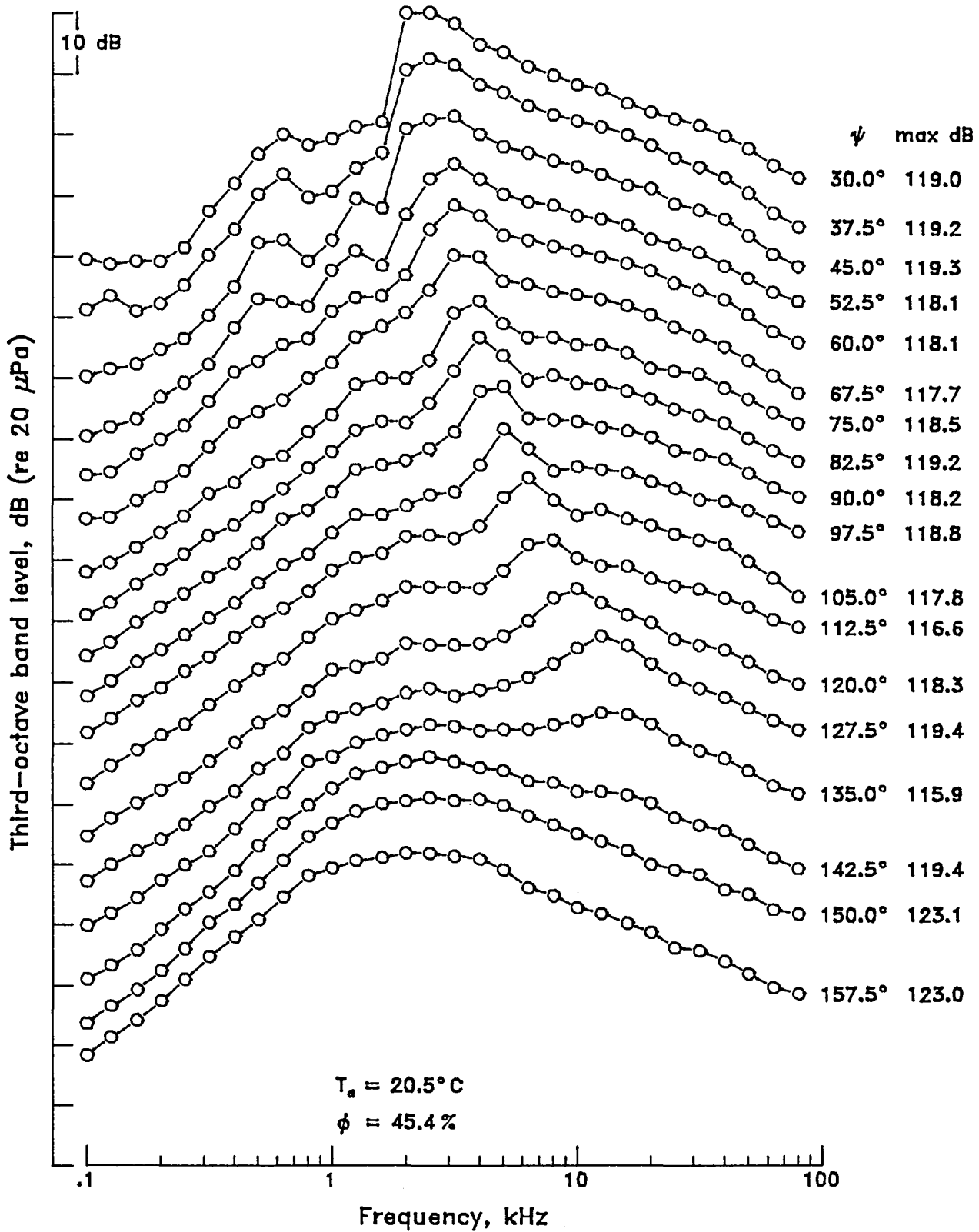

Mach 1.5 contoured nozzle without tab,  $\beta = 1.72$

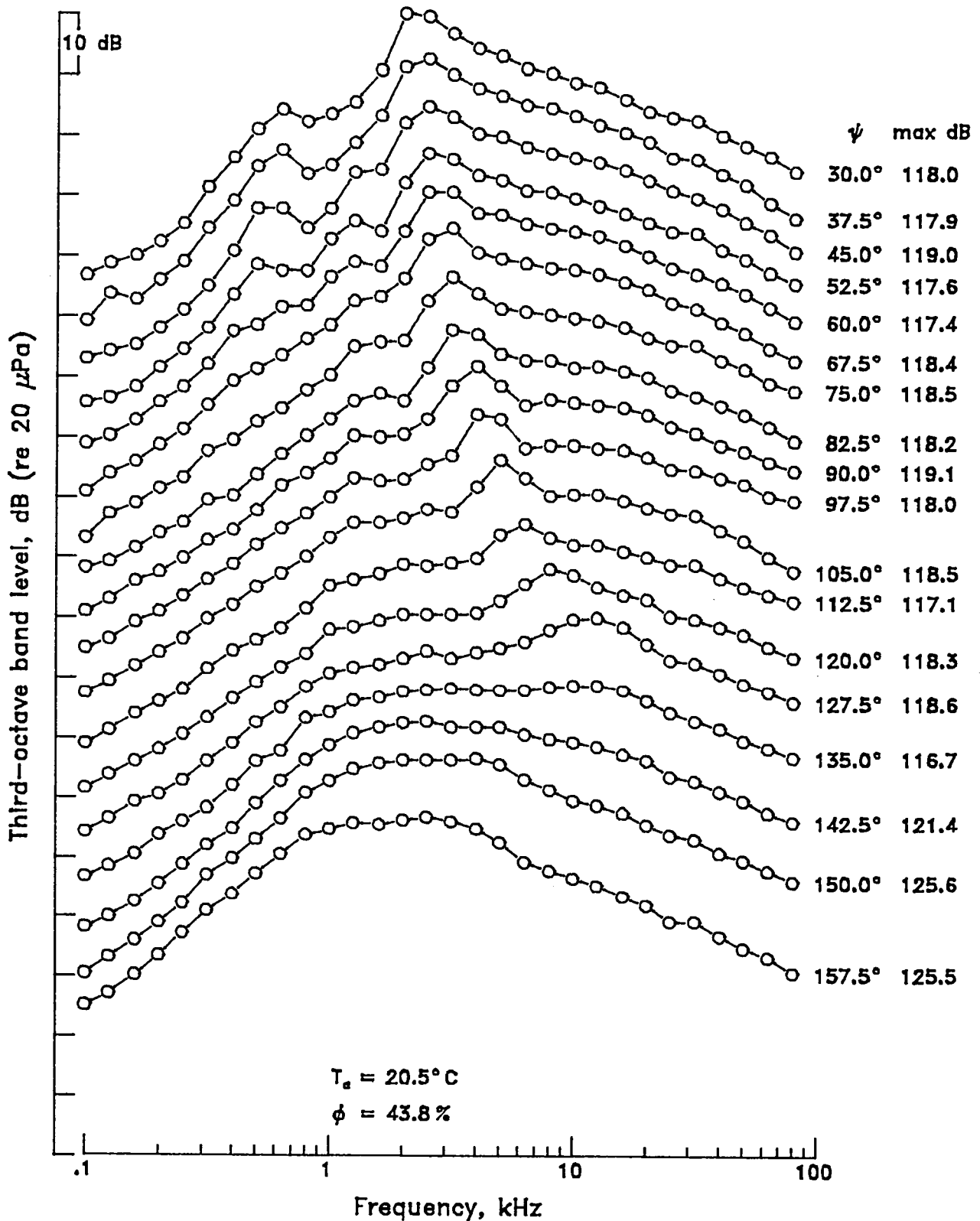

APPENDIX D

Mach 1.5 contoured nozzle without tab,  $\beta = 2.00$

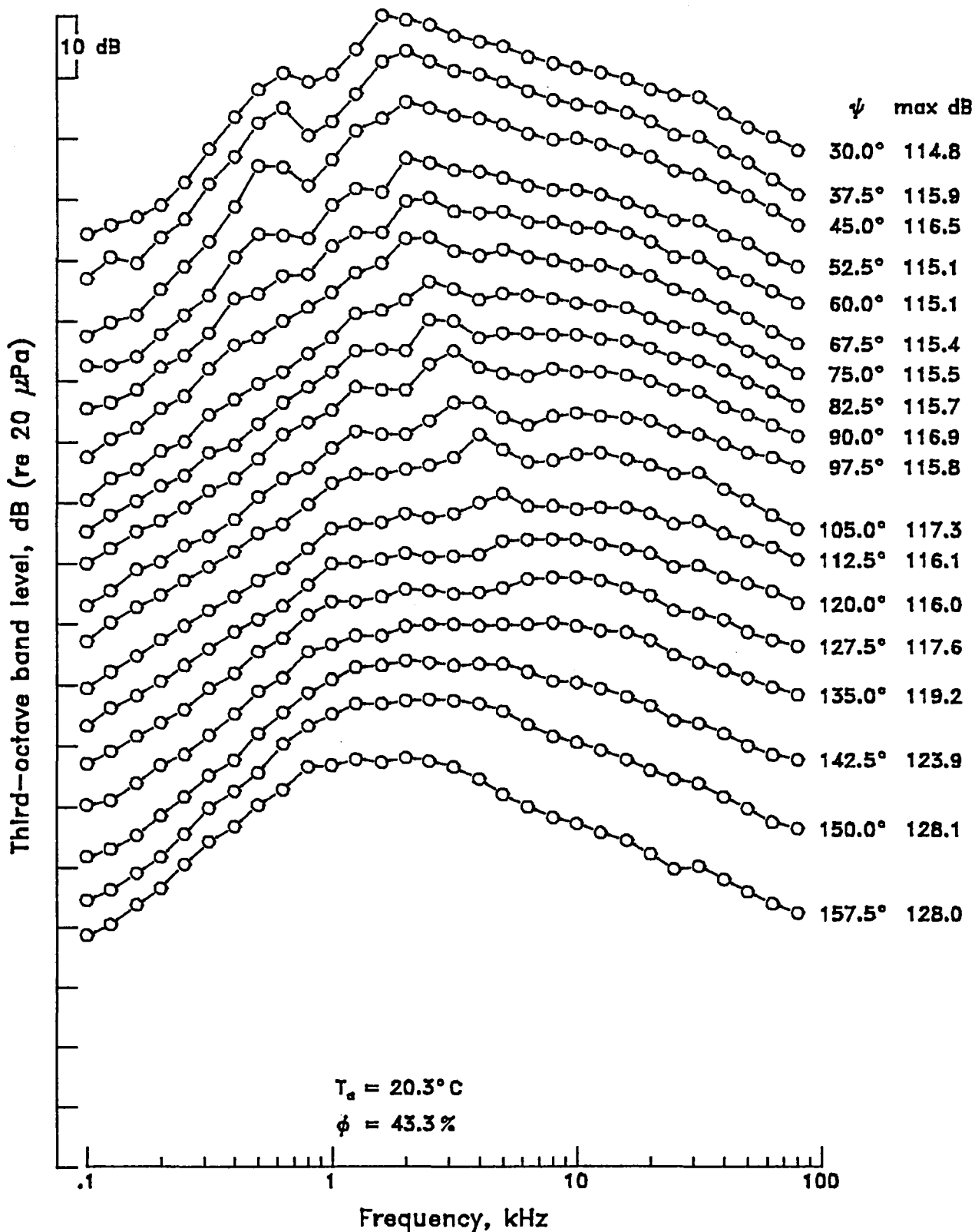

Mach 1.5 contoured nozzle without tab,  $\beta = 2.10$

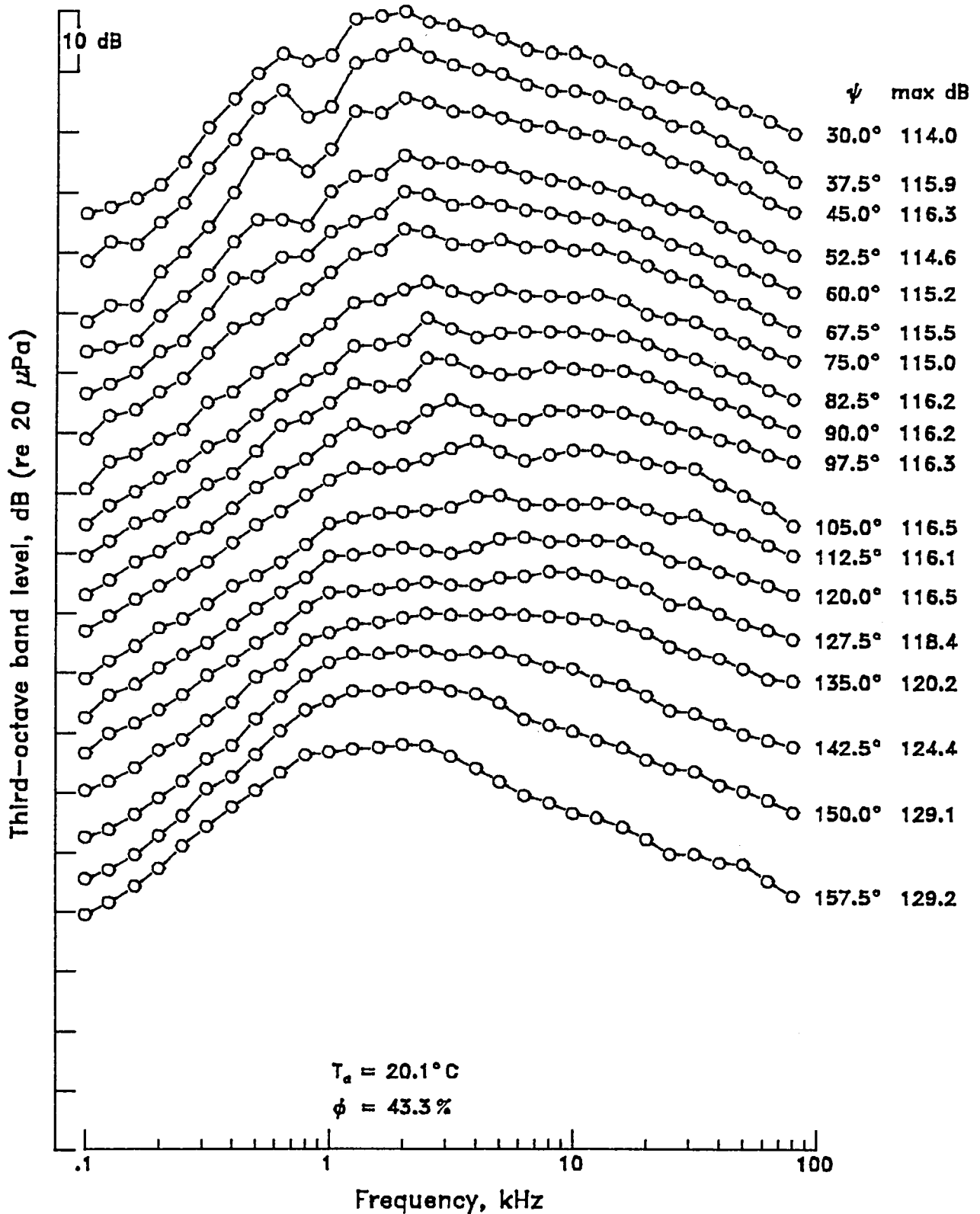

Mach 1.5 contoured nozzle without tab,  $\beta = 2.15$

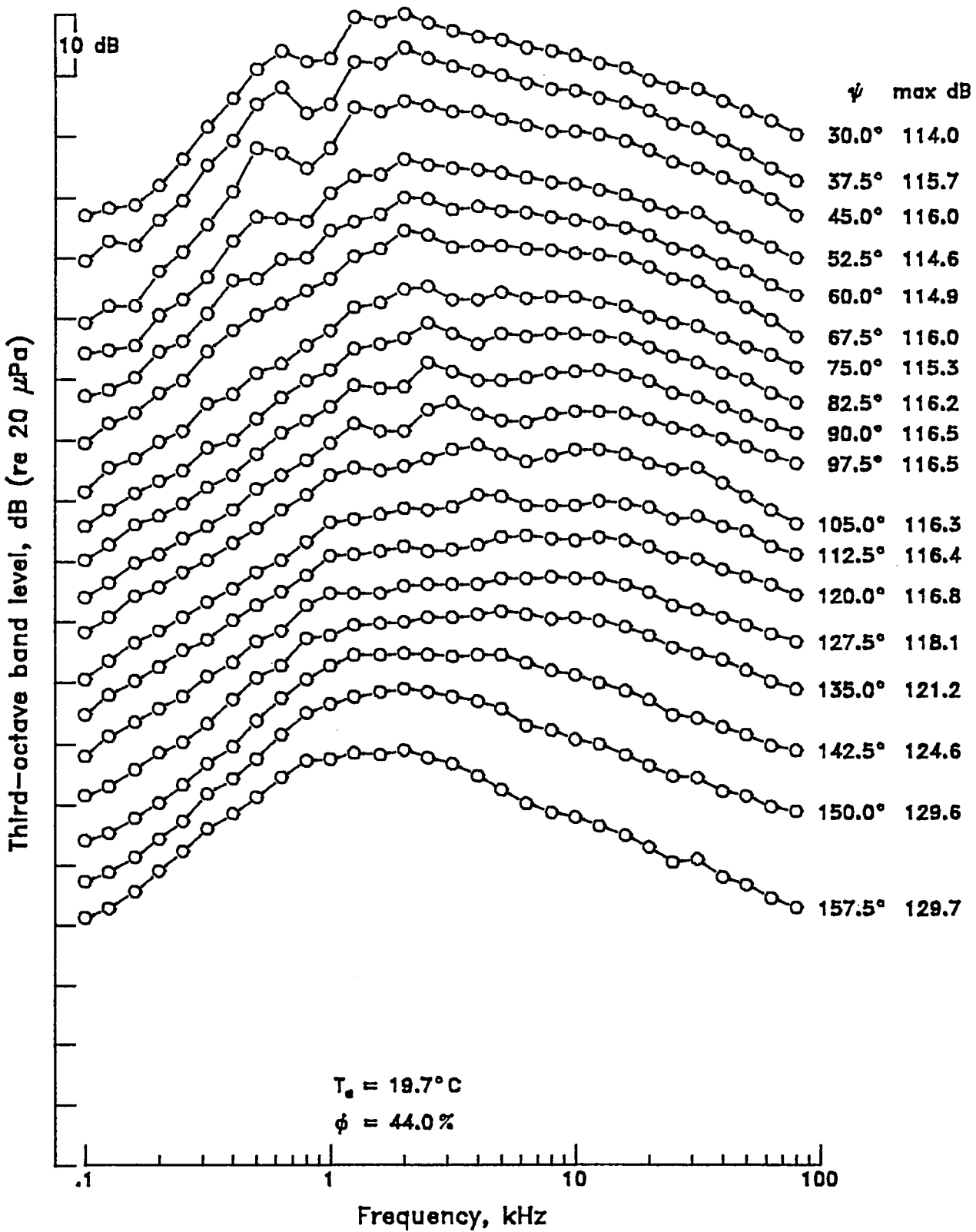

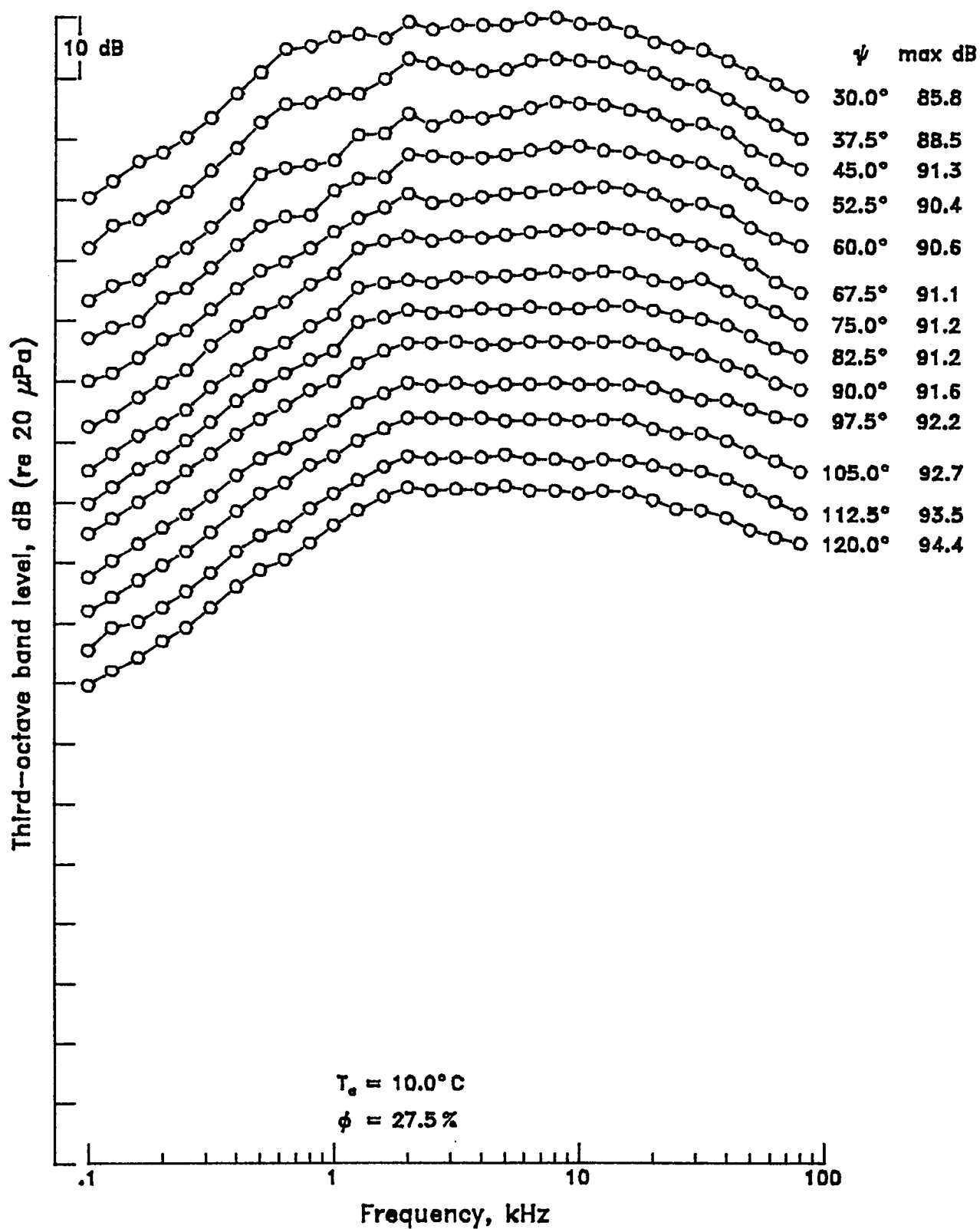
Mach 1.5 contoured nozzle with tab,  $\beta = 0.00$ 

Mach 1.5 contoured nozzle with tab,  $\beta = 0.20$

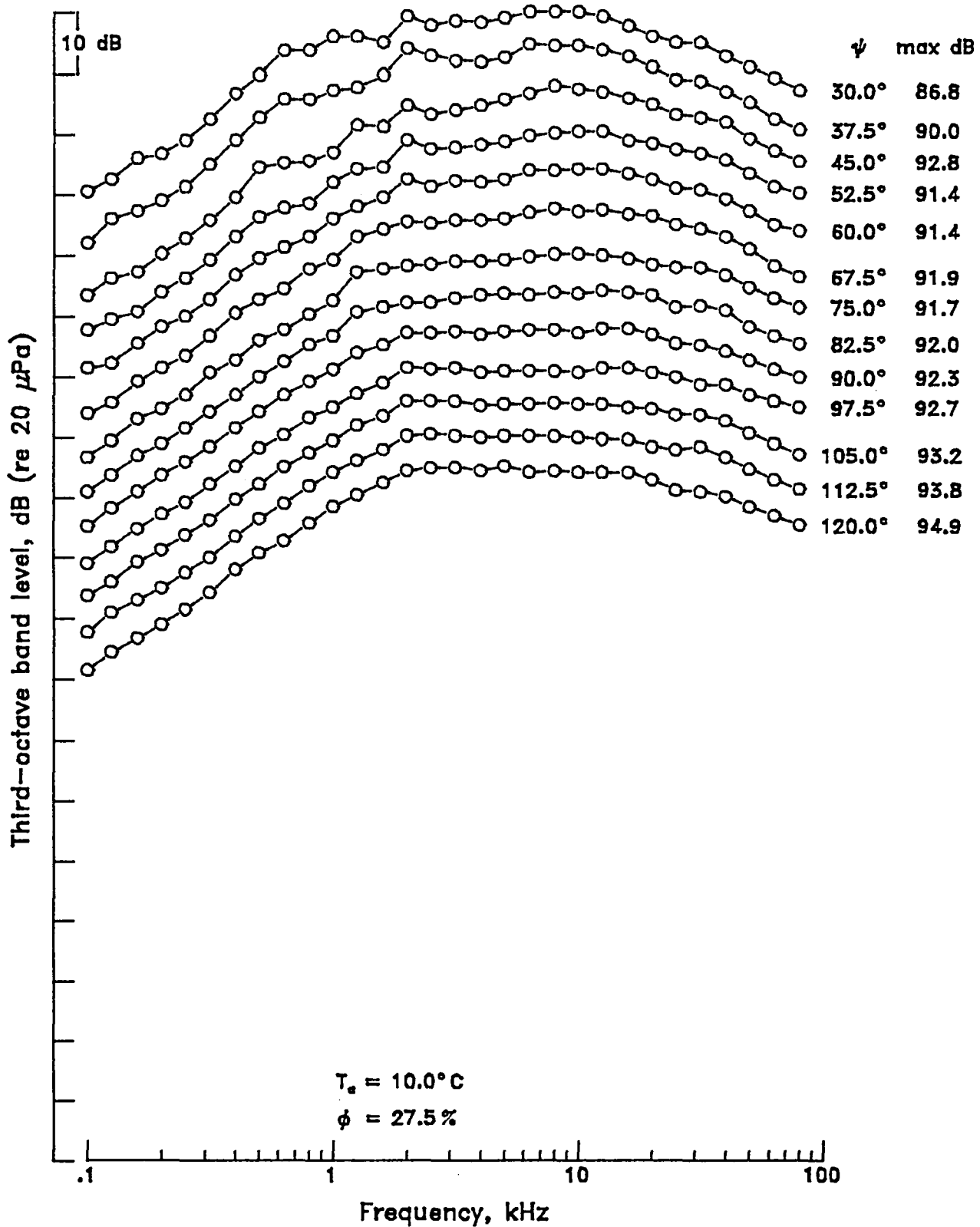

Mach 1.5 contoured nozzle with tab,  $\beta = 0.40$

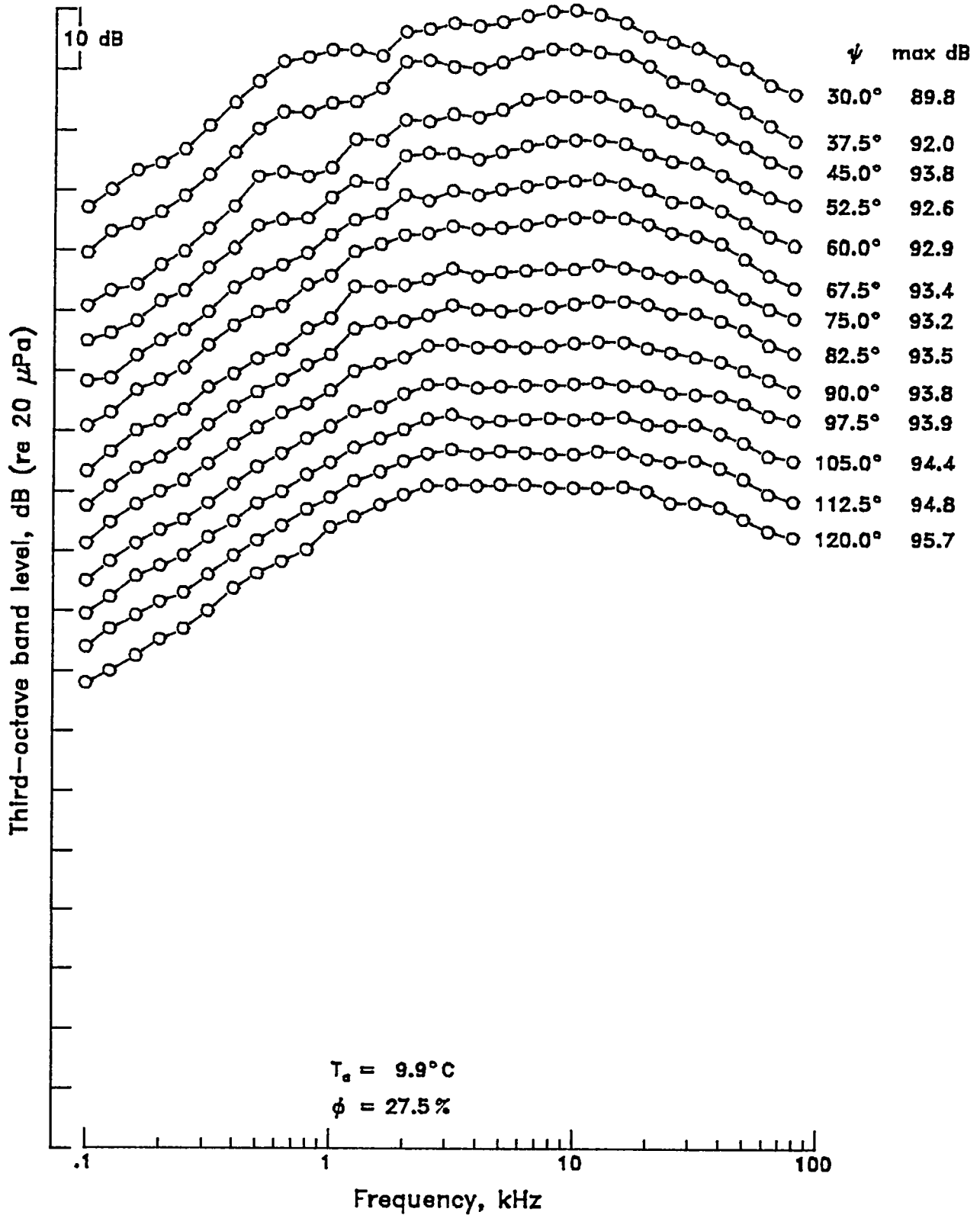



Mach 1.5 contoured nozzle with tab,  $\beta = 0.60$

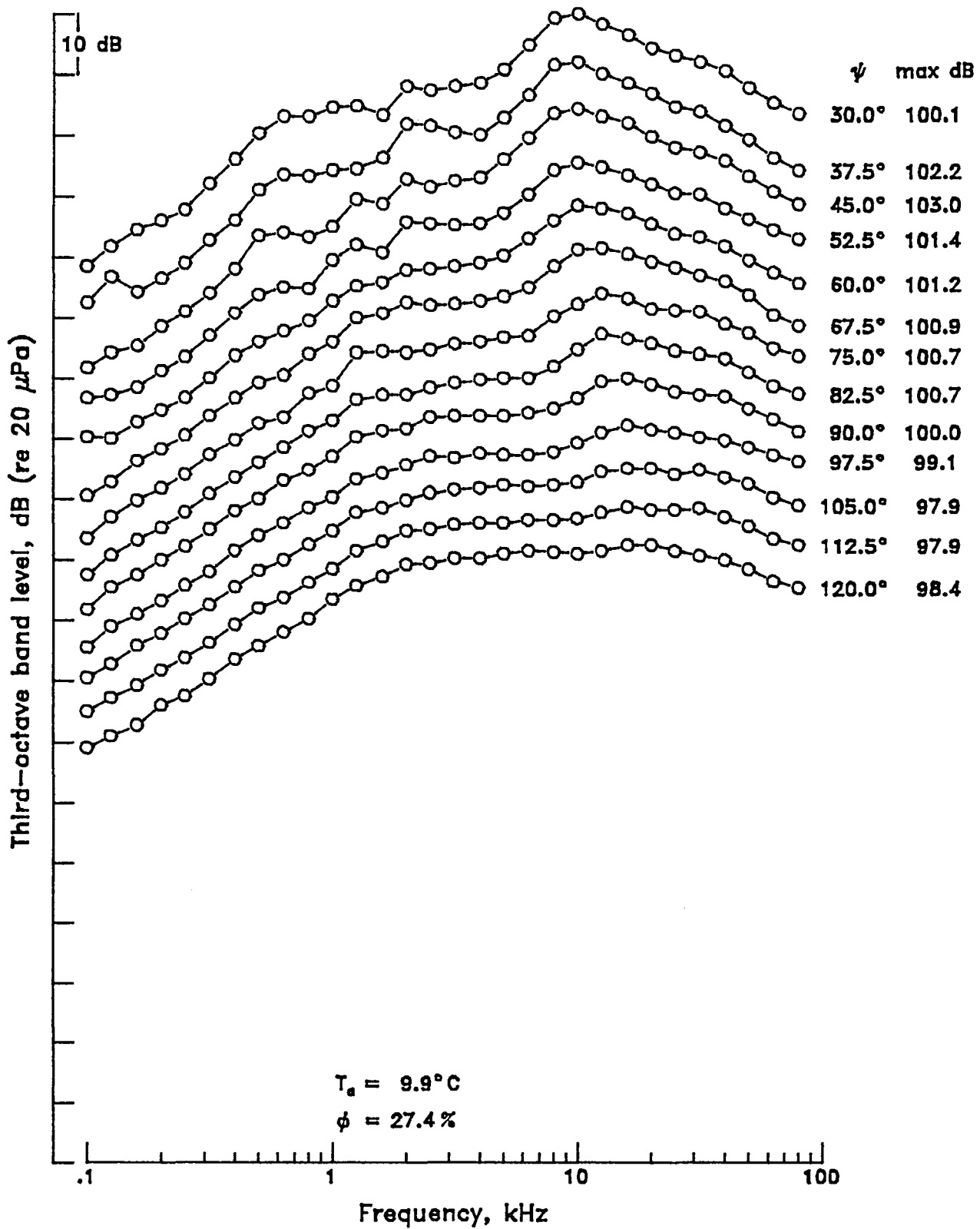

Mach 1.5 contoured nozzle with tab,  $\beta = 0.70$

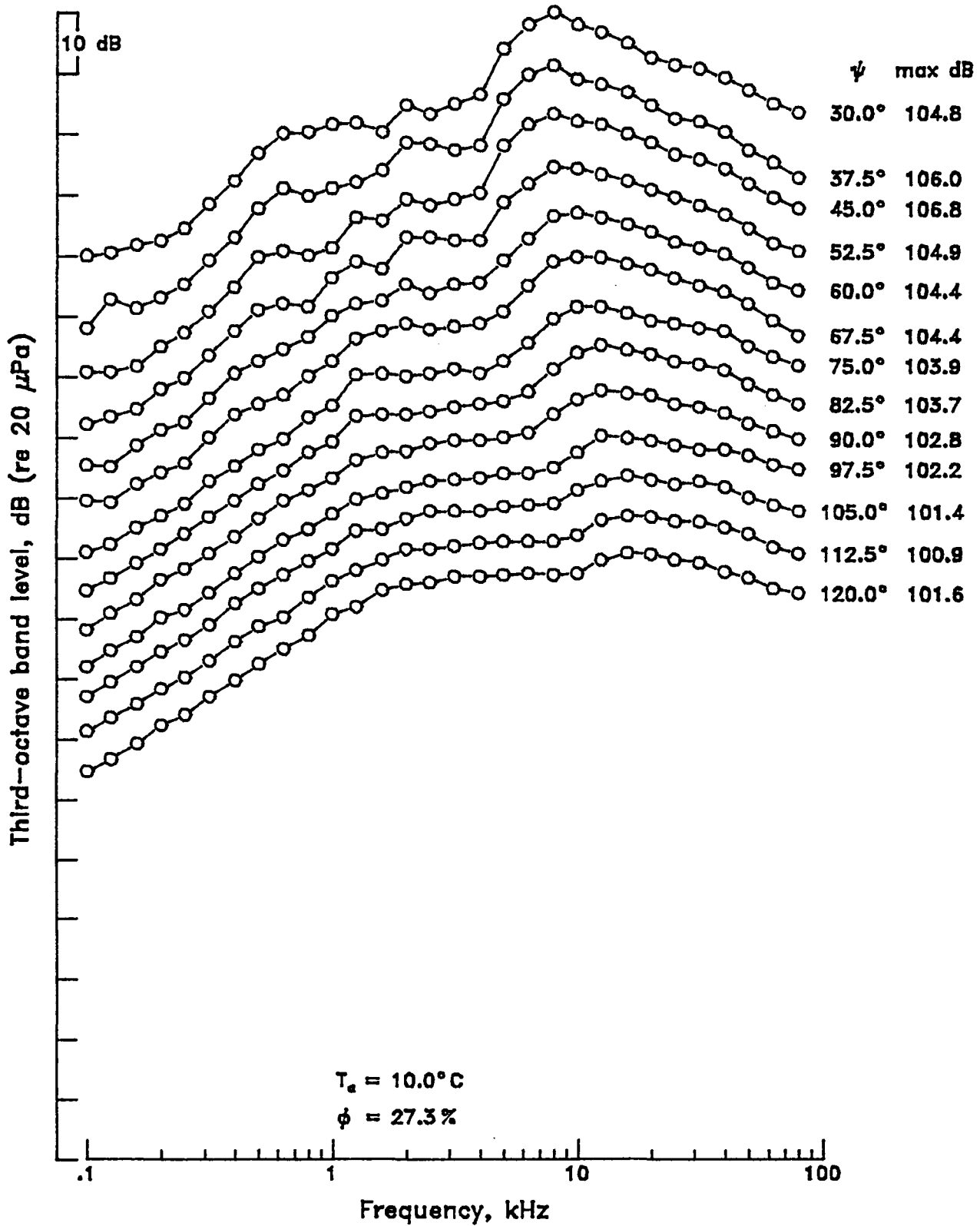

Mach 1.5 contoured nozzle with tab,  $\beta = 0.80$

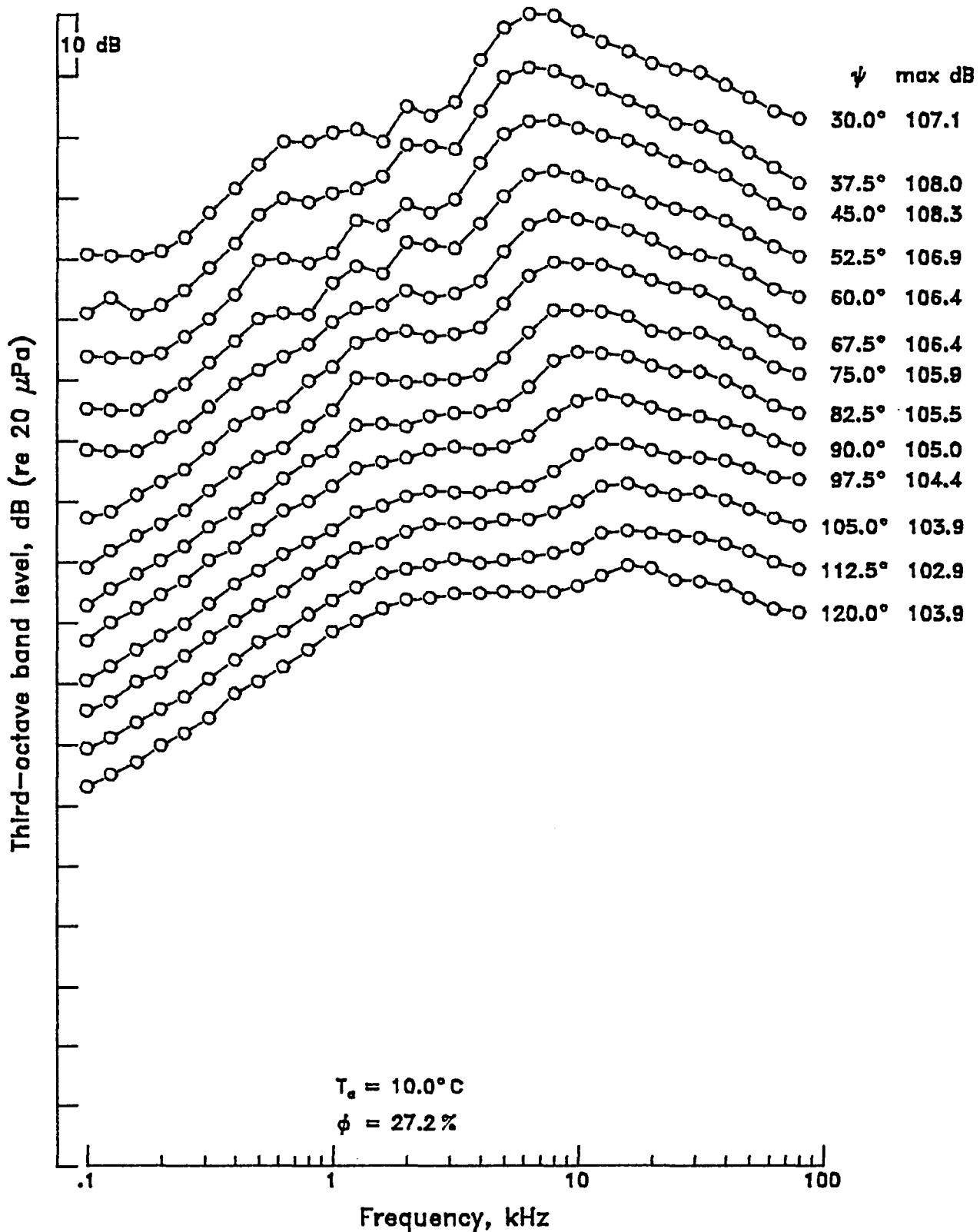

Mach 1.5 contoured nozzle with tab,  $\beta = 0.94$

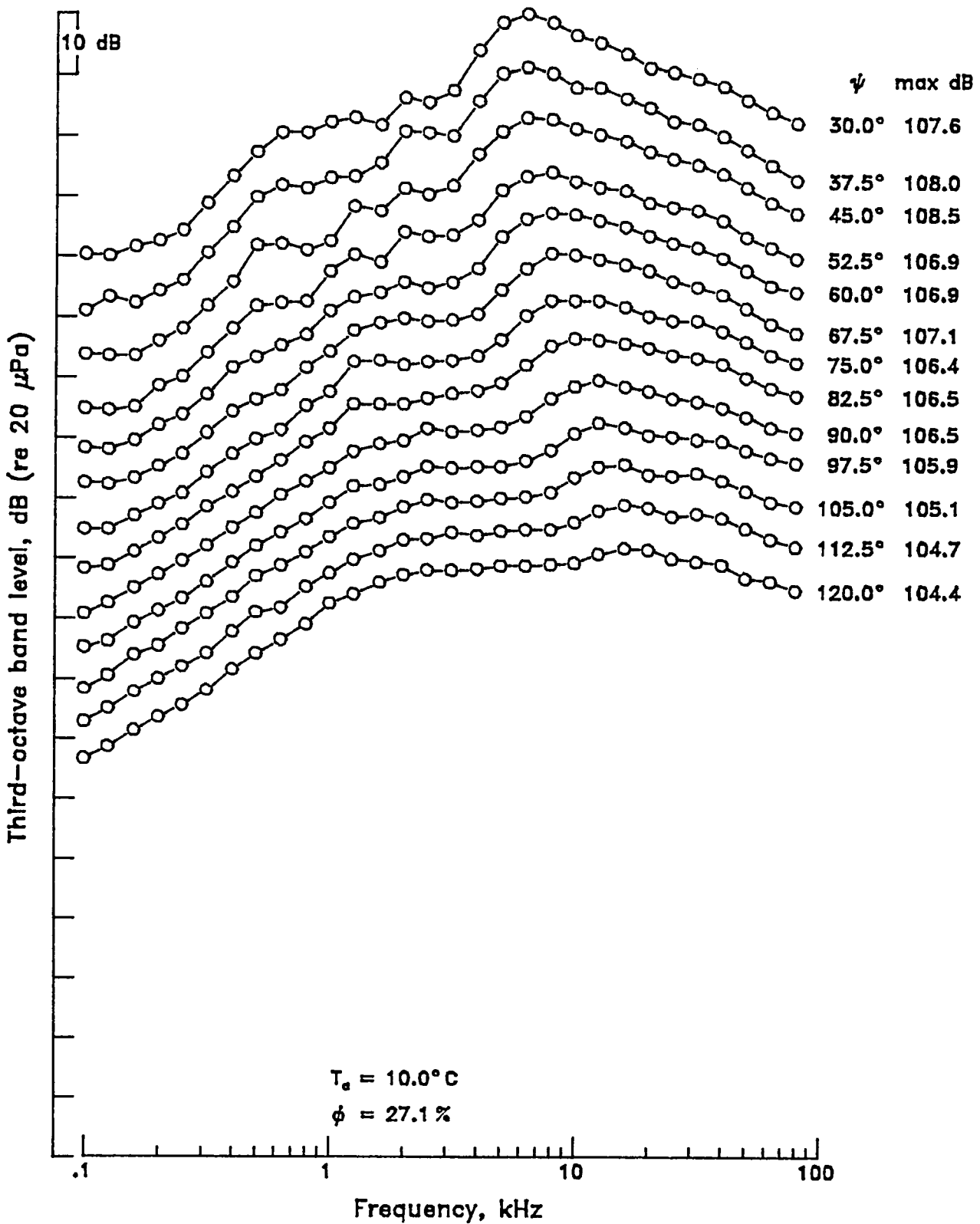

Mach 1.5 contoured nozzle with tab,  $\beta = 1.00$

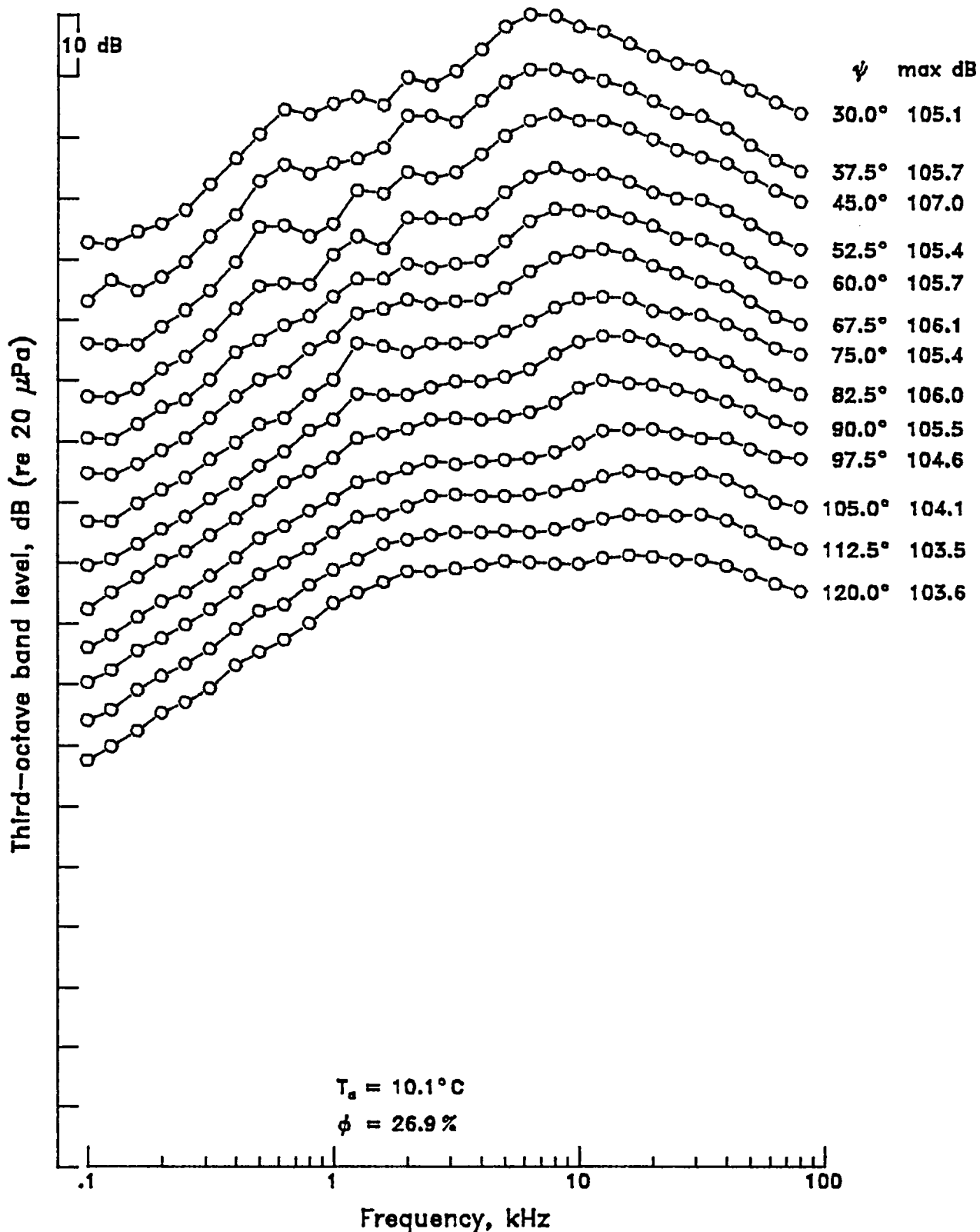

Mach 1.5 contoured nozzle with tab,  $\beta = 1.10$

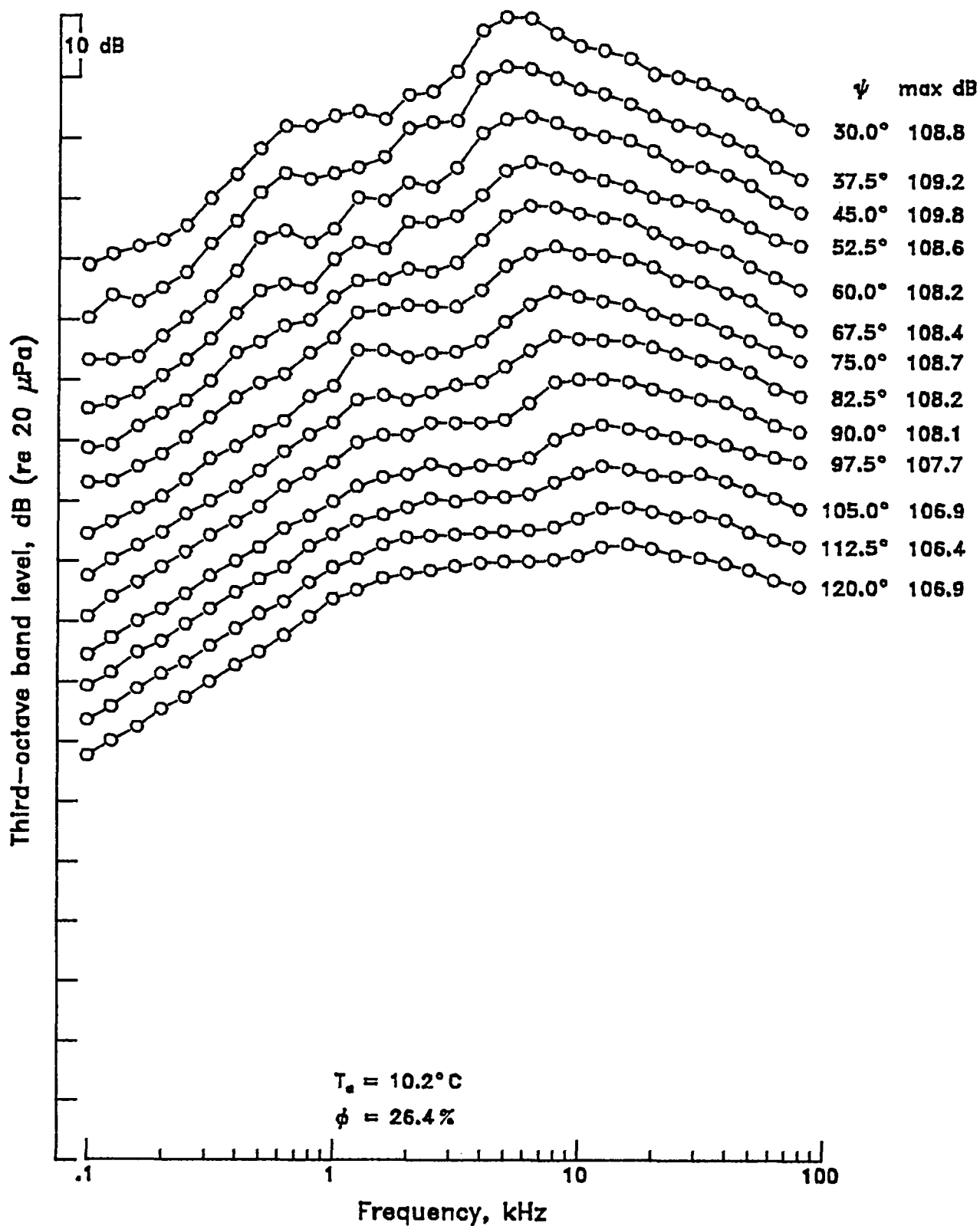

Mach 1.5 contoured nozzle with tab,  $\beta = 1.34$

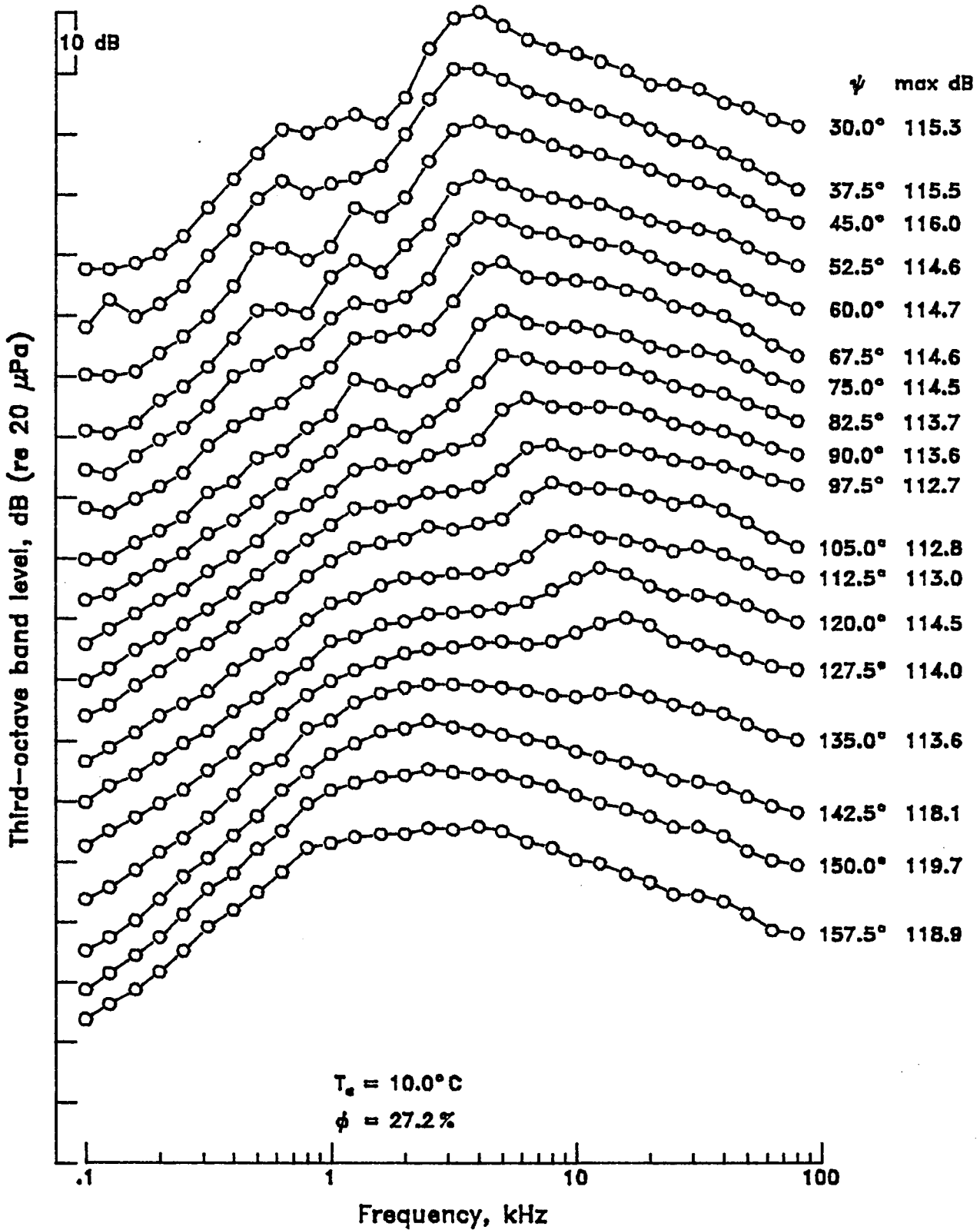

Mach 1.5 contoured nozzle with tab,  $\beta = 1.50$

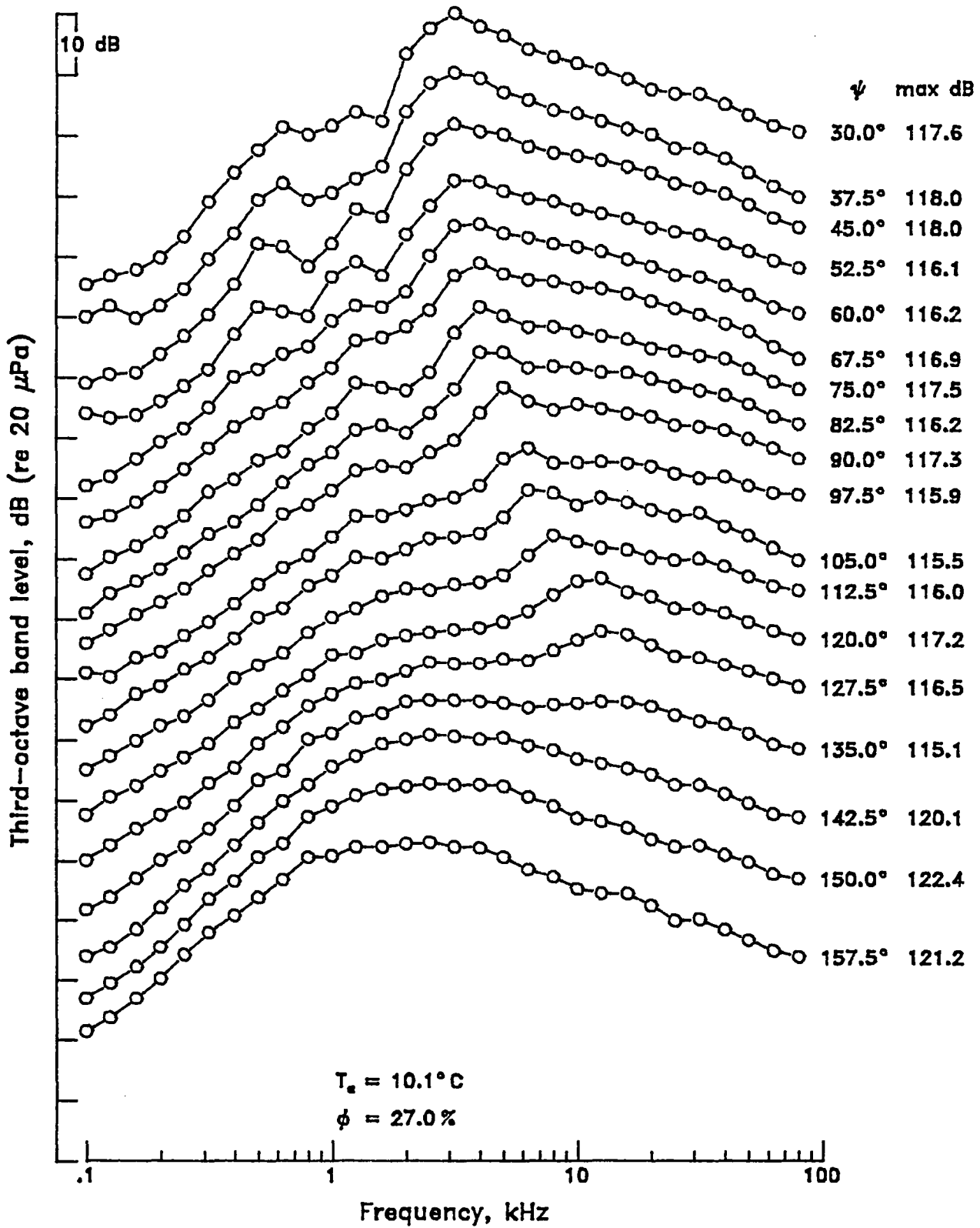



Mach 1.5 contoured nozzle with tab,  $\beta = 1.72$

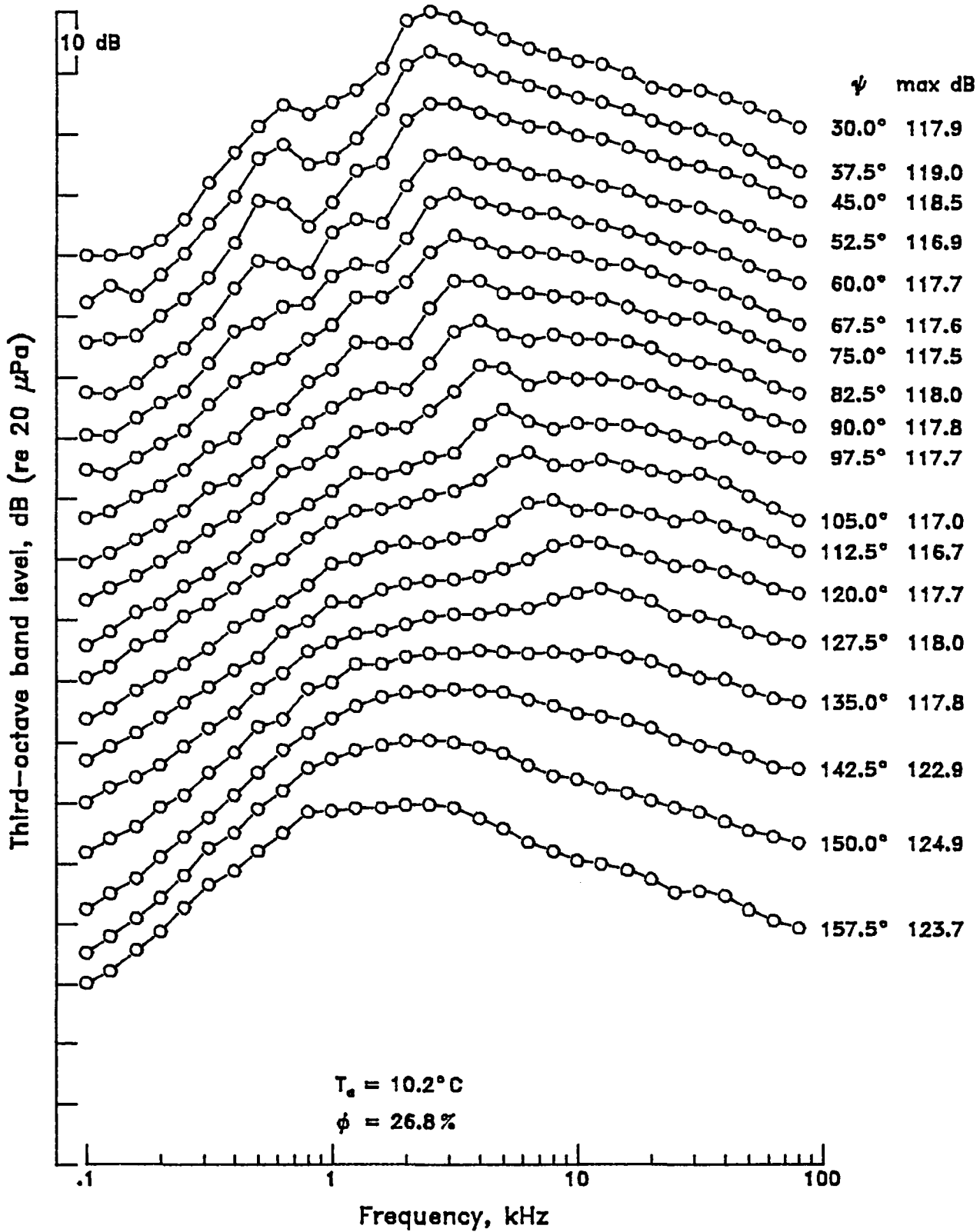

Mach 1.5 contoured nozzle with tab,  $\beta = 2.00$

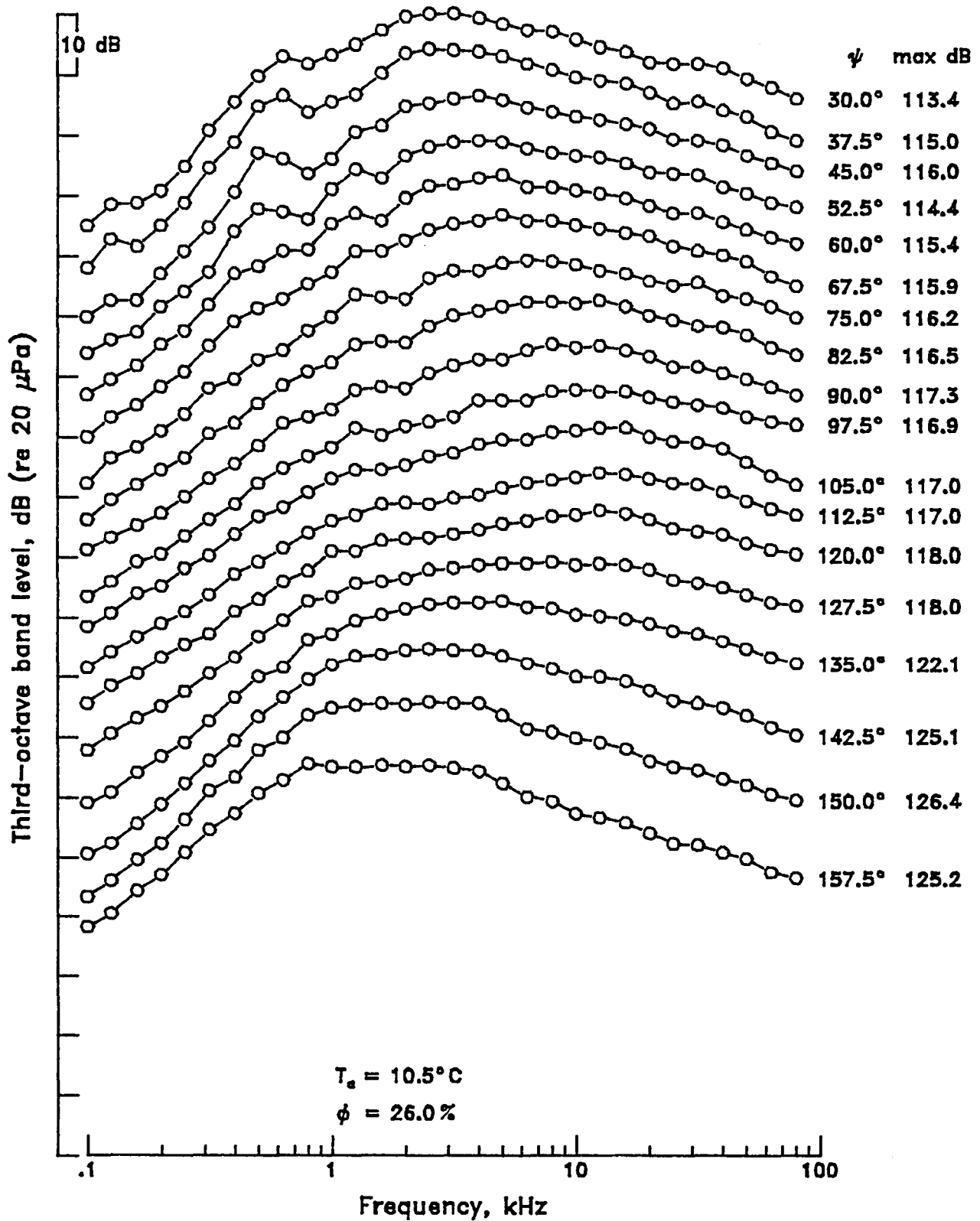

Mach 2.0 contoured nozzle without tab,  $\beta = 0.00$

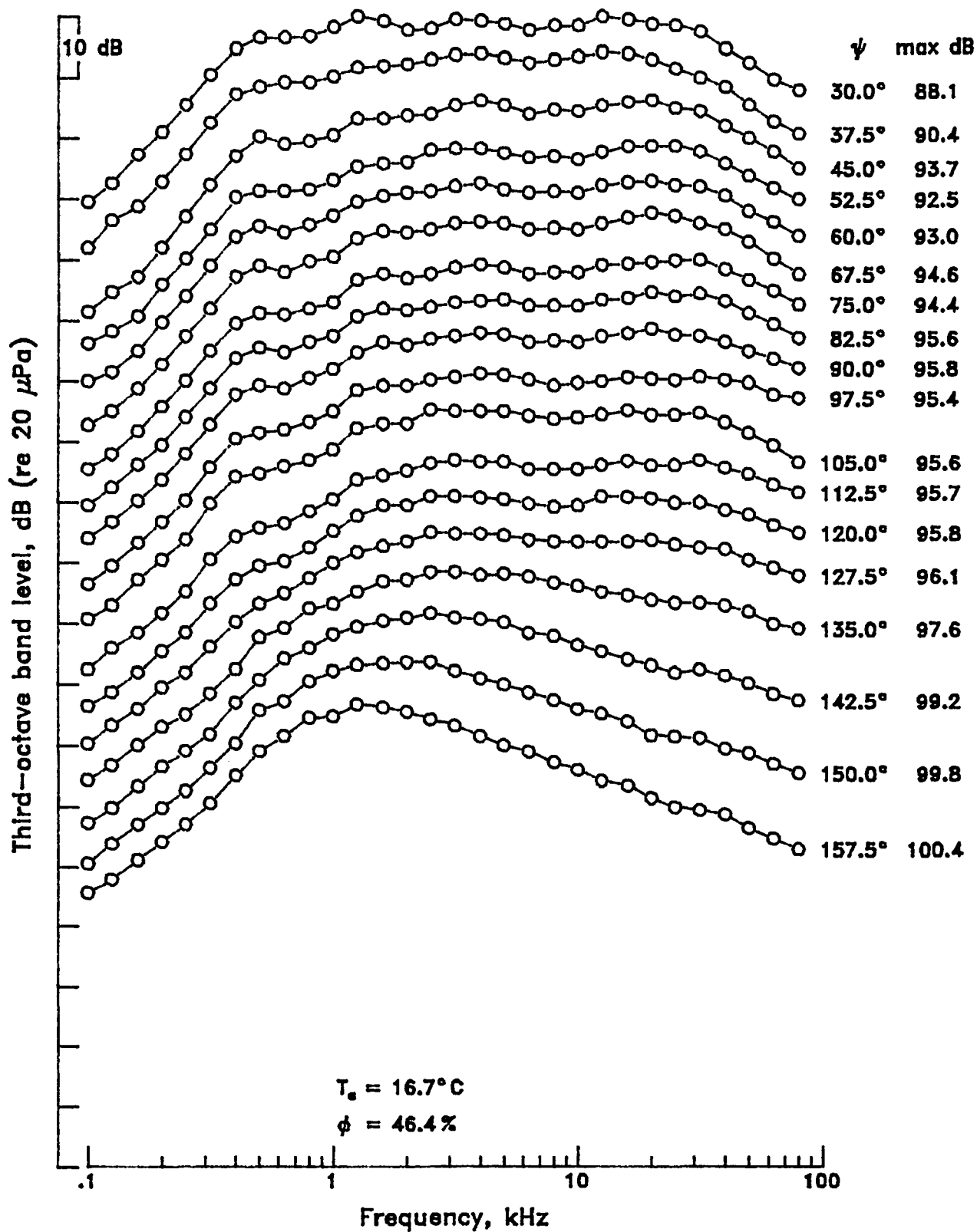

Mach 2.0 contoured nozzle without tab,  $\beta = 0.20$

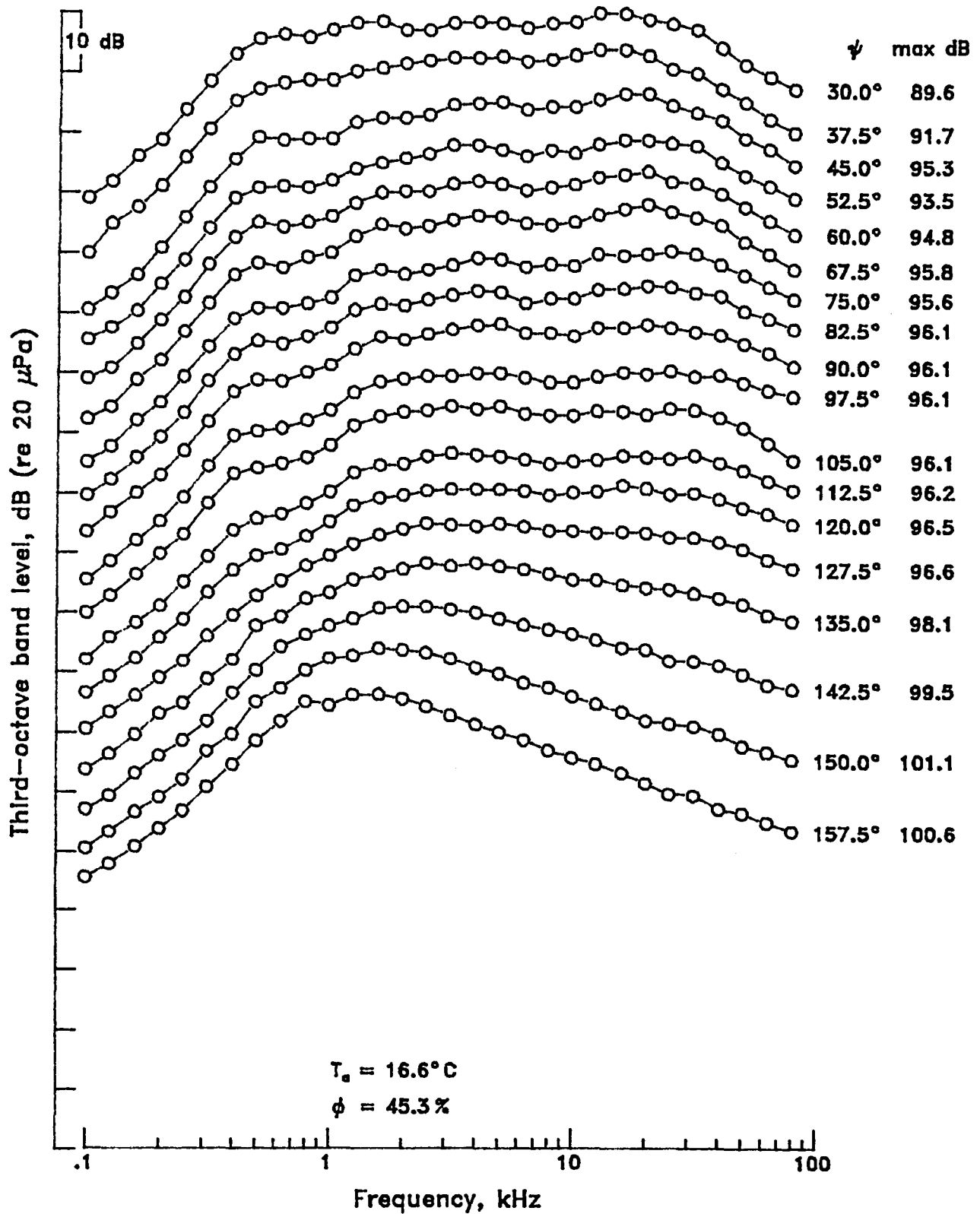

Mach 2.0 contoured nozzle without tab,  $\beta = 0.40$

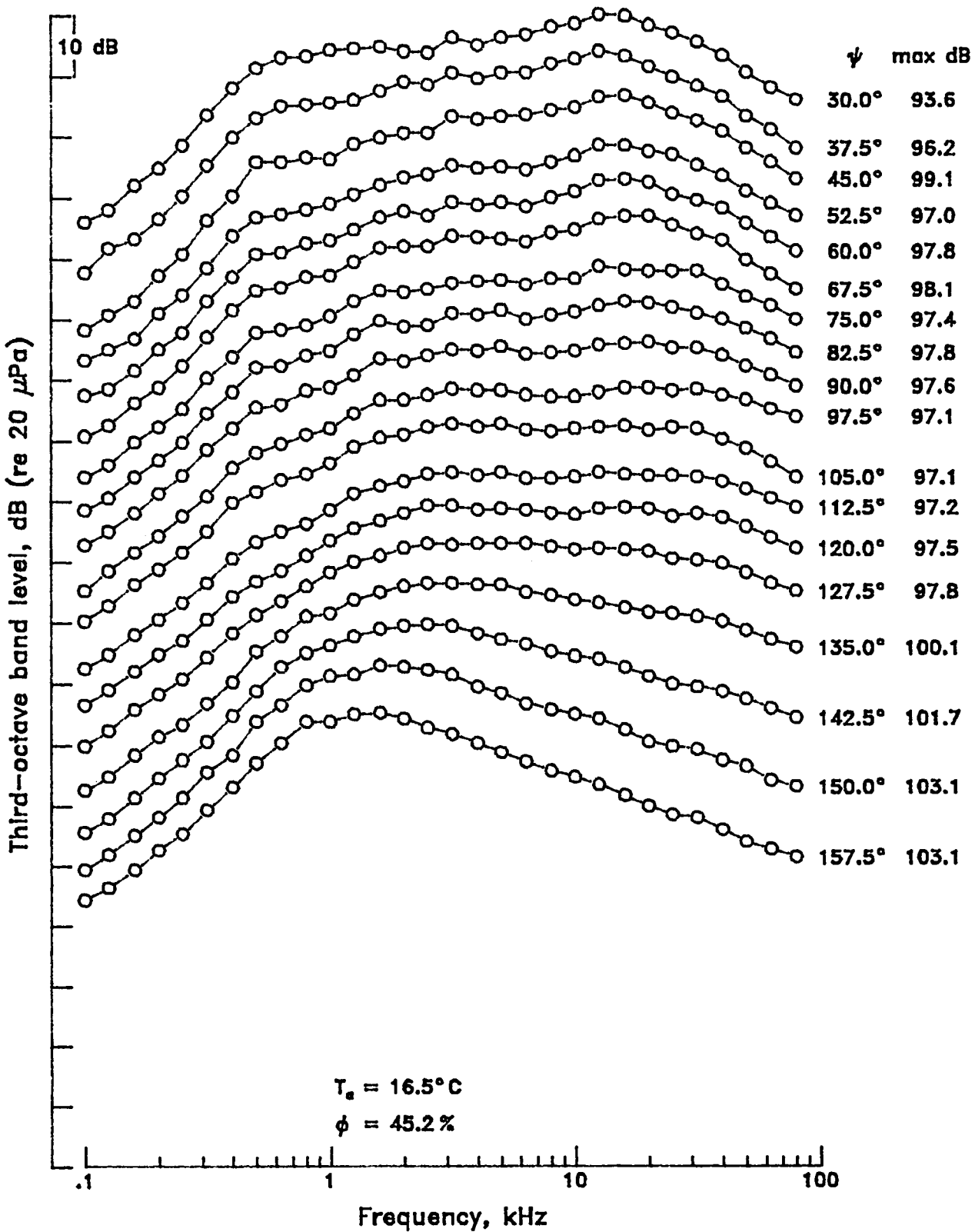

Mach 2.0 contoured nozzle without tab,  $\beta = 0.60$

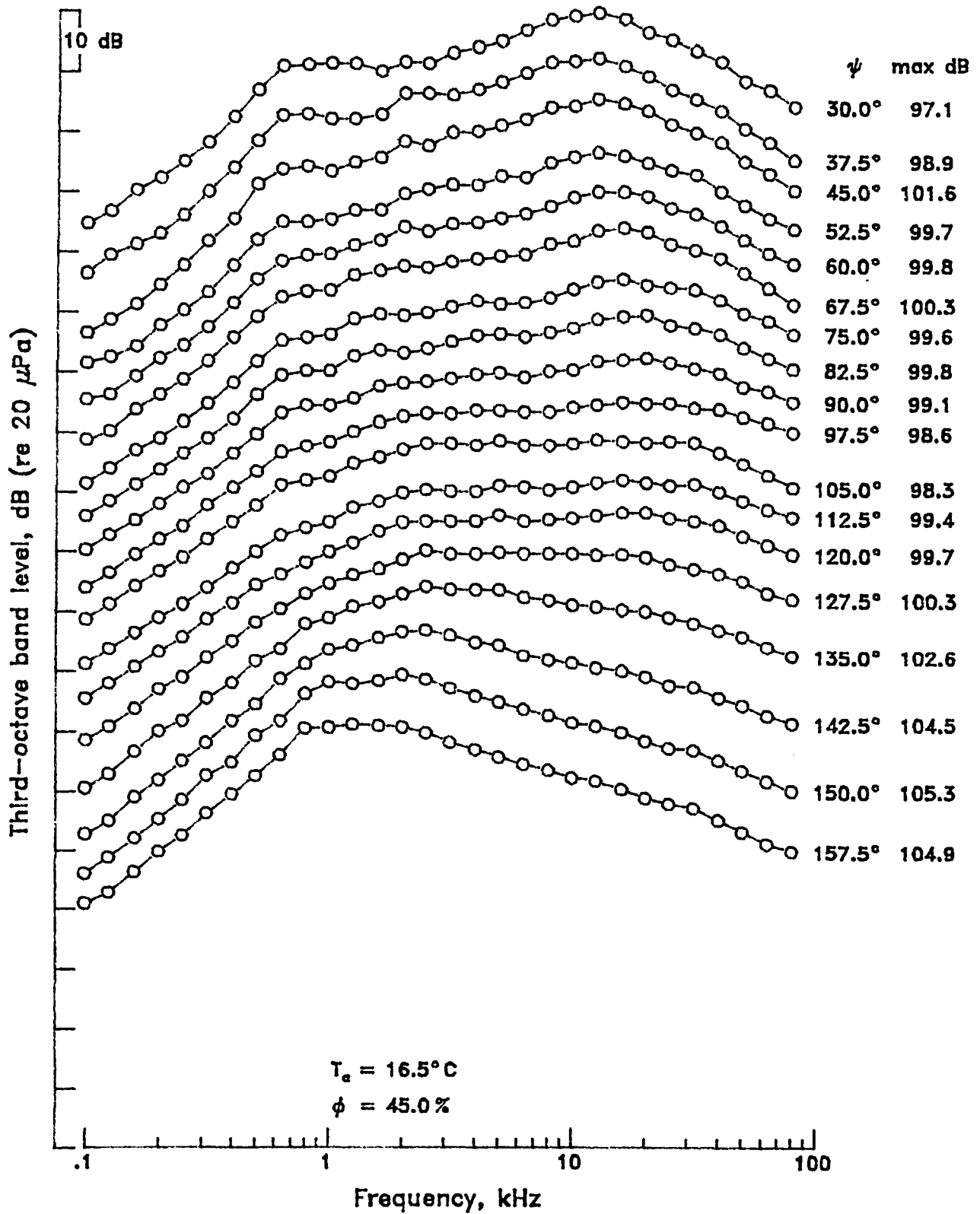

Mach 2.0 contoured nozzle without tab,  $\beta = 0.70$

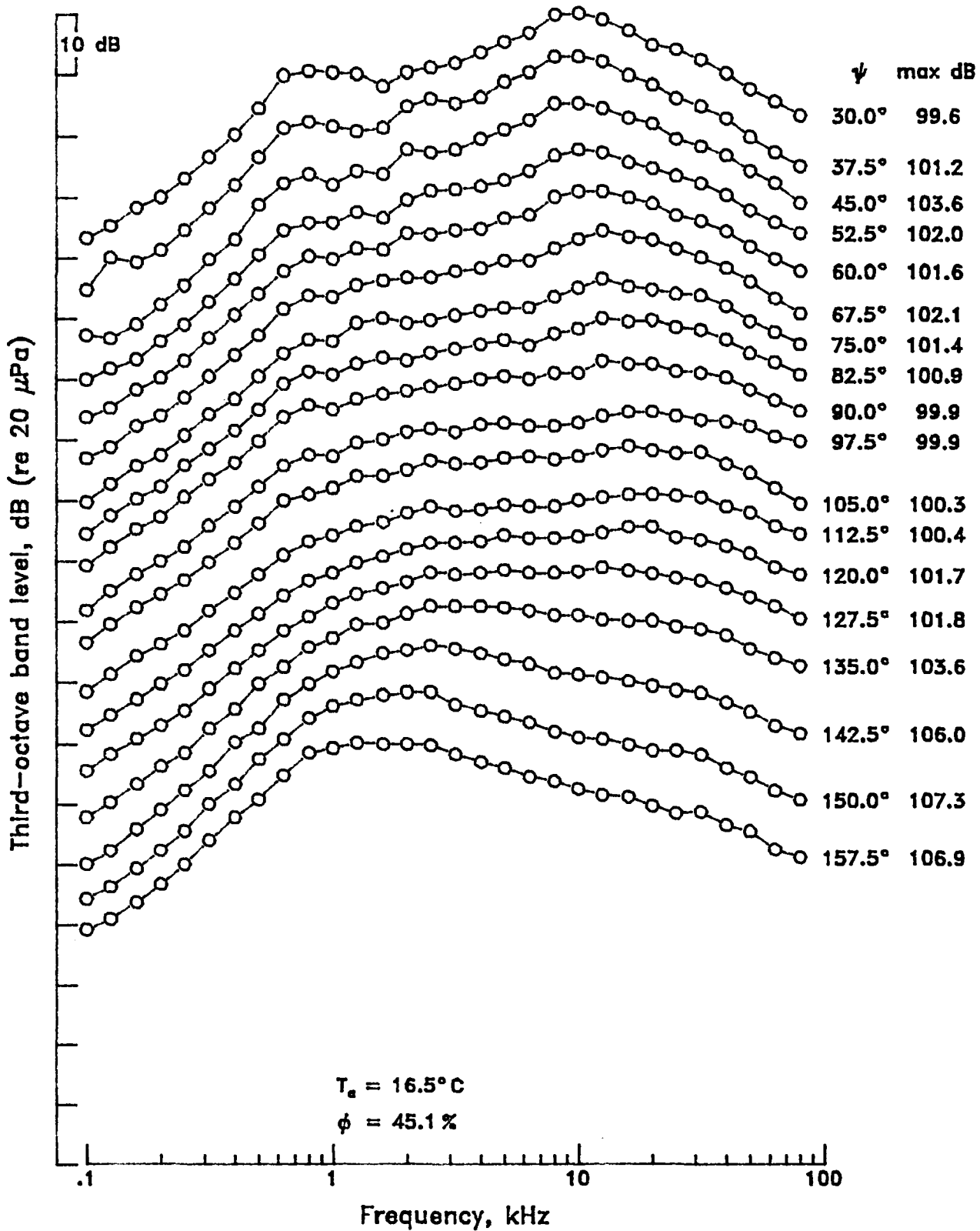

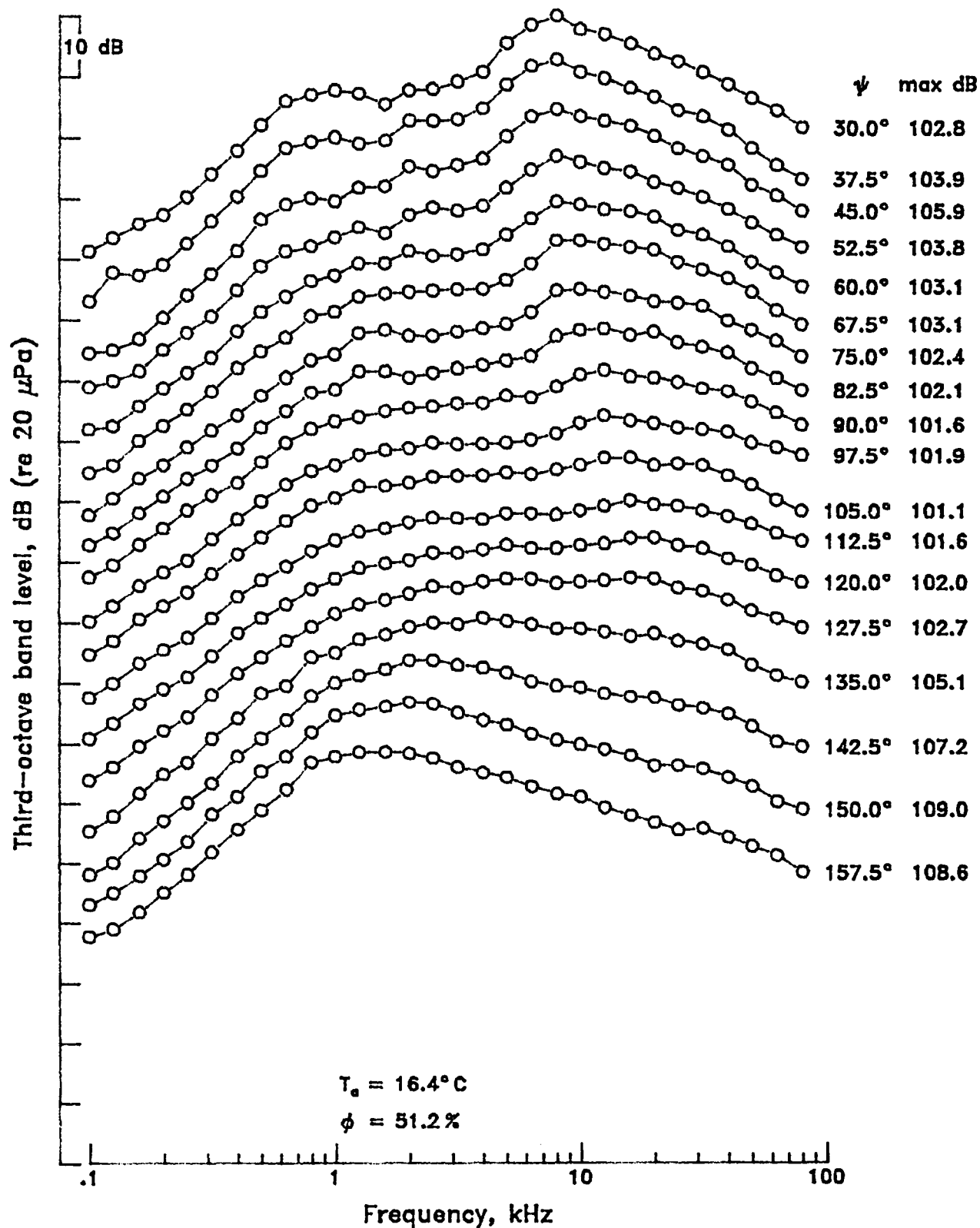
Mach 2.0 contoured nozzle without tab,  $\beta = 0.80$ 



Mach 2.0 contoured nozzle without tab,  $\beta = 0.94$

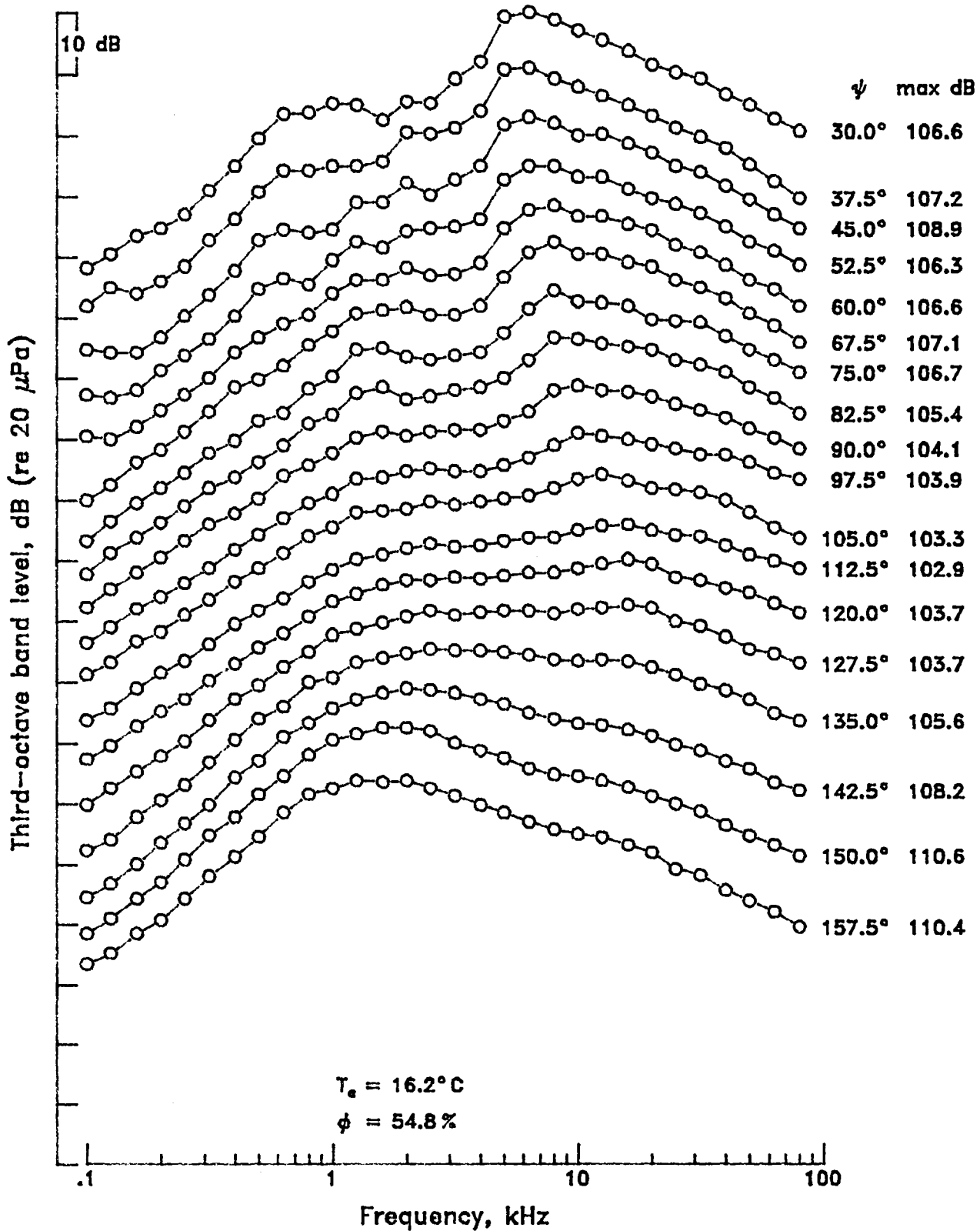

Mach 2.0 contoured nozzle without tab,  $\beta = 1.00$

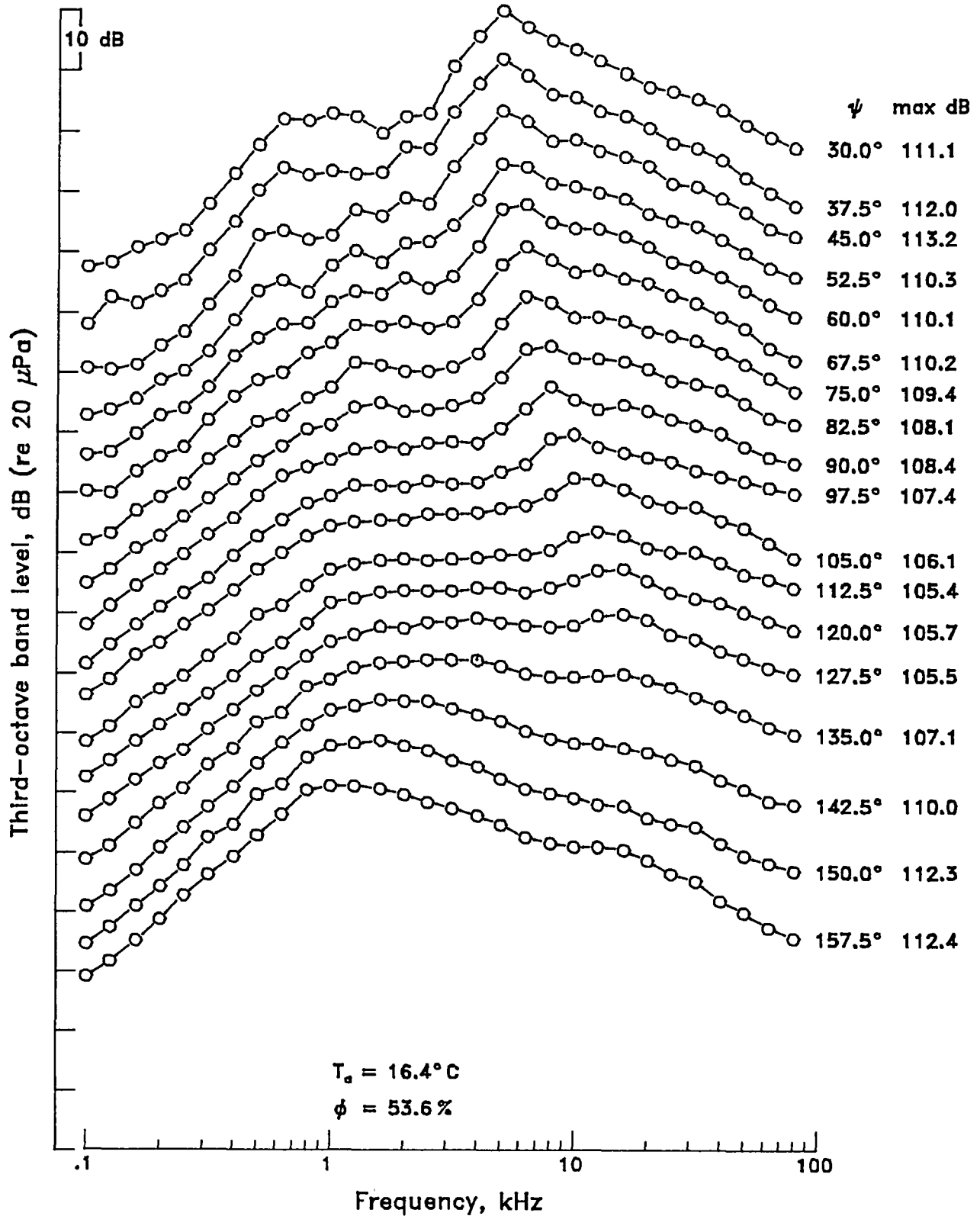

Mach 2.0 contoured nozzle without tab,  $\beta = 1.10$

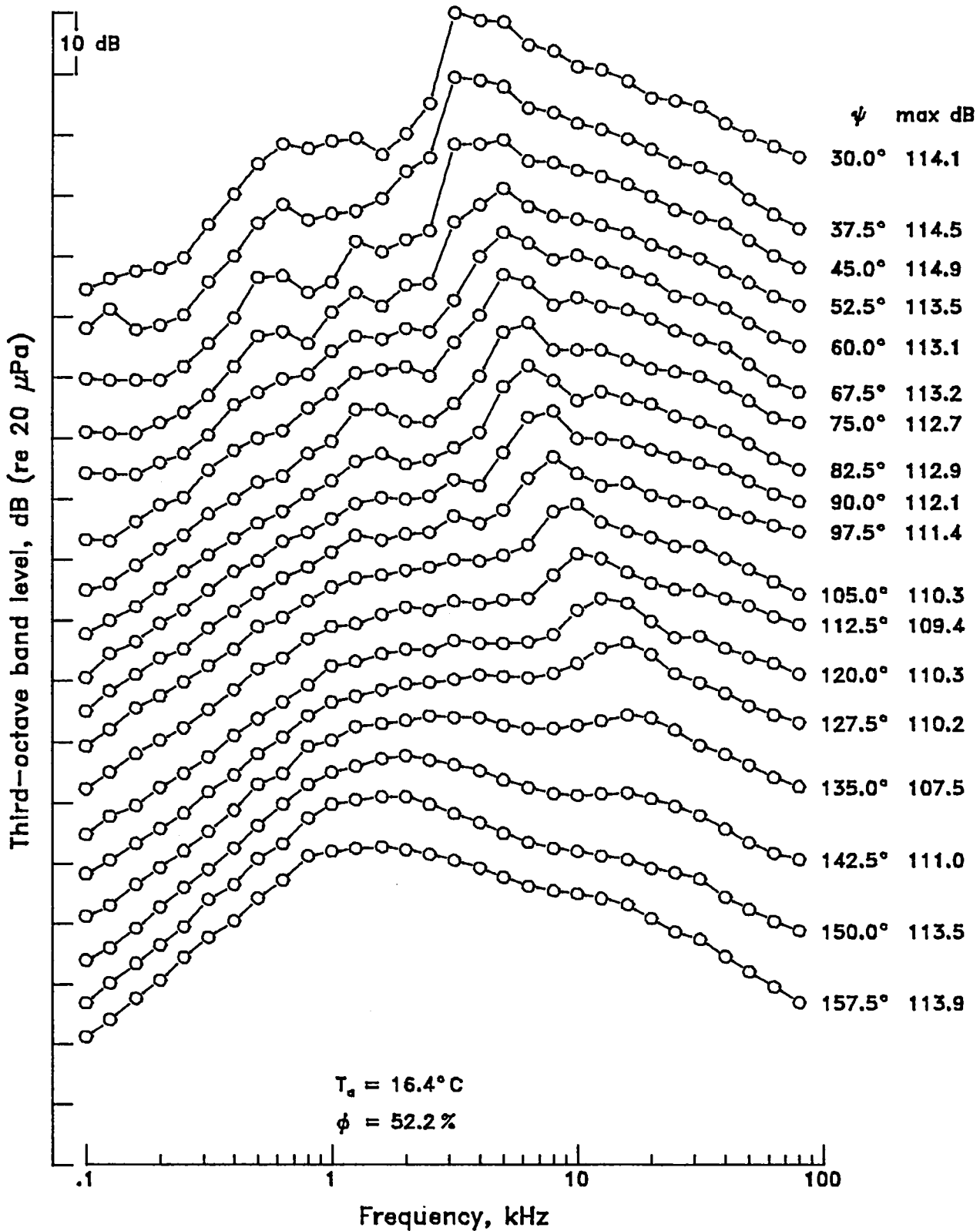

Mach 2.0 contoured nozzle without tab,  $\beta = 1.34$

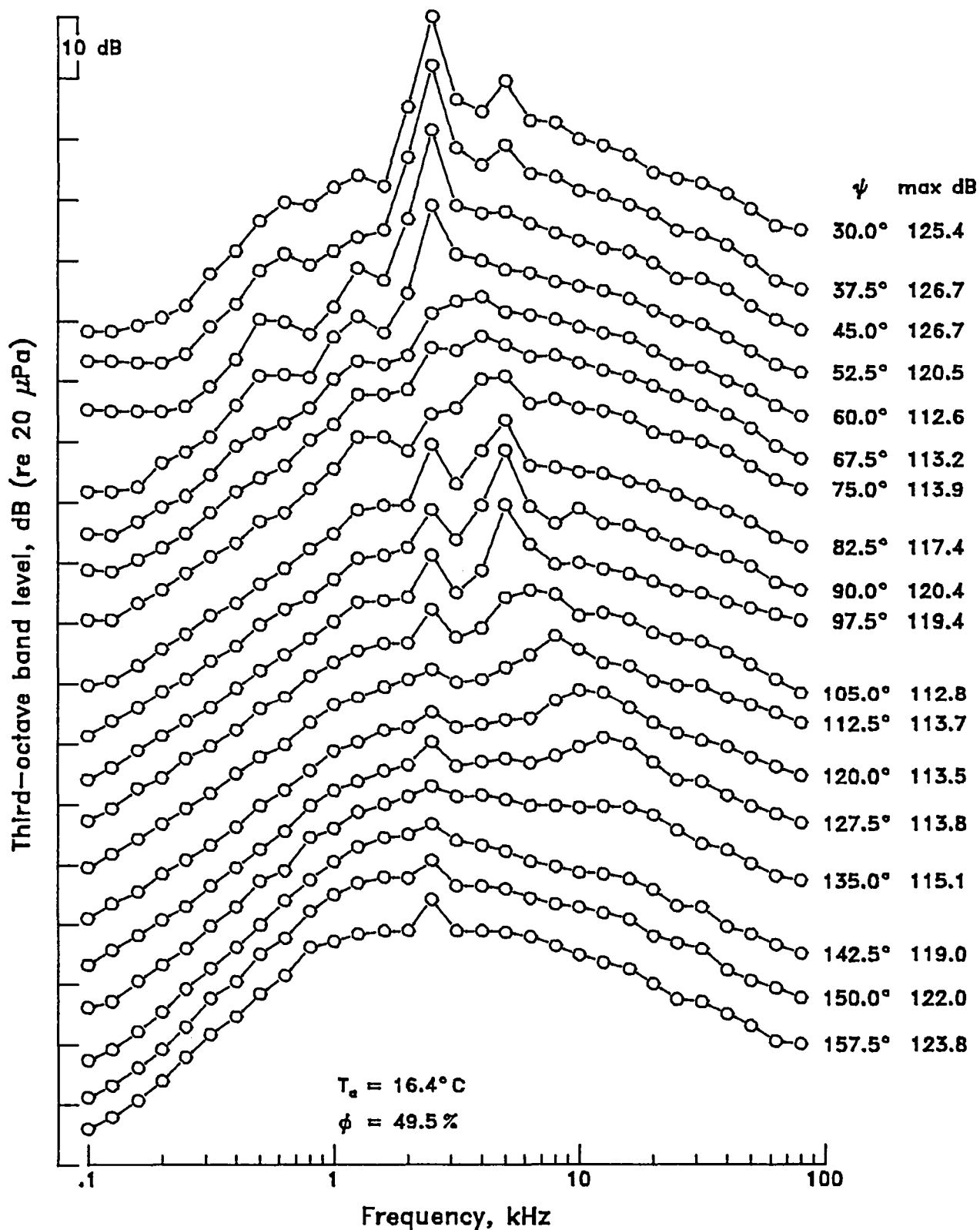

Mach 2.0 contoured nozzle without tab,  $\beta = 1.50$

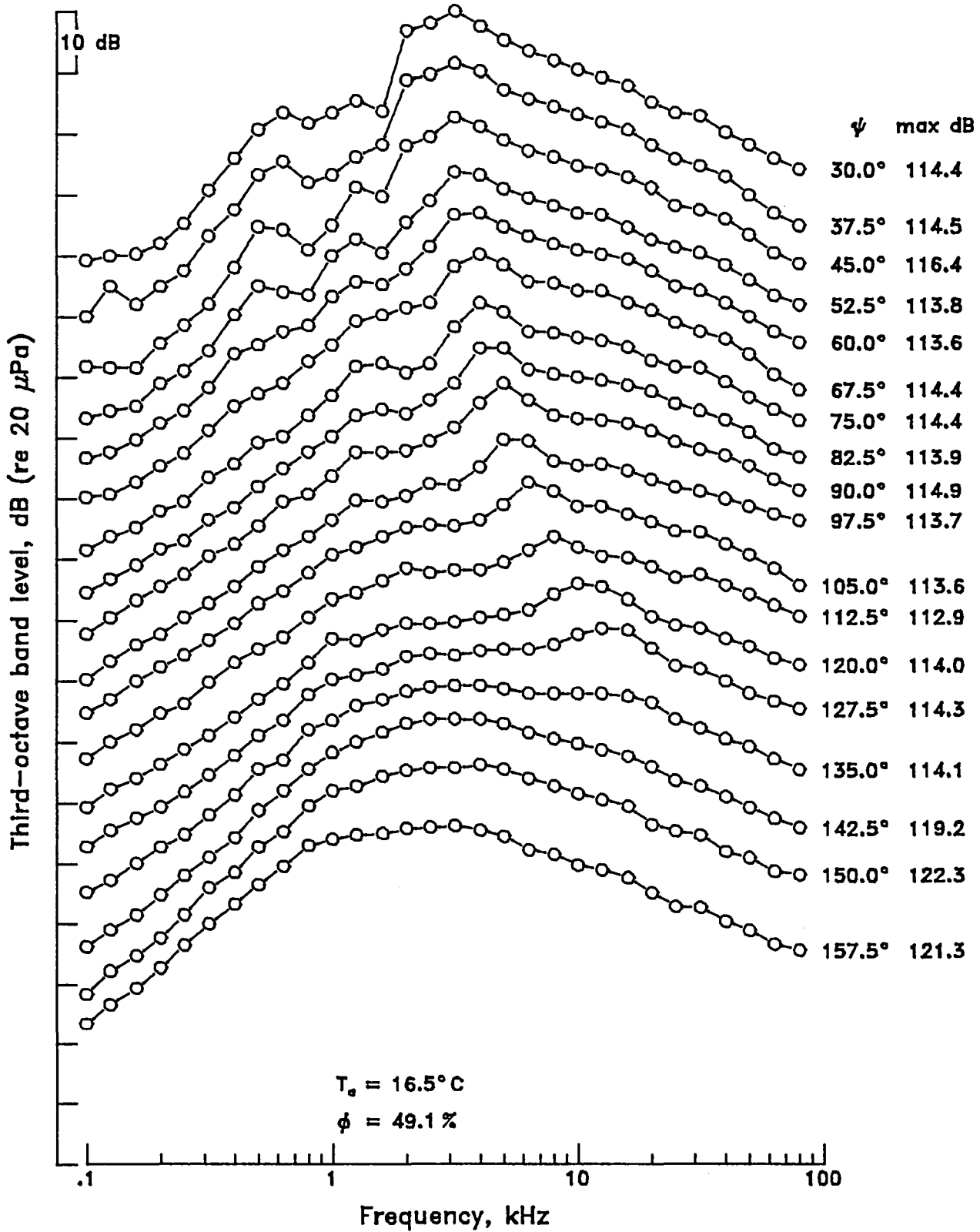

Mach 2.0 contoured nozzle without tab,  $\beta = 1.72$

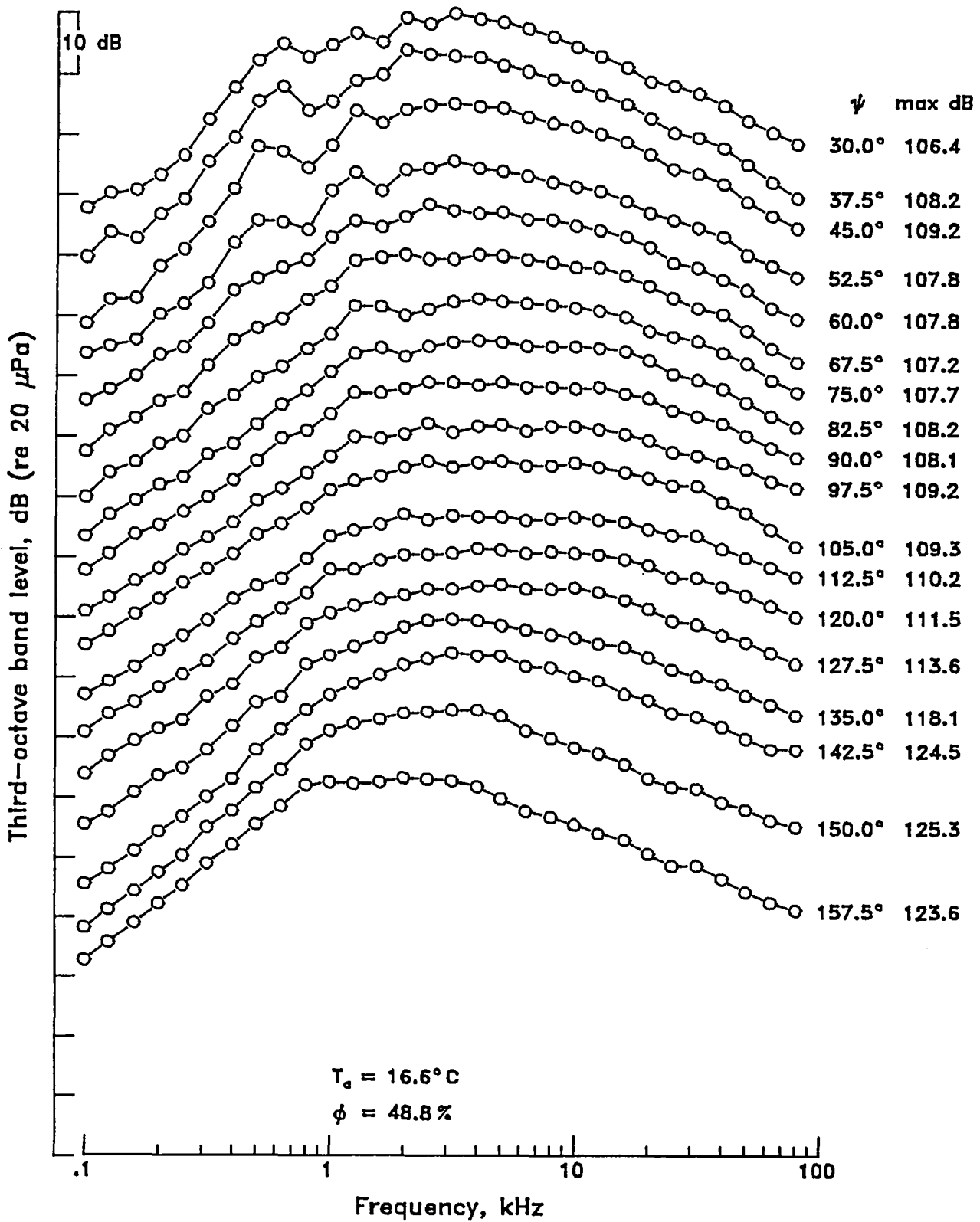

Mach 2.0 contoured nozzle without tab,  $\beta = 2.00$

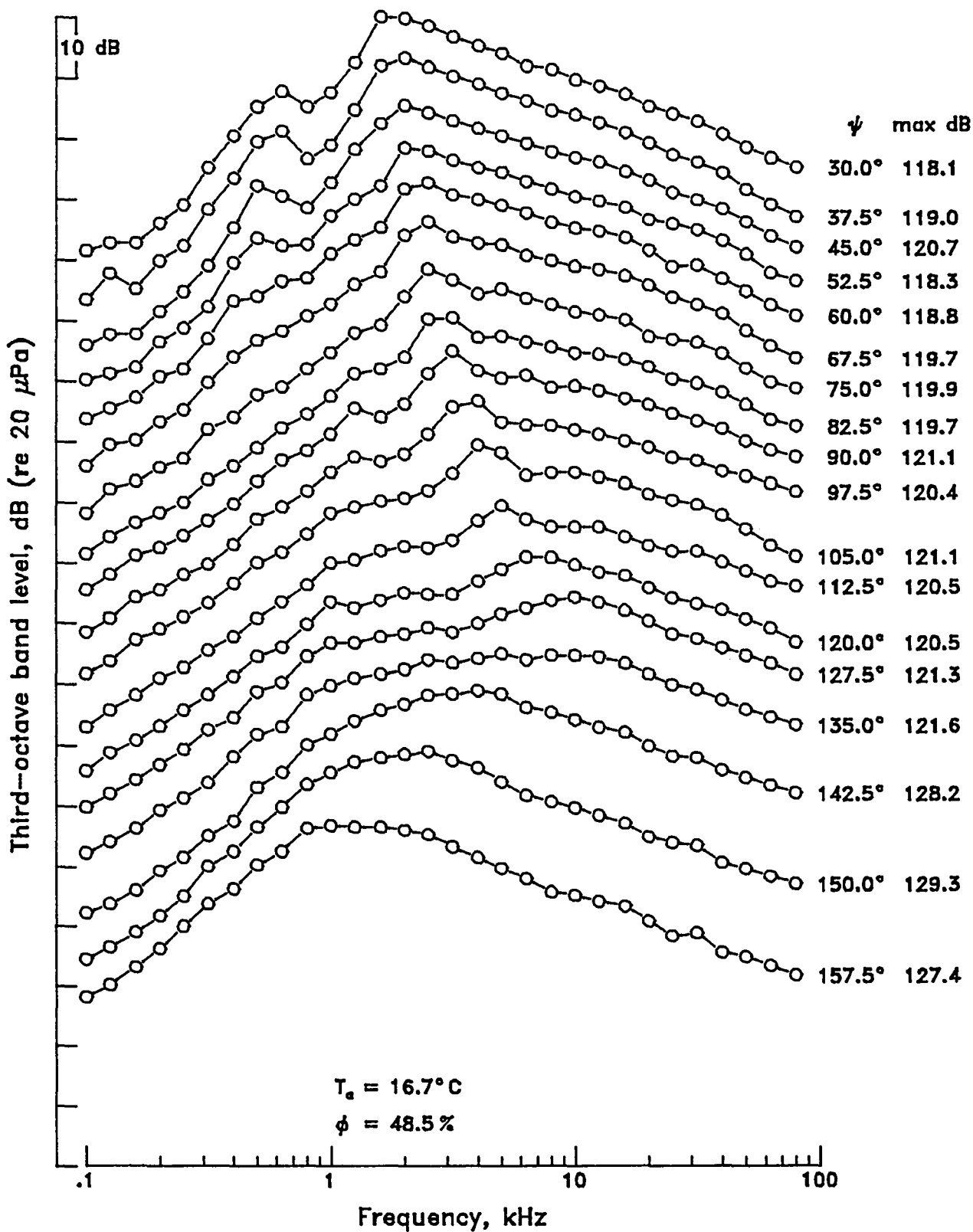

Mach 2.0 contoured nozzle without tab,  $\beta = 2.10$

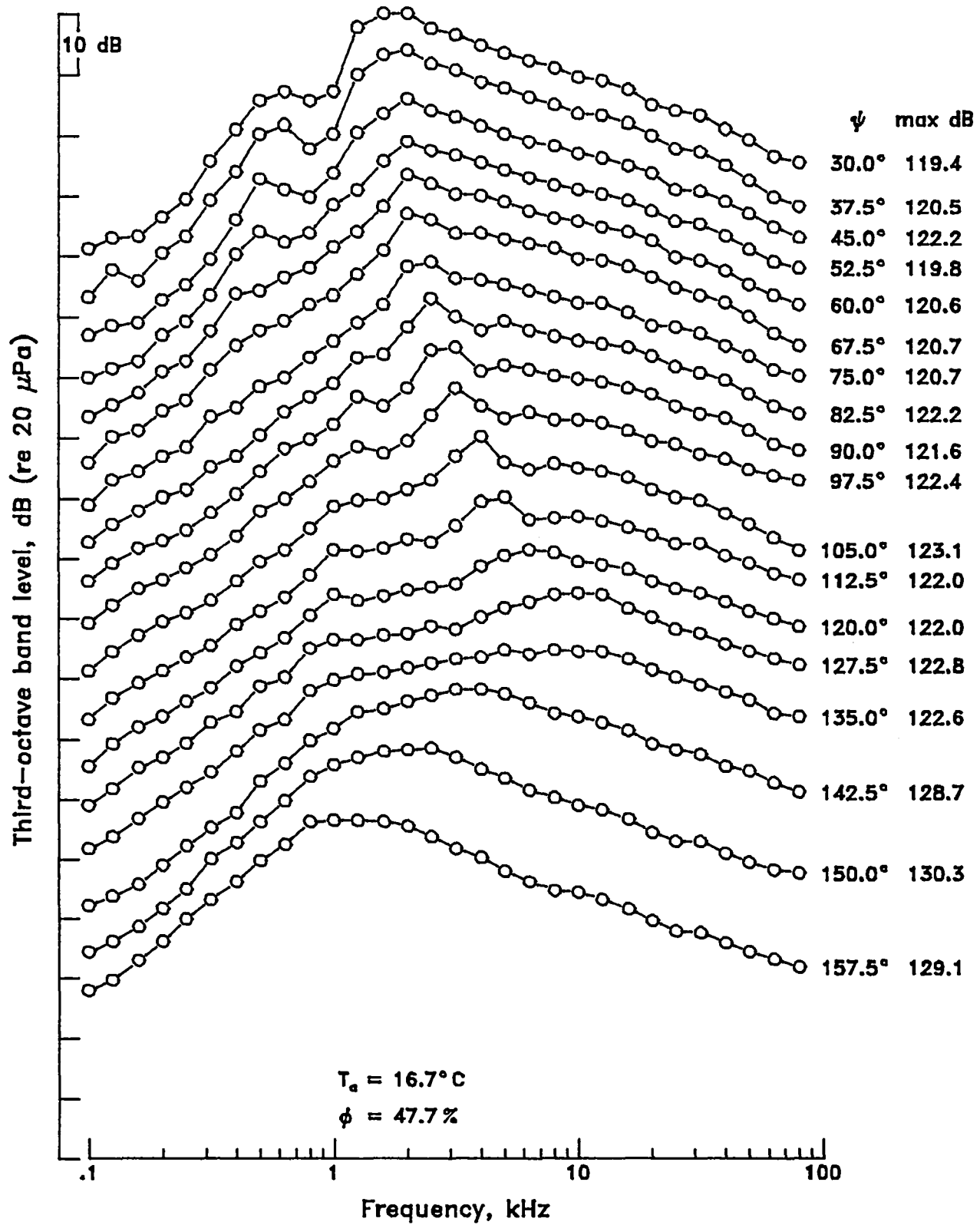



Mach 2.0 contoured nozzle without tab,  $\beta = 2.15$

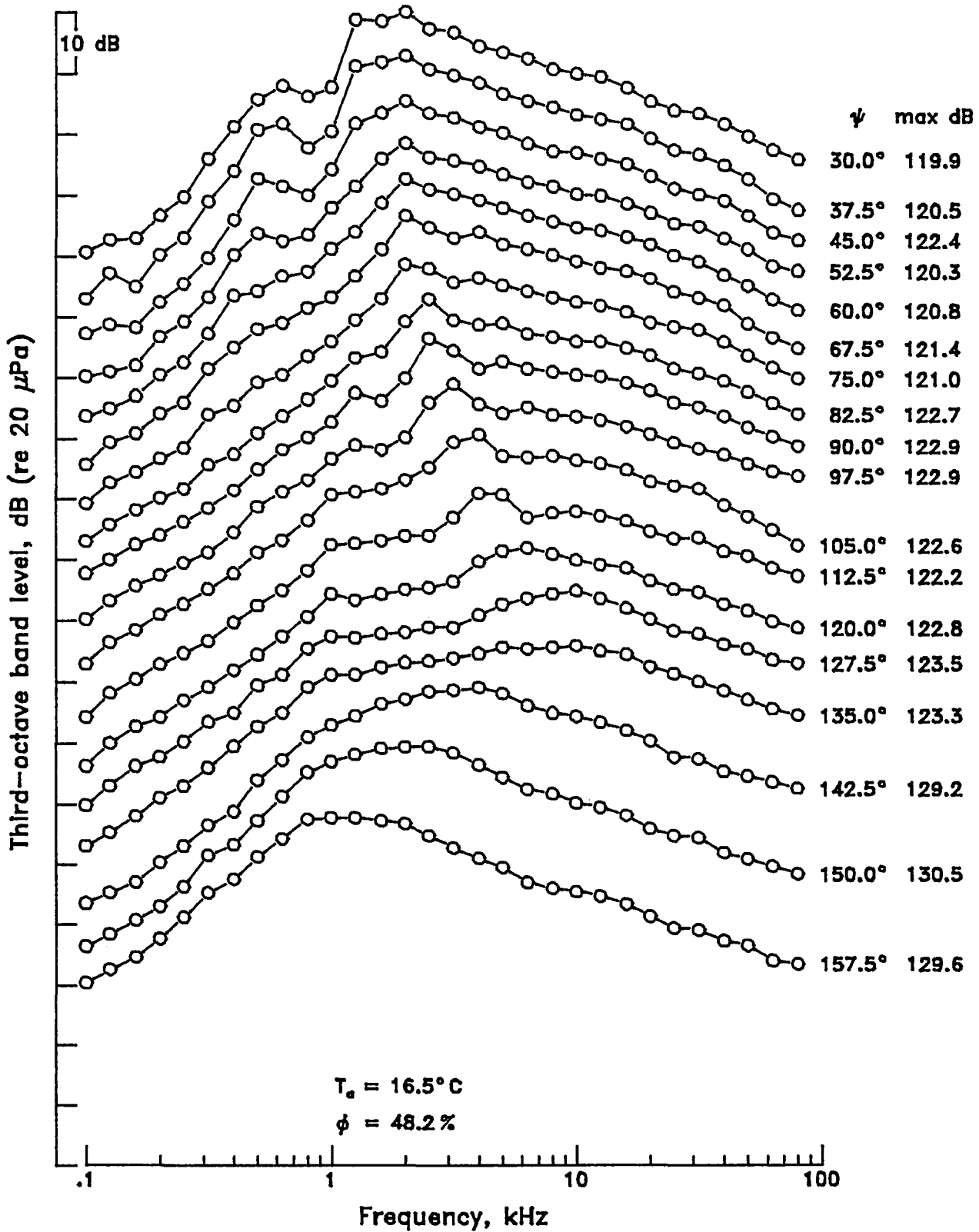

Mach 2.0 contoured nozzle with tab,  $\beta = 0.00$

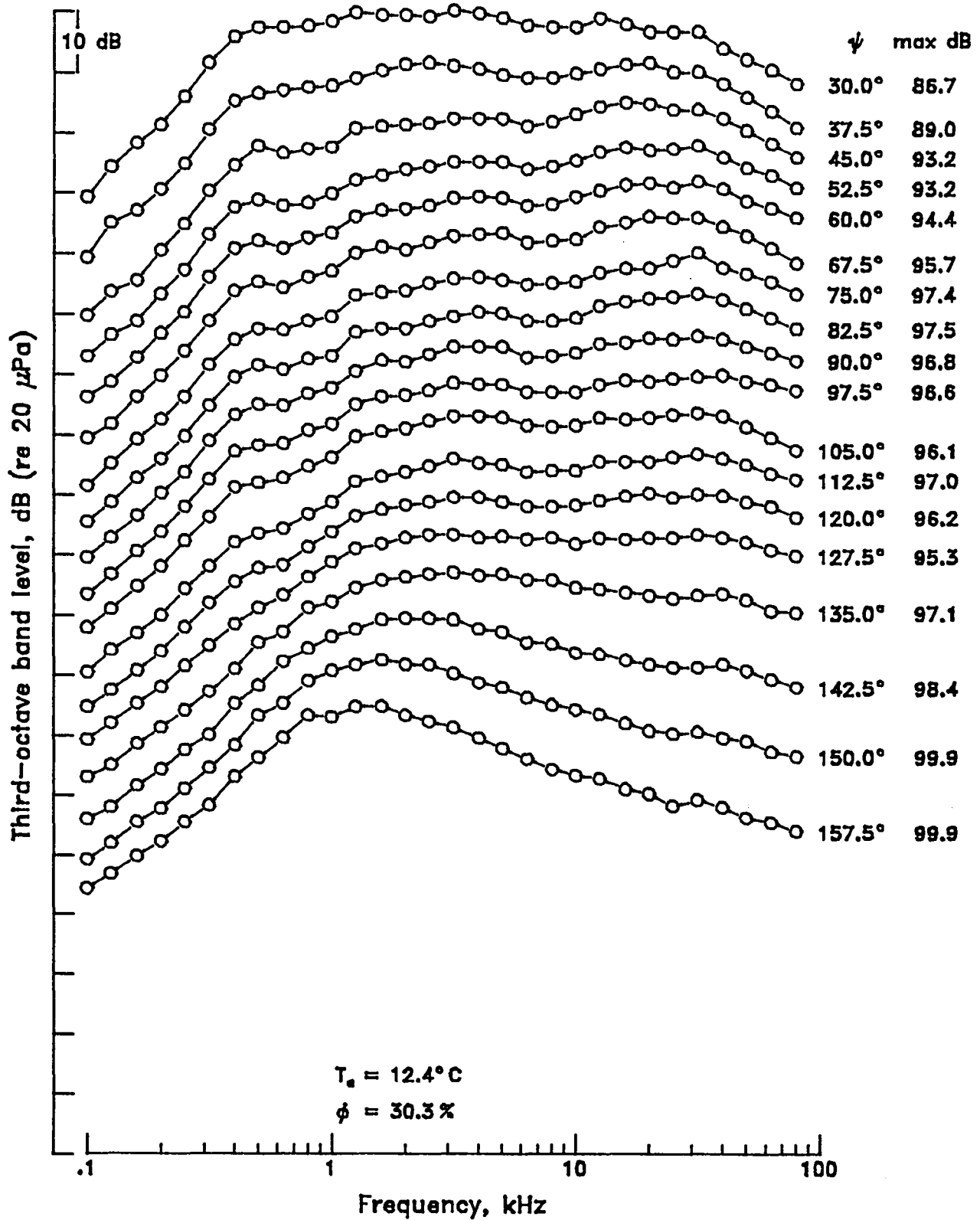

Mach 2.0 contoured nozzle with tab,  $\beta = 0.20$

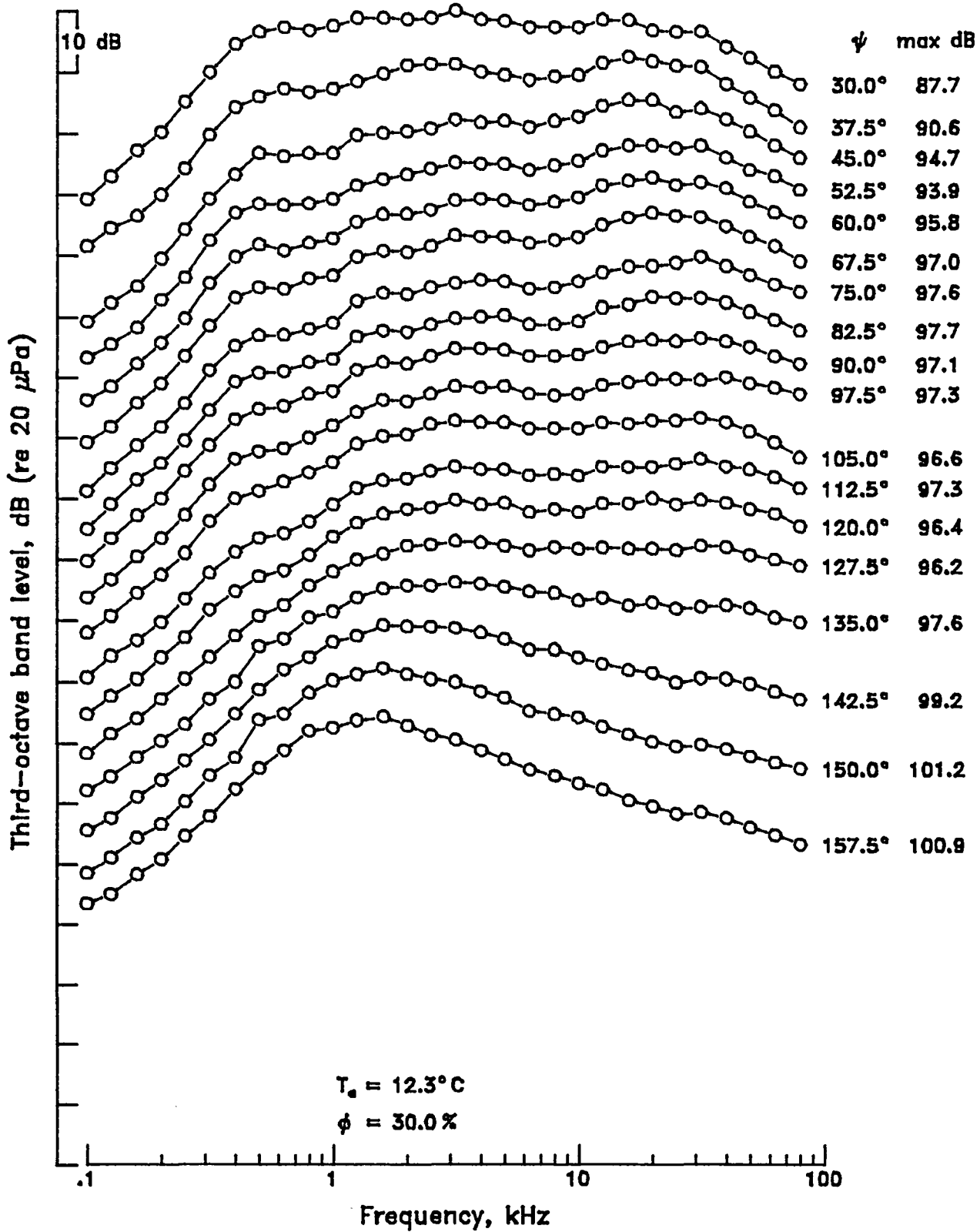

Mach 2.0 contoured nozzle with tab,  $\beta = 0.40$

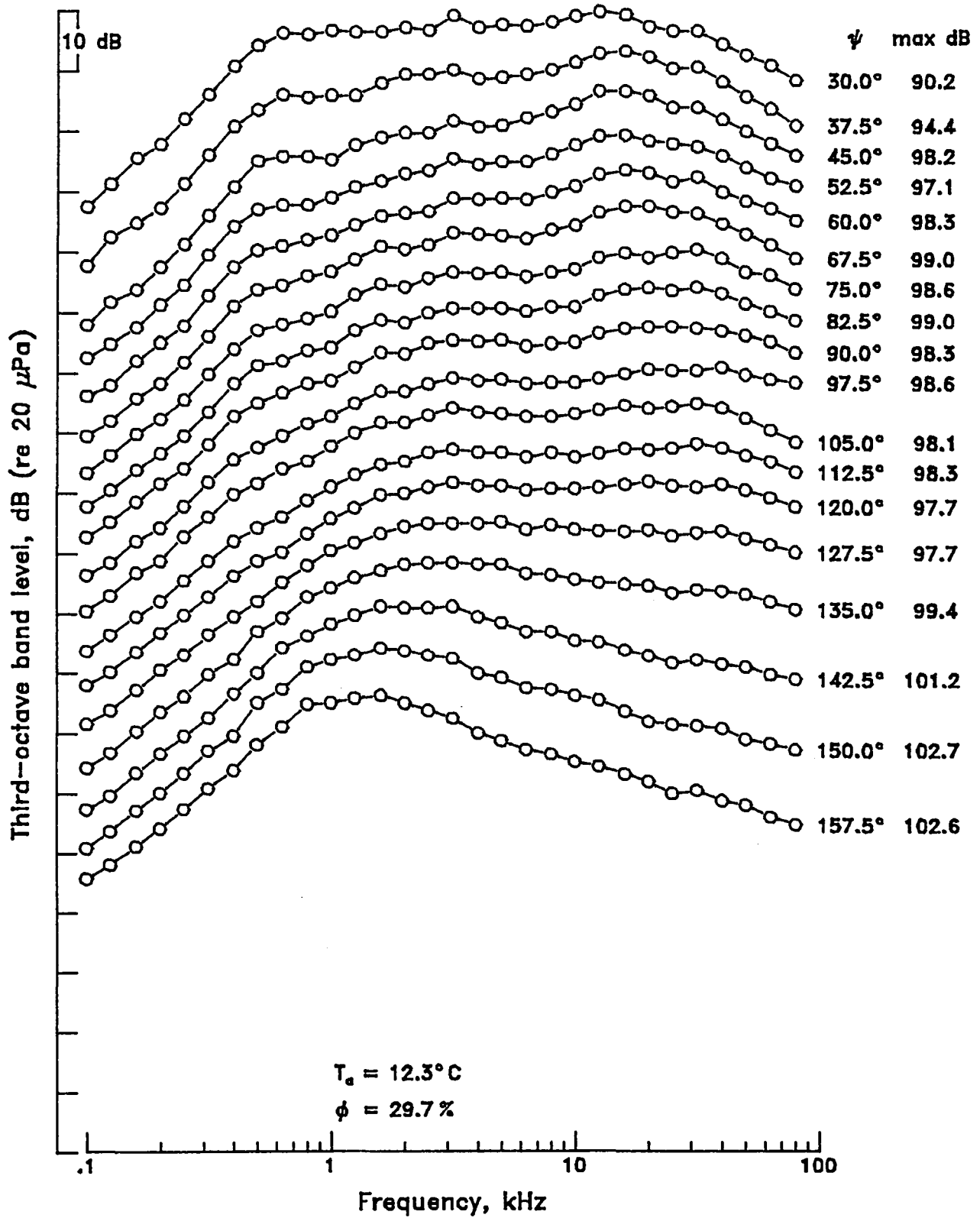

Mach 2.0 contoured nozzle with tab,  $\beta = 0.60$

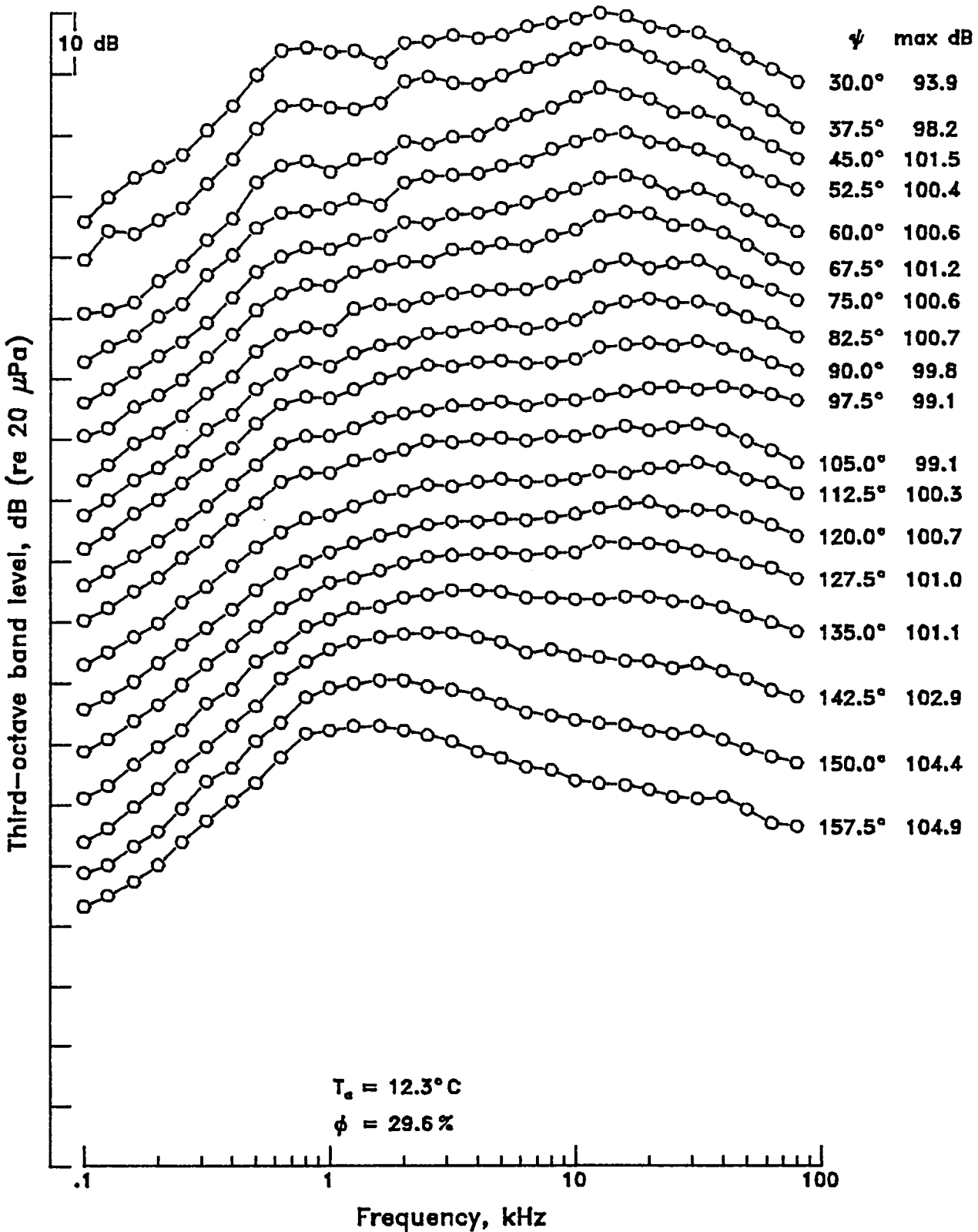

Mach 2.0 contoured nozzle with tab,  $\beta = 0.70$

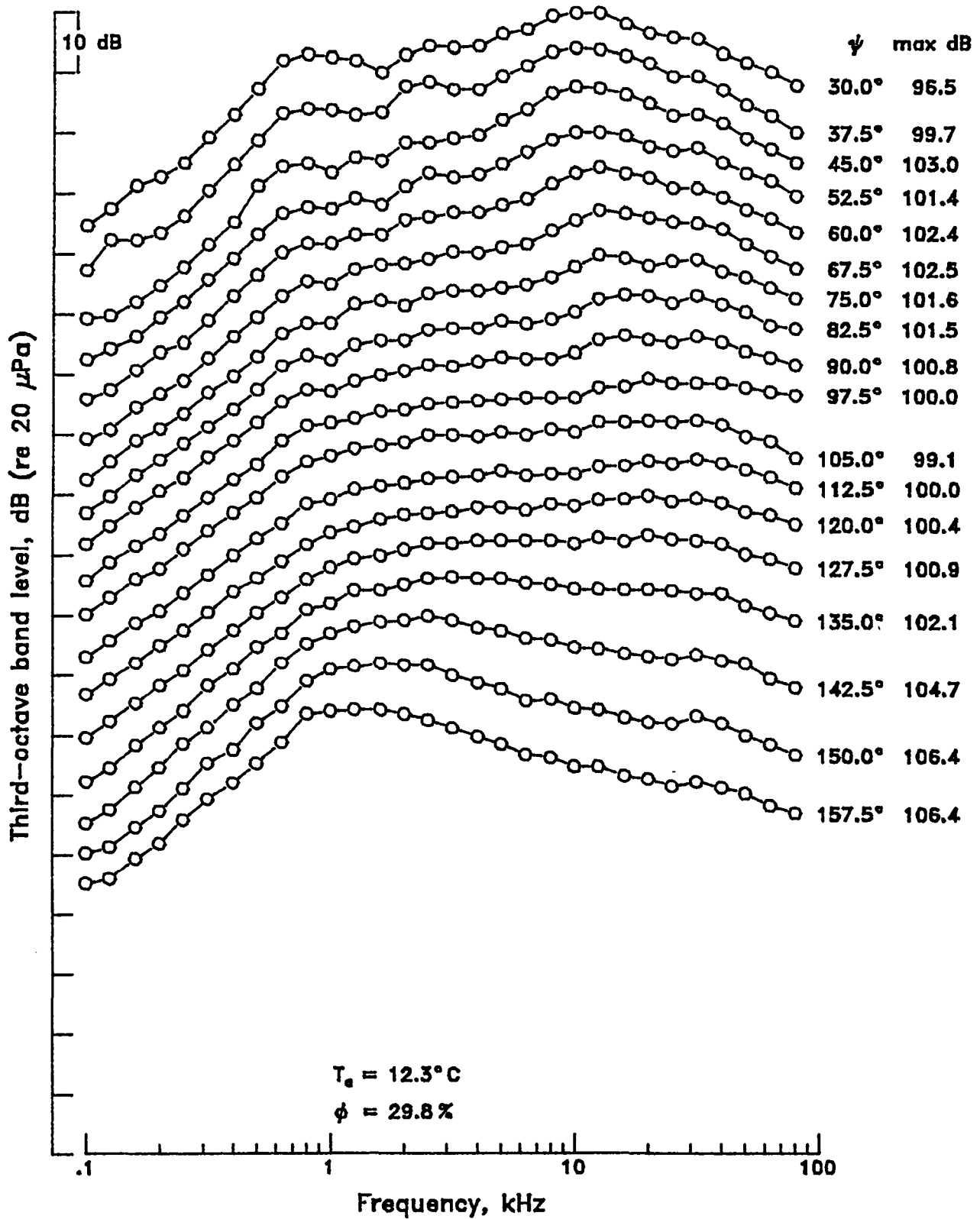

Mach 2.0 contoured nozzle with tab,  $\beta = 0.80$

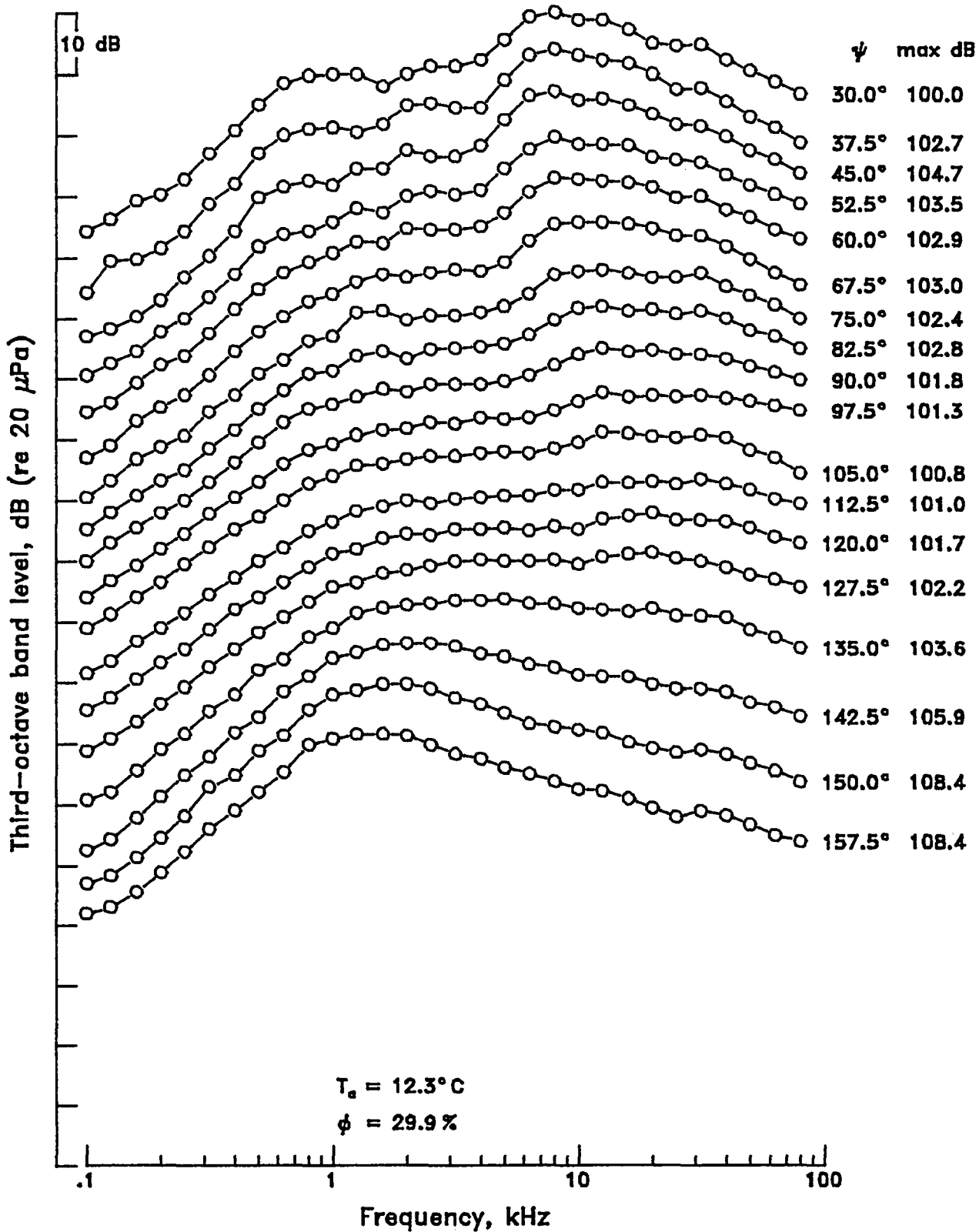

Mach 2.0 contoured nozzle with tab,  $\beta = 0.94$

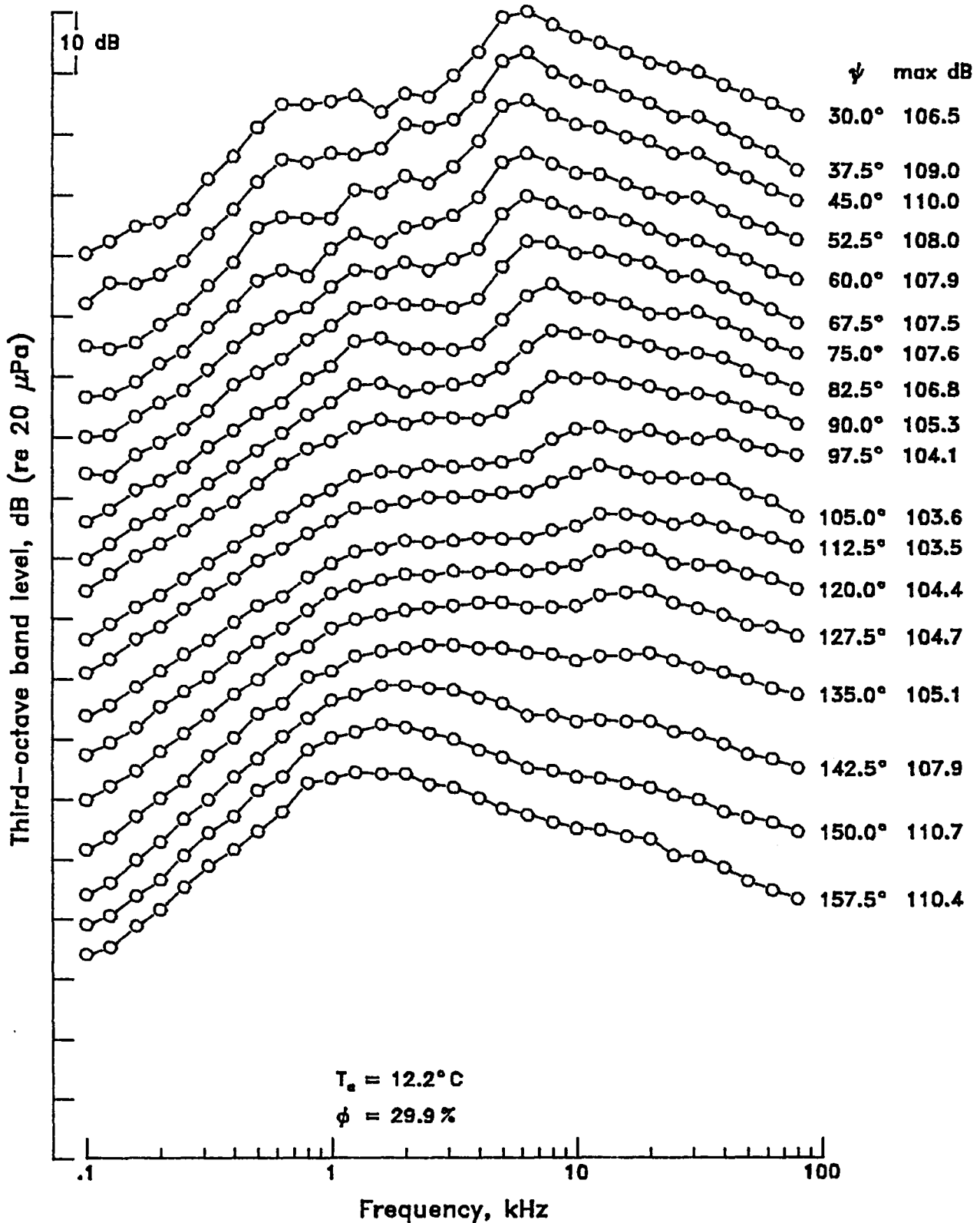



Mach 2.0 contoured nozzle with tab,  $\beta = 1.00$

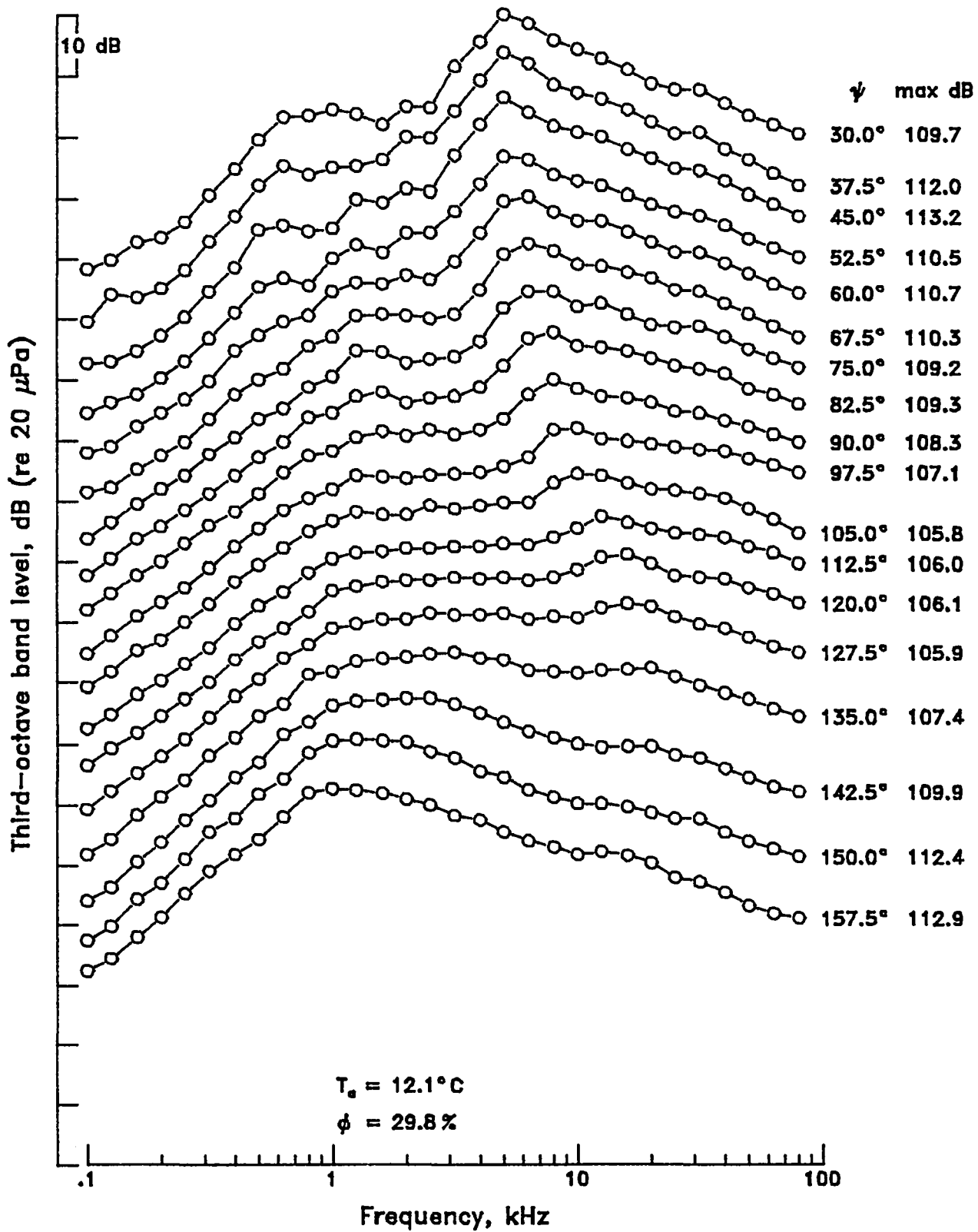

Mach 2.0 contoured nozzle with tab,  $\beta = 1.10$

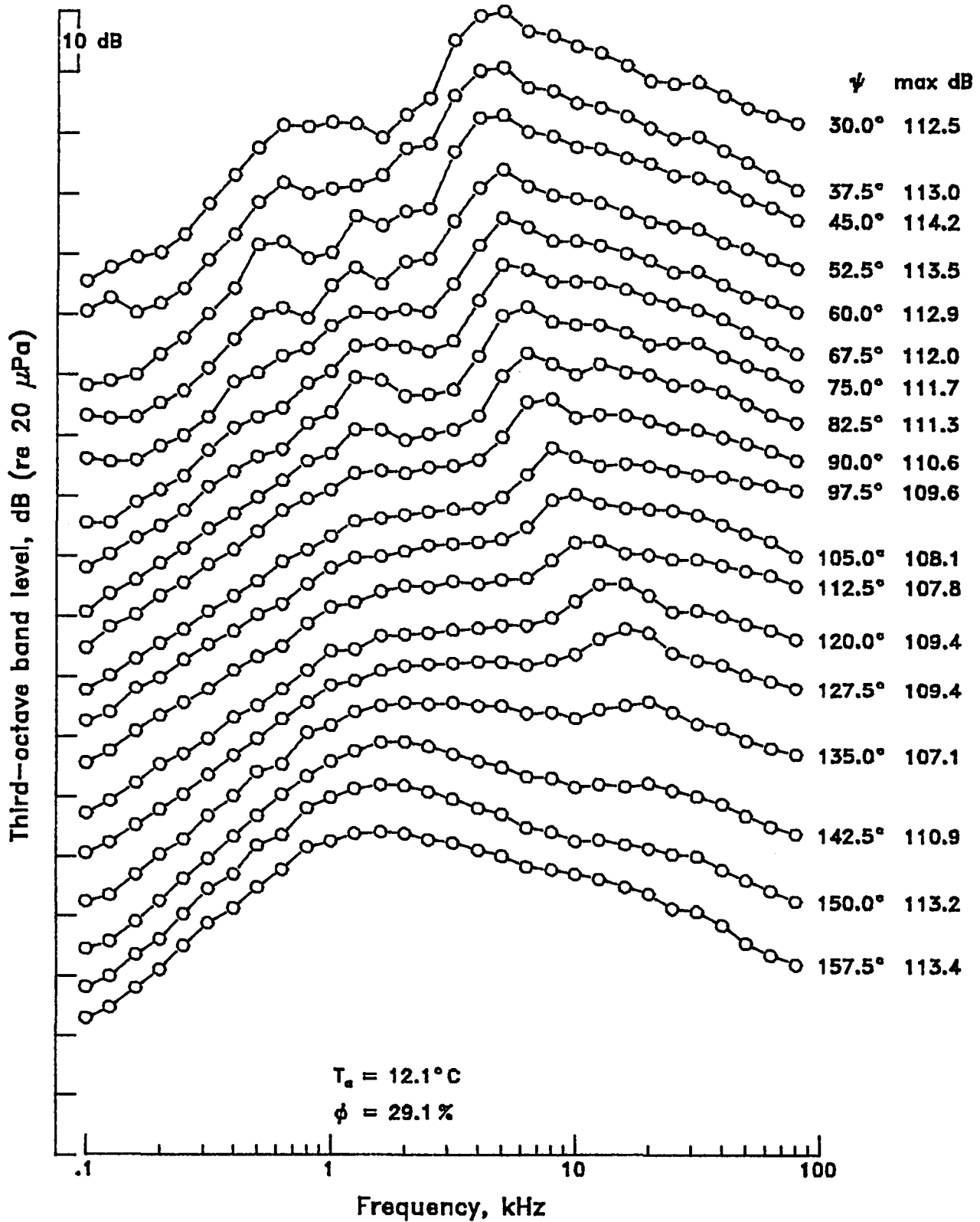

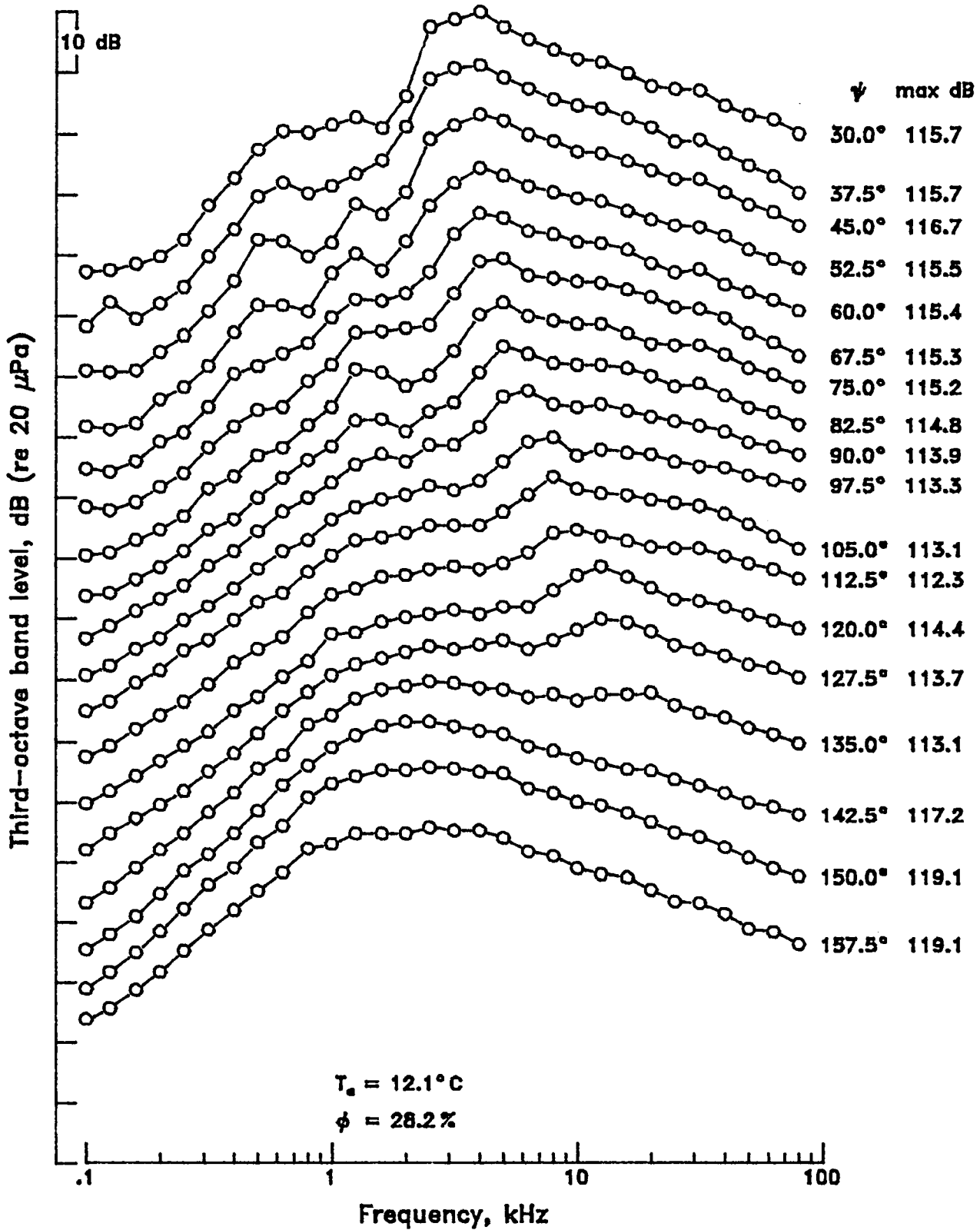
Mach 2.0 contoured nozzle with tab,  $\beta = 1.34$ 

Mach 2.0 contoured nozzle with tab,  $\beta = 1.50$

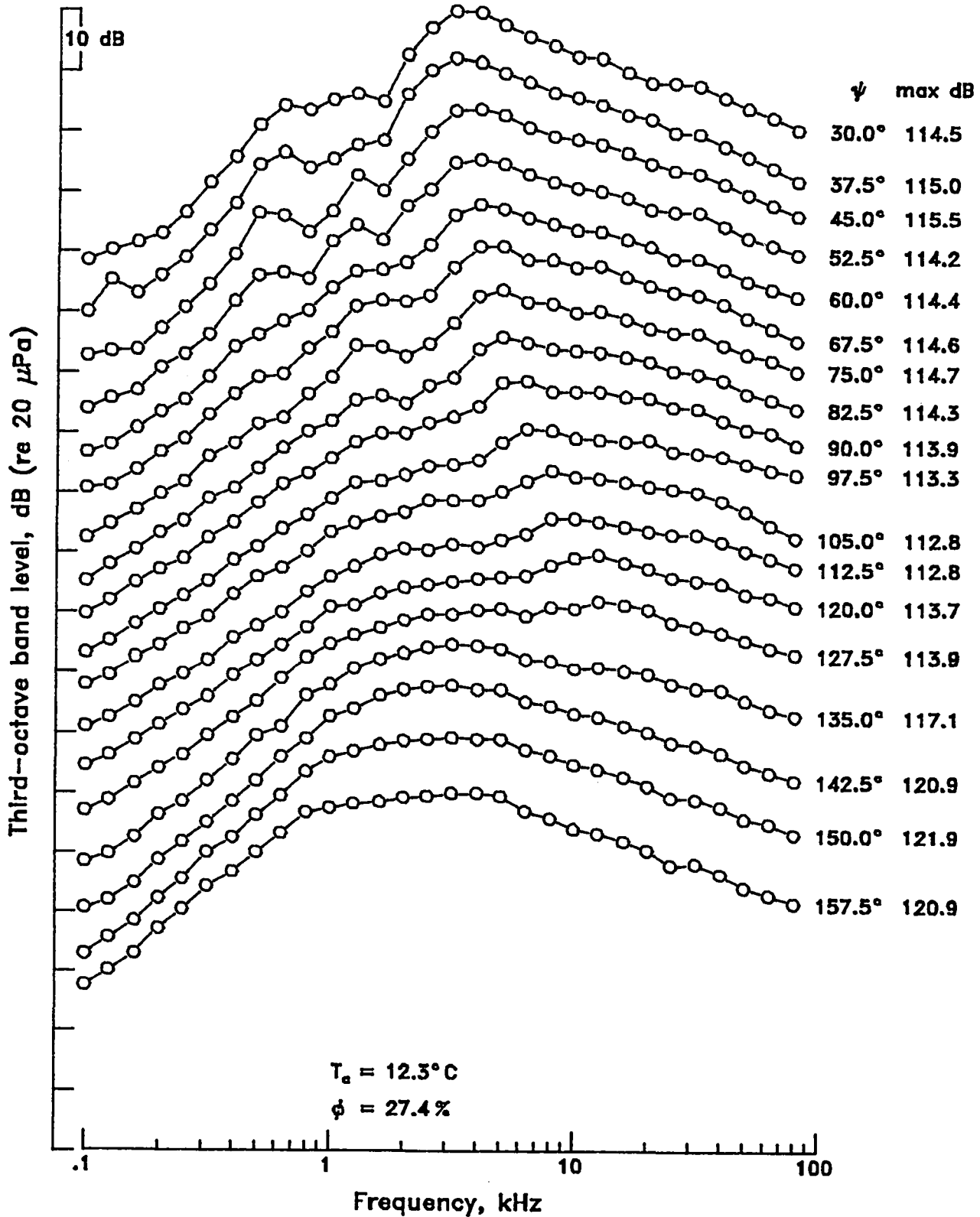

Mach 2.0 contoured nozzle with tab,  $\beta = 1.72$

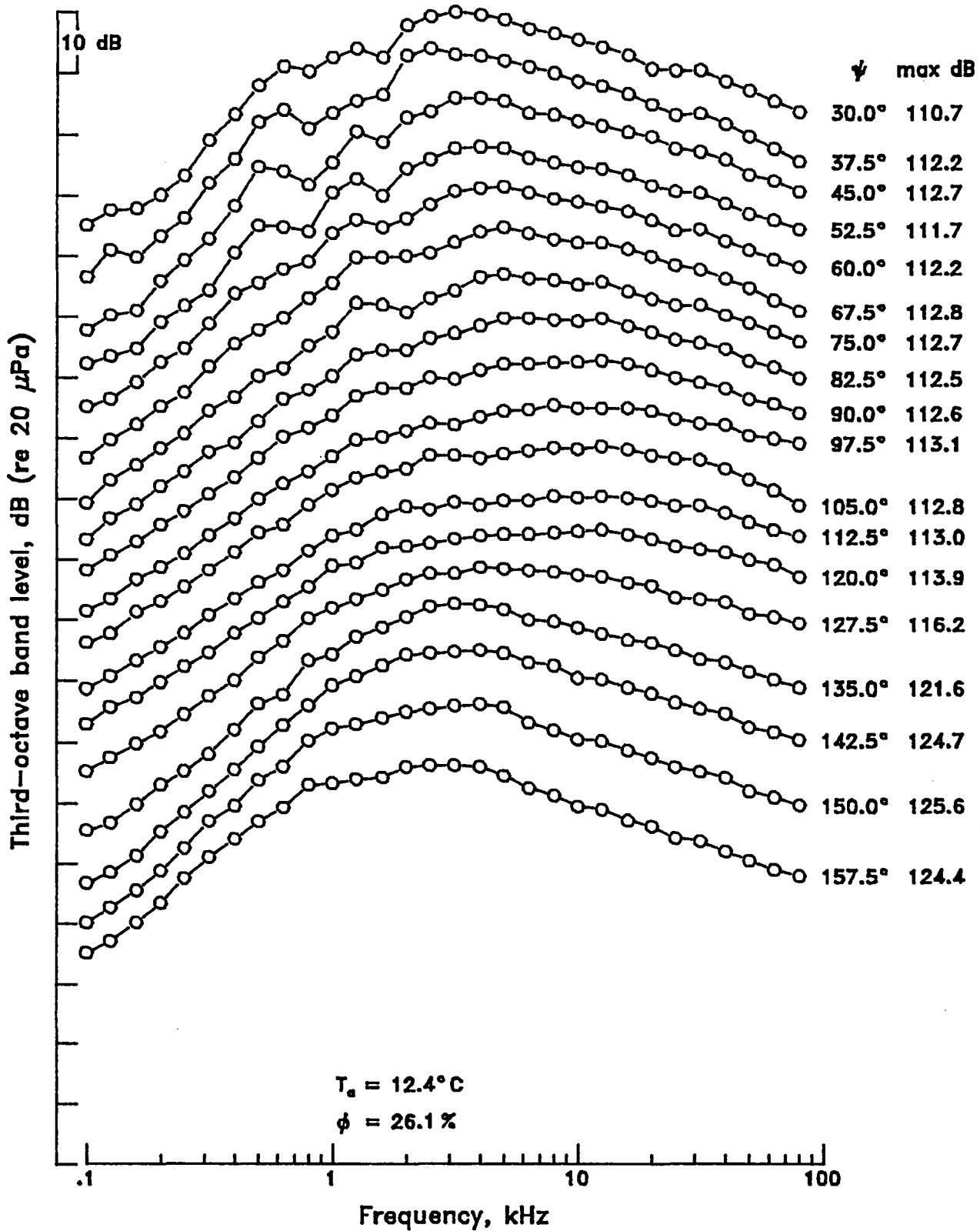

Mach 2.0 contoured nozzle with tab,  $\beta = 2.00$

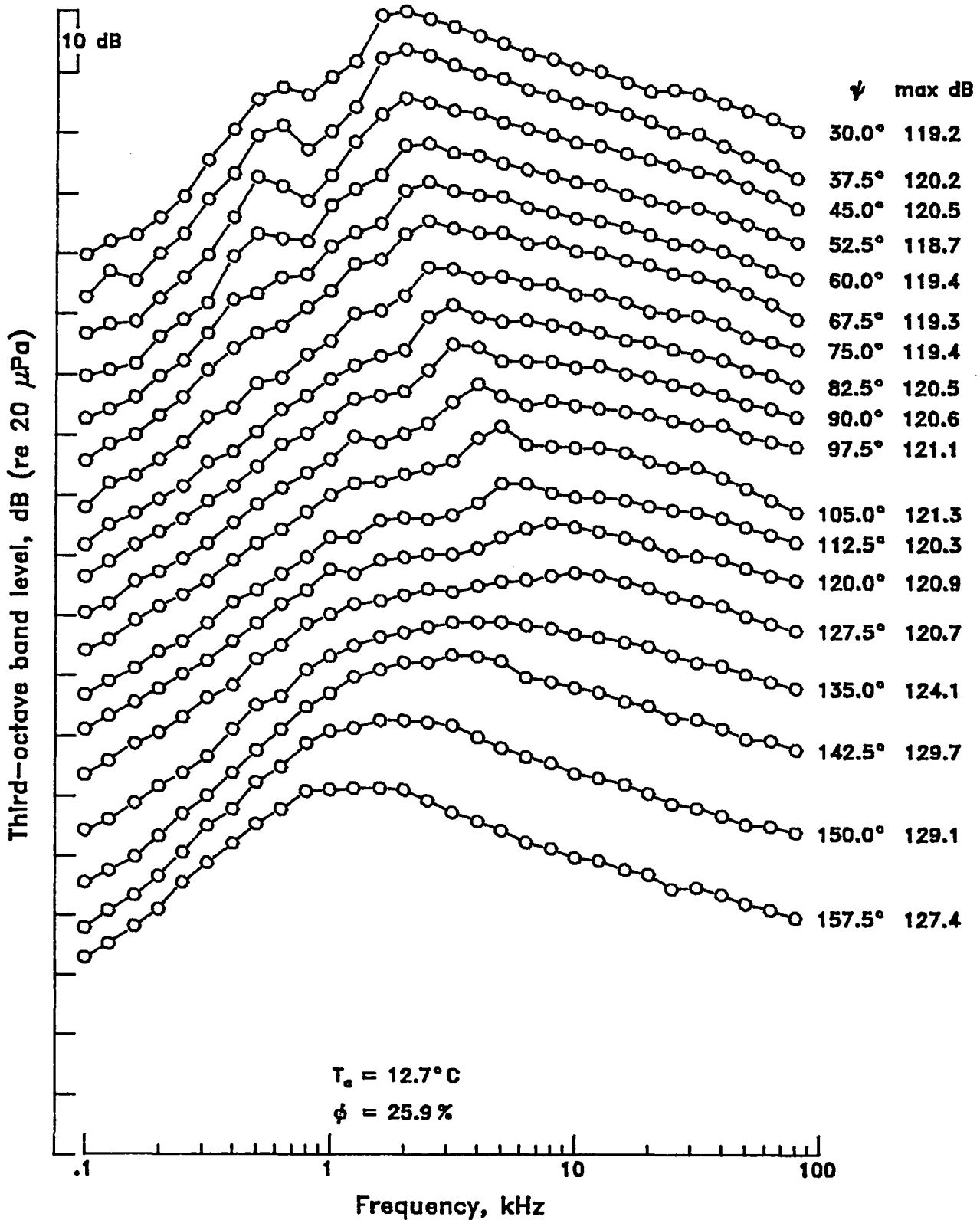

APPENDIX E

POWER SPECTRA WITH 40 HZ BANDWIDTH FOR DIFFERENT VALUES OF  $\psi$

<u>Nozzle configuration</u>	<u>Pages</u>
Mach 1.0 contoured nozzle without tab	140-152
Mach 1.0 contoured nozzle with tab	153-165
Mach 1.5 contoured nozzle without tab	166-177
Mach 2.0 contoured nozzle without tab	178-189

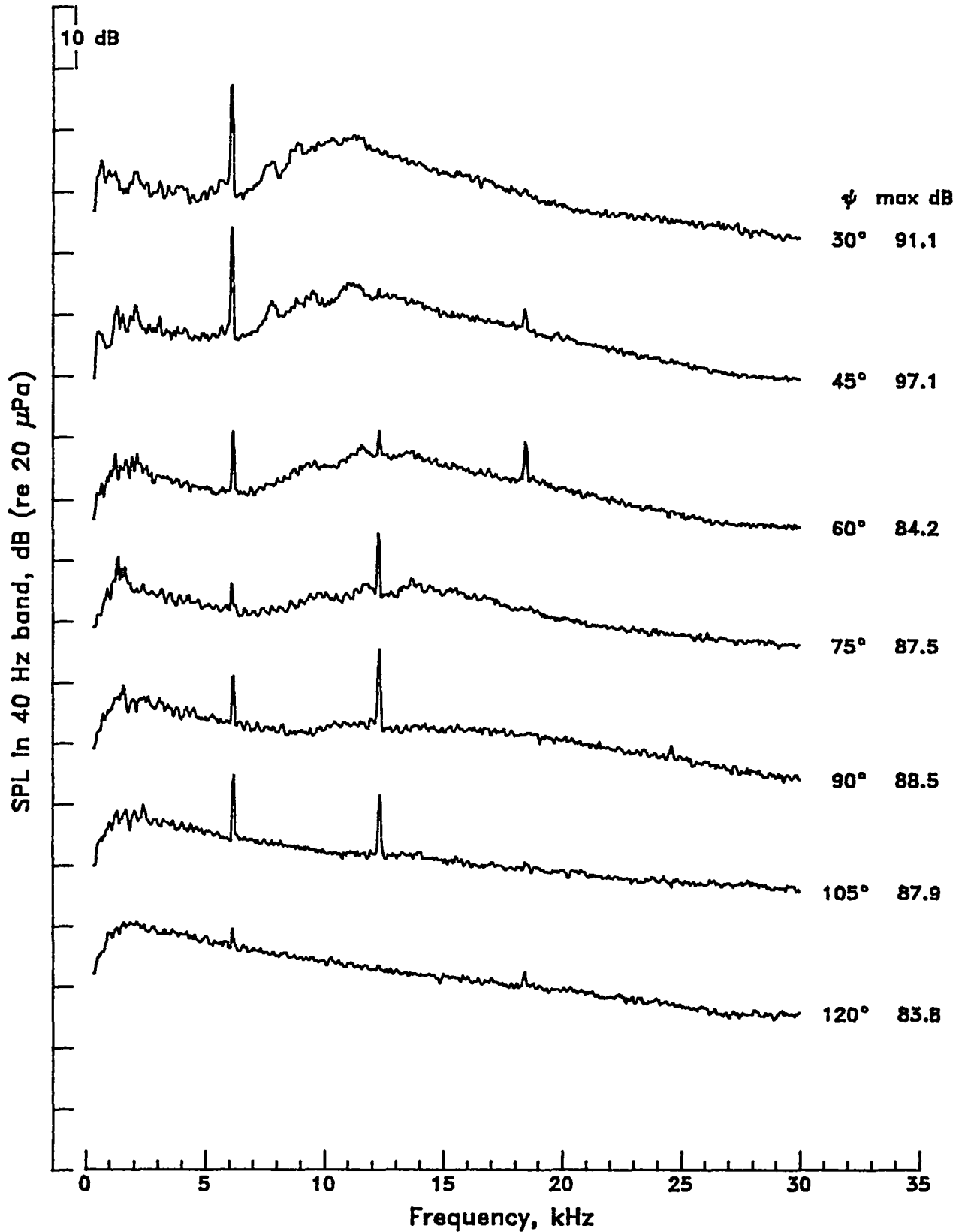
Mach 1.0 contoured nozzle without tab,  $\beta = 0.40$ 



APPENDIX E

Mach 1.0 contoured nozzle without tab,  $\beta = 0.60$

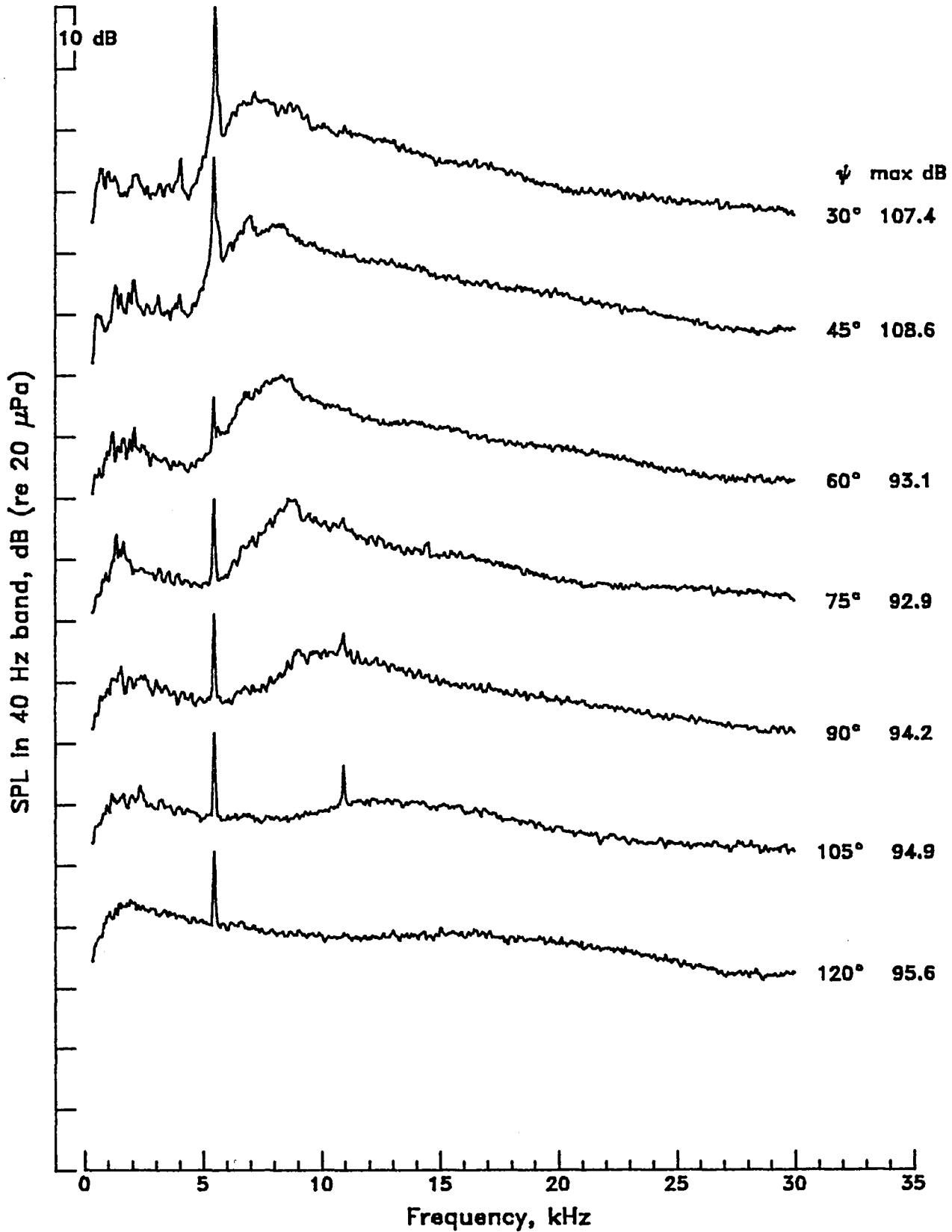

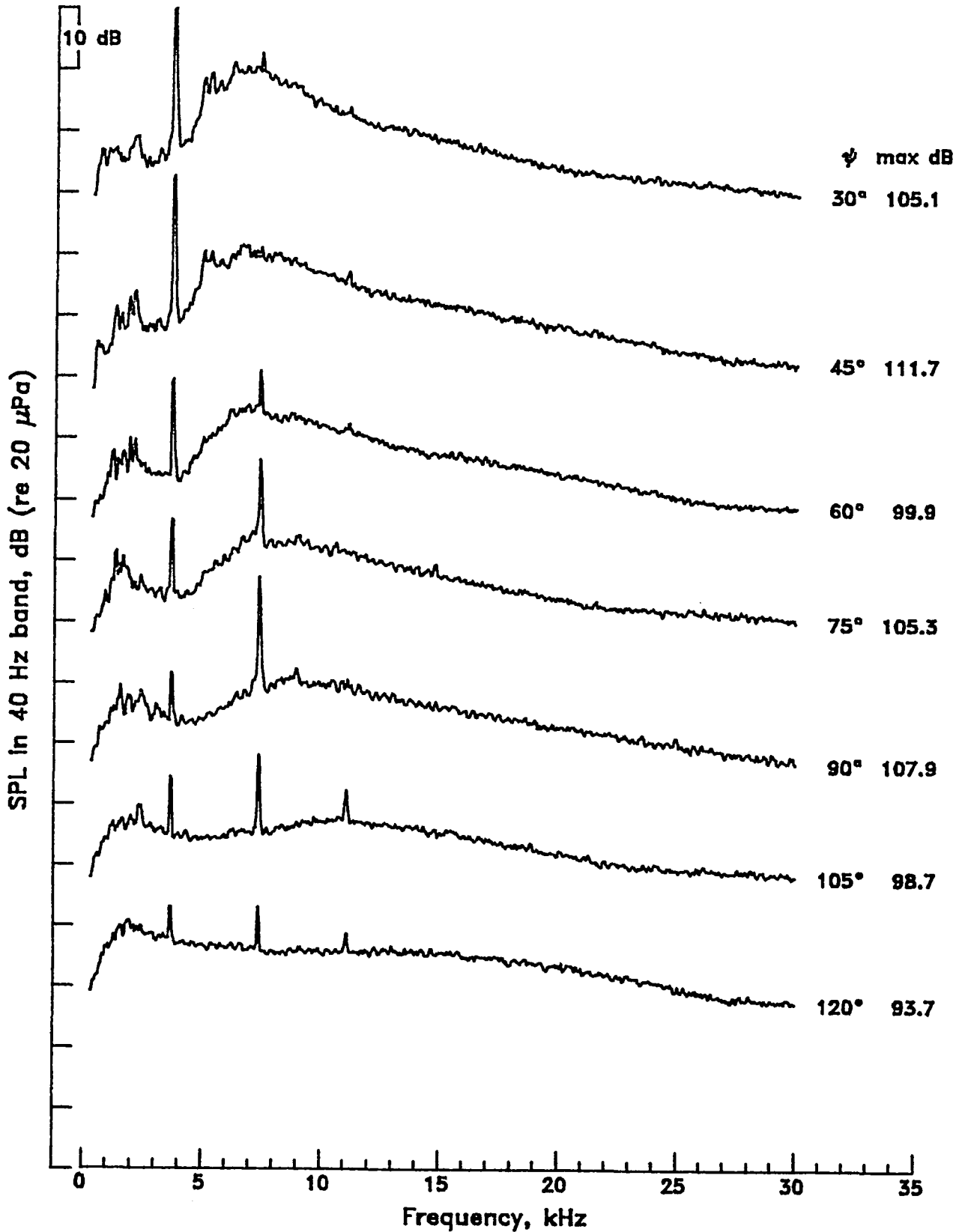
Mach 1.0 contoured nozzle without tab,  $\beta = 0.70$ 

Mach 1.0 contoured nozzle without tab,  $\beta = 0.80$

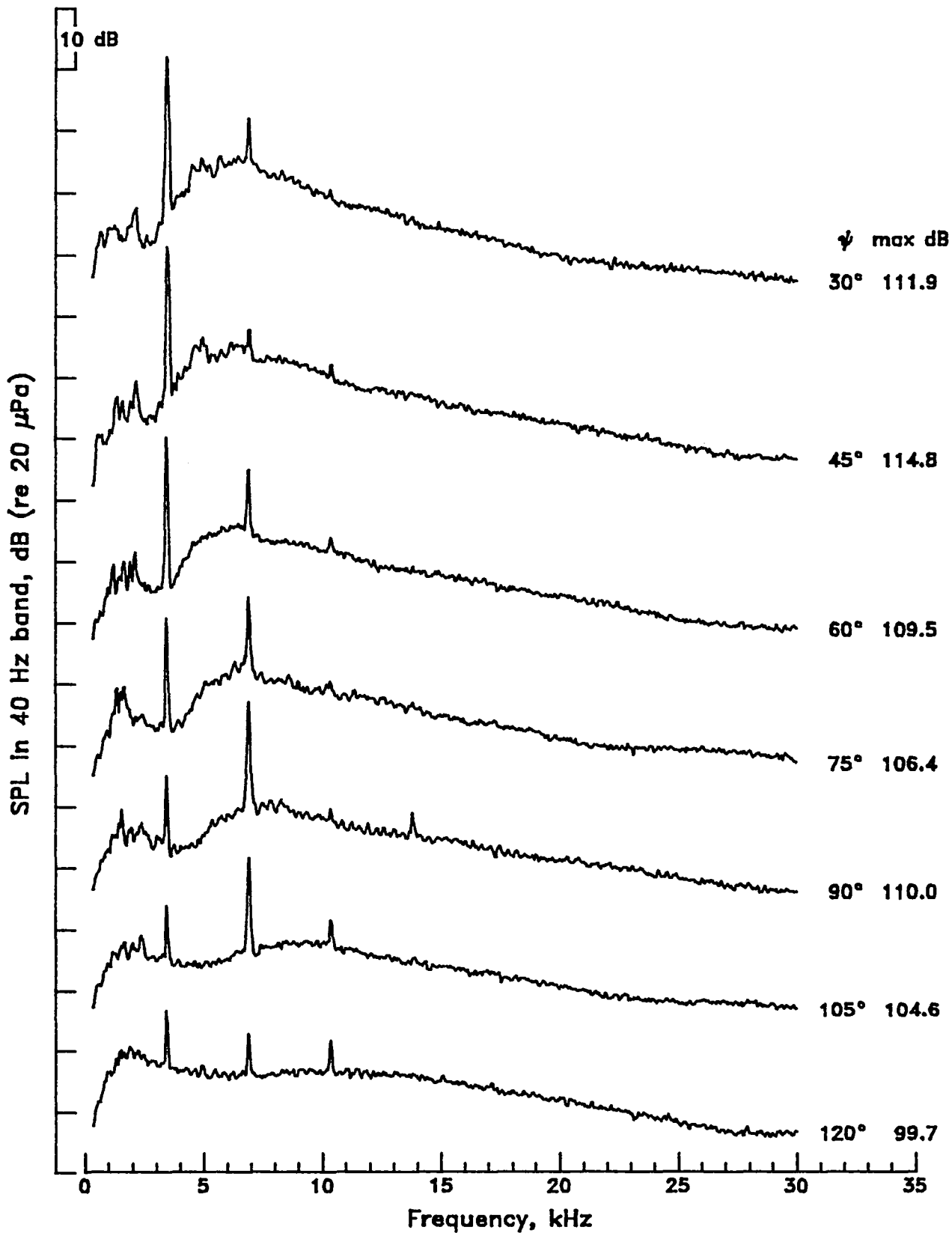

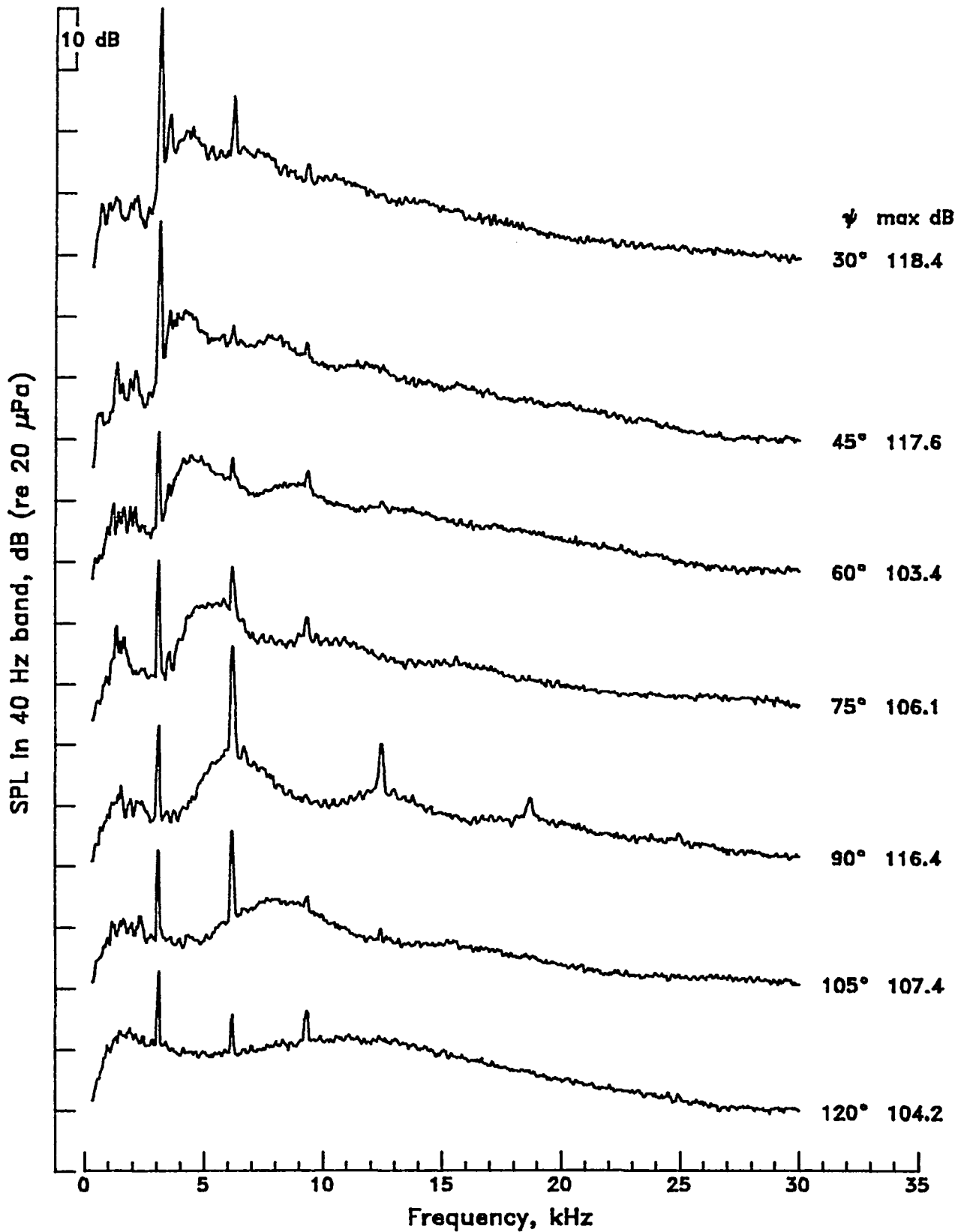
Mach 1.0 contoured nozzle without tab,  $\beta = 0.94$ 

Mach 1.0 contoured nozzle without tab,  $\beta = 1.00$

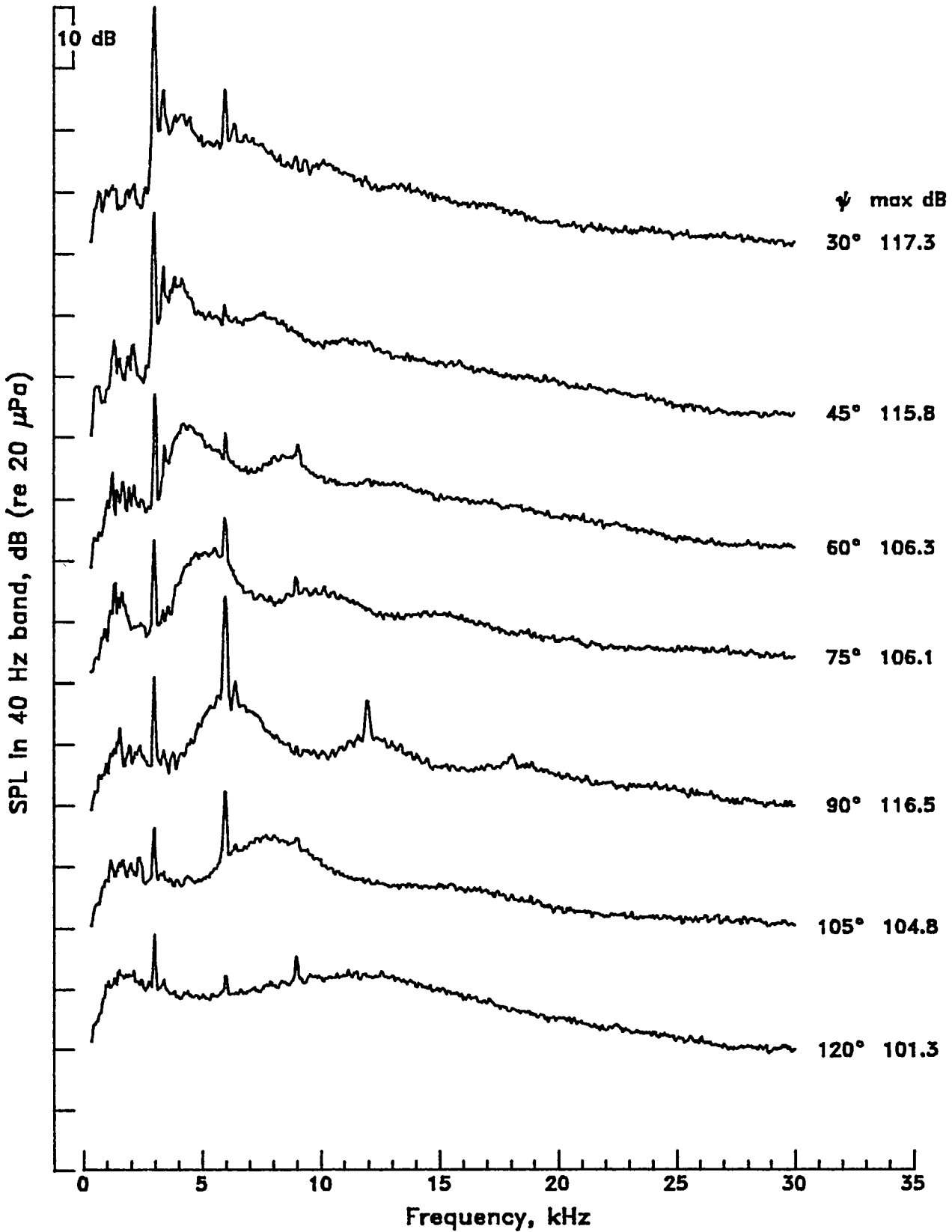

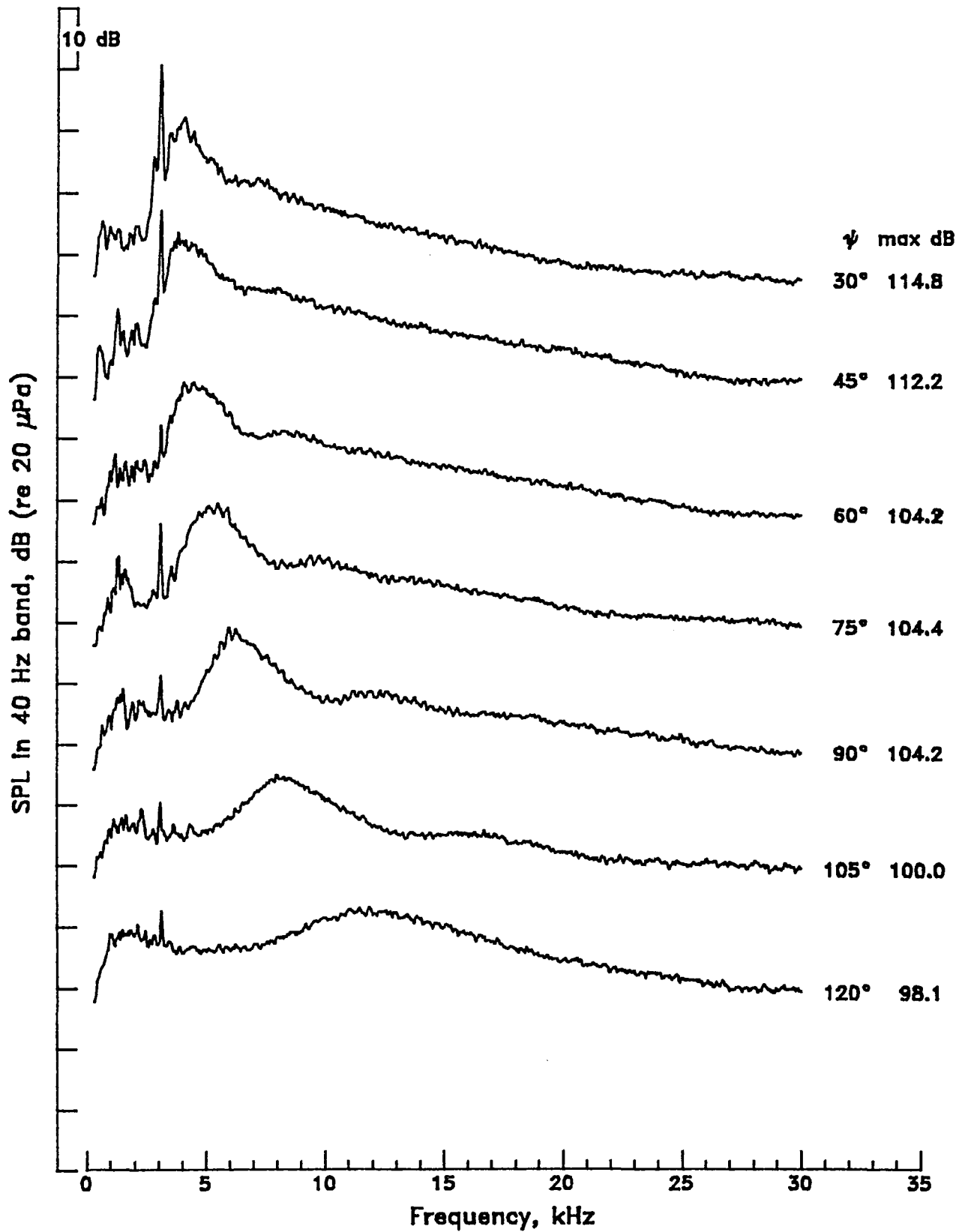
Mach 1.0 contoured nozzle without tab,  $\beta = 1.10$ 

Mach 1.0 contoured nozzle without tab,  $\beta = 1.34$

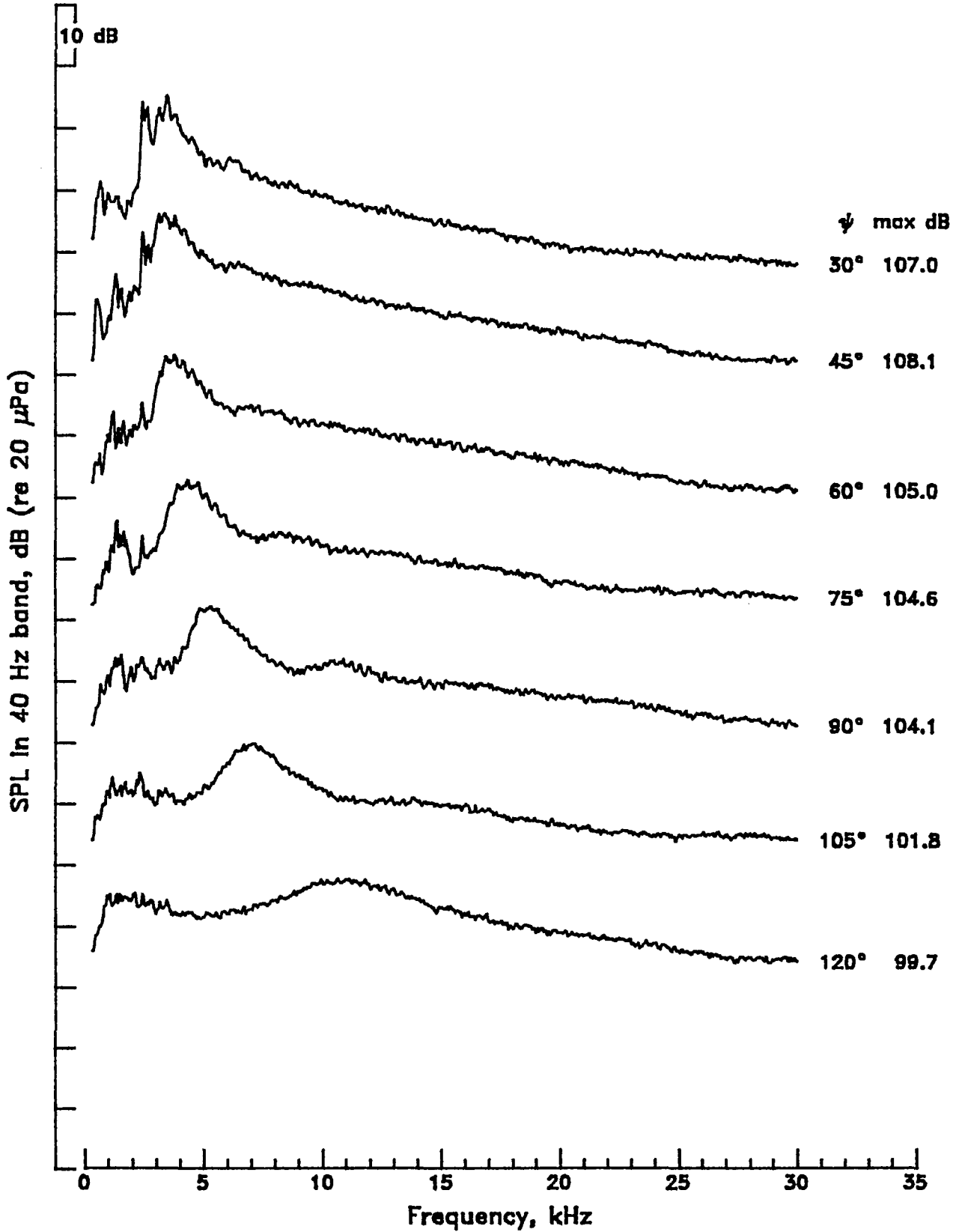

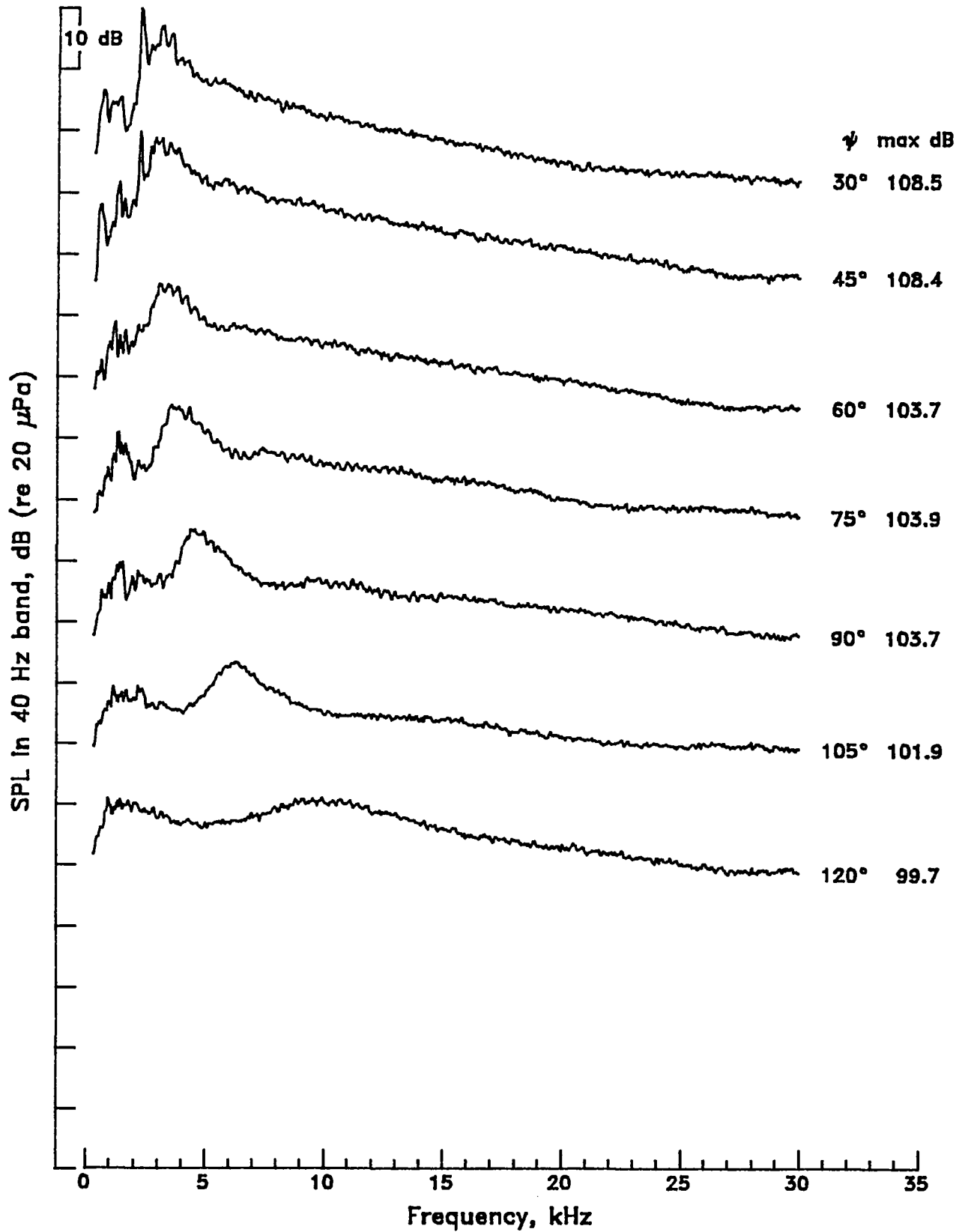
Mach 1.0 contoured nozzle without tab,  $\beta = 1.50$ 



Mach 1.0 contoured nozzle without tab,  $\beta = 1.72$

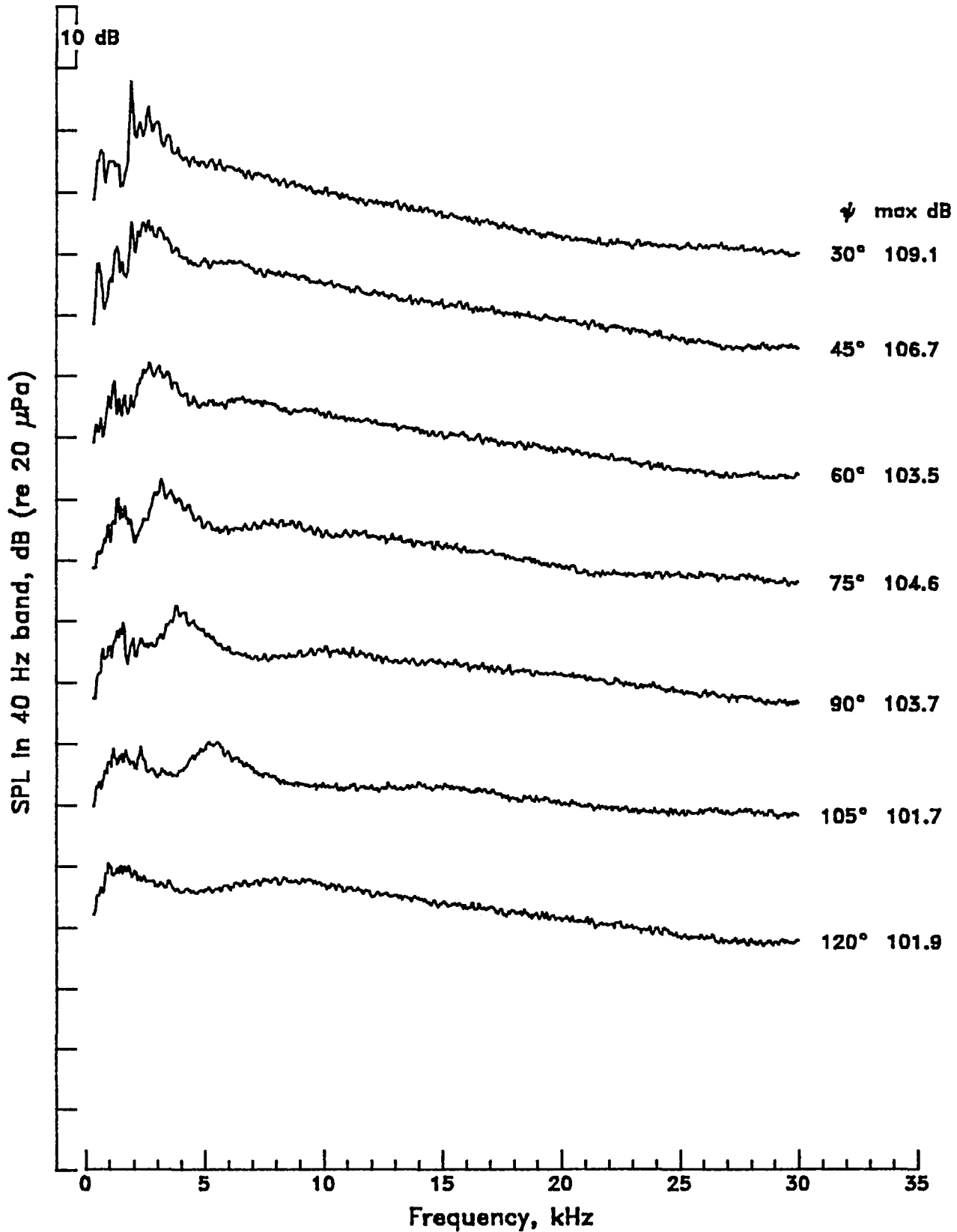

Mach 1.0 contoured nozzle without tab,  $\beta = 2.00$

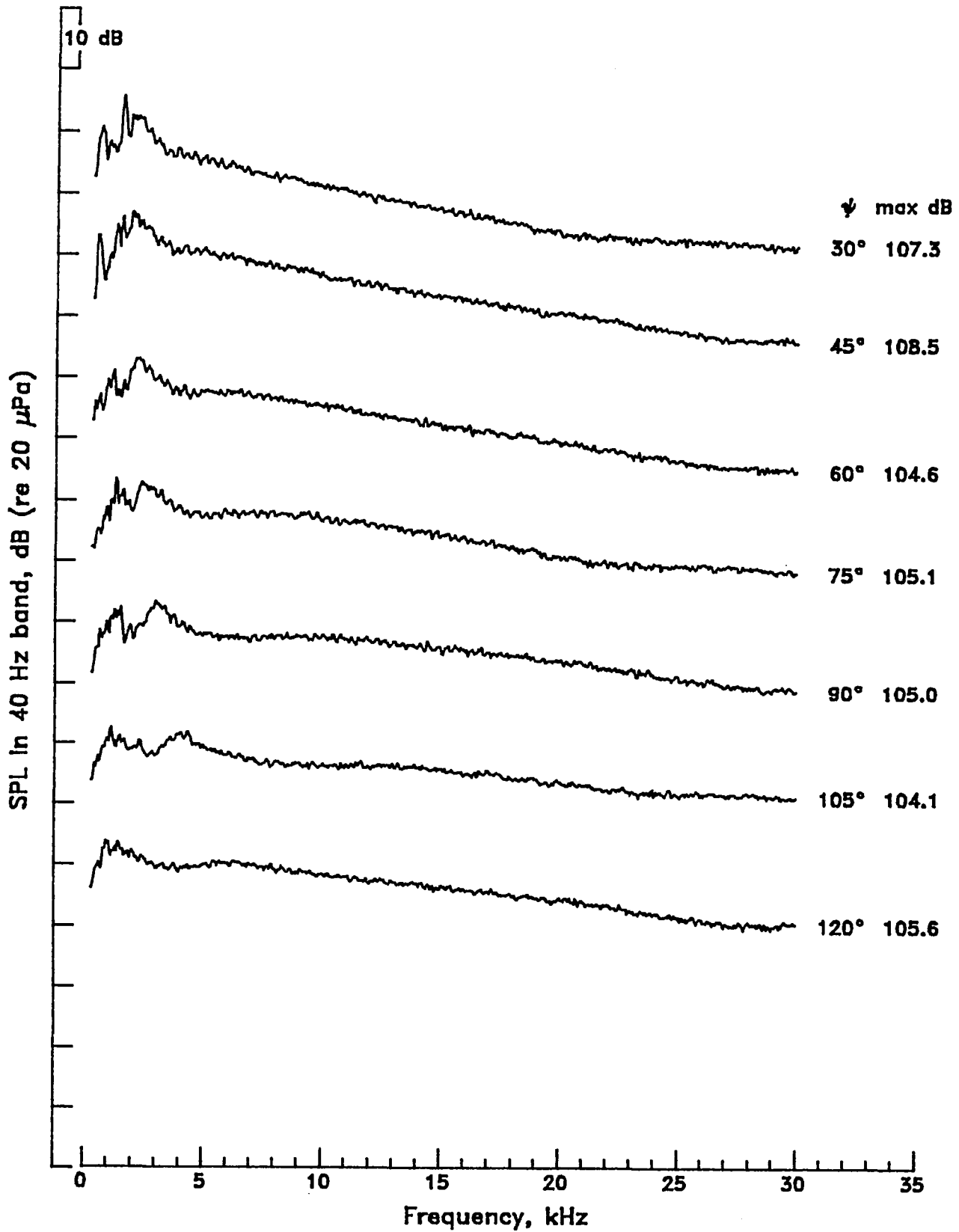

Mach 1.0 contoured nozzle without tab,  $\beta = 2.10$

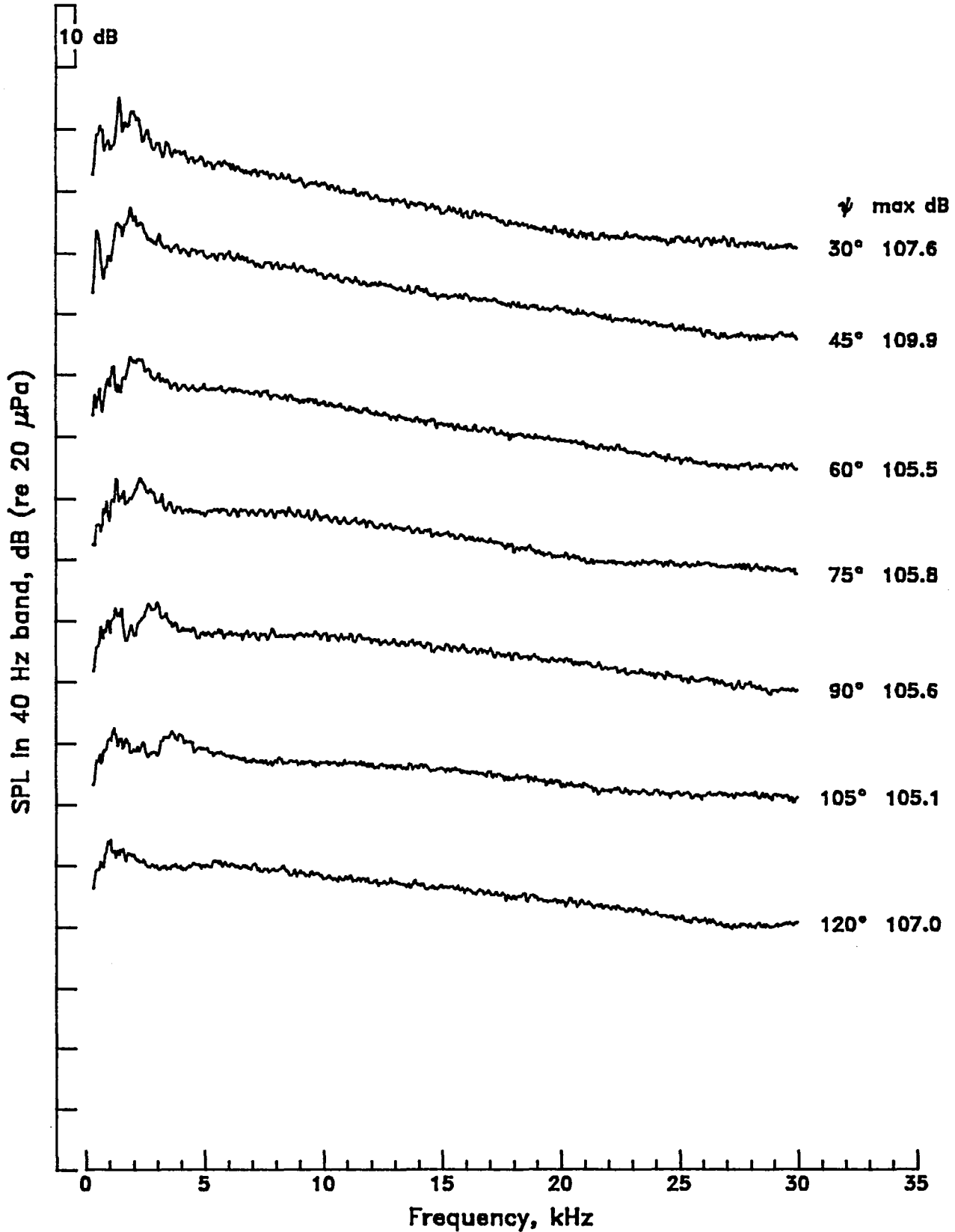

Mach 1.0 contoured nozzle without tab,  $\beta = 2.15$

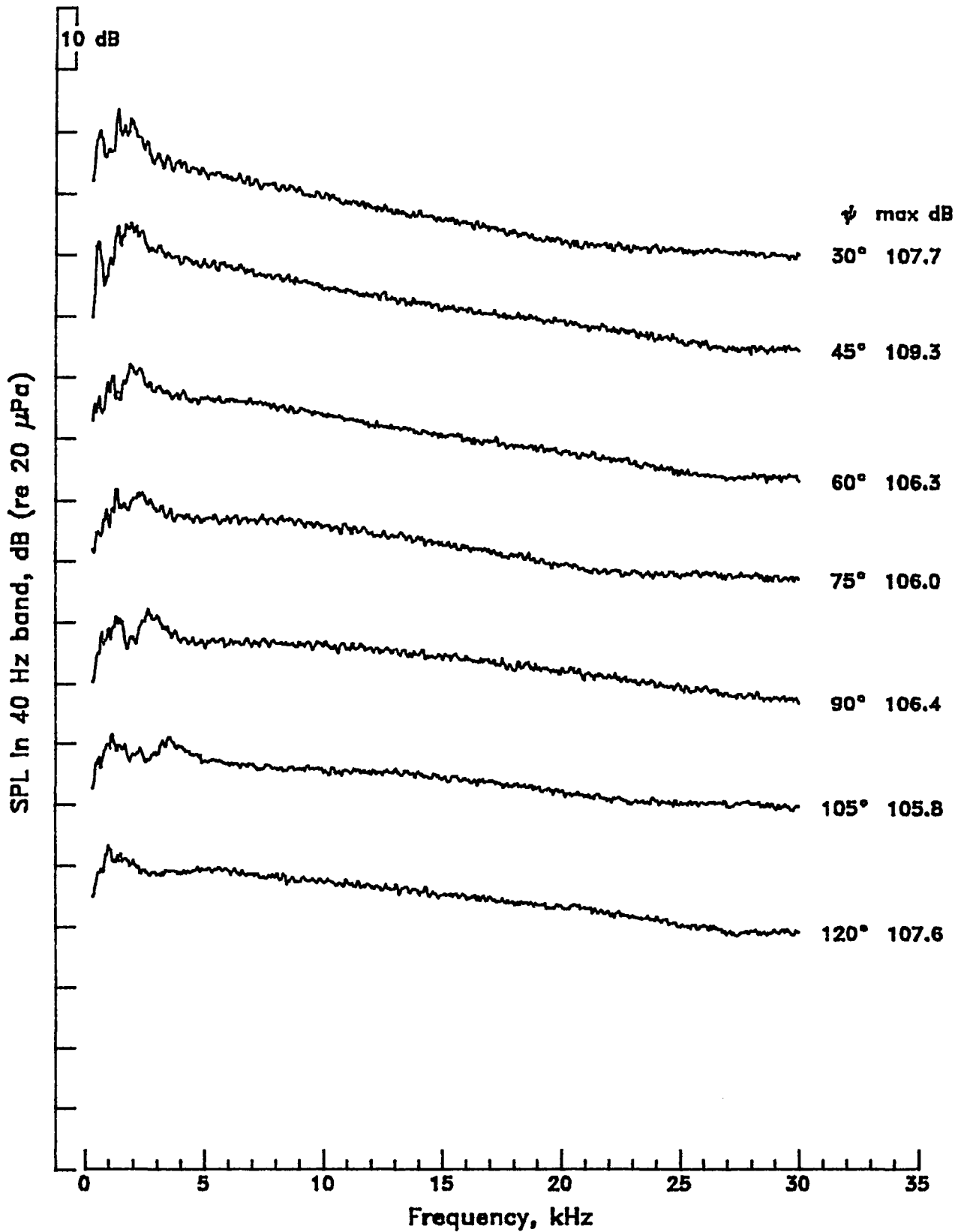

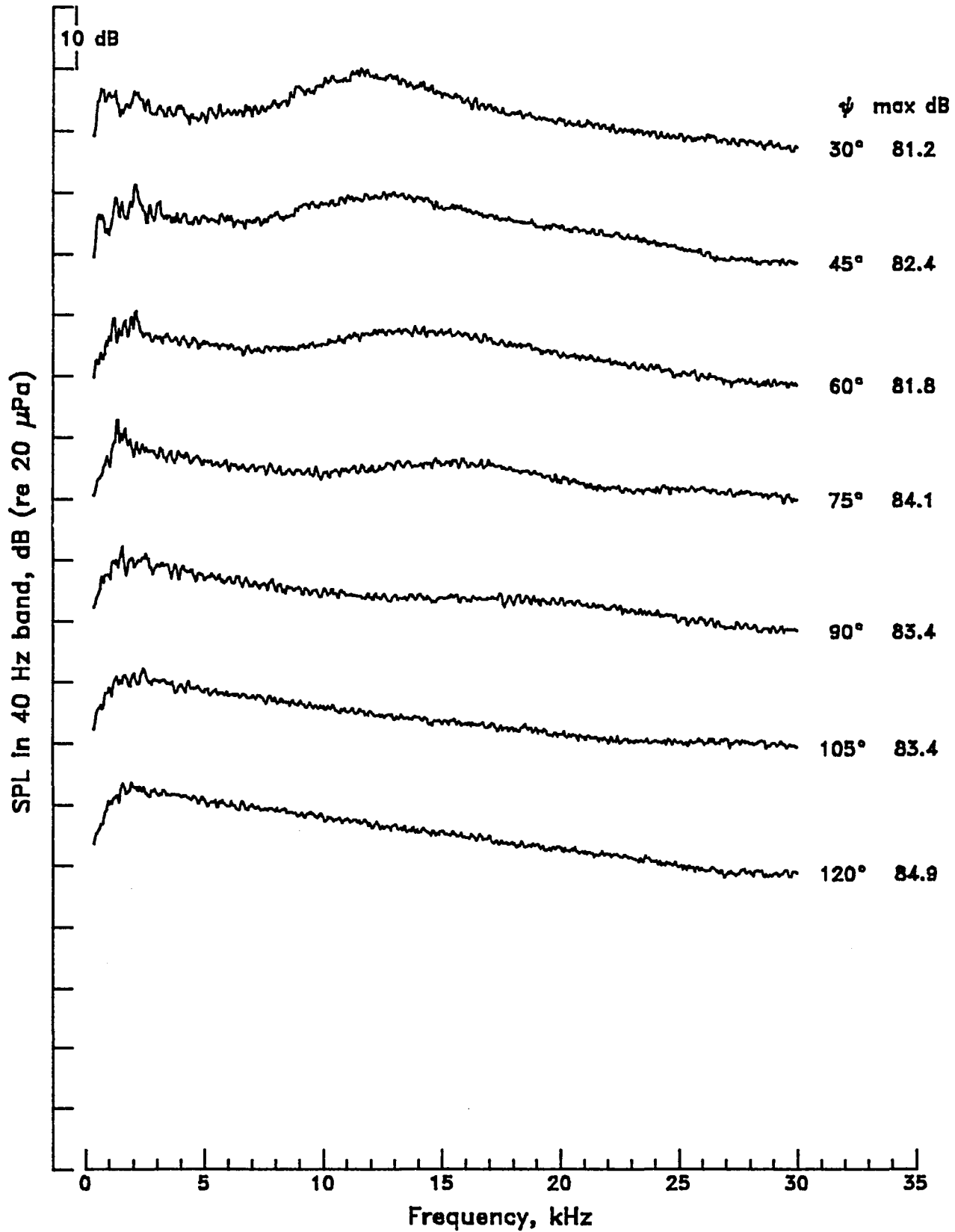
Mach 1.0 contoured nozzle with tab,  $\beta = 0.40$ 

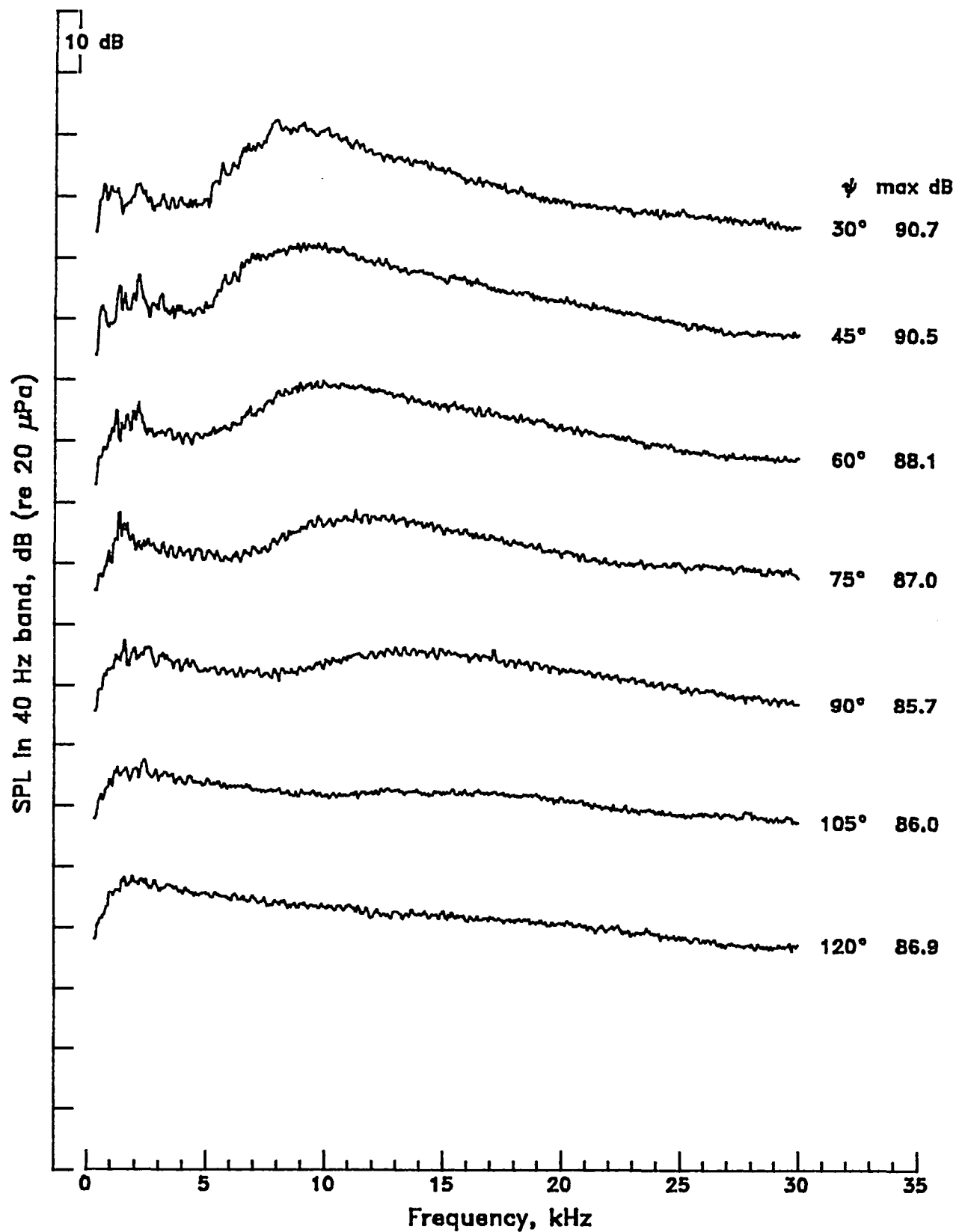
Mach 1.0 contoured nozzle with tab,  $\beta = 0.60$ 

Mach 1.0 contoured nozzle with tab,  $\beta = 0.70$

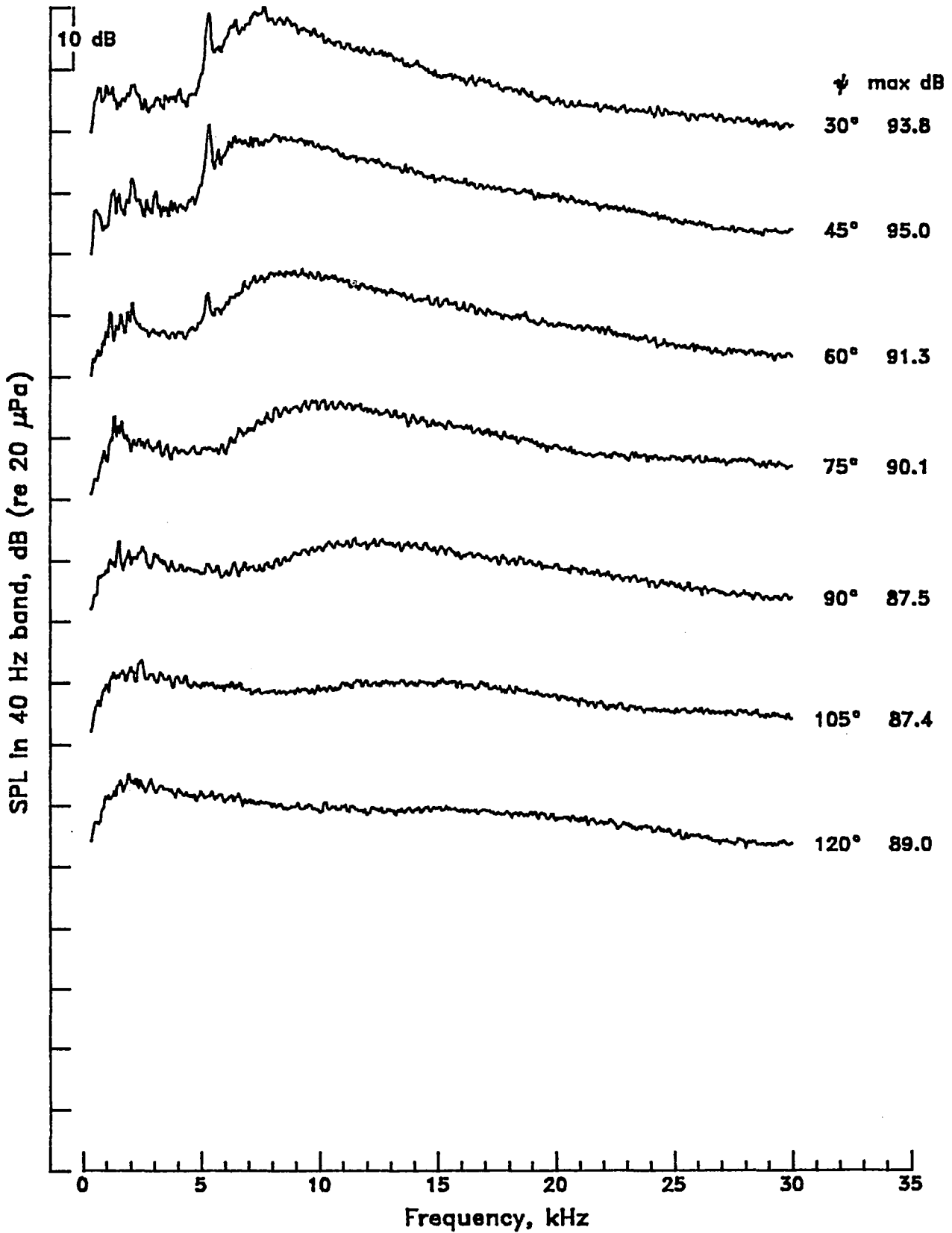

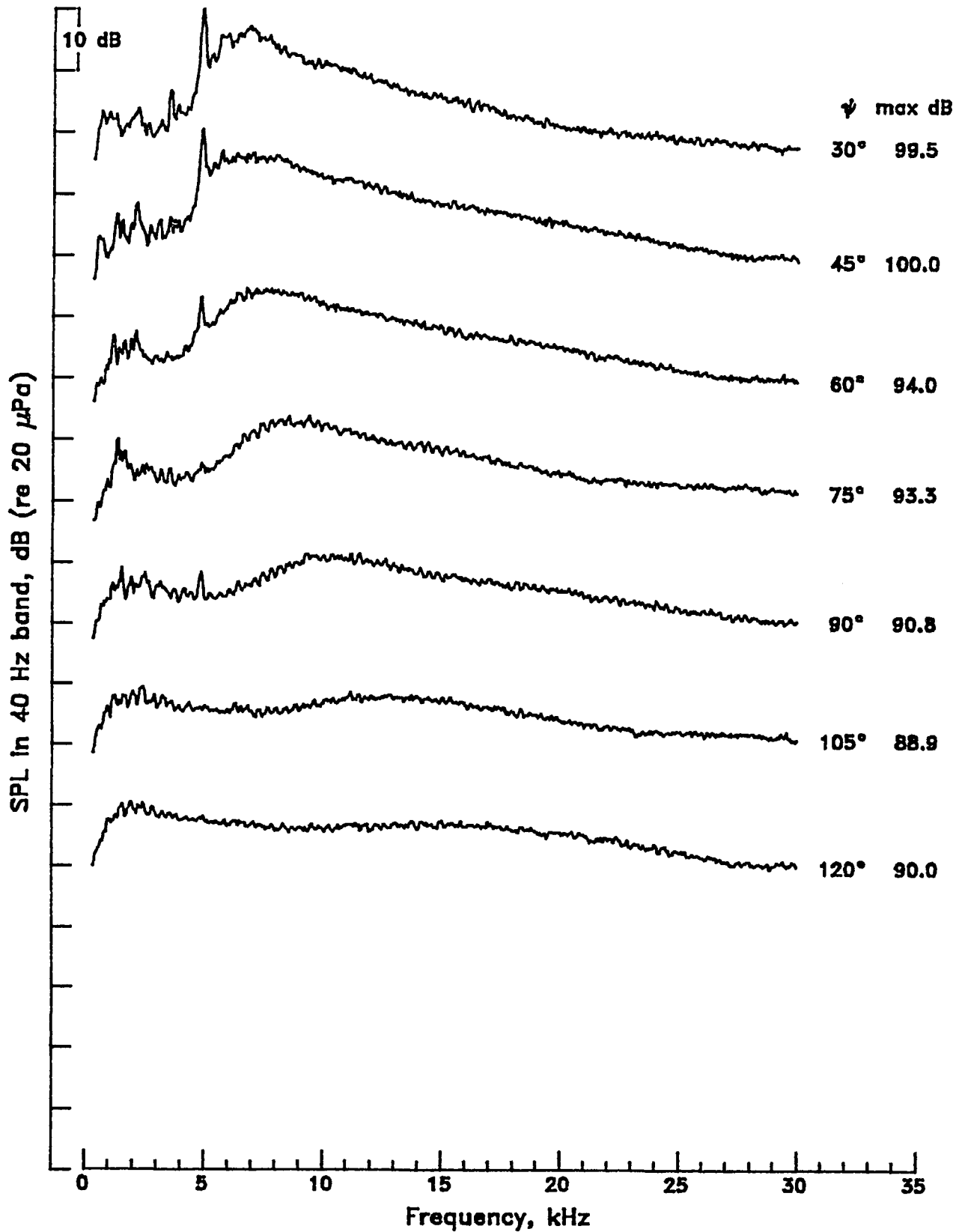
Mach 1.0 contoured nozzle with tab,  $\beta = 0.80$ 

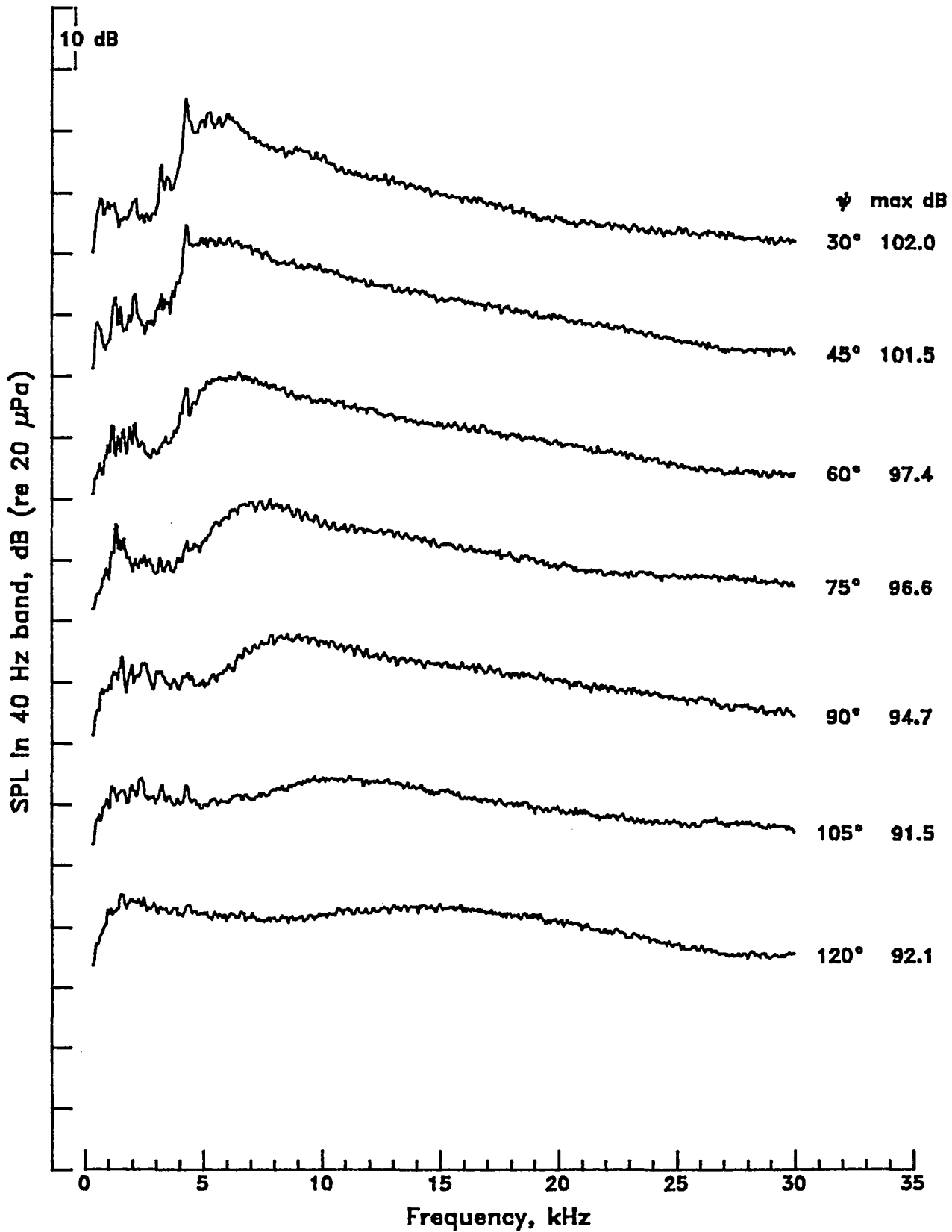

Mach 1.0 contoured nozzle with tab,  $\beta = 0.94$ 

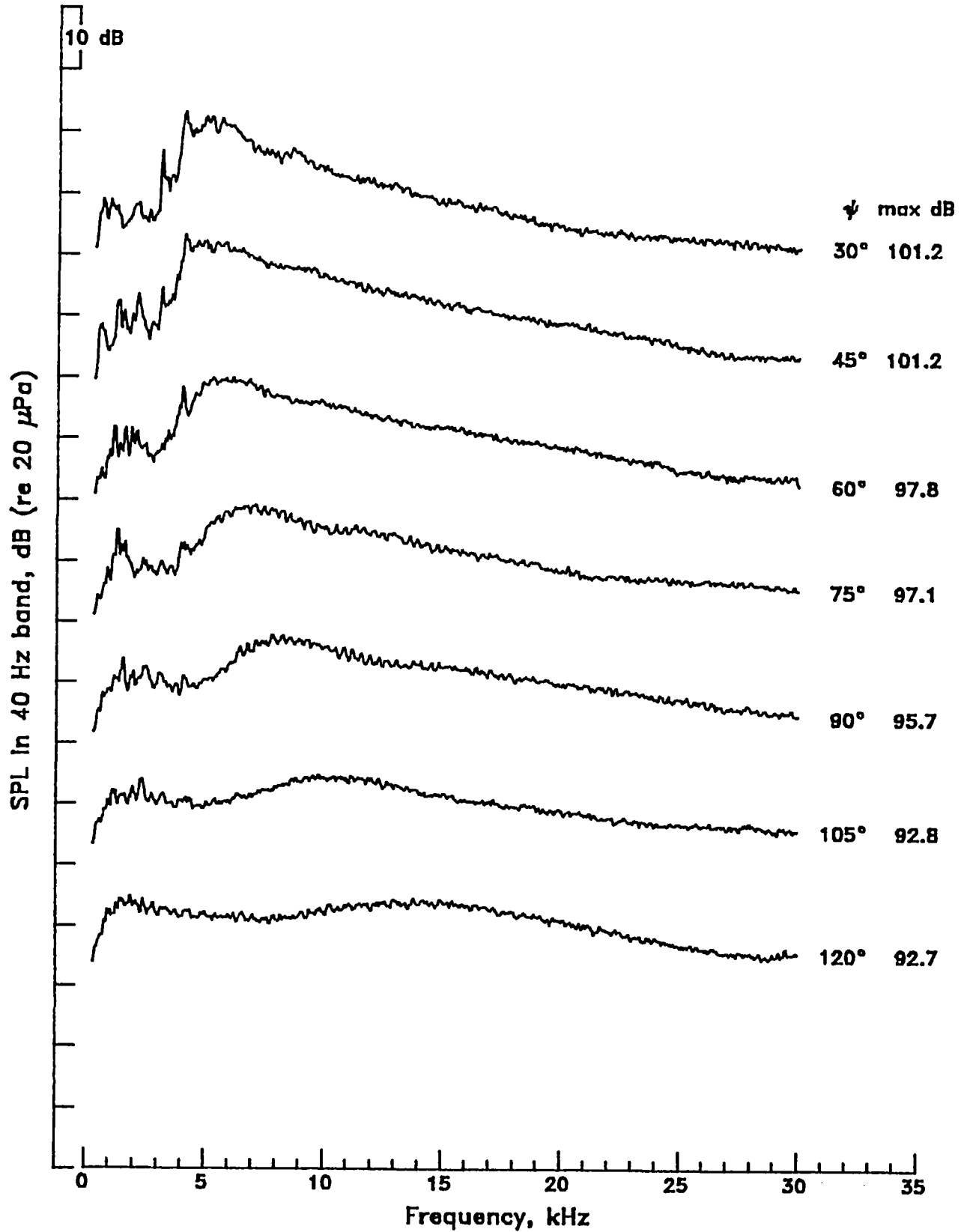
Mach 1.0 contoured nozzle with tab,  $\beta = 1.00$ 

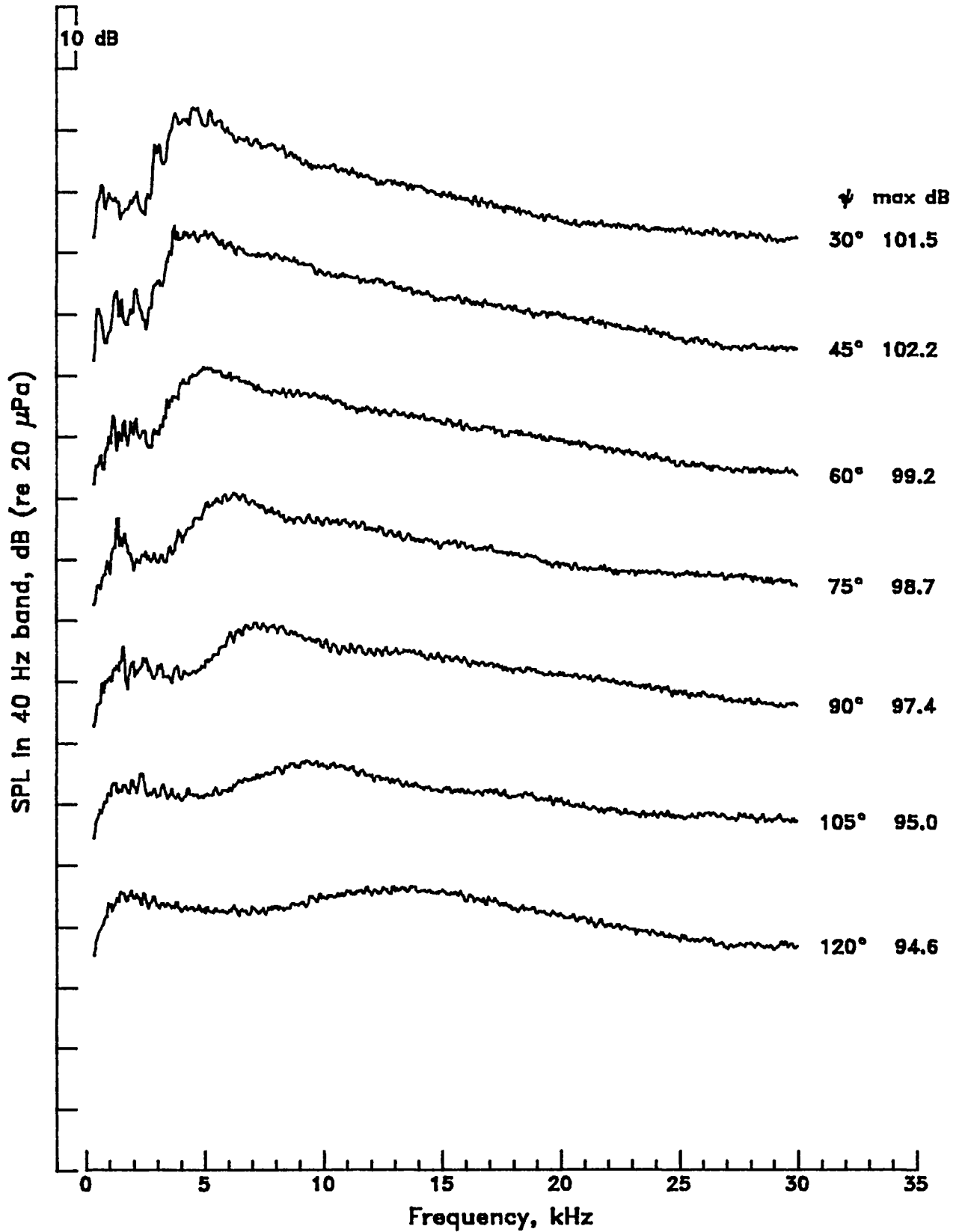
Mach 1.0 contoured nozzle with tab,  $\beta = 1.10$ 

Mach 1.0 contoured nozzle with tab,  $\beta = 1.34$

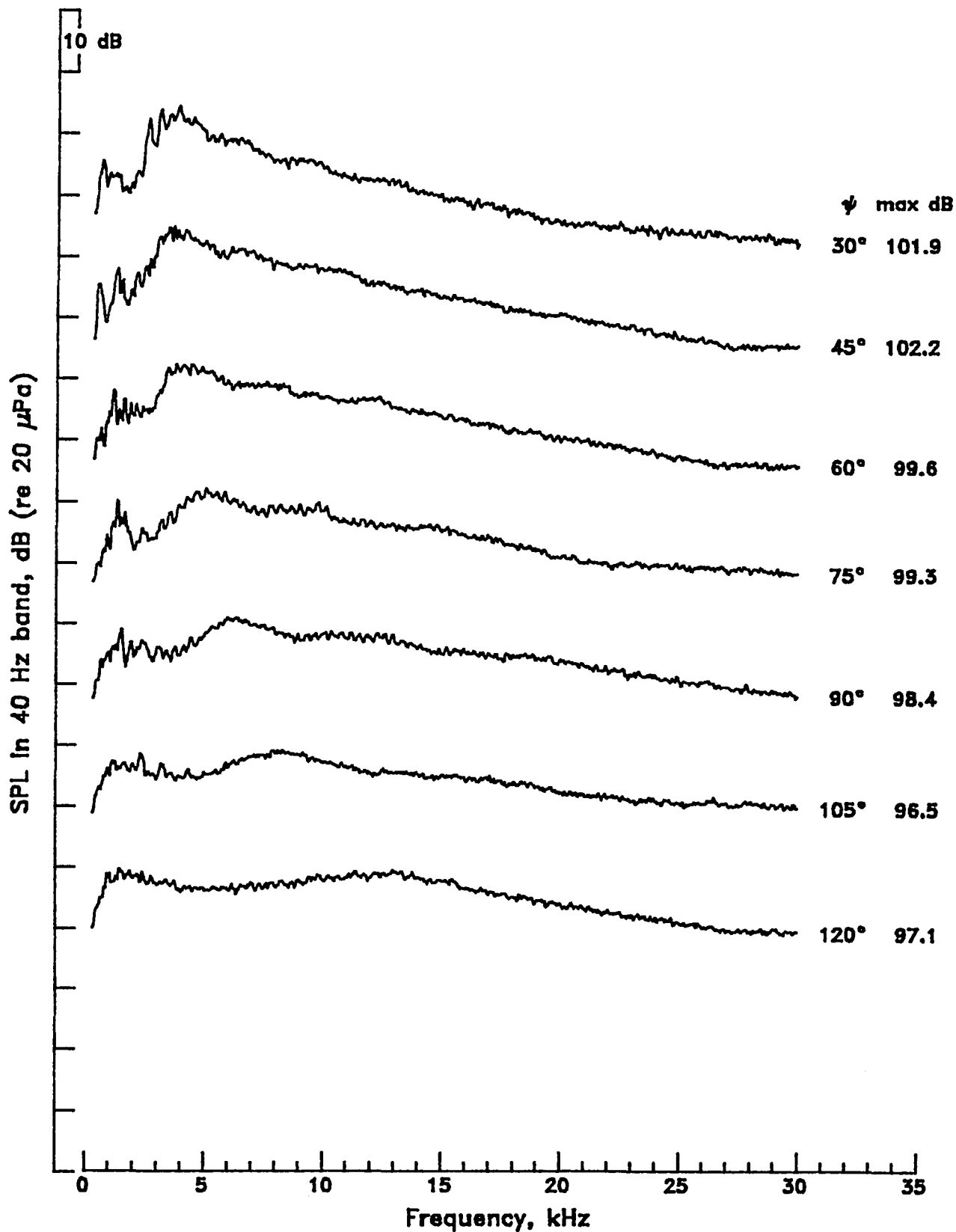

Mach 1.0 contoured nozzle with tab,  $\beta = 1.50$

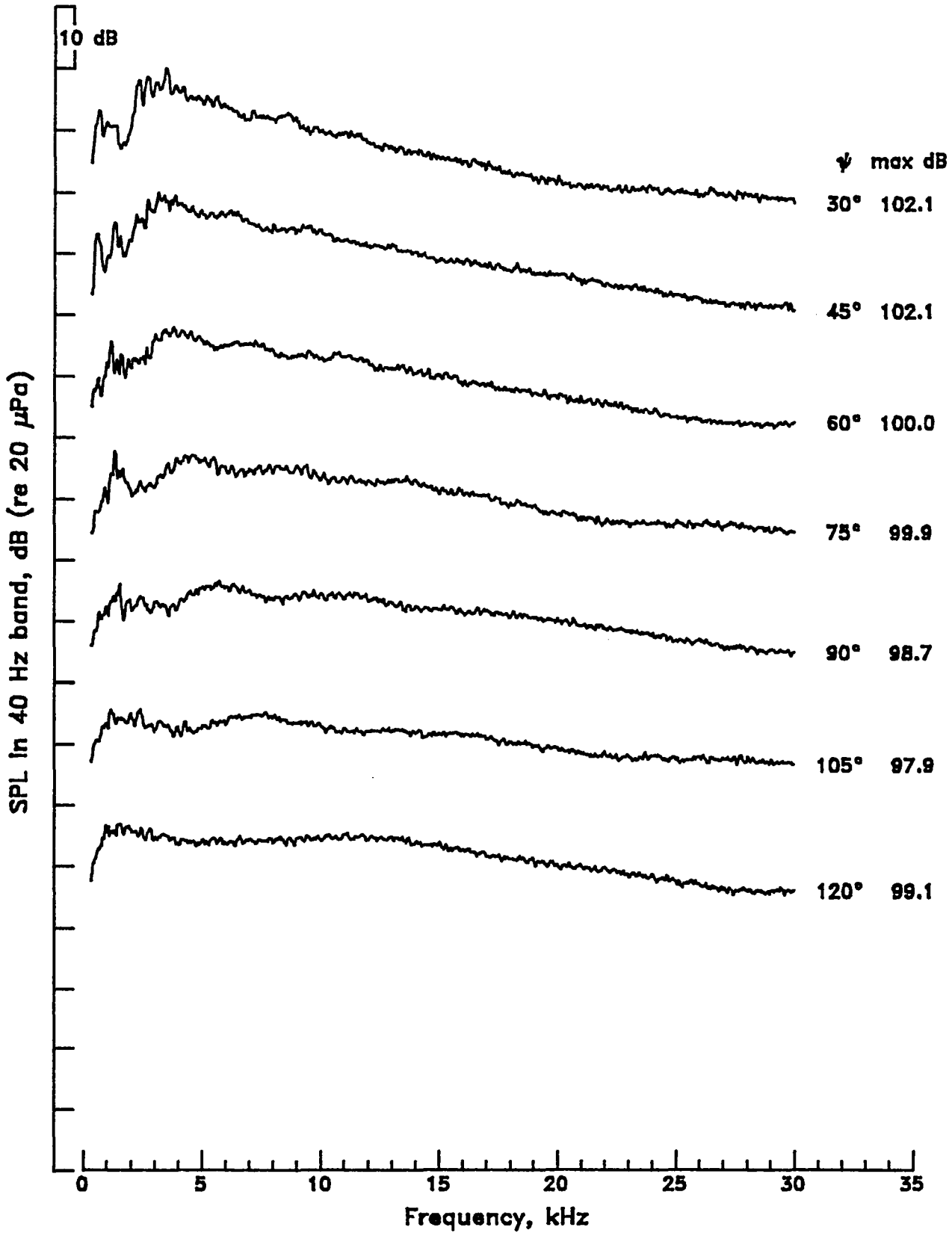

Mach 1.0 contoured nozzle with tab,  $\beta = 1.72$

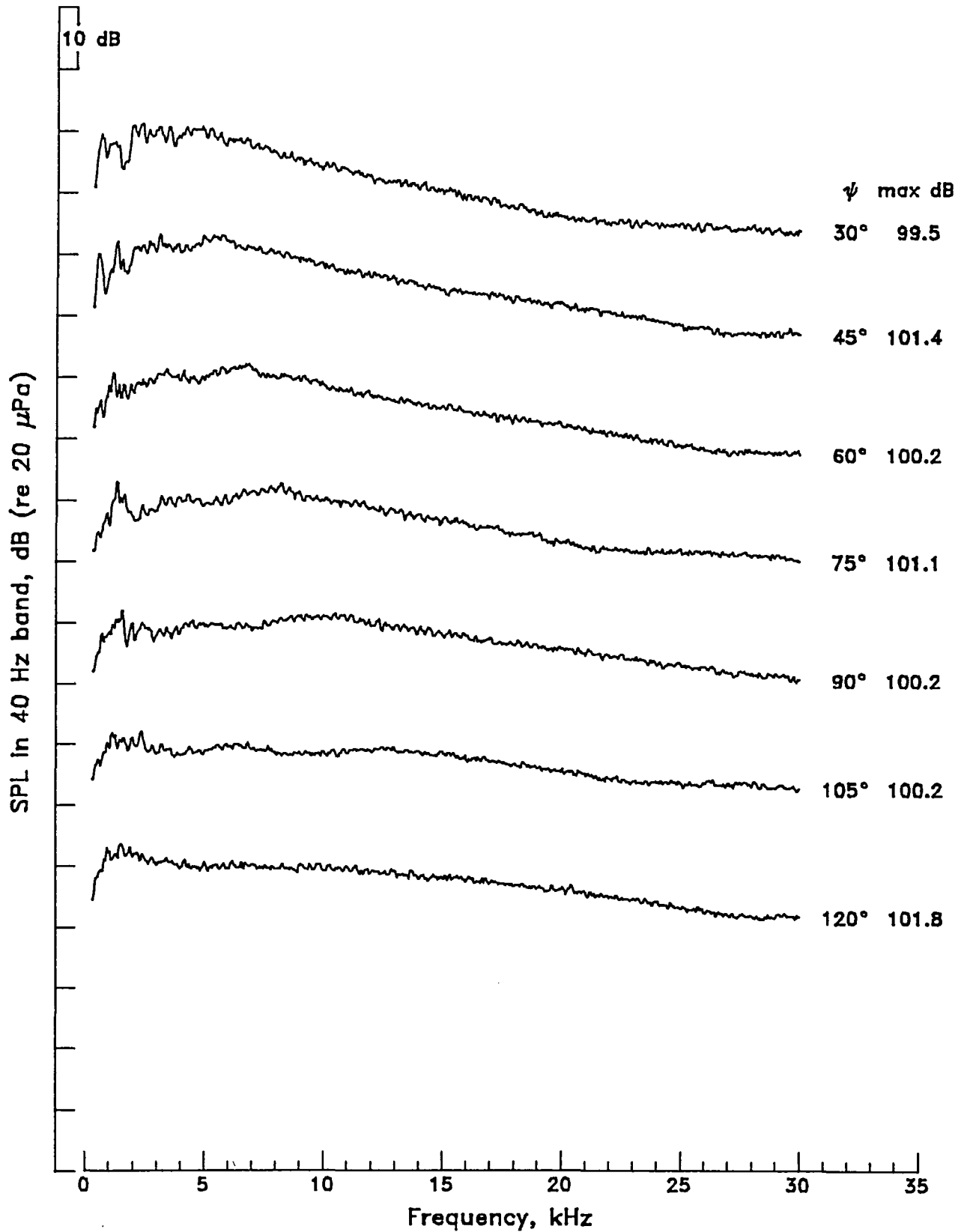

Mach 1.0 contoured nozzle with tab,  $\beta = 2.00$

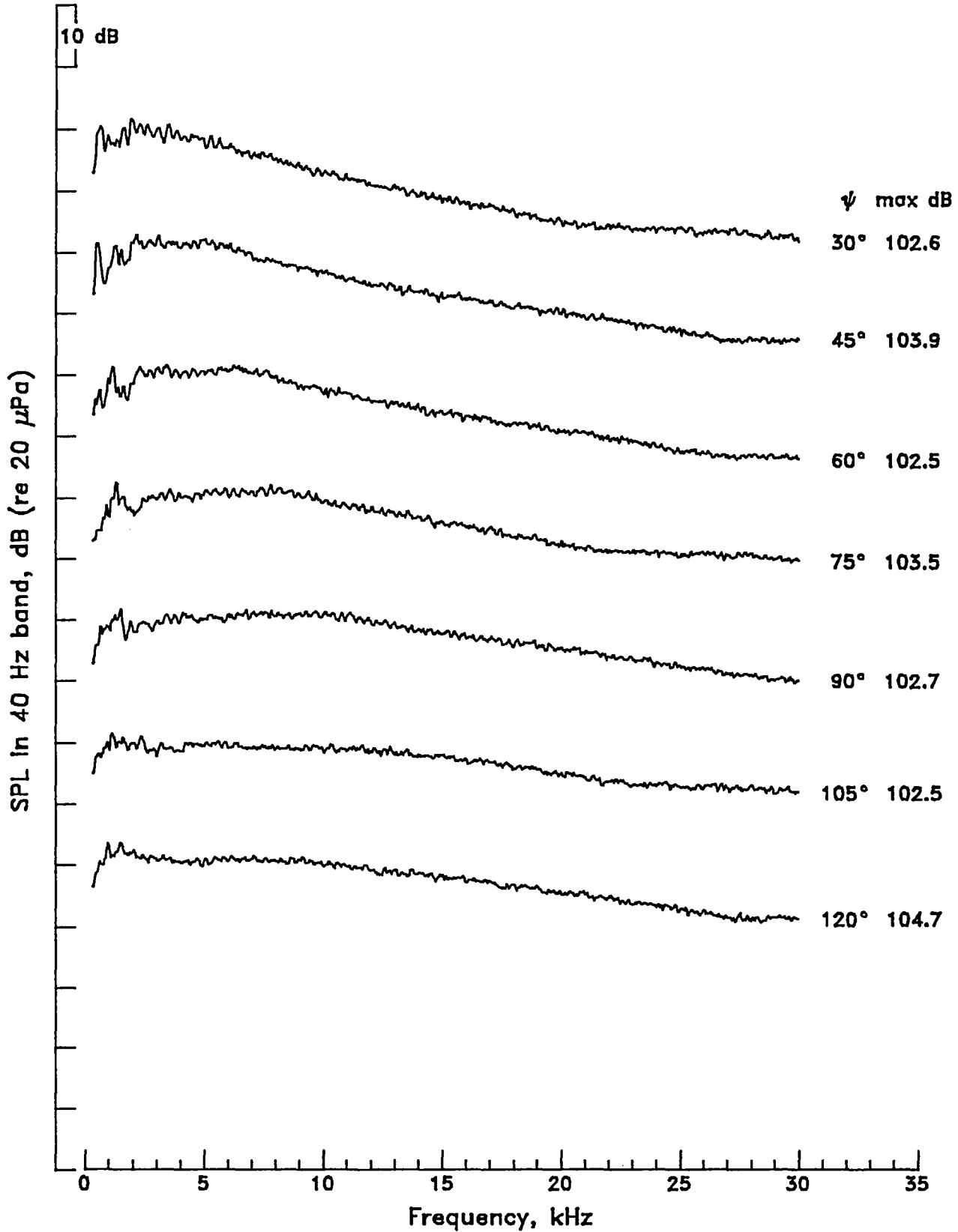

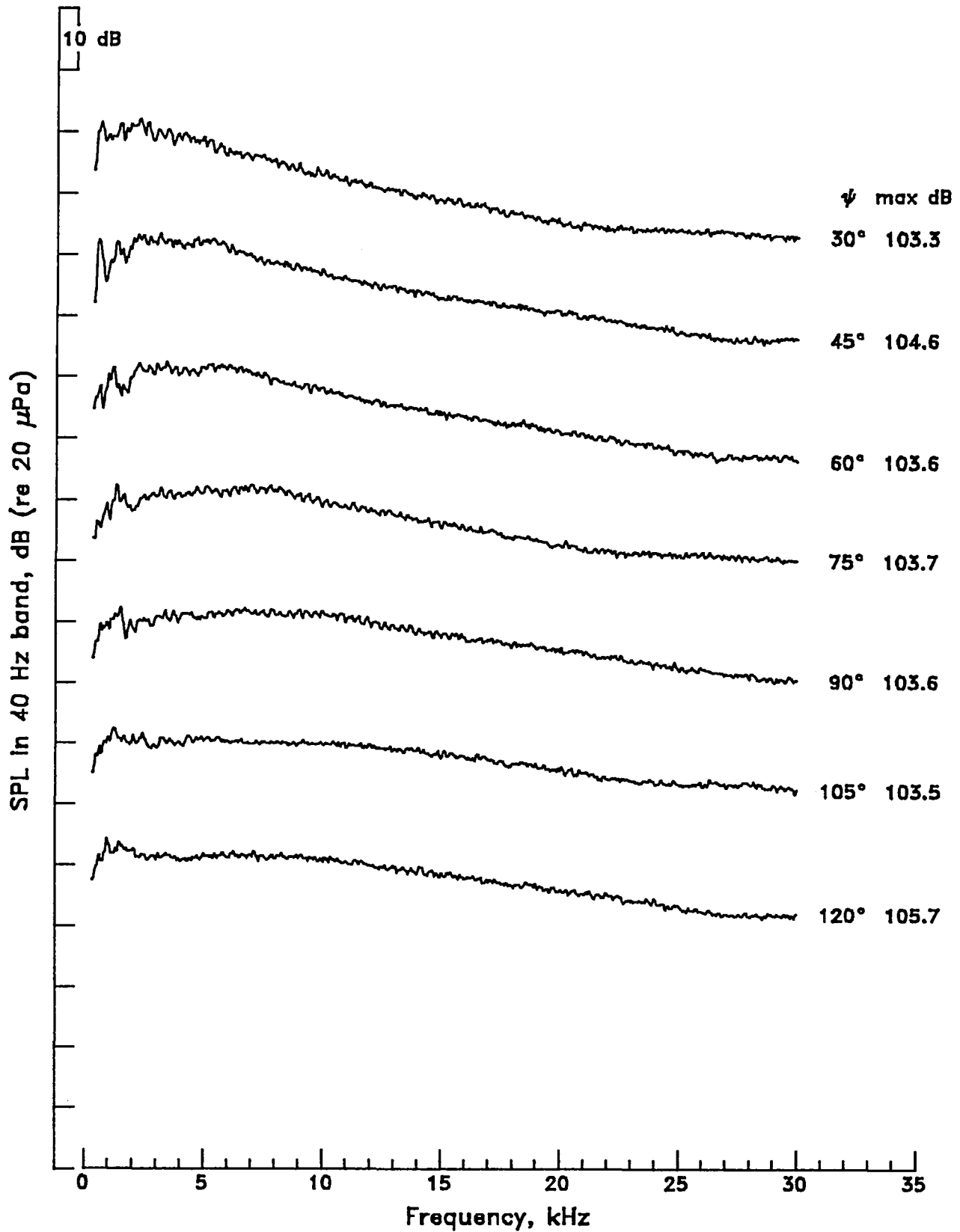
Mach 1.0 contoured nozzle with tab,  $\beta = 2.10$ 

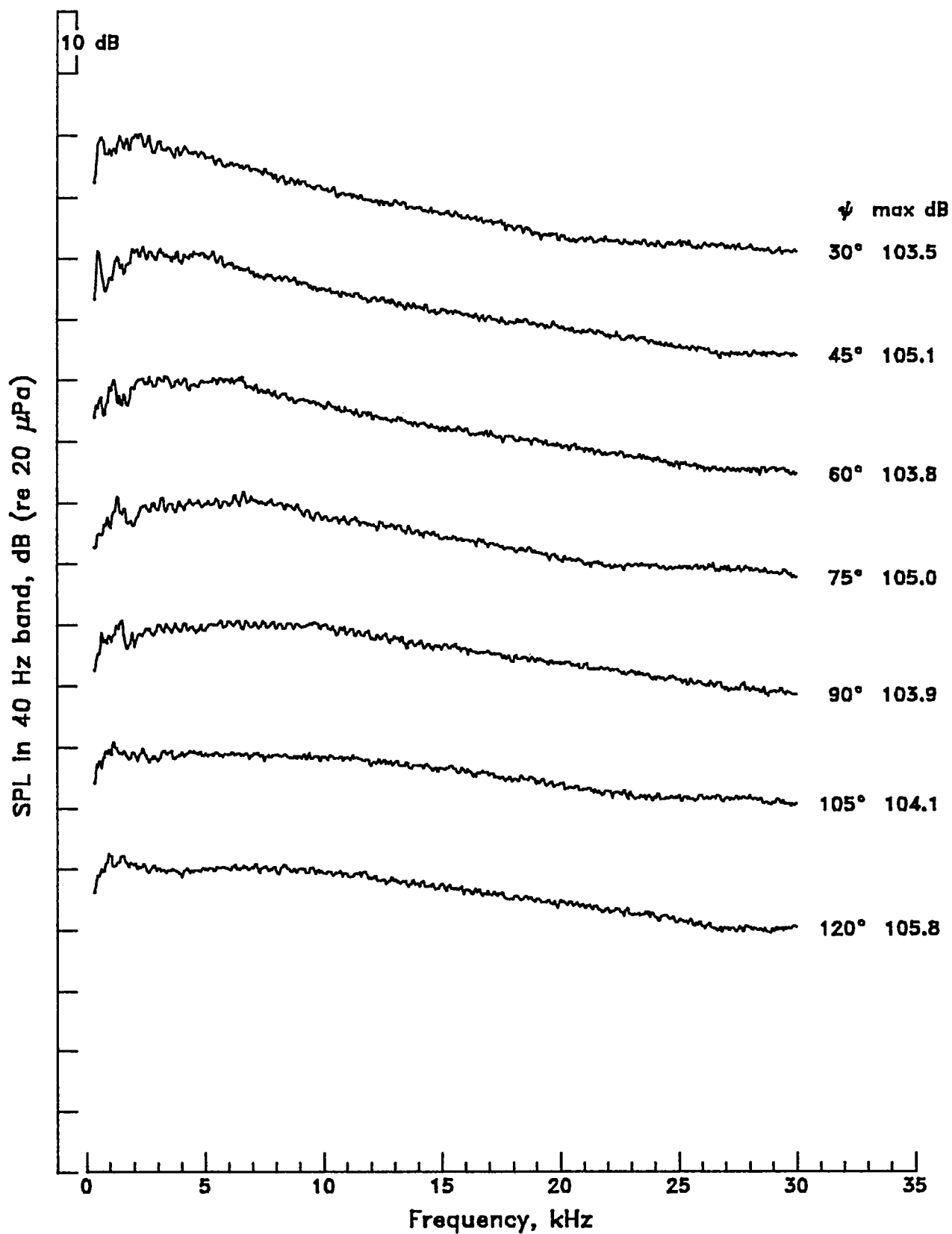

Mach 1.0 contoured nozzle with tab,  $\beta = 2.15$ 

Mach 1.5 contoured nozzle without tab,  $\beta = 0.40$

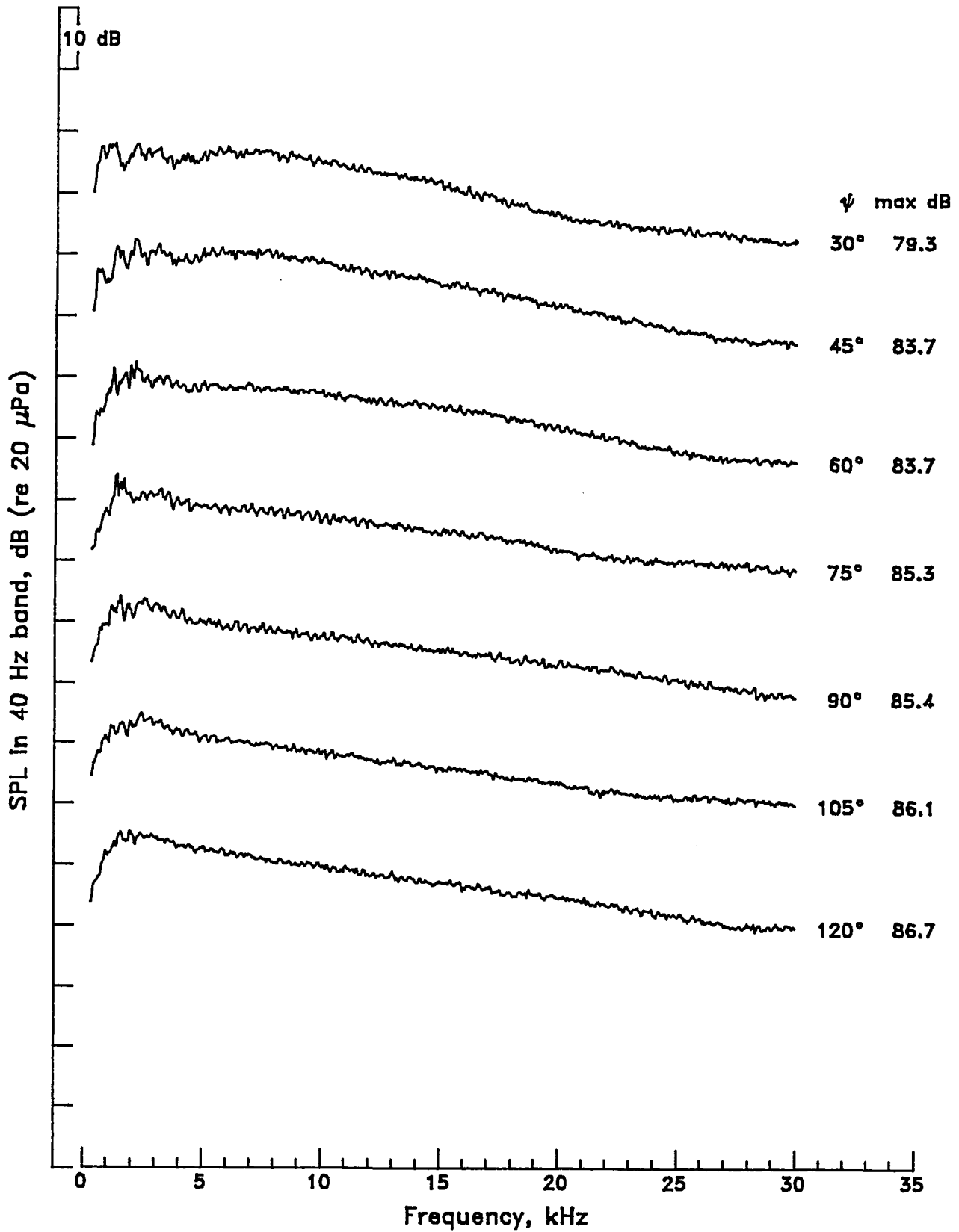

Mach 1.5 contoured nozzle without tab,  $\beta = 0.60$

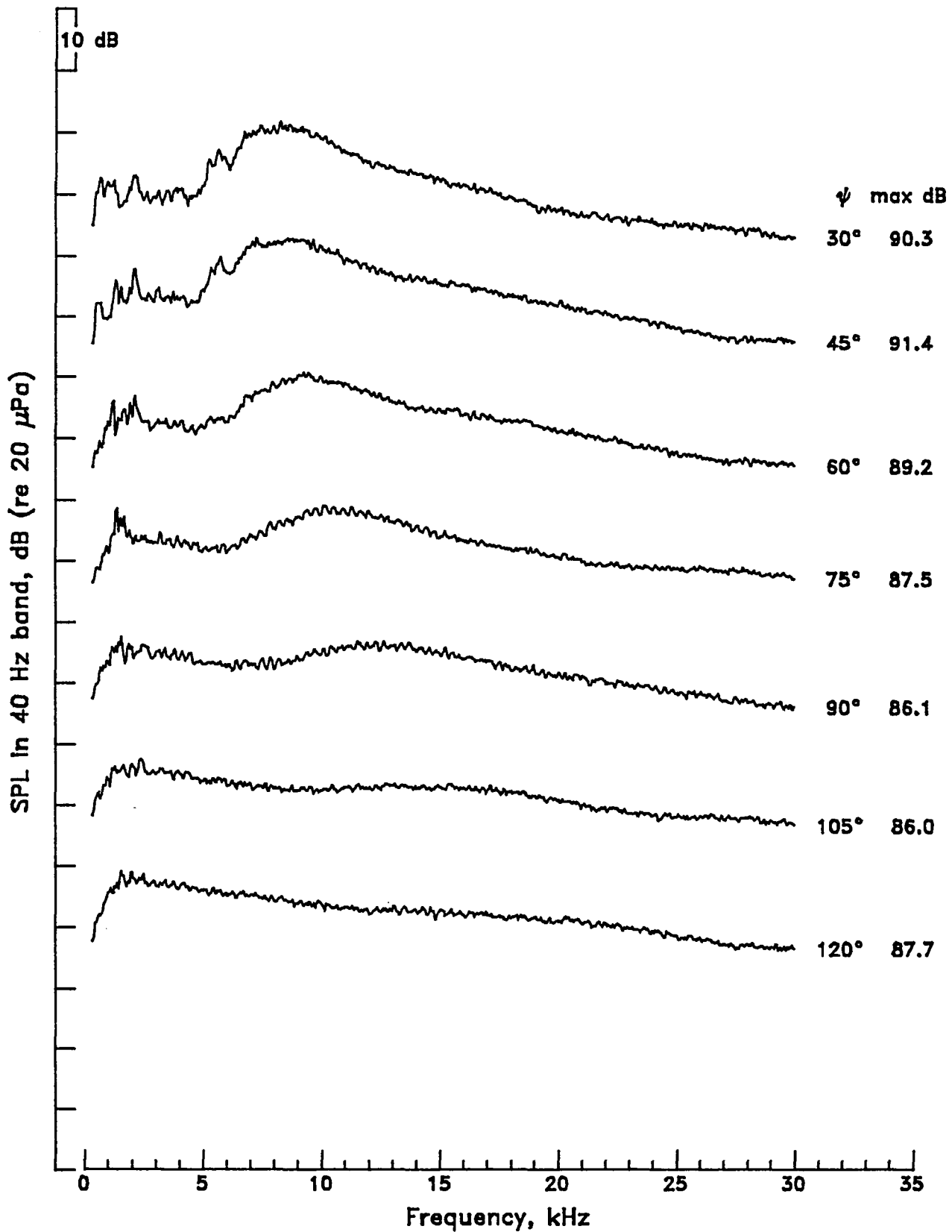

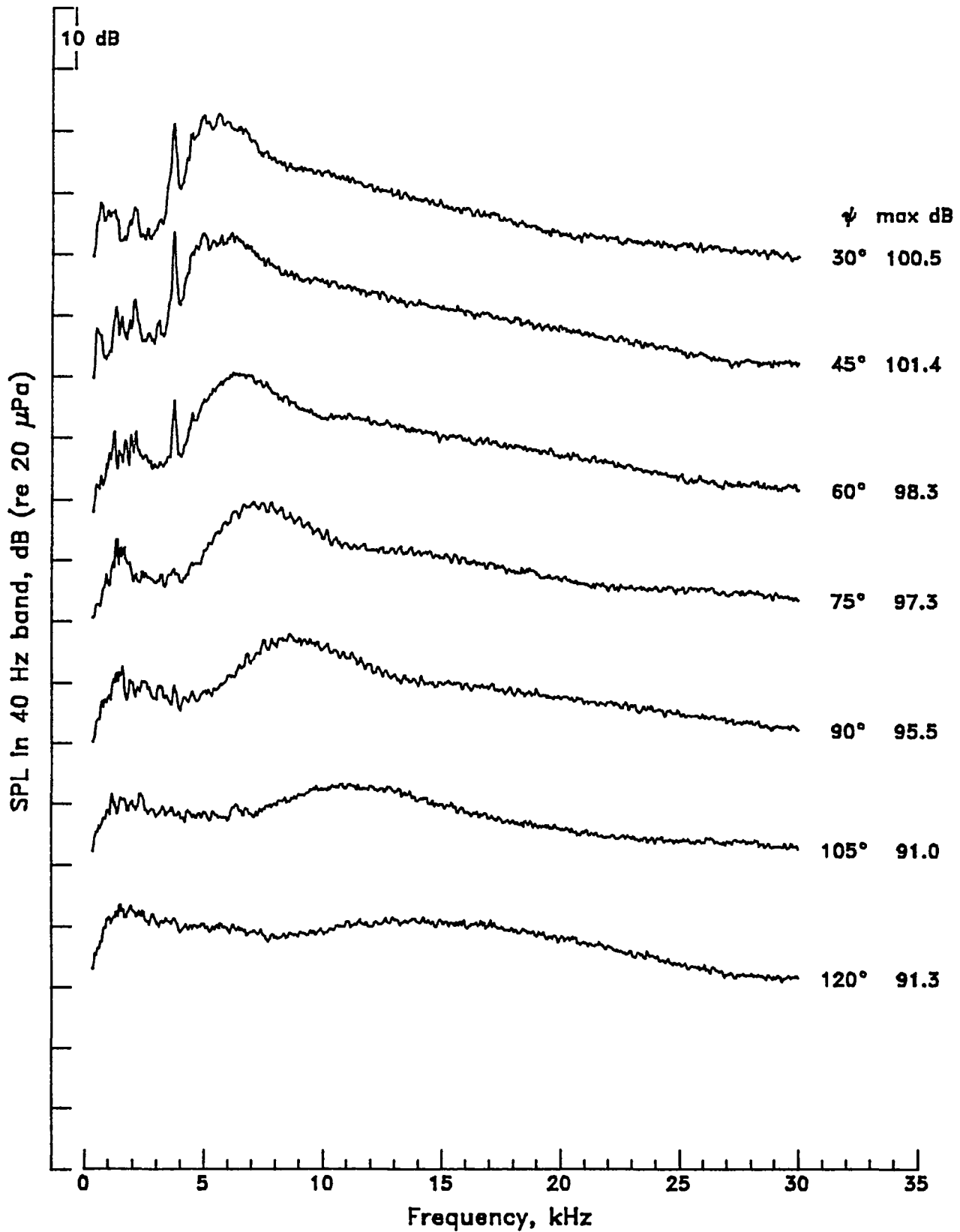
Mach 1.5 contoured nozzle without tab,  $\beta = 0.80$ 

Mach 1.5 contoured nozzle without tab,  $\beta = 0.94$

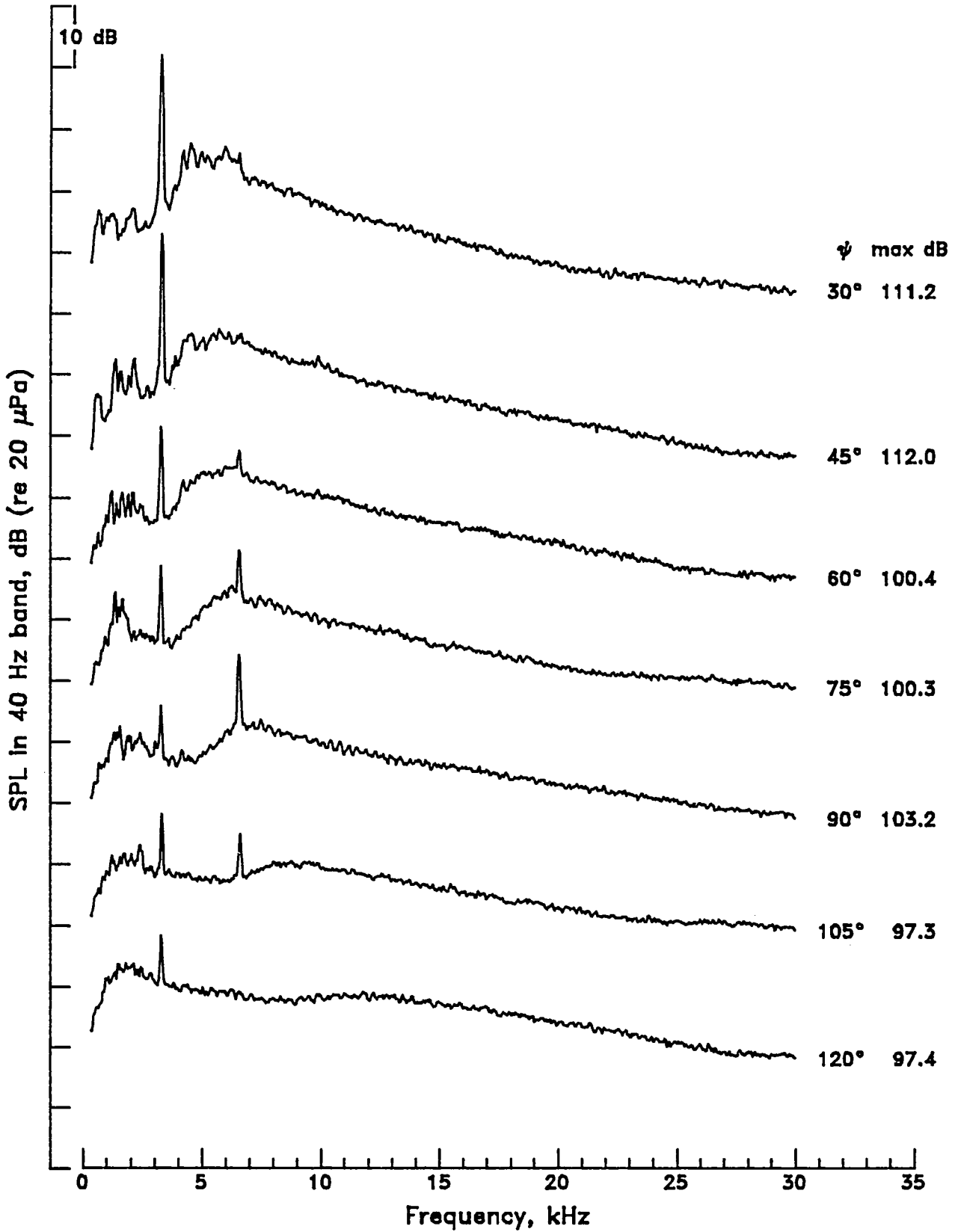

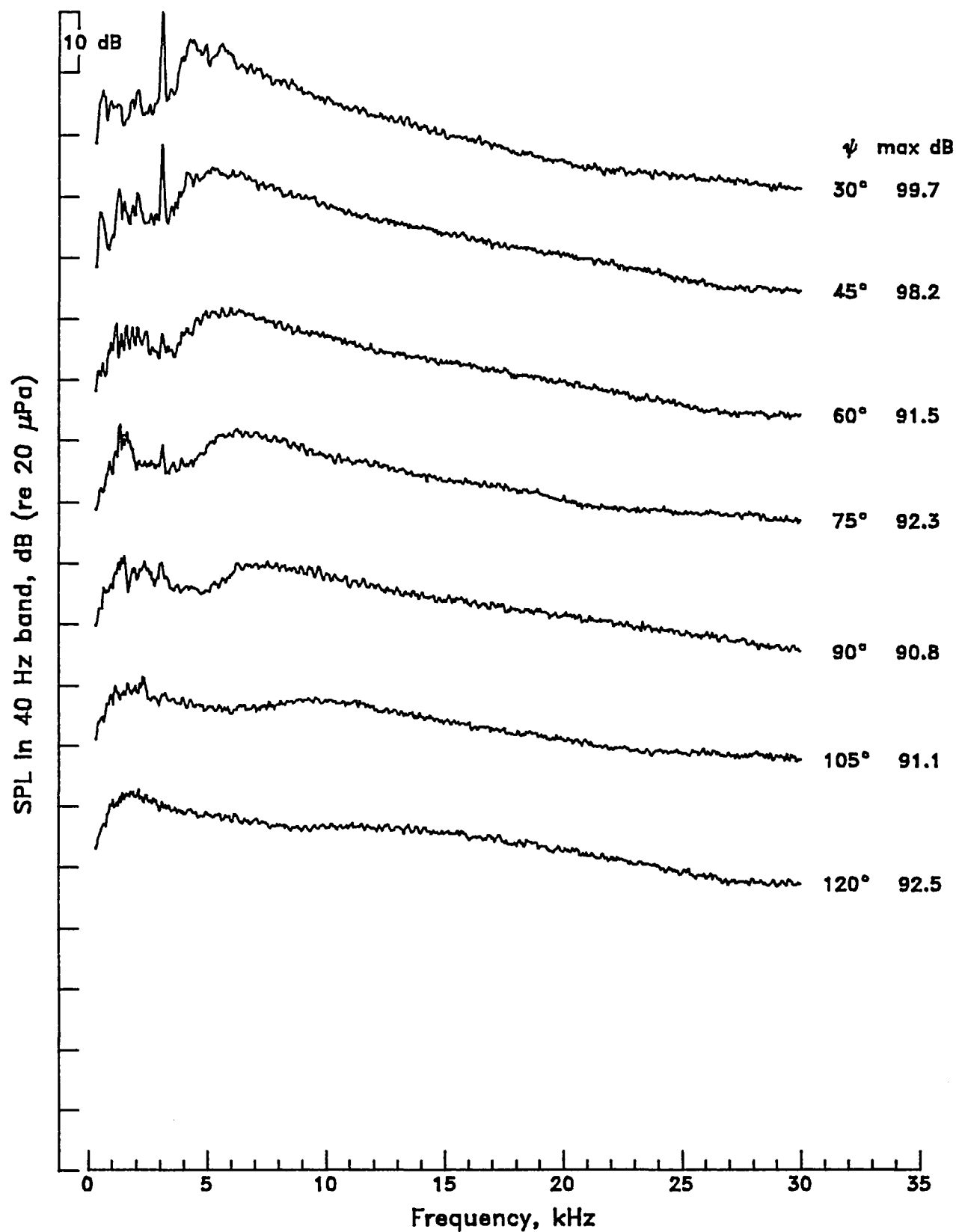
Mach 1.5 contoured nozzle without tab,  $\beta = 1.00$ 

Mach 1.5 contoured nozzle without tab,  $\beta = 1.10$

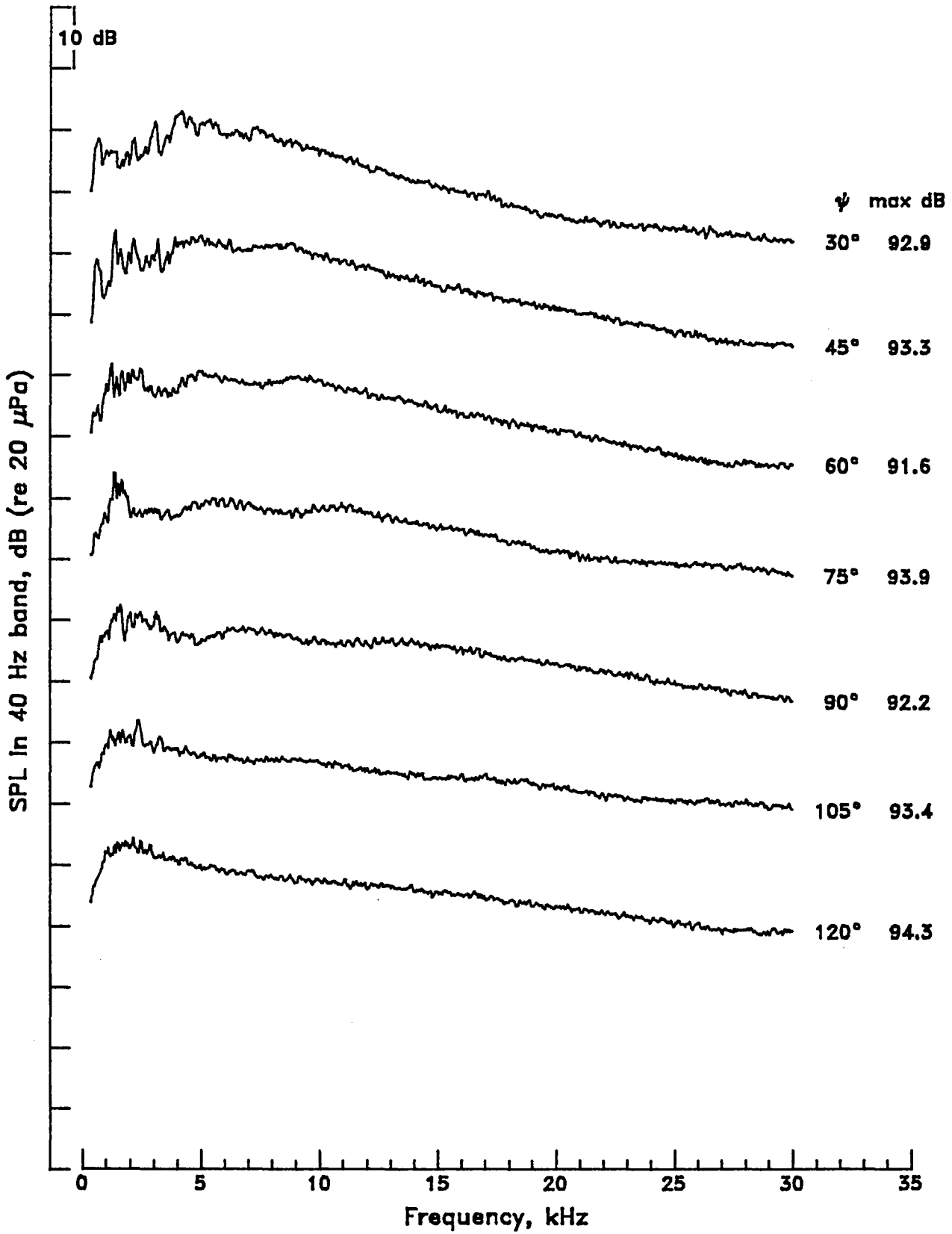

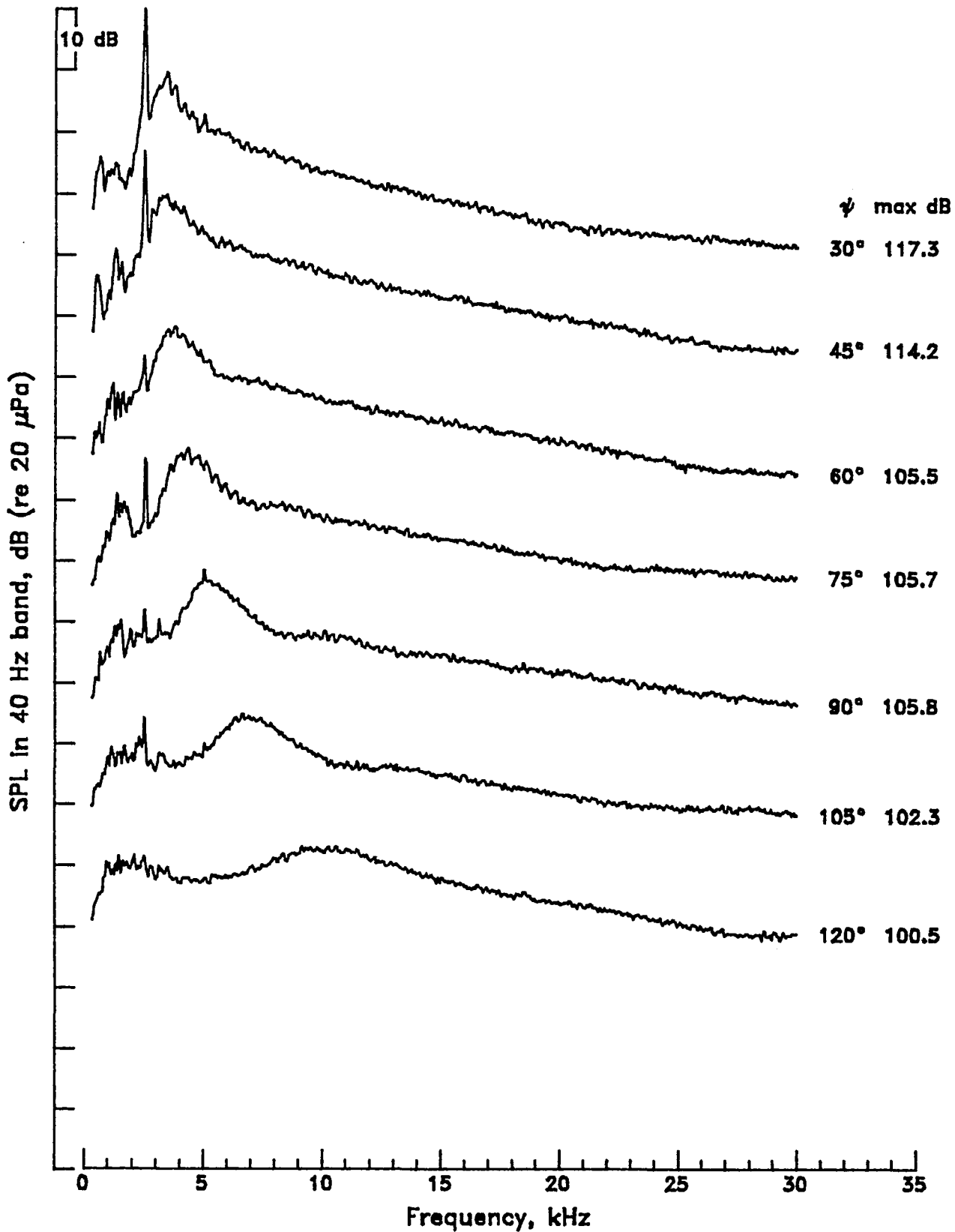
Mach 1.5 contoured nozzle without tab,  $\beta = 1.34$ 



Mach 1.5 contoured nozzle without tab,  $\beta = 1.50$

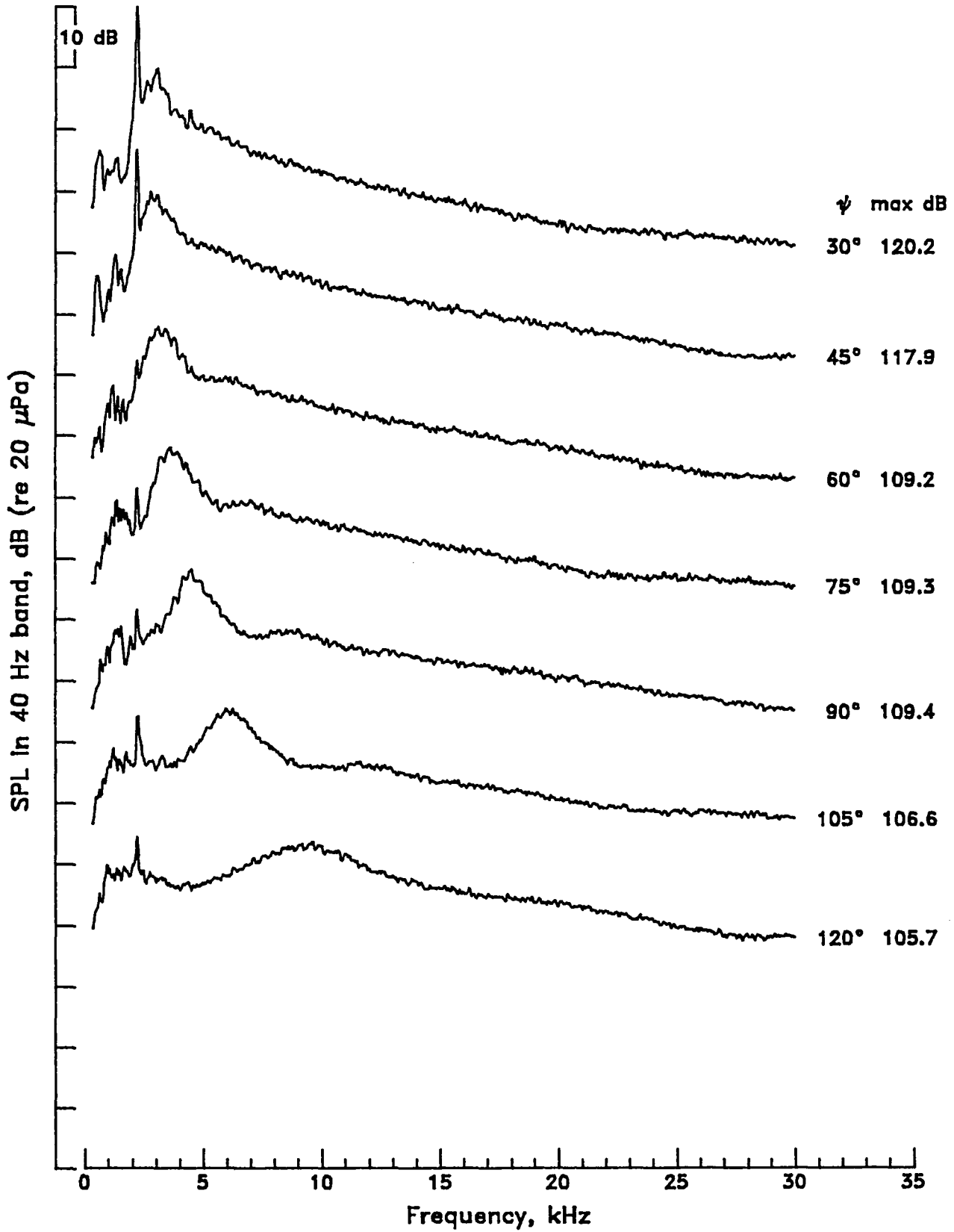

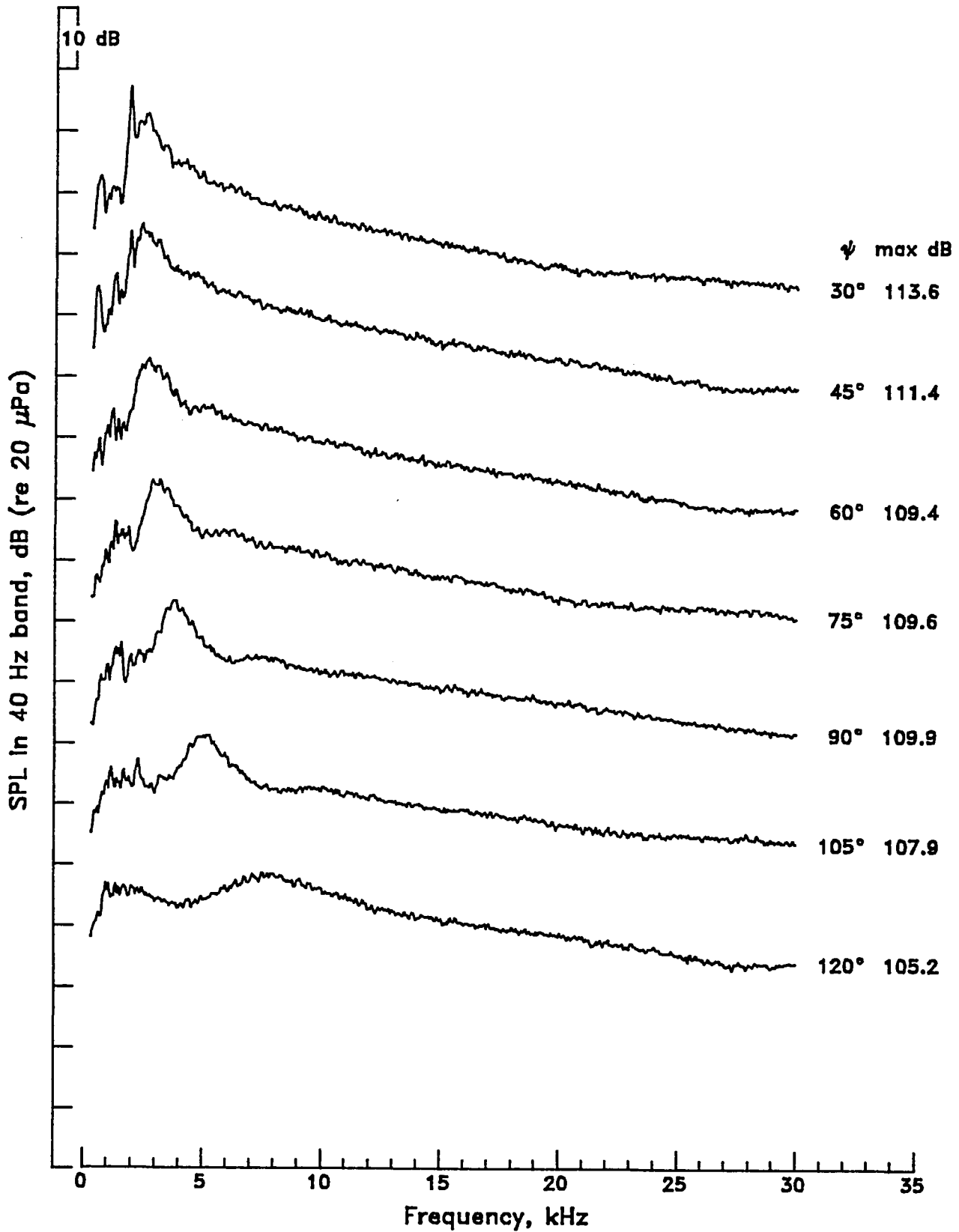
Mach 1.5 contoured nozzle without tab,  $\beta = 1.72$ 

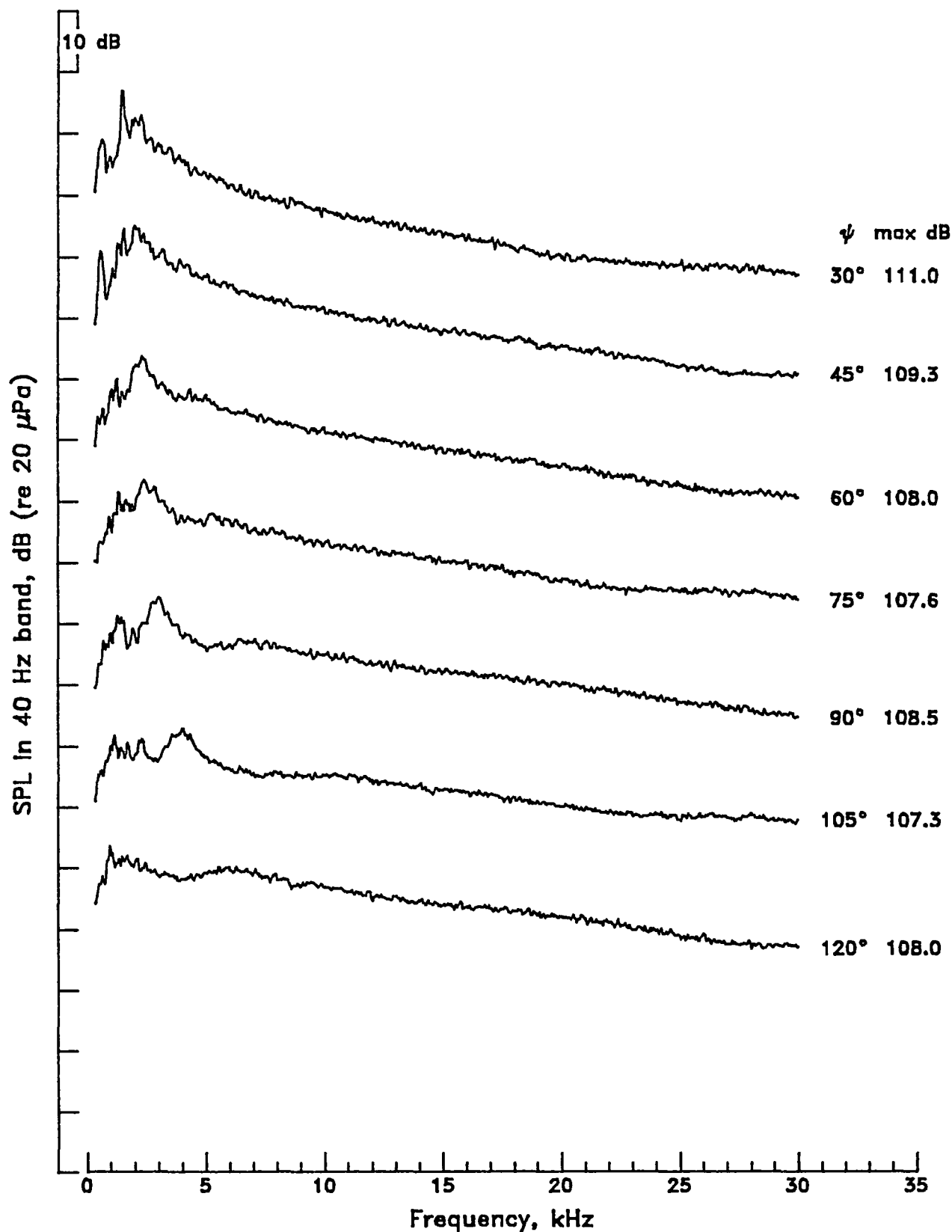
Mach 1.5 contoured nozzle without tab,  $\beta = 2.00$ 

Mach 1.5 contoured nozzle without tab,  $\beta = 2.10$

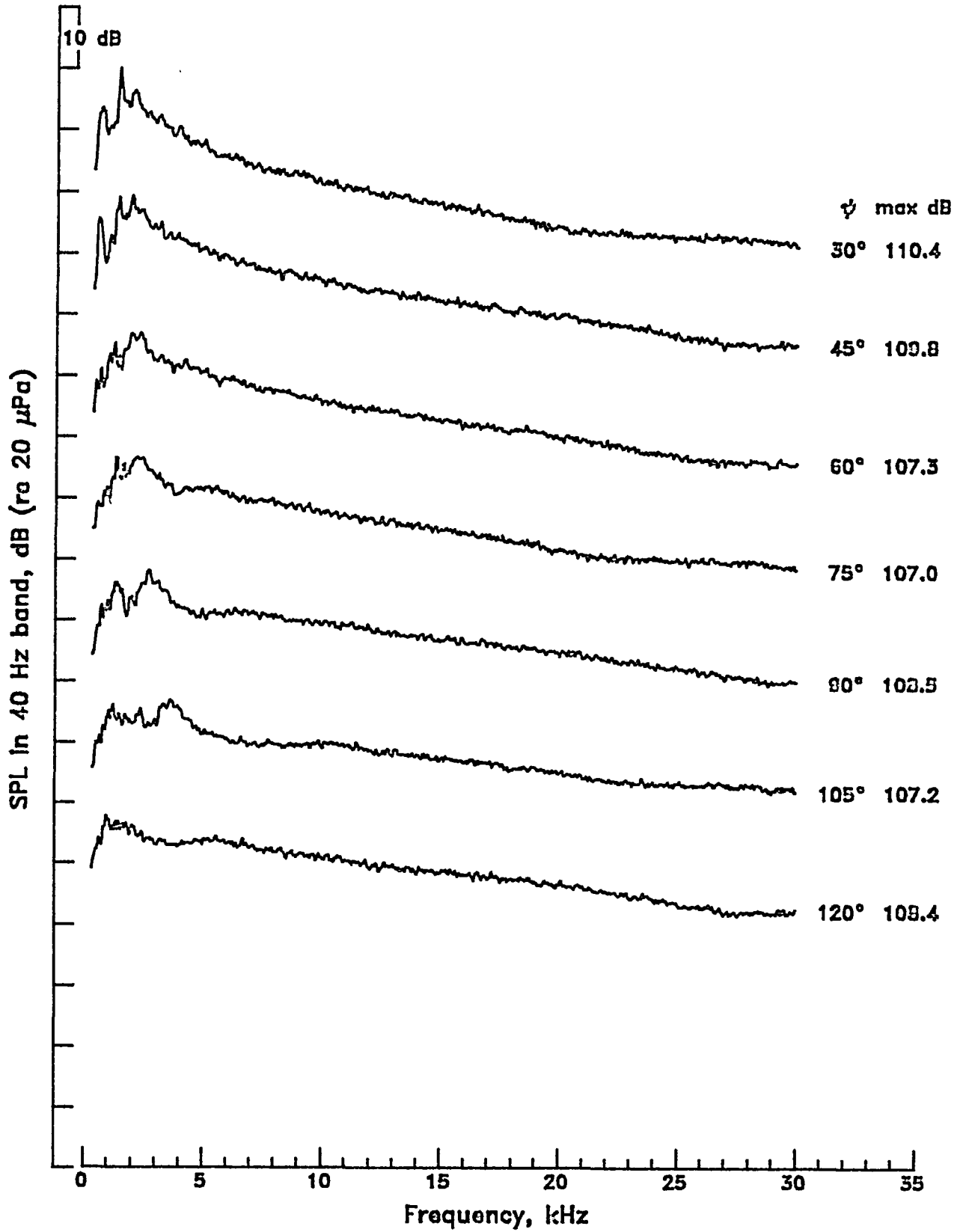

APPENDIX E

Mach 1.5 contoured nozzle without tab,  $\beta = 2.15$

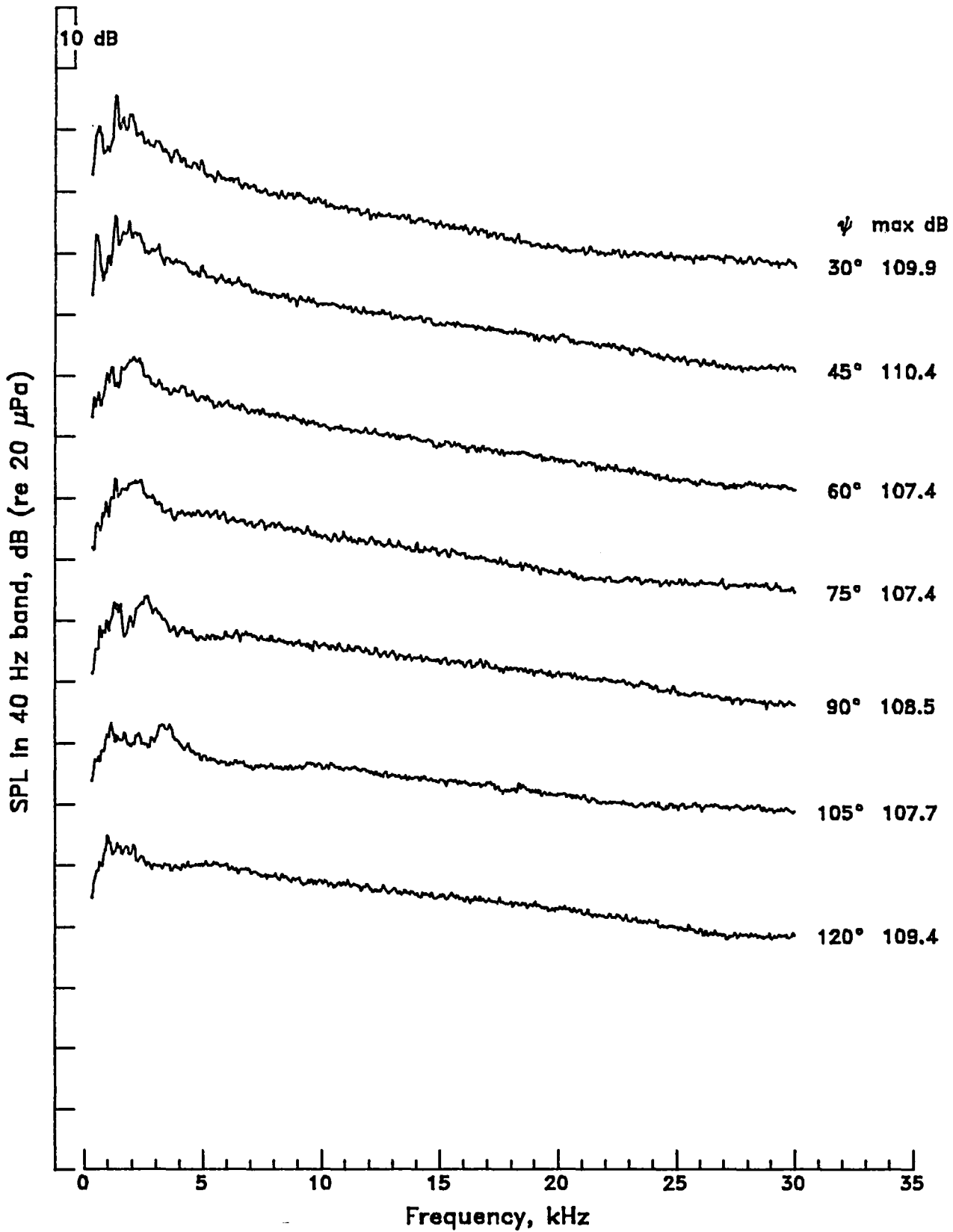

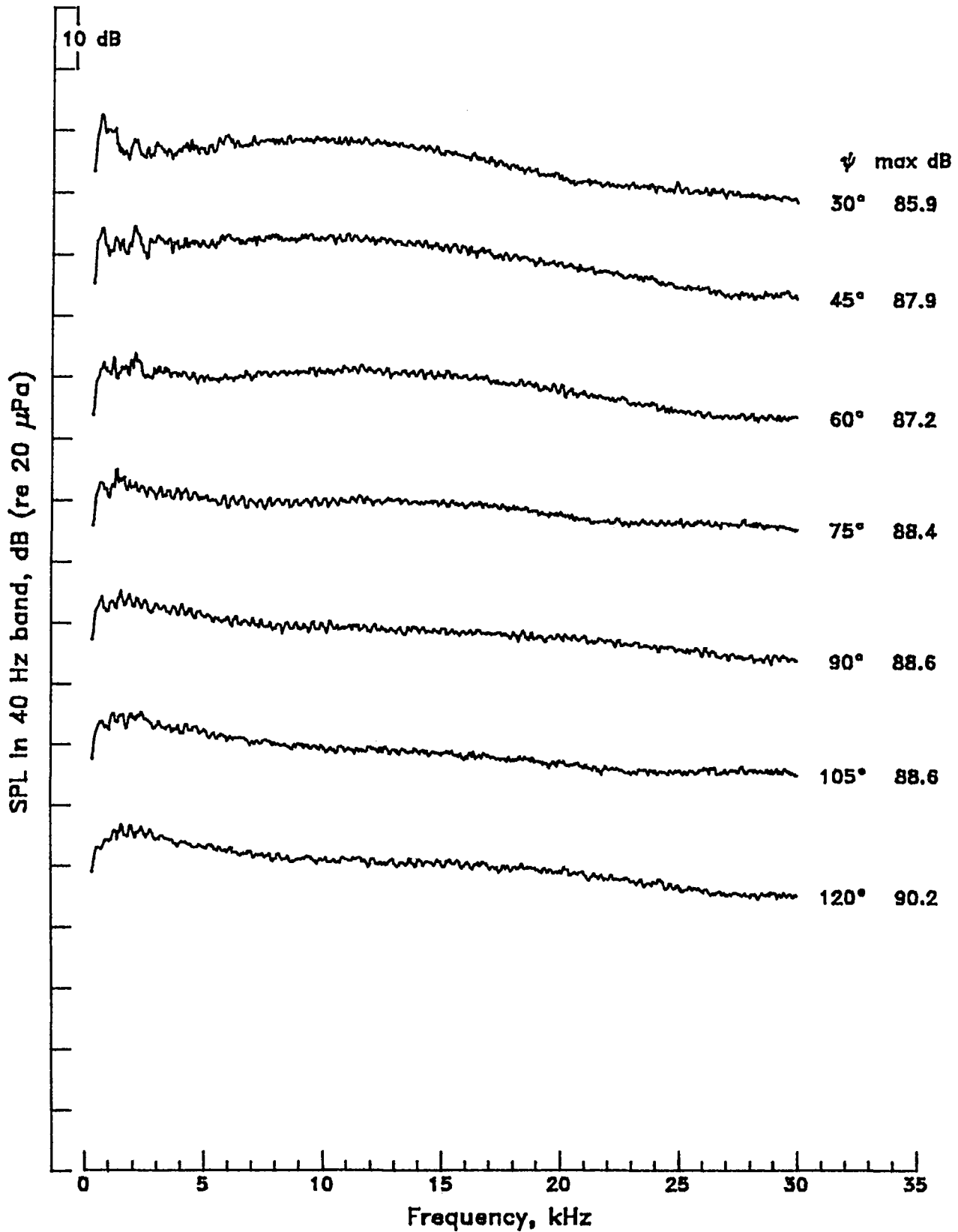
Mach 2.0 contoured nozzle without tab,  $\beta = 0.60$ 

Mach 2.0 contoured nozzle without tab,  $\beta = 0.70$

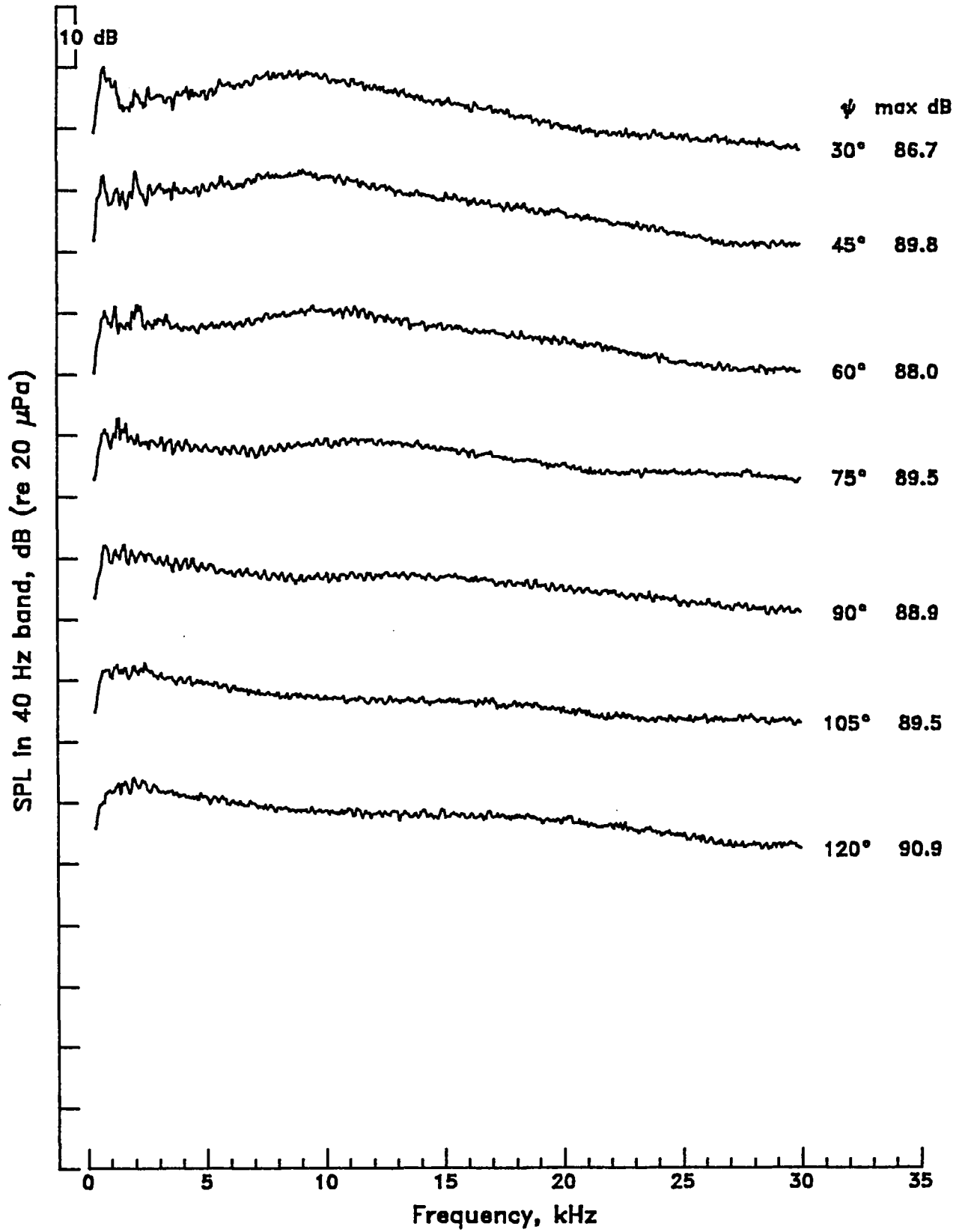

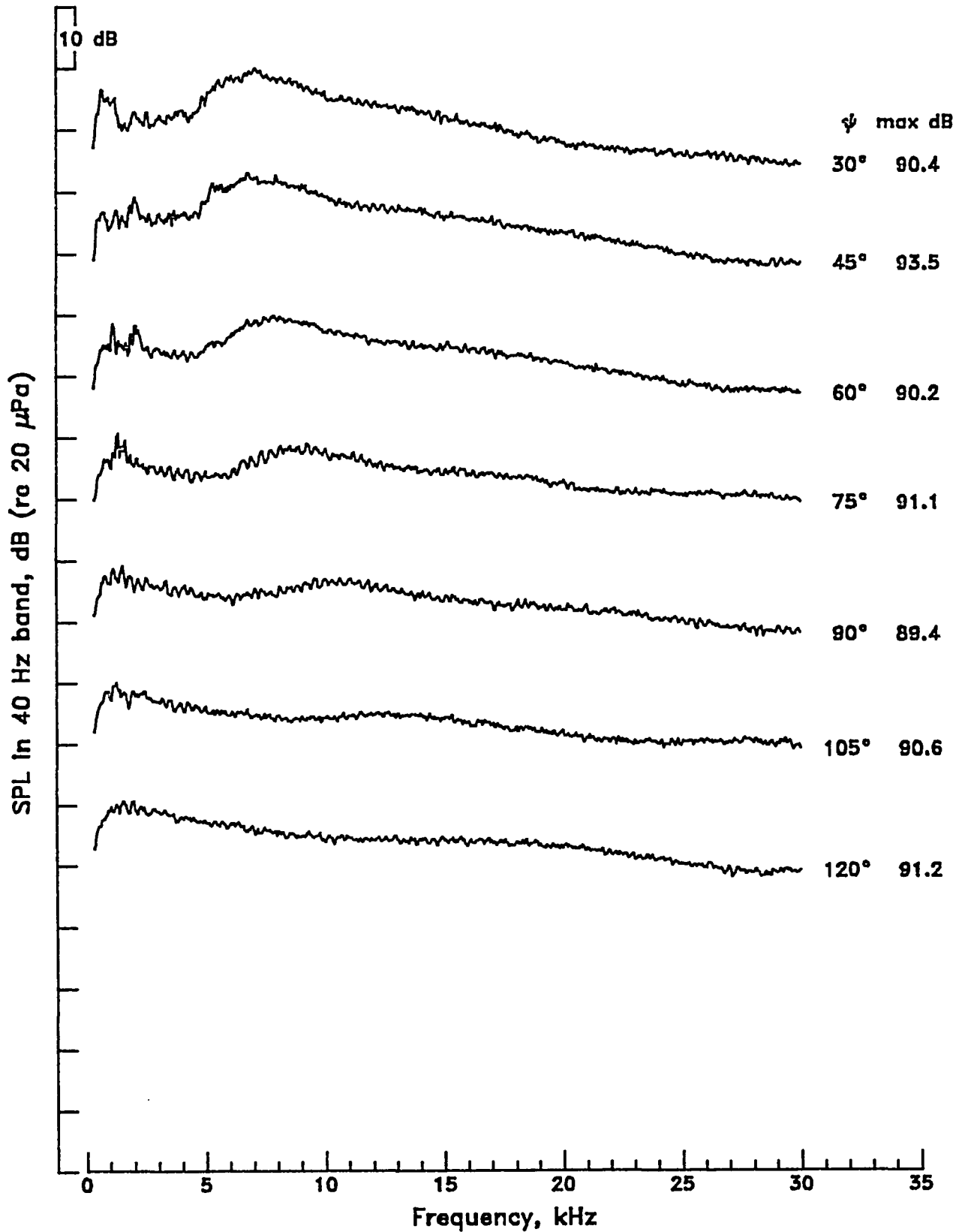
Mach 2.0 contoured nozzle without tab,  $\beta = 0.80$ 



Mach 2.0 contoured nozzle without tab,  $\beta = 0.94$

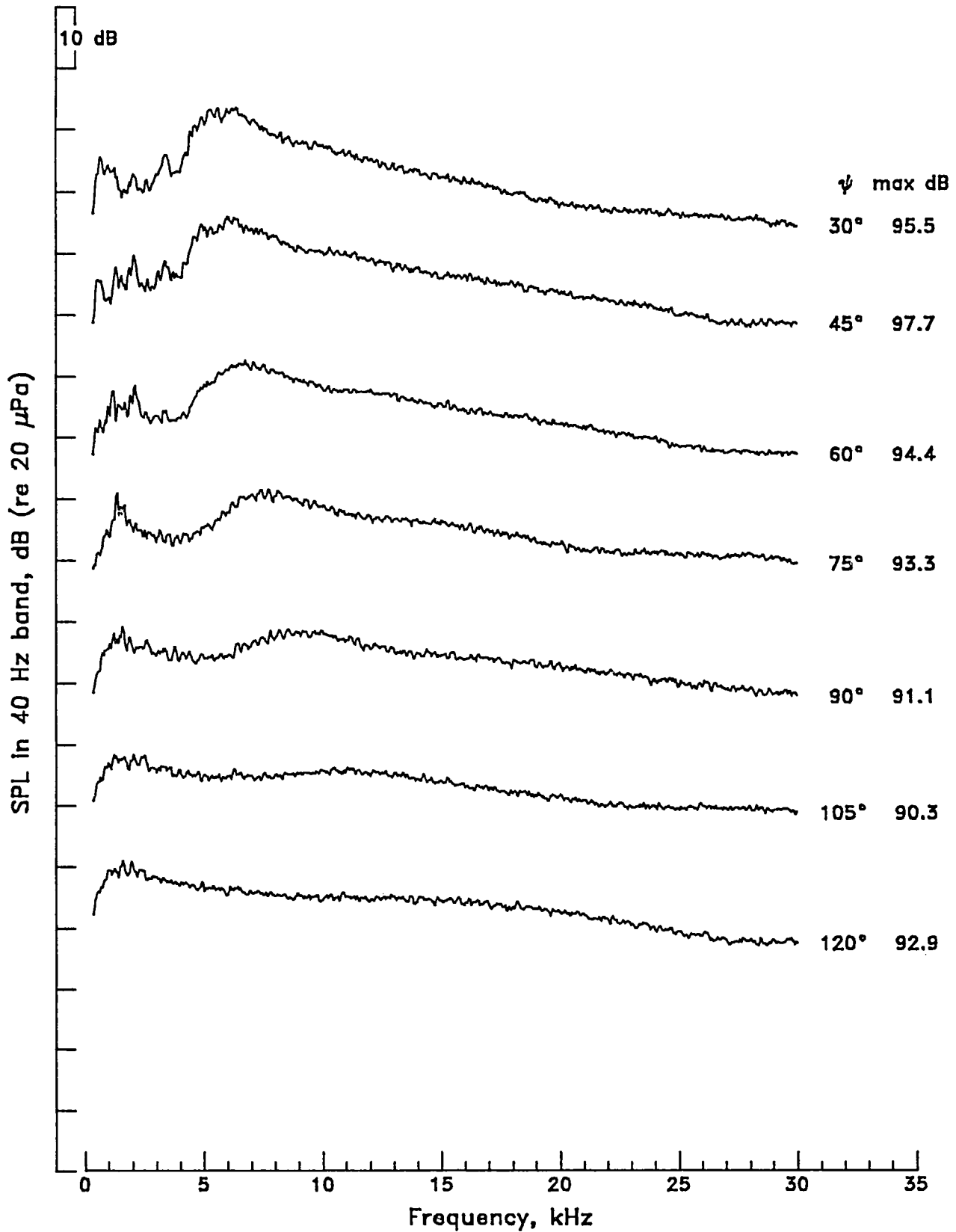

Mach 2.0 contoured nozzle without tab,  $\beta = 1.00$

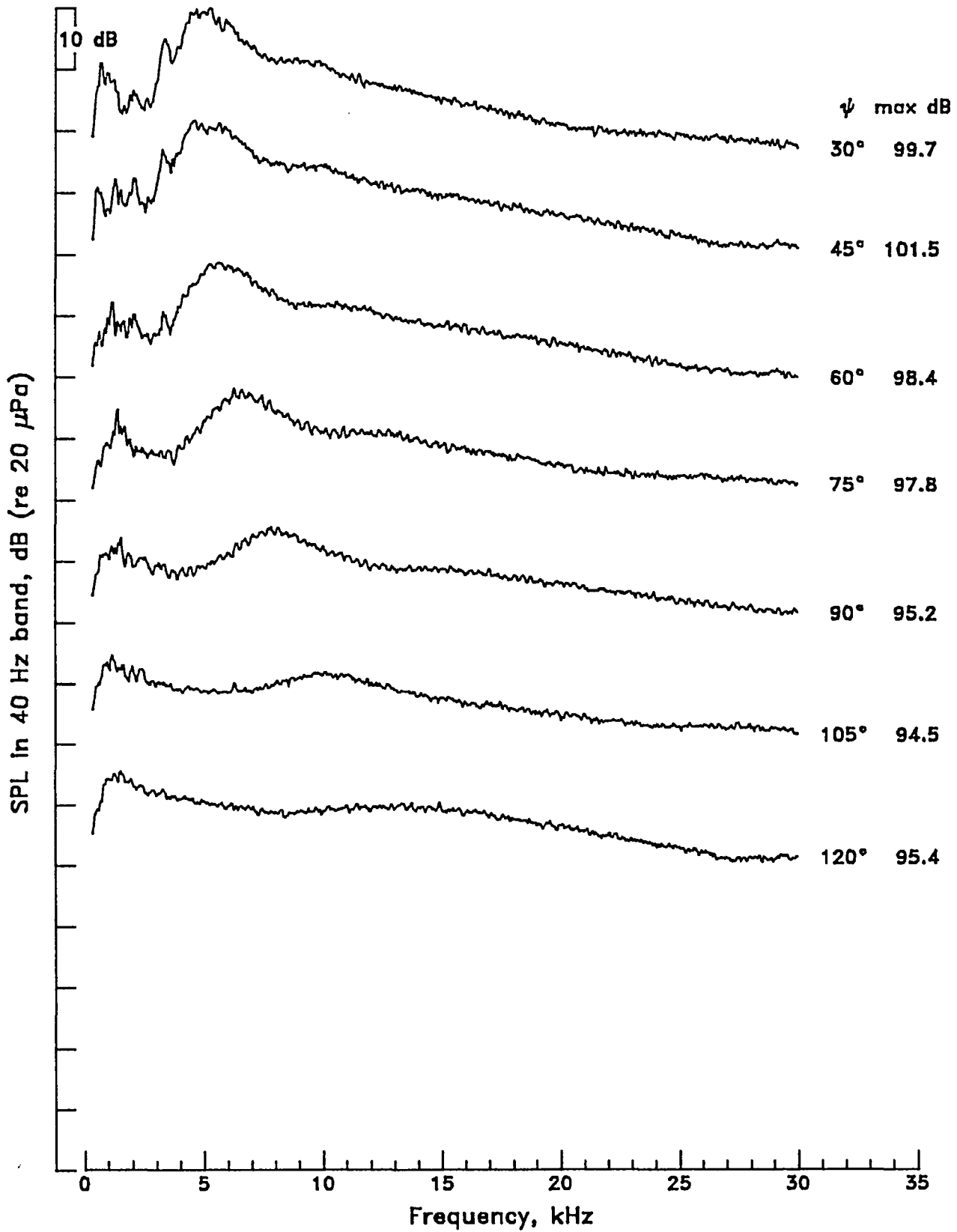

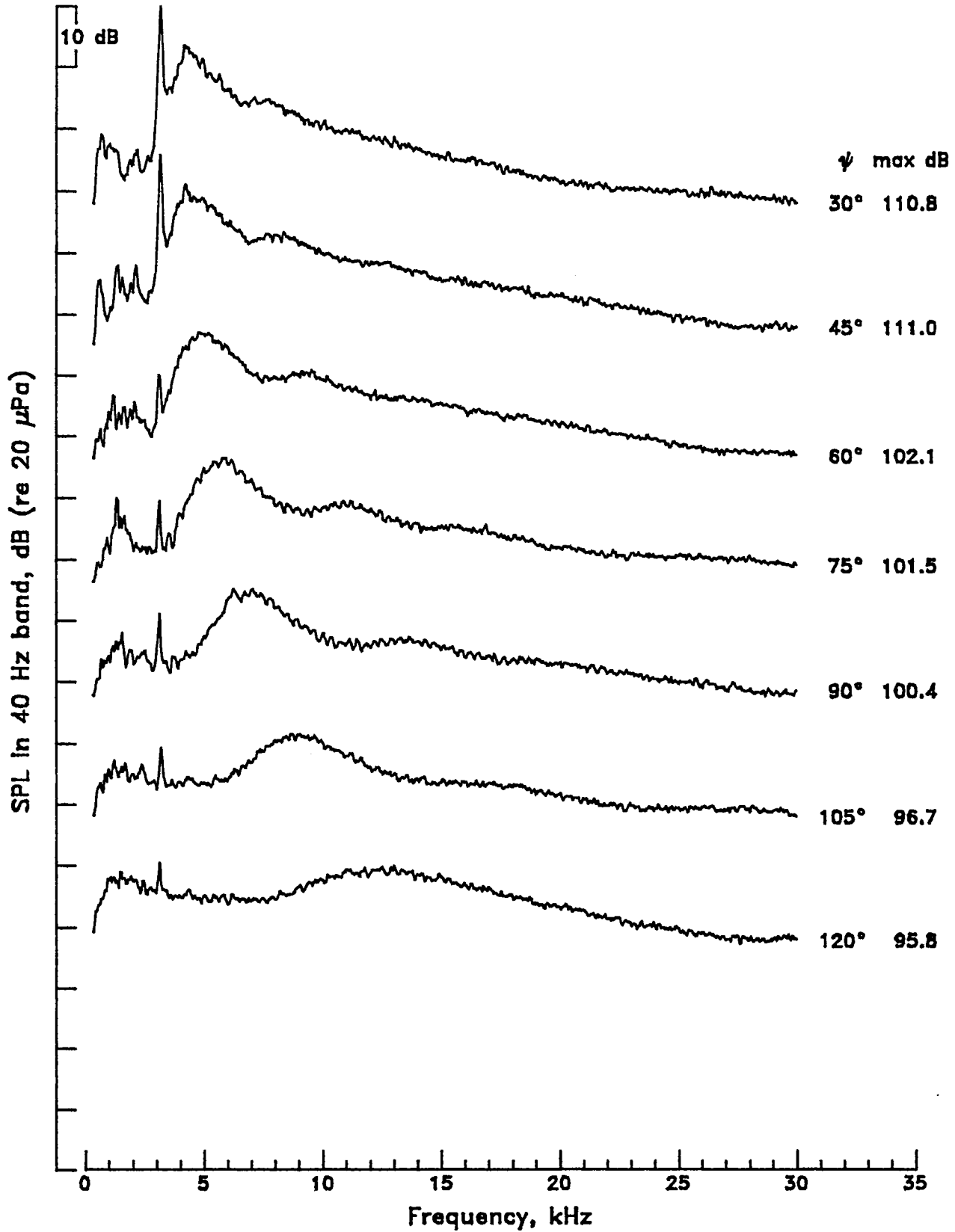
Mach 2.0 contoured nozzle without tab,  $\beta = 1.10$ 

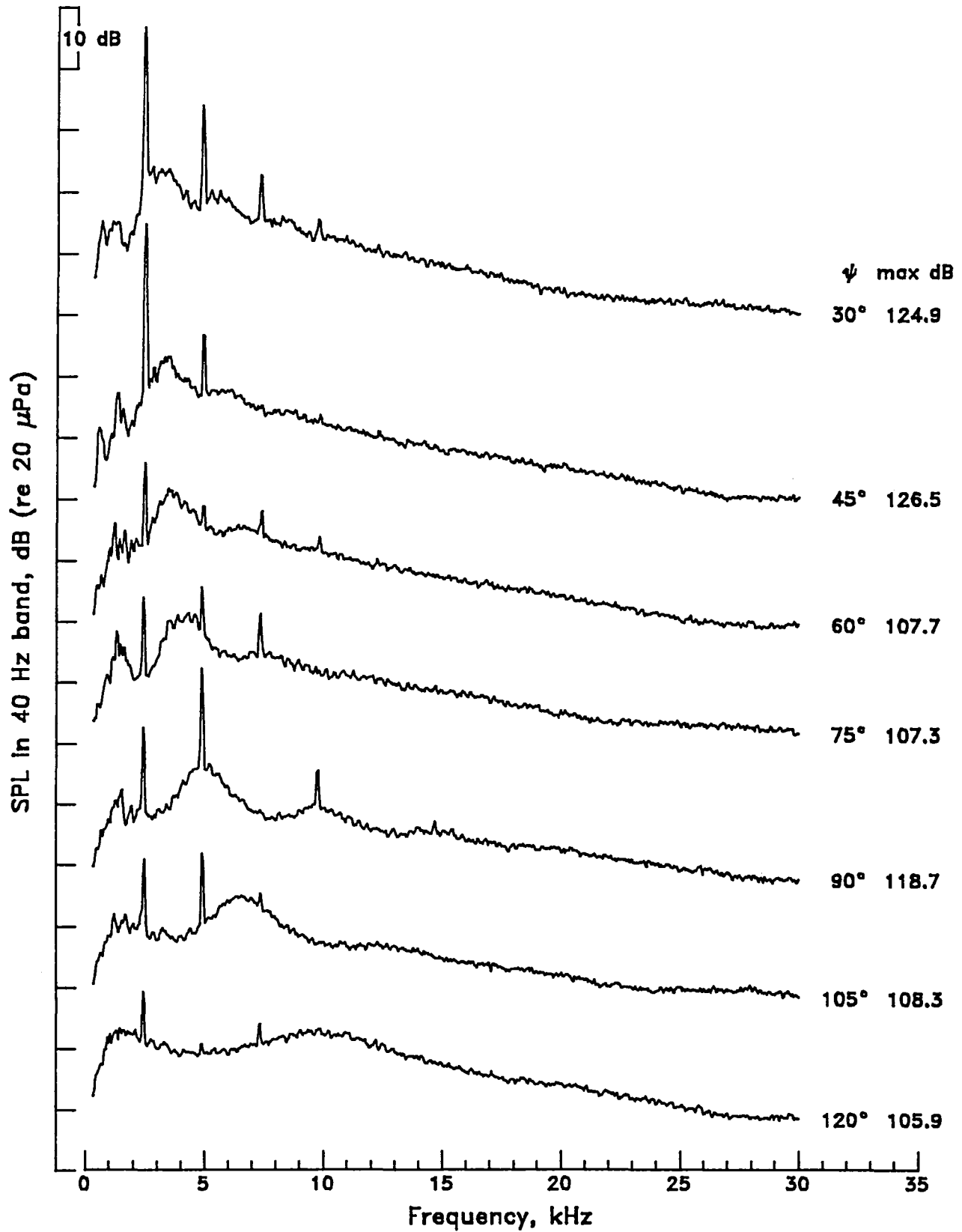
Mach 2.0 contoured nozzle without tab,  $\beta = 1.34$ 

Mach 2.0 contoured nozzle without tab,  $\beta = 1.50$

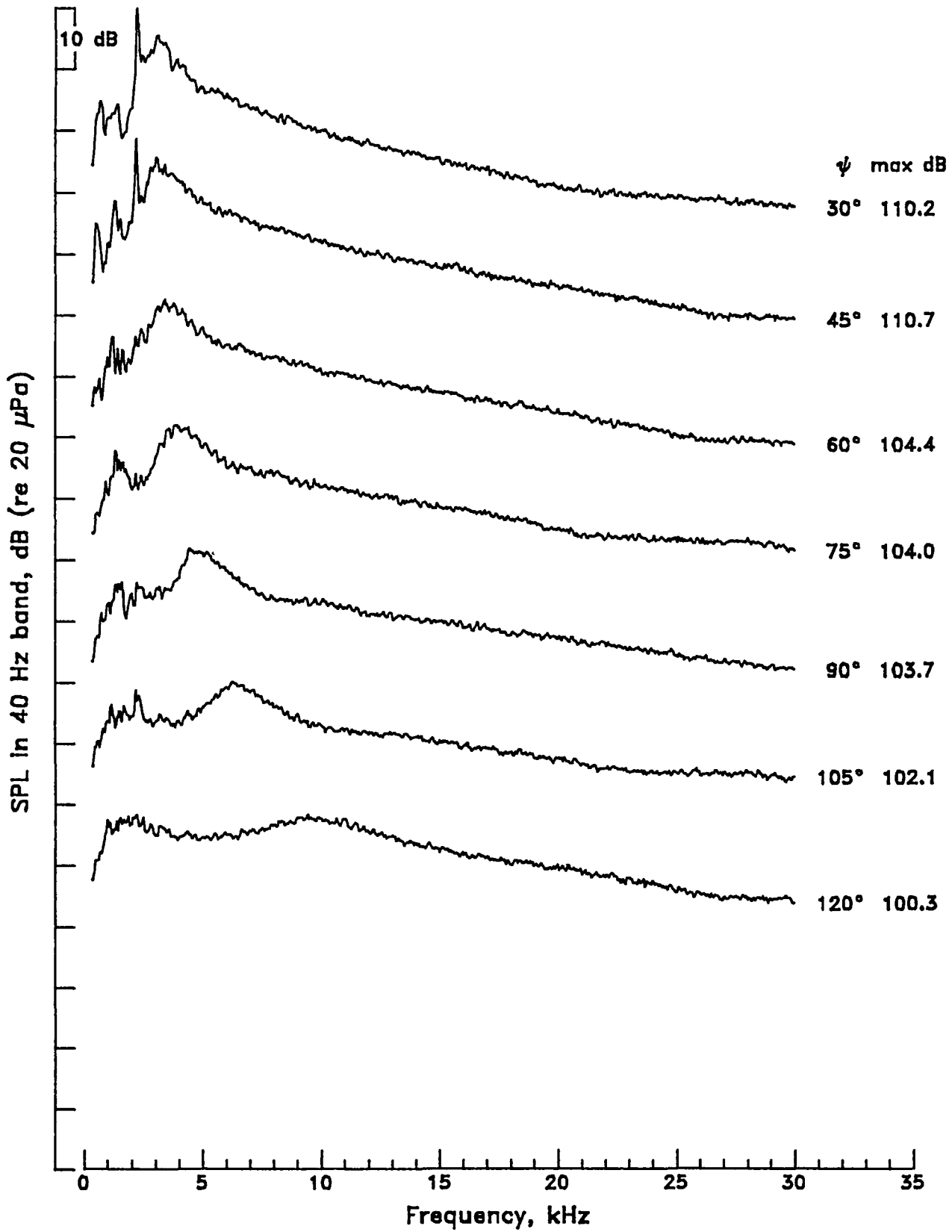

Mach 2.0 contoured nozzle without tab,  $\beta = 1.72$

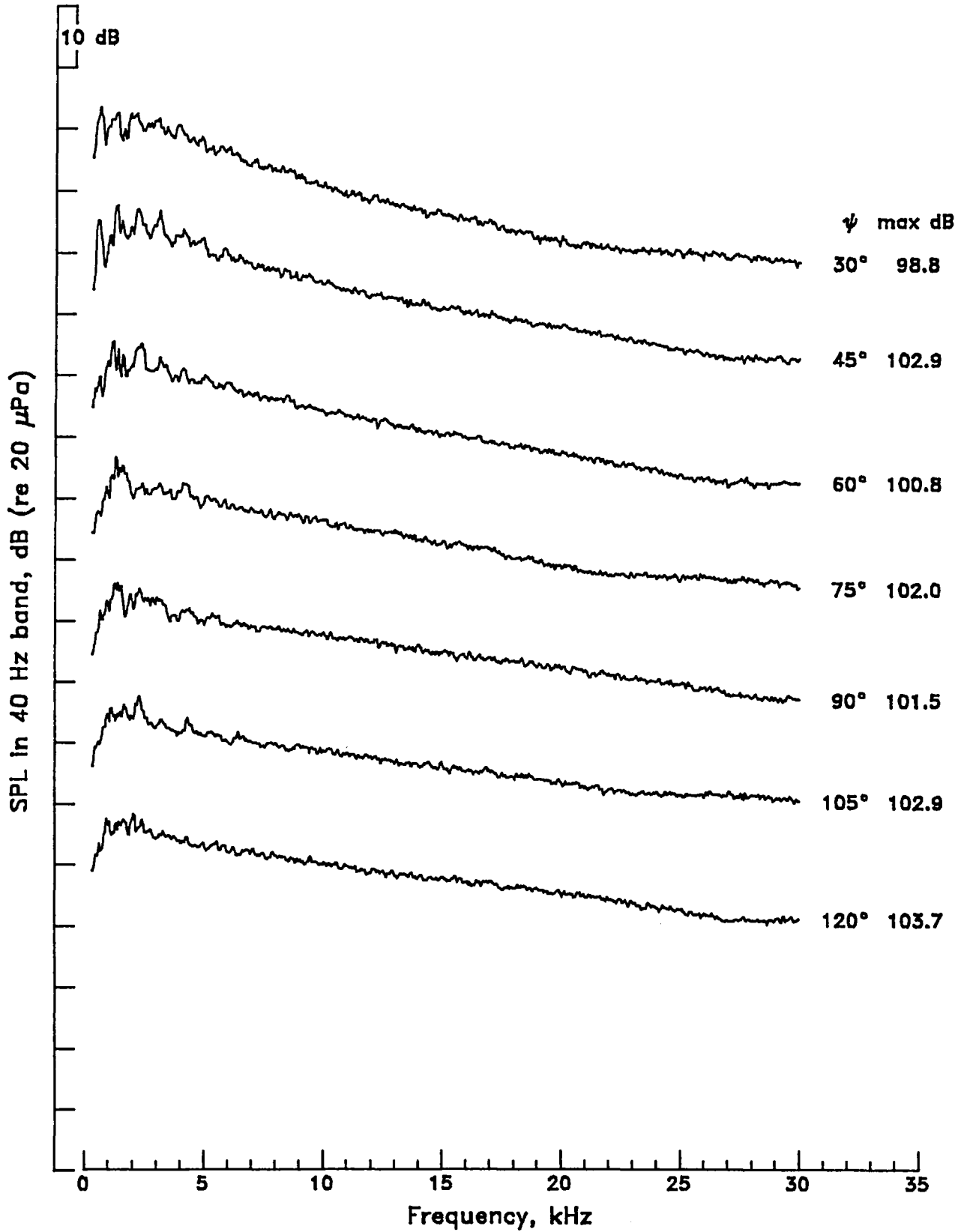

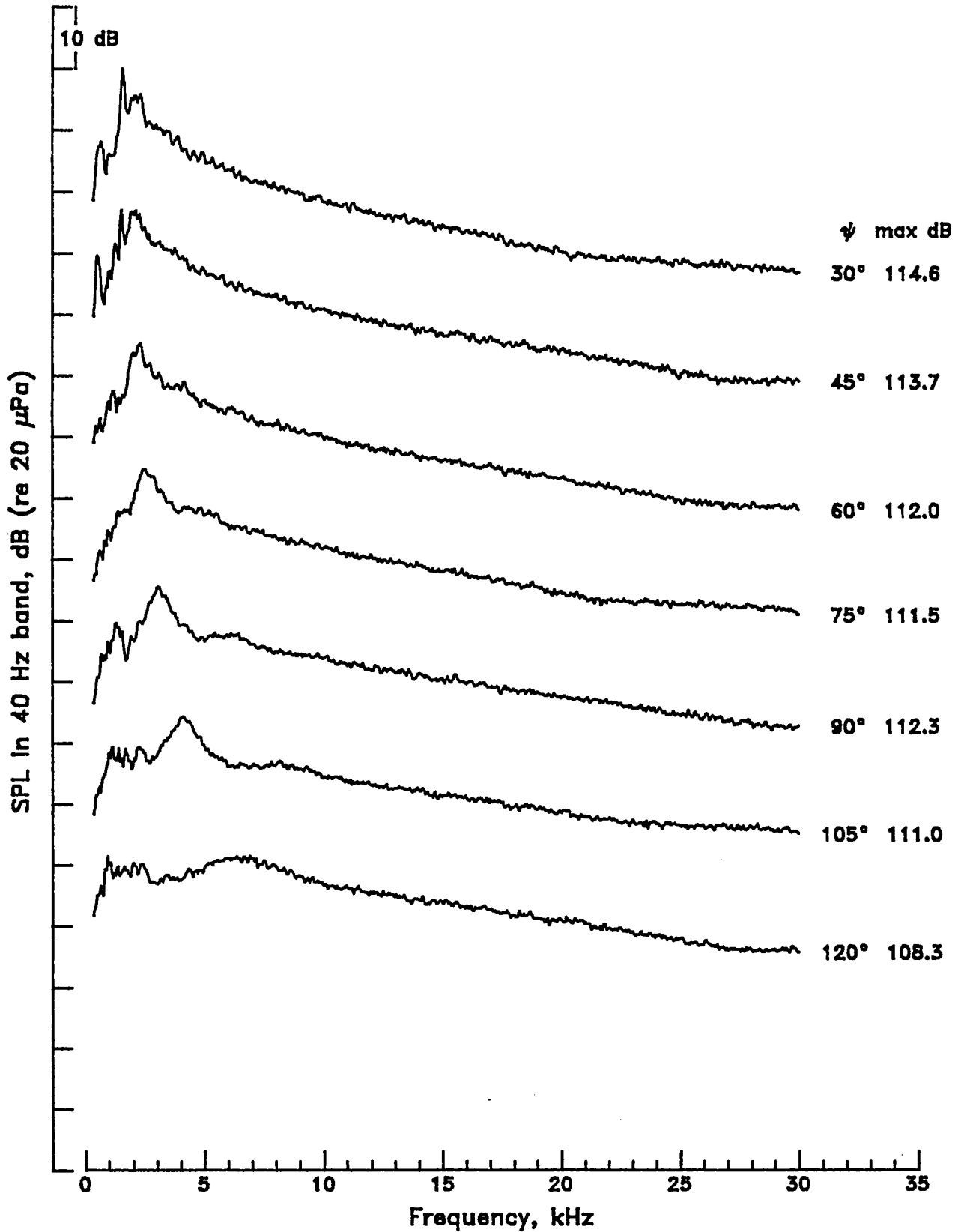
Mach 2.0 contoured nozzle without tab,  $\beta = 2.00$ 

Mach 2.0 contoured nozzle without tab,  $\beta = 2.10$

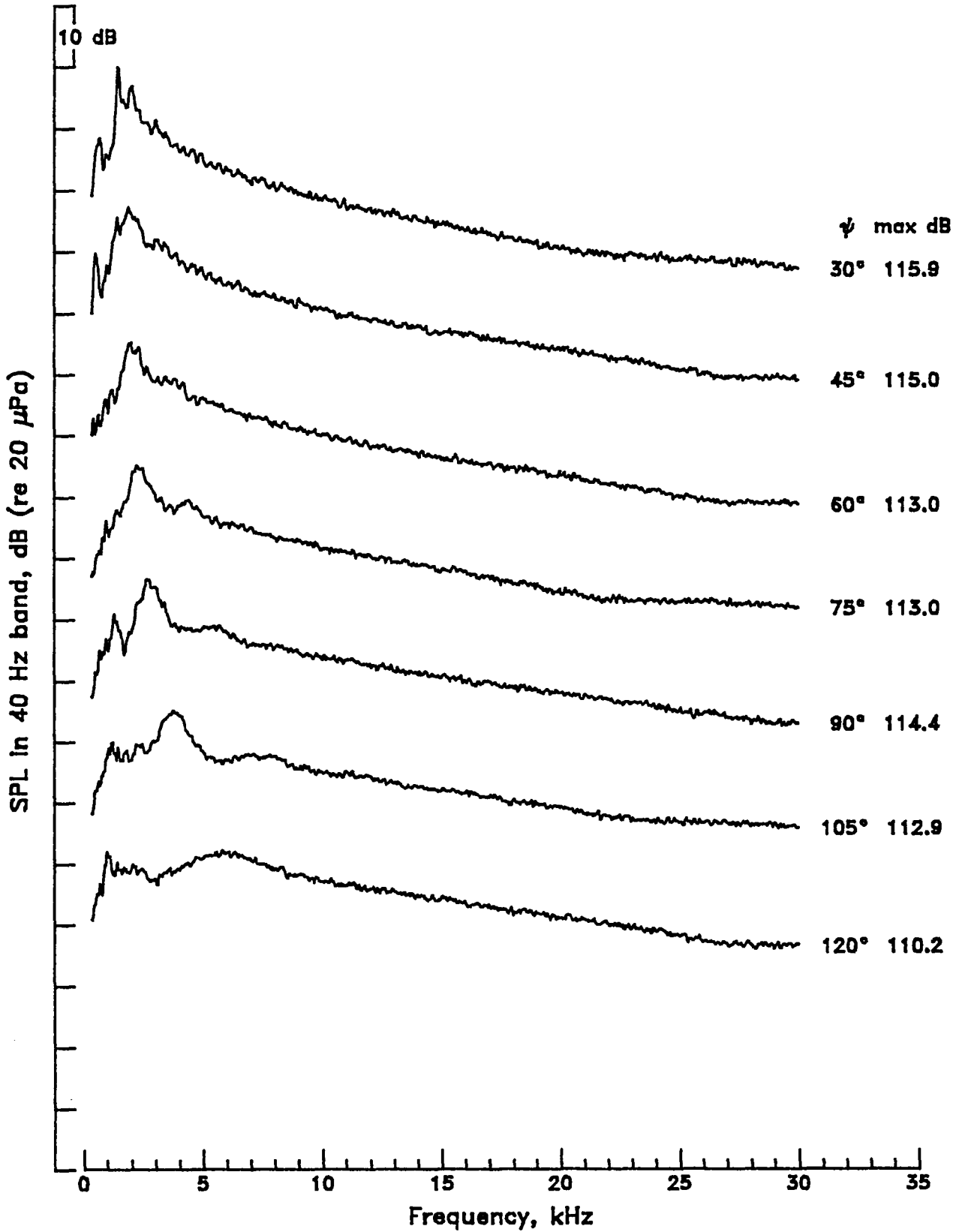

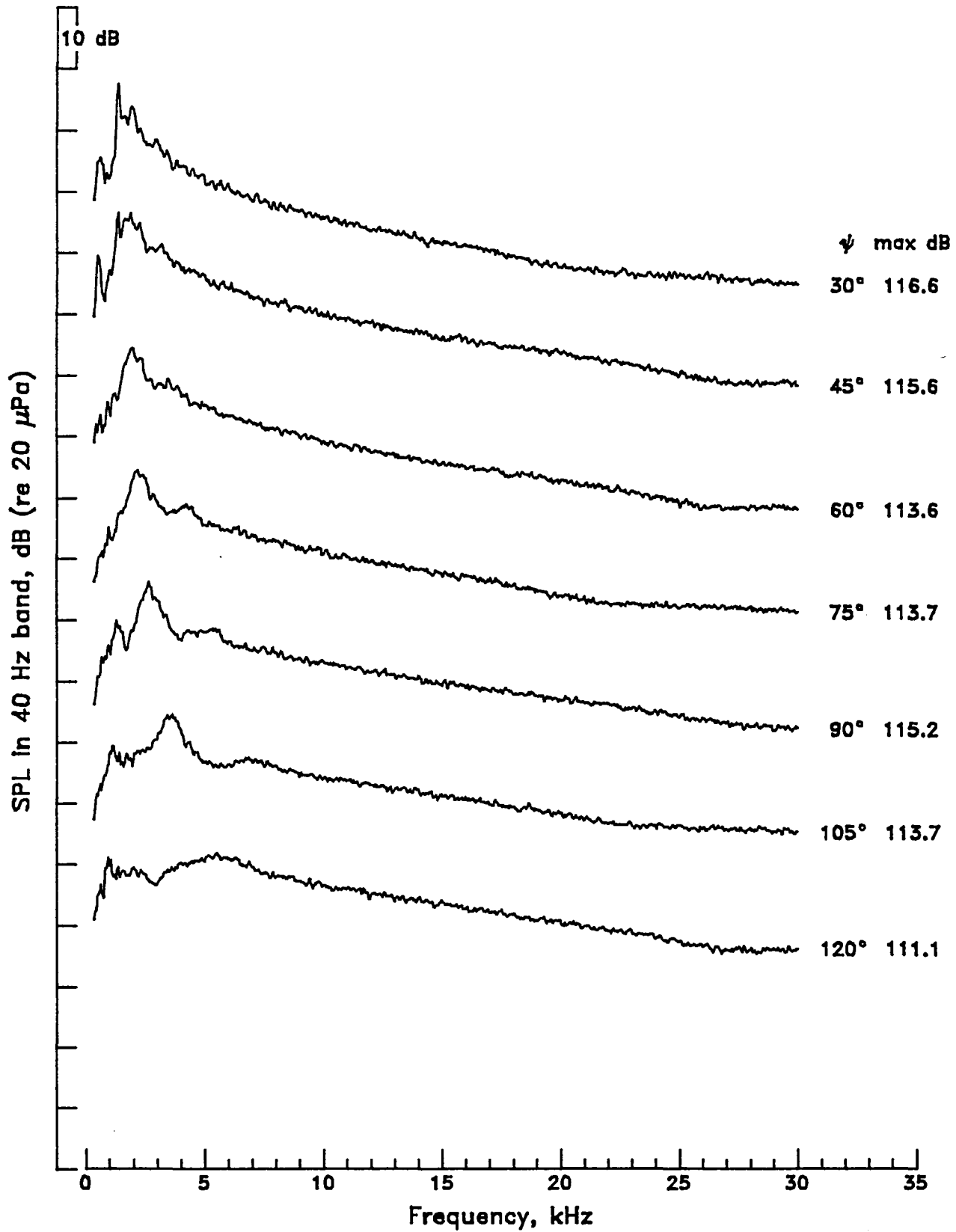

Mach 2.0 contoured nozzle without tab,  $\beta = 2.15$ 

## REFERENCES

1. Plumblee, Harry E.; and Doak, Philip E.: The Generation and Radiation of Supersonic Jet Noise. Volume I - Summary of Supersonic Jet Noise Studies. AFAPL-TR-72-53, Vol. I, U.S. Air Force, July 1972. (Available from DTIC as AD 749 428.)
2. Plumblee, Harry E., Jr.: The Generation and Radiation of Supersonic Jet Noise. Volume I - Summary. AFAPL-TR-76-65-Vol. I, U.S. Air Force, Sept. 1976.
3. Benzakein, Meyer J.; and Knott, Paul R.: Supersonic Jet Exhaust Noise. AFAPL-TR-72-52, U.S. Air Force, Aug. 1972. (Available from DTIC as AD 747 774.)
4. Knott, Paul R.: Supersonic Jet Exhaust Noise Investigation. Volume I - Summary Report. AFAPL-TR-76-68, Vol. I, U.S. Air Force, July 1976. (Available from DTIC as AD A038 682.)
5. Powell, A.: On the Mechanism of Choked Jet Noise. Proc. Phys. Soc. (London), vol. 66, pt. 12, no. 408B, Dec. 1, 1953, pp. 1039-1056.
6. Harper-Bourne, M.; and Fisher, M. J.: The Noise From Shock Waves in Supersonic Jets. Noise Mechanisms, AGARD-CP-131, Mar. 1974, pp. 11-1 - 11-13.
7. Seiner, John M.; and Norum, Thomas D.: Experiments on Shock Associated Noise of Supersonic Jets. AIAA Paper 79-1526, July 1979.
8. Norum, T. D.; and Seiner, J. M.: Location and Propagation of Shock Associated Noise From Supersonic Jets. AIAA-80-0983, June 1980.
9. Seiner, J. M.; and Norum, T. D.: Aerodynamic Aspects of Shock Containing Jet Plumes. AIAA-80-0965, June 1980.
10. McLaughlin, D. K.; Seiner, J. M.; and Liu, C. H.: On the Noise Generated by Large Scale Instabilities in Supersonic Jets. AIAA-80-0964, June 1980.
11. Seiner, J. M.; and Yu, J. C.: Acoustic Near Field and Local Flow Properties Associated With Broadband Shock Noise. AIAA-81-1975, Oct. 1981.
12. Pinckney, S. Z.: A Short Static-Pressure Probe Design for Supersonic Flow. NASA TN D-7978, 1975.
13. Hopkins, D. F.; and Hill, D. E.: Effect of Small Radius of Curvature on Transonic Flow in Axisymmetric Nozzles. AIAA J., vol. 4, no. 8, Aug. 1966, pp. 1337-1343.
14. Johnson, Charles B.; and Boney, Lillian R.: A Method for Calculating a Real-Gas Two-Dimensional Nozzle Contour Including the Effects of Gamma. NASA TM X-3243, 1975.

TABLE 1.- JET PARAMETERS AT TEST CONDITIONS

$\beta$	$P_t/P_a$	$M_j$	$V_j$ (m/s)	$T_j$ (K)	$\rho_j$ (kg/m <sup>3</sup> )
0.00	1.893	1.000	313.2	244.2	1.446
.20	1.937	1.020	318.4	242.5	1.455
.40	2.076	1.077	332.9	237.8	1.484
.60	2.321	1.166	354.8	230.3	1.532
.70	2.492	1.221	367.6	225.7	1.564
.80	2.699	1.281	381.3	220.6	1.600
.94	3.062	1.372	401.3	212.8	1.658
1.00	3.247	1.414	410.1	209.3	1.687
1.10	3.601	1.487	424.8	203.2	1.737
1.34	4.732	1.672	459.4	187.9	1.878
1.50	5.770	1.803	481.5	177.6	1.988
1.60	6.565	1.887	494.8	171.1	2.062
1.72	7.699	1.990	510.0	163.5	2.158
1.85	9.187	2.103	525.6	155.5	2.270
2.00	11.314	2.236	542.5	146.5	2.409
2.10	13.022	2.326	553.1	140.7	2.508
2.15	13.977	2.371	558.2	137.9	2.559

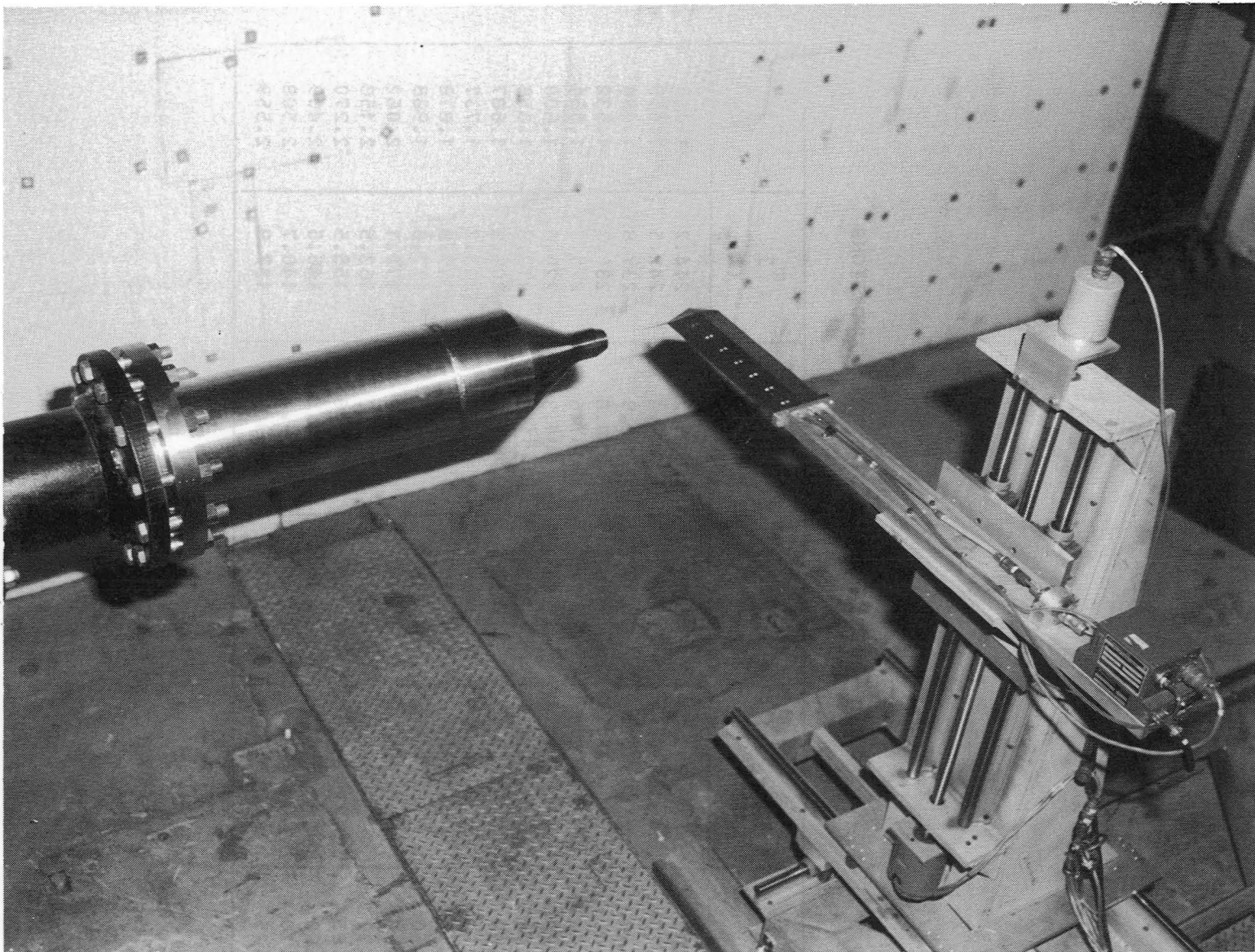

L-79-7298

Figure 1.- Nozzle and pressure probe drive mechanism in Langley Jet Noise Laboratory.

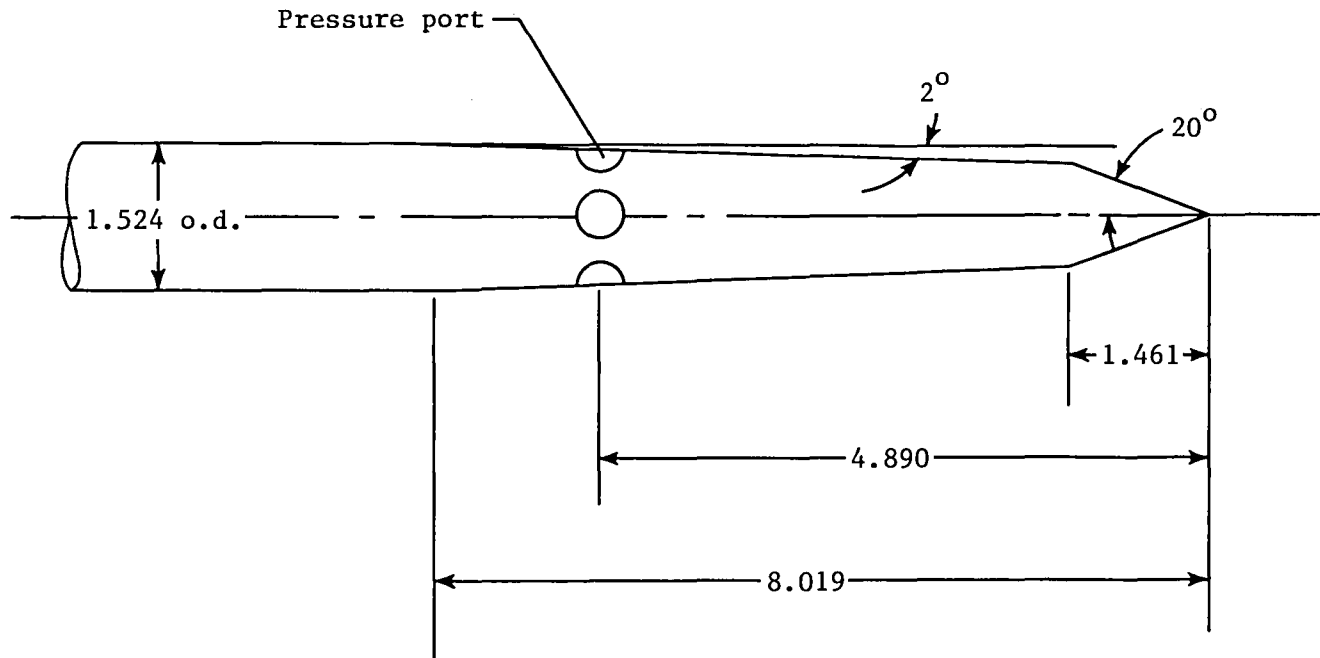
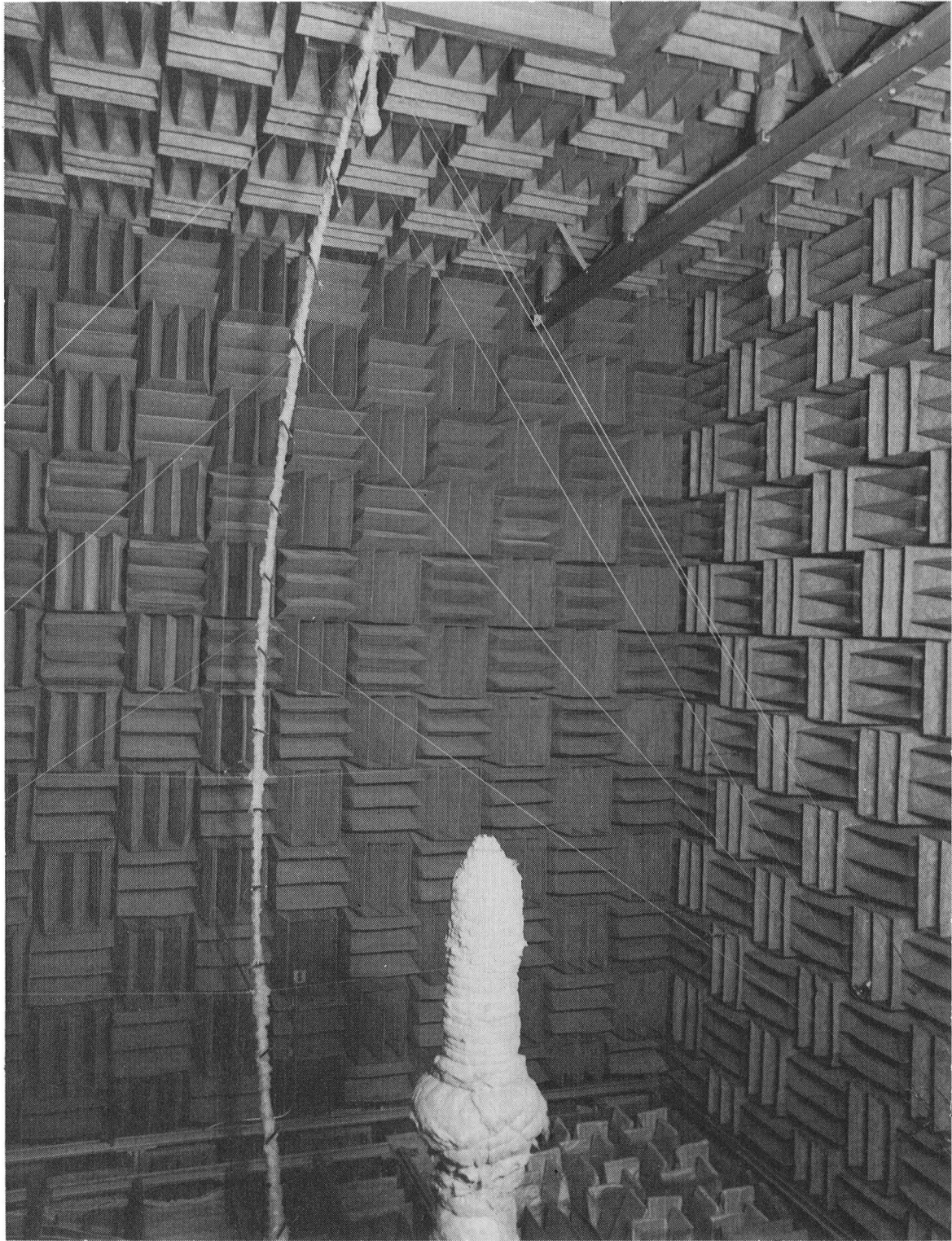
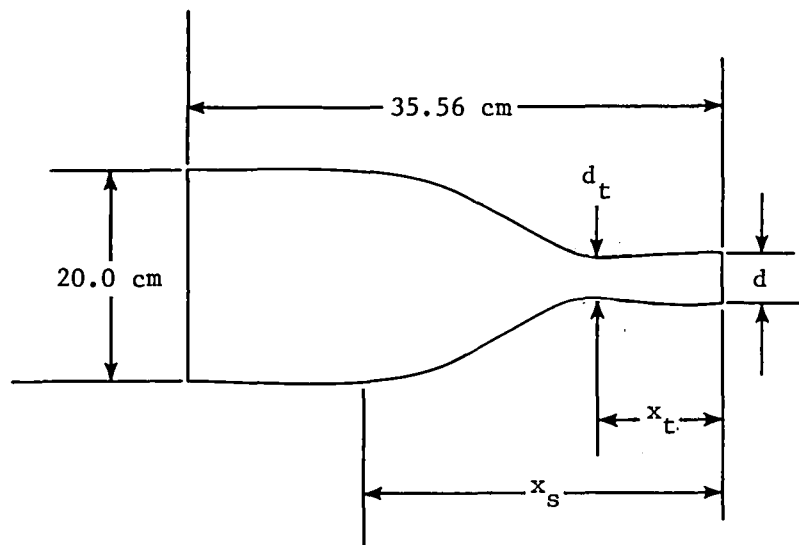

Figure 2.- Static-pressure probe. (All dimensions in mm unless otherwise noted.)



L-78-7914

Figure 3.- Nozzle and microphone array installed in Langley Anechoic Noise Facility.



Contoured nozzle

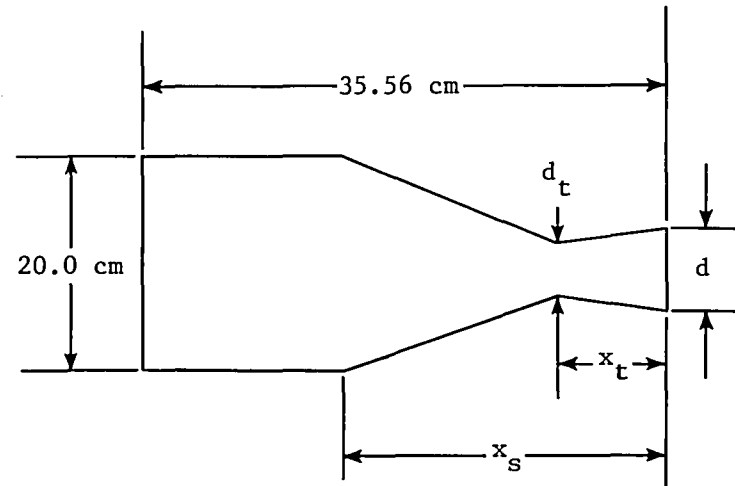

Conical nozzle

Nozzle	$d$ , cm	$d_t$ , cm	$x_s$ , cm	$x_t$ , cm	$\beta_d$
Mach 1.0 contoured	3.982	3.982	22.9	0	0
Mach 1.0 conical	3.962	3.962	22.9	0	0
Mach 1.5 contoured C-D	4.267	3.959	26.8	4.327	1.089
Mach 1.5 conical C-D	4.289	3.958	35.5	3.327	1.114
Mach 2.0 contoured C-D	4.989	3.848	33.3	10.648	1.726

Figure 4.- Internal dimensions of test nozzle.

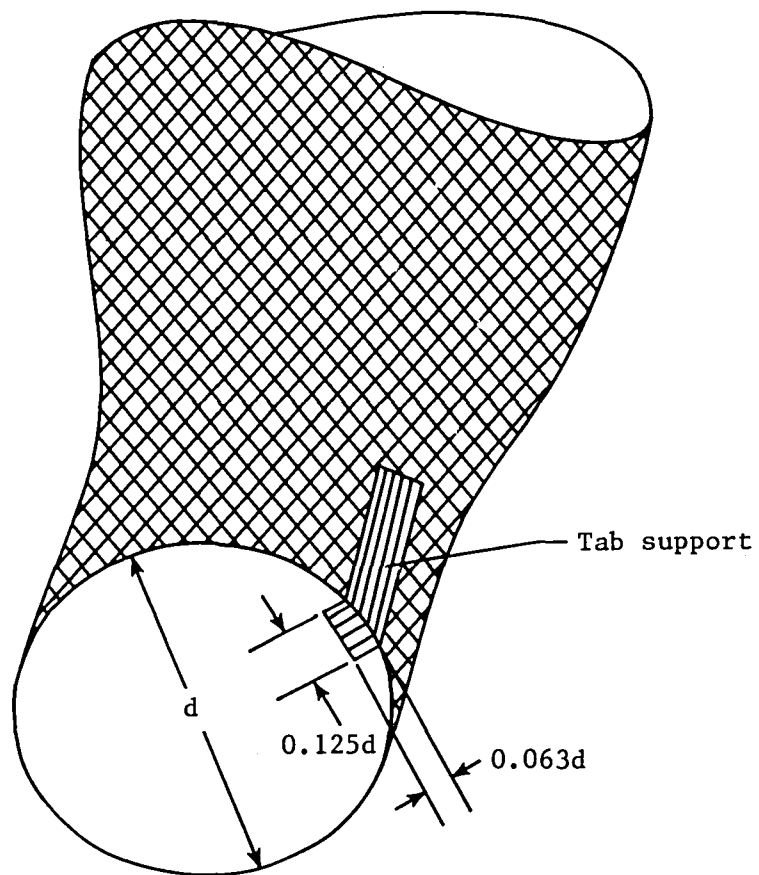
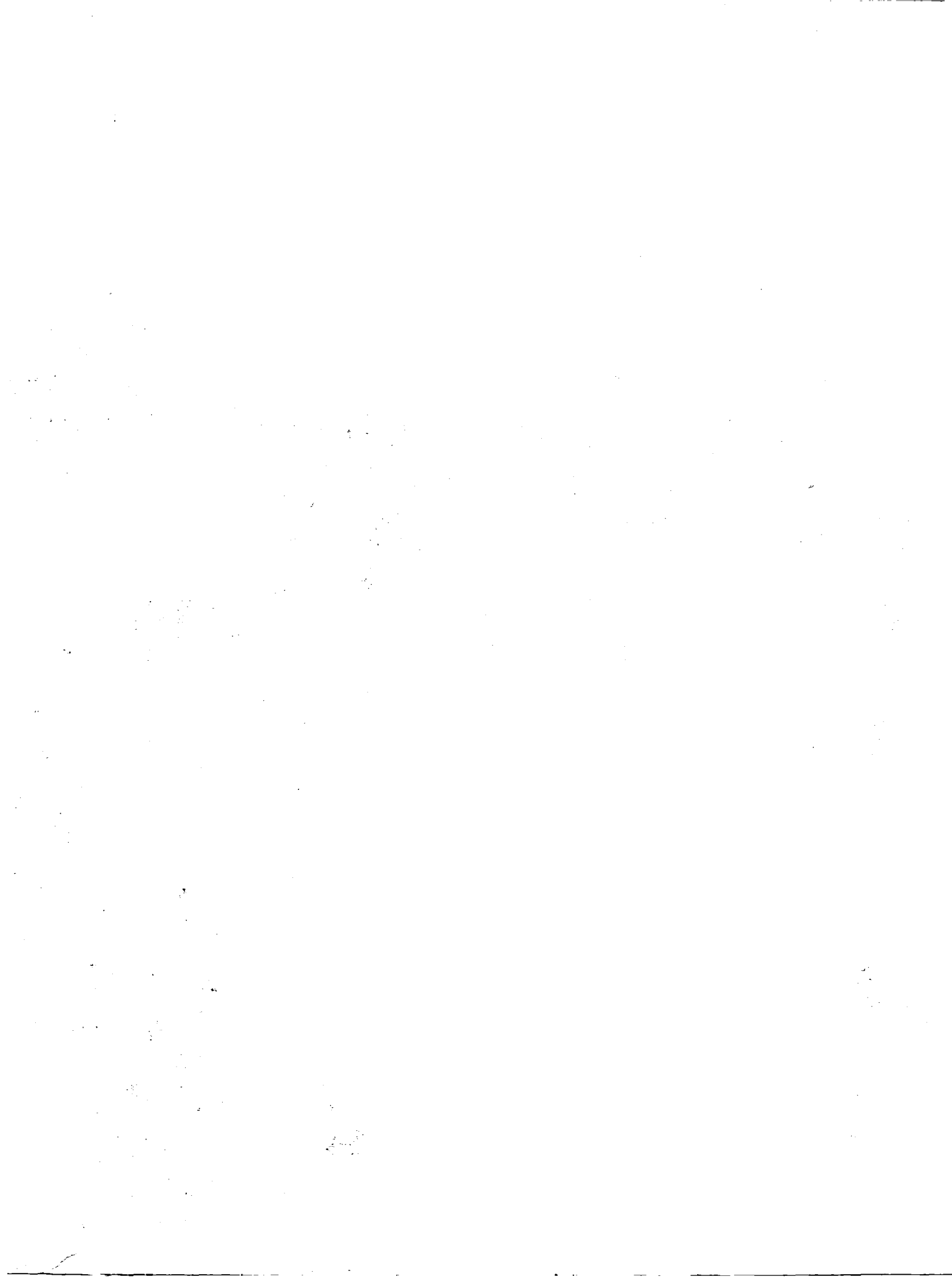

Figure 5.- Sketch of tab installed in nozzle exit plane.





1. Report No. NASA TM-84521	2. Government Accession No.	3. Recipient's Catalog No.	
4. Title and Subtitle MEASUREMENTS OF MEAN STATIC PRESSURE AND FAR-FIELD ACOUSTICS OF SHOCK-CONTAINING SUPERSONIC JETS		5. Report Date September 1982	
		6. Performing Organization Code 505-32-03-05	
7. Author(s) Thomas D. Norum and John M. Seiner		8. Performing Organization Report No. L-15378	
		10. Work Unit No.	
9. Performing Organization Name and Address  NASA Langley Research Center Hampton, VA 23665		11. Contract or Grant No.	
		13. Type of Report and Period Covered Technical Memorandum	
12. Sponsoring Agency Name and Address  National Aeronautics and Space Administration Washington, DC 20546		14. Sponsoring Agency Code	
		15. Supplementary Notes	
16. Abstract  The far-field acoustic data base generated in studies of broadband shock noise from supersonic jets is presented. Both conical and contoured nozzles of exit Mach numbers 1.0, 1.5, and 2.0 were tested using unheated air at pressure ratios ranging from 1.9 to 14. Tests were performed both with and without screech suppression tabs. Results include overall sound pressure variations and representative 1/3-octave and narrowband spectra. This data report also presents surveys of the mean static pressure measured within these jets.			
17. Key Words (Suggested by Author(s))  Supersonic-jet static pressure Supersonic-jet noise Shock noise		18. Distribution Statement  Unclassified - Unlimited  Subject Category 71	
19. Security Classif. (of this report) Unclassified	20. Security Classif. (of this page) Unclassified	21. No. of Pages 197	22. Price A09



National Aeronautics and  
Space Administration

Washington, D.C.  
20546

Official Business

Penalty for Private Use, \$300

THIRD-CLASS BULK RATE

Postage and Fees Paid  
National Aeronautics and  
Space Administration  
NASA-451



**NASA**

POSTMASTER: If Undeliverable (Section 158  
Postal Manual) Do Not Return

---