

## CELL AND MODULE FORMATION RESEARCH AREA

D.B. Bickler, Chairman

The Cell and Module Formation Research Area technology session opened with a presentation by Spectrolab, Inc., on its new metallization contract. Work is just beginning on this contract; the presentation was an outline of the program, with test-flow and work-flow diagrams.

Bernd Ross Associates announced that they have noted that the firing of base-metal pastes in reducing atmospheres is dramatically influenced by hydrogen. Apparently the surface of the silicon becomes hydrogenated and does not react with the metal. Carbon monoxide has been found to give excellent results as a reducing atmosphere that will not hydrogenate the silicon surface. Silver fluoride continues to be the leading fluxing agent for glass-free silver-metal systems. The hygroscopic nature of AgF presents a problem; packaging methods are important. Recently fabricated experimental cells have again shown that copper-metal pastes containing AgF make satisfactory back metallizations on silicon cells. This system works well on aluminum-back-surface field cells as well. Insufficient firing temperatures have been shown to result in an anomalous S-shaped I-V curve. This curve characteristic has been modeled satisfactorily using a second diode at the insufficiently fired surface.

Ron Daniel of the JPL FSA Analysis and Integration Area presented a method for optimization of metallization patterns. Individual contributions to cell power losses are considered, as are diffused-layer sheet resistance, metal-to-silicon contact resistance, grid-line conductive loss, bus-bar conductive loss, and metal shadowing of active cell area. An optimization can also include metallization area costs.

Photowatt reported on the status of its development of a process sequence involving an AR coating and thick-film metallization system capable of penetrating the AR coating during firing. The sequence produces solar cells with excessive series resistance. Efforts to build up the metallization using electrolytic copper plating have resulted in chemical attack upon the fired-metal-to-silicon interface. Photowatt has reorganized this effort and is investigating new formulations of thick-film metal pastes that were inspired by developments by other contractors in the Process Development effort of FSA.

Spire Corp. has completed the design of the NMA implantation machine to a point where construction is under way and is scheduled for completion in September 1982. The design incorporates a defocusing and steering device to spread the ion beam and make it more uniform. This technology is attributable to JPL leadership. It has potential usefulness to the semiconductor industry as well as to the photovoltaic industry.

JPL in-house NMA activity has been dealing with implanted back-surface fields and with NMA primary (front) junctions. The effect of thermal pretreatment was also investigated. Experimental cells previously fabricated did not produce open-circuit voltages ( $V_{oc}$ ) as high as those of cells

## CELL AND MODULE FORMATION RESEARCH AREA

processed conventionally. Among the possible causes was that metallic contamination was being introduced into the ion beam from the NMA source. Graphite parts were fabricated to eliminate this possibility, but the performance was not affected. Further experimentation has led to the opinion that implanted back-surface fields are not heavy enough under present methods. New work is starting in an effort to apply NASA pulse-thruster technology to the development of a pulsed-plasma epitaxy machine. This concept has possibilities far beyond silicon back-surface fields, and encompasses advanced semiconductor materials as well.

Solarex presented the last of its work under the MEPSDU (Module Experimental Process Development Unit) contract. It has recently completed the development of three processes: the use of glass beads in a sand-blasting type of process to remove the oxides that remain after firing the aluminum into the silicon back surface; the use of a commercial wave-soldering device to solder-coat the front cell nickel-plated contacts (unsuccessful in coating both sides of the cell), and the use of ion milling (heavy-duty plasma etching) to clean up the n-on-p junction edges of cells that are stacked tightly on top of one another when loaded into the chamber. Solarex performed a cost analysis, using the IPEG methodology, to determine that the current MEPSDU process sequence results in \$0.56 per watt add-on cost up to but not including cell assembly into modules. The new contractual thrust is toward specific processing characteristics unique to polycrystalline silicon. Semix material processing will be emphasized but the other types of polycrystalline material will also be tested (if not by Solarex, by JPL).

Westinghouse also presented the last of its MEPSDU work (that contract was also revised drastically in this reporting period). The Westinghouse effort involved processing through the module fabrication and environmental testing of its design. The previously reported passing of environmental tests at Westinghouse was repeated at JPL; the Westinghouse design more than passed the tests. The cost calculations have a direct inverse relationship to module operating efficiency; the Westinghouse goals include a 12% efficient module. Over the last year the efficiency of Westinghouse panels has increased from 7.5% to 11.2%; it is believed that Westinghouse would have achieved its 12% goal if the contract had not been redirected. The new contract activity focuses upon the junction formation process; the company is developing lower-cost diffusion sources based upon liquid application rather than the present gaseous sources. Ion implantation is also being pursued as a particularly applicable process for dendritic web silicon.

The University of Pennsylvania has completed assessment of metallization patterns by mathematical optimization. Prior work was limited to rectangular geometries. At the end of the assessment, the Westinghouse fan-shaped geometry was analyzed and found to be capable of the same optimization as rectangular geometries. The next assessment activity was directed toward determining the adequacy of currently accepted minority-carrier-lifetime measurement techniques and what, if any, errors are responsible for confusion in cell mathematical modeling activities. Apparently there is sufficient confusion in the accepted literature to cast doubts upon present ability to model advanced photovoltaic structures.

## CELL AND MODULE FORMATION RESEARCH AREA

# THICK-FILM METALLIZATION

## BERND ROSS ASSOCIATES

Bernd Ross

### Progress

1. SINCE HYDROGENATED SILICON SURFACES TEND TO REJECT METAL COATINGS, AN ALTERNATIVE REDUCING AMBIENT WAS SOUGHT.
2. PREVIOUSLY FABRICATED PASTES AS WELL AS NEW FORMULATIONS WERE FIRED IN NITROGEN AND CARBON MONOXIDE GASES.
3. SEM ANALYSIS SHOWED EXCELLENT STRUCTURE FOR CO FIRED COPPER ELECTRODES.
4. ELECTRICAL CHARACTERIZATION GAVE GOOD RESULTS FOR CONTACT RESISTANCE STUDIES AS WELL AS SOLAR CELL PERFORMANCE (BACK CONTACTS ONLY).
5. EXPERIMENTS WITH SILVER FLUORIDE CONTAINING DIFFERENT AMOUNTS OF MOISTURE WERE PERFORMED.
6. A SILVER FLUORIDE ACTIVATED COPPER PASTE ELECTRODE WAS OBSERVED TO PENETRATE A 700<sup>o</sup>A SILICON NITRIDE LAYER.

### Silver Fluoride Experiment

SILVER FLUORIDE FROM TWO SOURCES WAS UTILIZED.

TYPE "H" SILVER FLUORIDE, PACKED IN A PLASTIC BOTTLE APPEARED QUITE WET, WITH VISIBLE LIQUID MOISTURE IN EVIDENCE.

MELTING OCCURRED AT APPROXIMATELY 300<sup>o</sup>C (MELTING POINT FOR DRY MATERIAL APPROXIMATELY 435<sup>o</sup>C) FOR "H" MATERIAL, ACCOMPANIED BY BUBBLING AND AFTER REACTION TO METALLIC SILVER A GLASSY RESIDUE WAS IN EVIDENCE.

TYPE "A" SILVER FLUORIDE, PACKED IN A PLASTIC BAG WITHIN A GLASS JAR, SHOWED CONSIDERABLY LESS MOISTURE, HOWEVER, GRAIN AGGLOMERATION INDICATED A MOISTURE PROBLEM STILL EXISTS.

TYPE "A" MATERIAL MELTED CLOSER TO THE PUBLISHED MELTING POINT, AND NO MACROSCOPIC AMOUNTS OF RESIDUE WERE SEEN.

SEM MICROGRAPHY SHOWED EVIDENCE OF THE EXISTENCE OF SMALL AMOUNTS OF GLASSY MATERIAL FOR TYPE A SILVER FLUORIDE ALSO.

## Solar-Cell Experiment

F31 COPPER PASTE WITH 0.1 WT % AgF, 10 WT % Pb  
AND 0 WT % AL-SI EUTECTIC

F32 COPPER PASTE WITH 0.1 WT % AgF, 10% Pb AND  
5 WT % AL-SI EUTECTIC

PASTE	FIRING TEMPERATURES(°C)	QTY	AMBIENT GAS	AVERAGE UNCOATED EFFICIENCY AM %	AVERAGE FILL FACTOR
F31	550	3	N <sub>2</sub>	5.9	0.476
F31	550	3	CO	7.7	0.637
F31	600	3	CO	6.5	0.551
F31	650	3	CO	8.1	0.676
F32	550	3	CO	7.1	0.660
F32	600	3	CO	8.0	0.722
F32	650	3	CO	7.5	0.739

C-5



8.2A

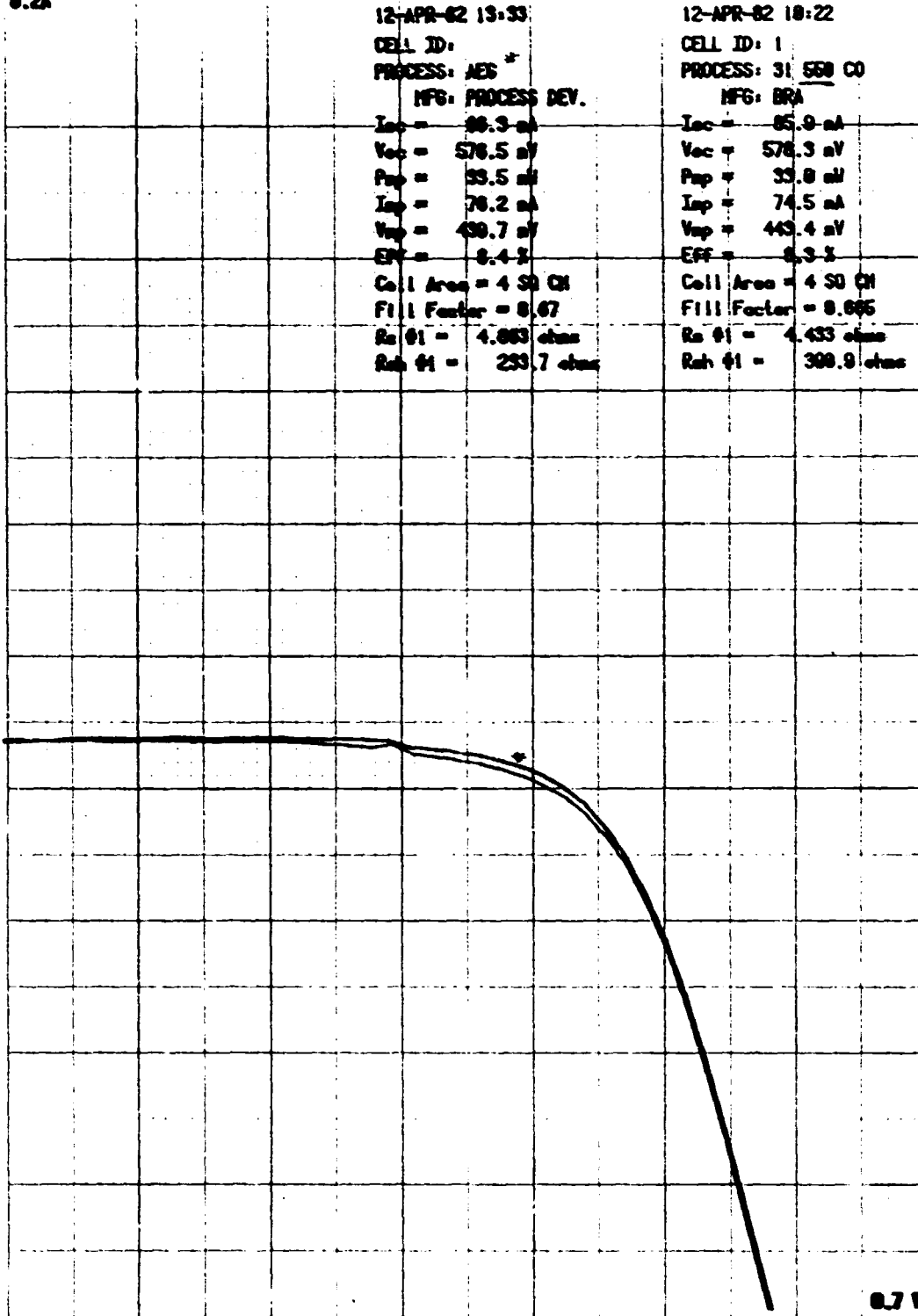

9.2A

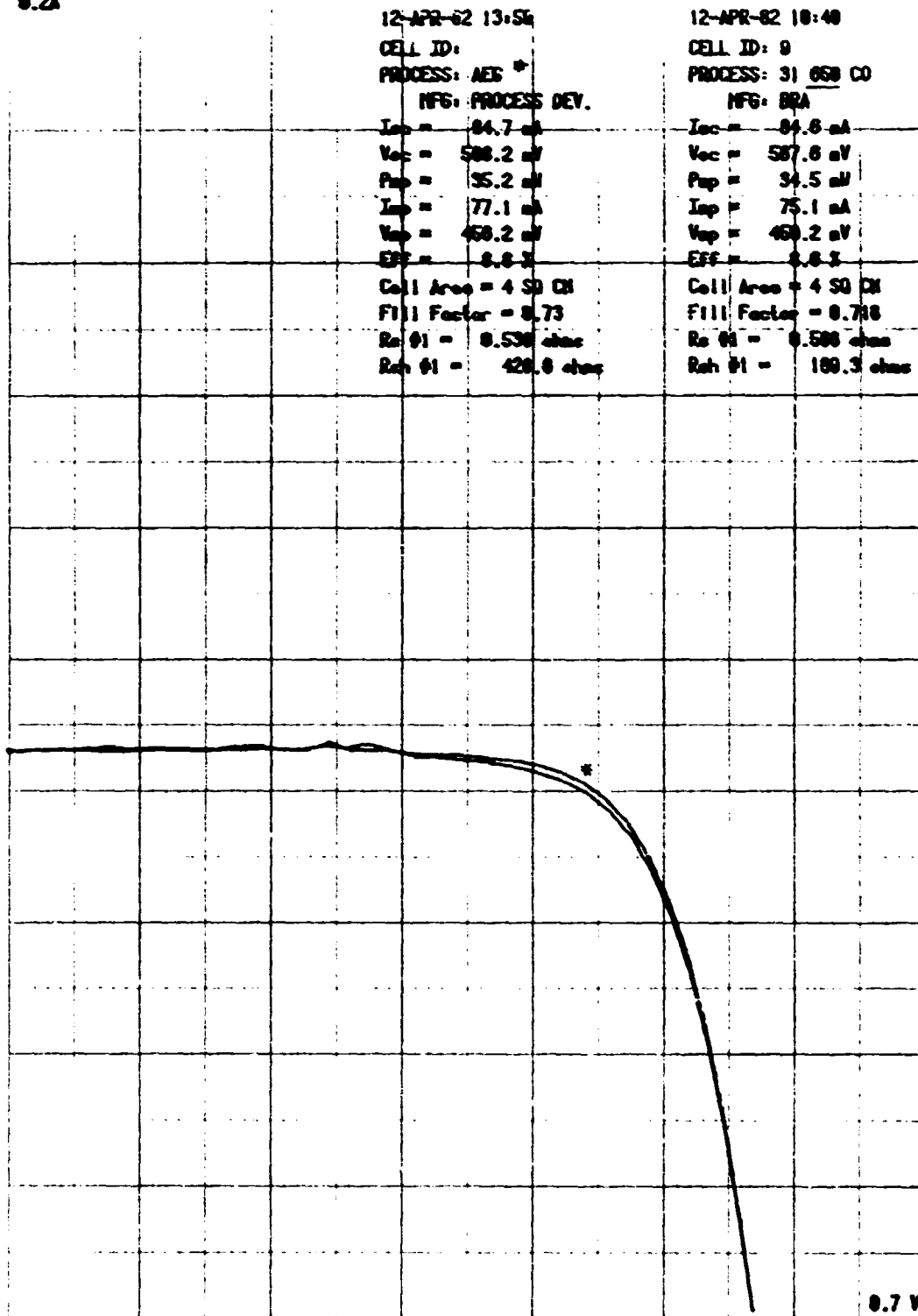

CELL AND MODULE FORMATION RESEARCH AREA

ORIGINAL DRAWING  
OF POOR QUALITY

0.28

12-APR-82 14:28

CELL ID:

PROCESS: AES #

MFG: PROCESS DEV.

Isc = 81.7 mA

Voc = 572.8 mV

Pmp = 34.4 mW

Imp = 75.4 mA

Vmp = 457.8 mV

EFF = 8.6%

Cell Area = 4 SQ CM

Fill Factor = 8.737

Rs @1 = 8.525 ohms

Rsh @1 = 238.2 ohms

12-APR-82 18:59

CELL ID: 17

PROCESS: 32 688 CO

MFG: BRA

Isc = 81.2 mA

Voc = 571.1 mV

Pmp = 33.7 mW

Imp = 73.5 mA

Vmp = 458.4 mV

EFF = 8.4%

Cell Area = 4 SQ CM

Fill Factor = 8.728

Rs @1 = 8.587 ohms

Rsh @1 = 249.8 ohms

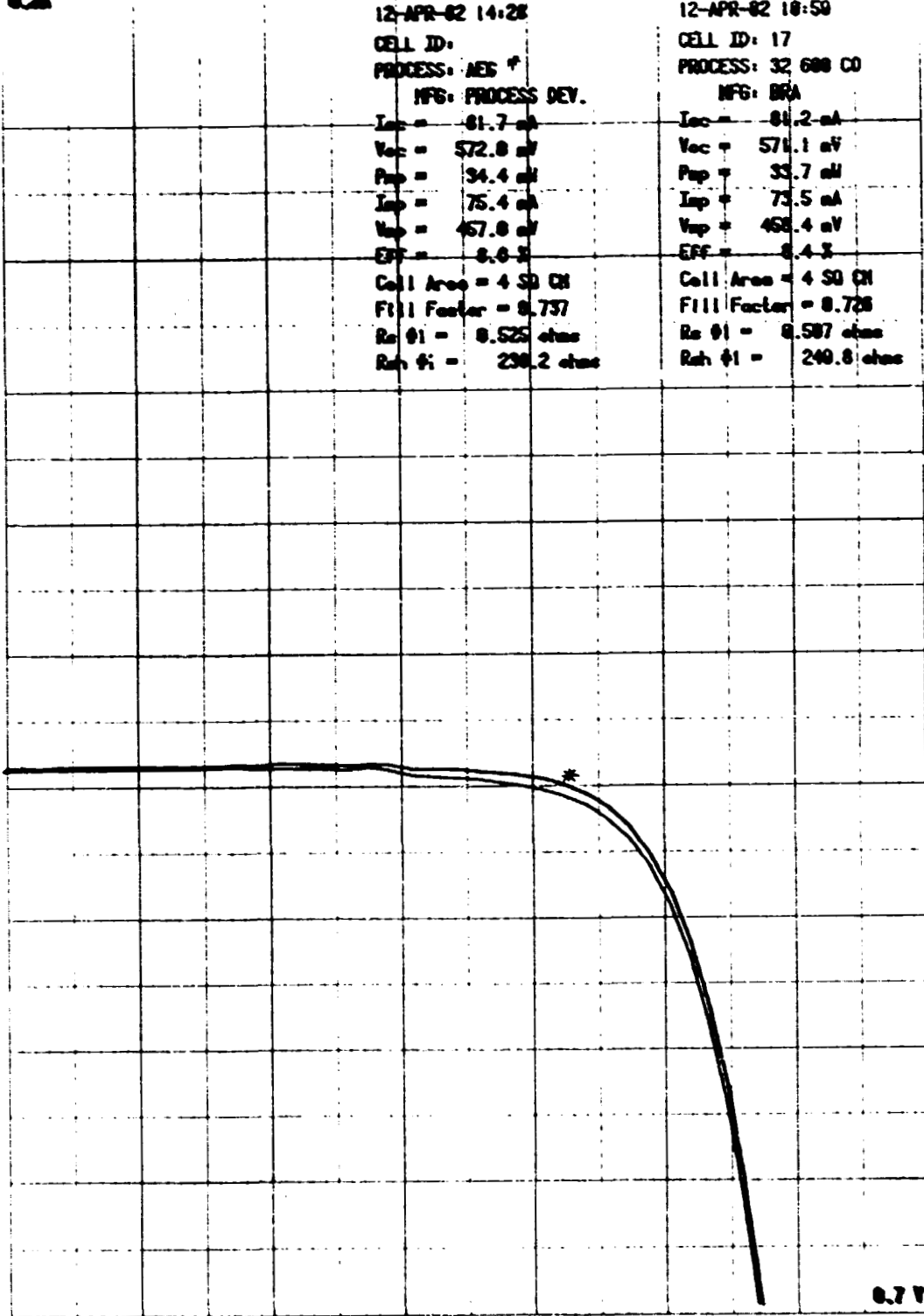

0.7 V

0.20

12-APR-82 13:46  
 CELL ID:  
 PROCESS: AES #  
 MFG: PROCESS DEV.  
 Isc = 86.3 mA  
 Voc = 554.8 mV  
 Pmp = 18.2 mW  
 Imp = 80.6 mA  
 Vmp = 200.4 mV  
 EFF = 4.5 %  
 Cell Area = 4 SQ CM  
 Fill Factor = 0.370  
 Ra @1 = 0.182 ohms  
 Rsh @1 = 80.5 ohms

12-APR-82 16:28  
 CELL ID: 3  
 PROCESS: 38 560 N2  
 MFG: BRA  
 Isc = 86.4 mA  
 Voc = 557.1 mV  
 Pmp = 18.6 mW  
 Imp = 84.7 mA  
 Vmp = 207.6 mV  
 EFF = 4.7 %  
 Cell Area = 4 SQ CM  
 Fill Factor = 0.386  
 Ra @1 = 0.088 ohms  
 Rsh @1 = 76.8 ohms

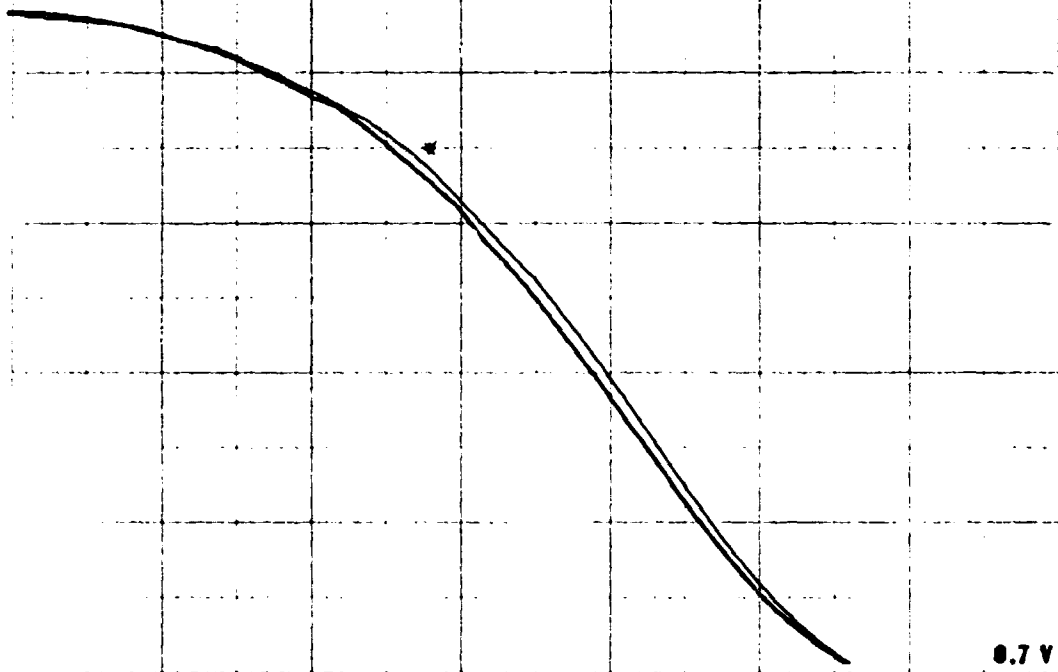

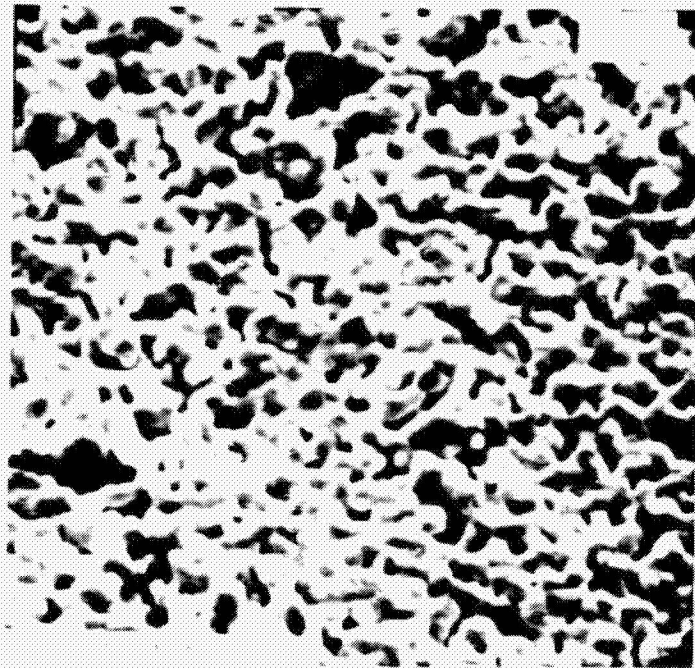

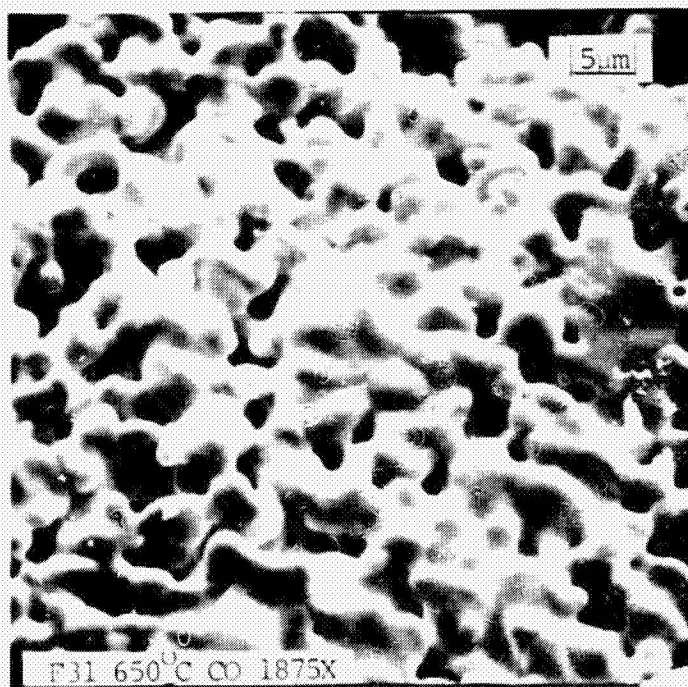
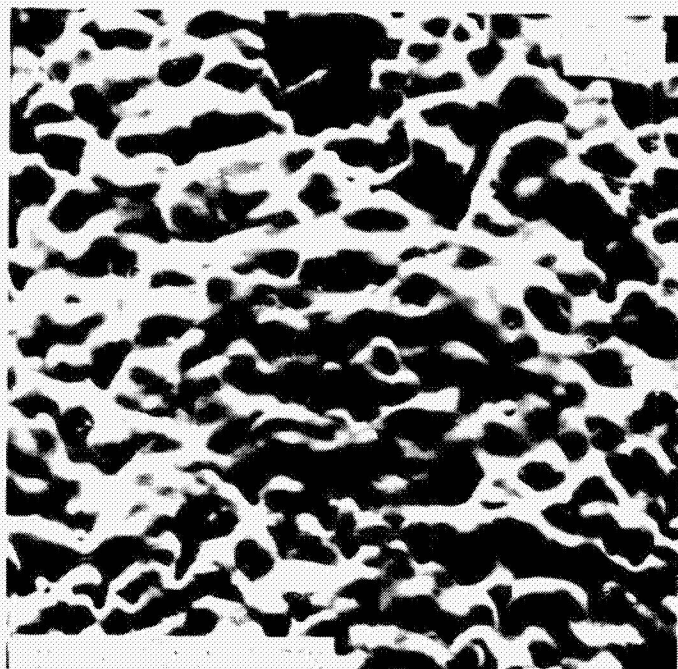



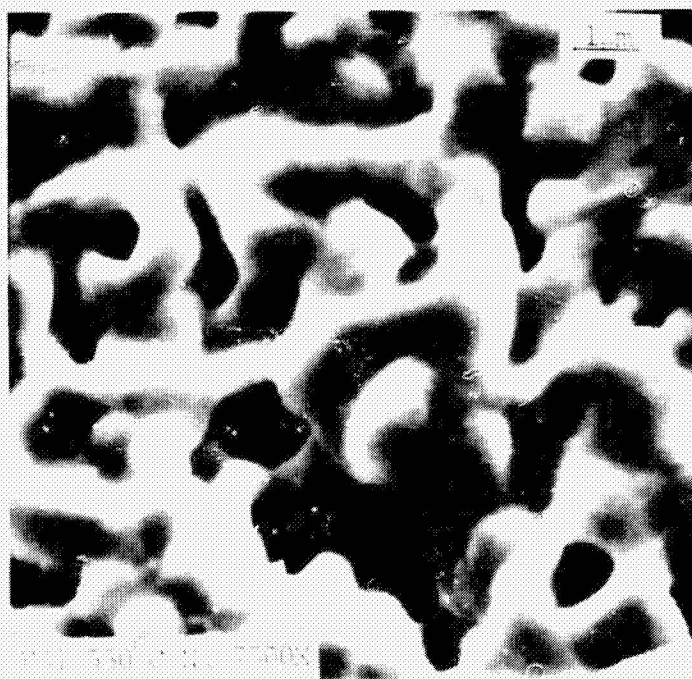
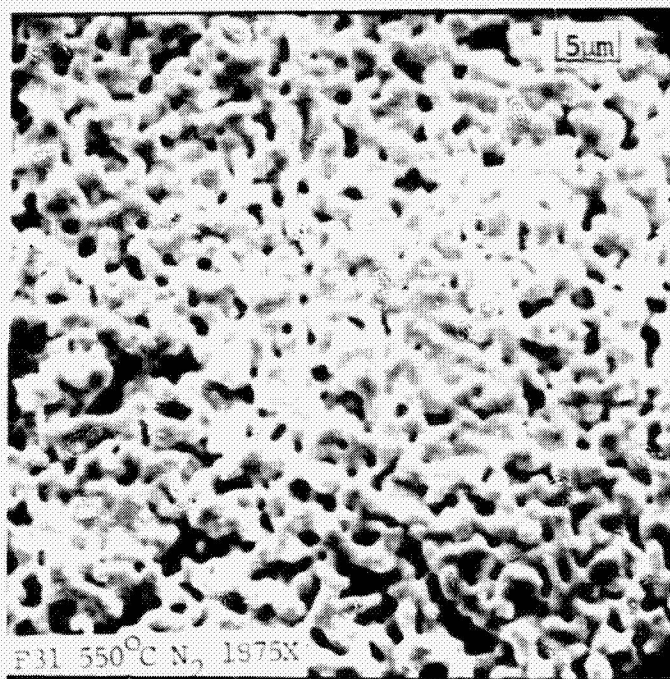

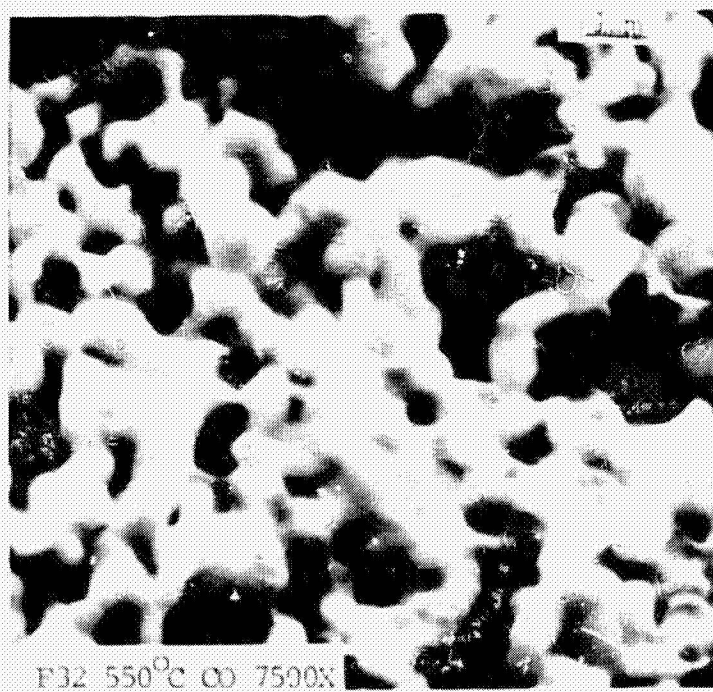
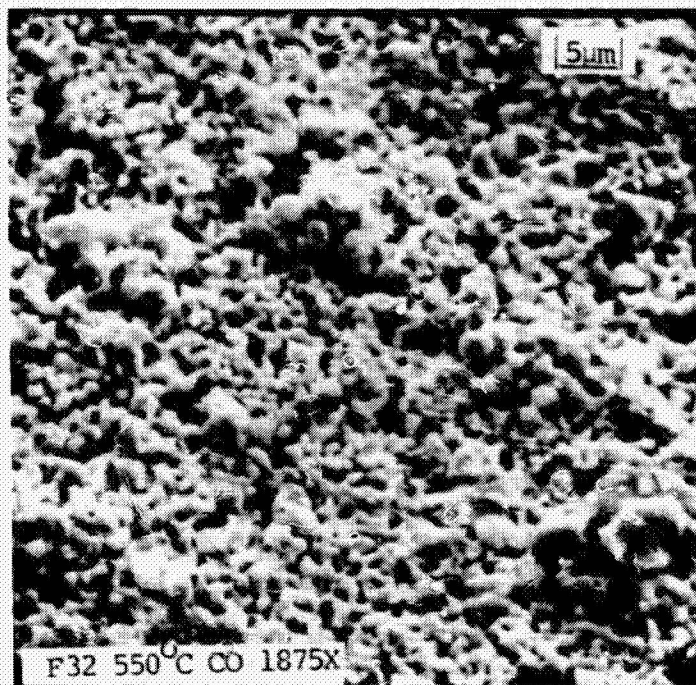



ORIGINAL PAGE IS  
OF POOR QUALITY

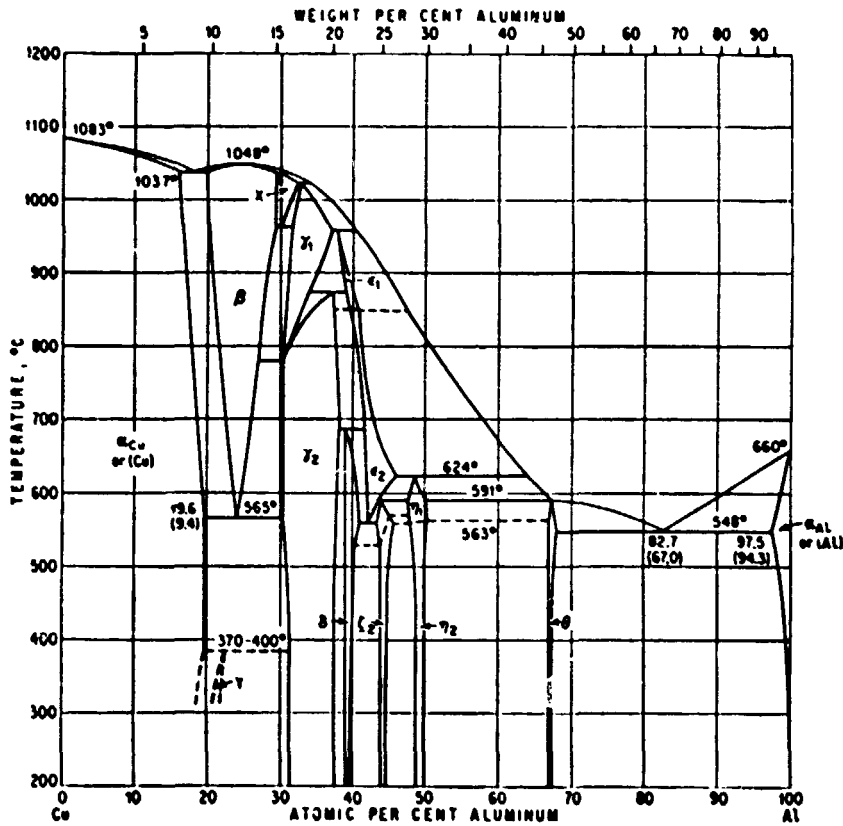
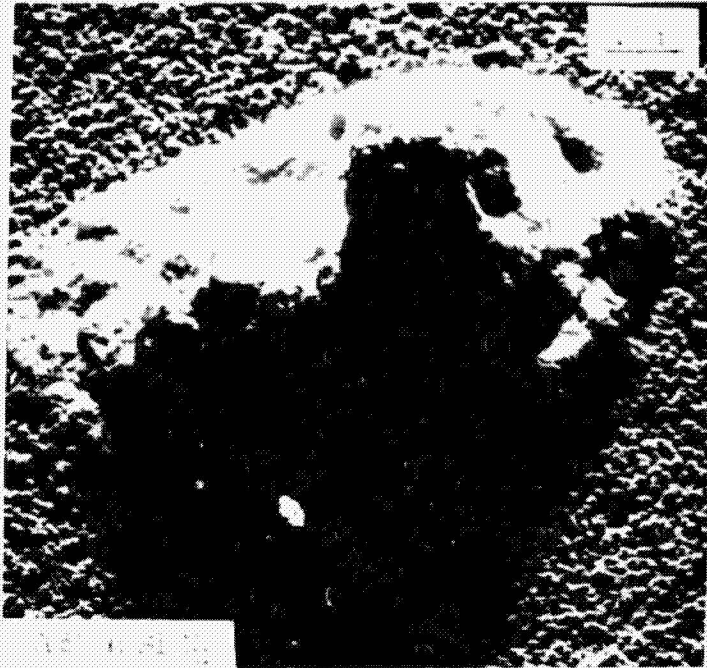

Fig. 52. Al-Cu. (See also Fig. 53.)

Phase Diagram of Al-Cu  
System, from "Constitution  
of Binary Alloys" by  
M.Hansen, 2<sup>nd</sup> Ed. p.85  
Mc Graw Hill, New York '58



Wet AqF on Si<sub>3</sub>N<sub>4</sub> No 1875X

## CELL AND MODULE FORMATION RESEARCH AREA

### Conclusions and Problems

1. CARBON MONOXIDE REDUCING AMBIENTS PROVIDED WELL SINTERED COHERENT COPPER STRUCTURES WITH RELATIVELY LARGE GRAIN AT THE LOWEST TEMPERATURES.
2. ADHERANCE OF CO FIRED COPPER ELECTRODES WAS SIGNIFICANTLY SUPERIOR TO HYDROGEN FIRED SPECIMEN.
3. ELECTRICAL PROPERTIES OF DEVICES AND TEST STRUCTURES ARE SATISFACTORY.
4. ELECTRODE STRUCTURES CONTAINING ALUMINUM RESULTED IN DIS-COLORED APPEARANCE WITH LITTLE OR NO SINTERING AND SMALL GRAINSIZE. ELECTRICAL PROPERTIES, HOWEVER, APPEARED UNAFFECTED.
5. PROCUREMENT AND STORAGE OF SILVER FLUORIDE REQUIRES SPECIAL CARE.

# OPTIMIZATION PROGRAM/DESIGN METHOD FOR SOLAR CELL GRID PATTERNS

JET PROPULSION LABORATORY

R.E. Daniel

## Introduction

- **There Is Extensive Literature About the Series Resistance Losses Associated With the Solar Cell Grid Pattern; However, There Have Been No Reports That Assist the Grid Pattern Designer to Design an Optimal Grid Pattern of Two or More Design Variables**
- **An APL Program Has Been Developed That Uses a Non-Linear Optimization Technique to Find Optimal Design Values for the Grid; the Power Losses Analyzed Include Photoconductor Sheet Losses, Fine Grid and Bus Resistance Losses and Shadow Losses, and Contact Resistance Between the Sheet and the Fine Grid Lines**
  
- **Typical Design Parameters Might Be:**
  - **Fine Grid Line Width**
  - **Fine Grid Line Spacing**
  - **Bus Bar Width**
  - **Metallization Thickness**
  
- **Assumptions**
  - **Current Uniformly Generated on the Surface of the Cell**
  - **Power Loss Between the Fine Grid Lines Is Found Using Sectional Integration**
  - **Fine Grid Lines and Bus Bar(s) Are Orthogonal**
  - **Bus Bar Same Thickness as the Fine Grid (or Strapped)**
  - **Fine Grid Line Width and Metallization Thickness at a Predetermined Ratio**

Cell Shape and Grid Geometry

MULTIPLE-BUS RECTANGULAR CELL

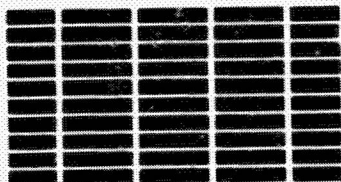

ROUND CELLS

ONE-BUS CELL

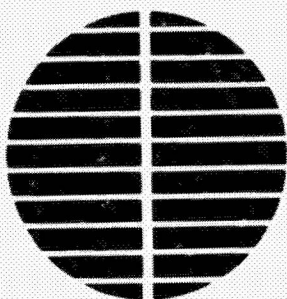

TWO-BUS CELL

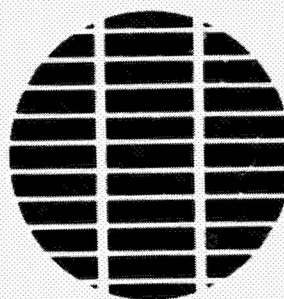

Power Loss Equations

General Form  
of Resistive Losses

$$P = \int I^2 dR$$

Sheet Loss to One Line

$$P_{SH} = 2 \int_0^{s/2} \frac{(J_M I_{xy})^2}{l_x} \rho_s dy$$

Fine Grid One Line

$$P_{FG} = \int_0^{l_x} \frac{(J_M s x)^2}{bt} \rho_m dx$$

Bus Bar

$$P_B = 2 \int_0^{l_B} \frac{(J_M l_x y)^2}{Wbt} \rho_m dy$$

Shadow

$$P_{SD} = J_M V_M (\text{Area Bus and Fine Grid})$$



## CELL AND MODULE FORMATION RESEARCH AREA

Contact Resistance

$$P_c = I^2 R_c$$

or

$$R_c = \frac{\rho_c}{\text{Area Fine Grid}} \quad (\text{Inverse Area Relationship})$$

$$R_c = \frac{(\rho_s \rho_c s)^{1/2}}{l \times 3/2} \quad (\text{Current Crowding})$$

where:  $J_M$  (mA/cm<sup>2</sup>) Current Density at Maximum Power

$V_M$  (volts) Voltage at Maximum Power

$\rho_m$  ( $\Omega \cdot \text{cm}$ ) Resistivity of Metal

$\rho_s$  ( $\Omega / \square$ ) Resistivity of Sheet

$\rho_c$  ( $\Omega \cdot \text{cm}^2$ ) Contact Resistivity

$W_B$  (cm) Width of Bus Bar

$s$  (cm) Spacing Between Fine Lines

$b$  (cm) Width of Fine Lines

$t$  (cm) Metal Thickness

$l \times$  (cm) Length of Fine Line

$L_B$  (cm) Length of Bus Bar

### Optimization Method

- Procedure Uses the Power-Loss Equations as the Objective Function  $P_T = \sum P$  (All Losses)
- Then, the First Partial Derivative of the Function With Respect to the Design Variables is Set Equal to Zero.

$$f_i(X) = \frac{\delta P_T}{\delta \theta_i} = 0 \quad (\theta_i \text{ are the design variables}) \quad i = 1, 2, \dots, n$$

- These Equations Are Solved by a Modified Newton-Raphson Method.

$$f_i(X) = f_i(X^K) + \Delta f_i(X^K) (X - X^K); X^K \text{ Is a Given Value}$$

- Matrix Notation

$$\begin{matrix} A_K + B_K (X - X^K) & 0 \\ X & X^K & B_K^{-1} & A_K \end{matrix}$$

Rectangular Cell Example

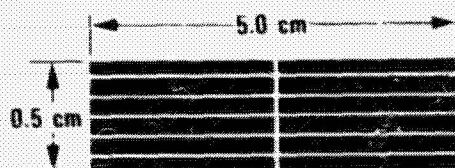

	OPTIMAL DESIGN	4 GRID LINES	10 GRID LINES	INPUT	
<b>P<sub>T</sub></b> , Total Power Lost (mW)	1.68	1.70	2.02	<b>Length</b>	5 cm
<b>%</b> Loss	4.48	4.5	5.4	<b>Width</b>	0.5 cm
<b>A</b> , Fine Grid Spacing (cm)	0.140	0.125	0.050	<b>No. Buses</b>	1
<b>W<sub>B</sub></b> , Bus Bar Width (μm)	142.0	147.8	202.45	<b>J<sub>M</sub></b>	0.03 A/cm <sup>2</sup>
<b>B</b> , Fine Grid Width (μm)	32.3	29.9	15.90	<b>V<sub>M</sub></b>	0.5 Volts
<b>T</b> , Metal Thickness (μm)	10.4	9.6	5.1	<b>ρ<sub>M</sub></b>	1.7x10 <sup>-6</sup> Ω-cm
<b>M<sub>V</sub></b> , Metal Volume (cm) <sup>3</sup>	7.6x10 <sup>-5</sup>	6.4x10 <sup>-5</sup>	4.5x10 <sup>-5</sup>	<b>ρ<sub>C</sub></b>	0.001 Ω-cm <sup>2</sup>
				<b>ρ<sub>S</sub></b>	60 Ω
				<b>B:T</b>	3.1

Rectangular Cell: Sensitivity to Number of Grid Lines

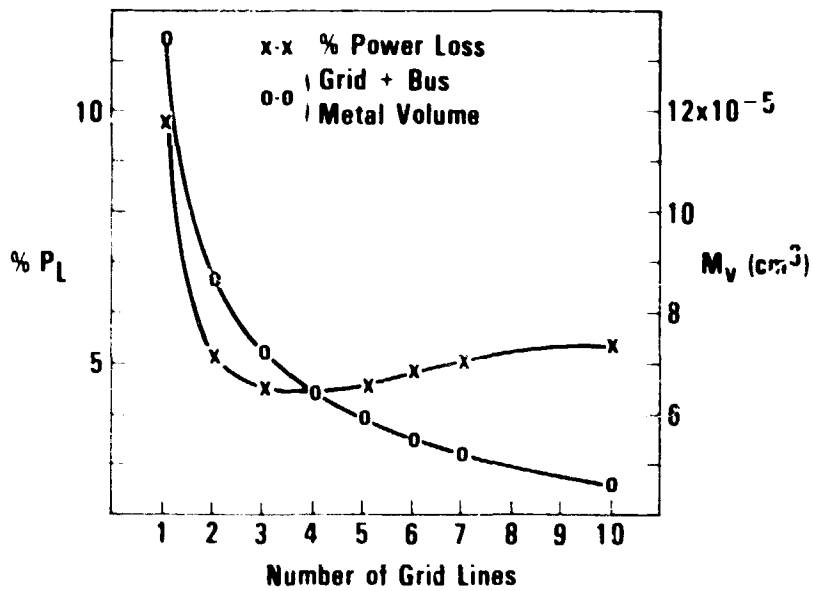
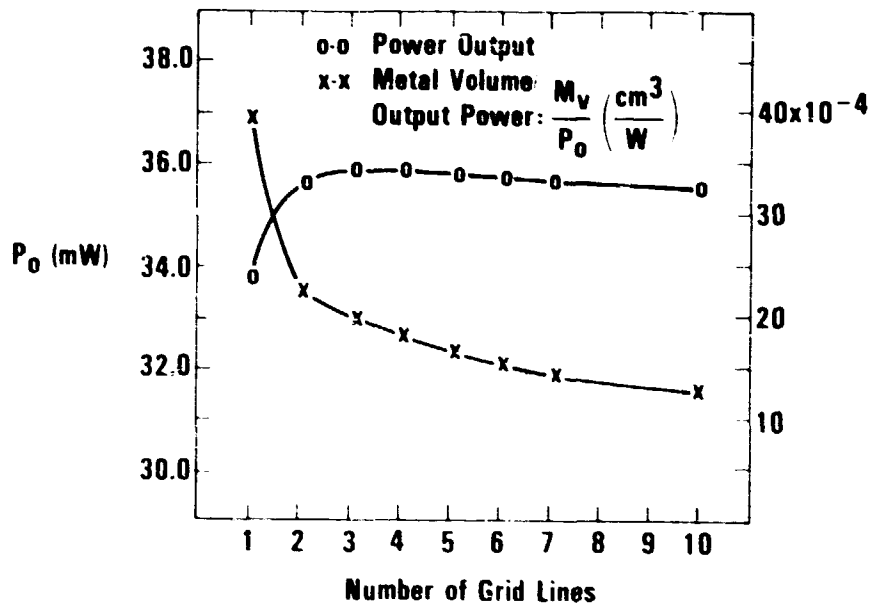



## Round Cell: 2-Bus Example

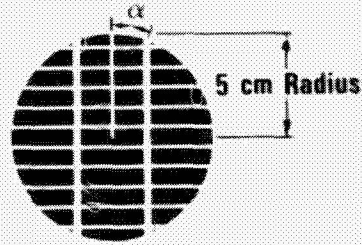

	SINGLE METALLIZATION	STRAPPED BUS (50 $\mu\text{m}$ )	INPUT	
P (mW)	219.3	169.7	Deg. ( $\alpha$ )	24
% Loss	20.68	16.00	Radius	5
A (cm)	0.443	0.331	JM	.03
V/B (cm)	0.184	0.096	VM	.45
B ( $\mu\text{m}$ )	396.0	218.0	$\delta\text{m}$	$1.6 \times 10^{-6}$
T ( $\mu\text{m}$ )	15.9	8.7	$\delta\text{B}$	$1.7 \times 10^{-6}$
Bus Vol. (cm <sup>3</sup> )	$5.4 \times 10^{-3}$	$1.5 \times 10^{-3}$	$\delta\text{c}$	0.01
Grid Vol. (cm <sup>3</sup> )	$9.1 \times 10^{-3}$	$3.7 \times 10^{-3}$	$\delta\text{s}$	38
			B:T	25

## Summary

- The Program Brings Together Two Standard Analyses:  
The Power Loss Equations and the Newton-Raphson Technique
- The Result is a Program That Will Provide an Optimal Grid Design, i.e.,  
One That Minimizes the Total Power Loss
- Program Can Also Be Used to Do Sensitivity Analysis
- Operation of the Program Is Being Prepared for COSMIC
- Experiments Are Under Way to Verify the Predictive Accuracy of the  
Power-Loss Equations
- Program Can Be Extended to Include Other Cell Shapes, Design  
Geometries, Cell Characteristics and Rudimentary Cost Sensitivities

CELL AND MODULE FORMATION RESEARCH AREA

THICK-FILM METALLIZATION

ORIGIN  
OF PAGES

SPECTROLAB, INC.

Mark Gillanders

Test Flow Diagram

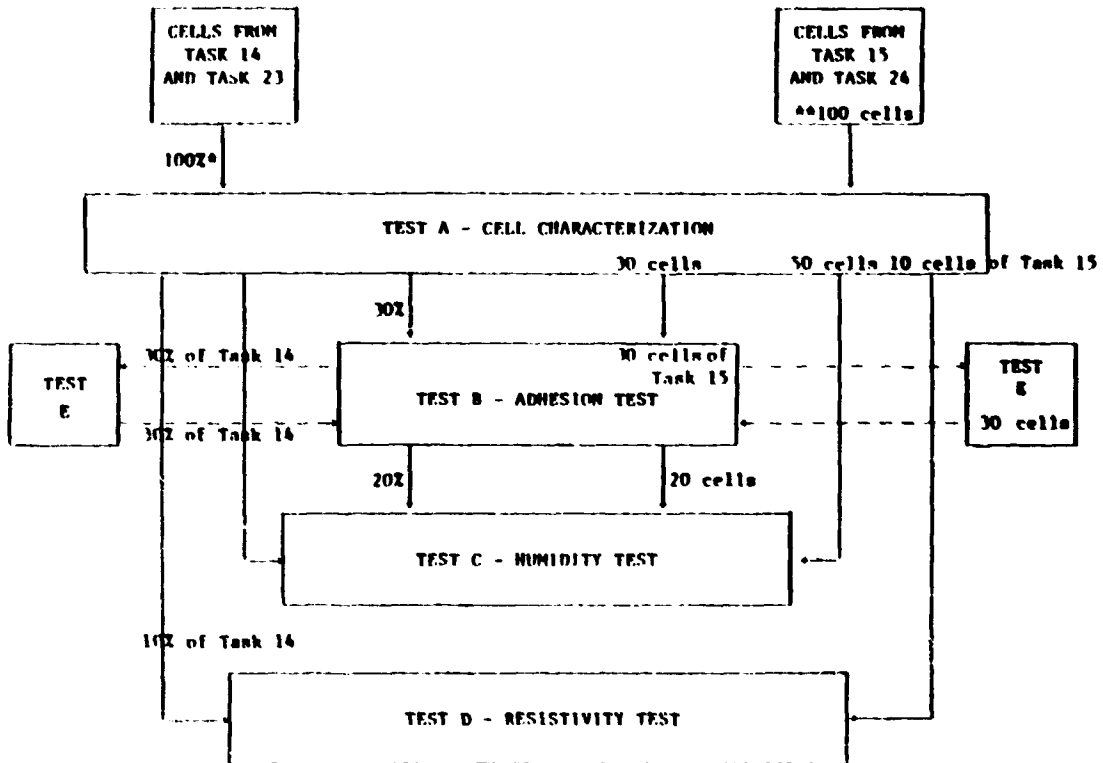

\*Note: The percentage indicated from one test area to the next is the percentage of the total cells produced from each of Tanks 14 and 23.

\*\*Note: The number indicated from one test area to the next is the number from each of Tank 15 and 24.

CELL AND MODULE FORMATION RESEARCH AREA

ORIGINAL DESIGN IS  
OF POOR QUALITY

Work Flow Diagram

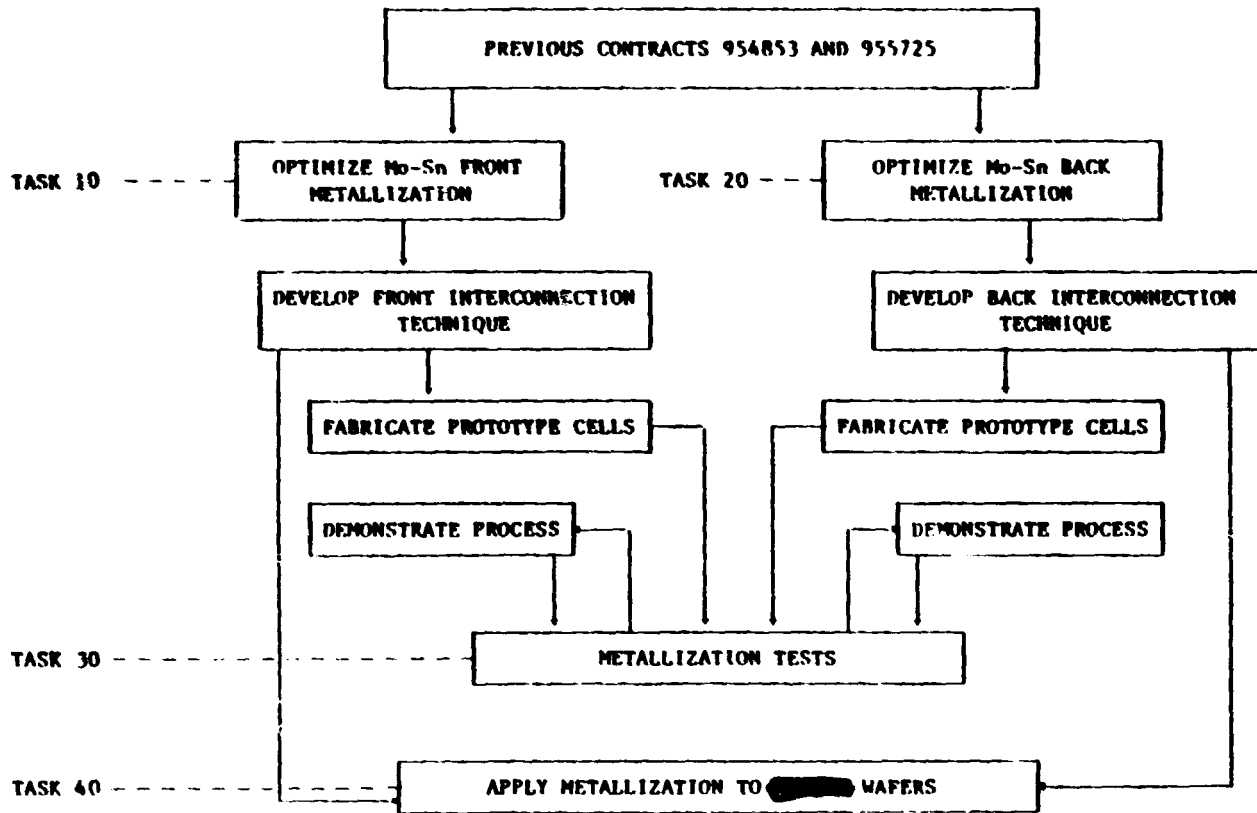

# NICKEL/COPPER METALLIZATION

PHOTOWATT INTERNATIONAL, INC.

## Goals

- TO DEVELOP A RELIABLE METALLIZATION WHICH:
  - USES NICKEL PASTE PRINTED OVER ( $\text{Si}_3\text{N}_4$ ) AR COATING
  - WHEN SINTERED PENETRATES THROUGH  $\text{Si}_3\text{N}_4$  AND BONDS TO SILICON
  - USES BRUSH PLATING OF COPPER FOR ADDITIONAL CONDUCTIVITY
  - PRODUCES 4" DIAMETER CELLS OF EFFICIENCY IN EXCESS OF 10% UNDER AMI 28°C
  - HAS PULL STRENGTH WITH 5 MM WIDE STRAP OF > 2 LBS WHEN PULLED 90° TO SURFACE
- TO PROVIDE COST DATA ON THE ABOVE SYSTEM

## Process Sequence

1. TEXTURE ETCH
2.  $\text{POCl}_3$  DIFFUSION
3. BACK ETCH
4. DEPOSIT NITRIDE
5. PRINT & FIRE ALUMINUM BACK
6. PRINT & FIRE NICKEL GRID
7. COPPER PLATE
8. TEST

## Series Resistance Problem

1. CONTACT RESISTANCE THRU SILICON NITRIDE
  - A. AgF NOT ATTACKING NITRIDE
  - B. AgF DEPLETED BY REACTING WITH FRIT
2. LOSS OF CONTACT BY REACTION WITH PLATING SOLUTION
3. OTHER

TFS #5517 Ni + 30% EMCA #7069 Ag Fired at 700°C for 5 min

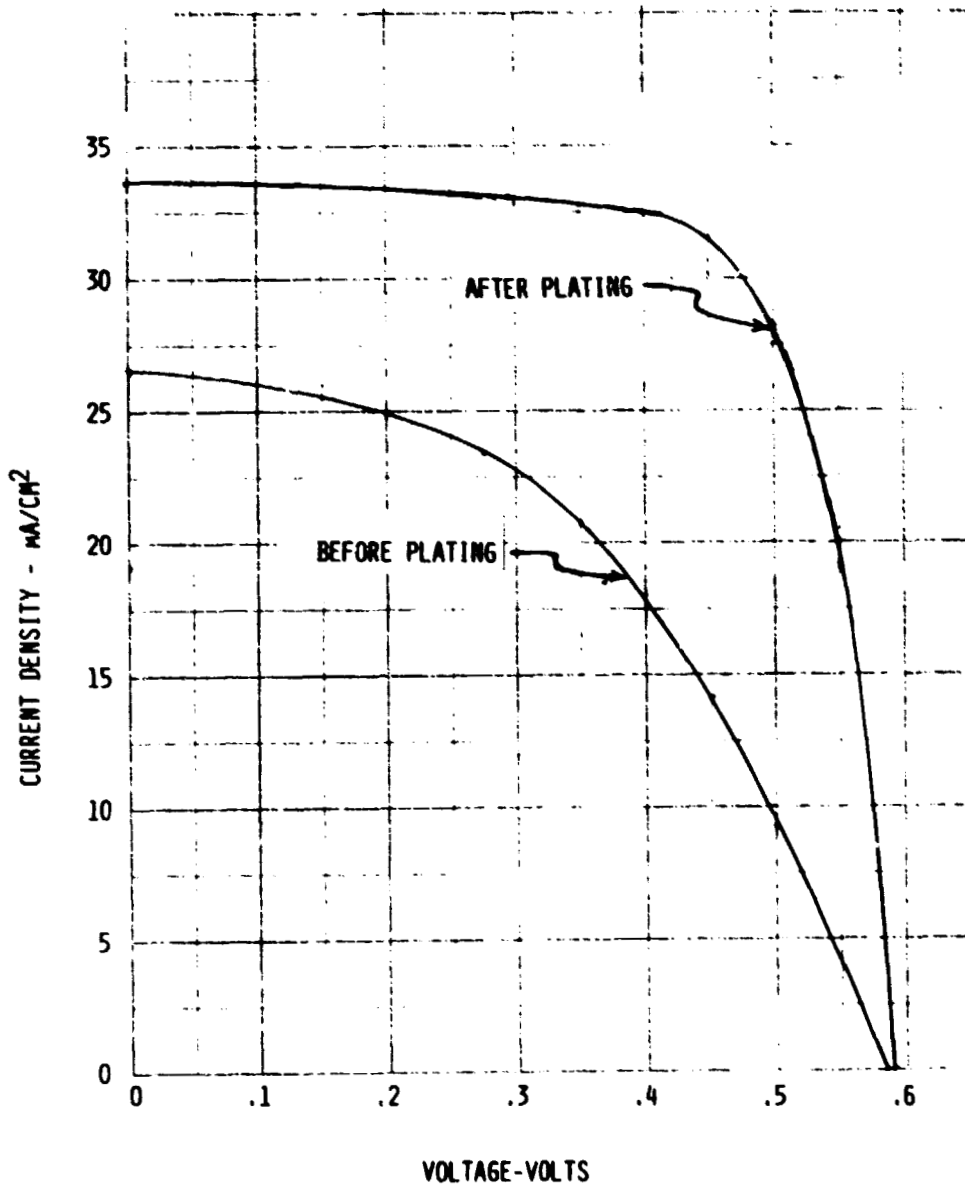

ESL Paste E + 5% EMCA Ag 7069 Fired at 700°C for 6 min

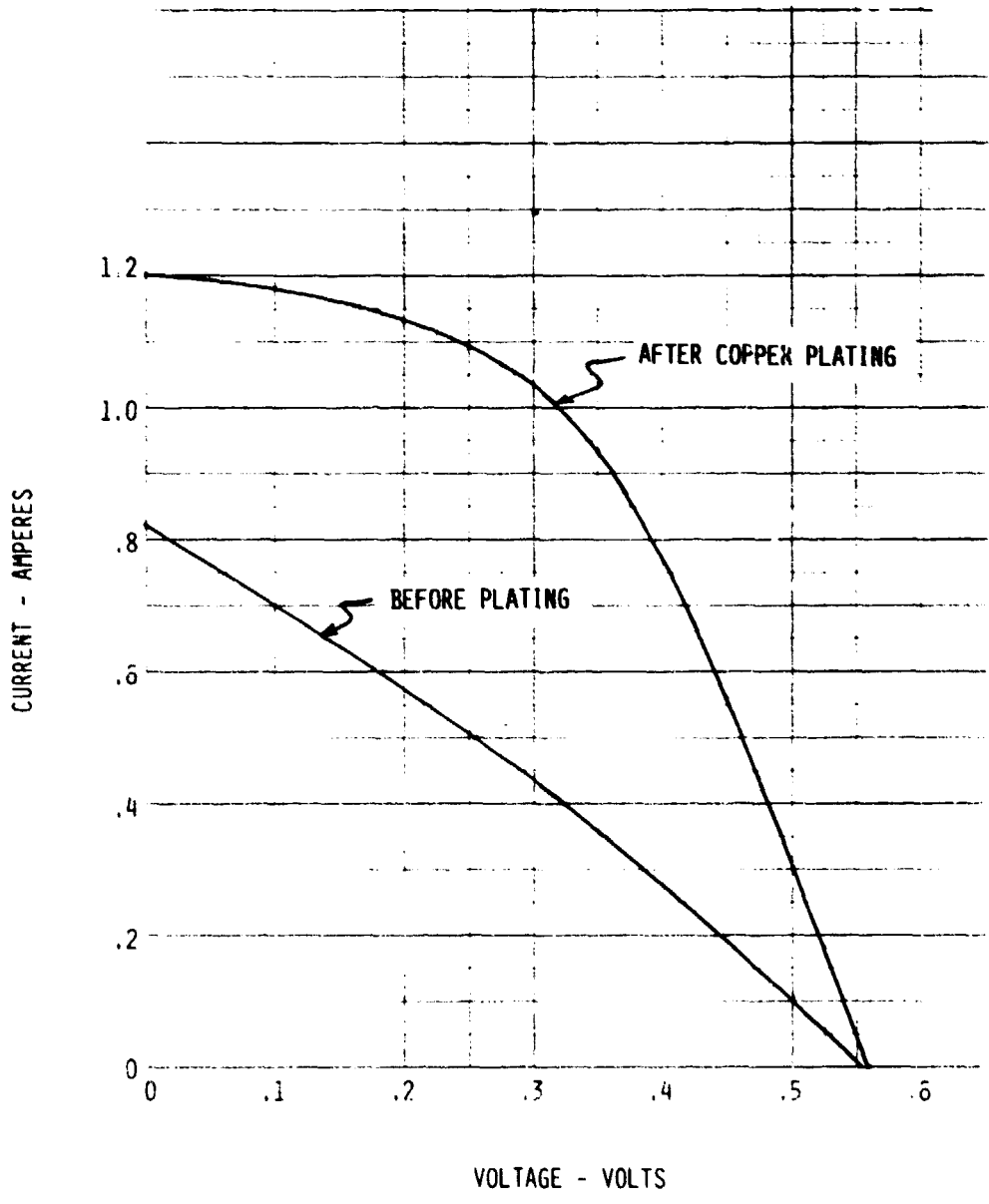

## CELL AND MODULE FORMATION RESEARCH AREA

### Plating

ORIGINAL PAGE IS  
OF POOR QUALITY

1. REACTION OF PLATING SOLUTION WITH FRIT
2. POROSITY OF PLATED LAYER

### New Directions

- FRITLESS PRINTING INKS
- ADDITIVES TO PENETRATE NITRIDE  
 $\text{Ag}_3\text{PO}_4$   
 $\text{NiF}_2$
- ADDITIVES TO IMPROVE ADHESION  
 $\text{Ti}$   
 $\text{Au}$ .

## CELL AND MODULE FORMATION RESEARCH AREA

# ION IMPLANTATION AND PULSE ANNEALING

SPIRE CORP.

## Program Description

### OBJECTIVES

1. To develop junction formation processes using Ion Implantation and pulsed annealing using equipment designed especially for solar cells.

### PROGRAM PLAN

1. Develop 4" Capability Pulse Annealer
2. Develop 4" Capability NMA Ion Implanter
3. Use this equipment to develop junctions on Advanced Sheet Materials

### Non-Mass-Analyzed (NMA) Implant Cells (Spire Test Facility)

	Lot 3969 Non Analyzed Implant	Lot 3969 Standard Implant
Voc (mV)	578 $\pm$ 1	573 $\pm$ 1
Jsc (mA/cm <sup>2</sup> ) <sup>*</sup>	28.7 $\pm$ 0.16	28.2 $\pm$ 0.08
Fill Factor (%)	75.7 $\pm$ 0.3	76.0 $\pm$ 0.2
$\eta$ (AMO) (%)	9.29 $\pm$ 0.05	9.08 $\pm$ 0.04
$\eta$ (AM1) <sup>+</sup> - Extrapolated (%)	15.4 $\pm$ 0.08	15.0 $\pm$ 0.07
R <sub>sheet</sub> (OHMS per square)	61.6 $\pm$ 3.1	55.4 $\pm$ 0.6
$\rho$ (ohm-cm)	10	10

\* No A.R. coating

+ Times 1.4 for A.R. coat and times 1.18 for AM1



Ions Produced by Commercial-Grade Solid Phosphorus

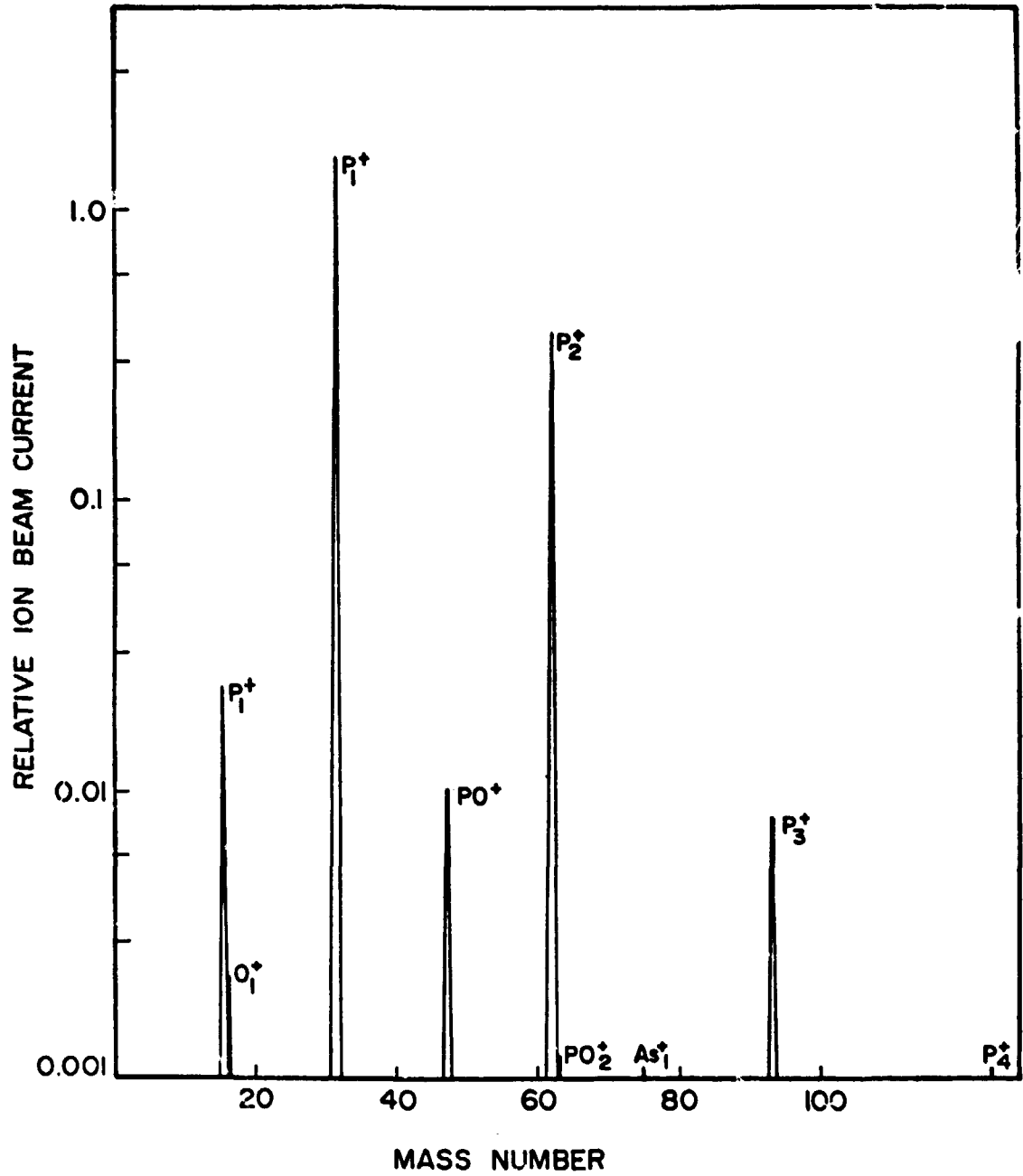

CELL AND MODULE FORMATION RESEARCH AREA

Ion Implanter Types

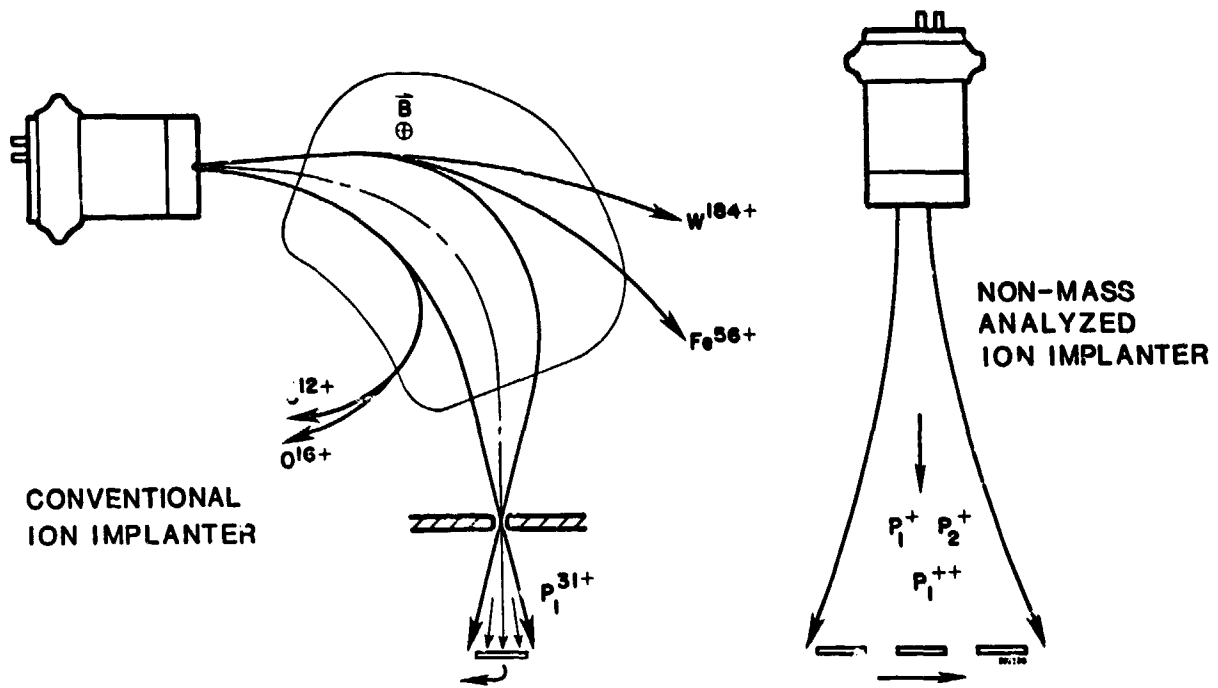

NMA Implanter Advantages

- Simple Machine
- Higher Throughput of Solar Cells
- Easily Automated (Continuous vs. Batch)
- Custom made for Solar Cells

## CELL AND MODULE FORMATION RESEARCH AREA

### Solar-Cell Ion Implanter Specifications

- Ion Energy: 5 - 20 KeV
- Ion Current: 10 - 15 mA
- Implant L. C.,  $P_1^+$ ,  $P_2^+$ , etc @  $2.5 \times 10^{15} / m^2$
- Beam Purity: 99% Phosphorous, <0.69%  $O_2$ , <0.3% Other
- Implant Rate: 4 seconds / wafer
- Uniformity:  $\pm 2.6\%$ ,  $1\sigma$
- Wafer heating: <150°C rise

# CELL AND MODULE FORMATION RESEARCH AREA

ORIGINAL PAGE IS  
OF POOR QUALITY

## Design of Solar Implanter

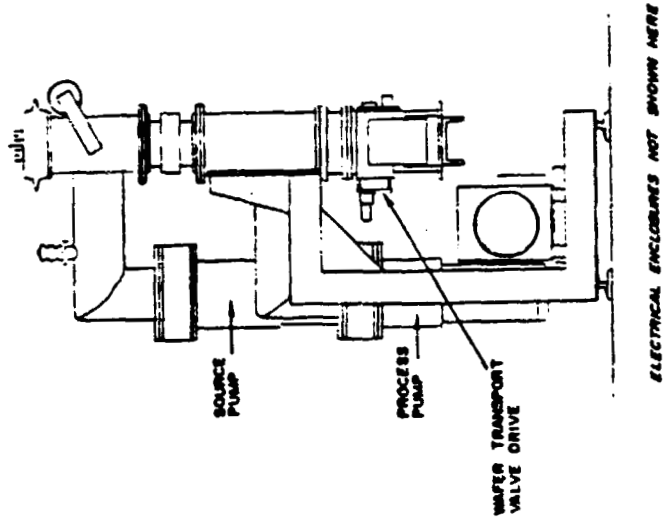
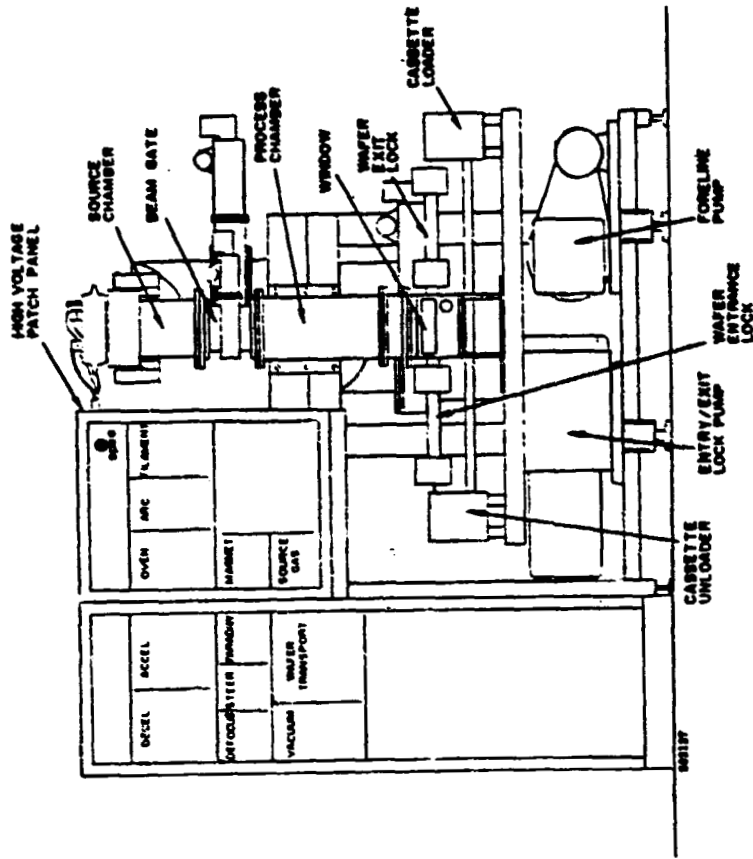

NMA Ion Implanter Beam Path

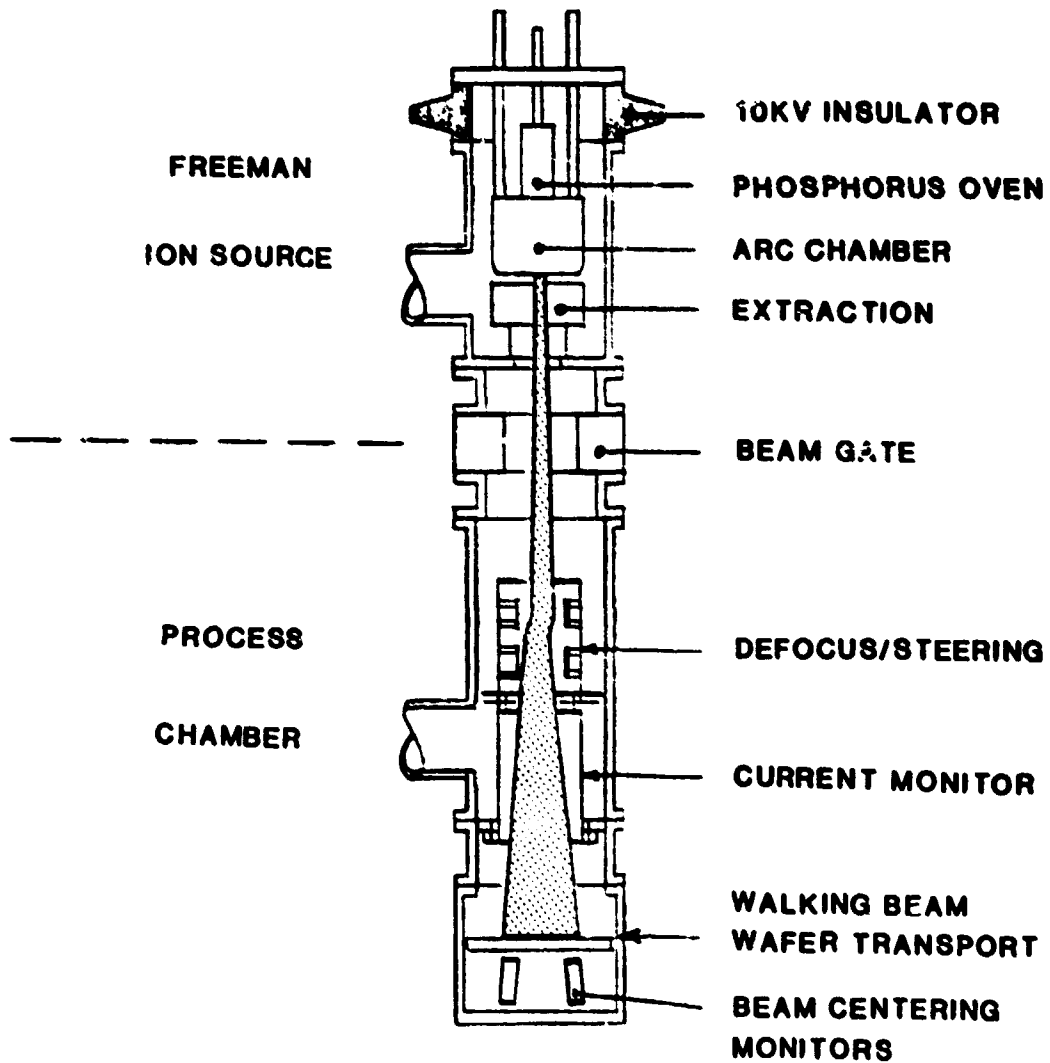

Electrostatic Beam Defocus

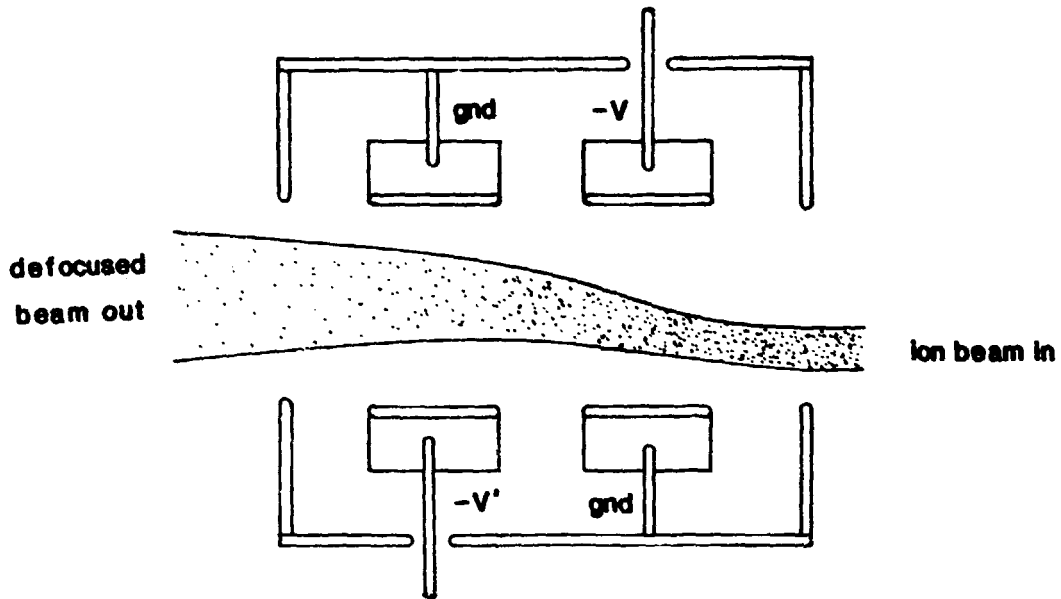

Uniformity Requirements With Walking Beam Track

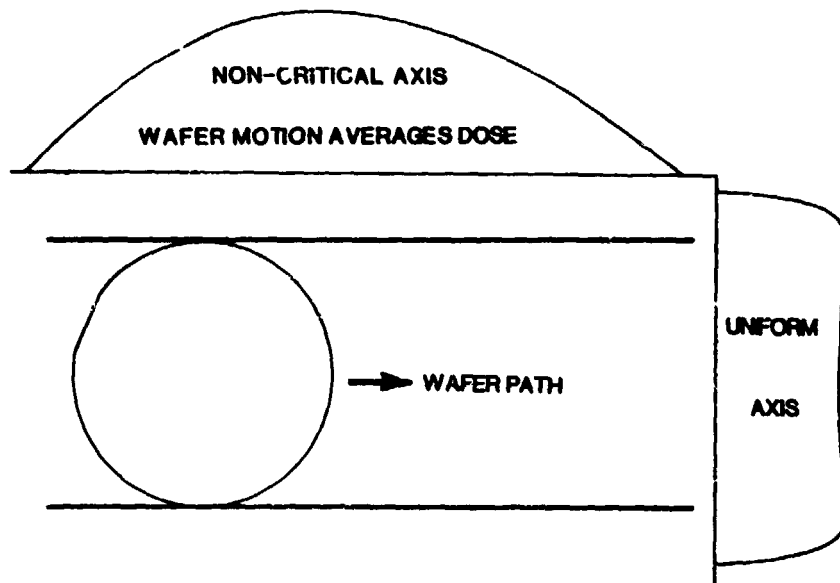

### NMA Ion Implanter Beam Studies

Purpose :

- o High Current Modification
- o Verify Ion Beam Transport
- o Beam Uniformity Measurements
- o Sample Solar Cells

Status :

- o High Current Modification Defined
- o Beam Characteristics Defined
  - Area
  - Uniformity
  - Divergence
  - Energy Dependence
- o Sample Solar Cells In Process

### NMA Test Implant Chamber

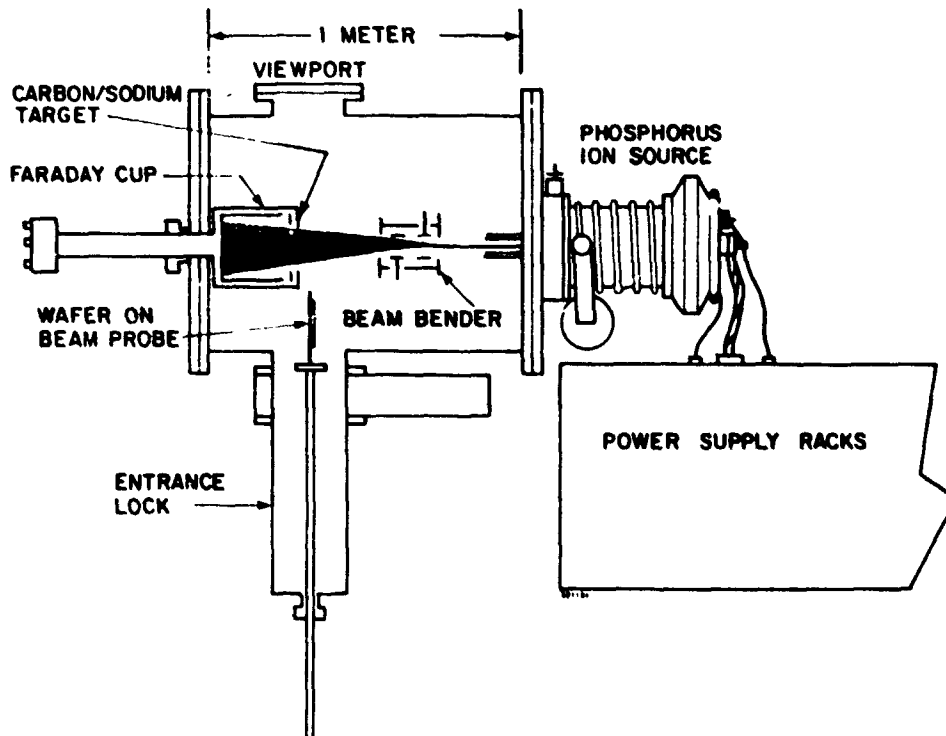

Ion Beam Studies, Phase II

<u>Parameter</u>	<u>Research Goal</u>	<u>Achieved To Date</u>
High Current	10 ma in 10 cm width	11 ma in 12 cm @ 10 KeV
Uniformity on one axis	$\pm 2 \frac{1}{2} \%$	Standard Deviation = $\pm 2.6 \%$
Energy Range	5 - 20 KeV	5 - 20 KeV
Beam Steering	$\pm 1$ cm	Not yet tested

Beam Observed in Phase II Studies at 10 keV

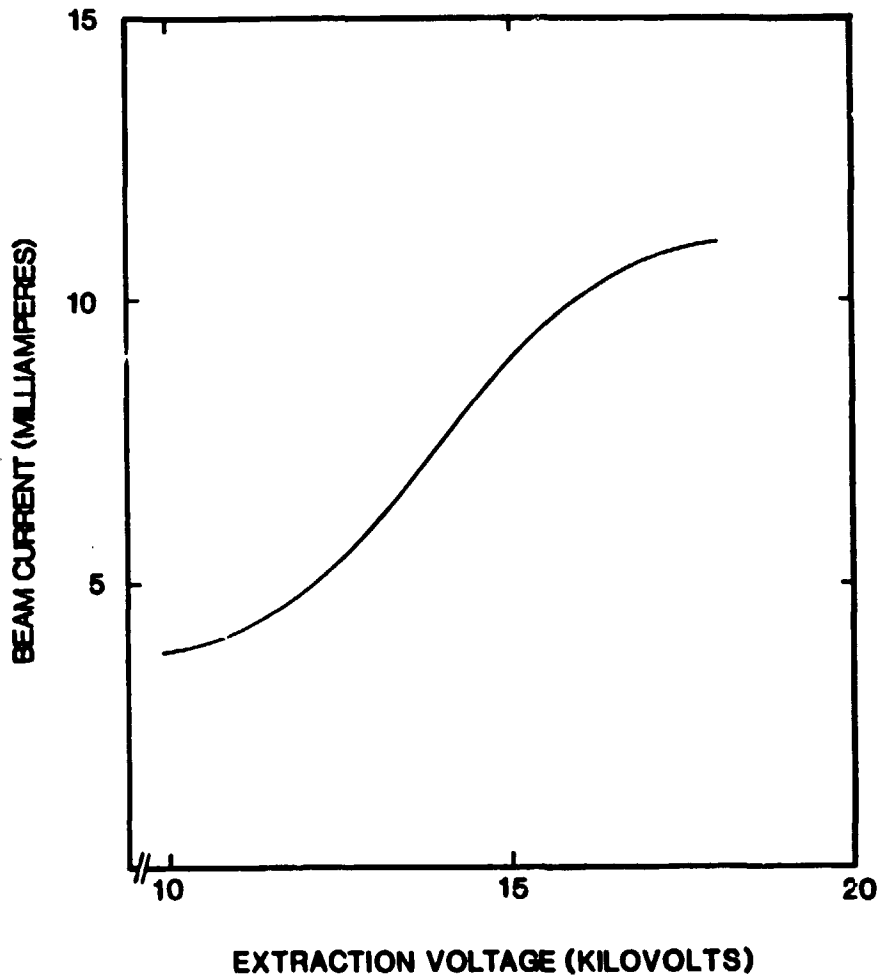



### Uniformity Improvement With Defocus

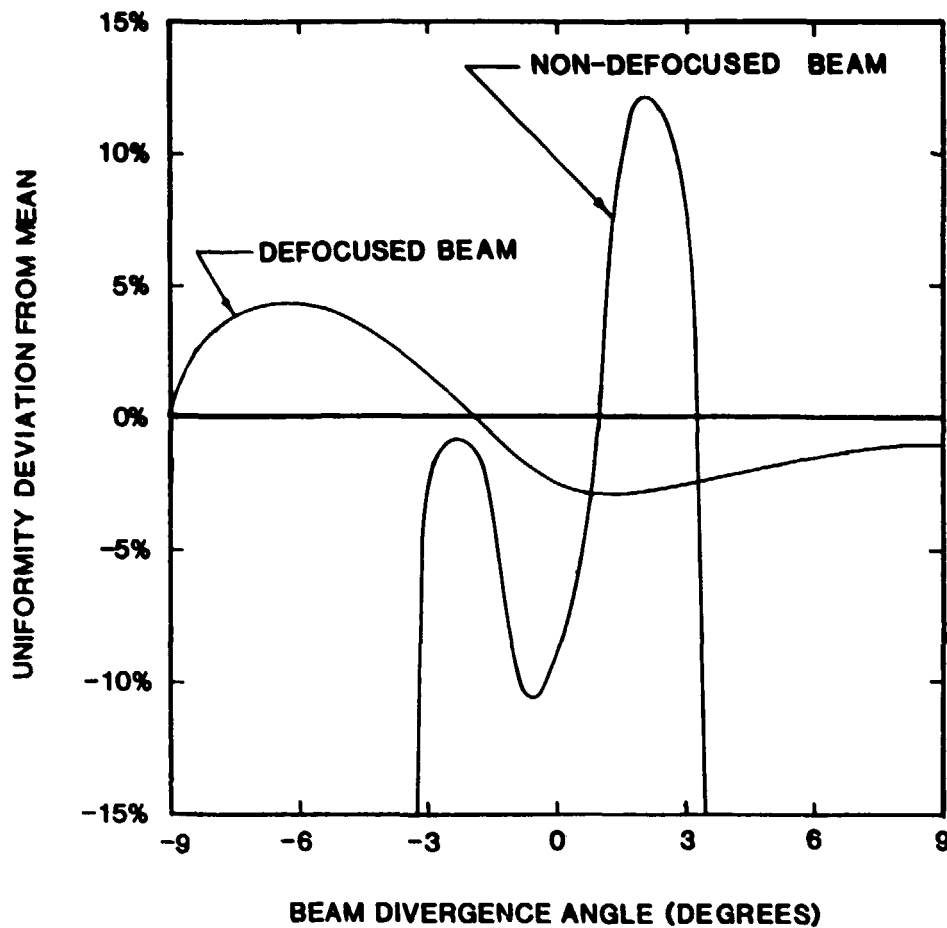

## CELL AND MODULE FORMATION RESEARCH AREA

### NMA Solar Cells Test Matrix

<u>TEST</u>	<u>IMPLANT ENERGY</u>	<u># OF CELLS</u>	<u>COMMENTS</u>
I. Energy	10 KeV	12	Mass analyzed controls
	10 KeV	12	Standard Energy
	7 1/2 KeV	12	
	5 KeV	12	
	2 1/2 KeV	12	Low Current Beam
II. Wafer Size	10 KeV	2	4" Wafer
	7 1/2 KeV	2	4" Wafer
III. PeBA	10 KeV	10	3" Wafers

### Plans

- Continue Beam Focusing and Intensity Experiments
- Detail Design Components
- Fabricate Implanter
- Test and Debug - Sept. - Oct.
- Research with Adv. Sheet Materials

# NON-MASS-ANALYZED ION IMPLANTATION

JET PROPULSION LABORATORY

D.J. Fitzgerald

## Current Objectives

- FIND EFFECT OF THERMAL PRETREATMENT OF MATERIAL ON CELL EFFICIENCY
- DETERMINE CAUSE OF LOWER  $V_{oc}$  OBSERVED IN RECENT N-M-A ION IMPLANTS
- EVALUATE COMBINED N-M-A ION IMPLANTED FRONT JUNCTIONS AND BACK SURFACE FIELD

### Effect of Thermal Pretreatment of Material

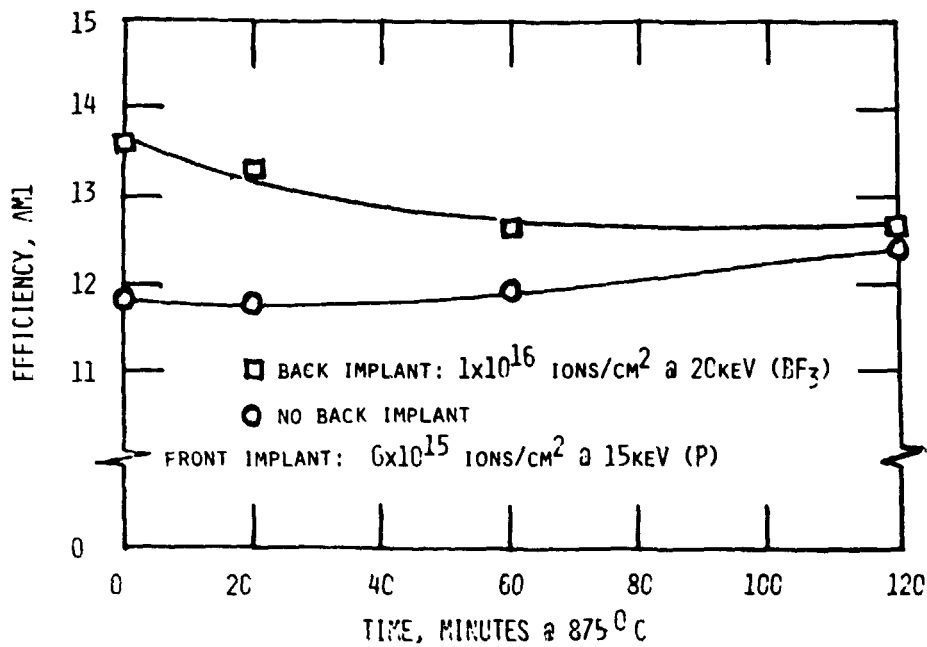

## CELL AND MODULE FORMATION RESEARCH AREA

### Evaluation of Low $V_{OC}$ in NMA Implants

#### PROBLEM:

$V_{OC}$  WITH N-M-A FRONT IMPLANT INCREASED FROM 500 mV TO 550 mV WITH  $BF_3$  BACK IMPLANT.  $V_{OC}$  SHOULD HAVE BEEN 50 mV HIGHER IN BOTH CASES.

#### POSSIBLE CAUSES:

- (A) BAD ACTORS SUCH AS IRON IN ION BEAM
- (B) INADEQUATE FRONT JUNCTION DOSE
- (C) POOR BACK CONTACT (NON-OHMIC)
- (D) INADEQUATE BACK SURFACE FIELD (DEPTH, DOSE, BORON ACTIVATION, ETC.)

#### APPROACH:

- (A) CHANGED S.S. MASKS TO GRAPHITE
- (B) EVALUATED EFFECT OF VARYING FRONT DOSE
- (C) TESTED SAMPLES FOR SHOTTKY BARRIER
- (D) TESTED FOR PRESENCE OF BACK SURFACE FIELD

## Effect of Varying Front Dose

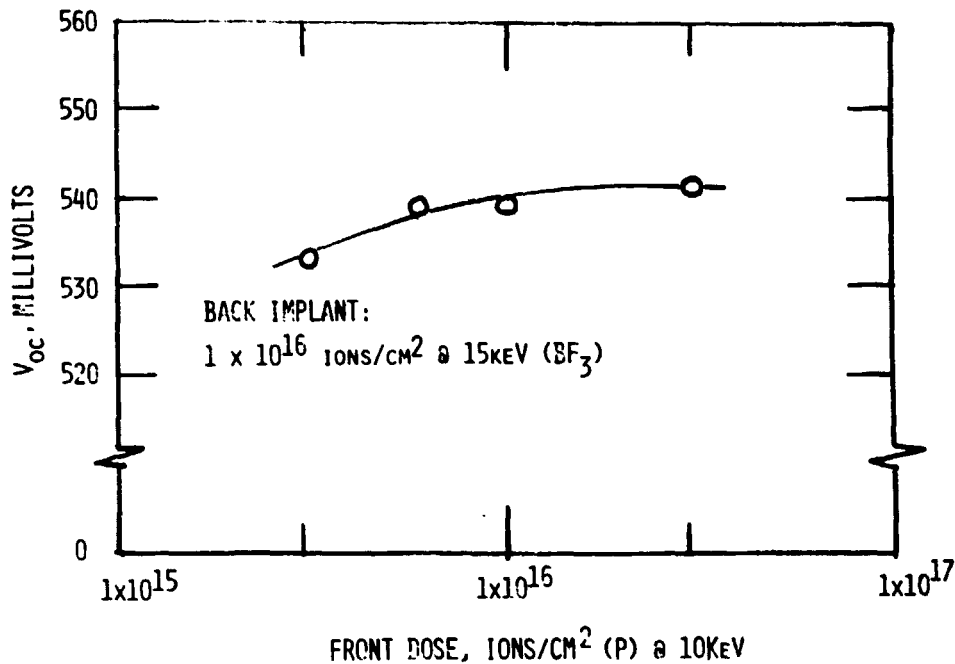

- FRONT STRIPPED SAMPLES INDICATED NON-OHMIC CONTACT ON BACK OF THOSE WITHOUT BACK IMPLANT
- CELLS WITH BACK IMPLANT STRIPPED OFF WITH NEW GOOD CONTACT INDICATED THAT SMALL BACK SURFACE FIELD WAS PRESENT (<10mV)
- SPIRE SUGGESTED THAT HIGH TEMPERATURE ANNEAL STEP (15 MINUTES @ 850°C) SHOULD BE EXTENDED TO 30 MINUTES TO ASSURE BORON ACTIVATION

## Conclusions

- THERMAL PRE-TREATMENT OF MATERIAL DEPENDS ON PRESENCE OF BACK IMPLANT
- V<sub>oc</sub> DEFICIENCY MOSTLY DUE TO NON-OHMIC BACK CONTACT - CAUSE NOT UNDERSTOOD
- BACK IMPLANT MADE CONTACT OHMIC BUT RESULTED IN SMALL BACK SURFACE FIELD
- POOR BACK SURFACE FIELD MAY BE DUE TO INSUFFICIENT BORON ACTIVATION

CELL AND MODULE FORMATION RESEARCH AREA

PROCESS RESEARCH: SEMIX SILICON MATERIAL

SOLAREX CORP.

John H. Wohlgemuth

Change in Program Emphasis

FORMERLY: DEVELOPMENT OF COST-EFFECTIVE PROCESS SEQUENCE

TITLE: MODULE EXPERIMENTAL PROCESS SYSTEM DEVELOPMENT UNIT (MEPSDU)

NOW: RESEARCH TO UNDERSTAND THE MECHANISMS OF PHOTOVOLTAIC CONVERSION  
IN SEMICRYSTALLINE SILICON

TITLE: PROCESS RESEARCH OF SEMIX SILICON MATERIAL (PROSSM)

DATE OF CHANGE: FEBRUARY 25, 1982

REPORT ON: THREE MONTHS OF MEPSDU  
TWO MONTHS OF PROSSM

MEPSDU Summary

1. COST EFFECTIVE PROCESS SEQUENCE IDENTIFIED
2. COST ANALYSIS OF 6.6MM PER YEAR LINE PROJECTED - \$0.56 PER WATT CELL ADD ON COST
3. THREE SPECIFIC PROCESSES DEVELOPED FOR PROGRAM
  - GLASS BEAD BACK CLEAN-UP
  - WAVE-SOLDERING OF FRONTS
  - ION MILLING FOR EDGES
4. SPRAY DOPANT - GOOD LABORATORY RESULTS, BUT INCONSIST RESULTS AND SHORT SHELF LIFE. NOT READY FOR PRODUCTION.
5. EQUIPMENT FOR HANDLING AND PROCESSING SOLAR CELLS IS AVAILABLE FOR ALL PROCESS STEPS IDENTIFIED IN THIS PROGRAM.

General Process Description

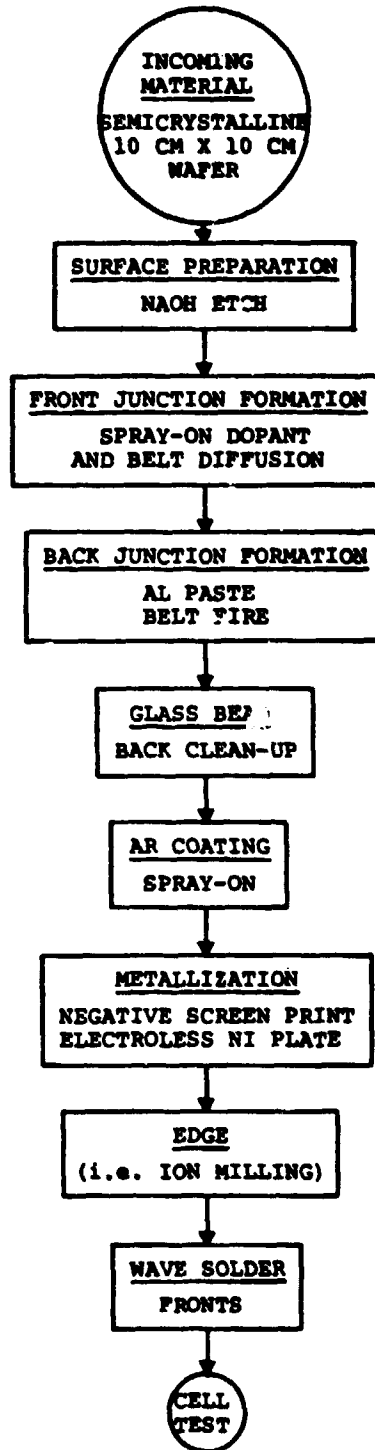

## Cost Estimate

## ASSUMPTIONS:

- 10% EFFICIENT CELLS
- 80% YIELDS
- THREE SHIFTS/DAY
- 345 DAYS/YR OPERATION
- PRODUCTION OF 1,000 GOOD CELLS/HR = 6.6 MW PER YR
- IPEG2 COEFFICIENTS

	EQUIP	EQUIP LIFETIME YRS	FT <sup>2</sup>	WORKERS/ SHIFT	DT:AB	MATS/YR	UTIL/YR
ETCH	65,000	5	200	1	70400.	\$ 25105	\$ 27886
DIFFUSION	173,000	10	504	1	70400.	48900	18307
BSF FORM	83,000	10	328	1/2	33000.	57017	8571
BACK CLEANUP	138,000	3	288	1	70400.	1.490	64738
AR COAT	104,000	10	224	1/2	33000.	73098	13743
RESIST PRINT	126,000	10	392	1	70400.	282307	6145
NI PLATE	50,000	5	378	1	70400.	282090	45248
ION MILL	135,000	10	200	1	65686.	5880	2468
WAVE SOLDER	100,000	5	400	1	65686.	70268	6285
TEST	<u>55,000</u>	10	<u>150</u>	<u>2</u>	<u>150543.</u>	<u>0</u>	<u>1130</u>
	\$1,029,000		3064 ft <sup>2</sup>	10	699,915./yr	\$862,255/yr	\$194,521/yr



CELL AND MODULE FORMATION RESEARCH AREA

ORIGINAL PRICE IS  
OF POOR QUALITY

Cost per Watt

	<u>C1 x EQUIP</u> 6.6 E-6	<u>FT<sup>2</sup> x 109</u> 6.6 E-6	<u>2.1 x DLAB</u> 6.6 E-6	<u>1.2 x MATS</u> 6.6 E-6	<u>1.2 x UTIL</u> 6.6 E-6	TOTALS
ETCH	.0064	.0033	.0224	.0046	.0050	.0417
DIFFUSION	.0136	.0083	.0224	.0089	.0033	.0565
BSF FORM	.0065	.0054	.0105	.0104	.0016	.0344
BACK CLEANUP	.0174	.0048	.0224	.0029	.0118	.0593
AR COAT	.0082	.0037	.0105	.0133	.0025	.0382
RESIST PRINT	.0099	.0065	.0224	.0513	.0011	.0912
NI PLATE	.0049	.0062	.0224	.0513	.0082	.0930
ION MILL	.0106	.0033	.0209	.0011	.0004	.0363
WAVE SOLDER	.0098	.0066	.0209	.0128	.0011	.0512
TEST	<u>.0043</u>	<u>.0025</u>	<u>.0479</u>	<u>.0000</u>	<u>.0002</u>	<u>.0549</u>
	.0916	.0506	.2227	.1566	.0352	.5567

ALL COSTS ARE EXPRESSED IN DOLLARS

Wave Soldering

- WITH PROPER SPEEDS, TILT ANGLE AND WAVE CELLS EXCEEDED DIPPED CELLS IN PERFORMANCE.
- SIMPLE IN-LINE FOAM FLUXER WORKS WELL.
- WAVE SOLDERING OF BOTH SIDES DID NOT WORK. FIRST SIDE PEELED OFF DURING SOLDERING OF SECOND SIDE.
- SOLAREX HAS ORDERED PRODUCTION MACHINE.

## CELL AND MODULE FORMATION RESEARCH AREA

### Spray AR Coating

- DETAILED TEMPERATURE TIME EXPERIMENTS

TEMPERATURE RANGE	400 - 410°C
TIME	45 SECOND PREHEAT
	5 SECOND SPRAY
	NO POST SPRAY HEATING

- RESULTS IN EXCELLENT QUALITY AR THAT IS READILY REMOVED IN FUMIC HF IN PATTERN AREA

### Edging

- SAND BLASTING - GOOD THRUPTUT BUT PROCESS IS VERY SENSITIVE TO OPERATIONAL PARAMETERS
- DIFFUSION/PLATING BARRIERS - FUMIC HF ATTACKS MOST OF THE STANDARD MATERIALS
- ION MILLING REMAINS BEST CANDIDATE ALTHOUGH REQUIRES OPTIMIZATION

### Spray Dopant (Emulsitone)

- SHORT SHELF LIFE - BREAKDOWN OF VINYL ACETATE PRODUCING ACETIC ACID
- VERY SENSITIVE TO SPRAY CONDITIONS - OVERSPRAYING MEANS YOU CAN'T REMOVE OXIDE
- INCONSISTENCY FROM BATCH TO BATCH

SOME BATCHES LASTED 2-3 MONTHS, OTHER DEGRADED IN LESS THAN ONE MONTH

SOME BATCHES WERE SUCCESSFUL ON MOST RUNS, OTHERS WERE MORE SENSITIVE TO SPRAY CONDITIONS

- CANNOT RECOMMEND FOR PRODUCTION NOW

## CELL AND MODULE FORMATION RESEARCH AREA

### PROSSM Program

1. PREPARE REVISED PROGRAM PLAN
2. PREPARE SUMMARY REPORT OF MEPSDU
3. INITIATE EFFORT TO UNDERSTAND MECHANISMS CONTROLLING EFFICIENCY IN SEMIX MATERIAL

### Two Experiments Under Way

1. USING 10 CM X 10 CM WAFER TO PRODUCE MATRIX OF 400 0.5 CM X 0.5 CM SOLAR CELLS. EVALUATE PERFORMANCE (VOC, ISC, P<sub>MAX</sub>, DIODE FACTOR, ETC.) AS A FUNCTION OF MACROSCOPIC POSITION ON BRICK AND AS INFLUENCED BY MICROSCOPIC, LOCAL STRUCTURE SUCH AS GRAIN BOUNDARIES, TWINS, ETC.
2. FABRICATING MATRIX OF SAMPLES AT VARIOUS BULK RESISTIVITIES IN THICKNESS FROM 300 MICRONS DOWN TO 50 MICRONS. EVALUATE AND ANALYZE RESULTANT CELLS TO DETERMINE DEPENDENCE OF MINORITY CARRIER DIFFUSION LENGTH ON BULK RESISTIVITY AND TO DETERMINE THE MECHANISMS CONTROLLING VOLTAGE.

## CELL AND MODULE FORMATION RESEARCH AREA

# MEPSDU

WESTINGHOUSE ELECTRIC CORP.

C.M. Rose

### Goals and Approach

- DESIGN MODULE MEETING JPL 5101-138 SPECIFICATIONS
- SELECT AND VERIFY PROCESS SEQUENCE FOR FABRICATING MODULES
- DESIGN AND BUILD A TEST FACILITY TO FABRICATE MODULES USING SELECTED PROCESS SEQUENCE
- PERFORM TECHNICAL FEASIBILITY EXPERIMENTS
- ACCEPTANCE AND QUALIFICATION TESTING OF MODULES PRODUCED
- DETERMINATION OF 1986 MODULE PRODUCTION COSTS

### Milestone Schedule

<u>MILESTONE</u>	<u>CURRENT PROGRAM PLAN</u>
START DATE	NOV. 26, 1980
PRELIMINARY DESIGN REVIEW	MAR. 3, 1981
PROTOTYPE MODULE DESIGN REVIEW	JULY 14, 1981
MEPSDU DESIGN REVIEW	MAY 15, 1982
ECONOMIC ANALYSIS REVIEW	SEPT. 14, 1982
MEPSDU INSTALLATION	JAN. 31, 1983
TECHNICAL FEASIBILITY EXPERIMENTS	DEC. 15, 1983
FINAL REPORT	DEC. 31, 1983

# CELL AND MODULE FORMATION RESEARCH AREA

## Baseline Process Sequence

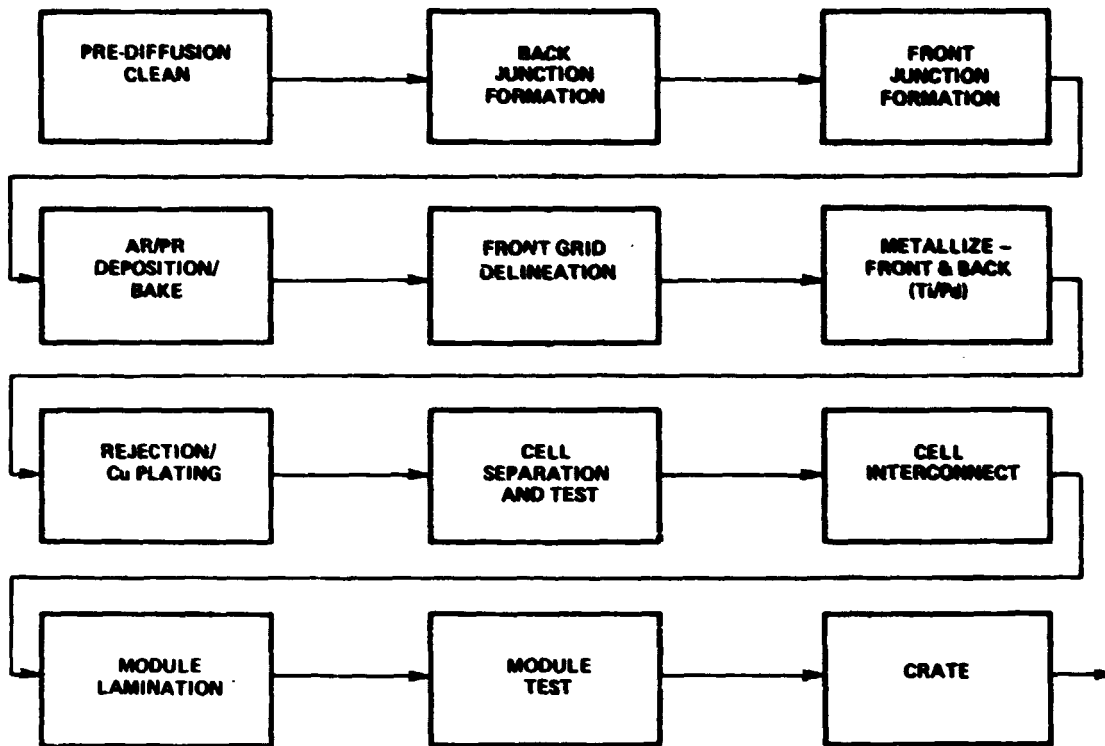

## Prototype Module Fabrication Progress

<u>DATE</u>	<u>AVG. CELL EFFICIENCY</u>	<u>MODULE EFFICIENCY</u>
MAR. 1981	10.8 %	7.5 %
SEPT. 1981	10.5	9.0
OCT. 1981	12.3	10.6
DEC. 1981	12.7	11.2

**CELL AND MODULE FORMATION RESEARCH AREA**

**Module Environmental Tests**

<u>TEST</u>	<u>RESULT</u>
THERMAL CYCLES (250)	NO MEASURABLE DEGRADATION
5101-138 HUMIDITY CYCLES	NO MEASURABLE DEGRADATION, NO OBSERVABLE DELAMINATION
CELL SHADING TESTS	NO MEASURABLE TEMP. INCREASE
CELL INTERCONNECT FAILURE	NO MEASURABLE POWER DEGRADATION WITH MULTIPLE INTERCONNECT FAILURES
POS./NEG. WIND LOAD TESTS	NO DAMAGE
HAIL IMPACT	NO DAMAGE AT IMPACT ENERGY UP TO 5 TIMES DESIGN LEVELS

**25 MW/yr Production Facility Cost Analysis**

<u>PROCESS STEP</u>	<u>PROCESS</u>	<u>VALUE ADDED (1980 \$/WATT)</u>	<u>% TOTAL</u>
1	PREPARE INPUT WEB	0.353	49.73
2	BORON DIFFUSION	0.032	4.51
3	PHOSPHOROUS DIFFUSION	0.023	3.33
4	APPLICATION OF AR/PR	0.016	2.24
5	DEFINE GRID PATTERN	0.017	2.40
6	METALLIZE WEB	0.037	5.18
7	REJECTION AND PLATING	0.037	5.26
8	CELL SEPARATION AND TEST	0.029	4.06
9	CELL INTERCONNECTION	0.026	3.67
10	LAMINATION	0.121	17.02
11	CRATING	0.019	2.62
TOTAL FOR PROCESS -		0.709	
		<u>1980 \$</u>	
		PEAK WATT	

Automated Laser Scribe

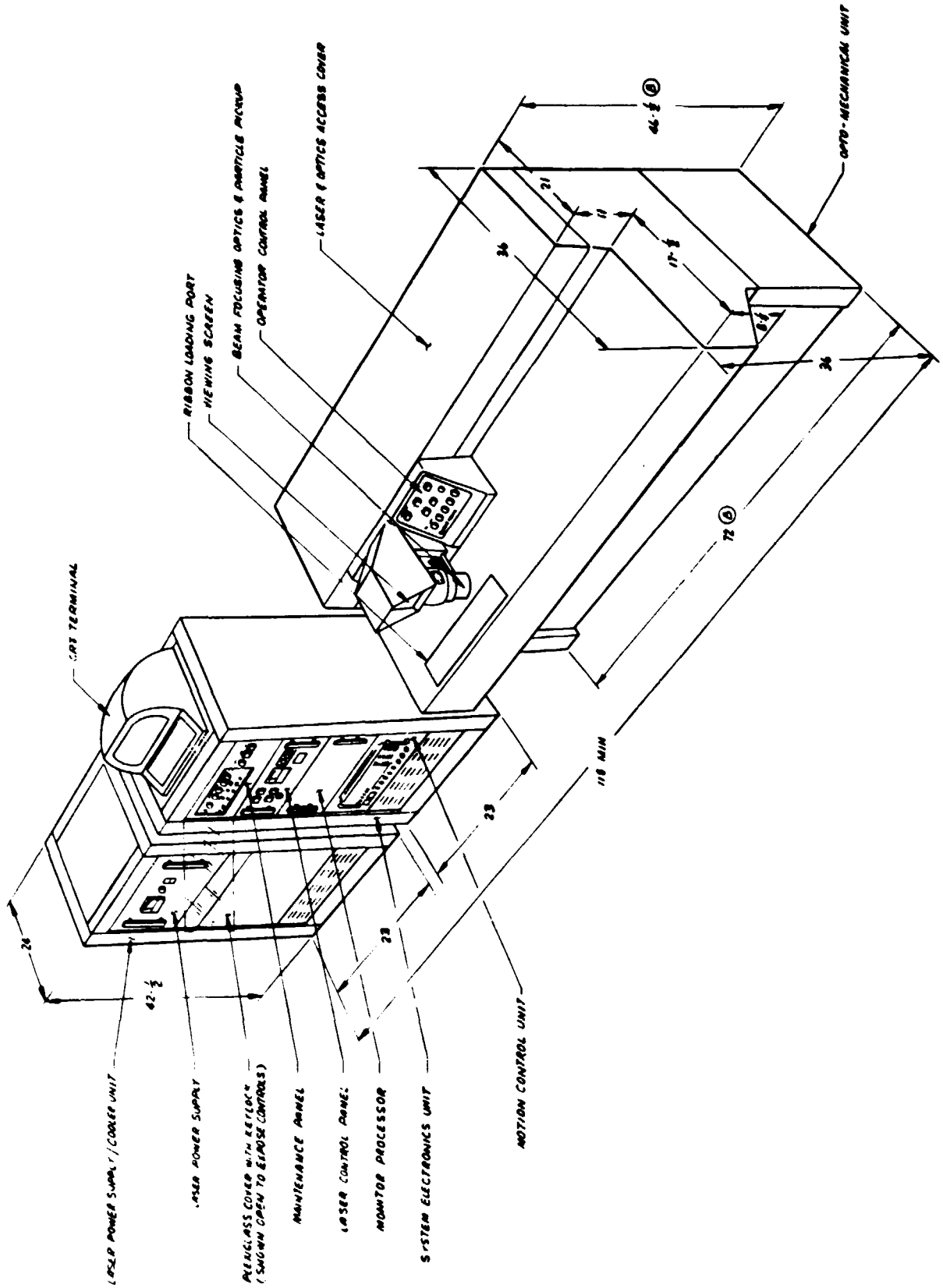

## DENDRITIC WEB SILICON

WESTINGHOUSE ELECTRIC CORP.

### Goals

- ESTABLISH FEASIBILITY OF SUBSTITUTING LIQUID DOPANTS FOR GASEOUS DIFFUSION PROCESS
- OPTIMIZE LIQUID DOPANT DRIVE-IN PARAMETERS
- OPTIMIZE LIQUID APPLICATION TECHNIQUE FOR:
  - DOPANTS
  - SiO<sub>2</sub> PRECURSOR DIFFUSION MASKS
  - AR/PR COATINGS
- ESTABLISH FEASIBILITY OF SUBSTITUTING ION IMPLANTATION FOR GASEOUS DIFFUSION PROCESS

### Liquid Dopants: Expected Advantages

- LESS EXPENSIVE EQUIPMENT
- LESS EXPENSIVE CHEMICALS
- FEWER CLEANING OPERATIONS
- SIMPLIFIED PROCESS CONTROLS
- AUTOMATABLE PROCESS
- BASELINE SEQUENCE COMPATIBILITY



## **CELL AND MODULE FORMATION RESEARCH AREA**

### **Liquid Dopants: Experimental Approach**

- **DIFFUSION PARAMETER OPTIMIZATION**
  - **TIME/TEMPERATURE FOR LIQUID BORON DRIVE**
  - **TIME/TEMPERATURE FOR LIQUID PHOSPHORUS DRIVE**
  - **TIME/TEMPERATURE FOR SIMULTANEOUS DRIVE**
- **LIQUID APPLICATION TECHNIQUE INVESTIGATION**
  - **DIPPING**
  - **SPRAYING**
  - **MENISCUS COATING**
- **LIQUID SiO<sub>2</sub> PRECURSOR FEASIBILITY DETERMINATION**
- **COST ANALYSIS**

### **Liquid Dopants: Experimental Tools**

- **CELL FABRICATION – LIGHT & DARK IV PARAMETERS**
- **SHEET RESISTIVITY**
- **JUNCTION PROFILES**

## CELL AND MODULE FORMATION RESEARCH AREA

### Meniscus Coater

ORIGINAL PAGE IS  
OF POOR QUALITY

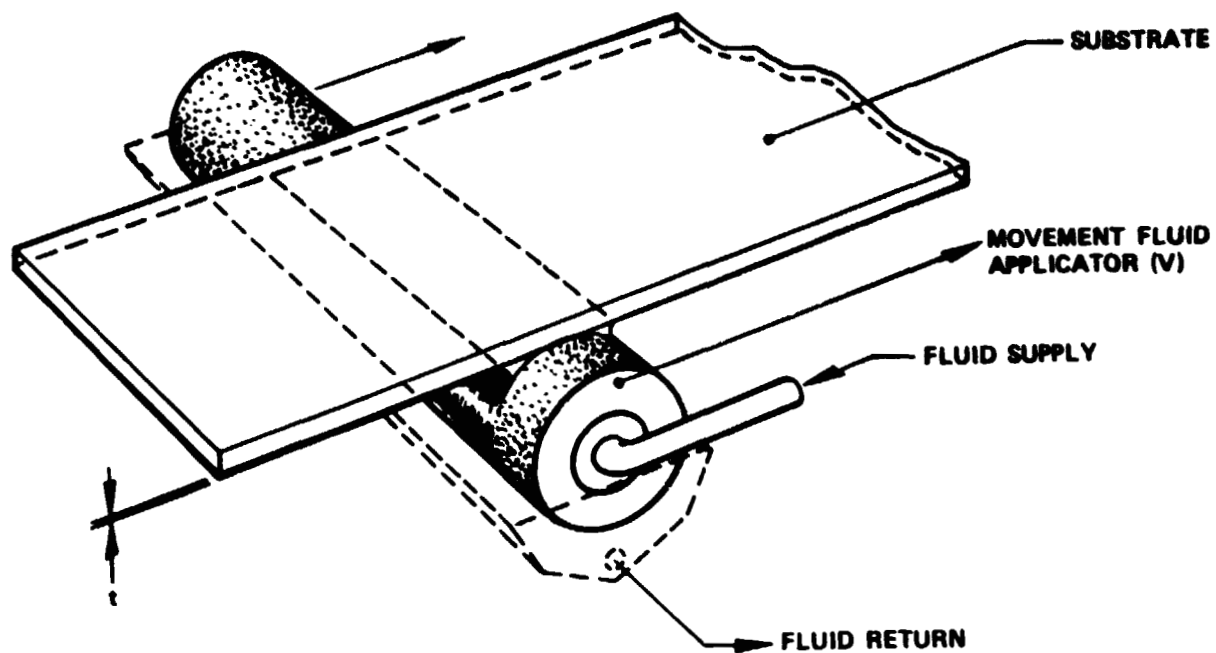

### Ion Implantation: Expected Advantages

- HIGHER CELL EFFICIENCY
- IMPROVED CELL PROPERTY UNIFORMITY
- DRY, ENVIRONMENTALLY BENIGN, PROCESSING
- BASELINE SEQUENCE COMPATIBILITY

## CELL AND MODULE FORMATION RESEARCH AREA

### Conclusions

- **Ⓜ** MEPSDU WORK STOPPED FEB. 10
- ALL PROGRAM TASKS ON SCHEDULE AND IN BUDGET
- MODULE PASSED ALL ENVIRONMENTAL SPECIFICATIONS
- PROJECTED PRODUCTION COSTS MET 70¢/WATT OBJECTIVE
- REDIRECTED TASKS
  - FINAL MEPSDU REPORT
  - LIQUID DOPANTS AND APPLICATOR STUDY
  - ION IMPLANTATION WORK
- REVISED PROGRAM PLAN SUBMITTED TO JPL

# PHOTOVOLTAIC ASSESSMENT

UNIVERSITY OF PENNSYLVANIA

M. Wolf

## Approximate Westinghouse Grid Line Pattern

(All Dimensions in cm)

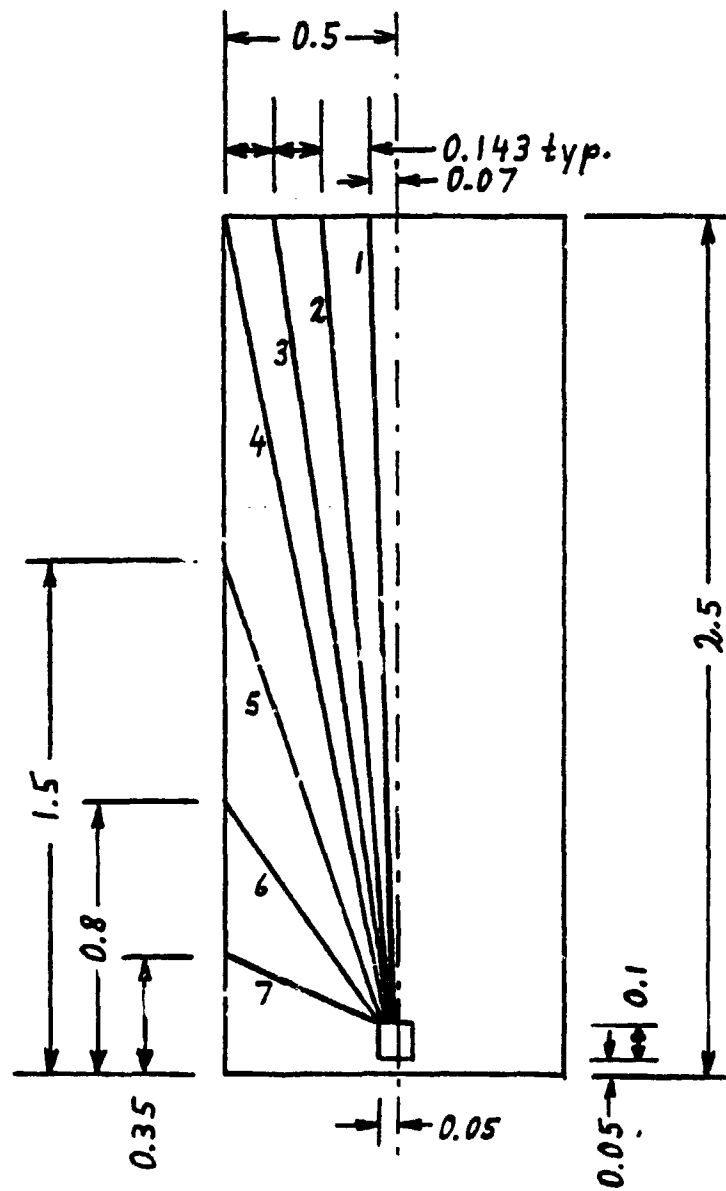

CELL AND MODULE FORMATION RESEARCH AREA

ORIGINAL PAGE IS  
OF POOR QUALITY

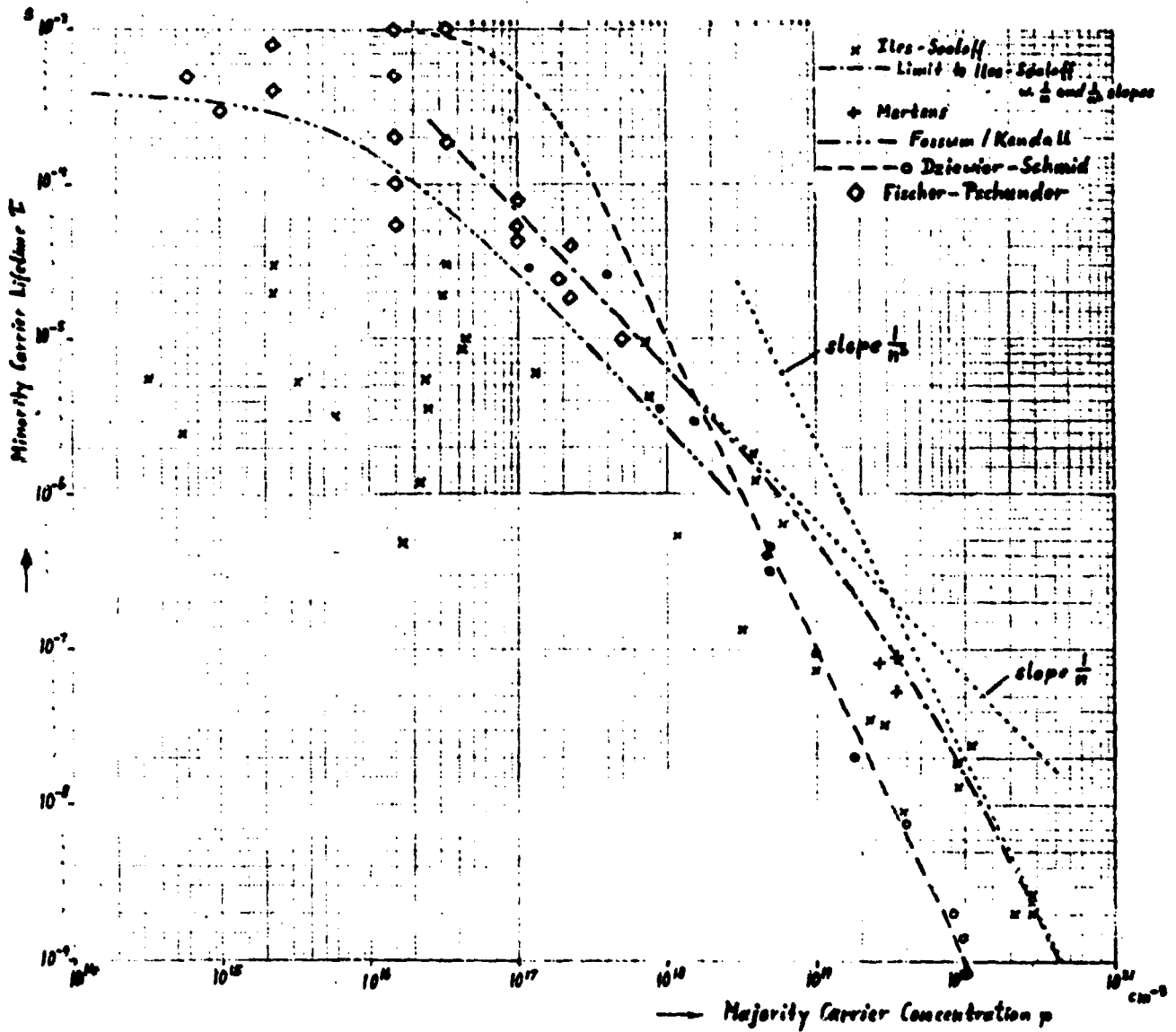

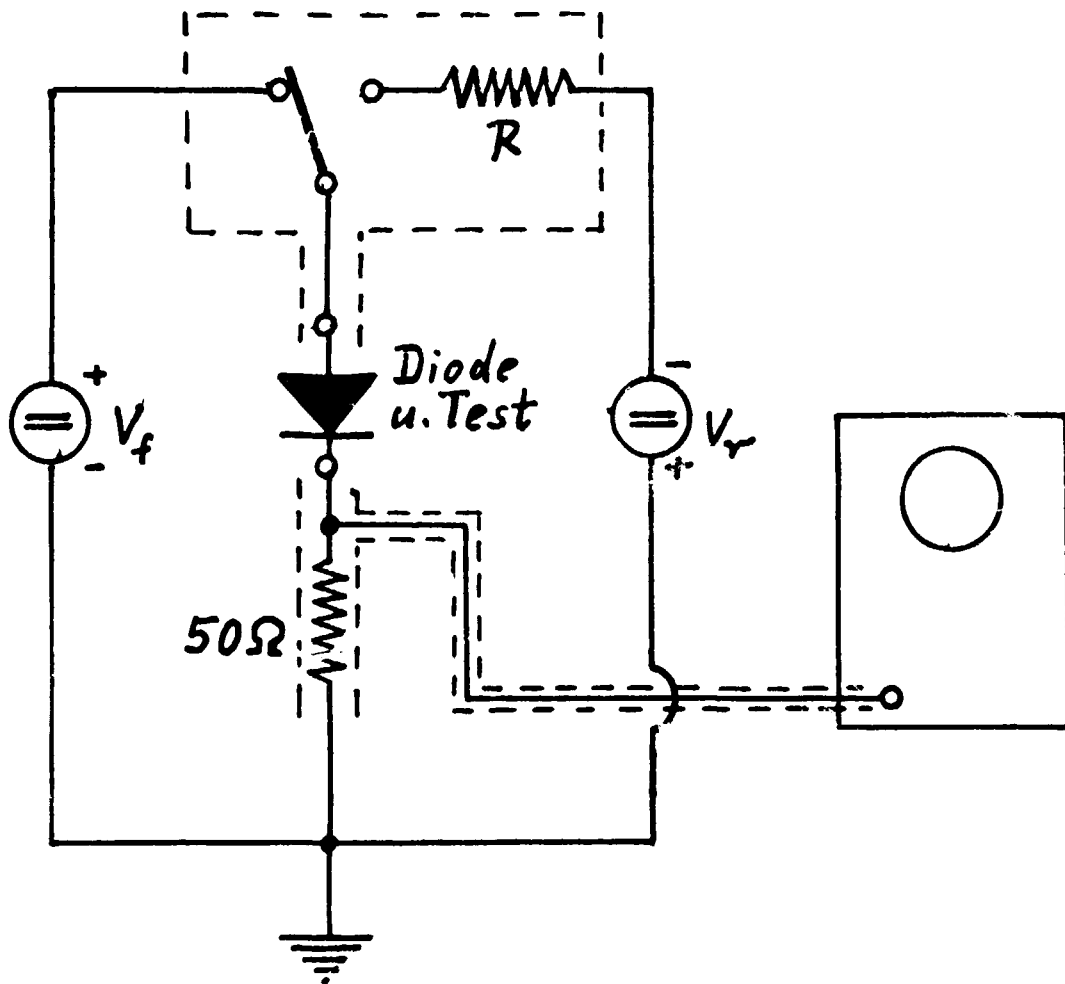
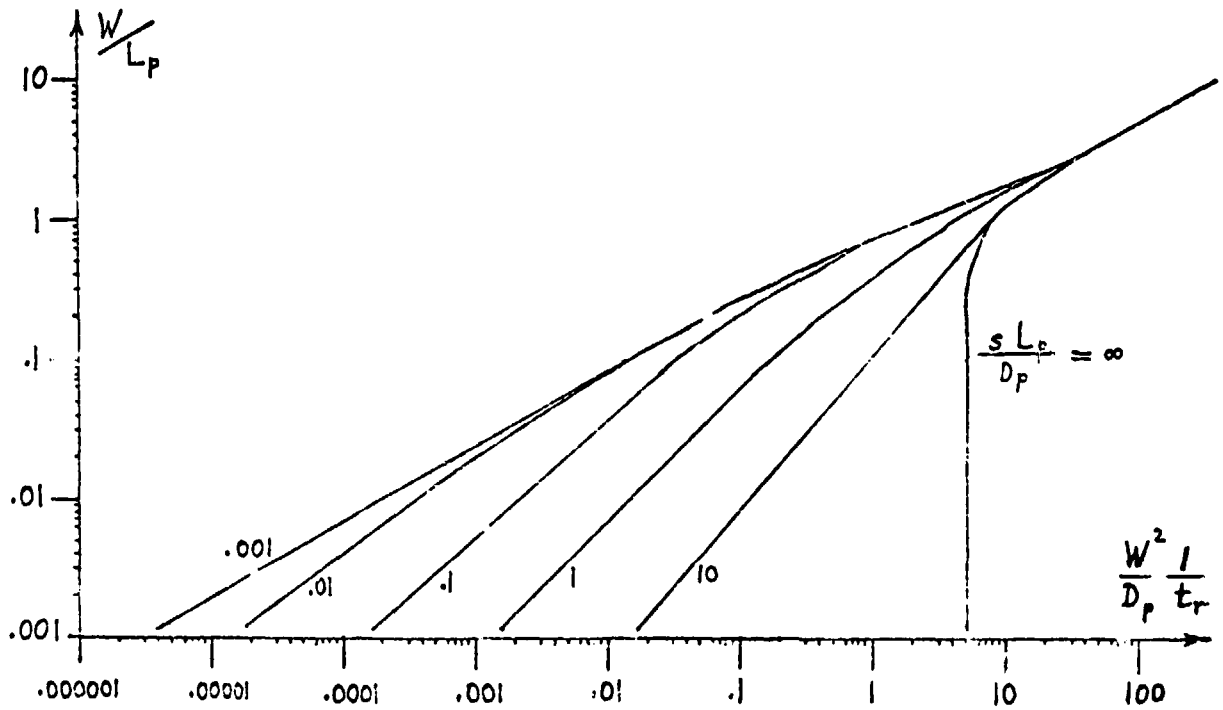

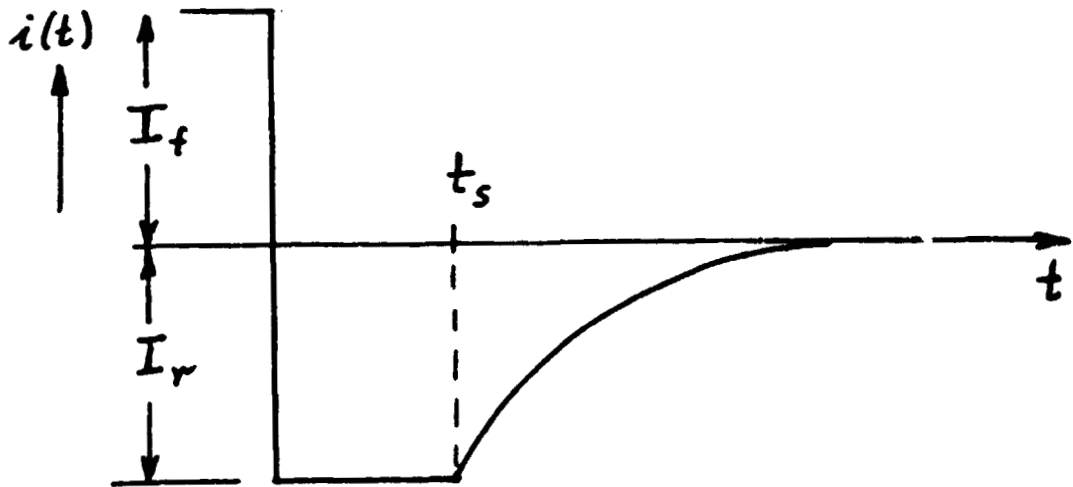
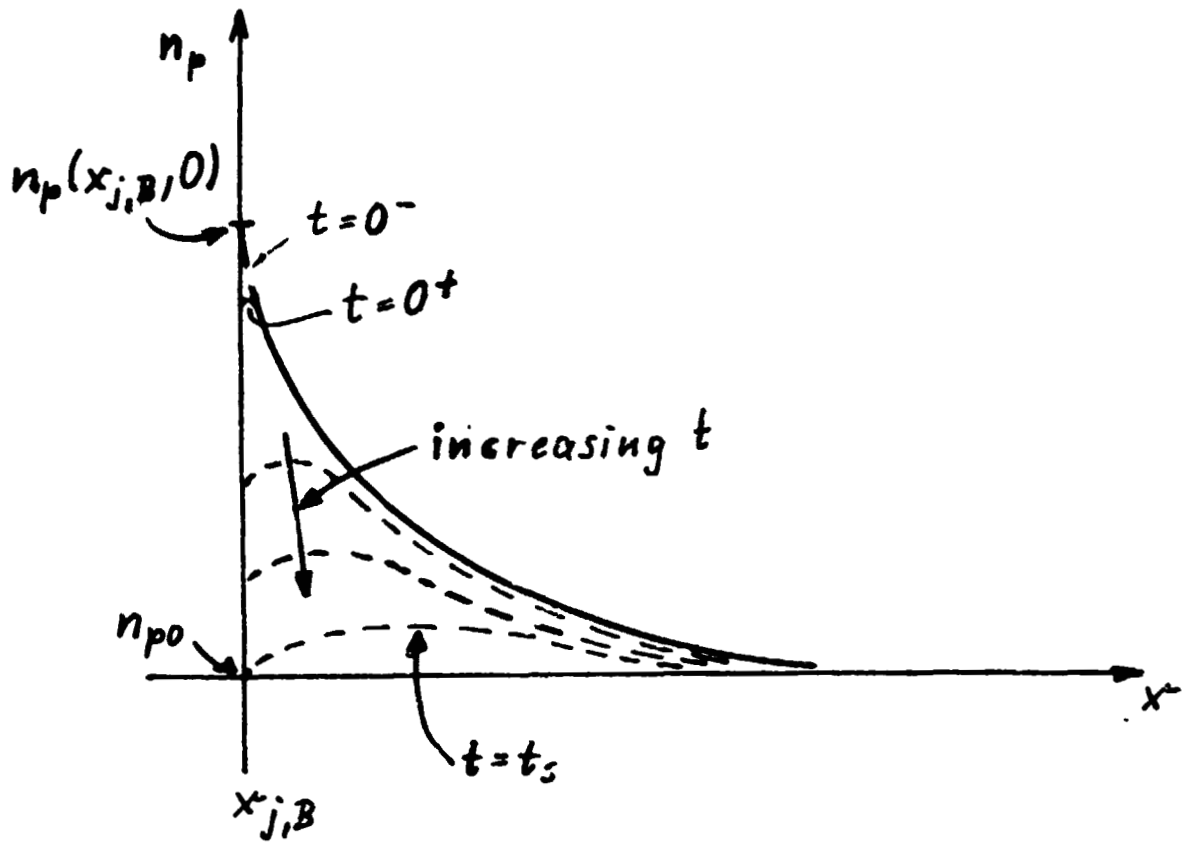

*Epoxy Diode*

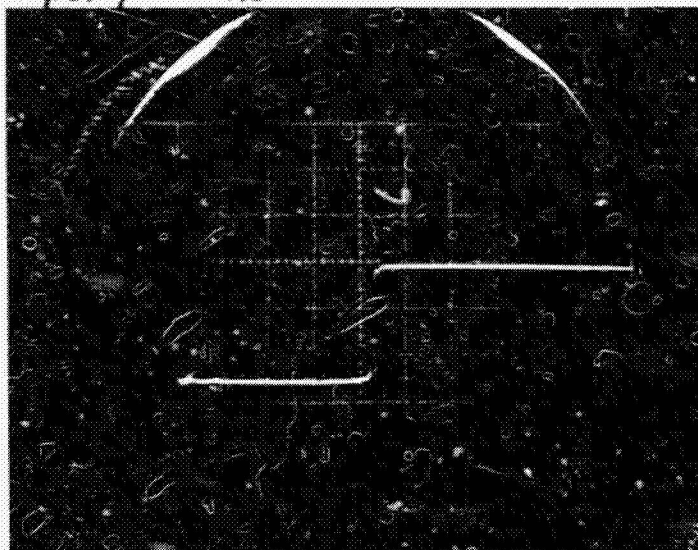

$I_f = I_r = 100 \text{ mA}; 1 \mu\text{s}/\text{div.}$





MODEL Solar Cell # 51A; T = 296.5 K DATE 3-26-82 MJD

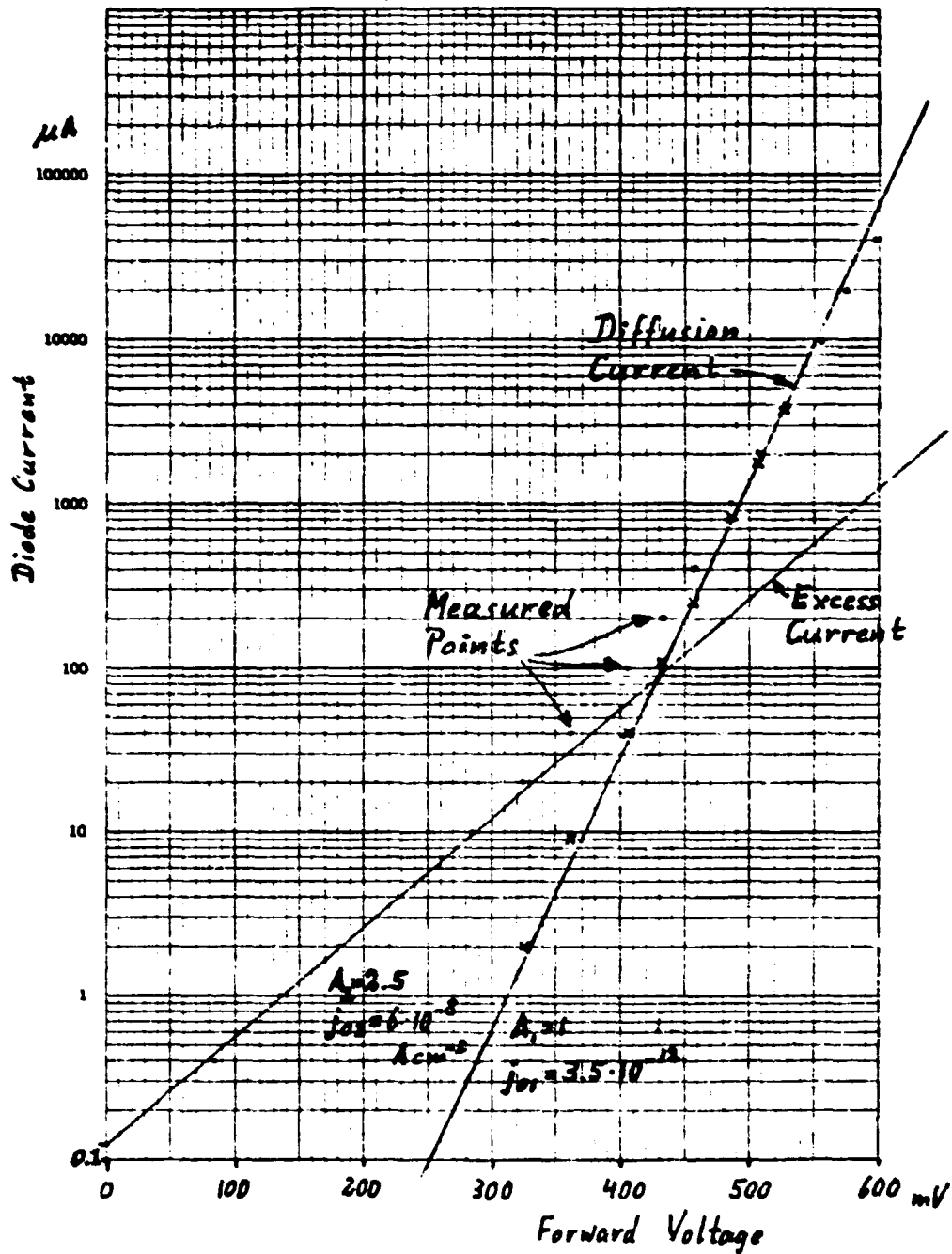

ORIGINAL PAGE IS  
OF POOR QUALITY

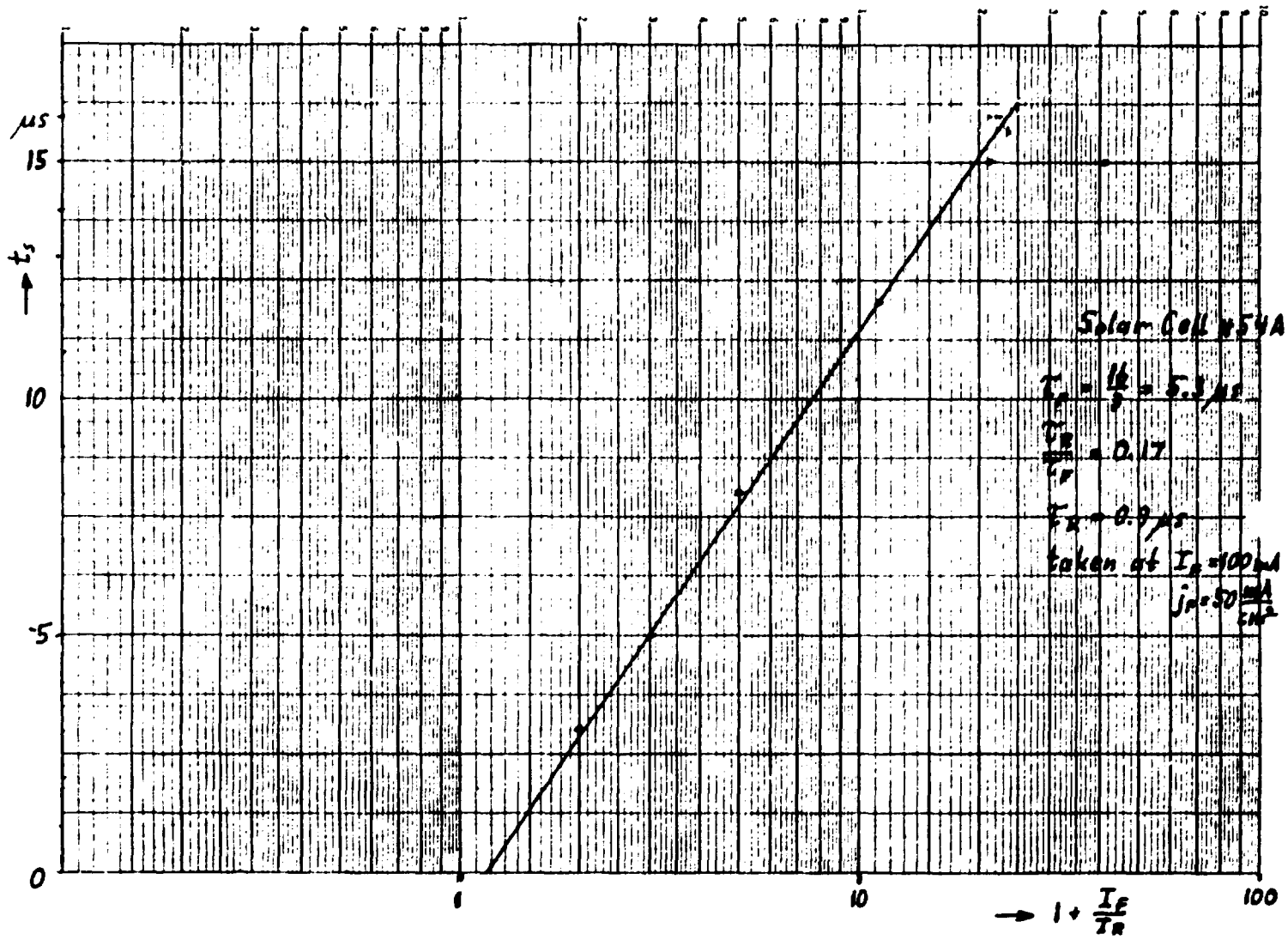

CHARACTERISTICS  
OF POOR QUALITY

