

General Disclaimer

One or more of the Following Statements may affect this Document

- This document has been reproduced from the best copy furnished by the organizational source. It is being released in the interest of making available as much information as possible.
- This document may contain data, which exceeds the sheet parameters. It was furnished in this condition by the organizational source and is the best copy available.
- This document may contain tone-on-tone or color graphs, charts and/or pictures, which have been reproduced in black and white.
- This document is paginated as submitted by the original source.
- Portions of this document are not fully legible due to the historical nature of some of the material. However, it is the best reproduction available from the original submission.

NASA
Technical Memorandum 82979
AHS-RWP-7

AVRADCOM
Technical Report 82-C-14

Army/NASA Small Turboshaft Engine Digital Controls Research Program

✓
J. F. Sellers and A. N. Baez
*Lewis Research Center
Cleveland, Ohio*



and

G. A. Bobula
Propulsion Laboratory
AVRADCOM Research and Technology Laboratories
*Lewis Research Center
Cleveland, Ohio*

(NASA-TM-82979) ARMY/NASA SMALL TURBOSHAFT
ENGINE DIGITAL CONTROLS RESEARCH PROGRAM
(NASA) 16 p HC A02/MF A01 CSCL 21E

83-11128

Unclass
63/07 0013

Prepared for the
Rotary Wing Propulsion System Specialist Meeting
sponsored by the American Helicopter Society
Williamsburg, Virginia, November 16-18, 1982

NASA



ORIGINAL PAGE IS
OF POOR QUALITY

ARMY/NASA SMALL TURBOSHAFT ENGINE
DIGITAL CONTROLS RESEARCH

by J. F. Sellers and A. N. Baez
NASA Lewis Research Center
and

G. A. Bobula
Propulsion Laboratory
U.S. Army Research and Technology Laboratories
Cleveland, OH 44135

Abstract

A cooperative Army/NASA program to conduct digital controls research for small turboshaft engines is described. The participating agencies are the Army RTL Propulsion Laboratory and NASA Lewis Research Center. The emphasis of the program is on engine test evaluation of advanced control logic using a flexible microprocessor-based digital control system.

The engine test facility is an indoor sea-level stand. It includes a 2500-hp eddy-current dynamometer to absorb engine shaft horsepower. The dynamometer control system provides capability to change the torque vs. speed characteristics of the load, thus permitting various rotor systems to be simulated. Flywheels are used to simulate various rotor moments of inertia. The dynamometer controls are designed to provide full-range load changes in less than one second. This provides the capability to evaluate system response to rapid load changes such as those induced by collective or cyclic pitch transients in actual flight.

The digital control system used in this program is designed specifically for research on advanced control logic. Control software is stored in programmable memory. New control algorithms may be stored in a floppy disk and loaded directly into memory. This feature facilitates comparative evaluation of different advanced control modes. The central processor in the digital control is an Intel 8086 16-bit microprocessor. Control software is programmed in assembly language. Software checkout is accomplished prior to engine test by connecting the digital control to a real-time hybrid computer simulation of the engine.

The engine currently installed in the facility is a General Electric YT700. This engine has a hydromechanical control for fuel flow and compressor variable geometry (VG). The hydromechanical control has been modified to allow electrohydraulic fuel metering and VG actuation by the digital control. The research objective for this engine test is to demonstrate improved power turbine speed governing compared to the baseline control. The improvements result from the application of modern control theory. Simulation results are presented which show that the modern control reduces the transient rotor speed droop caused by unanticipated load changes

such as cyclic pitch or wind gust transients.

Introduction

Fuel control design has been a challenging problem since the first application of free-turbine engines to helicopter propulsion. The challenge arises because of the difficult requirements imposed on the fuel control system. First, the fuel control is responsible for maintaining rotor speed at the level requested by the pilot, even in the face of large changes in load imposed by extreme maneuvers such as power recovery from autorotation. Second, the transmission/rotor system has complex, lightly-damped torsional dynamics within the bandwidth of the fuel control. These dynamics can easily cause instability in a closed-loop, turbine-speed-governing system unless they are fully modeled in the analytical phase of control design. References 1-5 provide an excellent summary of some of the problems encountered in past helicopter development programs.

Design requirements for helicopter fuel controls are becoming even more demanding as a result of the desire for improved helicopter maneuverability, especially in nap-of-the-earth military missions. Combined with the need for improved maneuverability is the need for reduced pilot workload. Ideally, the pilot should be able to perform extreme maneuvers with confidence that rotor speed will remain within safe limits. This would free his attention from monitoring rotor speed and enable him to concentrate on other tasks. Several studies, (e.g., references 6 and 7) have begun to explore the important relationship between engine control and helicopter handling qualities. Related work is also underway (ref. 8) to develop generic modeling techniques for predicting rotor/propulsion system dynamic interactions. Accurate rotor/propulsion system models are essential for helicopter fuel control design and handling qualities studies.

Fortunately, the emerging technology of digital control for helicopter engines holds significant promise for meeting the requirements of improved maneuverability and reduced pilot workload. Digital electronic fuel controls will allow greater freedom to transmit information across the flight/propulsion control interface and will permit the development of functionally integrated flight/propulsion controls. Further, digital control will permit more sophisticated

E-1408

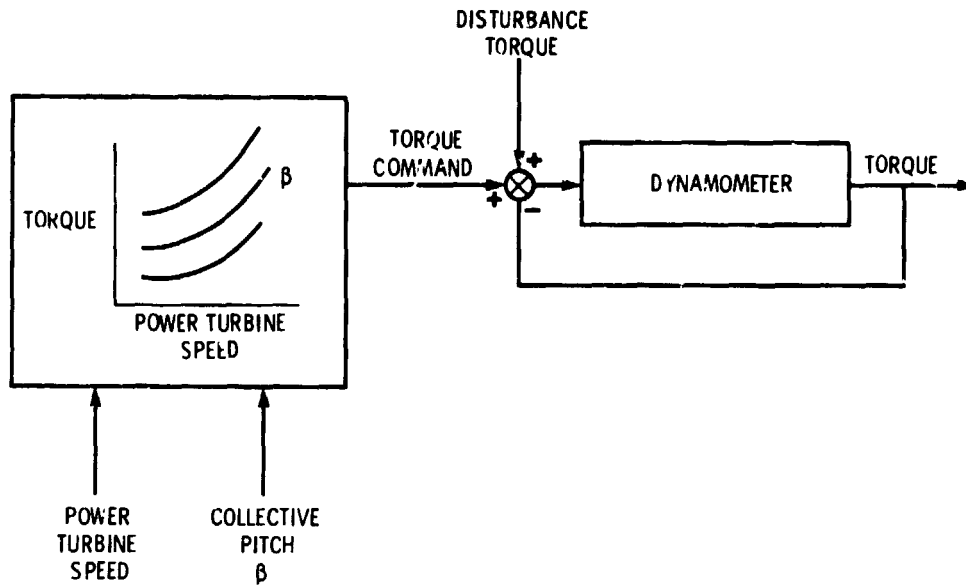

Figure 4. - Dynamometer control system.

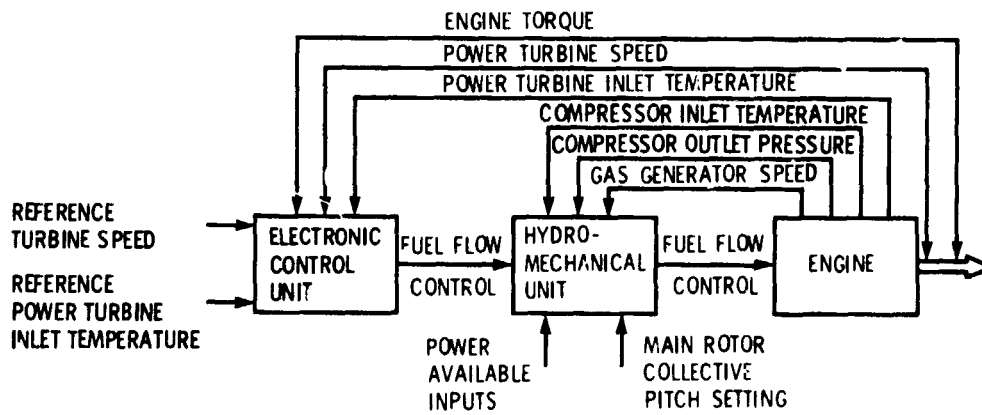

Figure 5. - YT700 control system.

nap-of-the-earth helicopter missions. The simulator is driven by a digital computer which solves the vehicle equations of motion in real time. In order to evaluate integrated flight/propulsion control modes, the equations of motion must include fairly detailed models of the propulsion system and its controls, as well as a complete representation of the vehicle and flight controls. The use of detailed propulsion models for piloted simulation is a recent technology developed at NASA Lewis to support research on the AV-8A Harrier V/STOL aircraft (refs. 13-14). Accurate propulsion modeling can be important for vehicles such as V/STOL and helicopters which depend on their propulsion systems for basic lift and attitude control forces. A detailed model of the engine control system is essential if fuel control effects on handling qualities are to be fully evaluated.

As shown in figure 1, a flight/propulsion control integration program should logically lead to flight experiments using a research helicopter. Flight testing would be used for final evaluation of integrated control modes which have been screened and refined through analysis and simulation. As envisioned here, the flight test vehicle would use a flexible research control system capable of evaluating a variety of integrated control modes. Thus far, the planned Ames/Lewis program extends only through piloted simulator evaluation of integrated control modes, since this can be accomplished at a reasonably low cost. Funding for flight hardware development is not yet available.

Engine testing, as shown in figure 1, is an essential element of the overall program. Engine testing will be used to validate math models of engine dynamics. Integrated control modes will be evaluated through engine testing, to the extent that this is possible in the absence of real rotor and transmission hardware. In the remainder of this paper, the plans and status of the engine test program will be described in greater detail.

Engine Test Facility

Figure 3 is a photograph of the small turboshaft engine test facility which is now operational at NASA Lewis. This facility was developed cooperatively by Lewis and the Army Propulsion Lab. The engine currently installed in the facility is a General Electric YT700, although the test cell can be used for other engines in the future. The test cell is limited to sea level operating conditions and includes a dynamometer to absorb shaft output power. The engine inlet duct includes a hydrogen burner to supply inlet temperature distortion.

The YT700 was selected as the first engine for use in this program because it was the latest technology engine available with an ample supply of spare parts. The YT700 contains components representative of other current technology small turboshaft engines. It has a five-stage

axial/single-stage centrifugal compressor with variable stators and bleeds. The core compressor is driven by a two-stage, air-cooled turbine. The two-stage power turbine drives the output shaft which exits through the front of the engine to a gearbox and then to the dynamometer.

The facility uses an eddy-current dynamometer supplied by Eaton Corporation. It has a maximum rating of 2500 horsepower. Helicopter rotor inertia is simulated by flywheels which can be changed to represent different rotors. A unique feature of this dynamometer is its control system which was designed specifically to simulate the torque vs. speed characteristics of a helicopter rotor. A schematic of the dynamometer control system is shown in figure 4. The torque output of the dynamometer is measured and fed back to form a closed-loop torque control system. The torque command signal to the dynamometer is a function of power turbine speed and collective pitch of the simulated rotor. The collective pitch signal is also sent to the engine control system. The torque command can be changed to simulate load changes such as those induced by cyclic pitch or wind gusts. The torque control loop is designed for maximum speed of response. The design goal was to be able to change the torque load over its full range in less than one second. This will permit evaluation of the response of control modes to large, rapid load changes.

Research Control System

The baseline YT700 control system is shown schematically in figure 5. This system is a hydromechanical/analog electronic control. The hydromechanical unit (HMU) provides gas generator speed governing, variable geometry (VG) scheduling and actuation, and fuel pumping and metering. The electronic unit (ECU) provides power turbine speed governing, temperature limiting, and torque matching in multiple engine installations. An excellent description of the YT700's control system is provided in ref. 15.

To use the YT700 as a testbed for digital controls research, it was necessary to add a research digital control unit and to modify the HMU so that the research digital control would have full authority over the fuel metering and VG actuation functions. The approach taken was to eliminate the mechanical computing functions from the HMU, but to retain the fuel pumping/metering and VG actuation hardware. Electrohydraulic servovalves were added to drive the fuel metering valve and VG actuators. Linear variable differential transformers (LVDT's) were added to measure fuel metering valve and VG actuator positions. The actuators are driven by fuel pressure supplied by the fuel pump. Since the actuation hardware is, for the most part, identical to that used in production T700 engines, the actuator response capability can be considered representative of state-of-the-art flight hardware. The modified HMU was developed

under contract by General Electric and Hamilton Standard. A photo of the modified HMU is shown in figure 6.

A separate unit, referred to as the "loop closer" was developed to close the LVDT position feedback loops and drive the electrohydraulic servovalves. These loops are closed using analog electronics. Thus, the digital control unit simply sends a 0-10 volt analog command signal to the loop closer for each of the two actuators. The loop closer can also be configured to close the actuator loops through the digital control, should this be desired for research purposes later in the program. The loop closer was also developed by General Electric and Hamilton Standard. A photo of the loop closer is shown in figure 7.

A schematic of the overall research control system is shown in figure 8. For the most part, the existing sensors in the YT700 control system are used. Exceptions are gas generator speed (N_g), compressor discharge pressure (P_{s3}), and compressor inlet temperature (T_2). These sensors are hydromechanical in the YT700 control and had to be replaced with electrical sensors that could communicate with the digital control. N_g is now derived from alternator frequency, P_{s3} is measured with strain gage pressure transducers, and T_2 is measured by a thermocouple rake at the compressor inlet.

Since the research control system is designed to evaluate control modes rather than digital control architecture, no attempt was made to develop a fault-tolerant control system. Instead, the system is designed to be fail-safe. The strategy is to cut back fuel to minimum flow and to move the compressor variable geometry to closed vane position whenever a failure is detected in the sensors or the electronics. External safety systems, completely independent of the digital control, protect the engine in the event of overspeed, overtemperature, off-schedule VG transients, or excessive vibration.

The heart of the research control system is the digital computer itself, referred to as the Engine Monitoring and Control (EMAC) unit. The EMAC was designed to provide maximum flexibility for changing the input/output configuration and control software.

EMAC System Description

The engine monitoring and control (EMAC) unit consists of two main systems, the monitoring unit and the control unit. The main function of the monitoring unit is to display, either in volts or engineering units (EU), all the information that comes into and out of the EMAC unit. This unit also allows the user to interrogate the control system while it is running. The monitoring unit contains status and warning lights to be used by the control engineer and switches to initialize the control and select the control mode. The

control unit's main function is to execute the control algorithms required for engine operation. A more detailed description of the EMAC unit is presented below.

A block diagram showing the main components of the monitoring unit is illustrated in figure 9. The heart of the monitoring unit is a custom design microcomputer. This microcomputer is based on the Intel Corp. 8085A-2 microprocessor. The 8085A-2 has a 0.8 microsecond instruction cycle and a 5 MHz internal clock. The microcomputer system consists of 8K bytes of Programmable Read Only Memory (PROM), 1K bytes of Random Access Memory (RAM), six 8-bit parallel input/output ports, and a programmable keyboard/display controller.

The control unit consists of a commercially-available, single board microcomputer, an analog input multiplexer (MUX) board, an analog output board, a discrete input board, and a floppy diskette hardware system. Communication between the user and the control microcomputer is accomplished by means of a Decwriter.

The single board microcomputer is the Intel iSBC 86/12A, which is based on the 8086 16-bit microprocessor. The 8086 has a basic instruction cycle of 400 nanoseconds and a 5 MHz internal system clock. The iSBC 86/12A board contains 64K bytes of RAM, 16K bytes of EPROM, 24 programmable parallel I/O ports, 2 programmable 16-bit BCD or binary timers/event counters, 9 levels of vectored interrupt control, and an iSBC 337 high speed numeric data processor. The iSB 337 provides high speed fixed and floating point functions and is based on the 8087 numeric data processor.

The memory size and processing capability of the control unit exceed the requirements for small turboshaft engine control. The excess capability was designed into the EMAC to facilitate the programming of new control algorithms, and to permit on-line data processing and storage. The floppy disk system serves two functions: storage of software for convenient downloading into program memory, and storage of data taken during engine testing. These features enhance the EMAC's capability as a research tool.

A signal flow diagram of the EMAC unit is shown in figure 10. A total of 100 channels are available as inputs. Eighty of these channels are split and fed to a switching matrix and to a patch panel in the EMAC unit. The other 20 channels are dedicated to strip chart recorders and analog data recorders. All input and output signals are fed to the patch panel. This feature permits user selection of any configuration of inputs and outputs, which could change with different applications of the EMAC unit.

Software Description

The monitoring unit software is all

programmed in assembly language and is stored in EPROM. The software package includes a main program or executive, an initialization routine, an input routine, a computational routine, a table look up routine, an output routine, and a data storage routine.

The control unit support software includes a CPM/86 operating system, a bootstrap loader, an analog input/output diagnostic, and a discrete input/output diagnostic. CPM/86 is a single user operating system for the Intel 8086 16-bit microcomputer family. Control unit software is currently programmed in 16-bit fixed-point arithmetic using assembly language, although future plans include the evaluation of floating-point arithmetic and high-order languages. Assembling and linking the various software modules is done using an Intel development system. The final software is stored on floppy disks. Use of the development system permits software to be edited and assembled without using the EMAC itself.

The flexibility of the EMAC's design makes it a useful research tool for evaluating a variety of advanced digital control modes. A photo of the EMAC is shown in figure 11.

Real-Time Engine Simulation

A real-time engine simulation is a valuable tool for evaluating advanced control modes. It can be used during the study phase of a research program, during which various control modes are compared and the most promising are selected for engine test evaluation. Once the final control modes are selected and programmed into the digital control, the real-time simulation becomes a valuable aid in debugging the digital control software. For this program, the Hybrid Computer Simulation facility at NASA Lewis is being used to provide real-time simulation of small turboshaft engines such as the YT700. A photo of this facility is shown in figure 12. The hybrid computing equipment is supplied by Electronic Associates, Inc. (EAI).

A real-time simulation of the YT700 and dynamometer is currently operational on the hybrid computers at NASA Lewis. The simulation includes compressor and turbine maps derived from actual engine test data using the YT700 in the sea level stand. The use of actual engine data was desirable for this program because the YT700 is configured for compressor inlet distortion experiments and has higher compressor blade tip clearances than do production engines. Consequently, compressor performance is different than for a nominal specification T700. Preliminary results indicate excellent agreement between simulated and measured performance. Figure 13 shows one example of the agreement between the simulation and engine data. Since the simulation is intended for use in evaluating control modes prior to engine test, close agreement is highly desirable to ensure a successful test.

Program Status and Plans

The first test of the YT700 under EMAC control is scheduled for December 1982. Control logic for the first engine test will be a digital emulation of the baseline YT700 control logic which is currently implemented in the hydromechanical/analog electronic control shown in figure 5. Use of the baseline YT700 control logic will guarantee minimum risk while engine test experience is gained with the modified HMU, the loop closer, and the EMAC. When confidence is established in the research control hardware, work on advanced control modes can begin.

Figure 14 shows the schedule for developing and testing advanced control logic. Work on integrated control modes will be conducted cooperatively by the Army, NASA, and General Electric. The objective of the engine test program is to evaluate integrated control modes for reducing transient rotor speed droop during maneuvers (e.g. power recovery from autorotation) or unanticipated disturbances such as wind gusts. One aspect of this effort will be to determine if additional control inputs, specifically compressor variable geometry, can be used in a multiloop control mode to help reduce transient rotor speed droop. In the baseline control mode, compressor variable geometry is scheduled with respect to gas generator corrected speed and is not affected by power turbine speed. Since compressor variable geometry affects engine airflow, it may provide a useful control input in combination with fuel flow.

Another aspect of the research effort will be to consider additional sensors, specifically torque, as inputs to a multiloop control. Preliminary analysis performed by General Electric indicates that a multivariable control system can reduce transient rotor speed droop relative to the baseline control logic. Figure 15 shows simulated power turbine speed and torque responses for an unanticipated load change such as might be induced by a cyclic pitch transient during a steep turn maneuver. As shown in figure 15, the multivariable control reduces rotor speed droop by about half in comparison to the baseline logic. The multivariable control uses torque and power turbine speed measurements to suppress the main and tail rotor torsional resonances, thereby permitting a higher gain control loop on power turbine speed.

The research control hardware fabrication and test phase of the Army/NASA digital controls program is essentially complete. The EMAC unit is now being used to control the real-time YT700 hybrid simulation using the baseline control logic. Future work will concentrate on advanced control modes. Continuous EMAC software updates will be required as advanced control modes are developed to the point of engine test. The hybrid simulation will also be updated as additional engine data is acquired.

Concluding Remarks

The rationale and approach for an Army/NASA helicopter integrated flight/propulsion control program have been presented. The approach emphasizes:

1. Development of generic math models of engine/rotor/vehicle dynamics
2. Evaluation of a variety of integrated control modes using total system simulations including eventual pilot-in-the-loop simulations at NASA Ames
3. Experimental validation of math models and integrated control modes using engine tests and eventual flight tests with flexible research control systems.

The plans and status for the engine test phase of the program were discussed in detail. Engine testing will be performed cooperatively by the Army and NASA using a sea level test stand at NASA Lewis. The engine currently installed in the facility is a General Electric YT700. The facility includes a dynamometer designed to simulate rapid load transients typical of helicopter operations.

A unique aspect of the program is the use of an Engine Monitoring and Control (EMAC) unit, a research digital control system designed to permit the implementation and evaluation of a variety of integrated control modes. Another key aspect of the program is real-time engine simulation using the hybrid computing facility at NASA Lewis. The real-time engine simulation permits extensive checkout of control logic prior to engine test.

A specific objective of the engine test program is to evaluate improvements in power turbine speed control made possible through the application of modern multivariable control theory. Results were presented which indicate that multivariable control can provide reduced power turbine speed droop, compared to the baseline control, for unanticipated load changes.

By late 1982, the small turboshaft engine digital controls research facility is scheduled to be fully operational. The facility will provide capability to support a variety of flight/propulsion control integration experiments for the Army and NASA.

REFERENCES

1. Richardson, D.A. and Alwang, J.R., "Engine/Airframe/Drive Train Dynamic Interface Documentation," USARTL-TR-78-11, April 1978.
2. Needham, J.F. and Banerjee, D., "Engine/Airframe/Drive Train Dynamic Interface Documentation," USARTL-TR-78-12, May 1978.
3. Twomey, W.J. and Ham, E.H., "Review of Engine/Airframe/Drive Train Dynamic Interface Development Problems," USARTL-TR-78-13, June 1978.
4. Bowers, K.A., "Engine/Airframe/Drive Train Dynamic Interface Documentation," USARTL-TR-78-14, June 1978.
5. Hanson, H.W., Balke, R.W., Edwards, B.D., Riley, W.W., and Downs, B.D., "Engine/Airframe/Drive Train Dynamic Interface Documentation," USARTL-TR-78-15, October 1978.
6. Kuczynski, W.A., Cooper, D.E., Twomey, W.J. and Howlett, J.J., "The Influence of Engine/Fuel Control Design On Helicopter Dynamics and Handling Qualities," Journal of the American Helicopter Society, Vol. 25. No. 2, April 1980, pp. 26-34.
7. Corliss, L.D., "A Helicopter Handling Qualities Study of the Effects of Engine Response Characteristics, Height Control Dynamics, and Excess Power On Nap-Of-The-Earth Operations," Paper Presented at the AHS/NASA Specialists' Meeting on Helicopter Handling Qualities, Palo Alto, California, April 1982.
8. Warmbrodt, W., and Hull, R., "Development of a Helicopter Rotor/Propulsion System Dynamic Analysis," Paper Presented at AIAA/ASME/SAE 18th Joint Propulsion Conference, Cleveland, Ohio, June 1982.
9. Morrison, T.; Howlett, J.; and Zagranski, R.: "Adaptive Fuel Control Feasibility Investigation for Helicopter Applications," ASME-82-GT-205, April 1982.
10. Bolton, R. L.: "Adaptive Fuel Control Feasibility Investigation," AHS Paper A-82-38 15-7000, presented at 38th Annual AHS Forum, May 1982.
11. Zeller, J., Lehtinen, B. and Merrill, W., "The Role of Modern Control Theory in the Design of Controls for Aircraft Turbine Engines," NASA TM-82815. Jan. 1982.
12. Howlett, J.J., "UH-60A Blackhawk Engineering Simulation Program," NASA CR-166309, Dec. 1981.
13. Mihalow, J.R., Roth, S.P., and Creekmore, R., "A Real-Time Pegasus Propulsion System Model for VSTOL Piloted Simulation Evaluation," NASA TM-82770, Dec. 1981.
14. Mihalow, J.R. and Roth, S.P., "A Piecewise Linear State Variable Technique for Real-Time Propulsion System Simulation," NASA TM-82851, April 1982.
15. Curran, J.J., "T700 Fuel and Control System," Paper Presented at 29th Annual AHS Forum, May 1973.

ORIGINAL PAGE IS
OF POOR QUALITY

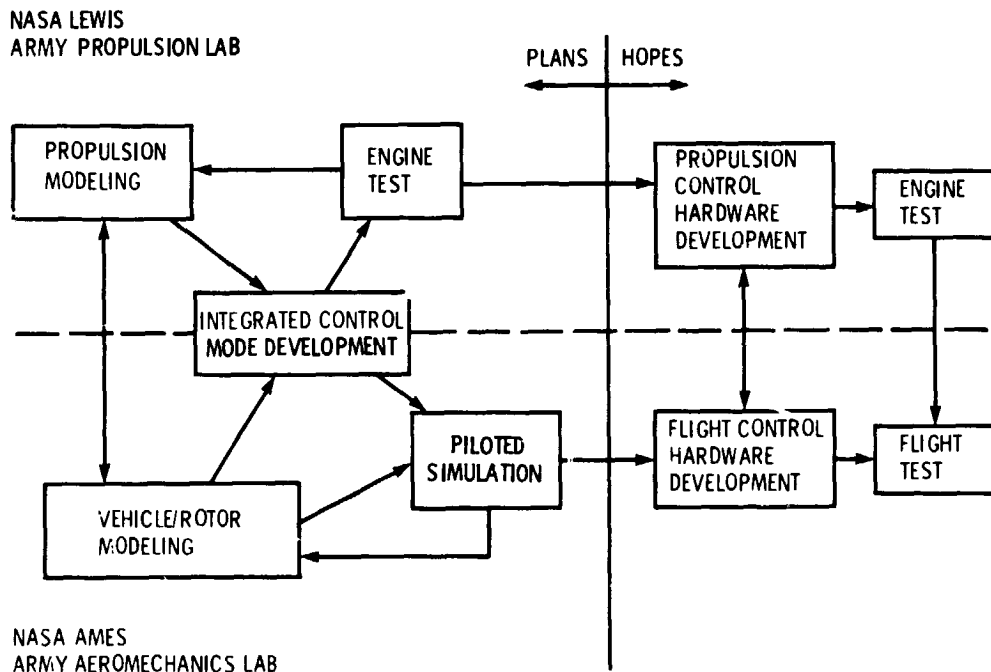

Figure 1. - Rotorcraft integrated flight/propulsion control.

ORIGINAL PAGE IS
OF POOR QUALITY



C-81-4117

Figure 3. - Small turboshaft engine test facility.

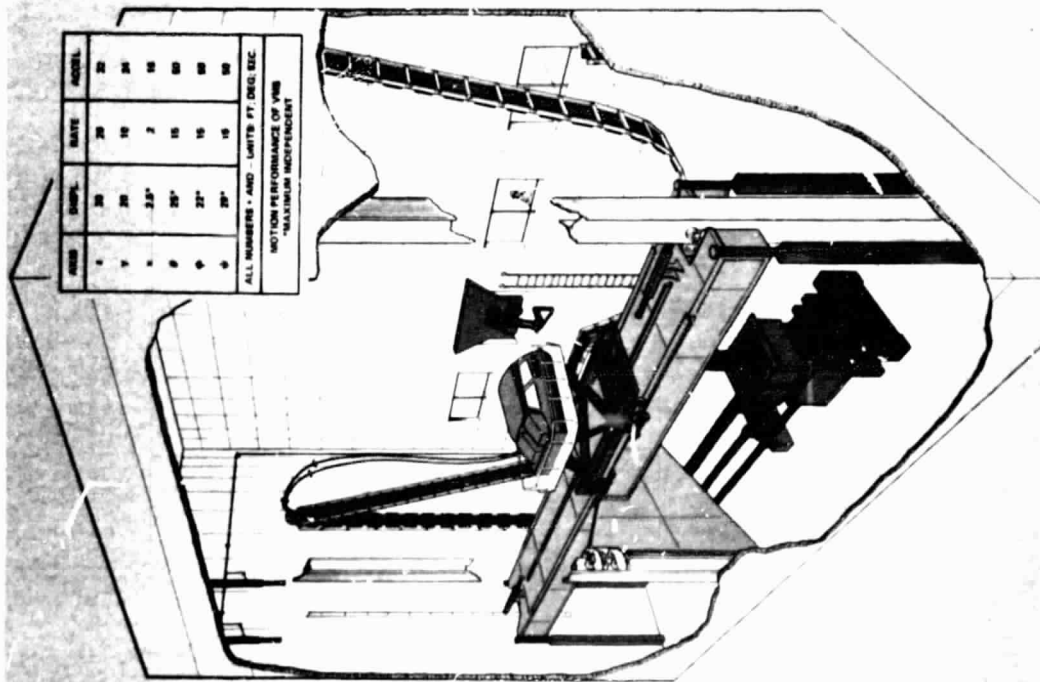

Figure 2. - Vertical motion simulator

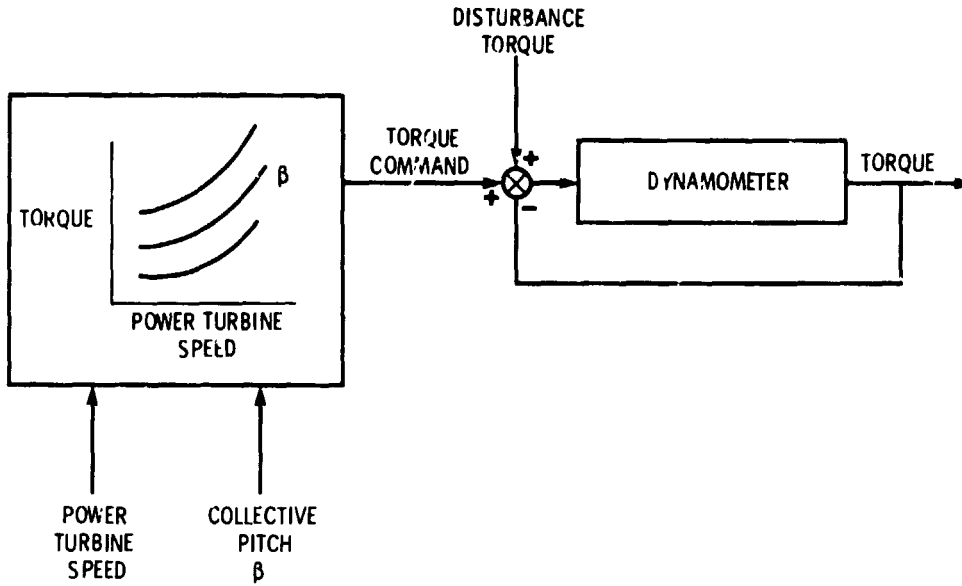

Figure 4. - Dynamometer control system.

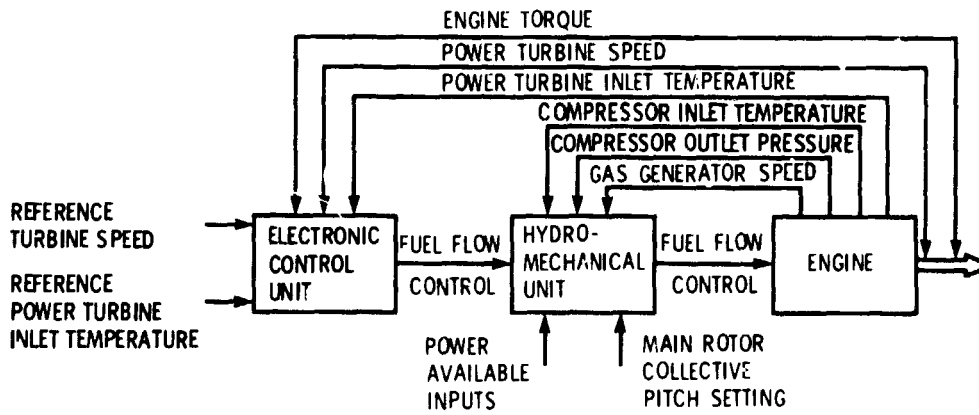

Figure 5. - YT700 control system.

ORIGINAL PAGE IS
OF POOR QUALITY

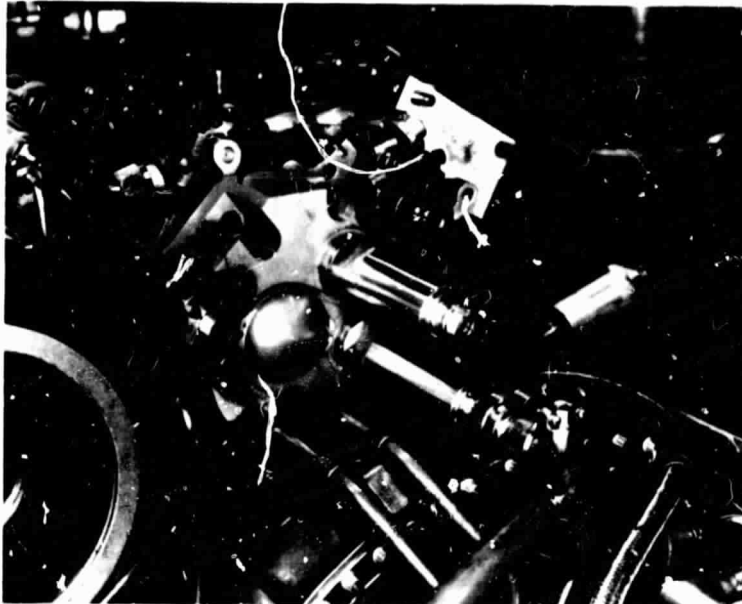

Figure 6. - Modified hydromechanical unit.

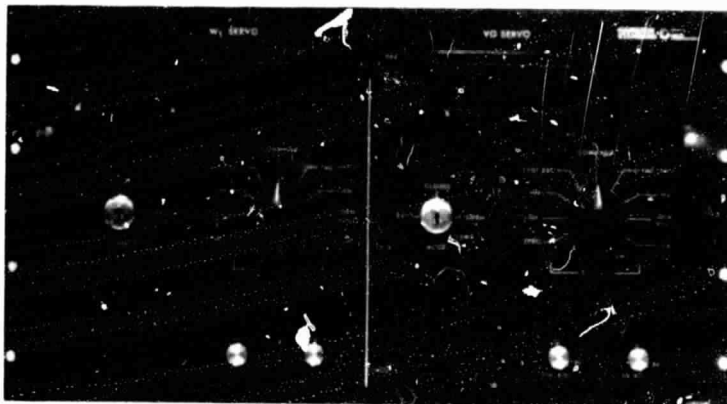

Figure 7. - Loop closer.

ORIGINAL PAGE IS
OF POOR QUALITY

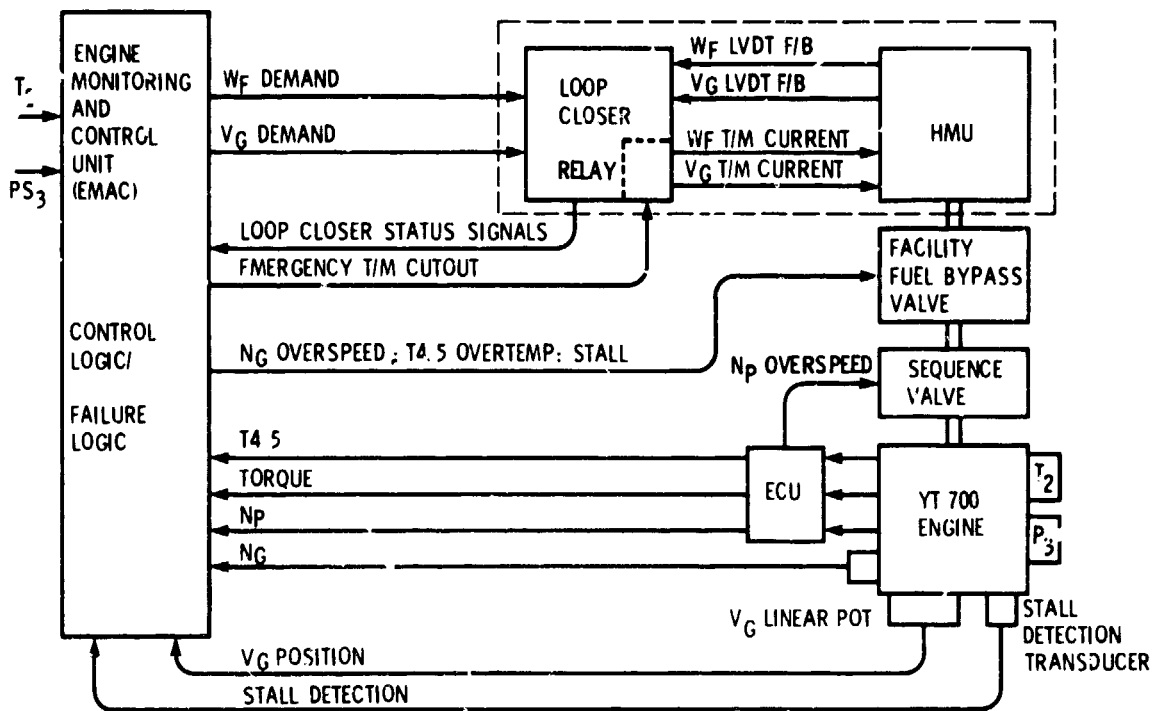

Figure 8. - Y700 research digital control system.

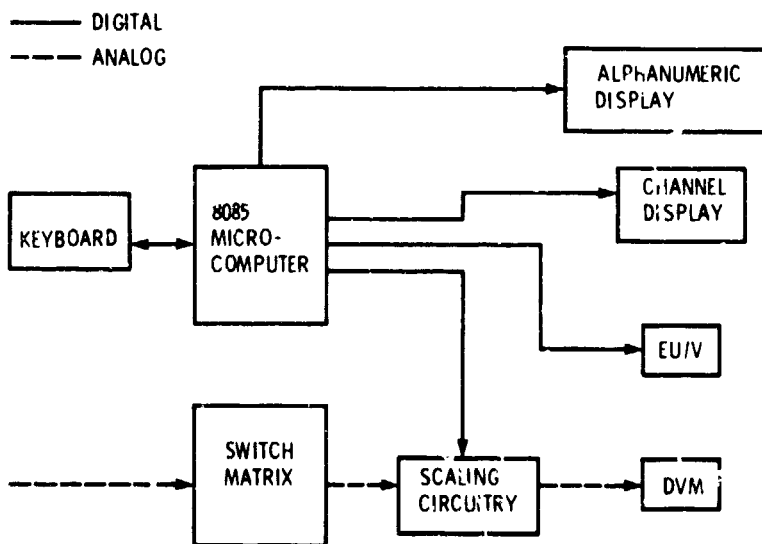

Figure 9. - EMAC monitoring unit.

ORIGINAL PAGE IS
OF POOR QUALITY

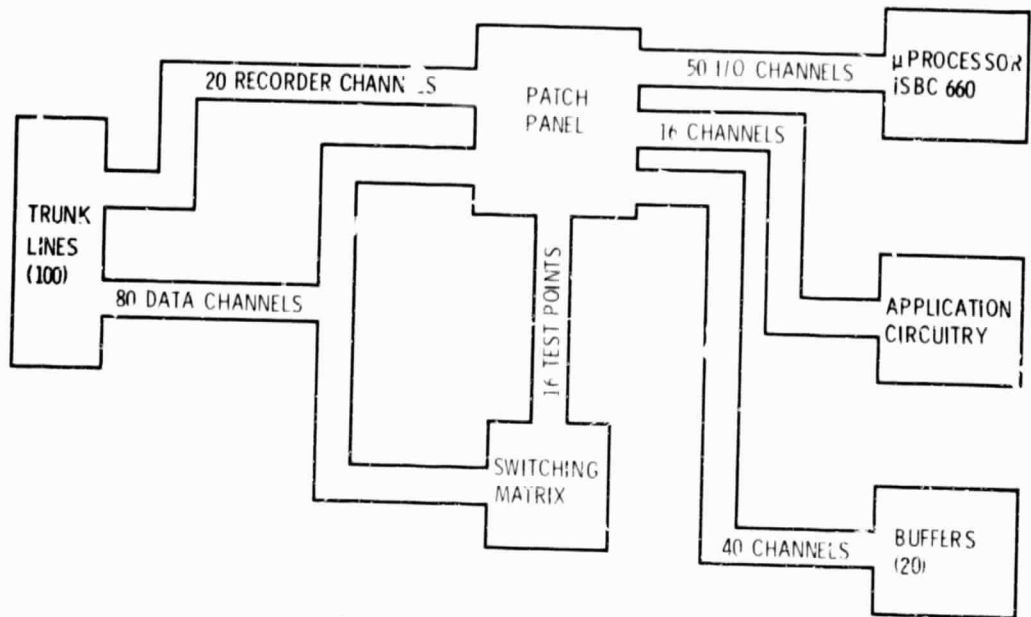

Figure 10. - EMAC unit signal flow.

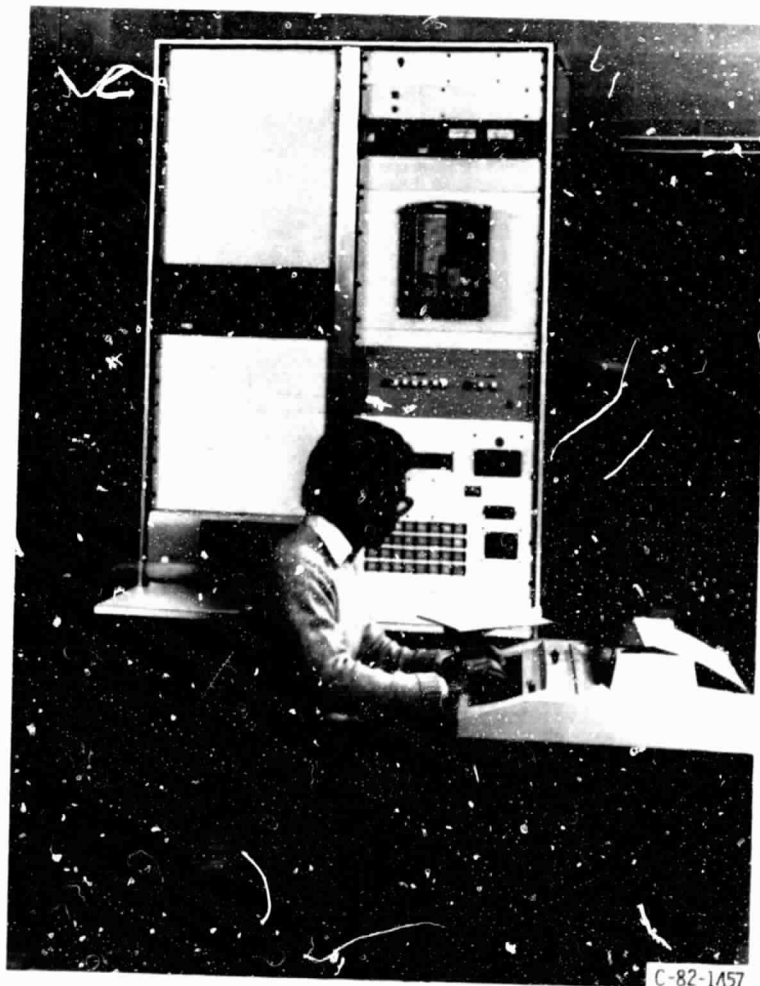

Figure 11. - Engine monitoring and control (EMAC) unit.

C-82-1457

ORIGINAL PAGE IS
OF POOR QUALITY



Figure 12. - Hybrid computer facility.

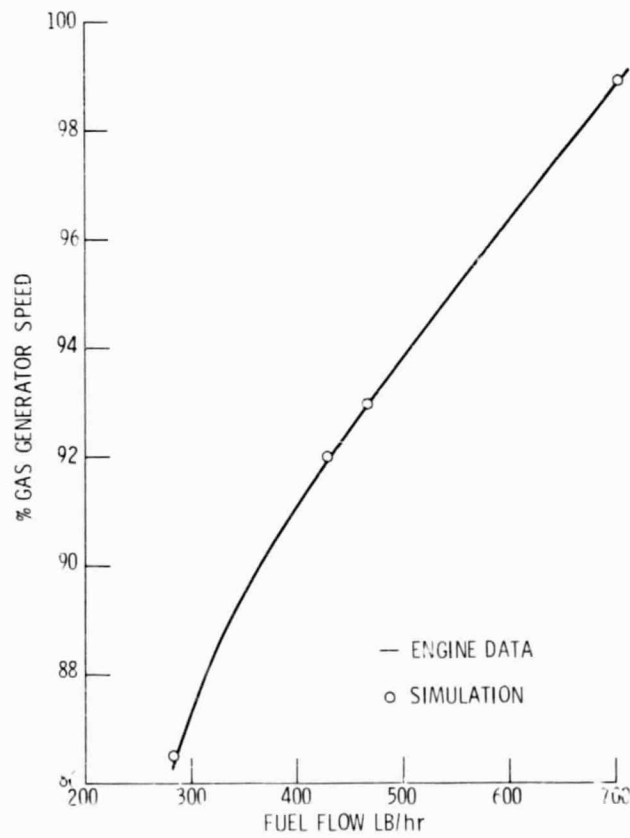

Figure 13. - Comparison of real-time hybrid simulation with engine data.

ORIGINAL PAGE IS
OF POOR QUALITY

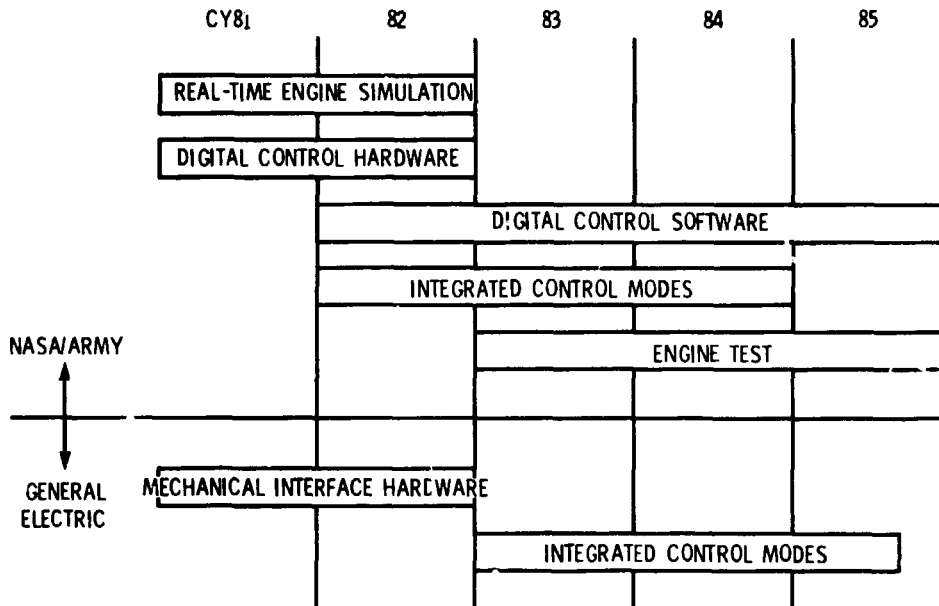
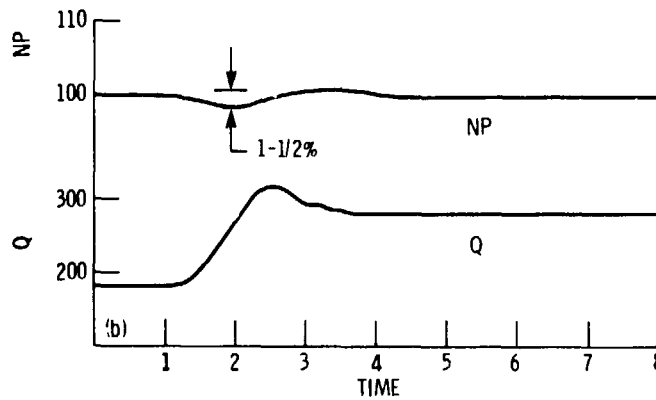
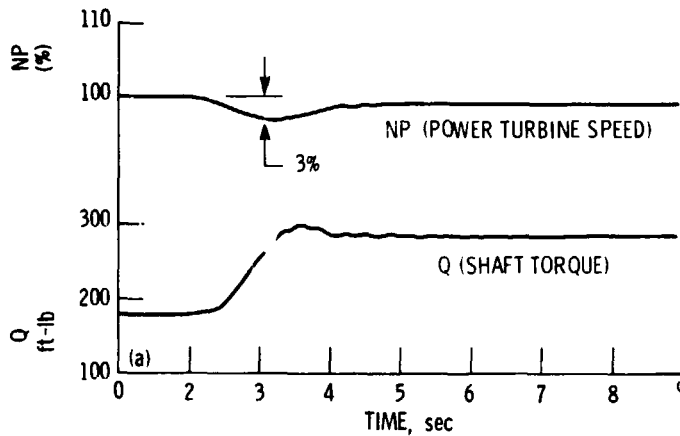

Figure 14. - Small turboshaft controls program.



- (a) Typical step turn or approach transient for baseline system.
- (b) Typical step turn or approach transient for multi-input system.

Figure 15 - Comparison of rotor speed responses for baseline and multivariable control systems.