

DEVELOPMENT TESTS FOR THE 2.5 MEGAWATT MOD-2
WIND TURBINE GENERATOR

J. S. Andrews and J. M. Baskin
Boeing Engineering & Construction Company
P.O. Box 3707, Seattle, Washington 98124

ABSTRACT

The development of the 2.5 megawatt MOD-2 wind turbine generator has included an extensive program of testing which encompassed verification of analytical procedures, component development, and integrated system verification. The test program was to assure achievement of the thirty year design operational life of the wind turbine system as well as to minimize costly design modifications which would otherwise have been required during on site system testing. Computer codes were modified, fatigue life of structure and dynamic components were verified, mechanical and electrical component and subsystems were functionally checked and modified where necessary to meet system specifications, and measured dynamic responses of coupled systems confirmed analytical predictions. It is clear that the importance of developmental testing has been demonstrated through the successful MOD-2 acceptance testing.

INTRODUCTION

The design of the MOD-2 wind turbine generator began in August, 1977 with final design being completed two years later in June, 1979. During this period, numerous wind tunnel, material and component development tests were conducted to support the concept, preliminary and detail design phases of this program. In conjunction with the fabrication phase and prior to first rotation, integrated system testing of critical components were conducted with the objective of design verification. These tests were planned so as to verify the function and dynamic characteristics of the components in an operating system.

This paper will describe the development tests and the impact that the test results had on component and system development. The MOD-2 wind turbine was designed using state-of-the-art materials and manufacturing techniques to reduce the development technical risks and eliminate expensive component development tests. Even with this conservative philosophy, the following additional tests were required; (1) wind tunnel tests to verify analytical load prediction models and aerodynamic configurations, (2) material testing to extend fatigue allowables data for steel to 10^8 cycles, (3) component tests to verify buckling, fatigue and operational characteristics to meet 30 year-life and, (4) integrated system tests to verify component design in a dynamic operating environment.

The MOD-2 is a 2.5 megawatt wind turbine generator designed for 30 years life. The 300 foot rotor is made of a hollow welded steel

shell on a steel spar framework. The rotor also teeters at its center using elastomeric bearings, and has partial span hydraulic pitch control to regulate power output. The drive train, located in the nacelle has a "soft" quill shaft which is integrated with the pitch control system to regulate power quality and reduce oscillatory loads in the gearbox and synchronous generator. The nacelle is mounted on top of a cylindrical steel tower cantilevered from a concrete foundation which places the rotor hub at 200 feet above the ground level.

WIND TUNNEL

It was recognized early in the conceptual design phase of the MOD-2 program that wind tunnel testing was necessary to obtain data for verifying the MOSTAS computer codes used for the determination of rotor blade design loads as well as being used for coupled dynamic analysis of a soft-tower wind turbine system. The test program which was subsequently conducted had several secondary objectives, in addition to the primary objective stated above. Included were (a) the comparison of fixed and teeter hinged rotors, and (b) the assessment of a rotor utilizing a controllable tip (as opposed to full-span) for providing rotor power control.

A 1/20 mach-scaled model of the MOD-2 WTS as shown in figure 1 was designed and fabricated for testing in the Boeing-Vertol 20 x 20 ft. V/STOL wind tunnel. The first model was designed to provide both hingeless and teetering rotor restraint, as well as incorporating full-span pitch control of the blades. Scaling of geometry, mass, stiffness and frequency were to be carried out in the model design. When it became impossible to scale nacelle mass (due to the weight of the model torque absorber system), compensating stiffness was added to the tower to obtain the proper frequency relationship between the tower and rotor rotational speed. When the evolution of the design progressed to the selection of a partial-span, blade pitch control, the model was modified to this configuration for a second test.

The operating wind turbine environment was simulated using a flow screen upwind of the rotor which had wire mesh density varying from tunnel floor to ceiling. The degree to which the design wind gradient was reproduced is shown in figure 2. Blade and tower bending and torsion loads were monitored throughout both tunnel tests.

The significant results of the MOD-2 wind tunnel test programs were as follows:

- a) The MOSTAB computer code was shown to provide a good prediction of power and of steady flapwise and chordwise bending moments. However, the MOSTAB program was found to underpredict the magnitude of alternating flapwise bending, and on the basis of the wind tunnel test results, a factor of 1.65 was incorporated into the program.

- b) The teetering rotor was shown to be superior to the hingeless rotor by reducing flapwise alternating moments approximately 50%.
- c) The dynamic characteristics of the soft tower concept, coupled with a dynamically scaled rotor, was proven over the operating wind speed and rotor rotation speed range.
- d) The MOSTAB and GEM-1 predictions of rotor performance were in agreement with test results for the tip controlled configuration.
- e) Performance of the tip controlled model compared well with that having full-span control.
- f) No deleterious vortex shedding characteristics of the cylindrical tower occurred throughout the test program.

MATERIAL

All material testing, aside from quality assurance tests for material acceptance, resulted from requirements to assure the design was adequate for thirty years of operation. During its design life, a MOD-2 wind turbine rotor blade is expected to experience greater than 2×10^8 load cycles. Thus fatigue is the major factor in the rotor design. No spectrum load fatigue data existed for the materials under consideration (ASTM-A588, A572, and A633) beyond 1×10^7 load cycles. Therefore a fatigue test program was initiated early in the concept design phase that was to extend the fatigue data base to cover MOD-2 data requirements, i.e. the derivation of fatigue design allowable stresses.

The rotor is subjected to a spectrum of loadings, namely, thrust bending (flapwise) resulting from the variability of the winds with time, chordwise bending being basically the once per revolution variation of weight moment, and blade axial loading derived from centrifugal force and the once per revolution weight variation.

The MOD-2 rotor blade is an all steel structure, with transverse as well as longitudinal weld joints. All transverse welds on tension-fatigue designed surfaces have the weld reinforcement removed and have through-thickness inspections, both ultrasonic and radiographic. The installation of ribs and spars produce special welding and inspection considerations which ultimately affect the design fatigue allowables. The weld joints and their fatigue design allowables are the primary design considerations in sizing skin gages and thereby directly affect weight and cost.

The development of the design fatigue allowable stresses has been accomplished using the "preexisting crack" tolerance approach. This approach assumes the statistically determined worst possible defect which could escape detection, to exist when the system is put into service. The growth of the initial flaw (assumed to be a crack) is

described by a crack growth model which employs the stress intensity concept for characterizing the crack growth. The determination of the proper crack growth model to be used was accomplished by testing pre-cracked specimens under representative spectrum load conditions and correlating the crack growth results with the predictions from the several growth models that follow.

- (a) A retardation model which accounts for load interaction effects and considers all cycles to produce crack growth

$$(da/dn) = C(1-R)^n(K_{max})^m(K/K_{ol})^L$$

- (b) A threshold model which considers only those load cycles above the threshold to produce damage.

$$(da/dn) = 0 \text{ for } K \leq K_{th}$$

$$(da/dn) = C(1-R)^n(K_{max})^m, \text{ for } K > K_{th}$$

- (c) A combined effects model which accounts for both threshold and load interaction effects

$$(da/dn) = 0 \text{ for } K \leq K_{th}$$

$$(da/dn) = C(1-R)^n(K_{max})^m(K/K_{ol})^L, \text{ for } K > K_{th}$$

The fatigue test was carried on in two phases, the first one involved testing eighteen specimens, using variations of the design spectrum of the full-span pitchable blade. The second phase involved the testing of seven additional specimens to the tip-control load spectrum. Each specimen contained a surface flaw introduced by electric discharge machining. The specimen was then constant-amplitude fatigue tested to initiate a crack at the edge of the flaw (final size .05 inch deep by .25 inch long). The specimen was subsequently stress relieved to free the specimen of overload retardation effects that may have been introduced by the pre-cracking process. Each specimen was tested in a machine automatically controlled by computer, which permitted programming spectrum load cycles on a 24 hour, 7 day a week basis.

Analyses of the test results were accomplished by determining the best fit to each of the model predictions, figure 3. The combined model provided excellent correlation, where as the retardation model underestimated the lives of the long term tests, and the threshold model underestimated the lives of the short term tests.

The final crack growth model used for MOD-2 fatigue analysis, for all A grade steels is as follows:

$$(da/dn) = 0, \text{ for } K_{max} \leq K_{max} \text{ (threshold)}$$

$$(da/dn) = 3 \times 10^{-10} (1-R)^{2.4} (K_{max})^{3.0} (K_{max}/K_{ol})^2,$$

$$\text{for } K_{max} > K_{max} \text{ (threshold)}$$

FIGURE 4

COMPONENT

Development tests were conducted to verify static strength, fatigue and operational characteristics of components to meet a 30 year life requirement. The following paragraphs will describe the component tests, test results and their impact on component design.

Crack Detection

The crack detection system incorporated in the MOD-2 was designed to detect through thickness cracks in the rotor blade and shut the wind turbine system down prior to catastrophic failure of the rotor. The system basically pumps warm dry air through the blade envelope and dumps the air overboard at the inboard end, through an orifice. The flow through each blade orifice is monitored, and the difference between blade flows is an indication of the existence of another exhausting orifice, a through crack. The determination of the minimum length crack which could be detected was estimated using design parameters i.e. flow through a given sharp-edge orifice. However, the flow through a crack like orifice is at best difficult to predict, especially under various states of stress in the structure. To minimize false alarms, the critical leakage rate should be reasonably high, yet low enough to provide a comfortable margin between detection and structural failure. Fracture toughness testing was required to provide the data necessary for assessing the critical crack length for the MOD-2 blade material, which toughness had been assumed as being $125 \text{ Ksi}\sqrt{\text{in}}$.

Operational Test

A test was conducted to verify that the MOD-2 crack detection system possessed adequate sensitivity and stability to detect a given crack in one rotor blade as well as to detect malfunction of the system. Secondary objectives of the test program were to determine the maximum pressure capability of the blower, the power consumption of the equipment, and ability of the system to dry the air delivered to the blades.

Two 12,500 gallon tanks were used to simulate the air volume of the two rotor blades. Cracks in the blades were simulated by use of a manual valve and flowmeter on each blade simulator. The wind turbine crack detection system was located indoors and was connected to the blade simulator tanks, which were located out of doors.

During testing of the crack detection system, it was found that the blade orifice tubes had to be shortened in order to increase the air flow and thus increase the sensitivity of the system to air flow imbalance between blades. The system was able to detect malfunctions such as blower failure or air blockage. A 2 psi over pressure relief valve was incorporated to prevent over pressuring the blades, and a check valve was added to the dehumidifier outlet. The ability of the system to deliver dry air to the blades was confirmed. A system calibration procedure was established.

Crack Flow Test

A crack flow test program was carried out on pre-cracked specimens .25 inches and .50 inches thick. The objective of the program was to experimentally develop a means of determining flow rate through a crack in a rotor blade under varying stress, pressure differential across the crack, and plate thickness for different crack lengths. Each specimen became the closeout panel of a rectangular flow chamber in which the pressure was varied by varying the inlet flow rate. Cracks of 9 inches and 12 inches were tested on the thicker panel, and cracks of 12, 18, and 24 inches were tested on the thinner panel. The test panels were clamped to the edges of the flow chamber so that the application of end loads on the specimen would produce uniform stress across the uncracked portions of the specimen. Gross area stresses were varied up to 9 Ksi and flow pressures (pressure differential across the crack) ranged up to 4 psi.

The state of stress affected the crack opening and thus the mass flow through the crack. The results of the testing indicated that the mass flow through a crack would follow the relationship:

$$\dot{m} = 2.7 \times 10^{-3} (t)^{-.25} (\sigma)^{1.65} (l)^{1.90} (\Delta P)^{.5}$$

Fracture Toughness Test

The fracture toughness tests were conducted on two pre-cracked specimens fabricated from .25 in. and .50 in. thick ASTM-A572 grade 50 material to verify that the assumed toughness was greater than $125 \text{ Ksi}\sqrt{\text{in}}$. Although the test material was not the MOD-2 rotor blade material (ASTM-A633 grade A, desulfurized) because of inavailability, it was felt that the differences favored the blade material as having higher toughness, and therefore the test results would be conservative.

The width of each specimen was 60 inches while the pre-crack was 24 inches long. The specimens were sized to give valid data up to $125 \text{ Ksi}\sqrt{\text{in}}$ and conservative results above $125 \text{ Ksi}\sqrt{\text{in}}$. Each specimen was instrumented with three crack propagation gages (Type TK040CPC 03-003), on the same side of the specimen. The first gage was located to one side of the crack tip by .08 and the second and third gages .08 inches from the first and second respectively. In this manner, a stable crack growth of 4.8 inches could be monitored.

During testing, the center portion of the specimen was enclosed in a styrofoam box which acted as a cryostat. Thus the test portions of the specimen was maintained at a temperature of -40°F , the minimum operating temperature for the wind turbine. The test load was applied at a rate such that a stress intensity of $125 \text{ Ksi}\sqrt{\text{in}}$ would be reached in thirty seconds. The .25 inch thick specimen failed at a net area stress of 55 Ksi, which was greater than the guaranteed yield strength of 50 Ksi. The material toughness was well in excess of $225 \text{ Ksi}\sqrt{\text{in}}$. The .50 inch thick specimen failed at a net area stress of 46.2 Ksi and an apparent toughness of $188 \text{ Ksi}\sqrt{\text{in}}$. The average toughness of

206 Ksi $\sqrt{\text{in}}$. for the two specimen tests is well in excess of the value which was to be verified (125 Ksi $\sqrt{\text{in}}$).

Crack Detection System Evaluation

The mass flow operation developed in the crack-flow test and the fracture toughness results were used to evaluate the ability of the crack detection system to detect cracks prior to reaching critical length. Figure 5 shows the relationship of crack-flow, as a ratio of detectable flow rate, to the number of days a detectable crack becomes critical. The relationship is for the blade station 360 which has the minimum time before a detectable crack becomes critical.

Rotor Rib Field Joint

The MOD-2 rotor blade has a field assembly splice at blade radial station 360 which attaches the blade mid-section to the hub through ribs that are welded to both skins and spars. The bolt attachment is symmetric about skin and spar. The joint is highly stressed under fatigue loading, and a test program was conducted to validate the joint for MOD-2 design. However, the results of this test provided additional substantiation for the crack growth model discussed under material testing.

The testing was carried out using an MTS (Material Testing System) test machine under the design fatigue spectrum of loads for the joint. The results shown in Figure 6 indicate good correlation was obtained between predictions and test results. The fatigue analytical model was validated and was used to design the field joint of the MOD-2 with a 30 year life.

Rotor Blade Static Buckling Test

The rotor blade has spars at two or three chordwise locations dividing the skin into long spanwise panels. Leading edge panels are curved in the chordwise direction, while those aft of the front spar are essentially flat. The panels on the airfoil upper surface are subjected to design limit compressive stresses during emergency shutdown in the outboard portion, and operating below rated wind with a gust in the inboard portion. The MOD-2 structural design criteria requires that initial buckling shall not occur at less than 1.35 times the design operating compressive stress.

Blade initial buckling stresses have been analyzed in the classical way, using the general equation, $\sigma_{cr} = KE(t/b)^2$. Buckling constant K is obtained from Boeing Design Manual DM 86B1 buckling curves for long flat or curved panels with simply supported edges. To verify the buckling analyses, and to validate their use for defining blade structural allowables, a bending test was conducted on a mid-span representative section of blade structure (see Figure 7).

The blade section included the field splice joint at station 360 and all structure outboard to station 780 inches. The specimen had a special bulkhead at station 780 to accommodate the load application fixture, while the inboard end was attached to a strong back. The loads at station 780 were applied in a combination of transverse shear and couple forces calculated to produce initial buckling in compression panels at stations 400 and 670 simultaneously. The specimen was instrumented with forty-two strain gages and twelve electrical deflection indicators. Test loads were monitored and controlled using three load transducers. Strain gage data from potentially critical buckling areas were monitored continuously during testing for any indications of initial buckling.

The results of the test have verified the conservative nature of the initial buckling analysis methods described above. The specimen was tested to 148% of the predicted initial buckling stress of one of the critical panels without buckling. The test results are summarized in the table below.

TABLE 1
COMPARISON OF TEST DATA
WITH PREDICTIONS OF INITIAL BUCKLING STRESS

<u>Blade Station</u>	<u>Analysis</u> Initial Buckling	<u>Test</u> Maximum Measured - Test Stress
400	12,480 psi	18,500 psi
670	8,350 psi	11,220 psi

The conservative nature of the blade buckling analyses, as established by the static test, has validated their use as part of the wind turbine system blade design procedure.

Rotor Spindle

The spindle test program was performed to substantiate the structural integrity of the rotor blade spindle and its supporting structure. The design requirement to rotate the blade tip section resulted in complex structural load paths surrounding a spindle bearing structure. A complex finite element stress analysis was performed to evaluate this structure.

The test program objectives were:

- (a) To validate the analytical means for predicting the deflection and internal stresses of the spindle and supporting structure.
- (b) To define the areas of high local stresses in the spindle and supporting structure, which occur during normal operating

conditions of the wind turbine.

(c) Validate the operation of the pitch control system

The tests were performed by mounting the spindle section of the blade in a cantilevered position and applying combinations of flapwise and chordwise loads selected to produce one full life of fatigue damage on both the upper and lower blade surfaces. The test specimen included all blade structure between spanwise stations 1144 and 1360. The pitch actuator and supporting hydraulics were also included. Specimen test loads were imposed by a series of hydraulic actuators connected to the outboard end of the specimen through a rigid adapter fitting. A schematic of the test setup and the loads applied are shown in Figure 8 and a photo of the hardware and general testing arrangement appear in Figure 9.

Strain, deflection and applied loading data were recorded for all test conditions. The instrumentation consisted of 73 strain gages, 12 deflection transducers, 7 load cells, and one angular potentiometer.

All test objectives were achieved. The design lifetime (30 years) was demonstrated and good correlation was obtained between analytical stress predictions and measured stresses. The areas of high local stress were identified by analysis and confirmed by test (see Figure 10). No additional high stress areas were detected, and all margins of safety in the critical areas were equal to or greater than predicted.

Pitch Control Testing

Pitch control system testing included the use of the spindle fatigue test specimen as a means to functionally test the hydraulic swivel in the blade-tip pitch control system. The swivel is that portion of the hydraulic supply that provides the connection between the fixed portion of the blade at station 1249 and the tip actuator. The swivelling motion is from a tip position of -5° to $+94^{\circ}$. The testing of the swivel joint included simulated startup, operate, and shutdown blade-tip pitch action as well as dithering for extended periods of time. During the spindle fatigue test, the control system was active and was used to pitch the tip section to operating or critical shutdown load positions (5° or $+28^{\circ}$). It was also used to maintain a given pitch position of the tip during the imposition of the time varying test loads. The control system held the pitch position to $\pm 1.0^{\circ}$ under load application, thereby validating its design stiffness

In order to develop and check out proposed changes in the pitch control system, open and closed loop frequency response tests were performed on the cyclic load test hardware. The test hardware provided the proper pitch actuator hydraulics and simulated tip rotary inertia. The objectives of the test were to evaluate proposed changes and optimize control system parameters to guarantee a 11Hz frequency response and demonstrate required stability margins. Various control system changes were evaluated on a patch board to arrive at an improved control system. In particular, the beneficial effects of eliminating

the Butterworth filter, implementing forward loop compensation and closed loop hardware were demonstrated. The optimum servo-driver gain at 0° and 15° was also determined.

Computer simulation of the control system had demonstrated that frequency response must exhibit a gain of -3db to $+9\text{db}$ at 1 Hz and outer loop stability requires a gain of at least -5 db at 180 degrees phase shift. The transfer function data obtained from the improved pitch control system of the cyclic load test specimen satisfied these requirements. Hardware and software modifications were later implemented and optimized during system integration testing.

Teeter Bearing

The rotor is connected to the drive shafting through a teeter hinge and its elastomeric radially (teeter) and axially (thrust) loaded bearings. The radial bearings react rotor thrust, rotor driving torque, and rotor dead weight loads. The axial bearings are basically to react rotor dead weight 90° after the radial teeter bearings accomplished this task.

Qualification Testing

The first elastomeric teeter bearing was subjected to qualification tests by the manufacturer in order to assure bond quality and to obtain performance data.

The soundness of the bonds between rubber and steel shims as well as between rubber and hub structure was verified by rotating the inner hub $\pm 15^\circ$ relative to the outer ring structure. This angular motion was 2.3 times the expected extremes of travel during bearing operation ($\pm 6\ 1/2^\circ$). The torsional stiffness of the teeter bearing was ascertained at -40°F as well as at room temperature. The results of the stiffness tests indicated compliance with bearing design specifications.

Fatigue Testing

The teeter bearings had been designed with methodology developed for much smaller bearings used in the helicopter industry, and those used in the oil industry that require application of low stress low motion design. Because of a lack of test data and experience on bearings of the MOD-2 size, as well as the fact that the life requirement was well beyond even helicopter experience, it was decided that a fatigue test was required. In addition, this test provided data for maintenance and inspection procedures. Spectrum testing for the 200×10^6 cycle equivalent of the design life (30 years) would be out of the question since the operating rotational frequency is 17.5 cpm . A review of the operating loads and teeter angle spectrum indicated that, at best, bearing testing with applied loads of rated drive torque loads in combination with a time varying rotor weight

load as well as a rotation to maximum teeter motion ($\pm 6.5^\circ$ to the teeter stops) applied for 2×10^6 cycles would expose the bearing to an equivalent 30 year life.

The test bearing was heavily instrumented, using 14 strain gages on the inner hub to measure tangential and radial strains. Thermocouples were located at 8 selected places in the bearing rubber as well as on the inner hub. Instrumentation on the load application arms, in conjunction with displacement transducers, were used to determine the torsional and radial spring rates of the bearing. The test set-up is shown in Figure 11.

Throughout the testing, the radial spring rate did not vary at all, and the torsional spring rate had reduced 7% by the end of the test, well below the 20% failure criterion set by the bearing supplier. Stabilized temperatures in the rubber were approximately 150°F without fan cooling, and 135°F with cooling. Design operating temperatures will be well below the no-fan cooling temperature because design operating teeter angles are of the order of ± 2 to $\pm 2 \frac{1}{2}^\circ$, not the $\pm 6 \frac{1}{2}^\circ$ continuous oscillation sustained during the bearing fatigue test.

Hydraulic Reservoir

The hydraulic reservoir is a tank located on the low speed shaft, providing storage for the hydraulic fluid necessary to power the blade pitch control. The fact that it is located on the low speed shaft eliminates the need for a hydraulic slip ring. However, it did require a special type of attachment structure so that it maintains constant orientation with the fixed system. Thus fluid is extracted from the reservoir from a fixed part of the tank.

It was determined that an operational test was necessary to evaluate (a) fluid sloshing at various fluid levels, (b) air entrainment in the fluid and its effect on bulk modulus, (c) adequacy of the sealing system, (d) adequacy of the fluid quantity indicating system, and (e) adequacy of the venting system, fluid return, and pump intake provisions.

The test reservoir was a specially designed cylindrical 30 gallon tank having a clear acrylic plastic outer shell, which in turn was rigidly mounted to a rotating fixture (Figure 12). The axis of the reservoir and the rotation axis of the fixture were parallel and separated by 30 inches. The test reservoir contained a system of baffles mounted on bearings and weighted so that the baffles maintained an upright position during rotation of the outer shell and test fixture. The reservoir vent and pump supply tubes were attached to longitudinal baffles. The hydraulic circuit included a flow meter, circulating pump, and an accumulator for applying flow surges in the system return line.

Test data was primarily in the form of photographs, visual observations,

and tabulation of bulk modulus measurements. Observation of air entrainment and the lack of a quiescent sump for collection of water and dirt resulted in design changes to the production system. The production reservoir is now trunnion mounted, without internal baffles. A return line diffuser has been incorporated to reduce turbulence and aeration. The bulk modulus remained essentially constant throughout the test and fluid sloshing was within limits up to 20 RPM (operating RPM is 17.5).

Gearbox, Back to Back Test

Fatigue Testing

The epicyclic gearbox selected for the MOD-2 utilized an existing design concept but its torque transmitting capability was improved by 200% and its new design life was thirty years. Because the capabilities extension was beyond the current state-of-the-art, a qualification test was deemed necessary to verify predicted performance parameters.

The selected test method was a back-to-back test in which two complete gearboxes and their lubrication systems would be connected in order to impose the high input torques of the operating wind turbine (Figure 13). The high speed output shafts were connected via way of a torsion bar, while the torque reactions were through the low speed shaft flanges, as both low speed shaft flanges were tied together. The torsion bar preload was varied throughout the test to provide simulated drive line power variations in operation. A drive motor was connected to the output shaft of one of the gearboxes, providing the rotational speed control. The gears of one of the boxes were strain gaged to monitor the tooth stresses throughout the program.

Table 2 provides the spectrum of operating conditions simulated in this test program. During the test program, it was determined that gear tooth bending stresses were well below AGMA predictions. Slight modifications to the first stage helical gears lead correction angle had to be made, and it should be noted that had a full load test not been conducted, such a deficiency would have gone unnoticed. Direct measurements of gear train efficiency, gearbox breakaway torque, noise levels and vibration characteristics were made throughout the test.

As a result of the back-to-back test program, the fatigue rating of the gearbox was substantiated up to 155% of design rated torque.

Vibration Survey

Running of the gearbox at zero torque during the back-to-back load test, a rapid buildup of horizontal vibration at 1400 output RPM was experienced. The system ran smoothly up to 1800 RPM with the application of only 15% of rated torque. It was determined that the

gearbox third stage planet passage frequency was resonant with the test stand yaw/lateral natural frequency. At low torque levels, the third stage planets and sun of this gearbox are free to move off their rotating center, causing unbalance at the planet passage frequency.

The gearbox mount lateral stiffness was determined from subsequent tests. Analysis of the gearbox as installed in the MOD-2 nacelle predicted natural frequencies well in excess of 2600 RPM. Therefore no mount vibration problem at planet passage frequency was expected. This was subsequently confirmed in integration testing of the installed gearbox.

TABLE 2
LOAD-ROTATIONAL SPEED SPECTRUM
GEARBOX BACK-TO-BACK TESTING

<u>TORQUE (%)</u>	<u>RPM(%)</u>	<u>TIME (HOURS)</u>
0	50	1
0	100	1
15	100	1
45	100	1
75	100	10
110	100	10
155	100	100
0	130	0.5

INTEGRATED SYSTEM TESTING OF COMPONENTS

Pitch Control System

During preliminary design, it was recognized that a test program was necessary for the evaluation of the blade pitch control system, end to end, prior to wind turbine system evaluation in the field. The assembly of the nacelle, including the complete drive train and the nacelle control unit (NCU) was planned to be completed well in advance of the rotor. Therefore it was necessary to design and fabricate a rotor simulator to be attached to the first nacelle-drive so that the pitch control could be functionally evaluated against a rotor load. The rotor simulator also permitted the rotation of the drive system at various RPM to assess electronic control through the rotor slip ring and hydraulic system functions under centrifugal loading. A field test unit (FTU) provided the means to input electrical signals which would simulate data sensed by those wind turbine sensors to which the control system would respond (wind speed, rotor speed, and yaw position).

Normal and emergency shutdown as well as normal operations were simulated and several control system hardware deficiencies were observed: (a) a valve in the rotor hydraulic control manifold leaked, and (b) a control system servo valve malfunctioned. Subsequent redesigns

replaced both valves with more reliable components. All control system responses to simulated operating loads were verified.

Pitch Control Rotor/WTS

The pitch control system was ground tested on the rotor and later during system integration testing with the nacelle and tower. The ground tests with the rotor (rotor stand-alone) were performed with the rotor in cradle supports with the blade tips free to move. The objective of the rotor stand-alone tests was to demonstrate that the pitch system design modifications, introduced to resolve hydraulic and electrical anomalies uncovered during the rotor simulator tests, were properly integrated into the wind turbine system. These tests also provided the opportunity to test the pitch control system with final hardware modifications including actuators, spindles and blade tips. The dynamics tests included emergency feather rate, controlled rate, blade standoff and position error and frequency response tests. All pitch system test requirements were met during rotor stand-alone testing or illustrated by the frequency response test results shown in Figure 14.

The same series of pitch control system tests were repeated with the rotor installed on the nacelle, during integration testing. All system tests were successfully completed and compared favorably with stand-alone results shown in Figure 14.

Modal Survey

Modal survey testing of wind turbine systems and their components is an important part of the design and testing process. The modal survey is an effective way to insure that the wind turbine subsystems meet performance expectations.

After evaluating alternative testing techniques, it was concluded that the MCD-2 modal survey would be conducted with the rotor and nacelle installed on the tower in the operational configuration. The advantages were that the system modes and damping would be measured directly, including all coupling mechanisms which were hard to model.

The testing approach selected involved the use of a HP 5451B Modal Analysis System (similar to the one used for the modal analysis of MOD-0). The test technique involved impacting the wind turbine at a prescribed point with a 1000 lb. instrumented ram and recording the responses of fixed accelerometers. The impact load transient and the response signals were simultaneously recorded and fed into the HP 5451B MAS to determine mode shapes, frequencies, and damping. The overall technique is based on the use of digital processing and the Fast Fourier Transform (FFT) to obtain transfer function data and then use of a least-squared error estimator to identify modal properties from the transfer function data.

A specially designed 1000 lb. ram was instrumented with a force transducer in its head. The ram was swung from the gin pole used for MOD-2 erection and allowed to impact the blade tip. To insure a proper impact, the ram was constrained to follow a cable, through the center of the target disc.

To excite the significant modes of interest, the impact force must be of sufficient magnitude and duration. The ram was calibrated before the modal survey by varying the stiffness of the ram impact head (interchangeable foam rubber pads) and varying the swing length to develop approximately 1000 lb. with 200 ms duration.

The modal frequencies and damping resulting from the modal survey are shown in Table 3. The data is a direct output of the HP 5451B Fourier Analyser System with the exception of chordwise bending, nacelle pitch and drive-train torsion modes which were determined by supplemental means.

The data gathered during the MOD-2 modal survey tests verified the achievement of required system design frequencies. In particular, the drive train, tower and blade modes were identified and shown to meet system frequency placement and separation. The measured damping provided assurance that design damping assumptions were reasonable.

TABLE 3
MOD-2 MODAL SURVEY RESULTS

Mode	Freq. (r)		Damping (%)
	Pred.	Meas.	Meas.
Tower	0.14	----	----
Drive Train Torsion	0.46	0.45	----
Tower Bending Fore/Aft	1.24	1.23	1.0
Tower Bending Lateral	1.27	1.28	4.2
Flap Bending Sym.	3.09	3.30	0.35
Chord Bending Sym.	6.22	6.17	----
Flap Bending Antisym.	6.45	6.55	1.04
Flap Bending 2nd Sym.	7.71	9.6	0.78
Nacelle Pitch		8.23	

SUMMARY AND CONCLUSIONS

A series of tests have been conducted in support of MOD-2 wind turbine component development. For the most part, these substantiated the soundness of the particular component design. Each test was conducted on a schedule such that the results could be incorporated into the design detail of the specific component. The objective of the test programs varied, but could be included in one of the following categories: (1) verification of analytical prediction methods, (2) provide data for design of the component, (3) verification of life

prediction, (h) verification of static strength capability, (i) assess critical load paths, and (j) functional verification. The component and integrated system tests described in this paper had one or more combinations of these objectives.

Component testing was vital to the development of the MOD-2 wind turbine system because the tests provided early visibility to design problems and provided the data required to develop sound design solutions. The design deficiencies brought to light by these tests were promptly corrected, thereby avoiding costly retrofits during the checkout and acceptance tests of the system. MOD-2 checkout and acceptance phases have proceeded on a faster schedule than anticipated, and is for the most part due to the component and integrated system testing described in this paper.

NOMENCLATURE

C	= Constant
K	= Stress Intensity, Ksi
K _{max}	= Maximum Stress Intensity of the Specific Load Cycle (Sum of Steady and Alternating Stresses), Ksi
K _{o1}	= Maximum Stress Intensity in the Spectrum of Stresses, Ksi
K _{th}	= Stress Intensity Threshold (Stress Below Which Damage is Not Produced), Ksi
L	= Exponent
ΔP	= Pressure Differential Across Panel, psi
R	= Stress Ratio, Minimum Stress/Maximum Stress
da/dn	= Crack Growth Rate in Inches/Cycle
l	= One Half of Crack Length, Inches
m	= Exponent
\dot{m}	= Airflow, in Cubic Feet per Minute (Std Conditions)
n	= Exponent
t	= Plate Thickness, Inches
σ	= Gross Area Stress in Plate, Ksi

ORIGINAL PAGE
BLACK AND WHITE PHOTOGRAPH

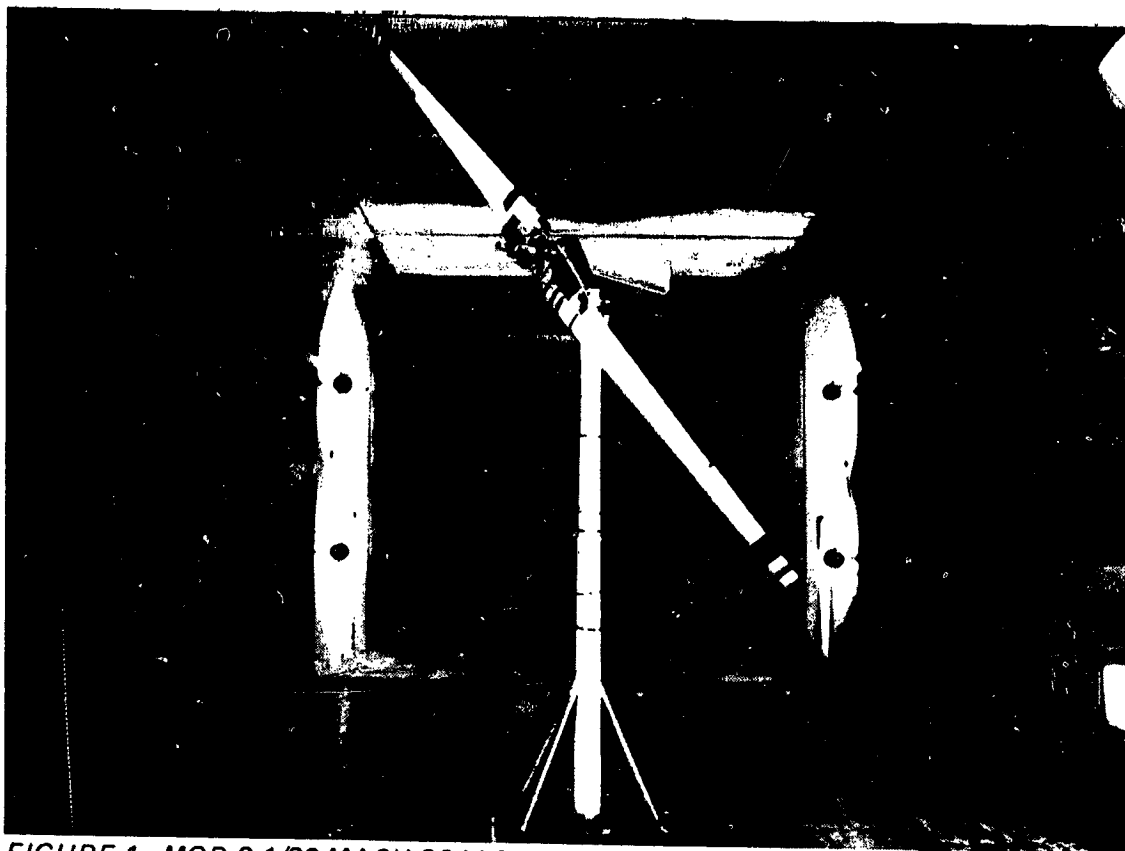

FIGURE 1. MOD-2 1/20 MACH SCALED MODEL IN BOEING V/STOL WIND TUNNEL

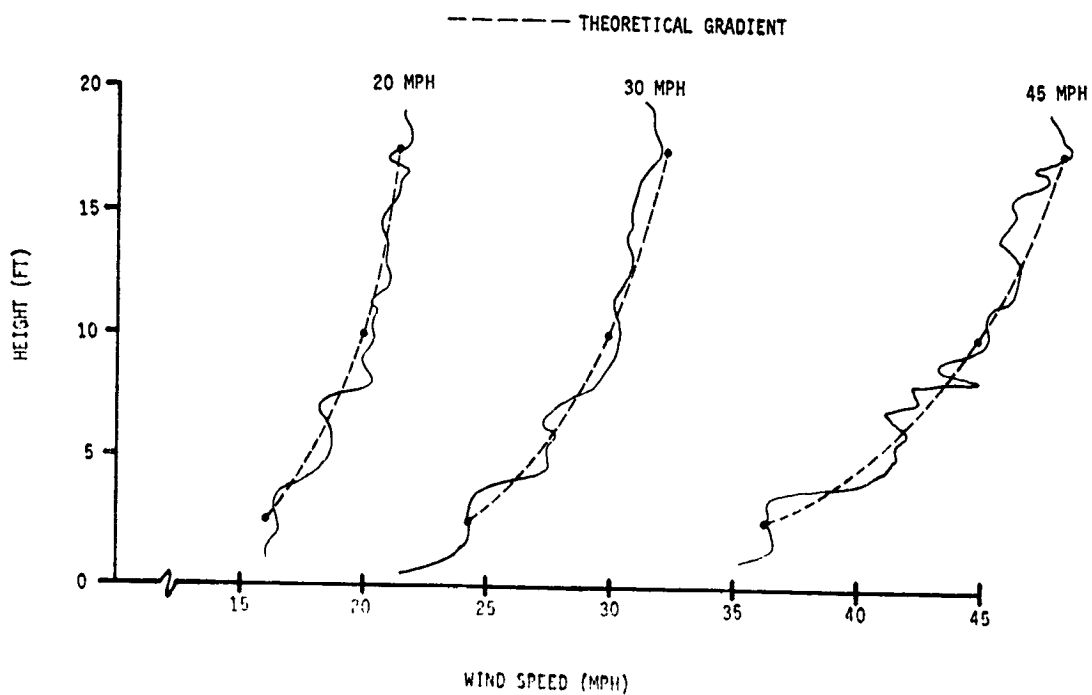

FIGURE 2. WIND GRADIENT SCREEN EVALUATION

ORIGINAL PAGE IS
OF POOR QUALITY

- Each bar represents a test data point
- Except as noted the test material was A533

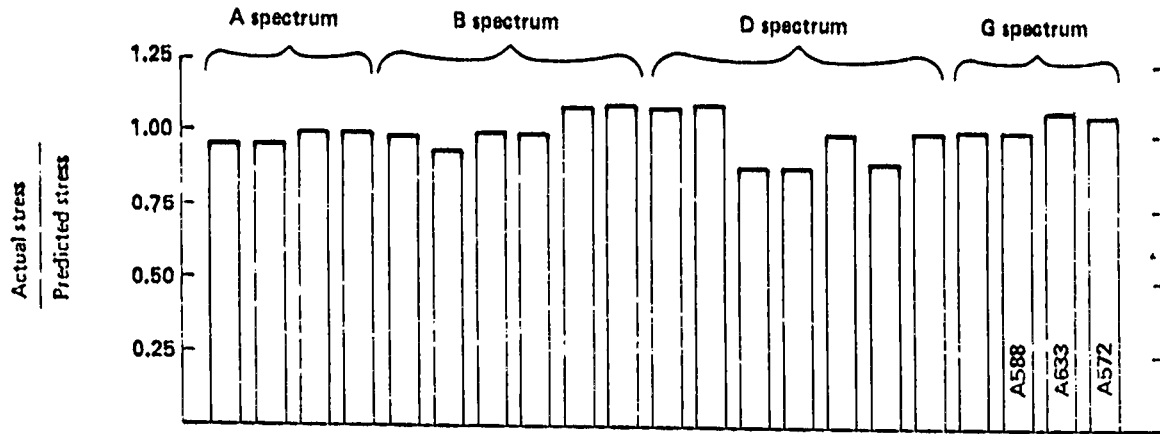

FIGURE 3. CORRELATION OF TEST AND PREDICTED RESULTS

- Model derived from spectrum load test results
- Model is good for all A grade steels
- Model applicable to all wind turbine spectra

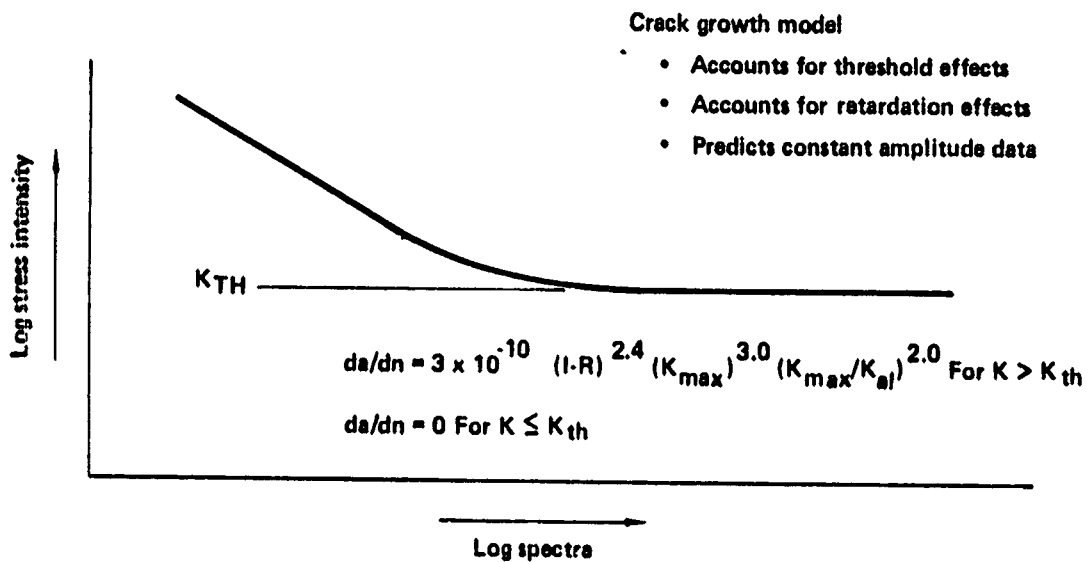

FIGURE 4. FATIGUE ALLOWABLE MODEL

ORIGINAL PAGE
BLACK AND WHITE PHOTOGRAPH

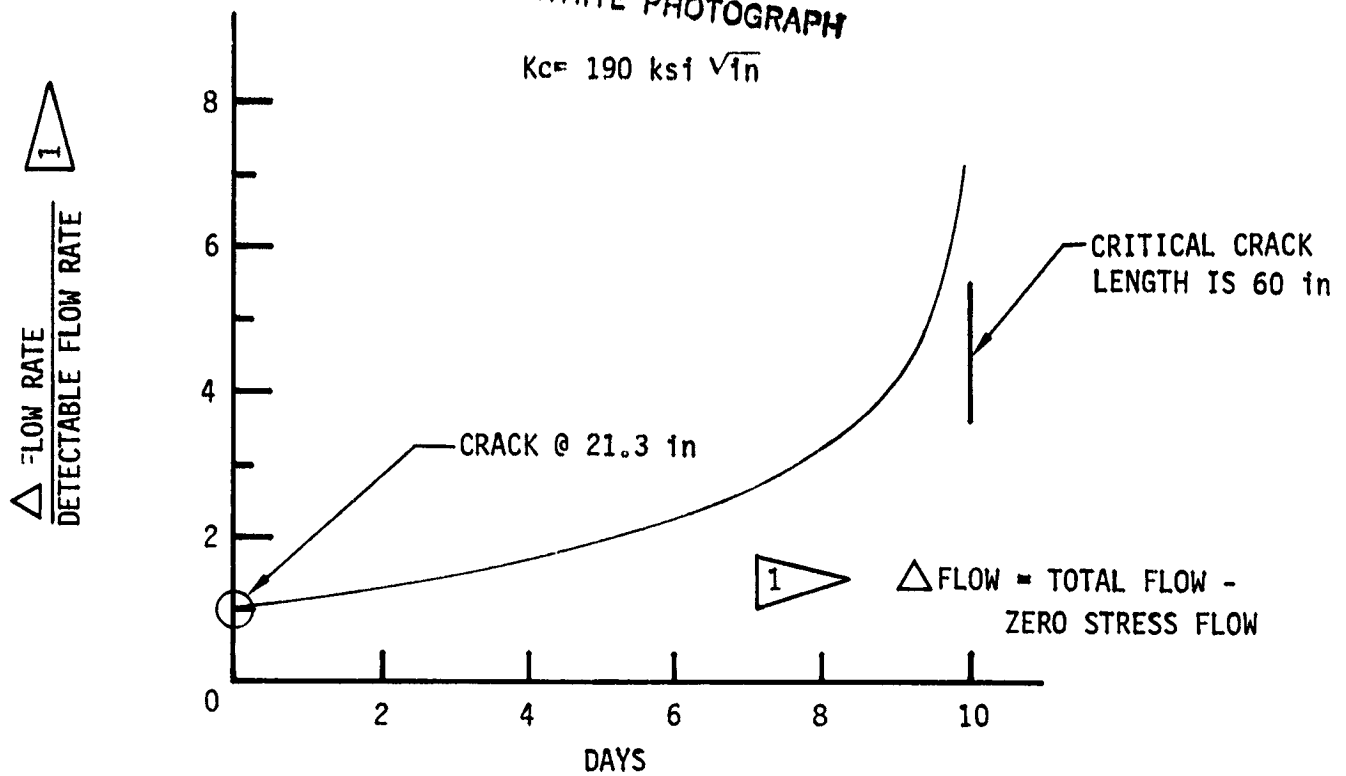
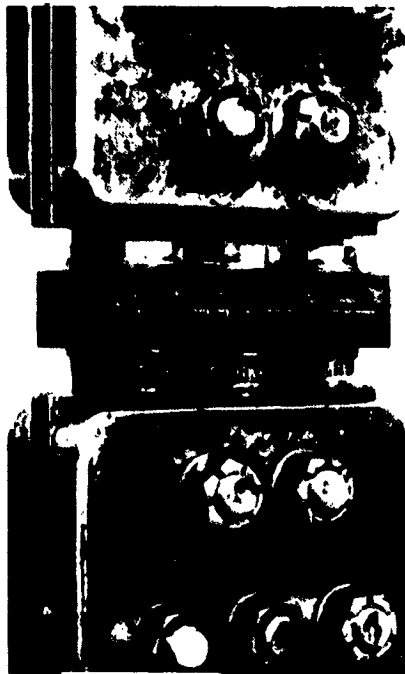
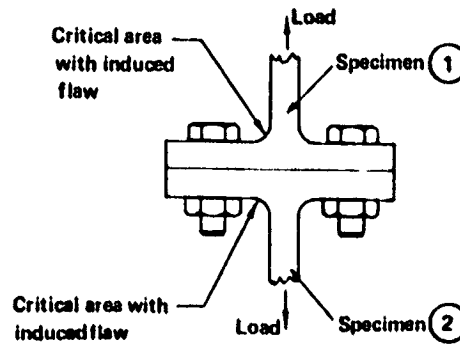

FIGURE 5. CRACK DETECTION SYSTEM CAPABILITY FOR MOD-2 BLADE STATION 360 BASED ON Δ FLOW



INSTALLATION
IN TEST MACHINE



TEST DATA

	(1)	(2)
● Fillet area stress (psi)	18,000	18,200
● Initial flaw length (in.)	0.248	0.234
● Predicted fatigue life	17,000,000	17,000,000
	Cycles	Cycles
● Test Specimen Life	18,953,754	21,151,277
	Cycles	Cycles

FIGURE 6. ROTOR BLADE FIELD JOINT TEST

ORIGINAL PAGE
BLACK AND WHITE PHOTOGRAPH

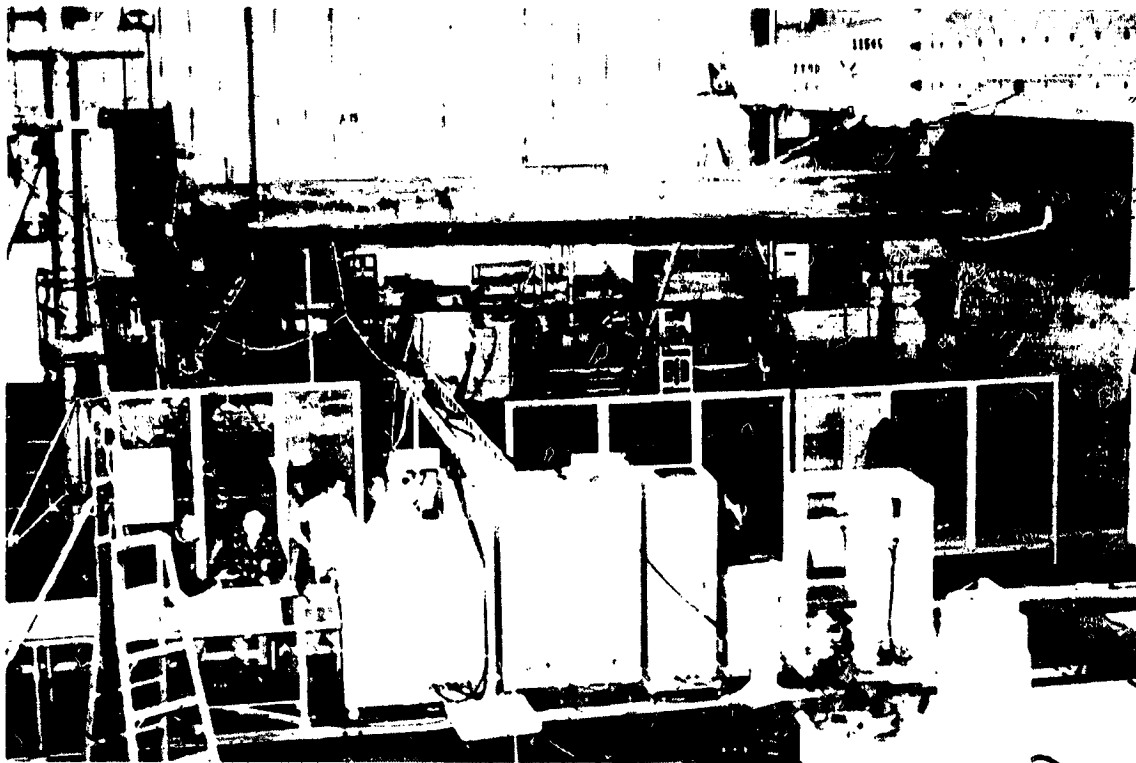

FIGURE 7. BLADE STATIC BUCKLING TEST

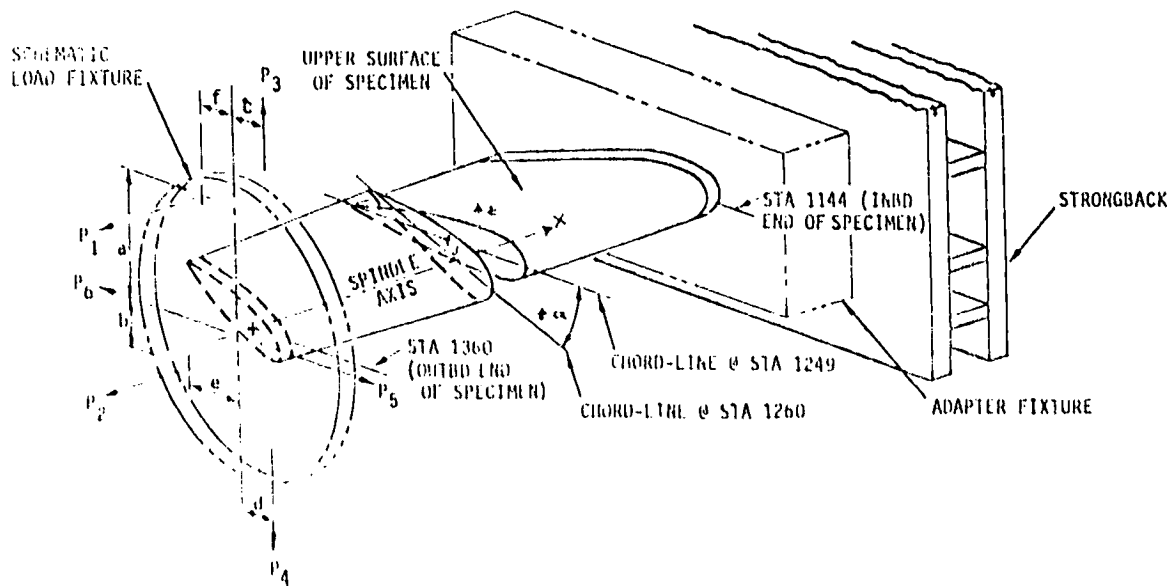

FIGURE 8. SCHEMATIC OF SPINDLE FATIGUE TEST SETUP

ORIGINAL PAGE
BLACK AND WHITE PHOTOGRAPH

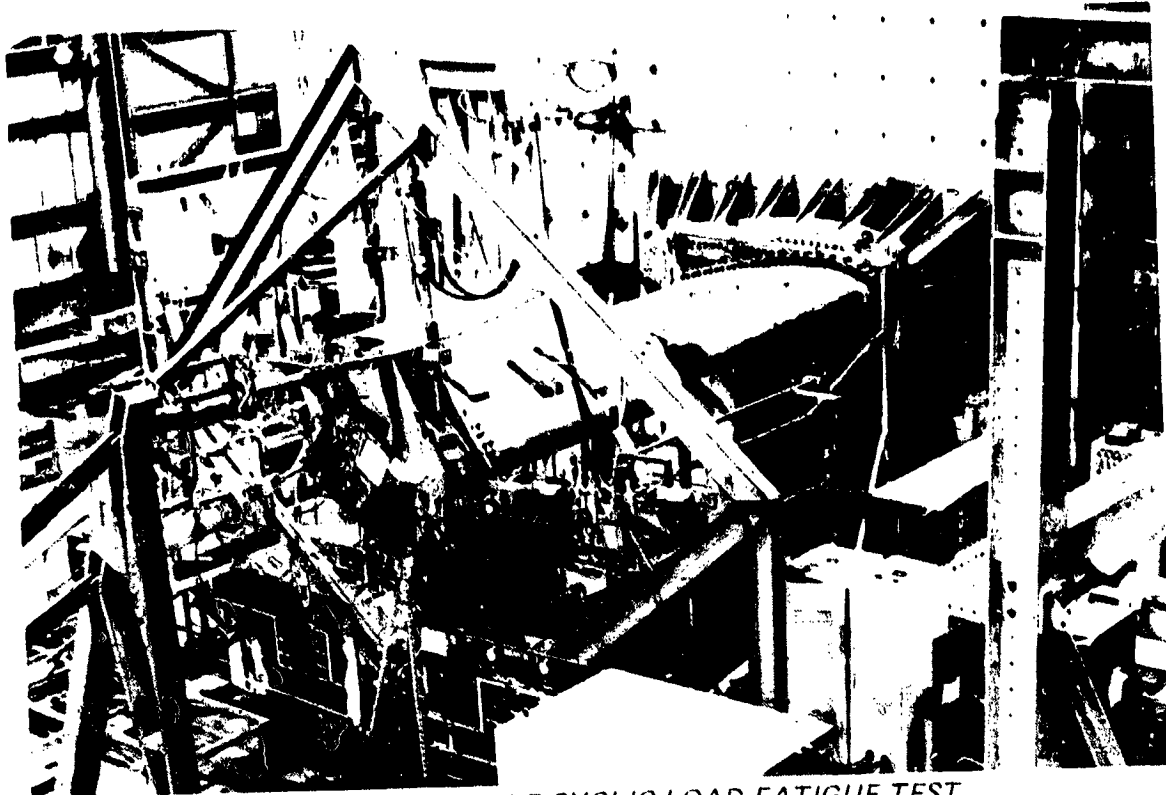

FIGURE 9. SPINDLE CYCLIC LOAD FATIGUE TEST

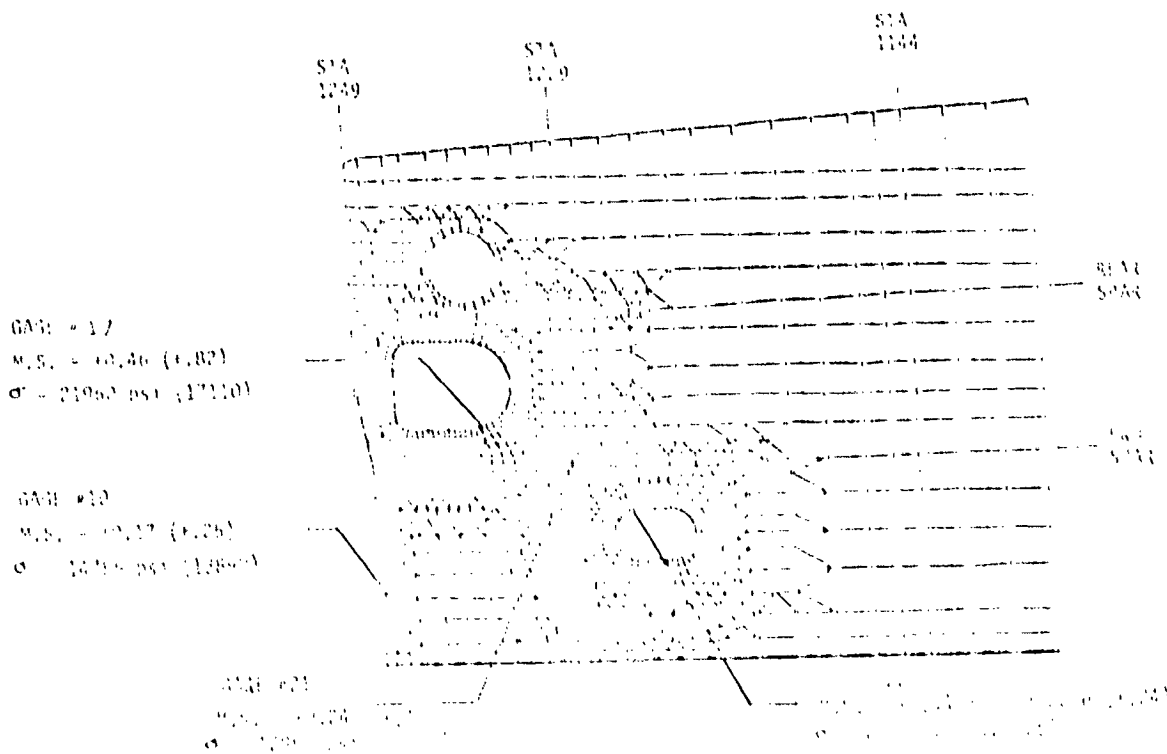

FIGURE 10. MARGINS OF SAFETY AT CRITICAL LOCATIONS OF TEST SPECIMEN. INBOARD SECTION, UPPER SURFACE COMPARISON OF ANALYSIS WITH (TEST)

ORIGINAL PAGE
BLACK AND WHITE PHOTOGRAPH

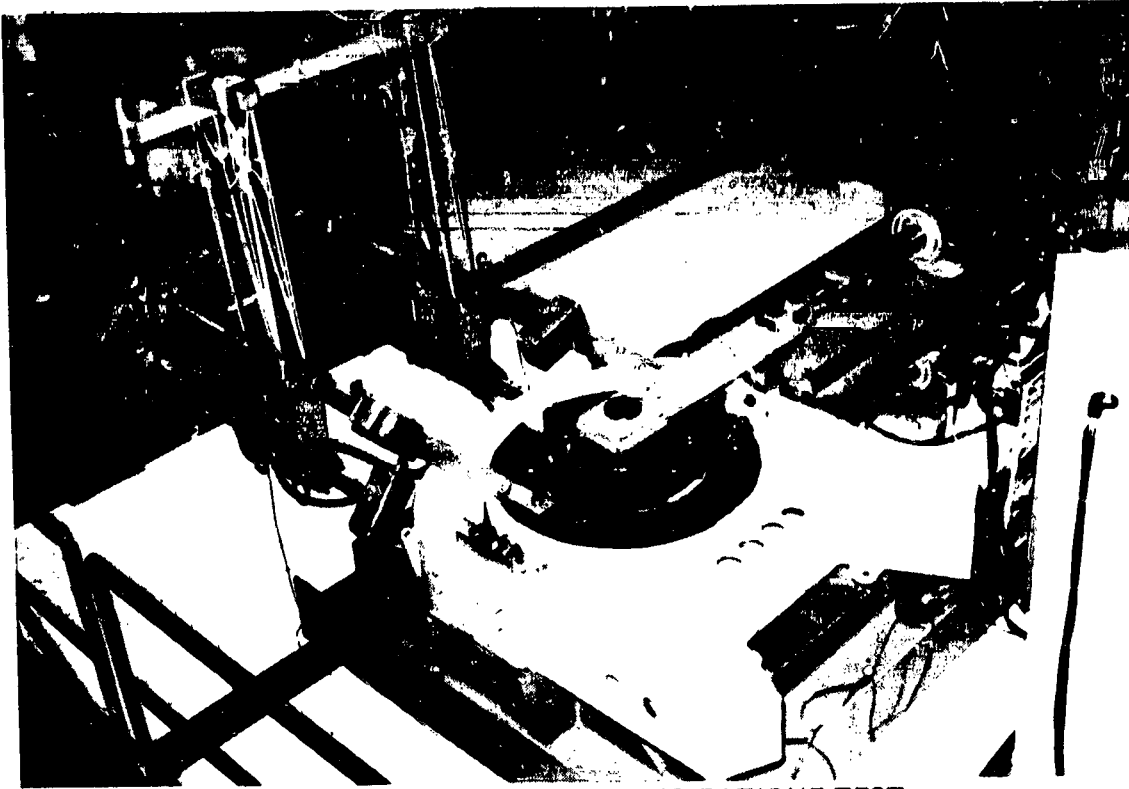

FIGURE 11. TEETER BEARING FATIGUE TEST

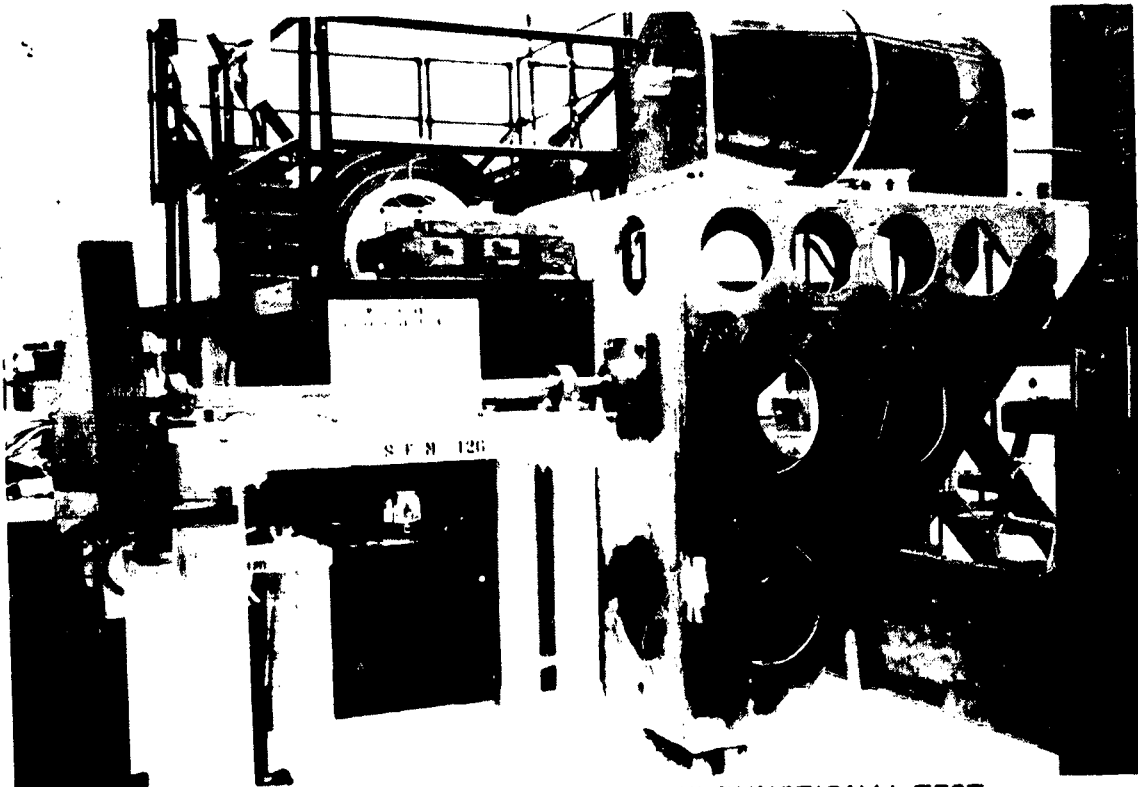

FIGURE 12. HYDRAULIC RESERVOIR FUNCTIONAL TEST

ORIGINAL PAGE
BLACK AND WHITE PHOTOGRAPH



FIGURE 13. GEARBOX BACK-TO-BACK TEST

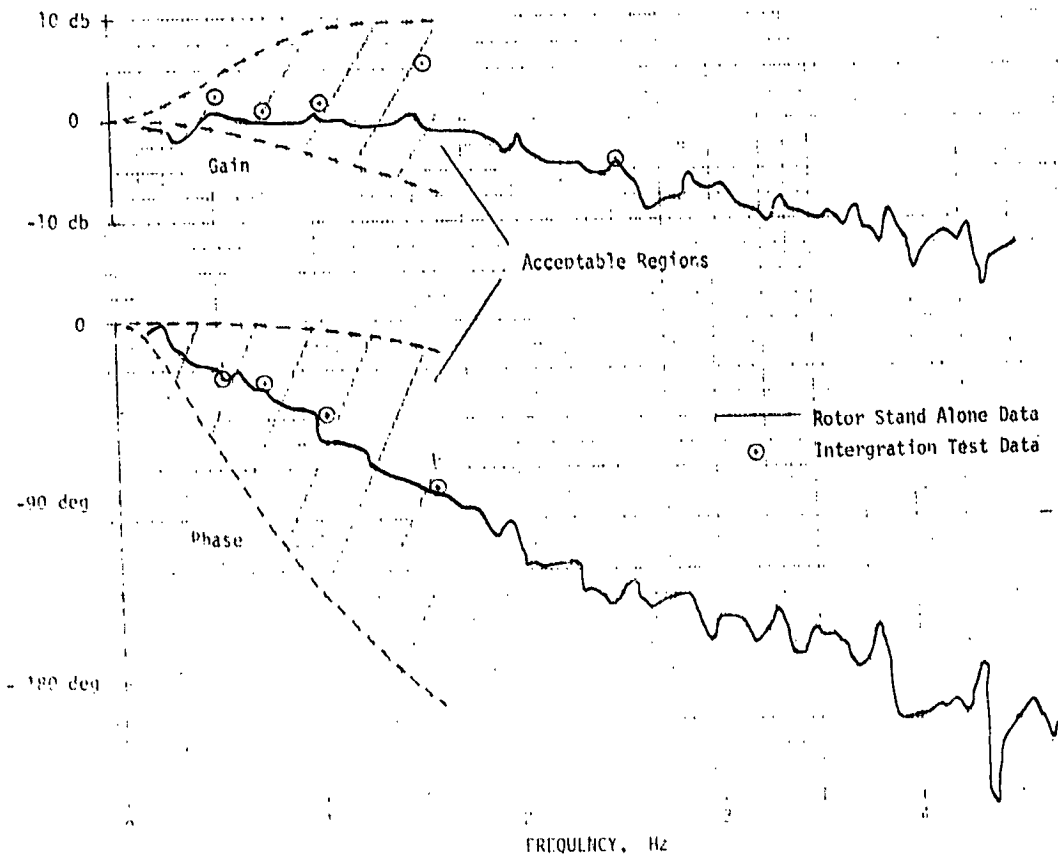

FIGURE 14. CONTROL SYSTEM RESPONSE TO INPUT COMMAND