

General Disclaimer

One or more of the Following Statements may affect this Document

- This document has been reproduced from the best copy furnished by the organizational source. It is being released in the interest of making available as much information as possible.
- This document may contain data, which exceeds the sheet parameters. It was furnished in this condition by the organizational source and is the best copy available.
- This document may contain tone-on-tone or color graphs, charts and/or pictures, which have been reproduced in black and white.
- This document is paginated as submitted by the original source.
- Portions of this document are not fully legible due to the historical nature of some of the material. However, it is the best reproduction available from the original submission.

NASA CONTRACTOR REPORT 166465

(NASA-CR-166465) SKELETAL AND BODY
COMPOSITION EVALUATION Final Report
(Wisconsin Univ.) 86 p HC A05/MF A01

N83-20538

CSSL 06P

Unclas
G3/52 09308

Final Progress Report on NASA-Y-NGR-50-002-051 and
NAG2-166 1968-1982

Richard B. Mazess



CONTRACT NAG 2-166
March 1983

NASA

NASA CONTRACTOR REPORT 166456

**Final Progress Report on NASA-Y-NGR-50-002-051 and
NAG2-166 1968-1982**

**Richard B. Mazess
Bone Mineral Laboratory
University of Wisconsin
Madison, Wisconsin**

**prepared for
Ames Research Center
Under Grant NAG2-166**



**National Aeronautics and
Space Administration**

**Ames Research Center
Moffett Field, California 94035**

From 1968 to 1982 this NASA project on skeletal and body composition evaluation was performed at the Bone Mineral Laboratory. The work done over that time included:

- (a) analysis of errors affecting single-photon absorptiometry and development of instrumentation,
- (b) analysis of errors affecting dual-photon absorptiometry and development of instrumentation,
- (c) evaluation of skeletal uptakes of diphosphonates,
- (d) comparison of other skeletal techniques,
- (e) cooperation with NASA projects for skeletal evaluation in space flight (MO-78) and in immobilized animals,
- (f) organization of scientific meetings on bone measurement methods and smaller workshops on absorptiometric measurement,
- (g) monkeys,
- (h) research on body composition and fluid shifts, and
- (i) research on radiation detectors for absorptiometry.

As a consequence of that support measurement systems were developed that allowed accurate and very precise (1-2% error) measurement of both compact and trabecular bone in vivo and in fact systems were developed which allowed measurement of the total skeleton. It is now realized that the loss of trabecular bone with immobilization or space flight amounts to 1%/week and that this loss in adults is recovered very slowly if at all. As a consequence bone loss is the major biological impediment to prolonged space flight. Similarly fluid shifts in space flight can become large and have adverse consequences. The absorptiometric procedures we established allow measurement of such shifts.

ORIGINAL PAGE IS
OF POOR QUALITY

A. SINGLE-PHOTON ABSORPTIOMETRY

Early in the project a direct readout instrument was developed for bone mineral measurement using ^{125}I . This became commercially implemented by both Norland Instruments (in the U.S.) and by Gammatec (in Denmark) with over 400 such instruments in clinical use. We defined various sources of error affecting measurements (scattered radiation, beam hardening, count losses due to deadtime, ^{125}I -contamination, beam profile effects, uneven tissue composition). These could not be corrected with earlier analog instruments but correction algorithms were implemented in latter direct readout instruments using microcomputers. A special linear scanner was built for possible use in space flight. Rectilinear scanning with ^{125}I was instituted to reduce the precision error by 30-50% and to allow measurement on bones with an irregular shape (such as the distal radius or os calcis). This reduced the precision error on the radius from 2% to 1.4%. The inter-relationship of single-photon scans on the long bones was examined, and it was found that such scans were highly related with each other ($r > 0.95$) and with total skeletal mineral. In normal subjects total body bone mineral could be predicted with an error (1 SEE) of only 8% but the prediction error was 12-18% on the femoral neck and 15% to 25% for the spine.

ORIGINAL PAGE IS
OF POOR QUALITY

THE COEFFICIENT OF VARIATION IN SINGLE-PHOTON ABSORPTIOMETRY CAN
BE REDUCED BY INCREASING THE COUNT RATE IN ADJACENT SOFT-TISSUE

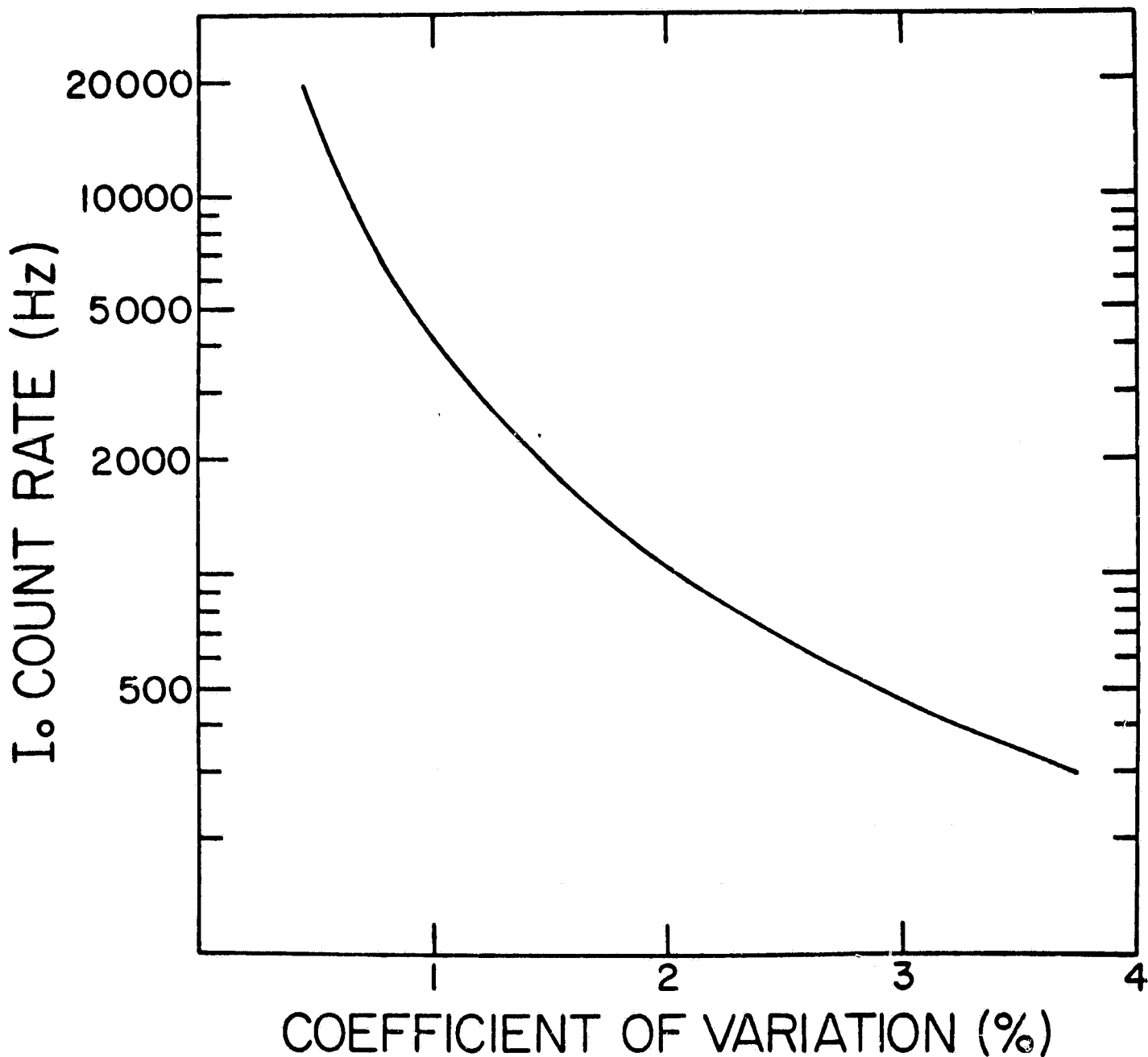

ORIGINAL PAGE IS
OF POOR QUALITY

AT HIGH COUNT RATES THE COEFFICIENT OF VARIATION CAN BE REDUCED
TO BELOW 1%.

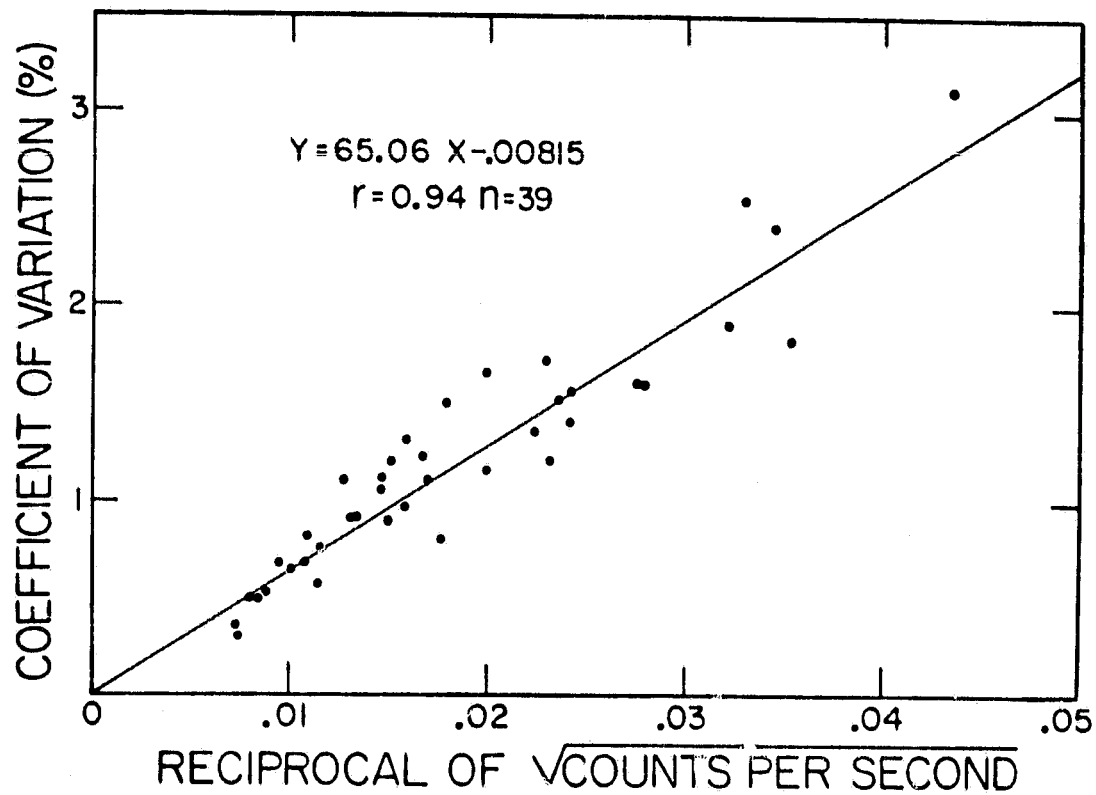

B. DUAL-PHOTON ABSORPTIOMETRY

Absorptiometry using two single-energy beams was developed early in the project in order to allow measurement of bone in vivo without the need for surrounding a limb in tissue equivalent material. In addition this allowed measurement of the tissue composition of that limb and evaluation of fluid shifts. A combination of ^{125}I and ^{241}Am sources (28 and 60keV) was used. With the availability of ^{153}Gd in 1970 it became possible to extend dual-photon measurements to the spine and to measurements of total body bone mineral. ^{153}Gd has nearly optimal energies (44 and 100keV) for measurement of thick body areas.

Sources of error in the dual-photon method were defined and a system was built and delivered to Ames Research Center to monitor bone mineral in immobilized monkeys. That system allowed precise long-term measurements (1.6% precision error on standards). The precision on monkeys was also good. Measurements of total body bone mineral content were made on normal subjects, patients and skeletons. The precision error in vitro was 1.5-2.0 and 2-3% in vivo. Recently the precision error in vitro was reduced to 0.7% without increase of the low dose (1 mrem). It has been possible to obtain measurements of regional bone mineral, including the spine, from the total body measurements.

DUAL PHOTON ABSORPTION EXPERIMENT

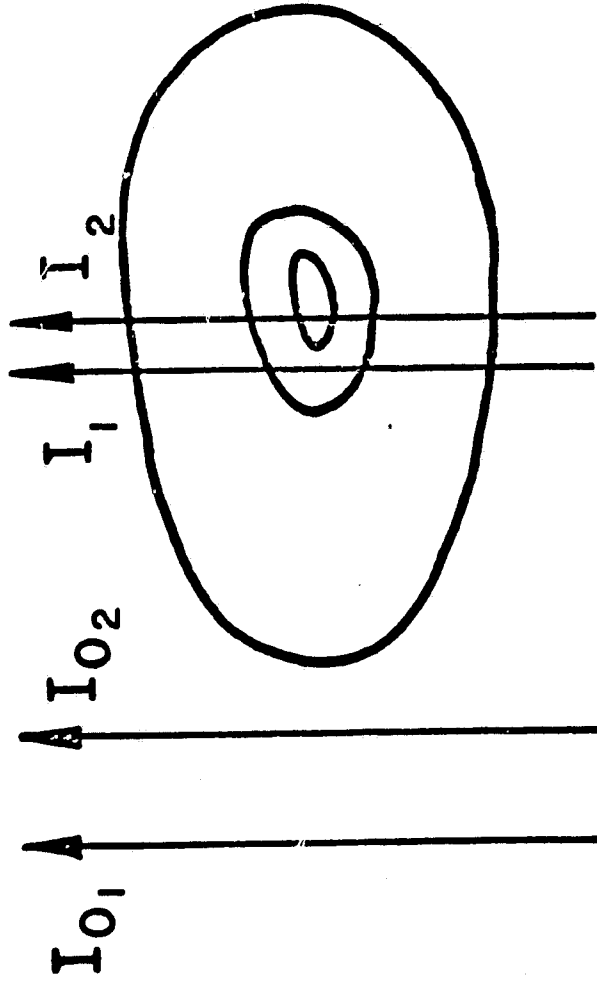

ORIGINAL PAGE IS
OF POOR QUALITY

$$I_1 = I_{0_1} \exp(-\mu_{BM1} \times BM - \mu_{ST1} \times ST)$$

$$I_2 = I_{0_2} \exp(-\mu_{BM2} \times BM - \mu_{ST2} \times ST)$$

ORIGINAL PAGE IS
OF POOR QUALITY

SUITABLE CORRECTIONS MUST BE APPLIED FOR
DUAL PHOTON ABSORTIOMETRY

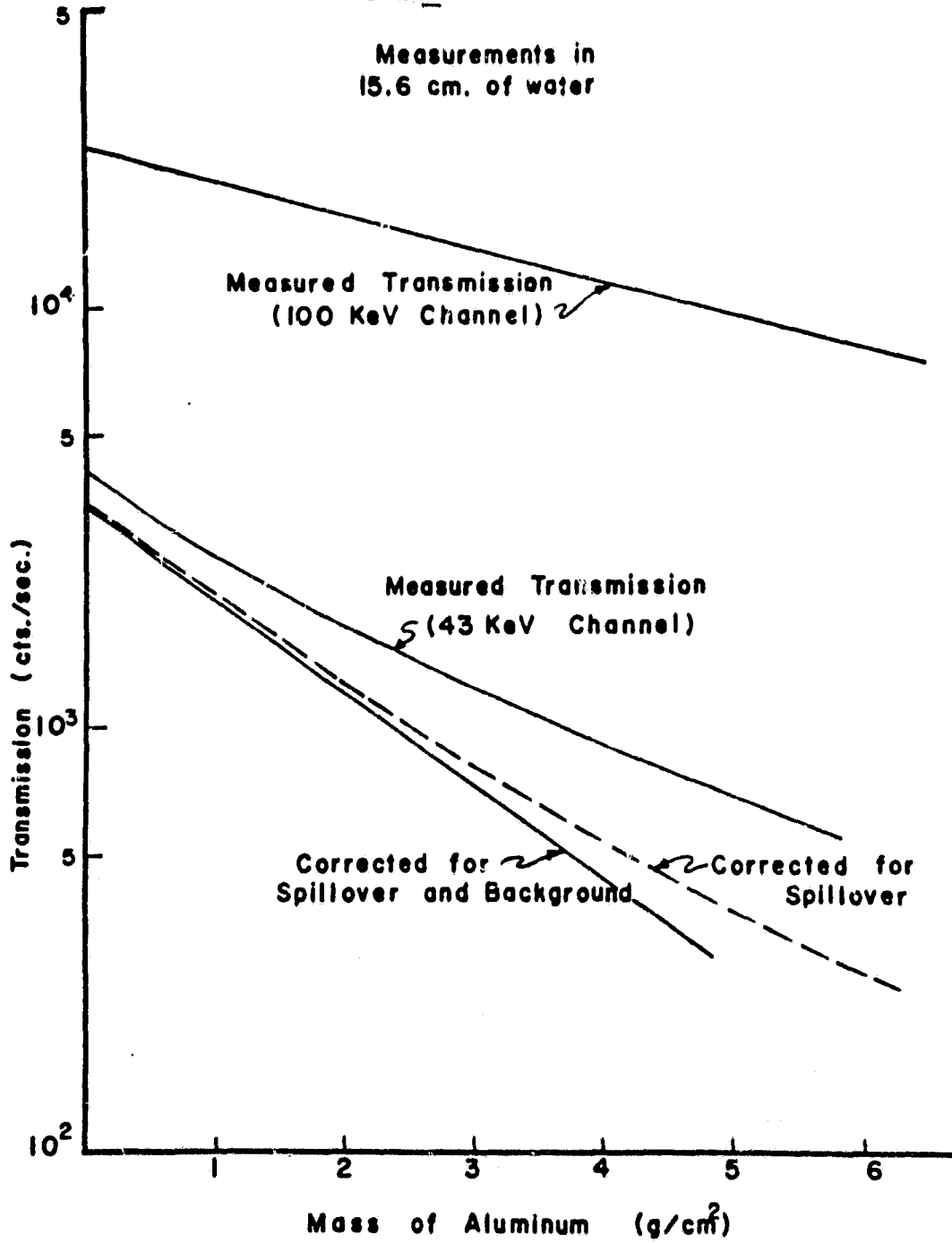

ORIGINAL PAGE IS
OF POOR QUALITY

LINEAR ATTENUATION CAN BE ATTAINED AT ALL SOFT-TISSUE
THICKNESSES

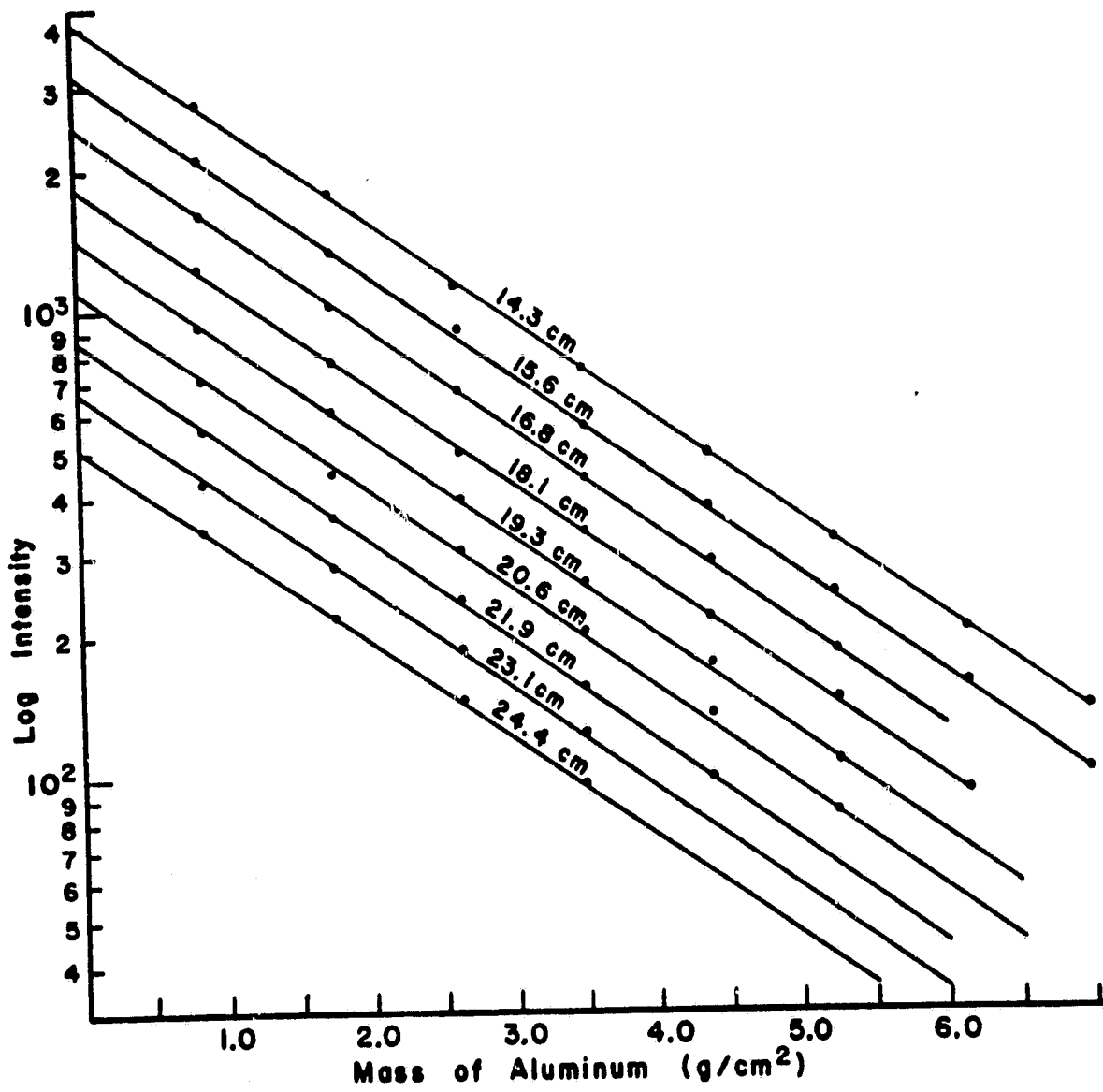

ORIGINAL PAGE IS
OF POOR QUALITY

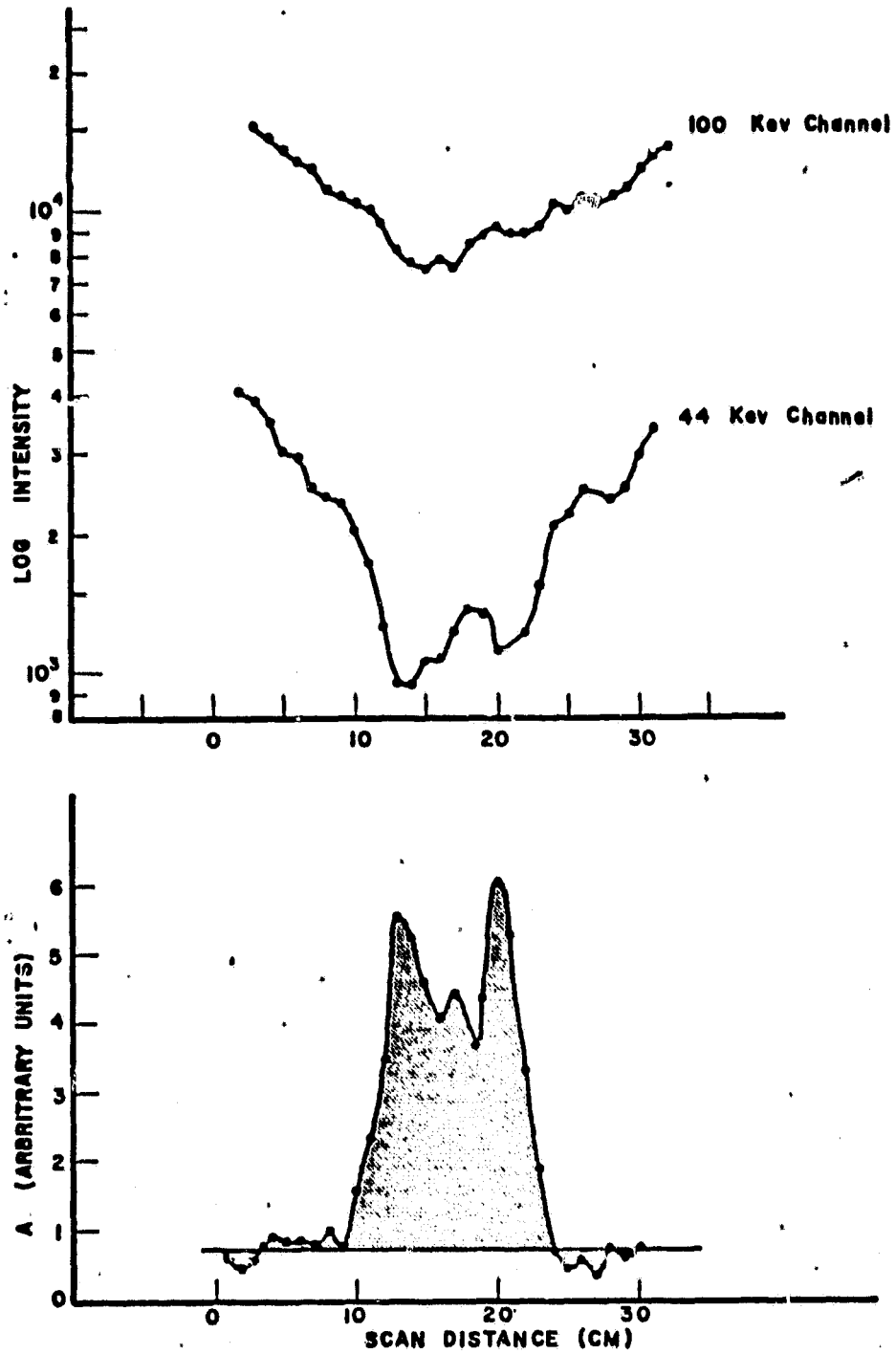

Figure 1. The transmitted intensities of the two photon beams and the value A versus scan distance.

ORIGINAL PAGE IS
OF POOR QUALITY

SCAN PATH ON LUMBAR SPINE

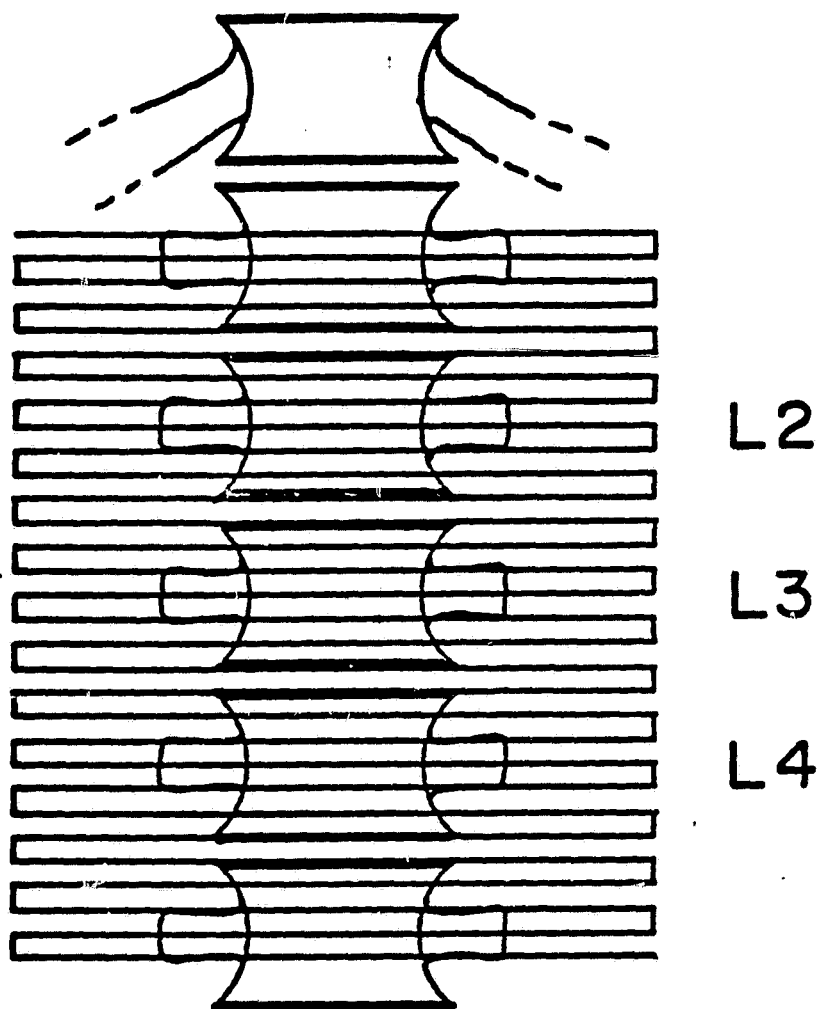
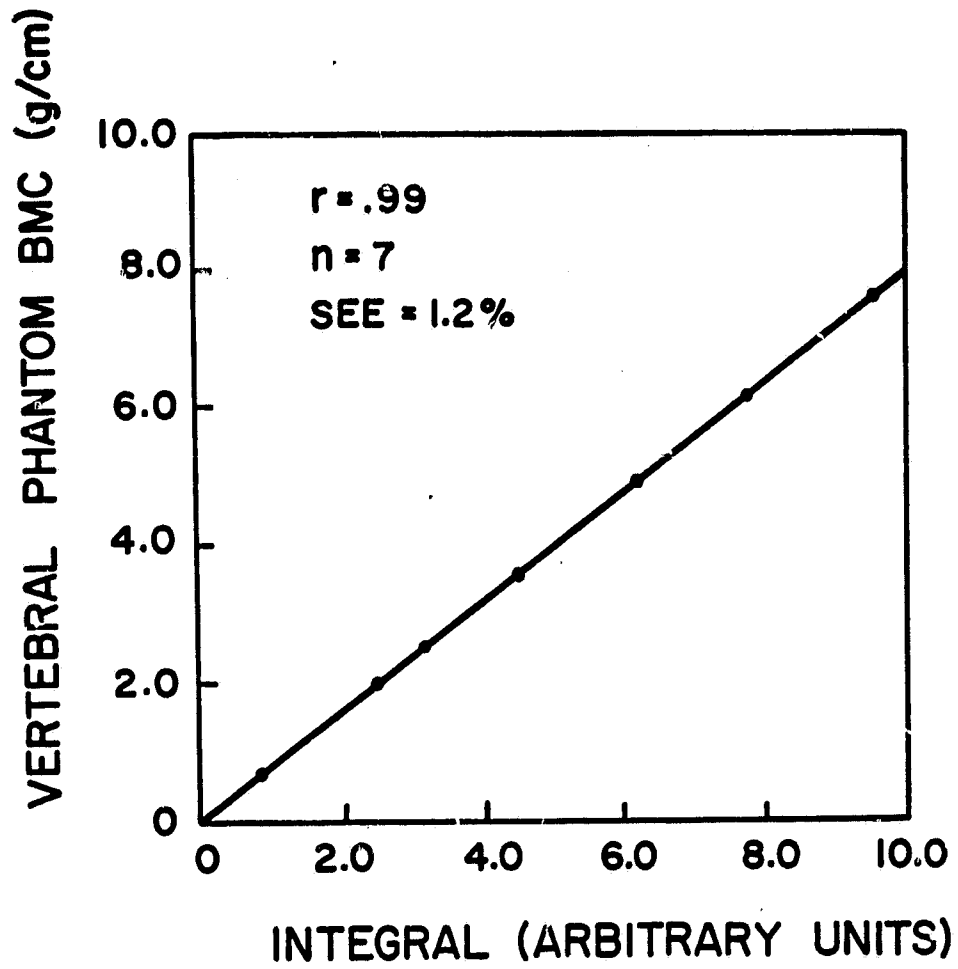

FIGURE 5
RECTILINEAR SCAN OF LUMBAR SPINE

ORIGINAL PAGE IS
OF POOR QUALITY

ACCURACY OF DUAL-PHOTON SCANS ON PHANTOMS



ORIGINAL PAGE IS
OF POOR QUALITY

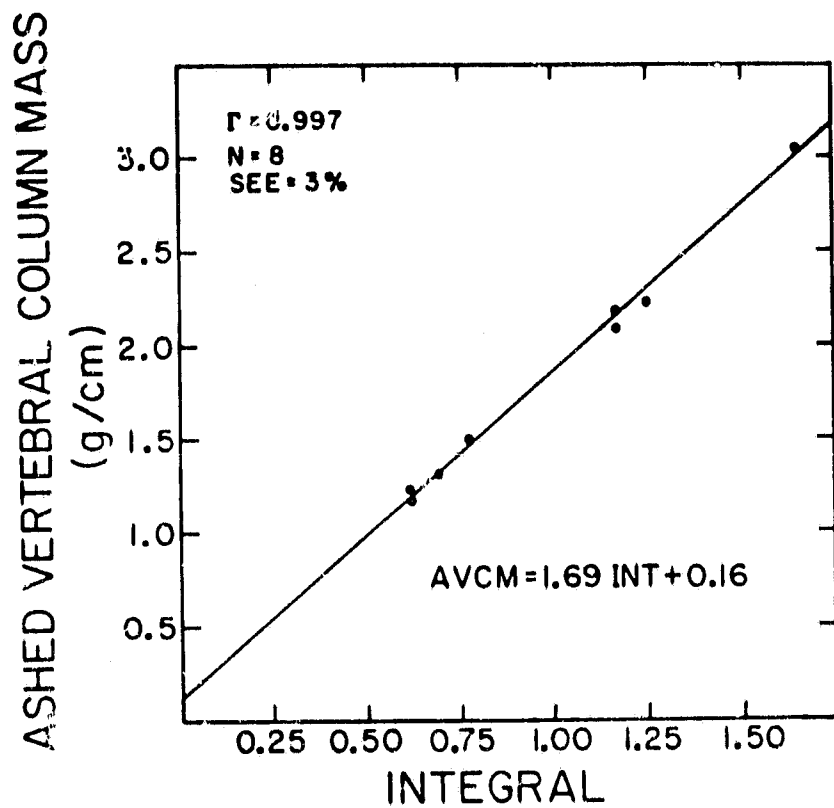
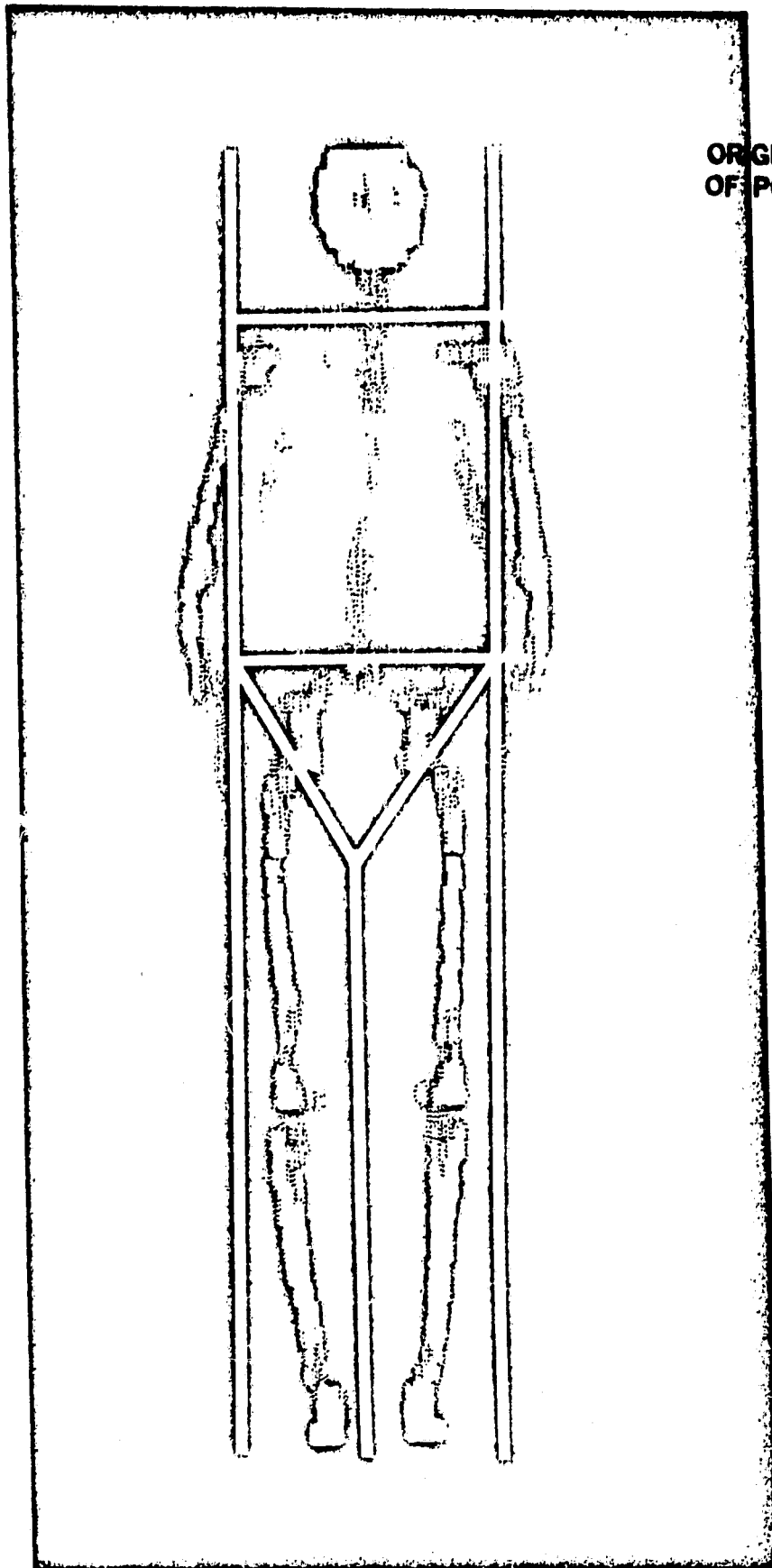

Figure 3
Regression of the absorptiometric estimate of bone mineral mass and the actual ashed vertebral bone mineral mass.

SCREEN APPEARANCE OF A TOTAL BODY BONE MINERAL SCAN SHOWING THE
REGIONAL AREAS MEASURED



ORIGINAL PAGE IS
OF POOR QUALITY

ACCURACY OF TBBM VERSUS TBCa (By neutron activation analysis)

ORIGINAL PAGE IS
OF POOR QUALITY

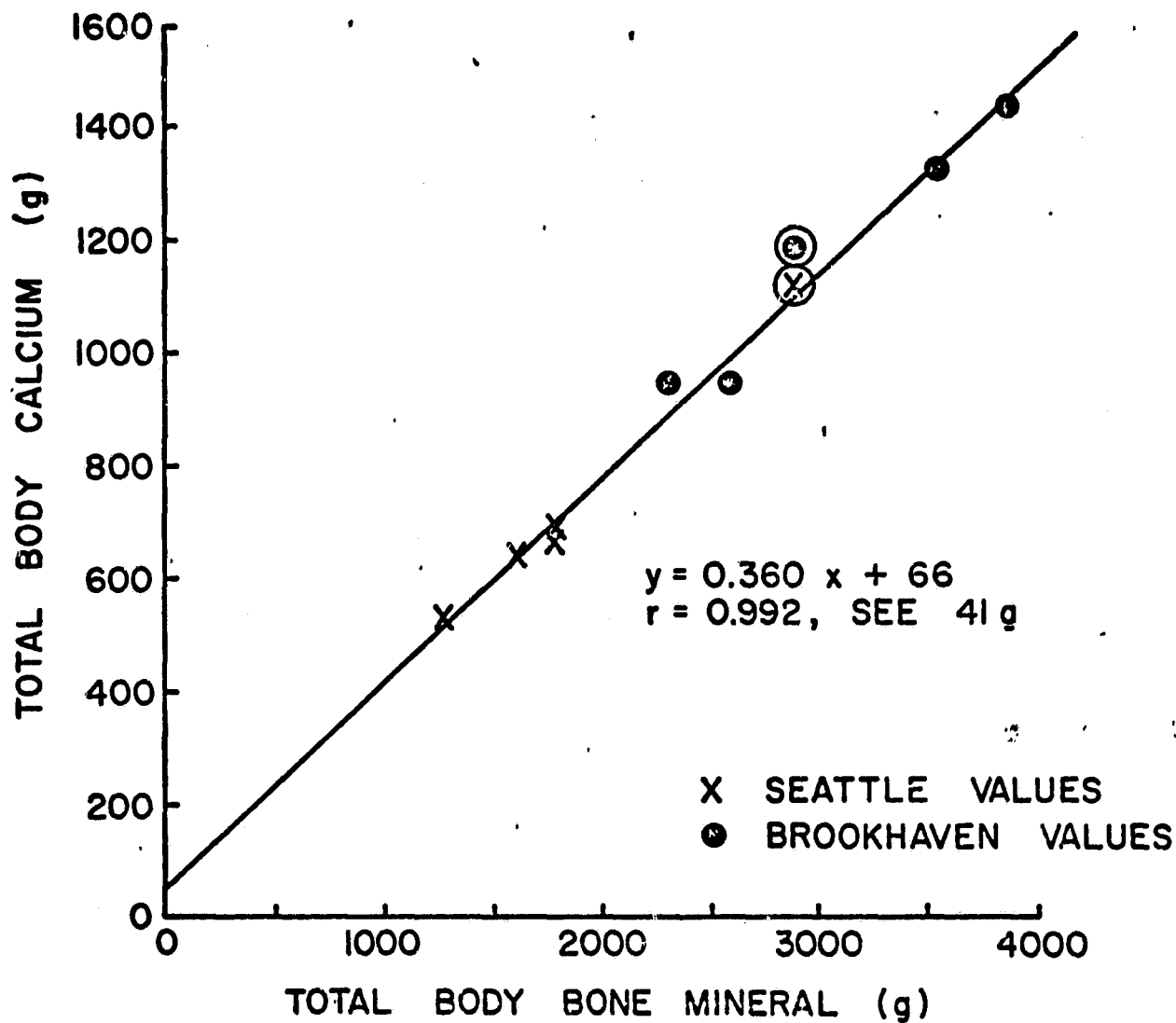

C. SKELETAL UPTAKE OF DIPHOSPHONATES

We have used a whole-body counter to monitor the uptake of ^{99m}Tc -labelled (50 μsec) diphosphonates (HEDP and MDP) over a 24-hour period.

These uptakes were shown to be fairly uniform in normal young men but there were marked deviations in patients with bone disease. There was a 20% retention of HEDP and a 30% retention of MDP at 24 hours in normal subjects. The retention corresponded directly to the amount excreted in the urine. A two-component exponential equation fitted the data very well. This allowed evaluation of bone activity (rather than mass or density) using a low dose (6mrem) method.

PARAMETERIZATION OF THE RETENTION OF ^{99m}Tc -DIPHOSPHONATES

Retention curves were easily resolved using a two-phase model of exponential loss (see enclosed sheets). The first phase of rapidly decreasing activity represented clearance from soft-tissue. The intercept at T_0 indicates the amount of clearance while the slope (A_4) indicates the rate. The slower second phase represents bone uptake; the intercept at T_0 (A_1) indicates the projected bone uptake at T_0 while the slope reflects long-term loss from bone (and soft-tissue). This model fit all areas (total body, head, chest, legs) quite well; X^2 was low and the standard error of estimate about each curve averaged 3%. For three normal adult males the values were:

		A_1	A_2 ($\times 10^{-4}$)	A_3	A_4
TOTAL BODY	HEDP	35.1	5.48	63.8	.0112
	MDP	38.2	2.58	63.3	.0120
HEAD	HEDP	42.6	4.28	57.4	.0084
	MDP	51.6	2.62	48.4	.0121
CHEST	HEDP	37.9	5.87	61.8	.0141
	MDP	42.7	2.05	57.3	.0183
LEGS	HEDP	24.1	3.03	75.0	.0054
	MDP	30.0	4.12	66.9	.0052

It is apparent from the table that the head had greater bone uptake (A_1) than the chest which in turn had greater uptake than the legs; in each case A_1 was greater for MDP than for HEDP. The bone avidity was usually greater for MDP as shown by the smaller slopes for A_2 . As a consequence the whole body retention at 24-hours was 30% with MDP and only 19% with HEDP. Measurements in renal patients showed high retention due to a lack of clearance. In subjects with bone disease retention was high although renal clearance was normal. The results explain the clinical finding of greater contrast in bone scans with MDP than HEDP. They also show that 24-hour whole body ^{99m}Tc -diphosphonate retention studies used in metabolic bone disease will be influenced not only by renal clearance, but by variation in local bone retention.

ORIGINAL PAGE IS
OF POOR QUALITY

ORIGINAL PAGE IS
OF POOR QUALITY

% χ^2 change = 8.5E-3

RETENTION IN HEAD

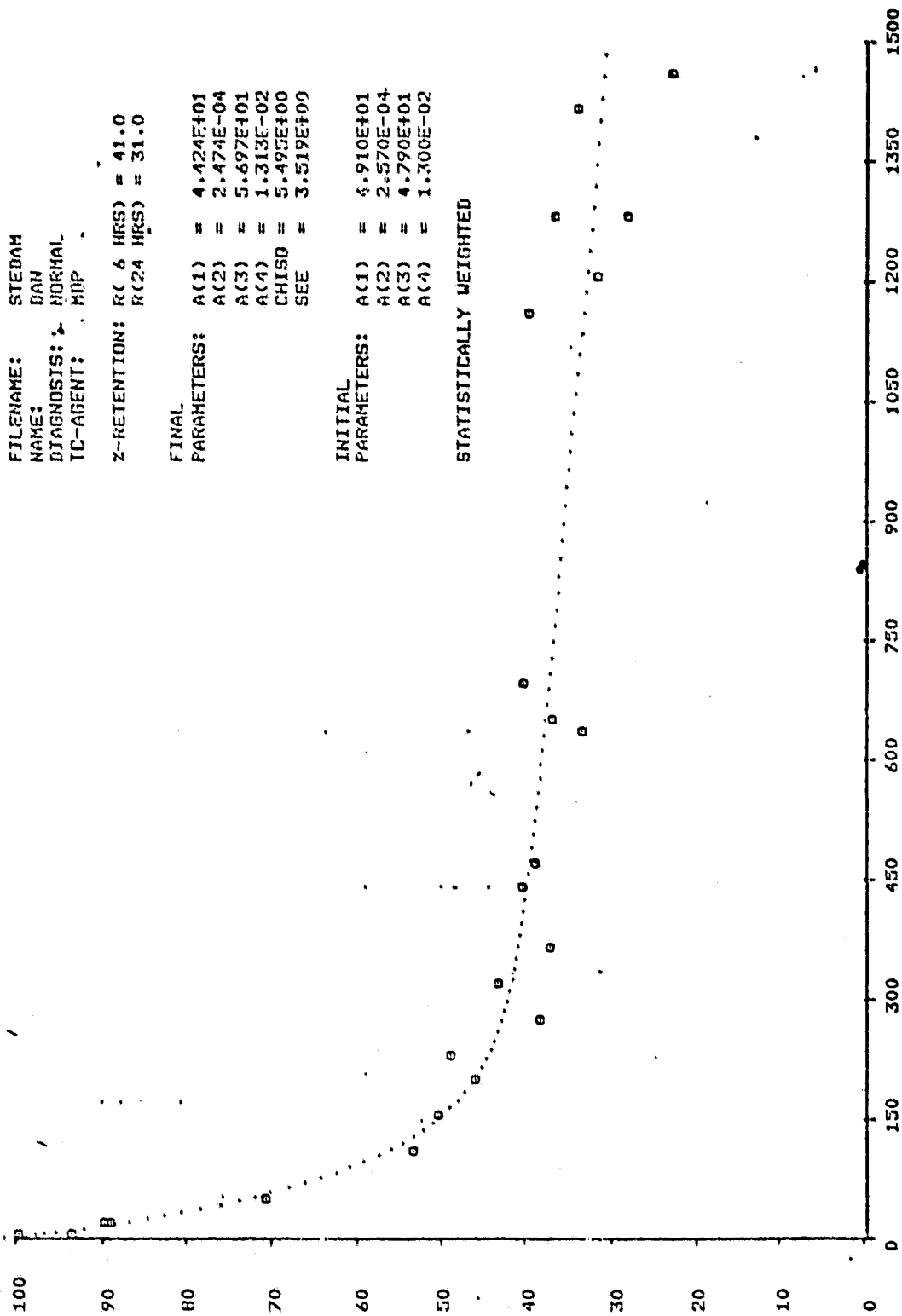

FILENAME: STEDAH
NAME: DAN
DIAGNOSIS: NORMAL
TC-AGENT: MDP

Z-RETENTION: R(6 HRS) = 41.0
R(24 HRS) = 31.0

FINAL
PARAMETERS: A(1) = 4.424E+01
A(2) = 2.474E-04
A(3) = 5.697E+01
A(4) = 1.313E-02
CHI50 = 5.495E+00
SEE = 3.519E+00

INITIAL
PARAMETERS: A(1) = 4.910E+01
A(2) = 2.570E-04
A(3) = 4.790E+01
A(4) = 1.300E-02

STATISTICALLY WEIGHTED

TIME (MIN) AFTER IV

PERCENT RETENTION

RETENTION IN CHEST

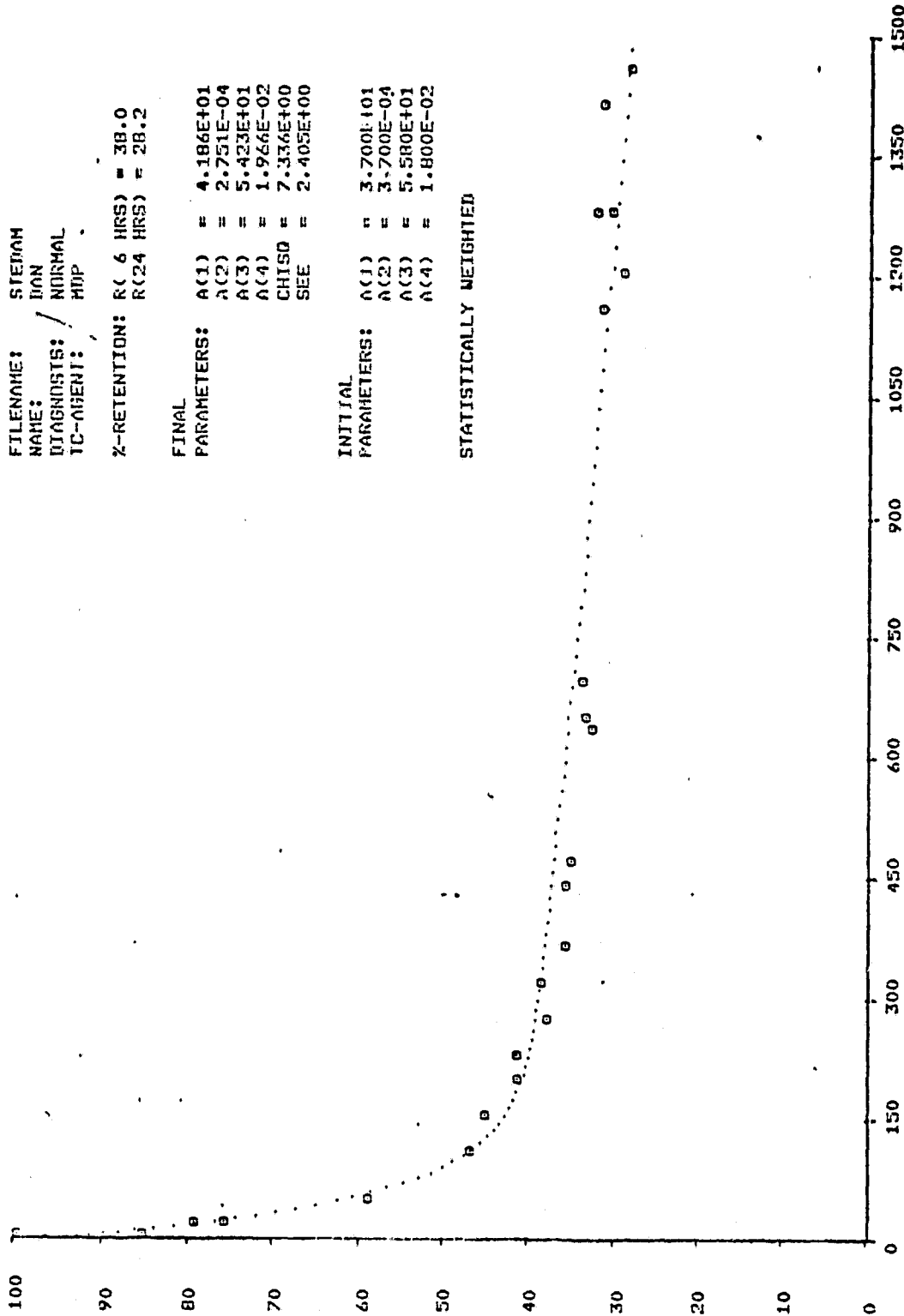

PERCENT RETENTION

TIME (MIN) AFTER IV

ORIGINAL PAGE IS
OF POOR QUALITY

FILENAME: STEDAM
NAME: IAN
DIAGNOSIS: NORMAL
IC-AGENT: MDP

Z-RETENTION: R(6 HRS) = 38.0
R(24 HRS) = 28.2

FINAL
PARAMETERS: A(1) = 4.186E+01
A(2) = 2.751E-04
A(3) = 5.423E+01
A(4) = 1.966E-02
CHISO = 7.336E+00
SEE = 2.405E+00

INITIAL
PARAMETERS: A(1) = 3.700E+01
A(2) = 3.700E-04
A(3) = 5.580E+01
A(4) = 1.800E-02

STATISTICALLY WEIGHTED

ORIGINAL PAGE IS
OF POOR QUALITY

RETENTION IN LEGS

FILENAME: STEDAM
NAME: DAN
DIAGNOSIS: NORMAL
TC-AGENT: HDP

Z-RETENTION: R(6 HRS) = 48.0
R(24 HRS) = 34.9

FINAL
PARAMETERS: A(1) = 3.843E+01
A(2) = 6.835E-05
A(3) = 6.278E+01
A(4) = 4.960E-03
CHISQ = 3.573E+00
SEE = 2.197E+00

INITIAL
PARAMETERS: A(1) = 3.920E+01
A(2) = 6.700E-05
A(3) = 7.750E+01
A(4) = 5.000E-03

STATISTICALLY WEIGHTED

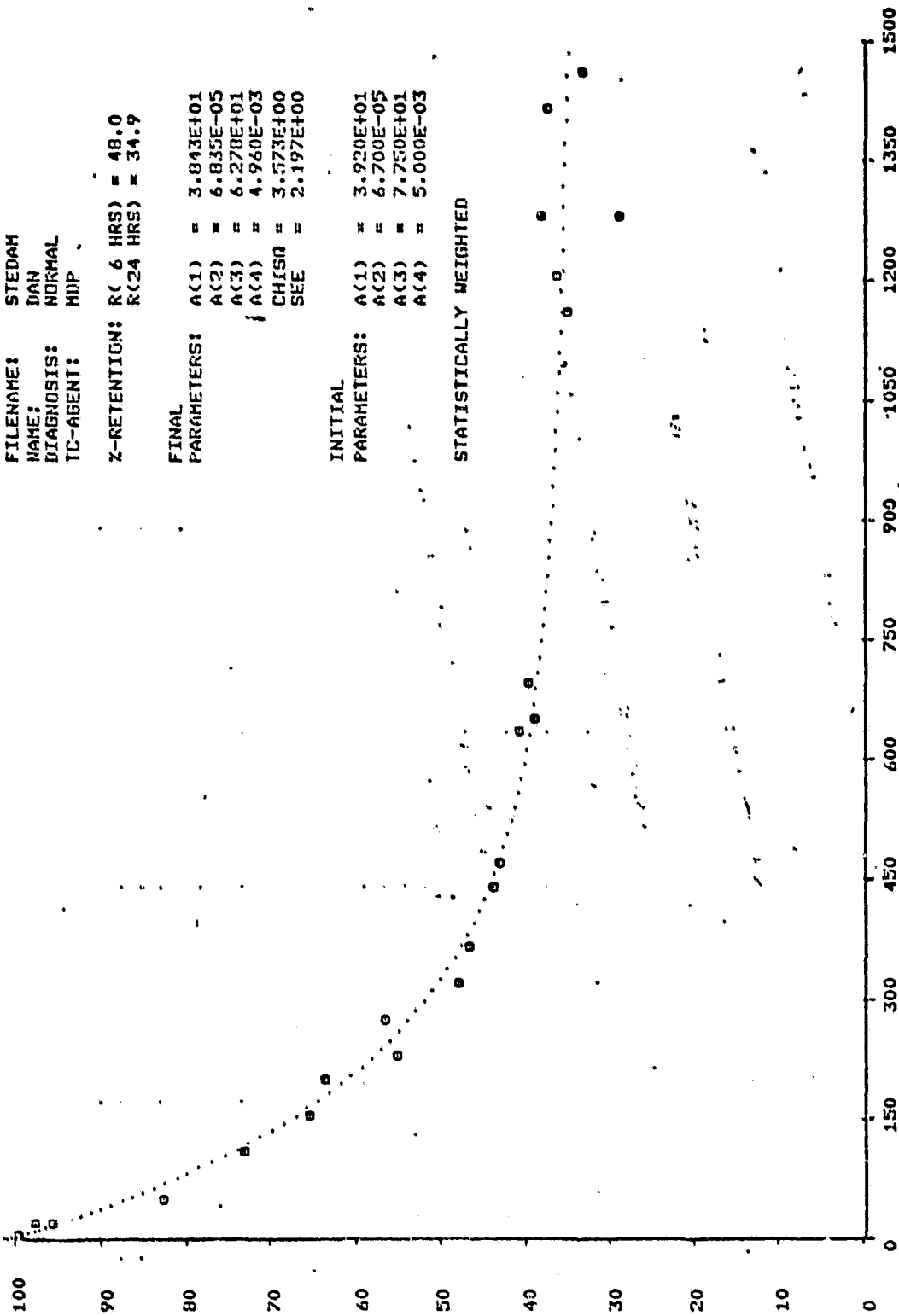

TIME (MIN) AFTER IV

PERCENT RETENTION

D. COMPARISON WITH OTHER TECHNIQUES

No one method provides all requisite information on bone quantity or quality. Consequently we have examined, and compared, several measurement approaches.

During the early part of the project extensive work was done on resonant frequency measurement in vivo (John Jurist). Comparisons were made between ¹²⁵I-absorptiometry and the various photodensitometric approaches (Vose and Mack at Texas Women's University and Colbert at Radiological Labs) which showed the latter to be faulty. An alternative radiological approach, videodensitometry, was developed. However, scattered radiation was minimized by using scanning slits. We have obtained good linearity ($\pm 3-5\%$) and high precision (0.7%) using this method. Compton scattering methods could provide a means for assessing trabecular bone so we developed a method using Compton-coherent scattering. This was fairly accurate and precise but the dose was very high (400mrem for 3% precision).

Finally we did studies using x-ray CT of the spine in monkeys and man. We showed that difficulties of repositioning led to very large errors (15%) in results (using a GE 7800 scanner). The results on the same spines were far more precise (2%) using dual-photon absorptiometry. It was also shown that x-ray CT of the spine was the most erroneous measurement method ever advocated for use in humans. The large potential errors (30%) of the method due to varying marrow fat make it totally unsuitable for monitoring bone in space flight.

ORIGINAL PAGE IS
OF POOR QUALITY

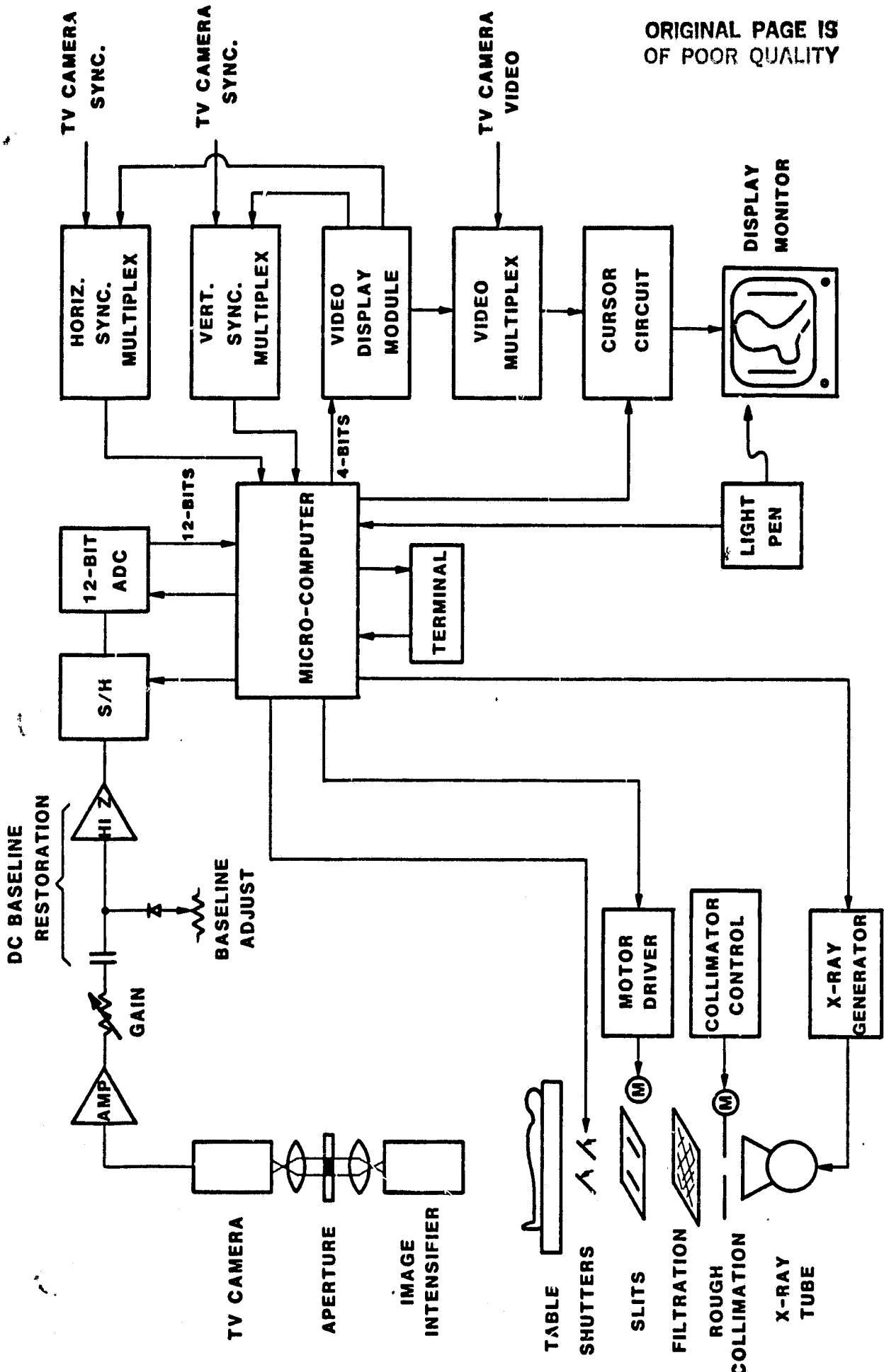

ROENTGEN VIDEOABSORPTIOMETRY SYSTEM

ORIGINAL PAGE IS
OF POOR QUALITY

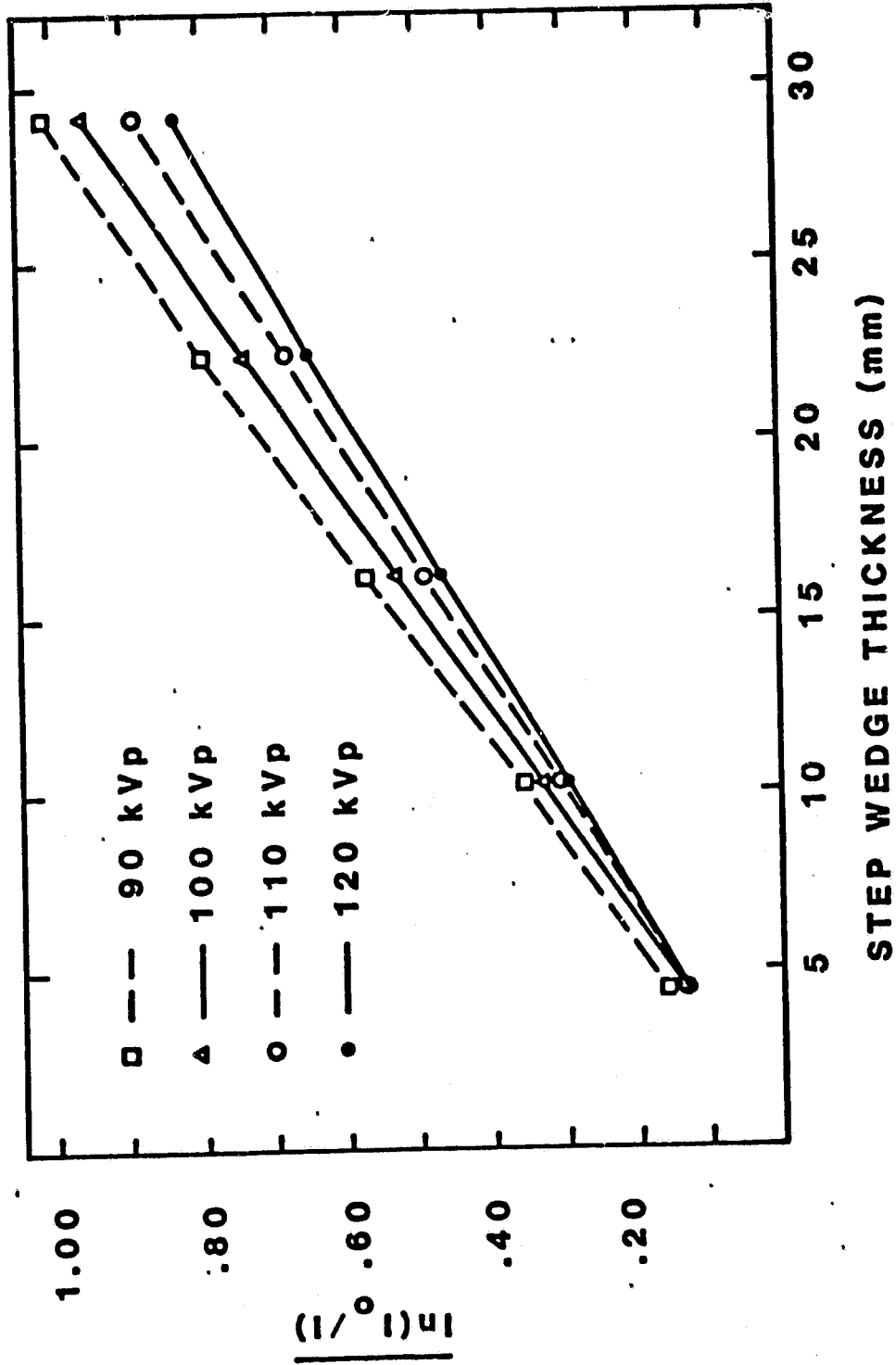

EFFECTS OF KVP ON ATTENUATION

Fig. 4

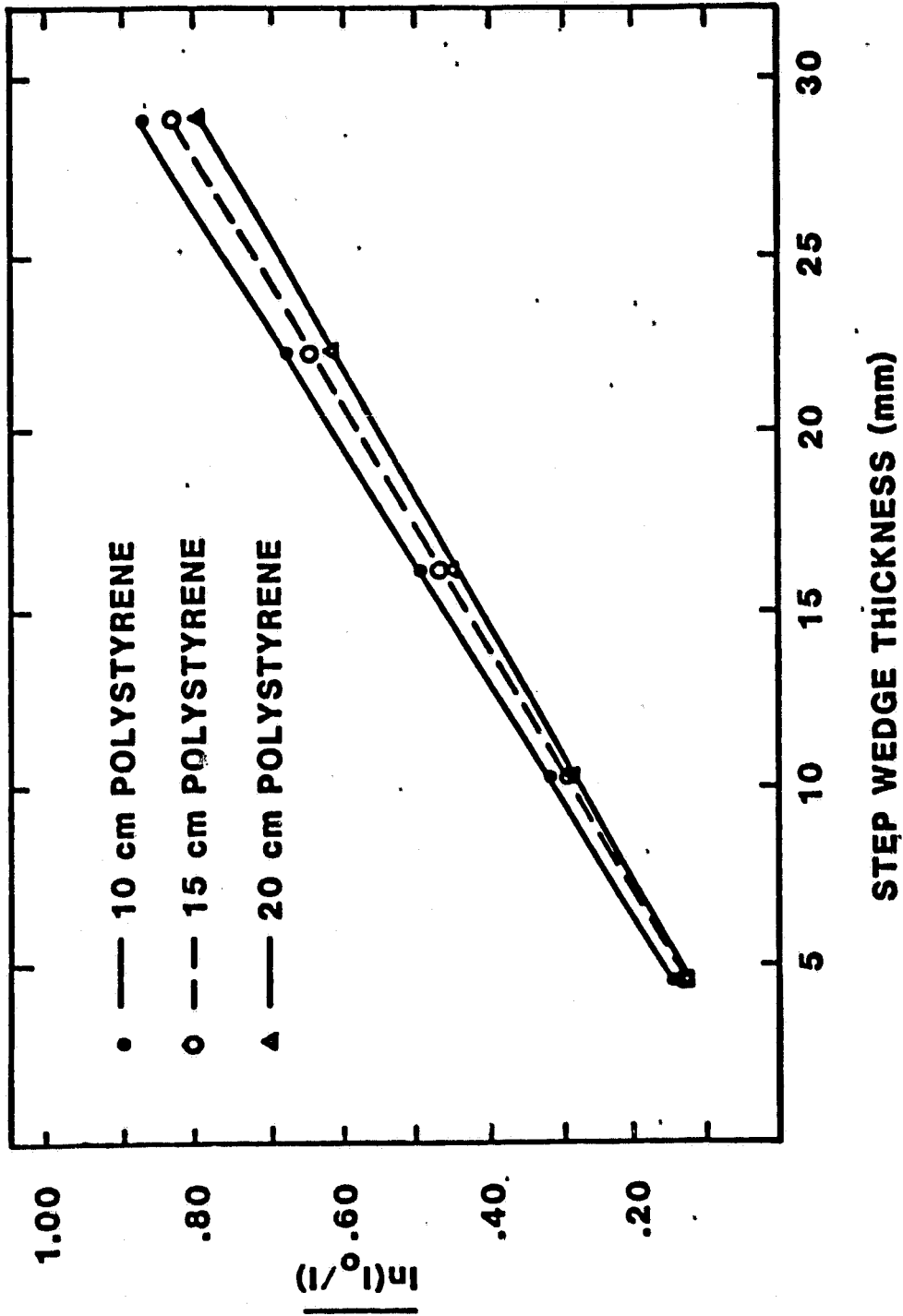

EFFECTS OF SOFT TISSUE THICKNESS ON ATTENUATION
THERE WAS A VERY SLIGHT EFFECT OF HARDENING AND SCATTER

Fig. 5.

ORIGINAL PAGE IS
OF POOR QUALITY

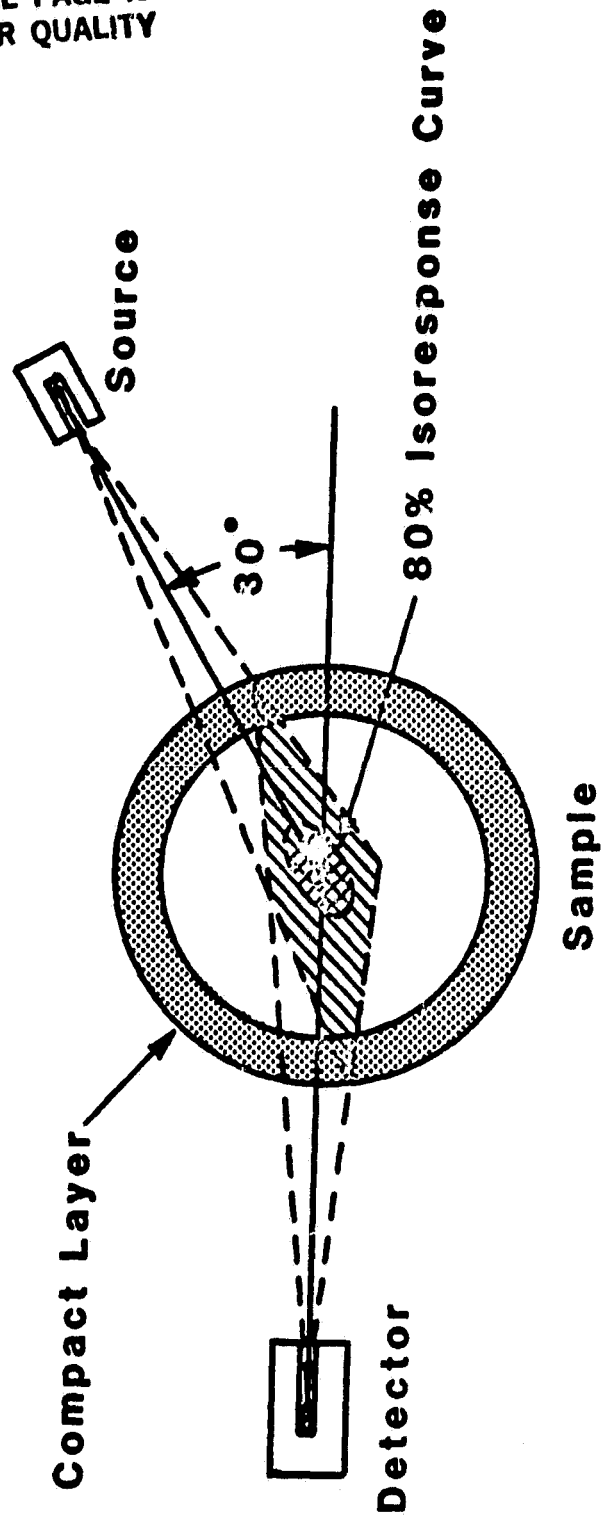

COMPTON-COHERENT SCATTERING METHOD IS OPTIMAL AT THE LARGE ANGLE
SINGLE-SOURCE COMPTON SCATTERING CAN ALSO BE DONE AT THIS ANGLE.

THE VERY LARGE ERROR OF X-RAY COMPUTED TOMOGRAPHY DUE TO MARROW FAT

CT - ERROR

CHANGE DUE TO A SHIFT
OF 25% IN MARROW FAT AT 60keV

ORIGINAL PAGE IS
OF POOR QUALITY

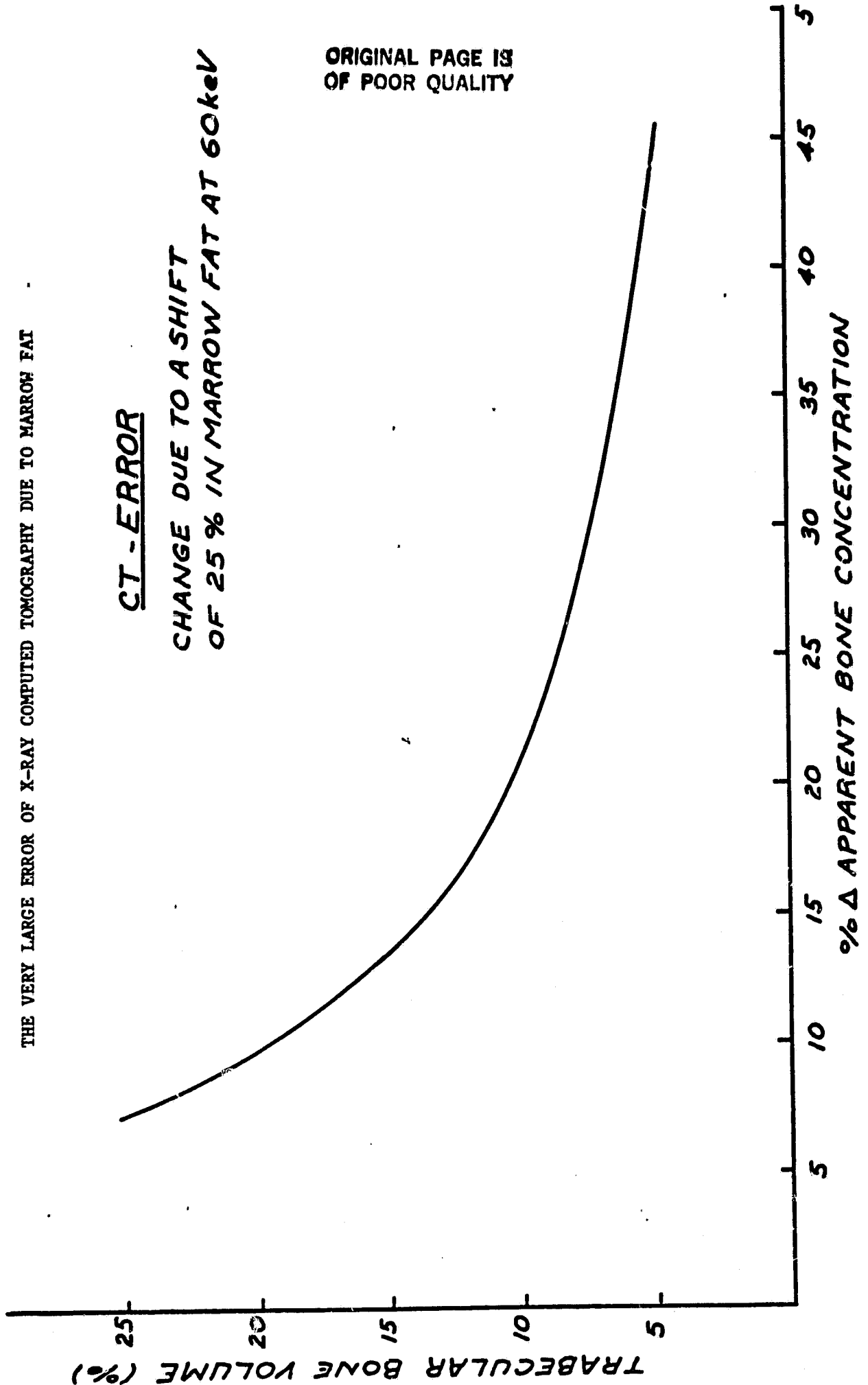

E. COOPERATION WITH NASA PROJECTS FOR SKELETAL EVALUATION IN SPACE FLIGHT
(MO-78) AND IN IMMOBILIZED ANIMALS

Technical support was provided for investigators at U.S. Public Health Service hospital in San Francisco for absorptiometric studies (^{125}I scanning of limbs and os calcis). Studies were subsequently done on immobilized subjects, in flight simulation and in astronauts during space flight.

We have also provided technical support to investigators at Ames Research Center and provided them with a dual-photon scanner system for monitoring immobilized animals.

ORIGINAL PAGE IS
OF POOR QUALITY

ORIGINAL PAGE IS
OF POOR QUALITY

F. MEETINGS AND WORKSHOPS

Since the inception of the project a series of scientific meetings have been organized in order to facilitate the interchange of information on bone measurement methods, and on specific applications (such as the 1982 meeting on immobilization outlined in Appendix C). This has permitted international input regarding problems of methodology as well as suggesting novel solutions to some of these problems. Published reports emanating from these meetings (1970, 1973, 1976 and 1978 specifically) have been widely disseminated.

- 1969 - Workshop on Absorptiometry - O'Hare
- 1970 - Bone Measurement Meeting - Chicago
- 1971 - Workshop on Absorptiometry - O'Hare
- 1973 - Bone Measurement Meeting - Chicago
- 1975 - Workshop on Absorptiometry - Madison
- 1976 - Bone Measurement Meeting - New Orleans
- 1978 - Bone Measurement Meeting - Toronto
- 1982 - Workshop on Immobilization - San Francisco
- 1982 - Workshop on Dual-Photon - San Francisco

G. ANIMAL STUDIES

ORIGINAL PAGE IS
OF POOR QUALITY

Single-photon absorptiometry was used to measure the limbs (radius, ulna, humerus) on a series of 63 adult female monkeys. Sequential measurements (4 occasions) were made over two years to examine the influence of oophorectomy. The operated animals had a higher rate of aging bone loss than controls. This project allowed us to develop higher precision linear scans on small animals and gave familiarity with the animal model used for immobilization studies at Ames Research Center.

We cooperated with Ames Research Center in doing spinal and total body bone mineral measurement of monkeys used in experimental studies. A special spine scanner was built, documented, tested and delivered to ARC. That scanner has allowed high precision measurements of the lumbar spine in immobilized animals. About 55% of animals tested several times over 4 months showed less than a 3% variability. Spinal bone loss in two immobilized monkeys at ARC was 0.5%/week and 1.2%/week.

H. DETECTORS

There has been extensive research done over the past decade on detectors that could be used for bone and soft-tissue absorptiometry in space flight.

A variety of conventional scintillation detectors using photomultiplier tubes were examined with respect to size, sensitivity and stability. A special folding linear scanner was made that used an experimental RCA detector; this could allow scanning of the limbs in space. In addition we evaluated ^{131}I and ^{201}Tl detectors but these small, low power detectors were not suitable because of high background. A large project was undertaken, which later received NIH support, on position-sensitive proportional counters (PSPC). The PSPC's could allow local and area bone and soft-tissue determinations without the need for a motor-driven scanner mechanism. We examined single- and multi-wire detectors and developed a multi-anode detector that allowed use of high count rates. The various problems with PSPC detectors were analyzed, particularly in regard to energy versus spatial resolution, and reduction of scatter and parallax errors (see thesis by J. Hanson). Quantitative data in vivo was obtained with a PSPC that was loaned to our laboratory by Oak Ridge National Lab. The results on limbs correlated very well with results of ^{125}I absorptiometry ($r=0.97$) on the same subjects. Quantitative images also were obtained on the femoral neck and the spine. However, the PSPC we had could not provide dual-energy discrimination and so could not be used for ^{153}Gd scans of these area.

ORIGINAL PAGE IS
OF POOR QUALITY

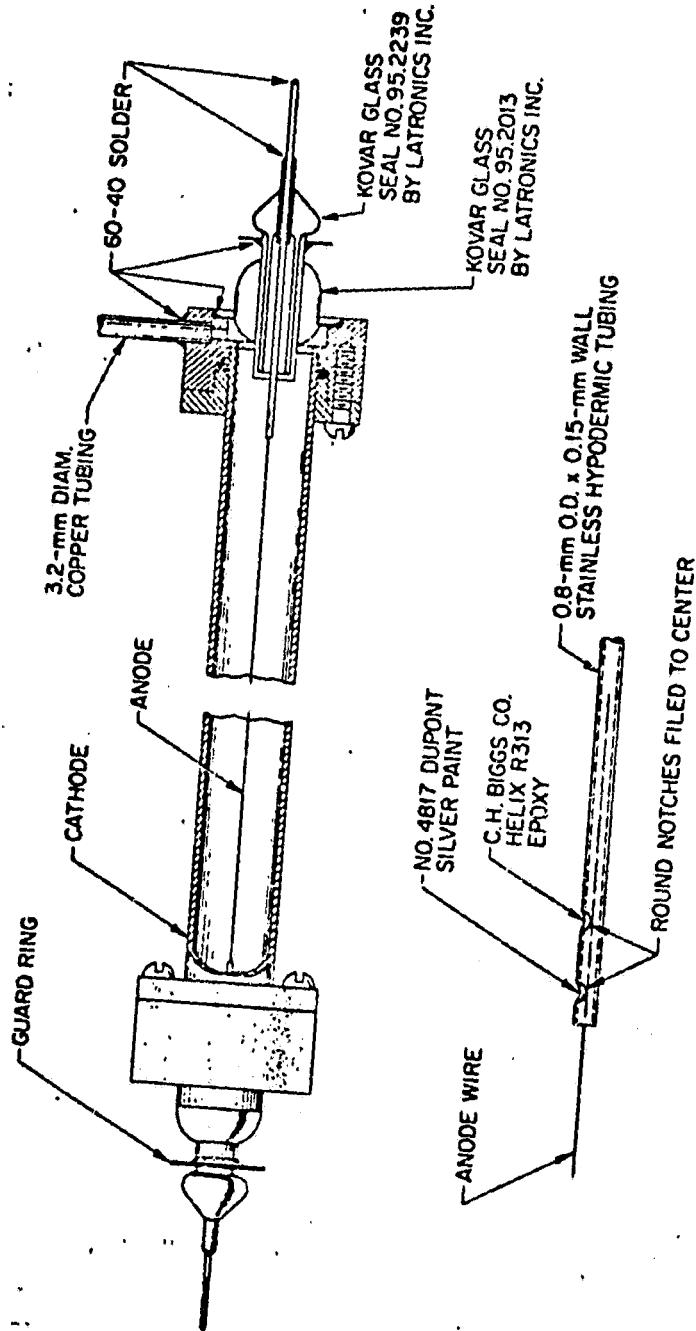

7
Figure 3.1-1 Construction details of a linear PSPC (courtesy of M.K. Kopp).

ORIGINAL PAGE IS
OF POOR QUALITY.

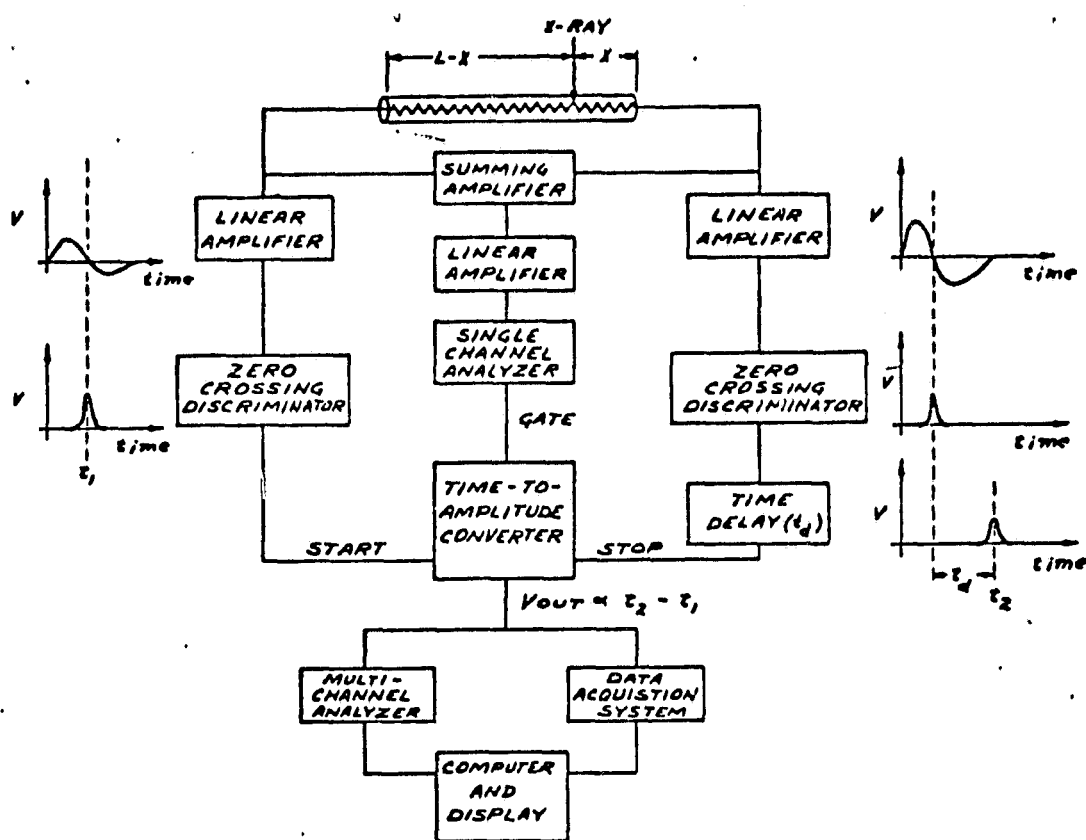
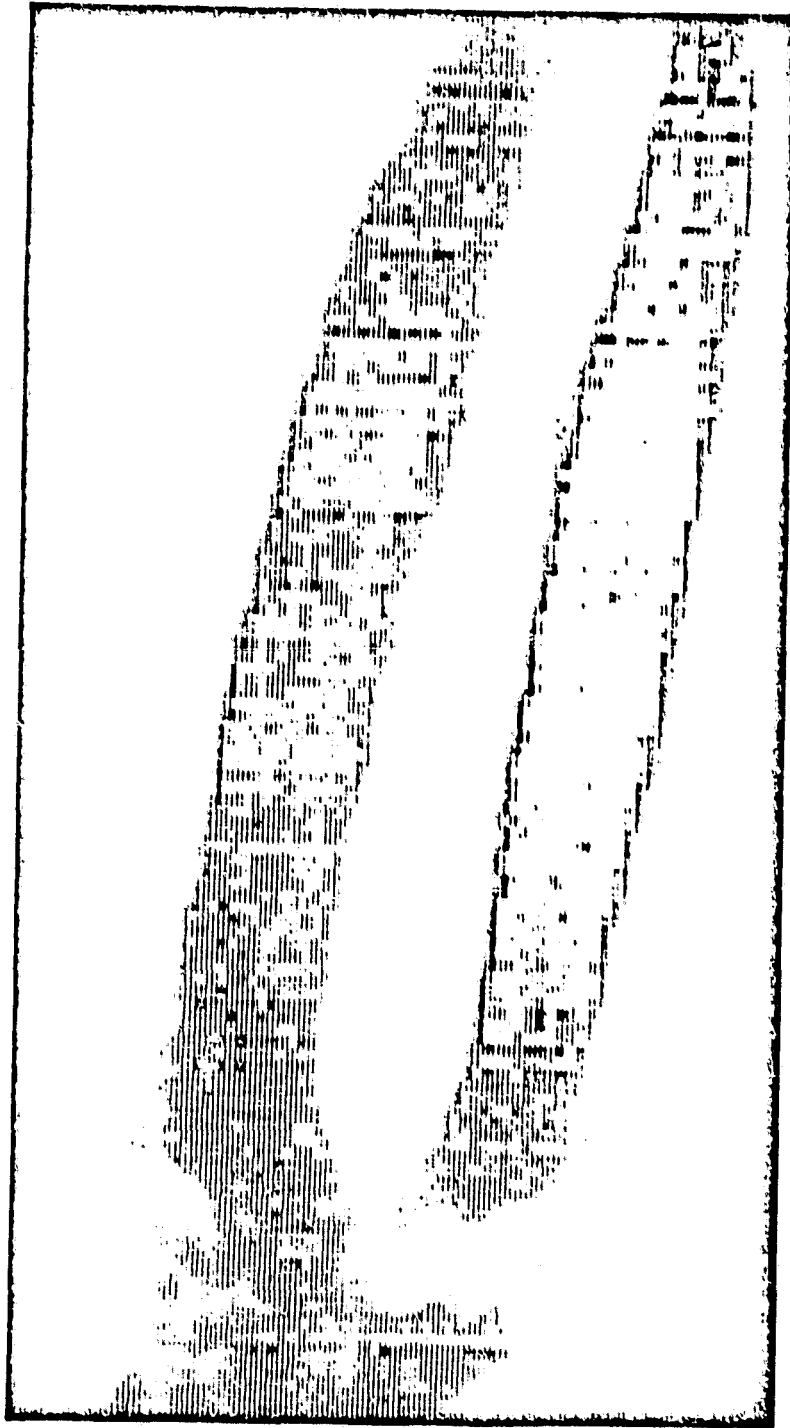

Figure 2 Block diagram of PSPC system components.

ORIGINAL PAGE IS
OF POOR QUALITY



PSPC IMAGE OF THE FOREARM IN VIVO (WITH ^{125}I).

ORIGINAL PAGE IS
OF POOR QUALITY

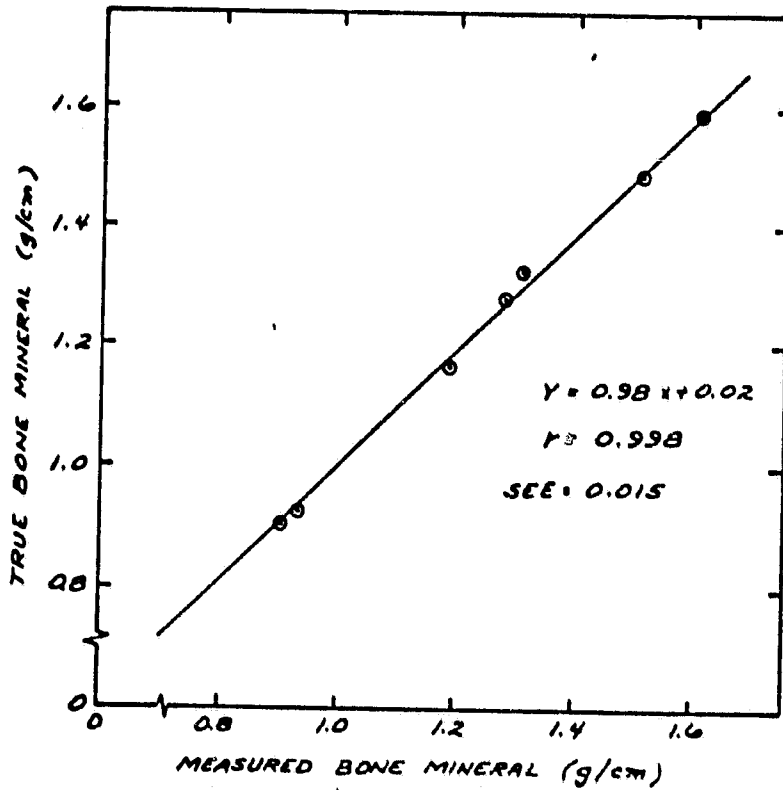

9
~~Figure 6.12~~ The radius bone mineral of 7 normal subjects measured with the 2MID linear PSPC compared to the true value determined from the conventional scanning method.

Figure 1

ORIGINAL PAGE IS
OF POOR QUALITY

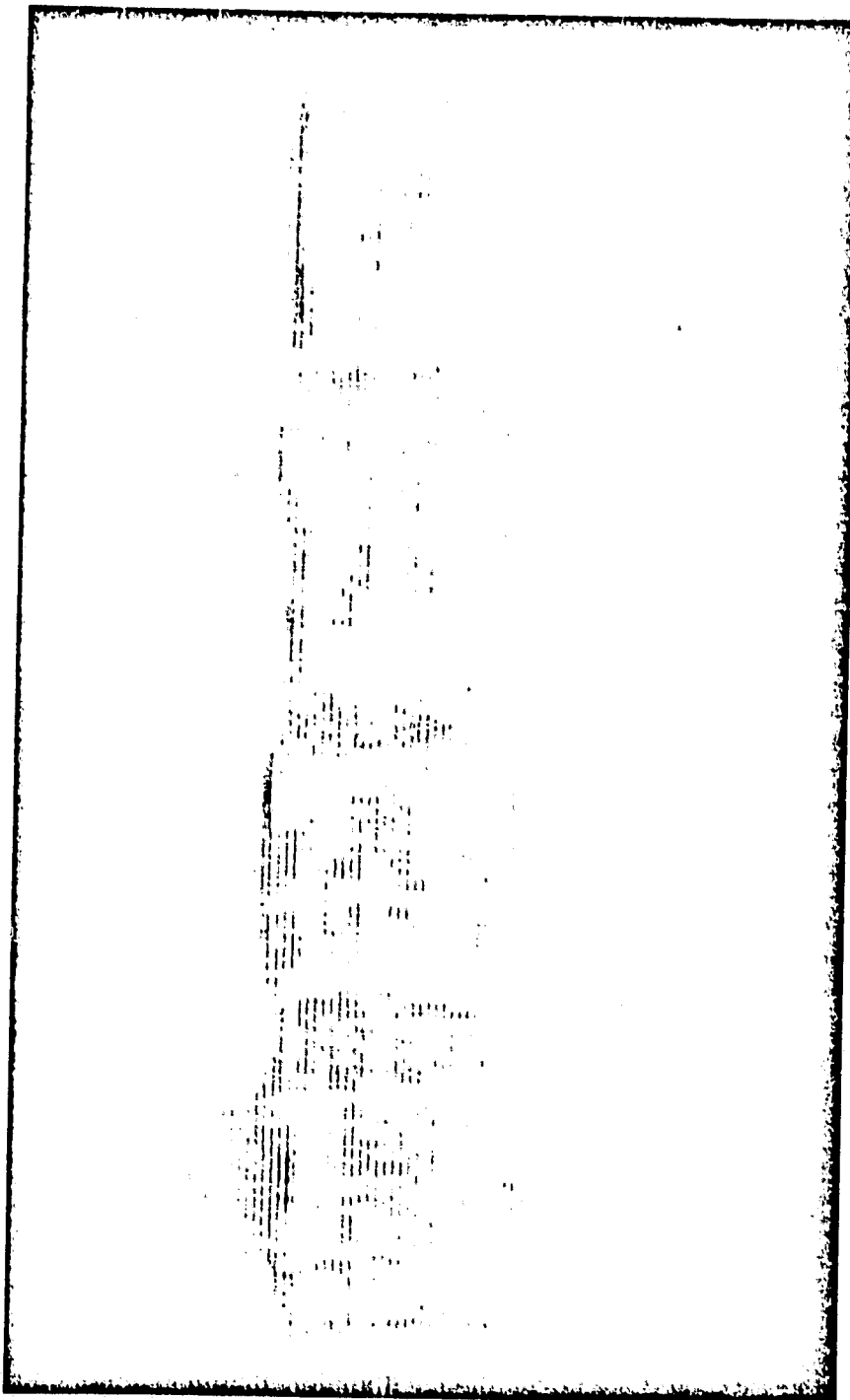

PSPC IMAGE OF THE LUMBAR SPINE (WITH ^{125}I) IN AIR.

A HIGHER ENERGY SOURCE IS NEEDED FOR WORK IN VIVO

I. BODY COMPOSITION AND FLUID SHIFTS

Pioneering work on measurement of body composition in the limbs was done during the first years of this project using a dual-photon absorptiometry approach. This initial research used ^{125}I (27keV) and ^{241}Am (60keV) sources to determine the amount and composition of soft-tissue on the forearms, legs, and upper arms of human subjects. We also showed that absorptiometry could be used to monitor fluid changes in the limbs by sequential monitoring of changes associated with venous occlusion. More detailed experiments were done to define sources of error of the method, to assess its use in monitoring fluid changes in patients, and to evaluate predictive accuracy of limb measurements in assessing total body composition. The fundamentals of the method were described in the Ph.D. thesis generated by Robert Witt and in the collaborative work done with physicians from the University of Wisconsin Department of Surgery (J. Maylan and Wm. Wolberg). It was shown that the time course of fluid changes could be very accurately monitored by limb measurements in dogs whose fluid volume was experimentally manipulated. However, there were differences between the magnitude of fluid changes in the limbs and the central body. Fluid changes were monitored in patients during and after surgery and in the course of therapy for large area burns. The major difficulty with these measurements was their local specificity; in many cases central pooling could occur without being reflected in the limbs.

This was also a factor in predicting total body composition (from body density assessed by combined underwater weighing and deuterium oxide dilution). Total body composition could be predicted with high accuracy from scans of the upperarm but not of the forearm in 10 young adult males. This was not affected by voluntary dehydration (loss of 2% body weight).

After 1976 our studies used dual-photon absorptiometry with ^{153}Gd (44 and 100keV) for measurement of body composition. In these studies body composition and soft-tissue were determined in scans of the entire body (time required 60-minutes; dose about 2mrem). Regional values also were determined from these studies (arms, legs, trunk) so that the central body and limbs could be separately evaluated. Body composition was evaluated from body density measurements in 18 women and compared to the absorptiometric results. There was a high correlation ($r=0.90$) between body fat derived from the two methods, and the degree of association was increased ($r=0.94$) when the influence of skeletal mass (determined by absorptiometry) on density was taken into account. These studies showed that total body absorptiometry was a highly reliable and accurate measure of regional and total body composition, providing a direct measurement which was independent of the "constancy" assumptions indulging most composition methods. The low-dose makes repeat measurements feasible. This method could be used to monitor the fluid shifts occurring during and after immobilization and space flight.

ORIGINAL PAGE IS
OF POOR QUALITY.

Figure 1: Relationship between a known mass of water and values obtained by D.A.

ORIGINAL PAGE IS
OF POOR QUALITY

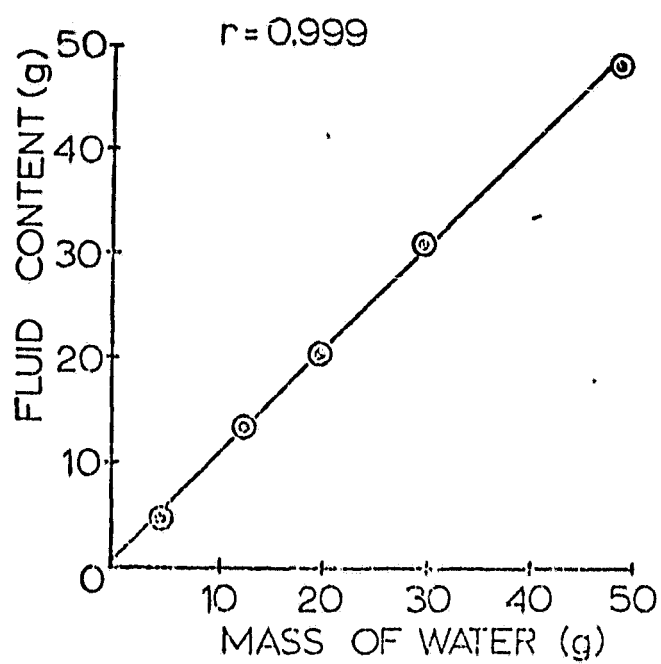
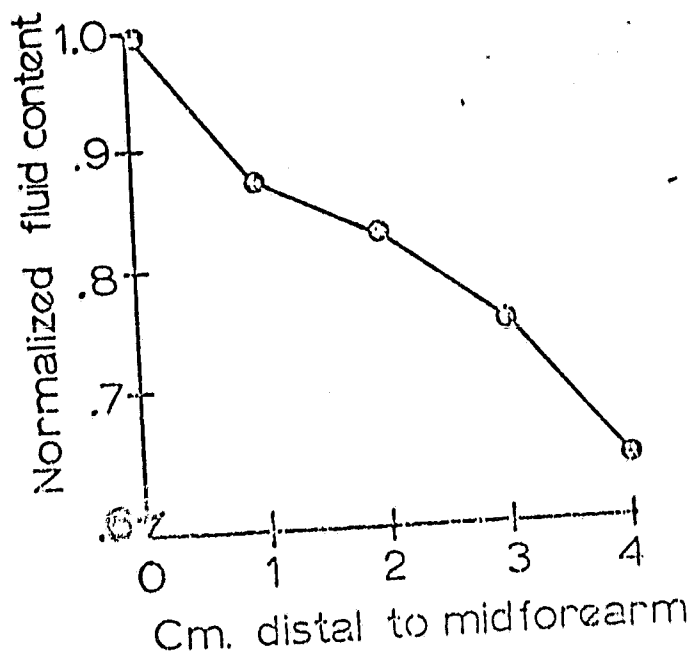

Figure 2: Fluid content of forearm determined by DA at 1 cm intervals distal to the midforearm.

ORIGINAL PAGE IS
OF POOR QUALITY



Figures 3-5: Dichromatic absorptiometry was used to determine changes in the fluid content in the thigh of a dog in which alterations in total body fluid were produced by exsanguination, transfusion and infusion. Data is presented as % change from baseline values.

..... = $\frac{\Delta \text{fluid}}{\text{TBW}}$

..... = $\frac{\Delta \text{STC}}{\text{FCo}}$

TBW = Total body water

STC = Lipid-free soft tissue content

FCo = Fluid content at beginning of study.

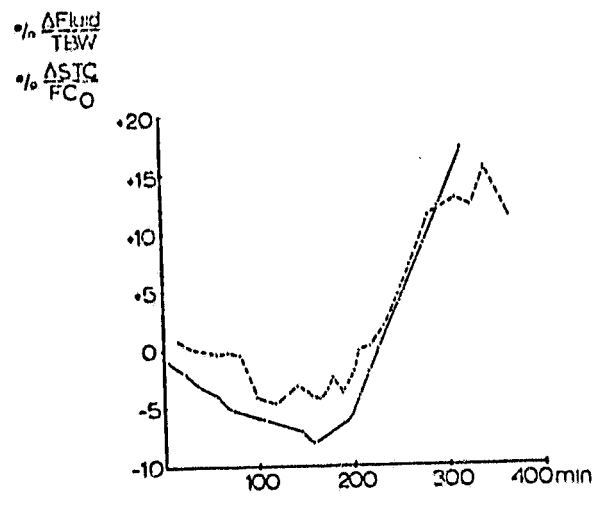

ORIGINAL PAGE IS
OF POOR QUALITY

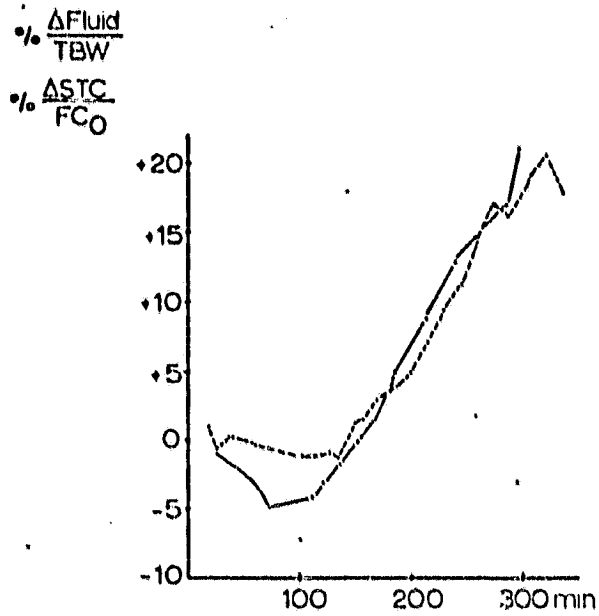
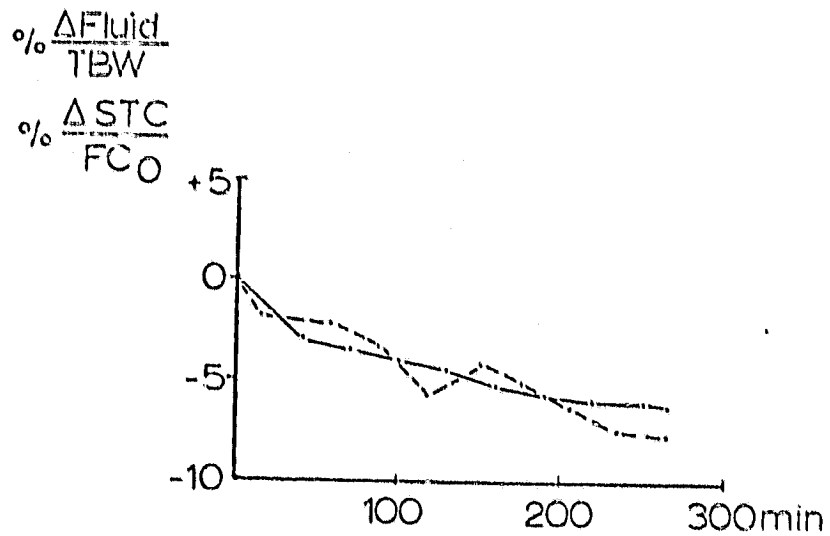

Figure 5



ORIGINAL PAGE 19
OF POOR QUALITY

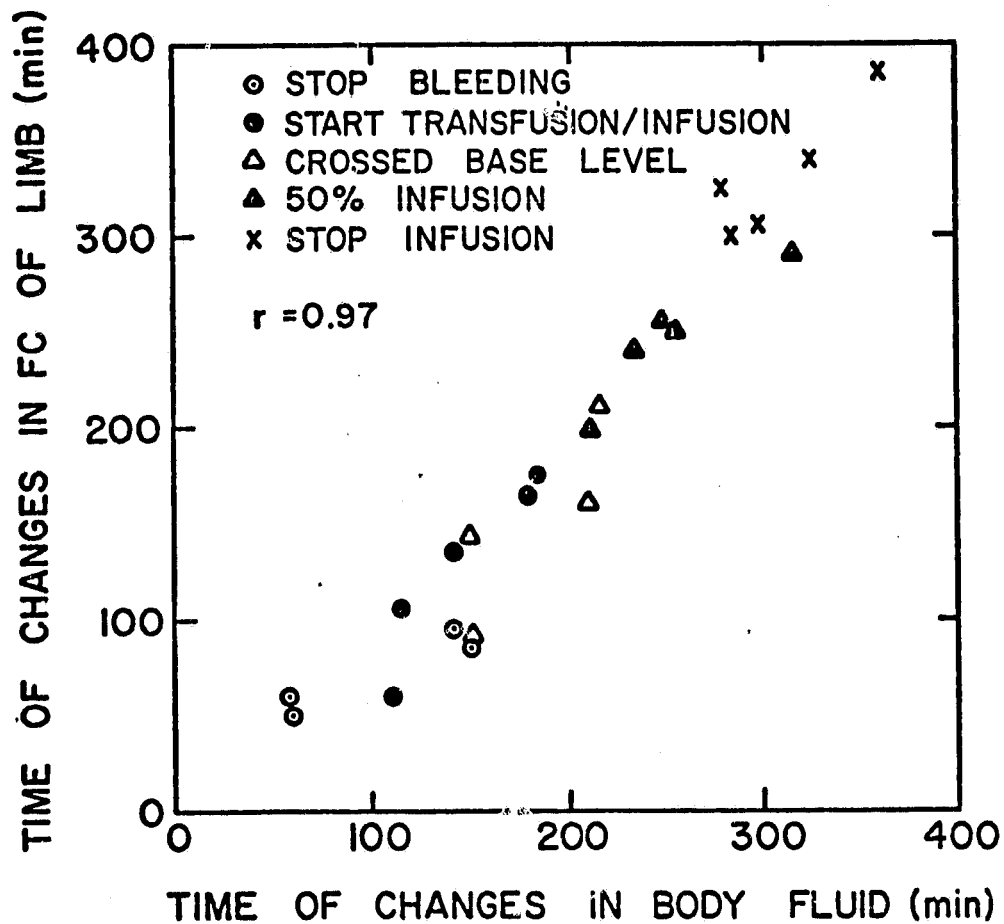

Figure 3. Temporal correspondence of absorptiometric changes in limb fluid content in dogs and actual body fluid changes.

Figure 6: D.A. was used to determine changes in the fluid content of patients undergoing a cholecystectomy and choledocholithotomy. Data is presented as % change from baseline values.

$$\begin{aligned} \text{---} &= \frac{\Delta \text{fluid}}{\text{TBW}} \\ \text{---} &= \frac{\Delta \text{STC}}{\text{FCo}} \end{aligned}$$

ORIGINAL PAGE IS
OF POOR QUALITY

TBW = Total body water

STC = Lipid free soft tissue content

FCo = Fluid content at beginning of study.

↑ Represents time of surgery.

Vertical divisions represent 24 hour midnight to midnight periods



Figure 7: Same as figure 6 determined in patient undergoing splenectomy.

ORIGINAL PAGE IS
OF POOR QUALITY

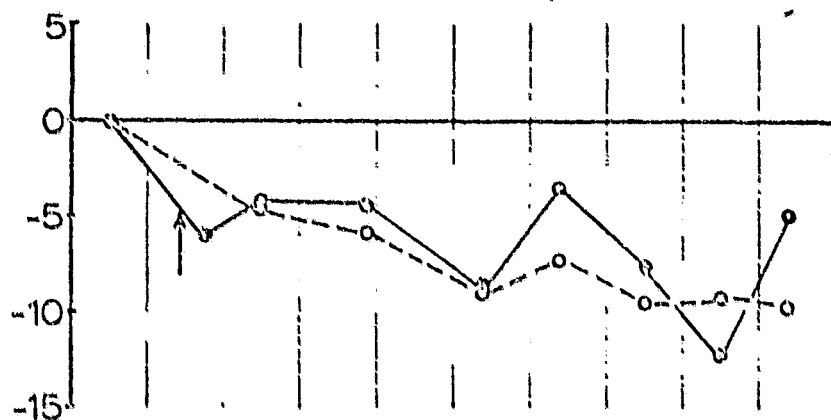
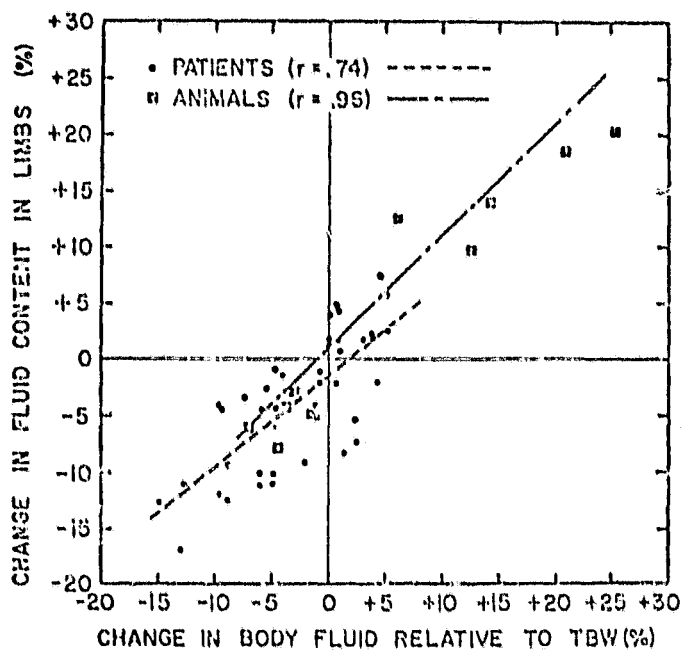

Figure 8: Relationship between changes in FC in the limbs relative to the baseline (FC₀) and the changes in body water relative to the estimated TBW.

- Patient measurements of FC when there was a corresponding value for the body water.
- Animal measurements at the time of maximum decrease and increase in FC.

ORIGINAL PAGE IS
OF POOR QUALITY.



ORIGINAL PAGE IS
OF POOR QUALITY

APPENDICES

- A. Contents of Joint AEC-NASA Progress Reports (C00-1422-1 to C00-1422-184)
- B. Bibliography of publications of R. B. Mazess from the Bone Mineral Lab
- C. Report on Immobilization and Bone meeting, San Francisco 1982
- D. Theses

APPENDIX A. CONTENTS OF JOINT AEC-NASA PROGRESS REPORTS

TABLE OF CONTENTS

1. C00-1422-1 Body Composition Determination by Differential Absorption of Monochromatic X-rays.*
2. C00-1422-2 Ash Weight vs Bone-Mineral Content by the Direct Photon Absorption Technique.
3. C00-1422-3 Longitudinal Studies of Bone-Mineral Content by the Photon Absorption Technique.
4. C00-1422-4 Factors Affecting the Measurement of Bone-Mineral Content by the Direct Photon Absorption Technique.
5. C00-1422-5 Improved Instrumentation for Bone-Mineral Measurement In Vivo**.
6. C00-1422-6 Bone-Mineral Measurement by Improved Photon Absorption Technique.***
7. Measurement of Bone-Mineral In Vivo: An Improved Method.

* Presented to the Symposium of Low-Energy X- and Gamma Sources, Ill. Inst. of Tech., Chicago, Illinois, Oct. 1964.

** Presented to the First International Conference on Medical Physics, Harrogate, England, September 1965.

*** Presented to the Conference on Progress in Development of Methods in Bone Densitometry (NASA), Washington, D.C. March 1965.

NOTE: Report No. 1 discusses work most of which was done prior to our obtaining our present AEC contract. Report No. 7 discusses work completed entirely before we obtained our present AEC contract. These reports are included for convenience.

10-

**ORIGINAL PAGE IS
OF POOR QUALITY**

TABLE OF CONTENTS

1. C00-1422-7 **Progress in the Measurement of Bone
Mineral Content by the Direct Photon
Absorption Technique**

2. C00-1422-8 **Body Composition Determination by Dif-
ferential Photon Absorption Technique**

3. C00-1422-9 **Progress in Development of a Bone-Equivalent
Material**

ORIGINAL PAGE IS
OF POOR QUALITY

TABLE OF CONTENTS

COO-1422-21	> Measurement of Bone Mineral by the Direct Photon Absorption Method: Principles and Instrumentation
COO-1422-22	> Measurement of Bone Mineral by the Direct Photon Absorption Method: Experimental Results
COO-1422-23	A Comparison of Radiological Methods for Determining Bone Mineral Content
COO-1422-24	Transmission Scanning with Tc-99m and Cs-137
COO-1422-25	Remineralization of a Fractured Tibia
COO-1422-26	Comparison of I-125, Pb-210, and Am-241 as Radiation Sources for Bone Mineral Measurements
COO-1422-27	Bone Mineral Measurement With a Line Printer Output and Desk-top Calculator Computations
COO-1422-28	Program for Bone Mineral Computation Using General Electric Time-Sharing Service
COO-1422-29	Bone Mineral Content and Bone Diameter vs. Age in the Radius and Humerus of Normal Subjects
COO-1422-30	Estimation of Bone and Skeletal Weight by the Direct Photon Absorptiometric Method
COO-1422-31	Distribution of Bone Mineral in the Femur
COO-1422-32	Precision and Accuracy of Bone Mineral Determination by Direct Photon Absorptiometry (Reprint)
COO-1422-33	The Effects of Physical Activity on Bone
COO-1422-34	<u>In Vitro</u> Measurements of Bone Volume by Air Displacement
COO-1422-35	Radiation Effects on Bone Mineral Content

**ORIGINAL PAGE IS
OF POOR QUALITY**

TABLE OF CONTENTS (CONTINUED)

COO-1422-36	Construction of an Iodine-125 Photon Source Using an Improved Source Holder
COO-1422-37	An Estimator of Variance of the Bone Mineral Content Measurement
COO-1422-38	A Description of the Bone Mineral Content Measurement With a Modulation Transfer Function
COO-1422-39	A Portable Scanning System With Direct Readout for Absorptiometric Determination of Bone Mineral Content
COO-1422-40	An Improved Linear Bone Mineral Scanner

TABLE OF CONTENTS

- COO-1422-41 Summary of Data on the Bone Mineral of the Radius in Normals by J.R. Cameron
- COO-1422-42 Bone Standards by R.M. Witt and J.R. Cameron
- COO-1422-43 X New Methods of Skeletal Status Evaluation in Space Flight, Aerospace Medicine, 1969, in press, by J.R. Cameron, J.M. Jurist, J.A. Sorenson, R.B. Mazess
- COO-1422-44 X Some Physical Methods of Skeletal Evaluation, Proceedings of the Symposium on Hypogravic and Hypodynamic Environments, text of a paper delivered at the syposium, June 16, 1969, French Lick, Indiana, in press, by J.R. Cameron, J.M. Jurist, R.B. Mazess
- COO-1422-45 A Coding System for Clinical and Normative Studies by J.M. Jurist, J.L. Fischer and K. Kianian
- COO-1422-46 Quantitative Evaluation of Skeletal Status in the Rheumatic Diseases by J.M. Jurist, M.N. Mueller, J.L. Fischer
- COO-1422-47 In Vivo Determination of the Elastic Properties of Bone: I. Theory, Apparatus, and Method of Ulnar Resonant Frequency Determination, 1969, in press, by J.M. Jurist
- COO-1422-48 In Vivo Determination of the Elastic Properties of Bone: II. Resolution and Precision of the Ulnar Resonant Frequency Determination, 1969, in press, by J.M. Jurist
- COO-1422-49 In Vivo Determination of the Elastic Properties of Bone: III. Ulnar Resonant Frequency in Osteoporotic, Diabetic, and Normal Subjects, 1969, in press, by J.M. Jurist
- COO-1422-50 In Vivo Measurement of Bone Quality, text of a paper delivered at the Symposium on Bioengineering in Wisconsin, March 6, 1969, Madison, Wisconsin, by J.M. Jurist and J.R. Cameron
- COO-1422-51 An Improved Apparatus for Determination In Vivo of Bone Resonant Frequency by Recording the Vibration Response Spectrum by J.M. Jurist, D. Loper, and C. Vought

- COO-1422-52 Dynamic Measurement of Young's Modulus for Excised Strips of Bone by C.R. Wilson and J.M. Jurist
- COO-1422-53 Study of Bone Strain by Holographic Interferometry by J.M. Hevezi
- COO-1422-54 Bone as the Resonant Element in a Feedback Oscillator by C.R. Wilson, C. Vought and J.R. Cameron
- COO-1422-55 X Body Composition by Absorptiometry of Monoenergetic Radiation by R.B. Mazess, J.R. Cameron, and J.A. Sorenson
- COO-1422-56 A Portable Unit for Determination of Bone Mineral Content by Photon Absorptiometry by R.B. Mazess and J.R. Cameron
- COO-1422-57 Bone and Soft-Tissue Changes During Protein-Calcium Restriction by R.B. Mazess
- COO-1422-58 Evaluation of Radionuclide Sources for Transmission Scanning by J.A. Sorenson and J.R. Cameron
- COO-1422-59 Computer Programs for Bone Mineral Calculations by K. Kianian
- COO-1422-60 A Dichromatic Absorption Method for the Measurement of Bone Mineral Content by P.F. Judy and J.R. Cameron
- COO-1422-61 Report of the First Bone Mineral Scanning Conference by J.R. Cameron
- COO-1422-62 A Quantitative Measure of Skin Transparency in Relation to Osteoporosis by J.R. Cameron, G. Fullerton, and M.N. Mueller
- COO-1422-63 An Improved Method of Repositioning Distal End Sites on the Linear Bone Mineral Scanner by M. Binder, J.L. Fischer, and J.A. Sorenson
- COO-1422-64 Bone Mineral Determination: Radiographic Photodensitometry and Direct Photon Absorptiometry by R.B. Mazess and C. Colbert
- COO-1422-65 X Preliminary Report: Bone Mineral Content of Wainwright Eskimo by R.B. Mazess
- COO-1422-66 ^{99m}Tc Point Source for Transmission Scanning (reprint) by J.A. Sorenson, R.C. Briggs, and J.R. Cameron
- COO-1422-67 Detection of Osteoporosis by Measurement of Monoenergetic Photon Absorption by E.L. Smith, S.W. Babcock and J.R. Cameron

ANNUAL PROGRESS REPORT ON AEC CONTRACT AT-(11-1)-1422

TABLE OF CONTENTS

1. COO-1422-68 Theoretical Accuracy and Precision in the Photon Attenuation Measurement of Bone Mineral.
. . . P. F. Judy.
2. COO-1422-69 Preliminary Report on a Direct Digital Readout System Absorptiometric Determination of Bone Mineral Content.
. . . R. B. Mazess and J. R. Cameron.
3. COO-1422-70 Standardization of Bone Mineral Measurements.
. . . R. M. Witt, R. B. Mazess and J. R. Cameron.
4. COO-1422-71 Absorptiometric Bone Mineral Determination Using ^{153}Gd .
. . . R. B. Mazess, M. G. Ort, P. F. Judy, W. E. Mather.
5. COO-1422-72 Relationship of Ulnar Resonant Frequency, Bone Mineral Content, and Various Measures of Body Development in Normal Children.
. . . J. M. Jurist.
6. COO-1422-73 Factors Affecting Reproducibility of Ulnar Resonant Frequency Measurement.
. . . J. M. Jurist and A. M. Dymond.
7. COO-1422-74 The Effect of Rheumatoid Arthritis and Corticosteroid Therapy on Bone.
. . . M. N. Mueller, J. R. Cameron and J. M. Jurist.
8. COO-1422-75 Effects of Fat on Bone Mineral Measurements.
. . . J. A. Sorenson and R. B. Mazess.

ORIGINAL PAGE IS
OF POOR QUALITY

9. COO-1422-76 Tissue Changes Following Venous Occlusion Using Photon Absorptiometry.
. . . R. B. Mazess.
10. COO-1422-77 Bone Mineral Content in Wainwright Eskimo: Preliminary Report.
. . . R. B. Mazess (Presented at the Am. Assoc. for Advancement of Science meeting held in Boston, Mass., Dec. 1969).
11. COO-1422-78 An Improved Bone Standard Containing Dipotassium Phosphate Solution for the Intercomparison of Different Transmission Bone Scanning Systems.
. . . R. M. Witt and J. R. Cameron.
12. COO-1422-79 Determination of Vertebral Bone Mineral In Vivo.
. . . M. G. Ort and J. R. Cameron.
13. COO-1422-80 The Bone Mineral Content of the Phalanx of Chronic Hemodialysis Patients.
. . . P. F. Judy, C. J. Beirne and J. R. Cameron.
14. COO-1422-81 Mineral Content and Compressive Strength of Cancellous Bone.
. . . C. R. Wilson, S. Disterhoft and J. R. Cameron.
15. COO-1422-82 Evaluation of Radionuclide Sources for Transmission Scanning (not included, available by request - Invest. Rad. 5: 92 (1970)).
. . . J. A. Sorenson.
16. COO-1422-83 Review of Body Composition Research at the University of Wisconsin 1960-1970.
. . . J. R. Cameron.

17. COO-1422-84 In Vivo Determination of the Elastic Response of Bone:
I. Method of Ulnar Resonant Frequency Determination.
. . . J. M. Jurist.
18. COO-1422-85 In Vivo Determination of the Elastic Response of Bone:
II. Ulnar Resonant Frequency in Osteoporotic, Diabetic,
and Normal Subjects.
. . . J. M. Jurist.
19. COO-1422-86 Reproducibility of Ulnar Resonant Frequency Measurement.
. . . J. M. Jurist and A. M. Dymond.

ORIGINAL PAGE IS
OF POOR QUALITY

ORIGINAL PAGE IS
OF POOR QUALITY

15 June 1971

ANNUAL PROGRESS REPORT ON AEC CONTRACT AT-(11-1)-1422

TABLE OF CONTENTS

1. COO-1422-87 Determining Body Composition by Radiation Absorption Spectrometry
.....R.B. Mazess, J.R. Cameron and J.A. Sorenson.
2. COO-1422-88 Skeletal Growth in School Children: Maturation and Bone Mass. Am. J. Phys. Anthropol. (in press).
.....R.B. Mazess and J.R. Cameron.
3. COO-1422-89 Methods for Quantitating Radioactivity In Vivo by External Counting Measurements. Ph.D. Thesis in Radiological Sciences (abstract only; thesis available upon request).
.....J.A. Sorenson.
4. COO-1422-90 A Dichromatic Attenuation Technique for the In Vivo Determination of Bone Mineral Content. Ph.D. Thesis in Radiological Sciences (abstract only; thesis available upon request).
.....P.F. Judy.
5. COO-1422-91 The Relationship of Photon Absorption Measurements of Bone Mineral Content to Bone Strengths. Ph.D. Thesis in Radiological Sciences (abstract only; thesis available upon request).
.....C.R. Wilson.
6. COO-1422-92 Effects of Physical Activity on Bone Loss. Ph.D. Thesis in Physical Education (abstract only; thesis available upon request).
.....E.L. Smith.
7. COO-1422-93 Estimation of Bone and Skeletal Weight by Direct Photon Absorptiometry. Invest. Radiol. 6(1): 52-60, 1971 (abstract only; article available upon request).
.....R.B. Mazess.
8. COO-1422-94 Review of Body Composition in Animals and Man. Human Biology 42: 138-140 (1970).
.....R.B. Mazess.
9. COO-1422-95 Bone Mineral Determination in Vitro by Radiographic Photodensitometry and Direct Photon Absorptiometry (abstract only; article available upon request).
.....C. Colbert, R.B. Mazess, and P.B. Schmidt.
10. COO-1422-96 Rectilinear Scanner for Determination of Bone Mineral Content
.....J.M. Sandrik, R.B. Mazess, C.E. Vought, and J.R. Cameron.

**ORIGINAL PAGE IS
OF POOR QUALITY**

11. COO-1422-97 Developments in the Dichromatic Attenuation Technique for the Determination of Bone Mineral Content In Vivo
.....P.F. Judy, M.G. Ort, K. Kianian, and R.B. Mazess.
12. COO-1422-98 Preliminary Report on a Dual Photon Bone Mineral Measuring Instrument
.....J.C. Sitzman, C.E. Vought, and R.B. Mazess.
13. COO-1422-99 Spectral Difference in Commercial ¹²⁵I Photon Sources
.....R.M. Witt, R.B. Mazess, and J.R. Cameron.
14. COO-1422-100 A Direct Digital Readout System for Measurement of Bone Mineral Content Using Photon Absorptiometry
.....R.B. Mazess, J.R. Cameron, and H. Miller.
15. COO-1422-101 Bone Mineral in Elderly Women Treated with Fluorides: Preliminary Report
.....R.B. Mazess, J.M. Jurist, and H. Hickey.
16. COO-1422-102 Preliminary Report on a Caliper for Measuring Tissue Composition by Radionuclide Absorption
.....R.B. Mazess and J.R. Cameron.
17. COO-1422-103 Bone Mineral Content of the Eskimos of Point Hope and Barrow: Preliminary Report
.....W.E. Mather and R.B. Mazess.
18. COO-1422-104 Three models of Vibrating Long Bones
.....J.M. Jurist and K. Kianian.
19. COO-1422-105 Experience with a Computer Based Clinical Data Retrieval System
.....J.M. Jurist and K. Kianian.
20. COO-1422-106 Measurement of Tibial Resonant Frequency: A Preliminary Report
.....J.W. Raasoch and J.M. Jurist.
21. COO-1422-107 Femoral Trabecular Patterns and Bone Mineral Content
.....D.H. Kranendonk and J.M. Jurist.
22. COO-1422-108 Skeletal Status in Rheumatoid Arthritis: A Preliminary Report
.....M.N. Mueller and J.M. Jurist.
23. COO-1422-109 Effects of Sodium Fluoride on Ulnar Resonant Frequency in Elderly Women
.....J.M. Jurist and C.H. Hickey.
24. COO-1422-110 Quantitation of Radioactivity In Vivo by External Counting Measurements (submitted for publication).
.....J.A. Sorenson.

August 1, 1972

ANNUAL PROGRESS REPORT ON AEC CONTRACT AT - (11 - 1) - 1422

Table of Contents

1. COO-1422-111 The Use of In Vivo Bone Mineral Determination to Predict the Strength of Bone. Abstract of Ph.D. thesis.
... C. R. Wilson
2. COO-1422-112 Skeletal Growth in School Children: Maturation and Bone Mass.
... R. B. Mazess and J. R. Cameron
3. COO-1422-113 Growth of Bone in School Children: Comparison of Radiographic Morphometry and Photon Absorptiometry.
... R. B. Mazess and J. R. Cameron
4. COO-1422-114 Direct Readout of Bone Mineral Content Using Radionuclide Absorptiometry. Abstract.
... R. B. Mazess, J. R. Cameron and H. Miller
5. COO-1422-115 Weight and Density of Sadlermiut Eskimo Long Bones. Abstract.
... R. B. Mazess and R. Jones
6. COO-1422-116 Technical Information on a Rectilinear Scanner for Determination of Bone Mineral Content.
... J. M. Sandrik
7. COO-1422-117 Effects of the Polyenergetic Character of the Spectrum of ^{125}I on the Measurement of Bone Mineral Content.
... J. M. Sandrik and P. F. Judy
8. COO-1422-118 Improved Version of the Dual-Channel System to Measure Bone Mineral Content
... R. M. Witt, C. E. Vought and R. B. Mazess

9. C00-1422-119 Comparison of Compact Scintillation Detectors for Bone Mineral Content Measurements.
... R. M. Witt and R. B. Mazess
10. C00-1422-120 A Compact Scanner for Measurement of Bone Mineral.
... R. B. Mazess and Y. Towliati
11. C00-1422-121 Bedrest Subject Measurements at USPHS.
... P. F. Judy and J. R. Cameron
12. C00-1422-122 Prediction of Body Composition from Absorptiometric Limb Scans.
... R. B. Mazess
13. C00-1422-123 Bone Mineral Content of Eskimos in Alaska and Canada: Preliminary Report.
... W. Mather and R. B. Mazess
14. C00-1422-124 Progress in Clinical Use of Photon Absorptiometry.
... R. B. Mazess, P. F. Judy, C. R. Wilson and J. R. Cameron
15. C00-1422-125 The Bone Mineral Content and Physical Strength of Avascularized Femoral Heads. An Experimental Study on Adult Rabbits. A Proposed Experiment.
... R. M. Witt
16. C00-1422-126 Determination of Vertebral Bone Mineral Mass by Transmission Measurements.
... P. F. Judy, J. R. Cameron, K. M. Jones and M. G. Ort
17. C00-1422-127 A New Material for the International Bone Mineral Standard.
... A. Kabluna, R. B. Mazess and W. Mather

ORIGINAL PAGE IS
OF POOR QUALITY

18. C00-1422-128 Experiences with the Use of Vibrational Techniques for the Determination of the Resonant Frequency of Bone In Vivo.
. . . C. R. Wilson
19. C00-1422-129 Report on the First Bone Mineral Workshop - 1971.
. . . R. B. Mazess
20. C00-1422-130 Interpretation of Fracture Index Charts.
. . . E. Smith and J. R. Cameron
21. C00-1422-131 Relationship Between Bone Mineral Contents of the Radius, Femoral Neck, Thoracic Vertebrae and Other Sites.
. . . C. R. Wilson and J. R. Cameron
22. C00-1422-132 Bone Mineralization and Unilateral Activity.
. . . R. C. Watson
23. C00-1422-133 Osteoporosis in Rheumatoid Arthritis (RA) Influence of Disease Duration, Severity, and Steroid Therapy.
. . . M. N. Mueller and J. M. Jurist
24. C00-1422-134 Skeletal Status in Rheumatoid Arthritis: A Preliminary Report.
. . . M. N. Mueller and J. M. Jurist

ORIGINAL PAGE IS
OF POOR QUALITY

ANNUAL PROGRESS REPORT ON AEC CONTRACT AT(11-1)-1422

Table of Contents

1. COO-1422-135 Direct Readout of Bone Mineral Content Using Radio-nuclide Absorptiometry.
. . . R. B. Mazess and J. R. Cameron
2. COO-1422-136 Weight and Density of Sadlermiut Eskimo Long Bones.
. . . Richard B. Mazess and Robert Jones
3. COO-1422-137 The Effects of Temporary Protein Deprivation on Bone Width and Bone Mineral Content in Rhesus Macaques.
. . . Walter Leutenegger, Robert M. Larsen and Sylvia Bravo
4. COO-1422-138 Age Related Changes in the Compressive Strength and Bone Mineral per Unit Volume of Compact Bone.
. . . Charles R. Wilson
5. COO-1422-139 Estimation of the Bone Mineral Content of the Femoral Neck and Spine from the Bone Mineral Content of the Radius or Ulna.
. . . Charles R. Wilson
6. COO-1422-140 Analysis of the Effects of Adipose Tissue on the Absorptio-metric Measurement of Bone Mineral Mass.
. . . W. W. Wooten, P. F. Judy and M. A. Greenfield
7. COO-1422-141 A Method to Estimate the Error Caused by Adipose Tissue in the Absorptiometric Measurement of Bone Mineral Mass.
. . . Philip F. Judy, John R. Cameron and John M. Vogel
8. COO-1422-142 Bone Mineral Content in Normal Subjects.
. . . R. B. Mazess and J. R. Cameron
9. COO-1422-143 The Bone Mineral Content and Physical Strength of Avascularized Femoral Heads: An Experimental Study on Adult Rabbits.
. . . Robert M. Witt
10. COO-1422-144 Measurements on Clinical Standard Using Direct Readout System.
. . . Howard Gollup

11. C00-1422-145 Detectors Suitable for Body Composition Measurements with the Photon Absorptiometry Technique.
 . . . R. M. Witt
12. C00-1422-146 A Compact Scanner for Measurement of Bone Mineral Content and Soft-Tissue Composition.
 . . . D. A. Hennies, R. B. Mazess and C. R. Wilson
13. C00-1422-147 Direct Readout of Bone Mineral Content with Dichromatic Absorptiometry.
 . . . W. C. Kan, C. R. Wilson, R. M. Witt and R. B. Mazess
14. C00-1422-148 Absorptiometry Using ^{125}I and ^{241}Am to Determine Tissue Composition In Vivo.
 . . . Norbert J. Pelc
15. C00-1422-149 Bone Mineral Content of North Alaskan Eskimos.
 . . . Richard B. Mazess and Warren E. Mather
16. C00-1422-150 The Bone Mineral and Soft Tissue Composition of the Siemens-Reiss Reference Step Wedges.
 . . . R. H. Jurisch, R. M. Witt and J. R. Cameron
17. C00-1422-151 The Expected Precision of Dual-Photon-Absorptiometry for Fat-Lean Composition.
 . . . James Hanson
18. C00-1422-152 Video-Roentgen Absorptiometry for the Measurement of Bone Mineral Mass.
 . . . C. R. Wilson, J. R. Cameron, E. L. Ritman, R. E. Sturm and R. A. Robb
19. C00-1422-153 Effects of the Polyenergetic Character of the Spectrum of ^{125}I on the Measurement of Bone Mineral Content.
 . . . John M. Sandrik and Philip F. Judy
20. C00-1422-154 Rectilinear and Linear Scanning in the Determination of Bone Mineral Content.
 . . . J. M. Sandrik, C. R. Wilson and J. R. Cameron
21. C00-1422-155 Determination of Lung Tumor Mass by Roentgen Video Absorptiometry.
 . . . J. M. Sandrik, C. R. Wilson and J. R. Cameron

22. C00-1422-156 Bone Loss in Rheumatoid Arthritis Accelerated by Corti-
costeroid Treatment.
. . . M. N. Mueller, R. B. Mazess and J. R. Cameron
23. C00-1422-157 Evaluation of Bone Mass in Arthritis Using Monoenergetic
Photon-Absorptiometry.
. . . M. N. Mueller
24. C00-1422-158 Early Recognition of Osteoporosis in the Aged Female.
. . . Everett Smith, Steven Babcock and John Cameron
25. C00-1422-159 Effects of Physical Activity on Bone Loss in the Aged.
. . . E. L. Smith and S. W. Babcock

**ORIGINAL PAGE IS
OF POOR QUALITY.**

ANNUAL PROGRESS REPORT ON AEC CONTRACT AT-(11-1)-1422

Table of Contents

1. COO-1422-160 Bone Mineral Content in Normal U.S. Whites
. . . Richard B. Mazess and John R. Cameron
2. COO-1422-161 Prediction of Femoral Neck and Spine Bone Mineral Content
from the BMC of the Radius or Ulna and the Relationship
Between Bone Strength and DMC
. . . Charles R. Wilson
3. COO-1422-162 Bone Standards for the Intercomparison and Calibration of
Photon Absorptiometric Bone Mineral Measuring Systems
. . . Robert M. Witt
4. COO-1422-163 Analysis of ^{153}Gd and of $^{125}\text{I}/^{241}\text{Am}$ Sources
. . . James Hanson
5. COO-1422-164 Direct Readout of Bone Mineral Content with Dichromatic
Absorptiometry
. . . W.C. Kan, C.R. Wilson, R.M. Witt and R.B. Mazess
6. COO-1422-165 Bone Growth and Physical Activity in Young Males
. . . Ronald C. Watson
7. COO-1422-166 The Effect of Physical Activity on Bone in the Aged
. . . Everett L. Smith
8. COO-1422-167 Corticosteroid Therapy Accelerated Osteoporosis in
Rheumatoid Arthritis
. . . Mark N. Mueller, Richard B. Mazess and John R. Cameron
9. COO-1422-168 Progress in Dual Photon Absorptiometry of Bone
. . . R.B. Mazess, C.R. Wilson, J. Hanson, W. Kan,
M. Madsen, N. Pelc and R. Witt
10. COO-1422-169 Physical Aspects of ^{125}I Bone Absorptiometry
. . . Philip F. Judy
11. COO-1422-170 Bone Mineral Content of North Alaskan Eskimos
. . . Richard B. Mazess and Warren Mather

12. COO-1422-171 Bone Mineral Content in Canadian Eskimos
. . . Richard B. Mazess and Warren E. Mather
13. COO-1422-172 Bone Mineral Content of Canadian and Alaskan Eskimos
. . . Richard B. Mazess
14. COO-1422-173 Bone Mineral Content in Alaskan Eskimos
. . . Richard B. Mazess
15. COO-1422-174 Abstract of Bone Mineral Work Done in the Department of
Poultry Science Since February, 1970
. . . Paul C. Miller
16. COO-1422-175 Body Composition Measurements Using ^{109}Cd
. . . Norbert Pelc
17. COO-1422-176 The Effects of Temporary Protein Deprivation on Bone
Width and Bone Mineral Content in Rhesus Macaques
W. Leutenegger, R.M. Larsen, and Sylvia Bravo
18. COO-1422-177 The Evaluation of the Direct Readout System of Bone
Mineral Content Using the Dichromatic Attenuation
Technique
. . . William Kan
19. COO-1422-178 Dual Photon Absorptiometry Measuring Systems: Corrections
to Detected Photon Counts
. . . Robert M. Witt
20. COO-1422-179 Measurements on Clinical Standard Using Direct Readout
System
. . . Howard Collup
21. COO-1422-180 A Method to Estimate the Error Caused by Adipose Tissue
in Bone Absorptiometry
. . . Philip F. Judy and John M. Vogel
22. COO-1422-181 An In Vivo Method for the Determination of Vertebral Bone
Mineral Content Utilizing ^{153}Gd
. . . Mark Madsen
23. COO-1422-182 Precision and Accuracy of Photon Absorptiometry
. . . James Hanson

24. COO-1422-183 Description of a Dual Photon Absorptiometry System
for the Determination of Body Composition In Vivo
. . . Robert M. Witt
25. COO-1422-184 $^{125}\text{I}/^{241}\text{Am}$ Dual Source Holder
. . . Robert M. Witt and James Hanson

ORIGINAL PAGE IS
OF POOR QUALITY

APPENDIX B. BIBLIOGRAPHY OF PUBLICATIONS OF R.B. MAZESS FROM THE BONE MINERAL LAB

ARTICLES PUBLISHED

1. Baker, P.T. and R.B. Mazess. Calcium: unusual sources in the highland Peruvian diet. Science 142: 1466-1467, 1963.
2. Mazess, R.B. and P.T. Baker. Diet of Quechua Indians living at high altitude: Nunoa, Peru. Am. J. Clin. Nutr. 15: 341-351, 1964
3. Mazess, R.B., J.R. Cameron, R. O'Connor and D. Knutzen. Accuracy of bone mineral measurement. Science 145: 388-389, 1964.
4. Mazess, R.B. Neonatal mortality and altitude in Peru. Am. J. Phys. Anthro. ns 23: 209-214, 1965.
5. Mazess, R.B. Bone density in Saldermuit Eskimo. Human Biology 38: 42-49, 1966.
6. Mazess, R.B. and D. Zimmerman. Pottery dating by thermoluminescence. Science 162: 347-348, 1966.
7. Baker, P.T., E.R. Buskirk, E. Picon-Reategui, J. Kollias and R.B. Mazess. Regulacion de la temperatura corporal en indios Quechuas nativos de la altura. Arch. Instituto Biol. Andina 1(5): 286-298, 1966.
8. Mazess, R.B. Skin color in Bahamian Negroes. Human Biology 39: 155-169, 1967.
9. Baker, P.T., E.R. Buskirk, J. Kollias and R.B. Mazess. Temperature regulation at high altitude: Quechua Indians and U.S. whites during total body cold exposure. Human Biology 39: 155-169, 1967.
10. Mazess, R.B., E. Picon-Reategui, M. Little and R.B. Thomas. The effects of alcohol on man during rest and work at high and low altitudes. Aerospace Med. 39: 403-406, 1968.
11. Mazess, R.B. and D. Zimmerman. Thermoluminescence dating of some Peruvian pottery. IN: Macdougall (ed) Thermoluminescence Methods in Geology. Academic Press, London, 1968.
12. Mazess, R.B. Hot-cold food beliefs among Andean peasants. J. Am. Dietetic Assoc. 53: 109-113, 1968.
13. Cameron, J.R., R.B. Mazess and J.A. Sorenson. Precision and accuracy of bone mineral determination by the direct photon absorptiometric method. Invest. Radiol. 3: 141-150, 1968.
14. Mazess, R.B. The oxygen cost of breathing in man: effects of altitude, training and race. Am. J. Phys. Anthro. 29: 365-376, 1968.
15. Mazess, R.B., E. Picon-Reategui, R.B. Thomas and M.A. Little. Oxygen intakes and body temperature during basal rest and sleep in Andean Indians. Aerospace Med. 40: 6-9, 1969.
16. Mazess, R.B. Exercise performance and altitude adaptation. Acta Intern. Cong. Americanists, Vol. IV: 213-224, 1968.
17. Mazess, R.B. Exercise performance at high altitudes (4000 meters) in Peru. (In: Proc. Intern. Symp. Altitude and Cold). Federation Proc. 28: 1301-1306, 1969.
18. Cameron, J.R., J.M. Jurist, J.A. Sorenson and R.B. Mazess. New methods for skeletal status evaluation in space flight. Aerospace Med. 40: 1119-1122, 1969.
19. Mazess, R.B. Exercise performance of Indian and White high altitude residents. Human Biology 41(4): 494-518, 1969.
20. Mazess, R.B. Cardiorespiratory characteristics and adaptation to high altitudes. (In: Symp.on Adaptation). Am. J. Phys. Anthro. 32(2): 267-278, 1970.
21. Sorenson, J.A., J.R. Cameron and R.B. Mazess. Measurement of bone mineral by the direct photon absorption method: experimental results. In: G.D. Whedon and J.R. Cameron (ed.) - Progress in Methods of Bone Mineral Measurement. U.S. Dept. of Health, Education, and Welfare, U.S. Gov't. Print. Office, Washington, D.C., 1970, pp. 269-283.

22. Mazess, R.B., J.R. Cameron and J.A. Sorenson. A comparison of radiological methods for determining bone mineral content, *ibid.* pp. 455-472.
23. Cameron, J.R., J.M. Jurist and R.B. Mazess. Some physical methods of skeletal evaluation. In: Proc. Symp. Hypodynamics and Hypogravics (French Lick, 1969).
24. Mazess, R.B. Bone mineral content in Wainwright Eskimo: preliminary report. Arctic Anthropology, 7(1): 114-117, 1970.
25. Mazess, R.B., J.R. Cameron and H. Miller. Preliminary report on a direct digital readout system for absorptiometric determination of bone mineral content. In: J.R. Cameron (ed): Proc. Bone Measurement Conference, pp. 22-27, U.S. Atomic Energy Commission Conf. 700515 (available CFSTI, Springfield, Va.).
26. Sorenson, J.A. and R.B. Mazess. Effects of fat on bone mineral measurements. *Ibid.* pp. 255-262.
27. Witt, R.M., R.B. Mazess and J.R. Cameron. Standardization of bone mineral measurements. *Ibid.* pp. 303-307.
28. Mazess, R.B., M.G. Ort, P.F. Judy and W.E. Mather. Absorptiometric bone mineral determination using ¹⁵³Gd. *Ibid.* pp. 308-312.
29. Colbert, C., R.B. Mazess and P.B. Schmidt. Bone mineral determination: radiographic photodensitometry and direct photon absorptiometry. Investigative Radiology 5: 336-371, 1970.
30. Mazess, R.B., J.R. Cameron and J.A. Sorenson. Body composition by radiation absorptiometry. Nature 228: 771, 1970.
31. Mazess, R.B. Estimation of bone and skeletal weight by direct photon absorptiometry. Investigative Radiology 6: 52-60, 1971.
32. Little, M.A., R.B. Thomas, R.B. Mazess, and P.T. Baker. Population differences and developmental changes in extremity temperature responses to cold among Andean Indians. Human Biology 43: 70-91, 1971.
33. Cameron, J.R., J.M. Jurist and R.B. Mazess. Some physical methods of skeletal evaluation. In: J.S. Laughlin (ed) - Advances in Medical Physics, Second Intern. Conf. Med. Physics, Boston, Mass. (pp. 79-89), 1971.
34. Mazess, R.B. and J.R. Cameron. Skeletal growth in school children: maturation and bone mass. Am. J. Phys. Anthropol. 35(3): 399-408, 1971.
35. Mazess, R.B. and J.R. Cameron. Growth of bone in school children: comparison of radiographic morphometry and photon absorptiometry. Growth 36: 77-92, 1972.
36. Mazess, R.B., J.R. Cameron and H. Miller. Direct readout of bone mineral content using radionuclide absorptiometry. Intern. J. Appl. Radiation Isot. 23: 471-479, 1972.
37. Mazess, R.B. and R. Jones. Weight and density of Sadleruit Eskimo long bones. Human Biology 44(3): 537-548, 1972.
38. Mazess, R.B. and R. Larsen. Responses of Andean highlanders to night cold. Int. J. Biometeor. 16(2): 181-192, 1972.
39. Mazess, R.B., P.F. Judy, C.R. Wilson and J.R. Cameron. Progress in clinical use of photon absorptiometry. In: B. Frame, A.M. Parfitt, and H.M. Duncan (eds) - Clinical Aspects of Metabolic Bone Disease. Excerpta Medica, Amsterdam (pp. 37-43), 1973.
40. Mazess, R.B., J. Hanson, W. Kan, M. Madsen, N. Pelc, C.R. Wilson and R. Witt. Progress in dual photon absorptiometry of bone. In: P. Schmeling (ed) - Proc. Symp. Bone Mineral Determinations. Aktiebolaget Atomenergi Publ. 489, Studsvik, Nykoping, Sweden, 1974.
41. Mazess, R.B. (ed). International Conference on Bone Mineral Measurement. DHEW Publ. NIH 75-683, U.S. Dept. of Health, Education and Welfare, Washington, D.C., 1974.

ORIGINAL PAGE IS
OF POOR QUALITY

42. Kan, W.C., C.R. Wilson, R.M. Witt and R.B. Mazess. Direct readout of bone mineral content with dichromatic absorptiometry. In: R.B. Mazess (ed) - op cit., 1974.
43. Mueller, M.W., R.B. Mazess and J.R. Cameron. Corticosteroid therapy accelerated osteoporosis in rheumatoid arthritis. In: R.B. Mazess (ed) - op cit., 1974.
44. Mazess, R.B. and J.R. Cameron. Bone mineral content in normal U.S. whites. In: R.B. Mazess (ed) - op cit., 1974.
45. Mazess, R.B. and W.E. Mather. Bone Mineral content of North Alaskan Eskimos. Am. J. Clin. Nutr. 27: 916-925, 1974.
46. Mazess, R.B. and W.E. Mather. Bone mineral content in Canadian Eskimos. Human Biology. 47: 45-63, 1975.
47. Mazess, R.B. Human adaptation to high altitude. In: A. Damon (ed) - Physiological Anthropology. Oxford Univ. Press, New York, (pp. 167-209), 1975.
48. Mazess, R.B. Biological adaptation: aptitudes and acclimatization. In: E.S. Watts, F.E. Johnston and G.W. Lasker (eds) - Biosocial Interrelations in Population Adaptation. Mouton Publishers, The Hague (pp. 9-18) 1975.
49. Madsen, M., W. Peppler and R.B. Mazess. Vertebral and total body bone mineral by dual photon absorptiometry. In: S.Pors Nielsen and E. Hjorting-Hansen (eds) - Calcified Tissues 1975. F.A.D.L. Publishing, Copenhagen 1976
50. Mazess, R.B. Third International Conference on Bone Mineral Measurement. A. J. Roentgenol. 120: 1200-1214.
51. Wolberg, W. H., R. M. Witt, J. A. Moylan, and R. B. Mazess. Soft-tissue fluid determination by dichromatic absorptiometry. Arch. Surg., 112:462-471, 1977.
52. Chesney, R.W., R. B. Mazess, P. G. Rose, and D. K. Jax. Bone mineral status measured by direct photon absorptiometry in childhood renal disease. Pediatrics, 60:864-872, 1977.
53. Chesney, R. W., A. V. Moorthy, J. E. Eisman, D. K. Jax, R. B. Mazess, and H. F. DeLuca. Increased growth after long term oral 1 α , 25-vitamin D, in childhood renal osteodystrophy: influence on linear growth and bone remineralization. New Eng. J. Med., 298:238-242, 1978.
54. Witt, R. M. and Mazess, R. B. Photon absorptiometric measurement of soft-tissue and fluid content: the method and its precision and accuracy. Phys. Med. Biol. 23: 620-629, 1978.
55. Demling, R. H., R. B. Mazess, and W. H. Wolberg. The study of burn wound edema using dichromatic absorptiometry. J. Trauma. 18: 124-128, 1978.
56. Mazess, R. B. and S. H. Forman. Longevity and age exaggeration in Vilcabamba, Ecuador. J. Gerontol. 34: 94-98, 1979.
57. Mazess, R. B. Bone mineral in Vilcabamba, Ecuador. Amer. J. Roentg. 130:671-674, 1978.
58. Demling, R. H., R. B. Mazess, J. Hansen and W. Wolberg. The effect of heparin on edema after second and third degree burns. J. Surg. Res. 26:27-32, 1979.
59. Demling, R. H., R. B. Mazess and W. Wolberg. The effect of immediate and delayed cold immersion on burn edema formation and resorption. J. Trauma 19:56-60, 1979.
60. Chesney, R. W., R. B. Mazess, P. Rose and D. K. Jax. Effect of prednisone on growth and bone mineral content in childhood glomerular disease. Am. J. Dis. Child. 132: 768-772, 1978.
61. Chesney, R. W., R. B. Mazess, A. Hamstra and H. F. DeLuca. Reduction of serum 1,25-dihydroxyvitamin D3 levels in children receiving glucocorticoids. Lancet I (No. 25): 1123-1125, 1978.
62. Mischler, E. H., J. Chesney, R. W. Chesney and R. B. Mazess. Demineralization in cystic fibrosis detected by direct photon absorptiometry. Am. J. Dis. Child. 133:632-635, 1979.

ORIGINAL PAGE IS
OF POOR QUALITY

63. Forman S. H. and R. B. Mazess. Demography of the longevous Vilcabamba population. Science (In press).
64. Mazess R. B. "Non-invasive measurement of bone". In: V. Barzel (ed) - Osteoporosis II. Grune and Stratton, N.Y., (pp. 5-26) 1979.
65. Mazess R. B. Measurement of skeletal status by noninvasive methods. Calc. Tiss. Intern. 28:89-92, 1979.
66. Vishnu Moorthy A., A. R. Harrington, D. P. Simpson and R. B. Mazess. Long-term therapy of uremic osteodystrophy in adults with calcitriol. Clin. Nephrol. 16:93-100, 1979.
67. Christiansen C., R.B. Mazess, I. Transbøl, and G. Finn Jensen. Factors in response to treatment of early postmenopausal bone loss. Calc. Tiss. Intern. 33:575-581 (1981).
68. Stalp, J. T. and R. B. Mazess. Determination of bone density by coherent-Compton scattering Med. Physics 7:723-726, 1980.
69. Chesney, R. W., R. B. Mazess and H. F. DeLuca. The long term influence of calcitriol on growth patterns in childhood renal osteodystrophy (submitted).
70. Barden, H. S., R. B. Mazess, P. G. Rose and W. McAweeney. Bone mineral status by direct photon absorptiometry in institutionalized adults receiving long-term anticonvulsant therapy and multivitamin supplementation. Calcif. Tissue Int. 31:117-121, 1980.
71. Mathisen, R. W. and R. B. Mazess. A revised method for the calculation of life expectancy tables from individual death records which provides increased accuracy at advanced ages. Human Biology 53:35-45, 1981.
72. Riggs, B. L., H. W. Wahner, W. L. Dunn, R. B. Mazess, K. P. Offord and L. J. Melton III. Differential losses of cortical and trabecular bone in the appendicular and axial skeleton with aging: relationship to spinal osteoporosis. J. Clin. Invest. 67:323-335, 1981.
73. Chesney, R. W., A. Hamstra, D. K. Jax, R. B. Mazess and H. F. DeLuca. Influence of long-term oral 1,25-dihydroxyvitamin D in childhood renal osteodystrophy. Contr. Nephrol. 18:55-71, 1980.
74. Shore, R. M., R. W. Chesney, R. B. Mazess, P. G. Rose and G. J. Bargman. Bone mineral status in growth hormone deficiency. J. Pediatrics 96:393-396, 1980.
75. Chesney, R. W., R. B. Mazess, P. G. Rose, A. J. Hamstra and H. F. DeLuca. Supranormal 25-hydroxyvitamin D and subnormal 1,25-dihydroxyvitamin D: their role in x-linked hypophosphatemic rickets. Am. J. Dis. Child 134:140-143, 1980.
76. Shore, R. M., R. W. Chesney, R. B. Mazess, P. G. Rose and G. J. Bargman. Osteopenia in juvenile diabetes. Calc. Tiss. Int.
77. Peppler, W. W. and R. B. Mazess. Total body bone mineral and lean body mass by dual-photon absorptiometry. I. Theory and measurement procedure. Calc. Tiss. Int. 33:353-359, 1981.
78. Mazess, R. B., W. W. Peppler, C. H. Chesnut III., W. B. Nelp and S. H. Cohn. Total body bone mineral and lean body mass by dual-photon absorptiometry. II. Comparison with total body calcium by neutron activation analysis. Calc. Tiss. Int. 33:361-363, 1981.
79. Mazess, R. B., W. W. Peppler, J. E. Harrison and K. G. McNeill. Total body bone mineral and lean body mass by dual-photon absorptiometry. III. Comparison with trunk calcium by neutron activation analysis. Calc. Tiss. Int. 33:365-368, 1981.
80. Mazess, R. B. and W. W. Peppler. Total body bone mineral and lean body mass by dual-photon absorptiometry. IV. Measurements on normal subjects and in bone disease. (Submitted) Calc. Tiss. Int.
81. Mazess, R. B. "Photon Absorptiometry". Chapter 4 In: S. H. Cohn (ed) - Non-Invasive Measurements of Bone Mass and their Clinical Application. CRC Press, Baton Rouge, Fla. p. 85-99, 1981.
82. Mazess, R. B. and R. Mathisen. Lack of unusual longevity in Vilcabamba, Ecuador. Human Biology 54:517-524, 1982.

83. Mazess, R.B. On aging bone loss. Clin. Orthop. 165:239-252, 1982.
84. Mazess, R.B. Errors due to adipose tissue in measuring trabecular bone by computed tomography. Calc. Tiss. Intern. (in press).
85. Barden, H.S., R.B. Mazess, R.W. Chesney and P.G. Rose. Anticonvulsant osteomalacia in children. Metab. Bone Dis.
86. Shore, R.M., R.W. Chesney, R.B. Mazess, P.G. Rose and G.J. Bargman. Skeletal demineralization in Turner's syndrome. Calc. Tiss. Intern. (in press).
87. Mazess, R.B. Noninvasive measurement of local bone in osteoporosis. In: Osteoporosis: Recent Advances in Pathogenesis and Treatment. University Park Press, Baltimore, pp. 25-36. 1982.
88. Mazess, R.B. Non-invasive bone measurements. In A. Kunin (ed.) Skeletal Research II. pp. 277-343. Academic Press (in press).
89. Mazess, R.B. Non-invasive methods for quantitating trabecular bone. In: L. Avioli (ed.) Senile and Postmenopausal Osteoporosis. Grune & Stratton (in press).
90. Chesney, R.W., Zimmerman, J., Hamstra, A., DeLuca, H.F. and R.B. Mazess. Vitamin D metabolite concentrations in vitamin D deficiency. Am. J. Dis. Child 135:1025-1028, 1981.
91. Christiansen, C., Mazess, R.B., Transbøl, I. and Finn Jensen, G. Factors in response to treatment of early postmenopausal bone loss. Calc. Tiss. Intern. 33:575-581, 1981.
92. Mazess, R.B. Non-invasive clinical measurements of bone mineral. In: Proc. World Congress Nuclear Med. Vol. I: 1054-1081, Pergamon Press, Paris.
93. Mazess, R.B. Noninvasive measurements of skeletal mass. In: W. Peck (ed.) Annual Advances in Bone and Mineral Research, pp.223-279. Excerpta Medica, Amsterdam.
94. Dobbins, J., R.B. Mazess and J.R. Cameron. Roentgen videoabsorptiometry for measurement of bone mineral content. (In preparation).
95. Mazess, R.B., J. Hurst, E. Fromm and W.W. Pepler. Direct readout of bone mineral content using a microcomputer for photon absorptiometry. (In preparation)
96. Mazess, R.B., J. Stalp, W.W. Pepler, S. Wiener and S. Riederer. A microcomputer-based system for dual-photon absorptiometry of bone mineral. (In preparation)
97. Mazess, R.B., W.W. Pepler and M. Gibbons. Dual-photon absorptiometry for body composition. (In preparation)
98. Mazess, et al. Does radius bone measurement indicate skeletal status? Submitted J. Nucl. Med.
99. Mazess, R.B., et al. Advances in total body and regional bone mineral by dual-photon absorptiometry. In: Intern. Symp. Osteoporosis, J. Wiley (ed.).
100. Harper, A.B., W.S. Laughlin and R.B. Mazess. Bone in St. Lawrence Island Eskimos. Am. J. Phys. Anthropol. (in press).
101. Harper, A.B., W.S. Laughlin and R.B. Mazess. Bone mineral variation among Alaskan, Canadian, and Greenland populations (in preparation).
102. Lindgren, U., R.B. Mazess, A. Hamstra and H.F. DeLuca. Vitamin D status and bone mineral measurement in patients undergoing chronic prednisone therapy. Submitted to Metab. Bone Dis.
103. Greer, F.R., J. Lane, S. Weiner and R.B. Mazess. An accurate and reproducible absorptiometric technique for determining bone mineral content in newborn infants. Ped. Research (in press).
104. Riggs, B.L., H.W. Wahner, E. Seeman, K.P. Offord, W.L. Dunn, R.B. Mazess, K.A. Johnson, and L.J. Melton III. Changes in bone mineral density of the proximal femur and spine with aging. J. Clin. Invest. 70:716-723, 1982.

APPENDIX C. REPORT ON IMMOBILIZATION AND BONE MEETING, SAN FRANCISCO 1982

IMMOBILIZATION AND BONE

Richard B. Mazess¹ and G. Donald Whedon²

ORIGINAL PAGE IS
OF POOR QUALITY

1. Department of Medical Physics
University of Wisconsin
Madison, WI 53706
2. National Institute of Arthritis, Diabetes and
Digestive and Kidney Diseases
National Institutes of Health
Bethesda, MD 20205

**ORIGINAL PAGE IS
OF POOR QUALITY**

The major advances of the past several years in bone measurement have direct applications for manned space missions, for paraplegics, for patients confined to bed by disease and for the large population of relatively hypodynamic elderly individuals. A meeting held in San Francisco (June 16, 1982) focussed on newer measurement methods and on major results obtained by both histological and non-invasive approaches. The specific aim was to provide NASA with information to help implement appropriate programs of research.

G. Donald Whedon (NIH) summarized the history of research on bone loss in immobilization and space flight. Negative calcium balance of 150-200mg/day continued for up to 20-30 weeks in young bed rest subjects; in the Skylab astronauts, the pattern and degree of calcium loss was similar to that in bed rest but with much inter-individual variation. Calcium losses in patients with spinal cord injuries appeared somewhat higher than in bed rest subjects, and higher losses were found in subjects with complete versus incomplete spinal cord lesions. Calciuria usually declined to the normal range by 30 weeks, but in some patients a modest elevation was evident even after one year (N. Eric Naftchi, New York University). Losses in paraplegic patients were evidenced histomorphometrically by a 33% reduction of trabecular bone volume in iliac crest biopsy over 25 weeks (P. Minaire and C. Alexandre, Hospital Regional, St. Etienne, France). There was both an increase in osteoclastic resorption and a decrease in bone formation. Cortical bone was affected slightly at first but to a greater extent after 2-3 months. There was a dramatic increase in yellow marrow (from 30-80%, or 1%/week) which later returned to normal.

Bone losses were also observed in 34 adults transiently (11-61 days) immobilized for prolapsed intervertebral disc. Dual-photon absorptiometry of the lumbar spine showed a mean bone decrease of $0.9\pm 0.3\%$ /week (B. Krølner, Hillerød Hospital, Denmark). Reambulation led to recovery which was nearly complete in 15 weeks. In a group of 31 older women exercise 1 hour 2-5 times weekly produced an increase of lumbar bone of 3.5% over 8 months. T. Hansson (Goteborg University, Sweden) using dual-photon absorptiometry observed a decrease of 1-2%/week in spinal bone in 13 adolescent girls immobilized for 3-6 weeks for correction of scoliosis. Only 4 of the 13 (those least mature at time of operation) had regained all lost bone 5 years later; the remaining 9 showed variable recovery with 5 showing no restitution at all. The above losses in the spine were of the same magnitude as those observed in the trabecular bone of the os calcis (5%/month, using single-photon absorptiometry) during the prolonged bed rest studies sponsored by NASA at the PHS Hospital, San Francisco (J. Vogel, Dominican Hospital, Santa Cruz, CA). These same NASA-PHS studies suggested that diphosphonates may be able to inhibit some of this bone loss particularly if there is treatment prior to immobilization (J. Bevan, Proctor & Gamble, Cincinnati).

Experimental studies in animals also have shown bone losses during immobilization and space flight. Immobilized (body cast) monkeys lost spinal bone and the concomitant decrease of mechanical strength continued even after short-term (14 day) immobilization was terminated; the degree of reversibility may be age-related (L. Kazarian, Wright-Patterson AFB). Localized bone loss was evident (23-31% over 6 months) in compact bone of the proximal tibia at a site of muscular insertion even though there was not loss of compact bone in the radius and ulna (D. Young, NASA Ames Research Center). Recovery of the

ORIGINAL PAGE IS
OF POOR QUALITY

loss may take as much as 5-10 times longer than the period of immobilization. Growing rats observed after space flight (18-22 days - Kosmos) showed many of the changes noted in monkeys and man: decreased trabecular bone volume, increased marrow fat, decrease in bone formation (E.R. Morey, Holton, NASA Ames Research Center). All changes in flight returned to control levels within 25 days post-flight except for trabecular bone mass. D. Baylink (Loma Linda University) described a "coupling factor" (a high molecular weight protein with mitogenic activity specific to bone and cartilage) and speculated on the possible role it might have in the bone loss during immobilization.

... Dual-photon absorptiometry for bone measurement in vivo (with ¹⁵³Gd) was reviewed by R. B. Mazess. Long-term precision error in spinal measurements on man and monkeys has been 2-3%. Accuracy on spinal samples was 2-4%. Total body bone mineral measurements also have acceptable precision and accuracy and though more complex than spinal measurements do indicate regional changes of both bone mineral and lean body mass. Quantitative computed tomography (QCT) using a conventional x-ray source provides a reproducible (1.6 - 2.3%) measure of spinal bone (H. Genant, C.E. Cann and D. Boyd, U.C., San Francisco). The measure could be more sensitive than dual-photon spine scans since QCT can measure the purely trabecular bone in the centrum whereas the total of spinal bone is measured with DPA. At the menopause, women lost twice as much bone in the anterior centrum as in the entire vertebra and 7 times more than in compact bone. However, conventional single-energy x-ray CT is subject to errors due to shifts in marrow fat (a 10% fat shift gave a 5% error). This error can be reduced greatly (to 1.4%) by making determinations at two energies, or by using a low-energy CT scanner in areas where marrow fat is invariant. A special dual-energy scanner using

ORIGINAL PAGE IS
OF POOR QUALITY

153 Gd sources and a ring of semi-conductor detectors is under construction. Single-energy CT scanners (using ^{125}I or filtered x-ray tube sources) have been developed for measurement of trabecular bone in the limbs (P. Ruegsegger, Institute for Biomedical Engineering, Zurich). These devices provide very precise (<0.3%) values (yet with low x-ray dose). Trabecular bone measurements at peripheral sites (tibia and radius) were well correlated, with each other and with spinal mineral ($r \approx 0.9$). Trabecular bone loss in an immobilized limb was about 16% after 16 weeks while compact bone loss was only 3%. Compton-scattering methods provide a totally different alternative for measurement at peripheral sites (M.A. Greenfield, UCLA). Investigators have obtained precise (4%) values at both the distal radius and the os calcis in vivo, but the accuracy is affected by multiple scattering and other factors.

The consensus of the group was that immobilization and space flight entail considerable losses of trabecular bone (averaging about 1%/week), but the degree of loss may vary greatly among individuals. It has been estimated that mechanical properties of the spine may be seriously compromised with a bone loss of 30%. Generally, loss of compact bone from the weightbearing skeleton occurs at slower rates (<1%/month) than trabecular bone loss but localized loss of compact bone at areas of muscle insertion also can occur at a high rate. In non-weightbearing bones there is apparently little loss of compact bone. Both increased bone resorption and decreased bone formation can be implicated in the bone loss of immobilized or weightless states but there was divided opinion on their relative roles which may reflect different mechanisms operative at different periods in the course of immobilization.

Reversibility of bone loss does occur but the period of recovery , several times longer than the period of loss. Again, there is wide individual variation in recovery with some individuals showing little, if any, response to reambulation, the slower bone turnover of increased age probably being an important factor. Evidence is not conclusive on prevention of immobilization bone loss through diet or drug treatment.

The influences of high calcium intake, disphosphonates, salmon thyrocalcitonin, and exercise on prevention or suppression of the calcium loss in bed rest have been studied recently but only preliminary reports have appeared; fluoride has yet to be tested in this area. Undoubtedly, further studies are merited in which newer methods are used for measurement of trabecular bone (dual-photon absorptiometry, computed tomography, Compton-scattering) as well as older methods (single-photon absorptiometry) for measurement of the os calcis or of long bones. Measurements at several locations, both axial and appendicular, are recommended because of the anatomical variability. Serial measurements of total body bone mineral could provide a noninvasive indicator of calcium balance as well as showing regional changes. Measurements need to be made at fairly frequent intervals in order to define the pattern of change in an individual; the lower radiation dose of absorptiometric approaches, and x-ray CT on the limbs, makes these methods attractive for sequential monitoring. The large changes of marrow composition which accompany immobilization must be recognized as a problem for non-invasive bone measurement. A 50% increase of marrow fat will appear to be a 25% bone loss to single-energy spinal CT, a 12% bone loss with Compton-scattering, a 7% bone loss to dual-energy CT and a 3% bone loss to dual-photon absorptiometry. These errors can be relatively large compared to an actual, localized bone loss of perhaps 25% after 6 months of immobilization; changes in marrow fat also can complicate assessment of recovery.

ORIGINAL PAGE IS
OF POOR QUALITY

The new findings in animals and humans reported at the Workshop confirm the import of bone loss with immobilization. New methods are available which will permit non-invasive monitoring of loss and recovery, and which will facilitate studies related to prevention of and therapy for such loss. Immobilization bone loss occurs at a rate 5 to 20 times greater than those in other demineralizing conditions and hence may provide a useful model for examination of metabolic bone disease and its therapy.

ACKNOWLEDGEMENTS

Supported by NASA-Y-NGR 50-002-051.

ORIGINAL PAGE IS
OF POOR QUALITY

APPENDIX D. THESES

ORIGINAL PAGE IS
OF POOR QUALITY

- 1971 Judy, P.F. A Dichromatic Attenuation Technique for the In Vivo Determination of Bone Mineral Content. (Ph.D.)
- 1971 Sorenson, J. Methods for Quantitating Radioactivity In Vivo by External Counting Measurements (Ph.D.)
- 1972 Wilson, C.R. The Use of In Vivo Bone Mineral Determination to Predict the Strength of Bone. (Ph.D.)
- 1975 Kan, W. Direct Readout of Bone Mineral Content with Dichromatic Absorptiometry. (M.S.)
- 1975 Witt, R.M. The Determination of Fluid Content by Dichromatic Absorptiometry. (Ph.D.)
- 1978 Sandrik, J. A Roentgen Video Absorptiometric System for the Measurement of Lung Tumor Mass. (Ph.D.)
- 1979 Hanson, J.A. Absorptiometry with a Linear Position-Sensitive Proportional Counter. (Ph.D.)
- 1981 Pepler, W.W. Combined Transmission-Emission Scanning Using Dual-Photon Absorptiometry. (Ph.D.)

APPENDIX E: Report for INTERN. SYMP. SPACE PHYSIOL. (Toulouse, France 1982)
MEASUREMENT OF SPINE AND TOTAL BODY MINERAL
BY DUAL-PHOTON ABSORPTIOMETRY

RICHARD B. MAZESS AND DONALD YOUNG

Department of Medical Physics
University of Wisconsin, Madison, WI (USA)
and
NASA Ames Research Center, Moffett Field, CA (USA)

ABSTRACT

Dual-photon absorptiometry (^{153}Gd at 43 and 100 keV) was used to monitor the bone mineral content (BMC) in phantoms, vertebrae in vitro, the lumbar spine in humans and immobilized monkeys as well as total body bone mineral (TBBM). The accuracy of measurement was excellent on phantoms and on bone specimens (1 SEE 2%). Accuracy was only moderately affected by experimental alteration of "marrow fat". A 10% shift from red to yellow marrow caused only a 0.3% shift in BMC. In comparison such a compositional alteration causes a 3-4% error in single-energy X-ray computed tomography of the spine. Precision of measurement on spinal phantoms in vitro was 1.5%. The precision on human subjects and on monkeys averaged 2-3%. In 50 monkeys measured repeatedly (3-5 times) over 4 months 55% showed a precision error of under 3%. The precision of TBBM in vivo was about 2% but recent improvements have decreased the error to 1%.

The spinal bone loss in two restrained (4 weeks and 11 weeks) monkeys was about 1.2 and 0.5%/week respectively. This was similar to the loss shown in immobilized humans by both absorptiometry and histomorphometry (1%/week).

Dual-photon absorptiometry allows frequent monitoring (dose 20 mrem) during immobilization and remobilization without the great influence of the very large marrow composition shifts (2%/week) that accompany these events.

INTRODUCTION

Dual-photon absorptiometry with two radionuclides was developed during the late 1960's to provide a means of measuring the peripheral skeleton without the necessity of embedding the limb in a layer of tissue-equivalent material (West and Reed, 1968; Judy 1971). There was some attempt to use the method on the spine (Roos 1974) but it was not until the introduction of ^{153}Gd with emissions at two energies (44 and 100 keV) optimal for thick body sections that this became practical (Mazess et al 1970, 1974; Dugg et al 1980; Krolner and Pors Nielsen 1980; Price et al 1976). ^{153}Gd has a relatively long half-life (242 days) and the usual 1 Ci source can be used for at least one year. The initial work done with ^{153}Gd showed that accurate results could be obtained regardless of soft-tissue thickness or composition (Wilson and Madsen 1977). It also was shown that factors such as marrow composition would have a minor effect on bone determinations. A

ORIGINAL PAGE IS
OF POOR QUALITY

change of 10% from red to yellow marrow produces an artifact of only 0.3% in the dual-photon measure of bone. This contrast with an error that is 10 to 15 times larger (3.5 to 4.5%) for X-ray computed tomography.

Dual-photon measurements have been shown to accurately indicate the mass of bone specimens (Wilson and Madsen 1977; Dunn et al 1980). Measurements on entire skeletons indicated the total body bone mineral (TBM) with a very small error (1.5% - Pepler and Mazess, 1981) and measurements in vitro were highly correlated with total body calcium determined in the same subjects by neutron activation (Mazess et al 1981). These studies have indicated that the method can be used for accurate determinations at limited local sites, over small areas, or even over the entire body. Spinal measurements have been shown to be extremely sensitive in detection of osteoporosis (Riggs et al 1981). Dual-photon absorptiometry is ideally suited for measurement of the bone changes seen with immobilization and for evaluation of preventive agents and of therapy.

METHODS

Local area measurements are usually done on the lumbar spine because of the high sensitivity of this zone to both disease processes and to therapeutic agents. The radionuclide source is coupled to a collimated scintillation detector on a rigid yoke which can be passed in a rectilinear raster pattern across the patient. Detector collimation must be relatively small (1 cm) to minimize the influences of scattered radiation. Corrections in the data must be made for:

- (a) count loss due to amplifier deadtime
- (b) background radiation
- (c) Compton-scatter in the detector crystal
- (d) scattered radiation from the subject
- (e) beam-hardening by soft-tissue

For spine scans a transverse speed of 2 to 5mm/sec is used with longitudinal steps of 3 to 5mm. For total skeletal scans the transverse speed is 1 to 3cm/sec with step intervals of 1 to 3cm. Initially data was collated on magnetic tape for subsequent analysis but direct on-line calculations are now possible using microcomputers.

A special microcomputer-based dual-photon system has been used for scanning the spine of monkeys at Ames Research Center over the past three years. That system has been used in measuring adult male pigtail monkeys (8-15kg in body weight) as well as smaller (1.5-3.2kg) adult Cebus monkeys. The precision in measurement of standards was 1.6%. Spinal scans were performed on 50 monkeys (3-5 replications) to assess precision. In 55.4% of the animals the variability was under 3% and these monkeys were selected for later use in biological experiments.

A similar system is used for spinal scanning on humans at the University of Wisconsin. The precision on standards was about 1%.

ORIGINAL PAGE IS
OF POOR QUALITY

HIGH PRECISION MEASUREMENT

It has been possible recently to diminish the precision error for remeasurement of both spinal and total body mineral without any increase of dose. Some improvement has been achieved by decreasing the usual step interval. At the same time the transverse speed was increased to keep the time of scanning (and dose) constant. For spine scans a step interval of about 3mm provides better resolution than the usual step interval of 4.5mm while the transverse scan speed can be increased to 4 or 5mm/sec. The precision on a 10 cm long area covering L4 through L2 is given in Table 1 at different speeds and step intervals.

Table 1. Precision of remeasurement on a lumbar spine in vitro

<u>SPEED</u>	<u>STEP</u>	<u>n</u>	<u>DENSITY</u> <u>(g/cm²)</u>	<u>CV(%)</u>
2.5 mm/sec	3.0	44	.934	.61
2.5 mm/sec	4.5	21	.929	.67
2.5 mm/sec	10.0	10	.953	1.35
5.0 mm/sec	3.0	33	.953	.52
5.0 mm/sec	4.5	10	.949	.74
5.0 mm/sec	10.0	30	.917	.80

The above results show that the area density of a series of vertebrae can be determined with a fairly low precision error even without precise relocation. The variation about the average value for the six different series was only 1.5%. This reflects the relative uniformity (3%) along the spine in area density compared to the variability in density of the body itself (about 10%).

Similarly, procedures for measurements of TBBM have been refined over the past years. The previous transverse scan speed of 2 cm/sec. has been doubled and the step interval has been reduced to 1.3 mm from 2.6 mm. With the previous procedure the precision of measurement on an isolated skeleton was 1.4% (n=142) over a 4-year period, but with the new procedure the precision error was 0.7%. This same low precision error was observed in one study on normal subjects while the error in osteoporotic patients was 1.2% (Chris Gallagher, personal communication). The precision error in spinal density from a total body scan was about 3% (n=12).

IMMOBILIZATION STUDIES

Studies have been carried out in several centers on immobilized patients and monkeys using dual-photon scanning. One of the first studies was done on the third lumbar vertebrae of 13 adolescent girls immobilized for 3 to 6 weeks for correction of scoliosis (Roos 1974). The average bone loss was 1 to 2% per week. The four least mature girls at the time of operation regained all lost bone 5 years later while nine others showed variable recovery and five did not regain the lost bone. The bone loss in 34 adults immobilized for 11 to 61 days was somewhat less than in the adolescents (0.9% 0.3% per week) but in these cases reambulation led to complete recovery in 15 weeks (Krolner and Toft 1982). In another study (Krolner et al 1982) exercise was shown to increase spinal bone mineral. In

ORIGINAL PAGE IS
OF POOR QUALITY.

two monkeys immobilized for 4 weeks and 11 weeks the bone loss from the lumbar spine was 1.2% and 0.5% per week. Thus dual-photon results on the spine confirm the pattern of loss observed by histomorphometry of the pelvis (Minaire et al 1974). It is interesting that the rate of bone loss from the os calcis, observed with single-photon (^{125}I) absorptiometry, was very similar to that seen in the axial skeleton (Vogel and Whittle, 1976).

CONCLUSIONS

Low precision errors are essential for monitoring bone changes with immobilization and with space flight. The best precision seems to be obtained with gamma-ray CT of the extremities where errors of about 0.5% can be achieved (Rueggsegger et al 1981). However, changes in the extremities may not accurately reflect changes in other areas of trabecular bone, such as the spine. For example, there may be a latency of several weeks before bone loss occurs in the distal radius or os calcis when the body is immobilized, yet this delay does not occur in the spine or pelvis. In fact, trabecular bone of the adult radius does not decrease at all with immobilization (though that of adolescents does). Consequently, studies are needed to demonstrate if the precise gamma-ray CT results on lower limbs do in fact correlate with spinal results. Similarly, the studies done on astronauts using ^{125}I -absorptiometry of the os calcis suggest that a slightly more precise improvement of that method could prove valuable for evaluation of bone with immobilization and/or space flight. Conventional X-ray CT simply cannot be used to examine the spine even if its relatively poor precision (5%) can be overcome because the method is very inaccurate (30% error). The large changes of marrow fat (2%/week) that can occur with immobilization (and perhaps with reambulation) render this approach invalid. Dual-photon absorptiometry of the spine has a definite role to play in (a) providing a noninvasive criterion against which other techniques may be evaluated, and (b) providing an errorfree modality for precise assessment of bone changes during and after space flight. Dual-photon absorptiometry also can provide a measurement of TBBM and hence of total body calcium (which is about 37% of TBBM). Sequential observations of TBBM could eliminate the need for costly and time-consuming studies of calcium balance and thereby facilitate evaluation of dietary factors in the space environment. Adequate results can be achieved with instrumentation that is readily available in both Europe and the United States.

Supported by NASA-Y-NGR-50-002-051 and NAG2-166.

REFERENCES

- Dunn, W.L., Wahner, H., and Riggs, B.L., 1980. Measurement of bone mineral content in human vertebrae and hip by dual-photon absorptiometry. Radiology 136:485-487.
- Judy, P.F., 1971. A Dichromatic Attenuation Technique for the In Vivo determination of Bone Mineral Content. Ph.D. thesis in Radiological Sciences, University of Wisconsin, Madison, Wisconsin.
- Krolner, B. and Pors Nielsen, S., 1980. Measurement of bone mineral content (BMC) of the lumbar spine, I. Theory and application of a new

ORIGINAL PAGE IS
OF POOR QUALITY

- two-dimensional dual-photon attenuation method. Scand. J. Clin. Lab. Invest. 40:653-663.
- Krolner, B. and Toft, B., 1982. Effect of immobilization on lumbar spine bone mineral content. Presented at NASA Meeting on Immobilization and Bone, San Francisco.
- Krolner, B., Tondevold, E., Toft, B., Berthelsen, B., and Pors Nielsen, S., 1982. Bone mass of the axial and the appendicular skeleton in women with Colles' fracture: its relation to physical activity. Clinical Physiology 2:147-157.
- Mazess, R.B., Orth, M., Judy, P., and Mather, W., 1970. Absorptiometric bone mineral determination using ^{153}Gd . In: J.R. Cameron (ed.) Proc. Bone Measurement Conference pp. 308-312, USAEC Conf. 700515.
- Mazess, R.B., Wilson, C.R., Hanson, J., Kan, W., Madsen, M., Pelc, N., and Witt, R., 1974. Progress in dual photon absorptiometry of bone. In: P. Schmelting (ed.) Proc. Symp. Bone Mineral Determinations. Aktiebolaget Atomenergi Publ. AE-489, Vol. 2, pp.40-52. Studsvik, Nykoping, Sweden.
- Mazess, R.B., Peppler, W.W., Chesnut, C.H., Nelp, W.B., Cohn, S.H., and Zanzi, I., 1981. Total body bone mineral and lean body mass by dual-photon absorptiometry. II. Comparison with total body calcium by neutron activation analysis. Calc. Tiss. Int. 33:361-363.
- Minaire, P., Meunier, P., Edouard, C., Bernard, J., Courpron, P., and Bourret, J., 1974. Quantitative histological data on disuse osteoporosis; comparison with biological data. Calc. Tiss. Int. 17:57-73.
- Peppler, W.W. and Mazess, R.B., 1981. Total body bone mineral and lean body mass by dual-photon absorptiometry. I. Theory and measurement procedure. Calc. Tiss. Int. 33:353-359.
- Price, R.R., Wagner, J., Larsen, K., Patton, J., and Brill, A.B., 1976. Regional and whole-body bone mineral content measurement with a rectilinear scanner. Am. J. Roentgenol. 126:1277-1278.
- Riggs, B.L., Wahner, H.W., Dunn, W.L., Mazess, R.B., Offord, K.P., and Melton, L.J. III, 1981. Differential changes in bone mineral density of the appendicular and axial skeleton with aging. J. Clin. Invest. 67:328-335.
- Roos, B., 1974. Dual Photon Absorptiometry In Lumbar Vertebrae. Akademisk Avhaling, Goteborg.
- Ruegsegger, P., Anliker, M., and Dambacher, M., 1981. Quantification of trabecular bone with low dose computed tomography. Journal of Computer Assisted Tomography 5(3):384-390.
- Vogel, J.M. and Whittle, M.W., 1976. Bone mineral content changes in the Skylab astronauts. Amer. J. Roentgenol. 126:1296-1297.