



N83-22289

THE SHUTTLE ENVIRONMENT WORKSHOP

Jules Lehmann, Workshop Organizer
Shelby G. Tanner, Co-Editor
Tom Wilkerson, Co-Editor

A Workshop sponsored by the
NASA Office of Space Science and Applications
Held at the Ramada Inn
Calverton, Maryland
October 5-7, 1982

February 1983

Prepared for
NATIONAL AERONAUTICS AND SPACE ADMINISTRATION
by
Systematics General Corporation
Contract NAS5-27362

REPRODUCED BY
NATIONAL TECHNICAL
INFORMATION SERVICE
U.S. DEPARTMENT OF COMMERCE
SPRINGFIELD, VA. 22161

(NASA-CR-170496) THE SHUTTLE ENVIRONMENT
WORKSHOP Final Report (Systematics General
Corp.) 327 p HC A15/MF A01 CSCI 22B

N83-22289
THRU
N83-22312
Unclas
08788

G3/16

1. Report No.	2. Government Accession No.	3. Recipient's Catalog No.	
4. Title and Subtitle The Shuttle Environment Workshop		5. Report Date February 1983	6. Performing Organization Code
		8. Performing Organization Report No. 24-5087	
7. Author(s) Jules Lehmann, Workshop Organizer Shelby Tanner, Co-Editor Tom Wilkerson, Co-Editor		10. Work Unit No.	
9. Performing Organization Name and Address Systematics General Corporation 1606 Old Ox Road Sterling, Virginia 22170		11. Contract or Grant No. NAS5-27362	
		13. Type of Report and Period Covered Final	
12. Sponsoring Agency Name and Address NASA Goddard Space Flight Center Greenbelt, Maryland		14. Sponsoring Agency Code	
		15. Supplementary Notes	
16. Abstract <p>The Shuttle Environment Workshop was a three-day meeting sponsored by the Spacelab Flight Division of the NASA Office of Space Science and Applications for users of the Space Shuttle interested in obtaining information on what the Shuttle environment is like and what to expect in the payload bay.</p> <p>The Workshop was attended by industry, university, and government personnel concerned with the payload bay as experimenters, users, manufacturers, and vehicle integrators. Approximately 360 people attended the Workshop and participated in technical sessions on Environmental Measurements, Infrared, Ultraviolet, and Space Plasma experiments.</p> <p>Results of Shuttle environmental measurement programs were presented during the first two days of the Workshop. Panels of experts then discussed the implications for Plasma, Infrared and Ultraviolet experiments. The Workshop covered pre-launch environmental conditions, results of key environmental measurements made during the flights of STS-1, -2, -3, -4, and post-landing environmental conditions.</p> <p>The overall areas of concern from the Shuttle Environment Workshop and the recommendations from the participants are presented in summary form in this report.</p> <p>A summary of each of the papers presented in the Environmental Measurements Session is presented. The papers themselves are presented in full in an Appendix to the publication. A synopsis of the deliberations and recommendations of the Infrared, Ultraviolet and Plasma Panel sessions is given. Comments regarding the future outlook for the Shuttle given in the report were derived from transcripts of presentations made at the Workshop during the final plenary session.</p>			
17. Key Words (Suggested by Author(s)) Space Shuttle Environmental Contamination Infrared Ultraviolet		18. Distribution Statement Space Plasma EMI/EMC Thermal Optical Emissions	
19. Security Classif. (of this report) Unclassified	20. Security Classif. (of this page) Unclassified	21. No. of Pages 365	22. Price*

NOTICE

THIS DOCUMENT HAS BEEN REPRODUCED FROM THE BEST COPY FURNISHED US BY THE SPONSORING AGENCY. ALTHOUGH IT IS RECOGNIZED THAT CERTAIN PORTIONS ARE ILLEGIBLE, IT IS BEING RELEASED IN THE INTEREST OF MAKING AVAILABLE AS MUCH INFORMATION AS POSSIBLE.



THE SHUTTLE ENVIRONMENT WORKSHOP

Jules Lehmann, Workshop Organizer
Shelby G. Tanner, Co-Editor
Tom Wilkerson, Co-Editor

**A Workshop sponsored by the
NASA Office of Space Science and Applications
Held at the Ramada Inn
Calverton, Maryland
October 5-7, 1982**

February 1983

**Prepared for
NATIONAL AERONAUTICS AND SPACE ADMINISTRATION
by
Systematics General Corporation
Contract NAS5-27362**

i.b

ORIGINAL PAGE IS
OF POOR QUALITY.

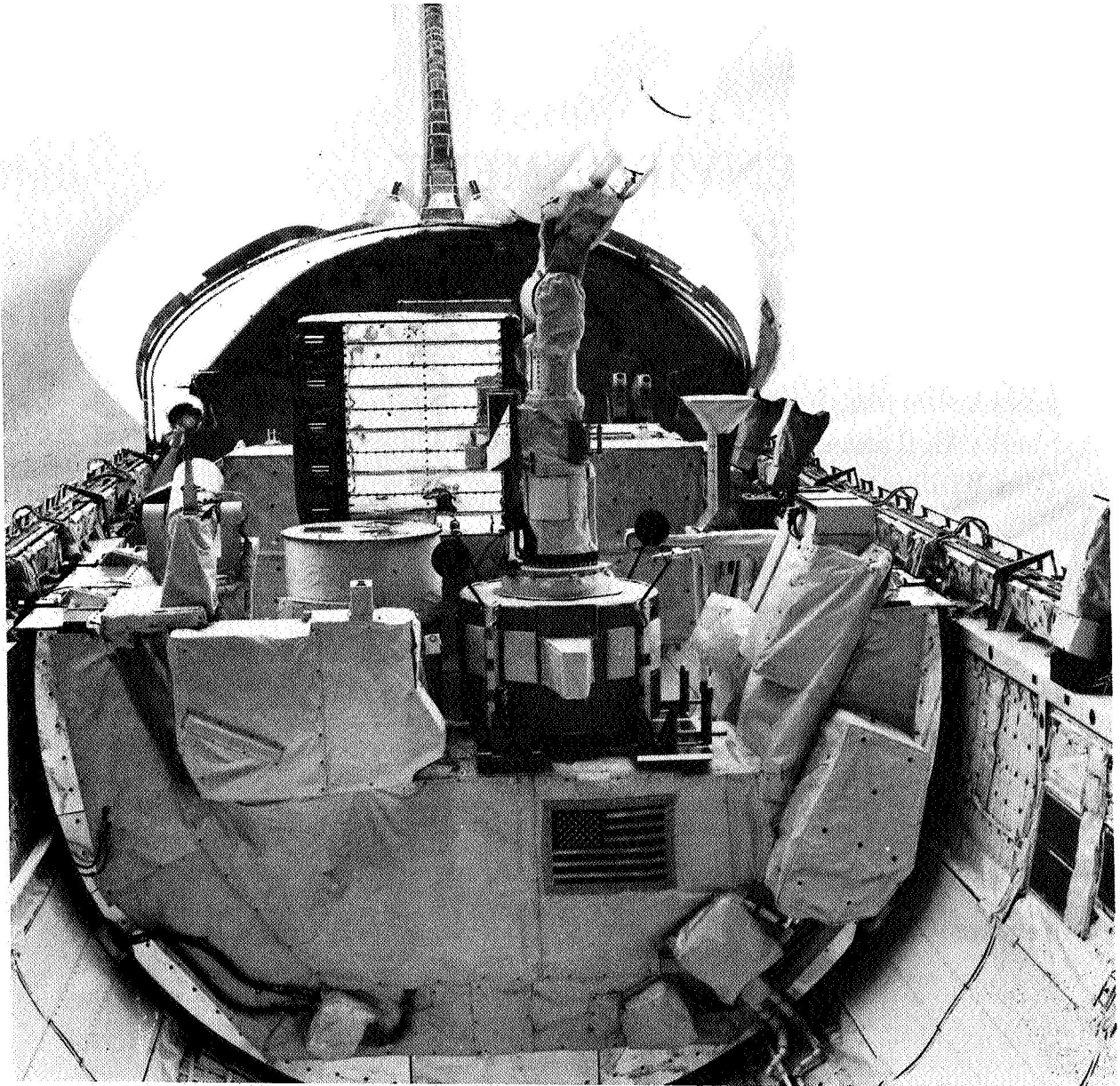

FRONTISPIECE - THE SHUTTLE PAYLOAD BAY

PREFACE

The Shuttle Environment Workshop was a three-day meeting sponsored by the Spacelab Flight Division of the NASA Office of Space Science and Applications for users of the Space Shuttle interested in obtaining information on what the Shuttle environment is like and what to expect in the payload bay.

The Workshop was attended by industry, university, and government personnel concerned with the payload bay as experimenters, users, manufacturers, and vehicle integrators. Approximately 360 people attended the Workshop and participated in technical sessions on Environmental Measurements, Infrared, Ultraviolet, and Space Plasma experiments.

The Workshop was organized by Mr. Jules Lehmann of the Spacelab Flight Division. Dr. Tom Wilkerson of the University of Maryland was the Technical Chairman. Dr. Lubert Leger of the Johnson Space Center and Mr. Ed Miller of the Marshall Space Flight Center were responsible for organizing the Environmental Measurements Session. Dr. Warren Hovis of the National Oceanic and Atmospheric Administration was the Chairman of the Infrared Panel. Dr. Theodore Gull of the NASA Goddard Space Flight Center was Chairman of the Ultraviolet Panel and Dr. Roger Williamson of Stanford University was the Chairman of the Space Plasma Panel. Administrative and logistics support and documentation preparation for the Workshop was provided by Mr. Shelby Tanner and Mrs. Julie Sheehan and other members of the staff of Systematics General Corporation, Sterling, Virginia under Contract NAS5-27362.

Results of Shuttle environmental measurement programs were presented during the first two days of the Workshop. Panels of experts then discussed the implications for Plasma, Infrared and Ultraviolet experiments. The Workshop covered pre-launch environmental conditions, results of key environmental measurements made during the flights of STS-1, -2, -3, and -4, and post-landing environmental conditions.

The overall areas of concern from the Shuttle Environment Workshop and the recommendations from the participants are presented in summary form in Chapter I of this report.

A summary of each of the papers presented in the Environmental Measurements Session is presented in Chapter II of this report. The papers themselves are presented in full in Appendix A of this publication. A synopsis of the deliberations and recommendations of the Infrared, Ultraviolet and Plasma Panel sessions is given in Chapter III. Comments regarding the future outlook for the Shuttle given in Chapter IV were derived from transcripts of presentations made at the Workshop during the final plenary session.

TABLE OF CONTENTS

	Page
Preface	iii

CHAPTER I

EXECUTIVE SUMMARY AND WORKSHOP PROCEDURES

Introduction	1
Summary of Panel Findings	5

CHAPTER II

ENVIRONMENTAL MEASUREMENTS SESSION SUMMARIES

Introduction	9
EMI/EMC and Vibroacoustics	10
Thermal Measurements	10
KSC Shuttle Ground Turnaround Evaluation	11
Evaluation of the Ground Contamination Environment for STS Payloads	11
Low Earth Environment Interaction with Vehicle Surfaces - Material Effects	11
Observations of Optical Emissions From STS-3	12
Observations of Optical Emissions on STS-4	12
Induced Environment Contamination Monitor Ascent/Entry, Optical and Deposition Measurements	12
Induced Environment Contamination Monitor Mass Spectrometer Results	13
Modeling Correlation with Flight Data	13
Effects of Shuttle Environment on Instrument Performance	14
OSS-1/Contamination Monitor	14
Test for Contamination of MgF ₂ Coated Mirrors	15

Preceding page blank

TABLE OF CONTENTS
(continued)

	Page
Vehicle Charging and Potential on the STS-3 Mission	15
STS-3/OSS-1 Plasma Diagnostics Package (PDP) Measurements of the Temperature Pressure, and Plasma.	15
STS-3/OSS-1 Plasma Diagnostics Package (PDP) Measurements of Orbiter Transmitter and Subsystem Electromagnetic Interference	16
OSS-1/STS-3 Shuttle Induced Atmosphere Experiment	16
Solar Ultraviolet Spectral Irradiance Monitor Experiment on OSS-1	16
Results of Thermal Environment Measurements on the Thermal Cannister Experiment and Get Away Special Enclosure	16
STS-3 "Snowflake" Study.	17
Space Shuttle: A View of What We Have Done So Far.	17

CHAPTER III

**REPORTS OF THE INFRARED, ULTRAVIOLET
AND SPACE PLASMA PANELS**

Introduction	19
Infrared Panel Report	19
Ultraviolet Panel Report	23
Space Plasma Panel Report	27

CHAPTER IV

FUTURE OUTLOOK AND COMMENTS

Introduction	31
Environmental Measurements	32

TABLE OF CONTENTS
(continued)

	Page
Contamination Effects	33
Orbiter Constraints on Deployable Payloads	33
Documentation and Environmental Information	34
Ultraviolet Experiments	34
Infrared Experiments	36
Plasma Experiments	37
Shuttle Lidar	39

APPENDIX A

Papers Presented in Environmental Measurements Workshop	A-1
---	-----

APPENDIX B

List of Attendees	B-1
-------------------------	-----

CHAPTER I

EXECUTIVE SUMMARY AND WORKSHOP PROCEDURES

INTRODUCTION

The success of the experimental flights of the Space Shuttle Columbia have led the way to a new era in space. The Shuttle success brings a new capability for placing large payloads into orbit, and for retrieving those payloads for analysis and reflight. This offers scientific investigators and users an exciting opportunity for much more complex instruments and comprehensive investigations than have been feasible heretofore. With this excitement comes the potential of re-igniting the interest of the American people in the nation's space program.

From the inception of the Shuttle program, NASA was concerned about the Shuttle environment. Much work was done by NASA scientists and engineers to create a payload bay environment that would be compatible with virtually any payload NASA could launch. NASA has succeeded in conducting measurements of the environment and in ensuring a relatively clean payload during the pre-launch, flight and post-launch phases.

One of the main experimental monitors used by NASA to determine the environment in the payload bay was the Induced Environment Contamination Monitor. This package of instruments has made environmental measurements during STS flights with a high degree of success. This has shown that the Shuttle environment is relatively free of contaminants, except for special instances of increased abundance of methane, water vapor and particulates. Results of these measurements are rapidly becoming more available.

In establishing the Shuttle Environment Workshop, NASA shared the findings with scientific experimenters, users and other individuals who need to know what the Shuttle is like and what future experimenters may expect in the payload bay. The Workshop was centered around results obtained from the environmental measurements made on the Shuttle.

The Program Agenda for the Workshop is given in Table 1. Figure 1 indicates the procedures and flow of communications for the Workshop. The first two days of the meeting were devoted to the Environmental Measurements session in which speakers made presentations to all Workshop attendees. Question-and-answer sessions followed the presentations, clarifying points and, in some cases, bringing out new details. Chapter II of the Proceedings contains the presentation summaries. All attendees were urged to submit written questions for consideration by Panels (lower right). Following the presentations of results, the three Panels addressed specific issues of concern to Panel participants, and considered the questions that were submitted.

TABLE I



SHUTTLE ENVIRONMENT WORKSHOP PROGRAM

TUESDAY, OCTOBER 5th

7:30 Registration
 8:30 Welcome
 8:40 Introductory Remarks
 8:50 Workshop Plans and Panel Structure

PLENARY SESSION ENVIRONMENTAL MEASUREMENTS
 Introduction by Chairmen
 Summary of EM/EMC and Vibration
 Summary of Thermal Measurements

QUESTIONS AND ANSWERS
 BREAK
 KSC Shuttle Ground Turnaround Evaluation
 Ground Environment Evaluation

QUESTIONS AND ANSWERS
 LUNCH
 Low Earth Orbital Environment Interaction with Vehicle Surfaces
 Material Effects
 Vehicle Glow
 Glow Spectral Measurements

QUESTIONS AND ANSWERS
 Induced Environment Contamination Monitor
 Ascent/Reentry
 Optical Measurements

QUESTIONS AND ANSWERS
 BREAK

4:00 Induced Environment Contamination Monitor (Cont.)
 Deposition
 Mass Spectrometer

5:00 **QUESTIONS AND ANSWERS**
 5:30 **ADJOURN**
 6:30 **COCKTAIL PARTY - Cash Bar**

WEDNESDAY, OCTOBER 6th

8:00 Opening Remarks
 8:10 Modeling Correlation with Flight Data
 8:30 OSTA-1
 8:50 OSS-1 Measurements
 Contamination Monitor and Surface Effects

9:20 Test for Contamination of Magnesium Fluoride (MgF₂)
 Coated Mirrors
 BREAK
 OSS-1 Measurements (Cont.)
 Vehicle Charging and Potential

9:30 Plasma Diagnostics
 9:45 EM/EMC
QUESTIONS AND ANSWERS
 LUNCH
 OSS-1 Measurements (Cont.)
 Induced Atmosphere

1:30 Solar U.V. Spectral Irradiance
 1:45 Solar Flare X-Ray Polarimeter
 2:00 Thermal Environment

TUESDAY, OCTOBER 6th (Cont.)

2:30 The Microablation Foil Experiment (MFE)
QUESTIONS AND ANSWERS
 BREAK
 3:15 Other Measurements
 The Particulate Environment of STS-3 as Observed by the Cargo Bay Television System

3:30 Radar Detection of Particles Near Orbiting Manned Spacecraft
 4:00 Other Papers and Speakers to be Selected
 4:15 **QUESTIONS AND ANSWERS**
 5:00 Summary and Panel Session Plans

WEDNESDAY, OCTOBER 7th

6:30 Panel Sessions
 Plasma Panel, New York Room
 Discussion of Questions
 Recommendations from Panel
 Infrared Panel, North Carolina Room
 Discussion of Questions
 Recommendations from Panel
 Ultraviolet Panel, Pennsylvania Room
 Discussion of Questions
 Recommendations from Panel
 11:00 **BREAK**
 11:15 Moderator's Work Session
 12:00 **LUNCH**

WORKSHOP DISCUSSION AND RECOMMENDATIONS
 1:00 Panel Reports to Workshop
 Plasma Panel Report
 Infrared Panel Report
 Ultraviolet Panel Report
 2:30 **BREAK**
 2:45 Discussion of the Compatibility of Shuttle Environment and Experiments

7:00 Panel Sessions
 Plasma Panel, New York Room
 Introduction and Objectives
 Organization of Submitted Questions
 Discussion of Questions
 Recommendations from Panel
 Infrared Panel, North Carolina Room
 Introduction and Objectives
 Organization of Submitted Questions
 Discussion of Questions
 Recommendations from Panel
 Ultraviolet Panel, Pennsylvania Room
 Introduction and Objectives
 Organization of Submitted Questions
 Discussion of Questions
 Recommendations from Panel
 9:00 **ADJOURN**

Participants:
 T. Wilkerson, University of Maryland
 L. Leger, JSC
 E. Miller, MSFC
 R. Williamson, Stanford University
 W. Hovis, NOAA
 T. Gull, NASA/GSFC

THURSDAY, OCTOBER 7th

J.A.M. McDonnell,
 W. C. Carey,
 Kent University
 The Microablation Foil Experiment (MFE)
QUESTIONS AND ANSWERS
 BREAK
 3:15 Other Measurements
 The Particulate Environment of STS-3 as Observed by the Cargo Bay Television System

3:30 Radar Detection of Particles Near Orbiting Manned Spacecraft
 4:00 Other Papers and Speakers to be Selected
 4:15 **QUESTIONS AND ANSWERS**
 5:00 Summary and Panel Session Plans
 7:00 Panel Sessions
 Plasma Panel, New York Room
 Introduction and Objectives
 Organization of Submitted Questions
 Discussion of Questions
 Recommendations from Panel
 Infrared Panel, North Carolina Room
 Introduction and Objectives
 Organization of Submitted Questions
 Discussion of Questions
 Recommendations from Panel
 Ultraviolet Panel, Pennsylvania Room
 Introduction and Objectives
 Organization of Submitted Questions
 Discussion of Questions
 Recommendations from Panel
 9:00 **ADJOURN**

Participants:
 T. Wilkerson, University of Maryland
 L. Leger, JSC
 E. Miller, MSFC
 R. Williamson, Stanford University
 W. Hovis, NOAA
 T. Gull, NASA/GSFC

Participants:
 T. Wilkerson, University of Maryland
 L. Leger, JSC
 E. Miller, MSFC
 R. Williamson, Stanford University
 W. Hovis, NOAA
 T. Gull, NASA/GSFC

Participants:
 T. Wilkerson, University of Maryland
 L. Leger, JSC
 E. Miller, MSFC
 R. Williamson, Stanford University
 W. Hovis, NOAA
 T. Gull, NASA/GSFC

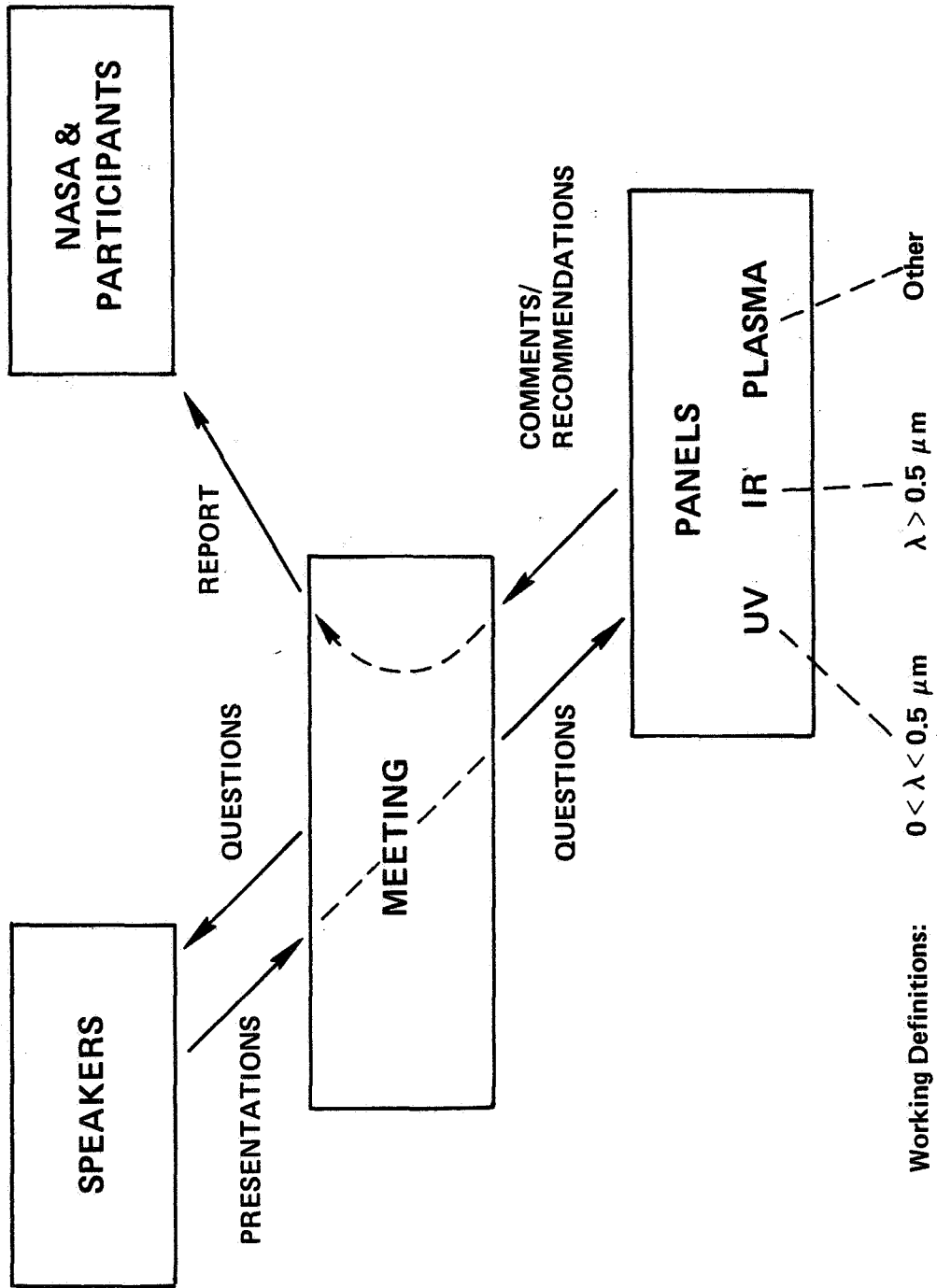

Figure 1. SHUTTLE ENVIRONMENT WORKSHOP PROCEDURES

TABLE 2

**AREAS OF CONCERN FROM THE SHUTTLE ENVIRONMENT WORKSHOP
AND RECOMMENDED ACTIONS**

	Area of Concern	Recommended Actions
1.	Vehicle Glow: Optical contamination	Study glow and coordinate with other agencies
2.	Particulates: Optical contamination, damage to surfaces	Eliminate source or minimize effect, and clean up ground environment
3.	Operational Vehicle Data: Vehicle influence on observations	Redesign information system to make data available more easily
4.	Users/Operators Interface: Mismatch of environment and experiment requirements	Management to re-examine and improve the user-operator interfaces
5.	Environmental Qualifications: Feedback from measurements to future operations	Review, modify procedures based on measurements
6.	Erosion of Materials: Degradation of essential components	Avoid use of affected materials; use substitutes
7.	Gas Environment: Role of vehicle payload, thrusters, atmosphere	Establish more measurements to determine parameters under varying conditions
8.	Operational Monitoring: Flight intercomparisons needed for planning	Develop standardized monitoring module with other users
9.	Induced Electric Fields: Uncertain vehicle effects, and microwave transmission	Review EMI test plan and include all frequencies and environmental conditions
10.	Temperature: Damage to instruments, compromise data	More extensive temperature measurements, and provide protection options

The Panels represented three major classes of instruments/measurements on future Shuttle missions. Their purpose was to reflect on the material presented in the meeting, on the basis of their experience with operations in space, and make recommendations to NASA accordingly. The Panels met in an evening and a morning session and reported back to the Workshop as a whole. A group of "areas of concern" was developed in these Panels for general consideration, and detailed recommendations were made to the Workshop at large. These recommendations appear in Chapter III of the Proceedings, which is the "report" called out in the figure (upper right). Summary comments and the outlook for the future made by several of the principals of the Workshop were presented in the final session. These comments are included in the Proceedings in Chapter IV.

SUMMARY OF PANEL FINDINGS

This summary highlights the areas of concern from the Infrared, Ultraviolet, and Space Plasma Panels of the Shuttle Environment Workshop. These areas and the recommended actions from the Workshop deliberations are itemized in Table 2. The Panels expressed concerns falling into the following areas:

- Vehicle Glow
- Particulates
- Operational Vehicle Data
- User/Operator Interface
- Environmental Qualifications
- Erosion of Materials
- Gas Environment
- Operational Monitoring
- Induced Electric Fields
- Temperature

Summaries of each topic are given in the following paragraphs.

I. Vehicle Glow

The properties of this glow need to be determined. Information is needed on the following:

- spectrum and intensity
- vehicle surfaces involved
- geometry of glow layer around vehicle (thickness and extent)
- dependence on altitude and surface materials
- day/night effects
- ways to minimize glow contamination of optical measurements
- relationship (if any) of glow to surface deterioration

Although the origin of the glow is important from a scientific standpoint, the above practical questions need to be answered first for maximum benefits to early Shuttle flights. NASA, DoD, and other organizations are all concerned.

2. Particulates

The data on particulates are confusing at present, even though some sensational imagery has been recorded with cameras in the payload bay of the Shuttle. Several sources of particles are known to exist: debris released during initial payload bay door opening, (2) ice particles which are known to form, with the dumping of waste water, (3) water released from thermal protection system (developmental problem), (4) particles released from aft end of vehicle (also probably associated with developmental problem). However, IECM data indicates that the particle environment is within specifications for a significant portion of each mission after the first 24 hours of the mission. These possible particles source correlations need to continue to better define the particle environment. Apparently, the ground environment of the Shuttle needs to be made cleaner with regard to the accumulation of dust on surfaces.

3. Operational (Vehicle) Data

The need has been expressed for additional (and more timely) operational data to compare with events detected by experimenters. Part of this problem appears to be the long lead time needed for the vehicle people to reply to a specific request by experimenters. Another part is the great volume of operational data that might conceivably be wanted by experimenters. The continuing impasse on this issue, attested to by several scientists and engineers, may be a management/communications problem that needs to be addressed by NASA.

4. Management System for Shuttle Environment and Communications between Experimenters and Vehicle Engineers

There is a recurring dialogue in which experimenters are characterized as not knowing how to specify their Shuttle environment needs, and engineers are described as reluctant to say what the environment will be like unless expensive procedures are instituted. Given that both groups are clearly striving for the best possible results (and have achieved many of their goals), work is needed at the management level to resolve this situation. A sound "conflict management" process could help identify the sources of the problem and point to a solution.

5. Definition of Environmental Specifications for Operations on the Ground and In Orbit

The process whereby these specifications are set up, and how they may be modified by experience and measurements, needs to be reviewed and elucidated for the users - and perhaps modified. Not many of those present at the meeting seemed to know how the clean room specifications at KSC were set up, how to have it adjudicated whether a given improvement can be made without undue costs, etc. NASA needs to face this issue squarely or there will be a continuing potential for unfair criticism of the Shuttle project and environment.

6. Loss of Material

The attrition of selected surfaces in the Shuttle environment needs to be documented more completely, and the consequences assessed for:

- thermal control of vehicle and payload
- contributions to gaseous species
- sources for particulates observed
- effects on exposed optical reflectors and coatings
- possible substitution of other materials at key points on the vehicle and in payload.

7. Gas Environment

The gaseous environment around the Orbiter needs better definition. Sources discussed so far include:

- thruster firings
- vehicle outgassing/venting
- payload outgassing/venting
- "ram" from the atmosphere
- leak of cabin pressure
- chemical interactions of the above

8. Routine Payload/Vehicle Monitoring

In addition to the extensive monitoring systems already in use, it has been proposed that standardized monitoring modules be flown on every operational Shuttle flight. Costs and benefits of this proposal need to be considered. The principle seems sound - while it is not clear that such a monitor will be representative of the environment on any given flight, or typical of a set of flights, in view of changes from payload to payload. However, standard items such as upper stages may need additional measurements.

9. Induced Electric Fields

While some of the data show that the Shuttle affords a fairly benign electromagnetic environment (DC to high frequency), there seem to be gaps in: (1) the understanding of the relationship of the field to vehicle operations; and (2) the certainty that the payload bay is safe from EMI problems for all possible microwave operations (e.g., Ku band). The test plan for EMI checkout may need to be reviewed to satisfy all the users.

10. Temperature

While measured temperatures have agreed well with modeled data, one anomalous temperature measurement of 260⁰ needs to be documented more fully.

CHAPTER II

ENVIRONMENTAL MEASUREMENTS SESSION SUMMARIES

INTRODUCTION

The Shuttle Environment Workshop was organized to present data collected during flights STS-1 through STS-4 relating to the definition of the environment associated with Shuttle flight. Although the "environment" is generally considered to include all aspects, i.e., vibroacoustics, loads, thermal, electromagnetic and contamination in the form of light emissions, particles and gases, only a limited number of these aspects could be covered in detail at this conference. Prime emphasis was placed in presenting data from payloads flown on the subject flights including results from the Induced Environment Contamination monitor (IECM). Brief summaries of the vibroacoustics, loads, electromagnetic and thermal aspects of the environment, as derived from Shuttle system measurements, were presented primarily to indicate where the environment was different than observed and, therefore, where specification changes may be forthcoming. In addition, brief summaries of two somewhat unexpected effects, the "vehicle glow" and interaction between the low earth environment and Shuttle payload bay materials were presented as an aid in interpreting other environmental data.

Papers for each payload/experiment involved in Shuttle flights were presented essentially in flight-related chronological order. A significant portion of time was allocated for presentation of IECM data since this payload was flown on STS-2, STS-3, and STS-4 and, therefore, represents the largest data base relative to the contamination environment. Comparison of data gathered using the IECM on these three flights in question could be made. Summaries of papers presented follow and copies of the presentation material used by each speaker are included in Appendix A.

In general summary form the following comments regarding the data presentation portion of the workshop are appropriate. Information collected from the first four Shuttle flights represent a significant base which can be used for assessment of the Shuttle environment not only in the area of contamination but also for the electromagnetic aspects as measured by portions of the OSS-1 payload. This conclusion can be drawn in spite of the preliminary nature of the measurements presented. Although not covered in detail at this workshop, a large number of measurements relating to the vibroacoustics, load and thermal environments also have been made.

The contamination measurements made to date, however, present only a limited view of the Shuttle operational environment, since mission planning for the subject flights was driven by system performance assessment considerations and was not optimized for contamination assessment. For example, it has been recognized for years that contamination sensitive measure-

Preceding page blank

since they were expected to perturb the environment significantly. There were periods that did represent operational conditions typical of that which can be expected by sensitive payloads. Under such conditions and taking into account the development nature of the flights, the operational limitations as previously discussed and the unexpected low earth environmental interaction with the vehicle, the Shuttle environment does seem to be in compliance with the contamination requirements as originally defined. This assessment is limited by the extent of the data gathered to date. For example, background light emission measurements have not been made in the far ultraviolet and infrared portions of the spectrum so that detailed assessment of the environment in these spectral regions will have to await data from future payloads. Information of this nature will define detail operational characteristics of the Shuttle and allow proper planning of future missions.

EMI/EMC AND VIBROACOUSTICS

Payloads to be flown on the Orbiter must be able to withstand the induced environment that will be present in the payload (P/L) bay during main engine ignition, SRB ignition/lift-off, transonic/max Q, and entry/ landing. A comprehensive study was conducted during the orbital flight test (OFT) program to affirm the predicted induced environment that would be present in the P/L bay. The induced environments of major concern are loads from structural responses, random vibration generated by the acoustic environment at lift-off, the aeronoise environment during ascent, and the mechanically-induced vibration. Data for study were obtained from microphones located in the P/L bay and from accelerometers located on structural members of the bay. Additional data were obtained from transducers located on the payloads that were flown on the OFT flights. The measured flight data were compared with the analytical predictions and were found to be equal to or less than the predictions.

The electromagnetic environments to be considered in the design and development of STS cargo are currently defined in the Core ICD. Environmental data are based on vehicle level testing (OV-101), test data from the Shuttle Avionics Integration Lab and component level test data. No in-flight electromagnetic environmental data have been taken, and there are no plans to do so. STS performance results to date indicate that the design environments are adequate.

THERMAL MEASUREMENTS

The Orbiter payload bay on-orbit thermal data in general have been warmer than predicted. The hottest and coldest thermal environment for the payload bay occurred during STS-3. In the STS tail-to-sun and nose-to-sun attitudes, temperatures dropped to a minimum of -140°F as compared to preflight prediction of -180°F . The measured temperature on the payload bay insulation near the centerline reached 260°F as compared to preflight predicted temperature of approximately 200°F in the top-to-sun attitude.

The payload retention fitting minimum temperature ranged from -62°F on the DFI pallet longeron trunnion to -45°F on the DFI pallet keel trunnion. The flight measurements for STS-3 were 10 to 15°F warmer than predicted in the tail-to-sun or nose-to-sun attitudes and up to 30°F warmer during the top-to-sun attitude. Review of the data also shows that for a given location, the latch, rail, and trunnion temperatures were generally within 10°F of each other.

KSC SHUTTLE GROUND TURNAROUND EVALUATION

Prior to launching, STS Orbiters and their cargoes are integrated at the launch site. An overview of the various payload processing flows, facility interfaces, operational considerations, facility internal environments and the ambient KSC environment was presented to acquaint the experimenter with the conditions to which the payloads will be exposed at the launch site. Generic classes of experiments most frequently requiring stringent environmental control was discussed as well as methods of supplemental payload protection. The post-landing servicing environment was described. The early and complete identification by STS users of experiment environmental and cleanliness requirements in the requirements documents for the mission was presented as the essential first step in adequate protection of payloads. These requirement statements form the basis for KSC development of the Launch Site Support Plans (LSSP), KSC development of orbiter payload bay cleaning instructions and identification of other actions suggested for payload element protection.

EVALUATION OF THE GROUND CONTAMINATION ENVIRONMENT FOR STS PAYLOADS

The Space Transportation System must accommodate the requirements of a wide variety of spacecraft systems and experiments. The contamination environment during ground processing operations was recognized as an area of concern early in the program.

NASA established the Particles and Gases Contamination Panel (PGCP) and Contamination Requirements Definition Group (CRDG) to provide advice and define requirements. In order to define the cleanliness performance requirements for ground facilities it was necessary to review payload requirements as well as to evaluate the technology of clean facilities.

The presentation reviewed the requirements, defined terms, and discussed the results of measurements performed during checkout of facilities and ground operations through the first four STS missions. Trends and expectations in the ground contamination environment of the STS were discussed based on current data.

LOW EARTH ENVIRONMENT INTERACTION WITH VEHICLE SURFACES – MATERIAL EFFECTS

Significant surface characteristic changes have been noticed on materials that were exposed in the payload bay of the Space Shuttle Orbiter on the first four flights. The most notable change was mass loss of Kapton film used as a component of thermal blankets. This film exhibited 35% mass loss on STS-3 and loss of material was noticed on all flights. Other changes consist of rapid aging of paints, oxidation of silver and other minor effects.

A mechanism has been proposed for the effects described and involve the interaction of these organic materials with atomic oxygen available at low earth orbital altitudes. Acceleration of this oxidation reaction is probably caused by solar heating. Evidence supporting the mechanism as derived from measurements made on Shuttle materials was presented.

OBSERVATIONS OF OPTICAL EMISSIONS FROM STS-3

Photographic and television observations made during the flight of STS-3 in March, 1982 reveal the presence of three separate optical emissions which may have direct impact upon planned scientific uses of the space shuttle. The first is a bright, orangish glow which appears as a thin halo surrounding all vehicle surfaces exposed to the ram direction. Observations show that this emission competes in intensity with bright stars seen within the photographic field of view and estimates based on the airglow background give photon fluxes larger than 100,000 R. The processes giving rise to the vehicle glow phenomenon are unknown at the present time, but it has been conjectured that excited states of the hydroxyl radical (OH) as well as certain states of molecular oxygen and nitric oxide may be responsible. Based on the present results, it appears likely that the peak radiant intensity of the vehicle glow may occur in the near infrared, beyond the viewing capability of the optical instruments used on STS-3. A second major source of optical emission seen during STS-3 was luminosity produced through the firings of the Vernier and Primary Reaction Control System jets. Large, bright clouds of gas having lifetimes on the order of 0.5 to 1.0 seconds were seen frequently during the TV observation periods. The intensity of these light bursts was substantially greater than that due to vehicle glow. Based on the color film results, it appears that the principal emissions of these clouds lies in the infrared. The third source of light observed at nighttime during the flight arose from Earth's airglow emissions. When positioned correctly, the STS-3 cameras and TV systems observed a single bright emission layer at about 100 km altitude. Between this layer and the surface of Earth, a more general, diffuse emission could be readily detected. Based on other observing programs, the two principal emissions are that of atomic oxygen at 5577\AA and the combination of OH and molecular oxygen emissions at wavelengths longer than 7600\AA .

OBSERVATIONS OF OPTICAL EMISSIONS ON STS-4

Following the discovery of the intense vehicle glow of the space shuttle on the STS-3 mission a new experiment was devised rapidly and flown on the shuttle STS-4 mission. The experiment consisted of a conventional camera which was equipped with an objective transmission grating. Exposures were taken of the shuttle tail from the aft flight deck window. Shuttle glow was observed on a long (400 second) exposure and the spectrum was interpreted. It appears that the shuttle glow has a diffuse spectral component in the spectral region 6300 to 8000\AA . The flight deck window limits the observations in the range from 4000 to 8000\AA . By interpreting the shadow of the aft tail stabilizer section as it was superimposed on a bright background caused by the firing of an orbiter thruster we have found that this light is confined to a narrower spectral band in the 7200 to 8000\AA region.

INDUCED ENVIRONMENT CONTAMINATION MONITOR ASCENT/ENTRY, OPTICAL AND DEPOSITION MEASUREMENTS

A summary of ascent/entry, optical, and deposition results was presented from the measurements obtained from the Induced Environment Contamination Monitor (IECM) on STS-2, 3 and 4 flights.

Ascent and Entry results from the Dew Point Hygrometer Humidity Monitor, Air Sampler, Cascade Impactor, and Temperature-Controlled Quartz Crystal Microbalances were presented.

Optical measurement results were presented from the Optical Effects Module, Passive Sample Array and the Camera/Photometer-instruments.

Molecular deposition measured by the Temperature-Controlled Quartz Crystal Microbalances located on five sides of the IECM and the Cryogenic Quartz Crystal Microbalance were discussed.

The on-orbit optical and deposition measurements were presented for transient events (water dumps, payload bay door openings and closings, reaction control system operation) and for quiescent periods.

INDUCED ENVIRONMENT CONTAMINATION MONITOR MASS SPECTROMETER RESULTS

A neutral gas mass spectrometer has been flown successfully on STS-2, STS-3, and STS-4 as part of the Induced Environment Contamination Monitor. The collimated field of view of 10° half angle is normally oriented to view along the shuttle -Z axis so that the measured contaminants are the consequence of scattering, mostly from the ambient atmosphere.

Gaseous atoms and molecules with a mass to charge ratio of 1-150 amu are sampled with each integral mass number sampled for 2.0 seconds or during special events for 0.2 seconds. A full spectrum is thus obtained in either 300 or 30 seconds respectively. Particular emphasis is placed on the measurement of the H_2O contamination, so it is sampled on a continuous basis between scans of the entire spectrum.

H_2O is the major gaseous contaminant; the return flux of H_2O has been seen to vary from less than $1 \times 10^{12} \text{ cm}^{-2} \text{ sr}^{-1} \text{ s}^{-1}$ to perhaps 200 times that value. STS-3 showed the lowest values – frequently below the limit of detectability.

Large fluxes of methane were observed correlated with thruster firings, however, these have been due to an instrument artifact. H_2O fluxes also increase significantly during these methane events and NH_3 and C_2H_6 have also been identified.

The contaminant environment above mass 50 was remarkably clean. A few hydrocarbons were seen and on STS-4, Freon 21 was a significant contaminant. For the most part, the fluxes of heavy molecules were less than $10^9 \text{ cm}^{-2} \text{ sr}^{-1} \text{ s}^{-1}$.

Noble gases in the atmosphere are well measured by the mass spectrometer and the results for helium and argon are in good agreement with model values for these constituents. The important aspect of this result is the confidence that it brings to the contaminant flux measurements.

MODELING CORRELATION WITH FLIGHT DATA

In space, the Space Shuttle Orbiter, like any spacecraft, induces its own particulate and molecular environment. This may be harmful to certain measurement and operational mission activities. In recognition of this fact, specific requirements establishing goals for maximum allowable levels of contamination were defined during the early days of the Orbiter development.

In order to provide the capability to predict the Orbiter on-orbit molecular environment as a function of specific configurations and operating modes for comparison with these requirements, a molecular flow math model called Shuttle/payload contamination evaluation program (SPACE) has been developed. So far, the model has supported the Orbiter development as well as the STS test series mission planning. Since an induced environment contamination monitor (IECM) flew on mission STS-2/3/4 to provide measured environmental data, the model also was used to predict values from certain parameters measured by IECM instruments on-orbit. Therefore, a comparison of predicted and measured data was made to verify model performance.

A brief summary of the model was given along with the results of this comparison. Processes such as (a) the direct flux from molecular sources resulting in deposition on the TQCMs, (b) return flux to the mass spectrometer (MS) from the molecular environment, and (c) direct flux from molecular sources to the MS during the environment survey of STS-4 with the unberthed IECM on the RMS were discussed. Gas sources analyzed were outgassing (early absorption), cabin leakage, flash evaporator, and a special H_2O^{18}/Ne gas source. Since column densities were not specifically measured, the model is used to derive approximate values from the measured return flux data. The comparison performed so far indicate an overall satisfactory agreement.

EFFECTS OF SHUTTLE ENVIRONMENT ON INSTRUMENT PERFORMANCE

OSTA-1 carried four earth-viewing optical instruments. These were the Ocean Color Experiment (OCE), Measurement of Air Pollution from Satellites (MAPS), Feature Identification and Location Experiment (FILE) and the Shuttle Multispectral Infrared Radiometer (SMIRR). The instruments were in orbit slightly more than two days. Pre-flight and post-flight calibrations of these instruments showed no change in performance within experimental error. Any effects of the Shuttle environment were too small to be detected.

OSS-1/CONTAMINATION MONITOR

The Contamination Monitor Package (CMP) was one of the nine OSS-1 experiments flown on STS-3. It contained four temperature controlled quartz crystal microbalances (TQCM) which were commanded real-time to temperatures simulating contamination sensitive surfaces. Molecular mass build-up and loses on these surfaces were measured almost continuously from pre-launch to post-landing.

Results have provided an insight to accretion rates (Angstroms/hr.) for surface temperatures of -50 to $+60^{\circ}C$ showing a very strong dependence on the Shuttle bay temperature or attitude. The data has been corrected for TQCM residual temperature sensitively; solar induced shifts were removed. Selected events occurring during the eight day mission were indicated on the time line in an effort to show dependence or lack of same.

Three high temperature ($60^{\circ}C$) clean-up phases were conducted during the on-orbit period which provides reference levels useful in assessing cleanability of the various surfaces after exposure to the attitude dependent environments. Significant amounts of material ($50-90\text{\AA}$) remained after the bay to sun exposure and subsequent clean up phase. This information scopes the molecular contamination hazard for solar viewing attached instruments.

The bay door-closed on-orbit phase provides preliminary data for a near-empty bay condition useful in the contamination control assessment for both attached and free-flyer payloads.

TEST FOR CONTAMINATION OF MgF₂ COATED MIRRORS

Results of reflectivity tests made on MgF₂ mirror samples during pre-flight, the actual STS-3 flight, and post-flight were presented for both covered and exposed conditions. Both the control mirror and flight mirror samples were contained in the OSS-1 Contamination Monitor. The comparison of results for these mirrors was presented for each sample before and after flight. The results showed (1) No change $> 1.8 \sigma$ observed, except for fingerprint, (2) Weak evidence ($\leq 1.8 \sigma$) for degradation at 1216Å and 1600Å found in several samples, (3) No significant difference between flight mirrors and control mirrors, (4) Covered samples suffered more than samples exposed to sun, but differences barely significant, and (5) Exposed side of flight mirrors found to be somewhat dusty.

The conclusions indicate that there was no evidence for permanent solar induced deterioration. Further, there was no evidence of deterioration on surfaces exposed during coating to oil-pumped (vs oil-free) vacuum conditions.

VEHICLE CHARGING AND POTENTIAL ON THE STS-3 MISSION

The Vehicle Clearing and Potential (VCAP) experiment flown on STS-3 was designed to study the electrical interaction of the shuttle orbiter with the low earth orbit environment. Measurements were made in the payload bay of the ion energy and density, electron density and temperature, ion and electron currents to metallic surfaces and charging of dielectric surfaces. These measurements were made under a wide range of conditions. Parameters included sun angle, magnetic field direction and the vehicle attitude with respect to the velocity vector. An electron gun which emitted a 100 mA beam of 1 keV electrons was used to perturb the vehicle potential and the environment in a series of active experiments. Measurements from the VCAP experiment vary greatly depending on the conditions. Large effects in plasma density were observed which depended on wake effects and exposure to sunlight. Dielectric charging was observed and in some cases the discharge times approached minutes in duration. Operationally, it was found that EMI was not a problem; on-orbit data are the quietest data obtained during the testing, integration and mission activities. Photographs and videotape of the electron beam were obtained which indicate approximately ambient pressure levels near the orbiter. A surface glow was discovered as a result of the VCAP Photo/TV sequences. The glow was produced by impact of the ambient atmosphere on surfaces oriented generally in the ram direction. Light emission from the electron beam and the surface glow was completely dominated for short periods of time by firing of the attitude control thrusters.

STS-3/OSS-1 PLASMA DIAGNOSTICS PACKAGE (PDP) MEASUREMENTS OF THE TEMPERATURE, PRESSURE, AND PLASMA

Operating at its pallet location and maneuvered by the RMS, the PDP made measurements of temperature, pressure, plasma, potentials and fields in and just above the payload bay.

While on the pallet without a coldplate, the PDP was designed to be held above -25°C by heaters and below 50°C by thermal blankets and radiators; on-orbit the measured extremes were -25°C and $+52^{\circ}\text{C}$. Pressure was measured between 10^{-7} torr (ambient at 240 km altitude) and 10^{-3} torr (corona regime); it took 24 hours for the Orbiter to outgass to ambient levels; the pressure was modulated between 10^{-7} and 10^{-5} torr with Orbiter attitude – the peak occurring with the bay in the ram direction; at a primary thruster burn, the pressure increased to 3×10^{-4} torr; and during the top-to-sun attitude, the pressure reached 2×10^{-5} torr.

Ambient O^+ , N_2^+ and O_2^+ ions were observed with the addition of Orbiter-produced H_2O^+ . The ion density varied over 5 magnitudes with Orbiter attitude, day/night and charge state. Directed ion beams with 10 eV energies were detected associated with the Orbiter wake; at times energized ions up to 30 eV and electrons up to 100 eV are observed in the vicinity of the payload bay.

STS-3/OSS-1 PLASMA DIAGNOSTICS PACKAGE (PDP) MEASUREMENTS OF ORBITER TRANSMITTER AND SUBSYSTEM ELECTROMAGNETIC INTERFERENCE

The PDP included a complement of receivers covering the frequency range of 30 Hz to 800 MHz and S-band at 2200 ± 200 MHz to assess the intentional (transmitter) and unintentional (subsystem) electromagnetic interference (EMI) levels. The measured S-band data downlink transmitter field strength was 90/Range in meters Volts/meter whereas the predicted value was 50/R V/m. At the pallet location, the UHF voice downlink transmitter field strength did not exceed 0.1 V/m; on the RMS the PDP measured less than 0.5 V/m. Above 300 kHz Orbiter subsystem noise was not detected at the receiver noise levels ($80 \text{ dB } \mu\text{V/m/MHz} \pm 20 \text{ dB}$) which was well below the ICD spec limits. Below 300 kHz, the magnetic field noise was nearly constant at $30 \text{ dBpT} \pm 20 \text{ dB}$ due probably to power converters and clocklines. Also, below 300 kHz, the electric field noise was broadband and variable over at least 60 dB depending on thruster firings and Orbiter attitude. This noise may be generated by the Orbiter interaction with the ambient plasma. Emissions stimulated by the electron beam were $\sim 20 \text{ dB}$ above Orbiter associated levels at all frequencies $\gtrsim 60 \text{ MHz}$.

OSS-1/STS-3 SHUTTLE INDUCED ATMOSPHERE EXPERIMENT

Preliminary results from the OSS-1/STS-3 Shuttle Induced Atmosphere experiment identified difficulties associated with making pointable, low light level observations during Orbiter day - due to both stray light in the bay and to sky brightness (induced atmosphere) arising from sunlight scattered by particulates originating from the Orbiter and its payload. On-board television in a split screen "stereoscopic" format was used to provide information on individual contaminant particulates. Astronomical data were obtained from measurements over large regions of the Milky Way and zodiacal light. Coordinated and sometimes simultaneous observations were successfully made from Mt. Haleakala, Hawaii and from STS-3 to provide unique information on atmospheric sources and sinks of radiation.

SOLAR ULTRAVIOLET SPECTRAL IRRADIANCE MONITOR EXPERIMENT ON OSS-1

The need to improve the accuracy of measurement of the absolute solar flux within the wavelength range of 120-400 nm requires an extensive effort in contamination control and in tracking the instruments stability. The techniques used in the Solar Ultraviolet Spectral Irradiance Monitor (SUSIM) flown by the Naval Research Laboratory on OSS-1 resulted in very high calibration stability as proven by pre-flight and post-flight calibration. In-flight calibration and the pointing accuracy provided by the shuttle attitude control system was described.

RESULTS OF THERMAL ENVIRONMENT MEASUREMENTS ON THE THERMAL CANNISTER EXPERIMENT AND GET AWAY SPECIAL ENCLOSURE

Thermal sensors located on the radiators of the thermal cannister experiment and several locations on the GAS (Get Away Special) enclosure measured the total thermal flux (UV + IR) through the use of thermopile sensors and the IR only using selective (silver Teflon) coatings. Flight data compared to preflight predictions shows significant differences occurred during tail and nose to sun conditions with fairly good agreement in the bay to sun attitude.

STS-3 "SNOWFLAKE" STUDY

During the STS-3 mission, a significant number of particles was observed being released from the orbiter. Video tape recordings were made on days 3 and 7 with the forward bay television camera. Studies of the data were made to determine sources and sizes. The determinant particles ranged in size from 0.11 cm to 0.72 cm. Indeterminant particle sizes ranged from 0.85 cm to 2.6 cm. The tapes indicated that a significant number of 1 mm to 1 cm diameter particles in the vicinity of the STS-3 were observed. Their origin may be near the aft end of the orbiter, but for the examined trajectories (33) over half were definitely forward of the aft end of the bay. It was also determined that there may be larger particles near the aft end of the orbiter.

SPACE SHUTTLE: A VIEW OF WHAT WE HAVE DONE SO FAR

Accomplishment of the Shuttle is reviewed at the transition point of the Workshop, where the agenda shifts from presentations of the environmental measurements to Panel deliberations on the role of the Shuttle environment in future programs. Questions directed to the presenters and to the IR, UV and Plasma Panel sessions sharpen the discussion of what changes are expected, or need to be made, on the Shuttle for the maximum compatibility of vehicle and payloads.

Unlike the common viewpoint of problems getting in the way of a desired result, the philosophy of "context" is adopted. Context is illustrated using the Apollo program as an example; that program was an idea large enough to include many problems, difficulties and alternatives that could have been said to oppose the program.

The context put forth for the Shuttle is that its success marks the era of the accomplished "spaceship" – a vehicle that can carry large payloads into space, perform complicated functions there including observation, construction and satellite launches, and return to Earth. This context for the Shuttle was created, and the successful Shuttle vehicle is the result.

The creation of context is a conscious process that shapes the future. As the Shuttle program continues and opens up further possibilities for man's exploration of space, the Workshop participants can be expected to establish new contexts for their work. This process will inspire, create and direct the further development and use of the Shuttle as a spaceship.

CHAPTER III

REPORT OF THE INFRARED, ULTRAVIOLET AND SPACE PLASMA PANELS

INTRODUCTION

Following the presentation of environmental results in the Environmental Measurements Session, three Panels were convened to discuss the current status of the payload bay and the needs of Infrared, Ultraviolet and Space Plasma experiments.

A general discussion was held in each Panel which included a review of those measurements important in each area. Discussions were held on the issues of concern to each group and how these environmental conditions might impact future experiments. The discussions revealed several common issues among the three Panels, as evidenced in the following summary reports. Many recommendations were made and are given in the individual reports and in the Summary.

INFRARED PANEL REPORT

The Infrared Panel treated various issues and environmental impacts regarding infrared experiments. Various environmental factors can contribute to the ability of infrared devices flown on the Shuttle to perform the mission for which they are designed. The Panel members concentrated on what should be done to:

- improve the measurements on the spacecraft
- improve the instruments that are to be flown
- develop protective devices for the instruments
- develop any other devices that should be flown

The discussions were categorized by the panel into the following areas of concern:

- vehicle glow
- particulates
- gases
- contaminants
- thermal control.

Each of these is summarized in the following pages.

1. Glow

Two issues were identified by the Infrared Panel concerning the glow that is observed on the Shuttle on surfaces on the forward direction of flight. The first concern was the effect that the glow would have on optical measurements looking outward from the shuttle, specifically (a) would there be direct radiance from the glow into instruments, and (b) would there be particulate scattering of the glow radiation into the optical instruments? Clearly, a number of the characteristics of the glow need to be measured.

An important characterization of the glow is knowing what is the reaction causing it. Is it O-O or O-H recombination, or some other reaction? Some of the information needed is the spectral character of the glow, i.e., is it a continuum, or does it have a line spectrum and what is the radiant intensity of the continuum and any line spectrum that may be present? These data are needed over a wavelength range from the ultraviolet out to approximately 2.5 micrometers in the infrared to answer the questions posed above.

Another factor that requires more information is the extent of the glow beyond the surfaces facing in the forward direction of flight. Even though the color film exposure was quite long (400 seconds), color film is not extremely sensitive in the yellow and red, and it is possible that the extent of the glow is greater than indicated by the color pictures. It is also not clear from the color pictures whether the maximum radiant output was at the surfaces or displaced somewhat from the surfaces towards the direction of flight.

A related issue is the air glow effects that are associated with the RCS firings, and the same types of measurements are needed on those; that is, what is the spectral content of the glow? What is its radiant intensity and its distribution around the spacecraft?

The second main concern about the glow is the question of the effect of chemical reaction on surfaces on which the glow forms. Weight loss was observed on the Shuttle flights for plastic materials, as well as formation of a chalky white coating and changes in the flexibility of the plastic materials used in thermal blankets. Tests should be made as soon as possible to determine if the glow is the cause of the changes observed in the plastic materials used in the thermal blankets to indicate whether the plastic materials should be protected with some other overlayer, or replaced with some other material. This is quite important since vaporized plastic will probably redeposit in other areas of the spacecraft, including the optics flown in the payload bay. It is well known from past flights that effluents from plastics can coat optics that, if they are also exposed to the sun, can degrade and cause overall sensitivity losses for infrared instruments.

2. Particulates

As with the glow, the principal need for information on the particulates is the material composition of the particulates; specifically, the volatility, conductivity, location and space in time, size distribution vs location, determination of the density of particles smaller than those detected so far, and the migration and redistribution of the particles including dwell time in the field of view of optical instruments.

Of particular concern are those particles that might reach optical surfaces and thereby deposit a residue that would not evaporate and would change the characteristic of reflecting (more than transmitting) surfaces. Since particles are observed with apparent diameters as large as 2 centimeters, these questions remain. Should optical instruments provide their own shields as a protection against such particles entering the optics, and should those shields be open and closed as events such as firing of the RCS thrusters occur?

The concern about particles also extends to spacecraft that may be launched from the Shuttle, because the plan now is to have a thermal shield for such spacecraft, but not to have a shield that would exclude particulates and gases. If these spacecraft require that optical apertures be protected and covered prior to separation from the Shuttle, this information should be known as soon as possible because of the added complexity and expense associated with shielding from any particulates that can enter optical apertures. Obviously, any action that can be taken to reduce the number of particulates in the Shuttle payload bay would be quite desirable and would reduce the necessity for added covers.

3. Gases

Despite the "snow storm" effect observed after the dumping of waste water, it appears that the H₂O column densities are below original specifications and of little or no concern to the sensors on the spacecraft. It would be desirable, however, to have these H₂O column densities confirmed on successive Shuttle flights to make sure they remain below the standards.

The presence of more complex gases such as monomethylhydrazine should be measured, if possible, as a function of location and persistence after firing of the RCS system. This again may lead to a requirement for instruments that would have deployable covers that can be closed during the firings and opened at some time after the firing when the gas concentration will have reached a satisfactory level.

4. Contaminants

This area is intended to cover contaminants other than the particulates and the gases such as monomethylhydrazine. In particular, the contaminants referred to are those which are outgassed from those plastics that have shown a weight loss on the spacecraft, and those that resulted in non-volatile residues that were collected on the quartz crystal microbalances. The chemical form of the material lost from the plastic should be determined. This will have a strong bearing on the necessity for individual experiments to provide covers that can be opened and closed during the flight of the spacecraft.

If non-volatile residues are left behind on the quartz crystal microbalances, it is also possible that such residues may be left behind on optical surfaces. Attempts should be made to analyze those residues and their origin to reduce, if possible, the quantity of the material produced in the residue, and to indicate whether protective covers are needed on optical systems. Any relationship between the residues and the previously mentioned glow should be established as quickly as possible as a step in reducing the amount of the residue.

5. Thermal Control

It was reported that, in one case in the so-called "sun up" position into the payload bay, a sensor measured a temperature of 260^o Fahrenheit. It is not clear if an optical sensor located in the same position would reach the same temperature, but it is known that the utility of optical sensors such as mercury cadmium teluride detectors would be severely affected, if not destroyed, by temperatures as high as 260^o Fahrenheit. Further information is needed on the temperatures that would be reached in flight by sensors, and whether operational control can prevent sensors from seeing the sun directly and being overheated, or whether protective shields are needed that may have to be deployed and restored during flight.

Such temperatures would probably accelerate the mass loss observed in some of the material in the payload bay, so it would appear that operational planning is necessary to avoid prolonged exposure to the "sun up" position and temperatures as high as those measured on the previous Shuttles. Passive control of temperatures of surfaces that see the sun directly has been achieved on the Shuttle either by the Shuttle itself as a whole, or by individual experiments that are forced, because of operational constraints, to view the sun directly.

6. General Considerations and Recommendations

With minor exceptions, the major thrust of the Infrared Panel output was that better characterization is needed of all of those features of the Shuttle that may affect optical instruments. Those characteristics identified were the glow, particulates that had been observed and those that may not have been observed due to smaller size, the various gases that are produced by the RCS system and leakage from other parts of the Shuttle and other instruments on the Shuttle, contaminants that are produced by mass loss from plastics and possibly from other instruments on the Shuttle, and thermal control to prevent temperatures from reaching as high as the 260^o Fahrenheit that was reported.

It was the feeling of the Panel that a basic "core" package of environmental measurements should be made on every Shuttle, and in as many locations as is feasible. This package of measurements should also be supplemented in special cases when unusual experiments are flown to build up a baseline of knowledge concerning the environment of the Shuttle. This would reduce the amount of funding and effort expended to protect individual instruments to that actually needed, rather than overdoing it because of lack of knowledge of the Shuttle payload bay environment. The Infrared Panel recognized the fact that while redesign of the Shuttle is not practical in any major way, better characterization of the Shuttle environment is certainly practical - and could, in the long run, lower the cost of experiments by reducing the complexity of the protective devices that had to be provided for each experiment.

ULTRAVIOLET PANEL REPORT

The UV Panel loosely interpreted the Shuttle environment to include things other than the on-orbit environment situation. The Panel was concerned with the environment which UV payloads would encounter at Kennedy Space Center plus pre and post-flight phases.

The Panel addressed issues during pre-launch, post-launch, and the Shuttle-induced background which is a real issue for ultraviolet experimenters since there is very little information on the UV to date. In these areas of concern, other issues addressed by the Panel included problems such as optical coatings, thermal effects, pointing stability, gas cloud/charged particle emission, affects on integrated circuits, and information/data dissemination. Each of the topics of interest to the UV Panel and recommendations made are summarized in the following paragraphs.

I. Integration During Pre-Launch

The Ultraviolet Panel paid particular attention to the integration of experiments at KSC prior to launch. The Panel addressed the need for defining the special integration procedures, such as cleanliness, in the Payload Integration Plan (PIP). The feeling from the integration people at KSC seems to be "Put it in your plan if you think you will need it."

One of the key problems raised was the cleanliness level which must be maintained for optical, UV and X-ray coatings. The general feeling is that just because there is a certain "visual cleanliness level" does not mean that the optical coatings are not contaminated. Visual inspection does not guarantee that there is no molecular surface contamination.

The Panel expressed the desire that a better cleanliness criterion be expressed that would translate into specifications driven by science objectives.

One other key problem addressed by the Panel in the optical and ultraviolet area was the routine "last access to the payload" situation. The last opportunity for an experimenter to have access to his instrument may be five weeks before launch. This is a major issue. As an example of interest, astronomical photographic emulsions fog rapidly if left at room temperatures. If hypersensitized within a few days of use and kept cool (0-10°C), improvements of three to four times sensitivity can be realized.

While the experimenters would like to use these emulsions (III AS, III AF, etc) in Shuttle experiments, the environment on board the Shuttle is not adequate.

Other issues expressed by the Ultraviolet Panel related to integration at the KSC and whether sufficient testing, integration and storage facilities exist for those instruments that will fly multiple flights. Would there be clean facilities where optics, perhaps detectors, could be changed at KSC. At the present time, experimenters are concerned with even getting access to change electronic boards. The Panel felt KSC facilities need to be evaluated systematically from a user viewpoint.

2. Post-launch Environment

The post-launch environment issues raised by the Ultraviolet Panel were cleanliness and thermal control, how fast the experimenter can get to critical components including photographic films before thermal fogging is significant. Rapid removal of the critical items will be required for many scientific experiments.

3. Shuttle-Induced Background

The shuttle-induced background is just now being addressed; we do know it comes from several already known sources. The photographs obtained to date are demonstrative of some problems. From the STS-3, significant red emission is known to exist near Shuttle surfaces. A correlation with exposure to the ram velocity vector is now known.

The UV Panel was concerned that similar velocity vector induced emissions will occur in the optical region possibly in the near ultraviolet region, but especially in the infrared region.

The Panel recommended that a study of this problem be done with high priority, since there are many shuttle payloads, including OSS-3, that are anticipated to go down to sky background. The shuttle-induced emission will greatly impact science goals.

4. Vernier Thruster Firing

The vernier thruster firings contaminate both by the chemical cloud properties and the pointing disruptions. There is insufficient information on cloud dissipation to the level where observations can be done in the ultraviolet and optical. Settling times of pointing systems are only modeled at this time.

Some of the STS-3 measurements indicated background enhancements during vernier thruster firings, even overhead the payload bay. The Panel is concerned as to how far into the ultraviolet these emissions extend, how bright they are, and what techniques could be employed to minimize the background.

Experimenters need a warning signal in the data channels in order to protect the experiment and/or accumulated data from thruster contamination. This problem was pointed out five years ago but to no avail. Many experimenters have reiterated that the need still exists because experimenters could have time to drop voltages on detectors and even close shutters. The Panel recommended that this issue be reconsidered by NASA.

Another issue was the number of thruster firings which would occur. This is a serious problem for a pointed system as the frequency of firings could be often enough that the pointing never settles down.

5. Water Dumps

Similar issues were raised by the Ultraviolet Panel concerning water dumps and flash evaporator operations. NASA needs to schedule water dumps and flash evaporator use around experiment timelines. Moreover, experimenters must be aware of the schedule and should receive data line signals during the operations.

6. Optical Coatings

Although the OSS-1 witness mirror tests of MgF_1 overcoated aluminum showed no deterioration, there were some questions raised by the Panel because the witness plates were not thermally monitored. They may have been as hot as 50-degrees Centigrade and very little adhesion of contaminants would have occurred. The Panel recommended that further experiments be flown with better control of conditions.

Much more information is needed about mirror coatings in the extreme ultraviolet. The Panel was concerned knowing that osmium, which oxidize rapidly at the Shuttle orbital altitude. Other mirror coatings, including iridium, need to be tested in Shuttle and the Long Duration Exposure Facility.

7. Contamination of Other Materials

Photographic emulsions were another area of interest to the Panel since experimenters need to know what emulsions are not affected by the Shuttle environment. Some films have been flown on OSS-1, but there are no results at this time.

The Panel recommended an experiment be developed to determine if emulsions can be hypersensitized in the payload bay on orbit.

8. Shuttle Gas Cloud/Charged Particle Environment

Some problems were identified by the Panel regarding upstream ram pressure and its effects on UV detector pumps. Windowless UV detectors will be flown on the OSS-3 mission. The ion pumps for these detectors are designed to pump pressures at 10^{-6} Torr and are rapidly used up at higher pressures.

The pressures reported from prior flights indicate that the Shuttle may never fall below the 10^{-6} Torr pressure. Obviously, if the pump is working continuously at a higher pressure, its lifetime is going to be limited. The problem becomes very serious as the ion pump may not last through the mission.

More information is needed about the payload bay gas pressure and whether or not these pumps are adequate.

Another issue for the Panel was the effect that charged particles will have on photographic emulsions, on detectors, and on certain optical surfaces. More information is needed.

9. Thermal Environment

The payload bay thermal environment is of concern to the Panel. An example is the environment the OSS-3 payload may encounter.

The OSS-3 payload consists of three co-aligned telescopes mounted on a MSFC - designed cruciform. The cruciform is mounted on the Instrument Pointing System (IPS) and the payload utilizes Spacelab hardware and avionics. The payload shares flights with deployable satellites. During the first few days when the satellites are deployed and tested, the

IPS remains stowed. Two of the telescopes will be in a very hot payload bay situation. The key issue is will they survive. The thermal problem might be resolved if the IPS could be deployed, looking out of the bay, so that all of the instruments had a much more benign environment.

The Panel recommended that this issue and related thermal problems be worked through over the next few years.

10. Pointing Stability

Pointing stability is a problem that has been compounded by the fact that the Shuttle is not stable in an inertial environment that it continuously uses vernier thruster to keep it stabilized.

At this time it is not known how many firings must occur per orbit for inertially pointed experiments. Estimates are that between 60 to 400 firings may occur per orbit. The IPS settling time may be as long as 15 seconds. With 400 thruster firings per orbit, the IPS may never settle down to a quiescent situation. The OSS-3 science goals require arc second pointing stability. Internal motion compensation will be required for the quiescent stability. The Panel recommended that consideration be given to reducing the thruster firing per observation.

11. Control from Aft Flight Deck

While operations and control are not really contamination, concern was expressed about the need for interactive control. If an experimenter can control automatically as well as from the aft flight deck and from the ground, then the unanticipated situations can be met much more successfully.

Experience gained through Spacelab 1 and 2 missions would provide a much better feeling on just how much control an experimenter will indeed work from the aft flight deck and from the ground. It should reveal how much the experiment can be changed orbit by orbit. The Panel felt this could make the difference between success and failure for a mission.

12. Integrated Circuits

Experimenters flying new experiments on the Shuttle are increasingly relying on state-of-the-art integrated circuits. Few devices are flight-qualified and indeed many may be susceptible to soft or hard failures due to radiation or energetic particle hits.

The Panel recommended that experiments be developed to test various integrated circuits both for short missions and for long duration exposure facilities.

13. Management Consideration

The Ultraviolet Panel recommended that there be an organization designated within NASA Headquarters that has the responsibility to follow the contamination control on the Shuttle, provide funding where it would be very useful to get more information, and effectively improve the contamination situation. The Panel felt that NASA would obtain a more positive response from the science and engineering community if they know that the contamination problem is being worked upon and being improved.

SPACE PLASMA PANEL REPORT

The Space Plasma Panel covered areas related to the plasma environment of the Shuttle, the electromagnetic interference generated by the Orbiter and its payload, and the electrical interaction of the Orbiter with the surrounding atmosphere. The Panel was also concerned about the environment as it affects instrumentation used for plasma measurements. The discussions and presentations made during the Workshop established many of the characteristics of the Shuttle environment and led to a number of recommendations from the Panel.

The discussions were categorized into the following topics:

- Vehicle Glow
- Electromagnetic Interference
- Pressure Environment
- High Voltage Systems
- Ground Contamination
- Data and Information.

Each of these is summarized below.

1. Orbiter Surface Glow

The first item of concern to the Plasma Panel was related to the vehicle glow detected on STS-3 and STS-4 and the glow process studies. The Orbiter surface glows as a result of impact by the ambient ionosphere on the surface of the vehicle with optical emission of undetermined brightness and an undetermined mechanism. The issues addressed were whether or not the glow could be seen on round objects and whether or not the glow is related to the thruster firings. Thus, the recommendation of the Plasma Panel was related to further understanding of the glow. The Panel recommended that the effort to understand the processes responsible for the surface glow observed on STS-3 and STS-4 be greatly intensified. Investigations aimed at studying this phenomenon should be given the highest possible priority on forthcoming Shuttle flights.

2. Electromagnetic Interference (EMI)

The measurements made with regard to the electromagnetic interference emission levels onboard STS-3 were of concern to the Plasma Panel since the electromagnetic interference (EMI) generated by the Orbiter and the payload is about 20 dB below the current specification.

The Panel felt that a large part of the EMI that was measured was actually generated by the payload. Accordingly, there is a relatively benign environment; but to take advantage of it, payloads must be coordinated. This coordination should be done at an early stage. The Plasma Panel recommended that user input within any particular proposed Shuttle payload should be coordinated to facilitate electromagnetic compatibility with the least degree of EMI limitations across the board.

3. Pressure Burst

The results from STS-3 revealed that pressure bursts produced by firing of the Reaction Control System (RCS) jets reached levels of 10^{-5} torr. This level is a problem when particle detectors and other instruments which use high voltages are operated in the payload bay.

The Panel recommended that the pressure environment in the payload bay and its dependence on angle of attack, thruster firings, and other pressure modifying events be measured with a suitable time resolution on subsequent flights to permit a better characterization of the pressure environment.

4. High Voltage Systems

Results from STS-3 have demonstrated that "active" experiments utilizing electron beams can be successfully operated in the payload bay with particle detectors and plasma wave diagnostic measurements performed in and near the payload bay. Changes in vehicle potential were observed, with the highest values occurring at night.

Orbits flown to date have been low inclination orbits. Polar orbit environments will be substantially different, particularly the flux of energetic particles from auroral beams which will bathe the entire Orbiter. The Panel recommended that measurements similar to those flown on STS-3 should be made in polar orbits.

The Panel also felt that parametric studies should be made pursuant to increasing the effective conducting area of the Orbiter, to allow the use of higher current beams in the future. Since future payloads will incorporate exposed high voltage systems, it is necessary to understand the operation of HV systems in the Orbiter environment.

5. Ground Contamination

High levels of contamination were present in the ground facilities during integration of the payload, although there was no detected impact on the on-orbit operation of any of the instruments. The Panel is concerned about the risk of payload equipment degradation or failure induced by contamination during payload preparation, particularly in the Orbiter Processing Facility.

The Panel recommended that efforts to characterize and document contamination during payload preparation should be continued, and that improvements should be made to facilities, where practical, to reduce the contamination levels. The Panel also recognized that shortened exposure to the environment reduces contamination and encourages improved scheduling of payload flow through the preparation facilities.

6. Data and Information

Many of the questions raised by participants during the workshop could be answered with data already obtained. The Panel felt that continued support for data analysis is needed and recommended that results be incorporated into modeling codes, specifications, and reports disseminated to the user community.

The Panel also recommended that an Environment Information Directory of available documentation concerning the Shuttle and Spacelab environments be made available quickly to users. The directory should include reports, specifications, guidelines, measurements, models, analyses, and the Operational Information (OI) downlink measurements list. An annotated bibliography of this documentation should be made available as soon as possible and be kept current with updates on a timely basis.

The Panel considered the need for this information to be of the highest priority and fundamental for future use of the Shuttle and Spacelab. The Panel further recommended that investigators on future Shuttle and Spacelab missions be provided realtime access to the OI measurements list. The experience of investigators on the orbital flight test missions has demonstrated the need for realtime Orbiter data provided to the Instrument Ground Support Equipment. Some of the operational changes developed as a result of the first four missions require detailed and timely knowledge of Orbiter operations including trajectory, attitude, thruster firings and water dumps.

CHAPTER IV

FUTURE OUTLOOK AND COMMENTS

INTRODUCTION

In this session of the Shuttle Environment Workshop Proceedings, the events of the Workshop Panel sessions are summarized and a synopsis of the future of the Shuttle and the Shuttle environment is given.

This workshop was organized by the NASA Office of Space Sciences and Applications (OSSA). This office is responsible for making use of the shuttle. It does not build it. Thus, the experimenters and users work with OSSA to use the shuttle that is being built by the Space Flight Office. The Office of Space Science and Applications represents investigators and users - a most important group because it is their requirements and their needs that drive our work.

During the Workshop, there were Panel sessions in the IR, UV, and Space Plasma areas. These Panels represented the experimenters in these technologies. These Panels discussed what is happening with the Shuttle, what it means for users, and what kind of activities NASA will be doing in future missions.

The recommendations from the Shuttle Environment Workshop will be sent to those who can make decisions. It may not mean you will get full satisfaction, because decisions of this type usually cost money and money is limited. NASA does not have unlimited funds but within the funding limits, NASA will do the best it can.

In the following paragraphs of this chapter, comments and future projections in a number of areas addressed during the workshop are presented. The material is taken from transcripts of individual remarks made in the final workshop session. The subjects and authors are:

- Environmental Measurements - L. Leger, JSC
- Contamination Effects - E. Miller, MSFC
- Orbiter Constraints on Deployable Payloads - R. Brown, JSC
- Documentation and Environmental Information - R. Colonna, JSC
- Ultraviolet Experiments - T. Gull, GSFC
- Infrared Experiments - W. Hovis, NOAA
- Plasma Experiments - R. Williamson, Stanford University
- Shuttle Lidar - T. Wilkerson, University of Maryland.

The following paragraphs indicate what the Shuttle future may hold.

Preceding page blank

ENVIRONMENTAL MEASUREMENTS

In summarizing the environmental measurements made on the Shuttle, it may be stated that NASA was surprised by the oxygen effects on surfaces, and the resulting effects in orbit. These effects confused the basic intent of trying to find contamination from the vehicle and, in fact, may be classified as a contamination that needs additional definition. However, NASA feels the measurements that have been made to date constitute a very significant data base in terms of measuring the environment on the Shuttle.

It should be noted that during the previous flights of the Shuttle, not all environments were measured. However, the specific parameters that are needed for payload development and decision processes and what needs to be done in the future have been characterized by the basic measurements that were made. The OSS measurements indicate that for quiescent periods, background light levels comparable to the galactic background can be achieved. The OSTA-1 payload provided a good indication that we have a very good vehicle from an Earth resources measurement standpoint.

Although the data obtained from all the measurements represents a very sizable data base, we cannot, within the period of four flights and within the constraints experienced, identify whether or not there is a background around the vehicle that might interfere with optical measurements that are critically sensitive to the opposite ends of the spectrum, i.e., UV and infrared. Over the next ten or twelve flights, NASA should continue to define the environment and at the same time try and understand the Shuttle environment's behavior, its development, and its characteristics.

Through that timeframe, the utilization of the already planned payloads is one way to augment the original measurements. However, there are some exceptions. For example, the problem of the oxygen effect on materials will require special studies and is being addressed at this time.

The other item of concern to experimenters is that they want orbiter data for assessment of their missions. Ways are being developed to provide this kind of information in an expedient fashion to payloads in the near future.

In the interim, we have to answer questions such as: what are the vernier control RCS systems doing to IR measurements, UV measurements? With that definition, it is hoped that we can operate the vernier system within a very reasonable mode acceptable to both the remaining portion of the vehicle and payload and get significant measurement times without perturbations by any vehicle-induced parameter.

With the additional ten flights, the perturbation in that environment should be defined. Hopefully, the users will find that verniers will not perturb their UV experiments and that the perturbations on the IR will be identified. We also hope to control contamination so that we can use the vehicle as it was really intended to be used and concentrate on making the scientific measurements, rather than concentrating on taking contamination measurements which have been a major consideration in the first four flights.

CONTAMINATION EFFECTS

The IECM experiment carried on the Shuttle was an instrument specifically designed to characterize the environment generally, whereas the scientific instruments that will be flying in the future will have the capability to measure their specific contamination requirements.

Examples of this have been seen in the OSS-1 mission where the electromagnetic environment payload which took excellent electromagnetic environment measurements. Another example is the infrared telescope where, initially, MSFC tried to get a similar instrument onboard as part of the IECM, but due to the cost, it was decided to wait until an infrared telescope was flown. The Infrared Telescope (IRT) selected for the Spacelab 2 mission will provide the best contamination measurement from the standpoint of the requirements of an infrared telescope. Other instruments, such as the UV instruments on the Spacelab 1, will provide similar specific UV contamination information. It should provide much better data than the IECM.

While the Shuttle environment and cross contamination are major concerns, experimenters should not lose sight of the need to maintain contamination control while the instruments are being built. The Space Telescope is a good example where studies have been performed that say the Shuttle environment will contribute very little to the Space Telescope contamination throughout the launch and deployment. However, the inside of the Space Telescope itself could cause a big problem, so they are having to select and process these materials very carefully. We expect that they will do a good job so that it will survive its own contamination. Thus, principal investigators should not lose sight of the need to clean up their own instruments.

ORBITER CONSTRAINTS ON DEPLOYABLE PAYLOADS

From the orbiter standpoint, NASA is trying to accommodate each experimenter's requirements, even though it may not be apparent. JSC has established a few constraints and requirements for the payload which are basically for the deployable type payloads.

These constraints are what NASA feels are necessary for making up the payloads, and for accomplishing a particular mission without having to juggle payloads each time a new deployable payload comes onboard.

The constraints that have been placed on deployable payloads are: (1) instruments have to be able to tolerate the Sun in the bay for 30 minutes and, (2) instruments must point in deep space for up to 90 minutes. The majority of the time, or the rest of the time, the missions will be flying in ZLV (Z Axis, Local, Vertical) or payload bay down towards the earth, which is the most benign attitude that is acceptable with deployable type payload.

For the majority of the experiments that will be flying on sortie-type missions, they will be looking at a fairly benign environment, if it is flown with a deployable payload.

The temperature for the ZLV in the payload bay is running anywhere from 0 to 20 degrees Fahrenheit, unless there is a lot of power dissipated right in the particular payload.

An example of the things that the orbiter will be doing for an operational mission is the STS-6, which will fly the Tracking and Data Relay Satellite (TDRS). NASA has accepted a constraint of a maximum of five minutes of Sun in the bay during that mission at any given time. For this mission, some specific maneuvers will be made to keep the Sun out of the bay.

In summary, it should be noted that during the operational timeframe, NASA will be working with the payloads trying to match the mission with a payload that is compatible with the experimenters' requirements.

DOCUMENTATION AND ENVIRONMENTAL INFORMATION

There has been a thread of continuity from manufacturers, users and scientists in the requests that have been made of the STS, particularly for a readily available data base for various types of information. However, from each of the three different groups, there was a slightly different variation on the type of data required.

Another common request is for a simplification of the documentation process and total integration process.

To respond to these two requests, two actions are underway. JSC has initiated very positive actions: the Mission Integration Office has started an activity to review the integration process in detail and will attempt to combine and simplify the documentation requirements. There is an attempt to combine a number of the document annexes so that instead of having nine, there will be only four or five. Hopefully, as time goes on, there will be less than four.

JSC has also begun work to create an STS Customer or User Service Center. One of the major activities is to provide a source for a uniform set of data for all the users. This will be the place to go to ask questions.

The intent is to provide an answer to all of the requests in terms of providing documentation. These activities have been started, and we hope to have them in place in the very near future.

ULTRAVIOLET EXPERIMENTS

The use of the Shuttle in the UV astronomy area will develop mainly in two directions that are very compatible with each other.

(1) The first direction is that, as new experiments are developed, the Principal Investigators want to test them. In the past, tests have been made on rocket payloads which are very, very short - 100 seconds or a few hundred seconds. This is not enough time. The prospect of having days or weeks to fly in the Shuttle payload is most exciting and interesting.

It is hoped that in the future, as we go through the Spacelabs and the OSS series, operations on the Shuttle can be simplified to the point of where, although they are more complicated than with rocket payloads, they are a lot less complicated than satellite operations, from the standpoint of getting launched and becoming operational.

(2) There is a large community that will be using the Shuttle in the future to test new concepts in UV astronomy, X-ray astronomy and solar physics. There is an even larger community, throughout the world, that has great interest in using facilities that NASA will be building, placing on the Shuttle, testing them out and eventually putting them on platforms and free flyers. That is the direction in which the major facilities in astronomy will be going.

That is exactly where the Space Telescope is heading. It is exciting to realize that in just a few years there is going to be a large telescope in orbit, and we expect it to last 10 or 20 years or more. It will be a major thrust in the field of astronomy.

An analogy to this is the International Ultraviolet Explorer. The IUE was launched in January, four and a half years ago. At the time, there was not as much interest in the community as eventually came out. Four and a half years later, that satellite is operating beautifully.

In the IUE, it took several years to see any degradation in terms of sensitivity in the detectors. We may be seeing 5 to 10 percent in one of the detectors at this time. The greater concerns are keeping the gyros going long enough to observe for another five years. Credit should go to the international team that is assembled in Britain, the European Space Agency, and NASA.

Success can be measured by the realization that the data from the IUE have been disseminated to astronomers throughout the world in a very well coordinated guest observer program. Over a third of the astronomers throughout the world have had access to those data, and the number of publications coming out of IUE keeps increasing.

This is the community that we, as Shuttle users and potential users, should be addressing. We need to be anticipating what is the experiment that is going to occur five to ten years from now that the community can use to forward research in the new frontiers of astronomy at that time.

The OSS-3 mission is one that we are working on in the meantime. We are going to be working with direct imagery in the ultraviolet, going to limits far exceeding anything previously expected, and doing polarization measurements, probing the extreme ultraviolet from 900 angstroms down to perhaps 400 angstroms, to find out how far we can see within our galaxy, and beyond.

As we learn from the OSS-3 experiments, we will be designing new experiments, new satellites and concepts that will be tried out first on the Shuttle, and then eventually made into a free flyer or put on platform. An example is the Solar Optical Telescope that is intended to be on the Shuttle by 1988.

A one-meter aperture telescope called Starlab has been studied for the past seven years. The Canadians and Australians have now joined the US, and an agreement is being worked out in which the Canadians will build the telescope so they can learn the technology and get involved in space. This is their major program in astronomy in space. The Australians have offered to build the instrumentation. They have been doing research for several years with ground-based telescopes. They recently obtained a major funding of \$2.5 million over the next few years to go into the Phase B studies of the instrumentation. This is their major astronomy space program for the next decade. The US is being asked to put this on the Shuttle, but we really want to put it on the platform. This is one of the instruments we want to see placed on the platform and used in orbit.

There are other instruments being studied that will be coming through in the near future. The far ultraviolet is becoming the last frontier in astronomy. In the spectrum between 100 angstroms and 900 angstroms, there is very little information known at this time, and the community is getting more and more interested in what can be done.

This community can be supported in the future with experiments first tried out on Shuttle, and then by satellites that are brought up and put overboard either to go into regular orbit, or perhaps geosynchronous orbit.

INFRARED EXPERIMENTS

It should be realized that the Shuttle offers an opportunity to do things that have never been done before. In the past we had to live in a 10 by 10 space, but now with the Shuttle, we have much more room. It will take a while to realize the freedom. We have worked with spacecraft having typically a ton of weight, 500 watts of power, for so long, it is hard to believe that things can get bigger. What can be done with the Shuttle?

One possibility is the assembly of large collectors in space. We are limited now in microwave measurements by diffraction effects to no better than 25 or 30-kilometer resolution for all weather measurements. With the Shuttle, we will be able to assemble collectors from the Shuttle hundreds of meters in size. In the future, we expect to do that.

Also with the Shuttle, we will be able to make important atmosphere-free measurements. We are awaiting the measurements of the solar spectral radiance that are going to be made by the European team on Spacelab 1.

Astronomy done in orbit is free from atmospheric limits, and in this area we will be growing by leaps and bounds.

Another area where the Shuttle will contribute is in justifying flight of active sensors such as lasers. People keep asking, Can you prove they work? The lowest power laser that is worth flying consumes about 2000 watts. Standard spacecraft today have 500 watts of power. At present, we cannot prove that lasers work from spacecraft, but we can certainly prove it from the Shuttle. The Shuttle will provide the means for flying bigger satellites, since there is now a way for launching them.

Another exciting thing is the ability to retrieve the experiments or the material from space, such as will be the case with the Long Durational Experimental Facility (LDEF) that will be in orbit a year before it is recovered. This will bring back material from the Shuttle itself, and lead to better designs of component reliability. From an experimenters standpoint, it has been maddening for 20 years to have the experiments go bad and not be able to get any closer than 600 miles to find out what went wrong with the instrument. The Shuttle enables us to get our hands on the experiments that have actually flown, to see what happened in space.

The Shuttle also offers the opportunity to re-excite the American people the same way as the first Explorer did. We should take advantage of that opportunity and get back the support of the American people for these major and important expeditions.

PLASMA EXPERIMENTS

From our previous flight experience, we found the orbiter to be a very good platform for conducting active experiments. During the OSS mission, we obtained science results and looked at the environment of the orbiter. Although these scientific results were not reported here, the fact that these experiments could be conducted is a demonstration of the capabilities of the orbiter within the environment.

We would like to know more about the orbit environment so we can do more with the orbiter. The recommendations made here are intended to make it better.

Over the next few years, a number of payloads have been identified which will be involved with the plasma aspects of the orbiter. Next month, STS-5 will fly a camera that is designed to take a look at the vehicle glow problem. There are some real problems internally in getting time line availability, even though the instrument is onboard. Although there is some time line in one night-time pass, substantially more time is needed. I feel that the time line should be expanded, or at least looked at and expanded if at all possible.

In September 1983, Spacelab 1 will carry probably the most complicated payload that will fly for many years to come. This flight will include a large number of plasma diagnostics instruments as well as active experiments.

It will include a 7.6 kilovolt, 1.7 ampere electron accelerator provided by the Japanese in conjunction with the United States. It also will include a magneto-plasmdynamic (MPO) arc jet of several kiloJoules of energy per pulse. There will be low light level television cameras and spectrometric measurements extending from the visible through the ultraviolet.

The Shuttle will also fly ion and electron accelerators for ESA experiments. A number of plasma diagnostic instruments will again be flown.

Spacelab 1 will provide a tremendous wealth of information of the environment around the vehicle, and it will give information on the plasma clouds. This flight will also produce information about the glow and about the operation of particle beams and high voltages within the payload bay area.

Spacelab 2, scheduled for late 1984, will fly a diagnostic package that will be the same one that was on OSS-1. It will be released to fly away from the orbiter, and will obtain measurements of electric fields far away and also make wake measurements.

The electron gun from OSS-1 will be on board to make measurements of the electrical charge on the vehicle and determine the nature of the dielectric surface interaction with the surrounding plasma. This information should be of substantial value in future programs.

Spacelab 6 is scheduled in the 1986-1987 timeframe. This mission has a full complement of diagnostic instrumentation and active experiments. It will re-fly the low light level Television Camera, and a new version of the plasma diagnostics package.

The significantly different instruments will be the WISP payload which is an HF/VLF transmitter with a long antenna. It is designed over the period of the project to go to very low frequency with voltages that approach ten kilovolts on the long antenna.

In another program, polar orbits will be begun in a few years. These will be launched from Vandenberg AFB. The Air Force has a very active program to study the interaction of the orbiter with the polar environment, specifically the energetic electron and ion beams which will bathe the orbiter as it goes through polar regions, through the auroral zone and into the polar cap. These effects deserve serious consideration, since they have not been treated in the results obtained to date.

In the distant future, solar power array modules are scheduled. These include 25 to 100 kilowatt solar arrays for low earth orbit. They also involve high voltages, dielectrics, high currents, and plasma interaction. The plans to fly such payloads really demand that we understand the interactions that we have begun taking a look at on the first four missions, specifically on STS-3.

Future space stations will be very large structures. Such large structures have not flown in the past. The physical size of large structures will give rise to higher potentials than have ever been experienced previously. We had better understand the electrical interaction of those large structures with the near earth environment, lest we have some more surprises such as the vehicle glow.

There is one system that is currently planned to be built called the Tethered Satellite System. One version of this is a long insulated wire which may have a length of 10-100 kilometers. This will certainly be the largest structure put into low earth orbit. It also can answer many of the questions about large space station structures. It extends only in one dimension for a great distance. For many of the questions that we have in plasma physics, that will be sufficient.

There is another aspect of the environment that should be treated, that might not seem like an environmental problem. That is access to data. Many of the questions that we had could have been answered in the near future through data analysis of previous missions. Some of them could have been done during preflight, given sufficient access to the information.

It is felt that the agency, at the present time, is unable to handle data in a timely manner. It is a recognized problem within the agency, and will require long-term solutions. Some of the requests that have been made, such as asking for the operational information, take continual contact to correct these problems. The problem also extends to documentation. We have continually asked for documentation, and have heard other Spacelab PIs on Spacelab 1, 2, 6 and other missions asking for documentation. They need access to it.

NASA should consider that the user community needs to have information. This includes information in the POCC, for example, of attitude and time line data; and of the position of the RMS. It is available. It is the format that is the problem, and it is a question of handling the data.

With respect to the post-mission data handling, it should be noted that we only recently received the attitude data from the mission launched March 22. This was six months late. To date we have not received data on the attitude thruster of the control jets. Regardless of the data problem, we are very pleased with our flight experience and are very pleased with what happened during our mission.

SHUTTLE LIDAR

Because there is a NASA committee concerned with the Shuttle lidar, these remarks are addressed to that general class of experiments. Shuttle lidars are very much in the future because such instruments have not yet been scheduled for Shuttle flights. In this respect, there is reason for hope and caution both.

The day of active optical systems in space will surely come. The Shuttle lidar concept refers to the atmospheric probing from orbit using fluorescence methods for the upper atmosphere and differential absorption/scattering methods for the lower atmosphere. These are the ideas that have been examined by NASA's "Atmospheric Lidar Working Group."

The ultimate goal of many in the lidar field is global monitoring by means of active systems that can do height profiling directly. There also are other applications in the Department of Defense. There is another activity in which both NOAA and NASA are very active, namely the possibility of global wind measurements using coherent Doppler lidar. The first proposal in this area was to use coherent CO₂ systems in the 10-micron range; recently there has been some discussion of using coherent Nd systems operating around one-micron wavelength. With such global wind measurements, complete flow pictures of the atmospheric circulation at different altitudes could be developed.

So there is a serious and compelling prospect of using active laser systems to measure globally the motion, constituents, and the state variables such as temperature and pressure in the atmosphere.

A fair amount of optical power, and therefore a lot of pulsed electrical power, will be required to run a true lidar or laser radar system. There is some concern by those interested in lidar measurements that this should not create problems for other Shuttle experimenters with the high current pulses running around in the spacecraft. We are quite aware of the ground loop problems that can create electromagnetic contamination problems for everybody.

We are becoming confident about it, however, because lidar systems are now being operated run in high-altitude aircraft such as the U-2 and B-57, and medium altitude aircraft like NASA's 990, P-3, and Electra. They are also being flown in heavy balloons into the stratosphere to altitudes of 30-40 kilometers. The day of "hands off" remote operations of these systems is virtually at hand.

Thus, this lidar class of instruments is an oncoming development, for a number of scientific and technical reasons. We look forward to the experimentation with these systems on the Shuttle, and ultimately to more comprehensive, long-term experiments in the future.

APPENDIX A

**PAPERS PRESENTED IN
ENVIRONMENTAL MEASUREMENTS
SESSION**

APPENDIX A

TABLE OF CONTENTS

	Page
Introduction	A-5
<i>L.J. Leger, Johnson Space Center and E. R. Miller, Marshall Space Flight Center</i>	
Summary of EMI/EMC and Vibroacoustics	A-13
<i>R.A. Colonna, Johnson Space Center</i>	
Orbiter Cargo Bay Thermal Environment Data	A-31
<i>R.G. Brown, Johnson Space Center</i>	
KSC Shuttle Ground Turnaround Evaluation	A-47
<i>J.M. Ragusa, Kennedy Space Center</i>	
Evaluation of the Ground Contamination Environment for STS Payloads	A-69
<i>E.N. Borson, The Aerospace Corporation</i>	
Oxygen Atom Reaction with Shuttle Materials at Orbital Altitudes	A-101
<i>L.J. Leger, Johnson Space Center</i>	
Observation of Optical Emissions from STS-3	A-109
<i>P.M. Banks, P.R. Williamson, Stanford University and W.J. Raitt, Utah State University</i>	
Observation of Optical Emissions on STS-4	A-111
<i>S. B. Mende, Lockheed Palo Alto Research Lab; O. K. Garriott, Johnson Space Center, and P. M. Banks, Stanford University</i>	
Induced Environment Contamination Monitor Ascent/Entry, Optical and Deposition Measurements	A-123
<i>E. R. Miller, Marshall Space Flight Center</i>	
Neutral Gas Mass Spectrometer on the IECM	A-139
<i>G.R. Carignan, University of Michigan</i>	
Modeling Correlation with Flight Data	A-147
<i>H.K.F. Ehlers, Johnson Space Center</i>	
Effects of Shuttle Environment on Instrument Performance	A-157
<i>A.E. Potter, Johnson Space Center</i>	

Preceding page blank

APPENDIX A

TABLE OF CONTENTS (continued)

	Page
OSS-1/Contamination Monitor	A-163
<i>R. Kruger, J. Triolo, and R. McIntosh, NASA/Goddard Space Flight Center</i>	
Test for Contamination of MgF ₂ -Coated Mirrors	A-179
<i>A. Bunner, Perkin-Elmer Corporation; J.D. Bartoe, NRL; and J. Triolo, Goddard Space Flight Center</i>	
Vehicle Charging and Potential on the STS-3 Mission	A-187
<i>P.R. Williamson and P.M. Banks, Stanford University and W.J. Raitt, Utah State University</i>	
STS-3/OSS-1 Plasma Diagnostics Package (PDP) Measurements of the Temperature Pressure, and Plasma	A-207
<i>S.D. Shawhan, G. Murphy, University of Iowa</i>	
STS-3/OSS-1 Plasma Diagnostics Package (PDP) Measurements of Orbiter Transmitter and Subsystem Electromagnetic Interference.	A-233
<i>S.D. Shawhan, G. Murphy, University of Iowa</i>	
OSS-1/STS-3 Shuttle Induced Atmosphere Experiment	A-251
<i>J.L. Weinberg, F. Giovane, D.W. Schuerman, R.C. Hahn, University of Florida</i>	
Solar Ultraviolet Spectral Irradiance Monitor Experiment on OSS-1	A-267
<i>M.E. VanHoosier, Naval Research Laboratory</i>	
Results of Thermal Environment Measurements on the Thermal Cannister Experiment and Get Away Special Enclosure	A-275
<i>S. Ollendorf and D. Butler, NASA/Goddard Space Flight Center</i>	
STS-3 "Snowflake" Study.	A-289
<i>J. Barengoltz, C. Maag, F. Kuykendall, Jet Propulsion Laboratory</i>	
Space Shuttle: A View of What We Have Done So Far	A-295
<i>T. Wilkerson, University of Maryland</i>	

INTRODUCTORY COMMENTS

L. J. Leger
Johnson Space Center
and
E. R. Miller
Marshall Space Flight Center

INTRODUCTORY COMMENTS

L. LEGER

E. MILLER

The first two days of the workshop will consist of data gathered from the first three flights of the Space Shuttle. In order to limit the scope of the meeting, only summary data will be presented in two areas; the vibroacoustic and thermal environments. More extensive presentations of data in these areas are being planned for the near future. The emphasis of the meeting will be the characterization of the particulate, gaseous, and electromagnetic emissions associated with the Shuttle flight. Data as generated through the use of the Induced Environment Contamination Monitor (IECM) presents the largest base since it was collected on STS-2, STS-3, and STS-4 flights and therefore, a large portion of time has been allocated for these presentations. As an aid in interpreting other results, a short summary of measurements of "vehicle glow" light emissions and material effects (mass loss) due to the low earth environment interactions with the Shuttle vehicle will be presented.

An important consideration in planning the workshop was to schedule it as soon as possible after flight to allow as much time as possible for future payload planning. As a result, the presentations are in viewgraph form. Also, be aware that a large portion of the data to be presented is preliminary since a considerable amount of data analysis remains to be completed.

Preceding page blank

MEETING DEFINITION

- OBJECTIVE—PRESENTATION OF DATA WHICH RELATE TO DEFINITION OF ENVIRONMENT ASSOCIATED WITH SHUTTLE FLIGHT AS DERIVED FROM FOUR SHUTTLE FLIGHTS
- EMPHASIS
 - MAJORITY OF DATA PRESENTED WILL ADDRESS THE OPTICAL ENVIRONMENT (MOLECULAR AND PARTICULATE)
 - SUMMARY OF VIBROACOUSTIC, ELECTROMAGNETIC INTERFERENCE AND THERMAL MEASUREMENTS MADE USING DEVELOPMENT FLIGHT INSTRUMENTATION*
 - PAYLOAD MEASUREMENTS OF SOME THERMAL AND ELECTROMAGNETIC ENVIRONMENT
 - BRIEF DESCRIPTION OF AMBIENT OXYGEN EFFECTS PRESENTED AS AID IN INTERPRETATION OF OTHER MEASUREMENTS
- NOTE: SUMMARY OF ALL ENVIRONMENTAL DATA TO BE ADDRESSED AT MEETING TO BE HELD EARLY NEXT YEAR

In the 1974 timeframe, a set of contamination requirements/goals were developed for the Shuttle by two working groups; the Particles and Gases Contamination Panel and the Contamination Requirements Definition Group. These two charts summarize the requirements that were developed. The requirements will not be discussed in detail here but are presented as a reference and to point out that considerable planning was conducted to ensure that the Shuttle would provide an acceptable measurement platform for a large majority of payloads.

ORIGINAL PAGE IS
OF POOR QUALITY

SUMMARY OF CONTAMINATION SPECIFICATIONS AND MEASUREMENTS REQUIREMENTS

PRELAUNCH THROUGH ASCENT

CONTAMINATION SPECIFICATION	SPEC. REF.	MEASUREMENT REQUIRED	REQUIREMENT REF.
AIR TEMPERATURE 70° ± 5°F	A,B	TEMPERATURE AND HUMIDITY	C,D,E
HUMIDITY 30-50%	A,B	TEMPERATURE AND HUMIDITY	C,D,E
PURGE GAS CLASS 100, GUARANTEED CLASS 5000, LESS THAN 15 PPM HYDROCARBONS	A,B	TRACE GAS ANALYSIS AEROSOL COUNT AND SIZE DISTRIBUTION	C,D,E
PURGE GAS PRODUCE LESS THAN 10 ⁻⁶ gm/cm ² CONDENSIBLES ON SURFACES	B	NON-VOLATILE RESIDUE (NVR) DEPOSITION	C,D,E
CONTROL WORK DISCIPLINE TO MAINTAIN SURFACE CLEANLINESS AT LEVEL 300 A (VISIBLY CLEAN WITH LESS THAN 10 ⁻⁶ gm/cm ² NVR)	A,B	AEROSOL COUNT AND SIZE DISTRIBUTION DUST FALL MEASUREMENTS NON-VOLATILE RESIDUE NVR DEPOSITION	C,D,E D,E E
MAINTAIN PARTICLE COUNT LESS THAN 100K IN VICINITY OF P/L	B	AEROSOL COUNT AND SIZE DISTRIBUTION	C,D,E

- REFERENCES:
- A. JSC 07700, VOL. X, PARAGRAPHS 3.6.12.2.4.1-5
 - B. CRDG REQUIREMENTS DOCUMENT, PARAGRAPHS 4.1.2-1.10
 - C. JSC 08576, FTR 64VV011
 - D. SPACELAB FLIGHT NO. 1 VFT/VFI REQUIREMENTS DEFINITION, CON-02
 - E. CRDG REQUIREMENTS DOCUMENT, PARAGRAPH 6.1.1

SUMMARY OF CONTAMINATION SPECIFICATION
AND MEASUREMENT REQUIREMENTS
ON ORBIT

CONTAMINATION SPECIFICATIONS	SPEC. REF.	MEASUREMENT REQUIRED	REQUIREMENT REF.
MOLECULAR COLUMN DENSITY LESS THAN 10 ¹² H ₂ O/cm ² 10 ¹¹ H ₂ O + CO ₂ /cm ² 10 ¹³ N ₂ + O ₂ /cm ² 10 ¹⁰ OTHER MOLECULES/cm ²	A B B	MOLECULAR COLUMN DENSITY	C,E
SCATTERED/EMISSION LIGHT BACKGROUND LESS THAN m _v = 20 STAR/SEC ² (10 ⁻¹² BO IN U.V.) 10 ^{-14.2} BO IN VISIBLE 10 ⁻¹⁴ BO IN ULTRAVIOLET 10 ⁻¹¹ WATTS/m ² /μm λ < 30 μ 10 ⁻¹⁰ WATTS/m ² /μm λ > 30 μ	A B B B B	BACKGROUND SPECTRAL INTENSITY	C,E
FEWER THAN ONE 5 μ PARTICLE PER ORBIT IN 1.5 X 10 ⁵ STERADIAN FIELD-OF-VIEW	A,B	PARTICLE SIZE AND VELOCITY DISTRIBUTION (2.2.8)	C,D,E
MOLECULAR RETURN FLUX SUCH THAT: H ₂ O < 10 ¹² MOLECULES/cm ² /sec DEPOSITION 10 ⁷ gm/cm ² 30 DAYS 0.1 μ ON 300°K SURFACE DEPOSITION 10 ⁵ gm/cm ² / 30 DAYS 2 μ ON 300°K SURFACE DEPOSITION 10 ⁵ gm/cm ² / 30 DAYS 0.1 μ ON 20°K SURFACE DEGRADATION OF OPTICS 1%	A B B B A	MOLECULAR RETURN FLUX MOLECULAR DEPOSITION ON AN AMBIENT SURFACE MOLECULAR DEPOSITION ON AN AMBIENT SURFACE MOLECULAR DEPOSITION ON A CRYOGENIC SURFACE DEGRADATION OF OPTICAL SURFACES	C, D, E C, D, E C, D, E C, D, E

- REFERENCES:
- A. JSC 07700, VOL. X, PARAGRAPH 3.6.12.2.4.6
 - B. CRDG REQUIREMENTS DOCUMENT, PARAGRAPH 4.2
 - C. JSC 08576, FTR 64VV011
 - D. SPACELAB FLIGHT # 1 VFT/VFT REQUIREMENTS/DEFINITION, CON-01
 - E. CRDG REQUIREMENTS DOCUMENT, PARAGRAPH 6.1.2

ORIGINAL PAGE IS
OF POOR QUALITY

Essentially, all data interpretations to be presented in the workshop are dependent upon mission/vehicle parameters. This chart summarizes the major parameters for the STS-1 through STS-4 flights. Acronym definitions are as follows: -ZLV, -Z-axis of vehicle pointed to the earth (payload bay to the earth); Y-POP, y-axis perpendicular to the orbital plane; -XSI, -x-axis solar inertial; PTC, passive thermal control attitude (vehicle rotating about x-axis at 4 RPH).

STS MISSION DESCRIPTION

MISSION PARAMETER	STS-1	STS-2	STS-3	STS-4
LAUNCH DATE	4-12-81	11-12-81	3-22-82	6-27-82
DURATION (HOURS)	54	54	192	168
INCLINATION/ BETA ANGLE	40 °/.26° TO .19°	38°/.50° TO .45°	38°/.36° TO .23°	28.5°/.1° TO +20
ALTITUDE km(N. MI.)	240-278 (130-150)	222-259 (120-140)	241 (130)	306 (165)
MAJOR ATTITUDE(S)	-ZLV, Y-POP PAYLOAD BAY TO EARTH	-ZLV, Y-POP	TAIL TO SUN -X SI NOSE TO SUN 3 AXIS SI BAY TO SUN 3 AXIS SI PASSIVE THERMAL CONTROL PTC	TAIL TO SUN 3 AXIS SI BOTTOM TO SUN 3 AXIS SI TOP TO SUN 3 AXIS SI -ZLV PTC GRAVITY GRADIENT
PAYLOAD(S)	DEVELOPMENT FLIGHT INSTRUMENTATION (DFI)	OSTA-1, IECM + DFI	OSS-1, IECM AND DFI	DOD 82-1, IECM AND DFI

This chart contains pictorial descriptions of the major attitudes used during STS-1 through STS-4. This chart along with the mission description and STS flight mission timeline charts are to be used as references for the other presentations during the workshop.

ORIGINAL PAGE IS
OF POOR QUALITY

ORBITER ATTITUDES

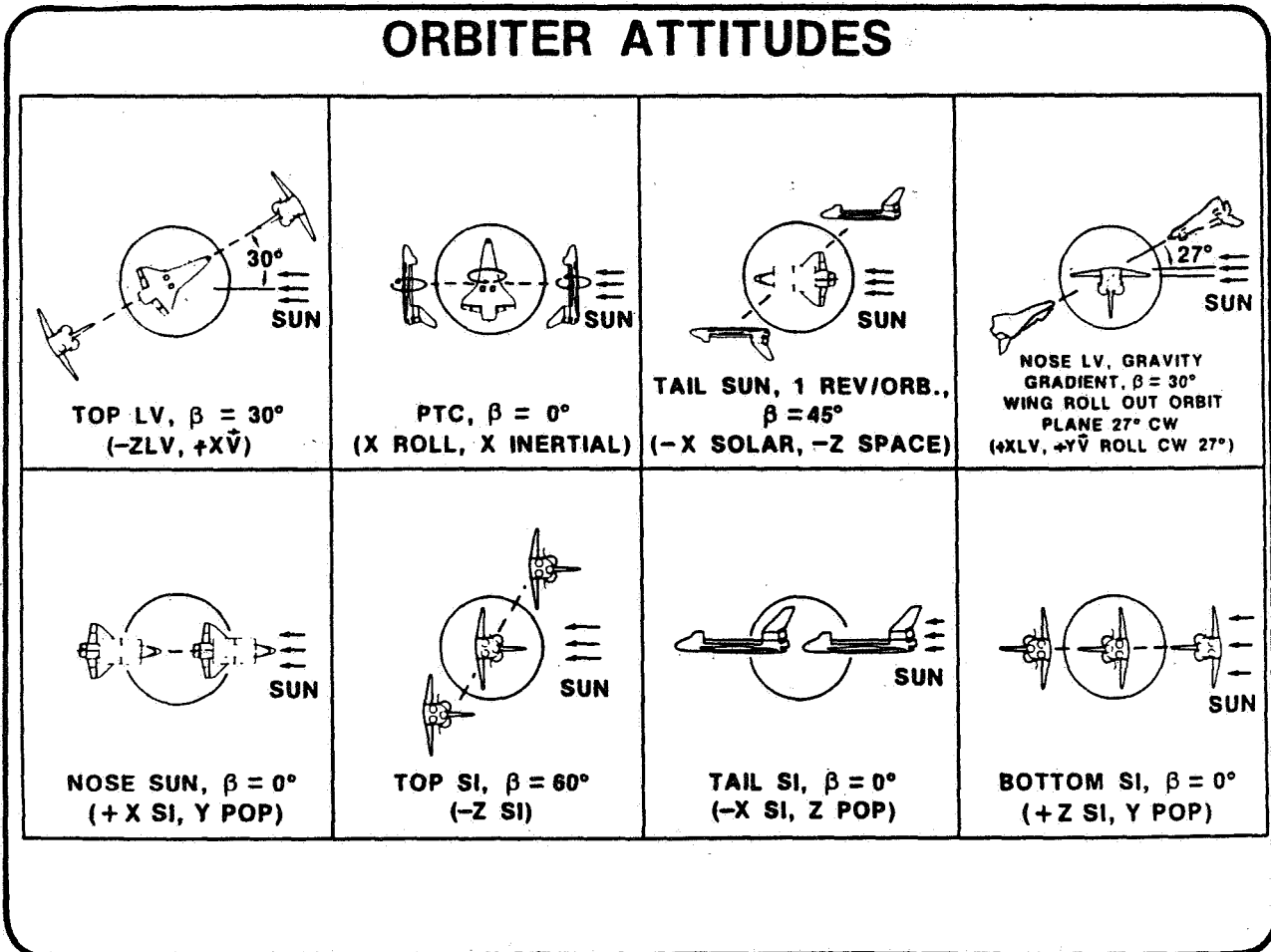

Additional detail of vehicle attitude is presented in this chart. Essentially, all of the attitudes for STS-1 through STS-4 were selected for system performance assessment rather than payload peculiar measurements. As such, these attitudes and other operational conditions do not represent the best conditions (low contamination) possible.

STS FLIGHTS MISSION TIMELINE SUMMARY

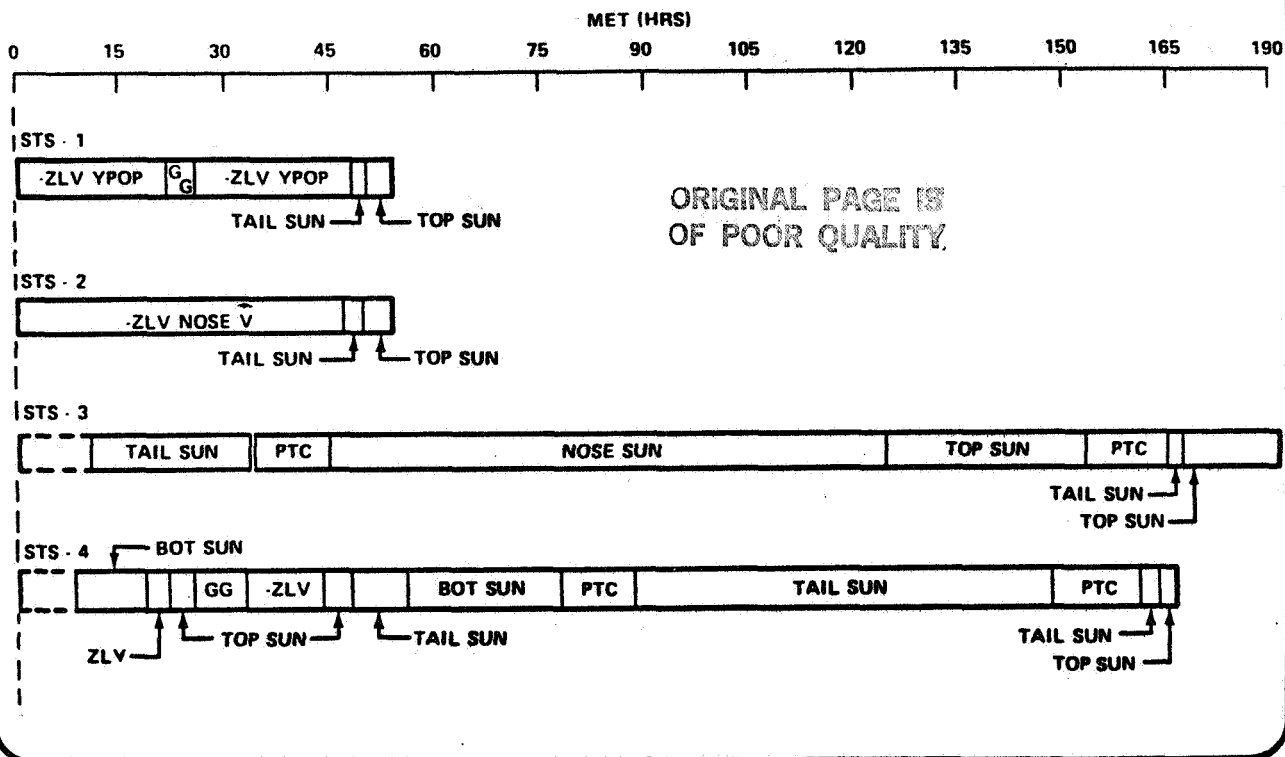

STS MISSION DESCRIPTION

MISSION PARAMETER	STS-1	STS-2	STS-3	STS-4
LAUNCH DATE	4-12-81	11-12-81	3-22-82	6-27-82
DURATION (HOURS)	54	54	192	168
INCLINATION/ BETA ANGLE	40° / 26° TO -19°	38° / 50° TO 45°	38° / 36° TO -23°	28.5° / 1° TO +20°
ALTITUDE km(N. N.L.)	240-278 (130-150)	222-259 (120-140)	241 (130)	306 (165)
MAJOR ATTITUDE(S)	-ZLV, Y-POP PAYLOAD BAY TO EARTH	-ZLV, Y-POP	TAIL TO SUN -X SI NOSE TO SUN 3 AXIS SI BAY TO SUN 3 AXIS SI PASSIVE THERMAL CONTROL PTC	TAIL TO SUN 3 AXIS SI BOTTOM TO SUN 3 AXIS SI TOP TO SUN 3 AXIS SI -ZLV PTC GRAVITY GRADIENT
PAYLOAD(S)	DEVELOPMENT FLIGHT INSTRUMENTATION (DFI)	OSTA-1, IECM + DFI	OSS-1, IECM AND DFI	DOD 82-1, IECM AND DFI

N83 22295^{D6}

SUMMARY OF EMI/EMC AND VIBROACOUSTICS

R. A. Colonna
Johnson Space Center

STS PAYLOAD BAY ENVIRONMENT

PRESENTER - R. A. COLONNA

PAYLOAD BAY ENVIRONMENTS

CONTENTS

- **ACOUSTIC**
- **VIBRATION**
 - **HIGH FREQUENCY**
 - **LOW FREQUENCY (LOADS) DATA**
- **ELECTROMAGNETIC EFFECTS**

PRECEDING PAGE BLANK NOT FILMED

ORIGINAL PAGE IS
OF POOR QUALITY

STS PAYLOAD BAY ACOUSTICS

STS PAYLOAD BAY ACOUSTIC MEASUREMENTS

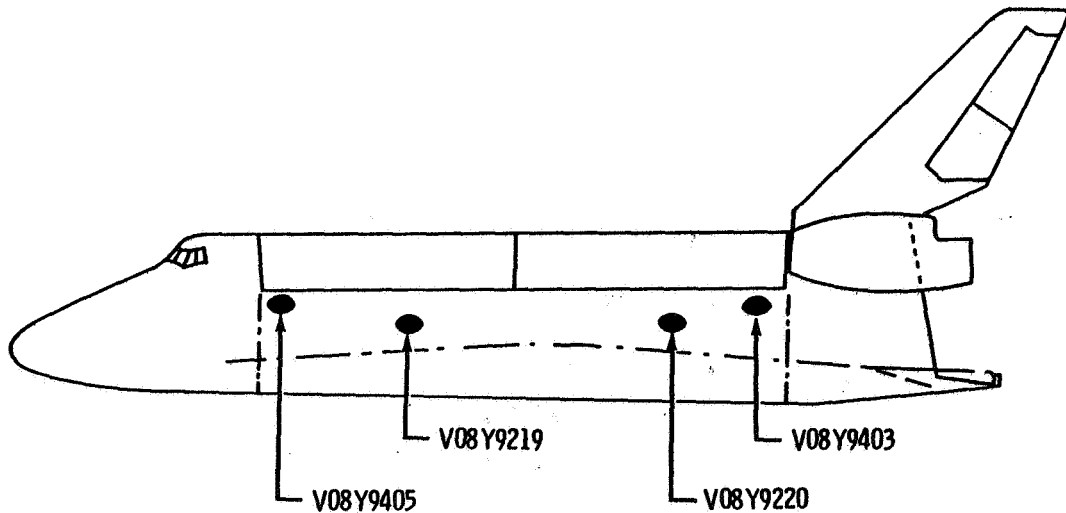

DATE MEASUREMENTS

- STS- 2 14 MICROPHONES ON DFI PACKAGE AND OSTA-1
- STS-3 8 MICROPHONES ON DFI PACKAGE AND OSS -1
- STS- 4 8 MICROPHONES ON DFI PACKAGE AND PAYLOAD

ORBITER PAYLOAD BAY INTERNAL ACOUSTIC ENVIRONMENT

ORIGINAL PAGE IS
OF POOR QUALITY

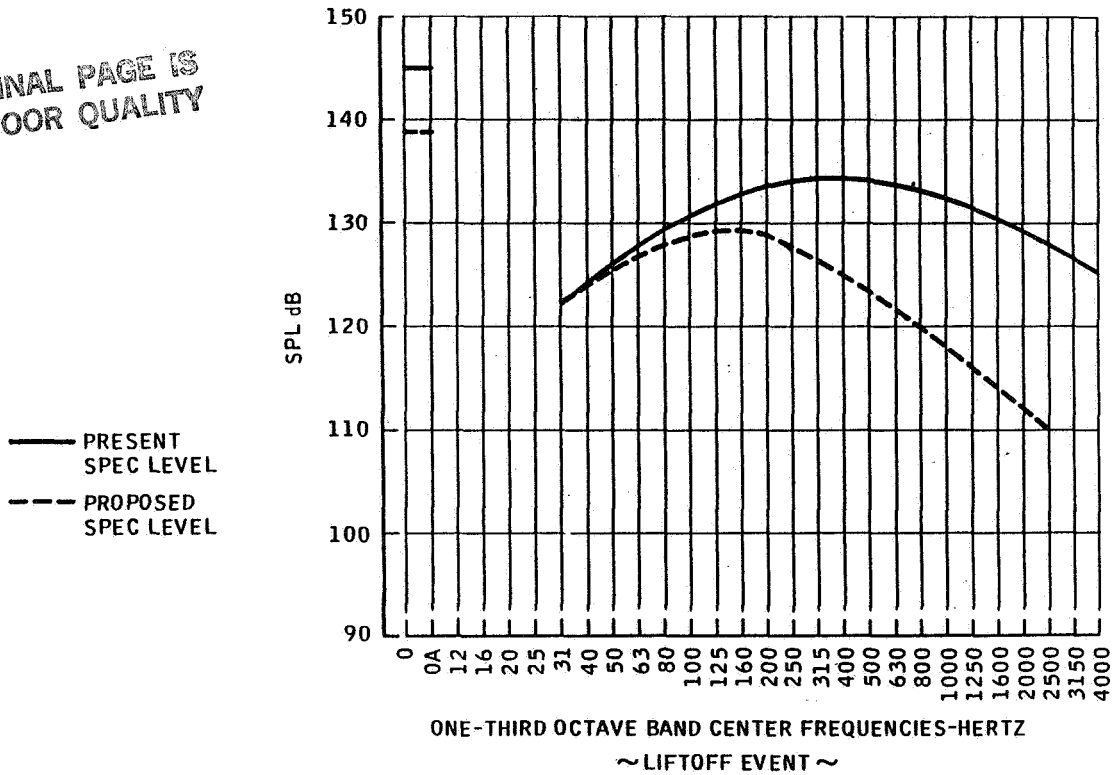

ORBITER PAYLOAD BAY INTERNAL ACOUSTIC ENVIRONMENT

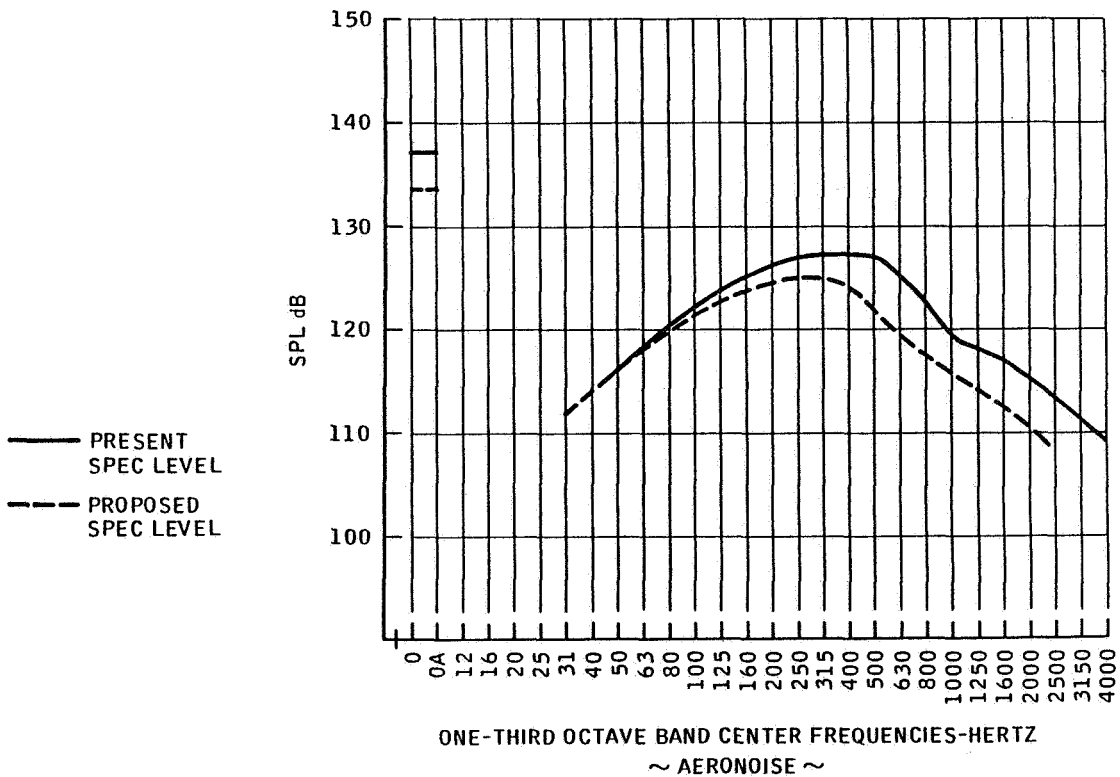

STS PAYLOAD BAY ENVIRONMENT

ACOUSTICS

- DERIVATION OF THE NEW PAYLOAD BAY CRITERIA
 - DATA WERE OBTAINED FROM 4 INTERNAL MICROPHONES (4 FLIGHTS)
 - DATA WERE ANALYZED FOR 6 FLIGHT EVENTS
 - MAIN ENGINE IGNITION
 - SRB IGNITION/LIFTOFF
 - TRANSONIC
 - MAX Q
 - SUPERSONIC
 - ENTRY
 - MAXIMUM NOISE LEVELS OCCUR DURING LIFTOFF AND TRANSONIC EVENTS
 - ACOUSTIC DATA WERE AVERAGED AND ENVELOPED FOR THE TWO EVENTS

STS PAYLOAD BAY ENVIRONMENT

ACOUSTIC (CONT)

- EVALUATION CONSIDERED THE NOISE LEVELS MEASURED ON THE DIFFERENT PALLETS
- SPECTRUM CONSIDERED TO BE THE MINIMUM TO CERTIFY TO FOR FLIGHT
- CONTINUING ANALYSIS WILL QUANTIFY 300 Hz VENT TONE AND INCLUDE IN CRITERIA

DATA CONCERNS:

- 300 Hz TONE
- 4000 Hz NOISE ON FORWARD BULKHEAD MEASUREMENT
- 600 Hz NOISE ON AFT BULKHEAD MEASUREMENT
- HIGH FREQUENCY (ABOVE 1000 Hz) CONTENT OF MOST MEASUREMENTS

STS PAYLOAD BAY ENVIRONMENT

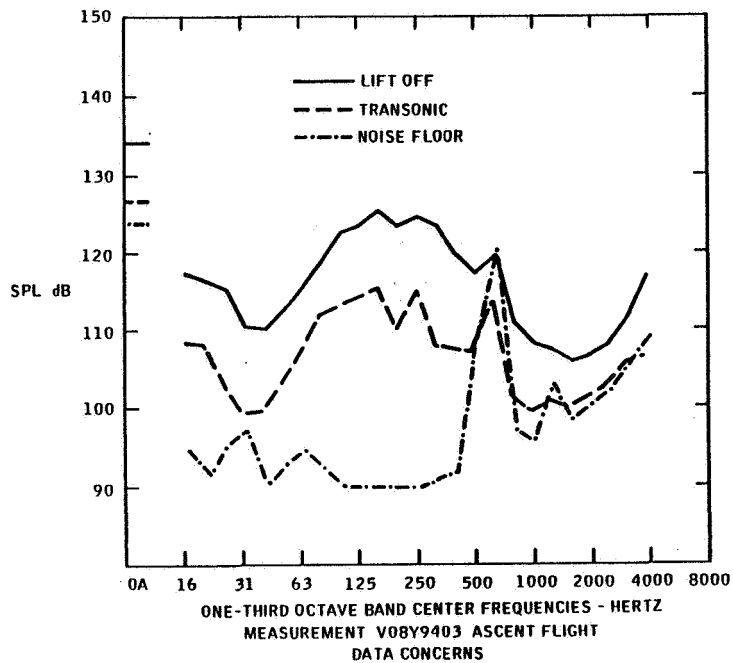

STS PAYLOAD BAY ENVIRONMENT

SUMMARY

- PAYLOAD INTERNAL ACOUSTICS ABOUT 6 dB LESS THAN ORIGINAL CRITERIA

**STS PAYLOAD BAY
VIBRATION**

**STS PAYLOAD BAY
HIGH FREQUENCY VIBRATION**

ORBITER HIGH FREQUENCY ACCELEROMETERS

ORIGINAL PAGE IS
OF POOR QUALITY

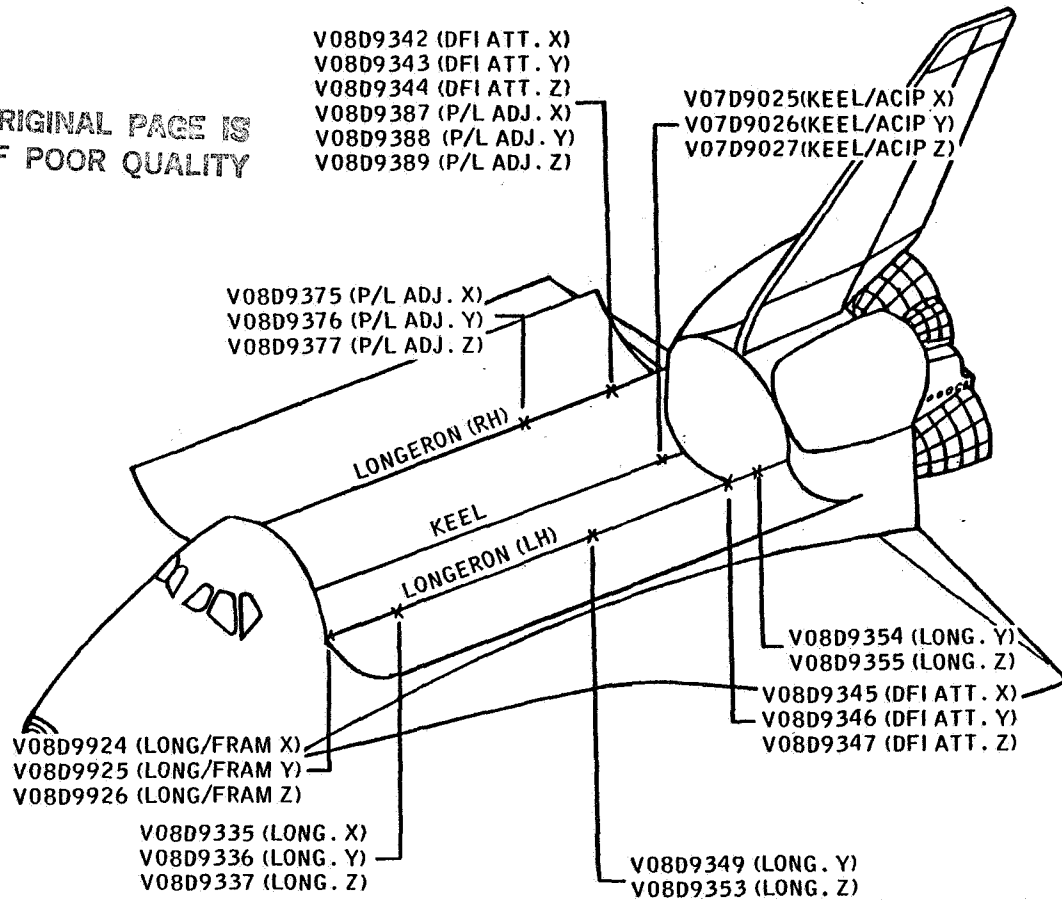

STS PAYLOAD BAY ENVIRONMENT

- VIBRATION SOURCES FOR PAYLOADS
 - LIFTOFF AND AERODYNAMIC NOISE EXCITATION OF ORBITER STRUCTURE
 - ACOUSTIC NOISE TRANSMITTED INTO PAYLOAD BAY
- VIBRATION ENVIRONMENT VARIES THROUGHOUT STRUCTURE
- CRITERIA ORIGINALLY DEVELOPED FOR ORBITER PAYLOAD BAY ZONES
 - MAIN LONGERON
 - KEEL
 - UNLOADED STRUCTURE

STS PAYLOAD BAY ENVIRONMENT

● ACCELERATION DATA ASSESSED FOR

- MAIN ENGINE IGNITION
- SRB IGNITION/LIFTOFF
- AERODYNAMIC FLIGHT
- ENTRY/LANDING

ORIGINAL PAGE IS
OF POOR QUALITY

● ASSESSMENT

- AMPLITUDES AND FREQUENCY CONTENT WERE COMPARED TO ANALYTICAL PREDICTIONS
- PAYLOAD WEIGHT EFFECT APPEARS TO HAVE LITTLE INFLUENCE ON MEASURED LEVELS
- REVISION TO BE ISSUED TO UPDATE THE ORBITER LONGERON LEVELS BASED ON FLIGHT DATA

ORBITER MAIN LONGERON RANDOM VIBRATION CRITERIA DERIVED FROM FLIGHT DATA

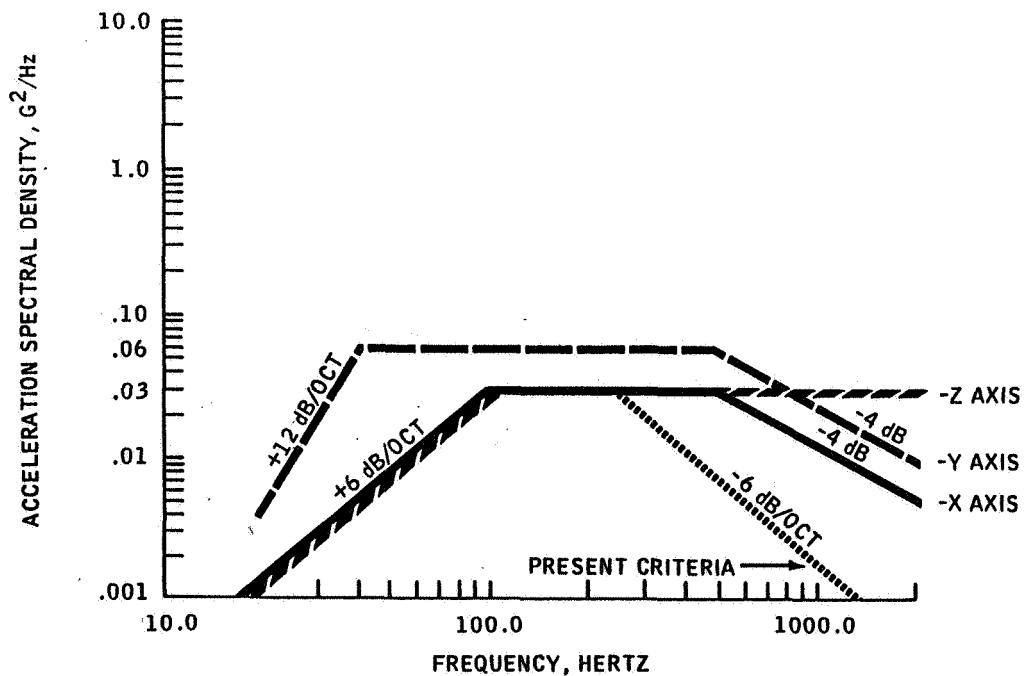

STS PAYLOAD BAY VIBRATION

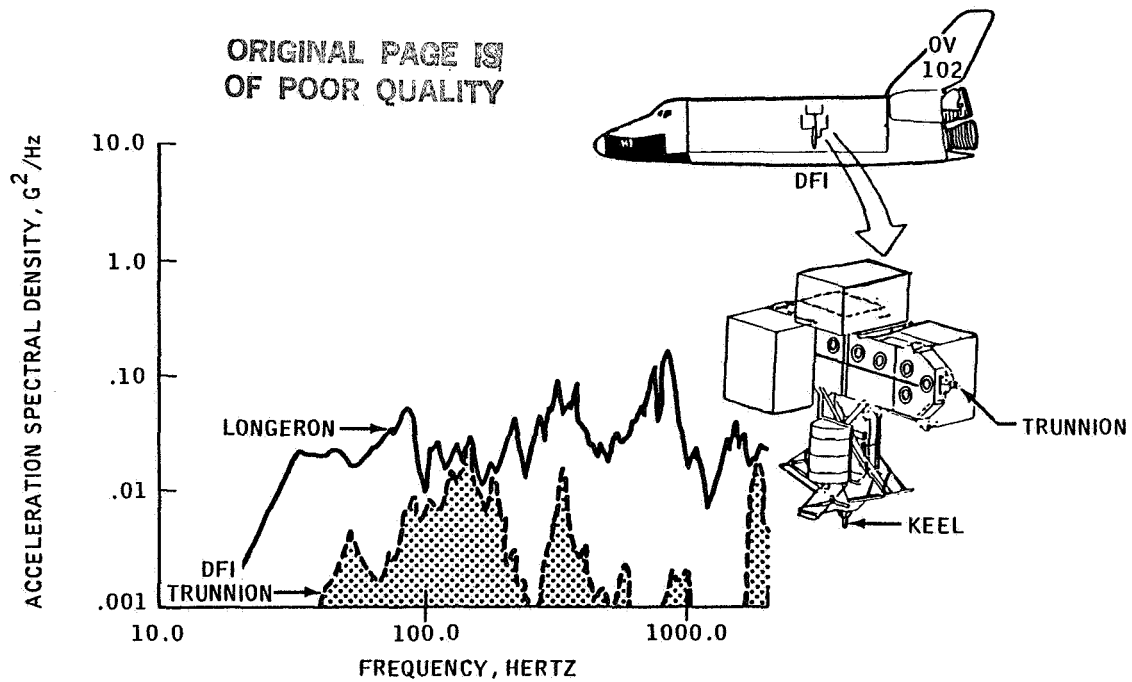

STS PAYLOAD BAY ENVIRONMENT

SUMMARY

- HIGH FREQUENCY RESPONSES OF LONGERON GREATER THAN PREDICTED (RANDOM VIBRATION)
- TRANSMISSION ACROSS TRUNNION LESS THAN EXPECTED WITH NET EFFECT ON PAYLOAD EXPECTED TO BE UNCHANGED

ORIGINAL PAGE IS
OF POOR QUALITY

STS PAYLOAD BAY LOW FREQUENCY VIBRATION

ORBITER LOW FREQUENCY ACCELEROMETERS

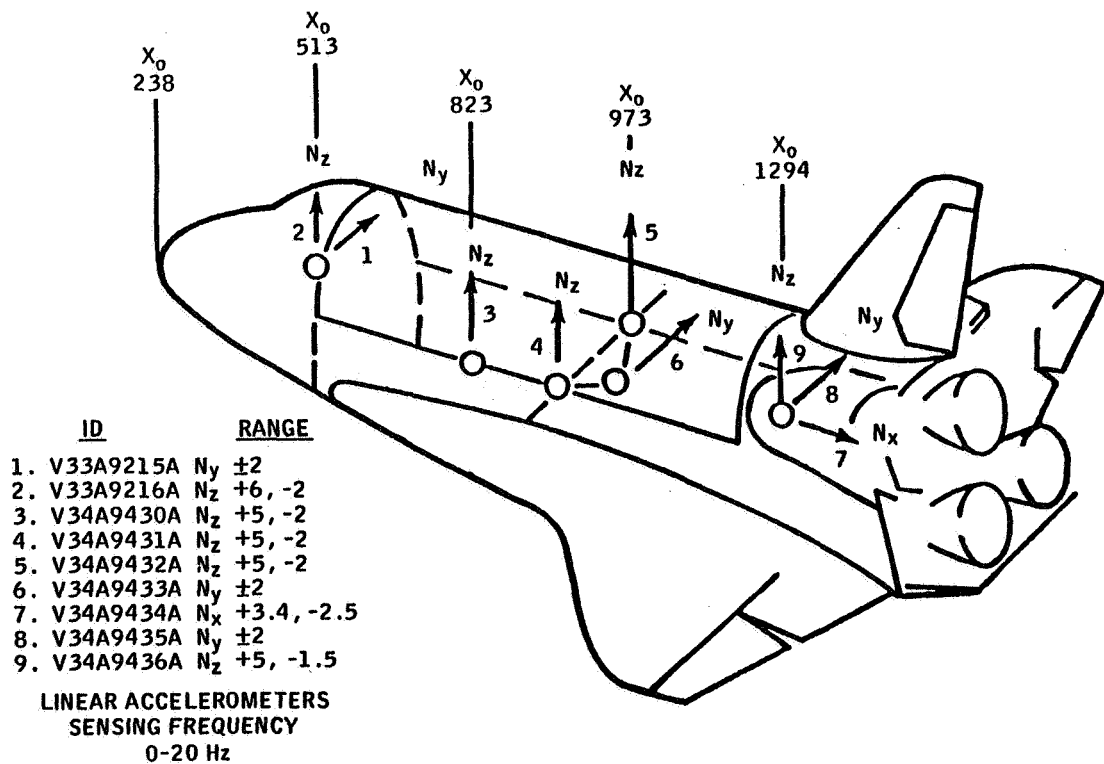

STS PAYLOAD BAY LOW FREQUENCY VIBRATION

- ACCELERATION DATA ASSESSED FOR
 - LIFTOFF, LANDING - DYNAMIC CONDITIONS
 - ASCENT, DESCENT - QUASI - STATIC CONDITIONS
- INSTRUMENTATION
 - LOW FREQUENCY ACCELEROMETERS - 0-20 Hz
 - "DATE" ACCELEROMETERS 0-50 Hz , 1 1/2-50 Hz , 5-2K Hz
- ASSESSMENT
 - AMPLITUDES, FREQUENCY CONTENT AND DAMPING OF MEASURED ACCELERATIONS ARE COMPARED TO ANALYTICAL PREDICTIONS
 - UPDATES TO ANALYTICAL DATA BASE USED IN PAYLOAD LOADS ANALYSES WILL BE DERIVED FROM FLIGHT DATA

ORIGINAL PAGE IS
OF POOR QUALITY

LIFTOFF COMPARISON

Xo LOCATION DESCRIPTION	DIRECTION	FLIGHT DATA				STS-3 PREFLIGHT DESIGN CASE*
		STS-1	STS-2	STS-3	STS-4	
1294, BULKHEAD	NX	2.10	1.79	1.91	1.82	2.18
979, KEEL	NY	0.4	0.16	0.16	0.14	0.55
1294, BULKHEAD	NY	0.25	0.13	0.19	0.08	0.39
823, LEFT LONGERON	NZ	2.8	0.74	0.72	0.84	1.51
973, LEFT LONGERON	NZ	2.9	0.60	0.66	0.70	1.65
973, RIGHT LONGERON	NZ	2.9	0.52	0.58	0.72	2.43
1294, BULKHEAD	NZ	1.25	0.25	0.25	0.35	1.08

* INCLUDES DISPERSION ON SRB THRUST, SSME THRUST, OVERPRESSURE, SRB MODEL, WINDS

ORIGINAL PAGE IS
OF POOR QUALITY

ASCENT & DESCENT COMPARISONS

<u>ASCENT</u>	<u>STS-1</u>	<u>STS-2</u>	<u>STS-3</u>	<u>STS-4</u>	<u>P/L REQUIREMENTS</u>
NX	-2.92	-2.99	-2.92	-2.93	-3.17
NY	0.1	0.2	0.1	0.2	0.4
NZ	-0.6	-0.6	-0.6	-0.6	-0.8
<u>DESCENT</u>					
NX	0.4	0.4	0.3	0.3	1.01
NY	0.2	0.2	0.1	0.2	0.85
NZ	1.6	1.9	1.6	1.8	2.5

LANDING TOUCHDOWN CONDITION COMPARISONS

CONDITION	<u>FLIGHT DATA</u>				<u>PAYLOAD VERIFICATION ANALYSIS</u>
	<u>STS-1</u>	<u>STS-2</u>	<u>STS-3</u>	<u>STS-4</u>	
HORIZONTAL VELOCITY AT MAIN IMPACT (KNOTS)	189	196	233	199	199
MAIN GEAR SINK RATE (FPS)	~1	<1	5.7	~1	6.0
NOSE GEAR SINK RATE (FPS)	5.7	5.1	8.8	5.4	11.0

ORIGINAL PAGE IS
OF POOR QUALITY

LANDING LOAD FACTOR COMPARISONS

Xo LOCATION DESCRIPTION	DIRECTION	FLIGHT DATA								REQUIREMENT	
		STS-1		STS-2		STS-3		STS-4			
		MG	NG	MG	NG	MG	NG	MG	NG	MG	NG
1294, BULKHEAD	NX	0.2	0.6	0.2	0.5	0.3	0.6	0.1	0.3	0.6	-
979, KEEL	NY	0.2	0.1	0.1	0.2	0.9	0.2	0.1	0.1	0.6	0.3
1294, BULKHEAD	NY	0.2	0.1	0.1	0.1	0.5	0.2	0.1	0.1	-	0.4
823, LEFT LONGERON	NZ	1.3	1.6	1.1	1.3	2.2	2.8	1.3	1.4	2.4	2.5
973, LEFT LONGERON	NZ	1.4	1.4	1.1	1.3	2.1	2.3	1.3	1.4	2.7	2.2
973, RIGHT LONGERON	NZ	1.4	1.4	1.1	1.2	2.0	2.3	1.3	1.4	2.4	2.3
1294, BULKHEAD	NZ	1.4	1.3	1.2	1.2	2.2	2.2	1.3	1.3	2.4	1.8

MG - MAIN GEAR IMPACT

NG - NOSE GEAR IMPACT

CORRELATION WITH AFT BULKHEAD Nx, FOR STS-2 LIFTOFF

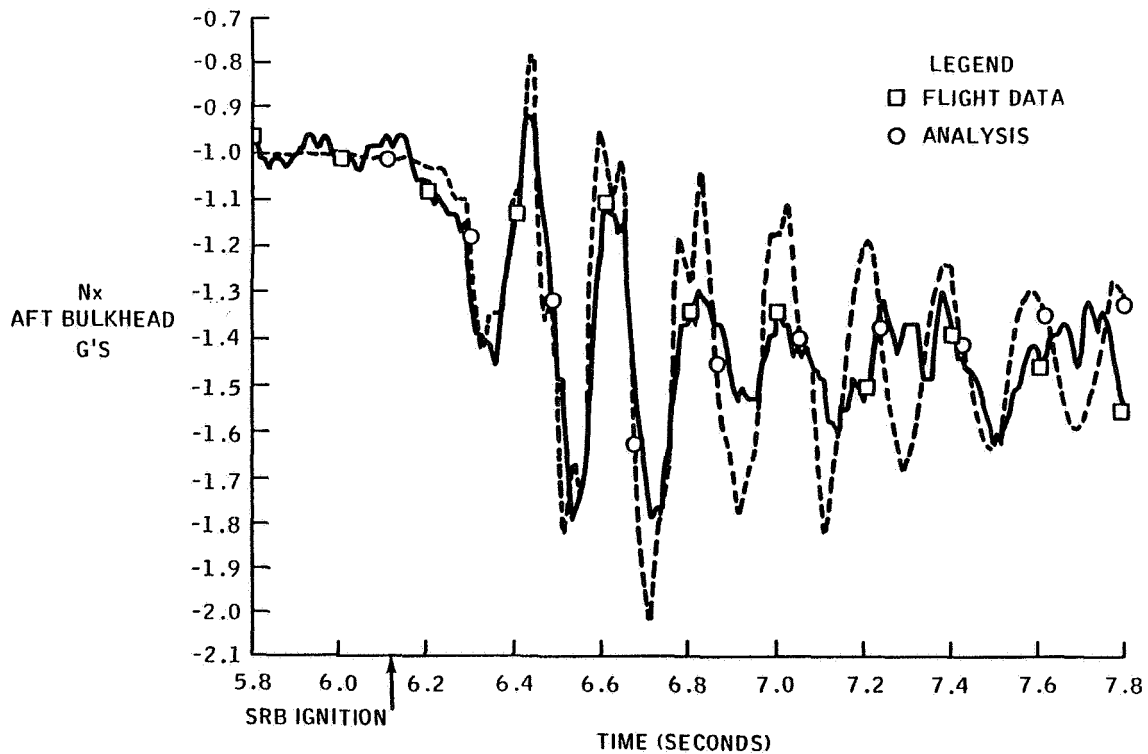

SUMMARY

- **LOW FREQUENCY RESPONSES MEASURED IN ORBITAL FLIGHT TESTS ARE GENERALLY WELL BELOW STS REQUIREMENT**
- **STRUCTURAL DAMPING FOR PAYLOAD LOADS ANALYSES MAY BE INCREASED**

STS ELECTROMAGNETIC ENVIRONMENT

STS ELECTROMAGNETIC COMPATIBILITY

STS ELECTROMAGNETIC ENVIRONMENT DEFINED IN ICD2-19001

- ENVIRONMENT INCLUDES CONTRIBUTION OF STS ELEMENTS AND PAYLOADS
- ENVIRONMENT VALID WHEN PAYLOAD CONTRIBUTION IS LIMITED TO LEVELS OF CONDUCTED AND RADIATED EMISSIONS ALLOWED IN ICD2-19001
- STS CONTRIBUTION TO ENVIRONMENT VERIFIED
 - GROUND TEST ON OV101
 - SPECIAL EMI TESTING IN SAIL
 - LRU TESTING
 - ANALYSIS

STS ELECTROMAGNETIC PERFORMANCE

- FLIGHT RESULTS INDICATE NO INTERFERENCE IN STS FLIGHT CRITICAL SYSTEMS FROM ON BOARD OR GROUND BASED SOURCES
- MINOR PROBLEMS NOTED TO DATE
 - MINOR AUDIO SYSTEM NOISE WHEN CREW NEAR WINDSHIELD - SOURCE IS TACAN XMTR'S. (NOTED IN GROUND TEST ONLY)
 - AFT PAYLOAD CURRENT SENSORS (BUS B&C) READ LOW WHEN HYDRAULIC PUMP IS RUNNING ON SAME BUS
 - NRL EXPERIMENT MALFUNCTIONED EACH TIME HYDRAULIC PUMP STARTED ON SAME BUS

SUMMARY

- **ELECTROMAGNETIC EFFECTS ARE ABOUT AS EXPECTED**

STS PAYLOAD BAY ENVIRONMENT

CONCLUSION

- **IN GENERAL THE PAYLOAD BAY ENVIRONMENTS ARE LESS SEVERE THAN PREDICTED**

N83 22296 27

ORBITER CARGO BAY THERMAL ENVIRONMENT DATA

R. G. Brown
Johnson Space Center

**ORIGINAL PAGE IS
OF POOR QUALITY**

**ORBITER CARGO BAY
THERMAL ENVIRONMENT DATA**

**ROBERT G. BROWN
SEPTEMBER 1982**



ORBITAL FLIGHT TEST THERMAL APPROACH

- **CONSERVATIVE FLIGHT TEST TIMELINE**
- **FIRST FLIGHT THERMALLY BENIGN AS POSSIBLE**
- **EACH ADDITIONAL FLIGHT INCREASING IN
THERMAL DIFFICULTY**
- **MEASUREMENT LOCATIONS DEFINED FOR ORBITER
PERFORMANCE**
- **ORBITER MODEL PREDICTION COMPARISON FOR
STS-1**
- **ORBITER MODEL CORRELATION BASED ON STS-2,
STS-3 AND STS-4**

ORBITAL FLIGHT TEST PROGRAM

	STS-1	STS-2	STS-3	STS-4
DATE	APRIL 12, 1981	NOVEMBER 12, 1981	MARCH 22, 1982	JUNE 27, 1982
BETA ANGLE	-26° TO -19°	-45° TO -51°	-23° TO -36°	-1 TO +20°
MAJOR ATTITUDES FLOWN	SERIES OF SHORT HOLD ATTITUDES EXCEPT FOR TWO 9-9.5 HRS OF +ZLV	BASICALLY +ZLV	24 HRS TAIL SUN TOP TO SPACE ORB RATE 11 HRS PTC 80 HRS XSI (NOSE TO SUN 2 REV PER ORBIT ABOUT X-AXIS) 27 HRS +ZSI (TOP 3-AXIS SI) 12 HRS PTC	10 HRS -ZSI (BOTTOM 3-AXIS SI) 7 HRS GRAVITY 12 HRS +ZLV (TOP 3-AXIS SI) 4½ HRS +ZSI 22 HRS -ZSI (BOTTOM 3-AXIS SI) 10 HRS PTC 61 HRS +XSI (TAIL 3-AXIS SI) 12 HRS PTC
END OF MISSION ATTITUDES	2 ORBITS TAIL TO SUN OPENED DOOR 2 ORBITS TOP TO SUN CLOSED DOOR	2 ORBITS TAIL TO SUN OPENED DOOR 2 ORBITS TOP TO SUN CLOSED DOOR	2 ORBITS TAIL TO SUN OPENED DOOR 2 ORBITS TOP TO SUN CLOSED DOOR	2 ORBITS TAIL TO SUN OPENED DOOR 2 ORBITS TOP TO SUN CLOSED DOOR

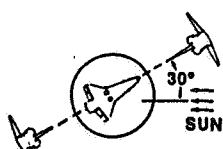
ORBITER ATTITUDES

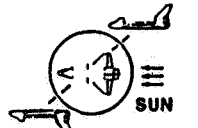
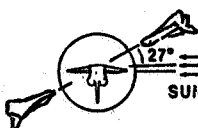
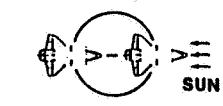
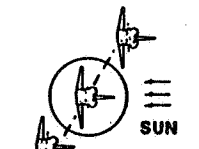
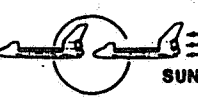
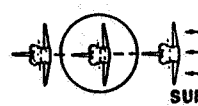
 <p>TOP LV, $\beta = 30^\circ$ (+ZLV, -XV)</p>	 <p>PTC, $\beta = 0^\circ$ (X ROLL, X INERTIAL)</p>	 <p>TAIL SUN, 1 REV/ORB $\beta = 45^\circ$ (+X SOLAR, +Z SPACE)</p>	 <p>NOSE LV, GRAVITY GRADIENT, $\beta = 30^\circ$ WING ROLL OUT ORBIT PLANE 27° CW (-XLV, -YV ROLL CW 27°)</p>
 <p>NOSE SUN, $\beta = 0^\circ$ (-X SI, Y POP)</p>	 <p>TOP SI, $\beta = 60^\circ$ (+Z SI)</p>	 <p>TAIL SI, $\beta = 0^\circ$ (+X SI, Z POP)</p>	 <p>BOTTOM SI, $\beta = 0^\circ$ (-Z SI, Y POP)</p>

ORIGINAL PAGE IS
OF POOR QUALITY

CARGO BAY MEASUREMENTS

- 14 CARGO BAY INSULATION SURFACE TEMPERATURES
- 2 WIRE TRAY SURFACE TEMPERATURES
- 12 SILL LONGERON TEMPERATURES
- 4 GAS TEMPERATURES
- 1 RADIATOR TEMPERATURE
- 1 GAS PRESSURE

CARGO BAY MEASUREMENT LOCATIONS

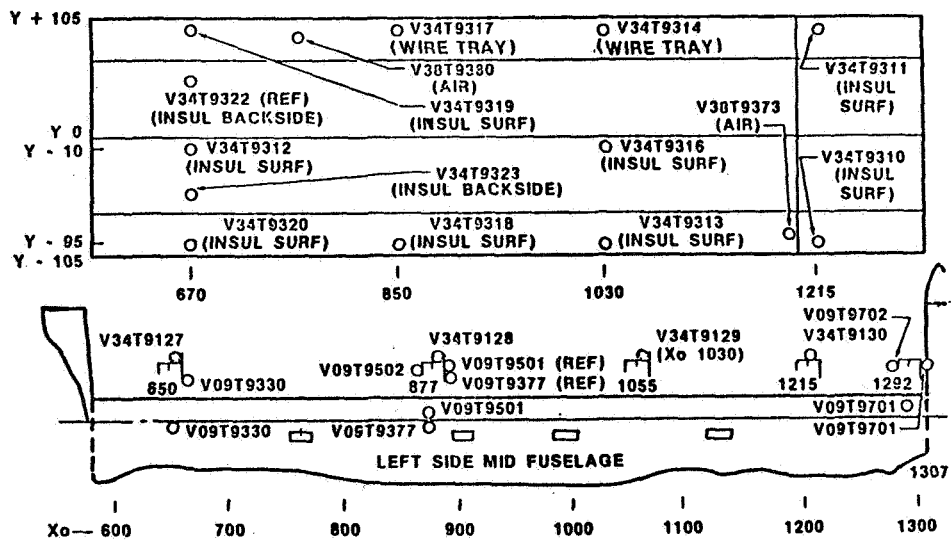

ORIGINAL PAGE IS
OF POOR QUALITY

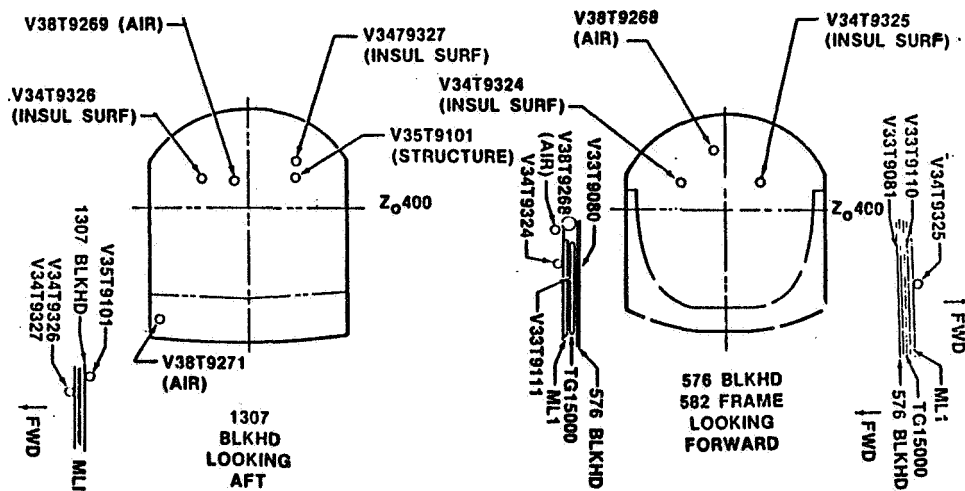
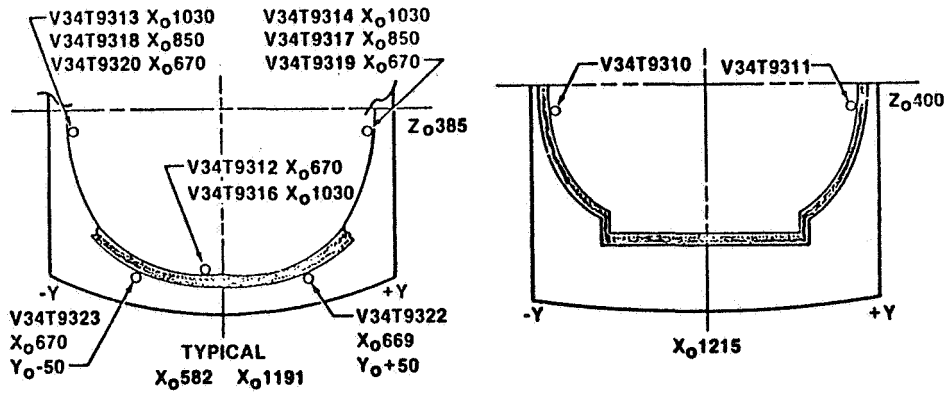

ORBITER PAYLOAD BAY
PRELAUNCH TEMPERATURES

ORIGINAL PAGE IS
OF POOR QUALITY

	STS-1		STS-2		STS-3		STS-4	
	DATA °F	PREDICTION °F	DATA °F	PREDICTION °F	DATA °F	PREDICTION °F	DATA °F	PREDICTION °F
PURGE	80	80	70	70	70	70	70	70
AIR	80	80	70	70	70	70	70	70
LINER	80	80	70	70	70	70	70	70
LONGERON	75	70	70	70	70	70	70	70
FITTING	-	-	-	-	70	70	70	70
RADIATOR	75	75	70	70	70	70	70	70
BULKHEAD	80	80	70	70	70	70	70	70

ORBITER PAYLOAD BY
ASCENT TEMPERATURES
LIFTOFF/MIH/MAX

	STS-1		STS-2		STS-3		STS-4	
	DATA °F	PREDICTION °F	DATA °F	PREDICTION °F	DATA °F	PREDICTION °F	DATA °F	PREDICTION °F
LINER	80/62/84	80/36/97	70/50/65	70/24/80	70/50/65	70/24/80	70/50/65	70/24/80
LONGERON	75	70	70	70	70	70	70	70
FITTING	--	--	--	--	70	70	70	70
RADIATOR	75/65/70	75/65/75	70/57/60	70/60/70	70/57/60	70/60/70	70/57/60	70/60/70
BULKHEAD	80/50/70	80/30/80	70/50/70	70/30/80	70/50/70	70/30/80	70/50/70	70/30/80

ORBITER PAYLOAD BAY
ON-ORBIT TEMPERATURES
MIN/MAX

ORIGINAL PAGE IS
OF POOR QUALITY

	STS-1 +ZLV $\beta \approx -30^\circ$		STS-2 +ZLV $\beta \approx -60^\circ$			
	DATA °F	PREDICTION °F	PORT		STBD	
			DATA °F	PREDICTION °F	DATA °F	PREDICTION °F
LINER	5/80	0/75	25/65	15/75	10/35	5/40
LONGERON	15/20	18/30	40/45	35/50	15/20	15/30
FITTING	-	-	-	-		
BULKHEAD	-10/+120	-25/+120	0/100	-10/115		

ORBITER PAYLOAD BAY
ON-ORBIT TEMPERATURES
MIN/MAX

	STS-3						STS-4		
	TAIL SUN ORB RATE		NOSE SUN 2 ORB RATE		TOP SUN		BOTTOM SUN	TAIL SUN	TOP SUN
	DATA °F	PRED °F	DATA °F	PRED °F	DATA °F	PRED °F	DATA °F	DATA °F	DATA °F
LINER	-153	-190	50/-100	50/-150	30/260*	0/200	30/-80	20/-100	210
LONGERON	-95/-50 ⁺	-90/-60	-40/-20 ⁺	-54/-30	100	115	-20	-40	-30
FITTING	-50	-60	-20	-35	125	140	-10	-35	110
BULKHEAD	-120	-55	20/-100	30/-130	0/100	-10/120	0/-80	30/-100	0/100

+ FWD/AFT LONGERON TEMPERATURE
* MEASUREMENT SUSPECT

ORBITER PAYLOAD BAY
ENTRY AND POSTLANDING TEMPERATURES
E1/TD/MAX*

ORIGINAL PAGE 13
OF POOR QUALITY

	STS-1		STS-2		STS-3		STS-4	
	DATA °F	PRED °F	DATA °F	PRED °F	DATA °F	PRED °F	DATA °F	PRED °F
PURGE**	55/65		55/65		55/65		55/65	
AIR ^A	- /45/80	- /50/80	- /70/80	- /105/105	- /60/85	- /105/105	- /70/80	
LINER	20/60/70	20/48/86	20/65/70	20/68/90	15/68/75	15/75/90	0/70/75	
LONGERON	3/30/75	3/25/70	10/40/70	10/30/60	5/60/70	5/45/65	0/50/75	
FITTING	-	-	-	-	15/65/70	-	10/60/75	
RADIATOR	10/32/80 ^B	10/35/100	15/80/85 ^C	15/85/95	20/80/85 ^C	20/85/90	-5/75/80 ^C	
BULKHEAD	20/50/65	20/42/87	20/60/65	20/42/87	15/60/70	15/65/80	0/65/75	

- * MAXIMUM TEMPERATURES OCCUR AFTER TOUCHDOWN
- ** PURGE WAS 55°F INITIALLY, THEN INCREASED TO 65°F AFTER A FEW HOURS
- A AIR MEASUREMENT APPEARS TO BE ENVIRONMENT TEMPERATURE
- B RADIATOR FLOW FROM TD TO TD +15 MIN.
- C RADIATOR FLOW FROM TD -6 MIN. TO TD +15 MIN.

TMM/FLIGHT DATA COMPARISON
ORBIT AVERAGE TEMPERATURES
STS-3 TAIL SUN (22 HOURS)
FWD (X₀ = 584 - 919)

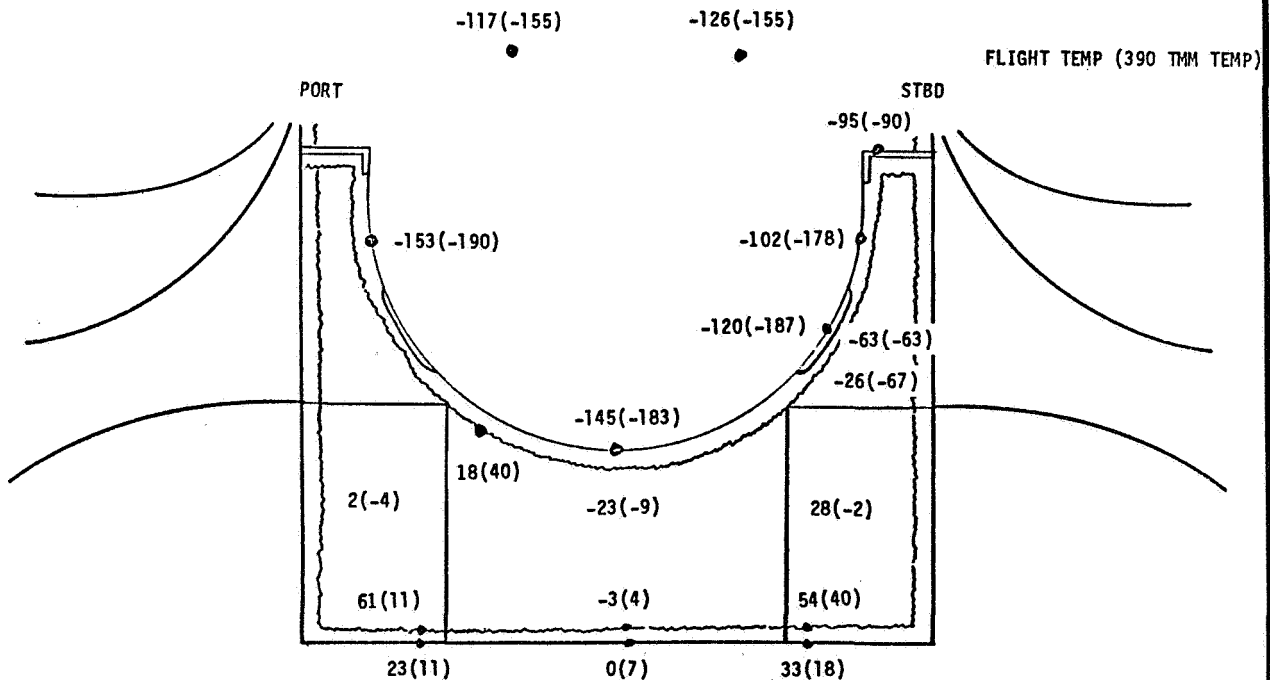

TMM/FLIGHT DATA COMPARISON
 ORBIT AVERAGE TEMPERATURES
 STS-3 TAIL SUN (22 HOURS)
 AFT ($X_0 = 919 - 1307$)

ORIGINAL PAGE IS
 OF POOR QUALITY

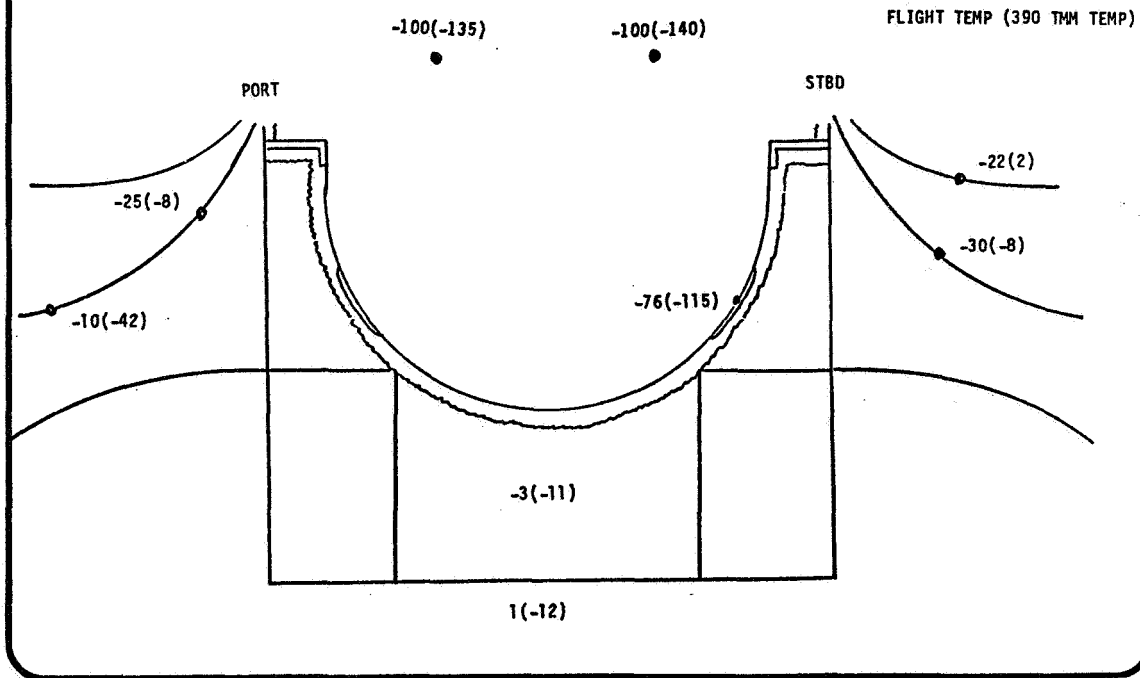

TMM/FLIGHT DATA COMPARISON
 ORBIT AVERAGE TEMPERATURES
 (STS-3 NOSE-SUN (78 HOURS)
 FWD ($X_0 = 584 - 919$)

FLIGHT TEMP (390 TMM TEMP)

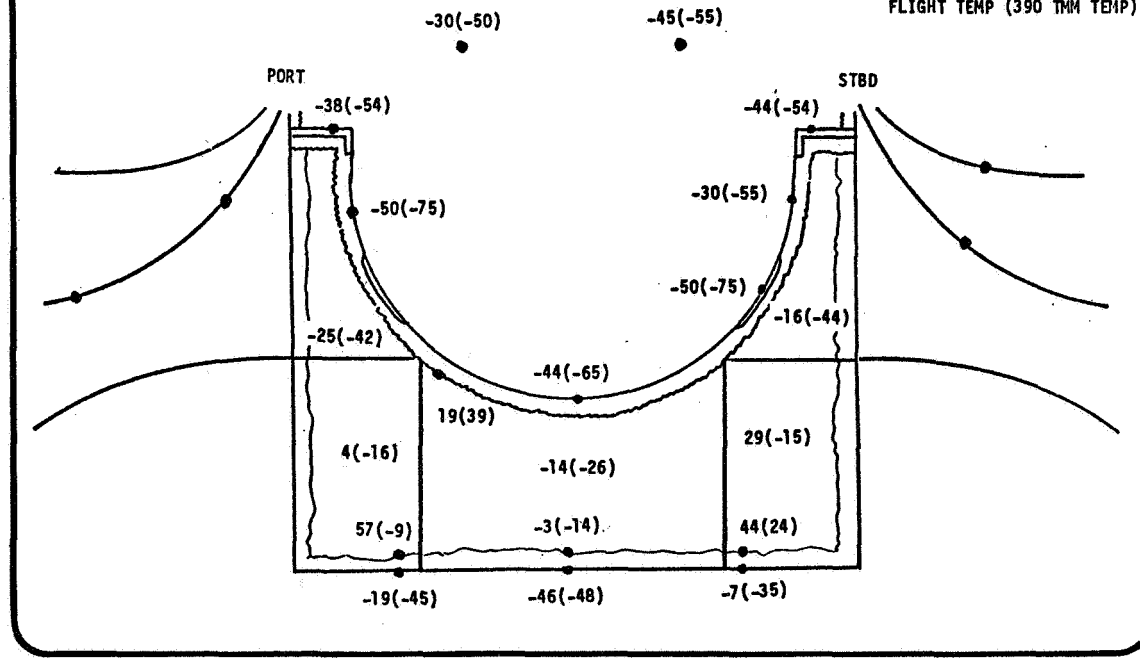

ORIGINAL PAGE IS
OF POOR QUALITY

TMM/FLIGHT DATA COMPARISON
ORBIT AVERAGE TEMPERATURES
STS-3 NOSE-SUN (78 HOURS)
AFT ($X_0 = 919 - 1307$)

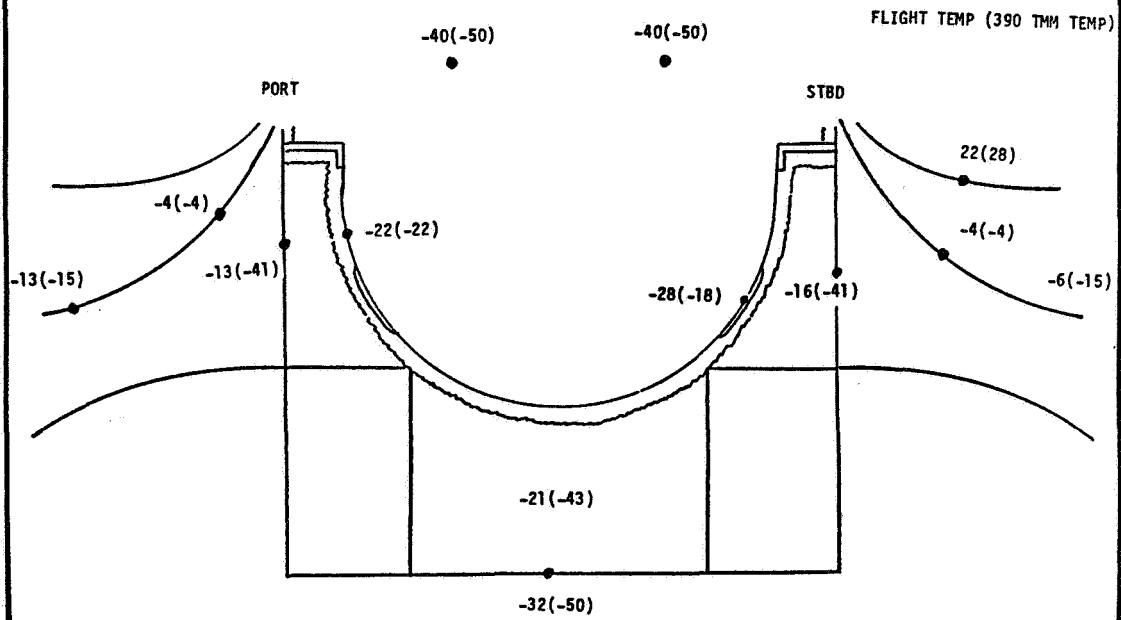

FLIGHT DATA
ORBIT MAXIMUM TEMPERATURES
STS-3 TOP SUN (24 HOURS)
FWD ($X_0 = 584 - 919$)

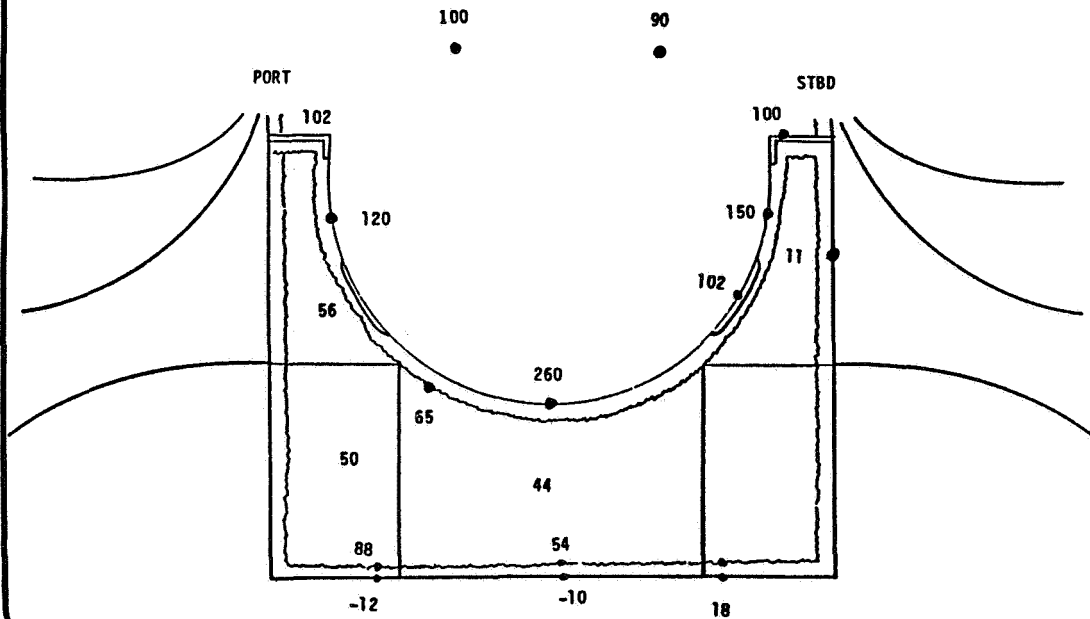

FLIGHT DATA
 ORBIT MAXIMUM TEMPERATURES
 STS-3 TOP SUN (24 HOURS)
 AFT ($X_0 = 919 - 1307$)

ORIGINAL PAGE IS
 OF POOR QUALITY

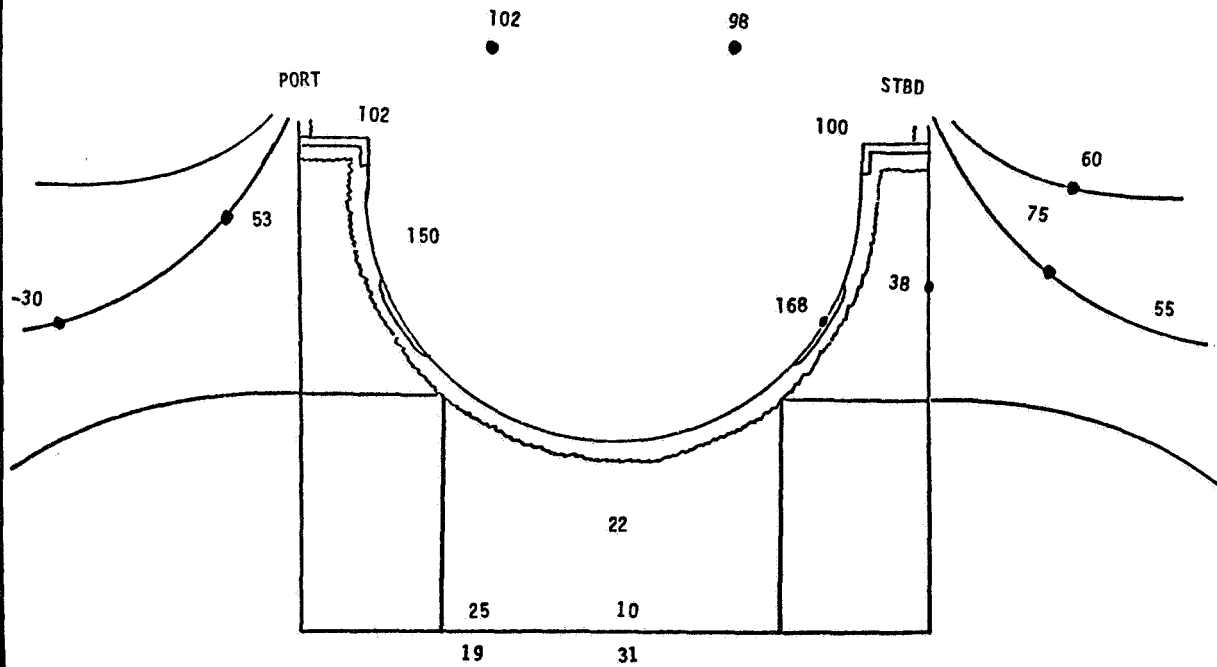

TMM/FLIGHT DATA COMPARISON
 STS-2 ASCENT

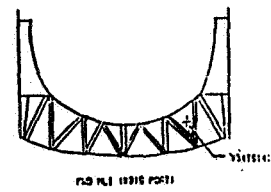
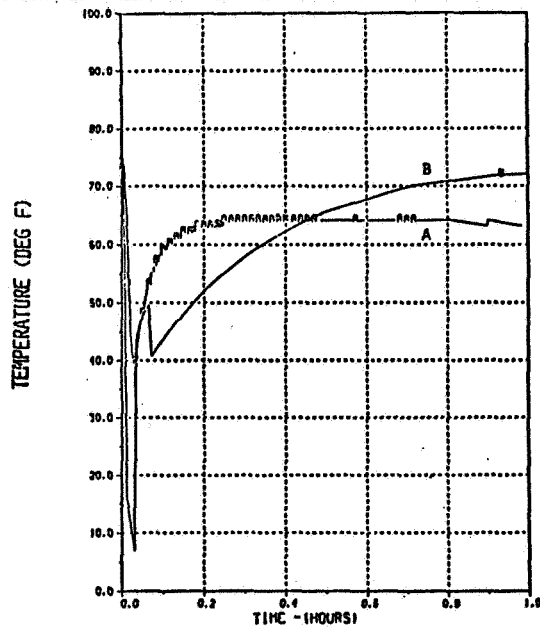

A - STS-2 FLIGHT DATA (V34T9142)
 B - NODE 1268 PREDICTIONS

X_0 919 NLI CLOSEOUT (FNU)

CURRENT MISSION STS-3DF1
LIFT-OFF: 3/22/82 16:00:0
REQ DATE: 4/28/82 14:46:3

ORIGINAL PAGE IS
OF POOR QUALITY

PAYLOAD BAY INSULATION SURFACE FWD

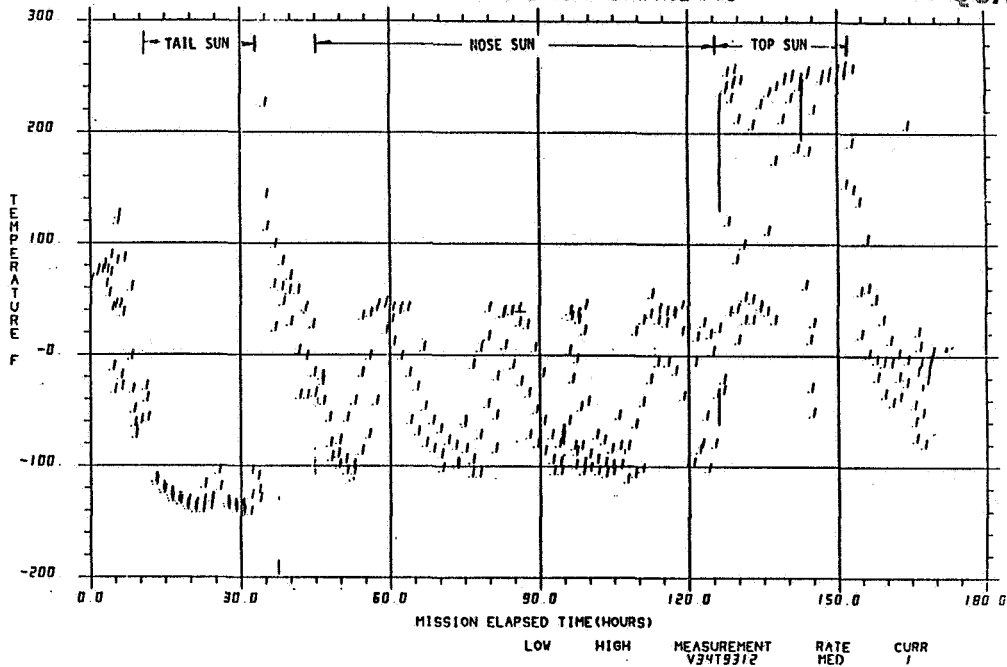

CURRENT MISSION STS-3
LIFT-OFF: 3/22/82 16:00:0
REQ DATE: 4/5/82 15:29:16

PORT LONGERONS

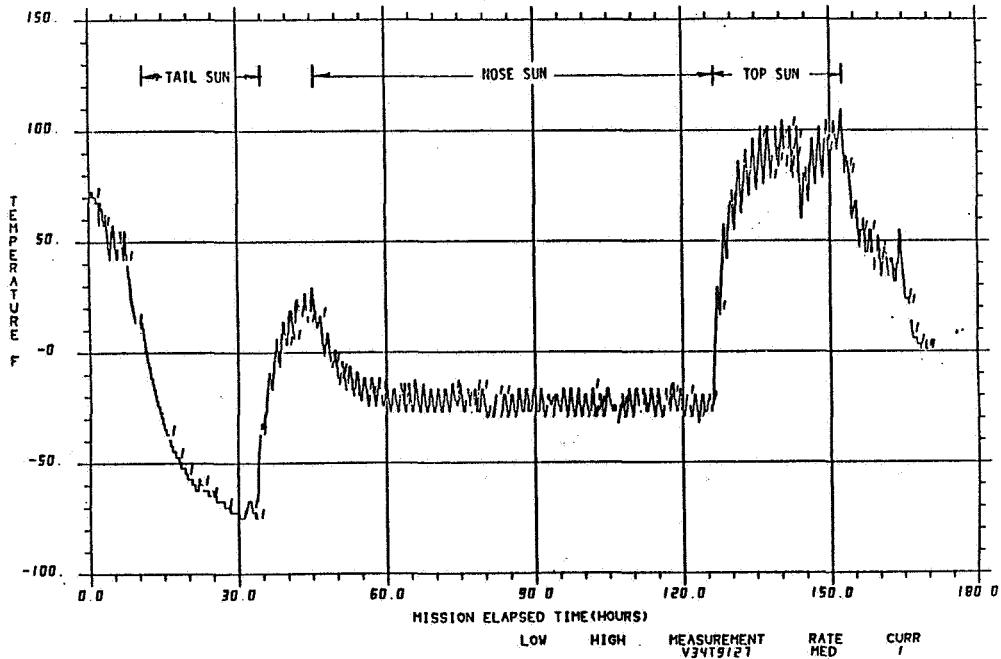

ORIGINAL PAGE IS
OF POOR QUALITY

DFI LONGERON RETENTION FITTING
- LATCH TEMPERATURE -

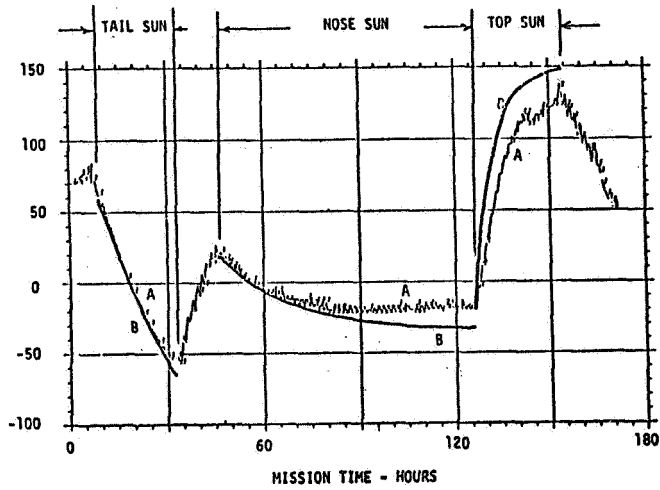

TM/FLIGHT DATA COMPARISON

DFI LONGERON RETENTION FITTING
- LATCH TEMPERATURE -

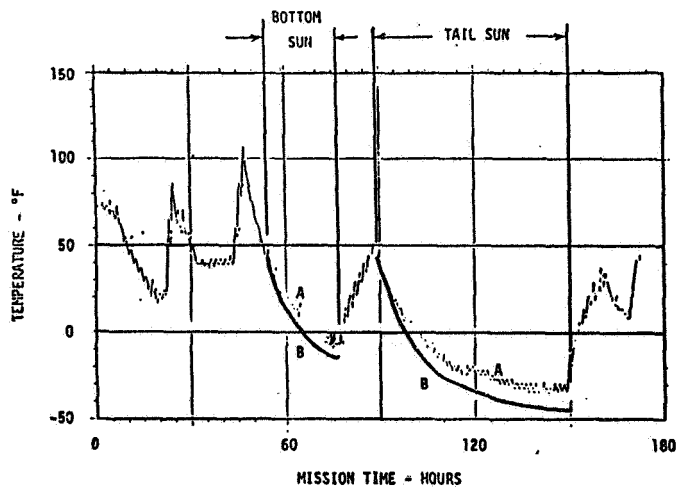

STS-3 ENTRY
FWD LINER (X₀=670)

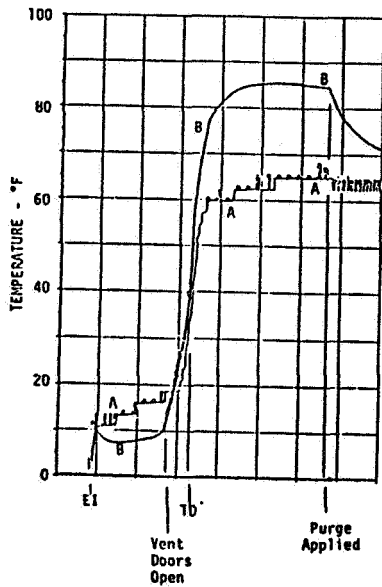

A - STS-3 FLIGHT DATA
B - 390 TMI

STS-1 POSTLANDING TEMPERATURES

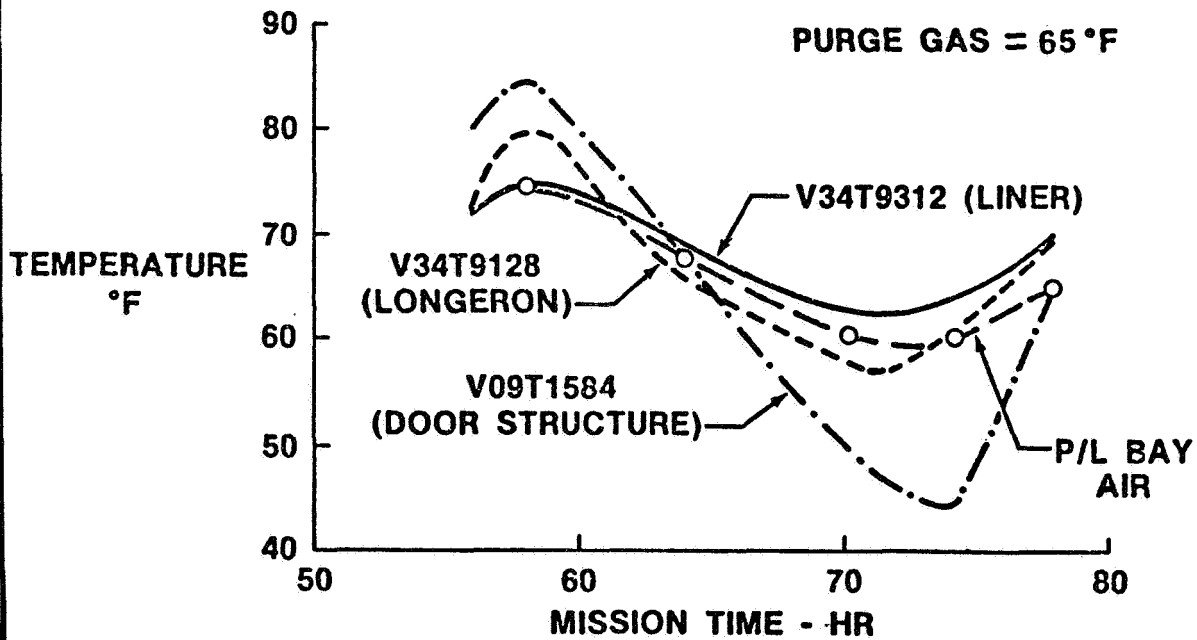

CONCLUSION

ORIGINAL PAGE IS
OF POOR QUALITY

- IN GENERAL THE FLIGHT THERMAL ENVIRONMENT IS LESS SEVERE THAN PREDICTIONS EXCEPT FOR POSSIBLY TOP SUN.
- NO ADVERSE THERMAL EFFECT ON THE ORBITER OR PAYLOAD AS A RESULT OF INTERACTION FOR PAYLOADS FLOWN ON THE FIRST FOUR FLIGHTS.

N83 22297 ^{Dg}

KSC SHUTTLE GROUND TURNAROUND EVALUATION

J. M. Ragusa
Kennedy Space Center

ORIGINAL PAGE IS
OF POOR QUALITY

KSC SHUTTLE GROUND TURNAROUND EVALUATION
KSC PAYLOAD ENVIRONMENTS

DR. JAMES M. RAGUSA
KSC (CP-SPO)
OCTOBER 5, 1982

AGENDA

- INTRODUCTION
- PAYLOAD PROCESSING FLOWS
- PAYLOAD FACILITIES/SYSTEMS CAPABILITIES/STATUS
- OPERATIONAL CONSIDERATIONS
- ORBITER INTERNAL ENVIRONMENT (PRELAUNCH - POSTLANDING)
- CONCLUSIONS

FOLLOWING THIS INTRODUCTION THE TOPICS TO BE DISCUSSED ARE:

1. THE VARIOUS GENERIC LAUNCH SITE PROCESSING SEQUENCES AND THE KSC FACILITIES INVOLVED IN EACH.
2. THE ENVIRONMENTAL CONTROL CAPABILITIES OF KSC FACILITIES AND SYSTEMS.
3. IMPORTANT OPERATIONAL CONSIDERATIONS.
4. THE INTERNAL ORBITER ENVIRONMENT DURING PRE-LAUNCH AND LANDING OPERATIONS.
5. AND FINALLY, SOME CONCLUSIONS.

Preceding page blank

ORIGINAL PAGE IS
OF POOR QUALITY

INTRODUCTION

- PURPOSE OF PRESENTATION
- BACKGROUND
- PHYSICAL FACTORS TO BE CONSIDERED
- MULTIPLICITY OF REQUIREMENTS
 - SOURCES
 - STANDARDS

PURPOSE OF PRESENTATION

- TO DESCRIBE FOR PAYLOAD/MISSION DEVELOPMENT, KSC PROCESSING FLOWS, FACILITIES/SYSTEMS, AND THE VARIOUS ENVIRONMENTS TO WHICH A PAYLOAD WILL BE EXPOSED DURING GROUND PROCESSING AT KSC AND SECONDARY/CONTINGENCY LANDING SITES
 - THESE CONSIDERATIONS WILL BE IMPORTANT FOR:
 1. PAYLOAD DESIGN
 2. GROUND PROCESSING REQUIREMENTS DEVELOPMENT
- TO MAKE IT CLEAR THAT KSC CAPABILITIES HAVE BEEN DESIGNED TO MEET THE BASIC NEEDS OF MOST PAYLOADS, AND MAY NOT SATISFY THE VERY STRINGENT NEEDS OF SOME.

THE PURPOSE OF THIS PRESENTATION IS TO ADVISE PAYLOAD INVESTIGATORS OF THE VARIOUS ENVIRONMENTS THAT MAY BE ENCOUNTERED WHILE AT KSC/CCAFA'S AND OTHER LOCATIONS. THIS INFORMATION SHOULD BE CONSIDERED DURING THE PAYLOAD DESIGN PHASE TO ACCOMMODATE OR MINIMIZE SPECIAL NEEDS THAT COULD BE REQUIRED DURING THE GROUND PROCESSING OF PAYLOADS.

IT SHOULD BE NOTED THAT PRESENT AND PLANNED KSC ENVIRONMENTAL CAPABILITIES MAY NOT MEET ALL PAYLOAD REQUIREMENTS.

ORIGINAL PAGE IS
OF POOR QUALITY

BACKGROUND

- HISTORY OF PAYLOAD ENVIRONMENTAL CONTROL AT KSC
 - VIKING
 - RANGER/SURVEYOR
 - APOLLO
- ALTERNATIVE APPROACHES
 - ENCAPSULATE PAYLOAD
 - ENVIRONMENTAL CONTROL
 - CLEANING AND/OR STERILIZATION
 - COMBINATION

ENVIRONMENTAL CONTROL HAS BEEN IMPORTANT THROUGHOUT THE SPACE EXPLORATION EFFORTS OF THE UNITED STATES. THE PRIMARY PURPOSE OF ENVIRONMENTAL CONTROL IS TO REDUCE CONTAMINATION THAT COULD LEAD TO THE FAILURE OF A SYSTEM OR ENDANGER THE MISSION.

THE EXPLORATION OF OTHER CELESTIAL BODIES REQUIRED THE PLANETARY QUARANTINE PROGRAM TO PREVENT POTENTIAL INFECTION WITH EARTH DISEASES.

THESE OBJECTIVES WERE ACHIEVED BY A VARIETY OF METHODS INCLUDING: ENCAPSULATION, ENVIRONMENTAL CONTROL, CLEANING AND STERILIZATION, OR A COMBINATION OF THESE METHODS.

PHYSICAL FACTORS TO BE CONSIDERED

- PARTICULATES
 - AIRBORNE
 - FALLOUT
- TOTAL HYDROCARBONS (THC)
- NON-VOLATILE RESIDUES (NVR)
- HUMIDITY
- TEMPERATURE

THE PHYSICAL FACTORS THAT MAKE UP THE ENVIRONMENT WHICH MUST BE CONTROLLED ARE: PARTICULATES, HYDROCARBONS, NON-VOLATILE RESIDUES, AS WELL AS HUMIDITY AND TEMPERATURE. THESE FACTORS CAN DAMAGE OR DEGRADE A CAPABILITY BY: CORROSION, OBSCURATION OF OPTICAL SURFACES, DEGRADATION OF ELECTRONICS, AND JAMMING MECHANICAL SYSTEMS.

ORIGINAL PAGE IS
OF POOR QUALITY

MULTIPLICITY OF REQUIREMENTS

- SOURCES
 - JSC-07700 SPACE SHUTTLE PROGRAM LEVEL II PROGRAM DEFINITION AND REQUIREMENTS
 - VOL. X FLIGHT AND GROUND SPECIFICATIONS
 - OUTLINES THE FLIGHT AND GROUND SPECIFICATIONS THAT IDENTIFY THE SHUTTLE PROCESSING ENVIRONMENT
 - VOL. XIV SPACE SHUTTLE PAYLOAD ACCOMMODATIONS
 - IDENTIFIES THE PAYLOAD TO ORBITER ENVIRONMENTAL INTERFACES DURING PROCESSING AT KSC
 - JSL-SH-C-0005A SPECIFICATION CONTAMINATION CONTROL REQUIREMENTS FOR THE SPACE SHUTTLE PROGRAM
 - ESTABLISHES COMMON, DEFINITIVE RESPONSIBILITIES AND REQUIREMENTS FOR CONTAMINATION CONTROL FOR THE SPACE SHUTTLE PROGRAM
 - K-STSM-09.7A KSC SIS INTEGRATION AND GROUND TURNAROUND CONTAMINATION CONTROL PLAN
 - OUTLINES THE REQUIREMENTS FOR IMPLEMENTATION OF CONTAMINATION CONTROL FOR FACILITY SYSTEMS AND GROUND SUPPORT EQUIPMENT INVOLVED WITH PAYLOAD INTEGRATION AND ORBITER TURNAROUND

THE REQUIREMENTS FOR ENVIRONMENTAL CONTROL AT KSC COME FROM A VARIETY OF SOURCES. THE JSC-07700 DOCUMENTS SPECIFY THE ENVIRONMENT FOR ORBITER HARDWARE AND SHUTTLE FACILITIES. JSC-SH-C-0005A ALSO SPECIFIES REQUIREMENTS FOR THE ORBITER/CANISTER AND ASSOCIATED PAYLOAD INTERFACE REQUIREMENTS. K-STSM-09.7A DESCRIBES FACILITY AND SYSTEM REQUIREMENTS FOR VARIOUS KSC PROCESSING AREAS.

MULTIPLICITY OF REQUIREMENTS

- STANDARDS
 - VARIOUSLY ADDRESSED
 - INLET AIR (I.E., PARTICULATE/THC CONTENT)
 - AMBIENT CONDITIONS/PROPERTIES (I.E., TEMPERATURE, RELATIVE HUMIDITY, THC)
 - SURFACE DEPOSITS (I.E., VISIBLY CLEAN)
 - MAY/MAY NOT BE TIME DEPENDENT (I.E., VISIBLY CLEAN)
 - MAY/MAY NOT BE INTERRELATED (I.E., RELATIVE HUMIDITY)
 - ARE IMPACTED BY ON-GOING OPERATIONS (I.E., DOOR OPENINGS, INDUSTRIAL ACTIVITIES)
- SUMMARY/IMPACT
 - REGARDLESS OF HOW STRINGENT INLET OR AMBIENT AIR REQUIREMENTS MAY BE, IF A PAYLOAD REMAINS EXPOSED LONG ENOUGH, SURFACE DEPOSITS WILL OCCUR AND/OR MOISTURE WILL BE ABSORBED

IN ADDITION TO THE VARIOUS REQUIREMENTS SOURCES THAT AFFECT KSC, ENVIRONMENTAL CONTROL PARAMETERS COME FROM SEVERAL STANDARDS. THESE STANDARDS VARIOUSLY ADDRESS THE CONDITIONS THAT THE PROCESSING FACILITIES SHOULD MEET. IN SOME CASES THE AIR FOR A FACILITY IS EXPRESSED IN TERMS OF INLET AIR PARTICLE CONTENT; IN OTHER CASES IT IS DEFINED IN TERMS OF SUSPENDED PARTICLES IN THE FACILITY AIR AND IN STILL OTHERS, IN TERMS OF THE CLEANINESS OF THE EXPOSED SURFACES.

THESE CONDITIONS MAY OR MAY NOT BE TIME DEPENDENT. FOR EXAMPLE, A SURFACE THAT STARTS AS VISIBLY CLEAN MAY NOT REMAIN THAT WAY WITHOUT PERIODIC CLEANING AS THE SUSPENDED PARTICLES FALL OUT.

OTHER PROPERTIES MAY ALSO BE INTERRELATED SUCH AS TEMPERATURE AND RELATIVE HUMIDITY. FINALLY, OPERATIONS SUCH AS DOOR OPENINGS OR CRANE MOVEMENTS MAY IMPACT THE CONDITIONS INSIDE THE FACILITY.

ORIGINAL PAGE IS
OF POOR QUALITY

PAYLOAD PROCESSING FLOWS

- HORIZONTAL
- VERTICAL
- MIXED
- SPECIAL
 - LIFE SCIENCES
 - GETAWAY SPECIAL (GAS)

PAYLOADS ARE GENERALLY CLASSIFIED AS HORIZONTAL (E.G., SPACELAB) AND VERTICAL (E.G., SATELLITES). THIS REFERS TO THE PAYLOAD COMPONENT ORIENTATION DURING CARGO INTEGRATION. MIXED PAYLOADS MAY HAVE BOTH HORIZONTAL AND VERTICAL COMPONENTS. PAYLOADS REQUIRING SPECIAL PROCESSING ARE THE LIFE SCIENCES EXPERIMENTS (LIVING SPECIMENS) AND GETAWAY SPECIAL (GAS) EXPERIMENTS, WHICH ARE SELF-CONTAINED AND HAVE A MINIMUM NUMBER OF ORBITER INTERFACES. OTHER SPECIAL PROCESSING FLOWS ARE, OF COURSE, POSSIBLE.

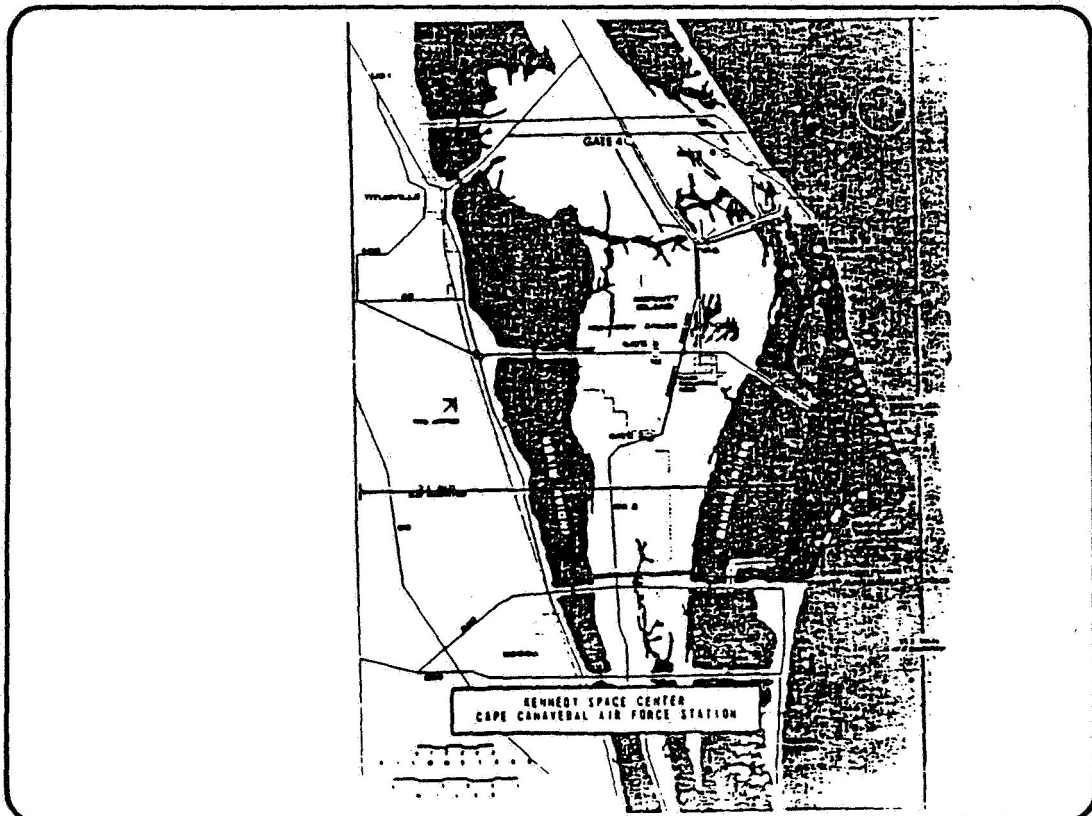

ORIGINAL PAGE (8)
OF POOR QUALITY

HORIZONTAL PAYLOAD PROCESSING FLOW

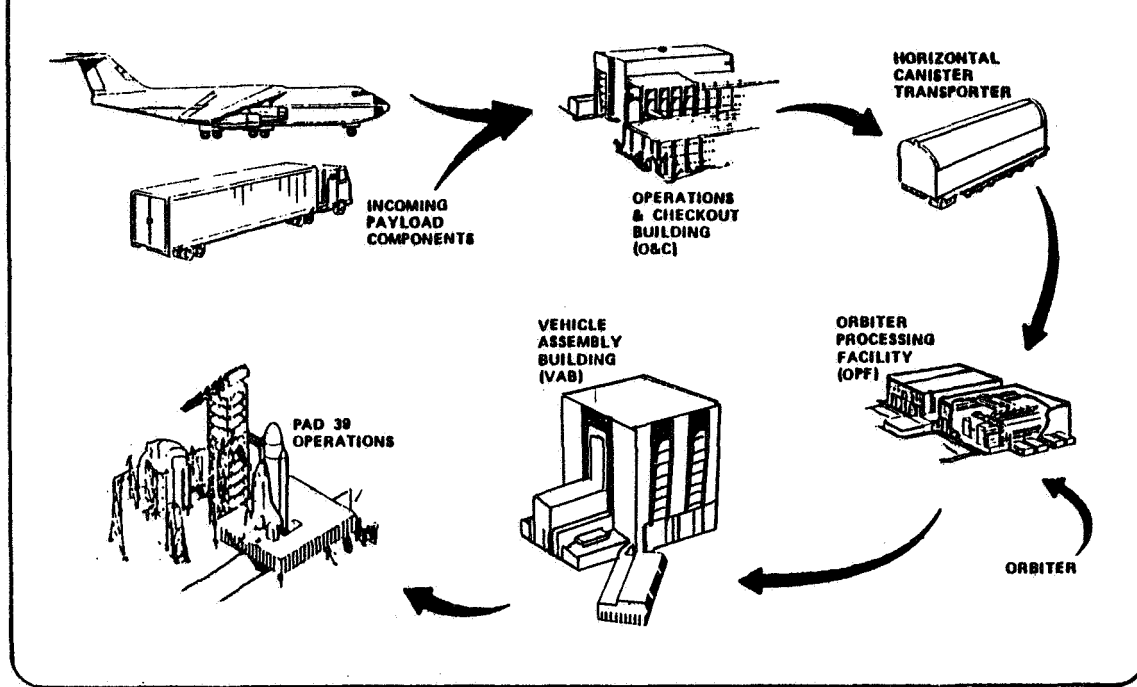

HORIZONTALLY PROCESSED PAYLOADS USUALLY CONTAIN MANY EXPERIMENTS INTEGRATED TOGETHER TO FORM A PAYLOAD THAT USES THE SPACELAB MODULE/PALLET(S) AS A CARRIER.

THE EXPERIMENTS ARE SHIPPED TO KENNEDY SPACE CENTER AND TRANSPORTED TO THE OPERATIONS AND CHECKOUT (O&C) BUILDING TO START THE INTEGRATION PROCESS. THE EXPERIMENTS ARE THEN INSTALLED INTO PREVIOUSLY STAGED SPACELAB RACKS AND ON FLOORS AND PALLET(S) AFTER VERIFICATION OF PAYLOAD ELEMENT COMPATIBILITY, RACKS/FLOORS ARE INSTALLED IN THE MODULE AND POSITIONED WITH THE PALLET(S), A STEP CALLED SPACELAB INTEGRATION. THIS WILL BE THE FINAL O&C BUILDING ACTIVITY UNLESS CARGO INTEGRATION TEST EQUIPMENT (CITE) TESTING IS REQUIRED. CITE SERVES AS AN ORBITER SIMULATOR TO MINIMIZE ANY ELECTRICAL/MECHANICAL PROBLEMS BETWEEN THE CARGO AND THE ORBITER.

THE FULL CARGO IS TRANSPORTED TO THE ORBITER PROCESSING FACILITY (OPF) IN THE PAYLOAD CANISTER AND THEN INSTALLED INTO A PRECLEANED AND PREPARED ORBITER PAYLOAD BAY. FINAL INTERFACE VERIFICATION AND PAYLOAD SERVICING/CLOSEOUT WILL OCCUR PRIOR TO PAYLOAD BAY DOOR CLOSURE WHICH IS THE FINAL PLANNED ACCESS TO THE PAYLOAD BAY PRIOR TO LAUNCH.

THE INTEGRATED ORBITER IS TOWED TO THE VEHICLE ASSEMBLY BUILDING (VAB), MATED TO THE EXTERNAL TANK/SOLID ROCKET BOOSTERS/MOBILE LAUNCHER AND THEN MOVED TO THE LAUNCH PAD BY THE CRAWLER TRANSPORTER FOR FINAL TESTING AND LAUNCH.

ORIGINAL PAGE IS
OF POOR QUALITY

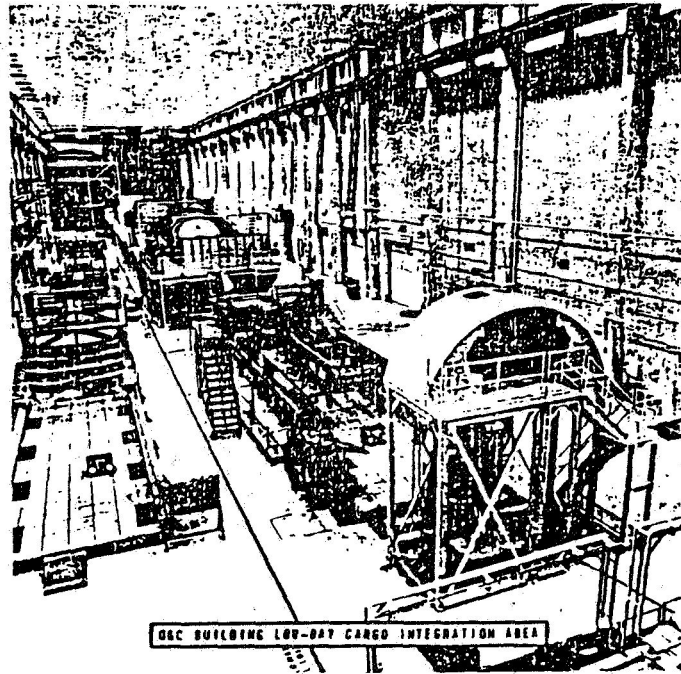

O&C BUILDING LOW-BAY CARGO INTEGRATION AREA

A PICTORIAL VIEW OF THE OPERATIONS AND CHECKOUT (O&C) BUILDING INTEGRATION AREA IS SHOWN. THE CARGO INTEGRATION TEST EQUIPMENT AREA (CITE) TEST STAND APPEARS IN THE BACKGROUND. THE TWO SPACELAB INTEGRATION STANDS (TEST STAND #2 AND #3) ARE SHOWN IN THE MIDDLE, AND IN THE FOREGROUND ARE THE EXPERIMENT INTEGRATION SOUTH AND NORTH STANDS.

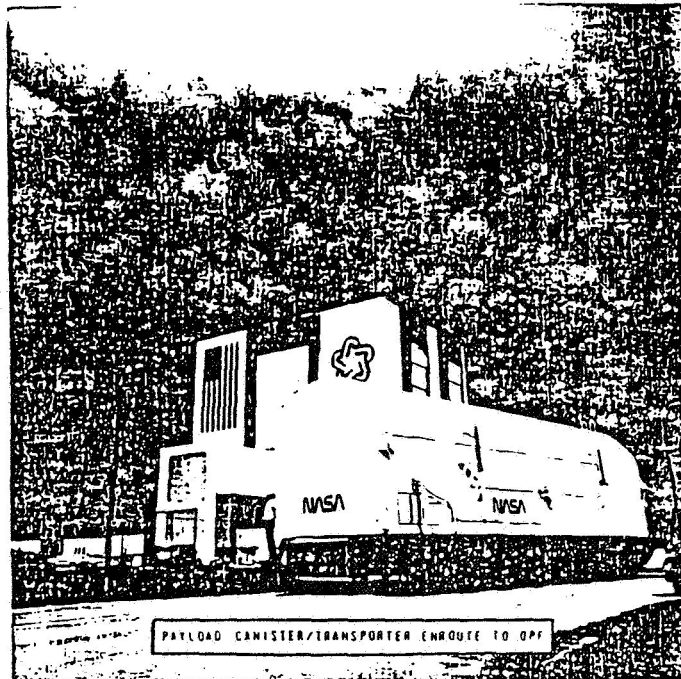

PAYLOAD CANISTER/TRANSPORTER ENROUTE TO OPF

THE PAYLOAD CANISTER IS MOVING AN INTEGRATED CARGO TOWARD THE ORBITER PROCESSING FACILITY (OPF). THE VEHICLE ASSEMBLY BUILDING (VAB) IS IN THE BACKGROUND.

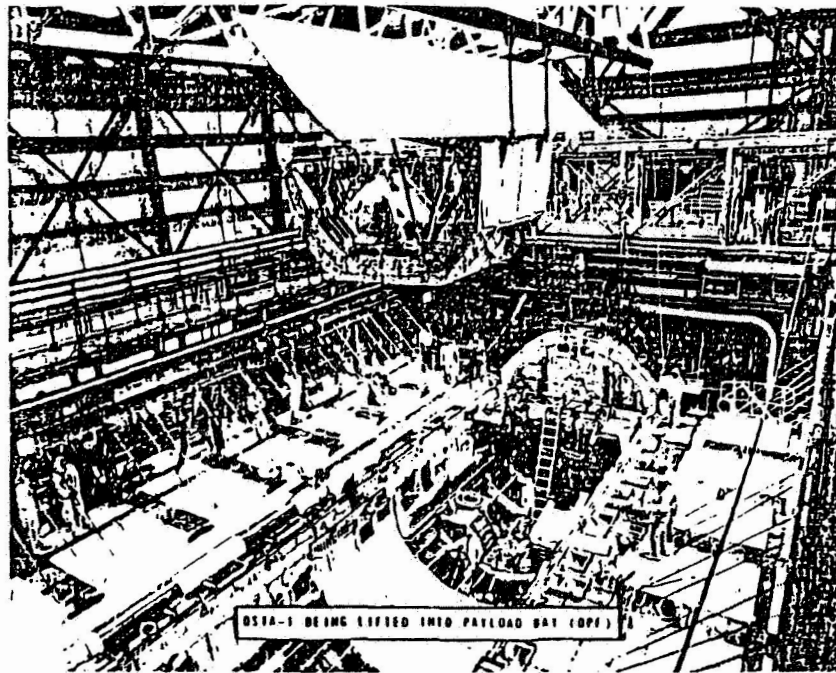

ORIGINAL PAGE IS
OF POOR QUALITY.

OSTA-1, OUR FIRST MAJOR PAYLOAD IS SHOWN BEING LOWERED INTO THE ORBITER CARGO BAY IN THE ORBITER PROCESSING FACILITY (OPF).

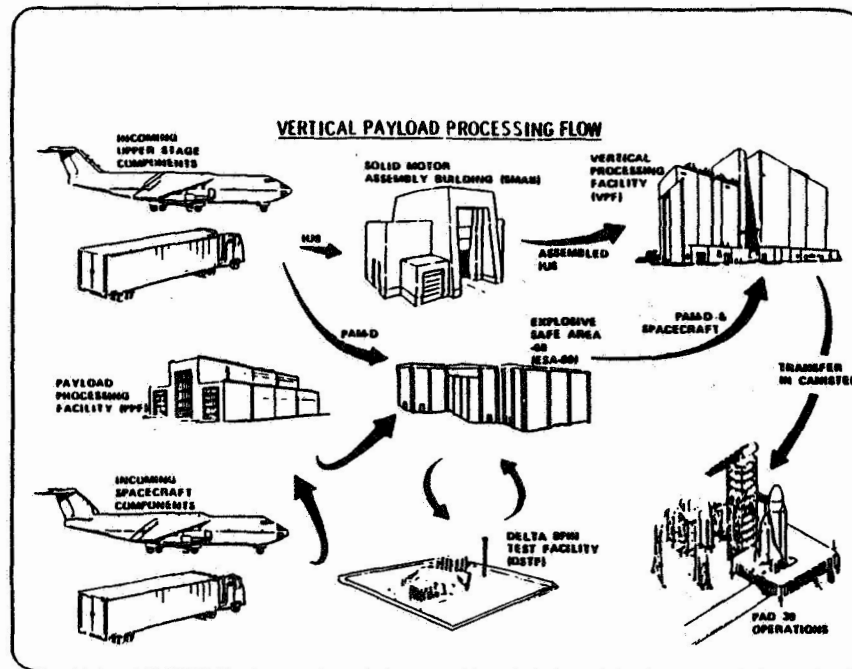

VERTICALLY PROCESSED PAYLOADS, INCLUDING COMMUNICATION SATELLITES WHICH REQUIRE UPPER STAGES, CAN FOLLOW SEVERAL DIFFERENT, YET SIMILAR PATHS. THE SPACECRAFT (S/C) ARRIVES AT ONE OF THE PAYLOAD PROCESSING FACILITIES (PPFs) AT THE CAPE CANAVERAL AIR FORCE STATION (CCAFS). AFTER ASSEMBLY/CHECKOUT, IT IS TAKEN TO THE EXPLOSIVE SAFE AREA (ESA-60A) FOR FUELING AND ORDNANCE INSTALLATION (AND INTEGRATION WITH A PAM-D). AFTER THIS, THE SPACECRAFT IS TAKEN TO THE VERTICAL PROCESSING FACILITY (VPF), INTEGRATED WITH A CARRIER, IF NECESSARY, AND SUBJECT TO CARGO INTEGRATION TEST EQUIPMENT (CITE) OPERATIONS. OTHER UPPER STAGE AND SPACECRAFT COMPONENTS ARE PROCESSED THROUGH THE SOLID MOTOR ASSEMBLY BUILDING (SMAB) AND DELTA SPIN TEST FACILITY (DSTF), RESPECTIVELY. FOLLOWING THIS CHECKOUT, THE INTEGRATED CARGO IS PLACED INTO THE CARRIER AND TRANSPORTED TO THE PAD. THERE IT IS RAISED TO THE PAYLOAD CHANGEOUT ROOM (PCR) FOR INSTALLATION INTO THE ORBITER, FINAL VERIFICATION, AND LAUNCH.

ORIGINAL PAGE IS
OF POOR QUALITY

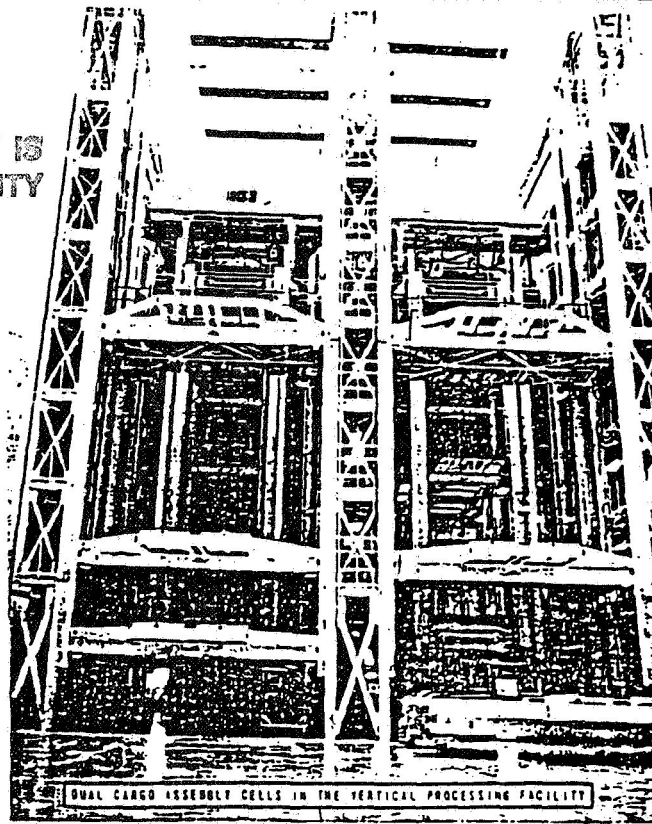

A PICTORIAL VIEW OF THE TWO CELLS IN THE VERTICAL PROCESSING FACILITY (VPF) IS SHOWN. HERE TWO CARGOS CAN BE PROCESSED SIMULTANEOUSLY.

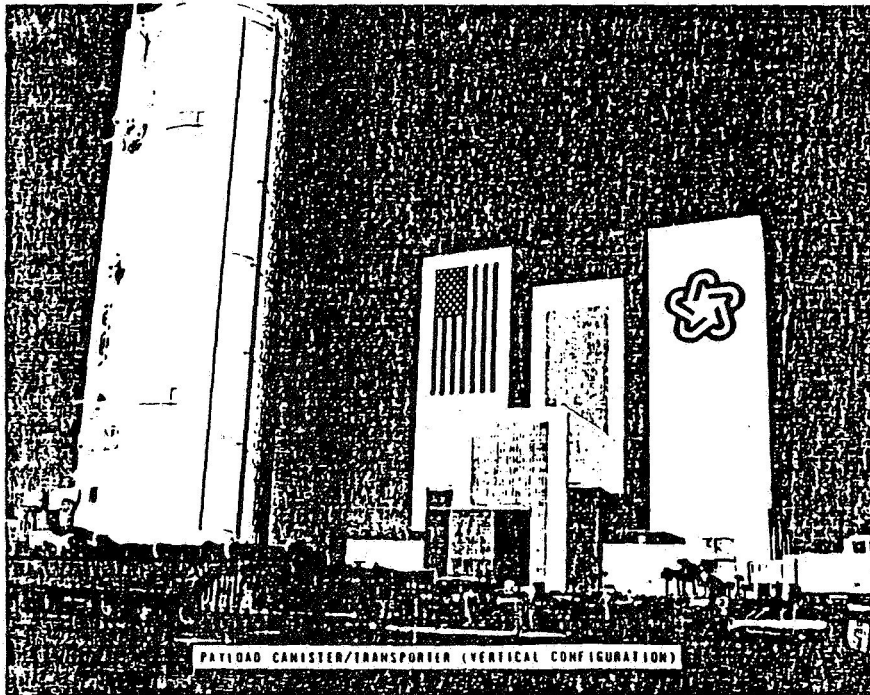

THE PAYLOAD CANISTER IS SHOWN TRANSPORTING A VERTICALLY PROCESSED CARGO ON ITS WAY TO THE LAUNCH PAD.

ORIGINAL PAGE IS
OF POOR QUALITY.

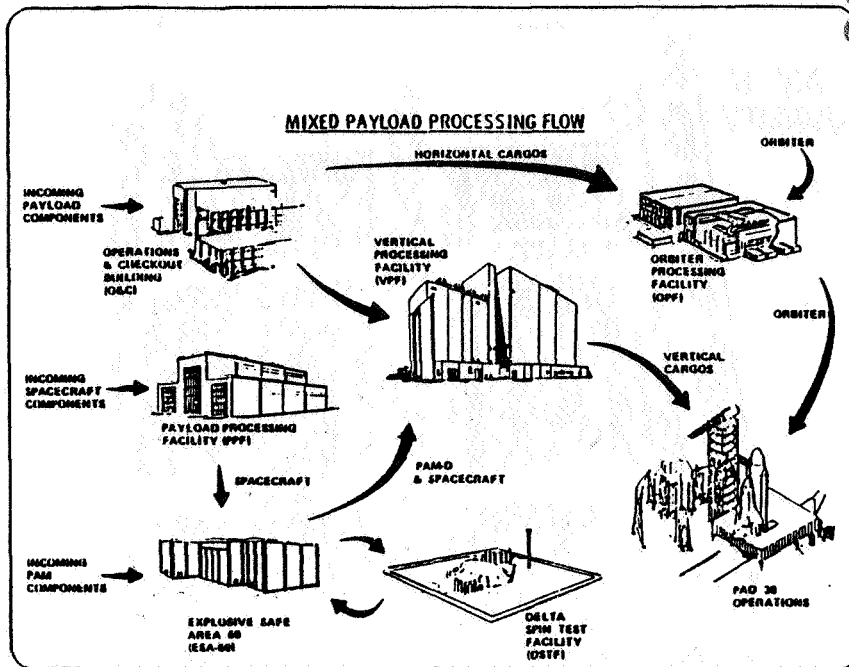

MIXED PAYLOADS (HORIZONTAL AND VERTICAL COMPONENTS) CAN FOLLOW VARIOUS INTEGRATION PATHS. THE MAJORITY OF THE PAYLOADS UNDERGO FINAL CARGO INTEGRATION IN THE VERTICAL PROCESSING FACILITY (VPF). IN THIS FLOW, THE HORIZONTAL COMPONENTS (E.G., PALLETS) ARE BUILT UP IN THE OPERATIONS & CHECKOUT (O&C) BUILDING AND TRANSFERRED TO THE VERTICAL PROCESSING FACILITY (VPF) FOR INTEGRATION WITH THE VERTICAL COMPONENTS. THE ENTIRE CARGO IS THEN TAKEN TO THE PAD AND INTEGRATED WITH THE ORBITER FOR LAUNCH.

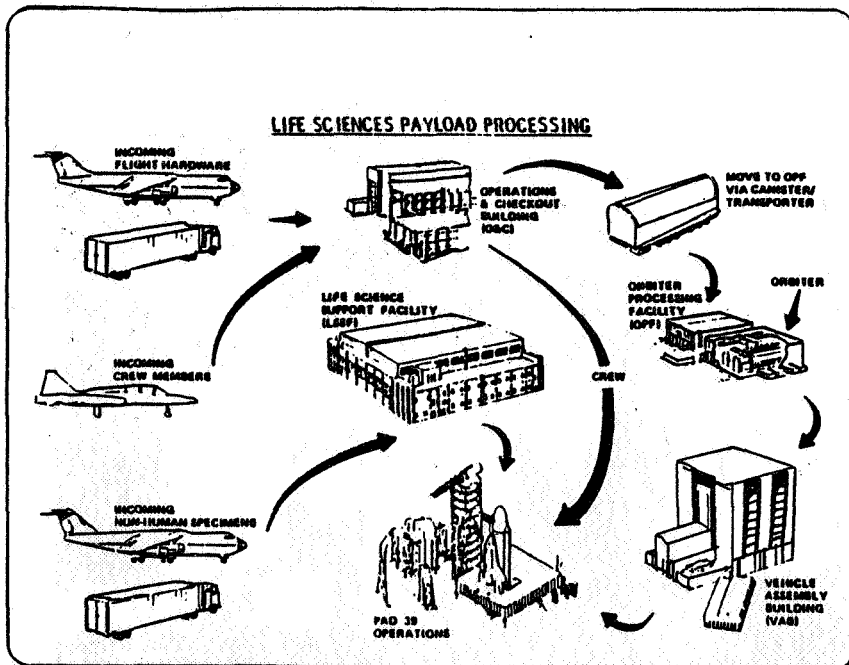

LIFE SCIENCES PAYLOADS FOLLOW THE SAME BASIC FLOW AS THE HORIZONTAL CARGOES. THE PRIMARY DIFFERENCE IS THE ADDITION OF THE LIVING TEST SUBJECTS (E.G., PLANTS, ANIMALS, ETC.). THESE NON-HUMAN SPECIMENS ARE TAKEN TO THE LIFE SCIENCES SUPPORT FACILITY (LSSF) FOR PREPARATION AND PRE-FLIGHT ISOLATION. AFTER THE FLIGHT HARDWARE HAS BEEN INTEGRATED AND THE ORBITER IS READY FOR LAUNCH, THE FLIGHT SPECIMENS ARE TAKEN TO THE PAD FOR LATE INSTALLATION INTO THE ORBITER.

ADDITIONALLY, ACTIVITIES INVOLVING HUMAN SUBJECTS WILL BE CONDUCTED IN THE O&C BUILDING BASELINE DATA COLLECTION FACILITY (BCDF) OR IN EXISTING MEDICAL FACILITIES.

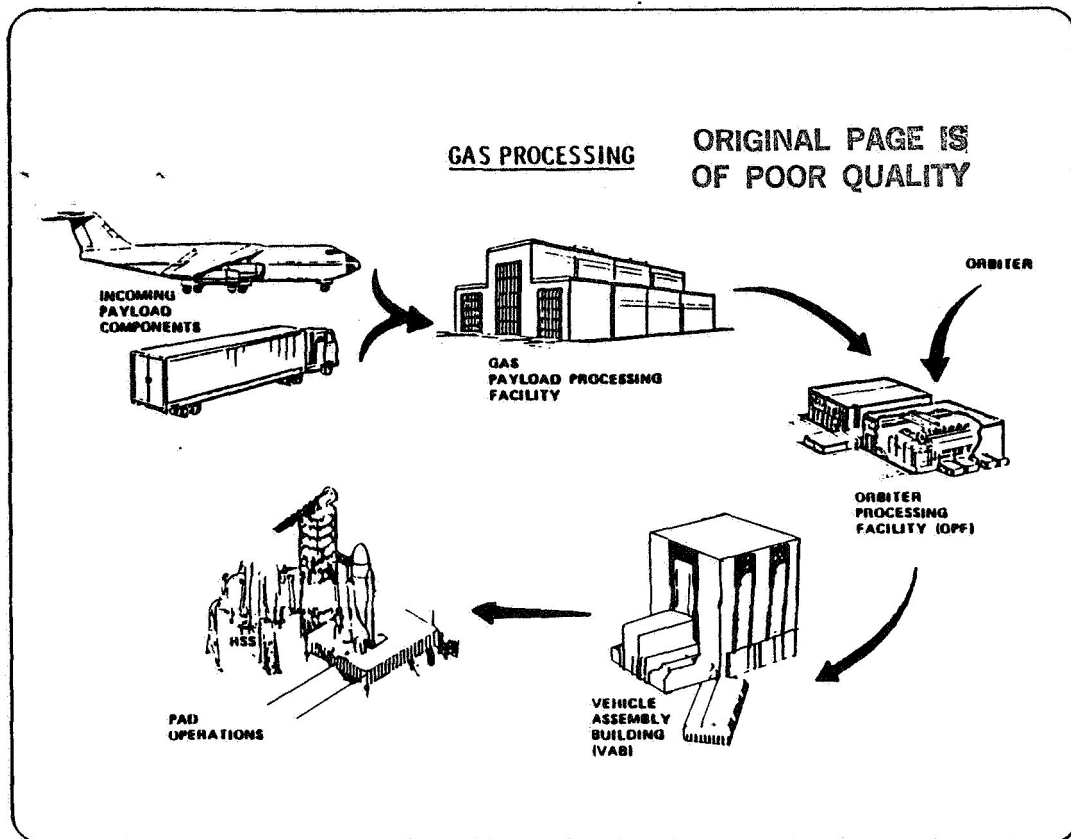

GETAWAY SPECIAL (GAS) PAYLOADS HAVE MINIMUM INTERFACES WITH THE ORBITER, THIS PERMITTING A SIMPLIFIED FLOW. UPON ARRIVAL THE ELEMENTS ARE PACKAGED INTO THE GAS CAN(S) AT THE DESIGNATED PAYLOAD PROCESSING FACILITY (PPF), USUALLY HANGAR 5, OR IN THE OPERATIONS AND CHECKOUT (O&C) BUILDING. THE INSTALLATION OF THE GAS CAN(S) WILL OCCUR IN THE ORBITER PROCESSING FACILITY (OPF) FREQUENTLY AS LATE AS POSSIBLE BECAUSE OF THE LIMITED LIFE OF INTERNAL BATTERIES.

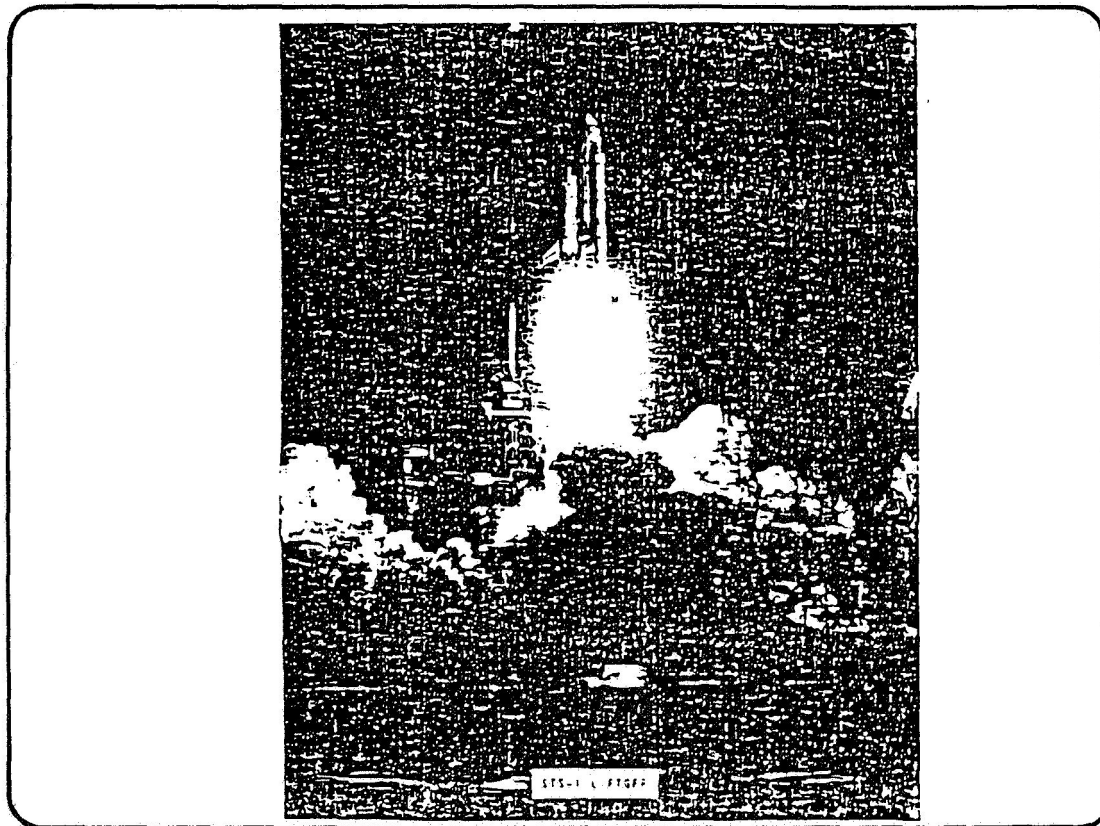

A PICTORIAL VIEW OF THE FIRST SHUTTLE LAUNCH.

ORIGINAL PAGE IS
OF POOR QUALITY

PAYLOAD FACILITIES/SYSTEMS CAPABILITIES/STATUS

- PAYLOAD TO FACILITY/SYSTEMS INTERFACES
- KSC FACILITIES/SYSTEMS CAPABILITIES
- OPERATIONS AND CHECKOUT (O&C) BUILDING STATUS
- ORBITER PROCESSING FACILITY (OPF) STATUS
- OPERATIONAL CONSIDERATIONS
- KSC AMBIENT ENVIRONMENT
- ATMOSPHERIC STABILITY

PAYLOAD TO FACILITY/SYSTEMS INTERFACES

● FACILITIES/SYSTEMS*

HORIZONTAL PROCESSING

- OFF-LINE LABS
- O&C BLDG, ASSEMBLY & TEST (A&T) AREA
- CANISTER/TRANSPORTER
- ORBITER PROCESSING FACILITY (OPF)**
- PAYLOAD ENVIRONMENTAL TRANSPORTATION SYSTEM (PETS)

VERTICAL PROCESSING

- PAYLOAD PROCESSING FACILITIES
- EXPLOSIVE SAFE AREA-60A (ESA-60A)
- VERTICAL PROCESSING FACILITY
- CANISTER/TRANSPORTER
- PAYLOAD CHANGEOUT ROOM (ON PAD)

OTHER

- LIFE SCIENCE SUPPORT FACILITY (LSSF)
- BASELINE DATA COLLECTION FACILITY (BDCF)

● PROBLEM AREAS

- OPERATIONAL IMPACTS (DOOR OPENINGS, ETC.)

- CAPABILITIES MATCH THOSE STATED; OPERATIONAL LIMITATIONS MAY BE REQUIRED FOR SOME OPERATIONS AND UNDER SOME AMBIENT CONDITIONS
- CAPABILITIES WILL MATCH THOSE STATED ON COMPLETION OF MODIFICATIONS IN WORK

THIS LIST SUMMARIZES THE FACILITIES AND GSE THAT TYPICAL PAYLOADS WILL INTERFACE WITH DURING PROCESSING AT KSC. THE GENERAL ENVIRONMENTAL PARAMETERS FOR THE PROCESSING FACILITIES ARE LISTED ON THE FOLLOWING PAGE.

THE BASELINE DATA COLLECTION FACILITY (BDCF) IS A PART OF THE HUMAN LIFE SCIENCES EXPERIMENT SUPPORT EFFORT AT KSC, AND IS LOCATED IN THE OPERATIONS AND CHECKOUT (O&C) BUILDING.

ORIGINAL PAGE IS
OF POOR QUALITY

KSC FACILITIES/SYSTEMS CAPABILITIES:

- TEMPERATURE: 65° TO 78° F
- RELATIVE HUMIDITY
 - HORIZONTAL PROCESSING ≤ 50%
 - VERTICAL PROCESSING ≤ 50%
 - LIFE SCIENCE SUPPORT FACILITY ≤ 60%
- AIR INPUT CLASS** ≤ 100 K
- NON-VOLATILE RESIDUES (NVR)*** ≤ 1 mg/0.1M²/24 HOUR
- TOTAL HYDROCARBONS (THC)*** ≤ 15 ppm
- CLEANLINESS OBJECTIVE VISIBLY CLEAN 1 IN PAYLOAD BAY & CANISTER ONLY
 - * INCLUDES ALL FACILITIES/SYSTEMS LISTED ON PRIOR PAGE
 - ** IN THE VERTICAL PROCESSING FACILITY (VPF), PAYLOAD CHANGEOUT ROOM (PCR), AND BUILDING AE (UPF IS BEING MODIFIED TO PROVIDE) CLASS 5000 GUARANTEED INPUT AIR (HEPA FILTERED)
 - *** NORMALLY ACHIEVED DUE TO KSC AMBIENT ENVIRONMENT

THE PARAMETERS LISTED ARE THE OUTSIDE LIMITS OF ALL PAYLOAD FACILITIES AND SYSTEMS THAT HAVE AN ENVIRONMENTAL CONTROL CAPABILITY. THE VEHICLE ASSEMBLY BUILDING (VAB) DOES NOT HAVE ENVIRONMENTAL CONTROL AND TOTAL HYDROCARBONS (THC), AND NON-VOLATILE RESIDUE REQUIREMENTS (NVR) ARE NOT IMPOSED ON ALL FACILITIES.

OPERATIONS AND CHECKOUT (O&C) BUILDING STATUS

- MODIFICATIONS IN WORK:
 - ALL UNUSED OPENINGS AND PENETRATIONS INTO THE ASSEMBLY AND TEST AREA ARE BEING SEALED
- MODIFICATIONS PENDING FUNDING APPROVAL
 - MODIFY HVAC SYSTEM TO IMPROVE CONTROL PERFORMANCE AND RELIABILITY
 - ESTIMATED COMPLETION DATE OCTOBER 1, 1983
- OFF-LINE LABS ARE OPERATIONAL

TO IMPROVE THE RELIABILITY OF THE OPERATIONS AND CHECKOUT (O&C) BUILDING ENVIRONMENTAL CONTROL SYSTEM, THE FOLLOWING MODIFICATIONS ARE BEING PURSUED. SEALING UNUSED OPENINGS AND PENETRATIONS WILL ALLOW A POSITIVE PRESSURE TO BE MAINTAINED IN THE OPERATIONS AND CHECKOUT (O&C) ASSEMBLY AND TEST (A&T) AREA. THIS WILL HELP REDUCE PARTICULATE CONTAMINATION IN THE HIGH BAY, AND ALLOW BETTER CONTROL OVER INTERNAL RELATIVE HUMIDITY AND TEMPERATURE.

A PENDING MODIFICATION TO THE HVAC SYSTEM WILL IMPROVE THE RELIABILITY OF THE SYSTEM, AND ALSO IMPROVE ITS OPERATIONAL EFFICIENCY FROM AN ENERGY POINT OF VIEW.

ORIGINAL PAGE IS
OF POOR QUALITY

ORBITER PROCESSING FACILITY (OPF) STATUS

- MODIFICATIONS IN WORK TO IMPROVE ECS CAPABILITY:
 - INSTALL CONTINUOUS PAYLOAD BAY CLASS 5000 AIR PURGE WHEN PAYLOAD BAY IS OPEN
 - OTHER PHYSICAL MODIFICATIONS WHICH WILL REDUCE PARTICULATES INCLUDE:
 - ADDED EXTERIOR PAVING
 - ADDED SMOKE SCRUBBERS
 - IMPROVED CLEAN UP CAPABILITY
 - IMPROVED HVAC SYSTEM INCORPORATING HEPA FILTERS
 - OPERATIONAL
 - IMPROVED SCHEDULING OF OPERATIONS
 - IMPROVED PERSONNEL CONTROL

- ESTIMATED COMPLETION DATE
 - PAYLOAD BAY PURGE
 - HI-BAY 2 FEBRUARY 1983
 - HI-BAY 1 JULY 1983

THE ORBITER PROCESSING FACILITY (OPF) WILL BE MODIFIED TO IMPROVE PAYLOAD CLEANLINESS. MODIFICATIONS WILL ENABLE THE ENVIRONMENTAL CONDITIONING SYSTEM TO MAINTAIN A CONTINUOUS CLEAN AIR PURGE INTO THE PAYLOAD BAY. ADDITIONAL ORBITER PROCESSING FACILITY (OPF) PHYSICAL MODIFICATIONS TO REDUCE PARTICULATE CONTAMINATION ARE LISTED. OPERATIONAL MODIFICATIONS SUCH AS SCHEDULING AND PERSONNEL CONTROL WILL ALSO BE USED TO HELP REDUCE CONTAMINANT LEVELS NEAR THE ORBITER PAYLOAD BAY.

OPF PURGE DUCT ARRANGEMENT

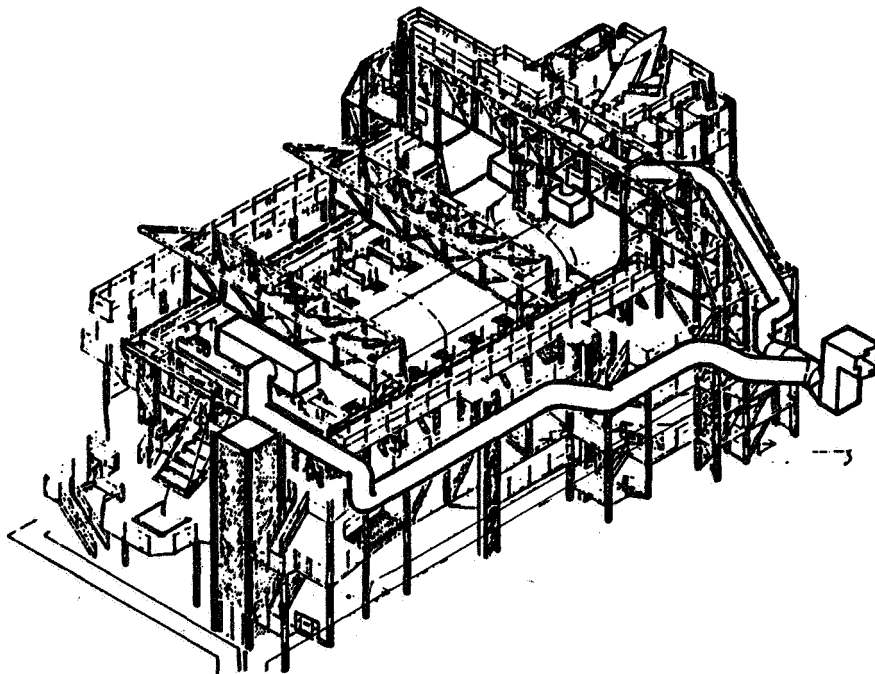

THIS SKETCH SHOWS THE PLANNED ARRANGEMENT OF THE PURGE AIR DUCTS IN THE OPF WORKSTANDS AS THE SYSTEM IS BEING DESIGNED.

ORIGINAL PAGE IS
OF POOR QUALITY

OPERATIONAL CONSIDERATIONS

- AMBIENT WEATHER
- DOOR OPENINGS
- ACCESSING OF PAYLOAD
- INDUSTRIAL TYPE OPERATIONS
- ENERGY CONSERVATION CONSISTENT WITH ACHIEVING ACCEPTABLE ENVIRONMENTAL CONTROL

SEVERAL FACTORS INFLUENCE THE PAYLOAD ENVIRONMENT AT KSC. THE AMBIENT CONDITIONS CAN HAVE AN IMPACT ON TEMPERATURE AND RELATIVE HUMIDITY. THIS CAN ALSO AFFECT ENVIRONMENTAL CONTROL SYSTEM OPERATING REQUIREMENTS, CONDITIONS AND TIMES. OPENING DOORS INTO THE PROCESSING AREAS CAN LEAD TO A DEGRADATION OF THE INTERNAL ENVIRONMENT AND MAY ALSO ALLOW DUST AND OTHER PARTICULATES TO ENTER THE AREA. PAYLOAD ACCESS PRESENTS CONTAMINATION PROBLEMS AS THE ACCESS EQUIPMENT AND PERSONNEL MAY CARRY CONTAMINANTS INTO CLOSE PROXIMITY OF EXPERIMENTS.

INDUSTRIAL OPERATIONS, SUCH AS CRANE OPERATIONS, ARE ALSO POTENTIAL CONTAMINATORS OF PAYLOAD PROCESSING AREAS.

KSC AMBIENT ENVIRONMENT

MONTH	J	F	M	A	M	J	J	A	S	O	N	D	ANNUAL
TEMPERATURE (°F) MEAN DAILY MAXIMUM	69.8	69.8	73.4	77.0	82.4	86.0	87.0	87.8	86.0	80.6	75.2	69.8	78.8
TEMPERATURE (°F) MEAN DAILY MINIMUM	51.8	53.6	57.2	62.6	66.2	71.6	73.4	73.4	73.4	69.8	60.8	53.6	64.4
(%) MEAN RELATIVE HUMIDITY	80	80	78	75	77	81	83	84	82	79	79	79	80
(INCHES) MEAN PRECIPITATION	2.95	3.40	4.13	2.01	1.80	4.23	5.70	5.97	8.85	5.10	3.45	1.58	49.17 CUM.

SOURCE: KSC-FINAL ENVIRONMENTAL IMPACT STATEMENT-1979; BASED ON A 14 YEAR DATA BASE.

THIS TABLE SHOWS THE AVERAGE WEATHER AT KSC DURING EACH MONTH. AS IT SHOWS, THE WEATHER AT KSC IS GENERALLY HOT, HUMID AND WET, WHICH CAN IMPACT THE INTERNAL ENVIRONMENT OF THE PROCESSING FACILITIES, TRANSPORTATION GSE AND THE ORBITER PAYLOAD BAY.

ATMOSPHERIC STABILITY

ORIGINAL PAGE IS
OF POOR QUALITY

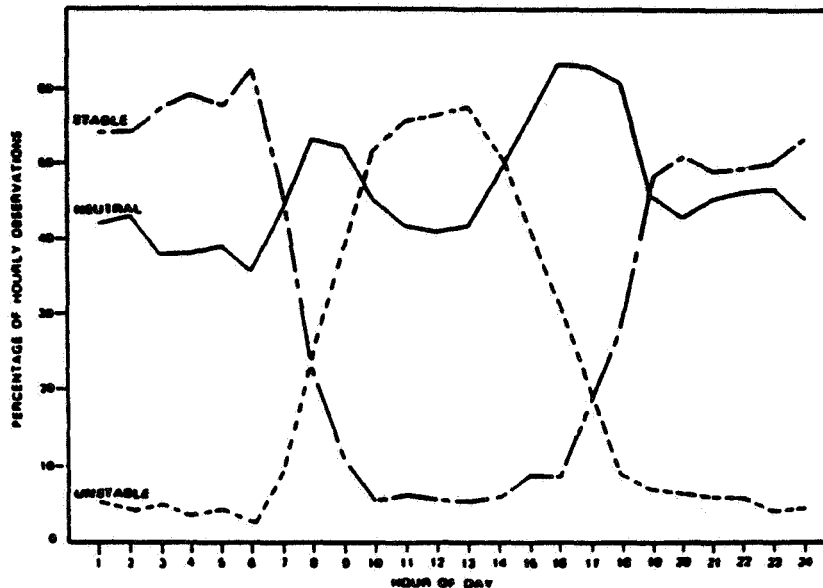

SOURCE: KSC-FINAL ENVIRONMENTAL IMPACT STATEMENT - 1979

THIS GRAPH INDICATES THAT THE ATMOSPHERE IS MOST STABLE (IMPLYING LITTLE OR NO WIND) DURING EARLY MORNING AND NIGHTTIME HOURS. THIS WOULD SUGGEST THAT THE BEST TIME FOR OPERATIONS REQUIRING DOOR OPENINGS OR PAYLOAD MOVEMENT EXTERNAL TO FACILITIES IS DURING THESE HOURS.

ORBITER INTERNAL ENVIRONMENT (PRELAUNCH - POSTLANDING)

- PRE-LAUNCH
 - CLOSURE OF PAYLOAD BAY DOOR IN ORBITER PROCESSING FACILITY (OPF) UNTIL LAUNCH

- POST-LANDING
 - PURGE HOOKUP UNTIL PAYLOAD BAY DOOR OPENING IN ORBITER PROCESSING FACILITY (OPF)

- SECONDARY/CONTINGENCY LANDING SITES

ORIGINAL PAGE IS
OF POOR QUALITY

SECONDARY/CONTINGENCY LANDING SITES

- SHUTTLE TRANSPORTATION SYSTEM (STS) PRIORITY AFTER LANDING AT CONTINGENCY SITE
 - CREW SAFETY
 - ORBITER SAFETY
- EXISTENCE OF PAYLOAD BAY PURGE IS DEPENDENT UPON WHICH LANDING SITE IS USED
 - SECONDARY LANDING SITE SAME AS PRIMARY SITE
 - CONTINGENCY LANDING SITE HAS NO PLANNED PURGE CAPABILITY
- PAYLOAD BAY ENVIRONMENT COULD VARY FROM MAXIMUM PLANNED CAPABILITY TO NO PAYLOAD BAY PURGE

SHOULD THE ORBITER LAND AT ANY SITE OTHER THAN THE PRIME OR SECONDARY LANDING SITES (KENNEDY SPACE CENTER [KSC] OR EDWARDS AIR FORCE BASE [EAFB]) THE PRIMARY CONCERNS OF THE GROUND TEAMS ARE CREW HEALTH AND SAFETY AND THEN THE SAFETY OF THE ORBITER. NO SPECIAL PAYLOAD ENVIRONMENTAL SUPPORT IS PLANNED AT A CONTINGENCY LANDING SITE. THE EXTENT OF PAYLOAD SUPPORT IS DEPENDENT UPON THE LANDING SITE USED AND MAY VARY FROM NO PAYLOAD PURGE OR SUPPORT TO FULL PAYLOAD SUPPORT AND PURGE.

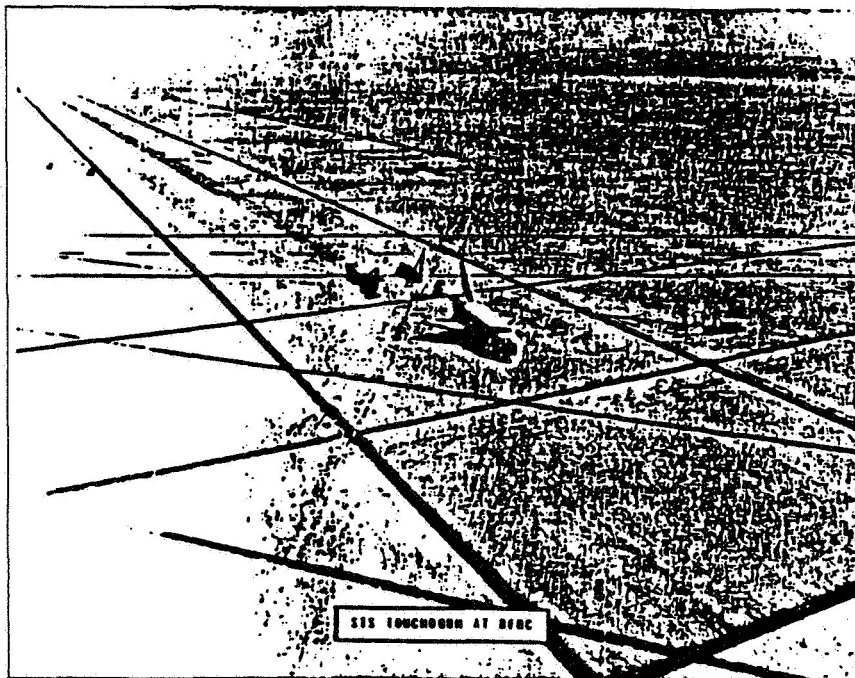

ORIGINAL PAGE IS
OF POOR QUALITY

PRE-LAUNCH

- POST PAYLOAD BAY (PLB) CLOSEOUT
 - TOW TO VAB* NO PURGE PROVIDED (1/2 HOUR)①
 - OTHER VAB PROCESSING NO PURGE PROVIDED UNLESS REQUIRED①
 - HOISTING & ET MATE* NO PURGE PROVIDED (30 HOURS)①
 - TRANSFER TO PAD PURGE PROVIDED②
 - PAD DWELL TIME** PURGE PROVIDED②
 - CRYOGENIC LOADING PURGE PROVIDED④
- SIS-3 EXPERIENCE - NO HUMIDITY PROBLEMS PER DATA
- ** VERTICAL AND HORIZONTAL PROCESSING - BAY WILL REACH AMBIENT IN ABOUT 20 HOURS

NOTES

- ① PAYLOAD BAY TEMP MAX 83° F, 31% MAX RELATIVE HUMIDITY (STS-2 AUG. 10-16 1981)
MAX 74.5° F, 34% MAX RELATIVE HUMIDITY (STS-3 FEB. 3-4, 1982)
- ② 70° ±5° F NOMINAL; 36% MAX RELATIVE HUMIDITY; 15 PPM MAXIMUM HYDROCARBONS;
NOMINAL AIR CLASS 100, GUARANTEED 5000
- ③ 70° ±5° F NOMINAL; 31% MAX RELATIVE HUMIDITY; 15 PPM MAXIMUM HYDROCARBONS;
NOMINAL AIR CLASS 100, GUARANTEED 5000
- ④ DURING FUEL CELL LOADING (L-52 TO L-44.5 HRS) PAYLOAD BAY PURGE SWITCHED TO GN₂;
70° ±5° F NOMINAL; 0% RELATIVE HUMIDITY; 15 PPM MAXIMUM HYDROCARBONS; NOMINAL CLASS
100 GUARANTEED CLASS 5000. ALSO, GN₂ PURGE 3 HOURS PRIOR TO START OF CRYO LOADING
(L-10 HR 30 MIN) THROUGH LAUNCH.

THERE ARE TWO TIME PERIODS OF NO PAYLOAD BAY PURGE AFTER THE PAYLOAD DOORS ARE CLOSED, THE FIRST BEING THE TIME TO TOW THE ORBITER FROM THE ORBITER PROCESSING FACILITY TO THE VEHICLE ASSEMBLY BUILDING (VAB) TRANSFER AISLE AND THE SECOND TIME OCCURRING AS THE ORBITER IS LIFTED FROM THE TRANSFER AISLE FLOOR AND MATED WITH THE EXTERNAL TANK/SOLID ROCKET BOOSTERS/MOBILE LAUNCH PLATFORM.

PAYLOAD DEVELOPERS SHOULD NOTE THAT THE PAYLOAD BAY PURGE IS CHANGED FROM AIR TO GN₂ DURING PERIODS OF FUEL CELL AND EXTERNAL TANK CRYOGENICS LOADING. PAYLOADS MOUNTED ON PALLETS/SPECIAL STRUCTURES WOULD BE EXPOSED TO A GN₂ ENVIRONMENT FOR THE SPECIFIED TIME PERIODS.

POST-LANDING (PRIMARY SITE)

- AFTER SAFING AT THE SHUTTLE LANDING FACILITY, AN AIR PURGE IS CONNECTED APPROXIMATELY 45 MINUTES AFTER LANDING TO CONDITION THE PAYLOAD BAY UNTIL THE ORBITER IS IN THE ORBITER PROCESSING FACILITY (OPF)*
- NO ECS CAPABILITY DURING FERRY FLIGHT TO KSC
- 70 ± 5° F NOMINAL; 36% MAX RELATIVE HUMIDITY; 15 PPM MAXIMUM HYDROCARBON; AIR CLASS 100, GUARANTEED 5000

LANDING SITES OTHER THAN THE KENNEDY SPACE CENTER MAY BE THE DESIGNATED PRIMARY LANDING SITE.

**ORIGINAL PAGE IS
OF POOR QUALITY**

CONCLUSIONS

- EXPERIMENT SPONSORS SHOULD CONSIDER DESIGNING FOR SUPPLEMENTAL PROTECTIVE MEASURES FOR CRITICAL OR ENVIRONMENTALLY SENSITIVE PAYLOAD ELEMENTS (TO BACKUP AND/OR AUGMENT FACILITY CAPABILITIES)
- MISSION UNIQUE PAYLOAD LAUNCH/LANDING SITE ENVIRONMENTAL CONTROL REQUIREMENTS SHOULD:
 - BE DETERMINED EARLY IN PLANNING CYCLE
 - NOT NECESSITATE FACILITY MODIFICATIONS IF POSSIBLE
 - BE IDENTIFIED EARLY TO PAYLOAD MISSION MANAGEMENT FOR TRANSMISSION TO KSC/JSC
 - KSC - IF FACILITY MODIFICATIONS, GROUND OPERATIONS CONSTRAINTS OR SCHEDULE IMPACTS ARE INVOLVED
 - JSC - IF USE OF PAYLOAD BAY LINER KIT IS PLANNED OR PAYLOAD BAY CLEANING TO BETTER THAN "VISIBLELY CLEAN 1" IS REQUIRED
- ANY INTEGRATION FLOW SERIAL IMPACTS OR FACILITY MODIFICATIONS WILL BE AN OPTIONAL SERVICE

SUMMARY

- IT SHOULD BE REMEMBERED THAT KSC'S ENVIRONMENTAL CAPABILITIES WERE DESIGNED TO MEET THE BASIC NEEDS OF MOST PAYLOADS AND NOT THE VERY STRINGENT NEEDS OF A FEW EXPERIMENTS

THE MAJORITY OF LAUNCH/LANDING SITE ENVIRONMENTAL CONTROL REQUIREMENTS FOR PAYLOAD PROCESSING CAN BE MET BY EXISTING AND/OR PLANNED CAPABILITIES. THE GOAL FOR PAYLOAD DEVELOPERS IS TO INVESTIGATE AND UNDERSTAND OUR CAPABILITIES AND USE THIS INFORMATION IN THE EARLY STAGES OF PLANNING/DEVELOPMENT OF THE PAYLOAD ITEM(S). ADDITIONALLY, ANY SPECIAL OR UNIQUE PROCESSING REQUIREMENTS SHOULD BE IDENTIFIED EARLY TO PERMIT TIMELY CONSIDERATION OF THIS CAPABILITY, ASSUMING APPROVAL.

N 83 22298

29

EVALUATION OF THE GROUND CONTAMINATION
ENVIRONMENT FOR STS PAYLOADS

E. N. Borson
The Aerospace Corporation

Preceding page blank

**ORIGINAL PAGE IS
OF POOR QUALITY**

**EVALUATION OF THE GROUND CONTAMINATION
ENVIRONMENT FOR STS PAYLOADS**

**E. N. BORSON, R. V. PETERSON, L. H. RACHAL
THE AEROSPACE CORPORATION**

**SHUTTLE ENVIRONMENT WORKSHOP
5-7 OCTOBER 1982**

**WORK PERFORMED FOR
SPACE DIVISION
AIR FORCE SYSTEMS COMMAND
CONTRACT NO. F04701-81-C-0082**

**DISSEMINATION OF THIS INFORMATION DOES NOT CONSTITUTE APPROVAL BY THE AIR FORCE OR
THE NATIONAL AERONAUTICS AND SPACE ADMINISTRATION. IT IS PRESENTED ONLY FOR THE
EXCHANGE AND STIMULATION OF IDEAS.**

OUTLINE

- **REQUIREMENTS**
- **FACILITY VERIFICATION PROGRAM**
- **RESULTS OF MEASUREMENTS**
- **CONCLUSIONS**

It is worthwhile to review the cleanliness and contamination control requirements for the Shuttle program and to discuss some background material before presenting some results of the measurements.

The objectives of the facility verification program are then discussed.

Although all the data have not yet been analyzed, and Shuttle ground operations are still evolving, it is possible to reach some conclusions.

Preceding page blank

Development of Cleanliness Requirements

- NASA WORKING GROUPS
 - PARTICLES AND GASES CONTAMINATION PANEL (PGCP)
 - ESTABLISHED IN 1974
 - ADVISORY GROUP TO STS PROJECT OFFICE
 - CONTAMINATION REQUIREMENTS DEFINITION GROUP (CRDG)
 - ESTABLISHED IN 1974
 - DETERMINE PAYLOAD REQUIREMENTS
- GROUND FACILITIES REQUIREMENTS
 - INPUT DATA
 - PROPOSED STS PAYLOADS
 - PAST EXPERIENCE
 - CLEAN ROOM TECHNOLOGY
 - PHILOSOPHY
 - MEET THE REQUIREMENTS OF THE MAJORITY OF PAYLOADS
 - DO NOT PRECLUDE MEETING MORE STRINGENT REQUIREMENTS

ORIGINAL PAGE IS
OF POOR QUALITY

Two NASA working groups on contamination were established in 1974. The PGCP (Particles and Gases Contamination Panel) was, and still is, chaired by Dr. L. Leger of the Johnson Space Center (JSC). The PGCP reviewed Shuttle requirements (1, 2, 3) with respect to cleanliness and contamination control and provided recommendations to the NASA Shuttle Project office.

The CRDG (Contamination Requirements Definition Group) was chaired by Dr. R. Naumann of the Marshall Space Flight Center (MSFC). It is now called the Contamination Working Group (CWG) and is chaired by Ed Miller of MSFC. The CRDG reviewed numerous payload requirements and issued a report containing recommendations⁽⁴⁾.

The following charts describe the STS requirements and the CRDG recommendations pertaining to ground facilities and operations.

The NASA philosophy in setting requirements was to meet the requirements of the majority of payloads without precluding the implementation of more stringent requirements when required.

System Requirements

JSC 07700, VOL. X

ORIGINAL PAGE IS
OF POOR QUALITY

3.6.12.1 SYSTEM CONTAMINATION CONTROL

CONTAMINATION OF THE SPACE SHUTTLE SYSTEM SHALL BE CONTROLLED TO ASSURE SYSTEM SAFETY, PERFORMANCE, AND RELIABILITY. CONTROL SHALL BE IMPLEMENTED BY A COORDINATED PROGRAM FROM DESIGN CONCEPT THROUGH PROCUREMENT, FABRICATION, ASSEMBLY, TEST, STORAGE, DELIVERY, OPERATIONS, AND MAINTENANCE OF THE SHUTTLE SYSTEM. THIS PROGRAM SHALL COMPLY WITH THE REQUIREMENTS OF SN-C-0005, SPECIFICATION CONTAMINATION CONTROL REQUIREMENTS FOR THE SPACE SHUTTLE PROGRAM. SELECTION OF SYSTEM DESIGN SHALL INCLUDE SELF-CLEANING (filtering) PROTECTION COMPATIBLE WITH COMPONENT SENSITIVITY.

EQUIPMENT DESIGN SPECIFICALLY FOR THE SPACE SHUTTLE PROGRAM SHALL COMPLY WITH THE SPECIFIED REQUIREMENTS. SELECTION OF OFF-THE-SHELF EQUIPMENT FOR APPLICATION TO THE SPACE SHUTTLE PROGRAM SHALL COMPLY WITH THE INTENT OF THESE REQUIREMENTS.

JSC 07700, Volume X, recognized the need for contamination control, internal and external, for the Shuttle system.

System Requirements

JSC 07700, VOL. X

3.6.12.2 OPERATIONAL CONTAMINATION CONTROL

CONTAMINATION CONTROL DURING THE OPERATIONAL PHASES OF THE SPACE SHUTTLE IS NECESSARY TO INSURE OVERALL SATISFACTORY PERFORMANCE OF THE SYSTEM. OF PARTICULAR CONCERN IS THE GASEOUS AND PARTICULATE ENVIRONMENT OF THE ORBITER DURING ALL OPERATIONAL PHASES. BECAUSE OF THE WIDE RANGE OF PAYLOADS IT IS THE OBJECTIVE OF THE FOLLOWING APPROACH TO PROVIDE REQUIREMENTS TO SATISFY THE NEEDS OF THE LARGE MAJORITY OF PAYLOADS. PAYLOADS THAT HAVE SPECIAL REQUIREMENTS NOT COVERED HEREIN SHALL PROVIDE THE NECESSARY SYSTEM(S) TO SATISFY SUCH REQUIREMENTS.

System Requirements

ORIGINAL PAGE IS
OF POOR QUALITY

JSC 07700, VOL. X

3.6.12.2.1 ELEMENT CROSS CONTAMINATION

SPACE SHUTTLE SYSTEM ELEMENT DESIGN AND OPERATION SHALL BE SUCH AS TO MINIMIZE CROSS CONTAMINATION OF THE ELEMENTS TO A LEVEL COMPATIBLE WITH MISSION OBJECTIVES

3.6.12.2.2 PAYLOAD BAY DESIGN

PAYLOAD BAY SHALL BE DESIGNED TO MINIMIZE CONTAMINATION OF PAYLOAD AND CRITICAL PAYLOAD BAY SURFACES TO A LEVEL COMPATIBLE WITH MISSION OBJECTIVES

3.6.12.2.3 PAYLOAD DESIGN

CRITICAL SURFACES SUCH AS ORBITER RADIATORS, WINDOWS, OPTICS, etc., WITHIN THE PAYLOAD BAY AND PART OF THE ORBITER SYSTEM MUST BE PROTECTED IN THE SAME MANNER AS PAYLOADS. THAT IS, PAYLOADS MUST INSURE THAT THEIR EFFLUENTS AND OPERATIONS DO NOT JEOPARDIZE THE PERFORMANCE OF THESE SYSTEMS.

JSC 07700, Volume X, also recognized the need to control contamination for all elements of the Shuttle system. This included the payload bay and ground facilities. It was also necessary to impose requirements on payloads so as to prevent excessive degradation of critical elements of the Orbiter and other payloads.

Requirements for ground operations are contained in paragraphs 3.6.12.2.4.1, 3.6.12.2.4.2, and 3.6.12.2.4.3 of Volume X.

A review of clean room technology confirmed^(6, 7, 8) that the cleanliness of the air entering a facility could be controlled to class 100 (per FED-STD-209B)⁽⁵⁾ or cleaner by using standard HEPA (high efficiency particulate air) filters (sometimes referred to as 99.97% filters)⁽⁹⁾.

It was also recognized that surface cleanliness of payloads was the goal of the contamination control effort and that this included both particulate and molecular contaminants.

System Requirements

ORIGINAL PAGE IS
OF POOR QUALITY

- PAYLOAD BAY AND CANISTER SURFACES
 - VISIBLY CLEAN PER SN-C-0005
- CLEANLINESS FOR AIR ENTERING PAYLOAD ENCLOSURES AND PAYLOAD BAY
 - NOMINAL CLASS 100, GUARANTEED CLASS 5000 PER FED-STD-209B
 - LESS THAN 15 PPM OF HYDROCARBONS, METHANE EQUIVALENT
 - TEMPERATURE: $70 \pm 5^{\circ}\text{F}$ ($21 \pm 3^{\circ}\text{C}$)
 - RELATIVE HUMIDITY: 50% OR LESS
- CLEANLINESS FOR GN_2 PURGE OF PAYLOAD BAY
 - SAME AS FOR AIR EXCEPT FOR LOW R.H.
- PAYLOAD BAY PURGE IS OFF
 - DURING SWITCHOVER BETWEEN MOBILE AND FACILITY SYSTEMS
 - DURING STACKING OPERATIONS IN THE VAB
 - CLOSING OF PAYLOAD BAY DOORS
 - IGNITION OF SHUTTLE MAIN ENGINES

3.6.12.2.4.1 Payload Loading and Checkout. Prior to payload loading the internal surfaces of the payload bay envelope shall be cleaned to a visibly clean level, as defined in SN-C-0005. This cleaning shall be accomplished within a protective enclosure in order to isolate sources of contamination from critical regions. This enclosure shall be continuously purged with nominally class 100, guaranteed class 5000 (HEPA filtered) air per FED-STD-209 and shall contain less than 15 parts per million hydrocarbons, based on methane equivalent. The air within the enclosure shall be maintained at $70 \pm 5^{\circ}\text{F}$ and 50% or less relative humidity. The payload loading operation shall be accomplished so as to avoid contaminating the payload and payload bay by temperature, humidity, and particulates consistent with requirements specified herein. More stringent particulate and relative humidity requirements may be implemented on particular payloads pending technical justification of the requirement.

3.6.12.2.4.2 Contamination Control Subsequent to Payload Loading. Subsequent to payload loading, accumulation of visible particulate and film contamination on all surfaces within the payload bay shall be prevented by controlled work discipline, cleanliness inspections and effective cleaning as required. The air purge, temperature, and humidity requirements of the above paragraph 3.6.12.2.4.1 shall be maintained.

3.6.12.2.4.3 Preparation for Closeup of Payload Bay. Prior to final closure of the payload bay in preparation for vehicle mating, inspection and cleaning, as required, shall be conducted to verify that all accessible surfaces within the payload bay, including external surfaces of payloads, meet the visibly clean level stipulated in the above paragraph 3.6.12.2.4.1. When payload changeout in the vertical configuration is required, the purge gas class, temperature, and humidity requirements of the above paragraph 3.6.12.2.4.1 shall apply.

FED-STD-209B AIR CLEANLINESS CLASSES

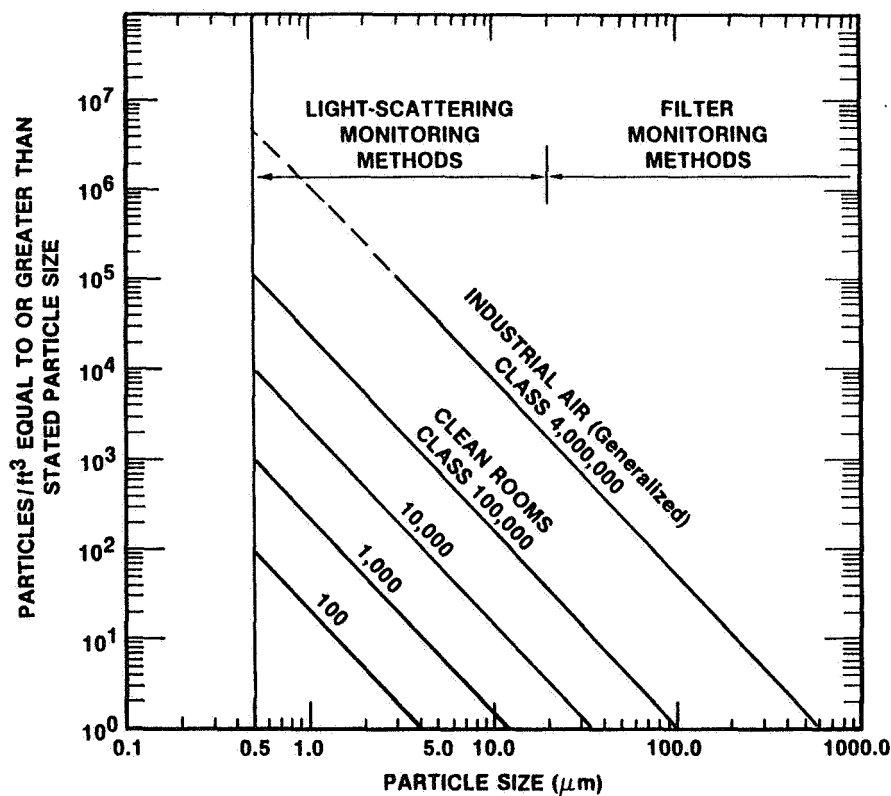

FED-STD-209B defines cleanliness on the basis of the number of particles per cubic foot of air. The "class of air" is defined as the total number of particles per cubic foot of air of all sizes of 0.5 μm and larger. Table II from FED-STD-209B defines a standard particle size distribution. For any particle size, the number per cubic foot is for all particles of that size and larger. Air cleanliness classes other than those plotted can be defined by parallel lines through the appropriate number on the ordinate.

The term "class" may be used in two ways. One is to describe the actual particulate environment as measured by an airborne particle monitor. The other is to designate a particular class of clean room.

The latter usage implies a facility that meets a number of operating and design requirements such as those described in T.O. 00-25-203⁽⁶⁾ and AFM 88-4, Chapter 5⁽⁷⁾. In this case the "class of clean room" designates the maximum airborne particle counts, and for normal operations the particle counts should be an order of magnitude or more below the maximum. For periods of no activity in a clean room the airborne particle counts will approach the cleanliness of the air leaving the HEPA filter, class 100 or less.

ORIGINAL PAGE IS
OF POOR QUALITY

Product Cleanliness Levels from MIL - STD - 1246A

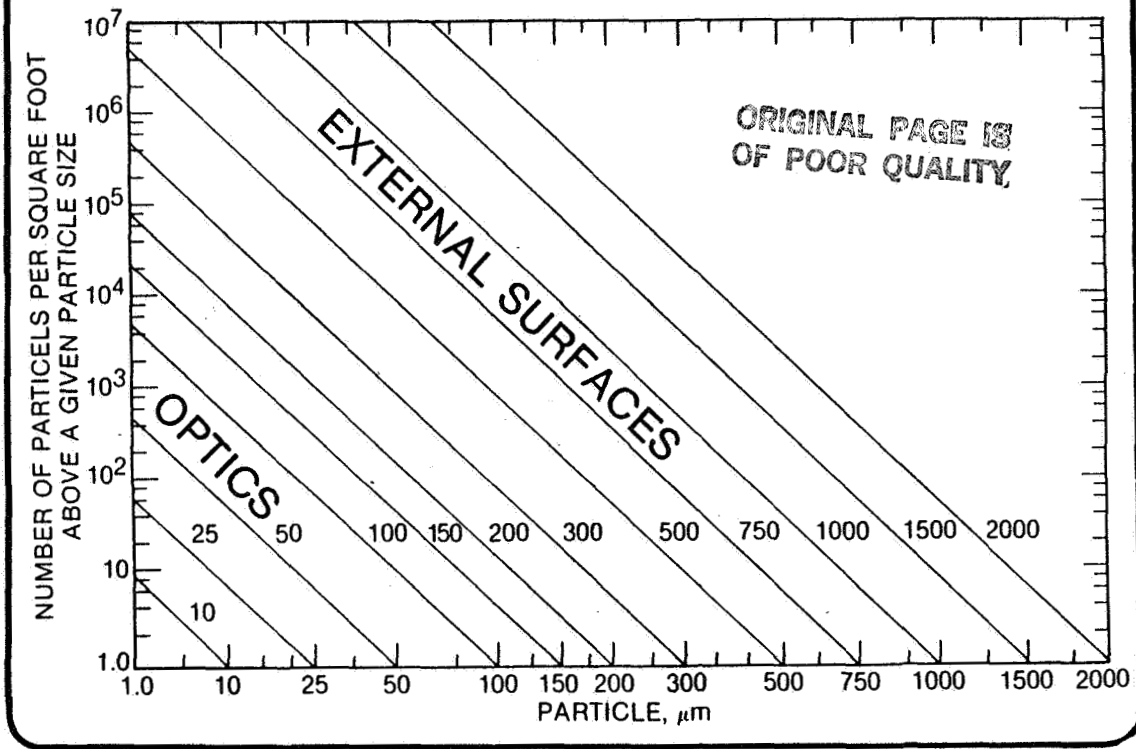

MIL-STD-1246A⁽¹⁰⁾ defines the product cleanliness levels on the basis of the number of particles on the components. A square foot area is generally used as a baseline for comparing surface cleanliness; however, MIL-STD-1246A specifies the use of the total number of particles for surface areas of less than one square foot.

The NASA Shuttle cleanliness specification, SN-C-0005A⁽¹⁾, is based on the same particle size distribution but does not contain the graph from MIL-STD-1246A that is on the chart on the facing page.

The number of particles per square foot of surface for all particles of the specified size and larger plot as a straight line on the log vs. \log^2 scales. The particulate cleanliness level is defined by the line crossing the abscissa. For example, the Level 500 line crosses the abscissa at one $500\mu\text{m}$ particle per square foot.

Typical external spacecraft surface cleanliness levels are in the range of 500 to 1000 but could be greater. For critical internal surfaces, such as optics, the levels could be at 100 or less.

MIL-STD-1246A and SN-C-0005A also define the NVR (non-volatile residue) levels on the basis of mg/ft^2 . For example, NVR Level A designates a quantity of $1 \text{ mg}/\text{ft}^2$ or less and Level B as $2 \text{ mg}/\text{ft}^2$ or less.

CRDG Recommendations

- CLEANING OF PAYLOAD SURFACES
 - PARTICLES: VISIBLY CLEAN PER SN-C-0005
 - NVR: $< 1 \mu\text{g cm}^{-2}$
 - ASSUMED TO BE LEVEL 300A PER MIL-STD-1246A OR SN-C-0005
- ENCLOSURE
 - ENTERING AIR
 - PARTICLES: NOMINAL CLASS 100, GUARANTEED CLASS 5,000 PER FED-STD-209B
 - MOLECULAR DEPOSITION: NO MORE THAN $1 \mu\text{g}\cdot\text{cm}^{-2}$ ON AMBIENT TEMPERATURE SURFACE
 - TEMPERATURE: $70 \pm 50^\circ\text{F}$ ($21 \pm 3^\circ\text{C}$)
 - RELATIVE HUMIDITY: 30% TO 50%, SELECTABLE TO $\pm 5\%$
 - ENVIRONMENT AROUND PAYLOAD
 - CLASS 100,000 OR LESS PER FED-STD-209B
- PAYLOAD BAY
 - USE PAYLOAD BAY LINER
 - VISIBLY CLEAN PER SN-C-0005
 - NVR: $< 1 \mu\text{g}\cdot\text{cm}^{-2}$

ORIGINAL PAGE IS
OF POOR QUALITY



The members of the working groups agreed that surface cleanliness is the critical aspect, and the CRDG recommended the use of NVR Level A ($1 \text{ mg}/\text{ft}^2$) which is equivalent to $1 \mu\text{g}/\text{cm}^2$ and $10 \text{ mg}/\text{m}^2$ for both payload and cargo bay surfaces⁽⁴⁾. If the NVR is assumed to have a density of $1 \text{ g}/\text{cm}^3$ and is uniformly distributed over the surface, the thickness would be 100 \AA for $1 \mu\text{g}/\text{cm}^2$.

Visibly clean per SN-C-0005 was selected for particulate surface cleanliness. This was optimistically assumed to be equivalent to a Level 300. Later studies showed that Level 500 or higher would be more representative of "visibly clean". The ability to see particles depends upon the surface roughness, color contrasts, and illumination.

The CRDG recommendations agreed with JSC 07700, Volume X, on the particulate cleanliness of the air entering the facilities (nominal Class 100, guaranteed Class 5,000). However, the CRDG recommended the measurement of molecular deposition rather than hydrocarbons based on methane equivalent.

The environment around the payload was recommended to be Class 100,000 or less. Based on experience, it would appear that typical payload environments have been well below Class 100,000 during ground operations.

For the payload bay, there was a consensus that the liner would be required and that visibly clean per SN-C-0005 would be satisfactory for particulate contamination. However, NVR Level A was recommended because visible inspection would not detect molecular deposits to an acceptable sensitivity.

Visibly Clean Levels and Inspection Criteria for the Orbiter Payload Bay, Payload Canister, and Payloads

<u>VC LEVEL</u>	<u>ILLUMINATION</u>	<u>OBSERVATION DISTANCE</u>	<u>REMARKS</u>
1	≥ 50 FOOT CANDLES	5 TO 10 ft	KSC STANDARD SERVICE
2	100 TO 200 FOOT CANDLES	6 TO 18 in.	OPTIONAL SERVICE
3	100 TO 200 FOOT CANDLES	6 TO 18 in.	OPTIONAL SERVICE: 2X TO 7X POWER OPTICAL AID PERMITTED FOR INSPECTION
VC + SPECIAL	100 TO 200 FOOT CANDLES	6 TO 18 in.	OPTIONAL SERVICE: SAME INSPECTION AS LEVELS 2 OR 3 PLUS SPECIAL METROLOGY REQUIREMENTS

From NASA SN-C-0005A

The Shuttle contamination control specification, SN-C-0005⁽¹¹⁾, was revised in March 1982 in order to better define visibly clean. The facing chart shows the visibly clean levels now defined in SN-C-0005A for the payload bay, payload canister and payload surfaces.

An OMI (Operational Maintenance Instruction)⁽¹²⁾ has been written to cover the cleaning and inspection of payload bay surfaces to the VC Level 1 criteria. Future changes will incorporate VC Level 2 and other criteria.

Special requirements, such as an NVR level, would be included under VC + Special.

ORIGINAL PAGE IS
OF POOR QUALITY

PARTICLE FALLOUT RATE ANALYSIS

- LOGARITHMIC REGRESSION ANALYSIS
- PREDICT FALLOUT RATE KNOWING AIR CLEANLINESS
- PROVIDE CONFIDENCE LIMITS OF PREDICTIONS

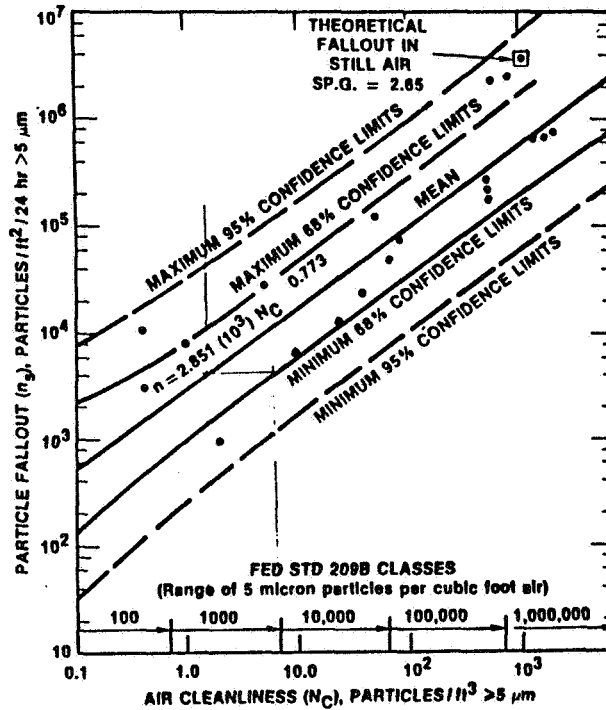

The relationship between surface cleanliness and air cleanliness for particles is not well defined. Hamberg⁽¹³⁾ calculated the particulate fallout rate for particles of 5 μm and larger. He assumed a constant concentration of 5 μm and larger sizes in the air in accordance with the distribution defined by FED-STD-209B⁽⁵⁾. The 5 to 200 μm size range and a specific gravity of 2.65 were used to calculate the particulate fallout rate.

The chart on the facing page shows the results of Hamberg's calculations and includes some experimental data points.

The relationship between airborne particle concentrations and fallout will be used to evaluate the data gathered during operations in the various KSC facilities.

ORIGINAL PAGE IS
OF POOR QUALITY

KSC Facility Contamination Verification Test Plan

- VERIFY BASIC REQUIREMENTS FROM JSC-007700, VOL. X
 - AIRBORNE PARTICLES
 - HYDROCARBONS (methane equivalent)
- VERIFY FACILITY CAPABILITIES
 - AIRBORNE PARTICLES
 - PARTICLE FALLOUT
 - MOLECULAR DEPOSITION
 - MICRO-BIOLOGICAL
- FACILITIES
 - VERTICAL PROCESSING FACILITY (VPF)
 - OPERATIONS AND CHECKOUT BUILDING (O&C)
 - PAYLOAD CANISTER AND TRANSPORTER
 - ORBITER PROCESSING FACILITY (OPF)
 - VEHICLE ASSEMBLY BUILDING (VAB)
 - ROTATING SERVICE STRUCTURE (RSS)/PAYLOAD CHANGEOUT ROOM (PCR)

ORIGINAL PAGE IS
OF POOR QUALITY,

The KSC Facility Contamination Verification Plan⁽¹⁴⁾ was drafted by KSC and reviewed by members of the working groups and participants in the measurement activities.

Experience gained during the facility measurement program has resulted in some changes from the originally published plan, and there is an effort in progress to revise the test plan.

The facility verification program has two general objectives. One is to verify the basic Level II requirements on air cleanliness:

1. Nominal class 100, guaranteed class 5000 for airborne particles.
2. Less than 15 ppm of hydrocarbons, methane equivalent.

The second objective is to define the environment within the facilities under various real and simulated operations. The measurements included the fallout and deposition of particles and molecular species. The surface contamination as a result of fallout and deposition is the major concern of people designing and building spacecraft and experiments.

The biological measurements were not performed.

ELS Shuttle Facilities

ORIGINAL PAGE IS
OF POOR QUALITY.

FACILITY	AIR FILTERS	AIR CHANGE RATE/FLOW RATE	RELATIVE HUMIDITY CONTROL
O&C BUILDING	80-85% NBS	3.9 CHANGES/hr	50% MAX
VPF	HEPA (99.97%)	8 CHANGES/hr	45 ± 5%
SPIF	HEPA + CARBON	15 CHANGES/HR	30%-50%
CANISTER	HEPA	150 LBM/MIN	30%-50%
OPF	80-85% NBS	4 CHANGES/HR	50% MAX
VAB	NONE	NONE	NONE
ORBITER BAY	HEPA + CARBON HEPA	112 TO 265 LBM/MIN (Mobile) 140 TO 290 LBM/MIN (PAD)	50% MAX 50% MAX
RSS/PCR	HEPA	15 CHANGES/HR	50% MAX

The operating characteristics of the air conditioning systems in various on-line Shuttle facilities are summarized in the facing chart.

The chart on page 28 shows typical airborne particle counts for a class 100,000 clean room. This is based on requirements in Air Force T.O. 00-25-203⁽⁶⁾.

Comparing the information on page 27 with that on page 28, it is possible to evaluate the facilities on the basis of clean room performance. However, it is important to consider the differences in operations within the Shuttle facilities as compared with typical clean rooms when the environments are analyzed.

The Assembly and Test Area (A&TA) in the O & C (Operations and Checkout) building is equivalent to a controlled area (Class 300,000) facility.

The VPF (Vertical Processing Facility) is equivalent to a class 100,000 clean room although the number of air changes per hour may be less than required for a clean room.

The payload canister has HEPA filtered air and can be considered to be equivalent to a class 100,000 facility.

The OPF (Orbiter Processing Facility) with only 4 air changes an hour might be considered as not meeting the requirements of a controlled area facility.

The VAB (Vehicle Assembly Building) has no environmental control, but the cargo bay doors are closed during Orbiter operations within the VAB.

The cargo bay purge air is HEPA filtered, and the portable purge units include a carbon filter that will remove molecular contaminants, such as hydrocarbons from the exhausts of internal combustion engines.

The PCR (Payload Changeout Room) on the RSS (Rotating Service Structure) at launch complex 39 is equivalent to a class 100,000 clean room.

Typical Guidelines for Clean Room Classes from Air Force T.O. 00-25-203

DESCRIPTION	MAXIMUM PARTICLE COUNT PER cu ft AIR >0.5µm (>5µm)	AIR CONDITIONING		AIR FILTRATION	PRESSURE DIFFERENTIAL	AIR FLOW	MONITORING	CLOTHING
		TEMPERATURE °F (°C)	RH %					
CONTROLLED AREA (Class 300,000)	300,000 (700)	80 MAX (27)	50 MAX	ROUGH (50 to 60%) MEDIUM (80 to 85%)	POSITIVE	10 AIR CHANGES PER hr, min	ONCE PER MONTH	DETERMINE LOCALLY
CONVENTIONAL CLEAN ROOM (Class 100,000)	100,000 (700)	72 ± 5 (22 ± 3)	30 TO 50	ROUGH (50 to 60%) MEDIUM (80 to 85%) HEPA (99.7%)	0.05 in WATER	15 TO 20 AIR CHANGES per hr	ONCE PER MONTH	COVERALLS CAP/HOOD/SNOOD CLEAN ROOM SHOES OR SHOE COVERS
LAMINAR CROSS FLOW (Class 10,000)	10,000 (65)	72 ± 5 (22 ± 3)	30 TO 50	ROUGH MEDIUM HEPA	0.05 in WATER	100 ft/min AT HEPA FILTER FACE	ONCE PER MONTH	SMOCK/FROCK CAP/HOOD/SNOOD "BUNNY SUIT" AS REQUIRED
LAMINAR DOWN FLOW (Class 1,000)	1,000	72 ± 5 (22 ± 3)	30 TO 50	ROUGH MEDIUM HEPA	0.05 in WATER	50 ft/min OVER ENTIRE FACILITY	ONCE PER MONTH	SMOCK/FROCK CAP/HOOD/SNOOD "BUNNY SUIT" AS REQUIRED
LAMINAR FLOW CLEAN WORK STATION (Class 100)	100	CONTROLLED BY ROOM	CONTROLLED BY ROOM	MEDIUM HEPA	NOT APPLICABLE	90 ft/min AVERAGE OVER AIR EXIT AREA BUT NOT LESS THAN 75 ft/min AT ANY POINT	ONCE EVERY 6 mo	AS REQUIRED

Typical Conventional Clean Room (Class 100,000)
AIRBORNE PARTICLES (FROM T.O.00-25-203)

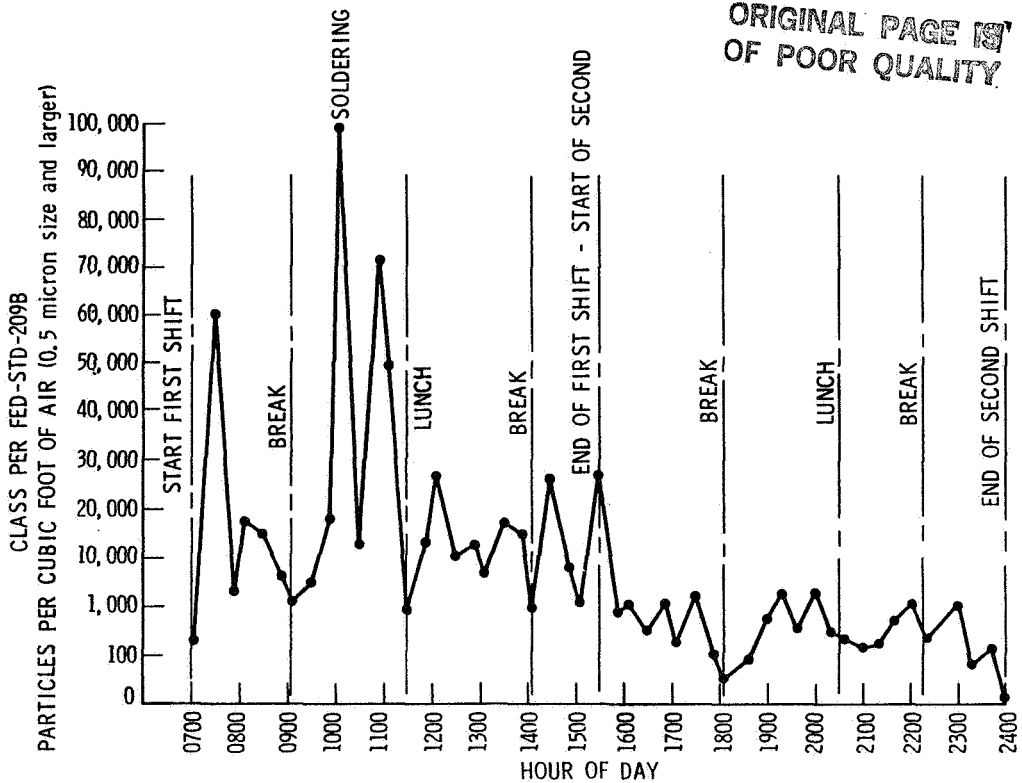

Product Cleanliness Levels from MIL - STD - 1246A

DAILY PARTICLE FALLOUT ON CITE STAND, O & C BUILDING

OSTA - 1 PAYLOAD, 23 - 26 JUNE 1981

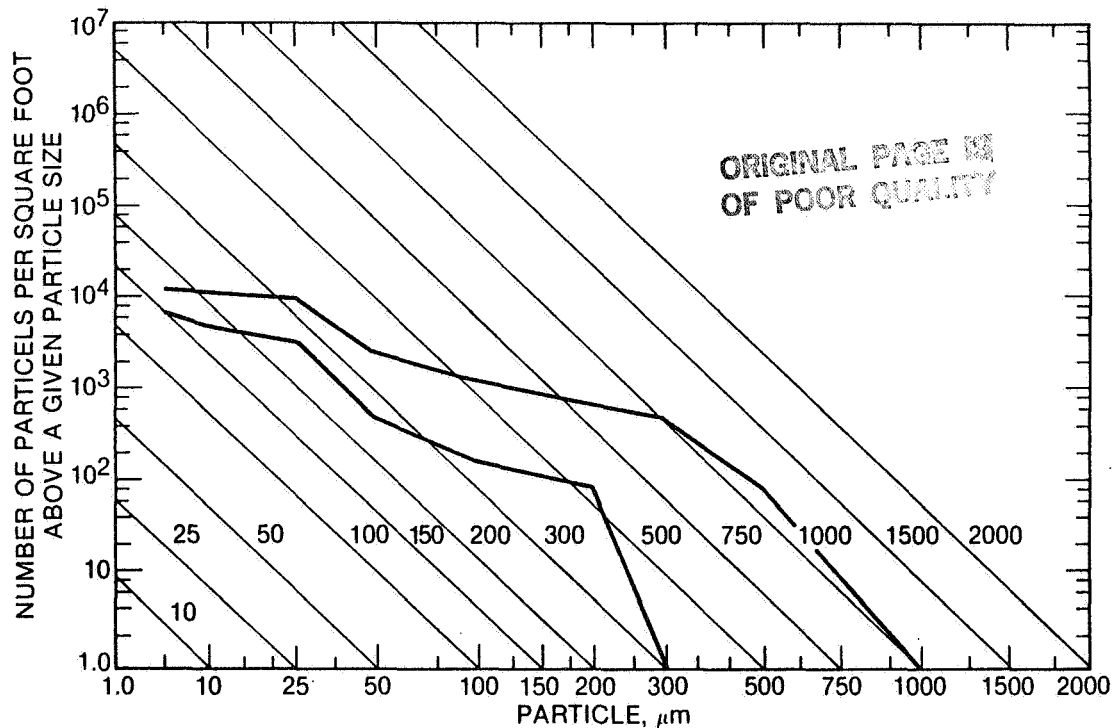

Particle fallout was measured by KSC contractor and Aerospace Corporation personnel during the integration activities of the OSTA-1 payload in the O & C building. The facing graph shows the maximum and minimum particle counts taken from data provided by Virginia Whitehead at KSC⁽¹⁹⁾.

The lower curve shows a period of no activity on the CITE stand where the fallout plates were located. The upper curve includes a period when the large doors were open and the canister was moved into the building. Particle fallout during transfer of the OSTA-1 pallet to the canister was slightly below the maximum.

O & C Building Assessment

ORIGINAL PAGE IS
OF POOR QUALITY

- AIRBORNE PARTICLES
 - LESS THAN CLASS 100,000 EXCEPT WHEN LARGE DOORS ARE OPEN
 - PARTICLES LARGER THAN 5 μm APPEAR TO BE GENERATED WITHIN THE FACILITY
- PARTICLE FALLOUT ON CITE STAND
 - 20 μm AND LARGER PARTICLES RESULT FROM ACTIVITIES ON THE CITE STAND
- COVERS CAN BE USED TO PROTECT SENSITIVE COMPONENTS
 - LOCAL COVERS
 - LARGE COVER OVER THE PAYLOAD
 - COVER WITH A HEPA FILTERED AIR PURGE OVER THE STAND
- NVR LEVELS ARE LOW
 - LESS THAN 0.004 mg/0.1 m² (0.004 $\mu\text{g}/\text{cm}^2$)

The airborne particle counts are generally less than class 100,000 except when the large doors are opened to admit the truck carrying the strongback (for lifting the pallet) and the canister transporter. At these times the airborne particle counts exceeded the class 100,000 requirements in the 5 μm and larger size range.

The airborne particle counts at other times were well below class 100,000.

The particle fallout data show large numbers of particles greater than 25 μm . This can be attributed to a number of factors. Large particles have high settling velocities and will tend to fallout near the locations where they are being generated. The sources of these particles probably are the personnel on the CITE stand and their activities. Except when the doors to the outside are open, the air entering the facility will have negligible large particles.

Airborne particle counters that use optical light scatter techniques may not be effective in measuring particles larger than 20 μm and were not located close to the fallout plates on the CITE stand.

NVR fallout levels were low as measured by the KSC wash plates and the Aerospace Corp. KRS-5 infrared plates. Level A of SN-C-0005A and MIL-STD-1246A is equal to or less than 1 mg/ft² (1 $\mu\text{g}/\text{cm}^2$ or 1 mg/0.1 m²). Measured levels were less than 0.004 mg/0.1 m² (N-hexadecane equivalent). Real time measurements using a QCM (quartz crystal microbalance) showed negligible change at a sensitivity of approximately 7 ng/cm² (0.007 $\mu\text{g}/\text{cm}^2$).

Protective covers over small components up to a cover over the CITE stand (with HEPA filtered air) are possible approaches to protecting sensitive components and payloads.

Product Cleanliness Levels from MIL - STD - 1246A

24 - hr PARTICLE FALLOUT ON VPF WORKSTAND

IUS PATHFINDER FLOW, 23 - 24 MARCH 1982

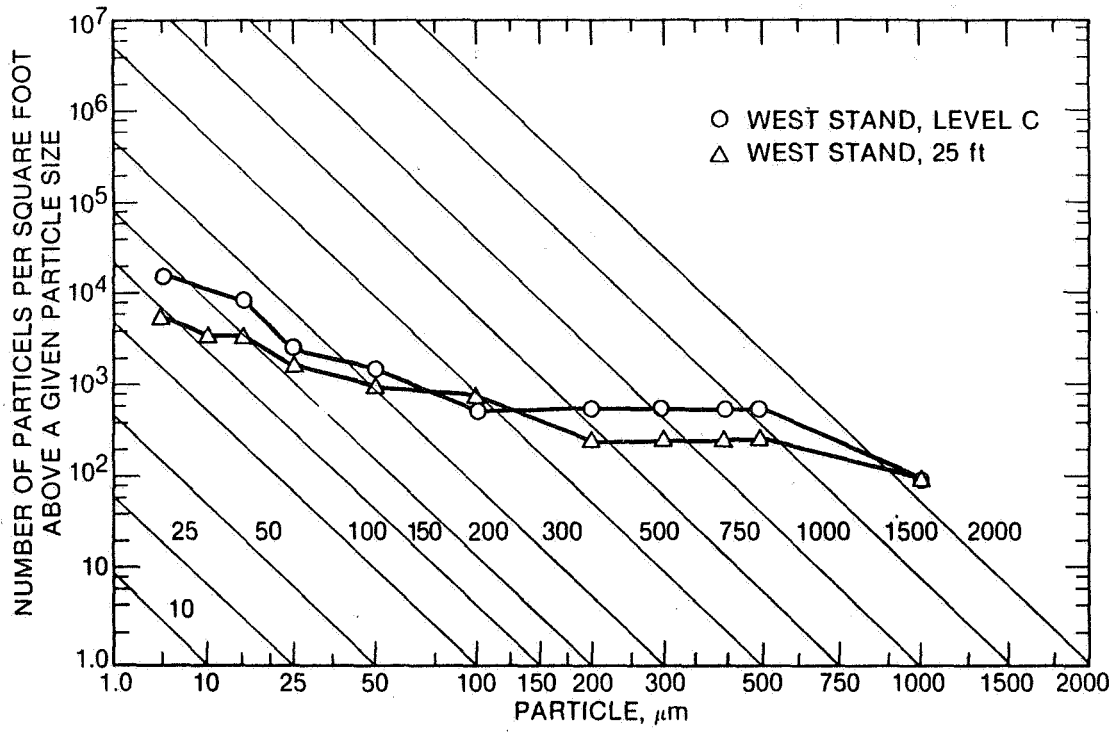

Particle fallout during the IUS pathfinder operations was measured by KSC contractor and Aerospace Corp. personnel. The plots on the facing graph are taken from data plotted by V. Whitehead⁽¹⁹⁾.

As observed in the O & C building, there are numerous large particles.

ORIGINAL PAGE IS
OF POOR QUALITY

VPF Assessment

ORIGINAL PAGE IS
OF POOR QUALITY

- AIRBORNE PARTICLES
 - CLASS 10,000 DURING OPERATIONS
 - TYPICAL OF CLASS 100,000 CLEAN ROOM
 - COULD BE HIGHER WITH INCREASED ACTIVITY
 - GREATER THAN CLASS 100,000 IN AIRLOCK WITH DOOR OPEN
- PARTICLE FALLOUT ON STAND
 - 20 μm AND LARGE PARTICLES RESULT OF LOCAL ACTIVITIES
- NVR
 - RANGED FROM <0.003 TO $0.70 \text{ mg}/0.1 \text{ m}^2$ IN 24 hr
 - HIGH LEVELS PROBABLY CAUSED BY FACILITY ACTIVITIES
- COMMENTS
 - CONTROL OF PROCEDURES CRITICAL TO MAINTAINING CLEANLINESS
 - FACILITY
 - PAYLOADS

The performance of the VPF is comparable to that of a class 100,000 clean room. The differences between the VPF and a typical clean room include equipment such as cranes and movable platforms, large numbers of people for some operations, and the movement of vehicles and equipment from outside into the facility.

The high airborne particle counts in the airlock when the door is open and equipment is moved in should be considered when planning operations.

The particle fallout onto surfaces is the result of activities in the vicinity of the surfaces. The airborne particle monitor will not necessarily measure the particles larger than 20 μm especially away from the location of the activity.

The occasionally high NVR levels probably are the result of activities with facility equipment such as cranes and platforms.

Although the facility environment is generally good, it is essential to plan and control procedures so as to avoid contamination during typical "dirty" operations. This applies to both facility and payload operations.

Payload Canister Assessment

ORIGINAL PAGE 18
OF POOR QUALITY

- AIRBORNE PARTICLES
 - LESS THAN CLASS 10,000 FOR MAJORITY OF TIME
 - PEAK COUNTS EXCEEDED CLASS 10,000 FOR SHORT TIMES
- PARTICLE FALLOUT
 - AN ANALYSIS SHOWS WALNUT SHELL PARTICLES
 - WALNUT SHELL BLASTING USED TO REMOVE INTERIOR PAINT
- NVR
 - APPEARS TO BE LOW
- COMMENTS
 - RESIDUAL WALNUT SHELL PARTICLES TO BE ELIMINATED BY FURTHER CLEANING
 - PAYLOADS COULD BE SOURCE OF PARTICLES
 - CROSS-CONTAMINATION BETWEEN CARGO ELEMENTS
 - MAY REQUIRE CLEANING TO REQUIREMENTS OF MOST SENSITIVE PAYLOAD

The transporter for the canister contains instrumentation to continuously monitor the airborne particles. The monitor only counts particles greater than $0.5 \mu\text{m}$ so it is not possible to determine the numbers of large particles within the count.

During transport, peak particle counts exceeded $10,246 \text{ per ft}^3$, the maximum number for the instrument scale being used. Therefore, the actual maximum count is not known.

The peak counts may occur during transport as a result of road bumps. The source could be the canister or the cargo within the canister.

Analyses of particles picked up on the Aerospace Corp. witness plates proved to be from walnut shells. Walnut shell blasting was used to remove white paint from the interior surfaces during refurbishment of the canister. The interior surfaces are unpainted aluminum and are easy to clean. However, residual walnut shell particles still appear to be in the nooks and crannies as of the STS-4 operations. Further cleaning is expected to eliminate these particles.

NVR levels appear to be low based on analyses of the Aerospace Corp. witness plates.

Since payloads could also be a major source of particles, cleanliness requirements and procedures should consider cross contamination between cargo elements. During vertical transport of the canister, the payload on the bottom of the stack could experience the most fallout.

Particulate Fallout in the Orbiter Processing Facility

ORIGINAL PAGE IS
OF POOR QUALITY

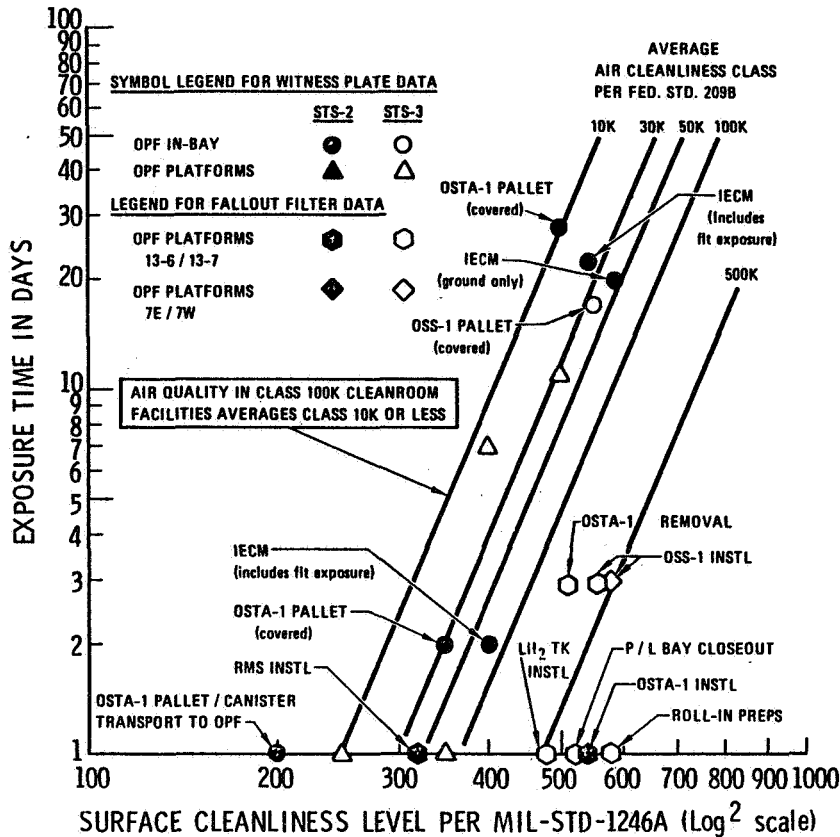

The chart on the facing page is based on the particle fallout rate presented earlier. The vertical axis is the exposure time in days. The horizontal axis is the particulate cleanliness level from MIL-STD-1246A. The solid lines show the theoretical fallout as developed by Hamberg⁽¹³⁾.

The theoretical fallout rates are calculated assuming an average air cleanliness class for the total exposure.

Data from various activities during STS-2 and STS-3 operations are plotted.⁽¹⁸⁾ The IECM data are from Aerospace Corp. plates on the passive sample array.

It appears that significant fallout occurs during specific operations that may take place in less than one full day. These activities in addition to long exposures contribute to payload contamination.

OPF Assessment

ORIGINAL PAGE IS
OF POOR QUALITY

- AIRBORNE PARTICLES
 - CLASS 200,000 TO 300,000 ARE NOT UNUSUAL
 - DEPENDS UPON ACTIVITIES
 - CLASS 10,000 TO GREATER THAN 100,000 IS OPERATING RANGE
- PARTICLE FALLOUT
 - GREATER THAN LEVEL 1000 FOR 24 hr PERIOD
 - FALLOUT ON PASSIVE SAMPLES FROM IECM APPEARS TO CORRELATE WITH EXPOSURE TO THE OPF
- NVR
 - 0.057 mg/0.1 m² PER 24 hr AVERAGE
 - 0.134 mg/0.1 m² PER 24 hr PEAK
 - INFRARED ANALYSES OF IECM SAMPLES SHOWS NEGLIGIBLE DEPOSITION
- COMMENTS
 - MODIFICATIONS TO OPF NECESSARY TO ISOLATE THE PAYLOAD BAY FROM OTHER OPF ACTIVITIES
 - CONTROL OF PROCEDURES CRITICAL TO MAINTAINING CLEANLINESS
 - FACILITY
 - PAYLOADS

The major difficulties in the OPF are the wide range of activities that must be performed during Orbiter maintenance and cargo installation.

Based on analyses of data gathered the two high bay areas that will isolate the cargo bay from the generally "dirty" operations that are done in the OPF.

Even when these modifications are completed, it will be necessary to plan ground operations so as to protect sensitive components from the "dirty" operations.

Particle Fallout Measurements During Pathfinder Operations

PTV - D

ORIGINAL PAGE IS
OF POOR QUALITY

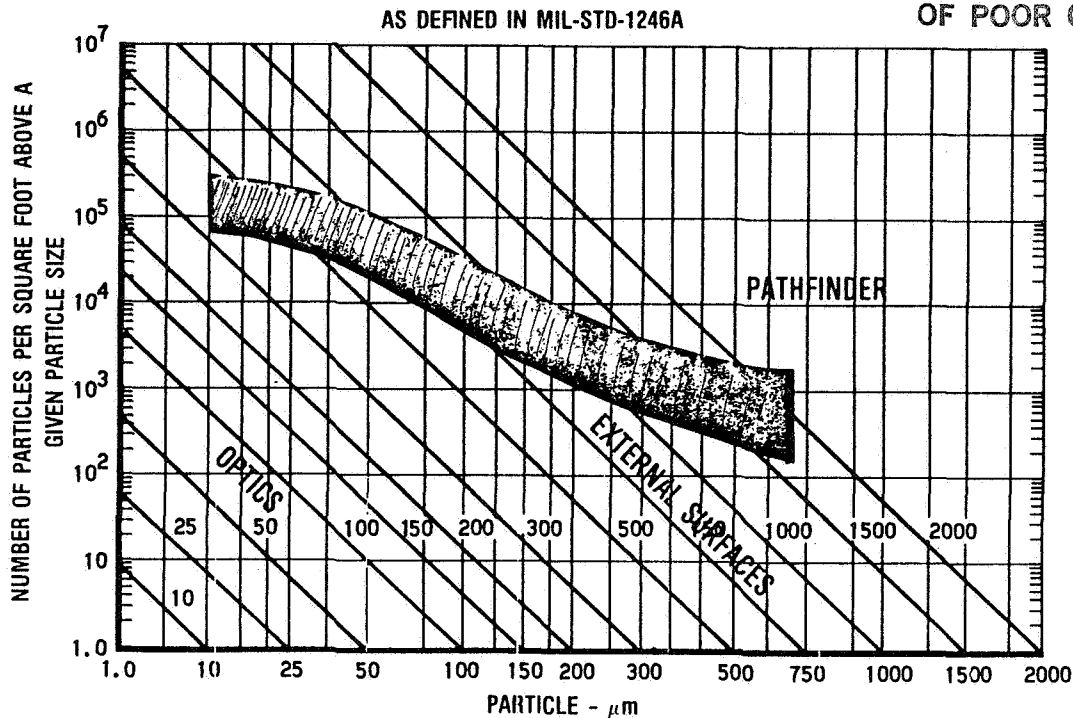

The PTV-D consisted of an IUS (Inertial Upper Stage) and a mechanical model simulating a spacecraft.

Contaminant fallout and airborne particle counts were measured at various times during the flow. The flow started in the Air Force Satellite Assembly building with the simulated spacecraft which was transported to the Vertical Processing Facility (VPF). The simulated spacecraft was integrated with the IUS in the VPF. The cargo was then placed into the canister and transported to Launch Complex 39A. The canister was mated to the Payload Changeout Room (PCR) on the Rotating Service Structure (RSS). The cargo was transferred to the Payload Ground Handling Mechanism (PGHM) in the PCR. The flow was reversed to complete the path finder program.

The band of particle fallout data on the opposite page represents exposures of 11 through 14 days on the simulated spacecraft during mating to the IUS and subsequent cargo operations.

The purpose of the PTV-D was primarily to evaluate the mechanical interfaces; therefore, there were no special contamination control procedures employed. However, the fallout data are typical of what can be expected during payload operations, but it may be possible to reduce the fallout levels during future operations.

Particle Fallout Measurements on STS - 4

ORIGINAL PAGE IS
OF POOR QUALITY

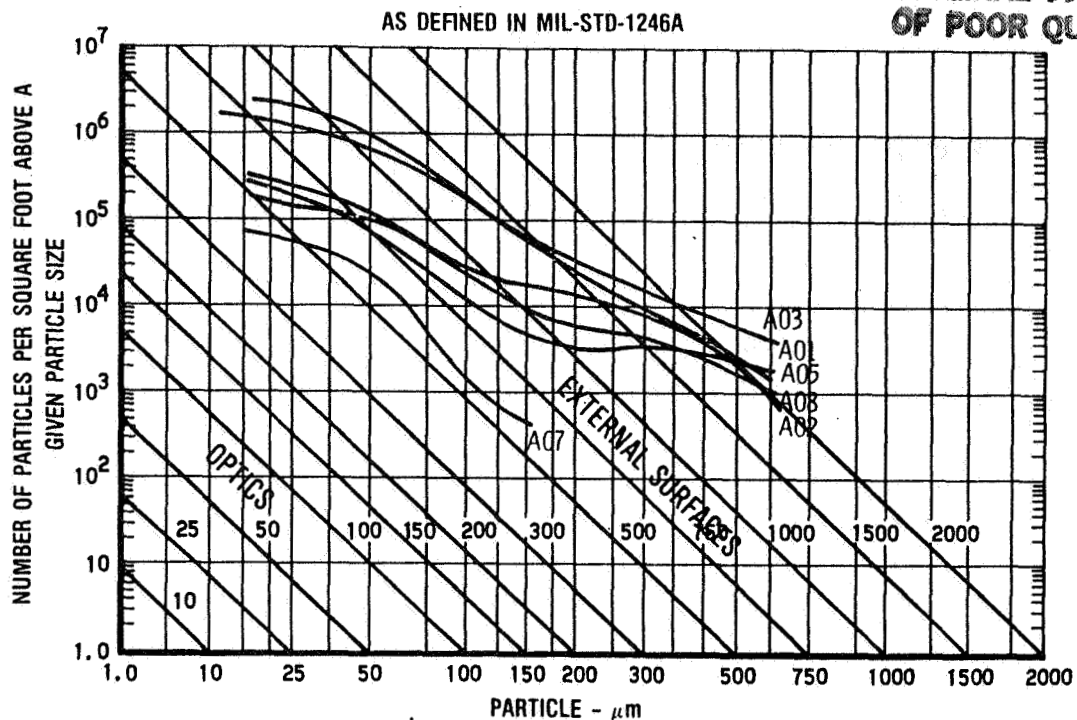

A01 PAYLOAD CHANGE-OUT ROOM (PCR) - ORBIT - ORBITER PROCESSING FACILITY (OPF)	A03 MARSHALL SPACE FLIGHT CENTER (MSFC) - CPF - PCR	A07 PCR/CARGO BAY (18 days)
A02 PCR - ORBIT - OPF	A05 MSFC - OPF	
	A08 OPF - PCR	



The vertical installation of the cargo on STS-4 provided an opportunity to monitor various phases of the ground operations from the OPF to the PCR. This was accomplished by changing out Passive Sample Array trays on the IECM at times through the ground flow.

The changeout schedule was as follows:

- A03 - Installed at MSFC, removed in OPF
- A05 - Installed at MSFC, removed in OPF
- A08 - Installed in OPF prior to bay door closing
- A07 - Installed in PCR, removed prior to flight (bay door closing)
- A01 - Installed in PCR, removed after flight and return to OPF
- A02 - Installed in PCR prior to bay door closing (replaced A07)

The only samples that were not exposed to the OPF were on tray A07. These samples were exposed only to PCR (for 18 days). At this time the A07 samples were vertical which would reduce the fallout as compared with horizontal samples.

The flight samples (A01 and A02) stayed on the IECM during the landing at Edwards Air Force Base and the ferry flight back to KSC, and were removed from the IECM while in the OPF.

There appears to be a correlation between the particle fallout and exposure to the OPF.

Fallout was also measured during ground operations using plates on the front end of the PGHM (Payload Ground Handling Mechanism). The results are shown on page 43a. The higher levels on these samples as compared with tray A07 may result from the two factors. Tray A07 was in the Cargo Bay and the surfaces were vertical. The plates on the PGHM were horizontal.

**Product Cleanliness Levels from MIL - STD - 1246A
TOTAL PARTICLE FALLOUT DURING STS - 4 OPERATIONS**

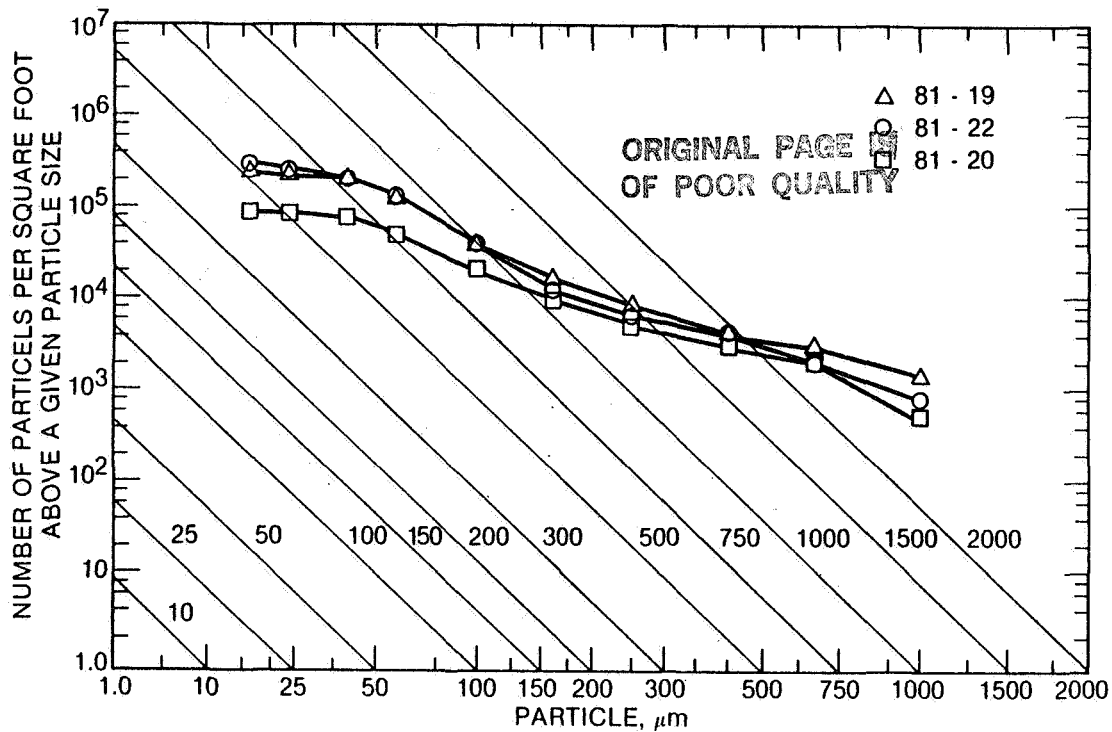

Aerospace Corp. witness plates provided data on the fallout of particles during operations with the 82-1 payload.

Plate 81-20 was exposed for 10-2/3 days during operations in the Satellite Assembly Building (SAB).

Plate 81-19 was exposed in the payload transporter during operations from the SAB to the Vehicle Processing Facility (VPF). The exposure time was 3-1/3 days.

Plate 81-22 was exposed for 21-1/4 days on the front of the PGHM (Payload Ground Handling Mechanism) during payload operations in the PCR.

The particle size distributions and numbers are similar although the locations and exposure times are quite different.

Airborne particle counts do not necessarily correlate with the fallout. In the PCR, the airborne counts were generally low, and the counters were well away from the witness plates.

It is reasonable to assume that activities in the vicinity of the witness plates were the sources for the particles.

PCR Assessment

ORIGINAL PAGE IS
OF POOR QUALITY

- AIRBORNE PARTICLES
 - LESS THAN CLASS 10,000 DURING MANY OPERATIONS
 - LESS THAN CLASS 400 DURING LOW ACTIVITY LEVELS
 - CLASS 60,000 DURING PURGE FOR HYPERGOL SPILL
- PARTICLE FALLOUT
 - LEVELS DEPEND ON ACTIVITIES
 - LARGE PARTICLES TYPICAL OF LOCAL ACTIVITIES
- NVR
 - NEGLIGIBLE ON IECM PASSIVE SAMPLES
 - MAXIMUM: 0.05 mg/0.1 m² PER 24 hr
 - MINIMUM: LESS THAN 0.001 mg/0.1 m² PER 24 hr
- COMMENTS
 - CONTROL OF PROCEDURES CRITICAL TO MAINTAINING CLEANLINESS
 - FACILITY
 - PAYLOADS

As was concluded with respect to other facilities, it appears that surface contamination is the result of payload and facility activities.

The facility appears to be comparable to a class 100,000 clean room in that it operates in the class 10,000 range and drops to below class 400 when there is no or minimal activity.

Again, control of procedures and local protection are important in maintaining payload cleanliness.

NVR ON OV-102 CARGO BAY SURFACES

LOCATION	STS-1 MG/FT ²	STS-2 MG/FT ²	STS-3 MG/FT ²
FWD, RT RADIATOR	1.14	0.33	0.15
MID, RT RADIATOR	0.80	-	-
AFT, RT RADIATOR	0.34	0.46	-
AFT, LFT RADIATOR	0.26	0.15	-
FWD, LFT RADIATOR	-	0.61	-
FWD BULKHEAD	-	0.48 0.80	1.45
RT LONGERON	-	14.9 5.0	1.60 0.05
AFT BULKHEAD	-	0	-

ORIGINAL PAGE IS
OF POOR QUALITY

The visual cleanliness definitions from NASA SN-C-0005A (See Page 21) do not provide quantitative cleanliness levels of surfaces and possible transfer of contaminants to payloads during launch through deployment operations.

NVR (non-volatile residue) measurements were performed on various cargo bay surfaces during operations of STS-1, 2, and 3.

Surfaces were sampled using cotton wipes that had been soxhlet extracted to remove residual molecular contaminants. Each surface (usually 1/4 to 1 square foot) was wiped with a cloth dampened with a mixture of 1, 1, 1 trichloroethane (75%) and ethanol which had been distilled so that the solvent NVR was less than one ppm. Each surface was wiped a second time with a fresh wipe in the same manner. The cloths were extracted, using the same solvent; the extract was filtered to remove particles and evaporated; and the residue was weighed. The NVR levels are reported in mg/ft² which is nearly equivalent to mg/0.1m² and µg/cm². 1 mg/ft² is NVR level A per SN-C-0005A and MIL-STD-1246A.

The results show NVR levels that are generally acceptable for most payloads. This is good considering that no formal cleaning and inspection procedures were implemented until STS-4.

The radiators show the lowest NVR levels, probably because of generally greater care in handling.

The high NVR levels on bay surfaces during STS-2 operations may be local spots that had not been cleaned or had recently been contaminated from Orbiter activities.

The NVR measurements for STS-3 were performed after the return of Columbia to the OPF at KSC.

Comparison of Ascent Particulate Environments

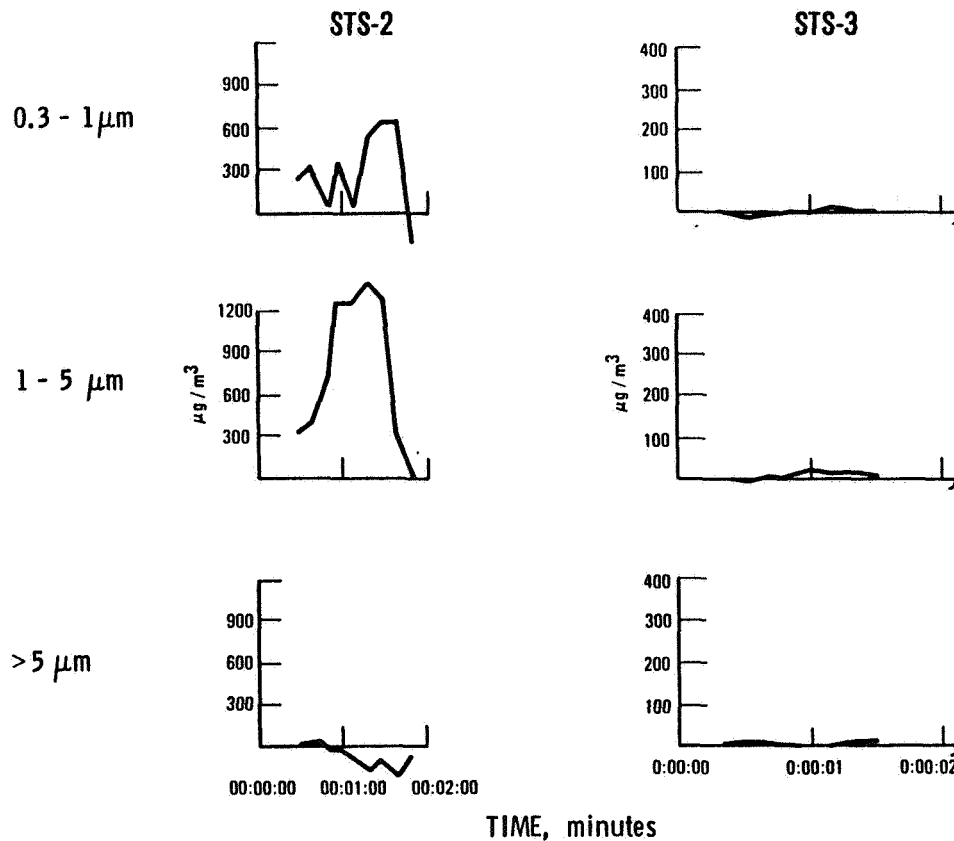

The particle data from the Cascade Impactor on the IECM are inconclusive. Also, it is not possible to deduce contamination of payloads in bay from this data.

The Cascade Impactor has three QCM (quartz crystal microbalance) stages designed to separate the particles into different size ranges. The three size ranges are 0.3 to 1 μm, 1 to 5 μm, and greater than 5 μm⁽¹⁵⁾. A single pump draws air from the cargo bay through the instrument. The data are reported in μg/m³ of air.

The peak particle concentrations for STS-2 appear to occur during the high vibration and acoustic levels during launch⁽²⁰⁾. Because the instrument depends upon a flow of air for operation, by approximately two minutes after Orbiter main engine ignition, the air density in the bay is too low for particles and air to be pumped. Therefore, the dropoff in particle concentrations may not indicate a reduction in particle fallout.

A comparison between STS-2⁽²⁰⁾ and STS-3⁽²¹⁾ data tends to indicate that the cargo bay and/or payload surfaces were cleaner than those on STS-2. Results from STS-4 show concentrations greater than those from STS-3 but less than those from STS-2.

At this time it is not possible to determine the effects of particle fallout on payloads during launch because of the difficulty in interpreting the cascade impactor results and no passive samples were on the +X side (forward looking side) of the IECM. Samples on the -Z side of the IECM (looking towards the bay doors) were vertical during launch so that the air flow and particle trajectories were parallel to the surfaces. Consequently, deposition onto the surfaces could be small relative to horizontal surfaces that would be normal to the flow.

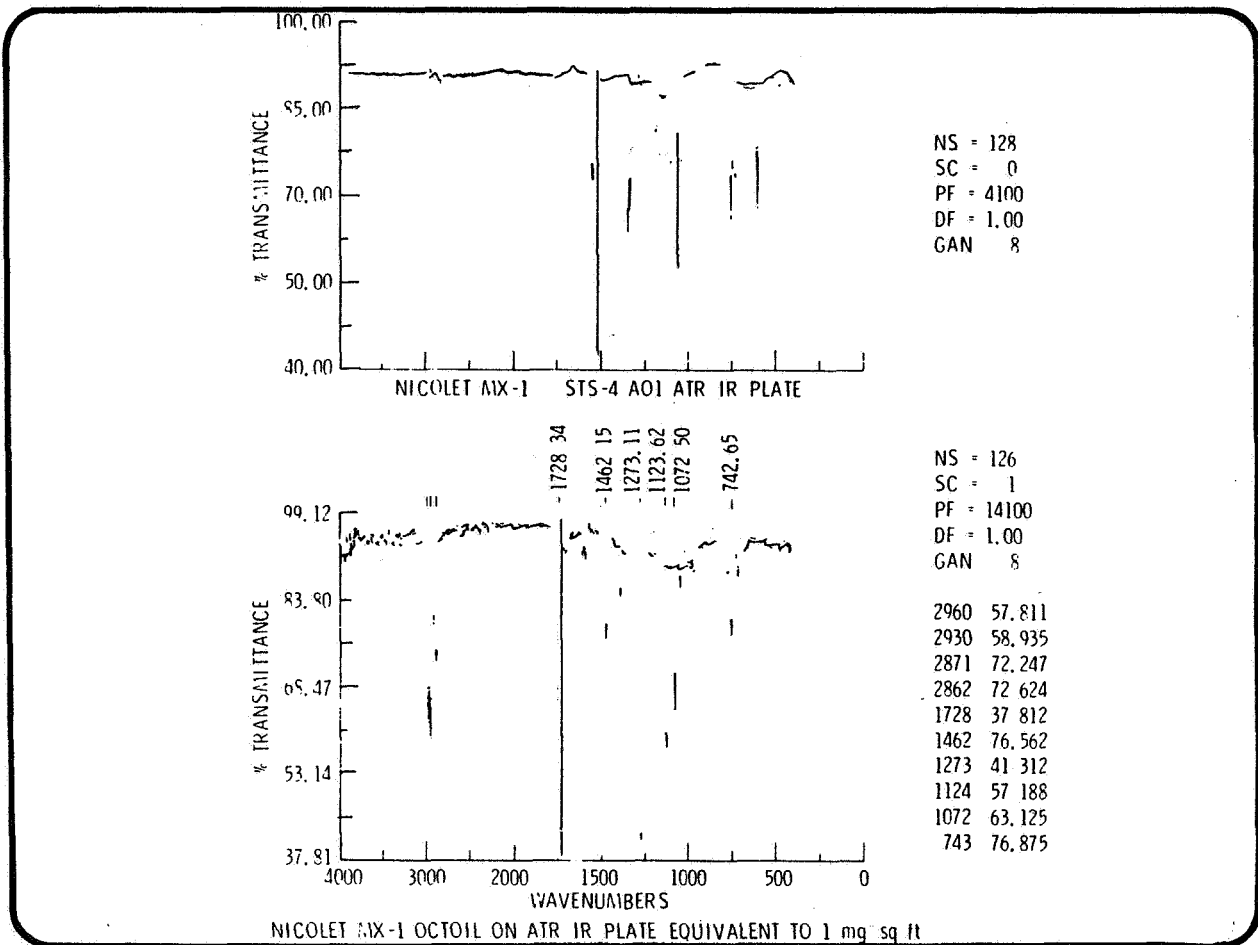

KRS-5 internal reflectance elements (IRE's) (also called ATR [attenuated total reflectance] plates) were included on the Passive Sample Array of the IECM. This provided opportunities to evaluate the deposition of contaminants during ground and flight operations.

The top IR spectra on the opposite page was exposed to the Orbiter bay environment during launch and on orbit as well as the out-of-bay survey of the RCS thruster plumes and Orbiter outgassing. It was also exposed in the Orbiter bay during entry, landing at Edwards Air Force Base, the return to KSC, and to the OPF.

The lower IR spectra is from a laboratory sample coated with 1 mg/ft² of Octoil diffusion dump fluid. The objective was to calibrate the hydrocarbon absorption loads at 2800 to 3000 cm⁻¹ and the carbonyl band at 1728 cm⁻¹.

A comparison of the two spectra showed significant quantities of silica-silicate type materials that could be from dust in the OPF.

The other absorption peaks in the above spectra could be from nitrates as a result of RCS thruster plumes or earth based air pollution.

SUMMARY/CONCLUSIONS/RECOMMENDATIONS

- O & C, VPF, CANISTER, AND PCR WILL GENERALLY PROVIDE ACCEPTABLE ENVIRONMENTS
- OPF MAY BE ACCEPTABLE WHEN MODIFICATIONS ARE COMPLETED
- FACILITY AND PAYLOAD ACTIVITIES ARE MAJOR SOURCES OF CONTAMINANTS
 - PARTICLES AND NVR
 - PLANNING AND CONTROL OF PROCEDURES IS ESSENTIAL
 - COVER SENSITIVE COMPONENTS DURING "DIRTY" OPERATIONS
 - USE LOCAL CLEAN AIR OR GAS PURGES
- DEFINE PAYLOAD CLEANLINESS REQUIREMENTS
 - NVR AND PARTICLES ON SURFACES
 - ANY SPECIAL SENSITIVITIES
- MONITORING CONTAMINATION MAY BE NECESSARY TO VERIFY CLEANLINESS
 - AIRBORNE PARTICLE COUNTS DO NOT NECESSARILY INDICATE SURFACE CLEANLINESS LEVELS

The OPF appears to be the only facility that has significant problems in meeting payload requirements. The modifications to the OPF should resolve these problems.

Although the O & C building is not a class 100,000 clean room, based on typical design criteria, it does appear to be acceptable.

It is evident, however, that even in the best clean room facilities that significant contamination results from personnel and operations within the facility.

Although particles are the major problem, there is always a possibility of molecular contaminants (NVR) as well.

Therefore, it is essential to plan facility and payload operations so as to protect payloads, especially during "dirty" activities.

The use of protective covers, HEPA filtered air purges or enclosures, and gaseous nitrogen purges may be used as appropriate to protect full spacecraft or sensitive components.

In order to plan ground operations it is necessary to define the surface cleanliness requirements for payloads and to indicate any special sensitivities that could affect the planning.

Payloads should consider the cleanliness/contamination monitoring that is necessary to verify performance. It is evident that airborne particle counts are not sufficient to verify surface cleanliness levels.

REFERENCES

1. JSC 07700, Vol. X, Space Shuttle Flight and Ground System Specification
2. JSC 07700, Vol. XIV, Space Shuttle Systems Payload Accommodations
3. ICD 2-19001, Shuttle Orbiter/Cargo Standard Interfaces, Appendix to JSC 07700, Vol. XIV
4. R. Naumann, Payload Contamination Control Requirements for STS Induced Environment, NASA Marshall Space Flight Center, 22 July 1975
5. FED-STD-209B, Clean Room and Work Station Requirements, Controlled Environment, April 24, 1973
6. T.O. 00-25-203, Contamination Control of Aerospace Facilities, U. S. Air Force, 11 Dec. 1978
7. AFM 88-4, Chapter 5, Criteria for Air Force Clean Facility Design and Construction, 9 Sept. 1968
8. P. R. Austin & S. W. Timmerman, Design and Operation of Clean Rooms, Business News Publishing Co., Detroit, Michigan, 1965
9. MIL-F-51068C, Filter, Particulate, High Efficiency, Fire Resistant, 8 June 1970
10. MIL-STD-1246A, Product Cleanliness Levels and Contamination Control Program, 18 Aug. 1967
11. SN-C-0005A, Specification, Contamination Control Requirements for the Space Shuttle Program, March 1982
12. Payload Bay, Crew Compartment and Aft Compartment Vacuuming and Cleaning, OMI No. V1176, Rockwell International Corp., Space Division, 17 June 1982
13. Otto Hamberg, Particulate Fallout Predictions for Clean Rooms, The Journal of Environmental Sciences, Vol. 25, No. 3, May/June 1982
14. W. E. Lockwood, KSC Facility Contamination Verification Test Plan, K-STSM-09.7.1, NASA Kennedy Space Center, 26 Nov. 1979
15. E. R. Miller & R. Decher, An Induced Environment Contamination Monitor for the Space Shuttle, NASA TM-78193, Aug. 1978
16. W. B. Fry, Integration and Ground Turnaround Contamination Control Plan, K-STSM-09.7A, Change 1, NASA Kennedy Space Center, April 1979
17. Launch Site Accommodations Handbook for STS Payloads, K-STSM-09.7A, NASA Kennedy Space Center, 14 March 1978
18. Personal Communications, T. Duncan, Martin Marietta Co., NASA Kennedy Space Center
19. Personal Communications, Virginia Whitehead, NASA Kennedy Space Center
20. E. R. Miller, STS-2 Induced Environment Contamination Monitor (IECM) - Quick-Look Report, NASA TM-82457, January 1982.
21. E. R. Miller and V. A. Fountain, STS-3 Induced Environment Contamination Monitor (IECM) - Quick-Look Report, NASA TM-82489

ACKNOWLEDGEMENTS

The work presented here is based on the contributions of many people.

Much of the data were gathered and analyzed by NASA and contractor personnel at the Kennedy Space Center. All NASA, Air Force and contractor personnel were extremely cooperative.

The Air Force Chemistry Laboratory of the Cape Canaveral Air Force Station provided NVR and particle analyses.

Numerous people within the Materials Sciences Laboratory of The Aerospace Corporation contributed to this effort. These included:

P. M. Adams
K. E. Wrightsel
G. A. To
N. Marquez
M. J. Meshishnek

N83 22299

D10

OXYGEN ATOM REACTION WITH SHUTTLE MATERIALS AT ORBITAL ALTITUDES

L. J. Leger
Johnson Space Center

ORIGINAL PAGE IS
OF POOR QUALITY

OXYGEN ATOM REACTION WITH SHUTTLE MATERIALS AT ORBITAL ALTITUDES

L. J. LEGER

OUTLINE

- EFFECTS OBSERVED FROM STS-1 THROUGH STS-4
- BRIEF DESCRIPTION OF MECHANISM
- DESCRIPTION OF STS-5 EXPERIMENT
- CONSIDERATIONS FOR THIS MEETING

ORIGINAL PAGE IS
OF POOR QUALITY

- SIGNIFICANT EFFECTS OF ENVIRONMENT ON PAYLOAD BAY MATERIALS OBSERVED ON ALL FLIGHTS
 - STS-1
 - FORWARD BULKHEAD KAPTON CAMERA BLANKET WAS MILKY YELLOW AFTER FLIGHT
 - YELLOW PAINT AGED RAPIDLY
 - STS-2
 - CAMERA BLANKETS - LOSS OF 4.8% ON KAPTON OUTER SURFACE; ALL CAMERAS AFFECTED
 - PAINT SIMILAR TO STS-1
 - STS-3
 - CAMERA BLANKETS - MASS LOSS OF 35% (0.1 MIL) ON SURFACES OF ESSENTIALLY ALL CAMERAS
 - TORLON THERMAL BLANKET BUTTON HAD WHITE DEPOSIT ON SURFACES
 - PAINT SIMILAR TO STS-1 EXCEPT WHITE PAINT ON SILL LONGERON ALSO AGING RAPIDLY

- STS-3 (CONTINUED)
 - OSS-1 KAPTON HAD LOSS OF 22% (0.22 MIL)
 - PDP SPHERES HAD COMPLETE LOSS OF AQUADAG ON UPPER SURFACES
 - OSS-1 PAINT SURFACES ALSO AFFECTED
- STS-4
 - KAPTON AFFECTS MINOR ON BOTH CAMERA AND PAYLOAD SURFACES
 - COATED KAPTON HAD RESISTANCE CHANGES
 - WITNESS SAMPLES OF FOUR MATERIALS FLOWN ON IECM HAD LOSS RANGING FROM .003 MIL FOR TEFLON TO .07 MIL FOR KAPTON AND MYLAR
 - WITNESS SAMPLES OF CARBON COATING 2000Å COMPLETELY REMOVED

ORIGINAL PAGE IS
OF POOR QUALITY

PROPOSED MECHANISM

- POLYMER FILMS SUCH AS KAPTON, PAINT BINDERS, THERMAL BLANKET BUTTONS (TORLON) ARE BEING OXIDIZED BY NEUTRAL OXYGEN ATOMS PRESENT AT ORBITAL ALTITUDES (LEO)
- SOLAR EXPOSURE ACCELERATED OXIDATION REACTION AND LEADS TO SHADOWING EFFECTS
- OXIDATION PROCESS FOR MOST ORGANICS PRODUCES H_2 , CH_4 , AND CO WHICH RESULTS IN MASS LOSS FOR KAPTON AND LOSS OF BINDER FOR PAINTS
- OXIDATION PROCEEDS WHEN SURFACES ARE EXPOSED TO OXYGEN FLUX (VEHICLE VELOCITY VECTOR) AND SOLAR EXPOSURE
- OXIDATION GREATEST FOR TOP SUN RAM EXPOSURE

BASIS FOR MECHANISM

- OXYGEN ATOMS PREDOMINANT SPECIES AT LEO ALTITUDES $1 \times 10^9/cm^3$; N_2 AT ABOUT SAME CONCENTRATIONS; OTHER SPECIES FACTOR OF 100-1000 LOWER
- COMPARISON OF SEM PHOTOS FOR LAB SIMULATED SURFACE AND EXPOSED SURFACE
- COMPARISON OF MASS LOSS RATES MEASURED IN LOW TEMPERATURE ASHER (RADIO FREQUENCY EXCITATION OF O_2 GAS TO PRODUCE OXYGEN ATOMS)

ORIGINAL PAGE IS
OF POOR QUALITY

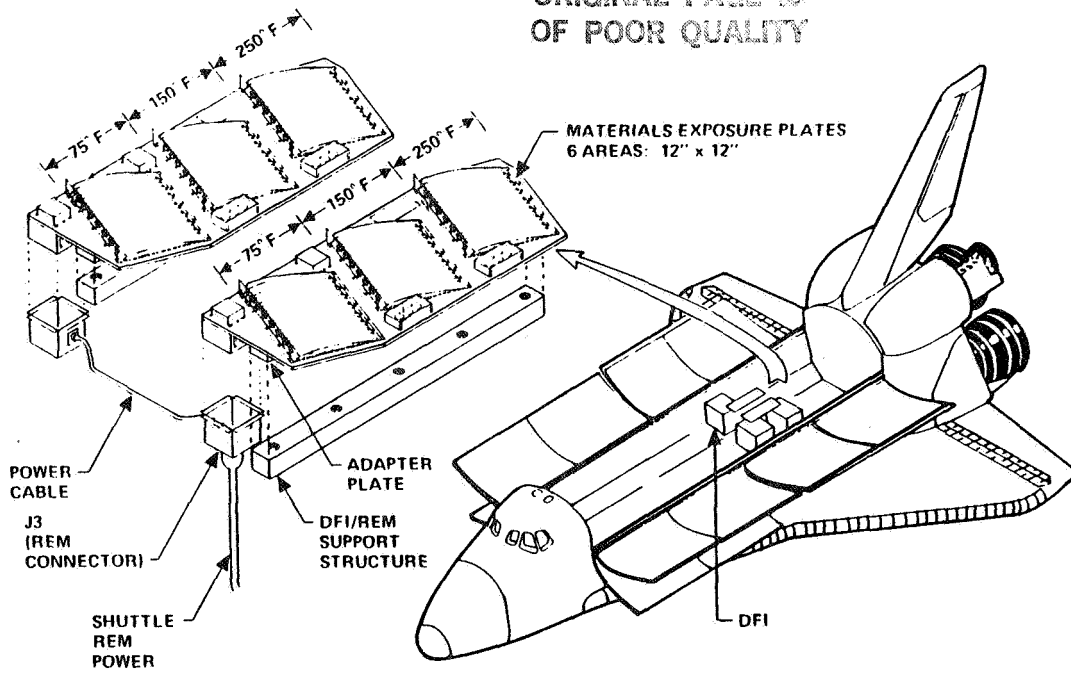

MATERIAL TRAY CONFIGURATION

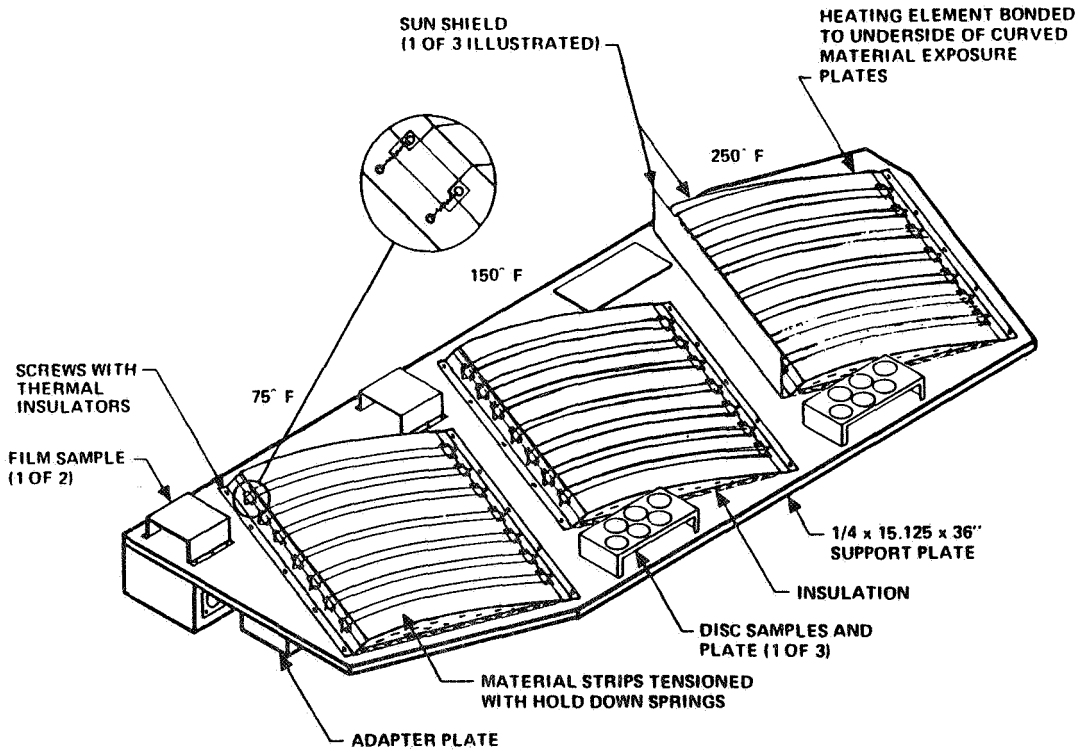

MATERIAL TRAY DETAIL

STS-5 SAMPLE DESCRIPTION

ORIGINAL PAGE IS
OF POOR QUALITY

● TEMPERATURE CONTROLLED TRAYS

- KAPTON
- MYLAR
- TEFLON - FEP/TFE
- KEVLAR
- EPOXY
- POLYSULFONE
- TEDLAR
- PAINTS
 - A276
 - A302
 - A306
 - 401-C10
 - S13-GLO
- GRAPHITE/EPOXY
- GRAPHITE/POLYIMIDE
- ALUMINUM
- SILVER
- OVERCOATS
 - SILICONE OIL
 - TETRAETHYLORTHOSILICATE
- ITO
- GOLD
- ALUMINUM

● TEMPERATURE UNCONTROLLED AREAS

- GERMANIUM
- ZOT
- SILVER FOIL
- RTV
- MS74
- P1700
- S13-GLO
- ITO

CONSIDERATIONS FOR THIS MEETING

- INCREASED OUTGASSING RATES RESULTING IN POSSIBLE LOCALIZED EFFECTS ON EXPERIMENTS
- CHANGES IN OPTICAL PROPERTIES OF THERMAL CONTROL SURFACES (% ϵ INITIAL = 0.4 % ϵ EXPOSED = .7 - .8)
- PHOTO EMISSION FROM REACTION PRODUCTS

OBSERVATIONS OF OPTICAL EMISSIONS FROM STS-3

P. M. Banks, P.R. Williamson
Stanford University

W. J. Raitt
Utah State University

(This paper is not available for this publication but
will appear in the February issue of Geophysical
Research Letters.)

Preceding page blank

OBSERVATIONS OF OPTICAL EMISSIONS ON STS-4

S. B. Mende, Lockheed
O. K. Garriott, Johnson Space Center
P. M. Banks, Stanford University

Preceding page blank

OBSERVATIONS OF OPTICAL EMISSIONS ON STS-4

S.B. Mende, O.K. Garriott, P.M. Banks

August 12, 1982

INTRODUCTION

Nighttime photographs taken by the crew of STS-3 revealed that there is an observable luminosity or glow of unknown origin enveloping certain parts of the Orbiter. In photographs and payload bay TV images from STS-3 this luminosity is particularly evident on the tail section and on the aft engine pods in directions corresponding to the windward side of the vehicle. The study of the STS-3 photographic data is currently continuing (Banks, et al, 1982). In addition to this recent work, in the past there were observational results from Atmospheric Explorer that a fast moving spacecraft creates luminosity in the upper atmosphere (Yee and Abreu, 1982). However, the existence of the shuttle glow was not specifically predicted.

The STS-3 photographs clearly show that the luminous envelope exists above surfaces which are predominately in the forward direction with respect to the velocity vector. The occultation of an occasional star by the glow shows that the glow is a layer of 5 to 10 cm thick. The temporal fluctuation of the glow as a function of the Orbiter maneuvering system jets is also under study since short term enhancements are seen at these times. Color photographs were also obtained during the flight of STS-3, showing that the glow has a strong reddish component when compared to the normal airglow layer consisting mainly of $OI(\lambda = 5577\text{\AA})$ radiation.

Because of the importance of shuttle glow as an optical contaminant to the high sensitivity astronomy or aeronomy experiments which will be carried on future shuttle missions, further experiments to study the glow were carried out on STS-4. Owing to

Preceding page blank

the short time between STS-3 and STS-4, it was not possible to introduce a complete spectroscopic experiment to study the vehicle glow. Consequently, a simple experiment using a 300 line per mm grating was proposed in combination with the same cameras which recorded the glow on STS-3. Close cooperation between all levels of NASA permitted us to procure the diffraction grating, schedule the photography, train the crew, and perform the experiment on STS-4 in a period of four weeks. In this report we provide the preliminary findings from these second generation experiments.

MEASUREMENT TECHNIQUE

The main object of the experiment was to obtain the optical spectral distribution of the glow. Because of the brief time available we had to minimize our impact on the flight hardware. We used the previously flown 70 mm Hasselblad camera with a 100 mm focal length lens. This same camera was used for the glow photography on the STS-3. The camera was mounted in the aft flight deck window on brackets and a window shade was used to screen out undesirable light contamination from the cabin.

The only item specially procured and delivered for the STS-4 experiment was the optical grating. The 300 lines per mm grating was purchased from Diffraction Products, Inc., Woodstock, Illinois and was used as an objective grating in front of the camera optical system, thereby making the camera into a slitless spectrograph. The optical path of the system is illustrated in Fig. 1. The camera and lens were pointed toward the tall, narrow tail section (vertical stabilizer) with the aft engine pods included in the frame. With the grating ruling approximately parallel to the vertical stabilizer, a "zero order image" will be located on the film at the same location as if the grating were absent. For this grating, however, most of the light is diffracted into a bright first order image to the right of the fainter zero order image. For a moderately bright object (such as a star), zero order image, first, and second order spectra may be observed. It is important to detect the zero order

image because the distance on the plate from the zero to first order image defines the wavelength. If the spectrum consists of a continuum emission then the first order image is widely spread and represents a convolution of the image intensity and the spectral profile. With good signal to noise ratio such a diffuse image can be processed to yield the high resolution spectra.

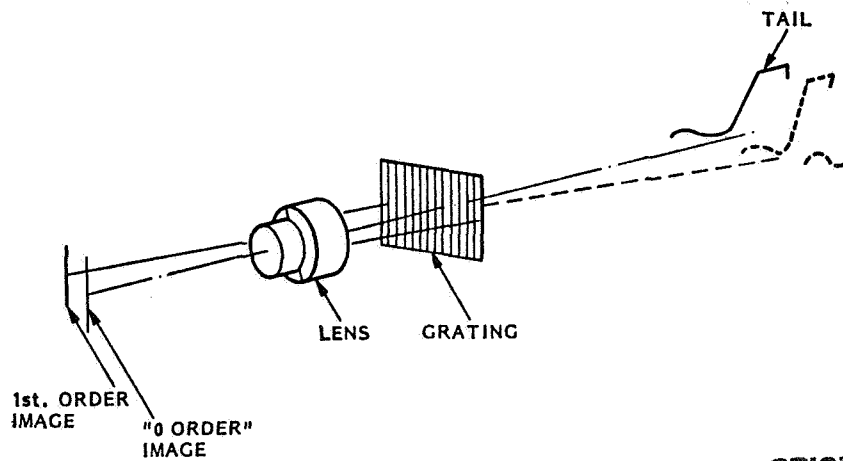

ORIGINAL PAGE IS
OF POOR QUALITY

Figure 1

CALIBRATION

Two kinds of calibrations were performed with a camera and grating combination. In one test performed prior to flight, we photographed a mercury lamp in a full scale JSC Orbiter trainer. In this situation it was possible to simulate the actual distances from the camera to the anticipated light-emitting portions of the vehicle tail. The mercury lamp was masked off to produce a slit and enabled us to calibrate the spectral resolution of the system. From photographs it was verified that the spectral dispersion of the system was closely in agreement with the theoretical prediction which assumed the use of a grating with 300 rulings per mm. The system could separate, in second order, two lines which

were at $\lambda = 5764\text{\AA}$ and $\lambda = 5790\text{\AA}$ i.e., only 26\AA apart. In the first order the resolution, therefore, is about $30\text{-}50\text{\AA}$.

The second set of calibrations was taken post-flight. During this calibration we obtained photographs of a light source of known spectral luminosity per angstrom as a function of wavelength. This measurement provided us with the absolute sensitivity of the grating camera system as a function of wavelength.

Following verification of the grating characteristics and measurement of its resolution, a wavelength calibration was performed using the nominal 100 mm focal length of the camera lens. Using the test prints, the system magnification was measured and actual wavelength scales could be determined by comparing distances of the film and final print.

FLIGHT OPERATIONS

From the STS-3 experiments we know that the shuttle glow is essentially subvisual, detectable only by low light level TV cameras or long exposure photography. (Some of the best STS-3 color photographs were taken with exposure durations of 50 seconds). Since the diffraction grating will produce additional transmission losses as well as spectral dispersion across the film, and the flight itself was to be conducted at a substantially higher altitude than STS-3 (about 300 km instead of 240 km), it was concluded that very long exposures would be necessary on STS-4. Photographic sensitometry data provided by the Johnson Space Center (courtesy of N. Lamar) showed that the problem of reciprocity failure in the 2485 black and white flight film is quite severe and an extension of the exposure time produces only moderate gains.

A second factor involved operational constraints. The schedule of STS-4 was such that the orbit was essentially always in moonlight except for about 12 minutes each orbit during the first few days of the flight. Furthermore, the crew was heavily scheduled at this time

in payload activities. Acting together, these constraints severely limited our ability to schedule many sessions with very long exposure durations. Consequently, we settled on a sequence consisting of 400, 100, 25 and 5 second exposures. This schedule virtually filled the entire 12 minute shadow period of an orbit. Two such operation sequences were scheduled. Because of the tight timeline, it was not possible to schedule any other experiment periods for photography without the grating for data to compare with STS-3. During the time when there was ground contact with the spacecraft we were able to monitor the progress of the experiment, which was carried out by T.K. Mattingly, the STS-4 flight commander.

During the first observation session, the full complement of pictures was taken. Mattingly reported during this session that he saw visible light by eye during the firing of the vehicle attitude control system, but otherwise no glow could be seen, even with the on-board closed circuit TV system. Mattingly also reported that during the last part of the session there was evidence of sunrise.

During the second photographic session, conducted on the next orbit, pictures were taken according to the scheduled checklist in the order given above. No discrepancies were noted and no comments were made by the crew. However, the last picture was omitted from the sequence as a consequence of sunrise contamination.

RESULTS

The best picture obtained from the flight was obtained during the 400 second exposure at the start of the first observing session. This result is shown in Figure 2. A second image, obtained with a 100 second exposure showed similar features but was too underexposed for effective analysis. The third and fourth exposures, of 25 and 5 seconds duration, respectively, show brighter images of the tail section in the first order spectrum with light at much shorter wavelengths (4000 to 5000Å) produced by faint sunrise illumination.

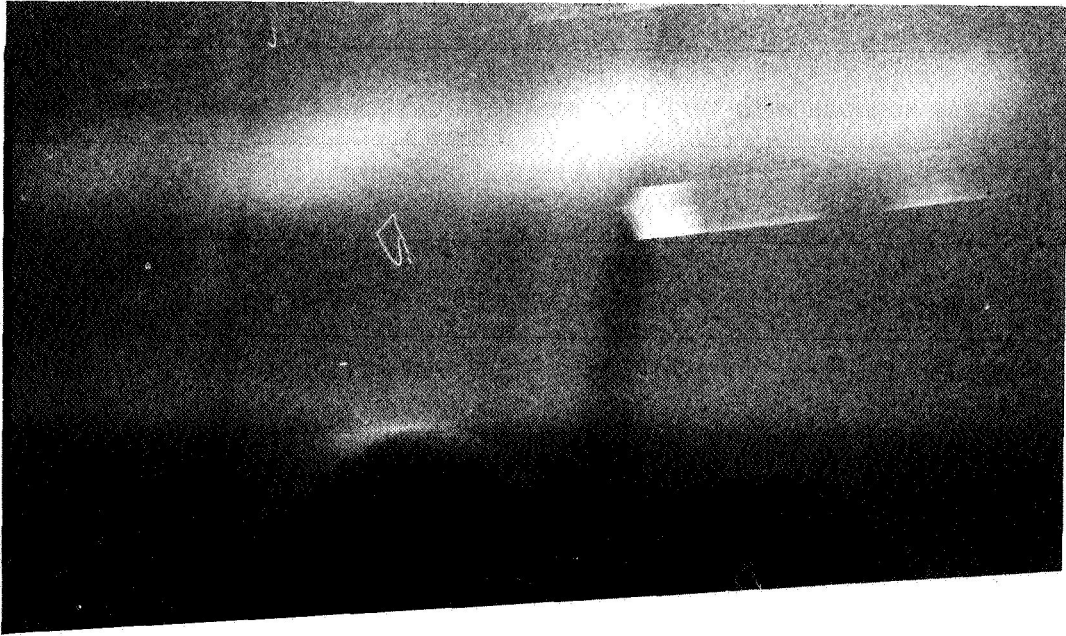

Figure 2

Examination of Fig. 2 reveals many interesting, complex features. Immediately apparent to the eye is what appears to be a dark image of the tail section and two engine pods of the Orbiter near the center of the frame. This dark feature corresponds to the first order image at wavelengths just below the optical pass band of the window-camera system. The zero order image is observed faintly near the left edge of the photograph. The general luminosity of the picture may be caused by a vernier thruster from the orbiter. It should also be noted that the diffuse, rope-like brightness running from left to right across the image is probably a result of stray light within the aft flight deck area. The three major portions of this light seem to correspond to the zeroth, first, and second order images of this source.

Although no bright glow is visible on the starboard or windward side of the tail (to the left in this aft-looking photograph), an area of dispersed glow is visible on the top of the starboard, aft engine pod. Also, the photograph will permit the spectrum of the thruster firing to be estimated, as described below.

Consider first the emission spectrum of the thruster firing, which we assume produces the general light emission around and even behind the spacecraft. To produce the faint, dark image in zero order, a major part of the light must be coming from behind the vertical stabilizer to show it in shadow. Remembering that most of the light is diffracted into first order and that the first order image is the convolution of the spatial image with the spectral profile, the only way to produce a narrow, dark first order image is to have a relatively narrow spectral emission. From the displacement of the dispersed shadow we conclude that the observed thruster emission extends from about 7200 to 8000Å, with the long wavelength cutoff established by the observing system, rather than the emission itself. Figure 3 provides a plastic overlay to Fig. 2 showing both the first order image and the wavelength calibration used to determine the various optical emission spectra.

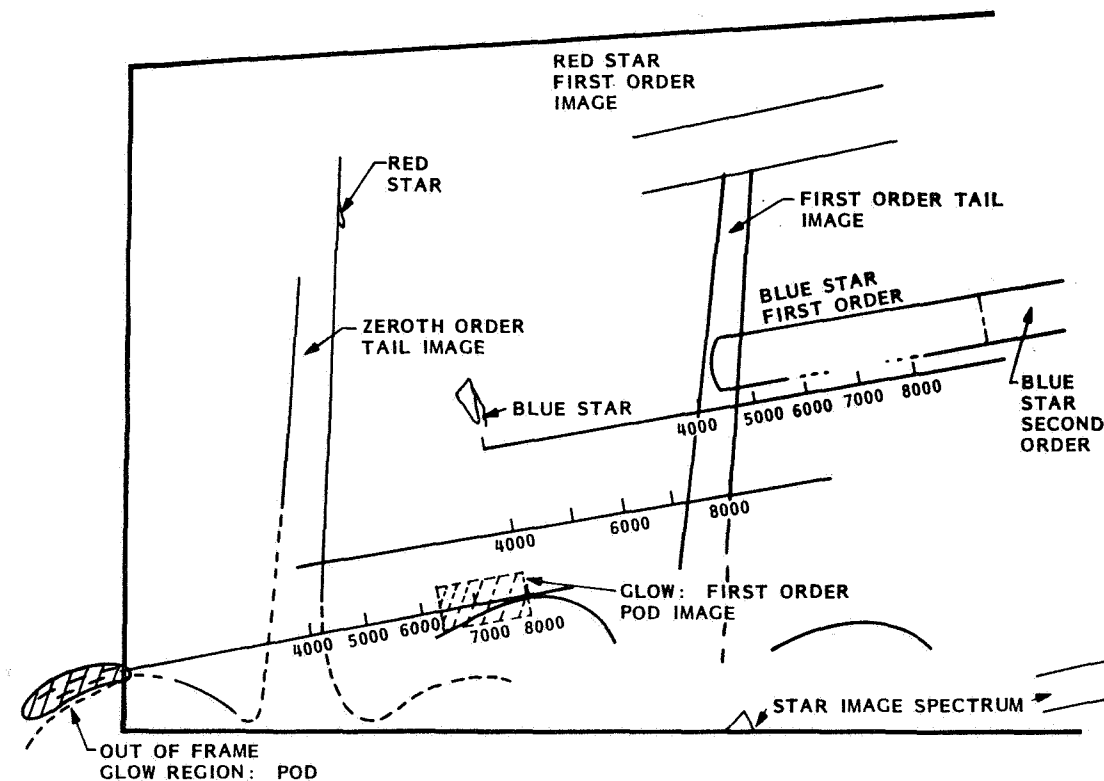

Figure 3

Data on the actual vehicle-associated glow comes from the apparent bright emission located on the starboard engine pod of the first order image. Unfortunately, in zeroth order this glow is just outside of the field of view of the photograph. Nevertheless, we can extrapolate its location using the known locations of the tail and the pods in zeroth order. This has been done on the overlay of Fig. 3 and a wavelength scale extending from 4000 to 8000Å is shown. From these data, it appears that the vehicle glow has a spectrum which extends from a short wavelength limit of about 6300Å up to the long wavelength measurement limit of 8000Å. More detailed information about this spectrum may be possible to obtain from microdensitometer traces along the spectrum brightness.

A separate source of luminosity visible in Fig. 2 arises from several stars. The bright, narrow track near the center of the image shows the apparent motion of a star during the course of the 400 second exposure. The spectrum of this star extends to the right of the zero order image and, using the scale provided by Fig. 3, shows strong emission in the blue portion of the spectrum. In addition, the second brightening to the right of the first order image is the second order image, again showing the strong blue emission. The calibrated wavelength scale given on Fig. 3 shows that the main optical output of this star lies between 4400 and 5500Å with the shorter wavelength end of the spectrum probably limited by the camera system.

Another star is visible in Fig. 2 just to the right of the zero order image of the tail. In this case the star is partially obscured by the tail itself. This accident has helped to provide information about the location of the zeroth order image of the tail and the location of the starboard engine pod. The spectrum of this star extends in first order to the right of the zero order image and shows an emission strongly weighted towards long wavelengths. Part of the second order image is also present. Both of these stars (and a third) show identical tracks, indicating the vehicle was in slow rotation, with directional changes at three points caused by (presumably) short vernier thruster firings.

CONCLUSIONS

The present results indicate that it is possible to obtain spectral measurements of optical emissions in the vicinity of the Orbiter using a simple grating-camera system. During STS-4 the absolute intensities of vehicle glow emissions appear to have been substantially lower than were observed on STS-3. Nevertheless, it was again observed that the glow occurred on surfaces of the Orbiter exposed to the passing atmosphere on the vehicle's windward side. It is likely that the lower emission intensities are a result of lower neutral gas densities at the STS-4 orbit altitude.

The spectral measurements provide important information about the spectral content of the glow; i.e., it extends from a lower wavelength of about 6300Å upwards towards the infrared. Such an emission would be consistent with an atomic oxygen interaction with the surface of the vehicle, but is in no way definitive that this is actually the process involved. These results also are in agreement with the earlier Atmospheric Explorer results of Yee and Abreu (1982) obtained at a much lower altitude.

An unexpected benefit of the present observations has been the opportunity to measure the spectral character of thruster light emission. This luminosity has a character substantially different from that of the vehicle glow and extends from a longer wavelength lower boundary on into the infrared. It appears likely that more details of the thruster optical emission spectrum can be obtained on future flights using this technique.

In summary, both of the important optical emissions associated with the Orbiter appear to have their peak intensities at the long wavelength end of the spectrum. From the present data it is difficult to identify particular molecular process leading to the emissions themselves. However, quantitative analysis of the results is underway and results from this will be reported soon.

DECAY OF GLOW ON TAIL AFTER THRUSTER FIRING
~ GMT 86/15:48:49

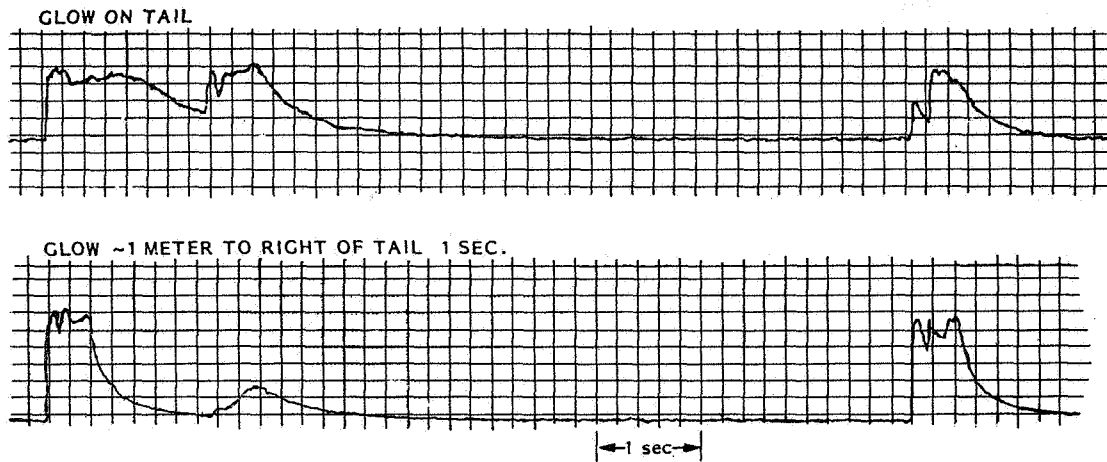

Acknowledgments

The authors are indebted to the many people who supported this experiment. Personnel at both NASA Headquarters and Johnson Space Center have made many important and timely contributions which enabled us to fly equipment in a very short period of time. We gratefully acknowledge the initiative and enthusiasm of the mission manager E.L. Michel which has been essential to the successful conduct of the experiment. Special mention should be made of spacecraft commander T.K. Mattingly of the Orbiter crew and Mr. N. Lamar and Mr. J. Holland of the photographic section of the Johnson Space Center.

References

Yee, J.H., and V.J. Abreu, *J. Geophys. Res.*, **87**,913,1982.

N83 22300

D11

INDUCED ENVIRONMENT CONTAMINATION MONITOR
ASCENT/ENTRY, OPTICAL AND DEPOSITION
MEASUREMENTS

Edgar R. Miller
Marshall Space Flight Center

ORIGINAL PAGE IS
OF POOR QUALITY

INDUCED ENVIRONMENT CONTAMINATION MONITOR

ORIGINAL PAGE IS
OF POOR QUALITY

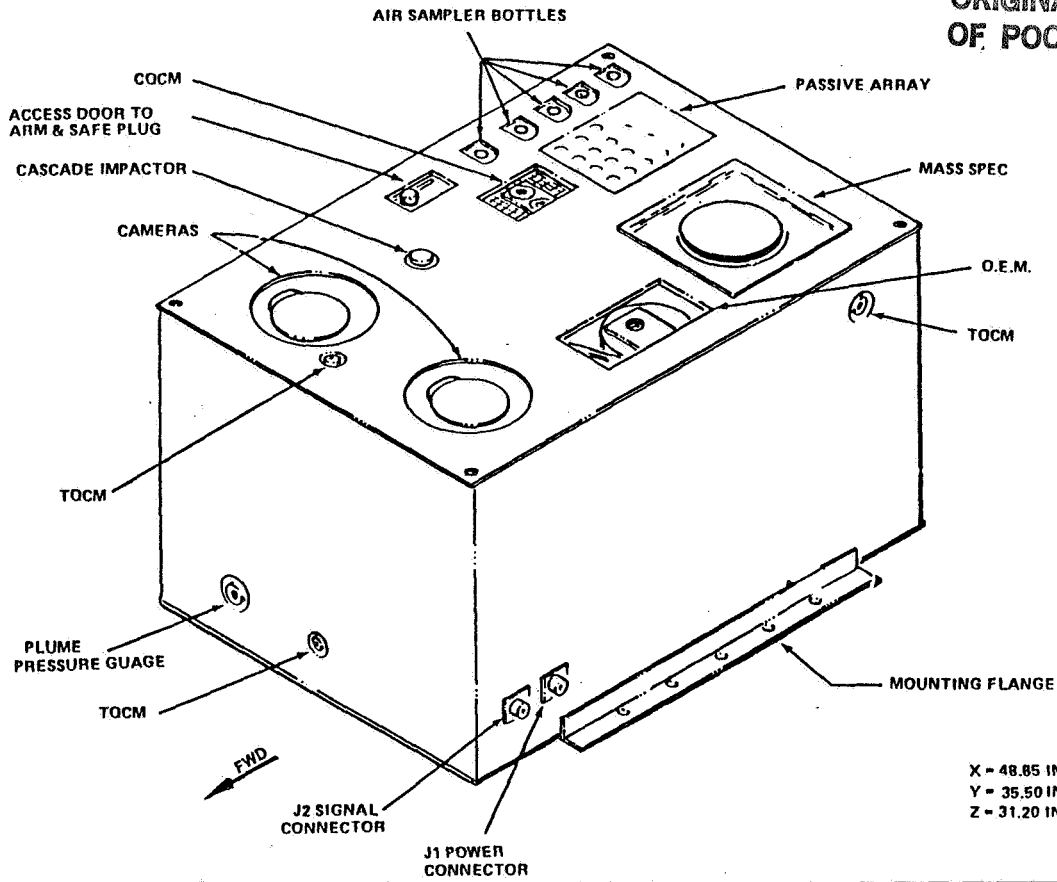

IECM ASCENT/REENTRY
HUMIDITY MONITOR
STS-2, STS-3, STS-4

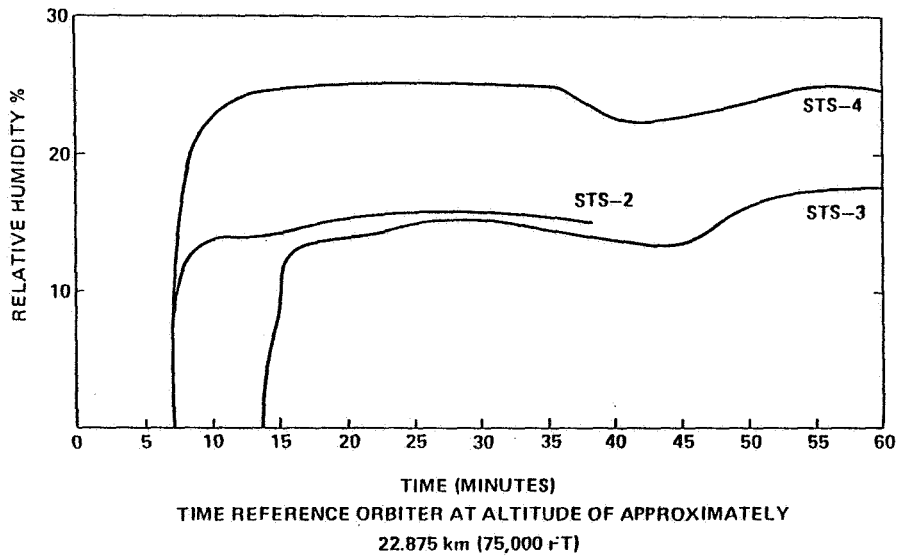

Preceding page blank

IECM ASCENT/REENTRY
TEMPERATURE (IECM AIR SAMPLER)
STS-2, STS-3, STS-4

ORIGINAL PAGE IS
OF POOR QUALITY

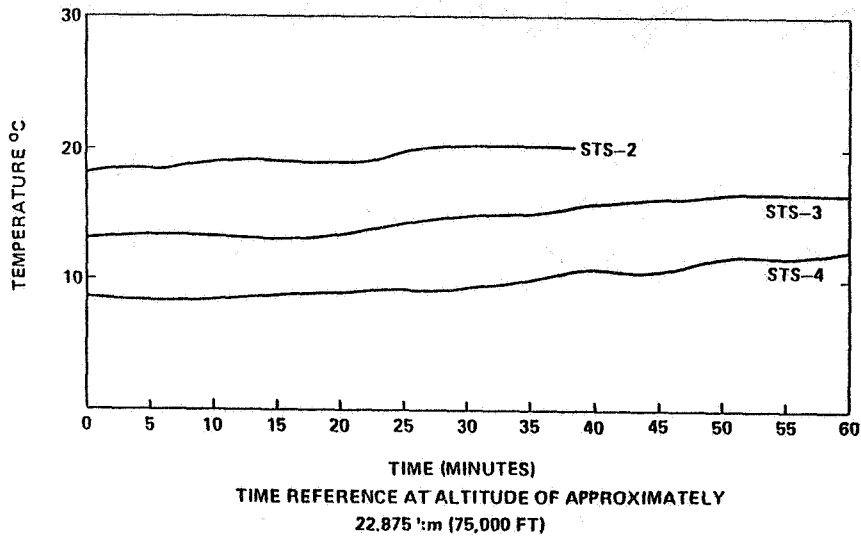

IECM
CASCADE IMPACTOR
PARTICULATE MEASUREMENTS
SUMMARY - STS-2, 3, 4

Measurement	Prediction	Flight Results																		
>5 μ size particulates	<375 $\mu\text{gms}/\text{m}^3$ (assuming $\bar{d}=25\mu$ $\rho=2\text{gms}/\text{cm}^3$)	<table border="1"> <tr> <td>STS-2</td> <td>Ascent</td> <td>$\sim 30 \mu\text{gms}/\text{m}^3$</td> </tr> <tr> <td></td> <td>Descent</td> <td>~ 10 "</td> </tr> <tr> <td>STS-3</td> <td>Ascent</td> <td>~ 10 "</td> </tr> <tr> <td></td> <td>Descent</td> <td>~ 10 "</td> </tr> <tr> <td>STS-4</td> <td>Ascent</td> <td>Non functional</td> </tr> <tr> <td></td> <td>Descent</td> <td>$\sim 20 \mu\text{gms}/\text{m}^3$</td> </tr> </table>	STS-2	Ascent	$\sim 30 \mu\text{gms}/\text{m}^3$		Descent	~ 10 "	STS-3	Ascent	~ 10 "		Descent	~ 10 "	STS-4	Ascent	Non functional		Descent	$\sim 20 \mu\text{gms}/\text{m}^3$
STS-2	Ascent	$\sim 30 \mu\text{gms}/\text{m}^3$																		
	Descent	~ 10 "																		
STS-3	Ascent	~ 10 "																		
	Descent	~ 10 "																		
STS-4	Ascent	Non functional																		
	Descent	$\sim 20 \mu\text{gms}/\text{m}^3$																		
1 μ to 5 μ size particles	<100 $\mu\text{gms}/\text{m}^3$ (assuming $\bar{d}=5\mu$ $\rho=2 \text{gms}/\text{cm}^3$)	<table border="1"> <tr> <td>STS-2</td> <td>Ascent</td> <td>$\sim 500 \mu\text{gms}/\text{m}^3$</td> </tr> <tr> <td></td> <td>Descent</td> <td>$\sim 250^*$ "</td> </tr> <tr> <td>STS-3</td> <td>Ascent</td> <td>< 10 $\mu\text{gms}/\text{m}^3$</td> </tr> <tr> <td></td> <td>Descent</td> <td>< 10 "</td> </tr> <tr> <td>STS-4</td> <td>Ascent</td> <td>$\sim 300 \mu\text{gms}/\text{m}^3$</td> </tr> <tr> <td></td> <td>Descent</td> <td>< 10 "</td> </tr> </table>	STS-2	Ascent	$\sim 500 \mu\text{gms}/\text{m}^3$		Descent	$\sim 250^*$ "	STS-3	Ascent	< 10 $\mu\text{gms}/\text{m}^3$		Descent	< 10 "	STS-4	Ascent	$\sim 300 \mu\text{gms}/\text{m}^3$		Descent	< 10 "
STS-2	Ascent	$\sim 500 \mu\text{gms}/\text{m}^3$																		
	Descent	$\sim 250^*$ "																		
STS-3	Ascent	< 10 $\mu\text{gms}/\text{m}^3$																		
	Descent	< 10 "																		
STS-4	Ascent	$\sim 300 \mu\text{gms}/\text{m}^3$																		
	Descent	< 10 "																		
0.3 μ to 1 μ size particles	<10 $\mu\text{gms}/\text{m}^3$ (assuming $d=1\mu$ $\rho=2 \text{gms}/\text{cm}^3$)	<table border="1"> <tr> <td>STS-2</td> <td>Ascent</td> <td>$\sim 250 \mu\text{gms}/\text{m}^3$</td> </tr> <tr> <td></td> <td>Descent</td> <td>$\sim 125^* \mu\text{gms}/\text{m}^3$</td> </tr> <tr> <td>STS-3</td> <td>Ascent</td> <td>< 10 $\mu\text{gms}/\text{m}^3$</td> </tr> <tr> <td></td> <td>Descent</td> <td>< 10 "</td> </tr> <tr> <td>STS-4</td> <td>Ascent</td> <td>$\sim 90 \mu\text{gms}/\text{m}^3$</td> </tr> <tr> <td></td> <td>Descent</td> <td>Non functional</td> </tr> </table>	STS-2	Ascent	$\sim 250 \mu\text{gms}/\text{m}^3$		Descent	$\sim 125^* \mu\text{gms}/\text{m}^3$	STS-3	Ascent	< 10 $\mu\text{gms}/\text{m}^3$		Descent	< 10 "	STS-4	Ascent	$\sim 90 \mu\text{gms}/\text{m}^3$		Descent	Non functional
STS-2	Ascent	$\sim 250 \mu\text{gms}/\text{m}^3$																		
	Descent	$\sim 125^* \mu\text{gms}/\text{m}^3$																		
STS-3	Ascent	< 10 $\mu\text{gms}/\text{m}^3$																		
	Descent	< 10 "																		
STS-4	Ascent	$\sim 90 \mu\text{gms}/\text{m}^3$																		
	Descent	Non functional																		
* Descent values may be largely instrumental (thermal), and should be considered upper limits.																				

ORIGINAL PAGE IS
OF POOR QUALITY

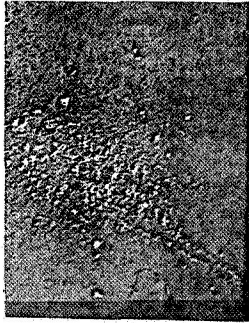

250x

STS-2, STAGE 2, POSTFLIGHT SENSING CRYSTAL
SEM PHOTOGRAPH

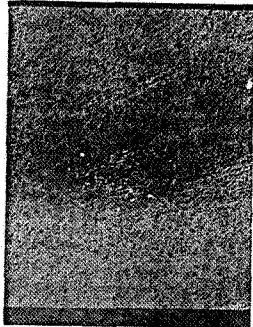

STS-2, STAGE 3, POSTFLIGHT SENSING CRYSTAL
PHOTOGRAPH WITH SEM

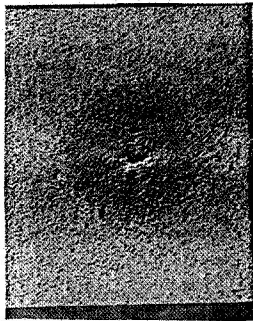

STS-2, STAGE 4, POSTFLIGHT SENSING CRYSTAL
PHOTOGRAPH USING SEM

ORIGINAL PAGE IS
OF POOR QUALITY

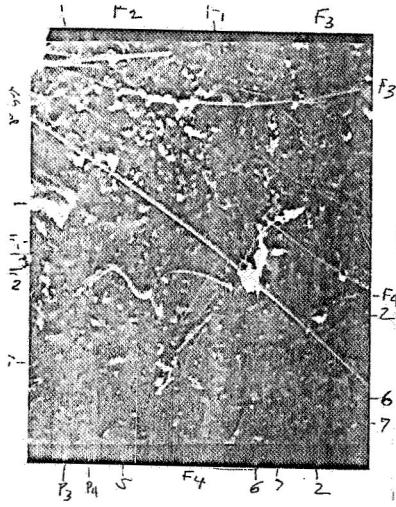

ENLARGEMENT OF AN AREA OF STAGE 3, STS-2, CONTAINING FIBERS, AND SPECTRA OF TYPICAL PARTICLES.

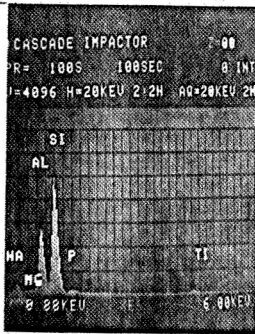
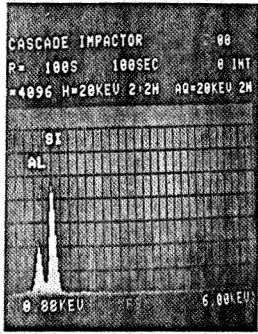
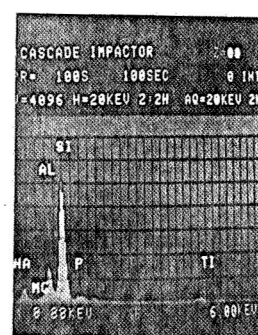
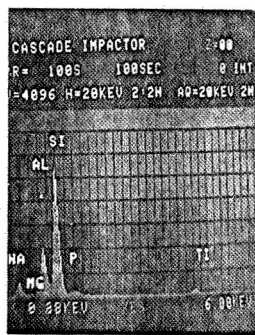
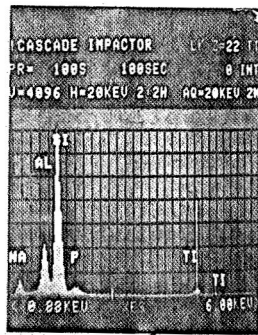
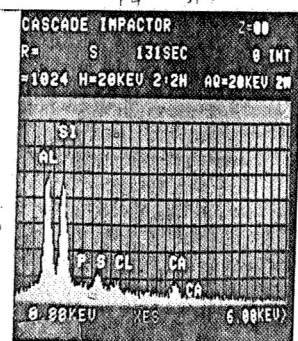
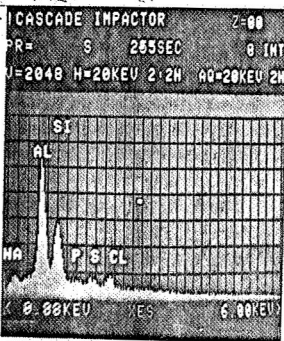
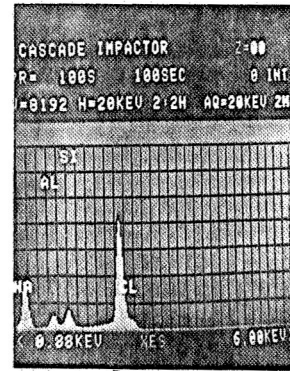
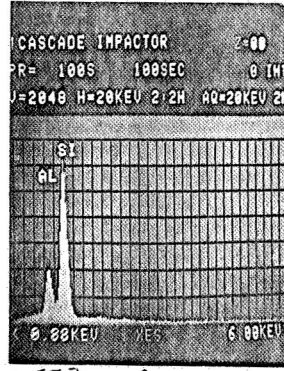

SPECTRA OF VARIOUS
FIBRES ON STAGE 3, STS-2

INDUCED ENVIRONMENT CONTAMINATION MONITOR

ORIGINAL PAGE IS
OF POOR QUALITY

Air Sampler Results
Contaminant Totals for Representative
STS Ground, Ascent, and Descent Phases

<u>LOCATION</u>	<u>SPECIES</u>	<u>LEVELS EXPECTED, SPEC.</u>	<u>DETECTION* METHOD</u>	<u>OBSERVED</u>
Ground	Volatile Hydrocarbonst	<15 PPM, <15 PPM in Purge Gas	A	<3 PPM by Wt. <1 PPM by Volumet
Ascent	Volatile Hydrocarbonst	Unknown, no Spec	A	~50 PPM by Wt. ~10 PPM by Volumet
Ascent	Reactive HCl	Unknown, no Spec	B	None detected to PPM sensitivity
Descent	Reactives NO, NO ₂ , NH ₃	Unknown, no Spec	C	None detected to PPM sensitivity
Descent	Volatile Hydrocarbonst	Unknown, no Spec	A	~20 PPM by Wt. ~ 4 PPM by Volumet

* A - Concentration on adsorbent; postflight GC/MS analysis.

B - Reaction with silver oxide/hydroxide surfaces; postflight analyses by ESCA.

C - Reaction with ruthenium trichloride surfaces; postflight analyses by ESCA.

† Covers C₉ to C₂₄ range and uses ~C₁₂ as average molecular weight to obtain PPM by volume.

IECM OPTICAL MEASUREMENTS

PASSIVE SAMPLE ARRAY

- AVERAGE CHANGE IN OPTICAL PROPERTIES:

PRE-LAUNCH ENVIRONMENT ----- ≤ 2%

FLIGHT MISSION ----- ≤ 1%

FERRY-FLIGHT ----- ≤ 1%

(MEASURED UNCERTAINTY ≈ 1%)

- NO MOLECULAR CONTAMINANT FILMS DETECTED
- MEASURED OPTICAL DEGRADATION ATTRIBUTED TO PARTICULATES

TECH OPTICAL MEASUREMENTS
 PASSIVE SAMPLE ARRAY
 FLIGHT MISSION RESULTS: STS-2, STS-3, STS-4

ORIGINAL PAGE IS
 OF POOR QUALITY

Sample	Wavelength λ (nm)	Range of AR (± 0.01 uncertainty)	Average % Change
MgF ₂ /Al (22 samples)	120	-0.07 to +0.03	+0.7%
	160	-0.01 to +0.04	+1.8%
	200	-0.03 to +0.02	+0.1%
	240	-0.04 to +0.01	-0.3%
	280	-0.06 to +0.01	-2.3%
Gold (18 samples)	120	-0.03 to +0.04	-1.7%
	160	-0.01 to +0.03	+0.9%
	200	-0.01 to +0.03	+4.2%
	240	-0.02 to +0.04	+0.9%
	280	-0.03 to +0.02	-0.1%

- MEASUREMENT UNCERTAINTY $\pm 1\%$ (ABSOLUTE).
- MOST OF THE OBSERVED DEGRADATION ATTRIBUTED TO EFFECTS OF PARTICULATES.
- NO EVIDENCE FOUND FOR MOLECULAR FILM DEPOSITS.

TECH OPTICAL MEASUREMENTS
 PASSIVE SAMPLE ARRAY

AVERAGED
 PRE-FLIGHT EXPOSURE RESULTS

CONTAMINATION SPECIFICATION:

PARTICLE DENSITY - OPTICAL SURFACES

\leq CLASS 300

- ORBITER PROCESSING FACILITY (OPF) AT KSC SUBJECTED TO CLEAN-UP FOLLOWING ROLL-OUT OF STS-2.
- DURING OPF OPERATIONS, SAMPLES AND INSTRUMENTS OF THE TECH DESIGNATED FOR FLIGHT WERE PROTECTED BY COVERS UNTIL FINAL ACCESS PRIOR TO ROLL-OUT.

STS-2	19 DAYS EXPOSURE: OPF $\rho = 1.4 \times 10^4$ PARTICLES/CM ² CLASS 750 TO 1500
STS-3	19 DAYS EXPOSURE: OPF $\rho = 6.5 \times 10^3$ PARTICLES/CM ² CLASS 500 TO 1500
STS-4	5 DAYS EXPOSURE: OPF $\rho = 1.3 \times 10^3$ /CM ² CLASS 500 IN-TRANSIT OPF-PCR (26 DAYS) $\rho = 6.7 \times 10^2$ /CM ² CLASS 200 16 DAYS EXPOSURE IN PCR $\rho = 5 \times 10^2$ /CM ² CLASS 300 SAMPLES EXPOSED FROM 1ST ACCESS OPF + LAST ACCESS PCR $\rho = 2.7 \times 10^3$ /CM ² CLASS 750

**ORIGINAL PAGE IS
OF POOR QUALITY**

IECM OPTICAL MEASUREMENTS
 PASSIVE SAMPLE ARRAY
 FLIGHT MISSION RESULTS: STS-2, STS-3, STS-4
 AVERAGED

CONTAMINATION SPECIFICATION:

PARTICLE DENSITY - OPTICAL SURFACES

≤ CLASS 300

- MEASUREMENTS PERFORMED WITH OMNICON OPTICAL IMAGING PARTICLE COUNTING FACILITY.
- RESULTS SHOWN INDICATE DIFFERENCE IN LEVELS MEASURED ON SAMPLES EXPOSED TO ENTIRE MISSION VERSUS LEVELS IN SAMPLES EXPOSED ONLY ON FERRY-FLIGHT.

FLIGHT MISSION RESULTS

STS-1	$\rho = 1.7 \times 10^3$ PARTICLES/CM ² <u>≤ CLASS 300</u>
STS-2	$\rho = 3.8 \times 10^3$ PARTICLES/CM ² <u>≈ CLASS 300</u>
STS-3	$\rho = 2.7 \times 10^3$ PARTICLES/CM ² <u>≈ CLASS 300</u>
STS-4	$\rho = 0.5 \times 10^3$ PARTICLES/CM ² <u>< CLASS 300</u>

IECM OPTICAL MEASUREMENTS

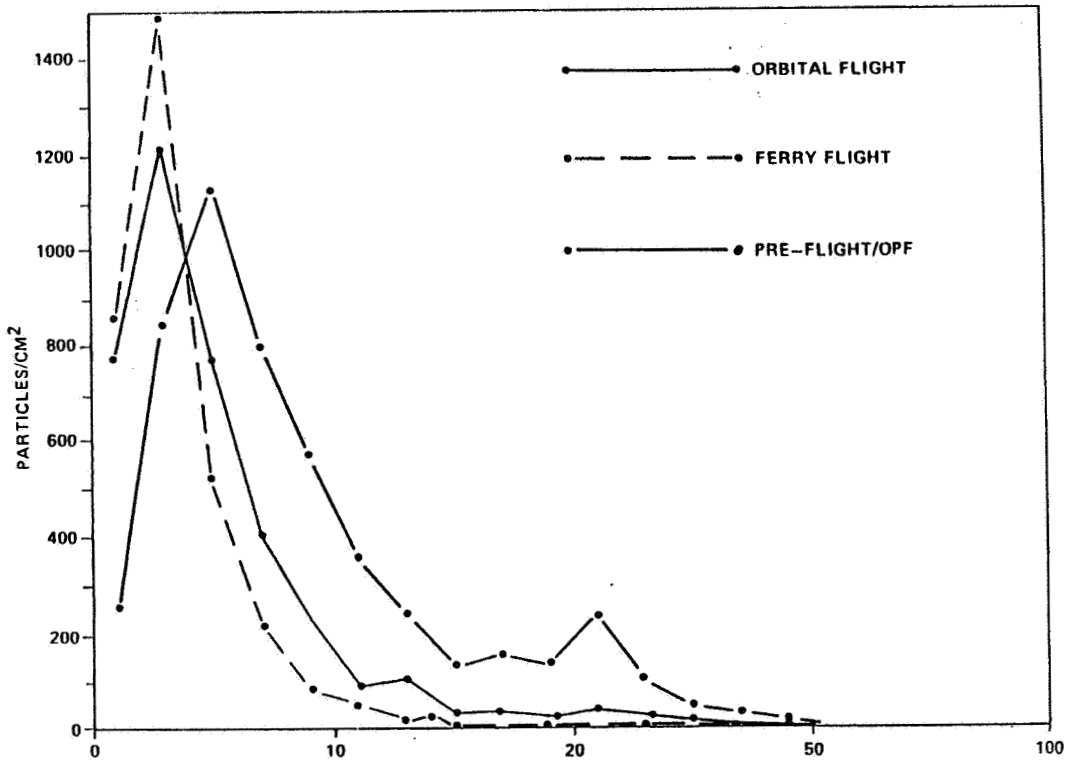

PARTICLE SIZE - DIAMETER (MICRON) TYPICAL PARTICLE DISTRIBUTIONS

IECM OPTICAL MEASUREMENTS

OPTICAL EFFECTS MODULE

ORIGINAL PAGE IS
OF POOR QUALITY

SUMMARY OF RESULTS: STS-2, STS-3, STS-4

MISSION PHASE	AVERAGE CHANGE IN TRANSMITTANCE (253.7 nm)				
	EXPOSED SAMPLES			UNEXPOSED SAMPLES	
	<u>LiF₂</u>	<u>CaF₂</u>	<u>MgF₂</u>	<u>SAPPHIRE</u>	<u>QUARTZ</u>
● KSC/OPF: GROUND OPERATIONS	0%	0%	-1%	-1%	0%
● GROUND TO ORBIT	0%	-2%	-1%	0%	0%
● ON-ORBIT	0%	+1%	+1%	-3%	0%
● DESCENT/LANDING FERRY FLIGHT	-1%	-1%	0%	-1%	-1%
● TOTAL	-1%	-1%	-2%	-3%	-1%

- OEM SAMPLES LABELED "EXPOSED" REMAIN EXTERNAL TO OEM HOUSING 95% OF MISSION DURATION.
- FLIGHT DATA - SCATTER CHANNEL INDICATE NO ACCUMULATIONS OF PARTICLES GREATER THAN CLASS 300 SURFACE LEVELS.
- POST-FLIGHT PARTICLE COUNTS ON OEM SAMPLES INDICATE LEVELS NO GREATER THAN CLASS 300.
- EFFECTS OF DISCRETE SHUTTLE EVENTS NOT DETECTABLE DUE TO LIMITED MAGNITUDE OF MEASURED OPTICS VARIATIONS.

INDUCED ENVIRONMENT CONTAMINATION MONITOR
OPTICAL MEASUREMENT CAMERA/PHOTOMETER

TYPICAL QUESTIONS

WHAT IS THE SIZE DISTRIBUTION OF PARTICLES?

WHAT IS THE VELOCITY DISTRIBUTION OF PARTICLES?

WHAT OPTICAL EFFECTS, IF ANY, ARISE FROM A MOLECULAR CLOUD?

WHAT ARE THE SOURCES OF CONTAMINATION?

DO ALL MANEUVERS RESULT IN INCREASED CONTAMINATION?

HOW DOES THE CONTAMINATION VARY WITH MET?

HOW LONG AFTER LAUNCH DOES THE SPACECRAFT ENVIRONMENT CLEAR?

WHAT IS THE DECAY TIME OF CONTAMINATION DUE TO WATER DUMPS?

WHAT IS BRIGHTNESS BACKGROUND DUE TO CONTAMINATION?

1. TYPICAL QUESTIONS WHICH HOPEFULLY WILL BE ANSWERED BY THE CAMERA/
PHOTOMETER EXPERIMENT ON THE IECM.

INDUCED ENVIRONMENT CONTAMINATION MONITOR
OPTICAL MEASUREMENT CAMERA/PHOTOMETER

ORIGINAL PAGE IS
OF POOR QUALITY

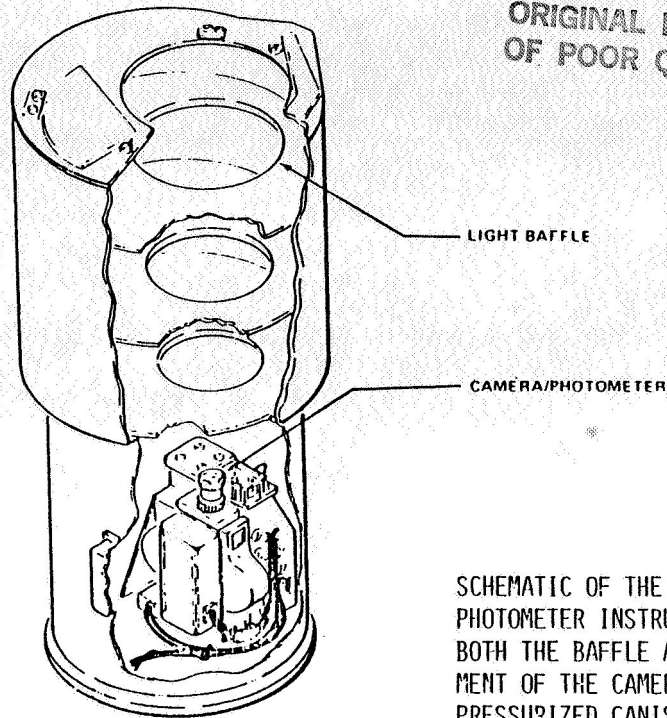

SCHEMATIC OF THE CAMERA/
PHOTOMETER INSTRUMENT SHOWING
BOTH THE BAFFLE AND THE PLACE-
MENT OF THE CAMERA ON THE
PRESSURIZED CANISTER.

Induced Environment Contamination Monitor Optical Measurement Camera/Photometer

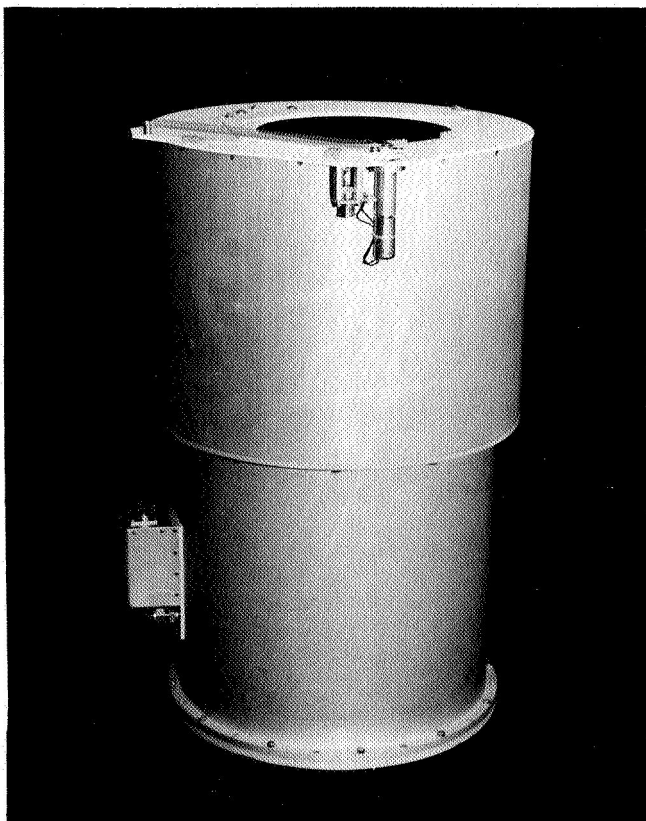

Picture of the camera/
photometer showing baffle
and pressurized canister.
A solar shutter to protect
the instrument from high
temperatures during solar
orientation is seen at the
top of the baffle.

Induced Environment Contamination Monitor Optical Measurement Camera/Photometer

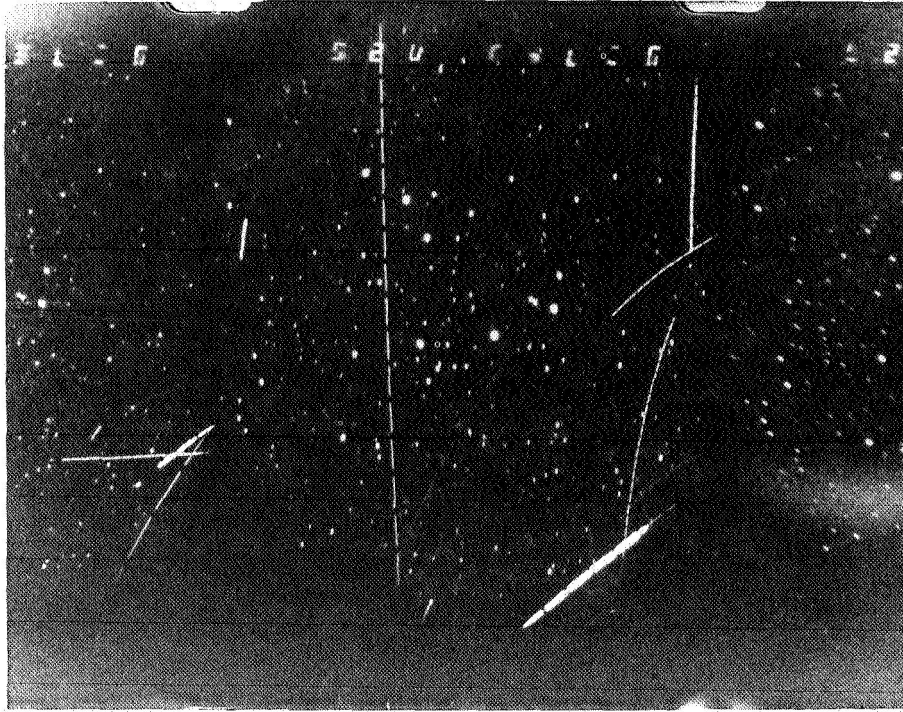

ORIGINAL PAGE IS
OF POOR QUALITY

One of the star fields observed during camera/photometer operation. Stars to the 10th magnitude were recorded by such observations during sunlit conditions.

Induced Environment Contamination Monitor Optical Measurement Camera/Photometer

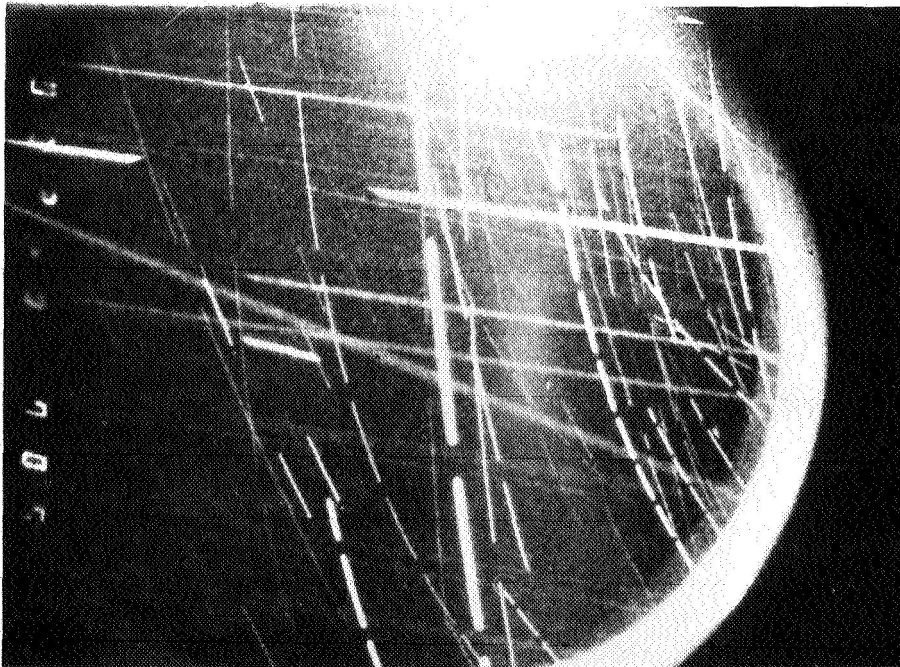

"Snowstorm" of contaminant particles seen during the early portion of STS-2. The chopping action of the shutter can be seen from the segmented tracks of the particles. This allows the determination of particle velocity.

INDUCED ENVIRONMENT CONTAMINATION MONITOR
OPTICAL MEASUREMENT CAMERA/PHOTOMETER

ORIGINAL PAGE IS
OF POOR QUALITY

Number of Events per Frame	Mission Elapsed Time								
	2-7h	7-12h	12-17h	17-22h	22-27h	27-32h	32-37h	37-42h	42-48h
x > 20	81%	25%	10%	3%	2%	0%	2%	0%	10%
20 > x > 10	8	12	4	6	3	2	2	0	0
10 > x > 5	6	16	5	1	2	5	0	0	5
5 > x > 2	0	32	11	5	11	10	2	0	10
1	5	9	22	14	12	12	7	3	5
0	0	6	48	71	70	71	87	97	70
Total Contamination	100	94	52	29	30	29	13	3	30

Data frames as a percentage of potential contamination frames as seen in the first 48 hours during STS-2, 3, and 4.

6. THE NUMBER OF FRAMES WITH X NUMBER OF EVENTS AS A PERCENTAGE OF POTENTIAL CONTAMINATION FRAMES. THE DATA IS A SUMMARY OF THE STS-2, 3, AND 4 MISSIONS DURING THE FIRST 48 HOURS OF THE RESPECTIVE MISSIONS.

INDUCED ENVIRONMENT CONTAMINATION MONITOR OPTICAL MEASUREMENT CAMERA/PHOTOMETER

ONBOARD SPACECRAFT EVENT	MISSION ELAPSED TIME (MET) HRS : MINS	ΔT TIME UNTIL OPPORTUNITY TO OBSERVE CONTAM	NUMBER OF POTENTIAL CONTAM. FRAMES RECORDED AT ΔT	NUMBER OF CONTAM. FRAMES	AMOUNT OF CONTAM. (PART/FR)
MANEUVERS PAYLOAD BAY DOOR TESTS	02:30 02:32	7	33	13	> 30
		5			
		60			
		96			
MANEUVER	04:15	45	1	1	> 30
		75			
		135			
		165			
OMS BURN	07:45 07:50	12	1	1	> 20
		1			
OMS BURN	08:33	1	1	1	20
		20			
MANEUVER	09:10	55	1	1	10
		110			
		34			
H ₂ O DUMP	11:53- 12:53	-	6	6	> 30

TABLE 3. CORRELATION OF OBSERVED CONTAMINATION WITH ON-BOARD SPACECRAFT EVENTS.

7. CORRELATION OF OBSERVED CONTAMINATION WITH ON-BOARD SPACECRAFT ACTIVITIES, SUCH AS MANEUVERS, WATER DUMPS, ENGINE BURNS, ETC. THE DATA WAS RECORDED DURING THE STS-2 MISSION.

INDUCED ENVIRONMENT CONTAMINATION MONITOR OPTICAL MEASUREMENT CAMERA/PHOTOMETER

ONBOARD SPACECRAFT EVENT	MISSION ELAPSED TIME (MET) HRS : MINS	ΔT TIME UNTIL OPPORTUNITY TO OBSERVE CONTAM.	NUMBER OF POTENTIAL CONTAM. FRAMES RECORDED AT ΔT	NUMBER OF CONTAM. FRAMES	AMOUNT OF CONTAM. (PART/FR)
MANEUVER	12:35	7	1	0	0
		75			
		150	1	0	0
		180	1	2	2
		240	1	0	0
		270	1	0	0
		330	1	0	0
MANEUVER	21:55	5	1	1	2
MANEUVER	22:18	40	1	0	0
RMS TESTS	23:00~ 27:00	--	4	1	1
		150	1	0	0
		210	1	1	3
		240	2	0	0
		270	1	0	0
MANEUVER	32:05	25	1	0	0
		50	1	0	0

CONTINUED

8. CORRELATION OF OBSERVED CONTAMINATION WITH ON-BOARD SPACECRAFT ACTIVITIES, SUCH AS MANEUVERS, WATER DUMPS, ENGINE BURNS, ETC. THE DATA WAS RECORDED DURING THE STS-2 MISSION.

INDUCED ENVIRONMENT CONTAMINATION MONITOR OPTICAL MEASUREMENT CAMERA/PHOTOMETER

ONBOARD SPACECRAFT EVENT	MISSION ELAPSED TIME (MET) HRS : MINS	ΔT TIME UNTIL OPPORTUNITY TO OBSERVE CONTAM.	NUMBER OF POTENTIAL CONTAM. FRAMES RECORDED AT ΔT	NUMBER OF CONTAM. FRAMES	AMOUNT OF CONTAM. (PART/FR)
MANEUVER	38:55	4	1	0	0
		90	1	0	0
		150	2	0	0
		180	2	0	0
		240	1	0	0
		330	2	0	0
		360	2	0	0
		420	2	0	0
		450	2	0	0
		510	2	0	0
		MANEUVER	45:51	6	1
MANEUVER	46:07	50	2	0	0
MANEUVER	47:21	6	2	0	0
		21	3	3	9, 2, 2
APU TEST	47:48- 47:52	1	4	4	1, 3 - > 30
		30	1	0	0
PAYLOAD BAY DOOR CLOSING	49:37	72	15	7	1, 2
		0	2	2	2

CONTINUED

9. CORRELATION OF OBSERVED CONTAMINATION WITH ON-BOARD SPACECRAFT ACTIVITIES, SUCH AS MANEUVERS, WATER DUMPS, ENGINE BURNS, ETC. THE DATA WAS RECORDED DURING THE STS-2 MISSION.

ORIGINAL PAGE IS
OF POOR QUALITY

IECM OPTICAL MEASUREMENTS

CAMERA/PHOTOMETER

PRELIMINARY RESULTS

BACKGROUND BRIGHTNESS: $\left\{ \begin{array}{l} \text{STS-2, 3: } 10^{-13} - 10^{-14} \text{ } \text{B}\theta \\ \text{STS-4 } 10^{-13} - 10^{-15} \text{ } \text{B}\theta \end{array} \right\}$ IN VISIBLE SPECTRUM

PARTICULATES: 0.01 25 μm PARTICLE/ 1.5×10^{-5} SR/ORBIT

LN83 22301

D12

NEUTRAL GAS MASS SPECTROMETER ON THE IECM

G. R. Carignan
University of Michigan

PRECEDING PAGE BLANK NOT FILMED

Preceding page blank

A-139

A-139
PAGE INTENTIONALLY BLANK

NEUTRAL GAS MASS SPECTROMETER
ON THE IECM

G. R. CARIGNAN

1. INSTRUMENT DESCRIPTION
2. GEOMETRY OF THE MEASUREMENT
3. CAPABILITIES AND LIMITATIONS
4. RESULTS
 - A. WATER
 - B. METHANE
 - C. ATMOSPHERIC GASES
 - D. HEAVY MOLECULES
 - E. THRUSTER FIRINGS
 - F. DOOR CLOSINGS
 - G. GAS CALIBRATION
5. CONCLUSIONS
6. FUTURE ACTIVITIES

ORIGINAL PAGE IS
OF POOR QUALITY

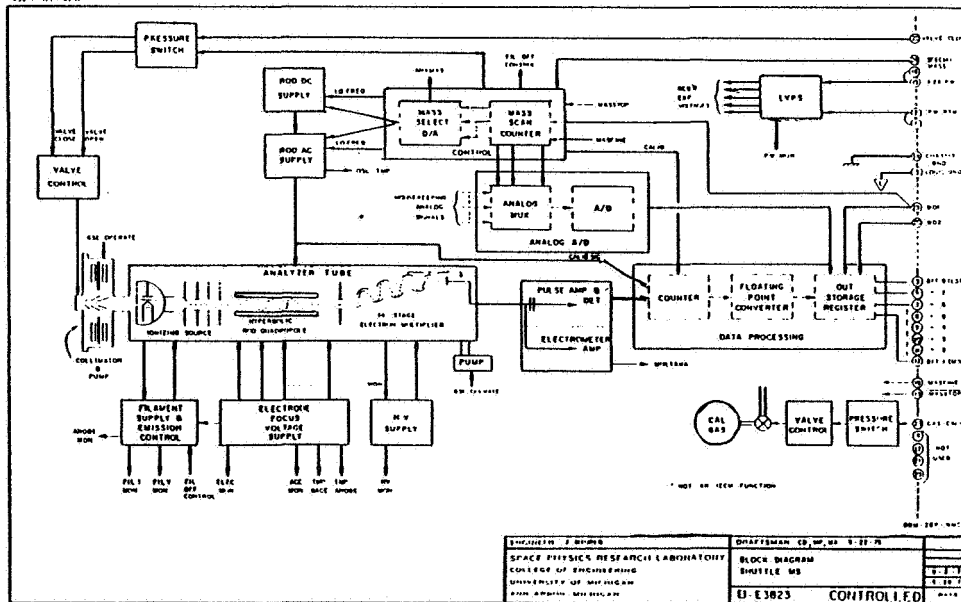

FUNCTIONAL DIAGRAM OF THE MASS SPECTROMETER

Preceding page blank

ORIGINAL PAGE IS
OF POOR QUALITY

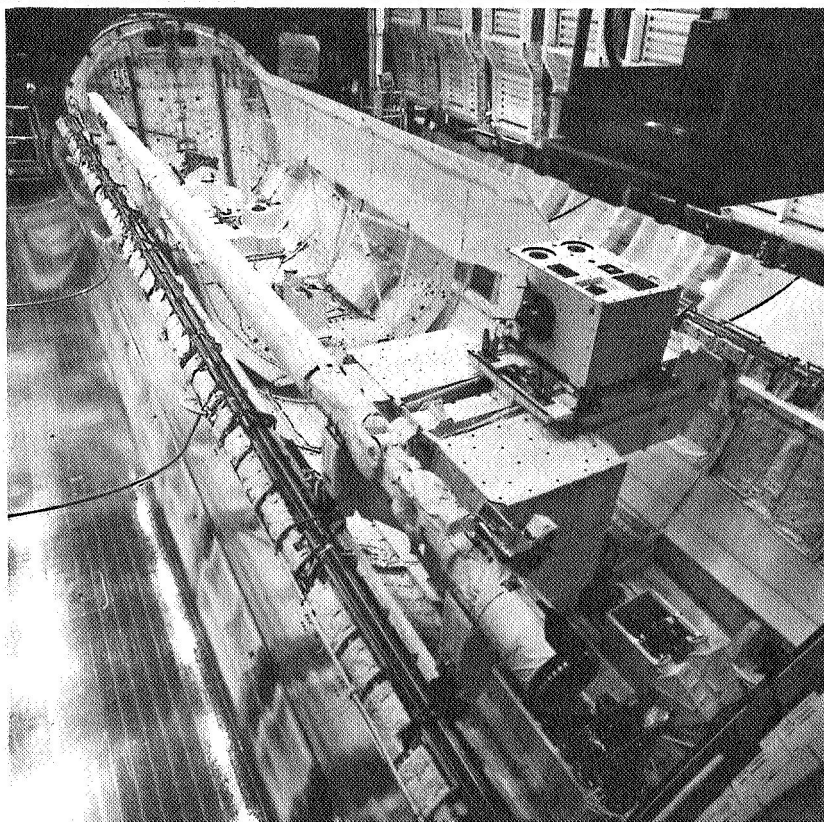

IECM WITH MASS SPECTROMETER IS THE LARGE
TOP MOUNTED BOX IN THE RIGHT-CENTER OF
THE PHOTO.

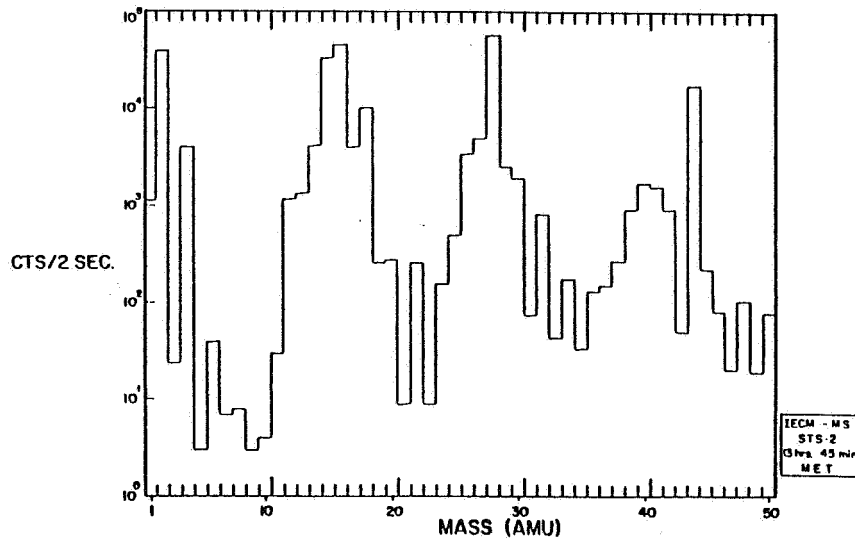

SPECTRUM TAKEN BY THE MASS SPECTROMETER ON STS-2 AT
13 HRS. 45 MIN. MET.

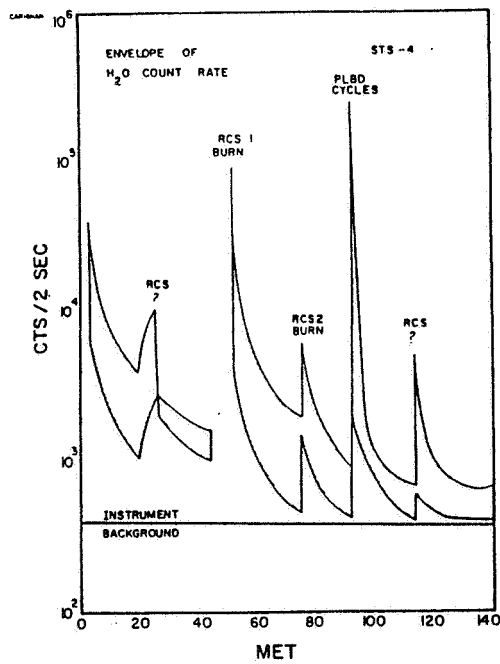

ENVELOPE OF H₂O COUNT RATE OVER THE DURATION OF
THE FLIGHT OF STS-4. THE VALUES WITHIN THE ENVELOPE
ARE STRONGLY MODULATED BY THE INSTRUMENT ANGLE OF
ATTACK.

H 2 0 O N S T S - 4

ORIGINAL PAGE IS
OF POOR QUALITY

MAXIMUM SOURCE DENSITY $2.5 \times 10^8 \text{ CC}^{-1}$
INTERPRETED AS A

FLUX $2.1 \times 10^{14} \text{ CM}^{-2} \text{ SR}^{-1} \text{ S}^{-1}$

FOR A NOMINAL SCATTERING CROSS SECTION

COLUMN DENSITY $3.2 \times 10^{13} \text{ CM}^{-2}$

TIME CONSTANT FOR DECREASE TO 1/E $\approx 10 \text{ HOURS}$

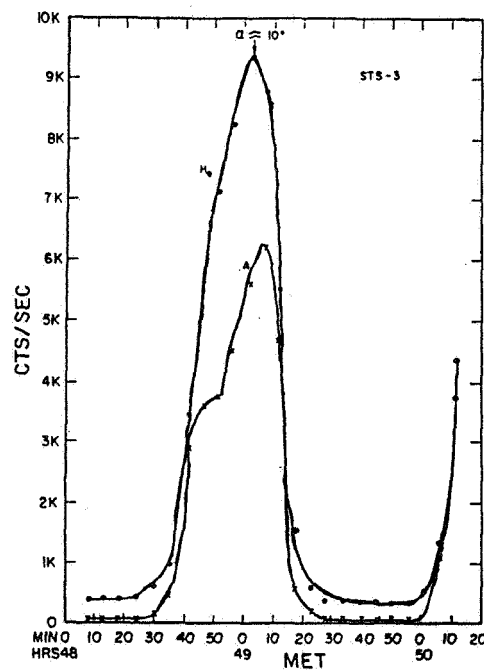

VARIATION IN MEASURED HELIUM AND ARGON AS INSTRUMENT ANGLE OF ATTACK VARIES FROM 170° TO 10° . THE ATMOSPHERIC DENSITIES OBTAINED FROM MANY SUCH OBSERVATIONS ON STS-2, STS-3 AND STS-4 AGREE WELL WITH MODEL VALUES.

AMBIENT DENSITIES

STS - 3 AT 49 HRS MET.

	MEASURED	MODEL (260)
ARGON	$1.2 \times 10^5 \text{ CC}^{-1}$	$1.7 \times 10^5 \text{ CC}^{-1}$
HELIUM	$3.0 \times 10^6 \text{ CC}^{-1}$	$5.4 \times 10^6 \text{ CC}^{-1}$

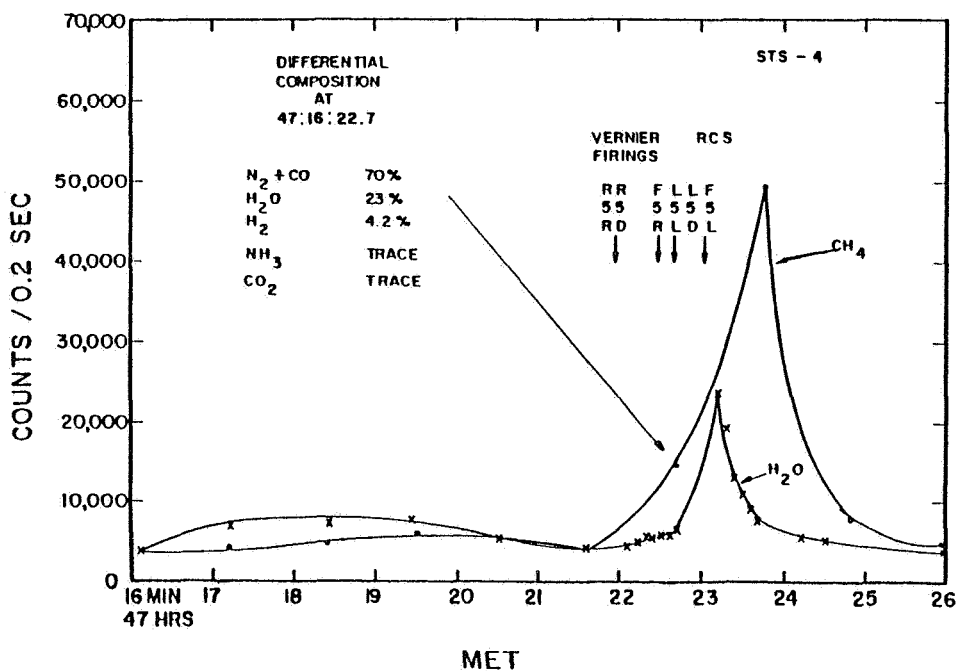

TYPICAL SIGNATURE OF A VERNIER RCS FIRING. METHANE IS BELIEVED TO BE ARTIFICIALLY PRODUCED ON THE ZIRCONIUM OXIDE GETTERS OF THE COLLIMATOR. NITROGEN, WATER AND HYDROGEN ARE THE PRINCIPAL PRODUCTS OBSERVED.

ORIGINAL PAGE IS
OF POOR QUALITY

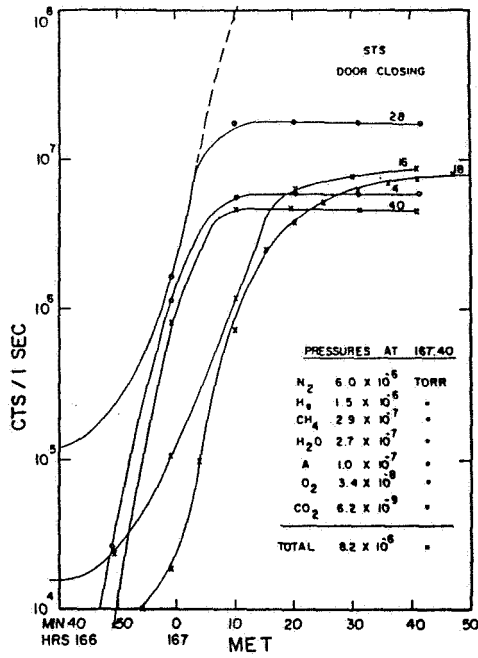

PRESSURE RISE AND THE COMPOSITION IN THE
PAYLOAD BAY DURING THE DOOR CLOSING EXERCISE
AT 167 HOURS MET ON STS-3.

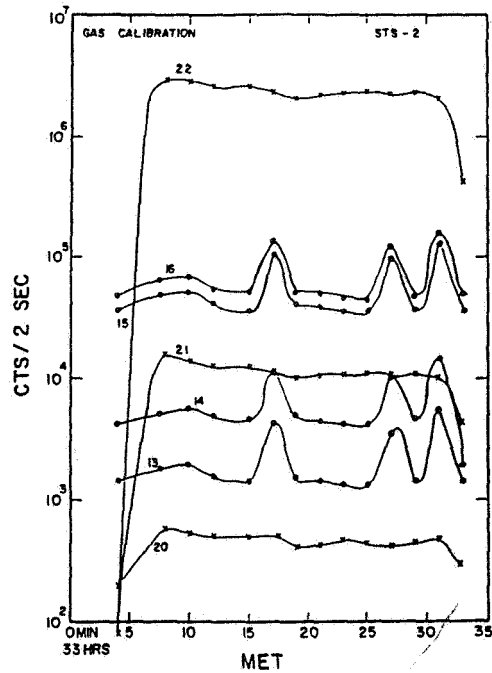

THE CALIBRATION GAS RELEASE AT 33 HOURS MET ON STS-2. THE MASS
22 ISOTOPE OF NEON DOMINATES THE SPECTRUM. THE ISOTOPICALLY LABELED
WATER AT MASS 20 WHICH WAS RELEASED SIMULTANEOUSLY IS NOT SEEN. THE
MASS 20 AND 21 COUNT RATES ARE CONSISTENT WITH THE PURITY OF THE
NEON-22 GAS LOAD.

N83 22302^{D13}

MODELING CORRELATION WITH FLIGHT DATA

H. K. F. Ehlers
Johnson Space Center

ORIGINAL PAGE IS
OF POOR QUALITY

SHUTTLE ENVIRONMENT WORKSHOP

MODELING CORRELATION WITH FLIGHT DATA

H. K. F. EHLERS

MOLECULAR (CONTAMINATION) FLOW MODELING
(SPACE 2 PROGRAM)

- PURPOSE OF THE MODEL
 - PREDICT THE INDUCED ENVIRONMENT OF THE SPACE SHUTTLE ORBITER/PAYLOAD ON-ORBIT
 - MODEL OUTPUT PARAMETERS
 - DENSITY
 - COLUMN DENSITY
 - RETURN FLUX
 - PREDICT THE INDUCED GAS FLOW BETWEEN ORBITER/PAYLOAD SURFACES
 - MODEL OUTPUT PARAMETERS
 - DIRECT SOURCE TO RECEIVER GAS FLOW
 - REFLECTED SOURCE TO RECEIVER GAS FLOW

Preceding page blank

MOLECULAR (CONTAMINATION) FLOW MODELING
(SPACE 2 PROGRAM)

ORIGINAL PAGE IS
OF POOR QUALITY

- MODEL DESCRIPTION

THE MODEL IS A COMPUTER PROGRAM RELATING CERTAIN INPUT PARAMETERS TO THE REQUIRED OUTPUT PARAMETERS. THE INPUT PARAMETERS CHARACTERIZE THE TIME DEPENDENT STATUS OF THE ORBITER/PAYLOAD

- INPUT PARAMETERS

- BODY GEOMETRY
- MATERIALS GAS EMISSION/REFLECTION/ABSORPTION CHARACTERISTICS
- ENGINE/VENT CHARACTERISTICS
- AMBIENT/EMITTED GAS INTERACTION
- TEMPERATURES
- TIME DEPENDENCE

- PROGRAM

- MOLECULAR TRANSPORT MECHANISMS

MODEL APPLICATION: ORBITER FLIGHT TESTS

- INDUCED GAS ENVIRONMENT OF ORBITER/PAYLOAD SYSTEM
 - STS-1
 - STS-2
 - STS-3
- INDUCED DIRECT GAS FLOW FROM ORBITER/PAYLOADS TO SENSITIVE AREAS (IN BAY)
 - IECM INSTRUMENTS
- RETURN FLUX TO SENSITIVE AREAS
 - IECM INSTRUMENTS
- INDUCED DIRECT GAS FLOW FROM ORBITER/PAYLOADS TO UNBERTHED PAYLOAD/SENSITIVE INSTRUMENTS
 - IECM ON RMS

MODELED SHUTTLE ORBITER CONFIGURATION

ORIGINAL PAGE IS
OF POOR QUALITY

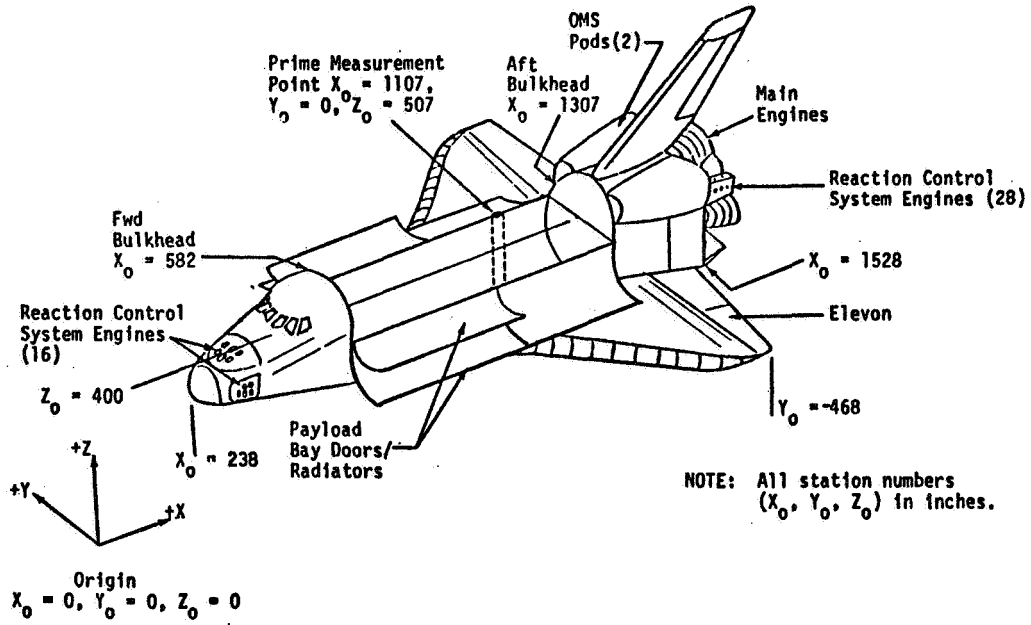

STS-2 PAYLOAD MODEL

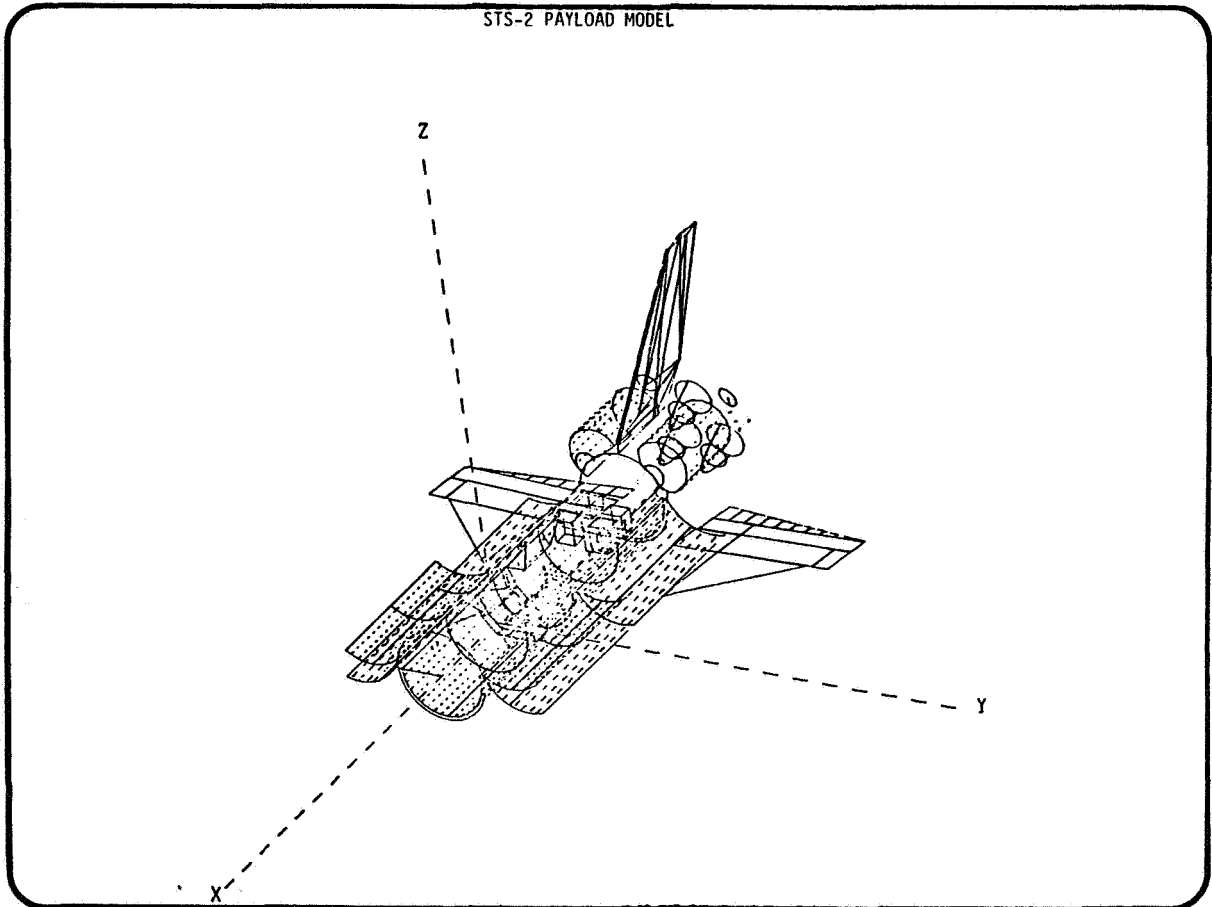

STS-3 PAYLOAD MODEL

ORIGINAL PAGE IS
OF POOR QUALITY

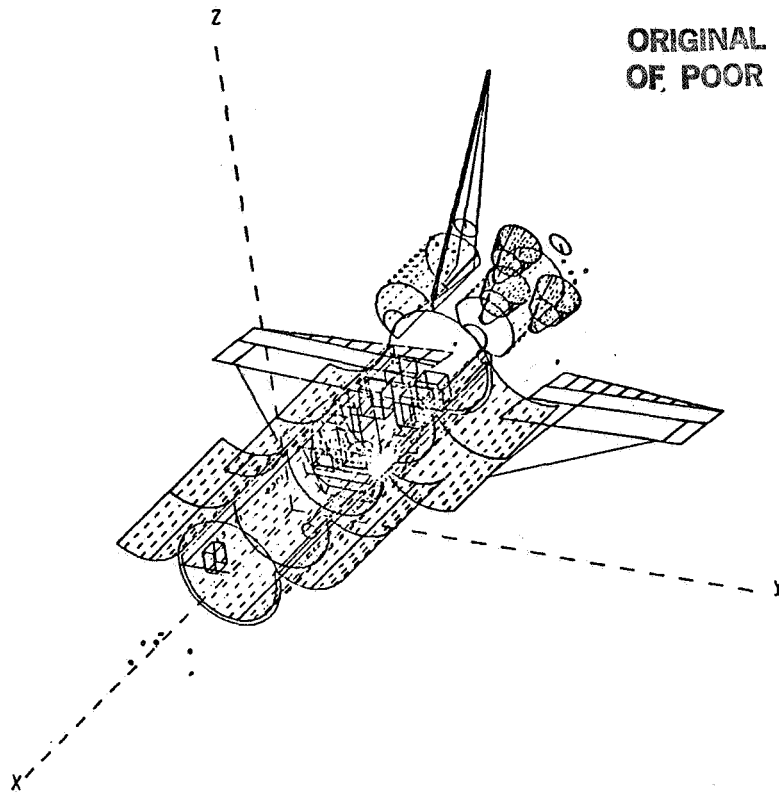

MODELING CORRELATION WITH FLIGHT DATA

- DIRECT FLOW OF OUTGASSING MOLECULES FROM BAY SURFACES TO TQCM'S ON THE IECM
(IN 10^{-12} G/CM² SEC) (STS-2/IECM IN ZLV ATTITUDE)

SPACE 2 PREDICTIONS	LOCATIONS	MEASUREMENTS
8.3	RIGHT	0...6.3
10.4	FWD	6.3...15.4
7.3	AFT	2...6.5
19.8	LEFT	0...4.0

ORIGINAL PAGE IS
OF POOR QUALITY

MODELING CORRELATION WITH FLIGHT DATA

- DIRECT FLOW OF OUTGASSING MOLECULES FROM BAY SURFACES TO TQCM'S ON THE IECM
(IN 10^{-12} G/CM² SEC) (STS-3/TAIL TO THE SUN ATTITUDE)

SPACE 2 PREDICTIONS	LOCATIONS	MEASUREMENTS
2.7	RIGHT	2...27
3.8	FWD	17...47
2.1	AFT	5...18
2.2	LEFT	7...25
0.07	TOP	5...15

MODELING CORRELATION WITH FLIGHT DATA

- RETURN FLUX OF WATER MOLECULES FROM THE FLASH EVAPORATORS TO THE MASS SPECTROMETER ON THE IECM
(IN COUNTS PER SEC) (STS-2/IECM IN ZLV ATTITUDE)

SPACE 2 PREDICTIONS	LOCATION	MEASUREMENT
1000	TOP	250...750

MASS SPECTROMETER MEASUREMENT OF RETURN FLUX
(IN COUNTS/2 SEC, NEAR RAM ATTITUDE)

ORIGINAL PAGE IS
OF POOR QUALITY

MISSION	AMU 18	AMU 28	AMU 32	AMU 44
STS-2	4E+5...4E+3	(9...7)E+5	1E+4*	(7...1.5)E+4
STS-3		(1...5)E+6	1.5E+2...5E+4	≈500

*1E+4 = 1.10⁴

SPACE 2 PREDICTIONS OF RETURN FLUX
(IN MASS SPECTROMETER COUNTS/2 SEC, RAM ATTITUDE)

MISSION	SOURCE	OUTG**	H ₂ O	N ₂	CO ₂	O ₂
STS-2	OUTGASSING/ DESORPTION*	106	83	66	48	22
STS-2	CABIN LEAKAGE		136	14000	166	3800

*AT 20 HOURS MISSION ELAPSED TIME
**MODELED AMU:100

MODELING CORRELATION WITH FLIGHT DATA

RETURN FLUX

PREDICTED STS-2 CONTRIBUTIONS FROM MOLECULAR SOURCES TO MEASURED VALUES

MOLECULAR SOURCE* \ AMU	18	28	32	44
DESORPTION	NORMAL: MINOR TILES: MAJOR	MINOR	MINOR	MINOR
CABIN LEAKAGE	MINOR	MINOR	MODERATE	MINOR
AMBIENT N ₂	-	MAJOR	-	-
AMBIENT O	-	-	MODERATE	-
OTHER	-	TO BE ANALYZED	MINOR	TO BE ANALYZED

*OUTGASSING - NO SIGNIFICANT AMOUNTS OF HEAVY MOLECULAR SPECIES HAVE BEEN OBSERVED ABOVE PREDICTED LEVELS

ORIGINAL PAGE IS
OF POOR QUALITY

RETURN FLUX MEASUREMENT ERROR ANALYSIS

MAJOR CONTRIBUTORS TO ERRORS IN THE DATA ANALYSIS ARE:

- MOLECULAR COLLISION PROCESS
- MASS SPECTROMETER CALIBRATION FACTOR, DEPENDING ON SYSTEM PUMPING SPEED
- MASS SPECTROMETER SYSTEM CHARACTERISTICS (H₂O, CH₄)
- AMBIENT CONTRIBUTIONS

SPACE 2 PREDICTIONS OF MOLECULAR COLUMN DENSITIES
(IN MOLECULES/CM² SEC)

MISSION	SOURCE	OUTG	H ₂ O	N ₂	CO ₂	O ₂
STS-2	OUTGASSING/ DESORPTION***	0.6E+10**	0.2E+11	0.1E+11	0.7E+10	0.4E+10
STS-3	OUTGASSING/ DESORPTION****	0.4E+11	0.1E+12	0.6E+11	0.4E+11	0.2E+11
STS-2/3	CABIN LEAKAGE	-	0.1E+12	0.6E+13	0.7E+11	0.2E+13
STS-2	FLASH EVAPORATORS	-	1.4E+13	-	-	-

GOALS		1.0E+10*	1.0E+11	1.0E+13	1.0E+11	1.0E+13

- * PER SPECIES
- ** 0.6E+10 = 0.6 · 10¹⁰
- *** AT 20 HOURS MISSION ELAPSED TIME, ZLV ATTITUDE
- **** AT 20 HOURS MISSION ELAPSED TIME, TOP SUN ATTITUDE

MODELING CORRELATION WITH FLIGHT DATA

SUMMARY

- GOOD CORRELATION FOR DIRECT FLOW (TQCM)
- GOOD CORRELATION FOR RETURN FLUX, STS-2/H₂O
- CORRELATION FOR RETURN FLUX FROM OTHER MOLECULAR SOURCES/SPECIES APPEARS TO BE WITHIN EXPECTATIONS. MORE ANALYSIS IS REQUIRED
- SPACE 2 MODEL SEEMS TO BE AN ADEQUATE PREDICTIVE TOOL

ORIGINAL PAGE IS
OF POOR QUALITY.

N83 22303 D14

EFFECTS OF SHUTTLE ENVIRONMENT ON
INSTRUMENT PERFORMANCE

A. E. Potter
Johnson Space Center

ORIGINAL PAGE IS
OF POOR QUALITY

OSTA-1 PAYLOAD
A. E. POTTER
NASA/JSC

STS-2 CARGO

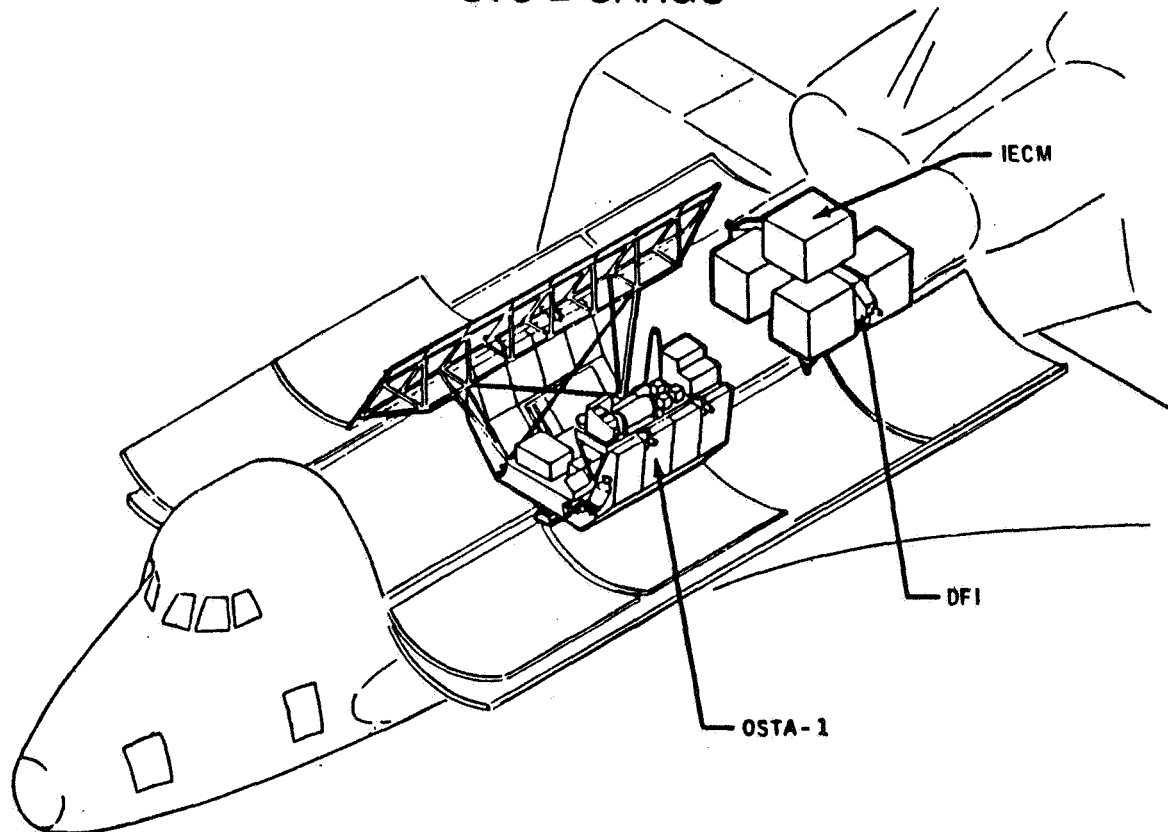

Preceding page blank

OSTA-1 PAYLOAD ON STS-2

ORIGINAL PAGE IS
OF POOR QUALITY

- 6 EARTH-VIEWING EXPERIMENTS IN PAYLOAD BAY.
 - 5 OPTICAL, 1 RADAR.
- 2 EXPERIMENTS IN CABIN.
 - LIGHTNING SURVEY, PLANT GROWTH EXPERIMENT.
- LAUNCHED 9:10 AM CST NOV 12, 1981, 140x139 NM ORBIT, 39° INCLINATION.
- PAYLOAD ACTIVATED +4.5 HRS, DEACTIVATED -7.5 HRS.
- TOTAL OPERATION TIME 54.25 HRS.

EXPERIMENT-BAY INSTRUMENTS FOR OSTA-1

- SHUTTLE MULTISPECTRAL INFRARED RADIOMETER (SMIRR) - ALEX GOETZ, JPL.
 - INFRARED SPECTRAL RADIANCE IN 10 BANDS FOR LITHOLOGIC CLASSIFICATION.
 - 3 1/4 HOURS DATA, 1 HOUR CLOUD-FREE.
- FEATURE IDENTIFICATION AND LOCATION EXPERIMENT (FILE). ROGER SCHAPPELL, MARTIN-MARIETTA.
 - TWO-COLOR TV IMAGERY FOR AUTOMATIC CLASSIFICATION OF SCENES AND FEATURES.
 - 0.7 FRAME OF IMAGERY (INSTRUMENT MALFUNCTION).
- MEASUREMENT OF AIR POLLUTION FROM SATELLITES (MAPS) - H. REICHELE, LARC
 - 4.3 MICRON INFRARED RADIOMETER FOR MAPPING CO.
 - 39 HRS DATA, ~8HRS ESSENTIALLY CLOUD-FREE DATA.
- OCEAN COLOR EXPERIMENT (OCE) - H. KIM, GSFC.
 - MULTISPECTRAL SCANNER FOR MAPPING OCEAN CHLOROPHYLL.
 - 6 HRS DATA, 1/2 HR CLOUD-FREE DATA.
- SHUTTLE IMAGING RADAR (SIR-A) - C. ELACHI, JPL.
 - SYNTHETIC APERTURE RADAR FOR NATURAL RESOURCE MAPPING (EMPHASIS GEOLOGY).
 - 7.5 HOURS GOOD DATA (10-MILLION SQ. KILOMETERS).

OSTA-1 OPTICAL EXPERIMENTS
EFFECT OF SHUTTLE ENVIRONMENT

ORIGINAL PAGE IS
OF POOR QUALITY

EXPERIMENT	EXPOSURE TIME OF OPTICS, HRS.	COMPARISON PRE & POST- FLIGHT CALIBRATIONS	REMARKS
MAPS	39	CONST. WITHIN 1%	DUST, PALLET TEMPERATURE FLUCTUATIONS, SCORCH MARKS ON BETA CLOTH.
OCE	8	CONST. WITHIN 0.5%	NO DUST, UNAFFECTED BY TEMP. FLUCTUATIONS
FILE	42	~10% CHANGE, CAMERA 1* ~20% CHANGE, CAMERA 2*	NO DUST, NO TEMP. PROBLEMS, 1/8" PRISM LOST POST-FLIGHT, SCORCH MARKS ON BETA CLOTH.
SMIRR	5	CONSTANT WITHIN 3 COUNTS. (PEAK SIGNAL LEVEL ~2500 COUNTS)	NO DUST, PALLET TEMP. FLUCTUATIONS.

* ~2 YEARS BETWEEN PRE- AND POST-FLIGHT CALIBRATION. FILTER DEGRADATION IN
GROUND STORAGE SUSPECTED.

SHUTTLE-BASED EXPERIMENTS: LESSONS LEARNED FROM OSTA-1

- FLIGHT SIMULATIONS ESSENTIAL
 - EXPERIMENT REPLANNING PRACTICE

- GROUND CONTROL OF EXPERIMENTS DESIREABLE
 - MALFUNCTIONS OF TOTALLY AUTOMATED EXPERIMENTS CANNOT
BE FIXED IN FLIGHT

- ALARM LIMITS FOR EXPERIMENTS MUST BE REALISTIC
 - CREW LOSES INTEREST AFTER A FEW ALARMS

- SHUTTLE ENVIRONMENT HAS NO MEASUREABLE EFFECT ON EARTH-VIEWING
EXPERIMENTS (54 HR MISSION EXPERIENCE)

N83 22304 D16

OSS-1/CONTAMINATION MONITOR

R. Kruger, J. Triolo, and R. McIntosh
NASA/Goddard Space Flight Center

Preceding page blank

7-142
INTENTIONALLY BLANK

Participants

Principal Investigator

Jack Triolo, NASA/GSFC

Co-Investigators

Raymond Kruger, NASA/GSFC

Carl Maag, JPL

Capt. Paul Porzio, USAF/SD

Instrument Engineer

Roy McIntosh, NASA/GSFC

Operations Assistance

Lt. Edward Christ, USAF/SD

Amelia Phillips, JPL

This figure shows the major participants in the program.

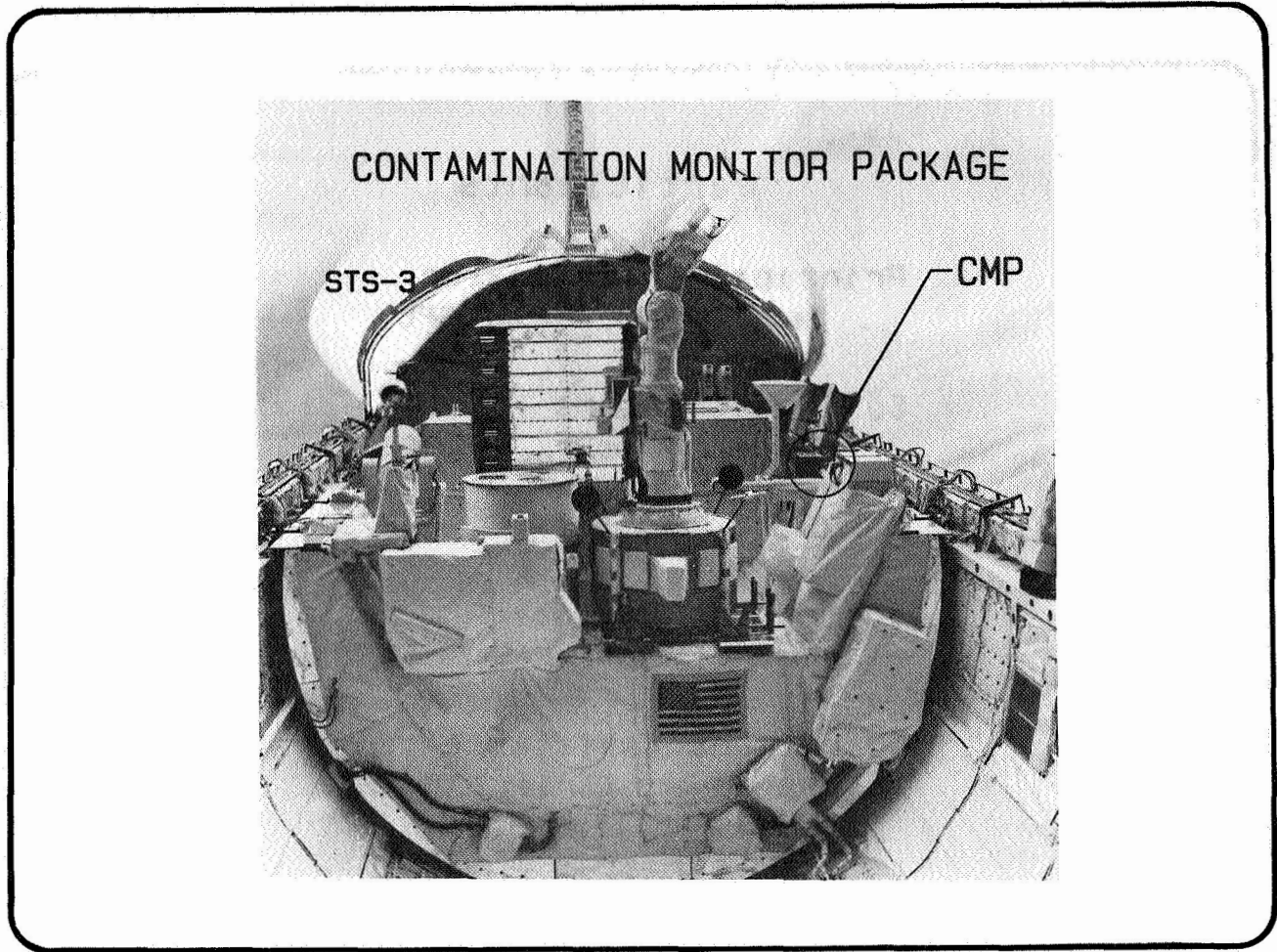

This figure shows a view of the Columbia and many parts of the OSS-1 pallet. The Contamination Monitor Package (CMP) is the small box shown within the circle.

The CMP effort was sponsored by the USAF; there were two major objectives:

- a. To monitor the mass build-up or accretion of condensible, volatile materials on surfaces in the Shuttle bay during all phases of ascent, on-orbit, and descent.
- b. To demonstrate the usefulness of a "small box" contamination monitor as an operational device for contamination management and control.

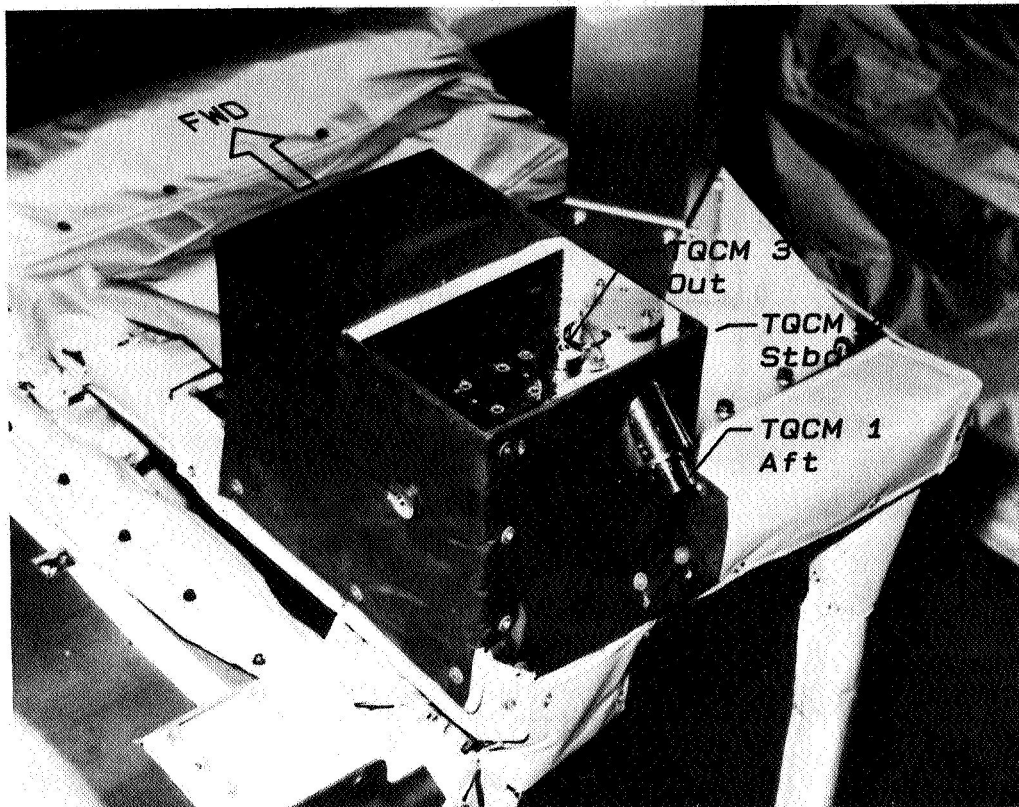

This is a view of the CMP. It is roughly 20 cm high, 18 cm wide, and 30 cm long (8x7x12 inches). It weighs about 7 kg (15 pounds). The average power consumption is about 7 watts. The box itself is passively thermally controlled using silver teflon for radiating surfaces and aluminized kapton multi-layer insulation for radiation isolation.

The instruments included two passively controlled witness samples (which will not be discussed here) and four actively temperature controlled quartz crystal microbalances (TQCM). The TQCM temperatures can be varied from -60°C to $+80^{\circ}\text{C}$. This control can be exercised by telemetry from the ground; there is no crew involvement. The data was recorded on the OSS-1 tape recorder for later playback on the ground, recorded on the Orbiter tape recorder for playback from orbit, and was telemetered in real-time during passes over ground stations.

The TQCM's have a sensitivity of $1.56 \times 10^{-9} \text{g.cm}^{-2}.\text{Hz}^{-1}$, and the data was recorded to ± 1 Hz. While the more basic unit of measure for the TQCM is a surface loading density (g.cm^{-2}), much of this report will be in terms of nm/10 (or Angstrom units) of thickness, assuming a contaminant density of 1.0g.cm^{-3} .

ACCRETION DURING ASCENT PHASE

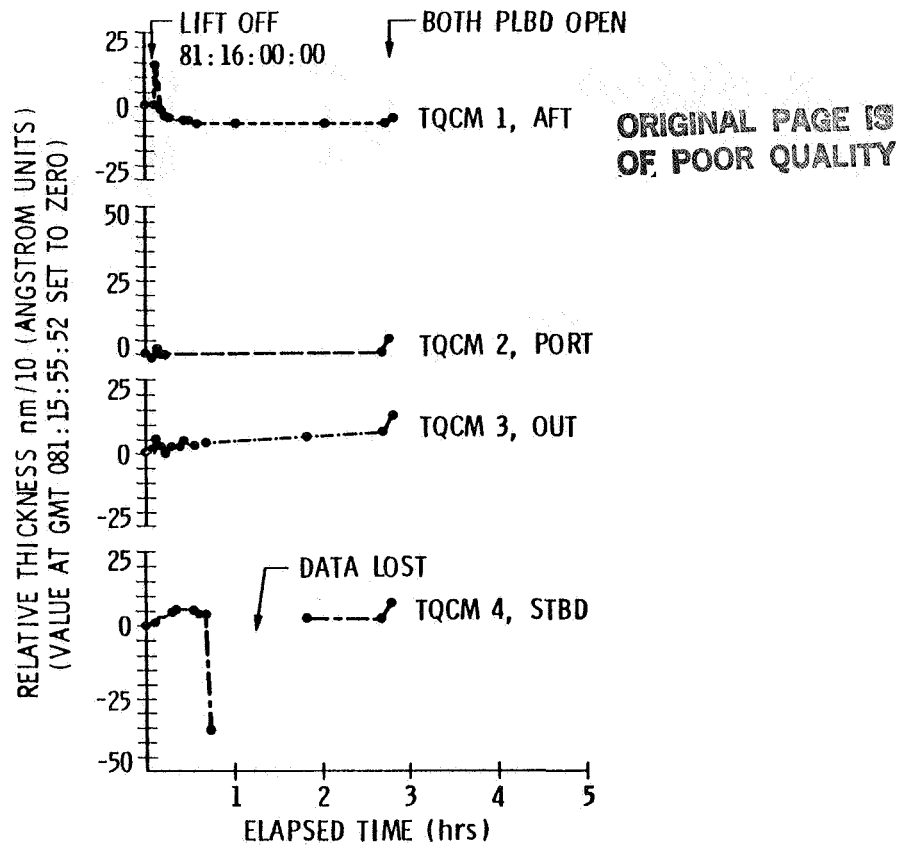

This figure shows the accretion indicated by the four TQCM's during the launch and early orbital phase. Note that the zero value has been set as the values indicated by the TQCM's at about 4 minutes prior to launch. (Launch occurred at 081:16:00:00 GMT.) The TQCM's were set to be controlled at +15°C during these phases.

Certain segments of the data have been lost.

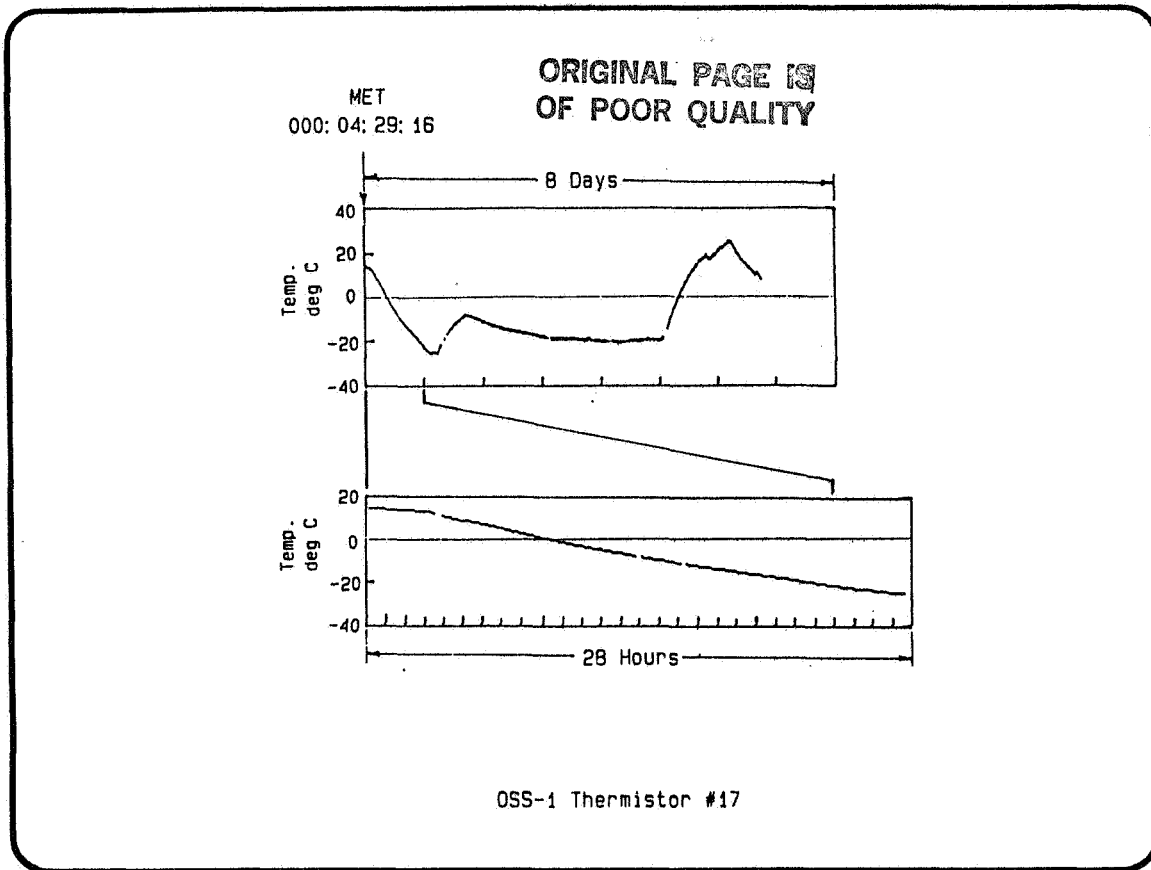

The STS-3 mission involved three major attitudes with respect to the sun for the purpose of verifying the Orbiter thermal design. These were: tail to the sun (TTS) with the orbiter bay always facing away from the earth; nose to the sun (NTS) where the roll rate allowed the orbiter to view the earth, and bay to sun (BTS) where the orbiter bay faced the sun. The TTS condition provided a very cold condition, NTS a moderately cold condition, and BTS a very hot condition.

These conditions are reflected in the temperatures indicated by OSS-1 thermistor #17 which was attached to a piece of equipment under the thermal blanket on the pallet.

For about the first day (TTS) the temperatures dropped sharply. This was followed by a Passive Thermal Control (PTC) mode that provided a more benign thermal environment indicated by the rise in temperature. This was followed by about 3-1/4 days in the NTS attitude shown by the cool-down. This was followed by the BTS condition for about a day with a warming trend. PTC, TTS, BTS, and other attitudes followed until deorbit.

The importance of these temperatures is that they influence the outgassing rates of the various materials, and so influence the measurements made by the CMP.

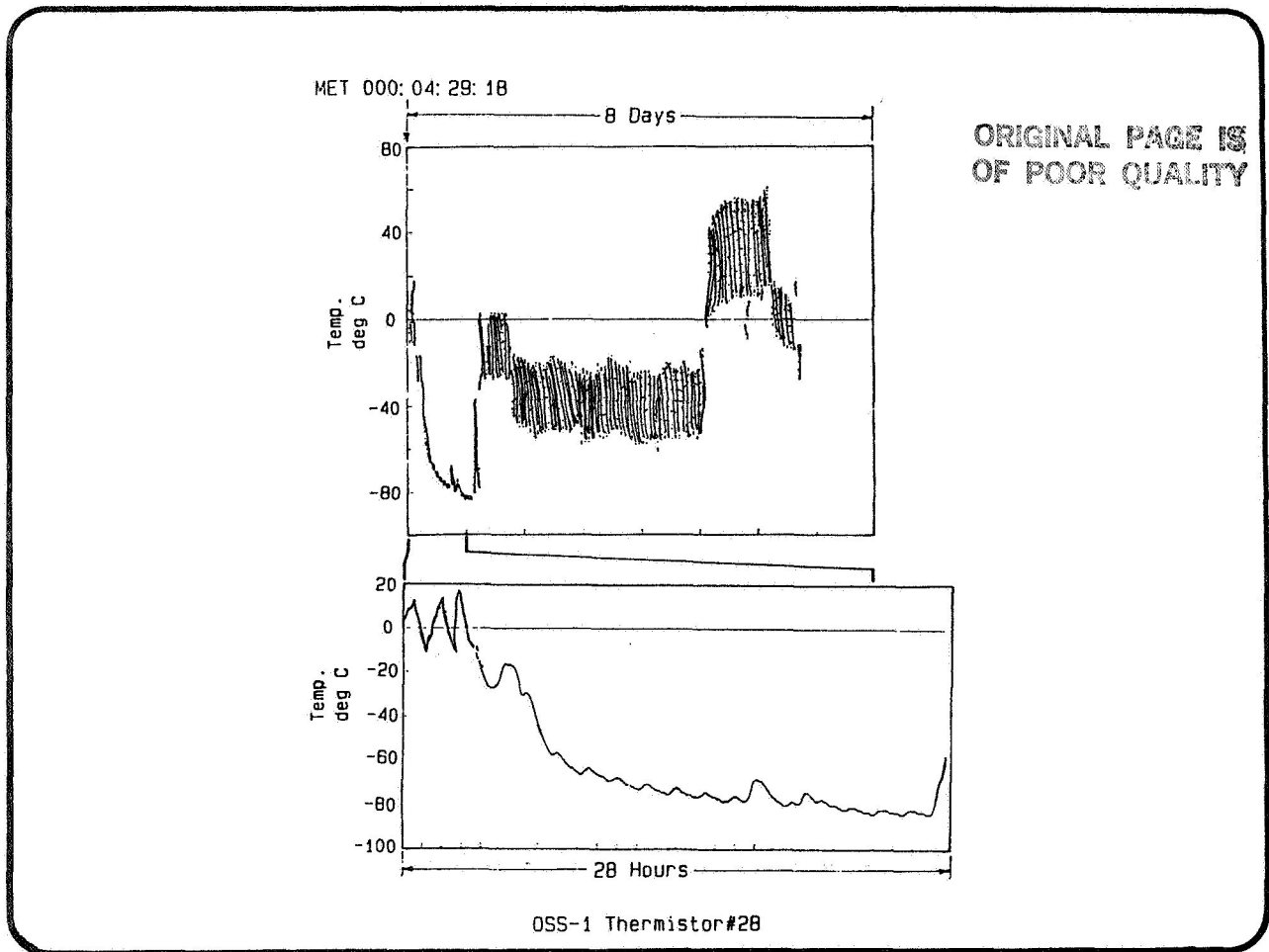

It is interesting to look at data from OSS-1 pallet thermistor #28 which basically measures the temperature of low thermal mass multi-layer insulation. Here we can see wide fluctuations in rapid response to the various Orbiter orientations. These are more specific in the expanded time-scale portion of the chart where the fluctuations with each orbit become apparent. Other temperature variations appear to be correlatable to other Orbiter maneuvers such as those for alignment of the Inertial Measurement Unit (IMU).

As one might expect, other temperature data exists for items with very high thermal inertia and these show relatively small changes with Orbiter attitude.

Since outgassing is a strong function of temperature, we can expect to see significant differences with orbiter attitude as indeed we do. However, since so many different temperatures and outgassing sources exist, one would expect to be able to predict only general trends. It is possible that in some cases, depletion of an outgassing source will occur while the temperature is increasing. These competing effects add to the uncertainty of predicting what will occur.

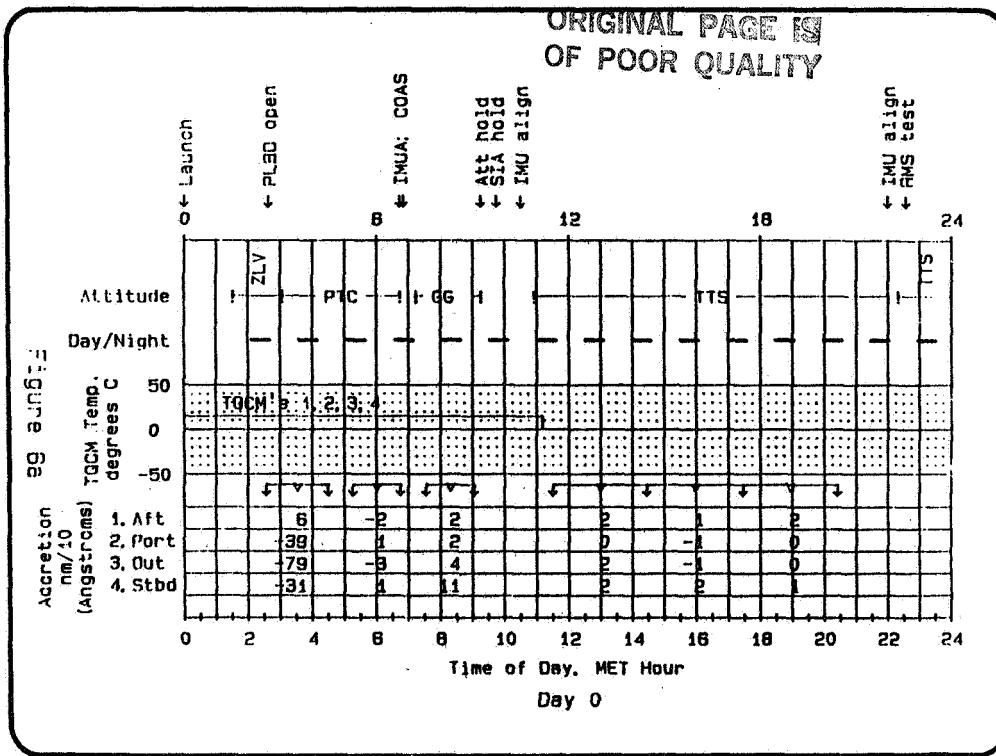

The published proceedings of this meeting contain data on 8 days of the mission so that they may be reviewed by the reader more carefully. In the interest of time, only some significant points will be highlighted in the presentation.

This figure is rather complicated in order to include many of the parameters that bear on the TQCM data.

Starting at the bottom, the Mission Elapsed Time (MET) is shown on the abscissa and includes the day and the hour of the day. The first section of the ordinate is labeled "Accretion." The values shown are the net accretions (given in nm/10 or Angstrom units assuming a material density of $1g.cm^{-3}$) occurring between the two downward pointing arrows above the printed values. These values may be either positive or negative indicating material being added to the TQCM or leaving it. The arrows, incidentally, are generally one or two orbits apart in time (1-1/2 or 3 hours). This is done to choose thermal conditions which are similar and thereby minimize corrections. Similarly, most data points used in this report are selected from the dark portion of the orbit.

Immediately above is the approximate temperature of the sensing surface of the TQCM. The TQCM's were actively controlled to +15°C at launch. Changes in orbit were commanded by telemetry.

Day and night are shown next with the dark line indicating the shadow portion of the orbit. Attitude is shown next. ZLV (the Orbiter Z axis in the local vertical) is shown first; the PTC, TTS, NTS, and BTS descriptions are as noted before. "GG" is a gravity gradient mode.

Finally, at the very top are notes indicating events during the flight--"PLBD" are bay door activities, IMU and COAS refer to Orbiter attitudes taken for purposes of the Inertial Measurement Unit and the Crew Optical Alignment System. SIA is an attitude taken for obtaining certain instrument measurements. RMS notes refer to the Remote Manipulator System.

Other notes (DSCr, LZU, VRCS, etc.) refer to other operations that affected the Orbiter Attitude. The "IECM ops" note refers to the gas release phase of the Integrated Environmental Contamination Monitor operations.

As yet, no accretions have been noted that could be related to RMS, PDP, VCAP, or similar operations with any certainty. None of these are therefore included in the notes.

The accretions shown are generally below 2 nm/10 (Angstrom units) with the TQCM's at 0°C and the Orbiter in the TTS attitude.

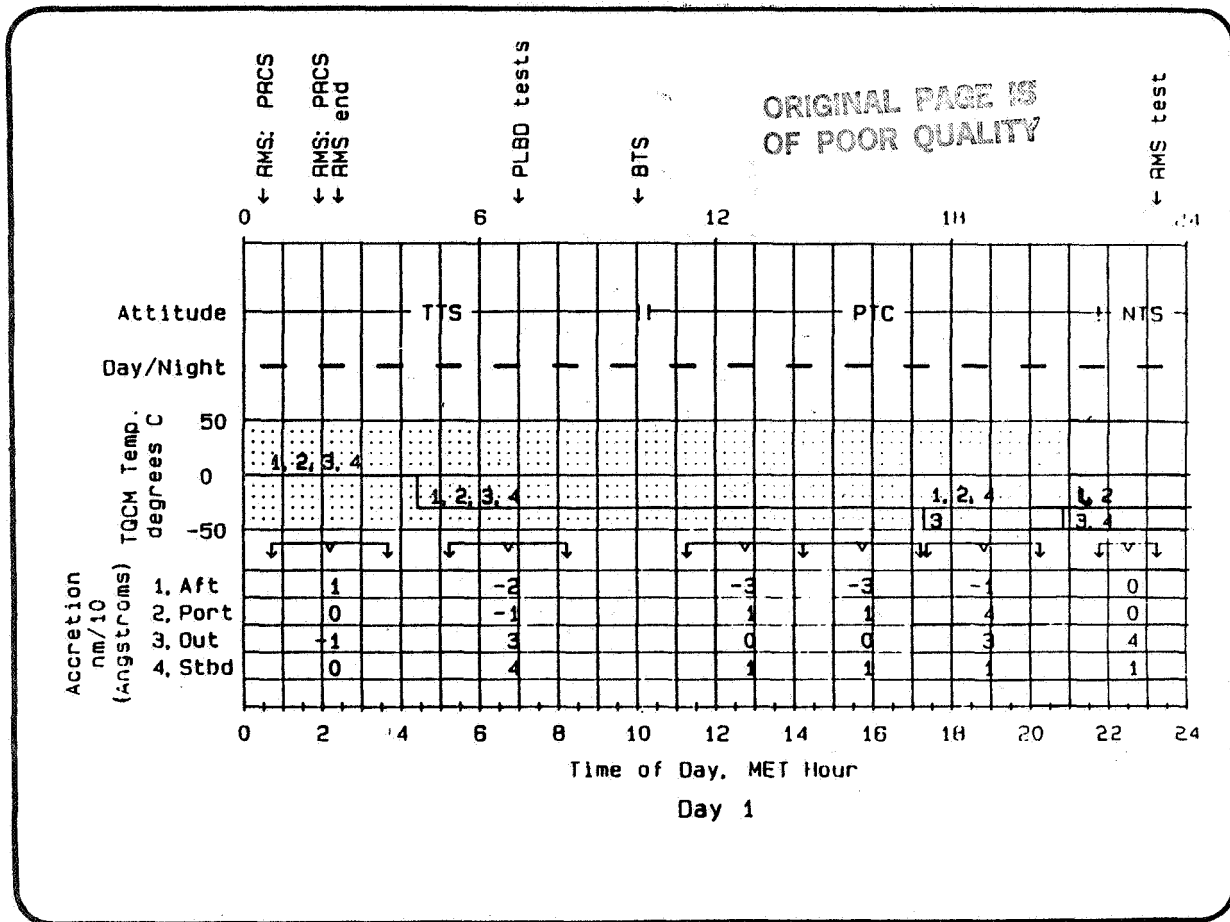

While in the NTS mode, a bake-out of the TQCM's was conducted. This involved raising their temperatures to +60°C to drive off accreted materials. This appears to happen rapidly and, possibly except for the value of -13 for TQCM 3, is not specifically seen on this chart.

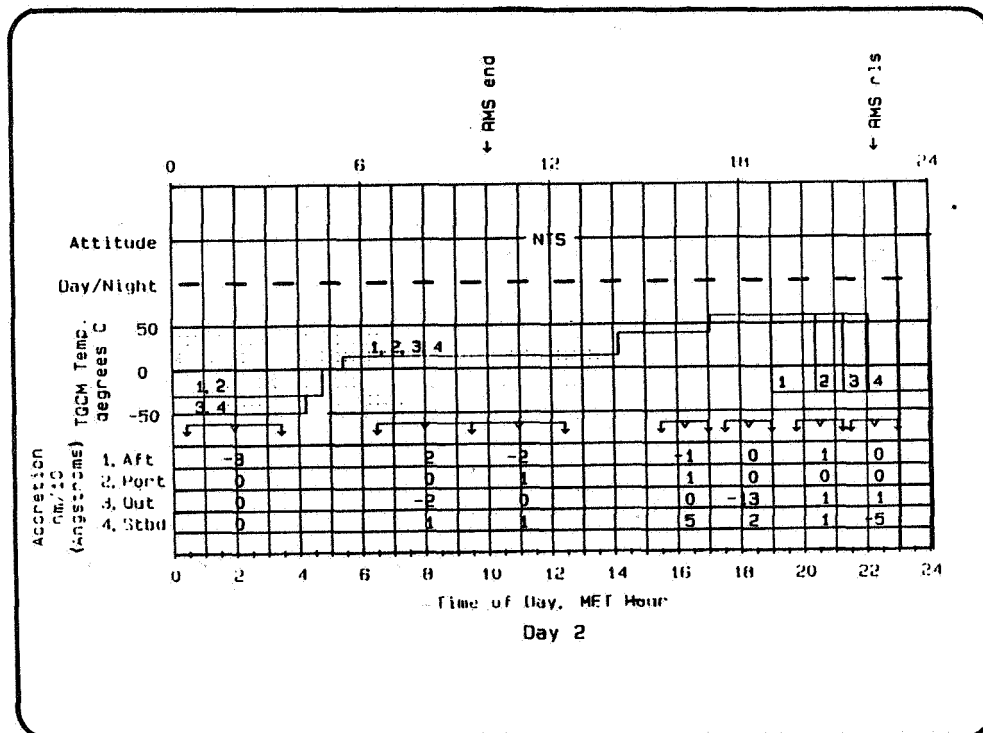

ORIGINAL PAGE IS
OF POOR QUALITY

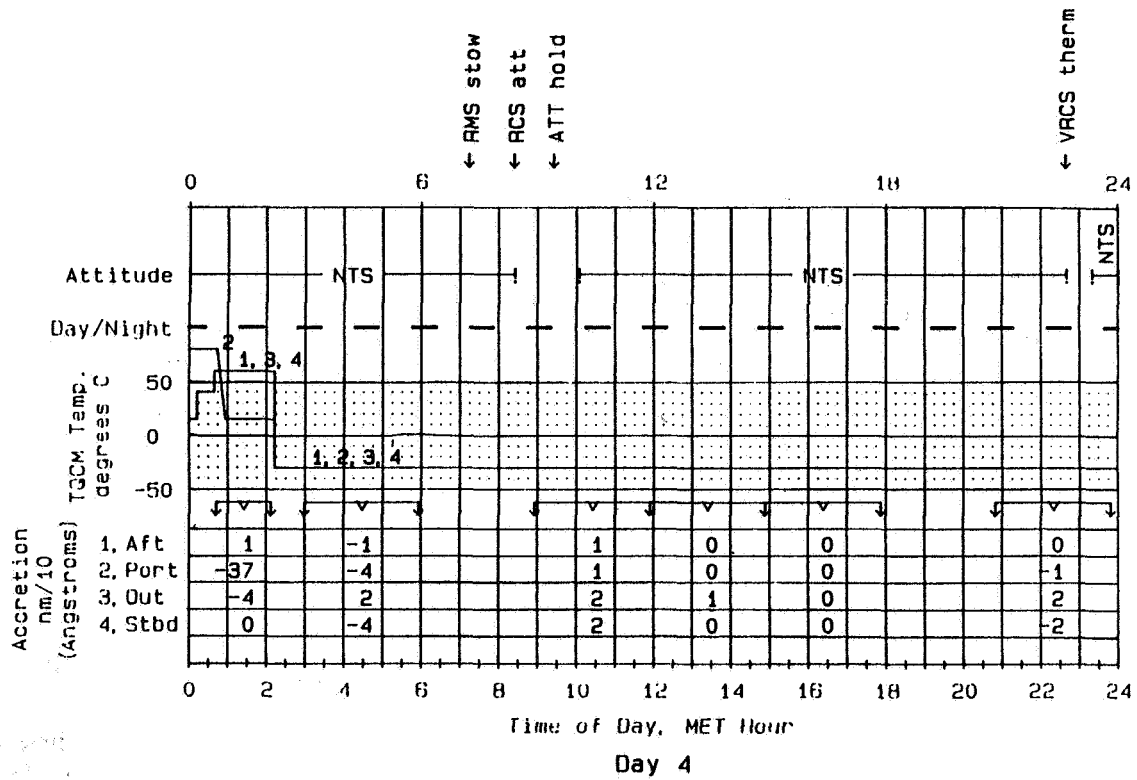
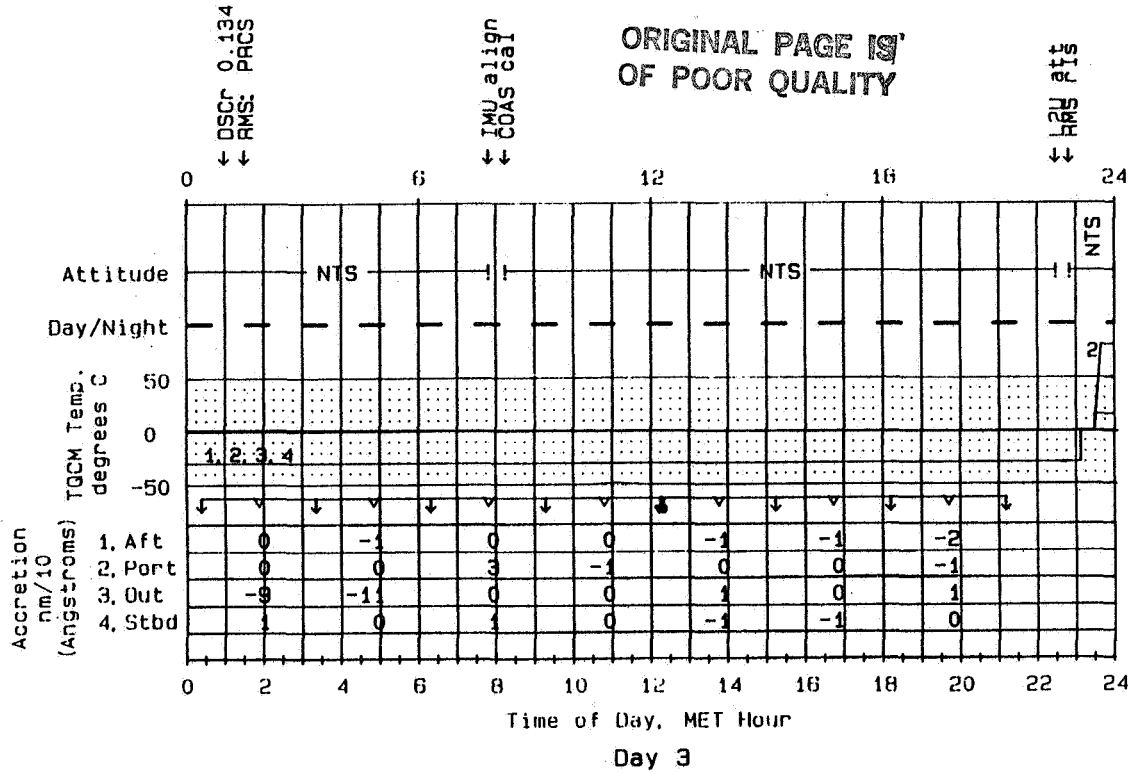

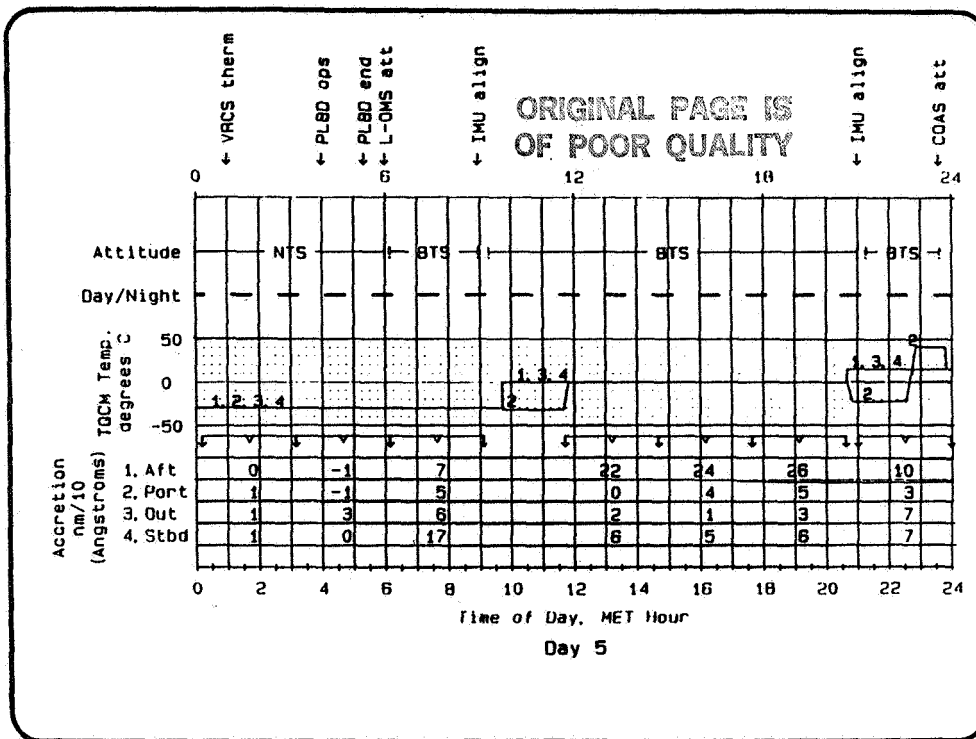

On day 5, the Orbiter took the BTS orientation. The immediate response of the TQCM's can be seen during the first section marked "BTS." Even when the TQCM temperatures were raised to 0°C and then +15°C, these accretions continue.

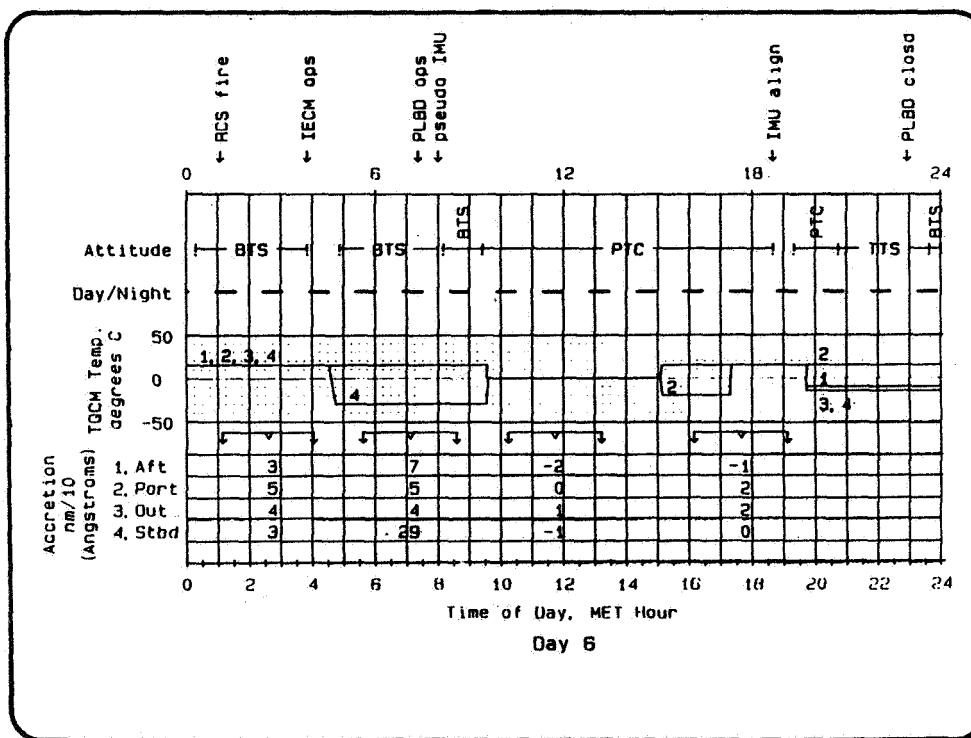

On day 6, the Orbiter left the BTS condition and the TQCM accretions show an immediate response. Towards the end of the day the TQCM's were all set to different temperatures in preparation for deorbit. However, because of landing site conditions, deorbit was delayed for 1 day.

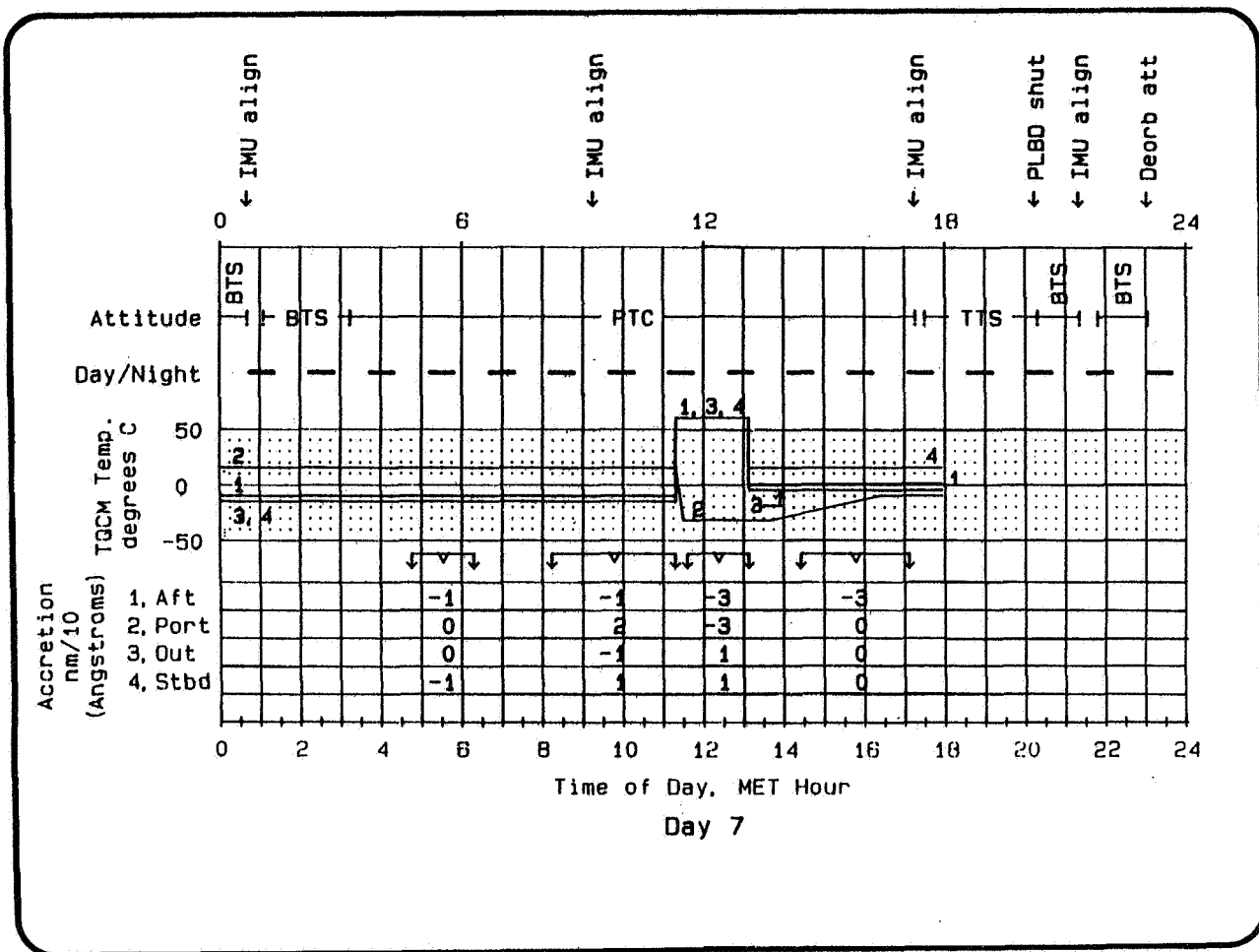

The data shown for day 7 is taken from the real-time transmissions. These are available only when the Orbiter passed over an appropriate ground station.

The TQCM's temperatures were reset on day 7 for deorbit which occurred at about 2300 hours.

ORIGINAL PAGE IS
OF POOR QUALITY

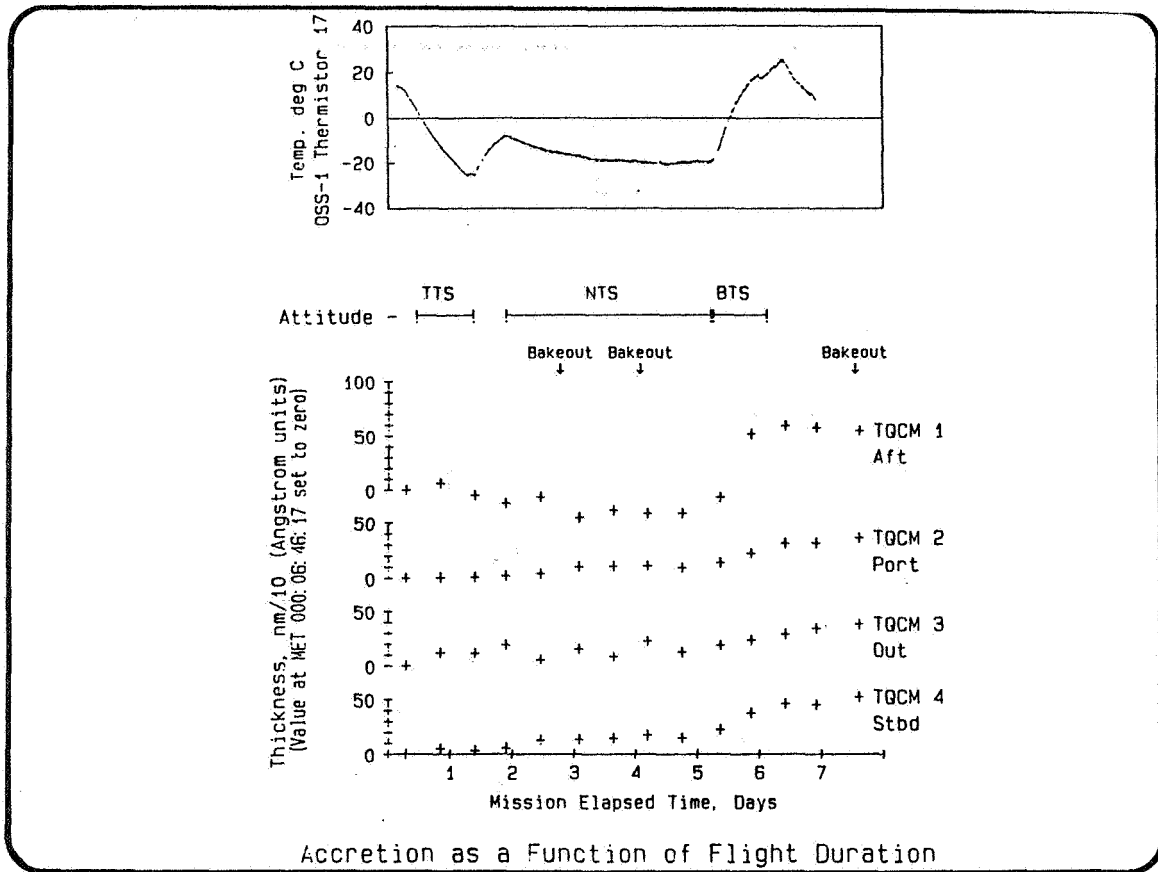

In order to see some of the longer-term trends, the data for the four TQCM's was plotted selecting portions about 10 orbits apart (to simplify the data reduction process). The data shown have been normalized by setting them all to zero at one time (day 0, 06:46:17).

The three bake-outs that were conducted are shown on this chart.

There is a general downward trend for TQCM 1 into day 5 and a general upward trend for TQCM's 2, 3, and 4. Most striking is the upward trend for all of them in the period from about day 5-1/2 to day 6-1/2. This corresponds to the BTS condition and occurs when we would expect outgassing to increase.

ORIGINAL PAGE IS
OF POOR QUALITY

<u>Time Difference</u>	<u>Thickness Difference, nm/10 (Angstrom Units)</u>		
	<u>TQCM 1, Aft</u>	<u>TQCM 3, Out</u>	<u>TQCM 4, Stbd</u>
Day 2 to Day 4	-5	-10	+7
Day 2 to Day 7	+89	+40	+59

Thickness Differences Between Bake-outs

ORIGINAL PAGE IS
OF POOR QUALITY

It is most interesting to note the results of the three bake-outs conducted on days 2, 4, and 7.

The difference in the thicknesses indicated by the TQCM's after a period at +60°C between days 2 and 4 show two at a lower thickness on the later date and one with an increase in 7 nm/10 (Angstrom units). However, the second line shows that, even with bake-out, there was a net increase of 40 to 89 nm/10 (Angstrom units) between days 2 and 7. This includes the period when the Orbiter was in the BTS. (TQCM 2 data is not presented because its temperature was not at +60°C during bake-outs on days 4 and 7.)

Mr. Carl Maag of JPL will continue this presentation and will discuss data taken during ascent and descent and will present the conclusions.

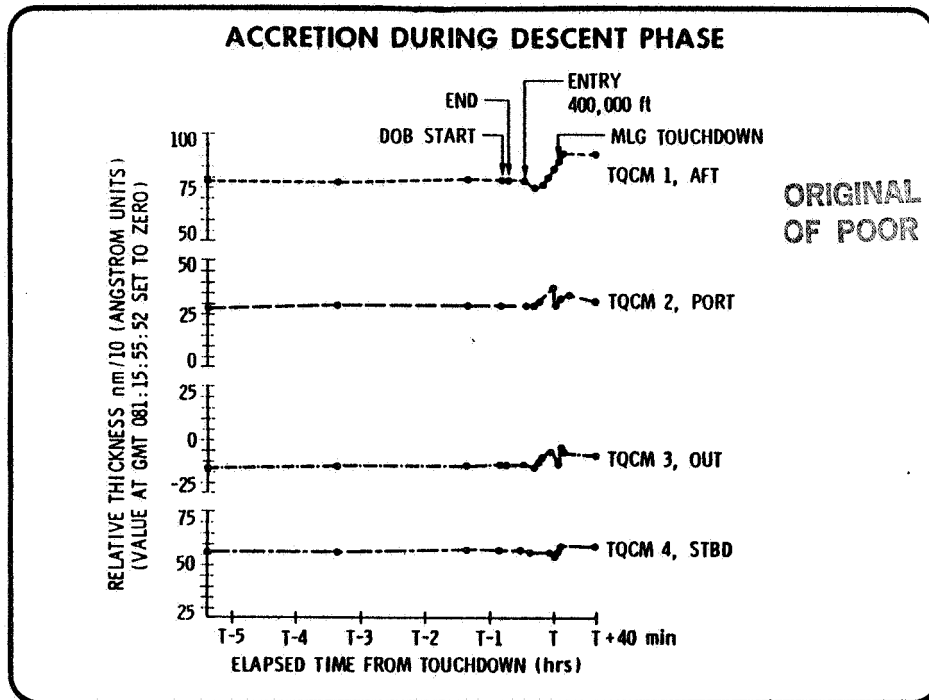

The data on this figure is referenced back to approximately 4 minutes prior to launch. TQCM 1 was set to 0°C, TQCM 2 to -10°C, TQCM 3 to -5°C, and TQCM 4 to +15°C in preparation for entry. The system was designed to hold these temperatures through the landing phase.

The data has not been corrected for temperature effects on the TQCM.

It is interesting to note that not even TQCM 2 at -10°C showed a very large increase or stopped oscillating by the time of end of data. This indicates that the dew point was below -10°C for the period over which the data was taken.

- ### RESULTS
- ALL OBJECTIVES OF CMP WERE MET, PRINCIPALLY THAT OF DEMONSTRATING THE USEFULNESS OF AN OPERATIONAL MONITOR FOR CONTAMINATION MANAGEMENT AND CONTROL
 - MASS ACCRETION HIGHLY DEPENDENT UPON ORBITER ATTITUDE AND TEMPERATURE
 - SOLAR VIEWING ATTACHED PAYLOADS MAY BE SUBJECT TO IRREVERSIBLE DEGRADATION BY NON-REMOVABLE DEPOSITS

The major results based on the data reduction to date are expressed on this figure.

TEST FOR CONTAMINATION OF MgF_2 - COATED MIRRORS

A. Bunner, Perkin-Elmer Corporation
J. D. Bartoe, NRL
J. Triolo, Goddard Space Flight Center

TEST FOR CONTAMINATION OF MgF_2 - COATED MIRRORS

J. -D. BARTOE, NRL
J. TRIOLO, GSFC
A. N. BUNNER, PERKIN-ELMER
B. FLINT, ACTON RESEARCH

ORIGINAL PAGE IS
OF POOR QUALITY

PRE-FLIGHT REFLECTIVITIES MEASURED: AUGUST 1981
STS-3 FLIGHT: 22 MARCH-30 MARCH 1982
POST-FLIGHT REFLECTIVITIES MEASURED: JULY-SEPTEMBER 1982

OSS-1 PALLET PAYLOAD

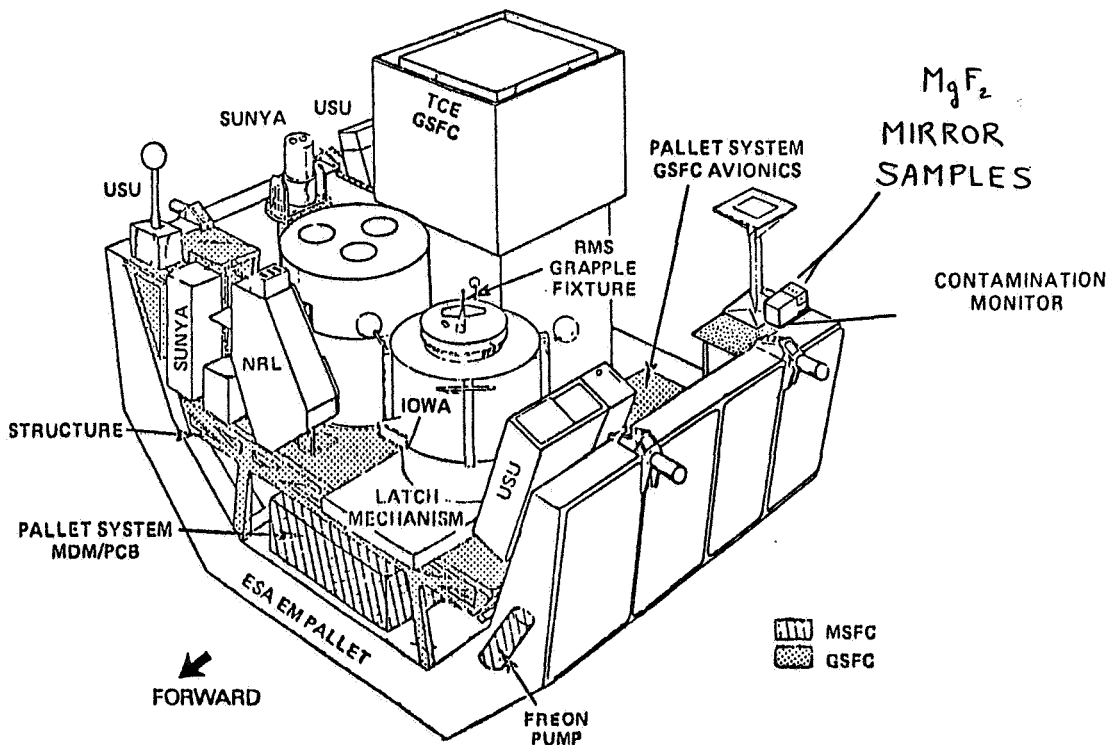

Preceding page blank

OSS-1 CONTAMINATION MONITOR

ORIGINAL PAGE IS
OF POOR QUALITY

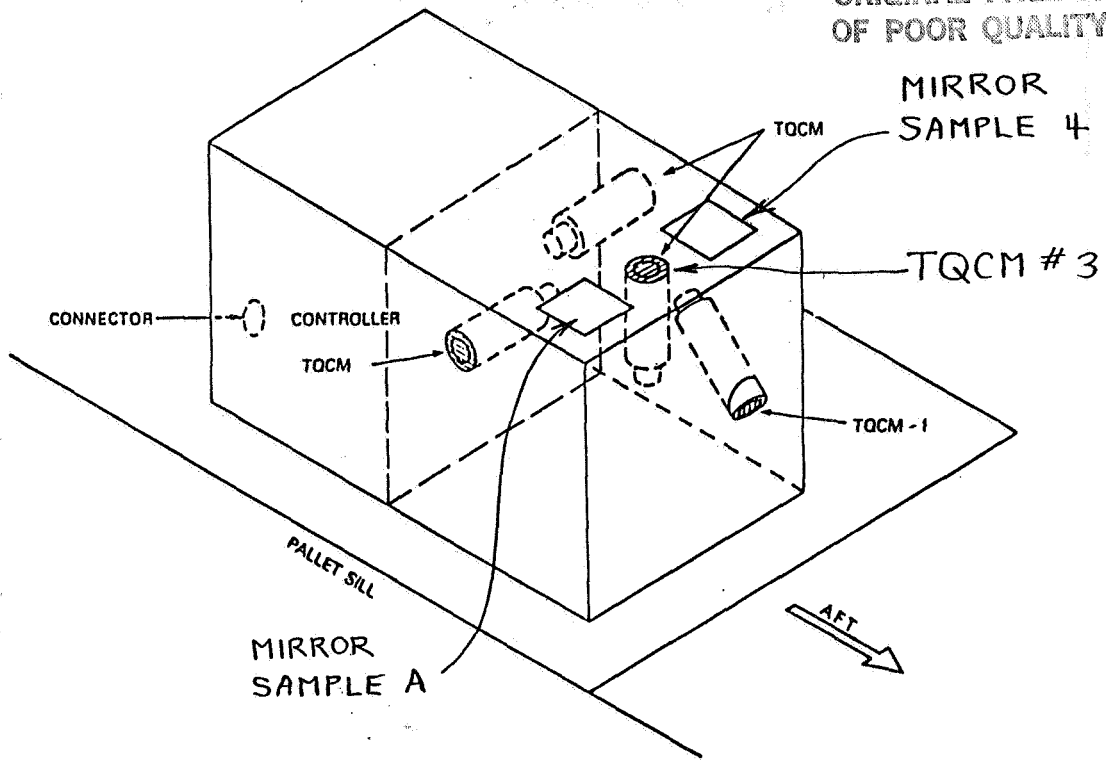

OPTICAL COATING PROCEDURE

ACTON RESEARCH

OIL-PUMPED VACUUM

-1×10^{-6} TORR

260-270 Å MgF_2

-1000 Å ALUMINUM

MgF_2 DEPOSITION @ -25 \AA/SEC

BOTH COATINGS ON IN -18 SEC

PERKIN-ELMER

OIL-FREE VACUUM

-3×10^{-7} TORR

250±25 Å MgF_2

-650 Å ALUMINUM

MgF_2 DEPOSITION @ -8 \AA/SEC

BOTH COATINGS ON IN -115 SEC

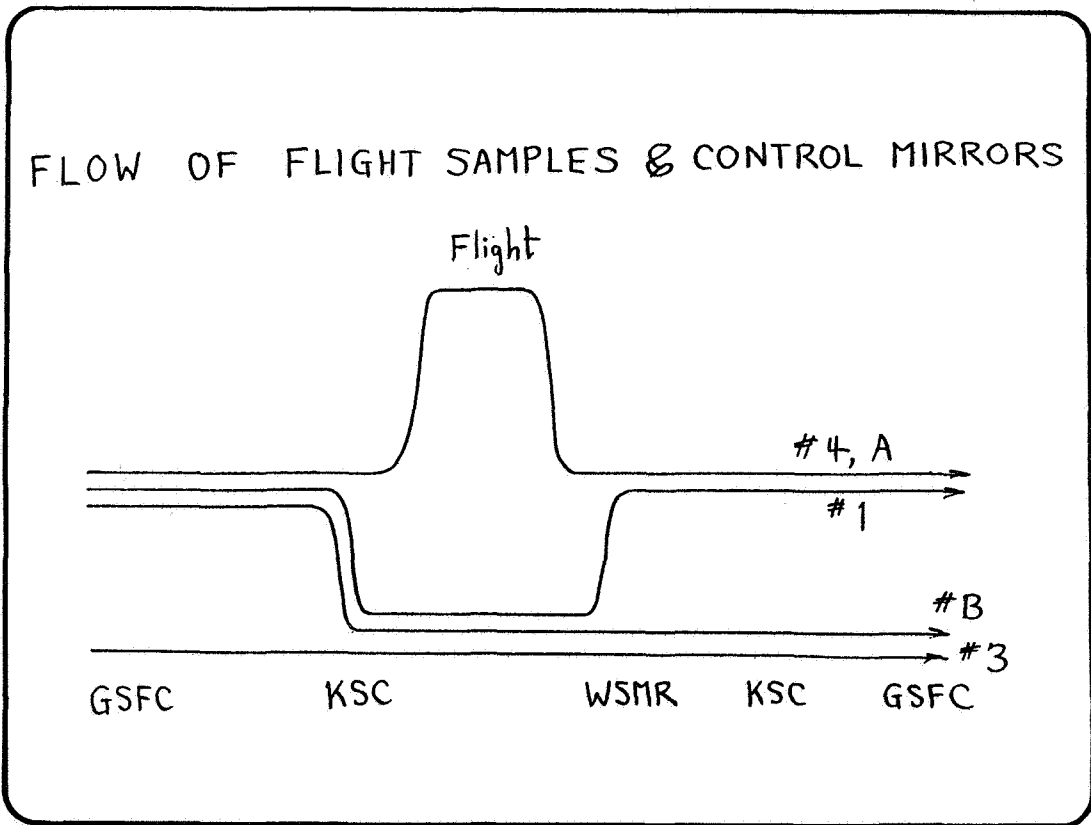
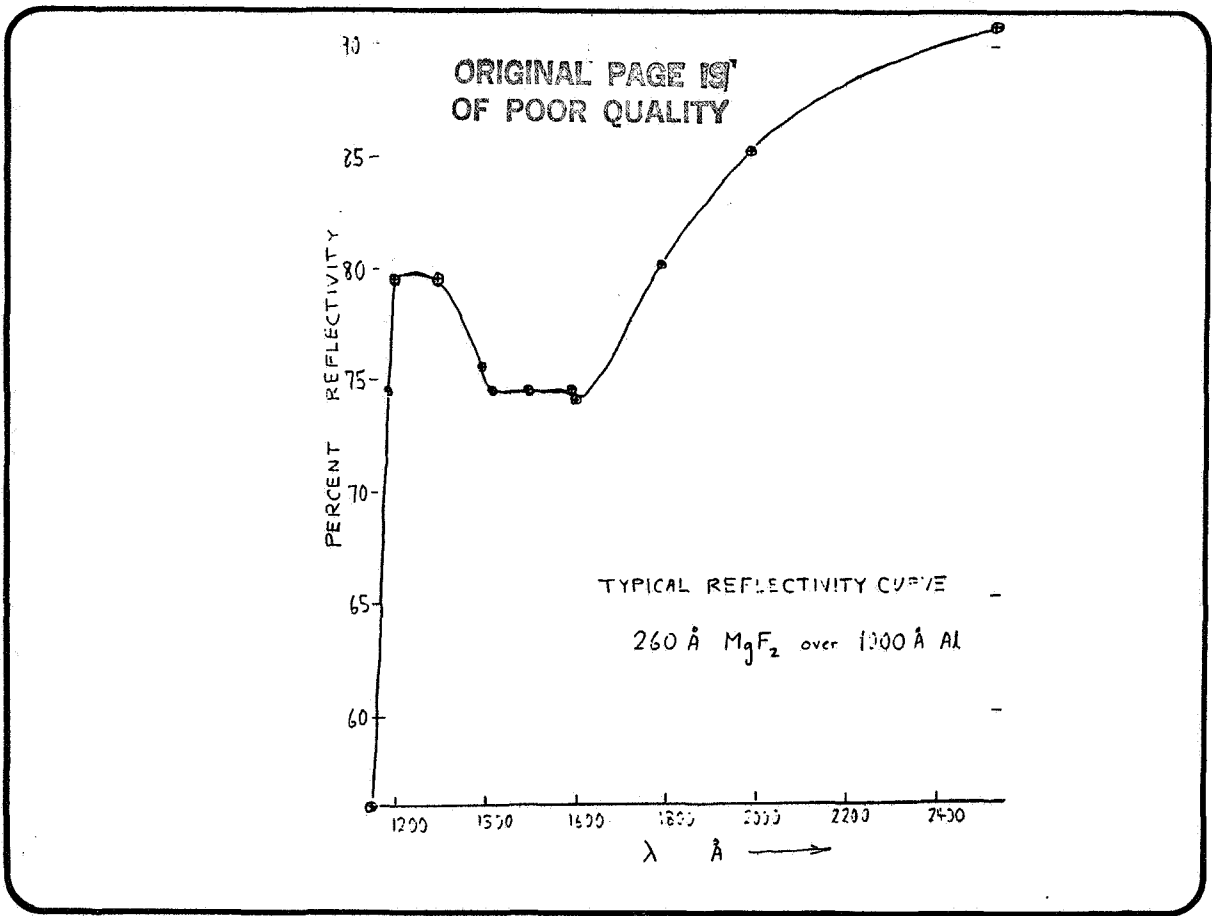

FLIGHT MIRRORS
REFLECTIVITIES IN PERCENT

ORIGINAL PAGE IS
OF POOR QUALITY

SAMPLE	BEFORE FLIGHT				AFTER FLIGHT			
	1150 Å	1216 Å	1600 Å	2200 Å	1150 Å	1216 Å	1600 Å	2200 Å
A EXPOSED	<70.	81.7	77.	86.1	66.5	80.	76.5	85.3
A COVERED	<70.	81.7	77.	86.1	59.4	77.2	72.2	87.2
4 EXPOSED	55.8	72.9	74.	86.6	57.4	67.9	73.9	83.2
4 COVERED	55.8	72.9	74.	86.6	57.2	67.8	71.2	84.1

ALL VALUES ARE ±2%.

"EXPOSED" = EXPOSED TO SUN IN FLIGHT.

ALL VALUES ARE CORRECTED MEANS OF MEASUREMENTS AT P-E AND ACTON.

CONTROL MIRRORS
REFLECTIVITIES IN PERCENT

SAMPLE	BEFORE FLIGHT				AFTER FLIGHT			
	1150 Å	1216 Å	1600 Å	2200 Å	1150 Å	1216 Å	1600 Å	2200 Å
1	55.8	72.9	74.	86.6	57.7	69.6	<u>70.1</u>	85.6
B	<70.	80.2	75.	87.2	-	81.2	74.5	87.2
3 EXPOSED	55.8	72.9	74.	86.6	57.3	<u>68.8</u>	<u>68.9</u>	85.8
3 COVERED	55.8	72.9	74.	86.6	56.1	<u>67.6</u>	<u>68.4</u>	<u>82.4</u>

(FINGERPRINT)

ALL VALUES ARE ±2%.

"EXPOSED" - NOT COVERED BY ALUMINUM SHADE.

ALL VALUES ARE CORRECTED MEANS OF MEASUREMENTS AT P-E AND ACTON.

OBSERVATIONS

ORIGINAL PAGE IS
OF POOR QUALITY

1. NO CHANGES $>1.8\sigma$ OBSERVED, EXCEPT FOR FINGERPRINT.
2. WEAK EVIDENCE ($\leq 1.8\sigma$) FOR DEGRADATION AT 1216 Å AND 1600 Å FOUND IN SEVERAL SAMPLES.
3. NO SIGNIFICANT DIFFERENCE BETWEEN FLIGHT MIRRORS AND CONTROL MIRRORS.
4. COVERED SAMPLES SUFFERED MORE THAN SAMPLES EXPOSED TO SUN, BUT DIFFERENCES BARELY SIGNIFICANT.
5. EXPOSED SIDE OF FLIGHT MIRRORS FOUND TO BE SOMEWHAT DUSTY.

CONCLUSIONS

1. NO EVIDENCE FOR PERMANENT SOLAR-INDUCED DETERIORATION.
2. NO EVIDENCE FOR PERMANENT SHUTTLE-INDUCED DETERIORATION.
3. NO EVIDENCE ON OIL-PUMPED VACUUM VERSUS OIL-FREE VACUUM DURING COATING.

N83 22306

D17

VEHICLE CHARGING AND POTENTIAL ON THE STS-3 MISSION

Roger Williamson
Stanford University

Preceding page blank

VEHICLE CHARGING AND POTENTIAL ON THE STS-3 MISSION

P.R. Williamson and P.M. Banks
STAR Laboratory/SEL, Stanford University, Stanford, CA 94305

W.J. Raitt
Center for Atmospheric and Space Science
Utah State University, Logan, UT 84322

**ORIGINAL PAGE IS
OF POOR QUALITY**

The Vehicle Charging And Potential (VCAP) experiment flown on the STS-3 mission was designed to study the electrical interaction of the shuttle orbiter with the low earth orbit environment. The interaction of a large, orbiting body with the low earth space environment is not well known. With the initiation of an operational era in space, it is necessary that we understand (1) the perturbations produced by the orbiter as it moves through the near earth environment, (2) the environment as provided to instrumentation operating in the payload bay of the orbiter and (3) the effects that the environment exerts upon the orbiter itself. Future missions which depend upon knowledge of the electrical interaction of the orbiter with the space environment include those with high power charged particle beam experiments and others with long antennas operating at high voltages in the VLF frequency range. Also, when operations begin with orbit inclinations above about 50 degrees, large fluxes of energetic electrons (and protons) will bombard the orbiter when the vehicle is at high magnetic latitudes. In the past, satellites have been adversely affected by electrical discharges induced by energetic particle bombardment and these problems present similar concerns for the dielectric covered orbiter. The VCAP experiment on STS-3 was designed to study the interactions between the orbiter and the environment which are of importance to understanding these problems.

INSTRUMENTATION

An electron gun with fast pulse capability was used in the VCAP experiment to actively perturb the vehicle potential in order to study dielectric charging, return current mechanisms and the techniques required to manage the electrical charging of the orbiter. Return currents and charging of the dielectrics were measured during electron beam emission and plasma characteristics in the payload bay were determined in the absence of electron beam emission.

The VCAP instrumentation as flown on the OSS-1 pallet during STS-3 includes five separate pieces of hardware:

1. Fast Pulse Electron Generator (FPEG) - The FPEG (Figure 1) consists of two independent electron guns which are of the diode configuration with a directly heated tungsten filament and a

Preceding page blank

tantalum anode. The two guns, designated as FPEG 1 AND FPEG 2 emit electrons with an energy of 1000 eV at currents of 100 mA and 50 mA, respectively. The electron beams are collimated to a beam width of about 5 degrees by focus coils mounted just beyond the anodes. Each gun is controlled by a 37 bit serial command word which selects the gun to be used, controls filament and high voltage power supplies, determines the on time, off time and number of pulses of the beam. The times are controllable in 32 logarithmic steps from 600 nanoseconds to 107 seconds and the number of pulses is controllable in powers of two from 1 to 32,768. The rise and fall times for the electron beam are 100 nanoseconds so that very short pulses (and therefore small increments of charge) can be emitted.

2. Charge Current Probes (CCP1 and CCP2) - Each Charge Current Probe (CCP) consists of two adjacent sensors --- one metallic and one dielectric --- as shown in Figure 2. The current flowing to the metallic sensor is used as an indication of the return current to exposed metal surfaces on the orbiter. The dielectric sensor provides a measurement of the charge accumulation on dielectric surfaces of the orbiter, the material used for the charge probe dielectric is from the same batch of Flexible Reusable Surface Insulation (FRSI) that was used on the Columbia (OV-102) and covers the payload bay doors and upper wing surfaces (Figure 3). Both of the CCP sensors respond to changes in the orbiter potential with rapid time response. Measurement rates were set at 60 samples per second but peak hold measurements of both current and charge were made which allowed spikes longer than 100 nanoseconds to be captured.

The Charge Probe measures directly the charging of a piece of FRSI. Since this is the same material as covers the payload bay doors and upper wing surfaces, we assume that measurements made on the FRSI in the payload bay are indicative of the behavior of this same material on the orbiter. The FRSI material on the Charge Probe covers an isolated metal plate which is connected to the input of a charge amplifier (Figure 4). When a charge is induced on the surface of the dielectric a similar (but opposite) amount of charge is induced on the metal plate. The charge amplifier converts the charge to a voltage which is the source of the data shown for the CCP measurement of vehicle potential. If the vehicle potential changes and the surrounding plasma provides a current to charge the surface of the dielectric, then the potential measured by the Charge Probe is an accurate measurement of the vehicle potential. If an electric field exists at the surface of the FRSI, then the measured potential is less than the actual vehicle potential.

Two sets of the CCP (designated CCP1 and CCP2) were used with CCP1 mounted adjacent to the FPEG and CCP2 mounted on the opposite corner of the pallet as far away from the FPEG as possible. These probes provide measurements of vehicle potential changes and return currents induced by operation of the FPEG with high time resolution at voltages up to 1000 volts and currents up to 4 mA.

3. Spherical Retarding Potential Analyzer (SRPA) - The Spherical Retarding Potential Analyzer (Figure 5) measures the density and energy of ions and provides an absolute value for the vehicle potential as well as a measurement of the plasma environment in the payload bay. The SRPA has a 19 cm diameter spherical collector surrounded by a 20 cm diameter spherical grid. The biasing voltages applied to these electrodes result in the collection of positive ions by the collector. In the frame of reference of the orbiter the dominant ambient ion O^+ will have a drift energy of approximately 5 eV. This energy is related to the orbiter velocity, which is well known, so any deviation of the O^+ drift energy from the expected value gives a measure of the electrical potential of the orbiter structure relative to the ionosphere. A Langmuir probe is attached to the SRPA. This probe is a small, spherical probe which measures the density and temperature of electrons and provides a cross check on the vehicle potential. The SRPA/Langmuir probe instrument is mounted on a corner of the pallet as far from other surfaces as possible to give the best opportunity to acquire data uncontaminated by wake effects.
4. Digital Control Interface Unit (DCIU) - The Digital Control Interface Unit provided all signal, command and power interfaces between the VCAP instrument and the pallet. Power switching and command decoding were done in the DCIU. Three microprocessors (1802 type) were used in the DCIU. The control microprocessor stored sequences of time-tagged serial commands in both ROM and RAM. These sequences of commands could be initiated in response to a single command sent from a source external to the DCIU and perform a series of operations such as FPEG pulsing, gain changing and resets. A second microprocessor was used to control the offset of the SRPA sweep voltage. The third microprocessor was used to monitor temperatures, voltages and currents and to set out of limit flags passed as bi-level signals to the orbiter GPC for display and alarm signaling.

Placement of the instrumentation on the OSS-1 pallet is shown in Figure 6. The SRPA (and Langmuir probe) is on one corner of the pallet (far left in the figure). The CCP's occupy positions on two opposite corners of the pallet, one on the lower right in the figure and the other partially hidden at the top of the figure. The electron gun (FPEG) is adjacent to the CCP at the lower right and is shown with a circular gun head.

MEASUREMENTS

Passive and active operations were performed during OSS-1. The SRPA and CCP's were operating throughout the mission and data obtained when the electron gun was not being operated determine the characteristics of the orbiter and the payload bay environment in the absence of perturbations from active experiments.

ORIGINAL PAGE IS
OF POOR QUALITY

SRPA data taken in passive mode with the payload bay in the ram direction (the direction of the velocity vector) are shown in Figures 7 and 8. In the daytime (Fig. 7) the SRPA signal is relatively high as compared to the expected ambient measurement and does not show the peak at energies around 5 volts where the peak signal associated with the atomic oxygen ion should be. The Langmuir probe data show that the vehicle potential is offset by about 0.5 volt from the ambient plasma at the location of the SRPA. At night (Fig. 8) the measurements are much lower and in some cases the O^+ peak of atomic oxygen ions can be seen. The shift in the peak of the O^+ ions and the shift in the Langmuir probe sweep indicate that the vehicle potential has been shifted by about 1 volt.

As the orbiter rolls very strong ram/wake effects are observed on plasma in the vicinity of the payload bay. Averages of the SRPA and Langmuir probe data are shown in Figure 9 and show this dramatic variation. The SRPA ion current is shown in two different channels called IPL and IPH for ion probe low and ion probe high. These channels are two different range measurements of the same signal. The Langmuir probe current is shown in the LP data and represents the density of electrons. In the PTC mode the orbiter rolls about the X axis at 0.4 degrees per second. As the payload bay alternates between the ram direction and the wake of the vehicle, the ion and electron currents alternate between high and low values. In the daytime the SRPA IPL channel saturates. When the orbiter is in shadow the most sensitive channel of the SRPA (IPH) shows no measurable signal. The measurements from the Langmuir probe are less sensitive but show similar behavior.

Measurements of the vehicle potential offset indicate that the main engine nozzles provide a reference potential to the ionospheric plasma surrounding the vehicle. Because the orbiter is 97% covered with dielectric materials, the main engine nozzles provide the primary contact between the orbiter metallic structure and the plasma. The velocity of the vehicle relative to the surrounding plasma induces a potential difference between any location on the orbiter and the main engine nozzles. The Langmuir probe measures this potential difference which is shown in Figure 10A for one orbit. The computed potential is shown in Figure 10B assuming that the main engine nozzles provide the reference point for the potential. The variation in the potential is caused primarily by the changing relative attitude of the orbiter with respect to the velocity vector and the direction of the geomagnetic field. Because the orbiter is so large and the nozzles form the voltage reference point, this variable voltage offset (which amounts to about 200 mV per meter of distance between the nozzles and the measurement point) must always be taken into consideration in the operation of any plasma diagnostic instrument which is sensitive to errors on the order of a few volts.

Active experiments were performed by emitting a series of electron beam pulses. Data taken during one such sequence, designed to study vehicle charging and return current mechanisms and labeled Charge Current (CC), is shown in Figure 11. Each pulse group consists of 16 pulses of increasing width. The sequence begins with one microsecond pulses (which show no measurable perturbation.) When the pulse widths are increased to more than a millisecond in duration significant charging of the orbiter occurs with induced potentials of tens of volts. The potentials measured close to the FPEG are higher than those on the far side of the pallet and

may indicate that a sheath developed around the vehicle. The currents at the two locations (CCP1 and CCP2) are also different with the larger current near the electron gun as might be expected since the beam produces locally enhanced ionization levels.

A higher time resolution plot of a portion of the same CC sequence is shown in Figure 12. The currents measured recover to their normal non-emission levels in the short time between pulses, but the charge on the dielectric is retained and decays much more slowly. Time constants for the vehicle potential (or dielectric charging) to return to non-emission levels vary from less than one second up to minutes. An example of the slow decay of the dielectric charge can be seen at 0423:45 GMT in the Charge 2 data.

CONCLUSIONS

The VCAP experiment on STS-3 has shown that active, controlled experiments can be successfully performed from the payload bay of the orbiter. Electron beams have been used to perform a series of experiments to study the electrical interaction of the orbiter with the surrounding environment and the environment provided to the payload. The emi levels during the mission were the lowest experienced during the project and were unmeasurably low on orbit. The thrusters produced disturbances which were variable in character and magnitude. Strong ram/wake effects were seen in the ion densities in the payload bay. Vehicle potentials are variable with respect to the plasma and depend upon location on the vehicle relative to the main engine nozzles, the vehicle attitude and the direction of the geomagnetic field.

Acknowledgements

This work was conducted with support under NASA contract NAS5-24455 at Utah State University and Stanford University and by NASA grant NAGW 235 at Stanford University. Many people have contributed to this project over the last five years and we especially wish to acknowledge the contributions of Mr. A.B. White at Utah State University. Special thanks are extended to Dr. O.K. Garriott at Johnson Space Center for his aid, particularly in organizing the Photo/TV observations. The VCAP experiment could not have been done without the careful attention and extensive participation of the flight crew, Cols. Jack Lousma and Gordon Fullerton.

ORIGINAL PAGE IS
OF POOR QUALITY

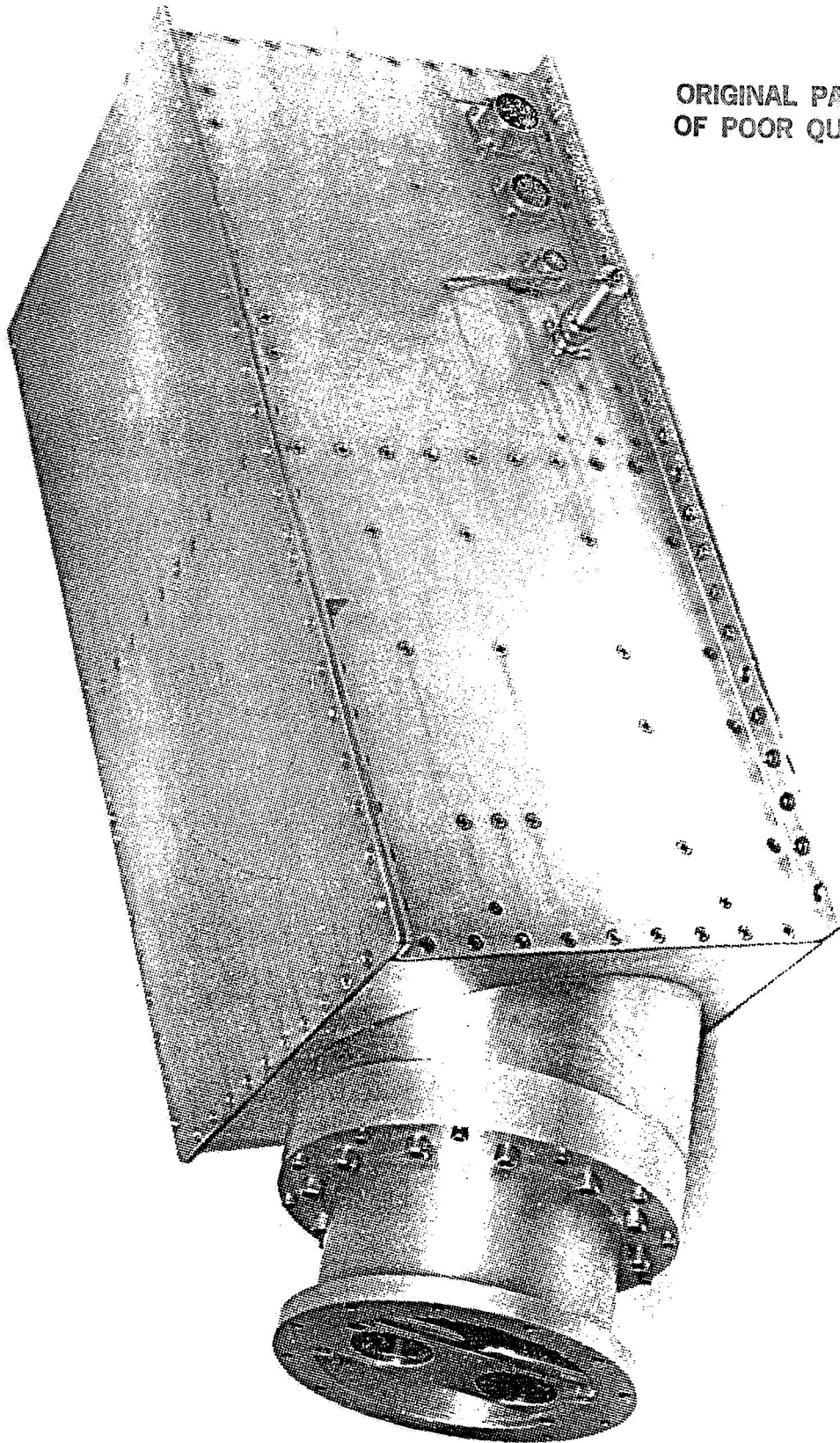

Figure 1. Photograph of the fast pulse electron generator. The two ports through which the electron beams are emitted can be seen at the left of the unit. The mated connector at the right of the unit is an arming plug which is removed during integration to avoid accidental heating of the filaments.

ORIGINAL PAGE IS
OF POOR QUALITY

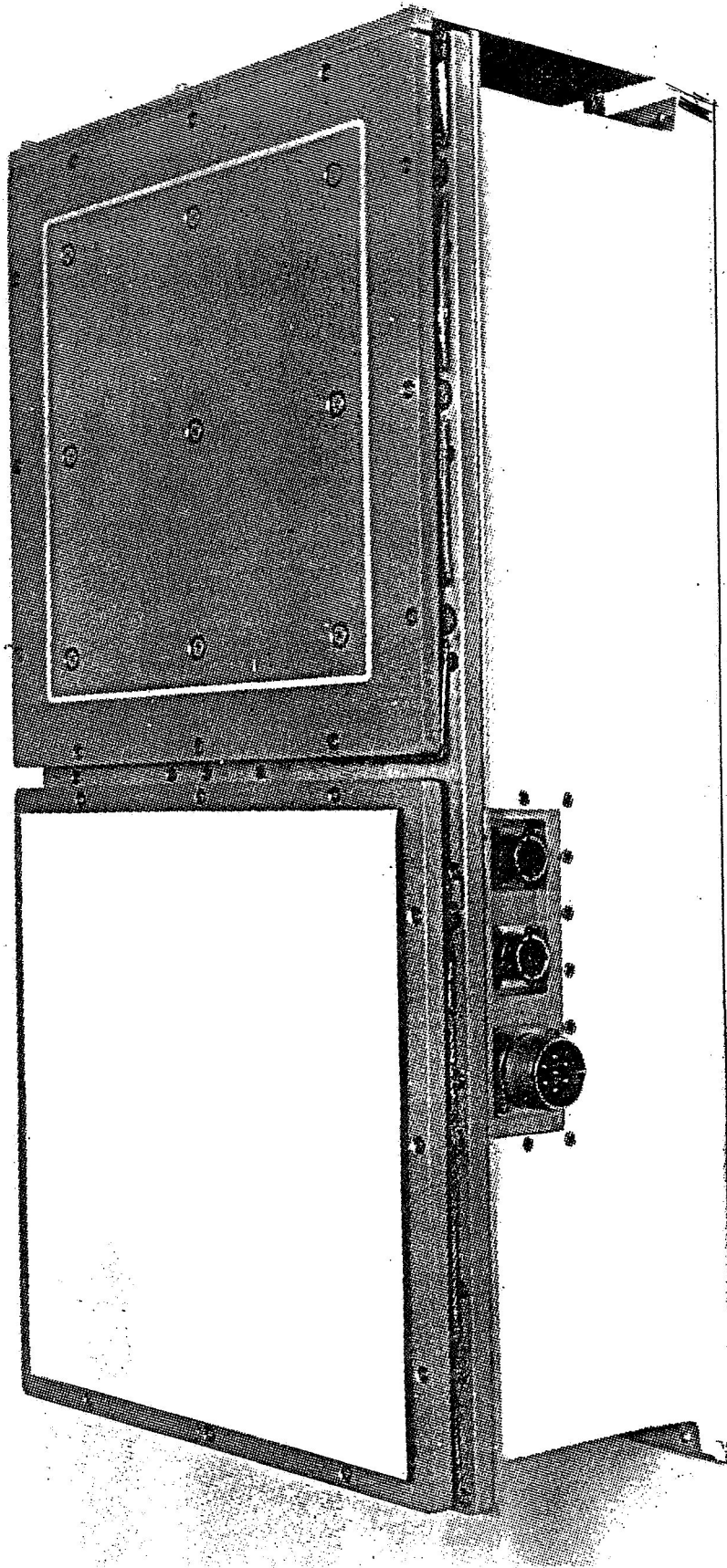
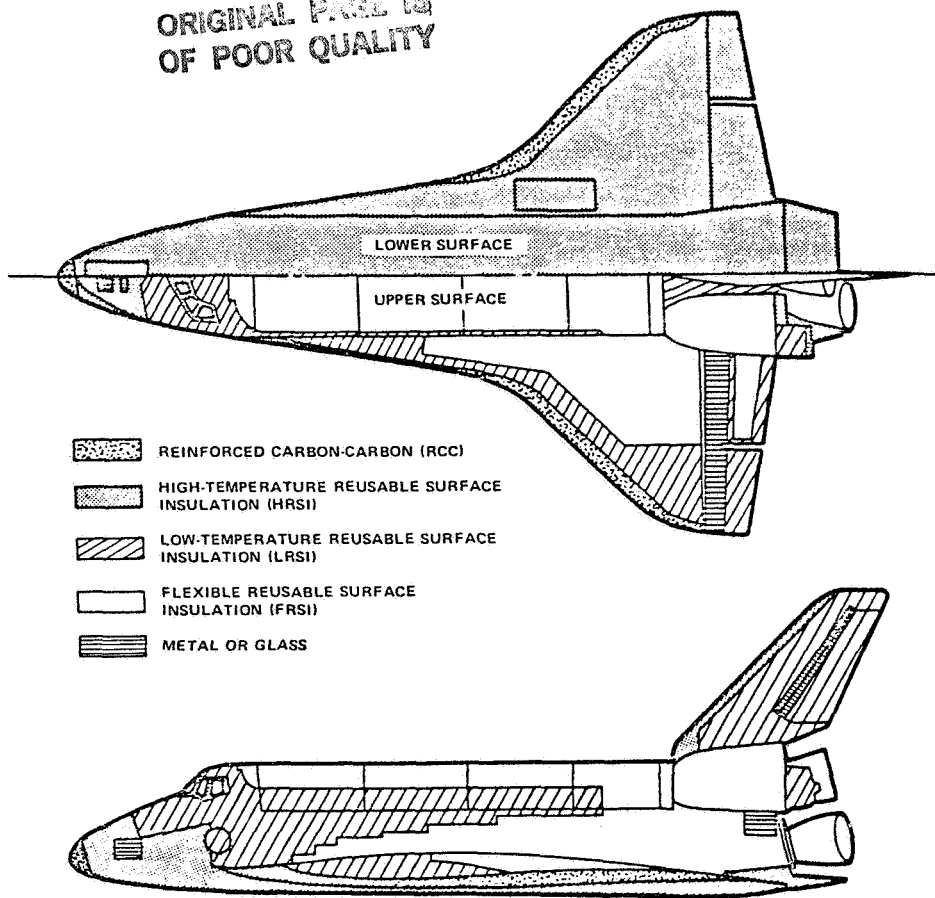

Figure 2. Photograph of one of the charge and current probes. The light colored surface to the left is the FRSI charge collecting surface, while the darker surface to the right is a gold-plated current collector.

ORIGINAL PAGE IS
OF POOR QUALITY



Insulation	Temperature limits	Area, m ² (ft ²)	Weight, kg (lb)
Flexible reusable surface insulation	Below 644 K (371° C or 700° F)	319 (3 436)	499 (1 099)
Low-temperature reusable surface insulation	644 to 922 K (371° to 649° C or 700° to 1200° F)	268 (2 881)	917 (2 022)
High-temperature reusable surface insulation	922 to 978 K (649° to 704° C or 1200° to 1300° F)	477 (5 134)	3826 (8 434)
Reinforced carbon-carbon	Above 1533 K (1260° C or 2300° F)	38 (409)	1371 (3 023)
Miscellaneous			632 (1 394)
Total		1102 (11 860)	7245 (15 972)

Figure 3. Thermal Protection System (TPS) on the orbiter which is about 97% covered with dielectric materials.

ORIGINAL PAGE IS
OF POOR QUALITY

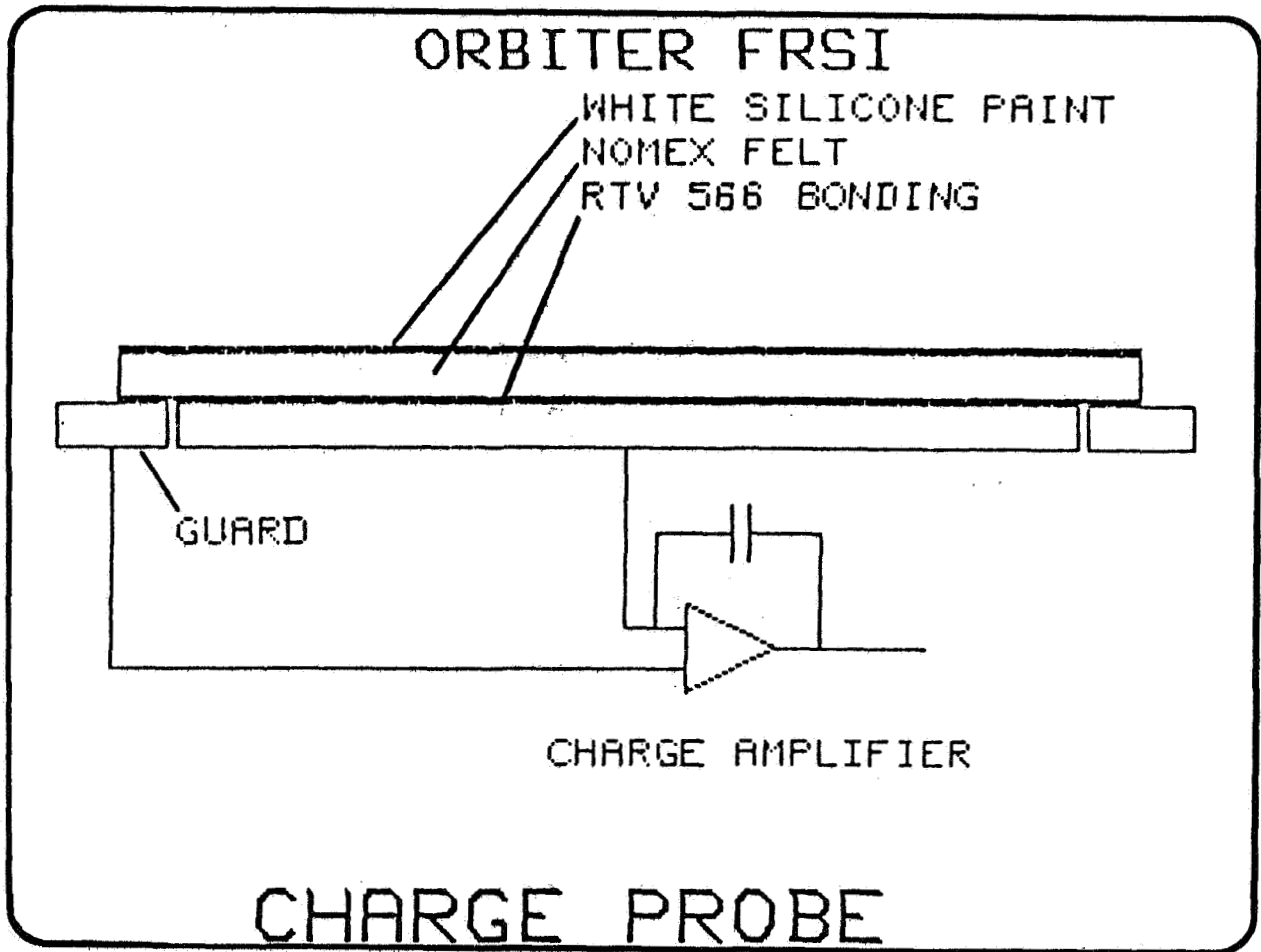

Figure 4. Charge Probe sensor plate construction and the input charge amplifier.

ORIGINAL PAGE IS
OF POOR QUALITY

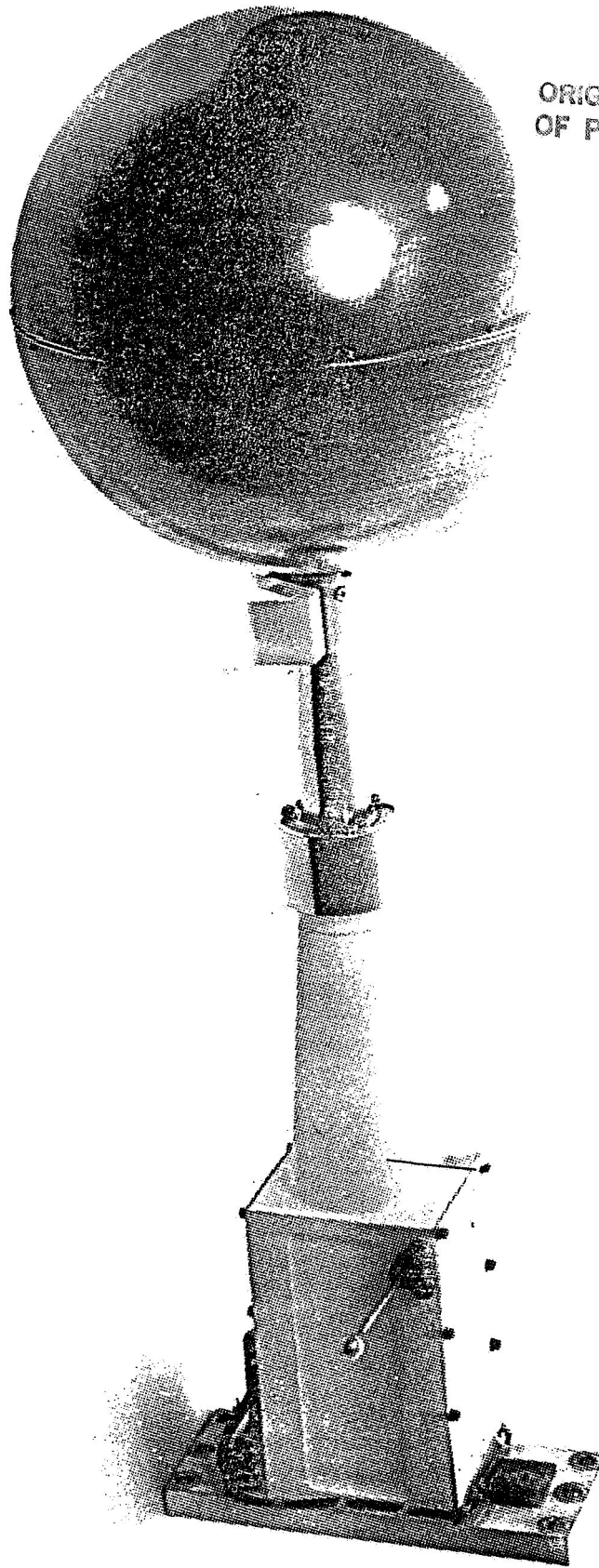

Figure 5. Photograph of the spherical retarding potential analyzer and Langmuir probe assembly. The rectangular box to the right houses preamplifier for the probe signals and is coated with a conducting paint to meet both thermal control and electrical requirements.

ORIGINAL PAGE IS
OF POOR QUALITY

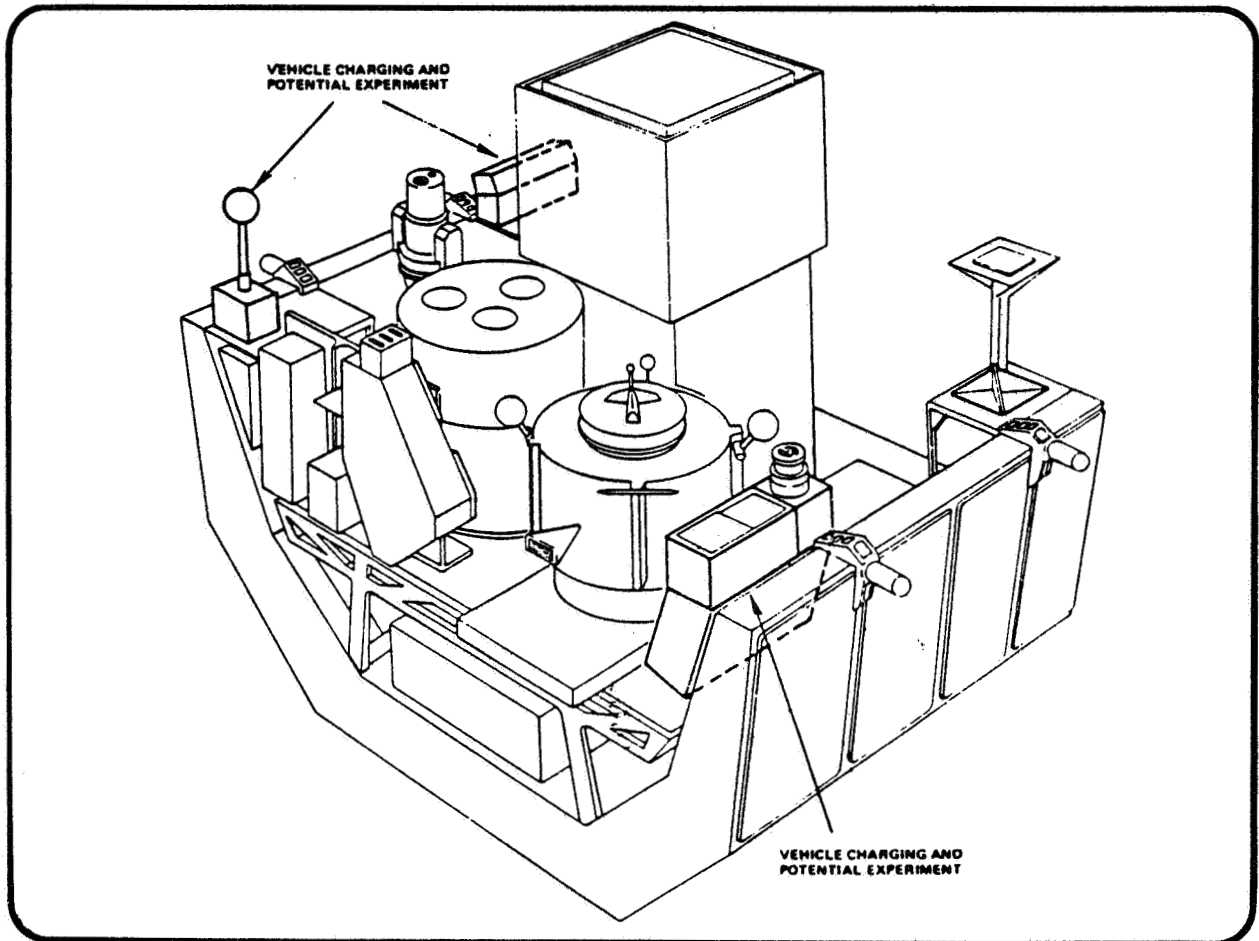
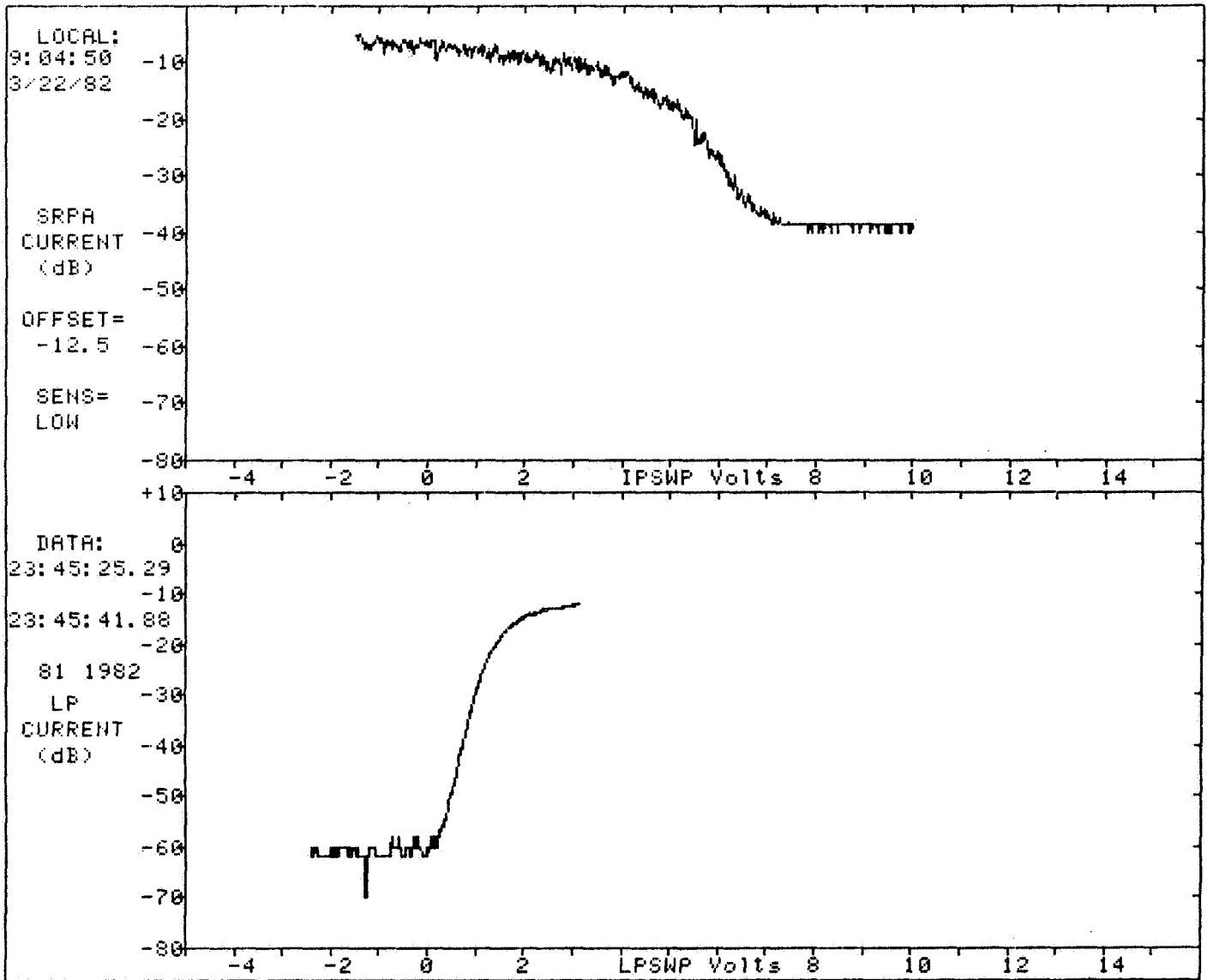

Figure 6. Location of the VCAP instrumentation on the OSS-1 pallet. The lower left in the figure was the forward side in the payload bay.

ORIGINAL PAGE IS
OF POOR QUALITY

VEHICLE CHARGING AND POTENTIAL OSS-1/STS-3



DAY

Figure 7. Ion probe current (SRPA) and electron probe current (Langmuir probe) when the payload bay is in the ram direction in sunlight.

VEHICLE CHARGING AND POTENTIAL OSS-1/STS-3

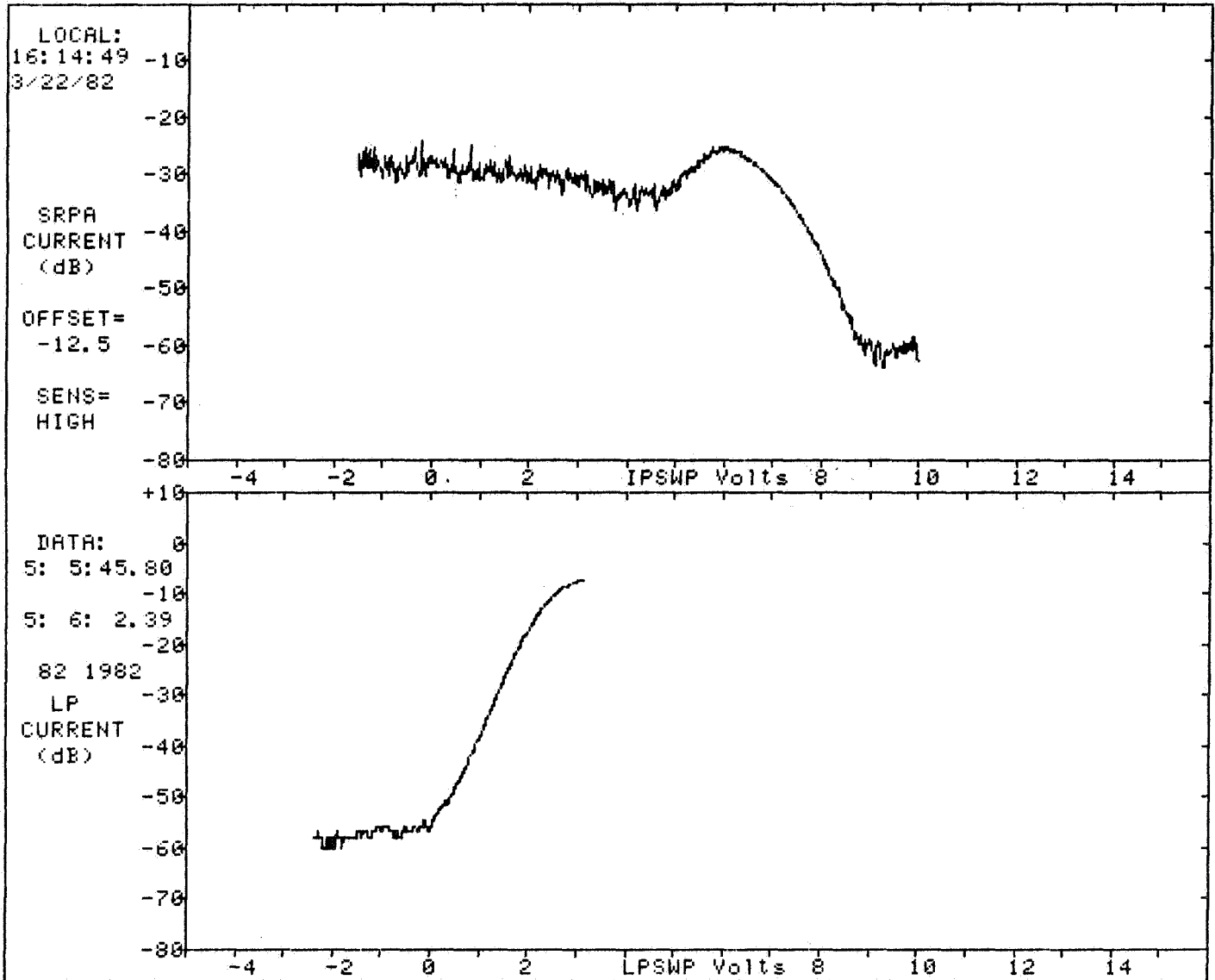

NIGHT

Figure 8. Ion probe current (SRPA) and electron probe current (Langmuir probe) when the payload bay is in the ram direction and shadowed.

ORIGINAL PAGE IS
OF POOR QUALITY

VEHICLE CHARGING AND POTENTIAL OSS-1/ STS-3

LANGMUIR PROBE & SPHERICAL RETARDING POTENTIAL ANALYZER
34 SECOND AVERAGES

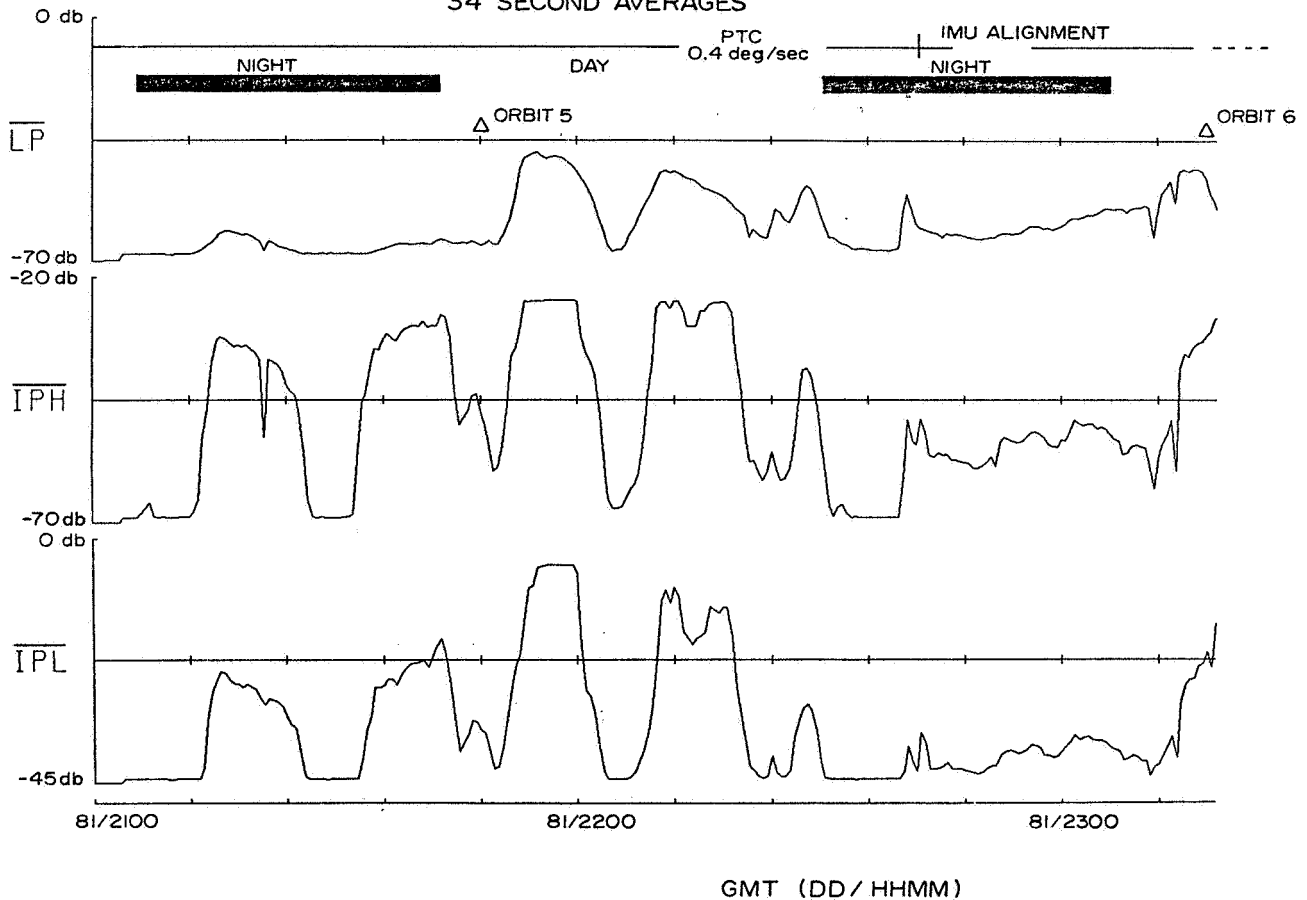

Figure 9. Langmuir probe current (LP), ion probe high range (IPH) and low range (IPL) current averaged over 34 seconds. The variations from near zero to maximum scale occur as the vehicle rolls with respect to the velocity vector and the payload bay alternately faces the ram and wake directions.

START GMT=82 /7 /29/19

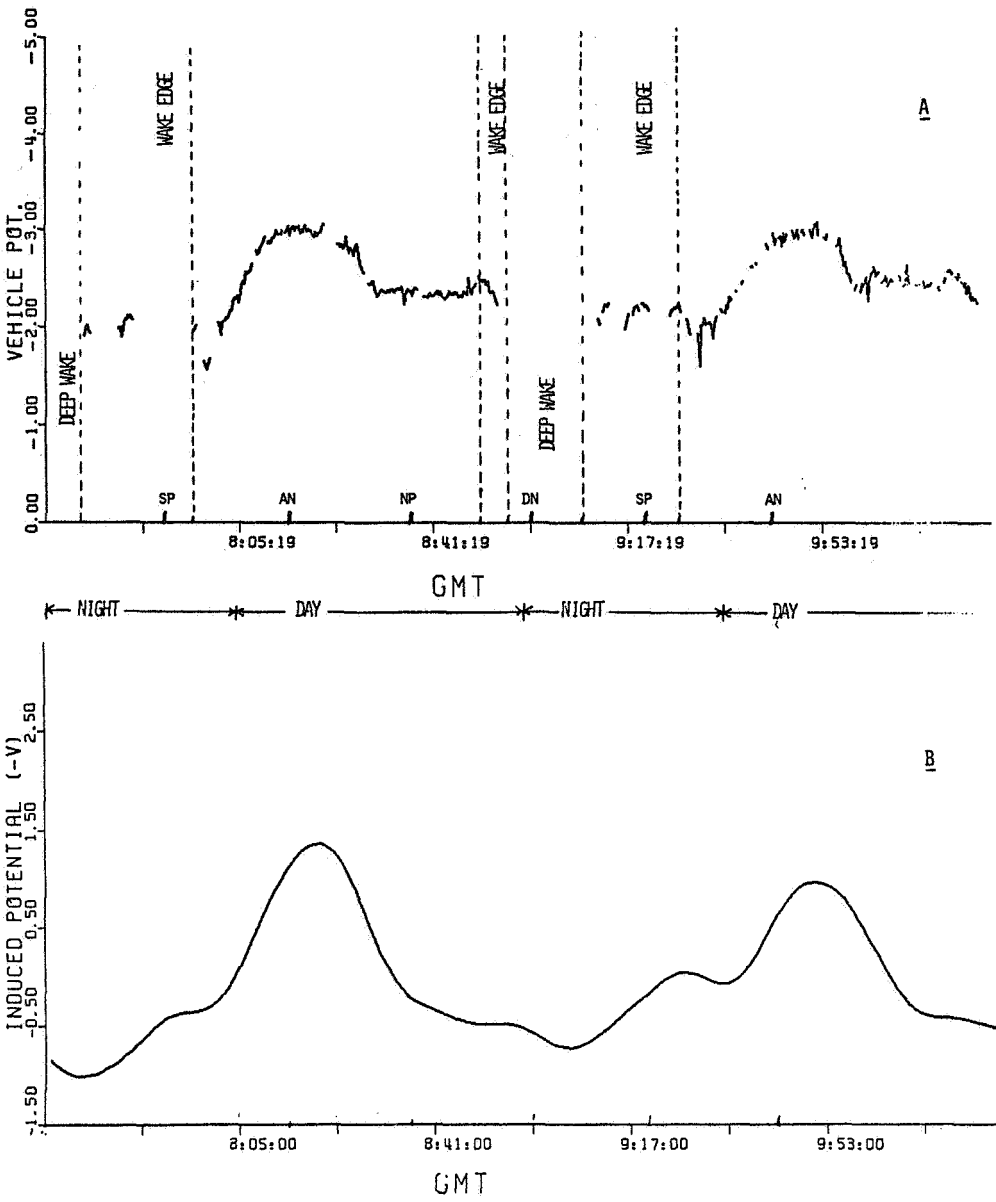
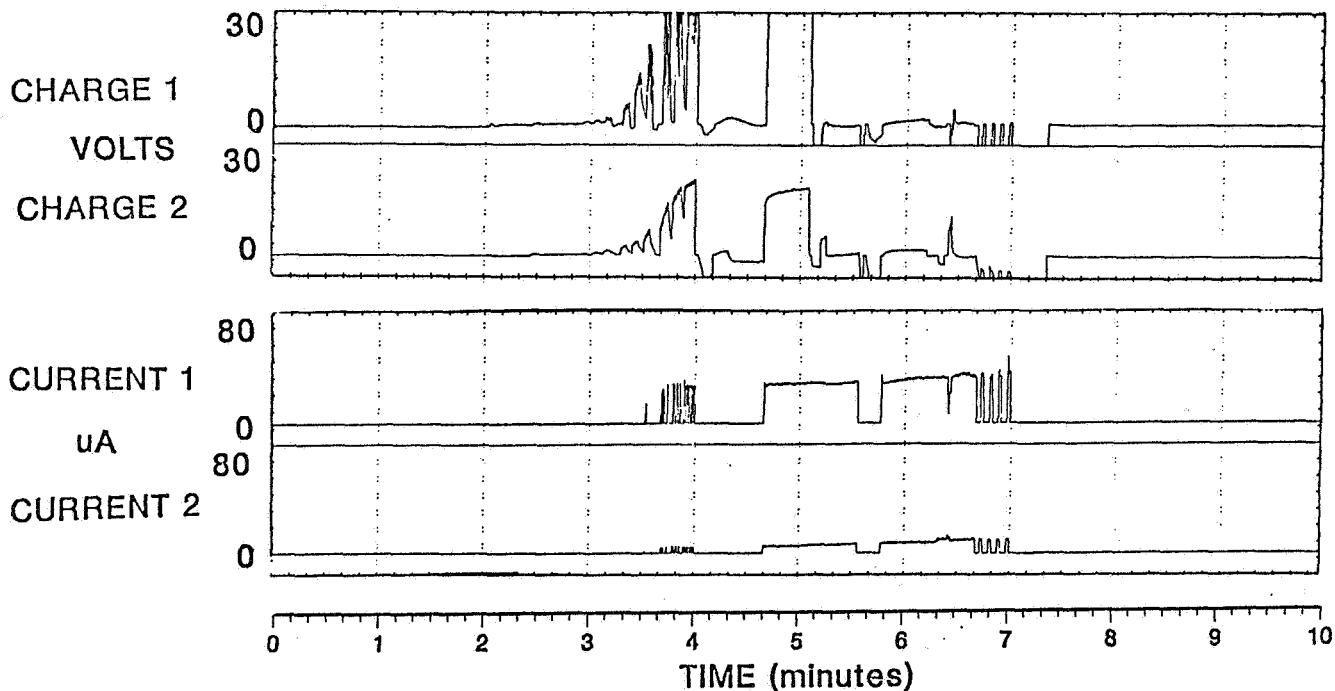

Figure 10. Vehicle potential at the location of the SRPA. The measured values are shown in Fig. 10A as determined by the offset potential of the Langmuir probe. The computed value of the potential is given in Fig. 10B assuming that the reference point is the main engine nozzles.

Vehicle Charging And Potential

VCAP SU/USU
OSS-1 STS-3 Launch March 22, 1982



START TIME 84/ 0420:00 -- CC SEQUENCE - NIGHT

Figure 11. Charge and current probe measurements of dielectric charging and return currents during a series of electron gun pulses emitted during the Charge Current (CC) sequence. CCP1 (Charge 1 and Current 1) data were measured adjacent to the FPEG and CCP2 (Charge 2 and Current 2) data were taken on the far corner of the pallet.

ORIGINAL PAGE IS
OF POOR QUALITY

Vehicle Charging And Potential

VCAP SU/USU
OSS-1 STS-3 Launch March 22, 1982

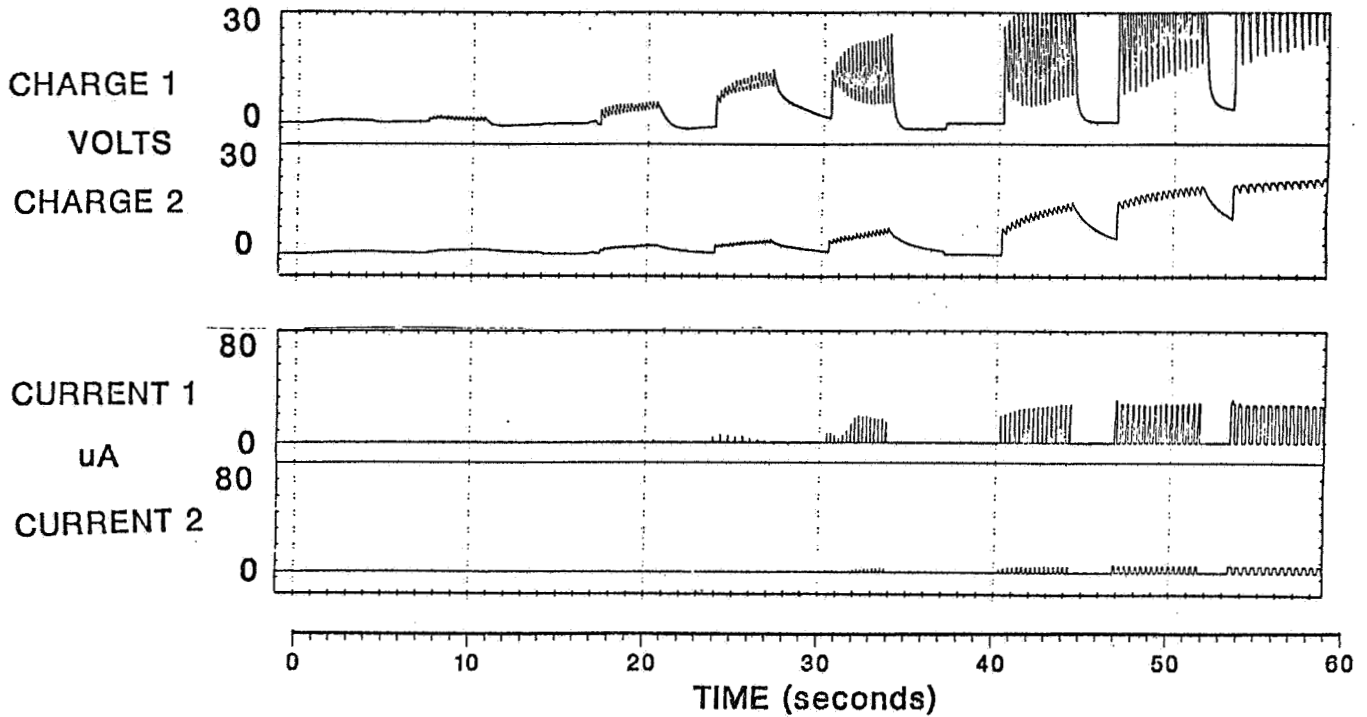

START TIME 84/ 0423:00 -- CC SEQUENCE - NIGHT

Figure 12. High time resolution for one minute of data shown in Fig. 11.

N83 22307 D18

STS-3/OSS-1 PLASMA DIAGNOSTICS PACKAGE (PDF)
MEASUREMENTS OF THE TEMPERATURE
PRESSURE, AND PLASMA

S. D. Shawhan and G. Murphy
University of Iowa

Preceding page blank

ORIGINAL PAGE IS
OF POOR QUALITY

STS-3/OSS-1

PLASMA DIAGNOSTICS PACKAGE (PDP)
90-DAY SUMMARY SCIENCE REPORT

by

Stanley D. Shawhan
PDP Principal Investigator

and

Gerald B. Murphy
PDP Data Processing Manager

Contributors:

Roger D. Anderson
Roger R. Anderson
Terry Averkamp
Bob Brechwald
Henry Brinton/NASA-HQ
Tim Clark
Terry Clausen
Ann Dresselhaus
Don Enemark

Dwight Fortna/GSFC
Lou Frank
Joe Grebowsky/GSFC
Don Gurnett
Marty Kerl
Rich Kroeger
Maja Lorkovic
Kerry Neal

Harry Owens
Merritt Pharo/GSFC
Dave Reasoner/MSFC
Joel Score
Nobie Stone/MSFC
Harry Taylor/GSFC
Lisa Vodra
Ev Williams

Contract NAS8-32807

Marshall Space Flight Center, Huntsville, Alabama 35812

July 1982

Department of Physics and Astronomy
The University of Iowa
Iowa City, Iowa 52242
319/353-3294

Preceding page blank

1.0 INTRODUCTION

This 90-day summary science report for the STS-3/OSS-1 PDP is submitted as required by the "OSS-1/Plasma Diagnostics Package Data Management Plan" dated January 1982 (Report OSS-1/PDP 82-01, University of Iowa) in accordance with the letter from A. Martin Eiband, dated 22 December 1982, Code 420, GSFC File 03496 "OSS-1, Phase III, Data Analysis." Mission operations and data analysis is supported through Marshall Space Flight Center Contract NAS8-32807 for the OSS-1 and Spacelab-2 PDP effort.

Data utilized for this report has included hard copy data from the POCC, PDP data received directly at the North Liberty (Iowa) Radio Observatory, processed flight data tapes (57 hours), and PDP data from the OSS-1/IUE data tapes (116 hours). In addition, ancillary data on the RMS coordinates in hard copy form has been utilized. Ancillary data not yet available include the best-estimate-trajectory and attitude, the operations status of key orbiter subsystems such as thrusters and flash evaporators, and the catalog of VCAP/FPEG operations. Of the PDP flight data, 28 hours have been displayed in ten minute summary plot format on 35mm color slides. All of the IUE data (16 selectable parameters) has been plotted against time at 30 minutes per plot.

For the STS-3/OSS-1 mission, the PDP was to carry out the following technical and scientific objectives:

1.1 Flight Test of Systems and Procedures

Flight test the systems and procedures and associated with the Spacelab-2 PDP experiment with particular emphasis on the RMS operations, on unlatching and relatching the PDP unit, and on evaluating the RF telemetry link.

1.2 Orbiter EMI and Plasma Contamination

Measure and locate the sources of fields, Electromagnetic Interference (EMI) and plasma contamination in the environment of the Orbiter out to 15 meters.

1.3 Orbiter Wakes and Shocks

Study the orbiter-magnetoplasma interactions within 15 meters of the orbiter through measurement of electric and magnetic fields, ionized particle wakes and generated waves.

1.4 Electron Gun Beam Diagnostics and Plasma Effects

Ascertain the characteristics of the electron beam emitted from the orbiter out to a range of 15 meters; measure the results of beam-plasma interactions in terms of fields, waves and particle distribution functions.

The technical objective 1.1 was discussed in the "STS-3/OSS-1 Plasma Diagnostics Package (PDP) 30-Day Engineering Report", dated 30 April 1982. Progress-to-date on the thermal and pressure environment of the PDP and on the science objectives 1.2, 1.3 and 1.4 is presented in this report in Sections 2.0 through 6.0 and is summarized in Section 7.0. In Section 8.0, the plan for continued data analysis is briefly described.

2.0 THERMAL AND PRESSURE HISTORY

ORIGINAL PAGE IS
OF POOR QUALITY

With the availability of the complete PDP flight tape recorded data and the OSS-1/IUE PDP data parameters, it has been possible to extract the PDP thermal and pressure history.

2.1 PDP Thermal History

The PDP was designed to withstand the thermal extremes of the STS-3 mission through the use of heaters and of thermal blankets. The PDP sat on the Release/Engagement Mechanism (REM) on the OSS-1 pallet without a coldplate and was attached to the RMS for two extended periods.

Figure 2.1 gives a plot of temperature vs. mission elapsed time MET for two temperative sensors. The solid curve labeled "PDP" is a thermistor internal to the PDP on the instrument deck. This point is seen to reach a minimum of -25°C after the extensive tail-to sun cold period near MET 1/0900. At this point, the PDP deck heater was activated and holding the -25°C setpoint. This same sensor showed a maximum of 52°C near MET 6/1000 at the end of the extensive hot top-to-sun period; model calculations predicted 50°C . Note that during the PDP deployment periods early on MET Day 3 and Day 4, the PDP warmed up slowly to -5°C .

The dotted curve in Figure 2.1 labeled "EGF" is a thermistor on the electrical grapple fixture connector which is external to the PDP. This point has a very much shorter thermal time constant. Variations are more rapid with a minimum of -35°C at MET 1/0600 and a maximum of 56°C near MET 6/0400. Still this point remains between the heater trip point of -32°C and a desired upper limit of 60°C . Consequently, the PDP thermal design is considered suitable for Spacelab-2. Similar designs should work for other spacelab pallet-mounted instruments without coldplates.

2.2 Pressure Profile

Pressure in the range of 10^{-3} to 10^{-7} torr, measured 3 inches from the skin of the PDP, is plotted in Figure 2.2 against GMT during the mission (0/0000 MET = 81/1600 GMT). Just after pallet activation, the pressure decreased to $\sim 10^{-6}$ torr and then slowly decreased over the day to as low as 10^{-7} torr which is near ambient level for 240 km altitude.

The most distinctive feature of the pressure profile is the modulation at the orbit period. This variation of between 10^{-5} torr and 10^{-7} torr has a 90 minute orbit period even though the Orbiter is

rolling at two-times the orbit rate (2 rolls/orbit). From interpretation of the attitude information, it is found that the pressure peaks when the atmospheric gas is rammed into the payload bay; the curve in Figure 2.2 can be fit with a log-sine function. This modulation is seen also when the PDP is on the RMS during the FPEG operations periods. Note that on GMT Day 81 near 2200, there is a 6x orbit rate modulation when the Orbiter was rolling at 6x orbit rate during PTC.

Ancillary data giving the status of Orbiter systems that might affect the pressure are not completely available. However, the primary thruster L2U burn at GMT 85/1430, increases the pressure to 3×10^{-4} torr. During the three minutes of closed payload bay doors, the pressure increased to 3×10^{-5} torr. Little data were taken during the top-to-sun attitude but pressure values as high as 2×10^{-5} were recorded--presumably due to increased outgassing of the Orbiter bay.

Instruments sensitive to pressure variations or to pressure levels above 10^{-4} torr--in the corona region if high voltages are involved--may need a pressure sensor to provide protection.

ORIGINAL PAGE IS
OF POOR QUALITY

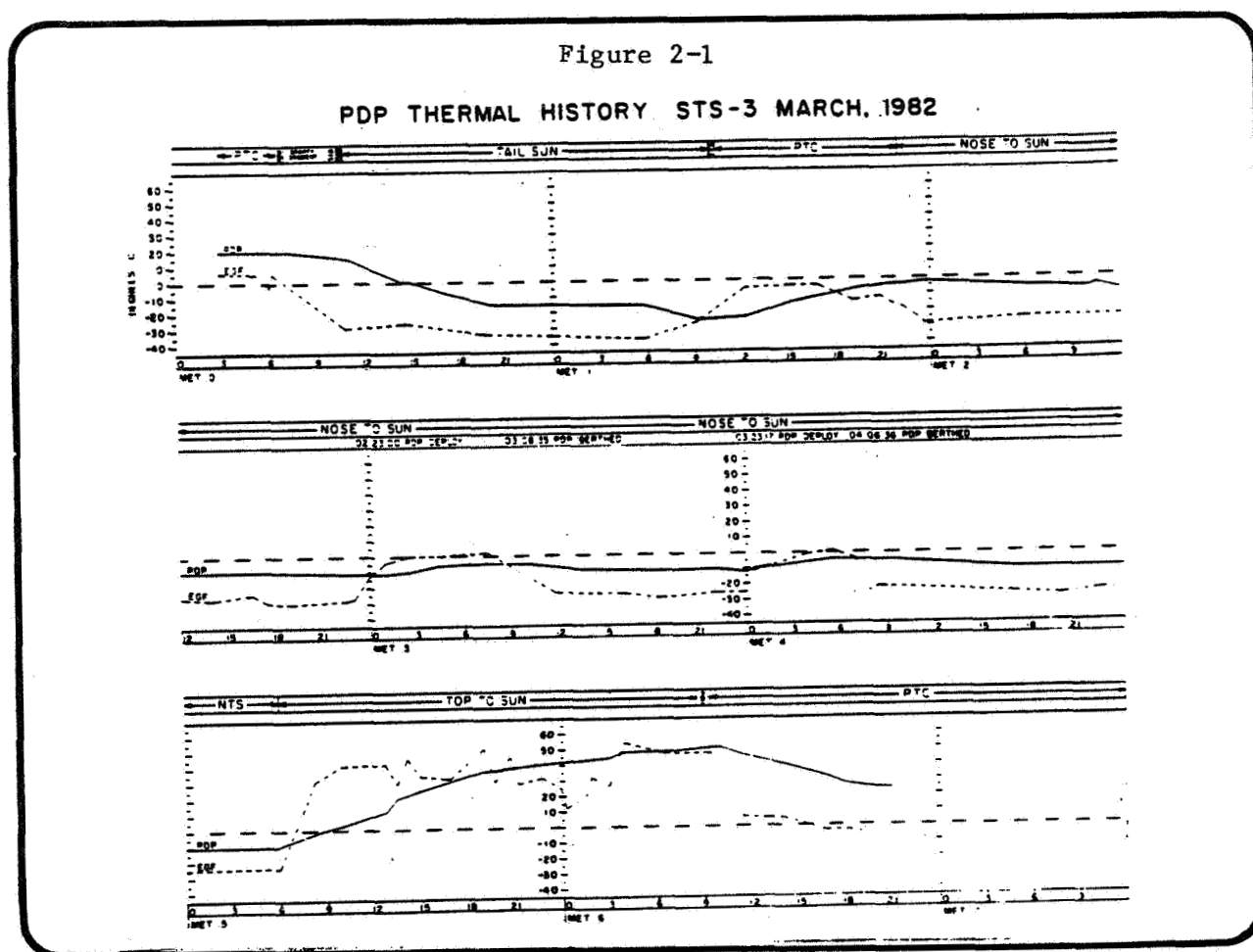
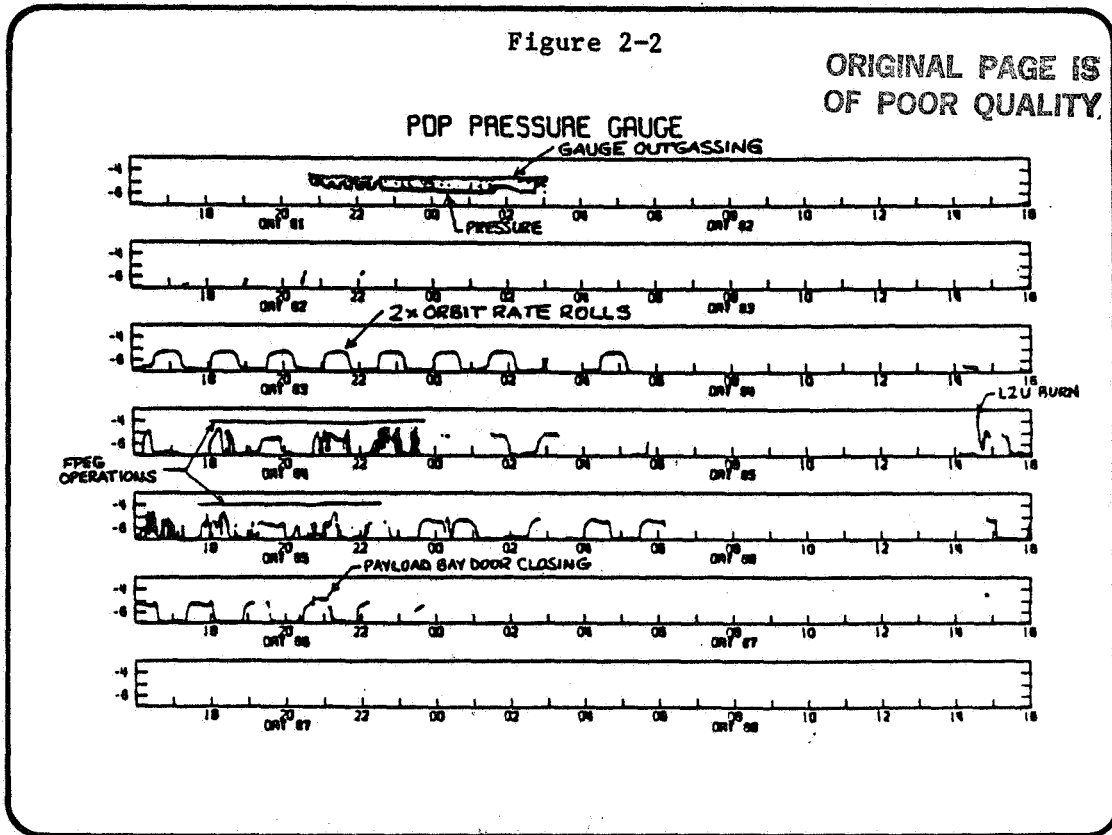

Figure 2-2

ORIGINAL PAGE IS
OF POOR QUALITY.



3.0 ORBITER RADIATED ELECTROMAGNETIC FIELDS

An extensive set of wave field receivers covering the frequency range of 30 Hz to 800 MHz and S-Band (2200 MHz) was included on the PDP. These receivers provided a capability to characterize the Orbiter's unintentional radiated spectrum and its time variability and intentional communication transmitter's field strength.

3.1 Pallet EMI Levels and Time Variations

One of the prime PDP measurements was to determine the electric and magnetic noise spectrum and time variability due to the Orbiter systems. It was found that the magnetic field was composed of discrete frequencies and harmonics. These emissions are probably due to power converters and clocklines. The characteristic amplitude of 60 dBpT \pm 20dB did not vary significantly over the mission.

Measurements of the electric field emissions showed a broadband spectrum which varied by at least 60 dB over time. An example of the time variability is shown in Figure 3.1 for the 16 VLF channels. Note that changes occur on the time scale of seconds--probably due to thruster firings. Also there is a large variation on the time scale of tens of minutes which is found to be correlated with the Orbiter orbit period. The intensity is usually maximum when the Orbiter is in a ram attitude--bay in the velocity vector direction. This modulation is similar to that of the pressure gauge.

ORIGINAL PAGE IS
OF POOR QUALITY

The range of observed electric field levels is plotted in Figure 3.2. Orbiter-associated noise was as low as the receiver noise levels. At frequencies above 300 kHz, the receivers were not sensitive enough to detect the noise at all. When the FPEG was operated, the fields exceeded the Orbiter-induced noise at all frequencies.

In general, it is found that the Orbiter unidirectional emissions are at the spec level or below and that the electric field noise is not due to Orbiter subsystems, but rather to the Orbiter's interaction with the plasma in the ionosphere. Work is continuing on this investigation.

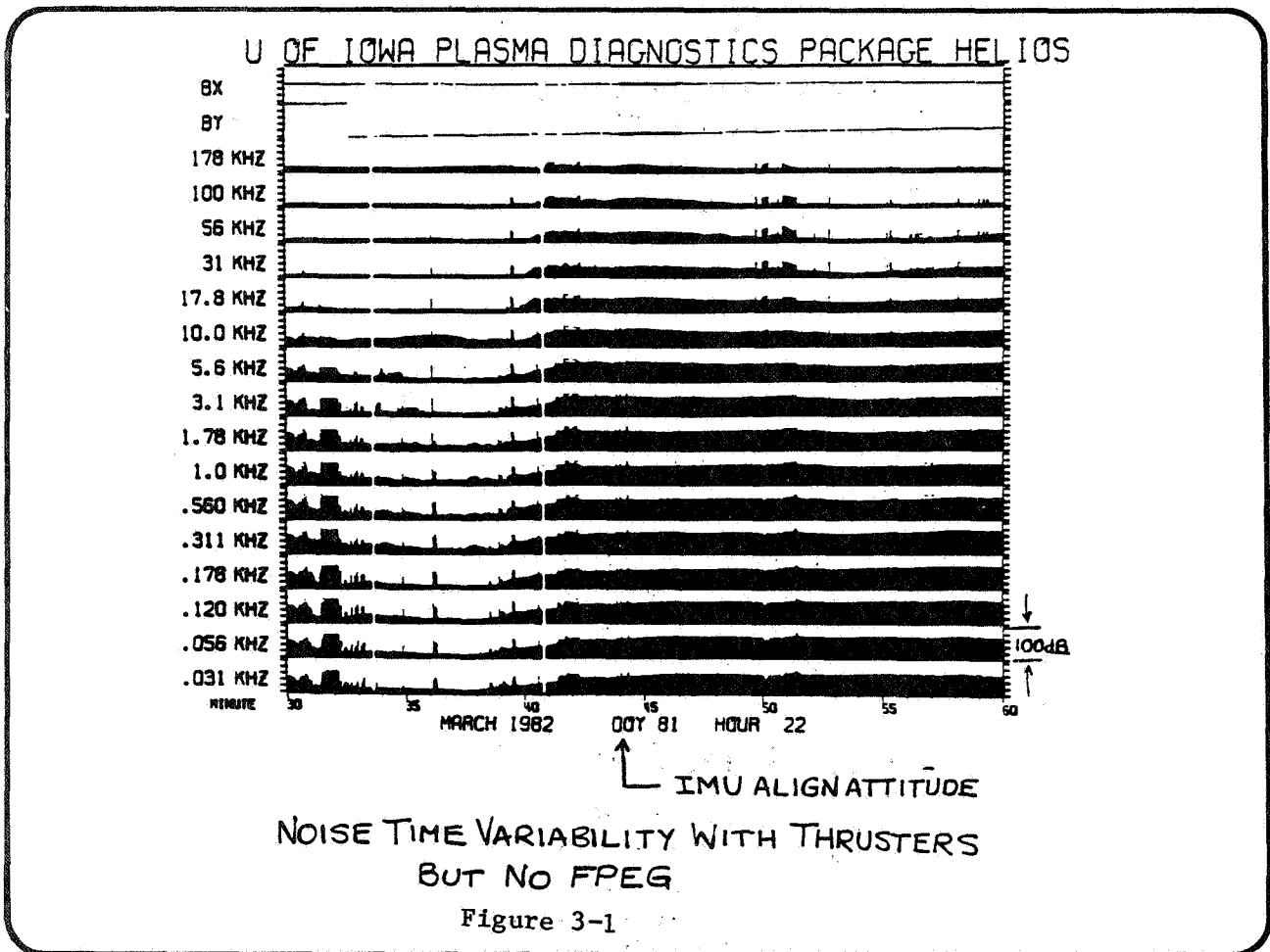

3.2 UHF and S-Band Transmitter Field Strengths

One filter channel of the PDP High Frequency Receiver covered the band of 165-400 MHz which includes the 295 MHz frequency of the UHF voice downlink transmitter. When this transmitter was keyed on and connected to the upper antenna, a signal was detected by the PDP. These measured field strengths were always below 0.5 V/m with the PDP on the RMS and below 0.1 V/m at the PDP pallet location. Average and peak field strengths are given in the following table:

<u>Location/Field Strengths ± 2dB</u>	<u>Average</u>	<u>Peak</u>
PDP on Pallet at 13 meters from Antenna	.05 V/m	0.08 V/m
PDP on RMS at 8 meters from Antenna	.23	.44

These levels are well below the suggested radiated susceptibility field strengths.

At S-Band, the 150 watt data downlink transmitter (2287.5 MHz) can produce fields which are modeled to be 49.6 V/m/R (meters) in the beam of the selected "quad" antenna. Even at many meters, these fields could be at damage level for payload instruments or for satellites being manipulated by the RMS. The PDP carried a receiver especially designed to measure the field strengths in and around the payload bay. These measured levels were about 5 dB ± 2 dB higher than the modeled values but comparable to a crude theoretically calculated value as follows:

Field Strength Relation
(V/m)

Modeled @ 150 Watts	49.6 /R (meters)
Measured with PDP (± 2dB)	90.3 /R (meters)
Calculated @ 150 Watts	94.9 /R (meters)

The calculated value assumes that all of the power is emitted into a hemisphere with 100% efficiency.

In the antenna beam, the fields exceed 20 V/m inside of 5 meters. However, with the PDP on the pallet at a range of 13 meters off the edge of the beam, the fields were not observed at the threshold of 2 V/m whereas the in-beam prediction would be 7V/m. Consequently, payload bay instrumentation is not subjected to damage levels.

ORIGINAL PAGE IS
OF POOR QUALITY

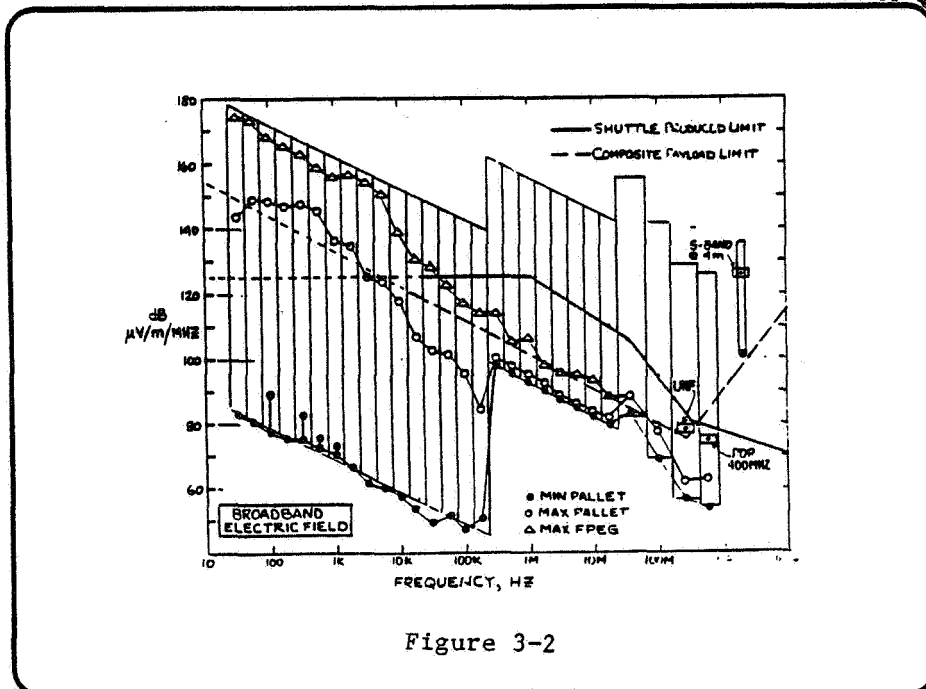

Figure 3-2

4.0 ORBITER ION PLASMA ENVIRONMENT
(Henry C. Brinton, Joseph M. Grebowsky, Merritt W. Pharo III,
Harry A. Taylor, Jr./GSFC)

The Bennett RF Ion Mass Spectrometer on the STS-3/OSS-1 Plasma Diagnostics Package (PDP) performed nominally throughout the mission. Measurements of ion spectra were obtained both in the cargo bay and during experiment periods in which the PDP was operated on the extended Remote Manipulator System (RMS) arm. Real time data obtained from several orbit passes over the North Liberty (Iowa) Radio Observatory ground station and playback data obtained while the PDP was operated on the extended RMS arm have been examined. Ion currents observed covered the entire dynamic range (2×10^5) of the ion mass spectrometer system demonstrated response to the extremes of ambient and perturbed plasma conditions. Data tapes provided were of sufficient quality to enable use of the GSFC developed software on the DEC 11/70 computer for initial data reduction activities.

Initial data processing was concerned with positively identifying the atomic mass numbers of the detected ion species. As anticipated, the effects of electrical charge buildup and/or the plasma ram velocity altered the calibrated direct relationship between the atomic mass number of an ion and the applied spectrometer voltage required for its detection. The net of such effects upon the spectrometer range from -3 to -8 volts on the various data samples studied. A detailed examination of a number of individual mass scans was therefore undertaken which considered apparent potential shifts in the fundamental current peaks due to spacecraft charging as well as the shifts in the locations of the harmonic derivatives of the fundamental peaks. This analysis provided a scheme for identifying the atomic mass number of the detectable ions. A more complete analysis will be made once the orbit-attitude data are available.

Since detailed event timeline and aspect information for determining the orientation of the spectrometer orifice with respect to the plasma flow, are not yet available, it was not possible to determine the exact magnitude of the ion concentrations sampled, nor to interpret the source of strong fluctuations. However, the collected ion currents provide the basis for a rough estimate of the relative abundance of each ions species, and of course, the variations of the ion currents with time reflect similar variations in the concentrations. Hence the preliminary evaluation of the data considered the ion currents only while one of the immediate future goals will be to convert these currents to concentrations.

Some examples of the ion currents collected during the flight of STS-3/OSS-1 are shown in Figures. Three distinctive phases of the PDP operations are depicted. Figure 4.1 corresponds to early measurements when the PDP was still in the shuttle bay while Figures 4.2 and 4.3 show measurements made on the extended RMS arm. In the event shown in Figure 4.3, the electron beam created abrupt disturbance of all the ion currents. As these figures show, the most dominant ion species observed correspond to atomic mass numbers of 16, 18, 30, and 32. The existence

ORIGINAL PAGE IS
OF POOR QUALITY

of mass numbers 16, 30 and 32 were expected since the shuttle is operating at F-region altitudes where there are substantial ambient plasma O^+ (16 amu), and NO^+ (30 amu) and O_2^+ (32 amu) plasma densities. The existence of mass 18, assumed to correspond to H_2O^+ ions, demonstrates that the shuttle not only dynamically perturbs the ambient plasma as it moves through it, but apparently has its own inherent atmosphere environment to interact with the ambient medium.

Further analysis of the ion spectrometer measurements will proceed, given operations and aspect data. From a merging of the orbit and attitude data with the ion measurements, it is expected that geophysical variations in the ion concentrations may be separated from shuttle induced perturbations - for example - the noticeable decreases in current seen in Figures 1 and 2 may be of either source. A further study will be made of the identification of ambient and contaminant ions and of composition changes due to electron gun and thruster firings.

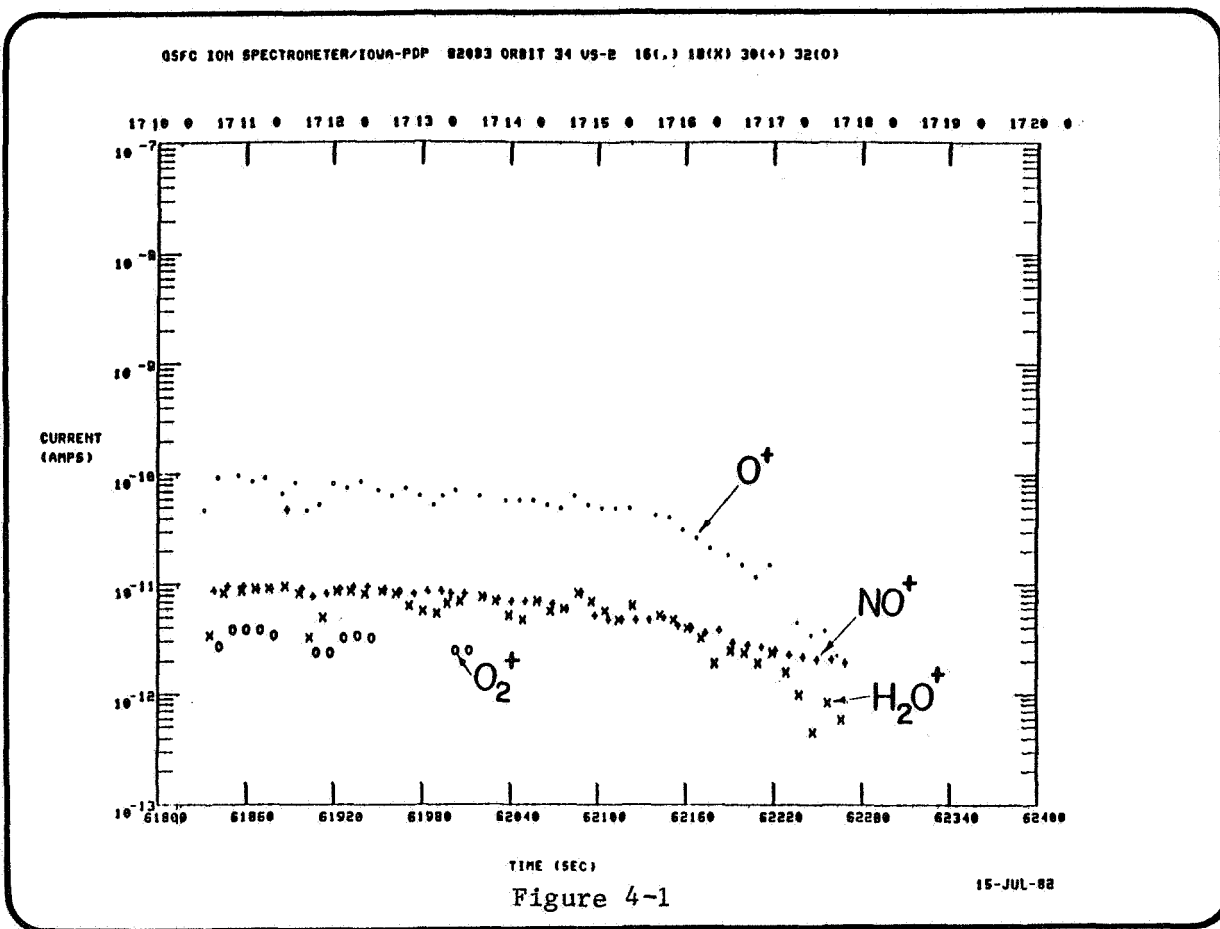

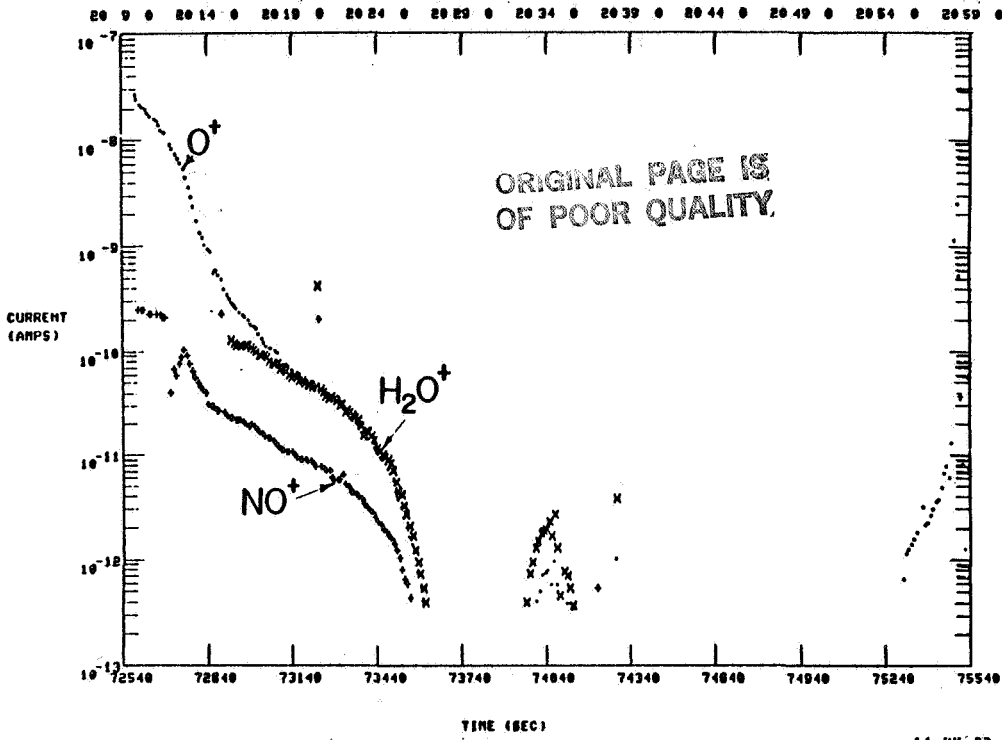

Figure 4-2

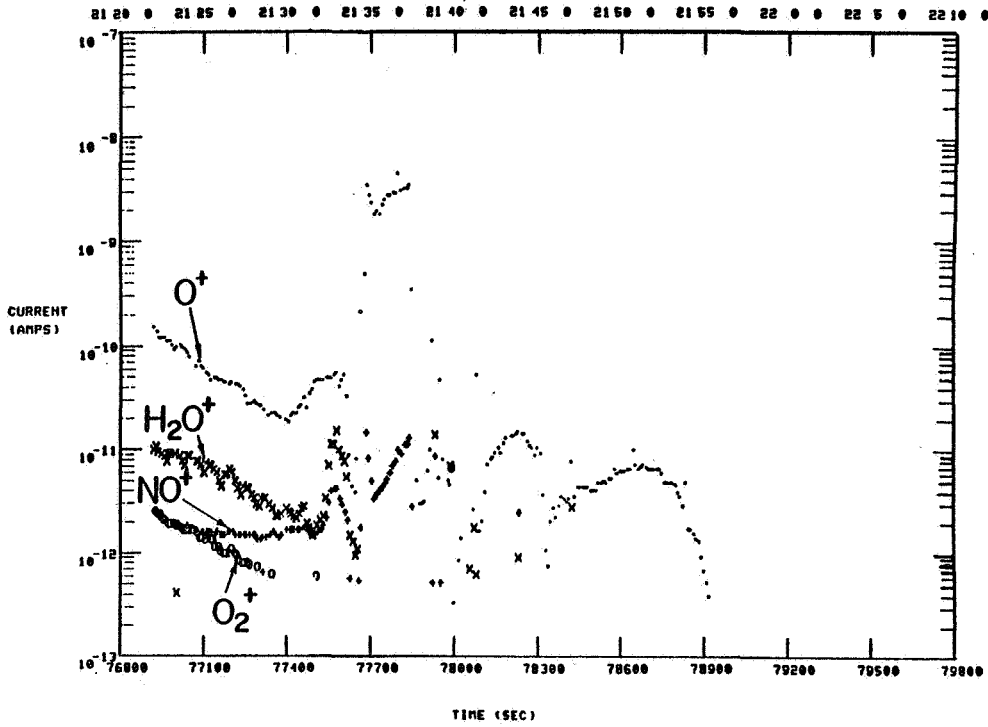

Figure 4-3

ORIGINAL PAGE IS
OF POOR QUALITY

5.0 ORBITER-INDUCED PLASMA WAKE
(Nobie H. Stone and David L. Reasoner/MSFC)

The RPA/DIFP instrument is designed to provide the total ion current density, energy and temperature (RPA) and the ion flow direction (even for multiple streams) and the associated current density, drift energy and temperature of each stream (DIFP).

Figure 5.1 is a color survey plot which includes the RPA/DIFP data showing; (1) an attitude change of the PDP with respect to the orbital velocity vector and (2), two distinct ion streams; i.e., the intense ram ion stream which flows parallel to the velocity vector (lower crescent) and a fainter stream inclined upward at $45^\circ - 50^\circ$ above the orbital velocity vector (upper crescent) in the time interval of GMT 85/1648-1652.

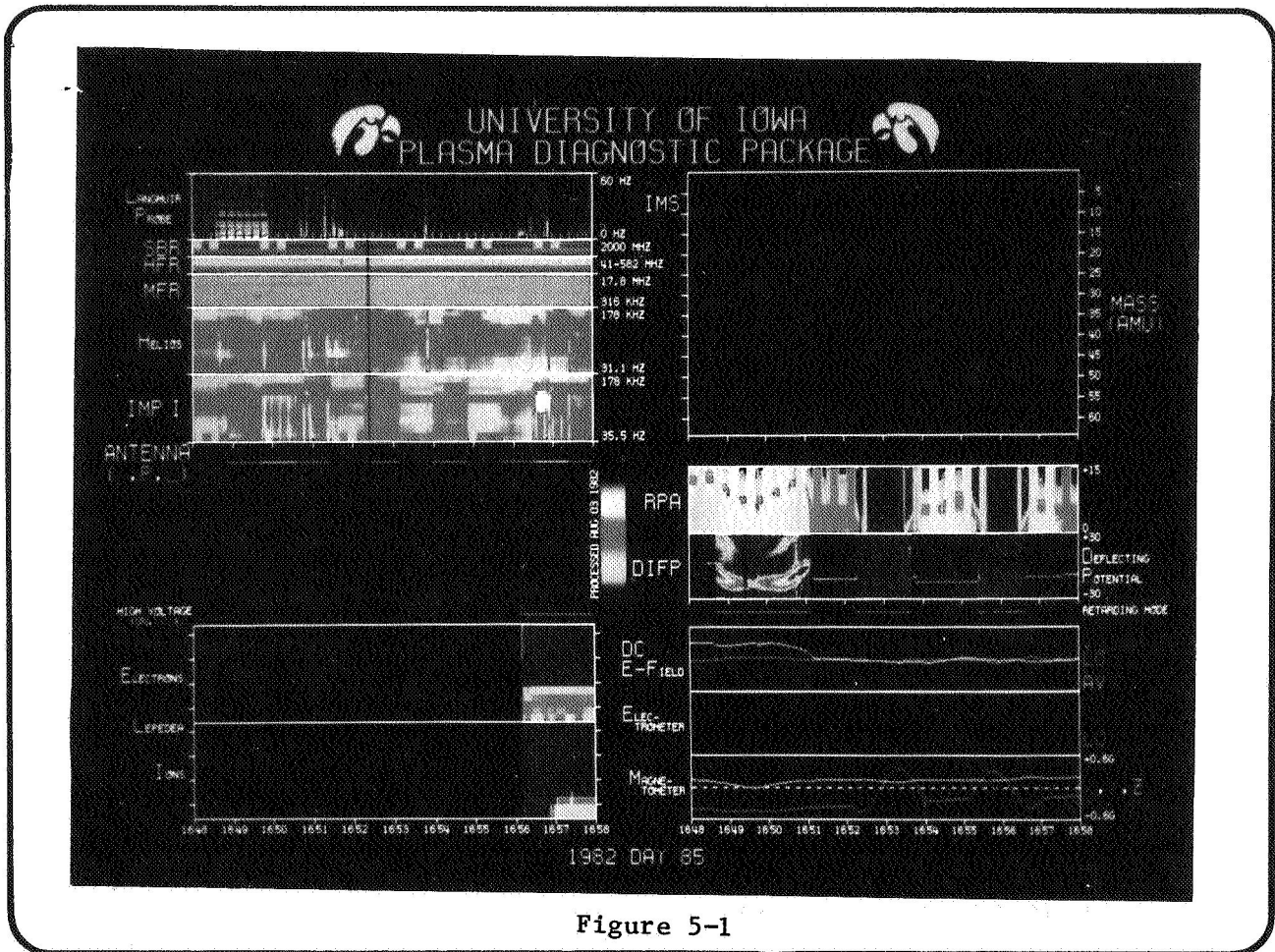
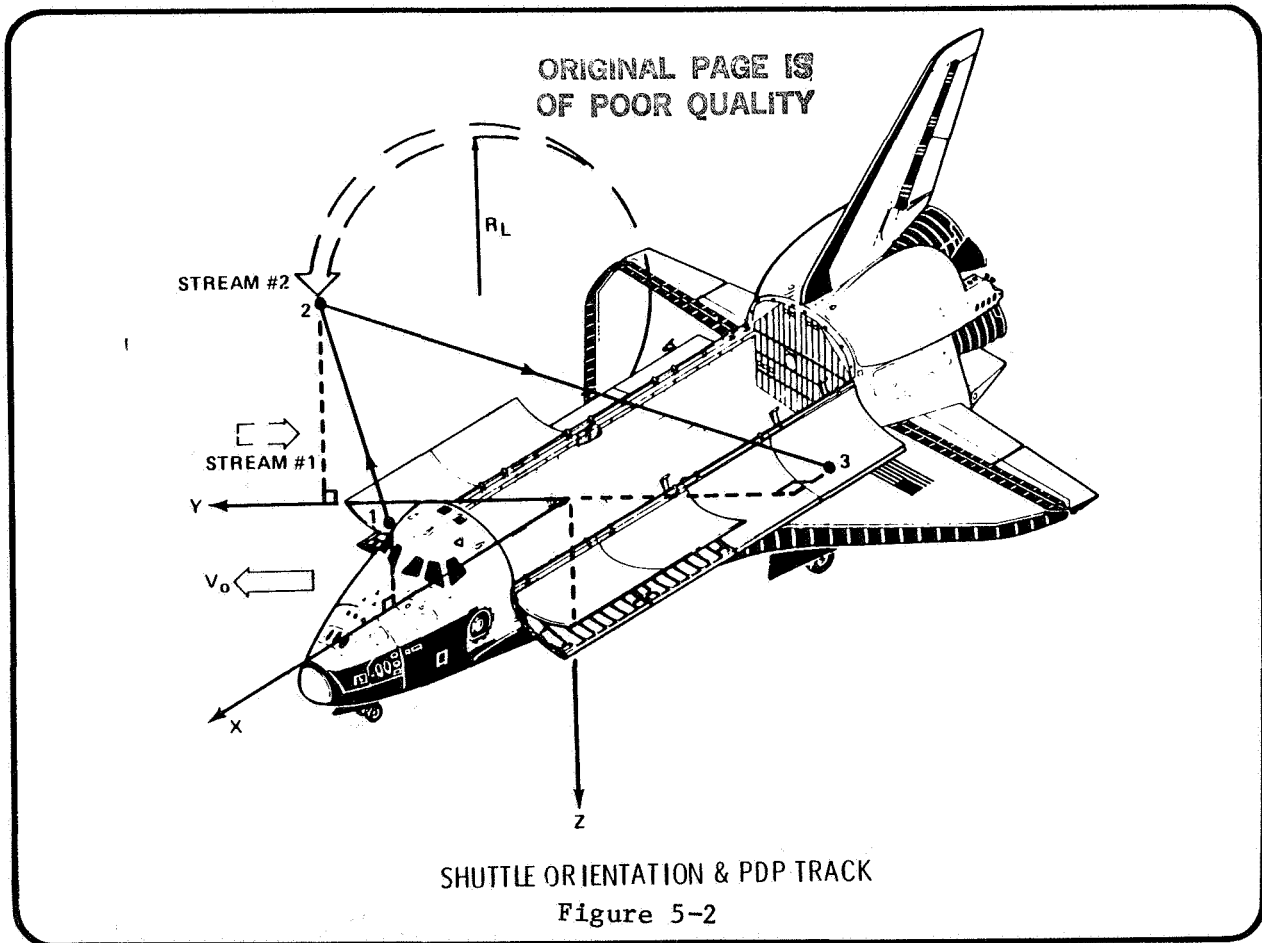

Figure 5-1

Figure 5.2 shows, schematically, the orientation of the Orbiter with respect to the velocity vector, V_0 , during the period in which the data were obtained. As the PDP was moved through the indicated path, its orientation changed, as indicated, at points 1, 2 and 3. It is the change in orientation of the PDP along the path that produces the crescent effect in the spectrogram. At point 1, the RPA/DIFP looked directly into the ram direction. It became perpendicular to the flow at point 2, but looked into the ram again at point 3. The deflection voltage on the DIFP, which is proportional to angle of attack, follows this maneuver precisely, being near zero when the PDP was at points 1 and 3 and highly negative at point 2.



A plot of the DIFP current as a function of deflection voltage during one sweep, made at time 16:49:01.7, is given in Figure 5.3 and shows two distinct peaks. These peaks arrive at -16° and $+26^\circ$. We assume that the PDP was inclined upward at 16° and that Peak No. 1 represents the ram current. The second ion stream, therefore, arrived at an angle of 42° to the velocity vector. This stream appears to result from ions that were accelerated by the interaction with the Orbiter and have reached the RPA/DIFP by traveling over an arc of a Larmor radius as indicated in Figure 4.3.

The streams were analyzed by a retarding potential and both have an energy of ~ 10 ev. (The RPA indicates an energy of 9 ev when most closely aligned with the velocity vector. The difference in energy may be due to the remaining angle of attack). Since the ram energy of O^+ is 5 ev, the observed energies suggest a potential -4 to -5 volts on the PDP. In fact, the average potential of the spheres with respect to the PDP is given by the yellow "AV" curve in the "DC E-Field" panel as $+6$ volts during the ion beam. This value means that the PDP was -6 volts with respect to the plasma in agreement with the RPA analysis.

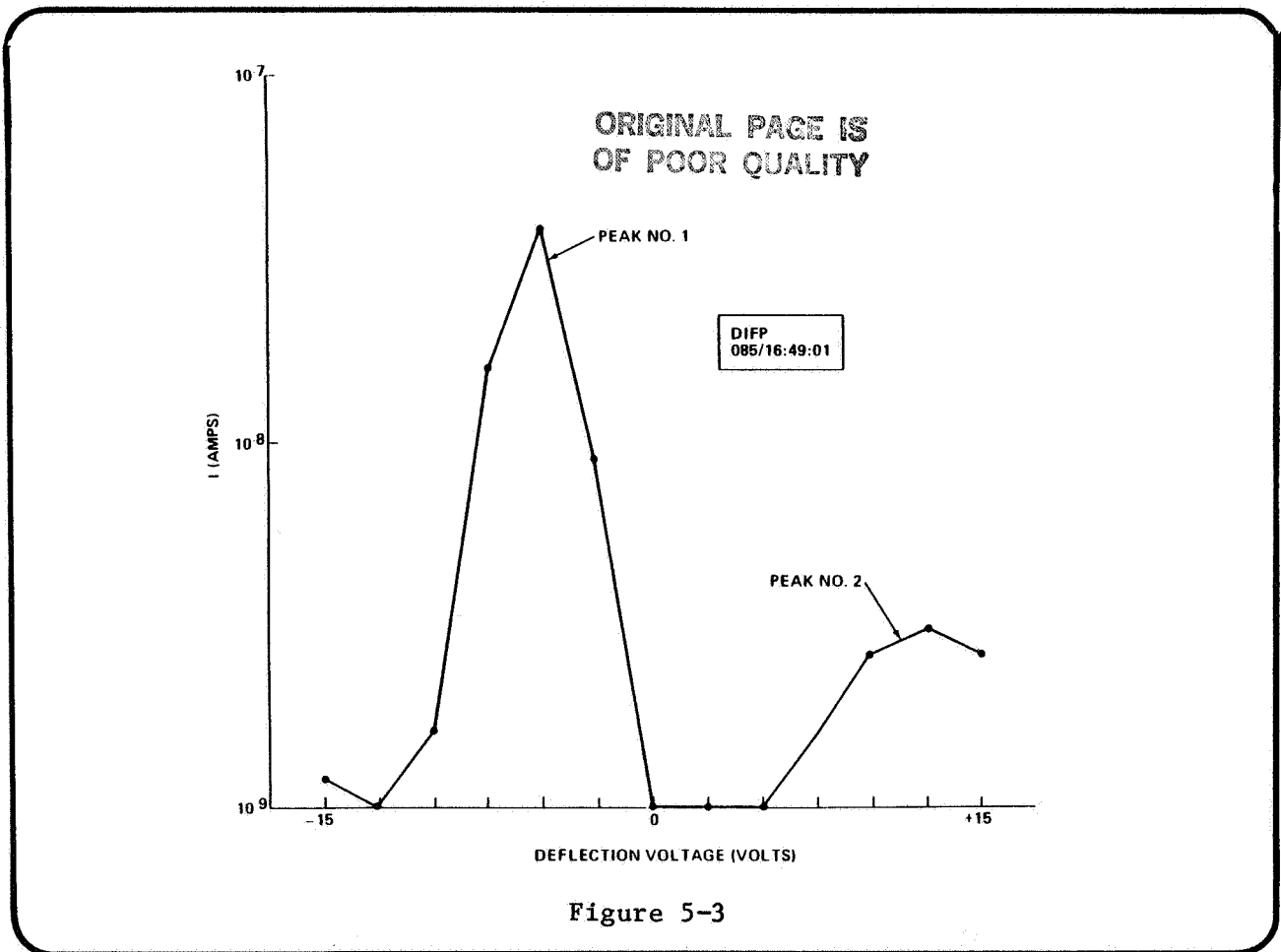

Figure 5-3

6.0 ELECTRON BEAM--PLASMA INTERACTIONS

Work on the FPEG beam and its interaction with the plasma has not progressed significantly. To effectively carry out this investigation, certain ancillary data are required. These required data and the status are listed below:

RMS Coordinates
 Orbiter-Attitude Timeline
 Orbiter Magnetic Alignments
 FPEG Firing Catalog

Provided by JSC as Printout
 State Vectors Available on Paper;
 Awaiting BET Tape
 Requires Orbiter-Attitude Timeline
 Just Received from Utah State

ORIGINAL PAGE IS
OF POOR QUALITY

Consequently, the major holdup is the Orbiter-attitude data. Once this information is received and interpreted, the separate data sets can be collated into a common timeline.

Addition VCAP/PDP Joint Beam Search data have processed into survey plots. An example is given in Figure 6.1 for 1982 Day 85 at 1750 GMT. During this period, the PDP on the RMS being maneuvered to search for the FPEG beam. Electrons are observed up to 1 keV in energy; low fluxes of ions are observed up to 250 eV. VLF emissions peak in the 0.5 - 2 kHz range. Emission in the several MHz range are probably associated with the gyrofrequency (\sim MHz) and the plasma frequency (\sim 10 MHz). Electric fields in excess of 10V/m and the PDP potential of greater than + 12V with respect to the plasma are also encountered.

Many of the beam-plasma characteristics observed on-orbit were also observed in the JSC Plasma Chamber Tests of March 1981. In parallel, the Chamber Test data are being processed through the same analysis and display programs so that detailed comparisons can be made.

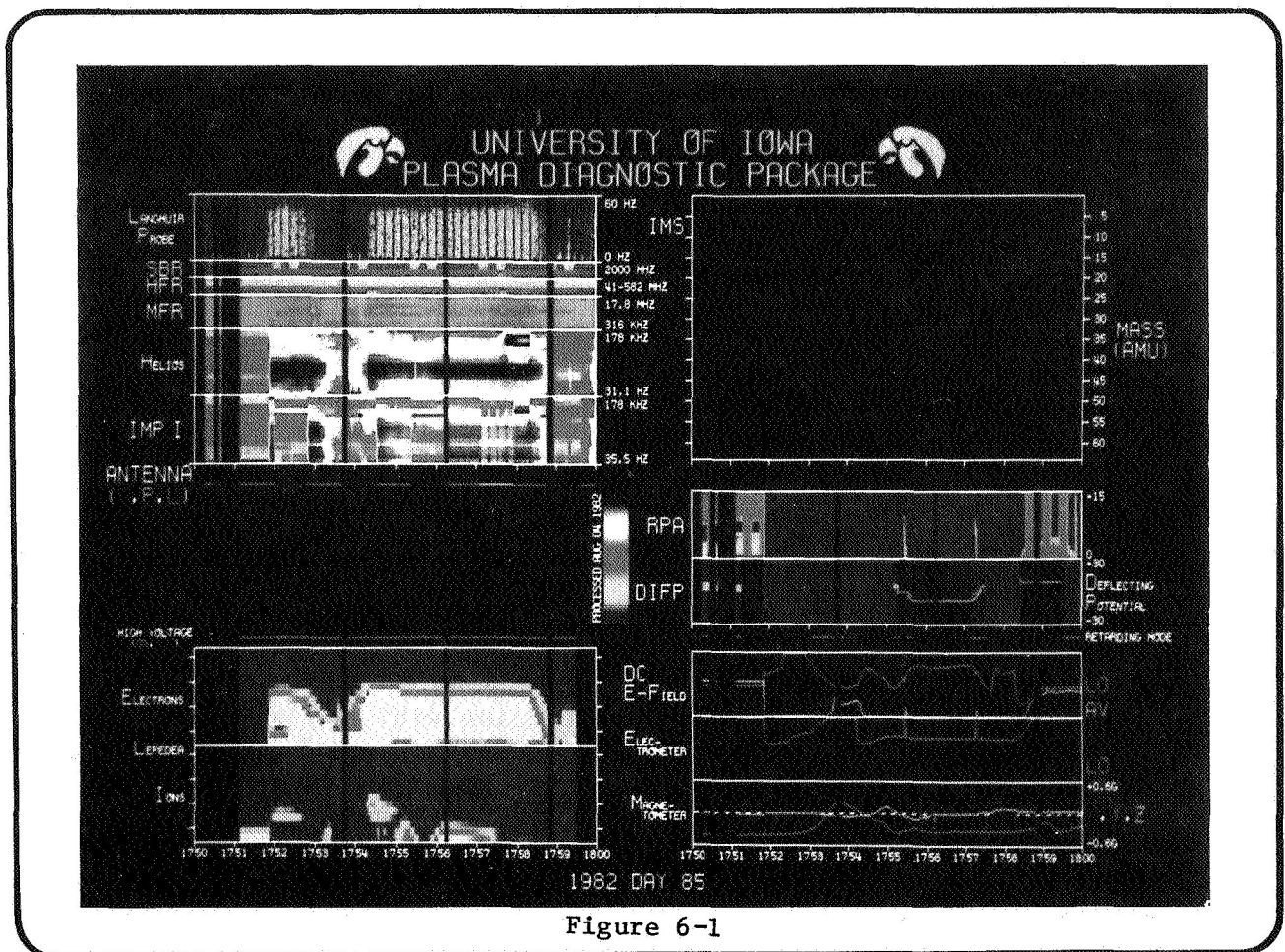

Figure 6-1

An overall summary of the environmental and science results to date is as follows:

- Orbiter related EMI levels are significantly low so that natural noise phenomena, FPEG stimulated waves and Orbiter-induced wake noise are detectable
 - With the bay doors closed, the PDP-detected noise levels dropped to the receiver threshold values for frequencies from 30 Hz to 800 MHz except for magnetic field discrete line emissions at 25 Hz, 1 kHz, 25 kHz and harmonics
 - Field strength measurements of the S-Band communication system are approximately a factor of two higher than the modeled values
 - Stimulated FPEG waves in the Hz to MHz ranges were clearly detectable
 - Natural noise emissions including spherics, whistlers, chorus and hiss were detected above the background noise levels
 - Based on the observed decrease of EMI noise levels with the bay doors closed and on the amplitude variation of the noise depending on Orbiter attitude, it is hypothesized that a broad spectrum of electrostatic noise is being generated by the Orbiter's motion in the plasma--probably in the wake. This noise is a maximum with the bay in the ram direction
 - Due to natural charging effects, the Orbiter can reach a few volts potential with respect to the plasma
 - Orbiter-caused magnetic field perturbations are typically less than .05 gauss
- The presence of the Orbiter and the Orbiter gaseous environment produces a plasma environment in and near the plasma bay which is significantly different than the ambient ionospheric plasma
 - Plasma density and temperature at the PDP pallet location can vary by at least 3 orders of magnitude in the time scale of minutes and by a larger factor depending on the Orbiter attitude
 - Time variations in pressure of about two orders of magnitude are observed with some correlation to Orbiter RAM/wake attitude and thruster operations; on the scale of minutes, the pressure reaches 10^{-5} torr with the bay in the ram direction whereas the pressure exceeded 10^{-4} for a PRCS jet operation.
 - Dominant ions include O^+ , N_2^+ and O_2^+ from the ambient ionosphere and H_2O^+ from the Orbiter itself.
 - Measured plasma energy depends on PDP charging which is controlled by day/night and RAM/wake effects

- On the RMS, directed ion streams are detected which are probably due to refilling of the Orbiter wake cavity. Modulation of the energy is associated with the charge state of the PDP
- The FPEG electron beam undergoes a strong interaction with the ambient ionospheric plasma and perhaps with the Orbiter gas cloud and local plasma
 - Electrons and energized ions reach the PDP in its pallet location below the FPEG
 - Waves are stimulated, ions energized and electrons deenergized and scattered along the electron beam column
 - Electrons of 1 keV and below are found within a column of approximately 6 meters diameter--the electron gyrodiameter--with a nearly uniform distribution in flux
 - Ions with energies up to 250 eV are associated with the beam--plasma interaction.
 - Significantly intense VLF and LF waves are stimulated by pulsing the FPEG beam
 - Potentials up several 10's of volts and electric fields in excess of 10V/m are measured during FPEG operations

8.0 DATA ANALYSIS PLAN

Within the limited resources to carry out the OSS-1/PDP data analysis, work is progressing to prepare reports and publications on the following topics:

- Potentials and Electric Fields of the Orbiter
- Nature of the Orbiter-Induced Plasma Wakes
- The Orbiter Plasma Environment
- Effects of the Beam-Plasma Interaction
- Characteristics of the Electrostatic Noise Generated by the Orbiter-Plasma Interaction
- Description of the OSS-1/PDP System
- Orbiter EMI Levels
- S-Band and UHF Communications Radiated Field Strengths
- Power Buss and Microprocessor Performance History
- Pressure Measurements by PDP on STS-3
- Thermal History of the PDP on STS-3

These reports and papers are to be the basis for presentations at a number of meetings in the near future:

- European Geophysical Society, Leeds, England 23-27 August
- Activate Experiments Working Group and Spacelab-1 IWG, MSFC, 30-31 August
- Workshop on Charging of Large Space Structures in Polar Orbit, AFGL, 14-15 September
- NASA/Spacelab Workshop on Orbiter Environment, Calverton, Maryland, 5-7 October
- Fall AGU Meeting, San Francisco, 7-12 December
- AIAA Meeting, Reno, 10-14 January
- URSI Meeting, Boulder, 17-21 January
- Spring AGU Meeting, Baltimore, 30 May - 3 June

ORIGINAL PAGE IS
OF POOR QUALITY

ORIGINAL PAGE IS
OF POOR QUALITY

ADDITIONS TO
DR. S. SHAMHAN
PRESENTATION

TABLE 6

SUMMARY OF PDP ORBITER ENVIRONMENT MEASUREMENTS

ORBITER POTENTIAL

- POTENTIAL WITH RESPECT TO PLASMA VARIED UP TO $\pm 5V$ WITH PDP ON RMS
- POTENTIAL VARIATION CONSISTENT WITH $\underline{V} \times \underline{B} \cdot \underline{L}$
WHERE \underline{L} = DISTANCE FROM ENGINES TO PDP
- ORBITER ALWAYS DRIVEN POSITIVE DURING FPEG OPERATIONS

EMC/EMI

- NO MICROPROCESSOR (2 UNITS) MALFUNCTIONS [WATCH-DOG TIMER UTILIZED]
- 28V PDP POWER BUSS RANGE: 27.0-31.0 VOLTS
- 28V PDP POWER BUSS STEPS: < 1.0V IN 1.6 SECONDS
< 1.5V IN 5 MINUTES
- ELECTRIC AND MAGNETIC FIELD RADIATED EMISSIONS WITHIN SPECIFICATIONS
- ORBITER-PLASMA INTERACTION GENERATES ELECTROSTATIC NOISE UP TO ~ 1 V/M
- UHF TRANSMITTER: < 0.1 V/M IN BAY; < 0.5 V/M ON RMS
- S-BAND TRANSMITTER: < 2 V/M IN BAY; < 20 V/M ON RMS > 5 M

TABLE 6

SUMMARY OF PDP ORBITER ENVIRONMENT MEASUREMENTS

ORIGINAL PAGE IS
OF POOR QUALITY

THERMAL PERFORMANCE

- FLIGHT HARDWARE MOUNTED ON COLD PLATE, PALLET AND RMS
- THERMAL CONTROL BY HEATERS, THERMAL BLANKETS AND RADIATING SURFACES
- ALL TEMPERATURES STAYED WITHIN DESIGN LIMITS

PRESSURE MEASUREMENTS

- APPARENT PRESSURE VARIES 10^{-7} TO 10^{-5} TORR AT ORBIT PERIOD WITH MAXIMA AT ASCENDING NODE (RAM IN NOSE-TO-SUN ATTITUDE)
- PRESSURE INCREASED TO 3×10^{-4} TORR DURING L2U BURN
- PRESSURE INCREASED TO 4×10^{-5} TORR DURING PAYLOAD BAY DOOR CLOSING (86/21:10)
- APPARENT PRESSURE IS MODULATED BY PDP ROTATION

PLASMA COMPOSITION AND ENERGY

- VERY SIGNIFICANT DENSITY VARIATION FOR DAY/NIGHT AND RAM/WAKE
- H_2O^+ ORBITER-PRODUCED ION ALWAYS PRESENT
- DIRECTED ION BEAMS OBSERVED IN WAKE AND WHEN ORBITER IS NEGATIVELY CHARGED
- INSTANCES OF 100 eV IONS AND ELECTRONS IN PAYLOAD BAY

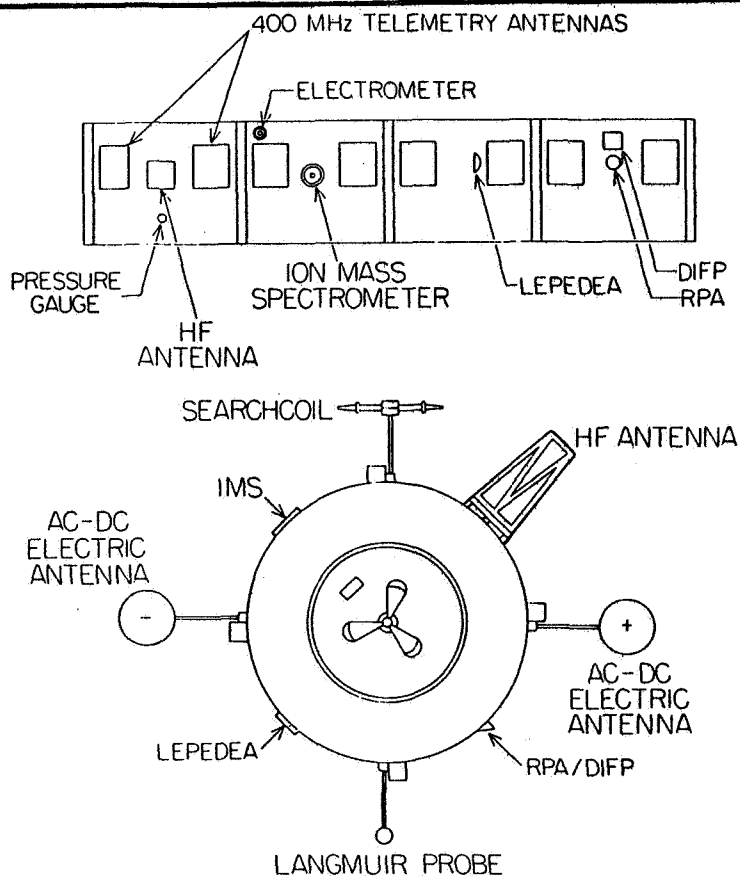

STS-3 ORBIT ATTITUDE
MARCH 24, 1982

ORIGINAL PAGE IS
OF POOR QUALITY.

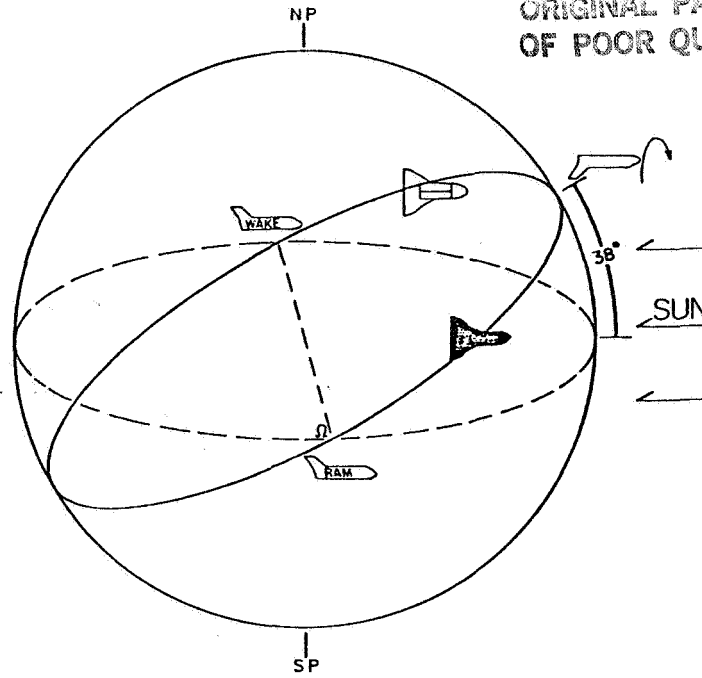

NOSE TO SUN 2x ORB RATE ROLL

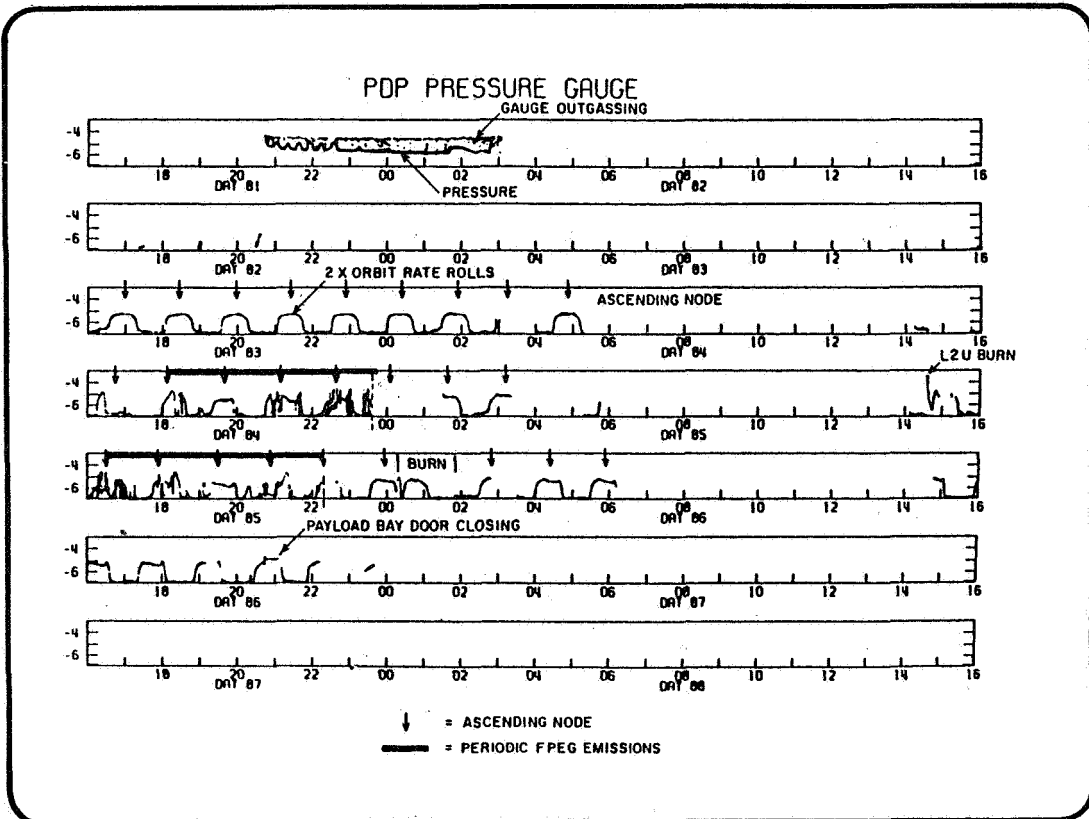

ORIGINAL PAGE IS
OF POOR QUALITY

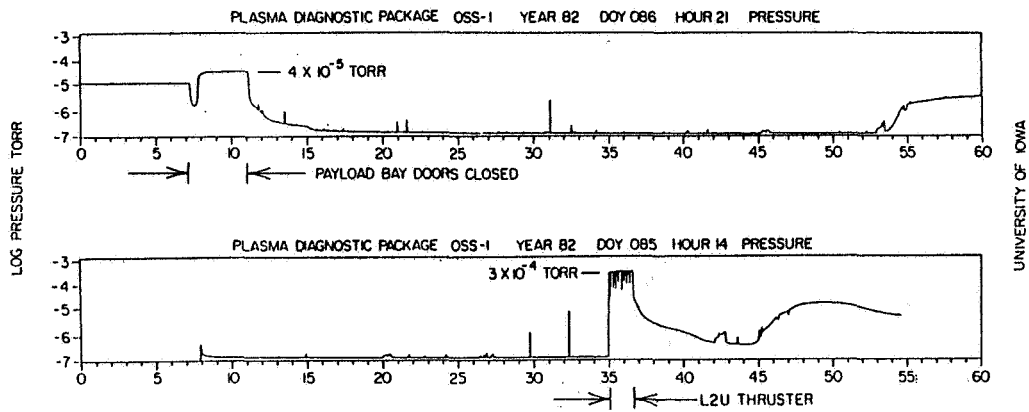
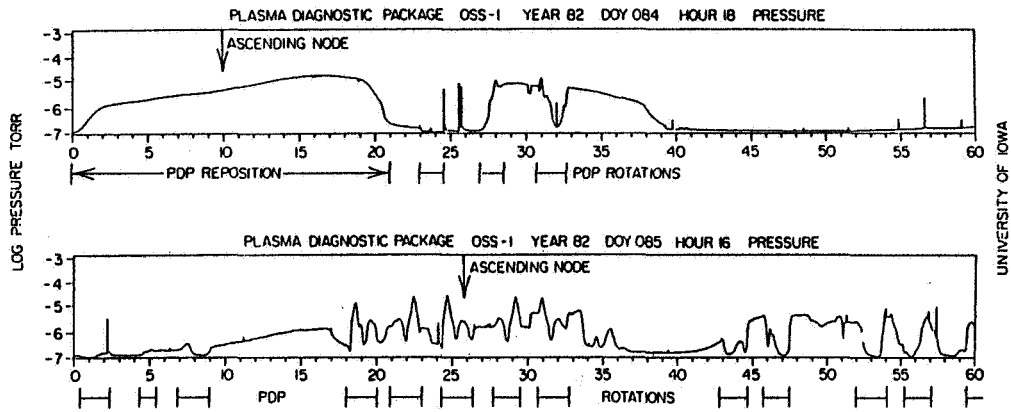

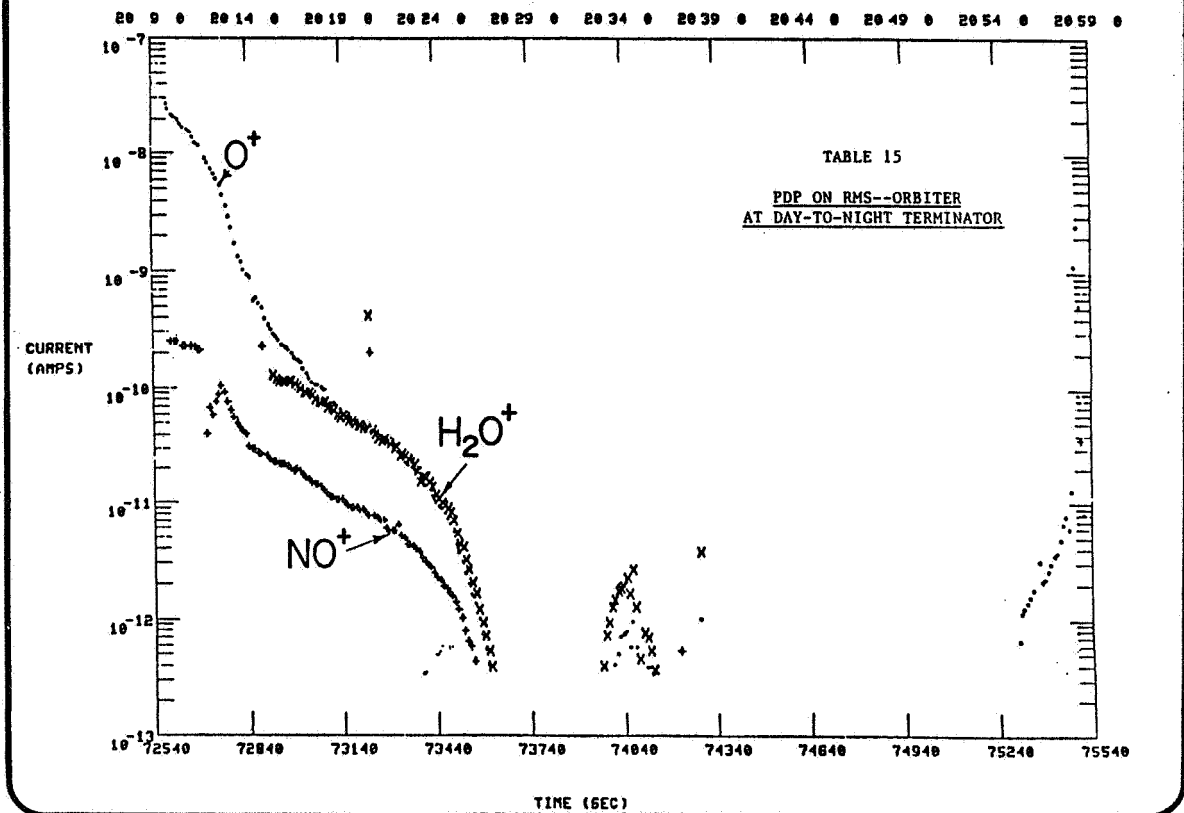
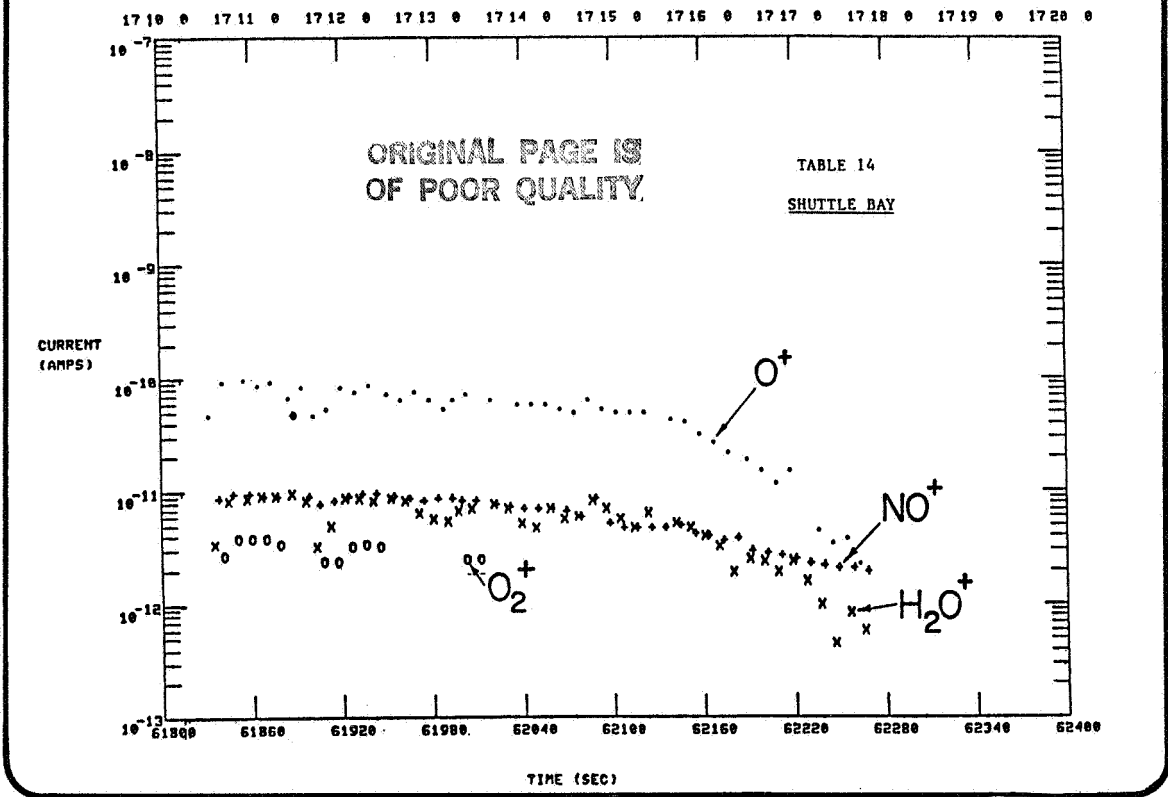
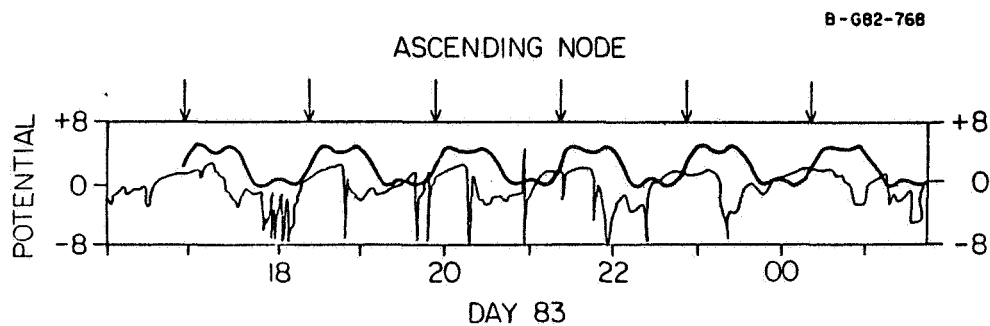

TABLE 18
ORBITER DC POTENTIAL

ORIGINAL PAGE 19
OF POOR QUALITY

- DAY 83 HAD THE PDP MOUNTED TO THE PALLET (AND GROUNDED TO ORBITER)
 - Δ PDP MEASURES THE AVERAGE POTENTIAL OF ITS TWIN CARBON COATED SPHERES WITH RESPECT TO THE SPACECRAFT GROUND AND OBTAINS A MAXIMUM POSITIVE POTENTIAL OF 3-4 VOLTS (NOT COUNTING ELECTRON GUN EMISSION TIMES) AND A MAXIMUM NEGATIVE POTENTIAL OF ~ 2-3 V
 - Δ PEAK POSITIVE POTENTIALS OCCURRED CLOSE TO SUNSET (DURING PAYLOAD BAY WAKE)
 - Δ THE ELECTRON GUN ALWAYS DROVE THE POTENTIAL OFFSCALE POSITIVE (> 8V) WITH A RECOVERY TIME VARIABLE FROM SECONDS TO MINUTES
 - Δ PEAK NEGATIVE POTENTIALS OCCURRED APPROXIMATELY 1/2 ORBIT LATER AT ASCENDING NODE (DURING PAYLOAD BAY RAM)
- DAY 84 HAD THE PDP ON THE RMS (STILL GROUNDED TO ORBITER)
 - Δ HOURS 16:30 TO 18:30 HAD THE PDP IN A FIXED POSITION ABOVE THE PAYLOAD BAY AND ARE SUITABLE FOR COMPARISON TO PREVIOUS DAYS RESULTS
 - Δ ONE ORBIT PERIODICITY STILL EXISTS WITH ~ ±5V VARIATION



N83 22308

D20

STS-3/OSS-1 PLASMA DIAGNOSTICS PACKAGE (PDP) MEASUREMENTS OF
ORBITER TRANSMITTER AND SUBSYSTEM ELECTROMAGNETIC INTERFERENCE

S. D. Shawhan and G. Murphy
University of Iowa

Preceding page blank

1.0 INTRODUCTION

ORIGINAL PAGE IS
OF POOR QUALITY

This report is intended to present a quick-look analysis of the Plasma Diagnostics Package (PDP) electromagnetic spectral measurements on the STS-3/OSS-1 mission from March 1982. Further interpretation of the data is awaiting ancillary information on the operation of Orbiter subsystems, such as thrusters and on the detailed trajectory and attitude.

The PDP receiver system is described to identify the various antennas and to characterize the complement of receivers which cover the frequency range of 30 Hz to 800 MHz and S-Band at 2200 ± 300 MHz. Sample results are presented to show the variety of electromagnetic effects associated with the Orbiter and the time variability of these effects. The electric field and magnetic field maximum and minimum field strength spectra observed during the mission at the pallet location are plotted. Values are also derived for the maximum UHF transmitter and S-band transmitter field strengths. Finally, calibration data to convert from the survey plots to actual narrowband and broadband field strengths are listed.

Support for the PDP on the STS-3/OSS-1 Mission was provided through NASA/MSFC Contract NAS8-32807. OSS-1 Mission management was provided by NASA/GSFC.

2.0 DESCRIPTION OF RECEIVER SYSTEM

Sensors for the detection of magnetic and electric wave fields are identified in Figure 1. Two spheres of 8 inch diameter, separated by 1.2 meters make up the electric dipole antenna which is utilized from DC to 20 MHz in frequency. Calibration measurements at NASA/GSFC before flight indicated that the effective electrical length of this dipole was only 0.22 meters because of the proximity to the PDP. For higher frequency electric fields, a broadband single polarization horn antenna is utilized. It covers the range of 20 MHz through S-band at 2200 MHz. In addition, the searchcoil sensor is used to detect the magnetic field component of electromagnetic waves from 30 Hz to 178 kHz. The Langmuir Probe is sensitive to electrostatic plasma waves over the same VLF range of 30 Hz to 178 kHz.

A block diagram of the PDP sensors and associated receivers is shown in Figure 2. One VLF range receiver from the IMP program VLFR-IMP is switched between the electric dipole, the searchcoil and the Langmuir Probe sensors every 51.2 seconds to provide 16 channels of VLF spectra--30 Hz to 178 kHz. In addition, the waveform is preserved in the Wideband Receiver (WBR) and this analog data is included in the PDP data stream. Every 12.8 seconds the WBR switches 10 kHz bands sequentially covering 0-10 kHz, 20-10 kHz and 20-30 kHz for each sensor. The VLFR-HELIOS always is connected to the electric dipole antenna to give a peak and average spectrum every 1.6 seconds.

The electric dipole also drives the Medium Frequency Receiver (MFR) which covers 316 kHz to 17.8 MHz in 8 channels. This MFR shares a logarithmic detector with the High Frequency Receiver (HFR) which has four broadband channels spanning the range of 20 MHz to 800 MHz. Bandwidths for the VLFR and MFR are narrower at $\pm 15\%$ and $\pm 30\%$, respectively. By mixing the S-band signal down to the HFR frequency range, the same log detector is used for the SBR by time multiplexing. Both peak and average spectra are obtained each 1.6 seconds.

A summary of the receiver characteristics is given in Table 1. Detailed performance specifications for the receivers and the other PDP instrument are given in Table 2. Note that the stated field strength ranges are only approximate.

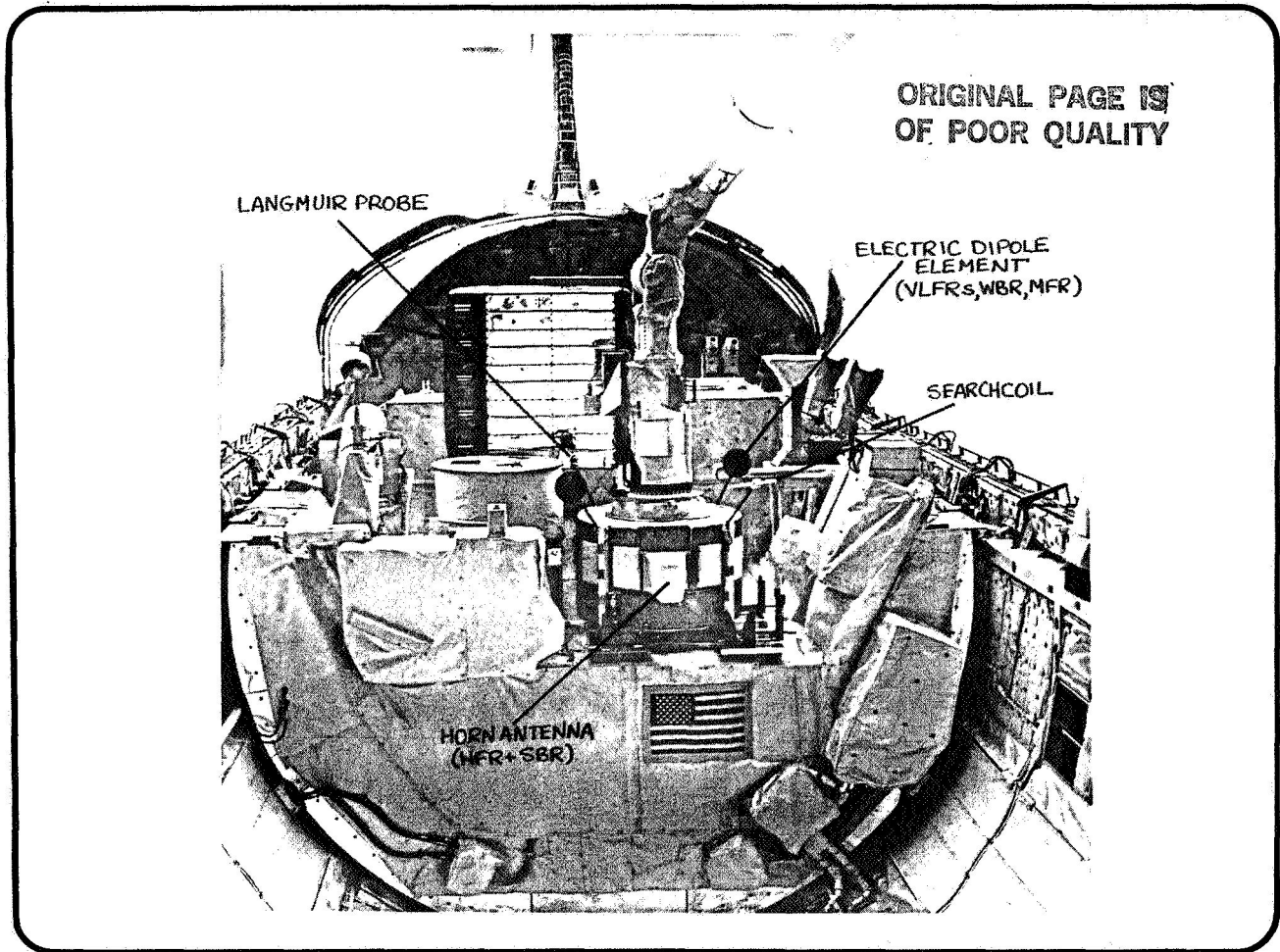

PDP on Pallet: Antennas Identified

Figure 1

Figure 2

C-68-899

ORIGINAL PAGE IS
OF POOR QUALITY

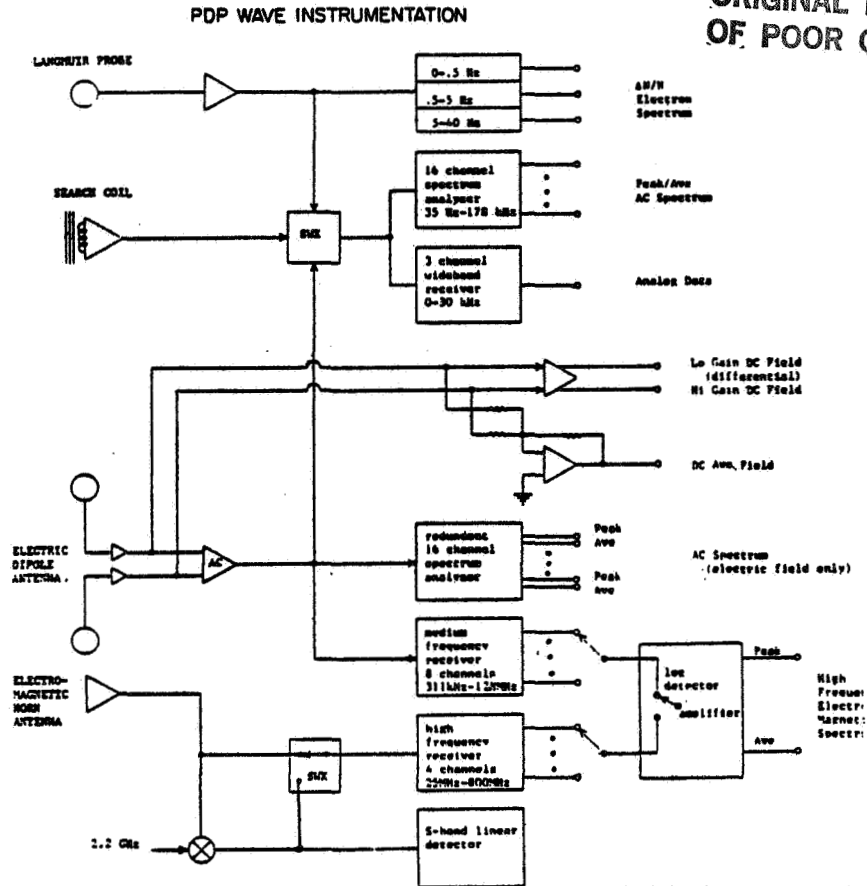

Table 1

STS-3/PDP RECEIVER CHARACTERISTICS

VERY LOW FREQUENCY (VLFR)

- 16 CHANNELS
- 30 HZ TO 178 KHZ

MEDIUM FREQUENCY RECEIVER (MFR)

- 8 CHANNELS
- 311 KHZ TO 17.8 MHZ
- 65 DB DYNAMIC RANGE

HIGH FREQUENCY RECEIVER (HFR)

- 4 CHANNELS
- 20 MHZ TO 800 MHZ

S-BAND RECEIVER (SBR)

- 4 CHANNELS WITH LOG DETECTOR
- 1 CHANNEL WITH LINEAR DETECTOR
- ~ 2200 MHZ ± 300 MHZ

Table 2

ORIGINAL PAGE IS
OF POOR QUALITY

PDP SCIENTIFIC INSTRUMENTS PERFORMANCE SPECIFICATIONS

MEASUREMENT	TECHNIQUE	PARAMETERS	VALUE/RANGE
DC Magnetic Field	Triaxial Fluxgate Magnetometer	Dynamic Range	± 12 milligauss to ± 1.5 gauss each axis
		Temporal Resolution	10 samples/second each axis
DC Electric Field	1m Double Probe with Spherical Sensors	Dynamic Range	± 2 mV/m to ± 2 V/m (average and differential)
		Temporal Resolution	20 samples/second
AC Magnetic Waves	Searchcoil Sensor; Wideband Receiver	Frequency Range	5Hz-1kHz & 0.65-10, 10-20, 20-30kHz
		Amplitude Range	100db @ 0.4db resolution; 3 μ v-300v
		Duty Cycle	12.8 seconds out of 51.2 sec.
	Searchcoil Sensor; VLF Spectrum Analyzer (IMP) VLFR-IMP	Frequency Range	16 channels 35.5 Hz to 178kHz
		Frequency Resolution	$\pm 15\%$ bandwidth
		Amplitude Resolution	100db @ 0.4dB resolution; $3 \times 10^{-5} - 3 \text{ Hz}^{-1/2}$ (peak and average)
Temporal Resolution	0.5 sample/second each channel		
Duty Cycle	12.8 seconds out of 51.2 sec.		
AC Electric and Electrostatic Waves	1m Dipole Antenna Wideband Receiver WBR	Frequency Range	5Hz-1kHz, 0.65-10kHz, 10-20kHz & 20-30kHz
		Amplitude Range	100db @ 0.4db resolution; 3 μ V/m - 300 mV/m
		Duty Cycle	38.4 seconds out of 51.2 sec.
	1m Dipole Antenna VLF Spectrum Analyzer (Helios) VLFR-HELIOS	Frequency Range	16 channels-31.2Hz to 178kHz
		Frequency Resolution	$\pm 15\%$ bandwidth
		Amplitude Resolution	100db @ 0.4dB resolution; $3 \times 10^{-8} - 3 \times 10^{-3} \text{ Vm}^{-1} \text{ Hz}^{-1/2}$ (peak and average)
	Temporal Resolution	0.6 sample/second each channel	
	Duty Cycle	100%	
	1m Dipole Antenna, Mid Frequency Receiver MFR	Frequency Range	8 channels-31.6Hz to 17.8 MHz
Frequency Resolution		$\pm 30\%$ bandwidth	
Amplitude Resolution		70db @ 1db resolution; $3 \times 10^{-3} - 10 \text{ V/m}$ (peak and average)	
Temporal Resolution	1.6 second/scan		
VHF/UHF EMI Levels	Horn Antenna VHF/UHF Receiver HFR	Frequency Range	4 channels-25-65, 65-160, 160-400, 400-800 MHz
		Frequency Resolution	$\pm 50\%$
		Amplitude Resolution	70db @ 1db resolution; $10^{-2} - 30 \text{ V/m}$; (peak and average)
		Temporal Resolution	1.6 sec/scan
S-Band Field Strength Monitor SBR	Horn Antenna VHF/UHF Receiver + Mixer and L.O.	Frequency Range	2000-2330 MHz
		Amplitude Range	.01 to 30 V/m (peak & average)
		Temporal Resolution	1.6 sec.
Suprathermal Particles	Low Energy Proton & Electron Differential Energy Analyzer (LEPEDEA)	Energy Range	2eV-50keV in 42 steps: electrons and ions
		Energy Resolution	34%
		Field of View	$6^\circ \times 16^\circ$ (7 detectors)
		Flux: Electrons	$30-1 \times 10^7$, electrons/cm ² sec sr eV
	Protons	$6-2 \times 10^8$ protons/cm ² sec sr eV	
	Temporal Resolution	1.6 sec for spectrum	
Electrometer		Flux Range	$10^9 - 10^{14}$ elect cm ⁻² sec ⁻¹
		Temporal Resolution	10 samples/second
Retarding Potential Analyzer/Differential Ion Flux Probe		Density Range	$2 \times 10^1 - 1 \times 10^7$ ions cm ⁻³
		Energy Range	0-16 eV
		Velocity Range	0-15km sec ⁻¹
		Temporal Resolution	0.8 sec/scan; 51.2 sec/analysis
Thermal Electrons	Langmuir Probe, Density	Dynamic Range	$10^3 - 10^7$ electrons cm ⁻³
		Temporal Resolution	1 second sweep every 12.8 sec.
	Langmuir Probe, Density Irregularities	Scale Sizes	10 meters to 100 km
Dynamit Range	80db @ 5db resolution; $10^2 - 10^8$ cm ⁻³		
Thermal Ions	Ion Mass Spectrometer	Dynamic Range	$20-2 \times 10^8$ ions cm ⁻³
		Mass Range	1-64 AMU @ < 1% overlap
		Temporal Resolution	1.6 seconds for mass scan
Ambient Pressure	Ionization Gauge	Pressure Range	10^{-7} to 10^{-3} torr

3.0 OVERVIEW OF ORBITER AC ELECTRIC FIELD ENVIRONMENT

ORIGINAL PAGE IS
OF POOR QUALITY

In Figure 3 is presented a 30 minute summary plot of the PDP measured electric fields from 30 Hz to S-band for GMT DAY 85 20:30 to 21:00. Noted in the figure are the variety of phenomena which have been detected during the mission. Note that for each frequency, the vertical scale represents approximately 100 dB of dynamic range.

Very short bursts in the VLF range near 20:37 and 20:39 are assumed to be due to thruster firings. The changing VLF field strength from 20:30 to 20:37 has been identified as a broadband electrostatic noise which is Orbiter-attitude dependent--it peaks when the plasma is rammed into the payload bay (-Z axis parallel to velocity vector). Also very obvious in the VLF range is the increased intensity as the Fast Pulse Electron Generator (FPEG) emits a 50 ma beam of 1 keV electrons. As the PDP is moved in and near the beam by the RMS (Remote Manipulator System), the noise is seen in the channels of the MFR. Probably these emissions occur near the electron gyrofrequency (~ 1 MHz) and the plasma frequency (3-10 MHz).

These FPEG generated plasma waves do not extend up into the HFR range, typically. At 271 MHz (165-400 MHz channel of the HFR) is seen the UHF downlink transmitter. Since the PDP is being rotated and positioned at various points just above the payload bay, it sees different S-band field strength levels as indicated.

Some of these effects are depicted in more detail in the next section.

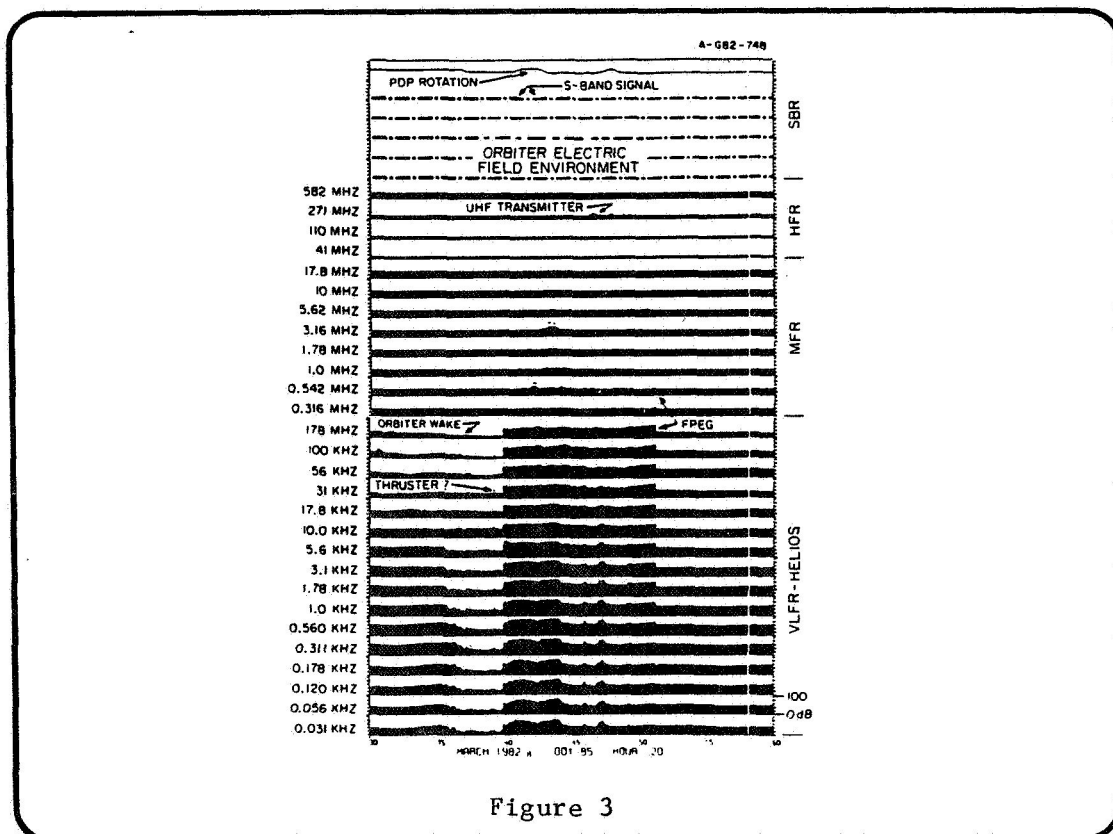

4.0 TIME VARIABILITY OF OBSERVED NOISE

ORIGINAL PAGE IS
OF POOR QUALITY

The following series of figures illustrate the time variability of the VLF electric field noise from time scales of seconds to tens of minutes. Typically only the UHF and S-band transmitters are observed above 178 kHz because the receivers are less sensitive and plasma-related waves do not extend to frequency above 10 MHz. Thus waves at frequencies of a few hundred kilohertz to 20 MHz are not seen unless the FPEG is operating.

In Figure 4 is seen a ~ 60 dB overall amplitude change in the matter 10 minutes with short bursts of only seconds in duration. The overall trend is attributed to the Orbiter-attitude related electrostatic noise. Short bursts are most likely thrusters. For Figure 4, the PDP is stowed on the pallet whereas for Figure 5 the PDP is on the RMS. The overall levels are not much different but the levels do change with PDP rotation. This change indicates that the noise sources are either strongly polarized or what is more likely, localized on the Orbiter. Note that BX is a component of the earth's magnetic field which indicates the PDP rotation.

Experiment and Orbiter systems can definitely affect the signal strengths. When the FPEG operates, levels increase by ~ 20 dB. In the one case of a Primary Reaction Control System (PRCS) jet firing at GMT DAY 85 14:36, the noise actually decreases at the higher frequencies. The momentary gas output may moderate the Orbiter interaction with the plasma which produces the broadband electrostatic noise.

Evidence that the broadband electrostatic noise is not due to an Orbiter subsystem or instrument is presented in Figure 7 at the time of a payload bay door closing. During this three minute interval, the noise dropped below the receiver noise levels at all frequencies. Consequently, the noise does not originate inside the bay; it is shielded by the doors. When the doors are opened, the noise returns. If this noise is a significant problem to payload instrumentation, it can be minimized by directing the bay away from the velocity vector.

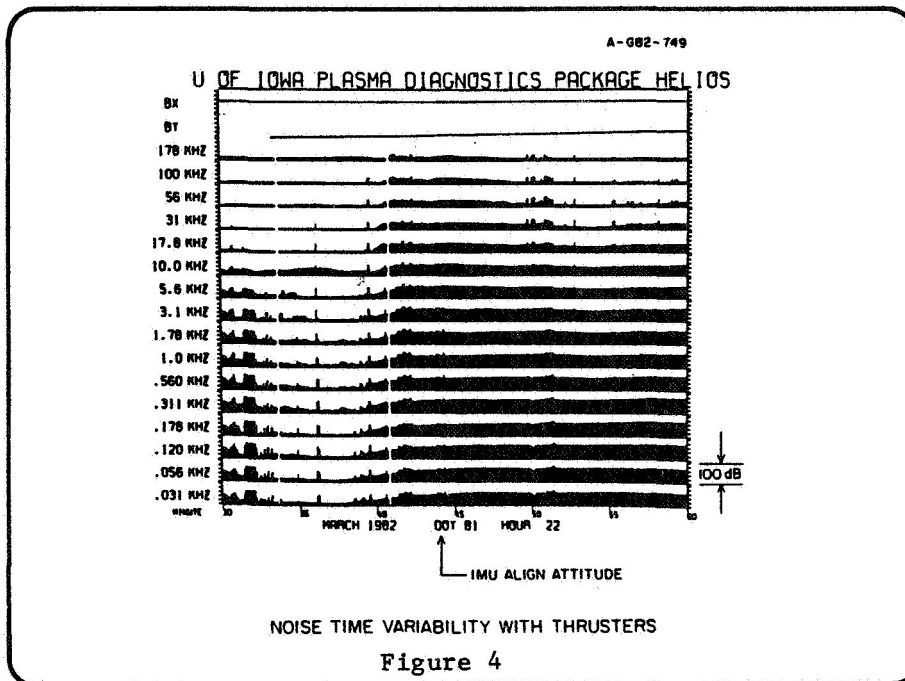

U OF IOWA PLASMA DIAGNOSTICS PACKAGE HELIOS

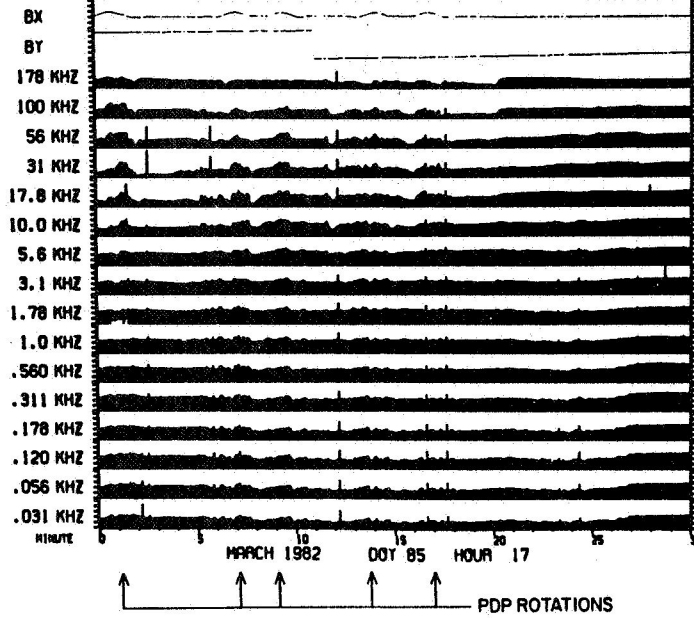

ORIGINAL PAGE IS OF POOR QUALITY

SIGNAL STRENGTH VS PDP ROTATION

Figure 5

U OF IOWA PLASMA DIAGNOSTICS PACKAGE HELIOS

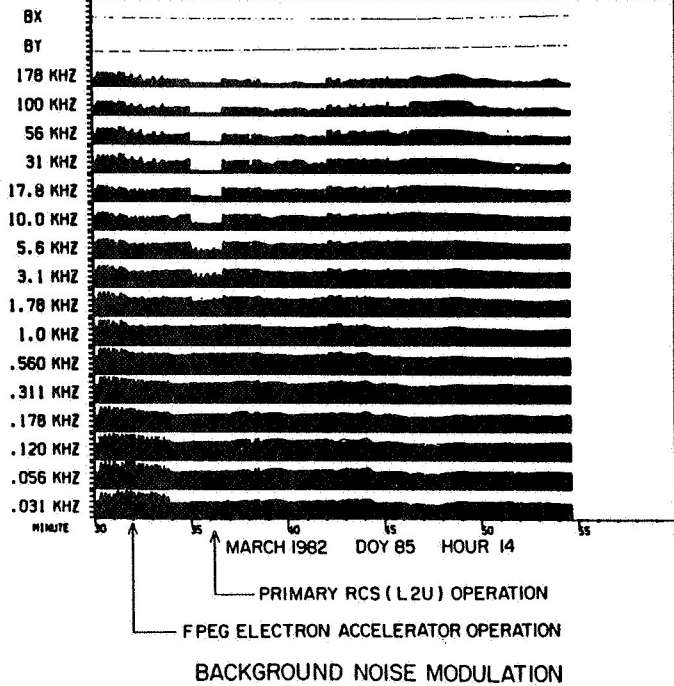
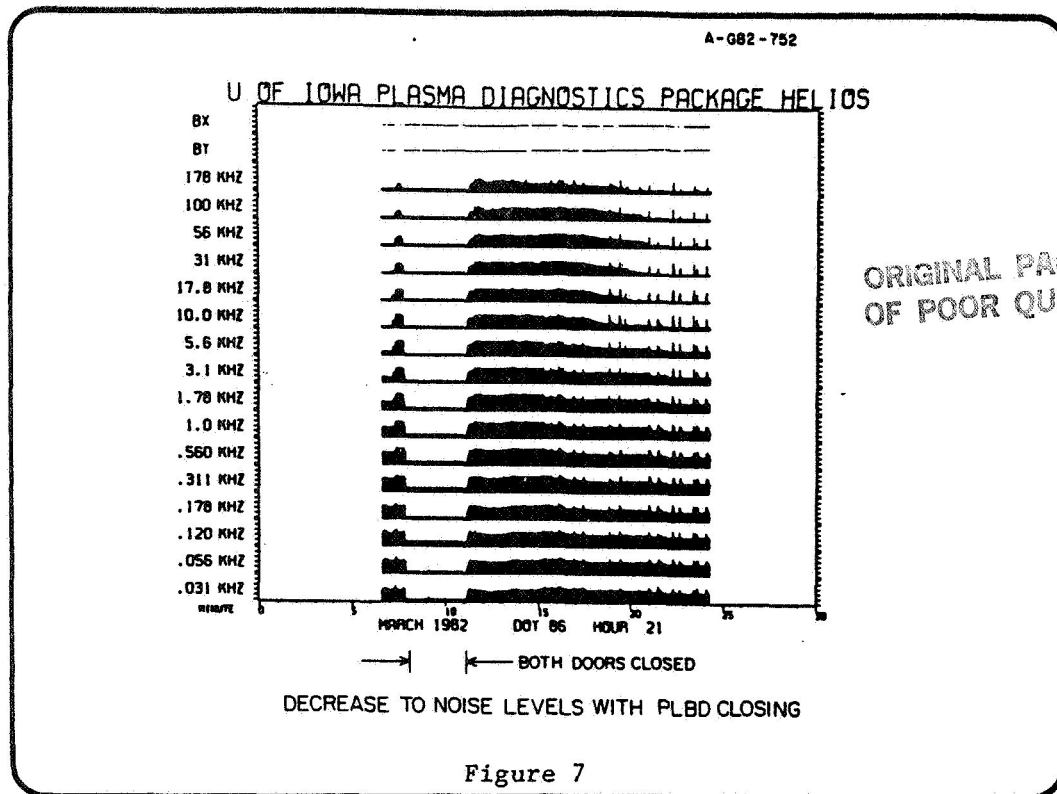

Figure 6



5.0 SPECTRUM OF ELECTROMAGNETIC NOISE

Use has been made of the Wideband Analog Receiver (WBR) to determine the spectral nature of the electric field and magnetic field noise. Spectra covering 0 to 30 kHz for several minutes of time are shown in Figure 8. The magnetic field noise shows intense lines with spacings of Hz, kHz, 10's kHz, and harmonics. Further work is in progress to identify the exact frequencies and their change with time. It is surmized that these lines are associated with data clocks and power converters.

On the other hand, the electric field spectra show a "white noise" characteristic which does not change much with time. During the payload bay door closing, weak spectral lines were evident since the external broadband noise was screened out. Note that the WBR has an automatic gain control so that the amplitude variations of Figure 4, for example, are not evident.

By searching over extended periods while the PDP was stowed on the pallet, values for the minimum and the maximum noise levels have been obtained and displayed in Figure 9. These values are calibrated in volts per meter and normalized to a 1 MHz bandwidth. The electric scales as 20 log (electric field), whereas, the bandwidth scales as 10 log (bandwidth) as the data are presented. Also plotted for comparison are the broadband electric field limits for the Shuttle itself and for a payload. When the FPEG is not operating, above the 14 kHz cutoff, the maximum level (open circles) does not exceed the payload limit. When the FPEG operates with the PDP in the beam, the levels are increased by ~ 20 dB in the VLF range.

Narrowband magnetic field strengths are much less variable ($< \pm 10$ dB) from the minimum to maximum observed levels. These levels are not Orbiter-attitude dependent and in fact, the levels were above the maximum door-opened levels with the payload bay doors closed. It is surmized that these levels are due to Orbiter subsystems which should be slightly time dependent as systems turn ON/OFF. During FPEG operations, levels in the 1-100 kHz range are increased.

ORIGINAL PAGE IS
OF POOR QUALITY

A-682-747

DETAILED PDP NOISE SPECTRA

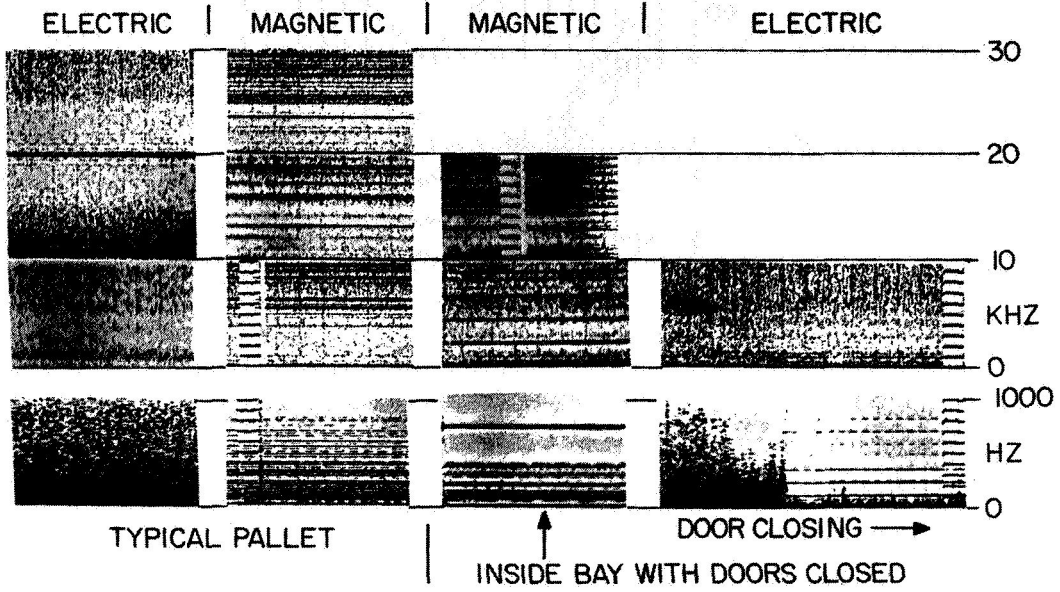

Figure 8

A-682-746

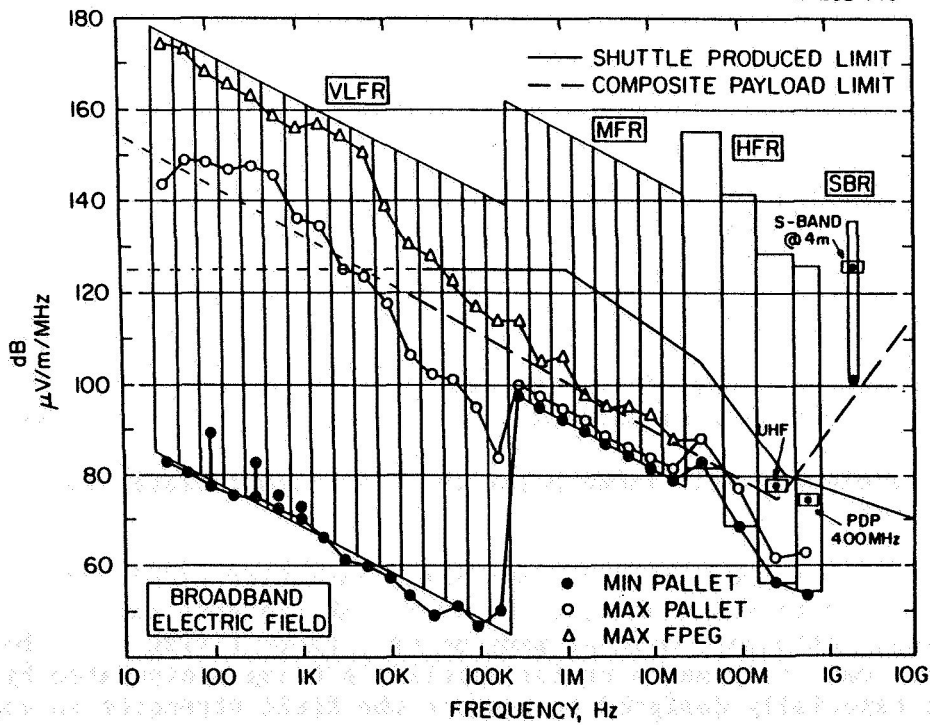
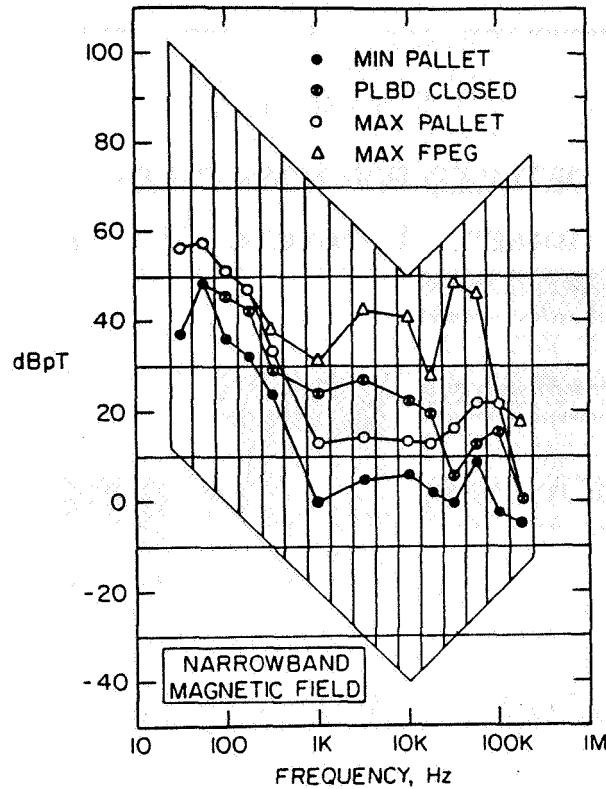

Figure 9



ORIGINAL PAGE IS OF POOR QUALITY

Figure 10

6.0 UHF AND S-BAND TRANSMITTER FIELD STRENGTHS

One filter channel of the PDP HFR covered the band of 165-400 MHz which includes the 295 MHz frequency of the UHF voice downlink transmitter. When this transmitter was keyed ON and connected to the upper antenna, a signal was detected by the PDP as shown in Figure 3. These measured field strengths were always below 0.5 V/m with the PDP on the RMS and below 0.1 V/m at the PDP pallet location. Average and peak field strengths are given in the following table:

<u>Location/Field Strengths ± 2dB</u>	<u>Average</u>	<u>Peak</u>
PDP on Pallet at 13 meters from Antenna	.05 V/m	0.08 V/m
PDP on RMS at 8 meters from Antenna	.23	.44

These levels are well known below the suggested radiated susceptibility field strengths.

At S-band, the 150 watt data downlink transmitter (2287.5 MHz) can produce fields which are modeled to be 49.6 V/mR (meters) in the beam of the selected "quad" antenna. Even at many meters, these fields could be at damage level for payload instruments or for satellites being manipulated by the RMS. The SBR was especially designed to measure the field strengths in and around the payload bay as shown in Figure 3. These measured levels were about 5 dB ± 2 dB higher than the modeled values but comparable to a crude theoretically calculated value as follows:

Field Strengths Relations
(V/m)

Predicted Field Strengths	49.6 /R (meters)
Measured with PDP (± 2 dB)	90.3 /R (meters)
Calculated @ (150 Watts)	94.9 /R (meters)

The calculated value assumes that all of the power is emitted into a hemisphere (2 π steradians) with 100% efficiency.

In the antenna beam, the fields exceed 20 V/m inside of 5 meters. However, with the PDP on the pallet at a range of 13 meters off the edge of the beam, the fields were not observed at the threshold of 2 V/m whereas the in-beam prediction would be 7V/m. Consequently, payload bay instrumentation is not subjected to damage levels.

7.3 HFR

Because of the variety of bandwidths, the dynamic range is listed in the following table:

<u>Center Frequency</u>	<u>Bandwidth</u>	<u>Minimum</u>	<u>Maximum</u>	<u>Slope</u>
40 MHz	20 - 65 MHz	-40 dBV/m	+32 dBV/m	16 dB/V
100	65 - 165	-40	+32	16
250	165 - 400	-31	+41	16
600	400 - 800	-22	+52	16

$$\text{dBV/m} \sim \text{Maximum dB} + 16 \text{ dB V/m} * \text{Output Voltage} - 80 \text{ dB}$$

7.4 SBR

Only the linear detector on the S-band system operated. An RF relay failure prevented the S-band signal from getting to the log-detector. Using calibrations at GSFC and Iowa before flight and re-calibration after flight, it is determined that the linear response is

$$\text{V/m} = 5.7 * \text{Output Voltage at 2287.5 MHz Boresight}$$

giving a fit to the field with range of about

$$\text{V/m} = \frac{90 \text{ V/m}}{\text{R (meters)}}$$

where R is the distance from the S-band quad antenna in the nominal beam.

8.0 COMMENTS

Comprehensive sets of Orbiter noise spectrum measurements have been obtained. It is found that the noise levels do not exceed the worst case predictions for the Orbiter. Consequently, the receivers really need to be more sensitive to obtain the science and the EMI data on Spacelab-2 especially since the PDP measures the Orbiter at 100 meters range. It is hoped that these improvements in sensitivity can be made for Spacelab-2.

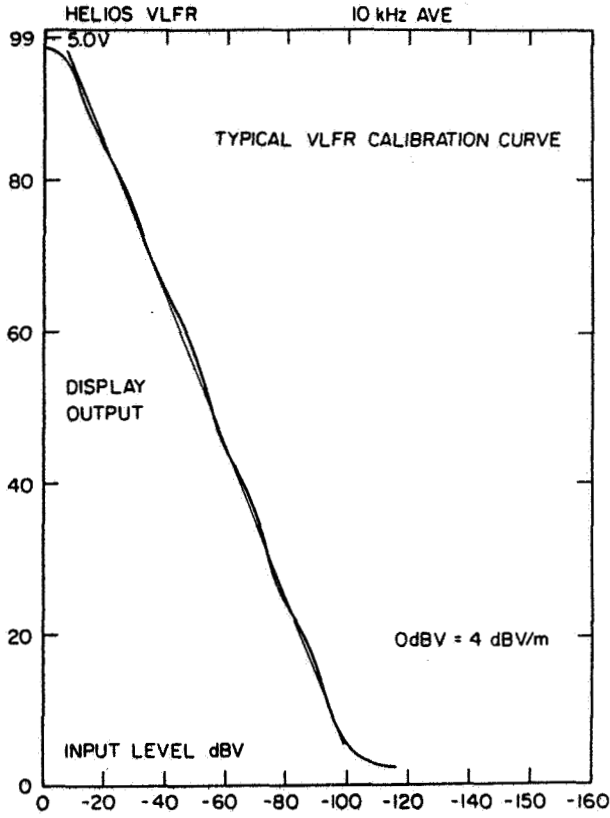

ORIGINAL PAGE IS
OF POOR QUALITY

Figure 11

ORIGINAL PAGE IS
OF POOR QUALITY

ADDITIONS TO
DR. S. SHAMHAN
PRESENTATION

TABLE 4

STS-3/PDP RECEIVER CHARACTERISTICS

VERY LOW FREQUENCY (VLFR)

- DOUBLE SPHERE ANTENNA FOR ELECTRIC FIELD
- SEARCH COIL ANTENNA FOR MAGNETIC FIELD
- 16 CHANNELS (x2 SYSTEMS)
- 30 HZ TO 178 KHZ
- WIDEBAND RECEIVER 30 HZ TO 30 KHZ

MEDIUM FREQUENCY RECEIVER (MFR)

- 8 CHANNELS
- 311 KHZ TO 17.8 MHZ
- 65 DB DYNAMIC RANGE

HIGH FREQUENCY RECEIVER (HFR)

- 4 CHANNELS
- 20 MHZ TO 800 MHZ

S-BAND RECEIVER (SBR)

- 4 CHANNELS WITH LOG DETECTOR (FAILED)
- 1 CHANNEL WITH LINEAR DETECTOR
- ~ 2200 MHZ ± 300 MHZ

P D P WAVE INSTRUMENTATION ON STS-3 / OSS-1

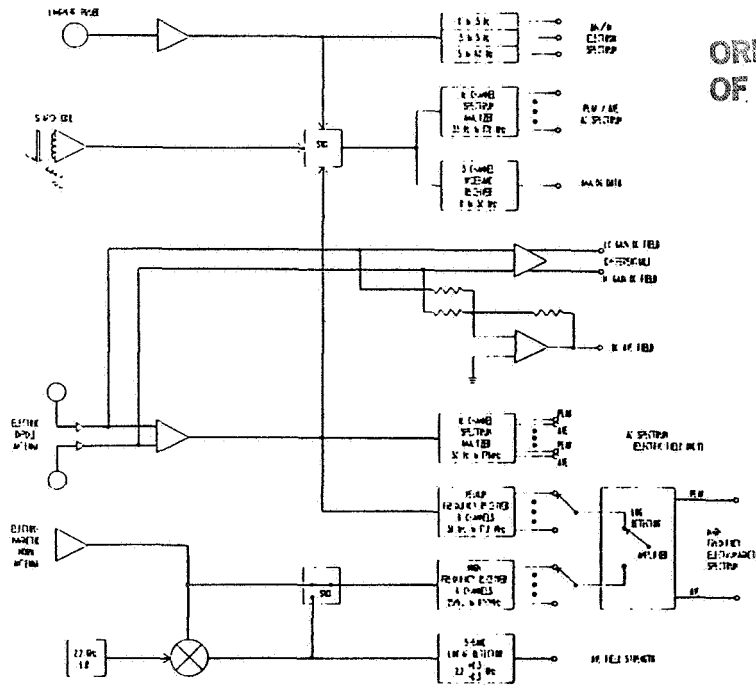

ORIGINAL PAGE IS
OF POOR QUALITY

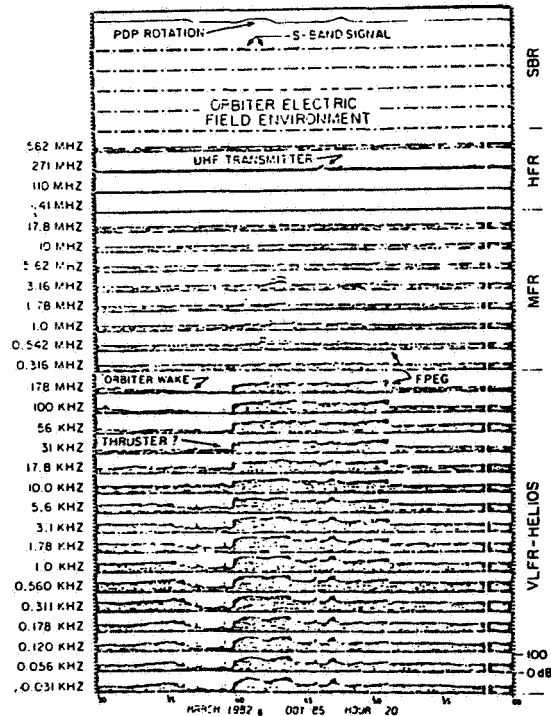

TABLE 17

ORBITER-GENERATED ELECTROSTATIC NOISE

• OBSERVED CHARACTERISTICS

ORIGINAL PAGE IS
OF POOR QUALITY

- Δ SPECTRAL EXTENT - 30 HZ TO 178 KHZ
- Δ SPECTRAL PEAK - 0.1 V/M @ 0.3 KHZ
- Δ VARIABILITY - 70 DB OVER ORBIT
- Δ MAGNETIC COMPONENT - NONE DETECTABLE OVER ORBITER MAGNETIC FIELD EMI
- Δ LOCATION - COMPLETELY DISAPPEARS WITH PAYLOAD BAY DOOR CLOSED;
IMPLIES EXTERNAL TO ORBITER
- NO SIGNIFICANT DIFFERENCE WITH PDP ON RMS: IMPLIES GENERATED
IN LARGE VOLUME
- Δ THRUSTER RESPONSE - HIGH FREQUENCIES (> 10⁴ KHZ) ARE ATTENUATED
DURING FIRINGS
- LOW FREQUENCIES ENHANCED IF NOT ALREADY PRESENT
- Δ ORBITER ATTITUDE - MAX INTENSITY ~ RAM
DEPENDENCE - MIN INTENSITY ~ WAKE
- SEE LOW FREQUENCY AT ALL ATTITUDES EXCEPT EXACTLY WAKE
- SEE HIGH FREQUENCY ONLY ~ RAM

• TENTATIVE INTERPRETATION

- Δ WAVE MODE ION ACOUSTIC
- Δ PHASE/GROUP VELOCITY $V \sim 2 \times 10^3$ M/SEC
- Δ MINIMUM WAVELENGTH λ (MIN) $\sim 2\pi\lambda$ (DEBYE)
 λ (MIN) ~ 0.02 METERS
- Δ MAXIMUM DOPPLER SHIFT FREQUENCY F (MAX) $\sim V/\lambda$ (MIN) ~ 100 KHZ
- Δ MAXIMUM WAVELENGTH λ (MAX) ~ 10 LARMOR RADII
- Δ MINIMUM FREQUENCY F (MIN) $\sim V/\lambda$ (MAX) ~ 30 HZ

• POSSIBLE ORBIT ENERGY DISSIPATION

- Δ ENERGY DENSITY (STIX)
$$W = \frac{w_i^2}{\omega^2} \cdot \left\{ \frac{1}{2} \cdot \epsilon_0 \cdot E^2 \right\} \quad (\text{MKS})$$

$$W \sim \left(\frac{50 \text{ kHz}}{300 \text{ Hz}} \right)^2 \cdot \frac{1}{2} \cdot 9 \times 10^{-12} \cdot (0.1 \text{ V/M})^2$$

$$W \sim 1 \times 10^{-9} \text{ Joules/m}^3$$
- Δ VOLUME ESTIMATE $V \sim (10 \text{ LARMOR RADII})^3 \sim (R_i)^3$
$$V \sim 2.2 \times 10^5 \text{ m}^3$$
- Δ TOTAL ENERGY/VOLUME $W \cdot V \sim 3 \times 10^{-4} \text{ Joules}$
- Δ POWER $P = \frac{W \cdot V}{T \cdot R_i} \cdot \text{Velocity}$
$$P \sim 4 \times 10^{-2} \text{ WATTS}$$

ORIGINAL PAGE IS
OF POOR QUALITY.

B-682-765

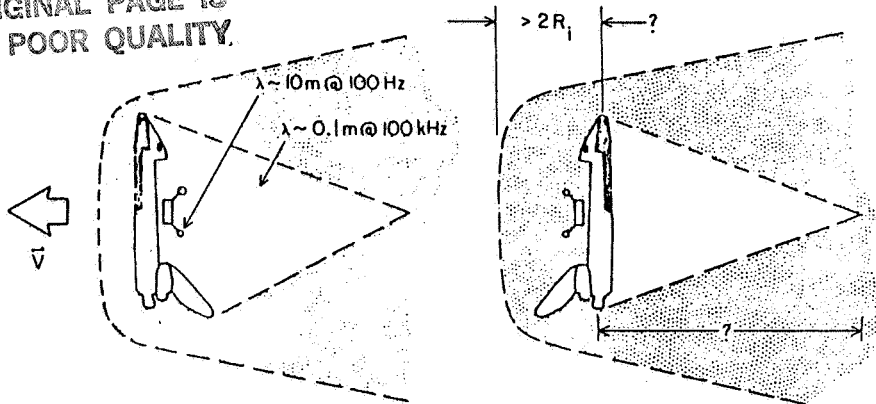

PDP IN WAKE
(SEE LOW FREQUENCIES)

PDP IN RAM
(SEE ALL FREQUENCIES)

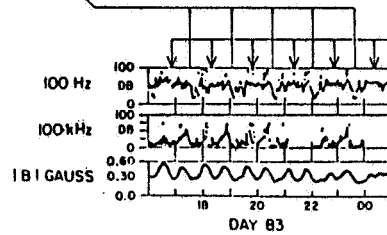

TABLE 9A

UHF/S-BAND TRANSMITTER FIELD STRENGTHS

UHF VOICE LINK (165-400 MHZ)

- PALLET LOCATION: < 0.1 V/METER
- RMS SCANS: < 0.5 V/METER

S-BAND COMMUNICATIONS LINK (2200 ± 300 MHZ)

	<u>V/M @ 1M</u>
• MEASURED WITH PDP (± 2 DB)	90.3
• EXPECTED @ 150W	49.6
• CALCULATED @ 150W (100% INTO HEMISPHERE)	94.9

N83 22309 D21

OSS-1/STS-3 SHUTTLE INDUCED ATMOSPHERE EXPERIMENT

J. L. Weinberg, F. Giovane, D. W. Schuerman*, R. C. Hahn
University of Florida

SHUTTLE ENVIRONMENT WORKSHOP
OCT 5 - 7, 1982
CALVERTON, MARYLAND

ORIGINAL PAGE IS
OF POOR QUALITY

FIRST RESULTS -
CHARACTERISTICS OF THE SHUTTLE/SPACELAB INDUCED ATMOSPHERE (SIA)

SPACE ASTRONOMY LABORATORY
UNIVERSITY OF FLORIDA (EXPERIMENT WAS STARTED AT SUNY ALBANY)
GAINESVILLE, FL

TEAM

JERRY WEINBERG	PRINCIPAL INVESTIGATOR
FRANK GIOVANE	CO-INVESTIGATOR
DON SCHUERMAN [†]	CO-INVESTIGATOR
DICK HAHN	PROJECT ENGINEER

EXPERIMENT OBJECTIVES

- ORBITER ENVIRONMENT DETERMINE THE OPTICAL PROPERTIES OF THE SHUTTLE INDUCED ATMOSPHERE [BRIGHTNESS, COLOR, POLARIZATION, ANGULAR DEPENDENCE, TIME VARIATIONS], ITS EFFECTS ON DAYTIME ASTRONOMICAL AND EARTH-VIEWING OBSERVATIONS, AND ITS POSSIBLE EFFECTS ON NIGHTTIME INFRARED OBSERVATIONS.
- ASTRONOMY DETERMINE THE BRIGHTNESS, COLOR, AND POLARIZATION OF THE DIFFUSE ASTRONOMICAL BACKGROUND, WITH EMPHASIS ON THE MILKY WAY AND IN SKY REGIONS CLOSER THAN 90 DEG TO THE SUN. USE THESE DATA TO EXAMINE THE INTEGRATED PROPERTIES OF DUST IN THE SOLAR SYSTEM AND MILKY WAY, INCLUDING A POSSIBLE EVOLUTIONARY SEQUENCE OF INTER-STELLAR (MILKY WAY) GRAINS TO COMETS TO INTERPLANETARY DUST.

[†] DR. DONALD W. SCHUERMAN WAS KILLED IN AN AUTOMOBILE ACCIDENT ON MAY 19, 1982.

Preceding page blank

RELATIVE* BRIGHTNESS	SOURCE
2×10^{15}	- SUN
4×10^9	- FULL MOON
VARIED	- PLANETS
	- ASTRONOMICAL BACKGROUND RADIATION
$50^i - 2200^{ii}$	INTERPLANETARY (ZODIACAL LIGHT)
VARIED	MILKY WAY - DISCRETE STARS
30 - 1000	- BACKGROUND STARLIGHT
1	EXTRAGALACTIC SOURCES
	- TERRESTRIAL
	SUNLIT EARTH (DAY)
	TWILIGHT
	ATMOSPHERIC EMISSIONS (AIRGLOW, AURORA)
	"DARK" EARTH
	- "LOCAL"
	BAY LIGHTS
	CABIN LIGHTING
	FPEG FILAMENT
	FPEG ELECTRON BEAM
	SUNLIGHT THROUGH CABIN BAY WINDOWS WHEN IN NOSE-SUN ATTITUDE (?)
	THRUSTER FIRINGS AND ASSOCIATED PHOTOCHEMICAL REACTIONS
	PHOTOCHEMICAL REACTIONS ON ORBITER SURFACES
	ORBITER/PAYLOAD-INDUCED GASEOUS MATERIAL
	ORBITER/PAYLOAD-INDUCED PARTICULATE MATERIAL
	DIRECTLY- AND INDIRECTLY-ILLUMINATED ORBITER/PAYLOAD
	SURFACES FROM ALL OF THE ABOVE

* THESE ARE ALSO ABSOLUTE VALUES, IN UNITS OFTEN USED IN LOW LIGHT LEVEL STUDIES:
EQUIVALENT NUMBER OF 10th MAGNITUDE STARS OF SOLAR TYPE PER SQUARE DEG [S₁₀(V) UNITS]
ⁱ NEAR THE ECLIPTIC POLES

ⁱⁱ AT 30 DEG FROM THE SUN IN THE ECLIPTIC

ORIGINAL PAGE IS
OF POOR QUALITY

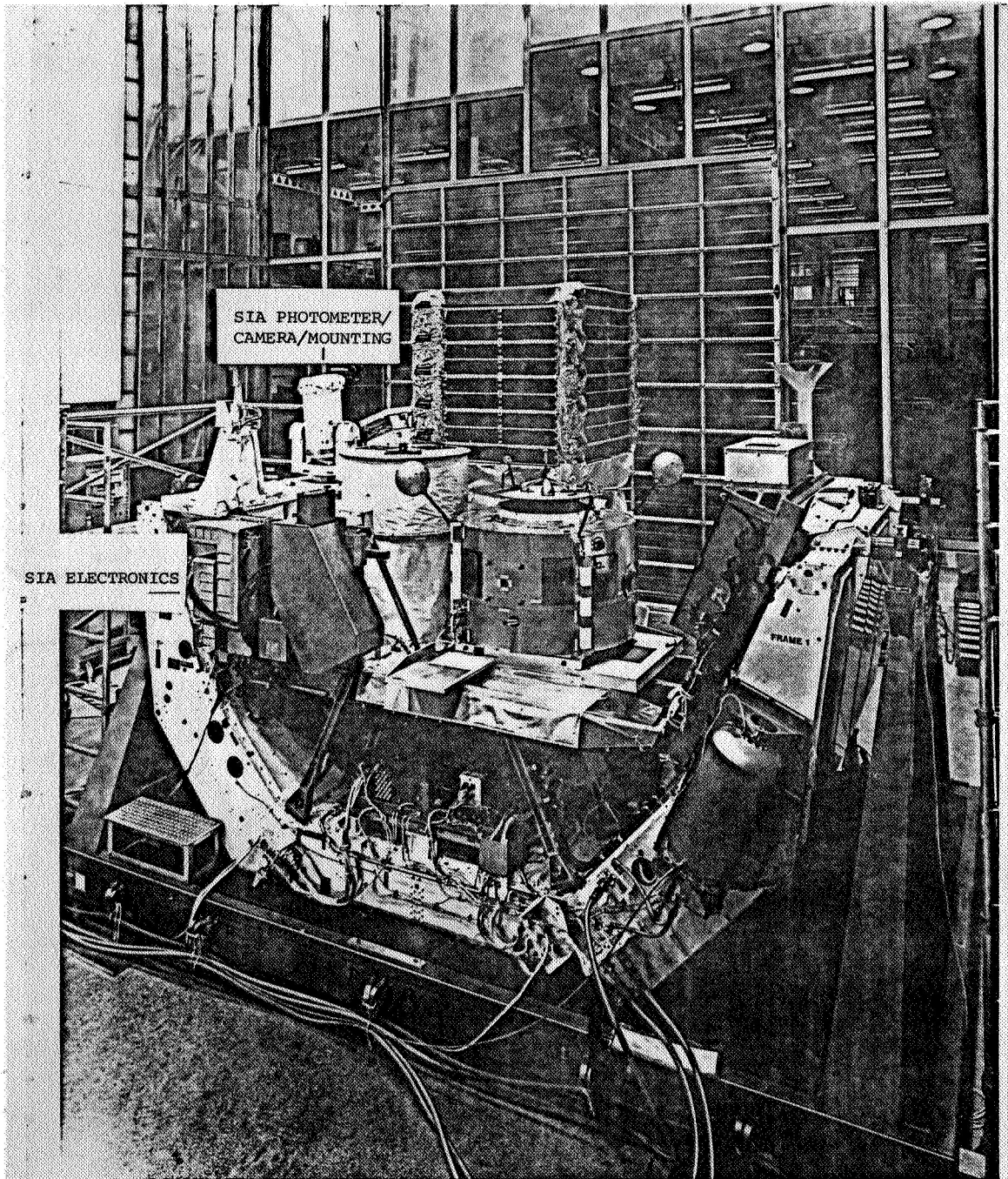

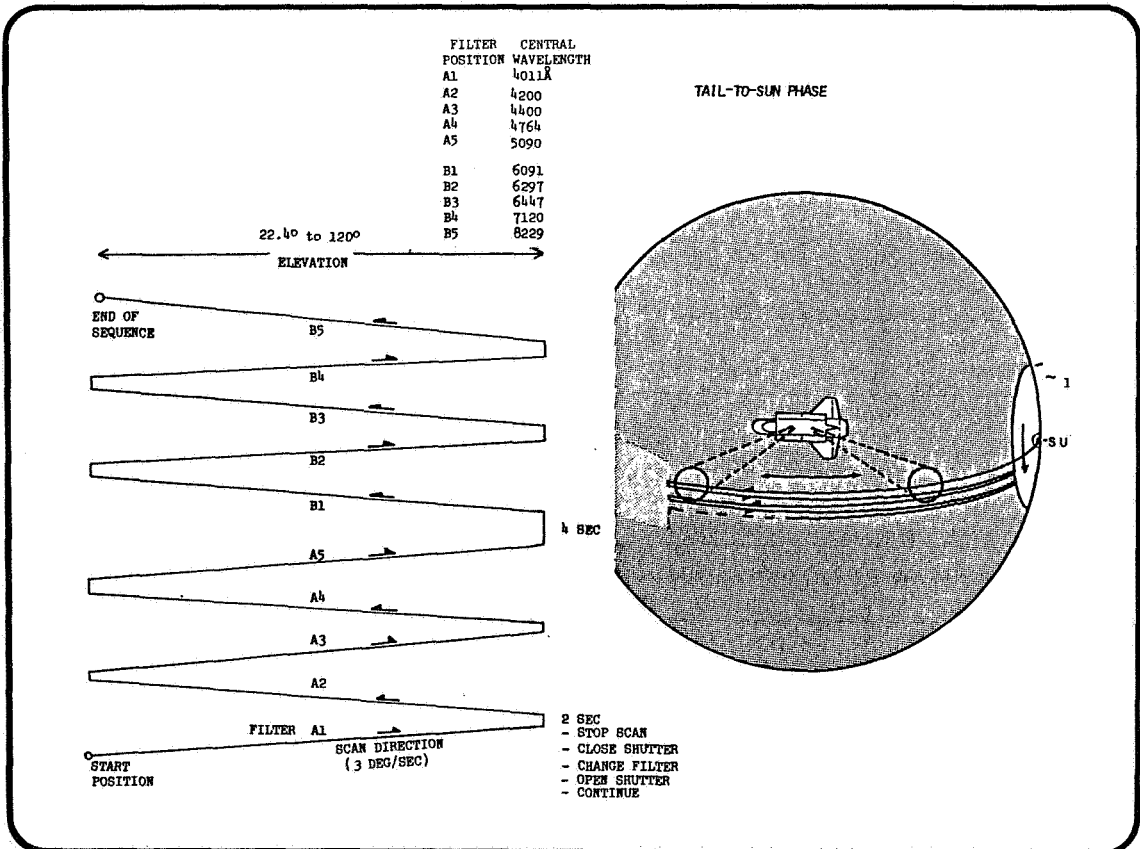
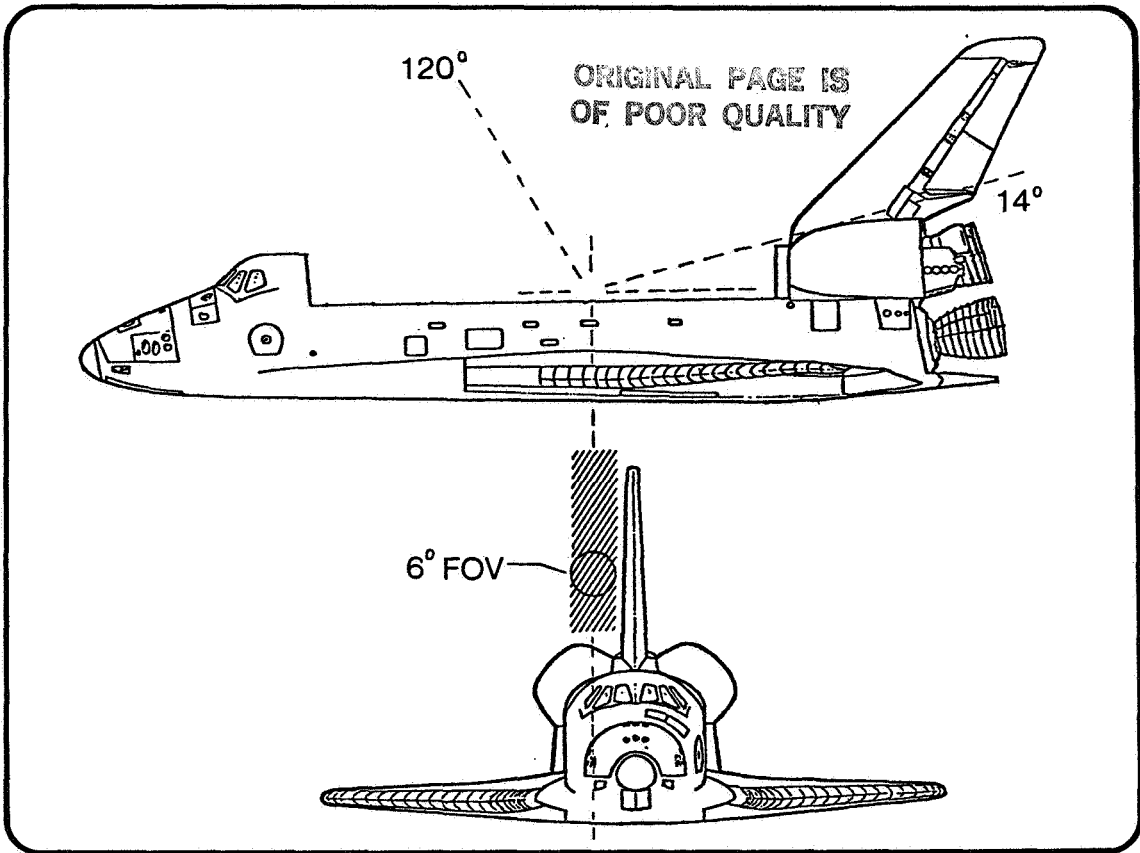

ORIGINAL PAGE IS
OF POOR QUALITY

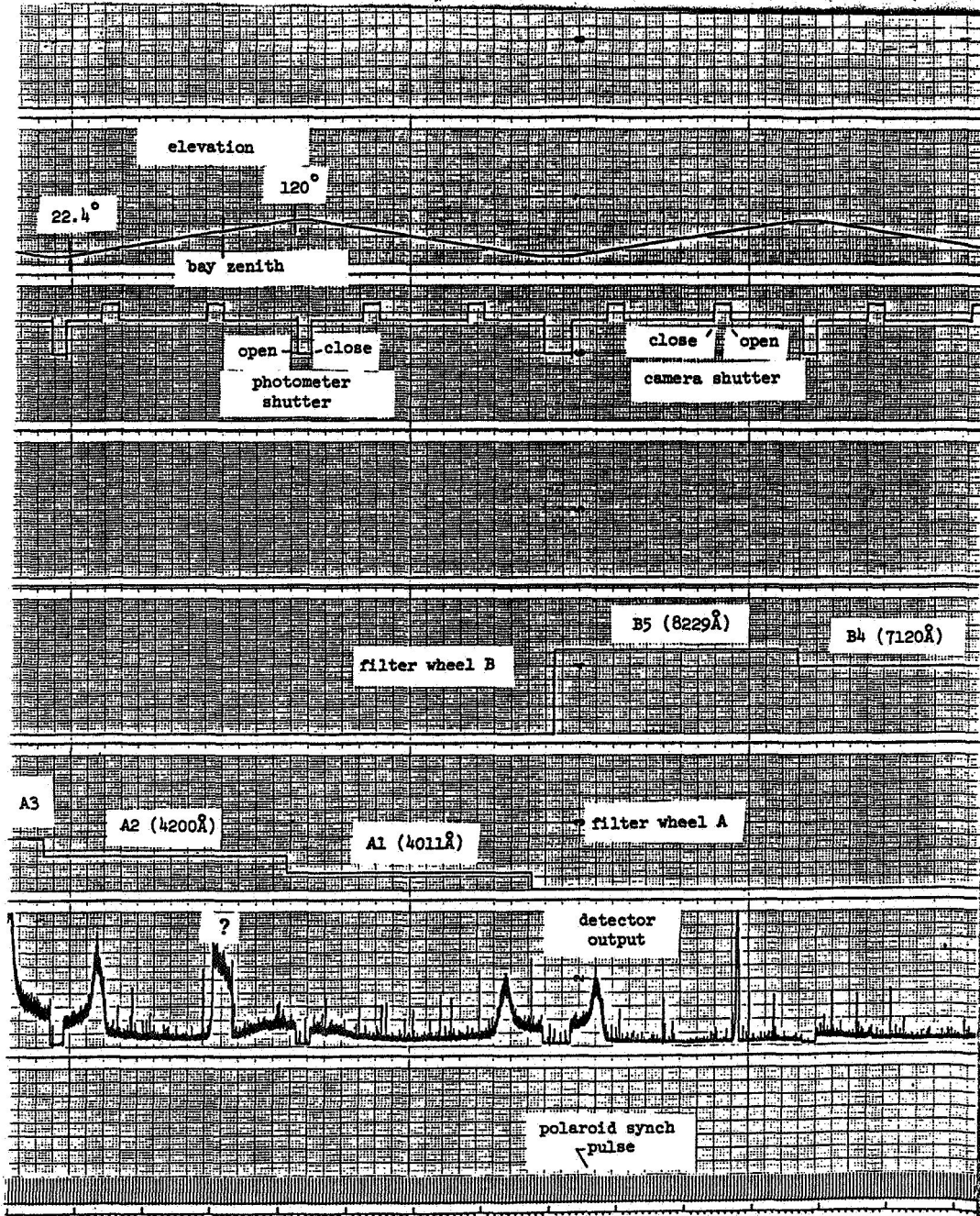

ORIGINAL PAGE IS
OF POOR QUALITY

RUN	ORBIT OF START	NOMINAL ATTITUDE	GMT START				GMT END				
			d	h	m	s	d	h	m	s	
1	4	PTC	81	21	04	34	81	22	38	34	
2	5	VARIOUS	81	22	41	15	82	00	15	15	
3	6	VARIOUS (DRIFT, IH)	82	00	25	00	82	01	59	00	
4	7	VARIOUS IH;TS	82	02	00	00	82	03	34	00	
5	8	TAIL-SUN	82	03	42	00	82	05	15	00	
6	-		NOT RUN								
7	10	TAIL-SUN	82	06	43	00	82	08	17	00	
8	12	TAIL-SUN	82	08	51	00	82	10	25	00	
9	13	TAIL-SUN	82	10	30	01	82	12	03	56	
10	14	TAIL-SUN	82	12	10	21	82	13	44	21	
11	-		NOT RUN								
12	19	TAIL-SUN	82	19	00	00	82	20	34	00	
13	20	TAIL-SUN	82	20	36	02	82	22	10	02	
14	24	PTC	83	03	00	00	83	04	34	00	
15	25	PTC	83	04	38	14	83	06	12	14	
16	26	PTC	83	06	23	00	83	07	57	00	
17	28	PTC	83	07	59	58	83	09	33	58	
18	31	PTC/NOSE-SUN	83	12	36	45	83	14	10	45	
19	32	NOSE-SUN	83	14	14	04	83	15	48	04	
20	44	NOSE-SUN	84	07	46	59	84	09	20	59	
21	66	NOSE-SUN	85	17	40	01	85	19	14	01	
22	71	NOSE-SUN/RCS BURN ATT	85	23	45	00	86	01	19	00	
22a	72	IH/NOSE-SUN	86	01	56	46	86	03	30	38	
23	75	NOSE-SUN	86	05	46	10	86	07	20	02	
24	104	PTC	88	01	32	01	88	03	10	00	
25	105	PTC	88	03	10	00	88	04	44	19	
26	106	PTC	88	04	45	00	88	06	19	20	
27	107	PTC	88	06	20	01	88	07	54	21	
28	108	PTC	88	07	55	00	88	09	29	20	
29	109	PTC/IMU IH	88	09	30	01	88	11	04	20	
30	110	IMU IH/PTC	88	11	05	00	88	12	39	20	
31	111	PTC/TAIL-SUN	88	12	40	01	88	14	00	54 (this run was shut down early)	

ORIGINAL PAGE IS
OF POOR QUALITY

1

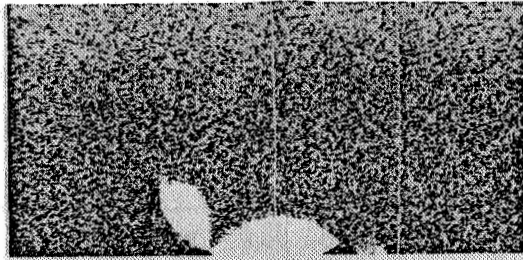

2

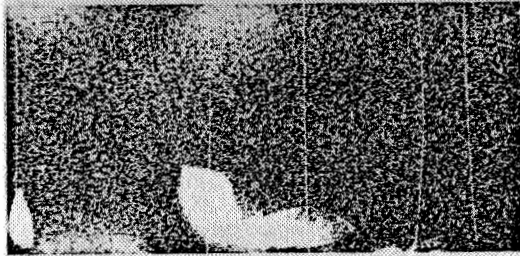

3

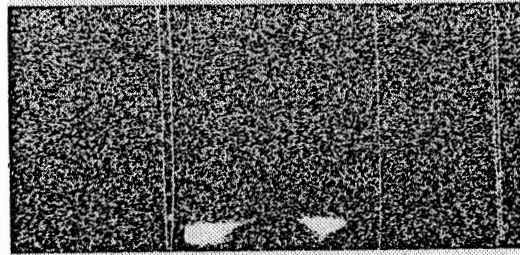

4

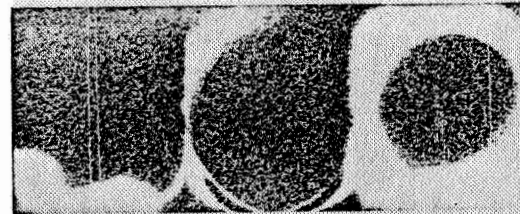

5

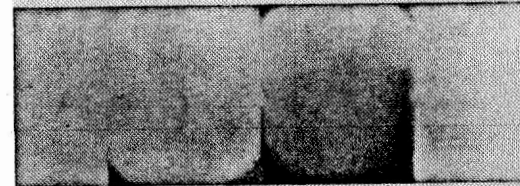

Representative frames, SIA/STS-3, 16 mm Maurer camera

ORIGINAL PAGE IS
OF POOR QUALITY

REPRESENTATIVE CAMERA FRAMES

THE 16MM CAMERA FRAMES ARE REPRESENTATIVE OF THE LIGHTING CONDITIONS/SOURCES THAT WERE ENCOUNTERED DURING STS-3. EACH OF THE FIVE SETS CONTAINS SEVERAL FRAMES. SETS 1 AND 2 ARE PRINTED IN REVERSE, BUT THIS DOES NOT AFFECT THE RESULTS. THE VERTICAL LINES ON SETS 1 THROUGH 4 ARE DUE TO FILM CRACKS. THE DIFFUSE GLOWS IN 2 AND 4 ARISE FROM ELECTROSTATIC FOGGING.

SUMMARY:

- 1 & 2. THE FRAMES NEAR CENTER SHOW PART OF THE ILLUMINATED TAIL ASSEMBLY AND ENGINE POD. THESE FRAMES CORRESPOND TO EXPOSURES STARTED AT ELEVATION 45 DEG AS THE INSTRUMENT SCANNED TOWARD THE TAIL; I.E., THE SHUTTER WAS STILL OPEN WHEN THE ORBITER ENTERED THE FIELD OF VIEW OF THE CAMERA/SUNSHIELD.
3. THE FRAME NEAR CENTER SHOWS THE EARTH'S LIMB BEHIND AND TO EITHER SIDE OF THE DARK ENGINE POD.
4. THE TWO RIGHT-MOST FRAMES SHOW DARK SKY WITH THE CAMERA SUNSHIELD BAFFLES BEING ILLUMINATED BY AN OFF-AXIS SOURCE OF LIGHT.
5. FRAMES 1 AND 4 ARE COMPLETELY OVEREXPOSED. THE SUNSHIELD IN FRAME 3 IS DARK, THEREBY RULING OUT OFF-AXIS STRAYLIGHT. THE BRIGHT CENTRAL REGION CORRESPONDS TO THE SKY ITSELF BEING BRIGHT.

PHOTOGRAPHS SUCH AS THESE ARE AN IMPORTANT DIAGNOSTIC TOOL IN EVALUATING LIGHTING CONDITIONS AS SEEN FROM THE SIA'S PALLET-MOUNTED POSITION AND IN EVALUATING MEASUREMENTS WITH THE BORESIGHTED PHOTOPOLARIMETER.

ORIGINAL PAGE IS
OF POOR QUALITY

SIA PHOTOMETER PROTECTIVE SHUTTER OPEN/CLOSE (■) HISTORY *

STS-3
TAIL-SUN

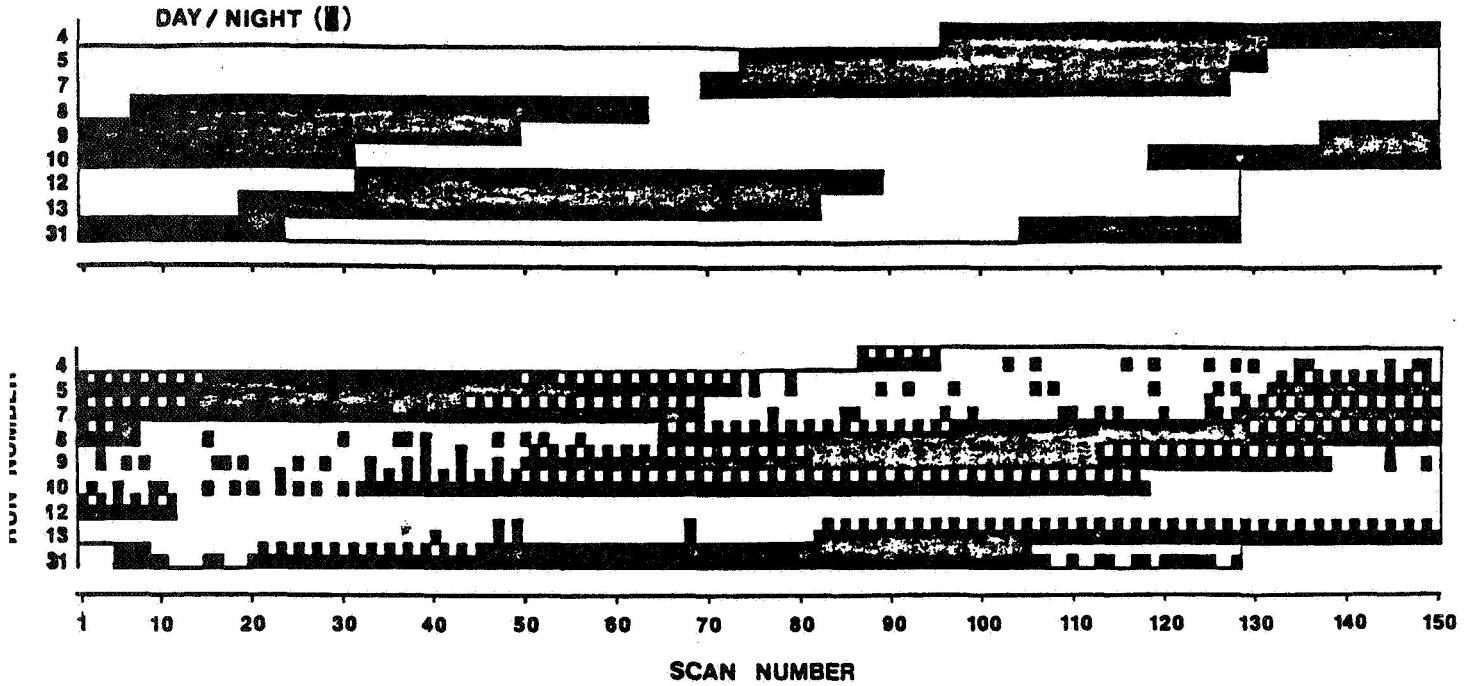

NOTES: ↑ 7 ↑ 6 ↑ 3 ↑ 4 5 ↑ 8 ↑ 2 ↑ 1 ↑ 9

- 1 RUN 4 TAIL-SUN ATTITUDE FROM SCAN 87 TO SCAN 103
- 2 RUN 5 SWITCH TRACKS ON FLIGHT RECORDER
- 3 RUN 10 TLM LOSS
- 4 RUN 10 TLM LOSS, TRACK SWITCH
- 5 RUN 10 TLM LOSS
- 6 RUN 13 FLIGHT RECORDER TRACK SWITCH
- 7 RUN 31 START OF TAIL-SUN ATTITUDE
- 8 RUN 31 TAPE DROPOUT, NOT RECOVERABLE
- 9 RUN 31 END OF RUN

* THE TOP FIGURE SERVES AS A DAY/NIGHT INDICATOR FOR EACH OBSERVING RUN. THE LOWER FIGURE INDICATES FOR WHICH SCANS THE SHUTTER IS OPEN (□) CLOSED FOR EVEN A FEW DEGREES (◻), OR SHUT DOWN ENTIRELY (■).

ORIGINAL PAGE IS
OF POOR QUALITY

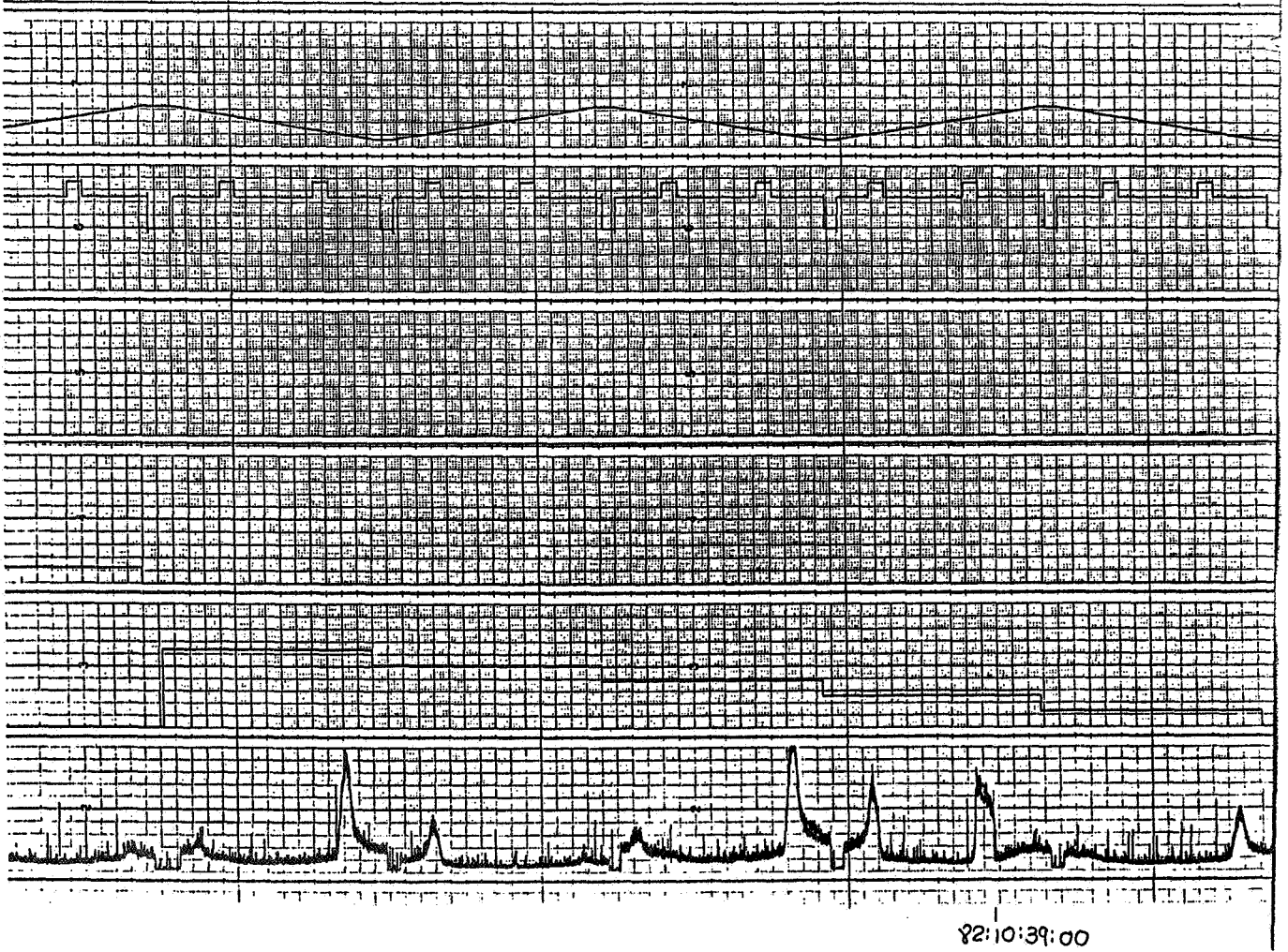

ORIGINAL PAGE IS
OF POOR QUALITY

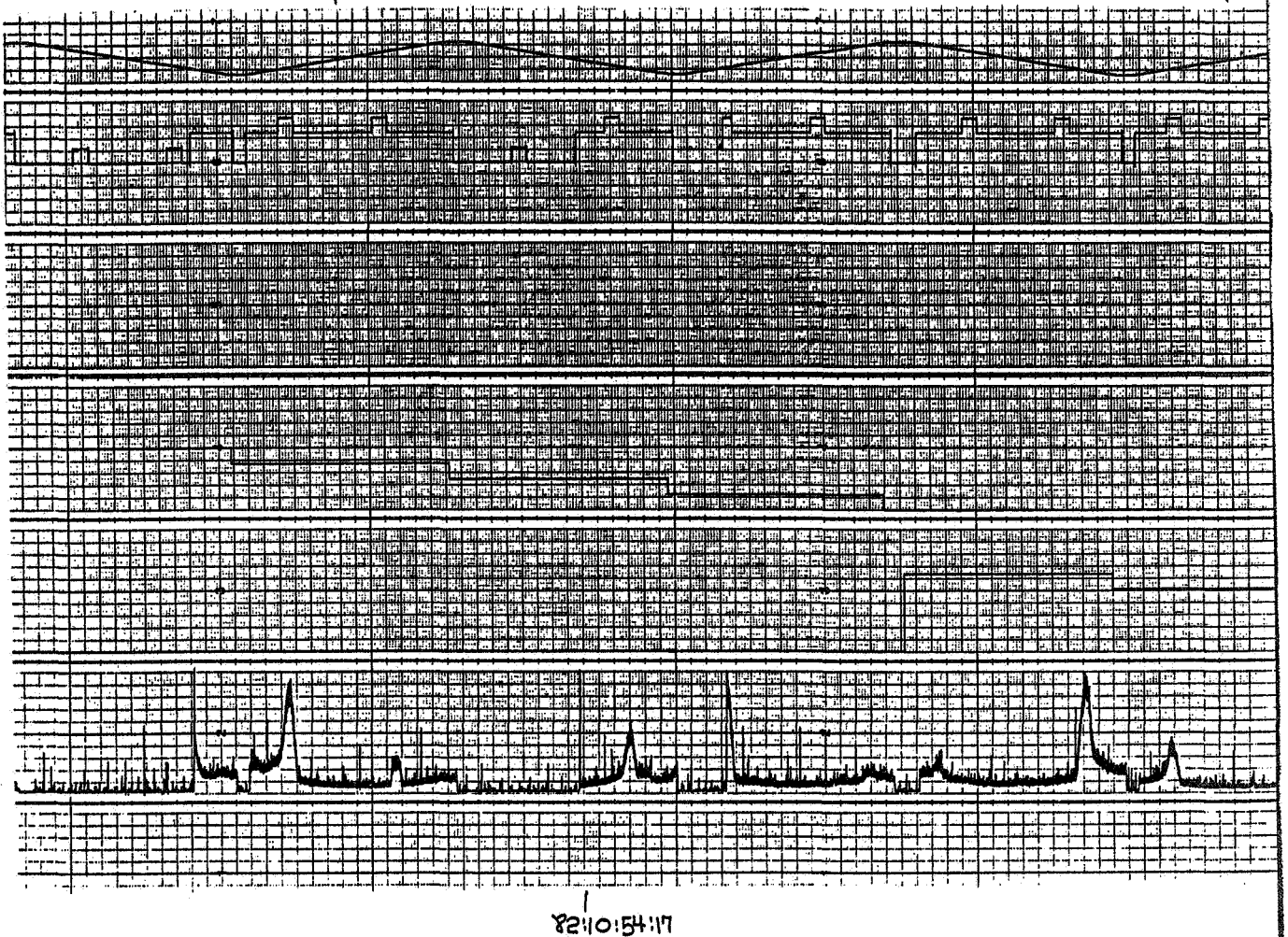

ORIGINAL PAGE 19
OF POOR QUALITY

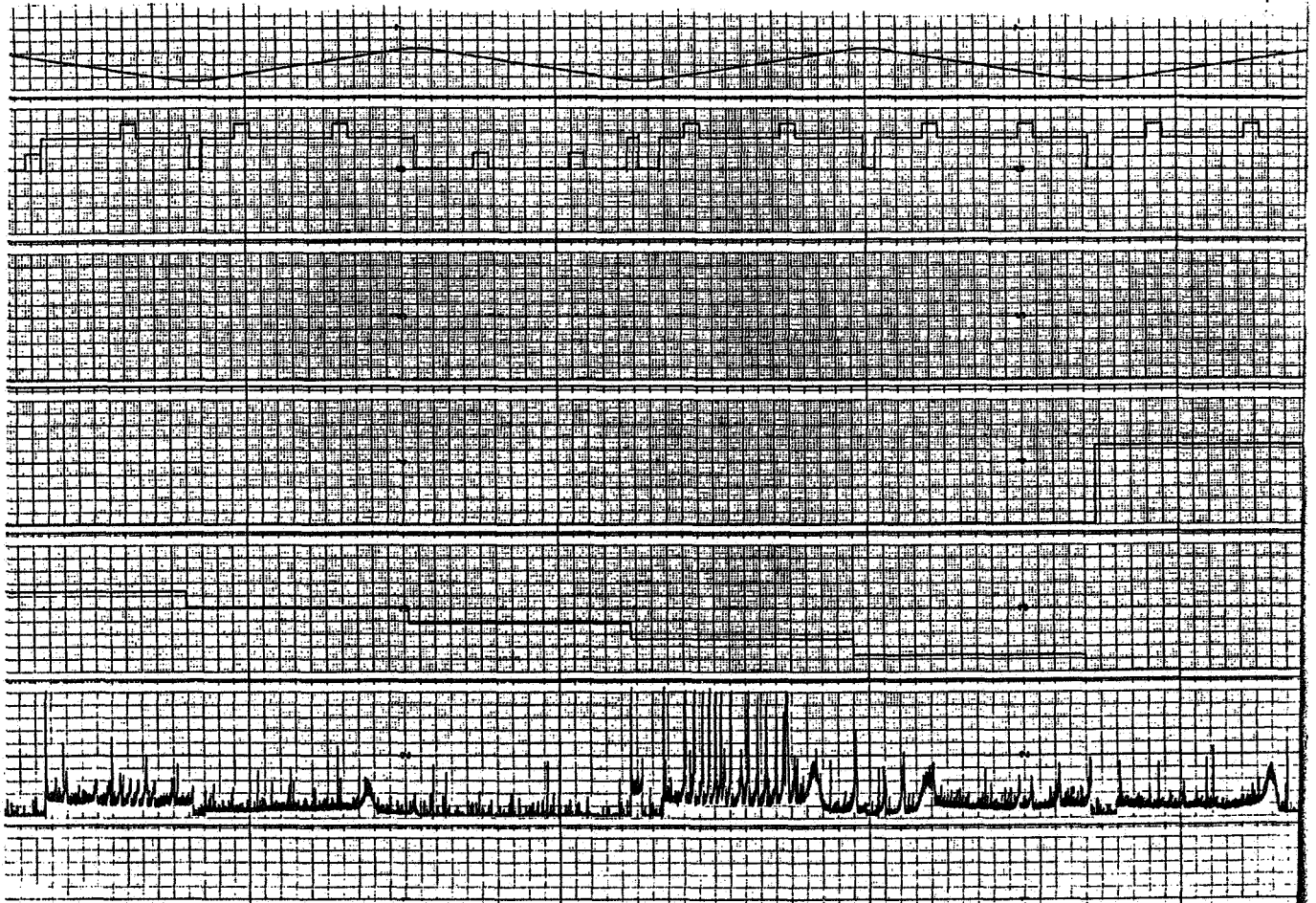

81:22:56.35

ORIGINAL PAGE IS
OF POOR QUALITY

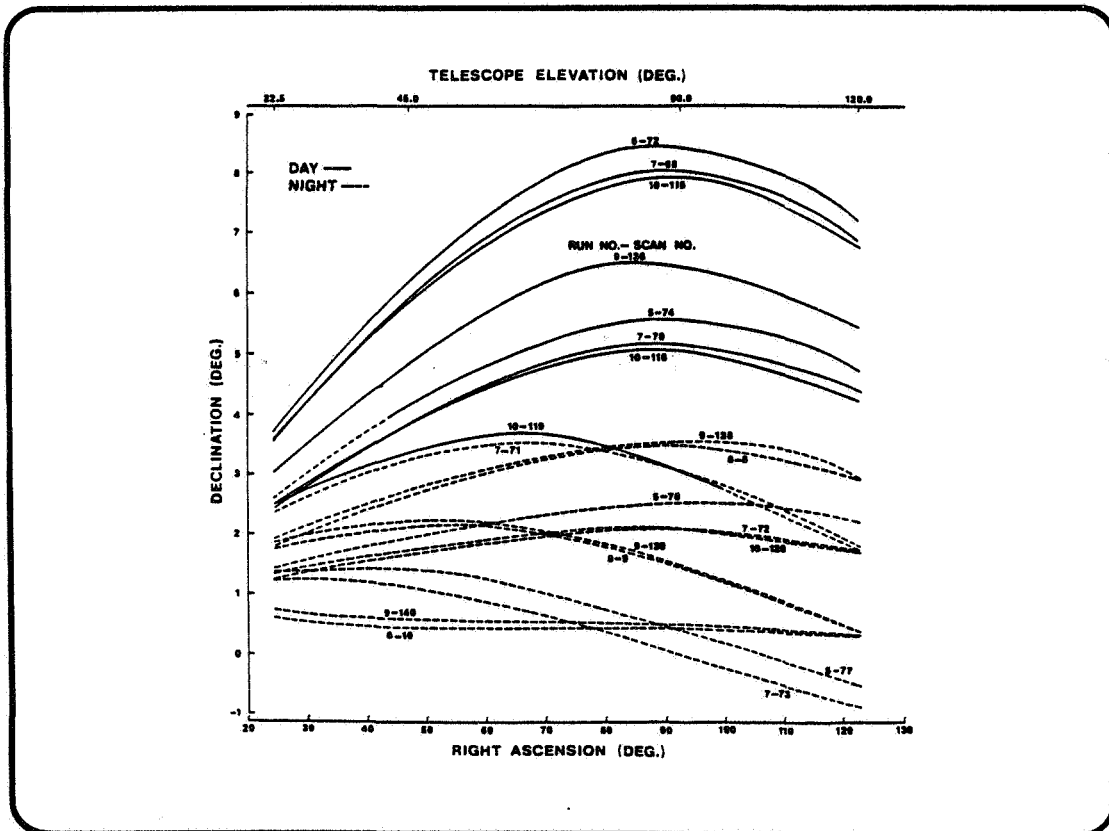
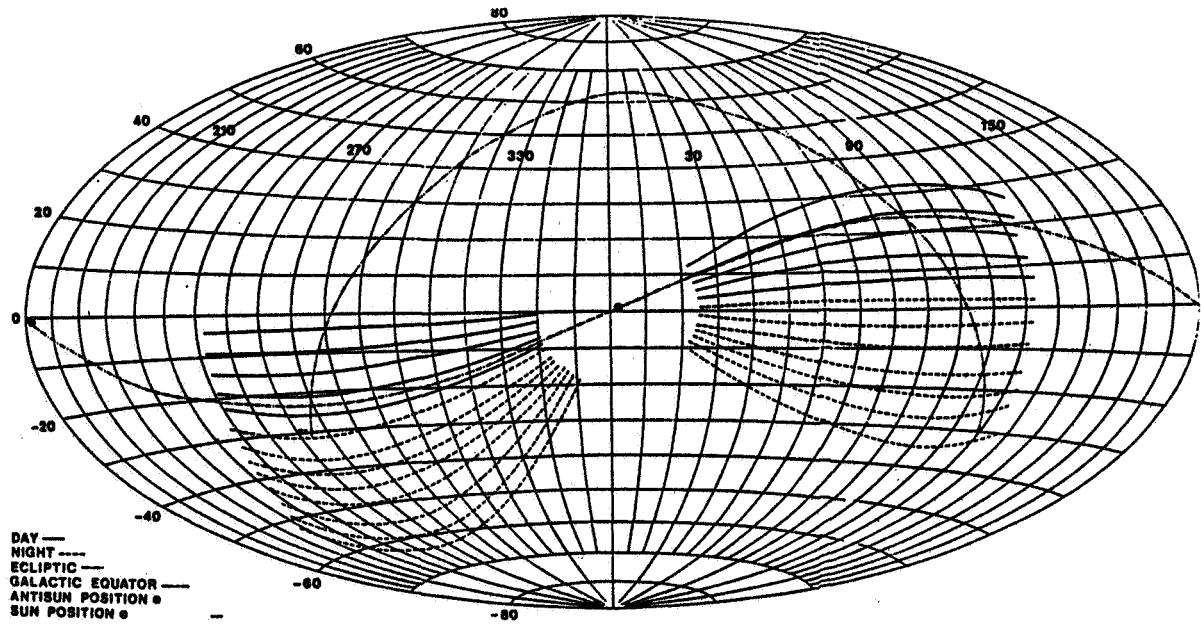

ORIGINAL PAGE IS
OF POOR QUALITY

SUMMARY OF FIRST RESULTS
SHUTTLE INDUCED ATMOSPHERE EXPERIMENT

OPTICAL ENVIRONMENT

TWO MAJOR SOURCES OF LIGHT WERE SEEN IN THE BAY DURING SPACECRAFT DAY:

1. DIRECT LIGHT FROM THE SUN AND FROM THE SUNLIT EARTH,
2. INDIRECT LIGHT FROM THESE SAME SOURCES (REFLECTED OFF PART(S) OF THE ORBITER AND ITS PAYLOAD).

TENTATIVE IDENTIFICATION HAS ALSO BEEN MADE OF BRIGHTNESS ARISING FROM SUNLIGHT REFLECTED OFF PARTICULATES ORIGINATING FROM THE ORBITER AND ITS PAYLOAD: I.E., SPACECRAFT CORONA OR INDUCED ATMOSPHERE.

SEVERAL SOURCES OF LIGHT WERE ALSO OBSERVED DURING SPACECRAFT NIGHT:

1. LARGE SCALE DIFFUSE GLOWS ASSOCIATED WITH VERNIER THRUSTER FIRINGS,
2. SURFACE GLOWS ON THE ORBITER IN THE DIRECTION OF ITS ORBITAL MOTION,
3. PERIODIC SKY BRIGHTNESS "STRUCTURES" -OBSERVED PRIMARILY AT 4200Å AND 6300Å - WHICH ARE NOT YET POSITIVELY IDENTIFIED.

PARTICULATE ENVIRONMENT

ON-BOARD TELEVISION IN A SPLIT-SCREEN "STEREOSCOPIC" FORMAT WAS USED IN AN ATTEMPT TO PROVIDE INFORMATION ON SIZES AND TRAJECTORIES OF INDIVIDUAL CONTAMINANT PARTICULATES. DUE TO POOR STATION CONTACT/TERMINATOR TIMING AND LACK OF CREW INVOLVEMENT, THE SELF-CONTROLLED TV MONITORS WERE OVER-POWERED BY LIGHT IN THE BAY AND ONLY A FEW PARTICLES COULD BE SEEN. SOME INFORMATION IS AVAILABLE ON THESE PARTICULATES FROM THE "STANDARD", SINGLE-FRAME TV FORMAT DATA; I.E., THE LARGE NUMBERS OF PARTICULATES SEEN DURING TAIL-SUN.

ASTRONOMICAL BACKGROUND

ASTRONOMICAL DATA WERE OBTAINED FROM MEASUREMENTS OVER LARGE REGIONS OF THE MILKY WAY AND ZODIACAL LIGHT, INCLUDING REGIONS TO WITHIN 35 DEG OF THE SUN AND POSSIBLY CLOSER.

OTHER

COORDINATED AND SOMETIMES SIMULTANEOUS OBSERVATIONS WERE SUCCESSFULLY MADE FROM MT. HALEAKALA , HAWAII AND FROM STS-3 TO PROVIDE UNIQUE INFORMATION ON ATMOSPHERIC SOURCES AND SINKS OF RADIATION.

N83 22310

D22 ✓

SOLAR ULTRAVIOLET SPECTRAL IRRADIANCE MONITOR
EXPERIMENT ON OSS-1

M. E. VanHossier
Naval Research Laboratory

SOLAR ULTRAVIOLET SPECTRAL IRRADIANCE
MONITOR EXPERIMENT ON OSS-1

ORIGINAL PAGE IS
OF POOR QUALITY

Michael E. VanHoosier
E. O. Hulburt Center for Space Research
Naval Research Laboratory
Washington, D.C. 20375

The need to improve the accuracy of measurement of the absolute solar flux within the wavelength range 120-400 nm requires an extensive effort in contamination control and in tracking the instruments stability. The techniques used in the Solar Ultraviolet Spectral Irradiance Monitor (SUSIM) flown by the Naval Research Laboratory on OSS-1 will be described. These methods have resulted in very high calibration stability as proven by pre-flight and post-flight calibration. In-flight calibration and the pointing accuracy provided by the Shuttle attitude control system will also be discussed.

SOLAR ULTRAVIOLET SPECTRAL IRRADIANCE MONITOR
(SUSIM)

P.I.: G.E. BRUECKNER
PROJECT SCIENTIST: M.E. VANHOOSIER
CO-1: D.K. PRINZ
CO-1: J.-D.F. BARTOE
PROJECT MANAGER: R.J. SCHUMACHER

E. O. HULBURT CENTER FOR SPACE RESEARCH
NAVAL RESEARCH LABORATORY
WASHINGTON, D.C. 20375

ORIGINAL PAGE IS
OF POOR QUALITY

SCIENTIFIC OBJECTIVE

HIGH PRECISION SOLAR ULTRAVIOLET IRRADIANCE MEASUREMENTS
TO DETERMINE ABSOLUTE FLUX IN THE 120-400 NM REGION AND
ITS VARIATION OVER AN 11-YEAR SOLAR CYCLE.

FIRST FLIGHT OF A NEW HIGH PRECISION PHOTOMETER

IMPROVEMENTS OVER PREVIOUS INSTRUMENTS:

1. IN-FLIGHT TRACKING SOURCE
2. TWIN SPECTROMETERS
3. DOUBLE DISPERSION ARRANGEMENT
4. MULTI-DETECTOR APPROACH
5. USE OF HIGH STABILITY DIODES
6. IN-FLIGHT ELECTRICAL CALIBRATION
7. COMPUTER-CONTROLLED OBSERVING SEQUENCES

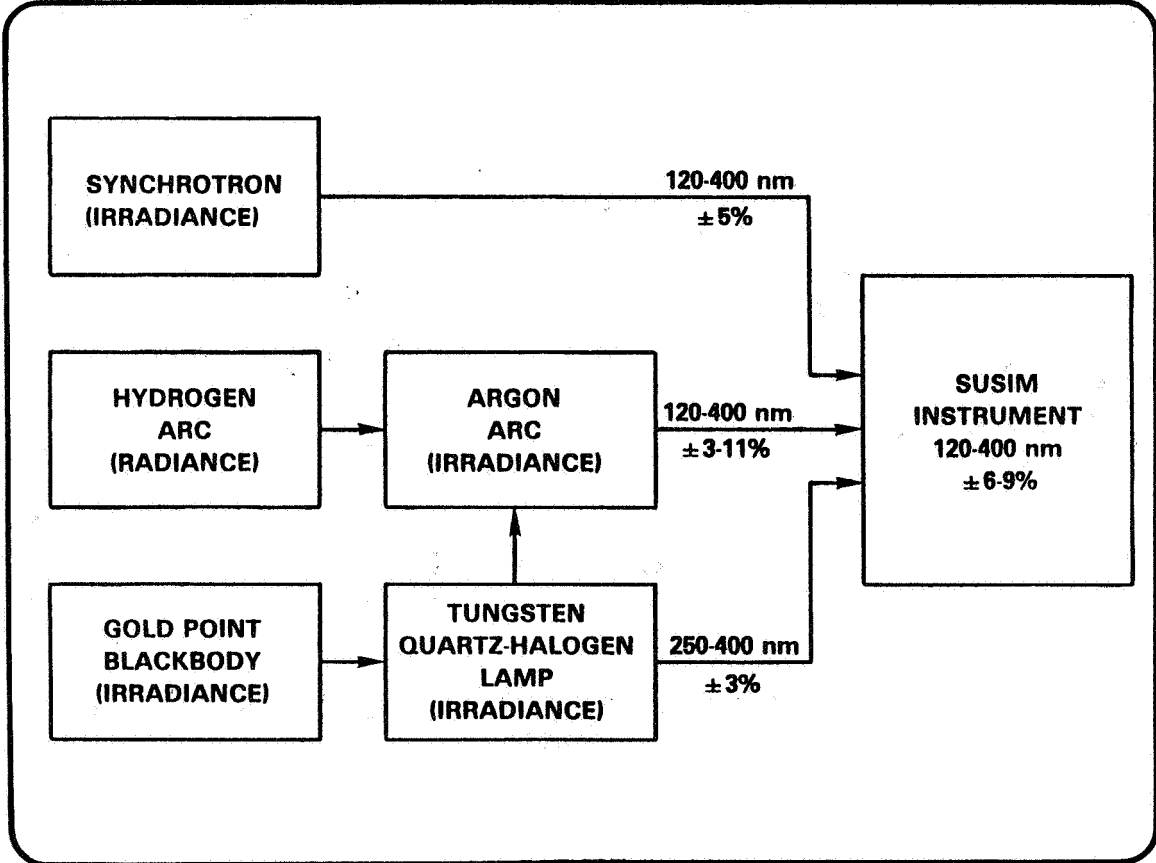
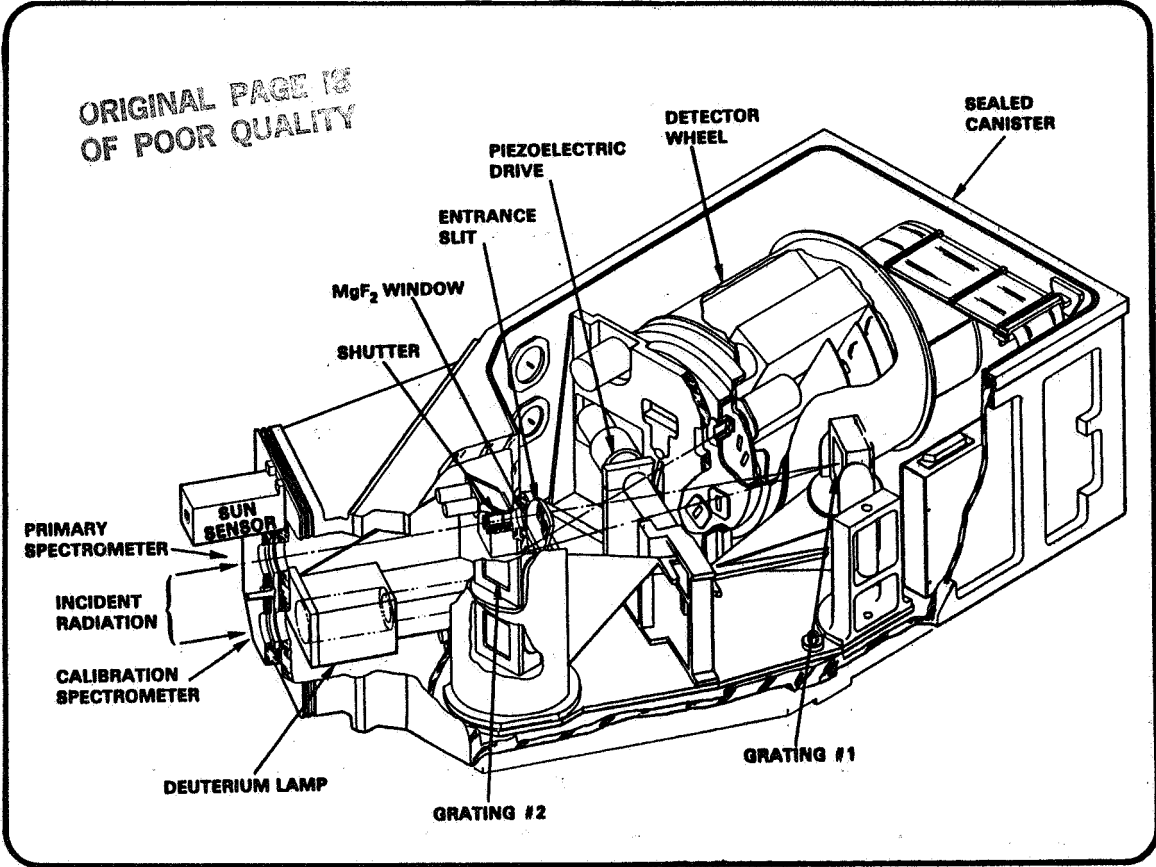

ORIGINAL PAGE IS
OF POOR QUALITY

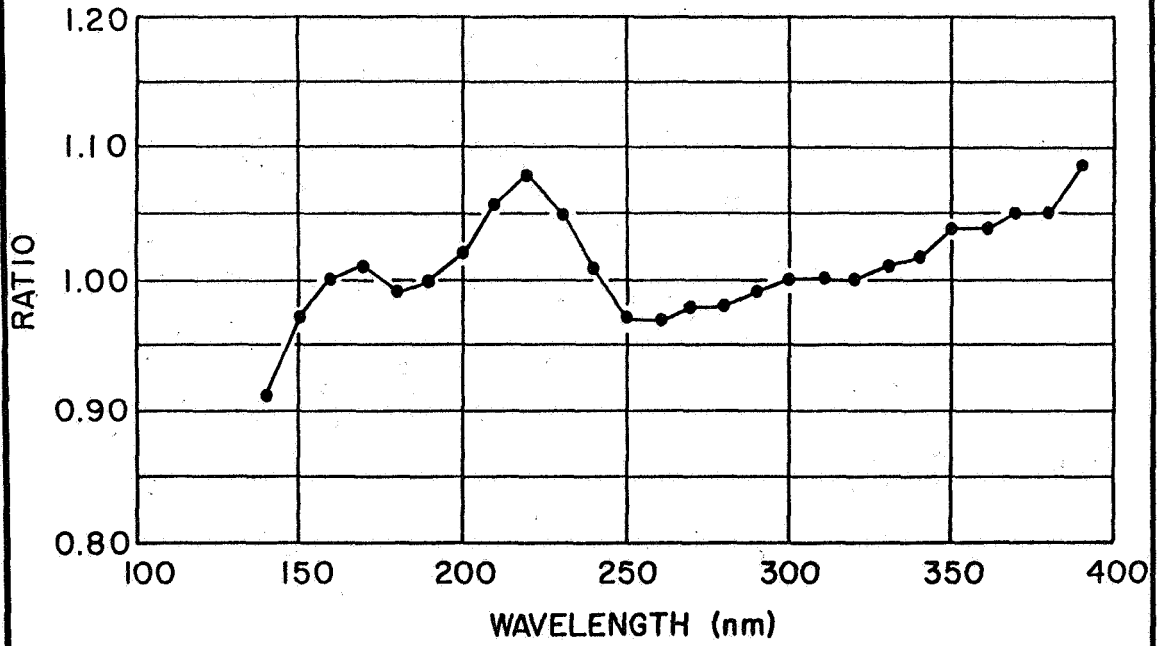

PREFLIGHT/POSTFLIGHT SENSITIVITY RATIO

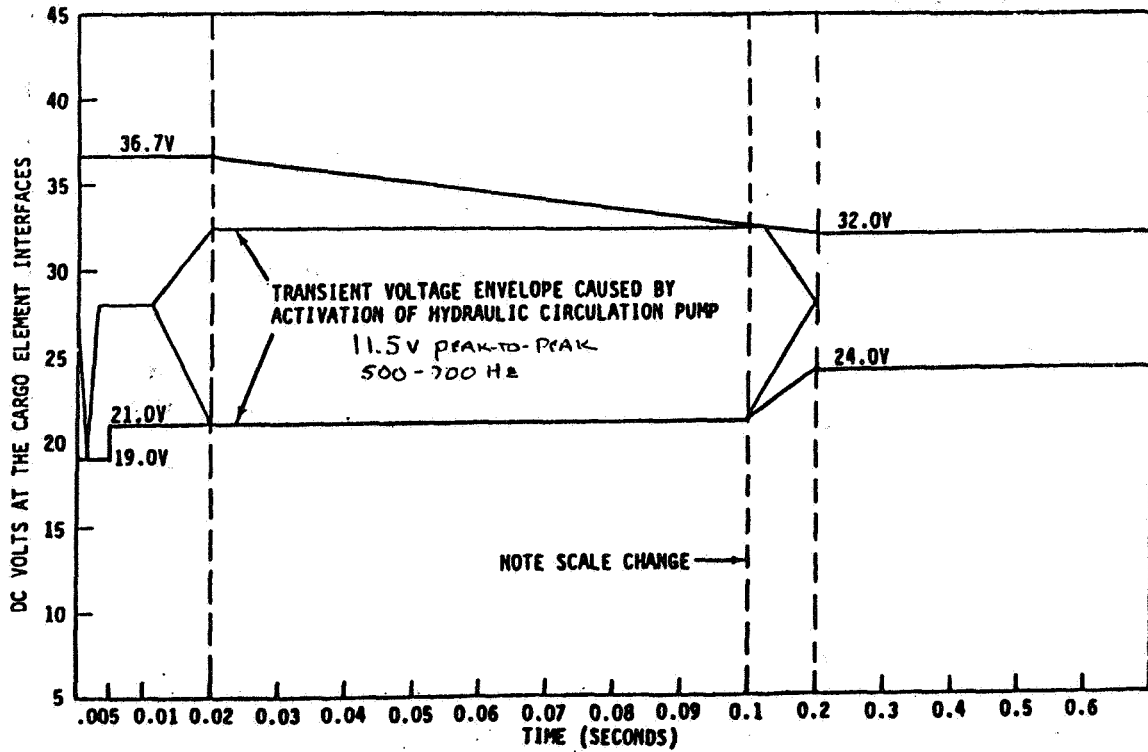
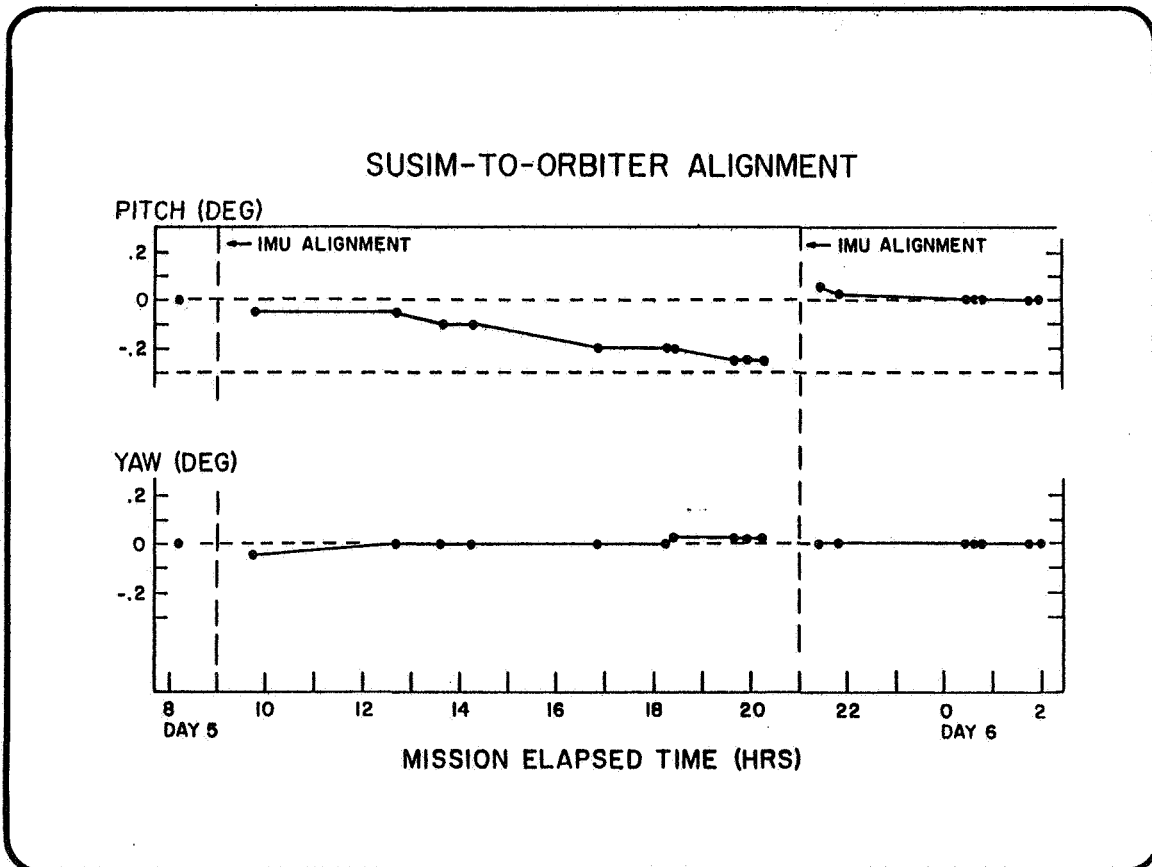
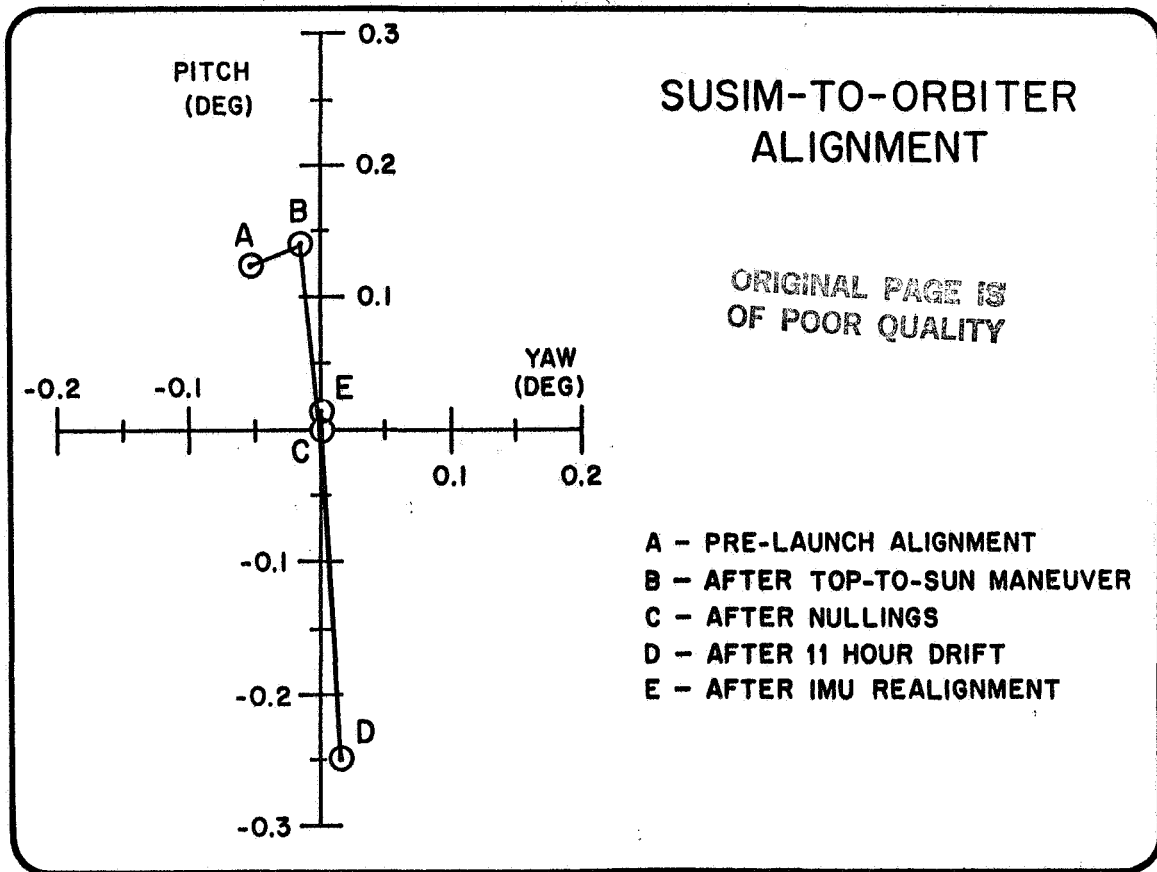
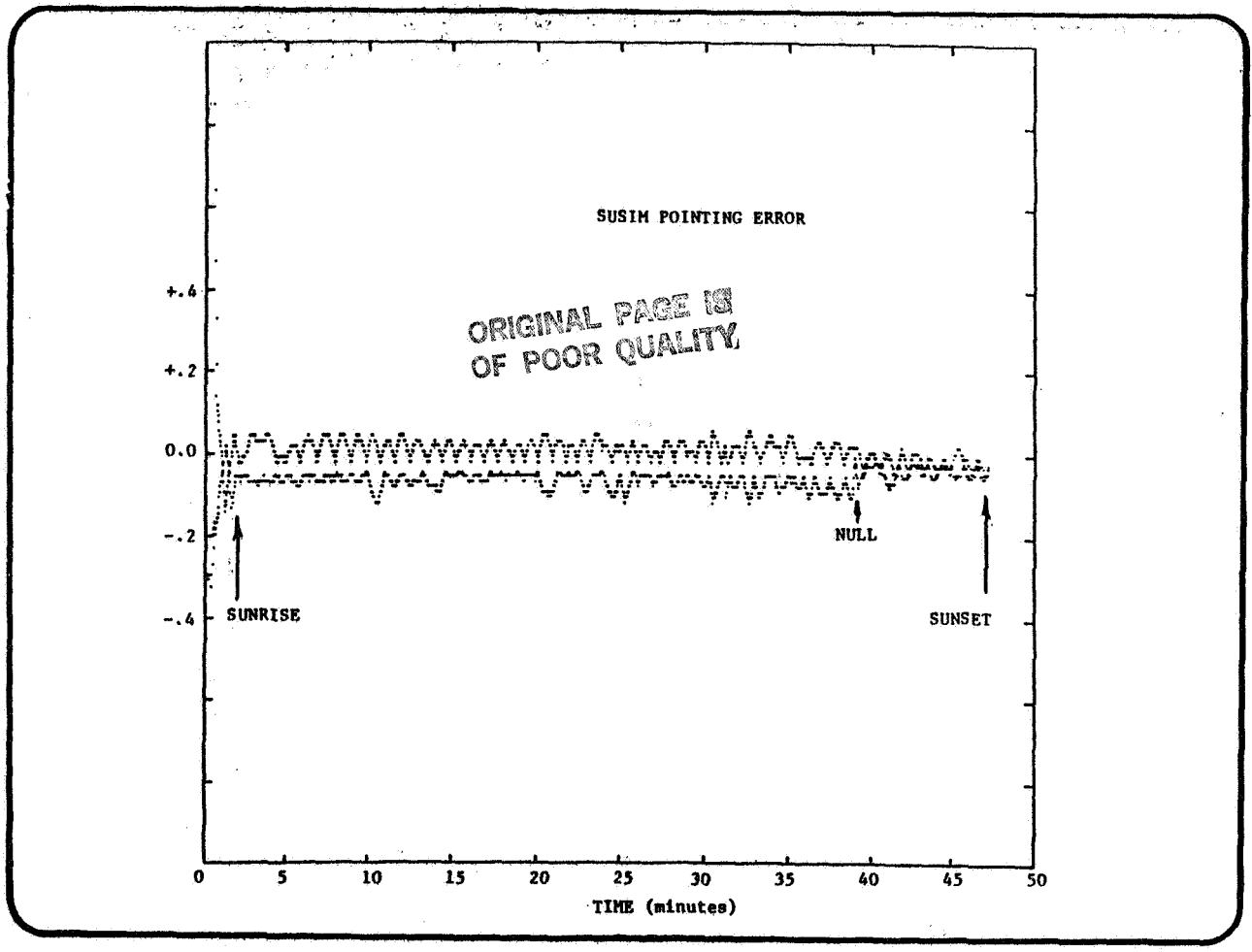

Figure 7.2.2-1 Transient Voltage Limits of Aft DC Buses B and C Only





RESULTS OF THERMAL ENVIRONMENT MEASUREMENTS
ON THE THERMAL CANNISTER EXPERIMENT AND
GET AWAY SPECIAL ENCLOSURE

S. Ollendorf and D. Butler
Goddard Space Flight Center

INSTRUMENTATION

ORIGINAL PAGE IS
OF POOR QUALITY

• FLUX SENSORS

- CUPS CONTAINING THERMALLY ISOLATED SURFACES
- PRT SENSORS WHICH MEASURED TEMPERATURE
- SILVER TEFLON COATED (SAME AS CANISTER RADIATORS)
- SIGNAL CONDITIONED THROUGH CANISTER ELECTRONICS
- PREVIOUSLY FLOWN ON OSO, IMP AS COATING EXPERIMENT

SENSOR CUP DESIGN

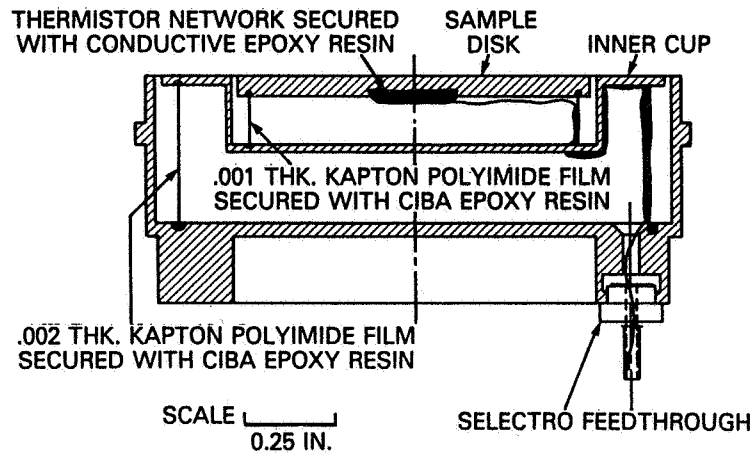

Preceding page blank

ORIGINAL PAGE IS
OF POOR QUALITY

UPPER & LOWER
FLUX SENSORS
(TYPICAL 4 SIDES)

FLUX SENSOR LOCATIONS

THERMAL CANISTER EXPERIMENT (TCE)

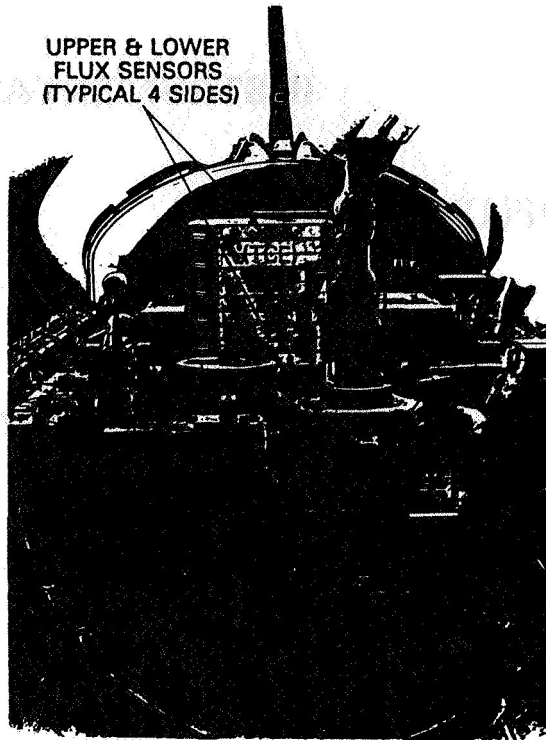

FLUX SENSOR TEMPERATURE HISTORY (-X_{SI} MODE)

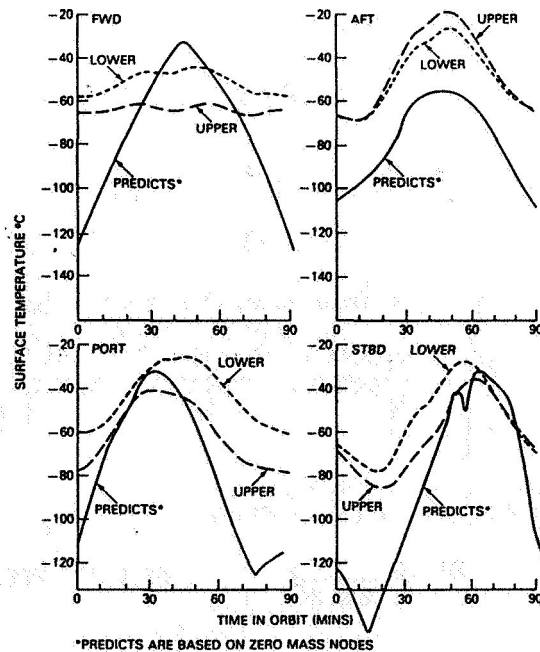

**FLUX SENSOR TEMPERATURE HISTORY
(+Z_{SI} MODE) HOT ORBIT**

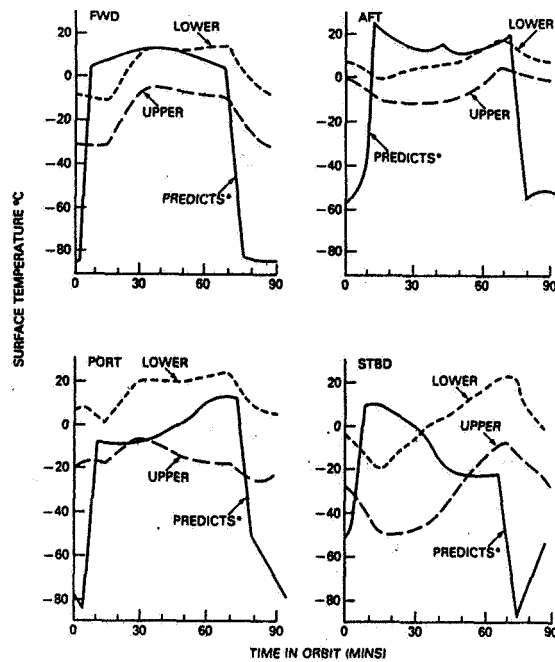

**ORIGINAL PAGE IS
OF POOR QUALITY**

*PREDICTS ARE BASED ON ZERO MASS NODES

FLUX SENSOR HISTORY (-Z_{LV} MODE) COLD ORBIT

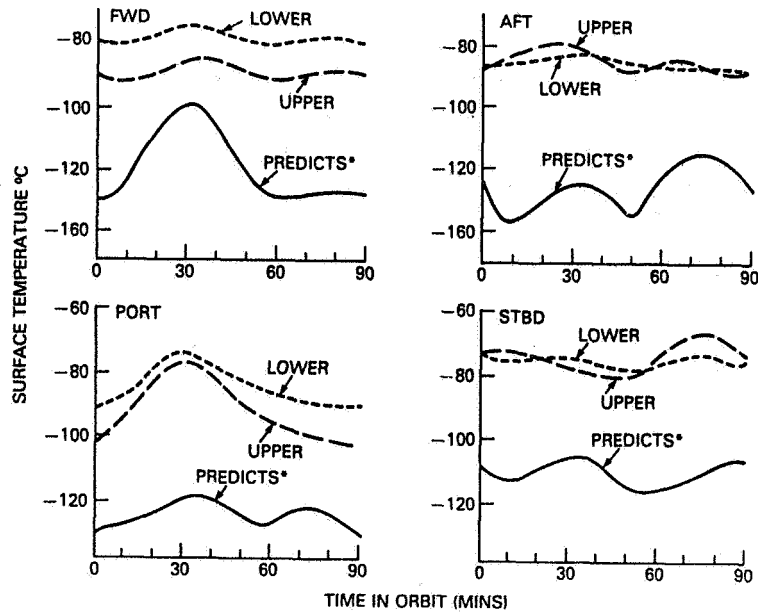

*PREDICTS ARE BASED ON ZERO MASS NODES

FLUX SENSOR TEMPERATURE HISTORY (PTC MODE)

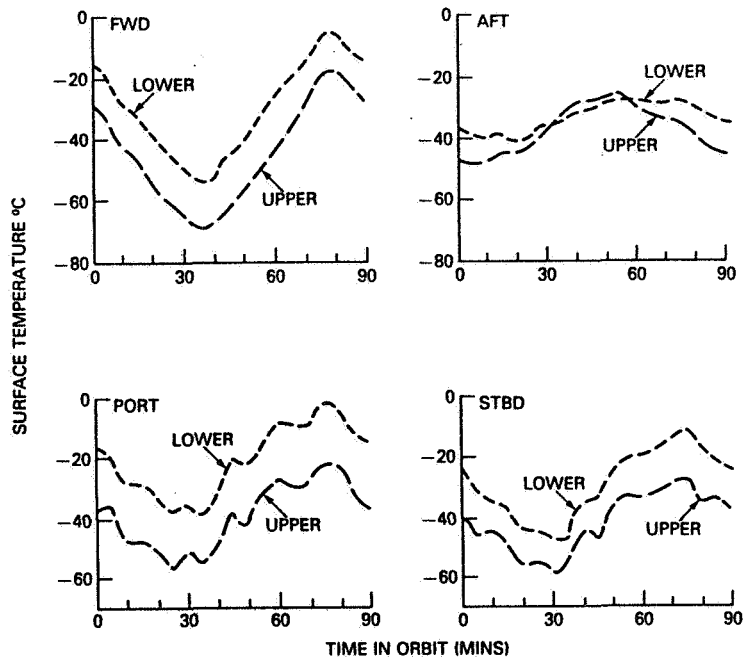

ORIGINAL PAGE IS OF POOR QUALITY

ORBITAL AVERAGE FLUXES

	$-Z_{Lv}$		$+X_{St}$		PTC		$+Z_{St}$	
	MEASURED	PREDICT	MEASURED	PREDICT	MEASURED	PREDICT	MEASURED	PREDICT
	W/ft ²	W/ft ²	W/ft ²	W/ft ²	W/ft ²	W/ft ²	W/ft ²	W/ft ²
FWD _L	5.8	1.9	9.9	6.1	16.8	7.1	24.1	18.4
FWD _U	4.6		7.8		11.7		17.9	
PORT _L	5.4	1.9	11.9	4.3	17.3	8.8	27.7	17.5
PORT _U	4.7		8.8		12.5		17.9	
AFT _L	4.8	1.7	10.7	6.6	13.4	6.6	25.1	22.3
AFT _U	4.9		11.3		12.5		21.4	
STBD _L	6.1	2.8	9.8	6.6	15.7	8.3	24.8	16.1
STBD _U	6.2		9.3		12.5		15.7	

**APPROXIMATE MLI TEMPERATURES FOR
THE FOLLOWING ORBITAL CASES:**

<u>ORBITER ATTITUDE</u>	<u>FLIGHT DATA</u>	<u>PREDICTIONS</u>
● TAIL TO SUN		
PALLET	-80°C (MINIMUM)	-112
UPPER PLATFORM	-60°C (MINIMUM)	-118
LOWER PLATFORM	-48°C (MINIMUM)	-112
● NOSE TO SUN		
PALLET	-15/-48°C (MAX/MIN)	-53/-86
UPPER PLATFORM	-50/-60°C (MAX/MIN)	-57/-91
LOWER	-48°C (MINIMUM)	-85/-56
● BAY TO SUN		
PALLET	100°C/-10°C (MAX/MIN)	107/65
UPPER PLATFORM	+75/+10°C (MAX/MIN)	103/63
LOWER PLATFORM	+80/+30°C (MAX/MIN)	117/75

ORIGINAL PAGE IS
OF POOR QUALITY

**THERMAL ENVIRONMENT OSS-1
THERMAL CANISTER EXPERIMENT RESULTS**

OBJECTIVE: TO MEASURE TOTAL ABSORBED FLUX ON THERMAL CANISTER RADIATORS IN ORDER TO DETERMINE HEAT REJECTION CAPABILITY

RATIONALE: OSS-1 PALLET CONTAINED A VARIETY OF INSTRUMENTS WITH IRREGULAR SURFACE GEOMETRY AND PROPERTIES WHICH LIMITED PREDICTABILITY

METHOD: MEASURE TEMPERATURE (T_s) OF ISOLATED SURFACES AND CALCULATE FLUX:

$$\frac{Q}{A} = \epsilon \sigma T_s^4$$

WHERE:

Q/A = ABSORBED FLUX (W/FT²)

ϵ = EMMITTANCE

σ = STEPHEN-BOLTZMANN CONSTANT

KAPTON EROSION

ORIGINAL PAGE NO.
OF POOR QUALITY

- KAPTON ON EXTERNAL SURFACES SUFFERED CONSIDERABLE EROSION DURING FLIGHT IN RAM DIRECTION
- SAMPLES REMOVED FROM THE TCE WERE MEASURED FOR WEIGHT LOSS, SOLAR ABSORBANCE, IR EMITTANCE, TENSILE STRENGTH AND PERCENT ELONGATION
- SURFACE TEMPERATURE WAS APPROXIMATELY
- RESULTS SHOWED BETWEEN 16-35% WEIGHT LOSS, A CHANGE IN α/ϵ FROM .62 TO .83, A CHANGE IN TENSILE STRENGTH FROM 22 TO 18K PSI AND PERCENT ELONGATION FROM 38 TO 10%
- CAUSE THOUGHT TO BE FROM INTERACTION OF ATOMIC OXYGEN/UV AND TEMPERATURE
- COVERING KAPTON WITH BETA CLOTH OR COATINGS WILL PROBABLY OFFER ENOUGH PROTECTION FOR FUTURE APPLICATIONS

GAS — STS-3

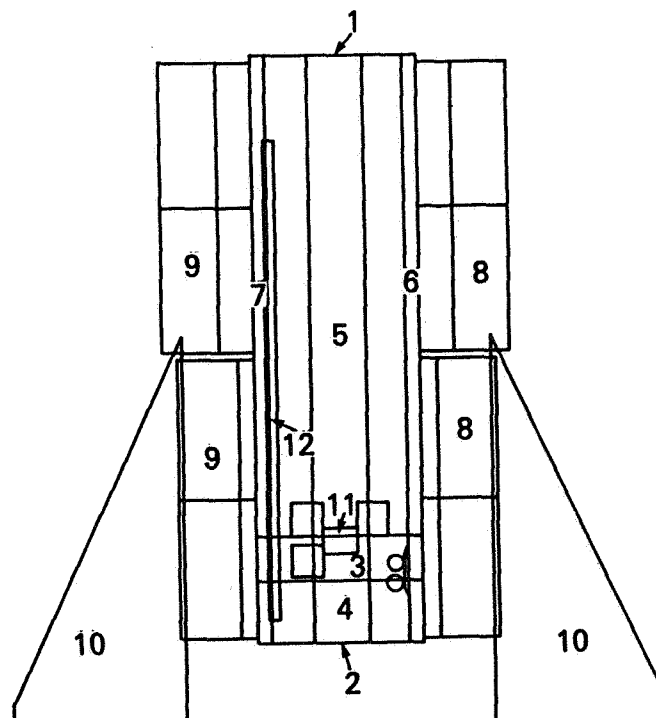

GSFC GAS CANS & ADAPTER BEAM EXTERNAL NODAL BREAKDOWNS STS-3

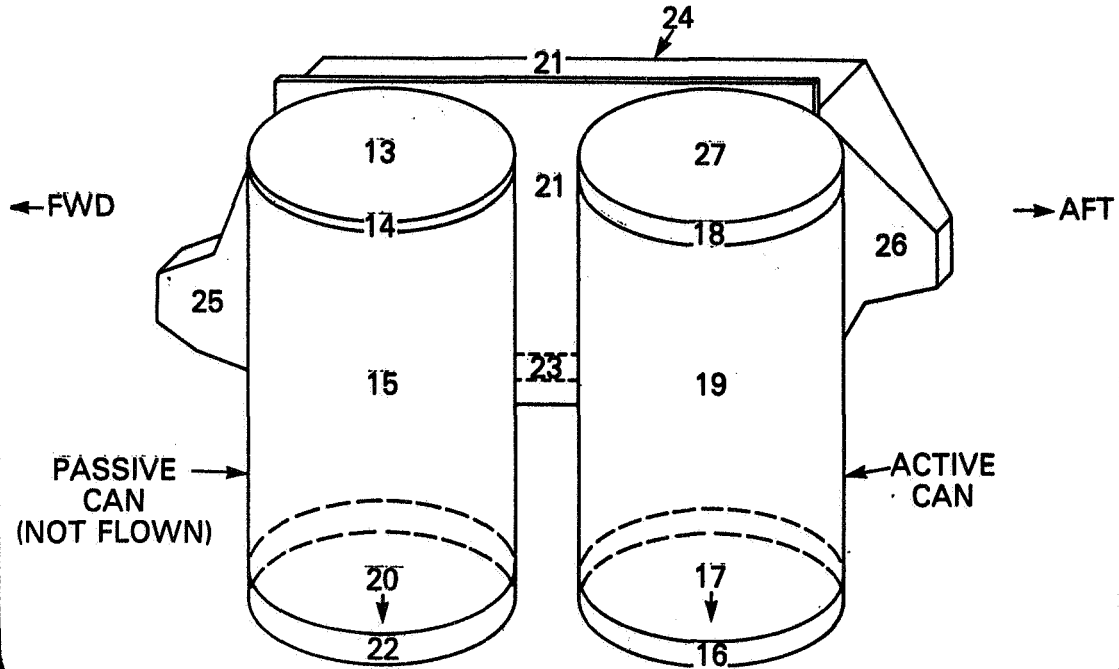

ADAPTER BEAM FACE

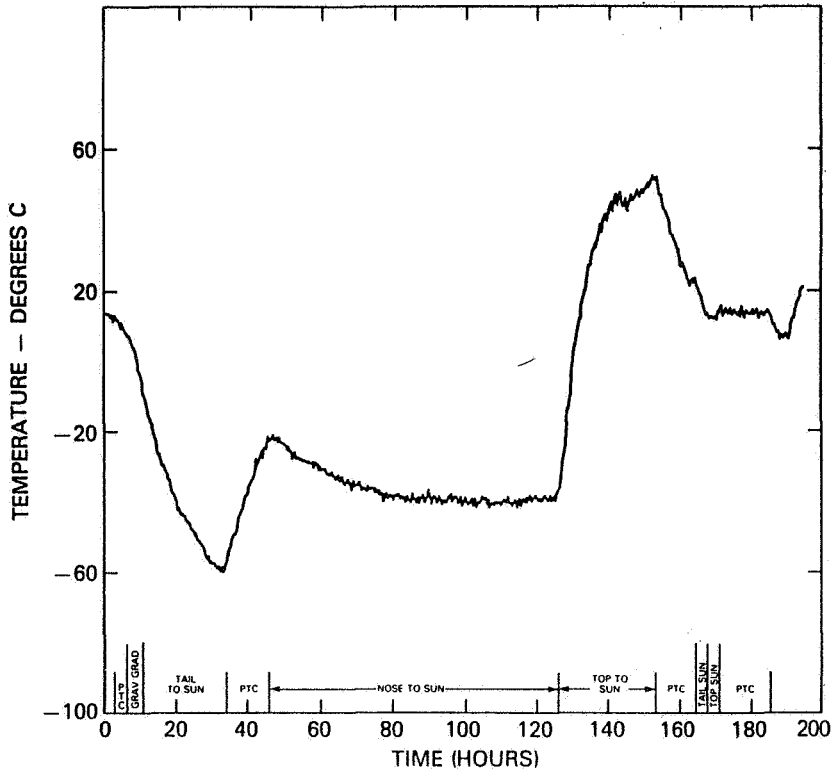

CONTAINER EXTERNAL TOP

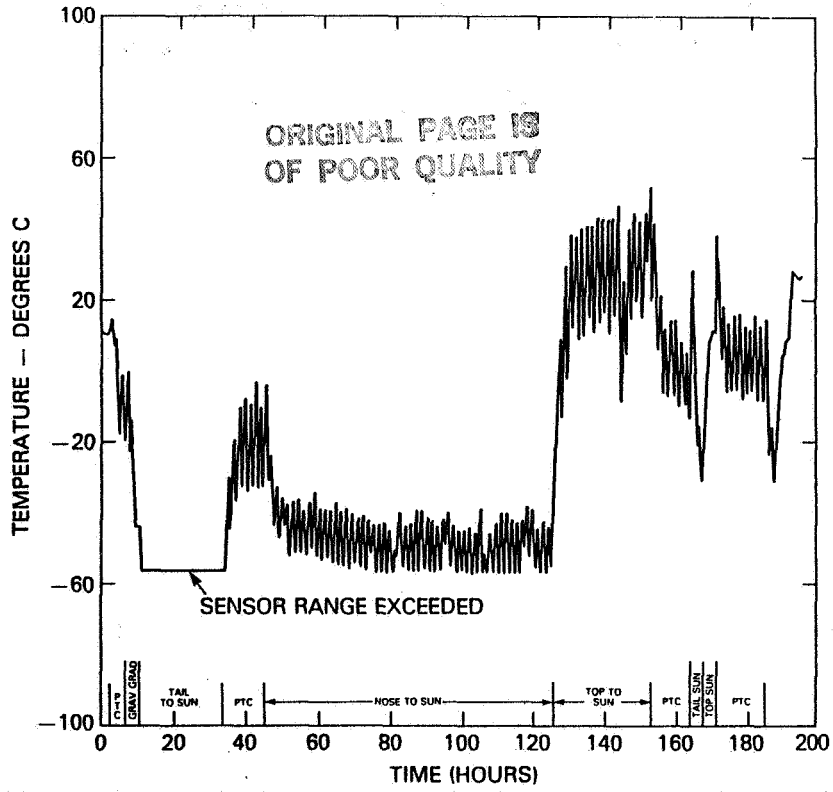

CONTAINER EXTERNAL BOTTOM

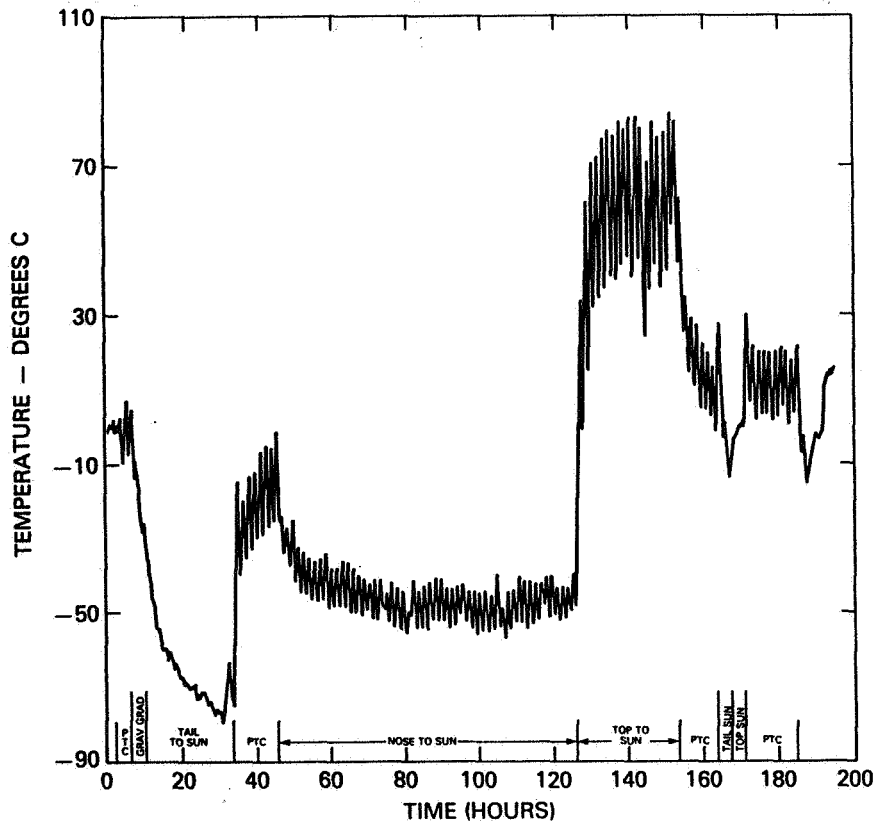

GAS THERMAL RESULTS

ORIGINAL PAGE 5
OF POOR QUALITY

	<u>PREDICTIONS</u>	<u>FLIGHT</u>
ADAPTER BEAM (HOT-BAY TO SUN)	+ 37°C ± 46°C ($\bar{a} = .32$) ($\bar{a} = .36$)	+ 45 TO + 50°C
ADAPTER BEAM (COLD-NOSE TO SUN)	- 78°C	- 40°C
BOTTOM COVER (HOT-BAY TO SUN)	+ 63°C	+ 60 TO + 65°C
BOTTOM COVER (COLD-NOSE TO SUN)	- 76°C	- 45 TO - 50°C
TOP COVER (HOT-BAY TO SUN) (BRACKET)	+ 31°C	+ 25 TO + 35°C
TOP COVER (COLD-NOSE TO SUN) (BRACKET)	- 73°C	- 47 TO - 51°C

OSS-1 THERMISTOR TEMPERATURES

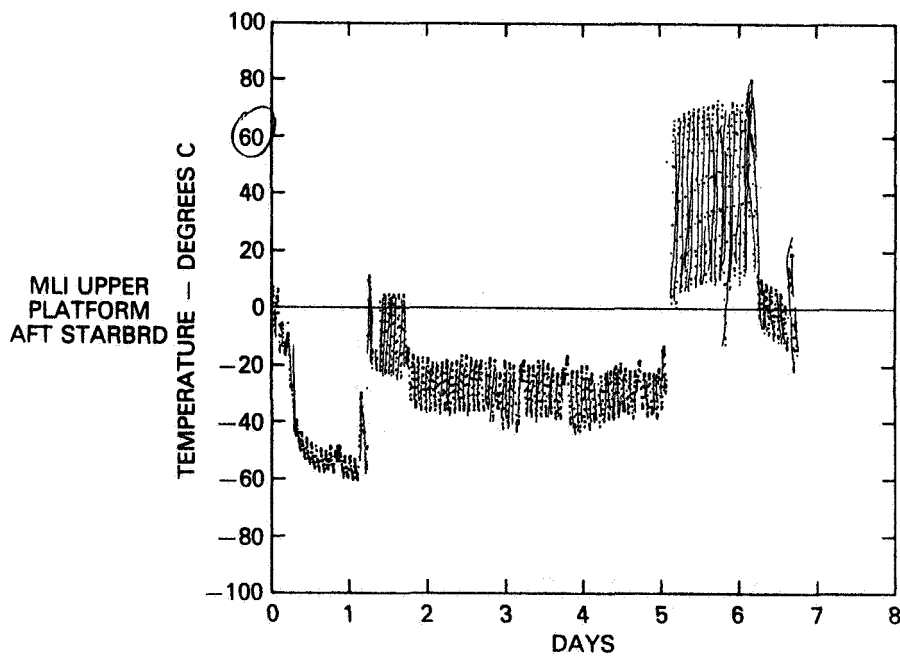

OSS-1 THERMISTOR TEMPERATURES

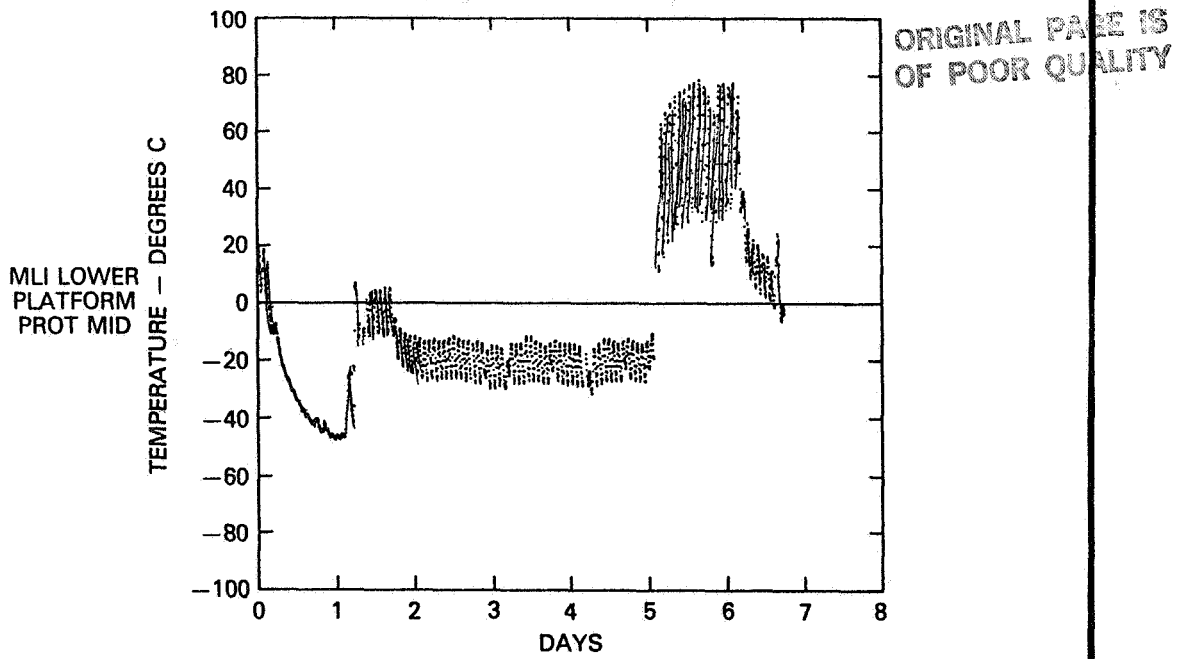

OSS-1 THERMISTOR TEMPERATURES

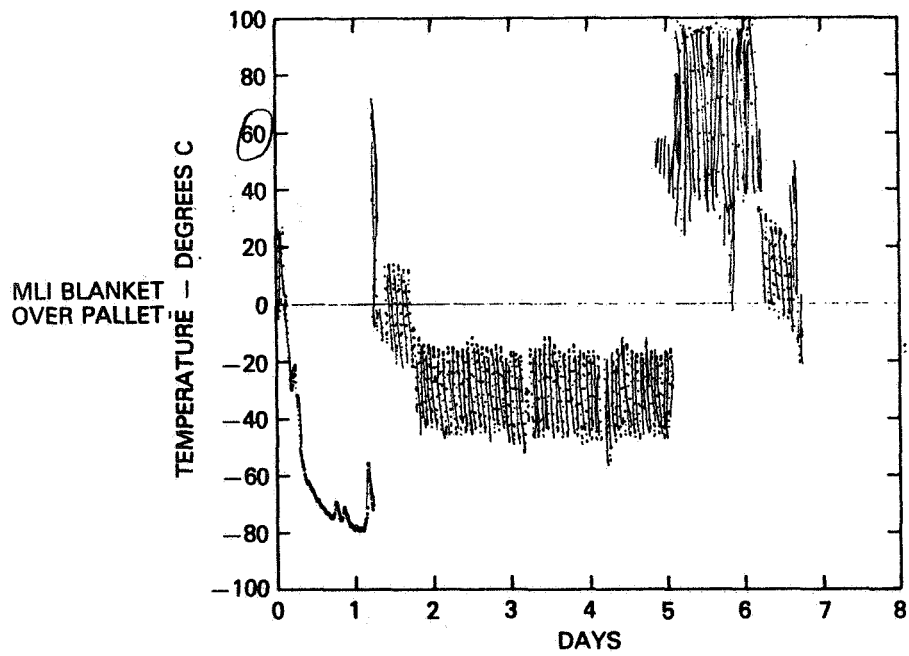

SUMMARY

ORIGINAL PAGE IS
OF POOR QUALITY

- FLUX LEVELS MEASURED IN ALL STS ATTITUDES ARE HIGHER THAN PREDICTIONS
- IN COLD ($-Z_{LV}$) AND MODERATE ($\mp X_S$) ATTITUDES FLIGHT RESULTS ARE A FACTOR OF 2 TO 3 HIGHER THAN PREDICTS
- IN HOT ATTITUDE MUCH BETTER AGREEMENT OCCURRED

CONCLUSIONS

- IN COLD OR MODERATE ATTITUDES OTHER SOURCES MAY BE CONTRIBUTING TO ADDED INPUTS I.E. ALBEDO, EARTH SHINE, SHUTTLE BACKGROUND, ETC.
- IN HOT ATTITUDE SMALLER DIFFERENCES COULD BE ATTRIBUTED TO COATINGS ASSUMPTIONS OR CALCULATION UNCERTAINTY

THERMAL CANISTER EXPERIMENT (TCE) RE-ENTRY DATA

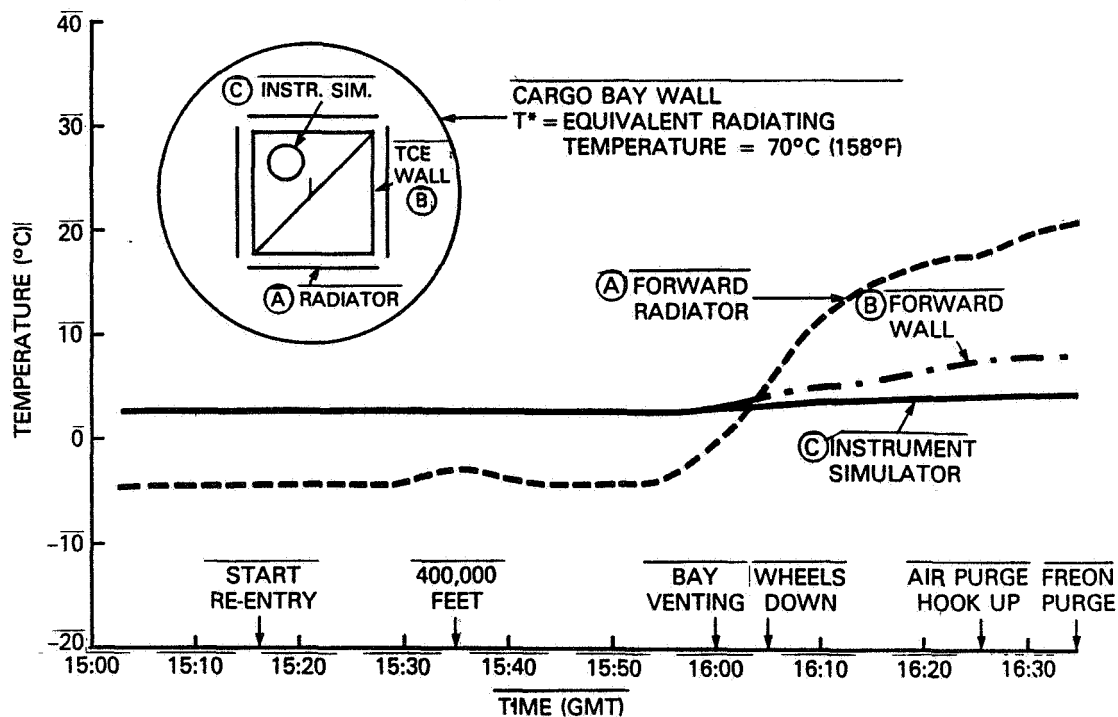

N83 22312 D24

STS-3 "SNOWFLAKE" STUDY

J. Barengoltz, C. Maag, F. Kuykendall
Jet Propulsion Laboratory

Preceding page blank

STS-3 "SNOW FLAKE" STUDY

**Carl Maag
Jack Barengoltz
Frank Kuykendall**

**ORIGINAL PAGE IS
OF POOR QUALITY**

6 October 1982

SHUTTLE ENVIRONMENT WORKSHOP

**JET PROPULSION LABORATORY
PASADENA, CALIFORNIA**

BACKGROUND

- DURING STS-3 MISSION A SIGNIFICANT NUMBER OF PARTICLES WERE OBSERVED BEING RELEASED FROM THE ORBITER
- VIDEOTAPE RECORDINGS WERE MADE ON DAYS (MET) 3 AND 7
- USAF/SD (Y00R) FUNDED REDUCTION OF THIS DATA TO OBTAIN SOURCES AND SIZES
- JPL IMAGE PROCESSING LAB REDUCED VIDEOTAPES

PRECEDING

Preceding page blank

APPROACH

- BASIC DATA - VIDEOTAPE FORWARD BAY TV CAMERAS
- ORIENTATION
 - CAMERA VIEW AFT
 - ORBITER TAIL TO SUN (\perp PLANE OF PHOTOS)
 - ORBITER VELOCITY +Y (LEFTWARD IN PHOTOS)
- APPARENT PARTICLE SIZE, IN-PLANE VELOCITY
BY IMAGE PROCESSING TECHNIQUES
- WORST CASE SCALING
BY OBJECTS OF KNOWN DIMENSION IN PHOTO AND ASSUMPTION
X-LOCATION AT ORBITER TAIL
- DETERMINISTIC PARTICLE SIZE AND X-LOCATION
BY ANALYSIS OF APPARENT Y-ACCELERATION ON THE BASIS OF DRAG
- DETERMINISTIC PARTICLE X-VELOCITY
BY ANALYSIS OF APPARENT Z-ACCELERATION ON THE BASIS OF CONSTANT
X-VELOCITY (ALSO USED TO CORRECT Y-ACCELERATION)

ORIGINAL PAGE IS
OF POOR QUALITY

CATALOGUED PARTICLE SUMMARY

- DETERMINANT PARTICLES

SIZE RANGE: 0.11 cm TO 0.72 cm

SPEED IN Y-Z PLANE: 0.5 cm/s TO 4 cm/s

VELOCITY X-COMPONENT: 2 cm/s TO 98 cm/s

SENSE OF VELOCITY: $V_Z > 0$, $V_Y < 0$ (USUALLY)

$V_X > 0$, (WITH ONE EXCEPTION)

X-COORDINATE RANGE

FROM CAMERA AND AFT: 350 cm TO 1100 cm

IN STS COORDINATES: 714 TO 1009 (in.)

CATALOGUED PARTICLE SUMMARY (contd)

ORIGINAL PAGE IS
OF POOR QUALITY

- INDETERMINANT PARTICLES (WORST CASE*)

SIZE RANGE: 0.85 cm TO 2.6 cm

SPEED IN Y-Z PLANE: 6 cm/s TO 21 cm/s

VELOCITY X-COMPONENT: 175 cm/s TO 980 cm/s

SENSE OF VELOCITY: $V_Z > 0, V_Y < 0$ (USUALLY)

$V_X > 0$ (WITH TWO EXCEPTIONS)

*X-COORDINATE (ASSUMED MAX)

FROM CAMERA AND AFT: 2670 cm

IN STS COORDINATES: 1627 (in.)

CATALOGUED PARTICLES

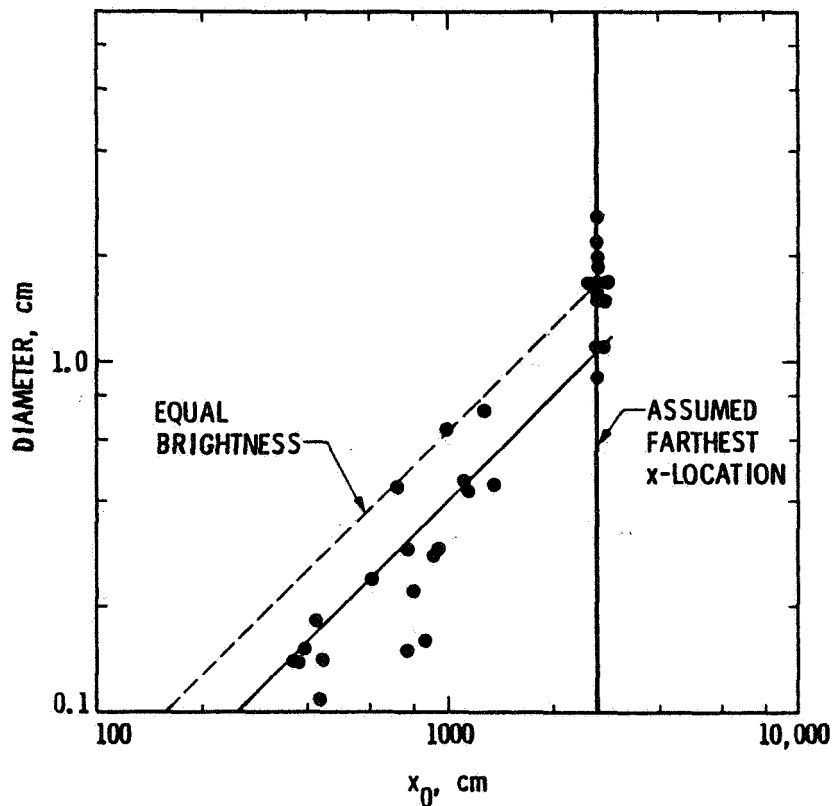

TYPICAL PARTICLE SIZE DISTRIBUTION
UNCATALOGUED PARTICLES
WORST CASE SIZE SCALING

APPROX FOV * (degrees)	MIN PARTICLE (cm)	MAX PARTICLE (cm)	SIZE GROUP (cm)	NUMBER OF* PARTICLES
3	0.5	2.6	0.5-1.1	21
			1.1-1.6	18
			1.6-1.9	16
			1.9-2.2	7
			> 2.2	3
				----- 65 TOTAL

ORIGINAL PAGE IS
OF POOR QUALITY.

*FIELD OF VIEW EXAMINED. NOT FOV OF CAMERA. NUMBER UNDERESTIMATED.
 SMALLER (DIMMER) PARTICLES ARE ESPECIALLY UNDER-REPRESENTED

CONCLUSIONS

- SIGNIFICANT NUMBER OF 1 mm TO 1 cm DIAMETER PARTICLES IN VICINITY OF STS-3 OBSERVED
- ORIGIN MAY BE NEAR AFT END OF ORBITER BUT FOR EXAMINED TRAJECTORIES (33) OVER HALF (19) WERE DEFINITELY FORWARD OF THE AFT END OF THE BAY
- THERE MAY BE LARGER PARTICLES NEAR AFT END OF ORBITER
- MOST PARTICLES MOVING GENERALLY REARWARD WITH RESPECT TO ORBITER (+X DIRECTION)

SPACE SHUTTLE: A VIEW OF WHAT WE HAVE DONE SO FAR

T. Wilkerson
University of Maryland

SPACE SHUTTLE: A VIEW OF WHAT WE HAVE DONE SO FAR

(T. Wilkerson)

I want to summarize this part of the meeting in two ways. First, I'll finish the logistical part. Second, I have something more unusual to discuss before we finish today.

(1) Diagram 1 reminds us of the meeting design we had at the outset. We've come to the end of the presentations, the responsive questions, and the answers following those. Now comes the time when our Panels will address the questions that have been submitted, and provide some of their own input on these and other topics, and report back to us tomorrow with their recommendations. Speaking personally for a moment, I want to say that I am profoundly impressed with the completeness of the presentations and discussions here.

The Panel meeting rooms have been assigned. These sessions will run from 7:00 to 9:00 tonight, and will reconvene tomorrow morning at 8:30. We urge everyone who is interested in the Panel topics to attend these sessions and contribute whatever comments and other input that will support the Panels' work.

(2) The rest of my comments are really in a different vein than most of the factual and detailed things that have been said so far. To set the stage, I'll tell you that I used to be quite involved with space flight and scientific satellites in the nineteen sixties. I've only re-entered the field again in the late seventies, through my interest in possible lidar (i.e., laser radar) missions for the Space Shuttle. So, not having been closely in touch with space flight for perhaps ten years, I am amazed to see how far things have come in this work.

We have seen a number of interesting pictures of the Space Shuttle in this meeting, including Ed Miller's picture of the Shuttle in assembly, looking like a boat being built in a shipyard, and another striking view in orbit with the large box, the IECM, jutting way out from the Shuttle on the movable arm with the cloud-covered Earth below. The picture that really hits home with me (Figure 2) shows the STS-3 payload bay in daylight--a place where there is experimental work going on, a place where you can imagine people working in future missions.

It is this image that conveys to me, and I want to convey to you, that what we have here is a *spaceship*. The *context* in which I hold the Shuttle, and its various properties and all that can be done with it, is that this vehicle is truly a spaceship. This is a vehicle that goes way out into space and manipulates things. It can carry large quantities of material, move things around, and can be used to construct other things. The *spaceship* is no longer a concept or some notion about the future that we have talked about for a long time. We can now consider that the *spaceship* is really here; this statement is a context in which to hold all the things that we can say about the Shuttle's properties and all the things we believe it can do. I am using the word *context* as in the context, "We will go to the moon in ten years"; that statement was a *context* for a whole program, a series of accomplishments that we had not been capable of before that time.

We hear the term context bandied about quite a bit... we should hold things in this context or that, where generally we mean a framework or a big idea. Actually a context is an idea that is big enough to include even ideas that might be seen to oppose it.

Preceding page blank

For example you might say that, against the idea I've put forth that the Shuttle is a spaceship, you could say, "Well, it's not really that great; it's a crude device that people could tear their space suits on if they walked around on it; really sophisticated vehicles will be coming along later; sure it can do a lot of things, but this era won't last-- budgets will be cut, we'll never be able to realize the promise of the current era; etc., etc., etc."

Now, you can choose whether you want to daily entertain such issues and arguments over and over, or instead what I propose as the way in which we really work creatively: Hold all of these seemingly opposing ideas within a *context* that *this is the era of the accomplished spaceship* whose reality has been demonstrated over and over again in this meeting.

Most of us work within several contexts at any given time. One that is virtually universal for people in science and technology is, "It will work, and it's worthwhile." That is, we are in the business of figuring out how to do things that are mechanical, electrical and chemical in nature--making material things work, in short. Our assumptions are, practically always, that we can find a way to get the job done and it will prove to be worthwhile. Clearly, people working on technology without that point of view would have a very hard time of it. So we continually work in a context called, "It will work, and it's worthwhile."

I invite each and every one of you to look over all the contexts for your work in this field, to identify what it is (or they are), and to create new ones if necessary in support of your work. And another thing: *context* is always created, it doesn't just happen. The context you create for your work will have a lot of influence on the results of your work. Thought is creative; let me illustrate: if you look around this room, all the things you see--the lights, the floor covering, the paint, our clothing--everything you see in here began with a thought. There is nothing in here that didn't begin in somebody's thought. Ultimately, what else can convert *what is not* to *what is*?

So one way to put it, when you look around at our environment, is that we made it up. We made up this whole world in which we are living--the good stuff, the bad stuff, the whole thing. Likewise we made up this *spaceship*; we created it.

There is no way that "we created it", moreover, without "you created it"--and you, and you, every one of you. It would be ridiculous to think otherwise, because if you look back to the time when this spaceship did not exist, and now it does exist, then somebody had to do it. It would be typical of us, as analytical creatures, to then get together and say, "Well, neither one of us did the whole thing, so we need to go find the person who did." So we'd find such a person, and he or she would say, "I did a lot of the work, but really thousands of people worked on it, etc., etc." And ultimately, out of everyone's considerations that really *they* didn't do it, we would have to confront the evidence of the creation of this spaceship with the ridiculous statement that no one did it. So you created this spaceship. Whatever qualifications occur to you, you did it.

So much for what happened, looking backward into the recent past. Now take these ideas and turn around with them, and point them into the future. You will create the spaceships of the future. That is what you do. Unquestionably that is the game you're in. So since that is what you're up to--you might say I caught you at it--I ask you to notice the context or contexts in which you hold your work. One of mine is that your work is an extremely valuable contribution to mankind; so, in support of it, I invite you to create new contexts, new settings that further your work, so as to manifest more and more those qualities of drive, zest, and imagination that will tell you when you are on the right track.

I will close with a quote from Shakespeare's *Julius Caesar* that is appropriate here. It can be significant or light, however you want to take it. Look beyond the words, if you will, to see where they might point for you:

*"There is a tide in the affairs of men
Which, taken at the flood, leads on to fortune;
Omitted, all the voyage of their life
Is bound in shallows...
On such a full sea are we now afloat,
And we must take the current when it serves
Or lose our ventures."*

Lastly I want to acknowledge the work you did and will do, and express my great appreciation for the chance to participate in this meeting with you. Thank you.

SHUTTLE ENVIRONMENT WORKSHOP (OCTOBER 5-7, 1982)

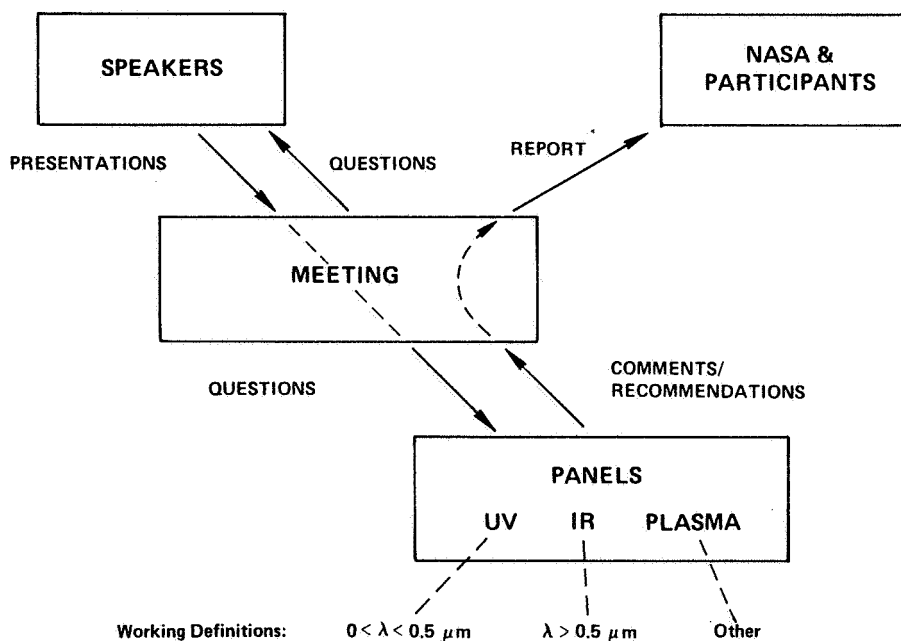

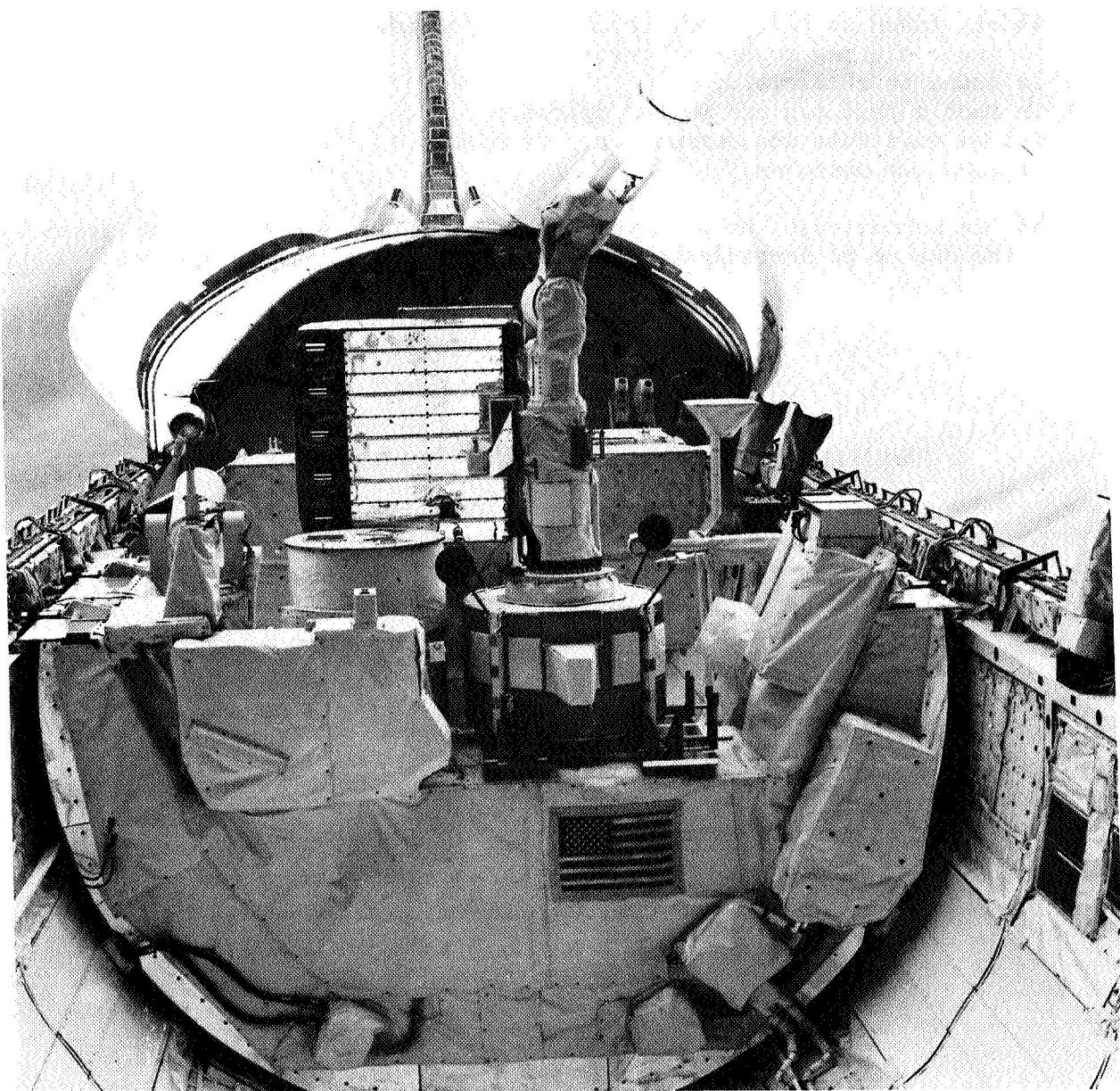

Figure 2 - The Shuttle Payload Bay

*OMIT TO
END*

**APPENDIX B
LIST OF ATTENDEES**

ORIGINAL PAGE IS
OF POOR QUALITY

Ackerman, Norman
NASA/Goddard Space Flight Center
Code 732
Greenbelt, MD 20771

Bangs, William F.
NASA/Goddard Space Flight Center
Code 302
Greenbelt, MD 20771

Allanby, Frederick O.
Langley Research Center
Code 158
Hampton, VA 23665

Banks, Professor Peter M.
Stanford University
Radioscience Lab.
Stanford, CA 94305

Alsbach, Walter
International Telecommunications
490 L'Enfant Plaza SW
Washington, DC 20024

Barengoltz, Dr. Jack
Jet Propulsion Lab.
Mail Stop 125/159
4800 Oak Grove Drive
Pasadena, CA 91103

Anderson, Hugh R
Science Applications Inc
13400B Northrup Way #36
Bellevue, Washington 98005

Barnhard, Gary
NASA/Goddard Space Flight Center
Code 402
Greenbelt, MD 20771

Anderson, Tom
Lockheed Missile & Space Co.
PO Box 504, Bldg 576
Sunnyvale, CA 94086

Barr, Andrew G.
NASA/Goddard Space Flight Center
Code 754
Greenbelt, MD 20771

Arlauskas, Joseph
NASA/Goddard Space Flight Center
Code 425
Greenbelt, MD 20771

Barth, Major Ron
SD/YOOR, Air Force Space Division
Box 92960, Worldway Postal Division
Los Angeles, CA 90009

Arman, Ali
Goddard Space Flight Center
Code 420
Greenbelt, MD 20771

Bartoe, John-David
Naval Research Lab
Code 4102
Washington DC 20375

Au, Ben
Naval Research Lab
Washington, D.C. 20546

Bauer, C. H.
Aerospace Corp
Suite 400, 955 LIENFANT Plaza SW
Washington, D.C. 20024

Austin, James D.
Ball Aerospace/Systems Division
PO Box 1062 TT-2
Boulder, CO 80306

Beck, Paul G.
Sandia National Lab.
Div. 72-42, P.O. Box 5800 KAFB-East
Albuquerque, NM 87185

Behanna, Paulette
Code 730
Goddard Space Flight Center
Greenbelt, MD 20771

Borson, Eugene N
The Aerospace Corp
P.O. Box 92957 MS M2-241
Los Angeles, CA 90009

Bensimon, Marc
NASA Headquarters
Astrophysics Division, Code EZ-7
Washington, DC 20546

Bowcutt, Kevin G.
University of Maryland
Wind Tunnel Operations
College Park, MD 20742

Bergeson-Willis, Samuel E
AMAO
NASA/Goddard Space Flight Center
Code 402
Greenbelt, MD 20771

Brown, Michael
NASA/Kennedy Space Center
Kennedy Space Center, FL 32899

Bettini, Ron
Perkin Elmer Corp
100 Wooster Heights Rd
Danbury, CT 06810

Brown, R. D.
NASA/Johnson Space Center
Code ES-5
Houston, TX 77058

Biswas, Professor Sukumar
Tata Institute of Fundamental Research
Homi Bhabha Road
Bombay India 400 005

Bunner, Alan N.
Perkin-Elmer
100 Wooster Hts. Rd, Mail Stop 879
Danbury, CONN. 06810

Blue, William H.
Boeing Aerospace Comp.
PO Box 3999, Mail Stop 8k-91
Seattle, WA 98124

Burrowbridge, Donald R
NASA/Goddard Space Flight Center
Code 420
Greenbelt MD 20771

Bodwell, James
Boeing Aerospace Corp
PO Box 3999, Mail Stop 81-83
Seattle, WA 98124

Butler, Daniel
Goddard Space Flight Center
Code 732
Greenbelt, MD 20771

Bolton, John
Johns Hopkins University
Physics Dept.
Baltimore, MD 21218

Cafferty, T. T.
Santa Barbara Research Center
75 Coromar Dr
Goleta, CA 93117

Borsody, Janon
NASA/Lewis Research Center
Code 500-116
21000 Brookpark Rd
Cleveland, OH 44135

Caldwell, Robert S.
Boeing Aerospace Comp.
PO Box 3999, Mail Stop 2R-00
Seattle, WA 98124

Campitelli, Anthony
NASA/Goddard Space Flight Center
Code 732
Greenbelt, MD 20771

Cassidy, Daniel E.
Marsh & McLennan Aviation
955 L'ENFANT Plaza N SW
Washington, DC 20024

Carignan, G.R., Director
Space Physics Research Lab
The University of Michigan
1106 Space Research Building
Ann Arbor, MI 48109

Castellano, John
NASA Headquarters
600 Independence Ave
Washington, D.C. 20546

Carolla, Anthony
Goddard Space Flight Center
Code 730.3
Greenbelt, MD 20771

Cervenka, A. J.
Space Services International
4920 Niagara Rd
College Park, MD 20704

Carr, Frank A.
NASA/Goddard Space Flight Center
Code 700
Greenbelt, MD 20771

Chaky, Rebecca
TRW, Bldg M-2, Room 1145
One Space Park
Redondo Beach, CA 90278

Carruthers, George
Naval Research Lab
Code 4140
Washington, D.C. 20375

Chalmers, Robert
Goddard Space Flight Center
Code 732
Greenbelt, MD 20771

Carter, Richard
Goddard Space Flight Center
Code 716
Greenbelt, MD 20771

Champetier, Robert J.
Hughes Aircraft
Mail Stop 5-B107
Culver City, CA 90230

Caruso, Paul
NASA/Goddard Space Flight Center
Code 732
Greenbelt, MD 20771

Chanan, G. A.
Columbia Astrophysics Lab
Columbia University
538 West 120th St
New York, NY 10027

Case, William R.
NASA/Goddard Space Flight Center
Code 725.1
Greenbelt MD 20771

Chappell, Dr. Charles R.
Marshall Space Flight Center
Code ES-53
Huntsville, AL 20771

Cassanto, John
G.E. Corporation Space Division
P.O. Box 85-55
Philadelphia, PA 19101

Chipman, Eric
NASA Solar Physics Office
NASA Headquarters Code EZ-7
Washington, DC 20546

Clatterbuck, Guy
NASA Headquarters
Code DP
Washington, DC 20546

Clifton, K. Stuart
Marshall Space Flight Center
Code ES-4
Huntsville, AL 35812

Colonna, R. A.
NASA/Johnson Space Center
602 Cedar Lane
Seabrook TX 77586

Conley, Thomas
Air Force Geophysics Lab
Hanscom AFB
Bedford, MA 01731

Corrigan, John F.
TIROS Project Office
Goddard Space Flight Center
Code 480
Greenbelt, MD 20771

Cutler, William D.
Aerospace Corporation
P.O. Box 92957
Los Angeles, CA 90009

Cyphers, Harry D.
NASA/Goddard Space Flight Center
Greenbelt, MD 20771

Darby, Shawn
Hughes Aircraft Co.
Bldg. S-12,
Mail Stop W-320
Los Angeles, CA 90009

Davenport, Roy

Daidsen, A. F.
Johns Hopkins University
Dept of Physics
34th Charles St
Baltimore, MD 21218

Denard, Capt Leland
SD/YOOR, Air Force Space Division
Box 92960, Worldway Postal Division
Los Angeles, CA 90009

Devine, Edward
Goddard Space Flight Center
Code 716
Greenbelt, MD 20771

Dodgen, John A.
NASA/Langley Research Center
FED - MS-476
Hampton, VA 23665

Doeler, Richard A.
Goddard Space Flight Center
Code 730.3
Greenbelt, MD 20771

Donohoe, Martin J.
NASA/Goddard Space Flight Center
Code 726
Greenbelt, MD 20771

Dubin, Maurice
Goddard Space Flight Center
Code 963
Greenbelt, MD 20771

Dyott, Mike
Rockwell International
12214 Lakewood Blvd
Downey, CA 90241

Edelson, Dr. Burton I.
NASA Headquarters
Code E
Washington, D.C. 20546

Ehlers, Horst K. F.
NASA/Johnson Space Center
Code ES5
Houston TX 77058

Eiband, Martin
NASA/Goddard Space Flight Center
Greenbelt, MD 20771

England, Dr. Tony
NASA/Johnson Space Center
Code CB
Houston, TX 77058

Evans, Jack
AMAO
NASA/Goddard Space Flight Center
Code 402
Greenbelt, MD 20771

Faust, Carl
G.E. Corporation Space Division
P.O. Box 85-55
Philadelphia, PA 19101

Fazio, Dr Giovanni G.
Smithsonian Astrophysical Observatory
60 Garden St
Cambridge, MD 02138

Ferguson, Dale
Spacecraft Environment Section
NASA/Lewis Research Center
Cleveland, Ohio 44135

Fisher, Steven C.
Rockwell International SOI&SSD
12214 Lakewood BL
Code SL50
Downey, CA 90241

Fitzpatick, Donald
Space Services International
4920 Niagara Rd.
College Park, MD 20704

Flaherty, John
NASA/Goddard Space Flight Center
Greenbelt, MD 20771

Fong, Michael C.
Spacecraft Thermodynamic
Dept 62-63, Bldg 104
Lockheed Missiles and Space Co.
P.O. Box 504
Sunnyvale, CA 94086

Forlifer, William
NASA/Goddard Space Flight Center
Code 300
Greenbelt, MD 20771

Fortna, Dwight
NASA/Goddard Space Flight Center
Code 302
Greenbelt, MD 20771

Fountain, Glen H.
Johns Hopkins University
34th Charles Street
Baltimore, MD 21218

Frew, Capt Joe
SD/YH
Los Angeles Air Force Station
Los Angeles, CA 90009

Fu, T.
Rockwell International
Downey, CA 90241

Gatlin, James A.
Goddard Space Flight Center
Code 972
Greenbelt, MD 20771

Gault, Dr. Bill
Cress York University
4700 Keele St
Toronato, CANADA

Gross, Fred C.
NASA/Goddard Space Flight Center
Code 313
Greenbelt, MD 20771

Gauronskas, Charles T.
Lockheed Missile & Space Co.
Org. 60-10, Bldg 156A
P.O. 504
Sunnyvale, CA 94088

Gualdoni, Richard A.
NASA
Code RSC-5
Washington, DC 20546

Gilman, David
NASA Headquarters
Code EX-7
Washington, DC 20546

Guidice, Donald Dr.
AF Geophysics Lab (PHK)
Hanscom AFB
Hanscom AFB, MA 01731

Gilmore, Michael R.
TRW
M32544
One Space Park
Redondo Beach, CA 90278

Gull, Dr Theodore R.
Goddard Space Flight Center
Code 683
Greenbelt, MD 20771

Gochar, Gene
Goddard Space Flight Center
Code 716
Greenbelt, MD 20771

Gunton, Ronald R.
Goddard Space Flight Center
Code 490
Greenbelt, MD 20771

Goeser, Mike
NASA Headquarters
Office of Space Flight
Customer Services Division
Washington, DC 20546

Hagler, Thomas
Analystic Services Inc.
400 Army Navy Drive
Arlington, VA 22202

Grady, Kevin
Goddard Space Flight Center
Code 712.4
Greenbelt, MD 20771

Hall, David F.
Code M-271
The Aerospace Corp
P.O. Box 92957
Los Angeles, CA 90009

Grebowsky, Joseph M.
NASA/Goddard Space Flight Center
Code 961
Greenbelt, MD 20771

Hamacher, Dr. Hans P.
German Aerospace Research
3931 Highridge Dr
Huntsville, AL 35802

Greenwell, Thomas J
NASA/Goddard Space Flight Center
Code 401
Greenbelt, MD 20771

Harris, Tom
Kennedy Space Center/MDTSCO
Kennedy Space Center, FL 32899

Hartmann, Hans
Dornier Systems
POSTFACHE 1360
7990 Griedrichshafen, West Germany

Hirschfield, Julius J.
NASA/Goddard Space Flight Center
Code 754
Greenbelt, MD 20771

Hayward, Lt. Jonathan K.
Wright Patterson Air Force Base
AFWAL/WEM
Dayton, Ohio 45433

Hoffman, Richard
Goddard Space Flight Center
Code 732
Greenbelt, MD 20771

Heath, Lt. Maureen
USAF, Headquarters Space Division
Los Angeles AFS
Los Angeles, CA 90009

Hough, Lt. Scott
SD/YOOR, Air Force Space Division
Box 92960, Worldway Postal Division
Los Angeles, CA 90009

Helenek, Andrew R.
Perkin Elmer Corp
100 Wooster Heights Rd
Danbury, CT 06810

Housten, Samuel
Lockheed Missile and Space Co.
Sunnyvale, CA 94086

Hendrickson, E. A.
48-50 B/142 Lockheed Missile Center
P.O. Box 504
Sunnyvale, CA 94086

Hovis, Dr. Warren A.
Department of Commerce - NOAA
FOB #4 Room 0135
Washington, DC 20233

Henize, Dr. G.
NASA/Johnson Space Center
Code CB
Houston, TX 77058

Hutter, D. E. C.
RCA/Astro Electronics
Mail Stop 56B PO Box 800
Princeton, NJ 08540

Heppner, James P.
NASA/Goddard Space Flight Center
Code 696
Greenbelt, MD 20771

Hynes, Shane
Orbital Systems Ltd
PO Box 700
Lanham, MD 20706

Hewitt, Dennis
Goddard Space Flight Center
Code 732
Greenbelt, MD 20771

Inada, T.
NASADA Washington Office
3716 S. Street NW
Washington, DC 20007

Higgins, Robert W.
Los Alamos National Laboratory
Los Alamos, NM 87545

Inoye, George
TRW, Bldg M-2, Room 1145
One Space Park
Redondo Beach, CA 90278

Ishimoto, Tak
TRW
One Space Park
Redono Beach, CA 90278

Kaylor, Dr. Charles
Teledyne Brown Engineer
Cumming Research Park Mail Stop 52
Huntsville, AL 35807

Jacobs, Stephen
NASA/Johnson Space Center
10277 S. Gessner
Houston, TX 77071

Kerstein, Lothar
MBB-ERNO
Raum/ahrt technic
GmbH
Hunefeldstr
028 Brenen
Germany

Johnson, A Gerald
NASA/Goddard Space Flight Center
Code 420
Greenbelt, MD 20771

Kidwell, Robert E. Jr.
Swales & Associates
11803 Renick Lane
Silver Spring, MD 20904

Johnson, Bertrand L. Jr.
NASA/Goddard Space FLight Center
Code 973
Greenbelt, MD 20771

Kinard, William H
NASA/Langley Research Center
LDEF Project Office
Hampton, VA 23665

Johnson, Edwin C.
NASA/Kennedy Space Center
215 7th Ave.
Indialantic, FL 32903

King, Tom
Orbital Systems Ltd
PO Box 700
Lanham, MD 20706

Kant, Seymor
NASA/Goddard Space Flight Center
Code 700
Greenbelt, MD 20771

Kinsley, Ronnie
NASA Headquarters
Code EM-8
Washington, DC 20546

Karch, David
Hughes Aircraft Co.
Mail Stop B354
Los Angeles, CA 90009

Knott, Karl
European Space Agency
KEPLERLAAN 1
NOORDWIJK HOLLAND

Kaul, Dr. Roger
Litton Industries
17609 Princess Anne Dr.
Olney, MD 20032

Kofsky, Irving L.
PhotoMetrics, Inc.
4 Arrow Dr
Woburn, MASS 01801

Kawashima, Nobuki
The Institute of Space and Astronautical
4-6-1 Komaba, Meguro-ku
Tokyo, Japan 153

Kraft, George E.
NASA/Goddard Space Flight Center
Code 744
Greenbelt, MD 20771

Kruger, Raymond
NASA/Goddard Space Flight Center
Code 302
Greenbelt, MD 20771

Kull, Frederick J.
NASA/Goddard Space Flight Center
1732 Stranton Road
Crofton MD 21114

Kunst, James W.
NASA/Goddard Space Flight Center
Code 733
Greenbelt, MD 20771

Kwan, Dr. Stephen
Lockheed Missile & Space Co.
1111 Lockheed Way
Sunnyvale, CA 94086

Lakebusch, A. O.
NASA/Goddard Space Flight Center
Code 302
Greenbelt, MD 20771

Leader, Frank A.
Lockheed Missile Center
1111 Lockheed Way
ORG 66-52, Bldg 573
Sunnyvale, CA 94088

Ledchnc, F. J.
AFGL/LKO
Bedford, MA 02172

Leger, Dr. Lubert J.
NASA/Johnson Space Center
Code ES-5
Houston, TX 77058

Lehmann, Jules
NASA Headquarters
Code EM-8
Washington, D.C. 20546

Leiter, Steve
Orbital Systems Ltd
PO Box 700
Lanham, MD 20706

Lindley, Jack
Lockheed Missile & Space Co.
O/6196 Bldg 576
P.O. Box 504
Sunnyvale, CA 94086

Liu, C. K.
Lockheed Missile Center
O/62-32, Bldg 205
3251 Hanover Street
Palo Alto, CA 94303

Logan, William
Space Services International
4920 Niagara Rd
College Park, MD 20704

Lohman, Robert
NASA Headquarters
Code ML Spacelab
Washington, DC 20546

Long, Knox S.
Johns Hopkins University
Physics Dept
Baltimore, MD 21218

Lynch, John
NASA Headquarters
Washington, D.C. 20056

Maksimovic, Velimir
NASA/Goddard Space Flight Center
Code 742.1
Greenbelt, MD 20771

Malcolm, John
The Boeing Aerospace Co.
PO Box 3999 Mail Stop 81-62
Seattle, Washington 98124

McKeown, Daniel
Faraday Laboratories Inc.
P.O. Box 2308
LaJolla, CA 92038

Malina, Roger
Space Science Lab
University of California
Berkeley, CA 94720

Melfi, Charles P.
Aerospace Corp
M1/122
P.O. Box 92957
Los Angeles, CA 90009

Malone, Eugene P.
Rockwell International Corporation
Mail Code AD35
Downey, CA 90241

Mende, S. B.
Lockheed Palo Alto Research Lab
3251 Hanover St
Palo Alto, CA 94304

Marian, Edward
Jet Propulsion Lab MC 144-218
4800 Oak Grove Dr
Pasadena, CA 91109

Mercer, Marne
Lockheed Missile & Space
Sunnyvale, CA 94086

Marshburn, James
GTE Satellite Corp
CO/RCA-AE
PO Box 800, Mail Stop 70B
Princeton, NJ 08540

Michalek, Theodore
Goddard Space Flight Center
Code 732
Greenbelt, MD 20771

Mazzuca, F
PSN/CNR
VIALE REGINA MARGHERITA 202
ROME ITALY 06798

Miller, Anthony J.
Goddard Space Flight Center
Code 733
Greenbelt, MD 20771

McClure, Allan H.
Boeing Aerospace IUS
5249 S. Mayflower St
Seattle, WA 98118

Miller, Edgar R.
NASA/Marshall Space Flight Center
ES61
Marshall Space Flight Center, AL

McDonnell, Dr. J. A. M.
University of Kent
Canterbury, England
CANTERBURY, KENT

Molgaard, Donald A.
TRW, Bldg R-5/10-31
One Space Park
Redondo Beach, CA 90279

McDonnell, Robert
Goddard Space Flight Center
Code 741
Greenbelt, MD 20771

Morris, Robert
Hughes Aircraft Co.
Bldg S-1
Mail Stop D304
Los Angeles, CA 90009

Muckley, Ed
NASA/Lewis Research Center
Code 500-116
21000 Brookpark Rd
Cleveland, OH 44135

Mullen, Charles R.
Boeing Aerospace Comp.
PO Box 3999, Mail Stop 8C-05
Seattle, WA 98124

Muller, Joseph
Goddard Space Flight Center
Code 732
Greenbelt, MD 20771

Muller, Ron
NASA/Goddard Space Flight Center
Code 402
Greenbelt, MD 20771

Mullins, James A.
NASA/Goddard Space Flight Center
Code 754
Greenbelt, MD 20771

Murphy, Jerry
Dept. of Physics & Astronomy
University of Iowa
Iowa City, Iowa 52242

Muscari, J. A.
Martin Marietta Corp
PO Box 179
Denver, CO 80201

Naegely, Chuck
GTE Satellite Corp
Co/RCA-AE
PO Box 800, Mail Stop 70B
Princeton, NJ 08540

Narcisi, Dr. Rocco S.
Air Force Geophysics Lab
AFGL/LKD
Hanson AFB, MA 01731

Nelson, Darrell
Lockheed Missiles and Space Co.
Sunnyvale, CA 94086

Neupert, Werner M.
NASA/Goddard Space Flight Center
Code 682
Greenbelt, MD 20770

Nichols, James H. III
University Research Foundation
Wind Tunnel, University of MD
College Park, MD 20742

Noblitt, Bob J.
Teledyne Brown Engineering
11300 Rockville Pike
Rockville, MD 20852

Novick, Robert
Columbia Astrophysics Lab
538 West 120th Street
New York, NY 10027

Nygaard, Maurice A.
NASA/Goddard Space Flight Center
Code 741.2
Greenbelt, MD 20771

O'Neil, Terry
Goddard Space Flight Center
Code 732
Greenbelt, MD 20771

O'Neil, Robert R.
Air Force Geophysics Lab
Hanscom AFB
Bedford, MA 01731

Ollendorf, Stanford
Goddard Space Flight Center
Code 732
Greenbelt, MD 20771

Olney, Dave
NASA/Goddard Space Flight Center
Code 745.1
Greenbelt, MD 20771

Osantowski, John F.
NASA/Goddard Space Flight Center
Code 717
Greenbelt, MD 20771

Overman, Larry
Teledyne Brown Engineering
Cummings Research Park
Mail Stop 172
Huntsville, AL 35807

Paddack, Stephen J.
AMAO
NASA/Goddard Space Flight Center
Code 402
Greenbelt, MD 20771

Park, Dr. John J.
Materials Control & Applications Branch
Goddard Space Flight Center
Greenbelt, MD 20771

Pennington, Frank
University Research Foundation
University of Maryland
College Park, MD 20742

Petruzzo, Charles
Goddard Space Flight Center
Code 470.3
Greenbelt, MD 20771

Pharo, Merritt W. III
NASA/Goddarda Space Flight Center
Code 961
Greenbelt, MD 20771

Pike, Charles
AF Geophysics Lab
(PHK) Hanscom Air Force Base
Hanscom AFB, MA 01731

Poporich, E. J.
NASA/Kennedy Space Center
Kennedy Space Center, FL 32899

Poteet, Wade
university of Arizona
Steward Observatory
Tuscon, AZ 85721

Potter, Dr. Andrew
NASA/Johnson Space Center
Code SC-4
Houston, TX 77058

Powell, Darryl
Goddard Space Flight Center
Code 733
Greenbelt, MD 20771

Power, John L.
NASA/Lewis Research Center
2100 Brook Park Rd
Cleveland, OH 44135

Powers, Edward I.
NASA/Goddard Space Flight Center
Code 730
Greenbelt, MD 20771

Predmore, Roamer
Materials Branch
Goddard Space Flight Center
Code 313
Greenbelt, MD 20771

Priedhorsky, William
Los Alamos National Laboratory
Mail Stop D-435
Los Alamos, NM 87545

Prinz, Dianne K.
Naval Research Lab
Code 4141.2
4555 Overlook Ave SW
Washington, DC 20375

Pugel, Nancy J.
Martin Marietta
PO Box 179
Denver, CO 80201

Robinson, John
Goddard Space Flight Center
Code 716
Greenbelt, MD 20771

Pumphrey, Ted
Rockwell International
12214 Lakewood Blvd
Downey, CA 90241

Roche, Aidan E.
Lockheed Palo Alto Research Lab
3251 Hanover Street
Palo Alto, CA 94304

Purvis, C. K.
NASA/Lewis Research Center
21000 Brookpark Rd
Code MS77-4
Cleveland Ohio 44135

Rock, William H.
NASA/Kennedy Space Center
Code CP
Kennedy Space Center, FL 32899

Ragusa, Dr. James M.
Kennedy Space Center
Code CP-SPO - 314-82
Kennedy Space Center, FL 32899

Rowen, William H.
Lockheed Missles & Space Company
P.O. Box 504
Sunnyvale, CA 94086

Reeves, Dr. Edmond M
NASA Headquarters
Code EM-8
Washington, DC 20546

Ryan, Al
NASA Headquarters
Code ML Spacelab
Washington, Dc 20546

Rhoades, George D.
Lockheed Missile & Space Co.
PO Box 504, D 62-63, Bldg 104
Palo Alto, CA 94304

Saflekos, Nicolaos A.
Boston College
140 Commonwealth Ave
Chestnut Hill, MA 02167

Rhodes, Russel E.
NASA/Kennedy Space Center
Code SP-FGS-1
Kennedy Space Center, FL 32899

Sander, Michael J.
NASA Headquarters
Code E
Washington, D.C. 20546

Rieb, S. L.
TRW
One Space Park
Mail Stop R5/B131
Redondo Beach, CA 90278

Sasaki, Chester N.
Jet Propulsion Lab
Code 158-224
4800 Oak Grove Dr
Pasadena, CA 91109

Roberts, W. T.
NASA/Marshall Space Flight Center
PS01
Marshall Space Flight Center, AL 35812

Saylor, William
G.E. Corporation Space Division
P.O. Box 85-55
Philadelphia, PA 19101

Schendel
MBB-ERNO
Raum/ahrt technic
GmbH
HunfeldSt
028 Brenen
Geremany

Schepis, Joseph
Goddard Space Flight Center
Code 716
Greenbelt, MD 20771

Schmerling, E. R.
NASA Headquarters
Washington, D.C. 20546

Schmidt, Ewald E.
NASA/Goddard Space Flight Center
Code 425
Greenbelt, MD 20771

Schumacher, R. J.
Naval Research Lab
Code 4161
Washington, DC 20375

Schurr, Gunther G.
Payload Integration Hardware
Rockwell International
12214 Lakewood Blvd
Downey, CA 90043

Schwarcott, Walter
Dornier Systems
POSTFACHE 1360
7990 Friedrichshafen, West Germany

Scialdone, John J.
Goddard Space Flight Center
Code 725
Greenbelt, MD 20771

Scottoline, Charles A.
Rockwell International Corp
Code FC-75
12214 Lakewood Blvd
Downey, CA 90241

Seidenberg, Benjamin
Goddard Space Flight Center
Code 732
Greenbelt, MD 20771

Seivold, Al
Goddard Space Flight Center
Code 732
Greenbelt, MD 20771

Shawhan, Stanley D.
Department of Physics and Astronomy
The University of Iowa
Iowa City, Iowa 52242

Shiple, Donald M.
Goddard Space Flight Center
Code 730.3
Greenbelt, MD 20771

Shirrod, Robert
Boeing Aerospace Comp.
PO Box 3999, Mail Stop 8k-91
Seattle, WA 98124

Shlanger, S. S.
Rockwell International
Code M/C VA01
P.O. Box 5277
Vandenberg AFB, CA 93437

Shrewsberry, David J.
NASA/Goddard Space Flight Center
Code 745
Greenbelt, MD 20771

Skladany, Joseph
Goddard Space Flight Center
Code 732
Greenbelt, MD 20771

Smith, Allyn
2205 Pike Ct.
Cocoa, FL 32922

Smith, D. C.
Hughes Aircraft
P.O. Box 906 El/186
El Segundo, CA 90654

Smith, Kevin
TRW
One Space Park 01/2220
Redondo Beach, CA 90278

Smith, Michael R.
USAF
6595 STG/SH
Vanderberg AFB, CA 93437

Socket, Dennis G.
Naval Research Lab
Code 4162 DS
4555 Overlook Ave SW
Washington, DC 20375

Sorge, William B.
Rockwell International
Downey, CA 90241

Springer, Louis
G.E. Corporation Space Division
P.O. Box 85-55
Philadelphia, PA 19101

Srivastava, S. K.
Jet Propulsion Lab
4800 Oak Grove Dr.
Pasadena, CA 91109

Stahl, Robert C.
Aerospace Corp.
PO Box 5068 Bldg. 8500, STS-IOSC
Vandenberg AFB, CA 93437

Staken, Petrick
Orbital Systems Ltd
PO Box 700
Lanham, MD 20706

Stallings, Robert
Teledyne Brown Engineering
Cummings Research Park MS 172
Huntsville, AL 35807

Stavelly, Richard
Goddard Space Flight Center
Code 732
Greenbelt, MD 20771

Stecher, Theodore P
NASA/Goddard Space Flight Center
Code 680
Greenbelt, MD 20771

Stencel, Robert
NASA Headquarters
EZ-7
Washington, DC 20546

Stevens, John N.
Hughes Aircraft
Bldg. S-12, Mail Stop V347
El Segundo, CA

Stipandic, Edward
G.E. Corporation Space Division
P.O. Box 85-55
Philadelphia, PA 19101

Stouffer, Charles G.
Goddard Space Flight Center
Code 425
Greenbelt, MD 20771

Studenick, David
Goddard Space Flight Center
Code 716
Greenbelt, MD 20771

Suddeth, David H.
AMAO
NASA/Goddard Space Flight Center
Greenbelt, MD 20771

Tyra, Neil
ORI, Inc
1400 Spring Street
Silver Spring, MD 20910

Sudey, John
Goddard Space Flight Center
Code 716
Greenbelt, MD 20771

Urban, Eugene
NASA/Marshall Space Flight Center
ES 63
MSFC, Alabama 35812

Szuszczewicz, E. P.
Naval Research Lab
Washington, D.C. 20375

VanHoosier, M. E.
Naval Research Lab
Code 4162V
Washington, DC 20375

Tarpley, John
NASA/Goddard Space Flight Center
Code 313
Greenbelt, MD 20771

Venkatavaradan, V.
Director of Naroub Planetarium
Bombay, India

Taylor, Dr. William W. L.
TRW/Space and Technology Group
One Space Park
Redondo Beach, CA 90278

Volpe, Frank
Goddard Space Flight Center
Code 420
Greenbelt, MD 20771

Thomas, Dr. Roger J.
NASA/Goddard Space Flight Center
Code 682
Greenbelt, MD 20771

Walter, Allison
NASA/Goddard Space Flight Center
Code 730.3
Greenbelt, MD 20771

Torgerson, Darrel D.
Solar and Optical Physics, Dept. 52-13
Lockheed Palo Alto Research Lab.
Palo Alto, CA 94304

Weekley, R. R.
Hughes Aircraft
P.O. Box 906 E1/186
El Segundo, CA 90654

Triolo, Jack

Weinberg, Dr. Jerry L.
Space Astronomy Lab,
University of Florida
1810 NW 6th St
Gainesville, FL 32601

Tyler, Allen
Goddard Space Flight Center
Code 716
Greenbelt, MD 20771

White, Julie
The Aerospace Corp
Mail Stop M1-122
Los Angeles, CA 90009

Tynan, Charles I., Jr
LDEF Project Office
NASA Langley Research Center
Mail Stop 258
Hampton, VA 23665

Whitehead, Virginia
NASA/Kennedy Space Center
Code CP
Kennedy Space Center, FL 32899

Wilkerson, Dr. T. D.
Institute of Physical Science and Technology
University of Maryland
College Park, MD 20742

Wilkinson, Robert
NASA/Goddard Space Flight Center
Code 302
Greenbelt, MD 20771

Willeford, Gene
TRW
One Space Park
Redondo Beach, CA 90278

Williams, Willie
DOD Space Activities
Washington, D.C. 20546

Williamson, Dr. Roger
Radioscience Laboratory,
Stanford Electronics Lab
Stanford University
202 Durand Bldg,
Stanford, CA 94305

Wirman, Nelson R.
NASA Headquarters
Code EM-8
Washington, DC 20546

Wise, Peter
RCA/Astroelectronics
PO Box 800 MS 113
Princeton, NJ 08540

Witteborn, Dr. Fred C.
NASA/Ames Research Center
Code N-245-6
Moffett Field, CA 94035

Wlochowicz, R.
National Research Council of Canada
100 Sussex Dr
Ottawa, Ontario KIA OR6

Woerner, Charles V.
NASA/Langley Research Center
ERBE/SAGE II Project Office
Mail Code 158
Hampton, VA 23665

Woodruff, William L.
NASA/Goddard Space Flight Center
6503 McCahill Dr
Laurel, MD 20707

Ximenez, Santiago
ESTEC
THE NETHERLANDS

Young, Earle W.
Goddard Space Flight Center
Code 420
Greenbelt, MD 20771

Zeiner, Gene
Hughes Aircraft Co.
Bldg. S-12/Mail Stop-V347
Space Communication Group
Los Angeles, CA 90009