

N83 22307 D18

STS-3/OSS-1 PLASMA DIAGNOSTICS PACKAGE (PDF)
MEASUREMENTS OF THE TEMPERATURE
PRESSURE, AND PLASMA

S. D. Shawhan and G. Murphy
University of Iowa

Preceding page blank

ORIGINAL PAGE IS
OF POOR QUALITY

STS-3/OSS-1

PLASMA DIAGNOSTICS PACKAGE (PDP)
90-DAY SUMMARY SCIENCE REPORT

by

Stanley D. Shawhan
PDP Principal Investigator

and

Gerald B. Murphy
PDP Data Processing Manager

Contributors:

Roger D. Anderson	Dwight Fortna/GSFC	Harry Owens
Roger R. Anderson	Lou Frank	Merritt Pharo/GSFC
Terry Averkamp	Joe Grebowsky/GSFC	Dave Reasoner/MSFC
Bob Brechwald	Don Gurnett	Joel Score
Henry Brinton/NASA-HQ	Marty Kerl	Nobie Stone/MSFC
Tim Clark	Rich Kroeger	Harry Taylor/GSFC
Terry Clausen	Maja Lorkovic	Lisa Vodra
Ann Dresselhaus	Kerry Neal	Ev Williams
Don Enemark		

Contract NAS8-32807

Marshall Space Flight Center, Huntsville, Alabama 35812

July 1982

Department of Physics and Astronomy
The University of Iowa
Iowa City, Iowa 52242
319/353-3294

Preceding page blank

1.0 INTRODUCTION

This 90-day summary science report for the STS-3/OSS-1 PDP is submitted as required by the "OSS-1/Plasma Diagnostics Package Data Management Plan" dated January 1982 (Report OSS-1/PDP 82-01, University of Iowa) in accordance with the letter from A. Martin Eiband, dated 22 December 1982, Code 420, GSFC File 03496 "OSS-1, Phase III, Data Analysis." Mission operations and data analysis is supported through Marshall Space Flight Center Contract NAS8-32807 for the OSS-1 and Spacelab-2 PDP effort.

Data utilized for this report has included hard copy data from the POCC, PDP data received directly at the North Liberty (Iowa) Radio Observatory, processed flight data tapes (57 hours), and PDP data from the OSS-1/IUE data tapes (116 hours). In addition, ancillary data on the RMS coordinates in hard copy form has been utilized. Ancillary data not yet available include the best-estimate-trajectory and attitude, the operations status of key orbiter subsystems such as thrusters and flash evaporators, and the catalog of VCAP/FPEG operations. Of the PDP flight data, 28 hours have been displayed in ten minute summary plot format on 35mm color slides. All of the IUE data (16 selectable parameters) has been plotted against time at 30 minutes per plot.

For the STS-3/OSS-1 mission, the PDP was to carry out the following technical and scientific objectives:

1.1 Flight Test of Systems and Procedures

Flight test the systems and procedures and associated with the Spacelab-2 PDP experiment with particular emphasis on the RMS operations, on unlatching and relatching the PDP unit, and on evaluating the RF telemetry link.

1.2 Orbiter EMI and Plasma Contamination

Measure and locate the sources of fields, Electromagnetic Interference (EMI) and plasma contamination in the environment of the Orbiter out to 15 meters.

1.3 Orbiter Wakes and Shocks

Study the orbiter-magnetoplasma interactions within 15 meters of the orbiter through measurement of electric and magnetic fields, ionized particle wakes and generated waves.

1.4 Electron Gun Beam Diagnostics and Plasma Effects

Ascertain the characteristics of the electron beam emitted from the orbiter out to a range of 15 meters; measure the results of beam-plasma interactions in terms of fields, waves and particle distribution functions.

The technical objective 1.1 was discussed in the "STS-3/OSS-1 Plasma Diagnostics Package (PDP) 30-Day Engineering Report", dated 30 April 1982. Progress-to-date on the thermal and pressure environment of the PDP and on the science objectives 1.2, 1.3 and 1.4 is presented in this report in Sections 2.0 through 6.0 and is summarized in Section 7.0. In Section 8.0, the plan for continued data analysis is briefly described.

2.0 THERMAL AND PRESSURE HISTORY

ORIGINAL PAGE IS
OF POOR QUALITY

With the availability of the complete PDP flight tape recorded data and the OSS-1/IUE PDP data parameters, it has been possible to extract the PDP thermal and pressure history.

2.1 PDP Thermal History

The PDP was designed to withstand the thermal extremes of the STS-3 mission through the use of heaters and of thermal blankets. The PDP sat on the Release/Engagement Mechanism (REM) on the OSS-1 pallet without a coldplate and was attached to the RMS for two extended periods.

Figure 2.1 gives a plot of temperature vs. mission elapsed time MET for two temperative sensors. The solid curve labeled "PDP" is a thermistor internal to the PDP on the instrument deck. This point is seen to reach a minimum of -25°C after the extensive tail-to sun cold period near MET 1/0900. At this point, the PDP deck heater was activated and holding the -25°C setpoint. This same sensor showed a maximum of 52°C near MET 6/1000 at the end of the extensive hot top-to-sun period; model calculations predicted 50°C . Note that during the PDP deployment periods early on MET Day 3 and Day 4, the PDP warmed up slowly to -5°C .

The dotted curve in Figure 2.1 labeled "EGF" is a thermistor on the electrical grapple fixture connector which is external to the PDP. This point has a very much shorter thermal time constant. Variations are more rapid with a minimum of -35°C at MET 1/0600 and a maximum of 56°C near MET 6/0400. Still this point remains between the heater trip point of -32°C and a desired upper limit of 60°C . Consequently, the PDP thermal design is considered suitable for Spacelab-2. Similar designs should work for other spacelab pallet-mounted instruments without coldplates.

2.2 Pressure Profile

Pressure in the range of 10^{-3} to 10^{-7} torr, measured 3 inches from the skin of the PDP, is plotted in Figure 2.2 against GMT during the mission (0/0000 MET = 81/1600 GMT). Just after pallet activation, the pressure decreased to $\sim 10^{-6}$ torr and then slowly decreased over the day to as low as 10^{-7} torr which is near ambient level for 240 km altitude.

The most distinctive feature of the pressure profile is the modulation at the orbit period. This variation of between 10^{-5} torr and 10^{-7} torr has a 90 minute orbit period even though the Orbiter is

rolling at two-times the orbit rate (2 rolls/orbit). From interpretation of the attitude information, it is found that the pressure peaks when the atmospheric gas is rammed into the payload bay; the curve in Figure 2.2 can be fit with a log-sine function. This modulation is seen also when the PDP is on the RMS during the FPEG operations periods. Note that on GMT Day 81 near 2200, there is a 6x orbit rate modulation when the Orbiter was rolling at 6x orbit rate during PTC.

Ancillary data giving the status of Orbiter systems that might affect the pressure are not completely available. However, the primary thruster L2U burn at GMT 85/1430, increases the pressure to 3×10^{-4} torr. During the three minutes of closed payload bay doors, the pressure increased to 3×10^{-5} torr. Little data were taken during the top-to-sun attitude but pressure values as high as 2×10^{-5} were recorded--presumably due to increased outgassing of the Orbiter bay.

Instruments sensitive to pressure variations or to pressure levels above 10^{-4} torr--in the corona region if high voltages are involved--may need a pressure sensor to provide protection.

ORIGINAL PAGE IS
OF POOR QUALITY

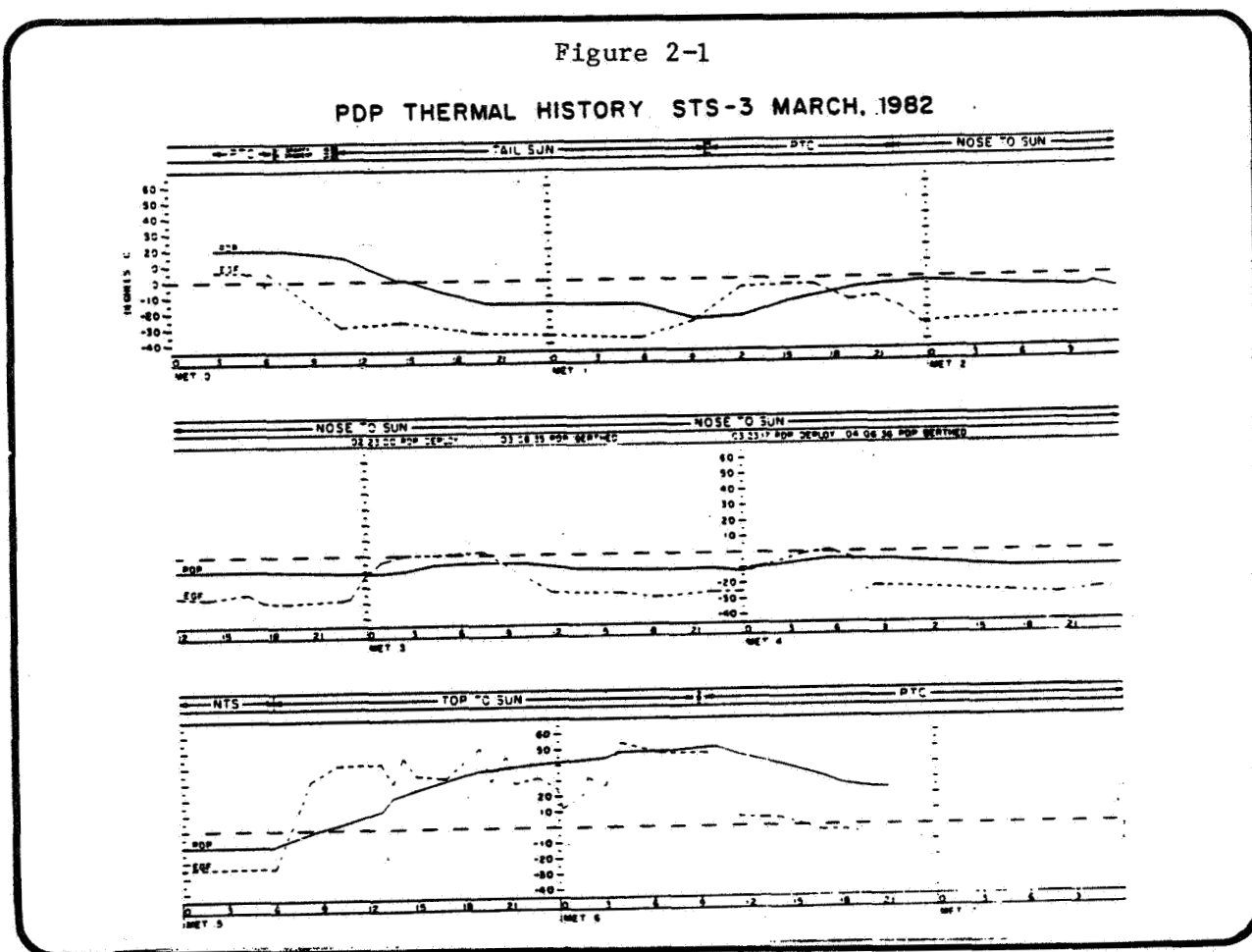
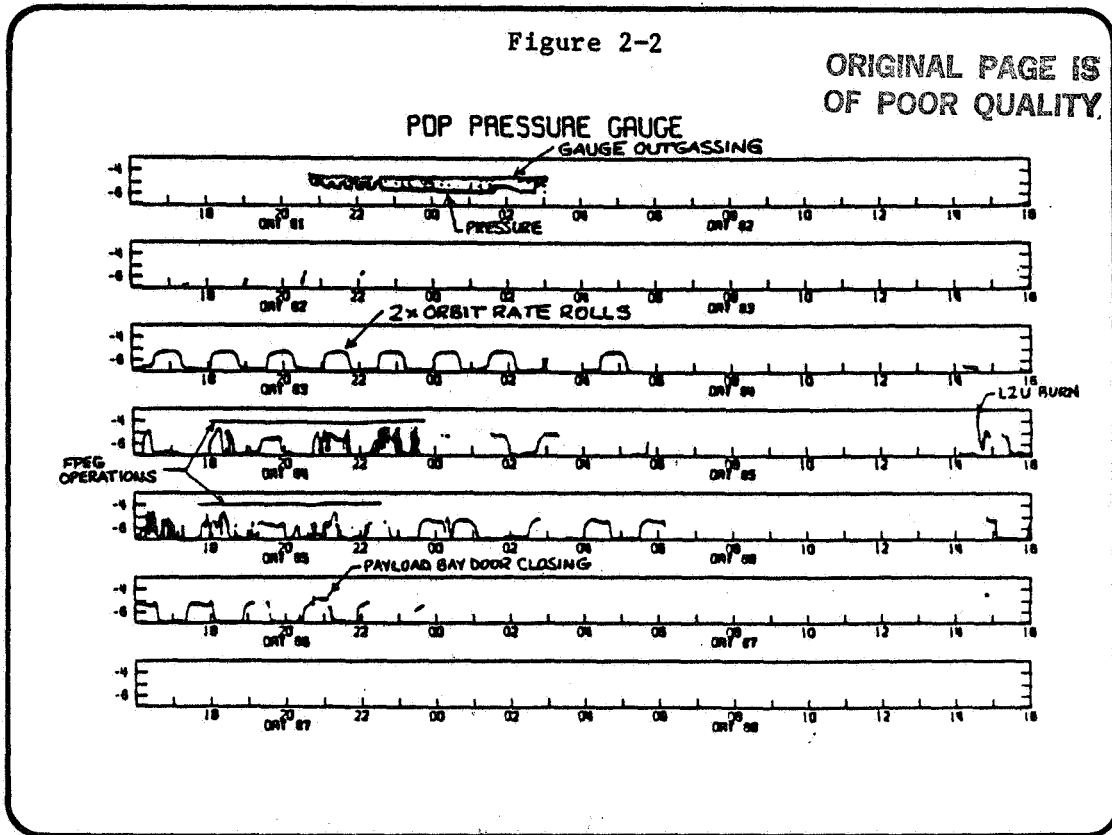

Figure 2-2

ORIGINAL PAGE IS
OF POOR QUALITY.



3.0 ORBITER RADIATED ELECTROMAGNETIC FIELDS

An extensive set of wave field receivers covering the frequency range of 30 Hz to 800 MHz and S-Band (2200 MHz) was included on the PDP. These receivers provided a capability to characterize the Orbiter's unintentional radiated spectrum and its time variability and intentional communication transmitter's field strength.

3.1 Pallet EMI Levels and Time Variations

One of the prime PDP measurements was to determine the electric and magnetic noise spectrum and time variability due to the Orbiter systems. It was found that the magnetic field was composed of discrete frequencies and harmonics. These emissions are probably due to power converters and clocklines. The characteristic amplitude of 60 dBpT \pm 20dB did not vary significantly over the mission.

Measurements of the electric field emissions showed a broadband spectrum which varied by at least 60 dB over time. An example of the time variability is shown in Figure 3.1 for the 16 VLF channels. Note that changes occur on the time scale of seconds--probably due to thruster firings. Also there is a large variation on the time scale of tens of minutes which is found to be correlated with the Orbiter orbit period. The intensity is usually maximum when the Orbiter is in a ram attitude--bay in the velocity vector direction. This modulation is similar to that of the pressure gauge.

The range of observed electric field levels is plotted in Figure 3.2. Orbiter-associated noise was as low as the receiver noise levels. At frequencies above 300 kHz, the receivers were not sensitive enough to detect the noise at all. When the FPEG was operated, the fields exceeded the Orbiter-induced noise at all frequencies.

In general, it is found that the Orbiter unidirectional emissions are at the spec level or below and that the electric field noise is not due to Orbiter subsystems, but rather to the Orbiter's interaction with the plasma in the ionosphere. Work is continuing on this investigation.

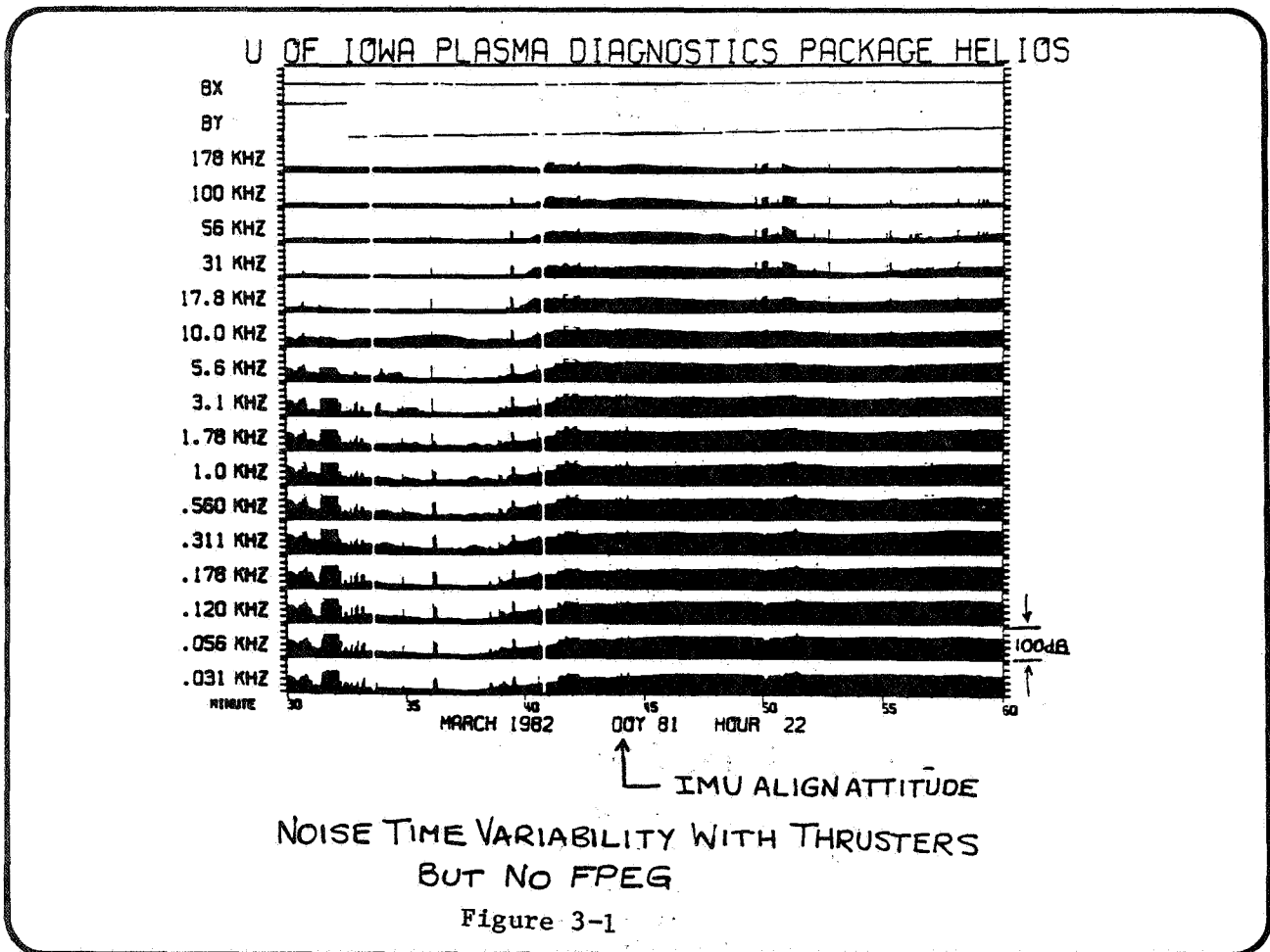

3.2 UHF and S-Band Transmitter Field Strengths

One filter channel of the PDP High Frequency Receiver covered the band of 165-400 MHz which includes the 295 MHz frequency of the UHF voice downlink transmitter. When this transmitter was keyed on and connected to the upper antenna, a signal was detected by the PDP. These measured field strengths were always below 0.5 V/m with the PDP on the RMS and below 0.1 V/m at the PDP pallet location. Average and peak field strengths are given in the following table:

<u>Location/Field Strengths ± 2dB</u>	<u>Average</u>	<u>Peak</u>
PDP on Pallet at 13 meters from Antenna	.05 V/m	0.08 V/m
PDP on RMS at 8 meters from Antenna	.23	.44

These levels are well below the suggested radiated susceptibility field strengths.

At S-Band, the 150 watt data downlink transmitter (2287.5 MHz) can produce fields which are modeled to be 49.6 V/m/R (meters) in the beam of the selected "quad" antenna. Even at many meters, these fields could be at damage level for payload instruments or for satellites being manipulated by the RMS. The PDP carried a receiver especially designed to measure the field strengths in and around the payload bay. These measured levels were about 5 dB ± 2 dB higher than the modeled values but comparable to a crude theoretically calculated value as follows:

Field Strength Relation
(V/m)

Modeled @ 150 Watts	49.6 /R (meters)
Measured with PDP (± 2dB)	90.3 /R (meters)
Calculated @ 150 Watts	94.9 /R (meters)

The calculated value assumes that all of the power is emitted into a hemisphere with 100% efficiency.

In the antenna beam, the fields exceed 20 V/m inside of 5 meters. However, with the PDP on the pallet at a range of 13 meters off the edge of the beam, the fields were not observed at the threshold of 2 V/m whereas the in-beam prediction would be 7V/m. Consequently, payload bay instrumentation is not subjected to damage levels.

ORIGINAL PAGE IS
OF POOR QUALITY

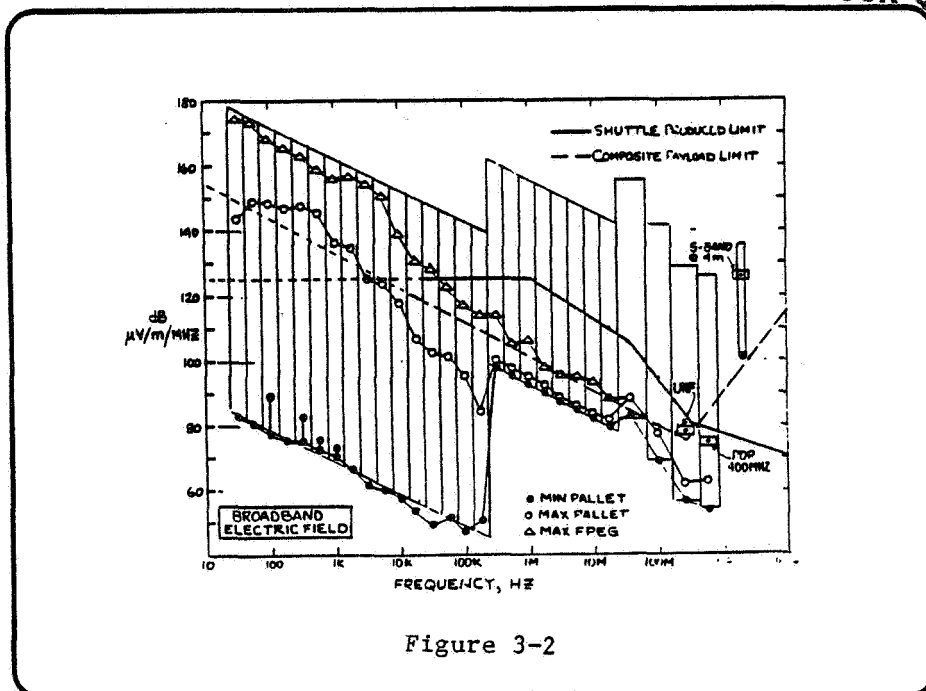

Figure 3-2

4.0 ORBITER ION PLASMA ENVIRONMENT

(Henry C. Brinton, Joseph M. Grebowsky, Merritt W. Pharo III,
Harry A. Taylor, Jr./GSFC)

The Bennett RF Ion Mass Spectrometer on the STS-3/OSS-1 Plasma Diagnostics Package (PDP) performed nominally throughout the mission. Measurements of ion spectra were obtained both in the cargo bay and during experiment periods in which the PDP was operated on the extended Remote Manipulator System (RMS) arm. Real time data obtained from several orbit passes over the North Liberty (Iowa) Radio Observatory ground station and playback data obtained while the PDP was operated on the extended RMS arm have been examined. Ion currents observed covered the entire dynamic range (2×10^5) of the ion mass spectrometer system demonstrated response to the extremes of ambient and perturbed plasma conditions. Data tapes provided were of sufficient quality to enable use of the GSFC developed software on the DEC 11/70 computer for initial data reduction activities.

Initial data processing was concerned with positively identifying the atomic mass numbers of the detected ion species. As anticipated, the effects of electrical charge buildup and/or the plasma ram velocity altered the calibrated direct relationship between the atomic mass number of an ion and the applied spectrometer voltage required for its detection. The net of such effects upon the spectrometer range from -3 to -8 volts on the various data samples studied. A detailed examination of a number of individual mass scans was therefore undertaken which considered apparent potential shifts in the fundamental current peaks due to spacecraft charging as well as the shifts in the locations of the harmonic derivatives of the fundamental peaks. This analysis provided a scheme for identifying the atomic mass number of the detectable ions. A more complete analysis will be made once the orbit-attitude data are available.

Since detailed event timeline and aspect information for determining the orientation of the spectrometer orifice with respect to the plasma flow, are not yet available, it was not possible to determine the exact magnitude of the ion concentrations sampled, nor to interpret the source of strong fluctuations. However, the collected ion currents provide the basis for a rough estimate of the relative abundance of each ions species, and of course, the variations of the ion currents with time reflect similar variations in the concentrations. Hence the preliminary evaluation of the data considered the ion currents only while one of the immediate future goals will be to convert these currents to concentrations.

Some examples of the ion currents collected during the flight of STS-3/OSS-1 are shown in Figures. Three distinctive phases of the PDP operations are depicted. Figure 4.1 corresponds to early measurements when the PDP was still in the shuttle bay while Figures 4.2 and 4.3 show measurements made on the extended RMS arm. In the event shown in Figure 4.3, the electron beam created abrupt disturbance of all the ion currents. As these figures show, the most dominant ion species observed correspond to atomic mass numbers of 16, 18, 30, and 32. The existence

ORIGINAL PAGE IS
OF POOR QUALITY

of mass numbers 16, 30 and 32 were expected since the shuttle is operating at F-region altitudes where there are substantial ambient plasma O^+ (16 amu), and NO^+ (30 amu) and O_2^+ (32 amu) plasma densities. The existence of mass 18, assumed to correspond to H_2O^+ ions, demonstrates that the shuttle not only dynamically perturbs the ambient plasma as it moves through it, but apparently has its own inherent atmosphere environment to interact with the ambient medium.

Further analysis of the ion spectrometer measurements will proceed, given operations and aspect data. From a merging of the orbit and attitude data with the ion measurements, it is expected that geophysical variations in the ion concentrations may be separated from shuttle induced perturbations - for example - the noticeable decreases in current seen in Figures 1 and 2 may be of either source. A further study will be made of the identification of ambient and contaminant ions and of composition changes due to electron gun and thruster firings.

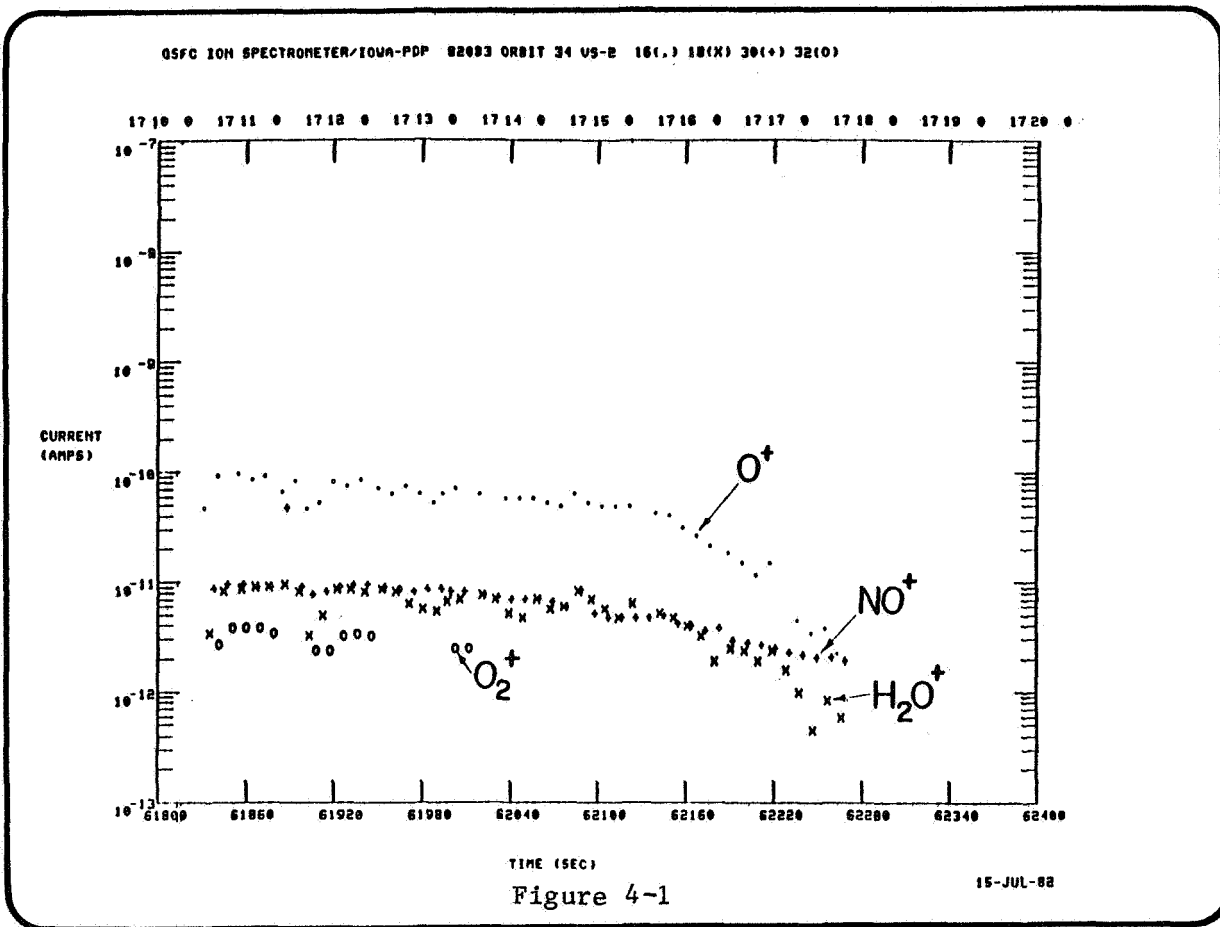

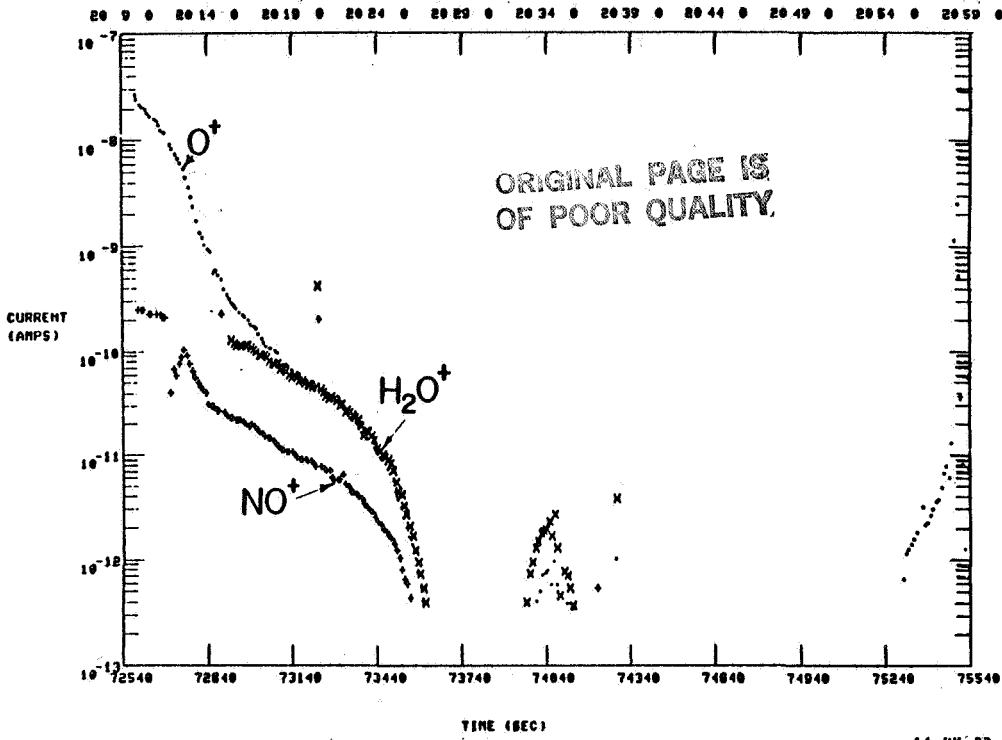

Figure 4-2

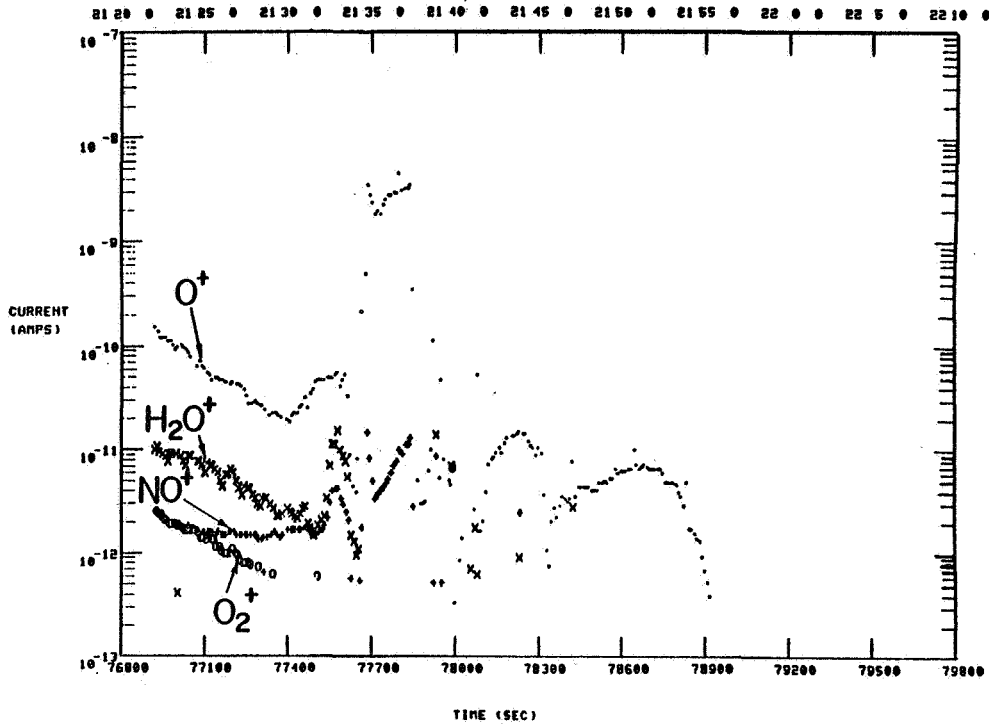

Figure 4-3

ORIGINAL PAGE IS
OF POOR QUALITY

5.0 ORBITER-INDUCED PLASMA WAKE
(Nobie H. Stone and David L. Reasoner/MSFC)

The RPA/DIFP instrument is designed to provide the total ion current density, energy and temperature (RPA) and the ion flow direction (even for multiple streams) and the associated current density, drift energy and temperature of each stream (DIFP).

Figure 5.1 is a color survey plot which includes the RPA/DIFP data showing; (1) an attitude change of the PDP with respect to the orbital velocity vector and (2), two distinct ion streams; i.e., the intense ram ion stream which flows parallel to the velocity vector (lower crescent) and a fainter stream inclined upward at 45° - 50° above the orbital velocity vector (upper crescent) in the time interval of GMT 85/1648-1652.

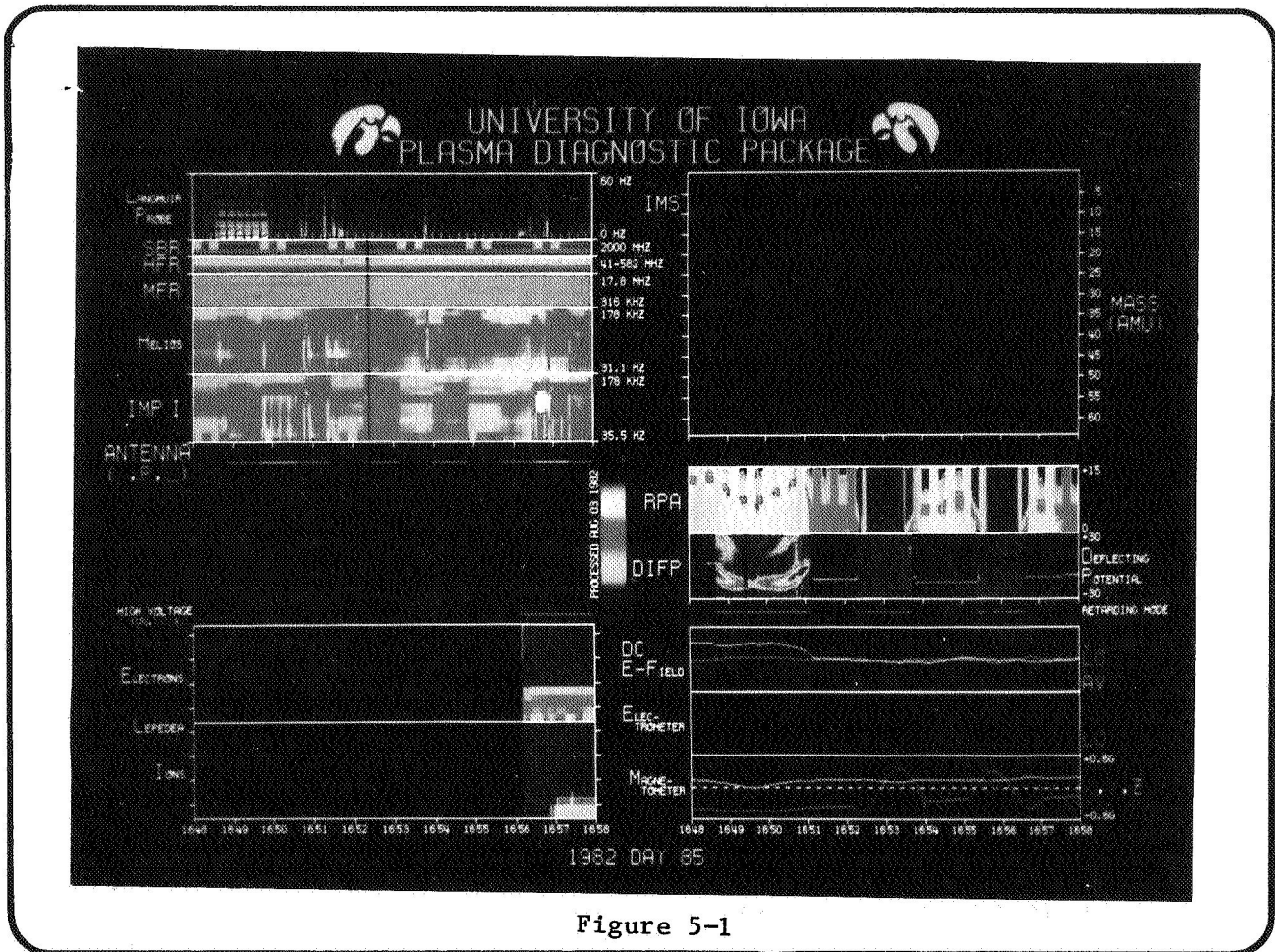
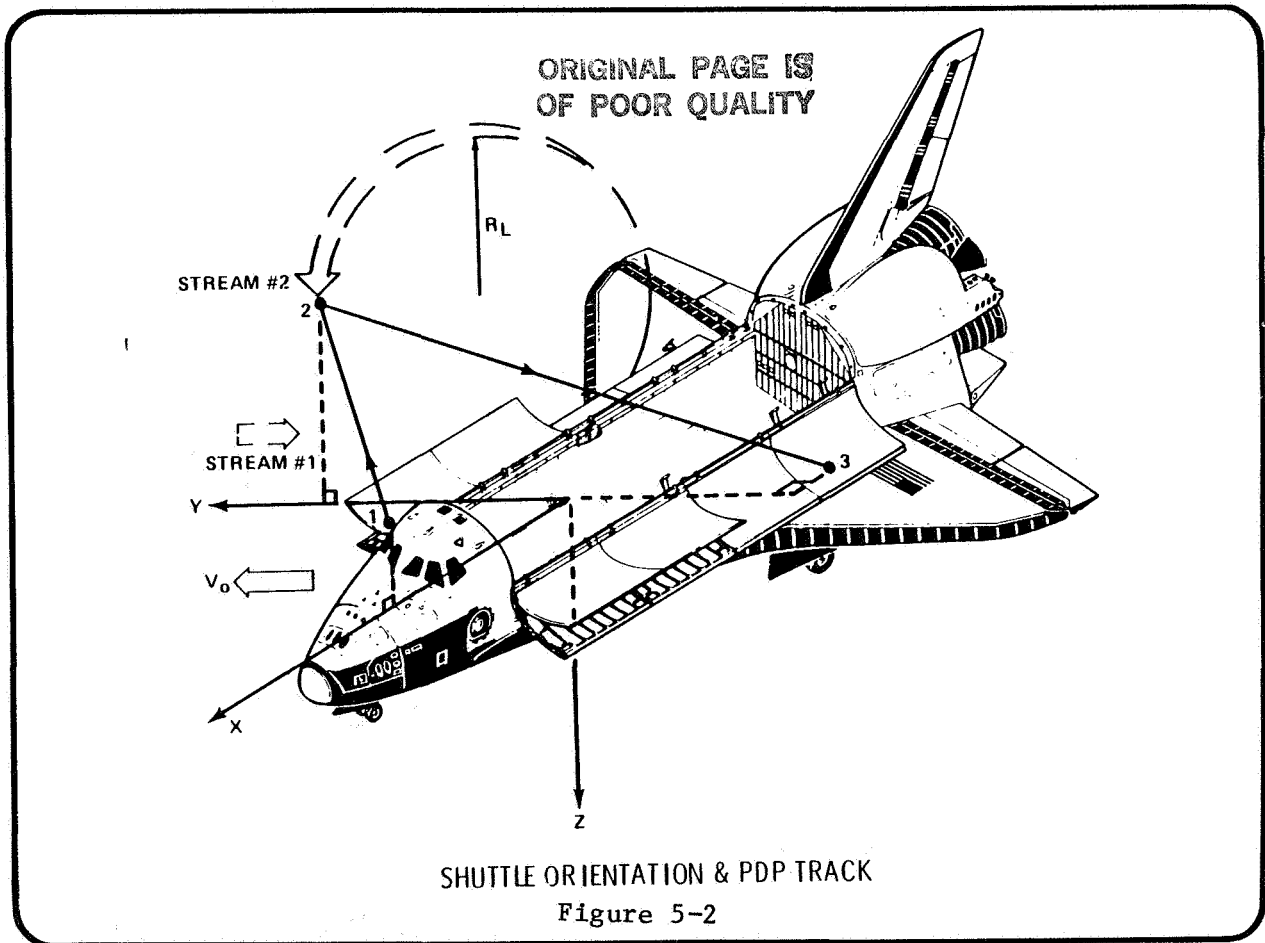

Figure 5-1

Figure 5.2 shows, schematically, the orientation of the Orbiter with respect to the velocity vector, V_0 , during the period in which the data were obtained. As the PDP was moved through the indicated path, its orientation changed, as indicated, at points 1, 2 and 3. It is the change in orientation of the PDP along the path that produces the crescent effect in the spectrogram. At point 1, the RPA/DIFP looked directly into the ram direction. It became perpendicular to the flow at point 2, but looked into the ram again at point 3. The deflection voltage on the DIFP, which is proportional to angle of attack, follows this maneuver precisely, being near zero when the PDP was at points 1 and 3 and highly negative at point 2.



A plot of the DIFP current as a function of deflection voltage during one sweep, made at time 16:49:01.7, is given in Figure 5.3 and shows two distinct peaks. These peaks arrive at -16° and $+26^\circ$. We assume that the PDP was inclined upward at 16° and that Peak No. 1 represents the ram current. The second ion stream, therefore, arrived at an angle of 42° to the velocity vector. This stream appears to result from ions that were accelerated by the interaction with the Orbiter and have reached the RPA/DIFP by traveling over an arc of a Larmor radius as indicated in Figure 4.3.

The streams were analyzed by a retarding potential and both have an energy of ~ 10 ev. (The RPA indicates an energy of 9 ev when most closely aligned with the velocity vector. The difference in energy may be due to the remaining angle of attack). Since the ram energy of O^+ is 5 ev, the observed energies suggest a potential -4 to -5 volts on the PDP. In fact, the average potential of the spheres with respect to the PDP is given by the yellow "AV" curve in the "DC E-Field" panel as $+6$ volts during the ion beam. This value means that the PDP was -6 volts with respect to the plasma in agreement with the RPA analysis.

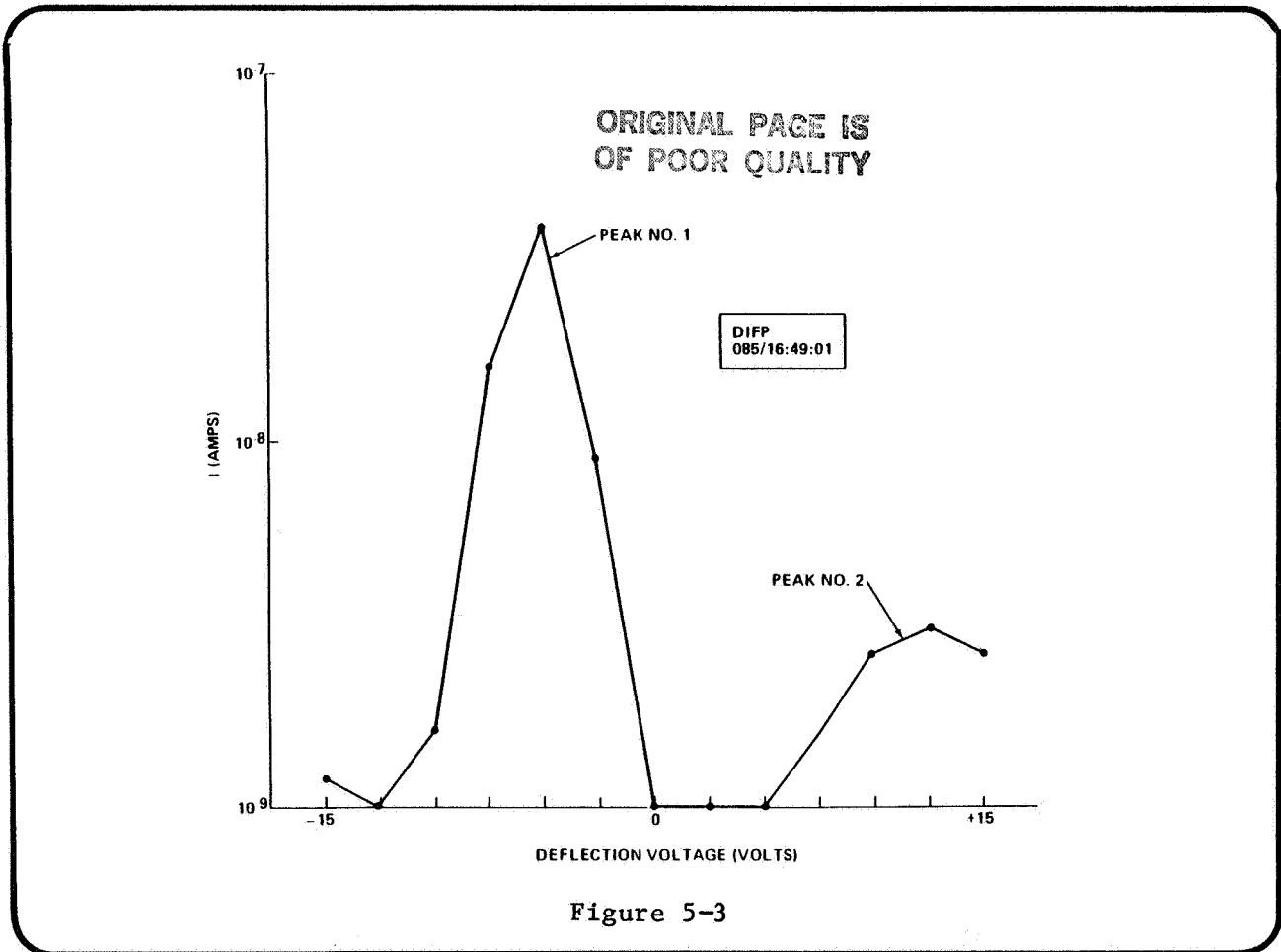

6.0 ELECTRON BEAM--PLASMA INTERACTIONS

Work on the FPEG beam and its interaction with the plasma has not progressed significantly. To effectively carry out this investigation, certain ancillary data are required. These required data and the status are listed below:

RMS Coordinates
 Orbiter-Attitude Timeline
 Orbiter Magnetic Alignments
 FPEG Firing Catalog

Provided by JSC as Printout
 State Vectors Available on Paper;
 Awaiting BET Tape
 Requires Orbiter-Attitude Timeline
 Just Received from Utah State

ORIGINAL PAGE IS
OF POOR QUALITY

Consequently, the major holdup is the Orbiter-attitude data. Once this information is received and interpreted, the separate data sets can be collated into a common timeline.

Addition VCAP/PDP Joint Beam Search data have processed into survey plots. An example is given in Figure 6.1 for 1982 Day 85 at 1750 GMT. During this period, the PDP on the RMS being maneuvered to search for the FPEG beam. Electrons are observed up to 1 keV in energy; low fluxes of ions are observed up to 250 eV. VLF emissions peak in the 0.5 - 2 kHz range. Emission in the several MHz range are probably associated with the gyrofrequency (\sim MHz) and the plasma frequency (\sim 10 MHz). Electric fields in excess of 10V/m and the PDP potential of greater than + 12V with respect to the plasma are also encountered.

Many of the beam-plasma characteristics observed on-orbit were also observed in the JSC Plasma Chamber Tests of March 1981. In parallel, the Chamber Test data are being processed through the same analysis and display programs so that detailed comparisons can be made.

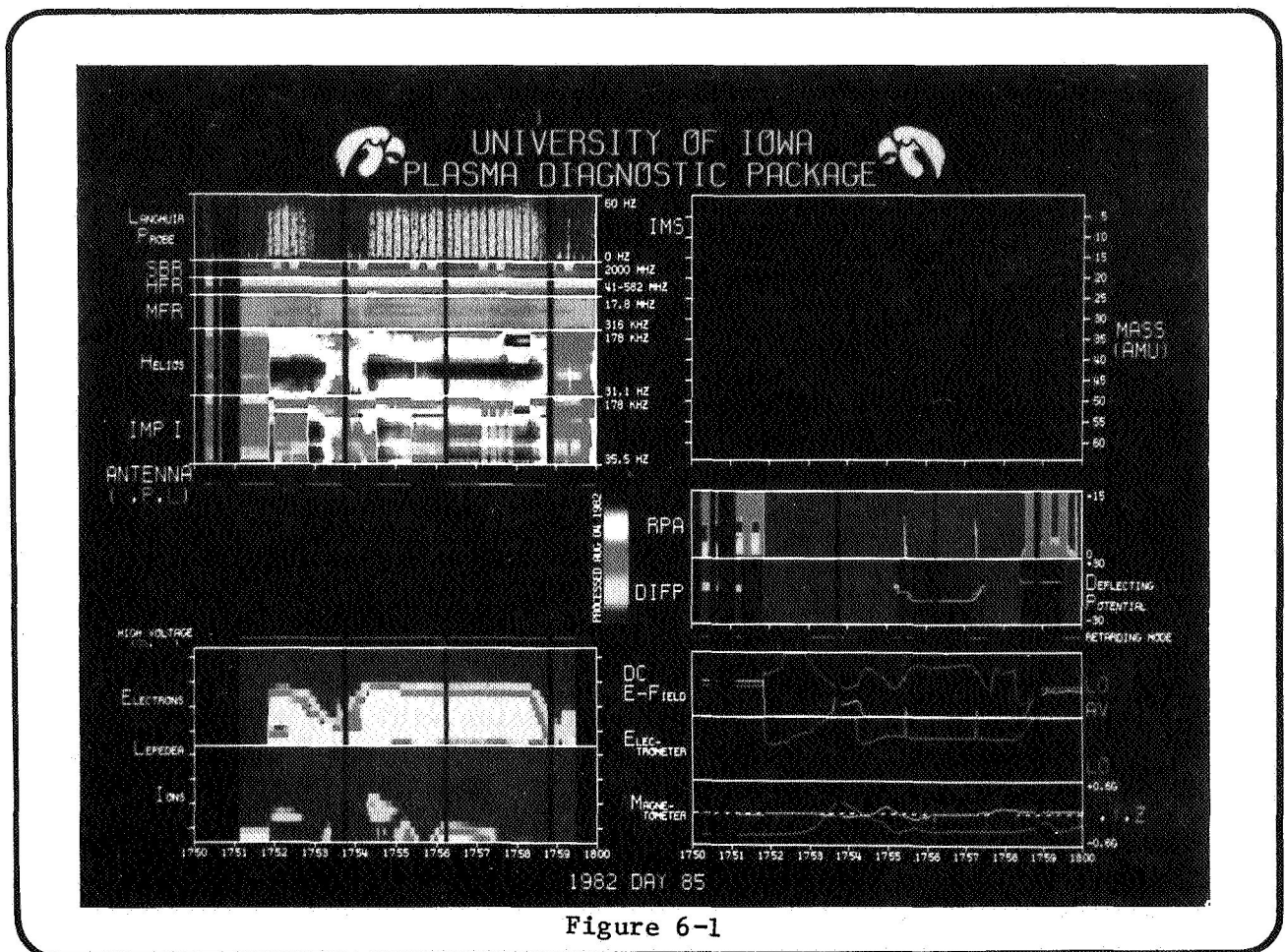

Figure 6-1

An overall summary of the environmental and science results to date is as follows:

- Orbiter related EMI levels are significantly low so that natural noise phenomena, FPEG stimulated waves and Orbiter-induced wake noise are detectable
 - With the bay doors closed, the PDP-detected noise levels dropped to the receiver threshold values for frequencies from 30 Hz to 800 MHz except for magnetic field discrete line emissions at 25 Hz, 1 kHz, 25 kHz and harmonics
 - Field strength measurements of the S-Band communication system are approximately a factor of two higher than the modeled values
 - Stimulated FPEG waves in the Hz to MHz ranges were clearly detectable
 - Natural noise emissions including spherics, whistlers, chorus and hiss were detected above the background noise levels
 - Based on the observed decrease of EMI noise levels with the bay doors closed and on the amplitude variation of the noise depending on Orbiter attitude, it is hypothesized that a broad spectrum of electrostatic noise is being generated by the Orbiter's motion in the plasma--probably in the wake. This noise is a maximum with the bay in the ram direction
 - Due to natural charging effects, the Orbiter can reach a few volts potential with respect to the plasma
 - Orbiter-caused magnetic field perturbations are typically less than .05 gauss
- The presence of the Orbiter and the Orbiter gaseous environment produces a plasma environment in and near the plasma bay which is significantly different than the ambient ionospheric plasma
 - Plasma density and temperature at the PDP pallet location can vary by at least 3 orders of magnitude in the time scale of minutes and by a larger factor depending on the Orbiter attitude
 - Time variations in pressure of about two orders of magnitude are observed with some correlation to Orbiter RAM/wake attitude and thruster operations; on the scale of minutes, the pressure reaches 10^{-5} torr with the bay in the ram direction whereas the pressure exceeded 10^{-4} for a PRCS jet operation.
 - Dominant ions include O^+ , N_2^+ and O_2^+ from the ambient ionosphere and H_2O^+ from the Orbiter itself.
 - Measured plasma energy depends on PDP charging which is controlled by day/night and RAM/wake effects

- On the RMS, directed ion streams are detected which are probably due to refilling of the Orbiter wake cavity. Modulation of the energy is associated with the charge state of the PDP
- The FPEG electron beam undergoes a strong interaction with the ambient ionospheric plasma and perhaps with the Orbiter gas cloud and local plasma
 - Electrons and energized ions reach the PDP in its pallet location below the FPEG
 - Waves are stimulated, ions energized and electrons deenergized and scattered along the electron beam column
 - Electrons of 1 keV and below are found within a column of approximately 6 meters diameter--the electron gyrodiameter--with a nearly uniform distribution in flux
 - Ions with energies up to 250 eV are associated with the beam--plasma interaction.
 - Significantly intense VLF and LF waves are stimulated by pulsing the FPEG beam
 - Potentials up several 10's of volts and electric fields in excess of 10V/m are measured during FPEG operations

8.0 DATA ANALYSIS PLAN

Within the limited resources to carry out the OSS-1/PDP data analysis, work is progressing to prepare reports and publications on the following topics:

- Potentials and Electric Fields of the Orbiter
- Nature of the Orbiter-Induced Plasma Wakes
- The Orbiter Plasma Environment
- Effects of the Beam-Plasma Interaction
- Characteristics of the Electrostatic Noise Generated by the Orbiter-Plasma Interaction
- Description of the OSS-1/PDP System
- Orbiter EMI Levels
- S-Band and UHF Communications Radiated Field Strengths
- Power Buss and Microprocessor Performance History
- Pressure Measurements by PDP on STS-3
- Thermal History of the PDP on STS-3

These reports and papers are to be the basis for presentations at a number of meetings in the near future:

- European Geophysical Society, Leeds, England 23-27 August
- Activate Experiments Working Group and Spacelab-1 IWG, MSFC, 30-31 August
- Workshop on Charging of Large Space Structures in Polar Orbit, AFGL, 14-15 September
- NASA/Spacelab Workshop on Orbiter Environment, Calverton, Maryland, 5-7 October
- Fall AGU Meeting, San Francisco, 7-12 December
- AIAA Meeting, Reno, 10-14 January
- URSI Meeting, Boulder, 17-21 January
- Spring AGU Meeting, Baltimore, 30 May - 3 June

ORIGINAL PAGE IS
OF POOR QUALITY

ORIGINAL PAGE IS
OF POOR QUALITY

ADDITIONS TO
DR. S. SHAMHAN
PRESENTATION

TABLE 6

SUMMARY OF PDP ORBITER ENVIRONMENT MEASUREMENTS

ORBITER POTENTIAL

- POTENTIAL WITH RESPECT TO PLASMA VARIED UP TO $\pm 5V$ WITH PDP ON RMS
- POTENTIAL VARIATION CONSISTENT WITH $\underline{V} \times \underline{B} \cdot \underline{L}$
WHERE \underline{L} = DISTANCE FROM ENGINES TO PDP
- ORBITER ALWAYS DRIVEN POSITIVE DURING FPEG OPERATIONS

EMC/EMI

- NO MICROPROCESSOR (2 UNITS) MALFUNCTIONS [WATCH-DOG TIMER UTILIZED]
- 28V PDP POWER BUSS RANGE: 27.0-31.0 VOLTS
- 28V PDP POWER BUSS STEPS: < 1.0V IN 1.6 SECONDS
< 1.5V IN 5 MINUTES
- ELECTRIC AND MAGNETIC FIELD RADIATED EMISSIONS WITHIN SPECIFICATIONS
- ORBITER-PLASMA INTERACTION GENERATES ELECTROSTATIC NOISE UP TO ~ 1 V/M
- UHF TRANSMITTER: < 0.1 V/M IN BAY; < 0.5 V/M ON RMS
- S-BAND TRANSMITTER: < 2 V/M IN BAY; < 20 V/M ON RMS > 5 M

TABLE 6

SUMMARY OF PDP ORBITER ENVIRONMENT MEASUREMENTS

ORIGINAL PAGE IS
OF POOR QUALITY

THERMAL PERFORMANCE

- FLIGHT HARDWARE MOUNTED ON COLD PLATE, PALLET AND RMS
- THERMAL CONTROL BY HEATERS, THERMAL BLANKETS AND RADIATING SURFACES
- ALL TEMPERATURES STAYED WITHIN DESIGN LIMITS

PRESSURE MEASUREMENTS

- APPARENT PRESSURE VARIES 10^{-7} TO 10^{-5} TORR AT ORBIT PERIOD WITH MAXIMA AT ASCENDING NODE (RAM IN NOSE-TO-SUN ATTITUDE)
- PRESSURE INCREASED TO 3×10^{-4} TORR DURING L2U BURN
- PRESSURE INCREASED TO 4×10^{-5} TORR DURING PAYLOAD BAY DOOR CLOSING (86/21:10)
- APPARENT PRESSURE IS MODULATED BY PDP ROTATION

PLASMA COMPOSITION AND ENERGY

- VERY SIGNIFICANT DENSITY VARIATION FOR DAY/NIGHT AND RAM/WAKE
- H_2O^+ ORBITER-PRODUCED ION ALWAYS PRESENT
- DIRECTED ION BEAMS OBSERVED IN WAKE AND WHEN ORBITER IS NEGATIVELY CHARGED
- INSTANCES OF 100 eV IONS AND ELECTRONS IN PAYLOAD BAY

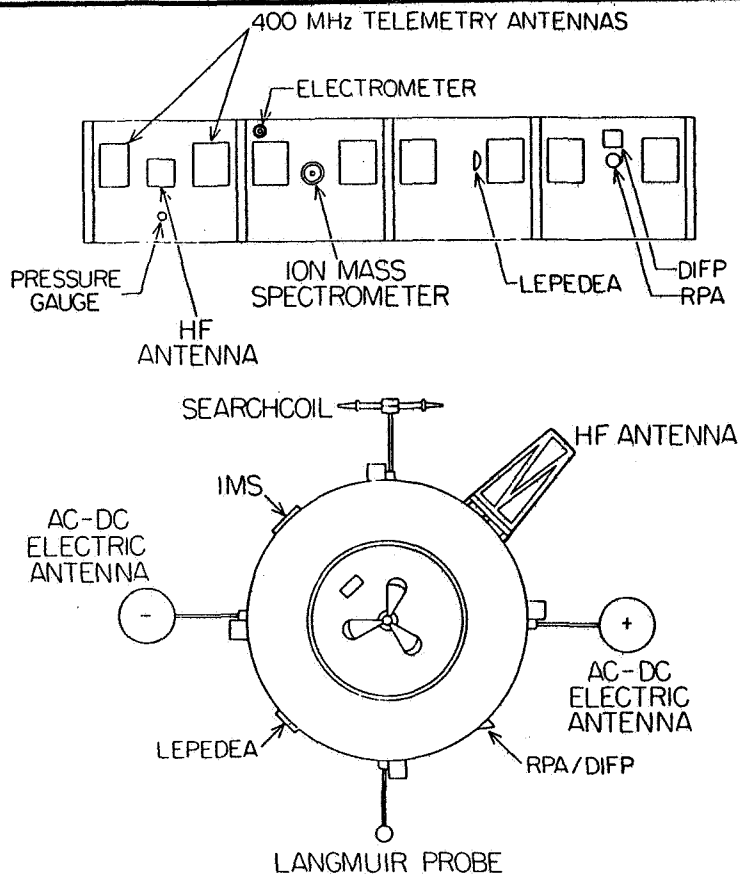

STS-3 ORBIT ATTITUDE
MARCH 24, 1982

ORIGINAL PAGE IS
OF POOR QUALITY.

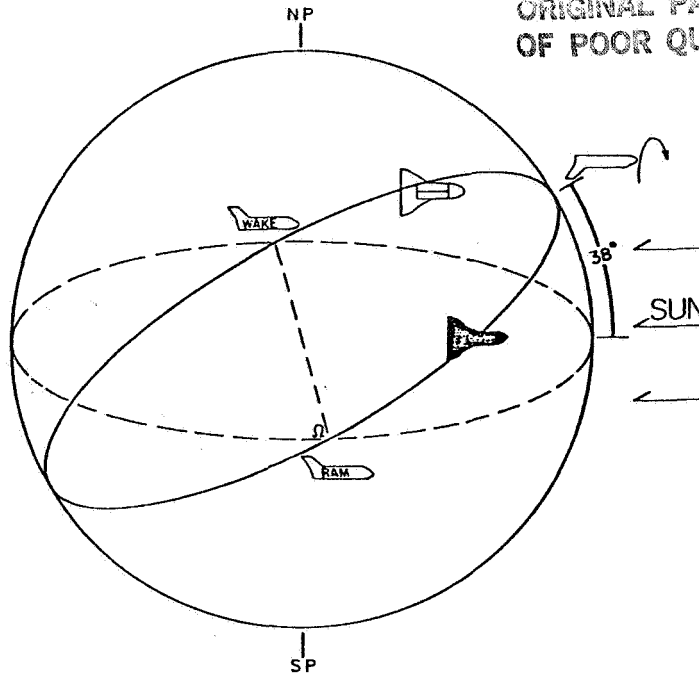

NOSE TO SUN 2x ORB RATE ROLL

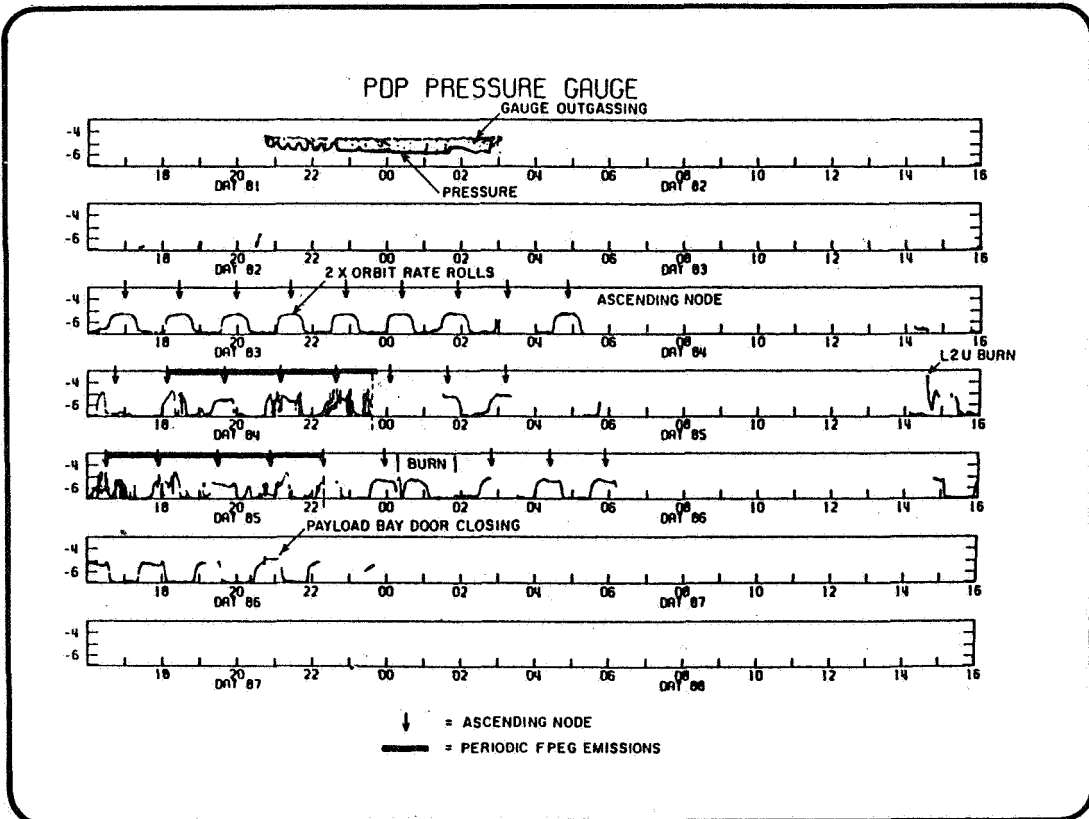

ORIGINAL PAGE IS
OF POOR QUALITY

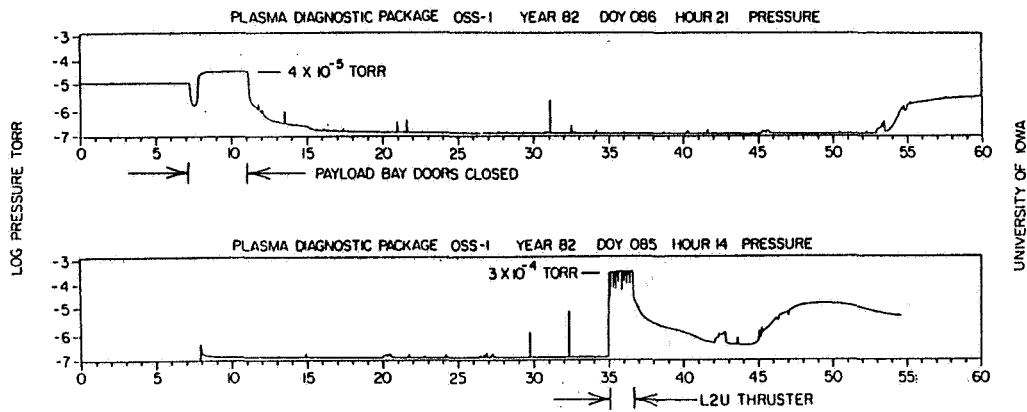
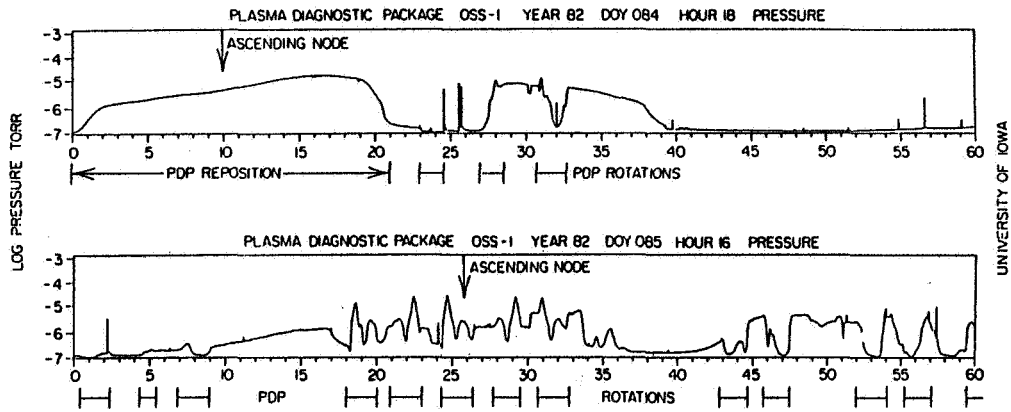

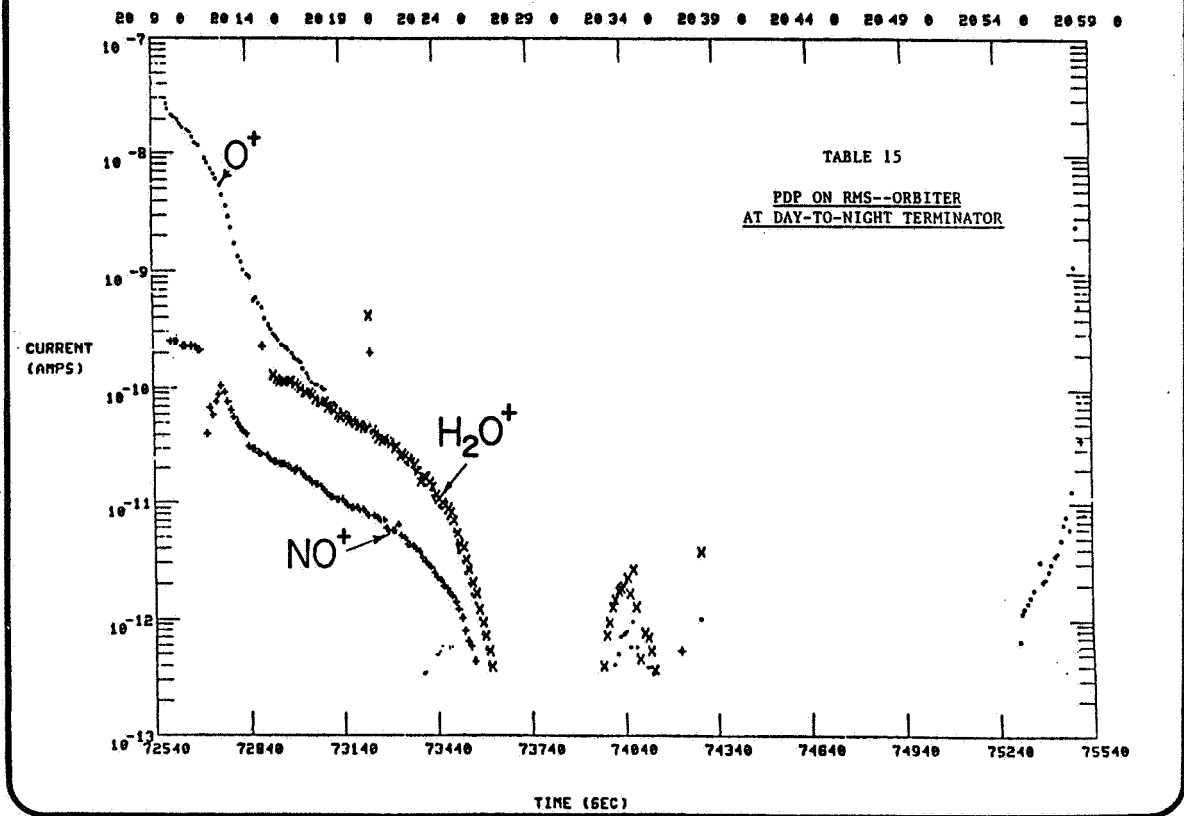
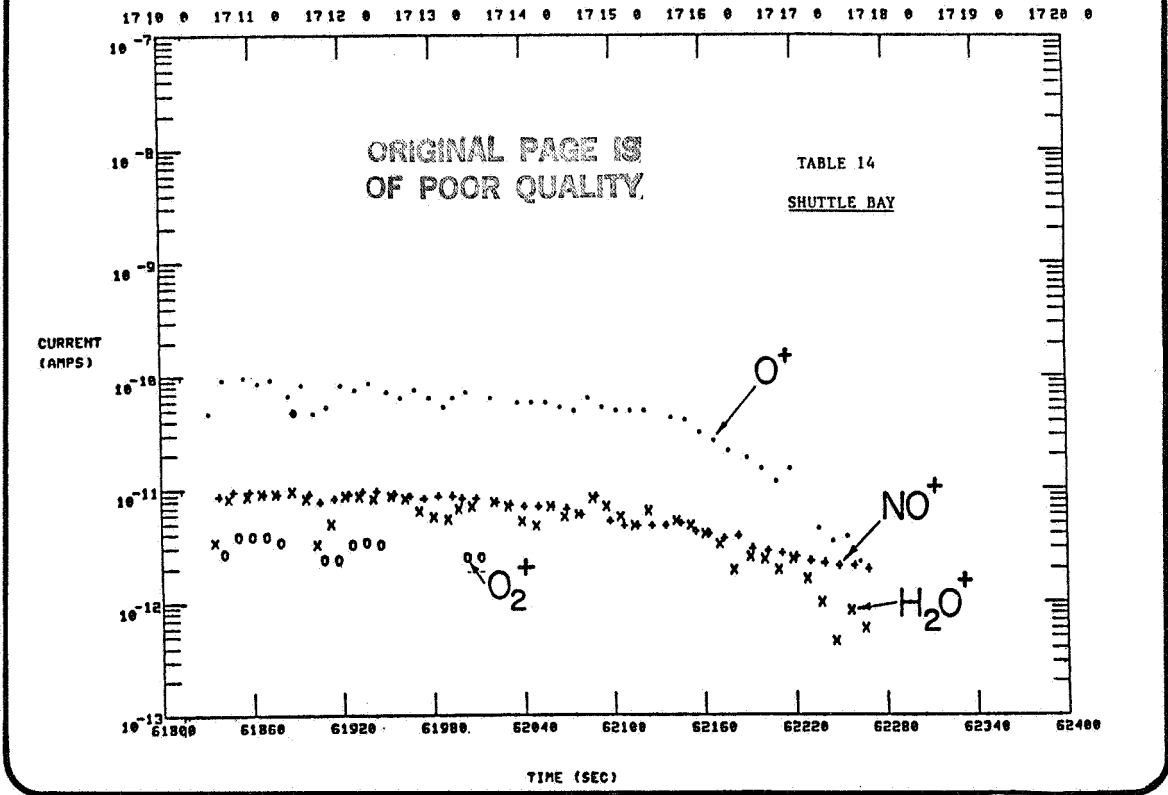

TABLE 18
ORBITER DC POTENTIAL

ORIGINAL PAGE 19
OF POOR QUALITY

- DAY 83 HAD THE PDP MOUNTED TO THE PALLET (AND GROUNDED TO ORBITER)
 - Δ PDP MEASURES THE AVERAGE POTENTIAL OF ITS TWIN CARBON COATED SPHERES WITH RESPECT TO THE SPACECRAFT GROUND AND OBTAINS A MAXIMUM POSITIVE POTENTIAL OF 3-4 VOLTS (NOT COUNTING ELECTRON GUN EMISSION TIMES) AND A MAXIMUM NEGATIVE POTENTIAL OF ~ 2-3 V
 - Δ PEAK POSITIVE POTENTIALS OCCURRED CLOSE TO SUNSET (DURING PAYLOAD BAY WAKE)
 - Δ THE ELECTRON GUN ALWAYS DROVE THE POTENTIAL OFFSCALE POSITIVE (> 8V) WITH A RECOVERY TIME VARIABLE FROM SECONDS TO MINUTES
 - Δ PEAK NEGATIVE POTENTIALS OCCURRED APPROXIMATELY 1/2 ORBIT LATER AT ASCENDING NODE (DURING PAYLOAD BAY RAM)
- DAY 84 HAD THE PDP ON THE RMS (STILL GROUNDED TO ORBITER)
 - Δ HOURS 16:30 TO 18:30 HAD THE PDP IN A FIXED POSITION ABOVE THE PAYLOAD BAY AND ARE SUITABLE FOR COMPARISON TO PREVIOUS DAYS RESULTS
 - Δ ONE ORBIT PERIODICITY STILL EXISTS WITH ~ ±5V VARIATION

