

(12)

DOCUMENT 361-83

AD A 1 2 5 5 3

MG



CAPE CANAVERAL, FLORIDA

RANGE REFERENCE ATMOSPHERE
0-70 KM ALTITUDE

FEBRUARY 1983

METEOROLOGY GROUP
RANGE COMMANDERS COUNCIL

WHITE SANDS MISSILE RANGE
KWAJALEIN MISSILE RANGE
YUMA PROVING GROUND

PACIFIC MISSILE TEST CENTER
NAVAL WEAPONS CENTER
ATLANTIC FLEET WEAPONS TRAINING FACILITY
NAVAL AIR TEST CENTER

EASTERN SPACE AND MISSILE CENTER
ARMAMENT DIVISION
WESTERN SPACE AND MISSILE CENTER
AIR FORCE SATELLITE CONTROL FACILITY
AIR FORCE FLIGHT TEST CENTER
AIR FORCE TACTICAL FIGHTER WEAPONS CENTER

DTIC
MAR 10 1983
H

DTIC FILE COPY

88 03 10 170

REPORT DOCUMENTATION PAGE		READ INSTRUCTIONS BEFORE COMPLETING FORM
1. REPORT NUMBER DOCUMENT 361-83	2. GOVT ACCESSION NO. AD-A125553	3. RECIPIENT'S CATALOG NUMBER
4. TITLE (and Subtitle) RANGE REFERENCE ATMOSPHERE 0-70 KM ALTITUDE CAPE CANAVERAL, FLORIDA		5. TYPE OF REPORT & PERIOD COVERED
		6. PERFORMING ORG. REPORT NUMBER
7. AUTHOR(s) Meteorology Group Range Commanders Council White Sands Missile Range, NM 88002		8. CONTRACT OR GRANT NUMBER(s)
9. PERFORMING ORGANIZATION NAME AND ADDRESS Same as Block 7		10. PROGRAM ELEMENT, PROJECT, TASK AREA & WORK UNIT NUMBERS
11. CONTROLLING OFFICE NAME AND ADDRESS Secretariat, Range Commanders Council ATTN: STEWS-SA-R White Sands Missile Range, NM 88002		12. REPORT DATE February 1983
		13. NUMBER OF PAGES 213
14. MONITORING AGENCY NAME & ADDRESS (if different from Controlling Office) Same as Block 11		15. SECURITY CLASS. (of this report) UNCLASSIFIED
		15a. DECLASSIFICATION/DOWNGRADING SCHEDULE
16. DISTRIBUTION STATEMENT (of this Report) APPROVED FOR PUBLIC RELEASE; DISTRIBUTION UNLIMITED.		
17. DISTRIBUTION STATEMENT (of the abstract entered in Block 20, if different from Report)		
18. SUPPLEMENTARY NOTES Supersedes Document 104-63, "Atlantic Missile Range, Cape Kennedy, Florida," Parts 1 and 2) AD451780 and AD751581.		
19. KEY WORDS (Continue on reverse side if necessary and identify by block number) Range reference atmosphere, data quality control, coordinate system, statistical parameters, wind models, orthogonal axes, data samples, altitude levels, derived monthly mean, annual mean model atmospheres, thermodynamic quantities.		
20. ABSTRACT (Continue on reverse side if necessary and identify by block number) <u>FOREWORD</u> See attached.		

AD A 125553

DOCUMENT 361-83

12

CAPE CANAVERAL, FLORIDA
RANGE REFERENCE ATMOSPHERE
0-70 KM ALTITUDE

February 1983

Prepared by

Range Reference Atmosphere Committee
Meteorology Group
Range Commanders Council

Published by

Secretariat
Range Commanders Council
White Sands Missile Range, New Mexico 88002

DTIC
ELECTE
MAR 10 1983
H

APPROVED FOR PUBLIC RELEASE; DISTRIBUTION UNLIMITED

TABLE OF CONTENTS

	Page
CHAPTER I. INTRODUCTION	1
A. Definition and Purpose of the Range Reference Atmosphere	1
B. Scope of the Range Reference Atmosphere and Arrangement of Tables	1
C. Data Quality Control Procedures	2
D. Organization of the Chapters	3
CHAPTER II. WIND STATISTICS AND MODELS	5
A. General Considerations	5
B. Coordinate System and Computation of Statistical Parameters	8
C. Statistical Wind Models	10
D. Statistical Parameters With Respect to Any Orthogonal Axes	25
CHAPTER III. STATISTICS OF THERMODYNAMIC QUANTITIES AND MODELS	27
A. General Considerations	27
B. Establishing Data Samples at the Required Altitude Levels	30
C. Computation of Statistical Parameters for Tables II and III	35
D. Derived Monthly Mean and Annual Mean Model Atmospheres	38
E. Thermodynamic Quantities Derivable from the Basic Tables	38
CHAPTER IV. CONCLUSIONS AND RECOMMENDATIONS	45
REFERENCES	46
CONVERSION UNITS	49
APPENDIX A	105
APPENDIX B	158

LIST OF ORGANIZATION ACRONYMS

AD	Armament Division
AFFTC	Air Force Flight Test Center
AFSC	Air Force Systems Command
AFSC/AFGL	AFSC/Air Force Geophysics Laboratory
AFSCF	Air Force Satellite Control Facility
AFTFWC	Air Force Tactical Fighter Weapons Center
AWS	Air Weather Service
BMD	Ballistic Missile Division
DOD	Department of Defense
DOE	Department of Energy
DOE/NTS	DOE/Nevada Test Site
DPG	Dugway Proving Ground
ESMC	Eastern Space and Missile Center
ETR	Eastern Test Range
KMR	Kwajalein Missile Range
NASA	National Aeronautics and Space Administration
NASA/MSFC	NASA/Marshall Space Flight Center
NASA/WFC	NASA/Wallops Flight Center
NOAA	National Oceanic and Atmospheric Administration
NWC	Naval Weapons Center
PMTC	Pacific Missile Test Center
SAMTO	Space and Missile Test Organization
USA/DTA	U.S. Army/Deseret Test Center
USAECOM	U.S. Army Electronics Command
USAFETAC	United States Air Force Environmental Technical Applications Center

UTTR	Utah Test and Training Range
WSMC	Western Space and Missile Center
WSMR	White Sands Missile Range
WTR	Western Test Range
YPG	Yuma Proving Ground
6585TG	6585th Test Group
TSCF	Targeting Systems Characterization Facility

Accession For	
NTIS GRA&I	<input checked="" type="checkbox"/>
DTIC TAB	<input type="checkbox"/>
Unannounced Justification	<input type="checkbox"/>
By _____	
Distribution/	
Availability Codes	
Dist	Avail and/or Special
A	

DTIC
COPY
INSPECTED
2

FOREWORD

Atmospheric parameters are essential to the research and development of missiles and aerospace vehicles. The need for realistic atmospheric models derived in a consistent manner for each of the several major test ranges was recognized in the early 1960's. An atmospheric model which is derived from statistical data for a particular geographical location is referred to as a reference atmosphere.

Following the first Range Reference Atmosphere (RRA) by the Inter-Range Instrumentation Group (IRIG) for Cape Kennedy, Florida, issued in 1963 and additional publications for several ranges up to 1974, improved upper-air data bases have become available from which to develop the RRA. This is the result of the extended period of records and improvement in the upper-air measuring program by rocketsondes for altitudes above the rawinsonde ceiling of 30 km altitude. Revised and improved RRAs are justified because:

1) Needs for more definitive statistical atmospheric models have arisen due to changes and advances in aerospace technology. The Space Transportation System (Space Shuttle) is one example.

2) There is now an extended and improved upper air data base for most ranges from which to develop a more definitive RRA.

3) There are requirements for RRAs for new ranges and range sites.

4) There have been scientific advances in understanding the upper atmospheric structure and physical relationships.

5) Advances in statistical modeling techniques have been made due to the general availability of high-speed electronic computers. This has led to the adoption of advanced concepts in atmospheric modeling. For these reasons the Range Reference Atmosphere Committee (RRAC) was tasked by the Range Commander's Council/Meteorology Group (RCC/MG) to establish new and improved RRAs. The purpose, scope, and objectives of this task are:

Purpose: This committee, Task MG-1, establishes RRAs for the several ranges as provided by the RCC. An RRA is a model of the Earth's atmosphere over a geographical location of interest for use by DOD and other U.S. Government range users. The RRA is used to provide planning data for evaluating environmental constraints for the particular configurations of environment-sensitive systems and components being developed or undergoing tests.

Scope: Using the best available upper atmosphere data base to include rawinsonde, rocketsonde and possibly other high-altitude data sources for the range location, the task is to establish a model of certain statistics for wind and thermodynamic quantities derived in a uniform manner and published in a standardized format.

Objectives: The wind statistics shall be, insofar as practical, modeled to be consistent with rigorous mathematical probability properties of the multivariate normal probability theory. The thermodynamic quantities statistics shall be, insofar as practical, modeled to be consistent with the hydrostatic equation, the equation of state, and the probability principles which are related through these physical equations. The document shall serve as an authoritative source of information and as an atmospheric model for a particular range. The first in the series of revised RRAs to be published is for Kwajalein Missile Range (KMR) (publication date December 1982). The altitude range required for KMR is 0 to 70 km. The order of priority for the subsequent publications is:

<u>Range</u>	<u>Altitude Range Required</u>
1. AFFTC/Edwards AFB, CA	0 - 70 km ^a
2. ESMC/Cape Canaveral AFS, FL	0 - 70 km
3. WSMC/Vandenberg, AFB, CA	0 - 70 km ^a
4. WSMR/White Sands, NM	0 - 70 km
5. PMTC/Point Mugu, CA	0 - 70 km
6. UTTR/Dugway (Michales AAF), UT	0 - 30 km ^b
7. AD/Eglin AFB, FL	0 - 30 km
8. ESMC/Ascension Island	0 - 70 km (Terminates at 66 km because of insufficient data)
9. NASA/Wallops Flight Center, VA	0 - 70 km
10. Taquac (Guam)	0 - 30 km
11. PMTC/Barking Sands, HI	0 - 70 km

In keeping with the RCC's objective of standardization, the modeling techniques, basic text, and tabulation format are to be the same for all RRAs. These new and revised RRAs present not only the mean values of the thermodynamic quantities (pressure, temperature, virtual temperature, and density) but also include a statistical measure for the dispersion, i.e., standard deviations and skewness coefficients. New quantities presented are water vapor pressure and dewpoint temperature. The statistical modeling for the wind is entirely new. The new approach uses the properties of the bivariate normal probability distribution function.

- a. Use rocketsonde data from PMTC/Point Mugu for altitudes above 30 km.
 b. Consider augmenting data base from Ely or Salt Lake City.*

All final computations were performed by the United States Air Force Environmental Technical Applications Center (USAFETAC) in response to a task from Eastern Space and Missile Center (ESMC).

The text was prepared jointly between USAFETAC and the NASA/George C. Marshall Space Flight Center's Space Sciences Laboratory, Atmospheric Sciences Division. The editing and preparation of the manuscript master was performed by the NASA/MSFC organization.

The co-chairmen express their gratitude to all RRAC members and their respective colleagues who have made significant technical contributions to the establishment of these RRAs.

Special thanks are tendered to Lt. B. Novogard for his diligence in performing the many computations and the development of the primary Tables, I through IV. Special thanks goes to Lt. F. Wirsing for editing and formulating the equations for the derivable thermodynamic equations. These gentlemen performed this outstanding work under the direction of Major B. Lilius, USAFETAC.

Grateful acknowledgment goes to Mrs. Annette Tingle, NASA/MSFC, for editing the manuscript.

The RCC/MG Range Reference Atmosphere Committee consists of representatives from the U.S. Air Force, U.S. Army, National Aeronautics and Space Administration, U.S. Navy, and National Oceanographic and Atmospheric Administration. The committee members for the RRA for the first publication are:

G. G. Boire, WSMC
O. H. Daniel, ESMC
R. de Violini, PMTC
F. G. Finger, NOAA/NWS
E. E. Fisher, HQ AFSC
B. R. Hixon, PMTC
J. M. Hobbie, KMR
E. J. Keppel, AD
S. F. Kubinski, WSMR
F. J. Schmidlin, NASA/WFC

O. E. Smith
Co-Chairman, NASA/MSFC

Maj. B. W. Galusha
Co-Chairman, USAF/ETAC

CHAPTER I. INTRODUCTION

A. Definition and Purpose of the Range Reference Atmosphere

A.1 Definition

A reference atmosphere is a statistical model of the Earth's atmosphere derived from upper-air measurements over a particular geographical location. Hence, the atmospheric models developed by the Range Reference Atmosphere Committee (RRAC) in response to a task by the Range Commander's Council/Meteorology Group (RCC/MG) and published by the Secretariat, Range Commander's Council (RCC) are called Range Reference Atmospheres (RRAs). This organization group, formerly called the Inter-Range Instrumentation Group/Meteorology Working Group (IRIG/MWG), published a series of RRAs during the period 1963 through 1974.

A.2 Purpose

A series of revised and expanded RRAs are to be published for locations of interest to the RCC. These publications are to serve as an authoritative reference source on certain upper air statistics and as atmospheric models for a particular range site (location). The technical usefulness of these documents for the ranges, range users, U.S. aerospace industries, and the scientific community is recognized because of the standardization of the development techniques and the presentation of the tabulations.

B. Scope of the Range Reference Atmosphere and Arrangement of Tables

B.1 Scope

The RRA contains tabulations for monthly and annual means, standard deviations, skewness coefficients for wind speed, pressure temperature, density, water vapor pressure, virtual temperature, dew-point temperature, and the means and standard deviations for the zonal and meridional wind components and the linear (product moment) correlation coefficient between the wind components. These statistical parameters are tabulated at the station elevation and at 1 km intervals from sea level to 30 km and at 2 km intervals from 30 to 90 km altitude. The wind statistics are given at approximately 10 m above the station elevations and at altitudes with respect to mean sea level thereafter. For those range sites without rocketsonde measurements, the RRAs terminate at 30 km altitude or they are extended, if required, when rocketsonde data from a nearby launch site are available. There are four sets of tables for each of the 12 monthly reference periods and the annual reference period.

B.2 Arrangement of Tables

The statistical parameters for the RRA models are presented in four tables.

Table I contains all the wind statistical parameters. This table gives the monthly and annual means and standard deviations of the zonal and meridional wind components and the linear (product moment) correlation coefficient between these two components; the mean, standard deviation and skewness coefficient of the wind speed; and the number of wind observations (sample size).

Table II contains the monthly and annual means, standard deviations, and skewness values of pressure, temperature, and density, and the number of observations used for each of these thermodynamic quantities.

Table III contains the monthly and annual means, standard deviations and skewness values of the water vapor pressure, virtual temperature and dew point, and the number of observations for each of these moisture-related quantities. The statistical parameters for water vapor pressure and dew point terminate at 15 km altitude. Above 15 km the statistical parameters for virtual temperature are considered to be the same as those for temperature.

Table IV contains the monthly and annual mean atmospheric models for the thermodynamic variables: pressure, virtual temperature, and density. This table is derived from the monthly and annual mean virtual temperature versus altitude (geometric) using the hydrostatic equation and the equation of state. Also presented is the geopotential height corresponding to the tabulated geometric altitudes.

The physical unit for all wind parameters is m/s. The physical unit for pressure is mb; for temperature and virtual temperature, K; for density, gm/m^3 ; and for water vapor pressure, mb. In all cases the skewness coefficient and the correlation coefficient between wind components are unitless. All reference to altitude is geometric altitude and has the unit km. All reference to height is geopotential height and has the unit geopotential m or km. All geometric altitudes and geopotential heights are with respect to mean sea level.

C. Data Quality Control Procedures

A small proportion (less than 10 percent) of the soundings in the data base used to calculate the RRA tables contained erroneous data values. The soundings which contained these erroneous values were eliminated from the data base using the following procedures:

- 1) Soundings containing gaps in their height data greater than 200 mb were rejected. This step was taken because some soundings only contained height values at their "mandatory" pressure levels, which were occasionally missing, resulting in soundings with no height information at all.

- 2) An initial set of RRA statistics was computed using all the remaining soundings. This initial set of statistics was used to determine data limits for the temperature, pressure, U and V components of the wind, and the dew point (for the 0-30 km portion of the RRA) or the density (for the

30-90 km portion of the RRA). The lower (upper) data limits were set at the mean value for a specific parameter, minus (plus) six standard deviations of that quantity. One pair of data limits was computed for each of these parameters, month of the year and data level.

3) This initial set of data limits was then used to screen the data base. All the soundings which contained values outside these data limits were rejected. A new RRA was then computed using the screened data base. This second RRA was used to generate a second set of data limits.

4) The second set of data limits was then used to screen the data base further. A new RRA was again generated. The skewness values in this RRA were then evaluated according to empirical criteria specified in Section II.A.3 of this document for the winds and according to criteria in Section III.A.3 for the thermodynamic quantities. If these criteria were satisfied, the new RRA was then used to generate a final set of data limits, which were used to quality control the data base for the final version of the RRA.

5) Occasionally, the third RRA which was generated did not satisfy all of the skewness criteria. This indicated that some incorrect values were still present in the data base. To complete quality control, the data limits-to-RRA-to-data-limits cycle was continued for additional iterations (usually one or two) until the resulting RRA satisfied the skewness criteria. At that point, a final set of data limits was generated. This final set of data limits was then used to quality control the data base and generate the final RRA.

D. Organization of the Chapters

Because there are plans to publish a series of RRAs, comments on the special organization of the document are in order. The RRA document is arranged in four chapters. Chapter I is the Introduction. Chapter II, Wind Statistics and Models, contains the techniques used to arrive at the wind statistical parameters, Table I, and the probability functions which are to be used as wind models to derive several wind statistics. Chapter III, Statistics of Thermodynamic Quantities and Models, contains the techniques used to arrive at the thermodynamic and moisture-related statistical parameters given in Tables II and III and the atmospheric thermodynamic model presented in Table IV. This chapter also contains sets of equations to calculate several atmospheric properties. Chapter IV contains the general conclusions and recommendations. These four chapters are reprinted without change for each documented RRA to assure consistency and for expediency in preparing the documentation. To account for variations particular to a specific RRA, two appendixes have been included. Appendix A, Examples of Wind Statistics, is designed to give a few illustrative examples of wind statistics for the specific RRA and cursory observations, comparisons, or comments on wind statistics. Appendix B, Range Specific Information, is designed to present specific information particular to the range, such as geographical location, data base, etc., and any cursory observations or comments on the thermodynamic quantities.

Read these appendixes! They are located as the last two units in the document because they may vary in length depending on the circumstances. Appendixes A and B and the principal Tables I, II, III, and IV are the only changes to be made to each RRA document published in this new RRA series.

CHAPTER II. WIND STATISTICS AND MODELS

A. General Considerations

A.1. Objectives

An objective of the RRA is to furnish minimum tabulation for the wind statistics. To meet this objective, the bivariate normal probability distribution was adopted as a statistical model for the wind treated as a vector quantity at the RRA data levels. Only five statistical parameters are required to completely describe this probability function. In Cartesian coordinates these parameters are the means and standard deviations of the two orthogonal components and the correlation coefficient between the two components. These five statistical parameters for the zonal and meridional (meteorological coordinates) components are given in Table I. The statistical properties of the bivariate normal probability distribution are used to derive many wind statistics that are of interest to the ranges and range users. This procedure produces consistent wind statistics that are connected through rigorous mathematical probability functions. By using these functions, extensive tabulations of wind statistics are avoided.

The statistical properties of the bivariate normal probability distribution presented for the vector wind statistical model are:

- 1) The wind components are univariate normally distributed.
- 2) The conditional distribution of one component given a value of the other component is univariate normally distributed.
- 3) The wind speed is of the form of a generalized Rayleigh distribution.
- 4) The frequency distribution of wind direction can be derived.
- 5) The conditional distribution of wind speed given a value of wind direction (wind rose) can be derived.
- 6) The five tabulated wind statistical parameters which are with respect to the meteorological zonal and meridional coordinate system can be derived for any arbitrary rotation of the orthogonal axes.

The probability distribution functions and sets of equations to derive wind statistics for the previously stated properties of the vector wind model are presented. Illustrative examples are presented in Appendix A. No attempt is made to give the derivation of the probability functions. The reader is referred to Smith (1976) for some derivations and several applications of the probability distribution properties for wind statistics.

TABLE A. LIST OF SYMBOLS USED IN CHAPTER II

N	- The number of wind measurements in Table I
r	- A general variable for the bivariate normal probability distribution in polar coordinates
R	- A generalized Rayleigh variable used for derived wind speed probability distribution
R (U, V)	- The linear (product moment) correlation coefficient between the zonal and meridional wind components in Table I
SK (W)	- Skewness parameter for wind speed in Table I
S (U)	- The standard deviation of the zonal wind component in Table I
S (V)	- The standard deviation of the meridional wind component in Table I
S (W)	- The standard deviation of wind speed in Table I
t	- A standardized normal variate used in text Table A
U	- The zonal wind component
UBAR	- The mean value of the zonal wind component in Table I
V	- The meridional wind component
VBAR	- The mean value of the meridional wind component in Table I
W	- Wind speed or modulus of wind vector, a scalar quantity
WBAR	- The mean value of wind speed in Table I
X	- A general component variable or coordinate axes
Y	- A general component variable or coordinate axes
\bar{X}	- A general component mean value in the [x,y] coordinate system
\bar{Y}	- A general component mean value in the [x,y] coordinate system
α (alpha)	- Rotation angle for the [x,y] coordinate system

TABLE A. (Concluded)

ϕ (theta) - Wind direction in the polar coordinate system
λ () (Lambda) - A parameter in the bivariate normal probability distribution in text Table B
ξ (Xi) - The mean value in the standardized normal probability distribution used in text Table A
π (Pi) - Constant = 3.14159 ...
ρ (Rho) - The general linear correlation coefficient between the two component variables in the [x,y] coordinate system
σ_x, σ_y - The general standard deviations of the x and y component variables in the [x,y] coordinate system.

A.2. Data Quality Control

The U and V components of the wind were used to generate data limits which were set at plus and minus six standard deviations from the mean for each of the quantities. These data limits were used to screen the wind data base, as described in Section I.C. The data base was considered to be free from errors if:

- 1) The skewness of the wind speed was below 4.0 at data levels where the mean wind speed was less than 15 m/s, and
- 2) The skewness of the wind speed was below 2.5 at data levels where the mean wind speed was greater than 15 m/s.

A.3. Limitations

For the wind statistics, the correlation coefficients for like wind components and unlike wind components between altitude levels were not computed. Therefore, wind statistics with respect to altitude (profile) cannot be derived from the RRA statistics. For wind profile modeling techniques the user is referred to Smith (1976). However, the wind statistics at discrete altitudes are valid; all of the probability distribution functions given in Chapter II can be derived from the five wind component statistical parameters contained in Table I, and the derived distributions can be considered as wind models at discrete altitudes

By convention, in the statistical literature Greek letters are used for population or theoretically known parameters, and sample estimates are denoted by English alphabetical letters or with a "hat" (^) over the Greek letters. In Chapter II Greek letters are used for the variances and the linear correlation coefficient, and the means are denoted by \bar{X} and \bar{Y} when dealing with the bivariate normal distribution. It will always be understood that Table I contains sample estimates of the statistical parameters and they are with respect to the meteorological zonal (U) and meridional (V) coordinate system.

B. Coordinate System and Computation of Statistical Parameters

B.1. Coordinate System

Wind measurements are recorded in terms of magnitude and direction. The wind direction is measured in degrees clockwise from true north and is the direction from which the wind is blowing. The wind magnitude (the modulus of the vector) is the scalar quantity and is referred to as wind speed or scalar wind. A statistical description that accounts for the wind as a vector quantity is appropriate and requires a coordinate system.

For the RRA the standard meteorological coordinate system has been chosen for the wind statistics, all tables of statistical parameters, and related discussions because the coordinate system used in aerospace and related applied fields has not always been consistent.

Using Figure 1, the polar and Cartesian forms for the meteorological coordinate system are defined:

W = wind speed, scalar wind, or magnitude of the wind vector in m/s.

θ = wind direction. θ is measured in degrees clockwise from true north and is the direction from which the wind is blowing.

U = zonal wind component, positive west to east in m/s.

V = meridional wind component, positive south to north in m/s.

The components θ and W define the polar form, and the U-V components define the Cartesian forms:

$$U = -W \sin\theta \quad , \quad 0 \leq \theta \leq 360^\circ \quad (1)$$

$$V = -W \cos\theta \quad . \quad (2)$$

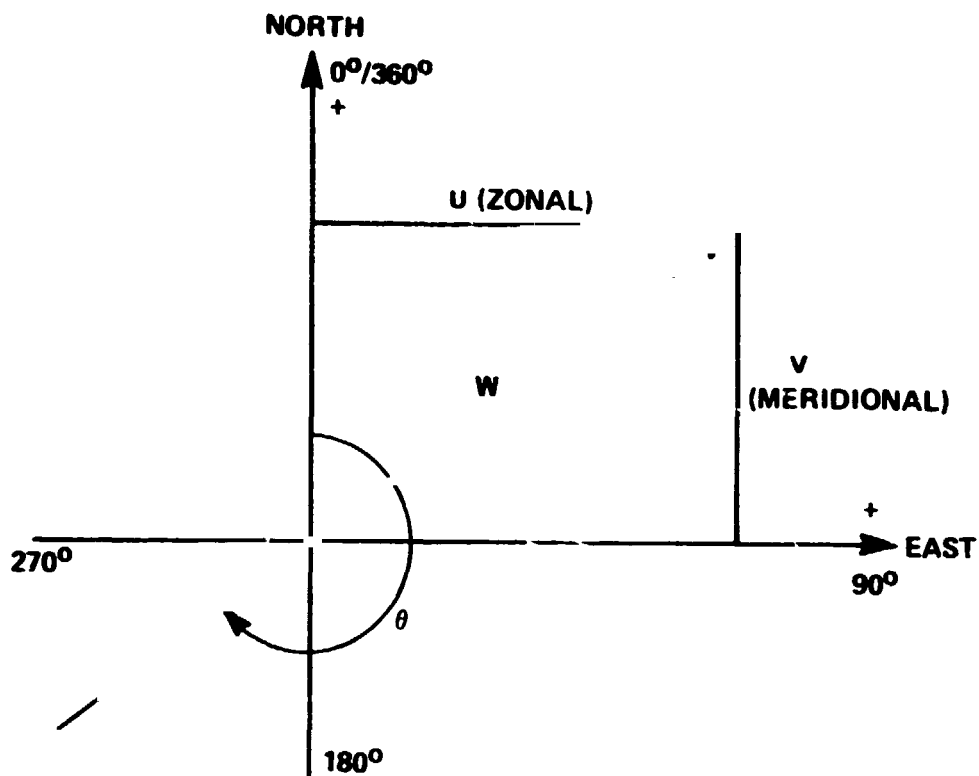

Figure 1. The meteorological coordinate system.

It is helpful to note the difference between the mathematical convention for a vector direction and the meteorological convention for wind direction, viz.:

$$\theta_{\text{met}} = 270 - \theta_{\text{math}} \quad (3)$$

when $0 \leq \theta \leq 270$ degrees

$$\theta_{\text{met}} = 360 + (270 - \theta_{\text{math}})$$

when $270 \leq \theta \leq 360$ degrees.

B.2. Computation of Statistical Parameters

The wind statistical parameters in Table I for the means and standard deviations of the zonal and meridional wind components and wind speed and the skewness parameter of wind speed were computed using the sums technique presented in Chapter III.C.3. In addition, the linear (product moment) correlation coefficient between the zonal and meridional wind components, $r(u,v)$ in Table I, was computed. This correlation coefficient is defined as

$$r(u, v) = \frac{\sum_{i=1}^n (U_i - \bar{U})(V_i - \bar{V})}{N s(u) \cdot s(v)} \quad (4)$$

These statistical parameters are with respect to the Standard Meteorological Coordinate System.

C. Statistical Wind Models

C.1. Wind Component Statistics

The univariate normal (Gaussian) probability distribution function is used to obtain wind component statistics. In generalized notations, this probability density function (pdf) is

$$f(t) = \frac{e^{-\frac{t^2}{2}}}{\sqrt{2\pi}} \quad (5)$$

where $t = X - \xi / \sigma_X$ is the standardized variate with ξ defining the mean and σ_X the standard deviation. The probability distribution function (PDF) is

$$F(t) = \int_{-\infty}^t f(t) dt \quad (6)$$

Because this integral cannot be obtained in closed form, it is widely tabulated for zero mean and unit standard deviation. For a convenient reference for the RRA, selected values of $F(t)$ are given in Table B. To emphasize the connotation of probability, $F(t)$ is shown in Table B as $P\{X\}$. The t values in Table B are used as multiplier factors to the standard deviation to express the probability that a normally distributed variable, X , is less than or equal to a given value as

$$P\{X \leq \text{mean} + t \sigma_X\} = \text{probability, } p \quad (7)$$

**TABLE B. VALUES OF t FOR STANDARDIZED NORMAL
(UNIVARIATE) DISTRIBUTION FOR PERCENTILES
AND INTERPERCENTILE RANGES**

t	$P(X)$	X	$P\{X_1 \leq X \leq X_2\} (\%)$
-3.0000	0.00135	$\xi - 3.0000 \sigma$	
-2.5758	0.00500	$\xi - 2.5758 \sigma$	
-2.3263	0.01000	$\xi - 2.3263 \sigma$	
-2.2365	0.01266	$\xi - 2.2365 \sigma$	
-2.0000	0.02275	$\xi - 2.0000 \sigma$	
-1.9602	0.02500	$\xi - 1.9602 \sigma$	
-1.6449	0.05000	$\xi - 1.6449 \sigma$	
-1.2816	0.10000	$\xi - 1.2816 \sigma$	
-1.0000	0.15866	$\xi - 1.0000 \sigma$	
-0.8416	0.20000	$\xi - 0.8416 \sigma$	
-0.6745	0.25000	$\xi - 0.6745 \sigma$	
-0.2533	0.40000	$\xi - 0.2533 \sigma$	
0.0000	0.50000	ξ	
0.2533	0.60000	$\xi + 0.2533 \sigma$	
0.6745	0.75000	$\xi + 0.6745 \sigma$	
0.8416	0.80000	$\xi + 0.8416 \sigma$	
1.0000	0.84134	$\xi + 1.0000 \sigma$	
1.2816	0.90000	$\xi + 1.2816 \sigma$	
1.6449	0.95000	$\xi + 1.6449 \sigma$	
1.9602	0.97502	$\xi + 1.9602 \sigma$	
2.0000	0.97725	$\xi + 2.0000 \sigma$	
2.2365	0.98731	$\xi + 2.2365 \sigma$	
2.3263	0.99000	$\xi + 2.3263 \sigma$	
2.5758	0.99500	$\xi + 2.5758 \sigma$	
3.0000	0.99865	$\xi + 3.0000 \sigma$	

20 (80)
 50 (50)
 60 (40)
 68.268 (31.732)
 80 (20)
 90 (10)
 95 (5)
 95.45 (4.55)
 97.468 (2.532)
 98 (2.00)
 99 (1.00)
 99.77 (0.27)

where $X_1 = \xi - t\sigma$
 and $X_2 = \xi + t\sigma$

For example, when $t = 1.6449$, the probability that X is less than or equal to the mean plus 1.6449 standard deviations is 0.95. That value of X which is less than or equal to the mean plus 1.6449 standard deviations is called the 95th percentile value of X . Also given in Table 2 are the numerical values to express the probability that X falls in the interval X_1 and X_2 ; i.e.,

$$P \left\{ X_1 \leq X \leq X_2 \right\} = \text{Interpercentile Range} \quad (8)$$

$$\text{where } X_1 = \bar{X} - t \sigma_x$$

$$X_2 = \bar{X} + t \sigma_x$$

For $t = 1.9602$ the probability that X lies in the interval X_1 and X_2 is 0.95. The values of X_1 and X_2 in this example comprise the 95th inter-percentile range.

For a normally distributed variable, the mode (most frequent value) and the median (50th percentile value) are the same as the mean value. The means and standard deviations of the zonal and meridional wind components from Table I are used in equations (7) and (8) to compute the percentile values and interpercentile ranges of the zonal and meridional wind components. When equation (7) is illustrated on a normal probability graph, a straight line is formed.

C.2. The Vector Wind Model

Because wind is a vector quantity having direction and magnitude which can be expressed as two components in an orthogonal coordinate system, a probability model which describes the joint relationship is the bivariate normal probability distribution. In general component notation, the bivariate normal probability density function (BNpdf) is

$$f(X, Y) = \frac{1}{2\pi\sigma_x\sigma_y\sqrt{1-\rho^2}} \left[\exp \frac{-1}{2(1-\rho^2)} \left\{ \frac{(X-\bar{X})^2}{\sigma_x^2} - \frac{2\rho(X-\bar{X})(Y-\bar{Y})}{\sigma_x\sigma_y} + \frac{(Y-\bar{Y})^2}{\sigma_y^2} \right\} \right] - \infty \leq X \leq \infty \text{ and} \\ - \infty \leq Y \leq \infty \quad , \quad (9)$$

where the five parameters are \bar{x}, \bar{y} , the component means, σ_x, σ_y , the component standard deviations, and ρ , the correlation coefficient between the two component variables, X and Y.

For many applications the interest is in determining the probability that a point $\{X, Y\}$ will fall within a contour of equal probability density. The exponential terms of equation (9), when set equal to a constant, λ^2 , give a family of ellipses depending on the value of the constant. The ellipses have a common center at the point $\{\bar{X}, \bar{Y}\}$. Integration of equation (9) over the region bounded by the contours of equal probability density gives

$$P(\lambda) = 1 - e^{-\frac{\lambda^2}{2(1 - \rho^2)}} \quad (10)$$

Solving for λ^2 and replacing $P(\lambda)$ by p gives

$$\lambda^2 = -2(1 - \rho^2) \ln(1 - p) \quad (11)$$

Now define

$$\lambda_e = \sqrt{2} \sqrt{-\ln(1 - p)} \quad (12)$$

For ready reference and comparisons, λ_e is shown in Table C for selected values of p.

The probability ellipse that contains p-percent of the wind vectors expressed in the most general form is the conic defined by

$$AX^2 + BXY + CY^2 + DX + EY + F = 0 \quad (13)$$

where

$$A = \sigma_y^2$$

$$B = -2\rho\sigma_x\sigma_y$$

TABLE C. VALUES OF λ FOR BIVARIATE NORMAL DISTRIBUTION
ELLIPSES AND CIRCLES

P(%)	λ_c (ellipse)	λ_c (circle)	P(%)	λ_c (ellipse)	λ_c (circle)
0.000	0.0000	0.0000	65.000	1.4490	1.0246
5.000	0.3203	0.2265	68.268	1.5151	1.0713
10.000	0.4590	0.3246	70.000	1.5518	1.0973
15.000	0.5701	0.4031	75.000	1.6651	1.1774
20.000	0.6680	0.4723	80.000	1.7941	1.2686
25.000	0.7585	0.5363	85.000	1.9479	1.3774
30.000	0.8446	0.5972	86.466	2.0000	1.4142
35.000	0.9282	0.6563	90.000	2.1460	1.5175
39.347	1.0000	0.7071	95.000	2.4477	1.7308
40.000	1.0108	0.7147	95.450	2.4860	1.7579
45.000	1.0935	0.7732	98.000	2.7971	1.9778
50.000	1.1774	0.8325	98.168	2.8284	2.0000
54.406	1.2533	0.8862	98.889	3.0000	2.1213
55.000	1.2637	0.8936	99.000	3.0348	2.1460
60.000	1.3537	0.9572	99.730	3.4393	2.4320
63.212	1.4142	1.0000	99.9377	4.2426	3.0000

$\lambda_c = \sqrt{2} \sqrt{-\ln(1-P)}$

$\lambda_c = \sqrt{-\ln(1-P)}$

$$C = \sigma_x^2$$

$$D = 2\sigma_x\sigma_y \rho\bar{Y} - 2\sigma_y^2\bar{X} = - (B\bar{Y} + 2A\bar{X})$$

$$E = 2\sigma_x\sigma_y \rho\bar{X} - 2\sigma_x^2\bar{Y} = - (B\bar{X} + 2C\bar{Y})$$

$$F = A\bar{X}^2 + C\bar{Y}^2 + B\bar{X}\bar{Y} - AC (1 - \rho^2) \lambda_e^2 ,$$

and

$$\lambda_e = \sqrt{2} \sqrt{-\ln(1 - \rho)} .$$

For graphical presentations the range of the variable is important in order to arrange the scale. The largest and smallest values of X and Y for a given probability ellipse, p, are given by

$$X_{L,S} = \bar{X} \pm \sigma_x \lambda_e \tag{14}$$

$$Y_{L,S} = \bar{Y} \pm \sigma_y \lambda_e , \tag{15}$$

where, as before, $\lambda_e = \sqrt{2} \sqrt{-\ln(1 - p)} .$

Although there are several approaches to graphing the probability ellipses, the following procedure is advantageous for electronic computer plotting. In establishing the computer plotting program, the sample estimates for $\bar{X}, \bar{Y}, \sigma_x, \sigma_y,$ and ρ are constants in equation (13). The user makes the choice of probability ellipses desired. Thus, p in equation (12) is programmed as a parameter. The largest and smallest values for X and Y are computed by equations (14) and (15) for the largest probability ellipse selected. This sets the graphical scale. Values of X within the range of X smallest to X largest are obtained by incrementing X between these limits. Using the quadratic equation, a solution of equation (13) is made for Y for each value of X and plotted. The centroid (\bar{X}, \bar{Y}) for the family of probability ellipses is plotted as a point. Labeling and other identification completes the plotting program.

For a given probability, equation (13) defines an ellipse which contains p-percent of the points X,Y. Since the entire area under the bivariate normal density function [equation (9)] is unity, upon integration for a given probability ellipse, that given ellipse contains p-percent of the total area. In the wind statistics p-percent of the wind vectors fall within the specified probability ellipse. From this point of view a specified probability ellipse gives the joint probability that p-percent of the U-V components lie within the given ellipse.

When $\sigma_x^2 = \sigma_y^2 = \sigma^2$ and $\rho = 0$ in the bivariate normal distribution, the probability ellipses of equation (13) reduce to circles whose centers are at the means \bar{X}, \bar{Y} . The radii of the probability circles are $\sigma_{V1} \lambda_c$, where

$$\sigma_{V1} = \sqrt{2\sigma^2} \quad (16)$$

and

$$\lambda_c = \sqrt{-\ln(1-p)} \quad (17)$$

Values for λ_c for selected probabilities, p, are given in Table 3.

Because this function is simple, it can be easily graphed manually. However, the generalized plotting technique for electronic computer plotters as represented by equation (13) can be advantageously used.

C.3. Derived Distributions for Wind Statistics

In this subsection the probability distribution functions and sets of equations are presented to derive certain probability distribution functions for wind statistics. These derived probability distributions are:

- 1) The conditional distribution of wind components
- 2) The generalized Rayleigh distribution for wind speed
- 3) The distribution for wind direction
- 4) The conditional distribution of wind speed given a wind direction (wind rose).

The required five statistical parameters for these derived distributions for wind statistics are given in Table 1.

C.3.1. The Conditional Distribution of Wind Components

Given that two random variables X and Y are bivariate normally distributed, the conditional distribution $f(Y|X)$ is read as f(Y) given X, and likewise $f(X|Y)$ is read as f(X) given Y. The conditional probability distribution function $F(Y|X)$ has the mean $E(Y|X)$ and variance $\sigma^2_{(x|y)}$, where

$$E(Y|X^*) = \bar{Y} + \rho \left(\frac{\sigma_Y}{\sigma_X} \right) (X^* - \bar{X}) \quad (18)$$

and

$$\sigma^2_{(y|x^*)} = \sigma_Y^2 (1 - \rho^2) \quad (19)$$

The conditional standard deviation is

$$\sigma_{(y|x^*)} = \sigma_Y \sqrt{1 - \rho^2} \quad (20)$$

By interchanging the variables and parameters, the conditional distribution function for $F(X|Y^*)$ has the conditional mean

$$E(X|Y^*) = \bar{X} + \rho \left(\frac{\sigma_X}{\sigma_Y} \right) (Y^* - \bar{Y}) \quad (21)$$

conditional variance

$$\sigma^2_{(x|y^*)} = \sigma_X^2 (1 - \rho^2) \quad (22)$$

and conditional standard deviation

$$\sigma_{(x|y^*)} = \sigma_X \sqrt{1 - \rho^2} \quad (23)$$

The preceding conditional probability distribution functions are univariate normal distributions for a (fixed) given value for one of the bivariate normal variables. Thus the t-values given in Table 2 are applicable for conditional probabilities statements. For example,

$$F(Y|X^*) = E(Y|X^*) + t\sigma_{(y|x^*)} \quad (24)$$

For $t = 1.6449$ there is a 95 percent chance that Y is less than or equal to $\bar{Y} + 1.6449 \sigma_{(y|x^*)}$ given that $X = X^*$. In symbols this statement reads

$$P\left\{ Y \leq E(Y|X^*) + 1.6449 \sigma_{(y|x^*)} \mid X = X^* \right\} = 0.9500 \quad (25)$$

Interval probability statements can also be made; namely,

$$P\left\{ Y_1 = E(Y|X^*) - t\sigma_{(y|x^*)} \leq Y \leq Y_2 = E(Y|X^*) + t\sigma_y \mid X = X^* \right\}$$

where X^* can take on any fixed value of X , but a convenient arrangement is to let $X^* = \bar{X} \pm t\sigma_x$.

The close connection of the regression function of Y on X to the conditional mean for the bivariate normal distribution is noted; namely,

$$Y = \bar{Y} + \rho \left(\frac{\sigma_y}{\sigma_x} \right) (X - \bar{X}) \quad (26)$$

Similarly, the regression function of X on Y is

$$X = \bar{X} + \rho \left(\frac{\sigma_x}{\sigma_y} \right) (Y - \bar{Y}) \quad (27)$$

These are linear functions and express the same results as would be obtained from a least-squares regression line.

C.3.2. The Generalized Rayleigh Distribution for Wind Speed

If two random variables, X and Y , are bivariate normally distributed, then the probability distribution for the modulus, R , can be derived in terms of the five parameters which define the bivariate normal distribution.

$$R = \sqrt{X^2 + Y^2} \quad (28)$$

The distribution of R so derived is called a generalized Rayleigh distribution because there are no restrictions on the parameters. For applications to the RRA, the variable R is recognized as wind speed or the modulus of the wind vector.

The probability density function for R is expressed as

$$f(R) = a_0 R e^{-a_1 R^2} \left[I_0(a_2 R^2) I_0(a_3 R) + 2 \sum_{k=1}^{\infty} I_k(a_2 R^2) I_{2k}(a_3 R) \cos 2k\psi \right] R \geq 0 \quad (29)$$

The functions, $I_0(\cdot)$, $I_k(\cdot)$, and $I_{2k}(\cdot)$ are the modified Bessel function of the first kind for zero order, kth order, and 2kth order. The coefficients are:

$$a_0 = \exp \left[-\frac{1}{2} \left\{ \frac{\bar{X}^2}{\sigma_a^2} + \frac{\bar{Y}^2}{\sigma_b^2} \right\} \right] / \sigma_a \sigma_b$$

where σ_a^2 and σ_b^2 are the rotated variances to produce zero correlation between X and Y. σ_a and σ_b are the positive and negative roots¹ of the expression

$$\sigma_{(+,-)}^2 = \frac{1}{2} \left\{ \sigma_x^2 + \sigma_y^2 \pm \left[(\sigma_x^2 + \sigma_y^2)^2 - 4\sigma_x^2 \sigma_y^2 (1 - \rho^2) \right]^{1/2} \right\}$$

$$a_1 = (\sigma_x^2 + \sigma_y^2) / 4(1 - \rho^2) \sigma_x^2 \sigma_y^2$$

1. See footnote on next page.

$$a_2 = \frac{\left[(\sigma_x^2 - \sigma_y^2)^2 + 4\rho^2 \sigma_x^2 \sigma_y^2 \right]^{1/2}}{4(1 - \rho^2) \sigma_x^2 \sigma_y^2} ,$$

$$a_3 = \left[\left(\frac{\bar{X}}{\sigma_a} \right)^2 + \left(\frac{\bar{Y}}{\sigma_b} \right)^2 \right]^{1/2} ,$$

and

$$\tan \psi = \frac{\bar{Y}}{\bar{X}} \frac{\sigma_a}{\sigma_b} .$$

Since this density function cannot be integrated in closed form from zero to R, numerical integration is used to obtain practical results for the probability distribution function; i.e.,

$$F(R) = \int_0^{R^*} f(R) dR . \quad (30)$$

A number of special cases can be obtained from the general Rayleigh distribution [equation (29)], the most simple of which is to let $\sigma_x \equiv \sigma_y = \sigma$ and $\bar{X} = \bar{Y} = 0$ with independent variables X and Y. This gives

1. This computational form is obtained from the determinant

$$\begin{vmatrix} \sigma_x^2 - K & \sigma_x \sigma_y \rho \\ \sigma_x \sigma_y \rho & \sigma_y^2 - K \end{vmatrix} ,$$

where K is $\sigma^2_{(+,-)}$, and σ_a and σ_b are analogous to the standard deviation of the major and minor axes of the bivariate normal probability ellipse.

$$f(R) = \frac{R}{\sigma^2} e^{-R^2/2\sigma^2}, \quad (31)$$

which is recognized as the classical Rayleigh probability density function. The density function, equation (31), can be integrated in closed form over any range of the variable R . Hence, the probability distribution function, $F(R)$, for equation (31) is

$$F(R) = 1 - \exp\left\{-\frac{R^2}{2\sigma^2}\right\}. \quad (32)$$

C.3.3. The Derived Distribution of Wind Direction

Considering the wind as a vector quantity and bivariate normally distributed, the wind direction can be derived. This is done by first writing the bivariate normal probability density function in polar coordinates whose variables are

$$g(r, \theta) = r d_1 e^{-\frac{1}{2}(a^2 r^2 - 2br + c^2)}, \quad (\text{see footnote 2}) \quad (33)$$

where

$$a^2 = \frac{1}{(1 - \rho^2)} \left[\frac{\sin^2 \theta}{\sigma_x^2} - \frac{2\rho \cos \theta \sin \theta}{\sigma_x \sigma_y} + \frac{\cos^2 \theta}{\sigma_y^2} \right],$$

$$b = \frac{-1}{(1 - \rho^2)} \left[\frac{\bar{x} \sin \theta}{\sigma_x^2} - \frac{\rho(\bar{x} \cos \theta + \bar{y} \sin \theta)}{\sigma_x \sigma_y} + \frac{\bar{y} \cos \theta}{\sigma_y^2} \right],$$

$$c^2 = \frac{1}{(1 - \rho^2)} \left[\frac{\bar{x}^2}{\sigma_x^2} - \frac{2\rho \bar{x} \bar{y}}{\sigma_x \sigma_y} + \frac{\bar{y}^2}{\sigma_y^2} \right],$$

2. This expression, equation (33), in Smith (1976) is given with respect to the mathematical convention for a vector direction.

$$d_1 = \frac{1}{2\pi\sigma_x\sigma_y\sqrt{1-\rho^2}},$$

and $r = \sqrt{x^2 + y^2}$ is the modulus of the vector or speed and θ is the direction of the vector. After integrating $g(r, \theta)$ over $r = 0$ to ∞ , the probability density function of θ is

$$g(\theta) = \frac{d_1}{a^2} e^{-\frac{1}{2}c^2} \left[1 + \sqrt{2\pi} \left(\frac{b}{a}\right) e^{\frac{1}{2}\left(\frac{b}{a}\right)^2} \Phi\left(\frac{b}{a}\right) \right], \quad (34)$$

where a^2 , b , c^2 , and d_1 are as previously defined in equation (33) and

$$\Phi\left(\frac{b}{a}\right) = \Phi(x) = \frac{1}{\sqrt{2\pi}} \int_{-\infty}^x e^{-\frac{1}{2}t^2} dt$$

is taken from tables of normal distribution functions or made available through a computer subroutine.

If desired, equation (34) can be integrated numerically over a chosen range of θ to obtain the probability that the vector direction will lie within the chosen range; i.e.,

$$F(\theta) = \int_{\theta_2}^{\theta_1} g(\theta) d\theta. \quad (35)$$

One application may be to obtain the probability that the wind will flow from a given quadrant or sector as, for example, onshore.

C.3.4. The Derived Conditional Distribution of Wind Speed Given the Wind Direction (Wind Rose)

Continuing with the considerations in Section C.3.3. of this chapter, the conditional probability density function (pdf) for wind speed, r , given a specified value for the wind direction, θ , can be expressed as

$$f(r|\theta) = \frac{a^2 r e^{-\frac{1}{2}(a^2 r^2 - br)}}{1 + \sqrt{2\pi} \left(\frac{b}{a}\right) e^{\frac{1}{2}\left(\frac{b}{a}\right)^2} \phi\left\{\frac{b}{a}\right\}} \quad (35)$$

where the coefficients, a and b and the function $\phi\left\{\frac{b}{a}\right\}$ are as previously defined in equation (33) and in equation (34).

From equation (36) the mode (most frequent value) of the conditional wind speed given a specified value of the wind direction is the positive solution of the quadratic equation,

$$a^2 r^2 - br - 1 = 0 \quad (37)$$

which is

$$(\bar{r}|\theta) = \frac{1}{2a} \left[\left(\frac{b}{a}\right) + \sqrt{4 + \left(\frac{b}{a}\right)^2} \right] \quad (38)$$

The locus of the conditional modal values of wind speed when plotted in polar form versus the given wind directions forms an ellipse.

The noncentral moment for equation (36) is expressed as

$$\mu'_n = \int_0^{\infty} r^n f(r|\theta) dr \quad (39)$$

Now the first noncentral moment is identical to the first central moment or the expected value, $E(r|\theta)$. The integration of equation (39) for the first moment is sufficiently simple to yield practical computations and can be expressed as

$$E(r|\theta) = \frac{\left(\frac{b}{a}\right) + \left[1 + \left(\frac{b}{a}\right)^2\right] \sqrt{2\pi} e^{\frac{1}{2}\left(\frac{b}{a}\right)^2} \phi\left\{\frac{b}{a}\right\}}{a \left[1 + \left(\frac{b}{a}\right) \sqrt{2\pi} e^{\frac{1}{2}\left(\frac{b}{a}\right)^2} \phi\left\{\frac{b}{a}\right\}\right]} \quad (40)$$

Hence, equation (40) gives the conditional mean value of the wind speed given a specified value for the wind direction.

The integration of equation (36) for the limits $r = 0$ to $r = r^*$ gives the probability that the conditional wind speed is $\leq r^*$ given a value for the wind direction, θ . This conditional probability distribution (PDF) can be written as

$$\Pr \left\{ r \leq r^* \mid \theta = \theta_0 \right\} = 1 - \left[\frac{e^{-\frac{1}{2} r_s^2 + \sqrt{2\pi} \left(\frac{b}{a}\right) \left\{ 1 - \phi \left(r_s \right) \right\}}}{e^{-\frac{1}{2} \left(\frac{b}{a}\right)^2 + \sqrt{2\pi} \left(\frac{b}{a}\right) \phi \left\{ \frac{b}{a} \right\}}} \right] \quad , \quad (41)$$

$$\text{where } r_s = \left[a r^* - \left(\frac{b}{a} \right) \right] .$$

By definition equation (41) is an expression for a "wind rose". Empirical wind rose statistics are often tabulated or graphically illustrated giving the frequency that the wind speed is not exceeded for those wind speed values which lie within assigned class intervals of the wind direction. After evaluation of equation (41) for various values of wind speed, r^* , and the given wind directions, θ , interpolations can be performed to obtain various percentile values of the conditional wind speed.

For the special case when \bar{b} in equation (33) (i.e., for $\bar{x} = \bar{y} = 0$), the conditional modal values of wind speeds [equation (38)], the conditional mean values of wind speeds [equation (40)], and the fixed conditional percentile values of wind speeds [interpolated from evaluations of equation (41)], when plotted in polar form versus the given wind directions produce a family of ellipses.

For the special case when $\bar{x} = \bar{y} = 0$, equation (36) reduces to the following simple case:

$$\Pr \left\{ r \leq r^* \mid \theta = \theta_0 \right\} = 1 - e^{-\frac{a^2 r^{*2}}{2}} \quad . \quad (42)$$

There is a special significance of equation (42) when related to the bivariate normal probability distribution. If r^* and θ are measured from the centroid of the probability ellipse, then the probability that $r < r^*$ is the same as the given probability ellipse. Further, solving equation (42) for r^* , gives

$$r^* = \frac{1}{a} \sqrt{-2 \ln (1 - P)} \quad . \quad (43)$$

If a probability ellipse P is chosen, equation (42) gives the distance of r along any θ from the centroid of the ellipse to the intercept of the specified probability ellipse. If there is an interest in conditional probability of winds for a given θ relative to the monthly means, equation (43) is applicable. If it is desired to find the magnitude of the wind along any θ relative to the monthly mean to the intercept of a given probability ellipse, equation (43) is applicable.

D. Statistical Parameters With Respect To Any Orthogonal Axes

The five wind statistical parameters presented in Table I are given with respect to the standard meteorological coordinate system; i.e., these parameters are for the zonal and meridional components. For many aerospace vehicles and range applications there is a need for wind statistics with respect to orthogonal axes other than west to east and south to north. For example, it may be required to present wind statistics with respect to a flight azimuth of an aerospace vehicle whose flight azimuth is α degrees from true north measured in a clockwise direction. The following sets of equations are presented to compute the five parameters for the new coordinate axes rotated α degrees clockwise from true north.

a. Rotation of the means through α degrees:

$$\bar{X}_\alpha = \bar{X} \cos (90 - \alpha) + \bar{Y} \sin (90 - \alpha) \quad (44)$$

$$\bar{Y}_\alpha = \bar{Y} \cos (90 - \alpha) - \bar{X} \sin (90 - \alpha) \quad (45)$$

b. Rotation of the variances through α degrees:

$$\begin{aligned} \sigma_{x_\alpha}^2 &= \sigma_x^2 \cos^2 (90 - \alpha) + \sigma_y^2 \sin^2 (90 - \alpha) \\ &+ 2\rho\sigma_x\sigma_y \cos (90 - \alpha) \sin (90 - \alpha) \end{aligned} \quad (46)$$

$$\begin{aligned} \sigma_{y_\alpha}^2 &= \sigma_y^2 \cos^2 (90 - \alpha) + \sigma_x^2 \sin^2 (90 - \alpha) \\ &- 2\rho\sigma_x\sigma_y \cos (90 - \alpha) \sin (90 - \alpha) \end{aligned} \quad (47)$$

c. Rotation of the linear correlation coefficient through α degrees:

$$\rho_{\alpha} = \frac{\text{cov}(X,Y)_{\alpha}}{\sigma_{x_{\alpha}} \sigma_{y_{\alpha}}} \quad , \quad (48)$$

where $\text{cov}(X,Y)_{\alpha}$ is the rotated covariance,

$$\begin{aligned} \text{cov}(X,Y)_{\alpha} = & \text{cov}(X,Y) [\cos^2(90 - \alpha) - \sin^2(90 - \alpha)] \\ & + \cos(90 - \alpha) \sin(90 - \alpha) (\sigma_y^2 - \sigma_x^2) \end{aligned}$$

and

$$\text{cov}(X,Y) = \rho \sigma_x \sigma_y \quad .$$

By using these rotational equations, the bivariate normal distribution with respect to any desired rotated coordinates can be obtained from sample estimates that have been computed with respect to a specific axis. The marginal distributions after rotation are also normally (univariate) distributed. By using the rotational equations, computational efforts are greatly reduced for applications requiring statistics with respect to several coordinate axes.

Appendix A presents some illustrative examples for the wind statistics of the specific RRA.

CHAPTER III. STATISTICS OF THERMODYNAMICS QUANTITIES AND MODELS

A. General Considerations

A.1. Objectives

The objectives inherent in developing the thermodynamic section of the RRA were to describe the thermodynamic characteristics of the atmosphere using a minimum of data tabulations. A set of parameters was selected which, together, thermodynamically describe the climatological state of the atmosphere. These parameters are the pressure, temperature, density, dew point, virtual temperature, and water vapor pressure. Used together, these parameters permit the calculation of a large number of derived quantities. Some of these quantities, such as the speed of sound, are dealt with in Section III.E.

The probability distribution of each of the six thermodynamic RRA parameters is described by its mean value, its standard deviation, and its skewness. Several of these parameters (temperature, pressure, dew point and density) have probability distributions which are close to a univariate normal distribution; the others do not. The skewness parameter gives an estimate of the asymmetrical departures of a probability distribution.

Hydrostatically modeled mean values of pressure and density were calculated (Table IV), so that users may determine the departure of the actual climatological values of these parameters from hydrostatic conditions. This was done by hydrostatically integrating the pressure from the lowest RRA data level to the termination altitude of the particular RRA.

TABLE D. LIST OF SYMBOLS USED IN CHAPTER III

C_s	- Speed of sound
C_d	- Collision diameter
E	- Vapor pressure
g_ϕ	- Gravity at latitude ϕ
H	- Geopotential height
H_m	- Geopotential height at a mandatory radiosonde data level
H_s	- Geopotential height at a significant radiosonde data level

TABLE D. (Continued)

K_t	- Coefficient of thermal conductivity
L	- Mean free path length
M	- Mean molecular weight of air at sea level
M3q	- Annual third moment of quantity Q
M3q	- Monthly third moment of quantity Q
n	- Refractive modulus
N	- Refractive index
NA	- Avogadro's constant
Nq	- Number of values of quantity Q
P	- Pressure
P_m	- Pressure at a mandatory radiosonde data level
P_s	- Pressure at a significant radiosonde data level
P_h	- Hydrostatically integrated mean monthly or annual pressure
Q	- Any tabulated RRA quantity
R^*	- Universal gas constant
R'	- Specific gas constant of dry air
r', r^*	- Parameters used in converting z to h and vice versa
S	- Sutherland's constant, used in the calculation of dynamic viscosity
T	- Temperature
T_d	- Dew point
T_v	- Virtual temperature
T_{vm}	- Virtual temperature at a mandatory radiosonde data level
T_{vs}	- Virtual temperature at a significant radiosonde data level
V	- Mean air particle speed

TABLE D. (Concluded)

V_c	- Mean collision frequency
w	- Parameter used in the hydrostatic interpolation of pressure and density
Z	- Geometric altitude
λ	- Wavelength
α_Q	- Skewness of quantity Q
β	- Constant used in the equation for viscosity
γ	- Ratio of specific heat at constant pressure to specific heat at constant volume
η	- Kinematic coefficient of viscosity
μ	- Dynamic coefficient of viscosity
ρ	- Density
ρ_h	- Mean monthly or annual density derived from P_h
σ	- Standard deviation of the quantity Q

A.2. Data Quality Control

Data limits derived from the following parameters were used to screen the thermodynamic portion of the RRA data base: temperature, pressure, dew point (for the 0-30 km portion only), and density (for the 30-70 km portion only). These limits were set to plus and minus six standard deviations from the mean values of each of these quantities. These limits were used to screen the thermodynamic portion of the RRA data base, according to the procedures described in Section I.C. The data base used to generate the thermodynamic portion of the RRA (Tables I, II, and IV) was considered to be free from errors if:

a) The skewness values of the pressure and temperature were between -2.5 and 2.5 at all data levels.

b) The skewness values of the density were between -3.5 and 3.5 at data levels between 0 and 30 km.

c) The skewness values of the density were between -3.0 and 3.0 at data levels between 30 and 70 km.

d) The skewness values of the dew point were between -2.5 and 2.5 at all data levels with more than 10 data values.

A.3. Limitation of Thermodynamic Statistics

The correlation coefficients between the thermodynamic quantities and the moisture-related quantities were not calculated at discrete altitudes nor were any of the correlations between altitudes. Therefore, valid statistical dispersion models that require the relationship between two or more of these quantities at the same altitude or between altitudes cannot be derived. Approximations for the correlation coefficients between pressure, virtual temperature, and density at discrete altitudes may be obtained from the coefficients of variation as developed by Buell (1970). The coefficient of variation is the standard deviation divided by the mean. The mean values and the standard deviations are taken from Table II. A model for the profile of monthly and annual mean pressure, virtual temperature, and density that is in excellent agreement with the respective statistical mean values is given by Table IV. This agreement results because the physical relationships, given by the hydrostatic equation and the equation of state, were used to derive Table IV. When only the monthly or annual mean values for pressure, virtual temperature, and density are required, it is recommended that Table IV be used.

B. Establishing Data Samples at the Required Altitude Levels

This section describes the computational procedures used to establish data samples of the thermodynamic RRA parameters at the RRA data levels. References are cited only when an equation given is one of many available in the literature or when an equation is stated in an unusual form.

B.1. Conversion of Data Recorded in Geopotential Heights to Geometric Altitude

The upper air rocketsonde observations used to obtain the table values above 30 km were recorded in terms of geometric altitude and can be interpolated directly to the altitude intervals shown in the tables. However, the radiosonde observations used to obtain the tabular values below 30 km were recorded in terms of geopotential heights. The change of coordinates from geopotential height to geometric altitude (h to z) is accomplished by calculating a table of geopotential heights which correspond exactly to the geometric altitudes at which the atmospheric parameters are tabulated. The radiosonde observations are then interpolated to these geopotential heights. The relationship used to calculate geometric altitude from geopotential height is

$$H = (r'z)/(r*z) \quad , \quad (49)$$

where

$$r' = gr*/9.80665$$

and

$$r^* = -2g_\phi / (\partial g_\phi / \partial z_0) \quad .$$

g_ϕ is the sea level gravity at the latitude ϕ corresponding to the proper location. This value is given by (List, 1968)

$$g_\phi = 9.780356 (1 + 5.2885 \times 10^{-3} \sin^2 \phi - 5.9 \times 10^{-6} \sin^2 (2\phi)) \quad . \quad (50)$$

$\frac{\partial g_\phi}{\partial z_0}$ is the rate of change of gravity at the sea level. This quantity is given by the equation

$$\frac{\partial g_\phi}{\partial z_0} = -3.085462 \times 10^{-6} + 2.27 \times 10^{-9} \cos (2\phi) - 2 \times 10^{-12} \cos (4\phi) \quad . \quad (51)$$

The units used for gravity are m/s^2 , while the units for $\frac{\partial g_\phi}{\partial z_0}$ are s^{-2} .

The resulting table of values of H obtained by using even increments of 2 in equation (49) is shown in Table IV of the RRA. The values of H above 30 km are not used in the interpolation of original data but are included for the convenience of the user.

B.2. Calculations on the Original Rawinsonde Data Records

It was necessary to interpolate the information from the original rawinsonde data records to the geometric altitudes specified as the RRA data levels. The parameters for which this interpolation was required were the temperature, dew point, and pressure. The other parameters were calculated from the interpolated values at each RRA data level. These "derived" parameters were the water vapor pressure, density, and virtual temperature.

B.2.1. Calculation of the Geopotential Height at Significant Levels

Two somewhat different interpolation procedures were used to obtain data at the levels shown in the tables from radiosonde and rocketsonde observations. The procedure used to interpolate radiosonde observations begins with the calculation of virtual temperature at each data level in a sounding. The virtual temperature was computed by

$$T_v = T / (1 - 0.379 (e/p)) \quad , \quad (52)$$

where T_v and T are in degrees K and e and p are in millibars.

The radiosonde soundings contain a mix of data taken at "mandatory" and "significant" levels. Pressure, temperature, and dew point information was given in these soundings at both types of levels. However, geopotential height information was only given at the mandatory levels. The heights at the significant levels were "filled in" (calculated) hydrostatically using pressure and temperature data from these levels. This procedure permitted the use of most of the significant level data in the calculation of the RRA tables. The equation used for this process was

$$H_s = H_m + 29.2712617 * \frac{(T_{vs} - T_{vm})}{2} * \ln(P_s/P_m) \quad , \quad (53)$$

where the subscripts s and m denote quantities at significant and mandatory levels. This equation was not used if the difference between two adjacent mandatory levels was greater than 200 mb. All soundings with such data gaps were rejected for use in compiling the RRA.

B.2.2. Temperature

Radiosonde temperatures were interpolated logarithmically with respect to pressure using the equation

$$T = T_U + (T_L - T_U) \frac{\ln p - \ln p_L}{\ln p_U - \ln p_L} \quad , \quad (54)$$

where the subscripts U and L indicate values at the nearest data levels in the actual sounding above and below the interpolated level.

B.2.3. Pressure

The pressure values in each radiosonde sounding were interpolated to the RRA data levels using the equation

$$p = p_L \exp\left(\frac{H_L - H_U}{29.2712617 (0.5) (T_{vU} + T_{vL})}\right) \quad (55)$$

where the subscript L indicates virtual temperature, geopotential, and pressure values at the data level below and closest to the level at which data were required.

B.2.4. Dew-Point Temperature

Dew-point values were interpolated logarithmically with respect to pressure using the equation

$$T_d = T_{dU} + (T_{dL} - T_{dU}) \left(\frac{\ln p - \ln p_L}{\ln p_U - \ln p_L} \right) \quad (56)$$

The subscripts U and L indicate data at the nearest upper and lower data levels in a sounding.

B.2.5. Derived Water Vapor Pressure

The water vapor pressure is calculated from the interpolated dew-point values at the RRA data levels using Teten's approximation:

$$e = 6.11 \text{ mb} \times 10^{7.5(T_d - 273.15)/(T_d - 35.86)} \quad (57)$$

B.2.6 Derived Density

The density values derived from radiosonde observations were calculated at the RRA data levels using the equation

$$\rho = 348.36787 p / T_v \quad (58)$$

B.2.7 Derived Virtual Temperature

The virtual temperature values are calculated at the RRA data levels for each sounding using the equation

$$T_v = T / (1 - 0.379(e/p)) \quad (59)$$

where T_v and T are in degrees K and p and e are the pressure and vapor pressure, respectively, in millibars.

B.3. Calculations on the Original Rocketsonde Data Records

The rocketsonde data records used to calculate the RRA table values above 30 km were given in terms of geometric altitude. For this reason, slightly different calculations were required to convert the recorded data values to values at the RRA data levels. The pressure, temperature, and density were all interpolated to the RRA data levels; moisture-related parameters (virtual temperature, water vapor pressure, and dew point) were not calculated, since atmospheric moisture at altitudes above 30 km was considered to be negligible.

No interpolation was done across gaps in the pressure or temperature data within a sounding larger than 7000 m. Data values at the RRA levels within such a gap were set to missing.

B.3.1. Temperature

Rocketsonde temperatures were interpolated linearly with respect to geometric altitude using the equation

$$T = T_U + (T_L - T_U) \frac{Z - Z_L}{Z_U - Z_L} \quad (60)$$

where the subscripts U and L indicate values at the nearest data level in the actual sounding above and below the interpolated level.

B.3.2. Pressure

The pressure values in each rocketsonde sounding were interpolated to the RRA data levels using the equation

$$P = P_L \exp \left(-\frac{g_\phi}{R^*} \frac{M(Z - Z_L)}{\bar{T}_v} \cdot W^2 \right) \quad (61)$$

$$\text{where } \bar{T}_v = \frac{T_{vU} + T_{vL}}{2} \quad \text{and } W = \left(\frac{r^*}{r^* + Z + \frac{Z - Z_L}{2}} \right)$$

B.3.3 Density

Rocketsonde density values were interpolated using the equation

$$\rho = \rho_L \exp \left(- \frac{g_\phi M}{R^*} \frac{(Z - Z_L)}{\bar{T}_v} \cdot W^2 \right) , \quad (62)$$

where W is specified in Section III.B.3.2.

C. Computation of Statistical Parameters for Tables II and III

The procedure used for computing the monthly and annual means, standard deviations, and skewness values from the data values at the RRA data levels was accomplished in three steps. Initially, certain statistical sums were calculated and stored as the soundings in the data base were processed. These sums were then used to calculate the monthly statistics given in the RRA tables. The annual statistics were then calculated from these stored sums and the monthly statistics.

C.1. Stored Statistical Sums

The sums which were calculated were

$$\sum Q, \sum Q^2, \text{ and } \sum Q^3 ,$$

where Q is any one of the quantities given in the thermodynamic part of the RRA.

C.2. Calculation of the Monthly Statistics

C.2.1. Monthly Means

The mean monthly values of the thermodynamic RRA quantities were calculated using the equation

$$\bar{Q} = \sum Q / N_Q ,$$

where N_Q is the number of observed values of the quantity Q for a given month.

C.2.2 Monthly Standard Deviations

The monthly standard deviations of the thermodynamic RRA quantities were calculated using the equation

$$\sigma_Q = \sqrt{\frac{(N_Q \Sigma Q^2) - (\Sigma Q)^2}{N_Q \cdot (N_Q - 1)}} \quad (63)$$

C.2.3 Monthly Skewness Values

The monthly skewness values of the wind speed and of the thermodynamic RRA quantities are calculated using the equation

$$\alpha_Q = \frac{M_{3Q}}{\sigma_Q^3}$$

where M_{3Q} is the third moment of the quantity Q , σ_Q is its standard deviation, and

$$M_{3Q} = \left[\frac{\Sigma Q^3}{N_Q} - \frac{3\Sigma Q \Sigma Q^2}{N_Q^2} - \frac{2\Sigma Q^3}{N_Q^3} \right] \cdot \frac{N_Q^2}{(N_Q - 1)(N_Q - 2)} \quad (64)$$

C.3. Calculation of the Annual Statistics

Equations (63) and (64), used to calculate the monthly values of the standard deviations and skewness values, involve taking the differences between two pairs of large sums containing Q^2 and Q^3 , where Q is any thermodynamic RRA quantity. Using these equations to compute the annual statistics would have resulted in a substantial loss of precision, as these sums become larger by several orders of magnitude in such a case. This problem was avoided by calculating the annual means, standard deviations, and skewness values from the monthly statistics.

C.3.1. Annual Mean Values

The annual mean values of the thermodynamic RRA quantities were calculated using the equation

$$Q_{ANN} = Q_A / N_Q$$

where Q_A is the total of all observed values of Q and N_Q is the total number of observations of Q .

C.3.2. Annual Standard Deviations

The annual standard deviations of the thermodynamic RRA quantities were calculated using the equation

$$\sigma_{Q_{ANN}} = \sqrt{\frac{1}{N_Q} \sum_{i=1}^{12} (N_{Qi} \sigma_{Qi}^2) + \frac{1}{N_Q} \sum_{i=1}^{12} (N_{Qi} \bar{Q}_i^2) - Q_{ANN}^2}, \quad (65)$$

where N_{Qi} = the number of data values for Q in month i ($i = 1$ to 12) and Q_i = the monthly mean of Q and σ_{Qi} = the standard deviation of quantity Q in month i .

C.3.3. Annual Skewness Values

The annual skewness values of the thermodynamic RRA quantities are calculated using the equation

$$\begin{aligned} M_{3Q_{ANN}} = & \frac{1}{N} \sum_{i=1}^{12} (N_{Qi} M_{3Qi}) + \frac{3}{N_{Q_{ANN}}} \sum_{i=1}^{12} (N_{qi} \bar{Q}_i \sigma_{Qi}^2) \\ & + \frac{1}{N_{Q_{ANN}}} \sum_{i=1}^{12} (N_{Qi} Q_i^3) - \frac{3\bar{Q}_{ANN}}{N_{Q_{ANN}}} \sum_{i=1}^{12} (N_{qi} Q_i^2) \\ & - \frac{3\bar{Q}_{ANN}}{N_{Q_{ANN}}} \sum_{i=1}^{12} (N_{Qi} \sigma_{Qi}^2) + 2\bar{Q}_{ANN}^3, \quad (66) \end{aligned}$$

where M_{3Q} = the third moment about the mean of quantity Q in month i and M_{3Q} = the annual third moment about the mean of the quantity Q .

D. Derived Monthly Mean and Annual Mean Model Atmospheres

A set of modeled monthly mean and annual mean hydrostatic values of pressure and density was calculated from the lowest RRA data level (0 km, mean sea level) upwards to 30 km, and from 30 km upwards to 70 km. The integration from 0 to 30 km was computed independently of the integration from 30 to 70 km because of the difference in data sources. The two different values for 30 km are provided for comparison. When 30 km data are required, the values given in the 0 to 30 km table should be used. These hydrostatically modeled mean values, which are given in Table IV, are useful as a check on the validity of the pressure and density values given in Table II. In most cases, the values in Tables II and IV for any given data level are within 1 percent of each other. The hydrostatic pressure values in Table IV were calculated using the equation

$$p_1 = p_0 \exp \left(- \frac{0.034162 (H_1 - H_0)}{0.5 (T_{v_1} + T_{v_0})} \right), \quad (67)$$

where, $H_1 - H_0$ is in meters and a "0" subscript refers to values at the RRA data level immediately below the level being checked. p_0 at the lowest data level is set equal to the RRA mean pressure; p_1 , calculated for the next highest data level, is taken as p_0 for the level above that. This process is repeated for all the other RRA data levels. The hydrostatic density corresponding to the hydrostatic pressures is calculated from these pressures and the RRA virtual temperature values using the formula

$$\rho_H = 348.36786 P_H / T_v, \quad (68)$$

where ρ_H and P_H are the hydrostatic density and pressure shown in Table IV of the RRA.

E. Thermodynamic Quantities Derivable from the Basic Tables

Several other quantities can be calculated from the statistics listed in Tables II and III. The equations given in this section can be used to calculate the approximate mean values of these quantities at each RRA data level. It is not possible to infer or derive any information concerning the standard deviation or skewness values of these quantities from the data in Tables II and III of the RRA.

TABLE E. LIST OF PRIMARY PHYSICAL CONSTANTS

P_o	= standard atmospheric pressure at sea level = 1.013250×10^5 Newton/m ² = 2116.22 lb/ft ²
ρ_o	= standard atmospheric density at sea level = 1.2250 kg/m ³ = 0.076474 lb/ft ³
T_o	= standard temperature at sea level = 288.15 K = 15.0°C = 59.0°F
g_o	= standard gravity at sea level at latitude 45°32'33" = 9.80665 m/s ²
s	= Sutherland's constant used in calculation of dynamic viscosity = 110.4 K
T_I	= ice-point temperature at P_o = 273.15 K
β	= constant used in calculation of dynamic viscosity = 1.458×10^{-6} kg/sec m K ^{1/2} = 7.3025×10^{-7} lb/sec ft R ^{1/2}
γ	= ratio of specific heat of air at constant pressure to specific heat of air at constant volume = 1.4
C_D	= mean effective collision diameter of air molecules = 3.65×10^{-10} m = 1.1975×10^{-9} ft
N_a	= Avogadro's constant = 6.022169×10^{26} /kg mol = 2.73179×10^{26} /lb mol
R^*	= gas constant = 8.31432 Joule/mol K
R'	= gas constant for dry air = 2.8704×10^2 Joule/kg K
M	= molecular weight of dry air = 28.966 gm/mol

E.1. Mean Air-Particle Speed

The mean air particle speed, V , is the arithmetic average of the speeds of all air particles in the volume element being considered. For a valid average to occur, there must be a sufficient number of particles involved to represent mean conditions. The equation for "V" for dry air is:

$$V = \sqrt{\frac{8}{\pi} \cdot \frac{R \cdot T}{M}} \quad (69)$$

A computational form for dry air, using tabulated values, is:

$$V = \sqrt{7.3094 \times 10^2 \times T} \quad , \quad (\text{m/s}) \quad (70)$$

where T is the temperature in degrees K from Table II. Equation (69), when corrected for moist air, becomes:

$$V = \sqrt{\frac{8}{\pi} \cdot R' \cdot T_v} \quad (71)$$

The computational form for moist air is:

$$V = \sqrt{7.3094 \cdot 10^2 \cdot T_v} \quad , \quad (\text{m/s}) \quad (72)$$

where T_v is the virtual temperature in degrees K from Table III.

E.2. Mean Free Path

The mean free path, L , is the mean value of the distance traveled by each neutral air particle, in a selected air parcel, between successive collisions with other particles in that parcel. A meaningful average requires that the selected parcel be large enough to contain a substantial number of particles. The equation for L is given by:

$$L = \left(\frac{\sqrt{2}}{2\pi} \right) \left(\frac{R^*T}{N_a C_d^2 P} \right) , \quad (73)$$

where C_d is the effective collision diameter of the mean air molecules. The 1976 standard atmosphere value of 3.65×10^{-10} is valid for the range of altitudes in the RRA.

A computational form for moist air, using tabulated values, is:

$$L = 2.335 \times 10^{-7} \frac{T}{P} \text{ (meters)} , \quad (74)$$

where T is the temperature in degrees K from Table II and P is the pressure, in mb, from Table II.

A form of (73) to correct L for moist air is:

$$L = \left(\frac{\sqrt{2}}{2\pi} \right) \frac{R^*MT_v}{N_a C_d^2} . \quad (75)$$

The computational form for moist air is:

$$L = 2.3325 \times 10^{-7} \frac{T_v}{P} \text{ (meters)} , \quad (76)$$

where T_v is the virtual temperature in degrees K from Table III and P is the pressure in mb from Table II.

E.3. Mean Collision Frequency

The mean collision frequency V_c is considered to be the average speed of air particles contained in an air parcel divided by the mean free path of the particles inside that parcel. Computationally this is equivalent to:

$$V_c = \frac{V}{L} \text{ (sec}^{-1}\text{)} . \quad (77)$$

To determine V_c for dry air, use V and L from equations (70) and (74). To determine V_c for moist air, use V and L from equations (72) and (76).

E.4. Speed of Sound

The expression for the speed of sound, C_s , in dry air, in m/s is

$$C_s = \sqrt{\frac{\gamma R^* T}{M}} \quad . \quad (78)$$

To compute C_s for dry air from tabulated values, use:

$$C_s = \sqrt{4.0185 \times 10^2 \times T} \quad , \quad (\text{m/s}) \quad (79)$$

where T is the temperature in degrees K from Table II. One form for the speed of sound in moist air is:

$$C_s \approx \sqrt{\gamma R^* T_v} \quad , \quad (80)$$

where T_v is the virtual temperature from Table III. A computational form for moist air is:

$$C_s \approx \sqrt{4.0185 \times 10^2 T_v} \quad , \quad (\text{m/s}) \quad . \quad (81)$$

E.5. Dynamic Coefficient of Viscosity

The coefficient of dynamic viscosity, μ , is defined as a coefficient of internal friction developed where gas regions move adjacent to each other at different velocities. The following expression is taken from the U.S. Standard Atmosphere (1976):

$$\mu = \frac{\beta \cdot T^{3/2}}{T + S} \quad . \quad (82)$$

The computational form is:

$$\mu = \frac{(1.458 \times 10^{-6}) T^{3/2}}{T + 110.4} \quad , \quad \left(\frac{\text{kg}}{\text{s} \cdot \text{m}} \right) \quad (83)$$

where T is temperature in degrees K from Table II.

E.6. Kinematic Coefficient of Viscosity

The kinematic coefficient of viscosity, designated as η , is defined to be the ratio of the dynamic coefficient of viscosity of a gas to its density, or:

$$\eta = \mu / \rho \quad . \quad (84)$$

The computational form is:

$$\eta = 1.0 \times 10^3 \mu / \rho \quad , \quad (\text{m}^2/\text{s}) \quad , \quad (85)$$

where μ is the dynamic coefficient of viscosity from equation (83) and ρ is the density in g m^{-3} from Table II.

E.7. Coefficient of Thermal Conductivity

The empirical expression used for the coefficient of thermal conductivity, designated as K_t , is given in the 1976 Standard Atmosphere as:

$$K_t = \frac{2.65019 \times 10^{-3} \cdot T^{3/2}}{T + 245.4 \times 10^{-(12/T)}} \quad , \quad (\text{watts/m-deg K}) \quad (86)$$

where T is in degrees K.

E.8. Refractive Modulus and Refractive Index

The refractive modulus or refractivity (Selby and McClatchey, 1975; Smith and Weintraub, 1953) is defined as N, where

$$N = (n - 1) \cdot 10^6 \quad (87)$$

and n is the refractive index.

For microwave frequencies below approximately 30 GHz (equivalent to wavelengths above 1 cm), N , the refractive modulus, is given by the empirical equation

$$N = 77.6 \frac{P}{T_d} + 3.73 \times 10^5 \frac{e}{T^2} \text{ (dimensionless) } , \quad (88)$$

where E and P are in millibars and T and T_d are in degrees K.

The following expression is valid for the visible and infrared wavelengths shorter than approximately 30 μm (0.03 mm).

$$N = 77.6 \frac{P}{T} + 0.584 \frac{P}{T\lambda} \text{ dimensionless } , \quad (89)$$

where λ is the wavelength in microns and T is in degrees K.

The expression for N for the wavelength from 0.03 mm to 1 cm is an extremely complex function of wavelength.

CHAPTER IV. CONCLUSIONS AND RECOMMENDATIONS

Conclusions

This document satisfies the technical objectives established for the Range Reference Atmosphere committee by the Range Commanders Council Meteorology Group. Upper air statistics and models for wind and thermodynamic quantities for the specific site have been derived in a consistent and uniform manner which will be used in publications for all other assigned site locations. These Range Reference Atmospheres represent an improvement over the previously published Range Reference Atmospheres because of the availability of more extensive upper air data bases and the adaptation of more advanced statistical techniques. A statistical measure of central tendency (mean values) and a measure of dispersion (standard deviation with respect to the mean values) for monthly and annual reference periods have been tabulated for all variables in a consistent manner from data bases that have been edited and quality controlled in the same manner. Further, a statistical measure for symmetry (skewness coefficient which involves the third statistical moment) has been tabulated for all variables except the zonal and meridional wind components. Even with these improvements, the user of these Range Reference Atmospheres must recognize certain limitations of the statistical tabulations. Namely:

- 1) The wind profile structure with respect to altitude cannot be modeled from the RRA statistics because the inter-level and cross-level correlations were not computed.
- 2) The profile structure with respect to altitude for any of the thermodynamic variables or any quantities derivable from these variables cannot be modeled because the prerequisite correlations were not computed. However, the profile of monthly and annual means for pressure, virtual temperature, and density are in agreement (Table IV) with the hydrostatic equation and the equation of state.

The preceding limitations are cited to prevent a misuse of the RRAs. More extensive statistical tabulations were beyond the scope of this committee's task. As greater insight is gained through usage of these RRAs, many adaptations of the statistical tabulations for specific engineering and scientific applications are envisioned.

Recommendations

It is recommended that the wind and thermodynamic statistical tabulations and attendant models contained in the RRAs be used as a standard reference source, as may be appropriate, by the Ranges and Range users. It is further recommended that the respective Range Staff Meteorologist or responsible agency staff member be consulted for the applicability of the Range Reference Atmospheres for specific engineering applications.

REFERENCES

Buell, Eugene C.: Statistical Relations in a Perfect Gas. *Journal of Applied Meteorology*, 9, 1970, pp. 729-731.

List, R. J., Editor: Acceleration of Gravity, *Smithsonian Meteorological Tables*, Sixth Ed. Smithsonian Institution, Washington, D.C., 1968, p. 488.

Selby, J.E.A.; and McClatchey, R.A.: AFCRL-TR-75-0255, Atmospheric Transmittance from 0.25 to 28.5 μm - Computer Code Lowtran 3., Air Force Cambridge Research Laboratories. Available through the National Technical Information Service, Washington, D.C., 1975.

Smith, E.K.; and Weintraub, S.: The Constants in the Equation for Atmospheric Refractive Index at Radio Frequencies, *Proceedings of the Institute of Radio Engineers*, 41. 8, August 1953, pp. 1035-1037.

Smith, O.E.: NASA TM X-73319, Vector Wind and Vector Wind Shear Models at 0-27 km Altitude for Cape Kennedy, Florida, and Vandenberg AFB, California. Prepared under sponsorship of the National Aeronautics and Space Administration. Available through the National Technical Information Service, Washington, D.C., July 1976.

U.S. Standard Atmosphere, 1976. Prepared under the sponsorship of the National Aeronautics and Space Administration, United States Air Force, and United States Weather Bureau, Available through U.S. Government Printing Office, Washington, D.C., October 1976.

PREVIOUS RANGE REFERENCE ATMOSPHERES PUBLISHED BY IRIG

Atlantic Missile Range Reference Atmosphere for Cape Kennedy, Florida (Part I), Document 104-63, April 16, 1963, (AD 451 780).

White Sands Missile Range Reference Atmosphere for White Sands Missile Range, New Mexico (Part I), Document 104-63, June 28, 1964. (AD 451 781).

Fort Churchill Missile Range Reference Atmosphere for Fort Churchill, Manitoba, Canada (Part I), Document 104-63, August 7, 1964, (AD 634 727).

Pacific Missile Range Reference Atmosphere for Eniwetok, Marshall Islands (Part I), Document 104-63, September 1, 1964, (AD 479 264).

Fort Greely Missile Range Reference Atmosphere for Fort Greely, Alaska (Part I), Document 104-63, October 6, 1964, (AD 634 726).

REFERENCES (Concluded)

Eglin Gulf Test Range Atmosphere for Eglin AFB, Florida (Part I), Document 104-63, January 25, 1965, (AD 472 601).

Pacific Missile Range Reference Atmosphere for Point Arguello, California (Part I), Document 104-63, April 1965, (AD 472 602).

Wallops Island Test Range Reference Atmosphere (Part I), Document 104-63, July 10, 1965, (AD 474 071).

Eastern Test Range Reference Atmosphere for Ascension Island, South Atlantic (Part I), Document 104-63, July 1966, (AD 645 591).

Johnston Island Test Site Reference Atmosphere (Part I), Document 104-63, January 1970, (AD 782 652).

Lihue, Kauai, Hawaii Reference Atmosphere (Part I), Document 104-63, January 1970, (AD 782 653).

Cape Kennedy, Florida Reference Atmosphere (Part II), Document 104-63, September 1971, (AD 753 581).

White Sands Missile Range Reference Atmosphere (Part II), Document 104-63, September 1971, (AD 782 654).

Wallops Island Test Range Reference Atmosphere (Part II), Document 104-63, September 1971.

Fort Greely Missile Range Reference Atmosphere (Part II), Document 104-63, September 1971.

Edwards Air Force Base Reference Atmosphere (Part I), Document 104-63, September 1972, (AD 782 651).

Kwajalein Missile Range Reference Atmosphere for Kwajalein, Marshall Islands (Part I), Document 104-63, October 1974.

CONVERSION UNITS

Physical Constants and Conversion Factors

Numerical values in this document are given in the International System of Units (SI, *Système International d'Unités*). The values in parentheses are equivalent U. S. Customary Units, which are English units adapted for use by the United States of America. The SI and U. S. Customary Units provided in Table F are those normally used for measuring and reporting atmospheric data.

By definition, the following fundamental conversion factors are exact:

<u>Type</u>	<u>U. S. Customary Units</u>	<u>Metric</u>
Length	1 U. S. yard (yd)	0.9144 meter (m)
Mass	1 avoirdupois pound (lb)	453.59237 gram (g)
Time	1 second (s)	1 second (s)
Temperature	1 degree Rankine (°R)	9/5 degree Kelvin (°K)

To aid in the conversion of units, conversion factors based on the above fundamental conversion factors are given in Table F.

TABLE F. FACTORS FOR CONVERSION UNITS

Type of Data	METRIC				U. S. CUSTOMARY				CONVERSION	
	Unit	Abbreviation	Unit	Abbreviation	Multiply	By	To	From		
TEMPERATURE	degree Celsius	C	degree Fahrenheit	F	$\times 1.8$	$\div 1.8$	C	F	1.8	
	degree Kelvin	K	degree Rankine	R	$\times 1.8$	$\div 1.8$	R	K	1.8	
Temperature Change	degree Celsius	C	degree Fahrenheit	F	$\times 1.8$	$\div 1.8$	F	C	1.8	
	degree Kelvin	K	degree Rankine	R	$\times 1.8$	$\div 1.8$	R	K	1.8	
DENSITY	gram per cubic meter	$g\ m^{-3}$	grain per cubic foot	$gr\ ft^{-3}$	$\times 62.4$	$\div 62.4$	$gr\ ft^{-3}$	$g\ m^{-3}$	62.4	
	gram per cubic centimeter	$g\ cm^{-3}$			$\times 16.01$	$\div 16.01$	$lb\ ft^{-3}$	$g\ cm^{-3}$	16.01	
	(Absolute Humidity)				$\times 0.075$	$\div 0.075$	$lb\ ft^{-3}$	$g\ m^{-3}$	0.075	
	and Ambient Density				$\times 0.075$	$\div 0.075$	$lb\ ft^{-3}$	$g\ m^{-3}$	0.075	
					$\times 0.075$	$\div 0.075$	$lb\ ft^{-3}$	$g\ m^{-3}$	0.075	
WIND	meter per second	$m\ s^{-1}$	mile per hour	mph	$\times 2.237$	$\div 2.237$	mph	$m\ s^{-1}$	2.237	
			knots	knots	$\times 1.944$	$\div 1.944$	knots	$m\ s^{-1}$	1.944	
			feet per second	$ft\ s^{-1}$	$\times 0.682$	$\div 0.682$	$ft\ s^{-1}$	$m\ s^{-1}$	0.682	
					$\times 0.682$	$\div 0.682$	$ft\ s^{-1}$	$m\ s^{-1}$	0.682	
					$\times 0.682$	$\div 0.682$	$ft\ s^{-1}$	$m\ s^{-1}$	0.682	
DISTANCE	meter	m	feet	ft	$\times 3.281$	$\div 3.281$	ft	m	3.281	
	micron	μ	inch	in	$\times 39.37$	$\div 39.37$	in	μ	39.37	
	Angstrom unit	\AA			$\times 10^8$	$\div 10^8$	\AA	μ	10^8	
					$\times 10^8$	$\div 10^8$	\AA	μ	10^8	
					$\times 10^8$	$\div 10^8$	\AA	μ	10^8	

* Defined exact conversion factor.

TABLE F. (continued)

Type of Data	METRIC		U. S. CUSTOMARY				CONVERSIONS	
	Unit	Abbreviation	Unit	Abbreviation	Multiply	By	To Get	
DISTANCE (continued)								
MASS Weight	gram		gram	gr	lb	0.45359237^*	kg	
	kilogram	kg	pound	lb	lb	453.59237^*	g	
					kg	2.20462	lb	
					gr	15.4324	gr	
							oz	
							oz	
PRESSURE Atmospheric	new ton per square meter	new ton m ⁻²	pound force per square inch	lb in. ⁻²	mb	10^{-3}^*	bar	
	millimeter of Mercury	mmHg	inch of Mercury	in. Hg	bar	10^{-3}^*	mb	
	bar	bar			new ton m ⁻²	10^{-2}^*	lb in. ⁻²	
	millibar	mb			lb in. ⁻²	1.4504×10^{-4}	lb in. ⁻²	
	dyns per square centimeter (mks. cgs.)	dynes cm ⁻²			lb in. ⁻²	6.8948×10^3	new ton m ⁻²	
	kilogram force per square meter	kg m ⁻²			lb in. ⁻²	1.4504×10^{-2}	lb in. ⁻²	
					mb	68.948	mb	
					dynes cm ⁻²	10^{-3}^*	dynes cm ⁻²	
					lb in. ⁻²	10^{-1}^*	mb	
					lb in. ⁻²	6.8948×10^4	dynes cm ⁻²	
					dynes cm ⁻²	1.4504×10^{-5}	lb in. ⁻²	
					mb	10.1972	kg m ⁻²	
					lb in. ⁻²	0.0980665	mb	
				kg m ⁻²	703.0696	kg m ⁻²		
				Pa	0.0014223	lb in. ⁻²		
				mb	2.9530×10^{-2}	mm Hg (32 F)		
				mb	0.75006	mm Hg (60 C)		
				mm Hg (32 F)	25.40^*	mm Hg (60 C)		
				mm Hg (60 C)	1.33322	mb		
				mm Hg (32 F)	33.8639	mb		
				Pa	1.00^*	new ton m ⁻²		

* Defined value, conversion factor

TABLE I-1. WIND STATISTICAL PARAMETERS

JANUARY

STATION = 747940		CAPE CANAVERAL		MEAN V	S.D. V	MEAN WS	S.D. WS	SKEW WS	NOBS
Z	MEAN U	S.O. U	R(U,V)						
KM	M/S	M/S		M/S	M/S	M/S	M/S		
.003	.82	2.82	-.2097	-.84	3.42	3.92	2.36	.52	885.
1.000	2.82	7.05	-.0201	1.49	6.45	8.72	5.04	.95	893.
2.000	7.03	7.26	.0973	1.70	6.11	10.05	6.17	1.01	891.
3.000	10.81	7.43	.0934	2.00	6.46	12.85	7.23	.82	899.
4.000	14.52	8.14	.1371	2.40	7.03	16.16	8.06	.59	898.
5.000	17.36	9.07	.1567	2.81	7.70	19.64	9.09	.53	888.
6.000	21.47	9.90	.1961	3.45	8.46	23.30	9.99	.48	895.
7.000	24.94	11.03	.2271	4.01	9.62	26.99	11.12	.42	882.
8.000	28.44	12.29	.2577	4.42	10.73	30.67	12.38	.43	879.
9.000	31.76	13.32	.2781	4.75	11.65	34.13	13.41	.39	872.
10.000	34.72	13.99	.2953	4.85	12.63	37.22	14.11	.30	865.
11.000	37.49	14.42	.2952	4.78	13.40	40.08	14.45	.26	847.
12.000	39.89	14.12	.2857	4.85	13.43	42.33	14.21	.14	846.
13.000	40.66	13.28	.2931	4.83	12.25	42.72	13.35	.30	835.
14.000	38.45	11.78	.2844	4.47	10.40	40.05	11.89	.30	823.
15.000	34.54	10.42	.2736	4.46	8.99	35.95	10.48	.47	819.
16.000	29.94	9.21	.2569	4.01	7.86	31.19	9.27	.39	808.
17.000	24.62	8.27	.2596	3.34	6.71	25.74	8.24	.58	779.
18.000	18.57	7.71	.2374	2.53	5.62	19.62	7.57	.71	777.
19.000	12.95	6.83	.2701	1.73	4.41	13.90	6.61	.85	759.
20.000	9.10	6.31	.3336	1.01	3.41	10.06	5.84	1.04	747.
21.000	6.62	6.58	.3828	.43	3.02	8.06	5.61	1.34	723.
22.000	5.12	7.59	.3181	-.14	3.36	7.74	5.67	1.58	719.
23.000	4.69	7.58	.2195	.04	3.15	7.83	5.29	1.33	707.
24.000	4.50	6.95	.2204	.29	3.64	8.79	6.03	1.43	698.
25.000	5.04	9.80	.1266	.47	3.91	9.68	6.57	1.40	673.
26.000	5.71	11.04	.0750	.95	3.91	10.85	7.26	1.36	656.
27.000	6.07	12.05	.0355	1.55	4.42	12.02	7.70	1.18	620.
28.000	6.42	13.26	-.0160	2.21	5.13	13.45	8.20	.94	580.
29.000	8.09	13.75	.0307	2.70	5.46	14.76	8.57	.71	425.
30.000	9.87	14.74	.0363	3.52	5.75	16.44	9.47	.61	407.
32.000	13.44	15.24	.0781	2.85	6.57	18.99	10.12	.31	135.
34.000	16.72	16.04	.1054	1.36	7.59	21.47	11.58	.62	140.
36.000	15.45	16.94	.0853	-.10	8.04	21.00	12.16	.73	140.
38.000	14.34	17.11	.1493	1.17	8.83	20.86	11.88	.68	142.
40.000	13.25	17.68	.3303	2.08	8.53	21.18	10.75	.94	147.
42.000	11.74	19.38	.1521	3.30	10.07	22.45	10.93	.79	146.
44.000	10.52	19.77	.1347	8.47	10.82	23.30	12.03	.65	147.
46.000	10.40	20.51	.1267	8.83	12.17	24.43	12.46	.82	147.
48.000	11.31	22.48	.1560	7.75	12.46	25.82	13.37	.65	146.
50.000	13.58	22.92	.1123	8.74	13.79	28.02	13.71	.62	142.
52.000	15.04	23.23	.0747	8.27	15.19	29.18	14.48	.77	141.
54.000	18.30	23.77	.1650	9.81	14.90	31.44	15.02	.40	136.
56.000	24.72	24.99	.1359	9.97	14.76	35.42	17.15	.24	125.
58.000	33.35	24.53	.2319	12.32	13.62	40.79	19.58	.19	112.
60.000	40.06	23.30	.3183	12.11	15.40	46.20	19.82	.07	80.
62.000	48.18	25.50	.4759	9.52	16.96	53.22	22.70	-.30	59.
64.000	52.01	29.94	.4160	3.91	17.14	56.80	25.96	-.25	50.
66.000	57.41	33.10	.3455	-3.08	19.24	63.09	27.84	-.17	44.
68.000	55.53	33.31	.1332	-9.47	18.04	63.19	26.64	-.11	42.
70.000	55.17	38.91	.0412	-15.67	20.80	65.05	29.11	.04	42.

TABLE I-2. WIND STATISTICAL PARAMETERS

FEBRUARY

STATION • 747940		CAPE CANAVERAL		MEAN V	S.D. V	MEAN WS	S.D. WS	SKED WS	NOBS
Z	MEAN U	S.D. U	R(U,V)						
KM	M/S	M/S		M/S	M/S	M/S	M/S		
.003	.95	2.88	-.2441	-.64	3.76	4.21	2.45	.58	796.
1.000	3.89	7.10	.0019	1.31	6.92	9.24	5.45	.92	797.
2.000	8.25	7.61	.0703	1.58	6.69	11.32	6.72	.88	797.
3.000	12.24	7.98	.0992	1.80	7.12	14.43	7.69	.68	796.
4.000	15.88	8.77	.1049	2.34	7.68	17.82	8.71	.55	789.
5.000	19.75	9.85	.1214	3.00	8.99	21.68	9.98	.52	788.
6.000	23.62	10.89	.1674	3.61	9.32	25.58	11.04	.40	789.
7.000	27.33	12.01	.2255	4.23	10.15	29.43	12.08	.29	787.
8.000	31.10	13.27	.2382	4.56	11.33	33.41	13.26	.23	780.
9.000	34.85	14.57	.2235	4.74	12.50	37.36	14.42	.10	774.
10.000	38.72	15.66	.2339	4.67	13.52	41.35	15.45	-.02	765.
11.000	41.70	16.01	.2396	4.25	14.03	44.28	15.78	-.06	741.
12.000	44.48	15.41	.2197	4.46	14.02	46.85	15.40	.03	738.
13.000	44.20	14.10	.2531	4.46	13.03	46.28	14.12	.13	726.
14.000	40.97	13.01	.2632	4.00	11.09	42.68	12.84	.23	710.
15.000	36.52	11.15	.2558	3.53	9.08	37.82	11.05	.12	707.
16.000	31.36	9.84	.2305	3.13	7.95	32.52	9.76	.14	702.
17.000	25.66	8.80	.2221	2.41	6.84	26.70	8.70	.21	690.
18.000	19.71	8.35	.2387	1.68	5.69	20.65	8.19	.31	687.
19.000	13.57	7.52	.2877	1.28	4.46	14.47	7.26	.63	684.
20.000	9.00	6.84	.3468	.68	3.43	10.17	6.06	.91	682.
21.000	6.17	7.07	.3594	-.05	3.29	8.18	5.65	1.37	670.
22.000	4.78	8.04	.3615	-.42	3.60	8.17	5.81	1.39	663.
23.000	4.07	7.62	.3222	-.46	3.18	7.51	5.34	1.22	659.
24.000	3.72	8.71	.3311	-.31	3.39	8.19	5.84	1.31	648.
25.000	3.70	9.51	.2351	.06	3.44	8.80	6.20	1.30	638.
26.000	4.20	9.49	.2374	.44	3.42	9.04	6.14	1.12	616.
27.000	5.16	9.85	.2466	.78	3.48	9.65	6.56	1.09	563.
28.000	6.15	10.22	.1955	1.30	3.81	10.51	6.92	.96	533.
29.000	8.25	10.82	.2804	1.86	4.16	12.29	7.41	.84	372.
30.000	10.50	11.23	.3000	2.48	4.31	14.01	8.02	.68	361.
32.000	15.09	13.11	.4269	2.73	6.68	17.89	11.43	.51	111.
34.000	16.58	14.64	.3381	1.22	5.99	19.30	12.38	.73	112.
36.000	14.53	15.36	.2646	-.75	6.57	18.95	11.42	.53	116.
38.000	12.09	16.60	.2769	.01	7.22	19.08	10.40	.34	117.
40.000	10.20	18.41	.0337	1.04	7.87	19.56	11.00	1.07	118.
42.000	9.38	19.01	.0105	3.46	8.18	19.68	11.75	.62	120.
44.000	10.98	19.16	.0869	6.39	9.58	21.28	12.84	.73	120.
46.000	12.92	21.02	.1373	7.43	10.87	24.07	14.14	.73	120.
48.000	15.67	22.74	.1909	8.18	11.41	27.29	14.54	.66	120.
50.000	18.89	22.86	.1345	8.67	12.80	29.59	15.45	.61	118.
52.000	22.59	23.26	.1939	8.81	12.55	32.29	15.48	.45	117.
54.000	27.28	22.08	.2773	8.57	13.34	34.96	16.05	.29	115.
56.000	34.85	21.34	.2476	12.28	14.50	41.65	17.13	.15	110.
58.000	41.01	20.84	.3470	14.98	13.60	47.00	17.69	-.14	95.
60.000	46.86	20.79	.2436	15.12	13.99	51.89	18.87	-.33	82.
62.000	50.67	22.98	.3723	11.54	14.38	54.32	21.91	-.45	53.
64.000	55.74	18.40	.1697	6.51	15.74	58.43	17.76	-.47	44.
66.000	57.25	19.22	.1879	-.45	17.40	59.87	18.88	-.12	39.
68.000	56.07	17.87	.2619	-8.14	13.65	58.57	16.67	.73	30.
70.000	49.27	20.28	.2182	-10.89	17.35	53.93	18.35	-.04	27.

TABLE I-3. WIND STATISTICAL PARAMETERS

MARCH

STATION = 747940		CAPE CANAVERAL		MEAN V	S.D. V	MEAN WS	S.D. WS	SKEN WS	NOBS
Z	MEAN U	S.D. U	R(U,V)						
KM	M/S	M/S		M/S	M/S	M/S	M/S		
.003	.28	2.98	-.2163	-.21	3.57	4.00	2.40	.94	866.
1.000	2.64	6.85	.0037	1.66	6.38	8.66	4.72	.80	870.
2.000	6.65	7.38	.0380	1.24	6.01	9.93	6.13	.83	872.
3.000	10.34	8.14	.0776	1.00	6.46	12.75	7.29	.83	872.
4.000	14.04	9.08	.0922	.75	6.84	15.96	8.48	.72	871.
5.000	17.80	10.09	.1597	.66	7.27	19.50	9.57	.73	870.
6.000	21.31	10.93	.1961	.72	7.85	22.96	10.41	.66	869.
7.000	24.88	11.75	.1988	.98	8.88	26.63	11.31	.50	866.
8.000	28.38	12.82	.1720	1.12	10.00	30.31	12.32	.47	856.
9.000	31.76	13.50	.1718	.92	11.41	33.95	13.01	.27	848.
10.000	35.62	14.54	.1723	.74	12.90	38.05	14.10	.25	842.
11.000	38.88	14.77	.1724	.32	14.05	41.49	14.35	.17	829.
12.000	41.71	14.24	.2047	.14	14.04	44.09	13.95	.18	828.
13.000	41.88	12.63	.2369	.48	12.14	43.67	12.41	.21	814.
14.000	39.07	11.09	.2390	.74	10.04	40.41	10.86	.23	807.
15.000	35.15	9.84	.2243	1.08	8.62	36.25	9.67	.24	798.
16.000	29.77	8.38	.1639	.97	7.37	30.74	8.17	.07	790.
17.000	23.61	7.27	.1569	.75	6.29	24.49	7.11	.07	773.
18.000	17.12	6.88	.1918	.50	5.23	17.97	6.71	.41	766.
19.000	11.18	5.93	.2041	.12	4.00	12.02	5.62	.73	765.
20.000	6.95	5.12	.2489	-.32	3.16	7.99	4.54	.89	760.
21.000	3.89	5.31	.2221	-.72	2.78	6.03	3.90	1.18	744.
22.000	1.93	5.77	.1113	-1.11	3.09	5.78	3.78	1.64	742.
23.000	.99	5.54	.0522	-.90	3.03	5.50	3.37	1.39	724.
24.000	.32	6.49	.0553	-.60	3.50	6.33	3.84	1.39	715.
25.000	.59	7.14	.0708	-.44	3.25	6.50	4.45	1.75	702.
26.000	1.26	7.57	.0675	-.04	3.23	6.86	4.71	1.83	683.
27.000	2.44	8.11	.1405	.35	3.39	7.51	5.19	1.54	624.
28.000	3.76	8.93	.1928	.92	3.52	8.47	5.94	1.40	610.
29.000	6.24	9.48	.2422	1.31	3.75	10.06	6.58	1.10	438.
30.000	8.24	10.24	.3232	1.70	4.00	11.76	7.30	.89	426.
32.000	14.72	10.32	.3831	2.63	4.67	17.08	7.72	-.07	136.
34.000	17.21	12.87	.2496	.80	5.86	19.93	9.95	-.12	135.
36.000	15.16	13.72	.1118	-.81	5.65	18.41	10.54	.27	135.
38.000	13.76	14.24	.2286	.19	6.14	17.66	10.82	.55	134.
40.000	14.35	16.24	.3232	2.53	6.75	19.43	11.96	.64	135.
42.000	15.31	18.19	.3171	4.21	7.75	21.89	12.73	.72	136.
44.000	16.92	19.45	.1444	4.42	7.94	24.13	12.76	.59	141.
46.000	18.60	20.24	.0734	6.31	8.74	26.76	12.40	.60	140.
48.000	20.75	20.09	.0975	7.86	7.81	27.91	13.27	.30	140.
50.000	24.21	20.95	.1093	8.31	8.02	31.01	13.96	.21	140.
52.000	27.09	21.27	-.0191	7.90	9.58	33.74	14.12	.15	134.
54.000	27.57	20.28	-.1321	5.53	11.47	34.67	13.76	.16	135.
56.000	29.09	20.35	.0237	10.74	10.16	35.50	14.71	.50	124.
58.000	30.60	21.01	.2356	11.67	10.41	36.85	16.17	.16	110.
60.000	34.30	21.79	.3368	12.47	13.05	41.39	16.11	-.03	90.
62.000	35.34	21.60	.2794	10.01	13.73	41.72	16.06	-.15	67.
64.000	33.95	23.65	.3191	7.54	13.40	40.16	18.09	.00	50.
66.000	27.67	23.71	.3133	1.26	13.04	34.63	17.03	.23	43.
68.000	19.54	27.68	.2353	-3.19	16.50	34.44	14.88	.12	36.
70.000	13.93	27.79	.3527	-6.64	17.13	31.12	17.69	.66	33.

TABLE I-4. WIND STATISTICAL PARAMETERS

APRIL

STATION = 747940		CAPE CANAVERAL		MEAN V	S.D. V	MEAN WS	S.D. WS	SKCH WS	NOBS
Z	MEAN U	S.D. U	R(U,V)						
K1	M/S	M/S		M/S	M/S	M/S	M/S		
.003	-.62	3.09	-.1605	.17	3.15	3.88	2.21	.49	870.
1.000	.53	6.26	-.0341	1.19	5.26	7.29	3.93	1.04	861.
2.000	2.92	7.16	.1468	.34	4.95	7.87	4.73	1.21	860.
3.000	5.60	7.93	.1295	-.46	5.56	9.49	5.94	1.05	859.
4.000	8.27	8.56	.1526	-1.12	5.91	11.34	7.02	.98	858.
5.000	10.83	9.32	.1993	-1.52	6.30	13.47	8.04	.87	856.
6.000	13.56	10.17	.2198	-1.84	6.86	16.03	8.98	.70	859.
7.000	16.30	11.12	.2702	-2.08	7.61	18.81	9.87	.61	858.
8.000	19.04	12.05	.2824	-2.28	8.55	21.66	10.81	.53	853.
9.000	21.89	13.31	.3120	-2.67	9.76	24.76	12.03	.52	853.
10.000	24.93	14.55	.3263	-3.32	11.27	28.20	13.26	.48	848.
11.000	27.86	15.28	.3295	-4.04	12.77	31.50	14.03	.30	841.
12.000	30.98	15.58	.3305	-4.60	13.63	34.67	14.39	.17	839.
13.000	32.72	14.47	.3509	-4.28	13.34	36.00	13.42	.03	834.
14.000	31.24	12.88	.3481	-3.70	11.60	33.83	12.06	.20	830.
15.000	27.78	10.70	.3582	-2.87	9.32	29.69	9.98	.19	830.
16.000	22.98	9.14	.3685	-2.51	7.79	24.64	8.44	.30	821.
17.000	17.50	8.03	.3381	-2.25	6.47	19.10	7.26	.43	824.
18.000	11.51	7.05	.2694	-1.90	5.18	13.26	6.07	.74	799.
19.000	5.82	5.69	.3014	-1.56	3.96	8.02	4.47	1.18	793.
20.000	2.18	5.05	.2688	-1.36	3.09	5.56	3.27	1.48	783.
21.000	-.17	4.78	.1502	-1.26	2.65	4.81	2.89	1.25	773.
22.000	-1.62	4.42	.0710	-1.17	2.65	4.86	2.62	1.03	765.
23.000	-2.22	4.23	.1191	-.86	2.40	4.76	2.57	.89	751.
24.000	-2.60	5.03	.1574	-.49	2.75	5.51	3.08	1.01	744.
25.000	-2.33	5.63	.2092	-.30	2.81	5.85	3.31	.97	737.
26.000	-1.47	6.07	.2308	.00	2.83	5.90	3.49	.95	701.
27.000	-.41	6.76	.1933	.37	3.09	6.39	3.82	.89	638.
28.000	.93	7.40	.1792	.63	3.02	6.94	4.11	.91	606.
29.000	2.48	8.11	.1357	.64	3.23	7.91	4.47	.83	461.
30.000	3.66	8.49	.1133	.69	3.34	8.48	5.00	.52	448.
32.000	6.99	9.77	.1770	.82	4.57	11.29	6.14	.64	122.
34.000	8.25	11.58	.1030	-.44	5.07	13.25	7.18	.62	123.
36.000	7.44	12.16	-.0395	-1.33	5.35	13.13	7.75	.52	123.
38.000	6.60	11.30	-.0402	-1.61	6.47	12.70	7.31	.38	123.
40.000	5.79	11.21	.0782	.42	6.28	12.07	7.22	.59	125.
42.000	5.31	10.77	.0872	.82	6.41	11.68	6.99	.66	127.
44.000	4.40	11.77	.1687	1.19	6.16	11.91	7.37	.91	128.
46.000	3.93	12.95	.0529	3.10	6.33	13.35	7.56	1.06	128.
48.000	3.41	14.19	.0089	3.86	7.02	14.19	8.64	1.23	128.
50.000	4.60	14.68	.0767	4.15	6.61	14.74	8.87	.83	128.
52.000	4.07	15.48	.0064	4.04	7.59	15.40	9.55	1.03	126.
54.000	2.80	15.34	.0034	4.35	7.03	15.14	8.97	.93	121.
56.000	1.77	14.04	.1471	5.13	7.99	14.91	8.15	1.07	118.
58.000	1.55	14.09	.1572	5.59	8.29	15.16	8.32	.51	105.
60.000	1.92	16.93	.1914	5.65	9.30	17.54	9.91	.40	91.
62.000	2.94	16.60	-.0659	8.12	8.98	18.41	9.38	.55	66.
64.000	5.93	16.96	-.0045	7.54	9.89	19.21	10.14	.29	52.
66.000	.76	15.82	-.0282	-.34	11.30	17.09	8.93	.50	44.
68.000	-6.67	16.71	.2001	-6.76	10.50	19.37	9.79	.24	35.
70.000	-12.37	16.38	-.0647	-8.04	13.06	22.52	11.85	.52	33.

TABLE I-5. WIND STATISTICAL PARAMETERS

MAY

STATION = 747940		CAPE CANAVERAL		MEAN V	S.D. V	MEAN WS	S.D. WS	SKEW WS	NOBS
Z	MEAN U	S.D. U	R(U,V)						
KM	M/S	M/S		M/S	M/S	M/S	M/S		
.003	-.91	2.83	-.0352	.30	2.59	3.37	2.08	.60	824.
1.000	-.13	4.99	.1511	1.10	4.48	5.90	3.37	1.06	823.
2.000	.66	5.71	.3425	.33	4.60	6.34	3.74	1.18	822.
3.000	2.14	5.96	.2949	.18	4.68	6.64	4.24	1.30	821.
4.000	3.61	6.43	.2242	-.18	5.13	7.53	4.69	1.25	820.
5.000	5.03	6.82	.2102	-.66	5.55	8.55	5.46	1.10	816.
6.000	6.56	7.12	.2056	-.97	6.12	9.81	5.99	1.02	814.
7.000	8.13	7.80	.2098	-1.04	6.92	11.40	6.78	.90	812.
8.000	9.66	8.79	.1895	-1.05	7.94	13.22	7.73	.83	809.
9.000	11.30	9.73	.1817	-1.13	9.27	15.35	8.60	.69	809.
10.000	13.33	10.83	.2046	-1.30	10.67	17.83	9.62	.60	806.
11.000	15.71	12.03	.2403	-1.81	12.29	20.74	10.75	.50	806.
12.000	18.27	13.01	.2759	-2.50	13.17	23.42	11.59	.43	806.
13.000	20.33	13.21	.3108	-3.27	13.22	25.16	11.85	.44	802.
14.000	19.76	11.77	.3394	-3.65	11.28	23.70	10.38	.37	801.
15.000	16.82	9.60	.3649	-3.43	8.96	19.95	8.31	.29	799.
16.000	12.70	7.88	.3389	-3.21	7.01	15.51	6.51	.48	795.
17.000	8.07	6.45	.2848	-2.97	5.51	10.99	4.99	.52	786.
18.000	3.52	5.50	.2087	-2.53	4.49	7.34	3.90	.81	780.
19.000	-.18	4.43	.2104	-1.96	3.31	5.15	2.82	.70	774.
20.000	-2.94	3.92	.0956	-1.30	2.53	5.02	2.62	.54	768.
21.000	-4.90	3.76	-.0406	-.50	2.56	6.02	2.96	.43	755.
22.000	-5.99	3.72	-.0836	-.04	2.26	6.66	3.23	.37	753.
23.000	-6.44	3.63	-.0459	.19	2.08	6.94	3.28	.36	743.
24.000	-6.70	3.96	.0327	.42	2.61	7.43	3.51	.37	736.
25.000	-6.57	4.51	.1146	.22	2.42	7.42	3.80	.55	717.
26.000	-6.50	4.98	.1043	.01	2.25	7.42	4.13	.62	682.
27.000	-6.28	5.56	.0175	-.12	2.73	7.69	4.32	.69	601.
28.000	-6.14	6.00	.0265	-.22	2.65	7.75	4.55	.81	579.
29.000	-6.01	6.68	.0717	-.39	3.14	8.22	4.81	.99	453.
30.000	-5.73	6.98	.0952	-.10	3.05	8.22	4.81	.95	450.
32.000	-4.24	6.98	-.0790	1.02	3.42	7.45	4.85	.91	111.
34.000	-2.15	7.67	.0656	.83	3.81	7.55	4.61	.93	111.
36.000	-3.61	8.24	.0384	-.74	3.26	8.39	4.63	.36	111.
38.000	-6.75	8.34	-.2143	-.94	4.70	10.23	5.70	.47	111.
40.000	-8.80	7.52	-.2882	.05	4.69	11.19	5.50	.33	110.
42.000	-12.32	7.41	-.0327	-.02	4.72	13.79	6.19	.21	109.
44.000	-16.33	7.50	.1402	1.26	5.69	17.61	6.81	-.09	111.
46.000	-19.48	8.12	.0621	2.76	5.06	20.39	7.91	.01	111.
48.000	-20.76	8.97	.1379	2.78	5.95	21.90	8.64	.67	110.
50.000	-23.00	9.93	-.0409	4.31	5.97	24.39	9.31	.65	109.
52.000	-24.91	9.60	-.1081	5.55	6.99	26.54	9.36	.31	104.
54.000	-25.55	10.60	-.0458	6.71	6.88	27.50	10.04	-.10	103.
56.000	-25.12	9.95	.0681	5.42	7.85	27.14	9.15	-.18	94.
58.000	-26.27	10.36	.0933	5.60	9.78	28.91	9.36	.24	85.
60.000	-29.74	10.85	.0154	4.31	7.69	31.17	10.37	.21	66.
62.000	-29.48	12.62	-.0630	1.57	10.97	31.80	11.67	-.02	41.
64.000	-28.03	13.14	.0226	1.91	12.93	32.49	11.17	-.17	35.
66.000	-31.63	16.84	.1811	.94	11.74	34.16	15.81	.26	31.
68.000	-32.61	17.76	.1501	-2.31	11.55	34.45	18.07	.68	29.
70.000	-36.48	16.86	.2281	-10.38	13.09	40.04	16.84	-.13	24.

TABLE I-6. WIND STATISTICAL PARAMETERS

JUNE

STATION = 747940		CAPE CANAVERAL		MEAN V	S.D. V	MEAN WS	S.D. WS	SKEW WS	NOOS
Z	MEAN U	S.D. U	R(U,V)						
KM	M/S	M/S		M/S	M/S	M/S	M/S		
.003	-.57	2.64	.0950	.70	2.33	2.94	2.13	.79	776.
1.000	.69	4.95	.1351	1.73	3.75	5.44	3.56	1.75	776.
2.000	1.31	5.09	.1968	1.43	3.80	5.55	3.65	1.91	776.
3.000	1.90	4.97	.1332	1.36	3.81	7.62	3.61	1.66	774.
4.000	2.25	5.04	.0781	1.11	3.84	5.77	3.62	1.35	762.
5.000	2.60	5.22	.0785	.78	4.03	6.12	3.68	1.17	761.
6.000	2.88	5.51	.1567	.45	4.41	6.53	3.95	1.20	760.
7.000	3.24	5.90	.2169	.21	4.83	7.09	4.29	1.22	751.
8.000	3.79	6.65	.2456	.25	5.71	8.12	5.03	1.23	746.
9.000	4.49	7.83	.2685	.29	6.77	9.54	6.02	1.15	745.
10.000	5.26	9.21	.3170	.21	8.07	11.25	7.14	1.17	740.
11.000	5.98	10.66	.3537	-.13	9.56	13.07	8.37	1.13	738.
12.000	6.89	11.87	.3567	-1.16	10.66	14.77	9.23	1.03	736.
13.000	7.49	12.68	.3413	-2.42	10.99	15.69	9.86	1.02	734.
14.000	6.82	11.81	.3336	-3.50	9.55	14.44	9.00	.92	731.
15.000	4.42	9.89	.2934	-4.03	7.16	11.83	7.03	.84	727.
16.000	1.97	7.38	.2336	-3.83	5.06	8.61	4.94	.80	723.
17.000	-1.26	5.34	.1884	-3.16	3.73	6.52	3.38	.74	715.
18.000	-4.36	4.07	.1760	-2.33	3.04	6.36	3.19	.74	709.
19.000	-7.02	3.58	.1364	-1.72	2.56	7.79	3.31	.20	707.
20.000	-9.46	3.49	.0663	-.86	2.49	9.86	3.38	.14	697.
21.000	-11.20	3.48	.0380	.35	2.45	11.49	3.41	.25	687.
22.000	-11.69	3.36	.0490	.93	2.10	11.94	3.29	.00	684.
23.000	-11.97	3.29	-.0012	.76	1.94	12.16	3.25	.05	675.
24.000	-12.24	3.70	-.0284	.24	2.32	12.48	3.63	.08	669.
25.000	-12.74	3.88	-.0613	-.26	2.27	12.96	3.81	-.06	656.
26.000	-13.40	4.06	-.0191	-.56	2.21	13.62	4.00	-.11	636.
27.000	-14.17	4.56	.0163	-.80	2.76	14.49	4.45	.03	572.
28.000	-14.60	4.65	.0859	-.65	2.46	14.84	4.56	-.18	552.
29.000	-14.84	5.39	.0515	-.54	3.05	15.23	5.20	-.10	428.
30.000	-15.23	5.27	.0666	-.27	2.55	15.49	5.14	-.17	417.
32.000	-16.99	5.71	-.1207	1.28	3.75	17.48	5.58	-.33	122.
34.000	-17.31	6.19	-.0936	.36	3.69	17.80	5.91	-.54	123.
36.000	-20.38	5.88	-.2265	-.56	4.03	20.89	5.50	-.19	124.
38.000	-24.57	5.88	-.1106	-.33	4.69	25.02	5.85	-.29	125.
40.000	-28.33	6.06	.0781	-.68	4.74	28.74	5.97	-.12	125.
42.000	-32.79	7.53	.1034	-1.29	5.00	33.22	7.42	-.06	129.
44.000	-37.36	8.15	.0227	-.16	5.40	37.74	8.20	-.14	129.
46.000	-39.91	7.48	-.0463	3.75	5.30	40.43	7.48	.04	130.
48.000	-41.72	8.17	.0838	6.49	6.67	42.81	7.83	.01	130.
50.000	-41.58	9.57	-.0483	7.28	7.18	42.88	9.28	-.22	131.
52.000	-43.74	8.79	-.0437	6.54	7.47	44.82	8.93	-.29	130.
54.000	-45.98	9.47	-.0283	4.87	8.25	46.96	9.49	.12	128.
56.000	-49.04	12.03	-.0740	3.69	9.78	50.19	11.79	-.25	125.
58.000	-50.87	13.43	-.0851	2.97	10.61	52.11	13.17	.05	118.
60.000	-52.99	11.92	-.1573	1.52	10.50	54.09	11.62	-.02	95.
62.000	-58.06	13.77	-.2151	.83	13.90	59.79	13.32	.00	70.
64.000	-60.04	15.11	.2111	1.12	15.83	62.29	14.14	.24	58.
66.000	-53.88	20.09	.2191	1.43	15.30	56.28	19.23	.17	43.
68.000	-55.11	20.79	-.0399	2.93	17.57	57.90	20.59	.44	30.
70.000	-51.16	19.22	.1920	6.46	18.05	54.68	18.72	.79	25.

TABLE I-7. WIND STATISTICAL PARAMETERS

JULY

STATION = 747940		CAPE CANAVERAL								
Z	MEAN U	S.D. U	R(U,V)	MEAN V	S.D. V	MEAN WS	S.D. WS	SKEW WS	NOBS	
KM	M/S	M/S		M/S	M/S	M/S	M/S			
.003	-.34	2.30	-.0423	1.21	1.09	2.69	1.80	.40	794.	
1.000	1.21	4.23	-.0443	2.48	3.16	5.23	2.84	.87	792.	
2.000	1.28	4.50	.0794	2.01	3.25	5.24	3.01	1.08	792.	
3.000	1.41	4.65	.0706	1.61	3.30	5.23	3.12	1.03	784.	
4.000	1.40	4.58	.0820	1.29	3.43	5.18	3.09	.88	779.	
5.000	1.30	4.46	.0145	.94	3.56	5.15	2.92	.94	777.	
6.000	.90	4.40	.0477	.72	3.67	5.11	2.83	.89	778.	
7.000	.40	4.56	.0904	.23	3.94	5.26	2.97	.93	777.	
8.000	-.16	5.12	.1833	-.30	4.38	5.81	3.42	1.19	777.	
9.000	-.86	5.89	.2678	-.87	5.03	6.66	4.09	1.22	774.	
10.000	-1.60	6.74	.3201	-1.52	5.64	7.72	4.73	1.15	767.	
11.000	-2.34	7.92	.3275	-2.22	6.36	9.22	5.35	1.05	764.	
12.000	-3.01	8.66	.3220	-3.19	6.85	10.37	5.78	.87	758.	
13.000	-3.75	9.11	.2685	-4.17	7.26	11.33	6.21	.81	754.	
14.000	-4.37	8.13	.2420	-4.65	6.72	10.80	5.95	.75	750.	
15.000	-4.75	6.38	.2751	-4.02	5.33	9.16	4.89	.72	750.	
16.000	-5.17	4.59	.3230	-2.04	3.88	7.51	3.81	.64	746.	
17.000	-6.14	3.43	.2961	-1.91	2.92	7.16	3.23	.20	738.	
18.000	-8.13	3.02	.1343	-1.67	2.66	8.74	2.95	-.04	739.	
19.000	-11.06	2.60	.1049	-1.23	2.39	11.38	2.60	.07	732.	
20.000	-13.74	2.86	.2043	-.22	2.40	13.96	2.81	-.01	721.	
21.000	-15.57	3.32	.115	.88	2.44	15.79	3.28	.18	703.	
22.000	-16.21	3.08	-.0187	1.30	2.12	16.40	3.05	.39	692.	
23.000	-16.84	2.90	-.1188	1.05	1.98	16.99	2.89	.31	673.	
24.000	-17.53	3.04	-.1369	.38	2.22	17.68	3.03	-.04	674.	
25.000	-18.20	3.12	-.0471	-.25	2.20	18.33	3.11	-.06	663.	
26.000	-18.84	3.50	.0090	-.66	2.27	18.99	3.49	.01	628.	
27.000	-19.63	4.13	-.0286	-.90	3.01	19.88	4.11	.02	581.	
28.000	-20.79	4.00	-.0951	-.92	2.59	20.98	3.97	.05	544.	
29.000	-21.89	4.79	-.0568	-.93	3.30	22.17	4.75	.33	433.	
30.000	-22.95	4.29	-.0096	-.42	2.66	23.12	4.27	.12	406.	
32.000	-26.25	4.77	-.0798	1.64	3.62	26.54	4.83	-.33	112.	
34.000	-27.01	5.07	-.1080	.63	3.41	27.23	5.06	-.10	112.	
36.000	-29.19	4.54	-.1421	.11	3.79	29.44	4.49	-.58	112.	
38.000	-32.36	5.49	.0578	.16	4.69	32.70	5.46	-.16	113.	
40.000	-35.86	5.29	-.0015	.02	5.03	36.22	5.23	-.17	114.	
42.000	-40.25	6.21	-.1655	-1.94	5.71	40.72	6.06	-.13	117.	
44.000	-46.74	6.07	-.0448	-.10	6.91	47.25	6.01	-.17	118.	
46.000	-49.20	7.90	.2535	3.49	7.60	49.97	7.45	-.45	117.	
48.000	-50.90	8.74	.2355	4.55	6.63	51.54	8.65	.19	117.	
50.000	-51.89	8.76	-.0387	5.17	7.25	52.66	8.70	-.16	116.	
52.000	-53.94	9.09	-.0807	5.74	7.95	54.74	8.98	-.22	115.	
54.000	-53.81	10.32	.0069	5.93	10.82	55.21	10.24	-.19	114.	
56.000	-52.11	12.03	.1768	5.55	11.13	53.68	11.52	-.52	105.	
58.000	-49.28	14.87	.0297	4.01	12.32	51.02	14.57	-.52	93.	
60.000	-45.41	16.66	.1015	4.52	13.28	48.01	15.09	-.05	71.	
62.000	-44.14	25.35	.2682	4.18	17.21	48.93	22.37	.15	42.	
64.000	-38.84	30.84	.1992	6.93	17.95	46.14	26.07	.10	28.	
66.000	-34.14	29.55	.2306	6.50	19.14	42.70	24.49	.65	27.	
68.000	-32.89	28.18	-.0928	11.59	22.23	44.36	22.37	.12	22.	
70.000	-21.50	24.35	-.2041	-.97	20.04	33.05	18.22	.31	20.	

TABLE I-8. WIND STATISTICAL PARAMETERS

AUGUST

STATION = 747940		CAPE CANAVERAL		MEAN V	S.D. V	MEAN WS	S.D. WS	SKEW WS	NOBS
Z	MEAN U	S.D. U	R(U,V)						
KM	M/S	M/S		M/S	K/S	M/S	M/S		
.003	-.62	2.10	.0723	.51	1.95	2.40	1.79	.58	779.
1.000	-.02	4.13	.1315	2.18	3.21	4.94	2.76	1.07	775.
2.000	.08	4.29	.2260	1.88	3.40	5.05	2.83	1.05	775.
3.000	.40	4.35	.2185	1.71	3.55	5.07	2.98	1.00	767.
4.000	.76	4.34	.2133	1.60	3.77	5.22	2.99	.94	760.
5.000	.83	4.43	.1947	1.39	3.94	5.31	3.10	1.08	756.
6.000	.42	4.51	.2364	1.16	4.10	5.38	3.11	1.24	756.
7.000	.08	4.66	.2508	.77	4.26	5.53	3.14	1.32	755.
8.000	-.31	5.01	.2665	.36	4.65	5.94	3.42	1.31	755.
9.000	-.83	5.57	.2895	-.13	5.21	6.56	3.94	1.19	753.
10.000	-1.26	6.45	.3280	-.64	6.12	7.70	4.65	1.08	749.
11.000	-1.79	7.65	.3382	-1.19	7.08	9.15	5.43	1.16	748.
12.000	-2.28	8.37	.3230	-1.96	7.81	10.28	5.85	1.02	746.
13.000	-2.56	8.64	.3120	-2.74	7.91	10.79	5.90	.87	734.
14.000	-2.77	7.68	.3421	-2.97	6.66	9.58	5.30	.76	730.
15.000	-3.20	5.91	.3129	-2.37	4.93	7.54	4.26	.89	728.
16.000	-4.20	4.17	.3144	-1.65	3.57	6.28	3.31	.80	722.
17.000	-5.66	3.16	.2543	-1.13	2.69	6.55	2.76	.38	717.
18.000	-7.79	3.16	.0935	-1.34	2.48	8.35	2.98	-.06	717.
19.000	-10.99	2.71	.0408	-.98	2.32	11.29	2.64	.18	701.
20.000	-13.61	2.89	.2387	-.11	2.43	13.04	2.84	.05	691.
21.000	-15.34	3.24	.1833	.76	2.39	15.55	3.20	-.01	676.
22.000	-16.13	3.12	.0052	1.13	1.80	16.27	3.11	.10	669.
23.000	-16.71	2.88	-.0884	.94	1.80	16.83	2.69	.01	660.
24.000	-17.34	2.93	-.0693	.38	2.17	17.48	2.91	-.07	655.
25.000	-18.02	2.98	-.0100	-.09	2.14	18.15	2.96	.03	647.
26.000	-18.70	3.23	.0059	-.54	2.05	18.82	3.20	-.07	608.
27.000	-19.50	3.69	.0001	-1.04	2.78	19.72	3.69	.05	548.
28.000	-20.55	3.42	-.0883	-1.14	2.42	20.73	3.29	.05	526.
29.000	-21.53	4.17	-.0616	-1.27	3.36	21.84	4.10	-.07	401.
30.000	-22.39	3.88	-.0205	-.59	2.68	22.57	3.84	.13	363.
32.000	-25.51	4.88	-.3500	1.75	3.13	25.76	4.88	-.03	101.
34.000	-25.64	4.97	-.0294	.88	3.61	25.90	4.96	-.08	101.
36.000	-26.65	5.83	-.1474	.28	4.43	27.04	5.70	-.29	101.
38.000	-28.04	6.28	-.1343	.32	4.83	28.48	6.17	.14	101.
40.000	-30.03	7.88	.0309	.13	4.65	30.44	7.77	-.17	104.
42.000	-33.37	8.63	-.2393	-1.01	5.44	33.87	8.44	-.17	105.
44.000	-37.86	8.45	-.2397	-.81	6.28	38.41	8.31	-.07	107.
46.000	-40.27	9.28	-.1644	2.24	7.74	41.07	9.22	-.12	107.
48.000	-40.35	11.76	-.0100	5.44	8.63	41.75	11.27	-.39	106.
50.000	-38.24	14.44	-.0461	6.73	8.90	40.07	13.74	-.11	105.
52.000	-34.78	14.95	-.1436	6.66	10.09	37.20	13.92	.45	104.
54.000	-30.10	15.69	.0302	4.72	10.44	32.84	14.27	.43	104.
56.000	-25.23	18.81	.0970	2.48	11.72	29.63	15.92	.52	100.
58.000	-23.97	20.40	-.1566	4.95	13.48	29.58	17.85	.66	86.
60.000	-16.93	17.33	-.1461	4.60	13.67	23.49	15.47	.83	67.
62.000	-0.47	17.59	-.0316	.87	14.86	21.60	11.31	.96	47.
64.000	-9.36	19.46	-.0067	-2.32	15.31	23.28	12.34	.89	39.
66.000	-7.70	16.32	-.1599	-3.97	15.51	20.23	12.77	.35	35.
68.000	-12.68	16.07	-.3039	-3.73	15.62	22.21	13.04	.17	24.
70.000	-9.22	21.33	-.2599	-5.15	17.93	24.95	15.48	.18	21.

TABLE I-9. WIND STATISTICAL PARAMETERS

SEPTEMBER

STATION #	CAPE CANAVERAL		I		S.D. V		S.D. WS		SKEW WS	NOBS
Z	MEAN U	S.D. U	R(U,V)	MEAN V	S.D. V	MEAN WS	S.D. WS	SKEW WS		
KM	M/S	M/S		M/S	M/S	M/S	M/S			
.003	-1.24	2.70	.1629	-.23	2.70	3.17	2.47	1.10	745.	
1.000	-1.78	5.24	.3285	.76	4.85	6.03	4.06	1.94	745.	
2.000	-.84	5.55	.3607	.91	4.49	5.96	4.11	2.03	744.	
3.000	.00	5.60	.3124	.92	4.39	5.92	4.05	1.90	739.	
4.000	.65	5.78	.2809	.63	4.45	6.03	4.19	1.74	736.	
5.000	.90	5.91	.2931	.29	4.64	6.34	4.13	1.63	736.	
6.000	1.03	6.19	.3066	-.03	4.96	6.84	4.15	1.74	735.	
7.000	1.22	6.53	.3376	-.23	5.41	7.34	4.42	1.56	732.	
8.000	1.55	7.03	.3774	-.56	6.00	8.01	4.88	1.36	725.	
9.000	2.09	7.74	.3745	-.78	6.70	9.06	5.36	1.09	721.	
10.000	2.74	8.79	.3500	-1.01	7.58	10.41	5.90	.87	710.	
11.000	3.36	10.06	.3151	-1.49	8.77	12.17	6.59	.73	717.	
12.000	4.20	10.65	.2776	-2.24	9.59	13.28	7.06	.60	718.	
13.000	4.45	10.86	.2580	-2.97	9.92	13.88	7.23	.60	714.	
14.000	3.65	10.05	.2580	-3.54	9.01	12.78	6.60	.52	714.	
15.000	1.94	8.26	.2758	-3.24	6.89	10.11	5.27	.57	704.	
16.000	-.18	6.49	.2513	-2.65	4.89	7.51	4.09	.82	702.	
17.000	-2.20	5.08	.2388	-1.74	3.37	5.86	3.27	.96	690.	
18.000	-3.86	4.27	.2466	-.75	2.89	5.71	3.05	.63	690.	
19.000	-5.93	3.66	.2591	-.71	2.40	6.69	3.17	.15	684.	
20.000	-8.33	3.64	.1501	-.51	2.22	8.73	3.40	.06	681.	
21.000	-9.95	3.61	.0852	.30	2.30	10.27	3.47	.18	665.	
22.000	-10.79	3.32	-.0059	.44	1.98	11.00	3.25	.25	663.	
23.000	-11.41	3.20	.0060	.28	1.95	11.60	3.14	-.03	641.	
24.000	-11.99	3.54	.0187	.04	2.36	12.25	3.43	-.16	637.	
25.000	-12.35	3.56	.0615	-.12	2.21	12.56	3.51	-.10	622.	
26.000	-12.64	3.83	.1262	-.33	2.21	12.85	3.79	-.08	592.	
27.000	-12.82	.64	.0801	-.58	2.32	13.21	4.50	.19	545.	
28.000	-13.08	4.72	.1046	-.68	2.46	13.35	4.65	.15	533.	
29.000	-13.52	5.26	.0791	-.88	3.12	13.95	5.15	-.12	422.	
30.000	-13.68	5.55	.1067	-.52	2.55	13.98	5.42	-.15	415.	
32.000	-14.59	6.75	.0961	1.60	3.70	15.40	6.10	-.09	90.	
34.000	-11.96	7.79	-.0646	1.04	3.46	13.05	6.81	.37	90.	
36.000	-10.10	8.46	-.2216	-.20	4.02	11.98	6.77	.59	91.	
38.000	-10.68	9.36	.0021	-1.13	4.52	13.20	6.96	.45	93.	
40.000	-9.99	10.68	-.1626	-.70	5.80	14.02	7.09	.76	95.	
42.000	-10.93	10.44	-.0308	.86	6.14	14.28	8.11	.51	94.	
44.000	-10.77	10.91	-.0680	1.52	6.23	14.27	8.47	.68	98.	
46.000	-9.40	12.03	-.1686	2.57	6.72	14.30	8.98	.97	98.	
48.000	-8.39	14.07	-.1088	2.47	7.61	15.68	9.20	.76	98.	
50.000	-5.42	14.99	.0095	3.20	7.41	15.02	9.58	.93	98.	
52.000	-1.60	14.46	-.0533	3.86	7.94	13.67	10.04	1.15	98.	
54.000	1.84	13.75	-.1898	4.64	8.29	14.42	8.54	1.26	98.	
56.000	3.13	12.36	-.1453	4.46	9.56	14.74	7.37	.79	93.	
58.000	5.51	11.27	.0844	3.80	9.25	14.35	7.06	.53	84.	
60.000	8.54	11.96	.1355	3.75	10.13	15.77	9.04	.92	64.	
62.000	10.16	10.99	-.1798	2.83	11.73	17.41	7.75	-.48	32.	
64.000	9.70	12.53	.0291	2.38	12.14	17.87	6.66	-.14	23.	
66.000	9.76	16.69	.0316	3.87	10.93	19.70	10.27	.56	20.	
68.000	6.88	14.73	-.0372	1.93	15.20	19.67	9.62	.59	18.	
70.000	9.69	14.78	.0936	1.19	18.15	22.12	11.37	.27	17.	

TABLE I-10. WIND STATISTICAL PARAMETERS

OCTOBER

STATION - 747940		CAPE CANAVERAL		MEAN V M/S	S.D. V M/S	MEAN WS M/S	S.D. WS M/S	SKEN WS	NOBS
Z KM	MEAN U M/S	S.D. U M/S	R(U,V)						
.033	-1.79	3.29	.0249	-1.36	2.92	4.02	2.38	.53	781.
1.000	-1.71	5.95	.1953	-1.08	4.98	7.02	3.86	.77	779.
2.000	.56	6.21	.2608	-.16	4.94	6.81	4.10	1.16	778.
3.000	2.35	6.20	.2460	.24	5.03	6.95	4.57	1.29	777.
4.000	4.01	6.57	.2531	.27	5.30	7.76	5.20	1.32	775.
5.000	5.78	7.08	.2535	.16	5.93	9.22	5.80	1.24	774.
6.000	7.58	7.67	.2751	.24	6.68	10.86	6.56	1.09	772.
7.000	9.50	8.52	.2972	.30	7.60	12.86	7.43	.95	772.
8.000	11.72	9.73	.2825	.41	8.93	15.41	8.60	.83	770.
9.000	13.95	11.07	.2651	.54	10.44	18.11	9.90	.74	767.
10.000	16.12	12.41	.2449	.60	12.09	20.87	11.15	.65	760.
11.000	18.37	13.40	.2437	.47	13.37	23.46	12.06	.42	758.
12.000	20.01	13.72	.2821	.28	13.81	25.02	12.37	.31	758.
13.000	20.44	13.50	.3197	-.22	13.24	25.02	12.20	.30	756.
14.000	19.03	12.37	.3120	-.70	11.23	22.78	11.08	.37	749.
15.000	15.96	10.46	.3040	-.89	8.90	18.90	9.32	.41	742.
16.000	11.67	8.43	.3085	-.89	6.60	14.01	7.42	.61	735.
17.000	7.03	6.83	.2934	-.64	5.03	9.45	5.66	1.10	723.
18.000	2.87	5.63	.2642	-.09	3.83	6.17	4.05	1.55	724.
19.000	.67	4.81	.2938	.17	2.85	4.76	3.02	2.12	722.
20.000	-.98	4.51	.2998	-.10	2.53	4.53	2.68	1.60	715.
21.000	-2.14	4.43	.2153	-.06	2.41	4.73	2.75	1.04	703.
22.000	-2.98	4.18	.0980	-.29	2.45	5.02	2.69	.77	702.
23.000	-3.34	4.09	.0907	-.42	2.20	5.03	2.75	.51	684.
24.000	-3.57	4.72	.0739	-.48	2.81	5.75	3.17	.62	675.
25.000	-3.40	4.90	.0652	-.22	2.67	5.78	3.05	.64	666.
26.000	-2.56	5.23	.0757	.00	2.60	5.61	3.02	.64	630.
27.000	-1.50	5.92	.0905	.15	2.97	5.98	3.23	.76	577.
28.000	-.39	6.34	.1141	-.11	2.80	5.97	3.52	.95	553.
29.000	.78	7.01	.1437	-.30	3.39	6.71	4.03	1.26	450.
30.000	1.84	7.35	.1765	.10	3.30	6.92	4.50	1.38	443.
32.000	.19	7.61	-.0329	2.04	4.11	7.14	5.24	1.64	99.
34.000	4.98	9.28	.1659	1.47	4.65	9.58	6.51	1.45	102.
36.000	8.55	12.20	.0580	-.78	5.12	13.54	8.03	.76	103.
38.000	11.98	12.89	-.1614	-.30	5.97	15.82	9.71	.70	106.
40.000	15.27	13.77	.0391	.14	6.17	18.30	11.19	.51	107.
42.000	18.92	14.77	.2843	1.43	5.86	21.07	12.96	.36	109.
44.000	22.81	15.44	.3797	2.75	6.20	24.75	14.95	.27	113.
46.000	27.44	18.01	.3056	3.97	7.01	29.16	17.05	.24	113.
48.000	30.79	19.89	.3536	4.97	8.29	32.82	18.95	.22	113.
50.000	34.24	20.25	.3990	5.58	8.29	36.08	48	.18	113.
52.000	36.71	22.19	.3769	6.79	8.57	38.56	21.46	.08	113.
54.000	39.54	21.65	.2929	-	8.24	40.43	21.05	.04	112.
56.000	40.18	21.67	-.634	-	8.56	41.56	21.51	.12	106.
58.000	38.98	20.59	.3405	3.74	9.73	40.49	20.19	.25	92.
60.000	36.95	19.89	.2468	4.39	10.75	39.15	19.00	.21	72.
62.000	33.38	19.89	.0487	2.95	9.81	35.43	18.89	.46	51.
64.000	33.75	20.74	-.0603	2.21	10.19	36.00	19.46	.40	42.
66.000	27.90	19.77	.0071	6.87	11.66	32.45	17.10	.24	34.
68.000	23.25	19.73	.2124	12.90	16.42	33.47	15.18	.53	32.
70.000	20.83	23.23	-.5494	17.96	21.73	36.30	20.76	2.00	30.

TABLE I-11. WIND STATISTICAL PARAMETERS

NOVEMBER

STATION = 747940		CAPE CANAVERAL								
Z	MEAN U	S.D. U	R(U,V)	MEAN V	S.D. V	MEAN WS	S.D. WS	SKEN WS	NCOS	
KM	M/S	M/S		M/S	M/S	M/S	M/S			
.003	.09	2.85	-.1401	-1.10	2.92	3.57	2.26	.63	861.	
1.000	.03	6.45	.0759	.07	5.24	7.37	3.85	.93	863.	
2.000	2.48	6.76	.1004	.63	4.92	7.44	4.60	1.29	862.	
3.000	5.01	7.18	.1443	.46	5.33	8.57	5.65	1.29	862.	
4.000	7.36	7.55	.1742	.47	5.91	10.19	6.52	1.04	861.	
5.000	9.96	8.22	.2048	.42	6.59	12.46	7.43	.90	861.	
6.000	12.41	8.98	.2562	.48	7.44	14.90	8.26	.04	862.	
7.000	15.15	9.65	.2966	.56	8.39	17.69	8.96	.70	858.	
8.000	18.01	10.51	.3132	.43	9.42	20.68	7.79	.52	851.	
9.000	23.79	11.49	.3408	.32	10.48	23.64	10.74	.46	849.	
10.000	23.67	12.44	.3758	.16	11.69	26.82	11.49	.33	843.	
11.000	26.51	13.05	.3867	-.07	13.04	30.03	11.90	.22	834.	
12.000	28.96	13.17	.4010	-.21	13.87	32.52	12.11	.22	833.	
13.000	29.77	12.77	.4076	-.17	13.15	32.93	11.73	.22	825.	
14.000	27.92	11.74	.3972	-.28	10.83	30.35	10.66	.09	816.	
15.000	24.16	10.21	.3440	-.24	8.90	26.07	9.37	.05	811.	
16.000	19.67	8.60	.3294	-.32	7.37	21.30	7.85	-.01	805.	
17.000	14.86	7.33	.2731	-.40	6.08	15.40	6.54	.08	789.	
18.000	9.95	6.34	.1930	-.26	4.95	11.54	5.54	.52	777.	
19.000	6.33	5.28	.1828	-.07	3.72	7.94	4.32	1.01	780.	
20.000	4.64	4.71	.2081	.11	3.02	5.28	3.66	1.12	771.	
21.000	3.90	4.84	.2635	.07	2.73	5.75	3.60	1.11	757.	
22.000	3.92	5.40	.2166	-.01	2.87	6.16	3.86	1.41	753.	
23.000	4.54	5.52	.1819	.12	2.68	6.60	3.83	1.02	735.	
24.000	5.29	6.29	.1225	.28	3.18	7.76	4.31	.90	724.	
25.000	6.65	7.09	.1677	.38	3.40	9.02	4.97	.75	713.	
26.000	8.10	7.60	.1805	.60	3.58	10.35	5.42	.36	689.	
27.000	9.61	8.48	.1229	1.11	4.00	12.06	6.01	.10	633.	
28.000	11.55	9.11	.0767	1.75	4.25	14.05	6.33	-.01	615.	
29.000	13.89	9.63	.0183	2.43	4.48	16.22	6.97	-.03	496.	
30.000	16.36	10.07	.0421	2.82	4.64	18.45	7.59	-.17	462.	
32.000	19.21	12.95	-.0280	3.77	5.12	21.71	10.25	.25	112.	
34.000	26.13	14.61	-.2686	3.24	5.21	27.83	12.58	-.40	113.	
36.000	32.07	15.15	-.1157	1.55	6.11	33.32	13.68	-.51	113.	
38.000	37.18	14.38	-.1409	2.05	7.90	38.42	13.39	-.61	115.	
40.000	41.46	14.08	.0083	3.07	8.51	42.43	14.08	-.17	118.	
42.000	45.30	14.52	.1750	5.29	8.62	46.08	14.61	.07	120.	
44.000	50.13	15.11	.3575	9.45	9.03	51.68	15.52	.12	122.	
46.000	56.52	14.57	.2031	11.38	9.51	58.39	14.75	-.32	122.	
48.000	61.24	14.79	.2400	14.14	11.04	63.71	15.17	-.18	122.	
50.000	65.10	14.96	.3622	13.48	11.00	67.23	15.63	-.07	121.	
52.000	68.03	15. .	.2456	12.46	11.08	69.98	15.84	-.22	119.	
54.000	63.19	16.32	.1098	11.88	12.29	71.22	16.51	-.10	115.	
56.000	62.75	16.31	.2285	10.55	11.25	70.43	16.40	.12	105.	
58.000	60.85	17.51	.2195	10.16	13.70	68.99	17.47	.19	97.	
60.000	64.41	18.09	.1617	8.42	13.15	66.48	17.22	.29	81.	
62.000	62.74	20.66	.2002	6.72	15.65	65.27	19.70	-.58	55.	
64.000	58.00	24.43	.0204	8.72	15.38	61.31	22.50	-.30	39.	
66.000	59.64	18.15	.0261	9.05	14.86	62.45	16.76	.46	33.	
68.000	52.45	21.46	.0325	5.96	18.26	46.43	19.53	-.30	28.	
70.000	41.02	20.36	-.2964	5.62	19.70	47.04	16.86	.56	26.	

TABLE I-12. WIND STATISTICAL PARAMETERS

DECEMBER

STATION = 747940		CAPE CANAVERAL									
Z	MEAN U	S.O. U	R(U,V)	MEAN V	S.O. V	MEAN WS	S.O. WS	SIGMA WS	MOBS		
M	M/S	M/S		M/S	M/S	M/S	M/S				
.003	.71	2.79	-.2572	-.87	3.21	3.77	2.27	.95		862.	
1.000	1.71	6.81	-.0375	.91	6.05	8.21	4.38	.79		864.	
2.000	5.17	7.04	.0205	1.18	5.71	9.01	5.39	1.09		863.	
3.000	8.54	7.49	.1308	1.07	6.12	11.12	6.63	.94		862.	
4.000	11.79	7.98	.1966	1.46	6.82	13.91	7.60	.82		862.	
5.000	14.76	8.72	.2121	1.85	7.48	16.89	8.43	.68		861.	
6.000	17.60	9.55	.2259	1.94	8.32	19.70	9.28	.57		862.	
7.000	20.57	10.49	.2421	2.21	9.13	22.76	10.16	.44		862.	
8.000	23.63	11.68	.2780	2.58	10.01	25.97	11.27	.37		858.	
9.000	26.56	12.85	.2901	2.70	11.04	29.15	12.45	.28		856.	
10.000	29.50	13.70	.2602	2.62	12.16	32.16	13.35	.21		850.	
11.000	32.04	14.16	.2492	2.10	13.12	34.83	13.79	.13		839.	
12.000	34.43	14.29	.2501	2.12	13.88	37.24	14.13	.11		835.	
13.000	34.83	13.53	.2580	2.42	12.92	37.26	13.46	.12		827.	
14.000	32.94	11.79	.2904	2.52	10.71	34.75	11.74	.06		819.	
15.000	29.64	10.44	.2765	2.25	9.27	31.17	10.32	.06		814.	
16.000	25.55	8.84	.2575	2.19	8.10	26.94	8.68	.09		806.	
17.000	20.80	7.74	.2433	1.96	6.93	22.08	7.53	.16		799.	
18.000	15.77	7.25	.2333	1.62	5.89	17.03	6.96	.41		785.	
19.000	11.01	6.69	.2929	1.23	4.71	12.21	6.36	.78		780.	
20.000	7.95	6.09	.3516	.81	3.74	9.16	5.56	1.00		766.	
21.000	6.41	5.96	.3421	.33	3.28	7.92	4.96	1.00		747.	
22.000	6.17	6.47	.3308	-.02	3.14	8.02	5.05	1.01		741.	
23.000	6.97	6.38	.3247	-.03	3.01	8.59	4.95	.75		734.	
24.000	8.14	7.49	.2855	.13	3.67	10.12	5.79	.81		726.	
25.000	9.82	8.61	.1832	.25	3.87	11.88	6.67	1.05		703.	
26.000	11.09	9.33	.0921	.42	3.94	13.34	6.90	.62		684.	
27.000	12.69	10.28	.0575	.74	4.36	15.24	7.35	.45		628.	
28.000	14.17	11.00	-.0102	1.33	4.83	16.94	7.73	.36		618.	
29.000	16.26	12.01	-.0108	2.22	5.51	19.44	8.11	.09		489.	
30.000	18.59	13.21	-.0300	3.36	5.95	22.16	8.68	-.11		474.	
32.000	25.74	10.93	.2932	7.61	6.97	27.85	10.61	-.52		111.	
34.000	31.40	12.61	.2402	7.15	7.81	33.52	11.52	-.70		111.	
36.000	33.35	14.13	-.0456	5.55	7.30	35.12	12.73	-.53		113.	
38.000	34.25	15.59	-.1957	6.59	8.98	36.87	13.42	-.22		113.	
40.000	34.46	15.33	-.0633	8.15	10.35	37.62	13.46	-.27		115.	
42.000	34.42	17.15	.0406	8.48	11.85	38.69	13.87	-.10		119.	
44.000	34.59	20.67	.0437	8.95	12.34	40.04	15.80	.36		120.	
46.000	34.51	22.43	-.1486	10.84	13.71	41.11	17.52	.27		120.	
48.000	32.97	24.94	-.1021	10.62	13.04	40.47	18.72	.32		118.	
50.000	34.24	24.74	.0237	12.21	12.93	41.56	19.24	.19		113.	
52.000	33.92	26.27	-.0686	13.12	14.22	42.98	19.06	.16		110.	
54.000	35.18	28.14	-.1119	11.55	13.33	44.21	19.51	.31		109.	
56.000	37.48	27.31	-.0133	11.90	15.70	46.06	20.30	.29		106.	
58.000	41.40	26.77	.0808	12.35	15.27	48.79	20.75	.35		94.	
60.000	42.43	26.88	.1606	13.27	16.57	51.11	20.97	.59		75.	
62.000	44.71	28.35	.1777	12.50	15.82	53.02	19.68	.34		56.	
64.000	49.49	29.32	.2768	8.17	15.80	55.96	21.94	.04		53.	
66.000	48.90	34.48	.2771	1.29	18.58	58.31	22.42	.04		42.	
68.000	48.83	33.00	.3468	.39	21.11	58.31	22.03	.02		32.	
70.000	56.54	24.62	.3220	-3.93	21.83	62.23	19.98	-.26		30.	

TABLE I-13. WIND STATISTICAL PARAMETERS

ANNUAL

STATION = 747940		CAPE CANAVERAL		MEAN V	S.D. V	MEAN WS	S.D. WS	SKEW WS	NOBS
Z	MEAN U	S.D. U	R(U,V)						
MM	M/S	M/S		M/S	M/S	M/S	M/S		
.003	-.16	2.88	-.1291	-.20	3.04	3.51	2.29	.67	9839.
1.000	.69	6.18	.0704	1.15	5.30	7.06	4.32	1.22	9838.
2.000	3.07	6.97	.1302	1.09	5.09	7.62	5.20	1.45	9832.
3.000	5.24	7.88	.1410	.98	5.38	8.05	6.41	1.38	9802.
4.000	7.27	9.00	.1603	.91	5.81	10.43	7.72	1.25	9759.
5.000	9.27	10.36	.1926	.85	6.36	12.28	9.14	1.18	9744.
6.000	11.17	11.82	.2281	.84	7.00	14.24	10.55	1.06	9741.
7.000	13.12	13.38	.2619	.87	7.81	16.38	12.02	.95	9712.
8.000	15.09	15.10	.2749	.86	8.77	18.71	13.53	.87	9659.
9.000	17.06	16.81	.2782	.76	9.85	21.17	14.94	.78	9621.
10.000	19.10	18.53	.2764	.54	11.04	23.81	16.24	.70	9554.
11.000	20.88	19.92	.2710	.10	12.13	26.28	17.01	.60	9462.
12.000	22.66	20.90	.2871	-.31	12.71	28.38	17.52	.50	9441.
13.000	23.14	20.78	.3258	-.63	12.24	28.84	16.91	.42	9355.
14.000	21.59	19.39	.3585	-.90	10.56	26.72	15.49	.39	9280.
15.000	18.77	17.40	.3762	-.77	8.70	23.22	13.87	.41	9229.
16.000	15.08	15.32	.3696	-.60	7.15	19.19	12.06	.50	9155.
17.000	10.87	13.37	.3453	-.47	5.85	15.27	9.92	.70	8993.
18.000	6.47	11.68	.3229	-.37	4.81	11.98	7.62	1.04	8963.
19.000	2.40	10.22	.3202	-.31	3.75	9.62	5.63	1.13	8881.
20.000	-.56	9.56	.2305	-.19	3.01	8.69	5.05	.74	8782.
21.000	-2.49	9.42	-.0369	.03	2.78	8.60	5.36	.69	8603.
22.000	-3.42	9.47	-.0680	.03	2.79	8.89	5.49	.70	8546.
23.000	-3.73	9.59	-.0607	.05	2.58	9.06	5.52	.57	8396.
24.000	-3.95	10.32	-.0483	.02	2.97	9.87	5.80	.56	8301.
25.000	-3.77	11.16	.1161	-.02	2.97	10.47	5.17	.60	8137.
26.000	-3.32	11.99	.1838	.04	3.01	11.02	5.17	.54	7805.
27.000	-2.81	13.04	.2269	.15	3.49	11.89	5.17	.51	7110.
28.000	-2.22	14.09	.2607	.41	3.65	12.75	5.17	.44	6849.
29.000	-1.39	15.48	.2958	.60	4.18	14.04	7.94	.40	5268.
30.000	-.41	16.71	.3210	1.09	4.22	15.05	8.46	.36	5106.
32.000	1.50	19.70	.2564	2.49	5.21	17.92	10.13	.31	1366.
34.000	3.95	21.84	.2242	1.52	5.62	19.81	11.59	.44	1373.
36.000	3.82	23.33	.1263	.16	5.83	20.39	12.37	.49	1382.
38.000	3.03	25.02	.1496	.57	6.81	22.57	13.14	.50	1393.
40.000	2.57	26.89	.2439	1.42	7.29	24.27	14.00	.53	1413.
42.000	1.64	29.37	.3335	2.06	8.10	26.54	15.20	.44	1431.
44.000	.96	32.47	.3581	3.80	8.86	29.38	16.88	.43	1454.
46.000	1.37	34.96	.2547	5.71	9.43	31.97	18.01	.42	1453.
48.000	2.00	36.92	.2432	6.73	9.76	33.82	19.08	.46	1446.
50.000	3.65	38.32	.2175	7.42	10.04	35.33	19.74	.47	1434.
52.000	4.71	37.70	.1693	7.48	10.70	36.75	20.46	.44	1411.
54.000	5.87	40.38	.1846	7.53	11.12	37.64	20.72	.47	1382.
56.000	7.62	41.10	.2370	7.42	11.85	38.63	21.24	.40	1311.
58.000	9.14	42.10	.2706	7.74	12.52	39.95	21.84	.34	1171.
60.000	11.29	42.53	.2934	7.64	13.24	41.22	21.78	.26	934.
62.000	13.38	44.32	.2663	6.31	14.41	43.05	23.23	.26	639.
64.000	14.88	45.52	.1966	4.69	14.76	44.15	24.25	.26	513.
66.000	15.31	44.76	-.0939	1.56	15.60	42.99	25.30	.45	435.
68.000	13.40	44.20	-.0277	-.51	17.82	43.14	24.39	.50	358.
70.000	13.64	42.67	-.0751	-3.25	51	42.89	24.50	.70	376.

TABLE II-1. THERMODYNAMIC STATISTICAL PARAMETERS

JANUARY

STATION Z KM	CAPE CANAVERAL		S.D. T DEG K	MEAN T DEG K	S.D. T DEG K	SKEW T	MEAN D G/M3	S.O. D G/M3	SKEW D	MOBS P	MOBS T	MOBS D
	S.O. P MB	SKEW P										
.000	1019.7000	4.9269	-56	287.90	5.80	-.69	1228.0000	28.9800	.83	778.	778.	778.
.003	1019.4000	4.9596	-52	287.66	5.80	-.61	1229.0000	28.8900	.75	896.	896.	896.
1.000	906.1100	4.5302	-60	284.60	4.46	-.90	1105.0000	18.7700	.75	896.	896.	896.
2.000	803.5100	4.4675	-75	280.93	3.25	-.85	993.7000	12.1800	.63	896.	896.	896.
3.000	711.3000	4.5342	-81	276.85	3.25	-.75	893.2000	8.6410	.25	895.	895.	895.
4.000	628.2200	4.6052	-50	271.56	3.24	-.84	804.5000	7.0440	.20	893.	893.	893.
5.000	553.4900	4.7125	-93	265.54	3.18	-.73	725.1000	5.9920	-.11	893.	893.	893.
6.000	486.1800	4.7629	-94	259.10	3.11	-.78	652.9000	5.1060	-.22	892.	892.	892.
7.000	425.5300	4.6987	-95	252.47	3.19	-.95	586.6000	5.1200	-.31	889.	889.	889.
8.000	371.2400	4.5983	-94	245.39	3.19	-.71	526.5000	5.0570	-.54	886.	886.	886.
9.000	322.4200	4.3842	-89	237.88	3.00	-.58	471.8000	5.0070	-.12	883.	883.	883.
10.000	278.8000	4.1672	-82	233.41	2.96	-.51	421.4000	5.1760	-.13	881.	881.	881.
11.000	242.0400	3.8582	-73	223.46	2.95	.39	329.6000	5.9840	-.146	878.	878.	878.
12.000	205.7500	3.3957	-69	217.52	3.35	.39	247.6000	6.8400	-.14	877.	877.	877.
13.000	175.7000	2.9419	-62	213.64	3.56	-.01	286.7000	6.8820	-.50	872.	872.	872.
14.000	149.7900	2.4915	-58	210.87	2.83	-.22	247.6000	5.5440	-.40	869.	869.	869.
15.000	127.3200	2.0450	-53	207.31	2.56	.39	214.0000	4.1290	-.71	865.	865.	865.
16.000	107.9400	1.6593	-44	204.15	2.69	.74	184.2000	4.3430	-.72	857.	857.	857.
17.000	91.3580	1.3154	-32	202.34	3.11	.73	157.3000	3.9790	-.60	836.	836.	836.
18.000	77.2280	1.0274	-.25	202.24	3.55	.57	133.1000	3.4440	-.44	827.	827.	827.
19.000	65.3540	.8025	-.23	204.46	3.52	.38	111.4000	2.6250	-.21	810.	810.	810.
20.000	55.4330	.6547	-.23	207.54	3.30	.29	93.0700	1.8870	-.08	797.	797.	797.
21.000	47.1370	.5627	-.27	210.60	3.14	.17	77.9900	1.3780	.08	747.	747.	747.
22.000	40.1890	.5006	-.21	213.36	3.09	.09	65.6000	1.0430	.10	736.	736.	736.
23.000	34.3120	.4578	-.14	215.45	2.94	.20	55.4900	.8002	-.03	724.	724.	724.
24.000	29.3290	.4179	-.09	217.49	3.11	.10	46.9800	.6683	.10	718.	718.	718.
25.000	25.1230	.3916	.00	219.27	3.19	.17	39.9200	.5550	-.09	701.	701.	701.
26.000	21.5400	.3645	.07	220.91	3.14	.14	34.9700	.4701	-.19	687.	687.	687.
27.000	18.4970	.3371	.09	222.71	3.25	.01	29.9300	.4311	-.14	623.	623.	623.
28.000	15.9010	.3157	.10	224.57	3.55	.01	24.6700	.4141	-.13	602.	602.	602.
29.000	13.6810	.2832	.19	226.25	3.57	-.03	21.0700	.3687	-.07	480.	480.	480.
30.000	11.7890	.2595	.15	228.00	3.76	.05	18.0100	.3376	-.10	474.	474.	474.
32.000	8.6982	.1924	.47	231.88	5.64	.05	13.1100	.2943	.43	107.	107.	107.
34.000	6.5252	.1626	.67	236.55	5.31	-.13	9.6270	.2549	.24	107.	107.	107.
36.000	4.9211	.1374	.58	242.31	7.10	.49	7.0820	.2310	-.26	106.	106.	106.
38.000	3.7389	.1129	.46	248.72	6.88	-.11	5.2420	.1780	.59	107.	107.	107.
40.000	2.8602	.0917	.43	256.21	6.41	-.13	3.0620	.1369	.67	109.	109.	109.
42.000	2.2072	.0744	.34	263.49	6.47	-.35	2.9130	.1044	.32	109.	109.	109.
44.000	1.7137	.0591	.18	268.84	6.67	-.40	2.2190	.0798	.30	107.	107.	107.
46.000	1.3358	.0476	.07	270.71	6.22	-.53	1.7180	.0666	.22	107.	107.	107.
48.000	1.0427	.0384	.03	268.95	5.90	-.55	1.3450	.0506	-.25	106.	106.	106.
50.000	.8110	.0312	.08	265.96	5.89	-.47	1.0620	.0411	.45	101.	101.	101.
52.000	.6287	.0258	.15	263.12	6.64	-.47	.8327	.0330	-.06	102.	102.	102.
54.000	.4865	.0216	.22	261.01	7.98	-.12	.6491	.0262	.14	99.	99.	99.
56.000	.3762	.0181	.20	259.54	7.57	-.45	.5045	.0211	-.10	95.	95.	95.
58.000	.2908	.0152	.30	258.23	8.75	-.43	.3328	.0170	.04	86.	86.	86.
60.000	.2228	.0129	.29	254.40	9.64	-.35	.3043	.0135	.22	78.	78.	78.
62.000	.1713	.0122	.17	251.62	12.00	-.18	.2371	.0117	.32	52.	52.	52.
64.000	.1284	.0110	.42	243.00	13.83	.30	.1848	.0103	-.08	36.	36.	36.
66.000	.0949	.0073	.03	237.22	12.35	.62	.1399	.0074	-.33	30.	30.	30.
68.000	.0706	.0059	.05	226.90	14.98	.58	.1086	.0064	-.46	29.	29.	29.
70.000	.0519	.0048	.24	220.60	12.44	.92	.0820	.0052	-.87	26.	26.	26.

TABLE II-3. THERMODYNAMIC STATISTICAL PARAMETERS

MARCH

STATION #	Z	MEAN P	CAPE	LAMINAR	MEAN T	S.D. T	SKEW T	MEAN D	S.D. D	SKEW D	MOBS P	MOBS T	MOBS D
747540	KH	MB	MB	SKEW P	DEG K	DEG K	G/M3	G/M3	G/M3	G/M3			
0.000	1017.7000	4.8125	-0.27	253.26	5.13	-0.40	1215.0000	25.2600	.51	.725	725	725	725
.003	1017.5000	4.7939	-0.23	250.05	5.24	-0.38	1215.0000	25.7300	.47	.872	872	872	872
1.000	995.1100	4.3300	-0.48	285.93	4.42	-0.95	1038.0000	18.5500	.70	.872	872	872	872
2.000	803.0500	4.2811	-0.83	281.96	3.62	-0.85	989.3000	12.4000	.59	.874	874	874	874
3.000	711.1600	4.3532	-1.05	277.50	3.40	-0.48	870.0000	9.3120	.14	.874	874	874	874
4.000	629.2000	4.4984	-1.02	271.76	3.39	-0.43	803.9000	7.6090	.09	.873	873	873	873
5.000	563.4300	4.5786	-1.04	265.48	3.39	-0.28	725.2000	6.5990	-.08	.873	873	873	873
6.000	485.1600	4.7040	-0.91	259.92	3.33	-0.27	653.3000	5.5440	-.02	.872	872	872	872
7.000	425.4800	4.8374	-0.81	252.25	3.35	-0.45	587.0000	5.1720	-.22	.871	871	871	871
8.000	371.1100	4.9334	-0.72	245.24	3.55	-0.51	526.7000	5.0210	-.50	.869	869	869	869
9.000	322.3100	4.9350	-0.62	237.81	3.51	-0.36	471.8000	4.9140	-.94	.861	861	861	861
10.000	278.6900	4.3751	-0.51	230.48	3.36	-0.22	421.2000	5.1120	-1.59	.857	857	857	857
11.000	239.9800	4.1172	-0.40	223.80	3.10	-0.08	373.6000	5.7380	-.14	.854	854	854	854
12.000	205.7900	3.6369	-0.33	218.37	3.26	.04	285.7000	6.9770	-.43	.852	852	852	852
13.000	175.9100	3.1588	-0.24	214.55	3.20	.04	247.4000	6.0410	-.28	.846	846	846	846
14.000	149.9800	2.6692	-0.17	211.27	2.90	.07	213.9000	5.1980	-.30	.846	846	846	846
15.000	127.5100	2.1913	-0.11	207.75	2.75	.22	184.0000	4.5700	-.23	.841	841	841	841
16.000	108.1400	1.7849	-0.07	204.84	2.79	.08	157.1000	4.1260	-.14	.824	824	824	824
17.000	91.5750	1.4249	-0.02	203.18	3.03	.08	132.9000	3.7290	.02	.814	814	814	814
18.000	77.4710	1.1037	-0.01	203.09	3.52	.02	111.3000	2.8680	.11	.805	805	805	805
19.000	65.6170	.8372	.02	205.49	3.45	.01	93.0100	2.0460	.16	.795	795	795	795
20.000	55.7020	.6411	-0.03	208.68	3.11	-.03	77.9600	1.4930	.12	.795	795	795	795
21.000	47.4110	.5083	-0.05	211.86	2.94	-.06	65.6200	1.1280	.09	.795	795	795	795
22.000	40.4420	.4286	.02	214.75	2.89	-.15	55.5700	.8333	.05	.741	741	741	741
23.000	34.5780	.3742	.02	216.81	2.74	-.06	47.1200	.6667	.01	.736	736	736	736
24.000	29.5820	.3342	.02	218.75	2.86	-.06	40.0700	.5587	-.18	.733	733	733	733
25.000	25.3020	.3080	.02	220.54	3.02	-.09	34.1000	.4590	-.21	.718	718	718	718
26.000	21.7680	.2843	.04	222.41	3.10	-.08	29.0500	.3989	-.48	.649	649	649	649
27.000	18.7070	.2609	-0.06	224.34	3.19	-.03	24.7700	.3400	-.14	.630	630	630	630
28.000	16.05	.2448	-0.10	226.41	3.32	-.06	21.1600	.2972	-.12	.510	510	510	510
29.000	13.8700	.2347	-0.03	228.34	3.32	-.13	18.0800	.2656	-.26	.500	500	500	500
30.000	11.9760	.2221	-0.02	230.77	3.32	-.27	13.2000	.2346	-.11	.108	108	108	108
31.000	8.9191	.1876	-0.17	235.67	5.00	-.40	9.7230	.2641	-.60	.109	109	109	109
32.000	6.7122	.1600	-0.20	241.19	6.29	-.20	7.1980	.1962	-.26	.108	108	108	108
36.000	5.0923	.1257	.31	246.98	6.48	-.17	5.3680	.1378	-.05	.106	106	106	106
38.000	3.6841	.1084	.25	251.68	6.08	-.17	4.0470	.1187	-.08	.106	106	106	106
40.000	2.9785	.0911	.16	256.78	5.59	-.21	3.0630	.0991	.24	.106	106	106	106
44.000	2.2967	.0751	.08	264.46	5.11	-.32	2.3430	.0746	.03	.107	107	107	107
44.000	1.7758	.0608	-0.03	264.29	4.74	-.00	1.8080	.0604	-.06	.105	105	105	105
46.000	1.3813	.0498	-0.04	266.96	4.74	-.63	1.3990	.0525	-.17	.104	104	104	104
50.000	.8333	.0334	-0.05	266.96	5.28	-.60	1.0900	.0429	-.01	.106	106	106	106
52.000	.6482	.0268	-0.14	263.60	5.34	-.85	.8209	.0343	-.92	.103	103	103	103
54.000	.5027	.0221	-0.02	263.63	6.10	-.93	.6647	.0262	-.44	.98	98	98	98
56.000	.3901	.0180	.03	262.46	7.23	-.83	.5193	.0240	.14	.98	98	98	98
58.000	.3015	.0148	.13	259.88	5.92	-.14	.4052	.0175	-.21	.92	92	92	92
60.000	.2319	.0123	.25	246.22	8.04	.31	.3161	.0145	-.12	.79	79	79	79
62.000	.1776	.0107	.49	251.99	9.30	.52	.2466	.0105	-.22	.66	66	66	66
64.000	.1348	.0092	.52	245.93	12.12	.42	.1923	.0097	-.50	.50	50	50	50
66.000	.1006	.0074	.75	237.31	11.59	1.03	.1481	.0080	1.02	.37	37	37	37
68.000	.0746	.0057	.86	227.19	15.18	1.33	.1152	.0063	.64	.32	32	32	32
70.000	.0550	.0048	1.00	221.93	16.19	1.91	.0859	.0048	1.47	.28	28	28	28

TABLE II-4. THERMODYNAMIC STATISTICAL PARAMETERS

APRIL

STATION Z KM	MEAN P		CAPE CANAVERAL		MEAN T DEG K	S.O. T DEG K	SKEW T	MEAN D G/M3	S.O. D G/M3	SKEW D	NOBS P	NOBS T	NOBS D
	MB	MMHG	S.O. P	SKEW P									
.000	1018.0000	4.4184	.34	233.22	4.52	-61	1201.0000	21.8700	.77	738.	738.	738.	
.003	1017.8000	4.4471	-.36	293.13	4.56	-61	1202.0000	13.4800	.77	871.	871.	871.	
1.000	906.4000	3.6471	-.49	288.25	3.00	-47	1090.0000	21.8300	.39	871.	871.	871.	
2.000	804.0600	3.3794	-.72	283.76	2.95	-46	985.1000	11.0200	.35	871.	871.	871.	
3.000	713.2700	3.2798	-.79	279.04	2.72	-29	908.5000	8.2050	.11	868.	868.	868.	
4.000	630.5500	3.2792	-.68	273.28	2.56	-13	802.3000	6.4920	-.11	868.	868.	868.	
5.000	545.9200	3.2764	-.61	266.65	2.54	-.24	724.6000	5.4430	-.03	867.	867.	867.	
6.000	489.6100	3.3414	-.56	260.19	2.56	-.30	653.3000	4.7703	-.11	867.	867.	867.	
7.000	427.9400	3.3651	-.47	253.48	2.68	-.56	587.4000	4.3740	-.08	866.	866.	866.	
8.000	373.4500	3.3519	-.49	246.38	2.94	-.63	527.5000	4.2470	-.12	864.	864.	864.	
9.000	324.5700	3.3469	-.49	238.69	2.97	-.51	472.9000	3.9380	-.69	861.	861.	861.	
10.000	280.8300	3.3304	-.44	231.27	2.86	-.20	422.9000	3.6740	-1.07	858.	858.	858.	
11.000	241.0800	3.1819	-.36	223.98	2.67	.01	376.2000	3.8020	-1.14	853.	853.	853.	
12.000	207.3600	2.8692	-.26	217.73	2.62	.22	331.8000	4.8130	-1.05	853.	853.	853.	
13.000	177.1500	2.5340	-.13	213.35	3.02	.09	289.0000	6.0780	-.47	847.	847.	847.	
14.000	150.9400	2.2962	-.02	210.63	3.03	-.31	249.7000	5.5750	.01	844.	844.	844.	
15.000	128.3000	1.7012	.05	207.67	2.68	.03	215.3000	4.5280	-.08	841.	841.	841.	
16.000	108.8200	1.3701	.13	203.05	2.54	.29	184.9000	3.7890	-.17	838.	838.	838.	
17.000	92.1090	1.0873	.21	203.49	2.70	.22	157.9000	3.3390	-.04	823.	823.	823.	
18.000	78.0110	0.8484	.28	203.52	3.04	.29	133.6000	2.9070	.03	817.	817.	817.	
19.000	66.1140	.5993	.32	206.23	2.93	.34	111.7000	2.1990	.04	814.	814.	814.	
20.000	56.1680	.5351	.24	209.82	2.67	.21	93.2700	1.6000	.23	805.	805.	805.	
21.000	47.6370	.4426	.18	213.18	2.48	.12	78.2100	1.1180	.28	770.	770.	770.	
22.000	40.8630	.3964	.14	215.92	2.42	-.03	65.9400	.8304	.25	766.	766.	766.	
23.000	34.9690	.3641	.12	218.20	2.38	-.11	55.8300	.6315	.36	755.	755.	755.	
24.000	29.9340	.3313	.15	220.44	2.40	-.08	47.3400	.5176	.24	752.	752.	752.	
25.000	25.7150	.3071	.06	222.55	2.43	-.10	40.2600	.4308	.13	750.	750.	750.	
26.000	22.1030	.2878	-.02	224.74	2.53	-.13	34.2600	.3873	.11	729.	729.	729.	
27.000	19.0220	.2671	-.01	226.90	2.70	-.06	29.2100	.3513	.03	658.	658.	658.	
28.000	16.3980	.2489	-.26	229.02	2.54	-.04	24.9400	.3141	-.09	635.	635.	635.	
29.000	14.1490	.2268	-.25	231.05	2.57	-.08	21.3300	.3003	-.12	534.	534.	534.	
30.000	12.2380	.2066	-.31	233.05	2.49	-.18	18.2900	.2765	-.35	525.	525.	525.	
32.000	9.1379	.1942	.01	237.49	4.80	.48	13.4200	.2698	-.97	101.	101.	101.	
34.000	6.8910	.1649	-.11	241.83	4.46	.04	9.9410	.2178	-.27	101.	101.	101.	
36.000	5.2192	.1416	-.09	246.55	4.37	-.33	7.3950	.2031	-.41	100.	100.	100.	
38.000	3.9841	.1084	-.02	251.32	4.50	-.30	5.5300	.1468	-.42	101.	101.	101.	
40.000	3.0556	.0890	.11	256.42	3.95	.27	4.1550	.1059	-.04	103.	103.	103.	
42.000	2.3562	.0701	.06	260.66	4.97	-.77	3.1510	.0777	.37	104.	104.	104.	
44.000	1.8244	.0544	.06	265.12	4.70	-.76	2.3990	.0777	.30	105.	105.	105.	
46.000	1.4181	.0408	.08	268.39	3.59	-.01	1.6400	.0570	-.14	104.	104.	104.	
48.000	1.1047	.0343	.08	269.47	4.42	.12	1.4290	.0430	.19	104.	104.	104.	
50.000	.8609	.0290	.11	268.94	5.01	-1.20	1.1150	.0337	-.09	104.	104.	104.	
52.000	.6703	.0230	.11	267.09	5.67	-.125	.6049	.0197	-.05	103.	103.	103.	
54.000	.5213	.0189	.13	265.28	5.42	-.11	.5304	.0171	-.38	98.	98.	98.	
56.000	.4046	.0159	.20	262.09	5.42	-.23	.4205	.0140	-.17	95.	95.	95.	
58.000	.3132	.0133	.18	259.68	5.46	-.04	.3304	.0121	.03	84.	84.	84.	
60.000	.2415	.0116	.21	255.33	7.19	-.04	.2578	.0101	-.15	73.	73.	73.	
62.000	.1856	.0102	.24	251.36	8.98	.02	.1990	.0085	-.01	49.	49.	49.	
64.000	.1383	.0077	.83	243.05	9.18	.88	.1520	.0063	.16	40.	40.	40.	
66.000	.1038	.0053	1.04	237.06	9.43	.88	.1187	.0037	.51	30.	30.	30.	
68.000	.0775	.0033	1.36	227.19	10.98	1.20	.0895	.0038	.50	22.	22.	22.	
70.000	.0550	.0032	2.37	218.11	8.63	1.26							

TABLE II-5. THERMODYNAMIC STATISTICAL PARAMETERS

MAY

STATION = 747940 Z KM	CAPE CANAVERAL		MEAN T DEG K	S.D. T DEG K	SKEW T	MEAN D G/M3	S.D. D G/M3	SKEW D	NOBS P	NOBS T	NOBS D
	S.D. P MG	SKEW P									
.000	1016.6000	3.5535	296.21	3.61	-.16	1186.0000	15.6600	.41	767.	767.	767.
.003	1016.3000	3.5805	296.05	3.68	-.24	1186.0000	16.0000	.49	828.	828.	828.
1.000	906.0000	3.1442	200.69	2.20	-.24	1080.0000	9.7220	.30	828.	828.	828.
2.000	805.3000	2.8936	285.23	1.89	-.25	979.9000	6.9520	.11	828.	828.	828.
3.000	714.1200	2.7707	279.90	1.91	-.29	886.5000	5.5790	-.12	826.	826.	826.
4.000	631.5800	2.7740	274.12	1.95	-.32	801.1000	4.9890	-.12	826.	826.	826.
5.000	557.1300	2.7277	258.11	2.06	-.39	722.7000	4.5330	.09	823.	823.	823.
6.000	490.0100	2.7610	261.70	2.17	-.40	651.4000	3.9590	-.02	822.	822.	822.
7.000	429.5000	2.8054	255.04	2.25	-.64	586.0000	3.4350	.00	820.	820.	820.
8.000	375.1600	2.8366	248.04	2.44	-.67	525.3000	3.2190	.04	818.	818.	818.
9.000	326.3300	2.8230	240.45	2.50	-.49	472.3000	2.9040	-.17	817.	817.	817.
10.000	282.6100	2.8131	232.71	2.45	-.47	422.9000	2.7400	-.15	816.	816.	816.
11.000	243.6600	2.7550	225.16	2.30	-.08	377.0000	2.6740	-.12	814.	814.	814.
12.000	208.9600	2.5003	218.14	2.24	.24	333.7000	3.6120	-.12	813.	813.	813.
13.000	178.5100	2.2645	212.60	2.62	.45	292.5000	5.0160	-.95	810.	810.	810.
14.000	151.9900	1.8712	209.61	3.11	.02	252.7000	5.4480	-.38	808.	808.	808.
15.000	129.1400	1.5101	207.67	2.83	.02	216.7000	4.3520	-.20	806.	806.	806.
16.000	109.5700	1.2262	205.98	2.48	-.15	185.4000	3.3550	-.05	805.	805.	805.
17.000	92.9200	1.0021	205.15	2.29	.02	157.8000	2.7570	-.14	792.	792.	792.
18.000	78.7470	.8107	205.69	2.50	.11	133.4000	2.3920	-.14	786.	786.	786.
19.000	66.8620	.6684	208.60	2.42	-.11	111.7000	1.8150	-.01	779.	779.	779.
20.000	56.9040	.5609	211.91	2.20	-.29	93.5500	1.3360	.11	776.	776.	776.
21.000	48.5480	.4839	215.02	1.95	-.21	78.6600	.5780	.03	748.	748.	748.
22.000	41.5130	.4282	217.58	1.84	-.19	66.4700	.8071	-.17	746.	746.	746.
23.000	35.5670	.3751	219.81	1.72	-.23	56.3700	.6340	-.19	738.	738.	738.
24.000	30.4960	.3358	221.90	1.83	-.26	47.6800	.5481	-.20	738.	738.	738.
25.000	26.2010	.2982	223.88	1.81	-.12	40.7700	.4485	-.23	726.	726.	726.
26.000	22.5430	.2664	225.81	1.77	.03	34.7800	.3772	-.33	695.	695.	695.
27.000	19.4110	.2376	227.62	1.86	.17	29.7100	.3379	-.16	617.	617.	617.
28.000	16.7450	.2153	229.49	1.80	.08	25.4200	.2956	-.10	505.	505.	505.
29.000	14.4570	.1902	231.26	1.93	.20	21.7800	.2778	-.03	500.	500.	500.
30.000	12.5060	.1705	233.03	1.84	.15	18.7000	.2415	-.12	496.	496.	496.
32.000	9.3500	.1447	238.31	4.10	1.05	13.7200	.2099	-.02	83.	83.	83.
34.000	7.0529	.1218	241.92	4.71	.59	10.1900	.1674	.21	84.	84.	84.
36.000	5.3457	.1050	246.52	4.56	.05	7.5790	.1428	.21	83.	83.	83.
38.000	4.0766	.0867	252.27	4.38	.54	5.6490	.1083	.37	83.	83.	83.
40.000	3.1283	.0716	258.33	3.96	-.13	4.2290	.0948	.26	82.	82.	82.
42.000	2.4143	.0599	262.69	4.53	.74	3.2080	.0758	-.47	82.	82.	82.
44.000	1.8717	.0496	266.45	5.34	-.54	2.4520	.0589	.78	82.	82.	82.
46.000	1.4560	.0418	269.32	5.28	.11	1.8850	.0441	-.39	82.	82.	82.
48.000	1.1353	.0350	271.39	5.09	.72	1.4600	.0407	.19	82.	82.	82.
50.000	.8858	.0290	271.28	5.19	.73	1.1410	.0339	.20	82.	82.	82.
52.000	.6906	.0241	268.97	6.33	.22	.6973	.0250	.79	81.	81.	81.
54.000	.5372	.0204	266.32	5.91	.70	.7048	.0217	.91	81.	81.	81.
56.000	.4172	.0171	263.78	6.14	.49	.5529	.0197	.46	76.	76.	76.
58.000	.3230	.0145	259.35	6.87	-.22	.4350	.0160	.82	71.	71.	71.
60.000	.2487	.0119	255.73	6.67	.13	.3390	.0122	.96	65.	65.	65.
62.000	.1706	.0092	251.51	8.00	-.25	.2643	.0105	.75	45.	45.	45.
64.000	.1455	.0088	244.46	8.57	-.44	.2075	.0102	.37	29.	29.	29.
66.000	.1095	.0067	234.20	11.89	-.13	.1630	.0099	1.43	26.	26.	26.
68.000	.0812	.0056	224.51	14.63	-.05	.1260	.0055	1.60	23.	23.	23.
70.000	.0594	.0050	216.56	13.37	.24	.0953	.0053	-.16	20.	20.	20.

TABLE II-6. THERMODYNAMIC STATISTICAL PARAMETERS

JUNE

STATION: = 747940		CAPE CANAVERAL		S.D. T		SKEW T		MEAN D		S.D. D		SKEW D		NOBS P		NOBS T		NOBS D	
Z	MEAN P	S.D. P	SKEW P	MEAN T	S.D. T	SKEW T	MEAN D	S.D. D	SKEW D	NOBS P	NOBS T	NOBS D	NOBS P	NOBS T	NOBS D	NOBS P	NOBS T	NOBS D	
KH	MB	MB	MB	DEG K	DEG K	DEG K	G/MS	G/MS	G/MS	G/MS	G/MS	G/MS	G/MS	G/MS	G/MS	G/MS	G/MS	G/MS	
.000	1015.0000	3.1005	-.57	208.22	2.07	.41	1175.0000	12.1800	-.21	754.	754.	754.							
.003	1015.7000	3.0929	-.57	208.15	2.08	.40	1175.0000	12.3000	-.19	771.	771.	771.							
1.000	905.3000	2.8409	-.59	202.69	1.99	.44	1071.0000	6.2730	.51	771.	771.	771.							
2.000	806.3000	2.6563	-.47	206.98	1.40	-.20	974.1000	5.2790	-.08	771.	771.	771.							
3.000	715.5900	2.4761	-.35	201.43	1.40	-.15	892.8000	4.3520	-.44	769.	769.	769.							
4.000	633.4000	2.3597	-.30	215.70	1.46	-.23	808.3000	4.3520	-.54	761.	761.	761.							
5.000	553.2000	2.2342	-.27	210.11	1.50	-.13	719.8000	4.0440	-.63	756.	756.	756.							
6.000	492.4000	2.1673	-.34	204.20	1.58	-.23	648.3000	3.6900	-.43	755.	755.	755.							
7.000	432.2000	2.1267	-.32	207.89	1.71	-.16	583.2000	3.3400	-.62	746.	746.	746.							
8.000	373.0900	2.0648	-.43	201.25	1.95	-.32	523.7000	3.1670	-.39	742.	742.	742.							
9.000	309.5100	2.0312	-.48	204.04	2.18	-.13	470.0000	2.9870	-.38	741.	741.	741.							
10.000	266.0100	2.0977	-.50	206.31	2.21	-.04	421.3000	2.7330	-.53	739.	739.	739.							
11.000	247.1700	2.1088	-.48	208.42	2.19	.10	377.0000	2.3410	-.59	736.	736.	736.							
12.000	212.2000	1.9704	-.41	220.67	2.15	.31	335.1000	2.4020	-.70	735.	735.	735.							
13.000	181.6400	1.8316	-.30	213.64	2.08	.35	296.2000	3.0210	-.75	732.	732.	732.							
14.000	154.6200	1.6620	-.18	209.14	2.39	.20	259.8000	4.0210	-.56	732.	732.	732.							
15.000	131.1600	1.3623	-.07	204.86	2.50	.22	223.0000	4.1510	-.27	725.	725.	725.							
16.000	111.0700	1.0770	-.03	203.87	2.54	.04	189.8000	3.4900	.09	724.	724.	724.							
17.000	94.0620	.8374	-.15	204.36	2.54	-.13	160.4000	2.7400	.32	710.	710.	710.							
18.000	79.7120	.6317	-.20	206.37	2.54	-.20	134.6000	2.1040	.46	707.	707.	707.							
19.000	67.7230	.5919	-.12	203.61	2.13	-.17	112.6000	1.4530	.30	704.	704.	704.							
20.000	57.6800	.5109	-.05	212.79	1.82	-.14	94.4300	1.0720	.15	699.	699.	699.							
21.000	49.2330	.493	.00	215.69	1.67	-.04	79.5200	.8528	.12	681.	681.	681.							
22.000	42.1200	.3357	-.02	218.05	1.54	-.11	67.3000	.7203	.03	674.	674.	674.							
23.000	36.0950	.3441	-.06	220.18	1.49	-.03	57.1100	.5914	.15	666.	666.	666.							
24.000	30.9620	.3054	-.10	222.16	1.66	.10	48.5500	.5310	.31	668.	668.	668.							
25.000	26.6020	.2690	-.15	223.93	1.57	.12	41.3900	.4538	.15	657.	657.	657.							
26.000	22.8820	.2316	-.15	225.61	1.59	.08	35.3300	.3826	.15	642.	642.	642.							
27.000	19.7080	.2071	-.22	227.32	1.86	.24	30.2000	.3165	.18	595.	595.	595.							
28.000	16.9970	.1845	-.31	229.03	1.67	-.13	25.8000	.2729	.05	571.	571.	571.							
29.000	14.6610	.1694	-.30	230.62	1.86	-.11	22.1500	.2536	-.07	476.	476.	476.							
30.000	12.6720	.1501	-.32	232.26	1.79	-.51	19.0100	.2146	-.05	468.	468.	468.							
32.000	9.4738	.1372	-.07	236.44	2.64	.81	13.9700	.2019	-.12	94.	94.	94.							
34.000	7.1402	.1126	-.06	240.90	2.98	.28	10.3300	.1506	.06	95.	95.	95.							
38.000	4.1225	.0757	.02	250.48	3.72	.50	5.7380	.1096	.16	96.	96.	96.							
40.000	3.1406	.0640	-.01	260.10	4.22	-.54	4.3020	.0908	.31	96.	96.	96.							
42.000	2.4334	.0508	.14	260.80	4.22	-.22	3.2540	.0736	.17	98.	98.	98.							
44.000	1.8840	.0406	.15	265.54	3.99	-.11	2.4720	.0544	.17	97.	97.	97.							
46.000	1.4645	.0332	.14	268.08	4.67	.91	1.9020	.0319	.16	97.	97.	97.							
48.000	1.1408	.0279	.10	269.22	4.20	.02	1.4750	.0267	.16	96.	96.	96.							
50.000	.8895	.0236	.05	267.94	4.65	-.59	1.1550	.0267	.17	96.	96.	96.							
52.000	.6908	.0200	.01	265.93	4.95	.05	.9050	.0234	.17	96.	96.	96.							
54.000	.5353	.0172	-.03	262.40	5.67	-.09	.7111	.0196	-.06	95.	95.	95.							
56.000	.4141	.0143	.04	258.58	6.02	-.35	.5581	.0153	-.13	94.	94.	94.							
58.000	.3190	.0121	.08	254.23	6.93	.53	.4375	.0126	-.06	93.	93.	93.							
60.000	.2447	.0102	.12	250.27	6.85	.05	.3406	.0107	-.25	83.	83.	83.							
62.000	.1855	.0083	.37	245.48	7.31	.35	.2637	.0096	-.51	68.	68.	68.							
64.000	.1387	.0065	.63	238.40	7.78	.20	.2028	.0077	-.37	46.	46.	46.							
66.000	.1030	.0046	.64	231.01	10.75	.72	.1555	.0054	.05	37.	37.	37.							
68.000	.0765	.0042	.39	222.09	17.31	.80	.1211	.0059	.33	22.	22.	22.							
70.000	.0562	.0061	1.96	205.52	10.79	.12	.0954	.0103	1.65	14.	14.	14.							

TABLE II-7. THERMODYNAMIC STATISTICAL PARAMETERS

JULY

STATION = 747940 Z KM	CAPE CANAVERAL		S.D. T DEG K	SKEH T	MEAN D G/MS	S.O. D O/MS	SKEH D	NOBS P	NOBS T	NOBS D
	MEAN P MB	SKEH P								
0.00	1017.6000	-41	299.20	.34	1173.0000	13.0400	-.11	789.	789.	789.
.003	1017.3000	-41	293.18	.34	1172.0000	13.0900	-.10	794.	794.	794.
1.000	908.2100	-40	293.86	.16	1069.0000	4.9070	-.01	794.	794.	794.
2.000	808.3800	-33	287.88	.14	973.2000	4.1010	.05	794.	794.	794.
3.000	717.6500	-21	282.22	.14	882.7000	3.6000	.14	793.	793.	793.
4.000	635.4700	-16	276.50	.12	798.6000	3.7300	.00	784.	784.	784.
5.000	561.2200	-14	270.90	.12	720.3000	3.5310	-.30	783.	783.	783.
6.000	494.4300	-10	265.10	.13	648.8000	3.4190	-.20	782.	782.	782.
7.000	434.2000	-10	258.89	.13	583.6000	2.9830	-.17	782.	782.	782.
8.000	380.0400	-18	252.37	.15	524.1000	2.9530	-.11	781.	781.	781.
9.000	331.4500	-23	245.24	.17	470.5000	2.8320	-.23	781.	781.	781.
10.000	287.9000	-24	237.46	.16	422.1000	2.4210	-.30	779.	779.	779.
11.000	248.9300	-32	229.44	.17	378.0000	1.9160	-.21	777.	777.	777.
12.000	213.9200	-31	221.44	.17	336.5000	1.6420	-.44	772.	772.	772.
13.000	183.1200	-29	213.97	.17	298.2000	2.0060	-.77	765.	765.	765.
14.000	155.8900	-24	209.04	.19	261.1000	2.7280	-.65	765.	765.	765.
15.000	132.2200	-30	204.76	.20	225.0000	3.1520	-.27	757.	757.	757.
16.000	111.9800	-30	204.29	.20	191.0000	2.7810	.04	754.	754.	754.
17.000	94.8950	-19	205.41	.21	161.0000	2.1810	.28	744.	744.	744.
18.000	80.4330	-11	207.63	.23	135.1000	1.6760	.44	745.	745.	745.
19.000	68.4400	-03	210.44	.17	113.3000	1.2110	.31	742.	742.	742.
20.000	58.3130	-03	213.35	.16	95.2200	.9741	.33	734.	734.	734.
21.000	49.8020	-08	216.03	.16	80.3000	.8488	.33	705.	705.	705.
22.000	42.6100	-13	218.18	.14	68.0400	.6757	.10	689.	689.	689.
23.000	36.5150	-15	220.14	.15	57.7900	.5767	.15	676.	676.	676.
24.000	31.3240	-19	222.03	.16	49.1500	.5040	-.15	673.	673.	673.
25.000	26.9040	-25	223.83	.16	41.8600	.4103	.10	676.	676.	676.
26.000	23.1370	-30	225.52	.16	35.7400	.3488	.21	652.	652.	652.
27.000	19.9300	-27	227.15	.17	30.5700	.3071	-.02	613.	613.	613.
28.000	17.1840	-27	228.66	.16	26.1600	.2433	-.09	585.	585.	585.
29.000	14.8250	-27	230.19	.16	22.4400	.2404	-.15	476.	476.	476.
30.000	12.8030	-22	231.71	.16	19.2000	.1924	-.26	446.	446.	446.
32.000	9.5361	-07	235.70	.15	14.1100	.1469	-.54	93.	93.	93.
34.000	7.1695	.00	239.80	.13	10.4300	.1625	-.35	92.	92.	92.
36.000	5.4367	.29	244.22	.13	7.7590	.1306	.07	89.	89.	89.
38.000	4.1365	.31	249.48	.12	5.7620	.1032	.43	89.	89.	89.
40.000	3.1607	.01	254.14	.11	4.3380	.0924	-.17	89.	89.	89.
42.000	2.4320	.05	259.19	.11	3.2710	.0757	-.36	89.	89.	89.
44.000	1.8794	.04	263.20	.11	2.4680	.0671	-.20	89.	89.	89.
46.000	1.4563	.04	265.96	.11	1.9090	.0524	-.11	89.	89.	89.
48.000	1.1333	.03	267.19	.11	1.4790	.0373	.25	89.	89.	89.
50.000	.8809	.23	265.78	.11	1.1140	.0326	.43	89.	89.	89.
52.000	.6839	.17	263.19	.11	.7073	.0218	-.11	86.	86.	86.
54.000	.5234	.02	260.85	.11	.5518	.0194	-.20	86.	86.	86.
56.000	.4079	.01	257.59	.11	.4305	.0179	-.11	86.	86.	86.
58.000	.3142	.01	254.61	.11	.3327	.0146	-.11	79.	79.	79.
60.000	.2392	.01	250.39	.11	.2480	.0118	-.11	67.	67.	67.
62.000	.1799	.01	244.14	.11	.1800	.0086	-.11	48.	48.	48.
64.000	.1345	.02	237.29	.10	.1595	.0106	.37	31.	31.	31.
66.000	.0991	.02	230.89	.09	.1503	.0082	.48	27.	27.	27.
68.000	.0737	.00	223.26	.09	.1158	.0056	.24	19.	19.	19.
70.000	.0540	.08	216.76	.16	.0875	.0048	.36	14.	14.	14.

TABLE II-8. THERMODYNAMIC STATISTICAL PARAMETERS

AUGUST

STATION = 747940 Z KM	CAPE CANAVERAL		S.D. P MB	SKEH P	MEAN T DEG K	S.D. T DEG K	SKEH T	MEAN D G/M3	S.D. D G/M3	SKEH D	NOBS P	NOBS T	NOBS D
	MEAN P MB	SKEH P											
.000	1015.6000	2.6682	-1.52	238.85	3.17	.35	1173.0000	13.1400	-1.16	769.	769.	769.	
.003	1016.3000	2.6748	-1.51	298.84	3.17	.34	1173.0000	13.1400	-1.15	775.	775.	775.	
1.000	907.4200	2.4131	-1.49	293.86	.99	-.35	1068.0000	4.4690	-1.05	775.	775.	775.	
2.000	807.6800	2.2356	-1.47	289.01	1.01	-.31	971.6000	3.9600	-1.10	775.	775.	775.	
3.000	717.1200	2.0680	-1.31	282.48	1.10	-.17	881.0000	3.8070	-.29	773.	773.	773.	
4.000	635.0500	1.9407	-1.34	276.79	1.21	.05	797.1000	3.6420	-.43	762.	762.	762.	
5.000	560.9700	1.7937	-1.26	271.19	1.26	.04	719.2000	3.5890	-.36	758.	758.	758.	
6.000	494.2700	1.7020	-1.23	265.35	1.28	-.12	648.0000	3.3510	-.32	756.	756.	756.	
7.000	434.1100	1.5912	-1.24	259.15	1.28	-.12	582.9000	2.9500	-.36	755.	755.	755.	
8.000	380.0400	1.5143	-1.26	252.64	1.45	-.25	523.5000	2.8680	-.26	753.	753.	753.	
9.000	331.4900	1.4891	-1.34	245.54	1.73	-.09	470.0000	2.9000	-.44	751.	751.	751.	
10.000	287.9900	1.4847	-1.27	237.79	1.77	.10	421.6000	2.6200	-.76	750.	750.	750.	
11.000	249.1300	1.4755	-1.30	229.82	1.80	.16	377.6000	2.1350	-.52	747.	747.	747.	
12.000	214.1100	1.4027	-1.06	221.89	1.72	.22	336.2000	1.9860	-1.35	746.	746.	746.	
13.000	183.3600	1.3737	.08	214.40	1.70	.23	297.9600	2.2380	-1.64	740.	740.	740.	
14.000	156.1400	1.2419	.21	208.28	1.90	.57	261.2000	2.9140	-.90	736.	736.	736.	
15.000	132.4100	1.0158	.03	204.65	2.25	.22	225.4000	3.1870	-.12	729.	729.	729.	
16.000	112.1200	.8326	.01	203.83	2.15	.04	191.6000	2.6430	.16	726.	726.	726.	
17.000	94.9510	.6909	.07	204.50	1.98	.04	161.5000	2.0050	.18	720.	720.	720.	
18.000	80.5350	.5879	.13	207.37	1.88	-.11	135.3000	1.5060	.18	719.	719.	719.	
19.000	68.4560	.5103	.26	210.18	1.65	-.03	113.5000	1.1180	.04	711.	711.	711.	
20.000	58.3290	.4521	.43	215.55	1.61	-.09	80.4800	.8966	.38	694.	694.	694.	
21.000	49.7950	.4004	.41	215.55	1.61	-.13	68.1600	.6151	.32	675.	675.	675.	
22.000	42.5930	.3510	.22	217.70	1.41	-.29	57.0600	.5150	.24	646.	646.	646.	
23.000	36.4890	.3111	.15	219.62	1.41	-.15	49.2300	.4636	.27	645.	645.	645.	
24.000	31.2820	.2783	.10	221.40	1.57	-.17	41.5300	.3910	.32	652.	652.	652.	
25.000	26.8630	.2446	.20	223.16	1.57	-.36	35.7800	.3414	.09	629.	629.	629.	
26.000	23.0920	.2186	.14	224.84	1.62	.04	30.5800	.3094	.02	576.	576.	576.	
27.000	19.8810	.1960	.18	226.46	1.93	.12	26.1800	.2435	.02	545.	545.	545.	
28.000	17.1330	.1704	-.07	227.96	1.68	.23	22.4400	.2382	.02	443.	443.	443.	
29.000	14.7730	.1575	.04	229.36	2.03	.20	19.2400	.1961	-.17	428.	428.	428.	
30.000	12.7610	.1400	-.02	231.01	1.78	.20	15.1100	.1461	.16	80.	80.	80.	
34.000	7.1420	.1261	.50	238.63	3.69	.36	10.4500	.1830	.29	79.	79.	79.	
36.000	5.3405	.1051	.53	243.06	3.59	.18	7.7480	.1434	.22	77.	77.	77.	
38.000	4.0985	.0879	.59	247.47	4.44	-.04	5.7620	.1063	.22	76.	76.	76.	
40.000	3.1242	.0780	.54	252.14	4.65	.17	4.3260	.0983	.22	77.	77.	77.	
42.000	2.3384	.0649	.68	257.35	4.73	-.06	3.2530	.0758	-.09	76.	76.	76.	
44.000	1.8499	.0537	.78	261.92	3.57	-.24	2.4650	.0695	.24	76.	76.	76.	
46.000	1.4319	.0426	.82	264.14	3.93	-.40	1.8910	.0560	.43	78.	78.	78.	
48.000	1.1108	.0349	.71	265.99	5.37	-.64	1.4580	.0427	.69	76.	76.	76.	
50.000	.8620	.0294	.57	265.51	5.26	-.15	1.1340	.0325	.75	75.	75.	75.	
52.000	.6688	.0244	.50	264.38	5.19	-.08	.8833	.0267	.33	74.	74.	74.	
54.000	.5104	.0204	.40	262.63	6.27	.02	.6693	.0234	.17	74.	74.	74.	
56.000	.4009	.0113	.53	253.21	6.36	-.12	.5393	.0109	-.04	74.	74.	74.	
58.000	.3971	.0130	.58	255.94	6.78	-.26	.4190	.0172	.76	65.	65.	65.	
60.000	.2365	.0107	.67	253.42	7.58	-.06	.3263	.0123	.75	59.	59.	59.	
62.000	.1794	.0085	.43	249.34	10.22	-.07	.2521	.0102	.76	44.	44.	44.	
64.000	.1348	.0102	1.79	241.35	10.81	.35	.1944	.0080	1.02	31.	31.	31.	
66.000	.1090	.0046	.28	245.93	10.61	.17	.1485	.0060	-.31	24.	24.	24.	
68.000	.0751	.0042	.14	233.05	12.90	-.34	.1145	.0036	.02	19.	19.	19.	
70.000	.0548	.0044	-.01	221.49	14.65	-.09	.0863	-.0066	.04	12.	12.	12.	

TABLE II-9. THERMODYNAMIC STATISTICAL PARAMETERS

SEPTEMBER

STATION Z KM	74794C MEAN P MB	CAPE S.D. P MB	GENERAL SKEW F	MEAN T C/G K	S.D. T C/G K	SKEW T	MEAN D G/M3	S.D. D G/M3	SKEW D	NOBS P	NOBS T	NOBS D
.000	1015.1000	3.0277	-.99	278.46	2.90	.02	1173.0000	12.3100	.14	728.	728.	728.
.003	1014.8000	3.0197	-.99	288.42	2.91	.03	1173.0000	12.3600	.13	741.	741.	741.
1.000	995.7800	2.7697	-.81	292.28	2.91	-.17	1069.0000	5.2930	-.35	741.	741.	741.
2.000	895.9900	2.1500	-.66	287.41	1.19	-.20	971.6000	4.7090	-.51	741.	741.	741.
3.000	775.4900	2.3551	-.49	282.77	1.26	.08	879.5000	4.2900	-.84	737.	737.	737.
4.000	633.6200	2.1928	-.35	276.86	1.34	.06	795.1000	4.1530	-.77	734.	734.	734.
5.000	553.7100	2.0900	-.27	271.32	1.34	-.16	717.2000	3.8240	-.65	733.	733.	733.
6.000	433.1600	1.8537	-.22	265.40	1.43	-.08	646.5000	3.6160	-.64	732.	732.	732.
7.000	433.1400	1.6390	-.16	259.05	1.47	-.27	581.8000	3.2720	-.58	731.	731.	731.
8.000	379.1400	1.7255	-.30	252.41	1.67	-.27	522.8000	3.2080	-.36	729.	729.	729.
9.000	330.6700	1.6846	-.40	245.24	1.93	-.18	469.4000	3.1270	-.39	724.	724.	724.
10.000	287.2100	1.6811	-.17	237.50	1.98	-.02	421.0000	2.7590	-.52	723.	723.	723.
11.000	246.4100	1.6806	-.2	229.59	1.98	.19	376.9000	2.3840	-.63	720.	720.	720.
12.000	213.4800	1.5658	-.45	221.73	1.88	.34	335.4000	2.2190	-.76	720.	720.	720.
13.000	182.8000	1.5235	-.23	214.33	1.95	.49	297.1000	2.5370	-.1.03	718.	718.	718.
14.000	155.6500	1.3742	-.15	208.08	1.88	.29	260.6000	2.9310	-.67	717.	717.	717.
15.000	131.5600	1.1718	-.10	203.78	1.99	.21	225.6000	3.0770	-.30	712.	712.	712.
16.000	111.6200	.9631	-.10	202.30	2.38	.05	192.2000	3.0450	.06	710.	710.	710.
17.000	94.4230	.7831	-.18	203.28	2.63	-.22	161.8000	2.6350	.36	699.	699.	699.
18.000	79.9735	.6672	-.17	205.28	2.29	-.13	135.1000	1.8850	.19	700.	700.	700.
19.000	67.9400	.5709	-.02	202.57	1.78	.01	112.9000	1.2530	.15	693.	693.	693.
20.000	57.8640	.5028	.06	212.65	1.56	-.13	94.8000	.9681	.00	686.	686.	686.
21.000	49.3070	.4380	.07	215.21	1.48	-.04	79.9500	.8199	.10	664.	664.	664.
22.000	42.2300	.3862	.03	217.27	1.45	-.13	67.7100	.6674	.16	659.	659.	659.
23.000	36.1640	.3392	-.03	219.22	1.48	-.10	57.4700	.5340	.17	642.	642.	642.
24.000	30.9990	.3067	-.06	221.01	1.67	.02	48.6500	.4628	.05	641.	641.	641.
25.000	26.6100	.2702	-.09	222.74	1.64	-.08	41.6300	.3833	-.05	633.	633.	633.
26.000	22.8150	.2436	-.10	224.39	1.61	-.02	35.5100	.3433	-.05	615.	615.	615.
27.000	19.6860	.2195	-.11	225.99	1.82	.31	30.3500	.3159	-.06	568.	568.	568.
28.000	16.9610	.1988	-.12	227.44	1.74	-.03	25.9800	.2621	-.11	550.	550.	550.
29.000	14.6180	.1815	-.09	228.92	2.00	.10	22.7500	.2461	-.10	475.	475.	475.
30.000	12.6260	.1565	-.09	230.44	1.94	.03	19.0300	.2113	-.28	466.	466.	466.
32.000	9.3033	.1514	.69	235.00	3.64	.53	13.9500	.2656	.36	70.	70.	70.
34.000	7.0472	.1181	.87	238.26	4.35	.95	10.3500	.1992	.34	70.	70.	70.
36.000	5.3149	.0972	.73	241.82	4.59	.08	7.6310	.1510	1.31	83.	83.	83.
38.000	4.0233	.0837	.67	246.47	5.01	-.17	5.7120	.1182	-.12	73.	73.	73.
40.000	3.0656	.0704	.62	252.56	5.39	-.34	4.2450	.1006	.22	75.	75.	75.
42.000	2.3531	.0599	.27	257.77	6.31	-.125	3.1900	.0829	.91	74.	74.	74.
44.000	1.8174	.0512	.11	263.52	5.28	-.73	2.4080	.0582	.10	73.	73.	73.
46.000	1.4095	.0427	.15	266.23	4.31	-.67	1.8470	.0498	.20	73.	73.	73.
48.000	1.0358	.0352	.10	267.81	5.13	-.49	1.4250	.0437	.07	80.	80.	80.
50.000	.8229	.0295	-.01	268.25	4.89	-.18	1.1080	.0317	.54	73.	73.	73.
52.000	.6639	.0244	-.11	267.96	4.53	-.11	.8344	.0299	-.07	73.	73.	73.
54.000	.5155	.0201	-.13	264.56	5.72	-.11	.6793	.0239	-.34	73.	73.	73.
56.000	.4000	.0167	-.03	252.94	5.65	-.34	.5310	.0189	-.50	71.	71.	71.
58.000	.3088	.0139	.19	259.67	6.57	-.28	.4156	.0158	-.34	66.	66.	66.
60.000	.2381	.0118	.23	255.46	7.55	-.03	.3253	.0130	-.41	60.	60.	60.
62.000	.1819	.0100	.51	250.79	9.88	-.11	.2547	.0097	.71	45.	45.	45.
64.000	.1307	.0074	.18	243.55	11.53	.11	.1357	.0072	.54	23.	23.	23.
66.000	.1063	.0058	.43	232.60	10.66	.91	.1515	.0053	.14	15.	15.	15.
68.000	.0740	.0041	.20	222.83	15.54	1.06	.1173	.0053	-.54	14.	14.	14.
70.000	.0540	.0034	.49	214.54	16.62	1.91	.3393	.0050	-.03	12.	12.	12.

TABLE II-10. THERMODYNAMIC STATISTICAL PARAMETERS

OCTOBER

STATION Z KM	7-4734C		CAPL CARATRAL		MEAN T DEG K	S.D. T DEG K	SKEW T	MEAN D G 13	S.D. D G/MS	SKEW D	NOBS P	NOBS T	NOBS D
	MEAN P MB	S.D. P MB	S.D. P MB	SKEW P									
0.00	1015.8000	3.7752	-0.06	236.22	3.82	-0.72	1185.0000	17.9600	.83	754	754	754	754
0.03	1015.3000	3.7788	-0.06	295.98	3.36	-0.72	1105.0000	18.5400	.82	775	775	775	775
1.00	905.2100	3.2552	-0.34	230.23	2.46	-0.65	1082.0000	11.2900	.66	775	775	775	775
2.00	804.5000	2.9709	-0.50	285.27	2.24	-0.71	978.4000	8.8610	.76	775	775	775	775
3.00	713.5000	2.7021	-0.51	280.75	2.09	-0.30	892.8000	7.1670	.16	775	775	775	775
4.00	631.5000	2.5909	-0.36	275.46	2.03	-0.18	796.6000	6.0200	-0.15	774	774	774	774
5.00	557.3000	2.5213	-0.29	263.64	2.10	-0.36	718.6000	5.3480	-0.03	774	774	774	774
6.00	490.3100	2.5020	-0.26	263.70	2.31	-0.40	648.2000	5.0400	-0.07	773	773	773	773
7.00	430.3100	2.6204	-0.23	256.54	2.59	-0.33	583.5000	4.5700	-0.18	772	772	772	772
8.00	376.1400	2.6774	-0.23	249.68	2.87	-0.26	524.2000	4.4630	-0.27	772	772	772	772
9.00	327.5100	2.7478	-0.23	242.39	3.03	-0.10	470.2000	4.1340	-0.46	765	765	765	765
10.00	294.0000	2.7923	-0.20	234.96	2.92	-0.08	420.7000	3.7850	-0.75	765	765	765	765
11.00	245.2400	2.7799	-0.16	227.57	2.68	-0.09	375.4000	3.4170	-0.97	759	759	759	759
12.00	210.6200	2.5398	-0.11	220.58	2.23	-0.21	332.6000	3.5270	-0.81	759	759	759	759
13.00	180.0200	2.3184	-0.07	214.15	2.03	-0.02	293.2000	4.1210	-0.58	757	757	757	757
14.00	153.4600	1.9746	-0.02	208.54	2.19	-0.10	256.4000	4.5770	-0.39	755	755	755	755
15.00	131.2000	1.5285	-0.08	204.25	2.53	-0.34	222.1000	4.5270	-0.16	749	749	749	749
16.00	111.2000	1.2457	-0.08	202.06	2.60	-0.28	189.9000	4.0270	.00	744	744	744	744
17.00	93.1120	.9670	-0.06	202.37	2.83	-0.06	160.3000	3.2670	.16	730	730	730	730
18.00	78.7830	.7764	-0.06	204.97	2.74	-0.31	133.9000	2.3650	.15	728	728	728	728
19.00	66.8720	.6482	-0.07	208.63	2.25	-0.02	111.7000	1.6000	.17	726	726	726	726
20.00	56.9180	.5629	-0.09	211.81	2.02	-0.06	93.6200	1.1720	.12	723	723	723	723
21.00	48.5400	.4919	-0.08	214.20	1.98	-0.05	78.9500	.9157	.06	695	695	695	695
22.00	41.4760	.4429	-0.10	216.40	1.85	-0.13	66.7700	.7521	-0.06	694	694	694	694
23.00	35.5920	.3937	-0.09	218.41	1.64	-0.25	56.6300	.5980	.03	685	685	685	685
24.00	30.4120	.3542	-0.06	220.34	1.84	-0.31	48.0800	.5507	-0.04	683	683	683	683
25.00	26.1000	.3181	-0.04	222.11	1.97	-0.17	40.9400	.4725	.01	673	673	673	673
26.00	22.4230	.2851	-0.04	223.81	1.97	-0.44	34.9000	.4077	.11	652	652	652	652
27.00	12.2020	.2531	-0.13	225.39	2.19	-0.24	29.6000	.3702	-0.03	601	601	601	601
28.00	16.6080	.2292	-0.15	226.84	2.29	-0.44	25.5100	.3218	.00	584	584	584	584
29.00	14.3080	.2072	-0.24	228.22	2.43	-0.28	21.8400	.2877	.16	512	512	512	512
30.00	12.3490	.1895	-0.31	229.70	2.42	-0.29	18.7300	.2520	.10	503	503	503	503
32.00	9.2103	.1465	-0.06	233.85	5.06	-0.33	13.7400	.2384	-0.67	82	82	82	82
34.00	6.9165	.1375	-0.36	237.42	4.95	-0.23	10.1600	.2177	.37	77	77	77	77
36.00	5.2162	.1157	-0.48	241.63	5.02	-0.47	7.5300	.1713	.28	83	83	83	83
38.00	3.9741	.0983	-0.46	246.17	5.44	-0.01	5.6010	.1479	1.20	80	80	80	80
40.00	3.0105	.0796	-0.52	251.10	6.07	-0.51	4.1870	.1221	.48	82	82	82	82
42.00	2.3170	.0674	-0.51	257.30	6.05	-0.13	3.1310	.0839	.17	82	82	82	82
44.00	1.7888	.0557	-0.50	263.08	5.63	-0.25	2.3680	.0625	.20	84	84	84	84
46.00	1.3977	.0455	-0.49	266.03	5.69	-0.85	1.8170	.0472	.50	85	85	85	85
48.00	1.0783	.0397	-0.41	267.73	5.94	-0.74	1.4030	.0478	.10	85	85	85	85
50.00	.8405	.0310	-0.59	267.43	6.29	-1.16	1.0990	.0359	.26	84	84	84	84
52.00	.6543	.0271	-0.63	266.40	6.24	-0.33	.8258	.0289	-0.37	84	84	84	84
54.00	.5081	.0215	-0.60	263.31	6.85	-0.63	.6723	.0256	.59	83	83	83	83
56.00	.3935	.0154	-0.63	261.31	7.28	-0.56	.5243	.0210	.64	84	84	84	84
58.00	.3034	.01162	-0.70	257.91	8.81	-0.39	.4097	.0173	.39	73	73	73	73
60.00	.2343	.0070	-0.71	254.41	8.81	-0.12	.2401	.0140	.26	67	67	67	67
62.00	.1795	.0033	-0.89	247.65	8.62	-0.02	.2474	.0108	.74	48	48	48	48
64.00	.1359	.0020	-1.27	241.16	9.23	-0.50	.1922	.0066	.61	33	33	33	33
66.00	.0948	.0013	-0.89	235.16	9.11	-0.50	.1460	.0051	.47	25	25	25	25
68.00	.0740	.0006	-0.95	225.62	10.08	-0.60	.1148	.0051	-0.37	24	24	24	24
70.00	.0551	.0004	-1.17	225.41	11.77	-0.65	.0874	.0038	-0.47	24	24	24	24

TABLE II-1. THERMODYNAMIC STATISTICAL PARAMETERS

NOVEMBER

STATION Z KM	CAPE CANAVERAL		S. D. T DEG K	SKCH T	MEAN D G/M3	S. D. D G/M3	SKCH D	NOBS P	NOBS T	NOBS D
	S. D. P MB	SKCH P								
000	1018.2500	4.2321	4.82	-1.68	1206.0000	22.9600	.79	771.	771.	771.
.023	1017.8000	4.1978	4.79	-1.67	1206.0000	22.7500	.80	866.	866.	866.
1.000	906.2300	3.7599	3.27	-1.31	1092.0000	14.3200	.98	866.	866.	866.
2.000	804.6400	3.4871	2.83	-1.59	985.2000	10.0700	.43	866.	866.	866.
3.000	713.1200	3.3798	2.60	-1.52	885.7000	7.7110	.25	805.	866.	866.
4.000	630.6200	3.4030	2.54	-1.38	799.6000	6.3140	.06	866.	866.	866.
5.000	566.2900	3.3858	2.59	-1.42	721.4000	5.4760	.22	865.	865.	865.
6.000	489.2900	3.4684	2.63	-1.45	650.3000	4.9600	.05	864.	864.	864.
7.000	428.8600	3.4938	2.66	-1.54	585.2000	4.3870	-.14	863.	863.	863.
8.000	374.5500	3.4499	2.80	-1.54	525.8000	4.1570	-.41	860.	860.	860.
9.000	325.7800	3.4128	2.90	-1.38	471.0000	3.160	-.77	857.	857.	857.
10.000	282.1400	3.3529	2.82	-1.38	421.8000	3.8010	-.89	857.	857.	857.
11.000	243.2800	3.2387	2.62	-1.38	375.9000	3.7460	-.92	851.	851.	851.
12.000	208.7000	2.9167	2.40	-1.13	332.7600	4.2930	-.88	851.	851.	851.
13.000	178.3400	2.6081	2.40	-1.14	292.4000	5.0320	-.78	845.	845.	845.
14.000	151.7100	2.2566	2.59	-.22	254.5000	5.1870	-.59	836.	836.	836.
15.000	128.6200	1.8297	2.61	.07	219.3000	4.6400	-.42	828.	828.	828.
16.000	108.9300	1.4886	2.54	.36	187.5000	4.0380	-.50	804.	804.	804.
17.000	92.0280	1.1775	2.79	.61	159.0000	3.6270	-.41	801.	801.	801.
18.000	77.7750	.9160	3.19	.31	133.5000	3.0910	.18	798.	798.	798.
19.000	65.9070	.7156	2.95	-.08	111.2000	2.1930	.05	786.	786.	786.
20.000	56.0670	.5933	2.56	-.23	93.0500	1.5050	.16	752.	752.	752.
21.000	47.6330	.5161	2.30	-.12	78.2000	1.1030	.14	744.	744.	744.
22.000	40.7500	.4544	2.36	.17	65.9700	.6977	.17	732.	732.	732.
23.000	34.8040	.4042	2.42	.10	55.8600	.7398	.17	732.	732.	732.
24.000	29.7820	.3670	2.00	.09	47.3600	.6765	.07	733.	733.	733.
25.000	25.5470	.3372	2.96	-.16	40.2700	.5683	.20	726.	726.	726.
26.000	21.3250	.3102	3.10	-.24	34.3200	.4655	.24	716.	716.	716.
27.000	18.6490	.2877	3.26	-.02	29.2900	.3820	.17	681.	681.	681.
28.000	16.2170	.2695	3.37	.02	25.0400	.3397	.09	648.	648.	648.
29.000	13.9220	.2517	3.45	.13	21.4200	.3081	.14	547.	547.	547.
30.000	12.0400	.2316	3.79	.13	18.3500	.2862	.13	540.	540.	540.
34.000	6.7427	.1694	5.18	-.47	10.0100	.3420	1.05	86.	86.	86.
36.000	5.0775	.1444	6.81	-.06	7.3770	.2482	.42	86.	86.	86.
38.000	3.8705	.1164	7.19	.51	5.4900	.2208	.78	87.	87.	87.
40.000	2.9347	.0934	7.20	.06	4.0700	.1772	.33	89.	89.	89.
42.000	2.2220	.0735	6.65	-.44	3.0220	.1404	.83	89.	89.	89.
44.000	1.7383	.0534	7.22	.00	2.3080	.0974	.74	88.	88.	88.
46.000	1.3492	.0613	7.53	.06	1.7660	.0712	1.03	86.	86.	86.
48.000	1.0502	.0514	7.53	-.46	1.3680	.0567	.88	84.	84.	84.
50.000	.8172	.0429	6.58	-.14	1.0600	.0474	.75	84.	84.	84.
52.000	.6753	.0359	7.95	-.61	.8336	.0378	.47	83.	83.	83.
54.000	.4970	.0295	7.78	-.36	.6263	.0331	.42	81.	81.	81.
56.000	.3791	.0242	7.84	-.23	.5115	.0264	.52	79.	79.	79.
58.000	.2975	.0195	8.66	-.47	.3977	.0209	.19	71.	71.	71.
60.000	.2238	.0160	8.74	-.58	.3071	.0184	.54	66.	66.	66.
62.000	.1636	.0111	9.31	.01	.2367	.0151	.00	47.	47.	47.
64.000	.1267	.0084	11.51	.10	.1822	.0133	.28	33.	33.	33.
66.000	.0958	.0058	11.26	.65	.1380	.0095	.34	27.	27.	27.
68.000	.0737	.0049	13.90	.61	.1066	.0067	.01	23.	23.	23.
70.000	.0521	.0042	14.10	1.46	.0818	.0045	-.22	21.	21.	21.

TABLE II-12. THERMODYNAMIC STATISTICAL PARAMETERS

DECEMBER

Z KH	STATION = 7479-U		CAPE CALVERTAL		S.O. T DEC	SKEW T	MEAN D G/MS	S.O. D G/MS	SKEW D	NOBS P	NOBS T	NOBS D
	MEAN P PD	SD P PD	MEAN T DEC K	SKEW P								
.000	1019.6000	4.4369	-.50	288.72	5.47	-.56	1224.0000	28.2000	.66	784.	784.	784.
.003	1019.2000	4.4397	-.44	288.48	5.81	-.53	1225.0000	29.3000	.66	873.	873.	873.
1.000	825.3000	4.1135	-.43	295.38	4.07	-.82	1102.0000	17.2600	.65	874.	874.	874.
2.000	803.8600	4.6604	-.50	281.76	3.36	-.42	991.2000	11.6100	.28	874.	874.	874.
3.000	712.0000	4.0543	-.51	277.83	2.91	-.34	930.8000	8.4100	.09	874.	874.	874.
4.000	623.1100	4.1246	-.53	272.52	2.79	-.45	802.8000	6.3400	.08	873.	873.	873.
5.000	554.3200	4.1327	-.53	266.44	2.82	-.42	723.9000	5.4460	-.10	873.	873.	873.
6.000	487.3000	4.2130	-.52	253.93	2.84	-.29	652.3000	4.8050	-.22	873.	873.	873.
7.000	426.7300	4.1791	-.48	253.24	2.93	-.32	586.4000	4.4870	-.09	872.	872.	872.
8.000	372.3700	4.321	-.45	246.12	3.15	-.47	526.6000	4.4110	-.10	869.	869.	869.
9.000	323.2400	4.0503	-.42	238.63	3.15	-.35	472.0000	4.1020	-.26	866.	866.	866.
10.000	279.9100	3.9385	-.39	231.11	2.98	-.23	421.8000	4.1420	-.82	865.	865.	865.
11.000	241.0700	3.7301	-.34	223.90	2.71	.05	375.1000	4.6430	-.97	860.	860.	860.
12.000	206.6400	3.3111	-.28	217.36	2.74	.25	331.2000	5.5840	-.94	860.	860.	860.
13.000	176.4600	2.9295	-.20	212.38	3.08	.27	289.5000	6.3250	-.90	855.	855.	855.
14.000	150.1900	2.4691	-.15	208.95	3.16	.21	250.5000	5.9580	-.05	854.	854.	854.
15.000	127.5000	2.0448	-.11	206.08	2.74	.21	215.6000	4.8370	-.17	849.	849.	849.
16.000	108.0100	1.6683	-.05	203.46	2.95	.41	185.0000	4.1910	-.25	844.	844.	844.
17.000	91.3070	1.3228	.01	202.03	2.83	.25	157.6000	3.8820	-.12	831.	831.	831.
18.000	77.2450	1.0694	.04	202.26	3.36	.08	133.1000	3.4690	-.02	828.	828.	828.
19.000	65.3800	.8196	.13	204.87	3.46	-.05	111.2000	2.7040	.03	811.	811.	811.
20.000	55.4880	.6601	.14	208.11	3.07	-.05	92.9100	1.8820	.08	805.	805.	805.
21.000	47.1930	.5541	.10	211.12	2.72	-.01	77.8700	1.3250	.22	783.	783.	783.
22.000	40.2290	.4030	.05	213.72	2.81	.10	65.5900	1.0650	.36	751.	751.	751.
23.000	34.3750	.3259	-.07	215.95	3.91	.17	55.4500	.8558	.42	747.	747.	747.
24.000	29.4080	.3026	-.13	218.06	3.31	.53	46.9300	.7654	.17	753.	753.	753.
25.000	25.6560	.3569	-.08	220.10	3.94	.78	39.9000	.6988	-.11	737.	737.	737.
26.000	21.6240	.3344	-.01	222.82	4.28	.77	33.9400	.5829	-.24	720.	720.	720.
27.000	18.5610	.3200	.04	223.93	4.59	.77	28.9100	.4777	-.30	653.	653.	653.
28.000	15.9420	.3104	.12	225.66	4.56	.63	24.6300	.3700	-.37	630.	630.	630.
29.000	13.7680	.2930	.23	227.33	4.19	.59	21.1000	.3306	-.17	534.	534.	534.
30.000	11.8710	.2748	.31	228.93	4.01	.37	18.0500	.3050	-.28	528.	528.	528.
32.000	8.8344	.2136	.36	233.40	5.56	-.17	13.2000	.3212	1.07	87.	87.	87.
34.000	6.6400	.1850	.24	238.17	5.93	.05	9.7320	.2906	.43	88.	88.	88.
36.000	5.0170	.1526	.07	243.44	6.22	.24	7.1980	.2592	.88	88.	88.	88.
38.000	3.8174	.1235	-.12	249.01	6.16	.21	5.3490	.1877	.58	87.	87.	87.
40.000	2.9128	.1006	-.11	254.84	6.77	-.56	3.9790	.1449	.07	88.	88.	88.
42.000	2.2437	.0820	-.01	260.63	7.32	-.65	3.0110	.1218	.74	91.	91.	91.
44.000	1.7435	.0683	.00	267.21	6.39	.19	2.2160	.0977	1.09	81.	81.	81.
46.000	1.3561	.0500	-.06	269.56	6.55	.00	1.3400	.0644	.30	90.	90.	90.
48.000	1.0667	.0474	-.01	270.13	6.94	-.27	1.0690	.0518	.25	87.	87.	87.
50.000	.8238	.0392	-.01	278.81	6.94	-.06	.8379	.0443	.62	84.	84.	84.
52.000	.6416	.0324	-.03	287.18	6.62	-.54	.6532	.0348	.43	84.	84.	84.
54.000	.4700	.0273	.11	294.20	6.60	-.19	.5191	.0273	-.04	83.	83.	83.
56.000	.3465	.0219	.07	299.06	6.17	-.15	.4214	.0221	-.38	80.	80.	80.
58.000	.2703	.0182	.13	293.69	6.05	-.11	.3146	.0175	.28	67.	67.	67.
60.000	.2186	.0147	-.01	293.79	9.05	-.26	.3146	.0175	.28	67.	67.	67.
62.000	.1728	.0117	.14	290.24	9.77	-.62	.2727	.0142	.42	36.	36.	36.
64.000	.1230	.0081	-.11	291.74	10.78	1.02	.1443	.0109	.50	33.	33.	33.
66.000	.0969	.0064	-.09	295.45	11.66	-.70	.1443	.0109	.50	33.	33.	33.
68.000	.0720	.0061	.24	293.03	10.34	-.47	.1133	.0068	-.06	23.	23.	23.
70.000	.0552	.0110	2.54	216.06	15.33	.59	.0702	.0171	2.79	20.	20.	20.

TABLE II-13. THERMODYNAMIC STATISTICAL PARAMETERS
ANNUAL

STATION = 747340	CAVE CANALS	S.D. T	SKEW T	MEAN D	S.D. D	SKEW D	MOBS P	MOBS T	MOBS D		
Z	S.D. P	CEG K	CEG K	G/M3	G/M3	G/M3					
KM	MB	MB	MB								
000	1017 4000	4.1772	-1.13	293.95	5.18	-0.80	1197.0000	30.0600	.97	9023.	9023.
003	1017 2000	4.2322	-1.11	293.60	6.27	-0.75	1198.0000	30.5300	.90	9863.	9863.
1.000	965.1500	3.7052	-1.64	289.03	4.70	-1.03	1086.0000	19.4800	1.00	9863.	9863.
2.000	804.9700	3.8368	-1.89	284.32	3.73	-0.99	962.7000	12.4400	.92	9865.	9865.
3.000	713.5900	4.0818	-1.95	274.54	3.26	-0.97	855.8000	8.4750	.64	9851.	9851.
4.000	631.0300	4.3248	-1.98	264.82	3.19	-0.95	822.6000	6.7110	.37	9813.	9813.
5.000	565.8300	4.4575	-1.99	255.09	3.33	-0.77	722.1000	5.8600	.26	9790.	9790.
6.000	499.6200	4.6407	-1.95	245.60	3.33	-0.63	642.6000	5.1700	.14	9780.	9780.
7.000	429.1600	4.7800	-1.89	236.25	3.36	-0.63	565.1000	4.5900	.09	9759.	9759.
8.000	374.5200	4.8071	-1.84	226.36	3.36	-0.54	505.4000	4.3750	-0.09	9729.	9729.
9.000	326.2100	4.8465	-1.75	211.01	4.08	-0.35	471.1000	4.1120	-0.62	9693.	9693.
10.000	282.6300	4.7997	-1.65	233.46	3.32	-0.27	421.9000	4.0380	-1.87	9675.	9675.
11.000	243.8100	4.6650	-1.55	225.09	3.53	-0.18	375.7000	4.0360	-1.87	9632.	9632.
12.000	209.2200	4.2195	-1.47	219.31	3.08	.18	312.4000	5.0150	-1.58	9620.	9620.
13.000	178.9200	3.7845	-1.36	213.70	2.82	.09	291.2000	6.9400	-0.93	9569.	9569.
14.000	152.3700	3.1786	-1.31	209.33	2.94	.30	253.6000	7.2350	-0.44	9534.	9534.
15.000	129.3400	2.1579	-1.29	205.94	2.94	.28	218.9000	6.3260	-0.26	9425.	9425.
16.000	109.5300	2.0964	-1.28	203.87	2.78	.20	187.3000	4.8870	-0.32	9425.	9425.
17.000	92.7730	1.7510	-1.22	203.34	2.95	-0.01	159.0000	3.7350	-0.44	9374.	9374.
18.000	78.5320	1.5188	-1.09	204.49	3.49	-0.23	133.9000	2.9360	-0.41	9218.	9218.
19.000	66.6110	1.3551	-1.04	207.35	3.40	-0.47	111.9000	2.2530	-0.39	9129.	9129.
20.000	56.6360	1.2211	-1.10	210.54	2.94	-0.53	93.7200	1.7540	-0.34	9027.	9027.
21.000	48.2750	1.1045	-1.11	213.44	2.94	-0.52	78.7900	1.4610	-0.10	8651.	8651.
22.000	41.2270	.9984	-1.11	215.92	2.84	-0.59	66.5200	1.3020	-0.08	8551.	8551.
23.000	35.2760	.8945	-1.09	217.95	2.93	-0.59	56.3700	1.1260	.02	8422.	8422.
24.000	30.2110	.8050	-1.07	219.97	2.93	-0.52	47.8400	1.0190	.06	8419.	8419.
25.000	25.9250	.7202	-1.02	221.81	3.05	-0.49	40.7200	.9011	.02	8333.	8333.
26.000	22.2660	.6409	-1.02	223.58	3.12	-0.45	34.6900	.8029	.04	8106.	8106.
27.000	19.1560	.5817	-1.07	225.36	3.24	-0.32	29.6100	.7294	.05	7399.	7399.
28.000	16.4950	.5227	-1.12	227.07	3.27	-0.42	25.3100	.6572	.01	7152.	7152.
29.000	14.2190	.4642	-1.15	229.74	3.29	-0.34	21.6200	.5916	.03	5934.	5934.
30.000	12.2740	.4053	-1.19	230.40	3.29	-0.47	18.5500	.5323	-0.04	5818.	5818.
32.000	9.1378	.3384	-1.16	235.14	5.04	.09	13.5700	.4659	-0.19	1077.	1077.
34.000	6.6714	.2618	-1.20	239.35	5.38	-0.10	10.0300	.3811	-0.16	1080.	1080.
36.000	5.1957	.2126	-1.20	244.21	5.77	.02	7.4290	.3071	-0.28	1077.	1077.
38.000	3.9527	.1676	-1.23	249.44	5.89	-0.08	5.5340	.2378	-0.23	1081.	1081.
40.000	3.0231	.1322	-1.20	255.08	5.93	-0.27	4.1360	.1876	-0.28	1092.	1092.
42.000	2.3077	.1033	-1.18	260.97	5.94	-0.40	3.1180	.1490	-0.23	1097.	1097.
44.000	1.8319	.0810	-1.16	266.16	5.81	-0.03	2.2600	.1144	-0.25	1097.	1097.
46.000	1.3499	.0642	-1.16	267.53	5.67	-0.07	1.6230	.0853	-0.26	1094.	1094.
48.000	1.0697	.0512	-1.13	268.34	5.79	-0.31	1.1150	.0645	-0.27	1087.	1087.
50.000	.8482	.0414	-1.11	267.44	5.85	-0.40	1.1060	.0504	-0.20	1076.	1076.
52.000	.6595	.0337	-1.09	265.68	6.31	-0.26	.8657	.0407	-0.25	1064.	1064.
54.000	.5110	.0276	-1.06	263.25	6.80	-0.39	.6779	.0330	-0.17	1043.	1043.
56.000	.3742	.0224	-1.02	261.90	7.02	-0.31	.5497	.0275	-0.17	1022.	1022.
58.000	.3148	.0182	-1.06	257.84	7.79	-0.25	.4139	.0227	-0.17	950.	950.
60.000	.2749	.0151	-1.07	254.20	8.47	-0.10	.3226	.0183	-0.17	840.	840.
62.000	.2490	.0122	-1.08	249.74	9.25	.02	.2504	.0148	-0.17	633.	633.
64.000	.1342	.0100	-1.39	242.74	10.90	.26	.1935	.0126	-0.06	428.	428.
66.000	.0742	.0075	-1.35	235.55	11.16	.48	.1483	.0104	.24	343.	343.
68.000	.0743	.0051	-1.30	234.84	14.31	.57	.1151	.0078	.00	262.	262.
70.000	.0547	.0058	-1.07	219.33	14.73	.90	.0873	.0066	2.74	234.	234.

TABLE III-1. MOISTURE RELATED STATISTICAL PARAMETERS

JANUARY

STATION #	CAPE CANAVERAL	TV	TV	SKEW TV	DEHPT T	S.D. DPT	SKEW DPT	NOBS T-P	NOBS TV		
Z	VAPOR P	S.D. VP	SKEW VP	MEAN	S.D.	MEAN	S.D. DPT	NOBS T-P	NOBS TV		
KM	MB	MB	DEG K	DEG K	DEG K	DEG K					
.000	14.414	5.176	-.23	289.45	6.32	-1.68	284.46	6.61	-1.11	779.	779.
.003	14.141	5.140	-.19	289.19	6.30	-.59	284.17	6.56	-1.01	894.	896.
1.000	9.835	4.379	-.41	285.78	4.88	-.84	277.84	9.22	-1.41	842.	896.
2.000	5.641	3.245	.21	281.74	3.76	-.84	269.44	9.62	-.61	779.	896.
3.000	3.231	2.085	.70	277.45	3.39	-.73	262.11	8.93	-.19	712.	895.
4.000	1.991	1.348	.94	272.05	3.36	-.79	256.11	8.56	-.08	669.	893.
5.000	1.194	.846	1.08	265.94	3.29	-.67	250.05	8.37	-.07	654.	893.
6.000	.735	.518	1.11	259.44	3.22	-.70	244.70	8.12	-.21	643.	892.
7.000	.427	.296	1.02	252.77	3.30	-.85	239.01	7.92	-.41	675.	889.
8.000	.239	.158	.93	245.65	3.31	-.63	233.45	7.42	-.56	644.	885.
9.000	.113	.074	.94	238.10	3.22	-.49	226.65	6.79	-.67	607.	883.
10.000	.047	.026	.79	230.48	3.07	-.32	219.72	4.97	-.35	441.	881.
11.000	.020	.010	.74	223.47	2.97	.20	213.30	4.18	-.43	369.	878.
12.000	.009	.004	1.18	217.52	3.35	.39	207.43	3.50	-.50	369.	877.
13.000	.005	.003	1.63	213.64	3.56	-.01	203.51	3.59	-.36	287.	872.
14.000	.003	.001	.63	210.82	2.89	-.22	200.28	3.13	-.58	103.	869.
15.000	.002	.001	.13	207.31	2.56	.39	196.99	2.27	-.13	13.	865.
16.000	99.999	99.999	999.99	204.15	2.69	.74	999.99	99.99	999.99	0.	857.
17.000	99.999	99.999	999.99	202.34	3.11	.73	999.99	99.99	999.99	0.	836.
18.000	99.999	99.999	999.99	202.24	3.55	.57	999.99	99.99	999.99	0.	827.
19.000	99.999	99.999	999.99	204.46	3.52	.38	999.99	99.99	999.99	0.	810.
20.000	99.999	99.999	999.99	207.54	3.30	.29	999.99	99.99	999.99	0.	797.
21.000	99.999	99.999	999.99	210.60	3.14	.17	999.99	99.99	999.99	0.	747.
22.000	99.999	99.999	999.99	213.35	3.09	.09	999.99	99.99	999.99	0.	736.
23.000	99.999	99.999	999.99	215.45	2.94	.20	999.99	99.99	999.99	0.	724.
24.000	99.999	99.999	999.99	217.49	3.11	.10	999.99	99.99	999.99	0.	718.
25.000	99.999	99.999	999.99	219.27	3.19	.17	999.99	99.99	999.99	0.	703.
26.000	99.999	99.999	999.99	220.91	3.14	.14	999.99	99.99	999.99	0.	687.
27.000	99.999	99.999	999.99	222.71	3.25	.11	999.99	99.99	999.99	0.	623.
28.000	99.999	99.999	999.99	224.57	3.55	.01	999.99	99.99	999.99	0.	602.
29.000	99.999	99.999	999.99	226.25	3.57	-.03	999.99	99.99	999.99	0.	480.
30.000	99.999	99.999	999.99	228.00	3.76	-.10	999.99	99.99	999.99	0.	474.

TABLE III-2. MOISTURE RELATED STATISTICAL PARAMETERS

FEBRUARY

STATION - 747940 Z	CAPE CANAVERAL VAPOR P S.O. VP	SKEW VP	TV MEAN DEG K	TV S.O. DEG K	SKEW TV	DEWPT T MEAN DEG K	S.O. DPT DEG K	SKEW DPT	NOBS T+P	NOBS TV	
.000	14.000	5.311	.02	289.20	6.49	-0.33	283.99	6.52	-.72	717.	717.
.003	13.770	5.316	.10	289.96	6.53	-.26	283.73	6.52	-.63	798.	799.
1.000	9.072	4.414	-.10	285.30	5.05	-.57	276.59	9.09	-1.01	760.	800.
2.000	5.213	3.183	.33	281.20	3.93	-.82	268.17	9.84	-.47	719.	800.
3.000	3.112	2.076	.81	276.61	3.60	-.48	261.52	9.07	-.16	663.	800.
4.000	1.919	1.341	1.04	271.10	3.52	-.07	255.95	8.72	-.07	634.	793.
5.000	1.196	.868	1.11	265.12	3.52	-.04	249.91	8.63	-.10	617.	792.
6.000	.731	.517	1.15	258.70	3.54	-.17	244.62	8.21	-.30	614.	792.
7.000	.430	.295	.93	252.05	3.57	-.47	238.96	8.29	-.62	621.	792.
8.000	.229	.148	1.00	244.98	3.67	-.47	233.10	7.29	-.66	608.	786.
9.000	.110	.067	1.05	237.75	3.60	-.36	226.65	6.28	-.71	563.	786.
10.000	.045	.024	.81	230.64	3.42	-.08	219.49	4.79	-.41	441.	785.
11.000	.020	.009	.51	224.17	3.39	.16	213.17	3.99	-.48	386.	782.
12.000	.010	.005	.71	218.98	3.77	.11	207.89	3.78	-.51	382.	780.
13.000	.006	.003	.86	215.07	3.59	-.14	202.72	3.91	-.47	235.	775.
14.000	.003	.001	.53	211.28	2.79	.19	200.23	3.37	-.67	76.	770.
15.000	.002	.001	.22	207.22	2.61	.35	197.39	2.43	-.20	12.	766.
16.000	99.999	99.999	999.99	203.97	2.72	.38	999.99	99.99	999.99	0.	759.
17.000	99.999	99.999	999.99	202.31	2.91	.33	999.99	99.99	999.99	0.	751.
18.000	99.999	99.999	999.99	202.45	3.25	.23	999.99	99.99	999.99	0.	746.
19.000	99.999	99.999	999.99	204.94	3.13	.10	999.99	99.99	999.99	0.	739.
20.000	99.999	99.999	999.99	208.08	2.91	.19	999.99	99.99	999.99	0.	727.
21.000	99.999	99.999	999.99	211.11	2.68	.16	999.99	99.99	999.99	0.	692.
22.000	99.999	99.999	999.99	213.72	2.64	-.07	999.99	99.99	999.99	0.	678.
23.000	99.999	99.999	999.99	215.56	2.51	-.11	999.99	99.99	999.99	0.	670.
24.000	99.999	99.999	999.99	217.38	2.66	-.17	999.99	99.99	999.99	0.	679.
25.000	99.999	99.999	999.99	218.97	2.66	.06	999.99	99.99	999.99	0.	667.
26.000	99.999	99.999	999.99	220.67	2.58	.12	999.99	99.99	999.99	0.	651.
27.000	99.999	99.999	999.99	222.47	2.62	.24	999.99	99.99	999.99	0.	585.
28.000	99.999	99.999	999.99	224.27	2.82	.20	999.99	99.99	999.99	0.	567.
29.000	99.999	99.999	999.99	226.25	2.93	-.02	999.99	99.99	999.99	0.	447.
30.000	99.999	99.999	999.99	228.20	3.09	-.12	999.99	99.99	999.99	0.	444.

TABLE III-3. MOISTURE RELATED STATISTICAL PARAMETERS

MARCH

STATION = 747940		CAPE CANAVERAL			TV	TV	SKEW TV	DEWPT T	S.D. DPT	SKEW DPT	NOBS T+P	NOBS TV
Z	VAPOR P	S.D. VP	SKEW VP	TV	TV	SKEW TV	DEWPT T	S.D. DPT	SKEW DPT	NOBS T+P	NOBS TV	
KM	MEAN			MEAN	S.D.		MEAN	DEG K				
	MB	MB	DEG K	DEG K	DEG K	DEG K	DEG K	DEG K	DEG K			
.000	16.256	5.189	-.23	292.03	5.62	-.40	286.58	5.64	-.91	725.	725.	
.003	15.788	5.258	-.17	291.78	5.73	-.38	276.07	5.85	-.88	872.	872.	
1.000	10.523	4.368	-.22	287.20	4.82	-.89	279.34	7.74	-1.16	835.	872.	
2.000	5.937	3.359	.16	282.82	3.83	-.85	270.20	9.50	-.57	726.	874.	
3.000	3.319	2.112	.68	278.14	3.57	-.44	262.55	8.74	-.13	668.	874.	
4.000	1.955	1.287	.91	272.28	3.51	-.39	256.03	8.32	-.10	654.	873.	
5.000	1.181	.796	1.06	265.91	3.50	-.20	250.14	8.03	-.12	644.	873.	
6.000	.713	.459	1.08	259.26	3.43	-.17	244.38	8.10	-.22	636.	872.	
7.000	.406	.282	1.02	252.55	3.47	-.26	238.46	7.98	-.42	642.	871.	
8.000	.224	.148	.86	244.48	3.65	-.37	232.75	7.44	-.53	654.	869.	
9.000	.110	.070	1.04	238.00	3.64	-.24	226.55	6.46	-.54	615.	861.	
10.000	.046	.028	1.12	230.54	3.47	-.09	219.38	5.29	-.30	464.	857.	
11.000	.024	.010	.80	223.80	3.11	.09	213.21	4.18	-.36	420.	855.	
12.000	.009	.004	.47	218.37	3.26	.22	207.76	3.48	-.55	418.	854.	
13.000	.005	.002	.50	214.55	3.20	.04	203.72	3.51	-.72	278.	852.	
14.000	.003	.002	.85	211.27	2.90	-.07	200.04	3.54	-.60	106.	848.	
15.000	99.999	99.999	999.99	207.75	2.75	.29	999.99	99.99	999.99	3.	846.	
16.000	99.999	99.999	999.99	204.84	2.79	.22	999.99	99.99	999.99	0.	841.	
17.000	99.999	99.999	999.99	203.18	3.03	.15	999.99	99.99	999.99	0.	824.	
18.000	99.999	99.999	999.99	203.09	3.52	.08	999.99	99.99	999.99	0.	814.	
19.000	99.999	99.999	999.99	205.49	3.45	.02	999.99	99.99	999.99	0.	805.	
20.000	99.999	99.999	999.99	208.68	3.11	.01	999.99	99.99	999.99	0.	795.	
21.000	99.999	99.999	999.99	211.86	2.94	-.03	999.99	99.99	999.99	0.	759.	
22.000	99.999	99.999	999.99	214.75	2.80	-.06	999.99	99.99	999.99	0.	755.	
23.000	99.999	99.999	999.99	216.81	2.74	-.15	999.99	99.99	999.99	0.	741.	
24.000	99.999	99.999	999.99	218.75	2.86	-.06	999.99	99.99	999.99	0.	736.	
25.000	99.999	99.999	999.99	220.54	3.02	-.09	999.99	99.99	999.99	0.	733.	
26.000	99.999	99.999	999.99	222.41	3.10	-.08	999.99	99.99	999.99	0.	718.	
27.000	99.999	99.999	999.99	224.34	3.19	-.03	999.99	99.99	999.99	0.	649.	
28.000	99.999	99.999	999.99	226.41	3.32	-.06	999.99	99.99	999.99	0.	630.	
29.000	99.999	99.999	999.99	228.34	3.32	-.13	999.99	99.99	999.99	0.	510.	
30.000	99.999	99.999	999.99	230.77	3.32	-.40	999.99	99.99	999.99	0.	500.	

TABLE III-4. MOISTURE RELATED STATISTICAL PARAMETERS

APRIL

STATION = 747940		CAPE CANAVERAL		TV	TV	SKEW TV	DWPT T	S.D. DPT	SKEW DPT	NOBS T-P	NOBS TV
Z	VAPOR P	S.D. VP	SKEW VP	MEAN	S.D.		MEAN				
KM	MB	MB		DEG K	DEG K		DEG K	DEG K			
.000	18.557	4.534	-.41	295.27	4.99	-.65	289.00	4.27	-.97	736.	736.
.003	18.205	4.564	-.32	295.14	4.92	-.65	288.68	4.33	-.88	871.	871.
1.000	11.505	3.860	-.31	289.66	3.27	-.52	281.23	6.05	-1.31	843.	871.
2.000	5.997	3.213	.22	284.67	3.10	-.45	270.70	8.75	-.58	736.	871.
3.000	3.265	2.007	.78	279.70	2.82	-.29	262.54	8.39	-.19	670.	869.
4.000	1.968	1.264	1.02	273.80	2.68	-.09	256.21	8.19	-.20	655.	868.
5.000	1.276	.839	.90	267.29	2.64	-.21	250.93	8.41	-.33	641.	867.
6.000	.756	.524	1.08	260.56	2.65	-.23	244.91	8.44	-.39	623.	867.
7.000	.35	.303	1.08	253.80	2.75	-.54	239.08	8.19	-.50	629.	866.
8.000	.227	.152	1.07	246.66	3.00	-.63	232.92	7.44	-.63	633.	864.
9.000	.110	.069	1.07	239.11	3.05	-.46	226.54	6.42	-.64	609.	861.
10.000	.046	.026	1.15	231.33	2.98	-.05	219.55	4.86	-.24	432.	858.
11.000	.020	.011	1.13	223.98	2.67	.01	212.93	4.32	-.28	375.	853.
12.000	.008	.004	.93	217.73	2.62	.22	206.95	3.53	-.34	375.	853.
13.000	.005	.002	.70	213.55	3.02	.09	202.75	3.56	-.44	240.	847.
14.000	.003	.002	.54	210.63	3.03	-.31	199.54	3.81	-.33	109.	844.
15.000	.002	.002	1.24	207.67	2.68	.03	195.72	5.18	.92	6.	841.
16.000	99.999	99.999	999.99	205.05	2.54	.29	999.99	99.99	999.99	0.	838.
17.000	99.999	99.999	999.99	203.49	2.70	.22	999.99	99.99	999.99	0.	823.
18.000	99.999	99.999	999.99	203.52	3.04	.29	999.99	99.99	999.99	0.	817.
19.000	99.999	99.999	999.99	205.23	2.93	.34	999.99	99.99	999.99	0.	814.
20.000	99.999	99.999	999.99	209.62	2.67	.21	999.99	99.99	999.99	0.	805.
21.000	99.999	99.999	999.99	213.18	2.48	.12	999.99	99.99	999.99	0.	770.
22.000	99.999	99.999	999.99	215.92	2.42	-.03	999.99	99.99	999.99	0.	766.
23.000	99.999	99.999	999.99	218.20	2.38	-.11	999.99	99.99	999.99	0.	755.
24.000	99.999	99.999	999.99	220.44	2.40	-.08	999.99	99.99	999.99	0.	752.
25.000	99.999	99.999	999.99	222.55	2.43	-.10	999.99	99.99	999.99	0.	750.
26.000	99.999	99.999	999.99	224.74	2.53	-.13	999.99	99.99	999.99	0.	729.
27.000	99.999	99.999	999.99	226.90	2.70	-.06	999.99	99.99	999.99	0.	658.
28.000	99.999	99.999	999.99	229.02	2.64	-.04	999.99	99.99	999.99	0.	635.
29.000	99.999	99.999	999.99	231.05	2.57	-.08	999.99	99.99	999.99	0.	534.
30.000	99.999	99.999	999.99	233.05	2.49	-.18	999.99	99.99	999.99	0.	525.

TABLE III-5. MOISTURE RELATED STATISTICAL PARAMETERS

MAY

STATION = 747940		CAPE CANAVERAL			TV	TV	SKW TV	DEWPT T	S.D. OPT	SKW OPT	NOBS T+P	NOBS TV
Z	VAPOR P	S.D. VP	SKEW VP	TV	TV	SKW TV	DEWPT T	S.D. OPT	SKW OPT	NOBS T+P	NOBS TV	
KM	MEAN	MB		MEAN	S.D.		MEAN	DEG K				
	MB			DEG K	DEG K		DEG K					
.000	22.565	3.582	-.47	298.72	3.87	-.28	292.39	2.71	-.90	767.	767.	
.003	22.246	3.760	-.50	298.53	3.95	-.35	292.13	2.92	-.99	828.	828.	
1.000	13.742	3.374	-.51	292.39	2.37	-.39	284.36	4.30	-1.39	821.	828.	
2.000	8.025	3.018	-.30	286.34	2.00	-.32	275.77	6.69	-1.23	767.	828.	
3.000	4.418	2.144	.30	280.62	1.96	-.31	267.15	7.32	-.56	715.	826.	
4.000	2.593	1.433	.64	274.66	2.02	-.26	260.05	7.57	-.38	648.	826.	
5.000	1.503	.940	.92	268.55	2.14	-.31	253.17	7.77	-.22	602.	823.	
6.000	.881	.592	1.08	262.06	2.25	-.32	246.87	7.89	-.23	578.	822.	
7.000	.486	.320	.98	255.35	2.33	-.55	240.59	7.51	-.35	589.	820.	
8.000	.271	.171	.85	248.32	2.51	-.60	234.82	7.13	-.59	582.	818.	
9.000	.127	.080	.93	240.70	2.59	-.45	227.97	6.50	-.62	591.	817.	
10.000	.051	.027	.82	232.82	2.57	-.32	220.53	4.79	-.36	426.	816.	
11.000	.020	.010	.75	225.16	2.30	-.08	213.26	4.13	-.59	398.	814.	
12.000	.008	.003	.53	218.14	2.24	.24	206.79	3.37	-.81	398.	813.	
13.000	.004	.002	.58	212.60	2.62	.45	202.09	3.22	-.73	230.	810.	
14.000	.003	.001	.38	209.61	3.11	.02	199.61	3.25	-.88	133.	808.	
15.000	.002	.001	-.40	207.67	2.83	.02	196.62	2.82	-1.24	10.	806.	
16.000	99.999	99.999	999.99	205.98	2.48	-.15	999.99	99.99	999.99	0.	805.	
17.000	99.999	99.999	999.99	205.15	2.29	.02	999.99	99.99	999.99	0.	792.	
18.000	99.999	99.999	999.99	205.69	2.50	.11	999.99	99.99	999.99	0.	786.	
19.000	99.999	99.999	999.99	208.60	2.42	-.11	999.99	99.99	999.99	0.	779.	
20.000	99.999	99.999	999.99	211.91	2.20	-.29	999.99	99.99	999.99	0.	776.	
21.000	99.999	99.999	999.99	215.02	1.95	-.21	999.99	99.99	999.99	0.	748.	
22.000	99.999	99.999	999.99	217.59	1.84	-.19	999.99	99.99	999.99	0.	746.	
23.000	99.999	99.999	999.99	219.81	1.72	-.23	999.99	99.99	999.99	0.	738.	
24.000	99.999	99.999	999.99	221.90	1.83	-.26	999.99	99.99	999.99	0.	738.	
25.000	99.999	99.999	999.99	223.88	1.81	-.12	999.99	99.99	999.99	0.	726.	
26.000	99.999	99.999	999.99	225.81	1.77	.03	999.99	99.99	999.99	0.	695.	
27.000	99.999	99.999	999.99	227.62	1.86	.17	999.99	99.99	999.99	0.	617.	
28.000	99.999	99.999	999.99	229.49	1.80	.08	999.99	99.99	999.99	0.	505.	
29.000	99.999	99.999	999.99	231.26	1.93	.20	999.99	99.99	999.99	0.	500.	
30.000	99.999	99.999	999.99	233.03	1.84	.15	999.99	99.99	999.99	0.	496.	

TABLE III-6. MOISTURE RELATED STATISTICAL PARAMETERS

JUNE

STATION # 7479+0 Z	CAPE S.D. VP	CANAVERAL SKEW VP	TV M"AN DEG K	TV S.D. DEG K	SKEW TV	DCHPT T MEAN DEG K	S.D. DPT DEG K	SKEW DPT	NOBS T+P	NOBS TV	
KM	MB	MB									
.000	26.502	2.657	-.50	301.20	3.07	.31	295.12	1.71	-.91	754.	754.
.003	26.416	2.717	-.54	331.11	3.09	.30	295.06	1.76	-.94	770.	771.
1.000	16.660	2.679	-.62	294.75	1.59	-.56	287.60	2.71	-1.24	767.	771.
2.000	10.291	2.644	-.80	288.39	1.46	-.37	279.96	4.79	-2.03	755.	771.
3.000	6.305	2.050	-.56	282.39	1.45	-.09	272.67	5.86	-1.67	740.	769.
4.000	3.982	1.577	-.27	276.41	1.54	-.05	266.18	6.61	-1.23	676.	761.
5.000	2.351	1.192	.20	270.63	1.62	.06	258.90	7.60	-.78	642.	756.
6.000	1.405	.765	.30	264.59	1.71	-.07	252.63	7.55	-.66	592.	755.
7.000	.765	.447	.58	258.19	1.82	-.06	245.69	7.33	-.50	564.	746.
8.000	.411	.235	.62	251.50	2.05	-.25	239.32	6.73	-.57	565.	742.
9.000	.195	.115	.72	244.25	2.28	-.15	231.91	6.62	-.76	564.	741.
10.000	.079	.043	.98	236.49	2.35	.03	224.12	5.16	-.47	412.	739.
11.000	.031	.016	1.35	228.42	2.20	.14	216.48	4.21	-.29	372.	736.
12.000	.012	.005	.97	220.67	2.15	.31	209.31	3.47	-.40	369.	735.
13.000	.005	.002	.58	213.64	2.08	.36	202.62	3.37	-.76	231.	732.
14.000	.002	.001	.87	208.14	2.39	.20	196.96	3.32	-.57	116.	732.
15.000	.001	.001	1.52	204.96	2.60	.22	194.46	3.13	1.33	7.	725.
16.000	99.999	99.999	999.99	203.87	2.54	.04	999.99	99.99	999.99	0.	724.
17.000	99.999	99.999	999.99	204.36	2.54	-.13	999.99	99.99	999.99	0.	710.
18.000	99.999	99.999	999.99	206.37	2.54	-.20	999.99	99.99	999.99	0.	707.
19.000	99.999	99.999	999.99	209.61	2.13	-.17	999.99	99.99	999.99	0.	704.
20.000	99.999	99.999	999.99	212.79	1.82	-.14	999.99	99.99	999.99	0.	699.
21.000	99.999	99.999	999.99	215.69	1.67	-.04	999.99	99.99	999.99	0.	681.
22.000	99.999	99.999	999.99	218.05	1.54	-.11	999.99	99.99	999.99	0.	674.
23.000	99.999	99.999	999.99	220.18	1.49	-.03	999.99	99.99	999.99	0.	666.
24.000	99.999	99.999	999.99	222.16	1.66	.10	999.99	99.99	999.99	0.	668.
25.000	99.999	99.999	999.99	223.93	1.57	.12	999.99	99.99	999.99	0.	657.
26.000	99.999	99.999	999.99	225.61	1.59	.08	999.99	99.99	999.99	0.	642.
27.000	99.999	99.999	999.99	227.32	1.86	.24	999.99	99.99	999.99	0.	595.
28.000	99.999	99.999	999.99	229.03	1.67	-.13	999.99	99.99	999.99	0.	571.
29.000	99.999	99.999	999.99	230.62	1.86	-.11	999.99	99.99	999.99	0.	476.
30.000	99.999	99.999	999.99	232.26	1.79	-.51	999.99	99.99	999.99	0.	468.

TABLE III-7. MOISTURE RELATED STATISTICAL PARAMETERS

JULY

STATION #	CAPE CANAVERAL			TV	TV	SKEW TV	DEWPT T	S.D. DPT	SKEW DPT	NOBS T+P	NOBS TV
	Z	VAPOR P	S.D. VP								
KM	MB	MB		DEG K	DEG K		DEG K	DEG K			
.000	27.789	2.486	-.25	302.33	3.33	.22	295.92	1.51	-.68	789.	789.
.003	27.768	2.483	-.25	302.30	3.35	.21	295.90	1.51	-.68	792.	794.
1.000	17.705	2.372	-.46	296.05	1.21	.19	288.61	2.22	-1.14	793.	794.
2.000	10.911	2.249	-.66	293.36	1.14	.03	281.07	3.95	-1.88	791.	794.
3.000	6.630	1.831	-.51	283.23	1.14	-.26	273.69	4.63	-1.55	767.	793.
4.000	4.133	1.418	-.20	277.22	1.26	.02	267.02	5.47	-1.28	710.	784.
5.000	2.521	1.127	.17	271.42	1.32	.09	260.19	6.69	-.93	681.	783.
6.000	1.519	.730	.35	265.50	1.42	.08	253.96	6.72	-.85	618.	782.
7.000	.849	.435	.38	259.21	1.42	.06	247.16	6.68	-.87	574.	782.
8.000	.436	.229	.44	252.63	1.62	-.17	240.02	6.70	-1.00	557.	781.
9.000	.216	.118	.52	245.44	1.88	-.08	233.02	6.53	-.95	545.	781.
10.000	.089	.048	.83	237.64	1.93	-.10	225.13	5.51	-.83	424.	779.
11.000	.035	.018	.87	229.44	1.85	-.18	217.49	4.42	-.30	364.	777.
12.000	.013	.006	.75	221.44	1.72	-.11	210.07	3.66	-.37	384.	772.
13.000	.005	.002	.75	213.97	1.71	.12	203.33	3.38	-.37	218.	765.
14.000	.002	.001	1.56	208.04	1.94	.23	197.62	3.19	-.34	113.	765.
15.000	99.999	99.999	999.99	204.76	2.15	.17	999.99	99.99	999.99	0.	757.
16.000	99.999	99.999	999.99	204.29	2.20	-.01	999.99	99.99	999.99	0.	754.
17.000	99.999	99.999	999.99	205.41	2.11	-.32	999.99	99.99	999.99	0.	744.
18.000	99.999	99.999	999.99	207.63	2.03	-.49	999.99	99.99	999.99	0.	745.
19.000	99.999	99.999	999.99	210.44	1.75	-.33	999.99	99.99	999.99	0.	742.
20.000	99.999	99.999	999.99	213.35	1.63	-.39	999.99	99.99	999.99	0.	734.
21.000	99.999	99.999	999.99	216.03	1.63	-.23	999.99	99.99	999.99	0.	705.
22.000	99.999	99.999	999.99	218.18	1.46	-.23	999.99	99.99	999.99	0.	689.
23.000	99.999	99.999	999.99	220.14	1.51	-.32	999.99	99.99	999.99	0.	676.
24.000	99.999	99.999	999.99	222.03	1.68	-.03	999.99	99.99	999.99	0.	673.
25.000	99.999	99.999	999.99	223.83	1.65	-.11	999.99	99.99	999.99	0.	676.
26.000	99.999	99.999	999.99	225.52	1.69	-.06	999.99	99.99	999.99	0.	652.
27.000	99.999	99.999	999.99	227.15	1.87	-.07	999.99	99.99	999.99	0.	613.
28.000	99.999	99.999	999.99	228.66	1.66	-.32	999.99	99.99	999.99	0.	565.
29.000	99.999	99.999	999.99	230.19	2.08	-.06	999.99	99.99	999.99	1.	476.
30.000	99.999	99.999	999.99	231.71	1.86	-.17	999.99	99.99	999.99	1.	446.

TABLE III-8. MOISTURE RELATED STATISTICAL PARAMETERS

AUGUST

STATION # 747940		CAPE CANAVERAL		TV	TV	SKEW TV	DEWPT T	S.D. DPT	SKEW DPT	NOBS T+P	NOBS TV
Z	VAPOR P	S.D. VP	SKEW VP	MEAN	S.D.		MEAN				
KM	MB	MB		DEG K	DEG K		DEG K	DEG K			
.000	27.716	2.485	-.32	301.97	3.38	.26	295.87	1.51	-.58	769.	771.
.003	27.704	2.476	-.33	301.95	3.38	.25	295.87	1.51	-.58	774.	775.
1.000	18.299	2.225	-.32	296.13	1.07	-.29	289.15	1.98	-.77	767.	775.
2.000	11.545	2.022	-.61	289.59	1.04	-.31	282.01	2.89	-1.51	769.	775.
3.000	7.130	1.713	-.51	283.56	1.12	-.13	274.87	3.89	-1.40	760.	773.
4.000	4.473	1.426	-.42	277.56	1.22	.10	268.16	5.24	-1.51	713.	762.
5.000	2.728	1.036	.06	271.74	1.32	.15	261.45	5.99	-.99	671.	758.
6.000	1.568	.746	.20	265.75	1.36	.04	254.29	6.87	-.92	616.	756.
7.000	.866	.439	.36	259.45	1.37	.11	247.43	6.77	-.83	600.	755.
8.000	.455	.243	.34	252.88	1.56	.02	240.34	7.03	-.96	565.	753.
9.000	.215	.115	.58	245.74	1.85	.22	233.06	6.36	-1.04	548.	751.
10.000	.087	.049	1.38	237.97	1.91	.47	224.94	5.42	-.77	419.	750.
11.000	.034	.017	1.40	229.83	1.84	.29	217.52	4.08	-.21	376.	747.
12.000	.013	.006	1.55	221.89	1.72	.22	210.18	3.32	-.07	382.	746.
13.000	.003	.003	1.57	214.40	1.70	.23	203.35	3.35	-.03	215.	740.
14.000	.002	.001	1.10	208.28	1.90	.57	197.18	3.16	-.28	106.	736.
15.000	99.999	99.999	999.99	204.65	2.25	.22	999.99	99.99	999.99	1.	729.
16.000	99.999	99.999	999.99	203.83	2.15	.04	999.99	99.99	999.99	0.	726.
17.000	99.999	99.999	999.99	204.90	1.98	.04	999.99	99.99	999.99	0.	720.
18.000	99.999	99.999	999.99	207.37	1.88	-.11	999.99	99.99	999.99	0.	719.
19.000	99.999	99.999	999.99	210.18	1.65	-.03	999.99	99.99	999.99	0.	711.
20.000	99.999	99.999	999.99	213.06	1.60	-.17	999.99	99.99	999.99	0.	694.
21.000	99.999	99.999	999.99	215.55	1.61	-.09	999.99	99.99	999.99	0.	675.
22.000	99.999	99.999	999.99	217.70	1.41	-.13	999.99	99.99	999.99	0.	659.
23.000	99.999	99.999	999.99	219.62	1.41	-.29	999.99	99.99	999.99	0.	646.
24.000	99.999	99.999	999.99	221.40	1.57	-.15	999.99	99.99	999.99	0.	645.
25.000	99.999	99.999	999.99	223.16	1.57	-.17	999.99	99.99	999.99	0.	642.
26.000	99.999	99.999	999.99	224.84	1.62	-.36	999.99	99.99	999.99	0.	629.
27.000	99.999	99.999	999.99	226.46	1.93	.04	999.99	99.99	999.99	0.	576.
28.000	99.999	99.999	999.99	227.36	1.68	.12	999.99	99.99	999.99	0.	545.
29.000	99.999	99.999	999.99	229.36	2.03	.23	999.99	99.99	999.99	0.	443.
30.000	99.999	99.999	999.99	231.01	1.78	.20	999.99	99.99	999.99	0.	428.

TABLE III-9. MOISTURE RELATED STATISTICAL PARAMETERS

SEPTEMBER

STATION = 747940		CAPE CANAVERAL		TV	TV	SKEW TV	DEWPT T	S.D. DPT	SKEW DPT	NOBS T+P	NOBS TV
Z	VAPOR P	S.D. VP	SKEW VP	TV	TV		MEAN				
KM	MS	MB		MEAN	S.D.		DEG K	DEG K			
.000	27.083	2.733	-.51	301.51	3.12	-.08	295.47	1.73	-.99	728.	728.
.003	27.025	2.744	-.58	301.46	3.13	-.07	295.44	1.74	-.96	741.	741.
1.000	18.014	2.580	-.75	295.20	1.31	-.24	288.85	2.44	-1.42	737.	741.
2.000	11.374	2.511	-.62	289.00	1.24	-.13	281.62	3.86	-1.65	728.	741.
3.000	6.907	2.188	-.42	283.42	1.26	.08	274.05	5.40	-1.37	706.	737.
4.000	4.270	1.694	-.07	277.62	1.55	.12	267.18	6.21	-.90	655.	734.
5.000	2.584	1.241	.22	271.88	1.39	-.13	260.30	7.13	-.78	625.	733.
6.000	1.496	.852	.56	265.81	1.50	-.03	253.38	7.43	-.51	572.	732.
7.000	.837	.431	.68	259.37	1.54	-.16	246.66	7.43	-.53	566.	731.
8.000	.446	.272	.89	252.66	1.73	-.24	239.95	7.11	-.51	550.	729.
9.000	.216	.138	1.06	245.44	1.99	-.22	232.66	7.04	-.64	525.	724.
10.000	.094	.059	1.34	237.68	2.03	-.08	225.30	6.05	-.65	420.	723.
11.000	.039	.023	1.71	229.59	1.93	.21	218.32	4.63	-.10	319.	720.
12.000	.015	.008	1.89	221.73	1.88	.34	211.02	3.82	-.13	382.	720.
13.000	.006	.003	1.57	214.33	1.85	.49	204.40	3.68	-.42	260.	718.
14.000	.002	.001	1.59	208.08	1.88	.29	197.96	3.23	-.27	127.	717.
15.000	99.999	99.999	999.99	203.78	1.99	.21	999.99	99.99	999.99	3.	712.
16.000	99.999	99.999	999.99	202.30	2.38	.05	999.99	99.99	999.99	0.	710.
17.000	99.999	99.999	999.99	203.28	2.63	-.22	999.99	99.99	999.99	0.	699.
18.000	99.999	99.999	999.99	206.28	2.29	-.13	999.99	99.99	999.99	0.	700.
19.000	99.999	99.999	999.99	209.57	1.78	.01	999.99	99.99	999.99	0.	693.
20.000	99.999	99.999	999.99	212.35	1.56	-.13	999.99	99.99	999.99	0.	686.
21.000	99.999	99.999	999.99	215.21	1.48	-.04	999.99	99.99	999.99	0.	664.
22.000	99.999	99.999	999.99	217.27	1.45	-.13	999.99	99.99	999.99	0.	659.
23.000	99.999	99.999	999.99	219.22	1.48	-.10	999.99	99.99	999.99	0.	642.
24.000	99.999	99.999	999.99	221.01	1.67	.02	999.99	99.99	999.99	0.	641.
25.000	99.999	99.999	999.99	222.74	1.64	-.08	999.99	99.99	999.99	0.	633.
26.000	99.999	99.999	999.99	224.39	1.61	-.02	999.99	99.99	999.99	0.	615.
27.000	99.999	99.999	999.99	225.99	1.82	.31	999.99	99.99	999.99	0.	568.
28.000	99.999	99.999	999.99	227.44	1.74	-.03	999.99	99.99	999.99	0.	550.
29.000	99.999	99.999	999.99	228.92	2.00	.10	999.99	99.99	999.99	0.	475.
30.000	99.999	99.999	999.99	230.44	1.94	.03	999.99	99.99	999.99	0.	466.

TABLE III-10. MOISTURE RELATED STATISTICAL PARAMETERS

OCTOBER

STATION = 747940		CAPE CANAVERAL		TV	TV	SKEW TV	DEWPT	S.D. DPT	SKEW DPT	MOBS T+P	MOBS TV
Z	VAPOR P	S.D. VP	SKEW VP	MEAN	S.D.		MEAN				
KM	MB	MB		DEG K	DEG K		DEG K	DEG K			
.000	22.307	4.728	-.47	298.71	4.21	-.76	292.03	3.77	-1.11	724.	724.
.003	22.063	4.807	-.43	299.45	4.39	-.76	291.84	3.86	-1.04	775.	775.
1.000	14.817	3.956	-.74	292.05	2.90	-.66	285.35	5.05	-1.72	768.	775.
2.000	8.616	3.655	-.30	265.47	2.42	-.65	276.41	7.70	-1.03	724.	775.
3.000	4.935	2.606	.25	281.60	2.21	-.21	268.11	8.48	-.46	658.	775.
4.000	3.011	1.851	.52	276.13	2.16	-.12	261.38	8.64	-.23	592.	774.
5.000	1.817	1.283	.82	270.20	2.24	-.26	254.75	8.91	-.03	563.	774.
6.000	1.075	.802	.95	263.67	2.50	-.25	248.50	8.87	-.04	562.	773.
7.000	.613	.451	.95	256.93	2.71	-.22	242.48	8.44	-.10	554.	772.
8.000	.327	.236	1.01	250.01	3.00	-.12	236.12	8.09	-.43	579.	772.
9.000	.157	.115	1.00	242.68	3.15	.03	229.97	7.33	-.61	560.	765.
10.000	.071	.046	1.47	235.17	3.12	.14	223.03	5.41	-.07	428.	765.
11.000	.029	.017	1.45	227.59	2.74	.22	215.85	4.52	-.01	398.	759.
12.000	.012	.006	1.21	220.58	2.23	-.21	209.53	3.63	-.20	399.	759.
13.000	.005	.002	.74	214.15	2.03	.02	203.28	3.41	-.49	272.	757.
14.000	.002	.001	1.09	208.54	2.19	.10	197.88	3.66	-.19	129.	755.
15.000	.001	.001	1.66	204.25	2.53	.34	194.40	4.19	-.29	12.	749.
16.000	99.999	99.999	999.99	202.06	2.68	.28	999.99	99.99	999.99	0.	744.
17.000	99.999	99.999	999.99	202.37	2.83	.06	999.99	99.99	999.99	0.	730.
18.000	99.999	99.999	999.99	204.97	2.74	.31	999.99	99.99	999.99	0.	728.
19.000	99.999	99.999	999.99	208.63	2.26	.02	999.99	99.99	999.99	0.	726.
20.000	99.999	99.999	999.99	211.81	2.02	.06	999.99	99.99	999.99	0.	723.
21.000	99.999	99.999	999.99	214.20	1.88	-.05	999.99	99.99	999.99	0.	695.
22.000	99.999	99.999	999.99	216.40	1.85	-.13	999.99	99.99	999.99	0.	694.
23.000	99.999	99.999	999.99	218.41	1.64	-.25	999.99	99.99	999.99	0.	685.
24.000	99.999	99.999	999.99	220.34	1.84	-.31	999.99	99.99	999.99	0.	683.
25.000	99.999	99.999	999.99	222.11	1.98	-.56	999.99	99.99	999.99	0.	673.
26.000	99.999	99.999	999.99	223.81	1.97	-.44	999.99	99.99	999.99	0.	652.
27.000	99.999	99.999	999.99	215.39	2.19	-.24	999.99	99.99	999.99	0.	601.
28.000	99.999	99.999	999.99	205.84	2.29	-.44	999.99	99.99	999.99	0.	584.
29.000	99.999	99.999	999.99	228.22	2.43	-.28	999.99	99.99	999.99	0.	512.
30.000	99.999	99.999	999.99	229.70	2.42	-.29	999.99	99.99	999.99	0.	503.

TABLE III-11. MOISTURE RELATED STATISTICAL PARAMETERS

NOVEMBER

STATION = 747940		CAPE CANAVERAL		TV		TV		DEWPT Y		S.D. DPT		SKEW DPT		NOBS T+P		NOBS TV	
Z	VAPOR P	S.D. VP	SKEW VP	TV	TV	SKEW TV	DEWPT Y	S.D. DPT	SKEW DPT	NOBS T+P	NOBS TV						
KM	MEAN	MB		MEAN	S.D.		MEAN	DEG K	DEG K								
.000	18.165	5.027	-.41	294.29	5.29	-.70	288.50	5.02	-1.18	771.	771.						
.003	18.000	4.949	-.36	294.17	5.25	-.70	288.37	4.95	-1.17	865.	865.						
1.000	12.352	4.029	-.58	289.15	3.63	-1.24	282.21	6.57	-1.94	341.	855.						
2.000	6.765	3.582	.14	284.94	2.88	-.59	272.31	8.99	-.68	772.	866.						
3.000	3.704	2.315	.69	280.20	2.73	-.47	264.01	8.74	-.16	694.	866.						
4.000	2.186	1.482	1.05	274.77	2.71	-.30	257.36	8.3	.06	657.	866.						
5.000	1.307	.933	1.29	268.66	2.73	-.35	251.21	8.08	.09	640.	865.						
6.000	.792	.570	1.35	262.12	2.81	-.33	245.57	7.97	-.07	636.	864.						
7.000	.458	.323	1.34	255.32	2.85	-.37	239.88	7.51	-.17	650.	863.						
8.000	.256	.183	1.21	248.19	2.99	-.38	237.31	7.56	-.34	640.	860.						
9.000	.125	.098	1.25	240.64	3.07	-.24	227.32	7.18	-.57	650.	857.						
10.000	.053	.032	1.61	233.04	3.06	-.13	220.65	5.02	-.15	463.	857.						
11.000	.021	.011	1.22	225.49	2.61	-.38	213.51	4.10	-.19	440.	851.						
12.000	.009	.004	1.16	218.52	2.40	-.13	207.25	3.44	-.25	440.	851.						
13.000	.004	.002	1.32	212.45	2.41	.14	201.57	3.69	-.09	288.	845.						
14.000	.002	.001	1.14	207.73	2.59	.22	195.48	4.07	-.24	154.	836.						
15.000	.001	.001	1.12	204.37	2.61	.07	192.66	4.71	.16	23.	828.						
16.000	99.999	99.999	999.99	202.26	2.54	.36	999.99	99.99	999.99	0.	823.						
17.000	99.999	99.999	999.99	201.66	2.78	.61	999.99	99.99	999.99	0.	804.						
18.000	99.999	99.999	999.99	203.09	3.19	.31	999.99	99.99	999.99	0.	801.						
19.000	99.999	99.999	999.99	206.48	2.95	-.08	999.99	99.99	999.99	0.	795.						
20.000	99.999	99.999	999.99	209.72	2.56	-.23	999.99	99.99	999.99	0.	786.						
21.000	99.999	99.999	999.99	212.48	2.30	.12	999.99	99.99	999.99	0.	752.						
22.000	99.999	99.999	999.99	214.93	2.36	.17	999.99	99.99	999.99	0.	744.						
23.000	99.999	99.999	999.99	217.08	2.42	.10	999.99	99.99	999.99	0.	732.						
24.000	99.999	99.999	999.99	219.11	2.80	.09	999.99	99.99	999.99	0.	733.						
25.000	99.999	99.999	999.99	220.95	2.96	-.16	999.99	99.99	999.99	0.	726.						
26.000	99.999	99.999	999.99	222.55	3.10	-.24	999.99	99.99	999.99	0.	716.						
27.000	99.999	99.999	999.99	224.19	3.26	-.11	999.99	99.99	999.99	0.	661.						
28.000	99.999	99.999	999.99	225.83	3.37	.02	999.99	99.99	999.99	0.	648.						
29.000	99.999	99.999	999.99	227.10	3.35	.13	999.99	99.99	999.99	0.	547.						
30.000	99.999	99.999	999.99	228.61	3.45	.16	999.99	99.99	999.99	0.	540.						

TABLE III-12. MOISTURE RELATED STATISTICAL PARAMETERS

DECEMBER

STATION = 747940		CAPE CANAVERAL		TV	TV	SKEW TV	DEWPT T	S.D. DPT	SKEW DPT	NOBS T+P	NOBS TV
Z	VAPOR P	S.D. VP	SKEW VP	MEAN	S.D.		MEAN				
KM	MB	MB		DEG K	DEG K		DEG K	DEG K			
.000	15.011	5.338	-.13	290.35	6.33	-.54	285.15	6.31	-.91	764.	764.
.003	14.691	5.352	-.11	290.08	6.32	-.51	284.76	6.30	-.94	875.	875.
1.000	10.218	4.484	-.25	286.60	4.48	-.74	278.61	6.60	-1.27	829.	874.
2.000	5.817	3.410	.31	282.60	3.57	-.40	269.85	9.58	-.53	764.	874.
3.000	3.377	2.165	.74	278.45	3.05	-.29	262.71	8.89	-.22	693.	874.
4.000	2.065	1.387	.98	273.02	2.92	-.37	256.60	8.52	-.15	654.	873.
5.000	1.257	.919	1.18	266.67	2.96	-.32	250.53	8.54	-.04	643.	873.
6.000	.774	.581	1.33	260.27	2.98	-.16	245.05	8.43	-.14	650.	973.
7.000	.452	.329	1.28	253.52	3.07	-.16	239.46	8.12	-.34	667.	872.
8.000	.243	.168	1.16	246.34	3.27	-.30	233.51	7.54	-.49	694.	869.
9.000	.119	.076	1.09	238.81	3.25	-.26	227.17	6.67	-.68	655.	866.
10.000	.050	.031	1.66	231.17	3.08	-.13	220.07	5.03	.01	479.	865.
11.000	.020	.010	1.05	223.90	2.71	.05	213.01	3.96	-.11	422.	860.
12.000	.008	.004	.79	217.36	2.74	.25	206.84	3.35	-.28	422.	860.
13.000	.004	.002	.64	212.38	3.08	.27	201.81	3.46	-.35	273.	858.
14.000	.003	.002	.56	209.95	3.16	.21	199.02	4.04	-.39	96.	854.
15.000	.002	.001	.68	206.08	2.74	.21	197.95	2.27	-.36	11	849.
16.000	99.999	99.999	999.99	203.46	2.55	.41	999.99	99.99	999.99	0.	844.
17.000	99.999	99.999	999.99	202.03	2.83	.25	999.99	99.99	999.99	0.	831.
18.000	99.999	99.999	999.99	202.26	3.36	.08	999.99	99.99	999.99	0.	828.
19.000	99.999	99.999	999.99	204.87	3.46	-.05	999.99	99.99	999.99	0.	811.
20.000	99.999	99.999	999.99	208.11	3.07	-.05	999.99	99.99	999.99	0.	805.
21.000	99.999	99.999	999.99	211.12	2.72	-.01	999.99	99.99	999.99	0.	763.
22.000	99.999	99.999	999.99	213.72	2.81	.10	999.99	99.99	999.99	0.	751.
23.000	99.999	99.999	999.99	215.35	2.91	.17	999.99	99.99	999.99	0.	747.
24.000	99.999	99.999	999.99	218.06	3.31	.53	999.99	99.99	999.99	0.	753.
25.000	99.999	99.999	999.99	220.10	3.94	.84	999.99	99.99	999.99	0.	737.
26.000	99.999	99.999	999.99	222.02	4.28	.78	999.99	99.99	999.99	0.	720.
27.000	99.999	99.999	999.99	223.93	4.50	.77	999.99	99.99	999.99	0.	653.
28.000	99.999	99.999	999.99	225.66	4.56	.63	999.99	99.99	999.99	0.	630.
29.000	99.999	99.999	999.99	227.33	4.19	.59	999.99	99.99	999.99	0.	534.
30.000	99.999	99.999	999.99	228.99	4.01	.37	999.99	99.99	999.99	0.	528.

TABLE III-13. MOISTURE RELATED STATISTICAL PARAMETERS

ANNUAL

STATION # 747340	CAPE CANAVERAL			TV	TV	SKEW TV	CLMPT T	S.D. DPT	SKEW DPT	NOBS T-P	NOBS TV
Z	VAPOR P	S.D. VP	SKEW VP	MEAN	S.D.		MEAN	DEG K			
KM	MB	MB		DEG K	DEG K		DEG K				
.000	20.900	6.745	-.48	296.28	6.88	-.79	290.40	6.27	-1.30	9023.	9023.
.003	20.396	6.841	-.40	295.87	6.98	-.73	299.95	6.44	-1.20	9855.	9863.
1.000	13.466	4.921	-.54	290.67	5.20	-.98	283.19	7.56	-1.75	9603.	9863.
2.000	8.027	3.844	-.23	265.42	4.04	-.94	274.03	9.12	-1.08	9030.	9865.
3.000	4.752	2.631	.16	290.34	3.45	-.92	267.35	9.10	-.65	8446.	9851.
4.000	2.902	1.778	.45	274.61	3.34	-.85	260.77	9.06	-.45	7917.	9813.
5.000	1.750	1.184	.76	269.56	3.46	-.73	254.35	9.05	-.31	7623.	9790.
6.000	1.030	.731	.95	262.18	3.63	-.60	248.15	8.83	-.31	7340.	9780.
7.000	.577	.412	1.04	255.56	3.78	-.60	241.91	8.46	-.41	7355.	9759.
8.000	.308	.217	1.11	248.62	4.04	-.52	235.66	7.89	-.49	7279.	9729.
9.000	.150	.105	1.26	241.22	4.16	-.35	228.98	7.19	-.52	7029.	9593.
10.000	.063	.042	1.69	233.58	4.04	-.22	221.75	5.70	-.16	5249.	9475.
11.000	.026	.016	1.84	226.10	3.54	-.15	214.78	4.68	-.09	4699.	9632.
12.000	.011	.006	1.64	219.31	3.08	-.18	208.37	3.81	-.22	4720.	9620.
13.000	.005	.002	1.22	213.70	2.82	.09	203.00	3.62	-.38	3027.	9569.
14.000	.003	.001	.96	209.33	2.94	.30	198.43	3.75	-.38	1368.	9534.
15.000	.002	.001	3.48	205.94	2.95	.28	195.44	3.59	-.24	103.	9473.
16.000	99.999	99.999	999.99	203.87	2.78	.20	999.99	99.99	999.99	0.	9425.
17.000	99.999	99.999	999.99	203.34	2.95	-.01	999.99	99.99	999.99	0.	9284.
18.000	99.999	99.999	999.99	204.49	3.49	-.23	999.99	99.99	999.99	0.	9218.
19.000	99.999	99.999	999.99	207.36	3.49	-.47	999.99	99.99	999.99	0.	9129.
20.000	99.999	99.999	999.99	210.54	3.24	-.53	999.99	99.99	999.99	0.	9027.
21.000	99.999	99.999	999.99	213.44	2.99	-.52	999.99	99.99	999.99	0.	8651.
22.000	99.999	99.999	999.99	215.92	2.84	-.59	999.99	99.99	999.99	0.	8551.
23.000	99.999	99.999	999.99	217.99	2.79	-.59	999.99	99.99	999.99	0.	8422.
24.000	99.999	99.999	999.99	219.97	2.93	-.52	999.99	99.99	999.99	0.	8419.
25.000	99.999	99.999	999.99	221.81	3.05	-.49	999.99	99.99	999.99	0.	8333.
26.000	99.999	99.999	999.99	223.58	3.12	-.45	999.99	99.99	999.99	0.	8106.
27.000	99.999	99.999	999.99	225.36	3.24	-.32	999.99	99.99	999.99	0.	7399.
28.000	99.999	99.999	999.99	227.07	3.27	-.42	999.99	99.99	999.99	0.	7152.
29.000	99.999	99.999	999.99	228.74	3.29	-.34	999.99	99.99	999.99	1.	5034.
30.000	99.999	99.999	999.99	230.48	3.29	-.47	999.99	99.99	999.99	1.	5818.

TABLE IV-1. HYDROSTATIC MODEL ATMOSPHERE

JANUARY

STATION = 747940		CAPE CANAVERAL		
Z	GEO. HT.	P	D	TV
KM	KM	MB	G/M3	DEG K
.000	.000	1019.7000	1228.0000	283.46
.003	.003	1019.3000	1228.0000	283.19
1.000	.998	905.6300	1104.0000	285.78
2.000	1.995	803.1000	993.0000	281.74
3.000	2.934	710.9300	892.6000	277.46
4.000	3.932	628.0000	804.2000	272.05
5.000	4.989	553.3100	724.8000	265.34
6.000	5.995	486.0300	652.0000	259.44
7.000	6.982	425.5400	586.5000	252.77
8.000	7.979	371.2200	526.4000	245.65
9.000	8.974	322.5100	471.9000	238.10
10.000	9.969	278.9300	421.6000	230.48
11.000	10.965	240.1300	374.3000	223.47
12.000	11.960	205.8300	329.6000	217.52
13.000	12.954	175.8100	286.7000	213.04
14.000	13.949	149.8100	247.6000	210.82
15.000	14.942	127.3500	214.0000	207.31
16.000	15.936	107.9800	184.3000	204.15
17.000	16.929	91.3750	157.3000	202.34
18.000	17.922	77.2670	133.0000	202.24
19.000	18.915	65.3980	111.4000	204.46
20.000	19.907	55.4740	93.1200	207.54
21.000	20.900	47.1720	78.0300	210.60
22.000	21.891	40.2040	65.6500	213.36
23.000	22.883	34.3290	55.5100	215.45
24.000	23.874	29.3500	47.0200	217.49
25.000	24.865	25.1420	39.9400	219.27
26.000	25.855	21.9590	34.0000	220.91
27.000	26.846	18.5090	28.9500	222.71
28.000	27.835	15.9120	24.6800	224.57
29.000	28.825	13.6960	21.0900	226.25
30.000	29.814	11.8029	18.0300	228.00
32.000	31.792	8.7976	13.0700	231.88
34.000	33.768	6.5647	9.6040	236.56
36.000	35.743	4.9752	7.0740	242.31
38.000	37.717	3.7803	5.2360	248.72
40.000	39.690	2.9945	3.8920	256.21
42.000	41.661	2.2338	2.9200	263.49
44.000	43.631	1.7347	2.2230	268.84
46.000	45.600	1.3519	1.7200	270.71
48.000	47.568	1.0542	1.3450	269.95
50.000	49.534	.8205	1.0630	265.96
52.000	51.500	.6365	.8334	263.12
54.000	53.464	.4928	.6504	261.01
56.000	55.427	.3808	.5055	259.54
58.000	57.388	.2940	.3922	258.23
60.000	59.349	.2264	.3066	254.40
62.000	61.308	.1738	.2379	251.62
64.000	63.266	.1326	.1879	243.06
66.000	65.222	.1004	.1458	237.22
68.000	67.178	.0753	.1143	226.90
70.000	69.132	.0559	.0872	220.60

TABLE IV-2. HYDROSTATIC MODEL ATMOSPHERE

FEBRUARY

STATION = 747940		CAPE CANAVERAL		
Z	GEO. HT.	P	D	TV
KM	KM	MB	G.M3	DEG K
.000	.000	1010.0000	1227.0000	289.20
.003	.003	1017.7000	1227.0000	288.96
1.000	.998	904.0100	1104.0000	285.30
2.000	1.996	801.4800	992.9000	281.20
3.000	2.994	709.2600	893.3000	276.61
4.000	3.992	626.3000	804.8000	271.10
5.000	4.989	551.5000	724.8000	265.12
6.000	5.985	484.3000	652.2000	259.70
7.000	6.982	423.9000	585.9000	252.05
8.000	7.978	369.6300	525.6000	244.98
9.000	8.974	321.0300	470.4000	237.75
10.000	9.969	277.6400	419.4000	230.64
11.000	10.965	239.0800	371.5000	224.17
12.000	11.960	205.0800	326.3000	219.98
13.000	12.954	175.3600	284.1000	215.07
14.000	13.948	149.5300	246.6000	211.28
15.000	14.942	127.1300	213.7000	207.22
16.000	15.936	107.7800	184.1000	203.97
17.000	16.929	91.2010	157.0000	202.31
18.000	17.922	77.1260	132.7000	202.45
19.000	18.915	65.2970	111.0000	204.94
20.000	19.907	55.4100	92.7700	208.08
21.000	20.900	47.1370	77.7000	211.11
22.000	21.891	40.1870	65.5100	213.72
23.000	22.883	34.3210	55.4600	215.56
24.000	23.874	29.3510	47.0400	217.38
25.000	24.865	25.1330	39.5600	218.97
26.000	25.855	21.5470	34.0200	220.67
27.000	26.846	18.4950	28.9600	222.47
28.000	27.835	15.8970	24.6900	224.27
29.000	28.825	13.6820	21.0700	226.25
30.000	29.814	11.7916	18.0000	228.20
32.000	31.792	8.7097	13.0000	235.36
34.000	33.768	6.6327	9.6300	240.28
36.000	35.743	5.0245	7.1350	245.67
38.000	37.717	3.9316	5.3050	251.93
40.000	39.690	2.9412	3.9800	257.78
42.000	41.661	2.2716	3.0070	263.51
44.000	43.631	1.7632	2.2970	267.75
46.000	45.600	1.3715	1.7870	267.75
48.000	47.568	1.0655	1.3940	266.78
50.000	49.534	.8287	1.0980	265.70
52.000	51.500	.6430	.8501	263.87
54.000	53.464	.4983	.6622	262.49
56.000	55.427	.3857	.5159	260.78
58.000	57.388	.2980	.4018	258.67
60.000	59.349	.2297	.3129	256.04
62.000	61.308	.1765	.2440	252.37
64.000	63.266	.1348	.1926	244.18
66.000	65.222	.1022	.1501	237.36
68.000	67.178	.0765	.1185	225.24
70.000	69.132	.0568	.0893	221.57

TABLE IV-3. HYDROSTATIC MODEL ATMOSPHERE

MARCH

STATION = 747940		CAPE CANAVERAL		TV
Z	GEO. HT.	P	D	DEG K
KM	KM	MB	G/M3	
.000	.000	1017.7000	1215.0000	292.03
.003	.003	1017.4000	1215.0000	291.78
1.000	.998	904.6100	1037.0000	287.20
2.000	1.936	802.6200	968.6000	282.62
3.000	2.994	710.7700	890.2000	278.14
4.000	3.992	628.0000	803.5000	272.28
5.000	4.969	553.3300	724.9000	265.91
6.000	5.985	486.0300	653.1000	259.26
7.000	6.982	425.4900	586.9000	252.55
8.000	7.978	371.1400	526.7000	245.48
9.000	8.974	322.4100	471.9000	238.00
10.000	9.969	278.8500	421.4000	230.54
11.000	10.965	240.0900	373.7000	223.80
12.000	11.960	205.8700	328.4000	218.37
13.000	12.954	175.9700	285.7000	214.55
14.000	13.948	150.0000	247.4000	211.27
15.000	14.942	127.5700	213.9000	207.75
16.000	15.936	108.2100	184.0000	204.84
17.000	16.929	91.6310	157.1000	203.18
18.000	17.922	77.5380	133.0000	203.09
19.000	18.915	65.6770	111.3000	205.49
20.000	19.907	55.7500	93.0800	208.49
21.000	20.900	47.4580	78.0400	211.86
22.000	21.893	40.4880	65.0800	214.75
23.000	22.883	34.6060	55.6100	216.81
24.000	23.874	29.6230	47.1800	218.75
25.000	24.865	25.3920	40.1100	220.54
26.000	25.855	21.7940	34.1400	222.41
27.000	26.846	18.7310	29.0300	224.34
28.000	27.835	16.1210	24.8100	226.41
29.000	28.825	13.8940	21.2000	228.34
30.000	29.814	11.9924	18.1000	230.77
32.000	31.792	8.9759	13.1800	235.67
34.000	33.768	6.7627	9.7040	241.19
36.000	35.743	5.1295	7.1880	246.98
38.000	37.717	3.9139	5.3820	251.69
40.000	39.690	3.0324	4.0470	256.78
42.000	41.661	2.3151	3.0670	261.23
44.000	43.631	1.7921	2.3450	264.46
46.000	45.600	1.3909	1.8050	266.29
48.000	47.568	1.0809	1.4010	266.96
50.000	49.534	.8403	1.0910	266.58
52.000	51.500	.6529	.8507	265.60
54.000	53.464	.5066	.6651	263.63
56.000	55.427	.3926	.5177	262.46
58.000	57.388	.3038	.4045	259.88
60.000	59.349	.2343	.3165	256.22
62.000	61.308	.1801	.2473	251.99
64.000	63.266	.1377	.1937	245.93
66.000	65.222	.1044	.1522	237.31
68.000	67.178	.0783	.1193	227.19
70.000	69.132	.0582	.0907	221.93

TABLE IV-4. HYDROSTATIC MODEL ATMOSPHERE

APRIL

STATION = 747940		CAPE CANAVERAL		TV DEC K
Z KM	GEO. HT. KM	P MB	D G/M3	
.000	.000	1012.0000	1201.0000	225.27
.003	.003	1017.7000	1201.0000	225.14
1.000	.998	905.9500	1020.0000	229.66
2.000	1.996	804.5200	904.5000	229.57
3.000	2.994	712.9800	808.0000	279.70
4.000	3.992	630.3800	802.1000	273.80
5.000	4.989	555.8100	724.4000	267.29
6.000	5.985	488.5300	653.2000	260.76
7.000	6.982	427.9600	597.4000	253.50
8.000	7.978	373.5400	527.6000	246.66
9.000	8.974	324.7000	473.1000	239.11
10.000	9.969	281.0000	423.2000	231.33
11.000	10.965	242.0200	376.4000	223.98
12.000	11.960	207.5000	332.0000	217.73
13.000	12.954	177.2500	293.1000	213.55
14.000	13.948	151.0200	249.8000	210.63
15.000	14.942	128.3900	215.4000	207.67
16.000	15.936	108.9100	185.0000	205.05
17.000	16.929	92.2410	157.5000	203.49
18.000	17.922	78.0770	133.6000	203.52
19.000	18.915	66.1660	111.8000	206.23
20.000	19.907	56.2150	93.3400	209.82
21.000	20.900	47.8910	78.2000	213.18
22.000	21.891	40.8750	65.9800	215.92
23.000	22.883	34.9860	55.8000	218.20
24.000	23.874	29.9010	47.3000	220.44
25.000	24.865	25.7320	40.2000	222.55
26.000	25.855	22.1190	34.2000	224.74
27.000	26.846	19.0420	29.2300	226.90
28.000	27.835	16.4160	24.9700	229.02
29.000	28.825	14.1720	21.3700	231.05
30.000	29.814	12.2518	18.3100	233.05
32.000	31.792	9.1931	13.4100	237.49
34.000	33.768	6.9365	9.9370	241.83
36.000	35.743	5.2619	7.3340	246.55
38.000	37.717	4.0132	5.5310	251.32
40.000	39.690	3.0774	4.1580	256.42
42.000	41.661	2.3718	3.1520	260.66
44.000	43.631	1.8361	2.3990	265.12
46.000	45.600	1.4269	1.8420	268.39
48.000	47.563	1.1113	1.4290	269.47
50.000	49.534	.8659	1.1150	268.94
52.000	51.500	.6740	.8742	267.09
54.000	53.464	.5238	.6841	265.28
56.000	55.427	.4063	.5325	262.89
58.000	57.388	.3144	.4195	259.88
60.000	59.349	.2424	.3289	255.33
62.000	61.308	.1861	.2565	251.36
64.000	63.266	.1420	.2024	243.05
66.000	65.222	.1075	.1571	237.06
68.000	67.178	.0806	.1229	227.19
70.000	69.132	.0597	.0949	218.11

TABLE IV-5. HYDROSTATIC MODEL ATMOSPHERE

MAY

STATION = 747940		CAPE CANAVERAL		TV
Z	GEO. HT.	P	D	DEG K
KM	KM	MB	G/M3	
.000	.000	1016.6000	1186.0000	298.72
.003	.003	1016.3000	1186.0000	298.53
1.000	.998	905.8100	1079.0000	292.38
2.000	1.996	805.1300	979.5000	286.34
3.000	2.994	713.9100	886.3000	280.62
4.000	3.992	631.4600	800.9000	274.66
5.000	4.989	557.0300	722.6000	268.55
6.000	5.985	489.9300	651.3000	262.06
7.000	6.982	429.5200	586.0000	255.35
8.000	7.978	375.2300	526.4000	248.32
9.000	8.974	326.4900	472.5000	240.70
10.000	9.969	282.8000	423.2000	232.32
11.000	10.965	243.7800	377.2000	225.16
12.000	11.960	209.1200	334.0000	218.14
13.000	12.954	178.6000	292.7000	212.60
14.000	13.948	152.0600	252.7000	209.61
15.000	14.942	129.2200	216.8000	207.67
16.000	15.936	109.6600	185.5000	205.98
17.000	16.929	92.9720	157.9000	205.15
18.000	17.922	78.8180	133.5000	205.69
19.000	18.915	66.9150	111.7000	208.60
20.000	19.907	56.9500	93.6200	211.91
21.000	20.900	48.5890	78.7200	215.02
22.000	21.891	41.5440	66.5100	217.59
23.000	22.883	35.5830	56.3900	219.81
24.000	23.874	30.5250	47.9200	221.90
25.000	24.865	26.2240	40.8100	223.88
26.000	25.855	22.5600	34.8000	225.81
27.000	26.846	19.4330	29.7400	227.62
28.000	27.835	16.7600	25.4400	229.49
29.000	28.825	14.4720	21.8000	231.26
30.000	29.814	12.5119	18.7000	233.03
32.000	31.792	9.3929	13.6900	238.31
34.000	33.768	7.0909	10.1700	241.92
36.000	35.743	5.3793	7.5740	246.52
38.000	37.717	4.1048	5.6480	252.27
40.000	39.690	3.1523	4.2350	258.33
42.000	41.661	2.4343	3.2160	262.69
44.000	43.631	1.8876	2.4590	266.45
46.000	45.600	1.4685	1.8920	269.32
48.000	47.568	1.1451	1.4650	271.39
50.000	49.534	.8941	1.1440	271.28
52.000	51.500	.6972	.8997	268.97
54.000	53.464	.5426	.7072	266.32
56.000	55.427	.4213	.5544	263.78
58.000	57.388	.3261	.4364	259.35
60.000	59.349	.2514	.3413	255.73
62.000	61.309	.1931	.2665	251.51
64.000	63.266	.1475	.2094	244.46
66.000	65.222	.1115	.1653	234.20
68.000	67.178	.0834	.1288	224.51
70.000	69.132	.0616	.0987	216.56

TABLE IV-6. HYDROSTATIC MODEL ATMOSPHERE

JUNE

STATION - 747540		CAPE CANAVERAL		TV
Z	GEO. HT.	P	D	DEG K
KM	KM	MB	G/M3	
.000	.000	1016.0000	1175.0000	301.20
.003	.003	1015.7000	1175.0000	301.11
1.000	.998	906.1200	1071.0000	294.75
2.000	1.996	806.1200	973.8000	289.39
3.000	2.994	715.3700	882.5000	282.39
4.000	3.992	633.2400	799.1000	276.41
5.000	4.989	559.0900	719.7000	270.63
6.000	5.985	492.2800	648.2000	264.59
7.000	6.982	432.1700	583.1000	258.19
8.000	7.978	378.1500	523.6000	251.50
9.000	8.974	329.6500	470.2000	244.25
10.000	9.969	286.1600	421.5000	236.49
11.000	10.965	247.2200	377.0000	228.42
12.000	11.960	212.4900	335.5000	220.67
13.000	12.954	181.7200	295.3000	213.64
14.000	13.948	154.6000	258.9000	208.14
15.000	14.942	131.2300	223.1000	204.26
16.000	15.936	111.1500	189.9000	203.87
17.000	16.929	94.1280	160.5000	204.36
18.000	17.922	79.7950	134.7000	206.37
19.000	18.915	67.7890	112.7000	209.61
20.000	19.907	57.7360	94.5200	212.79
21.000	20.900	49.2880	79.6100	215.69
22.000	21.891	42.1590	67.3600	218.05
23.000	22.883	36.1200	57.1500	220.18
24.000	23.874	30.9930	48.6000	222.16
25.000	24.865	26.6290	41.4300	223.93
26.000	25.855	22.9070	35.3700	225.61
27.000	26.846	19.7280	30.2300	227.32
28.000	27.835	17.0110	25.8700	227.03
29.000	28.825	14.6840	22.1800	210.62
30.000	29.814	12.6095	19.0300	232.26
32.000	31.792	9.5103	13.9700	236.44
34.000	33.768	7.1678	10.3300	240.90
36.000	35.743	5.4313	7.6000	245.50
38.000	37.717	4.1331	5.7350	250.48
40.000	39.690	3.1713	4.2990	255.10
42.000	41.661	2.4439	3.2530	260.80
44.000	43.631	1.8725	2.4740	265.54
46.000	45.600	1.4708	1.9040	268.08
48.000	47.568	1.1451	1.4770	269.22
50.000	49.534	.8718	1.1550	267.94
52.000	51.500	.6934	.9052	265.93
54.000	53.454	.5379	.7116	262.40
56.000	55.427	.4158	.5582	258.58
58.000	57.388	.3202	.4372	214.23
60.000	59.349	.2455	.3405	250.27
62.000	61.308	.1874	.2650	245.48
64.000	63.266	.1421	.2070	238.40
66.000	65.222	.1059	.1607	231.01
68.000	67.178	.0796	.1244	222.08
70.000	69.132	.0583	.0984	205.52

TABLE IV-7. HYDROSTATIC MODEL ATMOSPHERE

JULY

STATION = 747940		CAPE CANAVERAL		TV
Z	GEO. HT.	P	D	DEG K
KM	KM	MB	G/M3	
.000	.000	1017.6000	1173.0000	302.33
.003	.003	1017.2000	1172.0000	302.30
1.000	.998	907.9500	1068.0000	296.05
2.000	1.996	808.1100	972.9000	289.36
3.000	2.994	717.4100	882.4000	283.23
4.000	3.992	635.2700	790.3000	277.22
5.000	4.990	561.0800	720.1000	271.42
6.000	5.988	494.2400	648.5000	265.50
7.000	6.986	434.1000	583.4000	259.21
8.000	7.978	380.0400	524.1000	252.63
9.000	8.974	331.5200	470.5000	245.44
10.000	9.969	287.9700	422.1000	237.64
11.000	10.965	248.9600	378.0000	229.44
12.000	11.960	214.1200	335.8000	221.44
13.000	12.954	183.1800	299.2000	213.97
14.000	13.948	155.9400	261.1000	208.04
15.000	14.942	132.2900	225.1000	204.76
16.000	15.936	112.0500	191.1000	204.29
17.000	16.929	94.9400	161.0000	205.41
18.000	17.922	80.5630	135.2000	207.63
19.000	18.915	68.4970	113.4000	210.44
20.000	19.907	58.3700	95.3100	213.35
21.000	20.900	49.8460	80.3800	216.03
22.000	21.891	42.6430	68.0900	218.18
23.000	22.883	36.5370	57.8200	220.14
24.000	23.874	31.3480	49.1800	222.03
25.000	24.865	26.9320	41.9200	223.83
26.000	25.655	23.1560	35.7900	225.52
27.000	26.846	19.9500	30.6000	227.15
28.000	27.835	17.1990	26.2000	228.66
29.000	28.825	14.8420	22.4000	230.19
30.000	29.814	12.8221	19.2800	231.71
32.000	31.792	9.6025	14.1000	235.70
34.000	33.768	7.2200	10.4300	239.80
36.000	35.743	5.4702	7.7520	244.22
38.000	37.717	4.1626	5.7750	249.48
40.000	39.690	3.1850	4.3380	254.14
42.000	41.661	2.4501	3.2720	259.19
44.000	43.631	1.8936	2.4900	263.20
46.000	45.600	1.4695	1.9110	265.96
48.000	47.568	1.1411	1.4780	267.19
50.000	49.534	.8869	1.1550	265.78
52.000	51.500	.6890	.9048	263.19
54.000	53.464	.5326	.7067	260.85
56.000	55.427	.4112	.5525	257.59
58.000	57.388	.3165	.4303	254.61
60.000	59.349	.2428	.3356	250.39
62.000	61.308	.1852	.2606	244.14
64.000	63.266	.1403	.2046	237.29
66.000	65.222	.1054	.1580	230.89
68.000	67.178	.0786	.1219	223.06
70.000	69.132	.0580	.0926	216.76

TABLE IV-8. HYDROSTATIC MODEL ATMOSPHERE

AUGUST

STATION = 747940		CAPE CANAVERAL		
Z	GEO. HT.	P	D	TV
KM	KM	MB	G/M3	DEG K
.000	.000	1016.6000	1173.0000	301.97
.003	.003	1016.3000	1173.0000	301.95
1.000	.998	907.0500	1067.0000	296.13
2.000	1.996	807.3700	971.3000	289.59
3.000	2.994	716.8300	880.7000	283.56
4.000	3.992	634.8500	796.8000	277.56
5.000	4.989	560.8000	718.9000	271.74
6.000	5.985	494.0500	647.7000	265.75
7.000	6.982	433.9900	582.7000	259.45
8.000	7.978	380.6000	523.5000	252.88
9.000	8.974	331.5300	470.0000	245.74
10.000	9.969	288.0300	421.7000	237.97
11.000	10.965	249.0700	377.5000	229.83
12.000	11.960	214.2700	336.4000	221.89
13.000	12.954	183.3600	297.9000	214.40
14.000	13.948	156.1400	261.2000	209.28
15.000	14.942	132.4200	225.5000	204.65
16.000	15.936	112.1800	191.7000	203.83
17.000	16.929	95.0140	161.5000	204.90
18.000	17.922	80.5960	135.4000	207.37
19.000	18.915	68.5120	113.0000	210.18
20.000	19.907	58.3700	95.4400	213.05
21.000	20.900	49.8310	80.5400	215.55
22.000	21.893	42.6160	68.2000	217.70
23.000	22.883	36.5000	57.9000	219.62
24.000	23.874	31.3050	49.2600	221.40
25.000	24.865	26.8030	41.9600	223.16
26.000	25.855	23.1130	35.8100	224.84
27.000	26.846	19.8950	30.6100	226.46
28.000	27.835	17.1440	26.2000	227.96
29.000	28.825	14.7880	22.4600	229.36
30.000	29.814	12.7692	19.2500	231.01
32.000	31.792	9.5052	14.0900	235.08
34.000	33.768	7.1856	10.4400	238.63
36.000	35.743	5.4300	7.7460	243.06
38.000	37.717	4.1247	5.7790	247.47
40.000	39.690	3.1493	4.3310	252.14
42.000	41.661	2.4178	3.2570	257.35
44.000	43.631	1.8657	2.4690	261.92
46.000	45.600	1.4447	1.8960	264.14
48.000	47.568	1.1211	1.4610	265.99
50.000	49.534	.8707	1.1370	265.51
52.000	51.500	.6757	.8861	264.38
54.000	53.464	.5238	.6915	262.63
56.000	55.427	.4051	.5418	259.21
58.000	57.389	.3123	.4231	255.94
60.000	59.349	.2401	.3235	253.42
62.000	61.308	.1840	.2558	249.74
64.000	63.266	.1401	.2012	241.35
66.000	65.222	.1059	.1555	235.99
68.000	67.178	.0794	.1207	228.05
70.000	69.132	.0590	.0923	221.49

TABLE IV-9. HYDROSTATIC MODEL ATMOSPHERE

SEPTEMBER

STATION # 747940		CAPE CANAVERAL		TV DEG K
Z KM	GEO. HT. KM	P MB	D G/M3	
.000	.000	1015.1000	1173.0000	301.51
.003	.003	1014.8000	1173.0000	301.45
1.000	.999	905.4600	1069.0000	295.20
2.000	1.996	805.7000	971.2000	289.00
3.000	2.994	715.2400	879.2000	283.42
4.000	3.992	633.4300	794.9000	277.62
5.000	4.989	559.5700	717.0000	271.88
6.000	5.985	493.0000	645.1000	265.81
7.000	6.982	433.0600	581.6000	259.37
8.000	7.978	379.1500	522.8000	252.66
9.000	8.974	330.7400	469.4000	245.44
10.000	9.969	287.3000	421.1000	237.68
11.000	10.965	248.3900	376.9000	229.59
12.000	11.960	213.6600	335.7000	221.73
13.000	12.954	182.8300	297.2000	214.33
14.000	13.948	155.6700	260.6000	208.08
15.000	14.942	132.0000	225.7000	203.78
16.000	15.936	111.6800	192.3000	200.30
17.000	16.929	94.4710	161.9000	203.28
18.000	17.922	80.0480	135.2000	206.28
19.000	18.915	68.0010	113.0000	209.57
20.000	19.907	57.9120	94.8700	212.65
21.000	20.900	49.4270	80.0100	215.21
22.000	21.891	42.2590	67.7600	217.27
23.000	22.883	36.1830	57.5000	219.22
24.000	23.874	31.0240	48.9000	221.01
25.000	24.865	26.6340	41.6700	222.74
26.000	25.855	22.8930	35.5400	224.39
27.000	26.846	19.7000	30.3700	225.99
28.000	27.835	16.9700	25.9300	227.44
29.000	28.825	14.6230	22.2700	228.92
30.000	29.814	12.6313	19.0900	230.44
32.000	31.792	9.4481	13.9100	235.00
34.000	33.768	7.1032	10.3100	238.26
36.000	35.743	5.3627	7.6710	241.82
38.000	37.717	4.0684	5.7100	246.47
40.000	39.690	3.1053	4.2530	252.56
42.000	41.661	2.3851	3.2010	257.77
44.000	43.631	1.8423	2.4180	263.52
46.000	45.600	1.4292	1.8570	266.23
48.000	47.568	1.1111	1.4350	267.81
50.000	49.534	.8648	1.1150	268.25
52.000	51.500	.6732	.8690	267.96
54.000	53.464	.5233	.6834	264.86
56.000	55.427	.4059	.5339	262.94
58.000	57.388	.3141	.4183	259.67
60.000	59.349	.2421	.3279	255.46
62.000	61.308	.1858	.2570	250.08
64.000	63.266	.1417	.2012	243.55
66.000	65.222	.1070	.1591	232.60
68.000	67.178	.0798	.1239	222.83
70.000	69.132	.0588	.0948	214.54

TABLE IV-10. HYDROSTATIC MODEL ATMOSPHERE

OCTOBER

STATION = 747940		CAPE CANAVERAL		TV
Z	GEO. HT.	P	D	DEG K
KM	KM	MB	G/M ³	
.000	.000	1015.8000	1185.0000	298.71
.003	.003	1015.4000	1185.0000	298.45
1.000	.998	904.9400	1079.0700	292.05
2.000	1.996	804.3200	978.1000	286.47
3.000	2.994	713.3600	892.5000	281.60
4.000	3.992	631.3100	796.5000	276.13
5.000	4.989	557.3000	719.5000	270.20
6.000	5.985	490.5500	649.1000	263.67
7.000	6.982	430.4100	583.6000	256.93
8.000	7.978	375.3400	524.4000	250.01
9.000	8.974	327.7900	470.5000	242.68
10.000	9.969	284.3000	421.1000	235.17
11.000	10.965	245.4500	375.7000	227.59
12.000	11.960	210.9000	333.1000	220.58
13.000	12.954	180.3800	293.4000	214.15
14.000	13.948	153.6000	256.6000	208.54
15.000	14.942	130.3000	222.2000	204.25
16.000	15.936	110.2500	190.1000	202.06
17.000	16.929	93.2160	160.5000	202.37
18.000	17.922	78.9130	134.1000	204.97
19.000	18.915	66.9770	111.8000	208.63
20.000	19.907	57.0220	93.7500	211.81
21.000	20.900	48.6160	79.0700	214.20
22.000	21.891	41.5370	66.8700	216.40
23.000	22.883	35.5440	56.6900	218.41
24.000	23.874	30.4600	48.1000	220.34
25.000	24.865	26.1390	41.0000	222.11
26.000	25.855	22.4580	34.9000	223.81
27.000	26.846	19.3180	29.8600	225.39
28.000	27.835	16.6340	25.5500	226.84
29.000	28.825	14.3370	21.8400	228.22
30.000	29.814	12.3701	18.7600	229.70
32.000	31.792	9.2418	13.7200	233.05
34.000	33.768	6.9397	10.1400	237.42
36.000	35.743	5.2361	7.5300	241.63
38.000	37.717	3.9713	5.5990	246.17
40.000	39.690	3.0283	4.1950	251.10
42.000	41.661	2.3243	3.1780	257.90
44.000	43.631	1.7951	2.3980	263.08
46.000	45.600	1.3921	1.8160	266.03
48.000	47.568	1.0821	1.4030	267.73
50.000	49.534	.8419	1.0920	267.43
52.000	51.500	.6546	.8507	266.40
54.000	53.464	.5081	.6697	263.31
56.000	55.427	.3935	.5226	261.31
58.000	57.388	.3040	.4090	257.91
60.000	59.349	.2340	.3192	254.41
62.000	61.308	.1753	.2510	247.85
64.000	63.266	.1364	.1959	241.63
66.000	65.222	.1031	.1521	235.16
68.000	67.178	.0771	.1186	225.62
70.000	69.132	.0574	.0883	225.41

TABLE IV-11. HYDROSTATIC MODEL ATMOSPHERE

NOVEMBER

STATION = 747940		CAPE CANAVERAL		TV
Z	GEO. HT.	P	D	DEG K
KM	KM	MB	G/M3	
.000	.000	1018.2000	1206.0000	294.29
.003	.003	1017.8000	1205.0000	294.17
1.000	.998	905.8000	1091.0000	289.15
2.000	1.996	804.2800	994.7000	284.54
3.000	2.994	712.8100	896.2000	280.20
4.000	3.992	630.4500	799.3000	274.77
5.000	4.989	556.1700	721.2000	268.66
6.000	5.985	489.1900	650.2000	262.12
7.000	6.982	428.8800	585.2000	255.32
8.000	7.978	374.6500	525.9000	248.19
9.000	8.974	325.9700	471.9000	240.64
10.000	9.969	282.3600	422.1000	233.04
11.000	10.965	243.4500	376.1000	225.49
12.000	11.960	208.8900	333.0000	218.52
13.000	12.954	178.4200	292.6000	212.45
14.000	13.948	151.7800	254.5000	207.73
15.000	14.942	128.7200	219.4000	204.37
16.000	15.936	108.9300	187.6000	202.26
17.000	16.929	92.0780	159.1000	201.66
18.000	17.922	77.8670	133.6000	203.09
19.000	18.915	65.9030	111.3000	206.48
20.000	19.907	56.0630	93.1300	209.72
21.000	20.900	47.7470	78.2800	212.48
22.000	21.891	40.7460	66.0400	214.93
23.000	22.883	34.8120	55.9000	217.08
24.000	23.874	29.8230	47.4200	219.11
25.000	24.865	25.5710	40.3200	220.95
26.000	25.855	21.9520	34.3400	222.55
27.000	26.846	18.8670	29.3200	224.19
28.000	27.835	16.2330	25.0600	225.63
29.000	28.825	13.9810	21.4500	227.10
30.000	29.814	12.0543	18.3700	228.61
32.000	31.792	8.9972	13.4300	233.42
34.000	33.769	6.7503	9.9430	236.44
36.000	35.743	5.0686	7.3550	241.10
38.000	37.717	3.8587	5.1580	246.35
40.000	39.690	2.9450	4.0640	252.55
42.000	41.661	2.2628	3.0500	258.51
44.000	43.631	1.7457	2.3100	263.75
46.000	45.600	1.3573	1.7700	267.15
48.000	47.568	1.0559	1.3710	268.40
50.000	49.534	.8219	1.0700	267.72
52.000	51.500	.6383	.8385	265.52
54.000	53.464	.4956	.6573	262.71
56.000	55.427	.3834	.5136	260.16
58.000	57.388	.2960	.4005	257.54
60.000	59.349	.2279	.3112	255.28
62.000	61.308	.1750	.2430	250.97
64.000	63.266	.1338	.1887	247.00
66.000	65.222	.1016	.1477	239.79
68.000	67.178	.0766	.1149	232.25
70.000	69.132	.0572	.0887	224.54

TABLE IV-12. HYDROSTATIC MODEL ATMOSPHERE

DECEMBER

STATION - 747340		CAPE CAVERAL		TV DEG K
Z	SEO. MT.	P	D	
KM	KM	MB	G.M.S	
.000	.000	1019.6000	1224.0000	290.35
.003	.003	1019.2000	1224.0000	290.08
1.000	.998	905.0200	1101.0000	296.60
2.000	1.976	803.9500	990.6000	292.60
3.000	2.974	711.6100	890.3000	278.45
4.000	3.992	628.8900	802.4000	273.02
5.000	4.989	554.3300	723.6000	266.87
6.000	5.985	487.1500	652.0000	260.27
7.000	6.987	425.6900	586.3000	253.52
8.000	7.978	372.3700	525.6000	246.34
9.000	8.974	323.6400	472.1000	238.81
10.000	9.969	280.0300	422.0000	231.17
11.000	10.965	241.1500	375.2000	223.90
12.000	11.960	206.7300	331.3000	217.36
13.000	12.954	176.4700	290.5000	212.38
14.000	13.948	150.2100	250.4000	208.95
15.000	14.942	127.5400	215.6000	206.08
16.000	15.936	108.0500	185.0000	203.46
17.000	16.929	91.4010	157.6000	202.03
18.000	17.922	77.2900	133.1000	202.25
19.000	18.915	65.4200	111.2000	204.87
20.000	19.907	55.5140	92.9300	208.11
21.000	20.900	47.2260	77.9300	211.12
22.000	21.891	40.2530	65.6300	213.72
23.000	22.883	34.3900	55.4800	215.95
24.000	23.874	29.4220	47.0000	218.05
25.000	24.865	25.2100	39.9000	220.10
26.000	25.855	21.6310	33.9400	222.02
27.000	26.846	18.5600	28.9100	223.93
28.000	27.835	15.9900	24.6900	225.66
29.000	28.825	13.7730	21.1100	227.33
30.000	29.814	11.8773	18.0700	227.95
32.000	31.702	8.8772	13.1800	233.40
34.000	33.769	6.6506	9.7000	238.17
36.000	35.743	5.0323	7.1710	243.44
38.000	37.717	3.8467	5.3310	249.01
40.000	39.690	2.9284	3.9650	254.84
42.000	41.661	2.2752	3.0010	260.69
44.000	43.631	1.7476	2.2600	267.21
46.000	45.600	1.3502	1.7500	269.55
48.000	47.563	1.0597	1.3660	267.13
50.000	49.534	.8256	1.0650	269.81
52.000	51.500	.6426	.8342	267.18
54.000	53.464	.4992	.6554	264.20
56.000	55.427	.3869	.5121	262.06
58.000	57.388	.2992	.4006	259.05
60.000	59.349	.2304	.3149	255.79
62.000	61.308	.1766	.2457	249.24
64.000	63.266	.1344	.1929	241.74
66.000	65.222	.1016	.1497	235.45
68.000	67.178	.0759	.1181	223.03
70.000	69.132	.0560	.0899	216.06

TABLE IV-13. HYDROSTATIC MODEL ATMOSPHERE

ANNUAL

STATION = 747940		CAPE CA-AVERAL		TV
Z	GEO. HT.	P	D	DEG K
KM	KM	MB	CM3	
.000	.000	1017.4000	114.0000	295.29
.003	.003	1017.1000	114.0000	295.87
1.000	.938	905.7300	114.0000	292.57
2.000	1.974	804.5000	98.0000	287.42
3.000	2.954	713.2500	88.4000	281.34
4.000	3.932	630.8500	80.3000	274.61
5.000	4.909	556.4900	721.9000	268.56
6.000	5.985	489.4700	650.4000	262.18
7.000	6.962	429.1600	585.0000	255.56
8.000	7.978	374.9600	525.4000	248.62
9.000	8.974	326.3300	471.3000	241.22
10.000	9.969	282.7800	421.7000	233.58
11.000	10.963	243.8000	375.8000	225.10
12.000	11.960	209.3700	332.0000	219.31
13.000	12.954	178.9500	291.7000	213.70
14.000	13.948	152.4100	253.6000	209.33
15.000	14.942	129.4200	218.9000	205.94
16.000	15.936	109.6600	187.4000	203.87
17.000	16.929	92.8230	159.0000	203.34
18.000	17.922	78.5360	133.9000	204.43
19.000	18.915	66.6620	112.0000	207.36
20.000	19.907	56.6770	93.7800	210.54
21.000	20.900	48.3030	78.8400	213.44
22.000	21.891	41.2510	66.5600	215.92
23.000	22.883	35.2880	56.3900	217.99
24.000	23.874	30.2320	47.8000	219.97
25.000	24.865	25.9370	40.7400	221.81
26.000	25.855	22.2870	34.7200	223.53
27.000	26.846	19.1630	29.6200	225.36
28.000	27.835	16.5020	25.3200	227.07
29.000	28.825	14.2270	21.6700	228.74
30.000	29.814	12.2803	18.5600	230.48
32.000	31.792	9.1866	13.6500	235.14
34.000	33.768	6.9117	10.0100	239.35
35.000	35.743	5.2287	7.4220	244.21
39.000	37.717	3.3787	5.5300	249.44
40.000	39.690	3.0428	4.1400	255.09
42.000	41.661	2.3456	3.1220	260.47
44.000	43.631	1.8157	2.3740	265.16
45.000	45.600	1.4105	1.8280	267.53
48.000	47.568	1.0975	1.4180	268.34
50.000	49.534	.8541	1.1070	267.44
52.000	51.500	.6639	.8662	265.68
54.000	53.464	.5151	.6783	263.25
55.000	55.427	.3998	.5299	260.90
58.000	57.388	.3080	.4141	257.89
60.000	59.349	.2371	.3234	254.20
62.000	61.308	.1818	.2524	249.74
64.000	63.266	.1386	.1979	242.74
65.000	65.222	.1048	.1542	235.73
69.000	67.178	.0784	.1204	227.84
70.000	69.132	.0581	.0918	219.33

APPENDIX A

EXAMPLES OF WIND STATISTICS FOR CAPE CANAVERAL FLORIDA

Appendix A gives some examples of graphical displays of wind statistics that can be derived from the statistical parameters presented in Table I. These illustrations should aid the user of the RRA in understanding the functional relationships of the probability wind models and, thus, develop an appreciation of the powerful properties of the bivariate normal probability distribution function.

All illustrations for this Appendix are derived from the five wind component statistical parameters from Table I.1 for January and Table I.6 for July for eight selected altitudes. These selected altitudes are 4, 12, 20, 30, 40, 50, 60, and 70 km.

1. Wind Speed (Figures A-1 through A-4)

The five wind components from Table I are used as inputs to the generalized Rayleigh probability density function, equation (29), and then integrated as indicated by equation (30) to obtain the probability distribution function for wind speed. The derived distribution functions for wind speed are shown in Figures A-1 through A-4 on the normal probability scale.

2. Frequency of Wind Direction (Figures A-5 through A-20)

The derived frequencies for wind direction shown in Figures A-5 through A-20 were obtained using the five wind component parameters from Tables I.1 and I.6 as input values in equation (35). The limits of integration (performed numerically) are over the 22.5-degree interval for each of the 16 compass points. These graphs give the percentage frequency that the wind will blow from the direction intervals.

3. Mean Wind Components and 80th Interpercentile Range of Wind Components (Figures A-21 through A-36)

The wind component means with respect to any orthogonal axes are obtained by using the zonal and meridional mean wind components in equations (44) and (45). These component means form the circle shown in Figures A-21 through A-36. Further, the zonal and meridional wind component variances and correlation coefficients are used in equations (46) and (47) to obtain the variances with respect to any orthogonal axes. These rotated component variances and the rotated component means are used in equation (8) to obtain the 80th interpercentile range of wind components and are then illustrated in Figures A-21 through A-36.

4. Probability Ellipses (Figures A-37 through A-52)

Using the five wind component parameters from Tables I.1 and I.6 and $p = 0.50$, $p = 0.95$, and $p = 0.99$ as input values to equation (13), the wind probability ellipses shown in Figures A-37 through A-52 were obtained by computer graphics. The statistical inferences are, for example, that 50 percent of the wind vectors lie within the smaller ellipse and 99 percent of the wind vectors lie within the outer ellipse. These probability ellipses are illustrated using the standard meteorological coordinate system explained in Chapter I.B.1.

5. Conditional Wind Speed Given the Wind Direction (Figures A-53 through A-68)

The five wind component parameters from Table I.1 and Table I.6 are used to evaluate the conditional probability distribution function, equation (41). Interpolations of the conditional function are made to obtain the 5th, 15th, 50th (median), 85th, 95th, and 99th conditional percentile values of wind speed given the wind directions are as shown in Figures A-53 through A-68. The conditional mean wind speed given the wind direction is obtained from equation (40). The conditional mode (most probable) wind speed given the wind direction is obtained from equation (38). The conditional mean wind speed and the conditional wind speed modal value given the wind direction are also shown in these figures. For some figures, the conditional wind speed values are invalid for the given wind direction near 270 degrees (from the west). This is caused by the lack of computational precision in evaluating equations (40) and (41) when the arguments for the Gaussian probability distribution have large negative values, i.e., when the coefficients (b/a) become less than -4 in these equations.

This appendix contains only a few of the many options in presenting wind statistics illustrations.

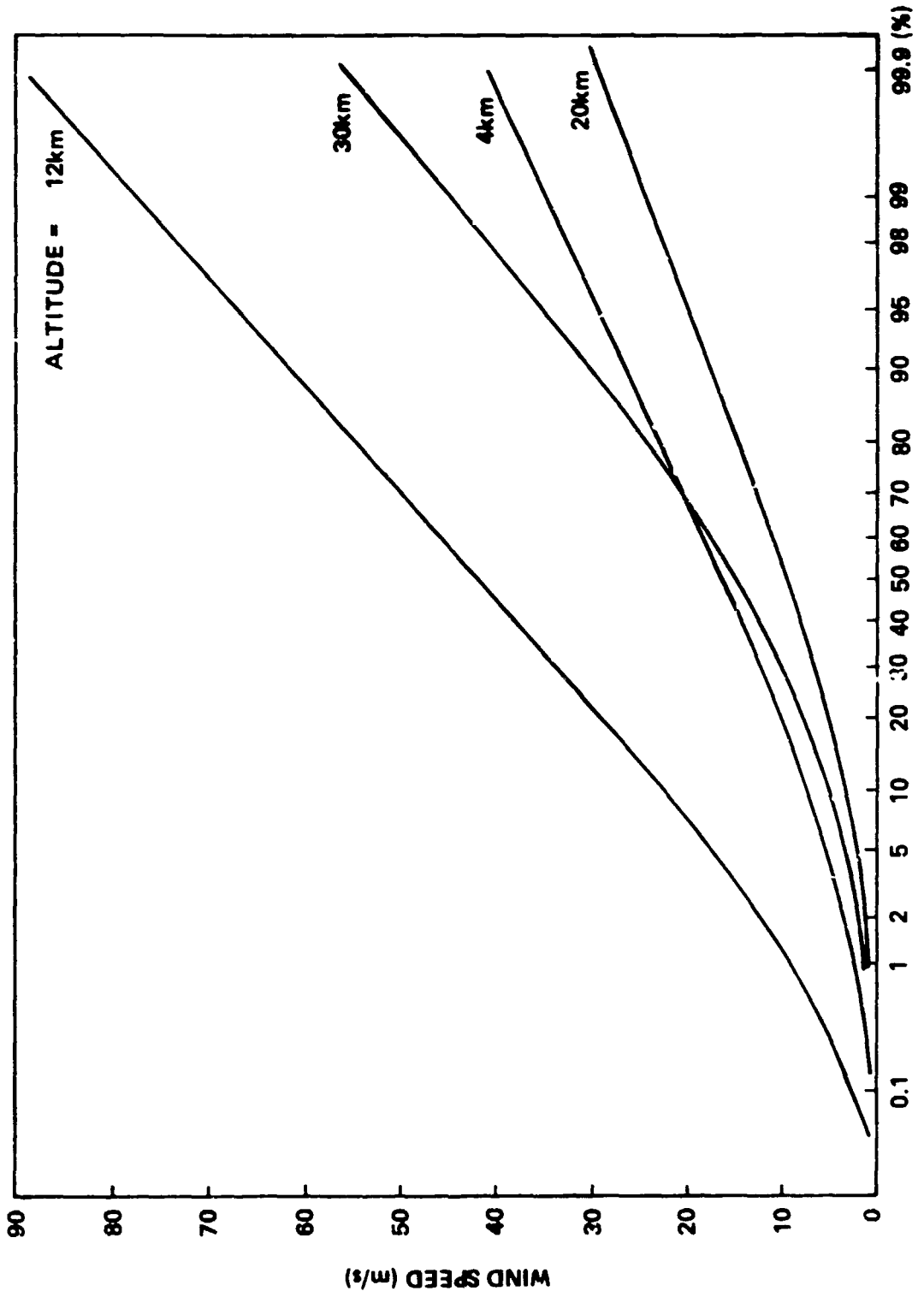

Figure A-1. Rayleigh PDF of wind speed, Cape Canaveral, January.

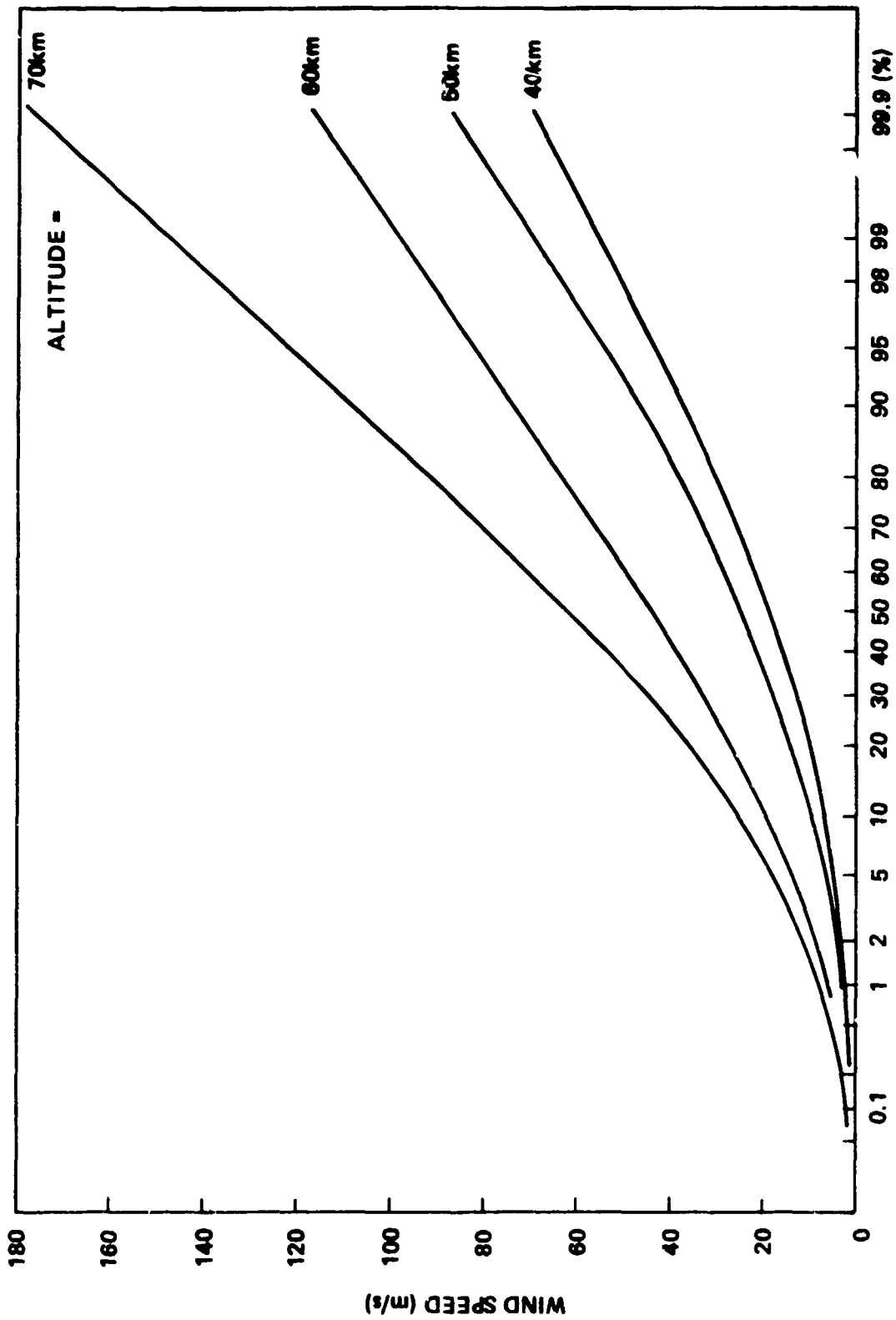

Figure A-2. Rayleigh PDF of wind speed, Cape Canaveral, January.

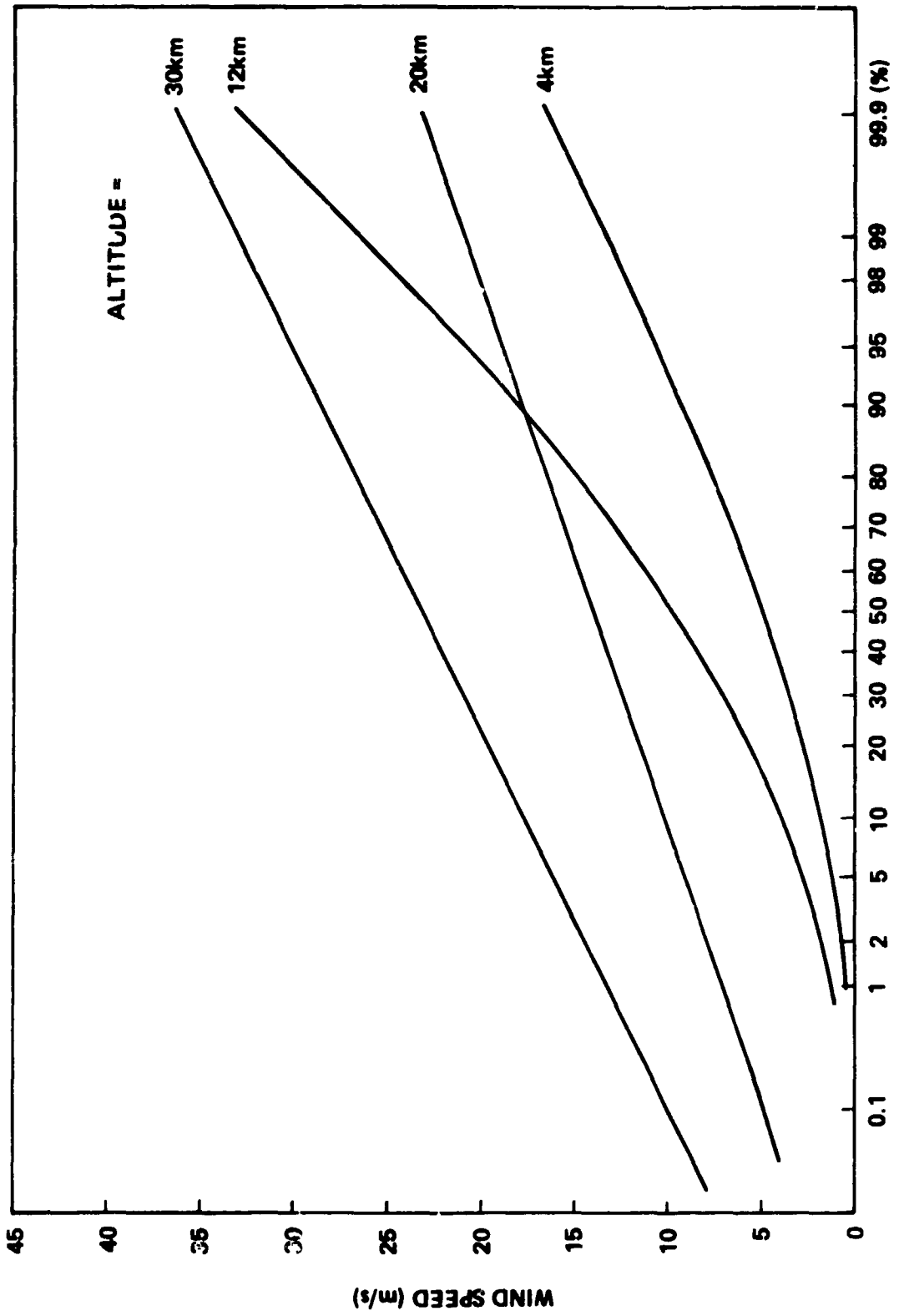

Figure A-3. Rayleigh PDF of wind speed, Cape Canaveral, July.

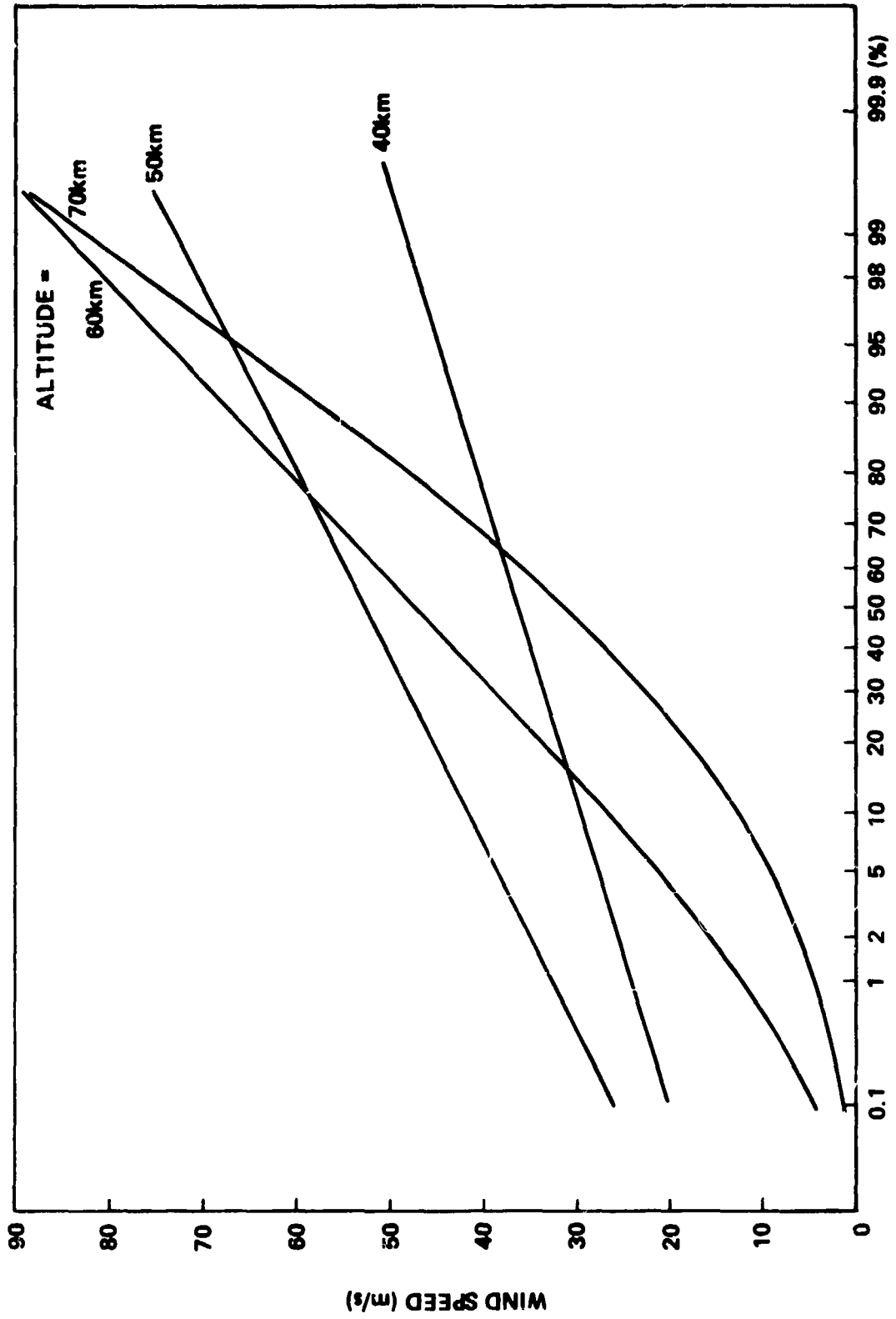

Figure A-4. Rayleigh PDF of wind speed, Cape Canaveral, July.

WIND STATION-KSC MONTH-JAN. ALTITUDE= 4 KM

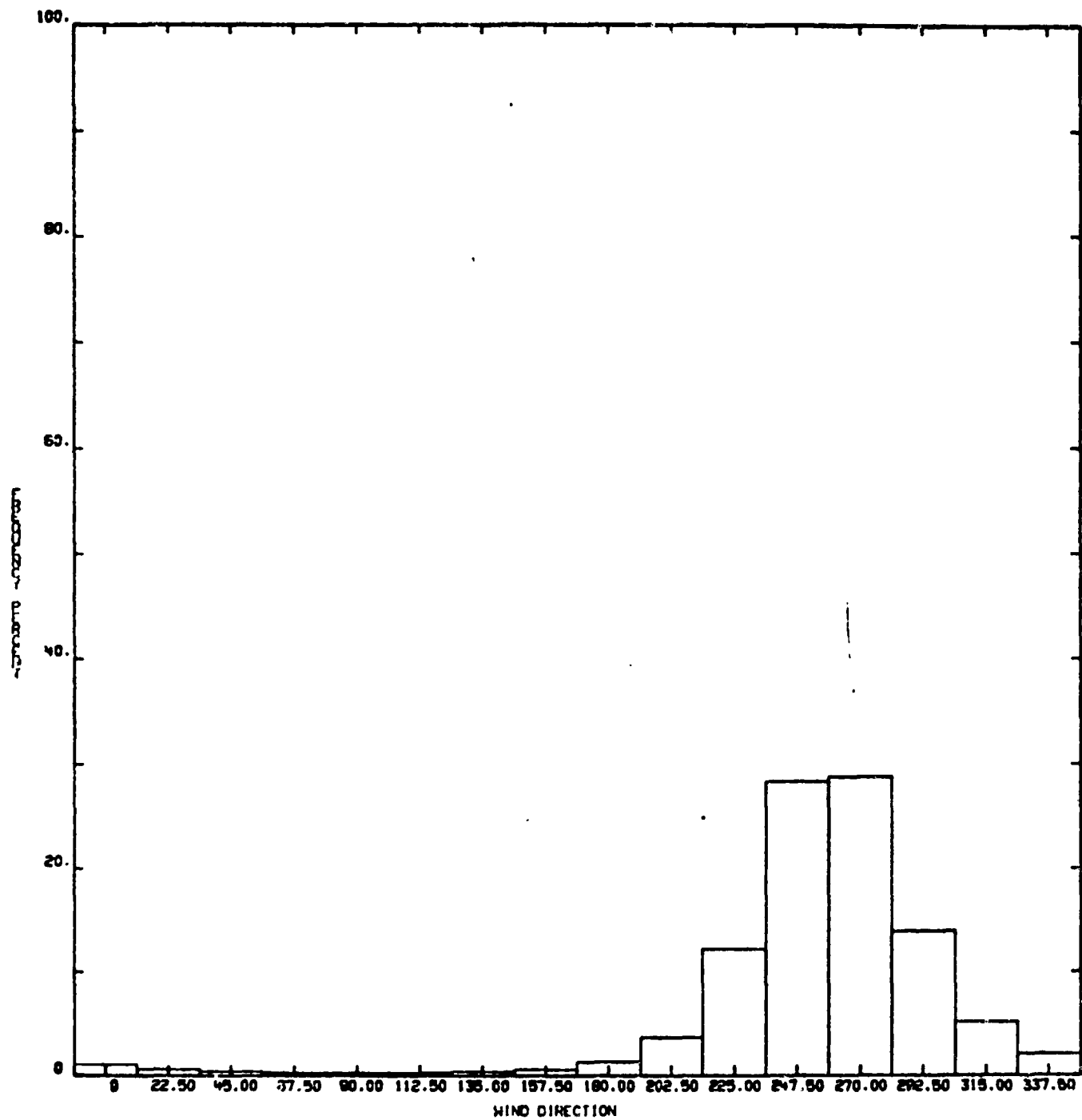

Figure A-5

WIND STATION-KSC MONTH-JAN. ALTITUDE=12 KM

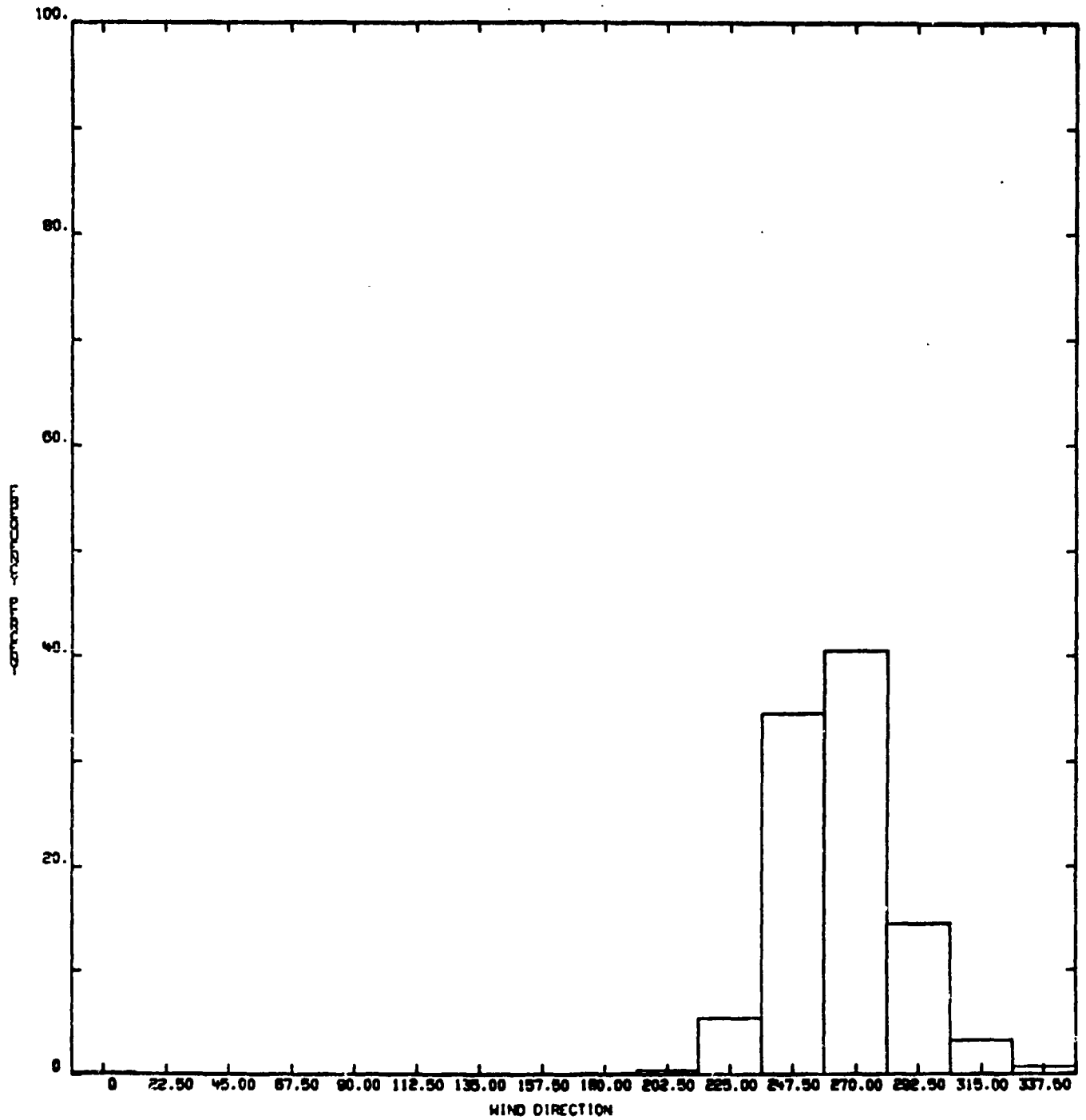

Figure A-6

WIND STATION-KSC MONTH-JAN. ALTITUDE-20 KM

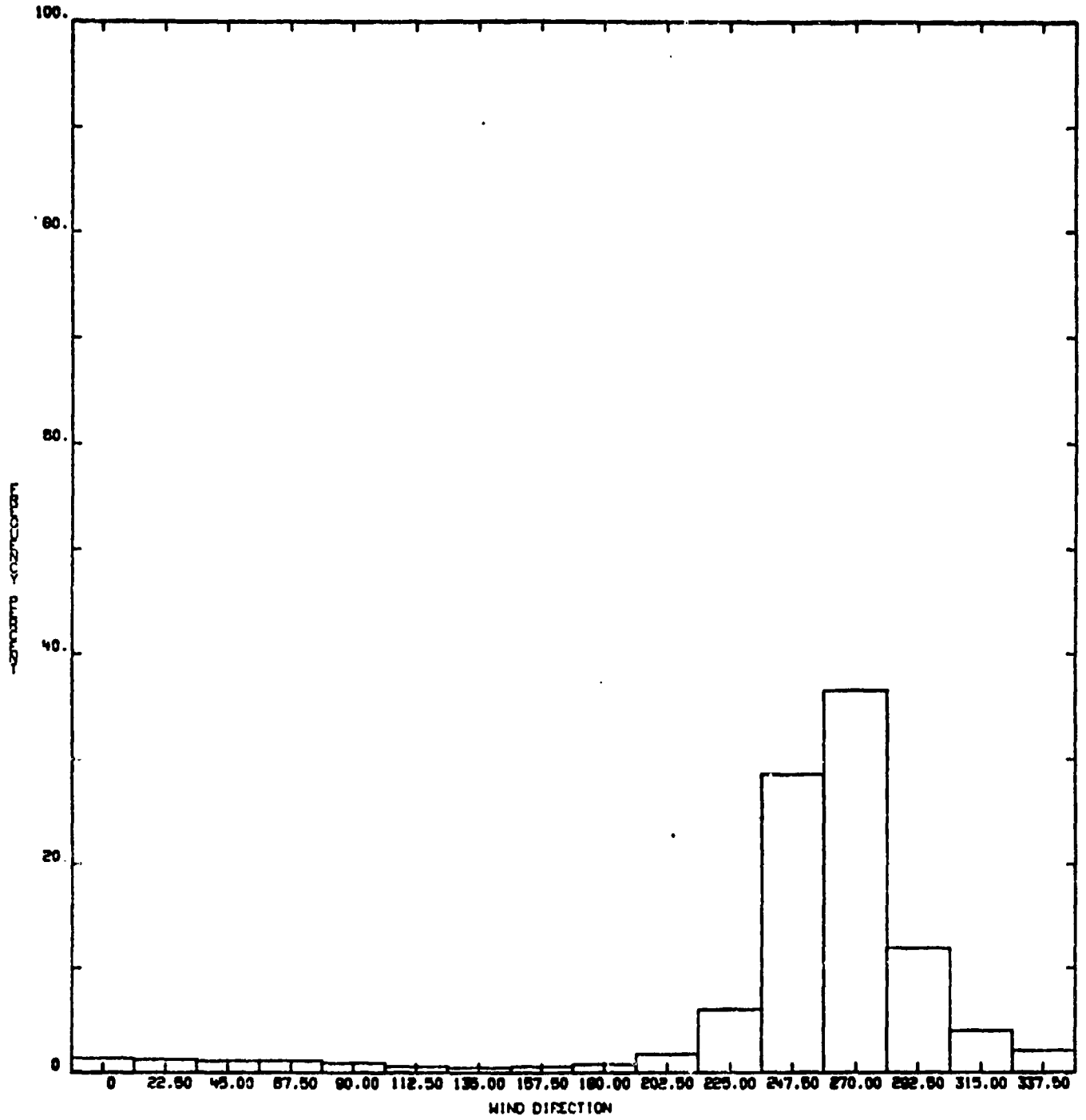

Figure A-7

WIND STATION-KSC MONTH-JAN. ALTITUDE=30 KM

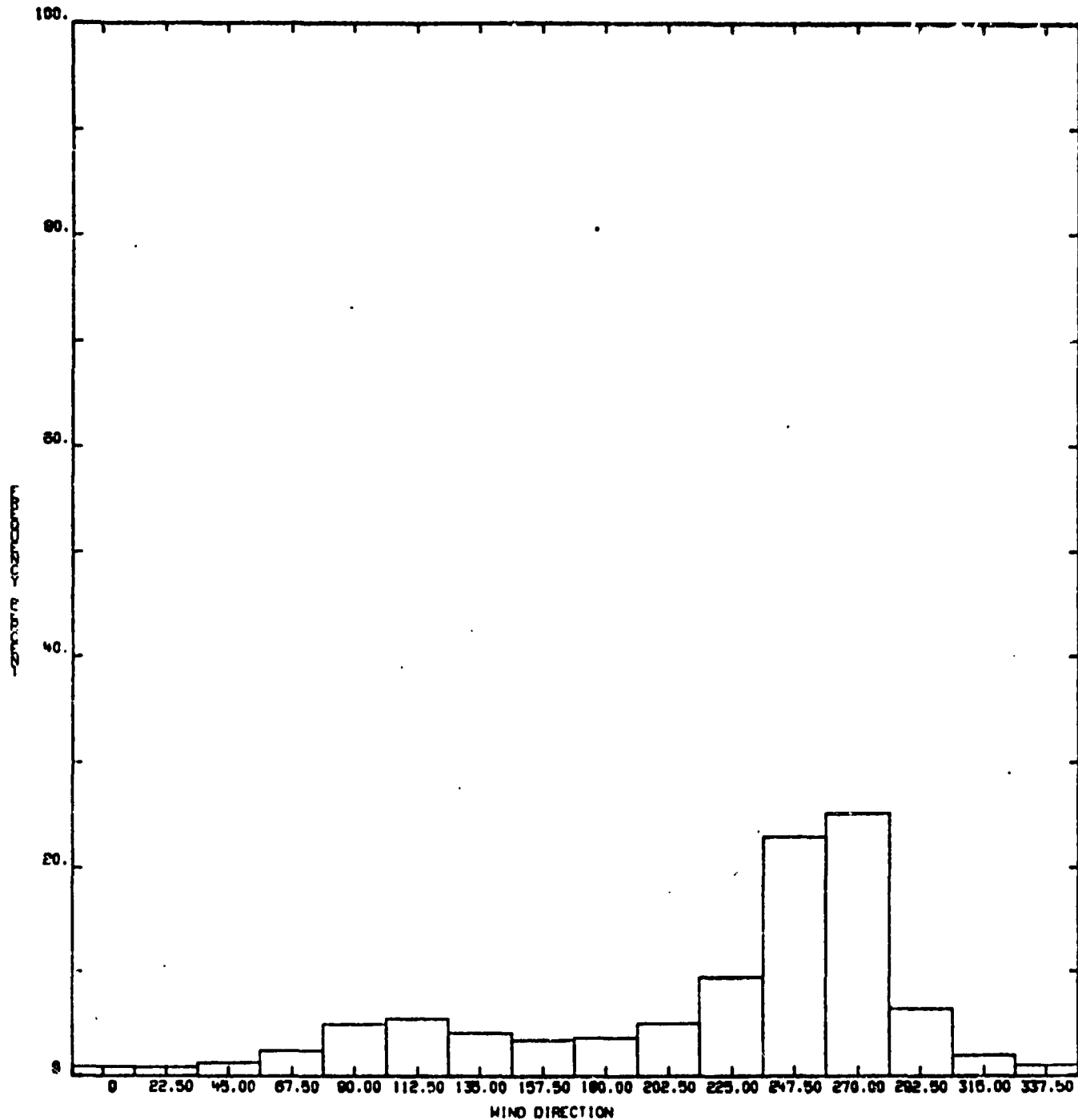

Figure A-8

WIND STATION-KSC MONTH-JAN. ALTITUDE=40 M

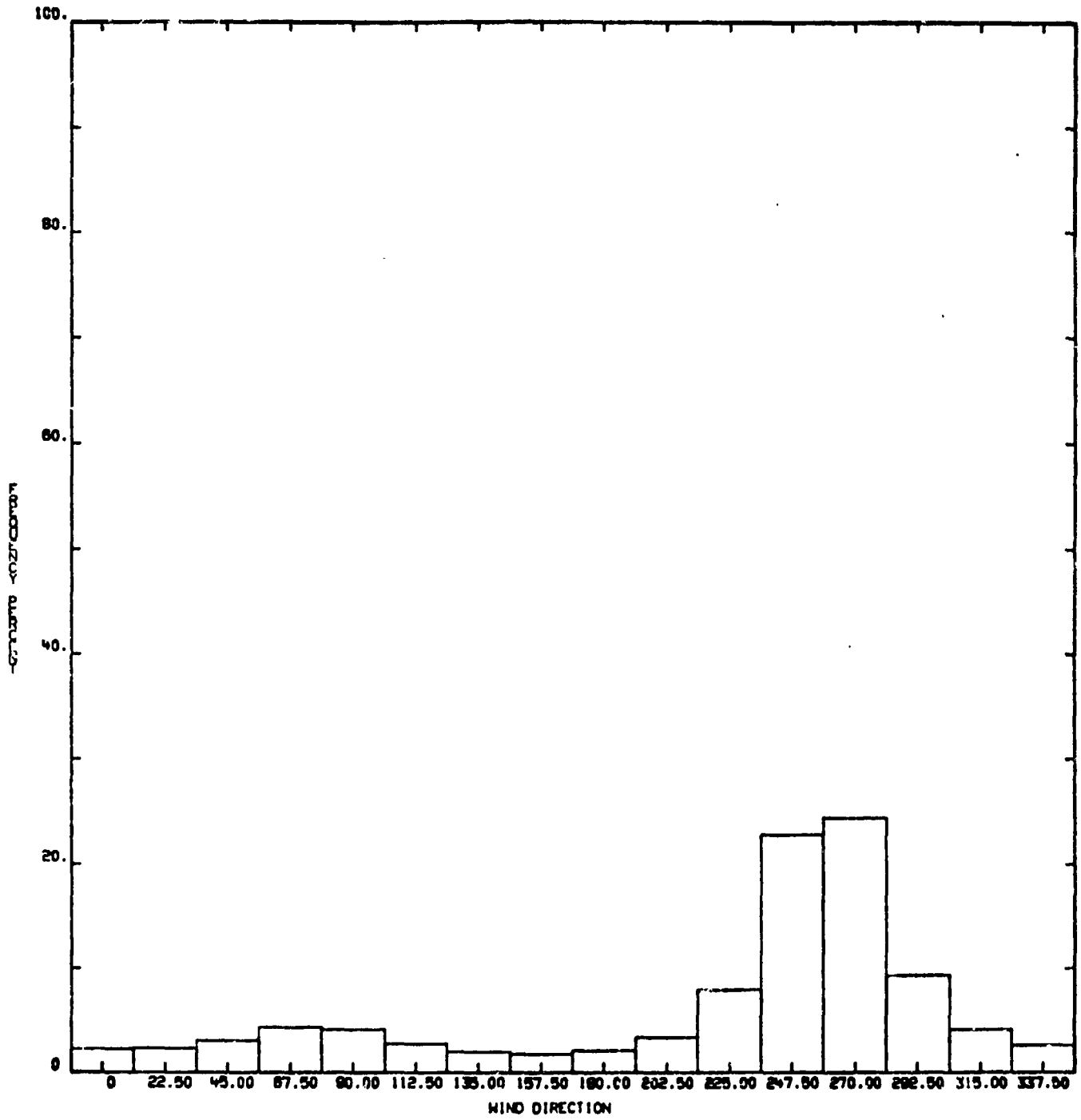

Figure A-9

WIND STATION-KSC MONTH-JAN. ALTITUDE-50 KM

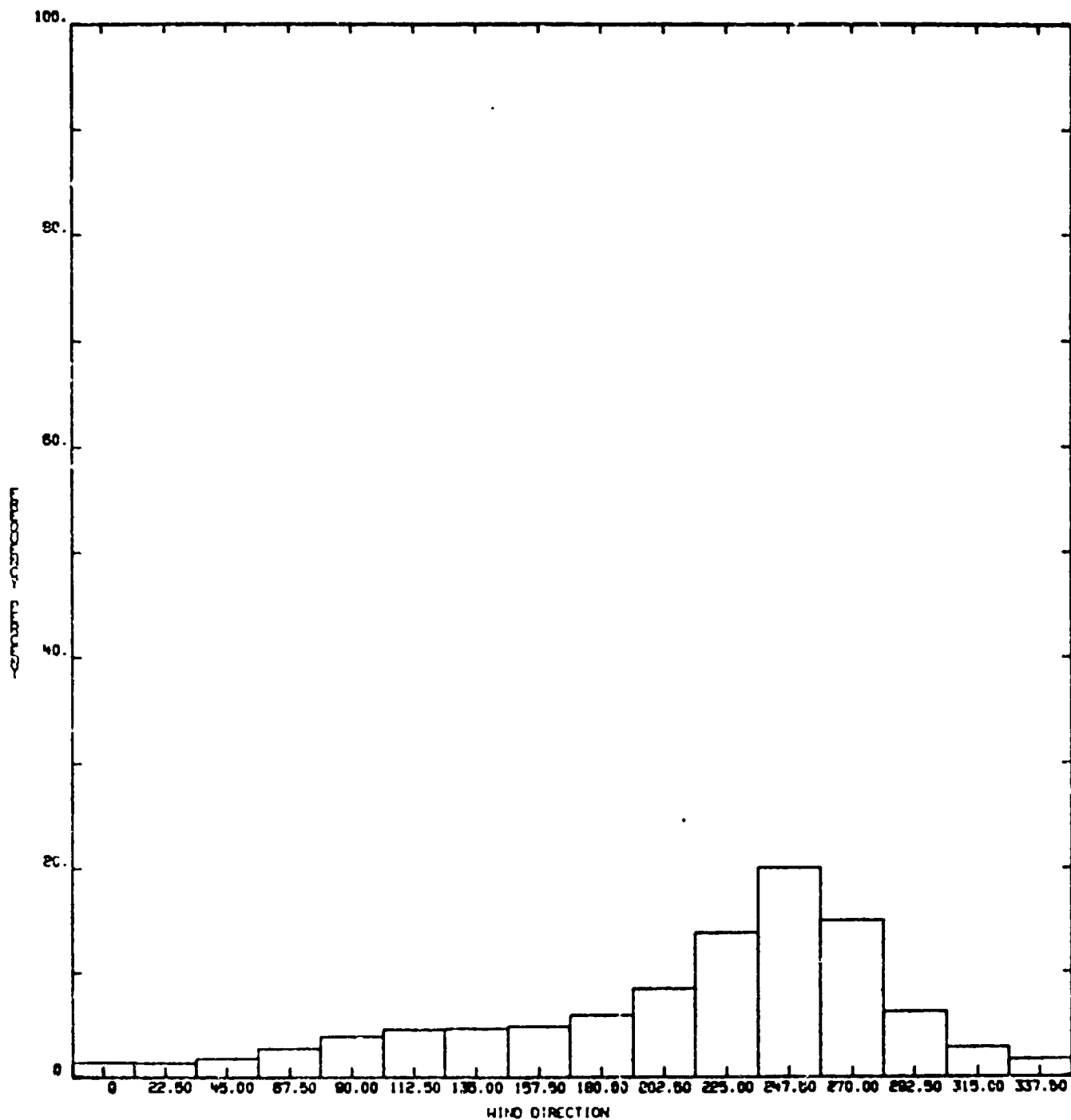

Figure A-10

WIND STATION-KSC MONTH-JAN. ALTITUDE-60 KM

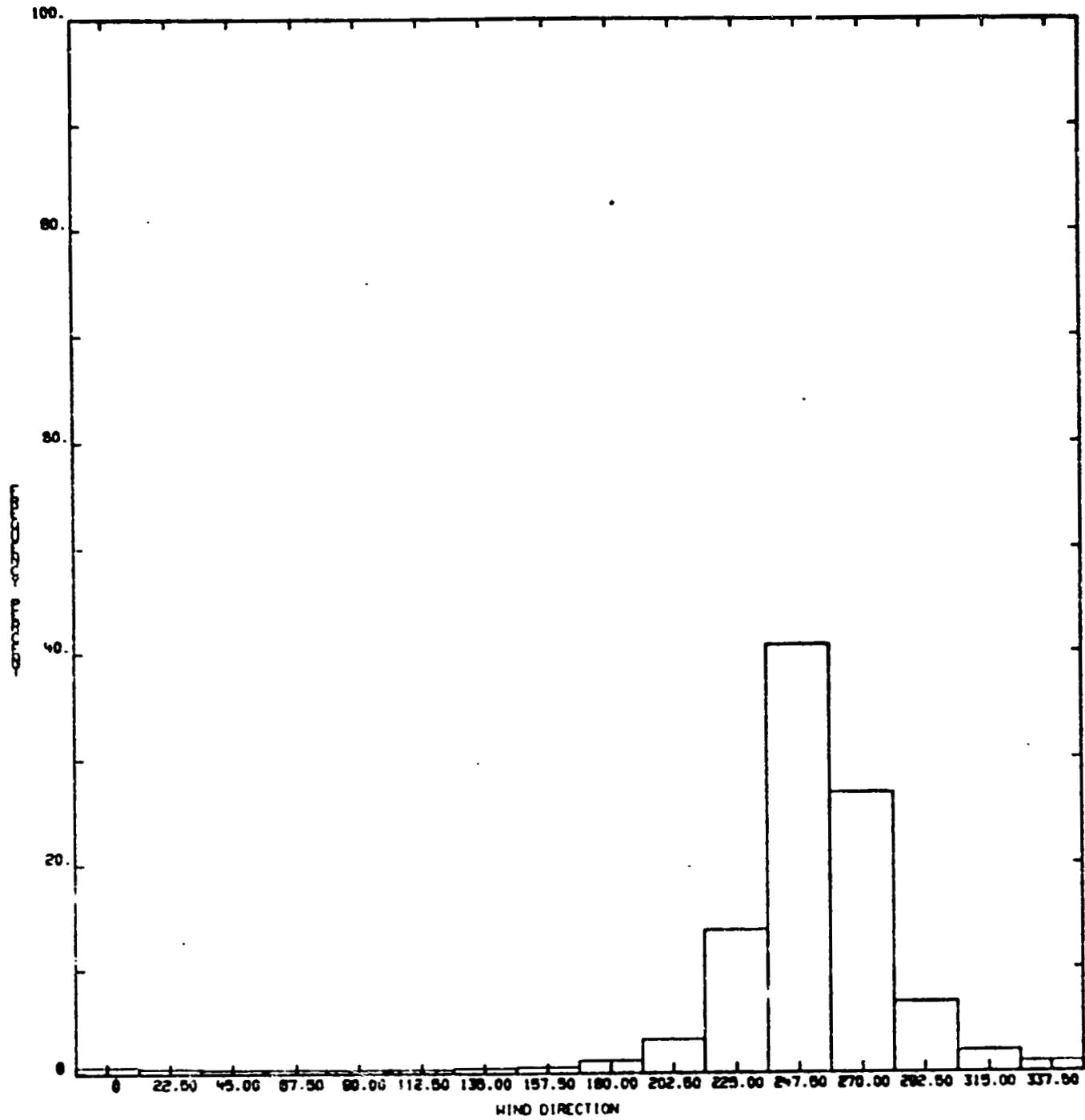

Figure A-11

WIND STATION-KSC MONTH-JAN. ALTITUDE-70 104

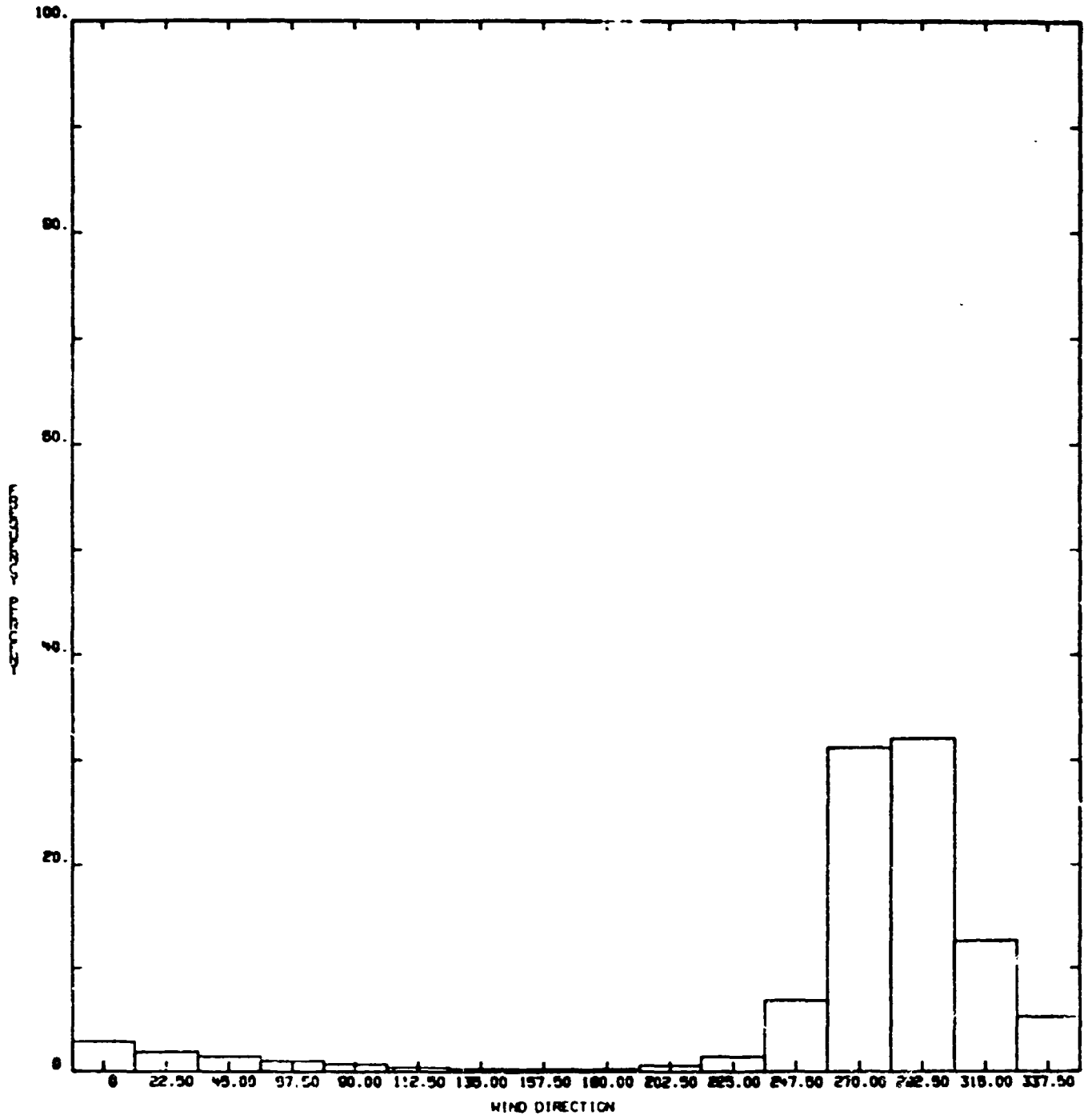

Figure A-12

WIND STATION-KSC MONTH-JUL. ALTITUDE= 4 KM

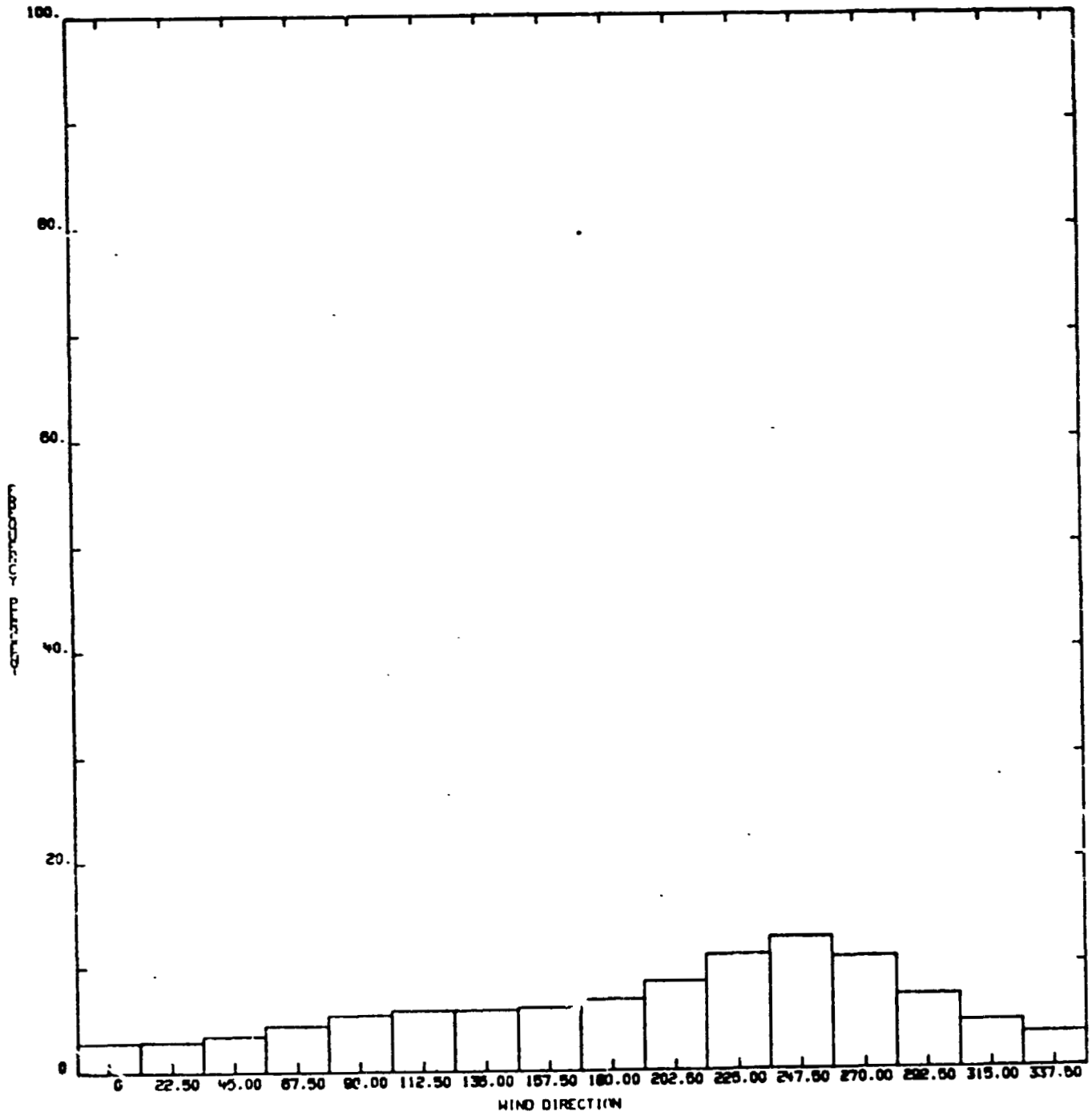

Figure A-13

WIND STATION-KSC MONTH-JUL. ALTITUDE-12 KM

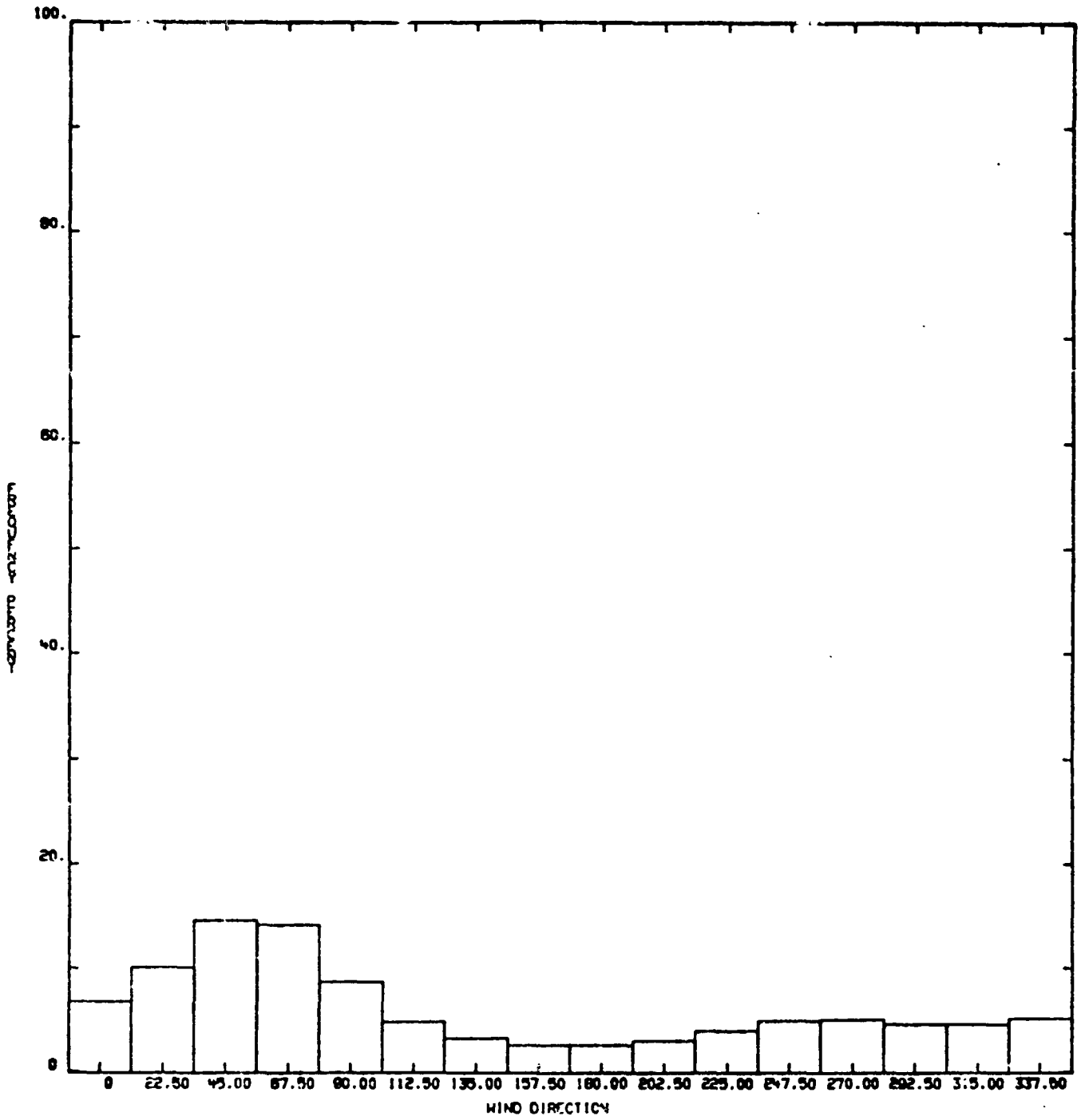

Figure A-14

WIND STATION-KSC MONTH-JUL. ALTITUDE-20 M1

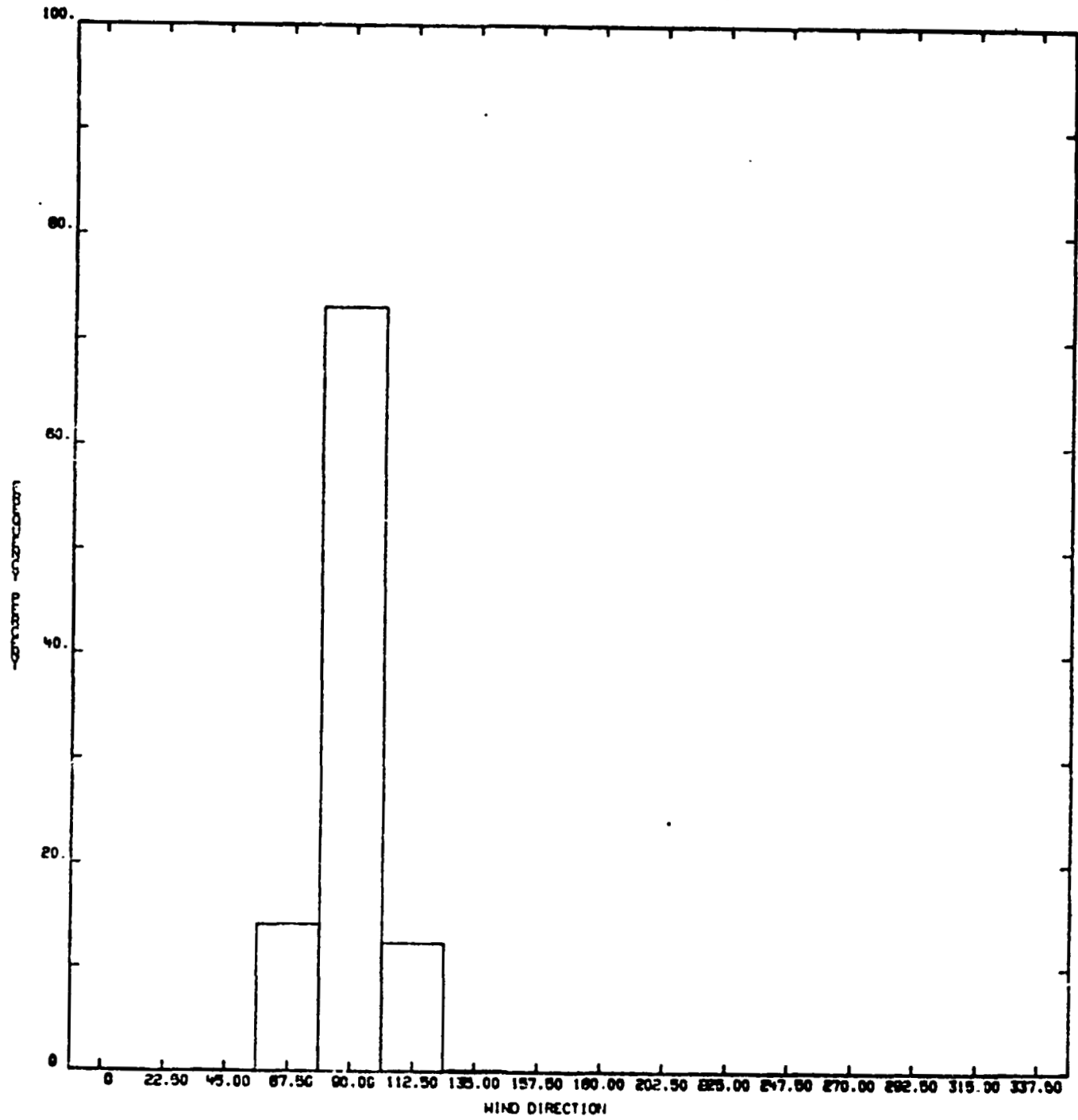

Figure A-15

WIND STATION-KSC MONTH-JUL. ALTITUDE=30 M

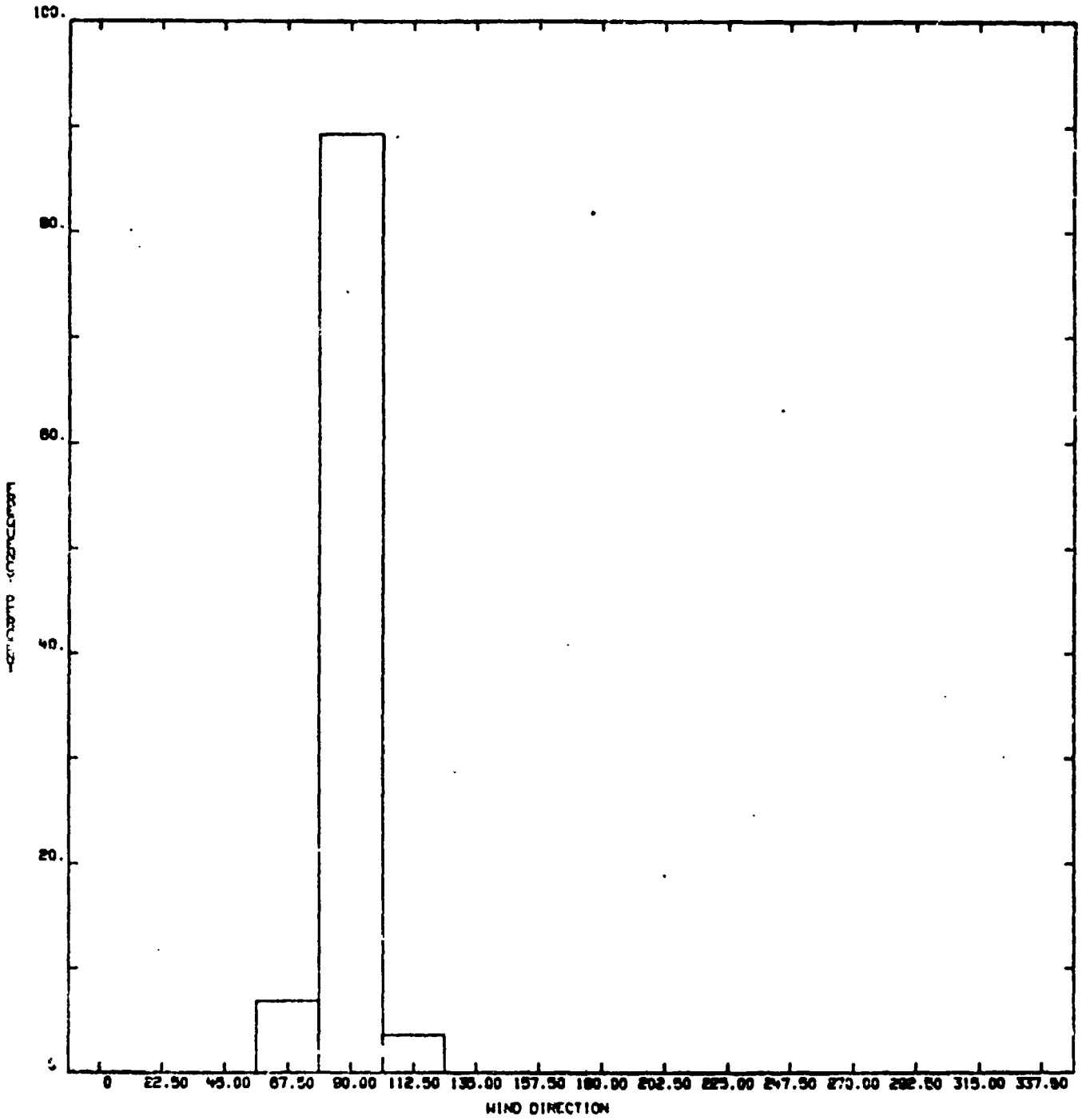

Figure A-16

WIND STATION=KSC MONTH=JUL. ALTITUDE=40 .01

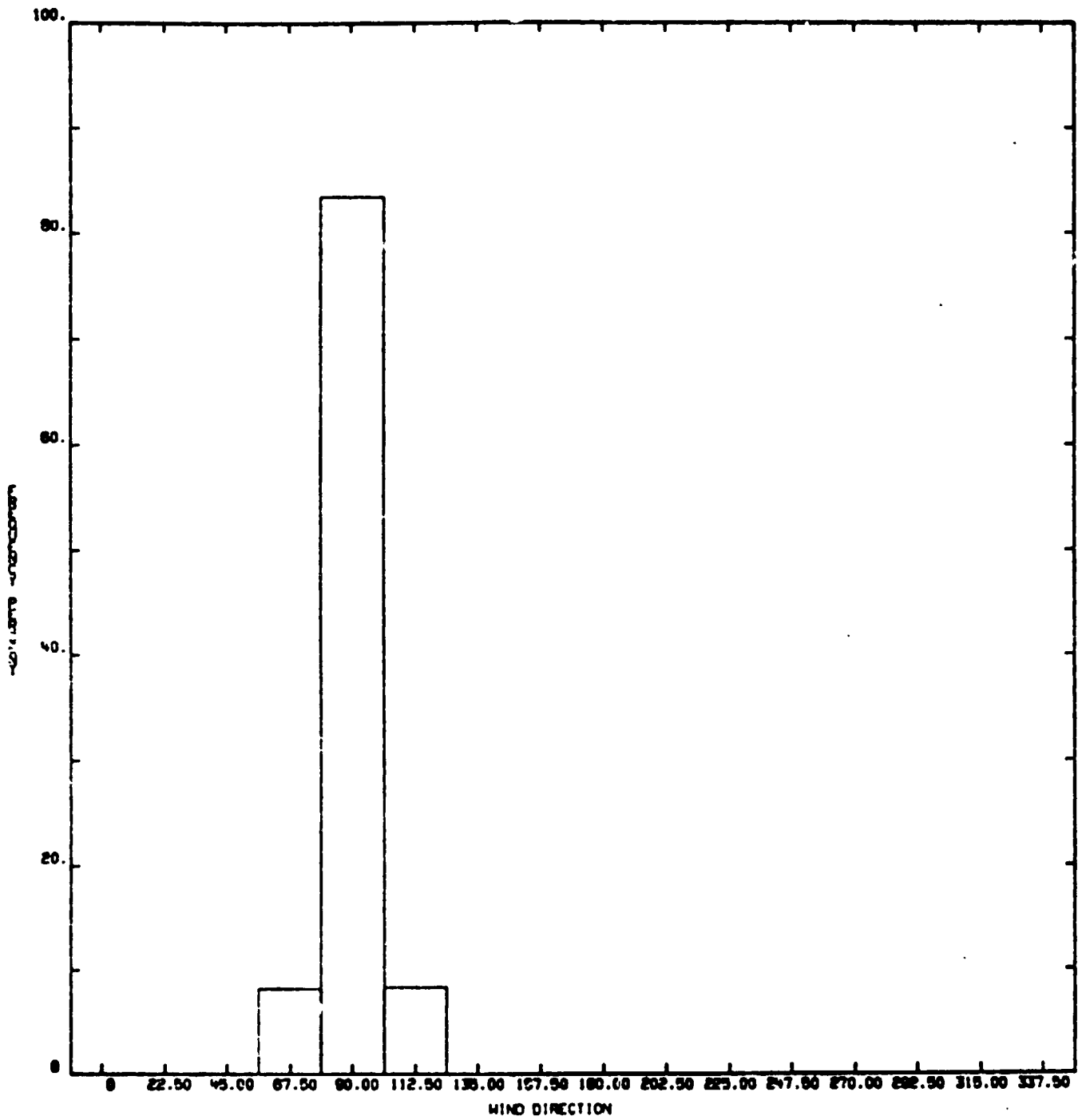

Figure A-17

WIND STATION-KSC MONTH-JUL. ALTITUDE-90 M

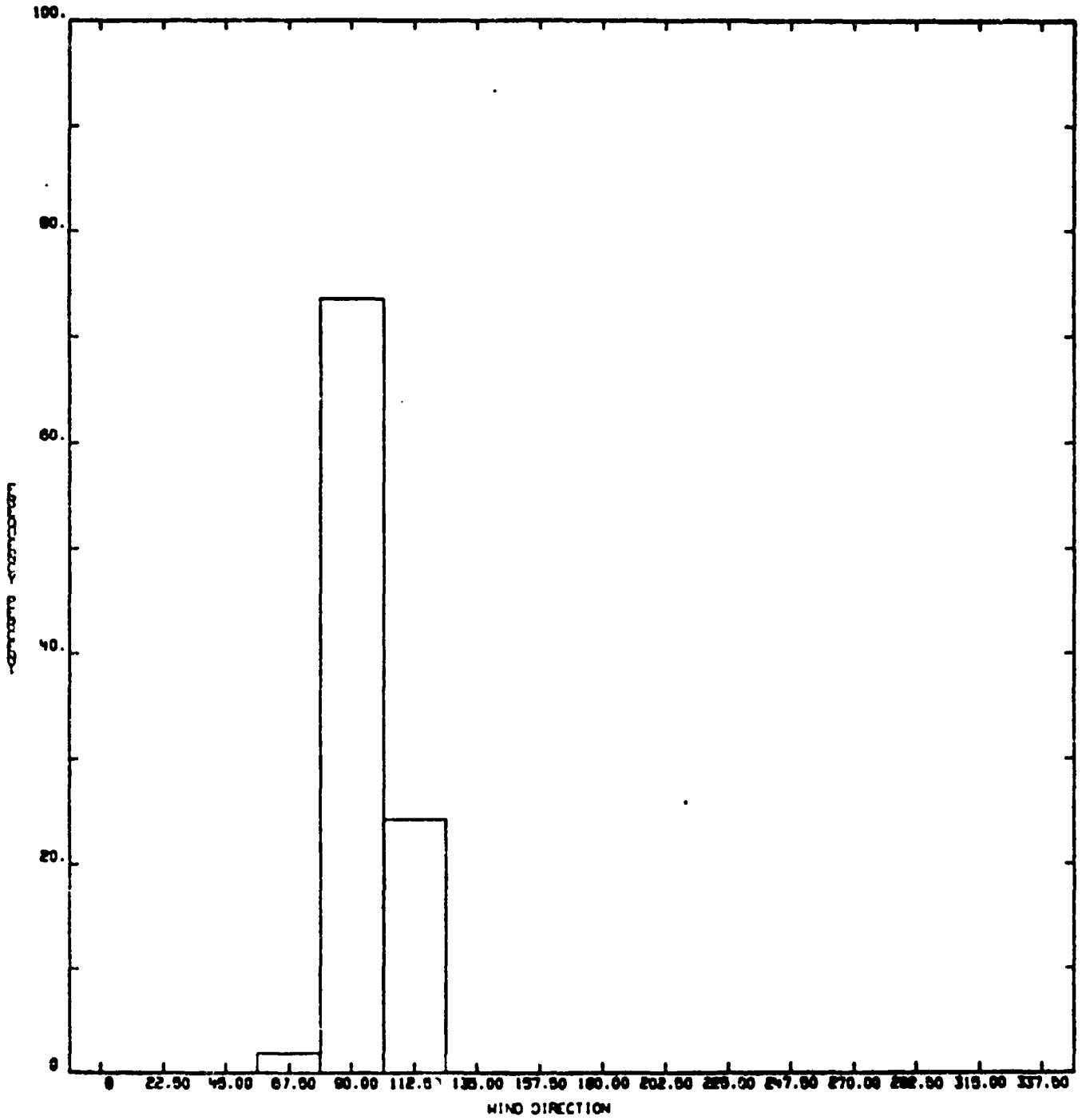

Figure A-18

WIND STATION-KSC MONTH-JUL. ALTITUDE-60 M

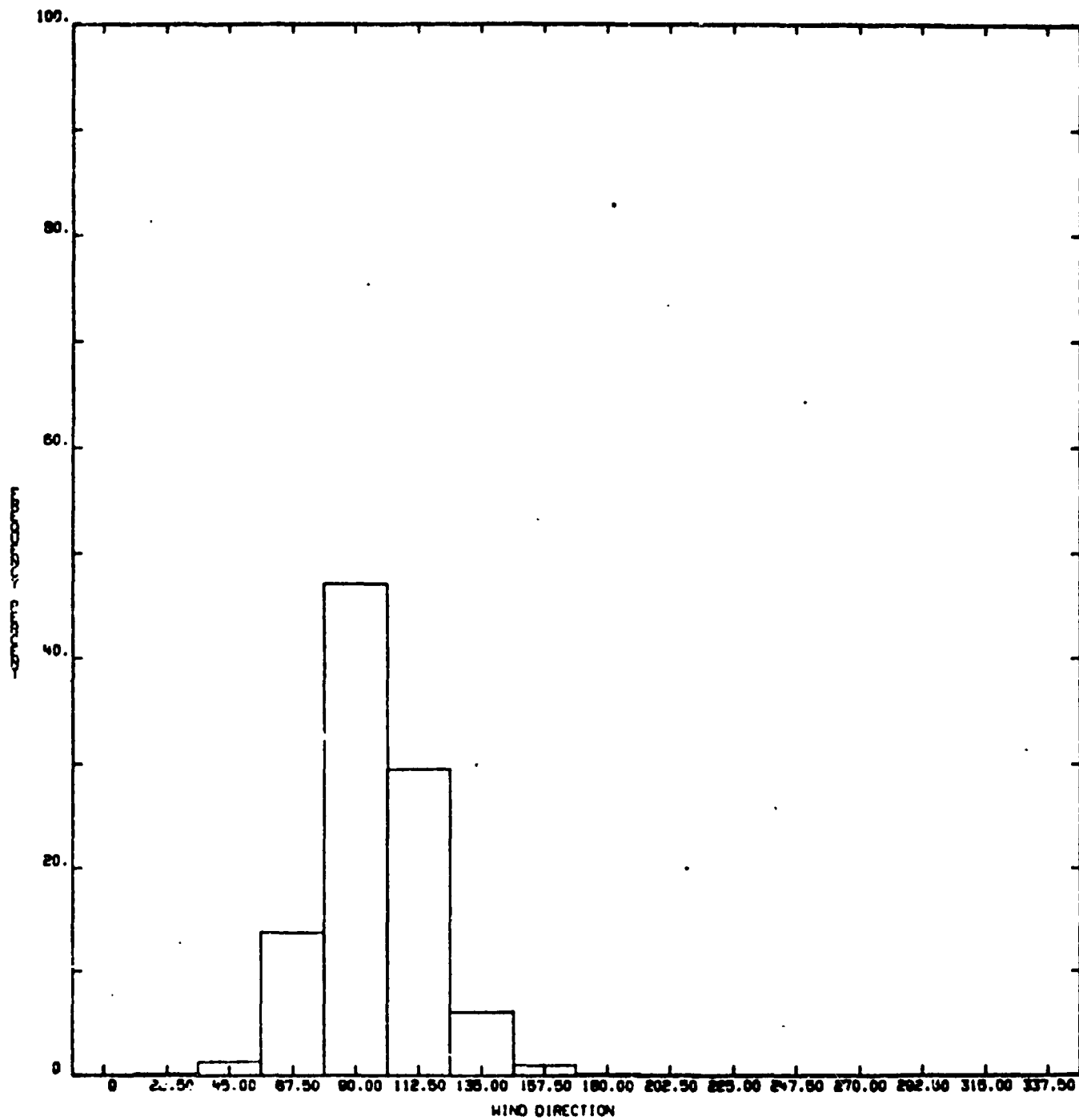

Figure A-19

WIND STATION-KSC MONTH-JUL. ALTITUDE-70 KM

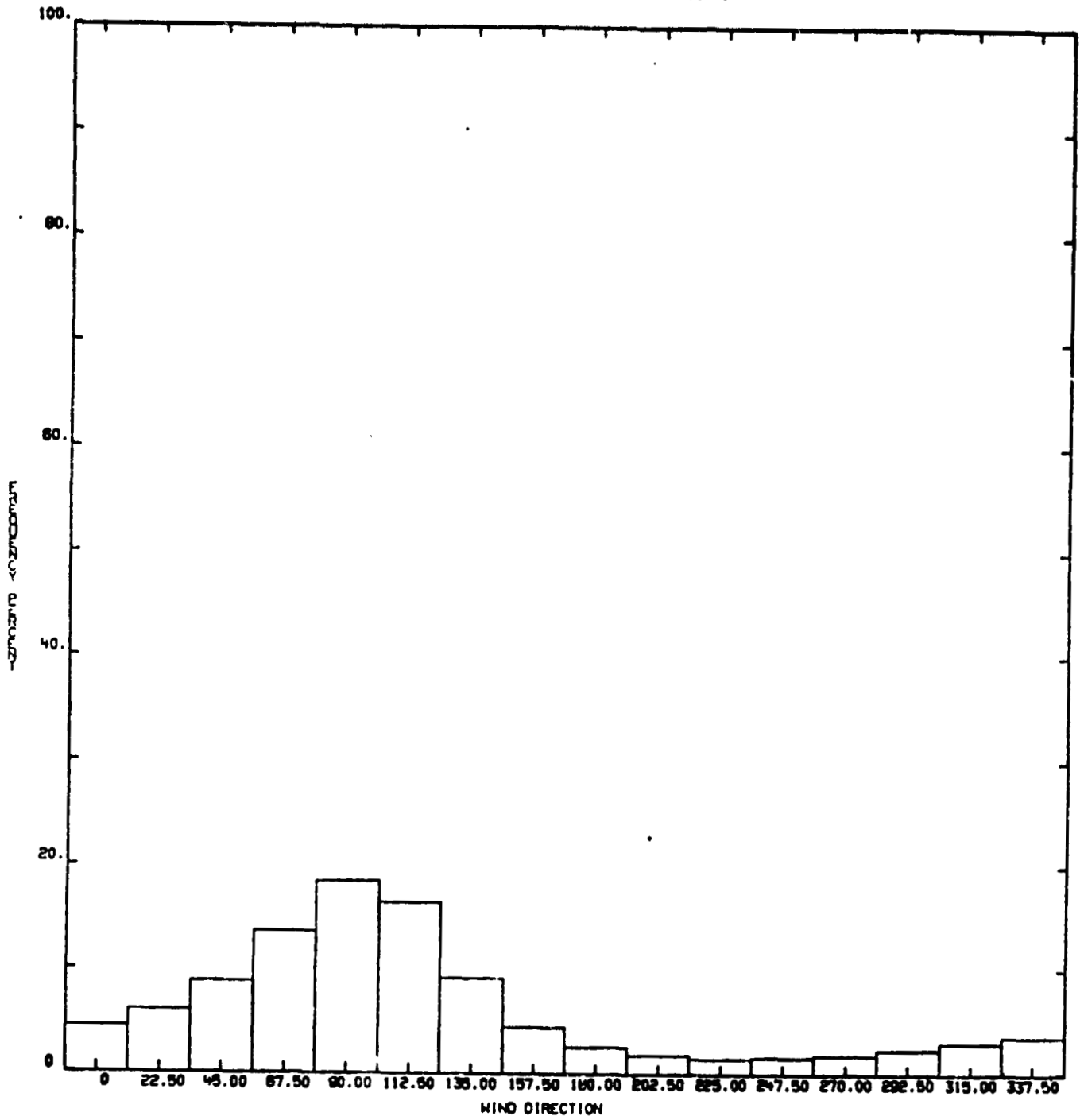

Figure A-20

XBAR= 14.32 SIGMAX= 8.14 RHO= .1371 YBAR= 2.40 SIGMAY= 7.03 PERCENT= 80.

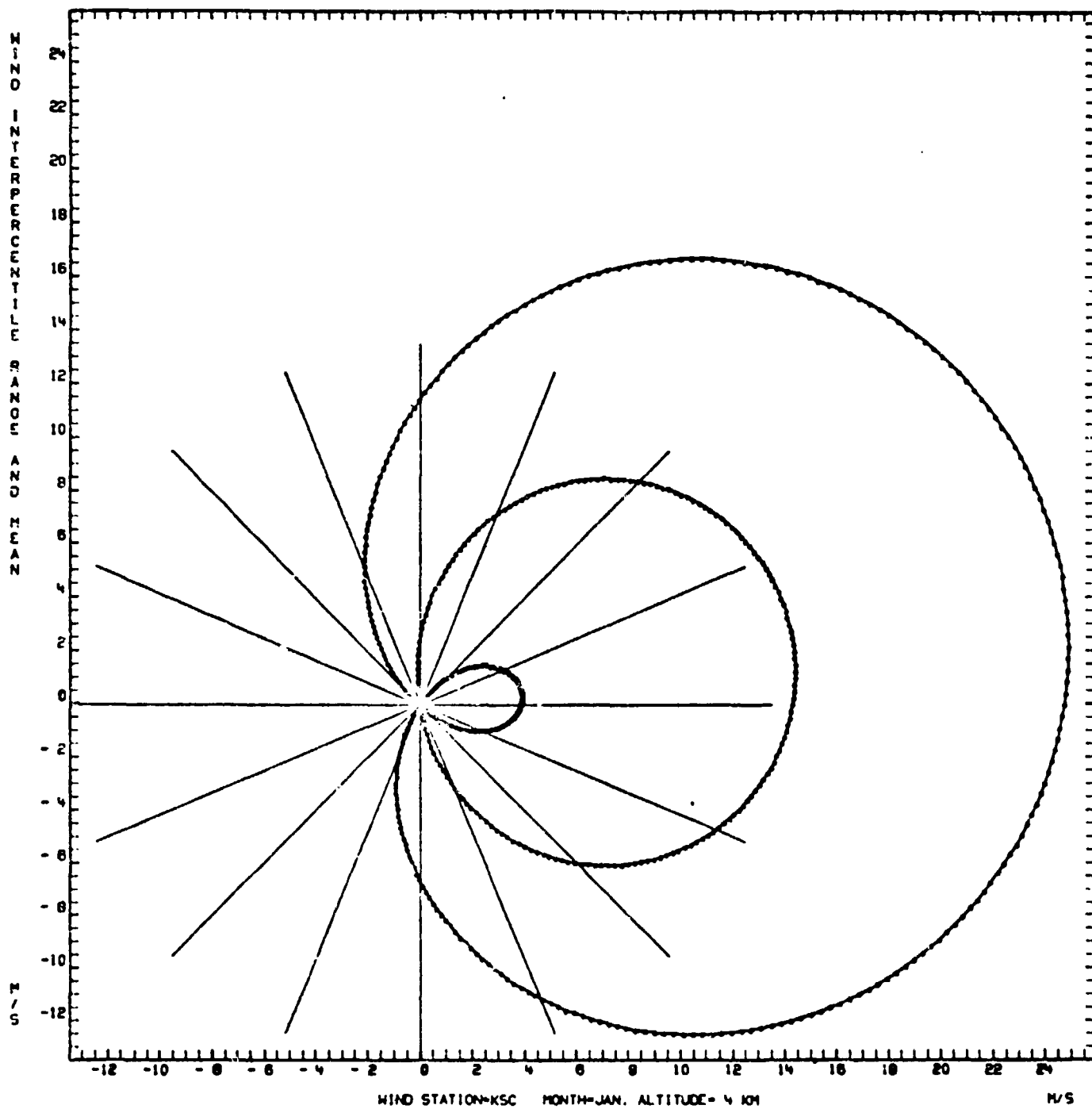

Figure A-21

XBAR= 39.89 SIGMAX= 14.12 RHO= .2857 YBAR= 4.85 SIGMAY= 13.43 PERCENT= 80.

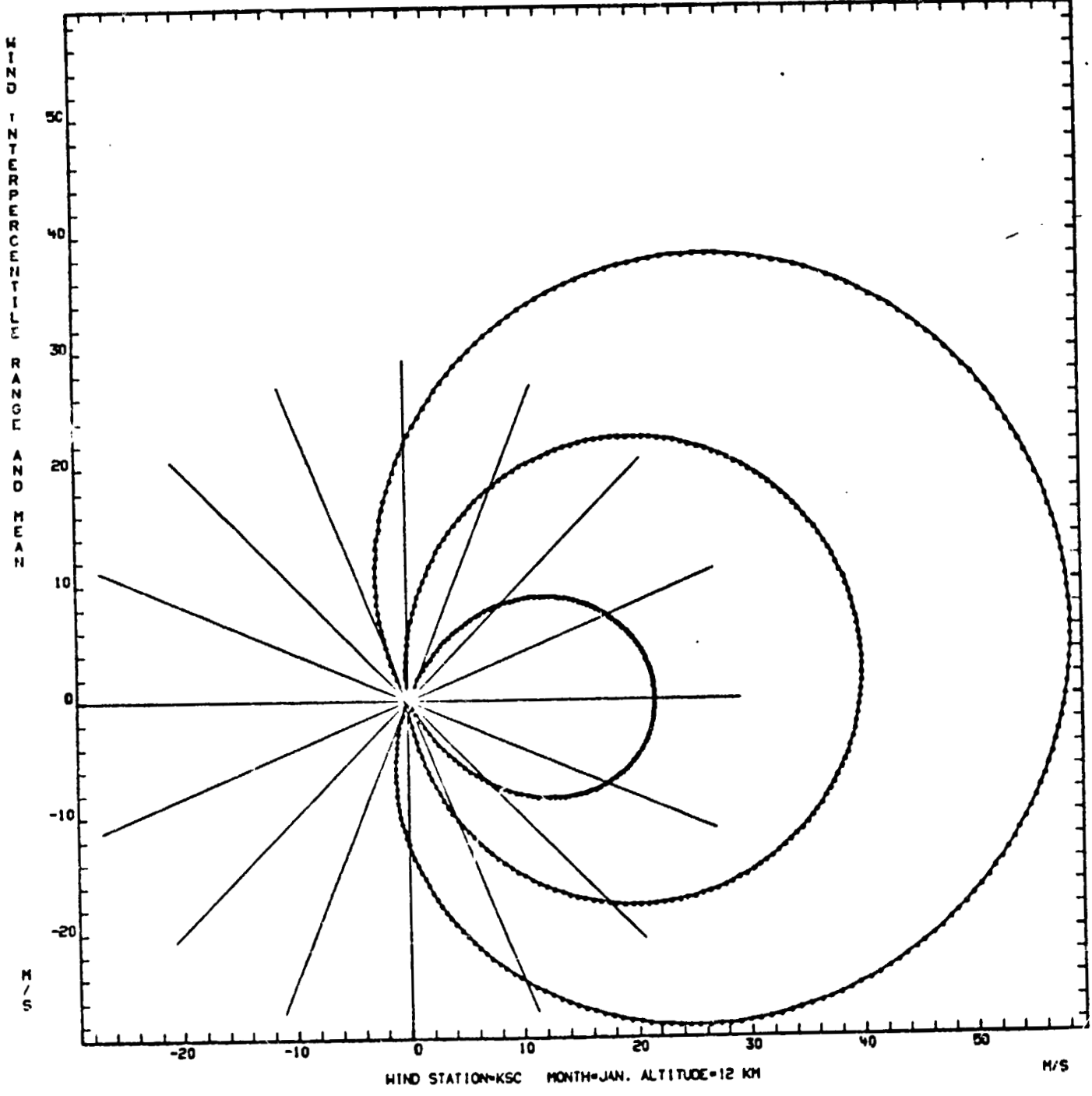

Figure A-22

XBAR= 9.10 SIGMAX= 8.31 RHO= .3336 YBAR= 1.01 SIGMAY= 3.41 PERCENT= 80.

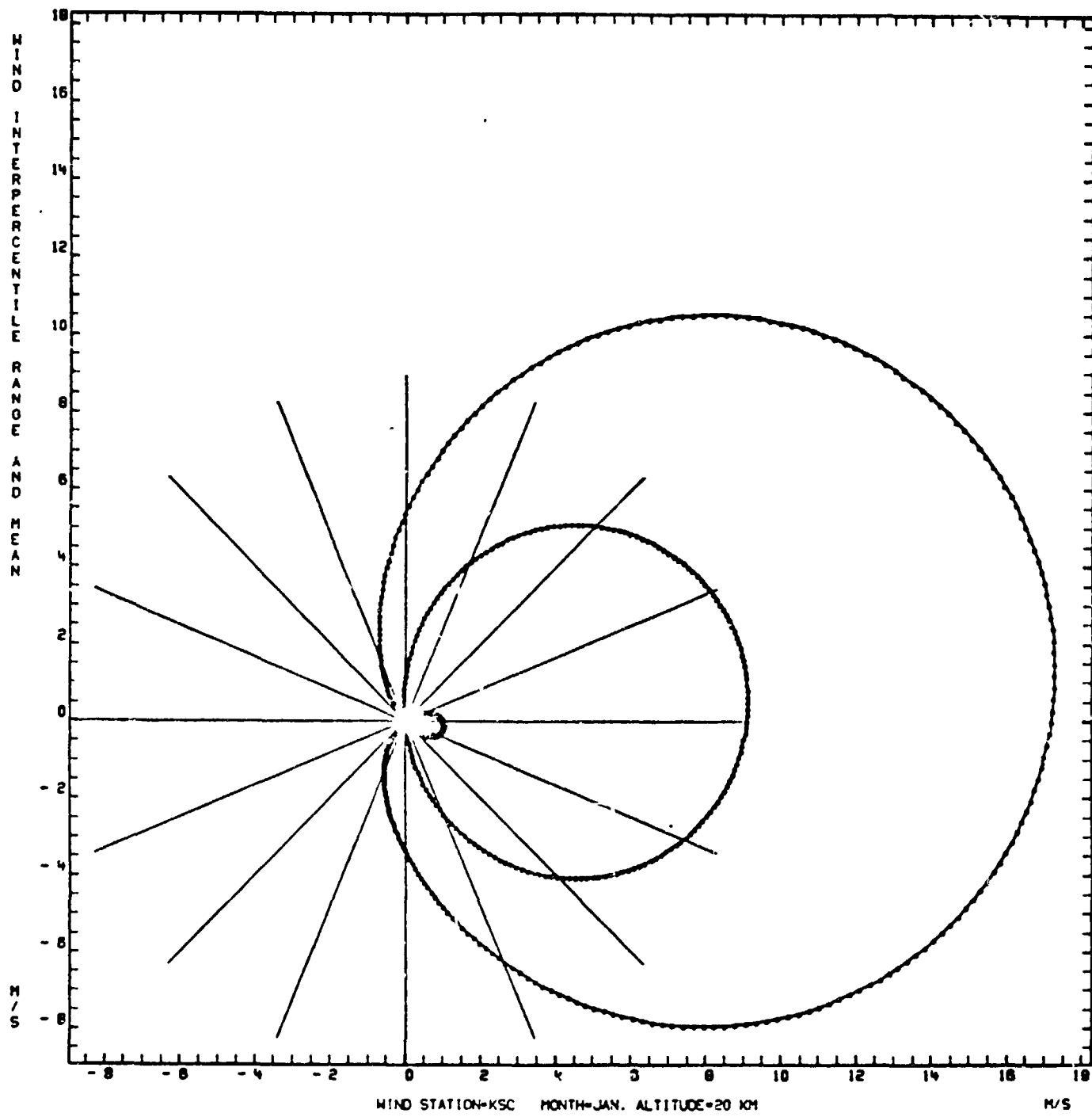

Figure A-23

XBAR= 9.87 SIGMAX= 14.74 RHO= .0383 YBAR= 3.53 SIGMAY= 5.75 PERCENT= 80.

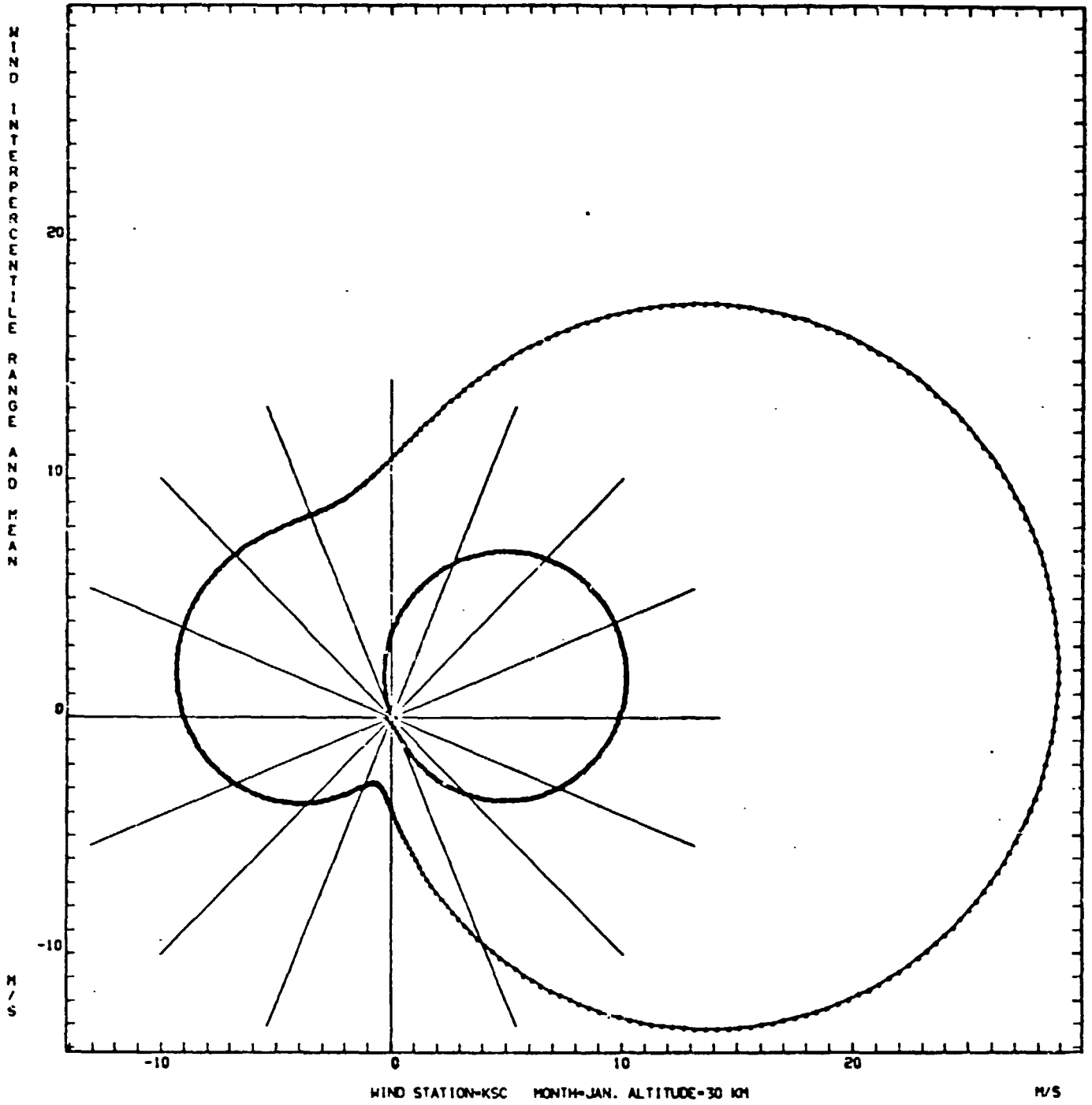

Figure A-24

XBAR= 13.25 SIGMAX= 17.68 RHO= .3303 YBAR= 2.08 SIGMAY= 8.59 PERCENT= 80.

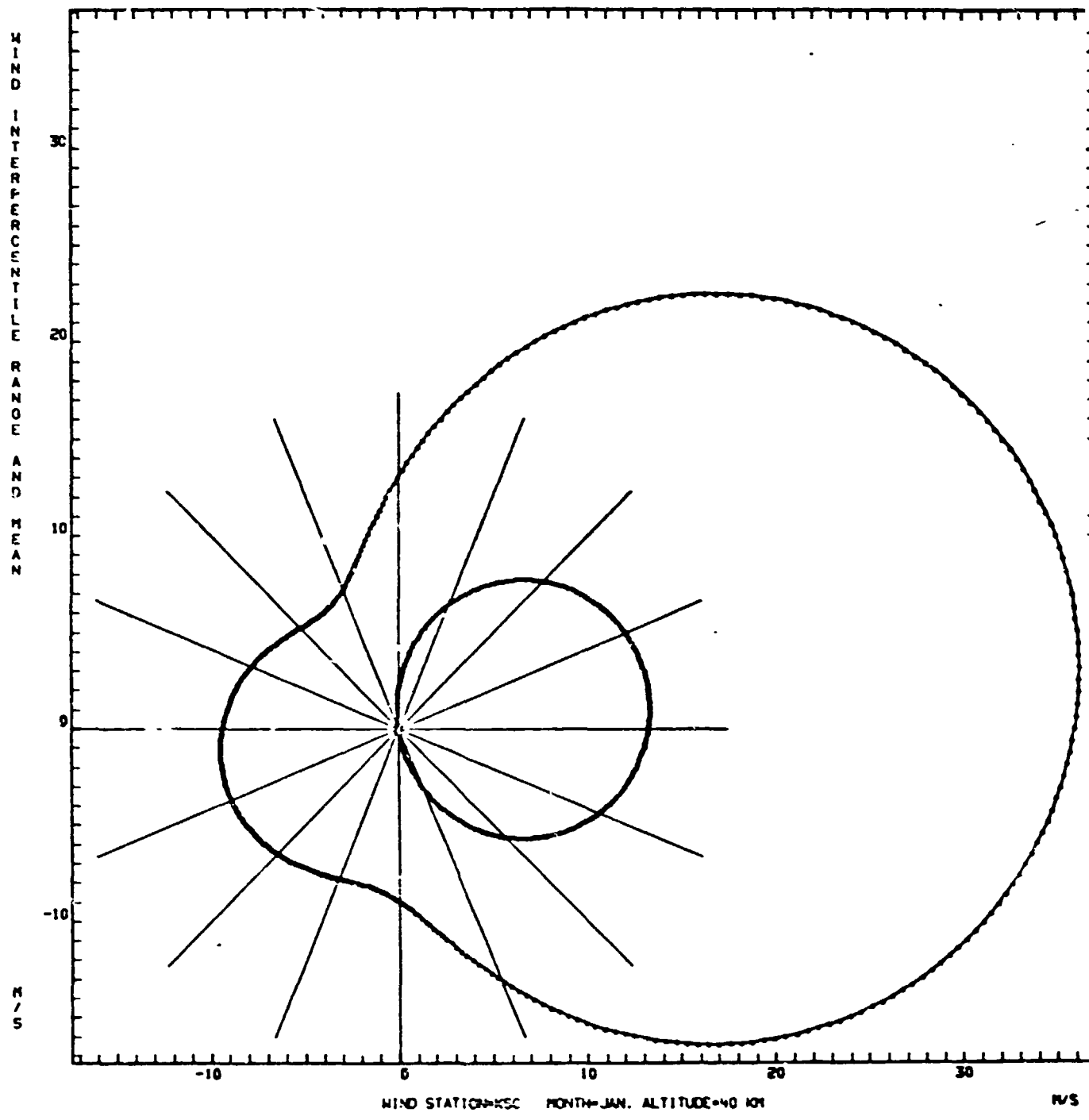

Figure A-25

XBAR= 13.98 SIGMAX= 22.92 RHO= .1123 YBAR= 8.74 SIGMAY= 13.19 PERCENT= 80.

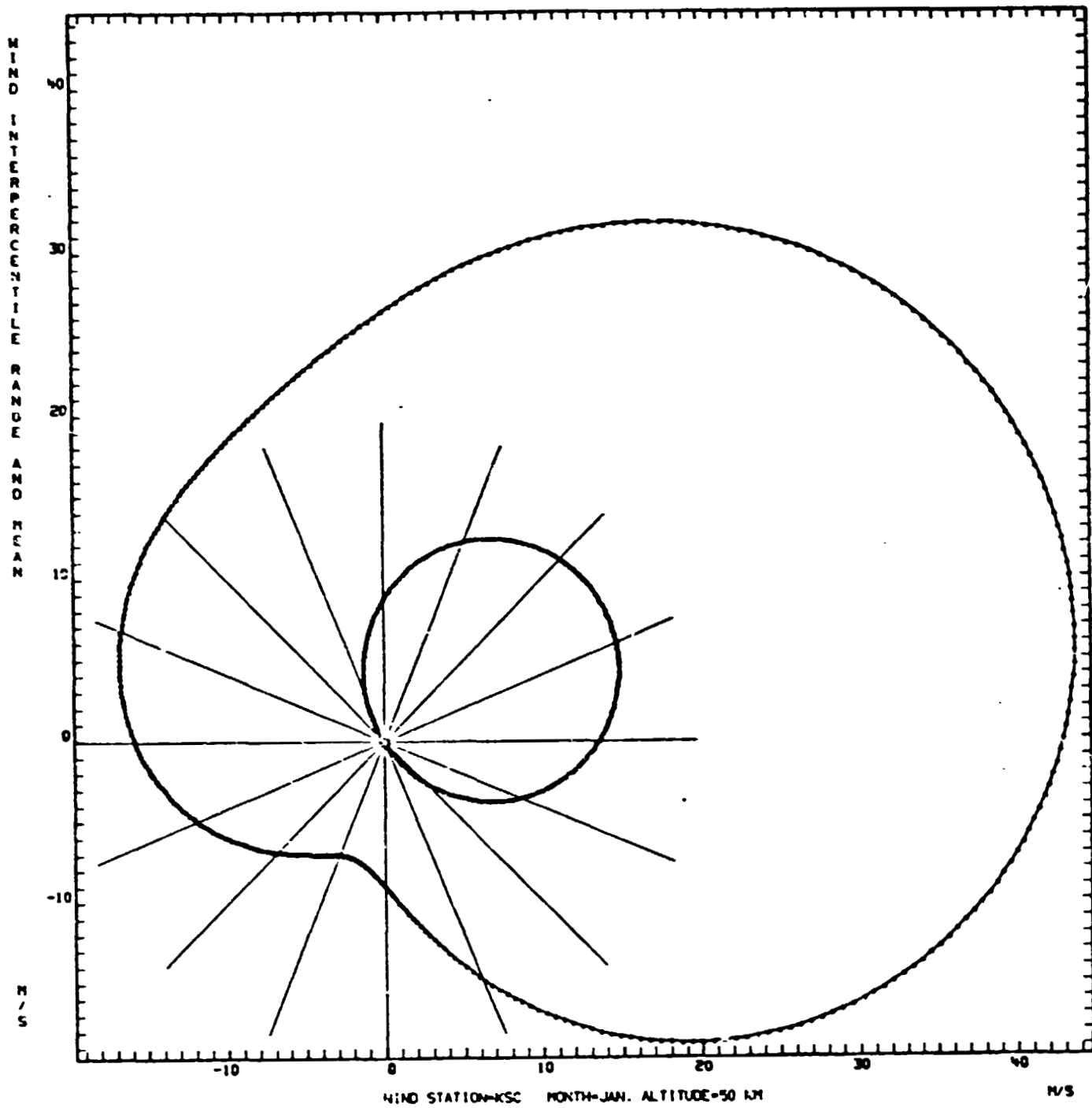

Figure A-26

XBAR= 40.06 SIGMAX= 23.30 RHO= .3183 YBAR= 12.11 SIGMAY= 15.40 PDF INT= 80.

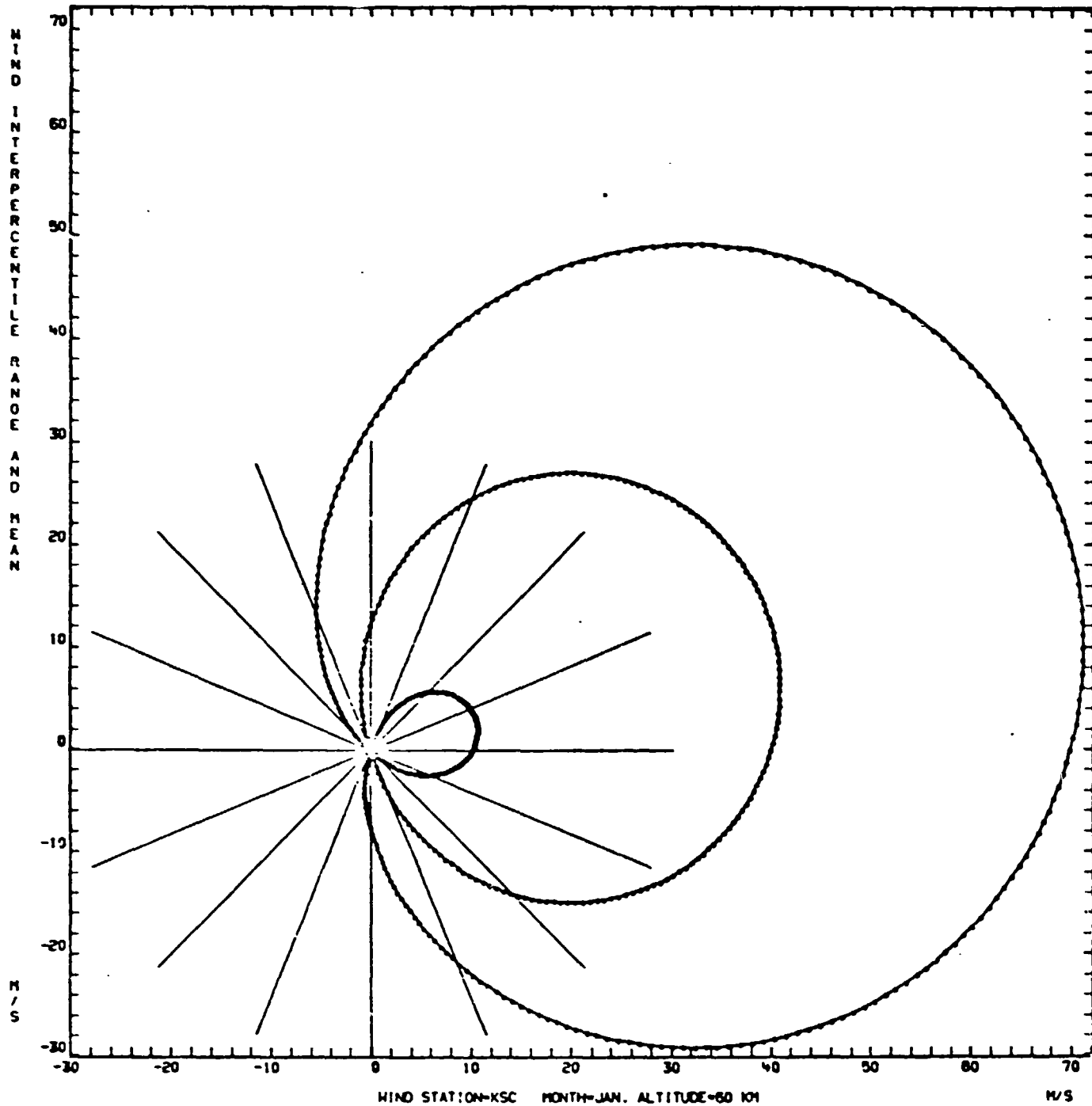

Figure A-27

XBAR= 55.17 SIGMAX= 38.91 RC= .0412 YBAR= -15.67 SIGMAY= 20.80 PERCENT= 80.

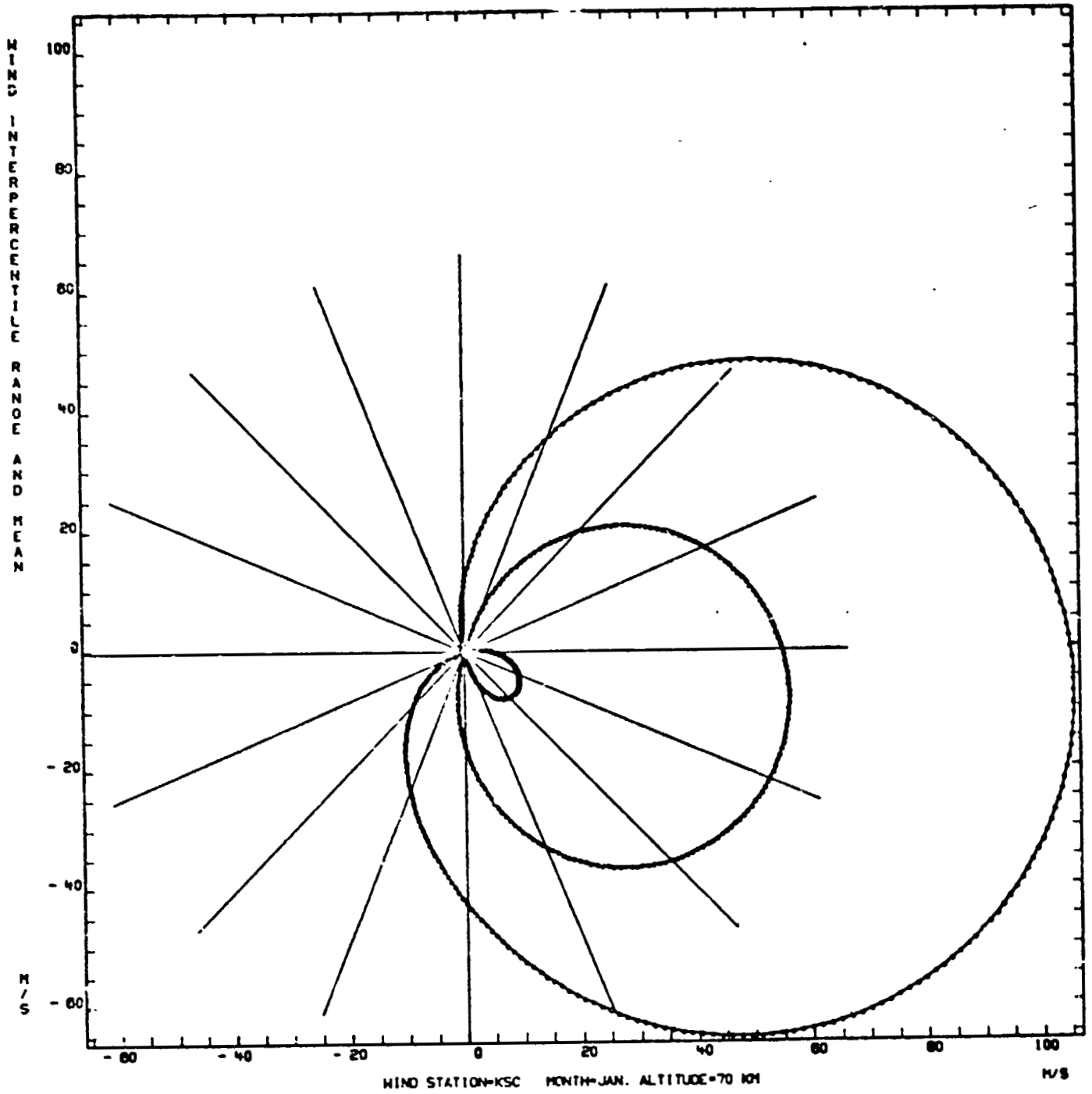

Figure A-28

XBAR= 1.40 SIGMAX= 4.58 RHO= .0820 YBAR= 1.29 SIGMAY= 3.43 PERCENT= 80.

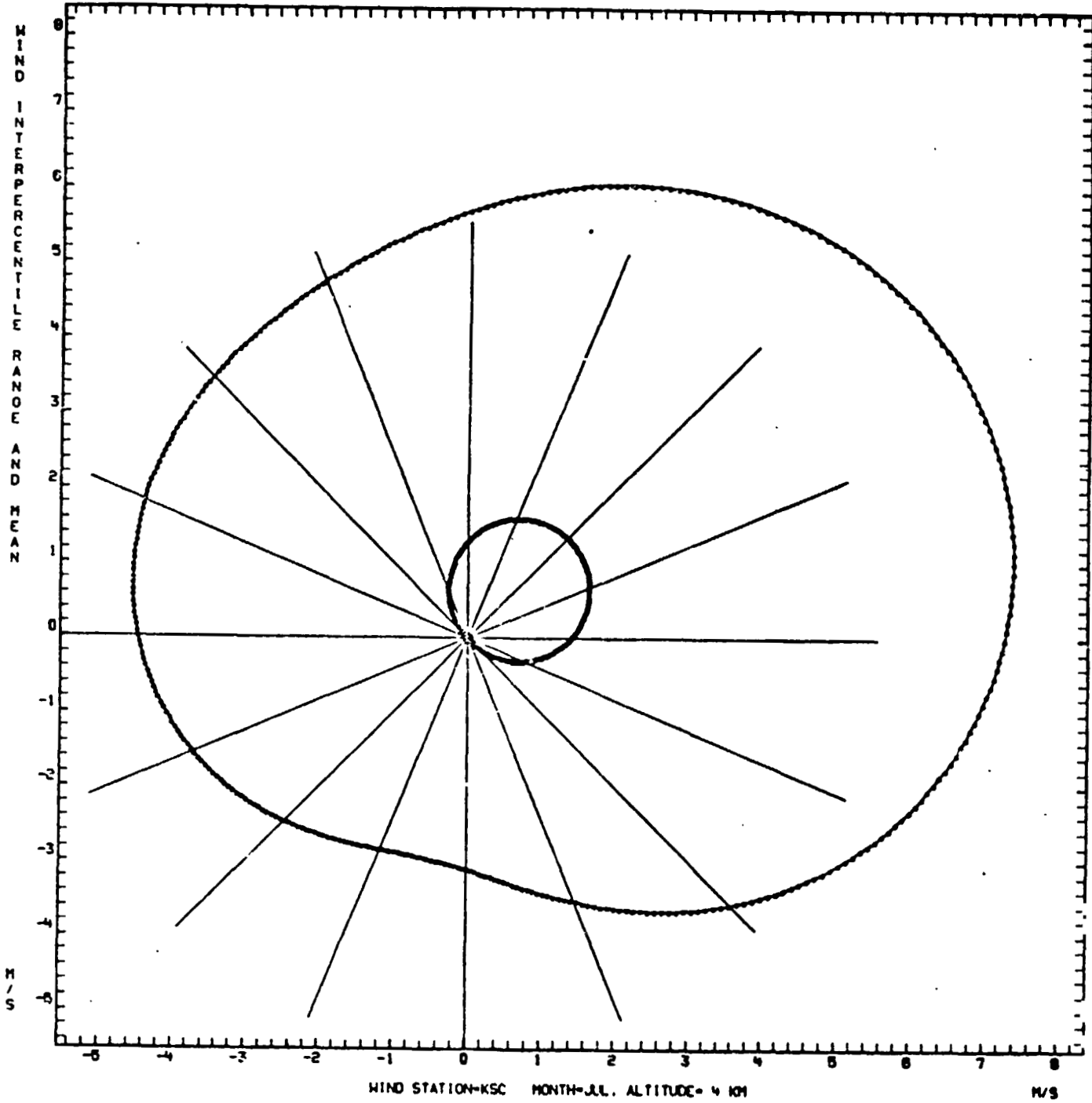

Figure A-29

XBAR= -3.01 SIGMAX= 8.68 RHO= .3220 YBAR= -3.19 SIGMAY= 6.95 PERCENT= 90.

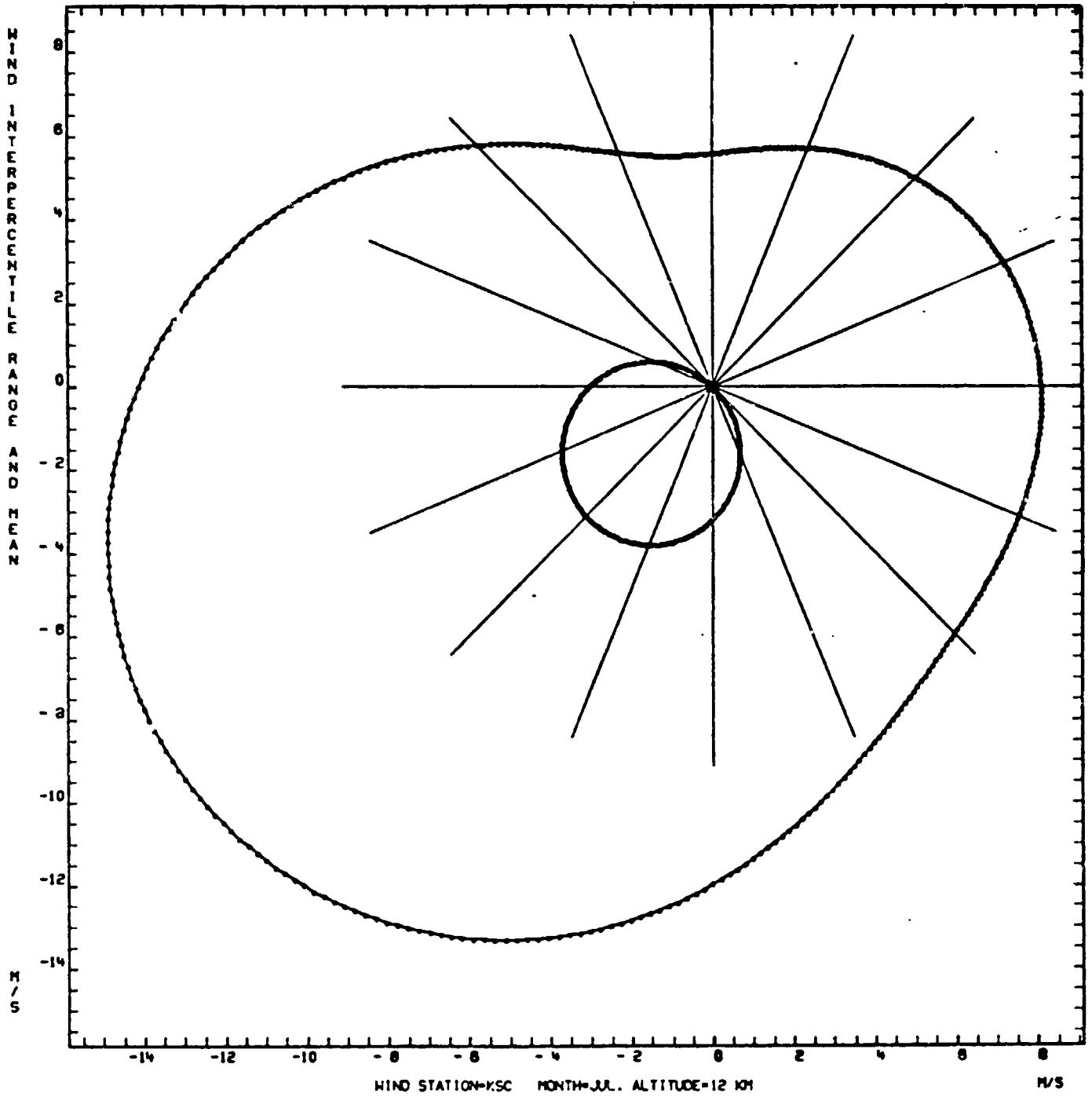

Figure A-30

XBAR=-13.74 SIGMAX= 2.85 RHO= .2043 YBAR= -.22 SIGMAY= 2.40 PERCENT= 80.

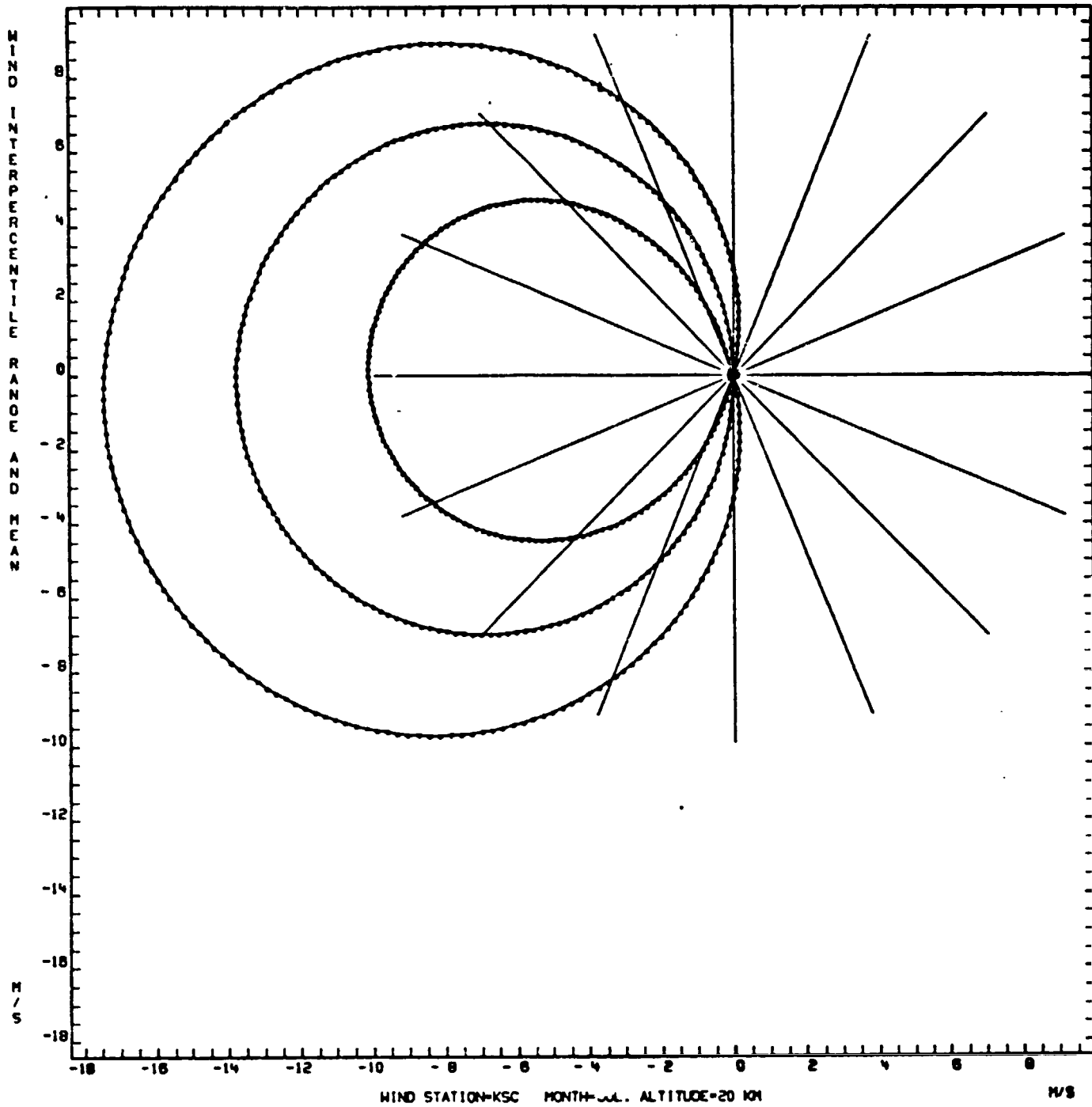

Figure A-31

XBAR=-22.95 SIGMAX= 4.29 RHO= -.0096 YBAR= -.42 SIGMAY= 2.66 PERCENT= 80.

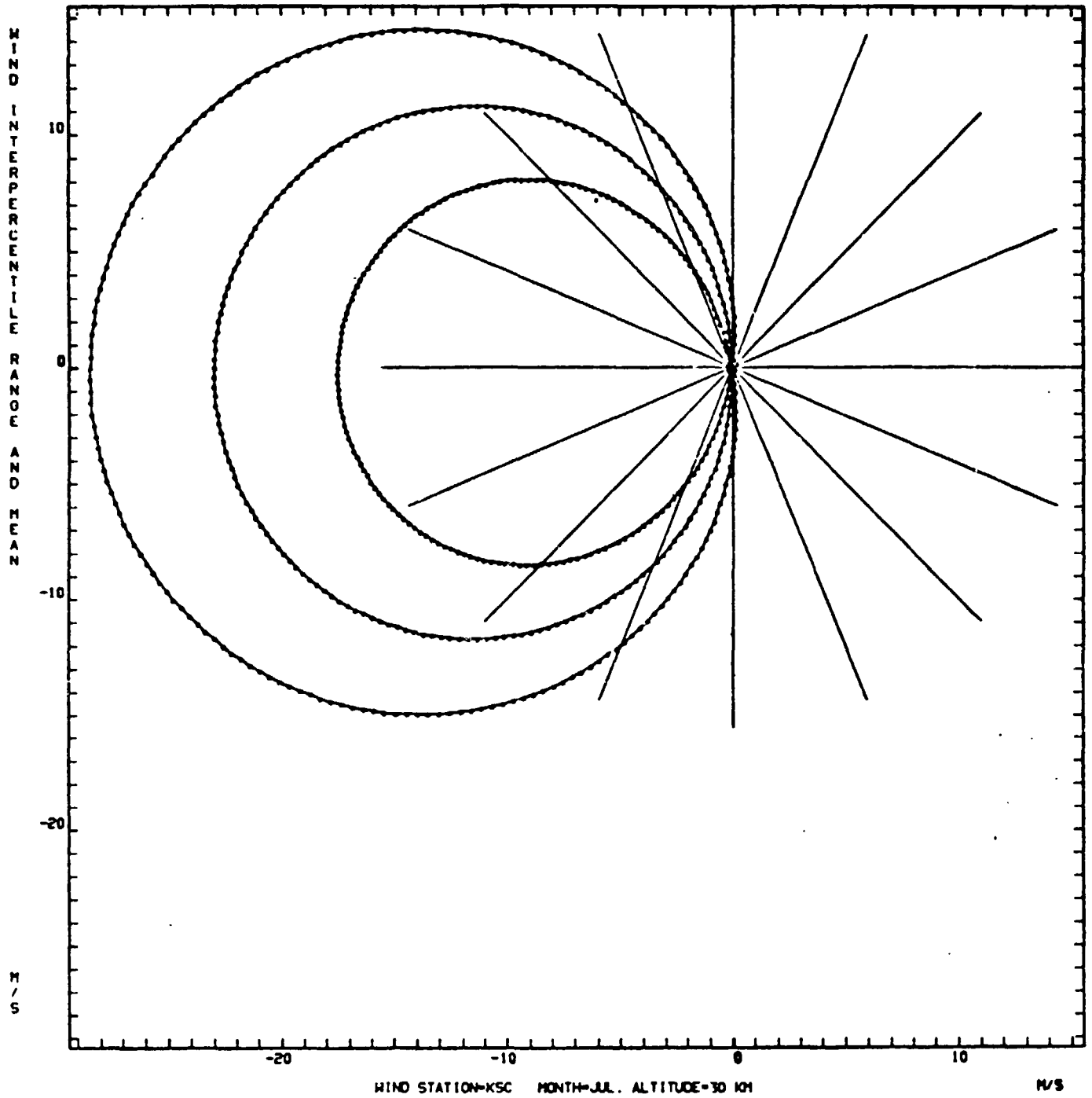

Figure A-32

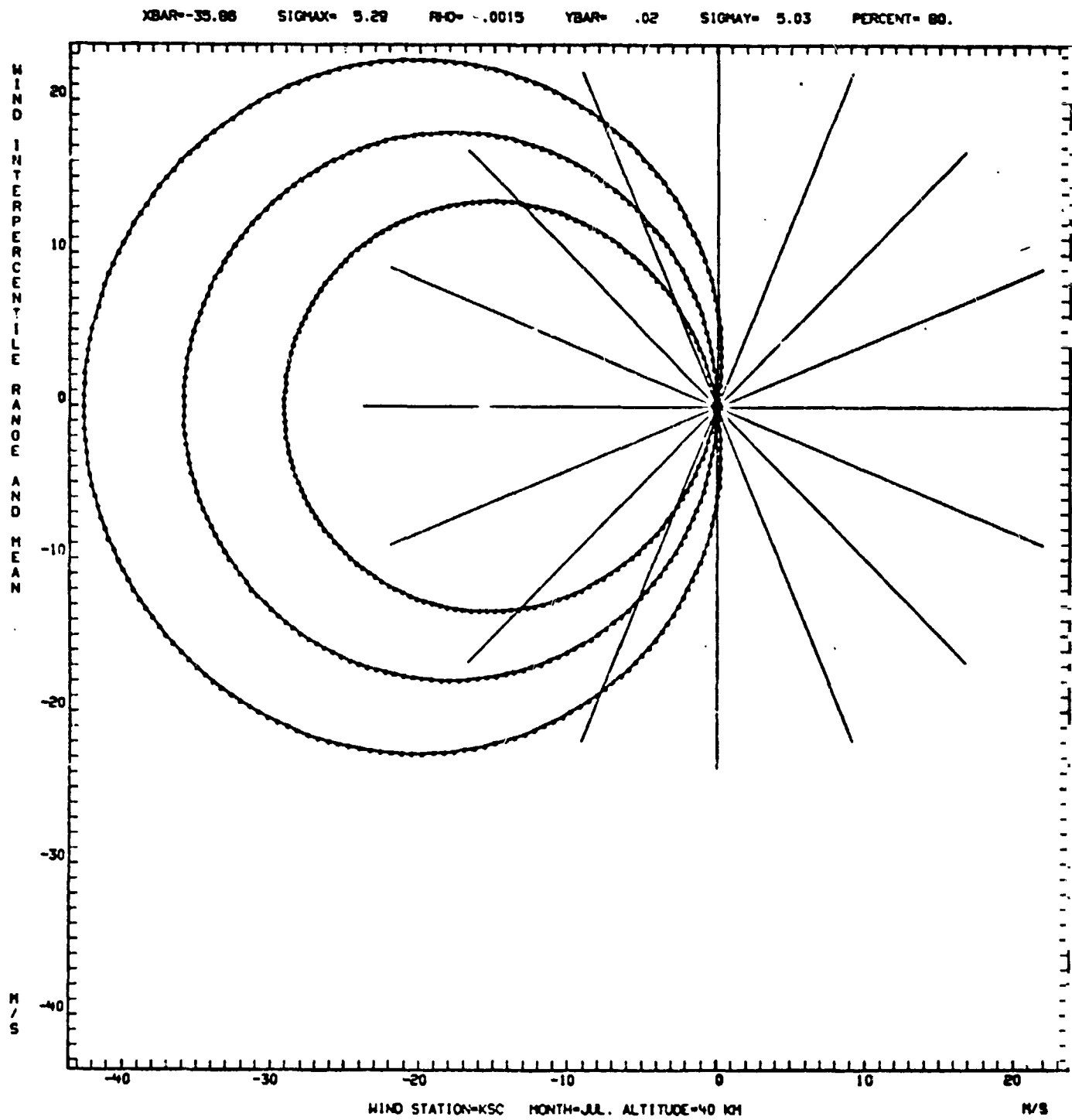

Figure A-33

XBAR=-51.89 SIGMAX= 8.78 RHO= -.0387 YBAR= 5.17 SIGMAY= 7.25 PERCENT= 80.

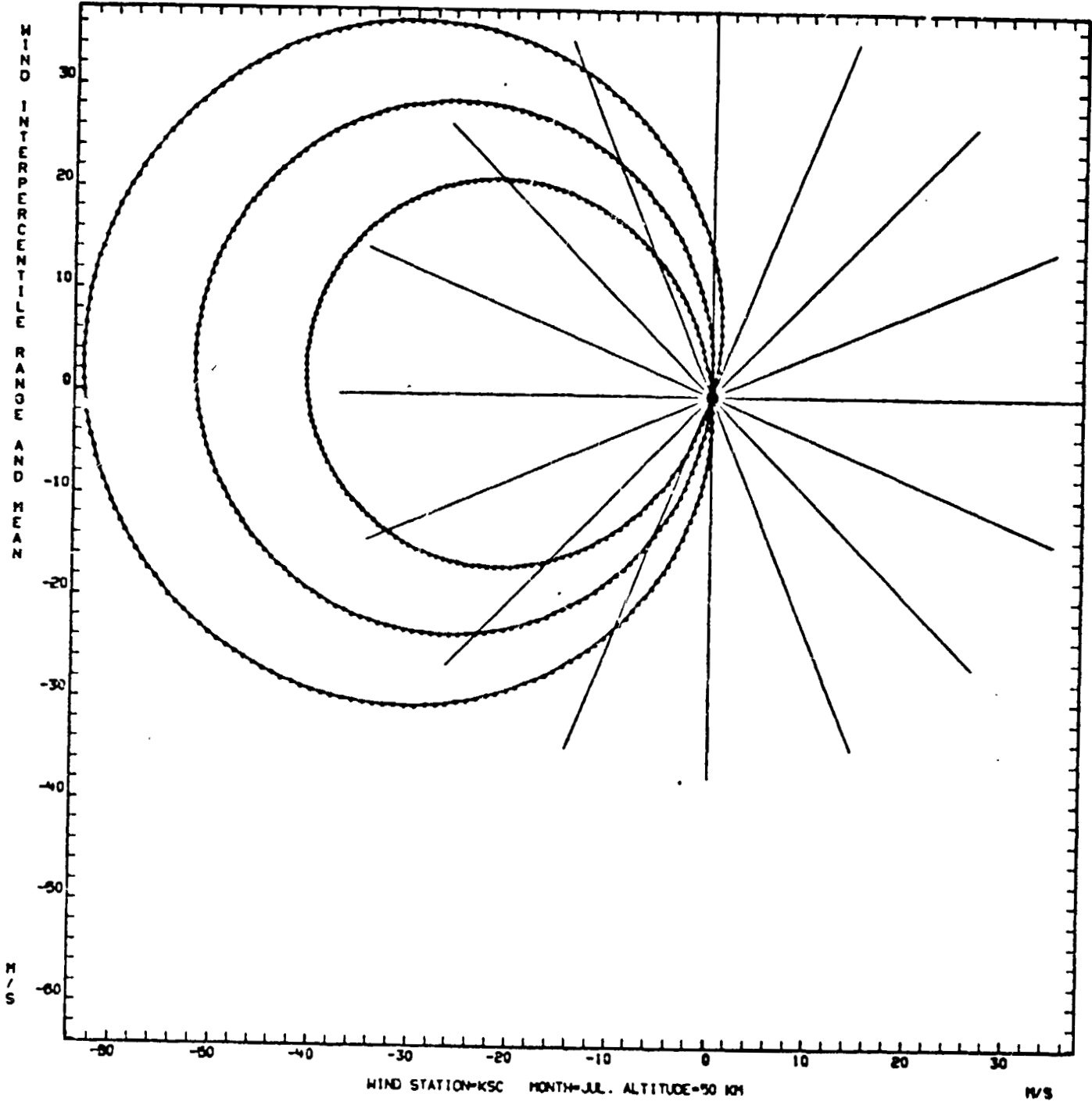

Figure A-34

XBAR=-45.41 S10MAX= 16.66 R40= .1015 YBAR= 4.52 S10MAX= 13.26 PERCENT= 60.

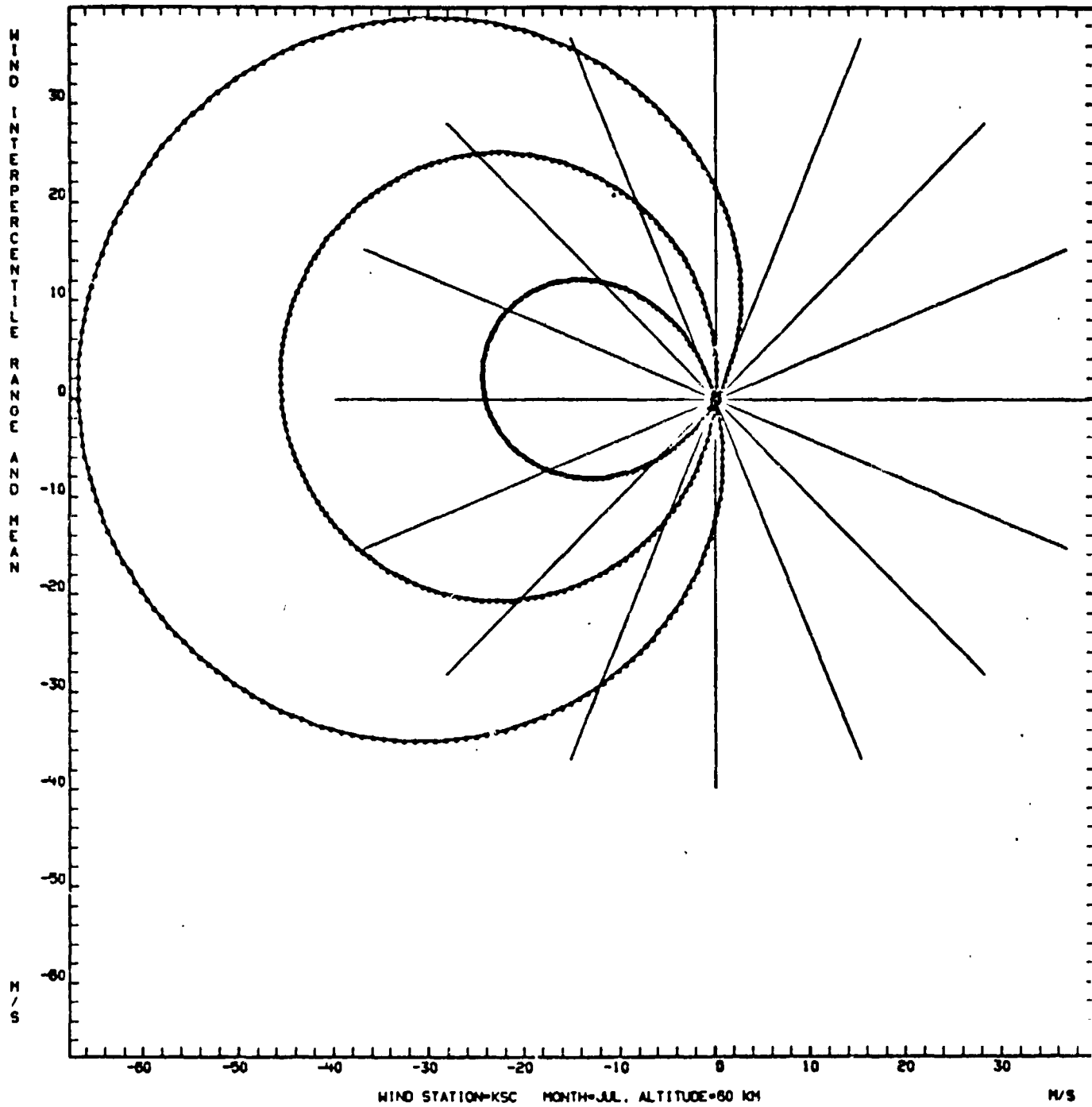

Figure A-35

XBAR=-21.50 SIGMAX= 24.35 RHO= -.2041 YBAR= -.97 SIGMAY= 20.04 PERCENT= 80.

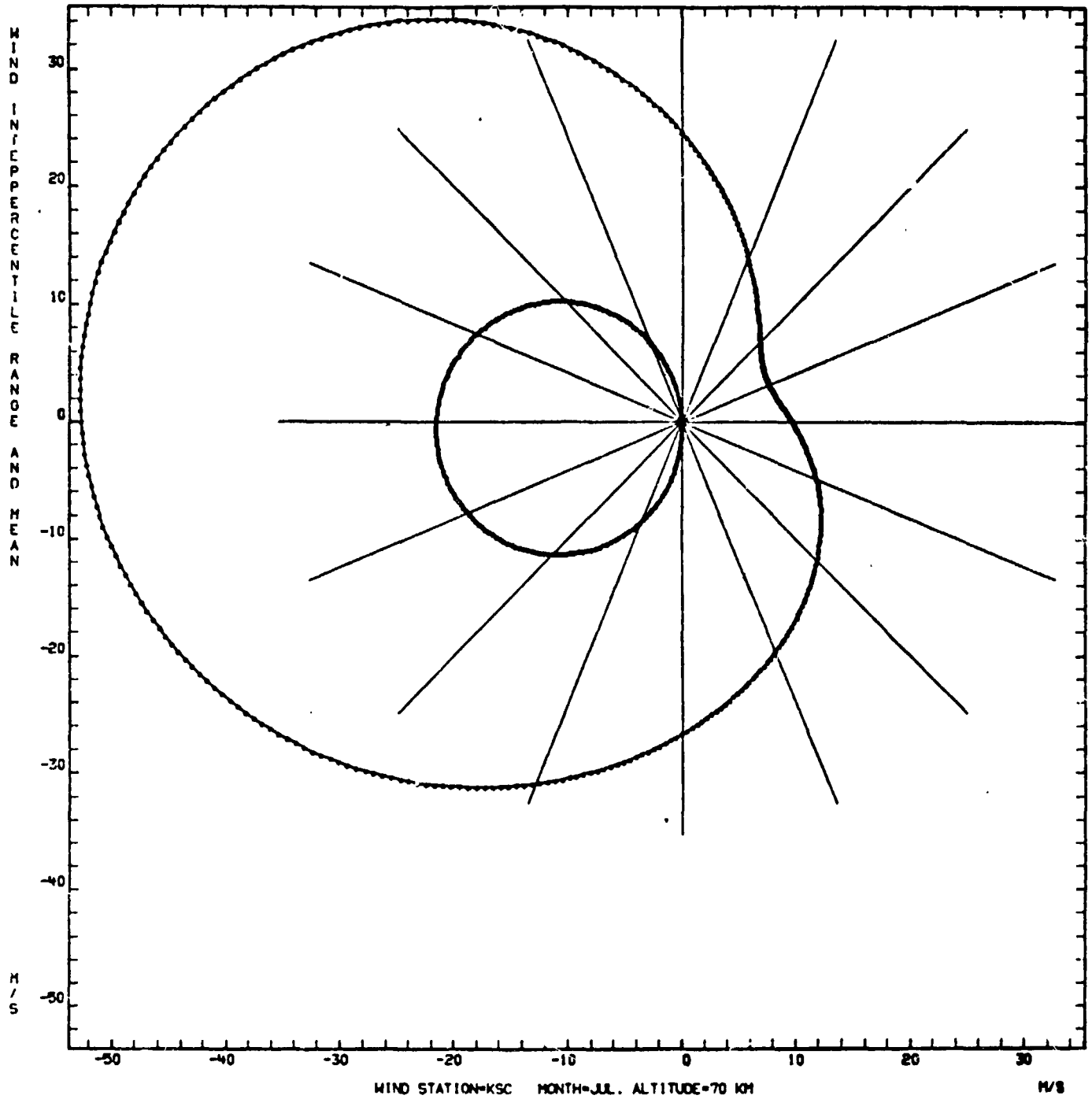

Figure A-36

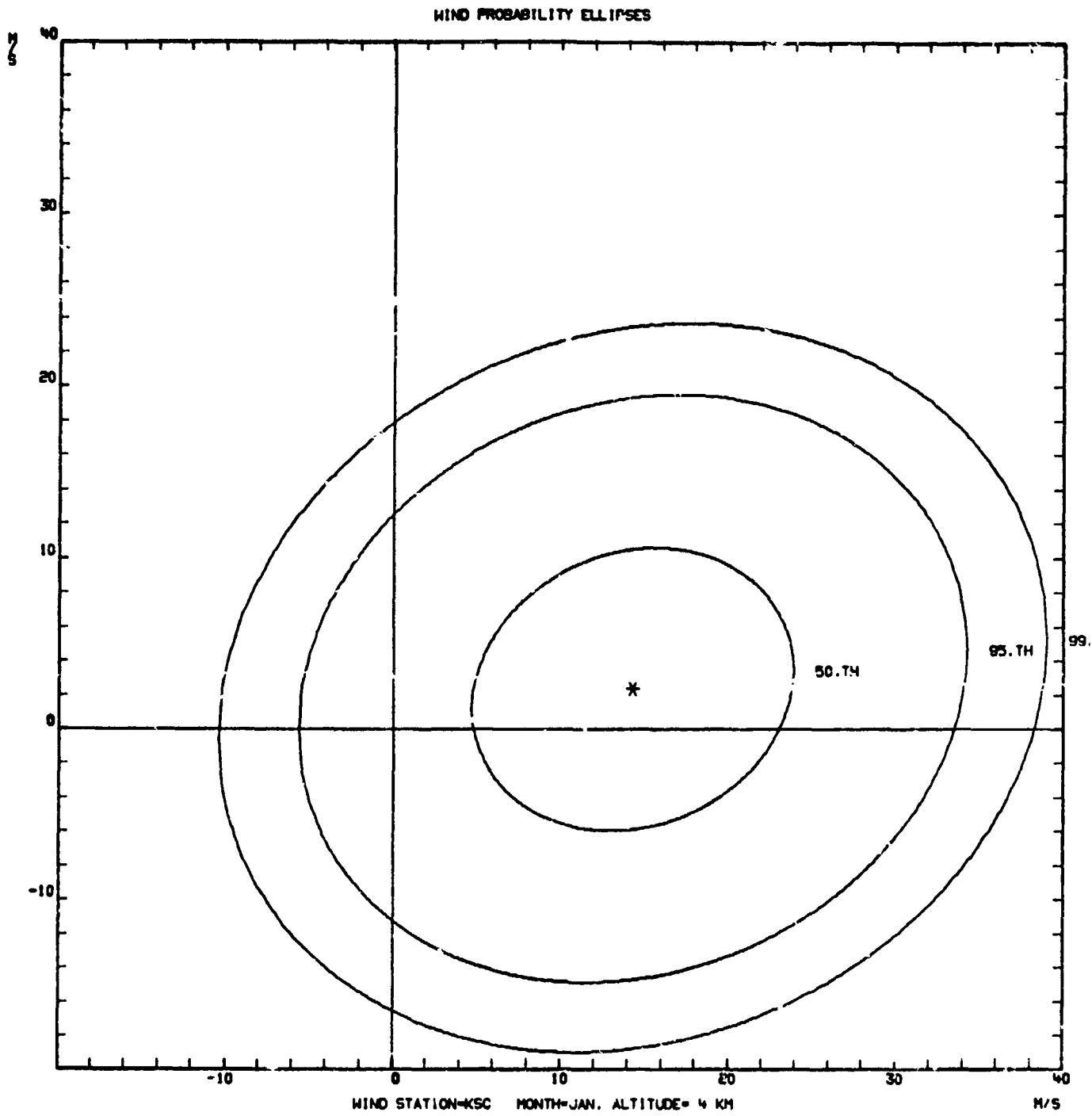

Figure A-37

WIND PROBABILITY ELLIPSES

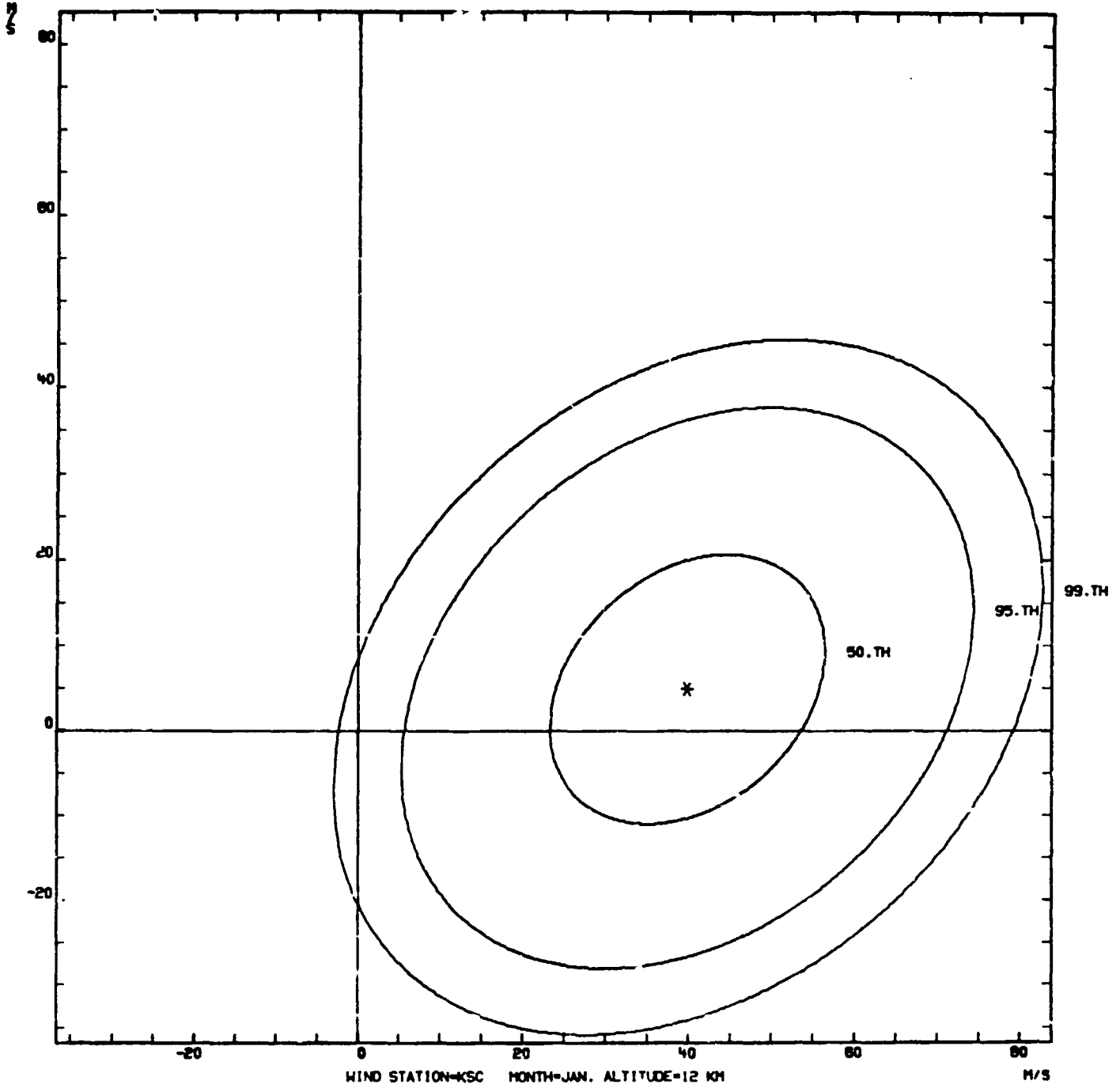

Figure A-38

WIND PROBABILITY ELLIPSES

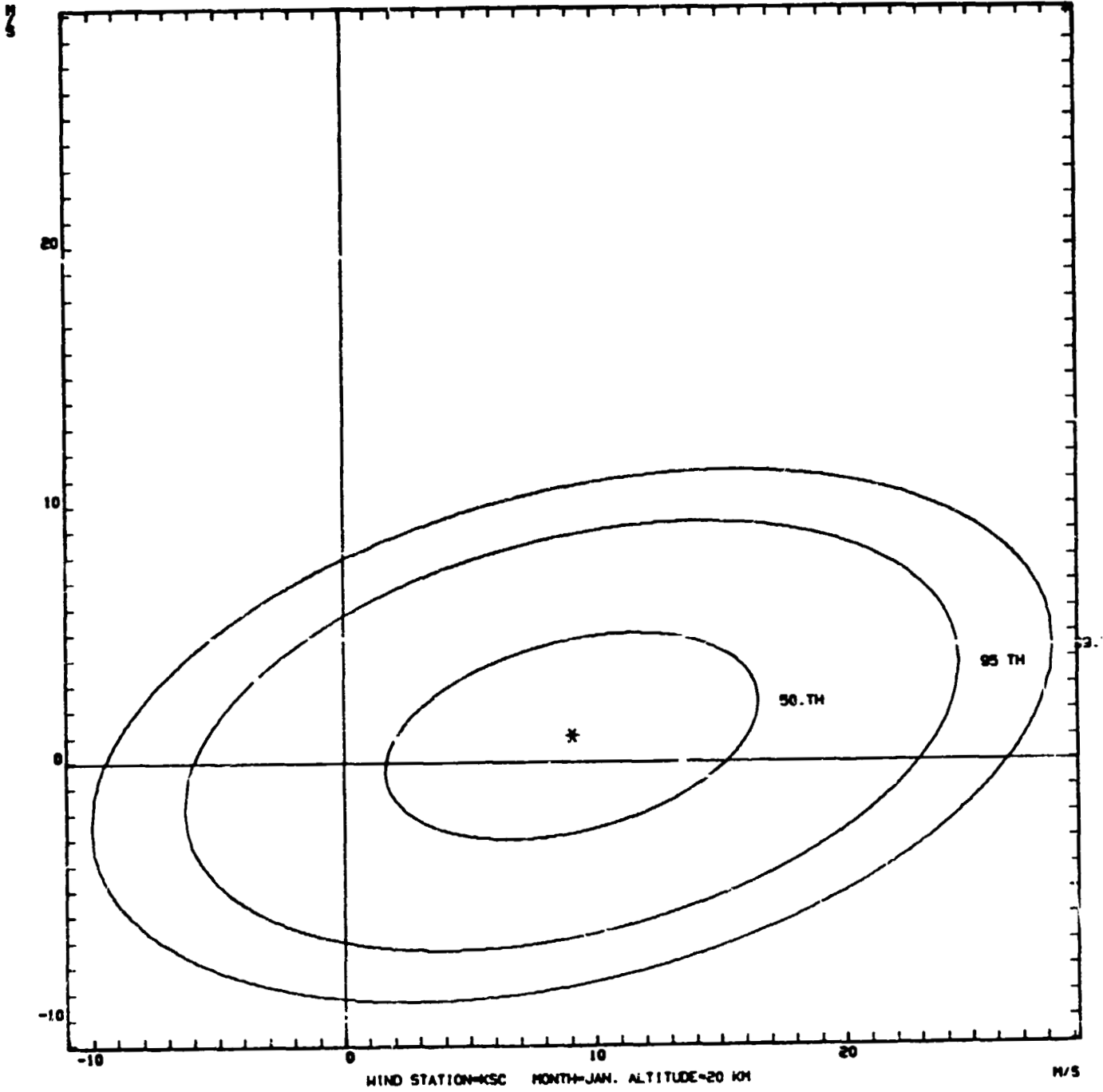

Figure A-39

WIND PROBABILITY ELLIPSES

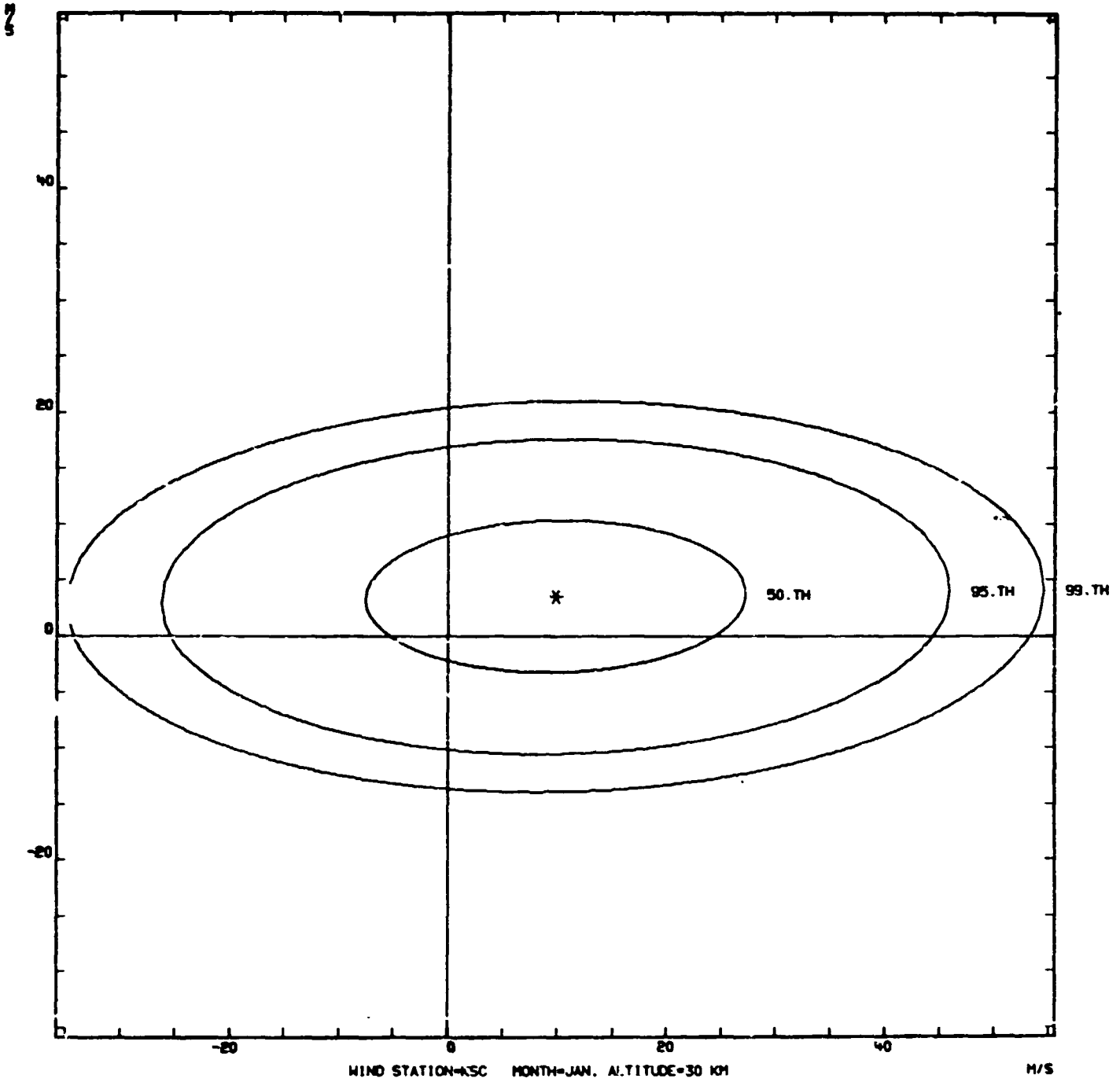

Figure A-4C

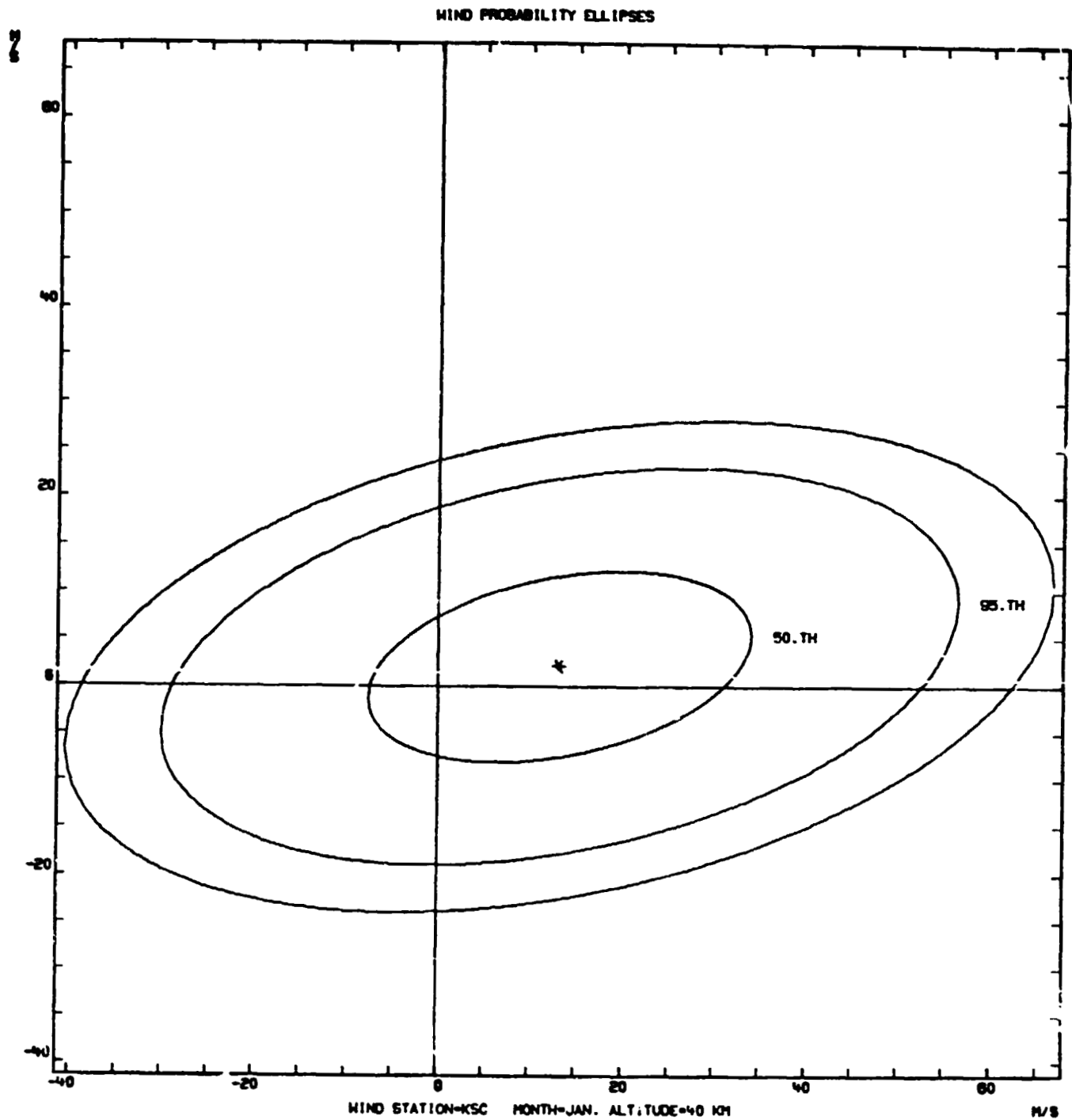

Figure A-41

HIND PROBABILITY ELLIPSES

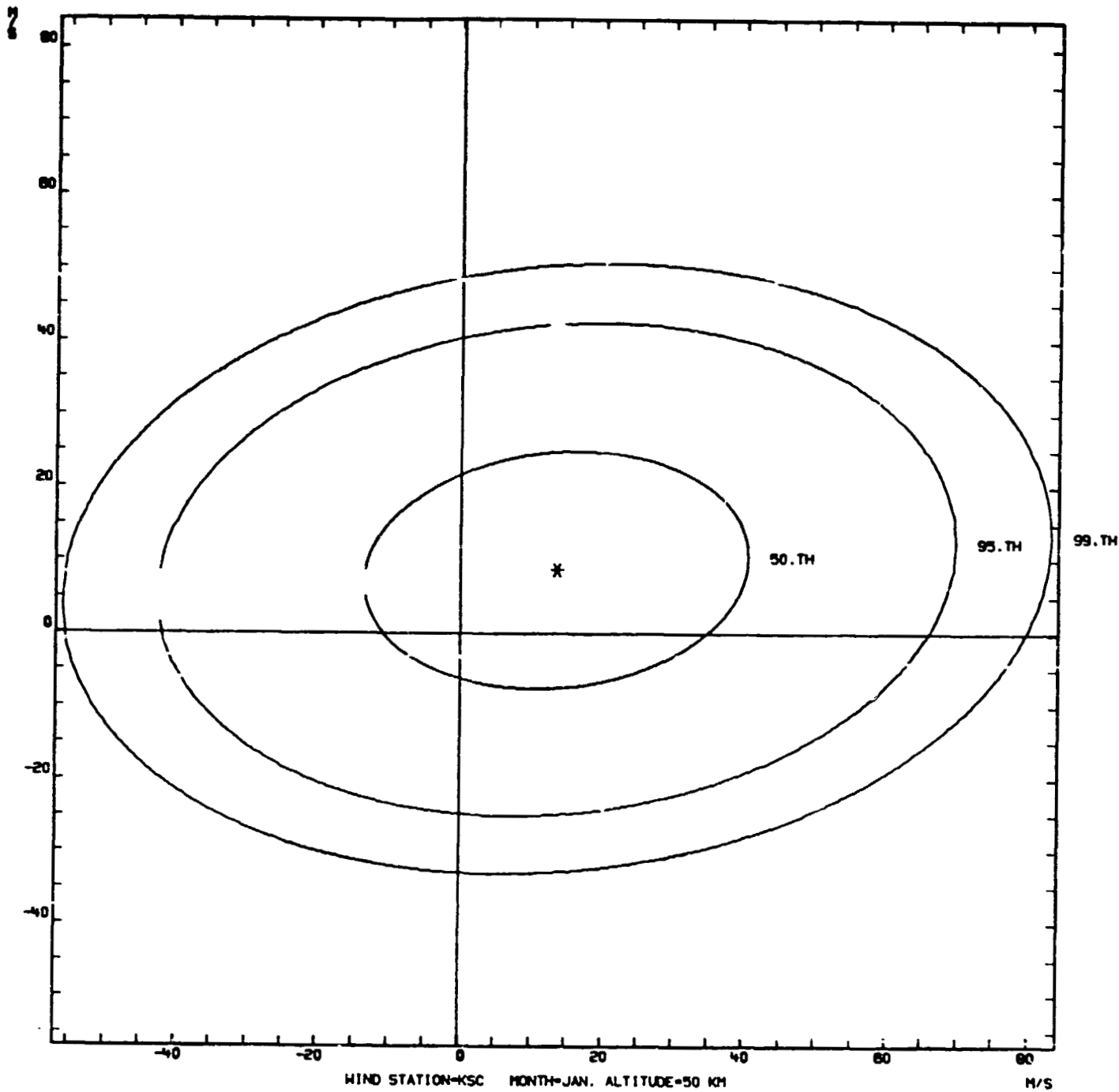

Figure A-42

WIND PROBABILITY ELLIPSES

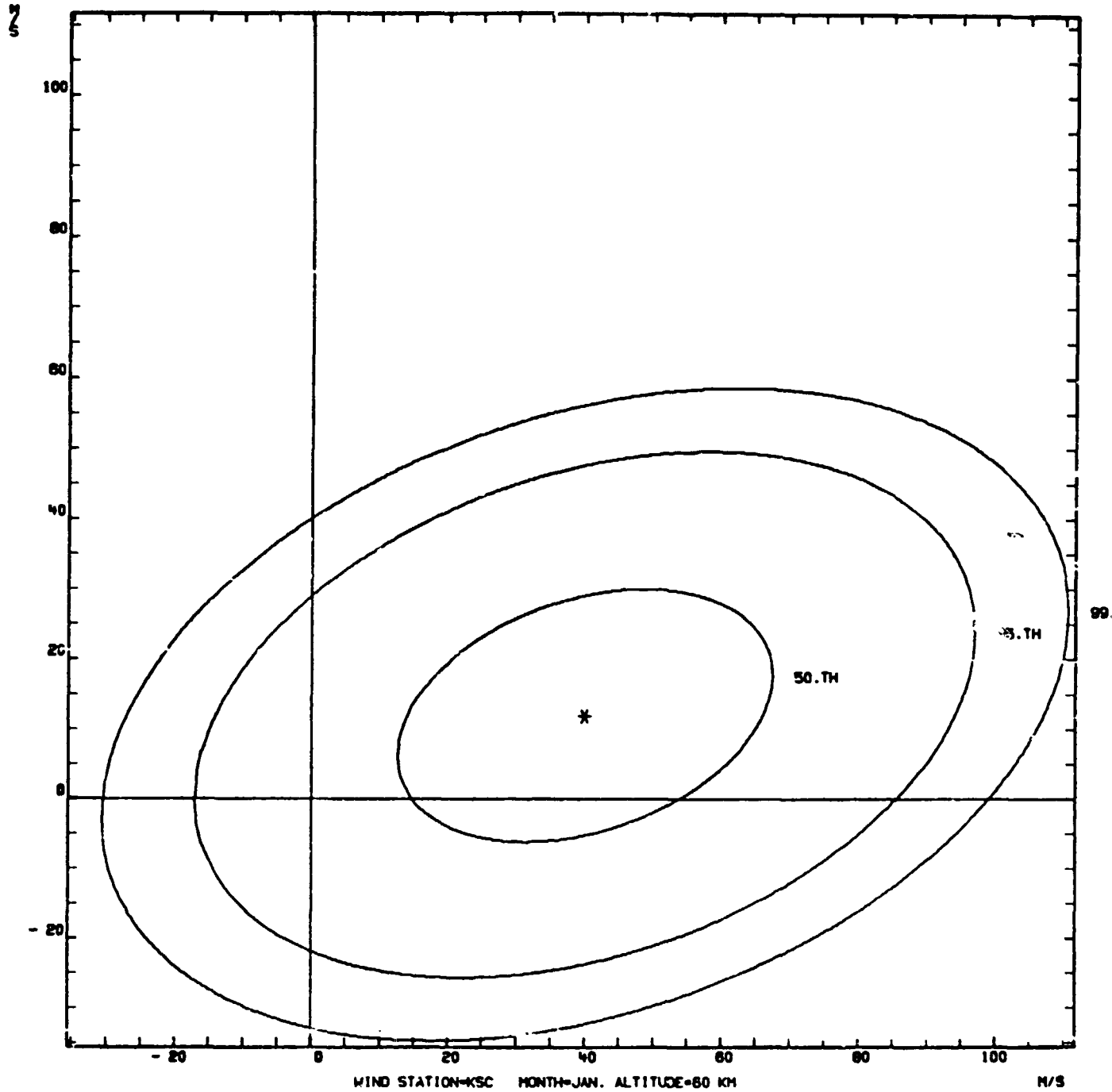

Figure A-43

WIND PROBABILITY ELLIPSES

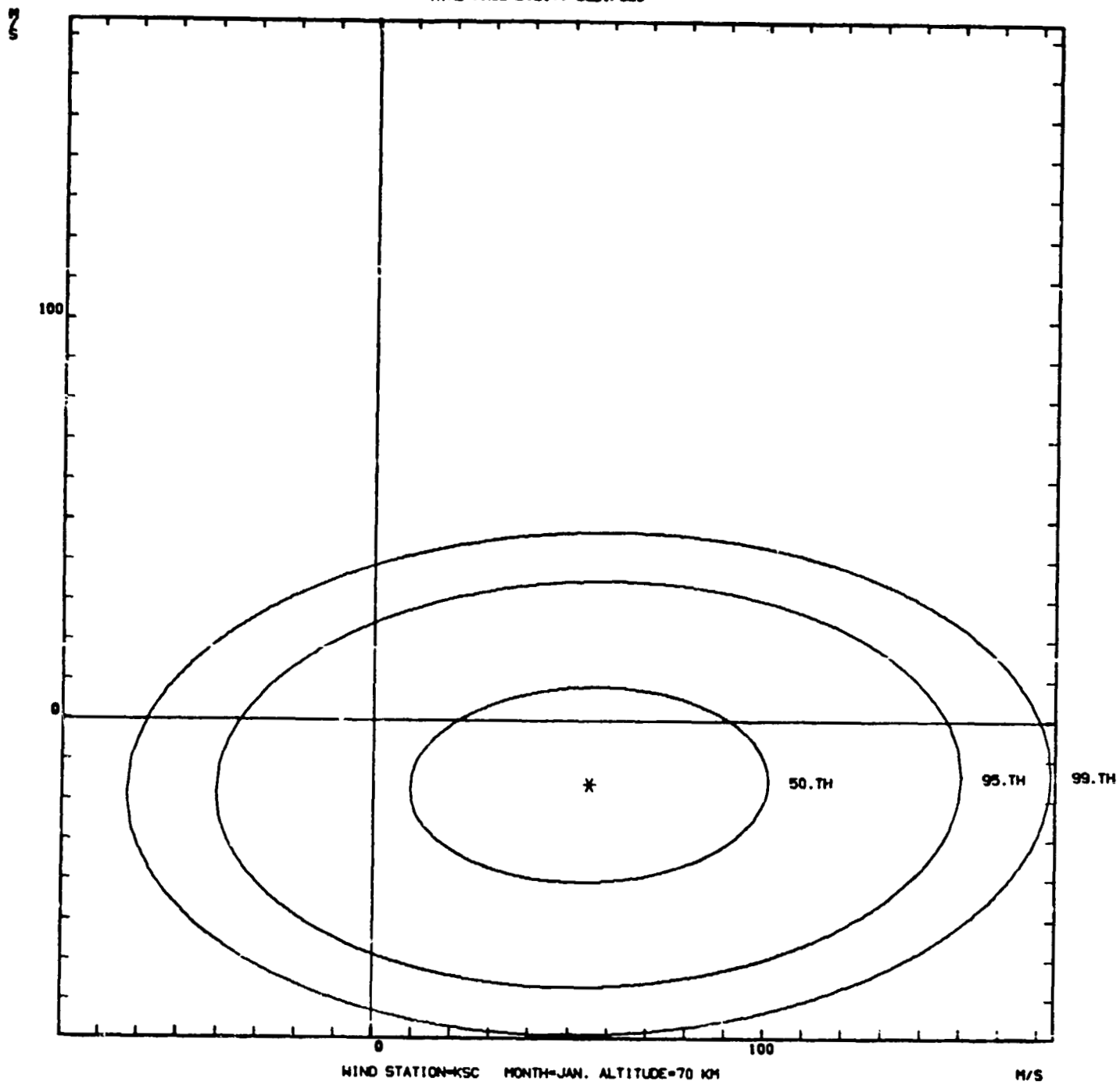

Figure A-44

WIND PROBABILITY ELLIPSES

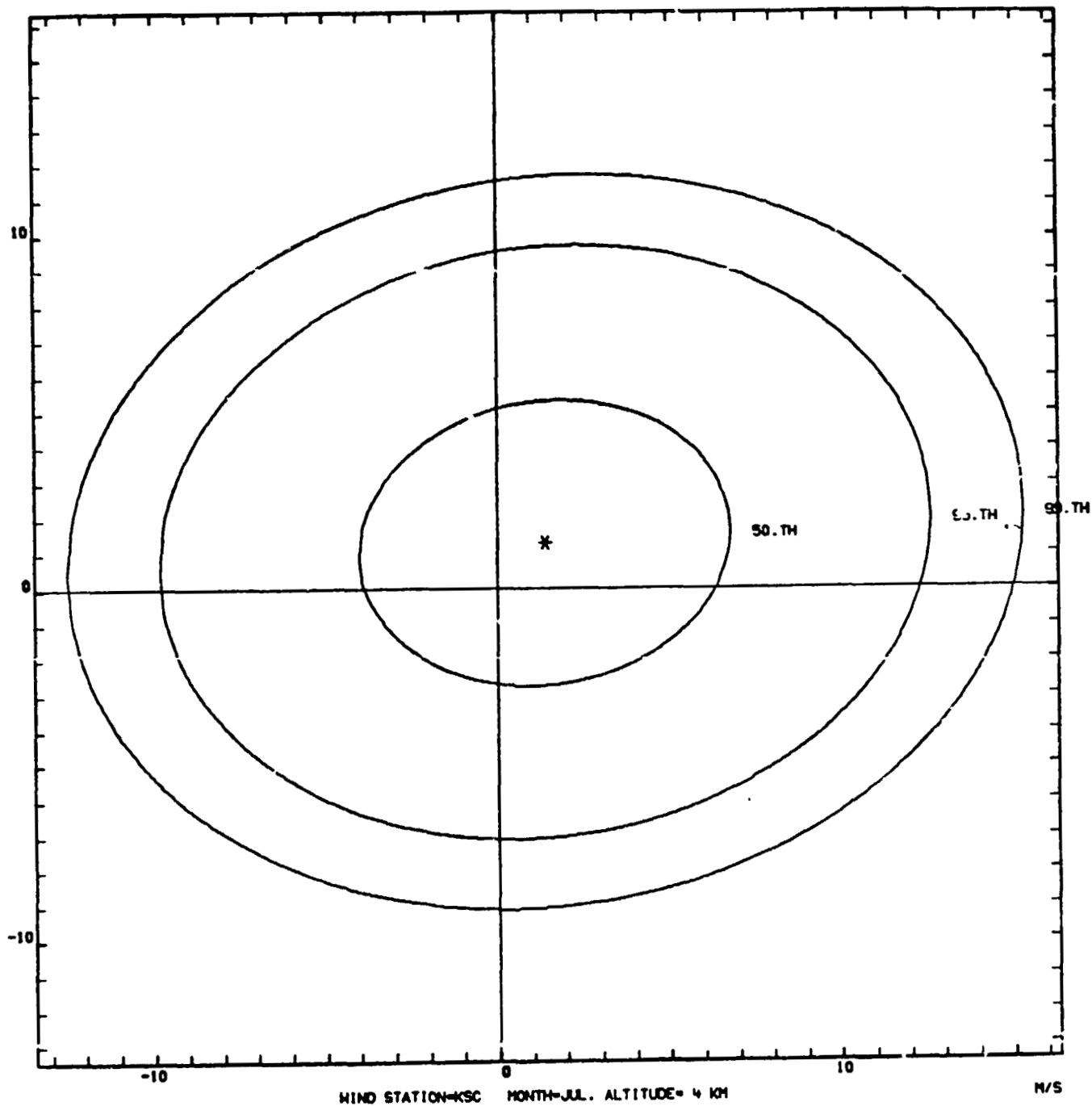

Figure A-45

HIND PROBABILITY ELLIPSES

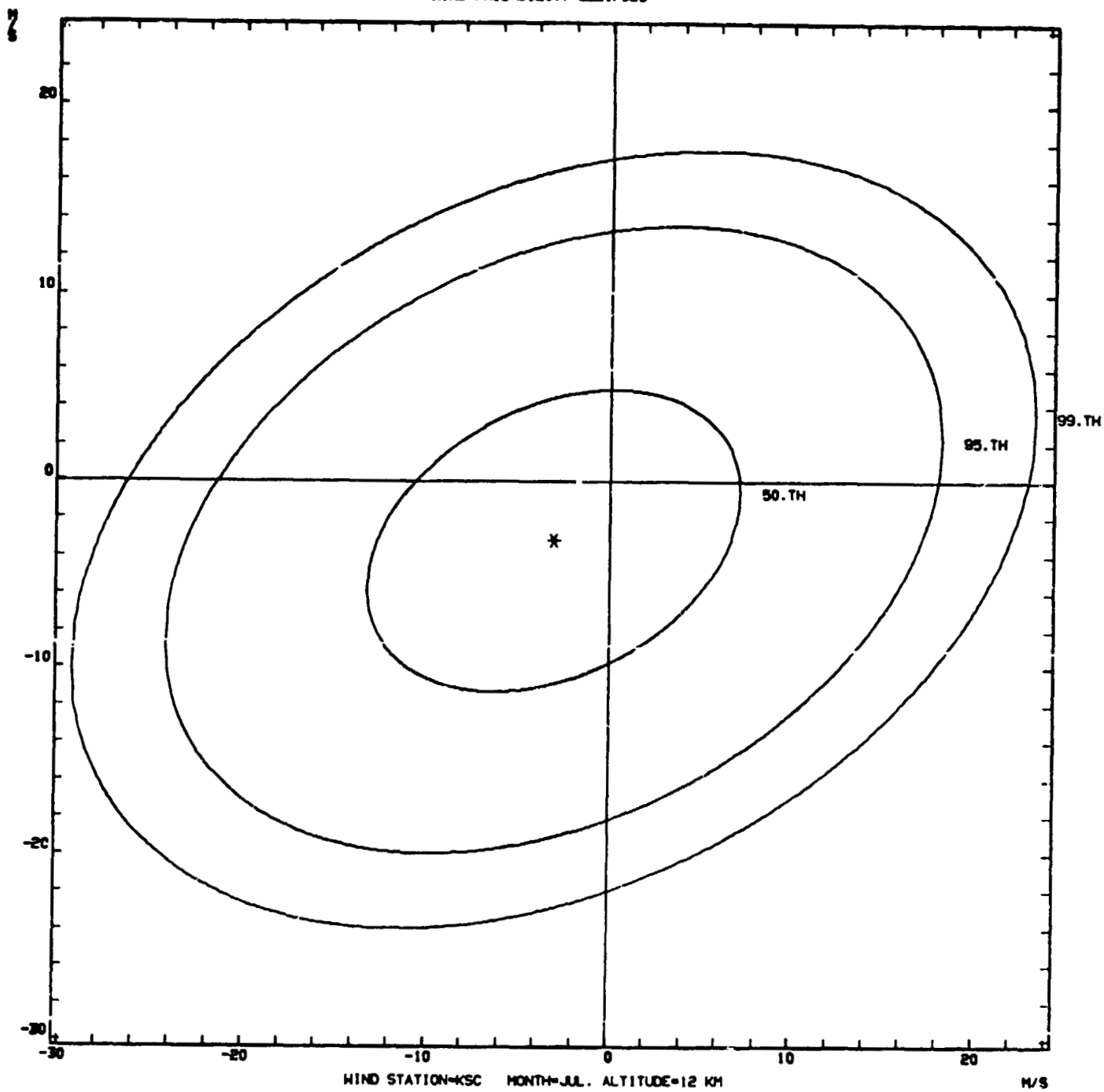

Figure A-46

WIND PROBABILITY ELLIPSES

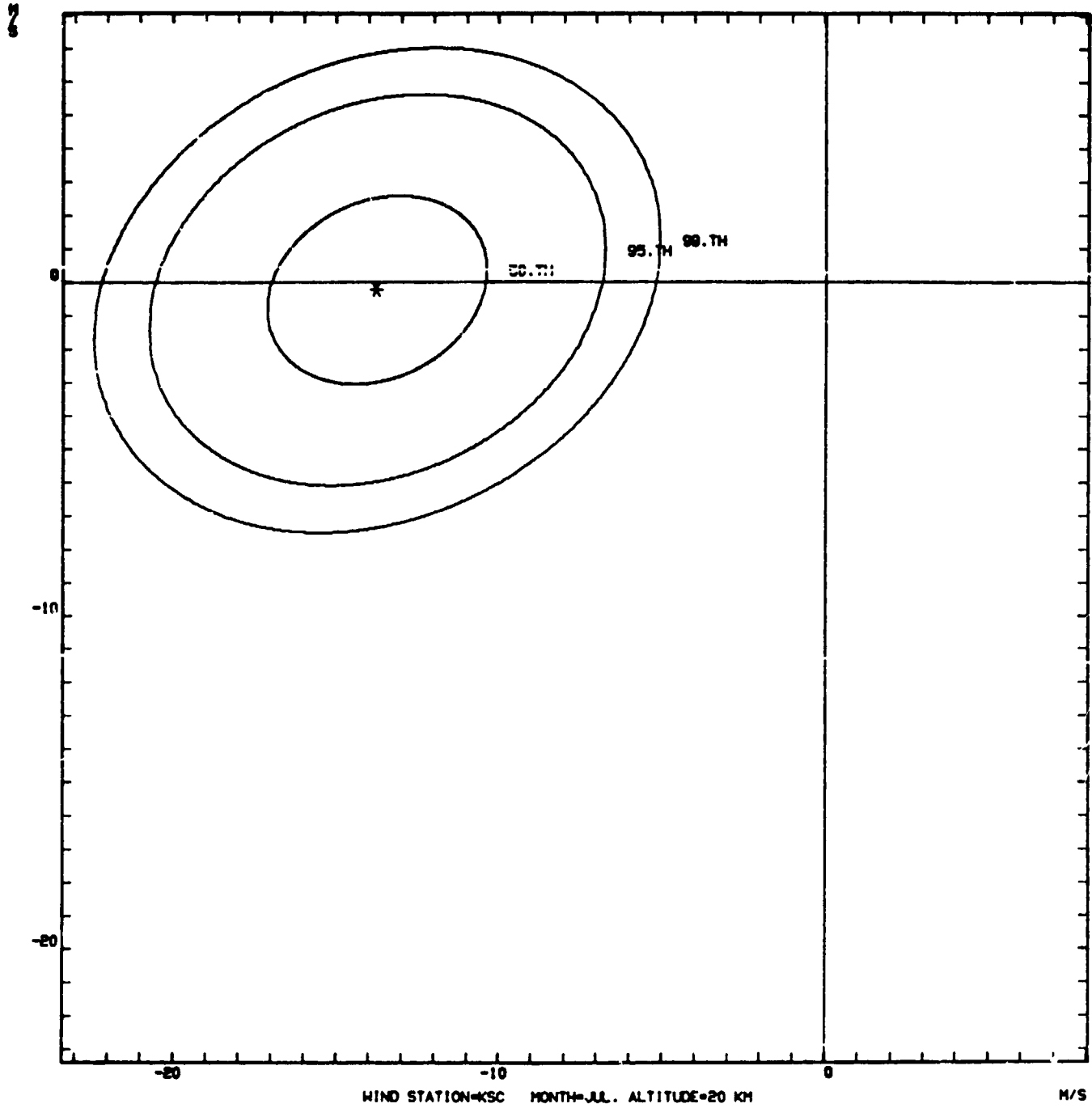

Figure A-47

HIND PROBABILITY ELLIPSES

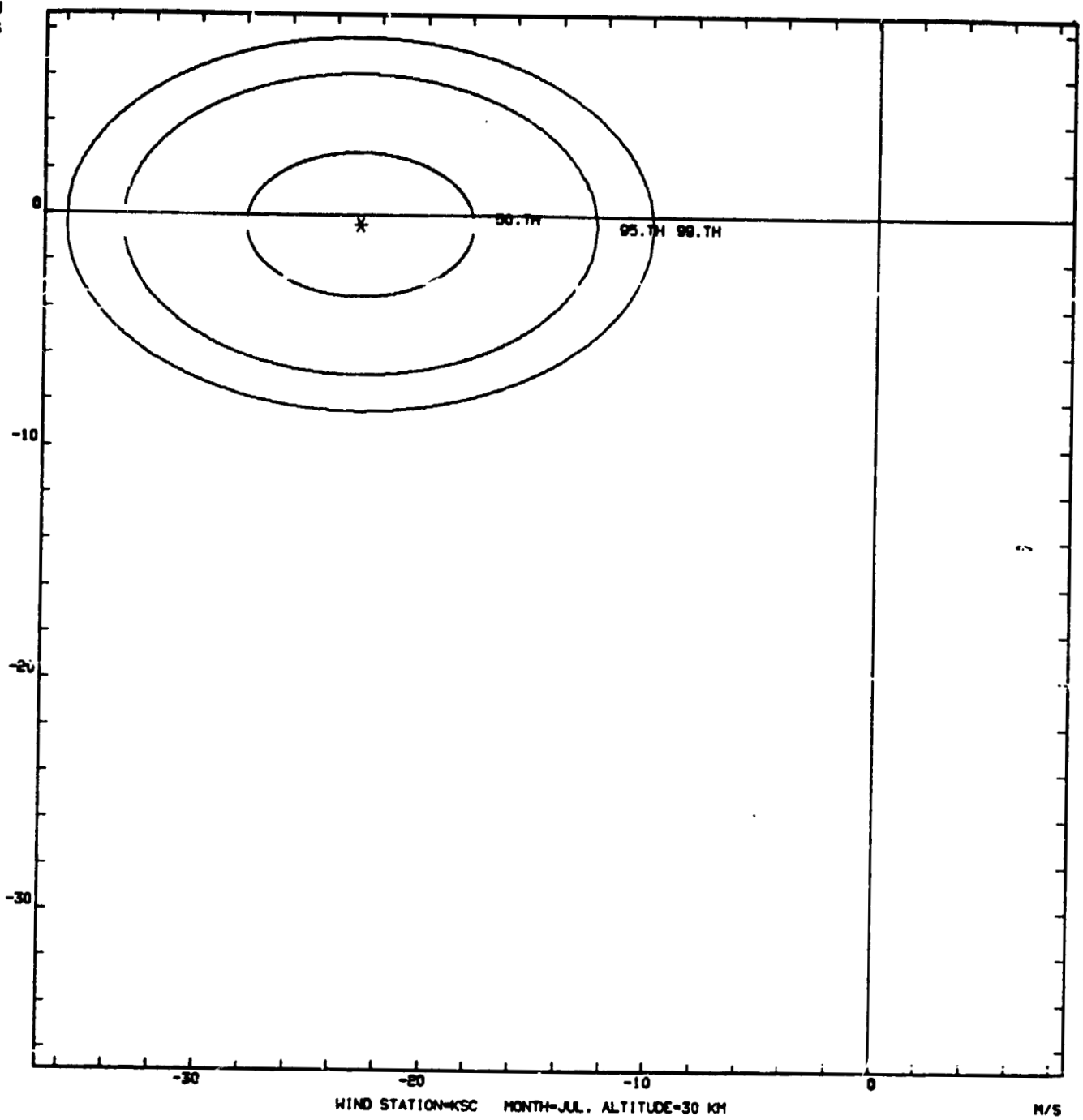

Figure A-48

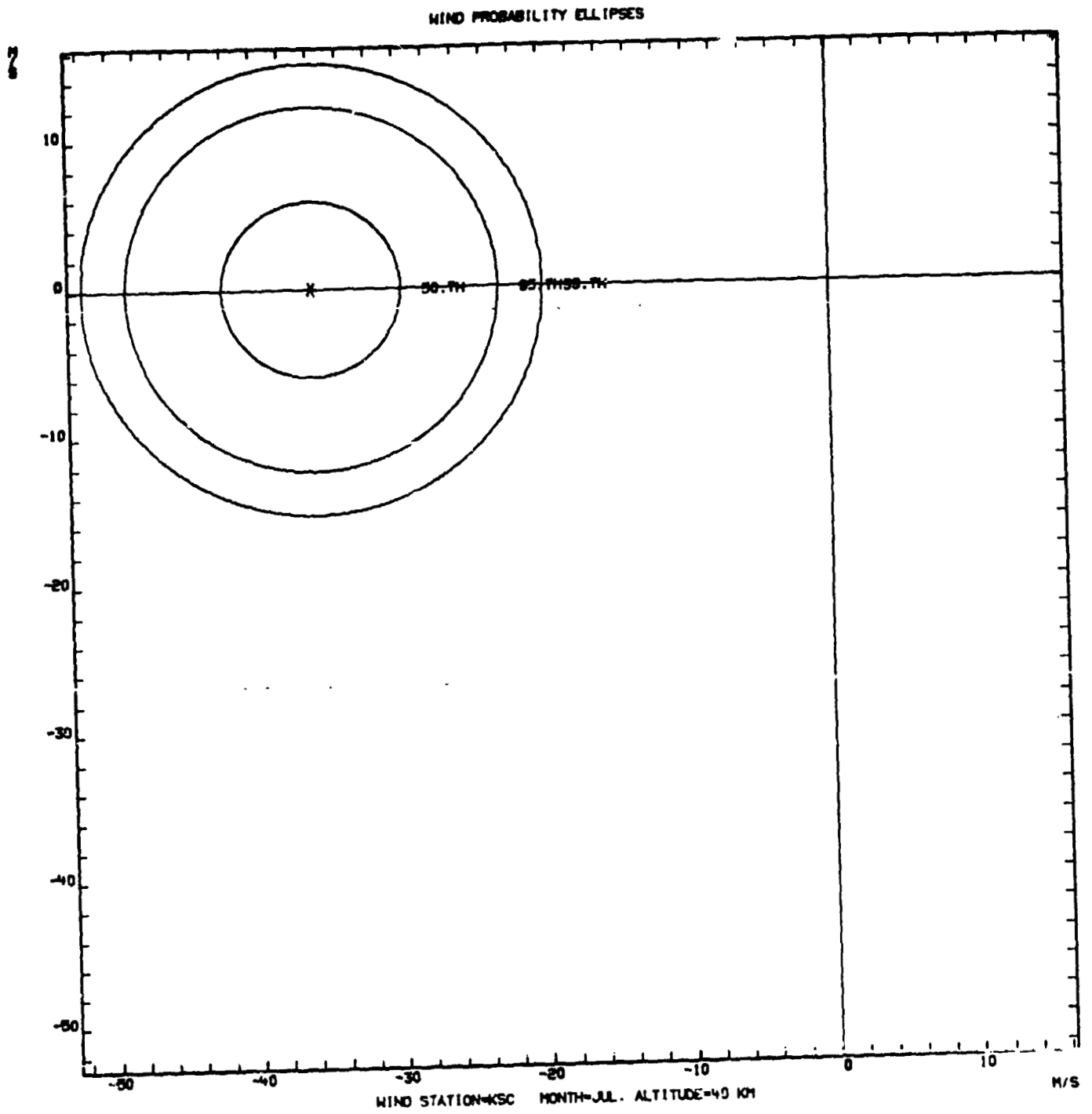

Figure A-49

HIND PROBABILITY ELLIPSES

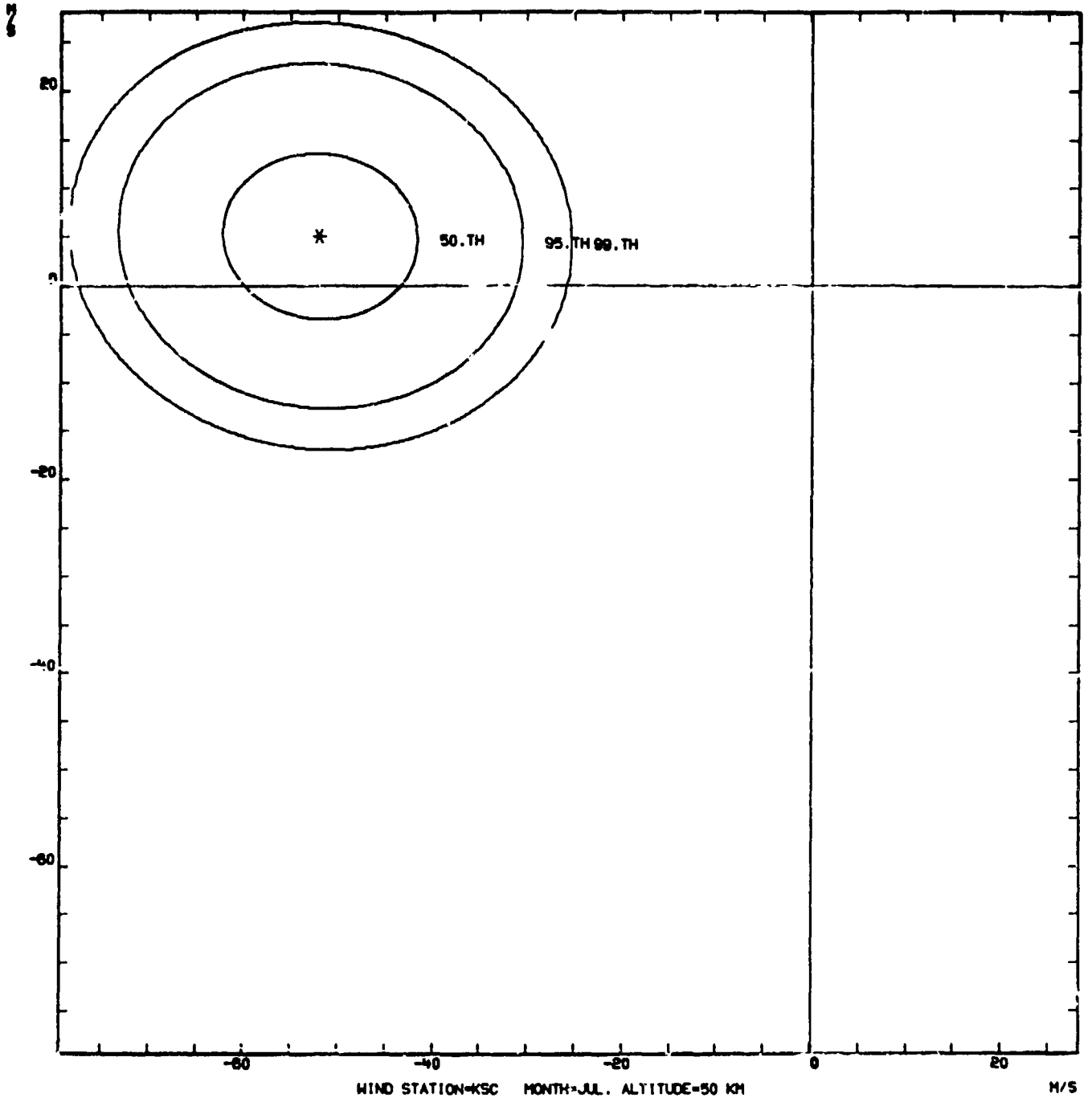

Figure A-50

WIND PROBABILITY ELLIPSES

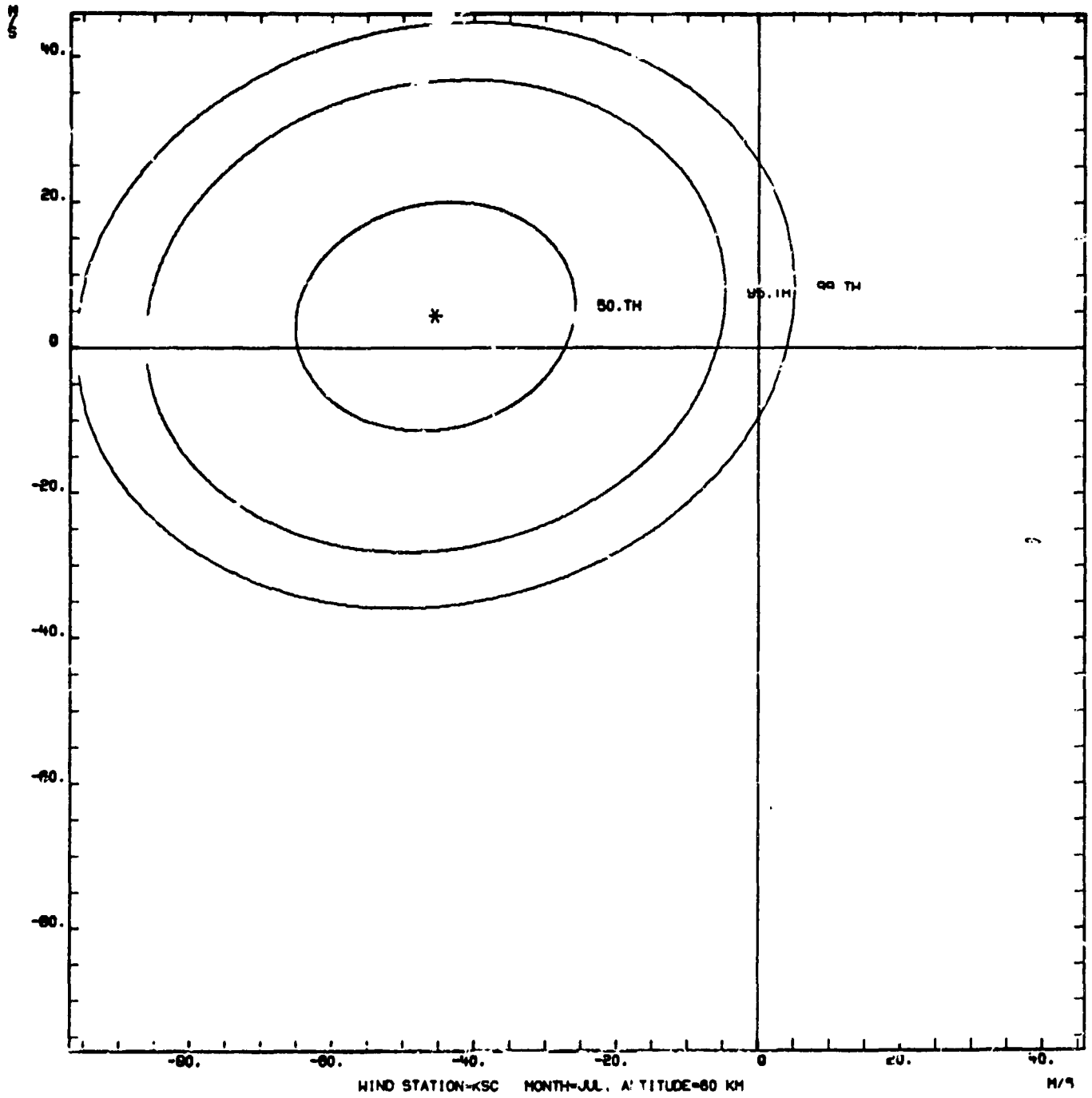

Figure A-51

WIND PROBABILITY ELLIPSES

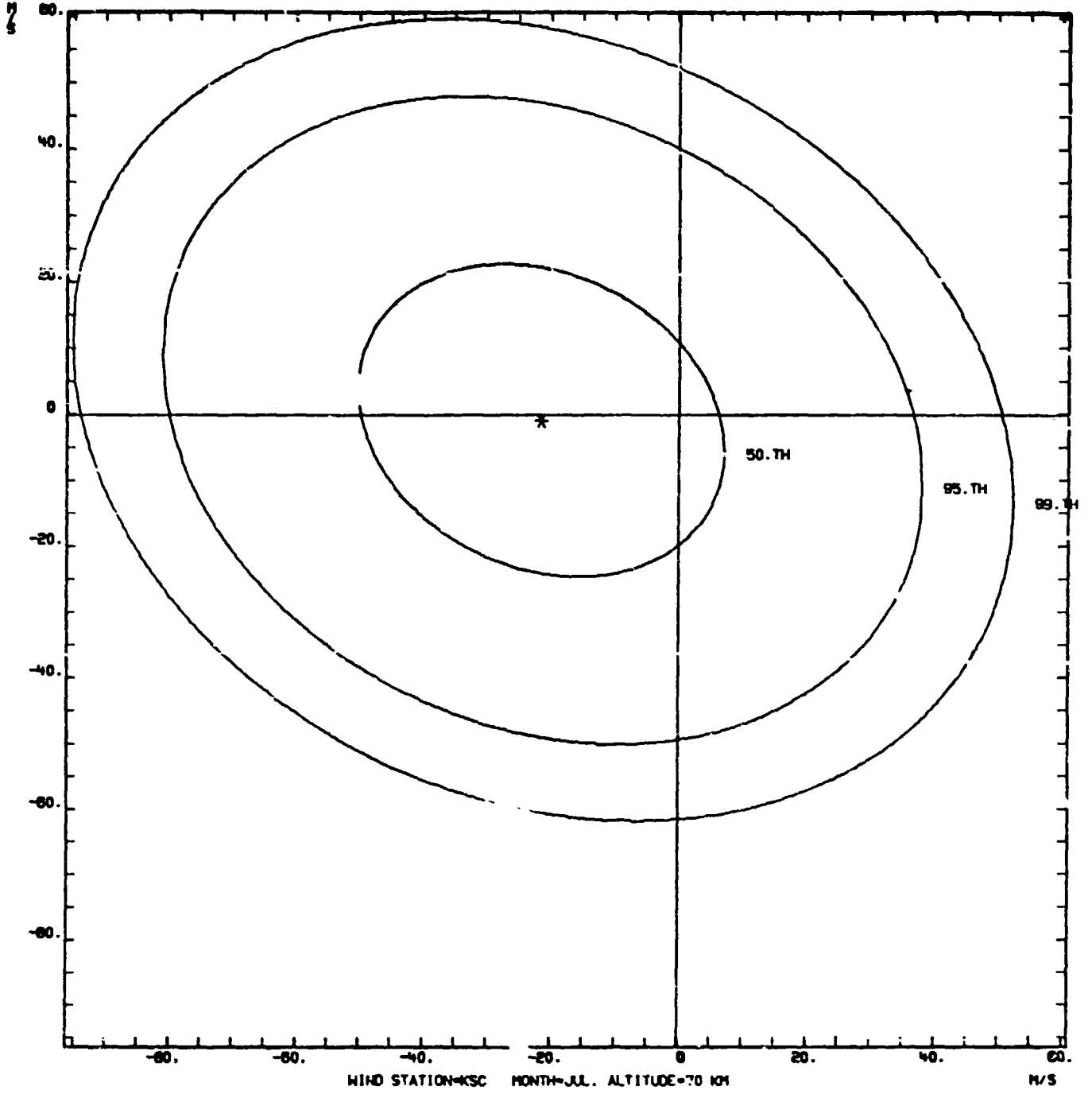

Figure A-52

WIND STATION=MSC MONTH=J ALTITUDE= 4 KM

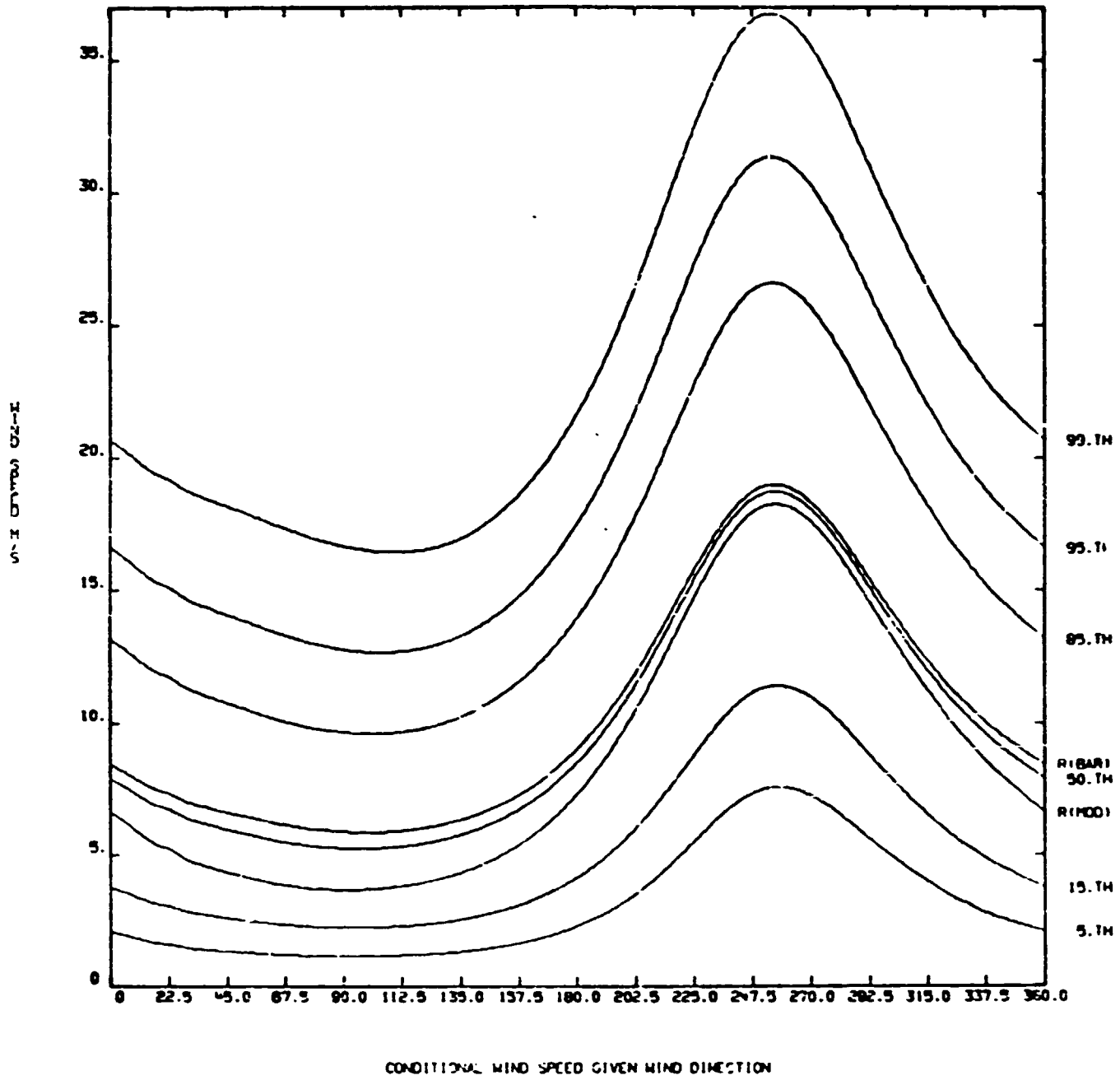

Figure A-53

WIND STATION-KSC MONTH-JA ALTITUDE-12 KM

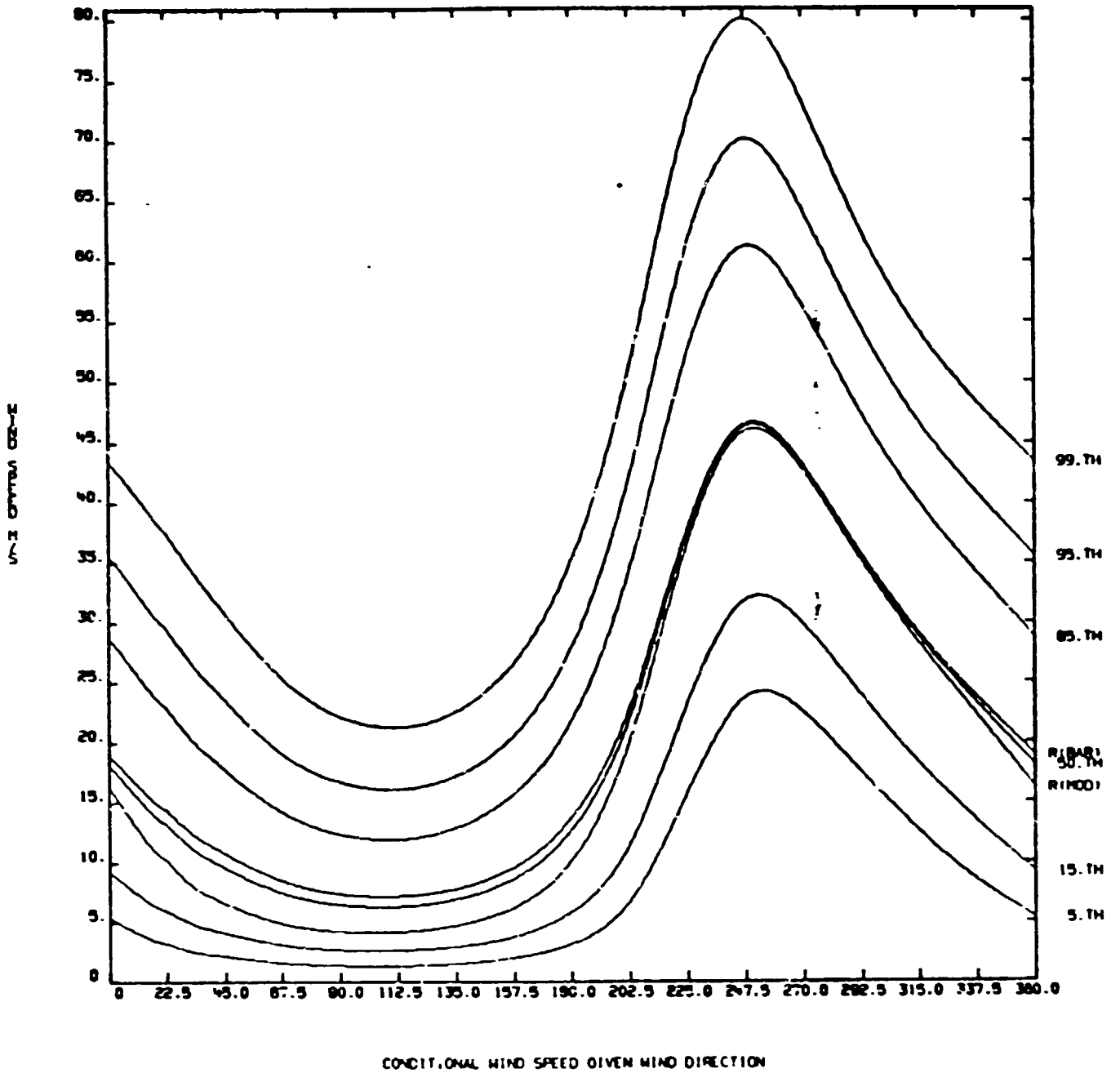

Figure A-54

MIND STATION-KSC MONTH-JULY ALTITUDE=20 KM

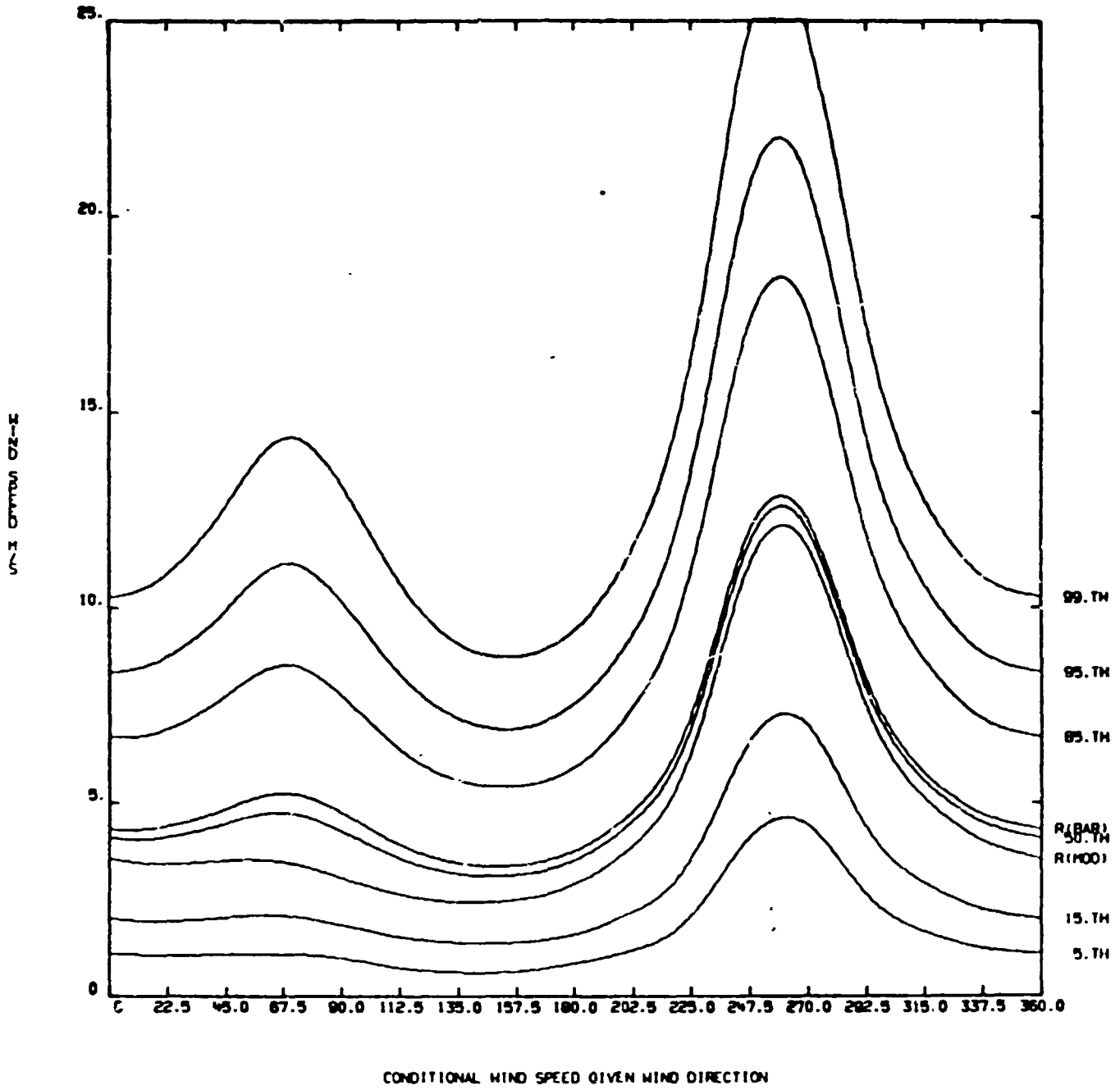

Figure A-55

WIND STATION-KSC MONTH-... ALTITUDE=30 KM

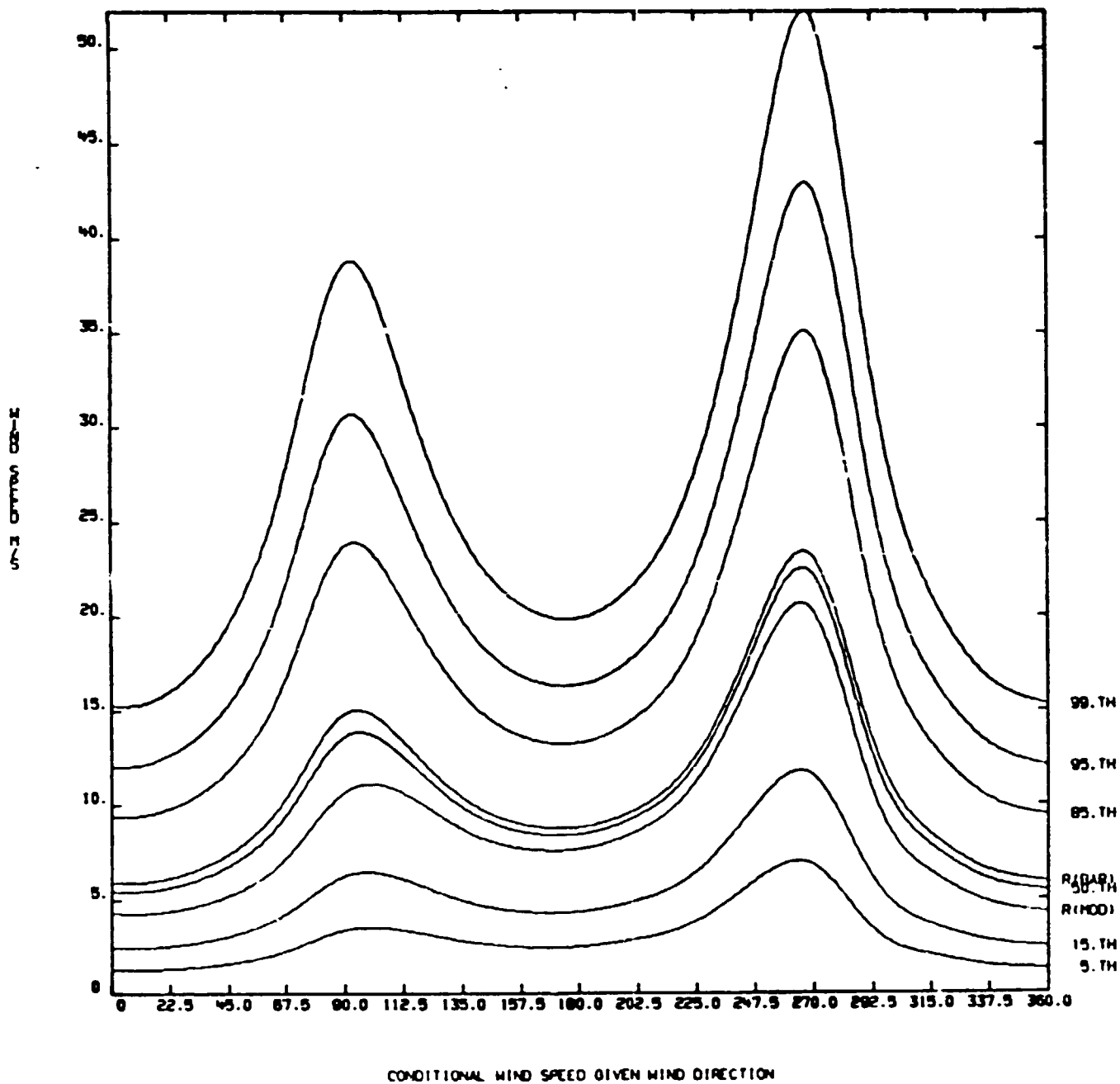

Figure A-56

WIND STATION-KSC MONTH-JUL. ALTITUDE=40 KM

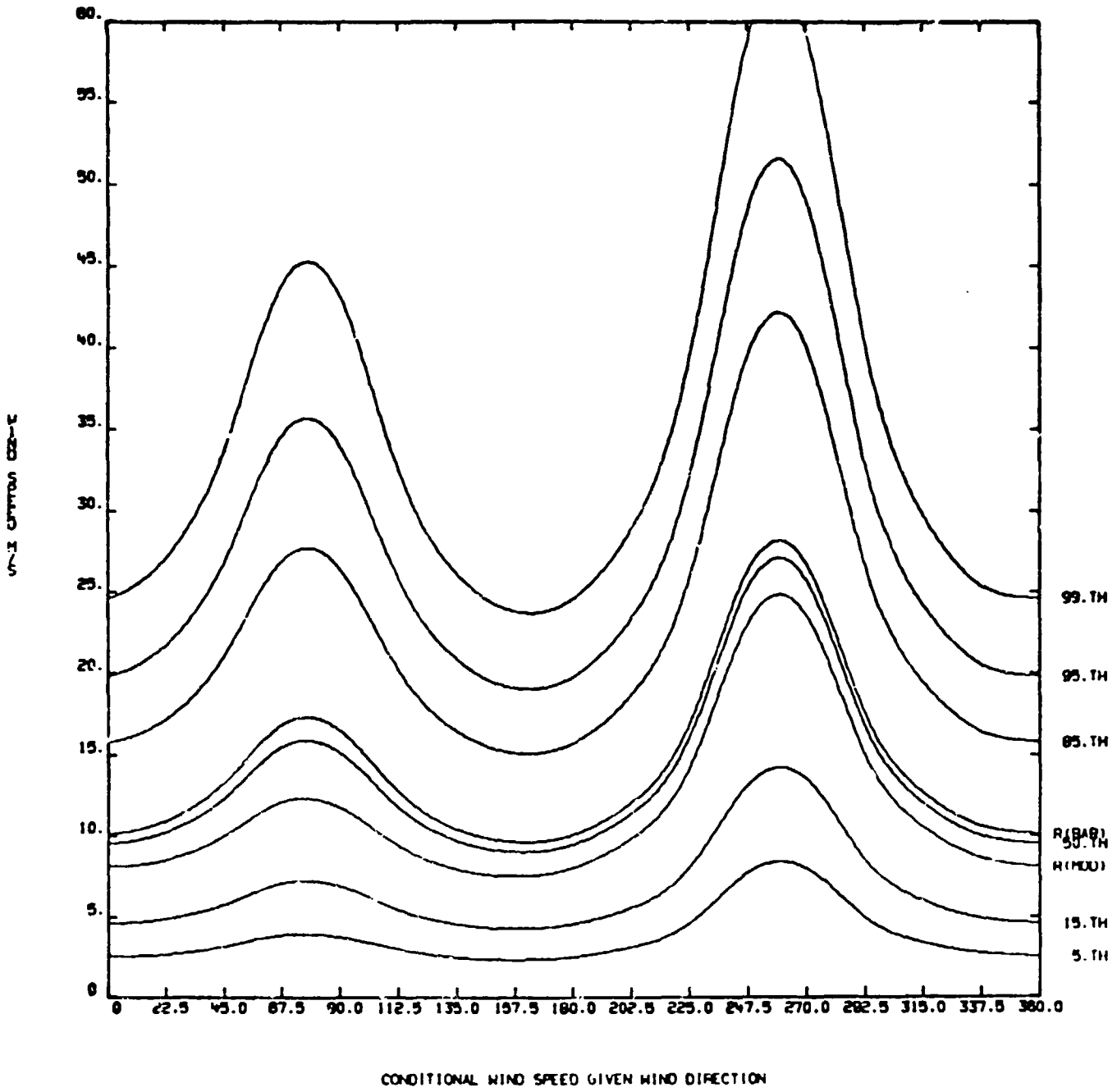

Figure A-57

WIND STATION-KSC MONTH-JA LATITUDE=50 101

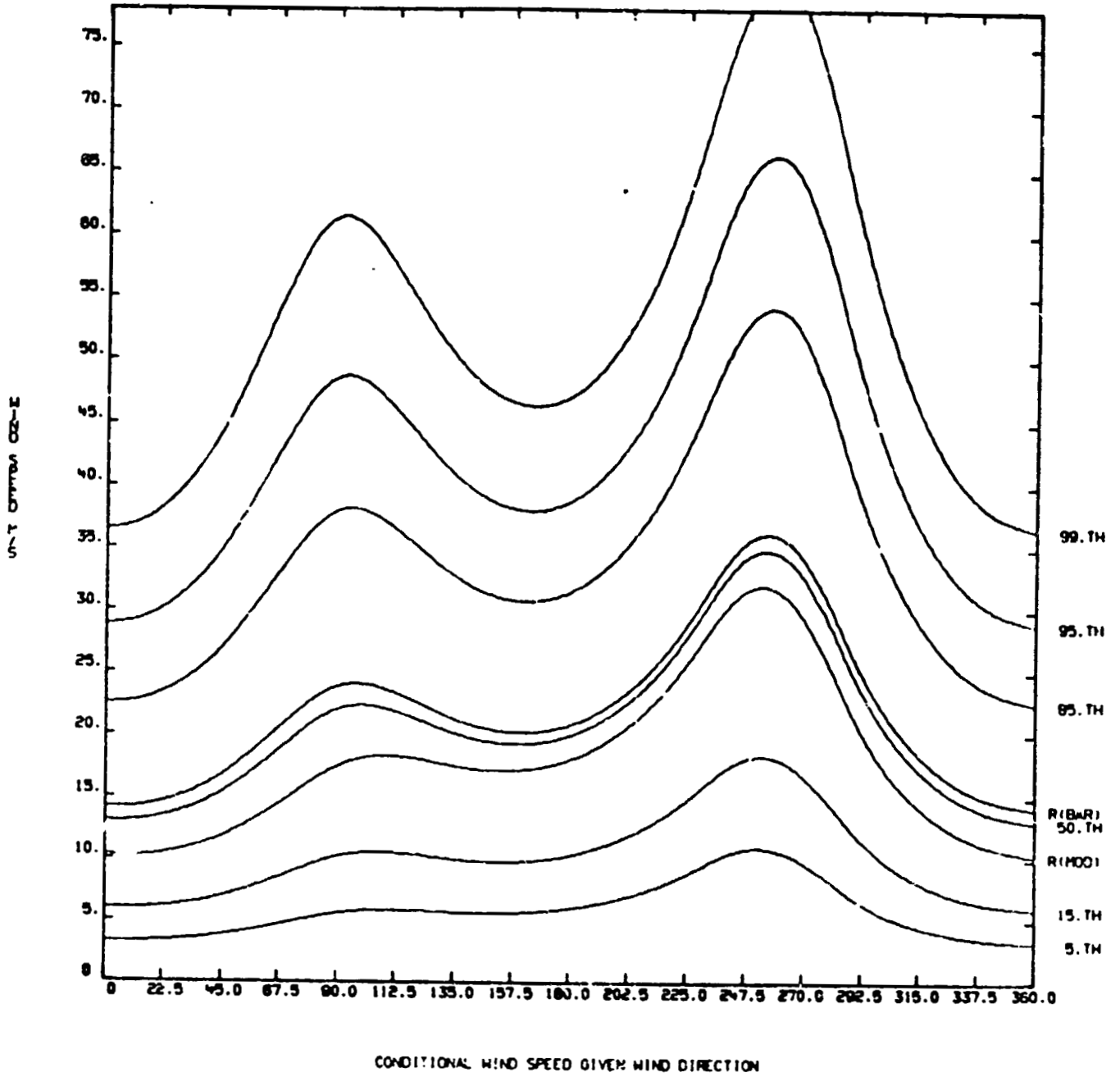

Figure A-53

WIND STATION-KSC MONTH-Jan. ALTITUDE-60 KM

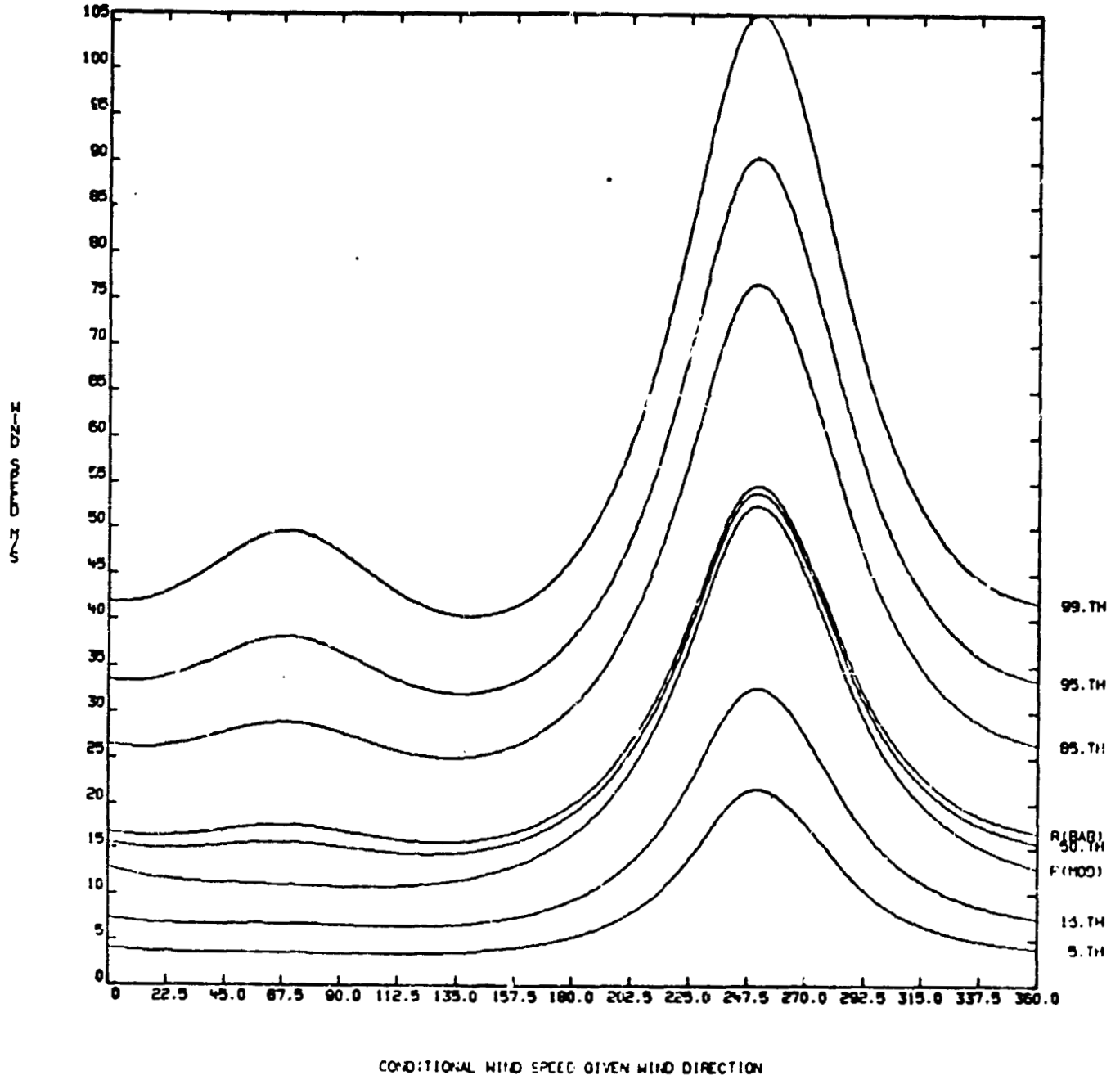

Figure A-59

WIND STATION=KSC MONTH=JAN. ALTITUDE=70 KM

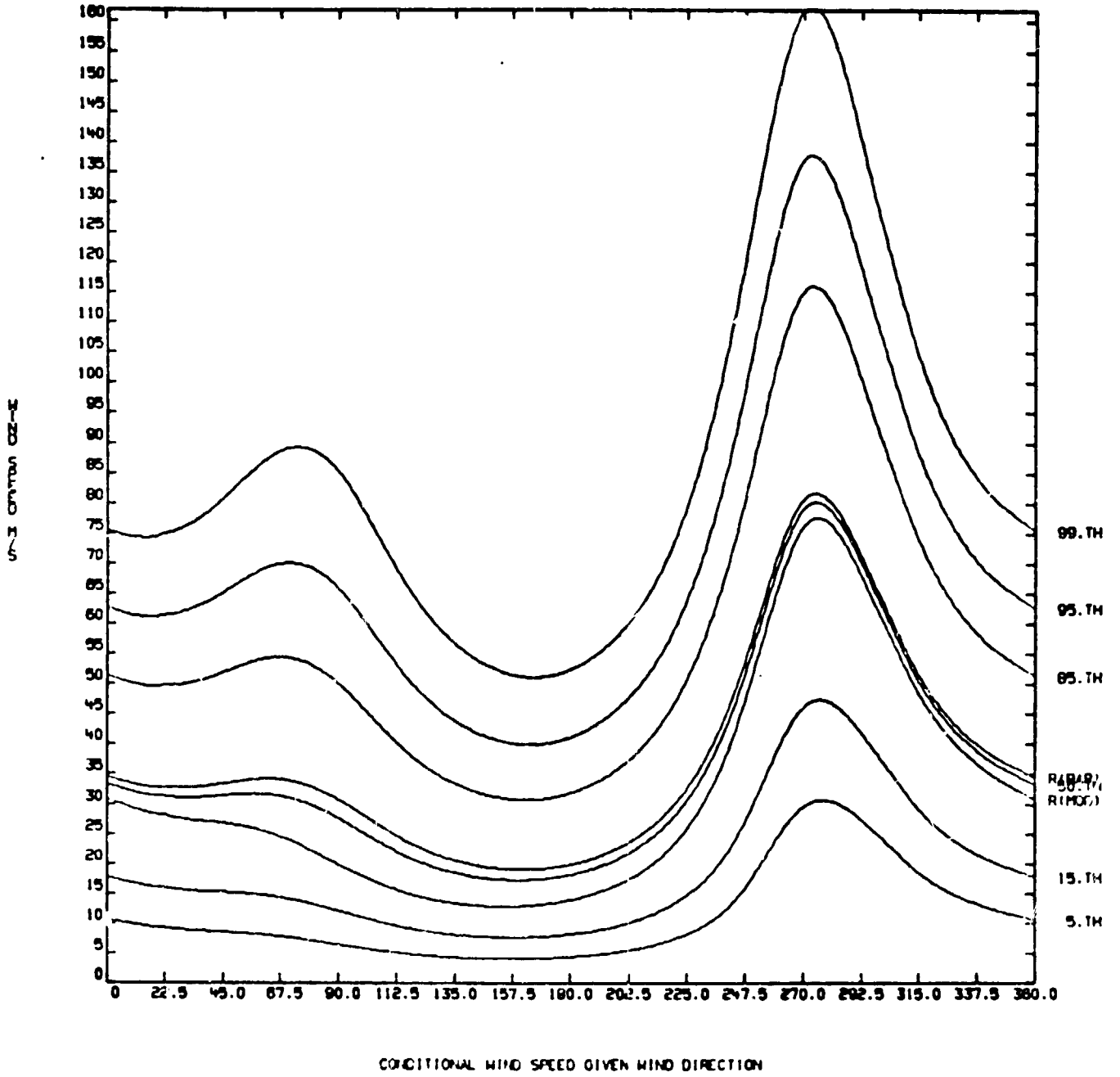

Figure A-60

WIND STATION=KSC MONTH=JUL. ALTITUDE= 4 KM

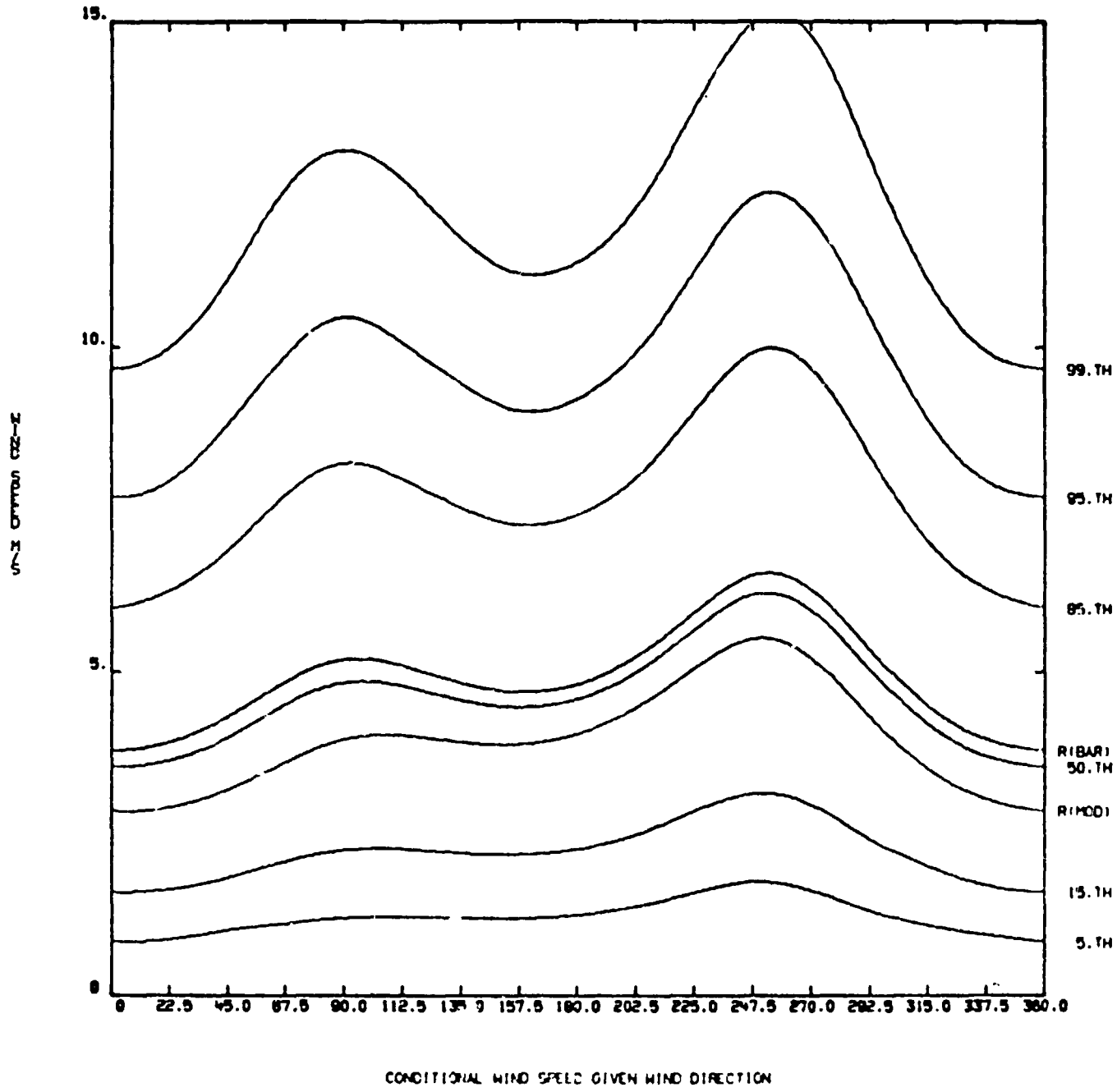

Figure A-61

WIND STATION=KSC MONTH=JUL. ALTITUDE=12 KM

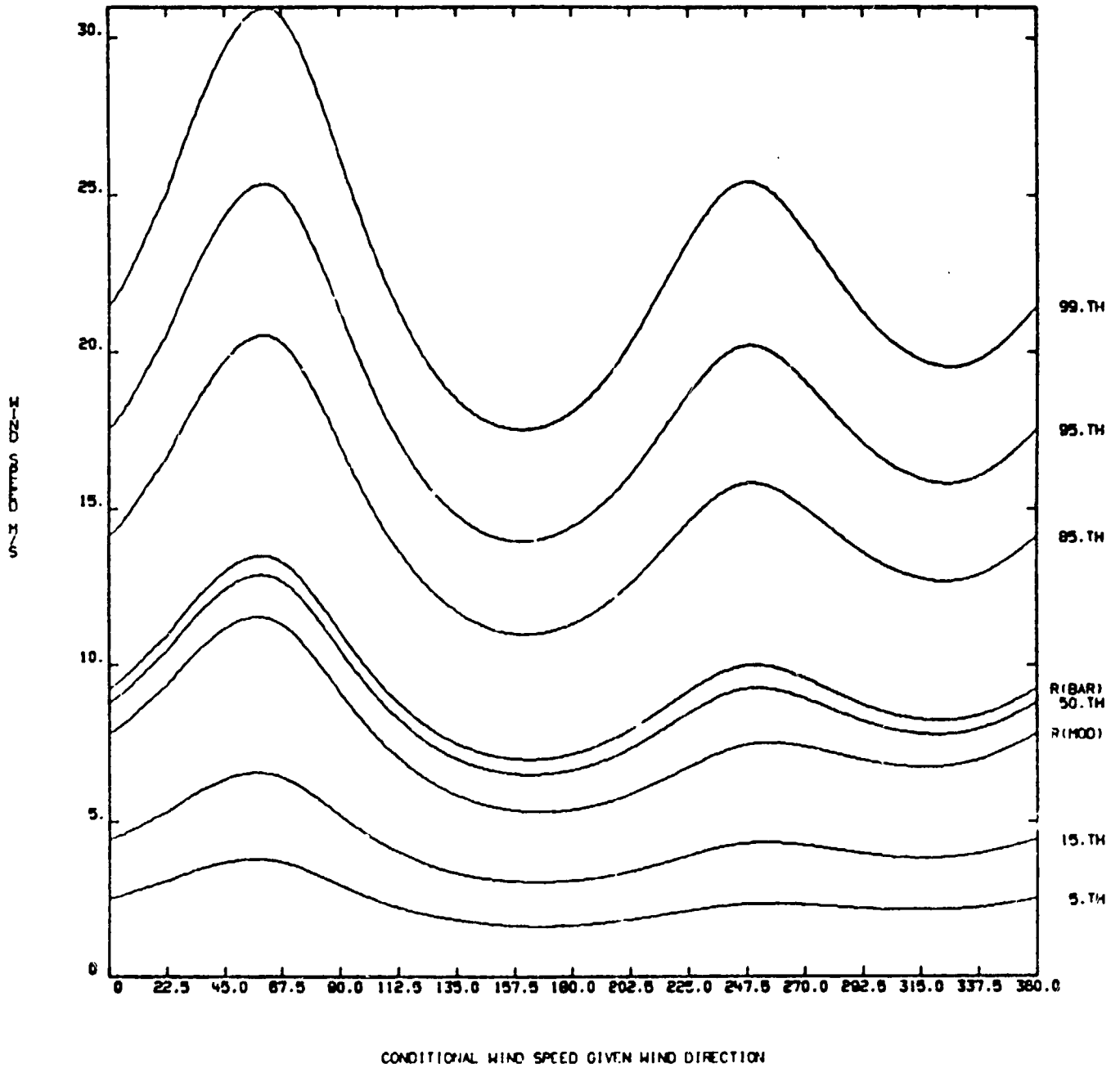

Figure A-62

WIND STATION-KSC MONTH-JUL. ALTITUDE=20 KM

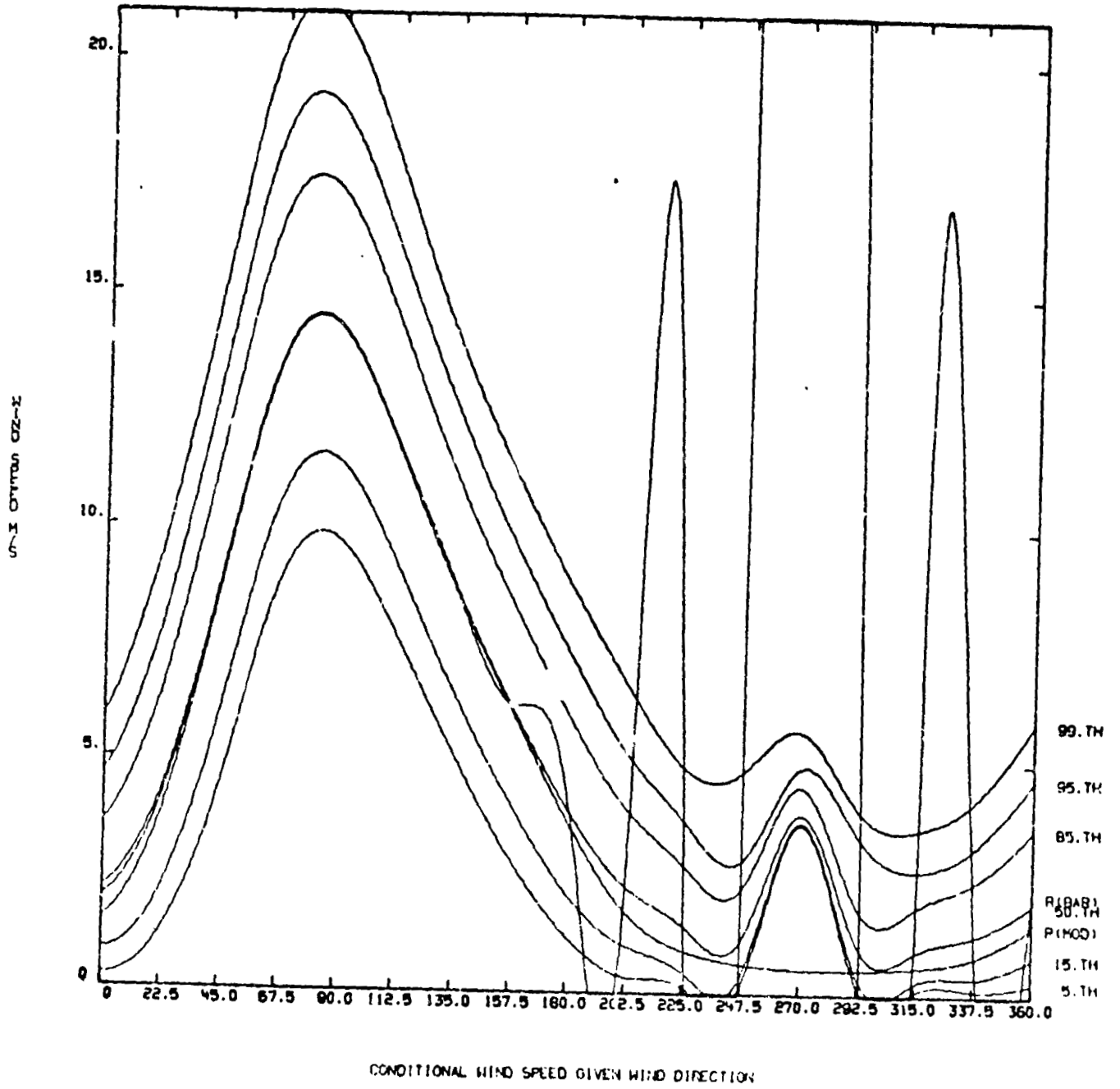

Figure A-63

WIND STATION=KSC MONTH=JUL. ALTITUDE=30 KM

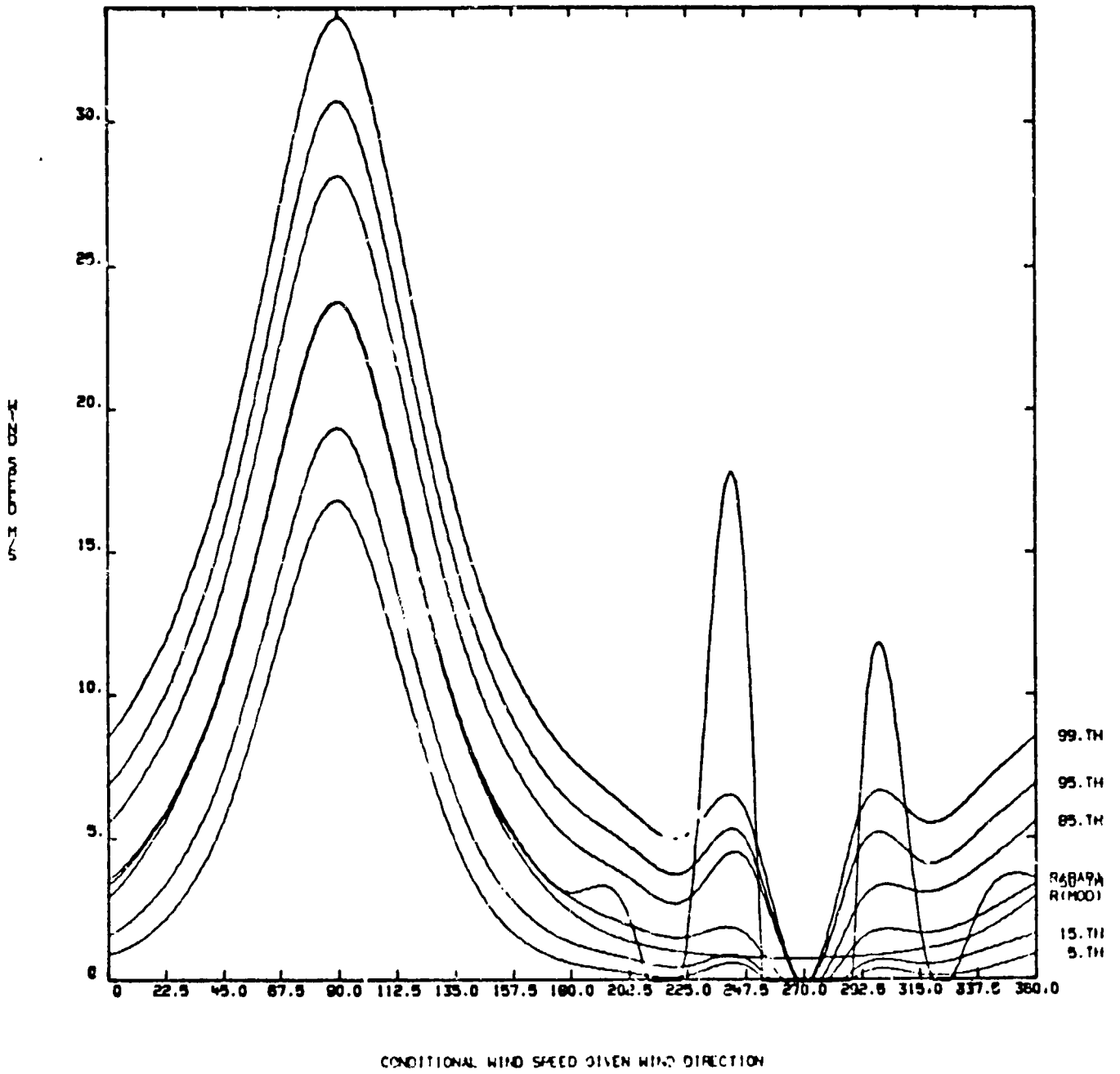

Figure A-64

WIND STATION-KSC MONTH-JUL ALTITUDE=40 KM

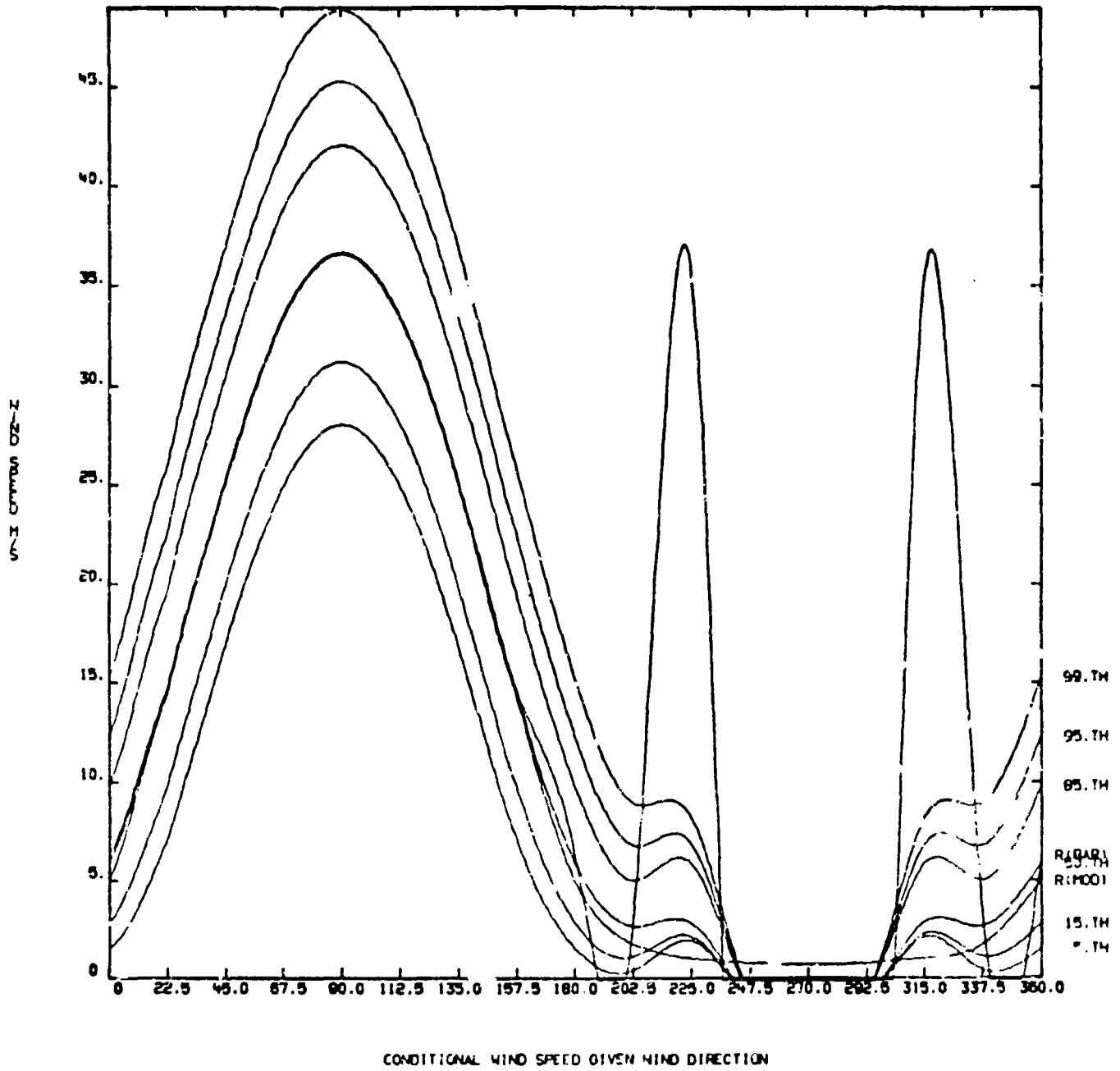

Figure A-65

WIND STATION=MSC MONTH=JUL. ALTITUDE=50 KM

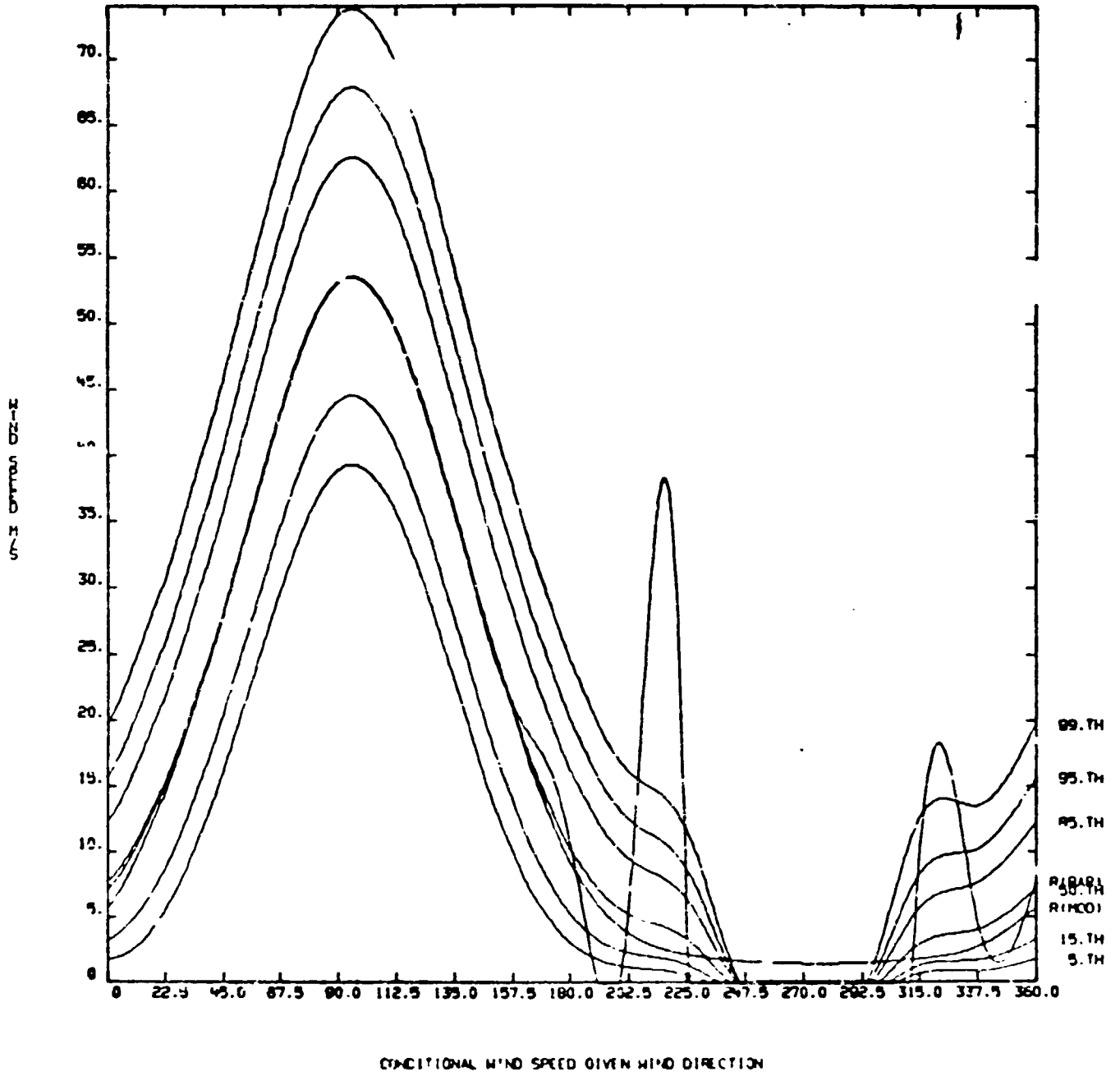

Figure A-66

WIND STATION-KSC MONTH-JUL. ALTITUDE-60 KPI

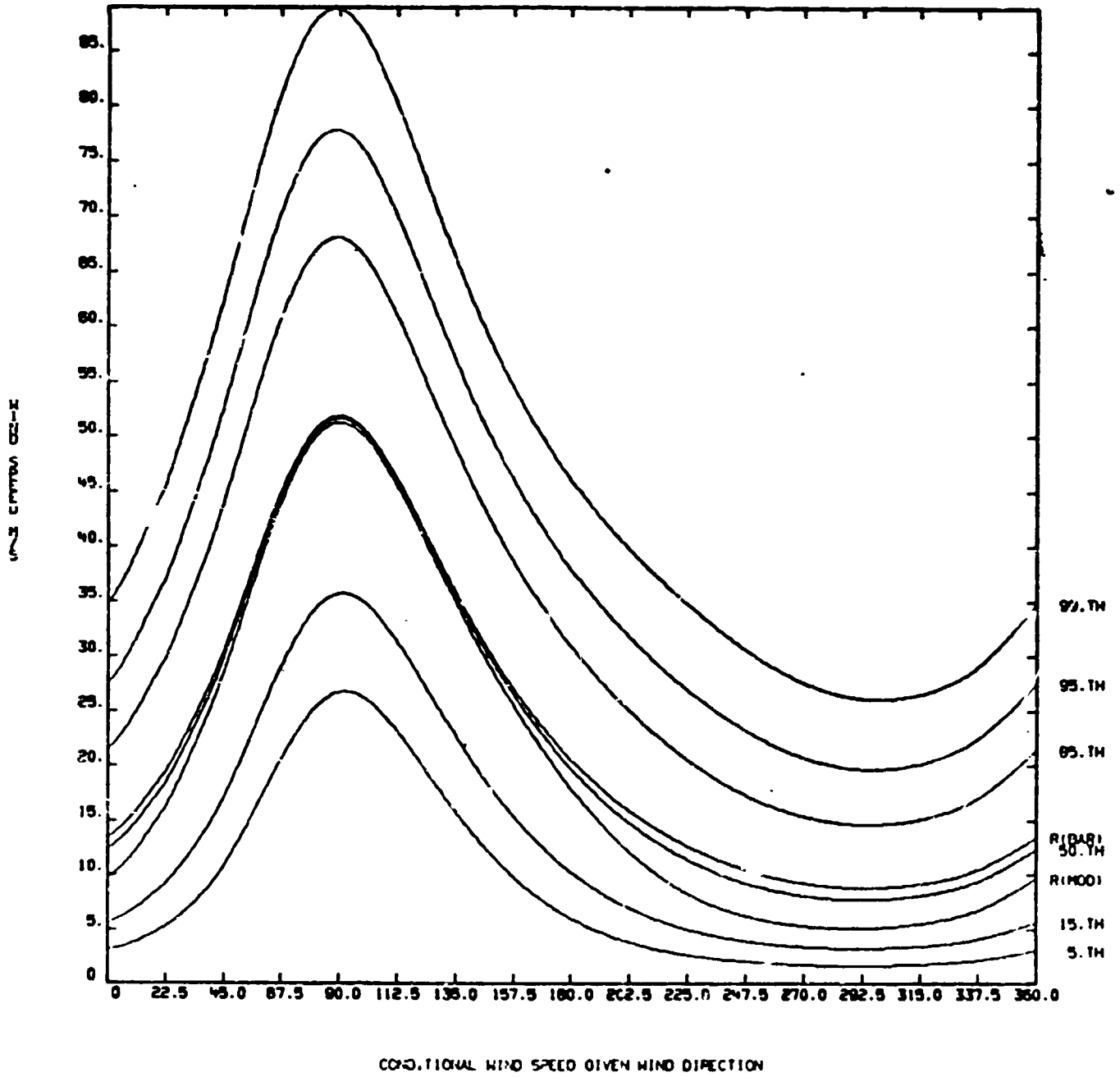

Figure A-67

WIND STATION=XSC MONTH=JUL. ALTITUDE=70 KM

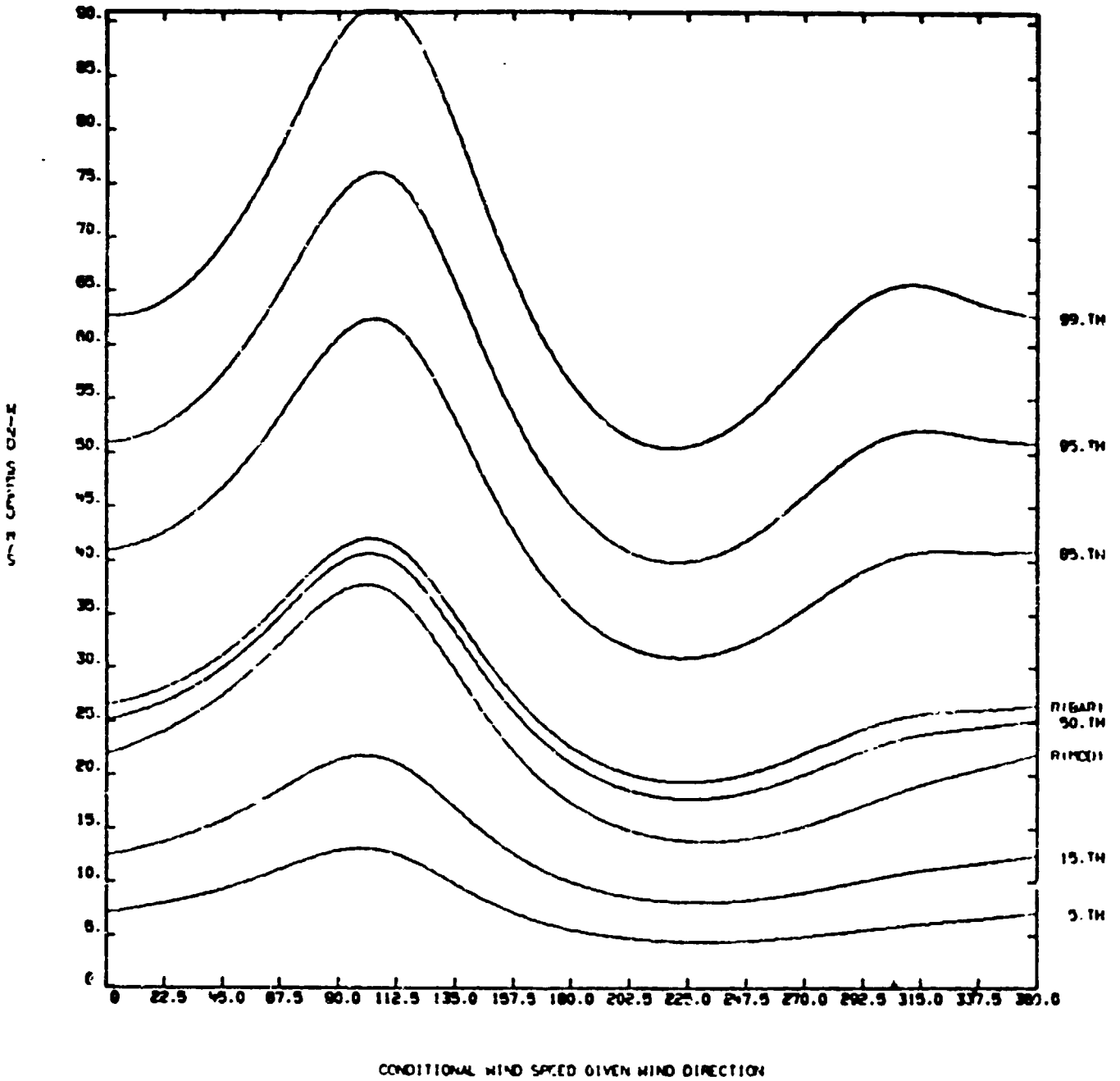

Figure A-69

APPENDIX B

RANGE SPECIFIC INFORMATION AND THERMODYNAMIC QUANTITIES FOR CAPE CANAVERAL FLORIDA

1. Range Specific Information

To prevent further character size reduction for Tables I through IV certain range specific information has been omitted. This important information is given in Table B-1.

TABLE B-1

HEADER RECORD 0-30 KM	HEADER RECORD 32 - 70 KM
TABLE NUMBER-----	0 TABLE NUMBER-----
DATA SOURCE (1=CATSAV,2=WDC-A)-----	1 DATA SOURCE (1=CATSAV,2=WDC-A)-----
CALL LETTERS-----	CALL LETTERS-----
WMO NUMBER-----	WMO NUMBER-----
LATITUDE-----	LATITUDE-----
DIRECTION (IN OR S)-----	DIRECTION (IN OR S)-----
LONGITUDE-----	LONGITUDE-----
DIRECTION (E OF W)-----	DIRECTION (E OF W)-----
ELEVATION IN METERS-----	ELEVATION IN METERS-----
START PERIOD OF RECORD (MO-YR)-----	START PERIOD OF RECORD (MO-YR)-----
END PERIOD OF RECORD (MO-YR)-----	END PERIOD OF RECORD (MO-YR)-----
NO. OF TIME WINDOWS (0,1 OR 2)-----	NO. OF TIME WINDOWS (0,1 OR 2)-----
START TIME WINDOW #1(HR-MNZ)-----	START TIME WINDOW #1(HR-MNZ)-----
END TIME WINDOW #1-----	END TIME WINDOW #1-----
START TIME WINDOW #2-----	START TIME WINDOW #2-----
END TIME WINDOW #2-----	END TIME WINDOW #2-----
DATE OF PRA-----	DATE OF PRA-----
ALTITUDE RANGE OF PRA LOW LEVEL (KM)-----	ALTITUDE RANGE OF PRA LOW LEVEL (KM)-----
ALTITUDE RANGE OF PRA HIGH LEVEL (KM)-----	ALTITUDE RANGE OF PRA HIGH LEVEL (KM)-----
STANDARD DEVIATION OF THERMODYNAMIC LIMITS-----	STANDARD DEVIATION OF THERMODYNAMIC LIMITS-----
WIND LIMITS-----	WIND LIMITS-----

2. Thermodynamic Quantities

This section presents examples of further computations and graphical displays of pressure, density, and virtual temperature statistics that can be derived from the data given in Tables I, III, and IV. No attempt is made to present complete nor exhaustive illustrations that can be made to aid in visualizing the relationships that can be made from the data in Tables II and IV. The choices are those which aided the committee to verify the reasonableness of the tabulations.

2.1 Monthly Means from the Annual Mean

The hydrostatic model values in Table IV are used to compute the monthly mean differences relative to the annual mean values of pressure, density, and virtual temperature expressed in percent and the monthly mean difference in virtual temperature for the annual mean virtual temperature expressed in degrees K. Examples of these four statistics are given in Table B-2 for January and Table B-3 for July. Graphical displays of the four statistics contained in Tables B-2 and B-3 are shown in Figures B-1 through B-8. Also the relative differences between the monthly mean values from Table IV-1 through IV-12 for all months from the annual mean values (Table IV-13) are illustrated in Figure B-9 for pressure, in Figure B-10 for density, and in Figure B-11 for virtual temperature. The monthly mean virtual temperature differences from the annual mean virtual temperature for all months is given in Figure B-12. The simple

sum of the monthly mean differences from the annual mean values of these quantities is not zero. This is because the annual mean statistical parameters are computed (see Section C of text) by weighting the monthly means by the number of observations in each month.

2.2 Coefficients of Variation and Derived Correlation Coefficients

The coefficient of variation, C_V , is defined by the standard deviation with respect to the mean divided by the mean. The coefficients of variation for pressure, C_{VP} , and density, C_{VD} , were computed using the standard deviations from Table II and the hydrostatic mean values from Table IV. The coefficient of variation for temperature uses the standard deviations of virtual temperature from Table III to the altitude where virtual temperature exists. Above this altitude the standard deviations of temperature are from Table II. The mean values for virtual temperature to the altitude where it exists and temperatures above this altitude are taken from Table IV. No distinction is made in the table headings in Table B-4 (Jan) and Table B-5 (July) and all related figures between virtual temperature and temperature.

From the coefficients of variation for pressure, and temperature (virtual temperature to the altitude where it exists), the correlation coefficients between these quantities are derived using Buell's method (see reference in text). The equations for these derived correlation coefficients are:

$$r(P,T) = \frac{(C_{VT})^2 + (C_{VP})^2 - (C_{VD})^2}{2 [C_{VT} \cdot C_{VP}]}, \quad (B-1)$$

$$r(P,D) = \frac{(C_{VD})^2 - (C_{VT})^2 + (C_{VP})^2}{2 [C_{VP} \cdot C_{VD}]}, \quad (B-2)$$

$$r(T,D) = \frac{(C_{VP})^2 - (C_{VD})^2 - (C_{VT})^2}{2 [C_{VT} \cdot C_{VD}]}, \quad (B-3)$$

The correlation coefficients in tables B-4 and B-5 are derived from the above equations.

A test for the validity of the derived correlation coefficients is that all three of the following inequalities be satisfied.

$$\left. \begin{aligned} C_{VP} - [C_{VD} + C_{VT}] &< 0 \\ C_{VD} - [C_{VT} + C_{VP}] &< 0 \\ C_{VT} - [C_{VP} + C_{VD}] &< 0 \end{aligned} \right\} \quad (B-4)$$

In these examples (Tables B-4 and B-5) the numerical values from equation (B-4) are all negative, hence, the derived correlation test is considered valid. The rare exceptions to this test for several RRAs occur at the extreme highest altitudes where sample sizes for the statistical sample are small.

The statistical parameters from Table B-4 (January) and Table B-5 (July) are illustrated in Figures B-14 through B-16.

For all months the $C_V P$ values are shown in Figure B-17, the $C_V D$ values are shown in Figure B-18, and $C_V T$ values are shown in Figure B-19. If the abscissa on the figures for the coefficient of variation is multiplied by 100, these figures would show the percentage of the random dispersion of these quantities over the month with respect to the monthly mean for these thermodynamic quantities.

The derived correlation coefficients for all months are illustrated in the following figures:

- a) Figure B-20 gives $r(P,D)$.
- b) Figure B-21 gives $r(P,T)$.
- c) Figure B-22 gives $r(T,D)$.

Table B-2

STATION 747940 MONTH 1
 DELTAS IN PERCENT RELATIVE TO ANNUAL

LEVEL	PRESSURE	DENSITY	TEMP.	THO-TAN: (C/O.K)
.000	.23	2.59	-2.30	-6.82
.003	.22	2.50	-2.26	-6.68
1.000	-.01	1.66	-1.68	-4.89
2.000	-.19	1.11	-1.29	-3.68
3.000	-.33	.70	-1.03	-2.80
4.000	-.45	.49	-.93	-2.56
5.000	-.57	.40	-.98	-2.62
6.000	-.70	.34	-1.05	-2.74
7.000	-.84	.26	-1.09	-2.79
8.000	-1.00	.19	-1.19	-2.97
9.000	-1.17	.13	-1.29	-3.12
10.000	-1.36	-.02	-1.33	-3.16
11.000	-1.54	-.40	-1.16	-2.53
12.000	-1.69	-.90	-.82	-1.79
13.000	-1.76	-1.71	-.03	-.06
14.000	-1.71	-2.37	.71	1.49
15.000	-1.60	-2.24	.67	1.37
16.000	-1.53	-1.65	.14	.28
17.000	-1.56	-1.07	-.49	-1.00
19.000	-1.69	-.60	-1.10	-2.25
19.000	-1.90	-.54	-1.40	-2.90
20.000	-2.12	-.70	-1.42	-3.00
21.000	-2.34	-1.03	-1.33	-2.84
22.000	-2.54	-1.37	-1.19	-2.56
23.000	-2.72	-1.56	-1.17	-2.54
24.000	-2.89	-1.80	-1.13	-2.49
25.000	-3.07	-1.95	-1.15	-2.54
26.000	-3.24	-2.07	-1.19	-2.67
27.000	-3.41	-2.26	-1.18	-2.65
28.000	-3.58	-2.53	-1.10	-2.50
29.000	-3.73	-2.68	-1.09	-2.49
30.000	-3.89	-2.86	-1.08	-2.48
32.000	-4.23	-3.54	-1.39	-3.26
34.000	-4.59	-4.05	-1.17	-2.80
36.000	-4.85	-4.69	-.78	-1.90
38.000	-4.99	-5.32	-.29	-.72
40.000	-4.97	-5.99	.44	1.13
42.000	-4.77	-6.47	1.16	3.02
44.000	-4.46	-6.36	1.39	3.68
46.000	-4.15	-5.91	1.19	3.18
48.000	-3.94	-5.15	.60	1.61
50.000	-3.93	-3.97	-.55	-1.49
52.000	-4.12	-3.79	-.95	-2.56
54.000	-4.34	-4.11	-.65	-2.24
56.000	-4.51	-4.60	-.52	-1.36
58.000	-4.56	-5.29	.13	.34
60.000	-4.53	-5.19	.08	.20
62.000	-4.43	-5.74	.75	1.88
64.000	-4.31	-5.05	.13	.32
66.000	-4.20	-5.45	.72	1.69
68.000	-4.04	-5.07	.47	1.05
70.000	-3.89	-5.04	.59	1.27

Table B-3

STATION 747940 MONTH 7
 DELTAS IN PERCENT RELATIVE TO ANNUAL

LEVEL	PRESSURE	DENSITY	TEMP.	TMO-TANNIDEQ.K)
.000	.02	-2.01	2.04	6.05
.003	.01	-2.17	2.17	6.43
1.000	.25	-1.66	1.85	5.38
2.000	.43	-.94	1.38	3.94
3.000	.58	-.45	1.03	2.89
4.000	.70	-.25	.95	2.61
5.000	.82	-.25	1.06	2.86
6.000	.97	-.29	1.27	3.32
7.000	1.15	-.27	1.43	3.65
8.000	1.35	-.25	1.61	4.01
9.000	1.59	-.17	1.75	4.22
10.000	1.84	.09	1.74	4.06
11.000	2.08	.59	1.48	3.34
12.000	2.27	1.26	.97	2.13
13.000	2.36	2.23	.13	.27
14.000	2.32	2.96	-.62	-1.29
15.000	2.21	2.83	-.57	-1.18
16.000	2.18	1.97	.21	.42
17.000	2.29	1.26	1.02	2.07
18.000	2.50	.97	1.54	3.14
19.000	2.75	1.25	1.49	3.08
20.000	2.99	1.63	1.33	2.81
21.000	3.19	1.95	1.21	2.59
22.000	3.37	2.30	1.05	2.26
23.000	3.54	2.54	.99	2.15
24.000	3.69	2.72	.94	2.06
25.000	3.84	2.90	.91	2.02
26.000	3.98	3.08	.87	1.94
27.000	4.11	3.31	.79	1.79
28.000	4.22	3.48	.70	1.59
29.000	4.32	3.65	.63	1.45
30.000	4.41	3.88	.53	1.23
32.000	4.53	4.06	.24	.56
34.000	4.59	4.20	.19	.45
36.000	4.62	4.45	.00	.01
38.000	4.62	4.43	.02	.04
40.000	4.57	4.78	-.37	-.94
42.000	4.45	4.80	-.49	-1.28
44.000	4.29	4.89	-.74	-1.96
46.000	4.11	4.54	-.59	-1.57
48.000	3.98	4.23	-.43	-1.15
50.000	3.94	4.34	-.62	-1.66
52.000	3.64	4.46	-.94	-2.49
54.000	3.39	4.19	-.91	-2.40
56.000	3.10	4.26	-1.27	-3.31
58.000	2.76	3.91	-1.27	-3.28
60.000	2.38	3.77	-1.50	-3.81
62.000	1.87	4.04	-2.24	-5.60
64.000	1.23	3.39	-2.25	-5.45
66.000	.63	2.46	-1.97	-4.54
68.000	.15	1.25	-1.23	-2.78
70.000	-.21	.61	-1.17	-2.57

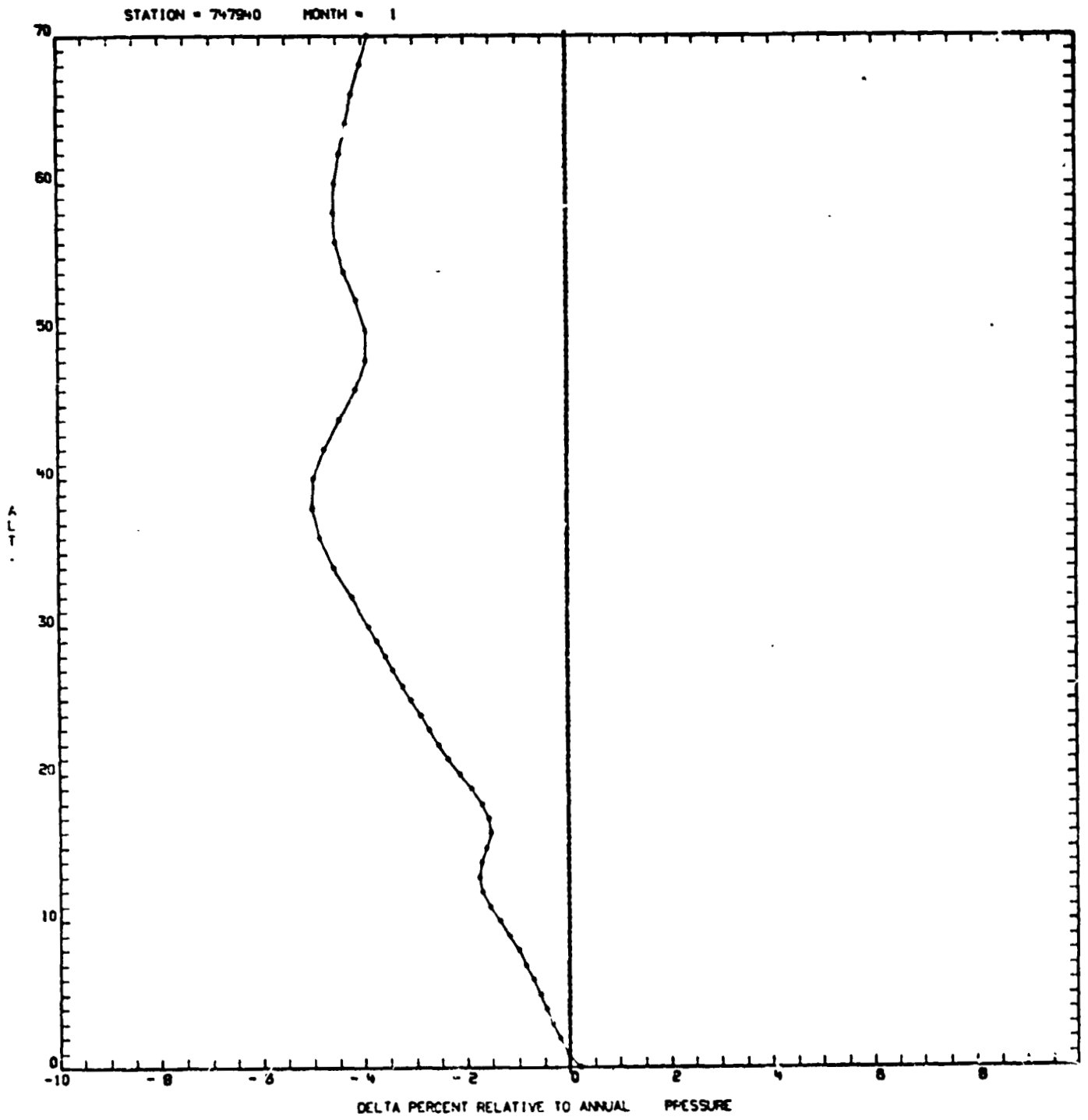

Figure B-1

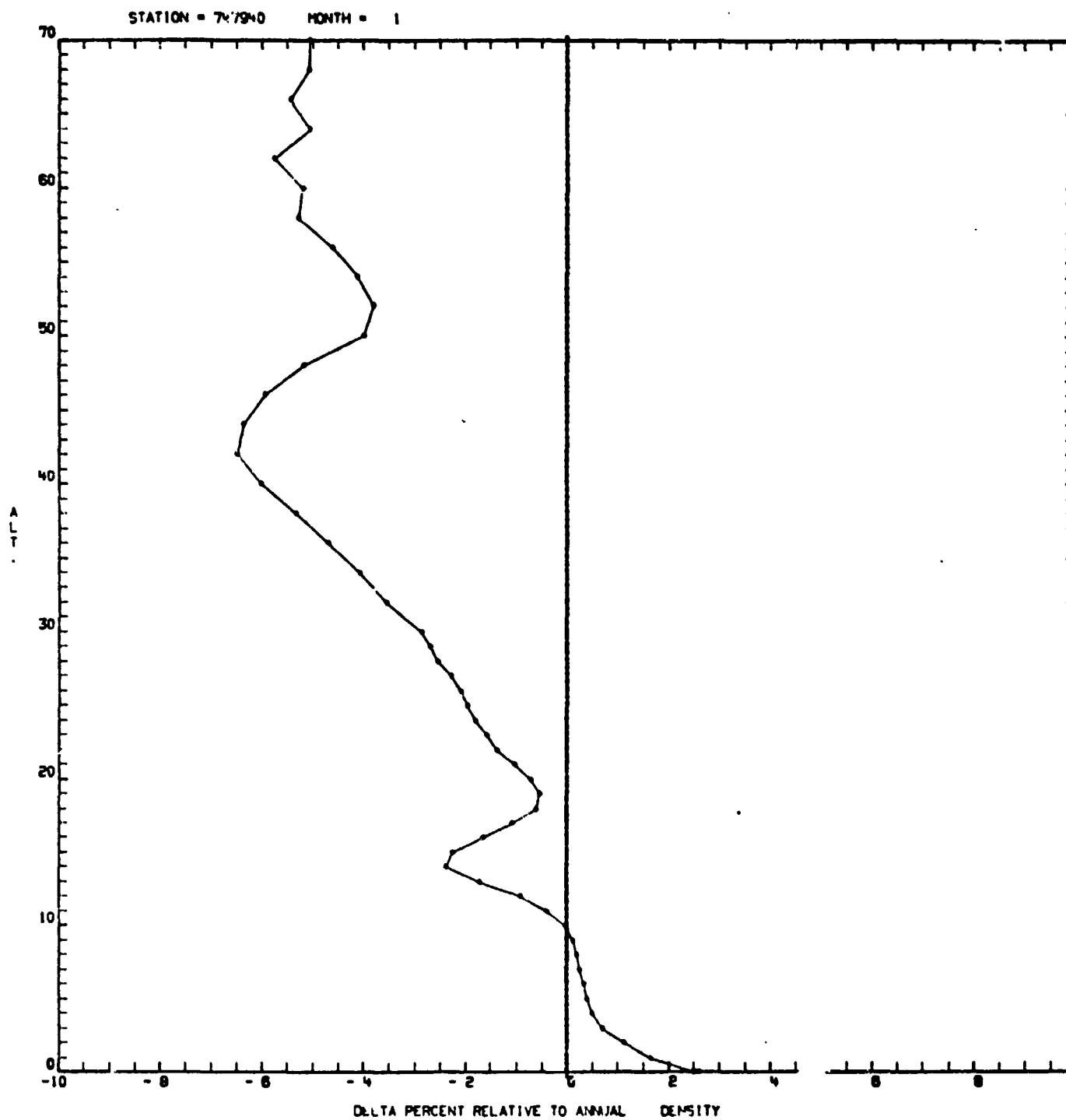

Figure B-2

STATION = 747940 MONTH = 1

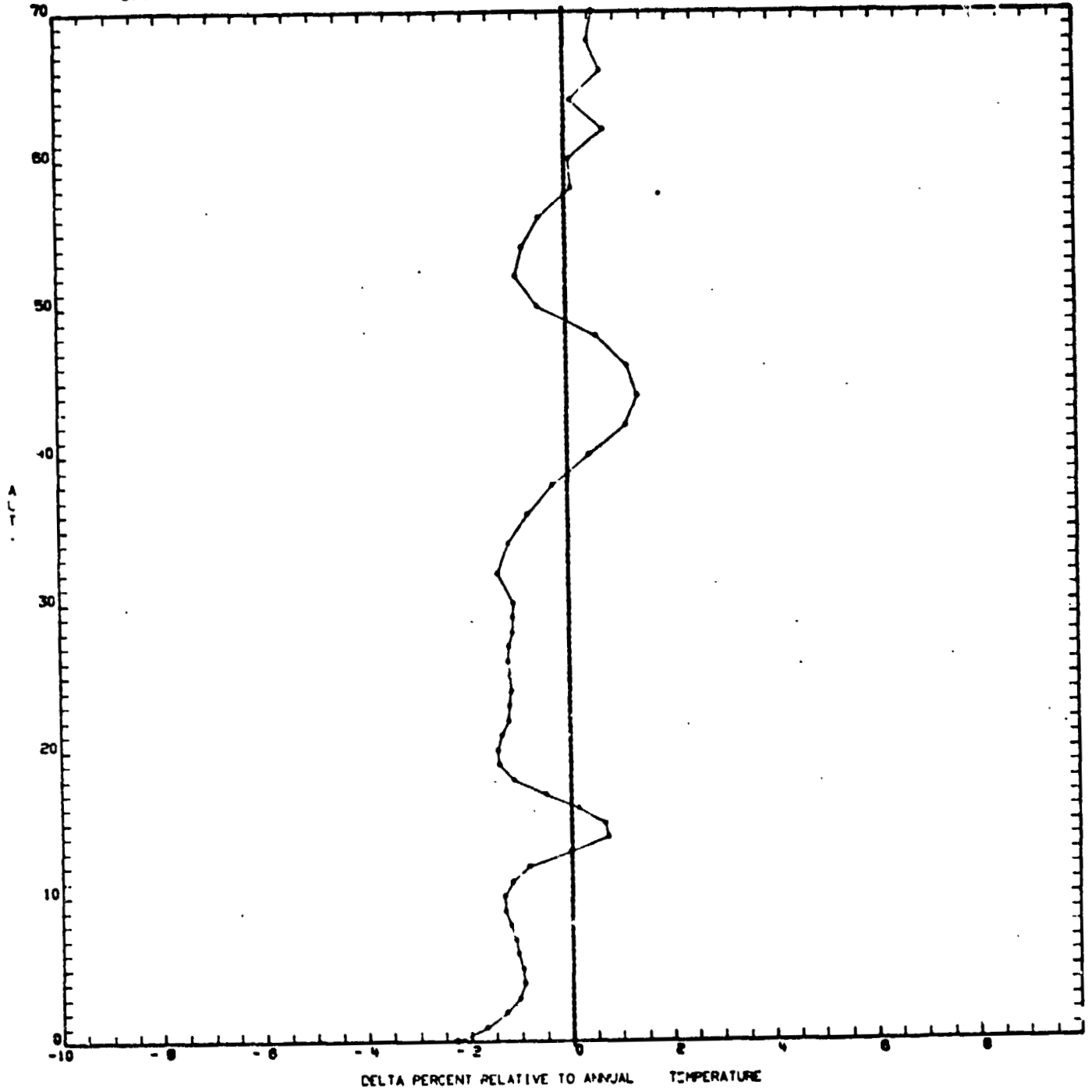

Figure B-3

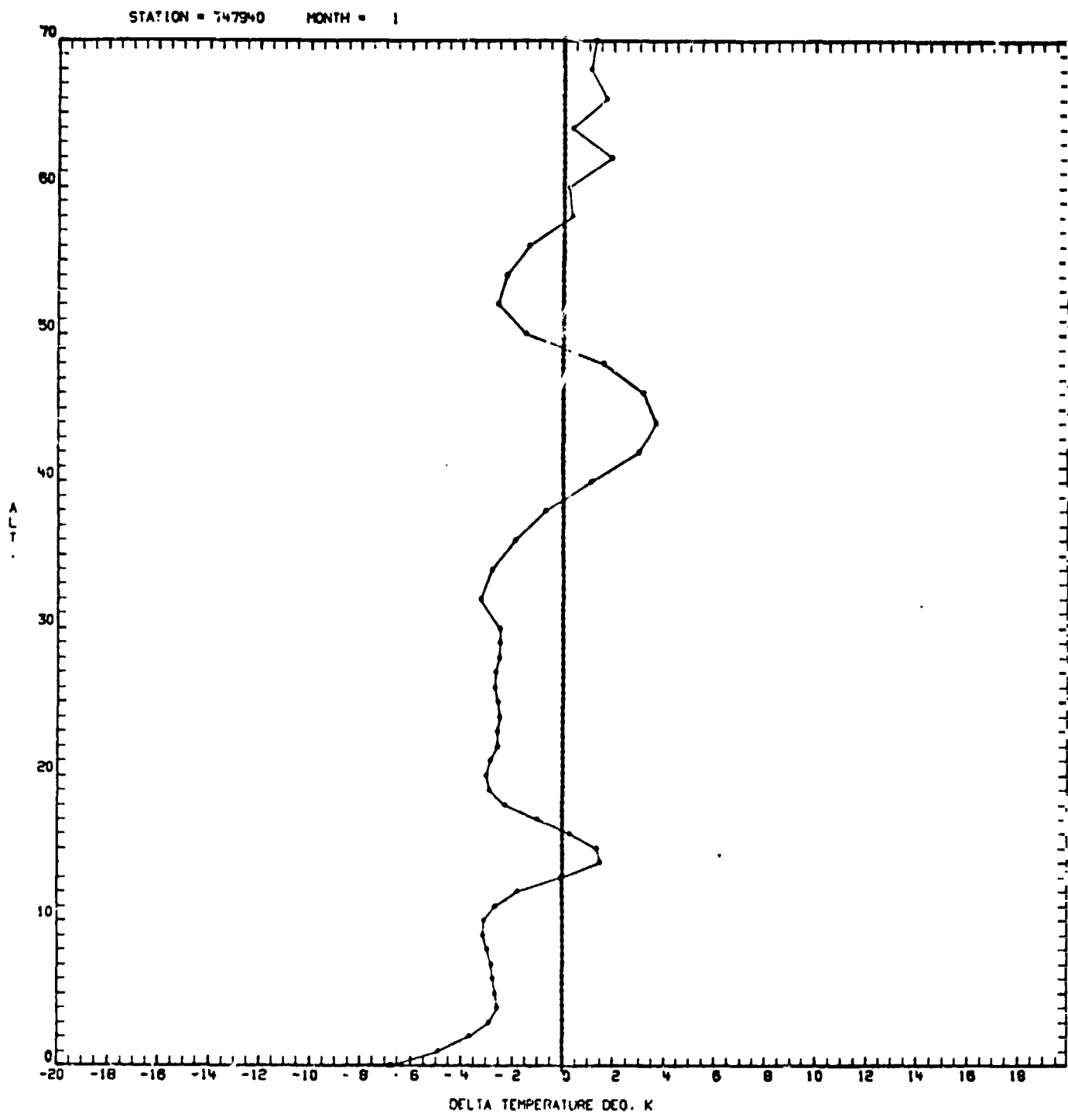

Figure B-4

STATION = 747940 MONTH = 7

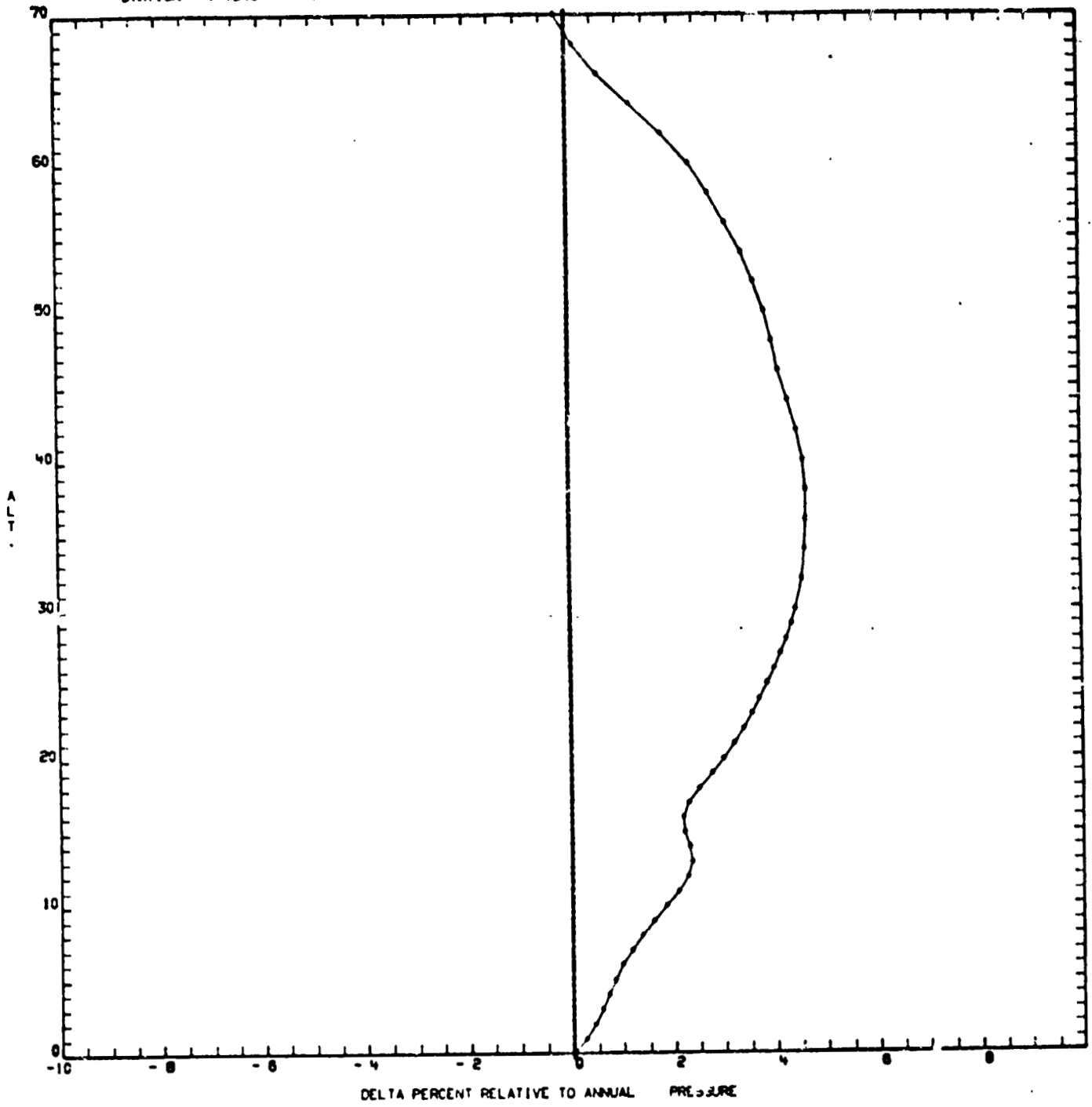

Figure B-5

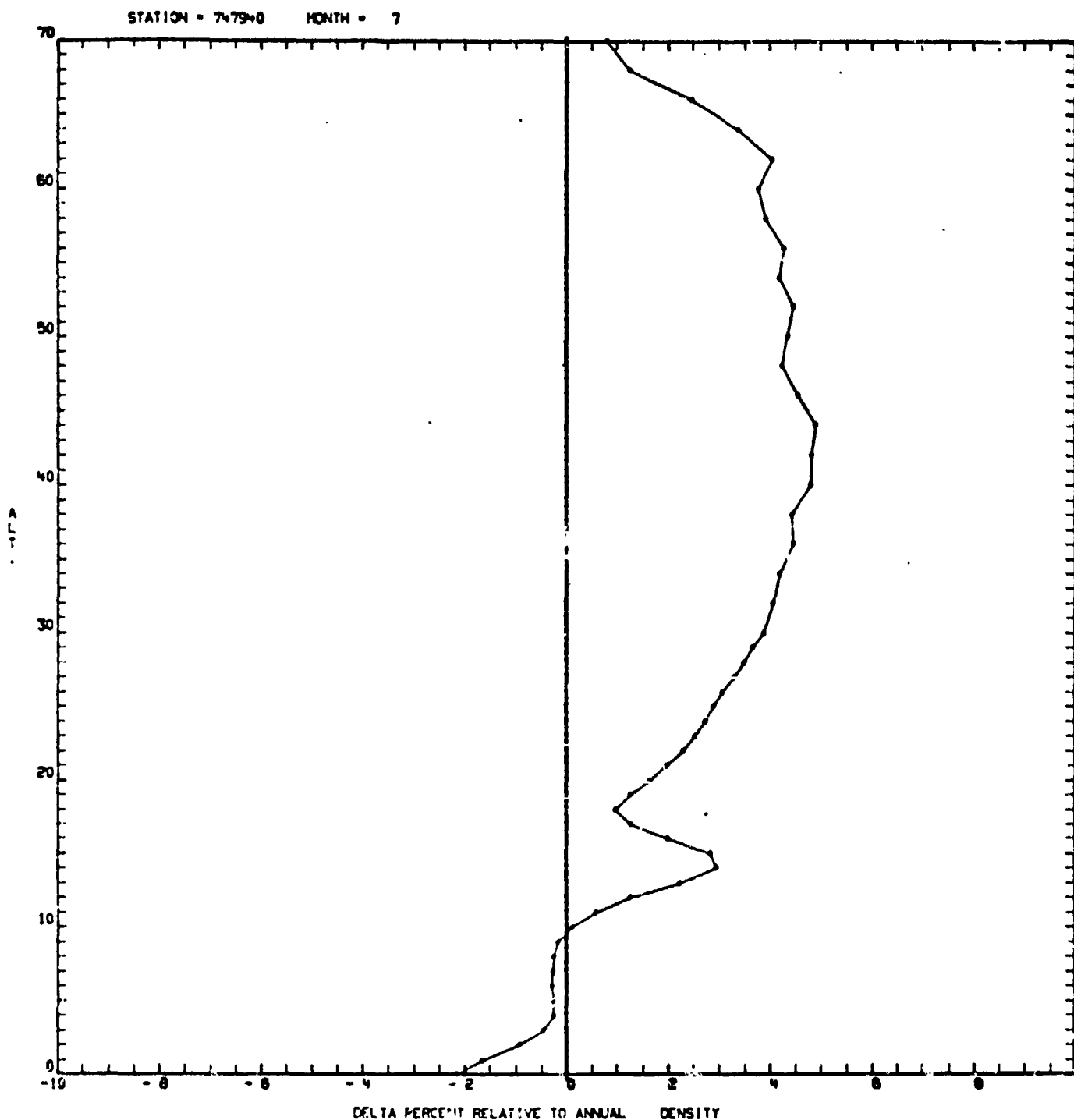

Figure B-6

STATION = 747940 MONTH = 7

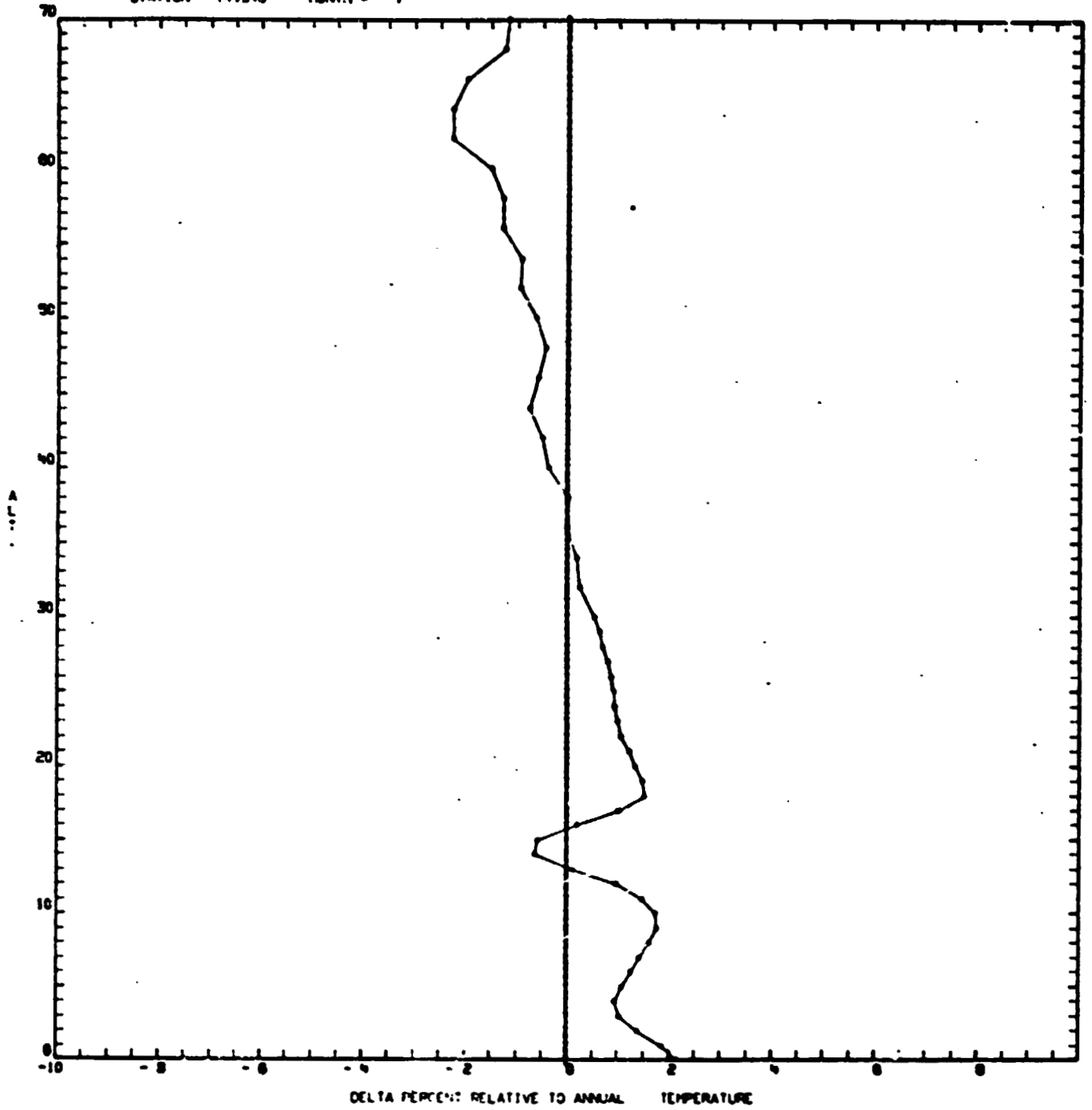

Figure B-7

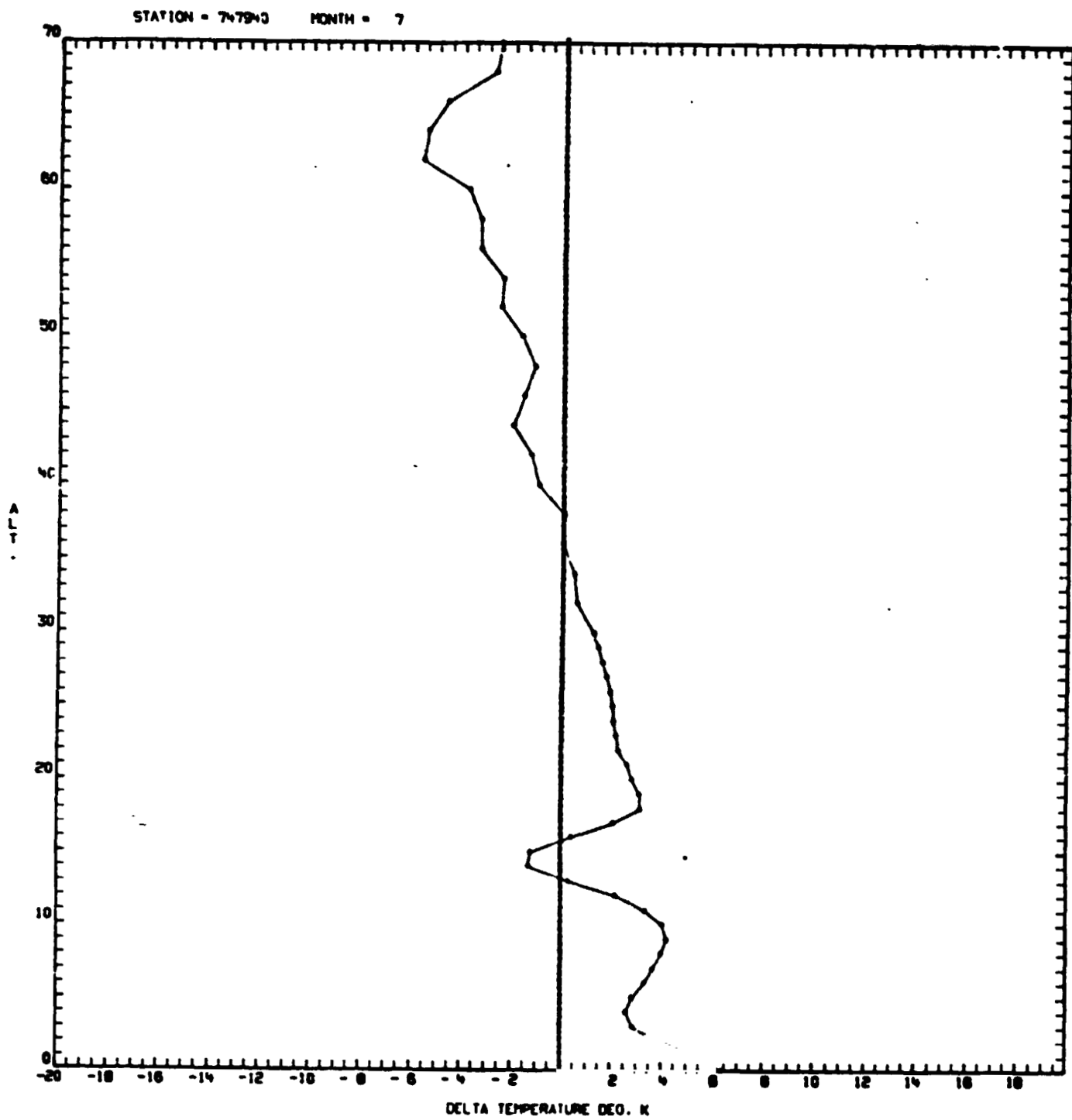

Figure B-8

STATION = 747940 ALL MONTHS

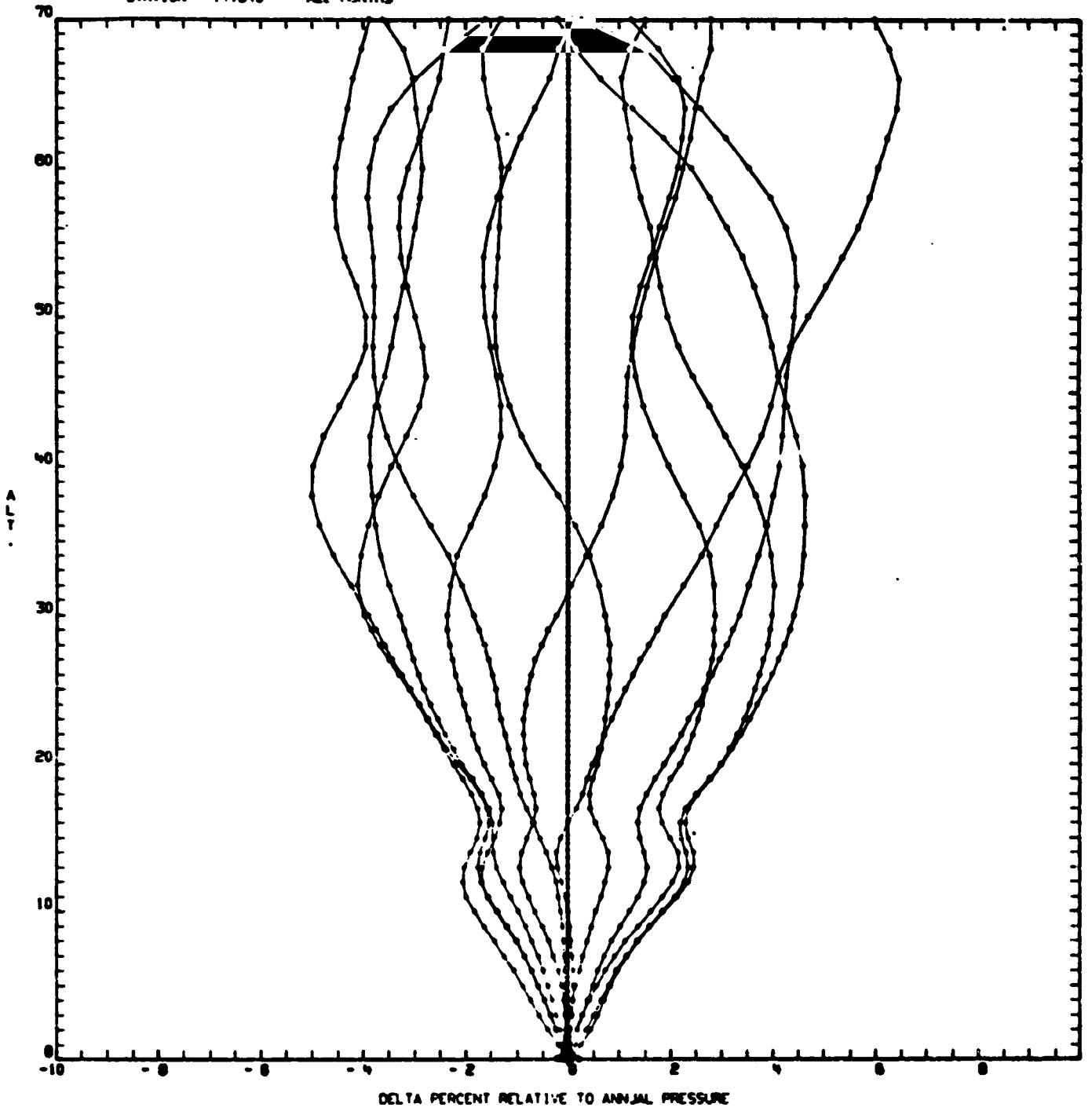

Figure B-9

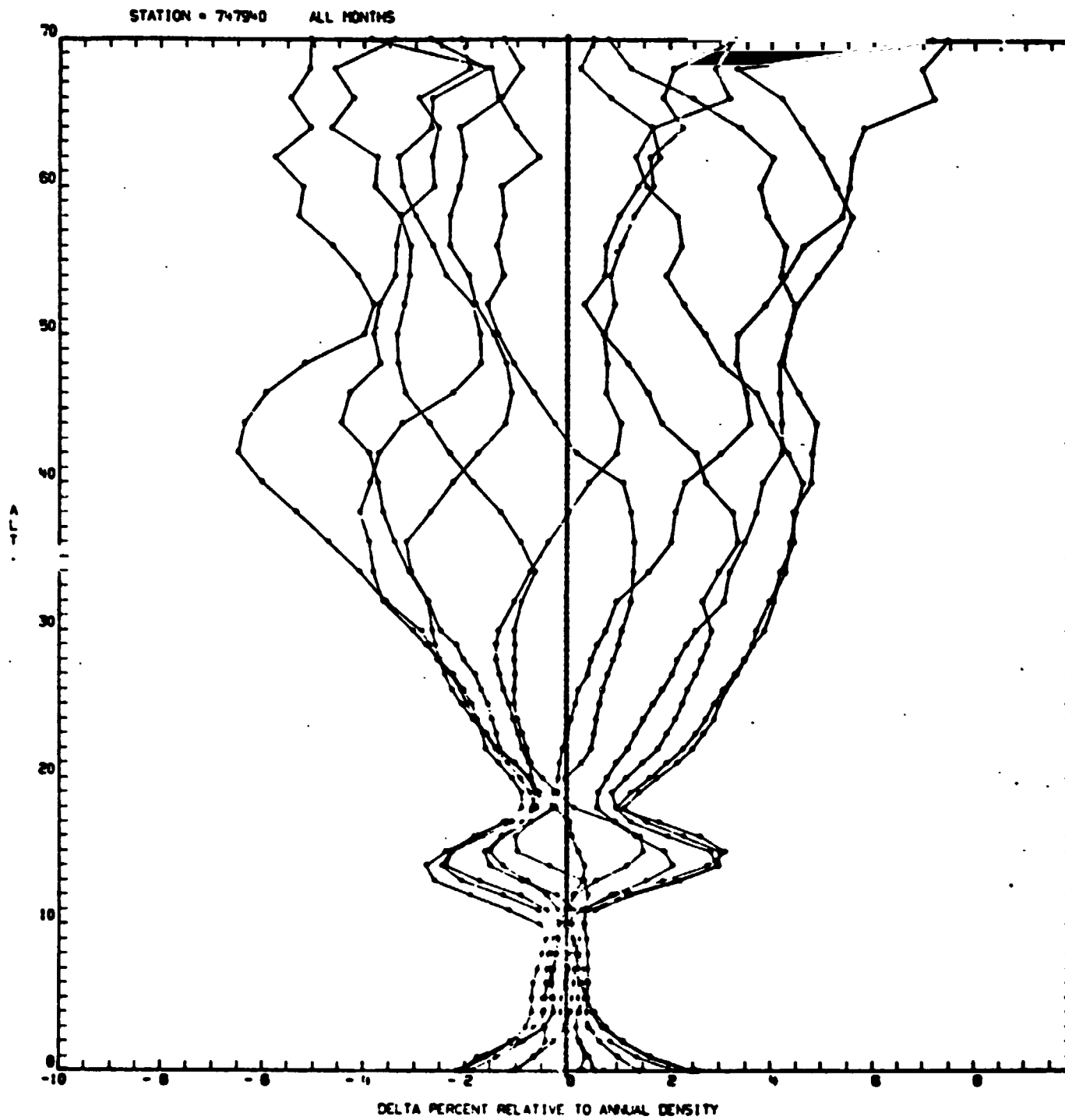

Figure B-10

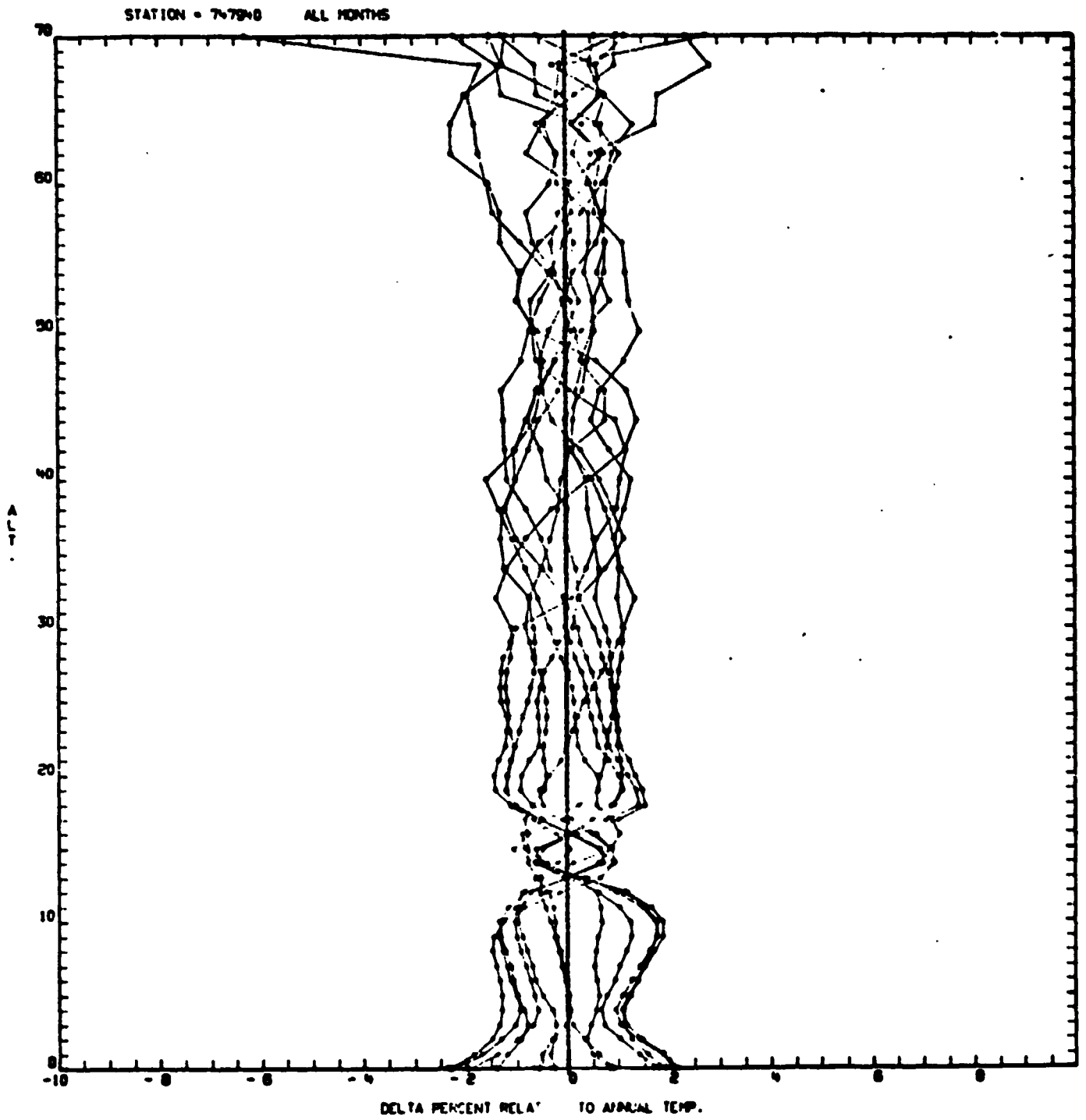

Figure R-11

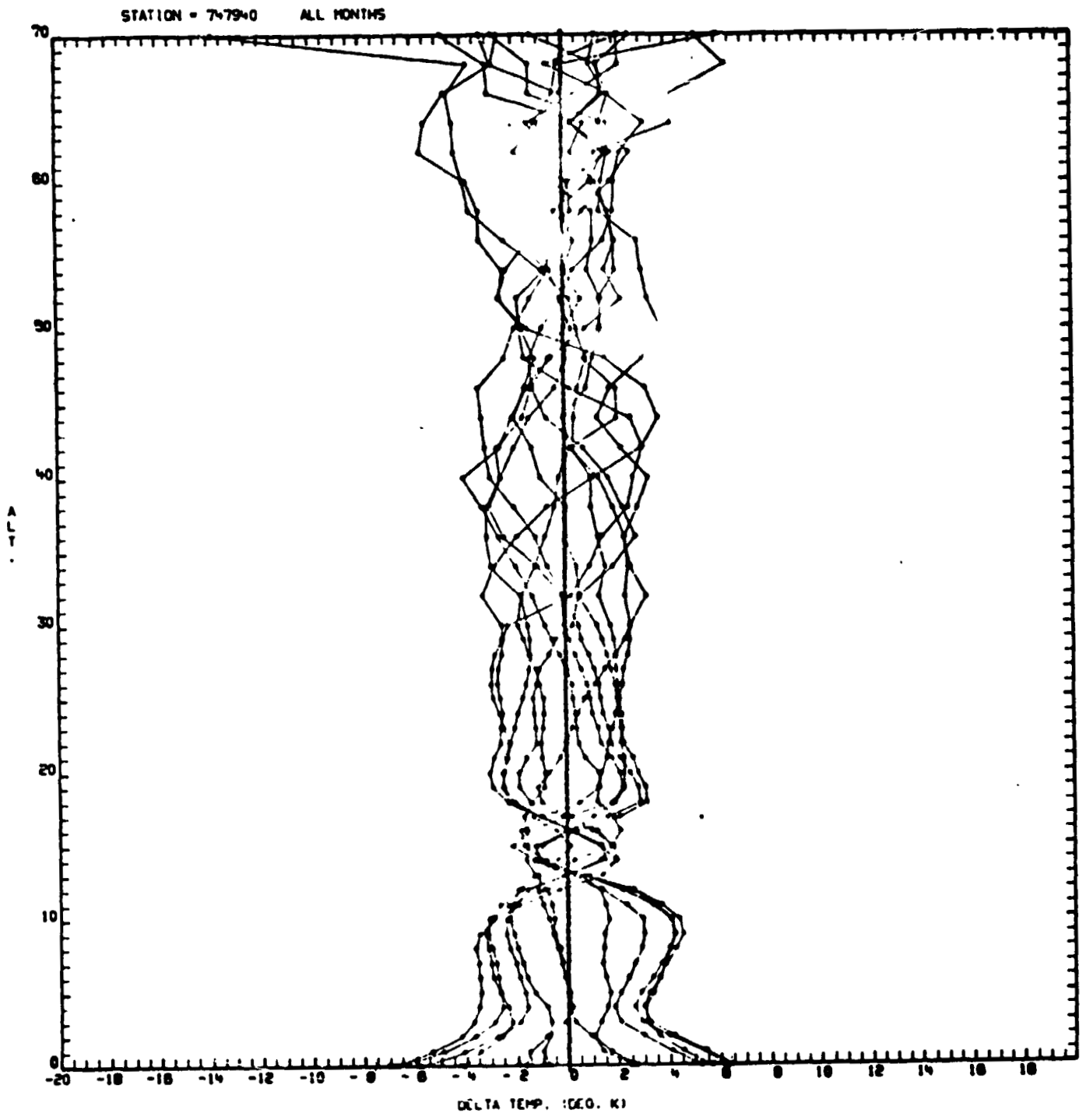

Figure B-12

Table B-4

STATION 747940	MONTH	1								
LEVEL	CVP	CV0	CVT	R(P,T)	R(P,D)	R(T,D)	OCVP	OCV0	OC'T	
.000	.0048	.0235	.0218	-.2695	.4541	-.9804	-.0406	-.0031	-.0066	
.003	.0049	.0235	.0218	-.2604	.4480	-.9799	-.0404	-.0031	-.0066	
1.000	.0050	.0170	.0171	.1613	.1322	-.9569	-.0291	-.0051	-.0049	
2.000	.0056	.0123	.0133	.3947	.0241	-.9090	-.0200	-.0066	-.0049	
3.000	.0064	.0097	.0122	.6175	-.1205	-.8553	-.0155	-.0089	-.0030	
4.000	.0074	.0088	.0124	.7139	-.1583	-.8045	-.0137	-.0110	-.0038	
5.000	.0085	.0083	.0124	.7452	-.0864	-.7277	-.0121	-.0126	-.0044	
6.000	.0098	.0081	.0124	.7563	.0508	-.6150	-.0107	-.0141	-.0055	
7.000	.0110	.0087	.0131	.7497	.1436	-.5472	-.0107	-.0154	-.0067	
8.000	.0123	.0096	.0135	.7254	.2607	-.4754	-.0108	-.0161	-.0084	
9.000	.0136	.0106	.0135	.6938	.3964	-.3856	-.0105	-.0165	-.0107	
10.000	.0149	.0123	.0133	.6279	.5357	-.3209	-.0107	-.0160	-.0139	
11.000	.0161	.0160	.0133	.4196	.6562	-.4096	-.0132	-.0134	-.0188	
12.000	.0165	.0208	.0154	.1549	.6800	-.6190	-.0197	-.0111	-.0218	
13.000	.0167	.0240	.0167	-.0332	.7202	-.7173	-.0239	-.0094	-.0241	
14.000	.0163	.0224	.0137	-.0808	.7922	-.6722	-.0195	-.0079	-.0253	
15.000	.0161	.0226	.0123	-.2492	.8480	-.7246	-.0189	-.0058	-.0263	
16.000	.0154	.0236	.0132	-.3594	.8531	-.7935	-.0214	-.0050	-.0258	
17.000	.0144	.0253	.0154	-.4438	.8368	-.8602	-.0263	-.0045	-.0243	
18.000	.0133	.0259	.0176	-.3955	.7822	-.8816	-.0301	-.0050	-.0216	
19.000	.0123	.0236	.0172	-.2563	.7080	-.8641	-.0285	-.0059	-.0186	
20.000	.0118	.0203	.0159	-.0494	.6211	-.8134	-.0244	-.0074	-.0162	
21.000	.0119	.0177	.0149	.1482	.5503	-.7442	-.0206	-.0092	-.0147	
22.000	.0125	.0159	.0145	.3115	.4997	-.6674	-.0179	-.0110	-.0139	
23.000	.0133	.0144	.0135	.4293	.5187	-.5495	-.0147	-.0126	-.0141	
24.000	.0142	.0142	.0143	.5037	.4946	-.5016	-.0143	-.0143	-.0141	
25.000	.0156	.0139	.0145	.5763	.5176	-.4003	-.0129	-.0162	-.0149	
26.000	.0169	.0138	.0142	.6173	.5882	-.2731	-.0111	-.0173	-.0165	
27.000	.0182	.0149	.0146	.6075	.6278	-.2369	-.0113	-.0179	-.0185	
28.000	.0198	.0168	.0158	.5772	.6388	-.2595	-.0127	-.0189	-.0208	
29.000	.0207	.0175	.0158	.5885	.6098	-.2302	-.0126	-.0190	-.0224	
30.000	.0220	.0187	.0165	.5582	.6626	-.2254	-.0132	-.0198	-.0242	
32.000	.0219	.0225	.0243	.5291	.3999	-.5662	-.0250	-.0237	-.0201	
34.000	.0248	.0265	.0224	.3725	.6196	-.4976	-.0242	-.0207	-.0289	
36.000	.0276	.0327	.0293	.3428	.5380	-.6074	-.0343	-.0243	-.0310	
38.000	.0299	.0340	.0277	.3033	.6315	-.5473	-.0318	-.0235	-.0362	
40.000	.0317	.0252	.0250	.2478	.7247	-.4688	-.0285	-.0215	-.0418	
42.000	.0333	.0358	.0246	.2658	.7494	-.4390	-.0270	-.0221	-.0445	
44.000	.0340	.0359	.0248	.2805	.7494	-.4177	-.0266	-.0230	-.0451	
46.000	.0352	.0387	.0230	.1663	.8109	-.4422	-.0265	-.0135	-.0510	
48.000	.0364	.0376	.0219	.2455	.8263	-.3431	-.0230	-.0207	-.0522	
50.000	.0381	.0396	.0221	.2658	.8334	-.3113	-.0227	-.0216	-.0546	
52.000	.0405	.0396	.0252	.3468	.8017	-.2626	-.0243	-.0261	-.0549	
54.000	.0439	.0403	.0305	.4615	.7393	-.2562	-.0270	-.0342	-.0536	
56.000	.0476	.0417	.0232	.4974	.7944	-.1317	-.0232	-.0351	-.0601	
58.000	.0517	.0433	.0339	.5539	.7592	-.1214	-.0256	-.0422	-.0611	
60.000	.0571	.0442	.0379	.6339	.7485	-.0385	-.0250	-.0508	-.0634	
62.000	.0703	.0492	.0477	.7156	.7356	-.0533	-.0266	-.0688	-.0718	
64.000	.0827	.0549	.0569	.7505	.7283	-.0938	-.0291	-.0847	-.0806	
66.000	.0726	.0507	.0521	.7156	.6974	-.0016	-.0302	-.0740	-.0713	
68.000	.0790	.0559	.0660	.7169	.5670	-.1678	-.0429	-.0892	-.0689	
70.000	.0851	.0598	.0564	.7137	.7505	-.0727	-.0311	-.0817	-.0885	

Table B-5

STATION LEVEL	747940 CVP	MONTH 7 CVO	CVT	RIP,T)	RIP,D)	RIT,D)	DCVP	DCVD	DC'T
.000	.0024	.0111	.0110	.0657	.1502	-.9766	-.0197	-.0023	-.0025
.003	.0024	.0112	.0111	.0719	.1437	-.9767	-.0198	-.0023	-.0025
1.000	.0015	.0046	.0041	.0837	.4624	-.8465	-.0062	-.0019	-.0030
2.000	.0026	.0042	.0039	.2135	.4078	-.8050	-.0056	-.0023	-.0028
3.000	.0027	.0041	.0040	.3203	.3557	-.7715	-.0054	-.0027	-.0028
4.000	.0029	.0047	.0045	.2750	.3540	-.8019	-.0063	-.0028	-.0030
5.000	.0030	.0049	.0049	.2974	.3215	-.8085	-.0067	-.0030	-.0031
6.000	.0033	.0053	.0053	.3292	.2870	-.8101	-.0073	-.0033	-.0032
7.000	.0036	.0051	.0053	.4276	.2490	-.7691	-.0070	-.0040	-.0033
8.000	.0038	.0050	.0064	.4899	.1247	-.8039	-.0082	-.0046	-.0031
9.000	.0044	.0050	.0077	.6205	-.0633	-.8220	-.0093	-.0060	-.0027
10.000	.0051	.0057	.0081	.7131	-.1211	-.7822	-.0088	-.0075	-.0027
11.000	.0060	.0051	.0081	.7785	-.0558	-.6701	-.0071	-.0090	-.0030
12.000	.0067	.0049	.0078	.7823	.1230	-.5219	-.0060	-.0096	-.0038
13.000	.0077	.0067	.0080	.6345	.3961	-.4583	-.0070	-.0090	-.0065
14.000	.0083	.0104	.0093	.3026	.5257	-.6517	-.0115	-.0072	-.0054
15.000	.0093	.0140	.0105	-.0949	.6054	-.8002	-.0162	-.0048	-.0118
16.000	.0081	.0146	.0108	-.1738	.6848	-.8367	-.0172	-.0043	-.0119
17.000	.0080	.0135	.0103	-.0895	.6554	-.8109	-.0159	-.0047	-.0112
18.000	.0090	.0124	.0098	.0384	.6155	-.7639	-.0142	-.0054	-.0108
19.000	.0082	.0107	.0083	.1654	.6405	-.6515	-.0108	-.0059	-.0106
20.000	.0079	.0102	.0076	.1408	.6725	-.6380	-.0099	-.0054	-.0105
21.000	.0081	.0106	.0075	.0913	.7026	-.6444	-.0100	-.0051	-.0111
22.000	.0082	.0039	.0067	.1246	.7427	-.5719	-.0084	-.0050	-.0114
23.000	.0084	.0100	.0059	.1531	.7336	-.5593	-.0053	-.0053	-.0115
24.000	.0086	.0102	.0076	.2028	.6908	-.5679	-.0032	-.0059	-.0113
25.000	.0097	.0098	.0074	.2717	.6889	-.5104	-.0084	-.0063	-.0112
26.000	.0091	.0097	.0075	.3187	.6847	-.4726	-.0082	-.0068	-.0113
27.000	.0093	.0100	.0082	.3460	.6385	-.5011	-.0090	-.0075	-.0111
28.000	.0097	.0093	.0073	.4286	.7093	-.3328	-.0069	-.0077	-.0118
29.000	.0104	.0107	.0090	.3991	.6331	-.4571	-.0094	-.0087	-.0120
30.000	.0107	.0100	.0080	.4650	.7020	-.3040	-.0073	-.0088	-.0121
32.000	.0145	.0133	.0148	.5952	.4354	-.4543	-.0135	-.0162	-.0130
34.000	.0178	.0156	.0125	.5165	.7261	-.2136	-.0103	-.0147	-.0208
36.000	.0177	.0168	.0152	.4815	.6155	-.3945	-.0143	-.0160	-.0194
38.000	.0197	.0179	.0157	.5076	.6250	-.3188	-.0139	-.0175	-.0219
40.000	.0231	.0213	.0170	.4692	.7112	-.2870	-.0152	-.0188	-.0275
42.000	.0244	.0231	.0180	.4379	.7157	-.3145	-.0167	-.0193	-.0296
44.000	.0260	.0270	.0217	.3732	.6651	-.4446	-.0226	-.0208	-.0313
46.000	.0281	.0274	.0186	.3688	.7747	-.3020	-.0179	-.0194	-.0369
48.000	.0299	.0252	.0170	.5372	.8229	-.0372	-.0123	-.0217	-.0381
50.000	.0322	.0232	.0186	.4907	.8185	-.0999	-.0146	-.0226	-.0418
52.000	.0352	.0283	.0222	.5743	.7774	-.0685	-.0159	-.0285	-.0419
54.000	.0387	.0308	.0239	.6059	.7869	-.0142	-.0160	-.0318	-.0456
56.000	.0425	.0350	.0267	.5691	.7785	-.0732	-.0193	-.0342	-.0508
58.000	.0462	.0415	.0315	.5247	.7636	-.1490	-.0248	-.0382	-.0583
60.000	.0505	.0436	.0363	.5368	.7108	-.2119	-.0294	-.0432	-.0577
62.000	.0544	.0450	.0390	.5785	.7077	-.1668	-.0296	-.0483	-.0604
64.000	.0582	.0520	.0424	.5113	.7091	-.2540	-.0362	-.0485	-.0678
66.000	.0467	.0519	.0423	.3231	.6363	-.5244	-.0475	-.0371	-.0563
68.000	.0538	.0463	.0655	.7151	.1499	-.5239	-.0580	-.0730	-.0346
70.000	.0738	.0516	.0760	.7629	.3076	-.3805	-.0538	-.0982	-.0495

STATION = 747940 MONTH = 1

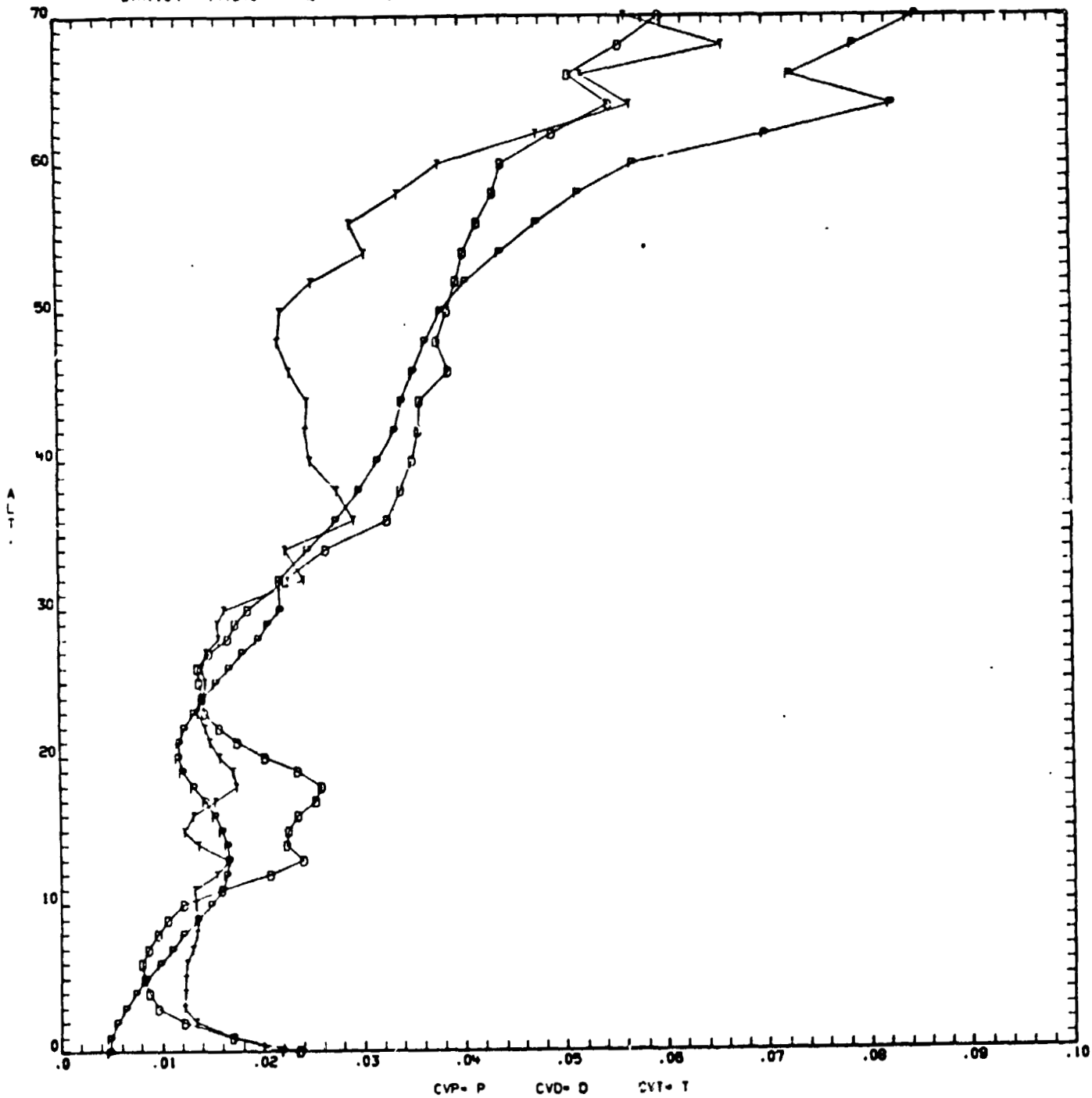

Figure B-13

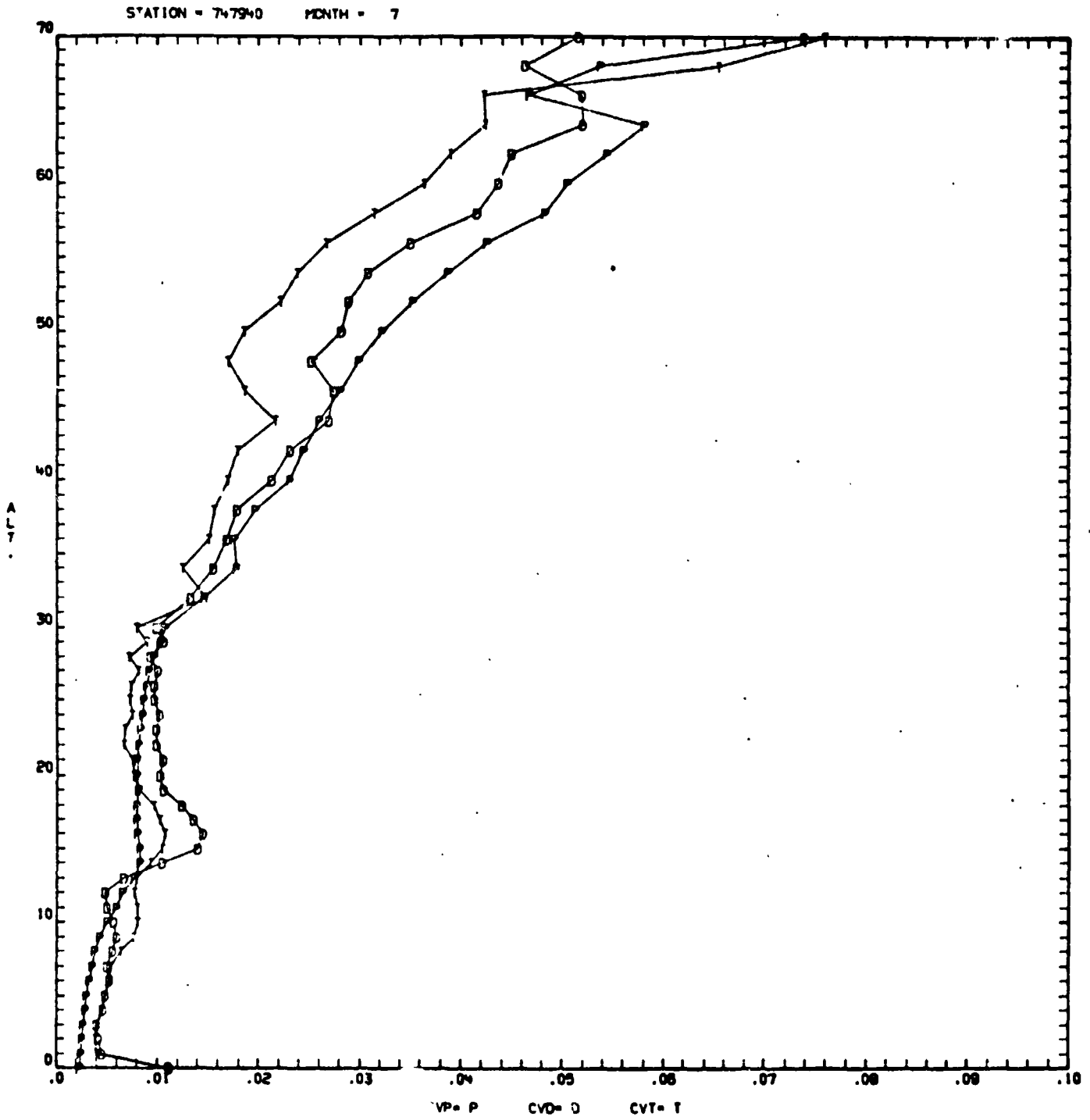

Figure B-14

STATION = 7479+0 MONTH = 1

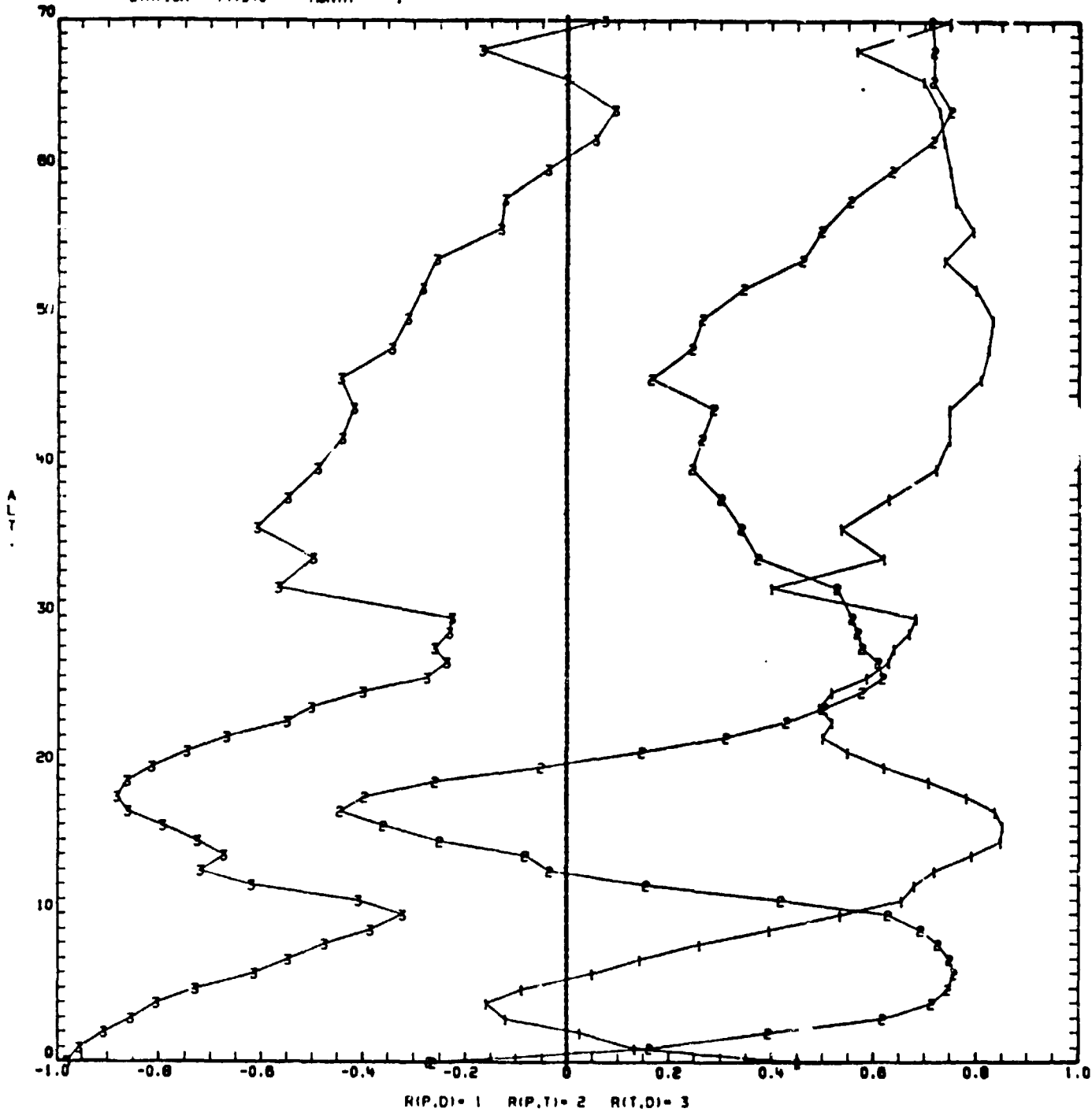

Figure B-15

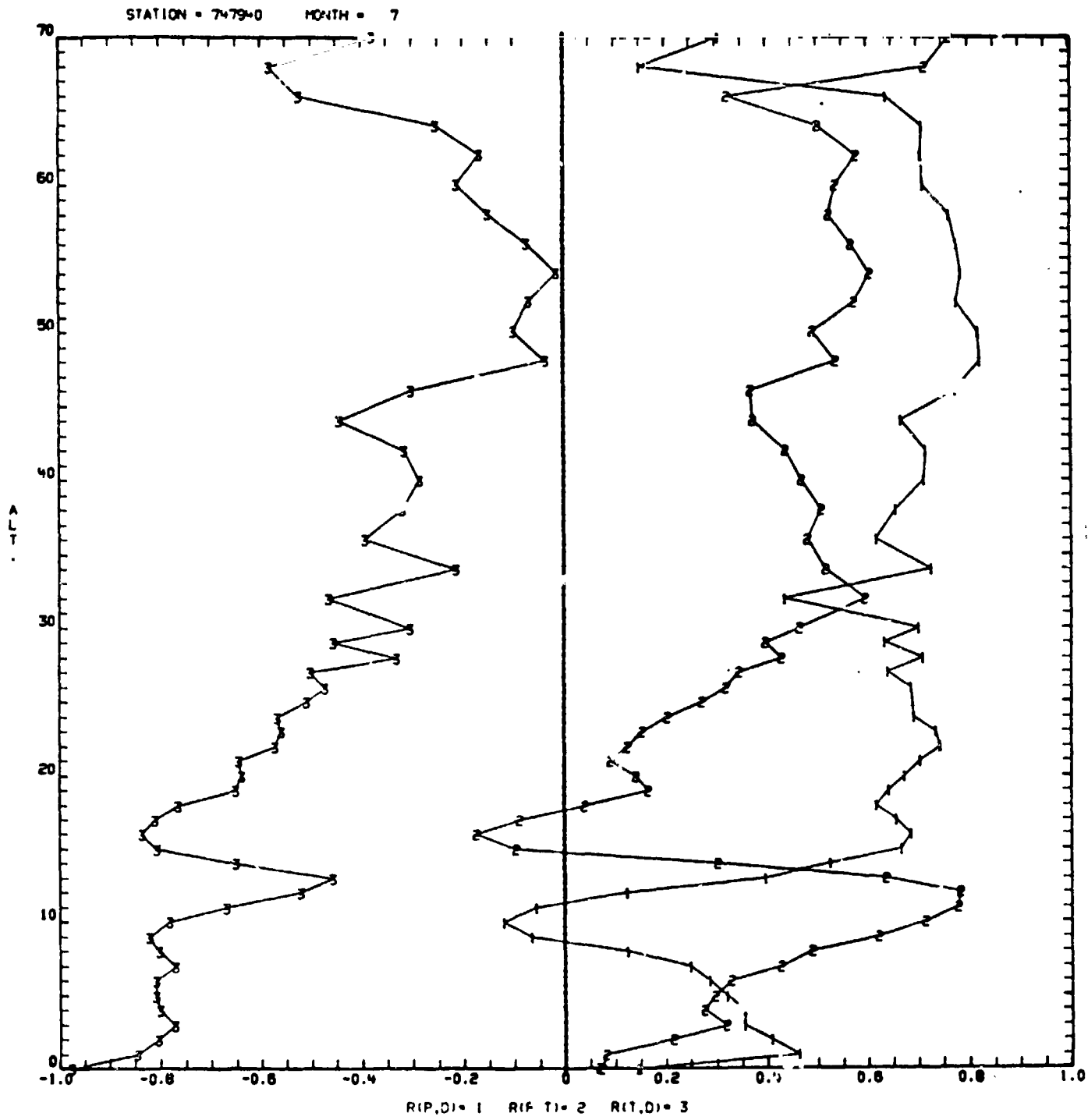

Figure B-16

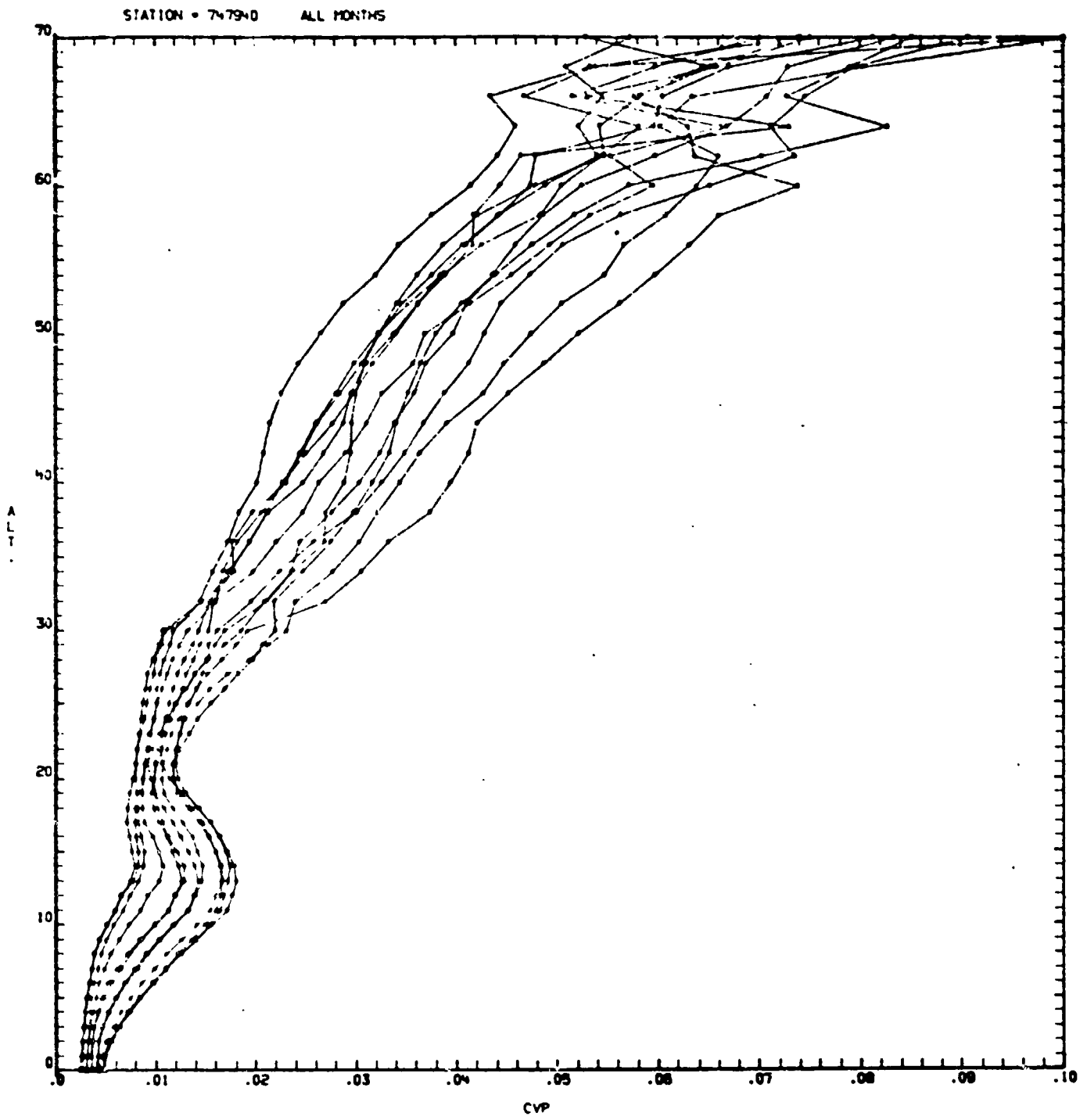

Figure B-17

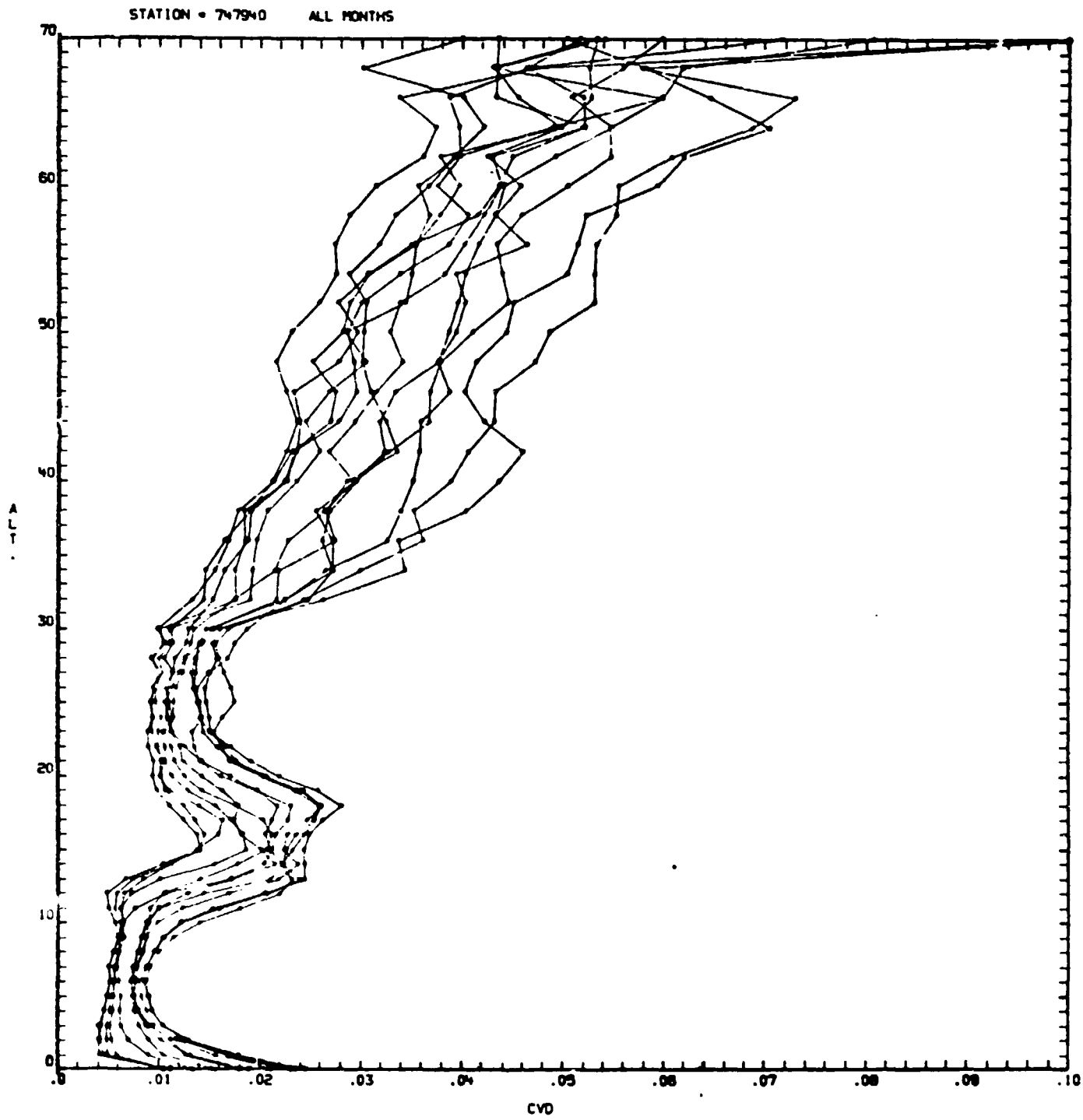

Figure E-18

STATION = 747940 ALL MONTHS

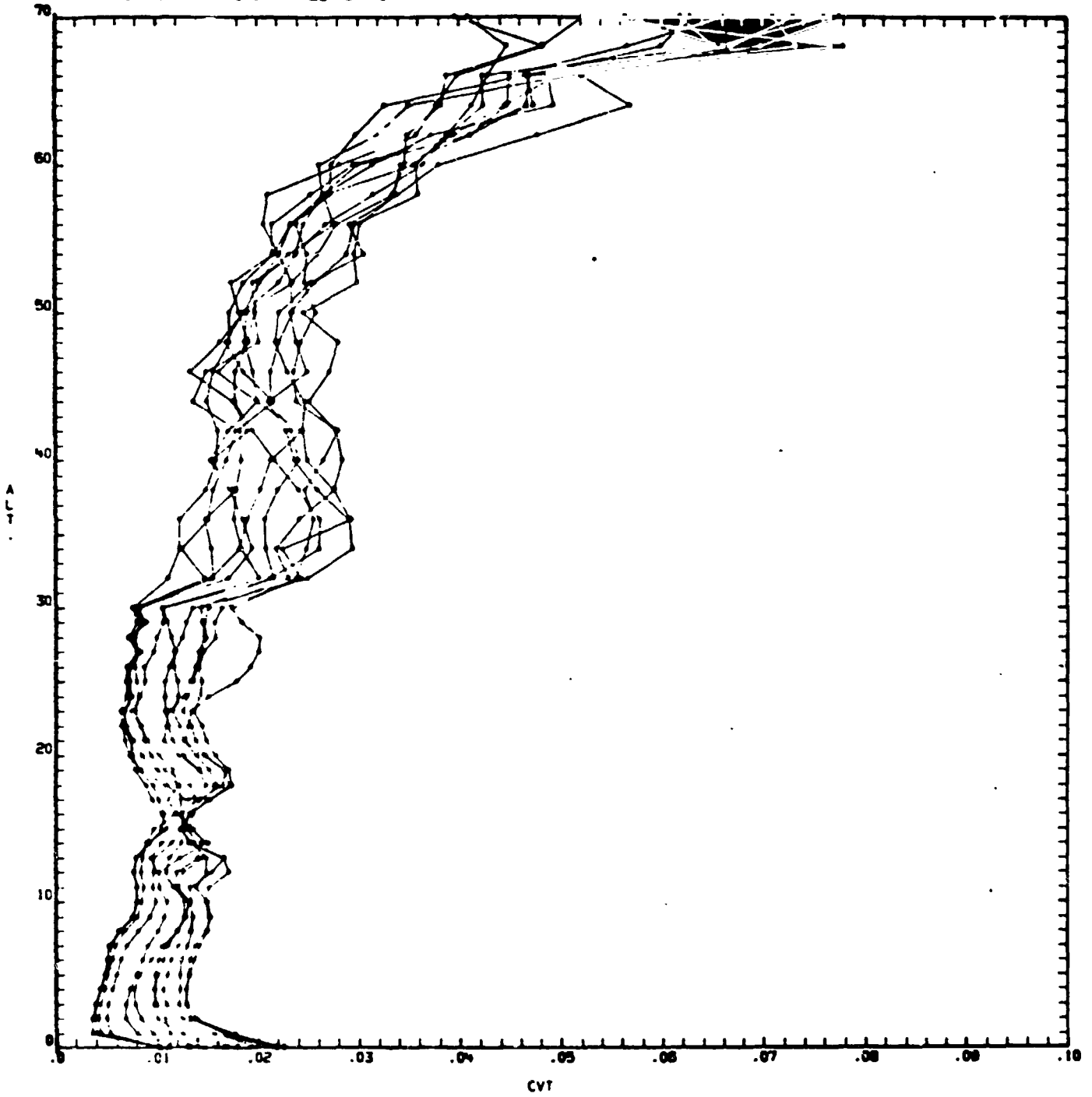

Figure B-19

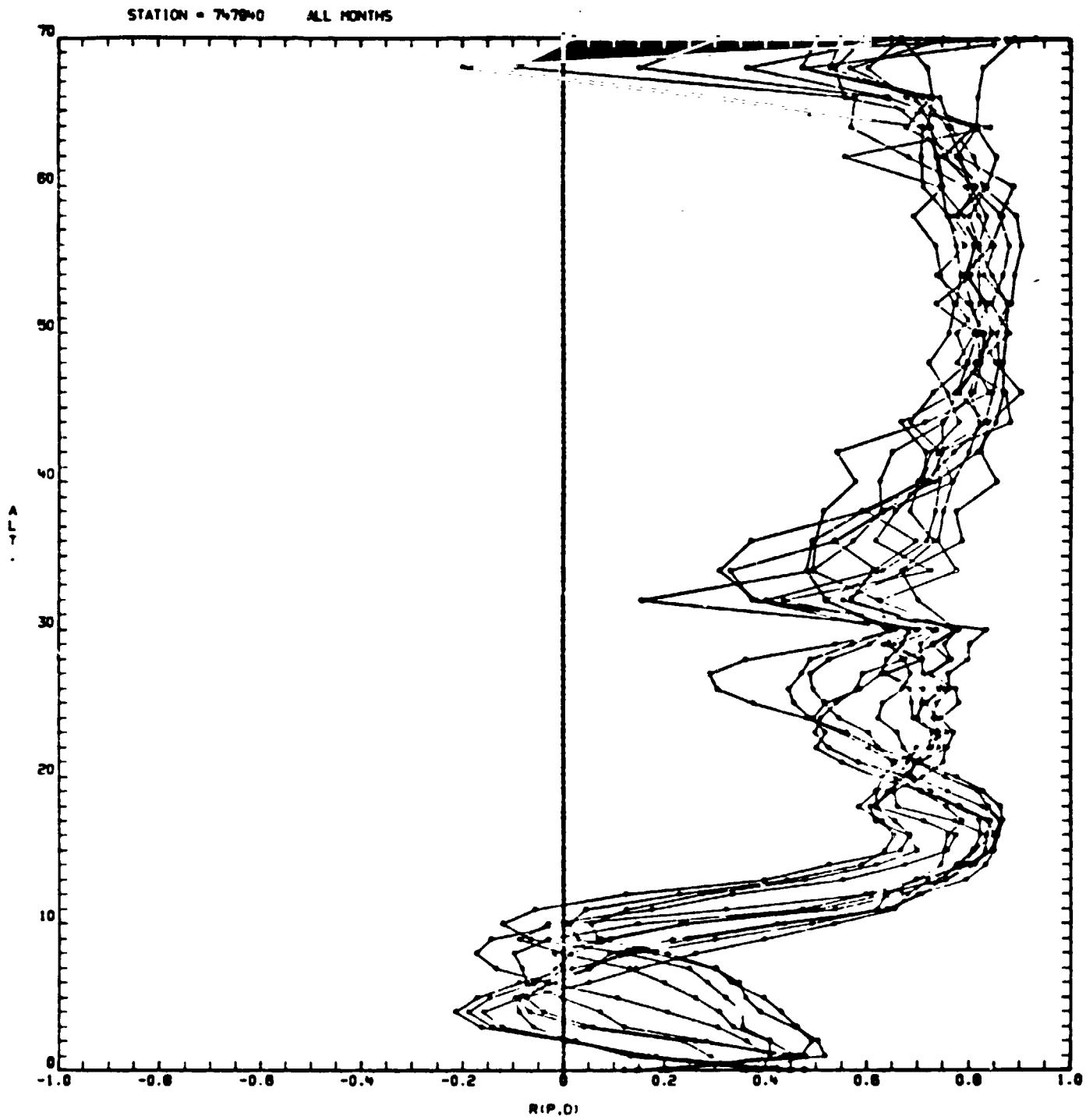

Figure B-20

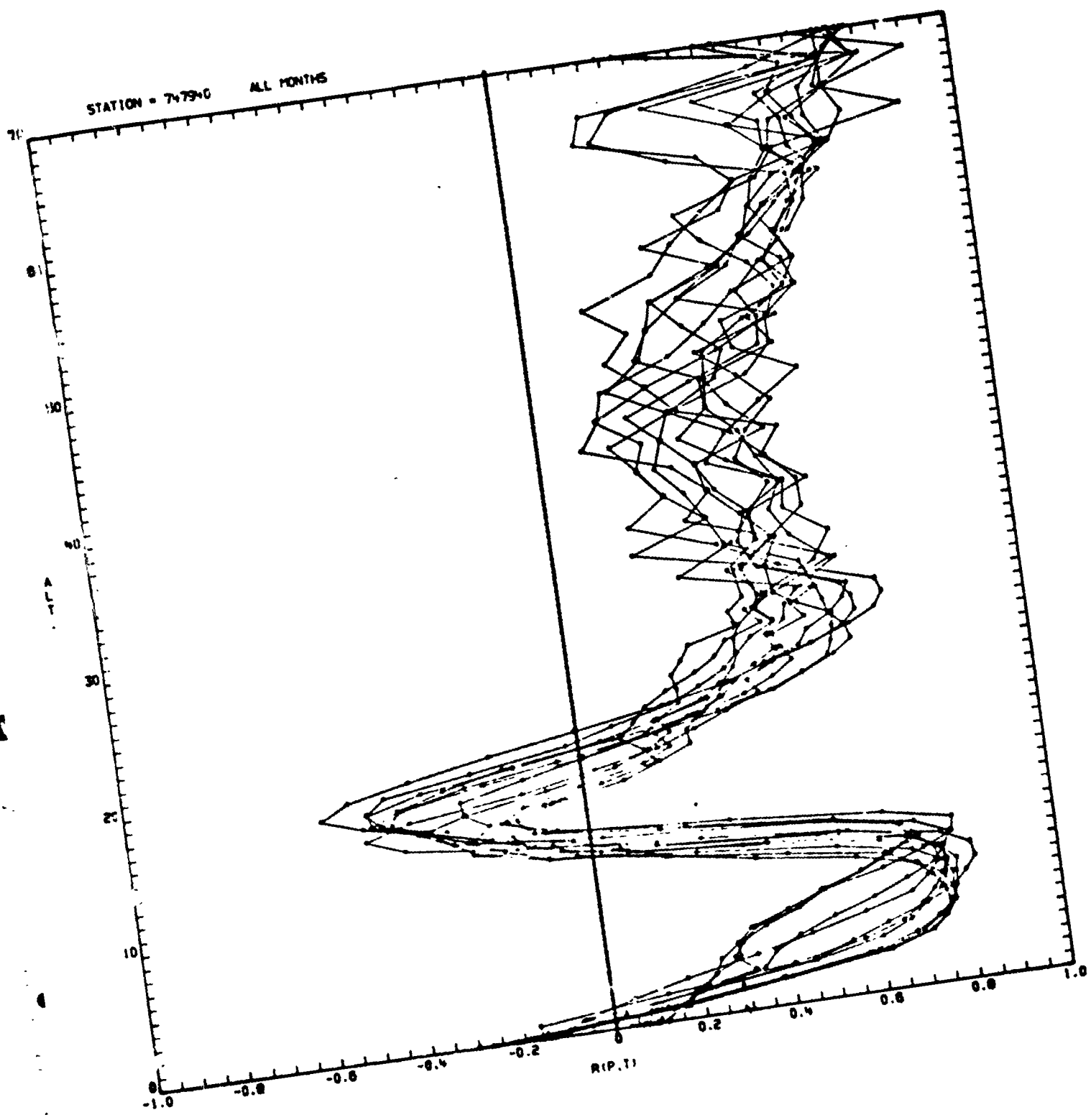

Figure B-21

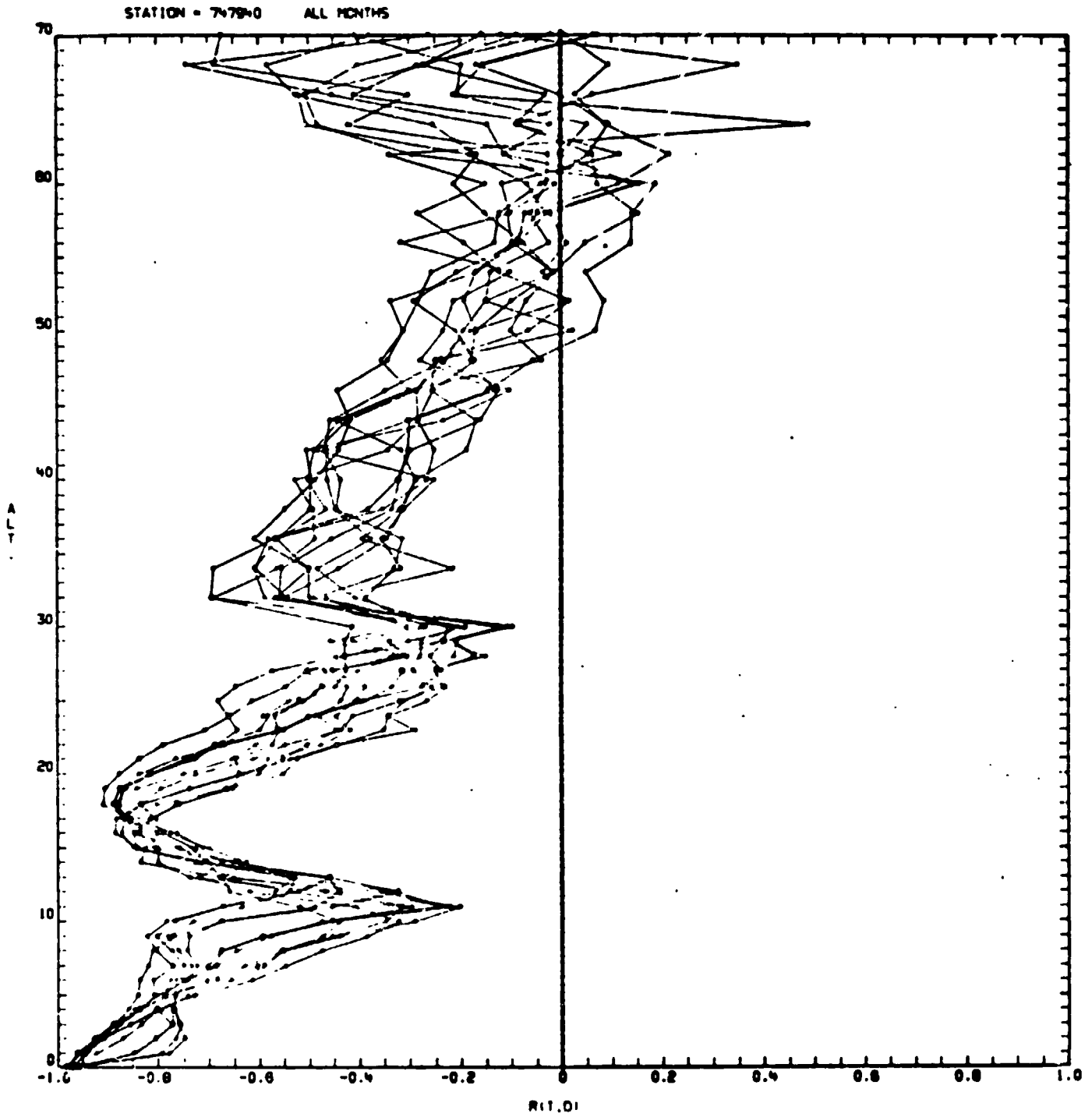

Figure B-22