

LASER INDUCED ASYMMETRY AND INHOMOGENEOUS BROADENING
OF THE MICROWAVE LINESHAPE OF A GAS CELL
ATOMIC FREQUENCY STANDARD

J.C. Camparo, R.P. Frueholz and C.H. Volk
Chemistry and Physics Laboratory
The Aerospace Corporation
P.O. Box 92957, Los Angeles, CA 90009

ABSTRACT

Recently, there has been interest in the possibility of replacing the rf discharge lamp in a rubidium gas cell clock with a single mode laser diode. Since the short term stability of the rubidium frequency standard is limited by the shot noise of the photodetector, an increased signal-to-noise ratio due to more efficient laser diode optical pumping might improve the short term performance. Because the emission wavelength of the laser diode can be tuned, improved long term performance could be gained through the control of the light shift effect. However, due to the nature of the gas cell frequency standard, various physical phenomena are strongly coupled in their effect on the frequency output, and thus careful consideration must be given to any change in one parameter because of its interrelation with other parameters. We report here some investigations concerning the coupled effect of the optical and microwave fields in the rubidium atomic clock. We show that this type of coupling is an important consideration for any attempt to incorporate a laser diode into a gas cell clock.

INTRODUCTION

Laser diodes have been proposed for use in atomic frequency standards because of the potential for improved clock performance.¹⁻⁶ In particular, in the gas cell frequency standard, the use of a laser diode in place of the conventional rf discharge lamp should increase the signal-to-noise ratio and thus produce better short term stability, while drastically reducing the detrimental effects due to the light shift.^{1,3,4} These projections of laser pumped clock performance must be tempered by the possibility of new effects that could arise due to the intense optical pumping provided by lasers. We report here our investigations into laser induced asymmetries and broadening of the rubidium microwave lineshape. These effects are important both in determining and understanding the optimum conditions for laser optical pumping.

A schematic diagram of a typical gas cell clock is shown in Figure 1. Some of the more important elements in the physics package of this device include: i). the source of optical pumping radiation; ii). the light filter; iii). the absorption cell; iv). the microwave cavity; and, v). the externally applied axial magnetic field.

Traditionally, an rf discharge lamp has been used as the optical pumping source. The limitations in these lamps include: stability,⁷ reliability,^{7,8} tunability and limited light intensity due to size constraints. Additionally, light from a discharge lamp must be filtered to achieve optimum optical pumping, and this filtering necessitates either a separate filter cell,⁹ mixed isotopes in the absorption cell,¹⁰ a lamp filter combination,¹¹ or magnetic tuning.¹² Conversely, a laser diode can provide an intense tunable light beam which, because of its narrow spectral linewidth, would eliminate the need for light filtering. Also, the tunable nature of the laser diode would allow for the possibility of either eliminating or controlling light induced frequency shifts that arise from a spectral offset between the pumping radiation and the absorption lines.

The microwave lineshape, which controls the clock's performance, has complex dependencies on various physical phenomena that occur in the absorption cell. The optical pumping radiation, the buffer gas, the microwave power and distribution in the cavity, the magnetic field and the thermal environment all affect the size and the shape of the microwave line. As a result of the inhomogeneous nature of the microwave line, the effects of various parameters on the clock performance are coupled.¹³ Thus, a change in one parameter, e.g. the pumping light intensity, designed to improve performance could result in degraded performance due to an incomplete understanding of the way these parameters affect the microwave lineshape and center frequency. In this present study we consider the coupled effect of the optical and microwave fields on the incorporation of a laser diode in a gas cell frequency standard.

EXPERIMENTAL

The experimental apparatus is shown schematically in Figure 2. The absorption cell of an Efratom FRK-L rubidium frequency standard¹⁴ is illuminated by the emission from a single mode diode laser, Mitsubishi ML-4001, which is tuned to one of the ⁸⁷Rb D₁ hyperfine resonance lines (794.7 nm). We measure the lineshape by ramping the frequency of a VCXO through the hyperfine resonance and monitoring the light transmitted through the absorption cell. The VCXO is linear and carefully calibrated which allows us to convert VCXO voltage directly to frequency. The microwave field is chopped with a diode switch at a few Hz, and a lock-in amplifier is used to enhance signal-to-noise on each sweep. Typically, sixteen repetitive scans, taking about two minutes each, are averaged with the aid of an HP 9825 computer. We estimate about 5 Hz accuracy in the lineshapes with this method.

We do not have a direct measure of the strength of the microwave field in the cavity. Multiplication up to the microwave frequency from the nominal VCXO frequency is accomplished using a 'step-recovery' diode. Ideally, the microwave power in the Nth harmonic is expected to be:¹⁵

$$P_N = P_0/N \quad (1)$$

where P₀ is the input power to the step-recovery diode. However, the coupling coefficients between the diode and the cavity antenna, and the cavity antenna

and the cavity, will modify Eq. (1). We believe that a reasonable estimate of the microwave power in the cavity is on the order of $10 \mu\text{W}$.

The spectral linewidth of the ML 4001 diode laser, measured with a Fabry-Perot interferometer, was found to be about 100 MHz. The laser's wavelength could be tuned to either of the Doppler broadened hyperfine absorption lines, $\Delta\nu_D \sim 500$ MHz, by varying either the diode temperature or injection current. The diode laser is heat sunk into a copper block whose temperature is stabilized and controlled by a thermistor in one leg of a bridge circuit, which controls the current through a solid-state thermoelectric device. In this manner, the diode laser's center frequency can be held to less than 100 MHz of the center of the hyperfine absorption line for about 30 minutes without active stabilization of the laser diode.

Typically, the laser is tuned by first adjusting the temperature so that the lasing wavelength is near the Rb D_1 line at 794.7 nm. The injection current is then used as a fine control to tune the laser over the hyperfine absorption spectrum, and as long as lasing mode hops do not occur, the injection current can be calibrated to the lasing frequency. This is found to be approximately 16 GHz/mA. Since the laser's single mode output power is a function of the injection current, the laser power will vary as the laser is tuned. However, the fractional change in power is found to be only about 1% as the laser is tuned over several GHz, and thus the variations in laser power are neglected for these measurements. The typical total laser power in the single mode line is found to be about 3 mW in a Gaussian beam diameter of ~ 0.45 cm.

RESULTS

In Figure 3 we present representative samples of our microwave lineshape measurements. The upper lineshapes correspond to low incident laser intensity, $\sim 0.5 \text{ mW/cm}^2$, for several different detunings of the laser frequency. From left to right these are -420 MHz, 0 and $+420$ MHz. The lower curves were observed with full laser intensity, $\sim 10 \text{ mW/cm}^2$. The frequency axis indicates the total scan of the microwaves from some arbitrary start frequency, and $\Delta\nu_{\text{hfs}}$ denotes the shift of the center frequency of the microwave line from that found for zero laser detuning, shown in both the upper and lower center scans. From the figure it is apparent that for higher laser intensities the microwave lineshape is asymmetric when the laser is tuned off resonance, and that this asymmetry has the same sign as the light shift. Furthermore, this asymmetry is correlated to the recently observed non-linearity of the clock's light shift.¹⁶ In Figure 4 we have plotted the microwave frequencies corresponding to a lineshape's peak and first moment as a function of laser intensity (the laser detuning was ~ -400 MHz). The difference between these two frequencies can be considered as a measure of the asymmetry of the line. It should be noted that the asymmetry and non-linearity become significant for the same light intensity levels. This is more than coincidental; it is the result of both effects being due to light induced inhomogeneous broadening, and in this type of broadening the light intensity and microwave field strength act together to produce the shape and center frequency of the observed resonance line.

DISCUSSION

We have recently developed a lineshape model for the gas cell clock which describes optical pumping with a spectrally narrow, low intensity laser source (i.e. low with respect to the intensity necessary to saturate the optical transition).¹⁶ Since the typical gas cell clock uses a buffer gas in the absorption cell, we consider the atoms in our model as being essentially frozen in place due to the presence of this buffer. Atoms in different regions of the cell experience different local light intensities and different local microwave field strengths. The observed lineshape, and thus the shape that controls clock performance, is a superposition of regional transmission signals which are determined by the local parameters. The local light intensity and magnetic field strength determine the local resonance frequency through the light shift effect and second order magnetic field dependence, respectively; the combined effect of the local light intensity and the local Rabi frequency, determined by the microwave field strength, determines the amplitude of the regional transmission signal. In Figure 5 we present the calculated microwave lineshape in a TE₁₁₁ cavity for both low and high laser intensity, off-resonance pumping. In Figure 6 we show the calculated inhomogeneous light shift for several values of laser detuning. The close agreement between the theoretical model and our experimental results demonstrates the significance of light induced inhomogeneous broadening on the clock signal.

In practice the calculation of the clock lineshape is performed numerically by summing all the regional transmission signals as a function of microwave frequency. Though this is an accurate and straightforward procedure for obtaining the lineshape, it does not readily lend itself to an intuitive understanding of the relationships among the parameters in the problem. In this context we therefore consider the effect of the local parameters on the homogeneous lineshape.

It is quite easy to show that the amplitude of a regional transmission signal can be written approximately as:

$$S = I_{\text{trans}}(\Delta\omega=\infty) - I_{\text{trans}}(\Delta\omega=0) \sim \frac{\Gamma/2}{\Gamma+\gamma} \left[\frac{\omega_1^2}{(\Gamma + \gamma)^2 + \omega_1^2} \right] \quad (2)$$

where some constants have been omitted for clarity.¹⁷ In the above

- I_{trans} = the transmitted light intensity,
- $\Delta\omega$ = microwave frequency detuning from the hyperfine resonance,
- Γ = optical pumping rate,
- γ = relaxation rate (we assume the longitudinal rate is equal to the transverse rate), and
- ω_1 = microwave Rabi frequency.

The regional behavior of S is reflected in the fact that both Γ and ω_1 have spatial dependencies.

It is important to realize that the complexity of the problem in obtaining the total transmitted intensity is not due to the form of Eq. (2), but to the fact

that the pumping rate, and hence the light shift, in the n^{th} region of the cell depends on the transmission from the $n-1$ previous regions:

$$S_n(r, \theta) = f(S_1(r, \theta), S_2(r, \theta), \dots, S_{n-1}(r, \theta)) \quad (3)$$

However, we can gain qualitative information on the processes that determine the total transmission signal by considering the regional transmission signals at a particular axial position.

In Figure 7 we have plotted the regional transmission signal S as a function of (Γ/ω_1) for several different values of (γ/ω_1) . If we consider for example the case where $\gamma = 0.1\omega_1$, we see that the maximum transmission signal will occur for $\Gamma \sim 0.4\omega_1$, (i.e. not for arbitrarily large Γ). This implies that an increased pumping rate does not immediately guarantee larger signal amplitude and thus improved signal-to-noise. Rather, it is the ratio of Γ to ω_1 that is the important parameter. Furthermore, since the peak of the inhomogeneous lineshape corresponds to the largest amplitude homogeneous lineshape, and since this in turn is a function of both Γ and ω_1 , it follows that the inhomogeneous light shift is a function of Γ and ω_1 .

Let's now consider the radial dependence of Γ and ω_1 explicitly; we assume a Gaussian laser beam, and a TE_{111} microwave cavity:

$$I(r) = I_p \exp(-4 \ln^2(r/a)^2), \quad (4a)$$

$$\Gamma(r) = \Gamma_p \exp(-4 \ln^2(r/a)^2), \quad (4b)$$

$$\omega_1(r) = \omega_{1p} \lambda J_1(1.841(r/R)), \quad (4c)$$

where I is the light intensity, r is the radial position in the cell, a is the laser beam diameter, R is the cavity radius, λ is a normalizing factor and all quantities are related to their peak values, denoted by the subscript p . Substituting these expressions into Eq. (2), we have plotted the normalized transmission signal amplitude as a function of radial position within the cavity in Figure 8. The three different curves correspond to three different values of (Γ/ω_{1p}) assuming that $\gamma = 0.1\omega_{1p}$ and $(R/a)=2$. As we would have expected from Figure 7 if we consider Γ_p as fixed, then as ω_{1p} varies the radial position giving the maximum signal amplitude changes. Since these radial positions correspond to different light intensity levels, we have the so called position shift effect.¹³ Thus, the position shift effect is just one consequence of the coupled effect of Γ and ω_1 when light induced inhomogeneous broadening determines the clock lineshape.

It should now be understood that it is both Γ and ω_1 that determine the asymmetry observed in the present experiments. The distribution in Γ determines the distribution of homogeneous lineshapes; the ratio of Γ to ω_1 determines the envelope. It should be noted that even though no asymmetry was observed for on-resonance pumping, an asymmetry may be present due to the hyperfine splitting in the excited state of ^{87}Rb . Since the excited state hyperfine splitting is on the order of the Doppler linewidth, the absorption lines partially overlap and off-resonance pumping to some degree is unavoidable.

Operating on-resonance, moreover, increases the slope of the light shift forcing tighter constraints on the frequency control of the laser diode.³

SUMMARY AND CONCLUSIONS

We have observed a gross asymmetry in the microwave lineshape of a gas cell clock when pumping off resonance with a laser diode. This asymmetry, along with the non-linearity of the clock's light shift and the position shift effect, can be explained by a model based on light induced inhomogeneous broadening of the hyperfine transition.

In this model the light intensity and microwave field strength cannot be regarded as acting independently in their effect on the observed lineshape. Thus, the anticipated changes in clock performance on changing either of these parameters must be tempered by an appraisal of their combined effect. The significance of the asymmetry on actual clock performance, and the constraints it will place on laser optical pumping schemes is still unclear. However, its observation and interpretation lead to some rather important considerations. Since the inhomogeneous microwave lineshape has a center frequency and amplitude which depend both on the light intensity and microwave field strength, this could imply that many of the advantages of laser diode pumping may not be fully realized with the standard clock design. If this is the case, it might be advantageous to design a laser diode pumped clock with a bufferless wall coated cell, most likely a cesium cell in a TE_{011} cavity,¹⁸ which would have a homogeneous microwave line. However, with a bufferless cell one would have the additional complication of radiation trapping. Finally, since light induced inhomogeneous broadening is so significant in laser diode pumping, and since there is reason to believe that it is also important for the standard lamp pumping;¹³ it may be possible to extrapolate results from these laser diode studies to the regime of the lamp, and thus gain a better understanding of the mechanisms which limit the standard gas cell clock's performance.

REFERENCES

1. F.L. Walls, "Prospects for Advances in Microwave Atomic Frequency Standards," Proceedings of the 11th Annual Precise Time and Time Interval Applications and Planning Meeting; Greenbelt, Maryland; p. 619 (1979).
2. M. Arditi and J.L. Picque, "A Cesium Beam Atomic Clock Using Laser Optical Pumping. Preliminary Tests." J. de Phys. Lett. 41, L370 (1980).
3. L.L. Lewis and M. Feldman, "Optical Pumping by Lasers in Atomic Frequency Standards," Proceedings, 35th Annual Symposium on Frequency Control, US Army Electronics Command, Ft. Monmouth, N.J. pp. 612-624, (1981).
4. C.H. Volk, J.C. Camparo and R.P. Frueholz, "Investigations of Laser Pumped Gas Cell Atomic Frequency Standard," Proceedings of the 13th Annual Precise Time and Time Interval Applications and Planning Meeting; Greenbelt, Maryland; p. 631 (1981).
5. M. Arditi, "Microwave Ramsey Pattern in a Laser Pumped Cesium Beam, Application to Velocity Distribution and 2nd Order Doppler-Shift in Frequency Standard," J. de Phys. Colloque C-8, 42, 261 (1981).
6. L.L. Lewis, M. Feldman and J.C. Berquist, "Impact of Lasers on Primary Frequency Standards and Precision Spectroscopy," J. de Phys. Colloque C-8, 42, 271 (1981).
7. H. Oyamada, K. Takahashi, Y. Sato and H. Uchida, "A Consideration of Rubidium Lamp Stability for Rubidium Frequency Standard," Proceedings 28th Annual Frequency Control Symposium, US Army Electronics Command, Ft. Monmouth, N.J. pp. 340-343 (1974).
8. R.P. Frueholz, M. Wun-Fogle, H.U. Eckert, C.H. Volk and P.F. Jones, "Lamp Reliability Studies for Improved Satellite Rubidium Frequency Standard," Proceedings of the 13th Annual Precise Time and Time Interval Applications and Planning Meeting; Greenbelt, Maryland (1981).
9. M.E. Packard and B.E. Swartz, "The Optically Pumped Rubidium Vapor Frequency Standard," IRE Trans. on Instr. I-22, 215 (1962).
10. E. Jechart, "Miniature Rubidium Gas Cell Frequency Standard," Proceedings, 27th Annual Symposium on Frequency Control, US Army Electronics Command, Ft. Monmouth, N.J., p. 387 (1973).
11. N. Kuramochi, S. Naritsuka and N. Oura, "Composite-Type ⁸⁷Rb Optical-Pumping Light Source," Opt. Lett. 6, 73 (1981).
12. G. Rovera, A. De Marchi and J. Vanier, "The Optically Pumped Passive Cesium Frequency Standard: Basic Theory and Experimental Results on Buffer Gas Frequency Shifts," IEEE Trans. Instr. and Meas. IM-25, 203 (1976).

13. A. Risley and G. Busca, "Effect of Line Inhomogeneity on the Frequency of Passive Rb⁸⁷ Frequency Standards," Proceedings, 32nd Annual Symposium on Frequency Control, US Army Electronics Command, Ft. Monmouth, N.J. pp. 506-513 (1978).
14. Manufactured by Efratom California, Inc.
15. Hewlett-Packard Application Note, #913, "Step Recovery Diode Frequency Multiplier Design."
16. J.C. Camparo, R.P. Frueholz and C.H. Volk, "The Inhomogeneous Light Shift in Alkali Atoms," (submitted for publication in Phys. Rev.).
17. L.C. Balling, "Optical Pumping," Advances in Quantum Electronics, (Academic Press, N.Y., 1975).
18. A. Risley, S. Jarvis and J. Vanier, "The Dependence of Frequency Upon Microwave Power of Wall-Coated and Buffer-Gas-Filled Gas Cell Rb⁸⁷ Frequency Standards," J. Appl. Phys. 51, 4571 (1980); H.G. Robinson and C.E. Johnson, "Narrow ⁸⁷Rb Hyperfine-Structure Resonances in an Evacuated Wall-Coated Cell," Appl. Phys. Lett. 40, 771 (1982); R.P. Frueholz, C.H. Volk and J.C. Camparo, "The Use of Wall Coated Cells in Atomic Frequency Standards" (submitted for publication in J. Appl. Phys.).

FIGURE CAPTIONS

- 1) Schematic diagram of a typical gas cell clock. B_0 represents the externally applied magnetic field, with its direction indicated by the arrow.
- 2) Experimental set up for determining clock lineshape.
- 3) Experimental results of the clock's lineshape when pumping with a laser diode. The top row of lineshapes correspond to low laser intensity ($\sim 0.5 \text{ mW/cm}^2$), the bottom row to high laser intensity ($\sim 10 \text{ mW/cm}^2$). The frequency axis indicates the total scan of the microwaves from some arbitrary start frequency, and $\Delta\nu_{\text{hfs}}$ denotes the shift of the center frequency of the microwave line from that found for zero laser detuning.
- 4) Frequency of the peak and first moment of the laser pumped clock lineshape for a laser detuning of $\sim -400 \text{ MHz}$. The difference between these two curves is a measure of the lineshape's asymmetry; the change in the frequency of the lineshape's peak corresponds to the clock's light shift.
- 5) Calculated clock lineshapes for low and high laser intensity, laser detuning of -411 MHz .
- 6) Calculated clock light shift for several detunings of the laser. From top to bottom these are -411 MHz , -201 MHz and $+219 \text{ MHz}$.
- 7) Relative transmission signal amplitude for a homogeneous region in the absorption cell as a function of (Γ/ω_1) for several values of (γ/ω_1) . Γ is the optical pumping rate, ω_1 is the microwave Rabi frequency, and γ is the hyperfine spin relaxation rate.
- 8) Relative transmission signal amplitude at a particular axial position in the absorption cell as a function of radial position within the cavity. Curves for several different values of (Γ/ω_{1p}) are shown. Γ_p and ω_{1p} are the peak values of the optical pumping rate and the microwave Rabi frequency, respectively.

Schematic Diagram of Typical Gas Cell Frequency Standard

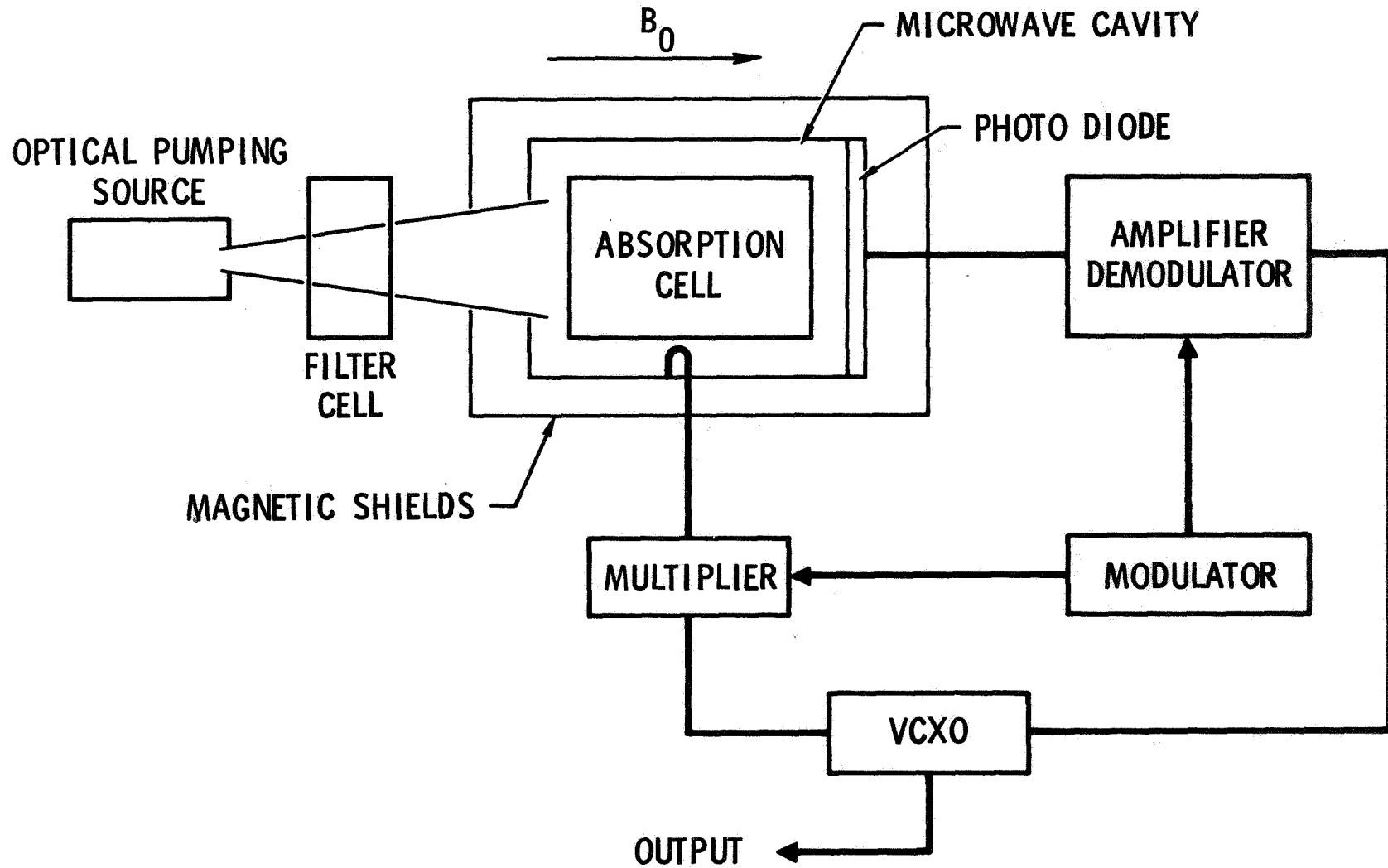

122

Figure 1



Apparatus for Lineshape Measurements

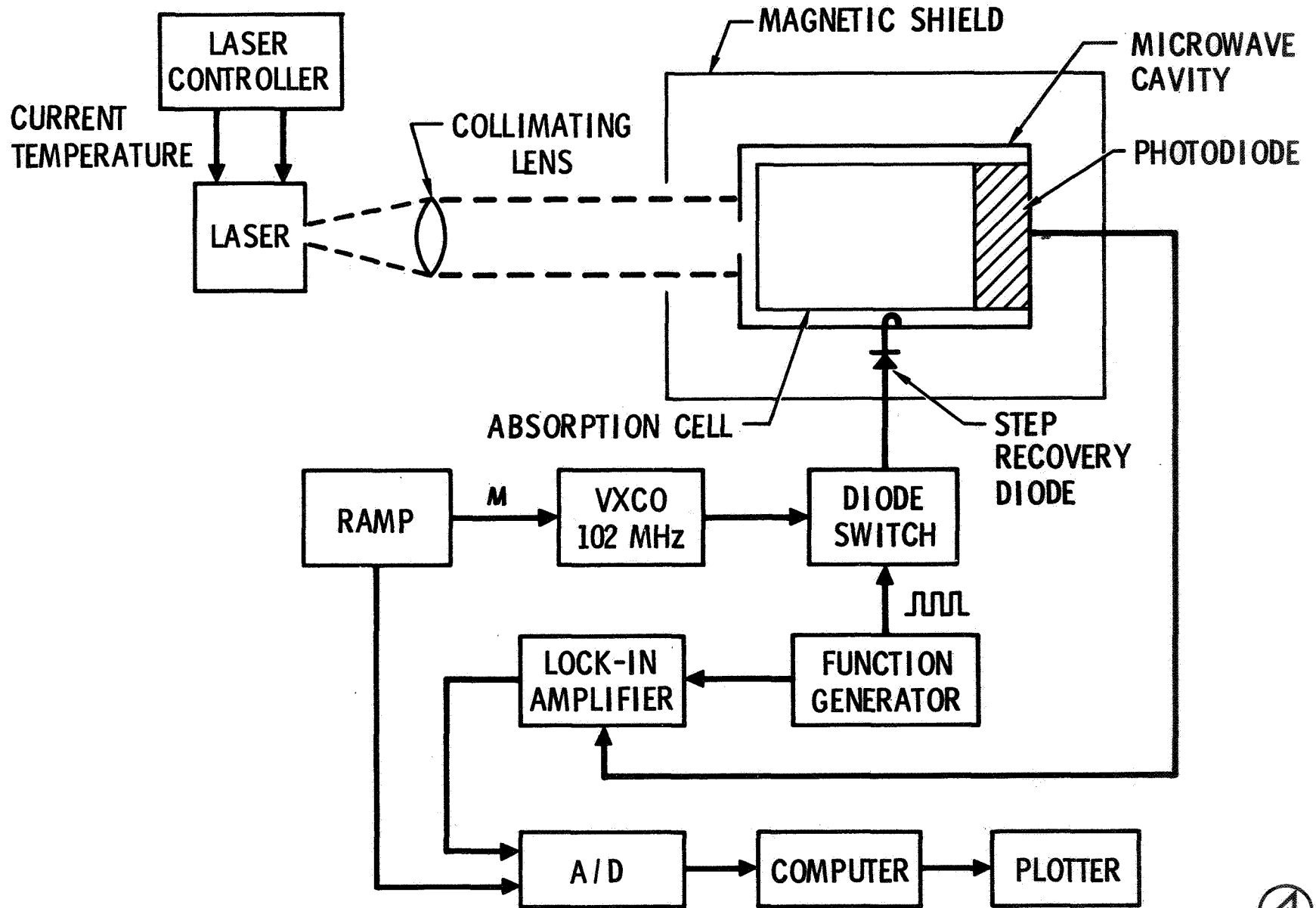

123

Figure 2



Observed Clock Lineshapes

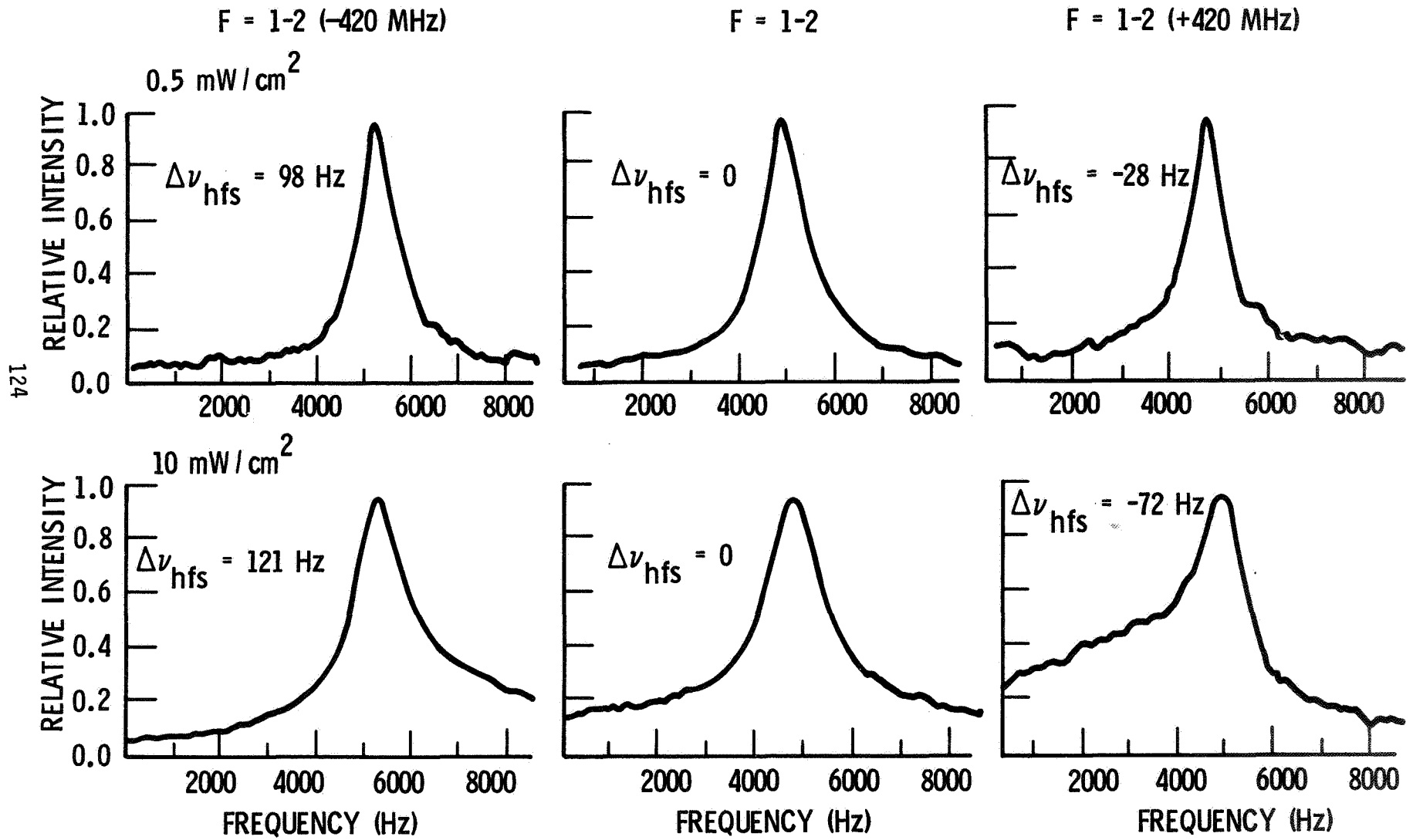

Figure 3



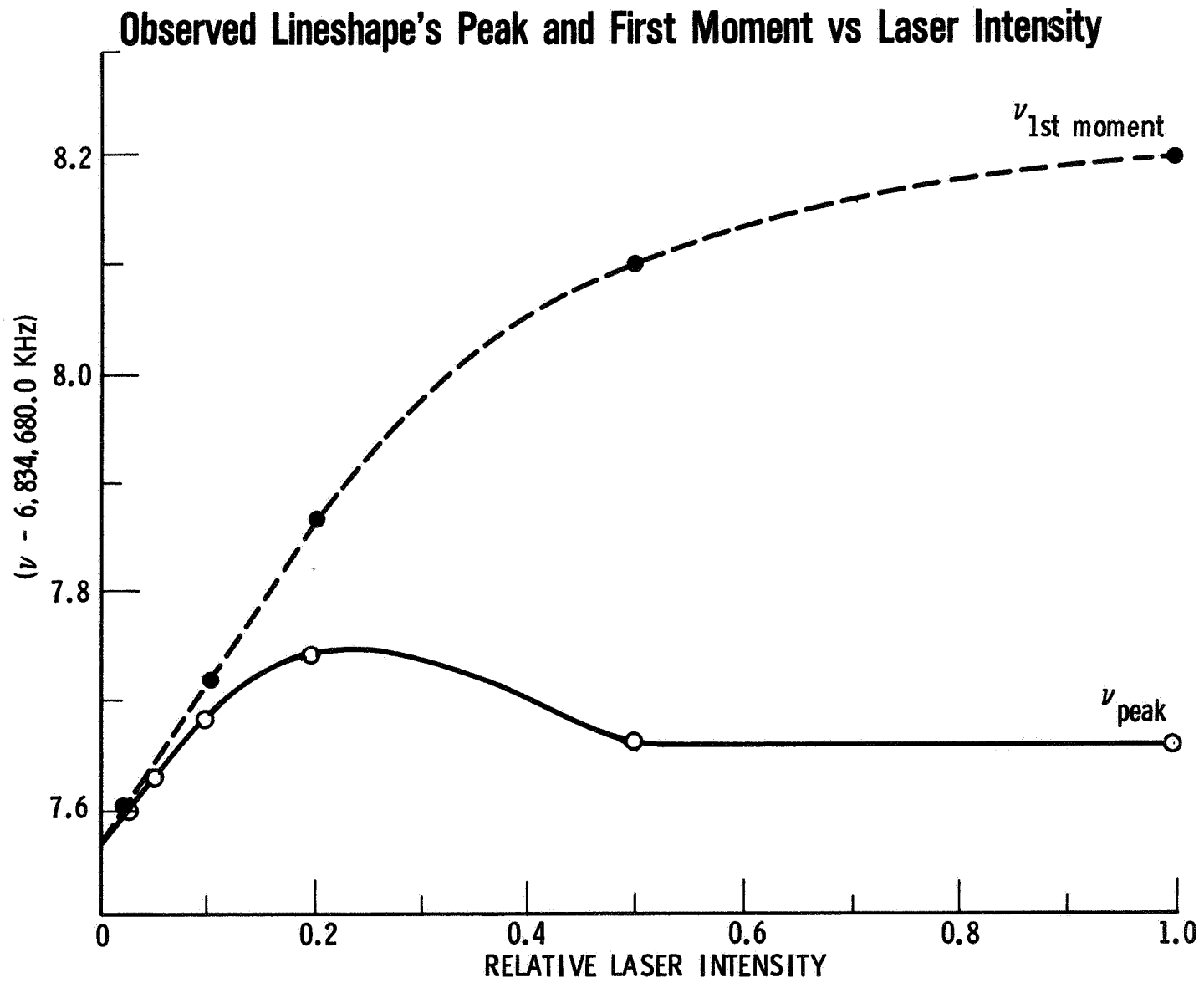
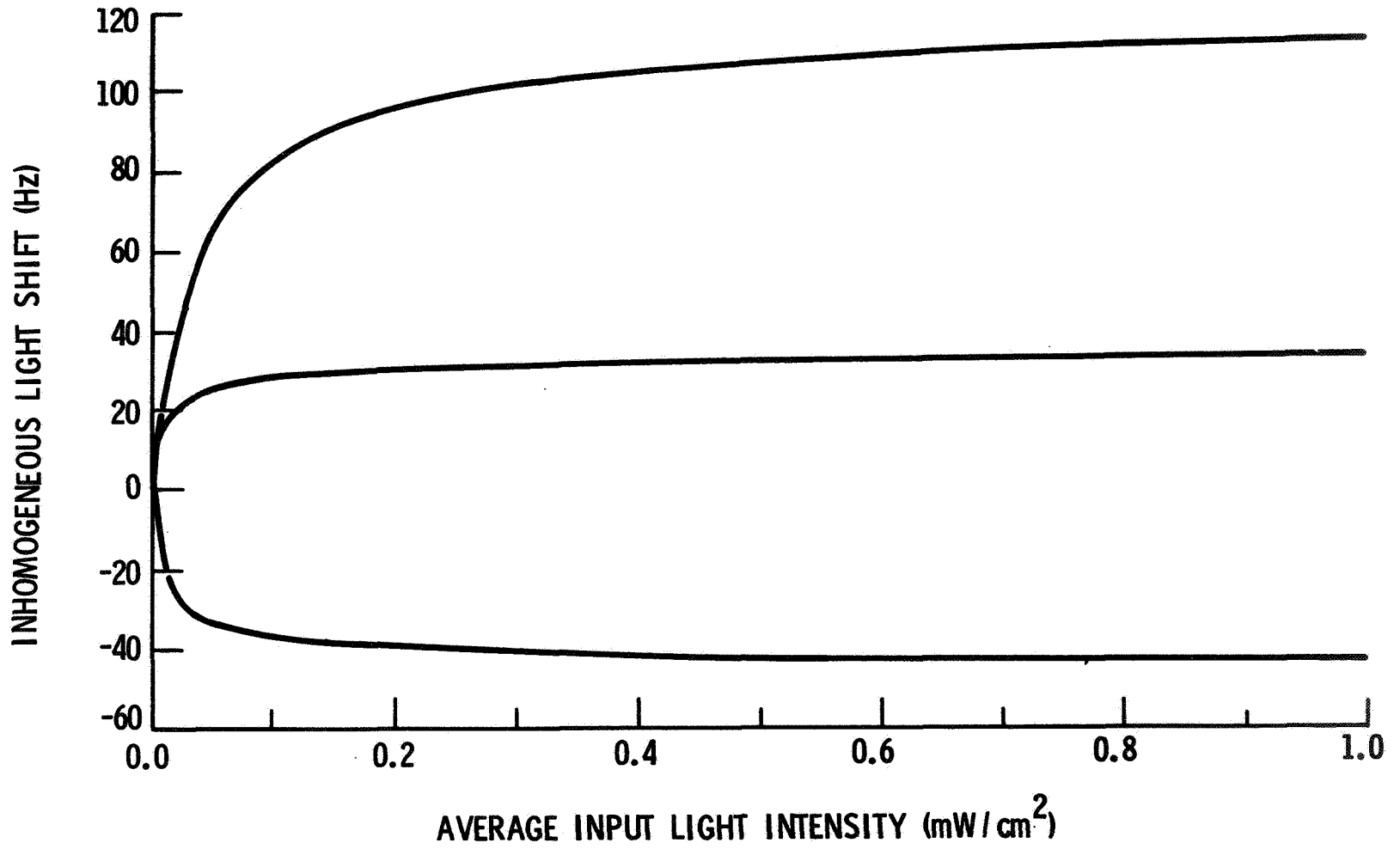

Figure 4

Calculated Inhomogeneous Light Shift



126

Figure 5



Calculated Lineshapes

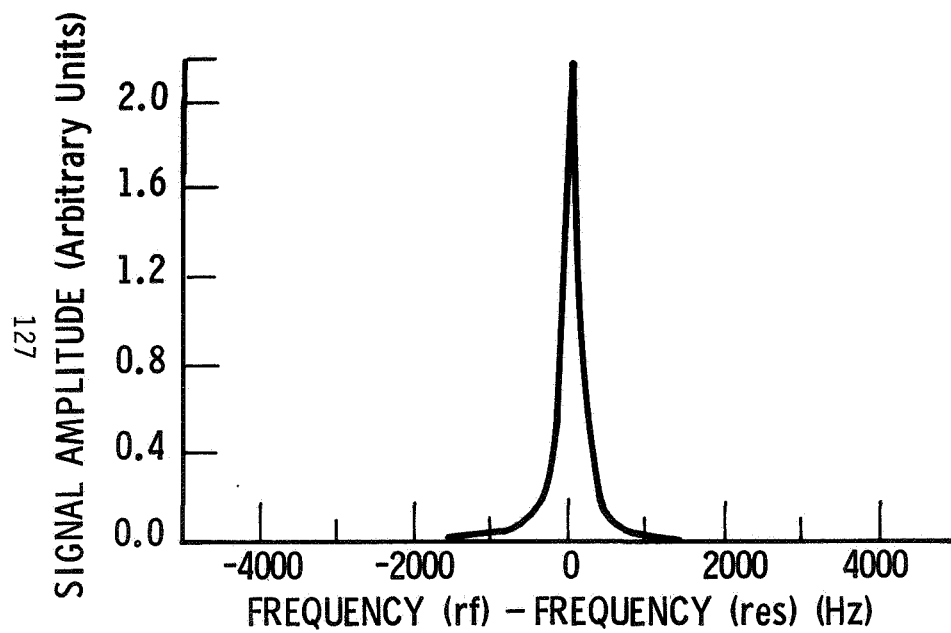

a) $10 \mu\text{W}/\text{cm}^2$

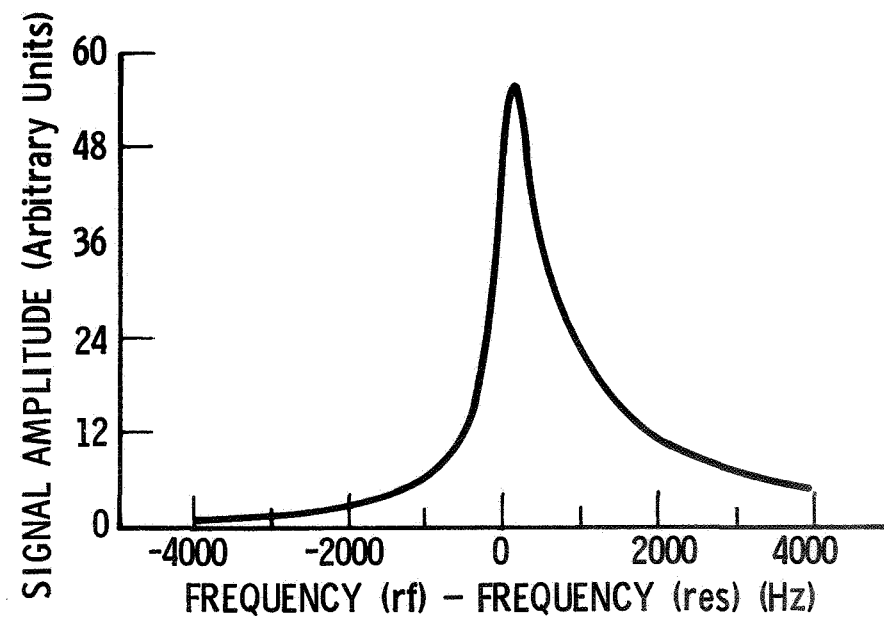

b) $10 \text{mW}/\text{cm}^2$

Figure 6

Transmission Signal Amplitude as a Function of (Γ/ω_1)

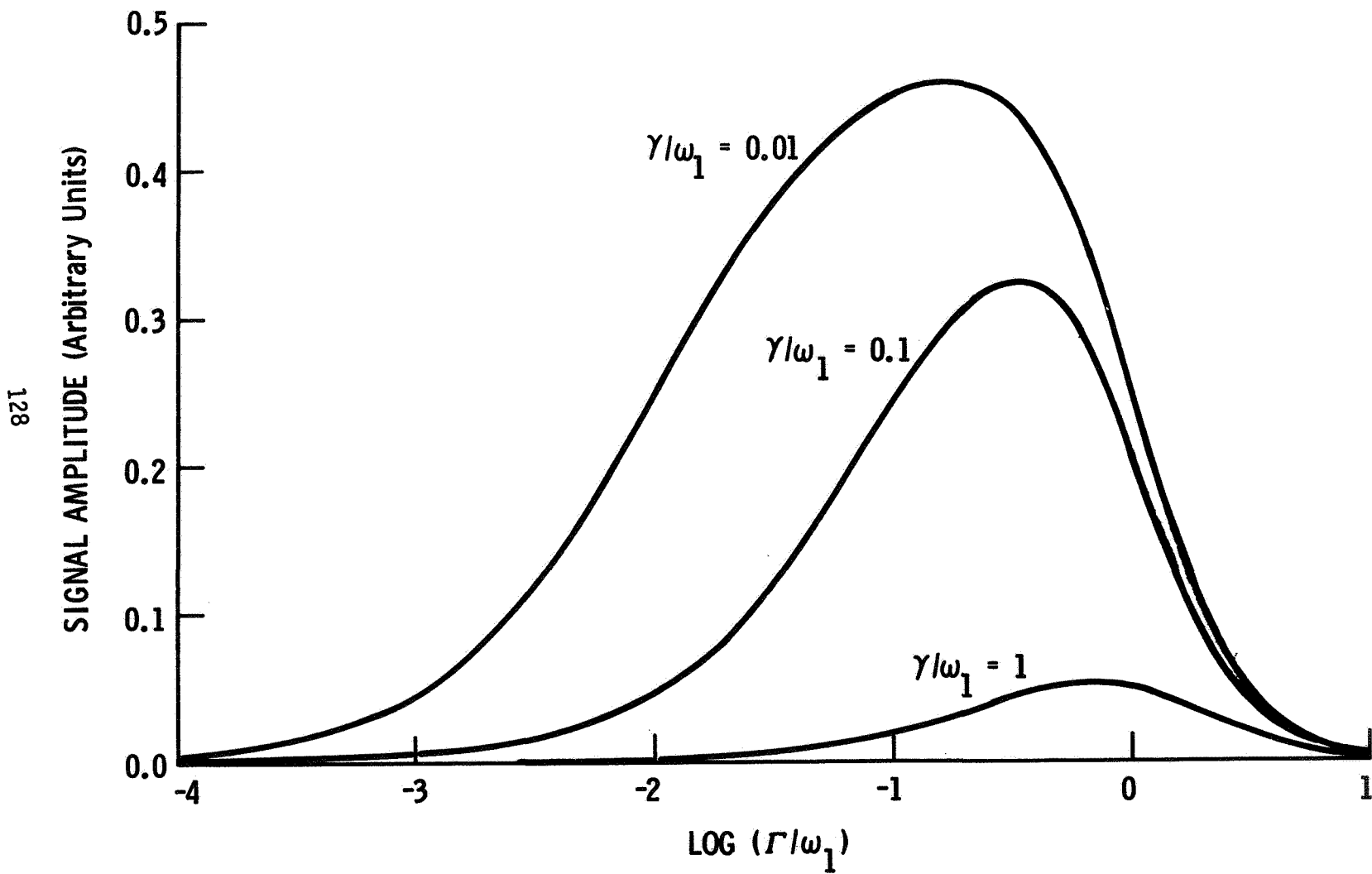

Figure 7



Transmission Signal Amplitude as a Function of Radial Position in the TE₁₁₁ Cavity

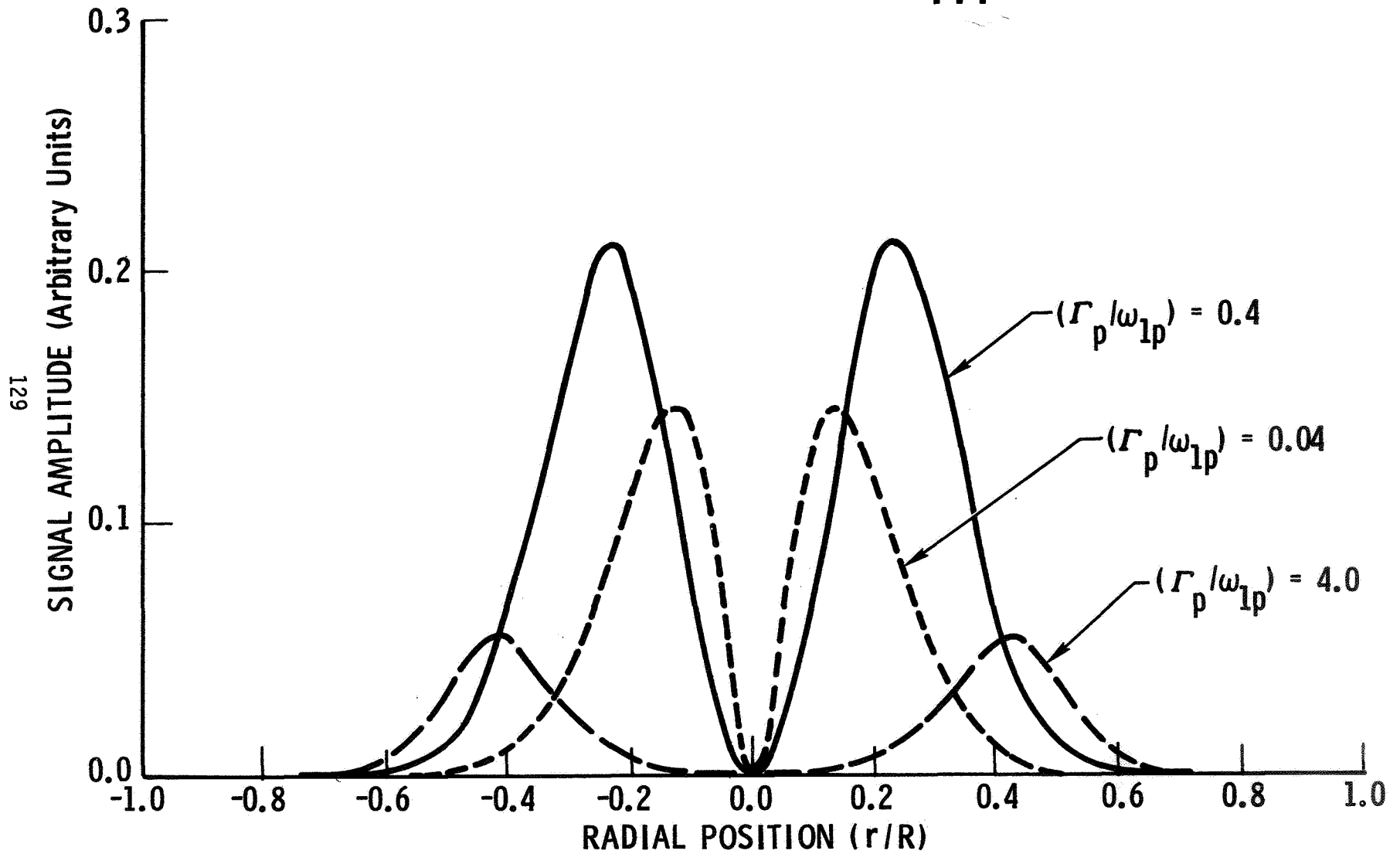

Figure 8

QUESTIONS AND ANSWERS

MR. DEHMELT:

Why does one want such a high intensity at all?

After all, the light goes up proportional to the power and the signal-to-noise goes only up by the square root of the power, so one doesn't want much power.

MR. VOLK:

Well, I think our computer model is showing that you have to reach optimum trade-off between that, that's certainly true.

You start broadening as soon as you start pumping but you must reach some degree of polarization before you can have a signal.

MR. DEHMELT:

I was under the impression this can be reached with ordinary lamps?

MR. VOLK:

The optimum? I'm not sure.

MR. DEHMELT:

Comment on it.

MR. VOLK:

I think even if you could reach that there would be advantages of replacing the lamp with the laser diode. And so, I think one must look at the ramifications of doing that.

MR. DEHMELT:

I can see that you couldn't see your maximum for diagnostic purposes.

MR. VOLK:

I'm sorry, I couldn't hear that last comment.

MR. DEHMELT:

For diagnostic purposes it's probably fine to use a laser.

MR. VOLK:

Yes, I agree with that.

DR. WINKLER:

Since you do have so much power, much more than you need, wouldn't it be advisable since you want to use the diode for other reasons to deliver this spread out the power over the total line width by noise modulating the laser, laser frequency. And then you would get away from these troubles of generating asymmetry by an unbalanced power distribution along the wavelength.

MR. VOLK:

I really think that's a good point.