

NASA-TM-83483

DOE/NASA/20320-53  
NASA TM-83483

NASA-TM-83483

19840002596

DOE/NASA/20320-53

# Examination, Evaluation, and Repair of Laminated Wood Blades After Service on the Mod-0A Wind Turbine

James R. Faddoul  
National Aeronautics and Space Administration  
Lewis Research Center

Work performed for  
**U.S. DEPARTMENT OF ENERGY**  
**Conservation and Renewable Energy**  
**Wind Energy Technology Division**

LIBRARY COPY

NOV 21 1983

LANGLEY RESEARCH CENTER  
LIBRARY, NASA  
HAMPTON, VIRGINIA

Prepared for  
National Conference of the American Wind Energy Association  
San Francisco, California, October 16-19, 1983

### DISCLAIMER

This report was prepared as an account of work sponsored by an agency of the United States Government. Neither the United States Government nor any agency thereof, nor any of their employees, makes any warranty, express or implied, or assumes any legal liability or responsibility for the accuracy, completeness, or usefulness of any information, apparatus, product, or process disclosed, or represents that its use would not infringe privately owned rights. Reference herein to any specific commercial product, process, or service by trade name, trademark, manufacturer, or otherwise, does not necessarily constitute or imply its endorsement, recommendation, or favoring by the United States Government or any agency thereof. The views and opinions of authors expressed herein do not necessarily state or reflect those of the United States Government or any agency thereof.

Printed in the United States of America

Available from

National Technical Information Service  
U.S. Department of Commerce  
5285 Port Royal Road  
Springfield, VA 22161

NTIS price codes<sup>1</sup>

Printed copy:  
Microfiche copy: A01

<sup>1</sup>Codes are used for pricing all publications. The code is determined by the number of pages in the publication. Information pertaining to the pricing codes can be found in the current issues of the following publications, which are generally available in most libraries: *Energy Research Abstracts (ERA)*; *Government Reports Announcements and Index (GRA and I)*; *Scientific and Technical Abstract Reports (STAR)*; and publication, NTIS-PR-360 available from NTIS at the above address.

# **Examination, Evaluation, and Repair of Laminated Wood Blades After Service on the Mod-0A Wind Turbine**

James R. Faddoul  
National Aeronautics and Space Administration  
Lewis Research Center  
Cleveland, Ohio 44135

Work performed for  
U.S. DEPARTMENT OF ENERGY  
Conservation and Renewable Energy  
Wind Energy Technology Division  
Washington, D.C. 20545  
Under Interagency Agreement DE-AI01-79ET20320

Prepared for  
National Conference of the American Wind Energy Association  
San Francisco, California, October 16-19, 1983

N84-10664#



# EXAMINATION, EVALUATION, AND REPAIR OF LAMINATED WOOD BLADES AFTER SERVICE ON THE MOD-OA WIND TURBINE

James R. Faddoul  
National Aeronautics and Space Administration  
Lewis Research Center  
Cleveland, Ohio 44135

## SUMMARY

As part of the NASA Lewis development effort for large, horizontal-axis, wind turbines, four blade sets (rotors) have been fabricated for the 200-kW Mod-OA machines by using an epoxy-impregnated, laminated wood material. These rotors are two bladed and 38.1 m (125 ft) in diameter, and each blade weighs less than 1361 kg (3000 lb). After operating in the field, two blade sets were returned for inspection. One set had been in Hawaii for 17 months (7844 hr of operation) and the other had been at Block Island, Rhode Island, for 26 months (22 months operating - 7564 hr).

The Hawaii blade set was returned because one of the studs holding the blade to the rotor hub had failed. The inspection found that the stud failure had been caused by a combination of improper installation and inadequate corrosion protection. Other items found by inspection were that the blade moisture content had remained stable and that no structural damage had occurred in any of the laminated wood material. Five studs in one blade were then removed and replaced and both blades were cleaned and placed in storage.

The Block Island blade set was returned for inspection at the end of the operational program for the wind turbine. Just before removing the rotor it was discovered that one of the blades had a small crack in the leading edge along the entire span. The crack was thoroughly investigated and found to be caused by a manufacturing process problem. The crack was not more than 0.64 cm (1/4 in.) deep and did not present a structural problem, as proven by a load-deflection test of the blade. Structural response to cantilever loading showed no change from time of manufacture to after completion of utility service. One of the Block Island blades was then cut apart for a detailed internal inspection, and again no significant structural problems were found. Conclusions reached as a result of this work were that the laminated wood blades were of generally high quality and well suited to wind turbine applications. Cleanup and repair of blades was found to be a simple process, but quality control must become more of a factor in manufacturing as indicated by the failed stud and the leading-edge crack.

## INTRODUCTION

Since 1977, NASA Lewis has been pursuing the development of low-cost rotor blade technology for large, horizontal-axis wind turbines (HAWT). This work has been done under Department of Energy sponsorship in an attempt to promote economical energy alternatives. The success or failure of a wind turbine will be measured, to a large extent, by the cost effectiveness of the rotor system. Laminated wood that is manufactured by bonding 0.25- to 0.32-cm (1/10- to 1/8-in.) thick sheets (plies) together with epoxy is a particularly attractive candidate material for a rotor blade or rotor assembly since the

raw material is low in cost and, in the grain direction, has high specific strength (strength-to-density ratio) and high specific stiffness (modulus-to-density ratio). The structural characteristics of laminated wood blades were studied under a conceptual design contract with Gougeon Brothers, Inc., starting in 1977. This led, in turn, to the manufacture of eight blades. An overview of the laminated wood blade program and its relation to the Mod-OA wind turbine is given in reference 1. Reference 2 contains the details of the blade design, and reference 3 discusses the laminated wood blade fabrication process. Test evaluation of the root end attachment configuration is discussed in references 4 and 5.

The first pair of laminated wood blades went into service on the Mod-OA wind turbine (200 kW, 38.1-m (125-ft) diameter rotor) at Kahuku Point on the north shore of Oahu, Hawaii. The second pair went into Mod-OA service at Block Island, Rhode Island. Both of these blade sets have been removed from the machines and returned to NASA Lewis. Blade set 3 is on the Mod-OA at Culebra, Puerto Rico, and blade set 4 was used to replace set 1 at Kahuku.

Blade set 1 (serial numbers 1010 and 1011) was removed from service after over 7800 hr of operation (18-month period) when a broken stud from the blade retention system was found on the ground. Blade set 2 (serial numbers 1012 and 1013) was removed from the Block Island machine when a final inspection (after operational testing and demonstration had been completed) indicated that a crack had developed in the leading edge of one blade along the entire span from root to tip.

This report presents the results of the inspections that were performed on both blade sets at NASA Lewis and evaluates the structural durability of laminated wood as a wind turbine blade material. For the Hawaii blades the inspection included cleaning, weighing, and checking for moisture content along with a detailed examination of the failed stud. In addition, procedures and tooling were developed and implemented to replace the broken stud (and four other corroded studs). For the Block Island blade set cleaning and weighing were performed, but the moisture content evaluation was much more extensive than that conducted on blade set 1. In addition, one of the Block Island blades was sectioned for a detailed internal inspection.

## DISCUSSION

Although there were many similarities in the findings for the two blade sets, each set is discussed separately and then the conclusions are drawn for both blade sets.

### Blades 1010 and 1011 (Kahuku Point, Hawaii)

The first two wood blades were manufactured in the spring of 1980 and were designated serial numbers 1010 and 1011. There were two deviations from the design on this blade set. One deviation involved the weight and the resulting root gravity moment (balance); the weight was 1181 kg (2603 lb), or 151 kg (333 lb) greater than estimated (with a gravity moment of 21.3 cm (8.4 in.) outboard of the design point). When the blade was coupled with the steel blade-to-hub adapter, the total blade weight was 1362 kg (3003 lb) with a gravity moment of 68 876 N-m (50 800 ft-lb). These values exceeded the

allowable weight by 1.4 kg (3 lb) and the allowable gravity moment by 5152 N-m (3800 ft-lb). The other deviation involved a misalignment of the blade retention studs on blade 1011, shown schematically in figure 1. Special shim washers were manufactured and were used to correct the out-of-plane condition of the stud faces of blade 1011. The out-of-plane condition of blade 1010 was found to be within design limits and the shim washers were not used on that blade. Some of the more important events in the history of the blade set are as follows:

March 1980	Blades were shipped to Kahuku, Hawaii, from Gougeon Bros., Inc.
April 1980	Repairs were made to trailing edge and transom sections damaged by excessive internal pressure buildup that occurred during shipment (ref. 3).
May 1980	Blade-to-hub adapter was mounted on blades by using special machined washers (blade 1011 only) to compensate for stud shoulders not being in one plane.
June 25, 1980	Blades were inspected from ground and lift with binoculars. Some paint was scraped off the leading-edge tape, but the blades looked good. Synchronization time, 105 hr.
August 5, 1980	Blades were inspected at 650 hr. Minor separation was observed in the transom joint. Otherwise nothing significant was noted. Stud nuts were torqued to 298 N-m (220 ft-lb). None turned.
October 15, 1980	Blades were inspected at 2000 hr. No changes were noted.
March 24, 1981	A minor increase in transom joint separation was noted. Otherwise, no change.
September 25, 1981	Blades were inspected at 6900 hr. Transom separation was unchanged from the 3/24/81 inspection.
November 25, 1981	Broken stud was found on the ground at 7844 hr.
March 6, 1982	Blades were removed from the machine.
April 5, 1982	Blades were received at NASA Lewis.

Initial examination. - Upon arrival at Lewis, blades 1010 and 1011 were visually inspected and weighed. The visual examination provided no evidence of any external problems. Both blades were covered with a thin coating of grease and dirt that had developed due to leaks in the pitch-control bearing seals. On a Dillon scale blade 1010 weighed 1404 kg (3095 lb) and blade 1011 weighed 1383 kg (3050 lb). This preliminary weighing indicated that the blades could have picked up as much as 23 kg (50 lb) of water. However, the accuracy of the Dillon scale and the amount of weight attributed to the surface dirt left the actual measurement in question, and it was decided to remove the spool pieces, clean the blades, and reweigh the blades on the electronic scale originally used by Gougeon Bros., Inc. (GBI). The results of this effort are discussed later in the section Moisture content study.

Once the visual and "rough" weight checks were made, the spool pieces were removed from both blades, and the stud/spool piece interface was visually inspected. During removal of the spools the torque on each nut was checked and none were found to have loosened. Observation of the studs indicated that significant corrosion had taken place on blade 1011 only and only on a stud-selective basis (figs. 2 to 4). Blade 1010 (figs. 5 and 6) had no serious corrosion.

Evaluation of stud/spool interface. - An extensive investigation of the stud and the stud/spool interface was conducted, and a summary of the results is presented in the appendix. The key findings are as follows:

(1) The stud material was not 4140 as specified but was 41L40. Although 41L40 has a lower allowable fatigue strength, the material change was not a significant contributor to the failure.

(2) Metal-to-metal contact between the stud shoulder and the spool was not consistent. When full contact was achieved, little or no rusting or corrosion had occurred. The broken stud had less contact and more corrosion than any other stud.

(3) A stud adjacent to the broken stud also appeared to have a hairline crack in its radius.

(4) Although the shim washers on blade 1011 had corrected the out-of-plane condition of the stud shoulders, there was evidence that a nonperpendicular condition (misalignment) also existed that could not be corrected with shims. This condition led to lack of metal-to-metal contact between the stud shoulder and the spool. This, in turn, created two problems. First, the misalignment prevented the preload of the stud from being fully effective in reducing the cyclic component of the applied load. And, second, the absence of full metal-to-metal contact allowed the corrosive moist salt air to attack the radius area of the stud, where failure ultimately occurred.

(5) The cause of failure was stress corrosion fatigue.

Blade cleaning and weighing. - Both blades were cleaned with a hot water/detergent combination that returned the surface to a "like new" condition. No permanent staining or discoloring was evident. On September 14, 1982, personnel from GBI brought their electronic scale (strain-gaged load link) to Lewis. This scale had been recently recalibrated by the manufacturer. Since the scale had a maximum load limit of 1157 kg (2550 lb), the blades were weighed by using a two-sling system. One sling was slightly inboard of the center of gravity and carried most of the blade weight through the instrumented scale link. The other sling was at the blade tip and carried only about 45 kg (100 lb) through a Dillon scale. This process was identical to that used at the GBI plant before the blades were shipped to Kahuku. Results of this reweighing were as follows:

	Blade			
	1010		1011	
	Weight			
	kg	lb	kg	lb
GBI electronic scale	1145	2524	1139	2510
Dillon scale	44	96	54	120
Total weight	1189	2620	1193	2630



Since both blades had originally been balanced to 1181 kg (2603 lb), it can be stated that blade 1010 had picked up 8 kg (17 lb) and blade 1011, 12 kg (27 lb). These are, however, considered to be maximum numbers for the following reasons: First, blade 1011 was subsequently found to have a sizable quantity (estimated to be between 1 and 3 kg (2 and 6 lb) of cleaning water and detergent inside that had leaked in through a seal which had not been replaced properly. And second, the blades were both weighed in an outdoor environment during a steady drizzle. Thus there was complete surface wetting of the blades, which accounts for another 2 to 5 kg (5 to 10 lb) of weight. Consequently, it is estimated that blades 1010 and 1011 had picked up between 0 and 5 kg (10 lb) of weight during the 30 months following fabrication. This represents a moisture increase of less than 1 percent of the wood weight, which is less than what had been expected. Wood moisture contents and their effect on blade performance are discussed further in the following section.

Moisture content study. - To evaluate the specific moisture content of the wood in the Hawaii blade, a series of four core sections were removed from the spar of both blades. Each section was removed by using an extended hole saw without a pilot drill, and each was approximately 1 cm (3/8 in.) in diameter. Lengths of the section were the full laminate thickness of the spar at the point of removal and ranged from about 9 down to 2.5 cm (3-1/2 in. down to 1 in.). The moisture contents for blade 1010 were 4.9, 5.2, 5.3, and 6.1 percent of the total specimen weight. Similarly, for blade 1011, the results were 6.9, 7.5, 7.7, and 7.8 percent. As can be seen, the numbers are quite closely grouped for each blade but are significantly different for the two blades. Blade 1010 had an average of 5.4 percent moisture, and blade 1011 averaged 7.5 percent. Neither of these values is thought to be excessively high and the difference is probably due to the time of year of fabrication. Blade 1010 was constructed during a colder time of year when more shop heating was required, and the probably less humid shop air dried the wood veneers. Subsequent evaluation and knowledge of the effects of veneer moisture content on the structural properties of wood have led to installation by GBI of an elaborate humidity control system in the shop to control the moisture content. The effect of moisture can most vividly be seen in figure 7, which shows a 24 percent decrease in modulus for an increase in moisture content of 16 percent. Strength follows an almost identical trend. In any case, blades 1010 and 1011 were found to be within the expected range of moisture content and therefore would be expected to be at or above the design allowable strength and modulus.

Blade repair. - One aspect of laminated wood blade technology development dealt with the consequences of the failure of one or more studs. If it were found to be necessary to scrap a blade because a stud was damaged in shipping, or by environmental attack, the cost effectiveness would be reduced. It was thus necessary to show the capability to replace one or more studs, and blade 1011 provided an opportunity for such a demonstration. Consequently, GBI was awarded a service contract to repair blade 1011. The replacement of a stud involved the following steps:

- (1) A straight cylindrical hole was bored around the stud by using a special cutter. (In effect, a 38-cm (15-in.) long hole-saw was used with an internal diameter slightly larger than the stud collar.)

(2) The stud/wood core at the bottom of the hole was twisted off by torquing on the stud with a wrench.

(3) The bottom of the hole was tapered and the hole was enlarged where the stud has been removed.

(4) A core of laminated wood was bonded to fill the hole.

(5) By using an alignment plate that mates to the remaining studs, a new stud hole was drilled in the newly replaced laminated wood core (step 4 above).

(6) Again by using a plate aligned to the remaining studs, a new stud was installed according to epoxy wetting and filling procedures identical to those used for the initial stud installation.

This process was used to replace five studs in blade 1011 and required only 2 days for two workers (4 worker-days), not including the time to make the studs, the fixtures, and the tapered wood cores. The specific studs replaced are designated by numbers 8, 9, 10, 14, and 15 in figure 2. No significant problems were encountered during this operation and the blade set, SN 1010 and SN 1011, is now considered to be ready for operation on a Mod-OA wind turbine.

#### Blades 1012 and 1013 (Block Island, Rhode Island)

The second set of laminated wood blades fabricated for Mod-OA service was designated as serial numbers 1012 and 1013. This blade set had no known deviations from the design. The weights of the blades when shipped were 1000 kg (2204 lb) for blade 1012 and 1000 kg (2205 lb) for blade 1013. Stud alignment was achieved with improved tooling and was not deemed to be a problem with the blade set. The blades were operational for approximately 22 months and accumulated 7564 operating hours followed by 4 months on the machine in a non-operating status. Some of the more important events in the history of the second laminated wood blade set are as follows:

July 1, 1980	Blades were received at NASA Lewis from GBI.
July 14 1980	The blade-to-hub adapter was mounted and a load-deflection test was conducted on blade 1012.
August 1, 1980	Blades were installed on the Block Island Mod-OA wind turbine.
August 5, 1980	First rotation of blade set 1012/1013 occurred at Block Island.
September 29, 1980	Machine speed was reset from 40 to 31 rpm for reduced-power (150 kW) operation.
January 1, 1981	Blades were inspected after 1800 hours of operation. No signs of structural deterioration were found.
September 15 to 18, 1981	Blades were inspected after 4870 hours of operation. Blade 1013 had no significant signs of deterioration. On blade 1012, however, several holes had appeared in the leading-edge protective tape and the leading edge was eroded and pitted under the tape. In addition, a very thin crack was noted in the leading edge, extending from station 260 to station 600. This crack was considered to be a paint separation but was called out for weekly inspection with binoculars.
November 13, 1981	No change was noted in the "paint" crack.

June 4, 1982	Mod-OA program was completed; machine operation was discontinued after 7564 operating hours on blades 1012 and 1013. No note of blade condition was made.
September 8, 1982	A crack in the leading edge of blade 1012 was found during an inspection.
October 3, 1982	Blades 1012 and 1013 were removed from the Block Island wind turbine.
October 10, 1983	Blades 1012 and 1013 were received at NASA Lewis.

Initial examination. - The Block Island blades were received at Lewis and photographed. The as-received blades are shown in figures 8 to 11. Considerable oil and dirt had accumulated on the blade surface, and this provided evidence of airflow patterns. These patterns have been carefully photographed and are being studied to determine if they have any significance for wind turbine operations. Similar patterns were not evident on the blades returned from Hawaii or on any other Mod-OA rotor blades although they also had oil and dirt on the surface. One possible explanation for the markings on the Block Island blades can be attributed to operating at derated power settings and at a rotor speed of 31 rpm as opposed to 40 rpm for the Kahuku, Hawaii, machine. Further studies of this aerodynamic "striping" will be required.

Also evident on blade 1012 was the leading-edge crack, which ran the entire length of the blade and seemed to be in the joint between the upper and lower blade halves. Figure 12 shows a plug section from blade 1012 that has two cracks separated by about 0.64 cm (1/4 in.). Less than 10 percent of the blade had this condition, but there were areas where the crack was discontinuous and would jump back and forth from one location to the other. Depth of the crack was estimated by inserting a thin "feeler gage" and proved to be less than 0.64 cm (1/4 in.). In some areas the crack appeared to be only superficial. At the tip of the blade from station 700 to 750, there was also a great deal of pitting and erosion of the leading edge (fig. 13). Both the leading-edge crack and erosion at the tip were unique to blade 1012. Neither of the Hawaii blades nor the other Block Island blade showed any signs of similar problems.

Spool pieces were then removed from both blades to determine the amount of corrosion that had occurred on the studs. As shown in figures 14 to 17, there was light-to-moderate rust but no significant pitting as had been found on blade 1010 from Hawaii. Stud-to-spool contact appeared to be complete and uniform, indicating that the studs had been installed properly with correct alignment and depth of insertion. No cracking or evidence of structural fatigue could be found by visual examination.

Blade cleaning and weighing. - The Block Island blades were cleaned by using the same techniques as used for the Hawaii blades and achieved the same result. No staining or discoloration remained (fig. 18) and, after cleaning, the blades were in the "like new" condition. Both blades were then weighed on December 14, 1982, by GBI personnel, who again had brought their own scale with them. Results of this weighing are as follows:

	Blade			
	1012		1013	
	Weight			
	kg	lb	kg	lb
As shipped	1000	2205	1000	2205
As returned	1024	2259	1005	2215
Change	24	54	5	10

Blade 1012, the one with the crack, had picked up considerably more weight than had blade 1013. This was not particularly surprising since the leading-edge crack represented a rather large open wound that had been permitted to absorb moisture. Even small percentage gains in moisture content would be enough to account for the 24 kg (54 lb). The 5-kg (10-lb) change of blade 1013 was similar to what had been experienced on the Hawaii blade and is somewhat less than the 1-percent change that had been expected. Details of measured moisture contents are given in the following section.

Plug studies. - To evaluate what had happened in the cracked area of the leading edge and to investigate any pattern of moisture absorption, a special plug cutter similar to the tool used to remove cores from the Hawaii blades was developed. This tool removed plugs approximately 2.5 cm (1 in.) in diameter, as shown in figure 19. This technique proved valuable in quickly determining what had happened to blade 1012. In addition, it was found that the holes could be easily repaired by tapering the hole with a tapered reamer and bonding in a properly oriented plug of material with a matching taper. A repaired and sectioned plug is shown in figure 20.

The plugs quickly showed the leading-edge crack to be a manufacturing defect. As shown in figure 21, the upper blade half had slid too far forward during bonding, leaving an overlap of 0.48 to 0.64 cm (3/16 to 1/4 in.). When the bonded blade section was removed from the mold, the overlap was sanded off to a smooth and fair surface. Unfortunately, this left the veneers of the upper blade half edge-glued to the plywood skin on the lower blade half. The combination of (1) thermal expansion and contraction, (2) dimensional changes due to moisture pickup and loss, (3) the grossly different moduli of the two materials, and (4) the very low cross-grain strength of the fir veneers caused the fir veneer to crack at the edge of the plywood layer. The cracks seemed to stabilize as they penetrated the thickness of the D-spar, and nowhere had they progressed to more than about 0.64-cm (1/4-in.) depth. However, over a period of 10 or 20 years, this would probably cause blade deterioration and ultimately lead to failure if left unrepaired. A repair can be conjectured as a trivial operation in which a low-tolerance slot would be routed in the leading edge and then a solid fir strip bonded into the slot and covered with 2 or 3 plies of fiberglass to provide cross-grain stability to the fir. The routed slot would have roughly square dimensions of 1.27 x 1.27 cm (1/2 x 1/2 in.), and the entire cracked section would be removed. Of course the problem could be avoided in the first place through more careful alignment of parts during the bonding operation. As shown in figure 21(d), with good fit, cracks do not develop.

The plug specimens were also used for evaluation of moisture content as had been done for the blade returned from Hawaii. Twenty-eight core specimens were removed and some were split into as many as 5 pieces to obtain moisture contents. The highest moisture content of any plug specimen was 10.2 percent for blade 1012. For blade 1013 the moisture content along the length of the blade and through the spar thickness appeared to be uniform and lower than that for blade 1012 (7.47 percent average as compared with 8.08 percent for blade 1012). Blade 1012, on the other hand, showed higher moisture content in the outside layer of the D-spar than in the inside layers and the least moisture in the middle layers. In addition, the highest individual-sample and total-plug moisture contents were found at the leading edge. This appears to be an obvious result since, with an open crack, considerable moisture could freely enter the wood, which was not protected by the paint or epoxy. This moisture would tend to work along and through the outside layers more rapidly than it would transfer across the epoxy bond lines between layers. This explains why the outside was the most moist. The inside layers picked up moisture more rapidly than the middle since moist air inside the blade affects the innermost layers long before working to the central mass of material. Thus, the plug specimens, as used for moisture content studies, were very informative but revealed no surprises or contradictions to engineering logic.

Structural testing. - One of the concerns with blade 1012 was whether the leading-edge crack had caused loss of structural efficiency. And, by a fortunate coincidence, blade 1012 was the only blade that had received a load-deflection test before being installed on a machine. Consequently, after visual examination and repair of the plug holes, blade 1012 was mounted in a cantilever fashion on a strongback and subjected to a load-deflection test. Test equipment and procedures were identical to those used before the blade was shipped to Block Island, and a direct comparison of the structural performance data from the "before" and "after" conditions was possible.

Table I lists the flatwise tip deflections and applied moments for both the July 1980 test and the November 1982 test. When the data were corrected for the small differences in applied moment, the variation between the maximum deflections was less than 1 percent. The correlation of data is shown graphically in figure 22. Because a leading-edge crack would be expected to have the greatest effect on flatwise performance, the very good agreement between the two data sets indicated that the crack had done no significant structural damage. The reader should note that the word "structural" refers to the immediate ability to carry load with a given stiffness. There has obviously been degradation of the material protection system by way of cracking paint and surface erosion. This condition would be expected to worsen and lead to structurally significant damage. The progression would also be expected to be exponential with time in that the older the structure, the more the damage and the faster the next increment of damage would occur.

Internal inspection. - After the structural test, blade 1013 was shipped to the NASA Lewis Plum Brook Station for storage, and blade 1012 was committed to a damage investigation program. To determine if internal damage had occurred or if manufacturing problems were present, the blade was first cut into six segments, each about 3 m (10 ft) long. Progressively smaller sections were then cut to permit evaluation of the following areas: stud bond, root blocking, internal rib and blocking, ice detector installation, shear web bond, honeycomb bond, leading edge crack, tip erosion, and general laminate bond quality. The findings in each of these are discussed individually.

Stud bond: The four most highly loaded studs were removed from the root of the blade by cutting out the stud and an accompanying block of wood, as shown figure 23(a). Each of the four stud/wood block specimens was then cut on two sides with a band saw that followed the stud taper and exposed the tip of the thread tooth and the epoxy bond. It was immediately obvious that two studs had been poorly bonded as major voids were found in the epoxy (figs. 23(b) and (c)). The other two studs were reasonably void free. The voids, however, did not seem to have an adverse effect on the structure. No cracking or crazing of the epoxy matrix could be found at any stud location. Figure 23(d) shows a stud taken from a fatigue test specimen that had failed (in the wood away from the stud area) after more than a million high-load cycles. As can be seen, the extent of cracking of the epoxy matrix around the stud is quite evident, albeit inconsequential to the performance of the stud. From the evidence, it can be concluded that while a very undesirable situation (large voids in the stud bond) existed in blade 1012, failure of the structure had not resulted nor was it imminent. However, it is also obvious that more care must be taken and nondestructive inspection techniques must be developed to assure that good stud bonds exist in future laminated wood blades.

Root blocking: Visual examination and evidence from the stud blocks removed from the root end indicated that the ply-to-ply compaction and bonding was excellent. No gaps or unbonded areas were found in this area of the blade. Some curvature of the laminated root blocking was noted previously in the plies that made up the back side of the "D." This can be seen in figure 24. This problem had been identified during fabrication, and subsequent blades used a premolded, thick, flat panel to build up the blade root.

Internal rib and blocking: The rib at station 150 was removed by making a chordwise cut 7.6 cm (3 in.) on either side of the rib centerline. Blocking at the edge of the rib and in the trailing-edge panel was then examined for any signs of structural degradation or cracking. None were found and there was no evidence of any manufacturing problems or defects.

Ice detector installation: The ice detector was removed from the blade, and the seal area was inspected for evidence of deterioration or water leakage. All surfaces appeared to be in the "as manufactured" state with no sign of moisture entrapment.

Shear web bond: As shown in figure 25, the bond of the shear web to the D-spar plies on the high-pressure surface was extremely porous. This condition existed from station 240 all the way to the tip (station 750). Inboard of station 240, and on the low-pressure side, the bond was satisfactory. It had been noted during fabrication that there was a potential problem in obtaining good adhesive fill in the shear web to the D-spar point. On at least one blade, an attempt was made to fill voids by drilling into the area and injecting epoxy resin. However, this technique was either not used on blade 1012 or was totally ineffective. Why the bond problem occurred on only one side of the blade is unknown. And, although structural failure had not occurred, nor was there evidence of any significant structural effect, the degree and extent of the problem is such that new procedures would be required for future blade fabrication.

Honeycomb bond: From station 520 to the blade tip, the entire trailing-edge cavity was filled with a resin-impregnated paper honeycomb. Fabrication

required four different honeycomb pieces to be bonded together to achieve the proper thickness. Thus, one piece of honeycomb was bonded to the outer plywood layer and a second piece of honeycomb was bonded to the first by sandwiching a fiberglass cloth impregnated with resin in between. When the blade halves were bonded together, another resin-impregnated fiberglass cloth layer was placed on top of the honeycomb layer in the bottom half to provide for the center bond line, as shown in figure 26. When sections were cut from this area, it was found that the bond lines between the two honeycomb layers in each blade half were very weak and that the section could be easily pulled apart. Little or no "footprint" was left on the fiberglass cloth, and no fillet of epoxy was found attached to the honeycomb cell edges. Thus it was concluded that the vacuum pressure used during the bonding operation was probably inadequate. As with other areas of the blade, however, the problem with the fabrication process had not caused any structural damage and there was no loss in the skin panel's ability to carry load.

**Leading-edge crack:** As determined from the plug studies, the leading-edge crack was due to a mismatch in the alignment of the upper and lower blade halves. This conclusion was further supported by the cross sectioning of blade 1012, as shown in figure 27. In addition, it was evident that the crack had not contributed to any significant loss in structural capability and that the crack did not progress past the external plywood nor did it turn and run along the layers. Even in areas where the ply-to-ply bonding was of poor quality the crack showed no tendency for enlargement. Preventing the crack is expected to be as simple as maintaining the alignment of the leading edges of the two blade halves during bonding.

**Tip erosion:** Erosion and cratering at the tip of blade 1012 were very severe, as shown in figure 13. Unfortunately, since the machine was operating at a reduced power level, it is impossible to determine the effect on aerodynamic performance, but it would, of course, be expected to be a large (5 percent minimum) penalty. When sections were cut through the blade at the tip, the cause of the erosion problem was easily visualized. Figure 28 shows that neither the plywood blade exterior nor the fir veneer conformed to the mold surface in the outboard sections of the blade. Consequently an epoxy filler material was used to provide the exterior airfoil surface. This condition is not unique to blade 1012, however; so it is not sufficient to cause the erosion. What is unique about blade 1012 is that a leading-edge crack developed because of other manufacturing problems. The crack eventually grew large enough at the blade tip to cause splitting of the leading-edge protection tape, a 7.6-cm (3-in.) wide self-adhesive polymeric material. The tape splitting (cracking) was promoted by embrittlement caused by ultraviolet and weathering effects. Once the tape had split, direct impingement of wind and rain at high velocity quickly eroded the epoxy filler. The erosion process was further accelerated by the epoxy filler being a low-density material as a result of the frothing and bubbling created by the vacuum bag manufacturing process. The erosion process removed only the epoxy filler and stopped when a wood surface was reached.

**General laminate bond quality:** In a number of areas of the blade individual plies had not bonded together, and in a few places plies had split or overlapped. A sequence of these events is shown in figure 29. As a percentage of volume, however, the defects were minimal and in no case was there any evidence that a structural failure had occurred, or would result, because of

the defect. In most cases, the problem could be eliminated in future production by using a slightly thicker (15 percent) epoxy coating on the wood. The extra epoxy would assure that layers were bonded together and would tend to flow and fill the few void areas that were found. In general, the wood laminate quality was considered to be excellent.

## CONCLUSIONS

As a result of the investigation and repair of the Hawaii and Block Island laminated-wood wind turbine blades, the following conclusions have been reached.

1. The general quality of the laminate produced by the manufacturing process was excellent.

2. The stud bonding operation requires close tolerance control to hold the stud faces all within the same plane and to assure alignment of all studs normal to the plane. Deviation from this condition can cause excessive loading of the studs and can provide a path for salt-laden moisture to get to the studs and cause corrosion damage.

3. Studs can be removed from a blade and replaced by using rather simple tooling.

4. Quality control of the laminated wood blades requires more effort. Voids, nonbonds, ply drops, and bond joint misalignment all require preventative actions.

5. The moisture content of laminated wood blades was stabilized by the paint and epoxy layers. If some degree of change in moisture content occurred, it was very slight (unless the blade was otherwise damaged).

6. The bond integrity of the studs was high enough that even large void areas around the most highly loaded studs did not result in cracking or in any signs of structural degradation after 18 months of operation in the field.

7. Although the blades had become quite dirty, the problem was related to leakage of oil and grease from the machine. Washing with a hot water and soap solution restored the paint to the "like new" condition.

8. Laminated wood blades are satisfactory for long-term operation on Mod-OA wind turbines.



## APPENDIX - FINAL REPORT OF FAILURE REVIEW COMMITTEE

4510

July 26, 1982

TO: 4500/Chief, Wind Stationary Power Division  
FROM: 4510/Chairman, Mod-OA Wood Blade Failure Review Committee  
SUBJECT: Final Report of the Mod-OA Wood Blade Failure Review Committee

This memo is the final report of the results of the investigation conducted by the Mod-OA Wood Blade Failure Review Committee. The committee, consisting of myself, Larry Viterna of WEPO, and John Reagan of R&QA, conducted an independent investigation and assessed the cause of failure. The committee relied heavily on R. Shaltens, Mod-OA Project Manager for data and information and R. Oldrieve for a metallurgical report to support our investigation. All of the specialists and consultants assigned to the committee participated and without this help the committee could not have performed its duties. The committee extends their thanks and appreciation for the help.

### Background

On December 1, 1981, R. Thomas of the Wind Energy Project Office, appointed a NASA Review Team to investigate the failure of a stud in blade 1011 on the Hawaii Mod-OA wind turbine. Over 17 million cycles representing 8000 hr of operation had been completed on that blade. Both blades were installed on the machine in June 1979.

### Results of Initial Investigation

The initial investigation was conducted during December 1981 and a preliminary report was presented on January 12, 1982. This report was considered preliminary since the blades had not been returned to Lewis and the findings lacked a complete inspection of both blades at the interface between the blade root and the root end adapter (often referred to as the spool piece).

The conclusions of the initial investigation were that corrosion and pits in the radius of the stud caused the failure. Further disassembly of the blade would indicate the extent of the problem. Recommendations made by the committee were to

- (1) Immediately inspect all assemblies in the field visually to verify that all studs are present
- (2) Retorque all studs on the field machines at the earliest convenience
- (3) Remove the blades on the Hawaii machine and inspect the interface as soon as possible
- (4) Appoint a design team for redesigning the stud to prevent corrosion from occurring

All of these recommendations have been carried out. The remainder of this report is the results of the inspection of the blade.

## Results of Final Investigation

In April 1982 the two blades were returned to Lewis. During May a detailed inspection was performed on both blades. The root end adapters were returned with the blades and their removal was conducted at Lewis and documented.

Of the two blades the blade containing the failed stud had the most corrosion evident. A stud adjacent to the broken stud also appeared to have a hairline crack in its radius where extensive corrosion was evident. The washer contact area was less than 10 percent on the broken stud and approximately 50 percent on the adjacent stud with the hairline crack. This small contact area appeared to allow corrosion to occur and, according to analysis, increased cyclic loading on the stud. Both of these conditions would contribute to the failure of the studs. Further inspection of the blade revealed that approximately 33 percent of the studs were extensively corroded. The corrosion appeared to be a result of poor contact area due to misalignment of the studs during fabrication.

The other blade was also inspected and in general found to be in good condition. Contact area was better and corrosion far less. No cracks were observed in any of these studs. The root end adapters, which interface with the hub, were inspected. The surface of the adapters that were in intimate contact with the hub were clean and lacked corrosion. It had become obvious that intimate contact is in itself a method of corrosion prevention.

The final conclusion is that the small contact area of the failed stud (less than 10 percent) resulted in extensive corrosion of the stud radius and permitted increased cyclic loads to be carried by the stud. Both corrosion and fatigue caused the stud to fail. Intimate contact between the blade root and the root end adapter can reduce the extent of corrosion.

Other observations made during the investigation are as follows:

- (1) The stud material was not 4140 as originally believed but 41L40. This material has a shorter fatigue life than 4140.
- (2) The studs on all blades inspected showed evidence of corrosion where the stud contacted the epoxy material.

The failure review committee recommends that

- (1) All Mod-0A wind turbines be scheduled for inspection to determine the amount of corrosion if they continue to be operated
- (2) If 4140 steel is used, the ultimate tensile strength be limited to 150 ksi, if possible
- (3) Future designs insure that corrosion is prevented

The Mod-5 Project Manager has been made aware of the results of this investigation and discussions were held with both contractors during their preliminary design reviews conducted earlier this year. J. Couch and R. Shaltens have been kept apprised of the results of the investigation and

have factored this into their future Mod-OA plans. Therefore no further activity or reporting is planned by the committee.

Richard L. Puthoff

CONCURRENCE:

---

John Reagan

---

Larry Viterna

cc:

4510/R. Thomas  
4510/D. Baldwin  
4510/WEPO Files  
4510/R. Puthoff  
4511/J. Couch  
4511/R. Shaltens  
4512/P. Finnegan  
4513/D. Spera  
5221/R. Oldrieve

## REFERENCES

1. Lark, R. F.: Construction of Low-Cost, Mod-OA Wood Composite Wind Turbine Blades. DOE/NASA/20320-43, NASA TM-83046, 1983.
2. Lieblein, S.; et al.: Design and Evaluation of Low-Cost Laminated Wood Composite Blades for Intermediate Size Wind Turbines: Blade Design, Fabrication Concept, and Cost Analysis. (DOE/NASA/0101-1, Technical Report Services; DEN3-101.) NASA CR-165463, 1982.
3. Lark, R. F.; et al.: Fabrication of Low-Cost, Mod-OA Wood Composite Wind Turbine Blades. DOE/NASA/20320-45, NASA TM-83323, 1983.
4. Faddoul, J. R.: Test Evaluation of a Laminated Wood Wind Turbine Blade Concept. DOE/NASA/20320-30, NASA TM-81719, 1981.
5. Faddoul, J. R.; and Sullivan, T. L.: Large Horizontal-Axis Wind Turbines. CONF-810752, NASA CP-2230, 1982, pp. 303-328.

TABLE I. - FLATWISE LOAD-DEFLECTION DATA FOR  
BLOCK ISLAND BLADE 1012

(a) SI units

July 1980	November 1982	July 1980	November 1982
Root moment, N-m		Tip deflection, cm	
0	0	0	0
24 700	26 300	8.26	8.59
49 400	50 600	17.48	16.84
74 000	78 600	25.65	27.31
98 700	101 300	34.93	36.20
74 000	78 200	26.37	26.37
49 400	52 200	17.78	17.78
24 700	25 600	9.22	8.59
0	0	0	0

(b) U.S. customary units

July 1980	November 1982	July 1980	November 1982
Root moment, ft-lb		Tip deflection, in.	
0	0	0	0
18 200	19 400	3.25	3.38
36 400	37 300	6.88	6.63
54 600	58 000	10.13	10.75
72 800	74 700	13.75	14.25
54 600	57 700	10.38	10.38
36 400	38 500	7.00	7.00
18 200	18 900	3.63	3.38
0	0	0	0

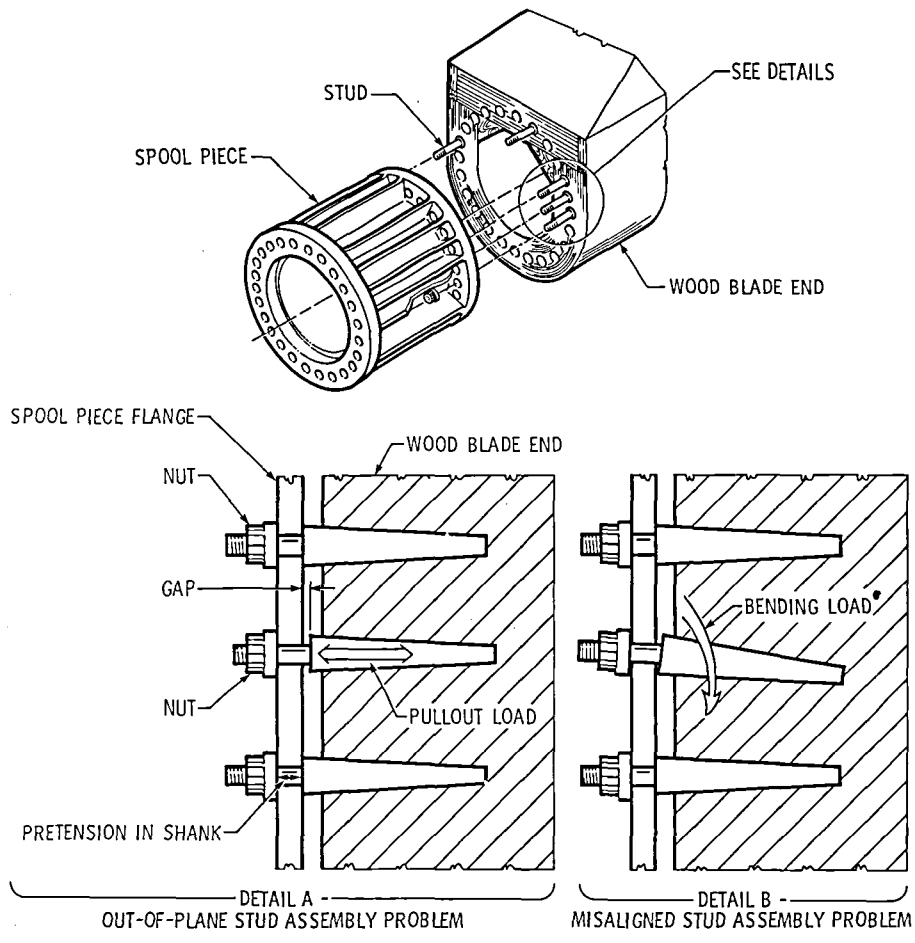

Figure 1. - Wood blade root end/stud/spool-piece assembly.

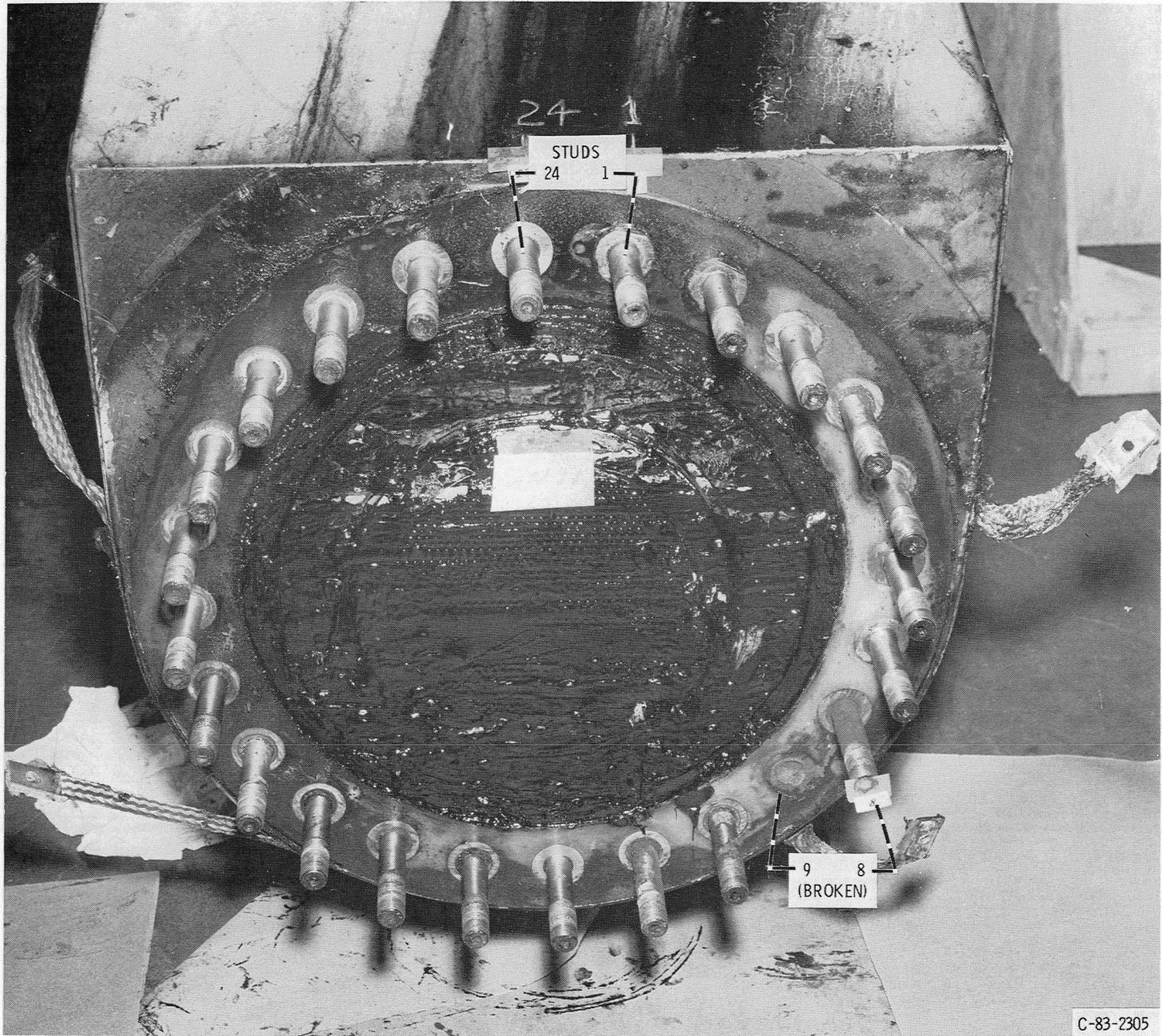
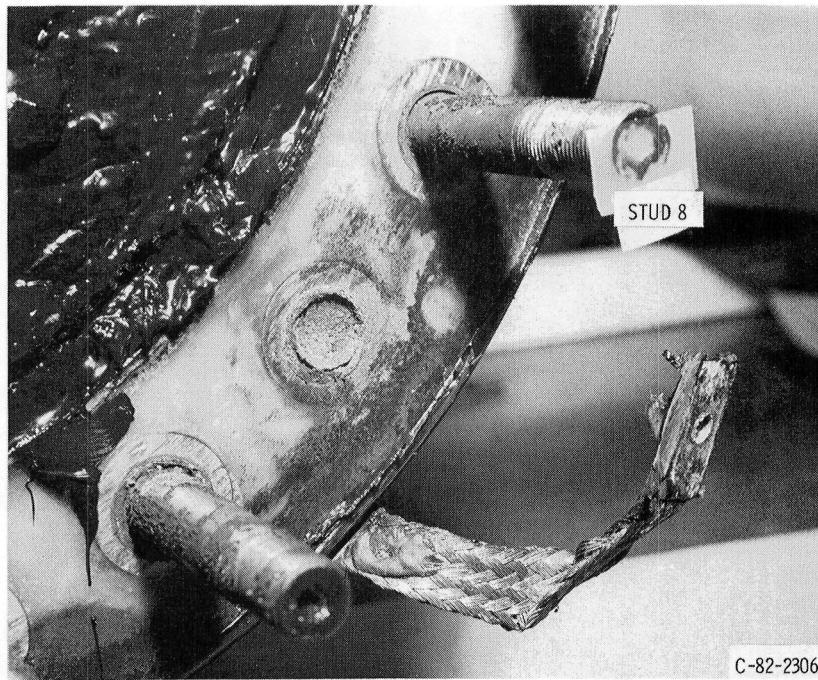
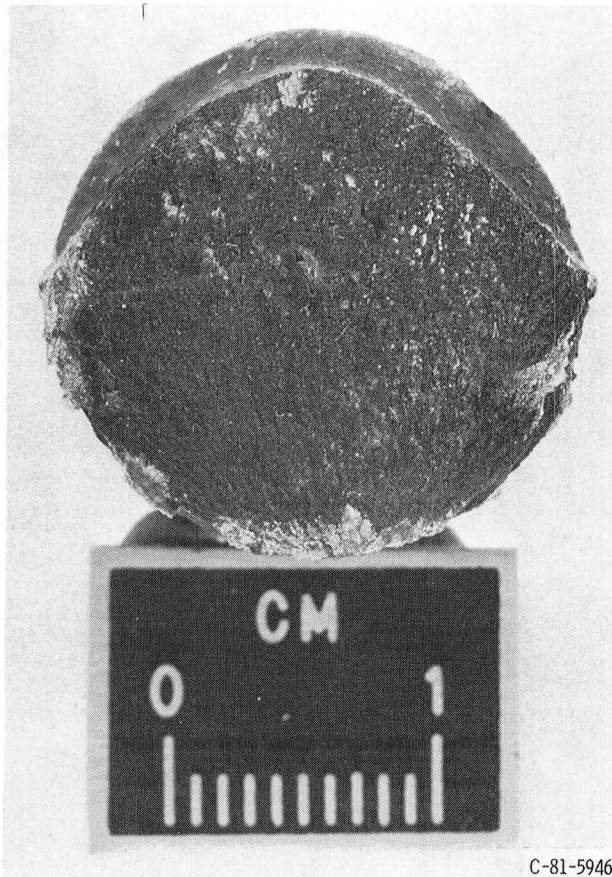

Figure 2. - Root end of blade 1011 showing bolt circle and stud numbering sequence.



(a) Studs 8 and 10 plus remains of 9.



(b) Fractured face of stud 9 blade 1011.

Figure 3. - Corrosion of and around stud 9 on blade 1011.

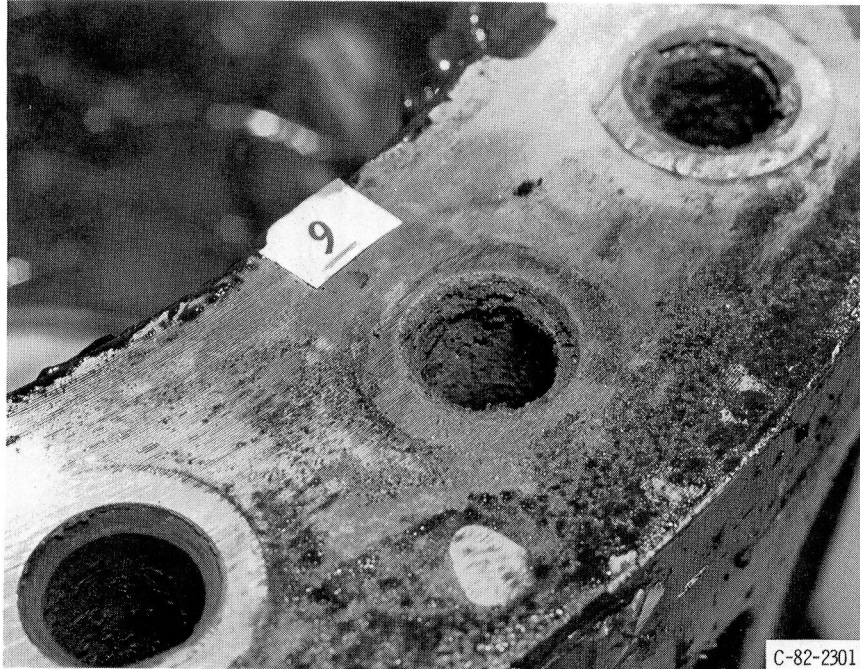

(c) Corrosion of spool piece in location of stud 9, blade 1011.

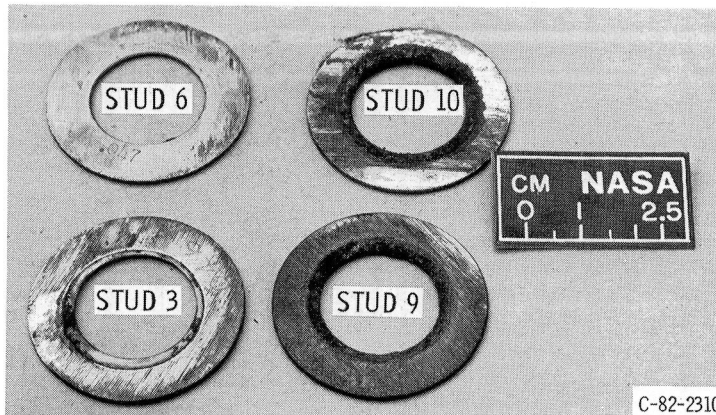

(d) Shim washers removed from four studs on blade 1011.

Figure 3. - Concluded.



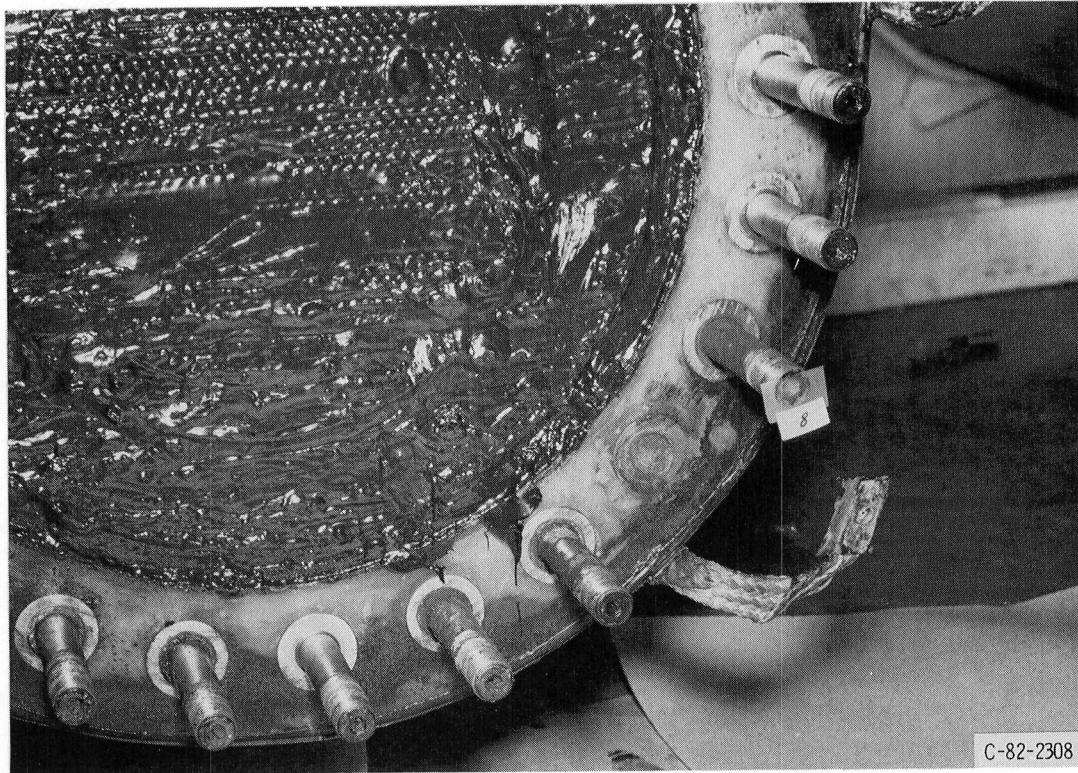

Figure 4. - Variability of corrosion of blade 1011.

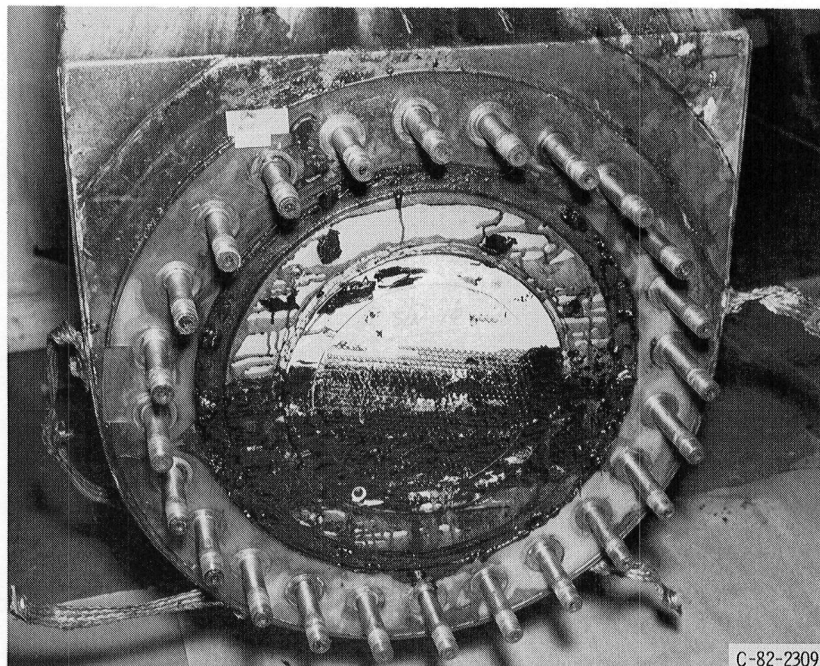

Figure 5. - Root end of blade 1010 showing very little significant corrosion.

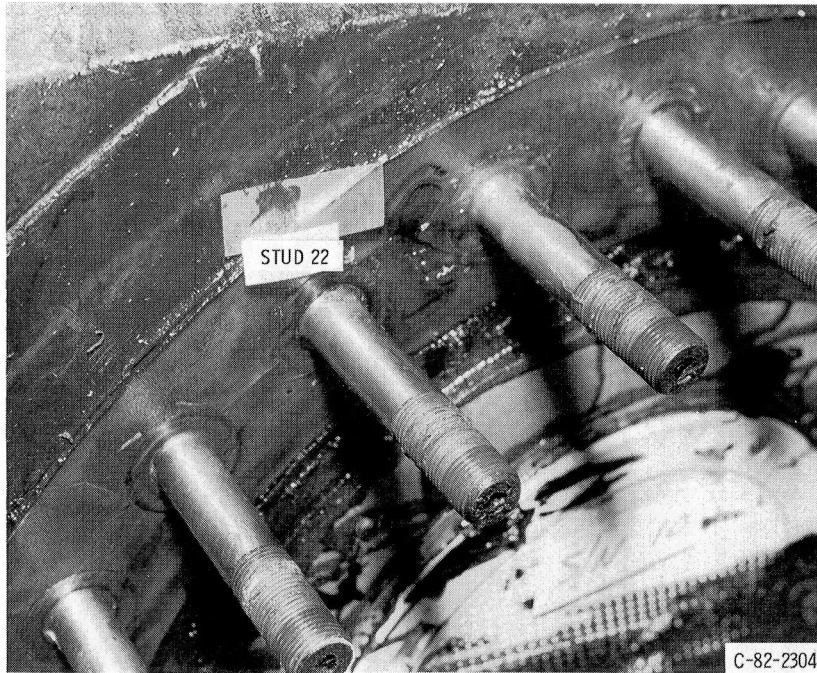

Figure 6. - Section of blade 1010 showing worst area of corrosion.

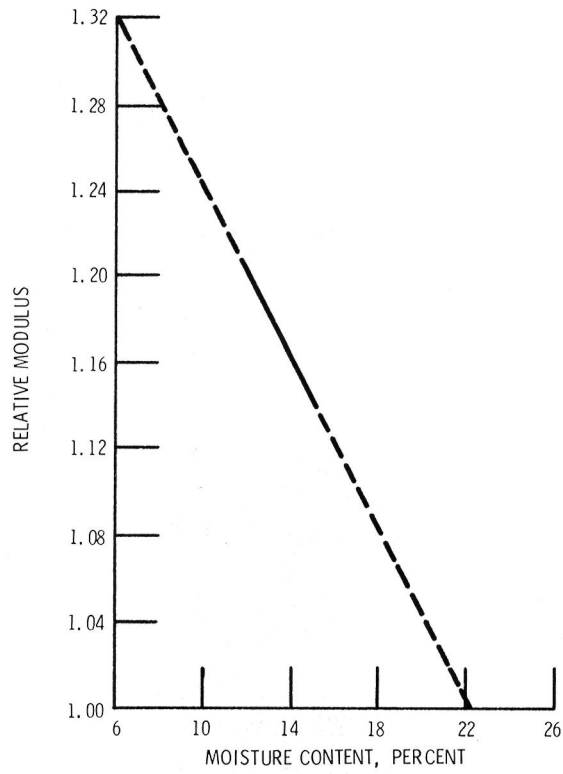

Figure 7. - Effect of moisture content on modulus of wood.

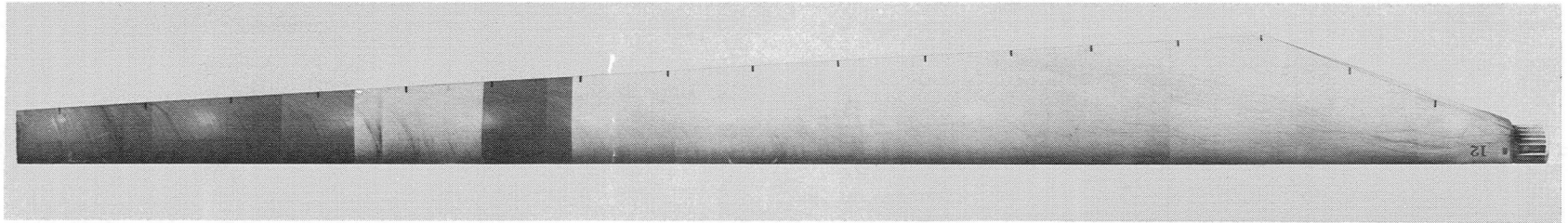

Figure 8. - High-pressure side of blade 1012.

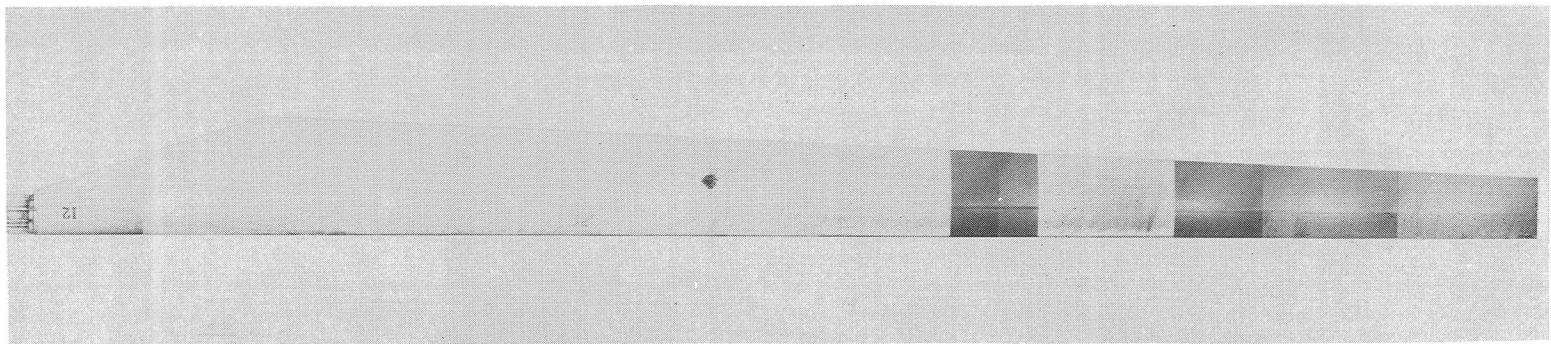

Figure 9. - Low-pressure side of blade 1012.

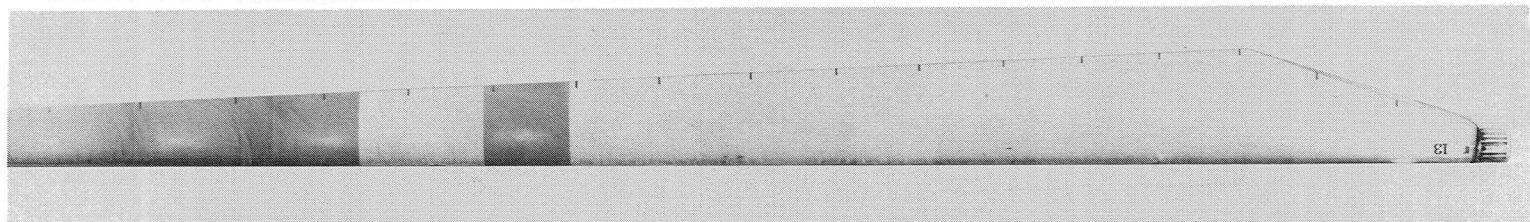

Figure 10. - High-pressure side of blade 1013.

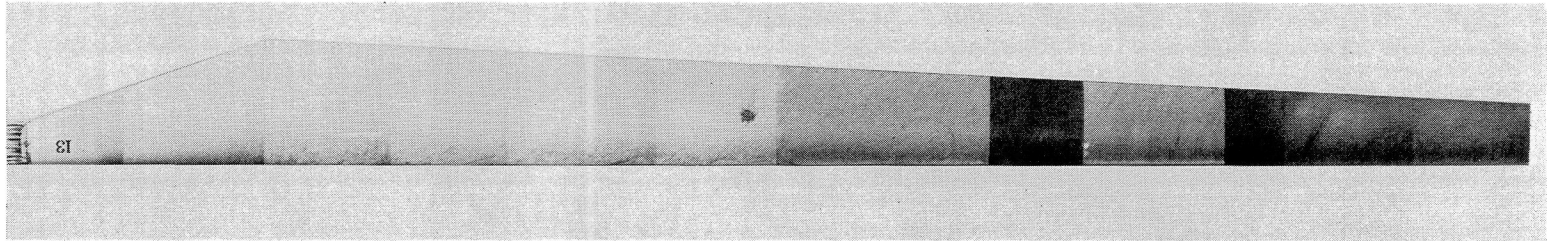

Figure 11. - Low-pressure side of blade 1013.

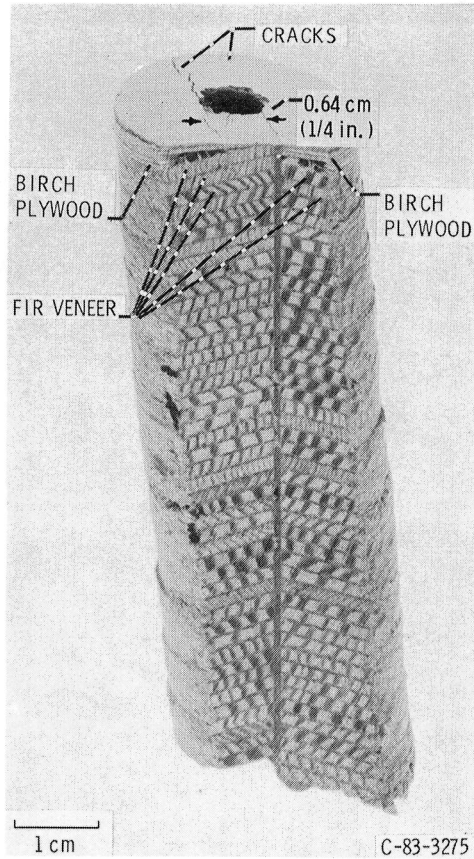

Figure 12. - Plug section from blade 1012 showing two leading-edge cracks.

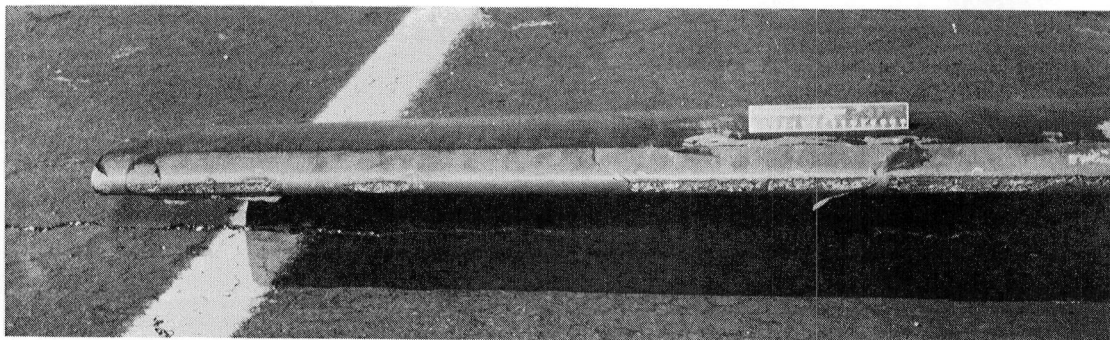
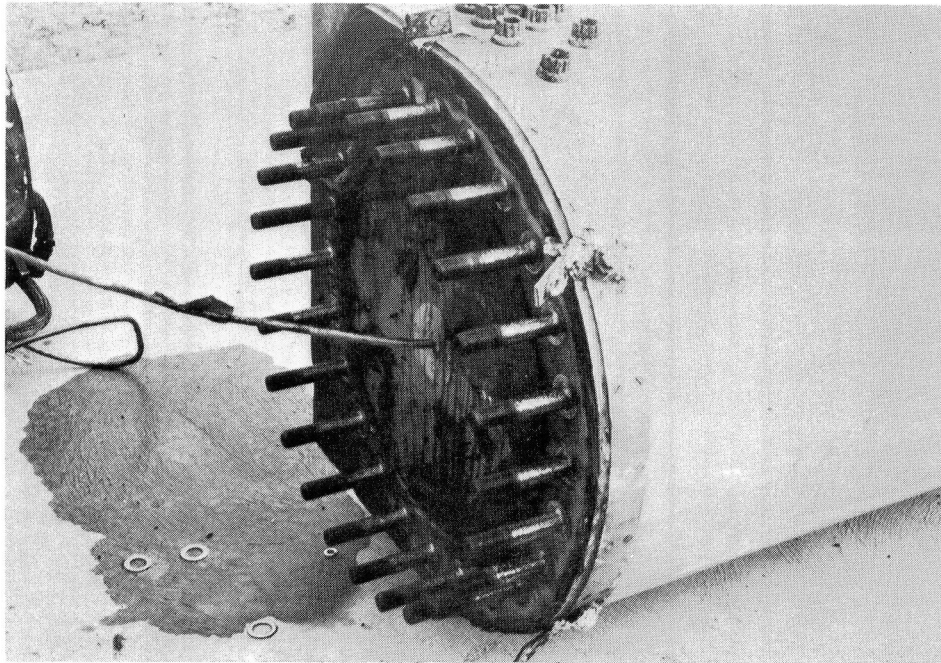
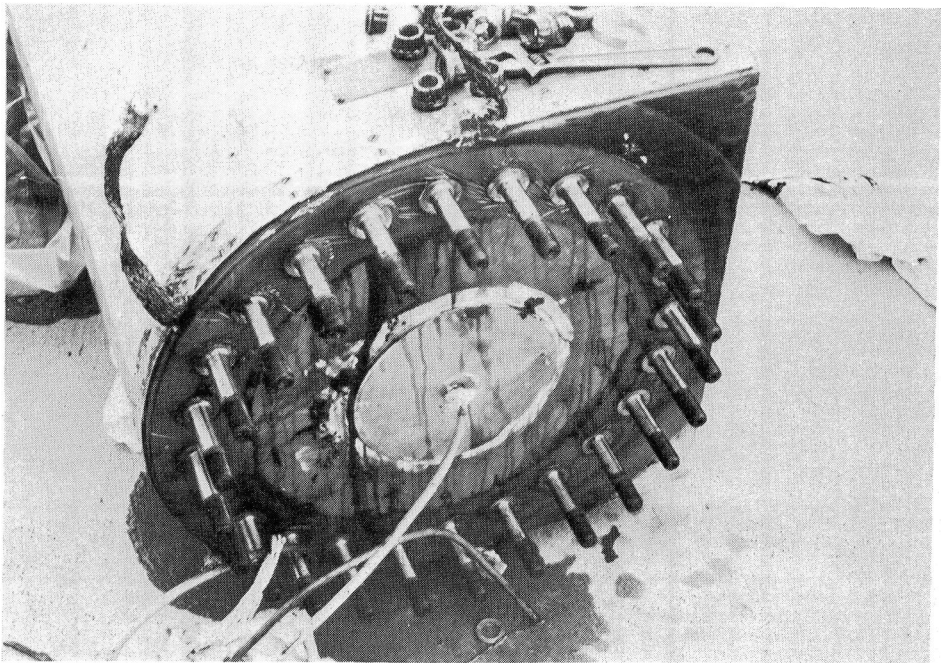

Figure 13. - Leading-edge erosion and pitting of blade 1012 after return from Block Island (7564 operating hr.).



(a) Blade 1012.



(b) Blade 1013.

Figure 14. - Root end studs of blades 1012 and 1013 after return from Block Island.

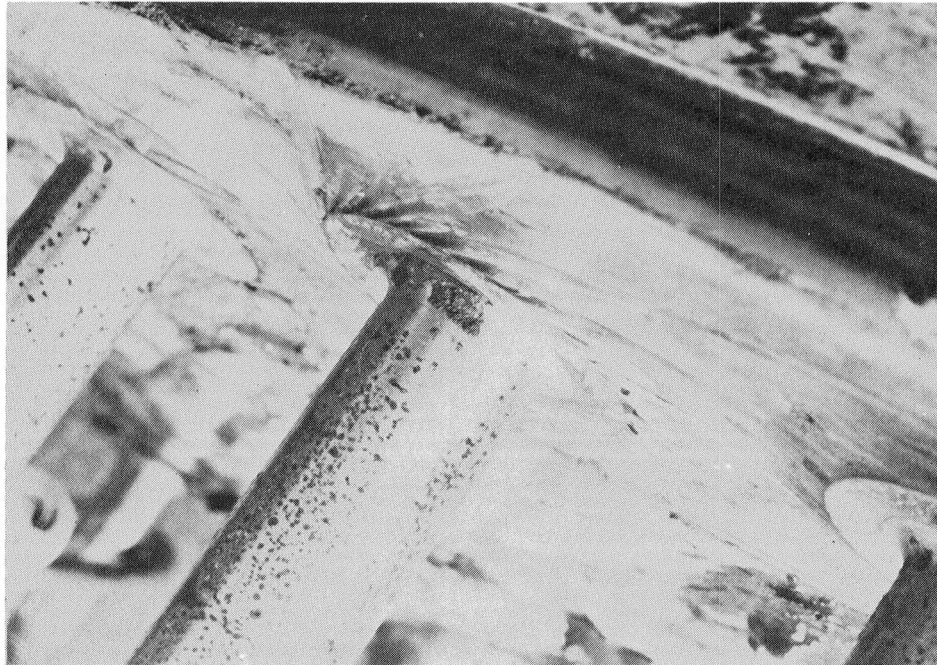

(a) Corrosion and pitting at radius of stud.



(b) Corrosion of face of spool piece.

Figure 15. - Most corroded stud and matching spool piece position for blade 1013.

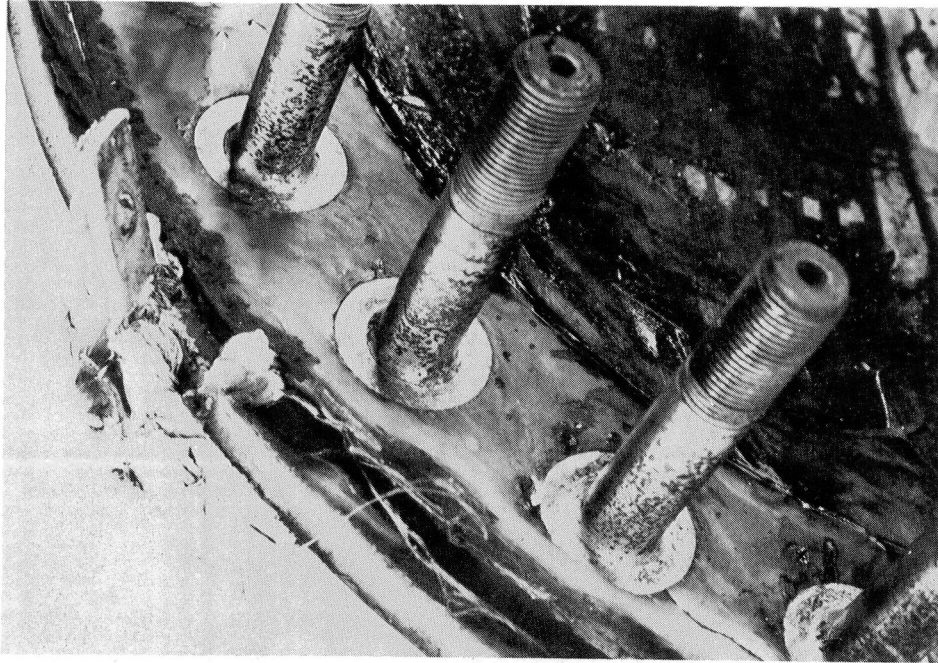
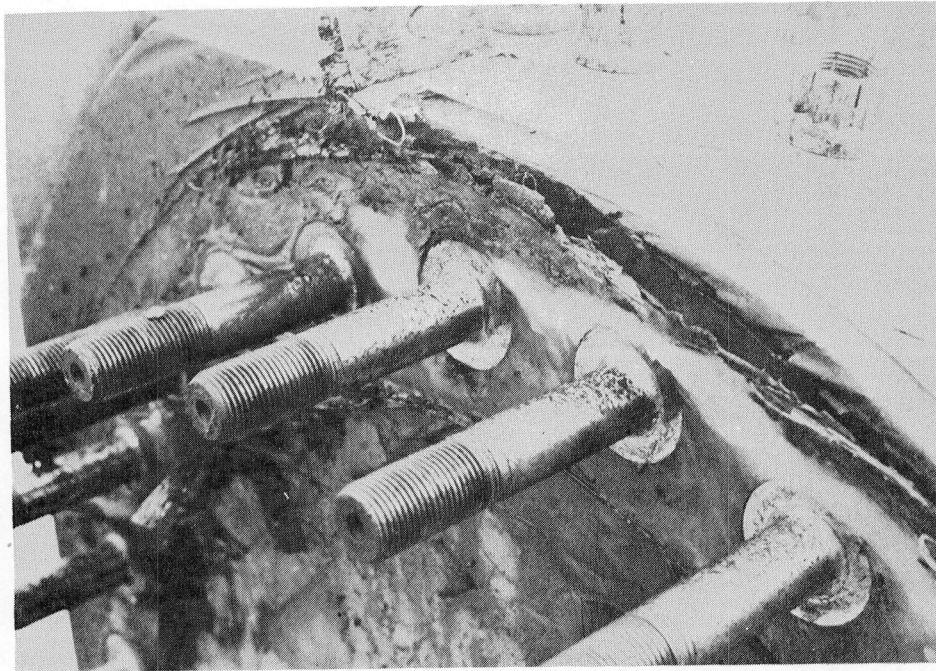

Figure 16. - General condition of moderate corrosion of studs from blade 1013.





(a) Overall view of stud condition.



(b) Closeup of general corrosion.

Figure 17. - Corrosion of studs from blade 1012.

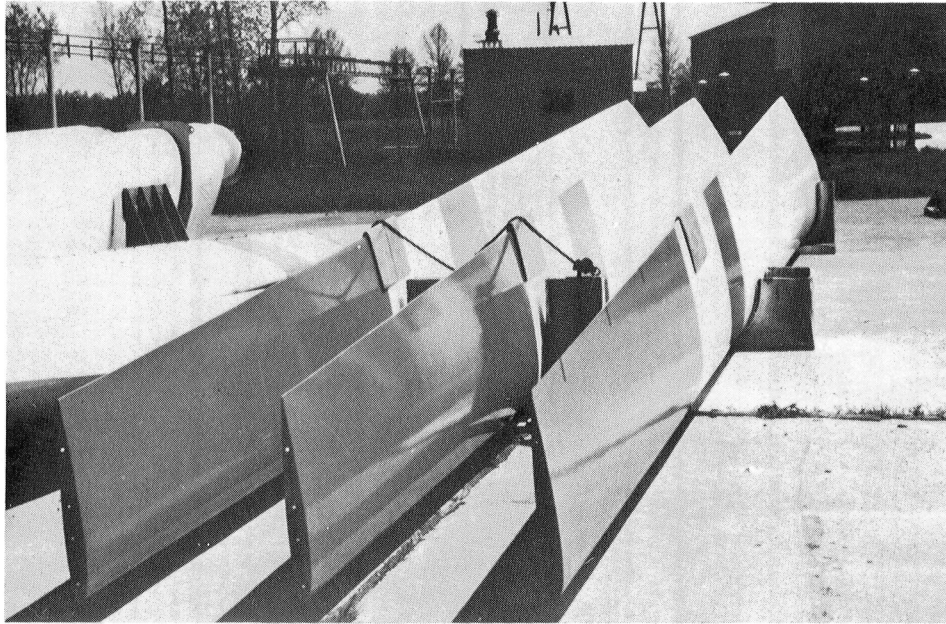

Figure 18. - Laminated wood blades after cleaning.

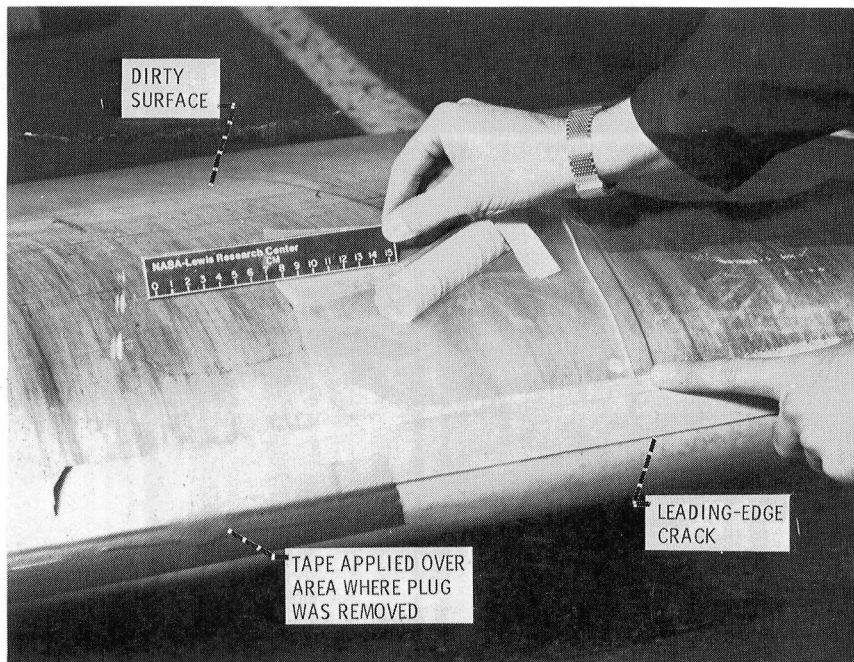
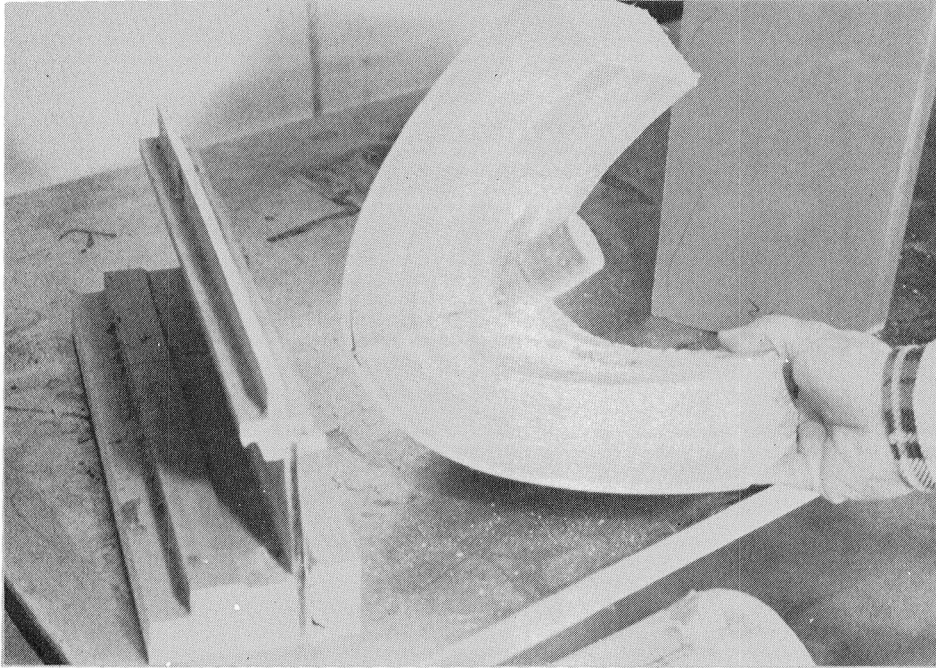
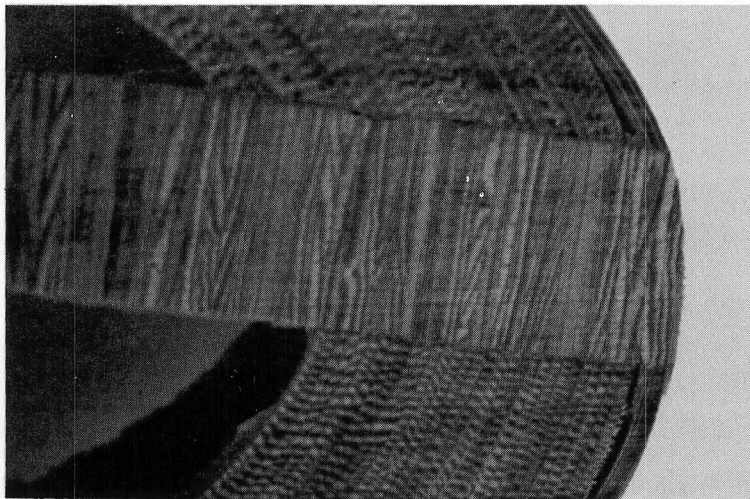

Figure 19. - Wood core specimen for blade 1012 and leading-edge crack. (Note condition of surface finish.)



(a) Plug repair cut from leading edge.



(b) Cross section cut through bonded-in plug repair.

Figure 20. - Sections from repaired blade 1012.

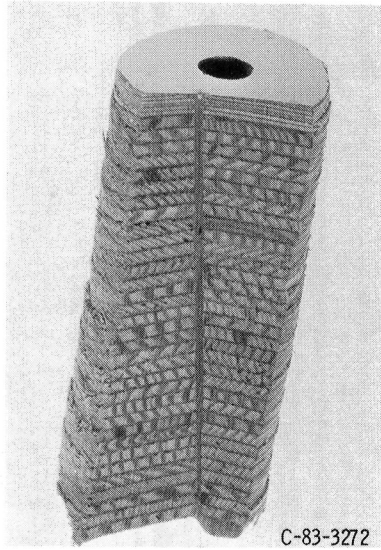

(a) Blade 1013 plug without cracked leading edge.

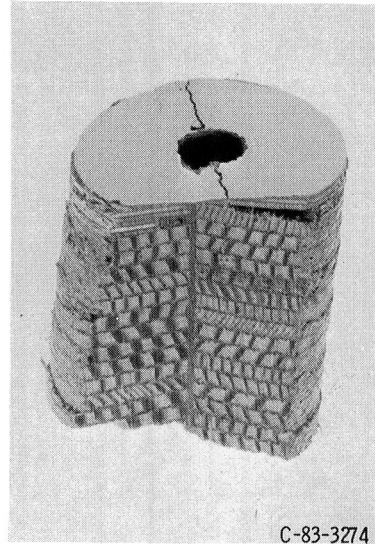

(b) Blade 1012 plug with crack displaced from bond line.

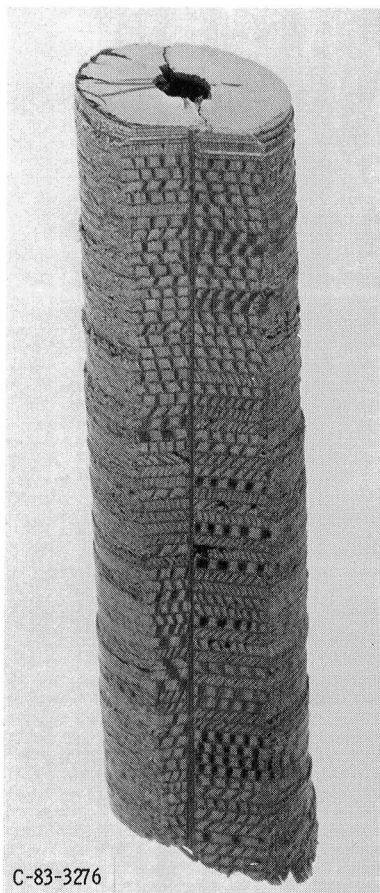

(c) Blade 1012 plug with crack at bond line.

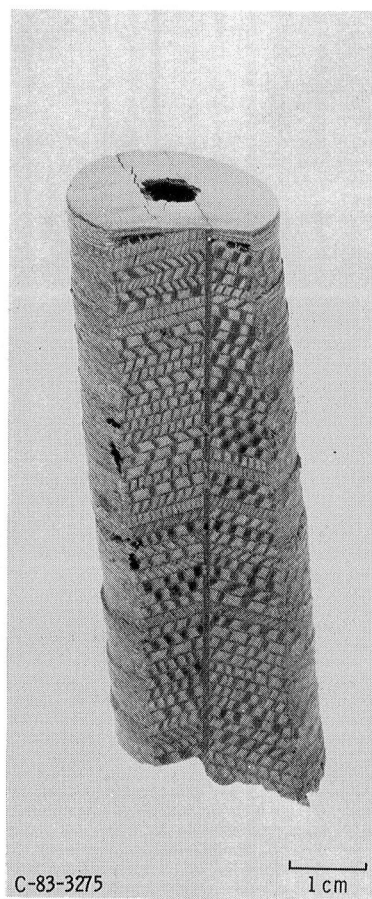

(d) Blade 1012 plug with crack at bond line and 1/4 in. away.

Figure 21. - Plug specimens from leading edge of blades 1012 and 1013.

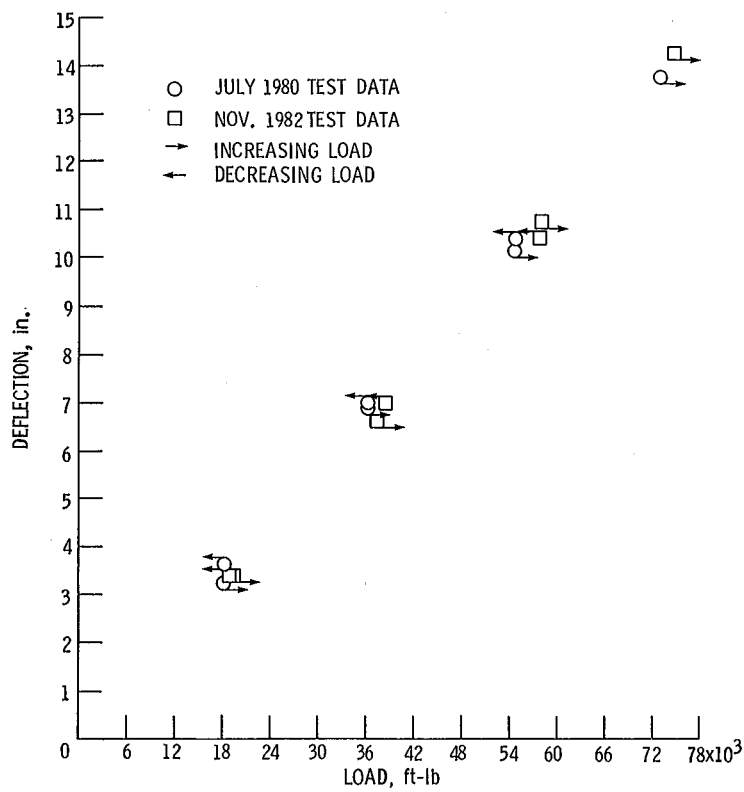
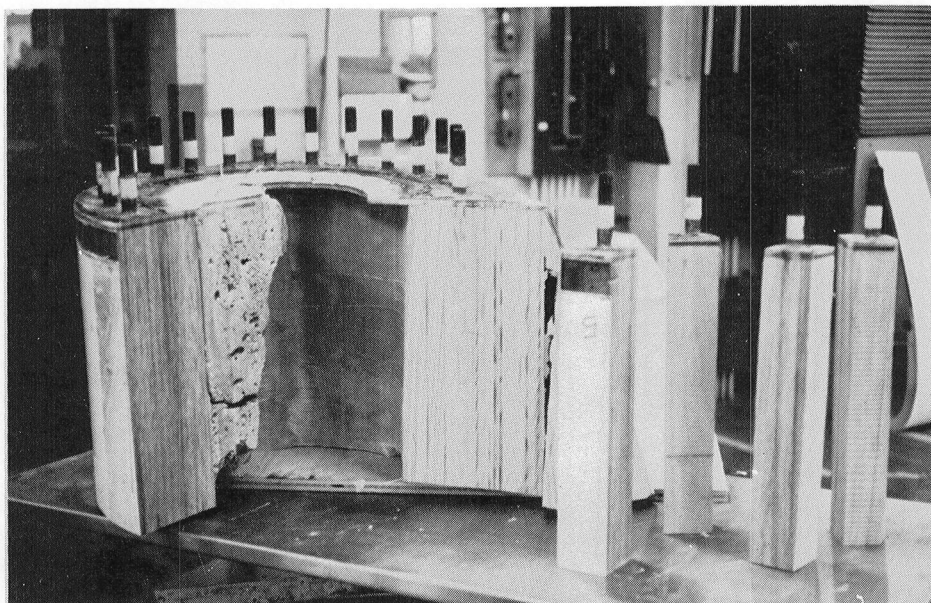
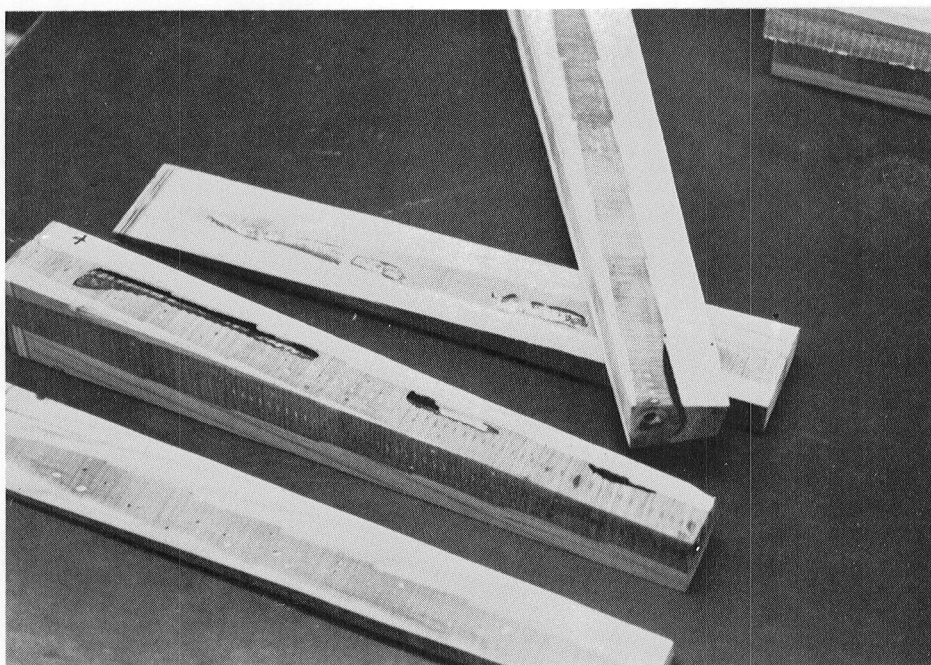

Figure 22. - Flatwise load-deflection test data for blade 1012 before and after 7564 hr of operation.



(a) Stud blocks as cut from root.



(b) Voids in stud bonds.

Figure 23. - Studs removed from blade 1012.

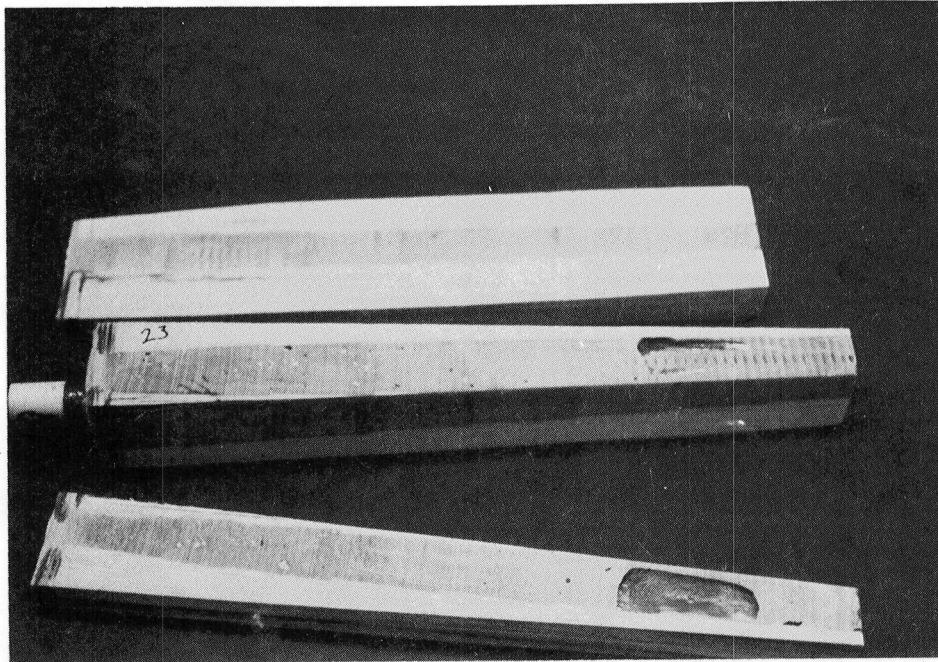

(c) Void in bond for stud 23.

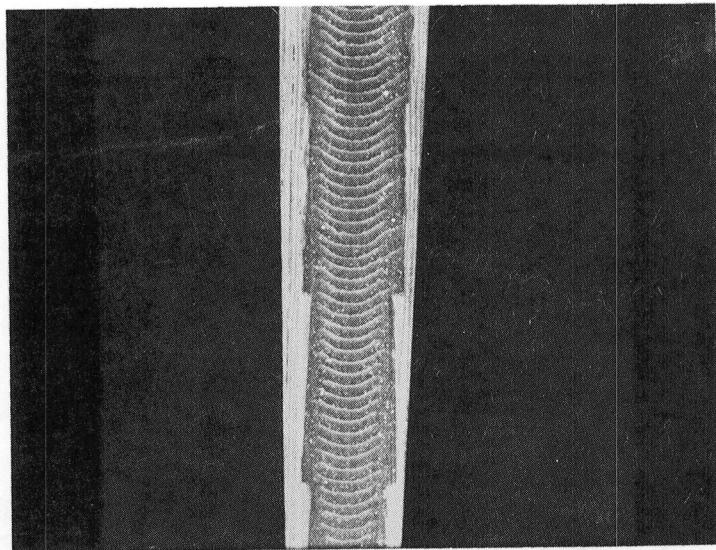

(d) Stud from wood-fatigue test specimen showing complete cracking of epoxy matrix.

Figure 23. - Concluded.

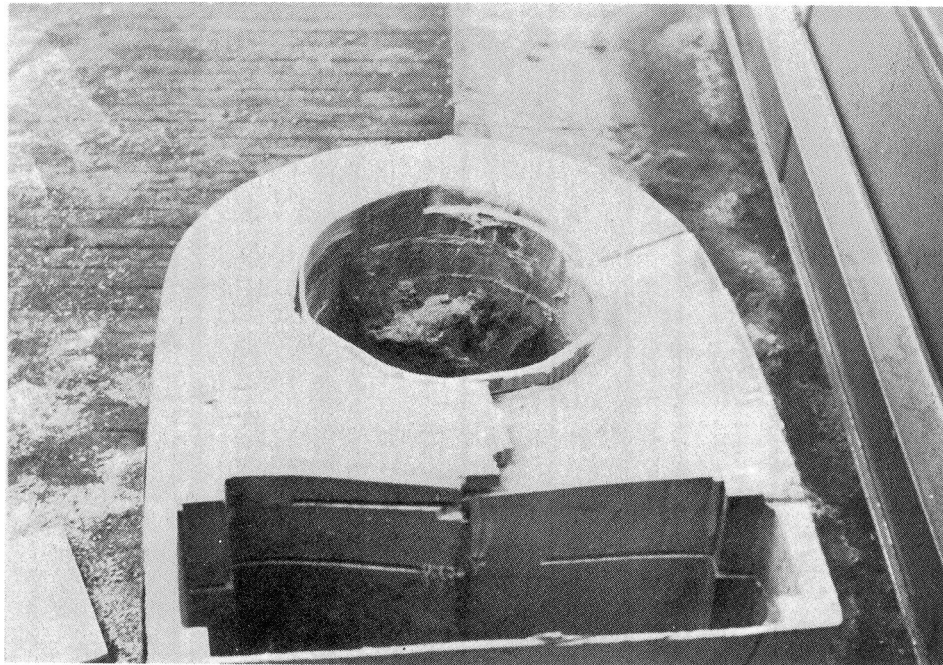

(a) Overall.

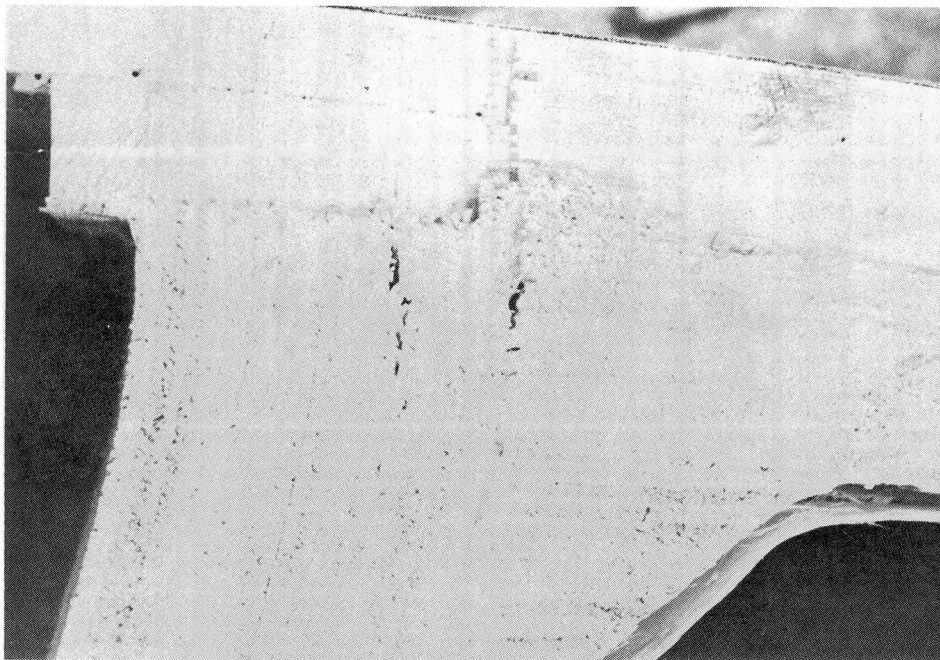

(b) Curved area.

Figure 24. - Curvature of root blocking from blade 1012.



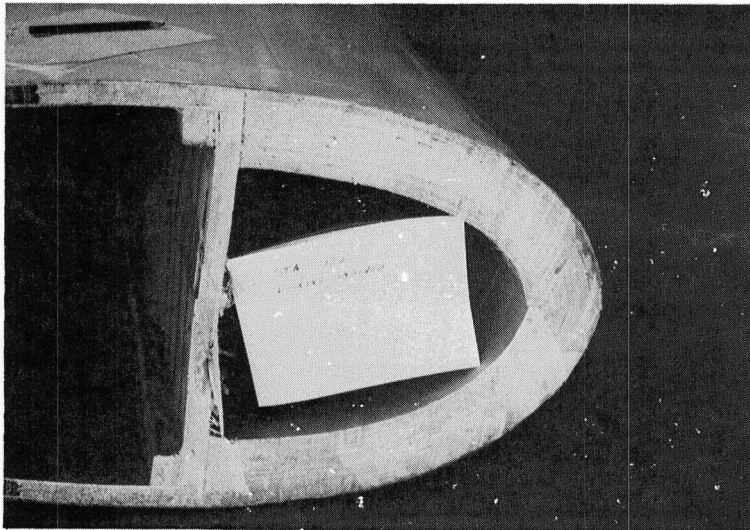

(a) Good bond at station 132.

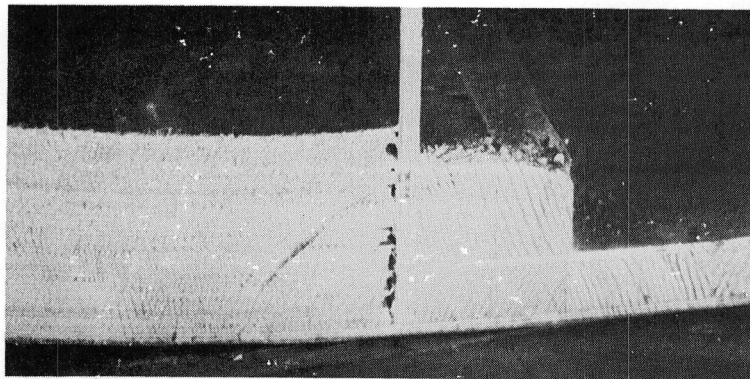

(b) Poor bond area on one-half of station 252.

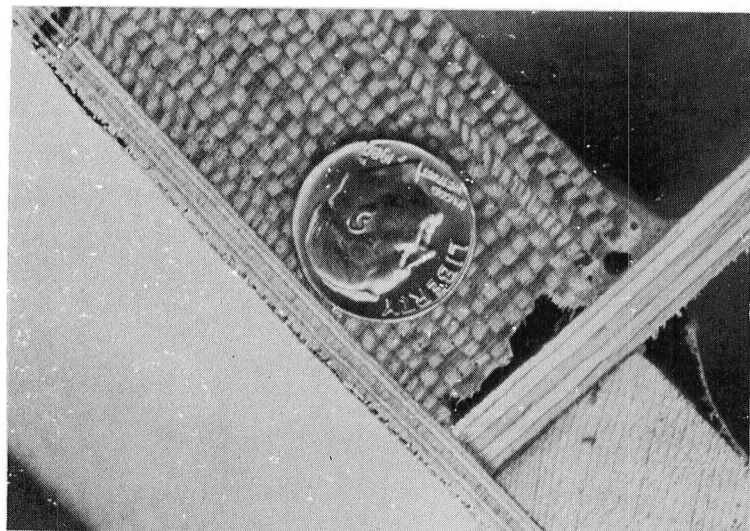

(c) Voids at station 612.

Figure 25. - Shear web bond problem.

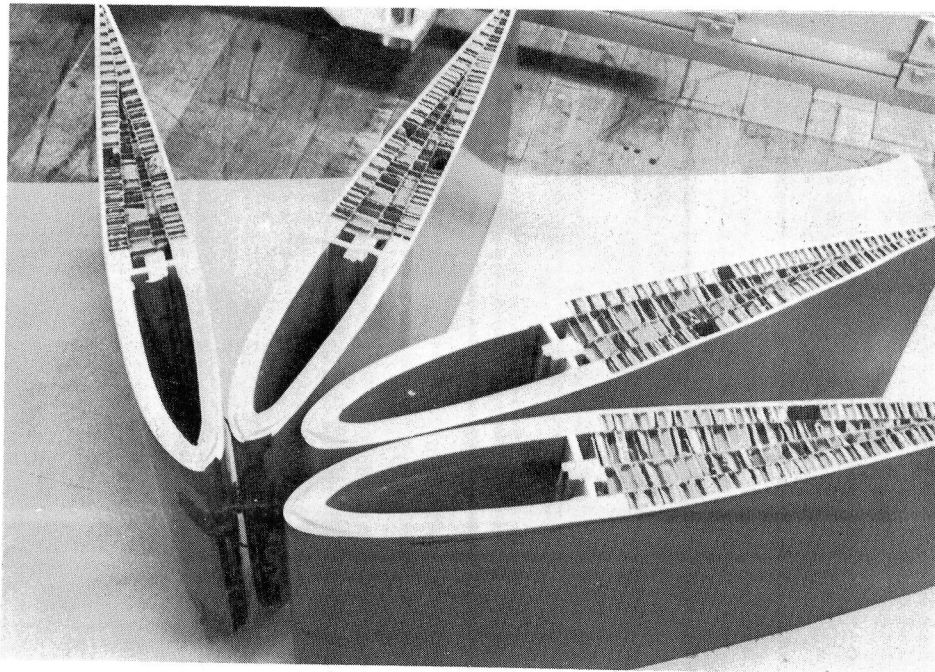

Figure 26. - Honeycomb layers as assembled in blade trailing edge.

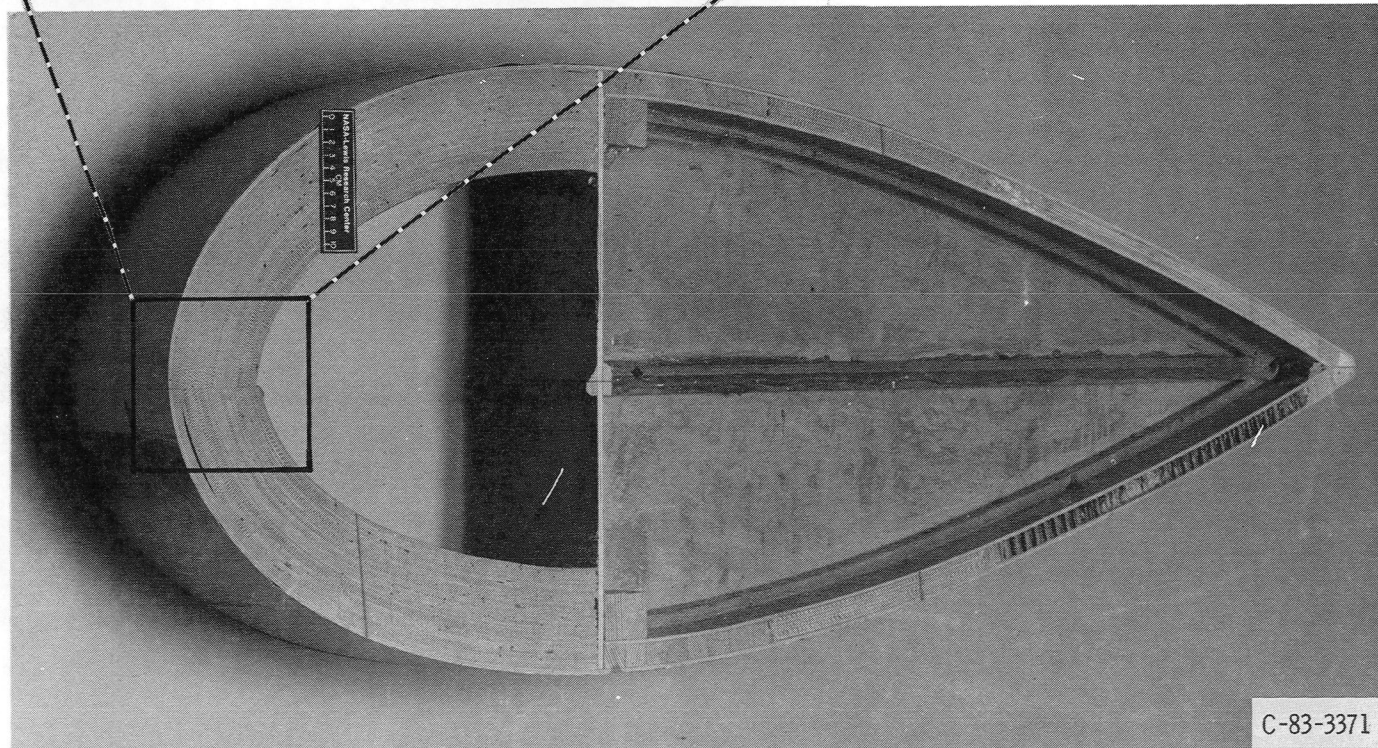
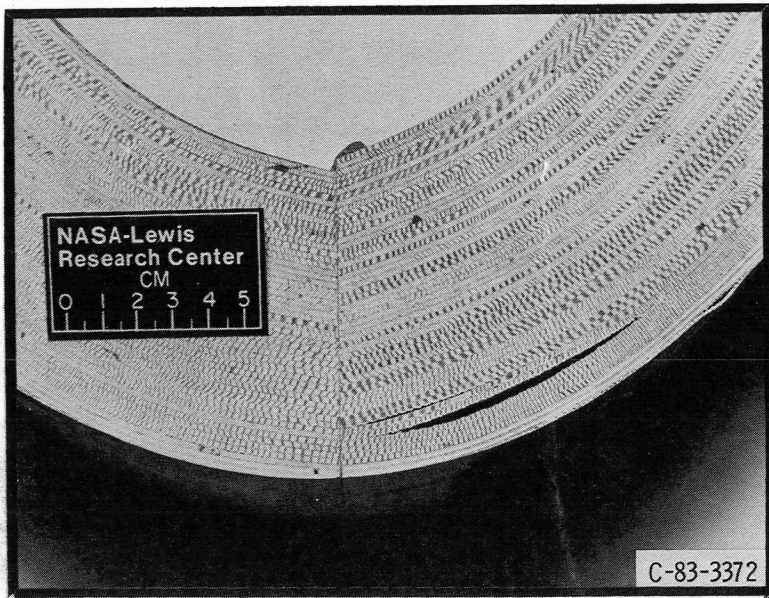

Figure 27. - Mismatch of leading edge (manufacturing defect) on blade 1012.

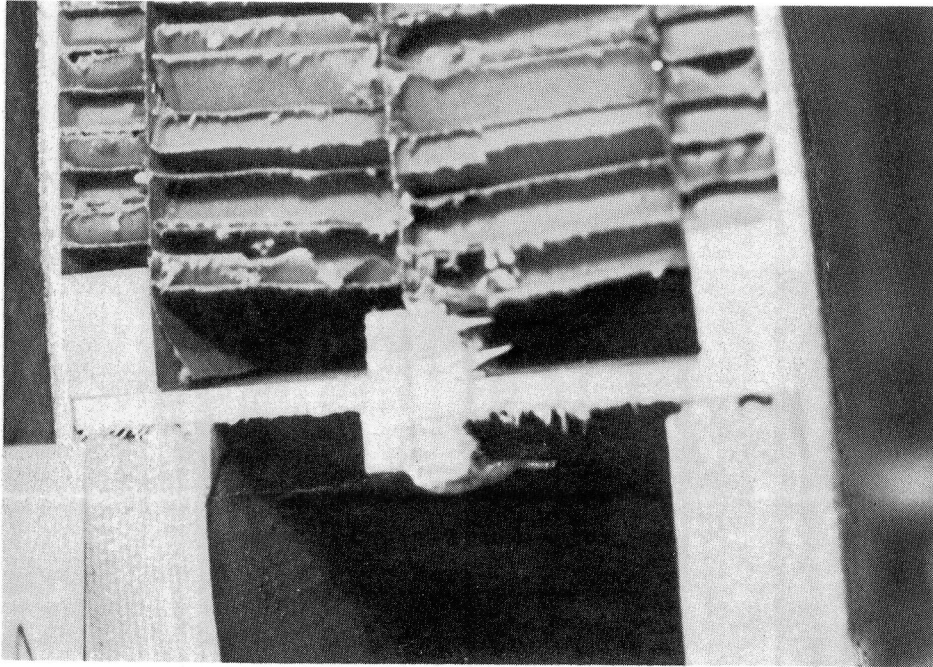
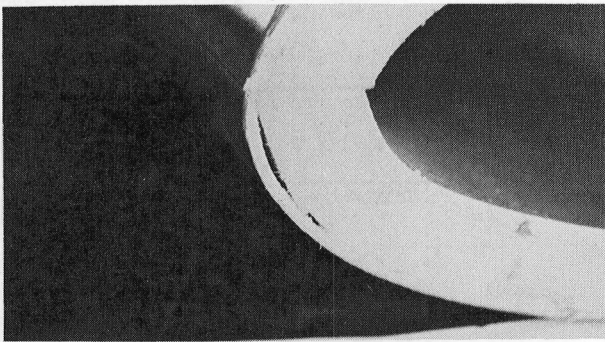
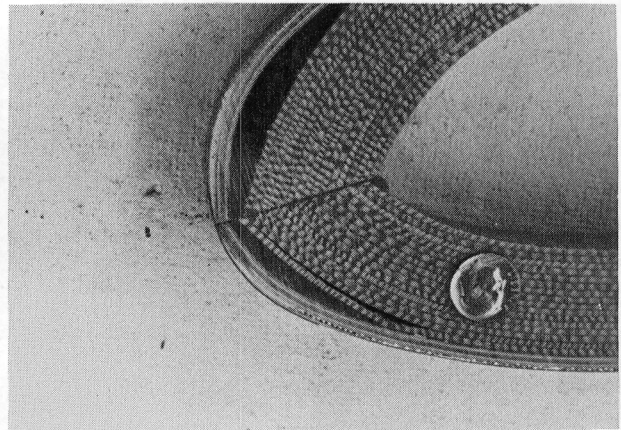

Figure 28. - Closeup of four-section honeycomb assembly.



(a) Nose delamination at station 492.



(d) Leading-edge crack, disbond, and nonconformance to mold at station 650.

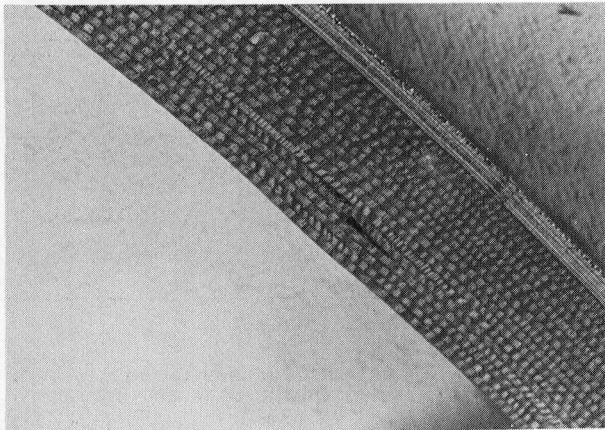

(b) Veneer overlap from sections near top.

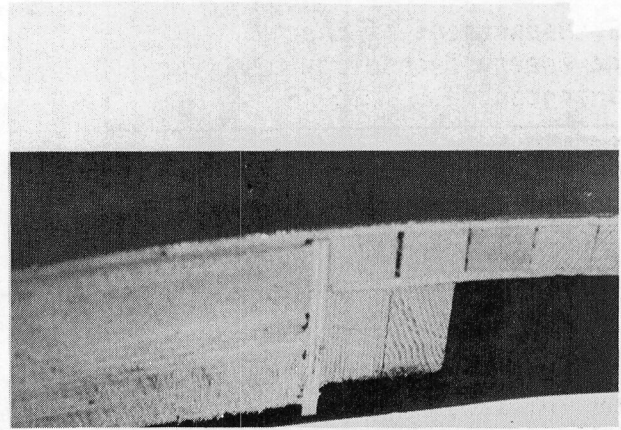

(e) Gaping between blocking at station 252.

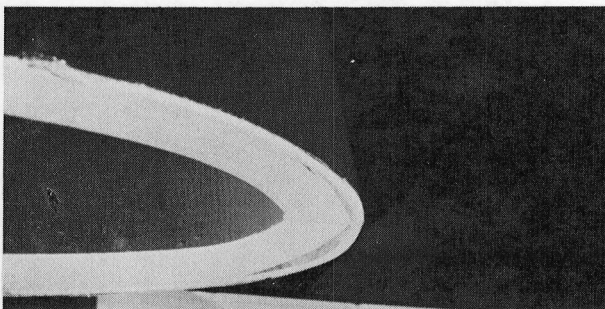

(c) Lack of ply conformance to mold from station 550 outboard.



(f) Curvature and voids in root blocking area.

Figure 29. - Minor fabrication problems of blade 1012.

1. Report No. NASA TM-83483		2. Government Accession No.		3. Recipient's Catalog No.	
4. Title and Subtitle  Examination, Evaluation, and Repair of Laminated Wood Blades After Service on the Mod-OA Wind Turbine				5. Report Date	
				6. Performing Organization Code 776-33-41	
7. Author(s)  James R. Faddoul				8. Performing Organization Report No. E-1805	
				10. Work Unit No.	
9. Performing Organization Name and Address  National Aeronautics and Space Administration Lewis Research Center Cleveland, Ohio 44135				11. Contract or Grant No.	
				13. Type of Report and Period Covered Technical Memorandum	
12. Sponsoring Agency Name and Address  U.S. Department of Energy Wind Energy Technology Division Washington, D.C. 20545				14. Sponsoring Agency Code Report No. DOE/NASA/20320-53	
15. Supplementary Notes Prepared under Interagency Agreement DE-AI01-79ET20320. Prepared for National Conference of the American Wind Energy Association, San Francisco, California, October 16-19, 1983.					
16. Abstract  As a result of about 7 years of effort at the NASA Lewis Research Center, laminated wood blades were designed, fabricated, and installed on a 200-kW wind turbine (Mod-OA). The machine uses a two-blade rotor with a diameter of 38.1 m (125 ft). Each blade weighs less than 1361 kg (3000 lb). After operating in the field, two blade sets were returned for inspection. One set had been in Hawaii for 17 months (7844 hr of operation) and the other had been at Block Island, Rhode Island, for 26 months (22 months operating - 7564 hr). The Hawaii set was returned because one of the studs that holds the blade to the hub had failed. This was found to be caused by a combination of improper installation and inadequate corrosion protection. No other problems were found. The broken stud (along with four others that were badly corroded) was replaced and the blades are now in storage. The Block Island set of blades was returned at the completion of the test program, but one blade was found to have developed a crack in the leading edge along the entire span. This crack was found to be the result of a manufacturing process problem but was not structurally critical. When a load-deflection test was conducted on the cracked blade, the response was identical to that measured before installation. In general, the laminate quality of both blade sets was excellent. No significant internal delamination or structural defects were found in any blade. The stud bonding process requires close tolerance control and adequate corrosion protection, but studs can be removed and replaced without major problems. Moisture content stabilization does not appear to be a problem, and laminated wood blades are satisfactory for long-term operation on Mod-OA wind turbines.					
17. Key Words (Suggested by Author(s)) Wind turbines; Wood composites; Laminated wood; Fatigue performance; Life testing; Performance testing; Environmental degradation; Propellor blades			18. Distribution Statement Unclassified - unlimited STAR Category 44 DOE Category UC-60		
19. Security Classif. (of this report) Unclassified		20. Security Classif. (of this page) Unclassified		21. No. of pages	22. Price*





DO NOT DETACH FROM REPORT  
PLEASE LINE THROUGH YOUR NAME  
BEFORE RETURNING TO THE LIBRARY

Name	Mail Stop
Patricia Christian	414

NASA Langley (May 1979)

MSD-TLB N-75